

User Guide

Copyright © 2018 Corel Corporation. All rights reserved.

CorelDRAW® 2018 User Guide

Product specifications, pricing, packaging, technical support and information (“specifications”) refer to the retail English version only. The specifications for all other versions (including other language versions) may vary.

Information is provided by Corel on an “as is” basis, without any other warranties or conditions, express or implied, including, but not limited to, warranties of merchantable quality, satisfactory quality, merchantability or fitness for a particular purpose, or those arising by law, statute, usage of trade, course of dealing or otherwise. The entire risk as to the results of the information provided or its use is assumed by you. Corel shall have no liability to you or any other person or entity for any indirect, incidental, special, or consequential damages whatsoever, including, but not limited to, loss of revenue or profit, lost or damaged data or other commercial or economic loss, even if Corel has been advised of the possibility of such damages, or they are foreseeable. Corel is also not liable for any claims made by any third party. Corel's maximum aggregate liability to you shall not exceed the costs paid by you to purchase the materials. Some states/countries do not allow exclusions or limitations of liability for consequential or incidental damages, so the above limitations may not apply to you.

Corel, the Corel logo, the Corel balloon logo, Corel DESIGNER, CorelDRAW, the CorelDRAW balloon logo, Corel Font Manager, CAPTURE, CONNECT, LiveSketch, PaintShop, PaintShop Pro, Painter, PerfectShapes, PHOTO-PAINT, PowerClip, PowerTRACE, Presentations, Quattro, Quattro Pro, VideoStudio and WordPerfect are trademarks or registered trademarks of Corel Corporation and/or its subsidiaries in Canada, the U.S. and/or other countries. Other product, font and company names and logos may be trademarks or registered trademarks of their respective companies.

Patents: www.corel.com/patent

218018

Contents

Getting started.....	19
Installing CorelDRAW Graphics Suite.....	21
System requirements.....	21
Preparing for installation.....	22
Installing CorelDRAW Graphics Suite applications.....	22
Installation options.....	22
Modifying and repairing installations.....	24
Uninstalling CorelDRAW Graphics Suite.....	25
Frequently Asked Questions.....	25
Corel accounts and services.....	27
Authenticating CorelDRAW Graphics Suite.....	27
Checking account settings.....	28
Updating Corel products.....	28
Changing user credentials.....	28
Corel Support Services.....	29
About Corel.....	29
What's new in CorelDRAW Graphics Suite?.....	31
Creative.....	31
Productive.....	35
Innovative.....	39
Finding out what was new in previous versions.....	42
Learning resources.....	43
Getting help.....	43
Using the Help and tooltips.....	44
Using Hints.....	45
Welcome screen.....	46
Quick Start Guide.....	46
Insights from the Experts.....	46
Video learning resources.....	47
Community website for developers.....	47

Network deployment guide.....	47
Web-based resources.....	47
Starting and setting up.....	49
Starting and quitting CorelDRAW.....	49
Changing the language.....	49
Changing startup settings.....	50
CorelDRAW basics.....	51
Understanding vector graphics and bitmaps.....	51
Starting and opening drawings.....	52
Scanning images.....	55
Working with multiple drawings.....	56
Undoing, redoing, and repeating actions.....	57
Zooming, panning, and scrolling.....	58
Previewing drawings.....	60
Choosing viewing modes.....	62
Working with views.....	63
Saving drawings.....	64
Working with locked files.....	67
Backing up and recovering files.....	67
Adding and accessing drawing information.....	68
Closing drawings.....	69
Exploring basic tasks.....	69
CorelDRAW workspace tour.....	71
CorelDRAW terms.....	71
Application window.....	72
Standard toolbar.....	75
Exploring the toolbox.....	77
Property bar.....	93
Dockers.....	93
Status bar.....	96
Choosing a workspace.....	96

Finding and managing creative tools and content.....	99
Acquiring applications, plug-ins, and content.....	99
Finding content with the CONNECT docker.....	100
Accessing content.....	103
Browsing and searching for content.....	105
Viewing content.....	108
Using content.....	108
Installing fonts.....	111
Managing content.....	111
Syncing trays with OneDrive.....	112
Changing content locations.....	114
Content types.....	115
Touch-enabled devices and wheel devices.....	117
Using touch.....	117
Using wheel devices.....	119
Lines, shapes, and outlines.....	125
Working with lines, outlines, and brushstrokes.....	127
Drawing lines.....	127
Drawing calligraphic and preset lines.....	136
Sketching naturally with intelligent stroke adjustment.....	138
Formatting lines and outlines.....	144
Adding arrowheads to lines and curves.....	149
Copying, converting, and removing outlines.....	151
Applying brushstrokes.....	153
Applying brushstrokes that respond to pen pressure, tilt, and bearing.....	154
Spraying objects along a line.....	156
Drawing connector and callout lines.....	158
Drawing dimension lines.....	161
Using pressure-sensitive pens and devices.....	164
Drawing shapes.....	167
Drawing rectangles and squares.....	167

Drawing ellipses, circles, arcs, and pie shapes.....	170
Drawing polygons and stars.....	172
Drawing spirals.....	174
Drawing grids.....	174
Drawing predefined shapes.....	175
Drawing by using shape recognition.....	176
Shaping objects.....	179
Using curve objects.....	180
Selecting and moving nodes.....	181
Aligning and distributing nodes.....	183
Manipulating segments.....	190
Joining curves.....	191
Copying and cutting segments.....	192
Adding, removing, and joining nodes.....	193
Using node types.....	195
Transforming nodes.....	196
Breaking the path of curve objects.....	196
Mirroring changes in curve objects.....	197
Skewing and stretching objects.....	198
Smudging and smearing objects.....	200
Roughening objects.....	203
Smoothing objects.....	204
Shaping objects by attracting or pushing away nodes.....	206
Applying distortion effects.....	207
Adding twirl effects.....	209
Shaping objects by using envelopes.....	210
Cropping and erasing objects.....	218
Splitting objects.....	222
Trimming objects.....	224
Filleting, scalloping, and chamfering corners.....	226
Welding and intersecting objects.....	228

Creating PowerClip objects.....	230
Setting options for nodes, handles, and previews.....	235
Symmetrical drawing.....	239
Creating symmetry groups.....	240
Editing symmetry groups.....	242
Fusing curves in symmetry groups.....	247
Removing symmetry and breaking symmetry links.....	248
Objects, symbols, and layers.....	251
Working with objects.....	253
Selecting objects.....	254
Transforming objects.....	257
Copying, duplicating, and deleting objects.....	260
Creating objects from enclosed areas.....	263
Creating a boundary around selected objects.....	263
Using object coordinates to draw and modify objects.....	264
Copying object properties, transformations, and effects.....	272
Cloning objects.....	273
Positioning objects.....	274
Aligning and distributing objects.....	276
Applying object hinting.....	279
Snapping objects.....	279
Using dynamic guides.....	283
Using alignment guides.....	286
Changing the order of objects.....	291
Sizing and scaling objects.....	292
Rotating and mirroring objects.....	293
Using the Object Properties docker to modify objects.....	295
Fitting objects to a path.....	297
Grouping objects.....	302
Combining objects.....	303
Locking objects.....	305

Finding and replacing objects.....	305
Hiding and displaying objects.....	306
Constraining objects.....	307
Inserting bar codes.....	308
Inserting and editing QR codes.....	309
Inserting QR codes.....	309
Editing QR codes.....	310
Validating QR codes.....	312
Working with layers.....	315
Creating layers.....	315
Changing layer properties.....	319
Moving and copying layers and objects.....	322
Working with symbols.....	325
Creating, editing, and deleting symbols.....	325
Using symbols in drawings.....	327
Managing collections and libraries.....	329
Reference: Working with symbols.....	330
Linking and embedding objects.....	333
Inserting linked or embedded objects.....	333
Editing linked or embedded objects.....	334
Managing and tracking projects.....	335
Setting up the project database.....	335
Assigning and copying object data.....	336
Viewing an object data summary.....	337
Tracking project time.....	338
Color, fills, and transparencies.....	345
Working with color.....	347
Understanding color models.....	347
Understanding color depth.....	349
Choosing colors.....	350
Using the Document palette.....	356

Creating and editing custom color palettes.....	359
Organizing and displaying color palettes.....	362
Displaying or hiding color palettes in the Palette libraries.....	363
Setting the properties of color palettes.....	365
Applying fills to objects.....	367
Applying uniform fills.....	367
Applying fountain fills.....	368
Applying vector and bitmap pattern fills.....	373
Applying two-color pattern fills.....	378
Applying texture fills.....	380
Applying PostScript fills.....	381
Applying mesh fills.....	382
Applying fills to areas.....	386
Working with fills.....	387
Changing the transparency of objects.....	389
Applying uniform transparency.....	390
Applying fountain transparency.....	391
Applying pattern transparency.....	394
Applying texture transparency.....	397
Copying, freezing, and removing transparencies.....	397
Applying merge modes.....	398
Finding, managing, and saving fills and transparencies.....	403
Finding and viewing fills and transparencies.....	403
Managing fills and transparencies.....	406
Saving fills and transparencies.....	408
Using color management.....	409
Understanding color management.....	409
Getting started with color management in CorelDRAW.....	413
Installing, loading, and embedding color profiles.....	416
Assigning color profiles.....	418
Converting colors to other color profiles.....	418

Choosing color-conversion settings.....	419
Soft proofing.....	419
Working with color management presets.....	422
Working with color management policies.....	423
Managing colors when opening documents.....	424
Managing colors when importing and pasting files.....	425
Managing colors for print.....	425
Using a safe CMYK workflow.....	426
Managing colors for online viewing.....	426
Special effects.....	427
Using lenses with objects.....	429
Applying lenses.....	429
Editing lenses.....	431
Adding 3D effects to objects.....	433
Contouring objects.....	433
Applying perspective.....	436
Creating extrusions.....	439
Creating bevel effects.....	443
Creating drop shadows.....	445
Adding block shadows.....	448
Blending objects.....	451
Creating mosaics.....	457
Creating vector mosaics with the Pointillizer effect.....	457
Creating bitmap mosaics with the PhotoCocktail effect.....	461
Adding movement and focus.....	465
Adding impact effects.....	465
Text.....	473
Adding and manipulating text.....	475
Importing and pasting text.....	475
Adding artistic text.....	477

Adding paragraph text.....	477
Adding columns to text frames.....	481
Combining and linking paragraph text frames.....	482
Aligning text by using the baseline grid.....	484
Selecting text.....	485
Finding, editing, and converting text.....	486
Shifting, rotating, mirroring, and flipping text.....	488
Moving text.....	489
Wrapping text.....	490
Fitting text to a path.....	491
Inserting special characters, symbols, and glyphs.....	493
Embedding graphics.....	497
Working with legacy text.....	498
Formatting text.....	499
Choosing typefaces and fonts.....	499
Formatting characters.....	502
Changing text color.....	504
Kerning a range of characters.....	505
Changing text case.....	506
Working with OpenType features.....	507
Adjusting character and word spacing.....	511
Adjusting line and paragraph spacing.....	513
Adding bullets to text.....	514
Inserting drop caps.....	516
Changing character position and angle.....	517
Aligning text.....	518
Adding tabs and indents.....	520
Working with text styles.....	521
Hyphenating text.....	521
Inserting formatting codes.....	524
Displaying nonprinting characters.....	525

Working with text in different languages.....	527
Formatting Asian text.....	527
Using line-breaking rules for Asian text.....	528
OpenType support for Asian text.....	529
Formatting multilingual text.....	529
Displaying text correctly in any language.....	531
Managing fonts.....	533
Changing the default font.....	533
Substituting fonts.....	534
Embedding fonts.....	535
Viewing fonts.....	536
Filtering fonts.....	537
Searching for fonts.....	539
Acquiring more fonts.....	540
Identifying fonts.....	541
Choosing fonts with Font Playground.....	541
Using Corel Font Manager.....	544
Using writing tools.....	545
Using QuickCorrect.....	545
Using the spelling checker and Grammatik.....	547
Using the thesaurus.....	549
Working with languages.....	550
Customizing the writing tools.....	550
Using checking styles.....	551
Using rule classes.....	554
Analyzing a drawing.....	555
Using word lists.....	556
Checking statistics.....	559
Reference: Using writing tools.....	559
Templates and styles.....	565
Working with templates.....	567

Searching for templates.....	567
Using templates.....	569
Creating templates.....	570
Editing templates.....	570
Working with styles and style sets.....	573
Creating styles and style sets.....	574
Applying styles and style sets.....	576
Editing styles and style sets.....	577
Managing default object properties.....	578
Exporting and importing style sheets.....	579
Assigning keyboard shortcuts to styles or style sets.....	580
Finding objects that use a specific style or style set.....	580
Breaking the link between objects and styles or style sets.....	580
Working with color styles.....	583
Creating and applying color styles.....	583
Editing color styles.....	586
Viewing color styles.....	590
Exporting and importing color styles.....	592
Breaking the link between a color style and an object.....	592
Pages and layout.....	593
Working with pages and layout tools.....	595
Specifying the page layout.....	595
Choosing a page background.....	598
Adding, duplicating, renaming, and deleting pages.....	599
Inserting page numbers.....	601
Using the rulers.....	603
Calibrating the rulers.....	605
Setting up the document grid.....	605
Setting up the baseline grid.....	607
Setting up guidelines.....	608
Modifying guidelines.....	610

Setting the drawing scale.....	611
Working with tables.....	613
Adding tables to drawings.....	613
Selecting, moving, and navigating table components.....	615
Inserting and deleting table rows and columns.....	617
Resizing table cells, rows, and columns.....	618
Formatting tables and cells.....	619
Working with text in tables.....	622
Converting tables to text.....	623
Merging and splitting tables and cells.....	623
Manipulating tables as objects.....	625
Adding images, graphics, and backgrounds to tables.....	625
Importing tables in a drawing.....	626
Bitmaps.....	629
Working with bitmaps.....	631
Converting vector graphics to bitmaps.....	631
Importing bitmaps.....	633
Cropping bitmaps.....	633
Changing the dimensions and resolution of bitmaps.....	633
Straightening bitmaps.....	635
Correcting perspective distortions.....	638
Using Digimarc watermarks to identify bitmaps.....	639
Removing dust and scratch marks from bitmaps.....	640
Working with colors in bitmaps.....	640
Using the Image Adjustment Lab.....	642
Adjusting color and tone.....	647
Using the Tone Curve filter.....	653
Transforming color and tone.....	656
Editing bitmaps with Corel PHOTO-PAINT.....	657
Applying special effects in bitmaps.....	657
Special effects categories.....	663

3-D special effects.....	663
Art strokes special effects.....	668
Blur special effects.....	674
Camera special effects.....	679
Color transform special effects.....	683
Contour special effects.....	685
Creative special effects.....	686
Custom special effects.....	691
Distort special effects.....	692
Noise special effects.....	697
Sharpen special effects.....	700
Texture special effects.....	702
Working with bitmap color modes.....	709
Changing the color mode of bitmaps.....	709
Changing bitmaps to black-and-white images.....	710
Changing bitmaps to duotones.....	711
Changing bitmaps to the paletted color mode.....	712
Tracing bitmaps and editing traced results.....	717
Tracing bitmaps.....	717
PowerTRACE controls.....	720
Previewing traced results.....	722
Fine-tuning traced results.....	723
Adjusting colors in traced results.....	725
Setting default tracing options.....	727
Tips for tracing bitmaps and editing traced results.....	728
Working with RAW camera files.....	729
Using RAW camera files.....	729
Bringing RAW camera files into CorelDRAW.....	730
Adjusting the color and tone of RAW camera files.....	733
Sharpening and reducing noise in RAW camera files.....	735
Previewing RAW camera files and obtaining image information.....	736

Printing	739
Printing basics.....	741
Printing your work.....	741
Laying out print jobs.....	742
Previewing print jobs.....	743
Applying print styles.....	744
Fine-tuning print jobs.....	745
Printing colors accurately.....	746
Printing to a PostScript printer.....	748
Using print merge.....	750
Viewing preflight summaries.....	754
Preparing files for print service providers.....	755
Preparing a print job for a print service provider.....	755
Working with imposition layouts.....	756
Printing printers' marks.....	758
Maintaining OPI links.....	760
Printing color separations.....	761
Working with color trapping and overprinting.....	762
Specifying In-RIP trapping settings.....	765
Printing to film.....	767
Preparing banners for printing.....	767
Working with a print service provider.....	769
Web graphics	771
Creating objects for the web.....	773
Exporting bitmaps for the web.....	773
Exporting and uploading bitmaps to WordPress.....	780
Saving and applying web presets.....	780
Exporting objects with transparent colors and backgrounds.....	781
Creating web-compatible text.....	782
Creating rollovers.....	782

Adding bookmarks and hyperlinks to documents.....	784
Adding hotspots and alternate text to objects.....	786
File formats.....	787
Importing and exporting files.....	789
Importing files.....	789
Exporting files.....	792
Exporting to PDF.....	795
Exporting documents as PDF files.....	795
Including hyperlinks, bookmarks, and thumbnails in PDF files.....	798
Reducing the size of PDF files.....	798
Working with text and fonts in PDF files.....	799
Specifying an encoding format for PDF files.....	801
Specifying a viewing option for EPS files.....	801
Specifying color management options for exporting PDF files.....	802
Setting security options for PDF files.....	803
Optimizing PDF files.....	804
Viewing preflight summaries for PDF files.....	805
Preparing PDF files for a print provider.....	806
Working with office productivity applications.....	809
Importing files from office productivity applications.....	809
Exporting files to office productivity applications.....	809
Adding objects to documents.....	809
Supported file formats.....	811
Adobe Illustrator (AI).....	812
Adobe Type 1 Font (PFB).....	814
Windows Bitmap (BMP).....	815
OS/2 Bitmap (BMP).....	816
Computer Graphics Metafile (CGM).....	816
CorelDRAW (CDR).....	817
Corel Presentation Exchange (CMX).....	817
Corel PHOTO-PAINT (CPT).....	818

Corel Symbol Library (CSL).....	818
Cursor Resource (CUR).....	819
Microsoft Word (DOC, DOCX, or RTF).....	819
Microsoft Publisher (PUB).....	821
Corel DESIGNER (DES, DSF, DS4, or DRW).....	821
AutoCAD Drawing Database (DWG) and AutoCAD Drawing Interchange Format (DXF).....	822
Encapsulated PostScript (EPS).....	824
PostScript (PS or PRN).....	828
GIF.....	828
JPEG (JPG).....	829
JPEG 2000 (JP2).....	830
Kodak Photo CD Image (PCD).....	831
PICT (PCT).....	832
PaintBrush (PCX).....	833
Adobe Portable Document Format (PDF).....	834
HPGL Plotter File (PLT).....	836
Portable Network Graphics (PNG).....	837
Adobe Photoshop (PSD).....	838
Corel Painter (RIF).....	839
Scalable Vector Graphics (SVG).....	839
Adobe Flash (SWF).....	842
TARGA (TGA).....	843
TIFF.....	844
Corel Paint Shop Pro (PSP).....	844
TrueType Font (TTF).....	845
Visio (VSD).....	845
WordPerfect Document (WPD).....	846
WordPerfect Graphic (WPG).....	846
RAW camera file formats.....	847
Wavelet Compressed Bitmap (WI).....	847
Windows Metafile Format (WMF).....	847

Additional file formats.....	848
Recommended formats for importing graphics.....	849
Recommended formats for exporting graphics.....	849
General notes on importing text files.....	850
Customizing and automating.....	851
Setting basic preferences.....	853
Disabling warning messages.....	853
Viewing system information.....	853
Customizing CorelDRAW.....	855
Saving and restoring defaults.....	855
Creating workspaces.....	856
Importing and exporting workspaces.....	856
Customizing workspace appearance.....	857
Customizing keyboard shortcuts.....	860
Customizing menus.....	861
Customizing toolbars.....	863
Customizing the toolbox.....	866
Customizing the property bar.....	866
Customizing the status bar.....	867
Customizing filters.....	868
Customizing file associations.....	869
Using macros to automate tasks.....	871
Working with macros.....	871
Reference.....	879
CorelDRAW for Adobe Illustrator users.....	881
Comparing terminology.....	881
Comparing tools.....	882
Using the Adobe Illustrator workspace.....	885
Glossary.....	887

Getting started

Installing CorelDRAW Graphics Suite.....	21
Corel accounts and services.....	27
What's new in CorelDRAW Graphics Suite?.....	31
Learning resources.....	43
Starting and setting up.....	49
CorelDRAW basics.....	51
CorelDRAW workspace tour.....	71
Finding and managing creative tools and content.....	99
Touch-enabled devices and wheel devices.....	117

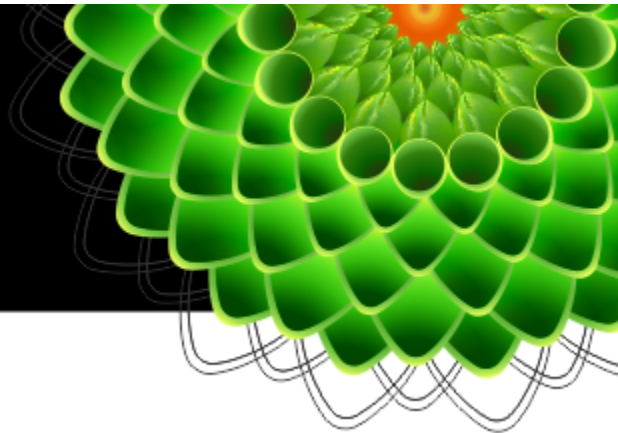

Installing CorelDRAW Graphics Suite

This section contains the following topics:

- “System requirements” (page 21)
- “Preparing for installation” (page 22)
- “Installing CorelDRAW Graphics Suite applications” (page 22)
- “Installation options” (page 22)
- “Modifying and repairing installations” (page 24)
- “Uninstalling CorelDRAW Graphics Suite” (page 25)
- “Frequently Asked Questions” (page 25)

System requirements

The following list includes the minimum system requirements. Note that for optimum performance, you need more RAM and hard disk space than indicated in the list.

- Windows 7 SP1, Windows 8.1 or Windows 10, in 32-bit or 64-bit, with the latest updates and service pack
- Intel Core i3/5/7 or AMD Athlon 64
- 2 GB RAM
- 1 GB hard disk space

Electronic software downloads require more space to allow for the download, the uncompressed setup files, and the actual installation, which includes copies of the source files as well.

- Mouse, tablet, or multi-touch screen
- Display resolution
 - 1280 x 720 screen resolution at 100% (96 dpi)
 - 1920 x 1080 at 150%
 - 2560 x 1440 at 200%
- DVD drive (required for installing the box version of the software)
- Microsoft .NET Framework 4.6
- Microsoft Internet Explorer 11 or later
- Internet connection is required to sign in to authenticate CorelDRAW Graphics Suite, receive performance and stability updates, access online content, and use some features, such as QR Codes or the Content Exchange.



If the Microsoft .NET Framework is not available on your computer, it will be installed during product installation.

Preparing for installation

- Make sure that your system's date and time are set correctly.
- Make sure that your system has the latest updates installed.
- Close all applications, including all virus detection programs and applications that are open in the system tray or on the Windows taskbar. Not doing so may increase the installation time and interfere with the installation.
- Log in as a user with administrative privileges.
- Make sure that you have enough free disk space available on the drive where you want to install the application.
- Delete the contents of the system's TEMP folders to avoid file and memory conflicts. To navigate to the Temp folders, type %temp% in the **Search** box on the Windows 7 SP1 or Windows 10 Start menu, or the Windows 8.1 desktop.
- Install CorelDRAW® Graphics Suite in its own directory to avoid conflicts with previous versions.

Installing CorelDRAW Graphics Suite applications

The installation wizard makes it easy to install CorelDRAW Graphics Suite applications and components. You can choose a typical installation to quickly install the suite, or you can customize the installation by choosing different options.

To install CorelDRAW Graphics Suite applications

- 1 Close all applications, including all virus detection programs.
For smooth installation, we recommend that you restart Windows. This action will ensure that no restart is required by the latest system updates, and there are no memory issues.
- 2 Do one of the following:
 - Insert the DVD in the DVD drive.
If the installation wizard does not start automatically, browse to the root of the DVD, locate **setup.exe** on the DVD, and double-click the file. Be sure to navigate to the folder that corresponds to the version of your operating system: **x64** for 64-Bit or **x86** for 32-Bit.
 - Download the product from the link provided on your order confirmation.
- 3 In the installation wizard, review the End User License Agreement and the Terms of Service by clicking the corresponding links.
- 4 Enable the **I agree to the End User License Agreement and the Terms of Service** check box, and click **Accept**.
- 5 Type your name in the **Full name** text box.
- 6 Type your serial number in the **Serial number** text box.
The serial number is not case-sensitive, and the dashes are optional.
- 7 Click **Next**.
- 8 Follow the instructions for installing the software.

Installation options

You can choose between the following types of installations:

- **Typical installation** — automatically installs the main programs and utilities of the suite to a default location in the Program Files folder. If later you need a component that is not installed, you can modify your installation.
- **Custom installation** — lets you choose additional features, exclude components that you don't need, and specify where to install the suite.
- **Deployment** — available only for multiseat purchases. This option lets you create a server image for installing the software to individual workstations. For more information, see the [CorelDRAW Graphics Suite 2018 Deployment Guide](#).

Programs

The following table lists the programs that are installed by default. To exclude a program from the installation, you must choose Custom installation.

Program	Description
CorelDRAW®	An intuitive and versatile graphics application for creating high-quality vector illustrations, logo designs, and page layouts
Corel® PHOTO-PAINT®	A complete image-editing application that lets you retouch and enhance photos as well as create original bitmap illustrations and paintings
Corel® CONNECT™	An application that provides easy access to content such as clipart, photos, and fonts
Corel® CAPTURE™	An easy-to-use application for capturing images from your computer screen
Corel Font Manager™	An application for finding, organizing, and managing fonts

Program features and utilities

The following table lists the program features that you can install. Not all components are available in all versions of the software.

Feature or utility	Description	Notes
Duplexing Wizard	Lets you configure a printer for two-sided printing	Included with the Typical installation
Microsoft Visual Basic for Applications 7.1	A subset of the Microsoft Visual Basic (VB) programming environment, which is suitable for beginners.	You can use VBA to create basic macros for personal use, but you can also use it to create more advanced macro projects.
Microsoft Visual Studio Tools for Applications (VSTA)	A built-in program environment that allows developers and other programming experts to use VSTA for creating the most advanced macro projects	To use VSTA with CorelDRAW Graphics Suite, you must have your own copy of Microsoft Visual Studio 2017 installed. If you install Microsoft Visual Studio after installing CorelDRAW Graphics Suite, you must re-install the VSTA feature by modifying your CorelDRAW Graphics Suite installation. For more information, see “To modify or repair a CorelDRAW Graphics Suite installation” on page 24.
Windows Shell Extension	Lets you view thumbnails of native Corel files such as CorelDRAW (CDR), Corel	If you have installed CorelDRAW Graphics Suite or CorelDRAW Technical Suite

Feature or utility	Description	Notes
	PHOTO-PAINT (CPT), pattern fill (FILL), and other native file.	before, this option does not appear in the installation wizard.
GPL Ghostscript	Highly recommended if you import EPS and PDF files in your documents. This feature lets you isolate and use individual elements of imported EPS files rather than only header images. It also improves the import of PDF files generated by third-party applications.	Included with the Typical installation
Language packs	Let you use the programs and Help in two or more languages	This option is included only with multilingual versions of the software and requires Custom installation.
Install desktop shortcuts	Adds product icons to your desktop for easy access	Included with the Typical installation
Copy installation files	Lets you maintain and update the software without using the installation disc	Included with the Typical installation

Modifying and repairing installations

You can also use the installation wizard to do the following:

- modify the current installation by adding or deleting components
- repair the current installation by fixing errors such as missing or corrupt files as well as inaccurate shortcuts and registry entries

Repairing an installation is helpful when you encounter problems in using the application, or when you suspect that the installation is corrupt.



Before repairing an installation, try resetting the current workspace to the default settings by holding down **F8** while starting the application. Note that when you reset the workspace, all workspace preferences are reset.

To modify or repair a CorelDRAW Graphics Suite installation

- 1 Close all applications.
- 2 On the Windows Control Panel, click **Uninstall a program**.
- 3 Double-click the suite's name on the **Uninstall or change a program** page.
- 4 Enable the **Modify** option or the **Repair** option in the wizard that appears, and follow the instructions.



Program features and utilities that are already installed may not appear in the wizard, or their check boxes appear disabled.

Certain features, such as **Copy installation files** and **Install desktop shortcuts**, cannot be added by modifying your installation.

Uninstalling CorelDRAW Graphics Suite

You can uninstall CorelDRAW Graphics Suite from the Control Panel. If you want to uninstall the product and then reinstall it with the same serial number on another computer, make sure to uninstall while being connected to the Internet. This will restore by one the number of computers on which you can legitimately install the product.

To uninstall CorelDRAW Graphics Suite

- 1 On the Windows Control Panel, click **Uninstall a program**.
- 2 Double-click the suite's name on the **Uninstall or change a program** page.
- 3 Enable the **Remove** option in the wizard that appears, and follow the instructions.

To completely uninstall the product by removing user files, such as presets, user-created fills, and customized files, enable the **Remove user files** check box.



Any additional components and applications that you installed with the suite, such as the Corel Graphics - Windows Shell Extension, GPL Ghostscript, or Microsoft Visual Studio Tools for Applications (VSTA), must be uninstalled separately.

Frequently Asked Questions

If your question is not included in the list below, visit [Corel® Support Services](#), and search the [Corel® Knowledge Base](#).

- [“I am upgrading my version of the software. Do I need to uninstall the previous version?” \(page 25\)](#)
- [“What is the difference between an upgrade and an update?” \(page 25\)](#)
- [“What if I lost my serial number and need to reinstall the software?” \(page 25\)](#)
- [“What is the difference between Typical and Custom installation? Which type of installation is suitable for me?” \(page 25\)](#)
- [“Why do you ask me to update my operating system with the latest service packs and critical updates?” \(page 25\)](#)
- [“How do I deploy CorelDRAW Graphics Suite to my organization’s network?” \(page 26\)](#)
- [“How do I change the language of the user interface and Help?” \(page 26\)](#)

I am upgrading my version of the software. Do I need to uninstall the previous version?

No, you don't need to uninstall the previous version. By default, the new version is installed to a separate folder, which ensures that you can work with both versions. Do not change the installation folder to install the upgrade and the previous version to the same folder.

What is the difference between an upgrade and an update?

An upgrade lets you install the latest major version of the software. After a major version is released, updates usually follow to offer defect fixes, and performance and stability improvements. Updates have the name of the major version with a number appended — for example, .1. Usually, the application notifies you when a product update is available, but you can also check for updates by clicking **Help**

► **Updates**.

What if I lost my serial number and need to reinstall the software?

Do one of the following:

- For download versions, check the email you received from Corel when you purchased the product.
- Sign in on [corel.com](#) to access **Your Account** page.
- If you purchased a box, check the cover of the installation disk.

What is the difference between Typical and Custom installation? Which type of installation is suitable for me?

See [“Installation options” on page 22](#).

Why do you ask me to update my operating system with the latest service packs and critical updates?

We ask you to install the latest service packs and critical updates in order to:

- protect your computer from malicious software

- resolve Windows issues and defects
- ensure smooth operation of the operating system and your Corel software
- help meet the minimum system requirements
- help speed up the installation process, sometimes bypassing prerequisites such as .NET Framework 4.6 and Microsoft Visual C++ 2015
- reduce the likelihood of needing to restart your operating system
- ensure that system drivers are up-to-date and optimized for the suite.

How do I deploy CorelDRAW Graphics Suite to my organization's network?

If you purchased multiple licenses of CorelDRAW Graphics Suite, you have the option of deploying the applications to your organization's network.

The [CorelDRAW Graphics Suite 2018 Deployment Guide](#) provides more information about network installations. To purchase a volume license of the software, please contact [Corel® Support Services](#).

How do I change the language of the user interface and Help?

You can change the language of the user interface and Help only if you have purchased and installed a multilingual version of the suite. For more information, see ["To change the language of the user interface and Help"](#) on page 49.

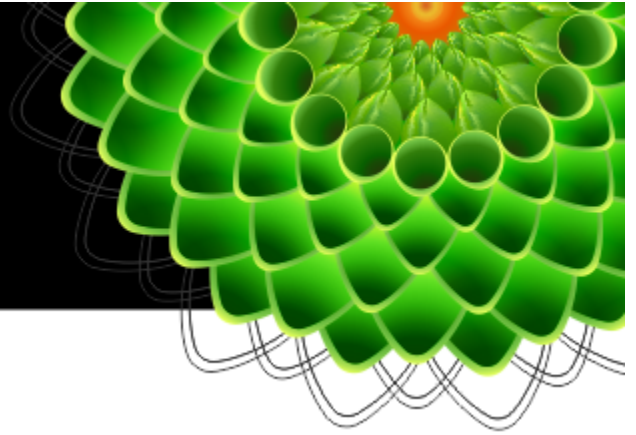

Corel accounts and services

This section contains the following topics:

- “Authenticating CorelDRAW Graphics Suite” (page 27)
- “Checking account settings” (page 28)
- “Updating Corel products” (page 28)
- “Changing user credentials” (page 28)
- “Corel Support Services” (page 29)
- “About Corel” (page 29)

Authenticating CorelDRAW Graphics Suite

Authentication lets you access online features and content that are included with your software. You can authenticate CorelDRAW Graphics Suite after the suite installation, before starting an application, or while using an application.

To authenticate CorelDRAW Graphics Suite, you must sign in with your Corel.com account. This action associates your product with your account. If you don’t have a Corel.com account or you want to associate your product with a new account, you need to create an account before signing in.

After you install and authenticate CorelDRAW Graphics Suite, the product appears in Your Account page on corel.com. If you want to associate the product with a different account, you must change your user credentials. For more information, see [“Changing user credentials”](#) on page 28.

To authenticate CorelDRAW Graphics Suite

- 1 Click the **Sign-in** button in the upper-right corner of the application window.



- 2 In the dialog box that appears, do one of the following:
 - Sign in by entering the email address and the password associated with your Corel.com account.

- Follow the instructions to create an account, and sign in.



You can now access online features and content provided you have Internet connection.

Checking account settings

You can check your account settings by accessing Your Account page from within the application. On Your Account page, you can find out more about the products associated with your account, and you can access support and set your communication preferences.

In those rare cases when your account settings may not reflect your latest transaction, you can refresh your account from within the application.

To check your corel.com account

- In CorelDRAW or Corel PHOTO-PAINT, click **Help** ► **Account Settings**.

To refresh your corel.com account

- In CorelDRAW or Corel PHOTO-PAINT, click **Help** ► **Refresh Your Account**.

Updating Corel products

Product updates, formerly known as service packs, include performance and stability improvements that enhance your product experience. By default, you are automatically notified when product updates and news become available. You can customize the update and message settings. For example, you can choose how often to receive updates and offers as tray notifications: daily, weekly, monthly, or not at all.



To view information about product updates, click **Help** ► **Updates**.

To customize update and message settings, click **Help** ► **Message Settings**.

Changing user credentials

As a user and owner of CorelDRAW Graphics Suite, you must know your user credentials:

- your product serial number — lets you install and reinstall your product. The serial number is the unique identifier of your product license.
- the email address associated with your Corel.com account. For each Corel.com account, a unique email address and password are required. When you authenticate your product to access online features and content, you sign in with a specific Corel.com account, associating the product with that account and its email address.

This topic describes two typical cases in which you need to change your account settings and then update your user credentials in the installed product to match the new account settings. Updating your user credentials ensures that you don't need to uninstall and reinstall the product.

You want to merge two product subscriptions that you purchased with the same Corel.com account at a different time so that the subscriptions have the same renewal date.

In this case, each subscription is associated with a different serial number. You must first go to Your Account page, and then associate both subscriptions with one of the serial numbers. Second, you must edit the user credentials in the product that now has an obsolete serial number.

Step 1: Go to **Your Account** page by signing in on corel.com, and then click **Merge** in the **Product Status** area. On the **Subscriptions** page, select the subscriptions that you want to merge. Proceed to the **Confirm selection** page, and choose the serial number that you want to keep.

Step 2: Start the version of CorelDRAW or Corel PHOTO-PAINT that now has an obsolete serial number. Click **Tools ► Options**, and in the **Global** list of categories, click **User Credentials**. Next, click **Edit Credentials**, and in the dialog box, type the serial number that you chose in step 1.

You have two Corel.com accounts associated with different email addresses, and you want to merge the two accounts.

First, you must call [Corel Support Services](#) to merge the accounts for you, and then you must update your email address through the product.

Step 1: Contact Corel Support Services with a request to merge the two accounts for you. You will be asked to provide an active email address for your merged account. If you have subscriptions or Upgrade Programs in each account, they are associated with different serial numbers so you need to choose one of the serial numbers.

Step 2: Start the version of CorelDRAW or Corel PHOTO-PAINT that is now associated with an obsolete account and email address. Click **Tools ► Options**, and in the **Global** list of categories, click **User Credentials**. Click **Edit Credentials**, and in the dialog box that appears, type the email address that you chose for your merged account. Type your password. If necessary, type the serial number that you chose in step 1.

Corel Support Services

Corel Support Services can provide you with prompt and accurate information about product features, specifications, pricing, availability, services, and technical support. For the most current information on support services available for your Corel product, please visit www.corel.com/support.

About Corel

Over the years, Corel has brought a spirit of innovation to the development of a range of award-winning products that includes graphics, painting, photo, video and office software. We've also earned a reputation for delivering high-quality products that are easy to learn and use, and help people achieve new levels of productivity. But more than that, we've built a relationship with our community of users—tens of millions strong—who have amazed and delighted us with everything they create using our software.

Corel's product line includes CorelDRAW Graphics Suite, CorelDRAW Technical Suite, Corel® Painter®, Corel® PaintShop® Pro, Corel® VideoStudio®, WinDVD, Corel® WordPerfect® Office, and WinZip. For more information about Corel, please visit www.corel.com.

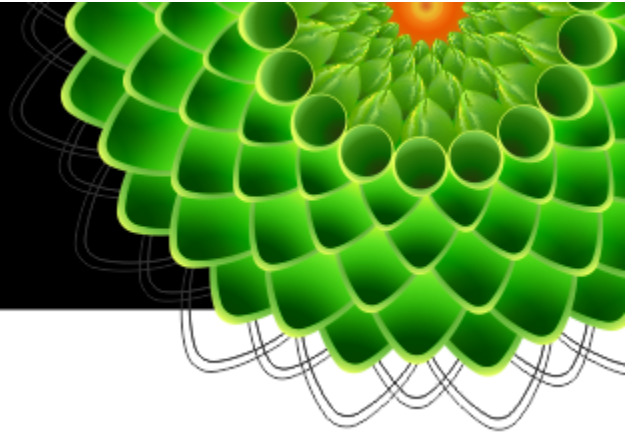

What's new in CorelDRAW Graphics Suite?

The new and enhanced features of CorelDRAW Graphics Suite 2018 are described in the following topics:

- “Creative” (page 31)
- “Productive” (page 35)
- “Innovative” (page 39)

For information about features and tools that were introduced or improved in earlier versions of CorelDRAW Graphics Suite, see [“Finding out what was new in previous versions”](#) on page 42.

Creative

Boost your creativity with the new Symmetry drawing mode, unique effects, new line options, and more.

Symmetry

Symmetry is a critical part of the graphics workflow because it creates balance, harmony, and order. Symmetry is everywhere in nature, so chances are a design element will rely on it. To that end, CorelDRAW 2018 introduces the Symmetry drawing mode, which boosts your productivity by automating what is usually a very time-consuming process. It lets you create a range of symmetrical designs, from simple objects to complex kaleidoscopic effects, in real time.



There are two ways to use Symmetry mode. You can work in Symmetry mode from the outset and start drawing symmetrically immediately. Or, you can apply symmetry to an existing object or group of objects, both vector and bitmap.

Symmetry mode can be used with a range of tools, giving you unprecedented creative freedom. Whether you want symmetry in curves, shapes, objects, text, you're free to experiment and play like never before. What's more, you're not limited to simple design tools. The ability to use transparency, fills and more in a symmetrical design opens up a world of possibilities.

Controlling the symmetry appearance is a breeze. You can add symmetry lines, adjust the reflection angle, and move symmetry lines independently of the objects in the group. And when you edit the original image or add new nodes or objects, you'll see the changes repeated and reflected in each copy.

Block shadow

CorelDRAW is a longtime favorite with vinyl cutters, screen printers and sign makers, so their feedback has been critical to the development of every version of the program. Working with users in those industries, CorelDRAW 2018 introduces the Block Shadow tool, which lets you add solid vector shadows to objects and text. This intuitive feature accelerates reprographic workflows by greatly reducing the number of lines and nodes in shadows, slashing the time it takes to get a file ready for output and vastly improving the final result.

Powerful property bar settings let you specify the exact depth and direction of the shadow, or you can manipulate those properties interactively within the drawing to get the look that you have in mind. Block shadow color is independent of the object from which it is being extruded, so there's no restrictions on your creativity. There's also an overprint option to ensure that block shadow colors remain intact beneath text or objects that have a block shadow applied to them.

Sed lectus

Sed lectus

Corner control in dashed lines and outlines

Thanks to invaluable feedback from our loyal user base, CorelDRAW 2018 gives you more control over the appearance of corners in objects, text, and symbols that use dashed lines. In addition to the existing default setting that renders dashed lines exactly as drawn, you can choose from two new options to create perfectly designed and defined corners. The Align dashes option ensures that there's no empty space in the corners and at the start and end of a line or outline by aligning dashes with the end and corner points. And the Fixed dashes option creates dashes in the end and corner points that are half the size of the first dash in the line pattern.



Impact tool

When you need to give a design a little more spark, the Impact tool is the answer. Inspired by comic books and graphic novels, it's perfect for quickly and effortlessly adding movement or focus to an element in a drawing. In just a few clicks, you can get results that used to be time-consuming and labor-intensive. The Impact tool has two modes: Parallel for adding "zoom" lines that signify motion, and Radial for adding an explosive burst of energy. These effects are non-destructive, highly customizable vector objects that can be edited with other tools. There are a variety of line styles that you can fine-tune, or you can opt to randomize tool settings for a more natural look.

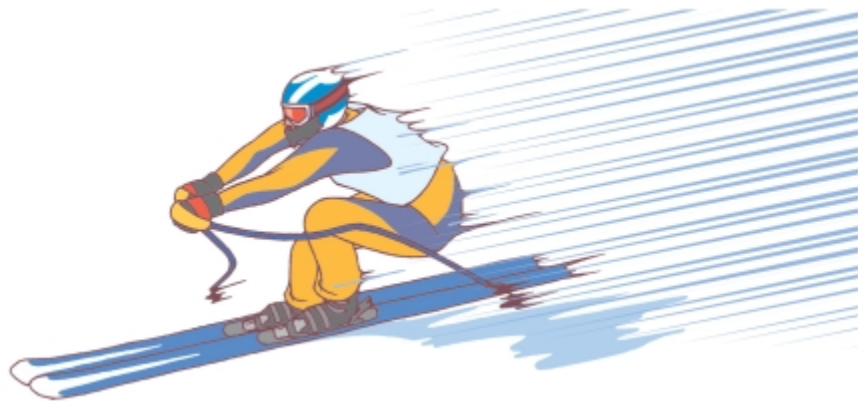

Pointillizer

In just a few clicks, you can generate high-quality vector mosaics from any number of selected vector or bitmap objects using the Pointillizer effect. Inspired by the Pointillism painting technique where multiple dots combine to form an image, it's great for creating vehicle wraps, window decor projects, and more. The ability to set the number, size, and shape of the tiles gives you limitless creative possibilities. There is a range of other options that you can experiment with to create striking designs. While other solutions can produce raster pointillistic images, only CorelDRAW lets you output the effect as a vector graphic.



PhotoCocktail

Whether you're creating promotional materials, a family memento or a piece of art, the PhotoCocktail effect lets you create stunning photo collages more easily than you can imagine. You start with a photo or vector object as the foundation of your mosaic, then choose a library of bitmap images that serve as the mosaic tiles, and PhotoCocktail does the rest. You have total control over how everything blends together, how the collage is output, and the resolution of the end result.



Turning artwork into a mosaic composed of images (Elements from artwork by Ariel Garaza Díaz)

Productive

Increase your productivity with the performance enhancements and high-caliber, yet intuitive, new features of CorelDRAW Graphics Suite 2018.

Launch time

Launch time has been reduced thanks to performance enhancements, so you can get to work faster than ever.

Improved vector previews

CorelDRAW Graphics Suite 2018 boosts your productivity with faster rendering of tool previews; curve previews, nodes, and handles; effect controls and sliders; and text. You can also open large files quicker and enjoy smoother editing of complex curves. In addition, you can work more efficiently thanks to tool and object previews that are more visible and user-friendly.

Work faster with text and fonts

Faster rendering of text, especially artistic text, helps accelerate the design workflow. What's more, the performance of the Font List in CorelDRAW 2018 has been enhanced so you can quickly find what you're looking for.

Work faster with fonts stored on a network

Finding the right font for the job is easier than ever thanks to enhancements to Corel Font Manager that improve monitoring fonts stored on a network.

Toggle snapping

As much as snapping can enhance productivity by offering the ability to precisely position design elements, users told us that there are stages in their workflow when they'd like to momentarily disable it. To that end, CorelDRAW 2018 makes it easy to temporarily turn off snapping options with a click of the Snap Off button. You can also use keyboard shortcuts to toggle snapping on or off (Alt+Q) or to disable snapping as you're repositioning without having to release the cursor (Q). This lets you fluidly move objects in the drawing window free of any snapping constraints. Then, when you need the precision of snapping again, you can quickly restore it using the same controls.

Align and distribute nodes

Since it was introduced, the Align and Distribute docker has become an indispensable tool for graphics professionals because of the quick and easy access it offers to time-saving controls for positioning objects. In CorelDRAW 2018, those same precise alignment options can

now be used for nodes. What used to be a slow, manual process can be achieved effortlessly in a few clicks. You can align nodes using the bounding box of a selection, the page edge or center, the closest grid line, or a specified point. What's more, you can align nodes from different curves. Distributing nodes is just as easy. You can add equal spacing between them horizontally or vertically using the drawing page or a bounding box as the reference point.

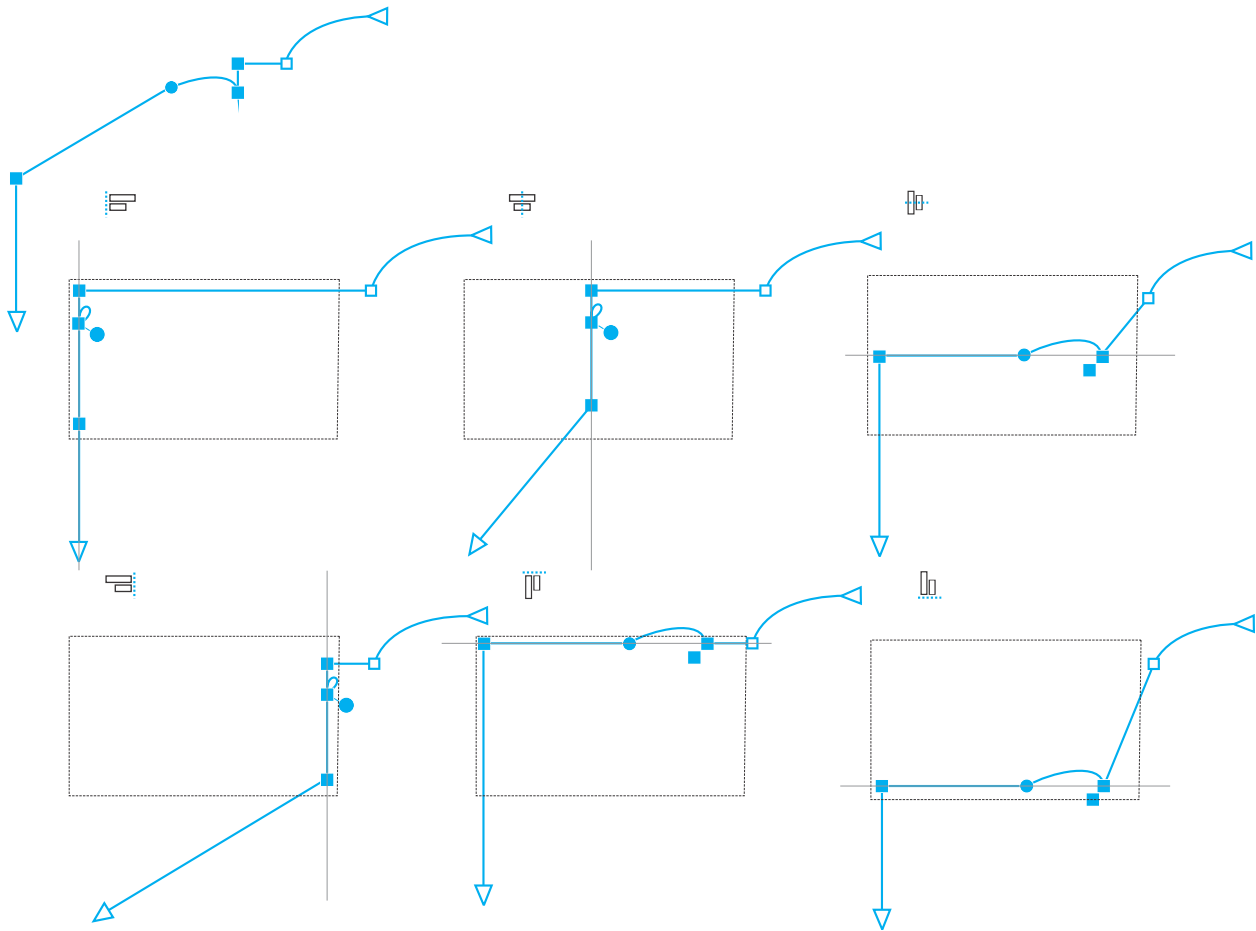

Warning when can't embed fonts

Another time-saver is a new warning that appears when you save a file listing any fonts that can't be embedded. This simplifies collaborative workflows by identifying any fonts that a colleague will need to continue working on the document.

Filter fonts based on embedding rights

You can save time and ensure hassle-free file sharing thanks to the new Embedding Rights font filter. It allows you to sort fonts based on four common font-embedding permissions, so you know right from the outset which fonts to use or avoid when choosing text styles. The filter gives you a quick idea of what other users will be able to do with text and fonts in a design that you share with them. You'll be able to see which fonts can't be embedded or which ones recipients of the drawing can install on their computer, allow for text editing, or can be only viewed and printed.

Apply and manage fills and transparencies

How users interact with design assets has undergone a complete overhaul in CoreDRAW Graphics Suite 2018. Totally redesigned Fill and Transparency pickers help boost your productivity and deliver improved performance when working with and managing fills and transparencies in CoreDRAW and Corel PHOTO-PAINT. A streamlined UI allows you to use, create, and find fills and transparencies faster than ever. You can download new content packs, add your own library, easily migrate an asset collection anywhere, and modify asset properties — all within the suite. In addition, you can use aliases to view content stored in another folder on your computer, a USB flash drive, or a shared network folder.

To easily find fills and transparencies you use often, simply mark them as favorites. To avoid clutter, you can move unused assets to a new folder or delete them. Locating the asset you want is a snap. You can view a list of your favorite or most recently used fills and transparencies. You also can search and browse one pack, folder or list at a time. And if you are looking to expand your fill collection, you can download additional fill packs from within the Get More dialog box.

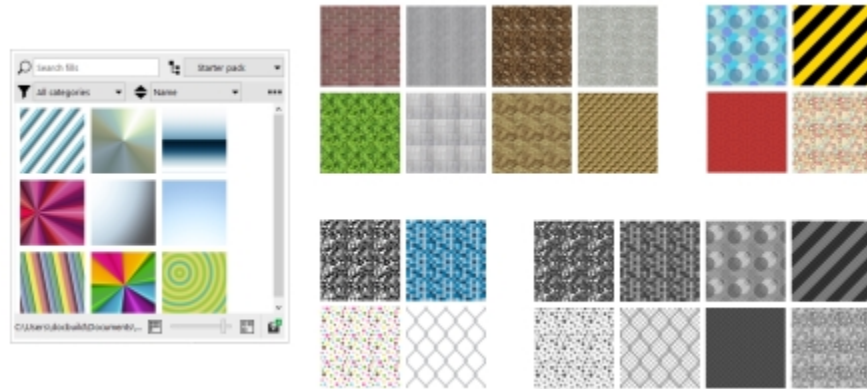

Default folder locations

To simplify finding and sharing design assets, you can choose where to store content rather than use the default folders. In response to user requests, CorelDRAW and Corel PHOTO-PAINT now let you customize where fills, fonts, image lists, photo frames, templates and trays are stored, including any that you've created or acquired from online content providers.

File Save indicator

If you work on multiple documents simultaneously in CorelDRAW and Corel PHOTO-PAINT, it's now easier to see which files contain unsaved changes. An asterisk appears next to the name of unsaved files on the Windows menu, the title bar and the document tab, so you can identify the status of your work in a glance.

Bilinear zooming

Corel PHOTO-PAINT 2018 gives you another magnification option with the introduction of bilinear zooming. It adds pixels by averaging the color values of surrounding pixels when zooming out, which prevents jagged edges and improves the display quality of sharp images that have fine detail.

Customize curve preview and editing

Node customization in CorelDRAW 2018 has been enhanced so it's easier to work with nodes in even the most complex designs. When nodes and handles become hard to see because the preview color is too similar to the background color, you can use a keyboard shortcut (Ctrl+Shift+I) to replace the main color with the secondary color and vice versa. You can also choose to show unselected nodes without a fill, and then toggle the node fill on or off using a keyboard shortcut (Ctrl+Shift+G).

Project Timer

CorelDRAW 2018 has a new tool designed to help graphics professionals keep organized, properly bill clients, and provide insight into how they work. The Project Timer is an accurate, non-intrusive way to track time spent on a project. Appearing as a discreet toolbar above the drawing window, the Project Timer is fully customizable to match your workflow. It offers a variety of ways to monitor and record tasks and project details. Tracking information is saved with the document and can be exported to file formats that can be opened in spreadsheet applications to create time sheet reports.

Fit objects to a path

In CorelDRAW 2018, fit any type and number of objects to a path of your choice. Smart spacing and rotation settings help you customize the arrangement of objects along the path.

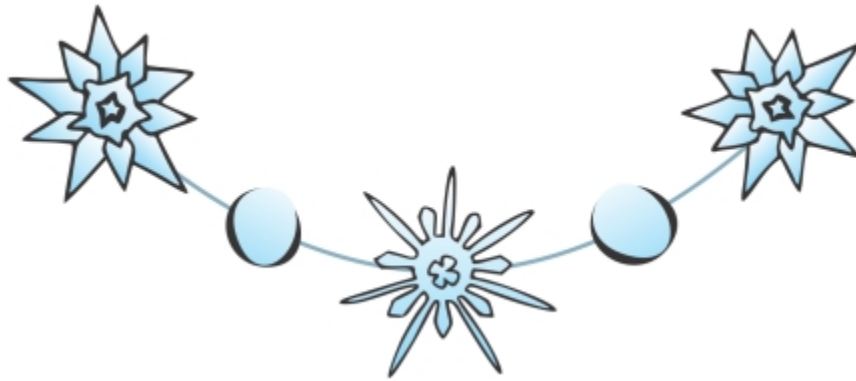

Straighten photos interactively

When something in a photo, such as a building or a road, is just a little off-kilter, it detracts from an otherwise great shot. Now thanks to the new Straighten tool in Corel PHOTO-PAINT, you can easily salvage those photos. It lets you rotate crooked images by interactively aligning a straightening bar to an element in the photo or specifying an angle of rotation. All the controls are easily accessible on screen or on the property bar, so you'll be amazed how quickly you can get perfect results. You can choose to rotate the image horizontally, vertically, or just let Corel PHOTO-PAINT decide which straightening mode works best. The Straighten tool can also rotate lenses, masks, objects, and groups of objects. In addition, you can crop the photo as you align it, or choose not to crop it and fill the edges with the background color instead.



Adjust photo perspective interactively

Corel PHOTO-PAINT 2018 has a new interactive feature that gives you the power and versatility of an expensive tilt correction lens. With the Perspective Correction tool, it's easy to adjust the perspective of landmarks or objects in photos to get the exact look that you wanted. Right in the image window, you simply move the four corner points to get the perspective that you have in mind. You can also display grid lines that make it easy to apply the rule of thirds as you adjust perspective.



Improved previews, cursors, and handles in Corel PHOTO-PAINT

CorelDRAW Graphics Suite 2018 simplifies painting, applying effects, and editing images with improved previews that are easier to see and manipulate. The vectors tools in Corel PHOTO-PAINT such as the Path tool and Line tool, have also been updated with a clearer appearance and more defines nodes and handles. Enhanced previews help you edit more efficiently by ensuring brush nibs and effect handles stand out against background colors in your design. And it's easier than ever to work with the interactive fills, transparencies, drop shadows and more thanks to enhanced interactive sliders that are more visible.

AfterShot 3 HDR

You can download Corel AfterShot 3 HDR at no extra cost from within CorelDRAW and Corel PHOTO-PAINT, and quickly learn professional-grade photo editing. It lets you make easy corrections and enhancements to your RAW or JPEG photos, and apply adjustments to thousands of photos in a click with batch-processing tools. Plus, you can create high dynamic range (HDR) images with the HDR module, included in AfterShot 3 HDR.

And if you want more powerful photo management and photo-editing features, you can upgrade to the latest version of AfterShot Pro through Get More.

Welcome Screen

The redesigned Welcome Screen can help kickstart your workflow when you launch CorelDRAW or Corel PHOTO-PAINT. It lets you quickly start a new document from scratch in both applications, from a template in CorelDRAW, or from the contents of the clipboard in Corel PHOTO-PAINT. You can also browse to open a file or use a revamped list of recent documents that displays thumbnails and file properties. All workspace options are at your fingertips, so you can get to work right away in the UI layout that best suits your needs. The enhanced Welcome Screen also provides one-click access to information about new features, online learning resources, a gallery of original artwork created with CorelDRAW Graphics Suite, as well as design assets, fonts, apps, and plug-ins.

Innovative

Make the most of innovative features and enhancements to create stunning projects and designs.

Add Perspective effect

CorelDRAW 2018 gives you the ability to use the Add Perspective effect on bitmaps with the same ease that you've always had when applying it to vector objects. It's never been easier to create the illusion of distance and depth by applying perspective to bitmaps, vector objects, or both simultaneously. You can work with speed and precision because you apply it interactively right in the drawing window. The Add Perspective effect is a great tool for graphics professionals who want to showcase their artwork in real world scenarios. It allows their clients to really see what a design will look like on a billboard, brochure, packaging, exhibition booth panel, and more. And if you want to experiment and play, no problem. The effect is applied non-destructively, so you can edit it or remove it and revert to the original image at any point.

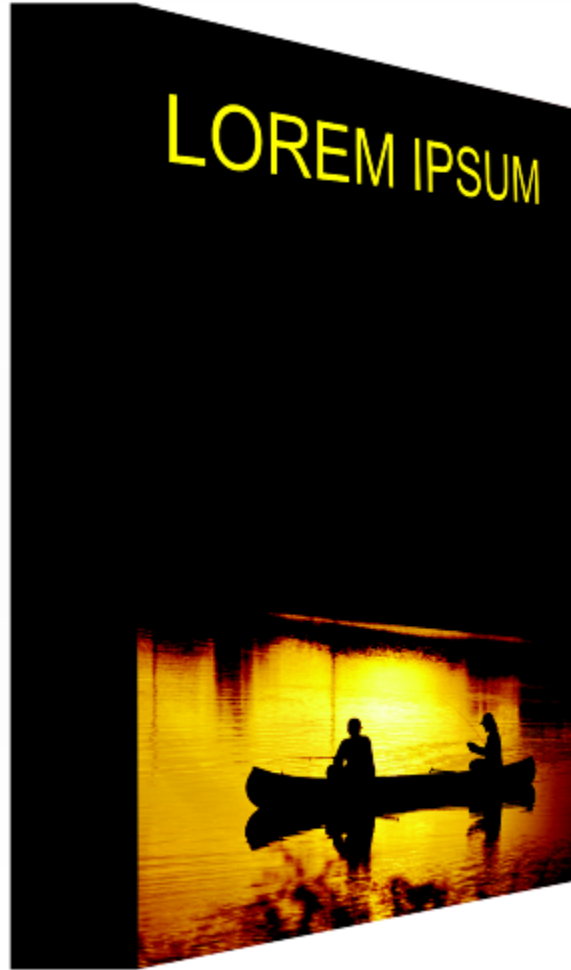
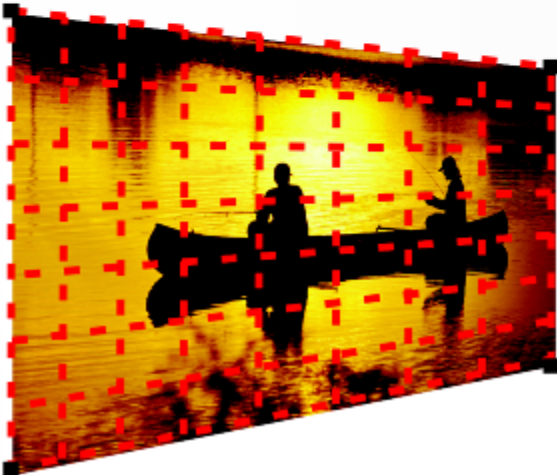

Apply envelopes to bitmaps

This longtime favorite of graphics professionals lets you interactively shape an object by placing it in an envelope and dragging its nodes. And now CorelDRAW 2018 gives you the same power and creative freedom to modify bitmaps that you've always had when working with vector objects. You can quickly and seamlessly blend a bitmap into an illustration using envelope presets, or you can craft one from scratch and save it for reuse. The enhanced Envelope tool can be used on a group of objects, whether vector, bitmap or both — all non-destructively. All the controls that you need are right on the canvas and property bar, so there's no time spent navigating a series of dialog boxes. Designers can quickly swap out the bitmaps used in an envelope with the Copy envelope properties option, so experimenting and getting the perfect look is effortless. What's more, you can turn any vector object into an envelope with the Create envelope from option.

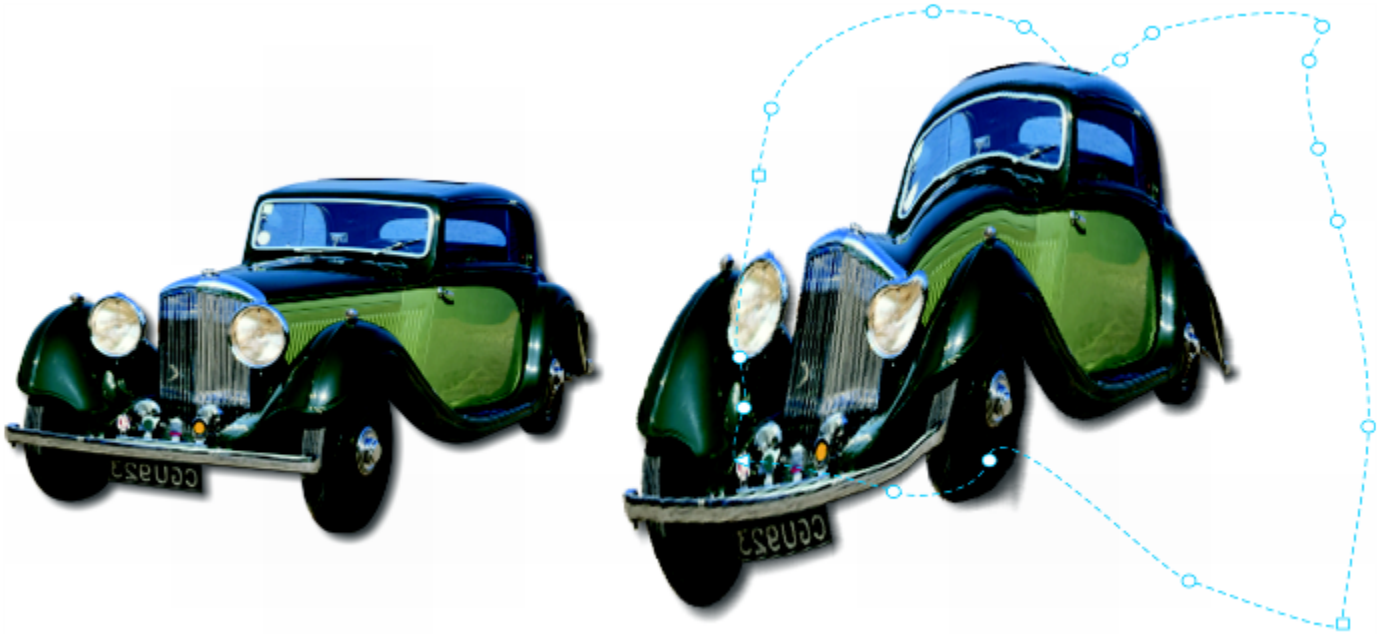

Enhanced LiveSketch tool

Users have come to love the LiveSketch tool for the freedom it offers them to design using hand-drawn vector curves right from the get-go. And in CorelDRAW 2018, this revolutionary tool has been enhanced. How CorelDRAW analyzes and adjusts your input strokes has been refined, delivering results that are more predictable than ever. You can harness this enhanced accuracy to speed up your workflow and focus on the creative process, making it even easier to get an idea onto the screen in front of you.

Flip the stylus pen to eraser

If you work with a pen or stylus, you can take advantage of a variety of real-time input factors to erase with the ease and accuracy of a pencil eraser. Now you can use pressure to vary the size of the eraser nib, as well as link tilt and bearing to its flatness and rotation. Flipping the stylus or pen activates the Eraser tool, so you can erase on the fly without having to go to the toolbox. In addition, you can use the Eraser tool on most object types, and it's easier to erase through groups of objects.

HDR merge

You can now access the High Dynamic Range (HDR) Merge module in AfterShot 3 HDR directly from the Camera RAW Lab in Corel PHOTO-PAINT 2018 to combine two or more photos of the same scene that were taken with different exposure settings. This lets you access a broader tonal range to create a final image that can be breathtaking.

Publish to WordPress

In CorelDRAW 2018, you can send your work directly to a WordPress media library from within the application. This new functionality enables you to convert selected objects or an entire project to a JPEG, GIF, or PNG file and then upload the image to a WordPress account — without ever leaving CorelDRAW. If you have multiple WordPress sites or accounts, you can easily specify where your content is uploaded.

You can also publish images to WordPress from Corel PHOTO-PAINT 2018.

GPU accelerated vector previews

Repositioning and editing complex vector shapes can tax your system's resources, especially when previews are displayed. By default, the central processing unit (CPU) of your computer is used to generate vector previews, but you can now opt to use the graphics processing unit (GPU) instead. The GPU is a specialized processor that greatly accelerates the display, editing, and manipulation of graphics. Choosing to use the GPU delivers faster rendering of tool previews, curves, and other effects in CorelDRAW and Corel PHOTO-PAINT. Since GPUs vary across machines, these enhancements may be more noticeable to some users than others.

Support for wheel devices

CorelDRAW Graphics Suite 2018 offers alternative ways of working thanks to enhanced support for wheel devices, such as the Microsoft Surface Dial. Put your keyboard aside and take advantage of the contextual onscreen UI. Design more naturally using a combination of ergonomic tools such as wheel devices, touch, or a stylus. This workflow lets you easily switch between tools and tasks with the non-dominant hand as you sketch or design with the other.

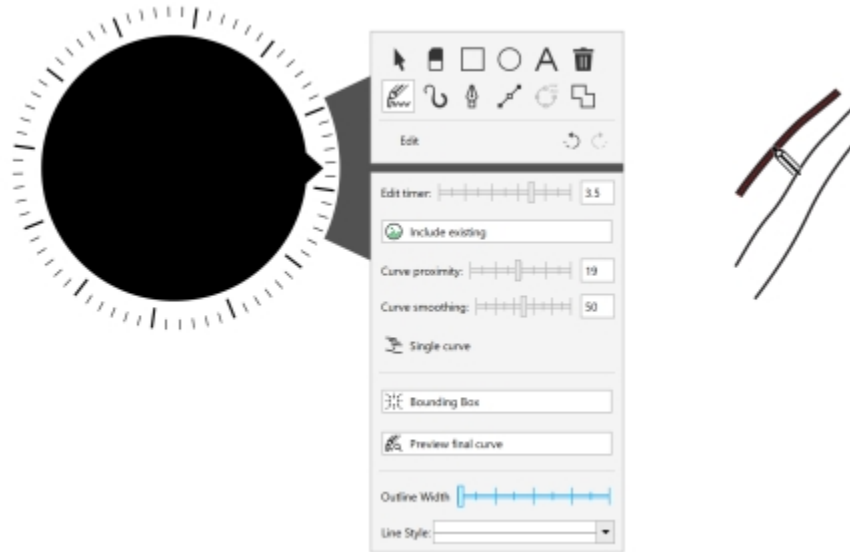

Finding out what was new in previous versions

You can easily identify what features have been improved or introduced since the last version of CorelDRAW Graphics Suite that you used.

To find out what was new in previous versions of CorelDRAW Graphics Suite

- Click **Help** ► **Highlight what's new**, and click one of the following commands:
 - **Since version 2017** — highlights menu commands and tools for features introduced or improved in this version
 - **Since version X7** — highlights menu commands and tools for features introduced or improved in version X7, X8, 2017, and 2018
 - **Since version X6** — highlights menu commands and tools for features introduced or improved in version X6, X7, X8, 2017, and 2018
 - **No highlight** — removes highlighting from menu commands and tools in the toolbox

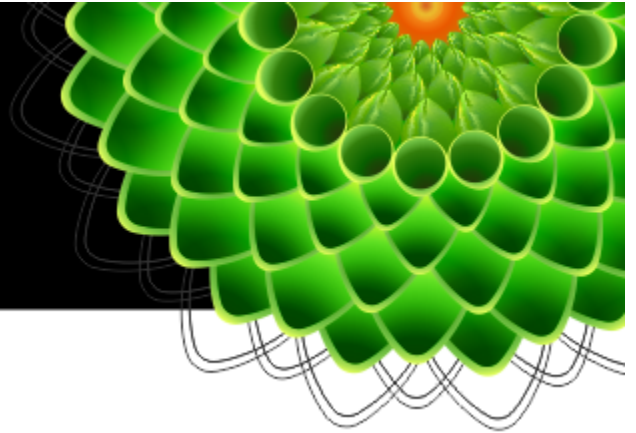

Learning resources

You can learn to use the product in various ways: by reading the *Quick Start Guide*; by accessing the Help and tooltips, by viewing video tutorials, and by exploring the resources on the Corel website (www.corel.com). On the website, you can access tips and additional tutorials. You can also check the Readme file ([readme.html](#)), which is installed with the software.

This section contains the following topics:

- “Getting help” (page 43)
- “Using the Help and tooltips” (page 44)
- “Using Hints” (page 45)
- “Welcome screen” (page 46)
- “Quick Start Guide” (page 46)
- “Insights from the Experts” (page 46)
- “Video learning resources” (page 47)
- “Community website for developers” (page 47)
- “Network deployment guide” (page 47)
- “Web-based resources” (page 47)

Getting help

Various learning resources are available. The following table can help you decide what learning resources to consult when you need assistance. You can access more information about some resources by clicking the corresponding links.

To	See
Start learning the applications	“Video learning resources ” on page 47 “Quick Start Guide ” on page 46
Learn about new and enhanced features	“Video learning resources ” on page 47
Obtain additional information about product tools and features	“Using the Help and tooltips ” on page 44 “Web-based resources ” on page 47

To	See
Advance your knowledge of the suite by learning from graphics design experts	"Using Hints " on page 45 "Insights from the Experts " on page 46 "Web-based resources " on page 47
Learn to automate tasks by using macros	Community website for developers
Find information about deploying the suite on a network	"Network deployment guide " on page 47
Find specific information about the latest version of the suite	Readme file, which is installed with the software. To find it, go the folder where the product is installed, open the Languages folder, and open the language folder you want.

Using the Help and tooltips

The Help provides comprehensive information about product features from within the application. If you are connected to the Internet, the application displays the web-based Help, which contains the latest updates. If no Internet connection is available, the application displays the local Help, which was copied to your computer during product installation.

You can browse through the entire list of topics or search for specific words. You can also access the [Corel Knowledge Base](#) on the Corel website and other online resources from the Help window.

Tooltips provide helpful information about application controls when you position the pointer over icons, buttons, and other user interface elements.

Documentation conventions

The following table describes important conventions used in the documentation.

Convention	Description	Examples
Menu ► Menu command	A menu item and menu command that you need to click in sequence	Click File ► Open .

Convention



Description

A note contains important information that is relevant to the preceding steps. It may describe conditions under which the procedure can be performed.

Examples

A compound blend cannot be copied or cloned.

If you click the **Equal margins** button, you must specify values in the **Top/left margin** boxes.



A tip contains suggestions for performing the preceding steps. It may present alternatives to the steps, or other benefits or uses of the procedure.

Trimming an object can reduce the drawing file size.

You can change the number of swatches in the color grid by dragging the **Size** slider.

To use the Help

- 1 Click **Help** ► **Product Help**.
- 2 Click one of the following tabs:
 - **Contents** — lets you browse through topics in the Help. To open a topic, click the topic heading in the left pane.
 - **Search** — lets you search the full text of the Help for a particular word or phrase

You can also

View context-sensitive Help from within a dialog box

Click the **Help** button in the dialog box.

Print a specific Help topic

Open a Help topic, click the page that you want to print, and click **Print** at the top of the Help window.



You can also access the Help by pressing **F1**.

To search the Help

- 1 Click **Help** ► **Product Help**.
- 2 Click the **Search** tab, and type a word or phrase in the search box.

For example, if you are looking for information about the RGB color mode, you can type "RGB" to display a list of relevant topics. To search for a phrase, type the phrase, and enclose it in quotation marks (for example, type "**dynamic guides**" or "**color mode**").
- 3 Choose a topic from the list that appears.

If your search results do not include any relevant topics, check whether you spelled the search word or phrase correctly. Note that the English Help uses American spelling (for example, "color," "favorite," "center," and "rasterize"), so searching for British spellings ("colour," "favourite," "centre," and "rasterise") produces no results.

Using Hints

Hints provide information about tools in the toolbox from within the application. When you click a tool, a hint appears, telling you how to use the tool. If you need additional information about a tool, you can access relevant learning resources such as a Help topic, video, or written tutorial.

Hints are displayed in the Hints docker on the right side of the application window, but you can hide them when you no longer need them. For information about working with dockers, see “[Dockers](#)” on page 93.

To use Hints

To	Do the following
Display or hide Hints	Click Help ► Hints . When the Hints command is enabled, the Hints docker appears and provides information about the active tool in the toolbox.
Display information about a tool	Click the tool, or perform an action with a tool that is already active.
Get additional information about the active tool	In the Learn more section, click a link to a relevant Help topic, video, or a written tutorial.
Navigate to previously viewed topics	Click the Back and Forward buttons at the bottom of the Hints docker.

Welcome screen

The Welcome Screen appears when you start the application. With the Welcome Screen, you can quickly start or open a document, choose a workspace that suits your needs, access online learning videos and other learning resources, and get inspired by a gallery of original artwork created with CorelDRAW.

To access the Welcome screen

- Click **Help** ► **Welcome screen**.



You can also access the Welcome screen by clicking the **Welcome screen** button on the tab bar. If you want to hide the **Welcome screen** button from the tab bar, click **Tools** ► **Options**, click **General** in the **Workspace** list of categories, and disable the **Show Welcome Screen** button on tab bar check box.

Quick Start Guide

The [Quick Start Guide](#), available in PDF format, can help you get started quickly with the suite by introducing you to useful tools and features.



You can also access the Quick Start Guide by clicking **Help** ► **Quick Start Guide**.

Insights from the Experts

The *Insights from the Experts* is a series of tutorials by graphic design professionals who use CorelDRAW Graphics Suite in their everyday work. You can access these online tutorials as individual PDF files directly from the Corel website.

Video learning resources

You can access video learning resources from the Welcome screen as well as from the Help menu.

The video tutorials show you how to complete basic tasks such as drawing, shaping, and coloring objects in CorelDRAW, or masking and cropping in Corel PHOTO-PAINT and help you get the most out of features such as symmetry, font management, fills and transparencies, alignment tools, QR codes, bitmap and vector effects, and more. Some videos don't have sound but include captions that provide useful tips and help you understand the features that are shown. Whether you are a new or long-time user, you will find useful demos and tips to boost your productivity and expand your experience.

To access a video

- Click **Help** ► **Video tutorials**.

Community website for developers

Whether you are automating tasks by using macros, creating custom tools, or developing commercial solutions that integrate with CorelDRAW Graphics Suite; the [developer community website](#) can help you with its wealth of useful resources: a programming guide, detailed Object Model reference documentation with code samples, and in-depth programming articles.

You can use either Microsoft Visual Basic for Applications (VBA) or Microsoft Visual Studio Tools for Applications (VSTA) to create macros and customized solutions for CorelDRAW and Corel PHOTO-PAINT.

Network deployment guide

The [CorelDRAW Graphics Suite 2018 Deployment Guide](#) is a step-by-step resource for deploying CorelDRAW Graphics Suite 2018 to a network. This guide is provided to customers who purchase a volume (“multi-seat”) license of CorelDRAW Graphics Suite 2018 for their organization. To purchase a volume license of the software and obtain its deployment guide, please contact [Corel Support Services](#).

Web-based resources

The following web-based resources can help you get the most out of CorelDRAW Graphics Suite:

- [Corel Knowledge Base](#) — articles written by the Corel Technical Support Services Team in response to questions by users
- [Community.CorelDRAW.com](#) — an online environment to share your experience with the product, ask questions, and receive help and suggestions from other users
- [Tutorials on the Corel website](#) — in-depth tutorials in which CorelDRAW Graphics Suite experts share their knowledge and techniques

An active Internet connection is required to access web-based resources.

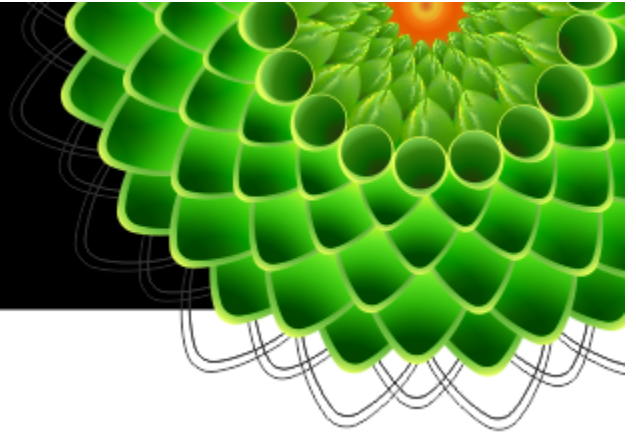

Starting and setting up

This section contains the following topics:

- “Starting and quitting CorelDRAW” (page 49)
- “Changing the language” (page 49)
- “Changing startup settings” (page 50)

Starting and quitting CorelDRAW

You can start CorelDRAW from the Windows taskbar and end a CorelDRAW session from the application window.

To start and quit CorelDRAW

To

Do the following

Start CorelDRAW

Do one of the following:

- (Windows 7 and Windows 10) From the Windows taskbar, click **Start** ► **Programs** ► **CorelDRAW Graphics Suite 2018** ► **CorelDRAW**.
- (Windows 8) Click the CorelDRAW 2018 tile on your desktop.

Quit CorelDRAW

Click **File** ► **Exit**.

Changing the language

If an application has been installed in more than one language, you can change the language of the user interface and Help at any time.

To change the language of the user interface and Help

- 1 Click **Tools** ► **Options**.
- 2 In the list of categories, click **Global**.

- 3 Choose a language from the **Select the language for the user interface** list box.
If you want to change the language of the user interface and Help when you start the application, enable the **Ask me the next time the software starts** check box.
- 4 Restart the application.



If there is only one language available in the **Select the language for the user interface** list box, you must first install the additional languages that you want. For more information, see [“To modify or repair a CorelDRAW Graphics Suite installation”](#) on page 24.

Changing startup settings

You can specify the startup settings for CorelDRAW, which control how the application appears when it’s opened. For example, you can start the application with the Welcome screen open or a new blank document.

To change startup settings

- 1 Click **Tools** ► **Options**.
- 2 In the **Workspace** list of categories, click **General**.
- 3 In the **Getting started** area, choose an option from the **On CorelDRAW start-up** list box.
If you want to hide the **Create a new document** dialog box when starting documents, disable the **Show New Document dialog box** check box.

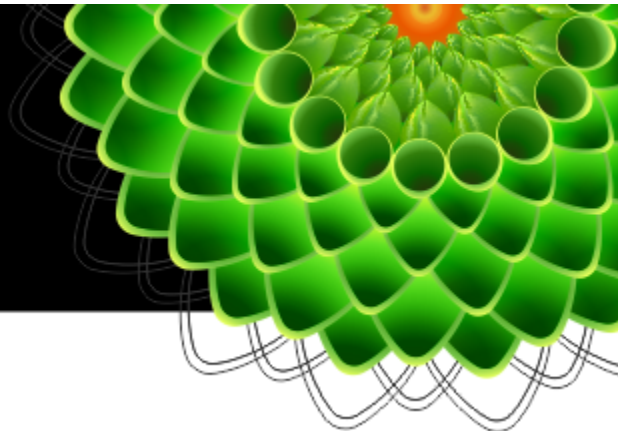

CorelDRAW basics

CorelDRAW lets you create and edit drawings. In this section, you can find information about commonly performed tasks.

This section contains the following topics:

- “Understanding vector graphics and bitmaps” (page 51)
- “Starting and opening drawings” (page 52)
- “Scanning images” (page 55)
- “Working with multiple drawings” (page 56)
- “Undoing, redoing, and repeating actions” (page 57)
- “Zooming, panning, and scrolling” (page 58)
- “Previewing drawings” (page 60)
- “Choosing viewing modes” (page 62)
- “Working with views” (page 63)
- “Saving drawings” (page 64)
- “Working with locked files” (page 67)
- “Backing up and recovering files” (page 67)
- “Adding and accessing drawing information” (page 68)
- “Closing drawings” (page 69)
- “Exploring basic tasks” (page 69)

Understanding vector graphics and bitmaps

The two main types of computer graphics are vector graphics and bitmaps. Vector graphics are made of lines and curves, and they are generated from mathematical descriptions that determine the position, length, and direction in which lines are drawn. Bitmaps, also known as raster images, are composed of small squares called **pixels**; each pixel is mapped to a location in an image and has numerical color values.

Vector graphics are ideal for logos and illustrations because they are resolution-independent and can be scaled to any size, or printed and displayed at any resolution, without losing detail and quality. In addition, you can produce sharp and crisp outlines with vector graphics.

Bitmaps are excellent for photographs and digital paintings because they reproduce color gradations well. Bitmaps are resolution-dependent — that is, they represent a fixed number of pixels. They look good at their actual size, but they can appear jagged or lose image quality when scaled, or when displayed or printed at a resolution higher than their original resolution.

You can create vector graphics in CorelDRAW. You can also import bitmaps (such as JPEG and TIFF files) into CorelDRAW and add them to your drawings. For information about working with bitmaps, see “Working with bitmaps” on page 631.

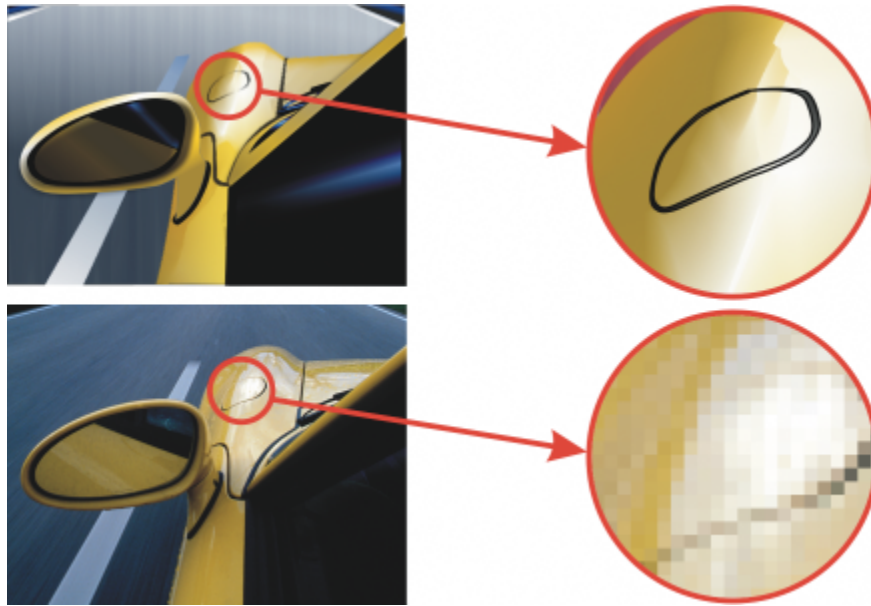

Top: A vector graphic consists of lines and fills. Bottom: A bitmap is made up of pixels.

Starting and opening drawings

CorelDRAW lets you start a new drawing from a blank page, a [template](#), or an existing drawing. A blank page gives you the freedom to specify every aspect of a drawing. A template provides you with a starting point and leaves the amount of customization up to you.

For information about starting a drawing from a template, see [“To start a document from a template” on page 569](#). For more information about creating and using templates, see [“Working with templates” on page 567](#).

Notes for starting new drawings

When starting a new drawing, CorelDRAW lets you specify page, document, and color management settings. You can choose from a list of preset settings, which are based on how you intend to use the drawing. For example, you can choose the **Web** option if you are creating a drawing for the Internet, or the Default CMYK option if you are creating a document destined for commercial printing. However, if the preset settings are not suitable for the drawing that you want to create, you can also customize the settings and save them for future use.

Notes for opening existing drawings

Basing a new drawing on an existing drawing lets you reuse objects and page settings. CorelDRAW lets you open existing drawings saved to the CorelDRAW (CDR) format as well as drawings and projects saved to various file formats such as Corel DESIGNER (DSF or DES), Adobe Illustrator (AI), Adobe Portable Document Format (PDF), Encapsulated PostScript (EPS), and Computer Graphics Metafile (CGM). However, you may not be able to open certain files, depending on their file type and contents. In such cases, you can try importing the files as objects in an open drawing. For information about the file formats that you can import into CorelDRAW, see [“Supported file formats” on page 811](#).

If the drawing you are opening is from an earlier version of CorelDRAW and contains text in a language different from the language of your operating system, you can choose [code page](#) settings to ensure that text is properly converted according to the Unicode Standard. Code page settings help you correctly display text such as keywords, file names, and text entries outside the drawing window — for example, in the **Object manager** and **Object data manager** dockers. To display text correctly in the drawing window, you must use encoding settings. For more information, see [“Displaying text correctly in any language” on page 531](#).

If the drawing you are opening contains an embedded International Color Consortium (ICC) profile, the embedded color profile remains the document’s color profile. For more information, see [“Understanding color management” on page 409](#).

You can search for drawings by different criteria, such as filename, title, subject, author, keyword, comment, text within the file, and other properties attached to the file. For more information about searching for files, see the Windows Help. For more information about browsing and searching for content, see ["Browsing and searching for content "](#) on page 105.

You can also display previous versions of a drawing.

To start a drawing

- 1 Do one of the following:
 - On the Welcome screen, click **Get started** ► **New document**.
 - In the application window, click **File** ► **New**.
- 2 Type a filename in the **Name** text box.
- 3 From the **Preset destination** list box, choose an output destination for the drawing:
 - **CorelDRAW default** — applies the CorelDRAW default settings for creating graphics that are destined for printing
 - **Default CMYK** — applies settings for creating graphics that are destined for commercial printing
 - **Default RGB** — applies settings for creating graphics that are destined for printing to a high-fidelity printer
 - **Web** — applies settings for creating graphics that are destined for the Internet
 - **Custom** — lets you customize destination settings for a document

You can also

Change the unit of measurement for the page	Choose a unit of measurement from the Drawing units list box.
Change the page size	Choose a page size for the drawing from the Size list box or type values in the Width and Height boxes.
Change the page orientation	Click one of the following page orientation buttons: <ul style="list-style-type: none">• Portrait• Landscape
Set the number of pages	Type a value in the Number of pages box.
Set the default color mode for the document to RGB or CMYK	Choose a color mode from the Primary color mode list box.
Set the resolution for effects that will likely be rasterized, such as transparency, drop shadow, and bevel effects	Choose a rendering resolution from the Rendering resolution list box.
Choose the preview mode for the drawing	Choose a preview mode from the Preview mode list box.
Choose an RGB profile for the drawing	In the Color settings area, choose a default RGB profile from the RGB profile list box.
Choose a CMYK profile for the drawing	Choose a default CMYK profile from the CMYK profile list box.
Choose a Grayscale profile for the drawing	Choose a default Grayscale profile from the Grayscale profile list box.

You can also

Choose a default method for out-of-gamut colors to be mapped into gamut

Choose an option from the **Rendering intent** list box.



When you choose a color mode from the **Primary color mode** list box, it becomes the default color mode for the document. The default color mode affects how colors work together in effects such as blends and transparencies. It does not restrict the type of colors that you can apply to a drawing. For example, if you set the color mode to RGB, you can still apply colors from a CMYK color palette to the document.

The primary color mode also specifies the default color mode for exporting documents. For example, if you choose the RGB color mode and export a document as a JPEG, the color mode is automatically set to RGB.

The settings that are displayed in the **Color settings** area of the **Create a new document** dialog box are based on the settings that are specified in the **Default color management settings** dialog box.



If you do not want to show the **Create a new document** dialog box and prefer to use the last used settings to create new documents, enable the **Do not show this dialog again** check box.

You can restore the **Create a new document** dialog box when starting drawings by clicking **Tools** ► **Options**, clicking **General** in the **Workspace** list of categories, and enabling the **Show new document dialog box** check box.

To create a custom preset

- 1 In the application window, click **File** ► **New**.
- 2 In the **Create a new document** dialog box, choose the settings that you want to save as a preset destination.
- 3 Click the **Add preset** button .
- 4 In the **Add preset** dialog box, type a name for the new destination preset.



You can delete a destination preset by choosing the preset name from the **Preset destination** list box and clicking the **Remove preset** button.

To open a drawing

- 1 Click **File** ► **Open**.
- 2 Locate the folder where the drawing is stored.
- 3 Click a filename.
- 4 Click **Open**.

You can also

Extract an embedded International Color Consortium (ICC) profile to the color folder in which the application is installed

Enable the **Extract embedded ICC profile** check box.

This option is not available for all file formats.

Maintain layers and pages when you open files

Enable the **Maintain layers and pages** check box.

You can also

If you disable the check box, all layers are combined in a single layer.

This option is not available for all file formats.

View [thumbnail](#) of a drawing

Click the arrow button next to the **Views** button, and click **Extra large icons**, **Large icons**, **Medium icons**, or **Small icons**.

Choose a code page

Choose a code page from the **Select code page** list box. This option is not available for all file formats.

Search for a drawing

Type a word or phrase in the search box.

The search box looks for files only in the current folder and subfolders. To search for a drawing in another location, you must first navigate to the folder where the drawing is stored.

Access a previous version of a file

Right-click a file, and click **Restore previous versions**.

You can access a previous version of a file only if System Protection is turned on.

For detailed information about accessing previous versions of files, see the Windows Help.



You can view file information, such as version number and compression ratio. For example, a compression ratio of 80 percent means that the file size was reduced by 80 percent after the file was saved. You can also see in what application and language the drawing was last saved, and you can view keywords and notes associated with a drawing.



To open a file you have recently worked on, click **File** ► **Open Recent**, and click the filename.

If you have multiple files open, you can navigate between them by clicking **Window**, and then clicking the name of the file that you want to display in the drawing window.

Scanning images

You can scan images in CorelDRAW. CorelDRAW supports scanners that use Microsoft Windows Image Acquisition ([WIA](#)), which provides a standard interface for scanning images.

If your scanner does not support WIA, but has a compatible [TWAIN](#) driver, you may be able to use this driver for scanning images in CorelDRAW. TWAIN is supported by both the 32-bit and 64-bit versions of CorelDRAW. However, note that there are very few 64-bit TWAIN drivers available.

The software interfaces and options vary. For information about using the software associated with your scanner, see the manufacturer's documentation.

To scan images

1 Click **File** ► **Acquire image**, and click one of the following commands:

- **Select WIA source** — for a scanner that uses a WIA driver
- **Select TWAIN source** — for a scanner that uses a TWAIN driver

A command appears disabled if a compatible WIA or TWAIN scanner driver is not installed.

- 2 Choose a scanner from the dialog box that appears.
- 3 Click **Select**.
- 4 Click **File** ▶ **Acquire image** ▶ **Acquire**.
- 5 Preview the image, and select the area that you want to scan.
WIA, in combination with some scanners, supports scanning of multiple areas to separate files.
- 6 Click **Scan**.

On your scanner's interface, this button may have a different name, such as **OK** or **Send**.



To scan additional images during the same session, click **File** ▶ **Acquire image** ▶ **Acquire**.

Working with multiple drawings

Multiple drawings can be opened in a single drawing window, making it easy to handle many drawings simultaneously. You can access each open drawing from its tab at the top of the drawing window, and you can start new drawings.

Open drawings appear docked, but you can undock any drawing you want and drag it inside or outside the application window.

You can also arrange drawings in overlapping (cascading) windows, side by side, or stacked vertically.

To work with multiple drawings

To	Do the following
Switch to another open drawing	At the top of the drawing window, click the tab that has the filename you want. An asterisk after the filename shows that the file has unsaved changes.
Start another drawing	Click the New button to the left of the last tab in the drawing window.
Undock a drawing	Drag the tab to a new position inside or outside the application window.

To arrange multiple drawing windows

- Click **Window**, and click one of the following commands:
 - **Cascade** — arranges drawings so that they overlap and the title bars are visible
 - **Tile Horizontally** — arranges drawings side by side
 - **Tile Vertically** — stacks drawings vertically

Undoing, redoing, and repeating actions

You can undo the actions that you perform in a drawing, starting with the most recent action. If you don't like the result of undoing an action, you can redo it. Reverting to the last saved version of a drawing also lets you remove one or more actions. Certain actions applied to objects, such as stretching, filling, moving, and rotating, can be repeated to create a stronger visual effect.

Customizing the **Undo** settings lets you increase or decrease the number of actions that you can undo or redo.

To undo, redo, and repeat actions

To	Do the following
Undo an action	Click Edit ► Undo [Last Action].
Redo an action	Click Edit ► Redo .
Undo or redo a series of actions	Click Edit ► Undo manager . In the Undo manager docker, click the action that precedes all the actions that you want to undo, or click the last undone action that you want to redo.
Revert to the last saved version of a drawing	Click File ► Revert .
Repeat an action	Click Edit ► Repeat .





When you undo a series of actions in the **Undo manager** docker, all actions listed below the action that you click are undone.

When you redo a series of actions in the **Undo manager** docker, the action that you click and all preceding undone actions are redone.



You can repeat an action on another object or group of objects by selecting the object or objects and clicking **Edit** ► **Repeat**.

You can also undo or redo a series of actions by clicking the arrow button next to the **Undo** button  or **Redo** button , on the **Standard** toolbar and choosing an action from the list.

To specify the Undo settings

- 1 Click **Tools** ► **Options**.
- 2 In the **Workspace** list of categories, click **General**.
- 3 In the **Undo levels** area, type a value in one or both of the following boxes:
 - **Regular** — specifies the number of actions that can be reversed when you use the **Undo** command with vector objects
 - **Bitmap effects** — specifies the number of actions that can be reversed when you work with bitmap effects



The value that you specify is limited only by your computer's memory resources. The higher the value you specify, the greater the demand on memory resources.

Zooming, panning, and scrolling

You can change the view of a drawing by zooming in to get a closer look or by zooming out to see more of the drawing. You can experiment with a variety of zoom options to determine the amount of detail you want.

You can also zoom in and out in preset increments by using common keyboard shortcuts, supported by web browsers and other applications.

Panning and scrolling are two additional ways to view specific areas of a drawing. When you work at high magnification levels or with large drawings, you may not be able to see the whole drawing. Panning and scrolling let you move the page around in the drawing window to view previously hidden areas.

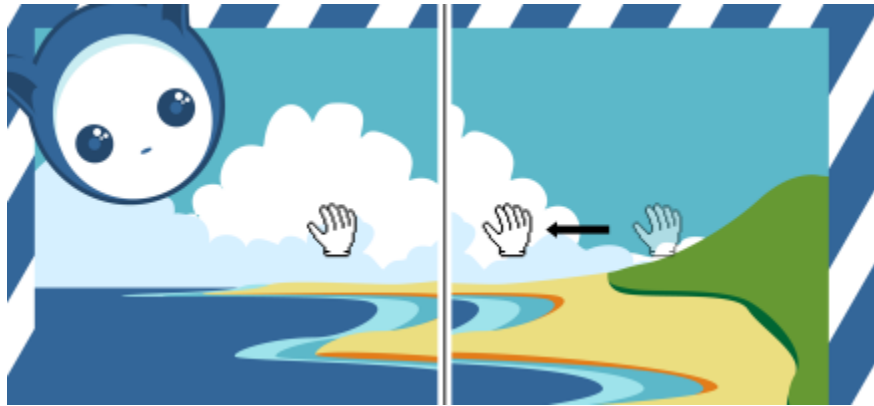

You can use the Pan tool to pan around a large image and view particular areas.









You can zoom in and out while you are panning, and you can pan while you are zooming. In this way, you can avoid having to alternate between the two tools.

You can also use the Quick Pan mode to switch from any active tool to the **Pan** tool. This feature lets you pan without having to change tools.

If you use a mouse wheel, the wheel zooms in and zooms out by default. You can also use the mouse wheel to scroll.

You can specify default zooming and panning settings.

To zoom

- 1 In the toolbox, click the **Zoom** tool .
- 2 On the property bar, click one of the following:
 - Zoom in 
 - Zoom out 
 - Zoom to selected 
 - Zoom to all objects 
 - Zoom to page 
 - Zoom to page width 
 - Zoom to page height 



The **Zoom to selected** button is available only if one or more objects are selected before you click the **Zoom** tool.



When you are not editing text, you can also access the **Zoom** tool by pressing **Z**.

Using the **Zoom** tool, you can also zoom in by clicking anywhere in the drawing window or dragging to select a specific area to magnify. To zoom out, right-click in the drawing window, or drag with the right mouse button to select a specific area.

You can also zoom in by using the **Pan** tool  and double-clicking in the drawing window. To zoom out, right-click in the drawing window.

To zoom using keyboard shortcuts

- Do one of the following:
 - To zoom in, press **Ctrl+(+)**.
 - To zoom out, press **Ctrl+(-)**.



You can use these keyboard shortcuts to adjust the zoom level in the document window as well as in dialog boxes and labs that feature preview windows such as the Print Preview dialog box, PowerTRACE, Image Adjustment Lab, and more.

To pan in the drawing window

- 1 In the toolbox, click the **Pan** tool .
- 2 Drag in the [drawing window](#) until the area you want to view appears.



When you are not editing text, you can also access the **Pan** tool by pressing the **H** key.

To pan in the drawing window while zoomed in on the drawing, click the **Navigator** button  in the lower-right corner of the drawing window.

You can quickly center the page in the drawing window by double-clicking the **Pan** tool in the toolbox.



Using the Navigator, you can display any part of a drawing without having to zoom out.

To switch to the Quick Pan mode

- 1 Click any selection, drawing, or shaping tool, and start using it.
- 2 Hold down the middle mouse button or wheel, and drag in the drawing window.

To scroll by using a mouse wheel

- Do one of the following:
 - To scroll vertically, press **Alt** while you move the wheel.
 - To scroll horizontally, press **Ctrl** while you move the wheel.



The mouse wheel can be used for scrolling only if the **Scroll** option for the mouse is enabled. For more information, see [“To establish default setting for the mouse wheel”](#) on page 60.

To specify default zoom settings

- 1 Click **Tools** ► **Options**.
- 2 In the **Workspace** list of categories, double-click **Toolbox**, and click **Zoom, Pan tool**.
- 3 To specify the action of the **Zoom** or **Pan** tool when you right-click in the drawing window, enable one of the following options:
 - **Zoom out** — zooms out by a factor of 2
 - **Context menu** — displays a menu of commands that let you zoom to a specific level
- 4 To specify how the page appears when the zoom is set to 100%, enable or disable the **Zoom relative to 1:1** check box.
 - When the option is enabled, a 100% zoom displays real-world dimensions.
 - When the option is disabled, a 100% zoom displays the full page, regardless of real-world dimensions.
- 5 To specify how the page appears when you zoom in and out using the mouse wheel, enable or disable the **Center mouse when zooming with the mouse wheel** check box.
 - When the option is enabled, the area where the mouse pointer is located moves to the center of the screen as you zoom in and out using the mouse wheel.
 - When the option is disabled, the area where the mouse pointer is located stays in the same position as you zoom in and out using the mouse wheel.



You can click **Calibrate rulers** to ensure that one inch on your screen equals one inch of real-world distance. For more information, see [“Calibrating the rulers”](#) on page 605.

To establish default setting for the mouse wheel

- 1 Click **Tools** ► **Options**.
- 2 In the **Workspace** list of categories, click **Display**.
- 3 To specify the default action of the mouse wheel, choose **Zoom** or **Scroll** from the **Default action for mouse wheel** list box.

Previewing drawings

You can preview a drawing to see how it will look when printed or exported. When you preview a drawing, only the objects on the drawing page and in the immediate area of the drawing window are displayed, and you can see all layers that are set to print in the **Object manager** docker. If you want a closer look at specific objects in a drawing, you can select and preview them. When you preview selected objects, the rest of the drawing is hidden.

Before you preview a drawing, you can specify the preview mode. The preview mode affects the speed with which your preview appears as well as the amount of detail displayed in the drawing window.

By default, the borders of a page are displayed in the drawing window, but you can hide them at any time. If a drawing is intended for print, you can display the area that will actually print as well as the bleed, the part of the drawing that extends beyond the page border. Bleeds are useful when a drawing contains a color page background or objects that are positioned on the page border. Bleeds ensure that no white space appears between the edges of a drawing and the edge of the paper after the printer cuts, binds, and trims the document.

To preview a drawing

- Click **View** ► **Full-screen preview**.

Click anywhere on the screen, or press any key, to return to the application window.



You can press **Page up** and **Page down** to preview pages in a multipage drawing.

To preview selected objects

- 1 Select the objects.
- 2 Click **View** ► **Preview selected only**.

Click anywhere on the screen, or press any key, to return to the application window.



If **Preview selected only** mode is enabled and no objects are selected, **Full-screen preview** displays a blank screen.

To choose a full-screen preview mode

- 1 Click **Tools** ► **Options**.
- 2 In the **Workspace** list of categories, click **Display**.
- 3 In the **Full-screen preview** area, enable one of the following options:
 - **Use draft view** — Drawings appear without PostScript fills or high-resolution bitmaps, and no anti-aliasing is used.
 - **Use enhanced view** — Drawings appear with or without PostScript fills, and anti-aliasing is used to sharpen the display of the drawings.



You can display PostScript fills when you preview a drawing in Enhanced mode by enabling the **Show PostScript fills in enhanced view** check box.

To set the page display

- 1 Click **Tools** ► **Options**.
- 2 In the **Document** list of categories, click **Page size**.
- 3 Enable one of the following options:
 - **Show page border** — displays page borders
 - **Show bleed area** — displays the area of the drawing extending beyond the page border. To change the bleed area, type a value in the **Bleed** box.



When preparing a drawing for commercial printing, you may also need to set a bleed limit. For more information, see [“To set a bleed limit” on page 759](#).



You can also click **View ▶ Page ▶ Page border**, or **View ▶ Page ▶ Bleed**.

You can display the printable area of a drawing by clicking **View ▶ Page ▶ Printable area**. The printable area is usually indicated by two dotted lines inside or around the page, depending on the current printer settings. One outline indicates the area that can be printed on the current printer; the other outline indicates the paper size that your printer is set to use.

Choosing viewing modes

As you work, CorelDRAW lets you display a drawing in any of the following modes:

- **Simple wireframe** — displays an outline of the drawing by hiding fills, extrusions, contours, drop shadows, and intermediate blend shapes; also displays the bitmaps in monochrome. This mode lets you quickly preview basic elements in a drawing.
- **Wireframe** — displays a drawing in simple wireframe mode plus intermediate blend shapes
- **Draft** — displays fills and bitmaps with a low resolution. This mode eliminates some detail to allow you to focus on the color balances in a drawing.
- **Normal** — displays a drawing without PostScript fills or high-resolution bitmaps. This mode refreshes and opens slightly faster than the Enhanced mode.
- **Enhanced** — displays a drawing with PostScript fills, high-resolution bitmaps, and anti-aliased vector graphics.
- **Pixels** — displays a pixel-based rendition of the drawing, which allows you to zoom in on an area of an object, and then position and size the object more precisely. This view also lets you see what the drawing will look like when it is exported to a bitmap file format.
- **Simulate overprints** — simulates the color of areas where overlapping objects were set to overprint and displays PostScript fills, high-resolution bitmaps, and anti-aliased vector graphics. For information about overprinting objects, see [“To overprint selected color separations” on page 763](#).
- **Rasterize complex effects** — rasterizes the display of complex effects, such as transparencies, bevels, and drop shadows when in Enhanced view. This option is useful for previewing how the complex effects will be printed. To ensure the successful printing of complex effects, most printers require complex effects to be rasterized.

The viewing mode you choose affects the amount of time it takes for a drawing to open or be displayed on the monitor. For example, a drawing displayed in Simple Wireframe view takes less time to refresh or open than does a drawing displayed in Simulate Overprints view.



Simple wireframe viewing mode (left); Enhanced viewing mode (center), and Simulate overprints viewing mode (right). The fill for the gray diamond shape and the cup's shadow are set to overprint.

To choose a viewing mode

- Click **View**, and click one of the following modes:
 - Simple wireframe
 - Wireframe
 - Draft
 - Normal
 - Enhanced
 - Pixels
 - Simulate overprints
 - Rasterize complex effects



If you are overprinting, it is important to preview the objects in the **Simulate overprints** mode before printing. The type of objects you are overprinting and the type of colors you are mixing determine how overprinted colors are combined. For more information about overprinting, see [“Working with color trapping and overprinting” on page 762](#).

You can set the default viewing mode by clicking **Tools** ▶ **Options**, clicking **General** in the **Document** list of categories, and choosing an option from the **View mode** list box.



You can quickly switch between the selected viewing mode and the previous viewing mode by pressing **Shift + F9**.

Working with views

You can save a view of any part of a drawing. For example, you can save a view of an object at 230% magnification and then return to this specific view at any time.

If a document contains multiple pages, you can view them all at once by using the Page Sorter view. You can also display consecutive left-hand and right-hand pages on the screen at the same time (facing pages) and create objects that span two pages.

To save a view

- 1 Click **Window** ▶ **Dockers** ▶ **View manager**.
- 2 Click the **Add current view** button .

You can also



Rename a view

Double-click a view name, and type a new name.

Delete a saved view

Click a view, and click the **Delete current view** button .



If you disable the page icon  next to a saved view in the docker, CorelDRAW switches to the magnification level only, not the page, when you switch to that view. Similarly, if you disable the magnifying glass icon , CorelDRAW switches to the page only, not the magnification level.



You can also save the current view by clicking the **Zoom** or **Pan** tool in the toolbox, clicking in the **Zoom levels** list box on the standard toolbar, typing a name, and pressing **Enter**.

To switch to a saved view

- 1 Click **Window** ► **Dockers** ► **View manager**.
- 2 Click a view in the **View manager** docker.



You can also switch to a saved view by selecting it from the **Zoom levels** list box on the standard toolbar.

To view all pages in a multipage document

- Click **View** ► **Page sorter view**.

To return to the default page view, click the **Page sorter view** button on the property bar.

To view facing pages

- 1 Click **Layout** ► **Page setup**.
- 2 In the **Document** list of categories, click **Layout**.
- 3 Enable the **Facing pages** check box.
- 4 Choose one of the following settings from the **Start on** list box:
 - **Left side** — starts the document on a left-hand page
 - **Right side** — starts the document on a right-hand page



You cannot view facing pages if the document uses a Tent Card or Top-fold Card layout style, or if it contains multiple page orientations. The **Left side** option is available only for the Full Page and Book layout styles.

When you enable the **Facing pages** check box, the content on the facing pages is merged on one page. The layer structure for the merged page is based on the left-hand page. The layers from the right-hand page are inserted above the layers on the left-hand page. This rule also applies if you reorder the pages. If you disable the **Facing pages** check box, the layers and content are redistributed across separate pages. Objects that cross both pages are assigned to a page according to where the center of the object is found.

It is recommended that you avoid switching back and forth between individual pages and facing pages within the same document.

Saving drawings

By default, drawings are saved to the CorelDRAW file format (CDR) and are compatible with the latest version of the application. You can also save a drawing that is compatible with an earlier version of CorelDRAW Graphics Suite and specify save options. Such options are useful when the file contains new text, fill, outline, and transparency features that are not supported in earlier versions.

You can save a drawing to other vector file formats as well. If you want to use a drawing in another application, you must save it to a file format that is supported by that application. For information about saving files to other formats, see “Exporting files” on page 792.

The application makes it easy to tell if a drawing has unsaved changes by adding an asterisk after its filename. The asterisk is added in different locations where the filename appears such as the Windows menu, the title bar, and the document tab.

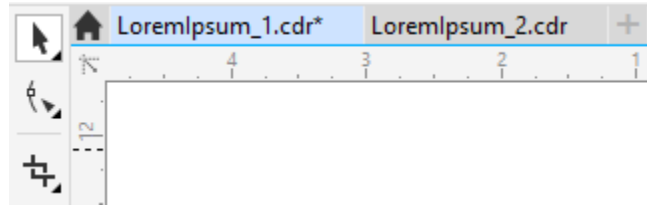

The asterisk after the filename on the document tab shows that the file *Lorem Ipsum_1.cdr* has unsaved changes. The file *Lorem Ipsum_2.cdr* has no unsaved changes.

When saving a drawing, you can embed the used fonts to facilitate file sharing. By default, CorelDRAW embeds all used fonts, with the exception of Asian fonts and fonts that do not have embedding permissions. For more information, see [“Managing fonts” on page 533](#).

When you save a drawing, CorelDRAW lets you add reference information so that you can easily find and organize drawings later on. You can attach tags (also known as properties) such as title, subject, and rating.

You can also save selected objects in a drawing. For large drawings, saving only the selected objects reduces the file size, which can decrease the time it takes to load the drawing.

When saving a file, you can use advanced options to control how [bitmaps](#), [textures](#), and vector effects, such as [blends](#) and [extrusions](#), are saved with the drawing.

You can also save a drawing as a template, which lets you create other drawings with the same properties. For information about saving a drawing as a template, see [“Working with templates” on page 567](#).

To save a drawing

- 1 Click **File** ► **Save as**.
- 2 Type a filename in the **File name** box.
- 3 Locate the folder where you want to save the file.
 - If you want to save the drawing to a vector file format other than CorelDRAW (CDR), choose a file format from the **Save as type** list box.

You can also

Save only selected objects

Enable the **Selected only** check box.

This option is available only if there are selected objects in the drawing.

Embed fonts

Enable the **Embed fonts** check box.

This check box is unavailable when you save a drawing to an earlier version of CorelDRAW.

Add reference information

Do any of the following:

- Type a title and subject in the corresponding box.
- Assign a rating to the file.



If you are using an expired trial version of CorelDRAW, you will not be able to save drawings.

Saving a drawing to a previous version of CorelDRAW may result in loss of certain effects that were not available in the previous version of the application.



You can also save a drawing by clicking **File** ► **Save**.

You can also save a drawing by clicking the **Save** button  on the **Standard** toolbar.

To use advanced options when saving

- 1 Click **File** ► **Save as**.
- 2 Click **Advanced**.
- 3 Enable any of the following check boxes:
 - **Save presentation exchange (CMX)** — saves a drawing as a Corel® Presentations™ Exchange (CMX) file so that you can open and edit it in other Corel applications, such as WordPerfect
 - **Use bitmap compression** — reduces the file size by compressing bitmap effects, such as bitmap extrusions, transparencies, and drop shadows
 - **Use graphic object compression** — reduces the file size by compressing vector objects, such as polygons, rectangles, ellipses, and perfect shapesUsing compression increases the time required for opening and saving a drawing.
- 4 If a drawing contains texture fills, enable one of the following options:
 - **Save textures with the file** — saves custom texture fills with the file
 - **Rebuild textures when opening the file** — re-creates texture fills when you open the saved drawing
- 5 If a drawing contains blends and extrusions, enable one of the following options:
 - **Save blends and extrudes with the file** — saves all blends and extrusions included in a drawing
 - **Rebuild blends and extrudes when opening the file** — re-creates blends and extrusions when you open the saved drawing



Choosing to save textures, blends, and extrusions with the file increases the file size but lets you open and save a drawing more quickly. Conversely, choosing to rebuild textures, blends, and extrusions when a saved drawing is opened decreases the file size but increases the time required for saving or opening a drawing.

To save a drawing that is compatible with an older version of CorelDRAW

- 1 Click **File** ► **Save as**.
 - 2 Type a filename in the **File name** box.
 - 3 Locate the folder where you want to save the file.
 - 4 Choose a version from the **Version** list box.
 - 5 Click **Save**.
- If the drawing includes new features; enable one of the following options in the **Save to a previous version** dialog box:
- **Keep appearance** — preserves the appearance of text, fills, outlines and transparencies when the file is opened in a previous version of CorelDRAW. However, this option may limit editing.
 - **Keep editable** — preserves the file editable. However, this option may change the appearance of text, outlines, fills, and transparencies when the file is opened in a previous version of CorelDRAW.

You can also

Specify save settings

Click **Tool ► Options**. In the **Workspace** list of categories, click **Save**, and enable one of the following options:

- **Keep appearance (suitable for limited edits)**
- **Keep editable (may change appearance)**

Disable the prompt that appears when saving to an earlier version

Click **Tool ► Options**. In the **Workspace** list of categories, click **Save**, and disable the **Ask when saving** check box.

Working with locked files

In a corporate environment you may open a locked file that is already being edited by another user. You can save changes that you make to a locked file in one of the following ways:

- If the other user has modified the file or still has the file open, you must save the file with a new name by clicking **File ► Save As**.
- If the other user has closed the file without modifying it, you can save the changes by clicking **File ► Save**.

Backing up and recovering files

CorelDRAW can save backup copies of drawings and prompt you to recover them in the event of a system error. The back-up feature creates a copy of the drawing when you save a drawing. This backup copy does not contain the changes that you made since you last opened the file. The backup copy is named **backup_of_filename**, and by default is stored in the same folder as the original drawing. You can change the location where backup files are created.

The auto-backup feature saves drawings that you have opened and modified. Auto-backup files are named **auto_backup_of_filename**. During any working session with CorelDRAW, you can set the time interval for automatically backing up files and specify whether you want the files to be saved in your temporary folder (the default location) or in a folder of your choice. You can recover the backup files from the temporary or specified folder when you restart CorelDRAW after a system error. If you choose not to recover the backup file, it is automatically erased when you quit the application.

To specify backup and auto-backup settings

- 1 Click **Tools ► Options**.
- 2 In the **Workspace** list of categories, click **Save**.
- 3 Perform a task from the following table.

To

Do the following

Create a backup file before saving

Enable the **Back up original file before saving** check box.

Change the location where backup files are created

In the **Back up original file to** area, enable the **Specific folder** option. Click **Browse**, and navigate to the folder you want.

Specify auto-backup settings

To set how often to back up the file automatically, enable the **Back up every** check box, and choose a value from the **Minutes** list box.

To choose the location for auto-backup files, in the **Always back up to** area, enable one of the following options:

To

Do the following

- **Temporary folder** — lets you save auto-backup files in the temporary folder
- **Specific folder** — lets you specify the folder for auto-backup files

Disable the auto-backup feature

Choose **Never** from the **Minutes** list box.



All open or modified files that are not in the CorelDRAW (CDR) file format are backed up as CorelDRAW files.



You can cancel the creation of an auto-backup file by pressing **Esc** while a file is being saved.

To recover a backup file

- 1 Restart CorelDRAW.
- 2 Click **OK** in the file recovery dialog box that appears.
The file recovery dialog box appears upon startup after a system error.
- 3 Save and rename the file in the specified folder.



If you click **Cancel**, CorelDRAW ignores the backup file and deletes it when you quit the application.

Adding and accessing drawing information

CorelDRAW lets you add reference information, such as language, title, author, subject, keywords, rating, and other notes to a drawing. Although adding document information is optional, doing so makes it easier to organize and locate drawings later on.

The application also lets you access other important document information, such as the number of pages and layers, fonts, object and text statistics, and the types of objects the drawing contains. You can also view color information such as the color profiles that are used to define document colors as well as the primary color mode and rendering intent.

To add drawing information

- 1 Click **File** ► **Document properties**.
- 2 In the **Document properties** dialog box, type text in any of the following boxes:
 - **Language**
 - **Title**
 - **Subject**
 - **Author**
 - **Copyright**
 - **Keywords**
 - **Notes**
- 3 To specify a rating, choose a rating from the **Rating** list box.
- 4 Click **OK**.



You can modify the drawing information at any time.

To access drawing information

- Click **File** ► **Document properties**.

Closing drawings

You can close one drawing, or multiple drawings, at any time before quitting CorelDRAW.

To close drawings

To	Do the following
Close one drawing	Click File ► Close .
Close all drawings	Click File ► Close all .



If you are unable to close a document, you may have a task, such as printing or saving, in progress or a task that has failed. Please refer to the status bar to view the status of a task.



You can also close a drawing by clicking **Window** ► **Close window**.

You can also close all drawings by clicking **Window** ► **Close all**.

Exploring basic tasks

CorelDRAW has a virtually unlimited number of tools and capabilities to help you create drawings. The following table provides you with the basic features of CorelDRAW to help you get started.

For information about	See
Drawing lines	“Formatting lines and outlines ” on page 144
Drawing shapes	“Drawing shapes ” on page 167
Creating and manipulating objects	“Working with objects ” on page 253
Adding color to objects	“Applying fills to objects ” on page 367
Adding text to a drawing	“Adding and manipulating text ” on page 475

For information about

Creating drawings for use on the web

Printing drawings

See

["Exporting bitmaps for the web "](#) on page 773

["Printing basics "](#) on page 741

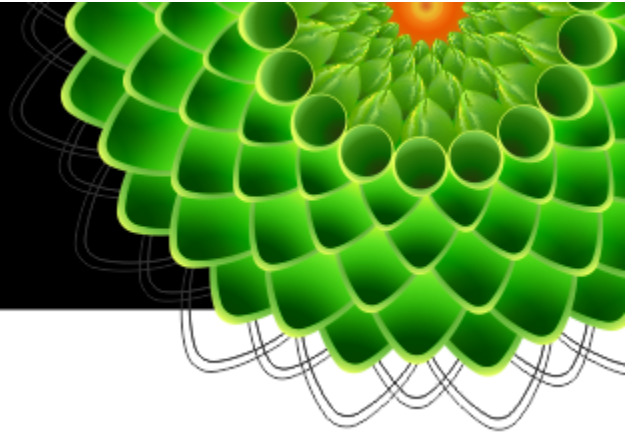

CorelDRAW workspace tour

Becoming familiar with the terminology and workspace of CorelDRAW will help you easily follow this user guide's concepts and procedures.

In this section, you'll learn about

- "CorelDRAW terms" (page 71)
- "Application window" (page 72)
- "Standard toolbar" (page 75)
- "Exploring the toolbox" (page 77)
- "Property bar" (page 93)
- "Dockers" (page 93)
- "Status bar" (page 96)
- "Choosing a workspace" (page 96)

CorelDRAW terms

Before you get started with CorelDRAW, you should be familiar with the following terms.

Term	Description
Object	An element in a drawing such as an image, shape, line, text, curve, symbol, or layer
Drawing	The work you create in CorelDRAW; for example, custom artwork, logos, posters, and newsletters
Vector graphic	An image generated from mathematical descriptions that determine the position, length, and direction in which lines are drawn
Bitmap	An image composed of grids of pixels or dots

Term	Description
Dock	A window that contains available commands and settings relevant to a specific tool or task
Flyout	A button that opens a group of related tools or menu items
List box	A list of options that drops down when a user clicks the down arrow button
Artistic text	A type of text to which you can apply special effects, such as shadows
Paragraph text	A type of text to which you can apply formatting options, and which can be edited in large blocks

Application window

When you launch CorelDRAW, the application window opens containing a drawing window. Although more than one drawing window can be opened, you can apply commands to the active drawing window only.

The CorelDRAW application window appears below.

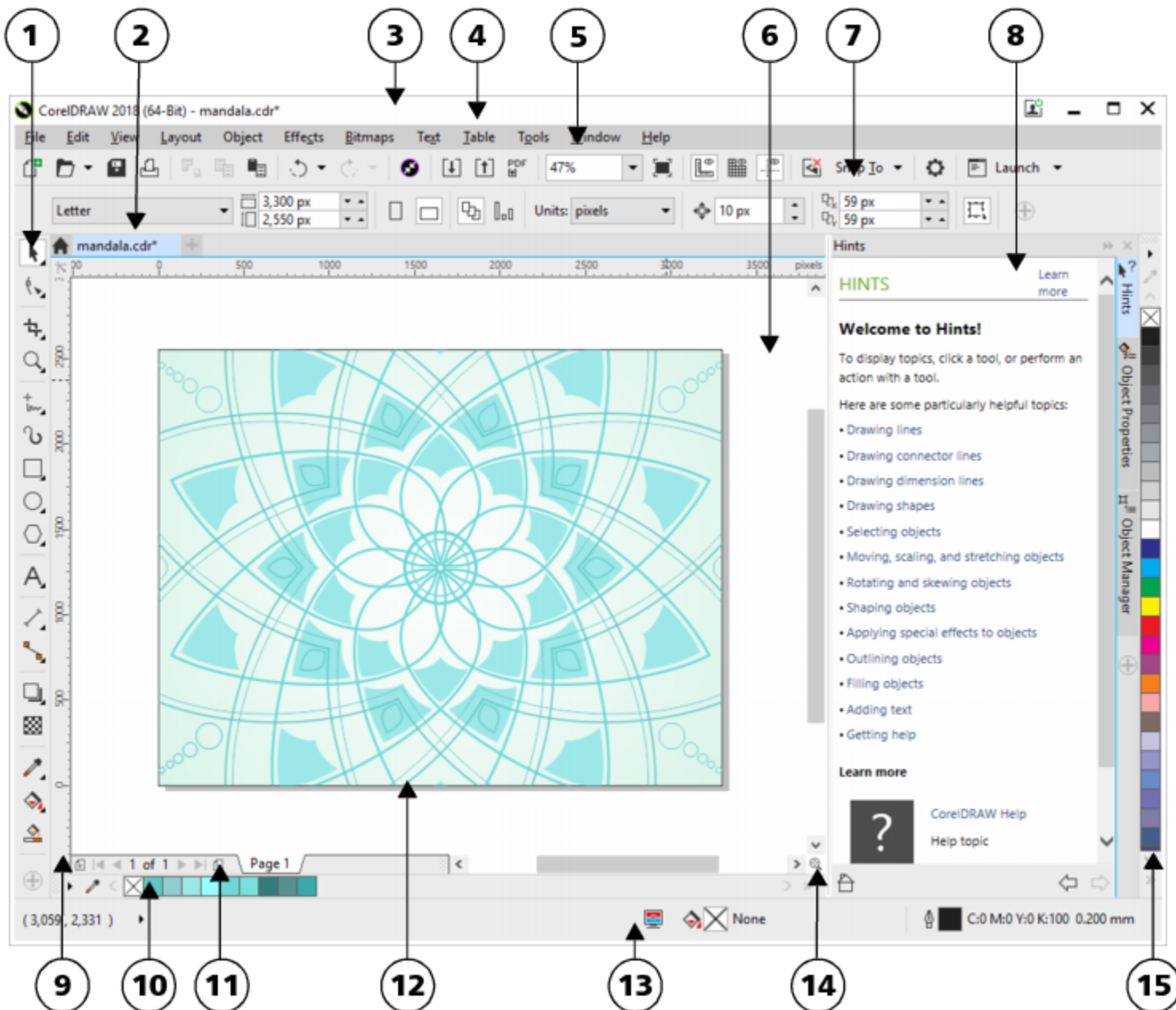

Circled numbers correspond to the numbers in the following table, which describes the main components of the application window. Artwork by Tricia Flohr.

Part	Description
1. Toolbox	A docked bar with tools for creating, filling, and modifying objects in the drawing
2. Document tab	A tab displays for each open document to allow you to quickly move between documents

Part	Description
3. Title bar	The area displaying the title of the currently selected drawing
4. Menu bar	The area containing pull-down menu options
5. Toolbar	A detachable bar that contains shortcuts to menu and other commands
6. Drawing window	The area outside the drawing page bordered by the scroll bars and application controls
7. Property bar	A detachable bar with commands that relate to the active tool or object. For example, when the text tool is active, the text property bar displays commands that create and edit text.
8. Docker	A window containing available commands and settings relevant to a specific tool or task
9. Rulers	Horizontal and vertical borders that are used to determine the size and position of objects in a drawing
10. Document palette	A dockable bar that contains color swatches for the current document
11. Document navigator	The area at the bottom left of the application window that contains controls for moving between pages and adding pages
12. Drawing page	The rectangular area inside the drawing window. It is the printable area of your work area.
13. Status bar	An area at the bottom of the application window that contains information about object properties such as type, size, color, fill, and resolution. The status bar also shows the current cursor position.
14. Navigator	A button at the lower-right corner that opens a smaller display to help you move around a drawing
15. Color palette	A dockable bar that contains color swatches



To toggle between displaying and hiding the status bar, click **Window** ► **Toolbars** ► **Status bar**.

To toggle between displaying and hiding the rulers, see [“To hide or display the rulers” on page 604](#).

You can customize the appearance of the application workspace by setting a scaling level, choosing a theme, and changing the color of the desktop and the window borders. For more information, see [“Customizing workspace appearance” on page 857](#).

Standard toolbar

The standard toolbar, which appears by default, contains buttons and controls that are shortcuts to many of the menu commands. For information about customizing the position, contents, and appearance of toolbars, see [“Customizing toolbars” on page 863](#).

Click this button



To

Start a new drawing



Open a drawing



Save a drawing



Print a drawing



Cut selected objects to the Clipboard



Copy selected objects to the Clipboard



Paste the Clipboard contents into a drawing



Undo an action



Restore an action that was undone



Display the **CONNECT** docker to find content such as clipart, photos, fonts, and more



Import a drawing



Export a drawing

Click this button

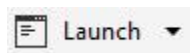
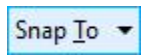
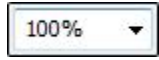

To

Publish to PDF

Set a zoom level

Display Full-screen preview

Show or hide rulers

Show or hide grid

Show or hide guidelines

Disable all snapping. Click again to restore the selected snapping options.

Enable or disable automatic alignment for the pixels, document grid, baseline grid, guidelines, objects, and page

Open the **Options** dialog box

Start Corel applications and plug-ins, or access the **Get More** dialog box to download other creative tools

More about toolbars

In addition to the standard toolbar, CorelDRAW has toolbars for specific kinds of tasks. For example, the **Text** toolbar contains commands relevant to using the **Text** tool. If you use a toolbar frequently, you can display it in the workspace at all times.

For information about customizing the position, contents, and appearance of toolbars, see ["Customizing toolbars" on page 863](#).

The following table describes toolbars other than the standard toolbar.

Toolbar	Description
Zoom	Contains commands for zooming in and out of a drawing page by specifying percentage of original view, clicking the Zoom tool, and selecting a page view

Toolbar	Description
Text	Contains commands for formatting and aligning text
Layout	Contains commands for converting objects to PowerClip frames and text frames, displaying alignment guides as well as setting columns and margins
Transform	Contains commands for skewing, rotating, and mirroring objects
Print merge	Contains commands for print merge items that combine text with a drawing such as creating and loading data files, creating data fields for variable text, and inserting print merge fields
Macros	Contains commands for editing, testing, and running macros
Internet	Contains commands for web-related tools for creating rollovers and publishing to the Internet
Project Timer	Contains controls that let you track the time spent on project tasks



To toggle between displaying and hiding a toolbar, click **Window ► Toolbars**, and click the command with the toolbar name.

To lock all toolbars so that you don't inadvertently change their position, click **Window ► Toolbars ► Lock toolbars**.

Exploring the toolbox

The toolbox contains tools for drawing and editing images. Some of the tools are visible by default, while others are grouped in flyouts. Flyouts open to display a set of related CorelDRAW tools. A small flyout arrow in the lower-right corner of a toolbox button indicates a flyout. You can access the tools in a flyout by clicking the flyout arrow. After you open a flyout, you can easily scan the contents of other flyouts by hovering over any of the toolbox buttons which have flyout arrows. Flyouts function like toolbars when you drag them away from the toolbox. This lets you view all the related tools while you work.

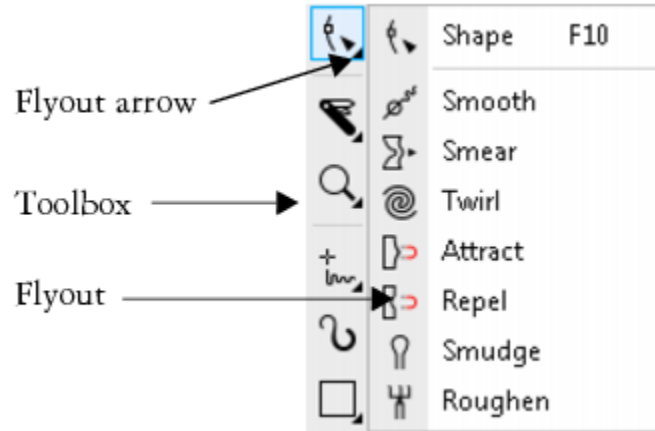

In the default workspace, clicking the flyout arrow on the Shape tool opens the Shape edit flyout.

Some tools in the toolbox are not visible by default. You can choose which tools to display in the toolbox.

Locating tools in the toolbox

The following illustration shows the other flyouts in the default CoreDRAW toolbox and can help you locate tools more easily.

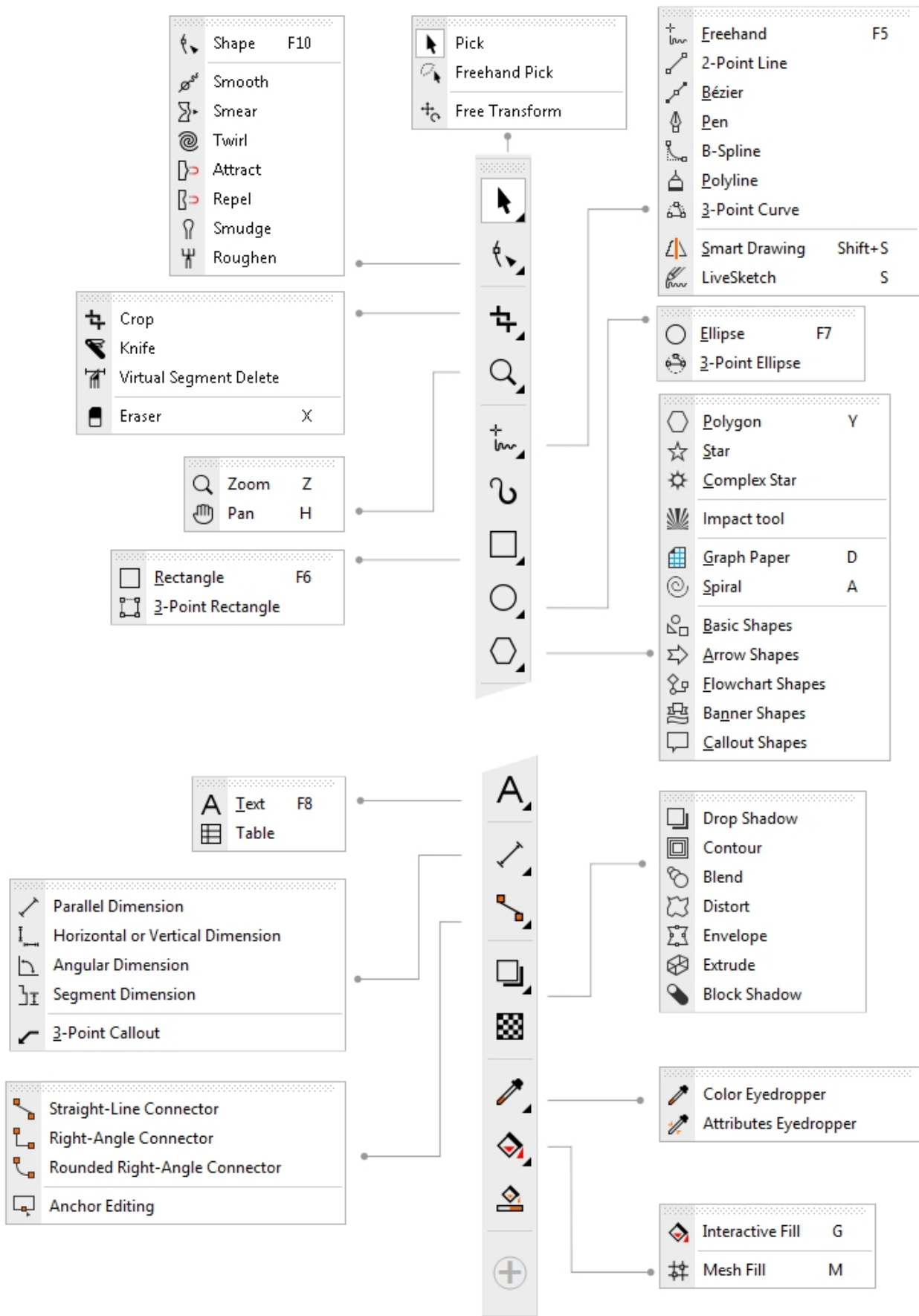



To toggle between displaying and hiding the toolbox, click **Window** ► **Toolbars** ► **Toolbox**.

To hide or display tools in the toolbox, click the **Quick customize** button , and enable or disable the corresponding check boxes. For more information, see “Customizing the toolbox” on page 866.

The following table provides descriptions of the tools in the CorelDRAW toolbox.

Pick tools



The **Pick** tool lets you select, size, skew, and rotate objects.



The **Freehand pick** tool lets you select objects by using a freehand selection marquee.

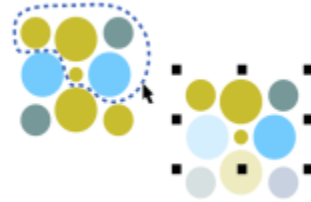

The **Free transform** tool lets you transform an object by using the **Free rotation**, **Free angle reflection**, **Free scale**, and **Free skew** tools.

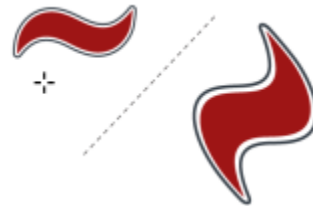

Shape edit tools



The **Shape** tool lets you edit the shape of objects.





The **Smooth** tool lets you smooth curved objects to remove jagged edges and reduce the number of nodes.

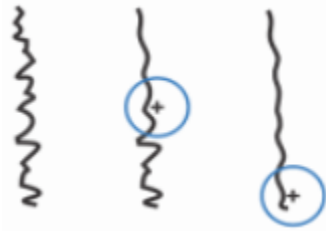

The **Smear** tool lets you shape an object by pulling extensions or making indents along its outline.

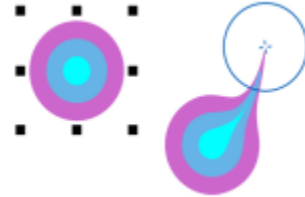

The **Twirl** tool lets you create swirl effects by dragging along the edge of objects.



The **Attract** tool lets you shape objects by attracting nodes to the cursor.

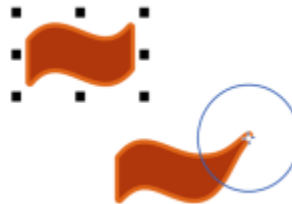

The **Repel** tool lets you shape objects by pushing away nodes from the cursor.



The **Smudge** tool lets you distort a vector object by dragging along its outline.





The **Roughen** tool lets you distort the outline of a vector object by dragging along the outline.

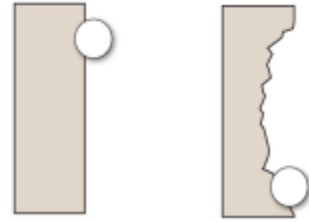

Crop tools



The **Crop** tool lets you remove unwanted areas in objects.

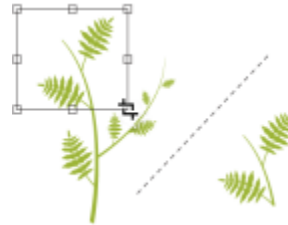

The **Knife** tool lets you slice objects, groups of objects, and bitmaps along any path you specify.



The **Virtual segment delete** tool lets you delete portions of objects that are between intersections.

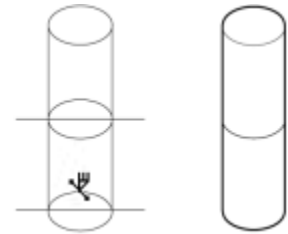

The **Eraser** tool lets you remove areas of your drawing.



Zoom tools



The **Zoom** tool lets you change the magnification level in the drawing window.

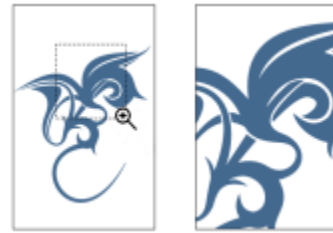

The **Pan** tool lets you control which part of the drawing is visible in the drawing window.

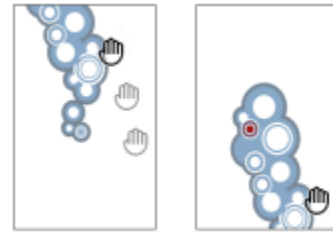

Curve tools



The **Freehand** tool lets you draw single line segments and curves.



The **2-point line** tool lets you draw a straight two-point line segment.

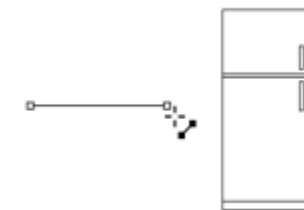

The **Bézier** tool lets you draw curves one segment at a time.





The **Pen** tool lets you draw curves one segment at a time.

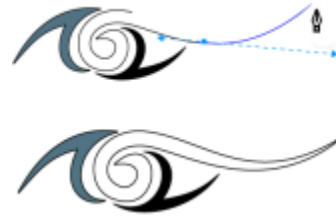

The **B-spline** tool lets you draw curved lines by setting control points that shape the curve without breaking it into segments.

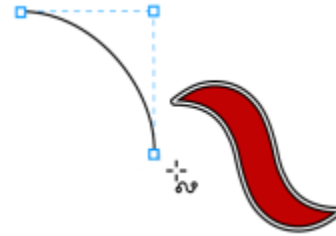

The **Polyline** tool lets you draw lines and curves in preview mode.



The **3-point curve** tool lets you draw a curve by defining the start, end, and center points.



The **Smart drawing** tool converts your freehand strokes to basic shapes and smoothed curves.

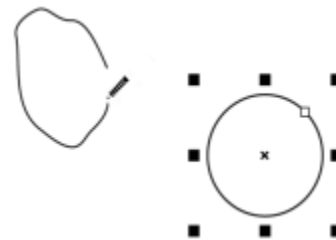

The **LiveSketch** tool lets you sketch naturally with intelligent stroke adjustment.

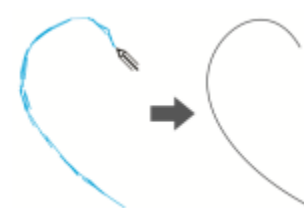

Artistic Media tool



The **Artistic media** tool provides access to the **Preset**, **Brush**, **Sprayer**, **Calligraphic**, and **Expression** tools.



Rectangle tools



The **Rectangle** tool lets you draw rectangles and squares.



The **3-point rectangle** tool lets you draw rectangles at an angle.



Ellipse tools



The **Ellipse** tool lets you draw ellipses and circles.





The **3-point ellipse** tool lets you draw ellipses at an angle.

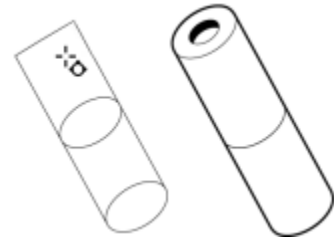

Object tools



The **Polygon** tool lets you draw symmetrical polygons and stars.

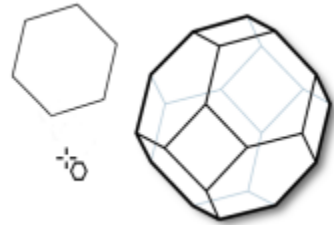

The **Star** tool lets you draw perfect stars.



The **Complex star** tool lets you draw complex stars that have intersecting sides.

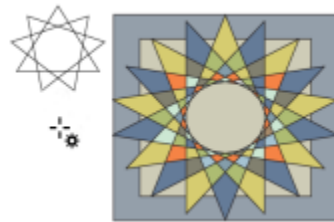

The **Impact** tool lets you create graphic effects in a style inspired by comic books and contemporary illustrations.





The **Graph paper** tool lets you draw a grid of lines similar to that on graph paper.

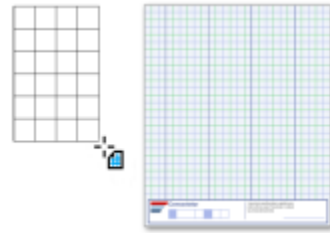

The **Spiral** tool lets you draw symmetrical and logarithmic spirals.



The **Basic shapes** tool lets you choose from a full set of shapes, including hexagram, a smiley face, and a right-angle triangle.

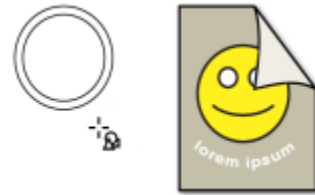

The **Arrow shapes** tool lets you draw arrows of various shape, direction, and number of heads.



The **Flowchart shapes** tool lets you draw flowchart symbols.

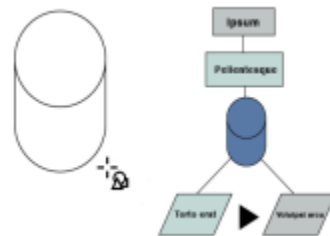

The **Banner shapes** tool lets you draw ribbon objects and explosion shapes.

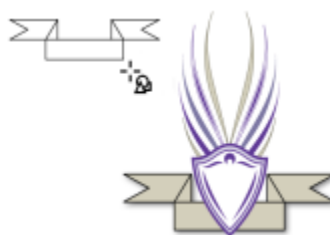



The **Callout shapes** tool lets you draw callouts and labels.



Text and Table tools



The **Text** tool lets you type words directly on the screen as artistic or paragraph text.



The **Table** tool lets you draw and edit tables.

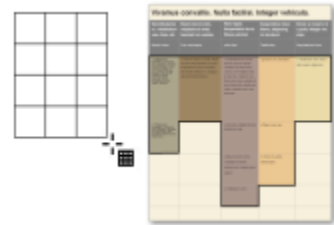

Dimension tools



The **Parallel dimension** tool lets you draw slanted dimension lines.



The **Horizontal or vertical dimension** tool lets you draw horizontal or vertical dimension lines.

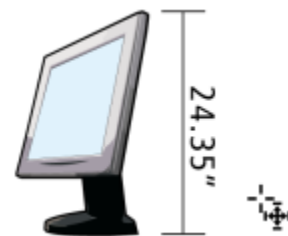



The **Angular dimension** tool lets you draw angular dimension lines.



The **Segment dimension** tool lets you display the distance between end nodes in single or multiple segments.

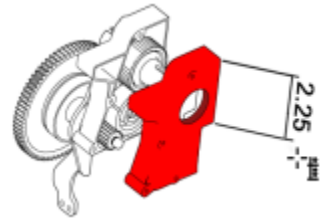

The **3-point callout** tool lets you draw a callout with a two-segment leader line.

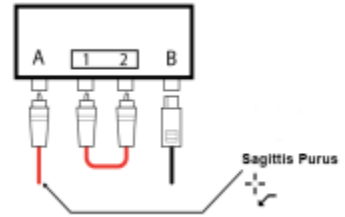

Connector tools



The **Straight-line connector** tool lets you draw a straight connector line.

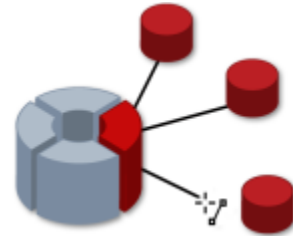

The **Right-angle connector** tool lets you draw a right angle connector line.

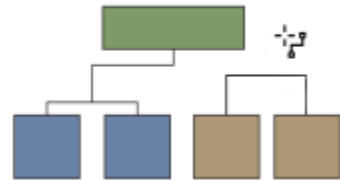



The **Rounded right-angle connector** tool lets you draw a right-angle connector line with curved corners.

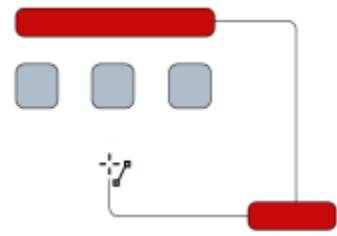

The **Anchor editing** tool lets you modify connector line anchor points.

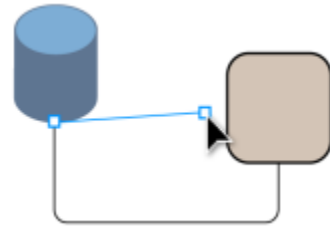

Interactive tools



The **Drop shadow** tool lets you apply a drop shadow to an object.

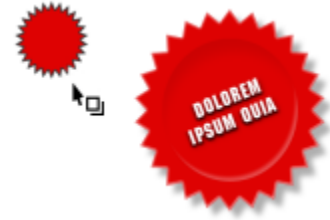

The **Contour** tool lets you apply a contour to an object.

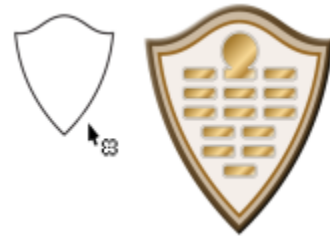

The **Blend** tool lets you blend two objects.

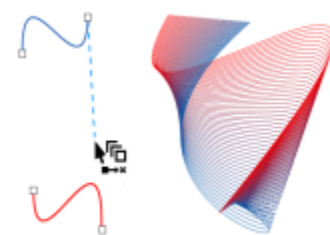



The **Distort** tool lets you apply a Push or Pull distortion, a Zipper distortion, or a Twister distortion to an object.



The **Envelope** tool lets you shape an object by dragging the nodes of the envelope.



The **Extrude** tool lets you apply the illusion of depth to objects.

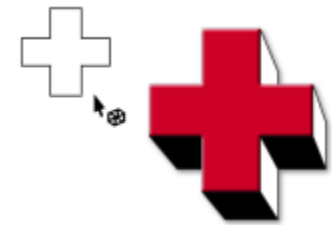

The **Block shadow** tool lets you add solid vector shadows to objects and text.



Transparency tool



The **Transparency** tool lets you apply transparencies to objects.

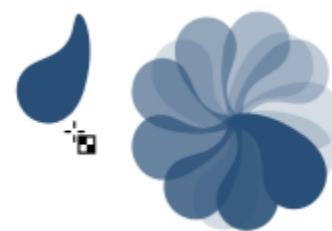

Eyedropper tools



The **Color eyedropper** tool lets you select and copy a color from an object on the drawing window or the desktop.

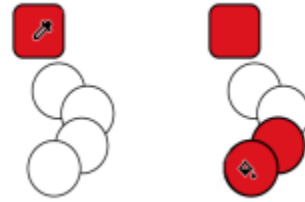

The **Attributes eyedropper** tool lets you select and copy object properties, such as line thickness, size and effects, from an object on the drawing window.

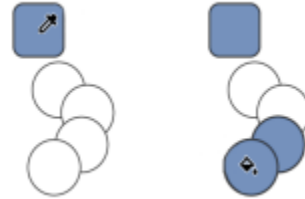

Interactive fill tools



The **Interactive fill** tool lets you apply various fills.

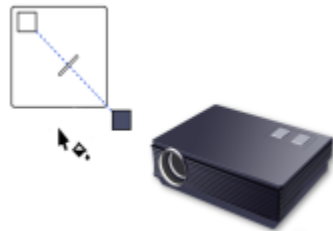

The **Mesh fill** tool lets you apply a mesh grid to an object.

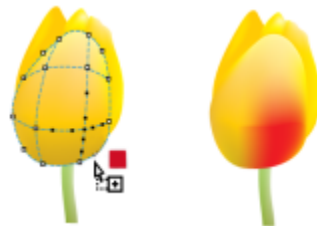

The **Smart fill** tool lets you create objects from enclosed areas and then apply a fill to those objects.

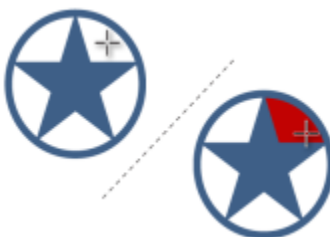

Outline tool



The **Outline** tool opens a flyout that gives you quick access to items such as the **Outline pen** dialog box and **Outline color** dialog box. This tool is not displayed by default in the toolbox. For information about how to display it, see [“To customize the toolbox” on page 866](#).

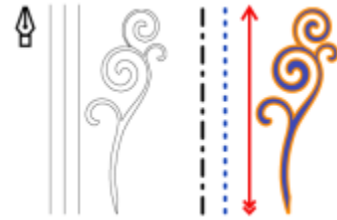

Edit fill tool



The **Edit fill** tool gives you quick access to the **Edit fill** dialog box. This tool is not displayed by default in the toolbox. For information about how to display it, see [“To customize the toolbox” on page 866](#).

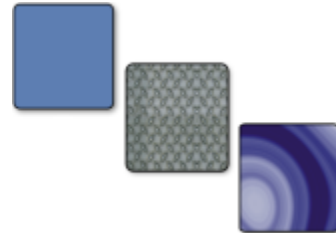

Property bar

The property bar displays the most commonly used functions that are relevant to the active tool or to the task you're performing. Although it looks like a toolbar, the property bar content changes depending on the tool or task.

For example, when you click the **Text** tool in the toolbox, the property bar displays text-related commands. In the example below, the property bar displays text, formatting, alignment, and editing tools.



You can customize the contents and position of the property bar to suit your needs. For more information, see [“Customizing the property bar” on page 866](#).



To toggle between displaying and hiding the property bar, click **Window** ► **Toolbars** ► **Property bar**.

To hide or display controls on the property bar, click the **Quick customize** button , and enable or disable the corresponding check boxes.

Dockers

Dockers display the same types of controls as a dialog box, such as command buttons, options, and list boxes. Unlike most dialog boxes, you can keep dockers open while working on a document, so you can readily access the commands to experiment with different effects. Dockers have features similar to palettes in other graphics programs.

Dockers can be either docked or floating. A docked docker is attached to the edge of the application window, a toolbar, or a palette. A floating docker is not attached to a workspace element. If you open several dockers, they usually appear nested, with only one docker fully displayed. You can quickly display a docker hidden from view by clicking the docker's tab.

You can move dockers, and you can collapse dockers to save screen space.

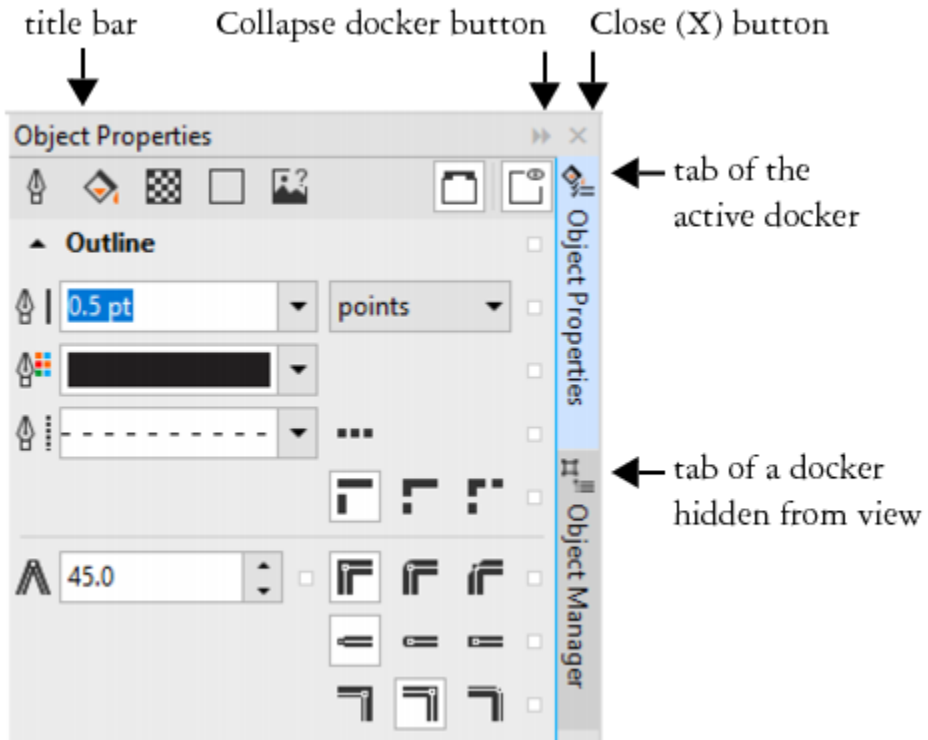

An example is the Object properties docker. When this docker is open, you can click an object in the drawing window to access various options for modifying object properties.

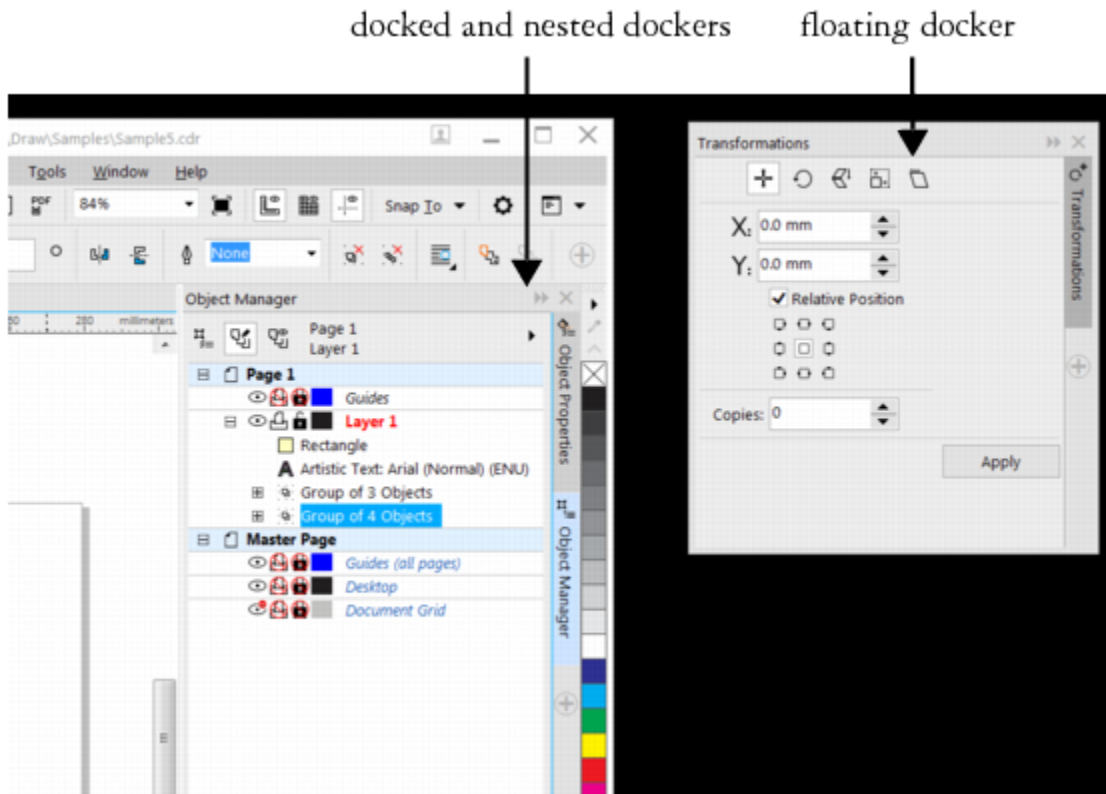

In this example, the Object properties and the Object manager dockers are docked and nested. The Transformations docker is floating.

To open a docker

- Click **Window** ► **Dockers**, and click a docker.



To open or close dockers, you can also click the **Quick customize** button  on the right side of a docker, and enable or disable the corresponding check boxes.

You can also close a docker by clicking the X button on its title bar. Clicking the X button on the title bar closes all nested dockers in a group. To close only a specific docker, click the X button on the docker's tab.

To move dockers

To move

A docker

Multiple nested dockers

Do the following

Drag the docker's tab to a new location.

Drag the title bar of the active docker to a new location.

To dock a floating docker

- Drag the docker's title bar or tab to an edge of the drawing window and position the pointer along the edge. When a gray preview of the docker's position appears, release the mouse button.

To collapse a docker

- Click the **Collapse docker** button  on the docker's title bar.



To expand a collapsed docker, click its tab.

Status bar

The status bar displays information about selected objects (such as color, fill type, and outline, cursor position, and relevant commands). It also displays document color information, such as the document color profile and color proofing status.

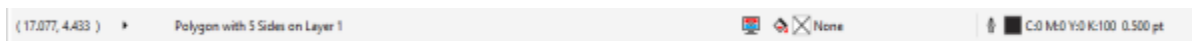

You can edit the fill and outline of selected objects by clicking the Fill  and Outline  icons on the status bar.

See “[Customizing the status bar](#)” on page 867 for information about customizing the contents and appearance of the status bar.

Choosing a workspace

CorelDRAW includes a collection of workspaces that are designed to help you increase your productivity. A workspace is a configuration of settings that specifies how the various command bars, commands, and buttons are arranged when you open the application. You can choose a workspace from the **Welcome Screen**, or you can switch to a different workspace from within the application.

The specialized workspaces in CorelDRAW are configured according to specific workflows or tasks, such as page layout work or illustrating. Their purpose is to make more accessible the tools that you use most often.

The following table describes the available workspaces.

Workspace	Description
Lite	This workspace makes CorelDRAW's most commonly used tools and features more accessible. If you are new to CorelDRAW, the Lite workspace is ideal for getting started.
X6 Inspired	This workspace is almost identical to the default CorelDRAW X6 workspace. It is best suited for experienced CorelDRAW users who are looking for a seamless transition to a modern yet familiar environment in CorelDRAW 2018. Many elements of the workspace have been optimized for a more streamlined workflow.
Default	This workspace has been redesigned to provide a more intuitive placement of tools and controls. This workspace is ideal for users who have experience with other vector graphics software, as well as users who are familiar with CorelDRAW. Help topics are based on the Default workspace.

Workspace	Description
Touch	Optimized for touch-enabled devices, the Touch workspace is ideal for field work and sketching. Complete your tasks by using touch, dial, or a stylus, without needing a mouse or keyboard.
Illustration	This workspace is designed to make the process of creating book cover designs, magazine ads, storyboards, and other types of illustrations more intuitive and efficient.
Page layout	This workspace is optimized for arranging graphics and text objects so you can create compelling layouts for business cards, branding materials, product packaging, or multipage documents such as brochures and newsletters.
Adobe Illustrator	Simulates the Adobe Illustrator workspace by positioning the CorelDRAW features where you would find the equivalent feature in Adobe Illustrator. This workspace is useful if you recently switched from Adobe Illustrator to CorelDRAW and you are not familiar with the CorelDRAW workspace.

If you have a unique workflow, you can create a custom workspace that is optimized for your specific needs. For more information, see [“Creating workspaces” on page 856](#).

To choose a workspace

- Click **Window** ► **Workspace**, and choose one of the available workspaces.



You can also choose a workspace from the Welcome Screen or by clicking **Tools** ► **Customization**, clicking **Workspace** in the list of categories, and then enabling the check box beside a workspace in the **Workspace** list.

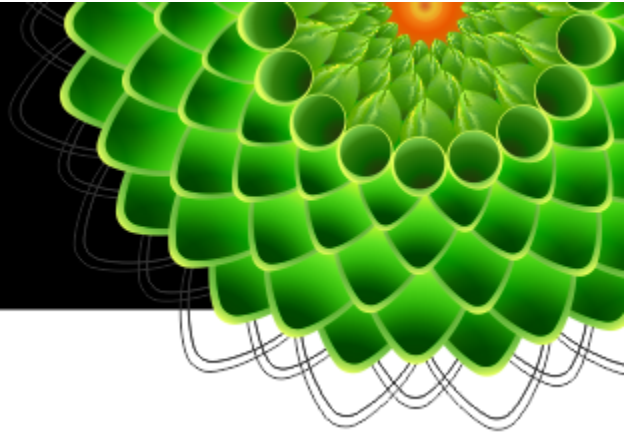

Finding and managing creative tools and content

With the Get More dialog box in CorelDRAW, you can expand your collection of creative tools by purchasing apps, plug-ins, and content packs as well as downloading free tools and content.

The CONNECT docker lets you search and manage content. You can access, search and browse the Content Exchange, an online collection of clipart, photos, fonts, frames, fills, and image lists. In addition, you can find content located on your computer, local network, or the website of an online content provider. When you find the content that you need, you can import it into your document, open it in its associated application, or collect it in a tray for future reference.

CorelDRAW is fully integrated with the search capabilities that are offered by Windows. By default, the application searches all locations that Windows Search is configured to index. For information about modifying indexing options in Windows Search, see the Windows Help.

This section contains the following topics:

- [“Acquiring applications, plug-ins, and content” \(page 99\)](#)
- [“Finding content with the CONNECT docker” \(page 100\)](#)
- [“Accessing content” \(page 103\)](#)
- [“Browsing and searching for content” \(page 105\)](#)
- [“Viewing content” \(page 108\)](#)
- [“Using content” \(page 108\)](#)
- [“Installing fonts” \(page 111\)](#)
- [“Managing content” \(page 111\)](#)
- [“Syncing trays with OneDrive” \(page 112\)](#)
- [“Changing content locations” \(page 114\)](#)

Acquiring applications, plug-ins, and content

The Get More dialog box lets you download apps and plug-ins as well as creative tools and content such as fill packs and font packs from within CorelDRAW. The available selection is updated with new offerings as they become available. Some items are free while other items are available for purchase.

Both applications and plug-ins require installation.



To uninstall an application or a plug-in, go to the Control Panel of the operating system.

AfterShot 3 HDR

You can download Corel® AfterShot™ 3 HDR for free from within CorelDRAW, and quickly learn professional-grade photo editing. Make easy corrections and enhancements to your RAW or JPEG photos, and apply adjustments to one or thousands of photos at once with batch processing tools. Plus, you can create HDR (high dynamic range) images with the HDR module, included in AfterShot 3 HDR.

To access even more powerful photo management and photo editing features, you can upgrade to the latest version of AfterShot Pro from within the **Get More** dialog box.

Restore purchases

After you purchase creative tools, check marks appear beside their names. If you reinstall the CorelDRAW Graphics Suite or install the suite on another computer, you can restore your purchases. This will ensure that the **Get More** dialog box shows the items that you have already purchased so that you can download them and reinstall them.

To access the Get More dialog box

- Click the **Launch** button on the standard toolbar, and click **Get More**.

To download AfterShot 3 HDR

- Click the **Launch** button on the standard toolbar, and click AfterShot 3 HDR.



After downloading AfterShot 3 HDR, you can start it from the **Launch** button on the standard toolbar.

For detailed information about how to use AfterShot 3 HDR, start the application and access the Help by pressing **F1**.

To access an application or a plug-in

- Click the **Launch** button on the standard toolbar, and click the application, plug-in, or extension that you want to use.

To restore your purchases

- 1 Click **Help** ► **Restore purchases**.
- 2 In the dialog box that appears, type the email address that was used to make the purchases, and click **Continue**.
A list of your purchases is displayed.
- 3 Click **Close**.
The list of offerings in the **Get More** dialog box is updated to show which items you have already purchased.
- 4 Download the purchased items you want.

Finding content with the CONNECT docker

You can browse and search for content by using the **CONNECT** docker. You can use the **Tray** docker to store content for later use.

The **CONNECT** docker has two viewing modes: single pane and full view. In full view, all panes are displayed. In single-pane view, either the viewing pane or the **Libraries**, **Favorite folders**, and **Folders** panes are displayed. You can resize the docker to display all panes or toggle between the viewing pane and the **Libraries**, **Favorite folders**, and **Folders** panes.

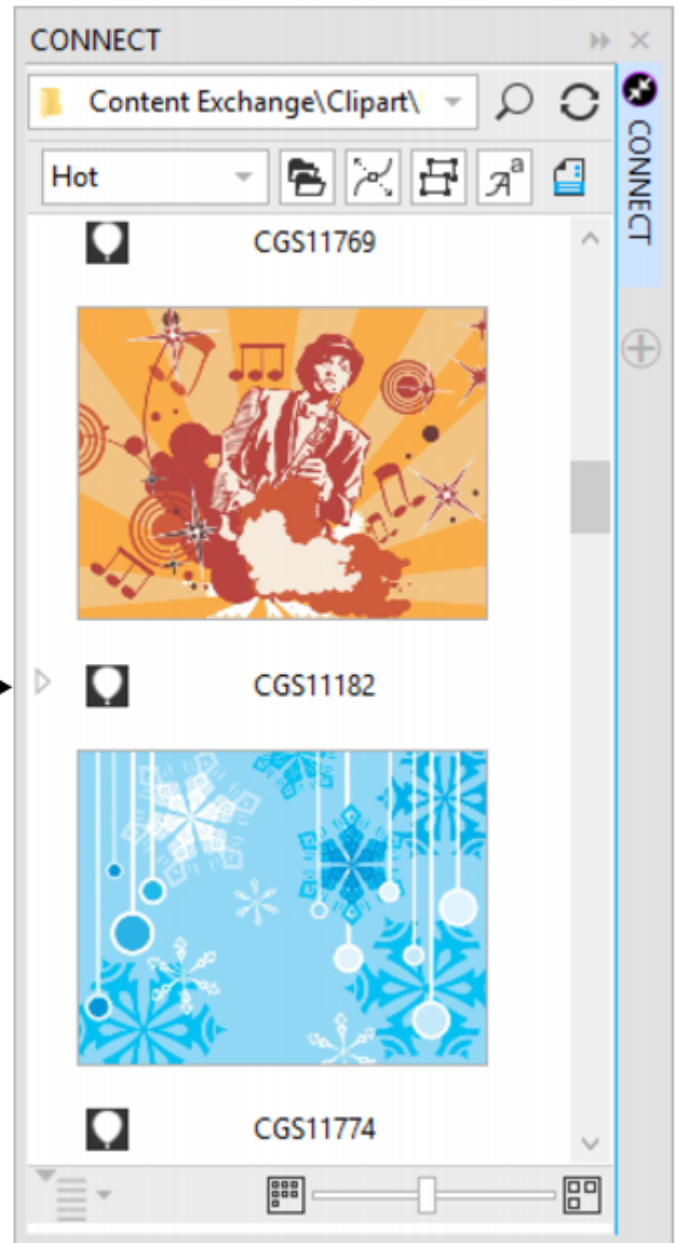
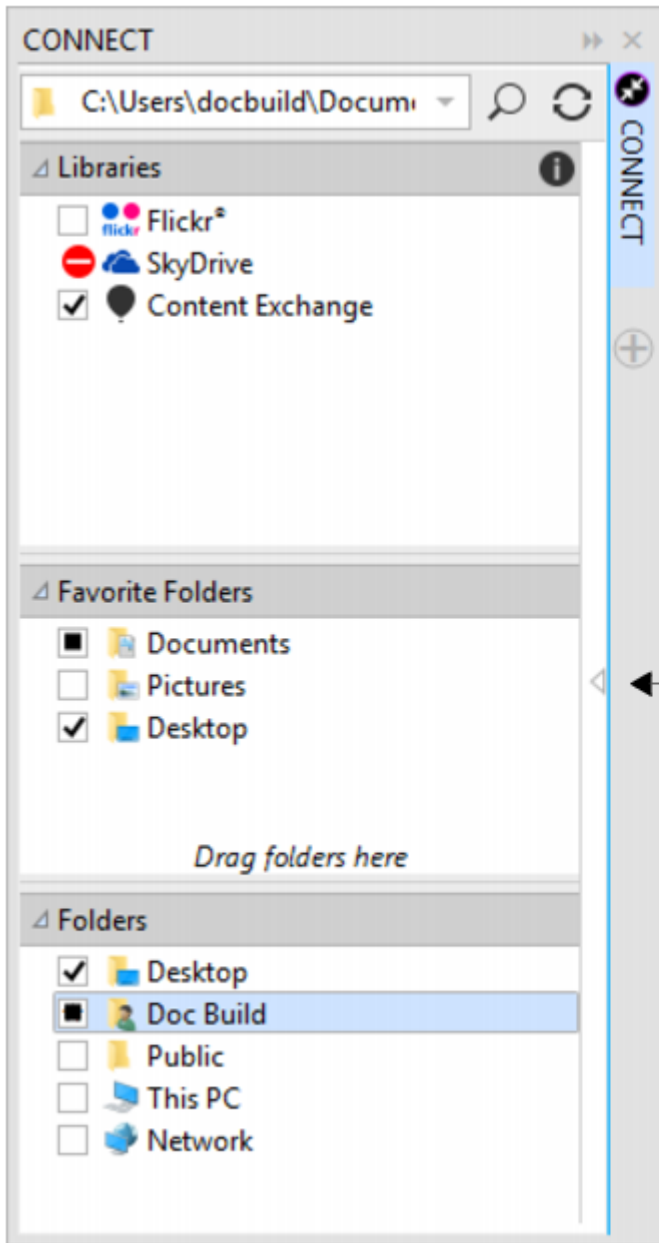

The CONNECT dock with the viewing pane hidden (left) and the navigation pane hidden (right).
Click the toggle arrow (1) to display or hide panes. Resize the dock to display both panes.

You can customize the size and display of individual panes.

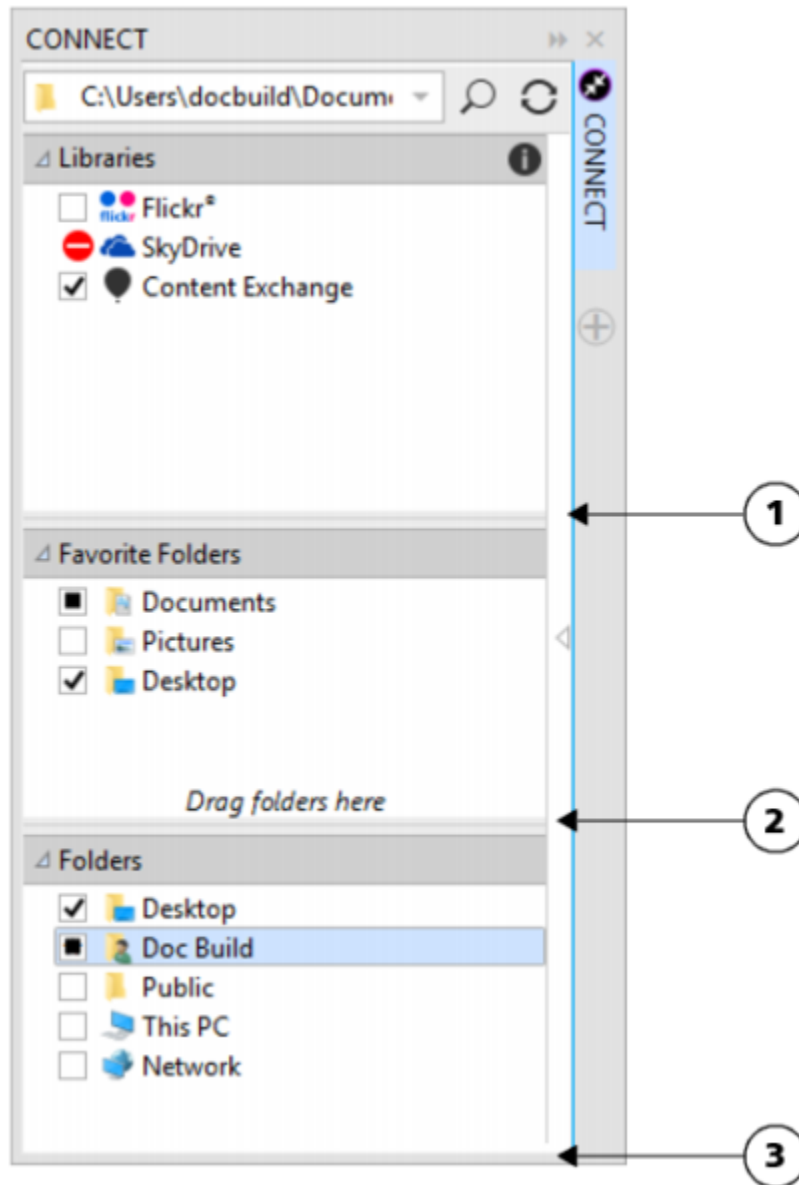

The grab area (1, 2, 3) lets you resize a pane.

You can use the **Favorite folders** pane to create shortcuts to folders that you visit frequently. You can add locations to and remove locations from the **Favorite folders** pane.

To display or hide the CONNECT and Tray dockers

To	Do the following
Display or hide the CONNECT docker	Click Window ► Dockers ► CONNECT .
Display or hide the Tray docker	Click Window ► Dockers ► Tray .



You can also access the CONNECT docker from the standard toolbar and the **File ► Search Content** menu command.

To resize a pane

- Point to the pane's grab area, and when the cursor changes to a two-directional arrow, drag the edge of the pane.

To display or hide a pane

- Click the arrow to toggle between displaying and hiding the pane.

To add a location to the Favorite Folders pane

- Drag a folder from the **Libraries**, **Folders**, or **viewing** pane to the **Favorite folders** pane.



You can also add locations to the **Favorite folders** pane by right-clicking a folder in the **Libraries** or **Folders** pane, and clicking **Add to Favorites**.

To remove a location from the Favorite Folders pane

- Right-click a location in the **Favorite folders** pane, and click **Remove from Favorites**.

Accessing content

You can access content available on the Content Exchange or on the websites of online content providers. You can also access content from previous versions of the software that is stored on a CD, DVD, or in a folder.

Using the Content Exchange

The Content Exchange provides a collection of clipart, photos, fonts, frames, vector and bitmap patterns, and image lists that you can access. You can browse the available content, or you can search by keywords, mark your favorites, vote for content that you like, or copy content from the Content Exchange to your personal folder.

You must sign in to your corel.com account to use content from the Content Exchange.

Using content from online content providers

You can find content on the websites of online content providers such as Flickr®. The images that you find online are often subject to usage restrictions and may be watermarked or low-resolution. For information about using such images, see ["Using content" on page 108](#).

Note that online content is unavailable in workplaces with restricted Internet access.











Using content stored on a CD or DVD

To access clipart and other content included on a CD or DVD from a previous version of the software, you must insert the CD or DVD, or browse to the folder to which you have copied the content.

To use the Content Exchange

- 1 Click **File ► Search Content** to open the CONNECT docker.
- 2 In the **Libraries** pane, click **Content Exchange**.
The available folders appear in the viewing pane.
- 3 Double-click a folder to access its content.
Thumbnail versions of the files appear in the viewing pane.

- 4 Point to a thumbnail to view more information about a file.
- 5 Click a thumbnail.
A pop-up window appears.
- 6 In the pop-up window, perform an action from the following table.

To	Do the following
Search content by keyword	<p>Click one of the keywords associated with a file to perform a search based on that keyword.</p> <p>Search results include all types of content in the Content Exchange that is tagged with this keyword. To narrow down search results to specific types of content (such as bitmaps, vectors, or fonts), click the corresponding button on the Filter toolbar.</p>
Copy fills, pattern, image lists, and photo frames from the Content Exchange to your personal folder	<p>Click the More options button , and click the Copy to personal button .</p> <p>The content is copied in the respective folder in the My Documents \Corel\Corel Content folder.</p>
Mark as a favorite	<p>Click the Favorite button .</p> <p>To remove content from your favorites, click the Unfavorite button .</p>
Vote to rank content higher or lower	<p>Click the Vote up  or the Vote down button .</p>
Report inappropriate content	<p>Click the More options button , and click the Flag button .</p>
Prevent a file from appearing in future searches	<p>Click the More options button , and click the Hide button .</p>



You must sign in to your corel.com account to use content from the Content Exchange.

To access a content library stored on a CD or DVD

- 1 Click **File** ► **Search Content** to open the CONNECT docker.
- 2 Insert the content CD or DVD.

The content library appears in the **Libraries** pane.

To access a CD or DVD content library that was copied to your computer

- 1 Click **File** ► **Search Content** to open the CONNECT docker.

- 2 In the **Libraries** pane, click the **Configure content libraries** button .
A warning sign next to a content library shows that it needs to be configured.
- 3 Click a content library, click **Locate**, and browse to the folder where the library is stored.
The content library appears in the **Libraries** pane.

Browsing and searching for content

With the CONNECT docker, you can browse for content, or you can search for content by using keywords.

You can browse and search for content in one or multiple locations on your computer or local network as well as online. You can also navigate to previously viewed content.

Searching for content

You can search by the name, category (for example, clipart, photo images, or fonts), or reference information (for example, tags or notes) associated with a file. When you type a term in the **Search and address** box and initiate a search, all matching files are displayed as thumbnail images in the viewing pane. For example, if you type **flower**, the application automatically filters out all files that do not match and displays only the files that have the word **flower** in the filename, category, or tags assigned to the file. You can also type phrases and multiple words, and you can fine-tune your search by using Boolean operators such as AND, NOT, and OR. For example, you can find content that contains both flower and sun images by typing **flowers AND sun**. For information about adding tags and reference information, see [“To add drawing information ” on page 68](#).

To increase the search speed for local content and improve results, you can adjust the Windows Search options by adding more locations to the index.

You can also find all images on a webpage by typing the web address. For example, typing **www.corel.com** displays all the images that appear on the Corel website.

Refining your search

By default, your search results include all relevant content such as vector graphics, bitmaps, and fonts. You can narrow down the search results by excluding content. For example, if you are searching for graphics, you can display only vector graphics or only bitmaps. If you want to choose a font for your project, you can display only fonts.

You can widen the scope of a search, and you can cancel a search at any time.

To browse for content

- 1 Click **File** ► **Search Content** to open the CONNECT docker.
- 2 Click a location in one of the following panes:
 - **Libraries** — lets you browse online and local content
 - **Favorite folders** — lets you browse your favorite locations
 - **Folders** — lets you browse the folder structure available on your computer



You can browse the contents of only one folder at a time.



To specify the location where you want to browse for content, type or paste a path in the **Search and address** box, and press **Enter**. The **Search and address** bar keeps track only of the locations that you enter manually. To delete all locations, click the drop-down arrow, and click **Clear list**.

To search for content

- 1 Click **File** ► **Search Content** to open the CONNECT docker.
- 2 Click a location in any of the following panes:
 - **Libraries** — lets you search for online and local content as well as content on a CD or DVD
 - **Favorite folders** — lets you search for content in your favorite locations
 - **Folders** — lets you search for content in the folder structure available on your computer
- 3 Type a word or multiple words in the **Search and address** box, and press **Enter**.
Files that match the search terms appear in the viewing pane.

If you want to search for a phrase, enclose the phrase with quotation marks.

You can also

Search for content in multiple locations

Enable the check boxes for the libraries and folders that you want to search, and click the **Refresh** button 

Show or hide search results for a location

In the viewing pane, click the **Show/Hide** arrow to the right of the location.

Specify how many online search results to display

In the **Libraries** pane, click the **Configure content libraries** button . Click an online content provider, and choose a number from the **Search results** list box. This number determines the initial number of search results that are displayed in the viewing pane, as well as the additional results that are displayed each time you click **More from**.

Fine-tune a search by using Boolean operators

Type one of the following Boolean operators between the search terms:

AND — lets you find content that contains all search terms in the **Search and address** box. Instead of **AND**, you can also use the plus sign (+).

NOT — lets you exclude content that contains the search term after **NOT**. Instead of **NOT**, you can also use the minus sign (-).

OR — lets you find content that contains at least one of the search terms

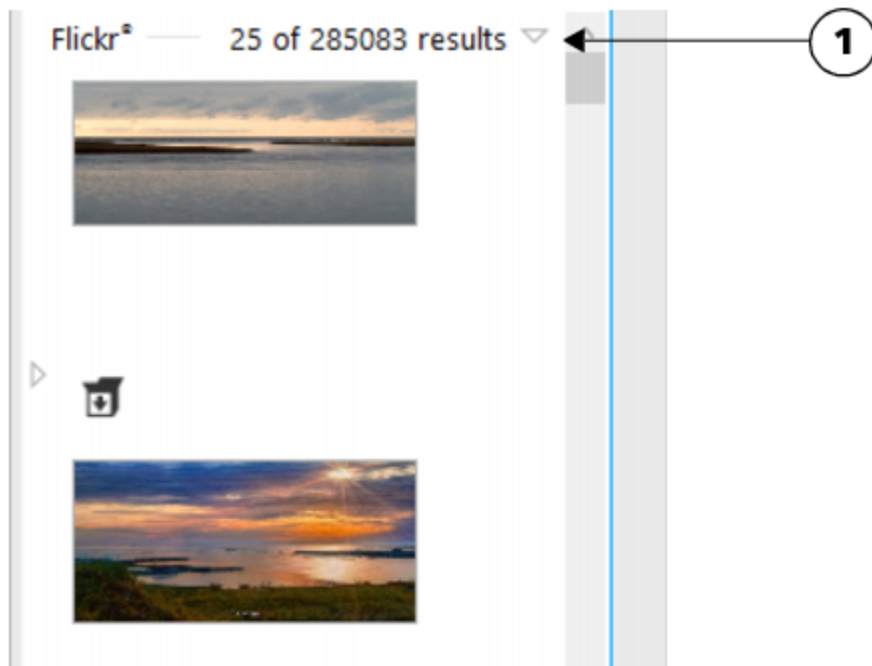

Clicking a Show/Hide arrow (1) lets you show or hide the search results for a specific location.



When you search for online content, only vector files and bitmaps are included in the search results.







If you want to browse the folder where a file is stored or access the source webpage of an image, right-click the file, and click **Open source location**.

To find all images on a webpage

- 1 Click **File** ► **Search Content** to open the CONNECT docker.
- 2 Type a web address (for example, www.corel.com) in the **Search and address** box.

To refine your search

- On the Filter toolbar, click one of the following buttons:
 - Folders  — to hide or display folders in selected folders
 - Vector drawing files  — to hide or display vector graphics that are supported by the suite
 - Bitmap files  — to hide or display bitmaps that are supported by the suite
 - Font files  — to hide or display TrueType (TTF), OpenType (OTF), and PostScript fonts (PFB and PFM)
 - Other files  — to hide or display file formats that are not supported by the suite



A category is included in the search results if the button appears pressed.

To stop a search

- Click the **Cancel search** button .

Viewing content

Clipart, photos, and fonts appear in the viewing pane as thumbnail images. You can select individual, multiple, or all thumbnails.

By positioning your pointer over a thumbnail, you can display a larger preview. You can also display file information such as filename, file size, image resolution, and color mode for content that was not provided by an online content provider. You can also preview the fonts that you find. Thumbnail zooming makes recognizing a particular file easier and faster.

To select a thumbnail

- 1 Search or browse for content in the **CONNECT** docker.
- 2 Click a thumbnail.

You can also

Select multiple thumbnails

Do one of the following:

- Drag around the thumbnails that you want to select.
- Hold down **Ctrl**, and in the viewing pane click the thumbnails that you want to select.
- Click a thumbnail, and holding down **Shift**, click the last thumbnail in the range that you want to select.

Select all thumbnails

Press **Ctrl + A**.

To view file information

- Hover over a thumbnail.

To preview a font

- Double-click a font thumbnail.



You can also preview a font by right-clicking a font thumbnail and clicking **Open**.

To adjust the size of thumbnails

- Drag the **Zoom** slider to the left to decrease the size of the thumbnails, or to the right to increase the size of the thumbnails.

Using content



If you want to view or edit a file before you incorporate it into your project, you can open it in CorelDRAW, Corel PHOTO-PAINT, or its associated application.

You can insert and place content in your document. Images that are obtained from online sources, such as Flickr, may be subject to copyright and usage restrictions. Such images, also referred to as “comp images,” are often low-resolution or watermarked. To use comp

images, you must first check with the owner if you have rights to use them and purchase them if necessary. Then, you can replace the comp images in your document with the purchased images. You can view a list of all comp images in a document.

To open a file

- 1 Click **File** ► **Search Content** to open the CONNECT docker.
- 2 Search or browse for content.
- 3 Select a thumbnail, and perform an action from the following table.





To	Do the following
Open a file by using the CONNECT docker	Do one of the following: <ul style="list-style-type: none">• In full view, click the Open button .• In single pane view, click the File commands button , and click Open.
Open a file by using the Tray docker	Click the Open button  .



You can also open a file by right-clicking it and choosing the option that you want.

You can also open multiple selected files.

To insert a file into an active document

To	Do the following
Insert a file into an active document by using the CONNECT docker	Do one of the following: <ul style="list-style-type: none">• Drag a file from the viewing pane of the CONNECT docker to the active document to insert the file as an embedded object.• In single-pane view, select a file in the viewing pane, click the File commands button , click Import to insert the file as an embedded object or Import and link to insert the file as a linked object, and click in your document.• In full view, select a file in the viewing pane, click the Import button  to insert the file as an embedded object or the Import and link button  to insert the file as a linked object, and click in your document.
Insert a file into an active document by using the Tray docker	Select the file, and click one of the following buttons in the Tray docker: <ul style="list-style-type: none">• Import  — lets you insert a file as an embedded object• Import and link  — lets you insert a file as a linked object• Import at original position — lets you import and place a vector graphic at the original position where it was created relative to the page

To

Do the following

Note that the **Import** buttons are not available in the standalone utility.

Insert and place a vector graphic in a document

Click the **Import** or **Import and link** button and do one of the following:

- Drag to place and resize the graphic.
- Press **Enter** to center the graphic on page.
- Press **Spacebar** to place the vector graphic at the original position where it was created relative to the page.



For information about inserting embedded and linked objects, see [“Linking and embedding objects ” on page 333](#).



You can also insert a file into an active document by dragging the file from the viewing pane or the **Tray** docker to the active document.

You can also insert a file into an active document by right-clicking the file in the viewing pane and choosing an import command.

You can also insert multiple selected files.

To check, purchase, and replace a comp image

- 1 In your document, click a comp image, and click the **Open comp source** button on the toolbar that appears below the comp image.
- 2 On the website of the online content provider, check the copyright and usage restrictions for the image, and purchase it if necessary.
- 3 In your document, select the comp image, and click the **Replace comp** button on the toolbar that appears below the comp image.
- 4 Navigate to the purchased image, and click **Import**.



Transformations, such as scaling, rotating, and resizing, that were applied to the comp image are preserved in the final image. However, effects, such as envelopes, distortions, perspective, as well as bitmap effects and adjustments, are not preserved.



You can also access the **Open comp source** and **Replace comp** commands by right-clicking a comp image.

To view a list of all comp images in a document

- Open a document, and do one of the following:
 - Click **File** ► **Print**, click the **Preflight (Issues)** tab, and click **Some images may be subject to copyright and usage restrictions**.
 - Click **File** ► **Document properties**.



When you export a document to the Adobe Illustrator (AI), Scalable Vector Graphics (SVG), HTML, or PDF file format, you can view a list of all comp images in the preflight summaries.

Installing fonts

You can install the fonts that you find, and you can install font families.

For information about finding fonts, see “To browse for content ” on page 105 and “To search for content” on page 106.

To install fonts

- 1 Click **File** ► **Search Content** to open the CONNECT docker.
- 2 Find the font that you want to install.
- 3 Do one of the following:
 - In the viewing pane, right-click the font thumbnail, and click **Install**.

A check mark appears in the lower-right corner of the font thumbnail to show that the font is installed.

- To install a font family, right-click the font thumbnail, and click **Install font family**.



To install a font from the Content Exchange collection, you must sign in with your Corel.com account to authenticate your product.



To uninstall a font, right-click the font thumbnail, and click **Uninstall**.

You can also use Corel Font Manager to install or download online fonts. Installed fonts become available to all applications on your computer. Downloaded fonts can be used only in CorelDRAW Graphics Suite.

Managing content

You can organize your content by using trays or by adding content files to specific folders on your computer.

A tray is useful for gathering content from various folders. While the files are referenced in the tray, they actually remain in their original location. You can add and remove content from the tray. The tray is shared between CorelDRAW, Corel PHOTO-PAINT, and Corel CONNECT. You can also open files from the tray to preview them more easily.

You can rename trays to give them meaningful names. When working with multiple trays, you can close some trays temporarily to avoid clutter. You can easily reopen a tray when you need it. In addition, you can load a tray file that is not listed among the available trays. You can delete a tray at any time.

To add content to a tray

- 1 Click **File** ► **Search Content** to open the CONNECT docker.
- 2 Search or browse for content.
- 3 Select one or more thumbnails in the viewing pane, and drag them to the tray.

If you want to open a file from the tray, double-click its thumbnail.



You can also drag content from a folder on your computer to the tray.

To add content to a folder

- Select one or more thumbnails in the viewing area, and drag them to a folder in the **Favorite folders** or **Folders** pane, or any other folder on your computer.



You can drag content from the tray to a folder.

To remove content from a tray

- Select one or more thumbnails in the tray, and click the **Remove from tray** button .

To create a tray

- Click the **Add new tray** button  in the lower-right corner of the tray pane.

By default, trays are saved to the **My Documents\Corel\Corel Content\Trays** folder.



You can email trays that contain only online content.

To work with trays

To	Do the following
Select a tray	Click the tray tab.
Rename a tray	Right-click the tray tab, click Rename , and type a new name.
Open a tray	Click the All trays arrow, and click a tray. An open tray has a check mark beside its name.
Close a tray	Right-click the tray tab, and click Close .
Load a tray file	Click the All trays arrow, click Open tray file , and navigate to the tray file.
Delete a tray	Right-click the tray tab, and click Delete .



You can also close and delete a selected tray from the **All trays** menu.

Syncing trays with OneDrive

You can sync your trays with OneDrive and have access to your content from other computers or mobile devices. You must have a OneDrive account to use this feature. After you sign in, you can see all your OneDrive folders in the **Libraries** pane in the CONNECT docker and view their content in the viewing pane.

When you delete files from the trays, the files are also deleted from OneDrive when the trays are synced.

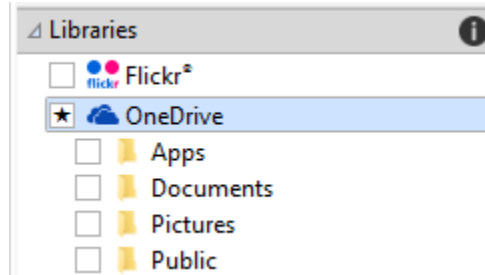

After you sign in, your OneDrive folders appear in the Libraries pane.

Trays are stored in your **Documents\Corel\Core Content\Trays** folder. You can change the default location to which trays are saved. For more information, see “Changing content locations” on page 114.

Each tray is stored as a separate folder. If the trays have never been synced with OneDrive, each tray folder contains shortcuts to the files that have been added to the tray, while the actual files remain in their original location. However, when you sync the trays with OneDrive, all files added to the trays are copied from their original location to the respective tray folder.

When you sync trays with OneDrive, the synced files appear in the following OneDrive folder: **OneDrive\Apps\Corel\Trays**.

To sync trays with OneDrive

- 1 Click **File** ► **Search Content** to open the CONNECT docker.
- 2 Click **OneDrive** in the **Libraries** pane.
- 3 Sign in when prompted.
The first time you sign in, you are asked to grant Corel Cloud Service access to your account. You can always change this setting by logging into OneDrive online and specifying which applications have access to your account.
- 4 When asked whether you want to enable Tray Sync, click **Yes**.
- 5 Make sure that the **Enable Tray Sync with OneDrive on this computer** check box is enabled, and choose an option from the **Sync frequency** list box.

Your OneDrive folders and content appear in the viewing pane.

You can also

Upload files to OneDrive

Drag the files from the viewing pane or from the desktop to a OneDrive folder.

You can also drag files to a tray. If the trays are synced, the files in the tray are automatically uploaded to OneDrive.

Import files from OneDrive into your document

Select the file in the viewing pane, and click the **Import** button



or drag the file to an open CorelDRAW or Corel PHOTO-PAINT document.

Remove files from a synced OneDrive folder

Select the file in the tray, and click the **Remove from tray** button



When the tray is synced, the file is removed from the synced location in OneDrive.

You can also





Access OneDrive online	If you delete a file from a synced OneDrive folder, the file from the local tray folder is moved to the Recycle Bin when the trays are synced. In the viewing pane, right-click a OneDrive file or folder, and choose Open source location from the context menu. OneDrive opens in a browser, where you can manage your OneDrive files and folders.
View the properties of a file in a OneDrive folder	Right-click the file, and then click Properties .
View the properties of a OneDrive folder	Right-click an empty space in the viewing pane, and then click Properties .
Sign out of OneDrive	In the Libraries pane, click the Configure content libraries button  , and click Sign out in the OneDrive area.



If trays are syncing and there is a conflict between two files with the same name, both files are kept, and a number is appended to the name of the second file.

If you do not enable Tray Sync, you can still see your OneDrive folders in Corel CONNECT and upload or download files.



The tray tab icons indicate the sync status of the tray: offline , error , syncing , or synced .

You can enable and disable Tray Sync directly from the Tray docker by clicking the **All trays** arrow in the lower-left corner and then clicking **Synchronize with** ► **OneDrive**.

Changing content locations

Fills, fonts, image lists, photo frames, templates, and trays are saved to your **Documents\Coreel\Coreel Content**[Content Type] folders. You can change the location of some or all these content files by browsing to different folders. For example, you can choose to save templates and fonts to a new location, but leave other content files in your **Documents\Coreel\Coreel Content** folder.

When you change a content location, you can choose to move the content files from the old location to the new location.

You can reset individual or multiple content locations to their default folders from the **Options** dialog box. Alternatively, you can reset all content locations when you reset the application to its default settings by holding down **F8** during startup. With this method, all files saved to custom locations remain in place. To restore your custom content locations, you must browse again to the respective folders.

To change a content location

- 1 Click **Tools** ► **Options**.
- 2 In the **Global** list of categories, click **File Locations**.
- 3 Click the location that you want to change, and click the **Browse** button , located to the right of the file path.
- 4 In the **Browse for Folder** dialog box, navigate to the folder you want.

If you want to move the content files saved to the old location to the new folder, click **Yes** in the **Move Content** dialog box.

You can also

Reset the location of a single content type

Click the content type name, and click **Reset**.

Reset the locations of multiple content types

Holding down **Ctrl**, click the content types you want, and click **Reset**.

Content types

Content types include fonts, clipart, photos, interactive frames, vector patterns, bitmap patterns, photo frames, image lists, and others.

Sample fonts

Lorem ipsum

LoRem ipsum

Sample clipart



Sample photos



Sample interactive frames



Sample vector patterns



Sample bitmap patterns

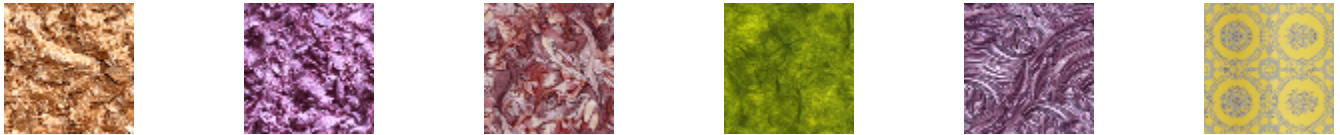

Sample photo frames



Sample image lists



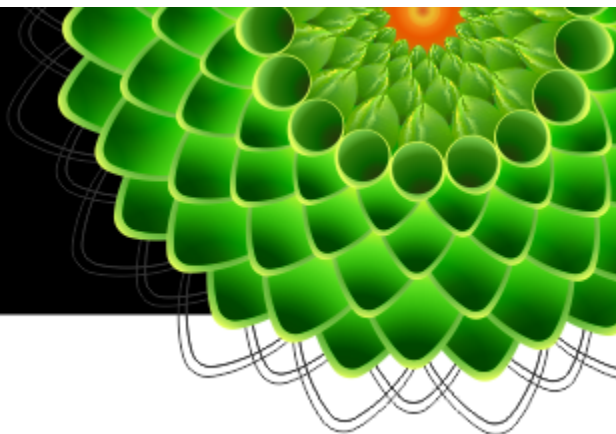

Touch-enabled devices and wheel devices

This section includes the following topics:

- “Using touch” (page 117)
- “Using wheel devices” (page 119)

For information about using a pen and stylus with CorelDRAW, see “Using pressure-sensitive pens and devices” on page 164.

Using touch

CorelDRAW provides touch gesture support, a Touch workspace, and automatic workspace switching to help you make the most of your touch-enabled device.

Gestures

You can use common gestures on your touchscreen device to scroll, zoom, and pan in a document as well as access tools grouped in flyouts. The following table describes how to complete common tasks using touch gestures.

To	Do the following
Scroll in a document	Tap the screen with two fingers and drag in the direction you want to scroll.
Zoom in and out	Using two fingers, pinch outwards to zoom in and pinch inwards to zoom out.
Zoom and pan simultaneously	Using two fingers, pinch outwards or inwards while dragging in the direction you want.
Choose a tool located in a flyout	In the toolbox, tap a flyout button, and tap the tool you want.

Touch workspace

Optimized for touch-enabled devices, the Touch workspace is ideal for field work and sketching. It allows you to complete your tasks by using touch, dial, and a stylus, without needing a mouse or keyboard.

The Touch workspace has streamlined user interface (UI) that shows you only the tools and commands that you are most likely to use when using a tablet. In comparison to the other available workspaces, the Touch workspace features the following changes:

- Buttons and other UI elements are bigger to be touch-friendly.
- The toolbox is modified to include only tools you are likely to use often.
- The toolbox lets you access Undo and Redo commands as well as Copy, Paste, and Delete.
- The menu bar is no longer at the top of the main window. You can access menu commands by clicking the Menu button in the lower-left corner of the status bar.
- The status bar lets you quickly change the zoom level as well as access commonly used commands and dockers.

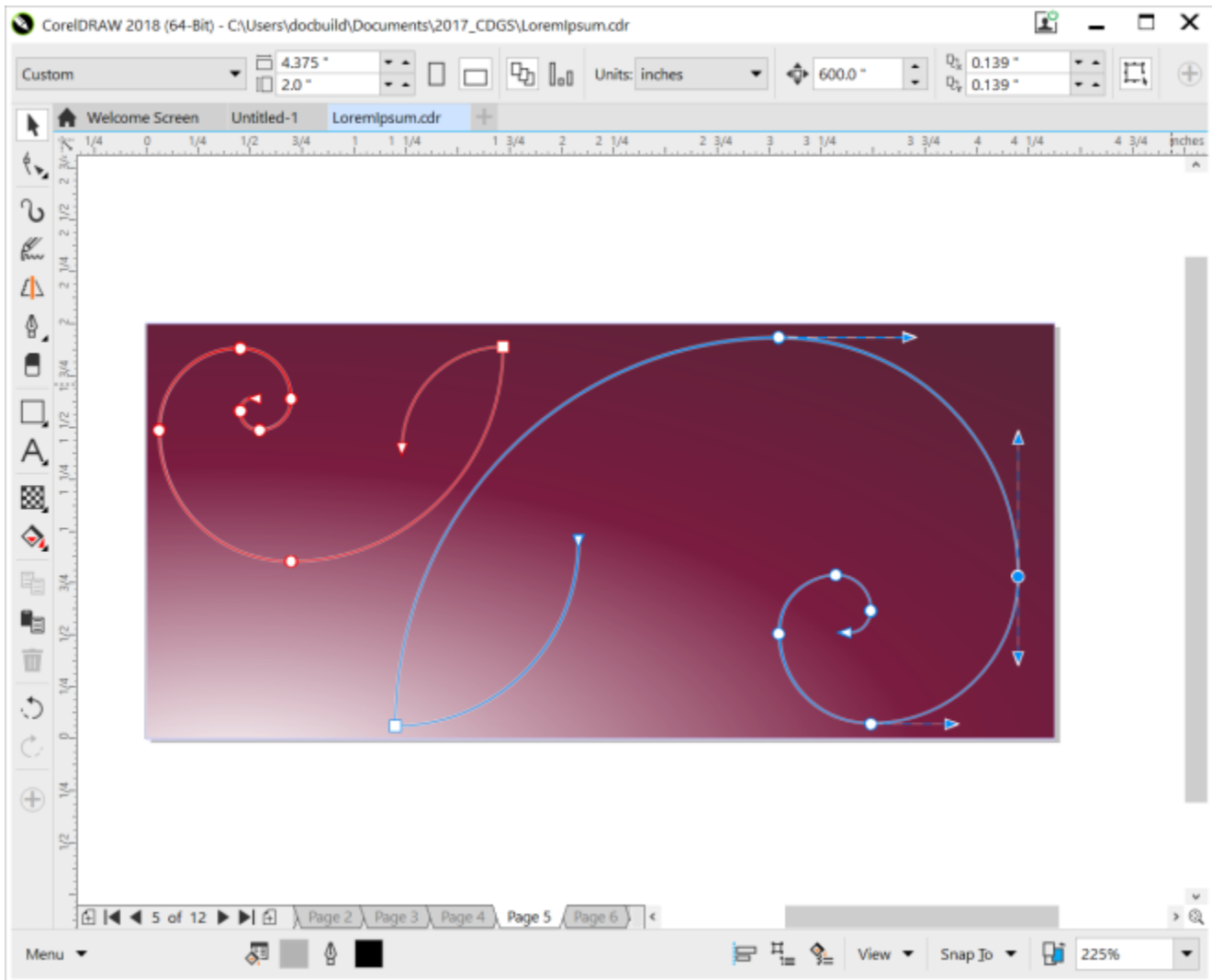

The Touch workspace in CorelDRAW

Switching between Touch and Desktop workspaces

Tablet mode is a Windows feature that optimizes the UI for touch-enabled devices. Usually, Tablet mode is activated when you detach a tablet from its base. When a tablet is attached to its base, it is in Desktop mode. On Windows 10, CorelDRAW automatically switches to the Touch workspace when Tablet mode is enabled. When Tablet mode is disabled, the application switches to a desktop workspace. You can choose which workspace to use in Desktop mode and which workspace to use in Tablet mode. You can also turn off automatic workspace switching.

In addition, you can show and hide the rulers for Desktop mode and Tablet mode independently to suit your workflow. For more information, see ["To show or hide the rulers for Desktop and Tablet mode"](#) on page 605.

Similarly to other workspaces, the Touch workspace can be selected from the **Window ▶ Workspace** menu.

To set options for switching between Tablet mode and Desktop mode

- 1 Click **Tools ▶ Options**.
- 2 In the **Workspace** list of categories, click **Tablet Mode**.
- 3 Perform a task from the following table.

To	Do the following
Turn on or off automatic workspace switching when changing between Desktop and Tablet mode	Enable or disable the Auto-switch between Tablet and Desktop workspaces check box. Automatic workspace switching is not available for Windows 8 or Windows 7. To switch to the Touch workspace, you must choose it manually (Window ▶ Workspace).
Set the workspace for Tablet mode	Choose a workspace from the Tablet mode list box.
Set the workspace for Desktop mode	Choose a workspace from the Desktop mode list box.

To choose the Touch workspace

- Click **Window ▶ Workspace ▶ Touch ▶ Touch**.

Using wheel devices

With CorelDRAW Graphics Suite, you can take advantage of Microsoft Surface Dial and other wheel devices so that you can focus on your creative tasks. Especially useful in combination with a stylus, a wheel device helps you draw and create naturally and ergonomically. You can easily transition between tools and tasks by using your nondominant hand while you are sketching or designing with your stylus.

Your wheel device can be used in two modes: off-screen (placed on your desk) and on-screen (placed directly on the screen).

For information about setting up your wheel device, see the manufacturer's instructions.

Off-screen mode

When the wheel device is off the screen, its on-screen interface lets you zoom in and out as well as undo and redo actions. In addition, you can now navigate the pages of your document, and you can change the object order by moving selected objects to the front or back of other objects. Plus, your wheel device can help you use the LiveSketch tool more efficiently. For more information, see [“Wheel devices and the LiveSketch tool” on page 122](#).



The on-screen UI of surface dial when used in off-screen mode in CorelDRAW.

On-screen mode

In on-screen mode (when you place the wheel device on the screen), the on-screen UI is designed to simulate an artist's palette, giving you quick access to tools and controls through the **Tool** and **Property** panels. To select a tool or control on the on-screen UI, you need to use your stylus, or you can simply tap on a touch-screen enabled device.

The default **Tool** panel lets you switch between the following tools: **Pick**, **Eraser**, **Rectangle**, **Ellipse**, **Text**, **Pen**, and **Bézier**. You can also access commonly used commands such as **Delete**, **Convert to curves**, and **Weld**.

From the **Property** panel, you can adjust document, tool, and object settings. For example, you can change the document dimensions and orientation as well as the unit of measurement.

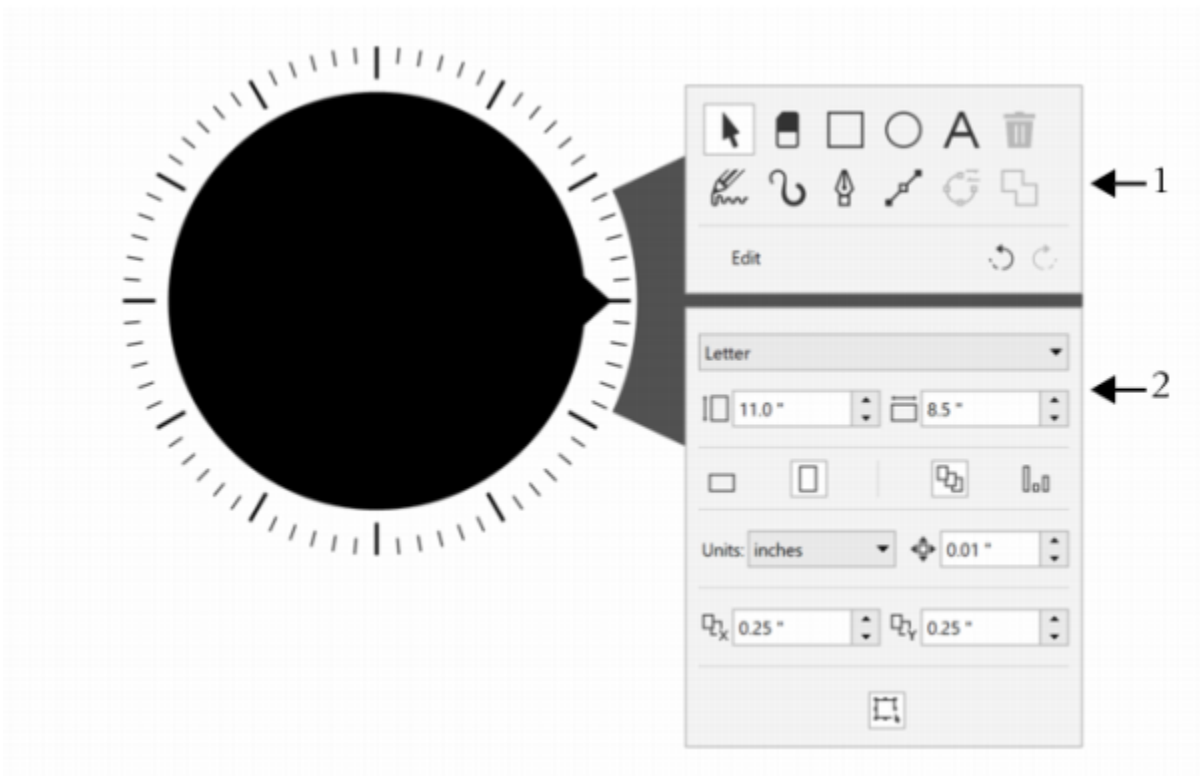

The Tool panel (1) and the Property panel (2) appear when you place the wheel device in the drawing window.

The **Property** panel is similar to the property bar. It includes controls that are relevant to the selected tool and object. Each time you switch tools on the **Tool** panel, the **Property** panel is updated to allow you to edit tool and object properties on the fly. For example, if you have an object selected in the drawing window, you can use the **Property** panel to quickly adjust object width, height, and outline width; and you can mirror and rotate the object. In addition, if you need to adjust property values, the wheel device can help you fine-tune them with precision.

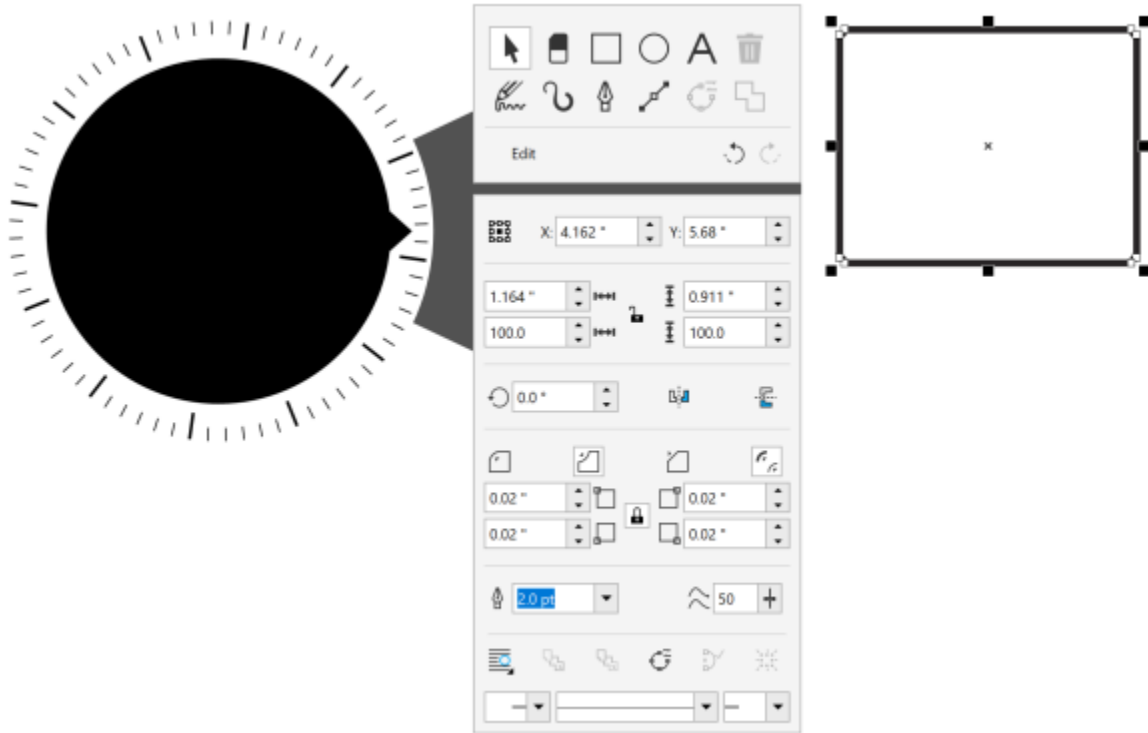

The *Property* panel displays controls that let you edit the selected object, a rectangle in this example.

To tailor the **Tool** panel to your workflow and have a non-cluttered yet complete collection of tools at your fingertips, you can remove, add, and rearrange tools.

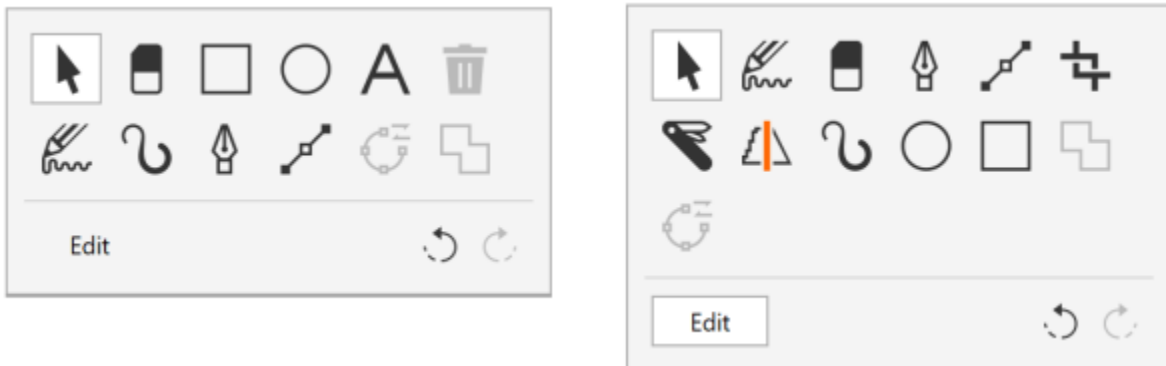

Left: The default *Tool* panel. Right: A customized *Tool* panel. In this example, new tools (*Crop*, *Knife*, and *Smart Drawing*) are added; the *Delete* button is removed; and the tools are rearranged.

Wheel devices and the LiveSketch tool

Your wheel device can be especially helpful when you are sketching with the LiveSketch tool. In off-screen mode, you can use the wheel device to easily undo and redo your strokes. In on-screen mode, you can fine-tune the time it takes to adjust strokes, and set other tool and stroke properties. Plus, you won't need to use a keyboard to reset the timer and have your strokes adjusted instantly in both modes of the wheel device.

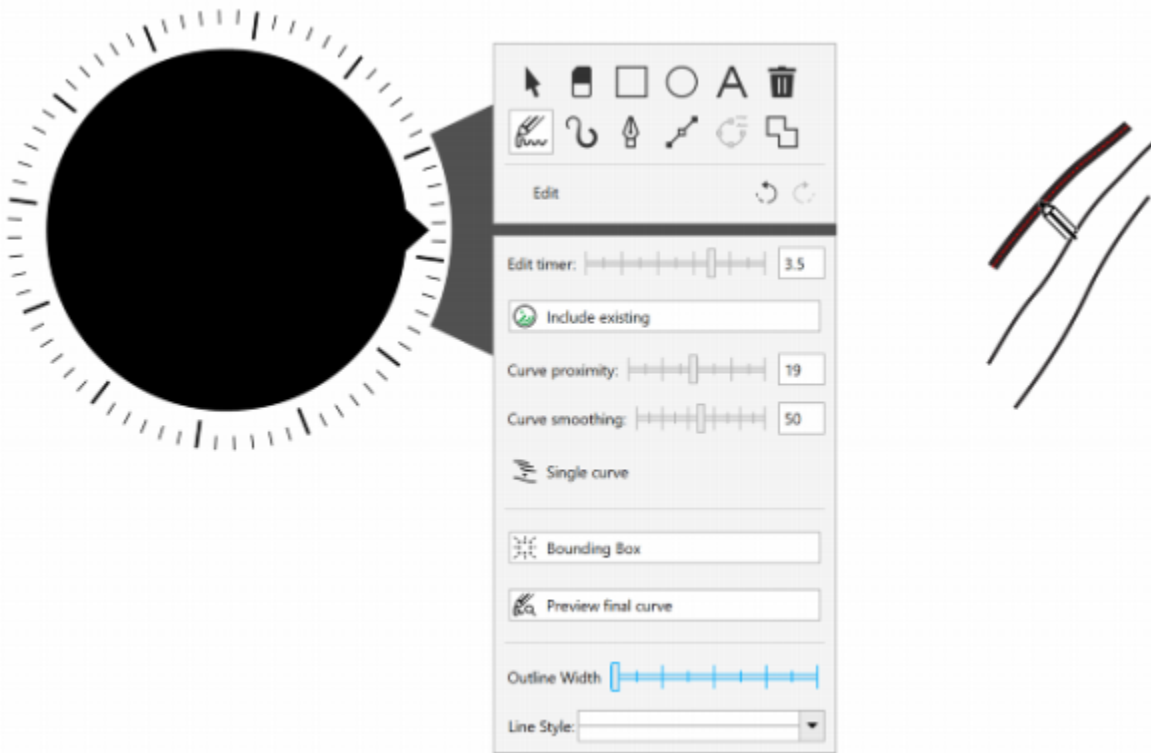

The Property panel displays controls related to the LiveSketch tool.

To use a wheel device in off-screen mode

- 1 Press down the wheel device to show the on-screen menu, and then release.
- 2 Rotate the wheel device to select one of the following commands on the on-screen menu, and click.
 - **Zoom** — lets you zoom in and out
 - **Undo** — lets you undo and redo actions
 - **LiveSketch** — lets you undo and instantly adjust strokes when using the **LiveSketch** tool. For more information, see [“To use the LiveSketch tool with a wheel device in off-screen mode”](#) on page 124.
 - **Object Order** — lets you move the selected object up or down in the stacking order
 - **Page** — lets you navigate the pages of your document
- 3 Rotate the wheel device clockwise or counterclockwise to complete your task.

To choose tools and adjust properties using a wheel device in on-screen mode

- 1 Place the wheel device on the screen with your nondominant hand.
The **Tool** and **Property** panels appear beside the wheel device.
- 2 Perform a task from the following table by using a stylus or mouse.

To

Adjust document properties

Choose a tool

Adjust tool and object properties

Do the following

Make sure that no object is selected in the drawing window. Select the **Pick** tool on the **Tool** panel. On the **Property** panel, select a control. To adjust values, rotate the wheel device clockwise or counterclockwise.

Select a tool on the **Tool** panel.

Select the control you want on the **Property** panel. To adjust values, rotate the wheel device clockwise or counterclockwise.

To delete, convert or weld objects using a wheel device in on-screen mode

- 1 Place the wheel device on the screen.
The **Tool** and **Property** panels appear beside the wheel device.
- 2 Perform a task from the following table using a stylus or mouse.

To

Delete a selected object

Convert selected objects to curves

Weld selected objects

Do the following

Select the **Delete** button  on the **Tool** panel.

Select the **Convert to curves** button  on the **Tool** panel.

Select the **Weld** button  on the **Tool** panel.

To customize the Tool panel

- 1 Place the wheel device on the screen.
The **Tool** and **Property** panels appear beside the wheel device.
- 2 Using your stylus or mouse, select **Edit** on the **Tool** panel.
The **Customization** panel opens.
- 3 Perform a task from the following table.

To

Add a tool

Delete a tool

Reposition a tool

Do the following

Drag the tool from the **Customization** panel to the **Tool** panel.

Drag the tool out of the **Tool** panel.

Drag the tool to a new position in the **Tool** panel.

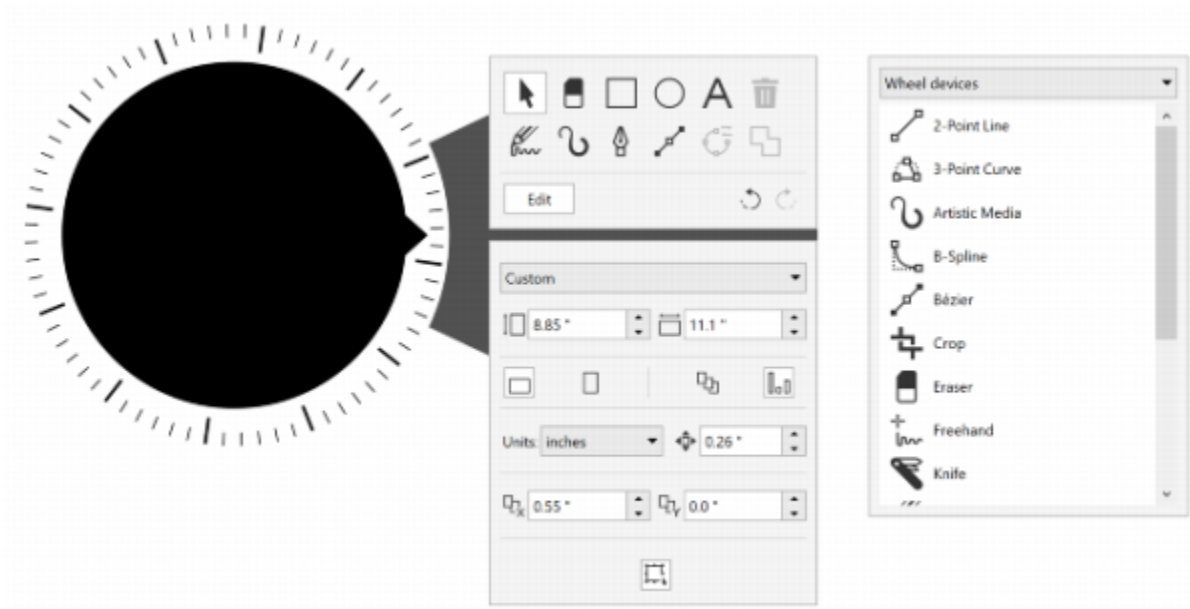

Add, remove, and rearrange tools to customize the Tool panel.

To use the LiveSketch tool with a wheel device in off-screen mode

- 1 In CorelDRAW, tap the **LiveSketch** tool in the toolbox.
- 2 Press down the wheel device to show the on-screen menu, rotate the wheel device to select **LiveSketch**, and click.
- 3 Start sketching, and do any of the following:
 - To undo or redo strokes, rotate the wheel device counterclockwise or clockwise.
 - To adjust a stroke instantly before the delay time has elapsed, click.

To use the LiveSketch tool with a wheel device in on-screen mode

- 1 In CorelDRAW, tap the **LiveSketch** tool in the toolbox.
- 2 Place the wheel device on the screen to show the on-screen menu.
- 3 Perform any of the tasks from the following table.

To

Adjust LiveSketch settings

Reset the timer and adjust strokes instantly

Do the following

Using a stylus or a mouse, select the control you want on the **Property** panel. To adjust values, rotate the wheel device clockwise or counterclockwise.

As you are sketching with the **LiveSketch** tool, click the wheel device when you want to finalize the stroke before the delay time has elapsed.

Without a wheel device, you can reset the time and adjust the strokes instantly by pressing **Enter**.

Lines, shapes, and outlines

- Working with lines, outlines, and brushstrokes..... 127
- Drawing shapes..... 167
- Shaping objects..... 179
- Symmetrical drawing..... 239

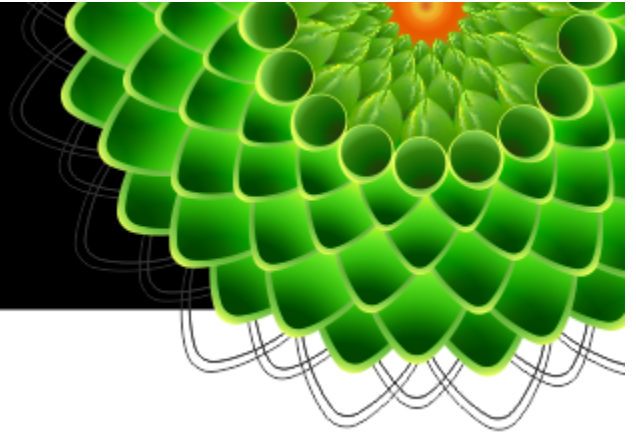

Working with lines, outlines, and brushstrokes

CorelDRAW lets you add lines and brushstrokes by using a variety of techniques and tools. After you draw lines or apply brushstrokes to lines, you can format them. You can also format the outlines that surround objects.

CorelDRAW provides preset objects that you can spray along a line. You can also create flow and dimension lines in drawings.

This section contains the following topics:

- “Drawing lines” (page 127)
- “Drawing calligraphic and preset lines” (page 136)
- “Sketching naturally with intelligent stroke adjustment” (page 138)
- “Formatting lines and outlines” (page 144)
- “Adding arrowheads to lines and curves” (page 149)
- “Copying, converting, and removing outlines” (page 151)
- “Applying brushstrokes” (page 153)
- “Applying brushstrokes that respond to pen pressure, tilt, and bearing” (page 154)
- “Spraying objects along a line” (page 156)
- “Drawing connector and callout lines” (page 158)
- “Drawing dimension lines” (page 161)
- “Using pressure-sensitive pens and devices” (page 164)



You can draw lines by using shape recognition. For more information, see “Drawing by using shape recognition” on page 176.

You can also draw lines with precision by using object coordinates. For more information, see “Using object coordinates to draw and modify objects” on page 264.

Drawing lines

A line is a path between two points. Lines can consist of multiple segments, and the line segments can be curved or straight. The line segments are connected by **nodes**, which are depicted as small squares. CorelDRAW provides various drawing tools that let you draw curved and straight lines, and lines containing both curved and straight segments.

Freehand and Polyline tools

The **Freehand**  and **Polyline**  tools let you draw freehand lines as if you were sketching on a sketchpad. If you make a mistake while drawing freehand curves, you can erase the unwanted part immediately and continue drawing. When drawing straight lines or segments, you can constrain them to straight vertical or horizontal lines.

The **Freehand** tool lets you control the smoothness of the curved line you are drawing as well as add segments to an existing line. However, the **Polyline** tool is easier to use for quickly drawing a complex line that consists of alternating curved and straight segments.



In addition to drawing freehand lines and straight segments, you can use the **Polyline** tool to draw circular arcs.

You can choose settings to control how the **Freehand** and **Polyline** tools behave. For example, you can change the default smoothness of a curved line that you've created with these tools.

2-point line tool

You can draw straight lines by using the **2-point line** tool. This tool also allows you to create straight lines that are perpendicular or tangent to objects.

Bézier and Pen tools

The **Bézier**  and **Pen**  tools let you draw lines one segment at a time by placing each node with precision and controlling the shape of each curved segment. When using the **Pen** tool, you can preview the line segments you are drawing.

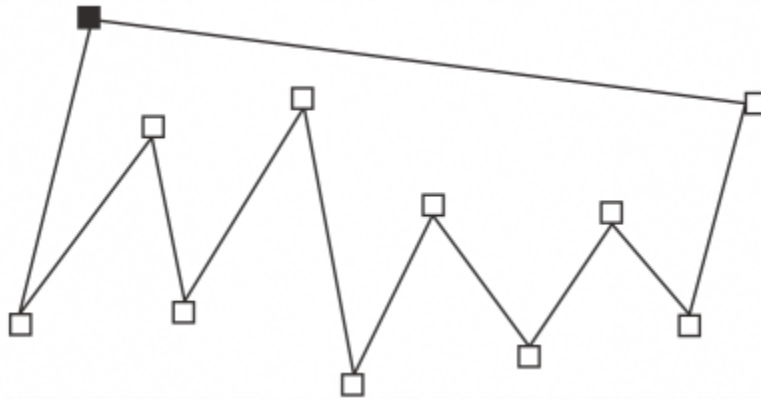

You can draw lines with multiple segments by using the Bézier tool and clicking each time you want the line to change direction.

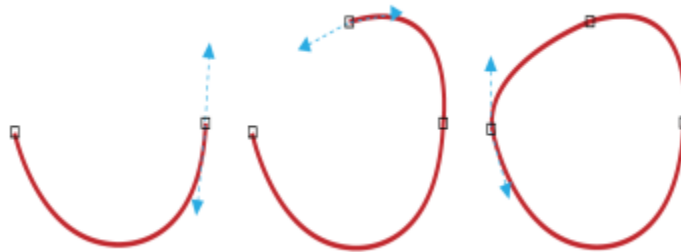

You can draw curves by using the Bézier tool and dragging the control handles at the ends of the Bézier curve.

B-spline tool

By using control points, you can easily shape a curved line and draw B-splines, which are typically smooth, continuous curved lines. B-splines touch the first and last control points and are pulled by the points in between. However, unlike the nodes on Bézier curves, control points don't let you specify the points through which a curve passes when you want to align a curve with other drawing elements.

The control points that touch the line are referred to as "clamped." Clamped control points function as anchors. The control points that pull the line but do not touch it are referred to as "floating." The first and last control points are always clamped on open-ended B-splines. The points in between float by default, but you can clamp points if you want to create **cusps** or straight lines within the B-spline. You can edit completed B-splines by using the control points.

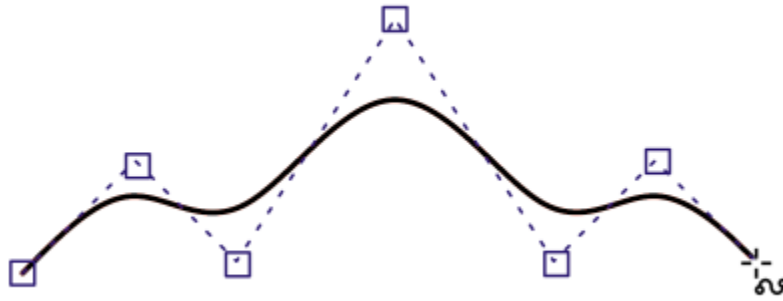

The path of a B-spline curve is determined by the control points you set.

3-point curve tool

The **3-point curve**  tool lets you draw simple curved lines by specifying their width and height. Use this tool to create arc shapes quickly without manipulating nodes.

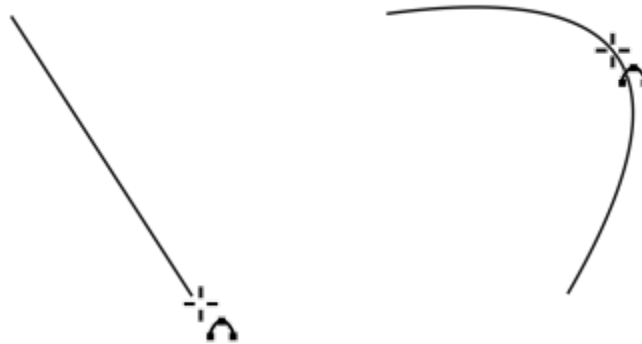

You can draw a curved line by specifying its width (left), and then specifying its height and clicking the page (right).

Smart drawing tool

The **Smart drawing** tool  lets you use shape recognition to draw straight and curved lines. For more information, see [“Drawing by using shape recognition”](#) on page 176.

Using nodes and control handles

Some lines have nodes and [control handles](#) that you can manipulate to shape lines as you draw. For information about node types, see [“Using curve objects”](#) on page 180.

Hiding the bounding box

When drawing lines by using the curve tools, you can hide the bounding box that is displayed around the lines once they are drawn. The curve tools include the **Freehand** tool, the **2-point line** tool, the **Bézier** tool, the **Artistic media** tool, the **Pen** tool, the **B-Spline** tool, the **Polyline** tool, and the **3-point curve** tool.

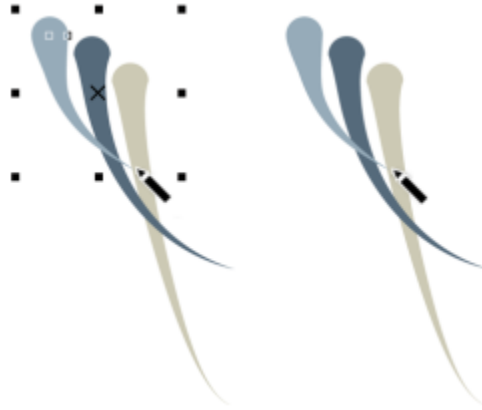

You can hide the bounding box to make drawing artistic media strokes in quick succession more fluid.

To draw a line by using the Freehand tool

- 1 In the toolbox, click the **Freehand** tool .
- 2 Perform a task from the following table.

To	Do the following
Draw a curved line	Click where you want to start the curved line, and drag.
Draw a straight line	Click where you want to start the line, and then click where you want the line to end.
Control the smoothness of a curved line	Type a value in the Freehand smoothing box on the property bar. Higher values produce smoother curves.
Reposition a line	Hold down both the left and right mouse buttons, and drag the line to a new position.
Place a copy of a line in the drawing	Hold down the right mouse button, and drag the line to a new position. Click Copy here .
Add line segments to an existing line	Click the end node of a selected line, and click where you want the new segment to end.
Create a closed shape from two or more connected lines	In a line that contains two segments, click the end node, and then click the start node.



You can constrain a line created with the **Freehand** tool to a predefined angle, called a constrain angle, by holding down **Ctrl** while you drag. This feature is useful for drawing straight vertical and horizontal lines. For information about changing the constrain angle, see [“To change the constrain angle” on page 308](#).

You can erase a portion of a curved freehand line by holding down **Shift** and dragging backward over the line before releasing the mouse button.

To draw a line by using the Polyline tool

- 1 In the toolbox, click the **Polyline** tool .
- 2 Do one of the following:
 - To draw a straight segment, click where you want to start the line segment, and then click where you want to end it.
 - To draw a curved segment, click where you want to start the segment, and drag across the drawing page.You can add as many segments as you want and alternate between curved and straight segments.
- 3 Double-click to end the line.

You can also

Reposition a line while drawing

Hold down both the left and right mouse buttons, and drag the line to a new position.

Place a copy of a line in the drawing

Hold the right mouse button, and drag the line to a new position. Click [Copy here](#).



You can close an open object by clicking the **Close curve** button  on the property bar.

To draw an arc by using the Polyline tool

- 1 In the toolbox, click the **Polyline** tool .
- 2 Click in the drawing window, and then release the mouse button.
- 3 Hold down **Alt**, and move the pointer to create an arc.
- 4 Do one of the following:
 - Click to finish the arc, and release **Alt** to return to freehand drawing.
 - Click to finish the arc, and, without releasing **Alt**, move the pointer to draw another arc.
- 5 Double-click to end the line.



You can hold down **Ctrl** in conjunction with **Alt** to constrain the arc to 15-degree increments or another predefined angle, called a constrain angle. For information about changing the constrain angle, see [“Constraining objects” on page 307](#).

To draw a straight line by using the 2-point line tool

- 1 In the toolbox, click the **2-point line** tool .
- 2 Point to where you want to start the line, and drag to draw the line.

As you drag, the length and angle of the segment appears in the status bar. If you're adding to a line, the total length for all segments also appears.

To draw a perpendicular line

- 1 In the toolbox, click the **2-point line** tool .

- 2 On the property bar, click the **Perpendicular 2-point line**  button.
- 3 Click the edge of an object, and drag to where you want the line to end.
If you want to draw a line that is perpendicular to two objects, drag to the edge of the second object, and release the mouse button when the perpendicular snap point appears.

To extend the line beyond the second object, hold down **Ctrl** when the perpendicular snap point appears, and drag to where you want the line to end.



This procedure cannot be used for drawing a line that is perpendicular to the baseline of a text object.



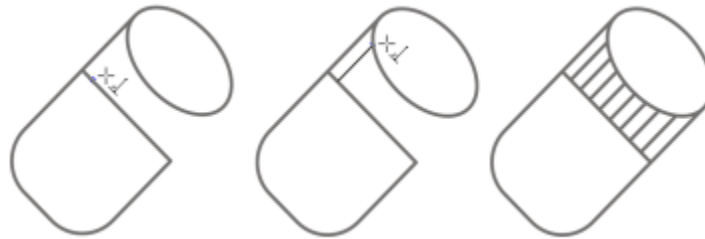

You can also drag from an existing curve to draw a perpendicular line.



Drawing perpendicular lines

To draw a tangent line

- 1 In the toolbox, click the **2-point line** tool .
- 2 On the property bar, click the **Tangential 2-point line** button .
- 3 Click the edge of a curved segment in an object, and drag to where you want the tangent line to end.
If you want to draw a line that is tangent to two objects, drag to the edge of the second object, and release the mouse button when the tangent snap point appears. When the quadrant snap point coincides with tangent snap point, the quadrant snap point appears.

To extend the line beyond the second object, hold down **Ctrl** when the tangent snap point appears, and drag to where you want the line to end.



The **Tangential 2-point line** mode can be used for drawing the sides of the cylinder.

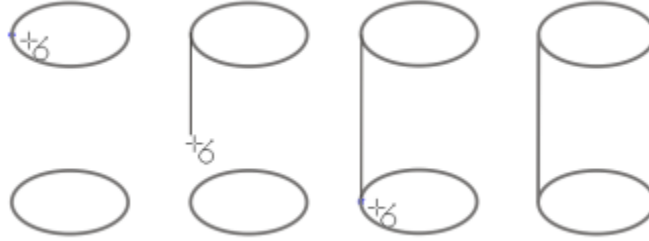

Drawing tangent lines

To draw a line by using the Bézier tool

- 1 In the toolbox, click the **Bézier tool** .
- 2 Do one of the following:
 - To draw a curved segment, click where you want to place the first node, and drag the control handle to where you want to place the next node. Release the mouse button, and drag the control handle to create the curve.
 - To draw a straight segment, click where you want to start the line segment, and click where you want to end it.
 You can add as many segments as you want.
- 3 Press the **Spacebar** to finish the line.

You can also

Draw a curved segment followed by a straight segment

Draw a curved segment, double-click the end node, and click where you want the straight segment to end.

Draw a straight segment followed by a curved segment

Draw a straight segment. Click the endpoint of the segment, drag to where you want, and release the mouse button. Drag to draw a curve.

Change curve angle to preset increments as you draw

While holding down **Ctrl**, drag a control handle.

To draw a line by using the Pen tool



- 1 In the toolbox, click the **Pen tool** .
- 2 Do one of the following:
 - To draw a curved segment, click where you want to place the first node, and drag the control handle to where you want to place the next node. Release the mouse button, and drag the control handle to create the curve you want.
 - To draw a straight segment, click where you want to start the line segment, and click where you want to end it.
 You can add as many segments as you want and alternate between curved and straight segments. For more information about alternating curved and straight segments, see ["To draw a line by using the Bézier tool" on page 133](#).
- 3 Double-click to finish the line.

You can also

Preview a line while drawing

Enable the **Preview mode** button in the property bar. Click on the drawing page, and release the mouse button. Move the mouse, and click to finish the line.

Add a node to a line

Enable the **Automatically add or delete nodes** button  on the property bar. Point to where in the line you want to add a node, and click when the pointer changes to the **Add nodes** state .

Delete a node from a line

Point to a node, and click when the pointer changes to the **Delete nodes** state .

To draw a B-spline



- 1 In the toolbox, click the **B-spline** tool .
- 2 Click where you want to start the line.
- 3 Click to set as many control points as you need to shape your line.
Control points float by default, but you can clamp control points to the line by pressing **V** while clicking.
- 4 Double-click to finish the line.
Pressing **Esc** cancels the line instead of finishing it.

You can also



Reshape the line by using control points

Select the line by using the **Shape** tool , and reposition the control points to reshape the line.

Float a control point

Select the line by using the **Shape** tool , click a clamped control point, and click the **Make control point floating** button  on the property bar.

Clamp a control point

Select the line by using the **Shape** tool , click a floating control point, and click the **Make control point clamped** button  on the property bar.

Add a control point

Select the line by using the **Shape** tool , and double-click along a control line.

Delete a control point

Select the line by using the **Shape** tool , and double-click the control point that you want to delete.

You can also

Select multiple control points

Select the line by using the **Shape** tool , and hold down **Shift** while you click on the control points that you want to select.



If you add to a B-spline by selecting the first or last control point, the clamped control point automatically changes to a floating control point as you draw the new portion of the line.



You can also add control points while you draw a B-spline by pressing **Spacebar** instead of clicking.

To draw a curve by using the 3-point curve tool

- 1 In the toolbox, click the **3-point curve** tool .
- 2 Click where you want to start the curve, and drag to where you want the curve to end.
- 3 Release the mouse button, and click where you want the center of the curve to be.

You can also

Draw a circular curve

Hold down **Ctrl** while dragging.

Draw a symmetrical curve

Hold down **Shift** while dragging.

To set options for the Freehand and Bézier tools

- 1 Click **Tools** ► **Options**.
- 2 In the **Workspace** list of categories, click **Toolbox**, and then click **Freehand/Bézier** tool.
- 3 Move the **Freehand smoothing** slider to set the default smoothness for curved lines.

Higher values produce smoother curves.



Double-click the **Freehand** or **Bézier** tool to display the **Freehand/Bézier** page in the **Options** dialog box.

To hide the bounding box when using curve tools

- 1 In the toolbox, click one of the following curve tools:
 - **Freehand**
 - **2-point line**
 - **Bézier**
 - **Artistic Media**
 - **Pen**
 - **B-Spline**
 - **Polyline**

- 3-point curve

2 Click the **Bounding box** button  on the property bar.



When you hide the bounding box while working with one curve tool, the bounding box remains hidden for all curve tools. For example, if you hide the bounding box when using the **Freehand** tool, it remains hidden when you switch to the **Bézier** tool.



You can also hide the bounding box by clicking **Tools** ► **Options**, clicking **Display** in the **Workspace** list of categories, and then enabling the **Hide bounding box for curve tools** check box.

Drawing calligraphic and preset lines

CorelDRAW lets you simulate the effect of a calligraphic pen when you draw lines. Calligraphic lines vary in thickness according to the direction of the line and the angle of the pen nib. By default, calligraphic lines appear as closed shapes drawn with a pencil. You can control the thickness of a calligraphic line by changing the angle of the line you draw in relation to the **calligraphic angle** you choose. For example, when the line you draw is perpendicular to the calligraphic angle, the line is at the maximum thickness specified by the pen width. Lines drawn at the calligraphic angle, however, have little or no thickness.



A calligraphic pen allows you to draw lines of various thicknesses.

CorelDRAW lets you create pressure-sensitive lines which vary in thickness. For more information, see “Applying brushstrokes that respond to pen pressure, tilt, and bearing” on page 154.



A flower drawn by using three different artistic media lines: calligraphic lines (left), pressure-sensitive lines of variable thickness (center), and flat preset lines (right).

CorelDRAW provides preset lines that let you create thick strokes in a variety of shapes. After you draw a calligraphic or preset line, you can apply a fill to it as you would to any other object. For information about applying fills, see “Applying fills to objects” on page 367.

To draw a calligraphic line

- 1 In the toolbox, click the **Artistic media** tool .
- 2 Click the **Calligraphic** button  on the property bar.
- 3 Type a value in the **Calligraphic angle** box on the property bar.
- 4 Drag until the line is the shape you want.

You can also

Set the width of the line

Type a value in the **Stroke width** box on the property bar.

Smooth the edges of the line

Type a value in the **Freehand smoothing** box on the property bar.



Apply transformations to line thickness when scaling

Click the **Scale stroke with object**  button on the property bar.



The width you set is the maximum line width. The angle of the line you draw in relation to the calligraphic angle determines the line's actual width.

To draw a preset line

- 1 In the toolbox, click the **Artistic media** tool .
- 2 Click the **Preset** button  on the property bar.
- 3 Choose a preset line from the **Preset stroke** list box.
- 4 Drag until the line is the shape you want.

You can also

Set the width of the line

Type a value in the **Stroke width** box on the property bar.

Smooth the edges of the line

Type a value in the **Freehand smoothing** box on the property bar.

Apply transformations to line thickness when scaling

Click the **Scale stroke with object**  button on the property bar.



You can also choose preset lines from the **Artistic media** docker. You can open the **Artistic media** docker by clicking **Effects** ► **Artistic media**.

Sketching naturally with intelligent stroke adjustment

The **LiveSketch** tool offers the simplicity and speed of freehand sketching combined with intelligent stroke adjustment and vector drawing. As you sketch, CorelDRAW analyses the properties, temporal order, and spacial proximity of your **input strokes**, adjusts them, and converts them into **Bézier curves**.

Perfect for quick sketches and drawings, the **LiveSketch** tool speeds up your workflow and allows you to focus on the creation process. Instead of being preoccupied with nodes and handles and switching between tools, you can let your creativity flow and achieve the desired result quickly and effectively. There is no need to scan your sketches and trace them any more. You can sketch out your design concepts and ideas using vector curves right from the get-go.



Whether you have great sketching skills or you are just learning to sketch, CorelDRAW can adjust your strokes and help you quickly move your ideas from imagination to reality. Artwork by Andrew Stacey.

CorelDRAW supports the most common drawing styles: discrete overlapping strokes, folded strokes (scribbling back and forth across the surface, with lines doubling back on each other), chicken scratch (drawing short lines rapidly one after the other to build long lines and large forms).

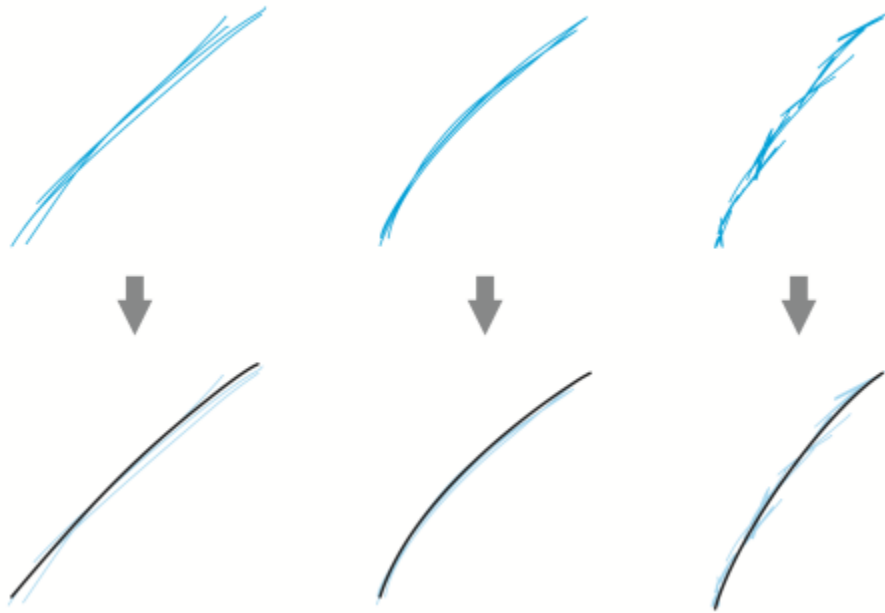

Strokes before (top) and after (bottom) stroke adjustment: discrete overlapping strokes (left), folded strokes (middle), chicken scratch (right)

To make the most of the **LiveSketch** tool, use a stylus and customize CorelDRAW to fit your sketching style.

You can specify the time it takes to activate stroke adjustment after you draw one or more strokes. For example, if you set the timer to one second and make a few strokes, stroke enhancement will take effect one second after you finish drawing the strokes. The timer creates a temporal window within which the discrete strokes that you make are analysed and converted into curves. Experiment with the timer to find a setting that best matches your sketching speed and style. If you use multiple small strokes to build up a bigger line, set a short delay time to create your curves right away and develop a sketching cadence. Alternatively, increase the delay time to 5 seconds and take advantage of the live preview to see your **input strokes** and build upon them. Setting a longer delay period also gives you more time to manipulate your lines.

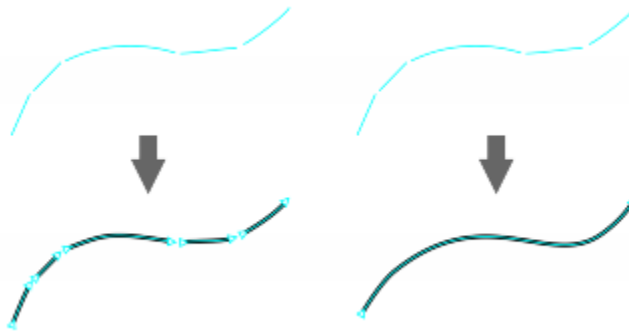

With the timer set to 0 milliseconds (left), successive strokes are converted into discrete curves. With the timer set to 1 second (right), successive strokes are joined into a single curve.

You can reset the timer and adjust the strokes before the specified time has elapsed. You can also delete strokes before they have been adjusted.

As your composition progresses, you may want to re-draw existing lines to change their position and shape or simply to refine them. CorelDRAW lets you modify existing curves by including them into your sketch as new **input strokes**. You can specify the width of the

editable area around previously drawn curves. When you sketch within this area, the existing curves are processed along with the other input strokes and are readjusted; when you sketch outside the specified distance, your input strokes are added as new objects.

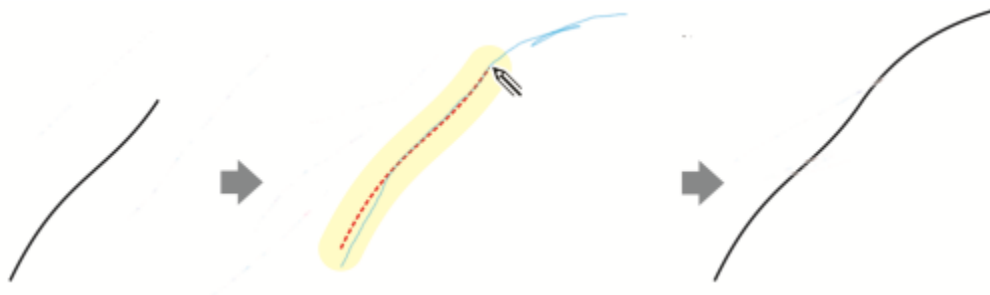

An existing stroke (left); A new stroke (in blue) is created close to the existing curve (middle); The existing stroke is extended and readjusted (right.)

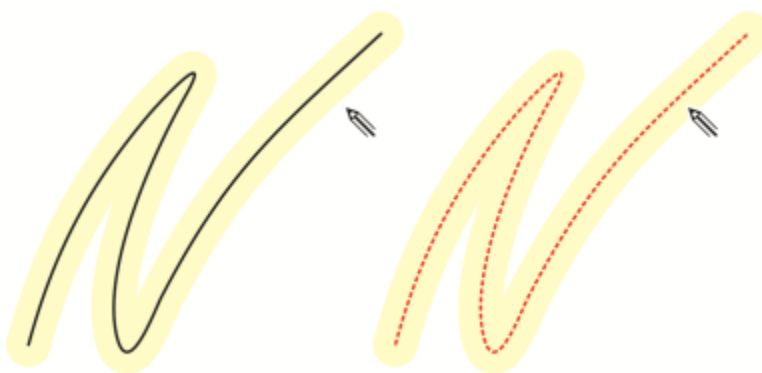

When you move the pointer inside the editable area of an existing curve, the curve is highlighted to indicate that you can modify it.

If you need to sketch very close to existing lines or draw over strokes to reinforce them, you can disable proximity-based stroke adjustment temporarily or permanently so that strokes are added as separate objects.

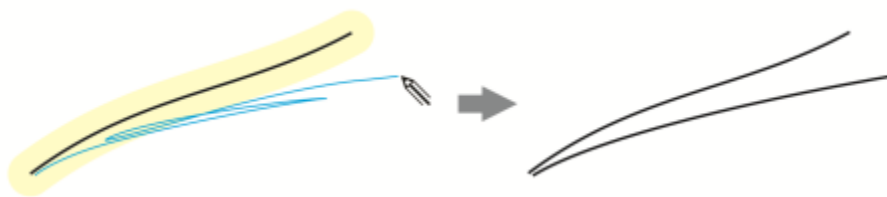

Disable proximity-based stroke grouping to keep your strokes as separate objects.

When you include an existing curve into a sketch, the resulting curve inherits the properties of the existing curve.



A curve created with the Artistic Media tool (left); The new stroke drawn with the LiveSketch tool is within the proximity threshold of the existing stroke (middle); The resulting stroke takes on the properties of the existing curve (right.)

At times, you may need to define the entire extent of a shape or an object with a single curve. It can be difficult, however, to maintain smooth lines for a long distance or over a long curve without lifting the stylus off the tablet or releasing the mouse button. CorelDRAW can help you work with continuous lines by creating a seamless curve from strokes that you draw within the specified time interval.

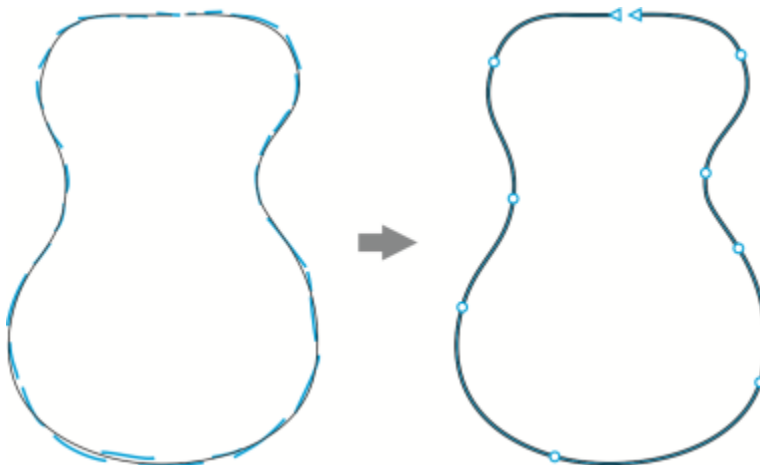

An example of an object created from strokes joined into a single curve.

Note that CorelDRAW processes only the input strokes that are within the specified delay time, so you may have to adjust the timer depending on your sketching speed.

As more and more of your sketch is laid down, and you start to improve the accuracy and appearance of the lines, you may need to erase existing curves or portions of curves. You can easily switch to erase mode by flipping the stylus (provided your stylus or pen has an eraser end) and then switch back to sketching mode by flipping the stylus again. Note that if a curve is selected, you erase only portions of that curve. If you want to erase any part of your drawing, make sure you deselect all objects before you use the stylus eraser. For information about deselecting objects, see [“To deselect objects” on page 256](#). When your stylus doesn't have an eraser end or you work with a mouse, you can erase curves with the **Eraser** tool. For more information about erasing Bézier curves, see [“To erase an image area” on page 220](#).

By default, CorelDRAW shows a representation of the adjusted stroke while you are drawing. If you find the live preview too distracting, you can hide it.

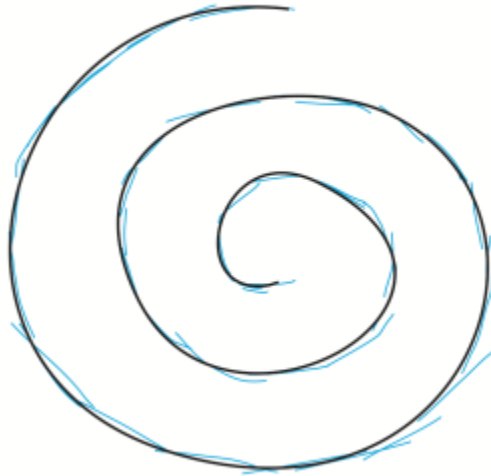

In preview mode, CorelDRAW displays the adjusted stroke (in black) before the delay time has elapsed and the input strokes (in blue) have been processed.

You can control the amount of smoothing applied to curves.

To sketch with the LiveSketch tool

- 1 In the toolbox, click the LiveSketch  tool.
- 2 Adjust any of the settings on the property bar.
- 3 Sketch in the document window.



You can also access the LiveSketch  tool by pressing **S** on your keyboard.

To set a delay before input strokes are adjusted

- Move the **Timer** slider.



By default, the delay is 1000 milliseconds or 1 second. The minimum delay is 0 milliseconds; the maximum is 5 seconds.

Clicking a different tool before the specified delay time has elapsed implements stroke adjustment.



Press **Enter** to reset the timer and adjust the strokes before the delay time has elapsed.

Press **Esc** to delete an input stroke before it has been adjusted.

Setting a longer delay period gives you more time to manipulate your lines.

To readjust an existing curve

- 1 Click the **Include curves**  toggle button on the property bar to enable it.

- 2 Move the **Distance from curve** slider to set the distance at which existing curves are included into a sketch as new input strokes.
- 3 Sketch over an existing stroke to modify it.



To disable proximity-based stroke adjustment temporarily, hold down **Shift** and make one or more strokes.

To disable proximity-based stroke enhancement permanently, click the **Include curves**  toggle button on the property bar.



By default, the distance threshold is 5 pixels. The minimum value is 0 pixels; the maximum is 40 pixels.

To create a single curve from strokes

- 1 Click the **Create single curve**  button on the property bar to allow **input strokes** to be converted into one continuous line.
- 2 Sketch in the document window.



For best results, set a longer delay time. CorelDRAW processes only strokes that are within the specified delay time.

To erase a curve

- 1 Perform a task from the following table.

To	Do the following
Erase an area in a drawing	Deselect all objects on the drawing page.
Erase portions of a curve	Select the curve. Note: The last curve that you draw before you lift the stylus off the tablet is automatically selected by default.

- 2 Flip the stylus to automatically switch to erase mode, and stroke over the unwanted areas.



To erase a curve or portions of a curve when your stylus doesn't have an eraser end or when using a mouse, select the curve, click the **Eraser**  tool in the toolbox, and drag where you want to erase.

You can change the size and shape of the eraser nib. For information, see ["To erase an image area" on page 220](#).

To show or hide a preview of the resulting curve

- Click the **Preview mode**  button on the property bar.

To control curve smoothness

- Type a value in the **Curve smoothing** box on the property bar.



Higher values produce smoother curves.

Formatting lines and outlines

Lines are treated the same way as outlines of closed shapes, such as ellipses and polygons. In some programs, outlines are known as strokes or thick lines.

You can change the appearance of both lines and [outlines](#) by using the controls in the **Outline** section of the **Object properties** docker, the **Outline pen** dialog box, and the property bar. For example, you can specify the color, width, and style of lines and outlines. The preset line styles available in CorelDRAW are solid or dashed.

Corners and ends

You can choose a corner style to control the corner shape in lines and a line cap style to change the appearance of a line's endpoints.

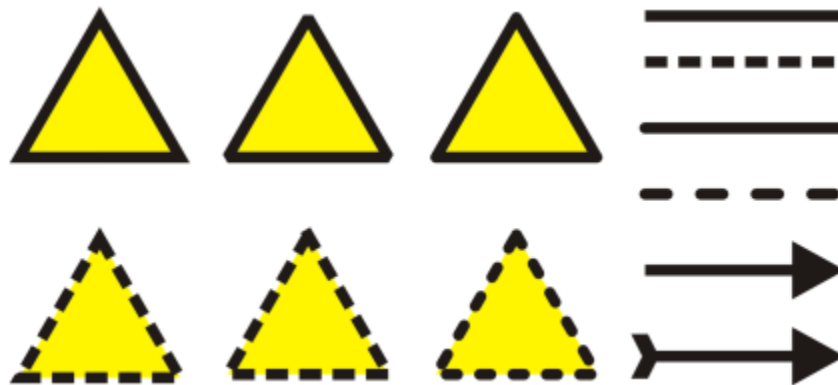

Different corner styles were applied to the upper and lower row of triangles. Different line caps were applied to the lines in the upper-right corner. Arrowheads were applied to the lines in the lower-right corner.

With dashed lines and outlines, the **Default dashes** option applies the dashes along the line and outline without any adjustments in the corners and endpoints. However, you can control the appearance of dashes in the end and corner areas by using two additional options. The **Align dashes** option aligns dashes with the end and corner points so that there is no empty space in the corners and at the start and end of a line or outline. The **Fixed dashes** options creates dashes of fixed length in the end and corner points.

Miter limit

You can set the miter limit to determine the corner shape in objects containing lines that meet at sharp angles. Corners with angles above the miter limit are pointed (mitered); corners with angles below the miter limit are beveled (squared off).

Behind fill, Scale with object, and Overprint outline settings

By default, an outline is applied on top of an object's fill, but you can apply it behind the fill, with the fill overlapping the outline. You can also link the outline thickness to an object's size so that the outline increases when you increase the object's size and decreases when you decrease the object's size. In addition, you can set the outline to print on top of underlying colors, without removing them during printing.

Outline position

You can specify the position of the outline by placing it outside or inside the object, or centering it so that it overlaps equally the outside and the inside of an object. The effect of outline position options are more obvious with thick outlines.

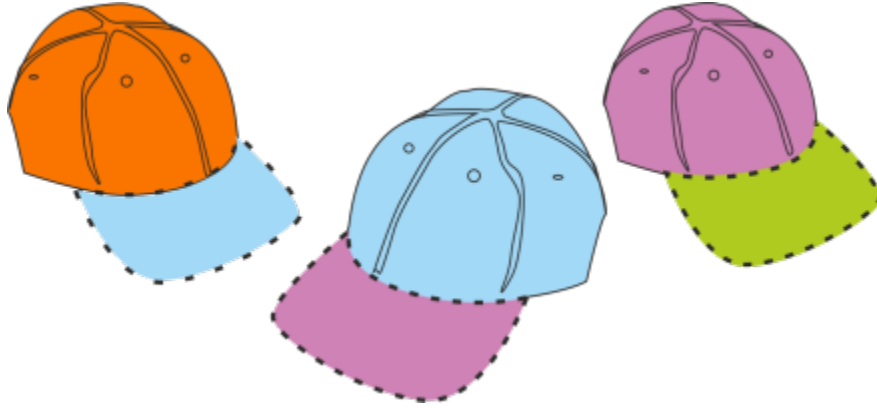

You can specify the position of the outline. Outline options from left to right: Outside, Centered, Inside.

Line styles and calligraphic outlines

You can create custom line styles, and you can edit the available preset line styles.

In addition, you can create calligraphic outlines. A calligraphic outline varies in thickness, creating the effect of a hand-made drawing.

Default line and outline properties

The default line and outline properties for each new object that you draw are as follows:

- black color
- solid line
- square corner and line cap styles
- centered outline
- no arrowheads applied
- outline applied on top of an object's fill
- outline not linked to an object's size.

However, you can change any of these default line and outline properties at any time.

Cutable outlines

To create a cutable outline for devices such as plotters, vinyl cutters and Print-Cut devices, you need to assign the appropriate predefined color name (usually CutContour) that is specified by the device manufacturer.

Note that cutable outlines do not print when identified by the RIP or Print-Cut device. If you want to make the outlines printable, you can use the **Object** ► **Shaping** ► **Boundary** command. For more information, see [“To create a boundary around selected objects” on page 264](#).

To change the color of a line or an outline

- 1 Select a line or an object that has an outline.
- 2 Right-click a color on the onscreen color palette.

To specify line and outline settings

- 1 Select an object.
- 2 Click **Window** ► **Dockers** ► **Object properties**.
- 3 In the **Outline** section, type a value in the **Width** box.
If the **Outline** section is not displayed, click **Outline**.

If you want to change the color, open the color picker, and click a color.

4 Choose a line style from the **Style** box.



You can also

Change the units of measurement for the outline width

Set the shape of corners

Choose a unit of measurement from the **Outline units** box.

Click one of the following buttons:



- **Mitered corners**  — creates pointed corners
- **Round corners**  — creates rounded corners
- **Beveled corners**  — creates squared off corners



Corners from left to right: Mitered, rounded, and beveled.

Set the appearance of endpoints in open paths

Click one of the following buttons:



- **Square cap**  — creates square end shapes
- **Round cap**  — creates rounded end shapes
- **Extended square cap**  — creates square end shapes that extend the length of the line



Line caps from left to right: Square cap, Extended square cap, and Round cap.

Control the corners and end points of dashed lines and outlines

Click one of the following buttons:

- **Align dashes** button  — aligns the dashes with the end and corner points of lines and outlines
- **Fixed dashes** button  — creates dashes of fixed length in the corners and ends. These dashes are half the length of the first dash in the dashed line pattern.

Tip: The **Default dashes** button  , which is enabled by default, spreads evenly dashes along the line or outline without making any adjustments.

You can also

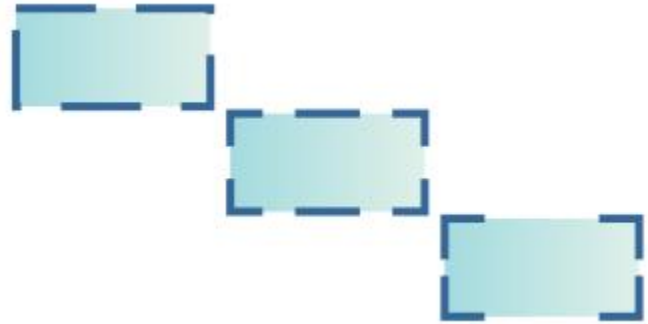

Dashed line options from top to bottom: Default dashes, Align dashes, and Fixed dashes.

Set the miter limit for lines that meet at sharp angles



Type a value in the Miter limit box.



Lines meet at the same sharp angle. Left: The angle exceeds the miter limit, creating a pointed corner. Right: The angle is below the miter limit, creating a beveled corner.

Specify the outline position

Click one of the following buttons:

- **Outside outline**  — places the outline outside the object
- **Centered outline**  — centers the outline along the object edge
- **Inside outline**  — places the outline inside the object

Apply an outline behind an object's fill

Enable the **Behind fill** check box.

If this check box is not displayed, click the arrow button at the bottom of the **Outline** section.

You can also



The *Behind fill* check box is disabled (left) and enabled (right).

Link the outline thickness to an object's size

Enable the **Scale with object** check box.

If this check box is not displayed, click the arrow button at the bottom of the **Outline** section.

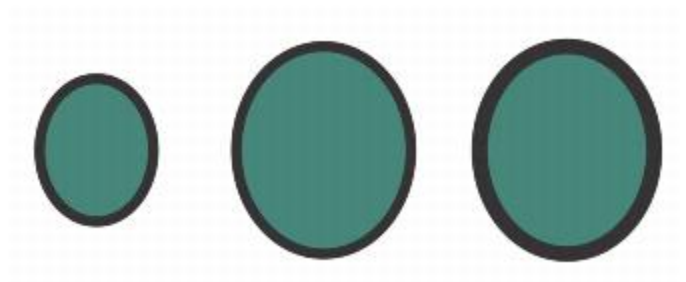

Left to right: Original object; scaled object with *Scale with object* disabled — there is no change in the outline thickness; scaled object with *Scale with object* enabled.

Set the outline to print on top of underlying colors during printing

Enable the **Overprint outline** check box.

If this check box is not displayed, click the arrow button at the bottom of the **Outline** section.



You can also specify line and outline settings in the **Outline pen** dialog box. To access the **Outline pen** dialog box, double-click the **Outline** icon  on the status bar or press F12.

You can also change the outline width of a selected object by typing a value in the **Outline width** box on the property bar.

To create or edit a line style

- 1 Select an object.
- 2 In the **Outline** section of the **Object properties** docker (**Window** ► **Dockers** ► **Object properties**), perform a task from the following table.

To

Do the following

Create a line style

Click the **Settings** button , and move the slider in the **Edit line style** dialog box. By clicking the boxes to the left of the slider, you

To

Do the following



can specify the placement and frequency of the dots in the new line style you create. Click **Add**.

Edit a line style

Choose a line style from the **Style** list box, and click the **Settings** button . Create a line style in the **Edit line style** dialog box, and click **Replace**.

To create a calligraphic outline

- 1 Select an object.
- 2 Click **Window** ▶ **Dockers** ▶ **Object properties**.
- 3 In the **Outline** section, click one of the following buttons to set the shape of corners:

- Mitered corners 
- Round corners 
- Beveled corners 

If the **Outline** section is not displayed, click **Outline**.

- 4 Type a value in the **Stretch** box to change the width of the pen's nib.

If the **Stretch** box is not displayed, click the arrow button at the bottom of the **Outline** section.

The value range is from 1 to 100, with 100 as the default setting. Reducing the value makes square nibs rectangular and round nibs oval, creating a more pronounced calligraphic effect.

- 5 Type a value in the **Tilt nib** box to change the orientation of the pen in relation to the drawing surface.

To reset the **Stretch** and **Tilt nib** values to their original values, click the **Default** button.



You can also create a calligraphic outline in the **Outline pen** dialog box. To access the **Outline pen** dialog box, double-click the **Outline** icon  on the status bar.

You can also adjust the **Stretch** and **Angle** values by dragging in the **Nib shape** preview box.

To set the line and outline properties for new objects

- 1 Using the **Pick** tool, click on an empty space in the drawing window to deselect all objects.
- 2 Double-click the **Outline** icon  on the status bar.
- 3 In the **Change document defaults** dialog box, enable the check boxes for the objects and text whose default settings you want to change, and click **OK**.
- 4 Specify the settings you want in the **Outline pen** dialog box.

Adding arrowheads to lines and curves

Arrowheads let you enhance the starting points and endpoints of lines and curves. You can specify the attributes of an arrowhead with precision. For example, you can define the exact size of an arrowhead as well as offset or rotate the arrowhead by a precise amount. You can also flip arrowheads vertically and horizontally. You can save your specified attributes as arrowhead presets for later use.

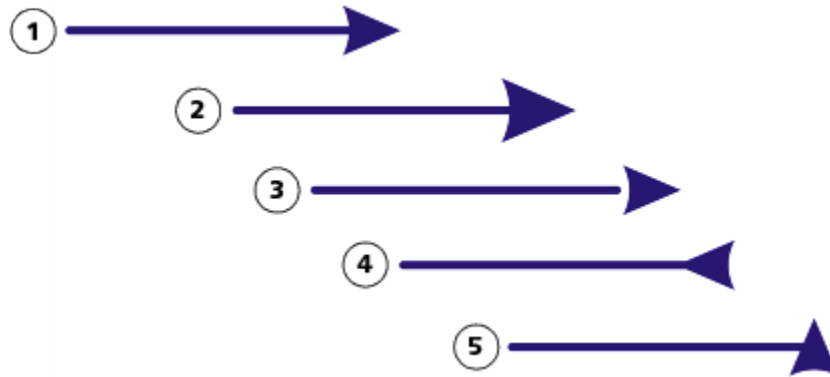

Arrowhead in its original form (1), resized (2), with offset of 6 0% along the x-axis (3), flipped horizontally (4), and rotated at 90 degrees (5).

You can edit existing arrowhead presets, and you can create an arrowhead preset based on an existing one. You can also create an arrowhead preset based on an object such as a curve or a closed shape. When you no longer need an arrowhead preset, you can delete it.

To add an arrowhead



- 1 Select a line or curve.
- 2 Open the **Start arrowhead** picker on the property bar, and click a line-ending shape.
- 3 Open the **End arrowhead** picker, and click a line-ending shape.



You can remove an arrowhead by choosing the **No arrowhead** preset from the **Start arrowhead** or **End arrowhead** picker.

You can also add arrowheads from the **Outline pen** dialog box or the **Outline** section of the **Object properties** docker.

To specify the arrowhead attributes of a line or curve

- 1 Using the **Pick tool** , select a line or curve that has an arrowhead.
- 2 Click **Window** ► **Dockers** ► **Object properties**.
- 3 In the **Outline** section, click the **Arrowhead settings** button  next to the **Start arrowhead** picker or the **End arrowhead** picker, and click **Attributes**.
If the **Outline** section is not displayed, click **Outline**. If the **Arrowhead settings** button is not displayed, click the arrow at the bottom of the **Outline** section.
If you want starting and ending arrowheads to have the same size, offset, rotation angle, and orientation, enable the **Share attributes** check box.
- 4 In the **Arrowhead attributes** dialog box, perform any of the tasks in the following table.

To

Do the following

Specify the size of an arrowhead

In the **Size** area, type a value in the **Length** or **Width** box.

If you want to create a nonproportional arrowhead, disable the **Proportional** check box.

Offset an arrowhead

In the **Offset** area, type values in the X and Y boxes.

To	Do the following
Mirror an arrowhead	In the Mirror area, enable the Horizontally or Vertically check box.
Rotate an arrowhead	Specify an angle in the Rotation box.
Save custom arrowhead attributes as an arrowhead preset	Enable the Save as arrowhead preset check box. You can access the new arrowhead preset from the Start arrowhead and End arrowhead pickers on the property bar.



You can switch arrowheads from one end of a line or curve to another by clicking the **Arrowhead settings** button, and clicking **Swap**.

You can remove an arrowhead from a line or curve by clicking the **Arrowhead settings** button and clicking **None**.

To edit an arrowhead preset

- 1 Using the **Pick tool** , select an object that has an arrowhead.
- 2 Click **Window** ► **Dockers** ► **Object properties**.
- 3 In the **Outline** section, click the **Arrowhead settings** button next to the **Start arrowhead** picker or the **End arrowhead** picker, and click **Edit**.
If the **Outline** section is not displayed, click **Outline**. If the **Start arrowhead** picker is not displayed, click the arrow at the bottom of the **Outline** section.
- 4 In the **Arrowhead attributes** dialog box, specify the attributes you want.



You can create an arrowhead preset that is based on an existing preset. Click **Arrowhead settings** button, and click **New**. Then, specify the attributes you want in the **Arrowhead attributes** dialog box, and type a preset name in the **Save arrowhead** area.

To delete an arrowhead preset, select the preset from the **Start** or **End arrowhead** picker, click the **Arrowhead settings** button, and click **Delete**.

To create an arrowhead preset from an object

- 1 Select an object to use as an arrowhead.
- 2 Click **Tools** ► **Create** ► **Arrowhead**.
- 3 In the **Create arrowhead** dialog box, type a value in the **Length** box or **Width** box.



If you want to create a nonproportional arrowhead, disable the **Proportional** check box, and type values in both the **Length** and **Width** boxes.

Copying, converting, and removing outlines

CorelDRAW lets you copy outline properties to other objects.

You can also convert an outline to an object, and you can remove an outline. Converting an outline to an object creates an unfilled closed object with the outline's shape. You can apply fills and special effects to the new object.

To copy outline properties to another object

- 1 Using the Pick tool , select the object that has the outline you want to copy.
- 2 With the right mouse button, drag the source object over the target object, to which you want to apply the outline. A blue outline of the original object follows the pointer to the new object.
- 3 When the pointer changes to a crosshair pointer , release the mouse button, and choose **Copy outline here** from the context menu.



You can also use the **Attributes eyedropper**  tool to copy outline properties. For more information, see [“To copy fill, outline, or text properties from one object to another” on page 272](#).

You can also sample the color of an existing object and apply the sampled color to the outline of another object. For more information, see [“To sample a color” on page 355](#).

To convert an outline to an object

- 1 Select an object.
- 2 Click **Object** ► **Convert outline to object**.

The outline becomes an unfilled closed object independent of the original object’s fill. If you want to apply a fill to the new object, the fill is applied to the area, which was the original object’s outline.



A star with an outline applied (left); the outline has been converted to an object independent of the original fill (center); a fountain fill was applied to the new closed object.



You can also convert an outline to an object by pressing **Ctrl + Shift + Q**.

To remove the outline of an object

- 1 Select an object.
- 2 On the property bar, choose **None** from the **Outline width** list box.



You can also remove an object’s outline by selecting the object and right-clicking the **No color** swatch  on the color palette.

Applying brushstrokes



CorelDRAW lets you apply a variety of preset brushstrokes, ranging from strokes with arrowheads to ones that are filled with rainbow patterns. When you draw a preset brushstroke, you can specify some of its attributes. For example, you can change the width of a brushstroke and specify its smoothness.

You can also create custom brushstrokes by using an object or a group of [vector objects](#). When you create a custom brushstroke, you can save it as a preset.



The above image was created by using many different brushstrokes and widths.

To apply a preset brushstroke

- 1 In the toolbox, click the **Artistic media** tool .
- 2 Click the **Brush** button  on the property bar.
- 3 Choose a brush category from the **Category** list box.
- 4 Choose a brushstroke from the **Brushstroke** list box.
- 5 Drag until the stroke is the shape you want.

You can also

Set the width of the brushstroke

Type a value in the **Stroke width** box on the property bar.

Smooth the edges of the brushstroke

Type a value in the **Freehand smoothing** box on the property bar.

Apply transformations to brushstroke thickness when scaling



Click the **Scale stroke with object**  button on the property bar.



If you have access to a brushstroke that isn't listed in the **Brushstroke** list box, you can apply it by clicking the **Browse** button on the property bar and locating the brushstroke file.

You can also choose brushstrokes from the **Artistic media** docker. You can open the **Artistic media** docker by clicking **Effects** ► **Artistic media**.

To create a custom brushstroke

- 1 Select an object or a set of grouped objects.
- 2 In the toolbox, click the **Artistic media** tool .
- 3 Click the **Brush** button on the property bar.
- 4 Click the object or grouped objects.
- 5 Click the **Save artistic media stroke** button  on the property bar.
- 6 Type a filename for the brushstroke.
- 7 Click **Save**.



Custom brushstrokes can be accessed from the property bar by choosing **Custom** from the **Category** list box. The custom brushstrokes display in the **Brushstroke** list box.



To delete a custom brushstroke, choose **Custom** from the **Category** list box on the property bar, choose the brushstroke from the **Brushstroke** list box, and click the **Delete** button .

Applying brushstrokes that respond to pen pressure, tilt, and bearing

You can apply brushstrokes that respond to pen pressure, tilt, and bearing provided your stylus or pen supports these features. Pen pressure lets you vary the size of the brush nib. Pen tilt lets you vary the flatness of the brush nib, and pen bearing lets you vary the rotation of the brush nib.







The Expression mode of the Artistic Media tool lets you vary brushstroke appearance by using the pressure, tilt, and bearing of your stylus.

You can use pen pressure, tilt, and bearing at the same time, or you can use only one or two of these features. For example, you can use pen pressure to vary the size of the brush nib, but disable pen tilt so that the flatness of the brush nib does not change. You can set a fixed value for pen tilt to flatten the nib. Disabling pen pressure lets you set a fixed nib size. Disabling pen bearing lets you use a nib of fixed rotation.

To apply a brushstroke that responds to pen pressure, tilt, and bearing

- 1 In the toolbox, click the **Artistic media** tool .

- 2 Click the **Expression** button  on the property bar.
- 3 Make sure the following buttons on the property bar are enabled:
 - **Pen pressure**  — lets you vary the size of the brush nib. If you are using the mouse, press the **Up arrow** or **Down arrow** to simulate changes in pen pressure and change the width of the stroke.
 - **Pen tilt**  — lets you vary the flatness of the nib
 - **Pen bearing**  — lets you vary the rotation of the brush nib
- 4 Drag until the stroke is the shape you want.

You can also

Change the width of the stroke

Type a value in the **Stroke width** box on the property bar.

Change the stroke width when scaling the object



Click the **Scale stroke with object**  button on the property bar.



The width you set represents the stroke's maximum width. The amount of pressure you apply determines the actual size of the brush nib.

You can use pen tilt and pen bearing to vary brushstrokes only if your stylus or pen supports these features.

To use a brush nib of fixed width, flatness, or rotation

- 1 In the toolbox, click the **Artistic media** tool .
- 2 Click the **Expression** button  on the property bar.
- 3 Perform a task from the following table.

To

Do the following

Set the size of the brush nib

Click the **Pen pressure** button  on the property bar to disable it. Type a value in the **Stroke width** box.

Flatten the brush nib by using a fixed value for pen tilt

Click the **Pen tilt** button  on the property bar to disable it. Type a value in the **Tilt angle** box.

Use a value between 15 and 90 degrees.

Rotate the brush nib by using a fixed value for pen bearing

Click the **Pen bearing** button  on the property bar to disable it. Type a value in the **Bearing angle** box.

Spraying objects along a line

CorelDRAW lets you spray a series of objects in a line. Besides graphic and text objects, you can import bitmaps and [symbols](#) to spray along a line.



You can control how a sprayed line appears by adjusting the spacing between objects, so they are closer or farther apart from each other. You can also vary the order of objects in the line. For example, if you are spraying a series of objects that includes a star, a triangle, and a square, you can change the spray order so that the square appears first, followed by the triangle and then the star. CorelDRAW also lets you shift the position of objects in a sprayed line by rotating them along the path or offsetting them in one of four different directions: alternating, left, random, or right. For example, you can choose a left offset direction to align the objects you spray to the left of the path.

You can also create a new spray pattern with objects of your own.



Objects sprayed along a curved line (left). The objects and line were edited after the objects were sprayed (right).

To spray a pattern

- 1 In the toolbox, click the **Artistic media** tool .
- 2 Click the **Sprayer** button  on the property bar.
- 3 Choose a spray pattern category from the **Category** list box on the property bar.
- 4 Choose a spray pattern from the **Spray pattern** list box on the property bar.
- 5 Drag to draw the line.

You can also

Adjust the number of objects sprayed at each spacing point

Type a number in the top box of the **Images per dab and image spacing**  box on the property bar.

Adjust the spacing between dabs

Type a number in the bottom box of the **Images per dab and image spacing**  box on the property bar.

Set the spray order

Choose a spray order from the **Spray order** list box on the property bar.

You can also

Adjust the size of spray objects

Type a number in the top box of the **Size of sprayed objects** box on the property bar.

Increase or decrease the size of the spray objects as they progress along the line

Type a number in the bottom box of the **Size of sprayed objects** box on the property bar.

Apply transformations to spray line thickness when scaling

Click the **Scale stroke with object**  button on the property bar.



Increasing the value for the size of spray objects along the line causes objects to become larger as they are distributed along the path.

Spray patterns that have more complex objects use more system resources. CorelDRAW requires more time to produce lines when complex objects are used, and these objects increase the file size. Using [symbols](#) for each group in the list can help reduce file size and ease the demands on your system. For more information about creating symbols, see [“Working with symbols” on page 325](#).



You can also choose spray patterns from the **Artistic media** docker. You can open the **Artistic media** docker by clicking **Effects** ► **Artistic media**.

To rotate the lines that you spray

- 1 Select the spray pattern that you want to adjust.
- 2 Click the **Rotation** button  on the property bar.
- 3 Type a value between 0 and 360 in the **Angle** box on the property bar.
If you want each object in the spray to rotate incrementally, enable the **Use Increment** check box and type a value in the **Increment** box.
- 4 Enable one of the following options:
 - **Relative to path** — rotates objects in relation to the line
 - **Relative to page** — rotates objects in relation to the page
- 5 Press **Enter**.

To offset the lines that you spray

- 1 Select a spray pattern.
- 2 Click the **Offset** button  on the property bar.
- 3 Enable the **Use offset** check box to offset objects from the path of the line sprayed.
If you want to adjust the offset distance, type a new value in the **Offset** box.
- 4 Choose an offset direction from the **Offset direction** list box.
If you want to alternate between the left and right of the line, choose **Alternating**.

To create a new spray pattern

- 1 Click **Effects** ► **Artistic media**.
- 2 Select an object, a set of grouped objects, or a [symbol](#).
- 3 Click the **Save** button on the **Artistic media** docker.
- 4 Enable **Object sprayer**.

- 5 Click **OK**.
- 6 Type a filename in the **Filename** box.
- 7 Click **Save**.



Spray patterns are saved as CorelDRAW (CDR) files and can be accessed by choosing **Custom** from the **Category** list box on the **Artistic media** property bar, and choosing a spray pattern from the **Spray pattern** list box.



To delete a custom spray pattern, select the spray pattern from the **Spray pattern** list box on the property bar, and click the **Delete** button .

Drawing connector and callout lines

You can draw connector lines between objects. Objects stay connected by these lines even when you move one or both objects. Connector lines, which are also known as “flow lines”, are used in technical drawings such as diagrams, flowcharts, and schematics. For information about drawing flowchart shapes, see “[Drawing predefined shapes](#)” on page 175.

There are three types of connector lines that you can draw. You can draw a straight connector line. You can also draw right-angle connector lines with a sharp corner or a rounded corner. You can edit connector lines by moving, adding, or deleting segments.

Using the controls on the property bar, you can modify the width and style of a connector line as well as apply arrowheads. For more information, see “[Formatting lines and outlines](#)” on page 144. You can also change the color of connector lines.

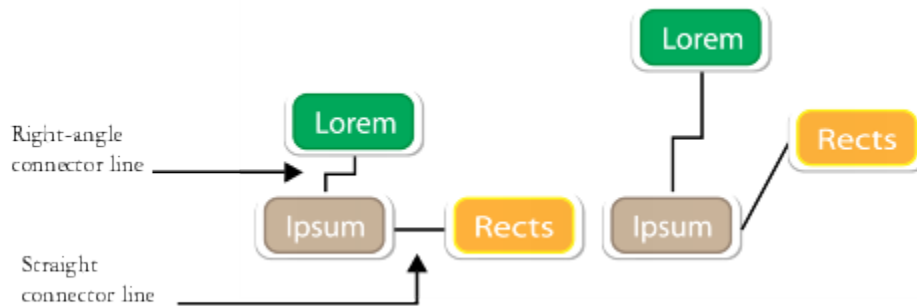

When you move objects, their connector lines remain attached.

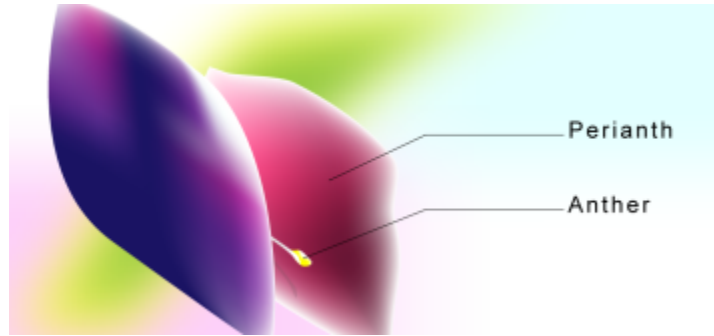

You can draw callout lines that label and draw attention to objects.



Examples of callouts

To use connector and callout lines with precision, you need to snap them to specific nodes in objects. For more information about snapping and snapping modes, see “Snapping objects” on page 279.

To draw a connector line between two or more objects

- In the toolbox, click the **Straight-line connector** tool button, and then click one of the following:
 - **Straight-line connector** tool  — to create a straight connector line at any angle
 - **Right-angle connector** tool  — to create a connector line containing vertical and horizontal segments at right angles
 - **Rounded right-angle connector** tool  — to create a connector line containing vertical and horizontal elements at rounded right angles
- Drag from a node on one object to a node on another object.

You can also

Move a horizontal segment in an angled connector line

Using the **Shape** tool , select a connector line, and drag the middle node on the segment that you want to move.

Move an end point of an angled connector line

Using the **Shape** tool , drag an end node along the edge of the object.



Add a segment in an angled connector line

Using the **Shape** tool , drag a corner node.

Delete a segment in an angled connector line

Using the **Shape** tool , drag a corner node over the closest corner node.

To change the direction of a connection line

- In the toolbox, click the **Edit anchor** tool .
- Click the anchor point from which you want to change the connector line direction.
- On the property bar, click the **Adjust anchor direction** button .
- In the **Adjust anchor direction** box, type one of the following values:
 - **0** — directs the connector line to the right

- 90 — directs the connector line straight up
- 180 — directs the connector line to the left
- 270 — directs the connector line straight down





You can change the direction of only right-angle connector lines.

To add an anchor point to an object

- 1 In the toolbox, click the **Edit anchor** tool .
- 2 Double-click anywhere on an object to add the anchor point.



By default, anchor points that you add to an object are not available as snap points for a connector line when the object is moved around in the drawing. To make an anchor point available as a snap point, select it with the **Edit anchor** tool, and click the **Auto anchor** button  on the property bar.

By default, the position of the anchor point is calculated relative to its position on the page. You can set the anchor point position relative to the object that it is attached to, which is useful if you want to set anchor points in the same relative position in multiple objects. To set the anchor point position relative to the object, select the anchor point with the **Edit anchor** tool . On the property bar, click the **Relative to object** button , and type the coordinates in the **Anchor position** box.

To move or delete an anchor point

To

Do the following

Move the anchor anywhere along the perimeter of an object

Using the **Edit anchor** tool , drag the anchor point to another point on the perimeter.

Move the anchor to the middle of an object

Drag the anchor point to any point inside the object.

Delete an anchor

On the property bar, click the **Delete anchor** button .

To set a connector line to flow around objects



- 1 Using the **Pick** tool , select the object to which the connector line is attached.
- 2 Click **Window** ► **Dockers** ► **Object properties**.
- 3 In the **Object properties** docker, click **Summary** to display additional options.
- 4 Enable the **Wrap connector line** check box.



To flow around an object, a connector line must be attached to the object by at least one end.

To add a text label to a connector line

1 In the toolbox, click one of the following tools.

- **Straight-line connector tool** 
- **Right-angle connector tool** 
- **Rounded right-angle connector tool** 

2 Double-click the connector line.

A text cursor appears.

3 Type the text.



As you move the connector line, the text label remains attached to it.

To draw a callout

1 In the toolbox, click the **3-Point callout tool** .

The **3-Point callout** tool is located on the **Dimension tools** flyout.

2 Click where you want the first callout segment to start, and drag to where you want the first segment to end.

3 Click where you want the second segment to end.

A text cursor  is displayed at the end of the callout line, indicating where to type a label for the object.

4 Type the callout text.

You can also

Change the callout shape

Choose a shape from the **Callout shape** box on the property bar.

Change the distance between the text and the callout shape

Type a value in the **Gap** box.



If you want to edit the callout line and callout text independently of each other, as a line and a text object, you must first separate the callout line from the callout text by clicking **Object** ► **Break callout apart**.

Drawing dimension lines

You can draw dimension lines to indicate the distance between two points in a drawing or the size of objects. You can add several types of dimension lines:

- *Parallel dimension lines* measure the actual distance between two **nodes**.
- *Vertical or horizontal dimension lines* measure the vertical (y-axis) or horizontal (x-axis) distance between any two **nodes**.
- *Angular dimension lines* measure angles.
- *Segment dimension lines* measure the linear distance between the end nodes of a segment, or the linear distance between the two most distant nodes in multiple segments. Segment dimension lines can also measure selected successive segments.

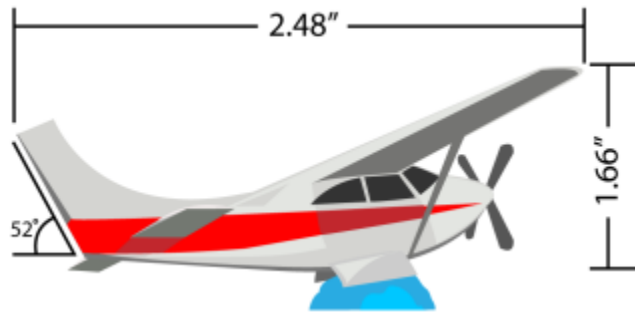

Dimension lines from left to right: Angular, Horizontal, and Vertical

You can set how dimension text and lines are displayed. For example, you can choose the unit of measurement, specify the position and font of the dimension units, and add a prefix or suffix to dimension text. You can also set default values for all new dimension lines that you create.

You can customize the extension lines on which dimension lines rest. You can specify the distance between the extension lines and the object that is measured, and the length of the extension overhang. Extension overhang is the portion of the extension line that falls beyond the dimension arrows.

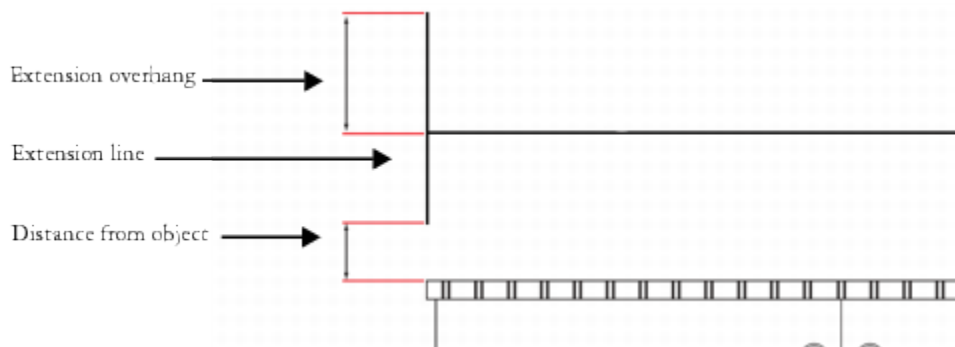



You can customize dimension lines by specifying values for the extension overhang, extension line, and distance from object.

By default, dimension text is dynamic. If you resize the object to which a dimension line is attached, the dimension text is updated automatically to display the new size. You can make the dimension text static, however, if necessary.

To be able to use dimension lines with precision, you need to snap them to specific nodes in objects. For more information about snapping and snapping modes, see ["Snapping objects" on page 279](#).

To draw a vertical, horizontal, or parallel dimension line

1 Do one of the following:



- To draw a parallel dimension line, click the **Parallel dimension** tool  in the toolbox.
- To draw a vertical or horizontal dimension line, click the **Horizontal or vertical dimension** tool .

2 Click to place the starting point, and drag to where you want to place the endpoint of the [dimension line](#).



3 Move the pointer to position the dimension line, and click to place the dimension text.

By default, dimension text is centered on the dimension line.

To draw an angular dimension line

- 1 In the toolbox, click the arrow in the bottom-right corner of the **Parallel dimension tool**  button to open the **Dimension tools** flyout, and click the **Angular dimension tool**  .
- 2 Click where you want the two lines that measure the angle to intersect, and drag to where you want the first line to end.
- 3 Click where you want the second line to end.
- 4 Click where you want the angle label to appear.

To draw a segment dimension line

- 1 In the toolbox, click the arrow in the bottom-right corner of the **Parallel dimension tool**  button to open the **Dimension tools** flyout, and click the **Segment dimension tool**  .
- 2 Click the segment that you want to measure.
- 3 Move the pointer to where you want to position the **dimension line**, and click where you want to place the dimension text.

You can also

Measure the distance between the two most distant nodes in multiple segments

Using the **Segment dimension tool** , marquee select the segments, drag to position the dimension line, and click where you want to place the dimension text.

Measure successive segments automatically

Click the **Automatic successive dimensioning** button  on the property bar, and marquee select the segments that you want to measure. Drag to position the dimension line, and click where you want to place the dimension text.

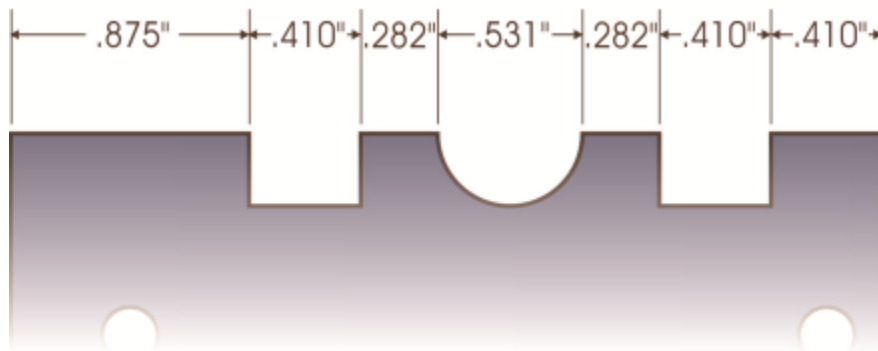

Segment dimension lines can be applied automatically to selected successive segments.

To set the display of dimension units

- 1 Select a **dimension line**.
- 2 On the property bar, choose options from the following list boxes:
 - **Dimension style** — lets you choose fractional, decimal or standard dimension units

- **Dimension precision** — lets you choose a level of precision for the measurements
- **Dimension units** — lets you choose the unit of measurement

You can also

Hide dimension units

Click the **Display units** button .

Specify the position of dimension units

Click the **Text position** button  on the property bar, and click a text position.

Change the point size and font of dimension units

Select the dimension text by using the **Pick** tool . On the property bar, choose a font style from the **Font** list box, and type a value in the **Font size** box.

Specify a prefix or suffix for dimension text

Type a prefix or suffix in the **Prefix** or **Suffix** box on the property bar.

Hide or show a leading zero with a dimension value

Click the **Leading zero** button  on the property bar. (The leading zero appears in dimension lines by default.)

Make dimension text static

Click the **Dynamic dimensioning** button .

Most dimension line controls on the property bar become unavailable. If you change the size of the object to which the dimension line is attached, the dimension line text is not updated.

To set default properties for new dimension lines

- 1 From the toolbox, double-click the **Parallel dimension** tool  button.
The **Dimension tool** page of the **Options** dialog box appears.
- 2 Specify the dimension style, precision, and units, prefix, and suffix.

To customize extension lines

- 1 Select a [dimension line](#).
- 2 On the property bar, click the **Extension lines options** button .
- 3 To specify the distance between the extension lines and the object, enable the **Distance from object** check box, and type a value in the **Distance** box.
- 4 To specify the length of the extension overhang, enable the **Extension overhang** check box, and type a value in the **Distance** box.

Using pressure-sensitive pens and devices

The following tools in CorelDRAW let you use the pressure of your pressure-sensitive pen, stylus, or other device: **Artistic Media (Expression mode)**, **Eraser**, **Smear**, **Twirl**, **Attract**, **Repel**, **Roughen**, and **Smudge**.

In addition, you can vary brushstrokes by using pen tilt and pen bearing with the **Artistic Media (Expression mode)** tool, **Eraser**, **Roughen** and **Smudge** tools. Note that pen tilt and pen bearing can be used only if your pen or stylus supports these features.

Pressure and pen settings

When you use a pressure-sensitive stylus or pen tablet with CorelDRAW, the amount of pressure that you apply controls the width of your strokes. Each person uses a different strength or pressure level in a stroke, and you can set the application to match your stroke strength by specifying pen settings. Proper pen settings are particularly useful if you have a light touch. If a light stroke leaves no trace, adjusting pen settings can increase sensitivity for specific tools. Abrupt changes in the width your brushstrokes shows that you need to adjust your pen settings on the **Pen Settings** page in the **Options** dialog box. Pen settings can be saved as presets to use later.

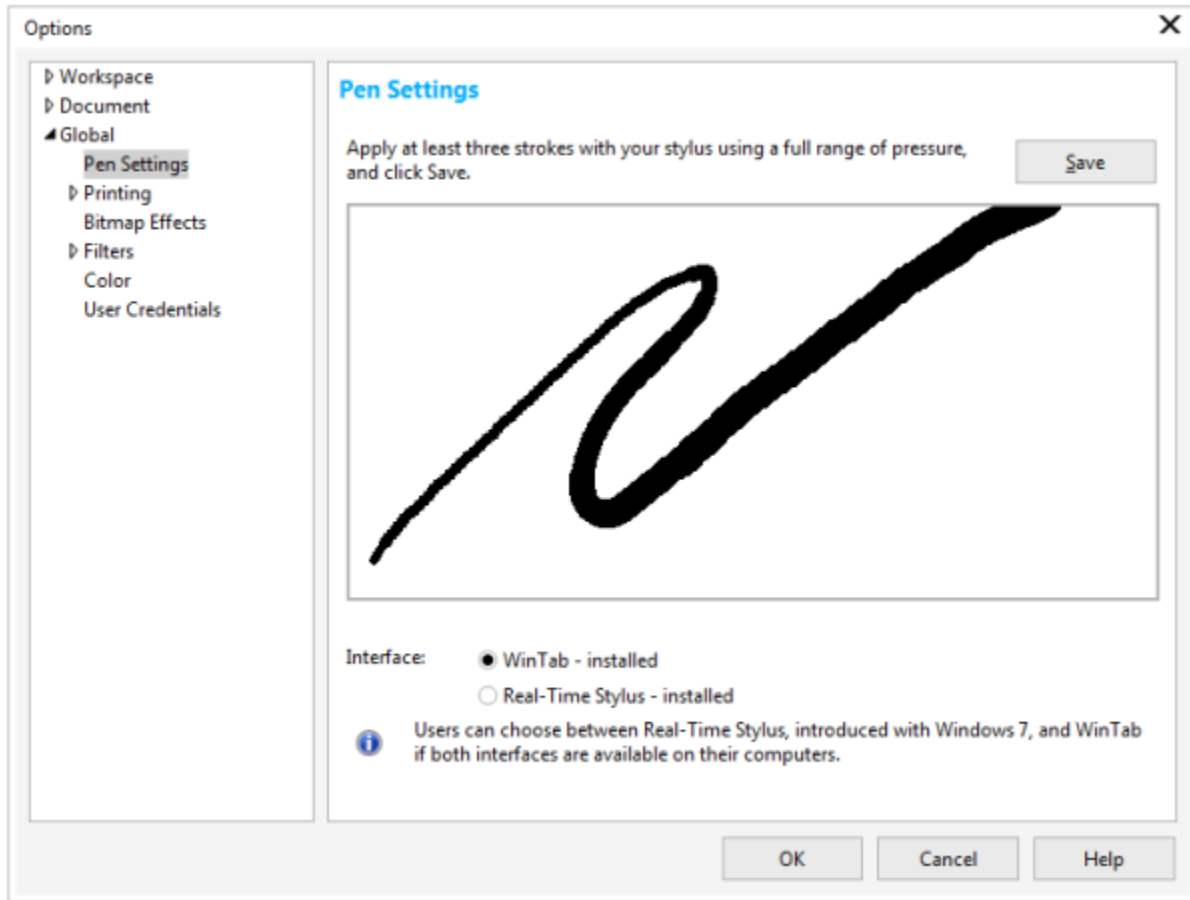

You can adjust pen settings to match your stroke strength.

Tilt and bearing

Pen tilt lets you vary the flatness of the nib. If you do not want nib flatness to vary, you can disable pen tilt, and specify a fixed value for tilt angle to determine the nib flatness. Pen bearing lets you use the direction in which the stylus is tilted to vary nib rotation. You can disable pen bearing, and set a fixed value for the bearing angle to rotate the nib.

Real-Time Stylus (RTS) and WinTab

You can take full advantage of the pressure and tilt of your RTS-compatible pen tablet or device to control your brushstrokes. CorelDRAW includes support for the Real-Time Stylus (RTS) interface, which was introduced with Windows 7. If you have a Wacom-compatible graphics tablet or device, you can still use the WinTab interface for optimal results.

To adjust pen settings

- 1 Click **Tools** ► **Options**.
- 2 In the **Global** list of categories, click **Pen Settings**.
- 3 Using your stylus or digital pen, apply at least three strokes, building from the lowest to the highest pressure.

To save the settings as a preset, click **Save**.

To choose a pen tablet interface

- 1 Click **Tools** ► **Options**.
- 2 In the **Global** list of categories, click **Pen Settings**.
- 3 Choose one of the following tablet options:
 - **WinTab** — recommended for Wacom-compatible pen tablets or devices
 - **Real-Time Stylus** — recommended for pen tablets or devices that use the RTS interface of Windows 7 and later versions

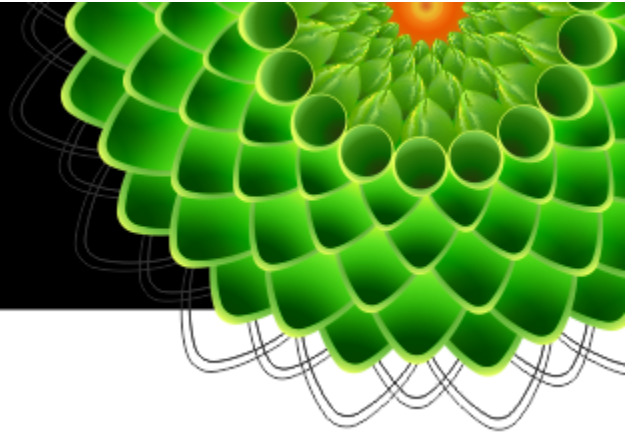

Drawing shapes

CorelDRAW lets you draw basic shapes, which you can modify by using special effects and reshaping tools.

In this section, you'll learn about

- “Drawing rectangles and squares” (page 167)
- “Drawing ellipses, circles, arcs, and pie shapes” (page 170)
- “Drawing polygons and stars” (page 172)
- “Drawing spirals” (page 174)
- “Drawing grids” (page 174)
- “Drawing predefined shapes” (page 175)
- “Drawing by using shape recognition” (page 176)

You can also draw shapes with precision by using object coordinates. For more information, see “Using object coordinates to draw and modify objects” on page 264.

Drawing rectangles and squares

CorelDRAW lets you draw rectangles and squares. You can draw a rectangle or square by dragging diagonally with the **Rectangle** tool or by specifying the width and height with the **3-point rectangle** tool. The **3-point rectangle** tool lets you quickly draw rectangles at an angle.



You can create a 3-point rectangle by first drawing its baseline and then drawing its height. The resulting rectangle is angled.

You can also draw a rectangle or square with rounded, scalloped or chamfered corners. You can modify each corner individually or apply the changes to all corners. In addition, you can specify that all corners scale relative to the object. You can also specify the default corner size for drawing rectangles and squares.

Understanding rounded, scalloped, and chamfered corners

Rounding produces a curved corner, scalloping replaces the corner with an edge that has a curved notch, and chamfering replaces the corner with a straight edge, also known as a bevel.



From left to right, you can see standard corners with no changes, rounded corners, scalloped corners, and chamfered corners.

To draw rectangles or squares with rounded, scalloped, or chamfered corners, you need to specify the corner size. For rounding or scalloping a corner, the corner size determines the corner radius. The radius is measured from the curve's center to its perimeter. Higher corner size values produce more rounded corners or deep scalloped corners.

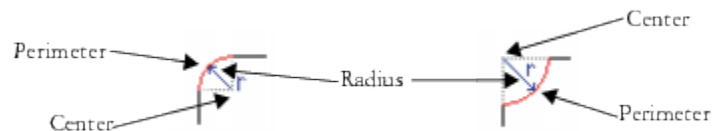

From left to right, you can see the radius of a rounded corner and the radius of a scalloped corner.

The size value for chamfering a corner represents the distance to set where the chamfer will begin in relation to the original corner. Higher corner size values produce a longer chamfered edge.



For more information about modifying the corners of curve objects, such as lines, text, or bitmaps, see ["Filleting, scalloping, and chamfering corners"](#) on page 226.

To draw a rectangle or square by dragging diagonally

To

Draw a rectangle

Draw a square

Do the following

In the toolbox, click the **Rectangle** tool . Drag in the drawing window until the rectangle is the size you want.

In the toolbox, click the **Rectangle** tool . Hold down **Ctrl**, and drag in the drawing window until the square is the size you want.



You can draw a rectangle from its center outward by holding down **Shift** as you drag. You can also draw a square from its center outward by holding down **Shift + Ctrl** as you drag.

You can draw a rectangle that covers the drawing page by double-clicking the **Rectangle** tool.

To draw a rectangle by specifying height and width



- 1 In the toolbox, click the **3-point rectangle** tool .
- 2 In the drawing window, point to where you want to start the rectangle, drag to draw the width, and release the mouse button.
- 3 Move the pointer to draw the height, and click.

To adjust the size of the rectangle, type values in the **Object size** boxes on the property bar.



To constrain the angle of the baseline to a preset increment, known as constrain angle, hold down **Ctrl** as you drag. For information about changing the constrain angle, see [“To change the constrain angle” on page 308](#).

To draw a rectangle or square with rounded, scalloped, or chamfered corners

- 1 Click a rectangle or square.
- 2 Click one of the following buttons on the property bar:
 - **Round corner**  — produces a curved corner
 - **Scalloped corner**  — replaces a corner with an edge that has a curved notch
 - **Chamfered corner**  — replaces a corner with a flat edge
- 3 Type values in the **Corner radius** areas on the property bar.
- 4 Click **Apply**.

You can also

Apply the same changes to all corners

Click the **Edit corners together**  button on the property bar.

Disable the scaling of corners relative to the object

Click the **Relative corner scaling**  button on the property bar.



You can also modify the corners of a selected rectangle or square by clicking the **Shape** tool , clicking a corner option button on the property bar, then dragging a corner node toward the shape’s center. If you prefer to modify only one corner, hold down **Ctrl**, then drag a corner node toward the shape’s center.

To specify the default corner size for drawing rectangles and squares

- 1 Click **Tools** ► **Options**.
- 2 Double-click **Toolbox** from the **Workspace** list of categories.

- 3 Click **Rectangle** tool.
- 4 In the **Rectangle corners** area, type values in the boxes.

You can also

Apply the same changes to all corners

Click the **Edit corners together**  button.

Disable the scaling of corners relative to the object

In the **Scale corners** area, click the **Relative corner scaling**  button.

Drawing ellipses, circles, arcs, and pie shapes

You can draw an ellipse or circle by dragging diagonally with the **Ellipse** tool, or you can draw an ellipse by using the **3-point ellipse** tool to specify its width and height. The **3-point ellipse** tool lets you quickly create an ellipse at an angle, eliminating the need to rotate the ellipse.

Using the **Ellipse** tool, you can draw a new arc or pie shape, or you can draw an ellipse or circle and then change it to an arc or a pie shape. You can also change the default properties of new objects that are drawn with the **Ellipse** tool. For example, you can set the default properties so that all new shapes you draw are arcs or pie shapes.



Using the 3-point ellipse tool, you can draw an ellipse by first drawing its centerline and then drawing its height. This method lets you draw ellipses at an angle.

To draw an ellipse or a circle by dragging diagonally

To

Do the following

Draw an ellipse

In the toolbox, click the **Ellipse** tool . Drag in the drawing window until the ellipse is the shape you want.

Draw a circle

In the toolbox, click the **Ellipse** tool . Hold down **Ctrl**, and drag in the drawing window until the circle is the size you want.



You can draw an ellipse or a circle from its center outward by holding down **Shift** as you drag.

To draw an ellipse by specifying width and height



- 1 In the toolbox, click the 3-point ellipse tool .
- 2 In the drawing window, drag to draw the centerline of the ellipse at the angle you want. The centerline runs through the center of the ellipse and determines its width.
- 3 Move the pointer to define the height of the ellipse, and click.

To draw an arc or a pie shape



To

Do the following

Draw an arc

In the toolbox, click the **Ellipse** tool . Click the **Arc** button  on the property bar. Drag in the drawing window until the arc is the shape you want.

Draw a pie shape

In the toolbox, click the **Ellipse** tool . Click the **Pie** button  on the property bar. Drag in the drawing window until the pie is the shape you want.



To draw an arc, the ellipse or circle must have an **outline**.



You can change the direction of a selected arc or pie shape by clicking the **Change direction** button  on the property bar.

You can constrain the movement of the node to 15-degree increments by holding down **Ctrl** as you drag.

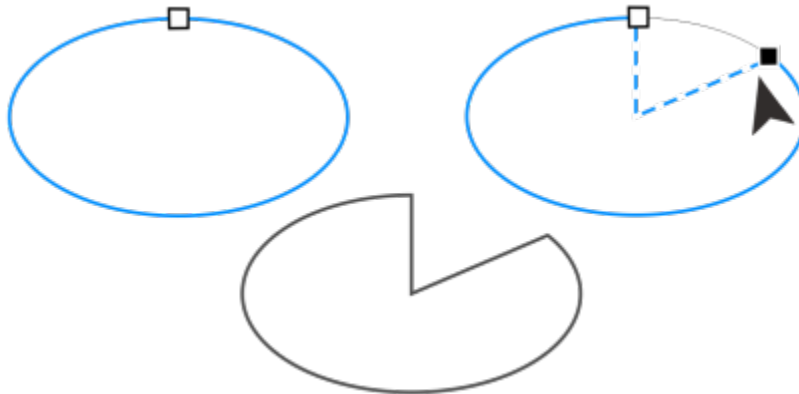

To use the Shape tool to create a pie shape, drag the node of the ellipse (left) to the inside of the ellipse (center). To create an arc, drag the node to the outside of the ellipse (right).

To change the default properties for new objects drawn with the Ellipse tool

- 1 Click **Tools** ► **Options**.
- 2 In the **Workspace** list of categories, click **Toolbox**, and then click **Ellipse tool**.
- 3 To change the shape of new objects to arcs or pie shapes, enable one of the following options:

- Pie
 - Arc
- 4 Type values in the **Starting angle** and **Ending angle** boxes.
- 5 To set the direction of all new arcs or pie shapes, enable one of the following options:
- Clockwise
 - Counterclockwise

Drawing polygons and stars

CorelDRAW lets you draw polygons and two types of stars: perfect and complex. Perfect stars are traditional-looking stars and can have a fill applied to the entire star shape. Complex stars have intersecting sides and produce original results with a fill applied.



Left to right: Polygon, perfect star, and complex star, each with a fountain fill applied

You can modify polygons and stars. For example, you can change the number of sides on a polygon or the number of points on a star, and you can sharpen the points of a star. You can also use the **Shape** tool to reshape polygons and complex stars, just as you would with any other curve object. For more information about working with curve objects, see [“Using curve objects” on page 180](#). Perfect stars can also be reshaped, but with some restrictions.

To draw a polygon

- In the toolbox, click the **Polygon** tool , and drag in the drawing window until the polygon is the size you want.



You can draw a polygon from its center by holding down **Shift** as you drag.

You can draw a symmetrical polygon by holding down **Ctrl** as you drag.

To draw a star

To

Draw a perfect star

Do the following

In the toolbox, click the **Star** tool , and drag in the drawing window until the star is the size you want.

To

Draw a complex star



You can draw a star from its center by holding down **Shift** as you drag.

You can draw a symmetrical star by holding down **Ctrl** as you drag.

Do the following

In the toolbox, click the **Complex star** tool , and drag in the drawing window until the star is the size you want.

To modify a polygon

To

Change the number of sides of a polygon

Do the following

Select a polygon, type a value in the **Points or sides** box on the property bar, and press **Enter**.

Reshape a polygon into a star

Select a polygon, click the **Shape** tool , and drag a node on the polygon until the star is the shape you want.

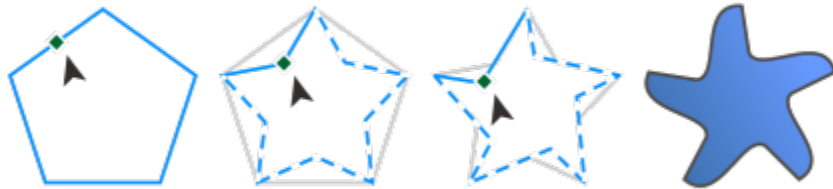

Left to right: The Shape tool was used to change a polygon into a star that can be shaped as a curve object. The line segments of the star were then converted to curves and adjusted to produce the starfish shape.

To modify a star

To

Change the number of points on a star

Do the following

Select a star, type a value in the **Points or sides** box on the property bar, and press **Enter**.

Sharpen a star's points

Select a star, and type a value in the **Sharpness** box on the property bar.

To

Reshape a star



When you use the **Shape** tool to reshape a perfect star, the node movement is constrained. Also, on perfect stars, you cannot add or delete nodes, nor can you convert line segments to curves.

Do the following

Select a star, click the **Shape** tool , and drag a node on the star.



Drawing spirals

You can draw two types of spirals: symmetrical and logarithmic. Symmetrical spirals expand evenly so that the distance between each revolution is equal. Logarithmic spirals expand with increasingly larger distances between revolutions. You can set the rate by which a logarithmic spiral expands outward.



A symmetrical spiral (left) and a logarithmic spiral (right)

To draw a spiral

- 1 In the toolbox, click the **Spiral** tool .
- 2 Type a value in the **Spiral revolutions** box on the property bar.
- 3 On the property bar, click one of the following buttons:
 - Symmetrical spiral 
 - Logarithmic spiral 

If you want to change the amount by which the spiral expands as it moves outward, move the **Spiral expansion factor** slider.

- 4 Drag diagonally in the drawing window until the spiral is the required size.



You can draw a spiral from its center outward by holding down **Shift** as you drag.

You can also draw a spiral with even horizontal and vertical dimensions by holding down **Ctrl** as you drag.

Drawing grids

You can draw a grid and set the number of rows and columns. A grid is a grouped set of rectangles that you can break apart.

To draw a grid

1 In the toolbox, click the **Graph paper** tool .

2 Type values in the top and bottom portions of the **Columns and rows** box  on the property bar.

The value you type in the top portion specifies the number of columns; the value you type in the bottom portion specifies the number of rows.

3 Point to where you want the grid to appear.

4 Drag diagonally to draw the grid.



If you want to draw the grid from its center point outward, hold down **Shift** as you drag; if you want to draw a grid with square cells, hold down **Ctrl** as you drag.

To ungroup a grid

1 Select a grid by using the **Pick** tool .

2 Click **Object** ▶ **Ungroup**.



You can also break apart a grid by clicking the **Ungroup** button on the property bar.

Drawing predefined shapes

Using the Perfect Shapes™ collection, you can draw predefined shapes. Certain shapes — specifically basic shapes, arrow shapes, banner shapes, and callout shapes — contain diamond-shaped handles that are called **glyphs**. You can drag a glyph to modify the appearance of a shape.

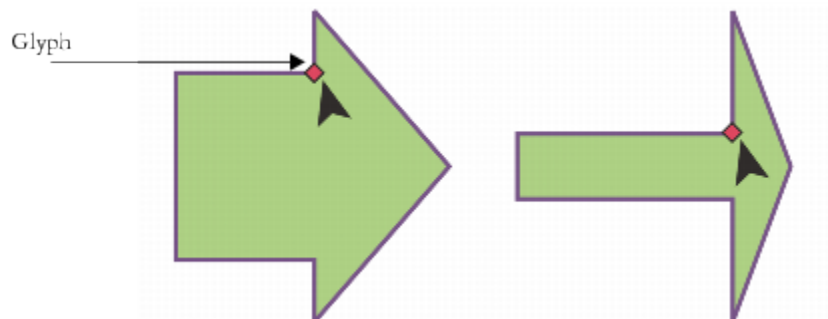





Using the Shape tool, you can drag a glyph to alter a shape.

You can add text to the inside or outside of the shape. For example, you might want to put a label inside a flowchart symbol or a callout.

To draw a predefined shape

1 In the toolbox, click one of the following tools:

- Basic shapes 
- Arrows shapes 

- Flowchart shapes 
- Banner shapes 
- Callout shapes 

- 2 Open the **Perfect Shapes** picker on the property bar, and click a shape.
- 3 Drag in the drawing window until the shape is the size you want.



Like other shapes, shapes that are drawn with a Perfect Shapes tool can be modified.



To modify a predefined shape

- 1 Select a shape that contains a [glyph](#).
- 2 Drag a glyph until you achieve the shape you want.



The right-angle, heart, lightning bolt, explosion, and flowchart shapes do not contain glyphs.

To add text to a predefined shape

- 1 Click the **Text** tool .
- 2 Position the cursor inside the shape's outline until it changes to a text cursor .
- 3 Type inside the shape, choose a font, and format the text.

Drawing by using shape recognition

You can use the **Smart drawing** tool to draw freehand strokes that can be recognized and converted to basic shapes. Rectangles and ellipses are translated to native CorelDRAW objects; trapezoids and parallelograms are translated to Perfect Shapes objects; lines, triangles, squares, diamonds, circles, and arrows are translated to curve objects. If an object is not converted to a shape, it is smoothed. Objects and curves drawn with shape recognition are editable. You can set the level at which CorelDRAW recognizes shapes and converts them to objects. You can also specify the amount of smoothing applied to curves.

You can set the amount of time to elapse between making a pen stroke and the implementation of shape recognition. For example, if the timer is set to one second and you draw a circle, shape recognition takes effect one second after you draw the circle.

You can make corrections as you draw. You can also change the thickness and line style of a shape that was drawn by using shape recognition.



Shapes created with the Smart drawing tool are recognized and smoothed.

To draw a shape or line by using shape recognition

- 1 In the toolbox, click the **Smart drawing** tool .
- 2 Choose a recognition level from the **Shape recognition level** list box on the property bar.
- 3 Choose a smoothing level from the **Smart smoothing level** list box on the property bar.
- 4 Draw a shape or line in the drawing window.



The **Smart drawing tool** property bar is displayed only when the **Smart drawing** tool is selected.

To set shape recognition delay

- 1 Click **Tools** ► **Options**.
- 2 In the **Workspace** list of categories, click **Toolbox**, and click **Smart drawing tool**.
- 3 Move the **Drawing assistance delay** slider.



The minimum delay is 10 milliseconds; the maximum is 2 seconds.

To make a correction while using shape recognition

- Before the delay recognition period has elapsed, hold down **Shift**, and drag over the area you want to correct.

You must start erasing the shape or line from the last point drawn.



If you are drawing a freehand shape consisting of several curves, you can delete the last curve drawn by pressing **Esc**.

To change the outline thickness of an object drawn with shape recognition

- 1 In the toolbox, click the **Smart drawing** tool .
- 2 Click the shape.
- 3 From the **Outline width** list box on the property bar, choose an outline thickness.



The **Smart drawing tool** property bar is displayed only when the **Smart drawing** tool is selected.

When you overlap lines drawn with the **Smart drawing** tool, the outline thickness is determined by the average.



You can change the line style of a shape drawn with shape recognition. For more information, see [“To specify line and outline settings” on page 145](#).

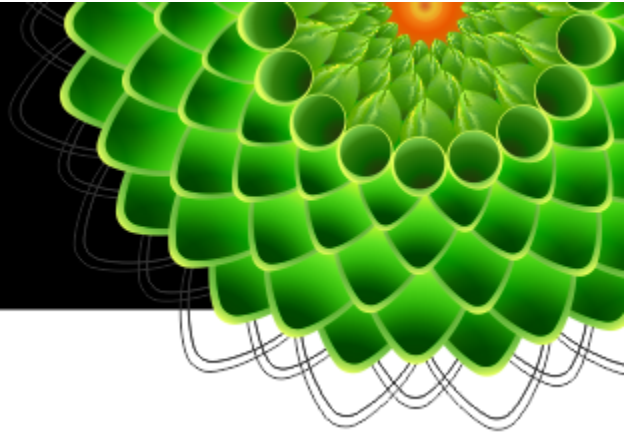

Shaping objects

CorelDRAW lets you shape objects in various ways.

This section contains the following topics:

- “Using curve objects” (page 180)
- “Selecting and moving nodes” (page 181)
- “Aligning and distributing nodes” (page 183)
- “Manipulating segments” (page 190)
- “Joining curves” (page 191)
- “Copying and cutting segments” (page 192)
- “Adding, removing, and joining nodes” (page 193)
- “Using node types” (page 195)
- “Transforming nodes” (page 196)
- “Breaking the path of curve objects” (page 196)
- “Mirroring changes in curve objects” (page 197)
- “Skewing and stretching objects” (page 198)
- “Smudging and smearing objects” (page 200)
- “Roughening objects” (page 203)
- “Smoothing objects” (page 204)
- “Shaping objects by attracting or pushing away nodes” (page 206)
- “Applying distortion effects” (page 207)
- “Adding swirl effects” (page 209)
- “Shaping objects by using envelopes” (page 210)
- “Cropping and erasing objects” (page 218)
- “Splitting objects” (page 222)
- “Trimming objects” (page 224)
- “Filleting, scalloping, and chamfering corners” (page 226)
- “Welding and intersecting objects” (page 228)
- “Creating PowerClip objects” (page 230)
- “Setting options for nodes, handles, and previews” (page 235)

Using curve objects

A curve object has nodes and control handles, which you can use to change the object's shape. A curve object can be any shape, including a straight or curved line. An object's nodes are the small shapes that appear along the object's outline. The line between two nodes is called a segment. Segments can be curved or straight. Each node has a control handle for each curved segment connected to it. Control handles help you adjust the curve of a segment.

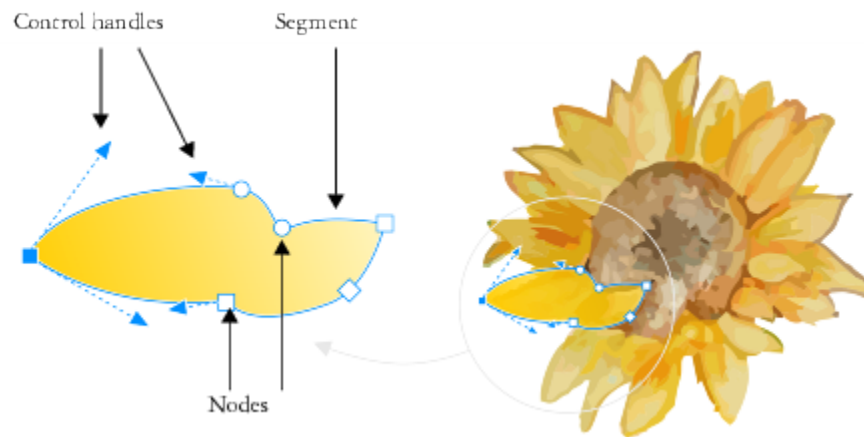

The components of a curve: control handles, segments, and nodes

Curve objects created in CorelDRAW follow a [path](#) that gives them their defining shape. A path can be open (for example, a line) or closed (for example, an ellipse) and can sometimes include subpaths. For more information about paths and subpaths, see [“Breaking the path of curve objects”](#) on page 196.

Most objects that are added to a drawing are not [curve objects](#), with the exception of spirals, freehand lines, and [Bézier](#) lines. Therefore, if you want to customize the shape of an object or text object, it is recommended that you convert it to a [curve object](#).

You can view the properties of a curve object in the **Object properties** docker.

To convert objects to curve objects

- 1 Select the [object](#).
- 2 Click **Object** ► **Convert to curves**.



You can convert [artistic text](#) to curves so that you can shape individual characters.

Bitmaps cannot be converted to curve objects.

To view curve properties

- 1 Select the curve object.
- 2 Click **Object** ► **Object properties**.
- 3 At the top of the **Object properties** docker, click the **Curve** button.



You can also convert an object to a [curve object](#) by selecting the object and clicking the **Convert to curves** button  on the property bar.

Selecting and moving nodes

You can select individual, multiple, or all of the object's nodes. Selecting multiple nodes lets you shape different parts of an object simultaneously. You can marquee select nodes by enclosing them with a rectangular marquee box, or by enclosing them with an irregularly shaped marquee box. Freehand marquee selection is useful when you want to select specific nodes in complex curves.

When a node is selected on curved segments, control handles are displayed. You can adjust the shape of the curved segments by moving the nodes and control handles.

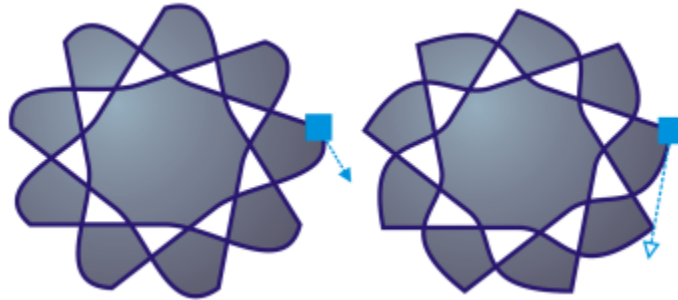

Usually, a control handle is displayed as a solid blue arrowhead (left). When a control handle overlaps with a node, it is displayed as an unfilled blue arrowhead beside the node (right).

You can reposition a node by specifying its coordinates.

The **Shape** tool is the standard tool for moving nodes. You can also set an option to use the **Pick** and **Bézier** tools for selecting and moving nodes.

To select a node

- 1 In the toolbox, click the **Shape**  tool.
- 2 Select a [curve object](#).
- 3 Click a [node](#).

You can also

Marquee select multiple nodes

On the property bar, choose **Rectangular** from the **Selection mode** list box, and drag around the nodes that you want to select.

Freehand marquee select multiple nodes

On the property bar, choose **Freehand** from the **Selection mode** list box, and drag around the nodes you want to select.

Select multiple nodes

Hold down **Ctrl**, and click each node.

Select all nodes on a selected curved object

Click **Edit** ► **Select all** ► **Nodes**.





Select consecutive nodes

Holding down **Shift**, click the first node, and then the last node that you want to select.

You can also

	To change the direction in which the nodes are selected, click while holding down Shift .
Select the node that follows or precedes a selected node	Press Tab or Shift + Tab .
Deselect a node	Hold down Ctrl , and click a selected node.
Deselect multiple nodes	Hold down Ctrl , and click each selected node.
Deselect all nodes	Click an unused space in the drawing window.







You can also select a node by using the **Pick** , **Freehand** , **Bézier** , or **Polyline**  tool. To do this, first click **Tools** ► **Options**. In the **Workspace** list of categories, click **Nodes and Handles**, and enable the **Enable node tracking** check box. Click a curve object, move the pointer over a node until the tool's shape state cursor  appears, and click the node. Note that when the **Enable node tracking** check box is enabled, you can no longer select and move an object by clicking and dragging any of its nodes. To select all nodes on a selected curve, double-click the **Shape** tool.



To move a node

- 1 Select an object by using the **Shape** tool .
- 2 Drag the node until you achieve the desired shape.



You can also move a node by using the **Pick** , **Freehand** , **Bézier** , or **Polyline**  tool. To do this, first click **Tools** ► **Options**. In the **Workspace** list of categories, click **Nodes and Handles**, and make sure that the **Enable node tracking** check box is enabled. Click a curve object, move the pointer over a node until the tool's shape state cursor  appears, and drag the node.

To specify a node's coordinate values

- 1 Click the **Shape** tool .
- 2 Select a node on a [curve object](#).
- 3 Click **Window** ► **Dockers** ► **Object coordinates**.
- 4 Click the **Multi-point curve** button .
- 5 Type values in the X and Y boxes to specify the exact position of the point along the x and y rulers.
- 6 Click one of the following:
 - **Create object** — adds a new curve object to the drawing window
 - **Replace object** — replaces the selected curve object with a new one

Aligning and distributing nodes

CorelDRAW lets you quickly align and distribute nodes in one or more curves.

First, you need to choose a reference point. The reference point can be the bounding box of the selection, the page edge or center, the closest grid line, or a specified point.

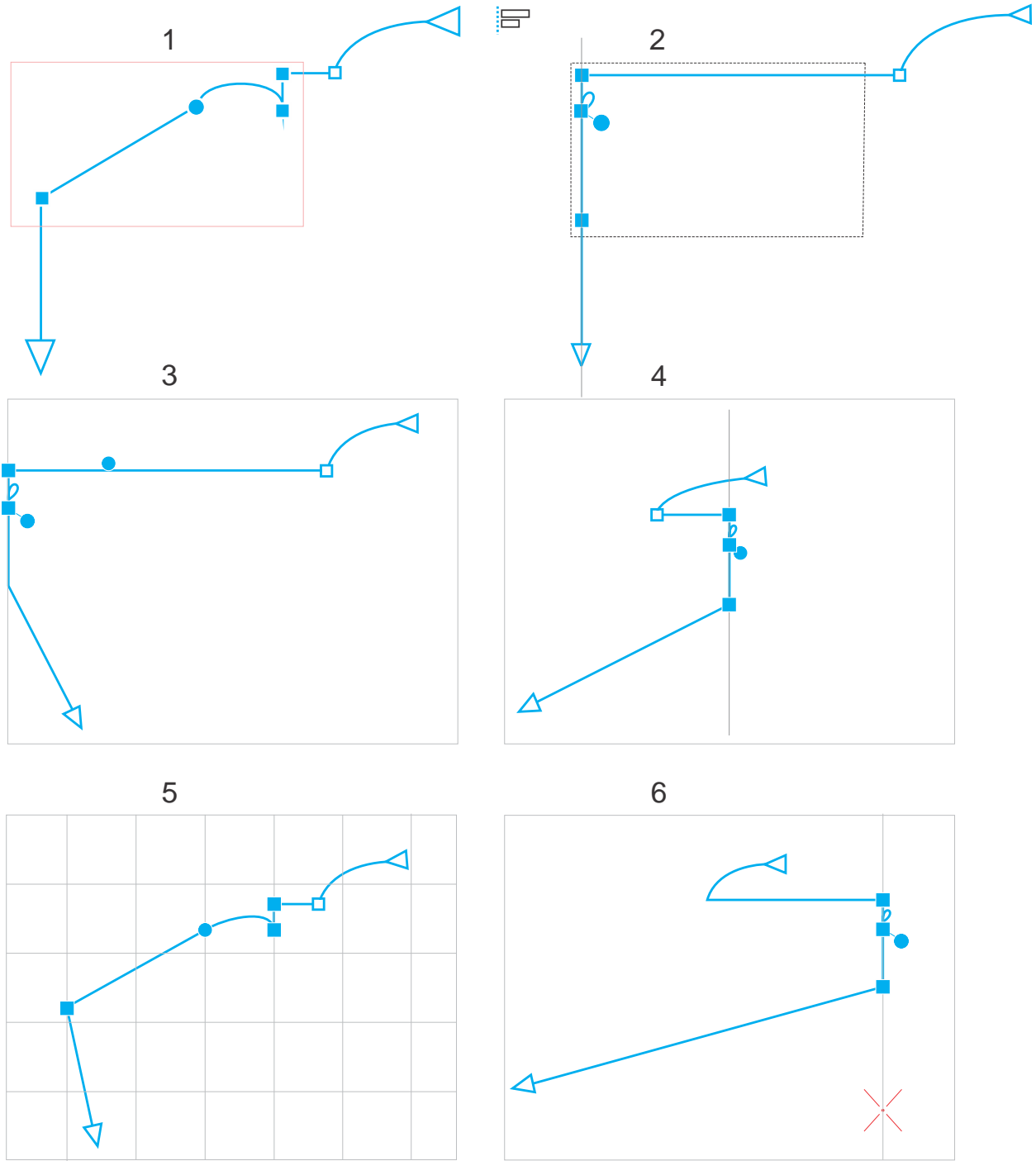

The nodes in a curve (1) are left-aligned relative to the bounding box of all active nodes (2), the page edge (3) or center (4), the closest grid line (5), or a specified point (6).

After you set a reference point, you can choose an alignment option. You can align nodes to the left, right, top, or bottom, or along a horizontal or vertical axis.

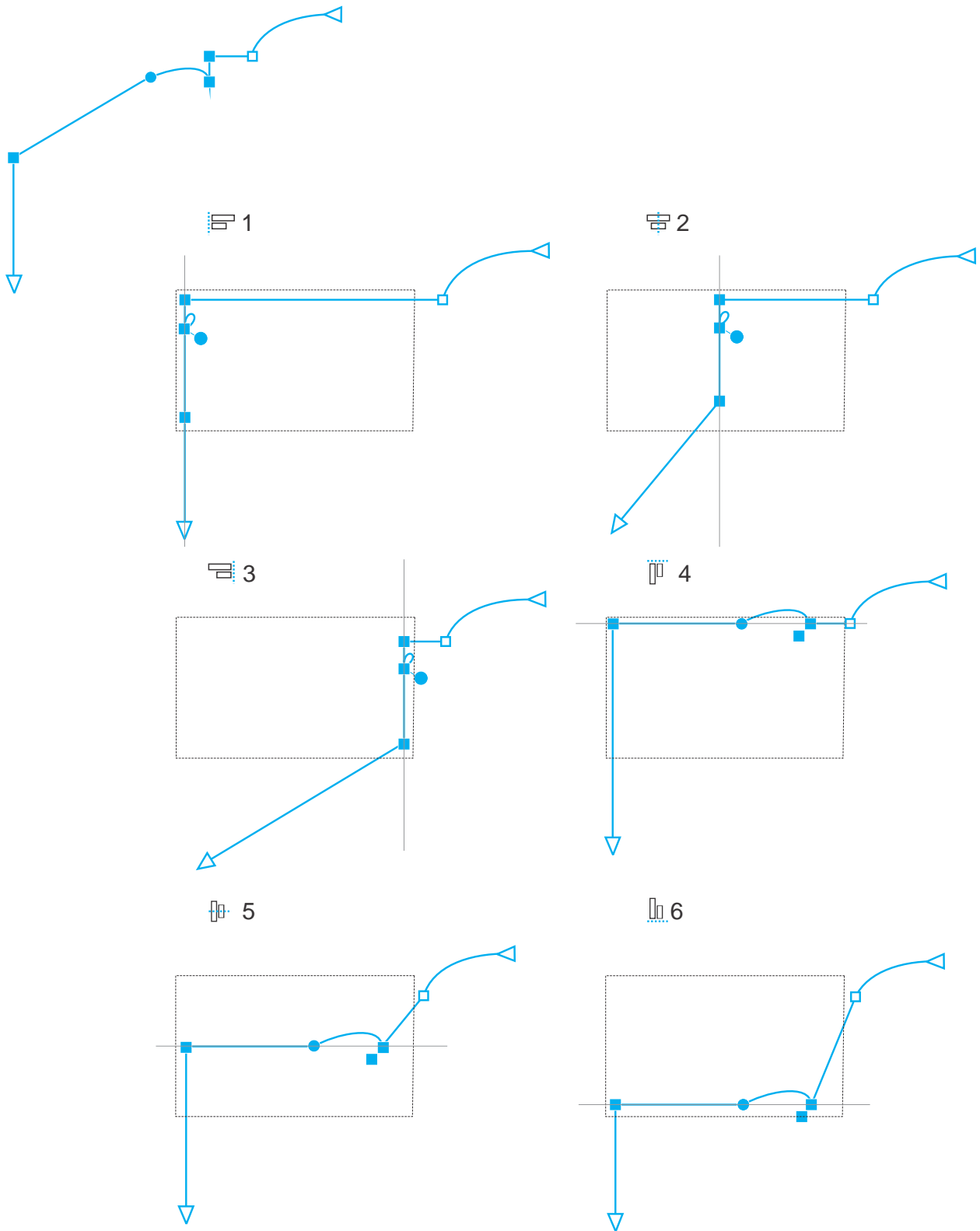

The active nodes in a curve (top left) are aligned to the left (1), right (3), top (4), bottom (6), and along a vertical (2) and horizontal (5) axis relative to the bounding box of the selection.

You can align nodes from different curves.

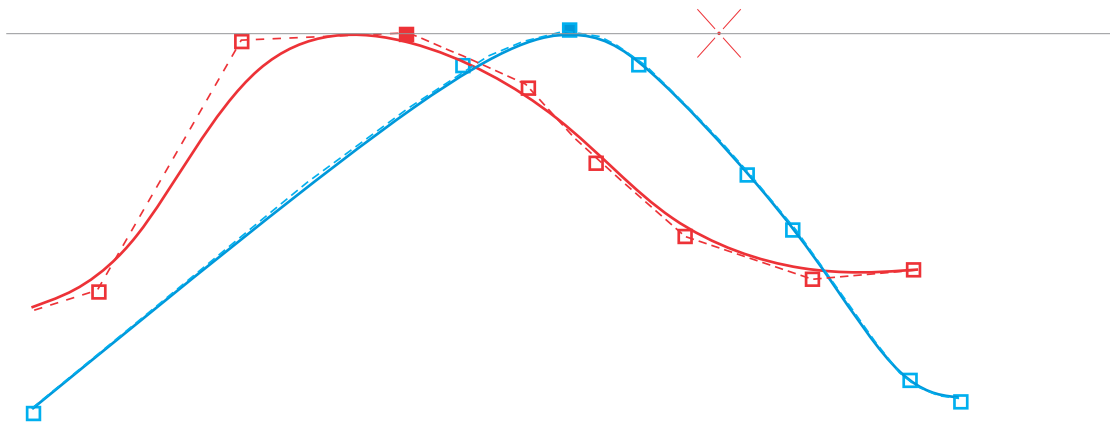
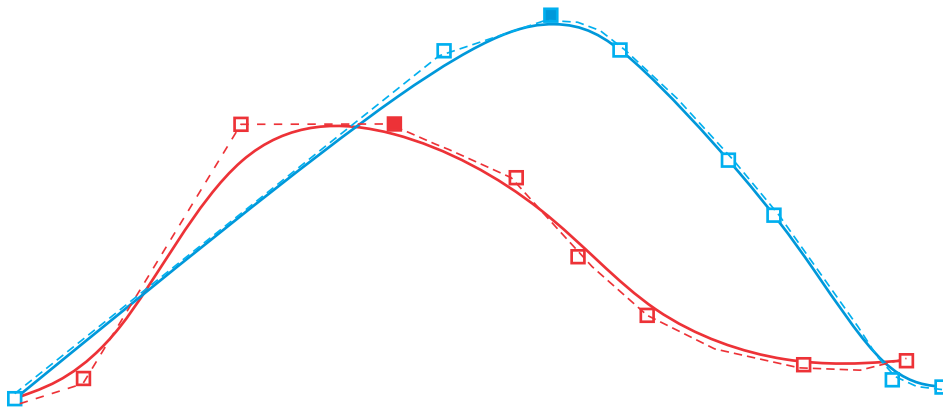

The selected nodes from the two curves are aligned relative to a specified point.

When you align nodes in a selection, the alignment is based on the average of the bounding area of the active nodes. CorelDRAW aligns nodes based on the order in which they appear along a curve rather than on the order in which you select them because it can be time-consuming to select nodes one at a time in complex objects with hundreds of nodes. You can change the order of the nodes by reversing the direction of the curve object.

Distributing nodes adds equal spacing between them horizontally or vertically. You can distribute nodes within the bounding box that contains them or over the drawing page.

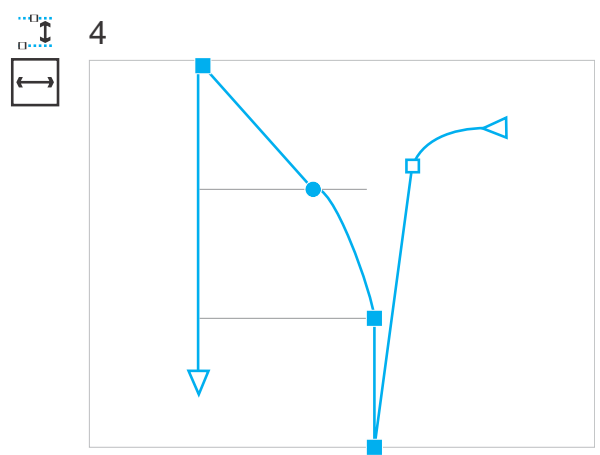
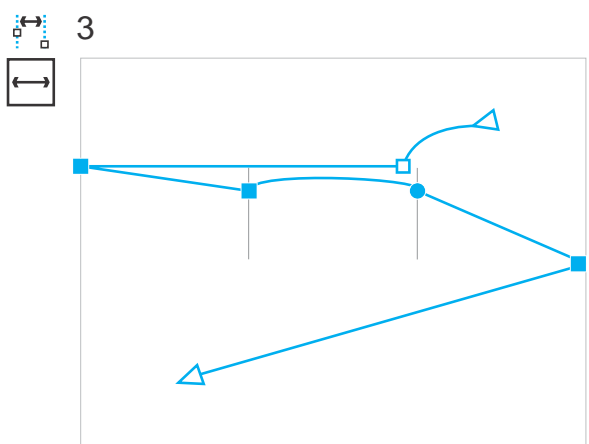
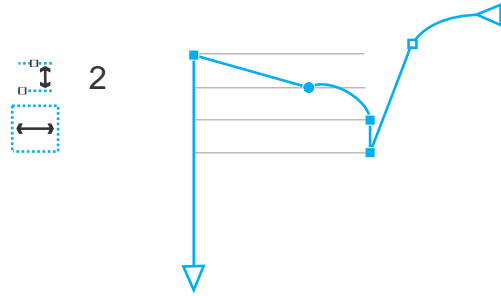
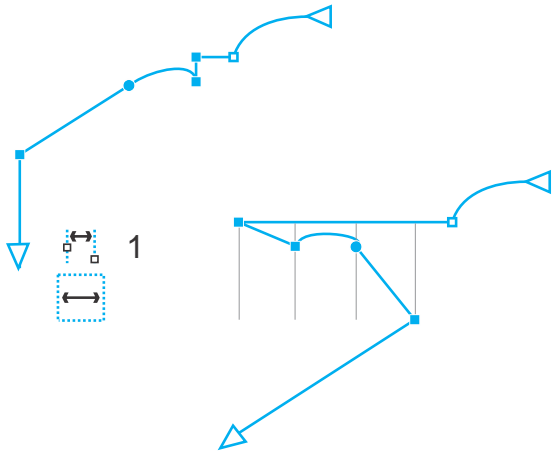

Nodes are distributed horizontally (1 and 3) and vertically (2 and 4) within the bounding box that surrounds them (1 and 2) and over the entire page (3 and 4).

CorelDRAW distributes nodes based on the order in which they appear along a curve.

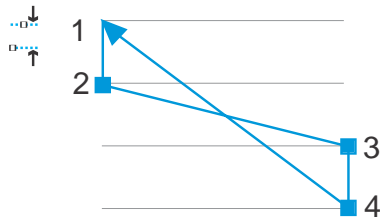
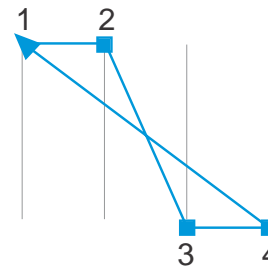
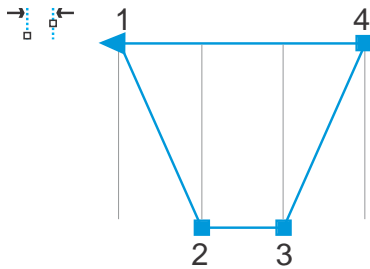
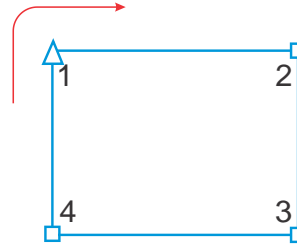
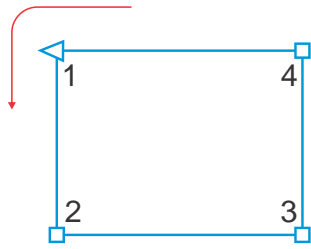

From top to bottom: The nodes in a curve (top left and top right) are distributed horizontally (middle) or vertically (bottom) based on the order in which the nodes appear along the curve.

To align nodes

- 1 Select the nodes with the Shape tool .
- 2 In the **Align and distribute** docker (**Window** ▶ **Dockers** ▶ **Align and distribute**), choose a reference point by performing a task from the following table:

To

Align nodes relative to the bounding box of the active nodes

Do the following

Click the **Active nodes** button  in the **Align nodes to** area.

Note: When you select nodes along a curve, the nodes are aligned based on the order in which they appear along the curve. To change the direction of a curve, click the **Reverse direction** button







 on the **Shape** tool property bar.

To

Align nodes with the page edge

Align nodes with the page center

3 In the Align area of the docker, click one of the following buttons:

- **Align left**  — to align nodes to the left
- **Align horizontally**  — to align nodes along a vertical axis
- **Align right**  — to align nodes to the right
- **Align top**  — to align nodes to the top
- **Align vertically**  — to align nodes along a horizontal axis
- **Align bottom**  — to align nodes to the bottom

You can also

Align a node with the closest grid line

Align a node with a specified point

Set an alignment option for text nodes





You can also align nodes within the active selection, vertically and horizontally, by clicking the **Align nodes** button  on the property bar, and enabling one or more alignment options in the **Node align** dialog box.

Do the following

Click the **Page edge** button  in the **Align nodes to** area.

Click the **Page center** button  in the **Align nodes to** area.



Tip: To align nodes with the page center, make sure that the **Align horizontally** button  and **Align vertically** button  in the **Align** area are enabled.

Click the **Grid** button  in the **Align nodes to** area.



Click the **Specified point** button  in the **Align nodes to** area, and type values in the **Specify coordinates** boxes.

Tip: You can also specify a point interactively by clicking the **Specify point** button , and clicking in the document window.

In the **Text** area, choose one of the following options:

- **First line baseline**  — aligns text by the baseline of the first line
- **Last line baseline**  — aligns text by the baseline of the last line
- **Bounding box**  — aligns text by its bounding box

To distribute nodes

- 1 Select the nodes with the **Shape** tool .
- 2 In the **Align and distribute** docker (**Window** ▶ **Dockers** ▶ **Align and distribute**), click one of the following buttons in the **Distribute nodes to** area to choose the area over which the nodes are distributed:
 - **Extent of selection**  — distributes the nodes over the area of the bounding box that contains them
 - **Extent of page**  — distributes the nodes over the drawing page
- 3 To distribute nodes horizontally, click any of the horizontal distribution buttons.
- 4 To distribute nodes vertically, click any of the vertical distribution buttons.



Since nodes have no real width or height, clicking any horizontal or vertical distribution button places equal space between the nodes along a horizontal or vertical axis, respectively.

Manipulating segments

You can move curved segments to change an object's shape. You can also control the smoothness of curved segments.

You can change the direction of a curve object by reversing the position of its start and end nodes. The effect is apparent only when the ends of a curve object are different. For example, when an arrowhead is applied to the end node of a curve object, changing the direction results in moving the arrowhead to the start node.



Changing the direction of a curve

To manipulate the segments of a curve object

- 1 In the toolbox, click the **Shape** tool .
- 2 Click a [curve object](#).
- 3 Perform a task from the following table.

To

Shape a segment by using the control handles without affecting the placement of the node

Shape a segment by using the control handles while moving a node

Do the following

Click a node, then drag one of the control handles.

Click a node. Hold down **Alt**, and drag one of the control handles.

You can also

Straighten a curve segment

Click a curve segment, and click the **Convert to line** button  on the property bar.

Curve a straight segment

Click a straight segment, and click the **Convert to curve**  button on the property bar.

Smooth a segment

Click a node, and move the **Curve smoothness** slider on the property bar. To smooth all segments in a curve object, [select all](#) of the object's [nodes](#) before moving the **Curve smoothness** slider.

Change the direction of a curve object

Click a segment, and click the **Reverse direction** button  on the property bar.

Joining curves

You can join curves and line segments to create more complex curves as well as closed objects. The shape of the connecting lines is determined by the mode that you choose: **Extend**, **Chamfer**, **Fillet**, or **Bézier Curve**.



*The lines in the upper-left corner were joined by using different modes.
Modes from left to right: Extend, Chamfer, Fillet, and Bézier Curve.*

You can also set the gap tolerance, which is the maximum distance between endpoints that can be joined. If the endpoints are further apart than the gap tolerance, they cannot be joined.

When you join curves, the resulting curve takes on the properties of the last object that was selected.

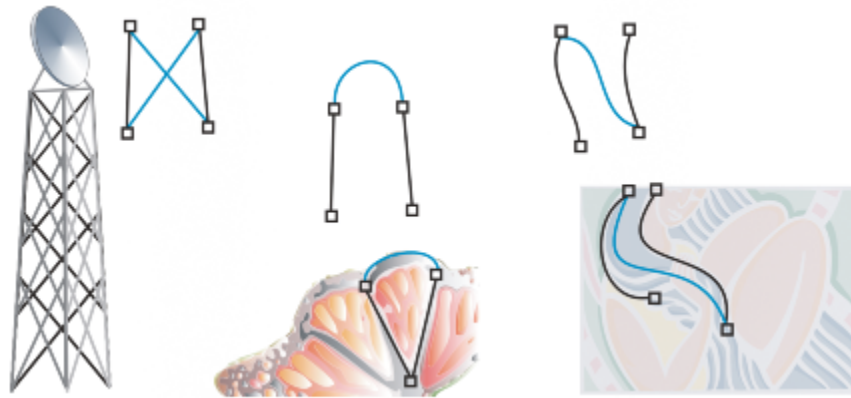

Joining curves and line segments can be the starting point for more complex drawings.

To join curves

- 1 Hold down **Shift**, and select each object using the **Pick tool** .
- 2 Click **Object** ► **Join curves**.
- 3 In the **Join curves** docker, choose one of the following modes from the list box:
 - **Extend**
 - **Chamfer**
 - **Fillet**
 - **Bézier Curve**
- 4 Click **Apply**.
If the curves are not joined, you must increase the gap tolerance.

You can also

Set the gap tolerance

Type a value in the **Gap tolerance** box.

Specify the radius

Type a value in the **Radius** box.

This control is available only for the **Fillet** mode.



You cannot join interior points, only endpoints.

If endpoints to be joined do not share coordinates, the endpoints are extended to their intersection.



You can also connect the **subpaths** in a group of objects.

You can also select lines by **marquee selecting**. If the lines are marquee selected, the properties from the bottom object on a layer are used. To see which object is the bottom one, open the **Object manager** docker by clicking **Window** ► **Dockers** ► **Object manager**.

Copying and cutting segments

You can copy and cut curve segments, and then paste them as objects, making it easy to extract subpaths or create adjacent shapes with similar contours.



A curve segment was copied (left) and then pasted as an object (right).

To copy or cut a curve segment

- 1 Select the curve object.
- 2 Using the **Shape** tool , select the nodes on a curve segment, and then press one of the following:
 - **Ctrl + C** to copy the curve segment
 - **Ctrl + X** to cut the curve segment
 - **Ctrl + D** to duplicate the curve segment at a specified offset distanceTo paste the curve segment, press **Ctrl + V**.

Adding, removing, and joining nodes

When you add nodes, you increase the number of segments and, therefore, the amount of control you have over the shape of the object. You can delete selected nodes to simplify an object's shape.

When curve objects contain many nodes, it is difficult to edit and output them to devices such as vinyl cutters, plotters, and rotary engravers. You can have the number of nodes in a curve object reduced automatically. Reducing the number of nodes removes overlapping nodes and can smooth a curve object. This feature is especially useful for reducing the number of nodes in objects imported from other applications.



Reducing the number of nodes to smooth a curve object

You can join the start and end nodes of an open [path](#) such as a line to create a closed object. This feature is useful for filling an object with color because you can apply fills only to the inside of closed objects. For information about applying fills, see [“Applying fills to objects” on page 367](#).

You can align the nodes of a curve object horizontally or vertically.

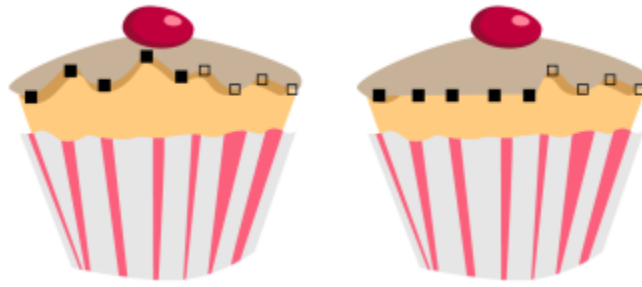

Aligning nodes horizontally

To add or delete a node

To

Add a node



Do the following

In the toolbox, click the **Shape** tool , select a curve object, and double-click where you want to add a node.



Delete a node

In the toolbox, click the **Shape** tool, select a curve object, and double-click a node.

To reduce the number of nodes in a curve object

- 1 In the toolbox, click the **Shape** tool .
- 2 Click a curve object, and do one of the following:
 - To reduce the number of nodes in the entire object, click the **Select all nodes** button  on the property bar.
 - To reduce the number of nodes in a part of a curve object, marquee select the part you want to change.
- 3 Do one of the following:
 - Click **Reduce nodes** on the property bar to have overlapping and redundant nodes automatically removed.
 - Move the **Curve smoothness** slider to control the number of nodes that are removed. Removing many nodes can reshape the curve object.

To join the end nodes of a single subpath

- 1 In the toolbox, click the **Shape** tool .
- 2 Click a **subpath**.
- 3 Click the **Close curve** button  on the property bar.



You can close multiple subpaths in an object by clicking **Object** ► **Join curves** and choosing settings in the **Join curves** docker. For more information, see “Joining curves” on page 191.

To join the nodes of multiple subpaths

- 1 In the toolbox, click the **Shape** tool .

- 2 Hold down **Shift**, and click a **node** from each **subpath**.
- 3 Click the **Extend curve to close** button  on the property bar.



If you want to join nodes from separate **curve objects**, you must first combine them into a single curve object, and then join the end nodes of the new subpaths. For information about combining objects, see [“Combining objects” on page 303](#).

Using node types

You can change the nodes on a curve object to one of three types: cusp, smooth, and symmetrical. The control handles of each node type behave differently.

Cusp nodes let you create sharp transitions, such as corners or sharp angles, in a curve object. You can move the control handles in a cusp node independently of one another, changing only the line on one side of the node.



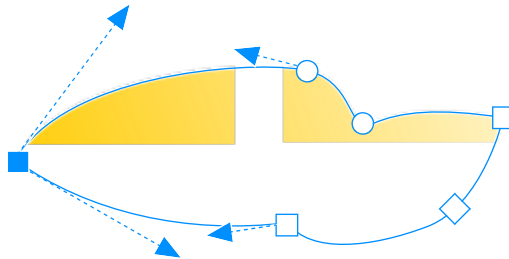

With smooth nodes, the lines passing through the node take on the shape of a curve, producing smooth transitions between line segments. The control handles of a smooth node are always directly opposite one another, but they may be at different distances from the node.

Symmetrical nodes are similar to smooth nodes. They create a smooth transition between line segments, but they also let you give lines on both sides of a node the same curve appearance. The control handles of symmetrical nodes are directly opposite each other and at an equal distance from the node.



Each node type appears with a different shape - smooth nodes as circles, cusp nodes as squares, and symmetrical nodes as diamonds.

To shape a curve object by using cusp, smooth, or symmetrical nodes

- 1 In the toolbox, click the **Shape** tool .
- 2 Click a **node**.
- 3 On the property bar, click one of the following buttons:
 - Cusp node 
 - Smooth node 
 - Symmetrical node 
- 4 Drag the node's control handles.



You can also change an existing node from one type to another by using shortcut keys. To change a smooth node to a cusp node or a cusp node to a smooth node, click the node using the **Shape** tool, and press **C**. To change a symmetrical node to a smooth node or a smooth node to a symmetrical node, click the node with the **Shape** tool, and press **S**.

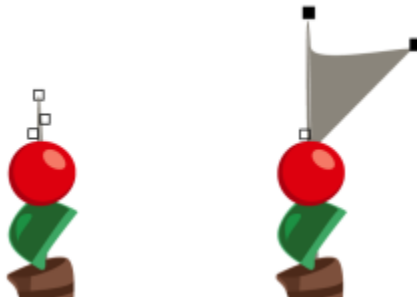

Transforming nodes

You can shape objects by stretching, scaling, rotating, and skewing their nodes. For example, you can scale the corner nodes of a curve object to enlarge the curve object proportionally. Also, a curve object or parts of a curve object can be rotated in a counterclockwise or clockwise direction.



Stretching nodes

To stretch, scale, rotate, or skew nodes

- 1 In the toolbox, click the **Shape** tool .
- 2 Select a **curve object**.
- 3 Select the **nodes** along the curve that you want to transform.
- 4 On the property bar, click one of the following buttons:
 - Stretch or scale nodes 
 - Rotate or skew nodes 
- 5 Drag a set of handles to transform the nodes.

Breaking the path of curve objects

You can break the path of a curve object.

Paths

Paths outline an **object's** shape and are often visible as one or more line or curve segments. You can disconnect line segments from one another to create subpaths. Even though they are not connected, subpaths are still part of the defining path of the original object; however, you can extract a subpath to create two separate objects: the extracted subpath and the object it was extracted from.

Subpaths

Subpaths are the basic curves and shapes from which a single **curve object** is constructed. For example, a single curve object with subpaths is often created when text is converted to curves. The letter "O," for instance, is composed of two ellipses: the outside ellipse that defines the letter's shape and the inside ellipse that defines the "hole." The ellipses are subpaths that compose the single curve object, "O." One of the

basic reasons for creating an object with subpaths is that you can produce objects with holes in them. In the following example, you can see objects underneath the center of the letter “O.”

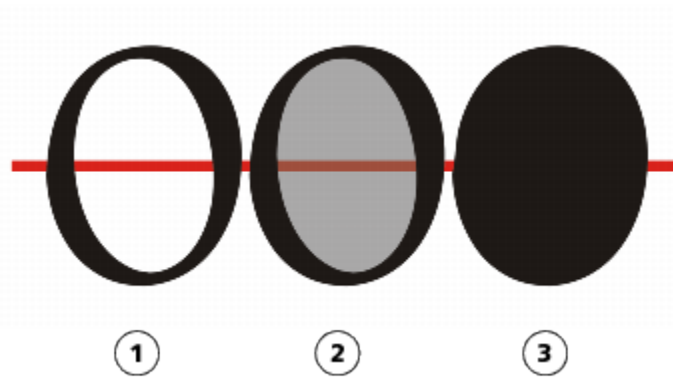



1) The letter “O” is converted to curves. 2) The resulting subpaths are the outside ellipse that defines the shape of the letter and the inside ellipse (tinted gray) that defines the hole. 3) In comparison, the black ellipse consists of a single path and cannot contain a “hole.”

To break a path

To

Break a path

Do the following

In the toolbox, click the **Shape** tool . Select a node on the path, and click the **Break curve** button  on the property bar.

Extract a broken path from an object

In the toolbox, click the **Shape** tool. Right-click a path, and click **Break apart**. Select a segment, node, or group of nodes that represents the portion of the path you want to extract, and click the **Extract subpath** button  on the property bar.



When you break a path in a curve object, the resulting subpaths remain part of the same object. When you extract a path from an object, you create two separate objects.

Mirroring changes in curve objects

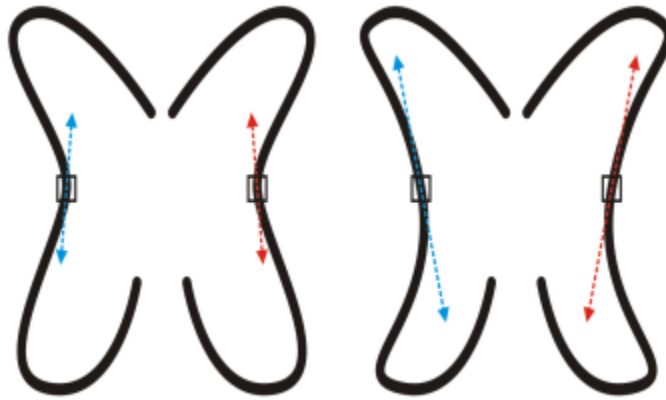

When you mirror changes in curve objects by using Reflect Nodes mode, you edit **nodes** and have the same edits take place in reverse on corresponding nodes. For example, you can move a node to the right, and its corresponding node moves the same distance to the left. This feature is useful when you want to shape a curve object and mirror the changes across the object’s left and right side or top and bottom side.

To mirror changes, you must select two curve objects one of which was created by mirroring the other, or a symmetrical object. For information about mirroring objects, see [“Rotating and mirroring objects” on page 293](#). Next, you need to choose whether to mirror changes horizontally (along a vertical line of symmetry) or vertically (along a horizontal line of symmetry). Finally, you need to select the appropriate corresponding nodes so that editing changes are mirrored across the selected objects.



Left: Two corresponding nodes are selected in mirrored curve objects. Right: When the blue control handles are moved, the change is reflected in the corresponding control handles (in red).

To mirror changes in curve objects

- 1 Using the Pick tool, select mirrored curve objects or a symmetrical curve object.
- 2 Click the Shape tool .
- 3 On the property bar, click one of the following:
 - **Reflect nodes horizontally** button  — lets you edit corresponding nodes in objects that have been mirrored horizontally
 - **Reflect nodes vertically** button  — lets you edit corresponding nodes in objects that have been mirrored vertically
- 4 Hold down **Shift**, and select corresponding **nodes** on the left and right, or top and bottom.
- 5 Edit the nodes on one side.

The changes occur in reverse on corresponding nodes on the other side.



To shape multiple **objects** by using Reflect Nodes mode, click the first object, and drag to select nodes; or hold down **Shift**, and click each node on the first object. Then hold down **Shift**, click the second object, and drag to select nodes, or hold down **Shift** and click each node on the second object.

Skewing and stretching objects

You can skew and stretch **objects** in CorelDRAW. When you skew an object, you specify the degree by which you want to slant the object. Stretching changes an object's vertical and horizontal dimensions non proportionally.

CorelDRAW also lets you change the skew and sizing anchor point of an object from its default center position.

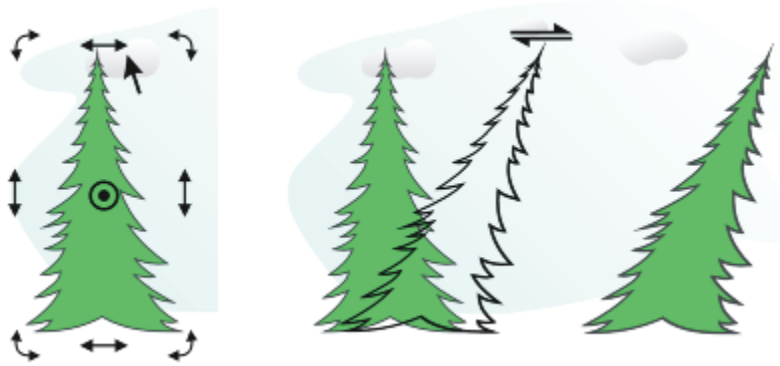

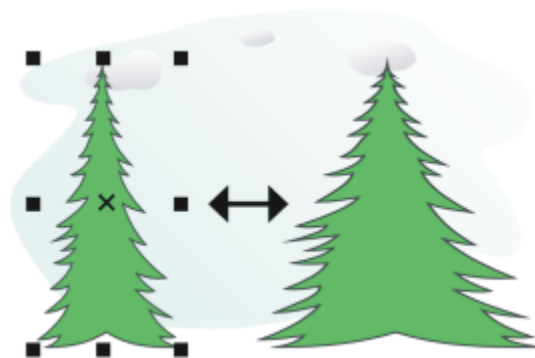

Skewing an object horizontally



Stretching an object horizontally

To skew an object

- 1 Select an [object](#).
- 2 Do one of the following:
 - In the toolbox, click the **Free transform** tool .
 - Click **Window** ▶ **Toolbars** ▶ **Transform**.
- 3 Click the **Free skew** button  on the property bar.
- 4 Type values in the **Skew angle** boxes on the property bar to specify the number of degrees by which you want to skew the object horizontally or vertically.

If you want to apply the scaling according to the object's position rather than the x and y coordinates, click the **Relative to object** button  on the property bar.



You can also skew an object interactively by dragging one of its skew handles . If the skew handles are not displayed, click the selected object again, and point to the middle handles.

You can also access skewing options from the **Transformation** docker by clicking **Object** ▶ **Transformations** ▶ **Skew**.

To stretch an object

- 1 Select an [object](#).

- 2 Click **Object** ▶ **Transformations** ▶ **Size**.
- 3 Disable the **Proportional** check box.
- 4 In the **Transformations** docker, type a value in the following boxes:
 - **H** — lets you specify the width of a selected object
 - **V** — lets you specify the height of a selected object
- 5 Click **Apply**.



The new values that you enter to stretch an object are the basis for a new ratio of the horizontal and vertical dimensions of the object. When you enable the **Proportional** check box, any resizing of the object is based on this new ratio. To revert the object to its original one-to-one proportions before transforming it again, you must enable the **Proportional** check box, and then retype the original values.



You can change object dimensions proportionally by enabling the **Proportional** check box, typing a value in either the **H** or **V** box, and pressing **Enter**.

You can also stretch an object from its center by pressing **Shift** and dragging a corner selection handle.

You can also stretch an object in increments of 100% by pressing **Ctrl**, and dragging a corner selection handle.

Smudging and smearing objects

Smudging and smearing let you shape an **object** by pulling extensions or making indents along its outline. With smudging, the extensions and indents resemble streaks that vary little in width as you drag with the **Smudge** tool. With smearing, the extensions and indents have a more fluid shape that decreases in width as you drag with the **Smear** tool.

Smudging objects

When applying smudging to an object, you can control the extent and shape of the distortion whether you activate the controls for the graphics tablet stylus or use the settings that apply to a mouse.

The smudging effect responds to both the angle of rotation — or bearing — and the tilt angle of a graphics tablet stylus. Rotating the stylus changes the angle of the smudging effect and tilting the stylus flattens the brush tip and changes the shape of the smudging. If you are using a mouse, you can simulate the bearing and tilt of the stylus by specifying values. Increasing the bearing angle from 0 - 359° changes the angle of the brushstroke. As you decrease the tilt angle from 90° - 15°, you change the smudging shape by flattening the brush tip.

Smudging can respond to the pressure of a stylus on a tablet where the smudging widens with more pressure and narrows with less. If you are using a mouse or want to override stylus pressure, you can enter real values to simulate the pressure of a stylus on a graphics tablet. Negative values to -10 create a narrowing distortion, 0 maintains an even stroke width, and positive values to 10 create an expanding distortion.

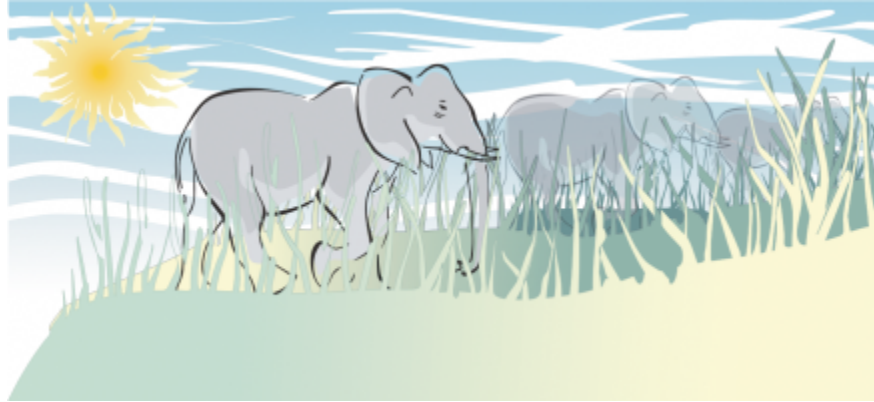

The sun's rays and blades of grass have been created by dragging outwards with the Smudge tool and the clouds by dragging inwards.

Whether you are using a stylus or a mouse, you can specify the nib size. The nib size determines the width of the smudging applied to an object.

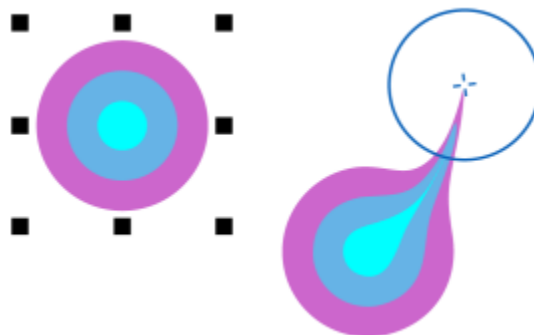

Smearing objects

To control the smearing effect, you can set the size of the brush nib and the amount of effect to apply, and you can use the pressure of your digital pen. You can use smooth curves or curves with sharp corners when smearing objects.





Smearing an object

To smudge an object

- 1 Select an **object** using the Pick tool .
- 2 In the toolbox, click the Smudge tool .
- 3 Do one of the following:
 - To smudge the inside of an object, click outside an object, and drag inwards.
 - To smudge the outside of an object, click inside an object, and drag outwards.

You can also

Change the size of the brush nib

Type a value in the Nib size box  1.27 mm  on the property bar.

You can also

Change the size of the brush nib when using the graphics stylus

Click the **Pen pressure** button  on the property bar and apply pressure to the stylus.

Widen or narrow the smudging

Type a value between -10 and 10 in the **Dryout** box  on the property bar.

Specify the shape of the smudging

Type a value between 15 and 90 in the **Pen tilt** box on the property bar.

Change the shape of the smudging when using the graphics stylus

Click the **Pen tilt** button  on the property bar.

Specify the angle of the nib shape for smudging

Type a value between 0 and 359 in the **Pen bearing** box on the property bar.

Change the angle of the nib shape for smudging when using the graphics stylus

Click the **Pen bearing** button  on the property bar.





You cannot apply smudging to Internet or embedded objects, linked images, grids, masks, mesh-filled objects, or objects with blend and contour effects.



To get the minimum and maximum values for the smudging controls, right-click the control on the property bar, and click **Settings**.

To smear an object

- 1 Select an **object** by using the **Pick** tool .
- 2 In the toolbox, click the **Smear** tool .
- 3 Do one of the following:
 - To smear the outside of an object, click outside an object, close to its edge, and drag outwards.
 - To smear the inside of an object, click inside an object, close to its edge, and drag inwards.

You can also

Change the size of the brush nib

Type a value in the **Nib size** box on the property bar.

Set the amount of smearing

Type a value in the **Pressure** box.

Use the pressure of a digital pen to control the amount of smearing

Click the **Pen pressure** button  on the property bar.

You can also

Use smooth curves when smearing

Click the **Smooth smear** button .

Use curves with sharp corners when smearing

Click the **Pointy smear** button .



The difference between a smooth smear and pointy smear is noticeable only with higher Pressure values.

Roughening objects

The roughening effect lets you apply a jagged or spiked edge to **objects**, including lines, curves, and text. You can control the size, angle, direction, and number of the indentations whether you activate the graphics tablet stylus or apply settings to a mouse.

The roughening effect is determined either by movements of a graphics tablet stylus, by fixed settings, or by automatically applying perpendicular spikes to the line. Tilting the stylus toward and away from the tablet's surface increases and decreases the size of the spikes. If you are using a mouse, you can specify the tilt angle from 0 - 90°. You can determine the direction of the spikes by changing the angle of rotation (or bearing) of the stylus as you apply the roughening effect to an object. When you are using a mouse, you can set the bearing angle from 0 - 359°. You can also increase or decrease the number of spikes that are applied as you drag.

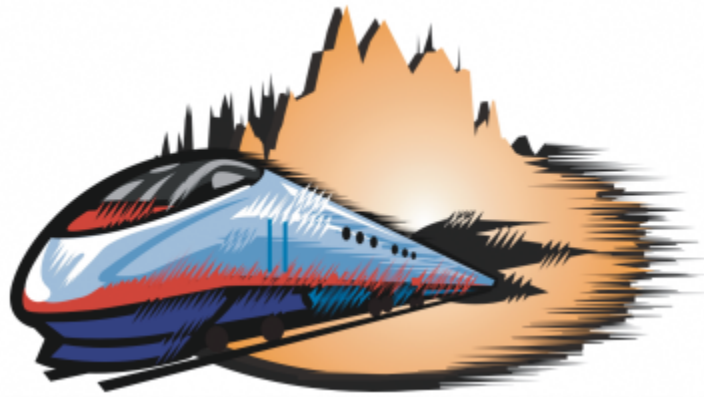

The roughening effect also responds to the pressure of the stylus on the tablet. The more pressure you apply, the more spikes are created in the roughened area. If you are using a mouse, you can specify values to simulate the stylus pressure.

You can also change the brush nib size.



Roughening allows you to apply jags or spikes to part of an outline or path.

To roughen an object

- 1 Select an **object** using the Pick tool .
- 2 In the toolbox, click the **Roughen** tool .
- 3 Point to the area on the outline you want to roughen, and drag the outline to distort it.

You can also

Specify the size of the roughening spikes

Type a value from 0.01 to 2.0 in the **Nib size** box



Change the number of spikes in a roughened area

Type a value between 1 and 10 in the **Frequency of spikes** box



Change the number of spikes in a roughened area when using a graphics stylus

Click the **Pen pressure** button  on the property bar.

Specify the height of the roughening spikes

Type a value between 0 and 90 in the **Pen tilt** box on the property bar.

Increase the number of roughening spikes as you drag

Type a value between -10 and 10 in the **Dryout** box on the property bar.

Change the height of the roughening spikes when using a graphics stylus

Click the **Pen tilt** button  on the property bar.

Specify the direction of the roughening spikes

Choose **Fixed direction** from the **Spike direction** list box. Type a value between 0 and 359 in the **Bearing** box on the property bar.

Change the direction of the roughening spikes when using a graphics stylus

Choose **Stylus setting** from the **Spike direction** list box on the property bar.

Create roughening spikes perpendicular to the path or outline

Choose **Auto** from the **Spike direction** list box on the property bar.



Objects with distortions, envelopes, and perspective applied to them are converted to [curve objects](#) before the roughening effect is applied.



To make the tilt angle and bearing angle responsive to the graphics tablet stylus, right-click the roughened object, and select a command from the submenu.

To get the minimum and maximum values for the roughening controls, right-click the control on the property bar, and click **Settings**.

Smoothing objects

You can smooth curved objects to remove jagged edges and reduce the number of nodes. Alternatively, you can smooth shapes, such as rectangles or polygons, to give them an organic, hand-drawn look.

To control the smoothing effect, you can vary the size of the brush nib and the speed at which the effect is applied, and you can use the pressure of your digital pen.

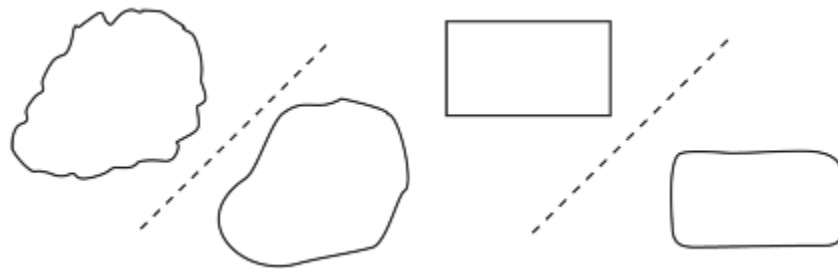

Lorem
Lorem

Text converted to curves (top) and the same text smoothed with the Smooth tool (bottom)



Smoothing jagged edges (left); giving shapes organic look (right)

To smooth an object

- 1 Select an **object** by using the Pick tool .
- 2 In the toolbox, click the Smooth tool .
- 3 Drag along the edge of the object.

You can also

Set the size of the brush nib

Type a value in the **Nib size** box on the property bar

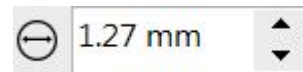

To change the size of the brush nib, you can also drag in the document window while holding down **Shift**. Drag towards the nib's center to decrease the size, and away from the nib's center to increase it.

Set the speed of the smoothing effect

Type a value in the **Rate** box .

You can also hold down **Alt** and drag to display an onscreen slider that lets you set the speed of the smoothing effect interactively.

You can also

Use the pressure of a digital pen to control the effect

Click the **Pen pressure** button  on the property bar.

Shaping objects by attracting or pushing away nodes

The **Attract** and **Repel** tools let you shape objects by attracting nodes or pushing nodes away. To control the shaping effect, you can vary the size of the brush nib and the speed at which the nodes are attracted or pushed away, and you can use the pressure of your digital pen.

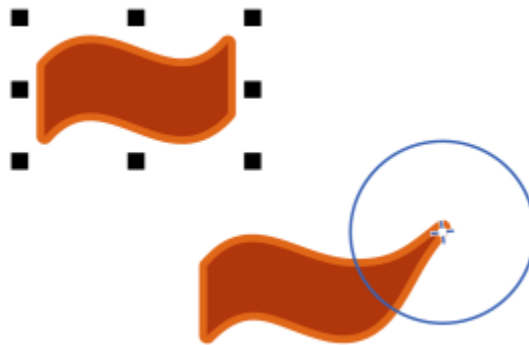



Using the Attract tool to shape an object



Using the Repel tool to shape an object

To shape an object by attracting nodes

- 1 Select an **object** by using the **Pick tool** .
- 2 In the toolbox, click the **Attract tool** .
- 3 Click inside or outside the object, close to its edge, and hold down the mouse button to reshape the edge. For a more pronounced effect, drag while holding down the mouse button.

You can also

Set the size of the brush nib

Type a value in the **Nib size** box on the property bar.

To change the size of the brush nib, you can also drag in the document window while holding down **Shift**. Drag towards the nib's center to decrease the radius, and away from the nib's center to increase it.



Set the speed of the attraction

Type a value in the **Rate** box.

Use the pressure of a digital pen to control the effect

Click the **Pen pressure** button  on the property bar.

To shape an object by pushing nodes away

- 1 Select an [object](#) by using the **Pick tool** .
- 2 In the toolbox, click the **Repel tool** .
- 3 Click inside or outside the object, close to its edge, and hold down the mouse button to reshape the edge. For a more pronounced effect, drag while holding down mouse button.

You can also

Set the radius of the brush nib

Type a value in the **Nib size** box on the property bar.

To change the radius of the brush nib, you can also drag in the document window while holding down **Shift**. Drag towards the nib's center to decrease the radius, and away from the nib's center to increase it.

Set the speed of the repel effect

Type a value in the **Rate** box.

Use the pressure of a digital pen to control the effect

Click the **Pen pressure** button  on the property bar.

Applying distortion effects

You can apply three types of distortion effects to shape [objects](#).

Distortion effect

Description

Push and pull

Lets you push the edges of an object in or pull the edges of an object out

Zipper

Lets you apply a saw tooth effect to the edges of the object. You can adjust the amplitude and frequency of the effect.

Distortion effect

Description

Twister

Lets you rotate an object to create a swirl effect. You can choose the direction of the swirl, as well as the degree and amount of rotation.



From left to right: Original image; Zipper and Twister distortions applied; Pull distortion applied

After you distort an object, you can change the effect by altering the center of distortion. This point is identified by a diamond-shaped handle, around which a distortion appears. It is similar to a mathematical compass, where the pencil moves around a stationary point. You can place the center of distortion anywhere in the drawing window, or choose to center it in the middle of an object so that the distortion is distributed evenly and the shape of the object changes in relation to its center.

You can create an even more dramatic effect by applying a new distortion to an already distorted object. You don't lose the effect of the original distortion if, for example, you apply a zipper distortion on top of a twister distortion. The CorelDRAW application also lets you remove and copy distortion effects.

To distort an object

- 1 In the toolbox, click the **Distort** tool .
- 2 On the property bar, click one of the following buttons, and specify the settings you want:
 - **Push and pull distortion**
 - **Zipper distortion**
 - **Twister distortion**
- 3 Point to where you want to place the center of distortion, and drag until the **object** is the shape you want.

You can also

Change the center of distortion

Drag the diamond-shaped position handle to a new location.

Adjust the number of points on a zipper distortion

Move the slider on the center of the distortion handle.

Apply a preset distortion

Choose a distortion preset from the **Preset** list box on the property bar.

Apply more than one distortion to an object

Click another distortion type on the property bar, click an object, and drag.



You can reapply the effects to distorted objects.



You can center a distortion by clicking the **Center distortion** button  on the property bar.

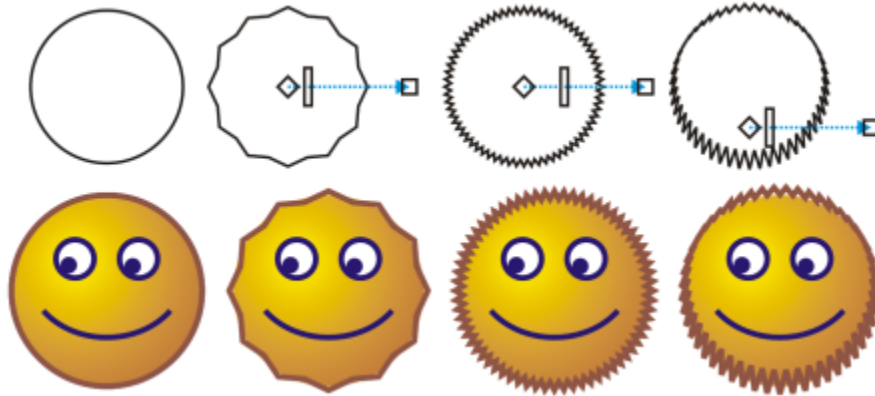

You can use the interactive vector controls to edit a distortion effect. Upper left: Zipper effect applied to circle. Upper right: Zipper effects with higher frequency (more spikes) applied. Bottom: Results of applying zipper effects.

To remove a distortion

- 1 Select a distorted **object**.
- 2 Click **Effects** ▶ **Clear distortion**.



Removing a distortion this way clears the most recent distortion you've applied.



You can also remove a distortion from a selected object by clicking the **Clear distortion** button  on the property bar.

To copy a distortion

- 1 Select the **object** to which you want to copy a distortion.
- 2 Click **Effects** ▶ **Copy effect** ▶ **Distortion from**.
- 3 Click a distorted object.



You can also use the **Eyedropper** tool  to copy the effect. For more information, see ["To copy effects from one object to another"](#) on page 273.

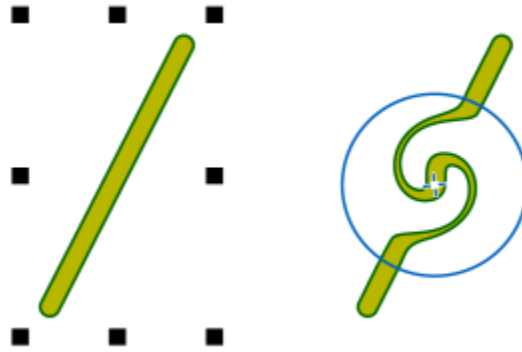

Adding twirl effects

You can add twirl effects to objects. You can set the radius, speed, and direction of the twirl effects, and you can use the pressure of your digital pen to change the intensity of the twirl effect.



Adding a twirl effect

To add a twirl effect to an object

- 1 Select an [object](#) by using the Pick tool .
- 2 In the toolbox, click the Twirl tool .
- 3 Click the edge of the object, and hold down the mouse button until the twirl is the size you want. To position and reshape the twirl, you can drag while holding down the mouse button.

You can also



Set the radius of the twirl effect

Type a value in the **Nib size** box on the property bar.

Set the rate at which the twirl effect is applied

Type a value between 1 and 100 in the **Rate** box on the property bar.

Set the direction of the twirl effect

Click the **Counterclockwise twirl** button  or the **Clockwise twirl** button .

Use the pressure of a digital pen to control the intensity of the twirl effect

Click the **Pen pressure** button  on the property bar.

Shaping objects by using envelopes

CorelDRAW lets you shape [objects](#), including lines, [artistic text](#), [paragraph text frames](#), and bitmaps by applying [envelopes](#). Envelopes are made of multiple [nodes](#) that you can move to shape the envelope and, as a result, change the shape of the object.



The original bitmap (left) with an envelope (right). The envelope is applied nondestructively, so you can edit it or remove it and revert to the original image at any point.

You can apply a basic envelope that conforms to the shape of an object, or you can also apply a preset envelope.



A preset envelope has been applied to a group of bitmaps.

If none of the presets fits your needs, you can create a custom envelope and save it for future use. Envelope presets are saved as Preset (.PST) files and are stored in the \AppData\Roaming\Corel\CorelDRAW Graphics Suite 2018\Draw\Presets\Envelope folder.

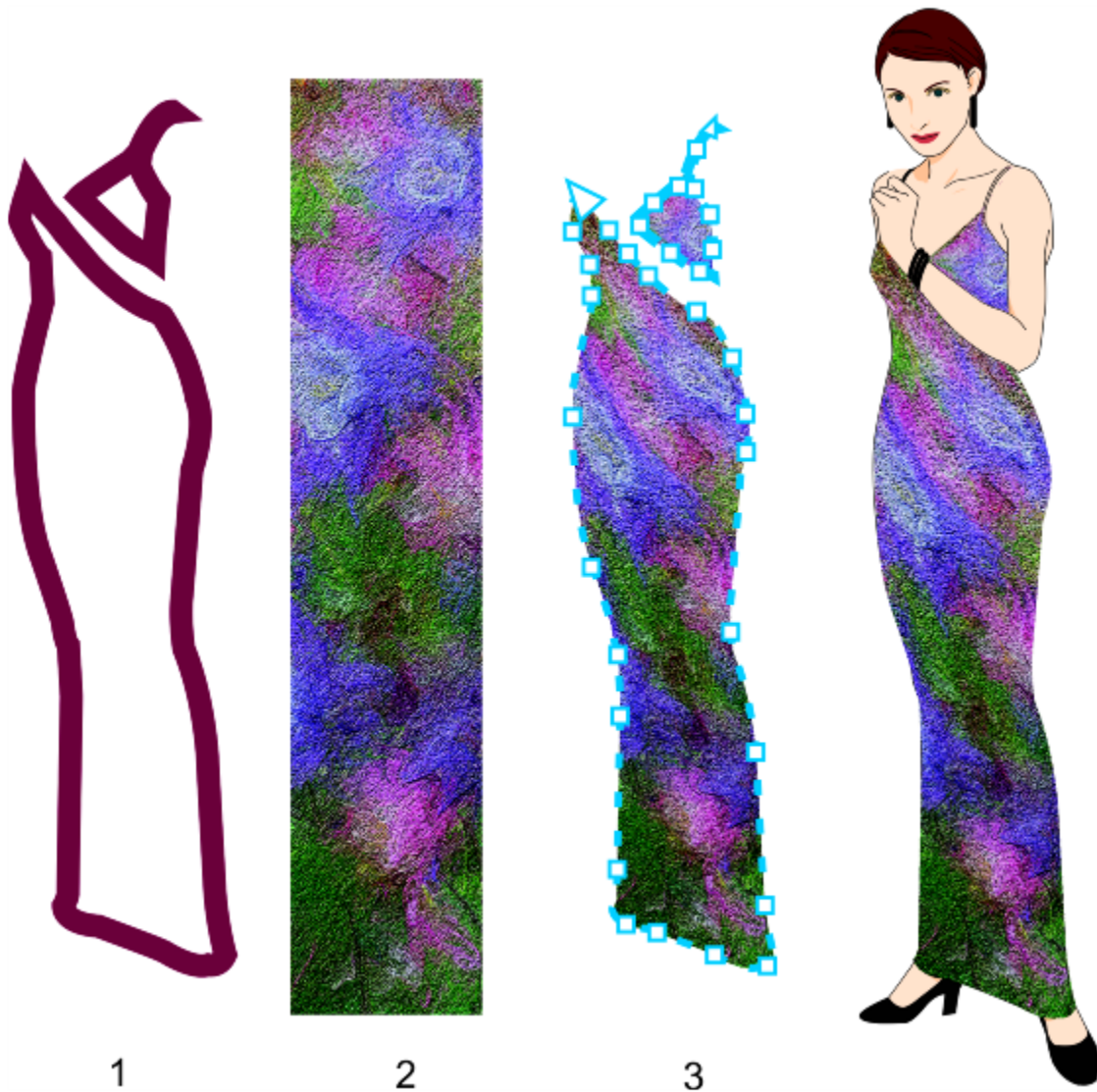

1 2 3
A custom envelope (3) is created from the shape of a vector object (1) and applied to a bitmap (2).





CorelDRAW also lets you copy and remove envelopes.

After you apply an envelope, you can edit it or add a new envelope to continue changing the object's shape. You edit an envelope by adding and positioning its nodes. Adding nodes gives you more control over the shape of the object contained in the envelope. CorelDRAW also lets you delete nodes, move multiple nodes simultaneously, change nodes from one type to another, and change a segment of an envelope to a line or curve. For more information about the different types of nodes, see ["Using curve objects"](#) on page 180.

You can also change the mapping mode of an envelope to specify how the object fits to the envelope. For example, you can stretch an object to fit the basic dimensions of the envelope, and then apply the horizontal mapping mode to compress it horizontally so that it fits the shape of the envelope.

To apply an envelope

- 1 Select an [object](#).
- 2 In the toolbox, click the **Envelope** tool .
- 3 On the property bar, click one of the following buttons:

- **Straight line mode**  — creates envelopes based on straight lines, adding perspective to objects
- **Single-arc mode**  — creates envelopes with an arc shape on one side, giving objects a concave or convex appearance
- **Double-arc mode**  — creates envelopes with an S shape on one or more sides
- **Unconstrained mode**  — creates freeform envelopes that let you change the properties of the nodes, and add and delete the nodes

4 Click the object.

5 Drag the nodes to shape the envelope.

If you want to reset the envelope, press **Esc** before releasing the mouse.

You can also

Apply a preset envelope

Click the **Preset list** list box on the property bar, and click an envelope shape.

Apply an envelope to an object with an envelope

Click the **Add new envelope** button  on the property bar, and drag the nodes to change the shape of the envelope.

Remove an envelope

Click **Effects** ▶ **Clear envelope**.



Applying an envelope to paragraph text allows you to modify only the shape of the text frame. To shape the text inside the frame, consider converting the frame to a curve after you finish editing and formatting the content. For information about converting objects to curves, see “To convert objects to curve objects” on page 180. Note that once you convert the frame to a curve, you can no longer edit the text. To shape individual characters with an envelope, use artistic text.



You cannot apply an envelope to a bitmap with an envelope.



You can also apply an envelope by using the **Envelope** docker (**Effects** ▶ **Envelope**).

You can prevent the straight lines of a vector object from being converted to curves by enabling the **Keep lines** button  on the property bar.

To create an envelope based on the shape of another object

- 1 Select an **object** to which you want to apply an **envelope**.
- 2 In the toolbox, click the **Envelope** tool .
- 3 Click the **Create envelope from** button  on the property bar.
- 4 Click the object from which you want to create an envelope.
The envelope is applied to the object that you selected in step 1.

To save the envelope for future use, click the **Add preset** button  on the property bar, type a filename in the **File name** list box, and click **Save**.



You can create an envelope only from a closed curve.

To copy an envelope

- 1 Select an [object](#) to which you want to apply an [envelope](#).
- 2 Click **Effects** ▶ **Copy effect** ▶ **Envelope from**.
- 3 Select the object from which you want to copy the envelope.



You can also copy an envelope by selecting an object, clicking the **Copy envelope properties** button on the property bar, and selecting an object with the envelope you want to copy.

You can also use the **Eyedropper** tool  to copy an envelope. For more information, see “[To copy effects from one object to another](#)” on page 273.

To edit the nodes and segments of an envelope

- 1 In the toolbox, click the **Envelope** tool .
- 2 Select an [object](#) with an [envelope](#).
- 3 Double-click the envelope to add a node or double-click a [node](#) to delete it.

You can also

Move several envelope nodes at once

Click the **Unconstrained mode** button  on the property bar, marquee select the nodes you want to move, and drag any node to a new position.



Marquee select multiple nodes

On the property bar, choose **Rectangular** from the **Selection mode** list box, and drag around the nodes that you want to select.

Freehand marquee select multiple nodes

On the property bar, choose **Freehand** from the **Selection mode** list box, and drag around the nodes you want to select.

Move two opposing nodes an equal distance in the same direction

Click the **Straight line mode** , **Single-arc mode**  or **Double-arc mode**  button on the property bar so that it appears raised, press **Ctrl**, and drag a node to a new position.

You can also

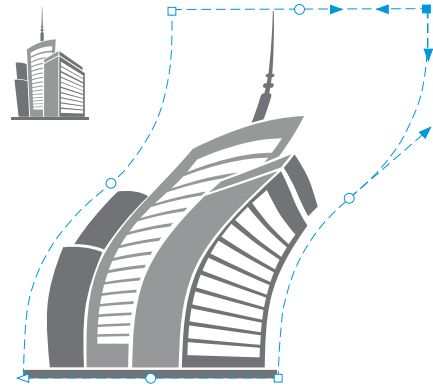

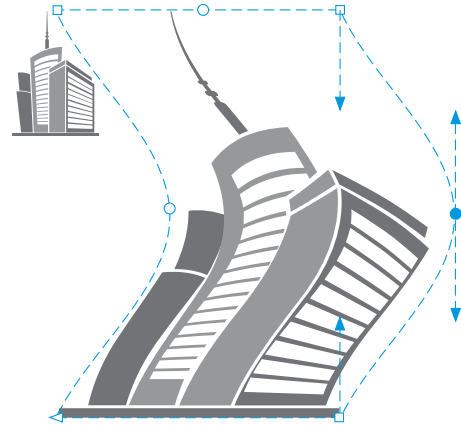

Moving corner nodes skews the envelope.



Moving middle nodes

Note: This feature applies only to some preset envelopes with symmetrical nodes.

Move two opposing nodes an equal distance in the opposite direction

Click the **Straight line mode** , **Single-arc mode**  or **Double-arc mode**  button on the property bar so that it appears raised, press **Shift**, and drag a node to a new position.

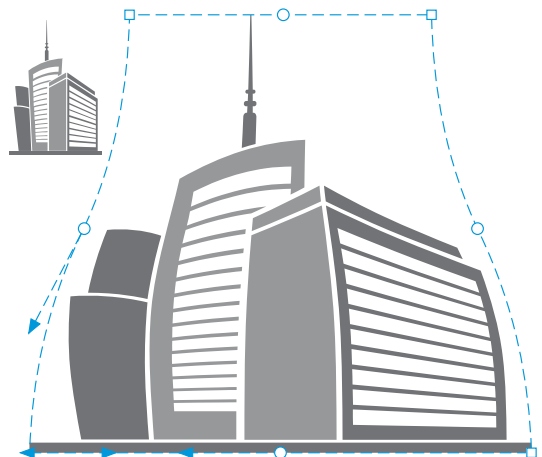

You can also

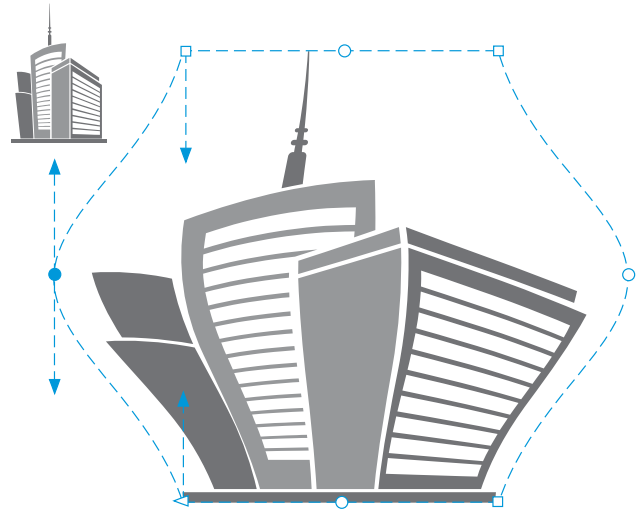

Moving corner nodes



Moving middle nodes

Note: This feature applies only to some preset envelopes with symmetrical nodes.

Move all opposing nodes symmetrically to or away from a central point

Click the **Straight line mode** , **Single-arc mode**  or **Double-arc mode**  button on the property bar so that it appears raised, press **Ctrl + Shift**, and drag a node to a new position.

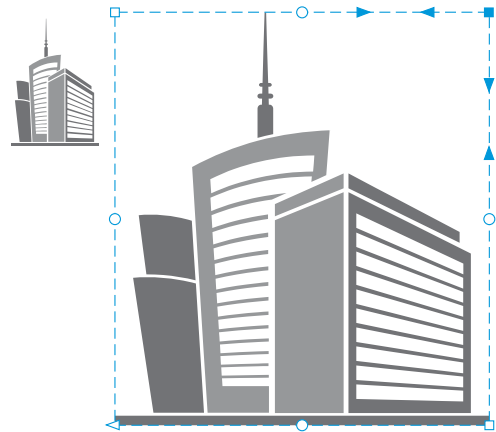

Moving all corner nodes stretches the envelope horizontally or vertically.



You can also





Moving all middle nodes lets you push the edges of the envelope in or pull the edges of the envelope out.



Note: This feature applies only to some preset envelopes with symmetrical nodes.

Change an envelope node type

Click the **Unconstrained mode** button on the property bar so that it appears pressed, and click either the **Cusp node** , the **Smooth node** , or the **Symmetrical node**  button.

Change an envelope segment to a straight line or curve

Click the **Unconstrained mode** button on the property bar so that it appears pressed, click a line segment, and click the **Convert to line**  button or the **Convert to curve**  button.

Note: Both the **Convert to line**  and **Convert to curve**  buttons are disabled when you apply an envelope to a bitmap.



If you split, crop, or erase portions of an object with an envelope, you can no longer edit the envelope.

If you edit a bitmap with an envelope in Corel PHOTO-PAINT, or if you copy a bitmap with an envelope and paste it into Corel PHOTO-PAINT or into an earlier version of CorelDRAW, the envelope is no longer editable.

To change the mapping mode

- 1 In the toolbox, click the **Envelope**  tool.
- 2 Click an **object** with an **envelope**.
- 3 On the property bar, choose one of the following from the **Mapping mode** list box:

- **Horizontal** — stretches the object to fit the basic dimensions of the envelope and then compresses the object horizontally to fit the shape of the envelope
- **Original** — maps the corner handles of the object’s selection box to the envelope’s corner **nodes**. The other nodes are mapped linearly along the edge of the object’s selection box.
- **Putty** — maps the corner handles of the object’s selection box to the envelope corner nodes
- **Vertical** — stretches the object to fit the basic dimensions of the envelope and then compresses the object vertically to fit the shape of the envelope

4 Drag the nodes or the control handles.



The mapping mode of **paragraph text** frames cannot be changed after an envelope is applied.

Cropping and erasing objects

You can crop and erase portions of objects.

Cropping objects

Cropping lets you quickly remove unwanted areas in objects and imported photos, eliminating the need to ungroup objects, break linked groups apart, or convert objects to curves. You can crop vector objects and bitmaps.



Cropping objects

When cropping objects, you define a rectangular area (cropping area) that you want to keep. Object portions outside the cropping area are removed. You can specify the exact position and size of the cropping area, and you can rotate and resize it. You can also remove the cropping area.

You can crop only selected objects without affecting other objects in a drawing, or you can crop all objects on the drawing page. In either case, the affected text and shape objects are automatically converted to curves.

Erasing image areas

CorelDRAW lets you erase unwanted portions of bitmaps and vector objects. The **Eraser** tool works just like a pencil eraser, removing any part of the image over which you click and drag. If you want to erase only portions of a specific object, you have to select it. When no object is selected, the **Eraser** tool removes any part of the drawing over which you drag. For information about selecting objects, see “[Selecting objects](#)” on page 254. Erasing automatically closes any affected paths and converts the object to curves. If you erase connecting lines, CorelDRAW creates subpaths rather than individual objects. You cannot erase objects with contours, blends, drop shadows, block shadows, and extrusions.

When working with a pen or stylus, you can use pressure to vary the size of the eraser nib. If your pen or stylus supports tilt and bearing, you can use these features to vary the flatness and rotation of the eraser nib. You can also set fixed values for the tilt angle and bearing angle so that the flatness and rotation of the nib remain the same.



You can use your stylus to vary the size and flatness of the eraser nib.

Deleting virtual line segments

You can also delete virtual line segments, which are portions of objects that overlap each other. For example, you can delete a loop in a line that crosses over itself, or loops in line segments in which two or more objects overlap.

To crop an object or imported photo

- 1 Select the object or imported photo that you want to crop.
You can select one or more objects. If no objects on the drawing page are selected, all objects in the drawing will be cropped.
- 2 In the toolbox, click the **Crop** tool .
- 3 Drag to define a cropping area.
- 4 Double-click inside the cropping area.

You can also

Specify the exact position of the cropping area

Type values in the **Crop position** boxes on the property bar, and press **Enter**.

Specify the exact size of the cropping area

Type values in the **Crop size** boxes on the property bar, and press **Enter**.

Rotate the cropping area

Type values in the **Angle of rotation** box.

Remove the cropping area

Click the **Clear crop marquee** button.



Objects on locked, hidden, Grid, or Guides layers cannot be cropped. Also, you cannot crop OLE and Internet objects, [rollovers](#), or the content of PowerClip objects.

During cropping, affected linked groups, such as [contours](#), [blends](#), and [extrusions](#), are automatically broken apart.



You can move, rotate, and size the cropping area interactively as you would any object. To move the cropping area, drag it to a new position. To size the cropping area, drag any of its handles. To rotate the cropping area, click inside, and drag a rotation handle .

You can remove the cropping area by pressing **Esc**.

To erase an image area

1 Perform a task from the following table.



To	Do the following
Erase an area in a drawing	Deselect all objects.
Erase portions of an object	Select the object.

2 Do one of the following:

- When using a mouse, click the **Eraser tool**  in the toolbox.
- When using a stylus, flip the stylus to automatically switch to erase mode.

3 Drag over the area that you want to erase.

You can also

Change the size of the eraser nib	Type a value in the Eraser thickness box on the property bar, and press Enter .
Change the shape of the eraser nib	Click the Round nib or the Square nib button on the property bar.
Vary the width of the eraser nib	Click the Pen pressure button  on the property bar to enable it. The maximum width of the nib is determined by the value specified in the Eraser thickness box. If you are using the mouse, press the Up arrow or Down arrow to simulate changes in pen pressure and change the width of the eraser nib.
Vary the flatness of the eraser nib	Click the Pen tilt button  on the property bar to enable it.
Flatten the eraser nib by setting a fixed value for pen tilt	Click the Pen tilt button  on the property bar to disable it, and type a value in the Tilt angle box. You can specify a value between 15 and 90. The lower the value, the flatter the nib.

You can also

Vary the rotation of the eraser nib

Click the **Pen bearing** button  on the property bar to enable it.

Rotate the eraser nib by setting a fixed value for pen bearing

Click the **Pen bearing** button  on the property bar to disable it, and type a value in the **Bearing angle** box.

You can specify a value between 0 and 359.

Maintain all the nodes of the area being erased

Disable the **Reduce nodes** button on the property bar.



When you erase portions of objects, any affected [paths](#) are automatically closed.



You can erase straight lines by clicking where you want to start erasing, and then clicking where you want to finish erasing. Press **Ctrl** if you want to constrain the line's angle.

You can also erase an area of a selected object by double-clicking the area with the **Eraser** tool.

To delete a virtual line segment

- 1 In the toolbox, click the **Virtual segment delete** tool .
- 2 Move the pointer to the line segment you want to delete. The **Virtual segment delete** tool snaps upright when positioned properly.
- 3 Click the line segment.

If you want to delete multiple line segments at one time, click the pointer to drag a marquee around all line segments you want to delete.

You can also

Delete multiple line segments at one time

Drag the pointer to enclose or intersect all target segments.

Delete a virtual line segment that intersects with a curve

Hold down **Alt**, and drag to draw a curve.

Weld line segments

Hold down **Shift**, click the two overlapping end points. You can also hold down **Alt + Shift**, and drag to marquee select the overlapping nodes.



The **Virtual segment delete** tool does not work on linked groups such as drop shadows, text, or images.

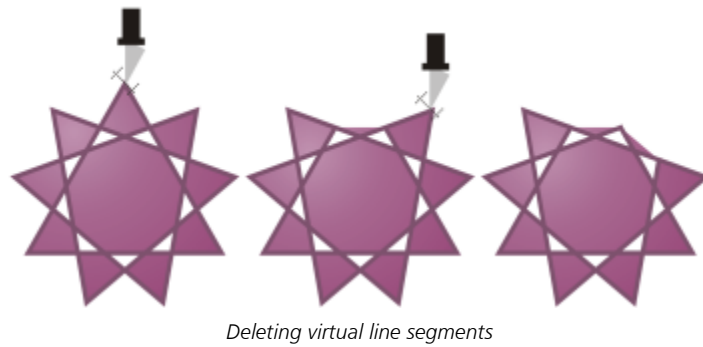

Splitting objects

You can split vector objects, text, and bitmaps. You can split single objects or groups of objects along straight, freehand, or Bézier lines.

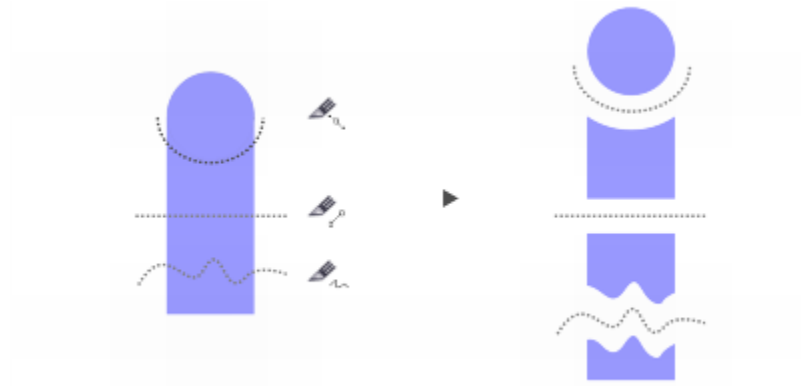

(From top to bottom) Three modes for splitting objects are available: Bézier, 2-Point Line, and Freehand.

In addition, you can create a gap between the new objects resulting from the splitting action, or you can make the new objects overlap.



This bitmap was split into two along a freehand line. The gap value was specified before cutting the bitmap.

When you split an object by using the Knife tool , CorelDRAW lets you choose whether to convert outlines to curve objects or keep them as outlines. By default, the application automatically chooses the option that best preserves outline appearance.

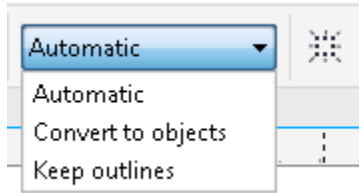

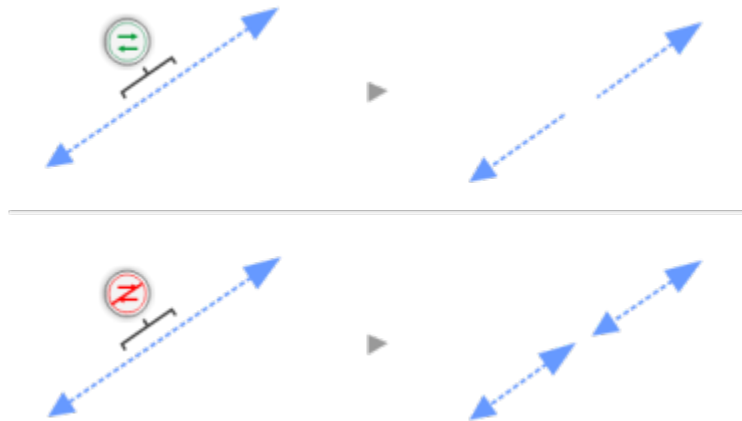

You can choose outlines options from the property bar.

When splitting objects that have dashed lines, arrowheads or end caps, the **Convert to objects** option preserves the outline appearance better. When you choose the **Automatic** option for such objects, CoreDRAW converts the outlines to objects.



Top: The outline (a dashed line with arrowheads in this example) was converted to objects after the split, preserving the original appearance. Bottom: The Keep outlines option was used, resulting in two lines with start and end arrowheads.

To split an object

- 1 In the toolbox, click the Knife tool .
- 2 On the property bar, click one of the following buttons:
 - 2-point line mode  — to split the object along a straight line. To constrain the line by 15-degree increments, hold down **Shift + Ctrl**.
 - Freehand mode  — to split the object along a freehand line
- 3 Drag across the object or group of objects that you want to split.

You can also

Split an object along a Bézier line

Click the **Bézier mode** button  on the property bar. Click where you want to start cutting an object, drag the control handle to where you want to position the next node, and click. Continue clicking to add more straight segments to the line. To add a curved segment, point to where you want to place the node and drag to shape the curve. To constrain the line by 15-degree increments, hold down **Shift + Ctrl**.

You can also

Create a gap or an overlap between the new objects

On the property bar, choose **Gap** or **Overlap** from the **Cut span** list box. Type a value in the **Width** box.

Choose outline options

On the property bar, choose an option from the **Outline options** list box.



When you split an object by using the **Knife** tool, the new objects become [curve objects](#).

Trimming objects

Trimming creates irregularly shaped [objects](#) by removing object areas that overlap. You can trim almost any object, including clones, objects on different layers, and single objects with intersecting lines. However, you cannot trim [paragraph text](#), dimension lines, or masters of clones.

Before you trim objects, you must decide which object you want to trim (the target object) and which object you want to use to perform the trimming (the source object). For example, if you want to create a star-shaped cut out of a square object, the star is the source object because you are using it to trim the square. The square is the target object because it's the object you want to trim. The source object trims the part of the target object it overlaps.

The target object retains its fill and outline attributes. For example, if you trim a rectangle that is overlapped by a circle, the area of the rectangle that was covered by the circle is removed, creating an irregular shape.

CorelDRAW lets you trim objects in different ways. You can use a front object as the source object to trim an object behind it, as well as use the back object to trim a front object. You can also remove hidden areas of overlapping objects, so that only the visible areas remain in the drawing. Removing the hidden areas can reduce file size when you convert vector graphics to bitmaps.



Trimming can be used to reduce the number of objects in a drawing. Instead of adding eyes and spots to the bug, areas (shown on the left in gray) are trimmed to reveal the black background (right).



The letter "A" is the front object used to trim the back object. A partial silhouette of the letter is created in the logo (right).

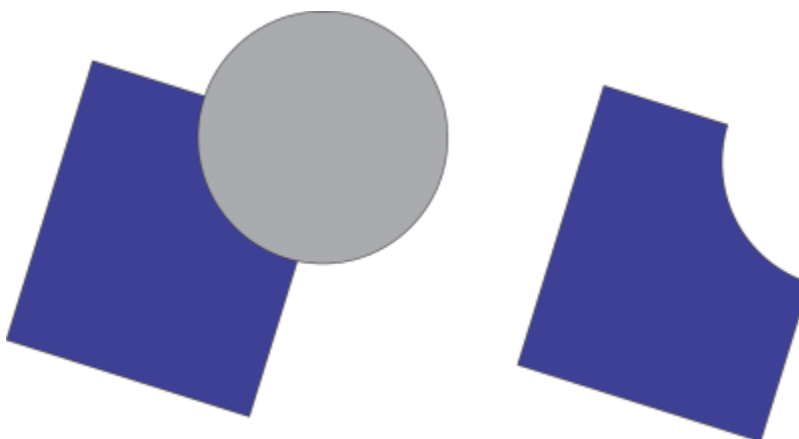

The circle is used to trim the rectangle.

To trim an object

- 1 Select the source [objects](#).
- 2 Hold down **Shift**, and click the target object.
- 3 Click **Object** ▶ **Shaping** ▶ **Trim**.

In the **Classic** workspace, this command appears under the **Arrange** menu.



If you marquee select the objects, CorelDRAW trims the bottom-most selected object. If you select multiple objects individually, the last object selected is trimmed.



You can also trim objects by marquee-selecting the source and target objects and clicking the **Trim** button  on the property bar.

To trim front or back objects

- 1 Marquee select the source and target [objects](#).
- 2 Click **Object** ▶ **Shaping**, and click one of the following:
 - **Front minus back** — removes the back object from the front one
 - **Back minus front** — removes the front object from the back one

In the **Classic** workspace, these commands appear under the **Arrange** menu.



You can trim the control object of a PowerClip object so that the object inside the PowerClip object will assume the new shape of the PowerClip container. For information about PowerClip objects, see [“Creating PowerClip objects” on page 230](#).

Linked objects such as drop shadows, text on a [path](#), blends, contours, and extrusions are converted to [curve objects](#) before they are trimmed.

To trim overlapping areas in objects

- 1 Marquee select the [objects](#) you want to trim.
- 2 Click **Object** ▶ **Shaping** ▶ **Simplify**.

In the **Classic** workspace, this command appears under the **Arrange** menu.



You can trim the control object of a PowerClip object, so that the object inside the PowerClip object assumes the new shape.

Linked objects, such as drop shadows, text on a [path](#), blends, contours, and extrusions, are converted to [curve objects](#) before they are trimmed.

Filleting, scalloping, and chamfering corners

You can fillet, scallop, or chamfer the corners of any curve object, whether it originates from a shape, lines, text, or a bitmap. Filleting produces a rounded corner, scalloping rounds and inverts the corner to create a notch, and chamfering bevels a corner so that it appears flat. CorelDRAW also lets you preview the corners before you apply the changes to them. For information about modifying the corners of squares and rectangles, see [“Drawing rectangles and squares ” on page 167](#).

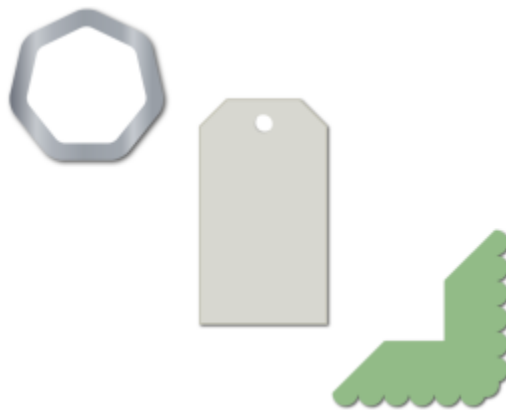

Filleting, chamfering, and scalloping applied to various shapes.

If you modify the corners of a non-curve shape, the shape is automatically converted to curves for you. The changes are applied to all corners unless you select individual nodes. However, you must convert an object to curves manually by using the **Convert to curves** command before you can select individual nodes. You cannot fillet, scallop, or chamfer a smooth or symmetrical curve; the corner must be created by two straight or curve segments that intersect at an angle of less than 180 degrees.

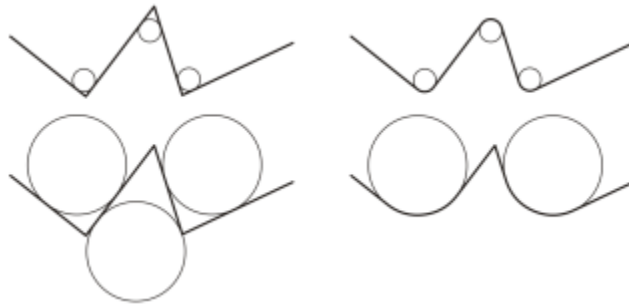

The operation is not applied to the corners when the fillet, scallop, or chamfer value is too high. This occurs when the line segments aren't long enough to apply the radius or chamfer distance. When setting values for these operations, consider that, although the line segments may appear long enough at the beginning of the operation, they shorten as the radius or chamfer values are applied across the object.



In this example, the circles represent fillet radius settings. The top row shows the proposed fillets on the left and the filleted results on the right. The bottom row shows the proposed fillets on the left, but in the results on the right, not all corners are filleted. After the first fillet is applied, the next corner cannot be filleted because the line segment is not long enough. This corner is skipped, and the final corner is filleted.

To round object corners by filleting

1 Do one of the following:

- Select a curve object using the **Pick tool** .
- Select individual nodes on a curve object using the **Shape tool** .

2 Click **Window** ► **Fillet/Scallop/Chamfer**.

3 In the **Fillet/Scallop/Chamfer** docker, enable the **Fillet** option.

4 Type a value in the **Radius** box.

The radius is used to create a circular arc whose center is equidistant from either side of a corner. Higher values produce more rounded corners.

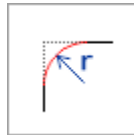

5 Click **Apply**.





The **Apply** button is disabled if no valid objects or nodes are selected.



If you have a square or rectangle, you can also round all corners at once by dragging a corner node toward the center of the object while the **Shape tool** is active. The shape is not converted to curves if you use this method.

To scallop object corners

1 Do one of the following:

- Select a curve object using the **Pick tool** .
- Select individual nodes on a curve object using the **Shape tool** .

2 Click **Window** ► **Fillet/Scallop/Chamfer**.

3 In the **Fillet/Scallop/Chamfer** docker, enable the **Scallop** option.

4 Type a value in the **Radius** box.

The radius value is measured from the original corner point to create a scalloping arc.





5 Click **Apply**.



The **Apply** button is disabled if no valid objects or nodes are selected.

To bevel object corners by chamfering

- 1 Using the **Pick tool** , select the object.
- 2 Click **Window** ▶ **Dockers** ▶ **Fillet/Scallop/Chamfer**.
- 3 In the **Fillet/Scallop/Chamfer** docker, choose **Chamfer** from the **Operation** list box.
- 4 In the **Chamfer distance** area, type a value in the **A** box to set where the chamfer will begin in relation to the original corner.

If you do not want the ends of the chamfer to be equidistant from the original corner, click the **Lock** button , and type a different value in the **B** box. **A** and **B** values are applied according to the direction in which the line is drawn.

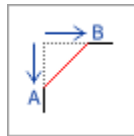

5 Click **Apply**.



To select individual nodes using the **Shape tool** , you must first convert the object to curves manually by using the **Convert to curves** command.

Welding and intersecting objects

You can create irregular shapes by welding and intersecting **objects**. You can weld or intersect almost any object, including clones, objects on different layers, and single objects with intersecting lines. However, you cannot weld or intersect **paragraph text**, dimension lines, or masters of clones.

You can weld objects to create one object with a single outline. The new object uses the welded objects' perimeter as its outline and adopts the fill and outline properties of the target object. All intersecting lines disappear.

You can weld objects regardless of whether they overlap each other. If you weld objects that do not overlap, they form a weld group that acts as a single object. In both cases, the welded object takes on the fill and outline attributes of the target object.

You can weld single objects with intersecting lines so that the object breaks into several **subpaths**, but its appearance remains the same.

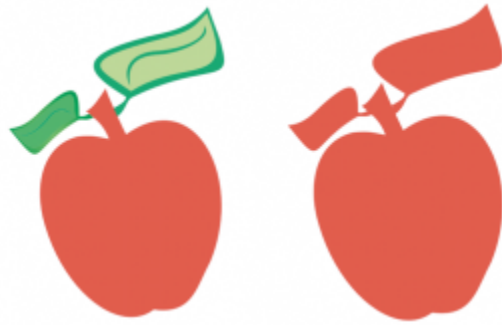

Welding the leaves to the apple creates a single object outline.

Intersecting creates an object from the area where two or more objects overlap. The shape of this new object can be simple or complex, depending on the shapes you intersect. The new object's fill and outline attributes depend on the object you define as the target object.

To weld objects

- 1 Select the source [object](#) or objects.
- 2 Hold down **Shift**, and click the target object.
- 3 Click **Object** ▶ **Shaping** ▶ **Weld**.

In the **Classic** workspace, this command appears under the **Arrange** menu.



The new object has the fill and outline properties of the target object.



You can also weld objects by marquee-selecting the source and target objects and clicking the **Weld** button  on the property bar.

To intersect objects

- 1 Select the source [object](#) or objects.
- 2 Hold down **Shift**, and select the target object.
- 3 Click **Object** ▶ **Shaping** ▶ **Intersect**.

In the **Classic** workspace, this command appears under the **Arrange** menu.



The new object, which is created from the overlapping parts of the source and target object, has the fill and outline properties of the target object.



You can also intersect objects by selecting the source and target objects and clicking the **Intersect** button  on the property bar.

To intersect multiple objects

- 1 Marquee select the source [object](#) or objects.
- 2 Hold down **Shift**, and click each target object.
- 3 Click **Object** ▶ **Shaping** ▶ **Intersect**.



You can also intersect objects by marquee-selecting the source and target objects and clicking the **Intersect** button  on the property bar.

Creating PowerClip objects

CorelDRAW lets you place vector **objects** and bitmaps, such as photos, inside other objects, or frames. A frame can be any object, for example **artistic text** or a rectangle. When the object is larger than the frame, the object, called the contents, is cropped to fit the form of the frame. This creates a PowerClip object.



Objects before becoming a PowerClip object: artistic text and a bitmap



In the PowerClip object, the artistic text is the frame, and the bitmap forms the contents. The bitmap is shaped to the letters of the artistic text.



The rectangle is used as a frame, and the tree is placed inside to create a PowerClip object.

You can create more complex PowerClip objects by placing one PowerClip object inside another PowerClip object to produce a nested PowerClip object. You can also copy the contents of one PowerClip object to another PowerClip object.

You can create an empty PowerClip frame from an object, or convert a PowerClip frame back to an object. Creating empty PowerClip frames or text frames is useful when you want to define the layout of your document before adding the content. For more information about text frames, see “Adding paragraph text” on page 477. After you create an empty PowerClip frame, you can add contents to it. You can also add contents to a PowerClip frame that already contains another object.

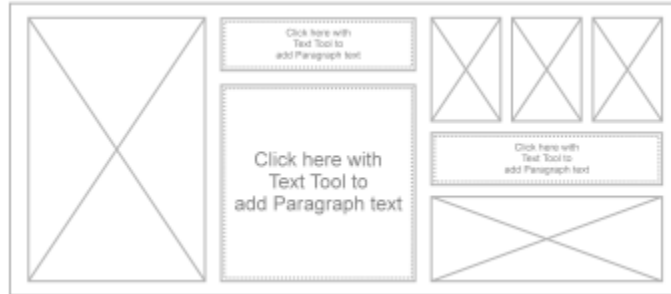

Creating empty PowerClip frames and text frames is useful when you want to visualize your page layout before adding the contents.

After you create a PowerClip object, you can select or edit its contents, or reposition the contents inside the frame. Whenever a PowerClip object is selected, a floating toolbar appears.



The PowerClip toolbar lets you edit, select, extract, lock, or reposition the contents inside the frame. The toolbar appears whenever a PowerClip object is selected.

You can lock the PowerClip contents, so that when you move the frame, the content moves with it. If you want to delete the contents of a PowerClip object or modify it without affecting the frame, you can extract the contents.

You can set the default behavior for dragging content to PowerClip frames, centering new content, and marking empty PowerClip frames.

To create a PowerClip object

- 1 Select the **object** that you want to use as the PowerClip contents.
- 2 Click **Object** ► **PowerClip** ► **Place inside frame**.
In the **Classic** workspace, this command appears under the **Effects** menu.
- 3 Click the object that you want to use as a frame.

If you want to create a nested PowerClip object, drag the PowerClip object inside another PowerClip object, and hold down the **W** key as you release the mouse button to place the object inside the frame.



You can also right-click an object or a group of objects, click **PowerClip inside**, and then click the object that you want to use as a container.

If the content is placed so that it falls outside the frame in its current position, it is automatically centered inside the frame to make it visible. To change this setting, click **Tools** ► **Options**, choose **Edit** in the **Workspace** list of categories, and set the options you want in the **PowerClip frame** area.

To create an empty PowerClip frame

- 1 Select an object that you want to use as a frame.
- 2 Click **Object** ► **PowerClip** ► **Create empty PowerClip frame**.
In the **Classic** workspace, this command appears under the **Effects** menu.



You can also right-click the object, choose **Frame type**, and click **Create empty PowerClip frame**.

You can also click the **PowerClip frame** button on the **Layout** toolbar. To open the **Layout** toolbar, click **Window** ► **Toolbars** ► **Layout**.

To add content to a PowerClip frame

- 1 Drag an object to the PowerClip frame.
When the object approaches the frame, the frame is highlighted.
- 2 Do one of the following:
 - To add the object to an empty PowerClip frame, release the mouse button.
 - To add the object to a full PowerClip frame, hold down the **W** key as you release the mouse button.



You can also drag content to the PowerClip frame directly from Corel CONNECT, or from the **Get more** docker.

If the content is placed so that it falls outside the frame, it is automatically centered inside the frame to make it visible. To change this setting, click **Tools** ► **Options**, choose **PowerClip Frame** in the **Workspace** list of categories, and set the option you want in the **Auto-center new content** area.

To convert a PowerClip frame back to an object

- Right-click the PowerClip frame, choose **Frame type**, and click **None**.



If the frame contains content, the content is deleted when the frame reverts to a regular object. To avoid losing the content, you can first extract it from the PowerClip object.



You can also click the **No frame** button on the **Layout** toolbar. To open the **Layout** toolbar, click **Window** ► **Toolbars** ► **Layout**.

To select the contents of a PowerClip object

- 1 Select the PowerClip object.
The PowerClip toolbar appears.
- 2 Click the **Select contents** button on the PowerClip toolbar.

To position the contents inside a PowerClip frame

- 1 Select a PowerClip object.
- 2 Perform a task from the following table.

To	Do the following
Center the contents inside the PowerClip frame	Click Object ► PowerClip ► Center contents .
Fit the contents proportionally inside the PowerClip frame	Click Object ► PowerClip ► Fit contents proportionally .

To

Do the following

The content is resized so that its longest dimension fits inside the frame. The content is not distorted, and its aspect ratio is preserved. The whole content is visible, but there may be empty areas in the frame.

Fill the PowerClip frame proportionally

Click **Object** ► **PowerClip** ► **Fill frame proportionally**.

The content is resized so that it fills the frame without being distorted. The content's aspect ratio is preserved. The frame is full, but there may be parts of the content that fall outside the frame and are not visible.

Fill the PowerClip frame by stretching the contents

Click **Object** ► **PowerClip** ► **Stretch contents to fill frame**.

The content is resized and distorted so that it fills the frame. The content's aspect ratio is not preserved. The frame is full, and all of the content is visible.



The **Fit contents proportionally**, **Fill frame proportionally**, and the **Stretch contents to fill frame** commands modify the PowerClip contents. The content remains modified even if you extract it from the frame.



You can also position the contents by clicking the arrow button on the PowerClip toolbar and clicking a command.

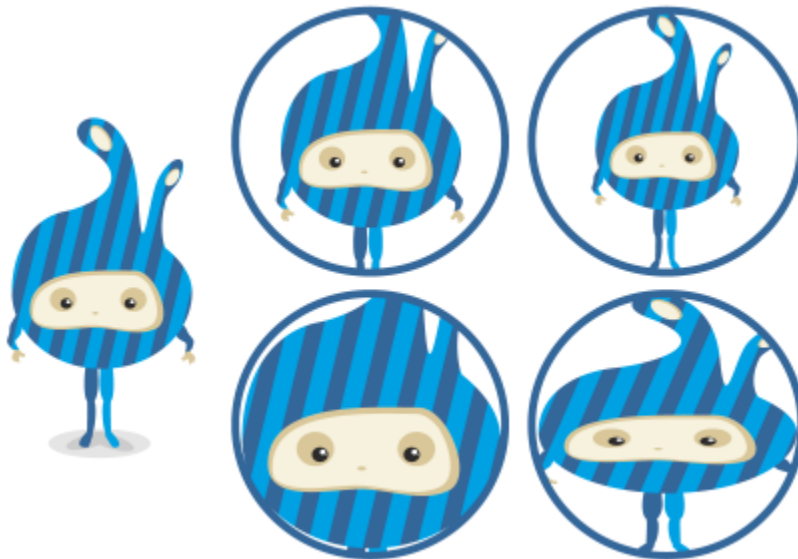

Examples of PowerClip contents positioned by using the following commands: Center contents (top left), Fit contents proportionally (top right), Fill frame proportionally (bottom left), and Stretch contents to fill frame (bottom right).

To copy the contents of a PowerClip object

- 1 Select an **object**.

- 2 Click **Object** ► **PowerClip** ► **Copy PowerClip from**.
- 3 Click a PowerClip object.

To edit the contents of a PowerClip object

- 1 Select a PowerClip object.
- 2 Click **Object** ► **PowerClip** ► **Edit PowerClip**.
- 3 Edit the contents of the PowerClip object.
- 4 Click **Object** ► **PowerClip** ► **Finish Editing PowerClip**.



While you edit the contents, the frame appears in Wireframe mode and cannot be selected or edited.



You can also double-click the PowerClip object to enable it for editing, or select the PowerClip object and click the **Edit PowerClip** button on the PowerClip toolbar. When you have finished editing the contents, click the **Finish Editing PowerClip** button.

To lock or unlock the contents of a PowerClip object

- 1 Select a PowerClip object.
- 2 Click **Object** ► **PowerClip** ► **Lock contents to PowerClip**.



If you move the frame while the content is unlocked, the content remains stationary and is not visible until you move the frame over it.



You can also right-click a PowerClip object and click **Lock contents to PowerClip**, or you can select the PowerClip object and click the **Lock contents to PowerClip** button on the PowerClip toolbar.

To extract the contents of a PowerClip object

- 1 Select a PowerClip object.
- 2 Click **Object** ► **PowerClip** ► **Extract contents**.

The contents remains in the same location, but it is separated from the frame. The PowerClip frame remains as an empty PowerClip frame.



You must extract the contents of each level in a nested PowerClip separately.



You can also select the PowerClip object and click the **Extract contents** button on the PowerClip toolbar.

To set default options for PowerClip frames

- 1 Click **Tools** ► **Options**.
- 2 In the **Workspace** category, click **PowerClip Frame**.

3 Perform a task from the following table.

To	Do the following
Set the default behavior for dragging content to a PowerClip frame	In the Drag content inside PowerClip area, choose PowerClip with content or Empty PowerClip from the list box, and then choose one of the following options: <ul style="list-style-type: none">• Ignore PowerClip frame — places the content on top of the PowerClip frame instead of inside• Add content to PowerClip frame• Replace existing content (available only for PowerClip frames with content)
Set the default behavior for centering new content in a PowerClip frame	In the Auto-center new content area, choose one of the following options: <ul style="list-style-type: none">• When content is completely outside frame — centers content only if it is beyond the boundaries of the PowerClip frame and will not be visible otherwise• Always — always centers new content• Never — turns off auto-centering
Mark empty PowerClip frames	Enable the Show lines in empty PowerClip frames check box, and choose one of the following options: <ul style="list-style-type: none">• Always — displays lines in empty PowerClip frames on screen and in printed or exported documents• On screen only — displays lines in empty PowerClip frames only on screen

Setting options for nodes, handles, and previews

The **Nodes and Handles** page of the **Options** dialog box (**Tools** ► **Options**) lets you customize the appearance of nodes, handles, and vector previews to match your preferences, making it easier to edit nodes and apply vector effects and transformations.



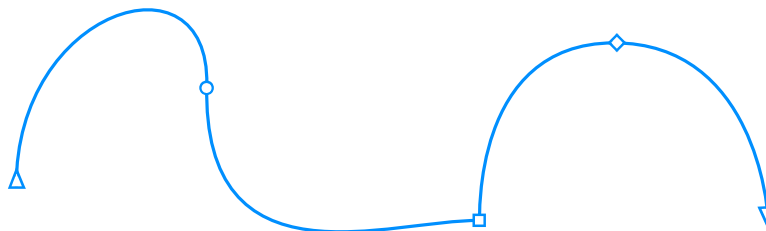

General settings

You can change the size and shape of nodes, and you can choose to hide or show the curve direction when editing. Three preset sizes are available for nodes and handles: small, medium, and large.

By default, each of the three node types has a different shape. Cusp nodes appear as squares, smooth nodes as circles, and symmetrical nodes as diamonds. You can change the shape of any node type, choosing from shapes such as triangles, diamonds, circles, and polygons. For information about the different type of nodes, see [“Using node types” on page 195](#).



By default, each node type is displayed with a different shape - circle, square, or diamond. The curve direction is shown by the orientation of the end nodes.

The **Shape** tool  is usually used to select and move nodes. You can enable node tracking to select and move nodes by using the **Pick** tool , **Freehand** , **Polyline** , or **Bézier**  tool.

Color settings

The Default color scheme uses blue as the main color and red as the secondary color for displaying nodes, control handles, and previews while you are editing. The main color is used in the first curve you select. When you select additional curves with the **Shape** tool, they are displayed in red, the secondary color. In addition, the Default color scheme applies a white highlight to improve visibility. This white highlight color is also used to fill unselected nodes and to make vector previews stand out. You can also choose to show unselected nodes without a fill.

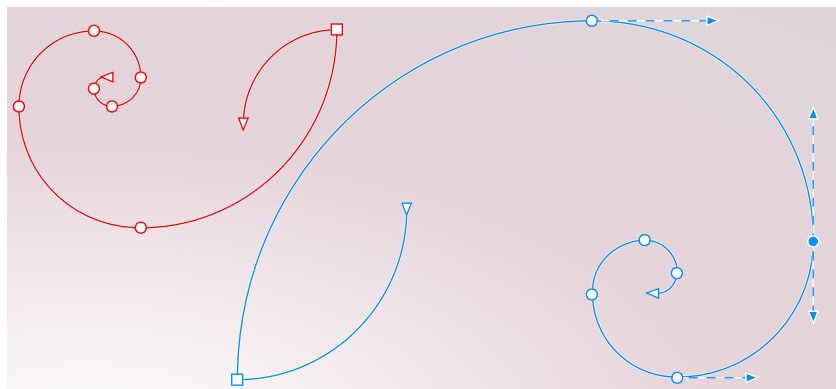

With the Default color scheme, the main color for nodes, handles, and previews is blue (right). The secondary color, red, is used for the additional curve selected with the Shape tool (left). Unselected nodes are filled with white, the highlight color.

When nodes and handles become hard to see against more complex backgrounds, you can use a keyboard shortcut (**Ctrl+Shift+I**) to replace the main color with the secondary color and vice versa. You can also switch between showing unselected nodes with and without a fill by using a keyboard shortcut (**Ctrl+Shift+G**).

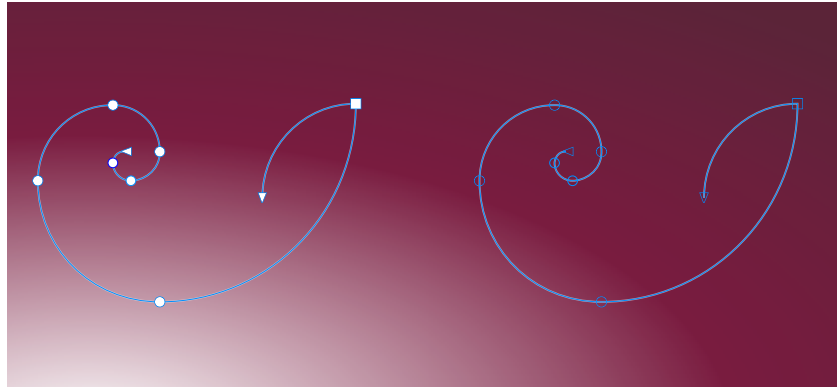

Unselected nodes are shown with a fill (left) and without a fill (right).





You can create a custom color scheme by changing the main and the secondary colors. In addition, you can hide the highlight from previews. To distinguish nodes types more easily, you can set the application to display each node type in a different color.

GPU for vector previews

By default, the central processing unit (CPU) of your computer is used to generate vector previews. You can set the application to use the graphics processing unit (GPU) instead. Using the GPU for vector previews may improve performance on some computers.

To set general options for nodes, handles, and previews

- 1 Click **Tools** ► **Options**.
- 2 In the **Workspace** list of categories, click **Nodes and Handles**.
- 3 In the **General settings** area, perform any of the tasks in the following table.

To	Do the following
Change the node size	Choose a size from the Node size list box.
Change the shapes of nodes	From the Node shape list boxes, choose a shape for each node type: cusp, smooth, and symmetrical.
Revert to the default node shapes	Next to the Nodes shape list boxes, click Reset .
Show or hide the direction of selected curves	Enable or disable the Show curve direction when editing check box.
Select and move nodes by using the Pick  , Freehand  , Polyline  , or Bézier  tool	Enable the Enable node tracking check box.
Show unselected nodes without a fill	Disable the Show unselected nodes with fill check box.

To switch color settings for nodes, handles, and previews by using keyboard shortcuts

- 1 Select the nodes you want with the **Shape** tool.
- 2 Perform a task from the following table.

To	Do the following
Replace the main color with the secondary color and vice versa	Press Ctrl+Shift+I .
Switch between showing unselected nodes with a fill and without a fill	Press Ctrl+Shift+G .

To choose a color scheme

- 1 Click **Tools** ► **Options**.
- 2 In the **Workspace** list of categories, click **Nodes and Handles**.
- 3 In the **Colors** area, choose one of the following color schemes from the **Color scheme** list box:
 - **Default**
 - **Custom**



- The controls below the **Color scheme** list box become available only after you choose **Custom** from the **Color scheme** list box.

To create a custom color scheme for nodes, handles, and previews

- 1 Click **Tools** ► **Options**.
- 2 In the **Workspace** list of categories, click **Nodes and Handles**.
- 3 In the **Colors** area, choose **Custom** from the **Color scheme** list box.
- 4 Open the following color pickers, and choose a color:
 - **Main color** — used in nodes and handles when an object is selected for editing. When you select multiple objects for editing, the main color is used for the nodes and handles of the first selected object
 - **Secondary color** — used in nodes and handles when additional objects are selected for editing with the **Shape** tool or when you are editing vector effects such as extrusions

You can also

Hide the highlight color from vector previews	Disable the Show highlight check box.
Display each node type in a different color	Enable the Show node types in different colors check box.
Revert to the default main and secondary colors	Click Reset next to the Main color and the Secondary color picker. The Reset button is available only for custom color schemes.

To use the GPU for vector previews

- 1 Click **Tools** ► **Options**.
- 2 Click **Global**.
- 3 Enable the **Use GPU for vector previews** check box.

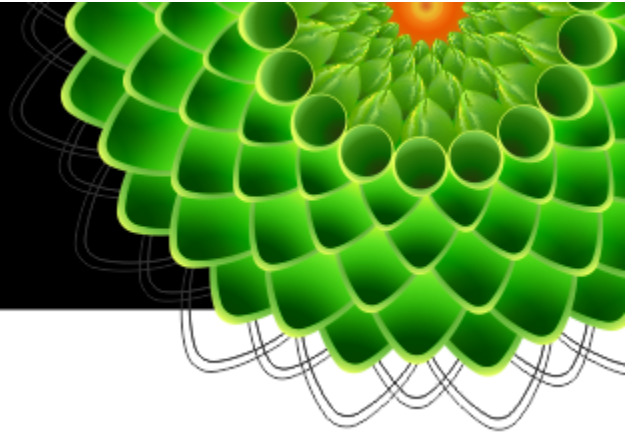

Symmetrical drawing

CorelDRAW lets you create symmetrical objects and designs in real time, making you more productive by automating what is usually a very time-consuming workflow. Whether you want to create simple symmetrical objects or a complex kaleidoscopic design, the Symmetry drawing mode provides you with the controls you need to accomplish your task.

You can include both vector and bitmap objects in your symmetrical designs.

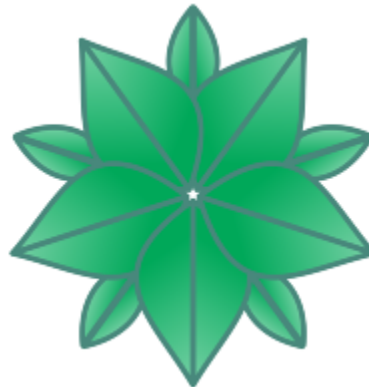

Examples of a simple and a more complex symmetrical design using vector objects



A symmetrical design that uses bitmaps

This section contains the following topics:

- “Creating symmetry groups” (page 240)
- “Editing symmetry groups” (page 242)
- “Fusing curves in symmetry groups” (page 247)
- “Removing symmetry and breaking symmetry links” (page 248)

Creating symmetry groups

To create a symmetry group, you can convert an existing object to a symmetry group, or you can start from scratch by drawing objects in symmetry mode. The objects that you convert or draw are known as primary objects; the objects generated by the symmetry are known as object copies.

CorelDRAW offers mirror symmetry, which lets you create identical shapes and curves that are mirrored or reflected on a set of planes. In the default mirror symmetry mode, primary objects are reflected along a single symmetry line. If you want to create a more complex design, you can add more symmetry lines.

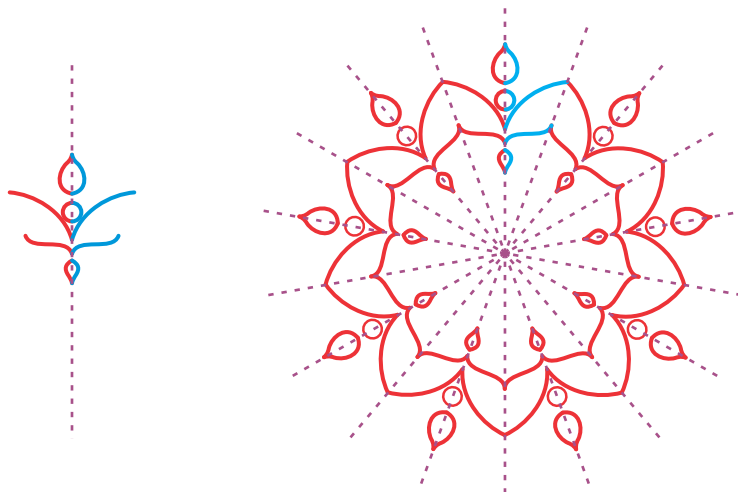

Single-line symmetry (left); multi-line symmetry (right)

When creating a symmetry group from scratch, you can start by setting up the planes of symmetry. You can add more symmetry lines to create more object copies. In addition, you can reposition and rotate the symmetry lines by dragging them in the drawing window or by specifying values on the property bar. Each symmetry group has a center of symmetry, which is shown by a circular cursor when the

symmetry lines are selected. With multi-line symmetry, the intersection point of the symmetry lines is the center of symmetry. Symmetry lines are rotated about the center of symmetry. You can move the center of symmetry by dragging it, or you can specify its exact location by using x and y coordinates.

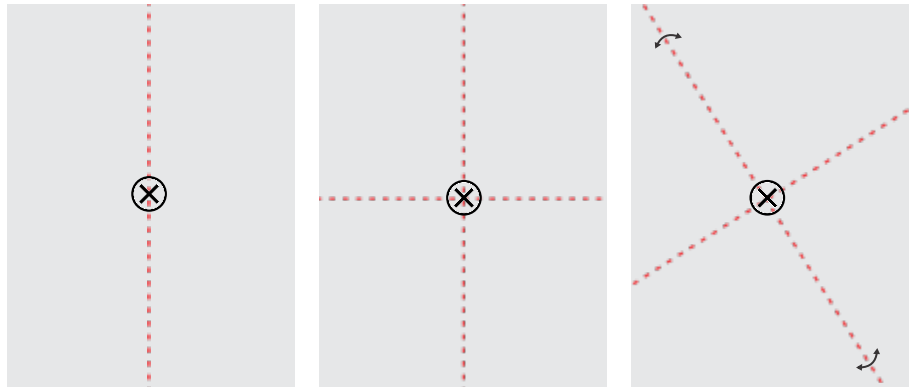

From left to right: Default symmetry line, adding a symmetry line, rotating the symmetry lines.

For information about how to edit symmetry groups, see [“Editing symmetry groups” on page 242](#).

To create a symmetry group from objects

- 1 Select or draw a curve or a shape.
- 2 Click **Object** ▶ **Symmetry** ▶ **Create New Symmetry**.
A symmetry line appears in the drawing window, and the primary object is duplicated and mirrored. Edit the primary object or add more objects.
- 3 Click **Object** ▶ **Symmetry** ▶ **Finish Editing Symmetry**.



To accurately mirror an object that has a calligraphic outline, you must first link the outline thickness to the object’s size. To do this, select the object, double-click the **Outline** icon  in the lower-right corner of the application window, and in the **Outline Pen** dialog box, enable the **Scale with object** check box.



You can also create a symmetry group from an object by right-clicking the object and clicking **Create New Symmetry**. You can create a symmetry group from multiple shapes and curves.

To create a mirror symmetry group from scratch

- 1 Click **Object** ▶ **Symmetry** ▶ **Create New Symmetry**.
To add more symmetry lines for a more complex symmetry group, type a number in the **Mirror lines** box on the property bar. You can use up to 12 lines of symmetry.
You can also adjust the symmetry lines. For more information, see [“To set up the planes of symmetry” on page 241](#).
- 2 Draw a curve or a shape.

To set up the planes of symmetry

- 1 Click **Object** ▶ **Symmetry** ▶ **Create New Symmetry**.
If you want to change the planes of symmetry in an existing symmetry group, click **Object** ▶ **Symmetry** ▶ **Edit Symmetry**.
- 2 Perform a task from the following table.

To

Specify the number of symmetry lines

Reposition a symmetry line

Rotate a symmetry line

Specify the center of symmetry

Do the following

Type a number in the **Mirror lines** box on the property bar.

You can add up to 12 symmetry lines.

Using the **Pick tool** , drag the symmetry line in the drawing window.

Using the **Pick tool** , click the symmetry line twice, and drag a rotation handle.

Tip: You can also rotate a symmetry line by typing a value in the **Angle of rotation** box on the property bar.

Type values in the **X** and **Y** boxes.

This action repositions the symmetry lines.



Editing symmetry groups

You can edit symmetry groups in any of the following ways: by editing the objects in the symmetry group; by adding, repositioning, and rotating symmetry lines; and by editing the symmetry group as a single entity.

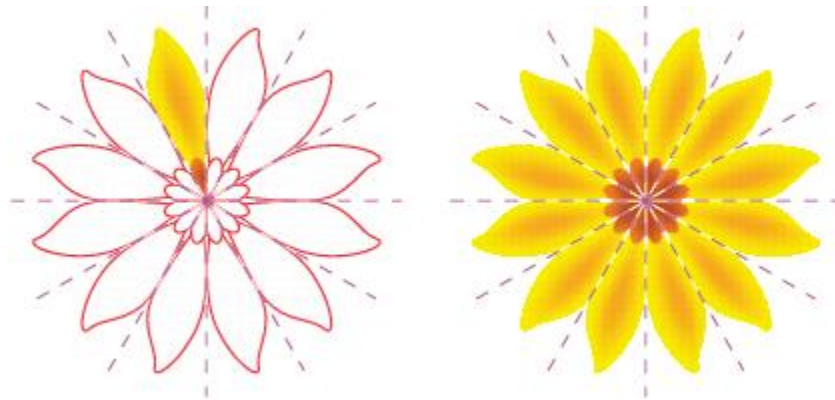
When editing a symmetry group, you can preview only the outline of object copies for faster rendering. This view makes it easy to identify the primary objects. You can also preview the object copies as full objects with the same fills, outlines, and effects that are applied to the primary objects. You can toggle quickly between the two preview modes. To evaluate the results more easily, you can also hide the symmetry lines.



Previewing object copies as outlines (left) and full objects (right)

You can use the **Pick tool**  and **Shape tool**  to modify the objects in a symmetry group. When you reshape the primary objects with the **Shape** tool, the vector previews appear in the default main color, and the object copy outlines appear in the default secondary color. For information about these preview colors and how to change them, see [“Setting options for nodes, handles, and previews”](#) on page 235.

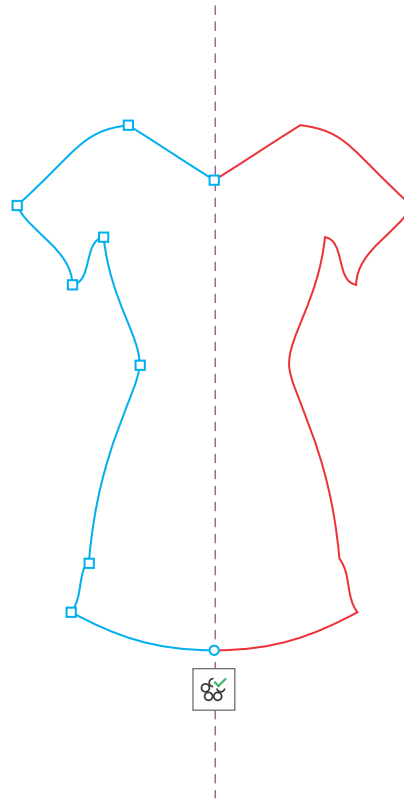

The vector previews of the primary objects appear in the default main color when you are reshaping objects with the Shape tool.

You can apply fills, effects, and transparencies to the primary objects. Any changes you make to the primary objects are reflected in the object copies. You can add objects to the symmetry group, and you can delete objects you no longer need. In addition, you can drag objects into a symmetry group even if the group is not in Edit symmetry mode.

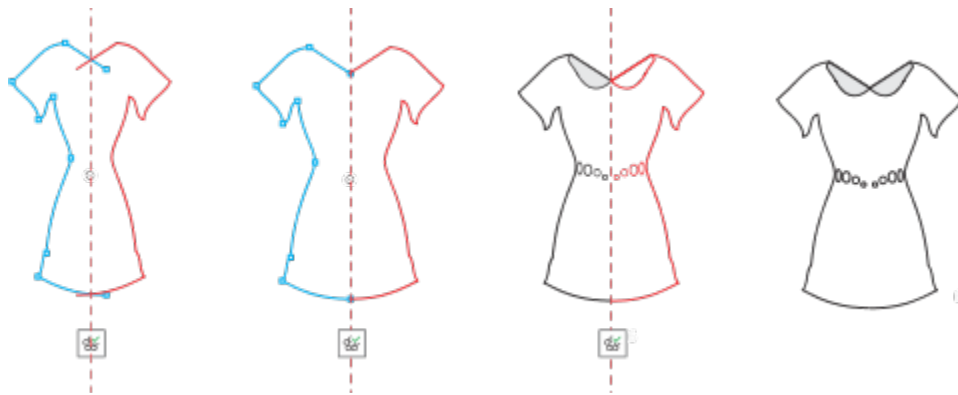

Editing a symmetry group

Modifying the symmetry lines affects how the elements in the symmetry group are positioned and oriented. You can add more symmetry lines for more object copies. In addition, you can move the symmetry lines to increase or decrease the distance between the primary objects and object copies; and you can rotate the symmetry lines. For more information, see ["To set up the planes of symmetry"](#) on page 241.

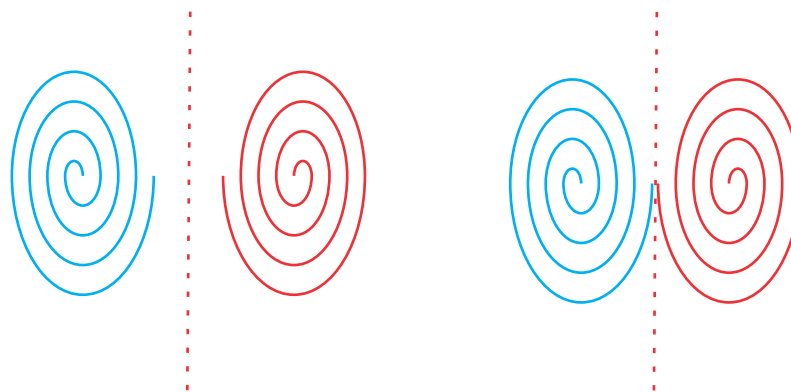

Move the symmetry line to change the distance between primary objects and object copies.

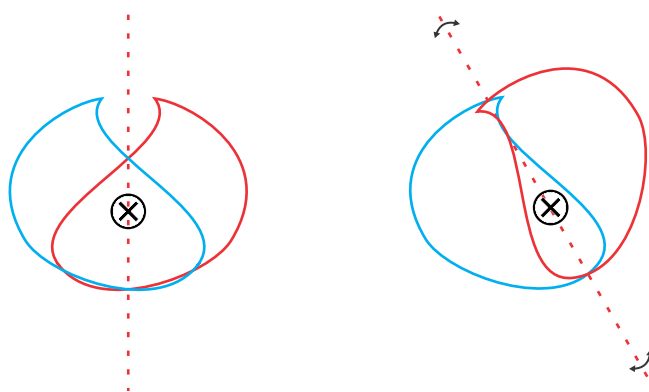

Rotating the symmetry line

As with any group of objects, you can move, rotate, and scale the symmetry as a single entity, preserving the spacial relationship between its elements. You can also apply fills and transparencies to the entire symmetry group, and you can modify the outline properties.

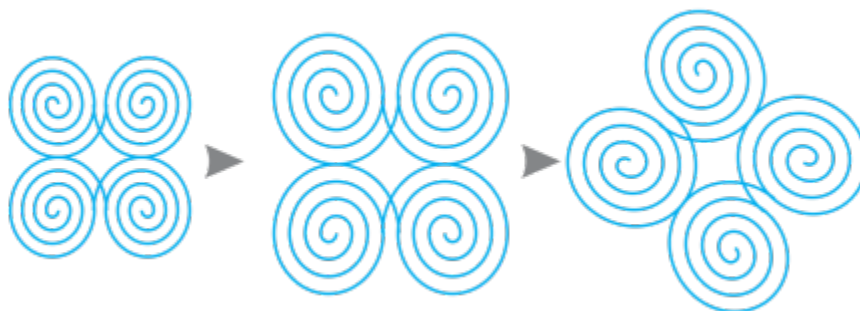





The symmetry group on the left is scaled (middle) and then rotated (right) with the Pick tool.

When you are editing a symmetry group, it is easy to snap objects to the symmetry line because the **View ▶ Snap to ▶ Symmetry Lines** command is enabled by default. This feature helps you fuse open curves and create closed shapes in your symmetrical design. If you don't want the objects you edit to snap to the symmetry line, you can disable snapping to symmetry lines.

To edit the objects of a symmetry group

- 1 Select a symmetry group.
The floating symmetry toolbar appears below the symmetry group.

- 2 Click the **Edit Symmetry** button  on the toolbar.
- 3 Edit the primary objects in the group by using the **Shape** tool  and the **Pick** tool . You can also apply fills and transparencies, and you can apply effects such as contours, envelopes, blends, and distortions.
- 4 Add and delete objects as needed.
- 5 Click the **Finish Editing Symmetry** button  below the symmetry group.

You can also

Display object copies as outlines or full objects

Click the **Show full preview** button  on the property bar to disable or enable it.

Show or hide symmetry lines

Click the **Show symmetry lines** button  on the property bar to disable or enable it.



You can start editing a symmetry group by double-clicking it or by clicking **Object** ▶ **Symmetry** ▶ **Edit Symmetry**.

You can also enter the **Edit Symmetry** mode by clicking a selected symmetry group while holding down **Ctrl**.

You can also finish editing a symmetry group by clicking **Object** ▶ **Symmetry** ▶ **Finish Editing Symmetry**.

To drag an object into a symmetry group that contains objects

- Drag the object over the symmetry group, hold down **W**, and release the mouse button.

To drag an object into an empty symmetry group

- Drag the object over the symmetry group, and release the mouse button.

To edit a symmetry group as a single entity

- 1 Using the **Pick** tool , click the symmetry group.
- 2 Perform a task from the following table.

To	Do the following
Move the symmetry group	Drag it to a new location in the drawing window.
Scale the symmetry group	Drag a corner selection handle.
Rotate the symmetry group	Click the symmetry group again to display the rotation handles, and drag a rotation handle.
Apply a fill to the symmetry group	Click the Interactive fill tool  , and drag across the symmetry group. For more information about fills, see “Applying fills to objects” on page 367.

To

Do the following

Applying a fill to a symmetry group changes the fill of each object in the symmetry group. Bitmap and vector pattern fills are not reflected.



Applying a fill to a symmetry group

Apply a transparency to the symmetry group

Click the **Transparency** tool , and choose transparency settings from the property bar. For more information about transparencies, see [“Changing the transparency of objects”](#) on page 389.

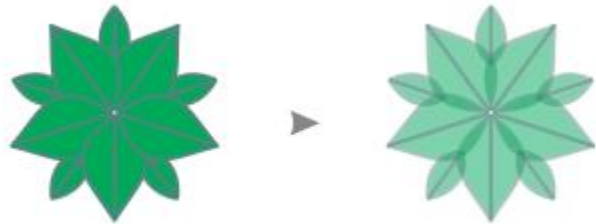

Applying a uniform transparency to a symmetry group

The transparency replaces any transparencies that may have been applied to individual objects in the group.

Bitmap and vector pattern transparencies are not reflected.

Add an outline to a symmetry group

Double-click the **Outline** icon  on the status bar, and set the outline properties you want in the **Outline Pen** dialog box. For more information about outlines, see [“Formatting lines and outlines”](#) on page 144.

Adding an outline to a symmetry group changes the outline of each object in the symmetry group.





To preserve the symmetry, skewing and stretching a symmetry group are not allowed.



You can move, scale, and rotate a symmetry group with precision by using the controls on the property bar.

To disable snapping to symmetry lines

- In Edit symmetry mode, click **View** ▶ **Snap to** ▶ **Symmetry Lines**.



Disabling snapping to symmetry lines makes it difficult to fuse curves in symmetry groups.

For more information about snapping options, see [“Snapping objects” on page 279](#).

Fusing curves in symmetry groups

If you want to apply a fill to an open curve and its mirrored copy, you need to fuse them into a single curve. For successful fusion to take place, the end points of the curves must be snapped to the symmetry line.

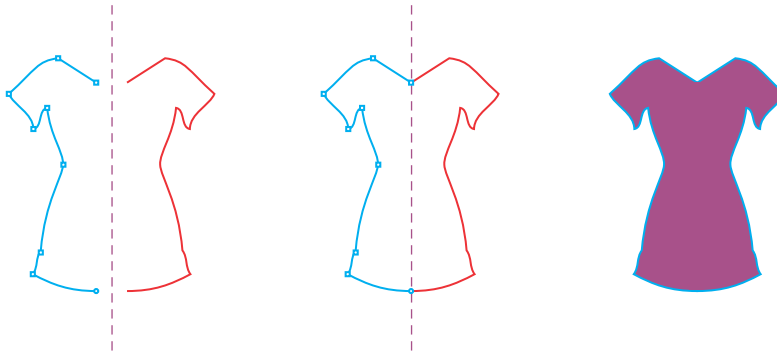

From left to right: Creating an open curve; snapping the end points to the symmetry line; filling the fused curve.

When two curves are fused, the fill of the primary curve is applied to the reflected curve. However, nodes appear only on the primary curve of the fused object. You can adjust the shape of the fused object by manipulating the nodes of the primary curve.

To fuse open curves in a symmetry group

- 1 Click **Object** ▶ **Symmetry** ▶ **Edit Symmetry**.
- 2 On the property bar, click the **Fuse open curves** button .
- 3 Click the open curve that you want to fuse with its mirrored copy.

If the curve end points do not meet on the symmetry line, drag them with the **Shape** tool until they snap to the symmetry line. If it is difficult to snap the end points of the primary curve to the symmetry line, make sure that the **Snap to Symmetry Lines** command is enabled (**View** ▶ **Snap to** ▶ **Symmetry Lines**).



Only the selected curve set is fused into a single object. Unselected open curves are not affected.



You can undo the fusion by clicking the **Fuse open curves** button  on the property bar to disable it.

Removing symmetry and breaking symmetry links

If you want to delete all object copies from a symmetry group and keep only the primary objects, you can remove the symmetry.

Left to right: Symmetry group in Edit mode; the symmetry group in normal state; the symmetry is removed, leaving only the primary objects.

After completing a symmetry group, you may want to make some of its elements non-symmetrical. To do this, you need to break the symmetry link of the symmetry group, turning it into a regular group of objects. You can then edit individual objects in the group.

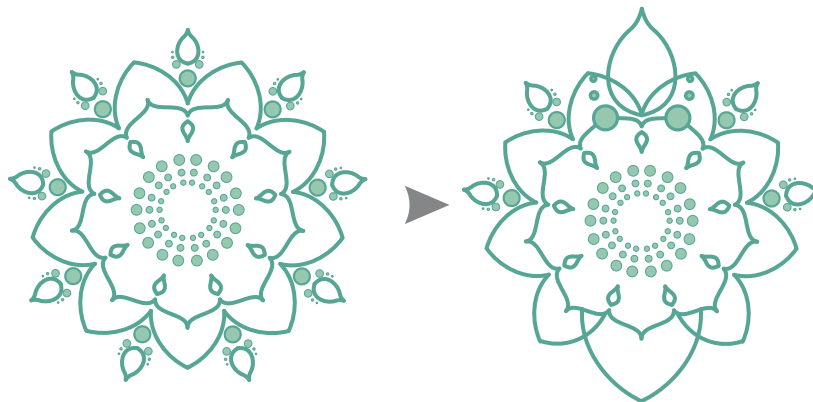

The symmetry link is broken in the symmetry group on the left. Then, some objects are resized, and other objects are deleted (right).

To remove the symmetry from a symmetry group

- 1 Select a symmetry group.

- 2 Click the **Remove Symmetry** button , which appears below or above the symmetry group.
All object copies are deleted.



You can also remove the symmetry link by clicking **Object ▶ Symmetry ▶ Remove Symmetry**.

You can also right-click a symmetry group, and click **Remove Symmetry**.

To break the symmetry link of a symmetry group

- 1 Select a symmetry group.
- 2 Click the **Break Symmetry Link** button  on the floating toolbar that appears below or above the symmetry group.
After the symmetry link is broken, the symmetry group becomes a regular group of objects.



You can also break the symmetry link by clicking **Object ▶ Symmetry ▶ Break Symmetry Link**.

You can also right-click a symmetry group, and click **Break Symmetry Link**.

Objects, symbols, and layers

Working with objects.....	253
Inserting and editing QR codes.....	309
Working with layers.....	315
Working with symbols.....	325
Linking and embedding objects.....	333
Managing and tracking projects.....	335

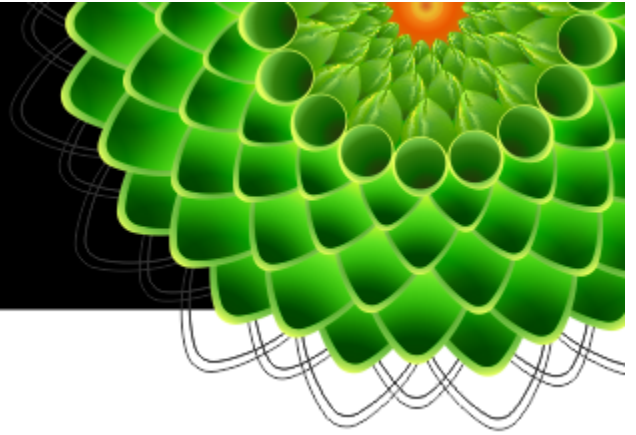

Working with objects

Working with objects is an essential part of creating drawings.

This section contains the following topics:

- “Selecting objects” (page 254)
- “Transforming objects” (page 257)
- “Copying, duplicating, and deleting objects” (page 260)
- “Creating objects from enclosed areas” (page 263)
- “Creating a boundary around selected objects” (page 263)
- “Using object coordinates to draw and modify objects” (page 264)
- “Copying object properties, transformations, and effects” (page 272)
- “Cloning objects” (page 273)
- “Positioning objects” (page 274)
- “Aligning and distributing objects” (page 276)
- “Applying object hinting” (page 279)
- “Snapping objects” (page 279)
- “Using dynamic guides” (page 283)
- “Using alignment guides” (page 286)
- “Changing the order of objects” (page 291)
- “Sizing and scaling objects” (page 292)
- “Rotating and mirroring objects” (page 293)
- “Using the Object Properties docker to modify objects” (page 295)
- “Fitting objects to a path” (page 297)
- “Grouping objects” (page 302)
- “Combining objects” (page 303)
- “Locking objects” (page 305)
- “Finding and replacing objects” (page 305)
- “Hiding and displaying objects” (page 306)
- “Constraining objects” (page 307)
- “Inserting bar codes” (page 308)

Selecting objects

Before you can change an object, you must select it. You can select visible objects, objects that are hidden from view by other objects, and a single object in a group or a nested group. In addition, you can select objects in the order in which they were created, select all objects at once, and deselect objects.



A bounding box appears around a selected object, and an "X" appears at its center.



You can select a single object from a group.

You can marquee select objects by enclosing them with a selection area of rectangular or irregular shape.

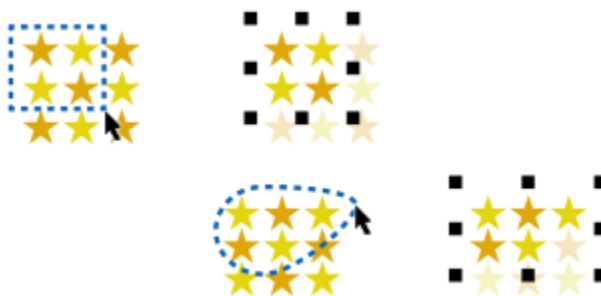

Marquee selecting objects using a rectangular selection area (top) and a selection area of irregular shape (bottom)

You can create selection groups that let you select specific objects simultaneously without grouping them. Selection groups are associated with numbers from 0 to 9 and are saved with the document. When you press the number associated with a selection group, all objects

in this group are selected. You can also select and zoom into all objects in a selection group at the same time. You can add objects to a selection group.

Usually, you select objects by using the **Pick** tool. By default, all objects are treated as filled so that you can select any unfilled object by clicking on its outline or the area surrounded by the outline. However, you can change this default behavior so that you can select unfilled objects only by clicking on their outlines. Changing the default behavior is useful when you work with line drawings and often need to select objects that appear beneath other objects.

To select objects

To

Do the following

Select an object

Click the **Pick** tool , and then click an object.

Select multiple objects

Click the **Pick** tool , hold down **Shift**, and click each object that you want to select.

Marquee select objects by using a rectangular selection area

Click the **Pick** tool , and drag around the objects that you want to select.

To constrain the selection area to a square, hold down **Ctrl** while dragging.

Marquee select objects by using a selection area of irregular shape

Click the **Freehand pick** tool , and drag around the objects that you want to select.

Objects that are only partially enclosed by the selection area are not selected.

To select objects that are only partially enclosed by the selection area, hold down **Alt** while dragging.

To constrain the selection area to a rectangular shape, hold down **Ctrl** while dragging.

Select an object while reviewing objects in the order of their creation, starting with the first object created

Click the **Pick** tool , and then press **Shift + Tab** one or more times, until a selection box appears around the object that you want to select.

Select an object while reviewing objects in the order of their creation, starting with the last object created

Click the **Pick** tool , and then press **Tab** one or more times, until a selection box appears around the object that you want to select.

Select all objects

Click **Edit** ► **Select all** ► **Objects**.

Select an object in a group

Hold down **Ctrl**, click the **Pick** tool , and then click an object in a group.

To

Select an object in a nested group

Select an object hidden from view by other objects

Select multiple hidden objects

Select a hidden object in a group



The status bar displays a description of each hidden object as you select it.

To create a selection group

- 1 Click the **Pick tool** , hold down **Shift**, and click each object that you want to include in the selection group.
- 2 Press **Ctrl** + a number from 0 to 9.

The number you pressed is associated with the new selection group.

You can also



Select all objects in a selection group



Select and zoom in on all objects in a selection group

Add an object to a selection group

Do the following

Hold down **Ctrl**, click the **Pick tool** , and then click an object one or more times, until a selection box appears around it.

Hold down **Alt**, click the **Pick tool**  or the **Freehand pick tool** , and then click the topmost object one or more times, until a selection box appears around the hidden object.

Hold down **Shift** + **Alt**, click the **Pick tool**  or the **Freehand pick tool** , and then click the topmost object one or more times, until a selection box appears around the hidden objects.

Hold down **Ctrl** + **Alt**, click the **Pick tool** , and then click the topmost object one or more times, until a selection box appears around the hidden object.

Press the number associated with the selection group.

Press twice the number associated with the selection group.

Select the object, and press **Alt** + the number associated with the selection group.

To deselect objects

To

Deselect all objects

Do the following

Click the **Pick tool** , and click a blank space in the drawing window.

To

Deselect a single object among multiple selected objects

Do the following

Hold down **Shift**, click the **Pick tool** , and then click the object.

To change how unfilled objects are selected

- 1 Click **Tools** ▶ **Options**.
- 2 In the **Workspace** list of categories, click **Toolbox** ▶ **Pick tool**.
- 3 Enable or disable the **Treat all objects as filled** check box.

Enabling the check box lets you select an unfilled object by clicking on its outline or the area enclosed by the outline; disabling the check box lets you select an unfilled object by clicking only on its outline.



Using the **Pick tool**, you can also click the **Treat all objects as filled** button on the property bar when no objects are selected.

Transforming objects

You can change the appearance of objects in the drawing window by using the following transformations.

Transformation

Example

Sizing lets you change the width and height of an object.



Scaling lets you size an object to a percentage of its original size.

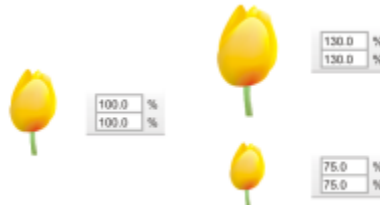

Skewing lets you slant an object to one side.



Transformation

Example

Stretching lets you change the height and width of an object nonproportionally.



Rotating lets you turn an object around its center axis or a point relative to its position.



Mirroring lets you create a horizontal or vertical mirror image of an object.



Transforming objects interactively

You can transform an object interactively by using the mouse and the **Pick** tool. This method is the quickest, but it is not recommended if you want to transform an object with precision.

Other methods for transforming objects

You can transform an object in any of the following ways:

- For more precise results, you can select an object with the **Pick** tool and adjust settings on the property bar. For example, you can specify a precise rotation angle or specify the size of an object.
- The **Transformation** docker lets you transform objects with precision and apply the transformation to the duplicate of an object, which is created automatically. This feature lets you experiment with transformations without affecting the original object. You can access the **Transformation** docker by clicking **Object** ▶ **Transformations** and clicking a command.
- The **Transform** toolbar also lets you transform objects with precision. You can access the **Transform** toolbar by clicking **Windows** ▶ **Toolbars** ▶ **Transform**.

Each of these methods lets you apply transformations to a single object or to multiple objects simultaneously.

Clearing and redoing transformations

All transformations can be simultaneously cleared at any time.

For more information about

See

Sizing and scaling

["Sizing and scaling objects "](#) on page 292

Skewing and stretching

["Skewing and stretching objects "](#) on page 198

Rotating and mirroring

["Rotating and mirroring objects "](#) on page 293

To transform an object interactively

1 Select an object by using the **Pick** tool.

The bounding box of the object appears. The bounding box includes eight selection handles that you can use to size, stretch, and mirror the object. If you click the object again, new handles appear. You can use these handles to rotate and skew the object.

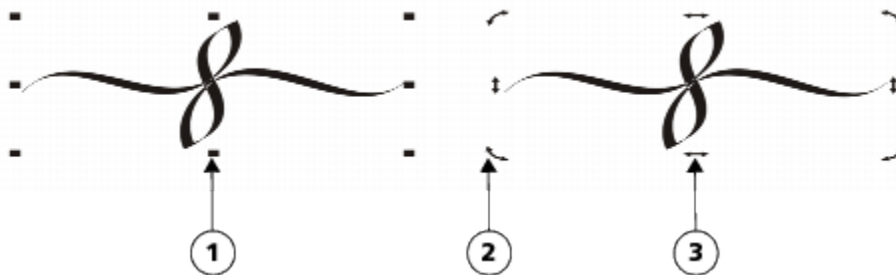

Handle types: selection (1), rotation (2), and skew (3)

2 Perform a task from the following table.

To

Do the following

Size or scale an object

Drag a corner selection handle.

Stretch an object

Drag a middle selection handle.

Skew an object

Click the object to display the skew handles, and drag a skew handle.

Rotate an object

Click the object to display the rotation handles, and drag a rotation handle.

Mirror an object

Hold down **Ctrl**, and drag a selection handle to the opposite side of the object.



If you want to leave the original object unchanged and apply the transformation to copies that are created, type a number in the **Copies** box in the **Transformation** docker.

To clear all transformations applied to an object

- 1 Select an object.
- 2 Click **Object** ▶ **Transformations** ▶ **Clear transformations**.



You can undo the **Clear transformations** command by clicking **Edit** ▶ **Undo clear transformations**.

Copying, duplicating, and deleting objects

CorelDRAW provides you with several ways to copy objects. When you no longer need an object, you can delete it.

Cutting, copying, and pasting

You can cut or copy an object to place it on the Clipboard and paste it into a drawing or another application. Cutting an object places it on the Clipboard and removes it from the drawing. Copying an object places it on the Clipboard but keeps the original in the drawing.

Duplicating

Duplicating an object places a copy directly in the drawing window and does not use the Clipboard. Duplicating is faster than copying and pasting. Also, when duplicating an object, you can specify the distance between the duplicate and the original object along the x and y axes. This distance is known as the offset.

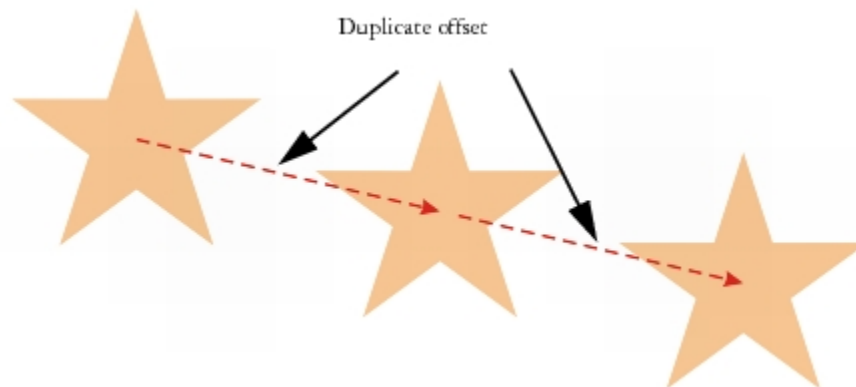

You can apply a transformation, such as rotating, sizing, or skewing, to the duplicate of an object while keeping the original object intact. If you decide that you want to keep the original object, you can delete the duplicate.

Copying objects at a specified position

You can create multiple copies of objects simultaneously, while specifying their position, without using the Clipboard. For example, you can distribute object copies horizontally, to the left or right of the original object; or you can distribute copies of objects vertically, below or above the original object. You can specify the spacing between copies of objects, or you can specify the offset at which copies of objects are created in relation to each other.

Copying objects quickly

You can use other methods to create copies of objects quickly, without using the Clipboard. You can use the plus sign (+) on the numeric keypad to place a copy of an object on top of the original object, or you can create copies instantly by pressing the **Spacebar** or right-clicking while dragging an object.

To cut or copy an object

- 1 Select an object.

- 2 Click **Edit**, and click one of the following:
 - **Cut**
 - **Copy**



You can also cut or copy an object by right-clicking the object and clicking **Cut** or **Copy**.

To paste an object into a drawing

- Click **Edit** ► **Paste**.



You can use this procedure to paste an object from another application.

To paste an object from an unsupported file format, or to specify options for the pasted object, click **Edit** ► **Paste special**. For more information about pasting objects from other applications, see [“Linking and embedding objects” on page 333](#).

To duplicate an object

- 1 Select an object.
- 2 Click **Edit** ► **Duplicate**.

When you duplicate objects for the first time, the **Duplicate offset** dialog box appears. To specify the distance between the duplicate and the original object along the x and y axes, type values in the **Horizontal offset** and **Vertical offset** boxes.

- Offset values of 0 place the duplicate on top of the original.
- Positive offset values place the duplicate up and to the right of the original.
- Negative offset values place the duplicate down and to the left of the original.



Duplicating an object is useful for creating cuttable drop shadows for devices such as vinyl cutters and plotters.



You can change the offset at which duplicates are created. Click **Tools** ► **Options** and in the **Document** list of categories, click **General**, and type values in the **Horizontal** and **Vertical** boxes.

You can also duplicate a selected object by pressing **Ctrl + D**.

To create copies of an object at a specified position

- 1 Select an object.
- 2 Click **Edit** ► **Step and repeat**.
- 3 In the **Step and repeat** docker, type a value in the **Number of copies** box, and click **Apply**.

To

Do the following

Distribute copies of objects horizontally

In the **Vertical settings** area, choose **No offset** from the **Mode** list box. In the **Horizontal settings** area, choose **Spacing between objects** from the **Mode** list box. To specify the spacing between object copies, type a value in the **Distance** box. To place the object copies to the right or left of the original, choose **Right** or **Left** from the **Direction** list box.

To

Distribute copies of objects vertically

Do the following

In the **Horizontal settings** area, choose **No offset** from the **Mode** list box. In the **Vertical settings** area, choose **Spacing between objects** from the **Mode** list box. To specify the spacing between copies of objects, type a value in the **Distance** box. To place the copies above or below the original, choose **Up** or **Down** from the **Direction** list box.

Offset all copies of objects by a specified distance

In the **Horizontal settings** and **Vertical settings** areas, choose **Offset** from the **Mode** list box, and type values in the **Distance** boxes.

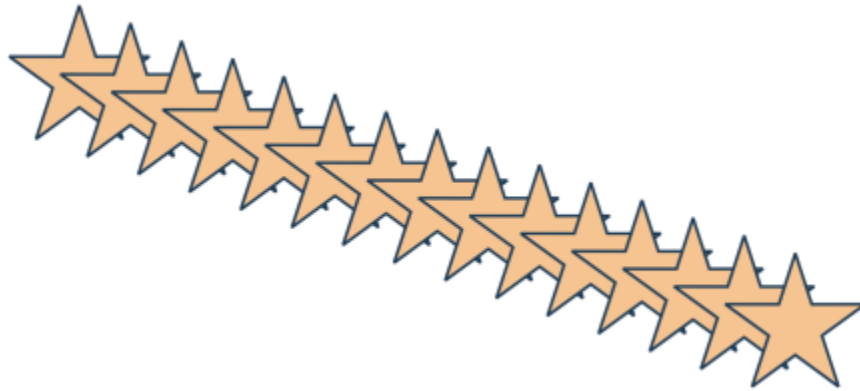

Multiple copies of an object are offset by a specified distance.



You can access the **Step and repeat** docker by pressing **Ctrl + Shift + D**.

To create copies of objects quickly

- 1 Select an object by using the **Pick tool** .
- 2 Press the **Spacebar** while moving, rotating, or transforming the object.

You can also

Place a copy of an object on top of the original

Press the plus sign (+) on the numeric keypad.

Create a single copy by using a mouse or stylus.

While moving, rotating, or transforming the object, right-click and then release both mouse buttons.

To transform the duplicate of an object

- 1 Select an object.
- 2 Click **Object** ► **Transformations**, and click a command.
- 3 Choose the settings you want in the **Transformation** docker.

- 4 Type 1 in the **Copies** box.
- 5 Click **Apply**.



You can clear a transformation by selecting an object and clicking **Object** ▶ **Transformations** ▶ **Clear transformations**.

To delete an object

- 1 Select an object.
- 2 Click **Edit** ▶ **Delete**.



To retrieve a deleted object, you must use the **Undo** command. For more information, see “Undoing, redoing, and repeating actions” on page 57.



You can also delete an object by selecting it and pressing **Delete**.

Creating objects from enclosed areas

You can create objects from areas enclosed by other objects. For example, if you draw a freehand line that crosses over itself to create loops, you can create an object from the loop shape. You can create an object in the shape of the area if the area is completely enclosed, regardless of the number of surrounding shapes and lines.

For more information about creating objects from enclosed areas, see “Applying fills to areas” on page 386.

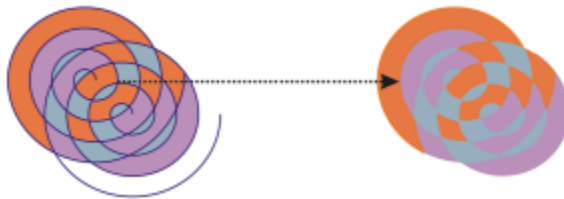

The Smart fill tool is used to enclose the areas created by the two spiral objects (left), so that new objects are created from the enclosed areas. In this example, the original spiral objects are deleted (right), and the newly created objects remain.

Creating a boundary around selected objects

You can automatically create a path around selected objects on a layer to create a boundary. This boundary can be used for various purposes, such as to produce keylines or cut lines.

The boundary is created by a closed path that follows the shape of the selected objects. The default fill and outline properties apply to the object created by the boundary.

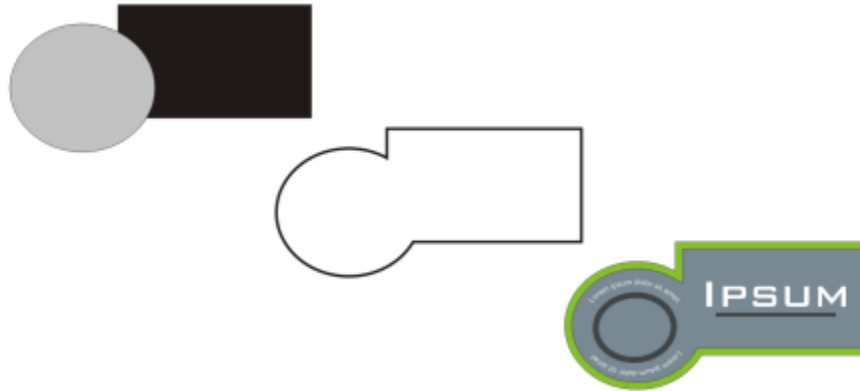

You can create a boundary around selected objects (left). The boundary is created as a new object (middle) that can be used as a cut line or keyline for a finished logo (right).

To create a boundary around selected objects

- 1 Select the objects that you want to surround with a boundary.
- 2 Click **Object** ▶ **Shaping** ▶ **Boundary**.
In the **Classic** workspace, this command appears under the **Arrange** menu.

Using object coordinates to draw and modify objects

You can use the **Object coordinates** docker to draw and modify shapes and lines with precision. The live preview in the drawing window lets you see the effects of your adjustments.

You can type coordinate values to specify the exact position, dimensions, and angle of rotation of an object. You can also set object attributes interactively by dragging in the drawing window.

Drawing rectangles and squares

To draw a rectangle with precision, you can specify an origin point, which is one of nine points in the rectangle (four corner points, four midpoints, and one center point). If you rotate the rectangle, the origin point is used as the center of rotation. You can also specify the angle of rotation, and the width and height of a rectangle.

If the angle of rotation is 0, you can specify the position of the lower-left and upper-right corners of the rectangle.

To draw a square, you can specify the origin point, the length of a side, and an angle of rotation.

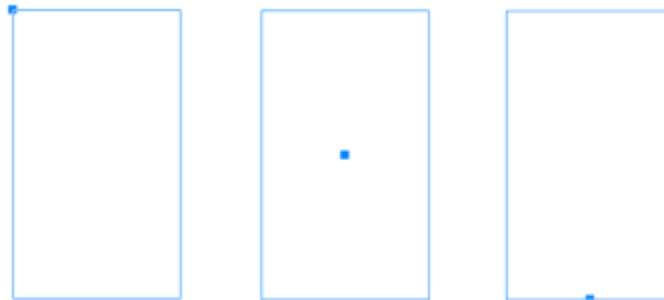

Left: The origin point of a rectangle appears as a blue node in the live preview. You can select the center point, or any corner or midpoint, as the origin point.

Drawing ellipses and circles

To draw an ellipse with precision, you can specify an origin point, which is one of nine points in the bounding box that can be drawn around the ellipse. The origin point is used as the center of rotation.

You can also specify the ellipse diameters, which are the width and height of the bounding box around the ellipse, and the angle of rotation. If the angle of rotation is 0, you can specify the exact position of the lower-left and upper-right corners of the bounding box around the ellipse.

To draw a circle, you can specify the origin point, diameter, and angle of rotation.

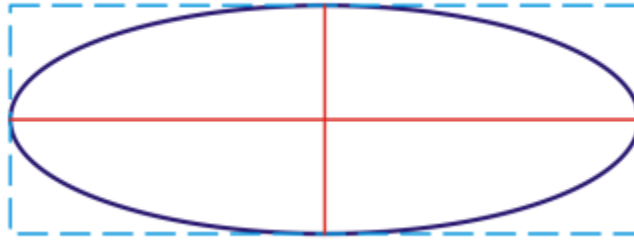

You can specify the width and height of the bounding box that can be drawn around an ellipse.

Drawing polygons

To draw a polygon, you can specify the number of sides, the angle of rotation, or the center and diameters of the bounding ellipse that can be drawn around the polygon. The center of the bounding ellipse, also known as the “polygon center,” is used as the center of rotation.

You can also draw regular polygons with precision. All sides of a regular polygon are of equal length. You can specify the side length and angle of rotation, or the center and diameter of the bounding circle that can be drawn around the regular polygon.

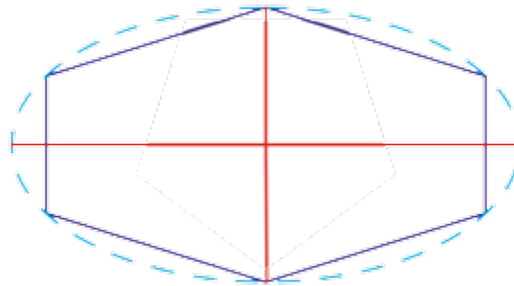

You can specify the diameters of the bounding ellipse that can be drawn around the polygon.

Drawing lines

You can draw a straight line by using one of two methods. With the first method, you specify the start point and endpoint of the line. With the second method, you specify the start point and length of the line, plus an angle of rotation.

You can create complex lines by specifying the coordinates of multiple points. You can delete points, and you can modify the coordinates of existing points. After adding all the points you want, you can close the curved line by connecting its start point to its endpoint.



Straight and multipoint lines

Modifying existing objects

You can use the **Object coordinates** docker to modify existing objects with precision. Note that when you modify an existing object, it is replaced with a new object. As a result, the following transformations and effects applied to the original objects are lost: envelope effects, rotations, and skew effects. In addition, any changes that were previously applied to the nodes on a polygon are lost.

To draw or modify a rectangle by using object coordinates

- 1 Click **Window** ► **Dockers** ► **Object coordinates**.

If you want to modify an existing rectangle, select the rectangle.

- 2 Click the **Rectangle** button .

- 3 Make any of the following adjustments:

- To set the origin point of the rectangle, click a point in the **Origin** area.
- To specify the exact position of the origin point, type values in the **x** and **y** boxes.
- To specify the width and height of the rectangle, type values in the **Object size** boxes.
- To specify only the height or width of the rectangle and have the other dimensions automatically adjusted in proportion, enable the **Proportional** check box.
- To rotate the rectangle at a specified angle, type a value in the **Angle of rotation** box. The origin point of the rectangle is used as the center of rotation.

- 4 Click one of the following:

- **Create object** — adds a new rectangle to the drawing window
- **Replace object** — replaces the selected rectangle with a new one

You can also

Draw a rectangle by specifying the exact position of its lower-left and upper-right corners

In the **Bounding box** area, type values in the **x** and **y** boxes.

The first pair of boxes controls the position of the lower-left corner. The second pair of boxes controls the position of the upper-right corner.

This method for drawing rectangles is available only when no rotation is applied.

Set the lower-left and upper-right corners of a rectangle directly in the drawing window

In the **Bounding box** area, click the **Set lower-left corner interactively** button or the **Set upper-right corner interactively** button , and click in the drawing window.

You can also

Set the origin point directly in the drawing window

Click the **Set origin point interactively** button , and click in the drawing window.

Specify the dimensions of the rectangle directly in the drawing window

Click either of the **Set dimensions interactively** buttons  and drag in the drawing window.

Set the angle of rotation directly in the drawing window

Click the **Set angle interactively** button , and drag in the drawing window.

To draw or modify a square by using object coordinates

1 Click **Window** ▶ **Dockers** ▶ **Object coordinates**.

If you want to replace an existing square, select the square.

2 Click the arrow at the bottom of the **Rectangle** button, and click the **Square** button .

3 Make any of the following adjustments:

- To set the origin point of the square, click a point in the **Origin** area.
- To specify the exact position of the origin point, type values in the **x** and **y** boxes.
- To specify the length of a side, type a value in the **Object size** box.
- To rotate the square at a specified angle, type a value in the **Angle of rotation** box. The origin point of the rectangle is used as the center of rotation.

4 Click one of the following:

- **Create object** — adds a new square to the drawing window
- **Replace object** — replaces the selected square with a new one

You can also

Set the origin point directly in the drawing window

Click the **Set origin point interactively** button , and click in the drawing window.

Specify the length of a square side directly in the drawing window

Click the **Set dimensions interactively** button , and drag in the drawing window.

Set the angle of rotation directly in the drawing window

Click the **Set angle interactively** button , and drag in the drawing window.

To draw or modify an ellipse by using object coordinates

1 Click **Window** ▶ **Dockers** ▶ **Object coordinates**.

If you want to modify an existing ellipse, select the ellipse.

2 Click the **Ellipse** button .

3 Make any of the following adjustments:

- To set the origin point of the ellipse, click a point in the **Origin** area.
- To specify the exact position of the origin point, type values in the **x** and **y** boxes.
- To specify the diameters (width and height) of the ellipse, type values in the **Object size** boxes.
- To specify only one of the diameters and have the other diameter automatically adjusted in proportion, enable the **Proportional** check box.
- To rotate the ellipse at a specified angle, type a value in the **Angle of rotation** box. The origin point of the ellipse is used as the center of rotation.

4 Click one of the following:

- **Create object** — adds a new ellipse to the drawing window
- **Replace object** — replaces the selected ellipse with a new one

You can also

Draw an ellipse by specifying the lower-left and upper-right corners of the bounding box around an ellipse

In the **Bounding box** area, type values in the **x** and **y** boxes.

The first pair of boxes controls the position of the lower-left corner of the bounding box. The second pair of boxes controls the position of the upper-right corner of the bounding box.

This method for drawing ellipses is available only when no rotation is applied to the ellipse.

Set the lower-left and upper-right corners of an ellipse's bounding box directly in the drawing window

In the **Bounding box** area, click the **Set lower-left corner interactively** or **Set upper-right corner interactively** button , and click in the drawing window.

Set the origin point directly in the drawing window

Click the **Set origin point interactively** button , and click in the drawing window.

Specify the dimensions of the ellipse directly in the drawing window

Click either of the **Set diameter interactively** buttons  and drag in the drawing window.

Set the angle of rotation directly in the drawing window

Click the **Set angle interactively** button , and drag in the drawing window.

To draw or modify a circle by using object coordinates

1 Click **Window** ► **Dockers** ► **Object coordinates**.

If you want to replace an existing circle, select the circle.

2 Click the arrow at the bottom of the **Ellipse** button, and click the **Circle** button .

3 Make any of the following adjustments:

- To set the origin point of the square, click a point in the **Origin** area.
- To specify the exact position of the origin point, type values in the **x** and **y** boxes.
- To specify the diameter of a circle, type a value in the **Object size** box.
- To rotate the circle at a specified angle, type a value in the **Angle of rotation** box. The origin point of the circle is used as the center of rotation.

4 Click one of the following:

- **Create object** — adds a new circle to the drawing window
- **Replace object** — replaces the selected circle with a new one

You can also

Set the origin point directly in the drawing window

Click the **Set origin point interactively** button , and click in the drawing window.

Specify the diameter of a circle directly in the drawing window

Click the **Set diameter interactively** button , and drag in the drawing window.

Set the angle of rotation directly in the drawing window

Click the **Set angle interactively** button , and drag in the drawing window.

To draw or modify a polygon by using object coordinates

1 Click **Window** ▶ **Dockers** ▶ **Object coordinates**.

If you want to modify an existing polygon, select the polygon.

2 Click the **Polygon** button .

3 In the **Object size** area, type a value in the **Points or sides** box.

4 Make any of the following adjustments:

- To rotate the polygon at a specified angle, type a value in the **Angle of rotation** box.
- To specify the polygon center, type values in the **x** and **y** boxes in the **Bounding ellipse** area. The polygon center is the center of the bounding ellipse that can be drawn around the polygon. The polygon center is used as the center of rotation.
- To specify the diameters of the bounding ellipse around the polygon, type values in the **Object size** boxes in the **Bounding ellipse** area.
- To specify only one diameter and have the other diameter automatically adjusted in proportion, enable the **Proportional** check box.

5 Click one of the following:

- **Create object** — adds a new polygon to the drawing window
- **Replace object** — replaces the selected polygon with a new one

You can also

Set the angle of rotation directly in the drawing window

Click the **Set angle interactively** button , and drag in the drawing window.

Set the polygon center directly in the drawing window

Click the **Set polygon center interactively** button , and click in the drawing window.

Specify the diameters of the bounding ellipse directly in the drawing window

Click either of the **Set diameter interactively** buttons  and drag in the drawing window.

To draw or modify a regular polygon by using object coordinates

- 1 Click **Window** ► **Dockers** ► **Object coordinates**.
If you want to modify an existing polygon, select the polygon.
- 2 Click the arrow at the bottom of the **Polygon** button, and click the **Regular polygon** button .
- 3 In the **Object size** area, type a value in the **Points or sides** box.
- 4 Type a value in the **Side length** box.
- 5 Make any of the following adjustments:
 - To rotate the polygon at a specified angle, type a value in the **Angle of rotation** box.
 - To specify the polygon center, type values in the x and y boxes in the **Bounding circle** area.
 - To specify the diameter of the bounding circle around the polygon, type a value in the **Object size** box.
- 6 Click one of the following:
 - **Create object** — adds a new polygon to the drawing window
 - **Replace object** — replaces the selected polygon with a new one

You can also

Set the side length directly in the drawing window

Click the **Set dimensions interactively** button , and drag in the drawing window.

Set the angle of rotation directly in the drawing window

Click the **Set angle interactively** button , and drag in the drawing window.

Set the polygon center directly in the drawing window

Click the **Set polygon center interactively** button , and click in the drawing window.

Specify the diameter of the bounding circle directly in the drawing window

Click the **Set diameter interactively** button , and drag in the drawing window.

To draw or modify a straight line by using object coordinates

- 1 Click **Window** ► **Dockers** ► **Object coordinates**.
If you want to modify an existing line, select the line.
- 2 Click the **2-point line** button .
- 3 To specify the start point and endpoint along the x and y rulers, type values in the x and y boxes in the **Points** area.
In the live preview, the start point is highlighted.
- 4 Click one of the following:
 - **Create object** — adds a new line to the drawing window
 - **Replace object** — replaces the selected line with a new one

You can also

Draw a straight line by specifying its start point, length, and angle of rotation

In the **Points** area, type values in the **Start point x** and **y** boxes. In the **Object size** area, type a value in the **Line length** box. Then, type a value in the **Angle of rotation** box.

Set the start point or endpoint of a line directly in the drawing window

In the **Points** area, click one of the **Set point interactively** buttons , and click in the drawing window.



Set the line length directly in the drawing window

In the **Object size** area, click the **Set line length interactively** button  and drag in the drawing window.

Set the angle of rotation directly in the drawing window

In the **Object size** area, click the **Set angle interactively** button , and drag in the drawing window.

To draw or modify a multi-point line by using object coordinates

- 1 Click **Window** ► **Dockers** ► **Object coordinates**.
If you want to replace an existing line with a new one, select the line.
- 2 Click the **Multi-point line** button .
- 3 Click the **Add point** button at the bottom of the **Object coordinates** docker.
- 4 Make either of the following adjustments:
 - To specify the exact position of the point along the x and y rulers, type values in the **X** and **Y** boxes.
 - To add another point, click the **Add point** button , and type values in the **X** and **Y** boxes.
- 5 After specifying all the points you need, click one of the following:
 - **Create object** — adds a new line to the drawing window
 - **Replace object** — replaces the selected line with a new one

You can also

Specify the position of a point directly in the drawing window

Click a point in the **Object coordinates** docker. Click the **Set point interactively** button , and click in the drawing window.

Delete a point

Click a point in the **Object coordinates** docker, and click the **Delete point** button .

Connect the start point with the endpoint of a line

Click the **Auto-close/open curve** button .



Use the following keyboard shortcuts to create a multi-point line quickly:

- To add a point, click in the **Points** area, and press **Insert**.

- To delete a selected point, press **Delete**.
- To activate the X or Y box of a selected point, press **F2**.
- To navigate through the X and Y boxes of the available points, select a box and press **Tab** repeatedly.
- To navigate backward through the X or Y boxes of the available points, select a box and press **Shift + Tab** repeatedly.
- To activate the **Set point interactively** button, double-click a point in the docker.

Copying object properties, transformations, and effects

CorelDRAW lets you copy attributes from one object to another. You can copy object properties such as outline, fill, and text properties. You can copy object transformations such as sizing, rotating, and positioning. You can also copy effects applied to an object.

To copy fill, outline, or text properties from one object to another

- 1 In the toolbox, click the **Attributes eyedropper** tool .
- 2 Click the **Properties** flyout on the property bar, and enable any of the following check boxes:
 - **Outline**
 - **Fill**
 - **Text**
- 3 Click the object whose properties you want to copy.
The **Attributes eyedropper** tool automatically switches to the **Apply object attributes** mode.
- 4 Click the object to which you want to apply the copied properties.



Options that are enabled in the **Transformations** and **Effects** flyouts on the property bar are also applied when you copy properties.



You can also copy fill or outline properties, or both, by right-clicking an object with the **Pick** tool , dragging over another object, releasing the mouse button, and choosing **Copy fill here**, **Copy outline here**, or **Copy all properties**.

To copy size, position, or rotation from one object to another

- 1 In the toolbox, click the **Attributes eyedropper** tool .
- 2 Click the **Transformations** flyout on the property bar, and enable any of the following check boxes:
 - **Size**
 - **Rotation**
 - **Position**
- 3 Click the object whose transformations you want to copy.
The **Attributes eyedropper** tool automatically switches to the **Apply object attributes** mode.
- 4 Click the object to which you want to apply the copied transformations.



Options that are enabled in the **Properties** and **Effects** flyouts on the property bar are also applied when you copy properties.

To copy effects from one object to another

- 1 In the toolbox, click the **Attributes eyedropper** tool .
- 2 Click the **Effects** flyout on the property bar, and enable any of the following check boxes:
 - Perspective
 - Envelope
 - Blend
 - Extrude
 - Contour
 - Lens
 - PowerClip
 - Drop shadow
 - Distortion
- 3 Click the object whose effects you want to copy.
The **Attributes eyedropper** tool automatically switches to the **Apply object attributes** mode.
- 4 Click the object to which you want to apply the copied effects.



Options that are enabled in the **Properties** and **Transformations** flyouts on the property bar are also applied when you copy properties.

Cloning objects

When you clone an object, you create a copy of an object that is linked to the original. Any changes you make to the original object are reflected automatically in the clone. Changes you make to the clone are not automatically reflected in the original, however. You can remove changes made to the clone by reverting to the original.

Cloning lets you modify multiple copies of an object simultaneously by changing the master object. This type of modification is especially useful if you want the clone and master objects to differ by certain properties, such as fill and outline color, but want the master object to control other properties, such as shape.

If you simply want to use the same object in a drawing multiple times, consider using symbols, instead of clones, to keep the file size manageable. For more information about symbols, see “Working with symbols” on page 325.



The object on the left was cloned twice. Different fill and outline properties were applied to the clones. The clone on the right was also reshaped.

To clone an object

- 1 Select an object.
- 2 Click **Edit** ► **Clone**.

You can also

Select the master object of a clone

Right-click the clone, and click **Select master**.

Select the clone objects of a master

Right-click the master, and click **Select clones**.



You can clone a master object multiple times, but you cannot clone a clone.

To revert to the master object of a clone

- 1 Right-click a modified clone, and click **Revert to master**.
- 2 Enable any of the following check boxes:
 - **Clone fill** — restores the master fill attributes
 - **Clone outline** — restores the master outline attributes
 - **Clone path shape** — restores the master shape attributes
 - **Clone transformations** — restores the master shape and size attributes
 - **Clone bitmap color mask** — restores the master color settings



Only the clone properties that are different from the master object are available in the **Revert to master** dialog box.

Positioning objects

You can position objects by dragging them to a new location, by nudging, or by specifying their horizontal and vertical coordinates.

Nudging lets you move an object in increments by pressing the **Arrow** keys. The increment value is known as “nudge distance.” Micro-nudging lets you move an object by a fraction of the nudge distance. Super-nudging lets you move an object by a multiple of the nudge distance. By default, you can nudge objects in 0.1-inch increments, but you can change this increment value to suit your needs. You can also change micro-nudge and super-nudge values.

To position an object, you can set horizontal and vertical coordinates that are relative to the center anchor point, or other anchor point, of the object.

You can also move an object to another page. For more information, see [“To move an object to another page” on page 601](#).

To move an object

- 1 Select an object.
- 2 Point to the center of the bounding box.
- 3 When the position cursor appears, drag the object to a new position in the drawing.



You can move an object to another page by dragging the object over a page number tab at the bottom of the document window and then dragging the object into the document window.

To move an object while drawing

- 1 Start drawing a shape such as a rectangle, ellipse, or polygon.

- 2 Hold down the right mouse button without releasing the left mouse button, and drag the unfinished object to its new position.
- 3 Release the right mouse button, and continue drawing.

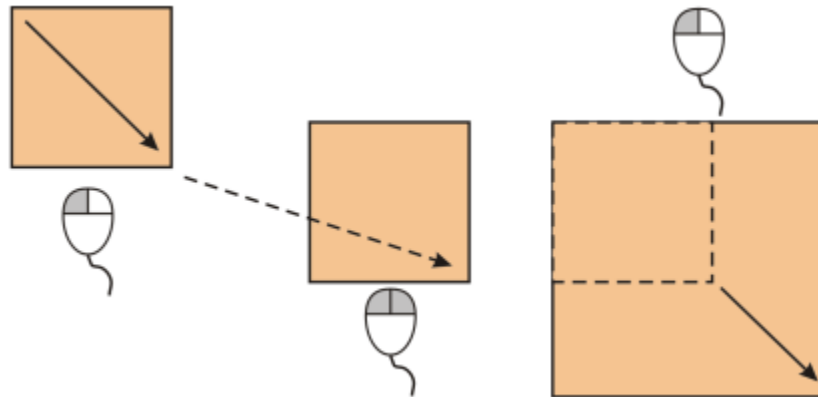

Moving an object while drawing

To nudge an object

To	Do the following
Nudge a selected object by the nudge distance	Press an Arrow key.
Nudge a selected object by a fraction of the nudge distance (micro-nudge)	Hold down Ctrl , and press an Arrow key.
Nudge a selected object by a multiple of the nudge distance (super-nudge)	Hold down Shift , and press an Arrow key.

To set nudge distances

- 1 Click **Tools** ► **Options**.
- 2 In the **Document** list of categories, click **Rulers**.
- 3 Type a value in the **Nudge** box.
- 4 Type a value in one of the following boxes:
 - **Super nudge**
 - **Micro nudge**



You can also set the nudge distance by deselecting all objects and typing a value in the **Nudge distance** box on the property bar.

To save the new nudge distances to use in new drawings, click **Tools** ► **Save settings as default**.

To position an object by x and y coordinates

- 1 Select an object.
If you want to change the object origin, click a point on the **Object origin** button on the property bar.
- 2 Type values in the following boxes:
 - **x** — lets you position the object on the x-axis

- **y** — lets you position the object on the y-axis
- The x and y values specify the exact position of the object origin.

3 Press **Enter**.



The object origin, also known as “anchor point” or “reference point,” can be the center of an object or any one of the object’s selection handles. The object origin remains stationary when an object is positioned by typing values in the **x** and **y** boxes on the property bar.

To position an object by changing the anchor point

- 1 Select an object.
- 2 Click **Window** ► **Dockers** ► **Transformations** ► **Position**.
- 3 Disable the **Relative position** check box in the **Transformation** docker.
- 4 Type values in the following boxes:
 - **H** — lets you specify a value for the position of an object along the horizontal axis
 - **V** — lets you specify a value for the position of an object along the vertical axis
- 5 Enable the check box that corresponds to the anchor point that you want to set.
- 6 Click **Apply**.



By default, the point of origin (0,0) is at the lower-left corner of the drawing page.

When you enable the **Relative position** check box on the **Transformation** docker, the position of the center anchor point is identified as 0,0 in the **H** and **V** boxes. When you specify a different position in the **H** and **V** boxes, the values represent a change from the current position as measured from the center anchor point of the object.

Aligning and distributing objects

CorelDRAW lets you precisely align and distribute objects in a drawing. You can align objects with each other and with parts of the drawing page, such as the center, edges, and grid. When you align objects with objects, you can line them up by their centers or by their edges.

You can align multiple objects horizontally or vertically with the center of the drawing page. Single or multiple objects can also be arranged along the edge of the page and to the nearest point on a grid. You can also align objects with a reference point by specifying its exact x and y coordinates.







Distributing objects automatically adds spacing between them based on their width, height, and center points. You can distribute objects so that their center points or selected edges (for example, top or right) appear at equal intervals. You can also distribute objects so that there is equal space between them. You can distribute objects over the extent of the bounding box surrounding them or over the entire drawing page.



Scattered objects (left) are vertically aligned and equally distributed (right).

To align objects

- 1 Select the objects.
- 2 Click **Object** ▶ **Align and distribute** ▶ **Align and distribute**.
- 3 In the **Align** area of the docker, click one of the following buttons to use an object edge or center for aligning.

- **Align left**  — to align the left edges of objects
- **Align center horizontally**  — to align object centers along a vertical axis
- **Align right**  — to align the right edges of objects
- **Align top**  — to align the top edges of objects
- **Align center vertically**  — to align object centers along a horizontal axis
- **Align bottom**  — to align the bottom edges of objects

To align objects from their outlines, click the **Outline** button .

- 4 In the **Align objects to** area, perform any of the following tasks.

To

Align an object with a specific object

Do the following

Click the **Active objects** button .



If you select the objects one at a time, the last object selected is the reference point for aligning the other objects. If you marquee select the objects, the object that is positioned in the upper-left corner of the selection is used as a reference point.

Align an object with the page edge

Click the **Page edge** button .

Align an object with the page center

Click the **Page center** button .

To align the center of the object with the page center, make sure that the **Align center horizontally** button  and **Align center vertically** button  in the **Align** area are enabled.

To

Do the following

Align an object with the closest grid line

Click the **Grid** button .



Align an object with a specified point

Click the **Specified point** button , and type values in the **Specify coordinates** boxes.

You can also specify a point interactively by clicking the **Specify point** button, and clicking in the document window.

Set an alignment option for text objects

In the **Text** area, choose one of the following options:









- **First line baseline**  — aligns text by the baseline of the first line
- **Last line baseline**  — aligns text by the baseline of the last line
- **Bounding box**  — aligns text by its bounding box



You can also align objects with another object quickly, without using the **Align and distribute** docker, by clicking **Object** ► **Align and distribute** and clicking any of the first six alignment commands. The letter next to a command name indicates the keyboard shortcut that you can use to align objects. For example, the letter **L** next to the **Align left** command shows that you can press **L** to align objects with the leftmost point of the object that is used as a reference point.

You can also align all objects with the page center, vertically and horizontally, by pressing **P**.

To distribute objects

- 1 Select the objects.
- 2 Click **Object** ► **Align and distribute** ► **Align and distribute**.
- 3 To distribute objects horizontally, click one of the following buttons:
 - **Distribute left**  — evenly spaces the left edges of the objects
 - **Distribute center horizontally**  — evenly spaces the center points of the objects along a horizontal axis
 - **Distribute right**  — evenly spaces the right edges of the objects
 - **Distribute space horizontally**  — places equal intervals between the objects along a horizontal axis
- 4 To distribute objects vertically, click one of the following buttons:
 - **Distribute top**  — evenly spaces the top edges of the objects
 - **Distribute center vertically**  — evenly spaces the center points of the objects along a vertical axis
 - **Distribute bottom**  — evenly spaces the bottom edges of the objects
 - **Distribute space vertically**  — places equal intervals between the objects along a vertical axis
- 5 To choose the area over which the objects are distributed, click one of the following buttons in the **Distribute objects to area**:
 - **Extent of selection**  — distributes the objects over the area of the bounding box surrounding them

- Extent of page  — distributes the objects over the drawing page

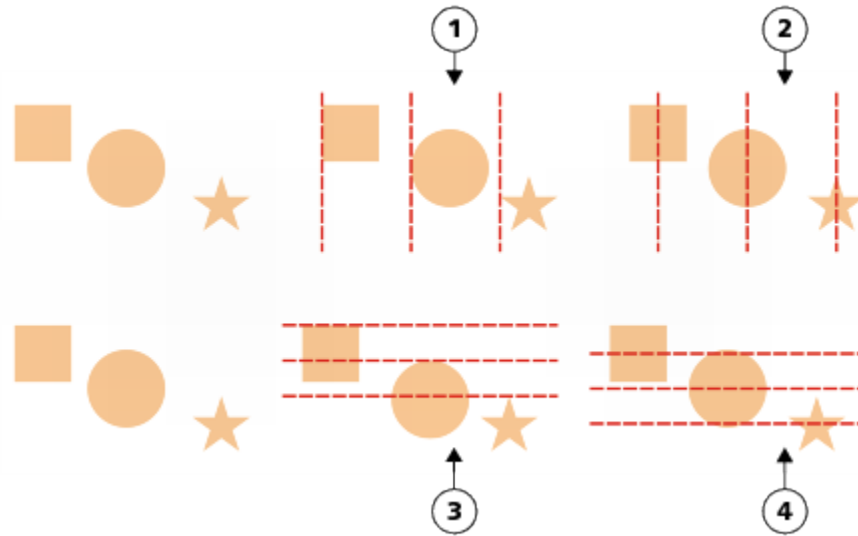

Top row: Options for distributing objects horizontally. 1) The Left option evenly spaces the left edges. 2) The Center option evenly spaces the center points. Bottom row: Options for distributing objects vertically. 3) The Top option evenly spaces the top edges. 4) The Center option evenly spaces the center points.

Applying object hinting

Object hinting allows you to improve object rendering by adjusting the display of an object so that it lines up with the pixel grid. For example, if you're creating a button for the web, you can enable object hinting to ensure the object appears clean and sharp when exporting it as a bitmap.

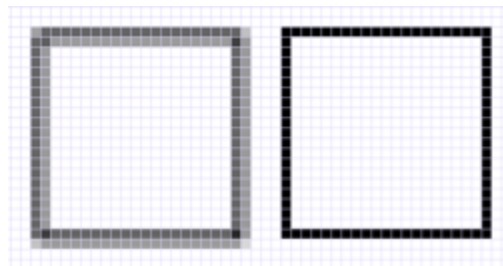

The Pixel view of a square (left) with a 1-pixel line width that was created without object hinting. A copy of the square (right) displayed with object hinting applied.

To apply object hinting

- 1 Select an object.
- 2 Click Object ► Object hinting.

Snapping objects

When you move or draw an object, you can snap it to another object in a drawing. You can snap an object to various snap points on the target object. When you move the pointer close to a snap point, the snap point becomes highlighted, which identifies it as the pointer's snapping target.

You can snap objects to other objects, to page elements (such as the center of the page), to the document grid, pixel grid, baseline grid, and guidelines. When editing symmetry groups, you can also snap objects to symmetry lines. All these snapping options can be turned on or off from the **View** menu and from the **Snap to** button on the standard toolbar.





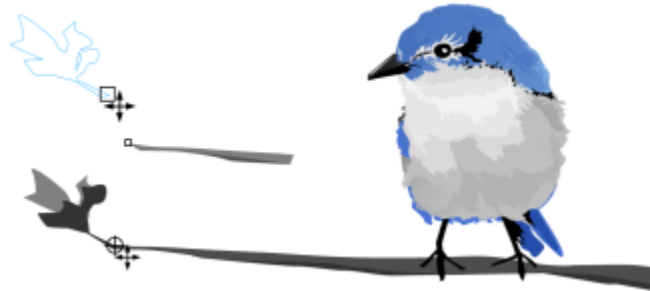

When you need to turn off the selected snapping options temporarily, you can disable all snapping from the **Snap off** button on the standard toolbar or the **View** menu. To restore the selected snapping options, you can enable snapping by using the same controls.



To snap an object to another object with greater precision, you can first snap the pointer to a snap point in the object, and then snap the object to a snap point in the target object. For example, you can snap the pointer to the center of a rectangle, drag the rectangle by the center, and then snap the rectangle to the center of another rectangle.



The pointer was snapped to an end node of the leaf (top), and then the leaf was dragged to snap to the end node of the branch (bottom).

Snapping modes determine which snap points you can use in an object. The table below includes descriptions of all available snapping modes.

Snapping mode	Description	Snapping mode indicator
Node	Lets you snap to a node on an object	
Intersection	Lets you snap to a geometric intersection of objects	
Midpoint	Lets you snap to a line segment midpoint	
Quadrant	Lets you snap to points that are at 0°, 90°, 180°, and 270° on a circle, ellipse, or arc	
Tangent	Lets you snap to a point on the outside edge of an arc, circle, or ellipse where a line touches, but does not intersect, the object	
Perpendicular	Lets you snap to a point on the outside edge of a segment where a line is perpendicular to the object	
Edge	Lets you snap to a point that touches the edge of an object	

Snapping mode	Description	Snapping mode indicator
Center	Lets you snap to the center of the closest object (arc, regular polygon, or curve centroid)	
Text baseline	Lets you snap to a point on the baseline of artistic or paragraph text	

You can adjust a number of snapping settings. For example, you can disable some or all snapping modes to make the application run faster. You can also set a snapping threshold, which specifies the distance from the pointer at which a snap point becomes active.

To turn snapping on or off

- Perform one or more tasks from the following table:

To	Do the following
Enable snapping for all objects	Click View ► Snap to ► Objects .
Enable snapping objects to page elements (edges, edge midpoints, and page center)	Click View ► Snap to ► Page .
Enable snapping objects to the pixel grid	Click View ► Snap to ► Pixels . This option is available only when pixel view is enabled. For more information, see “Choosing viewing modes” on page 62 .
Enable snapping objects to the document grid	Click View ► Snap to ► Document Grid . For more information, see “Setting up the document grid” on page 605 .
Enable snapping objects to the baseline grid	Click View ► Snap to ► Baseline Grid . For more information, see “Setting up the baseline grid” on page 607 .
Enable snapping objects to guidelines	Click View ► Snap to ► Guidelines . For more information, see “Setting up guidelines” on page 608 .
Enable snapping objects to symmetry lines	Click View ► Snap to ► Symmetry Lines . This option is available only in symmetry mode. For more information, see “Editing symmetry groups” on page 242 .



A check mark next to the snap command indicates that snapping is turned on.



You can also press **Alt + Z** to toggle snapping to objects on and off, or press **Ctrl + Y** to toggle snapping to the document grid on and off.

You can also turn snapping modes on or off from the **Snap to** button on the standard toolbar.

To disable and enable snapping

- Click **View ▶ Snap off**.

When there is a check mark beside the command, all snapping is off. The **View ▶ Snap to** menu commands and the **Snap to** button on the standard toolbar become grayed out. Clicking the **View ▶ Snap off** command again enables all snapping and restores all selected snapping options.



You can also disable and enable all selected snapping options by pressing **Alt + Q** or by clicking the **Snap off** button  on the standard toolbar.

To temporarily disable snapping as you are moving an object, hold down **Q**.

To snap objects

- 1 Select the object that you want to snap to the target object.
- 2 Move the pointer over the object until the snap point becomes highlighted.
- 3 Drag the object close to the target object until the snap point on the target object becomes highlighted.



To snap an object as you draw it, drag in the drawing window until the snap point in the target object becomes highlighted.

To adjust snapping settings

- 1 Click **Tools ▶ Options**.
- 2 In the **Workspace** list of categories, click **Snap to objects**.
- 3 On the **Snap to objects** page of the **Options** dialog box, enable one or more of the check boxes in the **Modes** area.
To enable all snapping modes, click **Select all**.
To disable all snapping modes without turning off snapping, click **Deselect all**.
- 4 Type a value in the **Snapping radius** box to set the radius, in pixels, of the snapping field around the pointer.

You can also

Display or hide snapping mode indicators

Enable or disable the **Show snap location marks** check box.

Display or hide screen tips

Enable or disable the **Screen tip** check box.

Using dynamic guides

You can display dynamic guides to help you precisely move, align, and draw objects in relation to other objects. Dynamic guides are temporary guidelines that you can pull from the following snap points in objects — center, node, quadrant, and text baseline. For more information about snap points and snapping modes, see “Snapping objects” on page 279.

As you drag an object along a dynamic guide, you can view the distance of the object from the snap point that was used to create the dynamic guide, which helps you position the object precisely. You can use dynamic guides to place objects in relation to other objects as you draw them. You can also display intersecting dynamic guides and then place an object at the intersection.

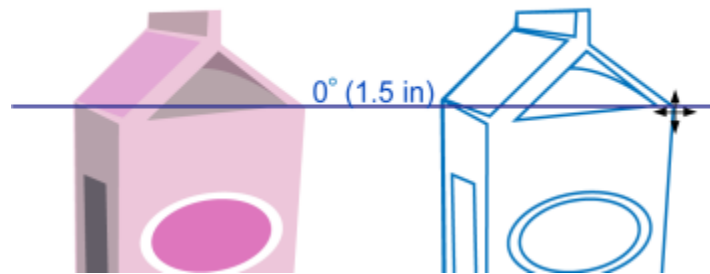

A dynamic guide was pulled from a node in the object on the left. The screen tip next to the node displays the angle of the dynamic guide (0°) and the distance between the node and the pointer (1.5 inches.) The object on the right was dragged along the dynamic guide and positioned precisely 1.5 inches away from the node that was used to generate the dynamic guide.

Dynamic guides contain invisible divisions, called ticks, to which your pointer gravitates. Ticks let you move objects with precision along a dynamic guide. You can adjust tick spacing to suit your needs, and you can disable snapping to ticks. You can set other options for dynamic guides. For example, you can choose to display dynamic guides at one or more preset angles, or at custom angles that you specify. You can preview the angle settings. You can also customize the color and line style of dynamic guides. When you no longer need a dynamic guide at a certain angle, you can delete the angle settings. You can also display dynamic guides that are extensions of line segments.

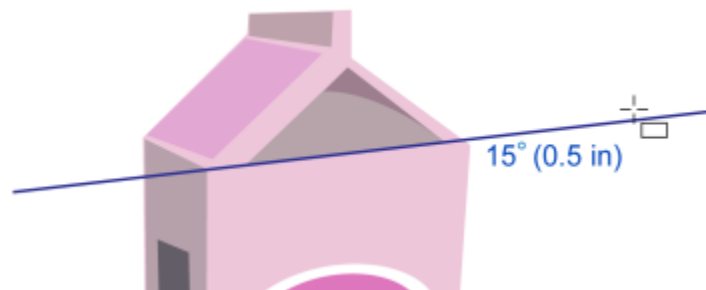

This dynamic guide is an extension of a line segment.

You can turn off dynamic guides at any time.

To enable or disable dynamic guides

- Click **View** ► **Dynamic guides**.



A check mark beside the **Dynamic guides** command indicates that dynamic guides are enabled.



You can toggle dynamic guides on and off by pressing **Shift + Alt + D**.

To display dynamic guides

- 1 With dynamic guides enabled, click a drawing tool.
- 2 Move the pointer over, and then off, an eligible snap point of an object.
- 3 Repeat step 2 with other objects to display other dynamic guides.

The snap points that you point to are registered in a queue and are used to create dynamic guides.



The eligible snap points — the node, center, quadrant, and text baseline snap points — appear only when the corresponding snapping modes are activated. For more information about snap points and snapping modes, see [“Snapping objects” on page 279](#).



To avoid displaying too many dynamic guides, you can clear the queue of points at any time by clicking in the drawing window or pressing **Esc**.

You can use the snap points you registered to display intersecting dynamic guides. To do this, display a dynamic guide, and then move the pointer along the dynamic guide to where an intersecting dynamic guide would appear from a registered snap point.

To place an object in relation to another object

- 1 With dynamic guides enabled, select an object.
If you want to move the object by a specific snap point, move the pointer over the snap point until the snap point becomes highlighted.
- 2 Drag the object to an eligible snap point of the target object.
- 3 When the snap point of the target object becomes highlighted, drag the object along the dynamic guide to position it.



The eligible snap points — the node, center, quadrant, and text baseline snap points — appear only when the corresponding snapping modes are activated. For more information about snap points and snapping modes, see [“Snapping objects” on page 279](#).

To draw an object in relation to another object

- 1 With dynamic guides enabled, click a drawing tool.
- 2 Move the pointer over an eligible snap point of an object.
- 3 When the snap point becomes highlighted, move the pointer to display a dynamic guide.
- 4 Move the pointer along the dynamic guide to the point where you want to draw, and drag to draw an object.



The eligible snap points — the node, center, quadrant, and text baseline snap points — appear only when the corresponding snapping modes are activated. For more information about snap points and snapping modes, see [“Snapping objects” on page 279](#).

To place an object at the intersection of dynamic guides

- 1 With dynamic guides enabled, select an object.

If you want to use a specific snap point to move the object, move the pointer over the snap point until the snap point becomes highlighted.

- 2 Drag the object to an eligible snap point of another object, drag to display a dynamic guide, and continue to hold down the mouse button.
- 3 Drag the object to another eligible snap point. When the snap point becomes highlighted, drag to display another dynamic guide where the two dynamic guides would intersect.
- 4 When the intersecting point appears, release the mouse button.

In the following example, intersecting dynamic guides are used to position an ellipse.

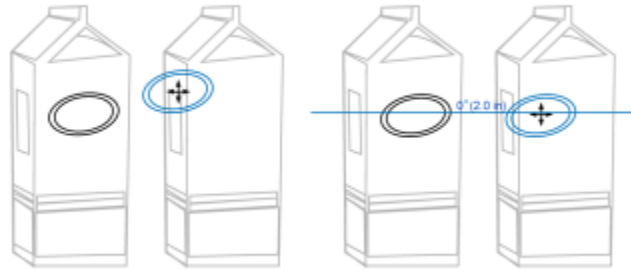

First, the ellipse was dragged by its center snap point (left) to the edge of the other carton, and then to the right to display a dynamic guide (right).

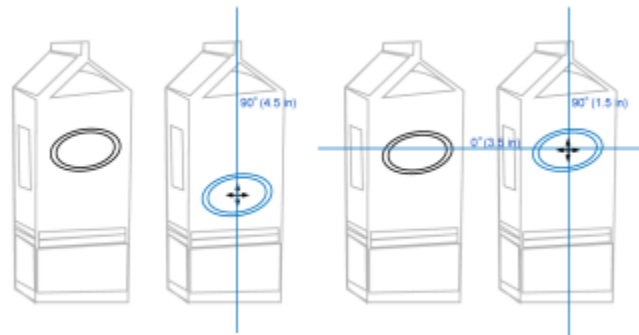









Next, the ellipse was dragged to the edge of the carton, and then down to display another dynamic guide (left). Finally, the ellipse was positioned at the intersection of the dynamic guides (right).



The eligible snap points — the node, center, quadrant, and text baseline snap points — appear only when the corresponding snapping modes are activated. For more information about snap points and snapping modes, see “Snapping objects” on page 279.

To set options for dynamic guides

- 1 Click **Window** ► **Dockers** ► **Alignment and dynamic guides**.
- 2 In the **Alignment and dynamic guides** docker, click the **Dynamic guides** button .
- 3 Perform one or more tasks from the following table.

To	Do the following
Enable or disable dynamic guides	Enable or disable the check box in the top-right corner of the Dynamic guides section of the docker.
Change the line style of dynamic guides	Open the Line style picker, and choose a line style.
Change the color of dynamic guides	Open the Line color picker, and choose a color.
Display or hide the angle of dynamic guides and the distance from the snap point used to create the dynamic guide	Click the Display screen tips button  .
Display dynamic guides that are extensions of line segments	Click the Extend along segment button  .
Snap to specified invisible divisions along the dynamic guide	Click the Snap to tick spacing button  , and type a value in the Tick spacing box.
Choose the angles at which to display the dynamic guides	<p>Enable or disable the angle check boxes.</p> <p>When you enable an angle check box, a preview of the dynamic guide appears in the Guides preview window.</p>
Add a custom dynamic guide angle	Type a value in the Custom angle box, and click the Add custom angle button  .
Delete a dynamic guide angle	Select a dynamic guide in the list, and click the Delete custom angle button  .
Display dynamic guides at all available angles	Click the Select all button  .
Disable dynamic guides at all available angles	Click the Deselect all button  .

Using alignment guides

You can align objects interactively on the drawing page by using [alignment guides](#). Alignment guides are temporary guidelines that appear when you create, resize, or move objects in relation to other nearby objects. While dynamic guides provide precise measurements for creating technical illustrations, alignment guides are useful in page layout to align text or graphic elements quickly and accurately.

Alignment guides help you align the center of an object with the center of another object (center to center) or the edge of an object with the edge of another object (edge to edge). In addition, you can align the edge of an object with the center of another object (edge to center).

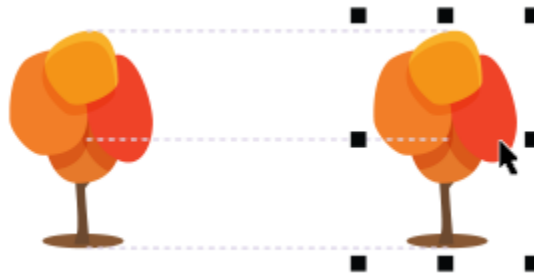

Alignment guides appear as an object is moved.

If you want to align an object at a set distance from the edge of another object, you can set margins for the alignment guides. After you specify the margins, you can choose how the edge guides appear: they can follow either the margins, or both the margins and the edges of the object.

Margin alignment guides let you use offset margins, inset margins, or both. There are separate controls for horizontal and vertical margin alignment guides, so you can modify settings for one without affecting the other.

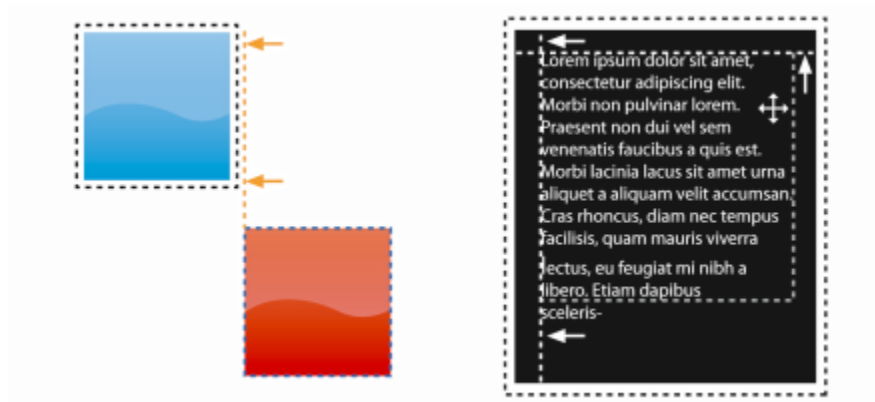

You can offset (left) and inset (right) margin alignment guides.

Alignment guides are turned off by default. You can easily enable or disable alignment guides, or modify their default settings, including the color and line style. You can choose whether alignment guides appear for individual objects in a group, or for the bounding box of the group as a whole.

The Intelligent Spacing feature lets you precisely arrange and position an object in relation to other onscreen objects, and the Intelligent Dimensioning feature lets you intuitively scale and rotate an object in relation to other onscreen objects.

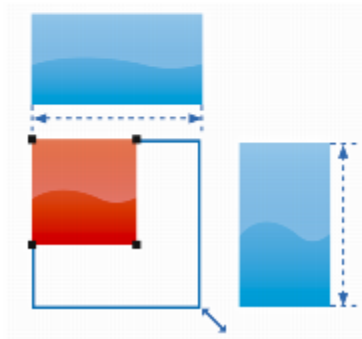
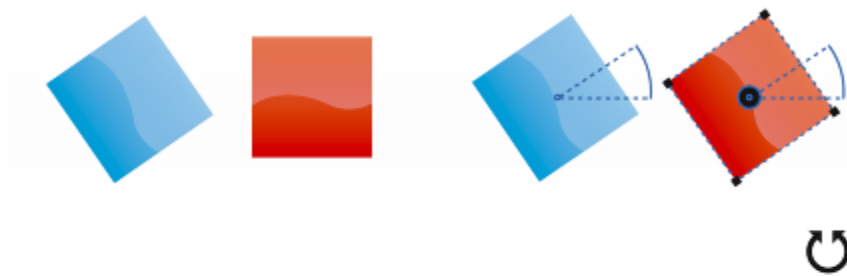

Intelligent Dimensioning displays indicators when an object is rotated to the same angle (top) or scaled to same size as the closest object (bottom).

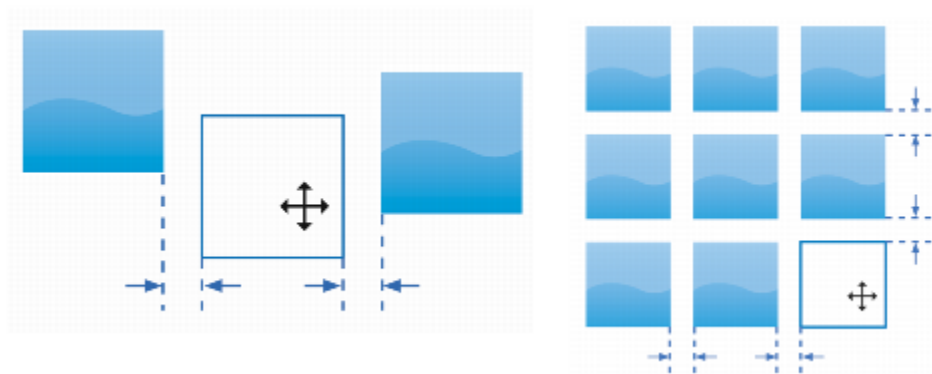

Intelligent Spacing displays indicators when an object is equidistant between two other objects (left) or has the same spacing as the closest onscreen objects (right).

To enable or disable alignment guides

- Click **View** ► **Alignment guides**.



A check mark beside the **Alignment guides** command indicates that alignment guides are enabled.







You can also enable or disable alignment guides by clicking the **Alignment guides** button on the **Layout** toolbar. To open the **Layout** toolbar, click **Window** ► **Toolbars** ► **Layout**.

You can also enable alignment guides by pressing **Shift + Alt + A**.

To modify alignment guide settings

- 1 Click **Window** ► **Dockers** ► **Alignment and dynamic guides**.
- 2 In the **Alignment and dynamic guides** docker, click the **Alignment guides** button .
- 3 Perform any of the following tasks.

To	Do the following
Enable or disable alignment guides	Enable or disable the check box in the top-right corner of the Alignment guides section.
Change the color of alignment guides	Open the Line color picker, and choose a color.
Change the line style of alignment guides	Open the Line style picker, and choose a line style.
Set guides to align the edge of an object with the edge of another object	Click the Object edges button  .
Set guides to align the edge of an object with the center of another object	Click the Object centers button  .
Set guides to align to individual objects in a group	Click the Individual objects in a group button  .
Distribute objects using the same spacing as the closest onscreen objects	Ensure that the Intelligent spacing button  is enabled, and drag the object until indicator arrows appear.
Position an object equidistantly between two other objects	Ensure that the Intelligent spacing button is enabled, and drag the object between two other objects until indicator arrows appear.
Scale objects to the same dimensions as other onscreen objects	Ensure that the Intelligent dimensioning button  is enabled, and scale the object until indicator arrows appear.
Rotate objects to the same angle as other rotated onscreen objects	Ensure that the Intelligent dimensioning button is enabled, and rotate the object until rotation indicators appear.



You can access most alignment guide controls on the **Layout** toolbar by clicking the **Layout toolbar** button .

To add margin alignment guides

- 1 Click **Window** ► **Dockers** ► **Alignment and dynamic guides**.
- 2 In the **Alignment and dynamic guides** docker, click the **Alignment guides** button .
- 3 Perform any of the following tasks.

To

Add margin alignment guides

Change the line color of margins

Change the line style of margins

Set horizontal margins

Set vertical margins

Lock the ratio between vertical and horizontal margins

View only margin alignment guides

Disable horizontal margins

Disable vertical margins



Do the following

Enable the **Margins** check box. If the **Margins** check box is not displayed, click the arrow button  located at the bottom of the **Alignment guides** section.



Open the **Margin line color** picker, and choose a color.

Open the **Margin line style** picker, and choose a line style.





Type a value in the **Horizontal margin** box, click the **Horizontal margin** button, and choose one of the following options:

- **Offset horizontally**  — creates a margin of the specified distance around an object
- **Inset horizontally**  — creates a margin of the specified distance within an object
- **Offset and inset horizontally**  — creates margins of the specified distance around and within an object

Type a value in the **Vertical margin** box, click the **Vertical margin** button, and choose one of the following options:

- **Offset vertically**  — creates a margin of the specified distance around an object
- **Inset vertically**  — creates a margin of the specified distance within an object
- **Offset and inset vertically**  — creates a margin of the specified distance around and within an object

Click the **Lock ratio** button .

Disable the **Object edges** button , the **Object centers** button , the **Intelligent spacing** button , and the **Intelligent dimensioning** button .

Click the **Horizontal margin** button, and choose **No horizontal margin** .

Click the **Vertical margin** button, and choose **No vertical margin** .

Changing the order of objects

You can change the stacking order of objects on a layer or a page by sending objects to the front or back of other objects. You can also position objects precisely in the stacking order, as well as reverse the stacking order of multiple objects.

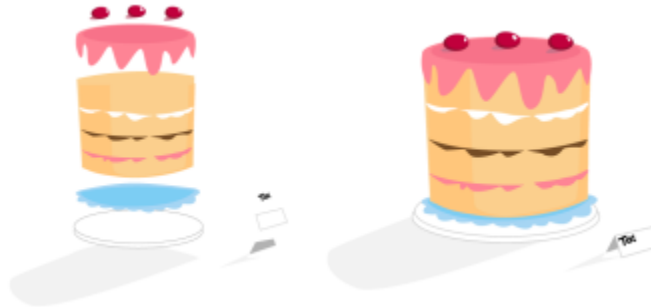

The four objects (left) are ordered from top to bottom to create the final image (right).

To move an object in the stacking order

- 1 Select an object.
- 2 Click **Object** ► **Order**, and then click one of the following commands:
 - **To front of page** — moves the selected object in front of all other objects on the page
 - **To back of page** — moves the selected object behind all other objects on the page
 - **To front of layer** — moves the selected object in front of all other objects on the active layer
 - **To back of layer** — moves the selected object behind all other objects on the active layer
 - **Forward one** — moves the selected object forward one position. If the selected object is in front of all other objects on the active layer, it is moved to the layer above.
 - **Back one** — moves the selected object behind one position. If the selected object is behind all other objects on the selected layer, it is moved to the layer below.
 - **In front of** — moves the selected object in front of the object that you click in the drawing window
 - **Behind** — moves the selected object behind the object that you click in the drawing window



An object cannot be moved to a locked (non-editable) layer; instead, it is moved to the closest editable layer. For example, when you apply the **To front of page** command, and the topmost layer is locked, the object is moved to the topmost editable layer. Any objects on the locked layer remain in front of the object.

By default, all objects on the master page appear on top of the objects on other pages. For information about reordering content on master page layers, see [“To move a layer” on page 322](#).

An **Order** command is unavailable if the selected object is already positioned in the specified stacking order. For example, the **To front of page** command is unavailable if the object is already in front of all the other objects on the page.

To reverse the order of multiple objects

- 1 Select the objects.
- 2 Click **Object** ► **Order** ► **Reverse order**.

Sizing and scaling objects

CorelDRAW lets you size and scale objects. In both cases, you change the dimensions of an object proportionally by preserving its aspect ratio. You can change the dimensions of an object by specifying precise values or by changing the object interactively. When you scale an object, you change its dimensions by a specified percentage.

To size an object

To	Do the following
Size a selected object	Drag any of the corner selection handles.
Set a precise size	Type values in the Object size boxes on the property bar.
Size a selected object from its center	Hold down Shift , and drag one of the corner selection handles.
Size a selected object to a multiple of its original size	Hold down Ctrl , and drag one of the corner selection handles.
Stretch and size a selected object simultaneously	Hold down Alt , and drag one of the corner selection handles.





The anchor point of an object, also known as “object origin,” remains stationary when you resize the object by typing values in the **Object size** boxes on the property bar. If you want to change the object origin, click a point on the **Object origin** button  on the property bar.



You can also size an object by clicking **Object** ► **Transformations** ► **Size** and then typing values in the **Transformations** dockers.

To scale an object

- 1 Select an object.
- 2 In the toolbox, click the **Free transform** tool .
- 3 Click the **Free scale** button  on the property bar.
If you want to change the object origin, click a point on the **Object origin** button  on the property bar.
- 4 Type a percentage by which you want to scale the object in the **Scale factor** boxes on the property bar.

You can also

Apply the scaling according to the object’s position rather than the x and y coordinates	Click the Relative to object button  on the property bar.
Scale an object using the Transformations dockers	Click Window ► Dockers ► Transformations ► Scale and mirror .

You can also

Leave the original object unchanged and apply the transformation to a copy

Click the **Apply to duplicate** button on the property bar, or type a number in the **Copies** box in the **Transformations** docker.



The object origin, also known as “anchor point” or “reference point,” can be the center of an object or any one of the object’s selection handles. The object origin remains stationary when an object is scaled by typing values in the **Scale factor** boxes on the property bar.



You can also scale an object by dragging a corner selection handle.

You can also scale an object by using the **Transform** toolbar. To open the toolbar, click **Window** ► **Toolbars** ► **Transform**.

Rotating and mirroring objects

CorelDRAW lets you rotate and create mirror images of objects. You can rotate an object by specifying horizontal and vertical coordinates. You can move the center of rotation to a specific ruler coordinate or to a point that is relative to the current position of the object.

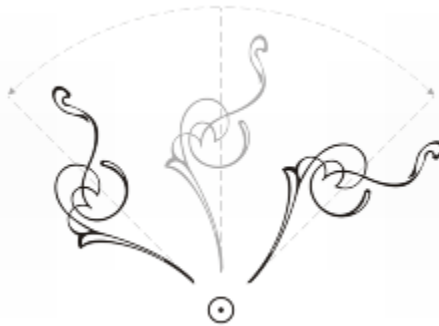



Rotating objects around a single point

Mirroring an object flips it from left to right or top to bottom. By default, the mirror anchor point is in the center of the object.



Mirroring an object from top to bottom

To rotate an object

- 1 Select an object.
- 2 In the toolbox, click the **Free transform** tool .
- 3 Click the **Free rotation** button  on the property bar.
- 4 Type a value in the **Angle of rotation** box on the property bar.

You can also

Apply the rotation according to the object's position rather than the x and y coordinates

Click the **Relative to object** button  on the property bar.

Use rotation handles to rotate an object

Using the **Pick** tool, click the object twice to display the rotation handles. Drag a rotation handle clockwise or counterclockwise.

Rotate an object using the **Transformations** dockers

Click **Window** ▶ **Dockers** ▶ **Transformations** ▶ **Rotate**.



You can also view and set the relative center of an object by clicking the object to display the rotation handles and dragging the relative center handle (circle with a dot in the middle) to a new position.



You can set the relative center of an object to its original position by enabling the **Relative center** check box in the **Transformations** dockers and clicking the center option in the area below the check box.

You can also rotate an object by using the **Transform** toolbar. To open the toolbar, click **Window** ▶ **Toolbars** ▶ **Transform**.

To rotate an object around a ruler coordinate

- 1 Select an object.
- 2 Click **Window** ▶ **Dockers** ▶ **Transformations** ▶ **Rotate**.
- 3 Disable the **Relative center** check box.
- 4 Type a value in the **Angle** box.
- 5 Type values in any of the following **Center** boxes:
 - **H** — lets you specify the point on the horizontal ruler around which the object rotates
 - **V** — lets you specify the point on the vertical ruler around which the object rotates
- 6 Press **Enter**.

To mirror an object

- 1 Select an object.
- 2 Click **Window** ▶ **Dockers** ▶ **Transformations** ▶ **Scale and mirror**.
- 3 In the **Transformations** dockers, click one of the following buttons:
 - **Mirror horizontally**  — lets you flip the object from left to right
 - **Mirror vertically**  — lets you flip the object from top to bottom

If you want to flip the object on a specific anchor point, enable the check box that corresponds to the anchor point you want to set.

- 4 Click **Apply**.



You can also mirror a selected object by holding down **Ctrl** and dragging a selection handle to the opposite side of the object.

You can also mirror a selected object by clicking the **Mirror horizontally** or the **Mirror vertically** button on the property bar.

Using the Object Properties docker to modify objects

The **Object properties** docker presents object-dependent formatting options and properties, letting you modify object settings from one location. For example, if you create a rectangle, the **Object properties** docker automatically presents outline, fill, transparency, and corner formatting options, as well as the rectangle's properties. If you create a text frame, the docker instantly displays character, paragraph, and frame formatting options, as well as the text frame's properties.

You can navigate quickly to the properties that you want to modify by using the controls at the top of the **Object properties** docker. In addition, two view modes are available: Scroll and Tab. Scroll mode displays all relevant object properties, letting you scroll to the options you want. Tab mode displays only one group of object properties at a time, hiding the other options. For example, you can view only fill options, and then click the **Outline** button to view only outline options.

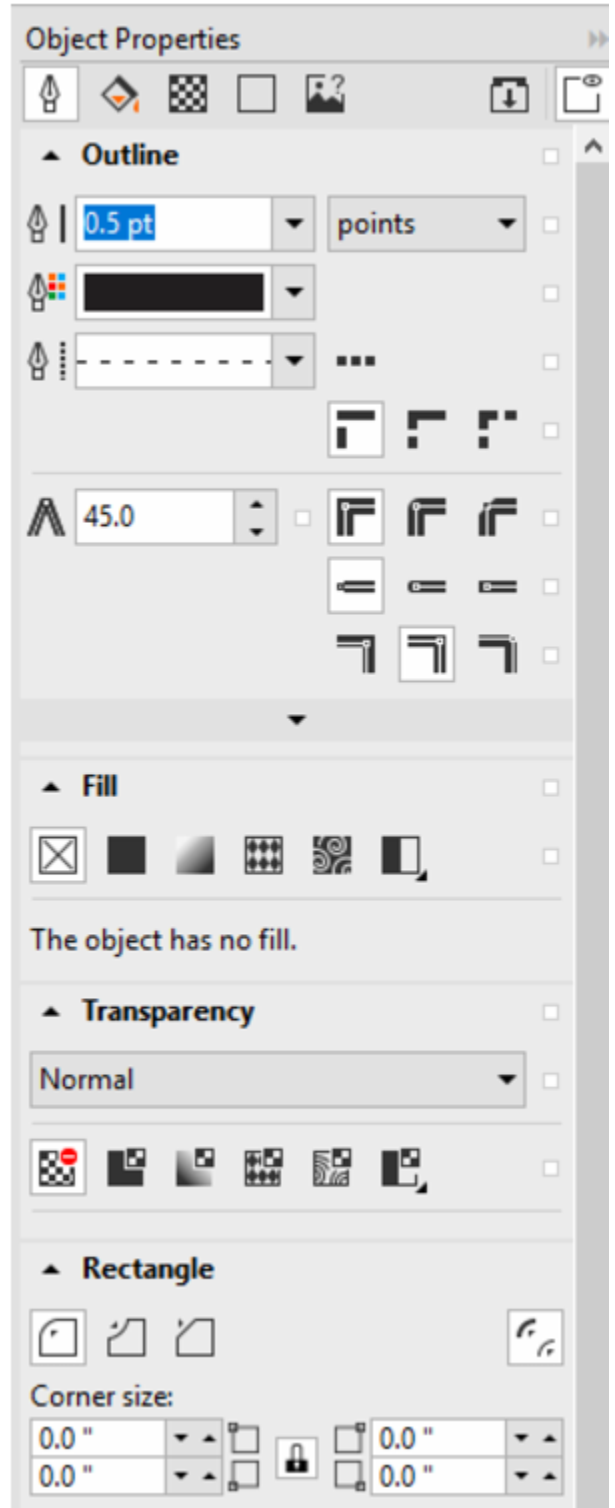
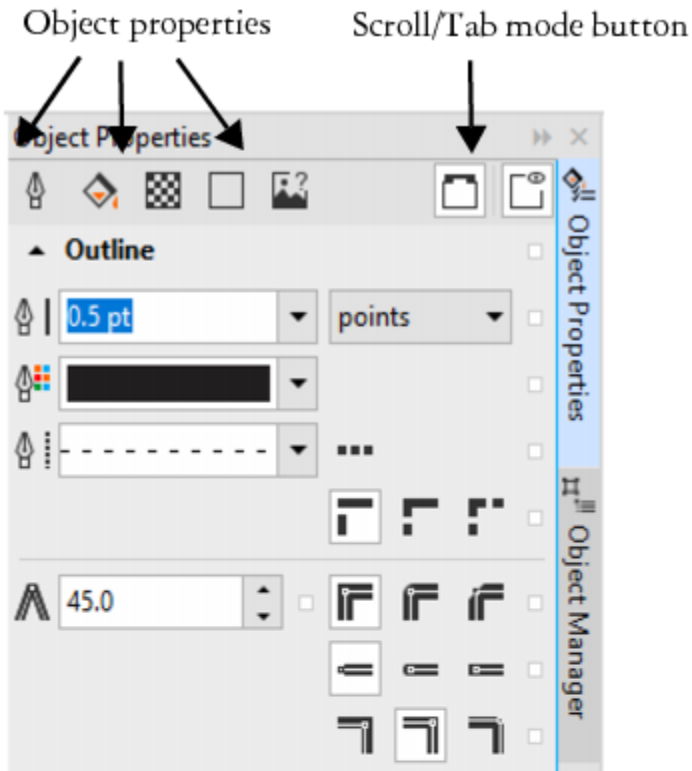

In this example, the Object properties docker displays the editable properties of a selected rectangle in Tab mode (left) and Scroll mode (right).

If objects have outline, fill, or other styles applied to them, style indicators appear beside the property in the Object properties docker. You can hide the style indicators to save space.

To use the Object Properties docker

- 1 Select an object.
If the **Object properties** docker is not open, click **Window** ► **Dockers** ► **Object properties**.
- 2 Perform any of the following tasks.

To	Do the following
Display the object properties that you want to modify	Click the corresponding button at the top of the docker.
Switch between Scroll and Tab mode	Click the Scroll/Tab mode button.
Display or hide the style indicators	Click the Style indicator button.

Fitting objects to a path

The **Fit Objects to Path** feature lets you fit any type and number of objects to a path of your choice. Smart distribution and rotation settings help you customize the placement of objects on the path.

You can distribute objects along a path by placing equal gaps between them and you can distribute objects by spacing evenly their reference points such as center of rotation or object origin. Objects can be rotated to follow the path. Moreover, you can use additional options such as different rotation styles and spin angles to create unique effects.

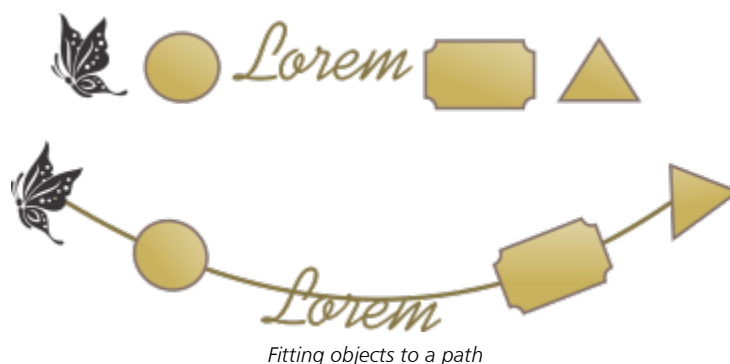

To fit objects to a path

- 1 Using the **Pick** tool, select the objects that you want to fit to a path.
- 2 Holding down **Shift**, click the path.
If you do not select a path, the last object you selected in step 1 is used as a path.
- 3 Click **Objects** ► **Fit Objects to Path**.
- 4 In the **Fit Objects to Path** docker, choose any settings you want.
- 5 Click **Apply**.



Objects that can be used as paths include curves, rectangles, ellipses, polygons, artistic text, and groups of objects. If a group contains an object that cannot be used as a path, this invalid object is excluded — selected objects are fit to the path of the remaining objects in the group.

The stacking order of the objects and path depends on the order of creation. If you draw the path first, it will appear behind the objects. If you draw the path last, it will appear on top of the objects.

Fitting linked groups, such as drop shadows, artistic media groups, and blends, to a path may produce unexpected results.

To use B-splines and connector lines as paths, you must convert them to curves first.



You can also access the **Fit Objects to Path** docker from the **Window ▸ Dockers** menu, or you can access it by clicking the **Quick customize** button of any docker and enabling the **Fit Objects to Path** check box.

To fit a blend to a path, we recommend that you use an alternative method. Click the **Blend** tool, click the **Path properties** button on the property bar, choose **New path**, and then click a path.

To choose Fit Objects to Path settings

Use the controls in the **Fit Objects to Path** docker (**Objects ▸ Fit Objects to Path**) to customize how objects are placed on the path and create unique effects.

Objects

Keep originals: Enable this check box to fit copies of the objects to the selected path and keep the original objects in place.

Duplicates: Fit Objects to Path can automatically create extra copies of the selected objects and place them on the path. Specify the number of additional copies to be fit to the path in the **Duplicates** box.

Group all objects: Enable this check box if you want the objects to be grouped after they are placed on the path. The path is not included in the group so that you can move it or delete it easily.

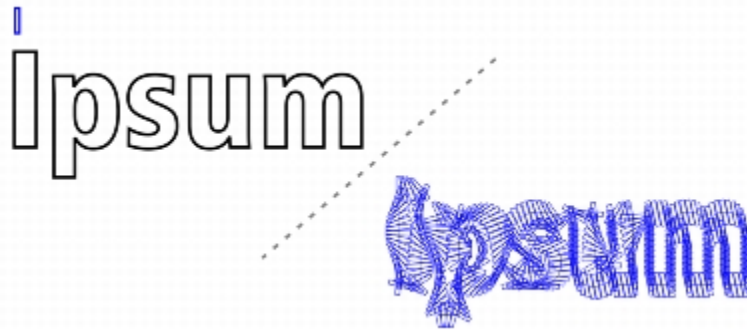

This effect was created by fitting a rectangle and 350 rectangle copies to the path of a text object.

Path

Treat as contiguous: This option has an effect when you want to fit objects to closed paths or to paths that consist of open subpaths.

Object positioning

Order: This list box lets you choose the order in which the selected objects appear on the path. The objects can be placed in the order in which they were selected or in reverse order. You can also place them based on their size, width, or height.

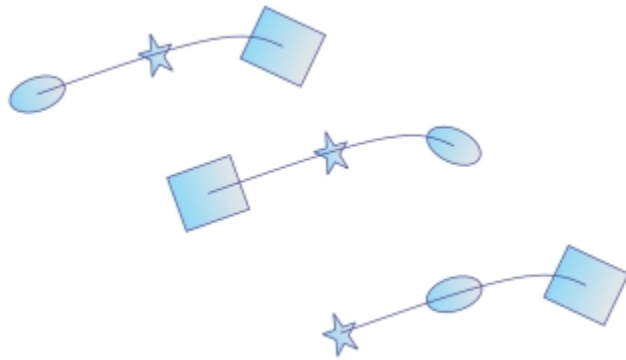

Order options shown from left to right: Selection: Follow selection order, Selection: Reverse order, and Area: Small to big.

Distribution: This list box lets you choose a distribution method. You can distribute objects by inserting equal space between them (Uniform object spacing). You can also distribute objects by spacing evenly the reference points that you select.

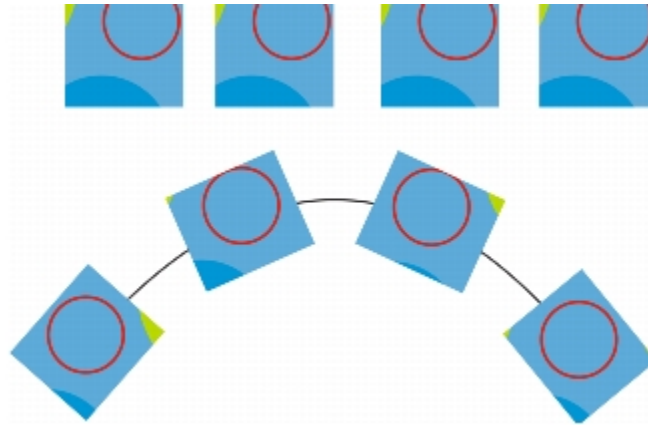

The Uniform object spacing method places equal gaps between the objects on the path.

Reference points: An object is anchored (fit) to the path by its reference point. The **Reference** list box lets you choose the center of rotation of each object or the object origin as a reference point. The object origin, also known as “anchor point”, can be the center of an object or any one of eight other points on the object’s bounding box. To change the origin point, simply click another point on the **Origin** control.

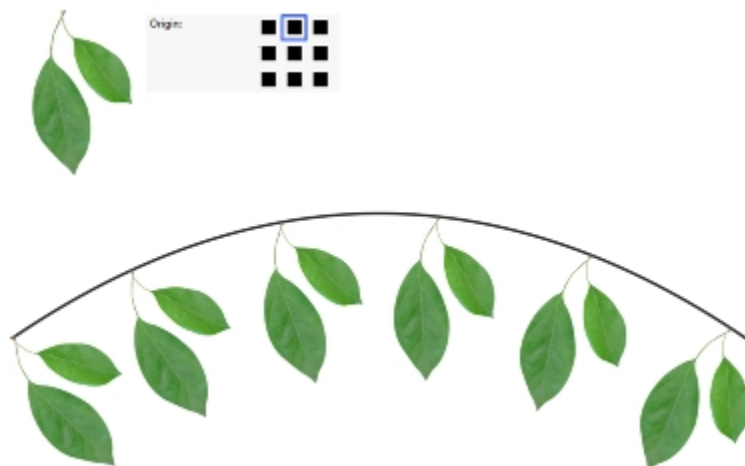

Object origin spacing method. The object origin point is changed to create the effect of leaves hanging from a branch.

Rotation options

Follow path: Enabling this check box rotates the objects so that they follow the curve of the path. In more technical terms, each object's angle of rotation matches the tangential angle of the location on the curve where the object is placed.

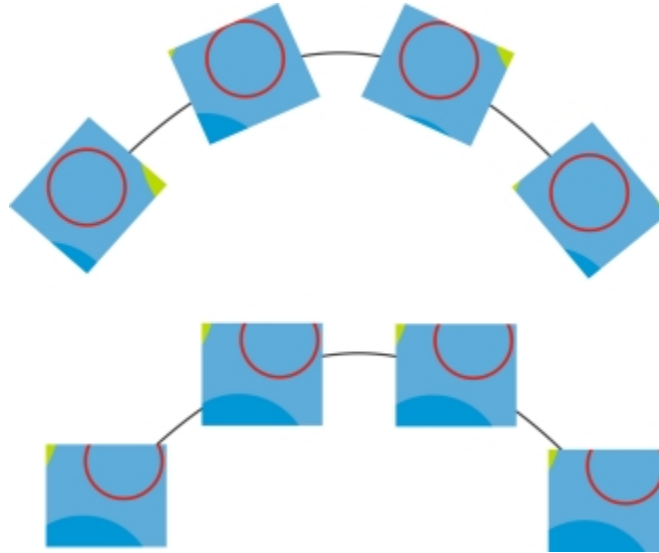

Objects are rotated to follow the curve of the path (top); objects are placed on the path without rotating them (bottom).

Ignore initial rotation: This control lets you clear all previous rotations applied to the objects before they were placed on the path.

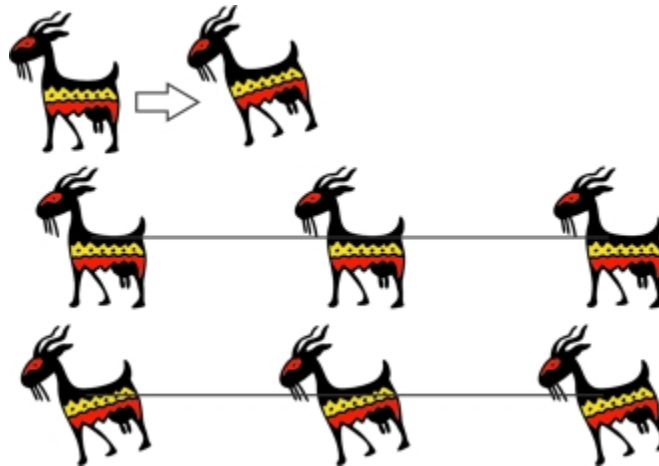

Top: The original clipart is rotated. Middle: It is fit to a straight path, ignoring the applied rotation. Bottom: The clipart is fit to the path, preserving its rotation.

The following controls let you enhance object rotation along the path.

Style: Choose from several rotation styles to create various rotation effects. The **Uniform** style lets you add the same rotation to each object along the path by specifying a value in the **Start angle** box. The **Progressive** style works together with the **Start angle** and **Spin angle** boxes to add a rotation that changes along the path. If you want to create a more organic rotation effect with angles of rotation varying randomly, you can choose **Jitter** or **Progressive jitter**. You can specify the [range](#) of the random rotations.

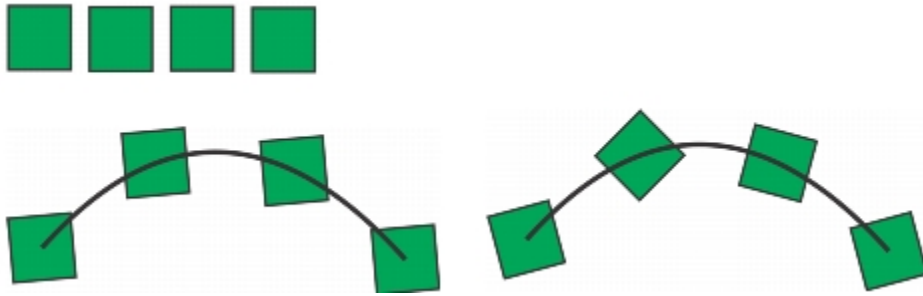

Left: With the Uniform style, the same angle of rotation is added to each object on the path. Right: With the Progressive style, the added angle of rotation changes for each object.

Direction: By default, added rotation is applied counterclockwise. To change the direction, enable the **Clockwise** check box.

Start angle: Add an angle of rotation to each object.

Spin angle: This control works together with the **Progressive** and **Progressive jitter** styles. It allows you to add an angle of rotation to each object, ranging from 0° to the specified value. Suppose that you want to fit an object and three duplicates to a path, and you specify a spin angle of 180° . This spin angle applies an additional rotation of 0° to the first object, 60° to the second object, 120° to the third object, and 180° to the last object.

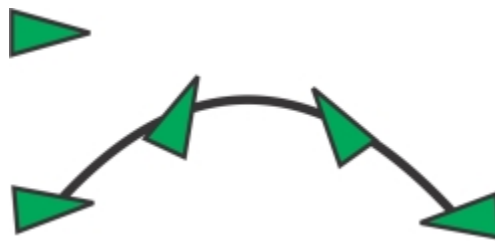

Progressive rotation style with a start angle of 5° and a spin angle of 180°

Revolutions: An alternative way of adding rotation to the objects on the path progressively. One revolution equals 360° .

Range: This control is available when the **Jitter** and **Progressive jitter** styles are selected. Specify a value range for random rotations used to create jitter. For example, with a value of 15° , the angles of rotation vary between 15° and -15° .

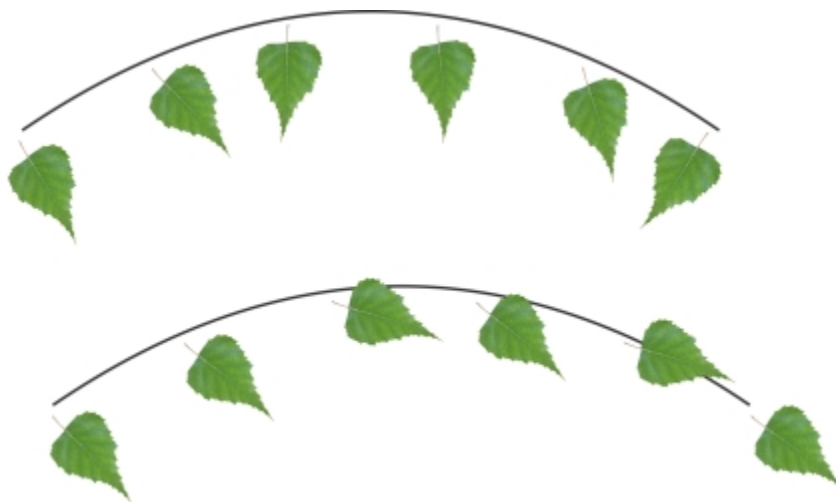

Examples of Jitter (top) and Progressive jitter (bottom) rotation styles with range of 30°

Grouping objects

When you group two or more objects, they are treated as a single unit but retain their individual attributes. Grouping lets you apply the same formatting, properties, and other changes to all the objects within the group at the same time. In addition, grouping helps prevent accidental changes to the position of an object in relation to other objects. You can also create nested groups by grouping together existing groups.

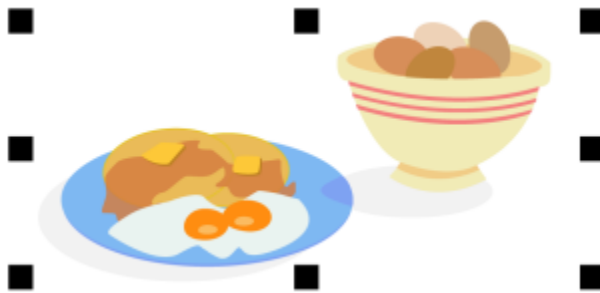

Individual objects retain their attributes when they are grouped.

You can add objects to or remove objects from a group, and you can delete objects that are members of a group. You can also edit a single object in a group without ungrouping the objects. If you want to edit multiple objects in a group at the same time, you must first ungroup the objects. If a group contains nested groups, you can ungroup all objects in the nested groups simultaneously.

To group objects

- 1 Select the objects.
- 2 Click **Object** ► **Group** ► **Group objects**.



The status bar indicates that a group of objects is selected.

You can select objects from different layers and group them; however, after objects are grouped, they reside on the same layer and are stacked on top of one another.



You can create a nested group by selecting two or more groups of objects and clicking **Object** ► **Group** ► **Group objects**.

You can also group objects by dragging an object in the **Object manager** docker over another object. If the **Object manager** docker is not open, click **Window** ► **Dockers** ► **Object manager**.

You can also group objects by clicking the **Group** button on the property bar.

To add an object to a group

- In the **Object manager** docker, drag the object to the group.
If the **Object manager** docker is not open, click **Window** ► **Dockers** ► **Object manager**.

To remove an object from a group

- In the **Object manager** docker, drag an object outside the group.
If the **Object manager** docker is not open, click **Window** ► **Dockers** ► **Object manager**.



To delete an object in a group, select the object in the object list, and click **Edit ▶ Delete**.

To edit an object in a group

- 1 Click the **Pick tool** .
- 2 Hold down **Ctrl**, and click an object in a group to select it.
- 3 Edit the object.



You can also select an object in a group by clicking the object in the **Object manager** docker. If the **Object manager** docker is not open, click **Window ▶ Dockers ▶ Object manager**.

To ungroup objects

- 1 Select one or more groups.
- 2 Click **Object ▶ Group**, and click one of the following commands:
 - **Ungroup objects** — breaks a group into individual objects, or a nested group into multiple groups
 - **Ungroup all objects** — breaks one or more groups into individual objects, including objects within nested groups



Choosing **Ungroup all objects** also ungroups all nested groups. To preserve nested groups, select **Ungroup objects**.



You can also ungroup objects by clicking the **Ungroup** button  on the property bar.

You can also ungroup all nested groups within a group by clicking the **Ungroup all** button  on the property bar.

Combining objects

Combining two or more objects creates a single object with common fill and outline attributes. You can combine rectangles, ellipses, polygons, stars, spirals, graphs, or text so that they are converted to a single curve object. If you need to modify the attributes of an object that has been combined from separate objects, you can break apart the combined object. You can extract a subpath from a combined object to create two separate objects. You can also weld two or more objects to create a single object. For information about welding objects, see [“Welding and intersecting objects” on page 228](#).

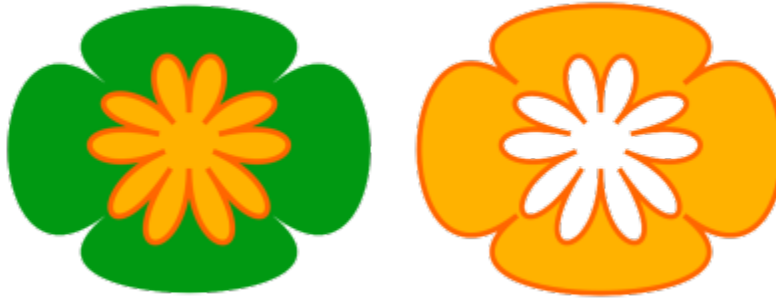

The two objects (left) are combined to create a single object (right). The new object has the fill and outline properties of the last object selected.

To combine objects

- 1 Select the objects to be combined.
- 2 Click **Object** ▶ **Combine**.



Combined text objects become larger blocks of text.



You can also combine selected objects by clicking the **Combine** button  on the property bar.

You can close open lines in a combined object by clicking **Object** ▶ **Join curves** and choosing settings in the **Join curves** docker.



To break apart a combined object

- 1 Select a combined object.
- 2 Click **Object** ▶ **Break curve apart**.



If you break apart a combined object that contains artistic text, the text breaks apart into lines first, and then into words. Paragraph text breaks into separate paragraphs.

To extract a subpath from a combined object

- 1 Click the **Shape** tool , and select a segment, node, or group of nodes on a combined object.
- 2 Click the **Extract subpath** button  on the property bar.



After you extract the subpath, the fill and outline properties of the path are removed from the combined object.

Locking objects

Locking an object prevents you from accidentally moving, sizing, transforming, filling, or otherwise changing it. You can lock single, multiple, or grouped objects. To change a locked object, you need to unlock it first. You can unlock one object at a time, or all locked objects at the same time.

To lock an object

- Select an object, and click **Object** ► **Lock** ► **Lock object**.



You cannot lock linked objects, such as blends, contours, or text inside an object. You also cannot lock objects within groups or linked groups.



You can also lock an object by right-clicking it and then clicking **Lock object**.

You can also lock an object by clicking the lock icon beside the object name in the **Objects** docker.

To unlock objects

- 1 Select a locked object or group of objects.
- 2 Click **Object** ► **Lock**, and then click one of the following:
 - **Unlock object**
 - **Unlock all objects**



You can also unlock an object by right-clicking it and then clicking **Unlock object**.

You can also unlock multiple locked objects by dragging in the second column in the **Objects** docker.

Finding and replacing objects

You can use the **Find** and **Replace** wizards to locate and edit objects in a large drawing.

Using search criteria that you specify, the **Find** wizard guides you step-by-step when you need to find and select objects in a drawing. The search criteria can include object type and its related properties, fill and outline properties, vector effects applied to objects, or the name of an object or style. For example, you can search for and select all rectangles with rounded corners and without fill, or all text on a path. You can also search for objects that contain the same properties as a selected object. You can change the search criteria in the middle of a search. You can also save search criteria for later use.

The **Replace** wizard guides you through the process of finding objects that contain the properties you specify and then replacing those properties with others. For example, you can replace all object fills of a certain color with fills of a different color. You can also replace color models and palettes, outline properties, and text attributes, such as font and font size.

You can also search for specific words and replace them with other words. For more information, see [“Finding, editing, and converting text” on page 486](#).

To find and select objects

- 1 Click **Edit** ► **Find and replace** ► **Find objects**.
- 2 Follow the instructions in the **Find** wizard.



You can also access the **Find** wizard by pressing **Ctrl + F**.

To replace object properties

- 1 Click **Edit** ► **Find and replace** ► **Replace objects**.
- 2 Follow the instructions in the **Replace** wizard.

Hiding and displaying objects

CorelDRAW allows you to hide objects and groups of objects, helping you edit objects in complex projects and experiment with your designs more easily.

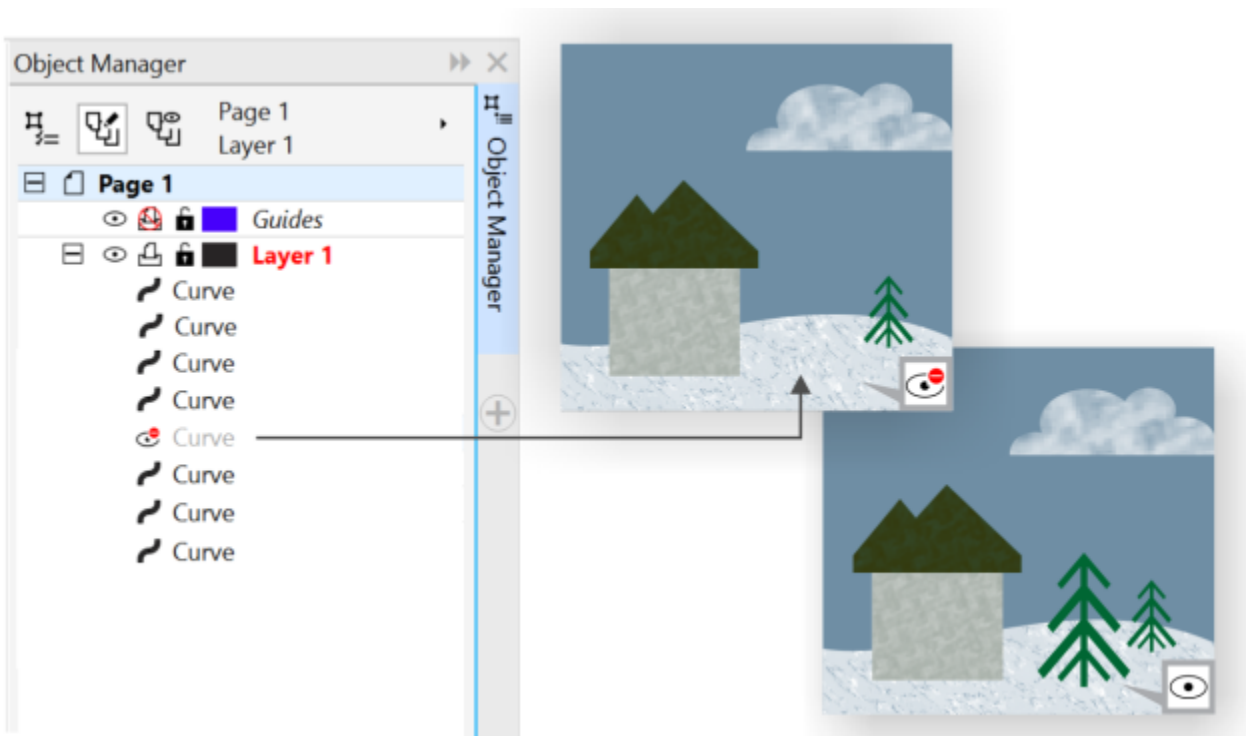

You can hide and display objects.

To hide an object

- 1 Select the object that you want to hide.
- 2 Click **Object** ► **Hide** ► **Hide Object**.



When an object is hidden in the **Objects** docker, an eye icon is displayed beside its name.



You can also access the **Hide Object** command by right-clicking an object.

To display hidden objects

- Click **Object** ► **Hide**, and click one of the following commands:
 - **Show Object**
 - **Show All Objects**



You can also show a hidden object by clicking the eye icon beside the object name in the **Objects** docker.

You can also show multiple hidden objects by clicking and dragging over the eye icons beside the object names.

Constraining objects

You can restrict how objects are drawn and edited by using a constrain key while you draw. For example, you can press a constrain key to constrain a rectangle to a square, an ellipse to a circle, or a straight line to a perfectly horizontal or vertical line. By default, the application uses the **Ctrl** key to constrain the shape or angle of objects, and the **Shift** key to draw shapes outward from their center of origin. However, you can change the default constrain key to **Shift** at any time.

You can use a control key to draw or rotate an object, or the nodes and control handles of an object, at a preset increment. This increment is known as the constrain angle. By default, the constrain angle is 15 degrees, but you can change it to suit your needs.

To constrain objects while drawing or editing

To	Do the following
Constrain a shape to equal width and height	While holding down Ctrl , draw diagonally.
Use a preset increment (the constrain angle) to draw or rotate an object	While holding down Ctrl , move the pointer to draw or rotate the object.



A rectangle is constrained to a square, an ellipse to a circle, and a polygon to a shape with sides of equal length.

To change the constrain key

- 1 Click **Tools** ► **Options**.
- 2 In the **Workspace** list of categories, click **Toolbox**, and then click **Pick tool**.
- 3 In the **Ctrl and Shift keys** area, enable one of the following options:
 - **Traditional CorelDRAW** — lets you use the **Ctrl** key as the **constrain key** and the **Shift** key to draw shapes outward from their center of origin
 - **Windows standard** — lets you use the **Shift** key as the constrain key and the **Ctrl** key to apply transformations to the duplicate of an object while leaving the original intact

To change the constrain angle

- 1 Click **Tools** ► **Options**.
- 2 In the **Workspace** list of categories, click **Edit**.
- 3 Type a value in the **Constrain angle** box.

Inserting bar codes

The **Barcode** wizard in CorelDRAW lets you add bar codes to drawings. A bar code is a group of bars, spaces, and sometimes numbers that is designed to be scanned and read into computer memory. Bar codes are most commonly used to identify merchandise, inventory, and documents.

The **Barcode** wizard guides you through the process of inserting a bar code. If you need additional information at any step, you can consult the Help in the **Barcode** wizard.

You can also insert QR codes. For more information, see [“Inserting QR codes” on page 309](#).

To insert a bar code

- 1 Click **Object** ► **Insert barcode**.
In the **Classic** workspace, this command appears under the **Edit** menu.
- 2 Follow the instructions in the **Barcode** wizard.

If you need help with choosing options, click **Help** in the **Barcode** wizard.



A bar code is inserted into a drawing as an object.

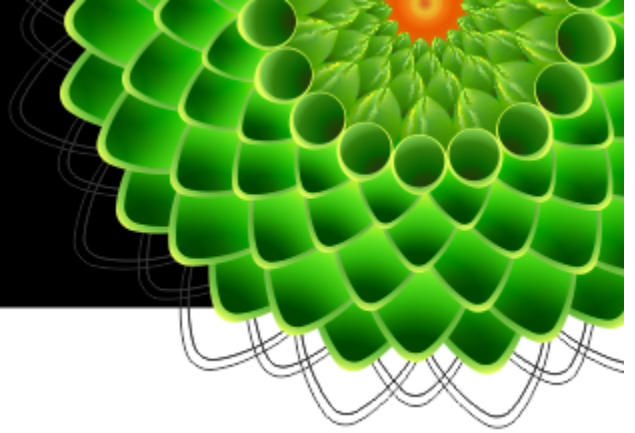

Inserting and editing QR codes

A Quick Response (QR) code is a type of barcode that represents information in two dimensions. Typically, QR codes consist of dots (also called “pixels”) arranged in a square pattern and displayed against a contrasting background. QR codes are known for their fast readability and can store information such as website addresses, phone numbers, and messages.

With the widespread use of smartphones, QR codes have become popular in consumer advertising and packaging. By scanning a QR code on your smartphone, you can quickly access the brand’s website for more information about a product.

To insert, edit, and validate QR codes, you must sign in to your account and be connected to the Internet.

This section contains the following topics:

- “Inserting QR codes” (page 309)
- “Editing QR codes” (page 310)
- “Validating QR codes” (page 312)

Inserting QR codes

CorelDRAW lets you insert QR codes with embedded information such as a web address, email address, phone number, text message, geo location, or plain text. After you insert a QR code, you can edit and validate it. For more information, see “Editing QR codes ” on page 310 and “Validating QR codes” on page 312.



An example of a QR code

To insert a QR code

- 1 Click **Object** ► **Insert QR code**.

In the **Classic** workspace, this command appears under the **Edit** menu.

2 In the **Object properties** docker, choose one of the following options from the **QR code type** list box:

- **URL** — lets you specify a URL for a website
- **Email address** — lets you specify an email address if you want to use the QR code to generate a blank email
- **Phone number** — lets you specify a phone number for the QR code. Depending on the QR reader that you use, scanning the code can initiate, with your permission, dialing the phone number on smartphones.
- **SMS** — lets you include a Short Message Service (SMS) message by typing a phone number and message text. With your permission, the QR reader can initiate sending the SMS message to the specified phone number.
- **Contact** — lets you specify contact information in vCard or meCard format. From the **Contact card type** list box, choose **vCard** or **meCard**, and type the contact information in the appropriate boxes. With your permission, this contact information can be automatically added to the address book on your phone.
- **Calendar event** — lets you schedule an event by specifying a name, location, start date/time, and end date/time for the event. With your permission, the event can be added to your calendar.
- **Geo location** — lets you show a geographic location by specifying latitude and longitude values
- **Plain text** — lets you include plain (unformatted) text



To insert, edit, and validate QR codes, you must sign in to your account and be connected to the Internet.

Editing QR codes

After you insert a QR code, you can use the **Object properties** docker to customize the pixel fill, the background fill, the pixel outline, as well as the pixel shape and corner roundness. When you customize the shape of the pixels, the markers (the three larger squares in the corners, as well as one or more smaller squares in the interior of the code pattern) remain unchanged to maintain the readability of the code. You can also specify the margin around the QR code or weld the pixels together.



A QR code with customized pixel shapes and added text. The markers remain unchanged.



From left to right: Custom pixel fill color, custom pixel fill and background color, custom pixel fill and outline color as well as custom pixel outline width



From left to right: QR codes with circular, diamond, and star pixel shapes

Error correction

Visual effects, logos, or text added to a QR code can give it an artistic look but may be considered errors by scanners. You can use the error correction settings to minimize the possibility of error when scanning the QR code. For example, if part of the pixel pattern is covered by a graphic or text, the error correction duplicates some of the hidden data so that this data can be recovered. Four levels of error correction are available.

You can move, resize, scale, and align the QR code like any other object. For more information, see [“Working with objects” on page 253](#).

With QR codes, you can use styles to control the appearance of the fill, outline, and other properties. For more information, see [“Working with styles and style sets” on page 573](#). You can also change the default look of QR codes by modifying the default object properties. For more information, see [“Managing default object properties” on page 578](#).

To edit a QR code

- 1 Double-click the QR code.
- 2 In the **Object properties** docker, perform any of the following tasks.

To

Apply a fill to the pixels of the QR code

Do the following

Choose a fill type from the **Pixel fill type** list box, and then choose a fill from the **Pixel fill color** picker.

If you want to customize the fill, click the **Pixel fill settings** button **■ ■ ■** next to the pixel color picker, and specify the fill settings.

Apply a fill to the background

Choose a fill type from the **Background fill type** list box, and then choose a fill from the **Background fill color** picker.

If you want to customize the fill, click the **Background fill settings** button **■ ■ ■** next to the background color picker, and specify the fill settings.

Specify the pixel outline width and color

Type a value in the **Pixel outline width** box, and then choose a color from the **Pixel outline color** picker.

If you want to customize the outline, click the **Pixel outline settings** button **■ ■ ■** next to the outline color picker, and specify the outline settings.

Specify the margin around the QR code

Type a value in the **Margin** box.

To

Choose a pixel shape

Weld pixels

Set the corner roundness of the pixels



When editing the fill, make sure that there is high contrast between the pixels and the background to avoid errors in scanning the code.

To insert, edit, and validate QR codes, you must sign in to your account and be connected to the Internet.

Do the following

Choose a shape from the **Pixel shape** picker.

To set the percentage of fill on the pixels, type a value in the **Pixel fill factor** box.

Click the arrow button ▼ at the bottom of the **QR code** section to expand it, and enable the **Weld pixels** check box.

Click the arrow button ▼ at the bottom of the **QR code** section to expand it, and type a value in the **Pixel roundness** box.

To add a text or graphic object to a QR code

- 1 Select the text or graphic object that you want to add.
- 2 Move the object and place it in the QR code.

If the object is behind the QR code, change the stacking order by using the **Object ► Order** command.

To set the error correction level

- 1 Double-click a QR code.
- 2 In the **Object properties** docker, click the arrow button ▼ at the bottom of the **QR code** section to expand it, and choose an option from the **Error correction level** list box.

The error correction levels specify what percentage of the information used in a QR code can be restored if lost.

- **Low** — restores 7% of the information
- **Medium** — restores 15% of the information
- **Quartile** — restores 25% of the information
- **High** — restores 30% of the information



Higher correction levels duplicate a higher percentage of the information, which may limit the amount of new information a QR code can store. This may be a problem for QR codes that are approaching, or already contain, the maximum amount of information before high error correction is applied. In that case, you are prompted to reduce either the correction level or the amount of data in the QR code.

Validating QR codes

After inserting and formatting a QR code, you can validate it to make sure that it can be read by QR code readers and scanners.

To validate a QR code

- 1 Double-click the QR code.
- 2 In the **Object properties** docker, click **Validate**.



To insert, edit, and validate QR codes, you must sign in to your account and be connected to the Internet.



To validate a QR code that was not created in CorelDRAW, click **Object** ► **Validate barcode**, and marquee-select the QR code. (In the **Classic** workspace, this command appears under the **Edit** menu.)

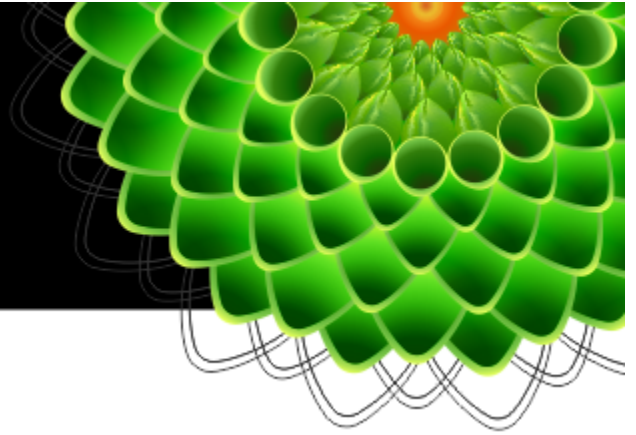

Working with layers

Layers help you organize and arrange objects in complex illustrations.

This section contains the following topics:

- “Creating layers” (page 315)
- “Changing layer properties” (page 319)
- “Moving and copying layers and objects” (page 322)

Creating layers

All CorelDRAW drawings consist of stacked objects. The vertical order of these objects — the stacking order — contributes to the appearance of the drawing. An effective way to organize these objects is by using invisible planes called layers.



Drawings can be assembled by placing objects on various levels or layers.

Layering gives you added flexibility when you organize and edit the objects in complex drawings. You can divide a drawing into multiple layers, each containing a portion of the drawing’s contents. For example, you can use layers to organize an architectural plan for a building. You can organize the building’s various components (for example, plumbing, electrical, structural) by placing them on separate layers.

Local layers and master layers

All content is placed on a layer. Content that applies to a specific page is placed on a local layer. Content that applies to all pages in a document can be placed on a global layer called a master layer. Master layers are stored on a virtual page called the Master Page.

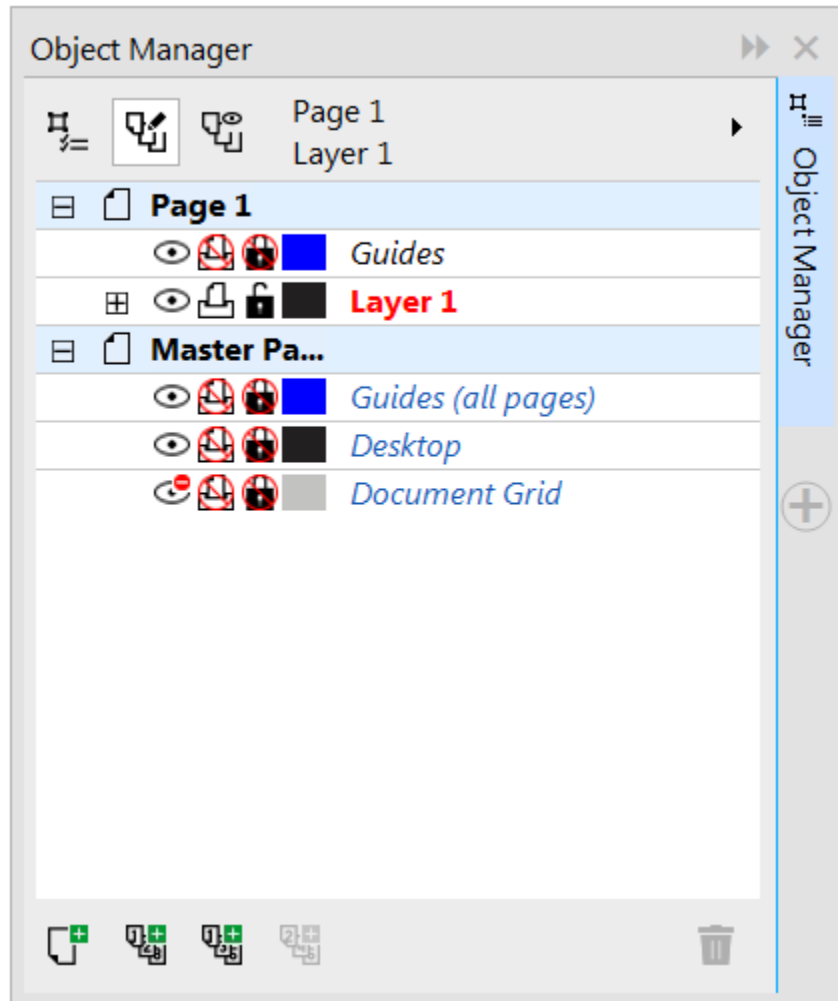

The Object manager docker displays the default layer structure. The names of the active page and layer appear at the top.

You can create master layers for all pages, for even pages, or for odd pages. For example, placing content on an even master layer means that the content will appear on all even pages but not on the odd pages.

Each new file is created with a default page (Page 1) and a Master Page. The default page contains the following layers:

- **Guides** — stores page-specific (local) [guidelines](#). All objects placed on the Guides layer appear as outlines only, and the outlines act as guidelines.
- **Layer 1** — represents the default local layer. When you draw objects on the page, the objects are added to this layer unless you choose a different layer.

The Master Page is a virtual page that contains the information that applies to all pages in a document. You can add one or more layers to a master page to hold content such as headers, footers, or a static background. By default, a master page contains the following layers:

- **Guides (all pages)** — contains the guidelines that are used for all pages of the document. All objects placed on the Guides layer appear as outlines only, and the outlines act as guidelines.
- **Desktop** — contains objects that are outside the borders of the drawing page. This layer lets you store objects that you may want to include in the drawing at a later time.
- **Document grid** — contains the [document grid](#) that is used for all pages of the document. The document grid is always the bottom layer.

The default layers on the master page cannot be deleted or copied.

To add content to a layer, you must first select the layer so that it becomes the active layer.

Viewing layers, pages, and objects





You can choose different views that let you display pages, layers, or all the objects in your document. The view you choose depends on the complexity of your document and the task you are performing. For example, in a long multipage document, you can choose a pages-only view so that you can navigate the document more easily and view only one page at a time. The **Current page, layers only** view lets you view and reorder all the layers that affect the current page, including the master layers.

For information about how facing page views affect layers, see [“To view facing pages” on page 64](#).

For information about how layers are affected when you save a file to an earlier version of CorelDRAW, see [“To save a drawing” on page 65](#).

To create a layer

- 1 If the **Object manager** docker is not open, click **Object** ► **Object manager**.
- 2 Perform a task from the following table.

To	Do the following
Create a local layer	In the upper-right corner of the Object manager docker, click the flyout button  , and click New layer .
Create a master layer for all pages	In the upper-right corner of the Object manager docker, click the flyout button  , and click New master layer (all pages) .
Create a master layer for odd pages	In the upper-right corner of the Object manager docker, click the flyout button  , and click New master layer (odd pages) . This command is available only when the active page is an odd page.
Create a master layer for even pages	In the upper-right corner of the Object manager docker, click the flyout button  , and click New master layer (even pages) . This command is available only when the active page is an even page.





To use a layer in the drawing, you must first make the layer active by clicking the layer name in the **Object manager** docker. The layer name appears in a red bold font to indicate that it is the active layer. When you start a drawing, the default layer (Layer 1) is the active layer.

Master layers are always added to the master page. Content added to these layers is visible on all pages of the document, all odd pages, or all even pages, depending on the type of master layer that you have chosen.

Master layers for odd and even pages cannot be created in Facing Pages view. If you have created odd and even master pages before switching to Facing Pages view, the odd and even master layers will be converted to all-page master layers. For more information about facing pages, see [“To view facing pages” on page 64](#).



You can also add a layer by clicking the **New layer** button  in the **Object manager** docker.

You can also create new master layers by opening the flyout at the bottom of the **Object manager** docker and clicking the respective button: **New master layer (all pages)** , **New master layer (odd pages)** , or **New master layer (even pages)** .

You can make any layer a master layer by right-clicking the layer name, and clicking **Master (all pages)**, **Master (odd pages)**, or **Master (even pages)**.

To make a layer active

- 1 If the **Object manager** docker is not open, click **Object** ► **Object manager**.
- 2 In the **Object manager** docker, click the layer name.

The layer name appears in a red bold font to indicate that it is the active layer.







By default, the active layer is Layer 1.

The name of the active layer and the type of the currently selected object appear on the status bar at the bottom of the application window. The names of the active page and layer also appear at the top of the **Object manager** docker.

To display pages, layers, and objects in the Object Manager docker

- 1 If the **Object manager** docker is not open, click **Object** ► **Object manager**.
- 2 Perform a task from the following table.

To	Do the following
Display pages	Click the flyout button  , and then click Show pages .
Display all layers for the current page	Click the name of a page, click the Layer manager view button  , and then click Current page, layers only .
Display all layers and objects across all pages	Click the Layer manager view button  , and then click All pages, layers and objects .
Display selected objects in the Object manager docker	Click the flyout button  , and then click Expand to show selection .



The name of the active layer and the type of the currently selected object appear on the status bar at the bottom of the application window. The names of the active page and layer also appear at the top of the **Object manager** docker.

If you want to view a document that has facing pages, see ["To view facing pages" on page 64](#).

To delete a layer

- 1 If the **Object manager** docker is not open, click **Object** ► **Object manager**.

- 2 Click the name of a layer.
- 3 Click the flyout button ►, and click **Delete layer**.



When you delete a layer, you also delete all the objects on it. To preserve an **object**, move it to a different layer before you delete the current layer.

You can delete any unlocked layer except the following default layers: **Document grid**, **Desktop**, **Guides**, and **Guides (all pages)**. For more information about locking and unlocking layers, see [“To set the editing properties of a layer”](#) on page 321.



You can also delete a layer by right-clicking the layer name in the **Object manager** docker and choosing **Delete**.

Changing layer properties

For each new layer that you create, the display, editing, and printing and exporting properties are enabled by default. You can change these properties at any time. You can also turn a local layer into a master layer, or a master layer into a local layer. For information about master layers, see [“Creating layers”](#) on page 315.

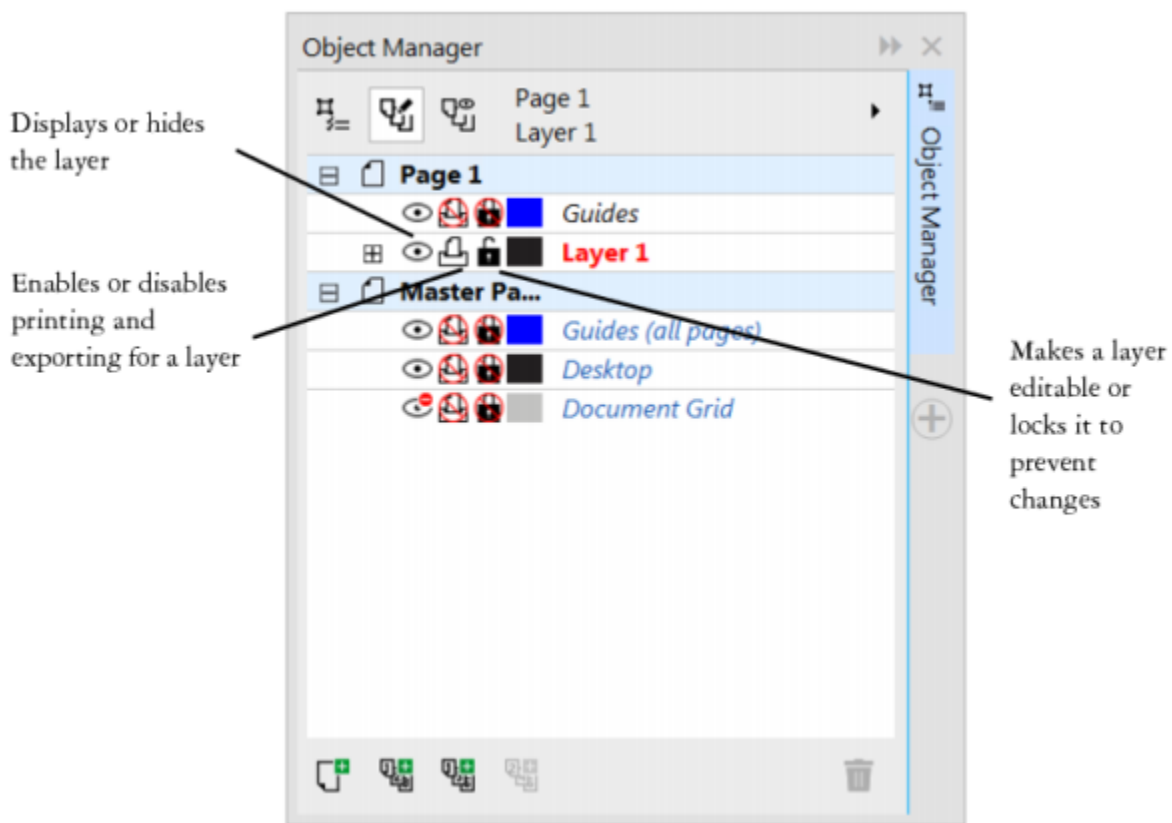

The icons to the left of a layer’s name let you change the layer’s properties.

Showing and hiding layers

You can choose to show or hide layers in a drawing. Hiding a layer lets you identify and edit the objects on other layers. It also reduces the time required for your drawing to refresh when you edit it.

Printing and exporting layers

You can set printing and exporting properties for a layer to control whether a layer is displayed in the printed or exported drawing. Note that hidden layers are displayed in the final output if the printing and exporting properties are enabled. The **Document grid** layer cannot be printed or exported.

Setting a layer's editing properties

You can allow editing of the objects on all layers or restrict editing so that you can only edit objects on the active layer. You can also lock a layer to prevent accidental changes to the objects it contains. When you lock a layer, you cannot select or edit the objects on that layer.

Renaming layers

You can rename layers to indicate their contents, their position in the stacking order, or their relationship with other layers.

Using layer color to view objects

You can change the layer color so that objects on the layer are displayed with the layer color when you use Wireframe view. For example, if you place various components of an architectural plan (plumbing, electrical, structural) on separate layers, you can use layer color to quickly identify to which component the objects belong. For more information about Wireframe view, see ["Choosing viewing modes "](#) on page 62.

To change layer properties

- 1 If the **Object manager** docker is not open, click **Object** ► **Object manager**.
- 2 Right-click the layer, and click **Properties**.
- 3 Specify the settings you want.

To show or hide a layer

- 1 If the **Object manager** docker is not open, click **Object** ► **Object manager**.
- 2 Click the **Show or hide** icon  beside the layer name.

The layer is hidden when the **Show or hide** icon is grayed out.



Objects on a hidden layer are displayed in the printed or exported drawing unless the layer's printing and exporting properties are disabled. For more information, see ["To enable or disable printing and exporting of a layer"](#) on page 320.



You can also show or hide a layer by right-clicking the layer in the **Object manager** docker and then clicking **Visible**.

To enable or disable printing and exporting of a layer

- 1 If the **Object manager** docker is not open, click **Object** ► **Object manager**.
- 2 Click the **Enable or disable printing and exporting** icon  beside the layer name.





Disabling the printing and exporting of a layer prevents its contents from appearing in the printed or exported drawing, or in full-screen previews. For information about full-screen previews, see ["Previewing drawings"](#) on page 60.



You can also enable or disable the printing and exporting of a layer by right-clicking the layer in the **Object manager** docker and clicking **Printable**.

To set the editing properties of a layer

- 1 If the **Object manager** docker is not open, click **Object** ► **Object manager**.
- 2 In the **Object manager** docker, click the name of the layer that you want to edit.
The layer name appears in a red bold font to indicate that the layer is active.
- 3 Perform a task from the following table.

To	Do the following
Lock or unlock a layer	Click the Lock or unlock icon  beside the layer name.
Allow editing on all layers	Click the flyout button  , and click Edit across layers .
Allow editing on the active layer only	Click the flyout button  , and disable Edit across layers .



If you disable editing across layers, you can work only on the active layer and the **Desktop** layer. You cannot select or edit **objects** on inactive layers. For example, if you use the **Pick** tool to marquee-select multiple objects on the drawing page, only the objects on the active layer are selected.

You cannot lock or unlock the **Document grid** layer.



You can also allow editing on all layers by clicking the **Edit across layers** button  in the **Object manager** docker. Editing across layers is enabled when the button appears pressed. Clicking the button again restricts editing to the active layer.

You can also lock or unlock a layer by right-clicking the layer in the **Object manager** docker and then clicking **Editable**.

To rename a layer

- 1 If the **Object manager** docker is not open, click **Object** ► **Object manager**.
- 2 Right-click the layer name, and click **Rename**.



Layer names may not be preserved when you save a CorelDRAW Graphics Suite file to a previous version.



You can also rename a layer by clicking the layer name twice and typing a new name.

To change the layer color

- In the **Object manager** docker, double-click the color swatch that appears to the left of the layer name, and choose a color.

Objects on the layer are displayed with the layer color when you use Wireframe view (**View ▶ Wireframe**).



You can also choose to display only the objects on a specific layer in Wireframe view by right-clicking the layer name, choosing **Properties**, and enabling the **Override full color view** check box in the layer properties dialog box.

Moving and copying layers and objects

You can move or copy layers on a single page or between pages. You can also move or copy selected **objects** to new layers, including layers on the master page.

Moving and copying layers affects the stacking order. Moving or copying an object to a layer below its current layer causes the object to become the top object on its new layer. Similarly, moving or copying an object to a layer above its current layer causes the object to become the bottom object on its new layer.

To move a layer

- 1 If the **Object manager** docker is not open, click **Object ▶ Object manager**.
- 2 In the layers list, drag a layer name to a new position.



You can change the order of the master layers relative to local layers by displaying the list of all layers for the current page and dragging a layer name to a new position in the layers list. To display all layers for a page, click a page name, click the **Layer manager** view button  at the top of the **Object manager** docker, and choose **Current page, layers only**.

To copy a layer

- 1 If the **Object manager** docker is not open, click **Object ▶ Object manager**.
- 2 In the layers list, right-click the layer that you want to copy, and click **Copy**.
- 3 Right-click the layer above which you want to place the copied layer, and click **Paste**.

The layer and the objects it contains are pasted above the selected layer.

To move or copy an object to another layer

- 1 If the **Object manager** docker is not open, click **Object ▶ Object manager**.
- 2 Click an **object** in the **Object manager** docker.
- 3 Click the flyout button , and click one of the following:
 - **Move to layer**
 - **Copy to layer**
- 4 Click the destination layer.



When you move objects to or from a layer, the layer must be unlocked.



You can move and copy an object to another layer by dragging the object to a new layer in the **Object manager** docker.

You can also move an object to another layer by using an **Order** command. For more information, see [“To move an object in the stacking order” on page 291](#).

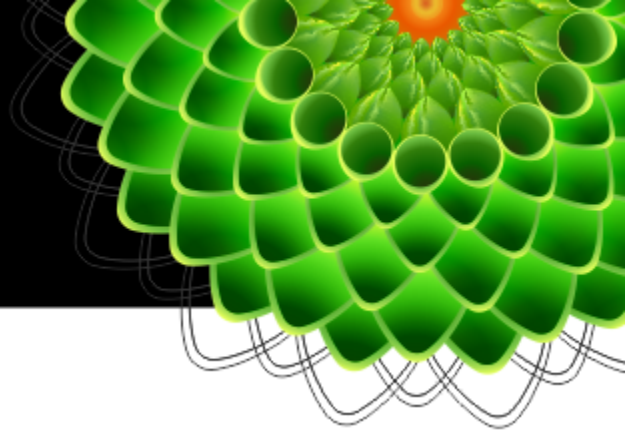

Working with symbols

CorelDRAW lets you create objects and save them as symbols. Symbols are defined once and can be referenced many times in a drawing. Each time you insert a symbol into a drawing, you create an instance of the symbol. Symbol definitions, as well as information about instances, are stored in a symbol manager, which is part of the CorelDRAW (CDR) file. Using symbols for objects that appear many times in a drawing helps to reduce file size.

In this section, you'll learn about

- [“Creating, editing, and deleting symbols”](#) (page 325)
- [“Using symbols in drawings”](#) (page 327)
- [“Managing collections and libraries”](#) (page 329)

For information about modifying symbol instances and about unsupported object types, see [“Reference: Working with symbols”](#) on page 330.

For information about working with special characters in text, see [“Embedding graphics”](#) on page 497.

Creating, editing, and deleting symbols

Symbols are objects that are defined once and can be referenced many times in a drawing. You can have multiple instances of a symbol in a drawing with little impact on file size. Symbols make editing a drawing quicker and easier, as changes made to a symbol are automatically inherited by all instances.



Using symbols for objects that appear many times helps to reduce file size.

Symbols are created from objects. When you convert an object to a symbol, the new symbol is added to the **Symbol manager** docker, and the selected object becomes an instance. You can also create a symbol from multiple objects. Most objects in CorelDRAW can be converted to symbols, with some exceptions. For more information, see [“Unsupported object types”](#) on page 331.

The symbols that you create in a drawing are saved with the CorelDRAW (CDR) file. In addition, you can create symbol libraries, which contain symbols that can be shared between drawings. For more information, see [“Managing collections and libraries”](#) on page 329.

You can edit a symbol; any changes you make affect all instances in the drawing. The selection handles for symbols differ from those for objects. Selection handles for symbols are blue; selection handles for objects are black. When you insert a symbol from an external library, a copy of the symbol is added to the active drawing, but it remains linked to the source symbol. You can edit a linked symbol or you can decide to break the link to the external library and make the symbol internal. When the link is broken, the local copy of the symbol remains in the drawing as an internal symbol, and it can be edited independently from the symbol in the external library.

You can delete a symbol. When you delete a symbol that is used in a document, all instances of the symbol are removed from the document. You can also delete all symbols that are stored in the document library but are not used in the document.

To create a symbol

- 1 Select an object or multiple objects.
- 2 Click **Object** ► **Symbol** ► **New symbol**.
- 3 Type a name for the symbol in the **Create new symbol** dialog box.



Symbols cannot span layers. If you convert objects on different layers to a symbol, the objects are combined on the topmost object's layer. For more information about layers, see [“Working with layers”](#) on page 315.

Not all objects can be converted to symbols. For more information, see [“Unsupported object types”](#) on page 331.



You can also convert an existing object or objects to a symbol by dragging the object or objects to the **Symbol manager** docker. To open the docker, click **Object** ► **Symbol** ► **Symbol manager**.

To edit a symbol

- 1 In the **Symbol manager** docker, choose a symbol from the list.
To open the **Symbol manager** docker, click **Object** ► **Symbol** ► **Symbol manager**.
- 2 Click the **Edit symbol** button .

- 3 Modify the objects on the drawing page.
- 4 Click the **Finish editing symbol** tab in the bottom-left corner of the drawing window.



Changes made to a symbol are automatically made to all instances in the active drawing.

While working in symbol edit mode, you cannot add layers or save a drawing.



You can also edit a symbol by selecting an instance in the drawing window and clicking the **Edit symbol** button  on the property bar, or holding down **Ctrl** and clicking a symbol instance.

To edit a linked symbol, click **File** ► **Open**. Choose the drive and folder of the library that contains the symbol that you want to modify. Click a library (.csl) filename, and click **Open**. The symbol appears in the **Symbol manager** docker, and it can be selected and edited like any other symbol. You may need permission to change files on the network.

To rename a symbol, double-click the symbol's name in the **Symbol manager** docker, and type a new name.

While editing a symbol, you can insert an instance of another symbol, which creates a nested symbol. You cannot, however, insert an instance of the same symbol.

To make a linked symbol internal

- 1 Select a symbol in the drawing window.
- 2 Click **Object** ► **Symbol** ► **Break link**.

If there are other instances of the symbol in the drawing, you are given the choice to break the link to all instances. If you do, the internal symbol will then apply to all the instances.



You can also make a linked symbol internal by right-clicking a symbol and choosing **Break link**.

To delete a symbol

- 1 In the **Symbol manager** docker, choose a symbol from the list.
- 2 Click the **Delete symbol** button .



When you delete a symbol, all instances of the symbol are removed from the drawing.

To delete unused symbols

- 1 In the **Symbol manager** docker, click the name of the active document.
- 2 Click the **Purge unused definitions** button .

Using symbols in drawings

You can insert a symbol into a drawing, which creates a symbol instance. You can modify certain properties of a symbol instance, such as size and position, without affecting the symbol definition stored in the library. For a full list of the properties that you can modify, see ["Modifying symbol instances"](#) on page 330. You can convert a symbol instance back to an object while preserving its properties.

You can share symbols between drawings. Copying symbols to the Clipboard leaves the originals in the library. You can also copy and paste instances of a symbol to and from the Clipboard. Pasting a symbol instance places the symbol in the library and also places an instance of the symbol in the drawing. Subsequent pasting will place another instance of the symbol in the drawing without adding it to the library. If a modified symbol instance is pasted into a drawing, the new instance maintains the properties of the original instance, and the new symbol definition in the library maintains the properties of the original symbol. Symbol instances are copied and pasted in the same way other objects are. For more information, see [“Copying, duplicating, and deleting objects” on page 260](#).

You can also export symbols to an external library that can be shared between drawings. For more information, see [“Managing collections and libraries” on page 329](#).

You can also delete a symbol instance.

To insert a symbol instance

- 1 Open the **Symbol manager** docker by clicking **Object** ▶ **Symbol** ▶ **Symbol manager**.

If you want the symbol scaled automatically to match the current drawing scale, ensure that the **Scale to world units** button  is enabled.

- 2 Choose a symbol from the list.

- 3 Click the **Insert symbol** button .



For information about working with special characters in text, see [“Embedding graphics” on page 497](#).



You can also insert a symbol instance by dragging a symbol from the **Symbol manager** docker to the drawing window.

To modify a symbol instance

- 1 Select a symbol instance.
- 2 Make any changes.

Not all properties of a symbol instance can be modified. For a list of properties that can be modified, see [“Modifying symbol instances” on page 330](#). To modify other properties, you can revert the symbol instance to an object, or modify the symbol itself.



If a symbol contains multiple objects, all objects in the symbol instance are treated as if they were a group. You cannot modify individual objects in a symbol instance.



When a symbol instance is selected, you can modify many object properties on the property bar.

To convert a symbol instance to an object or objects

- 1 Select a symbol instance.
- 2 Click **Object** ▶ **Symbol** ▶ **Revert to objects**.



The symbol remains in the **Symbol manager** docker.



You can also revert a symbol instance to an object by right-clicking the symbol instance and clicking **Revert to objects**.

To share symbols between drawings

To

Copy symbols to the Clipboard

Do the following

Open the source document. In the **Symbol manager** docker, choose the symbol or symbols from the list, right-click, and click **Copy**.

Paste symbols from the Clipboard

Open the target document. In the **Symbol manager** docker, right-click, and click **Paste**.



The first pasted symbol is named "Symbol1," and an increment number is appended to the names of subsequent copies: "Symbol2," "Symbol3," and so on.

To delete a symbol instance

- 1 Select a symbol instance.
- 2 Press **Delete**.



The symbol remains in the **Symbol manager** docker.

Managing collections and libraries

The symbols that you create in a drawing are saved with the CorelDRAW file. If you want to use the symbols in other drawings or share them with other users, you can save or export them to the Corel Symbol Library (CSL) format, creating a symbol library. When you save a drawing to the Corel Symbol Library (CSL) format, all symbol instances are saved with the document. When you export a library, only the symbols are saved with the document.

The **Symbol manager** docker displays the libraries that are in the local **Symbols** folder. The **Symbols** folder is the default location for custom symbol libraries that have been exported from CorelDRAW and imported libraries that are copied locally.

The symbols that are used within the document appear under the document filename in the **Symbol manager** docker.

You can add libraries and collections (groups of library files) to your drawing. You can also delete libraries and collections.

You can add symbols to an existing library.

To create a symbol library

- 1 Create the symbols you want.
- 2 Click **File** ► **Save**.
- 3 Choose the drive and folder where you want to store the library.
- 4 Choose **CSL - Corel Symbol Library** from the **Save as type** list box.
- 5 Type a filename in the **File name** box.

6 Click **Save**.

All symbols and symbol instances are saved with the document.



You can also click the name of the active document in the **Symbol manager** docker, and then click the **Export library** button . When you export a library, only the symbols are saved with the document.

To add a collection or library to a drawing

- 1 In the folder tree of the **Symbol manager** docker, click **Local symbols** or **Network symbols**.
- 2 Click the **Add library** button .
- 3 Locate and choose a collection or library.
- 4 Click **OK**.



By default, library files are referenced from their original location. If you want to copy a library to your **Symbols** folder, enable the **Copy libraries locally** check box.

If you are adding a collection, you can enable the **Recursive** check box to include subfolders.

To delete a collection or library

- 1 In the **Symbol manager** docker, click a collection or library.
- 2 Press **Delete**.



The collection or library is removed from the folder tree in the **Symbol manager** docker, but files are not deleted.

To add a symbol to an existing library

- 1 In the **Symbol manager** docker, right-click a symbol, and click **Copy**.
- 2 Click **File** ► **Open**.
- 3 Choose the drive and folder where the library is stored.
- 4 Choose **CSL - Corel Symbol Library** from the **Files of type** list box.
- 5 Choose the library file where you want to add a symbol.
- 6 Right-click in the **Symbol manager** docker, and click **Paste**.
- 7 Save the library file.

Reference: Working with symbols

Modifying symbol instances

The following object properties can be modified for symbol instances. If a symbol contains multiple objects, all objects in the symbol instance are treated collectively as a single object, just as if they were grouped.

Property	Notes
Position	Can be modified on the property bar. For more information, see "Positioning objects" on page 274.
Size	Can be modified on the property bar. For more information, see "Sizing and scaling objects" on page 292.
Scale	Percentage is relative to the symbol definition. Can be modified on the property bar. For more information, see "Sizing and scaling objects" on page 292.
Skew	For more information, see "Skewing and stretching objects" on page 198.
Rotation angle	Can be modified on the property bar. For more information, see "Rotating and mirroring objects" on page 293.
Transparency	Uniform transparency only. Can be modified in the Symbol section of the Object properties docker.
Mirror	Can be modified on the property bar. For more information, see "Rotating and mirroring objects" on page 293.
Wrap text	Can be modified in the Summary section of the Object properties docker. Can also be modified on the property bar. For more information, see "To wrap paragraph text around an object, artistic text, or a text frame" on page 490.
Order	Can be modified on the property bar. For more information, see "Changing the order of objects" on page 291.
Name	The name of an instance is displayed in the Symbol manager docker. Click twice to change it.

Unsupported object types

Most objects in CorelDRAW can be converted to symbols, with the following exceptions.

Unsupported object type	Notes
Linked or embedded objects	Includes bar codes
Objects with lenses that are not frozen	Lenses must be frozen.
Control objects in link groups (such as drop shadows, contours, blends, bevels, and extrusions)	All related objects in the link group must be included in the symbol. For example, if an object has a drop shadow, you cannot convert

Unsupported object type

Notes

the object without the drop shadow. Alternatively, you can break the group apart.

Objects with Artistic Media effects applied

Spray effects must be broken apart into curve objects. Other Artistic Media effects must be either broken apart, or converted as a link group. Spray effects that contain transparencies cannot be converted to symbols.

Print merge fields

Linked bitmaps

Placed PDF or EPS files

Locked object

Object must be unlocked.

Paragraph text

Connector and dimension lines

Must be broken apart or included with the linked object or objects

Guidelines

Rollovers

You cannot convert a rollover to a symbol; however, you can include a symbol instance in a rollover state.

Objects with transparency or transparency effects applied

Transparency effects must be converted to a bitmap.

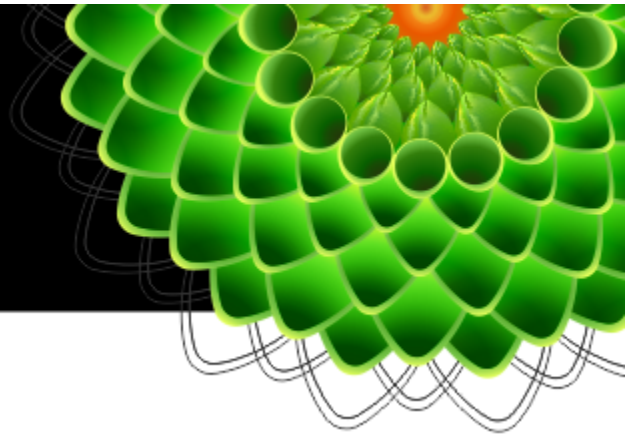

Linking and embedding objects

Object linking and embedding (OLE) is a method of exchanging information between applications. Using OLE, you can take selected [objects](#) or entire files from one application, called the source application, and place them into another application, called the destination application.

You can freely move objects and files between applications as long as all the applications involved support OLE. CorelDRAW lets you create and edit OLE objects, as well as insert objects and files created in other applications.

Linking results in a larger file size but is useful when you want to use an object or file in multiple files. To change every instance of the object or the file, you only need to change the object in the source application. Linking is also useful when the destination application does not directly support files created in the source application. Embedding is useful when you want to include all objects in one file. Embedded objects are not linked to the source file, and result in a smaller file size in the destination application.

This section contains the following topics:

- Inserting linked or embedded objects
- [“Editing linked or embedded objects”](#) (page 334)

Inserting linked or embedded objects

CorelDRAW lets you insert CorelDRAW files as linked or embedded objects in other applications. You can also insert a linked or embedded [object](#) in CorelDRAW. A linked object remains connected to its source file; whereas an embedded object is not linked to its source file but is integrated into the active document.

To insert a linked object

- 1 In CorelDRAW, select an [object](#).
Make sure that the file is saved first.
- 2 Click **Edit** ► **Copy**.
- 3 Click **Edit** ► **Paste special** in the destination application.
- 4 Enable the **Paste link** option.



To insert a linked object into the active drawing from another application, click **Object** ► **Insert new object**. In the **Insert new object** dialog box, enable the **Create from file** option, browse to the file you want to insert, and enable the **Link** check box.

To insert an embedded object

- 1 In the destination application, click **Object** ► **Insert new object**.
- 2 Enable the **Create from file** option.
- 3 Click the **Browse** button.
- 4 Click a filename.



You can also create an embedded [object](#) by enabling the **Create new** option, and choosing the application in which you want to create the object from the **Object type** list box.

You can also insert an embedded object by selecting an object in the source application, and dragging it to the window of the target application.

Editing linked or embedded objects

You can edit a linked or embedded [object](#). You can edit a linked object by editing its source file. Any changes you make to the source file are automatically applied to the linked object. You can also modify a linked object; for example, you can update a linked object, substitute the source file of a linked object for another, or break a link between a linked object and its source file.

To edit a linked or embedded object

- 1 Double-click the linked or embedded [object](#) to start the source application.
- 2 Edit the object in the source application.
- 3 Save the changes in the source application.
- 4 Close the source application.
- 5 Return to the active application window to review the edits.



In most cases, you can edit OLE objects only in the source application. If you try to change an OLE object using CorelDRAW, note the following limitations. Depending on the source of the OLE object, you might not be able to rotate, skew, clone, trim, weld, intersect, use as symbols, or combine OLE objects. Also, you might not be able to apply any of the effects in the **Effects** menu to OLE objects, except for PowerClip objects. You can only size, move, copy OLE objects and place them into PowerClip containers.



You can also edit linked or embedded objects by starting the source application and opening the file directly.

To modify a linked object

- 1 Select a linked [object](#) using the **Pick** tool .
- 2 Click **Object** ► **Links**.
- 3 Click one of the following buttons:
 - **Update now** — updates the linked object to reflect changes made in the source file
 - **Open source** — opens the object in the source application
 - **Change source** — redirects the link to another file
 - **Break link** — disconnects the link so that the object is embedded in the file

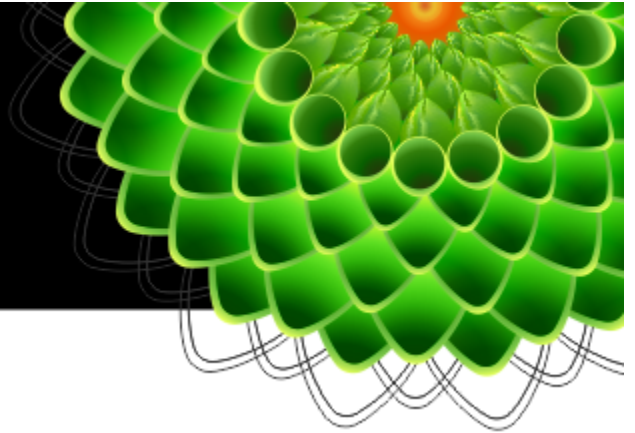

Managing and tracking projects

The Object Data Manager is an advanced feature that is particularly useful as a project management tool when you create or supervise a large project. Using the Object Data Manager is like having a small spreadsheet program, like Quattro Pro or Microsoft Excel, within your graphics program. It lets you track expenses, deadlines, assignments, progress, or anything else you need to organize. You can enter many types of project data about individual objects or groups of objects.

Project Timer offers a quick, automated, and non-intrusive way to track the time spent on a project.

This section contains the following topics:

- “Setting up the project database” (page 335)
- “Assigning and copying object data” (page 336)
- “Viewing an object data summary” (page 337)
- “Tracking project time” (page 338)

Setting up the project database

Before you assign project data to objects in a drawing, you need to know what information you want to display. By default, CorelDRAW creates four data fields: **Name**, **Cost**, **Comments**, and **CDRStaticID**. The first three fields can be edited or deleted as required. The **CDRStaticID** field is hidden; it is used by CorelDRAW to identify objects, and it can't be edited or deleted.

You can create and assign as many data fields as you want, as long as they use permitted format variables. For more information about assigning data fields, see “Assigning and copying object data” on page 336.

At any time, you can change the setting, such as the name or format, of a data field. If you require custom fields, you can define their formats using four basic field formats: **General**, **Date/time**, **Linear/angular**, and **Numeric**. Each of these formats provides a series of common settings. If the preset formats in CorelDRAW don't provide the information you want in your data summary, you can create your own custom formats using the variables available for the format type you're using. The field format you select is used for all objects in the active drawing.

You can also delete any data field except **Name** and **CDRStaticID**. When you delete a field, you also delete all data entered for that field in the active document.

To add a data field

- 1 Click **Window** ► **Dockers** ► **Object data manager**.
- 2 In the **Object data** docker, click the **Open field editor** button .

- 3 In the **Object data field editor** dialog box, click **Create new field**.
- 4 To change the name of the field you created, double-click the field, type a new name, and press **Enter**.
- 5 In the **Add field to** area, enable one or both of the following check boxes:
 - **Document defaults** — stores the new field in the current document
 - **Application defaults** — stores the new field in the application



You can also use this procedure to change the settings of an existing data field.

You can also

Change the format of a data field

Select the data field, and click **Change** in the **Format** area. In the **Format definition** dialog box, enable the option beside the format type that you want to use, and choose a format from the list.

Create a custom format for a data field

Select the data field, and click **Change** in the **Format** area. In the **Format definition** dialog box, enable the option beside the format type that you want to create. Type the format in the **Create** box, and press **Enter**.

Delete a data field

Choose the name of the data field from the list, and click **Delete**. To choose multiple fields, hold down **Ctrl**, and click the names in the list.

Assigning and copying object data

After creating all the data fields you want for a drawing, you can create a database. The **Object data** docker and the Object Data Manager (a spreadsheet launched from the **Object data** docker) provide all the commands and features that you need to add and edit object information.

The **Object data** docker is best for entering data for single objects. It lets you add, edit, and delete object data. The Object Data Manager, in contrast, is best for entering and editing data for multiple objects. It provides many of the editing features available in popular spreadsheet applications.

You can use one object's data entries to update another object's data entries. This function does not replace an object's data entries; rather, it appends fields and data where appropriate.

To add or edit data for an object

- 1 Select the object using the Pick tool .
- 2 Click **Window** ► **Dockers** ► **Object data manager**.
- 3 Select a data field. Type text in the **Value** column for the field, and press **Enter**.
- 4 Repeat step 3 to add data to other fields.

You can also

Clear one field



Click the **Clear field** button .

You can also



Clear all fields

Click the **Clear all fields** button .

To add or edit data for multiple objects

- 1 Select the objects using the **Pick** tool .
- 2 Click **Window** ▶ **Dockers** ▶ **Object data manager**.
- 3 In the **Object data** docker, click the **Open spreadsheet** button .
- 4 In the **Object data manager** window, click a cell, and type the appropriate data. Press **Enter** to assign the entry to the cell, the fields, and the objects.

To copy data from one object to another

- 1 Using the **Pick** tool , select the object to which you want to copy data.
- 2 Click **Window** ▶ **Dockers** ▶ **Object data manager**.
- 3 In the **Object data** docker, click the **Copy data from** button .
- 4 Click the object from which you want to copy data.

Viewing an object data summary



The Object Data Manager provides the commands and functions you need to view your object data summary. It summarizes the information you've assigned to the objects in a drawing. While the Object Data Manager can be used to view and edit data associated with a single object, its main purpose is to help you view and manage large amounts of data associated with multiple objects contained in various groups in a drawing.

You can change how object data displays:

- You can display individual group subtotals for fields shared by multiple groups. Use this command when more than one group of objects is displayed in a datasheet. This command applies only to fields with numeric formats.
- To create a visible distinction between groups in a column, you can place a two-space indent before data relating to objects in groups.
- You can have the Object Data Manager automatically total the values in the selected column. The total is displayed at the bottom of the column.

The Object Data Manager gives you access to all of the application's printing capabilities. This gives you the option to print quickly or print using specific settings.

To view an object data summary

- 1 Select the object or objects using the **Pick** tool .
If you want to view an object data summary for the entire document, click **Edit** ▶ **Select all** ▶ **Objects**.
- 2 Click **Window** ▶ **Dockers** ▶ **Object data manager**.
- 3 In the **Object data** docker, click the **Open spreadsheet** button .

The object data summary displays in the **Object data manager** window.

You can also

Display or hide group subtotals

Select the column by clicking the column title, and click **Field options** ► **Summarize groups**. A check mark beside the **Summarize groups** command indicates that the group subtotals are displayed in italics.

Indent or align groups in a column

Select the column by clicking the column title, and click **Field options** ► **Show hierarchy**. A check mark beside the **Show hierarchy** command indicates that the groups in a column are indented.

Display or hide the sum of values in a column

Select the column by clicking the column title, and click **Field options** ► **Show totals**. A check mark beside the **Show totals** command indicates that the sum of the values in a column are displayed.

Print the object data summary

Click **File** ► **Print**. Choose a printer from the **Printer** list box. Type a number in the **Number of copies** box. For more information about the printing capabilities of CorelDRAW, see [“Printing basics” on page 741](#).

Tracking project time

The Project Timer feature lets you track the time spent on a project with ease. To fine-tune the tracking records, you can add tasks and track the time spent on each task. You can give a task a meaningful name, and you can edit a task log by resetting the counter or specifying the task duration and start and finish date.

Tracking information is saved with the document and is easily accessible. In addition, you can save the tracking records as Comma-Separated Values (CSV) or text (TXT) files that can be opened and formatted in a spreadsheet application to create time sheet reports.

Additional settings are available to help you customize Project Timer to match your workflow. You can set automation preferences, specify whether and how to track inactivity, and simplify the Project Timer toolbar even more by hiding UI elements.

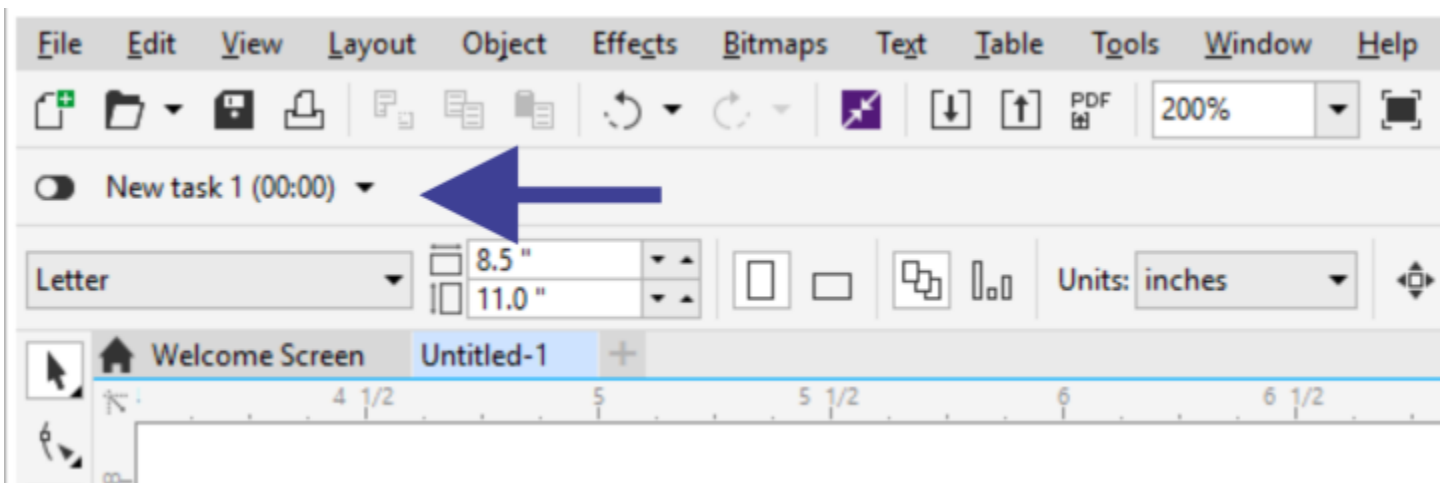

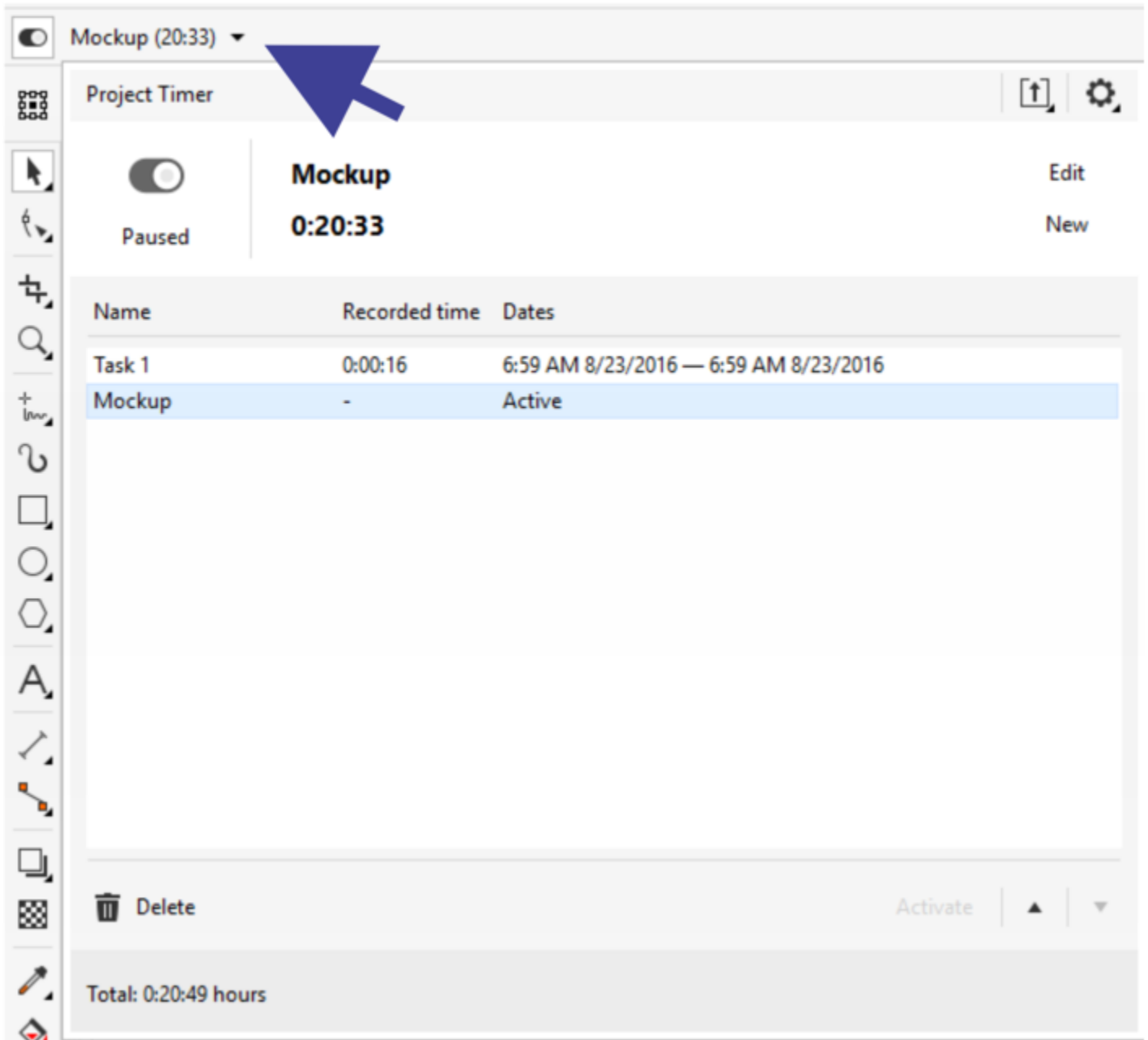

The Project Timer toolbar appears below the standard toolbar.



The arrow on the Project Timer toolbar lets you show and hide the Project Timer panel, where you can add and edit tasks and access various settings.

To track time spent on a project

- 1 Open or start the project that you want to track.
- 2 Click the Track/Pause/Off button on the Project Timer toolbar.
If the Project Timer toolbar is not displayed, click **Windows** ► **Toolbars** ► **Project Timer**.
- 3 Start working on the project.
The Track/Pause/Off button on the toolbar shows you if a task is being tracked. This button has the following states:
 - — shows that tracking is off

-  — shows that the active task is being tracked
-  — shows that tracking for the active task has been suspended temporarily, and Project Timer is not recording the time at present. Depending on Project Timer settings, this may happen when the Project Timer panel is open, or another document is in focus. For more information about settings, see [“To adjust Project Timer settings” on page 341](#).

To add, activate, delete, modify, or move a task

- Click the drop-down arrow on the **Project Timer** toolbar, and in the **Project Timer** panel, perform any of the tasks from the following table. When you are finished, click outside the **Project Timer** panel to hide it.

To	Do the following
Add a task	Click New .
Change the task that is being tracked	<p>Choose the task that you want to track from the task list, and click Activate.</p> <p>The task list shows the task as Active to indicate that this is now the task that you are tracking.</p> <p>You can also double-click a task to activate it.</p>
Delete a task	<p>Select the task, and click Delete.</p> <p>You can also delete the selected task by pressing the Delete key.</p>
Rename a task	Click the task name twice in the task list, and type a new name.
Change the task duration	<p>Click the Recorded time field twice, and specify the amount of time you want.</p> <p>Notes: From the task list, you can modify only the duration of a task that is not active (not being tracked). To modify the active task, you must use the Edit Active Task dialog box. For more information, see “To edit the active task” on page 341.</p> <p>Changing the task duration does not update the start and finish time and dates.</p>
Change the start and finish time and dates	<p>Click twice the Dates field of the task, and specify the start and finish time and dates you want.</p> <p>Notes: From the task list, you can modify only the start and finish time and date of a task that is not active. To modify the active task, you must use the Edit Active Task dialog box.</p> <p>Changing the task start and finish time and dates does not update the task duration.</p>
Move the selected task up or down the list	Select a task, and click the Up ▲ or Down ▼ button.

To edit the active task

You can reset the timer for the active task. You can also change the task start or finish time and date, or you can change the task duration.

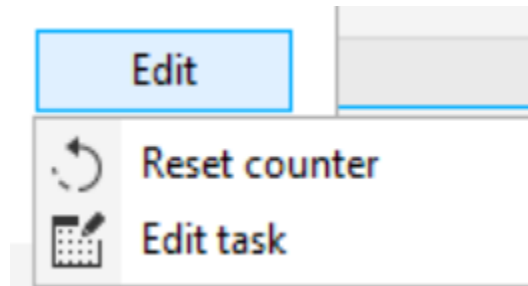

- 1 Click the drop-down arrow on the **Project Timer** toolbar.
- 2 Click **Edit**, and perform a task from the following table.

To	Do the following
Reset the timer for the active task to 0	Click Reset counter .
Modify task information	Click Edit task , and do any of the following: <ul style="list-style-type: none">• Type a new task name in the Name box.• Type values in the Recorded time boxes to specify the total time spent on the task. The first box shows hours, the second one — minutes, and the third one — seconds.• Specify the task start and finish time and date in the Start and Finish boxes. <p>The recorded time for task duration is not linked to the start and finish time and dates. Changing the value in the Recorded time box does not update the Start and Finish boxes, and vice versa.</p>

To create a time sheet report

You can save the tracking information as a CSV or TXT file, and you can then open and format the file in Microsoft Excel or other spreadsheet applications.

- 1 Click the drop-down arrow on the **Project Timer** toolbar.
- 2 Click the **Export options** button , and click one of the following commands:
 - **Export to CSV** — to save the time sheet as a CSV file. CSV files preserve the information in a table-structured format similar to spreadsheets. Unlike spreadsheets, they can contain only one sheet and do not support formatting options and formulas. The CSV files exported from Project Timer use commas as field separators.
 - **Export to TXT (Comma separated)** — to save the time sheet as a TXT file that uses commas as field separators
- 3 In the **Save As** dialog box, locate the folder where you want to save the file, and type a filename.
- 4 Open and format the file in a spreadsheet application.

To adjust Project Timer settings

With the help of the **Project Timer Settings** dialog box, you can set Project Timer to start or pause tracking automatically in response to specific actions or changes. In addition, inactivity settings help you decide how to treat periods of time when the project is open but there are no recorded document changes. For example, you can set Project Timer to display a prompt or pause tracking after a specified time of inactivity. You can also customize the Project Timer toolbar by displaying and hiding controls.

- 1 Click the drop-down arrow on the **Project Timer** toolbar to show the **Project Timer** panel.
- 2 Click the **Project Timer options** button , and click **Settings**. The **Project Timer Settings** dialog box appears.
- 3 In the **Project Timer Settings** dialog box, perform a task from the following table.

To	Do the following
Set Project Timer to start tracking automatically upon performing a specific action	In the Automation area, enable any of the following check boxes below Start recording when : <ul style="list-style-type: none"> • Document is opened • New document is created • Task is activated
Set inactivity preferences	In the Inactivity detection area, choose one of the following options from the On inactivity list box: <ul style="list-style-type: none"> • Prompt — to display a prompt after a specified time of inactivity • Pause timer — to pause recording after the specified time of inactivity and resume tracking when you continue working on the document • Always track — to ignore inactivity and record all time as work
Specify how long after inactivity to pause the timer or display a prompt	In the Inactivity tolerance box, type a value.
Pause tracking automatically in certain circumstances	Enable any of the following check boxes below Pause recording when : <ul style="list-style-type: none"> • CorelDRAW is minimized and out of focus • Another document is in focus • Project Timer panel is open <p>Recording resumes when you continue working on the document.</p>
Customize the Project Timer toolbar	Enable or disable any of the following check boxes in the Toolbar appearance area: <ul style="list-style-type: none"> • Track/Pause/Off button — to show or hide the Track/Pause/Off button • Task name — to show or hide the name of the task that is being tracked • Timer — to show or hide the timer displaying the current task duration

To respond to the Inactivity prompt

If no changes are made to the document for some time, by default Project Timer prompts you to decide how to track this time of inactivity. The prompt is displayed as soon as the inactivity tolerance time elapses.

- In the **Inactivity Detected** dialog box, click one of the following buttons:
 - **Discard** — to delete the entire period of inactivity from the tracking record
 - **Track as work** — to record the period of inactivity as work time. This option is useful to track time spent on tasks related to the project but not performed in CorelDRAW. For example, you may have done research on the project or discussed it at length with a client over the phone. Hence, you want to track this time even though you did not make any changes to the project itself.
 - **Custom** — to log a custom amount of time. In the **Custom Activity Log** dialog box, specify the amount of time (in minutes) that you want to be tracked as work. For example, you may have been away from your desk for an hour. If you worked for 20 minutes during that hour on project-related tasks, you can choose to log only 20 minutes. The remaining 40 minutes will be discarded.

If you want Project Timer to remember your choice and apply it all future inactivity, enable the **Remember and don't ask again** check box before clicking a button in the dialog box. This action suppresses all inactivity prompts. To start displaying prompts again, you must change the inactivity preferences in the **Project Timer Settings** dialog box. In the **Inactivity detection** area, choose **Prompt** from the **On inactivity** list box.

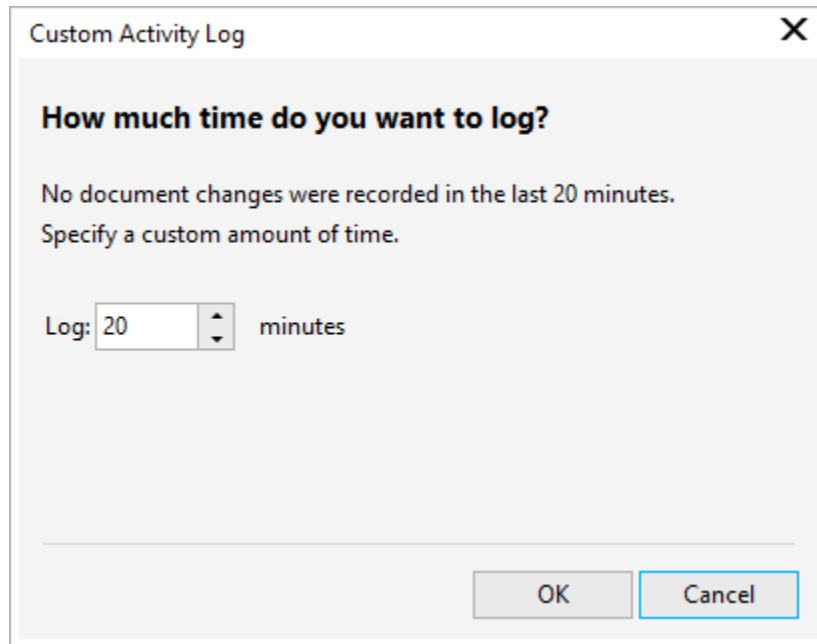

The Custom Activity Log dialog box

Color, fills, and transparencies

Working with color.....	347
Applying fills to objects.....	367
Changing the transparency of objects.....	389
Finding, managing, and saving fills and transparencies.....	403
Using color management.....	409

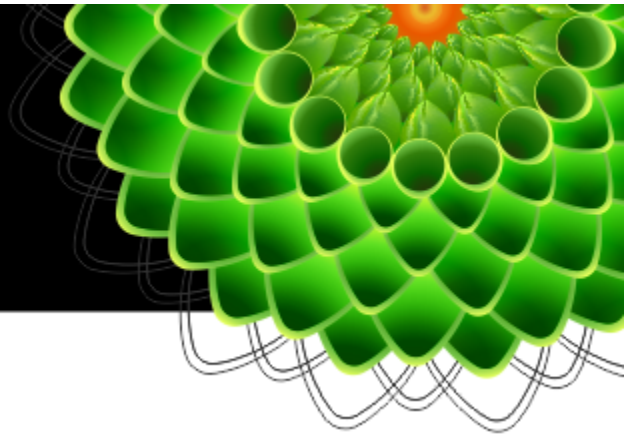

Working with color

CorelDRAW lets you choose and create colors by using a wide variety of industry-standard color palettes, color mixers, and [color models](#). You can store frequently used colors for future use by using the Document palette, or creating and editing custom [color palettes](#).

You can customize how a color palette appears on your screen by changing the size of [swatches](#), the number of rows, and other properties.

You can also create color styles. For more information, see [“Working with color styles”](#) on page 583.

This section contains the following topics:

- [“Understanding color models”](#) (page 347)
- [“Understanding color depth”](#) (page 349)
- [“Choosing colors”](#) (page 350)
- [“Using the Document palette”](#) (page 356)
- [“Creating and editing custom color palettes”](#) (page 359)
- [“Organizing and displaying color palettes”](#) (page 362)
- [“Displaying or hiding color palettes in the Palette libraries”](#) (page 363)
- [“Setting the properties of color palettes”](#) (page 365)

Understanding color models

[Color models](#) provide a precise method for defining colors, each model defining colors through the use of specific color components. There is a range of color models to choose from when creating graphics.

CMYK color model

The [CMYK](#) color model, which is used in printing, uses the components cyan (C), magenta (M), yellow (Y), and black (K) to define color. Values for these components range from 0 to 100 and represent percentages.

In [subtractive](#) color models, such as CMYK, color (that is, ink) is added to a surface, such as white paper. The color then “subtracts” brightness from the surface. When the value of each color component (C,M,Y) is 100, the resulting color is black. When the value of each component is 0, no color is added to the surface, so the surface itself is revealed — in this case, the white paper. Black (K) is included in the color model for printing purposes because black ink is more neutral and darker than blending equal amounts of cyan, magenta, and yellow. Black ink produces sharper results, especially for printed text. In addition, black ink is usually less expensive than using colored ink.

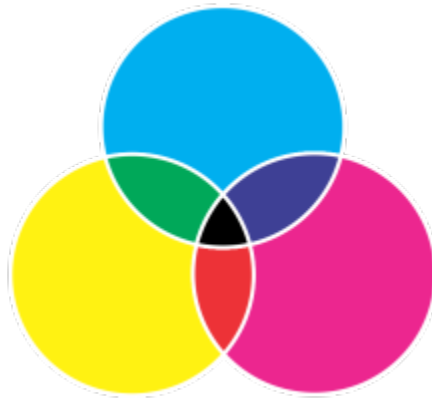

Black is the result of combining the three CMY colors at their highest intensities.

RGB color model

The **RGB** color model uses the components red (R), green (G), and blue (B) to define the amounts of red, green, and blue light in a given color. In a 24-bit image, each component is expressed as a number from 0 to 255. In an image with a higher bit rate, such as a 48-bit image, the value range is greater. The combination of these components defines a single color.

In additive color models, such as RGB, color is produced from transmitted light. RGB is therefore used on monitors, where red, blue, and green lights are blended in various ways to reproduce a wide range of colors. When red, blue, and green lights are combined at their maximum intensities, the eye perceives the resulting color as white. In theory, the colors are still red, green, and blue, but the pixels on a monitor are too close together for the eye to differentiate the three colors. When the value of each component is 0, which signifies an absence of light, the eye perceives the color as black.

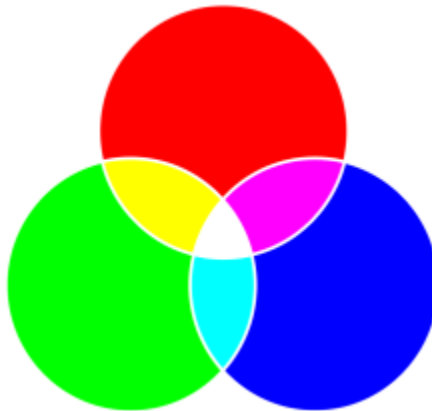

White is the result of combining the three RGB colors at their maximum intensities.

RGB is the most commonly used color model, because it allows a broad range of colors to be stored and displayed.

HSB color model

The **HSB** color model uses **hue** (H), **saturation** (S), and **brightness** (B) as components for defining color. HSB is also known as HSV (with the components hue, saturation, and value). Hue describes the pigment of a color and is expressed in degrees to represent the location on the standard color wheel. For example, red is 0 degrees, yellow is 60 degrees, green is 120 degrees, cyan is 180 degrees, blue is 240 degrees, and magenta is 300 degrees.

Saturation describes the vividness or dullness of a color. Values of saturation range from 0 to 100 and represent percentages (the higher the value, the more vivid the color). Brightness describes the amount of white in the color. Like saturation values, brightness values range from 0 to 100 and represent percentages (the higher the value, the brighter the color).



HSB color model

Grayscale color model

The [grayscale](#) color model defines color by using only one component, lightness, which is measured in values ranging from 0 to 255. Each grayscale color has equal values of the red, green, and blue components of the RGB color model. Changing a color photo to grayscale creates a black-and-white photo.

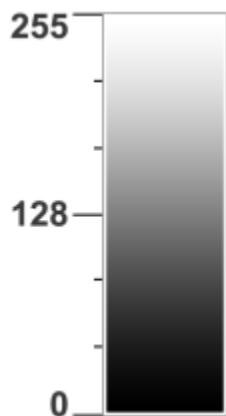

Grayscale color model

Understanding color depth

Color depth refers to the maximum number of colors an image can contain. Color depth is determined by the [bit depth](#) of an image (the number of binary bits that define the shade or color of each pixel in a bitmap). For example, a pixel with a bit depth of 1 can have two values: black and white. The greater the bit depth, the more colors an image can contain, and the more accurate the color representation is. For example, an 8-bit GIF image can contain up to 256 colors, but a 24-bit JPEG image can contain approximately 16 million colors.

Usually, RGB, grayscale, and CMYK images contain 8 bits of data per color channel. That is why an RGB image is often referred to as 24-bit RGB (8 bits x 3 channels), a grayscale image is referred to as 8-bit grayscale (8 bits x channel), and a CMYK image is referred to as 32-bit CMYK (8 bits x 4 channels).

Regardless of how many colors an image contains, the image displayed onscreen is limited to the highest number of colors supported by the monitor on which it is viewed. For example, an 8-bit monitor can display only up to 256 colors in a 24-bit image.

Choosing colors

You can choose fill and outline colors by selecting a color from the Document palette, custom [color palettes](#), palettes from the Palette libraries, color viewers, or color blends. When you want to use a color that already exists in an [object](#) or document, you can sample the color by using the [Color eyedropper](#) tool to achieve an exact match.

For information about applying the colors you choose, see [“Applying uniform fills”](#) on page 367 and [“Formatting lines and outlines”](#) on page 144. For information about saving colors for future use, see [“Working with color styles”](#) on page 583.

Default color palette

A [color palette](#) is a collection of color swatches. In some programs, color palettes are known as “swatch palettes.”

In CorelDRAW, the default color palette is based on the primary color mode of the document. For example, if the document’s primary color model is RGB, the default color palette is also RGB. For more information, see [“Understanding color models”](#) on page 347. You choose the default color model when you create a new drawing. You can open and use additional color palettes at any time.

You can choose both fill and outline colors by using the default color palette. The selected fill and outline colors appear in the color swatches on the status bar.

Document palette

When you create a new drawing, the application automatically generates an empty palette, called the Document palette. It helps you keep track of the colors that you use by storing them with your document for future use. For more information, see [“Using the Document palette”](#) on page 356.

Palette libraries and custom color palettes

The color palettes that are found in the Palette libraries cannot be edited directly. Some of them are provided by third-party manufacturers, for example [PANTONE](#), HKS Colors, and TRUMATCH. It may be useful to have on hand a manufacturer’s swatch book, which is a collection of color samples that shows exactly what each color looks like when printed.



The PANTONE solid coated palette is an example of a color palette from the Palette libraries.

Some palettes found in the Palette libraries — [PANTONE](#), [HKS Colors](#), [TOYO](#), [DIC](#), [Focoltone](#), and [SpectraMaster](#) — are collections of [spot colors](#). If you create [color separations](#) when you print, each spot color requires a separate printing plate, which can significantly affect the cost of the printing job. If you want to use color separations but would like to avoid using spot colors, you can convert the spot colors to [process colors](#) when printing. For more information, see [“Printing color separations”](#) on page 761.

Custom color palettes can include colors from any [color model](#), including palettes from the Palette libraries, such as a spot color palette. You can save a custom color palette for future use. For more information about working with custom color palettes, see [“Creating and editing custom color palettes”](#) on page 359 and [“Organizing and displaying color palettes”](#) on page 362.

Sampling colors

When you want to use a color that already exists in a drawing, palette, or on your desktop, you can sample the color to achieve an exact match. By default, you sample a single pixel from the drawing window.

Color viewers

Color viewers provide a representation of a range of colors by using either one-dimensional or three-dimensional shapes. The default color viewer is based on the [HSB](#) color model, but you can use this viewer to choose [CMYK](#), [CMY](#), or [RGB](#) colors. For information about color models, see [“Understanding color models”](#) on page 347.

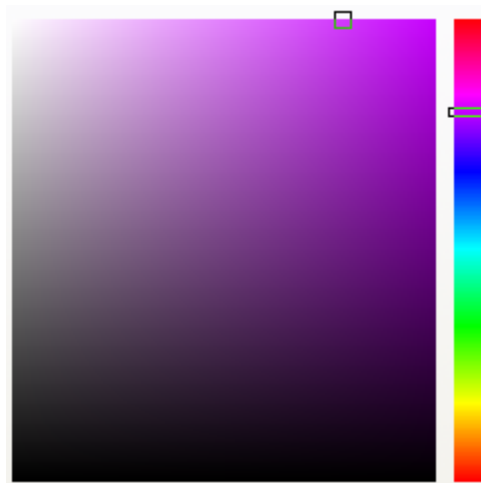

An example of a color viewer

Color blends

When you choose a color by using color blends, you combine base colors to produce the color you want. The color blender displays a grid of colors that it creates from the four base colors you choose.

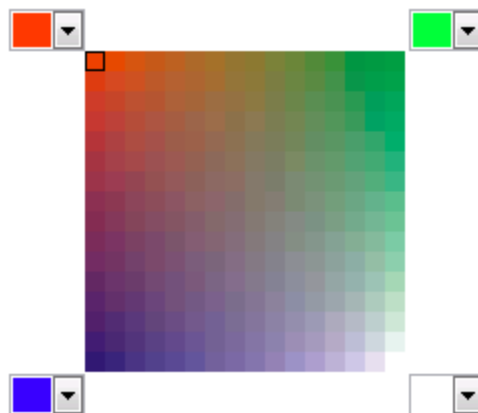

An example of color blends

Choosing web colors

You can use web colors when you design documents that will be published to the web. With CoreDRAW, you can define web colors by using RGB hexadecimal values (for example, [#aa003f](#)).

To choose a color by using the default color palette

To	Do the following
Choose a fill color for a selected object	Click a color swatch.
Choose an outline color for a selected object	Right-click a color swatch.
Choose from different shades of a color	Click and hold a color swatch to display a pop-up color picker, and then click a color.
View more colors on the default color palette	Click the scroll arrows at the top and bottom of the color palette.



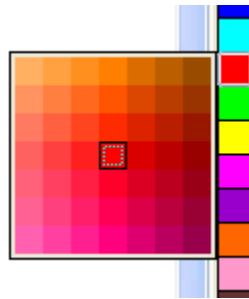

You can display color values by pointing to a [swatch](#).

To display color names instead of color values, click the **Options** flyout button  at the top of the default palette, and click **Show color names**. This action undocks the default color palette and displays the color names.



An example of a pop-up color palette

To choose a color by using a color palette

- 1 Select an [object](#).
- 2 Double-click the **Fill** button  on the status bar.
- 3 In the **Edit fill** dialog box, click the **Uniform fill** button.
- 4 Click the **Palettes** tab .
- 5 Choose a color [palette](#) from the **Palette** list box.
- 6 Move the color slider to set the range of colors displayed in the color selection area.
- 7 Click a color in the color selection area.

You can also

Display or hide the names of colors

Enable or disable the **Show color names** check box.

You can also

Swap the reference color (original color of the selected object) with the new color Click the **Swap colors** button.

Choose an outline color

Double-click the **Outline** button  on the status bar. In the **Outline pen** dialog box, open the **Color** picker, and click **More**. In the **Select color** dialog box, repeat steps 4 to 7.





Each spot **color swatch** on a color palette is marked with a small white square .

You should use the same **color model** for all colors in a drawing; the colors will be consistent and you will be able to predict the colors of the final output more accurately. For more information about reproducing colors accurately, see “Using color management” on page 409.



You can also access color palettes in the **Color** docker by clicking the **Show color palettes**  button, and choosing a palette from the list box. If the **Color** docker is not open, click **Window** ▶ **Dockers** ▶ **Color**.

To choose a color by using a color viewer

- 1 Select an **object**.
- 2 Double-click the **Fill** button  on the status bar.
- 3 In the **Edit fill** dialog box, click the **Uniform fill** button.
- 4 Click the **Models** tab .
- 5 Choose a **color model** from the **Model** list box.
- 6 Choose a color viewer from the **Color viewers** list box.
- 7 Move the color slider.
- 8 Click a color in the color selection area.

You can also

Sample a color from the drawing or desktop

Click the **Eyedropper** button , and click the drawing or desktop.

Swap the reference color (original color of the selected object) with the new color Click the **Swap colors** button.



If you choose a color that is out of the printer's **gamut**, CorelDRAW allows you to replace it with a similar color that is in the printer's gamut. To replace the color, click the **Bring color into gamut** button, which appears to the left of the **New color** swatch. For information about color correction, see "Using color management" on page 409.

You should use the same color model for all colors in a drawing; the colors will be consistent and you will be able to predict the colors of the final output more accurately. It is preferable to use the same color model in your drawing that you will be using for the final output.

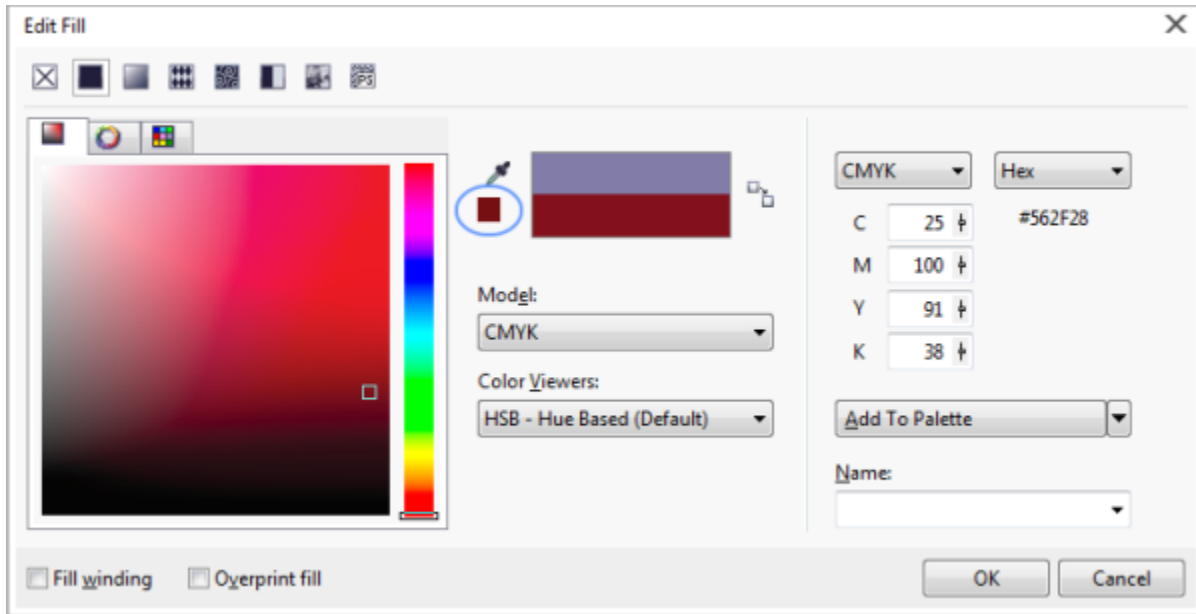

When you choose a color that is out of the printer's gamut, the Bring color into gamut button appears below the Eyedropper button.



You can also access color models in the **Color** docker by clicking the **Show color viewers** button  and choosing a color model from the list box. If the **Color** docker is not open, click **Window** ► **Dockers** ► **Color**.

To choose a color by using color blends

- 1 Select an **object**.
- 2 Double-click the **Fill** button  on the status bar.
- 3 In the **Edit fill** dialog box, click the **Uniform fill** button.
- 4 Click the **Mixers** tab.
- 5 Choose **Color blend** from the **Mixers** list box.
- 6 Open each color picker, and click a color.
- 7 Click a color in the color selection area.

You can also

Sample a color from the drawing or desktop

Click the **Eyedropper** button , and click the drawing or desktop.







Only colors that are on the default **color palette** can be blended. To blend other colors, you must change the default color palette. For more information, see “[To display or hide a custom color palette](#)” on page 362.



You can change the cell size of the color grid by moving the **Size** slider.

To sample a color

- 1 In the toolbox, click the **Color eyedropper** tool .
- 2 On the property bar, click one of the following buttons:
 - **1 × 1**  — lets you choose the color of the pixel you click
 - **2 × 2**  — lets you choose the average color in a sample area of 2 × 2 pixels. The pixel you click is in the middle of the sample area.
 - **5 × 5**  — lets you choose the average color in a sample area of 5 × 5 pixels

If you want to sample a color outside the drawing window, click **Select from desktop** on the property bar, and click a color on the desktop.

- 3 Click the color that you want to sample.
The **Color eyedropper** tool automatically switches to the **Apply** color mode.
- 4 Perform a task from the following table.

To

Do the following

Fill an object with a sampled color

Hover over an object. When the **Apply** color pointer changes to a solid color swatch , click to apply the sampled color.

Fill an object's outline color with the sampled color

Hover over an object's outline. When the **Apply** color pointer changes to an outline shape , click to apply the sampled color.

Add the sampled color to the Document palette

On the property bar, click the arrow next to **Add to palette**, and choose **Document palette**.

Sample an additional color

On the property bar, click the **Select color** button , and then click the color that you want to sample.

You can also

Drag a sampled color from one object to another

Drag the color to another object.

You can also

Apply a sampled color from the **Selected color** swatch on the property bar

Drag the sampled color from the **Selected color** swatch to the object.

Apply a sampled color from the **Uniform fill** swatch in the lower-right corner of the drawing window

Drag a color from the **Uniform fill** swatch to the object.

Add the sampled color to the Document palette

Drag the sampled color from the **Selected color** swatch or the **Uniform fill** swatch to the Document palette.



In some cases, the sampled color may be an RGB or CMYK color that is the closest equivalent to the original color, rather than being a complete match.

To choose a web color

- 1 Select an object.
- 2 Click **Window** ► **Dockers** ► **Color**.
- 3 In the **Color** docker, choose **RGB** from the list box.
- 4 Type or paste a value in the **Hex value** box.
Whether you use a three-digit (#fff) or six-digit format (#ffffff), the final value is presented in the six-digit format.
- 5 Click one of the following buttons:
 - **Fill** — fills the selected object with the new color
 - **Outline** — applies the color to the outline of the object



You can specify hexadecimal color values only when working with RGB colors.

If you type an invalid hexadecimal value, the color does not change.

You can view hexadecimal color values on the status bar.



You can also choose web colors from the **Select color** dialog box (on the status bar, double-click the **Outline pen** button, open the **Color** picker in the **Outline pen** dialog box, and click **More**) and the **Edit fill** dialog box (on the status bar, double-click the **Fill** button, and click the **Uniform fill** button), which let you view and copy the hexadecimal equivalents of non-hexadecimal color values.

Using the Document palette

When you start a new drawing, an empty color palette, called the Document palette, appears docked in the lower-left corner of the drawing window. Every time you use a color in your drawing, it's automatically added to the Document palette. However, if you prefer to control which colors are added to the Document palette, you can disable the automatic updates and add colors manually.

You can add colors from a color palette, an external image, a color picker, or a color-related dialog box, such as the **Uniform fill** dialog box. In addition, you can add colors from an imported image or object.

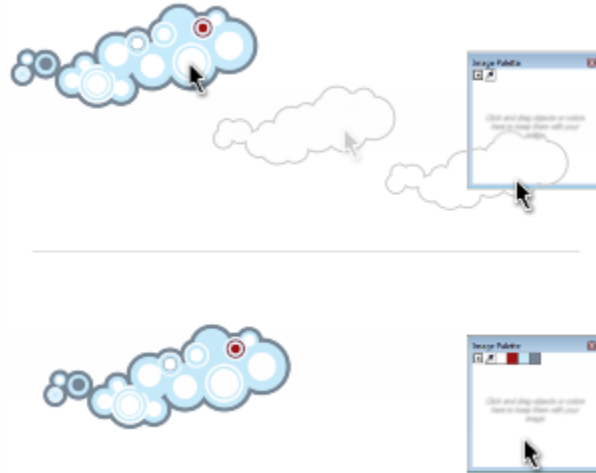

Drag a bitmap to the Document palette to add colors. When you open documents that were created in CorelDRAW X4 or an earlier version of the program, only custom spot colors and a maximum of 100 legacy color styles are added to the Document palette. The legacy styles are added to the palette as regular colors.

You can clear the Document palette of any unwanted or unused colors by removing colors individually or resetting the palette to remove all unused colors at once. You can also add all colors from an existing drawing to the Document palette.

The Document palette is automatically saved with the document. If you rename the .cdr file to .zip, the Document color palette (DocumentPalette.xml) is included in the .zip package.

To disable the automatic adding of color to the Document palette

- On the Document palette, click the flyout button , and click **Automatically update**.

By default, the Document palette is docked above the status bar at the bottom of the application window.



You can also disable the automatic adding of color by clicking **Tools** ► **Customization**, clicking **Color palette** in the **Customization** list of categories, and disabling the **Automatically update the document palette** check box.

To manually add colors to the Document palette

To	Do the following
Add a color from another color palette	Drag a color from an open color palette to the Document palette.
Add a color from a bitmap image	On the Document palette, click the Eyedropper button, and click a color in the image.
Add multiple colors from an image	On the Document palette, click the Eyedropper button  , hold down Ctrl , and then click the image until you add the colors that you want.

To

Add multiple colors from an image or object by dragging

Add colors from a selection

Add a color from a color-related dialog box

Move a color swatch

Do the following

Drag an image or object from the drawing window to the Document palette.

Select an object or multiple objects. On the Document palette, click the flyout button , and click **Add from selection**.

In the dialog box, click a color swatch, click the arrow next to **Add to palette**, choose **Document palette**, and then click **Add to palette**.

Drag a color swatch to a new position on the Document palette.



When dragging most vector objects to the palette, you add all object colors to the palette. When dragging a bitmap, you can specify the number of colors that you want to be added to the palette. If an object includes a fountain fill, texture fill, or pattern fill, only colors that are defined during the fill creation are supported. Colors from PostScript fills are not supported.

By default, the Document palette is docked above the status bar at the bottom of the application window.

To add colors from an existing drawing to the Document palette

- 1 Open a drawing.
- 2 On the Document palette, click the flyout button , and click **Add from document**.

By default, the Document palette is docked above the status bar at the bottom of the application window.



If the drawing was created in a previous version of CorelDRAW and it includes custom spot colors, they appear in the Document palette.



If you have a document with both vector and bitmap images, and you want to add only the colors from the vector images to the Document palette, specify 0 in the **Add colors from bitmap** dialog box.

To remove a color from the Document palette

- 1 Click a color swatch on the Document palette.
- 2 On the Document palette, click the flyout button , and click **Delete color**.

By default, the Document palette is docked above the status bar at the bottom of the application window.



You can also remove all colors that are no longer used from the Document palette by clicking the flyout button , choosing **Palette**, and clicking **Reset palette**.

To reset the Document palette

- On the Document palette, click the flyout button , choose **Palette**, and click **Reset palette**.

By default, the Document palette is docked above the status bar at the bottom of the application window.

To hide the Document palette

- Click **Window** ▶ **Color palettes** ▶ **Document palette**.



Hiding the Document palette does not disable the automatic adding of color.

Creating and editing custom color palettes



Custom **color palettes** are collections of colors or color styles that you save. They can include colors or color styles from any color model, including spot colors, or any color palette found in the Palette libraries. You can create a custom palette to store all colors or color styles that you need in a current, or future, project.

It's easy to share color palettes with others. The custom palettes are accessible from the **My palettes** folder in the Color Palette Manager.

You can create a custom color palette by choosing individual colors or color styles, or by using the colors in a selected **object** or an entire document. You can also edit, rename, and delete custom color palettes.

Custom color palettes are saved as XML files and are stored in the **My Documents\My Palettes** folder.

To create a custom color palette from scratch

- 1 Click **Window** ▶ **Dockers** ▶ **Color palette manager**.
- 2 Click the **Creates a new empty color palette** button .
- 3 Type a filename in the **File name** box.
- 4 Click **Save**.
- 5 In the **Color palette manager**, choose the custom palette that you created.
- 6 Click the **Opens the palette editor** button .
- 7 In the **Palette editor** dialog box, click **Add color**.
- 8 In the **Select color** dialog box, choose a color, and click **Add to palette**.

You can also

Treat the color as a spot color

In the **Selected color** area of the **Palette editor** dialog box, choose **Spot** from the **Treat as** list.

Treat the color as a process color

In the **Selected color** area of the **Palette editor** dialog box, choose **Process** from the **Treat as** list.

Rename a color

In the **Palette editor** dialog box, click a color in the color selection area, and type a name in the **Name** box.

To add a color to a custom color palette

- 1 Open a custom color palette.
- 2 Perform a task from the following table.

To

Add a color from another color palette

Add a color from an image

Add multiple colors from an image

Add multiple colors from an image or object

Add a color from a color-related dialog box

Add colors from a selection

Move a color swatch



When dragging most vector objects to the palette, you add all object colors to the palette. When dragging a bitmap, you can specify the number of colors that you want to be added to the palette. If an object includes a fountain fill, texture fill, or pattern fill, only colors that are defined during the fill creation are supported. Colors from PostScript fills are not supported.

To create a color palette from an object

- 1 Select an [object](#).
- 2 Click **Window** ► **Color palettes** ► **Create palette from selection**.
- 3 Type a filename in the **File name** box.
- 4 Click **Save**.

To create a color palette from a document

- 1 Click **Window** ► **Color palettes** ► **Create palette from document**.
- 2 Type a filename in the **File name** box.
- 3 Click **Save**.

Do the following

Drag a color from an open color palette to the custom palette.

On the custom palette, click the **Eyedropper** button , and click the color that you want to add.

On the custom palette, click the **Eyedropper** button , hold down **Ctrl**, and click the image until you add the colors that you want.

Drag an image or object from the drawing window to the custom palette.

In the dialog box, click a color swatch, click the arrow next to **Add to palette**, choose the name of your custom palette from the list, and then click **Add to palette**.

Select an object or multiple objects. On the custom palette, click the flyout button , and click **Add from selection**.

Drag a color swatch to a new position on the palette.

To edit a custom color palette

- 1 Click **Window** ► **Color palettes** ► **Palette editor**.
- 2 Choose a **palette** from the list box.
- 3 Perform a task from the following table.

To	Do the following
Add a color	Click Add color . In the Select color dialog box, click the Models tab, click a color in the color selection area, and click Add to palette .
Treat a color as a spot color	In the Selected color area of the Palette editor dialog box, choose Spot from the Treat as list.
Treat a color as a process color	In the Selected color area of the Palette editor dialog box, choose Process from the Treat as list.
Change a color	In the color selection area, click a color, and click Edit color . In the Select color dialog box, click the Models tab, and click a new color in the color selection area.
Delete a color	In the color selection area, click a color, and click Delete color .
Sort colors	Click Sort colors , and choose a color sorting method.
Move a color	Drag a color swatch to a new position.
Rename a color	Click a color in the color selection area, and type a name in the Name box.



You can delete multiple colors by holding down **Shift** or **Ctrl**, clicking the colors that you want to delete, and clicking **Delete color**.



If you add a process color to the palette, but treat it as a spot color, the color is changed to spot and the color name is preserved. However, if you choose a spot color with a trademarked name, for example a PANTONE color, and convert it to a process color, the trademarked name is substituted with the color components for that color.

To rename a custom color palette

- 1 Click **Window** ► **Dockers** ► **Color palette manager**.
- 2 From the **My Palettes** folder, right-click a custom **palette**, and click **Rename**.
- 3 Type a new name, and press **Enter**.

To delete a custom color palette

- 1 Click **Window** ► **Dockers** ► **Color palette manager**.
- 2 From the **My Palettes** folder, right-click a custom **palette**, and click **Delete**.

Organizing and displaying color palettes

The Color Palette Manager is a docker that lets you quickly access the available color palettes, including the Document palette and the Color Styles palette, and create custom color palettes. The color palettes in the Color Palette Manager are divided into two main folders: **My palettes** and **Palette libraries**.

You can use the **My palettes** folder to store all the custom color palettes that you create. You can add folders to store and organize your color palettes for different projects. You can also copy a color palette or move it to a different folder. You can open and control the display of all color palettes.

The **Palette libraries** folder of the Color Palette Manager contains collections of preset color palettes from which you can choose colors. You cannot edit any of the color palettes that are found in the **Palette libraries**. However, you can create a custom color palette by copying a color palette from the **Palette libraries** folder. For more information, see [“Displaying or hiding color palettes in the Palette libraries” on page 363](#).

To open the Color Palette Manager

- Click **Window** ► **Dockers** ► **Color palette manager**.

To display or hide a custom color palette

- 1 Open the Color Palette Manager.
- 2 In the **My palettes** folder, click the **Show or hide** icon  beside the custom palette name.

If you want to set a custom color palette as the default palette, click the custom palette flyout button , and click **Set as default**.

To open a custom color palette

- 1 Open the Color Palette Manager.
- 2 Click the **Opens a palette** button .
- 3 Choose the drive and folder where the custom color palette is stored.
If you want to open a color palette (.cpl file) that was created in a previous version of CorelDRAW, select **Legacy custom palette (*.cpl)** from the **Files of type** list box.
- 4 Click the custom palette.
- 5 Click **Open**.



When you open a legacy custom palette (.cpl) file, it is automatically converted to the XML format (.xml). The XML version is stored in the **x:\Documents and Settings\your name\My Documents** folder, and also appears in the **My palettes** folder in the Color Palette Manager.



If the custom color palette (.xml) was saved to the **My palettes** folder, you can open it by clicking **Window** ► **Color palettes** and choosing the custom palette from the list.

To create a folder for storing custom color palettes

- 1 Open the Color Palette Manager.
- 2 Click the **Create a new folder** button .
- 3 Type a new name, and press **Enter**.

If you want to move a custom color palette, drag it to the new folder.

To cut or copy a custom color palette

- 1 Open the Color Palette Manager.
- 2 In the **My palettes** folder, right-click a custom **palette**, and click one of the following:
 - **Cut**
 - **Copy**

If you want to paste the custom palette to a different folder, right-click the folder, and click **Paste**.

To copy a palette from the Palette libraries for editing

- 1 Open the Color Palette Manager.
- 2 Drag a palette from the **Palette libraries** folder to the **My palettes** folder.

An editable copy of the color palette appears in the **My palettes** folder.

Displaying or hiding color palettes in the Palette libraries

The Palette libraries contain a collection of color palettes. You can control the display of the default color palettes, such as the default RGB and default CMYK color palettes. The main Palette libraries that are included are Process color and Spot color.

The Process color library contains the default RGB, CMYK, and Grayscale color palettes. In addition, you can find preset color palettes that have a specific theme, such as nature. The Spot color library contains color palettes that are provided by third-party manufacturers, such as HKS Colors, PANTONE, Focoltone, and TOYO. These color palettes can be very useful when you need specific company-approved colors for your printed projects. The color palette libraries are locked, which means that you cannot edit them.

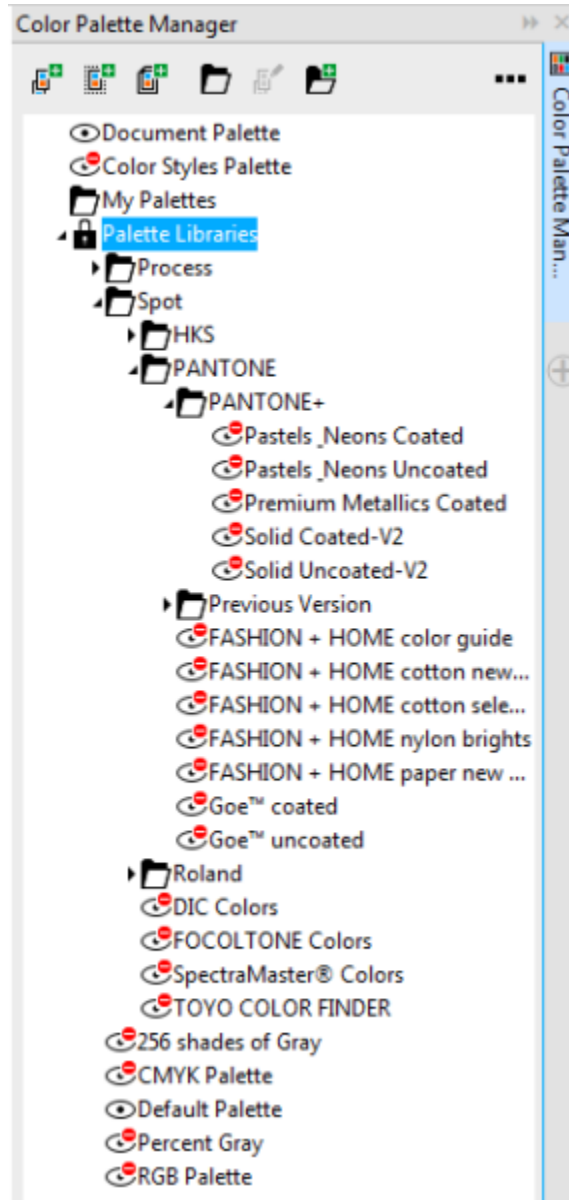

Palette libraries

To display a color palette in the Palette libraries

- 1 Open the Color Palette Manager.
- 2 In the **Palette libraries** folder, click the **Show or hide** icon  beside the color palette name.

To display spot or process color palettes

- 1 Open the Color Palette Manager.
- 2 In the **Palette libraries** folder, double-click one of the following folders:
 - **Spot**
 - **Process**
- 3 Click the **Show or hide** icon  beside the color palette name.

Setting the properties of color palettes

You can customize [color palettes](#).

Color palettes can be either docked or floating. Docking a color palette attaches it to the edge of the application window. Undocking a color palette pulls it away from the edge of the application window, so it floats and can be easily moved around.

With [color swatches](#), you can set the right mouse button either to display a context menu or to set the outline color. You can also adjust the color swatch border and size, and you can hide or display the **No color** well.

To dock or undock a color palette

To	Do the following
Dock a color palette	Click the top of the color palette border, and drag the color palette to any edge of the application window until a thin black toolbar outline appears.
Undock a color palette	Click the dotted border of the color palette, and drag the color palette away from the edge of the application window.
Change the number of rows on a docked color palette	On the palette, click the flyout button  , click Rows , and choose an option from the list.



You can also change the number of rows on a docked color palette by clicking **Tools** ► **Customization**, clicking **Color palette** in the **Customization** list of categories, and typing a value in the **Maximum palette rows when docked** box. You can set a maximum of seven rows on a color palette.

To set the action of the right mouse button for color swatches

- 1 Click **Tools** ► **Customization**.
- 2 In the **Customization** list of categories, click **Color palette**.
- 3 Enable one of the following check boxes:
 - **Context menu**
 - **Set outline color**



If you enable **Set outline color**, you can still display the context menu by right-clicking anywhere on the border of a [color palette](#).

To customize color swatches

- 1 Click **Tools** ► **Customization**.
- 2 In the **Customization** list of categories, click **Color palette**.
- 3 Enable or disable any of the following check boxes:
 - **Wide borders**

- Large swatches
- Show “no color” well



You can also display color names in the color swatches by clicking the flyout button  on a color palette and clicking **Show color names**.

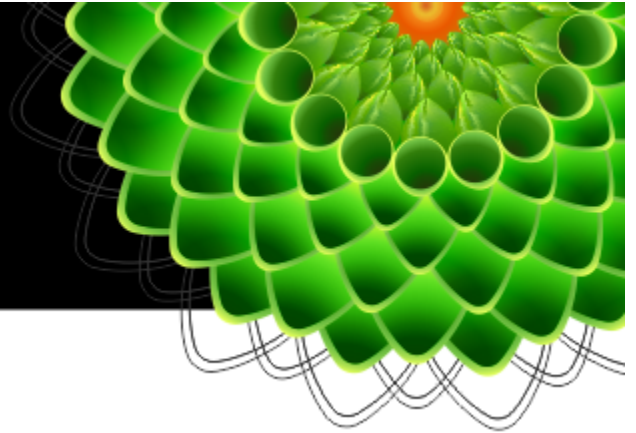

Applying fills to objects

You can add colored, patterned, textured, and other [fills](#) to the inside of objects or other enclosed areas. You can customize a fill and set it as a default, so that each object you draw has the same fill.

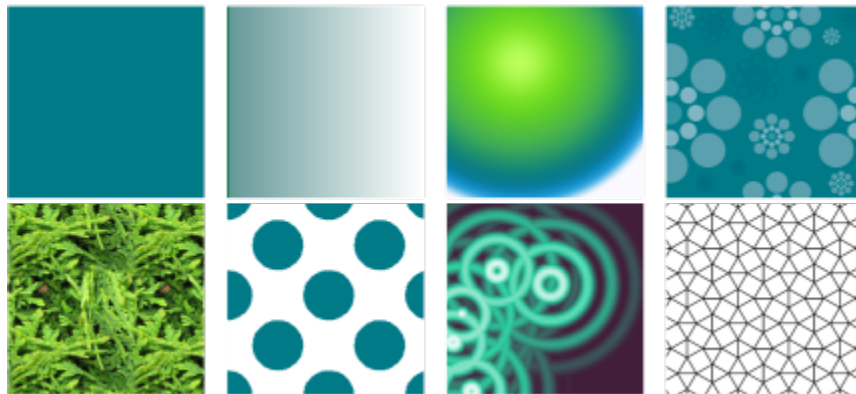

Fill samples: Uniform, linear fountain, elliptical fountain, vector pattern, bitmap pattern, two-color, texture, and PostScript

This section contains the following topics:

- “Applying uniform fills” (page 367)
- “Applying fountain fills” (page 368)
- “Applying vector and bitmap pattern fills” (page 373)
- “Applying two-color pattern fills” (page 378)
- “Applying texture fills” (page 380)
- “Applying PostScript fills” (page 381)
- “Applying mesh fills” (page 382)
- “Applying fills to areas” (page 386)
- “Working with fills” (page 387)

Applying uniform fills

You can apply a [uniform fill](#) to objects. Uniform fills are solid colors you can choose or create using [color models](#) and [color palettes](#). For information about creating colors, see “[Working with color](#)” on page 347.



To apply a uniform fill

- 1 Select an object.
- 2 Click a color on the color palette.

If you want to mix colors in a uniform fill, press **Ctrl**, and click another color on the color palette.



You can also choose a uniform fill by clicking

- the **Uniform fill** button  in the **Fill** section of the **Object properties** docker
- the **Interactive fill** tool  in the toolbox, and then clicking the **Uniform fill** button on the property bar

Applying fountain fills

A fountain fill is a smooth progression of two or more colors that adds depth to an object. Fountain fills are also known as gradient fills.

There are four types of fountain fills: linear, elliptical, conical, and rectangular. A linear fountain fill flows in a straight line across the object, a conical fountain fill creates the illusion of light hitting a cone, an elliptical fountain fill is dispersed in concentric ellipses from the center of the object, and a rectangular fountain fill is dispersed in concentric rectangles from the center of the object.



There are four types of fountain fills (left to right): linear, elliptical, conical, and rectangular.

The application provides a collection of fountain fills that you can access. You can browse the available fountain fills, search by keywords, mark fills as favorites, and sort fills. You can also download additional fill packs. For more information, see [“Finding and viewing fills and transparencies” on page 403](#).

Any fountain fill can be modified to suit your needs, and you can create your own fills from scratch. Fountain fills can contain two or more colors, which you can position anywhere in the fill’s progression. You can specify fill attributes such as the direction of a fill’s color blend, the fill’s angle, center point, and midpoint. You can also set the width and height of the fill as a percentage of the object’s width and height. Plus, you can smooth, skew, rotate, repeat, and mirror a fill.

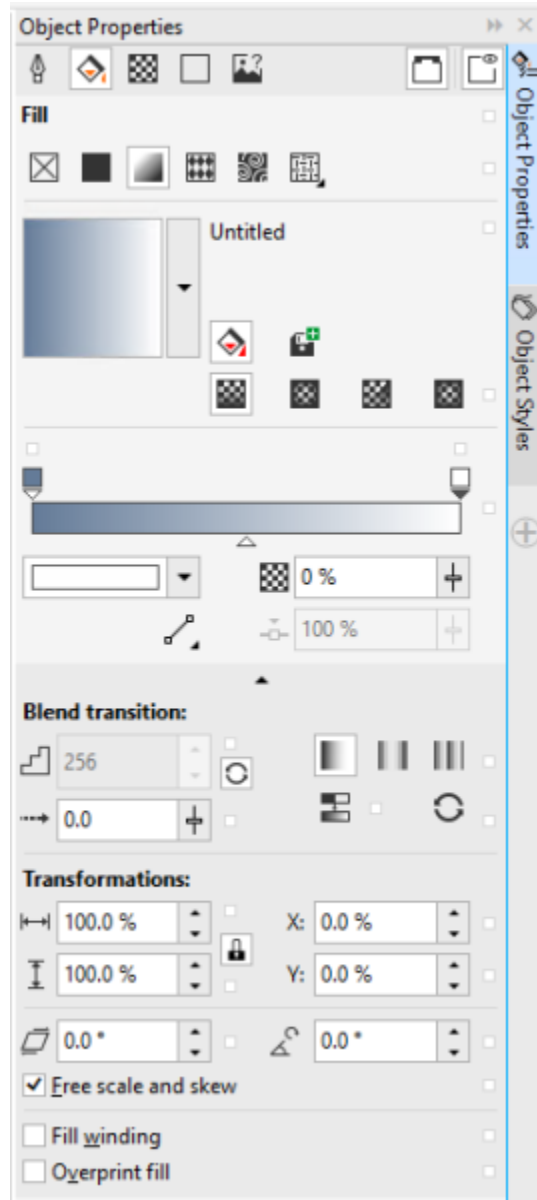

You can edit fill properties from the Object properties docker.

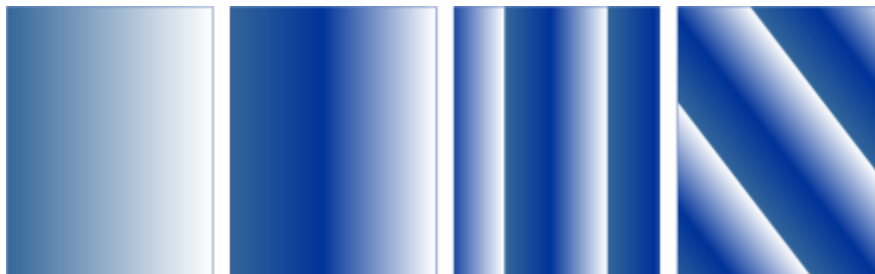

Left to right: An object with a linear fountain fill applied. Another color is added to the fill. The fill is resized to 50% of the object's width and height, and then repeated and mirrored. Last, the fill is rotated 45 degrees.

After you create a fountain fill, you can save it for future use. For more information, see ["Saving fills and transparencies"](#) on page 408.

You can adjust the print and display quality of the fountain fill by specifying the number of fountain steps. By default, the fountain steps setting is locked so that the print quality of the fountain fill is determined by the value specified in the print settings and the display quality is determined by the default value you set. However, you can unlock the fountain steps setting and specify a value that applies to both the print and view quality of the fill. For information about setting fountain fill steps for printing, see [“Fine-tuning print jobs” on page 745](#).

To apply a fountain fill

- 1 Select an object.
- 2 Click **Object** ► **Object properties**.
- 3 In the **Fill** section of the **Object properties** docker, click the **Fountain fill** button  to display fountain fill options.
- 4 Open the **Fill** picker, and double-click a fill thumbnail.







For information about how to find fills in the **Fill** picker, see [“To find, filter, and sort fills and transparencies” on page 404](#).



You can also apply a fill by clicking a fill thumbnail in the **Fill** picker. This action applies the fill without closing the **Fill** picker.

You can add a color to a fountain fill by clicking the **Interactive fill** tool  in the toolbox, clicking the **Fountain fill** button on the property bar, and dragging a color from the color palette to an object’s interactive vector handle.

To create a fountain fill

- 1 Select an object.
- 2 Click **Object** ► **Object properties**.
- 3 In the **Fill** section of the **Object properties** docker, click the **Fountain fill** button  to display fountain fill options.
- 4 Click one of the following buttons to choose a fountain fill type:
 - Linear fountain fill 
 - Elliptical fountain fill 
 - Conical fountain fill 
 - Rectangular fountain fill 
- 5 Click the start node above the color band, open the **Node color** picker, located below the color band, and choose a color.

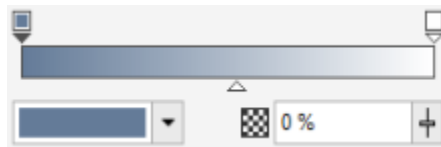

- 6 Click the end node above the color band, open the **Node color** picker, and choose a color.

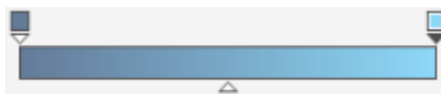

- 7 Move the midpoint slider below the color band to set the midpoint between the two colors.

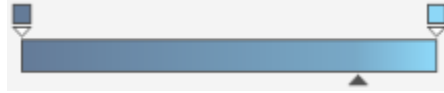

8 Click the **Save as new** button  to save the fill, or continue editing the fill by performing a task from the following table.

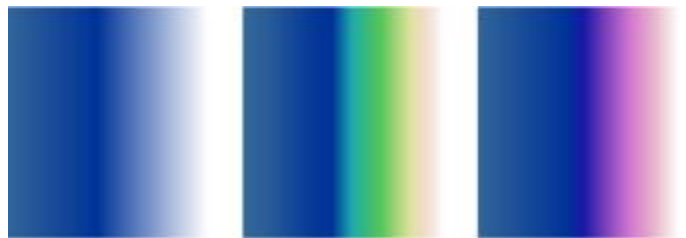

To	Do the following
Change the transparency of a color	Select the corresponding node, and type a value in the Node transparency box.
Add an intermediate color	Double-click the color band where you want to add a node. With the new node selected, open the Node color picker, and choose a color.
Change the position of an intermediate color	Drag the corresponding node to a new location above the color band, or type a value in the Node position box.
Delete an intermediate color	Double-click the corresponding node.
Specify the way the colors blend between two nodes	Select either the two nodes or the midpoint between them, click the Blend direction button, and choose an option from the list: <ul style="list-style-type: none"> • Linear color blend — blends the colors along a straight line, beginning at the start color and continuing across the color wheel to the end color • Clockwise color blend — blends the colors along a clockwise path around the color wheel • Counterclockwise color blend — blends the colors along a counterclockwise path around the color wheel



The following color blend options are illustrated below from left to right: Linear color blend, Clockwise color blend, Counterclockwise color blend.

Mirror, repeat, or reverse the fill

In the **Object properties** docker, click the arrow button  at the bottom of the **Fill** section to display more fill options, and click one of the following buttons:

- Repeat and mirror 
- Repeat 
- Reverse fill 

To

Do the following

Tip: To revert the fill to its default state, click **Default fountain fill**

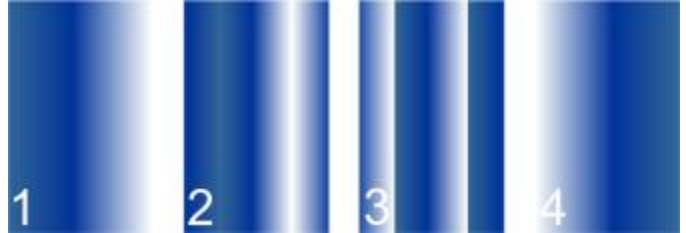

The effect of repeating and mirroring can be seen only if the fill is smaller than the object. The following illustration shows a default fill (1), the same fill resized and then repeated and mirrored (2), the fill resized and repeated (3), and the fill reversed (4).

Specify how quickly the fountain fill blends from one color to another

Move the **Acceleration** slider.

Create smoother color transitions between fountain fill nodes

Click the **Smooth** button .

Set the width and height of the fill as a percentage of the object's width and height

Type values in the **Fill width** and **Fill height** boxes.

Move the center of the fill up, down, left, or right

Type values in the **X** and **Y** boxes.

Slant the fill at a specified angle

Type a value in the **Skew** box.

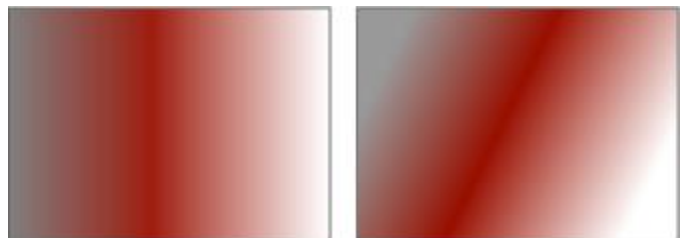

In this example, the fill is skewed at 15 degrees.

Rotate the color progression clockwise or counterclockwise

Type a value in the **Rotate** box.

Allow the fill to be skewed or stretched disproportionately

Enable the **Free scale and skew** check box.

Apply the selected fill to the intersecting area of combined objects

Enable the **Fill winding** check box.

For more information, see ["Combining objects"](#) on page 303.

Let the fill print on top of the underlying colors.

Enable the **Overprint fill** check box.



You can also apply a custom fountain fill by clicking the **Interactive fill** tool  in the toolbox and dragging colors from the color palette in the document window onto the object's interactive vector handles. You can mix colors by selecting one of the interactive vector handles, pressing **Ctrl**, and clicking a color on the color palette.

To change the fountain fill print and display quality

- 1 Select an object that has a fountain fill applied to it.
- 2 In the **Object properties** docker, click the arrow button  at the bottom of the **Fill** section to display more fill options.
- 3 Click the **Set to default** button  to unlock the fountain steps, and type a value in the **Fountain steps** box.

Higher numbers create a smoother transition between colors.



When the **Fountain steps** box is locked, the number of steps in the printed fountain fill is determined by the value specified in the **Print** dialog box. For information about setting fountain fill steps for printing, see [“Fine-tuning print jobs” on page 745](#).

To set the display quality for fountain fills

- 1 Click **Tools** ► **Options**.
- 2 In the list of categories, double-click **Workspace**, and click **Display**.
- 3 Type a value in the **Preview fountain steps** box.

Applying vector and bitmap pattern fills

You can fill objects with vector or bitmap pattern fills, as well as two-color fills. A vector pattern fill is a more complex [vector graphic](#) composed of lines and fills. A vector fill can have color or transparent background. A bitmap pattern fill is a bitmap image whose complexity is determined by its size, image [resolution](#), and [bit depth](#). For information about two-color fills, see [“Applying two-color pattern fills” on page 378](#).

CorelDRAW provides a collection of vector and bitmap patterns that you can access. You can browse the available pattern fills, search by keyword, mark fills as favorites, and sort fills. You can also download additional fill packs. For more information, see [“Finding and viewing fills and transparencies” on page 403](#).



Examples of vector pattern fills



Examples of bitmap pattern fills

Modifying pattern fills

You can modify pattern fills to suit your needs. For example, you can change the size of the pattern fill, or move the center of the pattern left or right and up or down. CorelDRAW also lets you offset tiles in a fill.

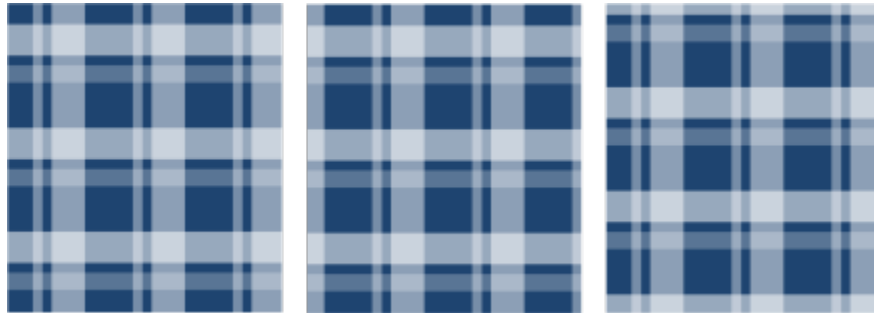

From left to right: Original vector pattern fill. The center of the pattern tile is moved to the right (middle). The center of the tile is moved down (right).

You can mirror the fill so that alternating tiles are reflections of each other. If you want a pattern fill to change according to actions you perform on the filled object, you can set the fill to transform with the object. For example, if you enlarge the object, the pattern becomes larger while the number of tiles remains the same.

The brightness and the contrast of bitmap patterns can be adjusted. You can also create a radial or linear seamless blend between the bitmap pattern tiles, and you can smooth the color transition between tiles by matching their edges. You can also adjust pattern parameters such as the brightness, luminance, and color contrast of the pattern.

Creating pattern fills

You can also create your own patterns. Vector and bitmap patterns are made up of smaller units called tiles. Depending on the size of the object, the pattern fill may consist of one or more tiles. The pattern is created by repeating the tile to fill up the object. You can create a new pattern by selecting an area of the workspace to use as a tile, or by using an imported image as a tile source.

After you create a new pattern, you can save it for future use. For more information, see “Saving fills and transparencies” on page 408.

To apply a vector or bitmap pattern fill

- 1 Select an object.
- 2 Click **Object** ► **Object properties**.
- 3 In the **Object properties** docker, click one of the following buttons:
 - Vector pattern fill 

- Bitmap pattern fill 

4 Open the Fill picker, and double-click a pattern thumbnail.







For information about how to find fills in the Fill picker, see “To find, filter, and sort fills and transparencies” on page 404.



You can also apply a fill by clicking a fill thumbnail in the Fill picker. This action applies the fill without closing the Fill picker.

You can also apply a vector or a bitmap pattern fill by clicking the **Interactive fill** tool  in the toolbox, clicking the **Vector pattern fill** or **Bitmap pattern fill** button on the property bar, and choosing a fill from the Fill picker.

To create a vector or bitmap pattern from the workspace

- 1 Select an object.
- 2 Click **Object** ▶ **Object properties**.
- 3 In the Fill area of the **Object properties** docker, click one of the following buttons:
 - Vector pattern fill 
 - Bitmap pattern fill 
- 4 Click the **New from document** button .
- 5 Select an area of the workspace that you want to use as a pattern.
The area can include any objects or parts of objects that you have drawn.
- 6 Click the **Accept** button  displayed below the selection, and click **OK** in the dialog box that appears.

To save the pattern, click the **Save as new** button .





Vector patterns can have transparent or color background.





You can also click the **New source from workspace** button  and select an area of the document to use as a tile source. In this case, the current settings in the **Transformations** area of the **Object properties** docker will apply to the new pattern.

To create a vector or bitmap pattern from an imported image

- 1 Select an object.
- 2 Click **Object** ▶ **Object properties**.
- 3 In the Fill area of the **Object properties** docker, click one of the following buttons:
 - Vector pattern fill 
 - Bitmap pattern fill 
- 4 Click the **New source from file** button .
- 5 In the **Import** dialog box, locate the image that you want to use, and double-click the filename.



To modify a vector or bitmap pattern fill

- 1 Select an object.
- 2 Click **Object** ► **Object properties**.
- 3 In the **Fill** area of the **Object properties** docker, click one of the following buttons:
 - **Vector pattern fill** 
 - **Bitmap pattern fill** 
- 4 Click the arrow button at the bottom of the **Fill** area to display more pattern fill options.
- 5 Perform a task from the following table.

To

Arrange the tiles so that alternating tiles are reflections of each other

Do the following

Click the **Mirror tiles horizontally**  or the **Mirror tiles vertically**  button.



This illustration shows a pattern fill (left) that is mirrored horizontally (middle), and vertically (right).

Set the width and height of the pattern tiles

Type values in the **Fill width** and **Fill height** boxes.



This illustration shows the effect of changing the size of a pattern tile from bigger to smaller.

Move the center of the pattern fill up, down, left, or right

Type values in the **X** and **Y** boxes.

Slant or rotate the pattern at a specified angle

Type a value in the **Skew** box or the **Rotate** box.



To

Do the following



The pattern fill in this illustration is slanted 15 degrees (middle) and rotated 15 degrees (right).

Specify row or column offset as a percentage of the tile's height or width

Click the Row offset  or the Column offset button , and type a value in the % of tile box.



This illustration shows a column offset by 50% (middle) and a row offset by 50% (right).

Apply object transformations to the pattern fill

Enable the **Transform with object** check box.

Apply the selected fill to the intersecting area of combined objects

Enable the **Fill winding** check box.

For more information, see ["Combining objects" on page 303](#).

Adjust additional properties of a bitmap pattern fill

See ["To adjust the color transitions, brightness, and contrast of a bitmap pattern fill" on page 377](#).



You can also click the **Interactive fill** tool in the toolbox and use the controls on the property bar.

You can also skew or rotate tiles by clicking the **Interactive fill** tool  in the toolbox, selecting an object, and dragging the skewing or rotation handles to change the appearance of the pattern.

To adjust the color transitions, brightness, and contrast of a bitmap pattern fill

- 1 Select an object.
- 2 Click **Object** ► **Object properties**.
- 3 In the **Fill** area of the **Object properties** docker, click the **Bitmap pattern fill**  button.
- 4 Click the arrow button at the bottom of the **Fill** area to display more pattern fill options.
- 5 Perform a task from the following table.

To

Create a radial or linear seamless blend



Smooth the color transition of the pattern tile edges with their opposite edge

Increase or decrease the brightness of the pattern

Increase or decrease the grayscale contrast of the pattern

Increase or decrease the color contrast of the pattern

Do the following

In the **Seamless** area, click the **Radial blend** button  or click the **Linear blend** button  and move the slider.

Enable the **Edge match** check box, and move the slider.

Enable the **Brightness** check box, and move the slider.

Enable the **Luminance** check box, and move the slider.

Enable the **Color** check box, and move the slider.

Applying two-color pattern fills

A two-color pattern fill is composed only of the two colors that you choose. In addition to specifying the colors, you can mirror the fill tiles vertically or horizontally, and you can set the size of the fill tiles. You can also skew and rotate the fill, and you can move its center.

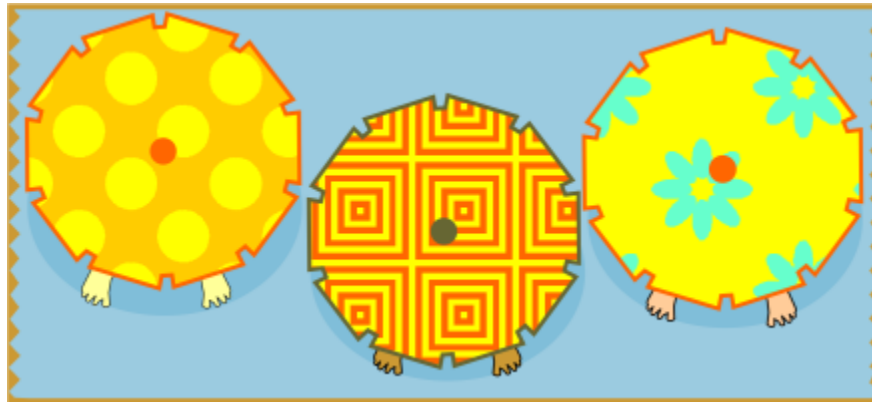

Examples of two-color pattern fills







A two-color fill applied to an object (left). Next, the fill is resized (middle), and rotated (right).

You can create your own pattern fill from objects in the drawing window by using the **Tools** ► **Create** ► **Pattern Fill** command.

To apply a two-color pattern fill

- 1 Select an object.
- 2 Click **Object** ► **Object properties**.
- 3 In the **Object properties** docker, click the **Two-color pattern fill** button .
- 4 Choose a fill from the **Fill** picker.
- 5 Open the **Front color** picker, and click a color.
- 6 Open the **Back color** picker, and click a color.

If you want to edit the attributes of the two-color fill, click the arrow button at the bottom of the Fill section, and perform a task from the following table.

To	Do the following
Arrange the tiles so that alternating tiles are reflections of each other	Click the Mirror tiles horizontally  or the Mirror tiles vertically  button.
Set the width and height of the pattern tiles	Type values in the Fill width and Fill height boxes.
Move the center of the pattern fill up, down, left, or right	Type values in the X and Y boxes.
Rotate the pattern at a specified angle	Type a value in the Rotate box.
Slant the pattern at a specified angle	Type a value in the Skew box.
Specify row or column offset as a percentage of the tile's height or width	Click the Row offset  or the Column offset button  , and type a value in the % of tile box.
Apply object changes to the pattern fill	Enable the Transform with object check box. Any transformations applied to the object such as resizing and rotating will be applied to the fill as well.
Apply the selected fill to the intersecting area of combined objects	Enable the Fill winding check box. For more information, see “Combining objects” on page 303 .



You can also mix colors in a two-color pattern fill by pressing **Ctrl** and clicking a color on the color palette.

You can also apply a fill by clicking the **Interactive fill** tool  in the toolbox and clicking the **Two-color pattern fill** button on the property bar. You can drag colors from the color palette to the interactive handles to change the colors of the fill. You can mix colors by holding down **Ctrl** while dragging a color to the interactive handles.

To create a two-color pattern fill

- 1 Click **Tools** ► **Create** ► **Pattern Fill**.

- 2 In the **Create pattern** dialog box, enable the **Two color** option, and click **OK**.
- 3 In the drawing window, select the pattern or area that you want to use for the fill.
- 4 Click the **Accept** button  displayed below the selection, and click **OK** in the dialog box that appears.
- 5 Restart CorelDRAW.
- 6 The new two-color pattern fill can be accessed from the **Fill** picker in the **Object properties** docker.

Applying texture fills

A texture fill is a randomly generated fill that you can use to give your objects a natural appearance. You can use existing texture fills, such as water, minerals, and clouds. You can change the colors of a texture fill. Texture fills can hold only **RGB** colors; however, other color models and palettes can be used as a reference to select colors. For information about color models, see [“Understanding color models” on page 347](#).

You can change the tile size of texture fills. Increasing the resolution of a texture tile increases the accuracy of the fill. You can also specify exactly where these fills begin by setting the tile origin. CorelDRAW also lets you offset tiles in a fill. Adjusting the horizontal or vertical position of the first tile, relative to the top of the object, affects the rest of the fill.

You can also rotate or skew the fill, adjust the tile size, and change the center of the texture.

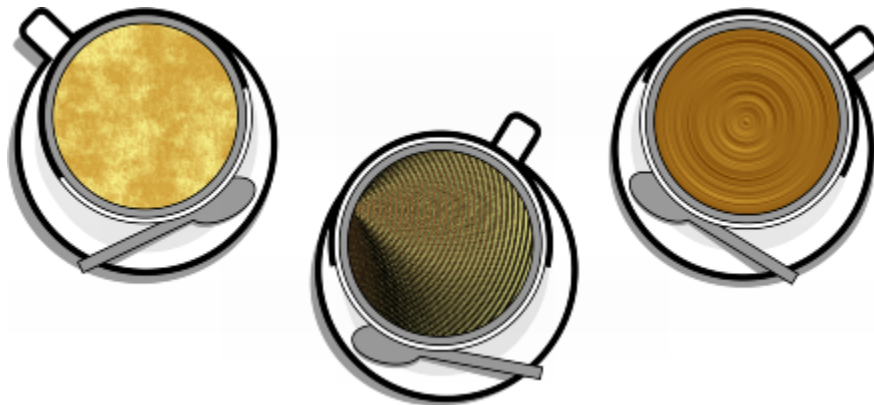

If you want a texture fill to change according to the actions you perform on the filled object, you can set the fill to transform with the object. For example, if you enlarge the filled object, the texture becomes larger while the number of tiles remains the same.

Texture fills can enhance a drawing. However, they also increase the size of a file and the time it takes to print, so you may want to use them in moderation.



Examples of texture fills

To apply a texture fill

- 1 Select an object.
- 2 Click **Object** ► **Object properties**.
- 3 In the **Fill** area of the **Object properties** docker, click the flyout arrow on the **Two-color pattern fill** button , and click the **Texture fill** button  to display texture fill options.
- 4 Choose a texture library from the **Texture library** list box.
- 5 Choose a texture from the **Fill** picker.

If you want to edit the texture, click the **Edit fill** button . In the **Edit fill** dialog box, perform an action from the following table.

To

Arrange the tiles so that alternating tiles are reflections of each other

Change the size of the fill

Move the center of the fill up, down, left, or right

Rotate the fill at a specified angle

Slant the fill at a specified angle

Specify a row or column offset as a percentage of the tile's width or height

Apply object changes to the texture fill



Specify the bitmap resolution of the texture fill

Apply the selected fill to the intersecting area of combined objects



You can also apply a texture fill by clicking the **Interactive fill** tool in the toolbox, clicking the **Texture fill** button  on the property bar, and using the controls on the property bar.

Do the following



Click **Transformations**, and click the **Mirror tiles horizontally**  or the **Mirror tiles vertically** button .

Click **Transformations**, and type values in the **Fill width** and **Fill height** boxes.

Click **Transformations**, and type values in the **X** and **Y** boxes.

Click **Transformations**, and type a value in the **Rotate** box.

Click **Transformations**, and type a value in the **Skew** box.

Click **Transformations**, and click the **Row offset**  or the **Column offset** button . Type a value in the **% of tile** box.

Click **Transformations**, and enable the **Transform with object** check box.

Click **Options**, and type a value in the **Bitmap resolution** box.

Enable the **Fill winding** check box.

For more information, see [“Combining objects” on page 303](#).

Applying PostScript fills

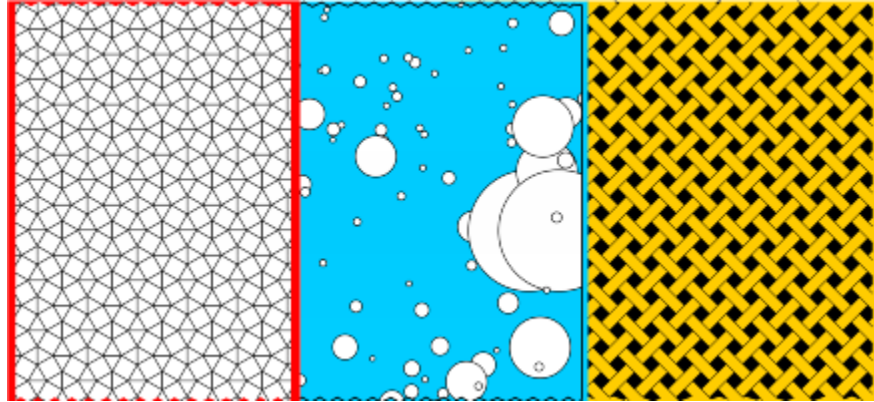

You can apply PostScript texture fills to objects. A **PostScript** texture fill is created in the PostScript language. Some textures are very complex, and large objects that contain PostScript texture fills may take time to print or to be updated on the screen. Depending on the view mode you are using, the letters “PS” — rather than the fill — may appear. For more information about displaying PostScript fills, see [“Working with views” on page 63](#).

When you apply a PostScript texture fill, you can change several properties, such as the size, line width, and the amount of gray that appears in the texture's foreground and background.



Examples of PostScript fills

To apply a PostScript fill

- 1 Select an object.
- 2 Click **Object** ► **Object properties**.
- 3 In the **Object properties** docker, click the flyout arrow on the **Two-color pattern fill** button , and click the **PostScript fill** button  to display postscript fill options.
- 4 Choose a fill from the **PostScript fill textures** list box.

If you want to change the fill properties, click the **Edit fill** button , and specify the settings you want.



You can also apply a PostScript fill by clicking the **Interactive fill** tool , clicking the **PostScript fill** button on the property bar, and choosing a fill from the **PostScript fill textures** list box.

Applying mesh fills

When you fill an object with a **mesh fill**, you can create unique effects. For example, you can create smooth color transitions in any direction without having to create **blends** or **contours**. When you apply a mesh fill, you specify the number of columns and rows in the grid, and you specify the grid's intersecting points. After you have created a mesh object, you can edit the mesh fill grid by adding and removing nodes or intersections. You can also remove the mesh.

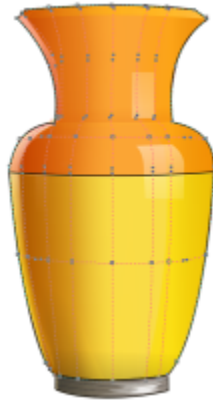

A mesh fill is applied to the vase.



The Mesh tool can be used to create smooth color transitions.

A mesh fill can be applied only to closed objects or a single path. If you want to apply a mesh fill to a complex object, you must first create a mesh-filled object and combine it with the complex object to form a PowerClip object. For more information about working with PowerClip objects, see “Creating PowerClip objects” on page 230.

You can add color to a patch of a mesh fill and to the individual intersection nodes. You can also choose to mix colors for a more blended appearance.



Left: Adding a color to a mesh fill. Right: Moving an intersection node in a mesh fill lets you adjust the progression of colors.

In addition, you can smooth the color in a mesh fill to reduce the appearance of hard edges. You can also reveal objects underneath a selected area by applying transparency to the mesh fill.



Mesh fills were used in this artwork by Ariel Garaza Díaz, based on photography by Rikk Flohr.

To apply a mesh to an object

- 1 Select an object.
- 2 In the toolbox, click the **Mesh fill** tool .
- 3 Type the number of columns in the top portion of the **Grid size** box on the property bar.
- 4 Type the number of rows in the bottom portion of the **Grid size** box on the property bar, and press **Enter**.
- 5 Adjust the grid nodes on the object.

You can also

Add a node or an intersection

Click once within a grid, and click the **Add intersection** button  on the property bar.

You can also add a node or an intersection by double-clicking within a grid.

Remove a node or an intersection

Click a node, and click the **Delete nodes** button  on the property bar.

Shape the mesh fill

Drag a node to a new location.

Remove the mesh fill

Click the **Clear mesh** button  on the property bar.



If the mesh object contains color, adjusting the intersection nodes of the mesh affects how the colors blend together.



You can also [marquee select](#) or [freehand marquee select](#) nodes to shape an entire area of the mesh. To marquee select nodes, choose **Rectangular** from the **Selection mode** list box on the property bar, and drag around the nodes that you want to select. To freehand select nodes, choose **Freehand** from the **Selection mode** list box, and drag around the nodes that you want to select. Holding down **Alt** while dragging lets you toggle between the Rectangular and Freehand selection modes.

You can add an intersection or a node by double-clicking in a space, or you can add a single line by double-clicking a line.

To fill a mesh with color

- 1 Select a mesh-filled object.
- 2 In the toolbox, click the **Mesh fill** tool .
- 3 Drag a color from the color palette to a patch in the object.

You can also

Color a node in a mesh fill

Click a node, and click a color on the color palette.

You can also drag a color from the color palette to a node.



Mix a color in a mesh fill

Select part of the mesh, press **Ctrl**, and click a color on the color palette.



You can also [marquee select](#) or [freehand marquee select](#) nodes to apply a color to an entire area of the mesh. To marquee select nodes, choose **Rectangular** from the **Selection mode** list box on the property bar, and drag around the nodes that you want to select. To freehand select nodes, choose **Freehand** from the **Selection mode** list box on the property bar, and drag around the nodes that you want to select. Holding down **Alt** while dragging lets you toggle between the Rectangular and Freehand selection modes.

To smooth color transitions in a mesh fill

- 1 Select a mesh-filled object.
- 2 In the toolbox, click the **Mesh fill** tool .
- 3 Make sure that the **Smooth mesh color** button  on the property bar is enabled.

To apply transparency to a mesh fill

- 1 Select a mesh-filled object.
- 2 In the toolbox, click the **Mesh fill** tool .
- 3 Click a node to select part of the mesh.
- 4 On the property bar, move the **Transparency** slider to the right to increase the transparency of the selected area.

Applying fills to areas

You can apply fills to any enclosed area by using the **Smart fill** tool. Unlike other fill tools, which fill only **objects**, the **Smart fill** tool detects the edges of an area and creates a **closed path** so that the area can be filled. For example, if you draw a freehand line that crosses over itself to create loops, the **Smart fill** tool can detect the edges of the loops and fill them.



In the example above, the original spiral object is duplicated and offset, resulting in enclosed areas that can be filled by using the Smart fill tool.

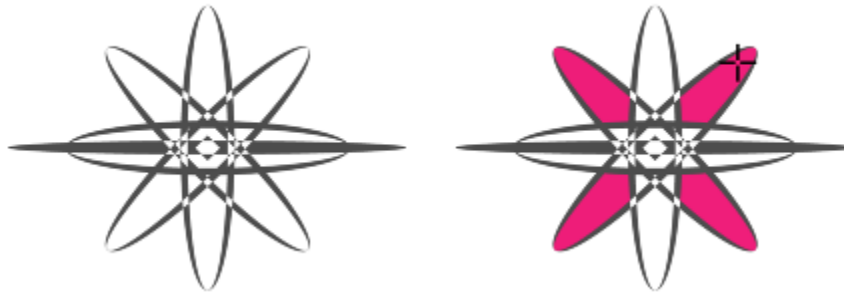

Using the Smart fill tool to fill enclosed areas

Because the **Smart fill** tool creates a path around the area, it essentially creates a new object that can be filled, moved, copied, or edited. This means that the tool can be used in one of two ways: to fill an area or to create a new object from an area.

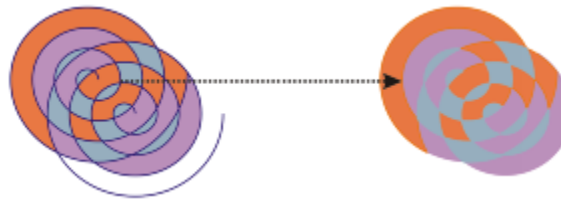

Although primarily used to fill areas, the Smart fill tool can also be used to create new objects. In the example above, the original objects — the two spirals (left) — are deleted (right), but the fill remains because each filled area is actually an object.

You can apply the default fill and outline to the area, use the property bar to specify a specific fill color and outline, or create an outline with no fill.

When you use the **Smart fill** tool on areas that already have fills applied to them, remember the following:

- An object with transparency applied to it is considered completely transparent — paths under any area of the object are detected, regardless of whether the specific area appears opaque.
- PostScript fills are considered transparent — paths under any area of a PostScript fill are detected.
- All fills other than PostScript fills are considered opaque — paths under these fills are not detected.

To apply a fill to an enclosed area

- 1 In the toolbox, click the **Smart fill** tool .
- 2 On the property bar, choose one of the following options from the **Fill** list box:
 - **Use default** — lets you apply the default fill settings
 - **Specify** — lets you fill the area with a solid color by choosing a color from the **Fill color** picker on the property bar
 - **No fill** — applies no fill to the area
- 3 From the **Outline** list box, choose one of the following options:
 - **Use default** — lets you apply the default outline settings
 - **Specify** — lets you choose a line width from the **Outline width** box and a line color from the **Outline color** picker
 - **No outline** — applies no outline to the area
- 4 Click inside the enclosed area that you want to fill.

A new object is created from the enclosed area, and the selected fill and outline options on the property bar are applied to it. The new object appears on top of the existing objects in the layer.



If you click outside an enclosed area, a new object is created from all objects on the page, and the selected fill and outline options on the property bar are applied to the new object.

The outline width is centered on an object's path. Because the **Smart fill** tool detects paths, not outlines, thick outlines appear partially covered by the new object. You can uncover the original outlines by changing the stacking order of the objects. For information about changing the stacking order of objects, see ["To move an object in the stacking order" on page 291](#).

Working with fills

There are a number of tasks that are common to all types of fills. You can choose a default fill color so that every object that you add to a drawing has the same fill. You can also remove a fill, copy it to another object, or use it to fill an area surrounded by an open curve.

If you want to apply the same fill to other objects or simultaneously modify the fill attributes of multiple objects in a drawing, you can save the fill settings as a style. For more information about styles, see ["Working with styles and style sets" on page 573](#).

To choose a default fill color

- 1 Click a blank area on the [drawing page](#) to deselect all objects.
- 2 On the status bar, double-click the **Fill** icon .
- 3 In the **Edit fill** dialog box, choose a fill type, choose a fill color, and click **OK**.
- 4 In the **Change document defaults** dialog box, enable the check boxes for the types of objects whose default fill you want to change.





You can also change the default fill color by editing the default style sets in the **Object styles** docker. For more information, see ["Managing default object properties" on page 578](#).



To remove a fill

- 1 Select an object.
- 2 Click **Object** ▶ **Object properties**.
- 3 In the **Object properties** docker, click the **No fill** button .





You cannot remove mesh fills by following this procedure. To remove a mesh fill from an object, select the object by using the **Mesh fill** tool , and click the **Clear mesh** button  on the property bar.

To copy a fill to another object

- 1 Using the **Pick** tool , select the object from which you want to copy the fill.
- 2 With the right mouse button, drag the object over the destination object to which you want to apply the fill. A blue outline of the first object follows the pointer to the destination object.
- 3 When the pointer changes to a crosshair pointer , release the mouse button, and choose **Copy fill here** from the context menu.



You can also click the **Interactive fill** tool , select the object to which you want to copy a fill, click the **Copy fill** button on the property bar, and click the object from which you want to copy the fill.

You can also use the **Attributes eyedropper** tool  to copy a fill. For more information, see [“To copy fill, outline, or text properties from one object to another” on page 272](#).

You can also sample the color of an existing object and apply the sampled color to another object as a uniform fill. For more information, see [“To sample a color” on page 355](#).

To show fills in open curves

- 1 Click **Tools** ► **Options**.
- 2 In the list of categories, double-click **Document**, and click **General**.
- 3 Enable the **Fill open curves** check box.

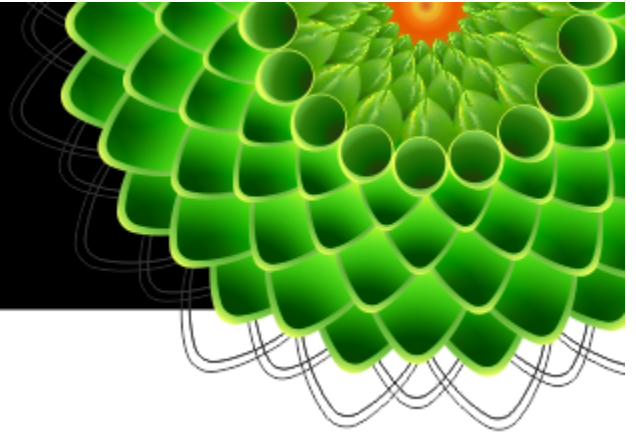

Changing the transparency of objects

When you apply a transparency to an [object](#), you make the objects beneath it partially visible. You can apply transparencies by using the same kind of fills you apply to objects; that is, [uniform](#), [fountain](#), [hatch](#), [texture](#), and [pattern](#). For more information about these fills, see “[Applying fills to objects](#)” on page 367.



Examples of different types of transparencies, including uniform, fountain, and pattern.



Transparency is layered on top of the mesh fill to create depth and highlights.

CorelDRAW also lets you specify how the color of the transparent object combines with the color of the object beneath it by using merge modes.

This section contains the following topics:

- “Applying uniform transparency” (page 390)
- “Applying fountain transparency” (page 391)
- “Applying pattern transparency” (page 394)
- “Applying texture transparency” (page 397)
- “Copying, freezing, and removing transparencies” (page 397)
- “Applying merge modes” (page 398)

Applying uniform transparency

Uniform transparency alters the transparency values of all pixels in the object or editable area by an equal amount.





A uniform transparency was applied to the text object.

To apply a uniform transparency

- 1 Select an [object](#).
- 2 Click **Object** ► **Object properties**.
- 3 In the **Transparency** area of the **Object properties** docker, click the **Uniform transparency** button .
- 4 Move the **Transparency** slider to increase or decrease the transparency.



You can click a color on the [color palette](#) to apply a color to the transparency.

To apply the transparency only to the fill or the outline of the object, click the **Fill** button  or the **Outline** button .

You can also click the **Transparency** tool  in the toolbox and use the controls on the property bar.

Applying fountain transparency

Fountain transparency makes the object fade from one transparency value to another. The fountain transparency can be linear, elliptical, conical, or rectangular.



From left to right: Original object with a linear, elliptical, conical, and rectangular transparency applied.

The application provides a collection of fountain transparencies that you can access. You can browse the available transparencies, search by keyword, mark transparencies as favorites, and sort them. You can also download additional fill packs, which can be used as transparencies. For more information, see [“Finding and viewing fills and transparencies” on page 403](#).

You can create a fountain transparency by adding and removing [nodes](#), and specifying a transparency value for each node. You can also reverse, mirror, resize, or skew a fountain transparency, or apply other transformations.



After you create a fountain transparency, you can save it for future use or share. For more information, see [“Saving fills and transparencies” on page 408](#).

To apply a fountain transparency

- 1 Select an [object](#).
- 2 Click **Object** ► **Object properties**.
- 3 In the **Transparency** area of the **Object properties** docker, click the **Fountain transparency** button  to display fountain transparency options.
- 4 Open the **Transparency** picker, and double-click a thumbnail.
This action applies the transparency and closes the **Transparency** picker. To apply the transparency without closing the **Transparency** picker, click the transparency thumbnail.

You can also

Apply the transparency only to the fill or the outline of the object

Click the **Fill** button  or the **Outline** button  in the **Transparency** area of the **Object properties** docker.

You can also

Modify the transparency





Click the **Edit transparency** button  in the **Object properties** docker, and specify the settings you want.



You can also click the **Transparency** tool  in the toolbox, and use the controls on the property bar to apply a fountain transparency.

For information about how to find transparencies in the **Transparency** picker, see [“To find, filter, and sort fills and transparencies” on page 404.](#)

To create a fountain transparency

- 1 Select an [object](#).
- 2 Click **Object** ▶ **Object properties**.
- 3 In the **Transparency** area of the **Object properties** docker, click the **Fountain transparency** button  to display fountain transparency options.
- 4 Click one of the following buttons to choose a fountain transparency type:
 - **Linear fountain transparency** 
 - **Elliptical fountain transparency** 
 - **Conical fountain transparency** 
 - **Rectangular fountain transparency** 
- 5 Click the first node above the grayscale band, and type a value in the **Node transparency** box.
- 6 Click the last node above the grayscale band, and type a value in the **Node transparency** box.
- 7 Move the midpoint slider below the grayscale band to set the midpoint of the transparency.

You can also

Change the transparency of the midpoint

Select the midpoint node, and type a value in the **Node transparency** box.

Add an intermediate transparency

Double-click the grayscale band where you want to add a node. With the new node selected, type a value in the **Node transparency** box.

Change the position of an intermediate transparency

Drag the corresponding node to a new location above the grayscale band, or type a value in the **Node position** box.

Delete an intermediate transparency

Double-click the corresponding node.



Allow the transparency to be skewed or stretched disproportionately

Click the **Free scale and skew** button .

You can also

Mirror, repeat, or reverse the transparency

Click the **Edit transparency** button , and click one of the following buttons:

- Repeat and mirror 
- Repeat 
- Reverse transparency 

Specify the number of steps used to display or print the fountain transparency

Click the **Edit transparency** button, and click the **Set to default** button  to unlock the fountain steps, and type a value in the **Fountain steps** box.

Specify how quickly the fountain transparency blends from one level of opacity to another

Click the **Edit transparency** button, and move the **Acceleration** slider.

Create smoother color transitions between fountain fill nodes

Click the **Edit transparency** button, and click the **Smooth** button 

Set the width and height of the transparency as a percentage of the object's width and height

Click the **Edit transparency** button, and type values in the **Transparency width** and **Transparency height** boxes.

Move the transparency center up, down, left, or right

Click the **Edit transparency** button, and type values in the **X** and **Y** boxes.

Slant the transparency at a specified angle



Click the **Edit transparency** button, and type a value in the **Skew** box.

Rotate the transparency at a specified angle

Click the **Edit transparency** button, and type a value in the **Rotate** box.

⁸ To save the transparency, click the **Save as new** button  in the **Transparency** area of the **Object properties** docker.



To apply the transparency only to the fill or the outline of the object, click the **Fill** button  or the **Outline** button .

You can also click the **Transparency** tool  in the toolbox. To adjust the transparency, use the controls on the property bar or the interactive vector handles that appear on the object.

You can also drag colors, which are converted to **grayscale**, from the **color palette** onto the transparency nodes. Alternatively, if the

Transparency tool is selected, you can drag the colors onto the object's interactive vector handles



Applying pattern transparency

There are three types of pattern transparency: vector pattern, bitmap pattern, and two-color pattern.

Vector pattern transparencies are pictures composed of lines and fills, instead of dots of color like **bitmaps**. These **vector graphics** are smoother and more complex than bitmap images and are easier to manipulate.

Bitmap pattern transparencies are color pictures composed of patterns of light and dark or differently colored pixels in a rectangular array.

Two-color pattern transparencies are simple pictures composed of “on” and “off” **pixels**. The only shades included in the picture are the two that you assign.



From left to right: Original object with a vector pattern, bitmap-pattern, and two-color pattern transparency applied.

You can choose pattern transparencies from a personal or shared library. You can browse the available transparency patterns, search by keyword, mark patterns as favorites, and sort patterns. You can also download additional fill packs, which can be used as transparency patterns. For more information, see “[Finding and viewing fills and transparencies](#)” on page 403.

You can modify pattern transparencies to suit your needs. For example, you can create seamless patterns and adjust the pattern parameters, such as the pixel configuration along the edge of the tile and the brightness, luminance, and color contrast of the pattern.

You can also create your own patterns. For example, you can create patterns from areas of the workspace or images that you import. Vector and bitmap patterns are made up of smaller units called tiles. Depending on the size of the object, the transparency may consist of one or more tiles. The pattern is created by repeating the tile to fill up the object.

After you modify or create a pattern transparency, you can save it for future use. For more information, see “[Saving fills and transparencies](#)” on page 408.

To apply a vector or bitmap pattern transparency



- 1 Select an **object**.
- 2 Click **Object** ► **Object properties**.
- 3 In the **Transparency** area of the **Object properties** docker, click one of the following buttons:
 - Vector pattern transparency
 - Bitmap pattern transparency
- 4 Open the **Transparency** picker, and double-click a thumbnail.

This action applies the transparency and closes the **Transparency** picker. To apply the transparency without closing the **Transparency** picker, click the transparency thumbnail.





For information about how to find transparencies in the **Transparency** picker, see “To find, filter, and sort fills and transparencies” on page 404.



To apply the transparency only to the fill or the outline of the object, click the **Fill** button  or the **Outline** button .

You can also click the **Transparency** tool  in the toolbox and use the controls on the property bar.

To modify or create a vector or bitmap transparency

- 1 Select an [object](#).
- 2 Click **Object** ▶ **Object properties**.
- 3 In the **Transparency** area of the **Object properties** docker, click one of the following buttons:
 - **Vector pattern transparency** 
 - **Bitmap pattern transparency** 
- 4 Click the **Edit transparency** button .
- 5 Perform a task from the following table.

To

Arrange the tiles so that alternating tiles are reflections of each other

Create a radial or linear seamless blend



Smooth the color transition of the pattern tile edges with their opposite edge



Increase or decrease the brightness of the pattern

Increase or decrease the grayscale contrast of the pattern.

Increase or decrease the color contrast of the pattern

Do the following

Click the **Mirror tiles horizontally**  or the **Mirror tiles vertically**  button.

In the **Seamless** area, click the **Radial blend** button  or click the **Linear blend** button  and move the slider.

This setting applies only to bitmap pattern transparency.

Enable the **Edge match** check box, and move the slider.

This setting applies only to bitmap pattern transparency.

Enable the **Brightness** check box, and move the slider.





This setting applies only to bitmap pattern transparency.

Enable the **Luminance** check box, and move the slider.

This setting applies only to bitmap pattern transparency.

Enable the **Color** check box, and move the slider.

This setting applies only to bitmap pattern transparency.

To	Do the following
Set the width and height of the transparency as a percentage of the object's width and height	Type values in the Transparency width and Transparency height boxes.
Move the center of the transparency up, down, left, or right	Type values in the X and Y boxes.
Rotate the transparency at a specified angle	Type a value in the Rotate box.
Slant the transparency at a specified angle	Type a value in the Skew box.
Specify row or column offset as a percentage of the tile's height or width	Click the Row offset  or the Column offset button  , and type a value in the % of tile box.
Apply object changes to the transparency	Enable the Transform with object check box.
Create a transparency pattern from the workspace	Click the New source from workspace button  , click OK , and select an area of the document to use as a tile source.
Create a transparency pattern from an image	Click the New source from file button  . In the Import dialog box, locate the image that you want to use, and double-click the filename.



To save the edited transparency, click the **Save as new** button .



You can also click the **Transparency** tool  in the toolbox and use the controls on the property bar.

You can also skew or rotate tiles by clicking the **Transparency** tool  in the toolbox, selecting an object, and dragging the skewing or rotation handles to change the appearance of the pattern.

To apply a two-color pattern transparency

- 1 Select an **object**.
- 2 Click **Object** ► **Object properties**.
- 3 In the **Transparency** area of the **Object properties** dock, click the **Two-color pattern transparency** button .
- 4 Choose a pattern from the **Transparency** picker.
- 5 Type values in the **Foreground transparency** and **Background transparency** boxes.



To apply the transparency only to the fill or the outline of the object, click the **Fill** button  or the **Outline** button .

To modify the pattern, click the **Edit transparency** button , and specify the settings you want.

You can also click the **Transparency** tool  in the toolbox and use the controls on the property bar.

Applying texture transparency



You can use textures to create transparency effects. You can use existing textures, such as water, minerals, and clouds, or you can edit a texture to create your own texture transparency.





A texture transparency is applied to the object filled with light green.

When you edit a texture, you can modify its parameters, such as softness, density, brightness, and colors. Parameters vary for each texture. You can also apply other transformations, such as mirror, resize, or offset the texture tiles. After you have edited a texture, you can save it for future use.

To apply a texture transparency

- 1 Select an [object](#).
- 2 Click **Object** ► **Object properties**.
- 3 In the **Transparency** area of the **Object properties** docker, click the flyout arrow on the **Two-color pattern transparency** button , and click the **Texture transparency** button  to display texture transparency options.
- 4 Choose a collection of textures from the **Texture library** list.
- 5 Choose a texture from the **Transparency** picker.



To apply the transparency only to the fill or the outline of the object, click the **Fill** button  or the **Outline** button .

To modify the texture, click the **Edit transparency** button , and specify the settings you want.

You can also click the **Transparency tool**  in the toolbox and use the controls on the property bar.

Copying, freezing, and removing transparencies

You can copy a transparency from one object to another. If you want to apply the same transparency to other objects or simultaneously modify the transparency attributes of multiple objects in a drawing, you can save the transparency settings as a style. For more information about styles, see [“Working with styles and style sets” on page 573](#).



When you position a transparency over an object, you can freeze it, making the view of the object move with the transparency.

You can also remove the transparency from an object.





When the transparency is frozen, the view of the object moves with the transparency.

To copy a transparency from another object

- 1 In the toolbox, click the **Transparency tool** .
- 2 Select the **object** to which you want to copy the transparency.
- 3 Click the **Copy transparency** button  on the property bar.
- 4 Click the object from which you want to copy the transparency.

To freeze the contents of a transparency

- 1 In the toolbox, click the **Transparency tool** .
- 2 Select an **object** to which a transparency has been applied.
- 3 Click the **Freeze transparency** button  on the property bar.



The view of the object beneath the transparency moves with it; however, the actual object remains unchanged.

To remove a transparency

- 1 Select an **object** to which a transparency has been applied.
- 2 In the **Transparency** area of the **Object properties** docker, click the **No transparency** button .

Applying merge modes

You can apply a merge mode to a transparency to specify how the color of a transparency is combined with the color of the object behind it. The following merge modes available for transparencies can also be applied to drop shadows.

Merge mode	Description
Normal	Applies the transparency color on top of the base color
Add	Adds the values of the transparency color and the base color

Merge mode	Description
Subtract	Adds the values of the transparency color and the base color together, and then subtracts 255
Difference	Subtracts the transparency color from the base color and multiplies by 255. If the transparency color value is 0, the result will always be 255.
Multiply	Multiplies the base color by the transparency color, and then divides by 255. This has a darkening effect, unless you are applying color to white. Multiplying black with any color results in black. Multiplying white with any color leaves the color unchanged.
Divide	Divides the base color by the transparency color, or conversely, divides the transparency color by the base color, depending on which color has the higher value
If lighter	Replaces any base color pixels that are a darker color with the transparency color. Base color pixels that are lighter than the transparency color are not affected.
If darker	Replaces any base color pixels that are a lighter color with the transparency color. Base color pixels that are darker than the transparency color are not affected.
Texturize	Converts the transparency color to grayscale, and then multiplies the grayscale value by the base color
Color	Uses the hue and saturation values of the source color and the lightness value of the base color to create a result. This merge mode is the opposite of the Lightness merge mode.
Hue	Uses the hue of the transparency color, as well as the saturation and lightness of the base color. If you are adding color to a grayscale image, there will be no change because the colors are desaturated.
Saturation	Uses the lightness and hue of the base color and the saturation of the transparency color
Lightness	Uses the hue and saturation of the base color and the lightness of the transparency color
Invert	Uses the transparency color's complementary color. If a transparency color value is 127, there will be no change because the color value falls in the center of the color wheel.

Merge mode	Description
Logical AND	Converts the transparency and base colors to binary values, and then applies the Boolean algebraic formula AND to these values
Logical OR	Converts the transparency and base colors to binary values, and then applies the Boolean algebraic formula OR to these values
Logical XOR	Converts the transparency and base colors to binary values, and then applies the Boolean algebraic formula XOR to these values
Behind	Applies the source color to those areas of the image that are transparent. The effect is similar to looking through the clear, silver-free areas on a 35-mm negative.
Screen	Inverts the source and base color values, multiplies them, and then inverts the result. The result color is always lighter than the base color.
Overlay	Multiplies or screens the source color according to the value of the base color
Soft light	Applies a soft, diffused light to the base color
Hard light	Applies a hard, direct spotlight to the base color
Color dodge	Simulates the photographic technique called dodging, which lightens image areas by decreasing the exposure
Color burn	Simulates the photographic technique called burning, which darkens image areas by increasing the exposure
Exclusion	Excludes the transparency color from the base color. This mode is similar to the Difference mode.
Red	Applies the transparency color to the red channel of RGB objects
Green	Applies the transparency color to the green channel of RGB objects
Blue	Applies the transparency color to the blue channel of RGB objects

To apply a merge mode to a transparency

- 1 Select an [object](#).
- 2 In the **Object properties** docker, choose a merge mode from the **Merge mode** list box in the **Transparency** area.



You can also click the **Transparency tool**  in the toolbox and choose a merge mode from the **Merge mode** list box on the property bar.

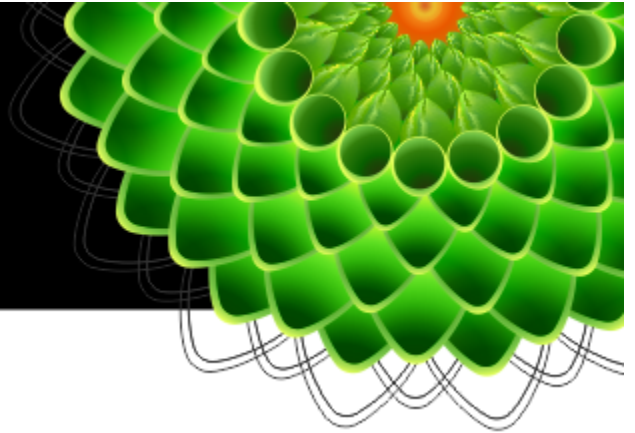

Finding, managing, and saving fills and transparencies

When working with vector patterns, bitmap patterns, or fountain fills and transparencies, you can access your personal local library as well as shared and local folders to browse, search, and save fills and transparency patterns.

This section contains the following topics:

- “Finding and viewing fills and transparencies” (page 403)
- “Managing fills and transparencies” (page 406)
- “Saving fills and transparencies” (page 408)

Finding and viewing fills and transparencies

CorelDRAW lets you use, browse, and search vector patterns, bitmap patterns, and fountain fills that are available locally on your computer, on portable media devices, and in network folders. Any of these fills can also be used as transparency patterns. For more information, see [“Changing the transparency of objects” on page 389](#).

To get you started, Corel provides local fills that are listed under **User content** in the **Fill** and **Transparency** pickers. These fills are stored in your **Documents\Corel\Corel Content\Fills** folder. If you are looking to expand your fill collection, you can download additional fill packs from within the **Get More** dialog box.

To access fills and patterns that are saved to local folders outside your **Documents\Corel\Corel Content\Fills** folder, you can create links to these folders in the **Fill** and **Transparency** pickers. Such links are known as aliases. In addition, aliases can be used to access fills saved to shared network locations as well as secondary storage devices such as USB flash drives, and portable hard drives.

You can also view the list of your favorite or most recently used fills and transparencies.

You can search and browse one pack, folder or list at a time. You can also browse and search your entire **User content** library by enabling the **Browse recursively** option.

When you copy a folder that contains many fills to your computer, it may take some time for Windows to index the folder. To view, browse, and search fills in such a folder right away, you may need to reindex the folder.

To find fills and transparencies more easily, you can filter them based on categories such **Abstract**, **Animals**, **Floral**, **Nature**, and more. You can also sort local fills and transparencies by name and the date they were created or modified.

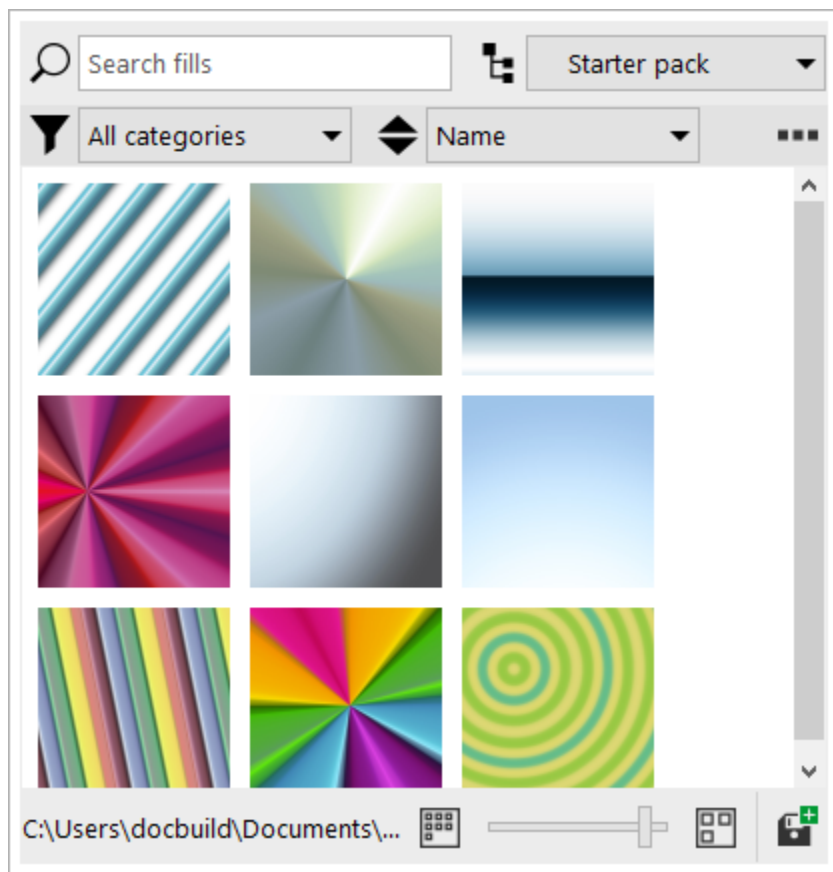







The Fill picker lets you search, browse, and manage local and shared fills.

Fills and transparencies appear as thumbnail images. By positioning your pointer over a thumbnail, you can view the filename and file location. You can adjust the size of the thumbnails for easier and faster preview of fills and transparencies. In addition, you can resize the **Fill** picker or the **Transparency** picker to view more thumbnails at a glance.

For more information about fills, see [“Applying fills to objects”](#) on page 367.

To find, filter, and sort fills and transparencies

- 1 Select an object.
- 2 Click **Object** ► **Object properties**.
- 3 In the **Object properties** docker, click one of the following buttons in the **Fill** or **Transparency** section:
 - Fountain fill  or Fountain transparency 
 - Vector pattern fill  or Vector pattern transparency 
 - Bitmap pattern fill  or Bitmap pattern transparency 
- 4 Open the **Fill** picker or the **Transparency** picker.
- 5 From the **Choose content source** list box, choose the local pack, folder, network location or list you want to search or browse. The items under **User content** show the fill packs provided by Corel and any fill packs and fills added by you. To search, type a keyword in the **Search** box, and press **Enter**.

You can also

Browse or search all items in your **User content** library

From the **Choose content source** list box, choose **User content**. Click the **Edit** button ■■■, and click **Browse recursively**.

Reindex a folder

From the **Choose content source** list box, choose **User content** or an alias. Click the **Edit** button ■■■, and click **Reindex folder**.

View the last 25 most recently used fills and patterns

From the **Choose content source** list box, choose **Recent**.

View your favorite fills and transparencies

From the **Choose content source** list box, choose **Favorites**. For information about how to mark a fill as favorite, see [“To manage fills and transparencies” on page 407](#).

Filter fills and transparencies

From the **Choose content source** list box, choose a pack under **User content** or an alias. Choose a category from the **Filter** list box.

Sort fills and transparencies

From the **Choose content source** list box, choose a pack under **User content** or an alias. Open the **Sort by** list box next to the **Filter** list box, and choose one of the following options:

- **Name** sorts fills and transparencies by the fill name, in alphabetical order.
- **Date created** sorts fills and transparencies by the date they were created, starting with the last created fill.
- **Last modified** sorts fills and transparencies by the date they were modified, starting with the last modified fill.

Fills and transparencies in your **Favorites** list are automatically sorted by the date you marked them as favorites, starting with the last fill and transparency added to **Favorites**.

Fills and transparencies in your **Recent** list are automatically sorted by the date you used them, starting with the last used fill or transparency.



This procedure applies only to vector patterns, bitmap patterns, and fountain fills and transparencies.

To download and add a new fill and transparency pack

- 1 Open the **Fill** picker or the **Transparency** picker in the **Fill** or **Transparency** section of the **Object properties** docker.
- 2 Open the **Choose content source** list box, and click **Add new**.
- 3 Click **Get More**.
- 4 In the **Get More** dialog box, click the fill pack you want.
- 5 Do one of the following:
 - Click **Buy**, and follow the onscreen instructions to purchase the item.
 - Click **Download** if the item is included in your product or subscription.

To add an alias to a location that contains fills and transparencies

- 1 Open the **Fill** picker or the **Transparency** picker in the **Fill** or **Transparency** section of the **Object properties** docker.
- 2 Open the **Choose content source** list box, and click **Add new**.
- 3 Click **Create alias**.
- 4 In the **Locate fills** library dialog box, browse to the folder or location you want.
- 5 Click **Select Folder**.

To view the filename and location of a fill or transparency

- In the **Fill** picker or the **Transparency** picker, point to a thumbnail.



The location of a fill or transparency is also displayed at the bottom of the **Fill** or the **Transparency** picker.

To adjust the size of fill or transparency thumbnails

- In the **Fill** picker or the **Transparency** picker, move the **Thumbnail size slider**.
You can also adjust the size of the thumbnails incrementally by clicking the **Smaller thumbnails** button or the **Bigger thumbnails** button.

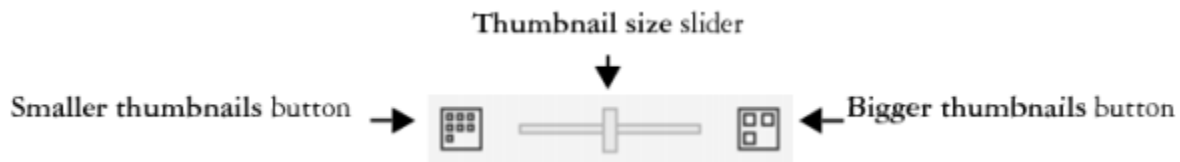

To resize the Fill picker or the Transparency picker

- Drag the lower-right corner of the **Fill** picker or the **Transparency** picker.
You can increase the width of the picker by dragging its right side, and you can increase the height of the picker by dragging its bottom side.

Managing fills and transparencies

The **Fill** and **Transparency** pickers let you manage the list of your local packs and aliases (links to local folders, network locations, and secondary storage devices). For example, you can rename the local packs or aliases, and you can remove aliases from the list. If an alias no longer works because the fill folder has been moved, you can browse to the new location to restore the link.

To find the fills and transparencies you like with ease, you can mark them as favorites. In addition, you can view and change the properties of a fill or transparency. For example, you can change its name and language; and you can add new tags (keywords) and delete existing tags. When you no longer need a fill or transparency, you can delete it.

To update the list of fill packs in the Fill and Transparency pickers

- 1 Open the **Fill** picker or the **Transparency** picker from the property bar or the **Fill** or **Transparency** section of the **Object properties** docker.
- 2 Choose a fill pack from the **Choose content source** list box under **User content**.
- 3 Click the **Edit** button , and perform a task from the following table.







To	Do the following
Rename a fill pack	Click Rename , and in the Rename Pack or Alias dialog box, type a name in the Name box.
Open the fill pack in Windows Explorer	Click Open folder location .
Delete a fill pack	Click Open folder location . Select the folder that contains the pack in Windows Explorer, right-click it, and click Delete . This action deletes the fill pack and removes it from the list in the Fill and Transparency pickers.

To update the list of aliases in the Fill and Transparency pickers

- 1 Open the **Fill** picker or the **Transparency** picker from the property bar or the **Fill** or **Transparency** section of the **Object properties** docker.
- 2 Choose an alias from **Choose content source** list box.
- 3 Click the **Edit** button , and perform a task from the following table.

To	Do the following
Browse to a folder that has been moved or renamed	Click Browse , and navigate to the folder that contains the fills.
Rename the alias	Click Rename , and in the Rename Pack or Alias dialog box, type a name in the Name box.
Remove the alias from the list	Click Remove .
Open the folder in Windows Explorer	Click Open folder location .

To manage fills and transparencies

- 1 Select an object.
- 2 Click **Object** ► **Object properties**.
- 3 In the **Object properties** docker, click one of the following buttons in the **Fill** or **Transparency** section:
 - Fountain fill  or Fountain transparency 
 - Vector pattern fill  or Vector pattern transparency 
 - Bitmap pattern fill  or Bitmap pattern transparency 
- 4 Open the **Fill** picker or the **Transparency** picker.
- 5 Perform an action from the following table.

To	Do the following
Mark a fill or pattern as a favorite	Right-click a thumbnail, and click Favorite .
Change the name of a fill or pattern in your local library, or the tags associated with it	Right-click a thumbnail, and click Properties . In the Properties dialog box, do any of the following: <ul style="list-style-type: none"> • Choose a language from the Language list box. • Type a new name in the Name box. • Choose a category from the Category list box to categorize the fill or pattern. • Add to or delete tags from the Tags box.
Delete a fill or pattern from your local library	Right-click a thumbnail, and click Delete .



This procedure applies only to vector patterns, bitmap patterns, and fountain fills and transparencies.

Saving fills and transparencies

After you create or modify a fill or transparency pattern, you can save it and add metadata such as name and tags (keywords) in the language of your choice. Fills and patterns are saved in a special file format with a `.fill` extension, which preserves information about the transformations applied to the fill or pattern.

To save a custom fill or transparency

- 1 In the **Fill** or **Transparency** section of the **Object properties** docker, click the **Save as new** button .

This button is available for fountain, vector pattern, and bitmap pattern fills and transparencies, but not for two-color pattern, texture, and PostScript fills and transparencies. For information about saving a two-color pattern fill, see [“To create a two-color pattern fill” on page 379](#).
- 2 In the **Create Custom [Fill Type]** dialog box, choose a language from the list box, type a name for the fill or pattern, and type any tags (keywords) that you want to associate with it.



Fills and patterns in your personal library are saved by default in your `Documents\Corel\Corel Content\Fills` folder. You can change the default location to which fills and patterns are saved. For more information, see [“Content types” on page 114](#).



You can also save a fill or transparency by clicking the **Save custom fill** button  in the **Fill** or **Transparency** picker. The fill or transparency is saved to the location selected in the **Choose content source** list box in the **Fill** or **Transparency** picker. If you have selected **Recent** from the **Choose content source** list box, the fill or transparency is saved to your `Documents\Corel\Corel Content\Fills` folder.

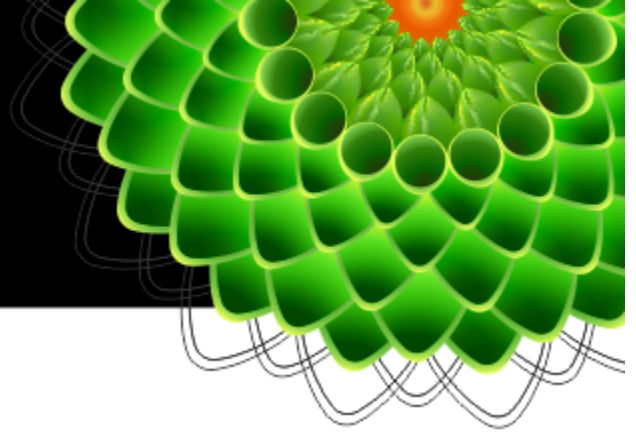

Using color management

Color management helps ensure colors appear consistent when you work with files from various sources and output these files on different devices.

This section contains the following topics:

- “Understanding color management” (page 409)
- “Getting started with color management in CorelDRAW” (page 413)
- “Installing, loading, and embedding color profiles” (page 416)
- “Assigning color profiles” (page 418)
- “Converting colors to other color profiles” (page 418)
- “Choosing color-conversion settings” (page 419)
- “Soft proofing” (page 419)
- “Working with color management presets” (page 422)
- “Working with color management policies” (page 423)
- “Managing colors when opening documents” (page 424)
- “Managing colors when importing and pasting files” (page 425)
- “Managing colors for print” (page 425)
- “Using a safe CMYK workflow” (page 426)
- “Managing colors for online viewing” (page 426)

Understanding color management

This section provides answers to the following commonly asked questions about color management:

- “Why don’t colors match?” (page 410)
- “What is color management?” (page 410)
- “Why do I need color management?” (page 410)
- “How do I get started with color management?” (page 411)
- “Is my monitor displaying the correct colors?” (page 411)
- “Should I assign a color profile or convert colors to a color profile?” (page 411)
- “What is a rendering intent?” (page 411)

Why don't colors match?

Different tools are used during the process of creating and sharing a document. For example, you may start with a file that was created in another application or import an image that was captured by a digital camera or scanner. After completing the document, you may print it or email it to a colleague for review. Each of the tools that you use in your workflow has a different way of interpreting color. In addition, each tool has its own range of available colors, called a color space, which is a set of numbers that define how each color is represented.



Example of a document workflow

In other words, when defining and interpreting color, each tool speaks a unique language. Consider a color in the color space of your digital camera: a vivid blue RGB color with the values Red = 0, Green = 0, and Blue = 255. This color may appear as a different color in the color space of your monitor. In addition, the color space of your printer may not contain a match for this color. As a result, when your document moves through the workflow, this vivid blue color gets lost in the translation and is not accurately reproduced. A color management system is designed to improve the communication of color in the workflow so that the color of the output matches your intended color.

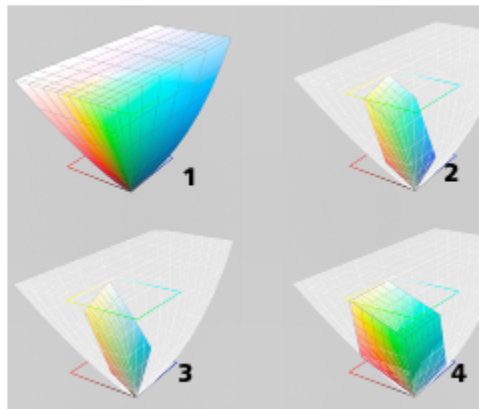

Colors are defined by their color space. 1. Lab color space. 2. sRGB color space, displayed against the Lab color space. 3. U.S. Web Coated (SWOP) v2 color space. 4. ProPhoto RGB color space.

What is color management?

Color management is a process that lets you predict and control color reproduction, regardless of the source or destination of the document. It ensures a more accurate color representation when a document is viewed, modified, shared, exported to another format, or printed.

A color management system, also known as a color engine, uses color profiles to translate the color values from one source to another. For example, it translates the colors that are displayed on the monitor into the colors that a printer can reproduce. Color profiles define the color space of monitors, scanners, digital cameras, printers, and the applications that you use to create or edit documents.

Why do I need color management?

If your document requires accurate color representation, you may want to learn more about color management. The complexity of your workflow and the ultimate destination of your documents are also important considerations. If your documents are destined only for online viewing, color management may not be as important. However, if you plan to open documents in another application or if you are creating documents for print or multiple types of output, then proper color management is essential.

Color management lets you do the following:

- reproduce colors consistently across your workflow, especially when opening documents that were created in other applications
- reproduce colors consistently when sharing files with others
- preview (or “soft-proof”) colors before they are sent to their final destination, such as a printing press, a desktop printer, or the web
- reduce the need to adjust and correct documents when sending them to different destinations

A color management system does not offer identical color matching, but it greatly improves color accuracy.

How do I get started with color management?

Here are some suggestions for adding color management to your workflow:

- Make sure that your monitor is displaying the correct colors. For more information, see [“Is my monitor displaying the correct colors?” on page 411](#).
- Install color profiles for any input or output devices that you are planning to use. For more information, see [“Installing, loading, and embedding color profiles” on page 416](#).
- Become familiar with the color management features of CorelDRAW. The default settings for color management produce good color results, but you can change these default settings so that they suit your specific workflow. For more information, see [“Getting started with color management in CorelDRAW” on page 413](#).
- Soft-proof documents to preview final results on-screen. For more information, see [“Soft proofing” on page 419](#).
- Embed color profiles when saving and exporting files. In this way, you help ensure color consistency when the files are viewed, modified, or reproduced. For more information, see [“Installing, loading, and embedding color profiles” on page 416](#).

Is my monitor displaying the correct colors?

Calibrating and profiling the monitor are essential steps for ensuring color accuracy. When you calibrate a monitor, you set it to display colors according to an established standard of accuracy. After calibration, you can create a color profile of the monitor, which describes how the monitor interprets colors. This custom color profile is usually installed in your operating system by the profiling software, so it can be shared with other devices and applications. Calibration and profiling work together to achieve color accuracy: If a monitor is incorrectly calibrated, its color profile is not useful.

Calibration and profiling are complex and usually require third-party calibration devices, such as colorimeters and specialized software. Furthermore, improper calibration may do more harm than good. You can learn more about monitor calibration and custom color profiles by researching color management techniques and products. You can also refer to the documentation that was provided with your operating system or monitor.

How you perceive the color that your monitor displays is also important for managing color consistency. Your perception is influenced by the environment in which you are viewing the documents. Here are some ways to create a suitable viewing environment:

- Ensure that your room has a consistent flow of light. For example, if the room is filled with sunlight, use a shade, or if possible, work in a room without windows.
- Set the monitor background to a neutral color, such as gray, or apply a grayscale image. Avoid using colorful wallpapers and screensavers.
- Don’t wear bright clothing that can clash with the display of colors on the monitor. For example, wearing a white shirt reflects onto the monitor and alters your perception of color.

Should I assign a color profile or convert colors to a color profile?

When you assign a color profile, the color values, or numbers, in the document do not change. Instead, the application uses the color profile to interpret the document colors. However, when you convert colors to another color profile, the color values in the document change.

The best practice is to choose a suitable color space when you create a document and to use the same color profile throughout your workflow. You should avoid assigning color profiles and converting colors to other color profiles while working on a document. For more information, see [“Assigning color profiles ” on page 418](#) and [“Converting colors to other color profiles” on page 418](#).

What is a rendering intent?

A color management system can perform effective translation of document colors to multiple devices. However, when converting colors from one color space to another, a color management system may be unable to match certain colors. This translation failure occurs because some colors in the source may not fit within the range (or gamut) of the destination color space. For example, the bright red

and blue colors that you see on your monitor are often outside the gamut of colors that your printer can produce. These “out-of-gamut” colors can dramatically change the look of the document, depending on how they are interpreted by the color management system. Each color management system has four methods of interpreting out-of-gamut colors and mapping them into the gamut of the destination color space. These methods are known as “rendering intents.” The choice of a rendering intent depends on the graphical content of the document.

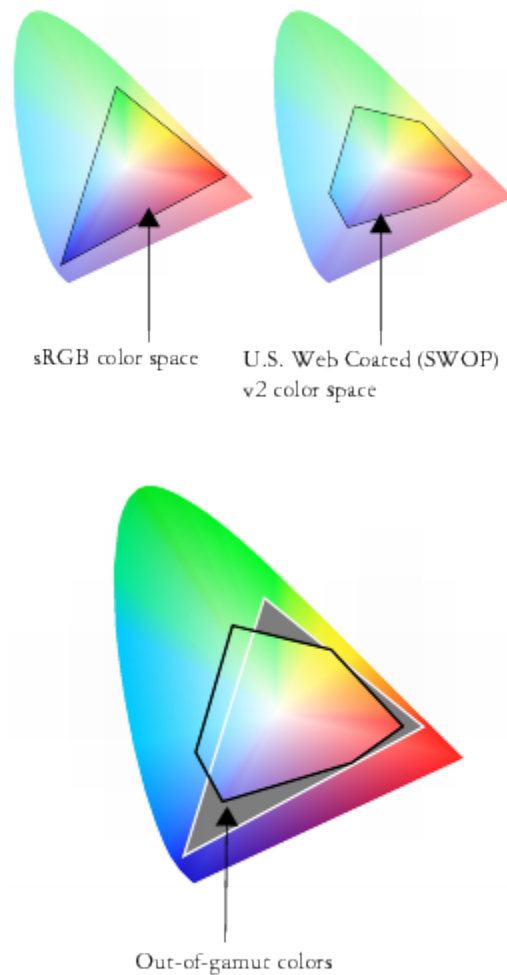

Many colors in an sRGB document may be out of gamut for the U.S. Web Coated (SWOP) v2 color space. The out-of-gamut colors are mapped into gamut according to the rendering intent.

The following rendering intents are available:

- The **Relative colorimetric** rendering intent is suitable for logos or other graphics that contain only a few out-of-gamut colors. It matches the out-of-gamut source colors with the closest in-gamut colors at the destination. This rendering intent causes the white point to shift. If you print on white paper, the whiteness of the paper is used to reproduce the white areas of the document. Therefore, this rendering intent is a good option if your document will be printed.
- The **Absolute colorimetric** rendering intent is suitable for logos, or other graphics, that require very precise colors. If no match is found for the source colors, then the closest possible match is used. The **Absolute colorimetric** and **Relative colorimetric** rendering intents are similar, but the **Absolute colorimetric** rendering intent preserves the white point through the conversion and does not adjust for the whiteness of the paper. This rendering intent is used mainly for proofing.

- The **Perceptual rendering** intent is suitable for photographs and bitmaps that contain many out-of-gamut colors. The overall color appearance is preserved by changing all the colors, including the in-gamut colors, to fit within the range of colors at the destination. This rendering intent maintains the relationships between colors to produce the best results.
- The **Saturation** rendering intent produces more concentrated solid colors in business graphics, such as charts and graphs. Colors may be less accurate than those produced by other rendering intents.

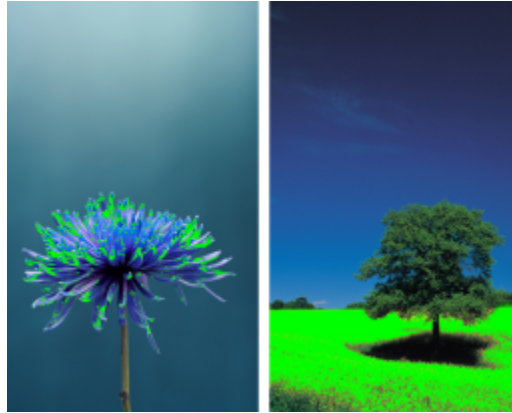

The number of out-of-gamut colors (indicated by the green overlay) may influence your choice of a rendering intent. Left: The Relative colorimetric rendering intent is suitable for this photo, which contains only a few out-of-gamut colors. Right: The Perceptual rendering intent is a good choice for this photo, which contains many out-of-gamut colors.

Getting started with color management in CorelDRAW

CorelDRAW has two types of color management settings: default settings for color management and document color settings. The default settings for color management control the colors of new documents and any documents that do not contain color profiles (also known as “untagged documents”). Documents that were created in earlier versions of CorelDRAW are treated as untagged. Document color settings affect only the colors of the active document.

Default settings for color management

The default settings for color management are essential for producing consistent colors.

- **Presets** — If you are new to color management and create designs for a specific output, you can choose a preset to help you get started with the right color management settings such as default color profiles and color-conversion settings. Examples are the **North America Prepress** preset, which is suitable for projects to be printed by North American print service providers, and the **Europe Web** preset, which is suitable for web projects that are created in Europe. For more information about color management presets, see [“Working with color management presets” on page 422](#).
- **Default color profiles** — define the RGB, CMYK, and grayscale colors in new and untagged documents. You can change these settings so that all new documents use the color profiles that you specify. In some applications, default color profiles are called “working space profiles.”
- **Primary color mode** — determines the document color palette that is displayed when you open or start a document as well as the default color mode of a document that is exported as a bitmap. The primary color mode is set for all new and untagged documents, but you can change this setting for the active document in the **Document color settings** dialog box. Note that the primary color mode does not limit colors in a CorelDRAW document to a single color mode.
- **Rendering intent** — lets you choose a method for mapping out-of-gamut colors in new and untagged documents. If the default rendering intent is not suitable for the active document, you can change it in the **Document color settings** dialog box. For information about choosing the right rendering intent for your projects, see [“What is a rendering intent?” on page 411](#).
- **Color conversion settings** — control how colors are matched when you are converting colors from one color profile to another. For example, you can change the color engine or specify options for converting pure black colors in RGB, CMYK, Lab, or Grayscale documents. For more information, see [“Choosing color-conversion settings” on page 419](#).
- **Spot color definition** — lets you display spot colors by using their Lab, CMYK, or RGB color values. These alternative color values are also used when spot colors are converted to process colors.
- **Color management policies** — manage colors in files that you open, or import or paste in an active document. For more information about color management policies, see [“Working with color management policies” on page 423](#).

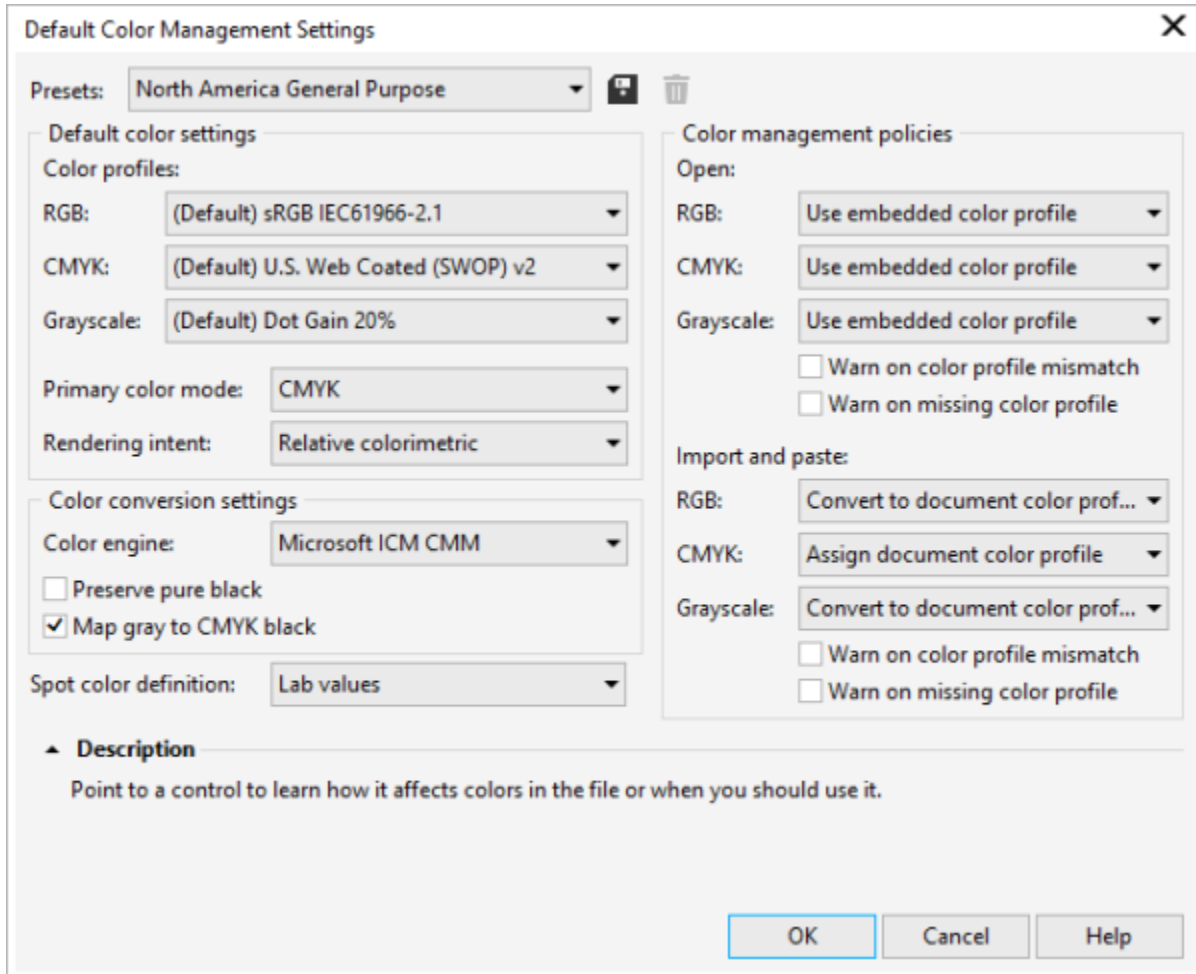

Default color management settings dialog box

Document color settings

You can view and edit the color settings of the active document, without affecting new and untagged documents. You can see what color profiles are assigned to the document as well as what are the default color profiles of the application. The color profiles that are assigned to an active document determine the document color space for RGB, CMYK, and grayscale colors.

You can also assign different color profiles to the active document or convert its colors to specific color profiles. For information about assigning color profiles, see [“Assigning color profiles”](#) on page 418. For information about converting document colors to other color profiles, see [“Converting colors to other color profiles”](#) on page 418.

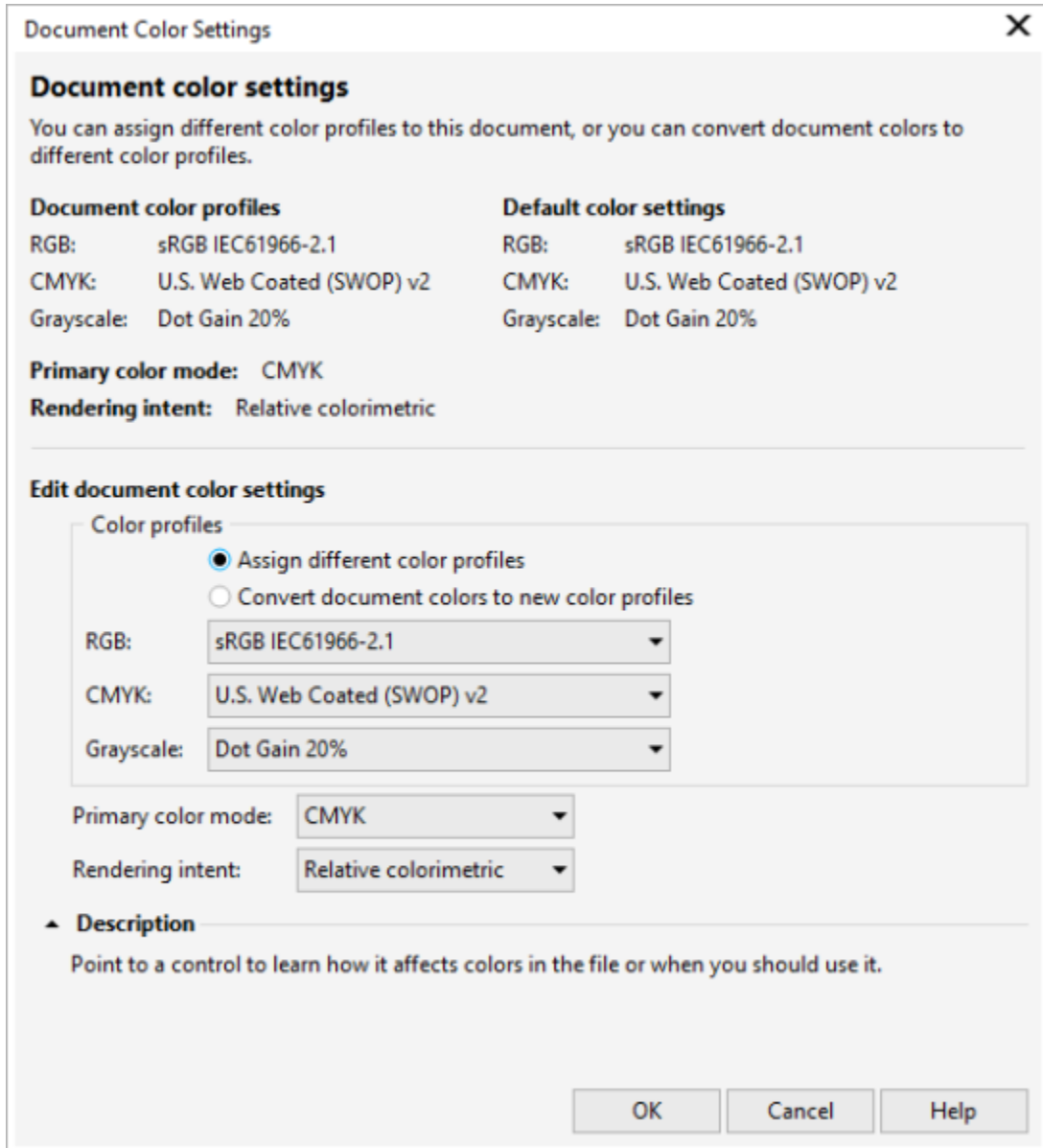

Document color settings dialog box

In addition, you can change the primary color mode and rendering intent for the active document.

Getting help

You can find information about each control available in the **Default color settings** and **Document color settings** dialog boxes by pointing to the control and viewing the description in the **Description** area.

To access default settings for color management

- Click **Tools** ▶ **Color management** ▶ **Default settings**.

To change the default color profiles

- 1 Click **Tools** ▶ **Color management** ▶ **Default settings**.

2 In the **Default color settings** area, choose a color profile from the following list boxes:

- **RGB** — describes RGB colors in new and untagged documents
- **CMYK** — describes CMYK colors in new and untagged documents
- **Grayscale** — describes grayscale colors in new and untagged documents

You can also

Change the primary color mode

Choose a color mode from the **Primary color mode** list box.

Changing the primary color mode in the **Default color management settings** dialog box does not affect the active document.

Change the rendering intent

Choose a rendering intent from the **Rendering intent** list box.

To access document color settings

- Click **Tools** ► **Color management** ► **Document settings**.



To display the color profiles that are used in the active document on the status bar, click the flyout ► button on the status bar, and choose **Color information**.

You can also view the document color settings in the **Document properties** dialog box by clicking **File** ► **Document properties**.

Installing, loading, and embedding color profiles

To ensure color accuracy, a color management system needs ICC-compliant profiles for monitors, input devices, external monitors, output devices, and documents.

- **Monitor color profiles** — define the color space that is used by your monitor to display document colors. CorelDRAW uses the primary monitor profile that is assigned by the operating system. The monitor profile is very important for color accuracy. For more information, see [“Is my monitor displaying the correct colors?” on page 411](#).
- **Input device color profiles** — used by input devices such as scanners and digital cameras. These color profiles define which colors can be captured by specific input devices.
- **Display color profiles** — include monitor profiles that are not associated with your monitor in the operating system. These color profiles are especially useful for soft-proofing documents for monitors that are not connected to your computer.
- **Output device color profiles** — define the color space of output devices such as desktop printers and printing presses. The color management system uses these profiles to map accurately document colors to the colors of the output device.
- **Document color profiles** — define the RGB, CMYK, and grayscale colors of a document. Documents that contain color profiles are known as “tagged.”

Finding color profiles

Many color profiles are installed with your application or can be generated with profiling software. Manufacturers of monitors, scanners, digital cameras, and printers also provide color profiles. In addition, you can access color profiles from websites such as:

- <http://www.color.org/findprofile.xalter> — This website of the International Color Consortium (ICC) can help you find commonly used standard color profiles.
- <http://www.eci.org/doku.php?id=en:downloads> — This website of the European Color Initiative (ECI) provides standard ISO profiles as well as profiles that are specific to Europe
- http://www.tftcentral.co.uk/articles/icc_profiles.htm — This website provides ICC profiles for many different types of LCD (Liquid Crystal Display) monitors to help you display consistent colors. However, if color accuracy is essential for your workflow, you should calibrate

and profile your monitor instead of relying on readily available monitor profiles. For more information, see [“Is my monitor displaying the correct colors?” on page 411](#).

Installing and loading color profiles

If you don't have the necessary color profile, you can install it, or you can load it within the application. Installing a color profile adds it to the **Color** folder of the operating system; loading a color profile adds it to the **Color** folder of the application. CorelDRAW Graphics Suite can access color profiles from both **Color** folders.

Embedding color profiles

When you save or export a document to a file format that supports color profiles, the color profiles are embedded in the file by default. Embedding a color profile attaches the color profile to the document to ensure that the same colors you used are shared with anyone who views or prints the document.

To install a color profile

- In Windows Explorer, right-click a color profile, and click **Install profile**.

To load a color profile

- 1 Click **Tools** ▶ **Color management** ▶ **Default settings**.
- 2 In the **Default color setting** area, choose **Load color profiles** from the **RGB**, **CMYK**, or **Grayscale** list boxes.
- 3 In the **Open** dialog box, navigate to the color profile.



After you load a color profile, you can also access it from the **Color proof settings** docker, **Print** dialog box, and **Document color setting** dialog box.

Note that you can load a color profile of any color mode from any list box: **RGB**, **CMYK**, or **Grayscale**. However, after you load the profile, you can access it only from the list box of the respective color mode. For example, you can load an RGB color profile from the **CMYK** list box, but you can access the profile only from the **RGB** list box.



You can also load a color profile from the **Document color settings** dialog box.

To embed a color profile

- 1 Click **File**, and then click one of the following commands:
 - **Save as**
 - **Export**
 - **Export for** ▶ **Web**
- 2 In the dialog box that appears, enable the **Embed color profiles** check box.



When you save or export a file to the CorelDRAW (CDR) or Adobe Portable Document Format (PDF) file format, you can embed up to three color profiles.

Embedding a color profile increases the file size of a document. To avoid increasing the file size unnecessarily, CorelDRAW embeds only color profiles for colors that are used in the document. For example, if your document contains only RGB objects, only the RGB color profile will be embedded.

Assigning color profiles

When you open or import a document that is missing a color profile, by default the application automatically assigns a color profile to the document. If the document has a color profile that is not suitable for the required destination, you can assign a different color profile to the document. For example, if the document is intended to be displayed on the web or to be printed on a desktop printer, you should make sure that sRGB is the document RGB profile. If the document is destined for print production, the Adobe RGB (1998) profile is a better choice, because it has a larger gamut and produces good results when RGB colors are converted to a CMYK color space.

When you assign a different color profile to a document, the colors may appear different, although the color values do not change.



Left: The SWOP 2006_Coated3v2.icc color profile is assigned to the active document. Right: When the Japan Color 2002 Newspaper color profile is assigned to the document, the colors appear much less saturated.

To assign color profiles to a document

- 1 Click **Tools** ▶ **Color management** ▶ **Document settings**.
- 2 In the **Edit document color settings** area, enable the **Assign different color profiles** option.
- 3 Choose color profiles from the **RGB**, **CMYK**, and **Grayscale** list boxes.

Converting colors to other color profiles

When you convert document colors from one color profile to another, the color values in the document are changed according to the rendering intent, but the appearance of colors is preserved. The main purpose of converting colors is to match the appearance of colors in the source color space as closely as possible to colors in the destination color space.

Because multiple color conversions deteriorate accuracy, it is recommended that you convert colors only once. Wait until the document is ready and you are sure of the color profile that will be used for the final output. For example, if you designed a document in the Adobe RGB (1998) color space, and the document will be posted on the web, you can convert document colors to the sRGB color space.

You can choose the color management engine that is used for converting colors. For more information, see [“Choosing color-conversion settings” on page 419](#).

To convert colors to other color profiles

- 1 Click **Tools** ▶ **Color management** ▶ **Document settings**.
- 2 In the **Edit document color settings** area, enable the **Convert document colors to new color profiles** option.
- 3 Choose a color profile from the **RGB**, **CMYK**, and **Grayscale** list box.
- 4 Choose a suitable rendering intent from the **Rendering intent** list box. For information about the available rendering intents, see [“What is a rendering intent?” on page 411](#).

Choosing color-conversion settings

When you choose **color profiles**, colors are matched between devices as closely as possible by the color management module (CMM) of the Microsoft Image Color Management (ICM), which is the default CMM. Color management modules are also known as “color engines.”

You can also use the Adobe CMM if it is installed on your computer.

Handling pure black and grayscale colors

You can preserve pure black color in the destination color space during color conversion. For example, if you are converting an RGB document to a CMYK color space, pure RGB black (R=0, G=0, B=0) can be mapped to pure black CMYK colors (K=100). This option is recommended for grayscale documents or documents that contain mostly text. Note that preserving pure black during color conversion may create solid edges of black in effects and gradient fills that contain black.

By default, grayscale colors are converted to the CMYK black (K) channel. This process ensures that all grayscale colors print as shades of black, and no cyan, magenta, and yellow inks are wasted during printing.

To choose color-conversion settings

- 1 Click **Tools** ▶ **Color management** ▶ **Default settings**.
- 2 In the **Color conversion settings** area, choose a color engine from the **Color engine** list box.

You can also

Keep pure black in the source color space as pure black in the destination color space

Map grayscale colors to CMYK black during conversion

Do the following

Enable the **Preserve pure black** check box.

Enable the **Map gray to CMYK black** check box.

Soft proofing

Soft proofing provides an on-screen preview of a document as it will appear when it is reproduced by a specific printer or displayed on a specific monitor. Unlike the “hard-proofing” technique that is used in a traditional printing workflow, soft proofing lets you look at the final result without committing ink to paper. You can verify whether the color profile of the document is suitable for a specific printer or monitor and avoid unwanted results.



Top left: An RGB color profile is assigned to the document. Middle and right: Assigning a specific CMYK profile allows an on-screen simulation of the printed output.

To simulate the output colors that are produced by a device, you need to choose the color profile of the device. Because the color spaces of the document and device are different, some document colors may not have matches in the gamut of the device color space. You can enable the gamut warning, which lets you preview the on-screen colors that cannot be reproduced accurately by the device. When the gamut warning is enabled, an overlay highlights all the out-of-gamut colors for the device that you are simulating. You can change the color of the out-of-gamut overlay, and you can also make it more transparent to see the underlying colors.



The gamut warning highlights colors that a printer or monitor cannot reproduce accurately.

You can change how out-of-gamut colors are brought into the gamut of the proof profile by changing the rendering intent. For more information, see [“What is a rendering intent?”](#) on page 411.

You can preserve the RGB, CMYK, or grayscale color values of the document when soft-proofing. For example, if you are soft-proofing a document to be printed to a printing press, you can keep the original document CMYK color values in the soft proof. In this case, all colors will be updated on-screen, but only the RGB and grayscale color values of the document will be changed in the soft proof. Preserving the CMYK color values can help you prevent unwanted color conversions in the final output.

If you often need to soft-proof documents for a specific output, you can create and save custom proof presets. You can delete the presets that you no longer need at any time.

You can save soft proofs by exporting them to the JPEG, TIFF, Adobe Portable Document Format (PDF), or Corel PHOTO-PAINT (CPT) file format. You can also print proofs.

By default, soft proofing is disabled when you start a new document or when you open a document. However, you can make sure that soft proofing is turned on by default at all times.

To turn soft proofing on or off

- Click **View** ► **Proof colors**.



When you turn soft proofing on, colors in the document window, color palettes, and preview windows of dialog boxes appear different.

Simulating printer output may cause on-screen colors to appear dull because all colors are brought into a CMYK color space, which has a smaller gamut than an RGB color space.



You can also enable or disable soft proofing by clicking the **Proof colors** button  on the status bar.

To specify soft-proof settings

- 1 Click **Window** ► **Dockers** ► **Color proof settings**.
- 2 Perform any of the following tasks.

To

Simulate the output of a specific device

Keep specific color values unchanged

Change the rendering intent

Enable the gamut warning

Change the color of the out-of-gamut overlay

Change the transparency of the out-of-gamut overlay

Save a custom proof preset

Choose a proof preset

Delete a proof preset



The accuracy of the simulation depends on factors such as the quality of your monitor, the color profile of the monitor and the output device, and the ambient lighting in your work area.

To export a soft proof

- 1 Click **Window** ► **Dockers** ► **Color proof settings**.
- 2 In the **Color proof settings** docker, click the **Export soft proof** button.
- 3 Type a filename in the **File name** box.
- 4 From the **Save as type** list box, choose one of the following options:
 - **JPG - JPEG Bitmaps**

Do the following

From the **Simulate environment** list box, choose the color profile of the device.

Enable the **Preserve numbers** check box.

Depending on the color profile in the **Simulate environment** box, the check box lets you preserve CMYK, RGB, or grayscale color values.

Choose a rendering intent from the **Rendering intent** list box.

In the **Gamut warning** area, enable the **Out-of-gamut colors** check box.

In the **Gamut warning** area, choose a color from the color picker.

In the **Gamut warning** area, type a value in the **Transparency** box. The value should be between 1 and 100.

Choose the settings that you want, click the **Save** button , and then type a name in the **Save preset as** box.

Out-of-gamut settings are not included in the proof preset.

From the **Proof preset** list box, choose a preset.

Click the **Delete** button .

- PDF - Adobe Portable Document Format
 - TIF - TIFF Bitmap
 - CPT - Corel PHOTO-PAINT image
- 5 Choose any settings in the dialog box that appears.

To print a proof

- 1 Click **Window** ► **Dockers** ► **Color proof settings**.
- 2 In the **Color proof settings** docker, click the **Print proof** button.

To turn soft proofing on by default

- 1 Click **Tools** ► **Options**.
- 2 In the **Workspace** list of categories, click **Display**.
- 3 Enable the **Proof colors by default** check box.

Working with color management presets

The application provides color management presets, which are default color settings that are applied to new and untagged documents. You can choose a color management preset that is suitable for the geographic region where a document is created or for the location of its final output.

You can also create your own presets, which allows you to retain your selections in the **Default color management settings** dialog box and reuse them in other documents. If you no longer need a preset, you can delete it.

To choose a color management preset for new documents

- 1 Click **Tools** ► **Color management** ► **Default settings**.
- 2 Choose one of the following color management presets from the **Presets** list box:
 - **North America General Purpose** — suitable for designs that will be used in multiple types of output in North America
 - **Europe General Purpose** — suitable for designs that will be used in multiple types of output in Europe
 - **Europe Prepress** — suitable for designs that will be printed by print service providers in Europe
 - **Europe Web** — suitable for web designs that are created in Europe
 - **Japan General Purpose** — suitable for designs that will be used in multiple types of output in Japan
 - **Japan Prepress** — suitable for designs that will be printed by print service providers in Japan
 - **Japan Web** — suitable for web designs that are created in Japan
 - **Minimal Color Management** — preserves the original RGB, CMYK, and Grayscale color values when opening, importing, or pasting documents
 - **North America Prepress** — suitable for designs that will be printed by print service providers in North America
 - **North America Web** — suitable for web designs that are created in North America
 - **Simulate Color Management Off** — produces the color-conversion results of the **Color Management Off** preset that is available in earlier versions of CorelDRAW
 - **Simulate CorelDRAW Graphics Suite X4** — displays colors as they appear in CorelDRAW Graphics Suite X4

To add a color management preset

- 1 Click **Tools** ► **Color management** ► **Default settings**.
- 2 Change any default color settings.
- 3 Click the **Save** button  next to the **Presets** list box.
- 4 In the **Save color management style** dialog box, type a name in the **Save style as** box.

To delete a color management preset

- 1 Click **Tools** ▶ **Color management** ▶ **Default settings**.
- 2 Choose a preset from the **Presets** list box.
- 3 Click the **Delete** button .

Working with color management policies

Color management policies determine how colors are managed in documents that you open and work with in an application. In CorelDRAW, you can set one color-management policy for opening documents and another for importing and pasting files and objects in the active document.

The color management policy for opening files determines what RGB, CMYK, and Grayscale color profiles are used in each file you want to open. By default, the application uses the color profiles embedded in the file. You can also choose to assign the default color profiles to the file or convert colors in the file to the default color profiles.

By default, the color management policy for importing and pasting files converts the RGB and Grayscale colors of the files to the document color profiles, and assigns the document CMYK color profile to files in the CMYK mode. You can also choose to assign the document color profiles to the file, or convert the colors of the active document to the color profiles that are embedded in the file.

The files that you are opening or importing may be missing color profiles, or may contain color profiles that do not match the default color profiles. By default, the application does not warn you about missing or mismatched color profiles but makes color management choices that produce good results. However, you can activate warning messages if you want to have full control over the colors in your documents.

To set a color management policy for opening documents

- 1 Click **Tools** ▶ **Color management** ▶ **Default settings**.
- 2 In the **Open** section of the **Color management policies** area, choose one of the following options from the **RGB** list box:
 - **Use embedded color profile** — preserves the RGB color profile that is embedded in the file. This option is recommended, because it preserves the original RGB color appearance and RGB color values of the document.
 - **Assign default color profile** — uses the default RGB color profile to define document colors. RGB color values are preserved, but the appearance of RGB colors may change.
 - **Convert to default color profile** — converts colors to the default RGB color profile. The appearance of RGB colors in documents is preserved, but the color values may change.
- 3 From the **CMYK** list box in the **Open** area, choose an option for managing CMYK colors in documents. The options are the same as the options that are available for RGB colors.
- 4 From the **Grayscale** list box in the **Open** area, choose an option for managing the grayscale colors in documents. The options are the same as the options that are available for RGB colors.

To set a color management policy for importing and pasting files

- 1 Click **Tools** ▶ **Color management** ▶ **Default settings**.
- 2 In the **Import and paste** section of the **Color management policies** area, choose one of the following options from the **RGB** list box:
 - **Convert to document color profile** — converts the RGB colors of the imported or pasted file to the RGB color profile of the active document. This option is used when the imported file contains a color profile that does not match the color profile of the document.
 - **Assign document color profile** — assigns the RGB color profile of the document to the imported or pasted file. The RGB color values of the file are preserved but the color appearance may change.
 - **Use embedded color profile** — uses the RGB color profile that is embedded in the file, preserving the RGB color values and appearance of the imported or pasted file. This option converts document colors to the color profile that is embedded in the imported or pasted file.

- 3 From the **CMYK** list box in the **Import and paste** area, choose an option for managing CMYK colors in imported and pasted files. The options are the same as the options that are available for RGB colors.
- 4 From the **Grayscale** list box in the **Import and paste** area, choose an option for managing the grayscale colors in imported and pasted files. The options are the same as the options that are available for RGB colors.

To activate warning messages for missing and mismatched color profiles

- 1 Click **Tools** ▶ **Color management** ▶ **Default settings**.
- 2 In the **Color management policies** area, enable any of the following check boxes in the **Open** and **Import and paste** areas:
 - **Warn on color profile mismatch**
 - **Warn on missing color profile**

Managing colors when opening documents

The default color management policy for opening documents preserves colors in all tagged documents that you open and assigns the default color profiles to untagged documents.

If a document that you open is missing a color profile or contains color profiles that do not match the default color profiles of the application, CorelDRAW makes color-management choices based on the color management policy. If you are comfortable with color management, you can view warnings about missing and mismatched color profiles and choose different color management options. For more information about how to activate warnings, see [“To activate warning messages for missing and mismatched color profiles” on page 424](#).

Opening documents with missing color profiles

The document you are opening may support one or multiple color modes and therefore be missing one or more color profiles. For example, a CorelDRAW (CDR) or PDF document may contain three types of objects: RGB, CMYK, and Grayscale, so up to three color profiles may be missing from such a document.

The following options are available when you are opening a document with a missing color profile and have activated warnings for missing color profiles.

- **Assign color profile** — lets you assign a color profile to the document. This option preserves color values, but may change the appearance of colors. For example, if the RGB color profile is missing from the document, the default RGB color profile of the application is assigned by default. The RGB color values are preserved but the RGB colors may not appear as originally designed. You can also choose to assign a color profile that is different from the default color profile of the application. This option is recommended only if you know the original color space of the document and have the associated color profile installed.
- **Convert to default color profile** — Used in conjunction with the **Assign color profile** control, this option converts colors from the assigned color profile to the default color profile. Colors will appear as they would in the assigned color space, but the color values may change.

Opening documents with mismatched color profiles

When a document contains a color profile that does not match the default color profile, you can choose one of the following options:

- **Use embedded color profile** — This option ensures that the color values are preserved and colors are displayed as originally intended.
- **Ignore embedded color profile, and use default color profile** — Assigning the default color profile will preserve the color values but may change the appearance of colors.
- **Convert from embedded color profile to default color profile** — This option converts colors from the embedded color profile to the default color profile. The appearance of colors will be preserved, but the color values may change. This option is recommended if you have already set color management options suitable for your workflow. For example, you may be creating graphics for the web, and you may have chosen sRGB as the application default color space. Enabling this option ensures that the document uses the sRGB color space, and document colors are consistent and suitable for the web.

Opening documents with missing and mismatched color profiles

Documents that support multiple color modes can be missing color profiles and contain mismatched color profiles at the same time. For example, a document that contains RGB, Grayscale, and CMYK objects may be missing an RGB profile and may have a mismatched CMYK color profile. In such cases, you are presented with warning dialog boxes that include options for missing and mismatched color profiles.

Managing colors when importing and pasting files

The default color policy for importing and pasting files converts the colors of imported and pasted files to the color profile of the active document. If the color profile of the imported or pasted file matches the color profile of the active document, no color conversion is performed. For more information about color management policies, see [“Working with color management policies” on page 423](#).

However, you can choose to view warnings about missing and mismatched profiles and set other color management options. For more information about how to view warnings, see [“To activate warning messages for missing and mismatched color profiles” on page 424](#).

Importing and pasting files with missing color profiles

If color profiles are missing from a file, you can choose to assign specific color profiles to the file, and then convert its colors to the document color profiles. The color values of the file will change.

Importing and pasting files with mismatched color profiles

If a file contains color profiles that do not match the document color profile, the following options are available:

- **Ignore embedded color profile, and assign the document color profile** — Color values are preserved, but the appearance of colors may change.
- **Convert from embedded color profile to the document color profile** (default option) — The color of the imported file are converted from the embedded color space to the document color space. The appearance of colors is preserved, but the color values may change.
- **Convert document colors to embedded color profile** — Document colors are converted to the color profile embedded in the imported file. The appearance and color values of the imported or pasted file are preserved.

Importing and pasting files with missing and mismatched color profiles

Some files can be missing color profiles and contain mismatched color profiles at the same time. In such cases, you are presented with dialog boxes that include options for missing and mismatched color profiles.

Managing colors for print

By default, CorelDRAW does not perform color conversions when a document is sent to the printer. The printer receives the color values and interprets the colors. However, if there is a color profile associated with the printer in the operating system, CorelDRAW detects the color profile and uses it to convert document colors to the color space of the printer.

If you have a PostScript printer, you can let CorelDRAW or the PostScript printer perform any necessary color conversion. When CorelDRAW manages the color conversion, document colors are converted from the assigned color space to the color space of the PostScript printer. Note that you must disable color management in the printer driver. Otherwise, both application and printer manage colors during printing, and document colors are corrected twice, which causes unwanted color shifts.

When the PostScript printer converts document colors, the color management feature must be enabled in the printer driver. Only PostScript printers and RIP engines that support printer color conversions can be used in this advanced method. Although it increases the file size, this method has the advantage of ensuring consistent colors when you send the same print job to different print service providers.

For more information about reproducing colors for print, see [“Printing colors accurately” on page 746](#).

You can also manage colors in PDF files that you create for commercial printing. For more information, see [“Specifying color management options for exporting PDF files” on page 802](#).

Using a safe CMYK workflow

Often, you may use specific CMYK color values in your projects. To ensure reliable color reproduction, you may obtain these CMYK color values from a color swatch book. By preserving these CMYK color values throughout the printing process, you can help prevent unwanted color conversions and ensure that colors are reproduced as they appeared in the original design. A workflow that preserves the CMYK color values is known as a “safe” CMYK workflow.

CorelDRAW supports a safe CMYK workflow. By default, CMYK color values are preserved in any document that you open, import, or paste. Also, CMYK color values are preserved by default when you print documents.

In some cases, you may want to bypass the safe CMYK workflow and preserve the appearance of CMYK colors when you open, import, or paste documents. This option is useful when you want to see the original colors of a design on-screen, or view a copy that is printed to a desktop printer. To preserve the appearance of CMYK colors, you can set color management policies that convert CMYK colors in documents that you open, import, or paste. In addition, when printing to a PostScript printer, you can convert CMYK colors to the printer color profile by disabling the **Preserve CMYK numbers** check box on the **Color** page of the **Print** dialog box.

Managing colors for online viewing

Managing colors for online viewing can be even more complex than managing colors for print. Documents and images on the web are displayed on a great variety of monitors, which are often uncalibrated. In addition, most web browsers do not support color management and ignore the color profiles that are embedded in files.

When you design documents for exclusive web use, it is recommended that you use the sRGB color profile as your document RGB color profile and choose RGB colors. If a document contains a different color profile, you should convert document colors to sRGB before saving the document for use on the web.

When you create a PDF file for online viewing, you can embed color profiles in the file to reproduce colors consistently in Adobe Reader and Adobe Acrobat. For more information, see [“To specify color management options for exporting PDF files” on page 802](#).

When you start a new document that is destined for online viewing, you can choose a preset that can help you achieve good color results. For more information, see [“To start a drawing” on page 53](#). In addition, CorelDRAW offers color management presets for web documents. For information about how to choose a color management preset, see [“To choose a color management preset for new documents” on page 422](#).

Special effects

Using lenses with objects.....	429
Adding 3D effects to objects.....	433
Creating mosaics.....	457
Adding movement and focus.....	465

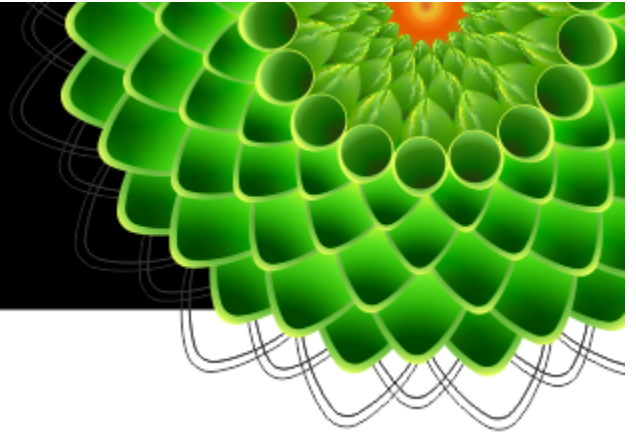

Using lenses with objects

Lenses contain creative effects that let you change the appearance of an [object](#) without actually changing the object.

This section contains the following topics:

- “Applying lenses” (page 429)
- “Editing lenses” (page 431)

Applying lenses

Lenses change how the object area beneath the lens appears, not the actual properties and attributes of the objects. You can apply lenses to any [vector object](#), such as a rectangle, ellipse, closed path, or polygon. You can also change the appearance of artistic text and bitmaps. When you apply a lens over a vector object, the lens itself becomes a vector image. Likewise, if the lens is placed over a [bitmap](#), the lens also becomes a bitmap.

After you apply a lens, you can copy it and use it with another object.



The lens types applied to the original (far left): (left to right) Heat map, Magnify, and Custom color map

The following are the types of lenses that you can apply to objects.

Lens	Description
Brighten	Lets you brighten and darken object areas and set the rate of the brightness and darkness
Color add	Lets you simulate an additive light model. The colors of the objects beneath the lens are added to the color of the lens as if you were mixing colors of light. You can choose the color and the amount of color you want to add.
Color limit	Lets you view an object area with only black and the lens color showing through. For example, if you place a green color limit lens over a bitmap, all colors except green and black are filtered out in the lens area.
Custom color map	Lets you change all the colors of the object area beneath the lens to a color ranging between two colors you specify. You can choose the range's start and end colors and the progression between the two colors. The progression can follow a direct, forward, or reverse route through the color spectrum.
Fish eye	Lets you distort, magnify, or shrink the objects beneath the lens, according to the percentage value you specify
Heat map	Lets you create the effect of an infrared image by mimicking the heat levels of colors in object areas beneath the lens
Invert	Lets you change the colors beneath the lens to their complementary CMYK colors. Complementary colors are colors that are opposite each other on the color wheel.
Magnify	Lets you magnify an area on an object by an amount that you specify. The magnify lens overrides the original object's fill, making the object look transparent.
Tinted grayscale	Lets you change the colors of object areas beneath the lens to their grayscale equivalents. Tinted grayscale lenses are particularly effective for creating sepia-tone effects.
Transparency	Lets you make an object look like a piece of tinted film or colored glass
Wireframe	Lets you display the object area beneath the lens with the outline or fill color of your choice. For example, if you set red for the outline and blue for the fill, all areas beneath the lens appear to have red outlines and blue fills.

To apply a lens

- 1 Select an [object](#).
- 2 Click **Effects** ▶ **Lens**.
- 3 Choose a lens type from the list box in the **Lens** docker.
- 4 Specify the settings you want.



You cannot apply the lens effect directly to linked groups such as contoured [objects](#), beveled objects, [extruded](#) objects, [drop shadows](#), paragraph text, or objects created with the **Artistic media** tool .



You can preview the different types of lenses in real time without auto-applying them to a drawing by clicking the **Lock** button and then choosing a lens and settings to preview. When you find the lens you want to use, click **Apply**, or click the **Lock** button again to resume auto-applying the lenses while previewing them.

To copy a lens

- 1 Select the [object](#) to which you want to copy the lens.
- 2 Click **Effects** ▶ **Copy effect** ▶ **Lens from**.
- 3 Click the object from which you want to copy the lens.

Editing lenses

You can edit a lens to change how it affects the area beneath it. For example, you can change the viewpoint of a lens, indicated by an X in the drawing window, to display any part of a drawing. The viewpoint represents the center point of what is being viewed through the lens. You can position the lens anywhere in the drawing window, but it always shows the area around its viewpoint marker. For example, you can use the viewpoint marker on the Magnify lens to enlarge part of a map.

You can also display a lens only where it overlaps other [objects](#) or the background. As a result, the lens effect is not seen where the lens covers blank space (white space) in the drawing window.

Freezing the current view of a lens lets you move the lens without changing what's displayed through it. In addition, changes you make to the areas beneath the lens have no effect on the view.

To edit a lens

- 1 Select an [object](#).
- 2 Click **Effects** ▶ **Lens**.
- 3 Enable the **Viewpoint** check box on the **Lens** docker.
If you want to display a lens only where it covers other objects, enable the **Remove face** check box.
- 4 Click **Edit** to display the viewpoint marker.
- 5 Drag the viewpoint marker in the drawing window to a new location.
- 6 Click **End**.
If you want to freeze the current view of a lens, enable the **Frozen** check box.
- 7 Click **Apply**.



The **Remove face** check box is not available for the Fish Eye and Magnify lenses.

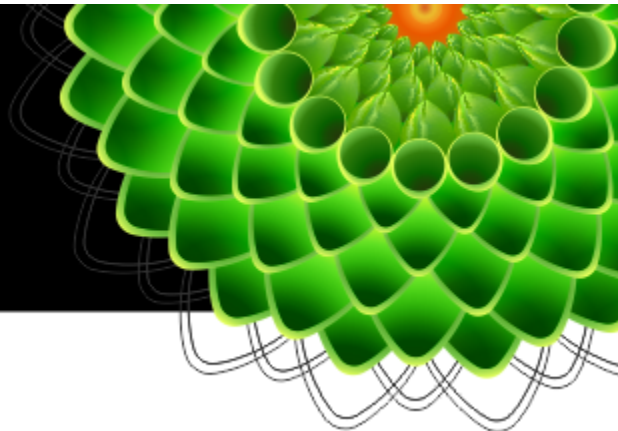

Adding 3D effects to objects

You can create the illusion of three-dimensional (3D) depth in objects by adding [contour](#), perspective, [extrusion](#), bevel, or [drop shadow](#) effects.

This section contains the following topics:

- “Contouring objects” (page 433)
- “Applying perspective” (page 436)
- “Creating extrusions” (page 439)
- “Creating bevel effects” (page 443)
- “Creating drop shadows” (page 445)
- “Adding block shadows” (page 448)
- “Blending objects” (page 451)

Contouring objects

You can [contour](#) an object to create a series of concentric lines that progress to the inside or outside of the object. CorelDRAW also lets you set the number and distance of the contour lines.

In addition to creating interesting 3D effects, you can use contours to create cuttable outlines for output to devices such as plotters, engraving machines, and vinyl cutters.

After contouring an object, you can copy or [clone](#) its contour settings to another object. You can also change the colors of the fill between the contour lines and the contour outlines themselves. You can set a color progression in the contour effect, where one color blends into another. The color progression can follow a straight, clockwise, or counterclockwise path through the color range of your choice.

You can also choose how contour corners appear. For example, you can use pointed or rounded corners, or you can bevel (square off) sharp contour corners.

You can separate an object from its contour lines.

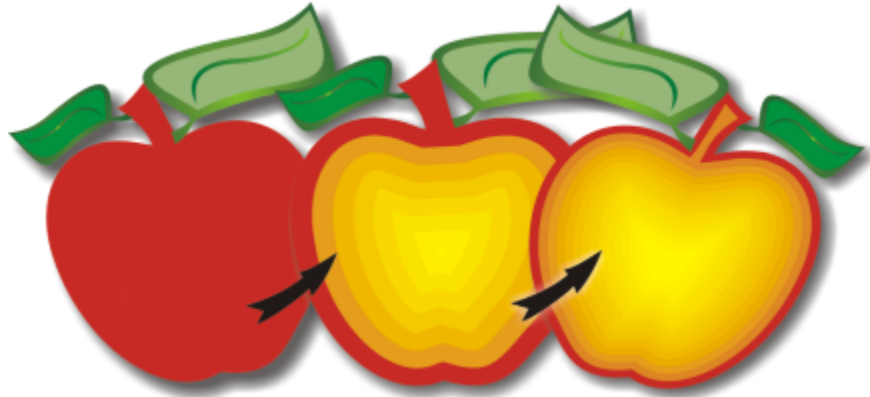

A center contour has been applied to the above object. The number of contour lines, as well as the distance between lines, can be changed.



An outside contour has been applied to the above object. Note that an outside contour projects from the outside edge of the object.

To contour an object



- 1 In the toolbox, click the **Contour** tool .
- 2 Click an object or a set of grouped objects, and drag the start handle toward the center to create an inside contour or away from the center to create an outside contour.
- 3 Move the object slider to change the number of contour steps.

You can also

Add contour lines to the center of the selected object

Click the **To center** button .

Specify the number of contour lines

Click the **Inside contour**  or **Outside contour**  button on the property bar, and type a value in the **Contour steps** box on the property bar.

Specify the distance between contour lines

Type a value in the **Contour offset** box on the property bar.

You can also

Accelerate contour line progression

Click the **Object and color acceleration** button  on the property bar, and move the object slider.

Use pointed contour corners

Click the **Mitered corners** button .

Use rounded contour corners

Click the **Round corners** button .

The effect of this control is more obvious with outside contours.

Use beveled contour corners

Click the **Bevel corners** button .



You can create contours by clicking **Effects** ► **Contour** and specifying the settings you want in the **Contour** docker.

To copy or clone a contour

- 1 Select the object to which you want to apply the contour effect.
- 2 Click **Effects**, and click one of the following:
 - **Copy effect** ► **Contour from**
 - **Clone effect** ► **Contour from**
- 3 Click the object whose contour effect you want to copy or clone.



You can also use the **Attributes eyedropper** tool  to copy a contour. For more information, see [“To copy effects from one object to another” on page 273](#).

To set the fill color for a contour object

- 1 In the toolbox, click the **Contour** tool .
- 2 Select a contour object.
- 3 Open the **Fill color** picker on the property bar, and click a color.
If you cannot apply the fill color, make sure that the **Fill color** option is enabled on the status bar.
If the original object has a fountain fill, a second color picker appears.



You can accelerate the fill color progression by clicking the **Object and color acceleration** button  on the property bar.





You can change the contour center's color by dragging a color from the [color palette](#) to the end fill handle.

To specify an outline color for the contour object

- 1 In the toolbox, click the **Contour** tool .

- 2 Select a contour object.
- 3 Open the **Outline color** picker on the property bar, and click a color.

To set the fill progression

- 1 In the toolbox, click the **Contour** tool .
- 2 Select a contour object.
- 3 Click the **Contour colors** button on the property bar, and then click any of the following buttons:
 - **Linear contour colors** 
 - **Clockwise contour colors** 
 - **Counterclockwise contour colors** 

To separate an object from its contour lines

- 1 Using the **Pick tool** , select a contoured object.
- 2 Click **Object** ► **Break contour group apart**.

Applying perspective

Adding perspective to objects creates the illusion of distance and depth. You can create a perspective effect by shortening one or two sides of an object. This effect gives an object the appearance of receding in one or two directions, thereby creating a **one-point perspective** or a **two-point perspective**.

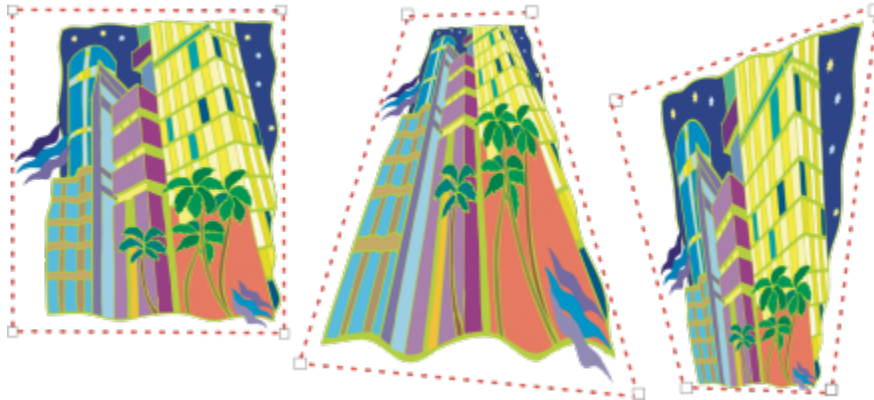

The original graphic (left) with one-point (middle) and two-point (right) perspective applied to it.

CorelDRAW lets you use perspective with both vector and bitmap objects. You add perspective to a bitmap interactively in the drawing window.

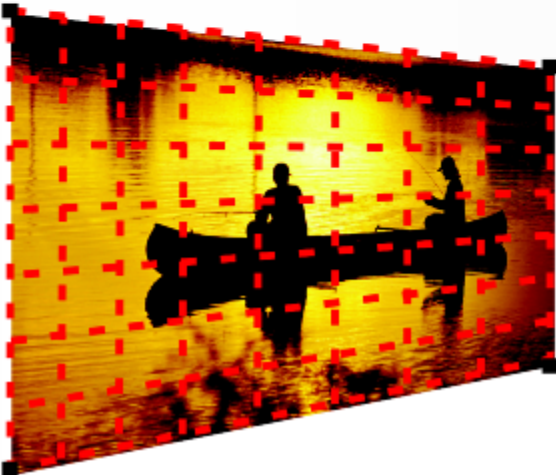
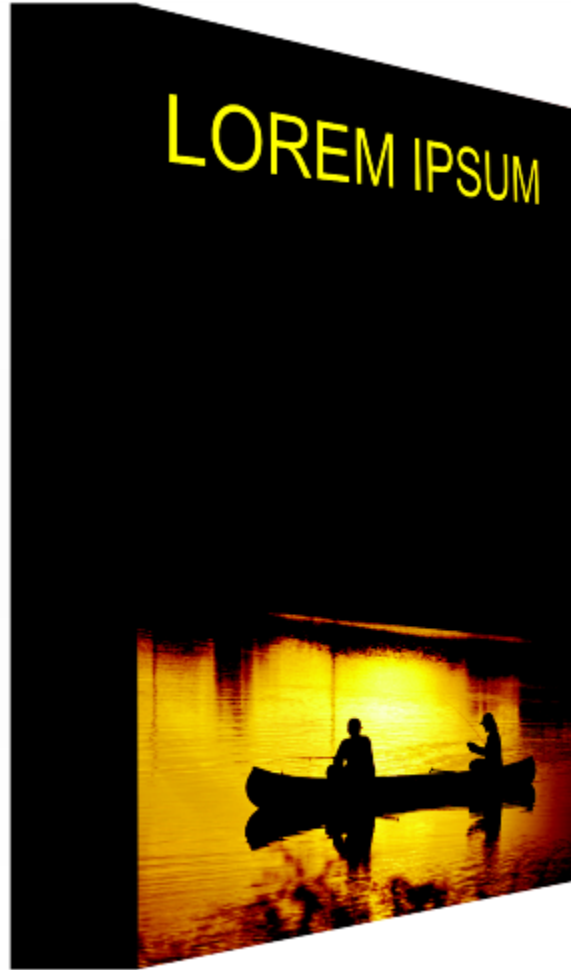

Two-point perspective (bottom left) is applied to a bitmap (top left).

The perspective effect is applied nondestructively, so you can edit it or remove it and revert to the original image at any point. After you add perspective to bitmaps, you can transform and manipulate them as you would any other vector objects. For information about transforming objects, see [“Working with objects” on page 253](#).

Perspective effects can be added to objects or grouped objects.



Perspective is applied to a group of vector and bitmap objects

You can also add a perspective effect to linked groups, such as contours, blends, and extrusions. You can't add perspective effects to paragraph text or symbols.

You can adjust perspective by moving the nodes on the perspective grid or the vanishing points. Moving a node lets you edit a two-point perspective; moving a vanishing point lets you edit a one-point perspective.

After you apply a perspective effect, you can copy it to other objects in a drawing, adjust it, or remove it from the object.

To apply a perspective

To

Apply a one-point perspective

Apply a two-point perspective



Pressing **Ctrl** constrains the node's movement to the horizontal or vertical axis to create a one-point perspective effect.



Press **Ctrl + Shift** as you drag to move two adjacent nodes symmetrically towards or away from a central point. This is useful when you want to distort an image symmetrically.

Do the following

Click **Effects** ► **Add perspective**. Press **Ctrl**, and drag a node.

Click **Effects** ► **Add perspective**. Drag the nodes on the outside of the grid to apply the effect you want.

To copy an object's perspective effect

- 1 Select an object to which you want to apply a perspective effect.

- 2 Click **Effects** ▶ **Copy effect** ▶ **Perspective from**.
- 3 Select an object whose perspective effect you want to copy.



You can also use the **Attributes eyedropper** tool  to copy a perspective effect. For more information, see [“To copy effects from one object to another” on page 273](#).

To adjust the perspective

- 1 In the toolbox, click the **Shape** tool .
- 2 Select an object that has a perspective effect.
- 3 Drag a node to a new position.



Pressing **Ctrl** constrains a node’s movement to the horizontal or vertical axis to create a one-point perspective effect.

Splitting, cropping, or erasing portions of an object with perspective flattens the perspective effect, so you can no longer edit it.



You can also adjust one-point perspective by dragging a [vanishing point](#).

Press **Ctrl** + **Shift** as you drag to move adjacent nodes closer together or further apart along a horizontal or vertical axis. This is useful when you want to achieve a symmetrical perspective effect.

To remove a perspective effect from an object

- 1 Select an object that has a perspective effect.
- 2 Click **Effects** ▶ **Clear perspective**.

Creating extrusions

You can make objects appear three-dimensional by creating extrusions. You can create extrusions by projecting points from an object and joining them to create an illusion of three dimensions. CorelDRAW also lets you apply a vector extrusion to an object in a group.

After you create an extrusion, you can **copy** or **clone** its attributes to a selected object. Cloning and copying transfer the extrusion attributes of an extruded object to another. However, the cloned extrusion settings cannot be edited independently from the **master**.

You can change an extruded form by rotating it and rounding its corners.

CorelDRAW also lets you remove a vector extrusion.

Bevels

Another way in which you can give an object a three-dimensional appearance is by applying a beveled edge to an extrusion. A bevel creates the illusion that an object’s extruded edges are cut on an angle. You can specify the angle and depth values of the bevel to control the effect.

You can create a bevel effect without extruding an object. For more information, see [“Creating bevel effects” on page 443](#).

Extruded fills

You can apply fills to an entire extrusion or only to the extruded surfaces. You can cover each surface individually with the fill, or you can drape the fill so that it blankets the entire object with no breaks to the pattern or texture.

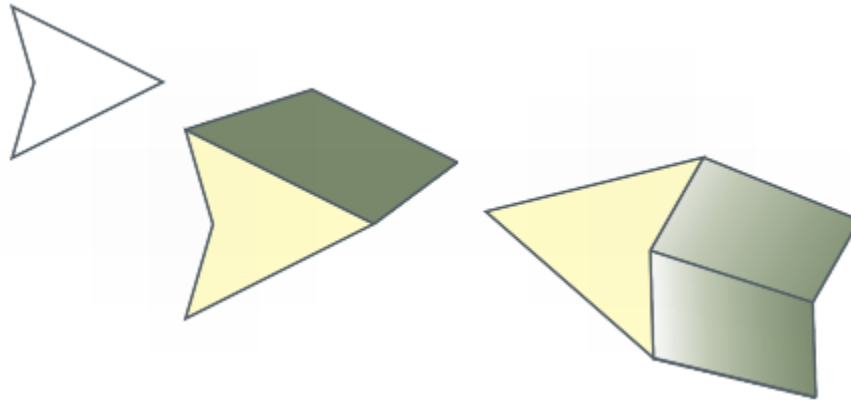

Left to right: a simple shape, the shape with an extruded fill of solid color, the shape with an extruded gradient fill and a rotation applied.

Lighting

You can enhance extrusions by applying light sources. You can add up to three light sources to project toward the extruded object with varying intensity. When you no longer need light sources, you can remove them.

Vanishing points



You can create a vector extrusion in which the lines of the extrusion converge at a [vanishing point](#). The vanishing point of a vector extrusion can be copied to another object so that both objects appear to recede toward the same point.

You can also give extrusions different vanishing points.



Extrusions with different vanishing points

To create an extrusion

- 1 Select an object using the Pick tool .
- 2 In the toolbox, click the Extrude tool .
- 3 Choose a preset from the Presets list box on the property bar.
- 4 Choose an extrusion type from the Extrusion type list box on the property bar.

If you want to reset the extrusion, press **Esc** before releasing the mouse button.



You can also create an extrusion by using the **Extrude** docker (**Effects** ► **Extrude**).

To copy or clone an extrusion

- 1 Select the object you want to extrude.
- 2 Click **Effects** and click one of the following:
 - **Copy effect** ▶ **Extrude from**
 - **Clone effect** ▶ **Extrude from**
- 3 Click an object whose extrusion properties you want to copy.



You can also use the **Attributes eyedropper tool**  to copy an extrusion. For more information, see [“To copy effects from one object to another”](#) on page 273.

To change the form of a vector extrusion

To

Rotate an extrusion

Do the following

Select an extruded object. Click the **Extrude rotation** button  on the property bar. Drag the extrusion in the direction you want.

Change the direction of an extrusion

Using the **Extrude** tool , click an extrusion. Click the vanishing point, and drag in the direction you want.

Change the depth of an extrusion

Using the **Extrude** tool , click an extrusion. Drag the slider between the interactive vector handles.

Round the corners of an extruded rectangle or square

In the toolbox, click the **Shape** tool . Drag a corner node along the outline of the rectangle or square.



To remove a vector extrusion



- 1 Select an extruded object.
- 2 Click **Effects** ▶ **Clear extrusion**.



You can also remove a vector extrusion by clicking the **Clear extrusion** button  on the property bar.

To apply a fill to an extrusion



- 1 Select an extruded object with the **Extrude** tool .
- 2 Click the **Extrusion color** button on the property bar.
- 3 Click one of the following buttons:
 - **Use object fill**  — applies the object’s fill to the extrusion

- Use **solid color**  — applies a solid color to the extrusion
- Use **color shading**  — applies a gradient fill to the extrusion



You can apply an unbroken pattern or texture fill to an object by enabling the **Drape fills** check box before you click the **Use object fill** button.

To apply beveled edges to an extrusion



- 1 In the toolbox, click the **Extrude** tool .
- 2 Select an extruded object.
- 3 Click the **Extrusion bevels** button  on the property bar.
- 4 Enable the **Use bevel** check box.
- 5 Type a value in the **Bevel depth** box.
- 6 Type a value in the **Bevel angle** box.



You can also set the bevel depth and angle by using the **Bevel interactive display** box  below the **Use bevel** check box.

You can show only the bevel and hide the extrusion by enabling the **Show bevel only** check box.

To add light to an extrusion

- 1 Select an extruded object.
- 2 Click the **Extrusion lighting** button  on the property bar.
- 3 Click any of the three **Light** buttons .

The lights appear as numbered circles in the preview window.
- 4 Drag the numbered circles in the **Light intensity preview** window to position the lights.

If you want to create more realistic shading, enable the **Use full color range** check box.

You can also

Adjust the intensity of a light source

Select a light in the **Light intensity preview** window, and move the **Intensity** slider.

Remove a light source

Click an active **Light** button.

To change the vanishing point of an extrusion

To

Do the following

Lock a vanishing point

Double-click an extruded object. Choose **VP locked to object** or **VP locked to page** from the **Vanishing point properties** list box on the property bar.

To

Copy a vanishing point

Set one vanishing point for two extrusions

Do the following

Double-click an extruded object whose vanishing point you want to change. From the **Vanishing point properties** list box on the property bar, choose **Copy VP from**. Select the extruded object that has the vanishing point you want to copy.

Double-click an extruded object. Choose **Shared vanishing point** from the **Vanishing point properties** list box on the property bar. Select the extruded object that has the vanishing point you want to share.

Creating bevel effects

A bevel effect adds 3D depth to a graphic or text object by making its edges appear sloped (cut at an angle). Bevel effects can contain both spot and process (CMYK) colors, so they are ideal for printing.

You can remove a bevel effect at any time.

Bevel effects can be applied only to vector objects and artistic text, not to bitmaps.

Bevel styles

You can choose from the following bevel styles:

- **Soft edge** — creates beveled surfaces that appear shaded in some areas
- **Emboss** — makes an object appear as a relief



Left to right: Logo without a bevel effect, with a Soft Edge bevel effect, and with an Emboss bevel effect

Beveled surfaces

You can control the intensity of the bevel effect by specifying the width of the beveled surface.

Light and color

An object with a bevel effect appears lit by white ambient (surrounding) light and a spotlight. The ambient light is of low intensity and cannot be changed. The spotlight is also white by default, but you can change its color, intensity, and location. Changing the spotlight color affects the color of the beveled surfaces. Changing the spotlight's intensity lightens or darkens the beveled surfaces. Changing the location of the spotlight determines which beveled surfaces appear lit.

You can change the location of the spotlight by specifying its direction and altitude. Direction determines where the light source is located in the plane of the object (for example, to the left or right of an object). Altitude determines how high the spotlight is located in relation to the object's plane. For example, you can place the spotlight flush with the horizon (altitude of 0°) or directly above the object (altitude of 90°).

In addition, you can change the color of the beveled surfaces that are in shadow by specifying a shadow color.

To create a Soft Edge bevel effect

- 1 Select an **object** that is **closed** and has a fill applied to it.
- 2 Click **Effects** ► **Bevel**.
- 3 In the **Bevel** docker, choose **Soft edge** from the **Style** list box.
- 4 Enable one of the following **Bevel offset** options:
 - **To center** — lets you create beveled surfaces that meet in the middle of the object
 - **Distance** — lets you specify the width of the beveled surfaces. Type a value in the **Distance** box.

You can also

Change the color of beveled surfaces in shadow

Choose a color from the **Shadow** color picker.

Beveled surfaces change to a shade of the specified shadow color.

Choose a spotlight color

Choose a color from the **Light** color picker.

Change the intensity of the spotlight

Move the **Intensity** slider.

Specify the position of the spotlight

Move either of the following sliders:

- **Direction**
- **Altitude**

Direction values range from 0° to 360°; altitude values range from 0° to 90°.



Bevel effects can be applied only to artistic text. You can convert paragraph text to artistic text by selecting the text using the **Pick** tool and then clicking **Text** ► **Convert to artistic text**.

The lowest altitude value (0°) places the spotlight on the plane of the object; the highest altitude value (90°) places the spotlight directly above the object.

The effect of the shadow color is most apparent when the spotlight is located close to the object's plane (low altitude value).

Using a given altitude value, you can change the spotlight's location by changing the direction value. For example, at an altitude of 45°, the following direction values change the spotlight location as noted:

- 45° places the spotlight on the upper right.
- 135° places the spotlight on the upper left.
- 225° places the spotlight on the lower left.
- 315° places the spotlight on the lower right.

To create an Emboss effect

- 1 Select an **object** that is **closed** and has a fill applied to it.

- 2 Click **Effects** ► **Bevel**.
- 3 In the **Bevel** docker, choose **Emboss** from the **Style** list box.
- 4 In the **Distance** box, type a low value.
- 5 To change the intensity of the spotlight, move the **Intensity** slider.
- 6 To specify the direction of the spotlight, move the **Direction** slider.
- 7 Click **Apply**.

If you want to create a more pronounced bevel effect, type a higher value in the **Distance** box, and reapply the effect.

You can also

Choose a shadow color

Choose a color from the **Shadow** color picker.

Choose a spotlight color

Choose a color from the **Light** color picker.



The Emboss bevel effect is achieved by creating two duplicates of the object. The duplicates are offset in opposite directions: one toward the light source and the other away from the light source. The color of the duplicate placed toward the spotlight is a blend of the spotlight and object colors and depends on the light intensity. The color of the duplicate placed away from the spotlight is a 50 percent blend of the shadow and object colors.

The **Altitude** slider is disabled for the Emboss bevel style.

To remove a bevel effect

- 1 Select an object with a bevel effect applied.
- 2 Click **Effects** ► **Clear effect**.

Creating drop shadows

Drop shadows simulate light falling on an object from one of five particular perspectives: flat, right, left, bottom, and top. You can add drop shadows to most objects or groups of objects, including [artistic text](#), [paragraph text](#), and [bitmaps](#). You can also use extrusions to create shadows.

Drop shadows and extrusions created in CorelDRAW are ideal for printed outputs, but are not appropriate for output to devices such as vinyl cutters and plotters. Cuttable shadows are needed for such projects. To add a cuttable shadow to an object, you must use a block shadow. For more information about block shadows, see ["Adding block shadows" on page 448](#). You can also create a cuttable shadow by duplicating the object, filling the duplicate with a dark color, and then placing it behind the original object.

When you add a drop shadow, you can change its perspective, and you can adjust attributes such as color, [opacity](#), fade level, angle, and [feathering](#).



A drop shadow applied to an object



The feathered effect softens the edges of a drop shadow.

Drop shadows look more realistic when they use Gaussian Blur feathering, which is the default option. You can change the feathering of drop shadows from the **Feathering direction** button on the property bar.

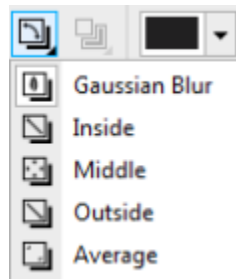

Feathering options for drop shadows

After you create a drop shadow, you can copy it or [clone](#) it to a selected object. When you copy a drop shadow, the original and copy have no connection and can be edited independently. With cloning, the master object's drop shadow attributes are automatically applied to its clone.

By separating a drop shadow from its object, you gain more control over the drop shadow itself. For example, you can edit the drop shadow as you would edit a transparency. For information about editing a transparency, see ["Changing the transparency of objects"](#) on page 389.

As with transparencies, you can apply a merge mode to a drop shadow to control how the color of the drop shadow blends with the color of the object underneath. For more information about merge modes, see ["Applying merge modes"](#) on page 398.

You can remove a drop shadow.

To add a drop shadow

- 1 In the toolbox, click the **Drop shadow** tool .
- 2 Click an object.
- 3 Drag from the center or side of the object until the drop shadow is the size you want.
- 4 Specify any attributes on the property bar.



Drop shadows cannot be added to linked groups, such as blended objects, contoured objects, beveled objects, extruded objects, objects created with the **Artistic media** tool , or other drop shadows.

To add a cuttable shadow

- 1 Select an object.
- 2 Click **Edit** ▶ **Duplicate**.
- 3 Click a dark color on the onscreen color palette.
- 4 Click **Object** ▶ **Order** ▶ **Behind**, and click the original to position the duplicate behind it.
- 5 Adjust the position of the duplicate.



You can also create a cuttable shadow by using the **Block Shadow** tool . For more information, see [“To add a block shadow” on page 449](#).

To copy or clone a drop shadow

- 1 Select the object to which you want to copy or clone a drop shadow.
- 2 Click **Effects** and click one of the following:
 - **Copy effect** ▶ **Drop shadow from**
 - **Clone effect** ▶ **Drop shadow from**
- 3 Click the drop shadow of an object.



You can also use the **Attributes eyedropper** tool  to copy a drop shadow. For more information, see [“To copy effects from one object to another” on page 273](#).

To separate a drop shadow from an object

- 1 Select an object's drop shadow.
- 2 Click **Object** ▶ **Break drop shadow group apart**.
- 3 Drag the shadow.

To apply a merge mode to a drop shadow

- 1 In the toolbox, click the **Drop shadow** tool .
- 2 Select an object with a drop shadow, and choose a merge mode from the **Merge mode** list box on the property bar.



The default merge mode Multiply produces natural-looking drop shadows.

To remove a drop shadow

- 1 Select an object's drop shadow.
- 2 Click **Effects** ► **Clear drop shadow**.



You can also remove a drop shadow from an object by clicking the **Clear drop shadow** button  on the property bar.

Adding block shadows

The **Block Shadow** tool in CorelDRAW lets you add solid shadows to objects and text. Unlike drop shadows and extrusions, block shadows consist of simple lines, which makes them ideal for screen printing and sign making.



Text with a block shadow

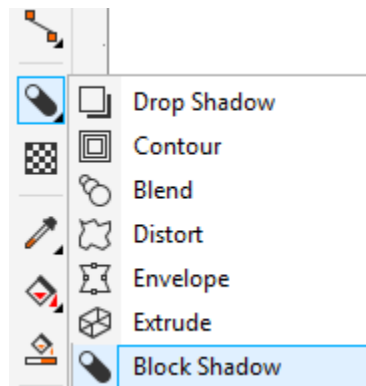

The Block Shadow tool is located on the Interactive tool flyout.

You can adjust the depth and direction of a block shadow, and you can change its color. A block shadow may contain holes, but you can remove them to create a solid curve object.

By default, a block shadow is generated from the object outline. You can also choose to ignore the outline and start the block shadow from the object edge. The effect of this option is more obvious when an object has a thick outline. In addition, you can expand a block shadow that is generated from the object outline.

lorem

lorem lorem lorem

Top: Original text. In the bottom row, different block shadows are added to the text. Lower-left: The block shadow extends from the object outline. Middle: The block shadow ignores the outline. Lower-right: The block shadow is expanded.

If you are planning to print or export your document, you can specify block shadow settings to suit your needs. For example, you can set a block shadow to overprint, that is to print on top of underlying objects. Also, overlapping areas between the object and its block shadow can be removed when the document is exported or printed.

You can remove block shadows from objects at any time.

To add a block shadow

- 1 In the toolbox, click the **Block Shadow** tool .
- 2 Click the object, and drag in the direction you want until the block shadow is the size you want.

To edit a block shadow

- 1 Using the **Block Shadow** tool , click the object.
- 2 Perform any of the tasks from the following table.

To

Adjust the depth of a block shadow

Do the following

Type a value in the **Depth** box.

Tip: You can also adjust the depth by dragging the vector handle in the drawing window.



Adjusting the depth of a block shadow

Set the direction of a block shadow

Type a value in the **Direction** box.

To

Change the color of a block shadow

Remove the holes from a block shadow

Expand a block shadows that is generated from the outline

Ignore the outline when generating a block shadow

To set printing and exporting options for block shadows

- 1 Using the **Block Shadow** tool , click the object.
- 2 Perform any of the tasks from the following table.

Do the following

This value specifies the angle of the block shadow in relation to the object.

Tip: You can also change the direction of a block shadow by dragging the triangular handle in the drawing window.

Choose a color from the **Block shadow color** picker on the property bar.

Tip: You can also change the color by dragging a color from the color palette to the vector handle in the drawing window.

Click the **Remove holes** button  on the property bar to enable it.



Top: A block shadow with holes. Bottom: The same block shadow with the holes removed.

On the property bar, click the **Generate from object outline** button  to enable it. Type a value in the **Expand block shadow** box on the property bar.

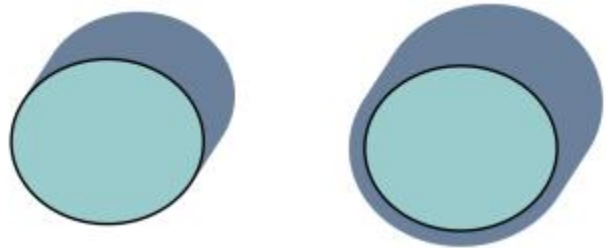

The block shadow on the right is expanded.

On the property bar, click the **Generate from object outline** button  to disable it.

To

Set a block shadow to print on top of underlying objects

Trim overlapping areas between the object and its block shadow

Do the following

Click the **Overprint block shadow** button .

Click the **Simplify** button .



dolor sit amet
dolor sit amet

The bottom row shows a block shadow that has been trimmed to remove the area where the text and block shadow overlap.

To remove a block shadow

- 1 Using the **Block Shadow** tool, click the block shadow.
- 2 Click the **Clear block shadow** button  on the property bar.

Blending objects

CorelDRAW lets you create blends, such as straight-line blends, blends along a [path](#), and compound blends. Blends are often used for creating realistic shadows and highlights in objects.



The highlights and shadows in the object on the right were created by using blends.

A straight-line blend shows a progression in shape and size from one [object](#) to another. The outline and fill colors of the intermediate objects progress along a straight-line path across the color spectrum. The outlines of intermediate objects show a gradual progression in thickness and shape.

After you create a blend, you can copy or clone its settings to other objects. When you copy a blend, the object takes on all the blend-related settings, except for the outline and fill attributes. When you clone a blend, changes you make to the original blend (also called the master) are applied to the clone.

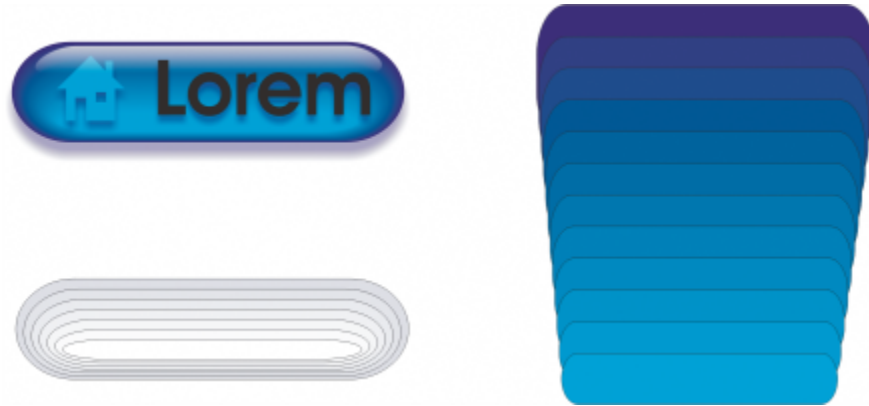

Straight-line blends can be used to create graphics with a glass-like appearance. The rollover button (left) contains a blend of tightly overlapped blended objects.

You can fit objects along part or all of a path's shape, and you can add one or more objects to a blend to create a compound blend.

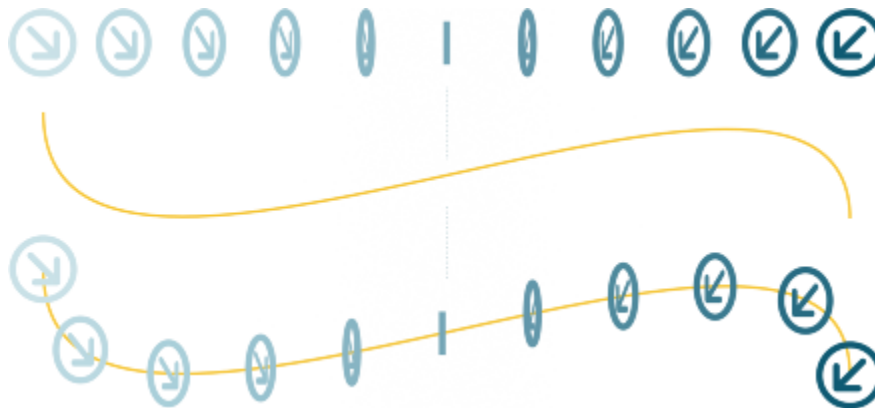

The straight-line blend (top) is fitted to a curved path (bottom).

You can change the appearance of a blend by adjusting the number and spacing of its intermediate objects, the blend's color progression, the nodes the blends map to, the blend's path, and the start and end objects. You can fuse the components of a split or compound blend to create a single object.



This compound blend consists of three blends.

You can also split and remove a blend.

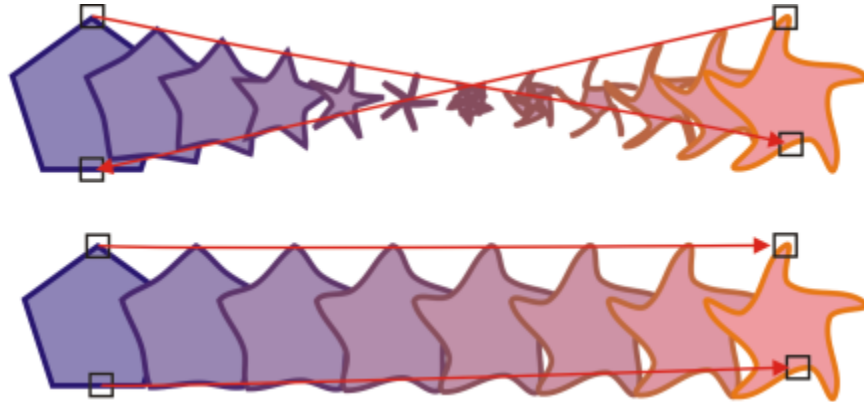

By mapping nodes, you can control the appearance of a blend. Two nodes on the polygon are mapped to two nodes of a star shape, showing a more gradual transition (bottom).

To blend objects

To

Blend along a straight line



Do the following

In the toolbox, click the **Blend** tool . Select the first object, and drag over the second object. If you want to reset the blend, press **Esc** as you drag.

Blend an object along a freehand path

In the toolbox, click the **Blend** tool. Select the first object. Hold down **Alt**, and drag to draw a line to the second object.

Fit a blend to a path

In the toolbox, click the **Blend** tool . Click the **Path properties** button  on the property bar. Click **New path**. Using the curved arrow, click the path to which you want to fit the blend.

Stretch the blend over an entire path

Select a blend that is already fitted on a path. Click the **More blend options** button  on the property bar, and enable the **Blend along full path** check box.

Create a compound blend

Using the **Blend** tool, drag from an object to the start or end object of another blend.



You can also blend objects by using the **Blend** docker (**Effects** ► **Blend**).

To copy or clone a blend

- 1 Select the two **objects** that you want to blend.
- 2 Click **Effects**, and click one of the following:
 - **Copy effect** ► **Blend from**

- Clone effect ► Blend from

3 Select the blend whose attributes you want to copy or clone.



You can't copy or clone a compound blend.



You can also use the **Attributes eyedropper** tool  to copy a blend. For more information, see ["To copy effects from one object to another"](#) on page 273.

To set the number of intermediate objects in a blend

- 1 Select a blend.
- 2 Type a value in the **Blend objects** box on the property bar.
- 3 Press **Enter**.



You can set **object** and color acceleration rates by clicking the **Object and color acceleration** button  on the property bar and moving the corresponding slider.

To set the distance between objects in a blend that is fit to a path

- 1 Select a blend that is fit to a path.
- 2 Click the **Blend spacing** button  on the property bar.
- 3 Type a value in the **Blend objects** box on the property bar.
- 4 Press **Enter**.





If you have used the **Blend along full path** command, the **Blend spacing** button is unavailable.



You can set **object** and color acceleration rates by clicking the **Object and color acceleration** button  on the property bar and moving the corresponding slider.

To set the color progression in a blend

- 1 Select a blend.
- 2 On the property bar, click one of the following:

- Direct blend 
- Clockwise blend 
- Counterclockwise blend 



You can't create color progressions by using blended **objects** filled with bitmaps, texture, pattern, or PostScript fills.



You can set how fast the object's colors transform from the first to the last object by clicking the **Object and color acceleration** button  on the property bar and moving the corresponding sliders.

To map the nodes of a blend

- 1 Select a blend.
- 2 Click the **More blend options** button  on the property bar, and click **Map nodes**.
- 3 Click a node on the start **object** and on the end object.

To work with the start or end objects in a blend

To

Select the start or end object



Do the following

Select a blend, click the **Starting and ending objects** button  on the property bar, and click **Show start** or **Show end**.

Change the start or end object of a blend

Select a blend, click the **Starting and ending objects** button on the property bar, and click **New start** or **New end**. Click an object outside the blend that you want to use as the start or end of the blend.

Fuse the start or end object in a split or compound blend

Hold down **Ctrl**, click a middle object in a blend, and then click a start or end object. Click the **More blend options** button  on the property bar. If you have selected the start object, click the **Fuse start** button . If you have selected the end object, click the **Fuse end** button .



You can reverse the direction of the blend by clicking **Object** ▶ **Order** ▶ **Reverse order**.

To change the blend path

- 1 Select a blend.
- 2 Click the **Path properties** button  on the property bar, and click **New path**.
- 3 Click the **path** you want to use for the blend.

You can also

Detach a blend from a path

Click the **Path properties** button  on the property bar, and click **Detach from path**.

Change the path of a selected freehand blend

Click the blend path with the **Shape** tool , and drag a path's node.



To select the blend path, click the **Path properties** button , and click **Show path**.

To split a blend

- 1 Select a blend.
- 2 Click the **More blend options** button  on the property bar.
- 3 Click the **Split** button .
- 4 Click the intermediate **object** at the point at where you want to split the blend.



You can't split a blend at the intermediate object that is immediately adjacent to the start or end object.

To remove a blend

- 1 Select a blend.
- 2 Click **Effects** ► **Clear blend**.



You can also remove a selected blend by clicking the **Clear blend** button  on the property bar.

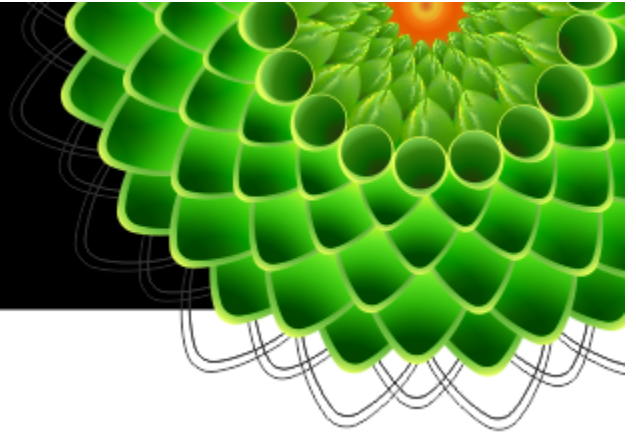

Creating mosaics

The Pointillizer and PhotoCocktail effects let you create mosaics from objects and images.

This section contains the following topics:

- “Creating vector mosaics with the Pointillizer effect” (page 457)
- “Creating bitmap mosaics with the PhotoCocktail effect” (page 461)

Creating vector mosaics with the Pointillizer effect

The Pointillizer effect lets you create high-quality vector mosaics from any number of selected vector or bitmap objects. Whether you are looking to create precise halftone patterns or artistic effects that resemble pointillistic art, this effect will give you the inspiration and tools you need to create striking designs.



A vector mosaic created with Pointillizer

Vector mosaics created with Pointillizer are ideal for vehicle wraps and window decor projects. You can fine-tune your designs to perfection by using an array of controls.

To create a vector mosaic

- 1 Select a vector object or bitmap.
You can also select multiple objects or groups of objects.

- 2 Click **Effects** ► **Pointillizer**.
 - 3 In the **Pointillizer** docker, adjust any settings you want.
 - 4 Click **Apply**.
- If you want to cancel the rendering process, press **Esc**.

To fine-tune a vector mosaic

Use any of the controls in the **Pointillizer** docker to customize and fine-tune your vector mosaic.

Density: This control lets you adjust the number of tiles per square inch.

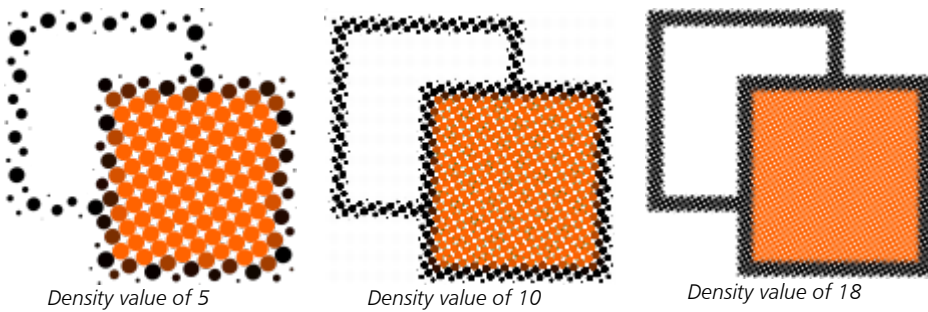

Scale: This control lets you adjust the size of all tiles by scaling them up or down. Values higher than the default value of 1 increase the tile size; values lower than 1 decrease the size.

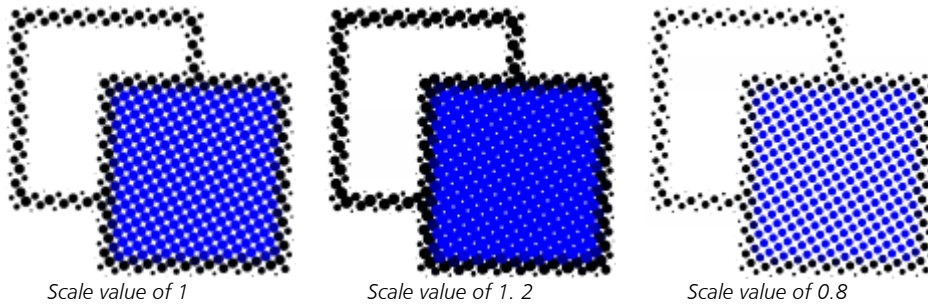

Screen angle: Use this control to rotate each row of tiles about the horizontal axis by the angle you specify. Positive values rotate the rows counterclockwise.

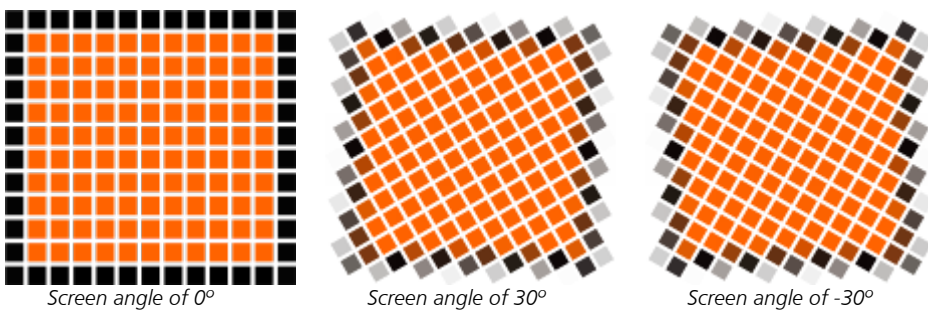

Keep original: When you enable the **Keep original** check box, the source graphic is preserved, and the vector mosaic (output) is placed on top. Disable the check box to have the source deleted automatically after the mosaic is created.

Limit colors: Enable this check box to control the number of colors that are used for rendering the mosaic. To specify the maximum number of colors in the output, type a value in the **Number** box.



Source (original)



With the Limit color check box disabled

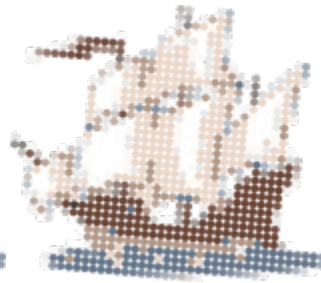

Limiting colors to maximum of 8

Tracing options

Choose from a selection of tracing algorithms to customize the mosaic.

Method lets you choose a technique for interpreting the source graphic. Three tracing methods are available — Uniform (white matte), Size modulation 1 (opacity), and Size modulation 2 (luminosity).

- **Uniform (white matte)** uses tiles of the same size to generate the mosaic. Transparencies are flattened against a white background.
- **Size modulation 1 (opacity)** interprets the source as a series of tiles that vary in size based sampled opacity values. The more opaque (less transparent) the areas are, the bigger the tiles are.
- **Size modulation 2 (luminosity)** interprets the source graphic based on its brightness values. Brighter areas in the source are rendered as smaller tiles; darker areas are rendered as bigger tiles.



Source



Merge adjacent lets you specify the maximum number of tiles of similar color to be combined into a single tile. This setting has effect only if there is enough space available.

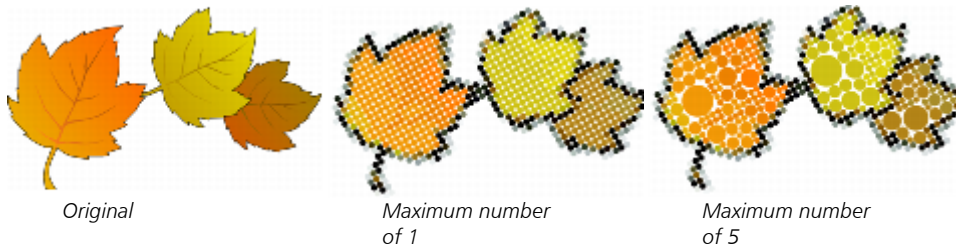

Weld adjacent lets you weld together overlapping tiles. Enable this check box to render the output in clusters of color; disable the check box to preserve more details.



Shape

The **Shape** list box lets you pick one of the preset tile shapes such as a circle or square. To use a custom tile shape, do the following:

- 1 Choose **Custom** from the **Shape** list box.
- 2 Click **Select** at the bottom of the **Preview** area.
- 3 Click a closed curve in the drawing window.
The **Preview** area shows the selected tile shape.



Circular tiles



Square tiles



Custom tiles

Creating bitmap mosaics with the PhotoCocktail effect

The **PhotoCocktail** effect lets you turn your photos and vector art into unique mosaics composed of selected images.



Turning artwork into a mosaic composed of images (Elements from artwork by Ariel Garaza Díaz)

You can customize your mosaic by adjusting the number of tiles and the extent to which your photo or vector art blends with the mosaic tiles. You can create the mosaic as a single bitmap or as an array of bitmap tiles that are easy to edit. Several methods are available to help you control the quality of the mosaic.

To create a mosaic from bitmap or vector objects

- 1 Select the reference image (bitmap, vector object, or group of objects) that you want to recreate as a mosaic.
- 2 Click **Effects** ► **PhotoCocktail**.
- 3 In the **PhotoCocktail** docker, click **Browse** in the **Library** area, and browse to the image library, the folder that contains the images to be used as tiles. Click **Select folder**.
PhotoCocktail indexes the images and shows how many of them can be used as tiles. The **Path** control shows the location of the selected image library.
- 4 Choose any settings you want.
- 5 Click **Apply**.

To choose settings

Additional controls are available in the **PhotoCocktail** docker to help you customize the effect.

Reference

Keep original: Enable this check box if you want to keep the reference image or objects after applying the effect. Disable the check box to delete the reference image and leave only the mosaic.

Grid density

Columns: This box lets you specify how many columns of tiles to include in the mosaic. The bigger the number, the more detail in the mosaic.

Rows: Shows the number of rows to be included in the mosaic. The number is automatically calculated based on the value in the **Columns** box.



Left: Mosaic with low grid density (fewer columns and rows); Right: Mosaic with high grid density

Optimization

You can recreate the reference image more accurately by applying a blending effect. Blending lets you superimpose the reference image over the mosaic tiles.

Blending: This box lets you specify to what extent to blend the reference colors with the tile colors. Higher values increase the likeness of the mosaic to the reference image.



Left: No blending; Right: Large amount of blending applied

Duplicates

You can use duplicate tiles in the final mosaic.

Allow duplicates: Enable this check box to repeat tiles in the final mosaic. You can specify the minimum number of tiles that surround duplicate tiles in the **Min. distance** box.

Output

Output controls let you define the composition and quality of the final mosaic.

Composition: This list box lets you choose one of the following options:

- **Single bitmap** renders the mosaic as a single rasterized image, with the blending effect incorporated in the image.
- **Bitmap stack** produces a single rasterized image with the blending effect layered on top as a single object.
- **Bitmap array** creates a group of bitmap tiles, with the blending effect layered on top as a single object.

Edges: This list box lets you choose a method for treating incomplete tiles around the edges. For example, incomplete tiles around the edges can be removed from the final mosaic, or the output can be stretched to match the reference image. Stretching the output results in mosaic tiles that are rectangular rather than square.



Left: Tiles are stretched to match the dimensions of the reference image; Right: Partial tiles along the bottom edge are removed.

Priority: This list box lets you choose one of the following methods for adjusting the output quality:

- The **Match document DPI** method automatically generates a mosaic that has the same DPI (dots per inch) as the active document.
- The **Custom DPI** method lets you specify the dpi of the final mosaic in the DPI box.
- The **Custom tile dimensions** method lets you specify the width of each tile in the first Tile box. The tile height is automatically calculated. Tile dimensions are shown in pixels.

- The **Custom output dimensions** method lets you specify the width of the final mosaic in the first Artwork box. The height is automatically calculated. The maximum dimensions of a mosaic are 15,000 x 15,000 pixels.

The mosaic DPI is influenced by the grid density and the dimensions of the mosaic.

The tile size is a good indicator of output quality. The higher the tile size, the better the quality. Dividing the mosaic size in pixels by the grid density gives you the tile size in pixels.

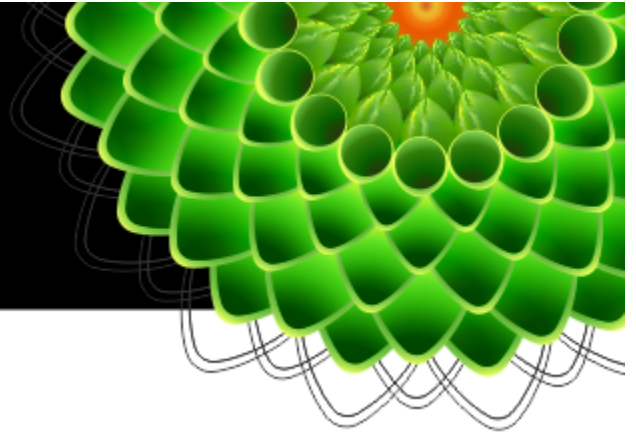

Adding movement and focus

The Impact tool lets you create graphic effects in a style inspired by comic books and contemporary illustrations. Such effects are perfect for adding impact, movement, or focus to designs or illustrations.

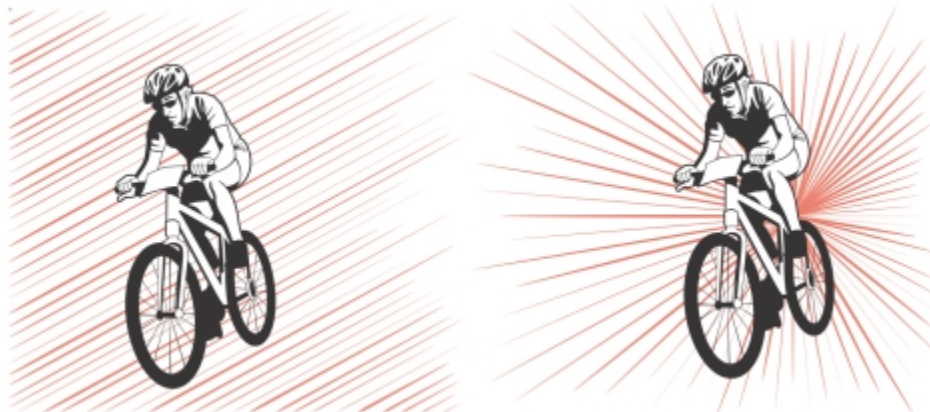

Effects created by using the Impact tool

This section contains the topic [“Adding impact effects”](#) on page 465.

Adding impact effects

Two impact effect styles are available: Radial and Parallel. Radial effects can be used to add perspective or bring focus to a design element. Parallel effects can be used to add energy or signify motion.

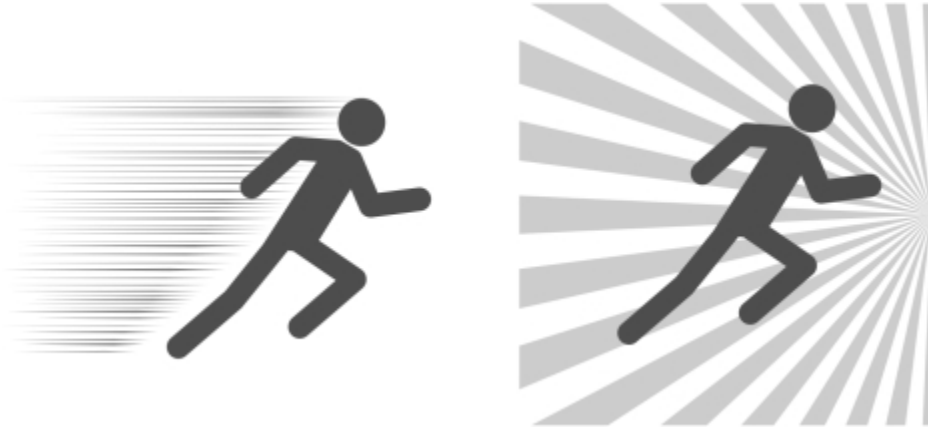

Impact effects: Parallel (left) and Radial (right)

You can shape the impact effect by adding inner and outer boundaries. To customize the effect, you can rotate the effect lines and change the line width and spacing as well as the shape of each stroke. You can also randomize line settings for a more natural look. For example, lines can start and end randomly within the boundaries of an effect.

The effects are vector objects and can be edited with other tools in CorelDRAW. For example, you can distort or reshape the effect lines, and you can change the effect color.

To add an impact effect

- 1 Click the **Impact** tool  in the toolbox.
- 2 On the property bar, choose **Radial** or **Parallel** from the **Effect style** list box.
- 3 Drag in the drawing window.
To resize the effect, drag the blue node along its edge.
- 4 Adjust any settings on the property bar.
For information about adding boundaries, see [“To add and remove effect boundaries”](#) on page 466.
For information about line and line spacing settings, see [“To adjust additional settings”](#) on page 468.

To add and remove effect boundaries

You can constrain the effect within inner and outer boundaries by using other objects as reference shapes. The reference objects are not connected to the effect and can be moved, hidden, or deleted without changing the effect appearance.

- 1 Select the effect.
- 2 Position the effect behind the reference objects, exactly where you want the effect to appear.
To place the effect behind the objects, you can use an appropriate command from the **Object** ► **Order** menu (for example, **To Back of Layer**).
- 3 Perform a task from the following table.

To

Add an inner boundary

Do the following

Click the **Inner boundary** button  on the property bar, and click the reference object in the drawing window.

This action shapes the inner edge of the effect, creating a gap with the shape of the selected object.

To

Do the following

If you no longer need the reference object, you can delete it.

Remove the inner boundary

Click the **Remove inner boundary** button .

The gap is removed from the effect, but the reference object used as an inner boundary is not deleted.

Add an outer boundary

Click the **Outer boundary** button , and click the reference object in the drawing window.

This action constrains the effect inside the bounding box of the reference object.

If you no longer need the reference object, you can delete it.

Remove the outer boundary

Click the **Remove outer boundary** button  to restore the effect to its original shape.

This action restores the effect to its original shape but does not delete the reference object that was used to define the outer boundary.



The following objects cannot be used to define boundaries: symbols, objects in text frames, grouped objects, the impact effect itself, and other impact effects.

Reshaping the reference objects after you use them as effect boundaries does not reshape the boundaries. If you need to reshape the boundaries, you must remove them and then add them again.

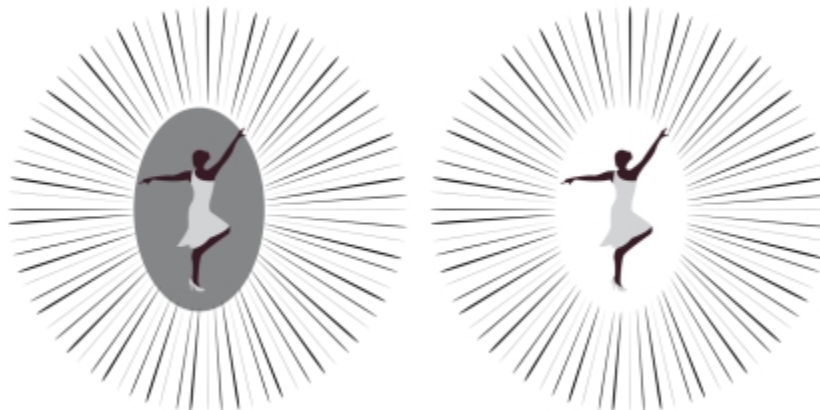

In this example, a gray ellipse is used to define the inner boundary of the effect (left). The ellipse is then deleted (right).



In this example, the red rectangle is used to define the outer boundary of the effect (left). The outer boundary is then removed, and the effect is restored to its original shape (right).

To adjust additional settings

The controls on the property bar let you customize the lines and line spacing in the effect.

Angle of rotation: Type a value to specify the angle of the lines in the effect (parallel style) or rotate the lines around the inner edge (radial style). Note that rotation can be applied to radial effects only if there is an inner boundary to rotate the lines against.

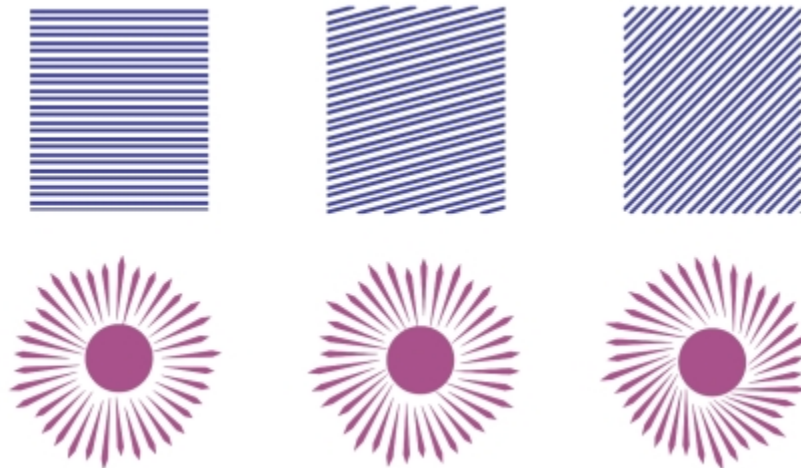

From left to right: Parallel and radial effects without rotation, with 15° rotation, and 45° rotation

Random start and end points : This button lets you start and end lines randomly within the boundaries of the effect. Click the button, and enable any of the following check boxes: **Random start points** and **Random end points**. When these check boxes are disabled, all effect lines start and end at the boundary edges.



From left to right: Before and after randomizing the start and end points of an effect

Line width: Type values in the **Min** and the **Max** box to set the minimum and maximum width for the lines in the effect. The minimum value cannot exceed the maximum value.

Width steps: Set the number of steps between the minimum and maximum width. When the value is 0, there are only two types of lines in the effect: of maximum width and of minimum width. Higher numbers add lines of increasing width between the thinnest and the thickest lines. For example, a value of 2 adds two lines between each line of minimum and maximum width.

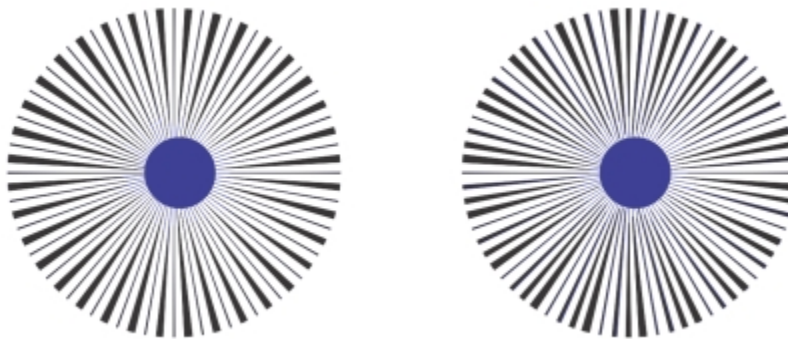

Left: Width step value of 0. Right: Width step value of 2. Two lines are added between the thickest and the thinnest lines in the effect.

Randomize: Click this button to randomize the order of lines in the effect. Lines will no longer appear in a repeating pattern from thinnest to thickest.



From left to right: Before and after randomizing the order of lines.

Line spacing: Type values in the **Min** and **Max** box to set the minimum and maximum amount of space between the lines in the effect. The minimum value cannot exceed the maximum value.

Spacing steps: Set the number of steps between the minimum and maximum line spacing. With a value of 0, there are only two types of spacing between lines: maximum and minimum. Values of 1 and higher create additional types of line spacing.

Randomize spacing order: Enable this check box to randomize the order of the additional spacing between the minimum and maximum line spacing.

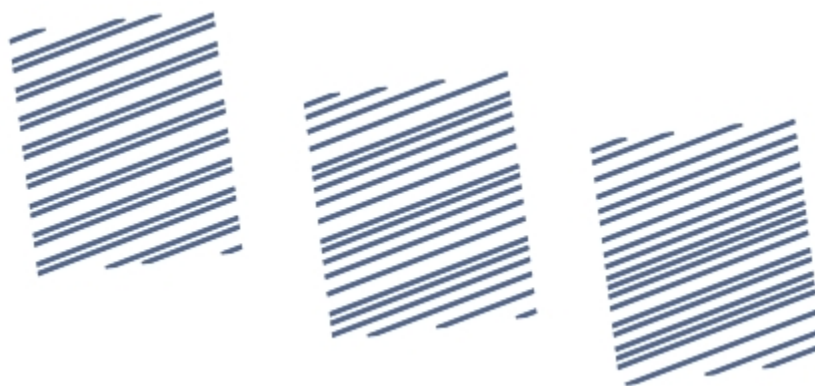

Left: The effect includes two alternating types of line spacing: maximum and minimum. Middle: More line spacing variations (spacing steps) are added. Right: Line spacing variations appear in random order.

Line style: This list box lets you choose a line shape.

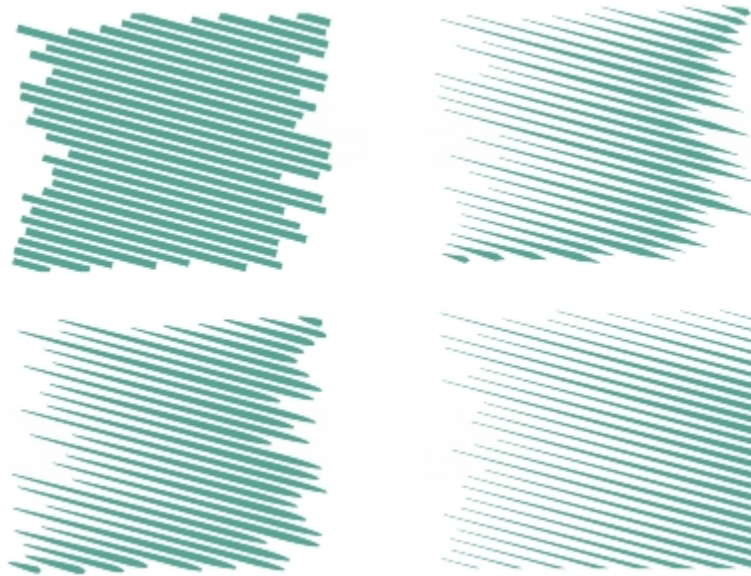

The same impact effect with four different line styles applied

Widest point: Available for line styles that have varying width, this box lets you set the position of the widest line point. The higher the value, the closer the widest points are to the end points of the lines.

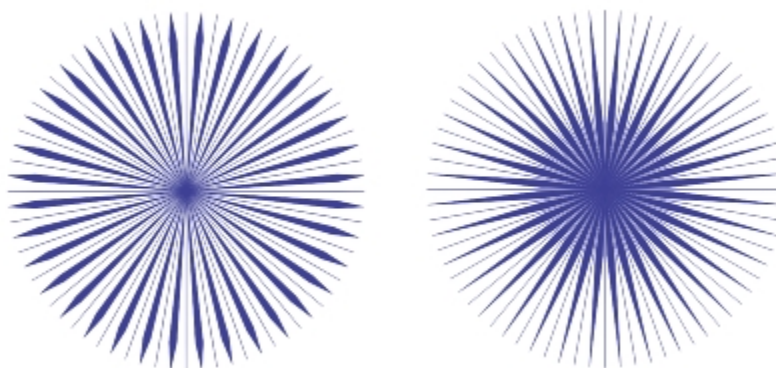

From left to right: A high and a low value of the Widest point setting

To edit an impact effect as a vector object

You can resize, transform, and move an effect the way you would resize, transform, and move any other object in CorelDRAW. You can also use the **Shape** tool to edit individual lines in the effect. In addition, you can change the line and outline color of the effects.

- 1 Select the effect by using the **Pick** tool .
- 2 Perform a task from the following table.

To

Transform an effect

Do the following

Drag the selection handles on the bounding box to size, stretch, and mirror the effect.

To

Do the following

Click the effect again to display a new set of handles, and drag a handle to rotate or skew the effect.

Edit lines by using the **Shape** tool

Click **Object** ► **Break Impact Effect Shape Apart**. Next, ungroup the lines by pressing **Ctrl + U**. Click the **Shape** tool , and edit the lines by adding, removing, and manipulating nodes.

Change the effect color

To change the line color, click a color on the onscreen color palette. To add an outline color to the effect lines, right-click a color on the onscreen color palette.



Each time you adjust a setting on the property bar of the **Impact** tool, the effect is redrawn, and some of the changes you made with the vector-editing tools may be lost. That is why we recommend that you make additional changes only after you finish adjusting the settings of the impact effect.

Text

Adding and manipulating text.....	475
Formatting text.....	499
Working with text in different languages.....	527
Managing fonts.....	533
Using writing tools.....	545

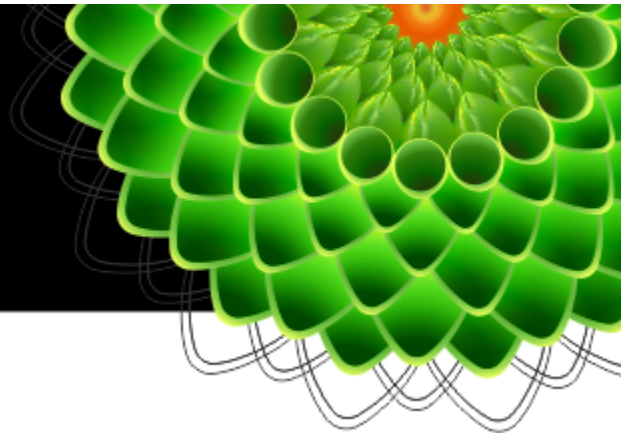

Adding and manipulating text

CorelDRAW provides multiple ways to add and manipulate text (also known as ‘type’). You can create two types of text objects: [artistic text](#) and [paragraph text](#). Artistic text is useful for adding a single word or a short line of text. Paragraph text is suitable for creating text-intensive documents, such as newsletters or brochures.

You can change the position and appearance of text. For example, you can fit text to a path, wrap text around objects, or rotate text. You can also format the appearance of characters and paragraphs. For more information, see [“Formatting text” on page 499](#).

This section contains the following topics:

- [“Importing and pasting text” \(page 475\)](#)
- [“Adding artistic text” \(page 477\)](#)
- [“Adding paragraph text” \(page 477\)](#)
- [“Adding columns to text frames” \(page 481\)](#)
- [“Combining and linking paragraph text frames” \(page 482\)](#)
- [“Aligning text by using the baseline grid” \(page 484\)](#)
- [“Selecting text” \(page 485\)](#)
- [“Finding, editing, and converting text” \(page 486\)](#)
- [“Shifting, rotating, mirroring, and flipping text” \(page 488\)](#)
- [“Moving text” \(page 489\)](#)
- [“Wrapping text” \(page 490\)](#)
- [“Fitting text to a path” \(page 491\)](#)
- [“Inserting special characters, symbols, and glyphs” \(page 493\)](#)
- [“Embedding graphics” \(page 497\)](#)
- [“Working with legacy text” \(page 498\)](#)

Importing and pasting text

You can import text in a new or existing document. This allows you to author text in a word processor and then add it to a CorelDRAW document. CorelDRAW supports the following text file formats:

- ANSI Text (TXT)
- Microsoft Word Document (DOC) files
- Microsoft Word Open XML Document (DOCX) files
- WordPerfect file (WPD)
- Rich Text Format (RTF) files

When importing or pasting text, you can choose to keep or discard fonts and formatting. Maintaining fonts ensures that imported or pasted text retains its original font. Maintaining formatting preserves information such as bullets and columns. If you choose to discard fonts and formatting, the properties of the selected text are applied to the imported or pasted text. If no text is selected, the default font and formatting properties are applied to the imported or pasted text. For more information about importing files, see [“Importing files” on page 789](#). For more information about pasting, see [“To paste an object into a drawing” on page 261](#).



The text import cursor lets you place text on the drawing page.

You can import text in a selected text frame, or, if you did not select a text frame, the imported text is automatically inserted in a new [text frame](#) in the document window. By default, the size of text frames remains static, regardless of how much text you add to them. Any text that does not fit the frame is hidden and the frame appears red until you enlarge it or link it to another text frame. You can adjust the text size so that the text fits perfectly in the frame. For more information, see [“Combining and linking paragraph text frames” on page 482](#).

To import text in a document

- 1 Using the **Text** tool , position the cursor in the text frame where you want to import the text.
If you do not have a text frame in the document, skip step 1 and proceed to step 2.
- 2 Click **File** ► **Import**.
- 3 Choose the drive and folder where the file is stored.
- 4 Click the filename.
- 5 Click **Import**.
- 6 In the **Importing/Pasting text** dialog box, choose one of the following options:
 - **Maintain fonts and formatting**
 - **Maintain formatting only**
 - **Discard fonts and formatting**If you want to apply **CMYK black** to the imported black text, enable the **Force CMYK black** check box. This check box is available when you choose an option that maintains text formatting.
- 7 Do one of the following:
 - Position the import cursor in the drawing page, and click.
 - Click and drag on the drawing page to define the size of the text frame.
 - Press the **Spacebar** to place the imported text in the default location.



For more information about importing a specific file format, see [“Supported file formats” on page 811](#).

To paste text in a document

- 1 Copy or cut text.
- 2 Click **Edit** ► **Paste**.
- 3 In the **Importing/Pasting text** dialog box, enable one of the following options:
 - **Maintain fonts and formatting**
 - **Maintain formatting only**

- **Discard fonts and formatting**

If you want to apply **CMYK black** to the imported black text, enable the **Force CMYK black** check box. This check box is available when you choose an option that maintains text formatting.



If you choose to maintain **fonts**, but the text that you import requires a font that is not installed on your computer, the **PANOSE font matching** system substitutes the font for you. For more information, see [“Substituting fonts” on page 534](#).

You can also set hyphenation options for imported text. For more information about hyphenation options, see [“To create a custom definition for optional hyphenation” on page 523](#).



If you want to use the same formatting options whenever you import or paste text, enable the **Don't show this warning again** check box. To reactivate the warning, click **Tools** ▶ **Options**, click **Warnings** in the **Workspace** list of categories, and enable the **Pasting and importing text** check box.

Adding artistic text

Artistic text is useful for adding single words or short lines of **text**, such as headlines, to a document. You can then apply a wide range of effects to the artistic text, such as drop shadows or a contour.

■ Lorem ipsum dolor sit amet ■

Artistic text appears in a bounding box in the document window

You can add artistic text along an open or **closed path** or fit existing artistic to a path. For more information, see [“Fitting text to a path” on page 491](#).

In addition, you can assign hyperlinks to text. For more information, see [“To assign a hyperlink to text” on page 785](#).

To add artistic text

- Using the **Text tool** **A**, click anywhere on the **drawing page**, and type.



You can convert artistic text to paragraph text by selecting the artistic text using the **Pick tool**  and then clicking **Text** ▶ **Convert to paragraph text**.

Adding paragraph text

You add paragraph text in a document by using **text frames**. **Paragraph text**, also known as “block text,” is generally reserved for larger bodies of text that have greater formatting requirements. For example, you can use paragraph text when creating brochures, newsletters, catalogs, or other text-intensive documents.

You can insert a text frame directly in the drawing window. You can also place text inside a graphic **object**, which increases the number of different shapes that you can use as text frames. You can create a text frame from a closed object and then type text inside the frame. You can separate the frame from the object at any time, so that you can modify them independently. You can convert a text frame back to an object.

If you want to see the layout of your document before you add the final content, you can fill the text frames with temporary placeholder text. You can also use custom placeholder text.

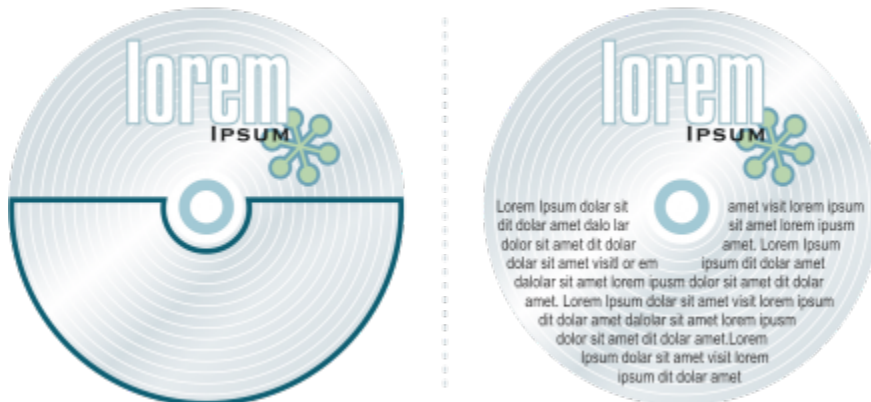

Paragraph text placed inside an object. You can make the object invisible by removing its outline.

By default, text frames have a fixed size, regardless of how much text you add to them. You can increase or decrease the frame size, so that the text fits in the frame. If you add more text than a frame allows, the text continues past the lower-right border of the text frame, but remains hidden. The color of the frame turns red to alert you that there's additional text. You can fix the overflow manually by increasing the frame size, adjusting the text size, adjusting the column width, or linking the frame to another text frame. For more information, see “Combining and linking paragraph text frames” on page 482.

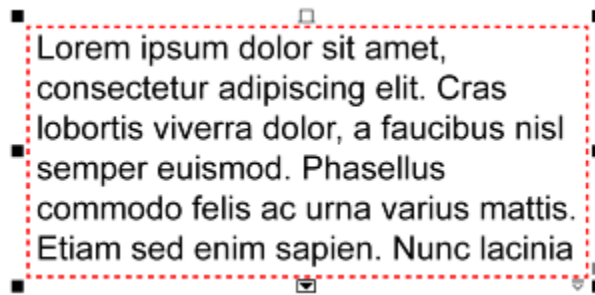

The text frame turns red to indicate that there is additional text.

You can also choose to automatically adjust the point size of text so that it fits neatly inside a frame. If the text overflows, CorelDRAW automatically decreases the point size; if you have little text, the application expands it to fill the frame.



The point size of the text in the frame (left) was automatically adjusted so that it fits neatly inside the frame (right).

You can also change the formatting of selected paragraph text frames and any frames to which they are linked. For information, see “To specify formatting preferences for text frames” on page 484. You can also align text inside a text frame by using the baseline grid. For more information, see “Aligning text by using the baseline grid” on page 484.

In addition, you can assign hyperlinks to paragraph text. For more information, see “To assign a hyperlink to text” on page 785. You can also change the text orientation for Asian text. For more information, see “To choose a text orientation for Asian text” on page 527.

To add paragraph text

- 1 Click the **Text** tool .
- 2 Drag in the drawing window to size the paragraph text frame.
- 3 Type in the text frame.

You can also

Set text frame column width to adjust automatically to fit the text

Click **Window** ▶ **Dockers** ▶ **Object properties**. In the **Object properties** docker, click the **Frame** button  to display the frame-related options. In the **Frame** area, click the **Columns** buttons. In the **Column settings** dialog box, enable the **Automatically adjust frame width** option.

Apply a background color to a text frame

Open the **Background color** picker, and click a color.



A red text frame indicates text overflow. You can fix the overflow manually by increasing the frame size, adjusting the text size, or linking the frame to another text frame. For more information, see “Combining and linking paragraph text frames” on page 482. You can also fix the overflow automatically by clicking **Text** ▶ **Paragraph text frame** ▶ **Fit text to frame**.





You can use the **Pick** tool  to adjust the size of a paragraph text frame. Click the text frame, and drag any selection handle.

To create a frame from an object

- 1 Do one of the following:
 - Using the **Pick** tool , click the object in which you want to insert a text frame.
 - Using a drawing tool, draw a closed shape.
- 2 Select the object, and click **Text** ▶ **Paragraph text frame** ▶ **Create empty text frame**.

You can also

Create a text frame from an object by using the **Text** tool

Click the **Text** tool . Move the pointer over the outline of the object, and click the object when the pointer changes to an **Insert in object** pointer . Type inside the text frame.

Create a text frame from an object from the right-click menu

Right-click the object, and click **Frame type** ▶ **Create empty text frame**.

You can also

Create a text frame from an object by using the **Layout** toolbar

Click **Window** ► **Toolbars** ► **Layout**. Using the **Pick** tool , click the object in which you want to insert a text frame. Click the **Text frame** button.

To convert a text frame back to an object

- Right-click the text frame, choose **Frame type**, and click **None**.



If the frame contains content, the content is deleted when the frame reverts to a regular object.



You can also click the **No frame** button on the **Layout** toolbar. To open the **Layout** toolbar, click **Window** ► **Toolbars** ► **Layout**.

To separate a text frame from an object

- 1 Click the **Pick** tool .
- 2 Select the object that includes the text frame.
- 3 Click **Object** ► **Break paragraph text inside a path apart**.

The text frame and the object can now be moved or edited separately.



When you separate a text frame from some objects, such as ellipses or stars, the text does not retain the shape of the object. Alternatively, the text is contained in a standard rectangular text frame.

To insert placeholder text

- 1 Select an empty text frame.
- 2 Click **Text** ► **Paragraph text frame** ► **Insert placeholder text**.



You can customize the placeholder text by creating text in a word processor or text application and saving the document as placeholder.rtf. You then need to store the file in the following **Users** folder: **My Documents\Coreel\Coreel Content**. The next time that you launch the application, the customized placeholder text is inserted in the text frame. However, if you save the file using an incorrect file name or in the wrong folder, the default Lorem ipsum placeholder text is inserted in the text frame.



You can insert placeholder text in multiple frames by clicking **Pick** tool , selecting the text frames while holding down **Shift**, and then clicking **Text** ► **Paragraph text frame** ► **Insert placeholder text**.

You can also select the empty text frame, right-click, and choose **Insert placeholder text**.

When you insert placeholder text in the first frame in linked frames, the placeholder text fills all frames.

You can undo inserting placeholder text by clicking **Edit** ► **Undo insert placeholder text**.

To adjust text to fill the text frame

- 1 Select a [text](#) frame.
- 2 Click **Text** ► **Paragraph text frame** ► **Fit text to frame**.



If you choose to fit text to a frame that is linked to other frames, the application adjusts the size of text in all linked text frames. For more information about linking text frames, see [“Combining and linking paragraph text frames”](#) on page 482.

Adding columns to text frames

You can lay out text in columns. Columns are useful for designing text-intensive projects, such as newsletters, magazines, and newspapers. You can create columns of equal or varying widths and gutters. You can also apply right-to-left text flow to the columns for bidirectional (bidi) text, such as Arabic and Hebrew (Note that this option is available only for certain languages).



The text in the frame (left) was laid out in two columns (right).

To add columns to a text frame

- 1 Select a [paragraph text](#) frame.
- 2 Click **Window** ► **Dockers** ► **Object properties**.
- 3 In the **Object properties** docker, click the **Frame** button  to display the frame-related options.
- 4 Type a value in the **Number of columns** box.

To resize text frame columns

- 1 Click the **Text** tool  and select a text frame with columns.
- 2 Perform a task from the following table.



To

Manually adjust column and gutter width

Set a specific column and gutter width

Do the following



Click the **Text** tool . Drag a column side selection handle.

In the **Object properties** docker, click the **Frame** button  to display the frame-related options. Click the **Columns** button , and type values in the **Width** or **Gutter** boxes.

To

Automatically create columns of equal width

Do the following

In the **Object properties** docker, click the **Frame** button  to display the frame-related options. Click the **Columns** button , and enable the **Equal column width** check box.

To change the flow of bidirectional text in columns

- 1 Select a **paragraph text** frame.
- 2 Click **Window** ► **Dockers** ► **Object properties**.
- 3 In the **Object properties** docker, click the **Frame** button  to display the frame-related options.
- 4 Enable the **Right-to-left columns** check box.



The **Right-to-left columns** option is available only for bidirectional languages, such as Hebrew and Arabic. The proper keyboard must also be installed.

Combining and linking paragraph text frames

You can combine **text** frames. You can also break text frames apart into subcomponents — columns, paragraphs, bullets, lines, words, and characters. Every time you break apart a text frame, the subcomponents are placed into separate text frames.

Linking text frames directs the overflow text of one text frame to another. If you resize a linked frame, or change the size of the text, the amount of text in the next frame is automatically adjusted. You can link text frames before or after you type text.

You cannot link **artistic text**. However, you can link a paragraph frame to an open or **closed object**. When you link a frame to an open object, such as a line, the text flows along the path of the line. Linking a text frame to a closed object, such as a rectangle, inserts a text frame and directs the flow of text inside the object. If text exceeds the open or **closed path**, you can link the text to another frame or **object**. You can also link to existing frames and objects across pages or create a linked frame in the same location on another page.

After linking text frames, you can redirect the flow from one object or text frame to another. When you select the text frame or object, a blue arrow indicates the direction of the text flow. You can hide or display these arrows.



You can make text flow between text frames and objects by linking the text.

You can remove links between multiple frames, and between frames and objects. When you have only two linked frames and you remove the link, the overflow text remains in the second frame. Deleting a frame that is part of a series of linked frames redirects the text flow into the next frame or object.

By default, paragraph formatting, such as columns, drop caps, and bullets, is applied to the selected text frames only. However, you can change your settings so that formatting is applied to all linked text frames, or to all selected and subsequently linked text frames. For example, if you apply columns to the text in one frame, you can choose whether to apply columns to the text in all the linked frames.

To combine or break apart paragraph text frames

1 Select a text frame.

If you are combining text frames, hold down **Shift**, and use the **Pick** tool  to select subsequent text frames.

2 Click **Object**, and click one of the following:

- **Combine**
- **Break apart**





Text frames with envelopes, text fitted to a path, and linked text frames cannot be combined.

If you first select a text frame with columns, the combined text frame will have columns.

To link paragraph text frames and objects

1 Using the **Text** tool , select the starting text frame.

2 Click the **Text flow** tab  at the bottom of the text frame or **object**.

If the text frame cannot hold all the text, the tab contains an arrow  and the text frame becomes red.

3 When the pointer changes to a **Link to** pointer , do one of the following:



- To link to a frame or object on the same page, click the text frame or object into which you want to continue the text flow.
- To link to an existing frame or **object** on a different page, click the corresponding **Page** tab on the document navigator, and then click the text frame or object.
- To create a new linked frame on another page, click the corresponding **Page** tab on the document navigator, and hover over the area of the drawing page that corresponds to the position of the first frame. When a preview of the frame appears, click to create the linked frame. The new frame has the same size and position as the original frame. If you click elsewhere on the page, the text frame that is created is the size of the entire page.



If a text frame is linked, the **Text flow** tab changes , and a blue arrow indicates the direction of text flow. If the linked text is on another page, the page number and a dashed blue line are displayed. To hide or display these indicators, see [“To specify formatting preferences for text frames” on page 484](#).

To link text frames successfully, you have to make sure that the automatic sizing of frames is disabled. For more information, see [“To add paragraph text” on page 479](#).

To redirect text flow to a different text frame or object

1 Using the **Pick** tool , click the **Text flow** tab  at the bottom of the frame or **object** that contains the text flow that you want to modify.

2 Select the new frame or object into which you want the text flow to continue.

To remove links between text frames or objects

- 1 Using the **Pick** tool, select the linked frames or objects.
- 2 Click **Text** ► **Paragraph text frame** ► **Unlink**.



You can disconnect linked frames on different pages only if they are on facing pages.



You can also remove links by clicking a text frame, and then clicking **Object** ► **Break text apart**.

To specify formatting preferences for text frames

- 1 Click **Tools** ► **Options**.
- 2 In the **Workspace** list of categories, double-click **Text**, and click **Paragraph text frame**.
If you want to hide or display the text flow indicators, disable or enable the **Show linking of text frames** check box.
- 3 In the **When editing, apply paragraph frames formatting** to area, enable one of the following options:
 - **All linked frames** — applies paragraph formatting to selected text frames and all text frames that are linked to them
 - **Selected frames only** — applies paragraph formatting to the selected text frames only
 - **Selected and subsequent frames** — applies paragraph formatting to selected text frames and any text frames that are later linked to them.

You can also

Display and hide text frames

Click **Tools** ► **Options**, double-click **Text**, and click **Paragraph text frame** from the **Workspace** list of categories. Enable the **Show text frames** check box.

Enable automatic expanding and shrinking of frames to fit text

Click **Tools** ► **Options**, double-click **Text**, and click **Paragraph text frame** from the **Workspace** list of categories. Enable the **Expand and shrink paragraph text frames to fit text** check box.

Ensure all text frames are web-compatible

Click **Tools** ► **Options**, double-click **Text**, and click **Paragraph text frame** from the **Workspace** list of categories. Enable the **Make all new paragraph text frames web compatible** check box.

Aligning text by using the baseline grid

You can align text within a frame or in different frames by using the **baseline** grid. This is useful, for example, when you want to align two or more text frames that contain different fonts, font sizes, and spacing.

All objects can snap to the baseline grid; only text frames can align to the baseline grid. Snapping is turned on or off for all objects (it's a grid setting). Alignment is turned on or off for individual frames (it's a text frame setting). For information about displaying or hiding the baseline grid, turning snapping on or off, changing the grid color, and setting the line spacing, see ["Setting up the baseline grid" on page 607](#).

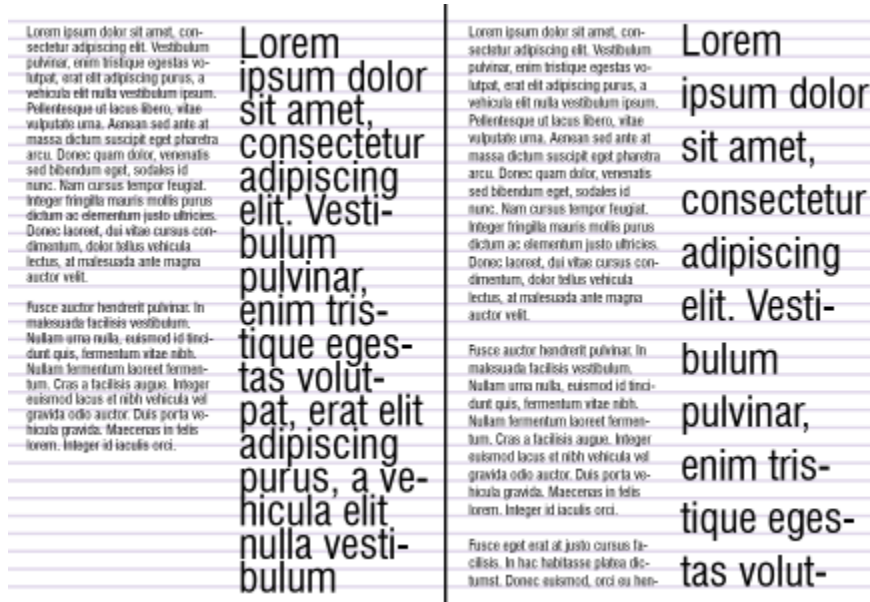

Text columns with different fonts and font sizes (left) are aligned by using the baseline grid (right).

When you align paragraph text to the baseline grid, the line spacing is adjusted automatically so that the lines of text sit on the baseline grid. When text is aligned to the baseline grid, the line spacing is controlled by the grid rather than by the text properties that have been previously set. For more information about line spacing, see [“Adjusting line and paragraph spacing” on page 513](#).

You can set one or more text frames to align to the baseline grid. When this option is enabled, the text in the text frame is aligned to the baseline grid when part or all of the text frame overlaps with the drawing page. If the text frame is moved completely outside the drawing page, the text is no longer aligned to the baseline grid.

If you align a text frame to the baseline grid and then link it to another frame, both frames are aligned to the baseline grid. If you align one of several already linked frames to the baseline grid, only the selected frame is aligned. For more information about linking text frames, see [“Combining and linking paragraph text frames” on page 482](#).

To align paragraph text to the baseline grid

- 1 Click **View** ► **Grid** ► **Baseline grid**.
- 2 Select a text frame.
- 3 Click **Text** ► **Align to baseline grid**.



You can also right-click the text frame and choose **Align to baseline grid**.

You can align multiple selected frames at the same time.

Selecting text

CorelDRAW lets you select text to edit specific characters or modify it as an object. For example, you can select specific characters to change the font or select a text object, such as a text frame, so you can move, resize, or rotate it.



To select a text object

To	Do the following
Select artistic text	Using the Pick tool  , click the artistic text.
Select a text frame	Using the Pick tool  , click the text frame.



You can use the **Pick** tool  to select multiple text **objects**. Hold down **Shift**, and click each text object.

To select text for editing

To	Do the following
Select specific characters of artistic or paragraph text for editing	Using the Text tool  , drag across the text.
Select a text frame for editing	Using the Text tool  , click the text frame.

Finding, editing, and converting text

You can find text in a document and replace it automatically. You can also find special characters, such as an em dash or optional hyphen. You can edit text directly in the [drawing window](#) or in a dialog box.

Additional formatting options are available for paragraph text. To apply these formatting options to [artistic text](#), you first need to convert the artistic text to [paragraph text](#). Likewise, you can apply special effects to paragraph text by converting the text to artistic text. Converting text may result in the loss of any formatting.

You can also convert both paragraph and artistic text to curves. By transforming characters into lines or [curve objects](#), you can add, delete, or move the [nodes](#) of individual characters to alter their shape. For more information, see [“Using curve objects” on page 180](#).

When you convert text to curves, the appearance of the text is preserved, including [font](#), style, character position and rotation, spacing, and any other text settings and effects. Any linked text objects are also converted to curves. If you convert paragraph text in a fixed-sized text frame to curves, any text that overflows the text frame is deleted. For information about fitting text to a text frame, see [“Formatting text” on page 499](#).

To find text

- 1 Click **Edit** ► **Find and replace** ► **Find text**.
- 2 Type the text that you want to find in the **Find** box.
If you want to find the exact case of the text that you specified, enable the **Match case** check box.
- 3 Click **Find next**.



You can also find special characters by clicking the right arrowhead next to the **Find** box, choosing a special character, and clicking **Find next**.

To find and replace text

- 1 Click **Edit** ► **Find and replace** ► **Replace text**.
- 2 Type the text that you want to find in the **Find** box.
If you want to find the exact case of the text that you specified, enable the **Match case** check box.
If you want to find only whole words, enable the **Find whole words only** check box.
- 3 Type the replacement text in the **Replace with** box.
- 4 Click one of the following buttons:
 - **Find next** — finds the next occurrence of the text that is specified in the **Find** box
 - **Replace** — replaces the selected occurrence of the text that is specified in the **Find** box. If no occurrence is selected, **Replace** finds the next occurrence.
 - **Replace all** — replaces every occurrence of the text that is specified in the **Find** box

To edit text

- 1 Click the **Text** tool .
- 2 Perform a task from the following table.

To	Do the following
Edit artistic text	Click in the artistic text.
Edit paragraph text	Click in the text frame.





Text that has been converted to curves cannot be edited.



You can also edit text by clicking **Text** ► **Edit text**, and making changes to the text in the **Edit text** dialog box.

To convert text

To	Do the following
Convert paragraph text to artistic text	Using the Pick tool  , select the text, and click Text ► Convert to artistic text .
Convert artistic text to paragraph text	Using the Pick tool  , select the text, and click Text ► Convert to paragraph text .
Convert artistic or paragraph text to curves	Using the Pick tool  , select the text, and click Object ► Convert to curves .



Paragraph text cannot be converted to artistic text when it's in a linked frame, has text overflow, or has special effects applied to it.



You can also convert text to curves by clicking the Pick tool , right-clicking the text, and clicking **Convert to curves**.

Shifting, rotating, mirroring, and flipping text



You can shift the characters of artistic and paragraph text vertically or horizontally or rotate them to create interesting effects. You can straighten characters into their original position, and you can return vertically shifted characters to the baseline. You can also mirror or flip artistic and paragraph text characters.

If you want to adjust the position of an entire text object that is fitted to a path, such as a circle or a freehand line, see “To adjust the position of text that is fitted to a path” on page 492.



Rotated characters

To shift or rotate a character

- 1 Using the **Text** tool , select the character or characters.
- 2 In the **Object properties** docker, click the **Character** button  to display the character-related options.
To display the **Object properties** docker, click **Window** ▶ **Dockers** ▶ **Object properties**.
- 3 Click the arrow button  at the bottom of the **Character** area to display additional options.
- 4 Type a value in one of the following boxes:
 - **Horizontal character offset** — A positive number moves characters to the right, and a negative number moves characters to the left.
 - **Vertical character offset** — A positive number moves characters up, and a negative number moves characters down.
 - **Character angle** — A positive number rotates characters counterclockwise, and a negative number rotates characters clockwise.





You can also use the **Shape** tool  to shift or rotate characters. Select the character node or **nodes**, and then type values in the **Horizontal character offset** box, **Vertical character offset** box, or **Character angle** box on the property bar.



To straighten a shifted or rotated character

- 1 Using the **Text tool** , select one or more characters.
- 2 Click **Text** ► **Straighten text**.

To return a vertically shifted character to the baseline

- 1 In the toolbox, open the **Shape tool**  flyout.
- 2 Click the **Shape tool** .
- 3 Select the text **object**, and select the **node** to the left of the shifted character.
- 4 Click **Text** ► **Align to baseline**.

To mirror text

- 1 Using the **Pick tool**, select a text object.
- 2 On the property bar, click one of the following buttons.
 - **Mirror horizontally**  — flips the text characters from left to right
 - **Mirror vertically**  — flips the text characters from top to bottom



You can also mirror text by holding down **Ctrl** and dragging a selection handle to the opposite side of the object.

You can also mirror text fitted to a path. For more information, see “[To mirror text that is fitted to a path](#)” on page 493.

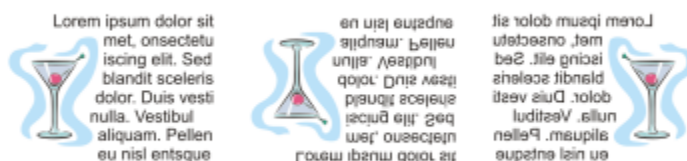

Left to right: Text in original form, mirrored vertically, and mirrored horizontally

To flip text by dragging diagonally

- 1 Using the **Text tool** , select the artistic text or the paragraph text frame.
- 2 Drag a middle selection handle across the text and past the corner handle on the opposite side.

Moving text

CorelDRAW offers different methods for moving text. If you select text as an object, such as a block of **artistic text** or a text frame, you can move it to a new position, as you would any other object.

You can also move a selection of **paragraph text** between text frames or move **artistic text** between artistic text objects. Conversely, you can move paragraph text to an artistic text object, or artistic text to a paragraph text frame.

To move a text object

- 1 Click the **Pick tool** .
- 2 Drag the text object to a new position in the drawing window.

To move a text selection

- 1 Click the **Text tool** .
- 2 Select the text that you want to move.
- 3 Perform a task from the following table.

To

Do the following

Move text within the same text object

Drag the text to a new position within the text object. The text cursor appears to indicate the insertion point.

Move the text to another text object.

Drag the text to another **text** object. The text cursor appears to indicate the insertion point.

Move or copy selected text to a new text object

With the right mouse button, drag the text to a new position, release the mouse button, and click **Copy here** or **Move here**.

Move an individual character freely in the drawing window

Click the **Shape tool** , select the text object, and drag a character's selection handle in the lower-left corner of the character.

Wrapping text



You can change the shape of text by wrapping paragraph text around an **object**, **artistic text**, or a **text frame**. You can wrap text by using **contour** or square wrapping styles. The contour wrapping styles follow the curve of the object. The square wrapping styles follow the bounding box of the object. You can also adjust the amount of space between paragraph text and the object or text, and you can remove any previously applied wrapping style.



Text wrapped around an object by using the contour wrapping style (left) and the square wrapping style (right)

To wrap paragraph text around an object, artistic text, or a text frame

- 1 Select the **object** or text around which you want to wrap text.

- 2 Click **Window** ▶ **Dockers** ▶ **Object properties**.
- 3 In the **Object properties** docker, click the **Summary** button  to display the wrap options.
- 4 Choose a wrapping style from the **Wrap paragraph text** list box.
If you want to change the amount of space between wrapped text and the object or text, change the value in the **Text wrap offset** box.
- 5 Click the **Text** tool , and drag over the object or text to create a **paragraph** text frame.
- 6 Type text in the text frame.



You can wrap existing paragraph text around a selected object by applying a wrapping style to the object and dragging the text frame over the object.

To remove a wrapping style

- 1 Select the wrapped text or the object it wraps.
- 2 Click **Window** ▶ **Dockers** ▶ **Object properties**.
- 3 In the **Object properties** docker, click the **Summary** button  to display the wrap options.
- 4 Choose **None** from the **Wrap text** list box.

Fitting text to a path

You can add **artistic text** along the path of an open **object** (for example, a line) or a **closed object** (for example, a square). You can also fit existing text to a path. Paragraph text in a text frame can be fitted to open paths only.

After you fit text to a path, you can adjust the text position relative to that path. For example, you can mirror the text horizontally, vertically, or both. Using **tick spacing**, you can specify an exact distance between the text and the path.

CorelDRAW treats text fitted to a path as one object; however, you can separate the text from the object if you no longer want it to be part of the path. When you separate text from a curved or closed path, the text retains the shape of the object to which it was fitted. You can also modify the text and path properties independently.

The text reverts to its original appearance when you straighten it.

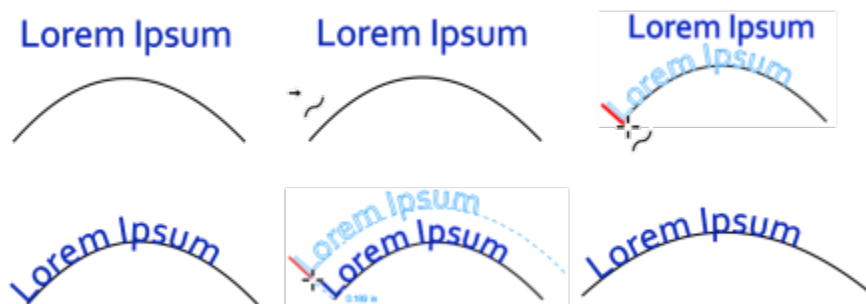

Text and curve as separate objects (upper left), choosing a path with the Fit Text to Path pointer (upper middle), aligning text while fitting it to path (upper right), text fitted to path (lower left), interactive feedback about offset distance (lower middle), and text and curve stretched horizontally by 200% (lower right)

To add text along a path

1 Using the **Pick tool** , select a path.

2 Click **Text** ► **Fit text to path**.

The text cursor is inserted on the path. If the path is open, the text cursor is inserted at the beginning of the path. If the path is closed, the text cursor is inserted at the center of the path.

3 Type along the path.



Text cannot be added to the path of another text **object**.



You can also fit text to a path by clicking the **Text tool** **A** and pointing to a path. When the pointer changes to the **Fit text to path** pointer , click where you want the text to begin, and type.

To fit text to a path

1 Using the **Pick tool** , select a text **object**.

2 Click **Text** ► **Fit text to path**.

The pointer changes to the **Fit text to path** pointer . By moving the pointer over the path, you can preview where the text will be fitted.

3 Click a path.

If the text is fitted to a **closed path**, the text is centered along the path. If the text is fitted to an open path, the text flows from the point of insertion.



Artistic text can be fitted to open or closed paths. Paragraph text can be fitted to open paths only.

Text cannot be fitted to the path of another text **object**.

To adjust the position of text that is fitted to a path

1 Using the **Pick tool** , select the text that is fitted to a path.

2 Choose a setting from any of the following list boxes on the property bar:

- **Text orientation** — specifies how the text bends to follow the path
- **Distance from path** — distance between the text and the path
- **Offset** — horizontal position of the text along the path

You can also

Use **tick spacing** to increase the distance between the path and the text in specified increments

Select the text. On the property bar, click **Tick snapping**, enable the **Tick snapping on** option, and type a value in the **Tick spacing** box.

When you move the text from the path, it moves in the increment you specified in the **Tick spacing** box. When you move the text, the distance from the path is displayed below the original text.

You can also

Change the horizontal position of fitted text



Using the **Shape** tool , select the text, and drag the **character nodes** that you want to reposition.

Move fitted text along or off the path

Using the **Pick** tool , drag the red **glyph** that appears next to the text.

When you drag the glyph along the path, a preview of the text is displayed. When you drag the glyph off the path, the distance between the text preview and the path is displayed.

To mirror text that is fitted to a path

- 1 Using the **Pick** tool , click the text that is fitted to a path.
- 2 On the property bar, click one of the following buttons:
 - **Mirror text horizontally**  — flips the text characters from left to right
 - **Mirror text vertically**  — flips the text characters upside down



You can apply a 180-degree rotation to text that is fitted to a path by clicking both the **Mirror text horizontally** and the **Mirror text vertically** buttons.

You can also mirror artistic text and paragraph text frames. For more information, see [“To mirror text” on page 489](#).

To separate text from a path

- 1 Using the **Pick** tool , select the path and the fitted text.
- 2 Click **Object** ▶ **Break text apart**.

To straighten text

- 1 Using the **Pick** tool , select the path and the fitted text.
- 2 Click **Object** ▶ **Break text apart**.
- 3 Using the **Pick** tool, select the text.
- 4 Click **Text** ▶ **Straighten text**.

Inserting special characters, symbols, and glyphs

Using the **Insert character** docker, you can find and insert special characters, symbols, and glyphs (variations of individual characters or character combinations) of OpenType fonts.

Filtering

All characters, symbols, and glyphs included in a font are displayed by default, but you can filter character subsets to display only the characters you want. For example, you can display only currency symbols or numbers, or you can display only Cyrillic characters and symbols.

Characters included in a font are organized in the following categories:

- **Common** — includes arrows, currency, mathematical symbols, numbers, punctuation marks, and separators as well as CJK symbols and punctuation marks (used in Asian scripts)
- **Scripts** — includes the scripts that the selected font supports, such as Latin, Greek, Cyrillic, Hiragana and Katakana, Han, Arabic, or Hebrew scripts
- **OpenType** — includes the OpenType features provided by the selected font such as standard ligatures, discretionary ligatures, fraction, alternate annotation forms, and more. For more information about OpenType features, see [“Working with OpenType features” on page 507](#).

OpenType fonts

The **Insert character** docker is ideal for viewing and applying the OpenType features provided by OpenType fonts. The default view shows a list of characters in which the glyphs for individual characters appear grouped. Alternatively, you can display a longer list that shows available glyphs at a glance.

Viewing character position

Each selected character appears against a set of blue lines that let you preview its position in relation to the text baseline.

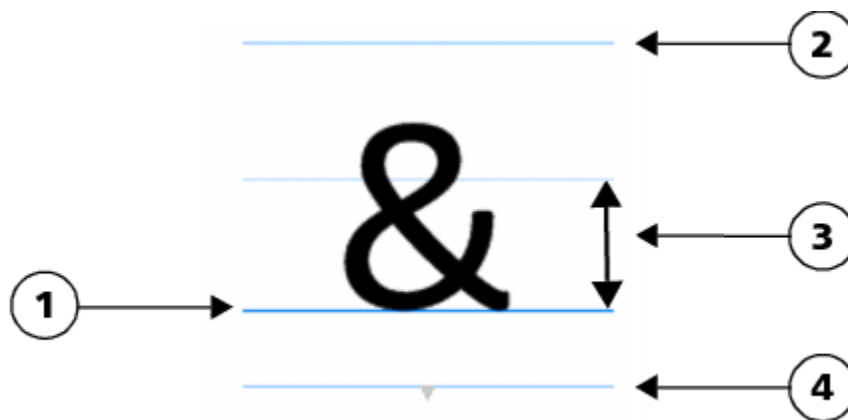

1) Text baseline

2) Ascender line

3) Font x-height

4) Descender line

Most recently used special characters

You can use the list of most recently used special characters to copy characters that you use often. The list retains the font attributes of most recently used characters and any OpenType features that were applied. You can manage the list by removing characters that you no longer need.

To add a special character, symbol, or glyph

- 1 Using the **Text** tool **A**, click where you want to add the special character.
- 2 Click **Text** ► **Insert character**.
- 3 In the **Insert character** docker, choose a font from the **Font** list box.
- 4 Double-click a character in the **Character and glyph** list.
If you cannot find the character you want, open the **Character filter** list box, and enable the **Entire font** check box.

You can also

Drag a character

Using the **Pick** tool **☛**, drag a character to the document window.

You can also

Copy a character

Click a character in the **Character and glyph** list, and click **Copy**.

View information about a selected character

Click the arrow button  at the bottom of the **Character and glyph** list to view any of the following attributes that are applicable: character name, ID, Unicode number, keyboard shortcut for inserting the character, the OpenType feature name, and the language for glyphs that can be displayed properly only in a specific language.

Zoom in and out

Move the **Zoom** slider.

To zoom in and out in preset increments, click the zoom buttons to the right and left of the **Zoom** slider.

Navigate to a special character by using an Alt code

Click in the **Character and glyph** list, hold down **Alt**, and type the Alt code for the character you want.



Navigate to a character

Press the corresponding key on the keyboard.

To filter special characters, symbols, and glyphs

- 1 Click **Text** ► **Insert character**.
- 2 In the **Insert character** docker, choose a font from the **Font list** box.
- 3 Open the **Character filter** list box, and enable the check boxes for the character subsets that you want to display.
- 4 Click **Close**.

To view glyphs of OpenType features

- 1 Click **Text** ► **Insert character**.
- 2 In the **Insert character** docker, choose an OpenType font from the **Font list** box.
- 3 Open the **Character filter** list box, and in the **OpenType** area, enable any of the check boxes for the available OpenType features.
- 4 Do one of the following:
 - To display a list that includes grouped glyphs, make sure that the **Show all glyphs** button  does not appear pressed. To view all glyphs in a group, click a character, and then click the OpenType feature indicator. Click a glyph to display it in the **Character and glyph** list.
 - To display a list that includes all available glyphs, click the **Show all glyphs** button .

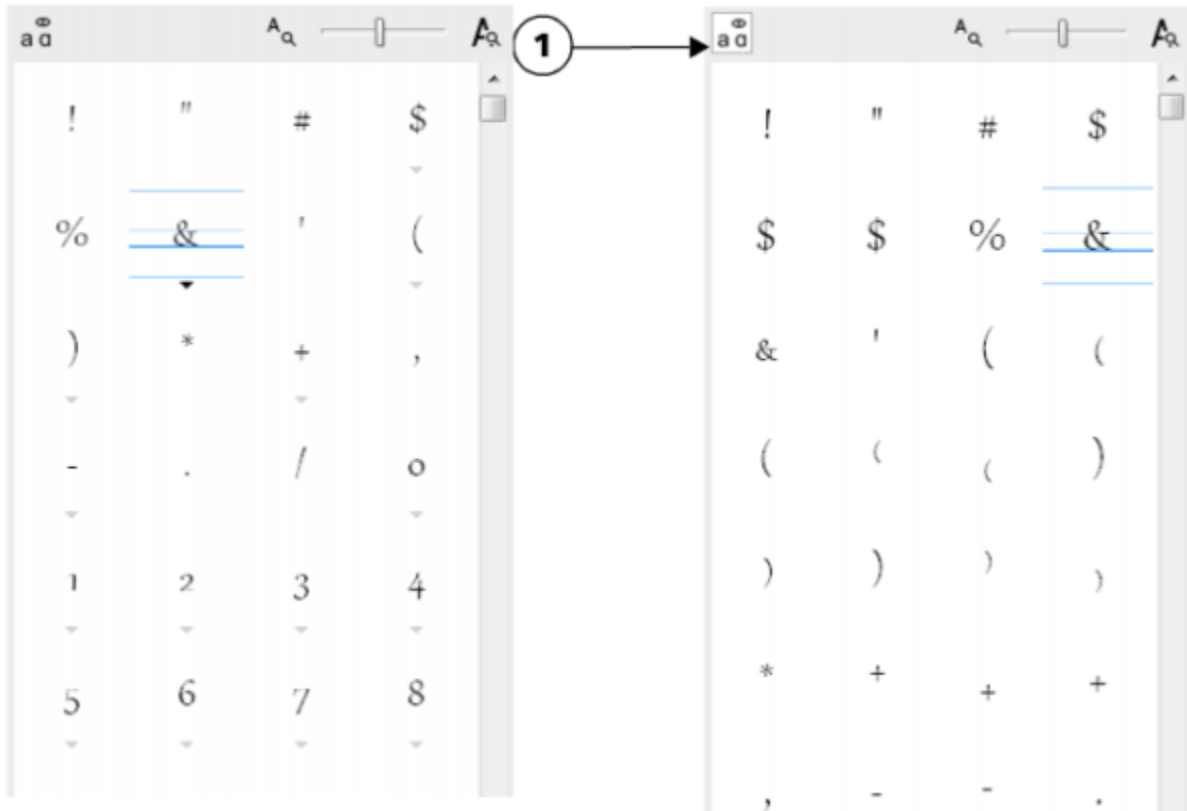

Left: The OpenType feature indicators below individual characters show that more glyphs are available.
 Right: When the Show all glyphs button (1) is pressed, you can see available glyphs at a glance.

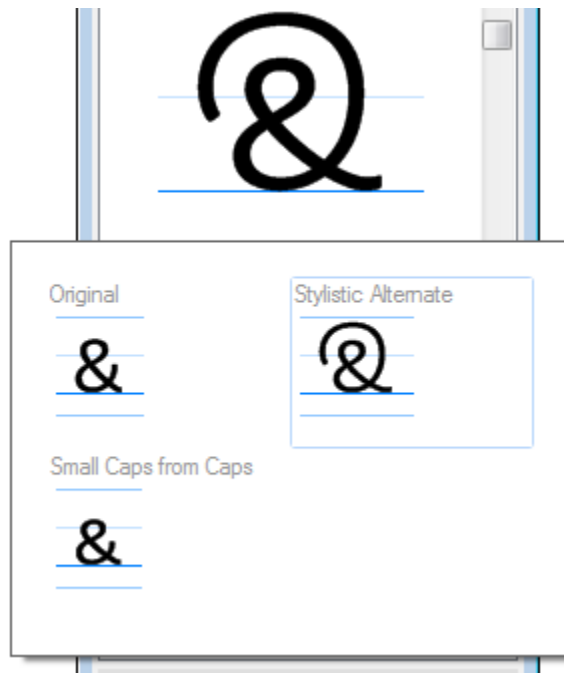

Viewing grouped glyphs



The **Show all glyphs** button is not available for fonts that do not support OpenType features.

Some glyphs provided by OpenType features vary depending on the context in which they appear and cannot be shown in the **Insert character** docker. You can view and insert such glyphs in the document window by using the onscreen OpenType feature indicator. For more information, see [“To enable the onscreen OpenType feature indicator” on page 511](#).

To use the list of most recently used special characters

- 1 Click **Text** ► **Insert character**.
- 2 In the list of most recently used special characters, perform a task from the following table.

To	Do the following
View the font and OpenType attributes of a character	Point to the character.
Copy a character from the list	Right-click the character, and click Copy .
Remove characters from the list	Right-click a character, and click Remove or Remove all .



Embedding graphics

You can embed a graphic **object** or **bitmap** in text. The graphic object or bitmap is treated as a text character. As a result, you can apply formatting options according to the type of text in which you embed the graphic object. You can also remove an embedded object from text, after which the object returns to its original state.

To embed a graphic object in text

- 1 Select a graphic **object**.
- 2 Click **Edit**, and click one of the following:
 - **Cut**
 - **Copy**
- 3 Using the **Text** tool , click where you want to embed the graphic object.
- 4 Click **Edit** ► **Paste**.

To remove an embedded object from text

- 1 Using the **Text** tool , select an embedded **object**.
- 2 Click **Edit** ► **Cut**.
- 3 Click the **Pick** tool , and click outside the text object.
- 4 Click **Edit** ► **Paste**.

Working with legacy text

If a document contains text and was created in a previous version of CorelDRAW, such as CorelDRAW X5, you must update the legacy text before you can use new text features such as OpenType options and aligning text with the [baseline grid](#). For more information, see [“Working with OpenType features”](#) on page 507 and [“Aligning text by using the baseline grid”](#) on page 484.

To update legacy text

- 1 Open the document with legacy text.

An **Update** toolbar appears at the top of the drawing window.

- 2 Click **Update**.

To undo the update, click **Undo** on the **Update** toolbar. However, once you make changes to the updated text, this option is no longer available.



When legacy text is updated, its flow and layout may change.

You can also update legacy text by clicking the **Update** button in the **Character** area of the **Object properties** docker.

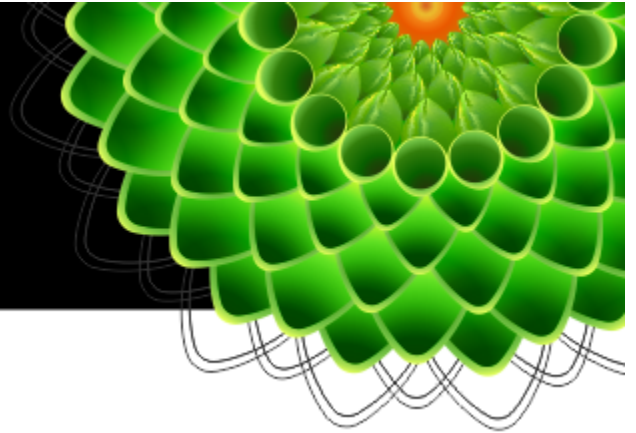

Formatting text

CorelDRAW offers many tools and controls for formatting individual characters, entire paragraphs, and text in frames.

This section contains the following topics:

- “Choosing typefaces and fonts” (page 499)
- “Formatting characters” (page 502)
- “Changing text color” (page 504)
- “Kerning a range of characters” (page 505)
- “Changing text case” (page 506)
- “Working with OpenType features” (page 507)
- “Adjusting character and word spacing” (page 511)
- “Adjusting line and paragraph spacing” (page 513)
- “Adding bullets to text” (page 514)
- “Inserting drop caps” (page 516)
- “Changing character position and angle” (page 517)
- “Aligning text” (page 518)
- “Adding tabs and indents” (page 520)
- “Working with text styles” (page 521)
- “Hyphenating text” (page 521)
- “Inserting formatting codes” (page 524)
- “Displaying nonprinting characters” (page 525)

Choosing typefaces and fonts

Text is an important element in the design and layout of documents. In CorelDRAW, you can choose the typeface that is best suited to your project. You can specify the font size and style. In addition, you can use an OpenType font to achieve a unique and distinctive style. For more information, see [“Working with OpenType features” on page 507](#). The default unit of measure for text is points; however, you can change the unit of measure for the active drawing and all subsequent drawings. For information about previewing fonts, see [“Viewing fonts” on page 536](#).

Fonts vs. typefaces

“Font” and “typeface” are two typography terms that are often used interchangeably, but they do not have the same meaning. A font is a collection of characters that includes letters, numbers, and symbols of one variation of a typeface, such as bold or italic. A typeface, which is also known as a font family, is made up of several fonts that share similar design characteristics. In other words, a font is the mechanism

that allows you to render the characters onscreen or in print, whereas the typeface, which embodies the style and visual distinctiveness of the characters, refers to the design and style of the type.

The following table lists a few examples of typefaces and fonts.

Typeface (Font family)	Font
Helvetica	Helvetica Bold-Italic
Times New Roman	Normal
Verdana	Verdana Bold-Italic

Choosing a typeface

Typefaces come in different shapes and sizes and have unique characteristics and expressive qualities. Choosing the right typeface is an important design consideration because it can set the tone of the project. Moreover, it can help, or hinder, effective communication. For example, if you design a poster with a typeface that is difficult to read, or sets the wrong tone, your message may not effectively reach your intended audience.



The typeface applied to the word "Menu" on the left is more suitable for an upscale restaurant menu than the typeface on the right.

Here are a few basic tips for choosing the right typeface:

- Choose a typeface that best suits the tone of your design.
- Choose a typeface that is appropriate for the final output of your design (e.g. web or print).
- Use less typefaces in your document. The general rule is not to exceed three or four typefaces in a document.
- Make sure the typeface characters are easy to read and recognize.
- Choose a typeface that is appropriate for the age of your target audience.
- Make sure the typeface of headings stands out and looks good when displayed at larger sizes.
- Make sure the typeface of body text enhances readability.
- Choose a typeface that supports multiple languages if you're working on multilingual documents.

To change the font

1 Using the **Text** tool , select a character or a block of text.

If the **Object properties** docker is not open, click **Window** ► **Dockers** ► **Object properties**.

2 In the **Object properties** docker, click the **Character** button  to display the character-related options.

3 In the **Character** area of the **Object properties** docker, perform one or more tasks from the following table.

To	Do the following
Choose a typeface	Choose a typeface from the Font list box.

To

Do the following

Set font size

Type a value in the **Font size** box.

Change the font style

Choose a style from the **Font style** list box.

Use lines to represent text that is smaller than a specific font size

Click **Tools** ► **Options**, click **Text** in the **Workspace** list of categories, and then type a value in the **Greek text below** box.



The method of “greeking” text helps increase the redraw speed, which is useful for creating prototypes of documents or drawings. You can make text readable again by reducing the greeking value or by [zooming](#) in on the text.



You can also change the font and font size from the property bar.

You can also change the font style of selected text by clicking the **Bold** button **B**, **Italic** button *I*, or **Underline** button U on the property bar.

To resize text

- 1 Using the **Text** tool **A**, select a character or a block of text.
- 2 On the property bar, choose a size from the **Font size** list box.

You can also

Resize artistic text using the **Pick** tool

Click the **Pick** tool , and drag one of the corner handles.

Resize paragraph text using the **Pick** tool

Click the **Pick** tool , press **Alt**, and then drag one of the corner handles.

Increase the size of text

Press **Num Lock** to activate the number pad on your keyboard, and use the **Text** tool **A** to select the text. Then, hold down **Ctrl**, and press **8** on the number pad.

Decrease the size of text

Using the **Text** tool **A**, select the text. Then, hold down **Ctrl**, and press **2** on the number pad.

Set an increment for resizing text

Click **Tools** ► **Options**. In the **Workspace** list of categories, click **Text**, and type a value in the **Keyboard text increment** box.

You can also

Change the default unit of measure

Click **Tools** ► **Options**. In the **Workspace** list of categories, click **Text**, and choose a unit from the **Default text units** list box.



You can also resize the text from the **Character** area of the **Object properties** docker, by choosing a size from the **Font size** list box.

Formatting characters

You can change the position and appearance of characters by displaying them as subscript or superscript, which is useful in drawings with scientific notations. If you select an OpenType font that supports subscript and superscript, you can apply the OpenType feature. However, if you select a font, including an OpenType font, that does not support subscript and superscript, you can apply a synthesized version of the character, which CorelDRAW produces by altering the characteristics of the default font character. For more information, see [“Working with OpenType features” on page 507](#).

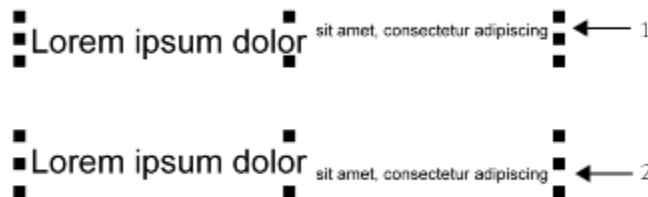

Artistic text with superscript (1) and subscript (2) applied

You can also add underlines, strikethrough lines, and overlines to selected characters.

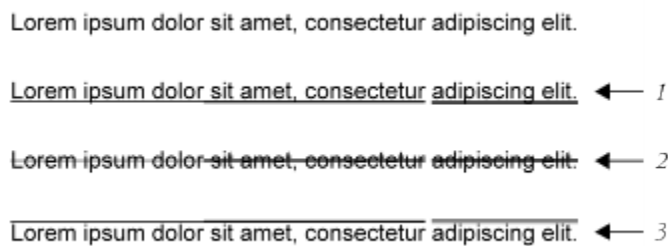

Artist text with underline (1), strikethrough (2), and overline (3) applied to the text using both single and double line styles.

If you want to reuse the formatting of selected text, you can use styles or copy the text attributes and apply them to another text selection. For more information, see [“Working with styles and style sets ” on page 573](#) and [“Copying object properties, transformations, and effects” on page 272](#).

You can modify the behavior of the text cursor that displays onscreen and enable text highlighting, which is useful when formatting text.

To insert superscript or subscript text

¹ Using the **Text** tool **A**, select a character or a block of text.

If the **Object properties** docker is not open, click **Window ▶ Dockers ▶ Object properties**.

- 2 In the **Object properties** docker, click the **Character** button **A** to display the character-related options.
- 3 In the **Character** area of the **Object properties** docker, click the **Position** button, and choose one of the following options.
 - **None** — turns off all the features in the list
 - **Superscript (auto)** — applies the OpenType feature if the font supports it, or applies a synthesized version if the font does not support superscript
 - **Subscript (auto)** — applies the OpenType feature if the font supports it, or applies a synthesized version if the font does not support subscript
 - **Superscript (synthesized)** — applies a synthesized version of the superscript feature, which looks the same as in previous versions of CorelDRAW
 - **Subscript (synthesized)** — applies a synthesized version of the subscript feature, which looks the same as in previous versions of CorelDRAW



Some OpenType fonts may appear to support features that are unsupported. For example, Superscript and Subscript options may appear available, but are not. If you apply one of these OpenType fonts, CorelDRAW cannot provide a synthesized version of Superscript and Subscript.

To underline, overline, or strikethrough text

- 1 Using the **Text** tool **A**, select a character or a block of text.

If the **Object properties** docker is not open, click **Window ▶ Dockers ▶ Object properties**.
- 2 In the **Object properties** docker, click the **Character** button **A** to display the character-related options.
- 3 In the **Character** area of the **Object properties** docker, click the arrow button ▼ located at the bottom of **Character** area to display the additional character options.
- 4 Perform one or more tasks from the following table.

To	Do the following
Underline text	Click the Underline button U and choose a style from the list box.
Apply a line through the selected text	Choose a style from the Character strikethrough list box.
Apply a line above the selected text.	Choose a style from the Character overline list box.

To modify the text cursor behavior

- 1 Click **Tools ▶ Options**.
- 2 In the list of categories, click **Text**.
- 3 In the **Text cursor** area, enable any of the following check boxes:
 - **Highlight formatting changes**
 - **Enhanced text cursor**

Changing text color

You can quickly change both the fill and outline color of text. You can change the fill, outline, and background color of text. You can change the color of individual characters, a block of text, or all characters in a text object.



Lorem Ipsum

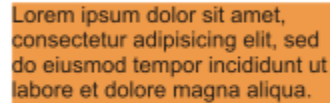

Lorem ipsum dolor sit amet, consectetur adipiscing elit, sed do eiusmod tempor incididunt ut labore et dolore magna aliqua.



Lorem Ipsum

Left to right: Background color is applied to artistic text, paragraph text, and selected characters

To quickly change the color of a text object

- 1 Using the **Pick tool** , click a text **object** to select it.
- 2 Perform a task from the following table.

To

Do the following



To fill characters in a text object with one color

Click any **color swatch** on the default color palette or drag a **color swatch** to the text object.

To apply an outline color to all characters in a text object

Right-click any **color swatch** on the default color palette or drag a **color swatch** to the edge of a character in the text object.

To change the color of a text selection

- 1 Using the **Text tool** , select a character or a block of text.
If the **Object properties** docker is not open, click **Window** ▶ **Dockers** ▶ **Object properties**.
- 2 In the **Object properties** docker, click the **Character** button  to display the character-related options.
- 3 In the **Character** area of the **Object properties** docker, perform one or more tasks from the following table.

To

Do the following

Choose a fill

In the text color area, choose a fill type from the **Fill type** list box, open the **Fill** picker, and then click a color or a fill.

Modify fill settings

In the text color area, click the **Fill settings** button , and modify the settings in the dialog box.

To	Do the following
Choose a background fill	In the text background color area, choose a fill type from the Background fill type list box, open the Fill picker, and then click a color or a fill.
Modify background fill settings	In the text background color area, click the Fill settings button, and modify the settings in the dialog box.
Choose an outline width	In the text outline color area, click the Outline width button, and choose an option from the list.
Choose an outline color	In the text outline color area, click the Outline color picker, and click a color.
Modify line outline settings	In the text outline color area, click the Outline settings button ■ ■ ■ , and modify the settings in the Outline pen dialog box.

Kerning a range of characters

You can **kern** pairs of selected characters. Kerning refers to the repositioning of two characters to balance the optical space between them. For example, kerning is often used to decrease the space in character pairs such as AW, WA, VA, or TA. Such character pairs are known as “kerning pairs.” Kerning increases readability and makes letters appear balanced and proportional, especially at larger font sizes.



To kern text

- 1 Using the **Text** tool **A**, select the characters that you want to kern.
If the **Object properties** docker is not open, click **Window** ▶ **Dockers** ▶ **Object properties**.
- 2 In the **Object properties** docker, click the **Character** button **A** to display the character-related options.
- 3 In the **Character** area of the **Object properties** docker, type a value in the **Range kerning** box.
Negative values decrease the spacing between characters; positive values increase the spacing between characters.

Changing text case

CorelDRAW lets you change the text case of artistic and paragraph text. For example, you can apply small caps to acronyms so they visually blend with the text. If you apply default capitalization, the text stands out too much and impacts the readability. In the following example, the acronym "A.M." is shown with both the default uppercase and small caps applied.

Default uppercase

The class begins at 9:00 A.M. in room 132.

Small caps

The class begins at 9:00 a.m. in room 132.

You control the case of words, sentences, or paragraphs of selected text. For example, you can apply title case to selected text to capitalize the initial letter of every word. This is a useful formatting technique for headings, such as book or chapter titles.

You can automatically convert text to lowercase or uppercase without deleting or retyping letters. For example, if you accidentally pressed the Caps Lock key and added uppercase text, you can convert the text to lowercase without retyping it.

With uppercase text, you can adjust the spacing between capital characters to improve readability provided the font supports capital spacing.

To change the text case

1 Using the **Text** tool , select a character or a block of text.

If the **Object properties** docker is not open, click **Window** ► **Dockers** ► **Object properties**.

2 In the **Object properties** docker, click the **Character** button  to display the character-related options.

3 In the **Character** area of the **Object properties** docker, click the **Caps** button, and click one of the following options:

- **None** — turns off all of the features in the list
- **All caps** — substitutes lowercase characters with upper case equivalents
- **Titling caps** — applies the OpenType version of the feature if the font supports it
- **Small caps (auto)** — applies the OpenType version of the feature if the font supports it
- **All small caps** — substitutes characters with a scaled-down version of the upper case characters
- **Small caps from caps** — applies the OpenType version of the feature if the font supports it
- **Small caps (synthesized)** — applies a synthesized version of **Small caps**, which appears the same as in previous versions of CorelDRAW

If the font supports capital spacing, you can click the **Capital spacing** button  to increase the spacing between capital characters and improve readability.



If you choose a non-OpenType font that supports Caps styles, CorelDRAW provides a synthesized version of the Small caps and All small caps styles.

Some OpenType fonts may appear to support features that are unsupported.



You can also change text case by selecting a character or a block of text, clicking **Text** ► **Change case**, and enabling an option in the **Change case** dialog box.

Working with OpenType features

CorelDRAW supports OpenType fonts so you can take advantage of their advanced typographic features. OpenType features allow you to choose an alternate appearance for an individual character (also referred to as a [glyph](#)) or a sequence of characters. For example, you can choose alternate glyphs for numbers, fractions, or ligature sets.

You can access OpenType commands and options in the Character area of the **Object properties** docker. You can also let CorelDRAW prompt you which OpenType features you can apply by enabling the Interactive OpenType option. When you select text, an indicator arrow appears below the text if an OpenType feature is available. You can click the indicator to access a list of the most popular OpenType features that are available for the selected text.

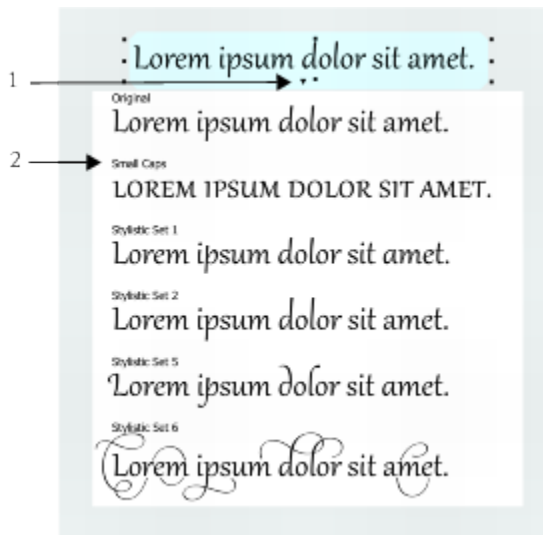

Clicking the Interactive OpenType indicator arrow (1) expands a list of the most popular OpenType features that are available for the selected text.

The OpenType font specification was created jointly by Adobe and Microsoft. Based on Unicode, OpenType fonts extend the capabilities of older font technologies. The most notable advantages of OpenType are:

- cross-platform support (Windows and Mac OS)
- extended character sets that offer better language support and advanced typographic features
- coexistence with Type 1 (PostScript) and TrueType fonts
- support for a larger [glyph](#) limit (64k)

OpenType features

The following table describes the OpenType features that you can apply in CorelDRAW provided that the feature is included in the font.

In addition, CorelDRAW also provides synthesized versions of some Caps and Position OpenType features. For example, if a font does not support a feature, such as Small Caps, CorelDRAW produces its own version of the [glyph](#) by scaling the font.

OpenType feature	Description	Example
Caps	Changes the case of text, which is useful for inserting titles and acronyms	LOREM Small caps

OpenType feature

Description

Example

Position

Displays characters as superscript or subscript, which is useful for inserting footnotes or mathematical symbols. If you select an OpenType font that does not support subscript and superscript, or a non-OpenType font, you can apply a synthesized glyph.

Lore^m
Superscript

Number styles

Includes features for controlling the appearance of numbers

See examples below

Number styles — Proportional lining

Displays numbers of varying width, which is best suited for inserting numbers in body text. However, the numbers have a fixed height, which generally matches the height of capital letters.

123

Number styles — Tabular lining

Displays numbers of equal width, spacing, and height, which is useful for aligning text and displaying text in a table

123

Number styles — Proportional Oldstyle

Displays numbers of varying width and height. The style is best suited for blending numbers with mixed text case.

123

Number styles — Tabular Oldstyle

Displays numbers of equal width, but varying height

123

Fraction

Displays numbers separated by a slash as fractions. The number of available fractions vary from font to font. Apply this feature only to the numbers that you want to display as a fraction.

See examples below

Fraction — Numerator



Displays a numerator, such as 456/, as a fraction glyph. This is useful for displaying a non-standard fraction, such as 456/789, as a fraction. Use the Numerator feature in conjunction with the Denominator feature to display non-standard fractions as fractions.

⁹⁹/100

OpenType feature	Description	Example
Fraction — Denominator	Displays a denominator, such as /789, as a fraction glyph. This is useful for displaying a non-standard fraction, such as 456/789, as a fraction. Use the Denominator feature in conjunction with the Numerator feature to display non-standard fractions as fractions.	
Fraction — Fraction	Displays standard fractions as fraction glyphs	
Fraction — Alternative fraction	Displays a fraction by using a horizontal dividing line instead of a slant or slash	Not available
Ordinals	Displays ordinals by using a number and a suffix in superscript. For example, you can display “first” as 1 st or “second” as 2 nd . Apply this feature only to the text that you want to display as an ordinal.	
Slashed zero	Displays zeros with a diagonal slash, which makes them easy to distinguish from the letter O. This feature is useful for displaying numbers in financial reports.	
Ornaments	Substitutes a character with an ornament that was created by the font designer to match the font’s motif	Not available
Stylistic alternates	Applies an alternate design to characters	
Stylistic sets	Applies an alternate design to a text selection	
Swash Variants	Inserts calligraphic-type decorative characters	
Contextual alternates	Lets you fine-tune text by applying an alternate design to a single character, or a sequence of characters, based on its surrounding characters. For example, you	Not available

OpenType feature	Description	Example
	can apply this feature to script-based text so that it flows more naturally.	
Case-sensitive forms	Shifts the position of punctuation marks so they align with capitalized text or lining numbers	Not available
Standard Ligatures	Replaces a letter pair (or a sequence of letters) with one glyph, which is called a ligature. Many OpenType fonts include standard ligatures for fi, fl, ff, ffi, and ffl. Their purpose is to improve text readability.	ff ff
Discretionary Ligatures	Replaces a non-standard letter combination with a ligature. Discretionary ligatures designed to be decorative and are not supported by the majority of OpenType fonts.	st st
Contextual ligatures	Inserts a glyph that best suits the surrounding characters. Contextual ligatures are designed to increase readability by improving the joining behavior between the characters of a ligature.	Not available
Historical ligatures	Substitutes a letter pair, or a letter sequence, with a ligature that is based on historical usages. Historical ligatures are designed to be ornamental and are not supported by the majority of OpenType fonts. The most commonly-used historical ligatures are the letter s combined with another character, such as sh si sl ss, and st.	Not available
Historical forms	Substitutes modern characters with characters that were commonly used in historical documents. Historical forms are useful for recreating historical text.	Not available

To apply an OpenType feature to text

- Using the **Text** tool , a single character or a sequence of characters.
If the **Object properties** docker is not open, click **Window** ► **Dockers** ► **Object properties**.
- In the **Object properties** docker, click the **Character** button  to display the character-related options.
- In the **Character** area of the **Object properties** docker, click an OpenType feature button, and, if applicable, choose a feature from the list.



Some OpenType fonts may appear to support features that are not supported.

To enable the onscreen OpenType feature indicator

- Click the **Text** tool , and then click the **Interactive OpenType** button  on the property bar.

If an OpenType feature is available for the selected text, an arrow  appears below the text.

You can also

View a list of the most popular OpenType features onscreen

Click the down arrow  below the text in the document window.

Apply an OpenType feature to a text selection

In the OpenType feature list, click a feature.

Adjusting character and word spacing

You can improve text readability by adjusting the character and word spacing. When letters or words are too close together, or too far apart, they become difficult to read. CorelDRAW offers you different tools for controlling text spacing.

Character spacing

You can change the spacing between characters (also known as “letter spacing”) in a block of text. For example, fully justifying a block of text may insert too much space between characters, which creates a visual imbalance. To improve readability, you can decrease the character spacing.

Lorem ipsum dolor sit amet, consectetur adipiscing elit. Vivamus scelerisque enim et est ullamcorper a fringilla lectus dictum.	Lorem ipsum dolor sit amet, consectetur adipiscing elit. Vivamus scelerisque enim et est ullamcorper a fringilla lectus dictum.
---	--

Increased character spacing (left) makes it difficult to read the text. Decreased character spacing (right) improves readability.

If you want to change the spacing between several characters, you need to adjust the kerning. For more information, see [“Kerning a range of characters” on page 505](#).

Word spacing

You can also adjust the spacing between words.



Lorem ipsum dolor sit
amet, consectetur
adipiscing elit. Vivamus
scelerisque enim et est
ullamcorper a fringilla
lectus dictum.

Lorem ipsum dolor sit
amet, consectetur
adipiscing elit. Vivamus
scelerisque enim et est
ullamcorper a fringilla
lectus dictum.

Decreased word spacing makes it difficult to discern the individual words in a paragraph (left). Increased word spacing (right) makes easier to read the paragraph.

To adjust character spacing

1 Do one of the following:

- Using the **Text** tool , position the cursor in a block of text.
- Using the **Pick** tool , click an artistic text object or a text frame.

If the **Object properties** docker is not open, click **Window** ▶ **Dockers** ▶ **Object properties**.



2 In the **Object properties** docker, click the **Paragraph** button  to display the paragraph-related options.

3 In the **Paragraph** area of the **Object properties** docker, type a value in the **Character spacing** box.



Values for adjusting spacing represent a percentage of the space character. The **Character** values range from -100 to 2000 percent. All other values range from 0 to 2000 percent.





You can also change the character spacing proportionally by clicking the **Shape** tool , selecting the text object, and dragging the **Interactive horizontal spacing** arrow  in the lower-right corner of the text object.

You can increase the character spacing in uppercase text by using capital spacing. For more information, see [“To change the text case” on page 506](#).

To adjust word spacing

1 Do one of the following:



- Using the **Text** tool , position the cursor in a block of text.
- Using the **Pick** tool , click an artistic text object or a text frame.

If the **Object properties** docker is not open, click **Window** ▶ **Dockers** ▶ **Object properties**.

2 In the **Object properties** docker, click the **Paragraph** button  to display the paragraph-related options.

3 In the **Paragraph** area of the **Object properties** docker, type a value in the **Word spacing** box.



You can also change the word spacing proportionally by clicking the **Shape** tool , holding down **Shift**, selecting the text object, and dragging the **Interactive horizontal spacing** arrow  in the lower-right corner of the text object.

Adjusting line and paragraph spacing

You can change the spacing between lines of text, which is also known as “leading” or “interline spacing.”

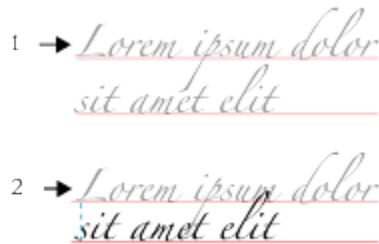

Well-balanced line spacing (1) can improve the readability of text. Insufficient line spacing can reduce readability by causing letters to overlap (2).

In CorelDRAW, you can also adjust line spacing of a text object by using the **Shape** tool.

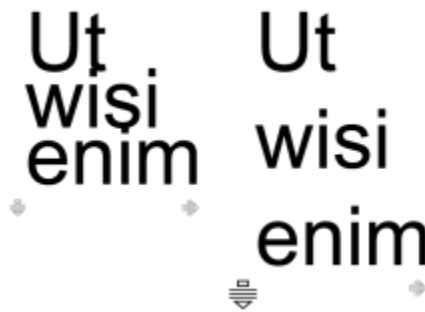

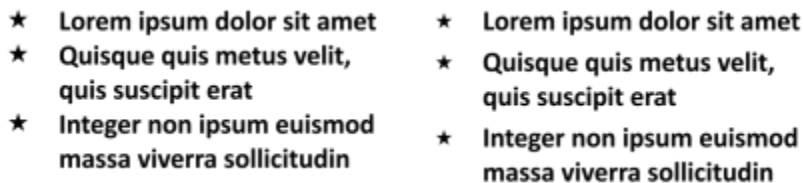

Adjusting line spacing proportionally by using the Shape tool

You can change the spacing between paragraphs, which is useful for copyfitting text. If a paragraph is positioned at the top or bottom of a frame, the spacing does not apply to the space between the paragraph text and the frame.



The spacing in between the lines in the bulleted list (left) was increased by adjusting the before and after paragraph spacing (right).



To adjust interline spacing

- 1 Using the **Text** tool , select the paragraph text.
If the **Object properties** docker is not open, click **Window** ▶ **Dockers** ▶ **Object properties**.
- 2 In the **Object properties** docker, click the **Paragraph** button  to display the paragraph-related options.
- 3 In the **Paragraph** area of the **Object properties** docker, choose one of the following units of measurement from the **Vertical spacing units** list box:

- **% of Char height** — lets you use a percentage value that is relative to the character height
- **Points** — lets you use points
- **% of Pt.size** — lets you use a percentage value that is relative to the character point size

4 Type a value in the **Line spacing** box.



You can also change the spacing between lines proportionally by clicking the **Shape** tool , selecting the text object, and dragging the **Interactive vertical spacing** arrow  in the lower-left corner of the text object.

To adjust the spacing between paragraphs

1 Using the **Text** tool , select the paragraph text.

If the **Object properties** docker is not open, click **Window** ► **Dockers** ► **Object properties**.

2 In the **Object properties** docker, click the **Paragraph** button  to display the paragraph-related options.

3 In the **Paragraph** area of the **Object properties** docker, choose a unit of measurement for line spacing from the **Vertical spacing units** list box.

4 Type a value in one of the following boxes:

- **Before paragraph spacing** — lets you specify the amount of space to insert above the paragraph text
- **After paragraph spacing** — lets you specify the amount of space to insert below the paragraph text



You can also use this procedure to adjust the spacing between items in a bulleted list.

Adding bullets to text

You can use bulleted lists to format information. You can wrap text around bullets, or you can offset a bullet from text to create a hanging indent. CorelDRAW lets you customize bullets by changing their size, position, and distance from text. You can also change the spacing between items in a bulleted list. For more information, see “[To adjust interline spacing](#)” on page 513.

<p> Lorem ipsum dolor Aenean tristique massa Proin tincidunt lacinia purus </p>	<ul style="list-style-type: none"> • Lorem ipsum dolor • Aenean tristique massa • Proin tincidunt lacinia purus
--	--

Three paragraphs (left) were converted into a bulleted list (right)





You can remove a bullet without deleting the text.

To quickly add bullets to paragraph text

1 Using the **Text** tool , drag across the **paragraph** text that you want to format as a bulleted list.

2 Click the **Bulleted list** button on the property bar.

To add bullets

- 1 Using the **Text** tool , select the **paragraph** text.
If the **Object properties** docker is not open, click **Window** ► **Dockers** ► **Object properties**.
- 2 In the **Object properties** docker, click the **Paragraph** button  to display the paragraph-related options.
- 3 In the **Paragraph** area of the **Object properties** docker, click the arrow button  located at the bottom of **Paragraph** area to display additional options.
- 4 Enable the **Bullets** check box.
- 5 Click the **Bullet settings** button , which is located to the right of the **Bullets** check box.
- 6 In the **Bullets** dialog box, perform a task from the following table.

To	Do the following
Preview text with bullets	Enable the Preview check box.
Choose a font	In the Appearance area, choose a font from the Font list box.
Choose a symbol	Open the Symbol picker, and click a symbol.
Set a bullet size	Type a value in the Size box.
Adjust the bullet position	Type a value in the Baseline shift box.
Set the distance from the text frame	In the Spacing area, type a value in the Text frame to bullet box.
Set the distance between the bullet and the text	Type a value in the Bullet to text box.
You can also	
Add a bullet with a hanging indent	Enable the Use hanging indent style for bulleted lists check box.
Change the color of a bullet	Select the bullet with the Text tool  , and click a color on the color palette .
Remove bullets	In the Paragraph area of the Object properties docker, disable the Bullets check box.



Bullets are inserted at the beginning of each new line that is preceded by a return.



You can adjust the spacing in between bullets by increasing or decreasing the space before and after a paragraph. For more information, see [“To adjust the spacing between paragraphs” on page 514.](#)

Inserting drop caps





Applying drop caps, also known as initial caps, to paragraphs enlarges the initial letter and insets it into the body of text. You can customize a drop cap by changing different settings. For example, you can change the distance between the drop cap and the body of text, or specify the number of lines of text that you want to appear next to the drop cap. You can remove the drop cap at any point without deleting the letter.



You can add a drop cap (left) or a hanging indent drop cap (right).

You can preview a drop cap before you add it to a drawing. The changes you make are temporarily applied to the text in the drawing window, so you can see how the drop cap will look when you add it.

To add a drop cap

- 1 Using the **Text** tool , select the paragraph text.
If the **Object properties** docker is not open, click **Window** ► **Dockers** ► **Object properties**.
- 2 In the **Object properties** docker, click the **Paragraph** button  to display the paragraph-related options.
- 3 In the **Paragraph** area of the **Object properties** docker, click the arrow button  located at the bottom of **Paragraph** area to display additional options.
- 4 Enable the **Drop caps** check box.
- 5 Click the **Drop caps settings** button .
- 6 In the **Drop cap** dialog box, perform a task from the following table.

To	Do
Specify the number of lines next to a drop cap	In the Appearance area, type a value in the Number of lines dropped box.
Set the distance between the drop cap and the body of text	In the Appearance area, type a value in the Space after drop cap box. This sets the space to the right of the drop cap.
Preview a drop cap	Enable the Preview check box.

To

Offset the drop cap from the body of text

Remove drop caps

Do

Enable the **Use hanging indent style for drop cap** check box.

In the **Paragraph** area of the **Object properties** docker, disable the **Drop caps** check box.

Changing character position and angle

You can modify the appearance of text by shifting the characters vertically or horizontally, which changes the position of the selected characters relative to the surrounding characters.

You can also rotate characters by specifying an angle of rotation.

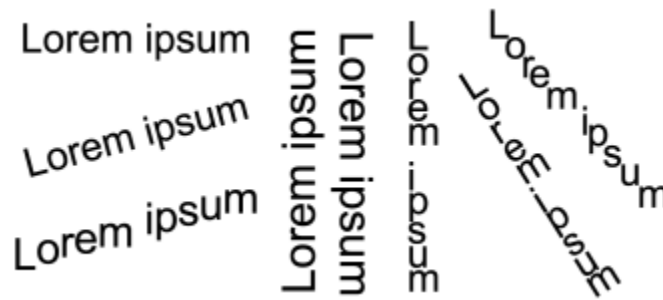

Examples of rotating text

To shift a character

- 1 Using the **Text** tool **A**, select a character or a block of text.
If the **Object properties** docker is not open, click **Window** ▶ **Dockers** ▶ **Object properties**.
- 2 In the **Object properties** docker, click the **Character** button **A** to display the character-related options.
- 3 In the **Character** area of the **Object properties** docker, click the arrow button ▼ located at the bottom of **Character** area to display additional options.
- 4 Perform one or more tasks from the following table.

To

Shift characters horizontally

Shift characters vertically

Do the following

Type a value in the **Horizontal character offset** box.

Type a value in the **Vertical character offset** box.

To rotate a character

- 1 Using the **Text** tool **A**, select a character or a block of text.
If the **Object properties** docker is not open, click **Window** ▶ **Dockers** ▶ **Object properties**.
- 2 In the **Object properties** docker, click the **Character** button **A** to display the character-related options.

- 3 In the **Character** area of the **Object properties** docker, click the arrow button ▼ located at the bottom of **Character** area to display additional options.
- 4 Type a value in the **Character angle** box.

Aligning text

CorelDRAW lets you align text in various ways. You can align paragraph text horizontally and vertically in relation to its **text frame**. You can align **paragraph** text with the **baseline grid**. For more information, see “Aligning text by using the baseline grid” on page 484. You can also align text to a selected object.

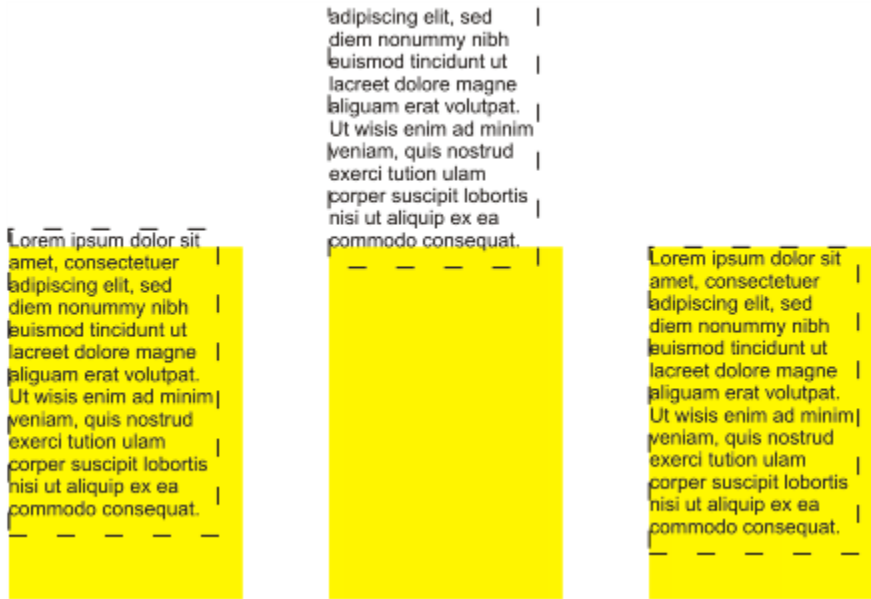

You can align a text object with other objects by using the baseline of the first line, the baseline of the last line, or the edge of the text frame.

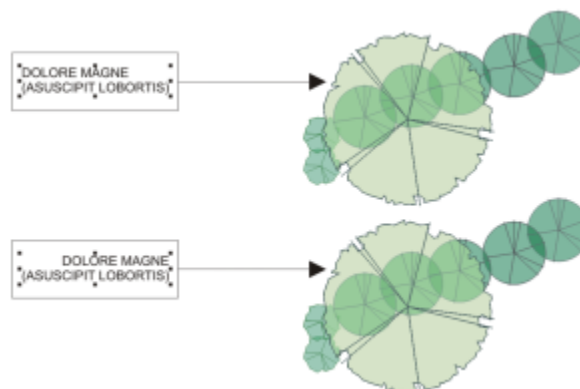

Artistic text can be aligned horizontally, but not vertically. When you align artistic text, the entire text object is aligned in relation to the **bounding box**. If characters have not been shifted horizontally, applying no alignment produces the same result as applying left alignment.



Artistic text is aligned within the bounding box, which is indicated by eight selection handles (black squares). The text at the top is left-aligned; the text at the bottom is right-aligned.

To align text horizontally

1 Do one of the following:

- Using the **Text** tool , select the text that you want to align.
- Using the **Pick** tool , click an artistic text object or a text frame whose content you want to align.

If the **Object properties** docker is not open, click **Window** ▶ **Dockers** ▶ **Object properties**.

2 In the **Object properties** docker, click the **Paragraph** button  to display the paragraph-related options.

3 In the **Paragraph** area of the **Object properties** docker, click one of the following buttons:

- **No horizontal alignment** — applies the default alignment setting
- **Align left** — aligns text with the left side of the text frame or the bounding box of artistic text
- **Center** — centers text within the text frame
- **Align right** — aligns text with the right side of the text frame and the bounding box of artistic text
- **Full justify** — aligns text, with the exception of the last line, with the left and right sides of the text frame
- **Force justify** — aligns text, including the last line, with the left and right sides of the text frame



You can also align text horizontally by clicking the **Horizontal alignment** button on the property bar and choosing an alignment style from the list box. The property bar displays an icon that corresponds to the current alignment style.

You can align multiple paragraphs in a text frame by selecting them with the **Text** tool  and choosing an alignment style.

To align paragraph text vertically

1 Using the **Pick** tool , click a text frame.

If the **Object properties** docker is not open, click **Window** ▶ **Dockers** ▶ **Object properties**.

2 In the **Object properties** docker, click the **Frame** button  to display the frame-related options.



3 In the **Frame** area of the **Object properties** docker, choose an alignment option from the **Vertical** alignment list box.

To align text with an object

1 Using the **Pick** tool , hold down **Shift**, click the text object, and then click the **object**.



2 Click **Object** ▶ **Align and distribute** ▶ **Align and distribute**.



3 In the **Text** area, click one of the following buttons:

- **First line baseline**  — uses the baseline of the first line of text to align the objects
- **Last line baseline**  — uses the baseline of the last line of text to align the objects
- **Bounding box**  — aligns text with its **bounding box**

4 In the **Align objects to** area, click the **Active objects** button .

5 In the **Align** area, click one of the following buttons to use an object edge or center for aligning.

- **Align left**  — to align the left edges of objects
- **Align center horizontally**  — to align object centers along a vertical axis
- **Align right**  — to align the right edges of objects

- **Align top**  — to align the top edges of objects
- **Align center vertically**  — to align object centers along a horizontal axis
- **Align bottom**  — to align the bottom edges of objects

To align objects from their outlines, click the **Outline** button .





If you select the text objects one at a time, the last object selected is the reference point for aligning the other objects. If you marquee select the objects before you align them, the object that is positioned in the upper-left corner of the selection is used.

Adding tabs and indents

You can modify existing tab stops by changing their alignment. You can also add trailing leader characters, so that dots, or other characters, automatically precede the tab stops. In addition, you can add new tab stops and remove existing tab stops.

Indenting changes the space between a text frame and the text that it contains. You can add and remove indents without deleting or retyping text. You can indent an entire paragraph, the first line of a paragraph, or all lines of a paragraph except the first line (a hanging indent). You can also indent from the right side of the text frame.

To modify a tab stop





- 1 Click **Window** ► **Dockers** ► **Object properties**.
- 2 In the **Object properties** docker, click the **Paragraph** button  to display the paragraph-related options.
- 3 In the **Paragraph** area of the **Object properties** docker, click the arrow button  located at the bottom of **Paragraph** area to display additional options.
- 4 Click the **Tab settings** button.
- 5 Perform a task from the following table.

To	Do the following
Change the alignment of tab stops	Click the cell in the Alignment column, and choose an alignment option from the list box.
Set tab stops with trailing leader characters	Click the cell in the Leaders column, and choose On from the list box.
Delete a tab stop	Click the cell, and click Remove .
Change the default leader character	Click Leader options , open the Character picker, and click a character.
Change the default leader spacing	Click Leader options , and type a value in the Spacing box.





You can also add, move, or delete tab stops on the horizontal ruler at the top of the drawing window. Click to add a tab stop, drag a tab marker to move it, and drag a tab marker off the ruler to delete it. For information about rulers, see “Using the rulers” on page 603.

To add a tab stop

- 1 Using the Text tool , select the paragraph text.
- 2 Click **Window** ▶ **Dockers** ▶ **Object properties**.
- 3 In the **Object properties** docker, click the **Paragraph** button  to display the paragraph-related options.
- 4 In the **Paragraph** area of the **Object properties** docker, click the arrow button  located at the bottom of **Paragraph** area to display additional options.
- 5 Click the **Tab settings** button .
- 6 Click **Add**.
- 7 Click the new cell in the **Tabs** column, and type a value.

To indent paragraph text

- 1 Using the Text tool , select the paragraph text.
- 2 Click **Window** ▶ **Dockers** ▶ **Object properties**.
- 3 In the **Object properties** docker, click the **Paragraph** button  to display the paragraph-related options.
- 4 In the **Paragraph** area of the **Object properties** docker, type values in the following boxes:
 - **First line indent** — indents the first line of text relative to the left side of the frame
 - **Left line indent** — creates a hanging indent relative to the left side of the text frame; all lines, except the first line, are indented
 - **Right line indent** — indents the text relative to the right side of the frame



You can remove indents by typing 0 in the **First line indent**, **Left line indent**, and **Right line indent** boxes.

You can indent an entire paragraph by typing the same value in both the **First line indent** and the **Left line indent** boxes.

Working with text styles

CorelDRAW provides advanced style capabilities that allow you to format document text with speed, ease, and consistency. A style is a collection of formatting attributes defining object properties, such as artistic and paragraph text properties. For example, to define a character style, you can specify font type, font style and size, text color and background color, character position, caps, and more. You can create styles and style sets for text. You can also change the default text style, so that the same properties are applied to all new artistic or paragraph text. For example, you can change the font type and size, or change the text to bold or italic. For more information, see “Working with styles and style sets” on page 573.



Hyphenating text

Hyphenation can be used to break a word if the entire word does not fit at the end of a line. You can hyphenate automatically by using a preset hyphenation definition in combination with your own hyphenation settings. You can set the minimum number of characters

before and after a hyphen. You can also specify the number of characters in the “hot zone,” which is the area at the end of a line where hyphenation can occur.

You can insert an optional hyphen in a word to produce a specific word break at the end of a line. You can also create custom definitions that specify the location of optional hyphens in specific words whenever you type, paste, or import the words in the application.

To hyphenate paragraph text automatically





- 1 Using the **Text** tool , select the text frame or [paragraph](#) text.
If the **Object properties** docker is not open, click **Window** ► **Dockers** ► **Object properties**.
- 2 In the **Object properties** docker, click the **Paragraph** button  to display the paragraph-related options.
- 3 In the **Paragraph** area of the **Object properties** docker, click the arrow button  located at the bottom of **Paragraph** area to display additional options.
- 4 Enable the **Hyphenation** check box.
- 5 Click the **Hyphenation** settings button.
- 6 In the **Hyphenation settings** dialog box, enable the **Automatically hyphenate paragraph text** check box.



Hyphenation can be used for any languages that have corresponding writing tools installed with the application. For more information about language modules, see [“Working with languages” on page 550](#).

If you do not see any hyphenated words in the paragraph after applying hyphenation, you may need to modify the hyphenation settings.

To modify the hyphenation settings

- 1 Using the **Text** tool , select the text frame or [paragraph](#) text.
If the **Object properties** docker is not open, click **Window** ► **Dockers** ► **Object properties**.
- 2 In the **Object properties** docker, click the **Paragraph** button  to display the paragraph-related options.
- 3 In the **Paragraph** area of the **Object properties** docker, click the arrow button  located at the bottom of **Paragraph** area to display additional options.
- 4 With the **Hyphenation** check box enabled, click the **Hyphenation settings** button .
- 5 In the **Hyphenation settings** dialog box, perform one or more tasks from the following table.

To	Do the following
Hyphenate capitalized words	Enable the Break capitalized words check box.
Hyphenate words that contain all uppercase letters	Enable the Break words using ALL CAPS check box.
Set a minimum word length for automatic hyphenation	In the Hyphenation criteria area, type a value in the Minimum word length box. This value represents the minimum number of characters that hyphenated words must contain.

To

Set the minimum number of characters to precede a hyphen

Set the minimum number of characters to follow a hyphen

Set the “hot zone”

Do the following

In the **Hyphenation criteria** area, type a value in the **Minimum characters before** box.

In the **Hyphenation criteria** area, type a value in the **Minimum characters after** box.

In the **Hyphenation criteria** area, type a value in the **Distance from right margin** box. This value represents the number of characters in the hot zone. A word that does not fit within this zone is hyphenated or moved to the next line.

To insert an optional hyphen

- 1 Using the **Text** tool , click in a word where you want to place an optional hyphen.
- 2 Click **Text** ► **Insert formatting code** ► **Optional hyphen**.



You can insert an optional hyphen by pressing **Ctrl + -**.

To create a custom definition for optional hyphenation

- 1 Click **Text** ► **Insert formatting code** ► **Custom optional hyphens**.
- 2 In the **Word** box, type the word for which you want to create the hyphenation definition. When you type in the **Word** box, the same text is entered in the **Hyphenated word** box.
- 3 In the **Hyphenated word** box, click where you want the optional hyphen inserted, and press the **Hyphen** key (-).
- 4 Click **Add definition**.

You can also

Create a custom hyphen definition for a specific language keyboard

Enable the **Show all languages** check box, and choose a language option from the **Language** list box.

Automatically insert custom optional hyphens when typing

Enable the **When typing** check box.

Automatically insert custom optional hyphens when typing, pasting, or importing text

Enable the **When pasting and importing text** check box.

Delete a custom optional hyphen definition

Click **Remove definition**.



The custom hyphenation definition is defined only for the language specified in the **Language** list box. You can choose another language without affecting your keyboard.



You can create a custom optional hyphen definition by selecting a word in the document. The word appears in the **Word** box of the **Custom optional hyphens** dialog box. After you insert the optional hyphen in the **Hyphenated word** box, you can apply it by clicking **Apply to selection**.

You can find and replace optional hyphens. For more information, see [“To find text ” on page 486](#) and [“To find and replace text” on page 487](#).

Inserting formatting codes

You can insert formatting codes, such as em dashes and nonbreaking spaces. In some programs, formatting codes are also known as “symbols.” The following table lists the available formatting codes and their corresponding keyboard shortcuts.

Formatting code	Keyboard shortcut
Em space	Ctrl + Shift + M
En space	Ctrl + Shift + N
1/4 em space	Ctrl + Alt + Space
Nonbreaking space	Ctrl + Shift + Space
Tab	Tab
Column break or text-frame break	Ctrl + Enter
Em dash	Alt + _
En dash	Alt + -
Nonbreaking hyphen	Ctrl + Shift + -
Optional hyphen	Ctrl + -

All shortcut keys for formatting codes are customizable. For information about customizing these shortcut keys, see the **Text** commands category in [“To assign a keyboard shortcut to a command” on page 860](#).

You can find and replace formatting codes. For more information, see [“To find text ” on page 486](#) and [“To find and replace text” on page 487](#).

To insert a formatting code

- 1 Using the **Text** tool , click to place the cursor where you want to insert a character or space.
- 2 Click **Text** ► **Insert formatting code**, and choose a formatting code from the menu.



The **Insert formatting code** menu is unavailable when the **Text** tool is not active.



You can insert a character not listed in the **Insert formatting code** menu by clicking **Text** ► **Insert character** and clicking the character in the **Insert character** docker.

Displaying nonprinting characters

You can display nonprinting characters, such as spaces, tabs, and formatting codes. For example, when you display nonprinting characters, a space appears as a tiny black dot, a nonbreaking space appears as a circle, and an em space appears as a line. When enabled, nonprinting characters are displayed only when you add or edit text.

To display nonprinting characters

- Click **Text** ► **Show non-printing characters**.



You can also display nonprinting characters by clicking **Tools** ► **Options**, choosing **Text** from the **Workspace** list of categories, and then enabling the **Show non-printing characters** check box.

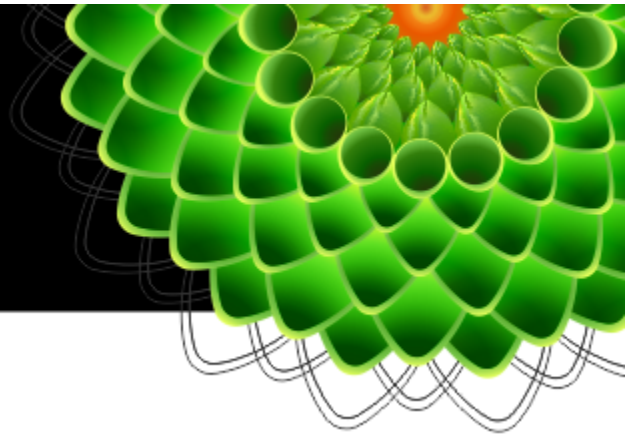

Working with text in different languages

In CorelDRAW, you can work with text in different languages. For example, if you are running CorelDRAW on an Asian operating system, or if you have Asian language support installed on another operating system, you can take advantage of the Asian text formatting capabilities available with CorelDRAW.

This section contains the following topics:

- “Formatting Asian text” (page 527)
- “Using line-breaking rules for Asian text” (page 528)
- “OpenType support for Asian text” (page 529)
- “Formatting multilingual text” (page 529)
- “Displaying text correctly in any language” (page 531)



Formatting Asian text

Asian character input is supported in CorelDRAW only when using an appropriate operating system or when language support is installed on a non-Asian operating system. You can choose a default font and text orientation (either horizontal or vertical) when typing text. When you type *artistic* or *paragraph* text, the program uses a default artistic or paragraph text style.

To choose a default font for Asian text

- 1 Click the **Text** tool .
- 2 Press **Esc** to ensure that no objects are selected.
- 3 Choose an input method from the Input Method Editor (IME) on the Windows status bar.
If the Windows **Language** bar is displayed, you can choose an input method from the **Language** bar.
- 4 Choose a font from the **Font list** box on the property bar.
- 5 Choose a font style from the **Font style** list box.

To choose a text orientation for Asian text

- 1 Using the **Pick** tool , select the frame that contains the text whose orientation you want to change.
- 2 Click **Window** ► **Dockers** ► **Object properties**.
- 3 In the **Object properties** docker, click the **Frame** button  to display the frame-related controls.

4 Choose one of the following orientation options from the **Text orientation** list box:

- **Horizontal**
- **Vertical**





The default orientation for Asian text is horizontal.

When you change the text orientation from horizontal to vertical, underlines become left lines and overlines become right lines.

The text orientation setting applies to the entire text **object**. You cannot have text with different orientations in one text object.



If you have Asian text support installed with your operating system, you can also change text orientation by clicking the **Vertical text orientation**  or **Horizontal text orientation**  buttons on the **Text** toolbar.

Using line-breaking rules for Asian text

CorelDRAW includes line-breaking rules for use with Asian text when you have an Asian operating system. For most Asian languages, a line of text can break between any two characters, with a few exceptions. Some characters cannot appear at the beginning of a line. These characters are referred to as “leading characters.” Other characters — referred to as “following characters” — cannot appear at the end of a line. The line breaks either after the following character or before the character that precedes the following character. Still others — referred to as “overflow characters” — are not wrapped but are, instead, allowed to extend beyond the right or bottom margin.

To enforce one or more of the line-breaking rules, you can enable any of the rules. To customize the rules, you can add or remove characters. You can also reset the rules to the default.

To disable or enable line-breaking rules

- 1 Click **Text** ► **Line-breaking rules**.
- 2 In the **Asian line-breaking rules** dialog box, enable any of the following check boxes:
 - **Leading characters** — ensures that a line does not break before any of the characters in the list
 - **Following characters** — ensures that a line does not break after any of the characters in the list
 - **Overflow characters** — ensures that the characters in the list are allowed to extend beyond the margin of the line



You must have Asian text support installed on your operating system to view the **Line-breaking rules** menu item.

To add or remove characters to a line-breaking rule

- 1 Click **Text** ► **Line-breaking rules**.
- 2 Type or remove the characters in the appropriate box.



You must have Asian text support installed on your operating system to view the **Line-breaking rules** menu item.

To reset a line-breaking rule to the default

- 1 Click **Text** ► **Line-breaking rules**.
- 2 Click the **Reset** button beside a rule.



You must have Asian text support installed on your operating system to view the **Line-breaking rules** menu item.

OpenType support for Asian text



You can apply advanced OpenType typography features to Asian text. OpenType features can be accessed from the **Character** area in the **Text properties (Text ▶ Text properties)**. The following table lists the OpenType features that you can use with Asian text provided the features are included in the font.

OpenType feature	Description
Asian widths	Changes the width by spacing or replacing the glyphs The Centered CJK punctuation feature centers punctuation marks horizontally and vertically.
Asian forms	Replaces the selected characters with a different glyph form. Forms cannot be combined.
Asian vertical metrics	The Alternate vertical metrics feature centers shorter characters vertically relative to full-height characters. This feature also applies to full-width Latin glyphs. The Alternate vertical half metrics feature centers characters vertically relative to half-height characters.
Horizontal Kana alternates	Substitutes the standard kana glyph with a horizontal kana glyph
Vertical Kana alternates	Substitutes the standard kana glyph with a vertical kana glyph
Vertical alternates and rotation	Substitutes characters with forms suitable for vertical text, often rotating them at 90 degrees
Alternate annotation forms	Applies an annotation form to the selected characters. This OpenType feature applies to both Latin and Asian text.

Formatting multilingual text

CorelDRAW includes controls that let you format text in different languages. You can limit any font, style, and size changes to only Latin, Asian, or Middle Eastern text by choosing the script type. For example, if you want to change the font size of Japanese text in a document that includes both English and Japanese text, you can choose the Asian script type, and then change the font size. This applies the new font size only to the Japanese text, the English text font size is unaffected. You can also enable right-to-left text flow when working with bidirectional languages, such as Middle Eastern languages. In addition, you can mix Latin text with Asian or Middle Eastern in one text **object** and set the spacing between the two words.



To limit font property changes to multilingual text

- 1 Using the **Text** tool , select the text.
If the **Object properties** docker is not open, click **Window** ► **Dockers** ► **Object properties**.
- 2 In the **Object properties** docker, click the **Character** button  to display the character-related options.
- 3 In the **Character** area of the **Object properties** docker, choose one of the following language options from the **Language group and script** list box:
 - All languages
 - Latin
 - Asian
 - Middle Eastern
- 4 Change any font properties.



The **Language group and script** list box is available only when using an Asian or Middle Eastern operating system or when language support is installed on the operating system.

To set right-to-left text flow in text



- 1 Do one of the following:
 - Using the **Text** tool , position the cursor in a block of text.
 - Using the **Pick** tool , click an artistic text object or a text frame.If the **Object properties** docker is not open, click **Window** ► **Dockers** ► **Object properties**.
- 2 In the **Object properties** docker, click the **Paragraph** button  to display the paragraph-related options.
- 3 In the **Paragraph** area of the **Object properties** docker, choose an option from the **Text direction** list box.



The **Text direction** option is available, and visible, only when you use a Middle Eastern operating system or when language support is installed on a non-Middle Eastern operating system.

You can also change the direction of text flow in columns. For more information, see [“To change the flow of bidirectional text in columns” on page 482](#).

To specify spacing between Latin and Asian words

- 1 Using the **Text** tool , select the **paragraph** that combines both the Latin and Asian text.
- 2 In the **Object properties** docker, click the **Paragraph** button  to display the paragraph-related properties.
- 3 In the **Paragraph** area of the **Object properties** docker, type values in the **Language spacing** box.



The language spacing value is based on the percentage of a standard space. For example, two spaces are represented by typing a value of 200.

Displaying text correctly in any language

In CorelDRAW, all text that is added to a document is encoded using the Unicode character set. When you open or import a drawing that contains text, CorelDRAW converts the encoding system that was used in the file to Unicode. For example, if you import an older document that includes 8-bit ANSI text that uses a specific [code page](#) (e.g. (949 ANSI/OEM - Korean), CorelDRAW converts code page 949 to Unicode. If the code page is not specified when you open a document, CorelDRAW uses a default code page to convert the text. Therefore, this may cause some text to display incorrectly in CorelDRAW. However, you can display the text correctly by selecting it and converting it back to Unicode by using the appropriate [code page](#).

Encoding settings do not affect the display of text outside the drawing window, such as keywords, filenames, and text entries in the **Object manager** and **Object data manager** dockers. For these types of text, you must use [code page](#) settings in the **Open** or **Import** dialog boxes to set the proper characters. For information about using code page settings, see [“Starting and opening drawings” on page 52](#).

To display text correctly in any language

- 1 Using the **Text** tool , select the text object that is displaying incorrectly.
- 2 Click **Text** ► **Encode**.
- 3 In the **Text encoding** dialog box, choose the **Other encoding** option.
- 4 From the **Other encoding** list, choose an encoding setting that makes the text readable.

The preview window displays the text with the selected encoding setting.



Changing the encoding allows you to use Unicode fonts, even if your original text was using non-Unicode fonts.

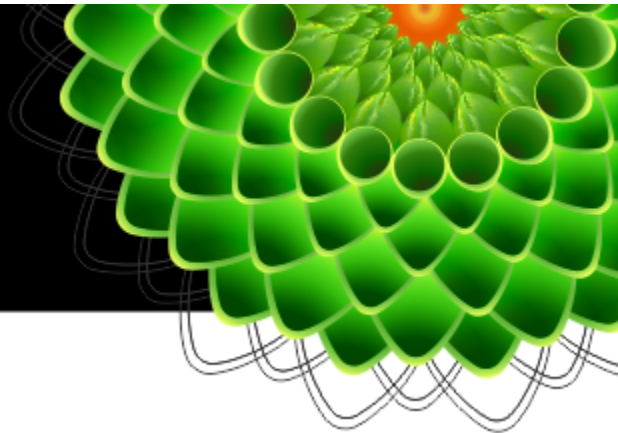

Managing fonts

CorelDRAW allows you to manage and preview fonts.

This section contains the following topics:

- “Changing the default font” (page 533)
- “Substituting fonts” (page 534)
- “Embedding fonts” (page 535)
- “Viewing fonts” (page 536)
- “Filtering fonts” (page 537)
- “Searching for fonts” (page 539)
- “Acquiring more fonts” (page 540)
- “Identifying fonts” (page 541)
- “Choosing fonts with Font Playground” (page 541)
- “Using Corel Font Manager” (page 544)

Changing the default font

You can change the default font that is used for artistic, callout, dimension, and paragraph text.

To change the default font

- 1 Click the **Text** tool and without clicking anywhere in the document window, choose a font from the **Font** list box on the property bar.
- 2 In the **Change Document Defaults** dialog box, enable any of the following check boxes to change the default font for the corresponding text types:
 - **Artistic text**
 - **Callout**
 - **Dimension**
 - **Paragraph text**

This step changes the default font for the active document. If you want to change the default font for all new documents that you create, click **Tools** ► **Save Settings as Default**.



You can also change the default font from the **Object Styles** docker. For more information, see [“To edit default object properties” on page 578](#).

Substituting fonts

You can use [PANOSE font matching](#) to access a list of fonts that can be used as substitutes for fonts used in a document but not found on your computer.

You can set options for font matching. You can use font matching in text only or in both text and text styles. You can also turn off font matching. When you use font matching, you can accept the default substitute font, or you can choose another font to substitute for the missing font. You can apply the substitution temporarily or permanently.

You can build a list of exceptions to font substitutions. Exceptions override the font substitutions recommended by the PANOSE font-matching feature. A list of exceptions can be useful when you share drawings and documents across platforms, because sometimes the same font is spelled differently on each platform.

To set options for font matching

- 1 Click **Tools** ► **Options**.
- 2 In the **Workspace** list of categories, double-click **Text**, and click **Fonts**.
- 3 Click **PANOSE font matching**.
- 4 In the **PANOSE font matching preferences** dialog box, enable one of the following options:
 - **Text** — lets you choose font substitutions for text in the document and applies default font substitutions for text styles
 - **Text and styles** — lets you choose font substitutions for text in the document and for text styles
 - **Never show** — applies default font substitutions for text in the document and for text styles

To use PANOSE font matching

- 1 Open or import a document.
If the document contains missing fonts, the **Substitute missing fonts** dialog box opens. The name of the missing font appears in the **Missing font** list, and the recommended substitute appears in the **Substituted font** list.
- 2 Enable the **Use the PANOSE suggested match** option.
- 3 Enable one of the following options:
 - **Temporary** — replaces the missing font with the substitution in the current session of the document
 - **Permanent** — permanently replaces the missing font with the substitution. When you save and reopen the file, the new font is used.

To substitute a missing font

- 1 Open or import a document.
If the document contains missing fonts, the **Font matching results** dialog box opens.
- 2 Enable the **Substitute font with** option.
- 3 Enable one of the following options:
 - **Show fonts in the same code page as missing font** — displays only missing fonts that support the [code page](#) of the active document
 - **Show all fonts** — displays all missing fonts
- 4 Choose a missing font from the **Missing font** list.
- 5 Choose a font from the **Substitute font with** list box.
- 6 Enable one of the following options:

- **Temporary** — replaces the missing font with the substitution in the current session of the document
- **Permanent** — permanently makes the font substitution in the document. When you save and reopen the file, the new font is used.



You can save font substitutions by enabling the **Save this exception for future font matching** check box.

You can substitute a font for more than one missing font by holding down **Shift** and selecting the fonts in the **Missing font** list in the **Font substitution for missing fonts** dialog box.

To build a list of exceptions to font substitutions

- 1 Click **Tools** ► **Options**.
- 2 In the **Workspace** list of categories, double-click **Text**, and click **Fonts**.
- 3 Click **PANOSE font matching**.
- 4 In the **PANOSE font matching preferences** dialog box, click **Exceptions**.
- 5 In the **PANOSE font matching exceptions** dialog box, type the name of the missing font in the **Missing font** box.
- 6 Choose a font that is installed on your computer from the **Substituted font** list box.

Embedding fonts

Font embedding can help you share drawings so that others can view, print, and even edit them without having to install or substitute fonts. By default, CorelDRAW embeds the fonts that are used in a drawing when the file is saved, but you can choose to disable font embedding for that particular drawing. For more information, see [“To save a drawing” on page 65](#). You can change the default option for embedding fonts in drawings.

Note that CorelDRAW respects the embedding permissions of each font. Some fonts allow embedding for print and preview purposes, but not for text editing; other fonts may not allow embedding. The following font embedding permissions are respected by CorelDRAW:

- **Editable** — allows fonts to be embedded in electronic documents and used by the recipients of the documents to edit the text.
- **Installable** — similar to **Editable**. In addition, this permission allows fonts to be permanently installed on a recipient’s computer and used to create new documents.
- **No Embedding** — does not allow fonts to be embedded in electronic documents
- **Preview and Print** — allows fonts to be embedded in an electronic document strictly for previewing and printing purposes. Such fonts cannot be installed and used to edit the document on other computers.

If a drawing contains fonts that cannot be embedded, a warning is displayed. You can disable this warning.

You can import files that contain embedded fonts. If an embedded font does not allow editing, a visual indicator appears next to the font name in the **Object manager** docker. When you try to edit text that uses this font, you are prompted to choose a font substitution. For more information, see [“Substituting fonts” on page 534](#).

To change the default option for embedding fonts

- 1 Click **Tools** ► **Options**.
- 2 In the **Workspace** list of categories, click **Save**.
- 3 In the **Fonts** area, enable or disable the **Embed fonts by default when saving files** check box.

To enable or disable the warning for fonts that cannot be embedded

- 1 Click **Tools** ► **Options**.
- 2 In the **Workspace** list of categories, click **Warnings**.
- 3 In the **Show warnings when** box, enable or disable the **Fonts cannot be embedded** check box.



The warning lists a maximum of 7 fonts that cannot be embedded. If a document contains more than 7 fonts that cannot be embedded, an ellipsis is displayed at the bottom of the list.

Viewing fonts

You can customize the font list, from within the **Font list** box, to make it easier to find fonts. For example, you can change the size of the font names displayed in the **Font list** box. You can display fonts grouped by family or as a flat list. If you have non-Latin fonts installed, you can show their names in Latin or in their native language. In addition, you can show recently used fonts at the top of the font list, or hide them, and you can specify the number of recently used fonts to display.

By default, font names use the corresponding fonts, but you can display all font names by using the same font.

CorelDRAW lets you preview fonts in the **Preview** area at the bottom of the Font list box or in the drawing window. You can also preview a font in all available styles, such as bold and italic.

You can resize the **Font list** area by adjusting its height and width or by hiding the preview area.

To customize the font list

- 1 Click the **Text** tool in the toolbox, and open the **Font list** box on the property bar.
- 2 To change the size of the font names, move the **Zoom** slider.
- 3 Click the **Font Options** button , and perform a task from the following table.

To	Do the following
Display the font list grouped by family or as a flat list	Click Group by family to enable or disable the command.
Show the names of non-Latin fonts in Latin or in the native language	Click Show Latin names to enable or disable the command. This option is useful when you work with Cyrillic, Arabic, and Asian fonts.
Display font names by using the same font	Click Use font to display the font name to disable the command.
Display or hide recently used fonts	Click Show recently used fonts to enable or disable the command.
Specify the number of recently used fonts to display	Click Font List Options , and on the Fonts page of the Options dialog box, type a value in the Number of recently used fonts displayed box. The maximum number of recently used fonts that you can display is 20.

To preview a font

- 1 Click the **Text** tool  in the toolbox.

If you want to preview a font in the drawing window, select the text you want.

2 On the property bar, click the **Font list** box.

The font name appears in the given font.

To preview the selected text with a specific font applied, point to the font name in the **Font list** box.



The names of symbol fonts are displayed in the default user interface font, with examples of the symbol font appearing to the right of the symbol font name and in the Preview area.



If a font has other styles, such as bold or italic, you can preview them by pointing to the flyout arrow ► next to the font name.

To resize the Font list area

1 Click the **Text** tool in the toolbox, and open the **Font list** box on the property bar.

2 Do any of the following:

- To hide the preview area, click the **Hide preview** button .
- To adjust the width of the **Font list** area, point to the vertical grab area (right edge) and drag when the double-sided arrow appears.
- To adjust the height, point to the horizontal grab area (above the **Zoom** slider), and drag when the double-sided arrow appears.

Filtering fonts

Filtering helps you view only the fonts that meet specific requirements. For example, you can display only the fonts used in the document or only symbol fonts. You can filter fonts based on the font technology, weight, width, style, supported language(s), OpenType features, and more; and you can apply one or more filters at the same time.

The following table lists available font filter categories and filters.

Font filter category	Description
Content Exchange	Lets you display only fonts downloaded from the Content Exchange
Document Fonts	Lets you display only the fonts used in the document
Font Status	Lets you filter fonts based on their status such as Installed, Not installed, and Protected System Fonts.
Embedding Rights	Lets you filter fonts based on embedding permissions such as whether fonts can be embedded, installed, and previewed. Available filers include: Editable, Installable, No Embedding, and Preview and Print. For information about embedding permissions, see “Embedding fonts” on page 535 . If fonts with a specific permission are not available, the corresponding filter is not displayed. For example, if all your fonts can be embedded in a document, the No Embedding filter is not displayed.

Font filter category

Description

Font Technology

Lets you filter fonts based on the font technology such as OpenType - TrueType, OpenType - PostScript, TrueType, and Type1

If a font technology is not available on your computer, it does not appear in the list of filters.

Weight

Lets you display fonts based on their weight such as Light, Normal, or Bold

Width

Lets you display fonts based on their width such as Condensed, Normal, and Expanded

Style

Lets you display fonts based on their style such as Decorative, Display, Monospaced, Sans Serif, Script, Serif, and Symbol



Character Range

Lets you filter fonts based on their language or script. Filters in this group include Arabic, Chinese Simplified, Chinese Traditional, Cyrillic, Devanagari, Greek, Hebrew, Japanese, Korean, Latin, and Turkish

OpenType

Lets you display fonts that have specific OpenType features such as Capital Spacing, Case-Sensitive forms, and more

To filter fonts

- 1 Click the **Text** tool  in the toolbox.
- 2 Open the **Font** list box on the property bar, and click the **Show filters** button .
- 3 Enable any of the filter check boxes.

You can also

Clear all filters

Click **Clear filters**.

Close the filter list

Click the **Hide filters** button .



You can filter only fonts that are installed on your computer.



You can also filter fonts from the **Font list** box in the **Object Properties** docker, **Text Properties** docker, **Font Playground**, and **Insert Character** docker.

Searching for fonts

Corel Font Service is a utility that checks what fonts are installed on your computer and generates a font database with keywords. These keywords include font names, font technology, and other metadata included in the fonts, and can be used to search for local fonts from within the **Font list** box.

When you start typing a font name or another keyword, a relevant list of fonts is displayed. This list is automatically updated as you type. To refine your search, you can type two or more keywords. For example, to find all available Arial fonts that have bold weight, you can type **Arial bold** in the **Font list** box.

To search for fonts by using keywords

- 1 Click the **Text** tool **A** in the toolbox.
- 2 Open the **Font list** box on the property bar.
- 3 Double-click in the **Font list** box, and type a keyword such as a font name or font technology.
- 4 To refine your search, press the space bar after typing the first keyword, and type another keyword.



The following table lists the search keywords that you can use organized by categories.

Category	Keywords
Document Fonts	Document Fonts
Font Technology	OpenType - TrueType, OpenType - PostScript, TrueType, Type1
Weight	Thin, Extra Light, Light, Regular, Medium, Semi Bold, Bold, Extra Bold, Black
Width	Ultra Condensed, Extra Condensed, Condensed, Semi Condensed, Normal, Semi Expanded, Expanded, Extra Expanded, Ultra Expanded
Style	Decorative, Display, Monospaced, Sans Serif, Script, Serif, Symbol
Character Range	Arabic, Armenian, Chinese Simplified, Chinese Traditional, Coptic, Cyrillic, Devanagari, Dhivehi, Georgian, Greek, Gujarati, Hebrew, Hiragana, Japanese, Kannada, Katakana, Korean, Latin, Russian, Syria, Tamil, Telugu, Thai, Turkish, Vietnamese

Category

Keywords

Manufacturer

Ale/Paul, Bitstream, Cultivated/Mind, DynaComware, Font Fabric, Fontlab, Fontographer, ITC, Linotype, Mark Simonson, Monotype, Typodermic, RW+ +

Embedding rights

Editable, Installable, No Embedding, Preview& Print, Restricted

OpenType



All Small Capitals, Alternate Annotation Forms, Alternate Half Widths, Alternate Vertical Half Metrics, Alternate Vertical Metrics, Alternative Fractions, Capital Spacing, Case Sensitive Forms Centered CJK Punctuation, Character Variants Contextual Alternates, Contextual Ligatures, Denominators Discretionary Ligatures, Expert Forms, Fractions, Half Widths, Historical Forms, Historical Ligatures, Hojo Kanji Forms, Horizontal Kana Alternates, JIS2004 Forms, JIS78 Forms, JIS83 Forms, JIS90 Forms, Kerning, Lining Figures, Localized Forms, NLC Kanji, Numerators, Ordinals, Ornaments, Proportional Kana, Proportional Lining, Proportional Oldstyle, Proportional Widths, Quarter Widths, Scientific Inferiors, Simplified Forms, Slashed Zero Small Capitals, Small Capitals from Capitals, Standard Ligatures, Stylistic Alternates, Stylistic Sets, Subscript, Superscript, Swash Variants, Tabular, Tabular Oldstyle, Third Widths, Titling, Traditional Forms, Traditional Name Forms, Vertical Alternates and Rotation

Acquiring more fonts

You can download additional fonts from within the **Font list** box in CorelDRAW and Corel Font Manager. These fonts are usually grouped in font packs. Some font packs are free while others are available for purchase. You can access information about the font packs and the fonts they include as well as view font samples.

You can change the default location to which fonts are saved. For more information, see [“Content types” on page 114](#).

To acquire a font pack

- 1 Click the **Text** tool  in the toolbox.
- 2 Open the **Font list** box on the property bar.
- 3 Click the **Get More** button .
- 4 In the **Get More** dialog box, click a font pack.
- 5 Do one of the following:
 - Click **Buy**, and follow the onscreen instructions to purchase the font pack.
 - Click **Download** if the font pack is free.

The downloaded font pack can be accessed from the **Font list** box. It also appears in the **Filters** list under **My collections**.

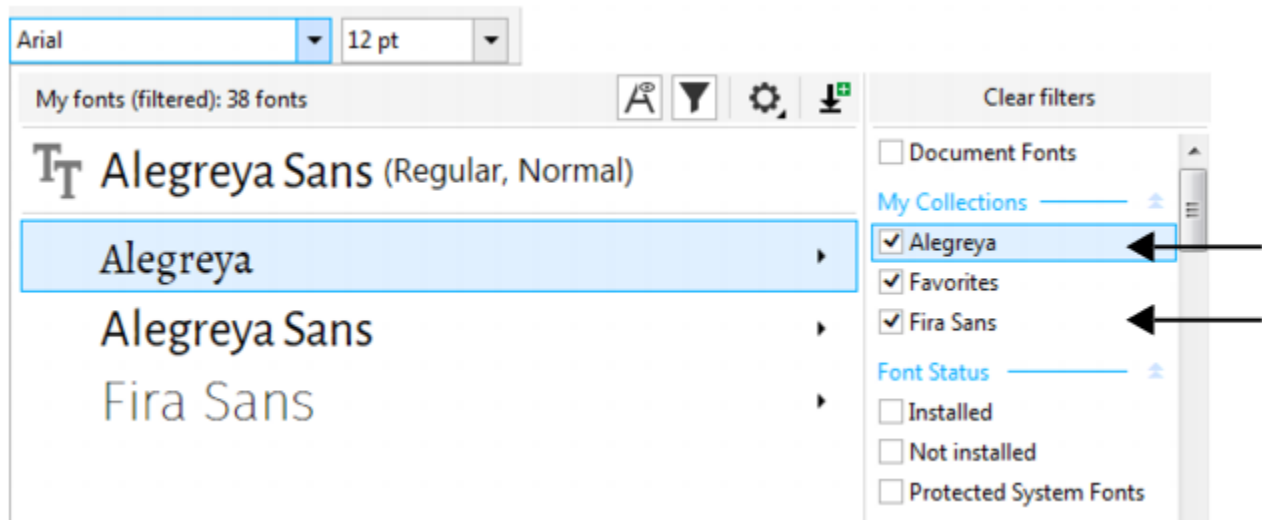

You can easily access the fonts from downloaded font packs by applying filters.

Identifying fonts

You can easily identify a font in the text portion of a webpage or a graphic design. CorelDRAW lets you capture a sample of the graphic and automatically upload it to www.whatthefont.com for identification.

To identify a font

- 1 Click **Text** ► **WhatTheFont?!**
- 2 Drag the cursor to create a marquee around the font that you want to identify. Click inside the capture area, or press **Enter** to complete the capture. To cancel, press **Esc**.
On the WhatTheFont?! website, the font you captured is displayed.
- 3 Follow the directions on the WhatTheFont?! website to complete the font identification.



The ideal letter height for the best search result is about 100 pixels. Capture only uppercase or lowercase letters, not numbers or special characters. Make sure that the captured text is horizontal and that the letters do not touch.

Choosing fonts with Font Playground

Font Playground lets you view the same sample text in different fonts and sizes to help you choose fonts for your project.

You can preview preset text samples, or you can type or paste text. In addition, you can view samples as single lines of text or multiline text, and you can view a text sample as single lines of text in increasing font sizes.

When a text sample uses an OpenType font, you can view available OpenType features and apply them to the text sample.



Eos accusam v...

Tahoma Normal

Eos accusam ve...

Segoe UI Normal

Eos accusam ve...

Footlight MT Light

Eos accusam venia...

Geometr231 BT Normal



Eos accusam
veniam ea
ipsum.

Tahoma Normal

Eos accusam
veniam ea ipsum.

Segoe UI Normal

Eos accusam
veniam ea ipsum.

Footlight MT Light

Eos accusam veniam
ea ipsum.

Geometr231 BT Normal



Eos accusam veniam ea ipsum.

Eos accusam veniam ea ipsum.

Eos accusam veniam ea ipsum.

Eos accusam veniam ea ipsum.

Eos accusam venia...

Eos accusa...

Eos acc...

Geometr231 BT Normal

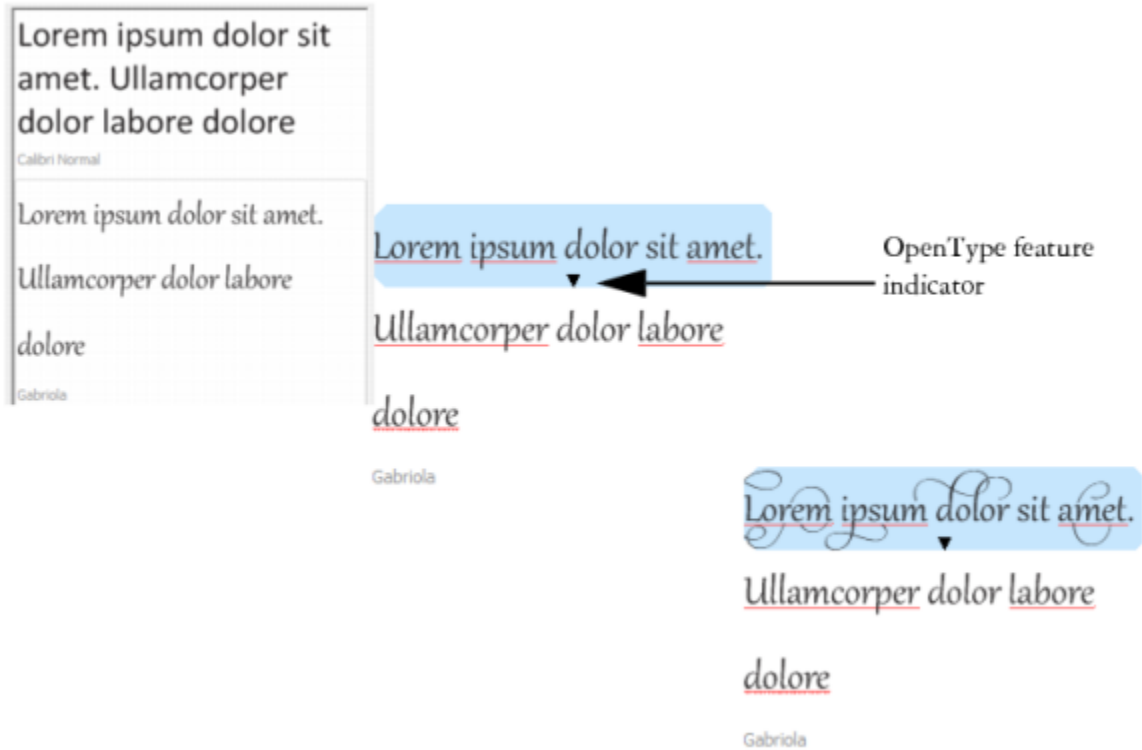

Views from left to right: Single line, Multiline, and Waterfall



With text samples using OpenType fonts, you can select text to display the OpenType feature indicator and apply an OpenType feature. In this example, a stylistic set was applied to the selected text.

To view a text sample in context, you can paste it where you want in the drawing window.

To preview fonts with Font Playground

- 1 Click **Text** ► **Font Playground**.
- 2 To change the font of a sample, click the sample, and choose a font from the **Font list** box.
If you want to change the text in all samples, double-click a sample, press **Ctrl+A** to select the text, and then type the new text.
- 3 To choose a view option, click any of the following buttons:
 - **Single line**  — shows the samples as single lines of text
 - **Multiline**  — shows the samples as multiline text
 - **Waterfall**  — shows the selected sample as single lines of text in increasing sizes
- 4 To change the size of sample text, move the **Zoom** slider.
If you want to change the text size in preset increments, click the **Zoom** buttons next to the **Zoom** slider.

You can also

Add a text sample

Click **Add another sample**, and choose a font from the **Font list** box.

You can also

Paste a text sample in a document

Click a text sample, and click **Copy**. Using the **Text** tool **A**, right-click where you want to place the text sample, and click **Paste**.

You can also drag a text sample to the document window.

Delete a text sample

Click a text sample, and click the **Close** button in the upper-right corner of the sample.

Paste text in a text sample

Click a text sample, and then press **Ctrl+V**.

Change the order of text samples

Drag a text sample to a new position in the list.

Using Corel Font Manager

Corel Font Manager is a standalone font management application included with CorelDRAW Graphics Suite. Corel Font Manager lets you easily handle, organize, and explore your typeface and font collections by giving you tools to control every aspect of your typography workflow. You can find and preview local and online fonts, install and uninstall fonts, and delete fonts that you no longer need. For more information, see the Help in Corel Font Manager.

To start Corel Font Manager

- Click the **Application launcher** button on the standard toolbar, and then click Corel Font Manager.

To access the Corel Font Manager Help

- In Corel Font Manager, click the **Help** button on the title bar.

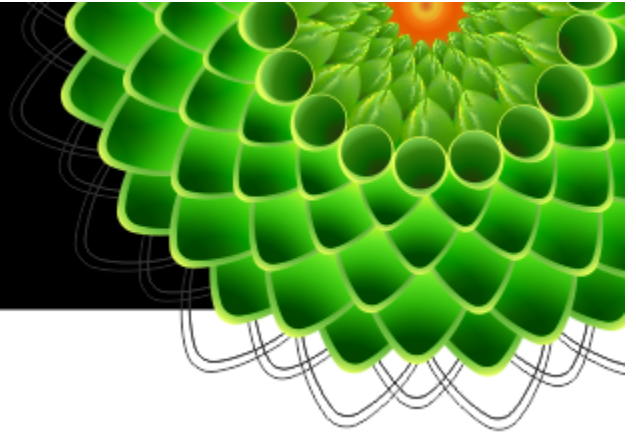

Using writing tools

You can use writing tools to correct errors in spelling and grammar, correct mistakes automatically, and refine your writing style.

This section contains the following topics:

- “Using QuickCorrect” (page 545)
- “Using the spelling checker and Grammatik” (page 547)
- “Using the thesaurus” (page 549)
- “Working with languages” (page 550)
- “Customizing the writing tools” (page 550)
- “Using checking styles” (page 551)
- “Using rule classes” (page 554)
- “Analyzing a drawing” (page 555)
- “Using word lists” (page 556)
- “Checking statistics” (page 559)

For more information about using the writing tools, see “Reference: Using writing tools” on page 559.

Using QuickCorrect

QuickCorrect™ automatically corrects misspelled words and capitalization errors. You can customize QuickCorrect by specifying which types of errors you want to correct automatically.

In CorelDRAW, the quotation marks that are applied to text vary according to the language that you have selected. You can further customize the quotation marks for different languages by using QuickCorrect. For example, you can change the style of double, single, and straight quotation marks for a language.

Adding words to QuickCorrect lets you replace words and abbreviations that you often mistype. The next time you type the misspelled word, QuickCorrect corrects the word automatically. You can use this feature to create shortcuts to frequently used words and phrases. For example, you can store the phrase “for your information” under the abbreviation “FYI” so that each time you type “FYI” followed by a space, it is replaced with the phrase.

You can have QuickCorrect add corrections made with the spelling checker to its word list so that the next time you misspell the word the same way, it is automatically corrected.

You can also undo a QuickCorrect correction.

To customize QuickCorrect

- 1 Click **Text** ► **Writing tools** ► **QuickCorrect**.
- 2 Enable any of the following check boxes:
 - **Capitalize first letter of sentences**
 - **Correct two initial, consecutive capitals**
 - **Capitalize names of days**
 - **Automatic hyperlink**
 - **Replace text while typing**



The **Correct two initial, consecutive capitals** option doesn't make a change when a capital letter is followed by a space or period, or if a word contains other capital letters.

Instead of enabling the **Capitalize first letter of sentences** check box, you can change the text case to sentence case. For more information, see ["To change the text case" on page 506](#).

To customize quotation marks for different languages

- 1 Click **Text** ► **Writing tools** ► **QuickCorrect**.
- 2 Choose a language from the **Language** list box.
- 3 Perform a task from the following table.

To	Do the following
Change straight quotation marks to typographic ("curly") quotation marks	Enable the Change straight quotes to typographic quotes check box.
Insert straight quotation marks when the quotation mark follows a number	Enable the Use straight quotation marks after numbers check box.
Change the appearance of single quotation marks	Choose a quotation mark style from the Open and Close list boxes, or type a character in each of the boxes.
Change the appearance of double quotation marks	Choose a quotation mark style from the Open and Close list boxes, or type a character in each of the boxes.



Straight quotation marks are sometimes used to represent feet (') and inches (").

To add words to QuickCorrect

- 1 Click **Text** ► **Writing tools** ► **QuickCorrect**.
- 2 Enable the **Replace text while typing** check box.
- 3 In the **Replace** box, type the text to be replaced.
- 4 Type the replacement text in the **With** box.
- 5 Click **Add**.



You can use this feature to create shortcuts to frequently used words and phrases. Type the abbreviation in the **Replace** box, and the word or phrase in the **With** box.

To add spelling corrections to QuickCorrect

- 1 Click **Tools** ► **Options**.
- 2 In the **Workspace** list of categories, double-click **Text**, and click **Spelling**.
- 3 Enable the **Add corrections to QuickCorrect** check box.

To undo a QuickCorrect correction

- Click **Edit** ► **Undo QuickCorrect**.

Using the spelling checker and Grammatik

The writing tools let you check your text in many ways. By using the spelling checker and Grammatik, you can check the spelling and grammar in an entire drawing, part of a drawing, or only selected text.

You can manually edit text and then resume checking the drawing.

The spelling checker and Grammatik replace words or phrases in two ways: you can choose a word, or define an automatic replacement for a word. Defining automatic replacement words is useful for words that are regularly misspelled. Automatic replacement words are stored in a user word-list file. For more information about user word-list files, see [“Using word lists” on page 556](#).

You can skip a writing error once but flag subsequent occurrences of the problem, or you can skip the error throughout the entire proofreading session.

To check the spelling or grammar in an entire drawing

- 1 Click **Text** ► **Writing tools**, and click one of the following:
 - **Spell check**
 - **Grammatik**
- 2 Choose **Document** from the **Check** list box.
- 3 Click **Start**.

To check the spelling or grammar in part of a drawing

- 1 Click **Text** ► **Writing tools**, and click one of the following:
 - **Spell check**
 - **Grammatik**
- 2 From the **Check** list box, choose one of the following:
 - **Paragraph**
 - **Selected text**
 - **Sentence**
 - **Word**
- 3 Click one of the following:
 - **Start** — begins a new check
 - **Resume** — continues an interrupted check



The options available from the **Check** list box vary according to the type of drawing that you are checking.

To check the spelling or grammar of selected text

- 1 Select the text you want to check.
- 2 Click **Text** ► **Writing tools**, and click one of the following:
 - **Spell check**
 - **Grammatik**

By default, the **Auto start** command is enabled for the spelling checker and Grammatik. If you want to disable the **Auto start** command, click **Options** ► **Auto start**; to check a drawing, you must click the **Start** button in the **Writing tools** dialog box.

To edit text manually

- 1 Click **Text** ► **Writing tools**, and click one of the following:
 - **Spell check**
 - **Grammatik**
- 2 When the spelling or grammar checker stops on a word or phrase, click where you want to make changes.
- 3 Edit the text.

To replace a word or phrase

- 1 Click **Text** ► **Writing tools**, and click one of the following:
 - **Spell check**
 - **Grammatik**
- 2 When the spelling or grammar checker stops, choose a word or phrase from the **Replacements** list.
- 3 Click **Replace**.



If the spelling checker does not offer replacement words, you can edit text manually in the **Replace with** box.

To define automatic text replacements

- 1 Click **Text** ► **Writing tools**, and click one of the following:
 - **Spell check**
 - **Grammatik**
- 2 When the spelling or grammar checker stops on a word, click **Auto replace**.

To skip a spelling or grammar error once

- 1 Click **Text** ► **Writing tools**, and click one of the following:
 - **Spell check**
 - **Grammatik**
- 2 When the spelling or grammar checker stops, click **Skip once**.

To skip all occurrences of an error

- 1 Click **Text** ► **Writing tools**, and click one of the following:

- Spell check
- Grammatik

2 When the spelling or grammar checker stops, click **Skip all**.



You can also skip all occurrences of a word for all proofreading sessions by adding it to a user word list. For more information about user word-list files, see [“Using word lists” on page 556](#).

Using the thesaurus

You can use the thesaurus to refine your writing style. The thesaurus lets you look up options such as synonyms, antonyms, and related words.

You can replace a word by using the thesaurus. When you look up a word, the thesaurus provides a short definition and a list of the lookup options selected. The thesaurus also maintains a history list of the words that you have looked up. Each time you start the thesaurus, it begins a new history list.

The thesaurus automatically replaces a word with a suggested word, but you can also use the thesaurus to insert words.

To replace a word

- 1 Select a word.
- 2 Click **Text** ▶ **Writing tools** ▶ **Thesaurus**.
- 3 Click **Look up**.
- 4 In the list of categories, double-click a definition and click a word.
- 5 Click **Replace**.

You can also

Look up words suggested by the thesaurus

View definitions in the pane to the right of the suggested words.

Look up any word

Type a word in the list box at the top of the **Thesaurus** page. Click **Look up**.

Look up recently checked words

Choose a word from the list box at the top of the **Thesaurus** page.



In some instances, you are prompted to select the correct form of the word that you want to insert. This prompt appears when the word that you want to replace is spelled the same in both the present and past tenses (for example, “read”), or when the word can be used as more than one part of speech (for example, “wonder,” which can be used as either a noun or a verb).



Click the left and right arrows to scroll through word lists.

To insert a word

- 1 In the drawing, click where you want to insert the word.
- 2 Click **Text** ▶ **Writing tools** ▶ **Thesaurus**.

- 3 Type a word in the box at the top of the **Thesaurus** page.
- 4 Click **Look up**.
- 5 Choose a word from the list box.
- 6 Click **Insert**.



In some instances, you are prompted to select the correct form of the word that you want to insert. This prompt appears when the word that you want to replace is spelled the same in both the present and past tenses (for example, “read”), or when the word can be used as more than one part of speech (for example, “wonder,” which can be used as either a noun or a verb).

Working with languages

A drawing can contain text that alternates between different languages. For example, if English is the default language of your computer’s operating system, and you also have a French language module installed, you can use the writing tools to check the spelling or grammar of both French and English text. When you run the spelling checker, Grammatik, or the thesaurus, CorelDRAW checks words, phrases, and sentences according to their assigned language. This prevents foreign words from being marked as misspellings. You can use the writing tools the same way you would if the text were all in one language.

You can select from a list of writing tool languages when you install the application. If you did not perform a custom installation to include additional languages, only the default writing tool language is installed. For more information about updating your installation to include more writing tool languages, see [“To modify or repair a CorelDRAW Graphics Suite installation” on page 24](#).

For more information about installing a Writing Tools language module, see [“Changing the language” on page 49](#).

You can also check for the formatting conventions of another language. For example, the spelling checker can format all dates in a drawing according to French conventions (such as “12 avril 2005”).

Many of the languages support hyphenation. Hyphenation lets you reduce the raggedness of text along the right margin by dividing a word that falls at the end of a line, instead of forcing the entire word to the next line.

You can also specify which quotation marks to use for different languages. For more information, see [“To customize quotation marks for different languages” on page 546](#).

To assign a language to text

- 1 Select the text.
- 2 Click **Text** ► **Writing tools** ► **Language**.
- 3 In the **Text language** dialog box, choose a language from the list.



You can assign a language to selected words, sentences, or paragraphs.

To use the writing tools for the language you select in the **Text language** dialog box, the module for that language must be installed.



You can check which language has been assigned to text by selecting the text and viewing the three-letter language code that appears in the status bar.

Customizing the writing tools

You can customize how the spelling is checked in a drawing. For example, you can choose how the spelling checker starts and whether it searches for misspelled words, irregular capitalization, duplicate words, or words with numbers.

You can customize how Grammatik checks grammar in a drawing. For example, you can customize Grammatik to start automatically, to prompt you before it automatically replaces words, and to show spelling suggestions for misspelled words.

You can customize the thesaurus to look up words or close automatically. The thesaurus can also be customized to suggest spelling suggestions for misspelled words and to display multiple alternative word lists.

To set spelling checker options

- 1 Click **Text** ► **Writing tools** ► **Spell check**.
- 2 Click **Options**, and then click one of the following:
 - Auto start
 - Beep on misspelled
 - Recheck all text
 - Check words with numbers
 - Check duplicate words
 - Check irregular capitalization
 - Prompt before auto replacement
 - Show phonetic suggestions



The options you click are applied the next time you open the spelling checker.

To set Grammatik options

- 1 Click **Text** ► **Writing tools** ► **Grammatik**.
- 2 Click **Options**, and click one of the following:
 - Auto start
 - Prompt before auto replacement
 - Suggest spelling replacements



The options you click are applied the next time you open Grammatik.

To set thesaurus options

- 1 Click **Text** ► **Writing tools** ► **Thesaurus**.
- 2 Click **Options**, and click one of the following:
 - Auto look up
 - Auto close
 - Spelling assist



The options you click are applied the next time you open the thesaurus.

Using checking styles

A checking style is a preset writing style rule applied to a drawing. Using a checking style lets you check a drawing that has a specific type of writing. For example, you can choose an advertising checking style to check advertising copy or marketing materials.

You can create, delete, edit, and restore a checking style.

You can specify a maximum number of items when Grammatik checks the grammar of a drawing. For example, you can specify the maximum number of consecutive nouns that Grammatik allows.

Choosing a formality level lets Grammatik check a drawing for strict or relaxed use of language and diction. Each checking style has a default level of formality assigned to it. Each formality level focuses on a different style of writing. You can choose from three formality levels: informal, standard, and formal.

To select a checking style

- 1 Click **Text** ► **Writing tools** ► **Grammatik**.
- 2 Click **Options** ► **Checking styles**.
- 3 In the **Checking styles** dialog box, choose one of the following:
 - Spelling plus
 - Quick check
 - Very strict
 - Formal memo or letter
 - Informal memo or letter
 - Technical or scientific
 - Documentation or speech
 - Student composition
 - Advertising
 - Fiction
 - Grammar As-You-Go
- 4 Click **Select**.



A checking style remains in effect until you disable the checking style or choose another one.

To create a checking style

- 1 Click **Text** ► **Writing tools** ► **Grammatik**.
- 2 Click **Options** ► **Checking styles**.
- 3 In the **Checking styles** dialog box, choose **Very strict** from the list.
- 4 Click **Edit**.
- 5 In the **Edit checking styles** dialog box, disable any rule classes in the **Rule classes** list that you do not want to include.
- 6 Modify any of the settings.
- 7 Click **Save as**.
- 8 In the **Save as checking style** dialog box, type a name in the **Custom style name** box.

To delete a checking style

- 1 Click **Text** ► **Writing tools** ► **Grammatik**.
- 2 Click **Options** ► **Checking styles**.
- 3 In the **Checking styles** dialog box, choose a checking style from the list.
- 4 Click **Delete**.



You can delete custom checking styles, but you cannot delete preset checking styles.

To edit a checking style

- 1 Click **Text** ► **Writing tools** ► **Grammatik**.
- 2 Click **Options** ► **Checking styles**.
- 3 In the **Checking styles** dialog box, choose a checking style.
- 4 Click **Edit**.
- 5 Modify any of the settings.
- 6 Click **Save**.



When you save an edited checking style, an asterisk (*) is added to the style name.

To restore an edited checking style

- 1 Click **Text** ► **Writing tools** ► **Grammatik**.
- 2 Click **Options** ► **Checking styles**.
- 3 In the **Checking styles** dialog box, choose an edited checking style from the list.
- 4 Click **Edit**.
- 5 Click **Restore**.

If you want to save an edited or restored checking style with a new name, click **Save as**, and type the new name in the **Save as checking style** dialog box.



Custom checking styles saved with new names cannot be returned to default settings.

To specify the maximum number of specific items

- 1 Click **Text** ► **Writing tools** ► **Grammatik**.
- 2 Click **Options** ► **Checking styles**.
- 3 In the **Checking styles** dialog box, choose a checking style from the list.
- 4 Click **Edit**.
- 5 In the **Maximum allowed** area, type values in any of the following boxes:
 - **Consecutive nouns**
 - **Consecutive prepositional phrases**
 - **Long sentence length**
 - **Spell numbers below or equal to**
 - **Words allowed in split infinitive**



Set the **Spell numbers below or equal to** value to zero if you do not want numerals to be flagged as errors.

To change a formality level

- 1 Click **Text** ► **Writing tools** ► **Grammatik**.
- 2 Click **Options** ► **Checking styles**.
- 3 In the **Checking styles** dialog box, choose a checking style from the list.
- 4 Click **Edit**.
- 5 In the **Formality levels** area, enable one of the following:
 - **Informal**
 - **Standard**
 - **Formal**

Using rule classes

Rule classes contain groups of grammar and style rules. Grammatik uses rule classes to detect common writing errors.

You can enable or disable rules at any time during a Grammatik session. When you disable a rule, Grammatik ignores all the errors associated with that rule during the current proofreading session. You can also choose which rule classes to apply during a Grammatik session or save a new set of rules as a checking style.

To enable a rule

- 1 Click **Text** ► **Writing tools** ► **Grammatik**.
- 2 Click **Options** ► **Turn on rules**.
- 3 In the **Turn on rules** dialog box, choose the rules you want to enable from the **Rules** list.



The **Turn on rules** command is available only when you have disabled a rule during proofreading. Otherwise, it is grayed.

To disable a rule

- 1 Click **Text** ► **Writing tools** ► **Grammatik**.
- 2 Start a new grammar-checking session.
- 3 When Grammatik alerts you to an error that you do not want to flag, click **Turn off**.

To add rule classes

- 1 Click **Text** ► **Writing tools** ► **Grammatik**.
- 2 Click **Options** ► **Checking styles**.
- 3 In the **Checking styles** dialog box, choose a checking style from the list.
- 4 Click **Edit**.
- 5 In the **Edit checking styles** dialog box, enable any check boxes beside the rule classes in the **Rule classes** list that you want to add.

To save a set of rules as a new checking style

- 1 Click **Text** ► **Writing tools** ► **Grammatik**.
- 2 Click **Options** ► **Save rules**.
- 3 In the **Save rules** dialog box, click **Save as**.
- 4 In the **Save as checking style** dialog box, type a name in the **Custom style name** box.



The **Save rules** command is available only when a rule has been turned off.

Analyzing a drawing

Grammatik lets you analyze the grammatical structure of text in a drawing. You can analyze parts of a sentence and parts of speech. When Grammatik analyzes a sentence, it assigns a sentence part to each word or group of words. Grammatik uses Parse Tree to let you view the parts of a sentence. When Grammatik analyzes text, it assigns a part of speech to each word in a sentence. You can view the parts of speech that Grammatik assigns to a sentence.

You can view a basic counts report to analyze a writing style. The basic counts report determines if there are too many long words or if paragraphs are too long and complicated for the reader to easily understand.

You can also view a flagged errors report to analyze a writing style. The flagged errors report lists the types of errors flagged in a drawing and reports the number of times each error was flagged. You can also use this report to identify the types of grammar problems that often appear in a drawing.

Viewing a readability report lets you analyze the amount of skill required for a reader to understand the text in a drawing. Grammatik analyzes the readability of a drawing by comparing the text with a comparison document. You can choose from one of three Grammatik comparison documents, or you can add a custom comparison document.

To view a parse tree

- 1 Click **Text** ► **Writing tools** ► **Grammatik**.
- 2 Click **Options** ► **Analysis** ► **Parse tree**.



The location of the cursor determines the sentence that appears in the parse tree.

To view parts of speech

- 1 Click **Text** ► **Writing tools** ► **Grammatik**.
- 2 Click **Options** ► **Analysis** ► **Parts of speech**.



The location of the cursor determines the sentence that appears in the **Parts of speech** dialog box.

To view a basic counts report

- 1 Click **Text** ► **Writing tools** ► **Grammatik**.
- 2 Click **Options** ► **Analysis** ► **Basic counts**.

To view a flagged errors report

- 1 Click **Text** ► **Writing tools** ► **Grammatik**.
- 2 Click **Options** ► **Analysis** ► **Flagged**.

To view the readability of a drawing

- 1 Click **Text** ► **Writing tools** ► **Grammatik**.

- 2 Click **Options** ► **Analysis** ► **Readability**.
- 3 In the **Readability** dialog box, choose a comparison document from the **Comparison document** list box.

To add a comparison document

- 1 Open the drawing you want to use as a comparison document.
- 2 Click **Text** ► **Writing tools** ► **Grammatik**.
- 3 Click **Options** ► **Analysis** ► **Readability**.
- 4 In the **Readability** dialog box, click **Add document**.



Grammatik lets you add only one custom comparison document. If you add a second document, it overwrites the first custom comparison document.

Using word lists

A word list is a list of words or phrases scanned when you proof text by using the writing tools. Writing tools scan two types of word lists: user word lists and main word lists. Each language comes with a default user word list. You can customize user word lists by adding, deleting, or replacing words. Main word lists are lists of specialized words used by the spelling checker for a particular language, field or company.

You can choose a user word list to help proof a text. You can have up to 10 user word lists active simultaneously. For example, if you want the spelling checker to scan both the US English and the Canadian English main word lists, choose both lists. If you work in the medical profession, you can select a third-party medical word list that runs with the writing tools. Each language supported by the spelling checker has a default main word list. The active user word lists are scanned first; if the word or phrase is not found there, the active main word lists are scanned. You can add, disable, or remove word lists.

You can add a word to a user word list so that the word is not flagged as an error. You can also add replacement words to a user word list, which lets you choose a replacement when the spelling checker or Grammatik stops on a word.

You can edit or delete words in a user word list at any time.

To choose a user word list

- 1 Click **Text** ► **Writing tools**, and click one of the following:
 - **Spell check**
 - **Grammatik**
- 2 Click **Options** ► **User word lists**.
- 3 Enable the **User word list** check box.

If there is only one user word list, no check box appears.



The default user word list for the language is always enabled.

To add a user word list

- 1 Click **Text** ► **Writing tools**, and click one of the following:
 - **Spell check**
 - **Grammatik**
- 2 Click **Options** ► **User word lists**.

- 3 Click in the **User word lists** list where you want to position the new user word list.
- 4 Click **Add list**.
- 5 In the **Add user word list** dialog box, choose the new user word list.
- 6 Click **Open**.



The filename extension for a user word list is **.uwl**.

When you check a drawing, the user word lists are scanned in the order of their appearance in the **User word lists** dialog box.

To disable a user word list

- 1 Click **Text** ► **Writing tools**, and click one of the following:
 - **Spell check**
 - **Grammatik**
- 2 Click **Options** ► **User word lists**.
- 3 Disable the check box that corresponds to a user word list.



The default user word list for the language is always enabled.

To remove a user word list

- 1 Click **Text** ► **Writing tools** ► **Spell check**.
- 2 Click **Options** ► **User word lists**.
- 3 Choose a user word list.
- 4 Click **Remove list**.



You cannot remove the default language word list.

To add a word to a user word list

- 1 Click **Text** ► **Writing tools**, and click one of the following:
 - **Spell check**
 - **Grammatik**
- 2 Click **Options** ► **User word lists**.
- 3 In the **User word lists** dialog box, choose a user word list.
- 4 Type a word in the **Word/phrase** box.
- 5 If you want to add a replacement word, type it in the **Replace with** box.
- 6 Click **Add entry**.
- 7 Click **Close**.



In the spelling checker, replacement words appear in the **Replacements** box.



Click **Add** from the **Spell checker** or **Grammatik** pages to add the word to the current user word list.

You can also add short phrases to a user word list.

To add alternative words to a user word list

- 1 Click **Text** ► **Writing tools**, and click one of the following:
 - **Spell check**
 - **Grammatik**
- 2 Click **Options** ► **User word lists**.
- 3 In the **User word lists** dialog box, choose a user word list.
- 4 Type a word in the **Word/phrase** box.
- 5 Type a replacement word in the **Replace with** box.
- 6 Click **Add entry**.
- 7 Click **Close**.



You can also add short phrases to a user word list.

To edit a word or phrase in a user word list

- 1 Click **Text** ► **Writing tools**, and click one of the following:
 - **Spell check**
 - **Grammatik**
- 2 Click **Options** ► **User word lists**.
- 3 Choose the user word list that contains the word or phrase you want to edit.
- 4 Choose the word or phrase you want to edit.
- 5 Edit the word or phrase in the **Replace with** box.
- 6 Click **Replace entry**.



If the word list you want to edit does not appear in the **User word lists** dialog box, click **Add list** to open the list.

To delete a word or phrase from a user word list

- 1 Click **Text** ► **Writing tools**, and click one of the following:
 - **Spell check**
 - **Grammatik**
- 2 Click **Options** ► **User word lists**.
- 3 Choose the word list you want to edit.
- 4 Choose the word or phrase you want to delete.
- 5 Click **Delete entry**.

Checking statistics

You can check text statistics to count text elements, including the number of lines, words, characters, and the names of the fonts and styles used. You can display statistics either for selected text objects or for the entire drawing. If no text is selected, all text elements in the drawing, including tab and space characters, are counted.

To count text elements for an entire drawing

- 1 Click a blank space in the [drawing window](#).
- 2 Click **Text** ► **Text statistics**.

You can also

Count text elements for selected text

Select a block of text. Click **Text** ► **Text statistics**.



If you want to display information about the styles used, enable the **Show style statistics** check box.

Reference: Using writing tools

Grammatik uses the following notations to identify parts of speech or parts of a sentence.

Notation in Grammatik	Grammatical term	Explanation
3v	third-person present verb	The following sentences use the third-person present-tense verb form: "He waits." "She brushes her hair." "Does it sing?"
<>	punctuation	Punctuation clarifies the meaning of a phrase or statement. Examples: <ul style="list-style-type: none">• period (.)• comma (,)• question mark (?)
abrv	abbreviation	An abbreviation is a shortened version of a word. For example, "etc." is an abbreviation of "etcetera."
adj	adjective	An adjective modifies a noun. Example: a "good" book.
adv	adverb	An adverb modifies a verb or an adjective. Examples:

Notation in Grammatik	Grammatical term	Explanation
		<ul style="list-style-type: none"> • go "quickly" • a "very" good book
aux	auxiliary verb	<p>An auxiliary verb is a form of "be," "have," or "do." Examples:</p> <ul style="list-style-type: none"> • "is" coming • "had" not run • "did" he say
bv	base verb	<p>A base verb is the form of a verb that comes after "to" in an infinitive, or after a modal (such as "would").</p>
c/s	comparative/superlative	<p>The comparative and superlative forms of adjectives or adverbs indicate a degree of comparison. Examples:</p> <ul style="list-style-type: none"> • happier • slowest
cj	conjunction	<p>A conjunction joins words, phrases, or clauses. Examples:</p> <ul style="list-style-type: none"> • the book "and" the pen • I want to leave "because" it is late.
det	determiner	<p>A determiner is a type of adjective. Examples:</p> <ul style="list-style-type: none"> • a • an • the • some • these • any
direct object	direct object	<p>A direct object receives the action. Example: Bob opened "the box."</p>
ij	interjection	<p>An interjection is an exclamation. Examples:</p> <ul style="list-style-type: none"> • Hi! • Oh! • Hey!
indirect object	indirect object	<p>An indirect object tells "to whom" or "for whom" the action of the sentence occurs. Examples:</p> <ul style="list-style-type: none"> • Bob gave "her" an apple. • I sent "him" a postcard.
inf	split infinitive	<p>A split infinitive is a verb in its infinitive form (to be, to run) that is split by intervening modifiers. For example, in the split infinitive</p>

Notation in Grammatik	Grammatical term	Explanation
		"to boldly go," the adverb "boldly" splits the infinitive "to go."
main clause	main clause	A main clause is complete in meaning without any other sentence component. Examples: <ul style="list-style-type: none"> • Let's have the picnic today unless it rains. (Main clause: "Let's have the picnic today") • When not in school, children play. (Main clause: "children play")
mod	modal	A modal is a type of auxiliary verb. Examples: <ul style="list-style-type: none"> • will • must • can • should • might
num	number	A number expresses a quantity. Examples: <ul style="list-style-type: none"> • "three" boys • "497" days • "62" percent
phrasal	phrasal preposition	A phrasal preposition is a preposition that belongs to, but is separated from, a verb phrase. Example: put the book "down."
pn	plural noun	A plural noun is the plural form of a noun. Examples: <ul style="list-style-type: none"> • books • children
poss	possessive noun	A possessive noun shows ownership. It is used as an adjective to modify another noun. Examples: <ul style="list-style-type: none"> • "dog's" leg • "students'" cars • "Joe's" son
ppt	past participle	A past participle is a past-tense verb form. Example: The note was "written" in ink.
prep phr	prepositional phrase	A prepositional phrase consists of a preposition and its object, plus any modifiers. Prepositional phrases function as adjectives, adverbs, or nouns. Example: We came back "for the second show."

Notation in Grammatik	Grammatical term	Explanation
pres-p	present participle	<p>A present participle is a verb form that can function as part of a verb phrase or as an adjective. It is usually created by adding "ing" to the base verb. Examples:</p> <ul style="list-style-type: none"> • He is "writing" a book. • She is "going" to bed. • The lawyers presented "closing" arguments.
prn	pronoun	<p>A pronoun takes the place of a noun. Examples:</p> <ul style="list-style-type: none"> • I • me • you • mine • yourself • these • who • which
pv	past tense	<p>The past tense expresses actions that have already occurred. Examples:</p> <ul style="list-style-type: none"> • He "wrote" the book. • We "went" to the store.
relative clause	relative clause	<p>A relative clause is a type of subordinate clause that acts like an adjective, describing the noun or pronoun that precedes it. A relative clause usually begins with a relative pronoun, such as "who," "whom," or "what." Example: The employees "who worked diligently" were rewarded.</p>
rel prn	relative pronoun	<p>A relative pronoun introduces a subordinate clause and links it with an independent clause. Examples: The noise "that" scared you was made by the boy "who" lives next door.</p>
sn	singular noun	<p>A singular noun is the name of one person, place, thing, or idea. Examples:</p> <ul style="list-style-type: none"> • Tom • Canada • pen • health
subject	subject	<p>The subject of a clause performs an action. A subject can be one word or several. Examples:</p> <ul style="list-style-type: none"> • "John" ran.

Notation in Grammatik	Grammatical term	Explanation
		<ul style="list-style-type: none"> • "The cats" meowed. • "All the children and their mothers" took naps.
subordinate clause	subordinate clause	<p>A subordinate clause, which is also called a dependent clause cannot stand alone. It depends on another clause to complete its meaning. Example: We will have the meeting today, "because everyone is here."</p>
that clause	that-clause	<p>A that-clause is a specialized subordinate clause starting with "that." Example: We were sure "that you would pay us."</p>
verb or verb phrase	verb or verb phrase	<p>A verb or verb phrase shows action. Verbs can contain one word or several words, but Grammatik uses "verb phrase" when the verb consists of more than one word. Examples:</p> <ul style="list-style-type: none"> • John "ran." • He "has gone."
wh-clause	wh-clause	<p>A wh-clause is a specialized subordinate clause starting with "when," "how," "why," or "where." A wh-clause can serve as a noun, an adverb, or an adjective. Examples:</p> <ul style="list-style-type: none"> • We knew "where she would go." • I will tell you "when I go."

Templates and styles

- Working with templates..... 567
- Working with styles and style sets.....573
- Working with color styles..... 583

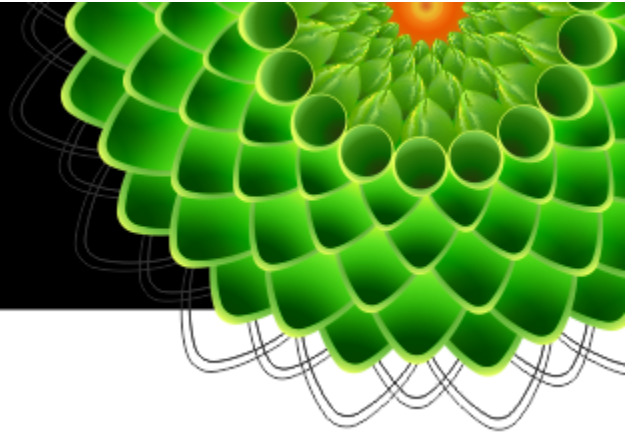

Working with templates

A template is a collection of styles and page layout settings that govern the layout and appearance of a drawing. Templates are sometimes referred to as “templets.”



Use a template for drawing designs that you want to reuse.

You can use the preset templates provided with CorelDRAW, and you can create and use custom templates.

This section includes the following topics:

- “Searching for templates” (page 567)
- “Using templates” (page 569)
- “Creating templates” (page 570)
- “Editing templates” (page 570)

Searching for templates

CorelDRAW provides an easy way of finding templates.

Searching

You can search by the name, category, or reference information associated with a template. For example, if you type “contemporary” in the text field, the application automatically filters out all files that do not match, and you see only the files that have the word “contemporary” in the template name, category, or designer notes attached to the file.

You can cancel a search at any time.

Filtering search results

You can narrow the search results by using different criteria, such as document type (for example, brochure, flyer, newsletter, or postcard) and industry (for example, hospitality or retail). You can choose to view only templates that you have created or all templates (the templates included with CorelDRAW and provided by third-party designers, as well as templates that you have created).

Viewing templates and template information

You can increase the size of thumbnails to recognize a particular template easier and faster, and you can decrease thumbnail size to view more search results at a glance. When you select a template in the viewing area, additional information is displayed about the template's category, style, pagination, and fold options, as well as any designer notes related to its intended use.

To search for templates

- 1 Click **File** ► **New from template**.
- 2 In the **New from template** dialog box, type a word in the **Search** box, and press **Enter**.
Thumbnails that match the search term appear in the **Templates** pane.
- 3 From the **View by** list box in the **Filter** pane, choose one of the following categories:
 - **Type** — sorts templates by document type, such as brochure, flyer, or newsletter
 - **Industry** — sorts templates by the industry that the template was designed for (for example, hospitality, retail, or services)
- 4 In the category list, click a category.
To view all templates (that is, templates included with CorelDRAW, created by third-party designers, or created by you or others), click **All**. To view only templates that you have created, click **My templates**.



Custom templates that do not contain any category information are displayed under **My templates**.

If the CorelDRAW shell integration components are not installed (that is, if you have disabled the **Windows Shell Extension** option under **Utilities** in the Setup wizard during a custom installation), you can search for templates only by filename, not by name, keywords, or other reference information.



You can also start a search by entering a search term in the **Search** box and clicking the **Start search** button .

To view templates and template information

- 1 Click **File** ► **New from template**.
- 2 In the **New from template** dialog box, search for templates.
- 3 Perform one or more tasks from the following table.

To

Do the following

Increase or decrease the size of thumbnails

Drag the **Zoom** slider to the right or left.

View template details

Click a thumbnail in the **Templates** pane. The template details are displayed in the **Template details** pane.

If the **Template details** pane is hidden, click the **Show/Hide template details** button  to display it.

To

View designer notes

Print designer notes

Do the following

Click a thumbnail in the **Templates** pane. The designer notes are displayed in the **Designer notes** pane.

Click the **Print designer notes** button  in the lower-left corner of the **Designer notes** pane.

If there are no designer notes associated with a template, the **Print designer notes** button is disabled.

Using templates

When you start a document from a template by using the **File** ► **New from template** command, CorelDRAW formats the page according to the page layout settings in the template and then loads all objects and template's styles into the new document. With this method, you can search and browse for templates.

If you want to use only the styles from a template, you can create a blank document by using the **File** ► **Open** command.

You can also import styles from a template into a document at any time.

To start a document from a template

- 1 Click **File** ► **New from template**.
- 2 Search or browse for templates.
- 3 Choose a template from the **Templates** list.
- 4 Click **Open**.



For information about searching for templates, see [“To search for templates” on page 568](#).

You can also start a document from a template by clicking **File** ► **Open**, locating the template, double-clicking it, and enabling the **New from template** check box in the **Open** dialog box. If you want to use only the template's styles, disable the **With contents** check box.

To import styles from a template into a document

- 1 Click **Window** ► **Dockers** ► **Object styles**.
- 2 In the **Object styles** docker, open the **Import, export, or save defaults** flyout, and then click the **Import style sheet** button .
- 3 Locate the folder where the template is stored.
- 4 Click the template that contains the styles that you want to load.
- 5 Click **Open**.



Only the template styles are imported. Page layout settings and objects saved with the template are ignored. The attributes of existing objects are maintained.

Creating templates

If the preset templates do not meet your needs, you can create your own templates, based on documents that you often use. For example, if you regularly put together a newsletter, you can save the page layout settings and styles to a template.

When you save a template, CorelDRAW allows you to add reference information, such as pagination, folds, category, industry, and other important notes. Although adding template information is optional, doing so makes it easier to organize and locate templates later on. For example, adding descriptive notes to a template lets you subsequently search for that template by entering text from the notes.

You can change the default location to which templates are saved. For more information, see [“Content types” on page 114](#).

To create a template

- 1 Click **File** ► **Save as template**.
- 2 Type a name in the **File name** list box.
- 3 Locate the folder where you want to save the template.
- 4 Click **Save**.
- 5 In the **Template properties** dialog box, specify the options you want:
 - **Name** — Assign a name to your template. This name will appear with the thumbnail in the **Templates** pane.
 - **Sided** — Choose a pagination option.
 - **Folds** — Choose a fold from the list, or choose **Other** and type the fold type in the text box next to the **Folds** list box.
 - **Type** — Choose an option from the list, or choose **Other** and type the template type in the text box next to the **Type** list box.
 - **Industry** — Choose an option from the list, or choose **Other** and type the industry for which the template is designed.
 - **Designer notes** — Type important information about the intended use of the template.



If you click **Cancel**, you close the **Template properties** dialog box without saving the template.

If you save a template to a previous version of CorelDRAW Graphics Suite (13.0 or earlier), you cannot add reference information.

The **Designer notes** text box supports HTML markup, so you can paste such content as graphics and hyperlinks. Graphics pasted from an HTML file are referenced from their original location and are not embedded in the CorelDRAW document. Therefore, if you plan to share a template with others, make sure that they have access to the location of the graphics. If you paste formatted text (also known as “rich text”) from a Rich Text Format (RTF) or HTML file, the formatting properties of the text are preserved.



If you don't want to add reference information, click **OK** without specifying any of the options.

You can also enter designer notes by copying content from another document and pasting it into the **Designer notes** text box.

To format text in the **Designer notes** text box, use the following shortcut keys:

- **Ctrl + B** — applies bold formatting to selected text
- **Ctrl + I** — italicizes selected text
- **Ctrl + U** — underlines selected text
- **Ctrl + K** — lets you assign a hyperlink to selected text

Editing templates

You can edit a template by making changes to the styles, page layout settings, or objects. For example, if you like a template but want to make it more versatile, you can add styles that you've created or that you've taken from another template. For information about editing

styles, see “Editing styles and style sets” on page 577. For information about setting page layout options, see “Specifying the page layout” on page 595.

To edit a template

- 1 Click **File** ► **Open**.
- 2 Locate the folder where the template is stored.
- 3 Double-click a template filename.
- 4 In the **Open** dialog box, enable the **Open for editing** check box.

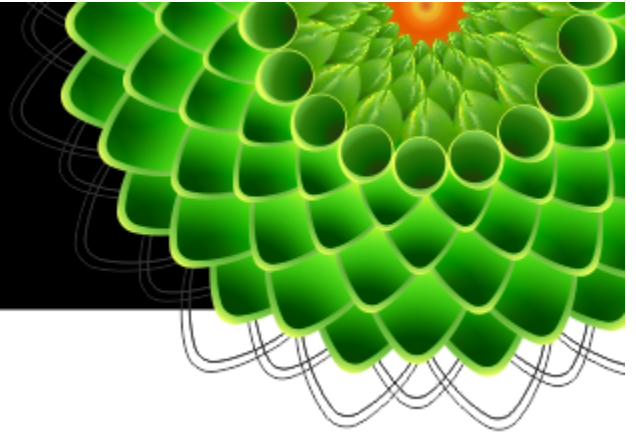

Working with styles and style sets

CorelDRAW provides advanced style capabilities that allow you to format your documents with speed, ease, and consistency. You can create and apply styles and style sets to different types of objects: graphic objects, artistic and paragraph text, callout and dimension objects, and any objects created with the Artistic Media tools.

Styles and style sets are groups of attributes that determine the appearance of objects. When you apply a style or style set to an object, all the attributes defined in that style are applied to the object in one step. That is how you can format simultaneously many different objects and significantly reduce your set-up and production time. What is more, when you edit a style or style set, all the objects defined by that style are automatically updated.

You can also export styles and style sets as style sheets for use in other documents, or import them from previously saved style sheets.



Styles simplify the task of formatting objects by saving time and ensuring a consistent look.

This section includes the following topics:

- “Creating styles and style sets” (page 574)
- “Applying styles and style sets” (page 576)
- “Editing styles and style sets” (page 577)
- “Managing default object properties” (page 578)

- “Exporting and importing style sheets” (page 579)
- “Assigning keyboard shortcuts to styles or style sets” (page 580)
- “Finding objects that use a specific style or style set” (page 580)
- “Breaking the link between objects and styles or style sets” (page 580)

Creating styles and style sets

A style is a group of formatting attributes that defines an object property, such as outline or fill. For example, to define an outline style, you can specify attributes such as outline width, color, and type of line. To define a character style, you can specify the font type, font style and size, text color and background color, character position, caps, and more. CorelDRAW lets you create and apply outline, fill, paragraph, character, and text frame styles.

CorelDRAW lets you group styles into style sets. A style set is a collection of styles that helps you define the appearance of an object. For example, you can create a style set containing a fill style and an outline style that you can apply to graphic objects such as rectangles, ellipses, and curves.

There are two options for creating styles. You can create a style or style set based on the formatting of an object that you like, or you can create a style or style set from scratch by setting the object attributes in the **Object styles** docker.

In CorelDRAW, styles can contain other styles. A style that contains another style is called a parent; a style that is contained within another style is called a child. Properties are automatically inherited from the parent; however, you can override inherited properties for a child and set its own specific properties. When you modify the parent style, the child style is updated automatically. If you set child-specific attributes, the attributes are no longer related to the parent, so if you modify the parent, the child-specific attributes will not be modified. The parent-child relationship applies to style sets as well.

You can use child and parent styles in documents where you want objects to share some, but not all, attributes, and you need to make global changes on a regular basis. For example, if you are working on a long document and you want to have headings and subheadings with similar formatting, you can create a parent character style for the headings and a child character style for the subheadings. The parent and the child styles can share the same color and font type but differ in size. If you choose a different color or font type for the parent, both the headings and the subheadings will be updated automatically. The subheadings, however, will still appear smaller than the headings.

To create a style from an object

- 1 Using the Pick tool , right-click an object.
- 2 Choose **Object styles**, choose **New style from**, and point to a style type.
A preview shows you what object attributes will be included in the new style.
- 3 Click a style type.
- 4 In the **New style from** dialog box, type a name in the **New style name** box.



If the **Object styles** docker is not open, enable the **Open object styles docker** check box in the **New style from** dialog box.



You can also create a style from an object by right-clicking the **Styles** folder in the **Object styles** docker, choosing **New from selected**, and then choosing a style type.

To create a style set from an object

- 1 Using the Pick tool , right-click an object.
- 2 Choose **Object styles**, and point to **New style set from**.

A preview shows you what object attributes will be included in the new style set.

3 Click **New style set from**.

4 In the **New style set from** dialog box, type a name in the **New style set name** box.



If the **Object styles docker** is not open, enable the **Open object styles docker** check box in the **New style set from** dialog box.



You can also create a style set from an object by dragging the object to the **Style sets** folder in the **Object styles** docker. If you drag the object over an existing style set in the **Style sets** folder, the attributes of the object replace the attributes of the style set, and all objects to which the style set has been applied are automatically updated.

To define a style

1 Click **Window** ▶ **Dockers** ▶ **Object styles**.

2 In the **Object styles** docker, click the **New style** button , and choose a style type.

The style appears in the **Styles** folder with a name assigned by the application, for example “Fill 1.”

3 Specify the style attributes that you want.

You can also

Rename a style

Right-click a style, click **Rename**, type a new name, and press **Enter**.

Delete a style

Do one of the following:

- Select a style in the **Styles** folder, and click the **Delete style** button .
- Right-click a style, and click **Delete**.

Duplicate a style

Right-click a style, and click **Duplicate**.

Create a child style

Do one of the following:

- Select a style in the **Styles** folder, and click the **New child style** button .
- Right-click a style, and click **New child style**.

To define a style set

1 Click **Window** ▶ **Dockers** ▶ **Object styles**.

2 In the **Object styles** docker, click the **New style set** button , to create an empty style set to which you can add styles.

The style set appears in the **Style sets** folder with a name assigned by the application, for example “Style Set 1.”

3 Do one of the following:

- Click the **Add or remove style** button  next to the style set, and select the style types that you want to add to the style set. Then, set the properties of each style.
- From the **Styles** folder, drag existing styles to the new style set.

You can also

Rename a style set

Right-click a style set in the **Style sets** folder, click **Rename**, type a new name, and press **Enter**.

Delete a style set

Do one of the following:

- Select a style set in the **Style sets** folder, and click the **Delete style set** button .
- Right-click a style set, and click **Delete**.

Duplicate a style set

Right-click a style set, and click **Duplicate**.

Create a child style set



Do one of the following:

- Select a style set in the **Style sets** folder, and click the **New child style set** button .
- Right-click a style set, and click **New child style set**.

Applying styles and style sets

When you apply a style or a style set to an object, the object takes on only the attributes that are defined by the style or style set. For example, if you apply an outline style, the object outline changes while its other attributes stay the same.

You can apply styles and style sets by using the **Object styles** docker and the **Object properties** docker.

In the **Object properties** docker, attributes which are defined by a style appear with a source indicator that is green and has a vertical line in the middle . (The source indicator is the little square next to the attribute name.) If there is no style applied, the source indicator appears blank . If there is an override of the applied style, the source indicator color is orange with a horizontal line in the middle .

To apply a style or style set to an object

- 1 Using the **Pick tool** , select an object.
- 2 Click **Window** ► **Dockers** ► **Object styles**.
- 3 In the **Object styles** docker, select a style or style set, and click **Apply to selected**.



To see a preview of the style or style set before applying it, point to it in the **Object styles** docker.

You can also apply a style by clicking a source indicator next to an object property (outline, fill, character, paragraph, or frame) in the **Object properties** docker and choosing a style from the list of styles.

You can also apply a style or style set to a selected object by using any of the following methods:

- In the **Object styles** docker, double-click a style or style set.
- Right-click the object, choose **Object styles**, choose **Apply style**, and then choose a style or style set from the list.
- In the **Object styles** docker, right-click a style or style set, and choose **Apply style** or **Apply style set**.
- In the **Object styles** docker, select a style or style set, and drag it to the object.

Editing styles and style sets

You can edit a style or style set either by changing its attributes in the **Object styles** docker, or by changing the attributes of an object linked to the style or style set, and then applying these changes to the style or style set.

You can also edit a style or style set by copying attributes from an object to the style or style set.

You can override style attributes. When you override an attribute, it is no longer related to the style definition, and changes to the style do not affect the object until you remove the override.

To edit a style

- 1 Click **Window** ▶ **Dockers** ▶ **Object styles**.
- 2 In the **Object styles** docker, open the **Styles** folder, and select a style.
- 3 In the style properties area of the **Object styles** docker, modify the attributes you want.

To edit a style set

- 1 Click **Window** ▶ **Dockers** ▶ **Object styles**.
- 2 In the **Object styles** docker, open the **Style sets** folder, and select a style set.
- 3 Click the **Add or remove style** button  next to the style set, and click the style type that you want to add or remove from the style set.

Check marks appear next to the style types that are included in the style set.

In the style properties area of the **Object styles** docker, you can edit the styles that are included in the style set.

To edit a style or style set by editing an object

- 1 Using the **Pick tool** , select an object that has a style or style set applied to it.
- 2 Click **Object** ▶ **Object properties**.
- 3 In the **Object properties** docker, edit the object properties.
- 4 In the document window, right-click the object, choose **Object styles** from the context menu, and choose **Apply to style**.

The new attributes of the object replace the attributes of the styles or style sets associated with this object.

To edit a style or style set by copying properties from an object

- 1 Click **Window** ▶ **Dockers** ▶ **Object styles**.
- 2 Drag an object from the document window over a style or style set name in the **Object styles** docker.





You can also copy the properties of an object to a style or style set by right-clicking the style or style set in the **Object styles** docker, choosing **Copy properties from**, and then clicking an object in the document window.

To override a style attribute



- 1 Using the **Pick tool** , select an object [that has a style](#) applied to it.
- 2 Click **Object** ▶ **Object properties**.

3 In the **Object properties** docker, edit an object attribute defined by a style.

The source indicator next to the attribute changes from green with a vertical line  to orange with a horizontal line , showing that the object attribute is no longer defined by the style.



To remove a style override, do one of the following:

- Click the orange source indicator , and choose **Revert**.
- In the document window, right-click the object by using the **Pick tool** , choose **Object styles** from the context menu, and choose **Revert to style**.

Managing default object properties

The default object properties in CorelDRAW control the appearance of text and graphic objects in the active document. For example, when you install CorelDRAW for the first time, the default properties for graphic objects determine that each new graphic object has a black outline and no fill.

You can modify the default properties of the following types of objects: artistic media, artistic text, callout, dimension, graphic, and paragraph text. When you modify the defaults, CorelDRAW automatically saves these changes to the current document. If you want to use the custom settings in subsequent documents that you create, you can set them as the new document defaults.

You can specify which object styles, style sets, color styles, or default object properties in the active drawing are set as the new document defaults.

To edit default object properties

- 1 Click **Window** ► **Dockers** ► **Object styles**.
- 2 In the **Object styles** docker, open the **Default object properties** folder, and choose one of the following object types:
 - **Artistic Media**
 - **Artistic text**
 - **Callout**
 - **Dimension**
 - **Graphic**
 - **Paragraph text**
- 3 Modify the attributes you want.

Any changes you make are applied to all new objects in the active document and are automatically saved with the document.

You can also

Undo changes by reverting selected default properties to the new document defaults

Do one of the following:

- Click the **Revert to new document default** button  next to the object type.
- Right-click the object type, and choose **Revert to new document default**.

Undo changes to the default object properties for all object types by reverting to the new document defaults

Do one of the following:

- Click the **Revert all to new document default** button  next to the **Default object properties** folder.

You can also

Set selected object properties as the default settings for new documents

- Right-click the **Default object properties** folder, and click **Revert all to new document default**.

Do one of the following:

- Click the **Set as new document default** button  next to the object type.
- Right-click the object type, and click **Set as new document default**.



You can also edit the default object properties by deselecting all objects in the document window, clicking a color or a color style on a palette, or choosing a control that lets you change fill, outline, or text properties, and then enabling the respective check boxes in the **Change document defaults** dialog box.

You can also edit the default object properties while editing any object in the document window. Right-click the **Default object properties** folder in the **Objects styles** docker, and choose **Update default properties when editing objects**. Any change you make to an object becomes the default setting for new objects.

To set the current style settings as the new document defaults

- 1 Click **Window** ► **Dockers** ► **Object styles**.
- 2 In the **Object styles** docker, click the **Import, export, or save defaults** button , and click **Set as new document defaults**.
- 3 Enable the check boxes for the settings that you'd like to save as the default settings for new documents.



You can also save settings as the default settings for new documents by using the **Options** dialog box. For more information, see [“Saving and restoring defaults” on page 855](#).

Exporting and importing style sheets

You can make styles and style sets available for use in other documents by exporting them to a CorelDRAW style sheet (.cdss) file. A style sheet contains all the object styles, style sets, color styles, and default object properties in the active document. You can also use styles and style sets from other documents by importing the style sheet to which they were saved.

To export a style sheet

- 1 Click **Window** ► **Dockers** ► **Object styles**.
- 2 In the **Object styles** docker, click the **Import, export, or save defaults** button , and click **Export style sheet**.
- 3 In the **Export style sheet** dialog box, choose the folder where you want to save the style sheet.
- 4 Type a file name in the **File name** box.
- 5 Click **Export**.
- 6 Enable the check boxes for the settings you'd like to export from the document.

To import a style sheet

- 1 Click **Window** ► **Dockers** ► **Object styles**.
- 2 In the **Object styles** docker, click the **Import, export, or save defaults** button , and click **Import style sheet**.

- 3 In the **Import style sheet** dialog box, choose the folder where the style sheet is stored.
- 4 Select the file name, and click **Import**.
- 5 Enable the check boxes for the settings you'd like to import into the document.



You can also import styles and style sets from an existing CorelDRAW file by selecting the file in the **Import style sheet** dialog box and clicking **Import**.

Assigning keyboard shortcuts to styles or style sets

You can assign a keyboard shortcut to a style or style set. When you press the keyboard shortcut, CorelDRAW applies the style or style set to the selected object. A keyboard shortcut can use up to four different keystrokes.

If a keyboard shortcut is already assigned to another command, you can override the existing setting.

For more information about working with keyboard shortcuts, see [“Customizing keyboard shortcuts” on page 860](#).

To assign a keyboard shortcut to a style or style set

- 1 Click **Window** ► **Dockers** ► **Object styles**.
- 2 In the **Object styles** docker, right-click a style or style set, and click **Assign keyboard shortcut**.
The **Options** dialog box opens with the **Shortcut keys** tab of the **Commands** page displayed and **Apply styles** in the top list box selected.
- 3 Select the style or style set to which you want to assign a shortcut.
If you have already assigned a keyboard shortcut to the selected style, the shortcut is displayed in the **Current shortcut keys** box.
- 4 Click in the **New shortcut key** box, and press a key combination.
If the key combination is already assigned to another command, that command is listed in the **Currently assigned to** box.
- 5 Click **Assign**.



If the same keyboard shortcut is already assigned to another command, the second assignment overwrites the first. By enabling the **Navigate to conflict on assign** check box, you can automatically navigate to the command whose shortcut you reassigned and assign a new shortcut.

Finding objects that use a specific style or style set

CorelDRAW allows you to find objects with a specific style or style set in the active drawing. For example, you can find all text objects that use a specific heading style.

To find objects that use a specific style or style set

- 1 Click **Window** ► **Dockers** ► **Object styles**.
- 2 In the **Object styles** docker, open the styles or styles sets folder that contains a specific style or style set.
- 3 Right-click the style or style set, and choose **Select objects using style**.

Breaking the link between objects and styles or style sets

You can break the link between an object and the style or style set applied to it. When you break the link, the object retains its current appearance. Subsequent changes to the style or style set will not affect the object attributes.

To break the link between an object and a style or style set

- In the document window, right-click an object by using the **Pick tool** , choose **Object styles** from the context menu, and click **Break link to style**.



If the **Break link to style** command is not available, there are no styles or style sets applied to this object.



You can also break the link between an object and a style by clicking the source indicator next to the styled property (outline, fill, paragraph, character, or frame) in the **Object properties** docker and choosing **Not styled**.

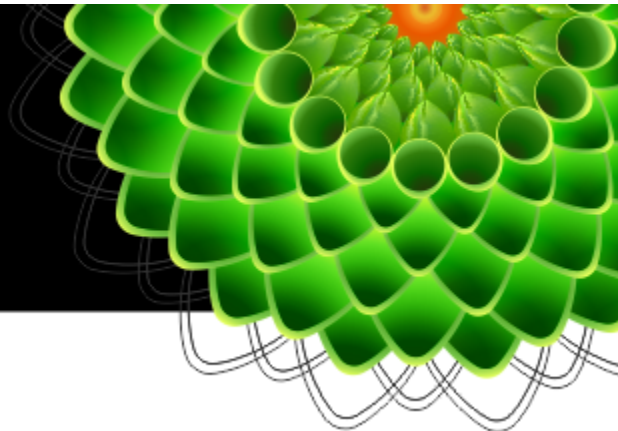

Working with color styles

A color style is a color you save and apply to objects in a document. Any time you update a color style, you also update all objects using that color style. Color styles allow you to apply custom colors with ease and consistency.

This section contains the following topics:

- “Creating and applying color styles” (page 583)
- “Editing color styles” (page 586)
- “Viewing color styles” (page 590)
- “Exporting and importing color styles” (page 592)
- “Breaking the link between a color style and an object” (page 592)

Creating and applying color styles

You can create color styles from the colors of an existing object or from scratch. When you create a color style, the new color style is saved to the active document and to the Color styles palette.

After you create a color style, you can apply it to objects in the document. CorelDRAW lets you access available color styles through various controls: the **Color styles** docker, the **Object styles** docker, the **Object properties** docker, the Color styles palette, and the Document palette. (A color style is automatically added to the Document palette when you apply it to an object.)

Color styles can be combined into groups called harmonies. A harmony allows you to link color styles into hue-based relationships and modify them together as a set. By editing color styles in a harmony, you can quickly create a variety of alternate color schemes by shifting the colors together, or you can alter the color composition of your artwork in one step.

CorelDRAW allows you to create a special type of color harmony called a gradient. A gradient consists of a master color style and a number of shades of that color style. For most of the available color models and palettes, the derivative color styles share the same hue as the master color style but have different saturation and brightness levels. With the PANTONE MATCHING SYSTEM and Custom spot color palettes, the master color style and the derivative color styles are linked to one another but have different tint levels.

You can create a harmony from the colors of an existing object or from scratch.

CorelDRAW also lets you select all color styles that are not used in the document or merge unwanted color styles into others. It also lets you convert color styles to different color modes or to spot colors to prepare your document for production printing.

To create a color style or harmony from a selected object

- 1 Select an object by using the Pick tool .

- 2 Click **Window** ▶ **Dockers** ▶ **Color styles**.
- 3 In the **Color styles** docker, click the **New color style** button , and choose **New from selected**.
- 4 In the **Create color styles** dialog box, enable one of the following options in the **Create color styles from** area:
 - **Object fill** — creates a color style from the color of the object fill
 - **Object outline** — creates a color style from the color of the object outline
 - **Both fill and outline** — creates color styles from the object fill and outline colors
- 5 To group the new color styles based on hues of similar saturation and value, enable the **Group color styles into harmonies** check box, and specify the number of harmonies in the box.



To convert the color styles to a different color mode, enable the **Convert all color styles to** check box, and choose a color mode from the list box.

You can also create color styles or color harmonies from a selected object by using any of the following methods:

- Drag the selected object to the top part of the gray area in the **Color styles** docker to create independent color styles, or drag the selected object to the bottom part of the gray area to create color styles grouped into harmonies. Then, specify the settings you want in the **Create color styles** dialog box.
- Right-click the object in the document window, and choose **Color styles** ▶ **New from Selected**. Then, specify the settings you want in the **Create color styles** dialog box.
- Click the arrow button on the **Color styles** palette, and choose **Add from selection**.

To create a color style

- 1 Click **Window** ▶ **Dockers** ▶ **Color styles**.
- 2 Drag a swatch from any open palette to the top part of the gray area in the **Color styles** docker.



You can also create a color style by clicking the **New color style** button , choosing **New color style**, and choosing a color in the **Color editor**. The **Color editor** provides a variety of options to choose the right color: **Eyedropper** tool, color viewers, sliders, and palettes. For more information about choosing colors, see [“Working with color” on page 347](#).

If you want to create color styles from all the colors in your document, do one of the following:

- In the **Color styles** docker, click the **New color style** button , and choose **New from document**.
- In the document window, right-click an object using the **Pick tool** , and choose **Color styles** ▶ **New from document**.
- On the **Color styles** palette, click the arrow button  and choose **Add from Document**.

To create a color harmony

- 1 Click **Window** ▶ **Dockers** ▶ **Color styles**.
- 2 In the **Color styles** docker, click the **New color harmony** button , and choose **New color harmony**.
A folder icon for the color harmony appears in the bottom part of the gray area.
- 3 Drag any color swatches or color style swatches to the harmony folder.



You can also duplicate a harmony by selecting its folder in the **Color styles** docker, clicking the **New color harmony** button  and choosing **Duplicate harmony**.

You can resize the **Color harmonies** area so that you can view available color harmonies without scrolling by pointing to the grab area, and when the cursor changes to a two-directional arrow, dragging the edge of the pane.

To create a gradient

- 1 Click **Window** ▶ **Dockers** ▶ **Color styles**.
- 2 In the **Color styles** docker, select a color style as the master color for the gradient.
- 3 Click the **New color harmony** button , and choose **New gradient**.
- 4 In the **New gradient** dialog box, specify the number of shades in the **Number of colors** box.
- 5 Adjust the **Shade similarity** slider.
Move the slider to the left to create very different shades; move the slider to the right to create very similar shades.
- 6 Enable one of the following options:
 - **Lighter shades** — creates shades that are lighter than the master color
 - **Darker shades** — creates shades that are darker than the master color
 - **Both** — creates an equal number of light and dark shades

To apply a color style

- 1 Click **Window** ▶ **Dockers** ▶ **Color styles**.
- 2 Select an object by using the **Pick tool** .
- 3 In the **Color styles** docker, do one of the following:
 - Double-click a color style to apply a fill.
 - Right-click a color style to apply an outline.

You can also

Delete a color style

Select the color style, and click the **Delete** button .

Merge selected color styles with the last selected color style

Click the **Merge** button .

Swap color styles

Select two color styles in the **Color styles** docker, and click the **Swap color styles** button . The fill color style becomes the object outline, and the outline color style becomes the object fill.

Select all color styles which are not used in the document

Click the **Select unused** button .



You can also apply a color style to a selected object by using any of the following methods:

- On the **Color styles** palette or the **Document** palette, click a color style to apply a fill or right-click a color style to apply an outline. To open the **Color styles** palette, click **Window** ► **Color palettes** ► **Color styles palette**.
- Drag a color style from a palette or the **Color styles** docker to the object.
- In the **Outline** or **Fill** section of the **Object properties** docker, click the source indicator next to the color picker, and choose from the list of previously created color styles.
- You can also use the **Object styles** docker to apply a color style, if the object style that is assigned to an object contains a color attribute, such as a fill or outline. In the style properties area of the **Object styles** docker, click the source indicator next to a color picker, and choose from the list of previously saved color styles.

Editing color styles

You can edit an individual color style or a color style in a harmony.

When you edit a harmony, you can edit color styles simultaneously by preserving the relationship between them, or you can modify individual color styles within the harmony.

When you change the hue of the master color style in a gradient, all its derivative shades are updated based on the new hue and the original saturation and brightness value.

Harmony rules

You can apply a rule to a color harmony to shift all colors according to predetermined logic and create various color schemes (combinations). The selected color in the color harmony is considered to be the base color and is used as reference to position the remaining colors on the color wheel.

You can also use a harmony rule to create a color harmony from scratch. The resulting color harmony contains five colors that are created randomly based on the chosen rule, and its base color is the selected color in the harmony swatch list.

The following harmony rules are available.

- **Analogous** — includes colors that are next to each other on the color wheel, creating clear and smooth color schemes
- **Analogous - Accented** — similar to the Analogous rule, but includes a complementary (contrasting) color in addition to the adjacent colors
- **Complementary** (also known as “contrast”) — balances the base color with the opposite color on the color wheel. Warm and cold colors are created for vibrant and energetic color schemes.
- **Monochromatic** — includes variations of a single color, creating soothing color schemes
- **Tetrad** — based on a pair of colors and their complements on the color wheel. This rule usually creates bold color harmonies and requires careful planning when used.
- **Triad** — balances the base color with colors that are situated close to the opposite end of the color wheel, forming a triangle. This harmony rule usually creates color schemes of soft contrast.

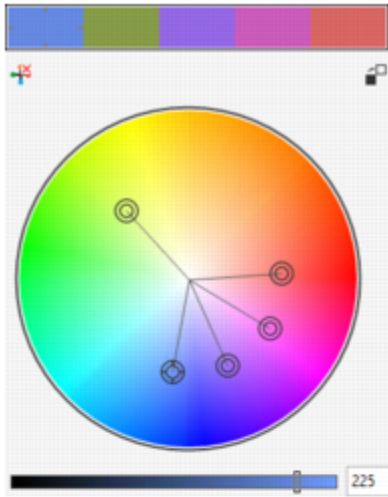

Analogous - Accented

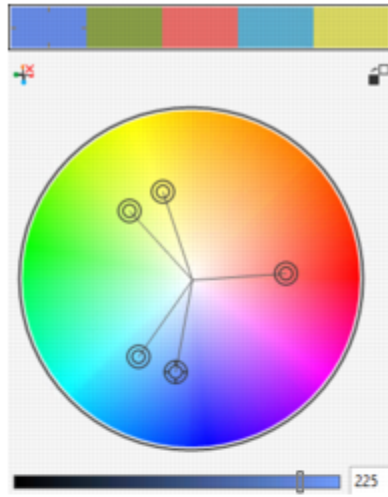

Analogous

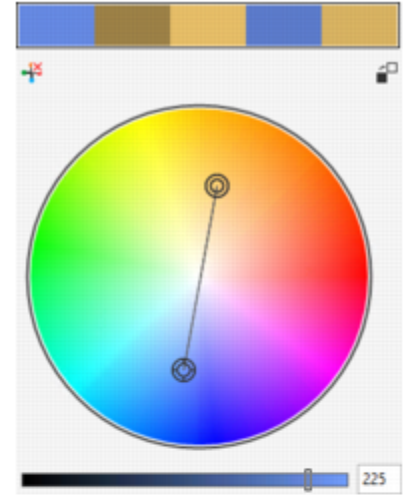

Complementary

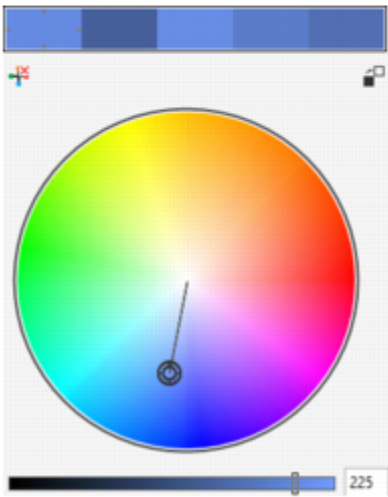

Monochromatic

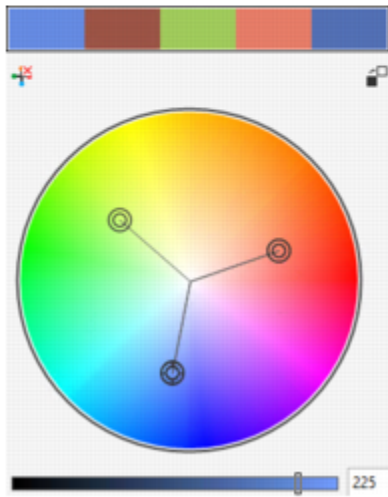

Triad

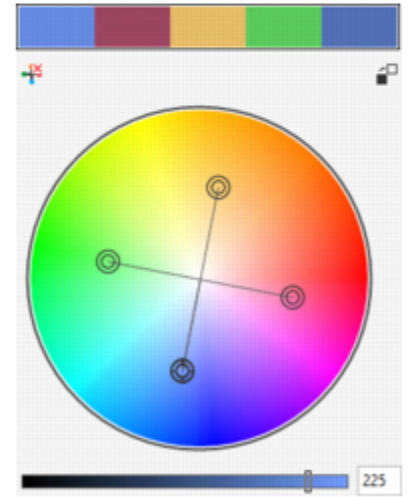

Tetrad

Examples of color harmonies created from scratch by using harmony rules

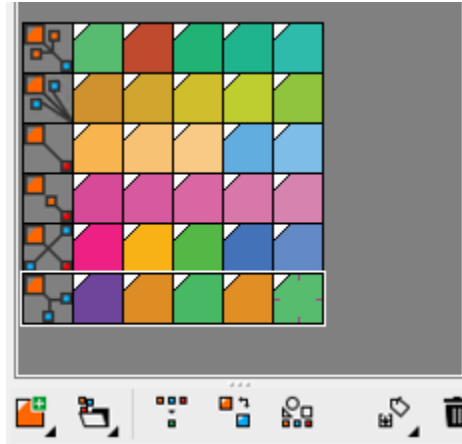

The icons on the harmony folders show that the color harmonies are based on different harmony rules. From top to bottom: Analogous - Accented, Analogous, Complementary, Monochromatic, Tetrad, and Triad.

Editing color harmonies

You can edit color harmonies in various ways: by removing a previously applied harmony rule, by substituting the base color with the opposite color on the color wheel, by moving colors to different arms on the color wheel, and by dragging the color harmony on the color wheel.

You can select colors from multiple color harmonies and edit them simultaneously. This feature lets you edit multiple rule-based color harmonies at the same time without removing the rules.

In addition, you can convert a color style to the Grayscale color mode from within the **Color styles** docker.

To edit a color style

- 1 Click **Window** ► **Dockers** ► **Color styles**.
- 2 In the **Color styles** docker, select an individual color style or a color style in a harmony.
- 3 In the **Color editor** or **Harmony editor**, edit the color style by using any of the available controls: **Eyedropper** tool, color viewers, sliders, and palettes.

For more information about choosing colors, see [“Working with color” on page 347](#).

You can also

Rename a color style

Select the color style in the **Color styles** docker, and type a new name in the name box at the top of the docker.

Convert a color style to a different color mode

Click the **Convert** button , and choose a color mode from the flyout.

Convert a color style to a spot color

Click the **Convert** button , and choose **Convert to Spot**.

To edit a color harmony

- 1 Click **Window** ► **Dockers** ► **Color styles**.
- 2 In the **Color styles** docker, click a harmony folder.

3 Do any of the following:

- In the **Harmony editor**, click a selector ring and drag to edit the color styles in the harmony. To constrain the movement of the selector ring, hold down **Ctrl** while dragging the selector ring to preserve the original saturation, or hold down **Shift** to preserve the original hue.
- In the **Color editor**, choose a color by using any of the available controls: Eyedropper tool, color viewers, sliders, and palettes. For more information about choosing colors, see “[Working with color](#)” on page 347.

4 In the **Harmony editor**, move the **Brightness** slider to change the tint of the color.

If you want to specify the exact tint, type a value in the **Brightness** box.



To edit an individual color style in the harmony, select the style by clicking its swatch in the harmony folder, or by clicking its respective selector ring or swatch in the **Harmony editor**.

You can resize the **Color harmonies** area so that you can view available color harmonies without scrolling by pointing to the grab area, and when the cursor changes to a two-directional arrow, dragging the edge of the pane.

You can reorder color harmonies by dragging a color swatch.

To apply a rule to a color harmony

- 1 Click **Window** ► **Dockers** ► **Color styles**.
- 2 In the **Color styles** docker, click a harmony folder.
- 3 Choose a rule from the **Harmony rule** list box.

You can also

Create a rule-based color harmony from scratch

Make sure that no color styles are selected, and choose a rule from the **Harmony rule** list box.

Distribute colors evenly when changing a harmony rule

Make sure the **Distribute colors** button  is enabled, and choose a harmony rule from the **Harmony rule** list box.

Colors will be distributed evenly along the arms on the color wheel, which can result in radical color changes.

When the **Distribute colors** button is disabled, color relationships in the color harmony are maintained.



You can choose **Custom** from the **Harmony rule** list box to remove a previously applied rule or start a new harmony folder.

To edit a color harmony

- 1 Click **Window** ► **Dockers** ► **Color styles**.
- 2 In the **Color styles** docker, click a color style in a color harmony.
- 3 In the **Harmony editor**, perform any of the following tasks.

To

Remove a rule from a color harmony

Do the following

Click the **Remove harmony rule** button .

To

Change to the opposite color on the color wheel

Move a color to another arm

Edit multiple color harmonies simultaneously

Convert a color style to the Grayscale color mode

Do the following

Click the **Switch to opposite color** button .

Holding down **Alt**, drag a selector ring to another arm.

This feature is available for color harmonies that are based on the Complementary, Tetrad, or Triad harmony rule as well as custom color harmonies.

Click the color styles you want while holding down **Ctrl**, and drag a selector ring in the Harmony editor.

Click the **Convert** button , and click **Convert to grayscale**.



You can also convert a color style or a color harmony to the Grayscale color mode in the **Create color styles** docker when you are creating a color style or a color harmony from a selected object. For information about how to access the **Create color styles** docker, see ["To create a color style or harmony from a selected object"](#) on page 583.

Viewing color styles

Several view options are available in the **Color styles** docker to help your work with color styles more easily.

Page Sorter view displays thumbnails of all pages in a document. When you edit a color style in Page Sorter view, you can see how all objects that use the color style are changed. You can change the size of the page thumbnails to suit your needs.

Hint view shows what objects are associated with color styles. When you point to a color style in the **Color styles** docker, an indicator marks the object that uses the color style in the document window.

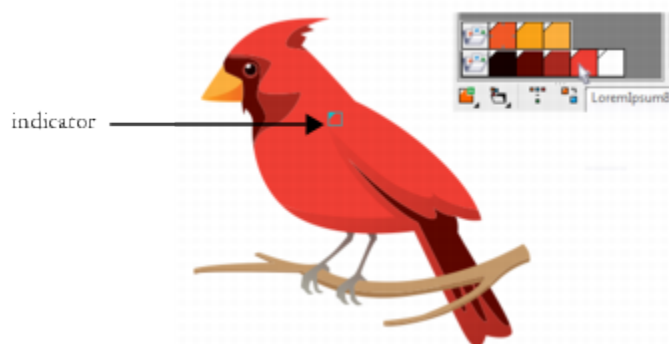



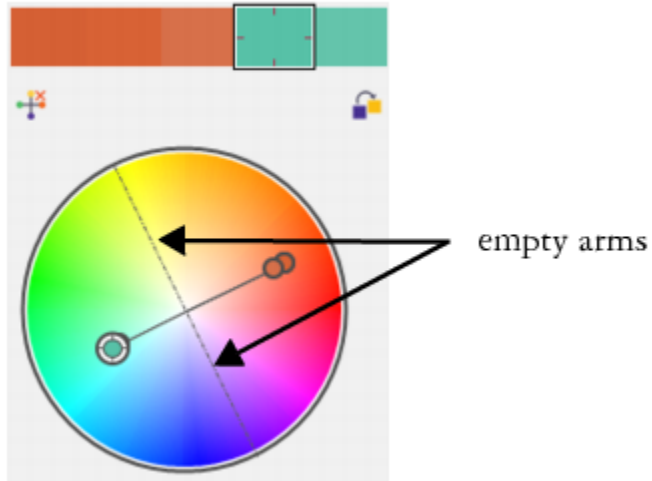

Hint view helps you identify objects that use specific color styles.

In addition, you can show larger color swatches, and you can view empty arms in color harmonies in the Harmony editor.



Two of the arms in this color harmony, based on the Tetrad harmony rule, do not contain any colors, but are displayed to help with editing tasks.

To enable Page Sorter view

- 1 Click **Window** ▶ **Dockers** ▶ **Color styles**.
- 2 In the **Color styles** docker, click the **View options** button  and click **Page sorter view**.
- 3 To change the size of the page thumbnails, click one of the following buttons on the property bar:
 - Small thumbnails 
 - Medium thumbnails 
 - Large thumbnails 



To return to the default page view, click the **Page sorter view** button  on the property bar.

To use Hint view

- 1 Click **Window** ▶ **Dockers** ▶ **Color styles**.
- 2 In the **Color styles** docker, click the **View options** button  and click **Hint view**.
- 3 Point to a color style that was applied to an object.

A small indicator appears in the center of the object that uses the color style.

To show larger color swatches

- 1 Click **Window** ▶ **Dockers** ▶ **Color styles**.
- 2 In the **Color styles** docker, click the **View options** button  and click **Use large swatches**.

To show empty arms in a color harmony

- 1 Click **Window** ► **Dockers** ► **Color styles**.
- 2 In the **Color styles** docker, click the **View options** button  and click **Show empty arms**.

Exporting and importing color styles

You can reuse color styles by adding them to custom palettes, saving them as the new document defaults, or exporting them to a style sheet. You can also import color styles from other documents. For more information, see [“Creating and editing custom color palettes” on page 359](#), [“Managing default object properties” on page 578](#), and [“Exporting and importing style sheets” on page 579](#).

Breaking the link between a color style and an object

When you break the link between a color style and an object, the object no longer derives its color properties from the color style; you can update the color style without modifying the object.

To break the link between a color style and an object

- Right-click an object by using the **Pick** tool , and choose **Color styles** ► **Break link to color styles**.



You can also break the link to a color style in the **Object properties** docker. Click the source indicator next to the color picker in the **Outline** or **Fill** sections of the **Object properties** docker, and choose **Break link to color style**.

Pages and layout

Working with pages and layout tools..... 595

Working with tables..... 613

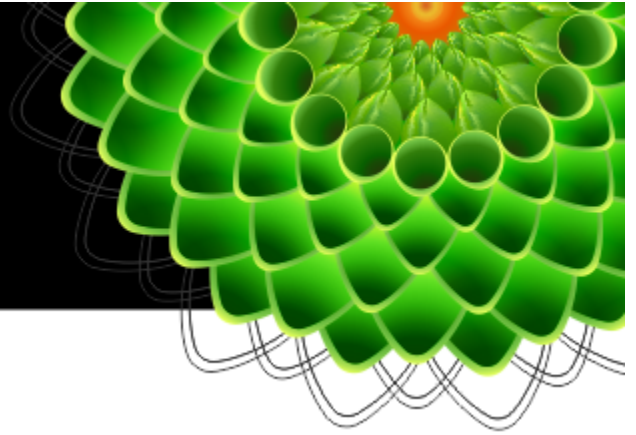

Working with pages and layout tools

CorelDRAW lets you specify the size, orientation, unit of [scale](#), and background of the drawing page. You can customize and display page [grids](#) and [guidelines](#) to help you organize [objects](#) and place them exactly where you want. For example, if you are designing a newsletter, you can set the dimensions of the pages and create guidelines for positioning columns and heading text. When you are laying out an advertisement, you can align graphics and text along guidelines and arrange graphic elements within a grid. [Rulers](#) can help you position grids, guidelines, and objects along a scale that uses units of your choice. Also, you can add and delete pages.

Page layout settings and tools are fully customizable and can be used as defaults for other drawings.

This section contains the following topics:

- “Specifying the page layout” (page 595)
- “Choosing a page background” (page 598)
- “Adding, duplicating, renaming, and deleting pages” (page 599)
- “Inserting page numbers” (page 601)
- “Using the rulers” (page 603)
- “Calibrating the rulers” (page 605)
- “Setting up the document grid” (page 605)
- “Setting up the baseline grid” (page 607)
- “Setting up guidelines” (page 608)
- “Modifying guidelines” (page 610)
- “Setting the drawing scale” (page 611)

Specifying the page layout

You can begin working on a drawing by specifying settings for the size, orientation, and layout style of the page. The options you choose when specifying the page layout can be used as a default for all new drawings you create. You can also adjust the page size and orientation settings to match the standard paper settings for printing.

Page size

There are two options for specifying a page size: choosing a preset page size and creating your own. You can choose from many preset page sizes, ranging from legal-size paper and envelopes to posters and webpages. If a preset page size does not meet your needs, you can create a custom page size by specifying a drawing's dimensions.

You can save custom page sizes as presets for later use, and you can delete any custom preset page sizes that you no longer need.

Page orientation

The orientation of the page can be landscape or portrait. In landscape orientation, the drawing's width is greater than its height, and in portrait orientation, the drawing's height is greater than its width. Any pages you add to a drawing have the current orientation; however, you can change the orientation of individual pages at any time.

Layout styles

When you use the default layout style (Full Page), each page in a document is considered a single page and prints on one sheet. You can choose layout styles for multipage publications, such as booklets and brochures. The multipage layout styles — Book, Booklet, Tent Card, Side-fold Card, Top-fold Card, and Tri-fold Brochure — split the page size into two or more equal parts. Each part is considered a separate page. The advantage of working with separate parts is that you can edit each page in upright orientation, and in sequential order in the drawing window, regardless of the layout required to print your document. When you are ready to print, the application automatically arranges the pages in the order required for printing and binding.

Label styles

You can choose from more than 800 preset label formats from different label manufacturers. You can preview the dimensions of labels and see how they fit on a printed page. If CorelDRAW does not provide a label style that meets your requirements, you can modify an existing style or create and save your own original style.

To set the page size and orientation

- 1 Click **Layout** ► **Page setup**.

The **Options** dialog box appears with the **Page size** page displayed.

- 2 Perform a task from the following table.

To	Do the following
Choose a preset page size	Choose a page size from the Size list box.
Match the page size and orientation to the printer settings	Click the Get page size from printer button.
Specify a custom page size	Type values in the Width and Height boxes.
Set the page orientation	Click the Landscape or the Portrait button.
Set the page size and orientation for an individual page in a multipage document	Make sure that the page you want to change is displayed in the drawing window, choose a page size and orientation, and enable the Apply size to current page only check box.
Display the page border	Enable the Show page border check box.
Add a frame around the page	Click Add page frame .
Choose a rendering resolution for the document	Choose a resolution from the Rendering resolution list box.
Set a bleed limit	Enable the Show bleed area check box, and type a value in the Bleed box.



You can also specify the page size and orientation by clicking **View ▶ Page sorter view** and adjusting the controls on the property bar.

You can also open the **Options** dialog box with the **Page size** page displayed by double-clicking the shadow of the drawing page.

To add or delete custom preset page sizes

- 1 Click **Layout ▶ Page setup**.
The **Options** dialog box appears with the **Page size** page displayed.
- 2 Perform a task from the following table.

To	Do the following
Add a custom preset page size	Specify a custom page size in the Width and Height boxes, click the Save button, and type a name for the custom page in the Save custom page type as box. The custom preset page size appears in the Size list box.
Delete a preset page size	Choose a page size from the Size list box, and click the Delete button.



With the **Pick** tool active and no objects selected, you can also add or delete custom preset page sizes by clicking **Edit this list** at the bottom of the **Page size** list box on the property bar.

To choose a layout style

- 1 Click **Layout ▶ Page layout**.
- 2 In the **Options** dialog box, choose a layout style from the **Layout** list box.
Each layout style is accompanied by a short description and illustration.

To use a label style

- 1 Click **Layout ▶ Page setup**.
- 2 In the **Document** list of categories, click **Label**, and enable the **Labels** option.
- 3 Choose a manufacturer name from the list.
- 4 Choose the label style you want from the list.

If you want to customize the label style, click **Customize label**, and adjust the label size, margins, gutters, and the number of labels appearing on each sheet.

If you want to save the custom label style you created, click the **Add** button , and type a name for the new label style in the **Save as** box.



You cannot use label styles if a drawing contains multiple pages.



For best results, choose **Letter** paper size and **Portrait** orientation before applying a label style.

To save the current page layout as the default

- 1 Click **Tools** ► **Options**.
- 2 In the list of categories, click **Document**.
- 3 Enable the **Save options as defaults for new documents** check box.
- 4 Enable the **Page options** check box.

Choosing a page background

You can choose the color and type of background for a drawing. For example, you can use a solid color if you want a uniform background. If you want a more intricate or dynamic background, you can use a **bitmap**. Some examples of bitmaps include textured designs, photographs, and **clipart**.

When you choose a bitmap as the background, it is embedded in the drawing by default. This option is recommended. However, you can also link the bitmap to the drawing so that if you later edit the source image, the change is automatically reflected in the drawing. If you send a drawing with a linked image to someone else, you must also send the linked image.

You can make a background bitmap printable and exportable, or you can save computer resources by exporting and printing a drawing without the background bitmap.

If you no longer need a background, you can remove it.

To use a solid color as the background

- 1 Click **Layout** ► **Page background**.
- 2 Enable the **Solid** option.
- 3 Open the color picker, and click a color.



When you export files to a bitmap format, the background color is used for anti-aliasing edges. If the bitmaps are of irregular shape and will be placed against a background different from white, it is recommended that you select a matching page background color. For example, if you are planning to place the exported bitmap against a blue background, you may want to choose a similar blue color for the page background.

To use a bitmap as the background

- 1 Click **Layout** ► **Page background**.
- 2 Enable the **Bitmap** option.
- 3 Click **Browse**.
- 4 Locate the folder in which the file is stored.
- 5 Double-click the filename.
- 6 In the **Options** dialog box, enable one of the following options:
 - **Linked** — links the **bitmap** to the drawing so that changes made to the source file are reflected in the bitmap background
 - **Embedded** — embeds the bitmap in the drawing so that changes made to the source file are not reflected in the bitmap backgroundIf you want the background to be printed and exported with the drawing, enable the **Print and export background** check box.
- 7 Enable one of the following options:

- **Default size** — lets you use the bitmap’s current size
- **Custom size** — lets you specify the dimensions of the bitmap by typing values in the H and V boxes.

If you want to specify nonproportional height and width values, disable the **Maintain aspect ratio** check box.



If the bitmap is smaller than the drawing page, it is **tiled** across the drawing page. If it is larger than the drawing page, it is **cropped** to fit the drawing page.

A background bitmap is not an object and cannot be edited.

To remove a background

- 1 Click **Layout** ► **Page background**.
- 2 Enable the **No background** option.

Adding, duplicating, renaming, and deleting pages

CorelDRAW lets you add pages to a drawing or duplicate existing pages. You can also rename pages and delete a single page or an entire range of pages. You can move **objects** from one page to another.

When you duplicate a page, you can choose to copy only the layer structure of the page or to copy the layers and all the objects they contain. For more information about layers, see “[Working with layers](#)” on page 315.

You can use the Page Sorter view to manage pages while viewing the page contents. The Page Sorter view lets you change the order of pages as well as copy, add, rename, and delete pages.



Page sorter view

To add a page

- 1 Click **Layout** ► **Insert page**.
- 2 In the **Pages** area, type the number of pages you want to add in the **Number of pages** box.
- 3 To place the new page before or after the current page, enable one of the following options:
 - **Before**
 - **After**

If you want to insert a page before or after a page other than the current page, type the page number in the **Existing page** box.

You can also

Specify the page size

Choose a page size from the **Size** list box.

Specify a custom page size

Type values in the **Width** and **Height** boxes.

Set the page orientation

Click the **Landscape** or the **Portrait** button.



You can also insert a page before or after the current page by clicking one of the **Add page** buttons in the document navigator.

You can also add a page by right-clicking a page tab in the document navigator and clicking **Insert page after** or **Insert page before**.

To duplicate a page

- 1 Click **Layout** ► **Duplicate page**.
- 2 In the **Insert new page** area of the **Duplicate page** dialog box, choose one of the following options:
 - **Before selected page**
 - **After selected page**
- 3 At the bottom of the dialog box, choose one of the following options:
 - **Copy layer(s) only** — lets you duplicate the layer structure without copying the contents of the layers
 - **Copy layer(s) and their contents** — lets you duplicate the layers and all their contents



You can also duplicate a page by right-clicking a page name and choosing **Duplicate page**.

To rename a page

- 1 Click **Layout** ► **Rename page**.
- 2 Type the name of the page in the **Page name** box.



You can also rename a page in the **Object manager** docker by clicking the page name twice and typing a new name. To access the **Object manager** docker, click **Object** ► **Object manager**.

To delete a page

- 1 Click **Layout** ► **Delete page**.
- 2 In the **Delete page** dialog box, type the number of the page that you want to delete.



You can delete a range of pages by enabling the **Through to page** check box and typing the number of the last page to delete in the **Through to page** box.

To change the order of pages

- Drag the page tabs in the document navigator.

To move an object to another page



- 1 Drag the object over the appropriate page tab in the document navigator.
The destination page appears in the drawing window.
- 2 Without releasing the mouse button, drag to position the object on the page.



You can also move an object to another page by dragging the object name in the **Object manager** docker over a layer name on the destination page.

To manage pages while viewing their contents

- 1 Click **View** ► **Page sorter view**.
- 2 Perform a task from the following table.

To	Do the following
Change the order of pages	Drag a page to a new location.
Copy a page	With the right mouse button, drag the page to a new location, release the mouse button, and click Copy here .
Add a page	Right-click a page, and click Insert page before or Insert page after .
Rename a page	Click the page name below a selected page, and type a new name.
Delete a page	Right-click a page, and click Delete page .
Change the size of the page thumbnails	Click one of the following buttons on the property bar: <ul style="list-style-type: none">• Small thumbnails • Medium thumbnails • Large thumbnails 
Return to normal view	Double-click a page.



You can also copy a page by right-clicking the page and choosing **Duplicate page**. For more information about duplicating pages, see [“To duplicate a page” on page 600](#).

Inserting page numbers

You can insert page numbers on the current page, all pages, all odd pages, or all even pages. When you insert page numbers on multiple pages, a new master layer is automatically created, and the page number is placed on it. The master layer can be an all-page master layer, an odd-page master layer, or an even-page master layer. For more information about master layers, see [“Creating layers” on page 315](#).

Page numbers are automatically updated when you add or delete pages in your document.

You can also insert a page number inside existing artistic or paragraph text. If the text is located on a local layer, the page number is inserted on the current page only. If the text is located on a master layer, the page number becomes part of the master layer and appears on all pages where the master layer is visible. For more information about artistic and paragraph text, see [“Adding and manipulating text” on page 475](#).

If the page numbers are on a master layer, you can hide the page number on a specific page by hiding the master layer on that page.

You can change the default page number settings before or after you insert page numbers in your document. For example, you can start the page count at a specific number other than 1. This is particularly useful if you want to create multiple CorelDRAW files that will be put together as one publication.

You can also specify whether to start page numbering on the first page or on another page. For example, if you choose to start page numbering on page 3, page 3 displays the number 1. If you insert a new page between 1 and 2, it becomes the new page 2, whereas the old page 2 becomes page 3 — the page where the first page number is displayed.

You can also choose from a variety of commonly used page number styles.

When you save to CorelDRAW X5 or earlier version, page numbers are preserved as editable artistic text. However, if you add or delete a page, the page count will not be updated.

Manipulating page numbers as objects

Page numbers are artistic text objects (unless you insert them in paragraph text) that can be modified and manipulated like any other artistic text object. For example, you can resize, scale, or rotate a page number, change its color, or apply effects such as texture fill or a drop shadow.

When the page number is on a master layer, applying transformations to it affects all page numbers.

The following table lists various ways to manipulate page numbers as objects.

You can	For more information see
Resize and scale a page number	“Transforming objects ” on page 257
Rotate a page number	“Transforming objects ” on page 257
Mirror a page number	“Transforming objects ” on page 257
Change the color of a page number	“Choosing colors ” on page 350
Apply texture to a page number	“Applying texture fills ” on page 380
Apply a drop shadow to a page number	“Creating drop shadows ” on page 445

To insert a page number

- Click **Layout** ► **Insert page number**, and choose one of the following options:
 - **On active layer** — lets you insert a page number on the layer that is currently selected in the **Object manager** docker. If the active layer is a master layer, page numbers are inserted on all pages of the document where the master layer is visible. If the active layer is a local layer, the page number is inserted on the current page only.
 - **On all pages** — lets you insert page numbers on all pages. The page number is inserted on a new all-page master layer.
 - **On all odd pages** — lets you insert page numbers on all odd pages. The page number is inserted on a new odd-page master layer.

- **On all even pages** — lets you insert page numbers on all even pages. The page number is inserted on a new even-page master layer.

By default, the page number is centered at the bottom of the page.



In the **Object manager** docker, the page number appears as an artistic text object with the name “Page number.”

You can insert page numbers on odd pages only if the current page is an odd page, and you can insert page numbers on even pages only if the current page is an even page.



You can move the page number anywhere on the page by selecting it with the **Pick** tool and dragging it to a new location. If you move a page number outside the drawing page, the page number turns into the generic number sign (#). If you then place it on another page, it displays the correct number of the page.

You can also insert a page number inside an existing text object. Using the **Text** tool, type artistic or paragraph text. With the cursor inside the text object, click **Layout** ▶ **Insert page number** ▶ **On active layer**. The page number is added as part of the existing text, and it will not appear as a separate object in the **Object manager** docker.

To hide the page number on a single page

- 1 Select the page in the **Object manager** docker.

If the **Object manager** docker is not open, click **Object** ▶ **Object manager**.

- 2 Click the **Layer manager view** button , and then click **Current page, layers only**.

Only layers on the current page are displayed. Changes you make to the layer visibility in this view affect only the current page.

- 3 Click the **Show or hide** icon  beside the master layer where the page number object is located.

The application hides the page number of the current page, but the page is still included in the page count. All other pages continue to display their page numbers.

To modify page number settings

- 1 Click **Layout** ▶ **Page number settings**.

- 2 In the **Page number settings** dialog box, choose any of the following options.

- **Start at number** — lets you start the page count at a specific number
- **Start on page** — lets you specify the page on which to start page numbering
- **Style** — lets you choose from commonly used page number styles

Using the rulers

You can display **rulers** in the drawing window to help you draw, size, and align **objects** precisely. You can hide the rulers or move them to another position in the drawing window. You can also customize the ruler settings to suit your needs. For example, you can set the ruler origin, choose a unit of measure, and specify how many marks or ticks appear within each full unit mark.

You can show and hide rulers for Desktop mode and Tablet mode independently to suit your workflow. By default, rulers are displayed in Desktop mode and hidden when you switch to Tablet mode.

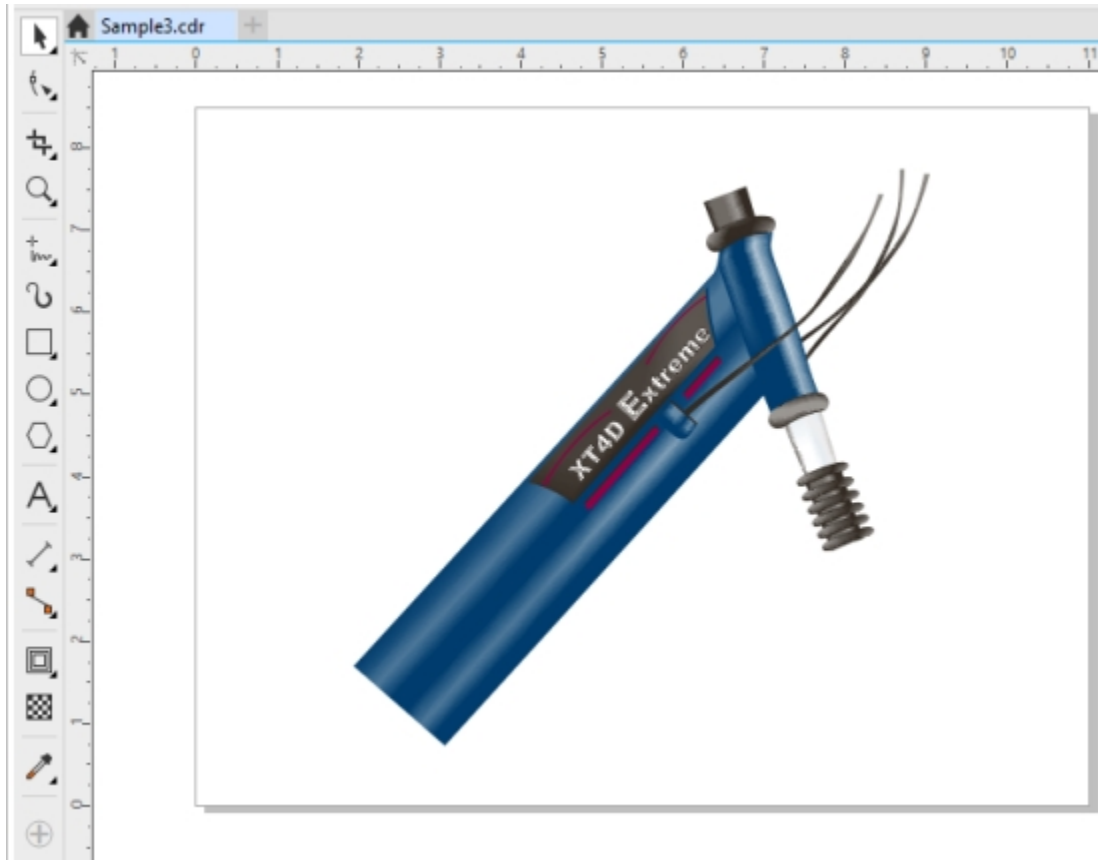

The rulers are usually displayed in Desktop mode.

By default, CorelDRAW applies the units used for the rulers to the duplicate and [nudge](#) distances. You can change the default and specify different units for these and other settings. For information about nudging, see ["Positioning objects" on page 274](#).

To hide or display the rulers

- Click **View** ► **Rulers**.

A check mark beside the **Rulers** command indicates that the [rulers](#) are displayed.

To move a ruler

- Hold down **Shift**, and drag a [ruler](#) to a new position in the drawing window.

To customize ruler settings

- 1 Click **Tools** ► **Options**.
- 2 In the **Document** list of categories, click **Rulers**.
- 3 In the **Units** area, choose a unit of measure from the **Horizontal** list box.
If you want to use a different unit of measure for the vertical [ruler](#), disable the **Same units for horizontal and vertical rulers** check box, and choose a unit of measure from the **Vertical** list box.
- 4 In the **Origin** area, type values in the following boxes:
 - **Horizontal**
 - **Vertical**
- 5 Type a value in the **Tick divisions** box.



If you change the unit of measure for rulers, the unit of measure for [nudge](#) distances automatically changes as well, unless you first disable the **Same units for duplicate distance, nudge and rulers** check box in the **Nudge** area.



You can access ruler settings directly by double-clicking a ruler.

You can specify nudge settings by typing values in the **Nudge**, **Super nudge**, and **Micro nudge** boxes in the **Nudge** area.

To show or hide the rulers for Desktop and Tablet mode

- 1 Click **Tools** ► **Options**.
- 2 In the **Document** list of categories, click **Rulers**.
- 3 On the **Rulers** page, enable or disable the following check boxes:
 - **Show rulers in Desktop mode**
 - **Show rulers in Tablet mode**

Calibrating the rulers

You can have one inch on your screen equal one inch of “real” distance. This lets you work with real-world distances as opposed to relative distances that depend on screen [resolution](#). This tool is particularly useful when you work with signs or draw in 1:1 [zoom](#) mode.

Before you can perform this procedure, you must have a clear plastic ruler for comparing real-world and on-screen distances. This ruler should use the same unit of measure that you set for the CorelDRAW rulers. For information about ruler settings, see [“Using the rulers” on page 603](#).

To calibrate the rulers to real-world distance

- 1 Click **Tools** ► **Options**.
- 2 In the **Workspace** list of categories, double-click **Toolbox**, and click **Zoom, Pan tool**.
- 3 Click **Calibrate rulers**.
- 4 Place a clear plastic ruler under the on-screen horizontal ruler.
- 5 Click the up or down arrows on the **Horizontal** box to match one unit of measure on the on-screen ruler with one unit of measure on the actual ruler.
- 6 Place the ruler beside the on-screen vertical ruler.
- 7 Click the up or down arrows on the **Vertical** box to match one unit of measure on the on-screen ruler with one unit of measure on the actual ruler.

Setting up the document grid

The [document grid](#) is a series of non-printing intersecting lines that you can display in the [drawing window](#). You can use the document grid to precisely align and position [objects](#).

You can customize the look of the document grid by changing the grid display and grid spacing. The grid display lets you view the document grid as lines or as dots. The spacing lets you set the distance between the grid lines. The spacing options are based on the unit of measure for the ruler. For example, if the ruler unit of measure is set to inches, the spacing options are based on inches.

If the ruler unit of measure is set to pixels, or if you enabled the Pixel preview, you can specify the color and opacity of the pixel grid. For more information about the Pixel preview, see [“Choosing viewing modes” on page 62](#).

You can also have objects snap to the document grid or the pixel grid, so that when you move the objects, they align with the grid lines.



The checkered effect in this graphic was created by using the document grid.

To display or hide the document grid

- Click **View** ► **Grid** ► **Document grid**.

A check mark beside the **Document grid** command indicates that the document grid is displayed.

To set the grid display

- 1 Click **Tools** ► **Options**.
- 2 In the **Document** list of categories, click **Grid**.
- 3 Enable the **Show grid** check box, and enable one of the following options:
 - **As lines**
 - **As dots**

To set the grid spacing

- 1 Click **Tools** ► **Options**.
- 2 In the **Document** list of categories, click **Grid**.
- 3 In the **Document grid** area, type a value in the **Horizontal** box.
If you want to change the grid spacing intervals or the number of lines displayed per unit of measure, choose an option from the list box. The options are based on the unit of measure used for the ruler.
- 4 Type a value in the **Vertical** box.



The unit of measure used for grid spacing is the same as that used for rulers. For information about ruler settings, see [“To customize ruler settings” on page 604](#).

To change the color and opacity of the pixel grid

- 1 Click **Tools** ► **Options**.
- 2 In the **Document** list of categories, click **Grid**.
- 3 In the **Pixel grid** area, open the **Color** picker, and click a color.
- 4 Move the **Opacity** slider to the right to increase the opacity of the grid.



You can disable the **Show grid (at 800% or higher zoom)** check box if you do not want the pixel view to automatically display zoomed in at 800% or higher.

To set objects to snap to the document grid

- 1 Click **View** ► **Snap to** ► **Document grid**.
- 2 Move the **objects** with the **Pick tool** .

To set objects to snap to the pixel grid

- 1 Click **View** ► **Snap to** ► **Pixels**.
- 2 Move the **objects** with the **Pick tool** .



This option is available only when pixel view is enabled. For more information, see [“Choosing viewing modes” on page 62](#).

Setting up the baseline grid

The guides of the **baseline grid** run across the drawing page and follow the pattern of a ruled notebook. You can display or hide the baseline grid, turn snapping on or off, change the grid color, and set the line spacing. By default, the line spacing is 14 pt. All objects can snap to the baseline grid; only text frames can align to baseline grid. For more information, see [“Aligning text by using the baseline grid” on page 484](#).

To display or hide the baseline grid

- Click **View** ► **Grid** ► **Baseline grid**.

A check mark beside the **Baseline grid** command indicates that the baseline grid is displayed.

To set baseline grid spacing and color

- 1 Click **Tools** ► **Options**.
- 2 In the **Document** list of categories, click **Grid**.
- 3 Perform a task from the following table.

To

Set spacing

Set distance from top

Set color

Do the following

In the **Baseline grid** area, type a value in the **Spacing** box.

Type a value in the **Start from top** box.

Setting this value to 0 makes the first line of the baseline grid overlap with the top edge of the drawing page.

Open the **Color** picker, and choose a color.

To turn baseline grid snapping on or off

- Click **View** ► **Snap to** ► **Baseline grid**.

A check mark beside the **Baseline grid** command indicates that snapping is turned on.



You can also click **Tools** ► **Options**, click **Grid** in the **Document** list of categories, and enable or disable the **Snap to grid** check box in the **Baseline grid** area.

Setting up guidelines

Guidelines are lines that can be placed anywhere in the drawing window to aid in **object** placement. In some applications, guidelines are known as guides.

There are three types of guidelines: horizontal, vertical, and angled. By default, the application displays guidelines that you add to the drawing window, but you can hide them at any time. You can also use objects as guides.

You can set guidelines for individual pages or you can set guidelines for the entire document. For more information about local and master guidelines, see “**Local layers and master layers**” on page 315.

You can add a guideline wherever you need one; however, you can also choose to add preset guidelines. There are two types of preset guidelines: Corel presets and user-defined presets. Examples of Corel presets include guidelines that appear at 1-inch margins and guidelines that appear at newsletter column borders. User-defined presets are guidelines whose location you specify. For example, you can add preset guidelines that display margins at a distance you specify or that define a column layout or grid. You can remove guidelines at any time.

You can have objects **snap** to the guidelines, so that when an object is moved near a guideline, it can only be centered on the guideline or lined up on either side of the guideline.

Guidelines use the unit of measure specified for rulers. For information about ruler settings, see “**To customize ruler settings**” on page 604.



Guidelines can be placed in the drawing window to aid in object placement.

To display or hide the guidelines

- Click **View** ► **Guidelines**.

A check mark beside the **Guidelines** command indicates that the **guidelines** are displayed.



You can also display or hide the guidelines by clicking **Window** ► **Dockers** ► **Guidelines** and clicking the **Show or hide guidelines** button .

You can also access additional guideline options by clicking **Tools** ► **Options**, and then clicking **Guidelines** in the **Document** list of categories.

To add a horizontal or vertical guideline

- 1 Click **Window** ► **Dockers** ► **Guidelines**.
- 2 Choose one of the following options from the **Guideline type** list box:
 - **Horizontal**
 - **Vertical**
- 3 Specify the location of the guideline in the x or y box.
- 4 Click **Add**.



You can also add a guideline by dragging from the horizontal or vertical ruler to the [drawing window](#).

To add an angled guideline

- 1 Click **Window** ► **Dockers** ► **Guidelines**.
- 2 Choose **Angled** from the **Guideline type** list box.
- 3 Specify the location of the guideline in the x and y boxes.
- 4 Type a value in **Angle of rotation** box.
- 5 Click **Add**.



You can also add an angled guideline by dragging from the horizontal or vertical ruler in the [drawing window](#), and typing a value in the **Angle of rotation** box on the property bar.

To use an object as a guide

- 1 In the **Object manager** docker, click the **Guides** layer on the page you want.
If the **Object manager** docker is not open, click **Object** ► **Object manager**.
- 2 Draw and position the object you want to use as a guide.

To set guidelines for the entire document

- 1 In the **Object manager** docker, click **Guides (all pages)** on the **Master page**.
If the **Object manager** docker is not open, click **Object** ► **Object manager**.
- 2 In the drawing window, add the guidelines you want.



The guidelines that you set on the **Guides (all pages)** layer of the **Master page** appear on all pages of the document. These guidelines appear in addition to any guidelines that you set for individual pages.

To add preset guidelines

- 1 Click **Tools** ► **Options**.
- 2 In the **Document, Guidelines** list of categories, click **Presets**.
- 3 Enable one of the following options:
 - **Corel presets**
 - **User-defined presets**
- 4 Specify guideline settings by enabling the corresponding check boxes.
If you enable the **User-defined presets** option, specify values in the **Margins, Columns, or Grid** area.
- 5 Click **Apply presets**.

To remove a guideline

- 1 Click **Window** ► **Dockers** ► **Guidelines**.
- 2 Choose a **guideline** from the list.
You can choose multiple guidelines by holding down **Ctrl** as you click.
- 3 Click the **Delete guideline** button .



You can also remove individual guidelines by dragging them off the document window, or clicking a guideline with the **Pick** tool and pressing **Delete**.

To delete a preset guideline, click **Tools** ► **Options**. In the **Document, Guidelines** list of categories, click **Presets**. Disable the check box beside the preset guideline that you want to delete.

To have objects snap to the guidelines

- 1 Click **View** ► **Snap to** ► **Guidelines**.
- 2 Drag the **object** to the **guideline**.

To snap the center of an object to a guideline, select the object, and drag it by its center over the guideline until the center **snaps** to the guideline.



You can also set objects and editable areas to snap to a guideline by clicking **Window** ► **Dockers** ► **Guidelines** and clicking the **Snap to guidelines** button .

Modifying guidelines

After you add a guideline, you can select it, move it, rotate it, or lock it in place. You can also change the line style and color of guidelines.

To select a guideline

To	Do the following
Select a single guideline	Click the guideline with the Pick tool  .

To

Select all guidelines on a page

Do the following

Click **Edit** ► **Select all** ► **Guidelines**. The local guidelines and master guidelines are selected.

To move or rotate a guideline

- 1 Click **Window** ► **Dockers** ► **Guidelines**.
- 2 Select the guideline.
- 3 Perform any of the following tasks.

To

Move a guideline

Do the following

Specify the new location of the guideline in the **x** and **y** boxes, and click **Modify**.

You can also drag a guideline to a new position in the drawing window.

Rotate a guideline

Choose **Angled** from the **Guideline type** list box, type a value in the **Angle of rotation** box, and click **Modify**.

You can also use the **Pick** tool  to click the guideline twice and then rotate the guideline when skewing handles appear.

To lock or unlock a guideline

- Right-click the guideline, and click **Lock object** or **Unlock object**.



You can also click **Window** ► **Dockers** ► **Guidelines** and click the **Lock guideline** button .

To set the line style and color of a guideline

- 1 Click **Window** ► **Dockers** ► **Guidelines**.
- 2 Open the **Guideline color** picker, and choose a guideline color.
- 3 Open the **Guideline style** picker, and choose a line style.

Setting the drawing scale

You can choose a preset or custom drawing scale so that distances in a drawing are proportionate to real-world distances. For example, you can specify that 1 inch in the drawing corresponds to 1 meter in the physical world. A preset drawing scale lets you set a typical scale, such as 1:2 or 1:10. A custom drawing scale lets you set any distance on the page to correspond to a real-world distance. For example, you can set a more precise scale that includes decimal numbers, such as 4.5 to 10.6.

Drawing scales are particularly useful if you are creating a technical or architectural drawing with [dimension lines](#). For information about dimension lines, see ["Drawing connector and callout lines"](#) on page 158.

To choose a preset drawing scale

- 1 Click **Tools** ► **Options**.
- 2 In the **Document** list of categories, click **Rulers**.
- 3 Click **Edit scale**.
- 4 Choose a drawing scale from the **Typical scales** list box.

To create a custom drawing scale

- 1 Click **Tools** ► **Options**.
- 2 In the **Document** list of categories, click **Rulers**.
- 3 Click **Edit scale**.
- 4 Choose **Custom** from the **Typical scales** list box.
- 5 Specify the settings you want.



The **Edit scale** button does not appear if the ruler's unit of measure is **pixels**.

If the drawing scale is set to anything other than 1:1, the units on the vertical ruler are the same as the units on the horizontal ruler.

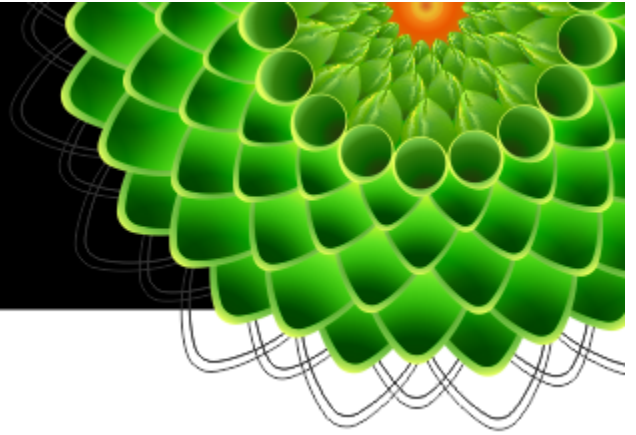

Working with tables

A table provides a structured layout that lets you present text or images within a drawing. You can draw a table, or you can create a table from paragraph text. You can easily change the look of a table by modifying the table properties and formatting. In addition, because tables are objects, you can manipulate them in various ways. You can also import existing tables from a text file or a spreadsheet.

This section contains the following topics:

- “Adding tables to drawings” (page 613)
- “Selecting, moving, and navigating table components” (page 615)
- “Inserting and deleting table rows and columns” (page 617)
- “Resizing table cells, rows, and columns” (page 618)
- “Formatting tables and cells” (page 619)
- “Working with text in tables” (page 622)
- “Converting tables to text” (page 623)
- “Merging and splitting tables and cells” (page 623)
- “Manipulating tables as objects” (page 625)
- “Adding images, graphics, and backgrounds to tables” (page 625)
- “Importing tables in a drawing” (page 626)

Adding tables to drawings

With CorelDRAW, you can add a table to a drawing to create a structured layout for text and images. You can draw a table, or you can create a table from existing text.



In this example, a table was used to organize the content.

To add a table to a drawing

- 1 Click the **Table** tool .
- 2 Type values in the **Rows** and **columns** boxes on the property bar.
The value that you type in the top portion specifies the number of rows; the value that you type in the bottom portion specifies the number of columns.
- 3 Drag diagonally to draw the table.



You can also create a table by clicking **Table** ► **Create new table**, and then typing values in the **Number of rows**, **Number of columns**, **Height**, and **Width** boxes.

To create a table from text

- 1 Click the **Pick** tool .
- 2 Select the text that you want to convert to a table.
- 3 Click **Table** ► **Convert text to table**.
- 4 In the **Create columns based on the following separator** area, choose one of the following options:
 - **Commas** — creates a column where a comma appears and a row where a paragraph marker appears
 - **Tabs** — creates a column where a tab appears and a row where a paragraph marker appears
 - **Paragraphs** — creates a column where a paragraph marker appears
 - **User defined** — creates a column where a specified marker appears and a row where a paragraph marker appears

If you enable the **User defined** option, you must type a character in the **User defined** box.



If you do not type a character in the **User defined** box, only one column is created, and each paragraph of text creates a table row.
You can also convert a table to text. For more information, see “To convert a table to text” on page 623.

Selecting, moving, and navigating table components

You must select a table, table rows, table columns, or table cells before you insert rows or columns, change the table border properties, add a background fill color, or edit other table properties. You can move selected rows and columns to a new location in a table. You can also copy or cut a row or column from one table and paste it in another table. In addition, you can move from one table cell to another when editing the table cell text, and you can set the direction in which the **Tab** key lets you move around a table.

To select a table, row, or column

- 1 Click the **Table** tool , and then click a table.
- 2 Perform one of the following tasks.

To

Select a table

Do the following

Click **Table** ▶ **Select** ▶ **Table**.

Select a row

Click in a row, and click **Table** ▶ **Select** ▶ **Row**.

Select a column

Click in a column, and click **Table** ▶ **Select** ▶ **Column**.

Select all table contents

Position the **Table** tool pointer over the upper-left corner of the table until a diagonal arrow appears , and click.

Use a keyboard shortcut to select a table

With the **Table** tool pointer inserted in an empty cell, press **Ctrl + A**.

Select a row interactively

Position the **Table** tool pointer over the table border to the left of the row that you want to select. When a horizontal arrow appears , click the border to select the row.

Select a column interactively

Position the **Table** tool pointer over the top border of the column that you want to select. When a vertical arrow appears , click the border to select the column.

To select table cells

To

Do the following

Select a table cell

Click the **Table** tool , click a table, and click a cell. Then, click **Table** ▶ **Select** ▶ **Cell**.

Select adjacent table cells

Using the **Table** tool, click inside the first cell that you want to select, and drag over the adjacent cells that you want to select.

To

Select nonadjacent table cells

Do the following

Using the **Table** tool, click a table. Then, hold down **Ctrl**, and click each table cell that you want to select.



You can also select a cell by inserting the **Table** tool pointer in an empty cell and pressing **Ctrl + A**.

You can also use the **Shape** tool  to select a single cell by clicking it, or to select adjacent cells by dragging over them.

To move a table row or column

- 1 Select the row or column that you want to move.
- 2 Drag the row or column to another location in the table.

To move a table row to another table

- 1 Select the table row that you want to move.
- 2 Click **Edit** ► **Cut**.
- 3 Select a row in the other table.
- 4 Click **Edit** ► **Paste**.
- 5 Choose one of the following options:
 - **Replace selected row**
 - **Insert above selected row**
 - **Insert below selected row**

To move a table column to another table

- 1 Select the table column that you want to move.
- 2 Click **Edit** ► **Cut**.
- 3 Select a column in the other table.
- 4 Click **Edit** ► **Paste**.
- 5 Choose one of the following options:
 - **Replace selected column**
 - **Insert left of the selected column**
 - **Insert right of the selected column**

To move to the next table cell

- With the **Table** tool inserted in a cell, press **Tab**.

If you are pressing **Tab** in a table for the first time, you must choose a tab order option from the **Tab order** list box.



You can use the **Tab** key to move to the next cell only if the **Move to the next cell** option is enabled in the **Tab key options** dialog box.

To change the navigational direction of the Tab key

- 1 Click **Tools** ► **Options**.

- 2 In the **Workspace**, **Toolbox** list of categories, click **Table tool**.
- 3 Enable the **Move to the next cell** option.
- 4 From the **Tab order** list box, choose one of the following options:
 - **Left to right, top to bottom**
 - **Right to left, top to bottom**



You can program the **Tab** key to insert a tab character in the table text by enabling the **Insert a tab character into the text** option.

Inserting and deleting table rows and columns

You can insert and delete the rows and columns in a table.

To insert a table row

- 1 Select a row in the table.
- 2 Perform a task from the following table.

To

Insert a row above the selected row

Insert a row below the selected row

Insert multiple rows above the selected row

Insert multiple rows below the selected row

Do the following

Click **Table** ► **Insert** ► **Row above**.

Click **Table** ► **Insert** ► **Row below**.

Click **Table** ► **Insert** ► **Insert rows**, type a value in the **Number of rows** box, and enable the **Above the selection** option.

Click **Table** ► **Insert** ► **Insert rows**, type a value in the **Number of rows** box, and enable the **Below the selection** option.



When you use either the **Row above** command or the **Row below** command from the **Table** ► **Insert** menu, the number of rows that are inserted depends on how many rows you have selected. For example, if you have selected two rows, then two rows are inserted in the table.

To insert a table column

- 1 Select a column.
- 2 Perform a task from the following table.

To

Insert a column to the left of the selected column

Insert a column to the right of the selected column

Do the following

Click **Table** ► **Insert** ► **Column left**.

Click **Table** ► **Insert** ► **Column right**.

To

Insert multiple columns to the left of the selected column

Insert multiple columns to the right of the selected column



When you use the **Column left** command or the **Column right** command from the **Table ▶ Insert** menu, the number of columns that are inserted depends on how many columns you have selected. For example, if you have selected two columns, then two columns are inserted in the table.

To delete a row or column from a table

- 1 Select the row or column that you want to delete.
- 2 Perform a task from the following table.

To

Delete a row

Delete a column



If you select a row but choose the option to delete a column, or if you select a column but choose the option to delete a row, the whole table is deleted.

Do the following

Click **Table ▶ Insert ▶ Insert columns**, type a value in the **Number of columns** box, and enable the **Left of the selection** option.

Click **Table ▶ Insert ▶ Insert columns**, type a value in the **Number of columns** box, and enable the **Right of the selection** option.

Do the following

Click **Table ▶ Delete ▶ Row**.

Click **Table ▶ Delete ▶ Column**.

Resizing table cells, rows, and columns

You can resize table cells, rows, and columns. In addition, if you previously changed the sizes of some rows or columns, you can redistribute all rows or all columns so that they are the same size.

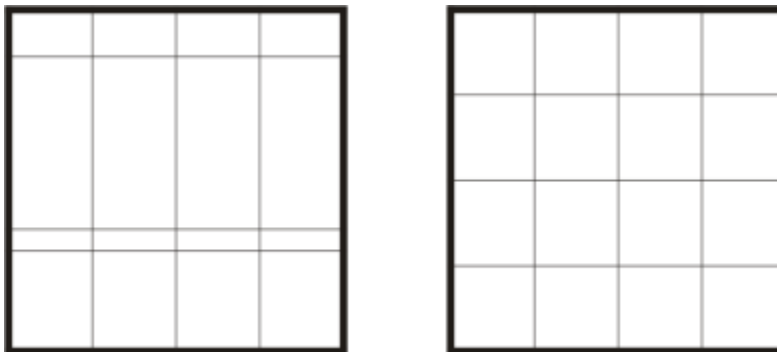

If table rows are different sizes (left), you can distribute them so that they are the same size (right).



Table rows and columns of different sizes (left) are distributed evenly (right).

To resize a table cell, row, or column

- 1 Click the **Table** tool , and then click the table.
- 2 Select the cell, row, or column that you want to resize.
- 3 On the property bar, type values in the **Table width and height** boxes.

To distribute table rows and columns

- 1 Select the table cells that you want to distribute.
- 2 Perform a task from the following table.

To	Do the following
Make the height of all selected rows the same	Click Table ► Distribute ► Rows evenly .
Make the width of all selected columns the same	Click Table ► Distribute ► Columns evenly .

Formatting tables and cells

You can change the look of a table by modifying both table and cell borders. For example, you can change the table border width or color.

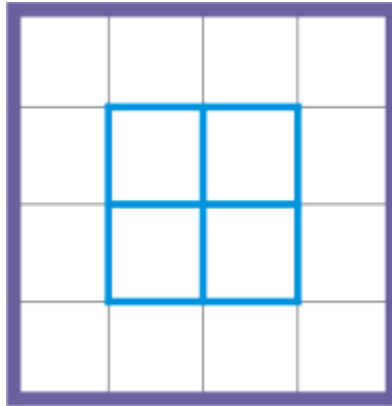

You can modify both table and table cell borders.



Thin table and cell borders (left) are made thicker (right).

In addition, you can change the table cell margins and cell border spacing. The cell margins let you increase the space between the cell borders and the text in the cell. By default, table cell borders overlap to form a grid. However, you can increase the cell border spacing to move the borders away from each other. As a result, the cells do not form a grid, but appear as individual boxes (also known as “separated borders”).

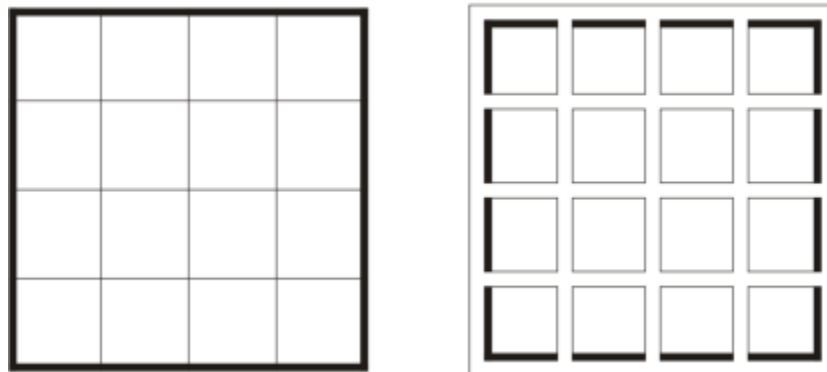

You can modify an existing table (left) by applying separated borders (right).



Separated borders applied to a table.

To modify table borders and cell borders

- 1 Select the table or table area that you want to modify.
A table area can include a cell, a group of cells, rows, columns, or the entire table.
- 2 Click the **Border selection** button  on the property bar, and choose the borders that you want to modify.
- 3 Perform a task from the following table.

To	Do the following
Modify the border thickness	Choose a border width from the Outline width list box on the property bar.
Modify the border color	Click the Outline color picker on the property bar, and then click a color on the color palette.
Modify the border line style and outline width	In the Outline area of the Object properties docker, choose a line style from the Line style picker, and type a value in the Outline width box. If the Object properties docker is not open, click Window ► Dockers ► Object properties .

To modify cell margins in tables

- 1 Click the **Table** tool , and then click the table.
- 2 Select the cells that you want to modify.
- 3 Click **Margins** on the property bar.
- 4 Type a value in the **Top margin** box.
By default, the value in the top margin box is applied to all margins, so that equal margins are created.

If you want to apply different values for the margins, click the **Lock margins** button to unlock the margin boxes, and type values in the **Top margin**, **Bottom margin**, **Left margin**, and **Right margin** boxes.

5 Press **Enter**.

To modify cell border spacing in tables

1 Click the **Table** tool , and then click the table.

2 Click **Options** on the property bar.

3 Enable the **Separated cell borders** check box.

4 Type a value in the **Horizontal cell spacing** box.

By default, the vertical cell spacing is equal to the horizontal cell spacing.

If you do not want equal cell spacing, click the **Lock cell spacing** button to unlock the **Vertical cell spacing** box, and then type values in both the **Horizontal cell spacing** and **Vertical cell spacing** boxes.

5 Press **Enter**.

Working with text in tables

You can easily add text to table cells, and you can modify this text as you would any other paragraph text. For example, you can change the font, add bullets, or add indents to table text. You can change the text properties of a single table cell, or of multiple table cells simultaneously. In addition, you can add tab stops to table cells so that text is shifted away from the cell margins.

When you type text in a new table, you can choose to automatically adjust the size of table cells.

To type text in a table cell

1 Click the **Table** tool .

2 Click a cell.

3 Type text in the cell.



You can select text in a cell by pressing **Ctrl + A**.

To change the properties of text in table cells

1 Using the **Table** tool , click a table.

2 Hold down **Ctrl**, and click the table cells that contain text to be formatted.

3 Click **Text** ► **Text properties**, and specify the settings you want in the **Text properties** docker.



For more information about formatting text, see [“Formatting text” on page 499](#).

To change the text properties for an entire row, column, or table simultaneously, you must first select the table component or table. For more information, see [“To select a table, row, or column” on page 615](#).

To insert a tab stop in a table cell

• With the **Table** tool pointer inserted in a cell, click **Text** ► **Insert formatting code** ► **Tab**.



Another way to insert a tab stop is by pressing the **Tab** key. To use this method, you must set the **Tab** key to insert tab stops. For information about changing the **Tab** key options, see [“To change the navigational direction of the Tab key” on page 616](#).

To automatically resize table cells when you type

- 1 Click the **Pick** tool , and then click the table.
- 2 Click **Options** on the property bar, and enable the **Automatically resize cells while typing** check box.



This option can be applied to new tables that do not yet have text or other content.
If a table already contains text, only cells to which new text is added will be resized.

Converting tables to text

If you no longer want table text to appear in a table, you can convert the table text to paragraph text. For more information about converting text to a table, see [“To create a table from text” on page 614](#).

To convert a table to text

- 1 Click the **Table** tool , and then click the table.
- 2 Click **Table** ► **Convert table to text**.
- 3 In the **Separate cell text with** area, choose one of the following options:
 - **Commas** — replaces each column with a comma and replaces each row with a paragraph marker
 - **Tabs** — replaces each column with a tab and replaces each row with a paragraph marker
 - **Paragraphs** — replaces each column with a paragraph marker
 - **User defined** — replaces each column with a specified character and replaces each row with a paragraph markerIf you enable the **User defined** option, you must type a character in the **User defined** box.



If you do not type a character in the **User defined** box, each of the table rows is converted into a paragraph, and the table columns are ignored.

Merging and splitting tables and cells

You can change how a table is configured by merging adjacent cells, rows, and columns. If you merge table cells, the formatting of the upper-left cell is applied to all merged cells. Alternatively, you can unmerge cells that were previously merged.

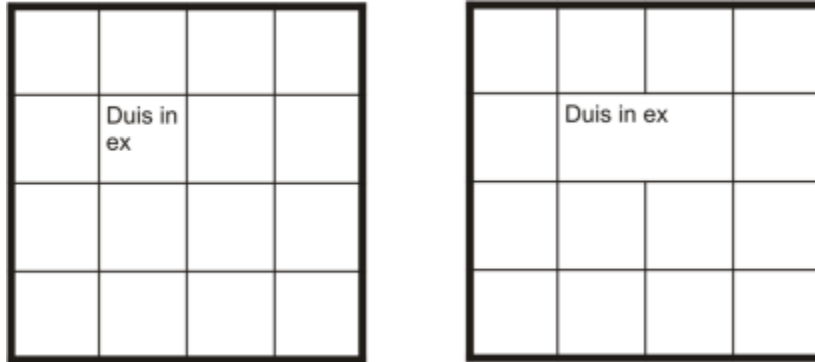

You can change the look of a table (left) by merging adjacent table cells (right).



The two cells at the bottom of the table (left) have been merged into a single cell (right).

You can also split table cells, rows, or columns. Splitting lets you create new cells, rows, or columns without changing the size of the table.

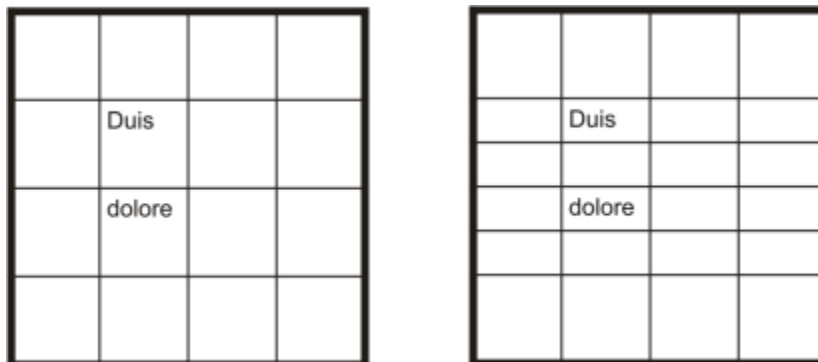

You can insert additional rows in a table (left) by splitting table cells (right).

To merge table cells

- 1 Select the cells to be merged.
The selected cells must be contiguous.
- 2 Click **Table** ► **Merge cells**.

To unmerge table cells

- 1 Select the cell that you want to unmerge.
- 2 Click **Table** ► **Unmerge cells**.

To split table cells, rows, or columns

- 1 Click the **Table** tool .
- 2 Select the cell, row, or column that you want to divide.
- 3 Perform a task from the following table.

To

Split a selection horizontally

Split a selection vertically

Do the following

Click **Table** ► **Split into rows**, and type a value in the **Number of rows** box.

Click **Table** ► **Split into columns**, and type a value in the **Number of columns** box.

Manipulating tables as objects

You can manipulate tables as you would other objects.

The following table lists the various ways to manipulate a table as an object.

You can

Resize and scale a table

Rotate a table

Mirror a table

Lock a table

Convert a table to a bitmap

Break a table apart

For more information see

["Transforming objects " on page 257](#)

["Transforming objects " on page 257](#)

["Transforming objects " on page 257](#)

["Locking objects " on page 305](#)

["Converting vector graphics to bitmaps " on page 631](#)

["To convert objects to curve objects " on page 180](#)

Adding images, graphics, and backgrounds to tables

If you want to arrange bitmap images or vector graphics in a structured layout, you can add them to tables. You can also change the look of a table by adding a background color.

To insert an image or a graphic in a table cell

- 1 Copy an image or a graphic.
- 2 Click the **Table** tool, and select the cell where you want to insert the image or graphic.
- 3 Click **Edit** ► **Paste**.



You can also insert a graphic or an image by holding down the right mouse button over the image, dragging the image to a cell, releasing the right mouse button, and then clicking **Place inside cell**.

To add a background color to a table

- 1 Click the **Table** tool , and then click the table.
- 2 Click the **Background** color picker, and then click a color on the color palette.



You can also modify the background color of specific cells, rows, or columns by selecting the cells, clicking the **Background** color picker on the property bar, and then clicking a color on the color palette.

Importing tables in a drawing

With CorelDRAW, you can create tables by importing content from Quattro Pro® (.qpw) and Microsoft Excel (.xls) spreadsheets. You can also import tables created in a word-processing application, such as WordPerfect or Microsoft Word.

To import a table from Quattro Pro or Excel

- 1 Click **File** ► **Import**.
- 2 Choose the drive and folder where the spreadsheet is stored.
- 3 Click the file to select it.
- 4 Click **Import**.
The **Import/Paste** dialog box appears.
- 5 From the **Import tables as** list box, choose **Tables**.
- 6 Choose one of the following options:
 - **Maintain fonts and formatting** — imports all fonts and formatting that are applied to the text
 - **Maintain formatting only** — imports all formatting that is applied to the text
 - **Discard fonts and formatting** — ignores all fonts and formatting that are applied to the text

To import a table from a word-processing document

- 1 Click **File** ► **Import**.
- 2 Choose the drive and folder where the text file is stored.
- 3 Click the file.
- 4 Click **Import**.
- 5 From the **Import tables as** list box, choose **Tables**.
- 6 Choose one of the following options:
 - **Maintain fonts and formatting** — imports all fonts and formatting that are applied to the text

- **Maintain formatting only** — imports all formatting that is applied to the text
- **Discard fonts and formatting** — ignores all fonts and formatting that are applied to the text

Bitmaps

Working with bitmaps.....	631
Special effects categories.....	663
Working with bitmap color modes.....	709
Tracing bitmaps and editing traced results.....	717
Working with RAW camera files.....	729

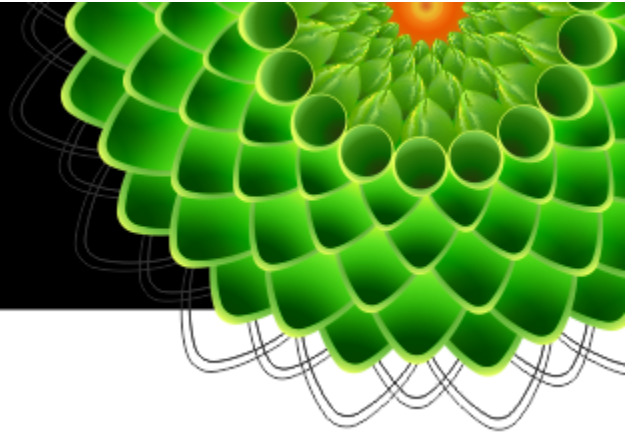

Working with bitmaps

You can convert a [vector graphic](#) to a [bitmap](#). You can also import and [crop](#) bitmaps.

You can add perspective, shape bitmaps with envelopes, apply color masks, [watermarks](#), and special effects, and change the color and [tone](#) of the images. For information about applying perspective to bitmaps, see [“Applying perspective”](#) on page 436. For information about shaping bitmaps with envelopes, see [“Shaping objects by using envelopes”](#) on page 210.

This section contains the following topics:

- [“Converting vector graphics to bitmaps”](#) (page 631)
- [“Importing bitmaps”](#) (page 633)
- [“Cropping bitmaps”](#) (page 633)
- [“Changing the dimensions and resolution of bitmaps”](#) (page 633)
- [“Straightening bitmaps”](#) (page 635)
- [“Correcting perspective distortions”](#) (page 638)
- [“Using Digimarc watermarks to identify bitmaps”](#) (page 639)
- [“Removing dust and scratch marks from bitmaps”](#) (page 640)
- [“Working with colors in bitmaps”](#) (page 640)
- [“Using the Image Adjustment Lab”](#) (page 642)
- [“Adjusting color and tone”](#) (page 647)
- [“Using the Tone Curve filter”](#) (page 653)
- [“Transforming color and tone”](#) (page 656)
- [“Editing bitmaps with Corel PHOTO-PAINT”](#) (page 657)
- [“Applying special effects in bitmaps”](#) (page 657)

Converting vector graphics to bitmaps

Converting a [vector graphic](#) or [object](#) to a bitmap lets you apply special effects to the object with CorelDRAW. The process of converting a vector graphic to a bitmap is also known as “rasterizing.”

When you convert the [vector graphic](#), you can select the [color mode](#) of the [bitmap](#). A color mode determines the number and kind of colors that make up the bitmap, so the file size is also affected. For more information about color modes, see [“Changing the color mode of bitmaps”](#) on page 709.

You can also specify settings for such controls as [dithering](#), [anti-aliasing](#), overprinting black, and background [transparency](#).

When you export a file to a bitmap file format, such as TIFF, JPEG, CPT, or PSD, the same bitmap conversion options are available. For more information about exporting, see [“Exporting files” on page 792](#).

To convert a vector graphic to a bitmap

- 1 Select an [object](#).
- 2 Click **Bitmaps** ► **Convert to bitmap**.
- 3 Choose a [resolution](#) from the **Resolution** list box.
- 4 Choose a [color mode](#) from the **Color mode** list box.
- 5 Enable any of the following check boxes:
 - **Dithered** — simulates a greater number of colors than those available. This option is available for images that use 256 or fewer colors.
 - **Always overprint black** — overprints black when black is the top color. Enabling this option prevents gaps from appearing between black objects and underlying objects when you print bitmaps.
 - **Anti-aliasing** — smooths the edges of the bitmap
 - **Transparent background** — makes the background of the bitmap [transparent](#)



You can change the black threshold for the **Always overprint black** option. For information about setting the black threshold, see [“To set the overprint black threshold” on page 764](#).

If you export a vector file to a bitmap format, such as GIF, you are prompted to set the bitmap conversion options described in the procedure above before you export the file.



Making the background of a bitmap transparent lets you see images or a background otherwise obscured by the bitmap background.

To convert a vector graphic to a bitmap when exporting

- 1 Click **File** ► **Export**.
- 2 Choose the folder where you want to save the file.
- 3 Choose a [bitmap](#) file format from the **Save as type** list box, and type a filename in the **File name** list box.
- 4 Set the options you want, and click **Export**.
- 5 In the **Convert to bitmap** dialog box, type values in one of the following pairs of boxes:
 - **Width** and **Height** — let you specify the image dimensions
 - **Width %** and **Height %** — let you resize the image to a percentage of its original size
- 6 To specify the [resolution](#), type a value in the **Resolution** box.
- 7 Choose a [color mode](#) from the **Color mode** list box.
- 8 Enable any of the following check boxes:
 - **Dithered** — simulates a greater number of colors than those available. This option is available for images that use 256 or fewer colors.
 - **Always overprint black** — overprints black when black is the top color. Enabling this option when you print bitmaps prevents gaps from appearing between black objects and underlying objects.
- 9 In the **Options** area, enable any of the following:
 - **Anti-aliasing** — smooths the edges of the bitmap
 - **Maintain layers** — preserves [layers](#)
 - **Transparent background** — makes the background of the bitmap [transparent](#)



You can change the black threshold for the **Always overprint black** option. For information about setting the black threshold, see [“To set the overprint black threshold” on page 764](#).

Not all options in the **Convert to bitmap** dialog box are available for all bitmap file formats.



Making the background of a bitmap transparent lets you see images or a background otherwise obscured by the bitmap background.

Importing bitmaps

You can import a [bitmap](#) into a drawing either directly or by linking it to an external file. When you link to an external file, edits to the original file are automatically updated in the imported file. After you import a bitmap, the status bar provides information about its color mode, size, and resolution. For more information about importing bitmaps, see [“Importing files” on page 789](#). For more information about managing externally linked bitmaps, see [“Adding bookmarks and hyperlinks to documents” on page 784](#).

You can also resample or crop a bitmap while importing. For more information, see [“To resample a bitmap while importing” on page 791](#) and [“To crop a bitmap while importing” on page 792](#).

Cropping bitmaps

[Cropping](#) removes unwanted areas of a [bitmap](#). To crop a bitmap into a rectangular shape, you can use the **Crop** tool. For more information, see [“To crop an object or imported photo” on page 219](#). To crop a bitmap into an irregular shape, you can use the **Shape** tool and the **Crop bitmap** command.

To crop a bitmap



- 1 In the toolbox, click the **Shape** tool .
- 2 Select a [bitmap](#).
- 3 Drag the corner [nodes](#) to reshape the bitmap.
If you want to add a node, double-click the node boundary (dotted line) by using the **Shape** tool where you want the node to appear.
- 4 Click **Bitmaps** ▶ **Crop bitmap**.



You cannot [crop](#) a bitmap comprised of more than one [object](#).



You can also quickly crop a bitmap into a rectangular shape by using the **Crop** tool . For information about the **Crop** tool, see [“To crop an object or imported photo” on page 219](#).

You can also crop a selected bitmap after you drag the corner nodes by clicking the **Pick** tool , then clicking the **Crop bitmap** button  on the property bar.

Changing the dimensions and resolution of bitmaps

After you add a bitmap to a drawing, you can change its dimensions and resolution.

Changing dimensions

You can change the physical dimensions of bitmaps by increasing or decreasing their height and width. When you increase the dimensions, the application inserts new pixels between existing pixels, and their colors are based on the colors of adjacent pixels. If you increase the dimensions of bitmaps significantly, bitmaps may appear stretched and pixelated.

The size of the bitmap on your screen depends on the pixel height and width of the bitmap, on the zoom level, and on your monitor settings. As a result, the size of the bitmap may appear different on your screen and in print.

Changing bitmap resolution

You can change the resolution of a bitmap to increase or decrease its file size. Resolution is measured by the number of dots per inch (dpi) when the bitmap is printed. The resolution you choose depends on how the bitmap is output. Typically, bitmaps created only for display on computer monitors are 96 or 72 dpi and bitmaps created for the web are 72 dpi. Bitmaps created for printing on desktop printers are generally 150 dpi, while professionally printed bitmaps are usually 300 dpi, or higher.

Higher-resolution bitmaps contain smaller and more densely packed pixels than lower-resolution bitmaps. Upsampling increases the resolution of a bitmap by adding more pixels per unit of measure. Bitmap quality may be reduced because the new pixels are interpolated based on the colors of neighboring pixels; the original pixel information is simply spread out. You cannot use upsampling to create detail and subtle color gradations where none existed in the original image.

Downsampling decreases the resolution of a bitmap by removing a specific number of pixels per unit of measure. Best results are usually achieved when downsampling is done after color and tone corrections but before sharpening.



Resizing an image

To change the dimensions of a bitmap

- 1 Select a **bitmap**.
- 2 Click **Bitmaps** ► **Resample**.
- 3 Choose a unit of measure from the list box next to the **Width** and **Height** boxes.
- 4 Type values in any of the following boxes:
 - **Width**
 - **Height**

If you want to minimize the jagged appearance of curves, enable the **Anti-alias** check box.

If you want to maintain the file size, enable the **Maintain original size** check box. When this check box is enabled, the resolution of the bitmap is automatically adjusted as you change the image dimensions.



You can maintain the proportions of the bitmap by enabling the **Maintain aspect ratio** check box and typing a value in either the **Width** or **Height** box.

You can also **resample** the bitmap as a percentage of its original size by typing values in the **Width %** and **Height %** boxes.

To change the resolution of a bitmap

- 1 Select a **bitmap**.
- 2 Click **Bitmaps** ▶ **Resample**.
- 3 In the **Resolution** area, type values in any of the following boxes:
 - **Horizontal**
 - **Vertical**

If you want to maintain the proportions of the bitmap, enable the **Maintain aspect ratio** check box.

If you want to maintain the file size, enable the **Maintain original size** check box. When this check box is enabled, the height and width of the bitmap are automatically adjusted as you change the resolution.



You can also **resample** a selected bitmap by clicking the **Resample** button  on the property bar.

Enable the **Anti-alias** check box to minimize the jagged appearance of curves.

Straightening bitmaps

The **Straighten image** dialog box lets you correct lens distortions and straighten bitmap images quickly. This feature is useful for straightening photos that were taken or scanned at an angle or contain lens distortions.

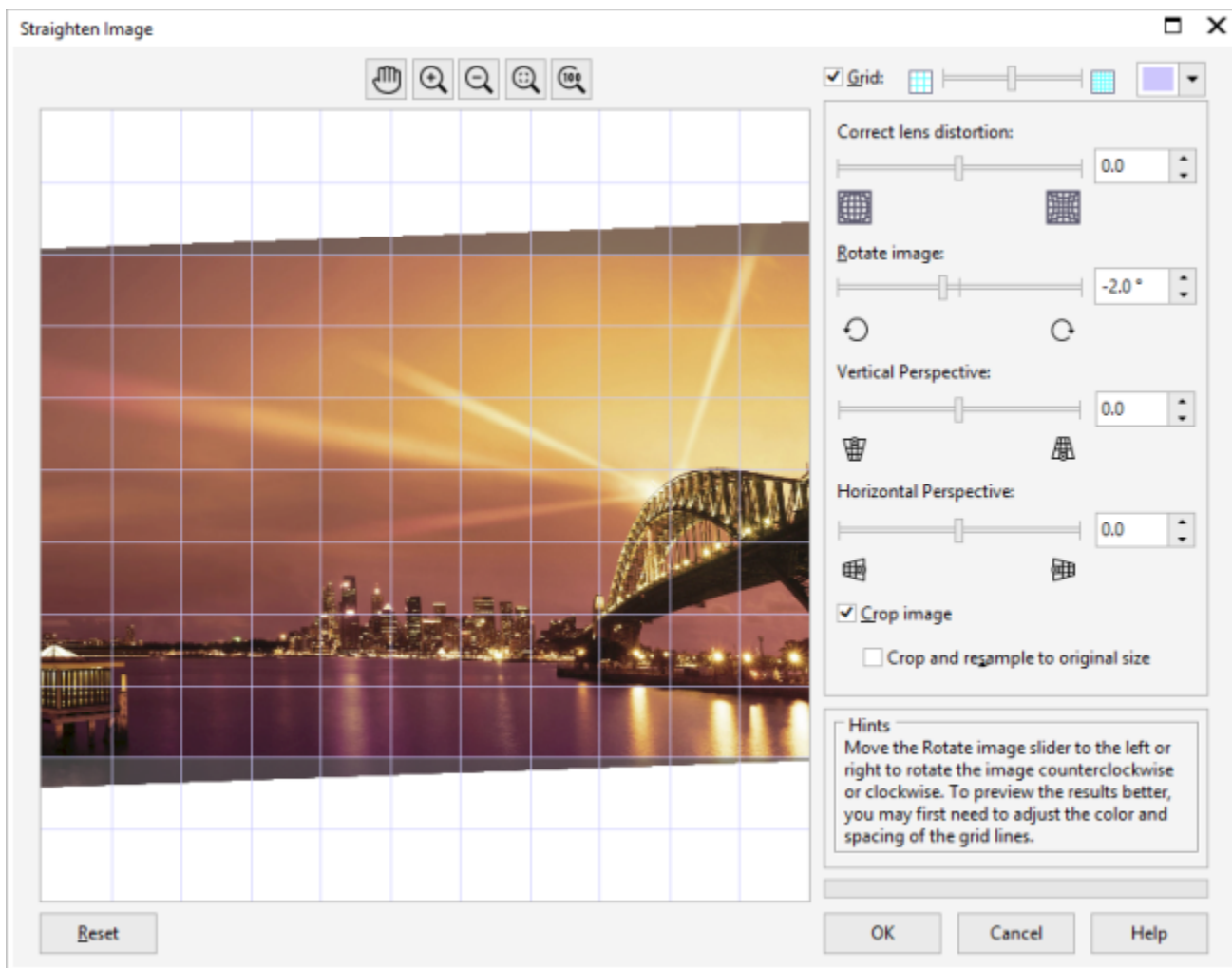

Straighten image dialog box

Correcting camera lens distortions

With photos that contain camera lens distortions, it is recommended that you start with correcting the lens distortion. You can correct two types of lens distortions, which make straight lines in photos appear curved: barrel and pincushion. Barrel distortions make photos appear pushed out at the center. Pincushion distortions make photos appear pushed in at the center.

Rotating and previewing

The **Straighten image** dialog box lets you rotate an image by moving a slider, typing a rotation angle, or using the arrow keys. You can specify a custom rotation angle from -15 to 15 degrees.

You can use the preview window to dynamically preview the adjustments that you are making. If you want to change the orientation of the image before straightening it, you can start by rotating the image 90 degrees clockwise and 90 degrees counterclockwise.

A grid is displayed in the preview window to help you straighten the image. You can make more precise adjustments by controlling the cell size of the grid. To heighten the contrast of the grid against the colors of the image, you can change the grid's color. You can also hide the grid if you want to preview the final result without the gridlines. In addition, you can zoom in and out, and pan the image in the preview window to evaluate the results.

Cropping

By default, the straightened image is cropped to the cropping area that is displayed in the preview window. The final image has the same aspect ratio as the original image, but it has smaller dimensions. However, you can preserve the original width and height of the image by cropping and resampling the image.

You can also produce an image at an angle by disabling cropping and then using the **Crop** tool to crop the image in the drawing window.

To straighten an image

1 Select an image.

2 Click **Bitmaps** ▶ **Straighten image**.

If the image has a lens distortion, move the **Correct lens distortion** slider to the left to correct a barrel distortion or to the right to correct a pincushion distortion.

3 Move the **Rotate image** slider, or type a value between **15** and **-15** in the **Rotate image** box.

4 If necessary, move the **Grid** slider to adjust the size of the grid cells.

5 To crop and straighten the image, enable the **Crop image** check box.

The image is cropped to preserve the aspect ratio of the original image, which means that the final image is smaller than the original image.

If you want to preserve the width and height of the original image, enable the **Crop and resample to original size** check box. The final image is resampled.

You can also

Change the grid color



Choose a color from the **Grid** color picker.

Align an image area with a gridline

Using the **Pan** tool , drag the image until the area is aligned with the gridline.

You can use the **Pan** tool only after you zoom in on the image.

Rotate the image 90 degrees in either direction

Click the **Rotate counterclockwise**  button or the **Rotate clockwise** button .

Hide or display the grid

Disable or enable the **Grid** check box.



Adjust the rotation angle by 0.1-degree increments

Click in the **Rotate image** box, and press the **Up arrow** or **Down arrow** key.

Reset the image to its original orientation

Click **Reset**.

Zoom in or out

Using the **Zoom in**  or **Zoom out**  tool, click in the preview window.

Fit an image in the preview window

Click the **Zoom to fit**  button.

You can also

Display an image at its actual size

Click the 100%  button.

Correcting perspective distortions

You can correct perspective distortions in photos that have straight lines and flat surfaces such as architectural photos and photos of buildings.

Perspective distortions usually occur when you take pictures of tall or wide objects, and the camera sensor is at an angle to the objects. As a result, the photographed objects may appear to be leaning or to be at an angle. Adjusting the vertical perspective helps straighten leaning objects; adjusting the horizontal perspective helps with angled objects. Often, you may need to adjust both the vertical and horizontal perspectives for best results.



Correcting perspective distortions

To correct perspective distortions in photos

- 1 Select an image.
- 2 Click **Bitmaps** ► **Straighten image**.
- 3 Perform a task from the following table.

To

Correct the vertical perspective

Do the following

Move the **Vertical perspective** slider. If the photo object appears to be leaning backwards, move the slider to the left. Tall buildings in photos usually appear to be leaning back when the picture is taken from the ground.

To	Do the following
Correct the horizontal perspective	Move the Horizontal perspective slider. If the photo was taken with the camera to the right of the object, move the slider to the left.
Crop and resample the corrected image to its original size	Enable the Crop check box, and then enable the Crop and resample to original size check box.

Using Digimarc watermarks to identify bitmaps

A Digimarc **watermark** embeds copyright details, contact information, and image attributes in an image. A watermark makes subtle changes to the brightness of **pixels** in an image. These changes cannot be readily seen; however, at high magnification, you might notice changes in the **brightness** of some pixels. Digimarc watermarks aren't affected by normal editing, printing, and scanning.

The detecting and embedding of Digimarc watermarks is not supported by the 64-bit version of CorelDRAW Graphics Suite.

Detecting watermarks

When you open an image in CorelDRAW, you can check for a watermark. If a watermark is present, a copyright symbol appears on the title bar. You can find information about the watermarked image by reading the embedded message and by linking to the contact profile in the Digimarc database.

Embedding watermarks

In CorelDRAW, you can also embed Digimarc watermarks in images. First, you must obtain a unique Creator ID by subscribing to Digimarc's online service. The Creator ID includes contact details, such as name, phone number, address, email, and web addresses.

Once you have a Creator ID, you can embed a watermark in an image. You can specify the copyright year, image attributes, and the durability of a watermark. You can also specify the target output method for an image, such as print or the web.

Digimarc watermarks do not prevent unauthorized image use or copyright infringement. But the watermarks do communicate copyright claims. They also provide contact information for those who want to use or license an image.

For more information about Digimarc, see www.digimarc.com.

To detect a watermark

- 1 Click **Bitmaps** ► **Plug-ins** ► **Digimarc** ► **Read watermark**.
- 2 Click **Web lookup** to view the webpage with contact details, or call the Digimarc fax-back service at the listed fax number.



This feature is not supported by the 64-bit version of CorelDRAW Graphics Suite.

To get a Creator ID

- 1 Click **Bitmaps** ► **Plug-ins** ► **Digimarc** ► **Embed watermark**.
- 2 Click **Personalize**.
- 3 In the **Personalize Creator ID** dialog box, click **Register**, and follow the instructions on the Digimarc website.
- 4 In the **Personalize Creator ID** dialog box, type your Creator ID in the **Creator ID** box.

To embed a watermark

- 1 Click **Bitmaps** ► **Plug-ins** ► **Digimarc** ► **Embed watermark**.
- 2 In the **Copyright year(s)** box, type a year or years.
- 3 In the **Image attributes** area, enable the check boxes for the applicable attributes.
- 4 Choose an option from the **Target output** list box.
- 5 Type a value in the **Watermark durability** box.
Higher values increase the persistence of the **watermark** under common image modifications such as **dithering**, **cropping**, compression, and **scaling**.

If you want to confirm the information available to viewers when they detect the watermark, enable the **Verify** check box.



This feature is not supported by the 64-bit version of CorelDRAW Graphics Suite.

In the **Copyright year(s)** box, you cannot type a year before 1922 or after the current year. Separate the years with commas.

In the **Target output** box, the **Monitor** and **Web** controls require a setting of less than 200 per inch (dpi), and the **Printer** control requires a setting of 300 dpi or higher.



Combine all **objects** with the background before adding a watermark. For more information about combining objects with the background, see [“Combining objects” on page 303](#).

Removing dust and scratch marks from bitmaps

You can quickly improve the appearance of a **bitmap** by removing dust and scratch marks. The dust and scratch filter works by eliminating the contrast between **pixels** that exceed the **contrast threshold** you set. You can set a **radius** to determine how many pixels are affected by the changes. The settings you choose depend on the size of the blemish and the area surrounding it. For example, to remove a white scratch that is 1 or 2 pixels wide on a dark background, you can set a radius of 2 or 3 pixels and set the contrast threshold higher than you would for a similar scratch on a light background.

To remove dust and scratch marks from a bitmap

- 1 Click **Effects** ► **Correction** ► **Dust and scratch**.
- 2 Move the following sliders:
 - **Radius** — sets the range of **pixels** used to produce the effect. To retain image detail, choose a setting as low as possible.
 - **Threshold** — sets the amount of **noise** reduction. To retain image detail, choose a setting as high as possible.

Working with colors in bitmaps

CorelDRAW lets you change colors in monochrome images, apply PostScript **halftone** screens to optimize color and black-and-white **bitmaps** for printing, hide and show colors, and mask colors. Monochrome bitmaps have two colors: black and white. You can replace the black and white **pixels** with any color on a **color palette**.

If you plan to print to a PostScript printer, you can optimize color or black-and-white printing by applying a halftone screen to an image. Halftone screens break down an image into small dots or lines for clearer printing, continuous **tones**, and special effects. However, you can see the effect of the screen on the bitmap only after you print it on a PostScript printer. For information about making changes to halftone screens, see [“To customize a halftone screen” on page 762](#).

You can hide and display selected colors by masking them. Hiding colors in a bitmap lets objects or backgrounds show through the image. Hiding a color can also alter the apparent shape of a bitmap. For example, if a bitmap shows a person on a black background, you can





hide the background so that the bitmap appears to take on the shape of the person rather than a rectangular shape. Also, hiding colors in bitmaps can increase the speed at which objects are rendered on the screen. You can also display certain colors in a bitmap to change the appearance of the image or to see where a particular color has been applied. You can mask as many as 10 colors in a bitmap.

Color masking also lets you change selected colors without altering the other colors in an image. You can also save a bitmap color mask to a file and open the file for future use.



To color a monochrome bitmap

- 1 Select a **bitmap** by using the **Pick tool** .
- 2 Right-click a color on the color palette to change the color of the foreground (black) pixels.
- 3 Click a color on the **color palette** to change the color of the background (white) pixels.

To apply a screen to a bitmap

- 1 Select a **bitmap** by using the **Pick tool** .
- 2 In the toolbox, click the **Interactive fill tool** .
- 3 On the property bar, click the **Uniform fill button** , and then click the **Edit fill button** .
- 4 In the **Edit fill** dialog box, click the **Palettes** tab .
- 5 Choose a spot color **palette** from the **Palette** list box.
- 6 Click **PostScript options**.
- 7 In the **PostScript options** dialog box, choose an option (other than **Default**) from the **Type** list to set the dot shape or line type.
- 8 Type a value in the **Frequency** box to set the number of dots or lines that appear in each inch of the screen.
- 9 Type a value in the **Angle** box to set the angle of the dots or lines that appear on the screen.

To hide or display a color in a bitmap

- 1 Select the **bitmap** by using the **Pick tool** .
- 2 Click **Bitmaps** ► **Bitmap color mask**.
- 3 Enable one of the following options:
 - **Hide colors**
 - **Show colors**
- 4 Enable the check box next to the **channel** that you want to hide or display.
- 5 Move the **Tolerance** slider to set the color tolerance for the color.
- 6 Click the **Color selector** button .
- 7 Click the color that you want to hide or display.
- 8 Click **Apply**.



Higher tolerance levels target a broader range of colors around the color you select. For example, if you select baby blue and increase the tolerance, CorelDRAW hides or displays such colors as pastel blue or electric blue.

To open a bitmap color mask

- 1 Click **Bitmaps** ► **Bitmap color mask**.

- 2 Click the **Open mask** button .
- 3 Choose the folder where the color mask file is stored.
- 4 Double-click the file.



Files containing bitmap color mask have the filename extension **.ini**.

To change a masked color

- 1 Click **Bitmaps** ► **Bitmap color mask**.
- 2 Choose a color from the list of masked colors.
- 3 Click the **Edit color** button .
- 4 Use the controls in the **Select color** dialog box to edit the color.



You can also change a masked color by clicking the **Color selector** button , selecting another color from the bitmap, and clicking **Apply**.

Using the Image Adjustment Lab

The Image Adjustment Lab lets you correct the color and **tone** of most photos quickly and easily.



1. Rotation tools

2. Pan tool

3. Zoom tools

4. Preview Modes

5. Select white point

6. Select black point

7. Undo, Redo, and Reset

8. Snapshots

9. Sliders

10. Hint for current tool

11. Histogram

The Image Adjustment Lab consists of automatic and manual controls, which are organized in a logical order for image correction. By starting in the upper-right corner and working your way down, you can select only the controls you need to correct the problems specific to your image. It is best to crop or retouch any areas of the image before beginning the color and tone corrections.

When you work in the Image Adjustment Lab, you can take advantage of the following features:

- **Create snapshot** — You can capture the corrected version of an image in a “snapshot” at any time. Thumbnails of the snapshots appear in a window below the image. Snapshots make it easy to compare different corrected versions of the image so you can choose the best one.
- **Undo, Redo, and Reset to original** — Image correction can be a trial-and-error process, so the ability to undo and redo corrections is important. The **Reset to original** command lets you clear all corrections so that you can start again.

Using automatic controls

You can begin by using the automatic correction controls:

- **Auto adjust** — automatically corrects the **contrast** and color in an image by detecting the lightest and darkest areas and adjusting the **tonal range** for each color channel. In some cases, this control may be all you need to improve an image. In other cases, you can undo the changes and proceed with more precise controls.
- **Select white point** tool — automatically adjusts the contrast in an image according to the white point that you set. For example, you can brighten an image that is too dark by using the **Select white point** tool.
- **Select black point** tool — automatically adjusts the contrast in an image according to the black point that you set. For example, you can darken an image that is too light by using the **Select black point** tool.

Using color correction controls

After using the automatic controls, you can correct color casts in your image. Color casts are typically caused by the lighting conditions when a photo is taken, and they can be influenced by the processor in your digital camera or scanner.

- **Temperature** slider — lets you correct color casts by “warming” or “cooling” the color in an image to compensate for the lighting conditions at the time the photo was taken. For example, to correct a yellow color cast caused by taking a photo indoors in dim incandescent lighting, you can move the slider toward the blue end to increase the temperature values (based on degrees Kelvin). Lower values correspond to low lighting conditions, such as candlelight or light from an incandescent light bulb; these conditions cause an orange cast. Higher values correspond to intense lighting conditions, such as sunlight; these conditions cause a blue cast.
- **Tint** slider — lets you correct color casts by adjusting the green or magenta in an image. You can add green by moving the slider to the right; you can add magenta by moving the slider to the left. Moving the **Tint** slider after using the **Temperature** slider lets you fine-tune an image.
- **Saturation** slider — lets you adjust the vividness of colors. For example, by moving the slider to the right, you can increase the vividness of a blue sky in an image. By moving the slider to the left, you can reduce the vividness of colors. You can create a black-and-white photo effect by moving the slider all the way to the left, so that all color in the image is removed.

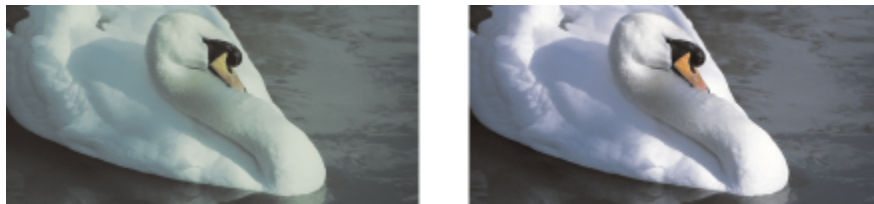

Correction of a color cast. The image on the right is the corrected version.

Adjusting brightness and contrast across an entire image

You can brighten, darken, or improve the contrast in an entire image by using the following controls:

- **Brightness** slider — lets you brighten or darken an entire image. This control can correct exposure problems caused by too much light (overexposure) or too little light (underexposure) at the time the photo was taken. If you want to lighten or darken specific areas of an image, you can use the **Highlights**, **Shadows**, and **Midtones** sliders. Adjustment made by the **Brightness** slider is nonlinear, so the current white point and black point values are not affected.
- **Contrast** slider — increases or decreases the difference in tone between the dark and light areas of an image. Moving the slider to the right makes the light areas lighter and the dark areas darker. For example, if the image has a dull, gray tone, you can sharpen the detail by increasing the contrast.

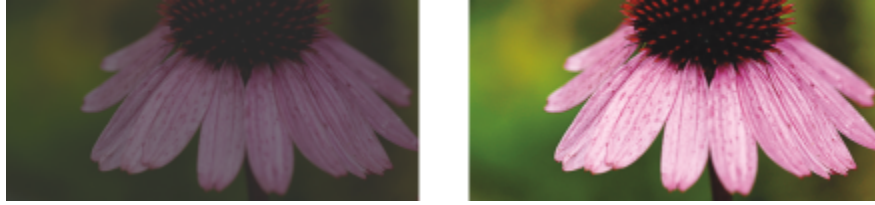

Adjusting the brightness and contrast of an image can reveal more image detail.

Adjusting highlights, shadows, and midtones

You can brighten or darken specific areas of an image. In many cases, the position or strength of the lighting at the time a photo is taken causes some areas to appear too dark and other areas to appear too light.

- **Highlights** slider — lets you adjust brightness in the lightest areas of an image. For example, if you take a photo with a flash, and the flash washes out the foreground subjects, you can move the **Highlights** slider to the left to darken the washed-out areas of the image. You can use the **Highlights** slider in conjunction with the **Shadows** and **Midtones** sliders to balance the lighting.
- **Shadows** slider — lets you adjust the brightness in the darkest areas of an image. For example, a bright light behind a photo subject (backlighting) at the time a photo is taken can cause the subject to appear in shadow. You can correct the photo by moving the **Shadow** slider to the right to lighten the dark areas and reveal more detail. You can use the **Shadows** slider in conjunction with the **Highlights** and **Midtones** sliders to balance the lighting.
- **Midtones** slider — lets you adjust the brightness of the midrange tones in an image. After adjusting the highlights and shadows, you can use the **Midtones** slider to fine-tune the image.



The Highlights and Shadows sliders can lighten or darken specific areas of an image.

Using the histogram

The histogram lets you view the tonal range of an image to evaluate and adjust the color and tone. For example, a histogram can help you detect hidden detail in a photo that is too dark because of underexposure (a photo taken with insufficient light).

The histogram plots the brightness values of the pixels in an image on a scale of 0 (dark) to 255 (light). The left part of the histogram represents the shadows, the middle part represents the midtones, and the right part represents the highlights. The height of the spikes indicates how many pixels are at each brightness level. For example, a higher number of pixels on the left side of the histogram indicates the presence of image detail in the dark areas of the image.



The photo on the left is underexposed. Right: The histogram indicates a large amount of image detail in the dark areas of the photo.

Viewing images in the Image Adjustment Lab

The tools in the Image Adjustment Lab let you view images in various ways, so that you can evaluate the color and tone adjustments you make. For example, you can rotate images, pan to a new area, zoom in or out, and choose how to display the corrected image in the preview window.

Using other adjustment filters

Although the Image Adjustment Lab lets you correct the color and tone of most images, a specialized adjustment filter is sometimes required. Using the powerful adjustment filters in the application, you can make precise adjustments to images. For example, you can adjust images by using a tone curve. For more information about adjustment filters, see “Adjusting color and tone” on page 647.

To correct color and tone in the Image Adjustment Lab

1 Click **Bitmaps** ► **Image Adjustment Lab**.

2 Click **Auto adjust**.

Auto adjust automatically adjusts color and contrast by setting the **white point** and **black point** for an image.

If you want to control the white point and black point setting more precisely, click the **Select white point** tool , and click the lightest area of your image. Then click the **Select black point** tool , and click the darkest area of your image.

3 Perform one or more tasks from the following table.



To	Do the following
Correct color in the image	Adjust the Temperature slider to warm or cool the colors, and then fine-tune the color correction by adjusting the Tint slider.
Make colors more vivid or less vivid	Move the Saturation slider to the right to increase the amount of color in the image; move the slider to the left to decrease the amount of color in the image.
Brighten or darken an image	Move the Brightness slider to the right to lighten the image; move the slider to the left to darken the image.
Improve image sharpness by adjusting tone	Move the Contrast slider to the right to make the light areas lighter and the dark areas darker.
Brighten or darken specific areas	Move the Highlights slider to brighten or darken the lightest areas of the image. Then, move the Shadows slider to lighten or darken the darkest areas of the image. Finally, move the Midtones slider to fine-tune the midrange tones in the image.



The Image Adjustment Lab is not available for CMYK images. For CMYK images, you can access the **Auto adjust** filter and other adjustment filters from the **Effects** menu.













You can capture the current version of your image by clicking the **Create snapshot** button. Thumbnails of the snapshots appear in a window below your image. Each snapshot is numbered sequentially and can be deleted by clicking the **Close** button in the upper-right corner of the snapshot title bar.

You can undo or redo the last correction you made by clicking the **Undo** button  or the **Redo** button . To undo all corrections, click the **Reset to original** button.

To view images in the Image Adjustment Lab

- 1 Click **Bitmaps** ► **Image Adjustment Lab**.
- 2 Perform a task from the following table.

To	Do the following
Rotate the image	Click the Rotate left button  or the Rotate right button  .
Pan to another area of an image	Using the Pan tool  , drag the image until the area you want to see is visible.
Zoom in and out	Using the Zoom in tool  or the Zoom out tool  , click in the preview window.
Fit an image in the preview window	Click the Zoom to fit  button.
Display an image at its actual size	Click the 100%  button.
View the corrected image in a single preview window	Click the Full preview button  .
View the corrected image in one window and the original image in another window	Click the Before and after full preview button  .
View the image in one window with a divider between the original and corrected versions	Click the Before and after split preview button  . Move your pointer over the dashed divider line, and drag to move the divider to another area of the image.

Adjusting color and tone

CorelDRAW lets you adjust the color and **tone** of bitmaps. For example, you can replace colors and adjust the brightness, lightness, and intensity of colors.

By adjusting color and tone, you can restore detail lost in shadows or highlights, remove color casts, correct underexposure or overexposure, and generally improve the quality of the bitmaps. You can also correct color and tone quickly by using the Image Adjustment Lab. For more information, see ["Using the Image Adjustment Lab"](#) on page 642.

You can adjust the color and tone of bitmaps automatically by using the Auto Adjust command or by using the following filters.

Effect	Description
Brightness/contrast/intensity	Lets you adjust the brightness of all colors and the difference between light and dark areas

Effect	Description
Channel mixer	Lets you mix color channels to balance the colors of a bitmap. For example, if a bitmap has too much red, you can adjust the red channel in an RGB bitmap to improve image quality.
Color balance	Lets you add cyan or red, magenta or green, and yellow or blue to selected tones in a bitmap. For example, if you want to tone down the blue color in a photo, you can shift the color values from blue to yellow.
Contrast enhancement	Lets you adjust the tone, color, and contrast of a bitmap while preserving shadow and highlight detail. An interactive histogram lets you shift or compress brightness values to printable limits. The histogram can also be adjusted by sampling values from the bitmap.
Desaturate	Lets you reduce the saturation of each color in a bitmap to zero, remove the hue component, and convert each color to its grayscale equivalent. This creates a grayscale black-and-white photo effect without changing the color model.
Gamma	Gamma is a method of tonal correction that takes the human eye's perception of neighboring pixels into account. For example, if you were to place a 10 percent gray circle on a black background and an identical gray circle on a white background, the circle surrounded by black appears lighter to the human eye than the circle surrounded by white even though the brightness values are identical. The Gamma effect lets you pick up detail in a low contrast image without significantly affecting the shadows or highlights. It affects the values in the image but it is curve-based so that the changes are weighted toward the midtones.
Hue/saturation/lightness	Lets you adjust the color channels in a bitmap and change the position of colors in the spectrum. This effect allows you to change colors and their richness, as well as the percentage of white in an image. Hue represents the dominant color (red, green, blue, yellow, and so on), saturation is the amount or richness of this color, and lightness represents the overall percentage of white in an image.
Local equalization	Lets you enhance contrast near edges to reveal detail in both light and dark regions. This process can produce artificial contrast variations in the center of relatively uniform regions. You can correct this by expanding the region so that it is larger than any uniform area in the image. You can set the height and width of the region around the pixels to accentuate contrast. To maintain equal proportions, enable the Lock button  .

Effect

Description

Replace colors

Lets you replace one bitmap color with another color. A color mask is created to define the color to be replaced. Depending on the range you set, you can replace one color or shift an entire bitmap from one color range to another. You can set the hue, saturation, and lightness for the new color.

Sample/Target balance

Lets you adjust color values in a bitmap with sample colors taken from the image. You can choose sample colors from the dark, midtone, and light ranges of an image and apply target colors to each of the sample colors. For example, you can increase the contrast in a bitmap by choosing the darkest and lightest tones in a bitmap and mapping them to black and white respectively. After you choose sample colors from the dark, midtone, and light ranges of the image and assign a target color to each sample color, the pixels with the same color as the sample colors adjust to display the corresponding target color.

Selective color

Lets you change color by changing the percentage of spectrum CMYK process colors from the red, yellow, green, cyan, blue, and magenta color spectrum in a bitmap. This filter also lets you add process color to the grayscale tonal component of an image. Selective color modifications increase and decrease the percentage of cyan, magenta, yellow, and black pixels that make up each primary color in the color spectrum. For example, decreasing the percentage of magenta in the reds spectrum results in a color shift toward yellow. Conversely, increasing the percentage of magenta in the reds spectrum causes a color shift toward magenta and an overall increase in red. The extent of color modification depends on the adjustment percentage method you choose.

Tone curve

Lets you perform color corrections precisely, by controlling individual pixel values. By changing pixel brightness values, you can make changes to shadows, midtones, and highlights. For more information, see [“Using the Tone Curve filter” on page 653](#).

To adjust color and tone automatically

- 1 Select a [bitmap](#).
- 2 Click **Bitmaps** ► **Auto adjust**.

To adjust the brightness, contrast, and intensity

- 1 Select a [bitmap](#).
- 2 Click **Effects** ► **Adjust** ► **Brightness/contrast/intensity** (or press **Ctrl + B**).
- 3 Move the **Brightness**, **Contrast**, or **Intensity** sliders to adjust the brightness, contrast, or intensity, respectively.



Adjusting the brightness, contrast, and intensity lets you improve the clarity and quality of the image.



Brightness shifts all pixel values up or down the tonal range, lightening or darkening all colors equally.

Contrast adjusts the difference between light and dark colors.

Intensity brightens the light areas of the drawing or darkens the dark areas.

Contrast and intensity usually go hand-in-hand because an increase in contrast sometimes washes out detail in shadows and highlights, and an increase in intensity can bring it back.

To adjust the color balance

- 1 Select a [bitmap](#).
- 2 Click **Effects** ► **Adjust** ► **Color balance** (or press **Ctrl + Shift + B**).
- 3 Perform a task from the following table.

To

Color correct the shadow, midtone, and highlight areas

Retain the image original brightness level

Add cyan or red

Add magenta or green

Add yellow or blue

Do the following

Enable the **Shadows**, **Midtones**, and **Highlights** check boxes, respectively.

Enable the **Preserve luminance** check box.

Move the **Cyan-Red** slider to the left or right, respectively.

Move the **Magenta-Green** slider to the left or right, respectively.

Move the **Yellow-Blue** slider to the left or right, respectively.



The Color balance effect has been used to shift the colors in the image from blue to yellow.

To apply the Gamma effect

- 1 Select a **bitmap**.
- 2 Click **Effects** ▶ **Adjust** ▶ **Gamma**.
- 3 Move the **Gamma value** slider.
Higher values brighten midtones; lower values darken them.



Adjusting the midtones lets you increase the detail in a low-contrast image without affecting the shadows or highlights.

To adjust hue, saturation, and lightness

- 1 Select a **bitmap**.
- 2 Click **Effects** ▶ **Adjust** ▶ **Hue/saturation/lightness** (or press **Ctrl + Shift + U**).
- 3 Perform a task from the following table.

To

Set the hue, saturation, and lightness for all channels

Set the hue, saturation, and lightness of a channel

Set the dominant color in an image

Do the following

Enable the **Master** option in the **Channels** area.

Enable the **Red**, **Yellow**, **Green**, **Cyan**, **Blue**, **Magenta**, or **Grayscale** option in the **Channels** area.

Move the **Hue** slider to redistribute the colors in an image.

To

Set the strength of colors

Set the amount of white (positive values) or black (negative values)

The **Before** and **After** color ribbons help you compare the original colors and the new colors



Do the following

Move the **Saturation** slider. A setting of -100 results in a grayscale image. A setting of 100 produces vibrant, unnatural colors.

Move the **Lightness** slider.



Use the Hue/saturation/lightness effect to change the colors in an image.

To replace colors

- 1 Select a **bitmap**.
- 2 Click **Effects** ► **Adjust** ► **Replace colors**.
- 3 Click the **Old color** picker and choose the color that you want to replace.

Tip: You can pick color from the bitmap by clicking the **Eyedropper** tool , and clicking the image.

- 4 Click the **New color** picker, and choose a replacement color.

You can also

Set the hue, saturation, and lightness level of the new color

Move the **Hue**, **Saturation**, and **Lightness** sliders, respectively.

Ignore grayscale pixels when replacing colors

Enable the **Ignore grayscale** check box.

Note: Disabling the **Ignore grayscale** check box replaces gray pixels based on saturation and lightness values alone.

Set the range of affected colors

Move the **Range** slider.

A range of 1 affects only a single color; a range of 100 shifts most of the colors in the direction of the new color.



Replace all colors that fall within the range of the new color

Enable the **Single destination** check box.



The Replace colors effect has been applied to replace all instances of the color red with purple.

To apply the Sample/target balance effect

- 1 Select a **bitmap**.
- 2 Click **Effects** ▶ **Adjust** ▶ **Sample/target balance**.
- 3 Choose a color channel from the **Channel** list box.
The color channels that appear in the **Channel** list box depend on the color mode of the bitmap. There is one composite channel and one channel for each color component. If you want to adjust all color channels, even when viewing only one channel, enable the **Always adjust all channels** check box.
- 4 Click the **Low-point** , **Mid-point** , and **High-point**  **Eyedropper** tool, and click in the image to choose a dark area, midtone area, and light area, respectively.
- 5 Double-click the target color for the shadows, midtones, or highlights, and choose a new color.



The shadows, midtones, and highlights in the image have been adjusted by mapping a sample color in the bitmap to a target color.



Enable the **Clip automatically** check box to set the range of the histogram display and ensure that all spikes fit on the chart. When the **Clip automatically** check box is disabled, use the **Clipping** box to set the percentage of brightness values that are ignored when identifying the light and dark colors in the histogram.

Using the Tone Curve filter

The **Tone curve** filter lets you perform color and tonal corrections by adjusting either individual color channels or the composite channel (all channels combined).

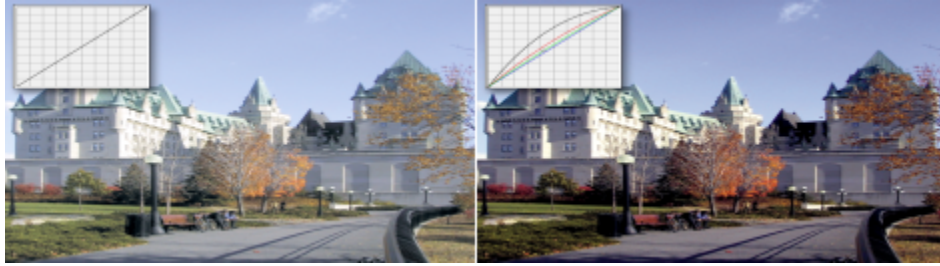

Original image (left); the image with adjusted tonal range (right)

Individual pixel values are plotted along a tone curve that appears in a graph and represents the balance between shadows (bottom of graph), midtones (middle of graph), and highlights (top of graph).

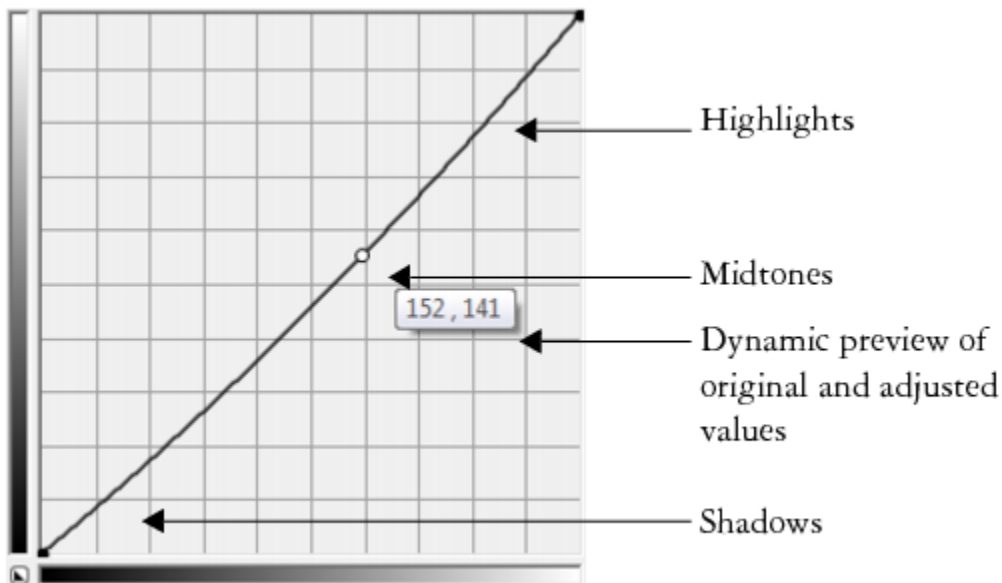

The tone curve shows the balance between the shadows, midtones, and highlights of an image. The original (x) and adjusted (y) pixel values are displayed side by side when you drag the tone curve. This example shows a small adjustment to the tonal range, in which pixel values of 152 are replaced with pixel values of 141.

The x-axis of the graph represents the tonal values of the original image; the y-axis of the graph represents the adjusted tonal values. Moving the curve up and to the left lightens the image and increases the color in any channel; moving the curve down and to the right darkens the image or decreases the color of a given channel. If you have an image with a blue cast, for example, you can decrease the blue in the image by selecting the **Blue** channel from the **Active channel** list box and moving the curve down and to the right.

You can adjust the color and tone of an image by dragging the tone curve interactively in the preview window, adding one or more nodes to the tone curve, selecting areas in the image window, or applying a preset. You can adjust multiple points along a curve, so you can lighten the shadows and darken the highlights.

You can also save tone curve settings as presets to use with other images. Response curve files are saved with the extension **.CRV**.

To apply the Tone curve effect

- 1 Select a bitmap.
- 2 Click **Effects** ► **Adjust** ► **Tone curve**.
- 3 Choose a color channel from the **Active channel** list box.
- 4 Choose a curve style from the **Style** list box.
 - **Curve** — smooths the distribution of the values

- **Straight** — retains straight line segments between nodes
- **Freehand** — lets you draw a freehand curve
- **Gamma** — lets you weigh corrections toward the midtones

5 Click and drag the curve in the preview window to adjust the bitmap interactively.

You can also

View the tone curves for all channels at once

Enable the **Display all channels** check box.

Adjust specific areas in an image

Click the **Eyedropper** tool, and click in the image. The pixels that you select appear as nodes on the tone curve.

Add a node to the tone curve

Click where you want to add a node along tone curve.

Smooth a freehand curve

Click the **Smooth** button.

Tip: Click and hold the **Smooth** button down to continuously smooth the tonal curve.

Reset the tone curve for a selected channel

Click the **Reset active channel** button.

Reset the tone curve for all channels

Click the **Reset** button.

Equalize the tonal range of an image

Click **Auto balance tone** button.

To specify the outlying pixels (clipped pixels) at each end of the tonal range, click the **Settings** button and specify the **Black limit to** and **White limit to** values in the **Auto-adjust range** dialog box.

Apply a preset

Click the **Open** button  to the right of the **Presets** box and choose the folder where the presets are stored.

Save tone curve settings as a preset

Click the **Save** button  to the right of the **Presets** box and locate the folder where you want to save the preset.



To flip the axis of the grid, click the **Invert** button .

To change the resolution of the grid, press **Alt** and click in the preview window.

To invert the selected tonal curve, click the **Horizontal Flip**  or **Vertical Flip** buttons .



The histogram lets you view the adjusted tonal range and evaluate the results. For more information about histograms, see [“Using the histogram” on page 645](#).

Transforming color and tone

You can transform the color and **tone** of an image to produce a special effect. For example, you can create an image that looks like a photographic negative or flatten the appearance of an image. To transform the color and tone of images, you can use the following effects:

- **Deinterlace** — lets you remove lines from scanned or interlaced images
- **Invert colors** — lets you reverse the colors of an **image**. Inverting an image creates the appearance of a photographic negative.



The Invert effect makes a negative of an image by converting all color values to their opposites: black becomes white, blue becomes yellow, and so on.

- **Posterize** — lets you reduce the number of tonal values in an image. Posterize removes gradations and creates larger areas of flat color.



The Posterize effect converts color ranges in an image to solid blocks of color.

To transform color and tone

- 1 Select a **bitmap**.
- 2 Click **Effects** ► **Transform**, and click any of the following:
 - **Deinterlace** — to remove lines from scanned or interlaced images. **Even lines** removes even lines. **Odd lines** removes odd lines. **Duplication** fills the gaps between the horizontal lines by duplicating the colors of the adjacent pixels. **Interpolation** fills the spaces with colors created by averaging the surrounding pixels.
 - **Invert** — to invert the color values in an image
 - **Posterize** — to reduce the number of tonal values in an image. Move the **Level** slider to set the level at which posterization begins. A level of 2 results in drastic posterization; a level of 32 has no effect on most images.

Editing bitmaps with Corel PHOTO-PAINT

You can access Corel PHOTO-PAINT, a complete image-editing application, from within CorelDRAW. When you finish editing a bitmap, you can quickly resume your work with CorelDRAW.

To send a bitmap to Corel PHOTO-PAINT, you can click the **Edit bitmap** button on the property bar, or you can use the **Edit bitmap** command from the **Bitmaps** menu. You can also enable an option that lets you access Corel PHOTO-PAINT by double-clicking a bitmap.

You can copy selected objects from Corel PHOTO-PAINT and then paste them into your drawing. The selected objects are pasted as a group of bitmaps.

For more information about editing images with Corel PHOTO-PAINT, click **Help** ► **Product help** from the Corel PHOTO-PAINT menu bar.

To edit a bitmap with Corel PHOTO-PAINT

- 1 Using the **Pick tool** , select the bitmap that you want to edit.
- 2 On the property bar, click **Edit bitmap** to start Corel PHOTO-PAINT.
The selected bitmap is displayed in the image window of Corel PHOTO-PAINT.
- 3 Edit the bitmap.
- 4 On the standard toolbar, click **Finish editing** to quit Corel PHOTO-PAINT.
The edited bitmap appears on the drawing page of CorelDRAW.



You can also use this procedure to edit groups of bitmaps. Corel PHOTO-PAINT opens the group of bitmaps as separate objects. If the bitmaps in the group have different color modes, you are prompted to change the color mode of all bitmaps in the group to the color mode of the bottom-most bitmap.

You can also open Corel PHOTO-PAINT by clicking **Bitmaps** ► **Edit bitmaps**.

To access Corel PHOTO-PAINT by double-clicking a bitmap

- 1 Click **Tools** ► **Options**.
- 2 In the **Workspace** list of categories, click **Edit**.
- 3 On the **Edit** page, enable the **Double-click to edit bitmaps in PHOTO-PAINT** check box.
Enabling this check box lets you access Corel PHOTO-PAINT by double-clicking the bitmap in CorelDRAW.

Applying special effects in bitmaps

You can apply a wide range of special effects to [bitmaps](#), such as three-dimensional (3D) and artistic effects.

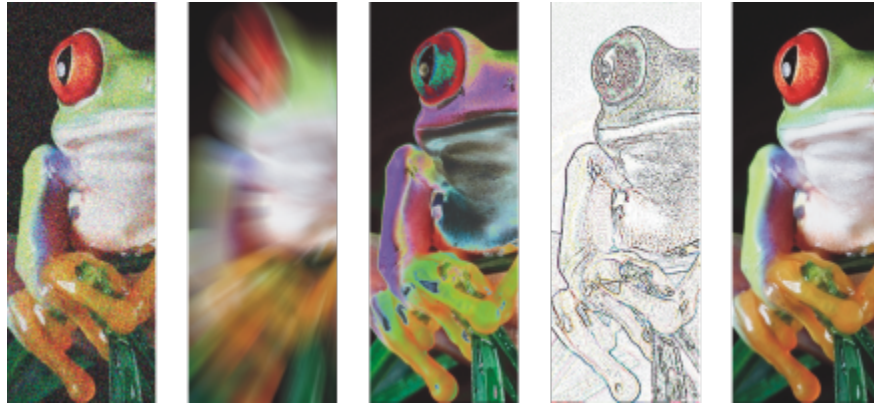

Left to right: Add noise effect, Zoom blur effect, Solarize color transform effect, Edge detect contour effect, Sharpen effect

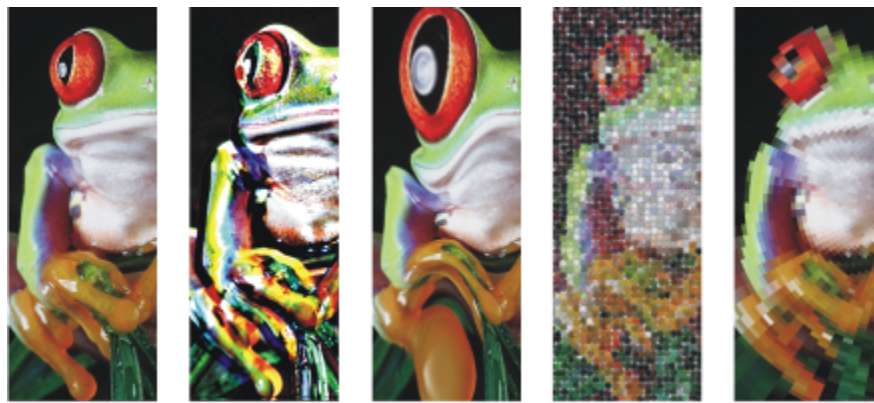

Left to right: Original image, Emboss effect, Cubist artistic effect, Mosaic creative effect, Distort pixelate effect

The special effects are organized into the following categories.

Special effect category

Description

3D Effects

Lets you create the illusion of depth. Effects include "3-D rotate " on page 663, "Bevel effect (Corel PHOTO-PAINT) " on page 664, "Cylinder " on page 664, "Emboss " on page 665, "Glass (Corel PHOTO-PAINT) " on page 665, "Page curl " on page 665, "Pinch/punch " on page 666, "Sphere " on page 666, "The Boss (Corel PHOTO-PAINT) " on page 667, and "Zig zag (Corel PHOTO-PAINT) " on page 667.

Art Strokes

Lets you apply hand-painted techniques. Effects include "Charcoal " on page 668, "Conte crayon " on page 668, "Crayon " on page 668, "Cubist " on page 669, "Dabble (Corel PHOTO-PAINT) " on page 669, "Impressionist " on page 670, "Palette knife " on page 670, "Pastels " on page 671, "Pen and ink " on page 671, "Pointillist " on page 671, "Scraperboard " on page 672, "Sketch pad " on page 672, "Watercolor " on page 673, "Water marker " on page 673, and "Wave paper " on page 673.

Special effect category

Description

Blur	Lets you blur an image to simulate movement, speckling, or gradual change. Effects include "Tune blur (Corel PHOTO-PAINT) " on page 674, "Directional smooth " on page 674, "Gaussian blur " on page 675, "Jaggy despeckle " on page 675, "Low pass " on page 676, "Motion blur " on page 676, "Radial blur " on page 677, "Bokeh blur (Corel PHOTO-PAINT) " on page 677, "Smooth " on page 677, "Soften " on page 678, "Zoom " on page 678, and "Smart blur (Corel PHOTO-PAINT) " on page 679.
Camera	Lets you simulate effects produced by various camera lenses. Effects include "Colorize " on page 680, "Diffuse " on page 680, "Lens flare (Corel PHOTO-PAINT) " on page 680, "Lighting effects (Corel PHOTO-PAINT) " on page 681, "Photo filter " on page 681, "Sepia toning " on page 682, "Spot filter (Corel PHOTO-PAINT) " on page 682, and "Time machine " on page 682, which lets you walk your image back through history to recreate some popular photographic styles from the past.
Color Transform	Lets you create photographic illusions by using color reduction and replacements. Effects include "Bit planes " on page 683, "Halftone " on page 684, "Psychedelic " on page 684, and "Solarize " on page 685.
Contour	Lets you highlight and enhance the edges of an image. Effects include "Edge detect " on page 685, "Find edges " on page 686, and "Trace contour " on page 686.
Creative	Lets you apply various textures and shapes to an image. Effects include "Crystalize " on page 686, "Fabric " on page 687, "Frame " on page 687, "Glass block " on page 688, "Mosaic " on page 688, "Scatter " on page 689, "Smoked glass " on page 689, "Stained glass " on page 689, "Vignette " on page 690, and "Vortex " on page 690.
Custom	Lets you apply a wide range of effects to your image. For example, you can add texture and patterns to an image (Bump-map effect). Effects include "Band pass (Corel PHOTO-PAINT) " on page 691, "Bump map " on page 691, and "User defined (Corel PHOTO-PAINT) " on page 691.
Distort	Lets you distort image surfaces. Effects include "Blocks " on page 692, "Displace " on page 692, "Offset " on page 693, "Pixelate " on page 694, "Ripple " on page 694, "Shear (Corel PHOTO-PAINT) " on page 695, "Swirl " on page 695, "Tile " on page 695, "Wet paint " on page 696, "Whirlpool " on page 696, and "Wind " on page 697.

Special effect category	Description
Noise	Lets you modify the graininess of an image. Effects include “Tune noise (Corel PHOTO-PAINT) ” on page 699 , “Add noise ” on page 697 , “3-D stereo noise (Corel PHOTO-PAINT) ” on page 698 , “Maximum ” on page 698 , “Median ” on page 698 , “Minimum ” on page 699 , “Remove Moire ” on page 700 , and “Remove Noise ” on page 700 .
Sharpen	Lets you add a sharpening effect to focus and enhance edges. Effects include “Adaptive unsharp ” on page 700 , “Directional sharpen ” on page 701 , “High pass ” on page 701 , “Sharpen ” on page 702 , and “Unsharp mask ” on page 702 .
Texture	Lets you add texture to an image by simulating a variety of surfaces, such as cobblestone, elephant skin, plastic, and relief sculpture. Effects include “Brick wall (Corel PHOTO-PAINT) ” on page 703 , “Bubbles (Corel PHOTO-PAINT) ” on page 703 , “Canvas (Corel PHOTO-PAINT) ” on page 703 , “Cobblestone ” on page 704 , “Elephant skin ” on page 704 , “Etching ” on page 705 , “Plastic ” on page 705 , “Plaster wall (Corel PHOTO-PAINT) ” on page 705 , “Relief sculpture ” on page 706 , “Screen door (Corel PHOTO-PAINT) ” on page 706 , “Stone ” on page 707 , and “Underpainting (Corel PHOTO-PAINT) ” on page 707 .
Plug-ins	Lets you use a third-party filter to apply effects to bitmaps in CorelDRAW. An installed plug-in appears at the bottom of the Bitmaps menu.

To browse the special effects that are available in the application, see [“Special effects categories” on page 663](#).

When you apply an effect to a bitmap, CorelDRAW automatically adds a border around the bitmap so that the effect covers the entire image. Disabling the automatic inflate option cuts off the effect at the edges of the image. For example, if you apply the Gaussian Blur effect to a rectangle, the corners are cut off.

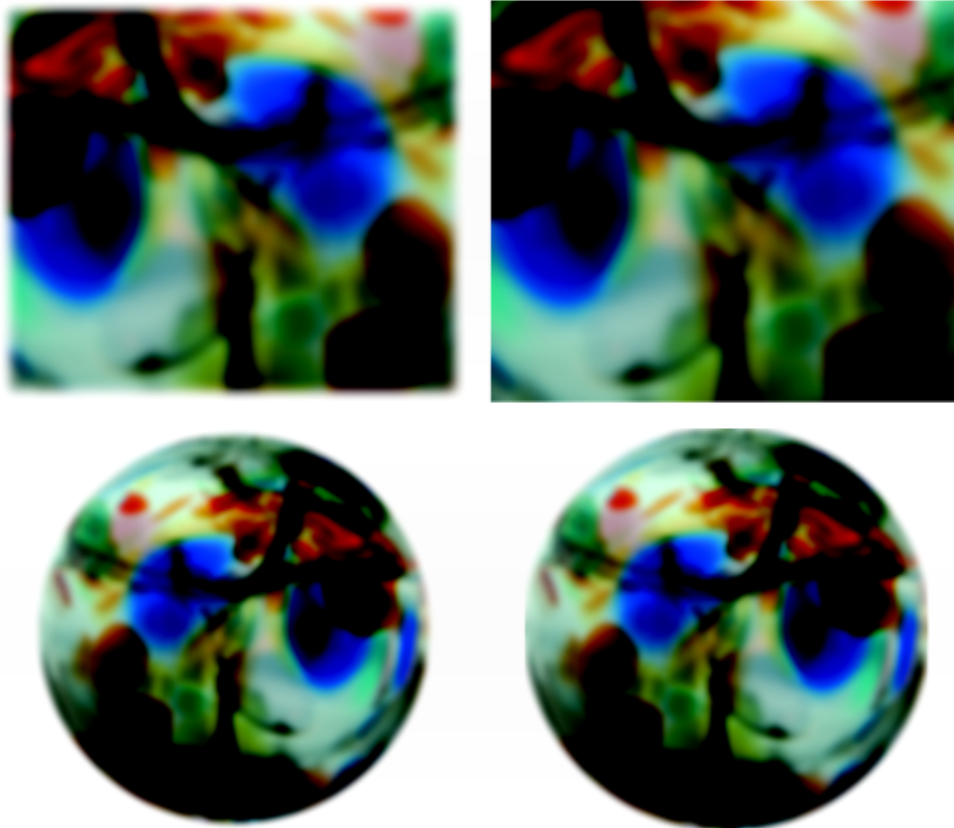

Gaussian Blur with Auto Inflate (left); Gaussian Blur without Auto Inflate (right)

If you want to use a custom border size, disable automatic inflation, and manually specify the dimensions of the inflated bitmap.

Adding plug-in filters to CorelDRAW provides additional features and effects that you can use to edit images. You can add plug-in filters, and you can remove them when you no longer need them.

To apply a special effect

- 1 Select a [bitmap](#).
- 2 Click **Bitmaps**, choose a special effect category, and click an effect.
- 3 Adjust any special effect settings.



To browse the special effects that are available in the application, see “Special effects categories” on page 663.

To inflate a bitmap manually

- 1 Select a [bitmap](#).
- 2 Click **Bitmaps** ► **Inflate bitmap** ► **Manually inflate bitmap**.
- 3 In the **Width** and **Height** areas, do one of the following:
 - In the **Inflate to** boxes, type the number of pixels that should make up the dimensions of the inflated bitmap.
 - In the **Inflate by** boxes, type the percentages by which to inflate the original bitmap.

To inflate the bitmap proportionally, enable the **Maintain aspect ratio** check box.



To automatically inflate the bitmap to cover the entire image, click **Bitmaps ▶ Inflate bitmap ▶ Auto inflate bitmap**.

To add a plug-in filter

- 1 Click **Tools ▶ Options**.
- 2 In the list of categories, double-click **Workspace**, and click **Plug-ins**.
- 3 Click **Add**.
- 4 Choose a folder containing a plug-in.
- 5 Restart the application.

The plug-in appears in the **Bitmaps ▶ Plug-ins** menu.



To remove a plug-in **filter**, click a plug-in folder from the **Plug-in folders** list, and click **Remove**.

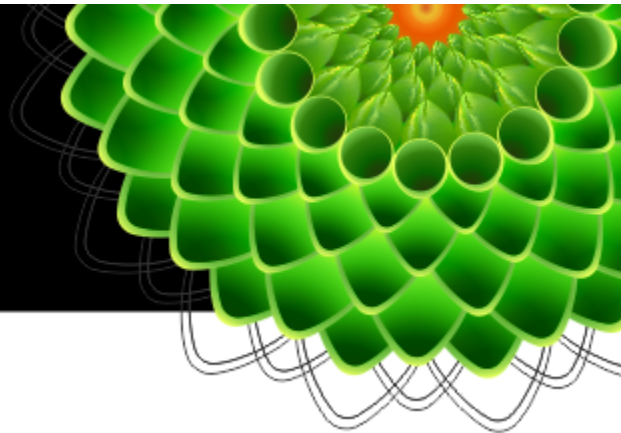

Special effects categories

In this chapter, you will find descriptions of the special effects that are available in the application as well as sample images that illustrate each effect. The special effects are organized into the following categories:

- “3-D special effects” (page 663)
- “Art strokes special effects” (page 668)
- “Blur special effects” (page 674)
- “Camera special effects” (page 679)
- “Color transform special effects” (page 683)
- “Contour special effects” (page 685)
- “Creative special effects” (page 686)
- “Custom special effects” (page 691)
- “Distort special effects” (page 692)
- “Noise special effects” (page 697)
- “Sharpen special effects” (page 700)
- “Texture special effects” (page 702)

For information about applying special effects, see [“Applying special effects in bitmaps”](#) on page 657.

3-D special effects

You can apply three-dimensional special effects to an image to create the illusion of depth.



To apply the effects that are labeled with ‘Corel PHOTO-PAINT’, you need to edit the bitmap in Corel PHOTO-PAINT. To send a bitmap to Corel PHOTO-PAINT, you can click the **Edit bitmap** button on the property bar, or you can use the **Edit bitmap** command from the **Bitmaps** menu. You can also enable an option that lets you access Corel PHOTO-PAINT by double-clicking a bitmap. For more information, see [“Editing bitmaps with Corel PHOTO-PAINT”](#) on page 657.

3-D rotate

The **3-D rotate** effect (**Bitmaps** ► **3D Effects** ► **3D Rotate**) lets you rotate an image by adjusting an interactive, three-dimensional model. Click and drag the interactive, three-dimensional model in the **3D Rotate** dialog box to rotate and position the image. Hold down **Ctrl** and

click a different plane on the three-dimensional model to assign the face of the image to that plane. Enable the **Best fit** check box to ensure that the image stays within the boundaries of the image window.



Original



3-D Rotate

Bevel effect (Corel PHOTO-PAINT)

The Bevel effect (Effects ▶ 3D Effects ▶ Bevel effect) lets you create the appearance of a raised surface.



Original



Bevel

Cylinder

The Cylinder effect (Bitmaps ▶ 3D Effects ▶ Cylinder) shapes an image into a cylinder.



Original



Cylinder

Emboss

The **Emboss** effect (**Bitmaps** ▶ **3D Effects** ▶ **Emboss**) transforms an image into a relief, with details appearing as ridges and crevices on a flat surface. You can choose the embossing color or depth, as well as the direction of the light source. The effect works best on images with medium to high contrast. **Depth** sets the depth of the ridges and indentations in the relief. **Level** sets the intensity of the effect. The **Direction dial** lets you specify the direction of the light source. **Original color** embosses the image using its original colors. **Gray** embosses the image in gray with moderate, embossed highlights. **Black** embosses the image in black with high-contrast, embossed highlights. **Other** embosses the image using a color that you choose from the **Other** color picker.



Original



Emboss

Glass (Corel PHOTO-PAINT)

The **Glass** effect (**Bitmaps** ▶ **3D Effects** ▶ **Glass**) places a three-dimensional, glass-like surface over an editable area. You can specify the width of the bevel, the area that is slanted to produce the three-dimensional look, the sharpness of the bevel's edges, and the angle at which the light is bent at the edges. You can also specify the **brightness**, direction, and angle of the light that strikes the bevel. The **Glass** effect lets you apply preset styles and create custom preset styles.



Original



Glass

Page curl

The **Page curl** effect (**Bitmaps** ▶ **3D Effects** ▶ **Page curl**) makes one of the corners of an image roll in on itself. You can specify a corner and set the curl orientation, **transparency**, and size. You can also choose a color for the curl and the background that is exposed where the image curls away from the paper. Click a thumbnail to specify the position of the page curl. Choose a vertical or horizontal direction for the page curl. The **Opaque** option creates a curl using a solid color, the **Transparent** option displays the underlying image through the curl. The **Curl**

color picker lets you choose the curl color. The **Background** color picker let you choose a color for the background that is exposed where the image curls away from the paper. The **Width%** and **Height%** sliders let you set the curl size.



Original



Page curl

Pinch/punch

The **Pinch/punch** effect (**Bitmaps** ▶ **3D Effects** ▶ **Pinch/punch**) warps an image by pinching it toward you or punching it away from you. You can position the effect by setting a center point.



Original



Pinch/Punch

Sphere

The **Sphere** effect (**Bitmaps** ▶ **3D Effects** ▶ **Sphere**) wraps an image around the inside or outside of a sphere. You can set a center point around which an image wraps, and you can control the wrapping. Positive values expand the central pixels toward the edges of an image resulting in a convex shape. Negative values compress pixels toward the center of an image resulting in a concave shape.



Original



Sphere

The Boss (Corel PHOTO-PAINT)

The **Boss** effect (Effects ▶ 3D Effects ▶ The Boss) raises the area of the image that falls along the edges of a **mask**. You can specify the width, height, and smoothness of the raised edge, as well as the brightness, sharpness, direction, and angle of the light sources. The **Boss** effect lets you apply preset styles and create custom preset styles.



Original



The Boss

Zig zag (Corel PHOTO-PAINT)

The **Zig zag** effect (Effects ▶ 3D Effects ▶ Zig zag) creates waves of straight lines and angles that twist an image outward from an adjustable center point. You can choose the type of waves and specify their number and strength.



Original



Zig Zag

Art strokes special effects

The art strokes special effects give images a hand-painted look. You can use these effects to make images look like pastel drawings, sponge paintings, and watercolors, or to create textured backgrounds.

Charcoal

The Charcoal effect (**Bitmaps** ▶ **Art strokes** ▶ **Charcoal**) makes an image look like a black-and-white charcoal drawing.



Original



Charcoal

Conte crayon

The Conte crayon effect (**Bitmaps** ▶ **Art strokes** ▶ **Conte crayon**) simulates textures produced with a conté crayon. You can select multiple crayon colors and set the crayon pressure and the granularity of the texture.



Original



Conte crayon

Crayon

The Crayon effect (**Bitmaps** ▶ **Art strokes** ▶ **Crayon**) makes an image look like a wax crayon drawing. You can specify the crayon pressure and create dark outlines around elements in the image.



Original



Crayon

Cubist

The **Cubist** effect (**Bitmaps** ▶ **Art strokes** ▶ **Cubist**) groups similarly colored pixels into squares to produce an image that resembles a cubist painting. You can specify the square size, the amount of light, and the paper color.



Original



Cubist

Dabble (Corel PHOTO-PAINT)

The **Dabble** effect (**Effects** ▶ **Art strokes** ▶ **Dabble**) makes image pixels look like dabs of paint. You can choose from a variety of brushstrokes and specify the brushstroke size.



To apply the **Dabble** effect, you need to edit the bitmap in Corel PHOTO-PAINT. To send a bitmap to Corel PHOTO-PAINT, you can click the **Edit bitmap** button on the property bar, or you can use the **Edit bitmap** command from the **Bitmaps** menu. You can also enable an option that lets you access Corel PHOTO-PAINT by double-clicking a bitmap. For more information, see [“Editing bitmaps with Corel PHOTO-PAINT” on page 657](#).



Original



Dabble

Impressionist

The **Impressionist** effect (**Bitmaps** ▶ **Art strokes** ▶ **Impressionist**) makes an image look like an impressionist painting. You can customize the dabs of color or the brushstrokes and specify the amount of light in the image.



Original



Impressionist

Palette knife

The **Palette knife** effect (**Bitmaps** ▶ **Art strokes** ▶ **Palette knife**) creates the impression that an image was created by spreading paint on a canvas with a palette knife. You can specify the amount of smudging and the size and direction of the brushstrokes.



Original



Palette knife

Pastels

The **Pastels** effect (**Bitmaps** ▶ **Art strokes** ▶ **Pastels**) makes an image look like a pastel drawing. You can specify the size and color variation of the brushstrokes.



Original



Pastels

Pen and ink

The **Pen and ink** effect (**Bitmaps** ▶ **Art strokes** ▶ **Pen & ink**) makes an image look like a pen-and-ink drawing created with a cross-hatching or stipple technique.



Original



Pen & ink

Pointillist

The **Pointillist** effect (**Bitmaps** ▶ **Art strokes** ▶ **Pointillist**) analyzes the main colors of an image and converts them to small dots. You can specify the size of the dots and the amount of light in the image.



Original



Pointillist

Scrapperboard

The Scrapperboard effect (Bitmaps ► Art strokes ► Scrapperboard) scrapes away a black surface to reveal white or another color, making an image look like a sketchy drawing. You can specify the density of the paint and the brushstroke size.



Original



Scrapperboard

Sketch pad

The Sketch pad effect (Bitmaps ► Art strokes ► Sketch pad) makes an image look like a pencil sketch.



Original



Sketch pad

Watercolor

The **Watercolor** effect (**Bitmaps** ▶ **Art strokes** ▶ **Watercolor**) makes an image look like a watercolor painting. You can specify the brush size, granulation level, and image brightness. You can also specify the intensity of the colors and determine the degree to which the colors blend.



Original



Watercolor

Water marker

The **Water marker** effect (**Bitmaps** ▶ **Art strokes** ▶ **Water marker**) makes an image look like an abstract sketch created with color markers. You can change the brushstrokes by selecting different modes. You can also specify the size and color variation of the brushstrokes.



Original



Water marker

Wave paper

The **Wave paper** effect (**Bitmaps** ▶ **Art strokes** ▶ **Wave paper**) makes an image look like a painting created on textured wave paper. You can create a black-and-white painting, or you can preserve the original color of the image.



Original



Wave paper

Blur special effects

The blur special effects change the [pixels](#) of an image to soften them, smooth their edges, blend them, or create motion effects.



To apply the effects that are labeled with 'Corel PHOTO-PAINT', you need to edit the bitmap in Corel PHOTO-PAINT. To send a bitmap to Corel PHOTO-PAINT, you can click the **Edit bitmap** button on the property bar, or you can use the **Edit bitmap** command from the **Bitmaps** menu. You can also enable an option that lets you access Corel PHOTO-PAINT by double-clicking a bitmap. For more information, see ["Editing bitmaps with Corel PHOTO-PAINT"](#) on page 657.

Tune blur (Corel PHOTO-PAINT)

The **Tune blur** effect (**Effects** ► **Blur** ► **Tune blur**) lets you apply any of four blurring effects, which are represented by [thumbnails](#), to an image. You can adjust the blur effect and preview the image with softer or sharper focus while you are editing it. The **Tune blur** filter lets you improve image quality or create exciting visual effects.



Original

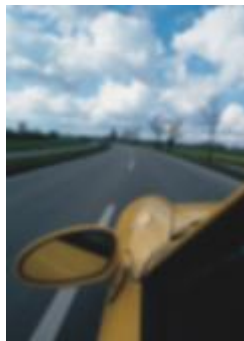

Tune blur

Directional smooth

The **Directional smooth** effect (**Bitmaps** ► **Blur** ► **Directional smooth**) smooths the regions of gradual change in an image while preserving edge detail and texture. You can use this filter to subtly blur the edges and surfaces of images without distorting the focus.



Original



Directional smooth

Gaussian blur

The **Gaussian blur** (Bitmaps ► Blur ► Gaussian blur) effect produces a hazy effect, blurring the focus of an image according to Gaussian distribution, which spreads the pixel information outward using bell-shaped curves. The effect can improve the quality of bitmaps with sharp edges. Move the **Radius** slider to adjust the intensity of the effect. The **Gaussian Blur** effect supports all color modes except Paletted and Black-and-White.



Original



Gaussian blur

Jaggy despeckle

The **Jaggy despeckle** effect (Bitmaps ► Blur ► Jaggy despeckle) scatters colors in an image, creating a soft, blurred effect with minimal distortion. It is most effective for removing the jagged edges that can appear in line art or high-contrast images. The **Jaggy despeckle** effect is also a preset lens type.



Original



Jaggy despeckle

Low pass

The **Low pass** effect (**Bitmaps** ▶ **Blur** ▶ **Low pass**) removes sharp edges and detail from an image, leaving smooth gradients and low-frequency areas. The higher the settings you specify, the more image detail is erased.



Original



Low pass

Motion blur

The **Motion blur** effect (**Bitmaps** ▶ **Blur** ▶ **Motion blur**) creates the illusion of movement in an image. You can specify the direction of movement.



Original

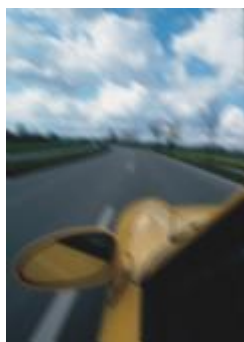

Motion blur

Radial blur

The **Radial blur** effect (**Bitmaps** ► **Blur** ► **Radial blur**) creates a blurring effect in an image that spins around or radiates outward from a center point that you specify.



Original



Radial blur

Bokeh blur (Corel PHOTO-PAINT)

The **Bokeh blur** effect (**Effects** ► **Blur** ► **Bokeh blur**) lets you control the amount of blur applied to the outside of an editable area and adjust the transition between the area in focus and the blurred area. For more information, see the [Corel PHOTO-PAINT help](#).



Original



Bokeh blur

Smooth

The **Smooth** effect (**Bitmaps** ► **Blur** ► **Smooth**) mutes the differences between adjacent pixels to smooth an image without losing detail. It is especially useful for removing the **dithering** that is created when you convert an image from the **paletted** mode to the **RGB** mode. The **Smooth** effect produces a more pronounced effect than the **Soften** effect. The **Smooth** effect is also a preset **lens** type.



Original



Smooth

Soften

The **Soften** effect (**Bitmaps** ► **Blur** ► **Soften**) smooths and tones down the harsh edges in an image without losing important image detail. The difference between the **Smooth** and **Soften** effects is subtle but is often apparent when images are viewed at high resolution. The **Soften** effect is also a preset lens type.



Original



Soften

Zoom

The **Zoom** effect (**Bitmaps** ► **Blur** ► **Zoom**) blurs image pixels outward from a center point. The pixels closest to the center point are the least blurry.



Original



Zoom

Smart blur (Corel PHOTO-PAINT)

The **Smart blur** effect (Effects ► Blur ► **Smart blur**) blurs an image but retains the edge detail. This effect is useful if you want to retain the sharp lines and edges, such as the ones that form the letters in text, when you export an image to a file format that would normally reduce the amount of detail. This effect is ideal for removing noise and artifacts from JPEG images.



Original



Smart blur



The Smart blur effect smooths the surfaces while keeping the edges sharp.

Camera special effects

The Camera special effects let you simulate the effect produced by photographic **filters**, such as spot filters and diffusion filters. You can also add lighting effects, such as sun flares or spot lights.



To apply the effects that are labeled with 'Corel PHOTO-PAINT', you need to edit the bitmap in Corel PHOTO-PAINT. To send a bitmap to Corel PHOTO-PAINT, you can click the **Edit bitmap** button on the property bar, or you can use the **Edit bitmap** command from the **Bitmaps** menu. You can also enable an option that lets you access Corel PHOTO-PAINT by double-clicking a bitmap. For more information, see "Editing bitmaps with Corel PHOTO-PAINT" on page 657.

Colorize

The **Colorize** effect (**Bitmaps** ► **Camera** ► **Colorize**) lets you replace all colors in an image with a single color (or hue) to create a duotone image. You can then adjust the saturation or vividness of the color. A color with 100% saturation contains no white. A color with 0% saturation corresponds to a shade of gray. With this effect, you can create various single-color images. For example, a brownish hue can create a sepia effect, simulating the color of old photographs.



Original



Colorize

Diffuse

The **Diffuse** effect (**Bitmaps** ► **Camera** ► **Diffuse**) softens images by distributing image **pixels** to fill in blank spaces and remove **noise**. The result simulates the soft focus of a photographer's diffusion filter. You can make this effect smooth or blurry.



Original



Diffuse

Lens flare (Corel PHOTO-PAINT)

The **Lens flare** (**Effects** ► **Camera** ► **Lens flare**) effect produces rings of light on an **RGB** image, simulating the flare that appears on a photograph when the camera is aimed towards a direct, bright light. For more information, see the Corel PHOTO-PAINT help.



Original



Lens flare

Lighting effects (Corel PHOTO-PAINT)

The **Lighting effects** (**Effects** ▶ **Camera** ▶ **Lighting effects**) let you add light sources to an RGB or grayscale image to create the illusion of spotlights, floodlights, or sunlight. You can also apply a texture to create embossed reliefs. You can use a preset light or texture style, or customize a preset style and save it in the preset list. For more information, see the Corel PHOTO-PAINT help.



Original



Lighting effects

Photo filter

The **Photo filter** effect (**Bitmaps** ▶ **Camera** ▶ **Photo filter**) lets you simulate the effect of placing a colored filter in front of a camera lens. You can choose the color of the filter and then adjust the color density and luminosity.



Original



Photo filter

Sepia toning

The **Sepia toning** effect (**Bitmaps** ▶ **Camera** ▶ **Sepia toning**) simulates the look created when you take a photo with sepia film. Sepia-toned images are similar to black-and-white photos (also known as grayscale photos), except the tones are brown instead of gray.



Original



Sepia toning

Spot filter (Corel PHOTO-PAINT)

The **Spot filter** effect (**Effects** ▶ **Camera** ▶ **Spot filter**) lets you control the focus area in an image and de-emphasize the surrounding area by applying a Gaussian blur to imitate a photographer's use of depth of field. You can set the position and **radius** of the area in focus, control the edges and degree of the blur, and decrease light in the surrounding areas. You can use a preset style or customize a preset style and save it in the preset list.



Original



Spot filter

Time machine

The **Time machine** effect (**Bitmaps** ▶ **Camera** ▶ **Time machine**) lets you walk your image back through history to recreate some popular photographic styles from the past. You can choose from seven styles, which range from the year 1839 to the 1960s.



Original



Time machine



The Time machine effect recreates photographic styles from the past.

Color transform special effects

The color transform special effects let you create dramatic effects by changing the color of an image.

Bit planes

The **Bit planes** effect (**Bitmaps** ► **Color transform** ► **Bit planes**) reduces an image to basic **RGB** color components and displays tonal changes using solid colors. You can adjust the tonal values of each color component individually or as a group.



Original



Bit planes

Halftone

The **Halftone** effect (**Bitmaps** ▶ **Color transform** ▶ **Halftone**) gives an image the appearance of a color **halftone**. A color halftone is an image that has been converted from a continuous tone image to a series of dots of various sizes that represent different tones. You can specify the size of the biggest dot and vary the color pattern. Move the **Max dot radius** slider to set the maximum radius of a halftone dot. The **Cyan**, **Magenta**, **Yellow**, and **Black** sliders specify the angles of the cyan, magenta, yellow, and black color screens.



Original



Halftone

Psychedelic

The **Psychedelic** effect (**Bitmaps** ▶ **Color transform** ▶ **Psychedelic**) changes the colors in an image to bright, electric colors, such as orange, hot pink, cyan, and lime green. The **Psychedelic** effect is also a preset **lens** type.

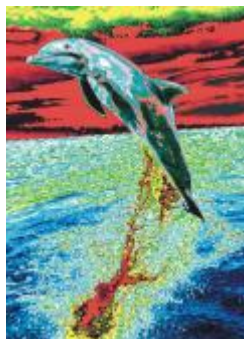

Original

Psychedelic

Solarize

The **Solarize** effect (**Bitmaps** ▶ **Color transform** ▶ **Solarize**) transforms colors in an image by reversing image tones. The **Solarize** effect is also a preset lens type.



Original



Solarize

Contour special effects

The contour special effects detect and accentuate the edges of **objects**. You can adjust the level of edge detection, the type of edges that are detected, as well as the color of the edges that are detected.

Edge detect

The **Edge detect** effect (**Bitmaps** ▶ **Contour** ▶ **Edge detect**) detects the edges in an image and converts them to lines on a single-color background. You can customize this effect by specifying the intensity of the outline and the background color. The **White**, **Black**, or **Other** button allow you to choose a white, black, or other color for the background, respectively. The **Sensitivity** slider lets you adjust the intensity of the effect.

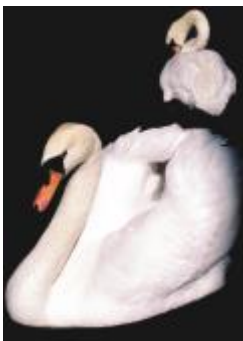

Original



Edge detect

Find edges

The **Find edges** effect (**Bitmaps** ▶ **Contour** ▶ **Find edges**) locates edges in an image and lets you convert these edges to soft or solid lines. When you convert edges to soft lines you create a smooth blurred outline. Converting edges to solid lines creates a sharper outline. The **Find edges** filter is particularly useful for high-contrast images, such as images that contain text.



Original



Find edges

Trace contour

The **Trace contour** effect (**Bitmaps** ▶ **Contour** ▶ **Trace contour**) highlights the edges of image elements using a 16-color palette. Trace contour lets you specify which edge pixels are highlighted.



Original



Trace contour

Creative special effects

The creative special effects use a variety of shapes and textures to transform an image into abstract art. They use crystals, fabric, glass, frames, or whirlpools as the foundation for creating something new.

Crystalize

The **Crystalize** effect (**Bitmaps** ▶ **Creative** ▶ **Crystalize**) makes an image look as though it was created with crystals. You can control the effect by specifying the dimensions of the crystals. Lower values produce smaller crystals, causing less distortion. Higher values produce larger crystals and create a more abstract effect.



Original



Crystalize

Fabric

The **Fabric** effect (**Bitmaps** ▶ **Creative** ▶ **Fabric**) makes an image look as though it was created with textiles, such as needlepoint, rug hooking, quilts, strings, ribbons, and tissue collage. You can specify the size and angle of the textile, as well as the brightness.



Original



Fabric

Frame

The **Frame** effect (**Bitmaps** ▶ **Creative** ▶ **Frame**) lets you frame an image with a preset or custom frame. You can change the color, **opacity**, orientation, and alignment of a frame, and you can save customized settings as preset styles. You can also update, load, and delete preset frame settings. To customize a frame, click the **Modify** tab. **Opacity** sets the opacity of the frame. **Blur/Feather** blurs or feathers the edge of the frame with the contents. **Horizontal** and **Vertical** set the horizontal and vertical frame size. The **Rotate dial** lets you specify the degree to which you want to rotate a frame. **Flip horizontal** and **Flip vertical** mirror the frame horizontally and vertically, respectively. **Align** lets you choose a center point for the frame from the bitmap. **Re-center** centers the frame on the bitmap. The **Save preset** button lets you save customized frame settings as a preset.



Original



Frame

Glass block

The **Glass block** effect (**Bitmaps** ▶ **Creative** ▶ **Glass block**) makes an image look as though it is being viewed through thick glass blocks. You can control the effect by specifying the dimensions of the glass blocks.



Original



Glass block

Mosaic

The **Mosaic** effect (**Bitmaps** ▶ **Creative** ▶ **Mosaic**) breaks an image into unequal elliptical pieces to form the appearance of a mosaic. You can specify the size of the pieces and the background color. You can also frame the mosaic.



Original



Mosaic

Scatter

The **Scatter** effect (**Bitmaps** ▶ **Creative** ▶ **Scatter**) distorts an image by scattering pixels. You can specify the direction of the scattering. The **Scatter** effect is also a preset lens type.



Original



Scatter

Smoked glass

The **Smoked glass** effect (**Bitmaps** ▶ **Creative** ▶ **Smoked glass**) applies a transparent colored tint to images. You can specify the color of the smoked glass, the opacity of the tint, and the amount of blurring.



Original



Smoked glass

Stained glass

The **Stained glass** effect (**Bitmaps** ▶ **Creative** ▶ **Stained glass**) transforms images into stained-glass artwork. You can adjust the size of the glass pieces and create solder between them.



Original



Stained glass

Vignette

The **Vignette** effect (**Bitmaps** ► **Creative** ► **Vignette**) lets you add an elliptical, circular, rectangular, or square frame around an image. You can specify the color and fade rate of the effect. Move the **Fade** slider to set the transition between the frame and the bitmap. The **offset** is the distance from the center of the image to the inner border of the frame. The higher the offset (that is, the higher the distance from the center of the image), the thinner the frame.



Original



Vignette

Vortex

The **Vortex** effect (**Bitmaps** ► **Creative** ► **Vortex**) produces a swirl around a center point that you specify in an image. You can specify the direction of the swirl's inner and outer pixels.



Custom special effects

The custom special effects offer you a wide range of effects to transform an image. You can create an artistic media painting, overlay an image with a customized image, or use a variety of blur, sharpen, and edge detect effects.

Band pass (Corel PHOTO-PAINT)

The **Band pass** effect (Effects ► Custom ► Band pass) adjusts the sharp and smooth areas on images. Sharp areas are areas where abrupt changes take place (for example, colors, edges, noise). Smooth areas are areas where gradual changes take place.



Original (left), Band pass effect (right)

Bump map

The **Bump map** (Bitmaps ► Custom ► Bump-map) effect adds texture and patterns to an image by embedding its surface with a relief based on the pixel values of a bump map image. The pixel values of the bump map image represent surface elevation. You can use a preset bump map or load a custom bump map image. You can specify the surface and lighting properties of the effect.



Original (left), Bump-map effect (right)

User defined (Corel PHOTO-PAINT)

These **User defined** effects (Effects ► Custom ► User defined) let you create blur, sharpen, or edge detect special effects by defining a new color value for each pixel based on the color values of adjacent pixels. You define the value of the selected pixel numerically, by typing values in a grid. The central box in the grid represents the selected pixel, and the boxes around it represent the adjacent pixels. The number you type in the central box of the grid is multiplied by the original color value of the selected pixel. The resulting number (the new color value of

the selected pixel) can be further modified by choosing how much it is influenced by the values of the adjacent pixels, which can be added to or subtracted from the value of the selected pixel. For example, if you type 0 in all the boxes surrounding the central pixel, the pixel's value is not influenced by the adjacent pixels, but only by the number you type in the central box. All numbers you type in the grid are multiplied by the corresponding pixel values and added together to create a new value for the pixel. The new pixel value is then divided by a divisor value you choose. If the divisor is the same as the number you type in the central box, then they will cancel each other out, and the new pixel value will depend only on the values of the adjacent pixels. The result of all numerical operations in the grid represents the final color value (1 to 255) of the pixel.



Original (left), User defined effect (right)

Distort special effects

The distort special effects transform the appearance of images without adding depth.

Blocks

The **Blocks** effect (**Bitmaps** ► **Distort** ► **Blocks**) breaks down the image into scrambled block pieces. You can specify the size of the blocks, the distance between the blocks, and the color of the background (exposed when the effect is applied).



Original



Blocks

Displace

The **Displace** effect (**Bitmaps** ► **Distort** ► **Displace**) shifts an active image according to the values of a secondary image known as a displacement map. Values from the displacement map display as forms, colors, and warp patterns in the image.



Original



Displace

Mesh warp

The **Mesh warp** effect (**Bitmaps** ▶ **Distort** ▶ **Mesh warp**) lets you distort an image by repositioning the **nodes** on a superimposed **grid**. You can increase the number of nodes on the grid by increasing the number of gridlines to a maximum of 10. Increasing the number of nodes on the grid provides finer control over small details in the image. You can use any of the preset mesh warp styles, and you can create and save custom mesh warp styles.



Original

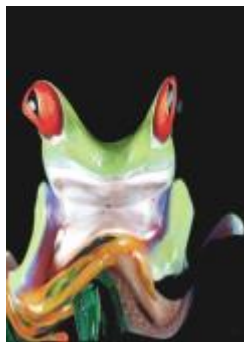

Mesh warp

Offset

The **Offset** effect (**Bitmaps** ▶ **Distort** ▶ **Offset**) changes an image's position by shifting it according to the parameters you specify. When an image is offset, empty areas display where the image was previously positioned. You can fill the empty areas by tiling or stretching the image, or by applying color.



Original



Offset

Pixelate

The **Pixelate** effect (**Bitmaps** ▶ **Distort** ▶ **Pixelate**) breaks an image into square, rectangular, or circular cells. The **Pixelate** effect is also a preset *lens* type.



Original

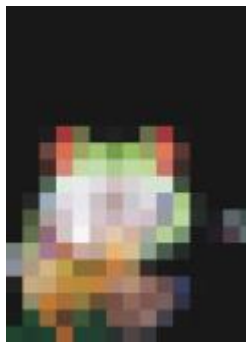

Pixelate

Ripple

The **Ripple** effect (**Bitmaps** ▶ **Distort** ▶ **Ripple**) distorts an image with one or more waves. You can specify the strength of the primary wave to set the warping of the image or add an additional perpendicular wave to increase the distortion.



Original



Ripple

Shear (Corel PHOTO-PAINT)

The **Shear** effect (**Effects** ▶ **Distort** ▶ **Shear**) maps the shape of an image to the shape of a line segment.



To apply the Shear effect, you need to edit the bitmap in Corel PHOTO-PAINT. To send a bitmap to Corel PHOTO-PAINT, you can click the **Edit bitmap** button on the property bar, or you can use the **Edit bitmap** command from the **Bitmaps** menu. You can also enable an option that lets you access Corel PHOTO-PAINT by double-clicking a bitmap. For more information, see [“Editing bitmaps with Corel PHOTO-PAINT”](#) on page 657.



Original



Shear

Swirl

The **Swirl** effect (**Bitmaps** ▶ **Distort** ▶ **Swirl**) creates a swirl across an image according to the direction, number of whole rotations, and angle that you specify.



Original



Swirl

Tile

The **Tile** effect (**Bitmaps** ▶ **Distort** ▶ **Tile**) reduces the image's dimensions and reproduces it as a series of tiles on a grid. You can use this effect in combination with a flood fill to create a background or to create a wallpaper effect for a webpage.



Original



Tile

Wet paint

The **Wet paint** effect (**Bitmaps** ▶ **Distort** ▶ **Wet paint**) creates the illusion of wet paint on images. You can specify the size of the drips and the range of colors that are affected in the image.



Original



Wet Paint

Whirlpool

The **Whirlpool** effect (**Bitmaps** ▶ **Distort** ▶ **Whirlpool**) applies a fluid, swirling pattern across an image. You can use a preset whirlpool style, or you can create a custom style by setting the smear length, spacing, twist, and streak detail of the effect. You can also save custom whirlpool styles.



Original

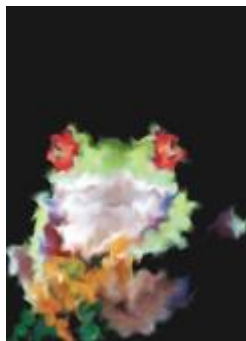

Whirlpool

Wind

The **Wind** effect (**Bitmaps** ► **Distort** ► **Wind**) blurs an image in a specific direction, creating the effect of wind blowing across the image. You can specify the strength and direction of the blur, as well as the transparency of the effect.



Original



Wind

Noise special effects

In bitmap editing, **noise** is defined as the random **pixels** that display across an image, which resemble static on television screens. The noise special effects let you create, control, or eliminate noise.



To apply the effects that are labeled with 'Corel PHOTO-PAINT', you need to edit the bitmap in Corel PHOTO-PAINT. To send a bitmap to Corel PHOTO-PAINT, you can click the **Edit bitmap** button on the property bar, or you can use the **Edit bitmap** command from the **Bitmaps** menu. You can also enable an option that lets you access Corel PHOTO-PAINT by double-clicking a bitmap. For more information, see ["Editing bitmaps with Corel PHOTO-PAINT" on page 657](#).

Add noise

The **Add noise** effect (**Bitmaps** ► **Noise** ► **Add noise**) creates a granular effect that adds texture to a flat or overly blended image. You can specify the type and amount of noise that is added to the image.



Original



Add noise

3-D stereo noise (Corel PHOTO-PAINT)

The **3-D stereo noise** effect (Effects ▶ Noise ▶ 3-D stereo noise) creates a **dithered** noise pattern giving an image the appearance of three-dimensional depth when viewed a certain way. This effect is particularly suited to high-contrast line art and **grayscale** images. This effect may be very difficult to perceive.



Original

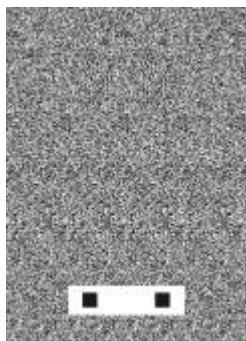

3-D stereo noise

Maximum

The **Maximum** effect (Bitmaps ▶ Noise ▶ Maximum) removes noise by adjusting the color value of a pixel based on the maximum color values of its neighboring pixels. This effect also produces a mild blurring effect when applied more than once.



Original



Maximum

Median

The **Median** effect (Bitmaps ▶ Noise ▶ Median) removes noise and detail by adjusting the color value of a pixel according to the median color value of the surrounding pixels.



Original



Median

Minimum

This effect (**Bitmaps** ▶ **Noise** ▶ **Minimum**) removes noise by adjusting the color value of a pixel, based on the minimum color values of its neighboring pixels.



Original



Minimum

Tune noise (Corel PHOTO-PAINT)

The Tune noise effect (**Effects** ▶ **Noise** ▶ **Tune noise**) lets you apply any of nine noise effects. Each effect is represented by a **thumbnail** which lets you preview the image as you apply an effect.



Original



Tune noise

Remove Noise

The **Remove Noise** effect (**Bitmaps** ► **Noise** ► **Remove Noise**) lets you remove noise from scanned images. Noise is the speckled effect produced by scanning or video-capturing.



Original



Remove noise

Remove Moire

The **Remove Moire** effect (**Bitmaps** ► **Noise** ► **Remove Moire**) lets you remove moiré from images. Moiré is the wave pattern produced when halftone screens of two different frequencies are superimposed on the same image.



Original



Remove moire

Sharpen special effects

You can sharpen images to increase contrast, enhance image edges, or reduce shading. Sharpening is usually done after adjusting the color and tone of an image and after resampling or resizing. For more information about sharpening images, see the Corel PHOTO-PAINT help.

Adaptive unsharp

The **Adaptive unsharp** effect (**Bitmaps** ► **Sharpen** ► **Adaptive unsharp**) lets you accentuate edge detail by analyzing the values of neighboring pixels. This filter preserves most image detail, but its effect is most apparent in high-resolution images.



Original



Adaptive unsharp

Directional sharpen

The **Directional sharpen** effect (**Bitmaps ▶ Sharpen ▶ Directional sharpen**) lets you enhance the edges of an image without creating a grainy effect.



Original



Directional sharpen

High pass

The **High pass** effect (**Bitmaps ▶ Sharpen ▶ High pass**) lets you remove image detail and shading to give an image a glowing quality by emphasizing its highlights and luminous areas. However, it can also affect the color and tone of the image.



Original



High pass

Sharpen

The **Sharpen** effect (**Bitmaps** ► **Sharpen** ► **Sharpen**) lets you accentuate the edges of the image by focusing blurred areas and increasing the contrast between neighboring pixels. Move the **Edge level(%)** slider to set the degree to which edge detail is accentuated. **Threshold** specifies how far apart adjacent tonal values have to be before the effect is applied. This is important to prevent smooth areas from becoming speckled. Low values produce a more exaggerated sharpening effect because fewer areas are excluded. Higher threshold values exclude areas of lower contrast. To prevent dramatic shifts in hue, enable **Preserve colors**.



Original



Sharpen

Unsharp mask

The **Unsharp mask** effect (**Bitmaps** ► **Sharpen** ► **Unsharp mask**) lets you accentuate edge detail and focus blurred areas in the image without removing low-frequency areas. **Percentage** sets the intensity of the sharpening effect. **Radius** sets the amount of pixels that are evaluated at once. **Threshold** sets how many pixels are affected.



Original



Unsharp mask

Texture special effects

The texture special effects let you add texture to an image using a variety of shapes and surfaces. You can use bricks, bubbles, canvas, elephant skin, plastic, and stone; or you can create etchings and underpaintings. You can also use these effects to make an image look as though it is painted on a plaster wall or as though you are viewing it through a screen door.



To apply the effects that are labeled with 'Corel PHOTO-PAINT', you need to edit the bitmap in Corel PHOTO-PAINT. To send a bitmap to Corel PHOTO-PAINT, you can click the **Edit bitmap** button on the property bar, or you can use the **Edit bitmap** command from the **Bitmaps** menu. You can also enable an option that lets you access Corel PHOTO-PAINT by double-clicking a bitmap. For more information, see ["Editing bitmaps with Corel PHOTO-PAINT"](#) on page 657.

Brick wall (Corel PHOTO-PAINT)

The **Brick wall** effect (**Effects** ► **Texture** ► **Brick wall**) groups pixels into a series of interlocking cells to make an image look like a painting on a brick wall. You can specify the brick size and the density of the brick pattern.



Original



Brick wall

Bubbles (Corel PHOTO-PAINT)

The **Bubbles** effect (**Effects** ► **Texture** ► **Bubbles**) creates a bubbling foam on an image. You can specify the size of the bubbles and the amount of the image that is covered.



Original



Bubbles

Canvas (Corel PHOTO-PAINT)

The **Canvas** effect (**Effects** ► **Texture** ► **Canvas**) applies a textured surface to an image by letting you use another image as a canvas. You can choose a preset canvas map, or you can load any image as a canvas map. For best results, choose images that have high to medium contrast.



Original



Canvas

Cobblestone

The **Cobblestone** effect (**Bitmaps** ▶ **Texture** ▶ **Cobblestone**) makes an image look as though it was created with cobblestones. You can specify the size, spacing, and granularity of the cobblestones.



Original



Cobblestone

Elephant skin

The **Elephant skin** effect (**Bitmaps** ▶ **Texture** ▶ **Elephant skin**) gives an image a wrinkled look by creating an overlay of wavy lines. You can specify the age of the elephant skin (up to 100 years) as well as the skin color.



Original



Elephant skin

Etching

The **Etching** effect (**Bitmaps** ▶ **Texture** ▶ **Etching**) transforms an image into an etching. You can control the depth of the etching, the amount of detail, the direction of the light, and the color of the metal surface.



Original



Etching

Plastic

The **Plastic** effect (**Bitmaps** ▶ **Texture** ▶ **Plastic**) makes an image look as though it is made of plastic. You can specify the image depth, as well as the color and angle of light shining on the plastic. You can also customize the angle of the light. **Highlight** sets the brightness of the image accents. **Depth** sets the depth of the plastic shading. **Smoothness** sets the amount of image detail. The **Light direction** dial lets you set the direction of the light. The color picker lets you choose a color for the light.



Original



Plastic

Plaster wall (Corel PHOTO-PAINT)

The **Plaster wall** effect (**Effects** ▶ **Texture** ▶ **Plaster wall**) redistributes pixels so that an image looks as though it was painted on a plaster wall.



Original



Plaster wall

Relief sculpture

The **Relief sculpture** effect (**Bitmaps** ▶ **Texture** ▶ **Relief sculpture**) transforms an image into a relief sculpture. You can set the smoothness of the relief, the amount of detail it contains, the direction of the light, and the surface color.



Original



Relief sculpture

Screen door (Corel PHOTO-PAINT)

The **Screen door** effect (**Effects** ▶ **Texture** ▶ **Screen door**) makes an image look as though it is being viewed through a screen door. You can specify the mesh detail and brightness, the softness within the image, as well as whether the image is color or black-and-white.



Original



Screen door

Stone

The **Stone** effect (**Bitmaps** ▶ **Texture** ▶ **Stone**) gives an image a stone texture. You can specify the amount of detail, the density of the pattern, and the angle of the light hitting an image. You can apply a preset stone style or create and save a custom stone style as a preset.



Original



Stone

Underpainting (Corel PHOTO-PAINT)

The **Underpainting** effect (**Bitmaps** ▶ **Texture** ▶ **Underpainting**) makes an image look like a painting created on a canvas that is subsequently covered with layers of paint. You can specify the degree to which the original image is painted over and adjust the **brightness** of the image.



Original



Underpainting

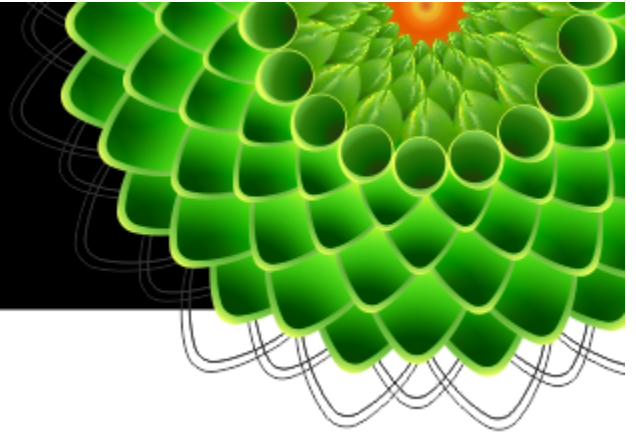

Working with bitmap color modes

Changing an image to another **color mode**, such as **RGB**, **CMYK**, or **Grayscale**, changes a bitmap's color structure.

This section contains the following topics:

- “Changing the color mode of bitmaps” (page 709)
- “Changing bitmaps to black-and-white images” (page 710)
- “Changing bitmaps to duotones” (page 711)
- “Changing bitmaps to the paletted color mode” (page 712)

Changing the color mode of bitmaps

The colors of the images that you work with in CorelDRAW are based on **color modes**. Color modes define the color characteristics of images and are described by their component colors. The **CMYK** color mode is composed of cyan, magenta, yellow, and black values; the **RGB** color mode is composed of red, green, and blue values.

Although you may not be able to see the difference between an image in the **CMYK** color mode and an image in the **RGB** color mode on screen, the images are quite different. For the same image dimensions, an **RGB** image has a smaller file size than a **CMYK** image, and the **RGB color space**, or gamut, can display more colors. Therefore, images intended for the web or desktop printers, which require accurate color fidelity, are generally in **RGB** mode. Where accurate print reproduction is needed, such as on a commercial printing press, images are generally created in **CMYK** mode. **Paletted color** images attempt to preserve color fidelity while reducing the file size, making them ideal for on-screen uses.

Each time you convert an image, you may lose color information. For this reason, you should save an edited image before you change it to a different color mode. For more information about color modes, see “[Working with color](#)” on page 347.

CorelDRAW supports the following color modes:

- Black and White (1-bit)
- Duotone (8-bit)
- Grayscale (8-bit)
- Paletted (8-bit)
- RGB Color (24-bit)
- Lab Color (24-bit)
- CMYK Color (32-bit)

To change the color mode of a bitmap

- 1 Click a bitmap.
- 2 Click **Bitmaps** ► **Mode**, and click a color mode.



The current mode of the selected bitmap is not available in the menu.

Changing bitmaps to black-and-white images

You can change any image to a black-and-white image. In addition to conversion settings such as [threshold](#), screen type, and [intensity](#), there are seven conversion options that affect how the converted images will look.

Conversion

Line art	Produces a high-contrast, black-and-white image. Colors with a grayscale value lower than the threshold value that you set change to black, while colors with a grayscale value higher than the threshold value change to white.
Ordered	Organizes the gray levels into repeating geometric patterns of black and white pixels. Solid colors are emphasized and image edges are hard. This option is best suited for uniform colors.
Halftone	Creates different shades of gray by varying the pattern of black and white pixels in an image. You can choose the screen type, angle for the halftone, lines per unit, and the unit of measure.
Cardinality-Distribution	Creates a textured look by applying a calculation and distributing the result to the screen.
Jarvis	Applies the Jarvis algorithm to the screen. This form of error diffusion is suitable for photographic images.
Stucki	Applies the Stucki algorithm to the screen. This form of error diffusion is suitable for photographic images.
Floyd-Steinberg	Applies the Floyd-Steinberg algorithm to the screen. This form of error diffusion is suitable for photographic images.

To change a bitmap to a black-and-white image

- 1 Click a bitmap.
- 2 Click **Bitmaps** ► **Mode** ► **Black-and-white (1-bit)**.
- 3 Choose an option from the **Conversion method** list box.

4 Move the **Intensity** slider.

If you want to view different parts of the image, you can drag the image in the **Preview** window.



The **Intensity** slider is not available for the **Halftone** conversion option.

Changing bitmaps to duotones

To convert an image to a duotone, you change a bitmap to the grayscale color mode and enhance it using one to four additional colors, giving the image greater tonal depth.

The following four variations of the color mode correspond to the number of additional inks:

- **Monotone** — a grayscale image colored with a single tone
- **Duotone** — a grayscale image colored with two tones. In most cases, one is black and the other is colored.
- **Tritone** — a grayscale image colored with three tones. In most cases, one is black and the other two are colored.
- **Quadtone** — a grayscale image colored with four tones. In most cases, one is black and the other three are colored.

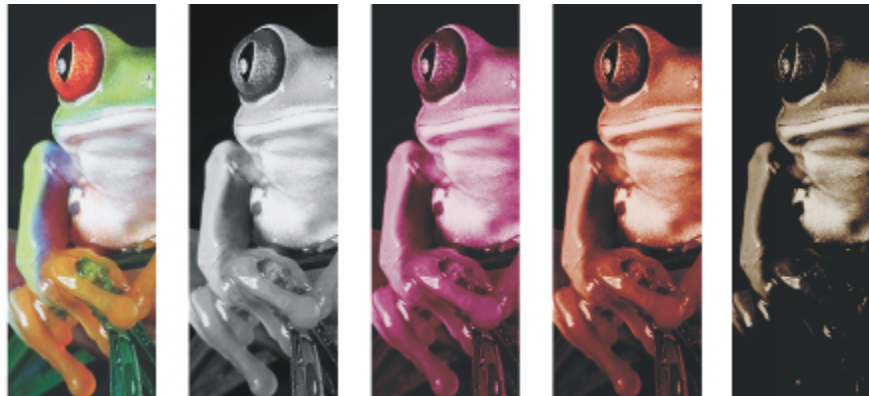

The four color mode variations. From left to right: the original image, monotone, duotone, tritone, and quadtone.

Adjusting tone curves

When you change an image to a duotone, a tone curve grid that represents the dynamic tone curves that are used throughout the conversion is displayed. The horizontal plane (x-axis) displays the 256 possible shades of gray in a grayscale image (0 is black; 255 is white). The vertical plane (y-axis) indicates the intensity of a color (from 0 to 100 percent) that is applied to the corresponding grayscale values. For example, a grayscale pixel with a color value of 25 is printed with a 25-percent tint of the color. By adjusting the tone curves, you can control the color and intensity of the tone that is added to an image.

Saving and loading inks

You can save an adjusted duotone tone curve and ink settings and then load them for use with other bitmaps.

Specifying how overprint colors display

When you change an image to a duotone, you can specify the colors to overprint when you print an image. Overprint colors are used to preserve color integrity when inks overlap. When you display the image, each color is applied on the screen in sequence, creating a layered effect.

You can view all instances in which the colors you choose for the duotone conversion overlap. Associated with each instance is the color that is produced by the overlap. You can also choose new overprint colors to see how they overlap.

Duotones hold their color ink information when you save to Encapsulated PostScript (EPS), Portable Document Format (PDF) and CorelDRAW (CDR) file formats. Other file formats don't support duotone images.

To change an image to a duotone

- 1 Click a bitmap.
- 2 Click **Bitmaps** ► **Mode** ► **Duotone (8-bit)**.
- 3 Click the **Curves** tab.
- 4 Choose a duotone type from the **Type** list box.
- 5 Double-click an ink color in the **Type** window.
- 6 In the **Select color** dialog box, choose a color, and click **OK**.
If you want to adjust the color's tone curve, click the ink tone curve on the grid to add a node, and drag the node to adjust the percentage of color at that point on the curve.
- 7 Repeat steps 5 and 6 for each ink color you want to use.

You can also

Display all the ink tone curves on the grid.

Enable the **Show all** check box.

Save the ink settings

Click **Save**. Choose the disk and folder where you want to save the file, and type a filename in the **File name** box.

Specify how overprint colors display

Click the **Overprint** tab, and enable the **Use overprint** check box.
Double-click the color you want to edit, and choose a new color.



You can load preset ink colors by clicking **Load**, locating the file in which the ink settings are stored, and double-clicking the filename.

Changing bitmaps to the paletted color mode

The paletted color mode, also called indexed color mode, is sometimes used for images on the World Wide Web. When you convert an image to the paletted color mode, a fixed color value is assigned to each **pixel**. These values are stored in a compact color table, or palette, containing up to 256 colors. As a result, the paletted color mode image contains less data than a 24-bit color mode image, and it has a smaller file size. Conversion to paletted color mode works best on images that have a limited range of colors.

Choosing, editing, and saving a color palette

When you change an image to the paletted color mode, you can use a predefined palette, or you can customize a **color palette** by replacing individual colors.

Saving conversion settings

After you choose a **color palette** and set the **dithering** and **range sensitivity** for changing an image to the paletted color mode, you can save the settings as a conversion preset that you can use with other images. You can add as many conversion presets as you want.

The color palette you use is called the processed color palette. It can be saved for use with other images.

For more information about the predefined color palettes available for the paletted color mode, see [“Palette types” on page 713](#). For more information about creating and opening custom color palettes, see [“Creating and editing custom color palettes” on page 359](#).

Dithering

Changing images to the paletted color mode lets you use dithering to enhance color information. Dithering places pixels with specific colors or values relative to other pixels of a specific color. The relationship of one colored pixel to another creates the appearance of additional colors that do not exist in the color palette.

You can use two types of dithering: ordered dithering and error diffusion. Ordered dithering approximates color blends using fixed dot patterns; as a result, solid colors are emphasized and edges appear harder. Error diffusion scatters pixels irregularly, making edges and colors softer. Jarvis, Stucki, and Floyd-Steinberg are conversion options that provide error diffusion.

The Ordered dithering option applies more quickly than the error diffusion options (Jarvis, Stucki, and Floyd-Steinberg) but is less accurate.

Specifying a range-sensitivity color

You can change an image to the paletted color mode and specify a focus color and a range sensitivity for the focus color, so that the focus color and colors that fall within the range settings are included in the processed color palette. You can also specify how much emphasis to place on the range sensitivity. Because the palette has a maximum of 256 colors, emphasizing a focus color reduces the number of colors that fall outside the range sensitivity.

Palette types

The table below outlines available palette types.

Palette type	Description
Uniform	Provides a range of 256 colors with equal parts of red, green, and blue
Standard VGA	Provides the Standard VGA 16-color palette
Adaptive	Provides colors original to the image and preserves the individual colors (the entire color spectrum) in the image
Optimized	Creates a color palette based on the highest percentage of colors in the image. You can also specify a range-sensitivity color for the color palette. This is the most common color palette for photographic images.
Black Body	Contains colors that are based on temperature. For example, black may represent cold temperatures, while red, orange, yellow, and white may represent hot temperatures.
Grayscale	Provides 256 shades of gray, ranging from black to white
System	Provides the predefined palette of colors used by the operating system
Web-safe	Provides a predefined palette of 216 non-dithered colors that will display the same on most browsers. This palette is not recommended for use with photographs and only benefits users with older computers.

Palette type	Description
Custom	Lets you add colors to create a customized color palette

To change an image to the paletted color mode

- 1 Click a bitmap.
- 2 Click **Bitmaps** ▶ **Mode** ▶ **Paletted (8-bit)**.
- 3 Click the **Options** tab.
- 4 Choose a color palette type from the **Palette** list box.
- 5 Choose an option from the **Dithering** list box.
- 6 Move the **Dithering intensity** slider.

If you want to save the conversion settings as a preset, click the **Add preset** button, and type a name in the **Save preset** box.



You can achieve better color fidelity by choosing the palette you want to use when you change an image to a paletted bitmap or when you export a GIF or PNG. For example, the standard color palette provides more colors than necessary for an image with a limited range of colors, but you can choose an optimized palette to ensure that color representation is accurate.



You can choose a custom color palette by clicking **Open**, locating the color palette file you want, and double-clicking the filename.

You can load preset conversion settings by choosing a preset from the **Preset** list box.

To create a custom processed color palette

- 1 Click a bitmap.
- 2 Click **Bitmaps** ▶ **Mode** ▶ **Paletted (8-bit)**.
- 3 Click the **Processed palette** tab.
- 4 Click a color, and click the **Edit** button.
- 5 In the **Color table**, specify the color you want, and click **Edit color**.
- 6 Edit the color, and click **OK**.
- 7 Click the **Save palette as** button  to save the new palette.
- 8 Choose the disk and folder where you want to store the color palette.
- 9 Type a name in the **Name** box, and click **Save**.

To change a bitmap by setting range sensitivity

- 1 Click a bitmap.
- 2 Click **Bitmaps** ▶ **Mode** ▶ **Paletted (8-bit)**.
- 3 Click the **Options** tab.
- 4 Choose **Optimized** from the **Palette** list box.
- 5 Enable the **Color range sensitivity to** check box.
- 6 Click the **Eyedropper** tool , and click a color in the image.
- 7 Click the **Range sensitivity** tab.

8 Move the range sensitivity sliders.

If you want to preview the color palette, click the **Processed palette** tab.

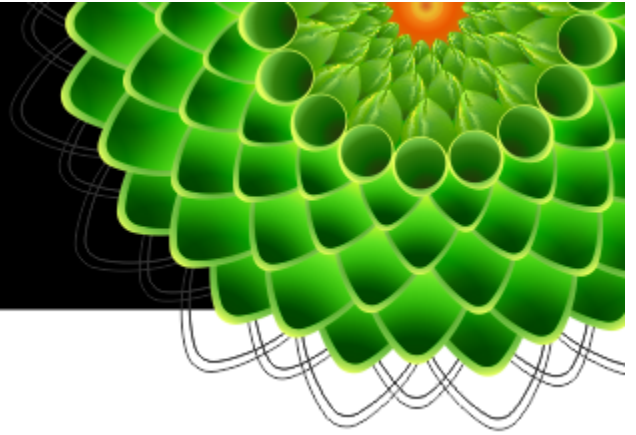

Tracing bitmaps and editing traced results

CorelDRAW lets you trace bitmaps to convert them to fully editable and scalable vector graphics. You can trace artwork, photos, scanned sketches, or logos and then easily integrate them into your designs.

For information about the difference between vector graphics and bitmaps, see [“Understanding vector graphics and bitmaps”](#) on page 51.

This section contains the following topics:

- [“Tracing bitmaps”](#) (page 717)
- [“PowerTRACE controls”](#) (page 720)
- [“Previewing traced results”](#) (page 722)
- [“Fine-tuning traced results”](#) (page 723)
- [“Adjusting colors in traced results”](#) (page 725)
- [“Setting default tracing options”](#) (page 727)
- [“Tips for tracing bitmaps and editing traced results”](#) (page 728)

Tracing bitmaps

You can trace a [bitmap](#) in one step by using the Quick Trace command. Alternatively, you can choose a suitable tracing method and preset style and then use the PowerTRACE® controls to preview and adjust the traced results. CorelDRAW offers two methods for tracing bitmaps: Centerline Trace and Outline Trace.

Choosing a tracing method

The Centerline Trace method uses unfilled closed and open curves (strokes) and is suitable for tracing technical illustrations, maps, line drawings, and signatures. This method is also referred to as “stroke tracing.”

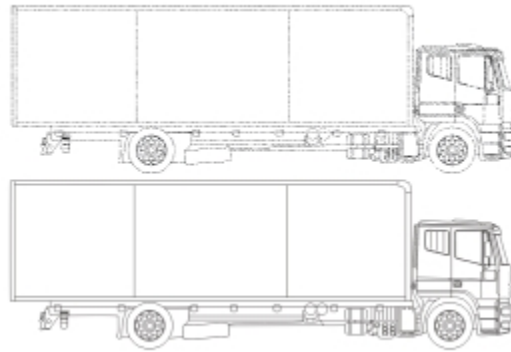

The Centerline Trace method was used to convert the original bitmap (top) into a vector graphic (bottom).

The Outline Trace method uses curve objects with no outlines and is suitable for tracing clipart, logos, and photo images. The Outline Trace method is also referred to as “fill” or “contour tracing.”

Choosing a preset style

A preset style is a collection of settings that are appropriate for the specific type of bitmap you want to trace (for example, line art or a high-quality photo image). Each tracing method comes with specific preset styles.

The Centerline Trace method offers two preset styles: one for technical illustrations and another for line drawings.

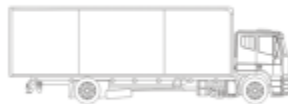

Technical illustration



Line drawing

The Outline Trace method offers the following preset styles that are suitable for line art, logos, clipart, and photo images.



Line art



Logo



Detailed logo



Clipart



Low-quality image



High-quality image

Adjusting traced results

You can adjust the traced results by using the controls in the **PowerTRACE** dialog box. For more information, see [“Fine-tuning traced results”](#) on page 723 and [“Adjusting colors in traced results”](#) on page 725.

To trace a bitmap by using Quick Trace

- 1 Select a bitmap.
- 2 Click **Bitmaps** ► **Quick Trace**.



You can also trace a bitmap in one step by clicking the **Trace bitmap** button on the property bar and clicking **Quick Trace**.

You can change the settings that are used by Quick Trace. For more information, see [“Setting default tracing options”](#) on page 727.

To trace a bitmap by using the Centerline Trace method

- 1 Select a bitmap.
- 2 Click **Bitmaps** ► **Centerline trace**, and click one of the following:
 - **Technical illustration** — to trace black-and-white illustrations with thin, faint lines
 - **Line drawing** — to trace black-and-white sketches with thick, prominent lines

If necessary, adjust the traced results by using the controls of the **PowerTRACE** dialog box.



You can also access PowerTRACE from the **Trace bitmap** button on the property bar.

To trace a bitmap by using the Outline Trace method

- 1 Select a bitmap.
- 2 Click **Bitmaps** ► **Outline trace**, and click one of the following:
 - **Line art** — lets you trace black-and-white sketches and illustrations
 - **Logo** — lets you trace simple logos with little detail and few colors
 - **Detailed logo** — lets you trace logos that contain fine detail and many colors
 - **Clipart** — lets you trace ready-to-use graphics that vary according to their amount of detail and number of colors
 - **Low quality image**— lets you trace photos that lack fine detail (or that contain fine detail that you want to ignore)
 - **High quality image** — lets you trace high-quality, highly detailed photos

If necessary, adjust the traced results by using the controls of the **PowerTRACE** dialog box.

PowerTRACE controls

The **PowerTRACE** dialog box contains controls that help you preview and edit traced results.

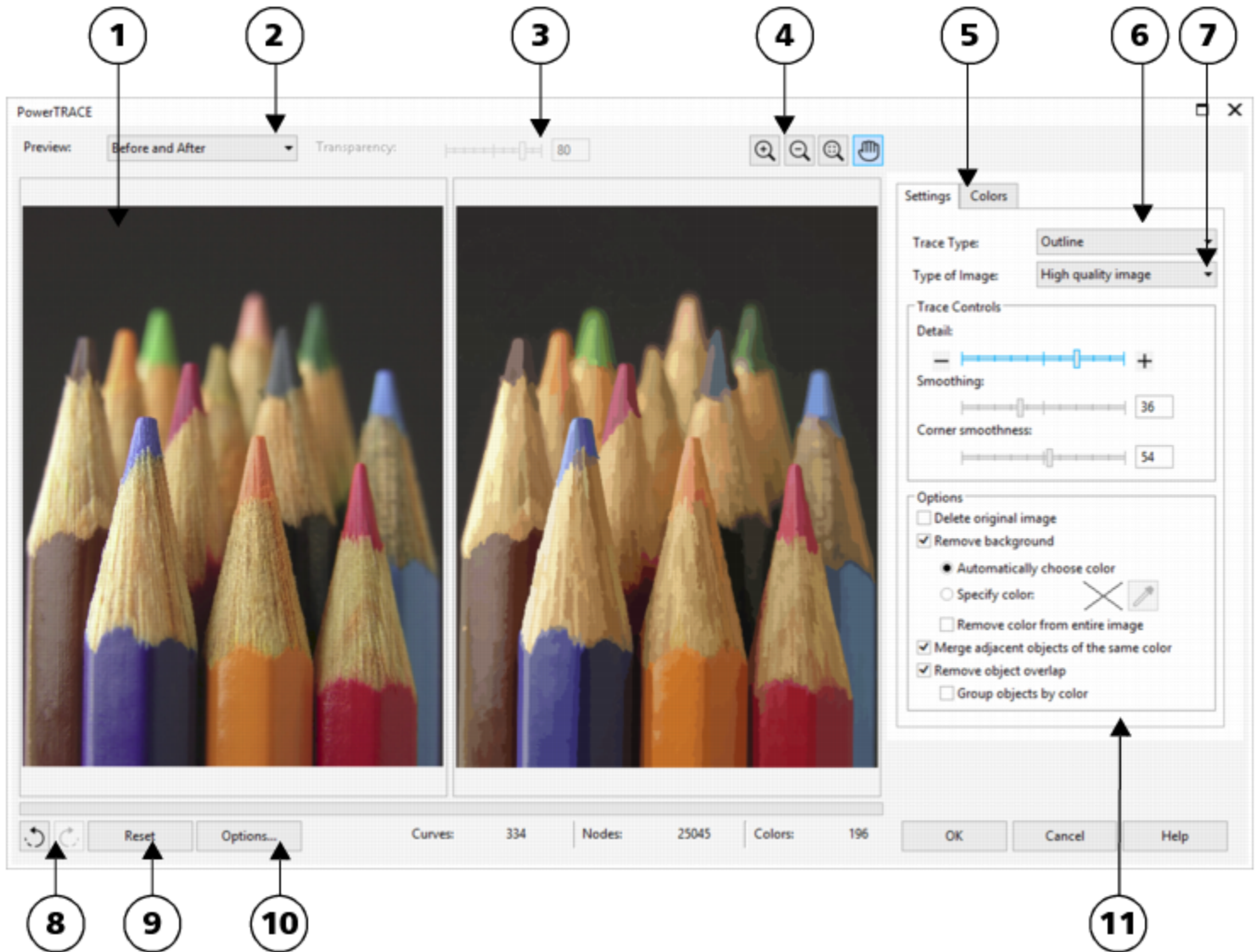

Circled numbers correspond to the numbers in the following table, which describes the main controls of PowerTRACE.

Control

1. Preview window
2. Preview list box

Description

Lets you preview the traced result and compare it to the source bitmap

Lets you choose one of the following previewing options:

- **Before and after** — lets you display both the source bitmap and the traced result
- **Large preview** — lets you preview a traced result in a single-pane preview window
- **Wireframe overlay** — lets you display a wireframe (outline) view of the traced result on top of the source bitmap

Control	Description
3. Transparency slider	Controls visibility of the source bitmap below the wireframe when the Wireframe overlay option is selected
4. Zooming and panning tools	Let you zoom in and out of an image displayed in the preview window, pan an image displayed at a zoom level higher than 100%, and fit an image to the preview window.
5. Colors page	Contains controls for modifying the colors of the traced results. For more information, see “Adjusting colors in traced results” on page 725 .
6. Trace type list box	Lets you change the tracing method
7. Type of image list box	Lets you choose a suitable preset style for the image to be traced. The available preset styles change, depending on the tracing method you choose.
8. Undo and Redo buttons	Let you undo and redo the last action you performed
9. Reset button	Lets you restore the first settings used to trace the source bitmap
10. Options button	Lets you access the PowerTRACE options page in the Options dialog box to set default tracing options. For more information, see “Setting default tracing options” on page 727 .
11. Settings page	<p>Contains controls for adjusting the traced results. The Traced result details area on the Settings page lets you view the number of objects, nodes, and colors in the traced result while you are making adjustments.</p> <p>For more information about adjusting traced results, see “Fine-tuning traced results” on page 723.</p>

Previewing traced results

By default, PowerTRACE displays both the source bitmap and the traced result. You can also preview a traced result in a single-pane preview window, or you can display a wireframe (outline) view of the traced graphic on top of the source bitmap.



You can zoom in and out to get a better view of the graphic, and you can pan to view areas that fall outside the preview window.

To preview traced results

- In PowerTRACE, choose one of the following options from the **Preview** list box:
 - **Before and after** — displays both the source bitmap and the traced result
 - **Large preview** — displays a preview of the traced result in PowerTRACE
 - **Wireframe overlay** — displays a wireframe (outline) preview of the traced result on top of the original bitmap. To control the visibility of the original bitmap underneath the wireframe, move the **Transparency** slider.

You can also

Zoom in or out

Click the **Zoom in**  or **Zoom out**  tool, and click in the preview window.

Fit an image in the preview window

Click the **Zoom to fit**  tool.

Pan a graphic

Click the **Pan** tool , and drag the graphic.

Fine-tuning traced results

PowerTRACE lets you perform the following adjustments to fine-tune your trace results.

Adjusting detail and smoothing

You can adjust the amount of detail in the traced result and smooth curved lines. When you adjust detail, you change the number of objects in the traced result. If you used the Outline Trace method to trace the bitmap, adjusting the traced result also changes the number of colors. Smoothing changes the number of nodes in the traced result. You can also control the appearance of corners in the traced result by setting the threshold for corner smoothness.



Outline tracing with a low detail value (left); outline tracing with a high detail value (right)

Completing a trace

By default, the source bitmap is preserved after being traced, and objects in the traced result are automatically grouped. You can have the source bitmap automatically deleted after the trace is complete.

Removing and preserving the background

You can choose to remove or preserve the background in the traced result. With the Outline Trace method, you can also specify the background color to be removed. If the background color around the edges is removed but some background color still shows through some areas of the image, you can remove the background from the entire image.

Setting other Outline Trace options

By default, object areas that are hidden from view by overlapping objects are removed from the traced result. You can choose to keep the underlying object areas. This feature is useful for traced results that will be output to vinyl cutters and screen printers.

To reduce the number of objects in the traced result, you can combine adjacent objects of the same color. You can also group objects of the same color so that you can manipulate them more easily in CorelDRAW.

Undoing and redoing actions

You can adjust the settings in PowerTRACE and retrace a bitmap as many times as necessary until you are satisfied with the result. If you make a mistake, you can undo or redo an action, or you can revert to the first traced result.

To fine-tune traced results

- 1 Select a bitmap.
- 2 Do one of the following:
 - Click **Bitmaps** ► **Centerline trace**, and click a command.
 - Click **Bitmaps** ► **Outline trace**, and click a command.
- 3 On the **Settings** page, move any of the following sliders:
 - **Detail** — lets you control the amount of original detail that is preserved in the traced result. Higher values maintain more detail and result in a greater number of objects and colors; lower values discard some detail and result in fewer objects.
 - **Smoothing** — lets you smooth curved lines and control the number of nodes in the traced result. Higher values result in fewer nodes and produce curves that do not closely follow the lines in the source bitmap. Lower values result in more nodes and produce more accurate trace results.
 - **Corner smoothness** — This slider works in conjunction with the **Smoothing** slider and lets you control the appearance of corners. Lower values maintain the appearance of corners; higher values smooth corners.

You can also



Change the tracing method	Choose a method from the Trace type list box.
Change the preset style	Choose a preset style from the Type of image list box.
Keep the source bitmap after a trace	In the Options area, disable the Delete original image check box.
Discard or preserve the background in the traced result	Enable or disable the Remove background check box.
Specify the background color you want to remove (Outline Trace)	Enable the Specify color option, click the Eyedropper tool  , and click a color in the preview window. To specify an additional background color to remove, hold down Shift , and click a color in the preview window. The last specified color is displayed next to the Eyedropper tool.
Remove a background color from the entire image (Outline Trace)	Enable the Remove color from entire image check box.
Keep object areas that are hidden by overlapping objects (Outline Trace)	Disable the Remove object overlap check box.
Group objects by color (Outline Trace)	Enable the Group objects by color check box. This check box is available only when the Remove object overlap check box is enabled.

You can also

Merge adjacent objects that have the same color (Outline Trace)

Enable the **Merge adjacent objects of the same color** check box.

Undo or redo an action

Click the **Undo**  or **Redo** , button.

Revert to the first traced result

Click **Reset**.



You can also access PowerTRACE from the **Trace bitmap** flyout button on the property bar.

Adjusting colors in traced results

When the source bitmap is traced, the application generates a color palette for the traced result. The color palette uses the color mode of the source bitmap (for example, RGB or CMYK). The number of colors on the color palette is determined by the number of colors in the source bitmap and the selected preset style.

You can change the color mode of the traced result, and you can reduce the number of colors in the traced result.

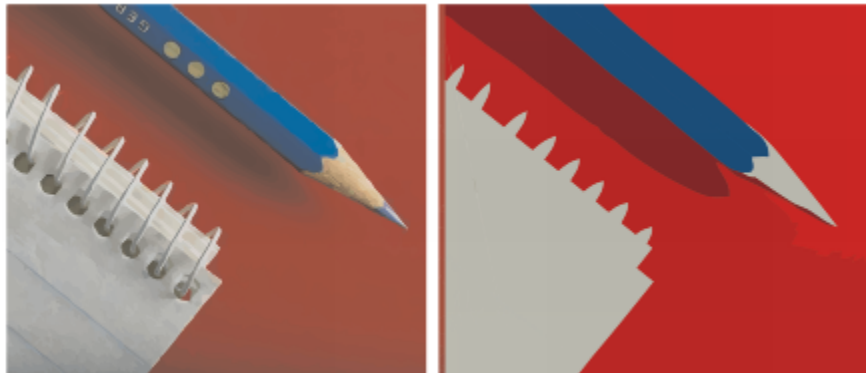

Traced graphic that contains 152 colors (left); traced graphic that contains 5 colors (right)

Sorting colors

To edit the color palette more easily, you can sort colors by similarity or frequency. Sorting by similarity arranges the colors based on their **hue** and lightness. Colors of similar hue and lightness appear close to each other on the color palette. Sorting by frequency arranges the colors based on how much they are used in the traced results. The colors that are used most appear at the top of the color palette.

Selecting colors

You can select a color by clicking it on the color palette of the traced result or by clicking the color in the preview window. You can also select multiple colors.

Editing, merging, and deleting colors

When editing a color, you can choose a color from a color model that is different from that of other colors on the palette. For example, if you are editing a color in an RGB traced result, you can change the color to a spot color, creating a mixed color palette. This feature is useful when you are preparing the traced result for commercial printing.

With the Outline Trace method, you can also merge and delete colors.

By default, when two or more colors are merged, their color values are averaged to produce a new color. The merged colors are replaced by the new color. However, you can change the default setting to replace the colors to be merged with the first color that you selected. For information on how to change the default setting, see [“Setting default tracing options” on page 727](#).

When you delete a color from the color palette, the deleted color is replaced by the next color on the color palette.

Using and creating color palettes

If you want the traced result to contain only colors from a specific color palette, you can open that color palette in PowerTRACE. The colors of the traced result are replaced by their closest match on the color palette.

After you edit the color palette of the traced graphic, you can save it to create a custom color palette for later use.

To adjust the colors of a traced result

- 1 Select a bitmap.
- 2 Do one of the following:
 - Click **Bitmaps** ► **Centerline trace**, and click a command.
 - Click **Bitmaps** ► **Outline trace**, and click a command.
- 3 Click the **Colors** tab, and perform any of the following tasks.

To	Do the following
Change the color mode	Choose a color mode from the Color mode list box.
Reduce the number of colors in a traced result (Outline Trace)	Type a value in the Number of colors box, and click outside the box.
Select a color	Do one of the following: <ul style="list-style-type: none">• Click a color on the color palette. The selected color swatch button appears pressed.• Click the Eyedropper tool , and click a color in the preview window. A marquee appears around the selected color. To select an additional color, hold down Shift, and click a color in the preview window. To deselect a color, hold down Ctrl, and click a color.
Select a range of adjacent colors	Hold down Shift , and click the first and last color swatch in the range you are selecting on the color palette.
Select multiple nonadjacent colors	Hold down Ctrl , and click the nonadjacent color swatches on the color palette.
Edit a color	Select the color you want to edit, click Edit , and modify settings in the Select color dialog box.
Merge colors (Outline Trace)	Select the colors that you want to merge, and click Merge . If you want to specify how to merge the colors, click Options to access the Options dialog box, and enable an option in the Merge colors area.

To

Delete a color from a traced result (Outline Trace)

Do the following

Select a color, and click the **Delete color** button .

The deleted color is replaced by the next color on the color palette.

Use a custom color palette

Click the **Open color palette** button , find the folder where the palette is stored, and click a filename.

Color palettes have a `.cpl` filename extension.

Each color of the traced graphic is mapped to a similar color on the custom palette.

Create a custom color palette from the edited color palette of a traced result

Click the **Save color palette** button . In the **Save palette as** dialog box, type a name in the **File name** box.



The number of colors cannot be reduced, and colors cannot be merged, when you use the Centerline Trace method.



To increase the number of colors in a traced result, you need to change the preset style or increase the amount of detail. For information about how to change the preset style and the amount of detail, see [“To fine-tune traced results” on page 724](#).

Setting default tracing options

You can enable any of the following tracing options.

- **Quick Trace method** — You can change the default Quick Trace settings to any preset style, or to the most recently used settings.
- **Performance** — This option determines how source bitmaps between 1 and 5 megapixels in size are handled, and how the quality of the traced results is affected. The performance of PowerTRACE depends on the size and color depth of the source bitmaps as well as on the available system memory. High-quality traced results require high-quality source bitmaps, which are often quite large. The larger the source bitmap, the more resources are required. Bitmaps that are too large need to be downsampled before tracing, which may decrease the image quality. To trace large bitmaps without sacrificing quality, you can set PowerTRACE to trace images as large as 5 megapixels (provided RAM is sufficient). To achieve maximum performance, you can set PowerTRACE to prompt you to downsample bitmaps larger than 1 megapixel.
- **Merge colors** — You can choose whether to merge colors in a traced result by averaging their values or by replacing the colors to be merged with the first color you select.

To set default tracing options

- 1 Click **Tools** ► **Options**.
- 2 In the **Workspace** list of categories, click **PowerTRACE**.
- 3 Perform any of the following tasks.

To

Choose a Quick Trace method

Do the following

From the **Quick Trace** method list box, choose a preset style or the most recently used settings.

To

Determine performance level and quality of a traced result

Do the following

Move the **Performance** slider to the left to increase performance, or to the right to increase the quality of the traced results. The lowest value prompts you to downsample all bitmaps that exceed 1 megapixel. The highest value prompts you to downsample all bitmaps that exceed 5 megapixels.

Choose how to merge colors in a traced result

In the **Merge colors** area, enable an option. The **Average merging colors** option replaces the colors to be merged with a color of their average value. The **Merge to first color selected** option replaces the colors to be merged with the first selected color.



You can also access the **PowerTRACE** page in the **Options** dialog box by clicking **Options** in PowerTRACE.

Tips for tracing bitmaps and editing traced results

The following tips can help you achieve high-quality trace results.

- Use high-quality source bitmaps. If **dithering** or JPEG compression was used in the source bitmap, the bitmap may contain additional noise. For best traced results, remove the noise before tracing the bitmap.
- For best results when you use the Centerline Trace method, convert the bitmap to the black-and-white color mode before tracing. Note that in this case you cannot adjust detail.
- When tracing technical illustrations and sketches with faint lines, you can improve the results by applying the **Find edges** special effect to the source bitmap. To do this, click **Bitmaps** ▶ **Contour** ▶ **Find edges**.
- For outline tracing, reduce the color depth of the bitmap by changing the color mode, and then adjust the color and contrast.
- You can adjust the traced results at any time, including during a trace, by changing the PowerTRACE settings.
- To trace a specific area in a bitmap, use the **Shape** tool  to define the area before clicking **Bitmaps** ▶ **Trace bitmap**.
- If important detail has been removed from the traced results, you can disable the **Remove background** check box on the **Settings** page of PowerTRACE. You can also try enabling the **Specify color** option on the **Settings** page and sampling the color you want to specify as a background color.
- If background color is removed around the edges but remains within image areas, enable the **Remove from entire image** check box.
- If too many colors or details are lost, move the **Detail** slider on the **Settings** page.
- To preserve detail in bitmaps that have fine details, thin lines, and no anti-aliasing applied, choose **Line art** from the **Type of image** list box on the **Settings** page.

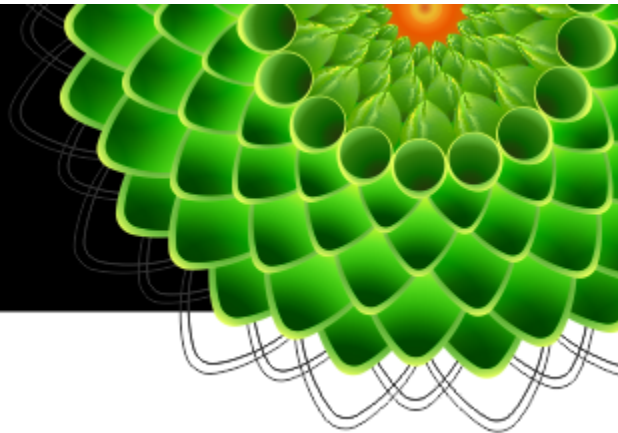

Working with RAW camera files

You can import and process RAW camera files in CorelDRAW.

This section contains the following topics:

- [“Using RAW camera files” \(page 729\)](#)
- [“Bringing RAW camera files into CorelDRAW” \(page 730\)](#)
- [“Adjusting the color and tone of RAW camera files” \(page 733\)](#)
- [“Sharpening and reducing noise in RAW camera files” \(page 735\)](#)
- [“Previewing RAW camera files and obtaining image information” \(page 736\)](#)

You can also download AfterShot 3 HDR to edit and process RAW camera files. For more information, see [“AfterShot 3 HDR” on page 1.](#) on page 100.

Using RAW camera files

RAW camera files contain picture data that is captured by the image sensor of a digital camera. These files are called RAW because, unlike JPEG and TIFF files, they contain minimal in-camera processing and need to be edited and prepared for printing in an image-editing application.

With RAW camera files, you can control the processing of image data, rather than having the camera make automatic color adjustments and conversions. You can adjust the white balance, tonal range, contrast, color saturation, and sharpness of a RAW image without any loss of image quality. In addition, you can reprocess RAW images at any time to achieve the results you want. In this sense, RAW camera files can be compared to an exposed but undeveloped film.

To take advantage of RAW camera files, you need to set your camera to save files to its own RAW file format. CorelDRAW lets you import RAW camera files from supported camera models. Supported camera models include:

- Canon EOS-1D X, Canon EOS 650D, Canon 5D Mark III, Canon G1-X, Canon ID-X, Canon EOS 6D, Canon A3300, Canon EOS C500, Canon EOS SX50
- Casio EX-ZR100
- Fuji X-Pro1, Fuji X-S1, Fuji XS50, Fuji X20, Fuji X100S, Fuji SL1000, Fuji X-E1, and Fuji XF1
- Olympus XZ-10
- Pentax K-5 II (s)
- Samsung EX2F, Samsung NX300, Samsung NX1000, Samsung NX20
- Sigma SD1, Sigma SD15, Sigma DP cameras
- Sony RX100

In addition, the Adobe's lossy Digital Negative (DNG) file format and the Imacon Flexframe 3f format are now supported.

For more information about supported cameras, visit the [Corel Knowledge Base](#).

Bringing RAW camera files into CorelDRAW

When you open single or multiple RAW camera files in CorelDRAW, they are first displayed in the Camera RAW Lab. You can use the controls in the Camera RAW Lab to adjust the color and tone of the RAW camera images. If you are satisfied with the adjustments of a file, you can apply the same adjustments to the remaining files.

After processing RAW camera files, you can edit them further by using the tools and effects available in CorelDRAW. Then, you can save the RAW camera files as TIFF or JPEG files, or you can save them to any other file format supported by CorelDRAW.

Note that RAW camera files cannot be saved to a RAW camera file format in CorelDRAW. Any changes made to the RAW camera files in the Camera RAW Lab are lost unless you save the files to a supported file format.

Processing RAW camera files

The Camera RAW Lab includes controls that are organized in a logical order for color correction and other adjustments of RAW camera images. It is recommended that you start from the top of the **Color** page and work your way down. Once you finish correcting the color and tone of your image, you can sharpen it and remove noise by using the controls on the **Detail** page. For information about the settings on the **Color** page, see ["Adjusting the color and tone of RAW camera files" on page 733](#). For information about the settings on the **Detail** page, see ["Sharpening and reducing noise in RAW camera files" on page 735](#).

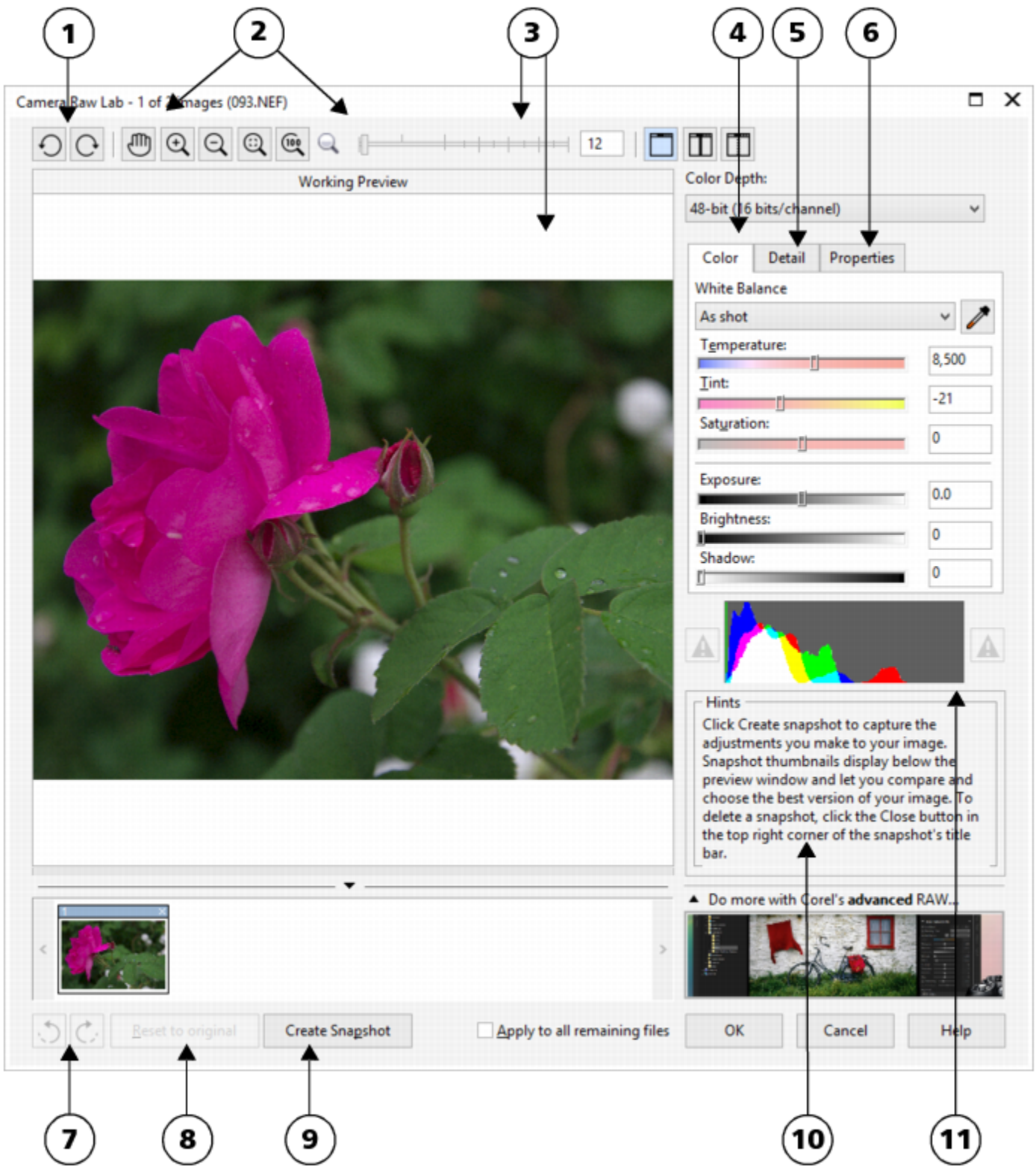



Camera RAW Lab: circled numbers correspond to the numbers in the following table, which describes the main components of the lab.

Component	Description
1. Rotation tools	Let you rotate the image 90 degrees clockwise and counterclockwise
2. Zooming and panning tools	Let you zoom in and out of an image displayed in the preview window, pan an image displayed at a zoom level higher than 100%, and fit an image to the preview window
3. Preview modes and Preview window	Let you preview the adjustments made to a RAW camera image in a single or split window. To compare the original and the adjusted image, you can display them side by side.
4. Color page	Contains controls that let you adjust the color and tone of RAW camera images to remove color casts and reveal hidden detail
5. Detail page	Contains controls that let you remove noise from RAW camera images
6. Properties page	Contains controls that let you view information about a RAW camera image, such as size, color mode, and camera settings
7. Undo and Redo buttons	Let you undo and redo the last action you performed
8. Reset to original button	Lets you clear all corrections so that you can start with the original RAW camera image
9. Create snapshot	Lets you capture the corrected version of an image in a "snapshot" at any time. Thumbnails of the snapshots appear in a window below the image.
10. Hints area	Displays information about the active control
11. Histogram	Lets you preview the tonal range of the image.

To bring a RAW camera file into CorelDRAW

- 1 Click **File** ► **Import**.
- 2 Select the RAW camera file or files that you want to import, and click **Import**.
- 3 In the Camera RAW Lab, adjust the color and tone of the RAW camera image. If necessary, you can also sharpen the image and reduce the amount of noise.
If you selected multiple RAW camera files and want to apply the same adjustments to all of them, enable the **Apply to all remaining files** check box.



You can rotate the image by clicking the **Rotate left** button  or **Rotate right** button .

Adjusting the color and tone of RAW camera files

You can adjust the color and tone of an image by using the following settings.

Color depth

Color depth refers to the number of colors an image can contain. One of the advantages of using RAW camera files is that they can contain more colors than photos saved as JPEG or TIFF files. This greater number of colors makes it easier to reproduce colors accurately, reveal detail in shadows, and adjust brightness levels.

The Camera RAW Lab lets you process the RAW camera files as 48-bit or 24-bit images. 48-bit images offer more accurate color representation and prevent loss of image quality during retouching. Note that some of the special effects available in CorelDRAW cannot be applied to 48-bit images.

White balance

White balance is the process of removing unnatural color casts from images so that image colors appear as they do in real life. White balance takes into consideration the lighting conditions in which a photo was taken and sets the color balance to produce realistic image colors.

By default, when a RAW camera file is brought into CorelDRAW, it reflects the camera setting for white balance. This setting appears as the preset **As shot** in the **White balance** list box. If you are not satisfied with this setting, you can have the white balance adjusted automatically by choosing the preset **Auto**. You can also apply any of the following presets: **Daylight**, **Cloudy**, **Shade**, **Tungsten**, **Fluorescent**, or **Flash**. These presets let you simulate different lighting conditions.



RAW camera image with incorrect white balance (left); the same image with adjusted white balance (right)

In addition, you can use the **Eyedropper** tool to automatically adjust the contrast in an image according to the white or gray point that you sample in the preview window.

If the **White balance** options do not produce the results you want, you can use the following controls to remove color casts:

- **Temperature** slider — lets you correct color casts by adjusting the color temperature of an image to compensate for the lighting conditions at the time the photo was taken. For example, to correct a yellow color cast caused by taking a photo indoors in dim incandescent lighting, you can move the slider to the left. Conversely, to correct a blue color cast caused by intense lighting conditions, you can move the slider to the right.
- **Tint** slider — lets you correct color casts by adjusting the green or magenta in an image. You can add green by moving the slider to the right; you can add magenta by moving the slider to the left. Moving the **Tint** slider after using the **Temperature** slider lets you fine-tune an image.

Tonal adjustments

You can use the following controls to adjust the tone of RAW camera files.

- **Saturation** slider — lets you adjust the vividness of colors. For example, by moving the slider to the right, you can increase the vividness of a blue sky in an image. By moving the slider to the left, you can reduce the vividness of colors.

- **Exposure** slider — lets you compensate for the lighting conditions at the time the photo was taken. Exposure is the amount of light allowed to fall on the image sensor of a digital camera. High exposure values result in areas that are completely white (no detail); low values result in increased shadows. Exposure values (EV) range from -3.0 to + 3.0.
- **Brightness** slider — lets you brighten or darken an entire image. If you want to darken only the darkest areas of an image, you must use the **Shadow** slider.
- **Shadow** slider — lets you adjust the brightness in the darkest areas of an image without affecting the lighter areas. For example, a bright light behind a photo subject (backlighting) at the time a photo is taken can cause the subject to appear in shadow. You can correct the photo by moving the **Shadow** slider to the right to lighten dark areas and reveal more detail.

Using the histogram

While you are making adjustments, you can view the tonal range of the image on the histogram to check for any clipping of shadow or highlight areas. Clipping is the shifting of image pixels to white (highlight clipping) or black (shadow clipping). Clipped highlight areas appear completely white and contain no detail; clipped shadow areas appear completely black and contain no detail.

The button on the left side of the histogram displays a warning if the image contains shadow clipping. The button on the right side of the histogram displays a warning if the image contains highlight clipping. You can also choose to apply shading to the clipped areas in the preview window.

To adjust the color and tone of a RAW camera file

- 1 Click **File** ► **Import**.
- 2 Select the RAW camera file or files that you want to import, and click **Import**.
- 3 From the **Color depth** list box, choose one of the following options:
 - **48-bit (16 bits/channel)**
 - **24-bit (8 bits/channel)**
- 4 To remove a color cast, select the **Auto** option from the **White balance** list box.

If you are not satisfied with the results, you can set the white point more precisely by using the **Eyedropper** tool  to sample a white or gray color in your image.

- 5 Perform one or more tasks from the following table.

To	Do the following
Simulate different lighting conditions	Select an option from the White balance list box.
Correct color in the image	Adjust the Temperature slider, and then fine-tune the color correction by adjusting the Tint slider.
Make colors more vivid or less vivid	Move the Saturation slider to the right to increase the amount of color in the image or to the left to decrease the amount of color in the image.
Adjust exposure	Move the Exposure slider to the left to compensate for high-exposure camera settings or to the right to compensate for low-exposure camera settings.
Brighten or darken an image	Move the Brightness slider to the right to lighten the image or to the left to darken the image.

To	Do the following
Adjust the brightness in the darker areas of an image without changing the lighter areas	Move the Shadow slider.
Show clipped shadow areas	Click the button to the left of the histogram.
Show clipped highlight areas	Click the button to the right of the histogram.



You can capture the current version of your image by clicking **Create snapshot**. Thumbnails of the snapshots appear in a window below your image. Each snapshot is numbered sequentially and can be deleted by clicking the close button in the upper right corner of the snapshot title bar.

To change a color or tone setting one increment at a time, you can click in the box to the right of a slider, and press the **Up** or **Down** arrow keys.

You can undo or redo the last correction you made by clicking **Undo** or **Redo**. To undo all corrections, click **Reset to original**.

Sharpening and reducing noise in RAW camera files

You can sharpen RAW camera files to enhance image edges.

RAW camera files may contain luminous (grayscale) and color (chroma) noise that is especially obvious in the darker areas of an image. Luminous noise appears as a “white snow” effect; color noise appears as random pixels of different colors scattered against image areas. You can reduce noise in RAW camera files to improve image quality.



Before (left) and after (right) the amount of noise is reduced in a RAW camera image

To sharpen a RAW camera file

- 1 Click **File** ► **Import**.
- 2 Select the RAW camera file or files that you want to import, and click **Import**.
- 3 In the Camera RAW Lab, click the **Detail** tab.
- 4 Move the **Sharpness** slider to enhance the edges in an image.

To reduce noise in a RAW camera file

- 1 Click **File** ► **Import**.
- 2 Select the RAW camera file or files that you want to import, and click **Import**.

- 3 Click the **Detail** tab.
- 4 Move any of the following sliders to the right:
 - **Luminance noise** — to reduce the amount of luminance noise
 - **Color noise** — to reduce the amount of color noise. Note that higher settings may decrease the color accuracy of an image.



Adjusting both the **Luminance noise** and **Color noise** settings produces better results.









Previewing RAW camera files and obtaining image information

By previewing RAW camera files in various ways, you can evaluate the color and tone adjustments you make. For example, you can rotate images, pan to a new area, zoom in or out, and choose how to display the processed image in the preview window.

You can obtain information about the color mode, size, and resolution of a RAW camera file. In addition, you can obtain information about the camera and camera settings used when the photo was taken.

To preview a RAW camera file

- 1 Click **File** ► **Import**.
- 2 Select the RAW camera file or files that you want to import, and click **Import**.
- 3 In the Camera RAW Lab, perform a task from the following table.

To	Do the following
Pan to another area of an image	Using the Pan tool  , drag the image until the area that you want to see is visible.
Zoom in and out	Using the Zoom in tool  or Zoom out tool  , click in the preview window. You can also zoom in and out by dragging the Zoom slider.
Fit an image in the preview window	Click the Zoom to fit  button.
Display an image at its actual size	Click the 100%  button.
View the corrected image in a single preview window	Click the Full preview button  .
View the corrected image in one window and the original image in another window	Click the Before and after full preview button  .
View the image in one window with a divider between the original and corrected versions	Click the Before and after split preview button  . Move your pointer over the dashed divider line, and drag to move the divider to another area of the image.

To obtain information about a RAW camera file

- 1 Click **File** ► **Import**.
- 2 Select the RAW camera file or files that you want to import, and click **Import**.
- 3 In the Camera RAW Lab, click the **Properties** tab, and view any of the properties that are available for the selected RAW camera file, such as color space, camera manufacturer and model, focal length, exposure time, and ISO speed ratings.

Printing

Printing basics.....741

Preparing files for print service providers..... 755

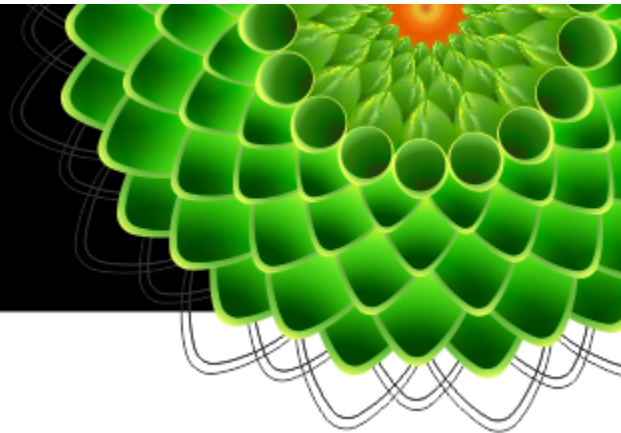

Printing basics

CorelDRAW provides extensive options for printing your work.

This section includes the following topics:

- “Printing your work” (page 741)
- “Laying out print jobs” (page 742)
- “Previewing print jobs” (page 743)
- “Applying print styles” (page 744)
- “Fine-tuning print jobs” (page 745)
- “Printing colors accurately” (page 746)
- “Printing to a PostScript printer” (page 748)
- “Using print merge” (page 750)
- “Viewing preflight summaries” (page 754)

Printing your work

Using CorelDRAW, you can print one or more copies of the same drawing. You can also specify the page type and the page range that you want to print.

Before printing a drawing, you can specify printer properties, including paper size and device options. For example, you can specify printer features such as duplexing stapling.

To set printer properties

- 1 Click **File** ► **Print**.
- 2 Click the **General** tab.
- 3 In the **Destination** area, choose a printer from the **Printer** list box.
- 4 Click **Preferences**.
- 5 Set any properties in the dialog box.

To print your work

- 1 Click **File** ► **Print**.

- 2 Click the **General** tab.
- 3 In the **Destination** area, choose a printer from the **Printer** list box.
- 4 In the **Destination** area, choose a page size and orientation option from the **Page** list box.
- 5 In the **Copies** area, type a value in the **Number of copies** box.
If you want the copies collated, enable the **Collate** check box.
- 6 In the **Print range** area, enable one of the following options:
 - **Current document** — prints the active drawing
 - **Current page** — prints the active page
 - **Pages** — prints the pages that you specify
 - **Documents** — prints the documents that you specify
 - **Selection** — prints the objects that you have selected
 If you enable the **Pages** option, you can choose to print a range of pages, only even pages, only odd pages, or both even and odd pages.

You can also

Automatically match the printer orientation to the document orientation

In the **Destination** area, choose **Match orientation** from the **Page** list box.

Apply the printer's default page size

In the **Destination** area, choose **Use printer default** from the **Page** list box.



You must select objects before printing a selection.



Certain printers support the automatic matching of page size and orientation. To enable this option, you need to modify the driver compatibility settings for the printer by clicking **Tools** ► **Options**. In the list of categories, double-click **Global**, double-click **Printing**, click **Driver compatibility**, and enable the **Printer can match document page sizes** check box. In the **Print** dialog box, you can then choose **Match orientation and size** from the **Page** list box.

Laying out print jobs

You can lay out a print job by specifying the size, position, and scale. Tiling a print job prints portions of each page on separate sheets of paper that you can assemble into one sheet. You would, for example, tile a print job that is larger than your printer paper.

To specify the size and position of a print job

- 1 Click **File** ► **Print**.
- 2 Click the **Layout** tab.
- 3 In the **Image position and size** area, enable one of the following options:
 - **As in document** — maintains the image size as it is in the document
 - **Fit to page** — sizes and positions the print job to fit to a printed page
 - **Reposition images to** — lets you reposition the print job by choosing a position from the list box



Enabling the **Reposition images to** option lets you specify size, position, and scale in the corresponding boxes.



You can also choose an imposition layout, such as **2 x 2 (4-up)** or **2 x 3 (6-up)**, from the **Imposition layout** list box. For more information, see [“Working with imposition layouts” on page 756](#).

To tile a print job

- 1 Click **File** ► **Print**.
- 2 Click the **Layout** tab.
- 3 In the **Image position and size** area, enable the **Print tiled pages** check box.
- 4 Type values in the following boxes:
 - **Tile overlap** — lets you specify the amount by which to overlap tiles
 - **% of page width** — lets you specify the percentage of the page width the tiles will occupy



You can include tiling alignment marks by enabling the **Tiling marks** check box.

Previewing print jobs

You can preview your work to show how the position and size of the print job will appear on paper. For a detailed view, you can [zoom](#) in on an area. You can view how the individual color separations will appear when printed.

Before printing your work, you can view a summary of issues for a print job to find potential printing problems. For example, you can check the current print job for print errors, possible print problems, and suggestions for resolving issues.

To preview a print job

- Click **File** ► **Print preview**.

To close the print preview, click **File** ► **Close print preview**.



You can quickly preview a print job in the **Print** dialog box by clicking **File** ► **Print** and clicking the **Mini preview** button .

To magnify the preview page

- 1 Click **File** ► **Print preview**.
- 2 Click **View** ► **Zoom**.
- 3 Enable the **Percent** option, and type a value in the box.



You can also magnify the preview page by choosing a preset zoom level.

You can also zoom in on a portion of the print preview by clicking the **Zoom** tool  in the toolbox and [marquee selecting](#) an area.

To preview color separations

- 1 Click **File** ► **Print preview**.
- 2 On the property bar, click the **Enable color separations** button .



You can preview the composite by clicking **View ▶ Preview separations ▶ Composite**.

You can view individual color separations by clicking the tabs at the bottom of the application window.

To view a summary of issues for a print job

- 1 Click **File ▶ Print**.
- 2 Click the **Preflight** tab.

If there are no print job issues, the tab name displays as **No issues**. If there are issues, the tab name displays the number of issues that were found.

If you want to exclude certain issues from the preflight check, click **Settings**, double-click **Printing**, and disable any check boxes that correspond to issues you want overlooked.



You can save settings by clicking the **Add preflight settings** button  and typing a name in the **Save preflight style** box.

Applying print styles

A print style is a set of saved printing options. Each print style is a separate file. This lets you move a print style from one computer to another, back up a print style, and keep document-specific styles in the same directory as the document file.

You can select an existing print style, create a new print style, or edit a print style and save the changes. You can also delete print styles.

To choose a print style

- 1 Click **File ▶ Print**.
- 2 Click the **General** tab.
- 3 Choose one of the following from the **Print style** list box:
 - **CorelDRAW defaults**
 - **Browse**

To create a print style

- 1 Click **File ▶ Print**.
- 2 Click the **General** tab.
- 3 Set any printing options.
- 4 Click **Save as**.
- 5 Choose the folder where you want to save the print style.
- 6 Type a name for the style in the **File name** box.



You can also save a print style by clicking **File ▶ Print preview**, and clicking the **Save print style as** button.

To edit a print style

- 1 Click **File ▶ Print**.
- 2 Choose a print style from the **Print style** list box.

- 3 Modify any of the printing options.
- 4 Click **Save as**.
- 5 Choose the folder where the print style is stored.
- 6 Click the filename.
- 7 Click **Save**.



You should save the modified settings as a print style or apply the changes before canceling; otherwise, you'll lose all the modified settings.

To delete a print style

- 1 Click **File** ► **Print preview**.
- 2 Select a print style.
- 3 Click the **Delete print style** button .

Fine-tuning print jobs

You can fine-tune print jobs to ensure print quality. Because problems sometimes occur when you are printing text to a non-PostScript printing device (GDI printer), you can decrease printing time by specifying driver compatibility for non-PostScript printing devices. For more information, see ["Printing colors accurately" on page 746](#).

If a printing device has difficulty processing large **bitmaps**, you can divide a bitmap into smaller, more manageable chunks by setting an output threshold. If any lines appear when the printing device prints the chunks, you can set an overlap value to produce a seamless image.

On occasion, you may experience difficulties with printing complex files. To print complex files, you may need to spend a considerable amount of time fixing and correcting the files. Another option is to convert a page to a bitmap, also known as rasterizing, which can allow you to print complex files more easily.

To reduce file size, you can downsample bitmaps. Because bitmaps are made up of **pixels**, when you downsample a bitmap, the number of pixels per line decreases, which decreases the file size.

To specify driver compatibility settings

- 1 Click **Tools** ► **Options**.
- 2 In the list of categories, double-click **Global**, double-click **Printing**, and click **Driver compatibility**.
- 3 Choose a non-PostScript printing device from the **Printer** list box.
- 4 Enable any of the check boxes that correspond to the settings that you want to specify.

To choose a threshold and chunk overlap

- 1 Click **Tools** ► **Options**.
- 2 In the list of categories, double-click **Global**, and click **Printing**.
- 3 From the **Special settings** list, choose one of the following:
 - **Bitmap output threshold (K)**
 - **Bitmap chunk overlap pixels**
- 4 Choose a value from the **Setting** list box.

To print as a bitmap

- 1 Click **File** ► **Print**.
- 2 On the **General** tab, enable the **Print as bitmap** check box, and type a number in the **dpi** box to set the **resolution**.

To downsample bitmaps

- 1 Click **File** ► **Print**.
- 2 Click the **Prepress** tab.
- 3 In the **Bitmap downsampling** area, enable any of the following check boxes and type a value in the corresponding box:
 - **Color and grayscale**
 - **Monochrome**



Downsampling **bitmaps** affects them only when their **resolution** is higher than the resolution specified in the **Bitmap downsampling** area.

Printing colors accurately

CorelDRAW allows you to manage colors when printing to ensure accurate color reproduction. You can print the document with the document colors settings applied or you can choose alternate color settings only for printing. You can also print a document using the color proofing settings that you previously specified in the **Color proof settings** docker.

In addition, you can choose a rendering intent to effectively interpret the out-of-gamut colors when printing. The rendering intent that you choose depends on the graphic content of the document.

For more information about color management, see [“Using color management” on page 409](#).

Notes for GDI printers

GDI printers support only two color spaces: RGB and Grayscale. If your document contains colors from multiple color spaces, for example RGB, CMYK, and spot colors, you must convert all the colors to RGB or Grayscale before printing.



You can determine if a printer is a GDI printer by clicking **File** ► **Print** and choosing a printer from the **Printer** list box. If the **PostScript** tab does not appear at the top of the dialog box, the selected printer is a GDI printer.

The following table describes different ways of managing color when printing to a GDI printer.

How to	In the Print dialog box
Print the document and preserve the RGB or Grayscale colors	Click the Color tab, and choose the appropriate color mode from the Output colors as list box.
Print the document with original colors	Click the Color tab, and choose the document color profile from the Document profile area of the Correct colors using color profile list box.
Print the document and convert the document colors to the printer colors	Choose the printer color profile from the Correct colors using color profile list box.

Notes for PostScript printers

Most PostScript printers support the use of multiple color spaces in a document. For example, a document can contain colors from multiple colors spaces, such as RGB, CMYK, and Grayscale.

The following table describes different ways of managing color when printing to a PostScript printer.

How to	In the Print dialog box
Print the document with the original colors	Click the Color tab, and choose Native from the Output colors as list box.
Print a document that contains multiple color modes using one color mode	Click the Color tab, and choose a color mode from the Output colors as list box. If the printer supports only one color mode, you can control the color conversion within CorelDRAW.
Print a document that contains only one color mode	Click the Color tab, and choose the color profile from the Output color as list box and from the Correct colors using color profile list box.

To specify color settings for printing

- 1 Click **File** ► **Print**.
- 2 Click the **Color** tab.
- 3 Enable the **Use document color settings** option.
If you selected a PostScript printer, you can choose one of the following options from the **Color conversion performed by** list box:
 - **CorelDRAW** — lets the application perform the color conversion
 - **(selected printer)** — lets the selected printer perform the color conversion (This option is only available for PostScript printers.)
- 4 Choose a color model from the **Output colors as** list box.
This allows you to merge all document colors into a specific color model when printing.

You can also

Convert spot colors to process colors	Enable the Convert spot colors to check box. If you selected Native from the Output colors as list box, you need to select a color mode from the list box.
Choose a color profile for correcting colors when printing to a specific printer	Choose a color profile from the Correct colors using color profiles list box. This option is available only for certain color models.
Retain the color values associated with the selected color model	Enable the Preserve (color model) numbers check box.

To print using color proofing settings

- 1 Click **File** ► **Print**.

- 2 Click the **Color** tab.
- 3 Enable the **Use color proof settings** option to apply the color settings that are defined in the **Color proof settings** docker. If you want to correct the proof colors, you can choose a color profile from the **Correct colors using color profile** list box.
- 4 Click **Print**.

To specify a rendering intent for printing

- 1 Click **File** ► **Print**.
- 2 Click the **Color** tab.
- 3 From the **Rendering intent** list box, choose one of the following options:
 - **Relative colorimetric** — for producing proofs on printers, without preserving the white point
 - **Absolute colorimetric** — for preserving the white point and proofing
 - **Perceptual** — for a variety of images, especially bitmaps and photographs
 - **Saturation** — for vector graphics and for preserving highly saturated colors (lines, text, and solid-colored objects, such as charts)

Printing to a PostScript printer

PostScript is a page-description language that sends printing instructions to a PostScript device. All the elements in a print job (for example, curves and text) are represented by lines of PostScript code that the printing device uses to produce the document. For improved compatibility, you can choose a device-independent PostScript option. You can also select a PostScript Printer Description (PPD) file. A PostScript Printer Description file describes the capabilities and features of your PostScript printer and is available from your printer's manufacturer.

You can automatically increase the fountain steps in a **fountain fill** to decrease banding. Increasing the number of steps used to **render** fountain fills produces smoother shading when printing. To ensure that your print jobs print properly, you can also reduce curve complexity by increasing flatness. Curve flatness determines how smooth a curve appears when printed.

A print job that contains too many **fonts** may not print properly, and a print job that contains too many **spot colors** increases file size. You can set the PostScript options to warn you when a print job contains more than a set number of fonts or spot colors.

By default, the printing device driver downloads Type 1 fonts to the printing device. You can disable the **Download Type 1 Fonts** option so that fonts are printed as graphics (either curves or bitmaps). This may be useful when the file contains many fonts that would take a long time to download or would fail to download because of their file size. Bitmap versions of TrueType fonts look better in small print and print faster than regular fonts. You can choose the maximum number of bitmap fonts that a print job can contain.

To select a PostScript Printer Description (PPD) file

- 1 Click **File** ► **Print**.
- 2 Click the **General** tab.
- 3 In the **Destination** area, choose a PostScript printer from the **Printer** list box.
- 4 Enable the **Use PPD** check box.
- 5 Choose the folder where the file is stored.
- 6 Double-click the filename.

To print to a PostScript device

- 1 Click **File** ► **Print**.
- 2 Click the **General** tab.
- 3 In the **Destination** area, choose a PostScript printer from the **Printer** list box.
- 4 Click the **PostScript** tab.
- 5 From the list box in the **Compatibility** area, choose the PostScript level that corresponds to the printer.

If you want to compress bitmaps when printing, choose an option from the **Compression type** list box in the **Bitmaps** area. If you choose JPEG compression, you can move the **JPEG quality** slider to adjust the compression.



Bitmap compression settings can be saved in PostScript Interpreted (PS or PRN) files when you print to a file using a PostScript driver. For information about printing to a file, see [“To print to a file” on page 755](#).

To test fountain fills for banding

- 1 Click **File** ► **Print**.
- 2 Click the **Preflight** tab.
If there are no print job issues, the tab name displays as **No issues**.
- 3 Click **Settings**.
- 4 Double-click **Printing**.
- 5 Enable the **Banded fountain fills** check box.

If you want to optimize **fountain fills** to reduce complexity, enable the **Optimize fountain fills** check box on the **PostScript** tab.



Testing **fountain fills** for banding applies only to linear fountain fills.

To automatically increase fountain steps

- 1 Click **File** ► **Print**.
- 2 Click the **PostScript** tab.
- 3 Enable the **Auto increase fountain steps** check box.

To reduce curve complexity

- 1 Click **File** ► **Print**.
- 2 Click the **PostScript** tab.
- 3 Enable the **Auto increase flatness** check box.



Reducing curve complexity can help alleviate printing problems caused by curves that have too many nodes on each curve, but it results in increased printing time.

To set color separations and font warning options

- 1 Click **Tools** ► **Options**.
- 2 In the list of categories, double-click **Global**, and click **Printing**.
- 3 Choose **Spot color separations warning** from the **Special settings** list.
- 4 Choose one of the following from the **Setting** list box:
 - If any spot colors are used
 - If more than 1 spot color used
 - If more than 2 spot colors used
 - If more than 3 spot colors used
- 5 Choose **Many fonts (preflight)** from the **Special settings** list, and choose a number from the **Setting** list box that appears.

To disable the downloading of Type 1 fonts

- 1 Click **File** ► **Print**.
- 2 Click the **PostScript** tab.
- 3 Disable the **Download Type1 fonts** check box.



Type 1 fonts can be downloaded only for PostScript devices.

When the **Download Type1 fonts** check box is enabled, the **Convert TrueType to Type1** check box is enabled by default. This ensures that TrueType fonts are converted to Type 1 fonts so that they can be downloaded. Disable the **Convert TrueType to Type1** check box only if the output device has difficulty interpreting Type 1 fonts.

To choose the maximum number of bitmap fonts

- 1 Click **Tools** ► **Options**.
- 2 In the list of categories, double-click **Global**, and click **Printing**.
- 3 Choose **Bitmap font limit (PS)** from the **Special settings** list.
- 4 Choose a value from the **Settings** list box.

If you want to set a maximum bitmap font size, choose a font size from the **Bitmap font size threshold (PS)** list box.

Using print merge

CorelDRAW lets you combine text from a data source with a drawing. When you merge documents, you can produce several different copies of a drawing. You can use merged documents to create personalized documents, such as mailing lists, questionnaires, and targeted marketing documents, where each printed document contains specific information from a record in a data source, such as a text file or an ODBC data source (a Microsoft Excel or Microsoft Access file).

When you merge documents, you create a form document in CorelDRAW and combine it with a data source. A form document provides the pattern and layout for a merged document. A data source supplies information for a drawing during the merge. CorelDRAW supports the following data source files: Text (TXT) files, comma-separated values (CSV) files, Rich Text Format (RTF) files, and files that can be opened by means of an ODBC data source.

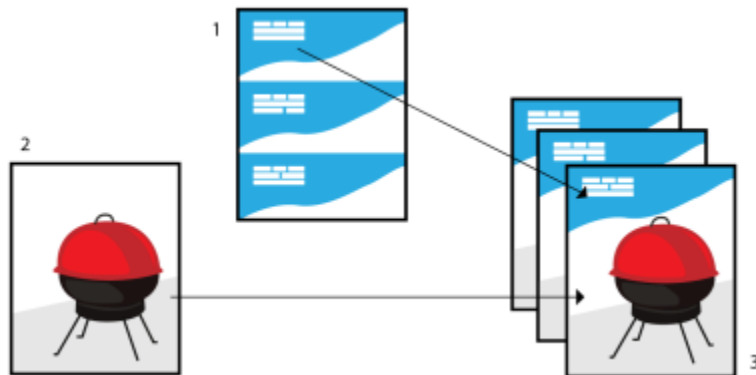

Data source document (1), form document (2), and merged documents (3)

Creating a data source file

Information in a data source file is organized into fields and records. A field can contain one or more characters. Fields can contain alphanumeric data or only numeric data. For example, a record may include a first name, last name, address, and other contact information. Each item within the record, such as first name, last name, or address, is recognized as a field. A record can contain one or more fields.

You can create a data source file or import an existing one. You can create a data text file by using CorelDRAW or a text editor. You can edit the data in a data source file at any time.

Creating a form document

Creating form documents is similar to creating regular drawings. For form documents, however, you insert merge fields, which are replaced by information from the data source during the merge.

Associating a form document with a data source file

When you use CorelDRAW to create a data file, or when you import an existing data file into CorelDRAW, the data file is associated with the form document. The association is always stored with the document and cannot be changed.

Performing a merge

CorelDRAW provides different output options for merge documents. You can print a merge document or save it to a new document. When you print a merge document, the form document is merged with the data source file during printing. When you save the merged document to a new file, the application merges the form document with the data from the data source file in a new CorelDRAW file. You can use this file to preview your final output and make minor adjustments before printing. For major changes, such as the addition or repositioning of merge fields or the addition of new records, you must work in the form document.

To create a data source file by using CorelDRAW

- 1 Click **File** ► **Print merge** ► **Create/Load merge fields** to launch the **Print merge** wizard.
- 2 Enable the **Create new text** option, and click **Next**.
- 3 On the **Add fields** page, do one or both of the following:
 - To create a text field, type a field name in the **Text field** box, click **Add**, and then click **Next**.
 - To create a numeric field, type a field name in the **Numeric field** box, click **Add**, and then click **Next**.
- 4 On the **Add or edit records** page of the **Print merge** wizard, do any of the following:
 - To add a record, click **New**, and then click **Next**.
 - To add data in a field, click in the field, type data, and click **Next**.
 - To modify existing data in a field, click in the field, modify the data, and click **Next**.
- 5 Enable the **Save data settings as** check box.
- 6 Type a filename, choose the drive and folder where you want to save the file, and click **Finish**.

You can also

Apply formatting to the data in a numeric field

On the **Add fields** page of the **Print merge** wizard, click a numeric field in the list, and choose a format from the **Numeric format** list box.

Different numeric formats are available in CorelDRAW. For example, the **X.0** format represents the value **1** as **1.0**; the **00X** format represents the value **1** as **001**.

Automatically increment the value in a numeric field

Enable the **Continually increment the numeric field** check box, and specify starting and ending values in the corresponding boxes.

You can also

Change the order of merge fields

Select a field in the list and click **Move up** or **Move down**.

Delete a record

On the **Add or edit records** page of the **Print merge** wizard, click **Delete**.



View records

On the **Add or edit records** page of the **Print merge** wizard, choose one of the following options from the **Current view** list box:

- **All records** — lets you display all records in a source data file
- **Single record** — lets you display one record at a time

Browse records

On the **Add or edit records** page of the **Print merge** wizard, click any of the following buttons:

- **First record** 
- **Next record** 
- **Previous record** 
- **Last record** 

Find text in a data file

On the **Add or edit records** page of the **Print merge** wizard, type a search term in the box, and press **Enter**.



You can edit the fields and records in an existing data source file by clicking **File** ► **Print merge** ► **Edit merge fields** and following the instructions in the **Print merge** wizard.

To create a data source by using a text editor

- 1 Open a text editor, and create a new file.
- 2 On the first line, type the number of merge fields that you want to insert in the drawing. For example:
3
- 3 On the second line, type the names of the merge fields by separating them with a backslash. Each merge field must begin and end with a backslash. For example:
\Name\Date\Instructor
- 4 On the next lines, type the data that you want to appear in the merged document. Each line constitutes a record. For example:
**\Pixie Parsons\6 September 2016\Mr. Randy Harris\
\Shirley Wilkinson\13 January 2016\Ms. Corinne Pitts**
- 5 Save the file as an ANSI text file (.txt extension) or as an RTF file.



Backslashes function as markers to indicate the beginning and end of merge fields; therefore, you cannot use them as data in fields.

Data in fields must end with a character. Blank spaces or lines before backslashes prevent the merge from being completed successfully.

To import a data source file

- 1 Click **File** ► **Print merge** ► **Create/Load merge fields**.
- 2 In the **Print merge** wizard, enable the **Import text from a file or an ODBC data source** option, and click **Next**.
- 3 Enable the **File** option, and navigate to the drive and folder where the data file is stored.
- 4 Choose a file.
- 5 Click **Open**.
- 6 Click **Next**.
- 7 Follow the instructions in the **Print merge** wizard.

To import an ODBC data source file

- 1 Click **File** ► **Print merge** ► **Create/Load merge fields**.
- 2 In the **Print merge** wizard, enable the **Import text from a file or an ODBC data source** option, and click **Next**.
- 3 Enable the **ODBC data source** option, and click **Select ODBC data source**.
- 4 In the **Select data source** dialog box, click the **Machine data source** tab.
- 5 Under **Data source name**, select **Excel files**, and click **OK**.
- 6 In the **Select workbook** dialog box, choose the database that you want to import, and click **OK**.

To create a form document

- 1 Open a drawing in which you want to insert merge fields.
- 2 Click **File** ► **Print merge** ► **Create/Load merge fields**.
- 3 Follow the instructions in the **Print merge** wizard to associate the drawing with a data source file, and then exit the **Print merge wizard**. The **Print merge** toolbar appears.
- 4 On the **Print merge** toolbar, choose a field name from the **Field** list box, and click **Insert**.
CorelDRAW places the merge field in the center of the current view. If you want to reposition the merge field, drag it to a new location on the drawing page.
- 5 Repeat step 4 to insert additional fields.

To perform a merge and print the document

- 1 Do one of the following:
 - Click **File** ► **Print merge** ► **Perform merge**.
 - Click **File** ► **Print**. In the **Perform merge** dialog box, enable the **Perform print merge** option, and click **OK**.
 - On the **Print merge** toolbar, click **Merge to new document**, and click **Print**.
- 2 Specify any printer settings.
- 3 Click **Print**.

If you want to print all records and pages, enable the **Current document** option.

To perform a merge and save the document to a new file

- Click **File** ► **Print merge** ► **Merge to new document**.



You can also perform a merge and save the document to a new file by clicking **Merge to new document** on the **Print merge** toolbar.

Viewing preflight summaries

Preflight checks the status of your file before you decide to output it and provides a summary of issues and potential problems, and suggestions for resolving them. You can specify which issues Preflight checks for. You can also save Preflight settings. For more information about specific Preflight settings, see any of the following:

- To check for issues related to printing a file, see [“To view a summary of issues for a print job”](#) on page 744.
- To check for issues related to publishing a PDF file, see [“To view the preflight summary for a PDF file”](#) on page 805.
- To check for issues related to exporting to Adobe Illustrator (AI), see [“To view the preflight summary for an AI file”](#) on page 813.
- To check for issues related to exporting a SWF file, see [“To view the issues summary for an Adobe Flash file”](#) on page 843.
- To check for issues related to exporting an SVG file, see [“Scalable Vector Graphics \(SVG\)”](#) on page 839.

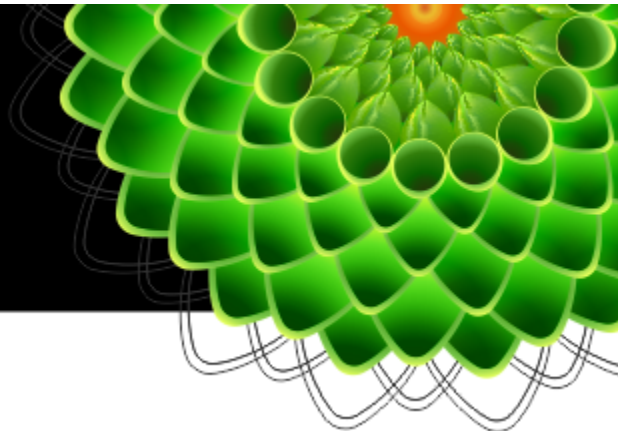

Preparing files for print service providers

With CorelDRAW, you can prepare a print job for sending to a print service provider.

This section contains the following topics:

- “Preparing a print job for a print service provider” (page 755)
- “Working with imposition layouts” (page 756)
- “Printing printers’ marks” (page 758)
- “Maintaining OPI links” (page 760)
- “Printing color separations” (page 761)
- “Working with color trapping and overprinting” (page 762)
- “Specifying In-RIP trapping settings” (page 765)
- “Printing to film” (page 767)
- “Preparing banners for printing” (page 767)
- “Working with a print service provider” (page 769)

Preparing a print job for a print service provider

You can print a drawing to a file, which lets the print service provider send the file directly to an output device. If you are unsure about which settings to choose, consult the print service provider.

For more information about commercial printing, see “Working with a print service provider” on page 769.

To print to a file

- 1 Click **File** ► **Print**.
- 2 Click the **General** tab.
- 3 In the **Destination** area, enable the **Print to file** check box.
- 4 Click the flyout arrow, and click one of the following commands:
 - **For Mac** — saves the drawing to be readable on a Macintosh computer
 - **Single file** — prints all pages in a document to a single file
 - **Pages to separate files** — prints each page to a separate file
 - **Plates to separate files** — prints each plate to a separate file
- 5 Click **Print**.

- 6 Choose one of the following from the **Save as type** list box:
 - **Print file** — saves the file as a PRN file
 - **PostScript file** — saves the file as a PS file
- 7 Choose the folder where you want to save the file.
- 8 Type a filename in the **File name** box.
- 9 Click **Save**.



If you prefer not to prepare PostScript files, print service providers equipped with the application in which you created your work can take the original files (for example, CorelDRAW files) and apply the required prepress settings.

Working with imposition layouts

Working with imposition layouts lets you print more than one page of a document on each sheet of paper. You can choose a preset imposition layout to create documents such as magazines and books to print on a commercial printing press; produce documents that involve cutting or folding, such as mailing labels, business cards, pamphlets, or greeting cards; or print multiple thumbnails of a document on one page. You can also edit a preset imposition layout to create your own layout.

You can select a binding method by choosing from three preset binding methods, or you can customize a binding method. When you choose a preset binding method, all but the first signature are automatically arranged.

You can arrange pages on a signature manually or automatically. When you arrange the pages automatically, you can choose the angle of the image. If you have more than one page across or down, you can specify the size of gutters between pages; for example, you can choose the automatic gutter spacing option, which sizes gutters so that the document's pages fill the entire available space in the layout.

When printing on a desktop printer, you can adjust the margins to accommodate the non-printable area of a page. If the margin is smaller than the non-printable area, the edges of some pages or some printers' marks may be clipped by your printer.

To choose a preset imposition layout

- 1 Click **File** ► **Print**.
- 2 Click the **Layout** tab.
- 3 Choose an imposition layout from the **Imposition layout** list box.



The layout you choose does not affect the original document, only the way it is printed.



To edit an imposition layout

- 1 Click **File** ► **Print**.
- 2 Click the **Layout** tab.
- 3 Choose an imposition layout from the **Imposition layout** list box.
- 4 Click **Edit**.
- 5 Edit any imposition layout settings.
- 6 Click **File** ► **Save imposition layout**.
- 7 Type a name for the imposition layout in the **Save as** box.



When editing an imposition layout, you should save it with a new name; otherwise the settings for a preset imposition layout will be overwritten.

To select a binding method





- 1 Click **File** ► **Print preview**.
- 2 Click the **Imposition layout tool** .
- 3 Choose **Edit basic settings** from the **What to edit** list box on the property bar.
- 4 Type values in the **Pages across/down** boxes.
If you want the page to be double-sided, click the **Single/double sided** button .
- 5 Choose one of the following binding methods from the **Binding mode** list box:
 - **Perfect binding** — cuts apart individual pages and glues them at the spine
 - **Saddle stitch** — folds pages and inserts them into one another
 - **Collate and cut** — collates and stacks all signatures together
 - **Custom binding** — lets you arrange the pages that are printed in each signature

If you choose either **Saddle stitch** or **Custom binding**, type a value in the corresponding box.



When you click the **Single/double sided** button for double-sided printing, and you are printing on a non-duplex printing device, a wizard automatically provides instructions on how to insert the paper into the printer, so that you can print on both sides of the page.



To arrange pages



- 1 Click **File** ► **Print preview**.
- 2 Click the **Imposition layout tool** .
- 3 Choose **Edit page placements** from the **What to edit** list box on the property bar.
- 4 Click one of the following buttons:
 - **Intelligent auto-ordering**  — automatically arranges the pages on a signature
 - **Sequential auto-ordering**  — arranges the pages from left to right and top to bottom
 - **Cloned auto-ordering**  — places the working page in each frame of the printable page

If you want to arrange the page numbering manually, click on the page and specify the page number in the **Page sequence number** box.

- 5 Choose an angle from the **Page rotation** list box.

To edit gutters

- 1 Click **File** ► **Print preview**.
- 2 Click the **Imposition layout tool** .
- 3 Choose **Edit gutters and finishing** from the **What to edit** list box on the property bar.
- 4 Click one of the following buttons:
 - **Auto gutter spacing**  — sizes gutters so that the document's pages fill the entire available space in the layout



- **Equal gutters**  — lets you set equal horizontal and vertical gutters
- 5 Click one of the following buttons:
- **Cut location**  — places cut marks between pages
 - **Fold location**  — places fold marks between pages



If you click the **Equal gutters** button, you must specify a value in the **Gutter size** box.

You can edit the gutters only if you've selected an imposition layout with two or more pages across and down.

To adjust margins

- 1 Click **File** ► **Print preview**.
- 2 Click the **Imposition layout tool** .
- 3 Choose **Edit margins** from the **What to edit** list box on the property bar.
- 4 Click one of the following buttons:
 - **Auto margins**  — sets the margins automatically
 - **Equal margins**  — lets you make the right margin equal to the left one, and the bottom margin equal to the top one



If you click the **Equal margins** button, you must specify values in the **Top/left margin** boxes.

When preparing a job for a commercial press, the print service provider may request minimum margin sizes, such as for page grippers and printers' marks.

Printing printers' marks

Printing printers' marks lets you display information on a page about how a document should be printed. You can specify the position of the printers' marks on the page.

The available printers' marks are as follows:

- **Crop/fold marks** — represent the size of the paper and print at the corners of the page. You can print crop/fold marks to use as guides to trim the paper. If you print multiple pages per sheet (for example, two rows by two columns), you can choose to print the crop/fold marks on the outside edge of the page so that all crop/fold marks are removed after the cropping process, or you can choose to add crop marks around each row and column. Crop/fold marks ensure that marks appear on each plate of a separated CMYK file.
- **Bleed limit** — determines how far an image can extend beyond the crop marks. When you use a **bleed** to extend the print job to the edge of the page, you must set a bleed limit. A bleed requires that the paper you are printing on is larger than the size of paper you ultimately want, and the print job must extend beyond the edge of the final paper size.
- **Registration marks** — are required to line up film for proofing or printing plates on a color press. They print on each sheet of a color separation.
- **Color calibration bars** — are color scales that print on each sheet of a color separation and ensure accurate color reproduction. To see calibration bars, make sure that the page size of the print job is larger than the page size of the work you are printing.
- **Densitometer scale** — is a series of gray boxes ranging from light to dark. These boxes are required to test the density of halftone images. You can position the densitometer scale anywhere on the page. You can also customize the levels of gray that appear in each of the seven squares on the densitometer scale.
- **Page numbers** — helps you collate pages of an image that do not include any page numbers or do not contain page numbers that correspond to the actual number of pages
- **File information** — prints file information, such as, the color profile; halftone settings; name, date, and time the image was created; plate number; and job name

To print crop and fold marks

- 1 Click **File** ► **Print**.
- 2 Click the **Prepress** tab.
- 3 In the **Crop/fold marks** area, enable the **Crop/fold marks** check box.

If you want to print all crop/fold marks, disable the **Exterior only** check box.



To print crop and fold marks, ensure that the paper on which you print is 0.5 inches larger on all sides than the page size of the image that you are printing.



To set crop and fold marks, see [“To edit gutters” on page 757](#).

To print composite crop and fold marks

- 1 Click **Tools** ► **Options**.
- 2 In the list of categories, double-click **Global**, and click **Printing**.
- 3 Choose **Composite crop marks (PS)** from the **Option** list.
- 4 Choose **Output on all plates** from the **Setting** list box.

To set a bleed limit

- 1 Click **File** ► **Print**.
- 2 Click the **Layout** tab.
- 3 Enable the **Bleed limit** check box.
- 4 Type a value in the **Bleed limit** box.



Usually, a **bleed** limit of 0.125 to 0.25 inches is sufficient. Any object extending beyond that uses memory needlessly and may cause problems when you print multiple pages with bleeds on a single sheet of paper.

To print registration marks

- 1 Click **File** ► **Print**.
- 2 Click the **Prepress** tab.
- 3 In the **Registration marks** area, enable the **Print registration marks** check box.
- 4 Choose a registration mark style from the **Style** picker.



To print registration marks, ensure that the paper on which you print is 0.5 inches larger on all sides than the page size of the image that you are printing.

To print color calibration bars and densitometer scales

- 1 Click **File** ► **Print**.
- 2 Click the **Prepress** tab.

3 In the **Calibration bars** area, enable any of the following check boxes:

- **Color calibration bar**
- **Densitometer scales**

If you want to customize the levels of gray in one of the densitometer scale squares, choose a number from the **Densities** list (lower values represent lighter squares), and type a new density for that square.

To print page numbers

- 1 Click **File** ► **Print**.
- 2 Click the **Prepress** tab.
- 3 In the **File information** area, enable the **Print page numbers** check box.



If you want to position the page number inside the page, enable the **Position within page** check box.

To print file information

- 1 Click **File** ► **Print**.
- 2 Click the **Prepress** tab.
- 3 In the **File information** area, enable the **Print file information** check box.
- 4 Type a job name in the **Print file information** box.

If you want to position the file information inside the page, enable the **Position within page** check box.

To position printers' marks

- 1 Click **File** ► **Print preview**.
- 2 Click the **Marks placement** tool .
- 3 Click the **Auto-position marks rectangle** button  on the property bar.
- 4 Type values in the **Marks alignment rectangle** boxes.



You can also change the position of printers' marks by clicking a printers' mark icon in the print preview window and dragging the **bounding box**.

If you want to affix printers' marks to the object's bounding box instead of to the page bounding box, click **File** ► **Print**, click the **Prepress** tab, and enable the **Marks to objects** check box.

Maintaining OPI links

Open Prepress Interface (OPI) lets you use low-[resolution](#) images as placeholders for the high-resolution images that appear in your final work. When a print service provider receives your file, the OPI server substitutes the high-resolution images for the low-resolution placeholders.

To maintain OPI links

- 1 Click **File** ► **Print**.
- 2 Click the **PostScript** tab.
- 3 Enable the **Maintain OPI links** check box.



The **Maintain OPI links** option is available for PostScript devices only.

You can reduce your work time by using OPI and print management server solutions, such as Creo Color Central. Low-resolution samples are automatically created from the high-resolution originals and are placed in CorelDRAW. These files contain their own OPI comments, which the Creo Color Central server recognizes when it receives the job and then substitutes the high-resolution version of the file for the low-resolution version.

Low-resolution images must be flagged as OPI images (this must be done using third-party software) before you can import them into a document.

Printing color separations

When you send color work to a print service provider or printing shop, either you or the print service provider must create [color separations](#). Color separations are necessary because a typical printing press applies only one color of ink at a time to a sheet of paper. You can specify the color separations to print, including the order in which they print.

Printing presses produce color using either [process color](#) or [spot color](#), or both. You can convert the spot colors to process colors at printing time. For more information on spot and process colors, see [“Choosing colors” on page 350](#).

When setting halftone screens to print color separations, we recommend that you use the default settings; otherwise, screens can be improperly set and result in undesirable [moiré patterns](#) and poor color reproduction. However, if you are using an imagesetter, the screen technology should be set to match the type of imagesetter the print service provider uses. Before customizing a halftone screen, consult the print service provider to determine the correct setting.

If you have overprinted areas, you can choose how you want those areas to print. For more information about overprinting, see [“Working with color trapping and overprinting” on page 762](#).

To print color separations

- 1 Click **File** ► **Print**.
- 2 Click the **Color** tab.
- 3 Enable the **Print separations** option.

If you want to print specific [color separations](#), click the **Separations** tab, and enable the corresponding check box in the list of color separations.



You can change the order in which color separations print, by enabling the **Use advanced settings** check box in the **Options** area. In the separations list at the bottom of the dialog box, click in the **Order** column next to the color separation that you want to change. Chose a new order value from the list box.

If you want to print separations using a color profile that is different from the document color profile, you can click the **Color** tab and choose a color profile from the **Correct colors using color profile** list box.

To convert spot colors to process colors

- 1 Click **File** ► **Print**.
- 2 Click the **Color** tab.
- 3 Enable the **Print separations** option.
- 4 Enable the **Convert spot colors to** check box.



Changing the **spot colors** to **process colors** does not affect the original CorelDRAW file; it affects the way colors are sent to the printer.

To customize a halftone screen

- 1 Click **File** ► **Print**.
- 2 Click the **Color** tab.
- 3 Enable the **Print separations** option.
- 4 Click the **Separations** tab.
- 5 In the **Options** area, enable the **Use advanced settings** check box.
- 6 Click **Advanced**.
- 7 Change any of the following settings:
 - **Screening technology**
 - **Resolution**
 - **Basic screen**
 - **Halftone type**



You can set the screen frequency, screen angle, and overprint options for **spot colors** as well as **process colors**. For example, if you have a **fountain fill** made up of two spot colors, you can set one to print at 45 degrees and the other at 90 degrees.

Working with color trapping and overprinting

When colors are trapped, they are intentionally overlapped so that misalignments of print separations are not noticeable. In manual trapping, one color must overprint the other. Overprinting is achieved by printing one color over another. Overprint trapping works best when the top color is much darker than the underlying color; otherwise, an undesirable third color may result (for example, cyan over yellow results in a green object). In some cases, you might actually want to create a third color; for example, you can overprint two spot colors to create a third color.

How overprinted colors mix depends on the type of colors and ink you are mixing and the types of objects you are overprinting. For example, an object that uses a CMYK color overprints differently from an object that uses a spot color. Bitmaps also overprint differently from vector objects. You can preview a simulation of how overprinted colors will mix by enabling the **Enhanced** viewing mode and the **Simulate overprints** viewing mode. For more information about choosing a viewing mode, see “[Choosing viewing modes](#)” on page 62. Some variation between the preview and the printed version may occur, depending on the printer you use.

When you are ready to print, you can choose to preserve overprint settings if you want to trap **objects** in a document, or if you want to mix the overlapping colors for effect. You can also choose to **knock out** the overprinted areas so that only the top color is visible. If you want to print a proof version of the file, you can simulate overprints. Simulating overprints rasterizes the file, and it prints using process colors only.

You can set a group of objects to overprint. You can allow text to overprint overlying objects. You can also overprint bitmaps; or each vector object’s **fill**, or **outline**, or both. In addition, you can overprint specific **color separations** and specify in which order they will print, as well as whether you want to overprint graphics, or text, or both.

The two methods for automatic color trapping include always overprinting black and auto-spreading. Overprinting black creates a color trap by causing any object that contains 95% black or more to overprint any underlying objects. This option is useful for artwork containing a lot of black text, but it should be used with caution on artwork with a high graphics content. You can adjust the threshold, if the print service provider recommends a black threshold value other than 95%.

Auto-spreading creates color trapping by assigning an outline to an object that is the same color as the object's fill and having it overprint underlying objects. Auto-spreading is created for all objects in the file that meet three conditions: they do not already have an outline, are filled with a uniform fill, and have not already been designated to overprint.

For advanced trapping options, see "Specifying In-RIP trapping settings" on page 765.

To preserve or ignore overprints when printing

- 1 Click **File** ► **Print**.
- 2 Click the **Color** tab.
- 3 Choose one of the following options:
 - **Print composite**
 - **Print separations**
- 4 Click one of the following tabs:
 - **Separations**
 - **Composite**
- 5 From the **Document overprints** list box, choose one of the following options:
 - **Ignore** — does not overprint areas; color on top prints and underlying colors are **knocked out**
 - **Preserve** — preserves overprinted areas

To print a simulated overprint

- 1 Click **File** ► **Print**.
- 2 Click the **Color** tab.
- 3 Enable the **Print composite** option.
- 4 Click the **Composite** tab.
- 5 From the **Document overprints** list box, choose **Simulate**.
The **Simulate** option rasterizes the file; the file is printed with process colors.

To overprint selected objects

- 1 Select an **object**.
- 2 Click **Object**, and choose any of the following:
 - **Overprint outline**
 - **Overprint fill**
 - **Overprint bitmap**



You can also set an object to overprint by right-clicking the object and choosing an overprint option from the context menu.

To print text over underlying objects

- 1 Using the **Text** tool , select the text.
- 2 In the **Character** area of the **Object properties** docker, enable the **Overprint fill** check box.

To overprint selected color separations

- 1 Click **File** ► **Print**.
- 2 Click the **Color** tab.
- 3 Enable the **Print separations** option.

- 4 Click the **Separations** tab.
- 5 In the **Options** area, enable the **Use advanced settings** check box.
- 6 Click **Advanced**.
- 7 In the **Advanced separations settings** dialog box, choose a **color separation** from the **Screening technology** list box.
- 8 In the **Overprint** column, click one or both of the following icons:
 - Overprint graphics 
 - Overprint text **A**



The icons appear darker when the separation is set to overprint.



You can change the order in which color separations print by selecting a color separation and choosing an order from the **Order** list box.

To trap by always overprinting black

- 1 Click **File** ► **Print**.
- 2 Click the **Color** tab.
- 3 Choose one of the following options:
 - **Print composite**
 - **Print separations**
- 4 Click one of the following tabs:
 - **Separations**
 - **Composite**
- 5 In the **Options** area, enable the **Always overprint black** check box.

To set the overprint black threshold

- 1 Click **Tools** ► **Options**.
- 2 In the list of categories, double-click **Global**, and click **Printing**.
- 3 Choose **Overprint black threshold (PS)** from the **Option** list.
- 4 Choose a number from the **Setting** list box.

The number you choose represents the percentage of black above which black objects overprint.

To trap by auto-spreading

- 1 Click **File** ► **Print**.
- 2 Click the **Color** tab.
- 3 Choose one of the following options:
 - **Print composite**
 - **Print separations**
- 4 Click one of the following tabs:
 - **Separations**
 - **Composite**
- 5 In the **PostScript trapping** or **Trapping** area, do one of the following:

- Enable the **Auto-spreading** option, and type a value in the **Maximum** box.
- Enable the **Fixed width** option, and type a value in the **Width** box.

6 Type a value in the **Text above** box.



The value that you type in the **Text above** box represents the minimum size to which auto-spreading is applied. If you set this value too low, small text may be rendered illegible when auto-spreading is applied.

The amount of spread assigned to an object depends on the maximum trap value specified in the **Maximum** box and the object's color. The lighter the color, the greater the percentage of the maximum trap value. The darker the color, the smaller the percentage of the maximum trap value.

Specifying In-RIP trapping settings

In-RIP trapping allows you to specify advanced trapping settings. Before selecting In-RIP trapping, ensure that your PostScript 3 printer supports In-RIP trapping options.

You can select a trap width — the amount that one color spreads into another. You can also specify image trap placement, which determines where the trap occurs. You can, for example, specify whether the trap is a **choke** or a **spread**, depending upon the neutral densities of adjacent colors. Neutral density indicates the lightness or darkness of a color and helps determine how adjacent colors spread into one another.

You can specify a **threshold** at which a trap is created by specifying a step trap limit. If trap colors are of similar neutral densities, the trap placement adjusts accordingly. The step trap limit specifies a threshold at which a trap adjusts.

Before trapping, you can set the inks; for example, you can set an ink to opaque, as in the case of a metallic ink, so that nothing shows through it. To reduce the visibility of a trap, you can decrease the amount of ink color in a trap. This is especially helpful in the case of pastel colors, contrasting colors, and colors with similar neutral densities.

To select a trap width

- 1 Click **File** ► **Print**.
- 2 Click the **Color** tab.
- 3 Enable the **Print composite** option.
- 4 Click the **PostScript** tab.
- 5 Choose **PostScript 3** from the **Compatibility** list box.
- 6 Click the **Composite** tab.
- 7 Enable the **PostScript level 3 In-RIP trapping** check box.
- 8 Click **Settings**.
- 9 Type a value in the **Trap width** box.

If you are trapping to black, type a value in the **Black trap width** box.



To select In-RIP trapping options, you must have selected **PostScript 3** from the **Compatibility** list box under the **PostScript** tab of the **Print** dialog box.

To specify image trap placement

- 1 Click **File** ► **Print**.
- 2 Click the **Color** tab.
- 3 Enable the **Print composite** option.

- 4 Click the **PostScript** tab.
- 5 Choose **PostScript 3** from the **Compatibility** list box.
- 6 Click the **Composite** tab.
- 7 Enable the **PostScript Level 3 In-RIP trapping** check box.
- 8 Click **Settings**.
- 9 From the **Image trap placement** list box, choose one of the following placements:
 - **Neutral density** — used to determine the lighter object and thus the direction and placement of the trap
 - **Choke** — used to trap a dark foreground object to a light background image
 - **Spread** — used to trap a light foreground object to a dark background image
 - **Centerline** — used when adjacent images and objects have similar neutral densities or when image density changes along an object's edge

If you want to trap an object to an image, enable the **Trap objects to images** check box.

To specify a threshold

- 1 Click **File** ► **Print**.
- 2 Click the **Color** tab.
- 3 Enable the **Print composite** option.
- 4 Click the **PostScript** tab.
- 5 Choose **PostScript 3** from the **Compatibility** list box.
- 6 Click the **Composite** tab.
- 7 Enable the **PostScript 3 In-RIP trapping** check box.
- 8 Click **Settings**.
- 9 Type a value in one or more of the following boxes:
 - **Step limit** — specifies a **threshold** between color variations. The lower the threshold value, the more likely it is that a trap will be created.
 - **Black limit** — specifies the threshold at which process black is considered pure black
 - **Black density limit** — specifies a neutral density value for the black ink
 - **Sliding trap limit** — specifies the difference between the neutral densities of adjacent colors at which a trap adjusts (slides) from the darker side of a color edge toward the centerline. The lower the sliding trap limit, the more gradual the transition.



To choose In-RIP trapping options, you must have selected **PostScript 3** from the **Compatibility** list box under the **PostScript** tab in the **Print** dialog box.

To set inks for trapping

- 1 Click **File** ► **Print**.
- 2 Click the **Color** tab.
- 3 Enable the **Print composite** option.
- 4 Click the **Composite** tab.
- 5 Enable the **PostScript Level 3 In-RIP trapping** check box.
- 6 Click **Settings**.
- 7 In the **Type** column, select one of the following for each **color separation**:
 - **Transparent** — the selected ink doesn't get trapped, but anything beneath it does
 - **Neutral density** — the neutral density of the selected ink determines how it is treated

- **Opaque** — the selected ink is treated as opaque
- **Opaque ignore** — the selected ink doesn't get trapped nor does anything beneath it



To choose In-RIP trapping options, you must have selected **PostScript 3** from the **Compatibility** list box under the **PostScript** tab in the **Print** dialog box.

To select a trap color reduction

- 1 Click **File** ► **Print**.
- 2 Click the **Color** tab.
- 3 Enable the **Print composite** option.
- 4 Click the **Composite** tab.
- 5 Enable the **PostScript 3 In-RIP trapping** check box.
- 6 Click **Settings**.
- 7 Type a value in the **Trap color reduction** box.



A reduction value of 100% indicates no reduction, while a lower value reduces the neutral density.

Printing to film

You can set up a print job to produce negative images. An imagesetter produces images on film that may need to be produced as negatives depending on which printing device you are using. Consult your print service provider to determine whether you can produce images on film.

You can specify to print with the emulsion down. Printing with the emulsion down produces a backward image on desktop printers.

To print a negative

- 1 Click **File** ► **Print**.
- 2 Click the **Prepress** tab.
- 3 In the **Paper/film settings** area, enable the **Invert** check box.



Do not choose negative film if you are printing to a desktop printer.

To specify film with the emulsion down

- 1 Click **File** ► **Print**.
- 2 Click the **Prepress** tab.
- 3 In the **Paper/film settings** area, enable the **Mirror** check box.

Preparing banners for printing

You can add borders and grommet markers to prepare banners for printing. Grommets are rings or edge strips inserted into holes through thin material such as textile fabric or composite of carbon fiber. Strings or ropes can be inserted through the grommets to stretch a banner properly.

You can create a banner from the active page or from selected objects on the page.

Borders can be used in two ways. You can add a border to a design that has important graphic or text elements around the edges to prevent cutoffs in the final banner. Alternatively, you can add a border that can be folded before placing the grommets to make the banner edges sturdier.

CorelDRAW lets you add borders that have the page background color or a solid color of your choice. You can also stretch or mirror the document edges to add a border. You can specify the border size, which is the height of the area added to the top and bottom of the document and the width of the area placed to the right and left of the document.

You can specify the size and number of the grommet markers, and you can place them within the boundaries of the original page or in the border areas. In addition, you can specify the margin — the distance from the grommet edge to the page edge. Grommet markers can be placed in the corners or along the top, bottom, left and right edges of the design. With this placement method, you can specify the number of grommet markers to be added vertically and horizontally. You can also add grommet markers by specifying the approximate space between them.

CorelDRAW saves your changes to a new document, which can be sent for printing, leaving the original document unchanged.

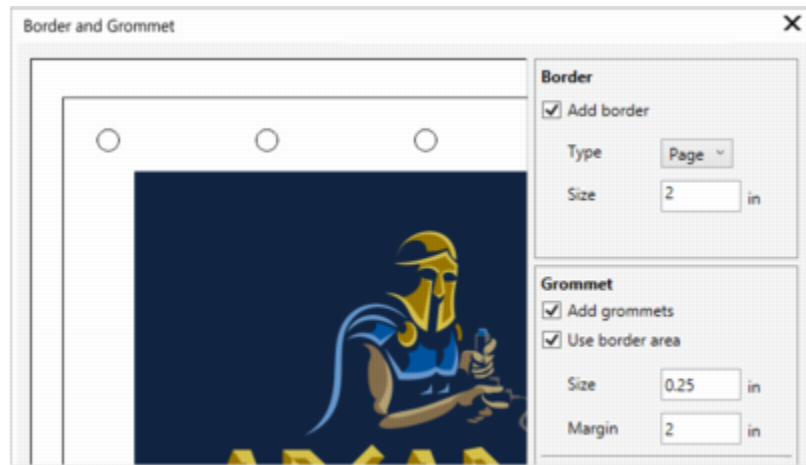

The Border and Grommet dialog box

To prepare a banner design for printing

- 1 Click **Tools** ► **Border and Grommet**.
- 2 Perform a task from the following table.

To

Add a border

Do the following

In the **Border** area, enable the **Add border** check box.

Add borders and grommet markers to a document based on the active page

In the **Source** area, enable the **Page** option.

Add borders and grommet markers to a document that includes only the selected object

In the **Source** area, enable the **Selection** option.

This option is unavailable if there are no selected objects on the page.

Choose a border type

In the **Border** area, choose an option from the **Type** list box:

- **Page** — uses the page background color

To	<p>Do the following</p> <ul style="list-style-type: none"> • Color — lets you select a solid color • Stretch — stretches the document edges to create a border • Mirror — mirrors the document edges to create a border
Set the border size	In the Border area, type a value in the Size box.
Add grommets	<p>Enable the Add grommets check box.</p> <p>If you want CorelDRAW to take into account the border area when placing grommet markers, enable the Use border area check box. Disabling this option places grommet markers within the boundaries of the original page.</p>
Set the grommet size	In the Grommet area, type a value in the Size box.
Set the distance from the grommet markers' edge to the closest page edge	In the Grommet area, type a value in the Margin box.
Specify the number and placement of grommet markers	<p>In the Placement and Distribution area, enable the Number of grommets option, and type values in the Vertical and Horizontal boxes.</p> <p>Click any of the following buttons:</p> <ul style="list-style-type: none"> • Corners — places the grommet markers in the page corners • Top — places the grommet markers along the top of the page • Bottom — places the grommet markers along the bottom of the page • Left — places the grommet markers along the left edge of the page • Right — places the grommet markers along the right edge of the page
Add grommet markers by specifying the space between them	In the Placement and Distribution area, enable the Spacing option, and type values in the Vertical and Horizontal boxes.

Working with a print service provider

When you send a file to a print service provider, the provider takes your file and converts it directly to film or to plates.

When you prepare a print job for printing, you can send camera-ready paper output or the work on disk. If you send the work on disk, the print service provider needs either a PostScript file or a native file from the application that you use. If you are creating a file to send to an [imagesetter](#) or a plate-setter, speak with the print service provider about the best file format and printing device settings to use. Always provide a final printout of the work to the print service provider, even if it is only a black-and-white representation. This helps the print service provider to identify and assess any potential problems.

Before printing a drawing, you must choose and properly configure the appropriate printing device driver. Consult the printing device manufacturer instructions, or the print service provider or printing shop that you use to print the work, to find out the best way to set up the printing device driver.

Web graphics

Creating objects for the web.....773

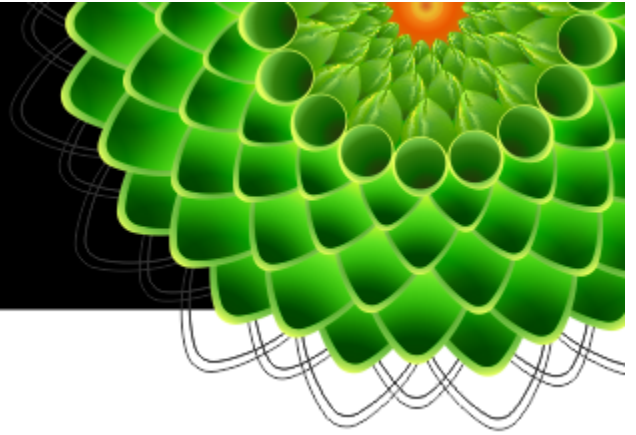

Creating objects for the web

CorelDRAW lets you export [objects](#) and projects to bitmaps that are optimized for viewing in a web browser. If you have WordPress accounts, you can export objects and projects to bitmaps and seamlessly upload these bitmaps to your WordPress media libraries. You can also make paragraph text web-compatible.

You can also create interactive [rollovers](#) from CorelDRAW objects. In addition, you can add hyperlinks and bookmarks to a drawing.

After creating the web-compatible object in CorelDRAW, you can add the object to a design using a web-authoring tool.

This section contains the following topics:

- “Exporting bitmaps for the web” (page 773)
- “Exporting and uploading bitmaps to WordPress” (page 780)
- “Saving and applying web presets” (page 780)
- “Exporting objects with transparent colors and backgrounds” (page 781)
- “Creating web-compatible text” (page 782)
- “Creating rollovers” (page 782)
- “Adding bookmarks and hyperlinks to documents” (page 784)
- “Adding hotspots and alternate text to objects” (page 786)

Exporting bitmaps for the web

CorelDRAW lets you export documents to the following web-compatible file formats: [GIF](#), [PNG](#), and [JPEG](#).

While specifying exporting options, you can preview an image with up to four different configurations of settings. You can compare file formats, preset settings, download speeds, compression, file size, image quality, and color range. You can also examine previews by [zooming](#) and [panning](#) within the preview windows.

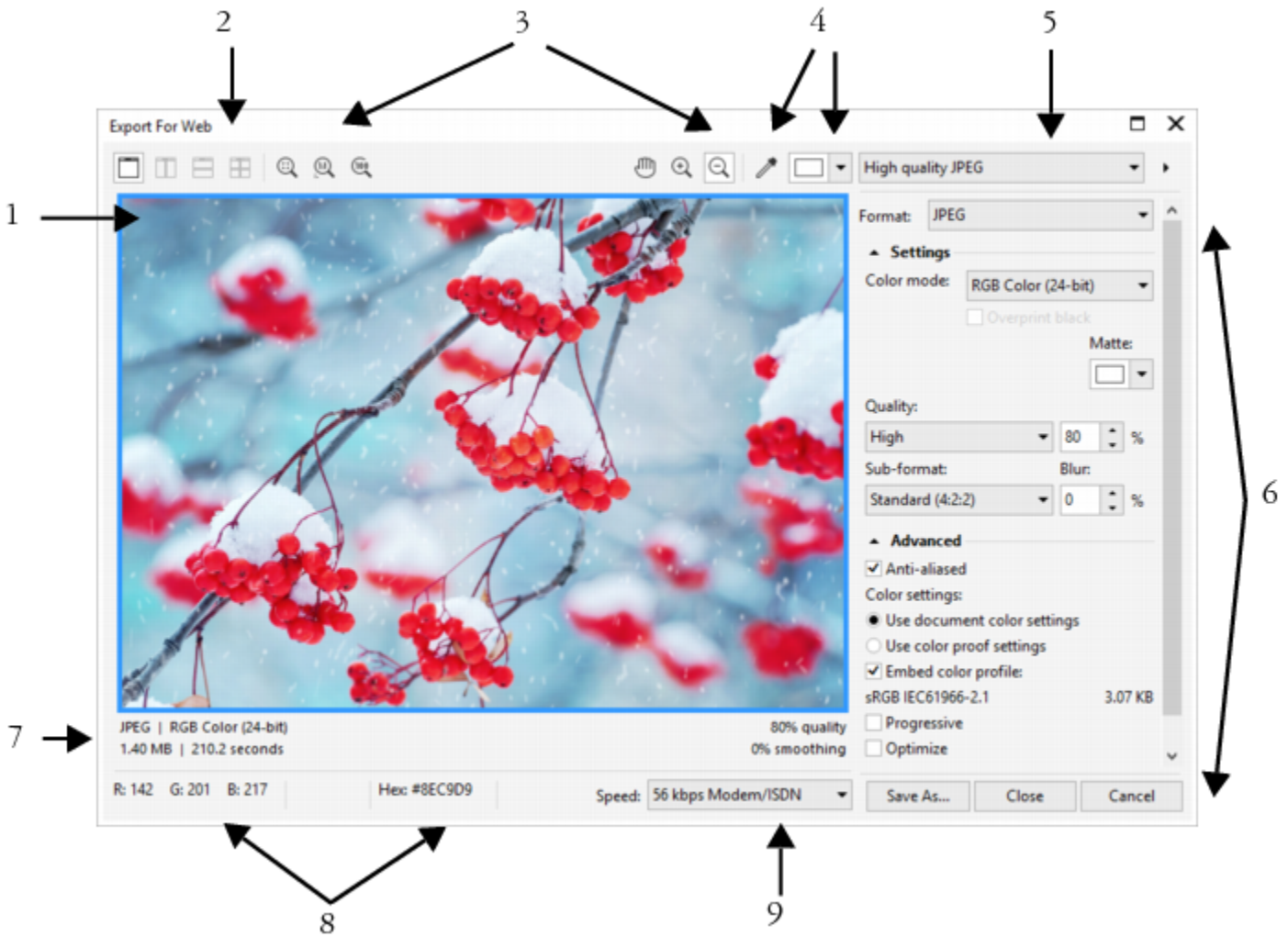

Component

1. Preview window

2. Preview modes

3. Zooming and panning tools

4. Eyedropper tool and sampled color swatch

5. Preset list box

Description

Displays a preview of the document.

Lets you preview the adjustments in a single or split frame.

Lets you zoom in and out of a document displayed in the preview window, pan an image displayed at zoom level higher than 100%, and fit an image in the preview window.

Lets you sample a color and display the sampled color.

Lets you choose preset settings for a file format.

Component	Description
6. Export settings	Lets you customize export setting, such as color, display options, and size.
7. Format information	Lets you view file-format information, which is available for each preview frame.
8. Color information	Displays the color values for a selected color.
9. Speed list box	Lets you choose an Internet speed for saving the file.

You can export web-compatible files using preset settings. This allows you to optimize the file, without the need to modify individual settings. You can also customize the settings to produce a specific result. For example, you can adjust its color, display quality, and file size.

Choosing a web-compatible file format

This table is a quick reference for choosing a web-compatible file format.

File format	Ideal for
GIF	Line drawings, text, images with few colors, or images with sharp edges, such as scanned black-and-white images or logos. GIF offers several advanced graphic options, including transparent backgrounds, interlaced images, and animation. It also lets you create custom palettes for the image.
PNG	Various image types, including photos and line drawings. The PNG file format (unlike the GIF and JPEG formats) supports the alpha channel. This allows you to save transparent images with superior results.
JPEG	Photos and scanned images. JPEG files use file compression to store an approximation of an image, which results in some loss of image data, but does not compromise the quality of most photographs. You can choose the image quality when you save an image — the higher the image quality, the larger the file size.

Exporting palette-based documents

Palette-based documents, such as paletted GIF and 8-bit PNG, allow individual pixels to retain their exact color value. This lets you control the display of colors in the file when exporting. Palette-based documents also allow you to introduce transparency to a file by choosing a color in the image and making it transparent. For information, see [“Exporting objects with transparent colors and backgrounds” on page 781](#).

To adjust the object-export preview

- 1 Click **File** ► **Export for** ► **Web**.
- 2 Perform one or more tasks from the following table.

To

View the bitmap in a single preview frame

View two versions of the bitmap in side-by-side frames

View the two versions of the bitmap with one frame placed above the other

View four versions of the bitmap in separate frames

Fit a bitmap in the preview window

Display each pixel in the image data to a single pixel on-screen

Display a bitmap at its actual size

Pan to another area of the bitmap

Zoom in and out

Change the display options for the object in a preview frame

Do the following

Click the **Full preview** button  on the **View** toolbar.

Click the **Two vertical previews** button .

Click the **Two horizontal previews** button .



Click the **Four previews** button .

Click the **Zoom to fit** button .

Click the **Zoom 1:1 pixel** button .

Click the **Zoom to actual size** button .

Using the **Pan** tool , drag the image until the area you want to see is visible.

Using the **Zoom in** tool  or **Zoom out** tool , click in the preview window.

Click a frame, then choose different export settings from the export settings area.

To export a web-compatible bitmap

- 1 Click **File** ► **Export for** ► **Web**.
- 2 In the **Export for web** dialog box, choose preset settings from the **Preset** list box in the upper-right corner of the dialog box. If you want modify the preset settings, you can change the exporting options in the dialog box.
- 3 Click **Save as**.
- 4 Choose the drive and folder where you want to save the file.
- 5 Type a name in the **File name** box.
- 6 Click **Save**.

You can also

Choose a color mode

In the **Settings** area, choose a color mode from the **Color mode** list box.

You can also

This option is unavailable for the GIF file format.

Embed the color profile

In the **Advanced** area, enable the **Embed color profile** check box.



You can also export to a web-compatible format by clicking **File** ► **Export**, and choosing a file format from the **Save as type** list box.

You can choose an Internet connection speed from the **Speed** list box at the bottom of the dialog box.

To resize an object when exporting a web-compatible bitmap

- In the **Export for web** dialog box, perform one or more tasks from the following table.

To	Do the following
Choose a unit of measurement for the bitmap	In the Transformation area, choose a unit of measurement from the Units list box.
Specify the bitmap dimensions	In the Transformation area, type values in the Width and Height boxes.
Resize the bitmap to a percentage of its original size	In the Transformation area, type values in the Width % and Height % boxes.
Avoid distortion by maintaining the width-to-height ratio of the bitmap	In the Transformation area, enable the Maintain aspect ratio check box.
Specify the bitmap resolution	In the Transformation area, type a value in the Resolution box.
Maintain the size of the file on your hard disk when you change the resolution of the bitmap	In the Transformation area, enable the Maintain size check box.

To customize options for exporting a JPEG bitmap

- 1 In the **Export for web** dialog box, choose **JPEG** from the **Format** list box.
- 2 Perform one or more tasks from the following table.

To	Do the following
Control document quality	In the Settings area, choose a quality option from the Quality list box, or type a percentage value.
Choose an encoding setting	In the Settings area, choose an option from the Sub-format list box.
Blur the transition between adjacent pixels of different colors	In the Settings area, type a value in the Blur box.

To	Do the following
Load the JPEG file gradually in certain web browsers to display only portions of the image before it finishes loading	In the Advanced area, enable the Progressive check box.
Use the optimal encoding method to produce the smallest JPEG file size	In the Advanced area, enable the Optimize check box.
You can also	
Apply the document-color settings	In the Advanced area, enable the Use document color settings option.
Apply the color-proof settings to the document	In the Advanced area, enable the Use color proof settings option.
Enable the overprinting of black when exporting to CMYK	In the Settings area, enable the Overprint black check box.
Apply a matte color to the object's background to help blend the edges of anti-aliased objects	In the Settings area, open the Matte color picker, and click a color.

To specify display-quality options for exporting web-compatible bitmaps

- In the **Export for web** dialog box, perform one or more tasks from the following table.

To	Do the following
Apply a matte color to the object's background to help blend the edges of anti-aliased objects	In the Settings area, open the Matte color picker, and click a color.
Smooth the edges of the object	In the Advanced area, enable the Anti-aliased check box.
Load the file gradually in certain web browsers to display only portions of the image before it finishes loading	In the Advanced area, enable the Interlaced check box. This option is unavailable for the JPEG file format.

To specify color settings for exporting palette-based web-compatible bitmap

- In the **Export for web** dialog box, perform one or more tasks from the following table.

To	Do the following
Choose a color mode	In the Settings area, choose a color mode from the Color mode list box. This option is unavailable for the GIF file format.
Choose a color palette	In the Settings area, choose a palette from the Color palette list box.

To

Do the following

This option is only available for the PNG file format in the Paletted (8-bit) color mode.

Specify a dithering setting and amount

In the **Settings** area, choose a dithering option from the **Dithering** list box, and type a value in the box.

This option is only available for the PNG file format in the Paletted (8-bit) color mode.

Embed the color profile

In the **Advanced** area, enable the **Embed color profile** check box.

You can also

Load a color palette

In the **Settings** area, click the arrow next to **Color palette** list box, and click **Load palette**.

This option is only available for the PNG file format in the Paletted (8-bit) color mode.

Sample a color and add it to a color palette

Click the **Eyedropper** on the toolbar, and then click in the drawing window to choose a color. In the **Settings** area, click the **Add the sampled color to palette** button .

This option is only available for the PNG file format in the Paletted (8-bit) color mode.

Add or modify colors

Double-click a color swatch on the color palette.

This option is only available for the PNG file format in the Paletted (8-bit) color mode.

Choose the number of colors that you want to display

In the **Settings** area, choose a value from the **Number of colors** list box.

This option is only available for the PNG file format in the Paletted (8-bit) color mode.

Delete a color from the color palette

In the **Settings** area, click a color on the color palette, and then click the **Delete the selected color** button.

This option is only available for the PNG file format in the Paletted (8-bit) color mode.



You can also add transparency to a palette-based document by choosing a color in the image and making it transparent. For information, see [“Exporting objects with transparent colors and backgrounds” on page 781](#).

Exporting and uploading bitmaps to WordPress

With CorelDRAW, you can export your projects to bitmap images suitable for WordPress and then upload them to your WordPress account without leaving the application.

You can export your entire project or only selected objects to a JPEG, GIF, or PNG file. After choosing the file format and options you want, you can upload the image to your WordPress account. If you have multiple WordPress sites, you can choose to which site to upload the bitmap. The exported bitmap is added to the media library of the selected site.

When you upload bitmaps to WordPress for the first time, you must authenticate your WordPress account and log in. If you have more than one WordPress account, you can switch accounts at any time.

To export and upload a bitmap to WordPress

- 1 Select the objects that you want to export, or deselect all objects to export the entire project.
- 2 Click **File** ► **Export For** ► **WordPress**.
- 3 In the **Export for WordPress** dialog box, choose the file format you want from the **Format** list box, and adjust any export settings you want.
The **Export for WordPress** dialog box lets you access the same export options that are available in the **Export for Web** dialog box. For detailed information about export options, see [“Exporting bitmaps for the web” on page 773](#).
- 4 Click **Upload**.
- 5 In the **Upload to WordPress** dialog box, perform one or more tasks from the following table.

To	Do the following
Authenticate your WordPress account and log in	Click Authenticate your WordPress account.
Choose a WordPress site	Choose a site from the Site box.
Upload the bitmap	Click Upload .
Log in to another WordPress account	Click Log out or switch accounts .



The exported bitmap is saved to a temporary file, which is deleted after you upload the image to WordPress.

Saving and applying web presets

Web presets allow you to save custom settings for exporting web-compatible file formats.

To save a preset for exporting web-compatible images

- 1 In the **Export for web** dialog box, choose a file format from the **Format** list box.
- 2 Choose the settings that you want to store as a preset.
- 3 Click the arrow next to the **Preset** list box, and click **Save preset**.
- 4 Type the name of the preset in the **File name** box.
- 5 Click **Save**.



You can delete a saved preset by choosing a preset from the **Preset** list box, clicking the arrow next to the **Preset** list box, and clicking **Delete preset**.

To apply a preset for exporting web-compatible images

- 1 In the **Export for web** dialog box, click the arrow next to the **Preset** list box, and click **Load preset**.
- 2 Click the name of the file.
- 3 Click **Open**.

Exporting objects with transparent colors and backgrounds

CorelDRAW lets you export palette-based bitmaps, such as paletted GIF or 8-bit PNG, with **transparent** colors and backgrounds. These bitmaps can contain objects, such as buttons and logos, which are commonly used on webpages with colored or patterned backgrounds.

If you place an object with an **opaque** background onto a webpage, the object background color appears as a rectangle on the page. By making an object background transparent, the object background blends in with the page. Transparent object backgrounds also let you change the color or pattern of a webpage background without having to change the backgrounds of the objects to match.

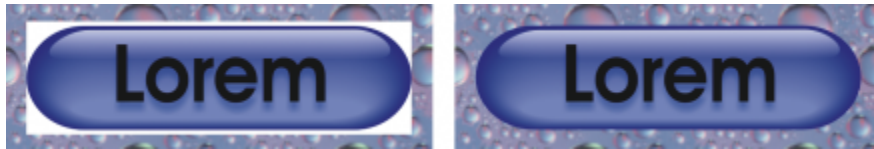

You can create a GIF with a transparent background to use on a webpage.

To save a bitmap with a transparent background

- 1 In the **Export for web** dialog box, choose a paletted file format, such as GIF or Paletted 8-bit PNG, from the **Format** list box.
- 2 Perform one or more tasks from the following table.

To	Do the following
Make the background of the object transparent	In the Settings area, enable the Transparency check box.
Make a selected color transparent	Click the Eyedropper on the toolbar, and then click the image to choose a color. In the Settings area, click the Make the selected color transparent button  .
Apply a matte color to the object's background to help blend the edges of anti-aliased objects	In the Settings area, open the Matte color picker, and click a color.



For best results, choose **None** from the **Dithering** list box in the **Settings** area.

Creating web-compatible text

When you convert paragraph text to web-compatible text, you can edit the text of the published document in an HTML editor. The default web font style is used automatically unless you override it with another font. If you choose to override it, the default font is used when visitors to your website don't have the same font installed on their computers. The bold, italic, and underline text styles are also available. You can apply **uniform fills**, but not **outlines**, to web-compatible text.

To make text web-compatible

To

Do the following

Change **paragraph** text to web-compatible text

Using the Pick tool , select the paragraph text frame. Click **Text** ► **Make text web compatible**.

Make new text web-compatible

Click **Tools** ► **Options**. In the list of categories, double-click **Workspace**, **Text**, and click **Paragraph**. Enable the **Make all new paragraph text frames web compatible** check box.



Ensure that the web-compatible text does not intersect or overlap other **objects** or extend beyond the boundaries of the drawing page; otherwise the text will be converted to a **bitmap**, and it will lose its Internet properties.

Artistic text cannot be converted to web-compatible text and is always treated as a bitmap. However, you can convert it to paragraph text and then make it web compatible. For information on converting text, see ["Finding, editing, and converting text"](#) on page 486.

Creating rollovers

Rollovers are interactive **objects** that change in appearance when you click or point to them. You can create rollovers using objects.

To create a rollover, you add the following rollover states:

- **Normal** — the default state of a button when no mouse activity is associated with the button
- **Over** — the state of a button when the pointer passes over it
- **Down** — the state of a clicked button

You can apply different object properties to each of the rollover states. You can also preview the rollover states.

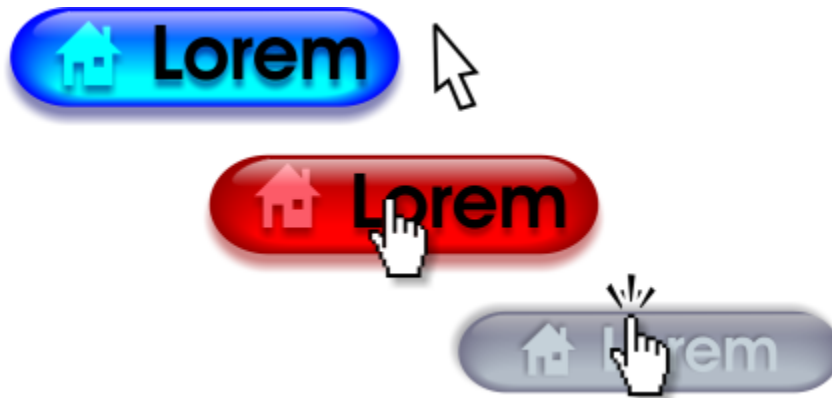



Rollovers showing Normal (left), Over (center), and Down (right) states

To add a rollover object to a web design, you must save the rollover to a the Macromedia Flash (SWF) format. For more information about creating and editing objects such as rollovers, see “Working with objects” on page 253.

To create a rollover object

- 1 Select an [object](#).
- 2 Click **Effects** ▶ **Rollover** ▶ **Create rollover**.

To modify an object’s rollover state

- 1 Click **Window** ▶ **Toolbars** ▶ **Internet**.
The **Internet** toolbar appears.
- 2 Click the rollover object to select it.
- 3 On the **Internet** toolbar, click the **Edit rollover** button .
- 4 From the **Active rollover state** list box, choose a state:
 - **Normal**
 - **Over**
 - **Down**
- 5 Modify the object properties, such as the color.
- 6 Click the **Finish editing rollover** button .

You can also

Delete a rollover state

On the **Internet** toolbar, click the **Delete rollover state** button



Duplicate a rollover state

On the **Internet** toolbar, click the **Duplicate rollover state** button



Undo a rollover

On the **Internet** toolbar, click the **Extract rollover objects** button



You can also

Specify what frame appears when the rollover is clicked

On the **Internet** toolbar, choose a target frame from the **Target frame** list box.





You cannot close a drawing in which you are editing a **rollover**. You must finish editing first.

To view rollover properties

- 1 Click **Window** ► **Dockers** ► **Object manager**.
- 2 Click the page and layer where the **rollover** resides.
- 3 Click the rollover name, and expand the **Normal**, **Over**, and **Down** states.



You can preview a **rollover** object's states in the drawing page by clicking the **Rollover live preview** button  on the **Internet** toolbar. To quit previewing the rollover so that you can edit it, click the **Rollover live preview** button . You cannot undo while previewing a rollover.

Adding bookmarks and hyperlinks to documents

CorelDRAW lets you add **bookmarks** and **hyperlinks** to your document. You can apply these to objects, including text objects, rollovers, and **bitmaps**. For information, see “Including hyperlinks, bookmarks, and thumbnails in PDF files” on page 798.

Bookmarks

To create an internal link within a file, you can assign a bookmark to text or to an object. You can then assign a link to an object so that, when it's clicked, it opens the bookmark.

Hyperlinks

You can also assign a **hyperlink** to an object. You can link to a web address, FTP server, email address, bookmark, or file. When the object is clicked, it opens to the assigned location in a appropriate application. After you create **hyperlinks**, you can display and verify them. You can also delete links and bookmarks. When working with text, you can assign a **hyperlink** to both artistic and paragraph text.

To assign a bookmark

- 1 Click **Window** ► **Dockers** ► **Links and bookmarks**.
- 2 In the workspace, click the **object** that you want to bookmark.
- 3 Click the **New bookmark** button .
- 4 Type the name of the **bookmark** in the name box.

To assign a hyperlink to an object

- 1 Click **Window** ► **Dockers** ► **Links and bookmarks**.
- 2 In the workspace, click the **object** to which you want to apply a hyperlink.
- 3 Click the **New link** button .
- 4 From the **Link type** list box, choose one of the following link types:

Link types

http:// or https://

Type a web address, or **URL**, for a webpage that opens when you click the **link**.

ftp://

Type a web address, or **URL**, to the FTP server that opens when you click the link.

mailto:

Type an email address.

file://

Click the browse button and navigate to the file that you want to open when you click the link.

bookmark

Choose a previously created bookmark from the list.



You can also assign a bookmark from the Object properties docker by clicking **Window** ► **Dockers** ► **Object properties** to open the docker, and then clicking the **Internet** button.

To assign a hyperlink to text

- 1 Click **Window** ► **Dockers** ► **Links and bookmarks**.
- 2 Using the **Text** tool **A**, select the text characters to which you want to assign a hyperlink.
- 3 Click the **New link** button .
- 4 From the **Link type** list box, choose one of the following link types:

Link types

http:// or https://

Type a web address, or **URL**, for a webpage that opens when you click the **link**.

ftp://

Type a web address, or **URL**, to the FTP server that opens when you click the link.

mailto:

Type an email address.

file://

Click the browse button and navigate to the file that you want to open when you click the link.

bookmark

Choose a previously created bookmark from the list.



You can also assign a hyperlink from the **Internet** toolbar by clicking **Window** ► **Toolbars** ► **Internet** to display the toolbar.

To verify a link

- 1 Click **Window** ► **Dockers** ► **Links and bookmarks**.
- 2 Choose the link that you want to open.
- 3 Click the **Open link** button .



To delete a bookmark or link

- 1 Click **Window** ► **Dockers** ► **Links and bookmarks**.
- 2 Choose the link or bookmark that you want to delete.
- 3 Click the **Delete** button .

Adding hotspots and alternate text to objects

You can also set a hotspot that follows the outline of the object, or fills the object's bounding box. CorelDRAW applies a crosshatch pattern to an object containing a link. You can change the color of the crosshatch pattern as well as its background fill. In addition, you can add alternate text to objects for text-only browsers or screen readers.

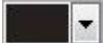
To set a hotspot

- 1 Click **Window** ► **Dockers** ► **Internet**.
- 2 In the workspace, click the [object](#) to which you want to add a hotspot.
- 3 In the **Internet** docker, choose **Link** from the **Behavior** list box, and type a web address in the **URL** box.
- 4 In the **Define hotspot using** area, click one of the following buttons:
 - **Shape** — defines the hotspot using the object's shape
 - **Bounds** — defines the hotspot using the object's bounding box
- 5 Open the **Background** color picker , and click a color.
- 6 Open the **Cross-hatch** color picker , and click a color.



If you choose a [hyperlinked](#) object first and then change the crosshatch and background [hotspot](#) colors, the change applies to the selected object only.

To add alternate text to an object

- 1 Click **Window** ► **Dockers** ► **Internet**.
- 2 In the workspace, click the linked [object](#) to which you want to add alternate text.
- 3 In the **Internet** docker, type the alternate text in the **Alt comments** text box.

File formats

Importing and exporting files.....	789
Exporting to PDF.....	795
Working with office productivity applications.....	809
Supported file formats.....	811

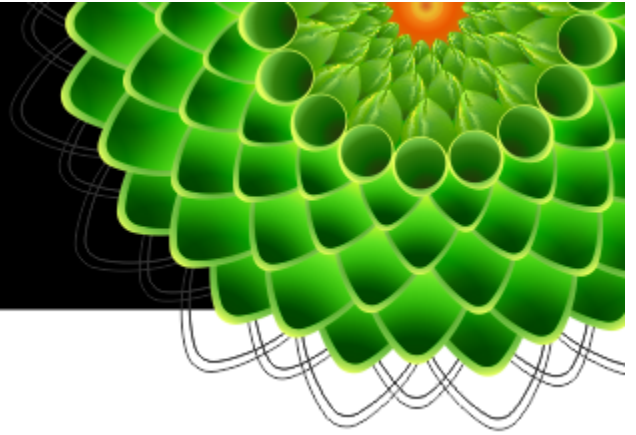

Importing and exporting files

Your application provides filters that convert files from one format to another when you import or export files.

This section contains the following topics:

- “Importing files” (page 789)
- “Exporting files” (page 792)

Importing files

You can import files created in other applications. For example, you can import an Adobe Portable Document Format (PDF), JPEG, or Adobe Illustrator (AI) file. You can import a file and place it in the active application window as an **object**. You can also resize and center a file as you import it. The imported file becomes part of the active file. You can also import a bitmap as an externally linked image. When you import a linked bitmap, edits to the original (external) file are automatically updated in the imported file.

While importing a **bitmap**, you can **resample** it to reduce the file size, or **crop** it to eliminate unused areas of the image. You can also **crop** a bitmap to select only the exact area and size of the image that you want to import.

When you import a file from an earlier version of CorelDRAW that contains text in a language different from the language of your operating system, you can use **code page** settings to ensure that object names, keywords, and notes saved with the file are displayed correctly.

To import a file into an active drawing

- 1 Click **File** ► **Import**.
- 2 Choose the folder where the file is stored.
If necessary, you can search for a file by using the search box. You can search for such things as file name, title, subject, author, keyword, comment, bitmap name, object name, and so on.
- 3 Choose a file format from the list box next to the **File name** box.
If you don't know the file's format, choose **All file formats**.
- 4 Click the file name.
If the file contains text in a language different from that of your operating system, choose the corresponding option from the **Select code page** list box to ensure that object names, keywords, and notes are correctly displayed.
These options are not available for all file formats.
- 5 Click **Import**, and do one of the following:
 - Click the drawing page to maintain the dimensions of the file and position its top-left corner where you click.

- Drag on the drawing page to resize the file. The import cursor displays the dimensions of the resized file as you drag on the drawing page.
- Press **Enter** to center the file on the drawing page.
- Press the **Spacebar** to place the file in the same position as it was in the original file (CDR and AI files only).

Active snapping options are applied to the imported file.

You can also

Link to a bitmap externally instead of embedding it

Click the arrow on the **Import** button, and then click **Import as externally linked image** check box.

If you want to display a list of the linked images, click **Window ▶ Links and bookmarks**.

Link to a high-resolution file for Open Prepress Interface (OPI) output

Click the arrow on the **Import** button, and then click **Import as high-resolution file for output using OPI** check box.

This procedure inserts a low-resolution version of a TIFF or Scitex® Continuous Tone (CT) file into a document. The low-resolution version is linked to the high-resolution image, which resides on an Open Prepress Interface (OPI) server.

Merge layers in an imported bitmap

Enable the **Combine multi-layer bitmap** check box.

Save the embedded [International Color Consortium \(ICC\)](#) profile

Enable the **Extract embedded ICC profile** check box to save the ICC profile to the color folder where the application is installed.

This option is not available for all file formats.

Check for watermark or copyright information

Enable the **Check for watermark** check box.

This option is not available for all file formats.

Use the default settings for the [filter](#) instead of opening the dialog box

Enable the **Do not show filter dialog** check box.

This option is not available for all file formats.

Preserve layers and pages in an imported file

Enable the **Maintain layers and pages** check box. If you disable the check box, all layers are combined into a single layer.

This option is not available for all file formats.

Select the pages to import when importing multi-page TIFF documents

In the **Import TIFF** dialog box, enable an option in the **Select the page(s) to import** area.

This option is available only for the TIFF file format.

Open only part of an image

In the **Load partial file** dialog box, type the range of frames to open in the **Load frames** box.



Not all importing options are available for all file formats.



You can import multiple files. Hold down **Shift** and click to select consecutive files in a list. Hold down **Ctrl** and click to select non-consecutive files.

To import a bitmap as an externally linked image

- 1 Click **Window** ► **Dockers** ► **Links and bookmarks**.
- 2 In the **Links and bookmarks** docker, click the **New linked image** button.
- 3 Browse to the drive and folder where the image is stored.
- 4 Click **Import**.
- 5 Click in the workspace to place the image.

You can also

Update a linked image

Click the **Update linked image** button.

Break the link to an externally linked image

Click the **Break link** button.

To resample a bitmap while importing

- 1 Click **File** ► **Import**.
- 2 Choose the folder where the image is stored.
If necessary, you can search for an image by using the search box. You can search for such things as file name, title, subject, author, keyword, comment, bitmap name, object name, and so on.
- 3 Choose a file format from the list box beside the **File name** box.
If you don't know the file's format, choose **All file formats**.
- 4 Click the file name.
- 5 Click the arrow next to the **Import** button, and then click **Resample and load**.
- 6 In the **Resample image** dialog box, type values in any of the following boxes:
 - **Width** — specifies the width of the graphic in a chosen unit of measure or as a percentage of its original width
 - **Height** — specifies the height of the graphic in a chosen unit of measure or as a percentage of its original height
- 7 In the **Resolution** area, type values in the following boxes:
 - **Horizontal** — lets you specify the horizontal resolution of the graphic in pixels or dots per inch (dpi)
 - **Vertical** — lets you specify the vertical resolution of the graphic in pixels or dots per inch (dpi)
- 8 Click the drawing page.

You can also

Maintain the width-to-height ratio of the image

Enable the **Maintain aspect ratio** check box.

Change the unit of measure

Choose a unit type from the **Units** list box.

You can also

Maintain equal horizontal and vertical resolution values automatically

Enable the **Identical values** check box.



If a dialog box for the import format opens, specify the options you want. For detailed information about file formats, see [“Supported file formats” on page 811](#).

Not all importing options are available for all file formats.

To crop a bitmap while importing

- 1 Click **File** ► **Import**.
- 2 Choose the folder where the image is stored.
If necessary, you can search for an image by using the search box. You can search for such things as file name, title, subject, author, keyword, comment, bitmap name, object name, and so on.
- 3 Choose a file format from the list box beside the **File name** box.
If you don't know the file's format, choose **All file formats**.
- 4 Click the file name.
- 5 Click the arrow next to the **Import** button, and click **Crop and load**.
- 6 In the **Crop image** dialog box, type values in any of the following boxes:
 - **Top** — specifies the area to remove from the top of the graphic
 - **Left** — specifies the area to remove from the left edge of the graphic
 - **Width** — specifies the width of the graphic that you want to keep
 - **Height** — specifies the height of the graphic that you want to keep
- 7 Click the drawing page.



You can also resize a graphic by dragging the selection [handles](#) in the preview window.

You can change the unit of measure by choosing a unit type from the **Units** list box in the **Crop image** dialog box.

Exporting files

You can use the **File** ► **Export** command to export files to a variety of bitmap and vector file formats that can be used in other applications. For example, you can export a file to the Adobe Illustrator (AI) or **JPG** format. You can also export a file so that it is optimized for use with a suite of office productivity applications, such as Microsoft Office or Corel WordPerfect Office.

When you are exporting a file, the original file is left open in the drawing window in its existing format.

You can use the **File** ► **Save as** command to save files to various vector formats. After you save a file to a different format, the saved file is displayed immediately in the drawing window. It is recommended that you first save the file as a CorelDRAW (CDR) file because some file formats do not support all of the features found in a CorelDRAW file.

To export a file

- 1 Click **File** ► **Export**.
- 2 Choose the folder where you want to save the file.
- 3 Choose a file format from the **Save as type** list box.

- 4 Type a file name in the **File name** list box.
- 5 Enable any of the following check boxes:
 - **Export this page only** — exports only the current page in a multipage file
 - **Selected only** — saves only the objects selected in the active drawing
 - **Do not show filter dialog** — suppresses dialog boxes that offer more advanced exporting options
 These options are not available for all file formats.

- 6 Click **Export**.

If a dialog box for the export format opens, specify the options you want. For detailed information about file formats, see [“Supported file formats” on page 811](#).

You can also

Compress a file on export

Choose a compression type from the **Compression type** list box.

Specify information about a file

Type any comments you want in the **Notes** box.



Not all of the options or compression types in the **Export** dialog box are available for all file formats. Objects on a hidden layer are displayed in the exported file unless the printing and exporting function for the hidden layer is disabled. For information about the options available when you export to a bitmap file format, see [“To convert a vector graphic to a bitmap when exporting” on page 632](#).

If you are using an expired trial version, you will not be able to export files.



You can specify which layers will appear in the exported file. For more information, see [“To enable or disable printing and exporting of a layer” on page 320](#).



To export a file to Microsoft Office or WordPerfect Office

- 1 Click **File** ► **Export for** ► **Office**.
- 2 From the **Export to** list box, choose one of the following:
 - **Microsoft Office** — lets you set options to meet the output requirements of Microsoft Office applications
 - **WordPerfect Office** — optimizes the image for Corel WordPerfect Office by converting it to a WordPerfect Graphics file (WPG)
- 3 If you chose **Microsoft Office**, choose one of the following options from the **Graphic should be best suited for** list box:
 - **Compatibility** — lets you save the drawing as a Portable Network Graphic (PNG) bitmap. This preserves the appearance of the drawing when you import it into an office application.
 - **Editing** — lets you save the drawing in the Extended Metafile Format (EMF). This retains most of the editable elements in vector drawings.
- 4 If you chose **Microsoft Office** and **Compatibility**, choose one of the following options from the **Optimized for** list box:
 - **Presentation** — lets you optimize the file for outputs such as slide shows or online documents (96 dpi)
 - **Desktop printing** — lets you maintain good image quality for desktop printing (150 dpi)
 - **Commercial printing** — lets you optimize the file for high-quality printing (300 dpi)
 An estimated file size appears in the lower-left corner of the dialog box.
- 5 Click **OK**.
- 6 Locate the folder in which you want to save the file.

- 7 Type a file name in the **File name** list box.
- 8 Click **Save**.

You can also

Zoom in and out in the preview window

Using the **Zoom in**  or **Zoom out**  tool, click in the preview window.

Pan to view another area of the drawing

Using the **Pan** tool , drag in the preview window until the area that you want to see becomes visible.



The **Graphic should be best suited for** and **Optimized for** options are available only if you choose the **Microsoft Office** and **Compatibility** options.

Layers in a drawing are flattened when exported to Microsoft Office or Corel WordPerfect Office.

To save a file to a different format

- 1 Click **File** ► **Save as**.
- 2 Choose the folder where you want to save the file.
- 3 Choose a file format from the **Save as type** list box.
- 4 Type a file name in the **File name** list box.
- 5 Enable any of the following check boxes:
 - **Selected only** — saves only the **objects** selected in the active drawing
 - **Save with embedded VBA project** — lets you save, with the file, macros you have created in the VBA editorThese options are not available for all file formats.
- 6 Click **Save**.

You can also

Specify information about a file

Type any comments you want in the **Add comments** box.

Add keywords

Type any keywords you want in the **Add a tag** box.

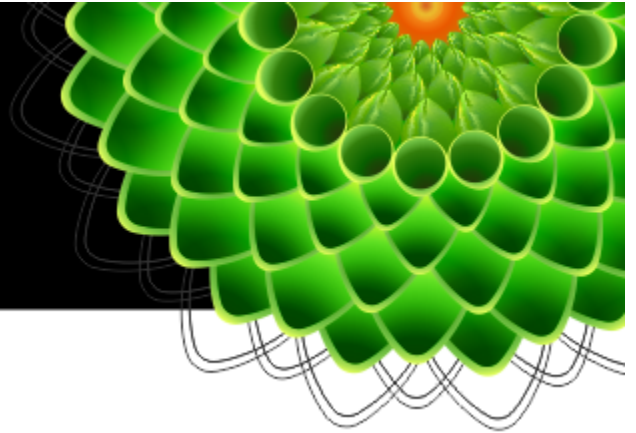

Exporting to PDF

PDF is a file format designed to preserve [fonts](#), images, graphics, and formatting of an original application file.

This section contains the following topics:

- [“Exporting documents as PDF files”](#) (page 795)
- [“Including hyperlinks, bookmarks, and thumbnails in PDF files”](#) (page 798)
- [“Reducing the size of PDF files”](#) (page 798)
- [“Working with text and fonts in PDF files”](#) (page 799)
- [“Specifying an encoding format for PDF files”](#) (page 801)
- [“Specifying a viewing option for EPS files”](#) (page 801)
- [“Specifying color management options for exporting PDF files”](#) (page 802)
- [“Setting security options for PDF files”](#) (page 803)
- [“Optimizing PDF files”](#) (page 804)
- [“Viewing preflight summaries for PDF files”](#) (page 805)
- [“Preparing PDF files for a print provider”](#) (page 806)

Exporting documents as PDF files

You can export a document as a PDF file. A PDF file can be viewed, shared, and printed on any platform provided that users have Adobe Acrobat, Adobe Reader, or a PDF-compatible reader installed on their computers. A PDF file can also be uploaded to an intranet or the web. You can also export an individual selection or an entire document to a PDF file.

When you export a document as a PDF file, you can choose from several PDF presets, which apply specific settings. For example, with the **Web** preset, the [resolution](#) of the images in the PDF file is optimized for the web.

You can also create a new PDF preset or edit any existing preset. PDF file security settings are not saved with a PDF preset. For information about PDF file security options, see [“Setting security options for PDF files”](#) on page 803.

If you have used symbols in a document, they will be supported in the PDF file. For more information on symbols, see [“Working with symbols”](#) on page 325.

To export a document as a PDF file

- 1 Click **File** ► **Publish to PDF**.

You can also save a PDF file by clicking the **Publish to PDF** button  on the **Standard** toolbar.

- 2 Locate the folder in which you want to save the file.
- 3 Type a filename in the **File name** box.
- 4 Choose one of the following options from the **PDF preset** list box:
 - **Archiving (CMYK)** — creates a PDF/A-1b file, which is suitable for archiving purposes. In comparison to traditional PDF files, PDF/A-1b files are better suited for long-term preservation of documents because they are more self-contained and more device-independent. PDF/A-1b files include embedded fonts, device-independent color, and their own description as XMP metadata. This PDF style preserves any spot or Lab colors included in the original document, but it converts all other colors, such as grayscale or RGB, to the CMYK color mode. In addition, this style embeds a color profile to specify how CMYK colors should be interpreted on the rendering device.
 - **Archiving (RGB)** — similarly to the previous style, creates a PDF/A-1b file, preserving any spot and Lab colors. All other colors are converted to the RGB color mode.
 - **Current proof settings** — applies the proofing color profile to the PDF
 - **Document distribution** — creates a PDF file that can be printed on a laser or desktop printer and is suitable for general document delivery. This style enables **JPEG** bitmap image compression and can include bookmarks and hyperlinks.
 - **Editing** — creates a high-quality PDF file intended to be sent to a printer or digital copier. This style enables **LZW** compression, embeds fonts, and includes hyperlinks, bookmarks, and thumbnails. It displays the PDF file with all the fonts, with all of the images at full resolution, and with hyperlinks, so that you can edit the file at a later date.
 - **PDF/X-1a** — enables **ZIP** bitmap image compression, converts all objects to the destination CMYK color space
 - **PDF/X-3** — This style is a superset of PDF/X-1a. It allows both CMYK and non-CMYK data (such as Lab or Grayscale) in the PDF file.
 - **Prepress** — enables **ZIP** bitmap image compression, embeds fonts, and preserves spot color options best designed for high-end quality printing. Before preparing a PDF file for printing, it's always best to consult your print provider to find out which settings are recommended.
 - **Web** — creates a PDF file intended for online viewing, such as a PDF file to be distributed by email or published on the web. This style enables **JPEG** bitmap image compression, compresses text, and includes hyperlinks.
- 5 Click **Settings**.
The **PDF settings** dialog box appears.
- 6 In the **Export range** area, enable one of the following options:
 - **Current document** — exports the current document
 - **Documents** — exports the documents that you specify
 - **Selection** — exports the objects that you have selected
 - **Current page** — exports the active page
 - **Pages** — exports the pages that you specify
- 7 In the **Page size** area, choose one of the following options:
 - **As defined in CorelDRAW** — applies the page size that is defined in the document
 - **Set by the selected objects** — allows the page size to be determined by the size of the objects on the page
- 8 Click **OK**.
- 9 Click **Save**.



If you want to create a PDF file for archiving purposes that conforms to the PDF/A-1b standards, embedding must be allowed for all the fonts in your document. To check for fonts that cannot be embedded, view the preflight summary of the PDF file. For more information about viewing summaries, see [“To view the preflight summary for a PDF file” on page 805](#). You can substitute any fonts that cannot be embedded, or you can convert all text to curves by enabling the **Export all text as curves** check box on the **Objects** page of the **Publish to PDF settings** dialog box.

If the document contains a 3D model, click **Settings** in the **Publish to PDF** dialog box, and choose **Acrobat 8.0** or higher from the **Compatibility** list box to ensure that the 3D model is interactive in PDF readers.

To check if a font can be embedded, you can view licensing information and embedding restrictions by using a free tool, such as the **Font properties** extension tool available on the Microsoft website.

To export multiple documents as a single PDF file

- 1 Click **File** ► **Publish to PDF**.
- 2 Locate the folder in which you want to save the file.
- 3 Type a filename in the **File name** box.
- 4 Click **Settings**.
The **PDF settings** dialog box appears.
- 5 On the **General** tab, enable the **Documents** option from the **Export range** area.
- 6 Enable the check box for each document you want to save.
- 7 Click **OK**.
- 8 Click **Save**.

To create a PDF preset

- 1 Click **File** ► **Publish to PDF**.
- 2 Locate the folder in which you want to save the file.
- 3 Type a filename in the **File name** box.
- 4 Click **Settings**.
- 5 In the **PDF settings** dialog box, specify any settings.
- 6 Click the **General** tab.
- 7 Click the **Add PDF preset** button  next to the **PDF preset** list box.
- 8 Type a name for the style in the **Save PDF preset as** list box.
- 9 Click **OK**.
- 10 Click **Save**.



If you want to delete a PDF style, select the style and click the **Delete PDF preset** button  next to the **PDF preset** list box.

To edit a PDF preset

- 1 Click **File** ► **Publish to PDF**.
- 2 Locate the folder in which you want to save the file.
- 3 Type a filename in the **File name** box.
- 4 Click **Settings**.
- 5 In the **PDF settings** dialog box, specify any settings.
- 6 Click the **General** tab.
- 7 Click the **Add PDF preset** button  next to the **PDF** list box.
- 8 Choose the style you want to edit from the **Save PDF preset as** list box.
- 9 Click **OK**.
- 10 Click **Save**.



If you save changes you make to preset settings, the original settings will be overwritten. To avoid this, save any changes to preset settings with a new name.

Including hyperlinks, bookmarks, and thumbnails in PDF files

You can include [hyperlinks](#), [bookmarks](#), and [thumbnails](#) in a PDF file. Hyperlinks are useful for adding jumps to webpages or to Internet URLs. Bookmarks allow you to link to specific areas in a PDF file. You can specify whether bookmarks or thumbnails are displayed when the PDF file is first opened in Adobe Acrobat or Acrobat Reader.

For information about assigning hyperlinks and bookmarks, see [“Adding bookmarks and hyperlinks to documents”](#) on page 784.

To include hyperlinks, bookmarks, and thumbnails in a PDF file

- 1 Click **File** ► **Publish to PDF**.
- 2 Locate the folder in which you want to save the file.
- 3 Type a filename in the **File name** box.
- 4 Click **Settings**.
The **PDF settings** dialog box appears.
- 5 Click the **Document** tab.
- 6 In the **Bookmarks** area, enable any of the following check boxes:
 - **Include hyperlinks**
 - **Generate bookmarks**
 - **Generate thumbnails**If you want to display bookmarks or thumbnails on startup, enable the **Bookmarks** or **Thumbnails** button in the **On start, display** area.
- 7 Click **OK**.
- 8 Click **Save**.

Reducing the size of PDF files

You can compress [bitmap images](#), text, and line art to reduce the size of a PDF file. Options for bitmap image compression include [JPEG](#), [LZW](#), and [ZIP](#). Bitmap images that use JPEG compression have a quality scale ranging from 2 (high quality, less compression) to 255 (lower quality, more compression). The higher the image quality, the larger the file size.

You can also reduce the size of a PDF file by downsampling color, grayscale, or monochrome bitmap images.

To set the bitmap compression in a PDF file

- 1 Click **File** ► **Publish to PDF**.
- 2 Locate the folder in which you want to save the file.
- 3 Type a filename in the **File name** box.
- 4 Click **Settings**.
The **PDF settings** dialog box appears.
- 5 Click the **Objects** tab.
- 6 Choose one of the following from the **Compression type** list box:
 - **None**
 - **LZW**
 - **JPEG**
 - **ZIP**
 - **JP2**
- 7 Click **OK**.
- 8 Click **Save**.



The **JP2 (JPEG 2000)** option is available only for Adobe Acrobat 6.0, Adobe Acrobat 8.0, and Adobe Acrobat 9.0



If you choose **JPEG** compression, you can specify the compression quality by moving the **JPEG quality** slider.

To compress text and line art in a PDF file

- 1 Click **File** ► **Publish to PDF**.
- 2 Locate the folder in which you want to save the file.
- 3 Type a filename in the **File name** box.
- 4 Click **Settings**.
The **PDF settings** dialog box appears.
- 5 Click the **Objects** tab.
- 6 Enable the **Compress text and line art** check box.
- 7 Click **OK**.
- 8 Click **Save**.

To downsample bitmap images in a PDF file

- 1 Click **File** ► **Publish to PDF**.
- 2 Locate the folder in which you want to save the file.
- 3 Type a filename in the **File name** box.
- 4 Click **Settings**.
The **PDF settings** dialog box appears.
- 5 Click the **Objects** tab.
- 6 Enable any of the following check boxes, and type a value in the corresponding box:
 - **Color**
 - **Grayscale**
 - **Monochrome**
- 7 Click **OK**.
- 8 Click **Save**.



Downsampling color, grayscale, or monochrome bitmap images is effective only when the resolution of the bitmap image is higher than the resolution specified in the **Bitmap downsampling** area.

Working with text and fonts in PDF files

You can determine how the text in your PDF file outputs by setting text and font options.

You can embed fonts in a PDF file. Embedding increases the file size but makes a PDF file more portable, since the fonts do not have to reside on other systems. When you embed base 14 fonts, the fonts are added to your PDF file, thus eliminating font variances on different systems. The base 14 fonts are resident on all PostScript devices.

You can also convert **TrueType fonts** to Type 1 fonts, which can increase file size if there are many fonts in a file. When you convert fonts, you can reduce file size by subsetting fonts if you use only a smaller number of characters (for example, English characters A to E). You can also

include a percentage of fonts used. For example, you can create a subset that contains 50 percent of the fonts. If the number of characters used in the document exceeds 50 percent, the whole set of characters is embedded. If the number of characters used in the document is less than 50 percent, only the characters used are embedded.

You can also eliminate font variances on different computers by exporting text as curves. For example, if you are using unusual text characters, you can export the text as curves. Exporting text as curves increases the complexity of the file and can increase file size. For general document publication, embed fonts in a document rather than convert text to curves.

To embed fonts in a PDF file

- 1 Click **File** ► **Publish to PDF**.
- 2 Locate the folder in which you want to save the file.
- 3 Type a filename in the **File name** box.
- 4 Click **Settings**.
The **PDF settings** dialog box appears.
- 5 Click the **Objects** tab.
- 6 Enable the **Embed fonts in document** check box.
If you want to install the basic fonts to your PDF file, enable the **Embed base 14 fonts** check box.
- 7 Click **OK**.
- 8 Click **Save**.



Enabling the **Embed base 14 fonts** check box increases file size, and, therefore, it is not recommended for publishing to the web.

To convert TrueType fonts to Type 1 fonts

- 1 Click **File** ► **Publish to PDF**.
- 2 Locate the folder in which you want to save the file.
- 3 Type a filename in the **File name** box.
- 4 Click **Settings**.
The **PDF settings** dialog box appears.
- 5 Click the **Objects** tab.
- 6 Enable the **Convert TrueType to Type 1** check box.
If you want to reduce file size, you can create a subset of fonts by enabling the **Subset fonts** check box and typing a percentage of fonts used in the **Under% of charset** box.
- 7 Click **OK**.
- 8 Click **Save**.



If you create a subset of fonts, some characters from the font may not be present in the file when editing the PDF file in Adobe Acrobat.

To export text as curves

- 1 Click **File** ► **Publish to PDF**.
- 2 Locate the folder in which you want to save the file.
- 3 Type a filename in the **File name** box.
- 4 Click **Settings**.
The **PDF settings** dialog box appears.

- 5 Click the **Objects** tab.
- 6 Enable the **Export all text as curves** check box.
- 7 Click **OK**.
- 8 Click **Save**.

Specifying an encoding format for PDF files

ASCII and binary are encoding formats for documents. When you publish a file to PDF, you can choose to export ASCII or binary files. The ASCII format creates files that are fully portable to all platforms. The binary format creates smaller files, but they are less portable, because some platforms cannot handle the file format.

To specify an encoding format for a PDF file

- 1 Click **File** ► **Publish to PDF**.
- 2 Locate the folder in which you want to save the file.
- 3 Type a filename in the **File name** box.
- 4 Click **Settings**.
The **PDF settings** dialog box appears.
- 5 Click the **Document** tab.
- 6 Enable one of the following options:
 - **ASCII 85**
 - **Binary**
- 7 Click **OK**.
- 8 Click **Save**.

Specifying a viewing option for EPS files

EPS files are PostScript files that are embedded in a document. You can choose how encapsulated PostScript (EPS) files are viewed in a PDF document. The **PostScript** option includes high-resolution images in the PDF document but does not let you view them in Adobe Acrobat. The **Preview** option includes high-resolution images in the PDF file and displays their low-resolution bitmap representation in Adobe Acrobat.

To choose a viewing option for EPS files

- 1 Click **File** ► **Publish to PDF**.
- 2 Locate the folder in which you want to save the file.
- 3 Type a filename in the **File name** box.
- 4 Click **Settings**.
The **PDF settings** dialog box appears.
- 5 Click the **Objects** tab.
- 6 Choose one of the following from the **EPS files** list box:
 - **PostScript** — includes high-resolution images in the PDF document but does not let you view them
 - **Preview** — includes high-resolution images in the PDF file and displays their low-resolution bitmap representation
- 7 Click **OK**.
- 8 Click **Save**.

Specifying color management options for exporting PDF files

You can specify color management options for exporting files to PDF. You can choose a color profile or leave the objects in their original color space. You can also embed the color profile with the PDF.

If you have **spot colors** in your file, you can either preserve the spot colors or convert them to **process colors** so that the file produces four plates for **CMYK** output.

If you want to export to PDF for the purpose of soft-proofing the document, you can apply the document's color proofing settings. In addition, you can choose additional soft-proofing options, such as preserving document overprints and overprinting black.

To specify color management options for exporting PDF files

- 1 Click **File** ► **Publish to PDF**.
- 2 Locate the folder in which you want to save the file.
- 3 Type a filename in the **File name** box.
- 4 Click **Settings**.
The **PDF settings** dialog box appears.
- 5 Click the **Color** tab.
- 6 In the **Color management** area, enable the **Use document color settings** option.
- 7 Choose a color profile option from the **Output colors as** list box:
 - **RGB**
 - **CMYK**
 - **Grayscale**
 - **Native**
- 8 Click **OK**.
- 9 Click **Save**.

You can also

Apply proofing color profile to the PDF

In the **Color management** area, enable the **Use color proof settings** option.

Convert all spot colors applied in the document to the chosen color profile

Enable the **Convert spot colors to** check box.

Embed the color profile in the PDF

Enable the **Embed color profile** check box.

Simulate how overprints appear, which is useful for soft-proofing the document

In the **Other color controls** area, enable the **Preserve document overprints** check box.

Enable the overprinting of black

In the **Other color controls** area, enable the **Always overprint black** check box.



If you choose the **Native** option from the **Output colors as** list box, a maximum of three color spaces are displayed, or embedded, in the PDF file.

Setting security options for PDF files

You can set security options to protect PDF files that you create. Security options let you control whether, and to what extent, a PDF file can be accessed, edited, and reproduced when viewed in Adobe Reader.

The level of security that is available is also determined by which version of Adobe Reader you use to create the PDF file. The encryption levels provided by Adobe Reader have increased over time. For example, if you save to Adobe Reader version 6, or lower, it has standard encoding, version 8 has 128-bit encoding, and version 9 has 256-bit encoding. For more information about choosing a version, see [“Optimizing PDF files” on page 804](#).

The security options are controlled by two passwords: the Permission password and the Open password.

The Permission password is the master password that lets you control whether a file can be printed, edited, or copied. For example, as the owner of the file, you can protect the integrity of the file’s content by choosing permission settings that prevent editing.

You can also set an Open password that lets you control who can access the file. For example, if your file contains sensitive information, and you want to limit the users who can view it, you can set an Open password. It is not recommended that you set an Open password without setting a Permission password, because users would then have unrestricted access to the PDF file — including the ability to set a new password.

The security options are applied when you save the PDF file. These settings can be viewed when a PDF file is opened in Adobe Acrobat.

To open and edit a secured PDF file, you must enter the Permissions password (or the Open password if no Permission password is set). For information about opening and importing PDF files, see [“Adobe Portable Document Format \(PDF\)” on page 834](#).

To set PDF file permissions

- 1 Click **File** ► **Publish to PDF**.
- 2 Locate the folder in which you want to save the file.
- 3 Type a filename in the **File name** box.
- 4 Click **Settings**.
The **PDF settings** dialog box appears.
- 5 Click the **Security** tab.
- 6 Enable the **Permission password** check box.
- 7 Type a password in the **Password** box.
- 8 Retype the password in the **Confirm Permission password** box.
- 9 In the **Printing permissions** box, choose one of the following options:
 - **None** — lets users view the PDF on-screen but prevents them from printing the PDF file
 - **Low resolution** — lets users print a low resolution version of the PDF file. This option is available for PDF files compatible with Adobe Acrobat 5 or higher.
 - **High resolution** — lets users print a high resolution version of the PDF file
- 10 In the **Editing permissions** box, choose one of the following options:
 - **None** — prevents users from editing the PDF file
 - **Insert, delete, and rotate pages** — lets users insert, delete, and rotate pages when editing the PDF file. This option is available for PDF files compatible with Adobe Acrobat 5 or higher.
 - **Any except extracting pages** — lets users edit the PDF file but prevents them from removing pages from the fileIf you want to allow copying of content from the PDF file to other documents, enable the **Enable copying of text, images, and other contents** check box.
- 11 Click **OK**.
- 12 Click **Save**.



The Permission password is the master password for the document. It can be used by the file owner to set permissions, or to open the file if an Open password is set.

Some PDF compatibility options, such as PDF/X-3 and PDF/A-1b, do not let you set PDF file permissions. If you choose such a compatibility option, all controls on the Security page appear disabled. To change the compatibility, see [“To select a compatibility option” on page 804](#).

To set a user password for a PDF file

- 1 Click **File** ► **Publish to PDF**.
- 2 Locate the folder in which you want to save the file.
- 3 Type a filename in the **File name** box.
- 4 Click **Settings**.
The **PDF settings** dialog box appears.
- 5 Click the **Security** tab.
- 6 Enable the **Open password** check box.
- 7 Type a password in the **Password** box.
- 8 Retype the password in the **Confirm Open password** box.
- 9 Click **OK**.
- 10 Click **Save**.



If you set an Open password, it is recommended that you also set a Permission password.

Optimizing PDF files

You can optimize PDF files for different versions of Adobe Acrobat or Acrobat Reader by choosing a compatibility option that matches the type of viewer used by the recipients of the PDF file. In CorelDRAW, you can select one of the following compatibility options: Acrobat 4.0, Acrobat 5.0, Acrobat 6.0, Acrobat 8.0, Acrobat 9.0, PDF/X-1a, PDF/X-3, or PDF/A-1b. The available controls differ, depending on which compatibility option you choose. If you are publishing a PDF file for a wide distribution, it is better to choose an earlier compatibility option such as Acrobat 8.0 or 9.0 to ensure that the file can be viewed in earlier versions of Acrobat. However, if security is a concern, you may want to choose a later version because the encryption levels are higher. For more information, see [“Setting security options for PDF files” on page 803](#).

You can optimize the viewing of a PDF document on the web to speed up the loading time of the PDF.

If you added complex fills to the document, you can choose to convert them to bitmaps, which is also known as rasterizing. This may increase the PDF file size, but it will ensure that the complex fills display correctly.

To select a compatibility option

- 1 Click **File** ► **Publish to PDF**.
- 2 Locate the folder in which you want to save the file.
- 3 Type a filename in the **File name** box.
- 4 Click **Settings**.
The **PDF settings** dialog box appears.
- 5 Click the **General** tab.
- 6 From the **Compatibility** list box, choose a compatibility option.



To preserve layers and layer properties in the published PDF file, you must choose the Acrobat 6.0, Acrobat 8.0, or Acrobat 9.0 option. Note that master layers will not be preserved.

To preserve transparencies in the published PDF file, you must choose the Acrobat 5.0, Acrobat 6.0, Acrobat 8.0, or Acrobat 9.0 option.

To optimize a PDF file for viewing on the web

- 1 Click **File** ► **Publish to PDF**.
- 2 Locate the folder in which you want to save the file.
- 3 Type a filename in the **File name** box.
- 4 Click **Settings**.
The **PDF settings** dialog box appears.
- 5 Click the **Document** tab.
- 6 Enable the **Optimize for fast web view** check box.

To convert complex fills to bitmaps

- 1 Click **File** ► **Publish to PDF**.
- 2 Locate the folder in which you want to save the file.
- 3 Type a filename in the **File name** box.
- 4 Click **Settings**.
The **PDF settings** dialog box appears.
- 5 Click the **Objects** tab.
- 6 Enable the **Render complex fills as bitmaps** check box.

Viewing preflight summaries for PDF files

Before saving a document as a PDF file, you can preflight your document to find potential problems. Preflighting checks and displays a summary of errors, possible problems, and suggestions for resolving issues. By default, many PDF issues are checked during a preflight, but you can disable the issues that you do not want to check.

To view the preflight summary for a PDF file

- 1 Click **File** ► **Publish to PDF**.
- 2 Locate the folder in which you want to save the file.
- 3 Type a filename in the **File name** box.
- 4 Click **Settings**.
The **PDF settings** dialog box appears.
- 5 Click the **Preflight** tab.

You can limit the issues to check during the preflight by clicking the **No issues** tab, clicking **Settings**, and, in the **Preflight settings** dialog box, disabling the check boxes next to the items that you want the preflight to overlook.



You can save settings by clicking the **No issues** tab, clicking **Settings**, and, in the **Preflight settings** dialog box, clicking the **Add preflight settings** button  and typing a name in the **Save preflight style as** box.

Preparing PDF files for a print provider

Open Prepress Interface (OPI) lets you use low-resolution images as placeholders for the high-resolution images that appear in your final work. When a print provider receives your file, the OPI server substitutes the low-resolution images with the high-resolution images.

Printers' marks provide information to the print provider about how the work should be printed. You can specify which printers' marks to include on the page. The available printers' marks are as follows:

- **Crop marks** — represent the size of the paper and appear at the corners of the page. You can add crop marks to use as guides in trimming the paper. If your output has multiple pages per sheet (for example, two rows by two columns), you can add the crop marks on the outside edge of the page so that all crop marks are removed after the cropping process, or you can choose to add crop marks around each row and column. A **bleed** determines how far an image can extend beyond the crop marks. A bleed requires that the paper you are printing on is larger than the size of paper you ultimately want, and the image area must extend beyond the edge of the final paper size.
- **Registration marks** — are required to line up the film, analog proofs, or print plates on a color press. Registration marks print on each sheet of a color separation.
- **Densitometer scale** — is a series of gray boxes ranging from light to dark. These boxes are required to test the density of **halftone** images. You can position the densitometer scale anywhere on the page. You can also customize the levels of gray that appear in each of the seven squares on the densitometer scale.
- **File information** — can be printed, including the **color profile**; name, date, and time the image was created; and page number.

To maintain OPI links in a PDF file

- 1 Click **File** ► **Publish to PDF**.
- 2 Locate the folder in which you want to save the file.
- 3 Type a filename in the **File name** box.
- 4 Click **Settings**.
The **PDF settings** dialog box appears.
- 5 Click the **Prepress** tab.
- 6 Enable the **Maintain OPI links** check box.



Don't use OPI links if you are not sure whether your PDF file is destined for an OPI server.

To include printers' marks in a PDF file

- 1 Click **File** ► **Publish to PDF**.
- 2 Locate the folder in which you want to save the file.
- 3 Type a filename in the **File name** box.
- 4 Click **Settings**.
The **PDF settings** dialog box appears.
- 5 Click the **Preflight** tab.
- 6 Enable any of the following check boxes:
 - **Crop marks**
 - **File information**
 - **Registration marks**
 - **Densitometer scales**

If you want to include a **bleed**, enable the **Bleed limit** check box, and type a bleed amount in the corresponding box.



Usually, a bleed amount of 0.125 to 0.25 inch is sufficient. Any object extending beyond this amount uses space needlessly and may cause problems when you print multiple pages with bleeds on a single sheet of paper.

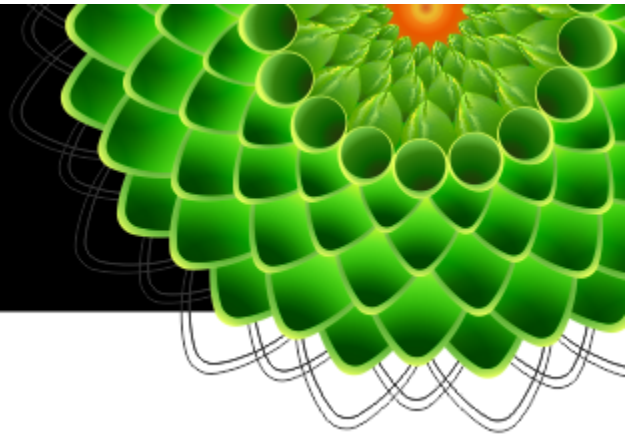

Working with office productivity applications

CorelDRAW is highly compatible with office productivity applications such as Microsoft Word and WordPerfect Office. You can import and export files between applications, and you can copy or insert objects from CorelDRAW into office productivity documents.

This section contains the following topics:

- [“Importing files from office productivity applications”](#) (page 809)
- [“Exporting files to office productivity applications”](#) (page 809)
- [“Adding objects to documents”](#) (page 809)

Importing files from office productivity applications

CorelDRAW lets you import files created in other applications. For example, you can import a file from a Microsoft Office or WordPerfect Office application. For more information about importing files, see [“WordPerfect Document \(WPD\)”](#) on page 846 and [“Microsoft Word \(DOC, DOCX, and RTF\) technical notes”](#) on page 820.

Exporting files to office productivity applications

You can export a file so that it is optimized for use with office productivity applications such as Microsoft Word or WordPerfect. For more information about exporting files from CorelDRAW, see [“To export a file to Microsoft Office or WordPerfect Office”](#) on page 793.

Adding objects to documents

CorelDRAW lets you copy an object and paste it into a drawing. You can also copy an object and place it into a document created in an office productivity application such as Microsoft Word or WordPerfect. For more information about copying objects, see [“Copying, duplicating, and deleting objects”](#) on page 260. You can insert an object into a CorelDRAW document, or into an office productivity document, such as a Microsoft Word or WordPerfect document. For more information about inserting objects into CorelDRAW, see [“Finding and managing creative tools and content”](#) on page 99. For information about inserting objects into office productivity documents, see [“Inserting linked or embedded objects”](#) on page 333, or see the office productivity application’s Help.

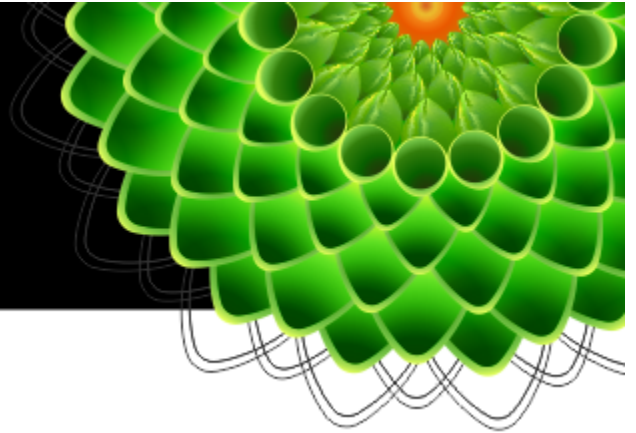

Supported file formats

A file format defines how an application stores information in a file. If you want to use a file created in a different application than the one you are currently using, you must import that file. Conversely, if you create a file in one application and want to use it in another application, you must export the file to a different file format.

When you name a file, an application automatically appends a filename extension, usually three characters in length (for example, `.cdr`, `.bmp`, `.tif`, and `.eps`). This filename extension helps you and the computer differentiate between files of different formats.

The following list includes all file formats used in this application. Note that not all file format filters are installed by default. If you cannot export or import a file from the list, you need to update your installation of CorelDRAW Graphics Suite. For more information, see “Modifying and repairing installations” on page 24.

- “Adobe Illustrator (AI)” (page 812)
- “Adobe Type 1 Font (PFB)” (page 814)
- “Windows Bitmap (BMP)” (page 815)
- “OS/2 Bitmap (BMP)” (page 816)
- “Computer Graphics Metafile (CGM)” (page 816)
- “CorelDRAW (CDR)” (page 817)
- “Corel Presentation Exchange (CMX)” (page 817)
- “Corel PHOTO-PAINT (CPT)” (page 818)
- “Corel Symbol Library (CSL)” (page 818)
- “Cursor Resource (CUR)” (page 819)
- “Microsoft Word (DOC, DOCX, or RTF)” (page 819)
- “Microsoft Publisher (PUB)” (page 821)
- “Corel DESIGNER (DES, DSF, DS4, or DRW)” (page 821)
- “AutoCAD Drawing Database (DWG) and AutoCAD Drawing Interchange Format (DXF)” (page 822)
- “Encapsulated PostScript (EPS)” (page 824)
- “PostScript (PS or PRN)” (page 828)
- “GIF” (page 828)
- “JPEG (JPG)” (page 829)
- “JPEG 2000 (JP2)” (page 830)
- “Kodak Photo CD Image (PCD)” (page 831)
- “PICT (PCT)” (page 832)
- “PaintBrush (PCX)” (page 833)
- “Adobe Portable Document Format (PDF)” (page 834)
- “HPGL Plotter File (PLT)” (page 836)

- “Portable Network Graphics (PNG)” (page 837)
- “Adobe Photoshop (PSD)” (page 838)
- “Corel Painter (RIF)” (page 839)
- “Scalable Vector Graphics (SVG)” (page 839)
- “Adobe Flash (SWF)” (page 842)
- “TARGA (TGA)” (page 843)
- “TIFF” (page 844)
- “Corel Paint Shop Pro (PSP)” (page 844)
- “TrueType Font (TTF)” (page 845)
- “Visio (VSD)” (page 845)
- “WordPerfect Document (WPD)” (page 846)
- “WordPerfect Graphic (WPG)” (page 846)
- “RAW camera file formats” (page 847)
- “Wavelet Compressed Bitmap (WI)” (page 847)
- “Windows Metafile Format (WMF)” (page 847)
- “Additional file formats” (page 848)
- “Recommended formats for importing graphics” (page 849)
- “Recommended formats for exporting graphics” (page 849)
- “General notes on importing text files” (page 850)

Adobe Illustrator (AI)

The Adobe Illustrator (AI) file format was developed by Adobe Systems, Incorporated for the Macintosh and Windows platforms. It is primarily vector-based, although later versions support bitmap information.

You can import AI files for use in CorelDRAW or export CorelDRAW files to the AI file format. Before exporting a document as an AI file, you can preflight your document to find potential problems. Preflighting checks and displays a summary of errors, possible problems, and suggestions for resolving issues. By default, many AI issues are checked during a preflight, but you can disable the issues that you do not want to check.

To import an Adobe Illustrator file

- 1 Click **File** ► **Import**.
- 2 Locate the folder in which the file is stored.
- 3 Click the filename.
- 4 Click **Import**.
- 5 Click in the [drawing page](#) where you want to import the file.

To export an Adobe Illustrator file

- 1 Click **File** ► **Export**.
- 2 Locate the folder in which you want to save the file.
- 3 Choose **AI - Adobe Illustrator** from the **Save as type** list box.
- 4 Type a filename in the **File name** list box.
- 5 Click **Export**.
- 6 From the **Compatibility** list box, choose an Adobe Illustrator file format.
- 7 In the **Export range** area, enable one of the following options:
 - **Current document** — exports the active drawing
 - **Current page** — exports the active page
 - **Selection** — exports the objects that you have selected

- **Pages** — exports the pages that you specify (This option is only available for CS 4 and later versions.)

8 In the **Export text as** area, enable one of the following options:

- **Curves** — lets you export text as curves
- **Text** — lets you export text as editable characters

You can also

Convert transparent areas to bitmaps

In the **Transparency** area, enable the **Preserve appearance and convert transparent areas to bitmaps** option.

(This option is only available for version 8 and lower.)

Discard transparent areas and preserve curves and text

In the **Transparency** area, enable the **Preserve curves and text by removing transparent effects** option.

(This option is only available for version 8 and lower.)

Convert an outline to an object to create an unfilled closed object with the outline's shape

In the **Options** area, enable the **Convert outlines to objects** check box.

Convert complex outlines to curves

In the **Options** area, enable the **Simulate complex filled curves** check box.

Convert spot colors to process colors

In the **Options** area, enable the **Convert spot colors to CMYK** check box.

Embed the color profile

In the **Options** area, enable the **Embed color profiles** check box.

Generate a preview of the document in the Adobe Illustrator File open dialog box

In the **Options** area, enable the **Include preview images** check box.



If you enable the **Simulate complex filled curves** check box, an object that is composed of complex curves, such as a text object that was converted to curves, may be broken into several objects on export to help minimize the complexity of the object.

If you disable the **Include placed images** check box and export the file, the exporting process generates one Adobe Illustrator file and a series of EPS files. The EPS files contain individual objects and images which are linked to the AI file. Always store the EPS files with the AI file to preserve the link to the AI file.

To view the preflight summary for an AI file

- 1 Click **File** ► **Export**.
- 2 Locate the folder in which you want to save the file.
- 3 Choose **AI - Adobe Illustrator** from the **Save as type** list box.
- 4 Type a filename in the **File name** list box.
- 5 Click **Export**.
- 6 In the **Adobe Illustrator Export** dialog box, click the second tab.

You can limit the issues to check during the preflight by clicking the **Settings** button, double-clicking **AI Export**, and disabling the check boxes next to the items that you want the preflight to overlook.



You can save settings by clicking the **Add preflight settings** button and typing a name in the **Save preflight style as** box.

Adobe Illustrator (AI) technical notes

Importing an AI file

- You can import AI file formats up to and including Adobe Illustrator CS6.
- For files saved in Adobe Illustrator CS or higher with PDF-compatibility, text can be imported as text or curves.
- Objects with gradient fills that were created in CS5 may not appear correctly when imported.
- Corel programs cannot import AI files containing **bitmaps** linked as EPS files.
- Adobe Illustrator graphics are imported into the program as a group of **objects**. Click **Object** ► **Ungroup** to manipulate objects in the imported graphic. If you open an AI file instead of importing it, you do not need to ungroup objects.
- Flash movies embedded in AI files are not imported.
- For AI CS4, CS5, and CS6 files, each Artboard is imported as an individual CorelDRAW page. In multi-page documents, objects that are placed off a page are placed on the first page of the CorelDRAW document.
- Objects filled by using Global Colors (color schemes) appear correctly in CorelDRAW, but the Global Colors are not maintained as color styles.
- Symbols, objects with patterns, and objects that have 3d extrude or bevel applied are converted as curves.
- Objects that have the Feather or Transparency effect applied are converted using the applicable lens effect in CorelDRAW.
- Objects that have the texture, drop shadow, blur, or brushstroke effect applied are converted as bitmap objects in CorelDRAW.

Exporting an AI file

- During export conversion, objects can become complex, making it difficult to edit them in other drawing programs or in CorelDRAW if you reimport them. To avoid this problem, save the file to the CorelDRAW (CDR) format before exporting it, and use CorelDRAW for all editing.
- If you create a file that will be printed in other programs, such as Adobe PageMaker, export it using the Encapsulated PostScript (EPS) filter, not the Adobe Illustrator (AI) filter. The Encapsulated PostScript filter supports more drawing effects than the Adobe Illustrator filter does and yields better results overall.
- Most linear and radial fountain **fills** are preserved. Conical and square fountain fills are exported as a series of filled bands, an effect similar to that achieved by **blending**. You can set the number of bands by clicking **Tools** ► **Options**. In the **Workspace** list of categories, click **Display**, and type a number in the **Preview fountain steps** box. The maximum number of bands supported is 256.
- You can export text as text when you are exporting AI files from versions CS and later.
- When exporting multi-page CorelDRAW files to CS4 or later version, individual pages are exported as Artboards. The **Arrange by row** format is used for the layout of the Artboards.
- When exporting multi-page CorelDRAW files to CS4 or later version, objects that are placed off of the page are removed.
- Some OpenType features are not supported by Adobe Illustrator.

Adobe Type 1 Font (PFB)

The Adobe Type 1 Font (PFB) is a file format that stores Adobe Type 1 fonts. Most Type 1 fonts are single master fonts that permit only style editing; for example, Roman, italic, bold. A single master Type 1 font contains two files: a Printer Font Metrics (PFM) file and a Printer Font Binary (PFB) file.

Some Type 1 fonts are also available in multiple master format. You can customize design elements of multiple master fonts such as weight, width, style, and optical size. A multiple master base font is the multiple master font itself, from which you create variations called multiple master instances. A multiple master base font is composed of a PFM file, a PFB file, and a Multiple Master Metrics (MMM) file. A multiple master instance is composed of a PFM file and a PostScript Printer Stub (PSS) file.

Adobe Type 1 Fonts technical notes

- Adobe Type 1 fonts exported from CorelDRAW are unhinted.

- Each exported character constitutes a single object. Before you export multiple objects, you must combine them by clicking **Object** ► **Combine**. You cannot export multiple objects or grouped objects.
- For best results, avoid intersecting lines. Any object in your character should lie completely inside or outside of others, as shown in the following example.

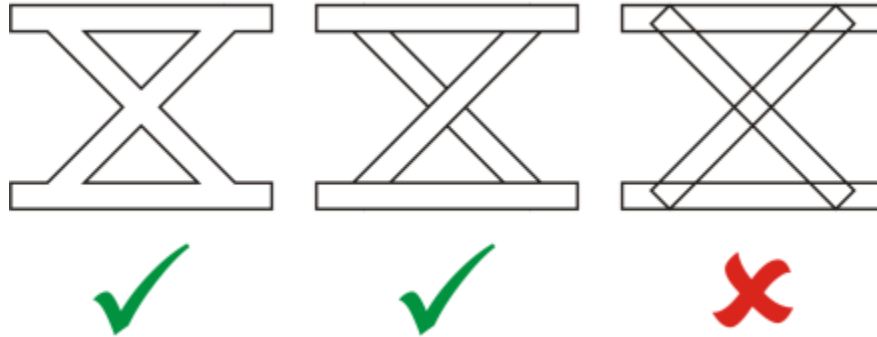

Left to right: three objects correctly combined; five objects correctly combined; five objects incorrectly combined

- Fill and outline attributes applied to objects are not exported.
- Adobe Type 1 fonts you create are compatible with Adobe Type Manager version 2.0, but not with earlier versions.

Windows Bitmap (BMP)

The Windows **bitmap** (BMP) file format was developed as a standard for representing graphic images as bitmaps on the Windows operating system.

To import a bitmap file

- 1 Click **File** ► **Import**.
- 2 Locate the folder in which the file is stored.
- 3 Choose **BMP - Windows bitmap (*.bmp; *.dib; *.rle)** from the list box next to the **File name** box.
- 4 Click the filename.
- 5 Click **Import**.
- 6 Click the [drawing page](#).

To export a bitmap file

- 1 Click **File** ► **Export**.
- 2 Locate the folder in which you want to save the file.
- 3 Choose **BMP - Windows bitmap** from the **Save as type** list box.
- 4 Type a filename in the **File name** list box.
- 5 Click **Export**.
- 6 In the **Convert to bitmap** dialog box, adjust the width, height, resolution, color mode, or any of the other settings.

Windows Bitmap (BMP) technical notes

Importing a BMP file

- You can import Windows Bitmap files conforming to the Windows and OS/2 BMP specifications.

- Windows Bitmap files may be **black-and-white**, 16 colors, **grayscale**, **paletted**, or **RGB** color (24-bit), and print accordingly, depending on your printer.
- Run-length encoding (RLE) compression may be used on all bitmaps, except RGB color (24-bit), and black-and-white bitmaps.
- The resolution ranges from 72 to 300 **dpi**, or higher if you choose custom settings.
- The maximum image size is 64,535 × 64,535 **pixels**.

Exporting a BMP file

- Because raster images such as **bitmaps** are mapped **pixel** by pixel to the page, the **resolution** does not increase. Instead, your bitmap appears jagged, with an apparent loss of resolution.

OS/2 Bitmap (BMP)

This type of bitmap file is designed for the OS/2 operating system. The OS/2 Bitmap file format supports a maximum image size of 64,535 × 64,535 pixels. OS/2 uses Run-length encoding (RLE) compression.

OS/2 Bitmap (BMP) technical notes

- Corel programs support Standard Version 1.3 and Enhanced Version 2.0, or later versions of the OS/2 Bitmap file format.
- Corel programs support the following color depths when importing and exporting BMP files: 1-bit black and white, 256 shade (8-bit) grayscale, 16-color (4-bit) and 256-color (8-bit) paletted, and 24-bit RGB.

Computer Graphics Metafile (CGM)

Computer Graphics Metafile (CGM) is an open, platform-independent metafile format used for storing and exchanging two-dimensional graphics. It supports **RGB** color. CGM files can contain both **vector graphics** and **bitmaps**, but they usually contain one graphic type or the other — rarely both.

CorelDRAW imports CGM Version 1, 3, and 4 files and exports version 1, 3, and WebCGM 1.0 profile files.

WebCGM is a binary file format that supports hyperlinks, document navigation, picture structuring and layers, as well as searching on WebCGM picture contents. It also supports Unicode and web fonts. The WebCGM profile is used widely in web electronic documents.

To import a CGM file

- 1 Click **File** ► **Import**.
- 2 Locate the folder in which the file is stored.
- 3 Choose **CGM - Computer Graphics Metafile (*.cgm)** from the list box next to the **File name** box.
- 4 Click the filename.
- 5 Click **Import**.

To export a CGM file

- 1 Click **File** ► **Export**.
- 2 Locate the folder in which you want to save the file.
- 3 Choose **CGM - Computer Graphics Metafile** from the **Save as type** list box.
- 4 Type a filename in the **File name** list box.
- 5 Click **Export**.
- 6 In the **CGM export** dialog box, choose a version from the **Version** list box.

Computer Graphics Metafile (CGM) technical notes

Importing a CGM file

- CorelDRAW can import CGM Version 1, 3 and 4 files.
- The CGM filter accepts only markers supported by the CGM file format standard. Private-use markers are ignored.
- Text is editable, provided the file is exported from the source program with the correct text options specified. The typeface you see may not correspond to the one used in the source program; however, you can easily correct the typeface in the Corel program.
- If the CGM file contains a [font](#) that is not on your computer, the [PANOSE font-matching](#) dialog box lets you replace the font with an available one.

Exporting a CGM file

- CorelDRAW can export version 1 and 3 CGM as well as WebCGM 1.0 files.
- CGM files can be saved in text or binary format provided the selected profile supports text encoding. Text-encoded files can be opened in an ASCII text editor.
- PostScript textures are converted to curves.

CorelDRAW (CDR)

CorelDRAW (CDR) files are primarily [vector graphic](#) drawings. Vectors define a picture as a list of graphic primitives (rectangles, lines, text, arcs, and ellipses). Vectors are mapped point by point to the page, so if you reduce or increase the size of a vector graphic, the original image will not be distorted.

Vector graphics are created and edited in graphics design applications, such as CorelDRAW, but you can also edit vector graphics in image-editing applications such as Corel PHOTO-PAINT. You can use vector images of various formats in desktop publishing programs.

To import a CorelDRAW file

- 1 Click **File** ► **Import**.
- 2 Locate the folder in which the file is stored.
- 3 Choose **CDR - CorelDRAW (*.cdr)** from the list box next to the **File name** box.
- 4 Click the filename.
- 5 Click **Import**.
- 6 Click the [drawing page](#).

CorelDRAW (CDR) technical notes

- Imported files appear as a group of [objects](#). Click **Object** ► **Ungroup** to manipulate individual objects in the imported graphic.

Corel Presentation Exchange (CMX)

Corel Presentation Exchange (CMX) is a metafile format that supports [bitmap](#) and vector information and the full range of [PANTONE](#), [RGB](#), and [CMYK](#) colors. Files saved in CMX format can be opened and edited in other Corel applications.

To import a Corel Presentation Exchange file

- 1 Click **File** ► **Import**.
- 2 Locate the folder in which the file is stored.
- 3 Choose one of the following from the list box next to the **File name** box:
 - **CMX - Corel Presentation Exchange** — for files created in Corel Presentations X6 or later
 - **CMX - Corel Presentation Exchange legacy** — for files created in Corel Presentations X5 or earlier

- 4 Click the filename.
- 5 Click **Import**.
- 6 Click the [drawing page](#).

To export a Corel Presentation Exchange file

- 1 Click **File** ► **Export**.
- 2 Locate the folder in which you want to save the file.
- 3 Choose one of the following from the **Save as type** list box:
 - **CMX - Corel Presentation Exchange** — for versions 16.0 or later
 - **CMX - Corel Presentation Exchange legacy** — for versions 15.0 or earlier
- 4 Type a filename in the **File name** list box.
- 5 Click **Export**.

Corel Presentation Exchange (CMX) technical notes

- The following versions are supported: 5, 6, 7, 8, 9, 10, 11, 12, X3, X4, X5, and X6.

Corel PHOTO-PAINT (CPT)

Files saved to the Corel PHOTO-PAINT (CPT) file format are [bitmaps](#) that represent shapes as [pixels](#) arranged to form an image. When you save a graphic to the Corel PHOTO-PAINT format, masks, floating objects, and lenses are saved with the image. CorelDRAW can import and export files in Corel PHOTO-PAINT format, including files that contain color and [grayscale](#) information.

To export a Corel PHOTO-PAINT file

- 1 Click **File** ► **Export**.
- 2 Locate the folder in which you want to save the file.
- 3 Choose **CPT - Corel PHOTO-PAINT image** from the **Save as type** list box.
- 4 Type a filename in the **File name** list box.
- 5 Click **Export**.
- 6 In the **Convert to bitmap** dialog box, adjust the width, height, resolution, color mode, or any of the other settings.



You can export CorelDRAW layers as objects in the CPT file format.

You can export to an image with transparent background.

Corel PHOTO-PAINT (CPT) technical notes

- This filter is available in CorelDRAW, Corel PHOTO-PAINT, and Corel DESIGNER.
- Corel PHOTO-PAINT files may be [black-and-white](#), [grayscale](#), [paletted](#), [CMYK color \(32-bit\)](#), [RGB color \(24-bit\)](#), or [Lab](#).

Corel Symbol Library (CSL)

Corel Symbol Library (CSL) files store symbols that can be used in other files.

Corel Symbol Library (CSL) files can be stored locally or on a network, allowing easy deployment and management of symbol collections.

For more information, see [“Managing collections and libraries”](#) on page 329.

Cursor Resource (CUR)

The Windows 3.x/NT Cursor Resource (.cur files) file format is used to create cursors for Windows 3.1, Windows NT, and Windows 95 interfaces. It supports cursor graphic elements that are used in Windows pointers. You can select a color for Transparent and Inverse masks.

The Windows 3.x/NT Cursor Resource file format supports a maximum image size of 32 × 32 pixels.

Cursor Resource (CUR) technical notes

- Corel programs support the following color depths when importing .cur files: 1-bit black-and-white, 16-color (4-bit) paletted, and 256-color (8-bit) paletted.

Microsoft Word (DOC, DOCX, or RTF)

You can import the following Microsoft Word files:

- Microsoft Word Document (DOC) files from versions 97, 2000, 2002, and 2003. In addition, files saved as DOC from MS Word 2007 and 2010.
- Microsoft Word Open XML Document (DOCX) files. This file format is based on Open XML and uses ZIP compression. It was introduced with Microsoft Word 2007.
- Rich Text Format (RTF) files. Rich Text Format (RTF) is a text format that stores plain text and text formatting, such as bold. When you import an RTF file to CorelDRAW, the text and any embedded Windows Metafile Format (WMF) graphics are transferred. However, graphic elements are not transferred in an RTF file exported from Corel DESIGNER.

Because Microsoft Word is a proprietary file format, it's sometimes difficult to precisely import all aspects of a Microsoft Word file in CorelDRAW. To successfully import text with fewer inconsistencies, it is recommended that you install the Microsoft Office Compatibility Pack. If the Microsoft Office Compatibility Pack was not previously installed on your computer, you will be prompted to install it when you attempt to import text.

To import a Microsoft Word file

- 1 Click **File** ► **Import**.
- 2 Choose **DOC, DOCX - MS Word** or **RTF - Rich Text Format** from the **All file formats** list box.
- 3 Choose the drive and folder where the file is stored.
- 4 Click the filename.
- 5 Click **Import**.

If the Microsoft Office Compatibility Pack was not previously installed on your computer, the **Install compatibility pack** dialog box appears. The installation of the Microsoft Office Compatibility Pack is highly recommended. To proceed with the installation, click OK and follow the instructions in the installation wizard.

- 6 In the **Importing/Pasting text** dialog box, you can choose to maintain or discard text formatting. You can also choose to import tables as tables or text.
- 7 Position the import cursor  in the drawing window, and click.



Any embedded Windows Metafile Format (WMF) or Enhanced Metafile Format (EMF) graphics are preserved in the imported file. If the file contains other graphic elements, these are lost during conversion and do not appear in CorelDRAW.



You can place your imported text by dragging a marquee to define a paragraph text box, or by pressing the **Spacebar** to place the imported text in the default location.

If you import text and choose not to install the Microsoft Office Compatibility Pack, the **Install compatibility pack** dialog box will reappear the next time you import text, unless you enable the **Do not ask me this question again** check box. You can reactivate the **Install compatibility pack** dialog box by clicking **Tools ► Options**. In the list of categories, double-clicking **Workspace**, clicking **Warnings**, and enabling the **Install Compatibility Pack for DOC and DOCX** check box from the **Show warnings when** list box.

To export a Microsoft Word file

- 1 Open a drawing that contains a text **object**.
- 2 Click **File ► Export**.
- 3 Choose **DOC - MS Word for Windows 6/7** or **RTF - Rich Text Format** from the **Save as type** list box.
- 4 Type a filename in the **File name** list box.
- 5 Click **Export**.



The filename extension for the format you choose is appended to the filename automatically.

Only text in drawings can be exported to the Microsoft Word file formats. Other graphical elements, such as lines, curves, and rectangles, are lost during conversion and do not display in the file. To export graphics, use a graphic format such as WMF.

Microsoft Word (DOC, DOCX, and RTF) technical notes

Importing a DOC, DOCX, and RTF file

- To successfully import text with fewer inconsistencies, it is recommended that you install the Microsoft Office Compatibility Pack. If the Microsoft Office Compatibility Pack was not previously installed on your computer, you will be prompted to install it when you attempt to import text.
- The following Microsoft Word versions are supported: Microsoft Word 97-2007, Microsoft Word for Windows 6/7, Microsoft Word for Windows 2.x, Microsoft Word 3.0, 4.0, 5.0, and 5.5.
- The embedded-field method for building indexes in Microsoft Word is supported, but the style-implied method for building indexes is not.
- The Corel program matches the fonts in the file you are importing with the same or similar fonts, depending on the fonts installed on your computer. However, the Normal text style in Microsoft Word is converted to the default text style. To set the default text style, click **Tools ► Options**. In the list of categories, double-click **Document**, enable the **Save options as defaults for new document** check box, and then enable the **Styles** check box.
- Whenever possible, the program automatically converts characters available in the sets "Symbol" or "MS Linedraw" to the corresponding Windows character set entries.
- Most fonts are proportionally spaced, and text is reflowed when imported. As a result, soft line and page breaks often appear in new locations if you are converting to a fixed-pitch or nonscalable font.
- When you import text, the page size in the original document is ignored. The text is adjusted to fit the current page size, which may affect the placement of text.
- If a table is longer than the current page, the table data continues down and off the page.
- Nested tables are not fully supported. The text within a nested table appears within the text box of the top-level table cell as text only (no bounding lines).
- Nested bullets are not fully supported.
- Objects and graphs are not supported.
- Equations are not maintained — the data and results may be maintained but they are unlinked.
- Text direction is not maintained.

Microsoft Publisher (PUB)

Microsoft Publisher (PUB) is the native format for files created in Microsoft Publisher, an application in the Microsoft Office line of products used for creating publications and market materials.

Microsoft Publisher (PUB) technical notes

- CorelDRAW imports Microsoft Publisher files from versions 2002, 2003, 2007, and 2010.
- Exporting is not supported.
- Two-page spread is imported as separate pages.
- Master pages are not supported. A master page is imported as a separate layer on the page. The name of the layer corresponds to the name of the master page in Microsoft Publisher.
- Headers and footers are not supported. Text from the header/footer is placed in the appropriate position on each page.
- Tables are supported. Not all border types are supported. If a border type is not supported, it is replaced with an outline of the desired thickness and color.
- Border art is not supported.
- Styles are not supported. Style and formatting attributes are mapped to text.
- Some underline styles are not supported. Unsupported underline styles are replaced with the best-match underline style available in CorelDRAW.
- Shadow, Emboss, and Engrave font effects are not supported.
- Horizontal rules in text objects are not supported.
- Color schemes are not supported. Color scheme colors are mapped to object colors.
- Font schemes are not supported. Font names and styles are mapped to their equivalents in CorelDRAW.
- 3D shapes are supported. Surface textures are not supported.
- Word art is imported as artistic text in CorelDRAW. Surface textures for extrudes are not supported.
- Linked text boxes are supported.
- Bookmarks and hyperlinks are supported.
- Form objects (Microsoft Publisher 2002) are not supported.

Corel DESIGNER (DES, DSF, DS4, or DRW)

You can import Corel DESIGNER files. Files from version 10 and later have the filename extension **.des**. Files from Micrografx versions 6 to 9 have the filename extension **.dsf**. Version 4 files have the filename extension **.ds4**. The **.drw** filename extension is used for a Micrografx 2.x or 3.x file. Micrografx template files (DST) are also supported.

To import a Corel DESIGNER file

- 1 Click **File** ► **Import**.
- 2 Locate the folder in which the file is stored.
- 3 Choose **DES - Corel DESIGNER (*.des)** or **DSF, DRW, DST, MGX - Corel/Micrografx Designer (*.dsf; *.drw; *.ds4)** from the list box next to the **File name** box.
- 4 Click the filename.
- 5 In the **Import** dialog box, adjust any of the settings.
- 6 Click **Import**.
- 7 Click the drawing page.

Corel DESIGNER (DSF) technical notes

- Guidelines and grid settings are not converted.
- [Snap points](#) are not converted — the program preserves the default gravity settings.

- **Objects** on some pages may be grouped together. You may want to select the group and then ungroup it before editing.
- DSF files display OLE data as picture objects. OLE data object types are lost in the conversion.
- Curvygons are converted to curves.
- Gradient **transparency** may be offset in some cases.
- Hatch fills are rendered but are actually part of the object fill. They are separate objects that are grouped.
- Unclosed, filled lines are converted to two objects: one for the line and one for the fill.
- Warped text is converted to curves.
- Repelled text (block text that wraps around an object) is converted to multiple text objects.
- Each line of a nonrectangular text object (text placed within an object) is converted to a separate text object.
- For block text that has many transformations, tab stops may stretch or shrink.
- Text flowing between containers is not preserved; each container is converted to a separate object.
- Dimensions of text in small caps vary when the text is imported.

Corel DESIGNER (DES) technical notes

- B-splines are preserved in the imported file but cannot be modified before you convert them to curve objects. For information about converting objects to curve objects, see ["To convert objects to curve objects"](#) on page 180.
- Hatch fills are preserved but cannot be modified in CorelDRAW. You can, however, apply a hatch fill to other objects in a drawing. For more information, see ["To copy fill, outline, or text properties from one object to another "](#) on page 272.
- Enhanced line styles are preserved but you can modify only some of their properties. For example, you can change the color and width of the lines, but you cannot modify the line pattern. You can apply an enhanced line style to other objects.

AutoCAD Drawing Database (DWG) and AutoCAD Drawing Interchange Format (DXF)

AutoCAD Drawing Database (DWG) files are vector files used as a native format for AutoCAD drawings.

The Drawing Interchange Format (DXF) is a tagged data representation of the information contained in an AutoCAD drawing file. The Drawing Interchange format is a native file format of AutoCAD. It has become a standard for exchanging CAD drawings and is supported by many CAD applications. The Drawing Interchange format is vector-based and supports up to 256 colors.

To import an AutoCAD Drawing Database file (DWG) or AutoCAD Drawing Interchange Format (DXF)

- 1 Click **File** ► **Import**.
- 2 Locate the folder in which the file is stored.
- 3 Choose **DWG - AutoCAD (*.dwg)** or **DXF - AutoCAD (*.dxf)** from the list box next to the **File name** box.
- 4 Click the filename.
- 5 Click **Import**.
- 6 From the **3D projection** list box in the **Import AutoCAD file** dialog box, choose a plane projection of a three-dimensional object as seen from a given focal point.
If you want to reduce the number of nodes on the imported object, enable the **Auto-reduce nodes** check box.
- 7 In the **Scaling** area, enable one of the following options:
 - **Automatic** — scales the drawing using the scale of the AutoCAD source file
 - **English (1 unit = 1 inch)** — lets you scale the drawing in inches
 - **Metric (1 unit = 1 mm)** — lets you scale the drawing in millimeters
- 8 Click **OK**.
If the file is password protected, type the password in the **Password** box.



If views are specified in your file, they appear automatically in the **3D projection** list box.

If your computer is missing a font that is included in a file you are importing, a **PANOSE font matching** dialog box appears and lets you substitute the font with a similar font.

To export an AutoCAD Drawing Database file (DWG) or an AutoCAD Drawing Interchange file (DXF)

- 1 Click **File** ► **Export**.
- 2 Locate the folder in which you want to save the file.
- 3 From the **Save as type** list box, choose one of the following options:
 - **DWG - AutoCAD**
 - **DXF - AutoCAD**
- 4 Type a filename in the **File name** list box.
- 5 Click **Export**.
- 6 In the **Export to AutoCAD** dialog box, choose an AutoCAD version from the **Export version** list box.
- 7 Choose a unit of measure from the **Export units** list box.
- 8 In the **Export text as** area, enable one of the following options:
 - **Curves** — lets you export text as curves
 - **Text** — lets you export text as editable characters
- 9 In the **Export bitmap as** area, enable one of the options to export the bitmaps in a drawing to a supported bitmap format.
- 10 In the **Fill unmapped fills** area, enable one of the following options:
 - **Color** — fills all unmapped fills with color. To change the color, click the **Color** picker and choose a color on the **palette**.
 - **Unfilled** — leaves unmapped fills unfilled

AutoCAD Data Interchange Format (DXF) technical notes

- The program supports AutoCAD files from version R2.5 to 2018.
- Layers are retained on import and export.

Importing an AutoCAD DXF file

- If a DXF file is too complex to import into CorelDRAW, you can configure your AutoCAD output device as an HP7475 plotter and perform a plot-to-file of the drawing. Then you can try importing this plot file with the HPGL import filter. Newer versions of AutoCAD allow you to create EPS files.
- Corel graphics programs try to center the imported image. The image is scaled down if the coordinates are larger than the maximum page size available in CorelDRAW — 150 □ 150 feet.
- Solid and trace entities are filled.
- Dimension lines are imported as dimension objects.
- A point is imported as an ellipse of minimum size.
- Files exported as “Entities only” may not appear as expected in the Corel program because of a lack of header information.
- Imported AutoCAD files that contain formatted paragraph text preserve text formatting such as spacing, alignment, and indents.
- Justification of text entries may not be preserved, especially if fonts are replaced in the imported files. For best results, avoid justification of text.
- If the DXF file contains a font that is not on the user’s computer, the **PANOSE font matching** dialog box lets the user replace the font with an available one.
- 3D objects are not supported.

Exporting an AutoCAD DXF file

- CorelDRAW saves drawings in a vector format accepted by computer-aided design/computer-aided manufacturing (CAD/CAM) programs and devices, such as AutoCAD and certain computer-driven sign and glass cutters.
- Files exported to AutoCAD version 2007 may not display correctly in AutoCAD 2007.

- Password protection is not available in the exported files.
- Only the outlines of objects are exported.
- Filled objects with no outlines have an outline appended to them on export.
- All text is exported by using a generic font. Text formatting is not preserved.

AutoCAD Drawing Database (DWG) technical notes

- CorelDRAW can import AutoCAD and export files from version R2.5 to 2018.
- Password protection is not available in the exported files.
- If the DWG file contains a font that is not on your computer, the **PANOSE font matching** dialog box lets you replace the font with an available one.

Encapsulated PostScript (EPS)

EPS files can contain text, vector graphics, and bitmaps and are intended to be included (encapsulated) in other documents. Unlike other PostScript files, which can contain multiple pages, an EPS file is always a single page.

EPS files usually contain a preview image (header) that lets you view the file content without the help of a PostScript interpreter. An EPS file without a preview image is displayed as a gray box in Corel applications.

You can import and export EPS files. You can import an EPS file as a group of editable objects as you would import any other PostScript (PS) file. You can also bring the file as encapsulated, placing the preview image in the drawing window. The preview image is linked to the file. It is recommended that you import an EPS file as encapsulated in the following situations:

- You want text in the EPS file to be displayed with the original fonts, without any font substitutions.
- You are working with a large EPS file, and you don't want to slow down the application.

During the CorelDRAW Graphics Suite installation, you have the option of installing Ghostscript, which is an application that interprets the PostScript file format. Ghostscript allows you to import PostScript Level 3 files. If you did not install Ghostscript when you first installed the product, you can do so now.

To import an encapsulated PostScript file

- 1 Click **File** ► **Import**.
- 2 Locate the folder in which the file is stored.
- 3 Choose **PS, EPS, PRN - PostScript (*.ps; *.eps; *.prn)** from the list box next to the **File name** box.
- 4 Click the filename.
- 5 Click **Import**.
- 6 In the **Import EPS** dialog box, enable one of the following options:
 - **Import as editable** —brings in the file as a group of CorelDRAW objects that you can modify
 - **Place as encapsulated PostScript** —places the preview image in the drawing. You cannot modify specific parts of the file, but you can edit the file as a whole by applying transformations, such as sizing and rotation.
- 7 If you are importing the file as editable, enable one of the following text options:
 - **Text** — preserves text objects in the imported file so that you can edit the text
 - **Curves** — converts text to curves
- 8 Click **OK**.
- 9 Click the [drawing page](#).



Some restrictions apply when you modify EPS files imported as editable. For more information, see “[PostScript \(PS or PRN\) technical notes](#)” on page 828.

If the EPS file contains text converted to curves, the text in the imported file is not editable, even if you choose to import the text as text.



You can also drag an EPS file from Windows Explorer into the drawing window.

To export an encapsulated PostScript file

- 1 Click **File** ► **Export**.
- 2 Locate the folder in which you want to save the file.
- 3 Choose **EPS - Encapsulated PostScript** from the **Save as type** list box.
- 4 Type a filename in the **File name** list box.
- 5 Click **Export**.
- 6 In the **EPS export** dialog box, adjust any of the settings.

To set general exporting options

- 1 In the **EPS export** dialog box, click the **General** tab.
- 2 Perform one or more tasks from the following table.

To	Do the following
Specify the color mode for exporting to eps	<p>In the Color management area, choose an option from the Output colors as list box:</p> <ul style="list-style-type: none">• Native• RGB• CMYK• Grayscale <p>If you choose the Native option, all objects preserve the color mode in which they were created, for example RGB, CMYK, Grayscale, or spot.</p>
Convert spot colors	<p>In the Color management area, enable the Convert spot colors to check box, and select an option from the list box.</p>
Choose a file format for previewing the PostScript image	<p>In the Preview image area, choose one of the following options:</p> <ul style="list-style-type: none">• None• TIFF• WMF <p>If you choose the TIFF format, choose a color mode and resolution.</p>
Specify how to export text	<p>Enable one of the following options in the Export text as area:</p> <ul style="list-style-type: none">• Curves — lets you export text as curves• Text — lets you export text as editable characters

To

Do the following

If you want to include PostScript font information with your file, enable the **Include fonts** check box.

Choose a compatibility option

From the **Compatibility** list box, choose a PostScript level that is supported by the printer or the application with which you will be printing or displaying the file.



Objects are always output as **CMYK**. Bitmaps have the option of different color modes.



If you choose the 8-bit TIFF format for previewing images, you can make the background of the bitmap transparent by enabling the **Transparent background** check box in the **Preview image** area.

To set advanced exporting options

- 1 In the **EPS export** dialog box, click the **Advanced** tab.
- 2 Perform one or more tasks from the following table.

To

Do the following

Specify the author's name

Type a name in the **Author** box.

Apply bitmap compression

In the **Bitmap compression** area, enable the **Use JPEG compression** check box. Move the **JPEG quality** slider to adjust the quality of the bitmaps.

Apply a trapping option

In the **Trapping** area, enable any of the following options:

- **Preserve document overprint settings** — maintains current settings on objects
- **Always overprint black** — creates a color trap by causing any objects that contain at least 95 percent black to overprint any underlying objects
- **Auto-spreading** — creates a color trap by assigning an outline to an object that is the same color as its fill and having it overprint underlying objects
- **Maximum** — lets you specify the amount of spread that the Auto-spreading option assigns to an object

If you want to specify the minimum font size to which Auto-Spreading is applied, type a value in the **Text above** box.

If you want the outlines of all objects on the page to have the same width, enable the **Fixed width** check box.

Apply a bounding box

In the **Bounding box** area, enable any of the following options:

- **Objects** — aligns the bounding box exactly to the objects in the file
- **Page** — aligns the bounding box to the page

To

Do the following

- **Bleed limit** — lets you specify how far the bleed extends beyond the edge of the area to be printed
- **Crop marks** — lets you use crop marks as alignment aids when you trim the print output to its final size
- **Floating point numbers** — lets you use numbers with decimals

Maintain OPI link

Enable the **Maintain OPI links** check box to use low-resolution images as placeholders for high-resolution images.

Automatically increase fountain steps

Enable the **Auto-increase fountain steps** check box to automatically increase the number of steps used to create fountain fills.



The **Use JPEG compression** check box remains disabled until you choose a PostScript level that supports this feature.

To install Ghostscript

- 1 Close any open programs.
- 2 On the Windows taskbar, click **Start** ► **Control panel**.
- 3 Click **Uninstall a program**.
- 4 Double-click CorelDRAW Graphics Suite 2018 from the **Uninstall or change a program** page.
- 5 Enable the **Modify** option.
- 6 On the Features page, enable the **GPL Ghostscript** check box.
- 7 Follow the instructions in the installation wizard.

Encapsulated PostScript (EPS) technical notes

Importing an EPS file

- When you import an EPS file as editable, the PostScript information in the file is converted to native CorelDRAW objects that you can edit with some restrictions. For information about these restrictions, see [“PostScript \(PS or PRN\) technical notes” on page 828](#).
- If the encapsulated PostScript file was imported with the **Place as Encapsulated PostScript** option, and if it contains a preview image (called a header), the preview image is imported and displayed. The EPS information remains attached to the header and is used when the image is printed to a PostScript printer.

Exporting an EPS file

- On a PostScript printer, graphics exported to the encapsulated PostScript (EPS) format print from other programs exactly as they do from a Corel graphics programs.
- You can save a header to the Tagged Image file format (TIFF) or Windows Metafile format (WMF) in **black and white**, 4-bit **grayscale** or **color**, or 8-bit **grayscale** or **color**. You can set the header **resolution** between 1 and 300 dots per inch (**dpi**); the default header resolution is 72 dpi. If the program importing the EPS file has a limitation on the image header size, you might receive an error message stating that the file is too large. To reduce file size, in the **EPS export** dialog box, choose **Black and White** from the **Mode** box, and lower the header resolution before exporting the file. The setting determines only the resolution of the header and has no impact on the print quality of a drawing. Color headers are useful for viewing EPS files. If the program in which you are going to use the file does not support color headers, try exporting with a mono header instead. You can also export without a header.
- Along with the graphic, exported EPS files contain a filename, program name, and date.
- To save font information in an EPS file, enable the **Include fonts** check box in the **Export text as** area.
- If you export text as curves, **text** is converted to vector curves.
- If a font used in the file is not available on the printer or has not been saved in the file, either the text is printed in Courier font or the drawing is not printed.

PostScript (PS or PRN)

PostScript (PS) files use PostScript language to describe the layout of text, vector graphics, or bitmaps for printing and display purposes. They can contain multiple pages. PostScript files are imported as a group of objects that you can edit.

PostScript files usually have a `.ps` filename extension, but you can also import PostScript files with a `.prn` extension. Files with a `.prn` filename extension, commonly known as Printer (PRN) files, contain instructions about how a file should be printed. These files let you reprint a document even if the application in which the document was created is not installed on your computer.

During the CorelDRAW Graphics Suite installation, you have the option of installing Ghostscript, which is an application that interprets the PostScript file format. Ghostscript assists the file importing process. If you did not install Ghostscript during the installation, see [“To install Ghostscript” on page 827](#).

You can also import encapsulated PostScript (EPS) files. For more information, see [“Encapsulated PostScript \(EPS\)” on page 824](#).

To import a PostScript (PS or PRN) file

- 1 Click **File** ► **Import**.
- 2 Locate the folder in which the file is stored.
- 3 Choose **PS, EPS, PRN - PostScript (*.ps; *.eps; *.prn)** from the list box next to the **File name** box.
- 4 Click the filename, and click **Import**.
- 5 In the **Import text as** area, enable one of the following text options:
 - **Text** — preserves text objects in the imported file so that you can edit the text
 - **Curves** — converts text to curves
- 6 Click **OK**.
- 7 Click the drawing page.



When the PostScript file contains text converted to curves, the text in the imported file is not editable, even if you choose to import the text as text.

PostScript (PS or PRN) technical notes

- PostScript files containing mesh fills with spot colors, [DeviceN](#) images, or duotone images cannot be imported. Installing Ghostscript resolves this issue.
- Mesh fills in the CMYK color mode are imported as bitmaps and cannot be edited.
- Gradient fills are imported as a group of filled objects simulating the gradient fill appearance and cannot be edited as gradient fills.
- RGB bitmaps are converted to CMYK in imported PS files. Installing Ghostscript resolves this issue.
- Font information is maintained only if the font was embedded in the original file before it was imported.
- Files that are too large cannot be imported into some programs because of memory limitations. This problem can be caused by complex gradient fills that increase the number of objects in a graphic.
- Only Printer (PRN) files, PS files, and EPS files in PostScript format are supported.

GIF

GIF is a bitmap-based format designed for use on the web. It is highly compressed to minimize file transfer time and supports images with up to 256 colors. The GIF file format supports a maximum image size of 30,000 × 30,000 pixels and uses LZW compression. For more information about exporting images to the GIF file format, see [“Exporting bitmaps for the web” on page 773](#).

The GIF format provides the ability to store multiple bitmaps in a file. When the multiple images are displayed in rapid succession, the file is called an animated GIF file.

For Internet use, you can also save images to the [JPEG](#) and [PNG](#) formats. If you want to publish an image to the web and are not sure which format to use, see [“Exporting bitmaps for the web” on page 773](#).

To import a GIF file

- 1 Click **File** ► **Import**.
- 2 Locate the folder in which the file is stored.
- 3 Choose **GIF - CompuServe Bitmap (*.gif)** from the list box next to the **File name** box.
- 4 Click the filename.
- 5 Click **Import**.
- 6 Click the [drawing page](#).

You can also

Resample a graphic while importing

For more information, see [“To resample a bitmap while importing” on page 791](#).

Crop a graphic while importing

For more information, see [“To crop a bitmap while importing” on page 792](#).



You can drag on the drawing page to resize the image.

GIF technical notes

- Corel programs import versions 87A and 89A of the [GIF](#) file format, but export only to version 89A. Version 87A supports basic features and interlacing. The newer version, 89A, includes all features found in 87A plus the ability to use transparent colors and to include comments and other data from the image file.
- Corel programs support the following color depths when importing animated GIF files: black and white (1-bit), 16 colors, grayscale (8-bit), and 256 color paletted (8-bit).

JPEG (JPG)

[JPEG](#) is a standard format developed by the Joint Photographic Experts Group. Through the use of superior compression techniques, this format allows the transfer of files among a wide variety of platforms. JPEG supports 8-bit [grayscale](#), 24-bit [RGB](#), and 32-bit [CMYK](#) color modes.

The JPEG format is commonly used on the web. For more information about exporting to the JPEG file format, see [“Exporting bitmaps for the web” on page 773](#).

To import a JPEG file

- 1 Click **File** ► **Import**.
- 2 Locate the folder in which the file is stored.
- 3 Choose **JPG - JPEG Bitmaps (*.jpg; *.jtf; *.jff; *.jpeg)** from the list box next to the **File name** box.
- 4 Click the filename.
- 5 Click **Import**.
- 6 Click the [drawing page](#).

You can also

Resample a graphic while importing

For more information, see “To resample a bitmap while importing” on page 791.

Crop a graphic while importing

For more information, see “To crop a bitmap while importing” on page 792.



You can drag on the [drawing page](#) to resize the image.

JPEG technical notes

- JPEG files can contain EXIF data. This data may affect how the JPEG files open.

JPEG 2000 (JP2)

The [JPEG 2000 \(JP2\)](#) file format is a JPEG image with advanced compression and file data capabilities. JPEG 2000 standard files can store more descriptive file data (or metadata), such as dimensions, tone scale, color space, and intellectual property rights, than JPEG 2000 codestream files. Codestream files are optimized for network transmission since they resist bit errors that can cause data loss on low-bandwidth channels.

Not all web browsers support JPEG 2000 formats. You may require a plug-in to view these files.

When you export the image to a JP2 file, you can choose to view download progression by [resolution](#), quality, and position.

To import a JPEG 2000 file

- 1 Click **File** ► **Import**.
- 2 Locate the folder in which the file is stored.
- 3 Choose **JP2 - JPEG 2000 Bitmaps (*.jp2; *.j2k)** from the list box next to the **File name** box.
- 4 Click the filename.
- 5 Click **Import**.
- 6 Click the [drawing page](#).

To export a JPEG 2000 bitmap

- 1 Click **File** ► **Export**.
- 2 Choose **JP2 - JPEG 2000 bitmaps** from the **Save as type** list box.
- 3 Type a name in the **File name** box.
- 4 Click **Export**.
- 5 Choose a **JPEG 2000** preset from the **Preset list** list box in the upper-right corner of the dialog box.
If you want modify the preset settings, you can change the exporting options in the dialog box.
- 6 Click **OK**.

You can also

Choose a color mode

In the **Settings** area, choose a color mode from the **Color mode** list box.

You can also

Embed the color profile	In the Advanced area, enable the Embed color profile check box.
Control image quality	In the Settings area, choose a quality option from the Quality list box or type a value.
Set the JPEG 2000 download from low to high resolution so that the size of the entire image increases	In the Advanced area, choose Resolution\Quality from the Progression list box.
Set the JPEG 2000 download from the upper-left corner of the image to the lower-right corner	In the Advanced area, choose Resolution\Position from the Progression list box.
Set the JPEG 2000 download from the upper-left corner of the image to the lower-right corner	In the Advanced area, choose Position from the Progression list box.
Set the JPEG 2000 download progressively by color channel	In the Advanced area, choose Channels from the Progression list box.
Allow JPEG 2000 codestream	In the Advanced area, enable the Codestream check box.

JPEG 2000 (JP2) technical notes

- CorelDRAW can import either JP2 or JPC files but export only to the JP2 format.
- CorelDRAW supports exporting JPEG 2000 files in 24-bit **RGB**, and 8-bit **grayscale**.
- **CMYK**, 48-bit **RGB**, and **black-and-white** images are not supported for export.

Kodak Photo CD Image (PCD)

Kodak Photo CD image file is a raster format developed by Eastman Kodak for scanning photographic images onto compact discs. PCD images are derived from 35-mm film negatives or slides that have been converted to digital format and stored on a CD. Photo CD allows high-quality digital storage and manipulation of photographic images. The PCD format is typically used by photofinishers and service bureaus who provide the service of placing photographs on CDs.

This file format is not supported by the 64-bit version of the application.

To import a Kodak Photo CD image file

- 1 Click **File** ► **Import**.
- 2 Choose the folder in which the file is stored.
- 3 Choose **PCD - Kodak Photo-CD image (*.pcd)** from the list box next to the **File name** box.
- 4 Click the filename.
- 5 Click **Import**.
- 6 In the **PCD import** dialog box, move any of the following sliders:
 - **Brightness** — lets you set the amount of light
 - **Contrast** — lets you specify the contrast between the **pixels** in the image
 - **Saturation** — lets you specify the purity of a color
 - **Red** — lets you specify the amount of red in the image

- **Green** — lets you specify the amount of green in the image
 - **Blue** — lets you specify the amount of blue in the image
- 7 From the **Resolutions** list box, choose an image size.
 - 8 From the **Image type** list box, choose a color mode.
 - 9 Position the import placement start cursor on the drawing window, and click.

You can also

Resample a graphic while importing

For more information, see [“To resample a bitmap while importing” on page 791.](#)

Crop a graphic while importing

For more information, see [“To crop a bitmap while importing” on page 792.](#)



You can drag on the [drawing page](#) to resize the image.

You can remove the adjustments made by the photofinisher at the time the original image was scanned and placed on the Photo CD disk by enabling the **Subtract scene balance** check box.

You can identify out-of-gamut areas of the image by enabling the **Show colors out of gamut** check box, which renders the out-of-gamut [pixels](#) in pure red or pure blue.

Kodak Photo CD Image (PCD) technical notes

- Kodak Photo CD (PCD) images may be subject to copyright. The Corel program does not display a warning message about this.
- Other Kodak-compatible programs may install the Kodak **pcdlib.dll** file in the **Windows** folder instead of the **Windows\System** folder. This difference in the folder location produces an error message.
- When you import **Photo CD** files, a dialog box appears and prompts you to choose the desired file resolution and color. The resolution is limited to 72 dpi and the maximum image size is 3072 × 2048 pixels.
- You can import the following color modes: RGB (24-bit), paletted (8-bit), and grayscale (8-bit).

PICT (PCT)

The Macintosh PICT file format was developed for the macOS platform by Apple Computer Inc. It is a native file format of QuickDraw and can contain both vectors and bitmaps. The Macintosh PICT file format is widely used in Macintosh applications.

To import a PICT file

- 1 Click **File** ► **Import**.
- 2 Locate the folder in which the file is stored.
- 3 Choose **PCT - Macintosh PICT (*.pct; *.pict)** from the list box next to the **File name** box.
- 4 Click the filename.
- 5 Click **Import**.
- 6 Click the [drawing page](#).



You can drag on the drawing page to resize the image.

To export a PICT file

- 1 Click **File** ► **Export**.
- 2 Locate the folder in which you want to save the file.
- 3 Choose **PCT - Macintosh PICT** from the **Save as type** list box.
- 4 Type a filename in the **File name** list box.
- 5 Click **Export**.

PICT (PCT) technical notes

- Corel graphics programs can import **vector** drawings and **bitmaps** contained in PICT (PCT) files.
- **Objects** that contain a fill and an outline open as a group of two objects. One object is the outline, and the other is the fill.
- PICT fills are often bitmap patterns, and the Corel program tries to maintain these fills as bitmap patterns.
- Pattern outlines are converted to a solid color.
- Text in PICT files opens as editable text. If a typeface in the imported file is not available on your computer, it is converted to the font that it most closely resembles.
- Text alignment may not be preserved in the original file. This is due to the differences in font size, and intercharacter and interword spacing between the two formats. Any misalignment is easily corrected using the text formatting settings in the program.

PaintBrush (PCX)

The PaintBrush (PCX) file format is a **bitmap** format originally developed by the ZSoft Corporation for the PC Paintbrush program.

To import a PaintBrush file

- 1 Click **File** ► **Import**.
- 2 Locate the folder in which the file is stored.
- 3 Choose **PCX - PaintBrush (*.pcx)** from the list box next to the **File name** box.
- 4 Click the filename.
- 5 Click **Import**.
- 6 Click the [drawing page](#).

To export a PaintBrush file

- 1 Click **File** ► **Export**.
- 2 Locate the folder in which you want to save the file.
- 3 Choose **PCX - PaintBrush** from the **Save as type** list box.
- 4 Type a filename in the **File name** list box.
- 5 Click **Export**.
- 6 In the **Convert to bitmap** dialog box, adjust the width, height, resolution, color mode, or any of the other settings.
- 7 In the **Convert to paletted** dialog box, adjust any of the settings.

PaintBrush (PCX) technical notes

Exporting a PCX file

- Bitmaps may be black-and-white, 16 colors, grayscale (8-bit), paletted (8-bit), or RGB color (24-bit).
- Run-length encoding (RLE) compression is supported, and the maximum image size is 64,535 × 64,535 pixels.
- These files may contain one, two, or four color planes.
- This file format is supported in CorelDRAW and Corel PHOTO-PAINT.

Importing a PCX file

- PCX files can be imported if they conform to the following PCX specifications: 2.5, 2.8, and 3.0.
- Bitmaps may be black-and-white, 16 colors, grayscale (8-bit), paletted (8-bit), or RGB color (24-bit).
- RLE compression is supported and the maximum image size is 64,535 × 64,535 pixels.
- These files may contain one, two, or four color planes. Files containing three color planes or more than four color planes cannot be imported.

Adobe Portable Document Format (PDF)

The Adobe Portable Document Format (PDF) is a file format designed to preserve fonts, images, graphics, and formatting of an original file. Using Adobe Reader and Adobe Acrobat, a PDF file can be viewed, shared, and printed by macOS, Windows, and UNIX users.

You can open or import a PDF file. When you open a PDF file, it is opened as a CorelDRAW file. When you import a PDF file, the file is imported as grouped objects and can be placed anywhere within your current document. You can import an entire PDF file, individual pages from the file, or multiple pages.

Some PDF files are secured by a password. You are prompted to enter a password before you can open and edit a secured PDF file. For information about PDF security options, see [“Setting security options for PDF files” on page 803](#).

You can save a file in the PDF format. For more information, see [“Exporting to PDF” on page 795](#).

Importing text

The method by which PDF files store information affects how text looks and how easily it can be edited. To help ensure the best results for your document, you can choose whether to import the text in your file as text or as curves.

When you import text as text, the font and text are preserved, and the text is fully editable as [artistic](#) or [paragraph text](#). However, some effects and formatting may be lost. This option is recommended if you have a PDF file that contains large blocks of text, such as a newsletter, and you want to reformat the text or add text content.

When you import text as curves, the appearance of the text, including all effects applied to it, are preserved, and each letter is converted to a [curve object](#). With this option, the text formatting features can no longer be used to edit the text. If you have a PDF file that contains a small amount of text that does not require editing, or if you do not have the fonts used in the PDF file, you can import the text as curves. For more information about converting text to curves, see [“Finding, editing, and converting text” on page 486](#).

Importing comments

Some PDF files can contain comments and annotations. These may consist of text, curves, and other drawings or shapes that are added to the PDF document by a reviewer. If commenting rights have been granted, you have the option of importing the comments with the PDF file. When comments are imported, they are placed on a separate “Comments” layer in the document. By default, this layer is set as non-printable.

If the PDF document contains comments written by multiple reviewers, the comments are grouped on the “Comments” layer based on the author’s name.

Cropping content

Some PDF files may contain objects that fall outside the drawing page. You can crop object parts that are not on the drawing page, or you can leave them intact.

To import an Adobe Portable Document Format file

- 1 Click **File** ► **Import**.
- 2 Locate the folder in which the file is stored.
- 3 Choose **PDF - Adobe Portable Document Format** or **All file formats** from the list box next to the **File name** box.
- 4 Click the filename.

5 Click **Import**.

If the file is protected by a password, type a valid password in the **Password** box.

6 In the **Import text as** area, choose one of the following options:

- **Text** — lets you edit and reformat the text from the PDF file
- **Curves** — converts text to curves. Choose this option when you do not need to edit the text from the PDF file, and you want to maintain the appearance of the original text.

If you are importing a multipage document, select the pages you want to import, and click **OK**.

If the document contains comments that you want to import, enable the **Import comments and place on a separate layer** check box.

If the document contains objects that fall outside the drawing page, you can choose to crop them to the drawing page or leave them intact by enabling or disabling the **Crop content to drawing page** check box.

7 Click the **drawing page**.



If a block of text is imported as separate text objects, you can combine the text objects by selecting them and clicking **Object ► Combine**.

Adobe Portable Document Format (PDF) technical notes

Publishing a PDF file

- Texture fills created in CorelDRAW are exported and imported as bitmap patterns.
- Embedded 3D models are exported as embedded interactive 3D objects. If a document contains a 3D model, click **Settings** in the **Publish to PDF** dialog box, and choose **Acrobat 9.0** or higher from the **Compatibility** list box to ensure that the 3D model is interactive in PDF readers.

Importing a PDF file

- Digital signatures are not supported.
- PDF Portfolios are not supported.
- Multimedia files — such as .mov, .mp3, .mp4, .mpeg, or .swf — are not supported and, as a result, are removed from the PDF file when imported in CorelDRAW.
- File link annotations are imported as artistic text.
- Transparency applied to text and graphics is preserved.
- Character attributes of text, including OpenType features, are preserved.
- **DeviceN** color spaces may be converted to RGB or CMYK processed colors in the imported file, depending on the file content.
- Layers are preserved in files created with Adobe Acrobat 6 and later.
- Xform objects, headers and footers are converted to symbols.
- Symbols are preserved when PDF files created with version 1.3 or later undergo **round-tripping**.
- Comments are preserved and imported on a separate “Comments” layer in the document.
- Text annotations, including free text and pop-up annotations, are imported as paragraph text.
- Sticky Notes display as a rectangle with the appropriate background and border color. Headers in Sticky Notes are not supported.
- Line annotations display as straight lines with the appropriate width and color. Arrows with different fill and outline colors display fill and outline of the same color.
- Square and circle annotations display as rectangles and ellipses with the appropriate fill/outline properties. Polygon and polyline annotations are mapped as polycurves with similar fill/outline properties. Cloud shapes display as polygons.
- Text markup annotations, such as highlights, underlining, and strikeouts, are imported.
- Standard ink and stamp annotations are supported. Custom stamp annotations are not supported.

HPGL Plotter File (PLT)

The HPGL Plotter File (PLT) format, developed by Hewlett-Packard, is vector-based. It is used in programs such as AutoCAD for printing drawings on plotters. Other Corel applications can interpret a SUBSET of the HPGL and HPGL/2 command set. This format uses a scaling factor of 1,016 plotter units to 1 inch.

To import an HPGL Plotter file

- 1 Click **File** ► **Import**.
- 2 Locate the folder in which the file is stored.
- 3 Choose **PLT - HPGL Plotter File (*.plt; *.hgl)** from the list box next to the **File name** box.
- 4 Click the filename.
- 5 Click **Import**.
- 6 In the **HPGL options** dialog box, adjust any of the settings.

To export an HPGL Plotter file

- 1 Click **File** ► **Export**.
- 2 Locate the folder where you want to store the file.
- 3 Choose **PLT - HPGL Plotter File** from the **Save as type** list box.
- 4 Type a filename in the **File name** list box.
- 5 Click **Export**.
- 6 In the **HPGL export** dialog box, adjust any of the settings.

HPGL Plotter (PLT) technical notes

Importing a PLT file

- Corel programs support versions 1 and 2 of PLT file formats although some features of version 2 are not supported.
- You can import images larger than the Corel program's maximum page size by enabling the **Scale** option in the **HPGL options** dialog box, which lets you resize the imported image.
- The curve resolution factor can be set to a value between 0.0001 and 1.0 inch. The value can be very precise; up to eight decimal places are accepted. A setting of 0.0001 results in the highest resolution, but it also greatly increases file size. A curve resolution of 0.004 inch is recommended.
- The PLT file format does not contain color information. Instead, the various objects in a PLT file have certain pen numbers associated with them. When imported into a Corel program, each pen number is assigned a specific color. You can specify the color assigned to a particular pen, so that you can match the original colors of the graphic.
- The **Pen selection** list contains 256 pens, although not all of the pens may be assigned. You can change the color assignments by choosing the pen and then choosing a new color for that pen from the **Pen color** list box. Choosing **Custom colors** brings up a color definition dialog box that allows you to define a custom color according to RGB values.
- You can change the pen width assignments by choosing the pen and then choosing a new width for that pen from the **Pen width** list box.
- You can change the pen velocity by choosing the pen and then choosing a new velocity for that pen from the **Pen velocity** list box. This is useful only for exporting PLT files.
- You can set a defined pen to the **Unused** option. You can also reset the current Pen Library pen settings to the previously saved settings.
- Corel programs support numerous dotted, dashed, and solid line types of the PLT file format. The pattern number of a line in a PLT file is translated to a line type pattern.
- If the PLT file contains a font that is not on the user's computer, the **PANOSE font matching** dialog box lets the user replace the font with an available one.

Exporting a PLT file

- In CorelDRAW, you now have the option of setting the **Plotter origin** to **Top left**.

- Only the outlines of objects are exported to the PLT file format.
- Dotted lines, dashed lines, and arrowheads are mapped to standard line types of the PLT file format.
- Bézier curves are converted to line segments.
- Outline thickness and calligraphic settings are lost.
- Outline colors are limited to eight: black, blue, red, green, magenta, yellow, cyan, and brown.

Portable Network Graphics (PNG)

The Portable Network Graphics (PNG) file format is an excellent file format for *lossless*, portable, and well-compressed storage of bitmaps. It takes up a minimum amount of disk space and can be easily read and exchanged between computers. The Portable Network Graphics format provides a replacement for the GIF format and can also replace many common uses of the TIFF format.

The Portable Network Graphics format is designed to work well in online viewing, such as on the web, and it's fully streamable with a progressive display option. Some web browsers do not support all formatting and features. You can export images to the Portable Network Graphics file format if you want to use transparent backgrounds, image interlacing, image maps, or animation in your webpages.

Exporting graphics to the Portable Network Graphics format converts them to *bitmaps* that can be used in desktop publishing programs and Microsoft Office applications. You can also edit Portable Network Graphics in image-editing programs such as Corel PHOTO-PAINT and Adobe Photoshop. For more information, see [“Exporting bitmaps for the web” on page 773](#).

You can also save images to the GIF and JPEG formats to use on the Internet. If you want to publish an image to the web but are not sure which format to use, see [“Exporting bitmaps for the web” on page 773](#).

To import a Portable Network Graphics file

- 1 Click **File** ► **Import**.
- 2 Locate the folder in which the file is stored.
- 3 Choose **PNG - Portable Network Graphics (*.png)** from the list box next to the **File name** box.
- 4 Click the filename.
- 5 Click **Import**.
- 6 Click the [drawing page](#).

You can also

Resample a graphic while importing

For more information, see [“To resample a bitmap while importing” on page 791](#).

Crop a graphic while importing

For more information, see [“To crop a bitmap while importing” on page 792](#).



You can drag on the drawing page to resize the image.

Portable Network Graphics (PNG) technical notes

- You can import Portable Networks Graphics (PNG) files from 1-bit black and white to 24-bit color; 48-bit color is not supported.
- Masks and indexed-color, grayscale, and true color images are supported. Masks, however, are not saved in 1-bit black-and-white or 8-bit paletted files.
- LZ77 compression is supported, and the maximum image size is 30,000 × 30,000 pixels. Sample depths range from 1 to 16 bits.
- The PNG file format also checks full-file integrity and detects common transmission errors. The PNG file format can store gamma and chromatic data for improved color matching on different platforms.

Adobe Photoshop (PSD)

The Adobe Photoshop (PSD) file format is the native [bitmap](#) file format for Adobe Photoshop.

To import an Adobe Photoshop file

- 1 Click **File** ► **Import**.
- 2 Locate the folder in which the file is stored.
- 3 Choose **PSD - Adobe Photoshop (*.psd; *.pdd)** from the list box next to the **File name** box.
- 4 Click the filename.
- 5 Click **Import**.
- 6 Click the [drawing page](#).

You can also

Resample a graphic while importing

For more information, see [“To resample a bitmap while importing” on page 791](#).

Crop a graphic while importing

For more information, see [“To crop a bitmap while importing” on page 792](#).

To export an Adobe Photoshop file

- 1 Click **File** ► **Export**.
- 2 Locate the folder in which you want to save the file.
- 3 Choose **PSD - Adobe Photoshop** from the **Save as type** list box.
- 4 Type a filename in the **File name** list box.
- 5 Click **Export**.
- 6 In **Convert to bitmap** dialog box, adjust the width, height, resolution, color mode, or any of the other settings.



You can export to an image with a transparent background.

Adobe Photoshop (PSD) technical notes

Importing a PSD file

- Monotone, grayscale, duotone, 48-bit RGB, and up to 32-bit CMYK images are supported.
- Some layer effects cannot be imported. (Gradient map adjustment layer is imported without Noise, Opacity stops, and Dither.)
- Imported layers using the Darken Color and Lighten Color blend modes map to the If Darker and If Lighter merge modes, respectively. For more information about working with merge modes, see [“Applying merge modes” on page 398](#).
- Files that contain spot color channels are imported as multichannel (DeviceN) bitmaps.

Exporting a PSD file

- This format supports 1-bit black-and-white and up to 32-bit CMYK color images.
- Layers are supported.
- Text is rasterized.
- Spot color channel information is preserved in the exported file.

Corel Painter (RIF)

Imported Corel Painter (RIF) files retain information such as floating objects, which makes the files much larger than GIF or JPEG files. Corel Painter files can be imported for resizing and adjusting floaters.

To import a Corel Painter file

- 1 Click **File** ► **Import**.
- 2 Locate the folder in which the file is stored.
- 3 Choose **RIFF - Painter (*.rif)** from the list box next to the **File name** box.
- 4 Click the filename.
- 5 Click **Import**.
- 6 Click the [drawing page](#).

You can also

Resample a graphic while importing

For more information, see [“To resample a bitmap while importing” on page 791](#).

Crop a graphic while importing

For more information, see [“To crop a bitmap while importing” on page 792](#).

Corel Painter (RIF) technical notes

- The embedded color profile is preserved, but can be changed after importing the file.
- If the Corel Painter image contains a transparent background, which is called a canvas in Corel Painter, it is preserved.
- Vector shapes are not preserved in the imported file.
- Text and annotations are not preserved.
- Bitmap layers are imported as grouped objects.
- Liquid Ink, Watercolor, Digital Watercolor, and plug-in layers are imported as RGB objects.
- Mosaics and tessellations are imported as RGB objects.
- Image slicing is not retained.

Scalable Vector Graphics (SVG)

Scalable Vector Graphics (SVG) is an open standard graphics file format that allows designers to put the power of [vector graphics](#) to work on the web. It was created by the World Wide Web Consortium (W3C).

SVG files are described in Extensible Markup Language (XML). They are vector graphic images, which can provide superior detail and faster download times than [bitmaps](#). Compressed SVG files have an **.svgz** filename extension.

To view SVG files, you need an SVG viewer plug-in such as the Corel SVG viewer.

Unicode support

SVG files support Unicode encoding for text. When exporting an SVG file, you can choose a Unicode encoding method.

Embedding and linking

You can embed information in an SVG file, or you can create additional files to store some of the information. For example, you can embed a style sheet in an SVG file, or you can create an external cascading style sheet and link it to the SVG file. By default, [JavaScript](#), such as

JavaScript related to rollovers, is embedded in the exported file, but you can choose to store it as a separate file linked to the SVG file. Also, you can embed bitmaps, or you can save bitmaps as externally linked files.

Exporting text

You can export text as text or curves. When exporting text as text, you can choose to embed all fonts in a Scalable Vector Graphics file to have full editing capabilities. You can also embed only the [fonts](#) used, and common English or common Roman fonts.

Using preset export options

To make your work easier, you can use preset export options, and you can create custom preset export options that you can reuse later.

Using SVG colors

SVG colors correspond to color keywords. You can use the SVG [color palette](#) available in the application to help ensure that colors in the exported SVG file are defined by color keywords. To ensure that the SVG color names you choose are retained in the SVG exported file, it is recommended that you disable color correction. For information about color correction, see [“Understanding color management” on page 409](#).

Adding reference information to SVG objects

Reference information can be added and retained in an exported Scalable Vector Graphics object. You can add information to an object so that the information appears in the file’s XML tags. These tags are derived from the data field names, each of which is formatted as general text, data and time, linear and angular dimensions, or numbers. For example, you can name individual objects in the drawing and add comments for each of these objects. The name and comments for each object display in the tags of the exported Scalable Vector Graphics file. For more information about assigning information to objects, see [“Assigning and copying object data” on page 336](#).

To export a Scalable Vector Graphics file

- 1 Click **File** ► **Export**.
- 2 Locate the folder in which you want to save the file.
- 3 Choose **SVG - Scalable vector graphics** or **SVGZ - Compressed SVG** from the **Save as type** list box.
- 4 Type a filename in the **File name** list box.
- 5 Click **Export**.
- 6 From the **Compatibility** list box, choose an SVG version for the exported file.
- 7 From the **Encoding method** list box, choose one of the following encoding options:
 - **Unicode - UTF-8** — produces a smaller file size. This is the default encoding method and is useful in most circumstances.
 - **Unicode - UTF-16** — produces a bigger file size
- 8 In the **Export text** area, enable one of the following options:
 - **As text** — exports text as editable characters, known as glyphs
 - **As curves** — exports text as curves
- 9 Choose one of the following options from the **Styling options** list box:
 - **Presentation attributes** — lets you specify attributes directly in an element in the exported file
 - **Internal style sheet** — uses the CLASS attribute to embed the style sheet in the Scalable Vector Graphics file
 - **External CSS** — creates an external cascading style sheet file and links it to the Scalable Vector Graphics file

[JavaScript](#) related to rollovers can be saved to a separate file by enabling the **Link externally** check box in the **JavaScript** area.



You must embed fonts when you require the display of a specific font that the users may not have installed on their computers. As the number of fonts or [fountain fill steps](#) increases, so does the size of the file. Objects with mesh fills or drop shadows are exported as [bitmaps](#).

If no single element in a drawing is selected, the content of the entire page is exported.

To choose a color by using the SVG color palette

- 1 Select an [object](#).
- 2 Click **Window** ► **Color palettes** ► **Color palette manager**.
The **Color palette manager** opens.
- 3 From the **Palette libraries** folder, double-click the **Process** folder.
- 4 Click the **Show or hide** icon beside the **SVG colors** palette.
- 5 Click a [color swatch](#) on the **SVG color palette**.

To add reference information to a Scalable Vector Graphics object

- 1 Select an [object](#) using the **Pick tool** .
- 2 Click **Window** ► **Dockers** ► **Object data manager**.
- 3 In the **Name/value** list, click a data field name.
- 4 Type the information in the text box.

You can also

Rename a data field

Click the **Open field editor** button . Choose the name of the data field, and type a new name.

Add a data field

Click the **Open field editor** button. Click the **Create new field** button, and type the name of the new field.

Change the data field format

Click the **Open field editor** button. Click a field name and then click the **Change** button. Enable a field type option.



Fields containing no values are ignored when a file is exported to the Scalable Vector Graphics format.

Scalable Vector Graphics (SVG) technical notes

Importing an SVG file

- Most of the information in SVG files created in other programs is preserved in the imported file, even if CorelDRAW does not support a feature. For example, information about ink strokes in an SVG file created in another program is preserved in the imported file, even though the ink strokes are not displayed.
- Clipped and masked objects are imported as PowerClip objects.
- Group, object, and symbol names and IDs are retained in the imported file.
- Symbols in the imported file appear in the **Symbol manager** docker.
- Bitmap files embedded in an SVG file are retained.
- Links to external files, such as GIF, PNG, or JPEG files, are supported on import unless the external files are stored on the web.
- SVG color definitions and names are supported.
- Round-tripping is supported.
- Metadata is supported.
- Hyperlinks are supported.

Exporting an SVG file

- Scalable Vector Graphics (SVG) allows three types of graphic objects: vector graphic shapes (for example, paths consisting of straight lines and curves), images, and text.
- Drop shadows are rasterized in SVG files.
- All CorelDRAW symbols are supported on export as SVG symbols.
- Object, layer, group, and symbol names are also supported. If the names are the same, the SVG file appends unique numbers to the object IDs. Invalid names are corrected on export.
- Graphical objects can be grouped, styled, transformed, and combined into previously rendered objects.
- You can export text as editable characters, so that after you publish an SVG graphic to the web, text continues to be recognized as text. Text strings can be restyled, copied and pasted, or indexed by search engines. Text can also be edited by SVG-capable editing programs, eliminating the need for maintaining multiple versions of graphic images for editing.
- The SVG standard allows the use of Cascading Style Sheets (CSS) to define font, text, and color properties of objects on a page.
- Layers are retained as groups in the exported file. If you import the file back into CorelDRAW, the layer groups are converted into layers with the original layer names preserved.
- Only the active page in a drawing is exported. If you want to export only a part of a drawing, enable the **Selected only** check box in the **Export** dialog box.
- URLs assigned to text objects are retained in the exported file.
- Transformations, such as rotation and skewing, are usually retained in the exported files. In some cases, transformations may be lost, and transformed shapes may be converted into curves.

Adobe Flash (SWF)

Adobe Flash is a file format for creating and displaying vector-based images and animation. Macromedia Flash files are extremely compact and of high quality, making them ideal for use on the web.

Before you save a file to the Adobe Flash file format, you can determine whether the file has potential export problems. You can check the current file and display a summary of errors, possible problems, and a suggestion for resolving the issue.

To export an Adobe Flash file

- 1 Click **File** ► **Export**.
- 2 Locate the folder in which you want to save the file.
- 3 Choose **SWF - Adobe Flash** from the **Save as type** list box.
- 4 Type a filename in the **File name** list box.
- 5 Click **Export**.
- 6 In the **Flash export** dialog box, choose values from any of the following list boxes:
 - **JPG compression** — specifies the amount of **JPEG** file compression
 - **Resolution (dpi)** — specifies the **resolution** of the image
 - **Smoothing** — tones down differences between adjacent **pixels**
- 7 Enable one of the following options in the **Bounding box size** area:
 - **Page** — applies the **bounding box** to the page
 - **Objects** — aligns the bounding box to the objects in the file
- 8 Enable any of the following check boxes in the **Optimization** area:
 - **Convert dashed outlines** — converts dashed outlines to solid lines
 - **Rounded caps and corners** — rounds the corners and endpoints of lines and curves
 - **Use default fountain steps** — lets you use the default **number of steps** for **fountain fills**

You can also

Prevent a Adobe Flash file from being loaded into the Adobe Flash editor

Enable the **File protection from import** check box.

Export sounds

Enable the **Use sound behaviors** check box, and choose a value for the sound compression from the **Compression** list box.



The more you compress a sound, the smaller the size and the lower the sound quality.



You can save the settings in the **Flash export** dialog box to a preset by clicking the **Add preset** button  and typing a name in the **Setting name** box.

To preview a Adobe Flash file in a browser, you must have the Adobe Flash Player plug-in installed on your computer.

To view the issues summary for an Adobe Flash file

- 1 Click **File** ► **Export**.
- 2 Locate the folder in which you want to save the file.
- 3 Choose **SWF - Adobe Flash** from the **Save as type** list box.
- 4 Type a filename in the **File name** list box.
- 5 Click **Export**.
- 6 In the **Flash export** dialog box, click the **Issues** tab.
- 7 Click an error or warning in the error list to see the details and suggestions for resolving the issue.

If you want to overlook certain issues, click **Settings**, and disable the check boxes that correspond to those issues.



The **Issues** tab heading indicates the number of issues. The icon on the tab heading changes, depending on the severity of the issue or issues identified.

Adobe Flash (SWF) technical notes

- Adobe Flash (SWF) files cannot be imported into CoreDRAW.

TARGA (TGA)

The TARGA (TGA) graphics format is used for saving **bitmaps**. It supports various compression systems and can represent bitmaps ranging from black-and-white to **RGB** color. You can import or export TGA files in CoreDRAW.

For more information about importing files, see [“Importing files” on page 789](#).

To export a TARGA file

- 1 Click **File** ► **Export**.
- 2 Locate the folder in which you want to save the file.
- 3 Choose **TGA - Targa bitmap** from the **Save as type** list box.

4 Type a filename in the **File name** list box.

To compress an image while exporting it, choose a compression type from the **Compression type** list box.

5 Click **Export**.

6 In the **Convert to bitmap** dialog box, adjust the width, height, resolution, color mode, or any of the other settings, and click **OK**.

7 In the **TGA export** dialog box, enable one of the following options:

- **Normal**
- **Enhanced**



Black-and-white images cannot be saved as TARGA files.

TARGA (TGA) technical notes

- The following features are supported: uncompressed color-mapped images, uncompressed RGB images, run-length encoding (RLE) compressed color-mapped images, RLE-compressed RGB images (types 1, 2, 9, and 10 as defined by the AT&T Electronic Photography and Imaging Center), and masks.
- The type of file produced depends on the number of colors exported. For example, 24-bit color TARGA (TGA) files are exported as RLE-compressed RGB bitmaps.
- You can import TGA files from 8-bit grayscale to 24-bit RGB.
- Masks are not saved in 1-bit black-and-white or 8-bit paletted files.
- RLE compression is supported, and the maximum image size is 64,535 × 64,535 pixels.

TIFF

The Tagged Image File format (TIFF) is a **raster** format designed as a standard. Almost every graphics application can read and write TIFF files. TIFF supports various color modes and bit depths.

For information about importing TIFF files, see [“To import a file into an active drawing” on page 789](#).

To export a TIFF file

1 Click **File** ► **Export**.

2 Locate the folder in which you want to save the file.

3 Choose **TIF - TIFF bitmap** from the **Save as type** list box.

4 Type a filename in the **File name** list box.

5 Click **Export**.

6 In the **Convert to bitmap** dialog box, adjust the width, height, resolution, color mode, or any of the other settings, and click **OK**.

TIFF technical notes

- When importing a TIFF that contains multiple pages, you can import all pages or choose the individual pages that you want to import.
- Black-and-white, color, and grayscale TIFF files up to and including the 6.0 specification can be imported and exported.
- TIFF files compressed using JPEG, ZIP, CCITT, Packbits 32773, or LZW compression can also be imported. However, you may notice additional loading time with these files because the program decodes the file compression.

Corel Paint Shop Pro (PSP)

The .PspImage file format is the native format for Corel Paint Shop Pro. You can import .PspImage files versions 9 and 10 that are in the RGB color mode (24- or 48-bit).

This file format is not supported by the 64-bit version of CorelDRAW Graphics Suite.

To import a PSP file

- 1 Click **File** ► **Import**.
- 2 Locate the folder in which the file is stored.
- 3 Choose **PSP - Corel Paint Shop Pro (*.pspimage)** from the list box next to the **File name** box.
- 4 Click the filename.
- 5 Click **Import**.
- 6 Click the drawing page.

Corel Paint Shop Pro (PSP) technical notes

- You can import only Corel Paint Shop Pro files with a **.PspImage** filename extension.
- Text and layers are merged with the background in the imported file.

TrueType Font (TTF)

The TrueType Font (TTF) file format was created jointly by Apple Computer and Microsoft Corporation. It is the most common format for fonts used in both Macintosh and Windows operating systems. The TTF file format prints font characters as bitmaps or vectors depending on the capabilities of your printer. True Type fonts appear the same in print and on-screen, and they can be resized to any height.

TrueType Fonts (TTF) technical notes

- TrueType fonts exported from CorelDRAW are unhinted.
- Each exported character constitutes a single object. Before you export multiple objects, you must combine them by clicking **Object** ► **Combine**. You cannot export multiple objects or grouped objects.
- Fill and outline attributes applied to objects are not exported.
- For best results, avoid intersecting lines. Any object in your character should lie completely inside or outside of others, as shown in the following example.

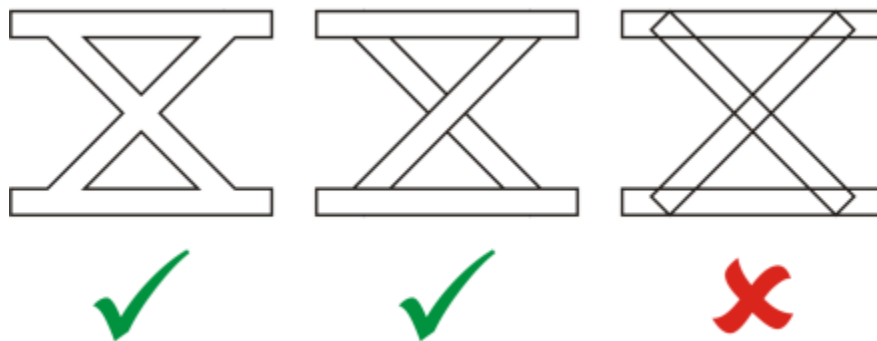

Left to right: three objects correctly combined; five objects correctly combined; five objects incorrectly combined

Visio (VSD)

- VSD is the Visio drawing format. It can contain bitmaps and vectors.
- You can import all VSD file types, up to VSD 2007.
- Rectangle shapes are imported as rectangle objects.
- Circle and ellipse shapes are imported as ellipse objects.
- Curvygon, pentagon, hexagon, heptagon, octagon, and megagon shapes are imported as polygon objects.
- All other shapes are imported as polycurves.

WordPerfect Document (WPD)

The WordPerfect Document format (WPD) is the native file format for WordPerfect files. CorelDRAW supports WPD files from versions 4.2 to 14. WordPerfect files for versions 4 and 5 have the file extensions **.wp4** and **.wp5**.

For more information, see [“General notes on importing text files”](#) on page 850.

WordPerfect Document (WPD) technical notes

- When you import text from a WPD file, you can maintain formatting, maintain fonts and formatting, or discard fonts and formatting.
- When you import or export a WordPerfect file, only text is transferred. Graphic elements are not imported or exported.
- The following features are not supported: index functions, text in tables of contents, and style sheets.
- Equations and formulas created in the WordPerfect equation language are converted to regular text.
- Graphic features like HLine and VLine are not converted.
- When importing text, the page size in the original document is ignored. The text is fit to the current page size, which may affect the placement of text.

WordPerfect Graphic (WPG)

The Corel WordPerfect Graphic file format (WPG) is primarily a vector graphic format, but it can store both bitmap and vector data. The WPG files may contain up to 256 colors, chosen from a [palette](#) of more than 1 million colors.

To import a WordPerfect Graphic file

- 1 Click **File** ► **Import**.
- 2 Locate the folder in which the file is stored.
- 3 Choose **WPG - Corel WordPerfect Graphic (*.wpg)** from the list box next to the **File name** box.
- 4 Click the filename.
- 5 Click **Import**.
- 6 Click the [drawing page](#).



Any embedded Windows Metafile Format (WMF) or Enhanced Metafile Format (EMF) graphics are preserved in the imported file. If the file contains other graphic elements, these are lost during conversion and do not appear in CorelDRAW.

To export a WordPerfect Graphic file

- 1 Click **File** ► **Export**.
- 2 Locate the folder in which you want to save the file.
- 3 Choose **WPG - Corel WordPerfect Graphic** from the **Save as type** list box.
- 4 Type a filename in the **File name** list box.
- 5 Click **Export**.
- 6 Enable one of the following options in the **Export colors** area:
 - **16 colors** — exports the image as a 16-color image
 - **256 colors** — exports the image as a 256-color image
- 7 Enable one of the following options in the **Export text as** area:
 - **Text** — exports text as editable characters
 - **Curves** — exports text as curves

- 8 Enable one of the following options in the **Export file as** area:
- **WordPerfect Version 1.0** — supported by WordPerfect 5.1 and earlier
 - **WordPerfect Version 2.0** — supported by WordPerfect 6 and later

WordPerfect Graphic (WPG) technical notes

- Graphics Text Type 2 is not supported.

RAW camera file formats

A RAW camera file is a data file captured by the image sensor of a high-end digital camera. RAW camera files contain minimal in-camera processing, such as sharpening or digital zoom, and they give you full control over the sharpness, contrast, and saturation of images. Various RAW camera file formats exist, so the files can have different filename extensions, such as **.nef**, **.crw**, **.dcr**, **.orf**, or **.mrw**.

You can import RAW camera files directly into CorelDRAW. For more information, see [“Working with RAW camera files”](#) on page 729.

Wavelet Compressed Bitmap (WI)

This file format is not supported by the 64-bit version of the suite.

Importing a WI file

- Corel programs support the following color depths when you import Wavelet Compressed Bitmap (**.wi**) files: 256-shade (8-bit) grayscale, and 24-bit RGB.

Exporting a WI file

- Corel programs support the following color depths when you export to the Wavelet Compressed Bitmap file format: 256 shade (8-bit) grayscale, 24-bit RGB.
- The Wavelet Compressed Bitmap file format supports Wavelet compression. It also supports a minimum image size of 16 pixels and a maximum size of 2,048 pixels.

Windows Metafile Format (WMF)

Developed by Microsoft Corporation, this file format stores both vector and bitmap information. It was developed as the internal file format for Microsoft Windows 3. It supports 24-bit RGB color and is supported by most Windows applications.

Windows Metafile Format (WMF) technical notes

Importing a WMF file

- CorelDRAW substitutes fonts that are missing from a file in the WMF format from similar fonts available on your computer.
- The following features are not supported: PANOSE font matching and rotated and skewed bitmaps.

Exporting a WMF file

- The WMF format is used to export graphics to Windows programs.
- A header contains additional information, such as sizing. Therefore, a WMF file can successfully be exported from CorelDRAW if the header is included.
- Text is maintained as text when exported, and WMF files can be very large. This can cause problems in programs that limit the size of imported files.
- The Windows Metafile Format is 16 bits, while CorelDRAW is 32 bits. When you export a WMF file, the 32-bit numbers are converted to 16 bits. For example, lines that are thinner than 0.01388 inch appear as hairlines because the WMF format does not have enough precision to specify these widths accurately.

Additional file formats

CorelDRAW also supports the following file formats:

- ANSI Text (TXT) — ANSI Text (TXT) is a vector format that stores ANSI characters. This format is able to store text information but not formatting information, such as the font type or size. When a TXT file is imported to or exported from CorelDRAW, only the text is transferred. If the file has graphic elements, they are not imported or exported.
- CALS Compressed Bitmap (CAL) — CALS Raster (CAL) is a bitmap format used mainly for document storage by high-end CAD programs. It supports a monochrome (1-bit) color depth and is used as a data graphics exchange format for computer-aided design and manufacturing, technical graphics, and image-processing applications.
- Corel ArtShow 5 (CPX) — The CPX file format is a native file format of Corel ArtShow 5. It can contain both vectors and bitmaps.
- Corel Presentations (SHW) — The SHW file format is a native format of Corel Presentations.
- Corel R.A.V.E. (CLK) — The CLK file format is an animation file format that is native to Corel R.A.V.E.
- CorelDRAW Compressed (CDX) — The CDX file format is a compressed CorelDRAW file.
- Corel DESIGNER or CorelDRAW Template (CDT) — The CDT file format is for a Corel DESIGNER or CorelDRAW template file.
- Encapsulated PostScript (Desktop Color Separation) — The DCS file format, developed by QuarkXPress, is an extension of the standard encapsulated PostScript (EPS) file format. Typically, the DCS file format consists of five files. Four of the five files contain information about high-resolution color. This information is expressed in CMYK (cyan, magenta, yellow and black) format. The fifth file, considered the master file, contains a PICT preview of the DCS file.
- EXE — The EXE format is a Windows 3.x/NT bitmap resource and can store an ICO file as a Windows 3.x/NT icon resource.
- FPX — The FlashPix file format stores images at different resolutions in a single file. This file format is not supported by the 64-bit version of the suite.
- Frame Vector Metafile (FMV) — The FMV file format is used for a Frame Vector Metafile.
- GEM Paint (IMG) — GEM Paint (IMG) is a bitmap format that is the native bitmap file format of the GEM environment. IMG files support 1- and 4-bit paletted color and are compressed by using an RLE method. IMG was a common format in the early days of desktop publishing.
- GEM File (GEM) — The GEM file format is used for a GEM file.
- GIMP (XCF) — XCF is the native GIMP format. It supports layers and other GIMP-specific information.
- ICO — The ICO format is a Windows 3.x/NT icon resource.
- Lotus PIC (PIC) — The PIC file format is used for a Lotus PIC file.
- MacPaint Bitmap (MAC) — MacPaint (MAC) is a bitmap format that uses the filename extensions MAC, PCT, PNT, and PIX. It is the format used by the MacPaint program that was included with the Macintosh 128. It supports only two colors and a palette of patterns. It is used mainly by Macintosh graphics applications to store black-and-white graphics and clipart. The maximum size for MAC images is 720 × 576 pixels.
- Macromedia FreeHand (FH) — the FH format is the native vector file format for Macromedia Freehand. Corel graphics applications support versions 7 and 8 of Macromedia FreeHand.
- MET Metafile (MET) — The MET file format is for a MET Metafile.
- Micrografx Picture Publisher 4 & 5 (PP4, PP5) — The PP4 file format is a native file format of Micrographx Picture Publisher 4. The PP5 file format is a native file format of Micrographx Picture Publisher 5. This file format is not supported by the 64-bit version of the suite.
- Picture Publisher File (PPF) — The PPF file format is native to Micrografx Picture Publisher 6, 7, 8, 9, and 10. This file format is not supported by the 64-bit version of the suite.
- Microsoft Excel (XLS) — The XLS file format is the native file format of a Microsoft Excel workbook.
- Microsoft PowerPoint (PPT) — The PPT file format is native to Microsoft PowerPoint.
- NAP Metafile (NAP) — The NAP file format is used for a NAP Metafile.
- Fill File (FILL) — This file format is used for saving custom fills in CorelDRAWCorel PHOTO-PAINT.
- PostScript Interpreted (PS or PRN) — PRN PostScript (PS or PRN) is a metafile format for PostScript printers. This format is written in ANSI text. The PostScript Interpreted import filter can import PS, PRN, and EPS PostScript files.
- SCITEX CT Bitmap (SCT) — The SCT file format is used for importing 32-bit color and grayscale SCITEX images. SCITEX bitmaps are created from high-end scanners. The bitmaps are then processed for output by film recorders or high-end page layout programs.
- WB — WB is the file format for Quattro Pro 6, 7, and 8 spreadsheets.
- WK — WK (.wk3, .wk4) is the extension of Lotus 1-2-3 spreadsheets.
- WSD — WSD is the document format for Wordstar 2000 and Wordstar 7.
- XPixMap Image (XPM) — The XPM file format is used with an XPixMap Image file.

Recommended formats for importing graphics

The table below shows what file formats to use when you are importing graphics from other applications.

Application	Recommended import format
Adobe Illustrator	AI, PDF
AutoCAD	DXF, DWG, HPGL (PLT files)
CorelDRAW	CDR, Clipboard
Deneba Canvas, Macromedia FreeHand and other vector packages	PCT, AI
Microsoft Office	WMF, PNG. For more information, see “Working with office productivity applications” on page 809.
WordPerfect Office	WPG
Micrografx Designer	DSF, DRW, AI, DS4



To import text from a text-editing application, you can use RTF files, or you can copy the text to the Clipboard and then paste it in your project.

Recommended formats for exporting graphics

When exporting graphics to be used in Adobe PageMaker, use the encapsulated PostScript file format if you have a PostScript printer. If you have a non-PostScript printer, the WMF format is recommended.

The following table lists the recommended file formats for exporting to page layout and desktop publishing packages that have graphics editing capabilities.

Application	Recommended format
Adobe Illustrator	AI, PDF
Adobe PageMaker	EPS, WMF
AutoCAD	DXF
Macromedia FreeHand and other vector programs	PCT, AI
Microsoft Office	PNG, WMF

Application	Recommended format
WordPerfect Office	WPG
Micrografx Designer	CGM

The HPGL or DXF outlines formats are recommended for exporting graphics to be output to devices such as plotters and computer-driven cutters.

General notes on importing text files

- When you import a text file into a Corel program, it appears almost the same as in the source program. However, some formatting attributes and page layout features may not be supported. In such cases, the program tries to simulate the results of a feature when a reasonable substitution can be made.
- The following word-processing features are not supported: headers, footers, footnotes and endnotes, columns, and macros.
- Font matching support is included. You can modify font-matching settings in the **Font matching results** dialog box. Fonts are converted by size and by family, provided the source file format includes font family information that the program can access.
- Rich Text Format (.rtf) files are automatically converted to the Microsoft Windows ANSI (American National Standards Institute) character set. The Macintosh Character Set and Standard IBM PC Code Page 437 are also supported.
- Corel graphics programs match characters as closely as possible. Font matching is used if the imported text font is not on the user's system. However, if a match cannot be made, the font characters appear in the program as unrecognizable text.
- Conversion of font sizes is supported.
- Corel graphics programs support all font families for the following word-processing programs and formats: Corel WordPerfect, Microsoft RTF, Microsoft Word PC, Microsoft Word Macintosh, Word for Windows.
- Corel graphics programs support only selected fonts from the fonts supported by Ami Professional. This typically includes Standard PostScript fonts and the Standard HP PCL fonts.
- When Macintosh files are converted, font support is limited to the supported font families of the Windows formats.
- Fonts converted to formats other than those listed in the table above are mapped to fonts that Corel graphics programs find as the best fit.
- You may encounter alignment problems when converting from and to a proportional and nonproportional font. Therefore, if you import a document created in a nonproportional font to a proportional font, some pages may have more text on a page than the original document.
- Source documents that contain a table of contents and index are converted into the appropriate functions in an .rtf file.
- Data that is automatically outlined is converted to regular text.
- Style sheet properties are converted to RTF. The file appears as in the source program; however, the style sheet from the original program is not imported.
- Text contained within a frame or a positioned object is retained.

Customizing and automating

- Setting basic preferences..... 853
- Customizing CorelDRAW.....855
- Using macros to automate tasks..... 871

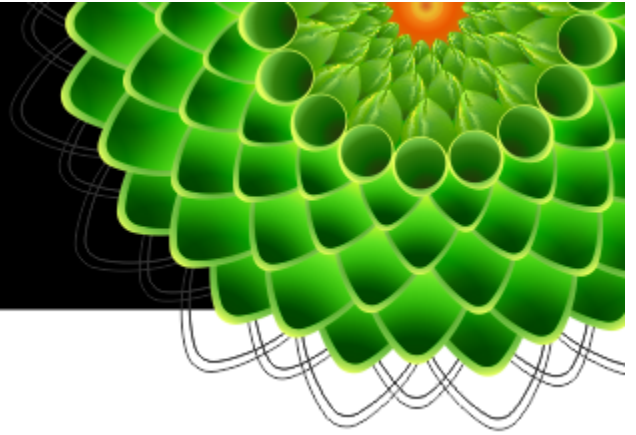

Setting basic preferences

This section includes the following topics:

- “Disabling warning messages” (page 853)
- “Viewing system information” (page 853)

Disabling warning messages

You may encounter warning messages while working in the application. Warning messages explain the consequences of an action you are about to perform, and inform you of permanent changes that might result from that action. Although the warnings are helpful, you can disable them so you don't have to view them after you become familiar with the software. Avoid disabling warning messages until you are comfortable with the application and familiar with the results of the commands you use.

To disable warning messages

- 1 Click **Tools** ► **Options**.
- 2 In the **Workspace** list of categories, click **Warnings**.
- 3 Disable one or more of the check boxes.

Viewing system information

You can view information about your computer as well as information about the application itself. For example, you can view details about your computer's setup. You can view detailed information about your system, display and printing properties, Corel applications and DLL files, and system DLL files. You can use this feature, for instance, to find out how much space you have on the drive to which you want to save a file.

To view system information

- 1 Click **Help** ► **About CorelDRAW**.
- 2 Click **System info**.
- 3 Choose a category from the **Choose a category** list box.



Click the **Save** button to store system information for printing.

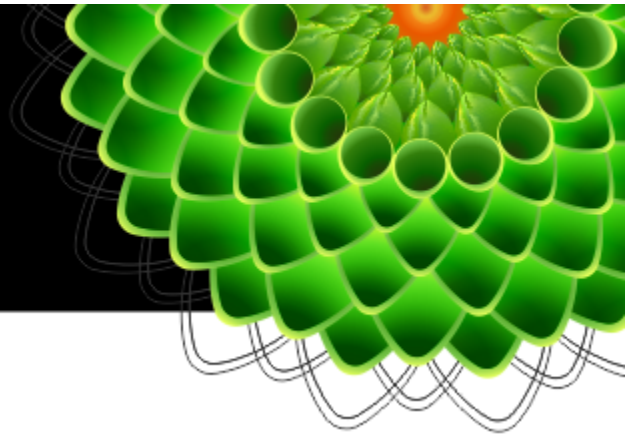

Customizing CorelDRAW

You can customize your application by arranging command bars and commands to suit your needs and changing the color of window borders. Command bars include menus, toolbars, the property bar, and the status bar.

Help topics are based on the application's default settings. When you customize command bars, commands, and buttons, the Help topics associated with them do not reflect your changes.

This section contains the following topics:

- Saving and restoring defaults
- "Creating workspaces" (page 856)
- "Importing and exporting workspaces" (page 856)
- "Customizing workspace appearance" (page 857)
- "Customizing keyboard shortcuts" (page 860)
- "Customizing menus" (page 861)
- "Customizing toolbars" (page 863)
- "Customizing the toolbox" (page 866)
- "Customizing the property bar" (page 866)
- "Customizing the status bar" (page 867)
- "Customizing filters" (page 868)
- "Customizing file associations" (page 869)

Saving and restoring defaults

Many application settings apply to the active drawing only. These include page layout options, [grid](#) and [ruler](#) settings, [guideline](#) settings, style options, save options, some tool settings, and web publishing options. Saving the current settings as defaults lets you use the settings of the active drawing for all new drawings you create. You can also choose to save only specific settings as defaults.

You can restore the default settings by resetting the current workspace.

To save current settings as defaults

- Click **Tools** ► **Save settings as default**.



Only the settings enabled on the **Document** page of the **Options** dialog box (**Tools ▶ Options**) are saved.

To save specific settings as defaults

- 1 Click **Tools ▶ Options**.
- 2 In the list of categories, click **Document**.
- 3 Enable the **Save options as defaults for new documents** check box.
- 4 Enable the check boxes that correspond to the options you want to save.

To reset the current workspace

- 1 Exit the application.
- 2 Restart the application while holding down **F8**.

Creating workspaces

You can create workspaces to make more accessible the tools that you use most often. For example, you can open dockers or add tools to toolbars. You can also delete the custom workspaces that you create.

Before creating a workspace, you can try the workspaces that are included with the application. These workspaces are optimized for a number of common workflows. For more information, see [“Choosing a workspace” on page 96](#).

You can change the default location to which workspaces are saved. For more information, see [“Content types” on page 114](#).

To create a workspace

- 1 Click **Tools ▶ Options**.
- 2 In the list of categories, click **Workspace**.
- 3 Click **New**.
- 4 Type the name of the workspace in the **Name of new workspace** box.
- 5 From the **Base new workspace on** list box, choose an existing workspace on which to base the new workspace.

If you want to include a description of the workspace, type a description in the **Description of new workspace** box.

To delete a workspace

- 1 Click **Tools ▶ Options**.
- 2 In the list of categories, click **Workspace**.
- 3 Choose a workspace from the **Workspace** list.
- 4 Click **Delete**.



You cannot delete the Default workspace.

Importing and exporting workspaces

You can import custom workspaces created on other computers or in other versions of the application (back to version X6). When importing a workspace, you can select which workspace elements to import. For example, you can import docker settings and position, but you can

discard application settings such as startup options. You can also import the selected workspace elements into the current workspace or into a new workspace. You can base the new workspace on one of the available workspaces, and you can give it a name and description.

You can also export the workspaces that you create to share them with others.

To import a workspace

- 1 Click **Window** ► **Workspace** ► **Import**.
- 2 In the **Open** dialog box, locate the workspace file you want to import, and click **Open**.
- 3 In the **Import Workspace** dialog box, select the workspace elements that you want to import. By default, all workspace elements are selected.
- 4 Enable one of the following options:
 - **Current workspace** — to replace the workspace elements of the current workspace with the imported workspace elements. For example, if you choose to import all toolbars, the toolbars of the current workspace are replaced with the imported ones.
 - **New workspace** — creates a workspace that includes the imported workspace elements

You can also

Specify the name of the new workspace

Type a name in the **Name** box.

Base the new workspace on an existing workspace

Choose a workspace from the **Base on** list box.

The imported workspace elements will be merged with the base workspace.

Add a workspace description

Type a description in the **Description** box.



Any new features that were not available when the workspace was created are added to the imported workspace. The new features may not be in the same location as they appear in the default workspace.

Custom icons may not be scaled properly in imported workspaces created in versions X6 and X7.

To export a workspace

- 1 Click **Window** ► **Workspace** ► **Export**.
- 2 Enable the check boxes beside the workspace items you want to export.
- 3 Click **Save**.
- 4 Choose the folder where you want to save the file.
- 5 Type a filename in the **File name** box.
- 6 Click **Save**.
- 7 Click **Close**.



The workspace items available for export are dockers, toolbars (including the property bar and toolbox), menus, and shortcut keys. A workspace is exported as a **.cdws** file.

Customizing workspace appearance

You can customize the size of user interface items, choose a theme, and change the color of window borders and the desktop.

Scaling

You can change the size of user interface (UI) items by changing the scaling level. The scaling level is relative to the scaling level of the operating system. The default setting is 100%, which means that UI items in the application appear the same size as similar UI items in the operating system. Scaling by 200% makes the application UI items appear twice as large as the UI items of the operating system.

Theme

To make the workspace lighter or darker, you can choose one of the following themes: Light, Medium, or Dark.

Window border color

You can customize the application window and dialog boxes by changing the color of their borders.

Desktop color

You can change the color of the desktop, the area surrounding the drawing page, to suit your documents. For example, if the document contains dark colors, you can change the desktop color from white to gray for lower contrast.

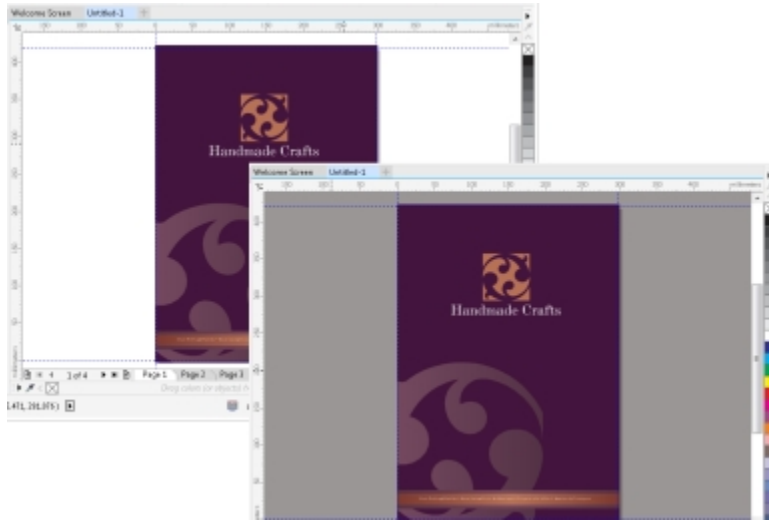

Custom desktop color

Choosing colors

To choose the color you want for the desktop and window borders, you can quickly sample any onscreen color; or you can use color sliders, color viewers, or color palettes.

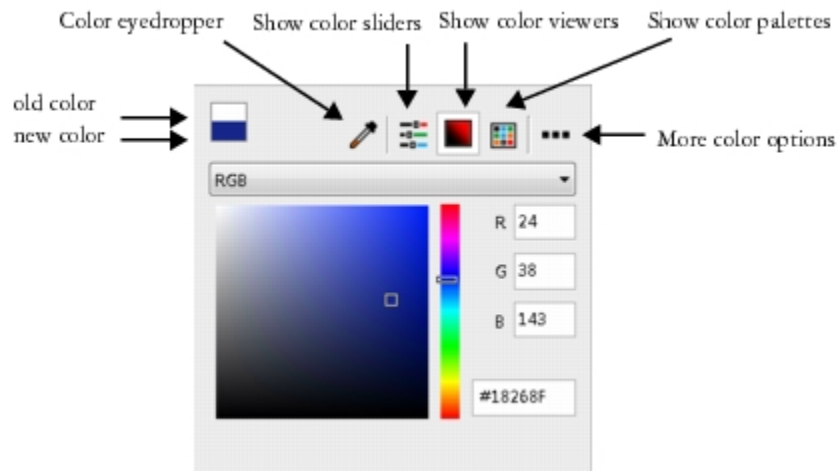

Various tools are available to help you change the desktop or window border color.

To set the scaling level for UI items

- 1 Click **Tools** ► **Options**.
- 2 In the **Workspace** list of categories, click **Appearance**.
- 3 In the **Size** area, move the slider to the right for larger UI items, and to the left for smaller UI items.

To choose a theme

- 1 Click **Tools** ► **Options**.
- 2 In the **Workspace** list of categories, click **Appearance**.
- 3 In the **Color** area, choose a theme from the **Theme** list box.

To change the color of window borders

- 1 Click **Tools** ► **Options**.
- 2 In the **Workspace** list of categories, click **Appearance**.
- 3 In the **Color** area, open the **Window border** color picker, and choose a color.

To change the desktop color

- 1 Click **Tools** ► **Options**.
- 2 In the **Workspace** list of categories, click **Appearance**.
- 3 In the **Color** area, open the **Desktop** color picker, and choose a color.

To specify a color by using various color tools

- In the **Color** area, open the **Desktop** or **Window border** color picker, and perform a task from the following table.

To

Do the following

Sample a color

Click the **Color eyedropper** tool , and click an onscreen color.

To

Use color sliders

Do the following

Click the **Show color sliders** button , choose a color mode from the list box, and move the sliders.

Use a color viewer

Click the **Show color viewers** button , choose a color mode from the list box, and click a color on the color viewer.

Choose a color from a color palette

Click the **Show color palettes** button , choose a color palette from the Palette Libraries, and click a color. To adjust the tint, move the **Tint** slider.

Access additional color options

Click the **More color options** button , and choose an option. The options are dependent on the selected method such as sampling or using a color viewer, color sliders or a color palette.

Customizing keyboard shortcuts

Although your application has preset keyboard shortcuts, you can change them, or add your own shortcuts, to suit your working style. You can assign keyboard shortcuts to the commands that you use the most, and you can delete keyboard shortcuts.

You can print a list of keyboard shortcuts. You can also export a list of keyboard shortcuts to the **CSV** file format — a comma delimited format that is easily opened by word processors and spreadsheet applications.

When you change keyboard shortcuts, the changes are saved in a file called an accelerator table. Your application comes with the following accelerator tables which can be customized to suit your work habits:

- Anchor editing table — contains shortcut keys for anchor editing
- Curve editing table — contains shortcut keys for editing curves
- Main table — contains all non-text-related shortcut keys
- Print preview — contains shortcut keys for print preview options
- Table editing table — contains non-text-related shortcut keys for table editing
- Table text editing table — contains shortcut keys for editing text in tables
- Text editing table — contains all text-related shortcut keys

To assign a keyboard shortcut to a command

- 1 Click **Tools** ► **Customization**.
- 2 In the **Customization** list of categories, click **Commands**.
- 3 Click the **Shortcut keys** tab.
- 4 Choose a shortcut key table from the **Shortcut key table** list box.
- 5 Choose a command category from the top list box.
- 6 Click a command in the **Commands** list.
The shortcut keys currently assigned to the selected command are displayed in the **Current shortcut keys** box.
- 7 Click the **New shortcut key** box, and press a key combination.
If the key combination is already assigned to another command, that command is listed in the **Currently assigned to** box.
- 8 Click **Assign**.



If the same keyboard shortcut is already assigned to another command, the second assignment overwrites the first. By enabling the **Navigate to conflict on assign** check box, you can automatically navigate to the command whose shortcut you reassigned, prompting you to assign a new shortcut.



You can view all of the existing keyboard shortcuts by clicking **View all**.

To delete a keyboard shortcut

- 1 Click **Tools** ► **Customization**.
- 2 In the **Customization** list of categories, click **Commands**.
- 3 Click the **Shortcut keys** tab.
- 4 Choose a shortcut key table from the **Shortcut key table** list box.
- 5 Choose a command category from the top list box.
- 6 Click a command in the **Commands** list.
- 7 Click a shortcut key in the **Current shortcut keys** box.
- 8 Click **Delete**.

To print keyboard shortcuts

- 1 Click **Tools** ► **Customization**.
- 2 In the **Customization** list of categories, click **Commands**.
- 3 Click the **Shortcut keys** tab.
- 4 Click **View all**.
- 5 Click **Print**.

To export a list of keyboard shortcuts

- 1 Click **Tools** ► **Customization**.
- 2 In the **Customization** list of categories, click **Commands**.
- 3 Click the **Shortcut keys** tab.
- 4 Click **View all**.
- 5 Click **Export to CSV**.
- 6 Choose the folder where you want to save the file.
- 7 Type a filename in the **File name** box.
- 8 Click **Save**.

Customizing menus

Corel customization features let you modify the menu bar and the menus it contains. You can change the order of menus and menu commands; add, remove, and rename menus and menu commands. You can search for a menu command if you do not remember the menu in which it belongs. You can also reset menus to the default setting.

The customization options apply to the menu bar menus as well as to shortcut menus that you access by right-clicking.

Help topics are based on the application's default settings. When you customize menus and menu commands, the Help topics associated with them do not reflect your changes.

To change the order of menus and menu commands

- 1 Click **Tools** ► **Customization**.
- 2 In the **Customization** list of categories, click **Commands**.
- 3 In the application window, drag a menu on the menu bar to the left or right.
If you want to change the order of menu commands, click a menu on the menu bar, click a menu command, and drag it up or down.
If you want to change the order of context menu commands, right-click in the application window to display the context menu, and drag a menu command to a new position.

To rename a menu or menu command

- 1 Click **Tools** ► **Customization**.
- 2 In the **Customization** list of categories, click **Commands**.
- 3 Choose a command category from the top list box.
- 4 Click a menu or command in the list.
- 5 Click the **Appearance** tab.
- 6 Type a name in the **Caption** box.



An ampersand (&) before a letter in the **Caption** box indicates a shortcut, also known as an accelerator key. Menus are displayed by pressing **Alt** + the letter. Commands are invoked by pressing the letter that is underlined when the menu is displayed.



You can reset the name to the default by clicking **Restore defaults**.

To add or remove an item on the menu bar

- 1 Click **Tools** ► **Customization**.
- 2 In the **Customization** list of categories, click **Commands**.
If you want to remove an item, drag it off the menu bar.
- 3 Choose a command category from the top list box.
- 4 Drag an item to the menu bar.

To add or remove a command on a menu

- 1 Click **Tools** ► **Customization**.
- 2 In the **Customization** list of categories, click **Commands**.
If you want to remove a command from a menu, click the menu name, and when the menu displays, drag the command off the menu.
- 3 Choose a command category from the top list box.
- 4 Drag a command to a menu in the application window.

To find a menu command quickly

- 1 Click **Tools** ► **Customization**.
- 2 In the **Customization** list of categories, click **Commands**.
- 3 Click the **Search** button .

- 4 In the **Find text** dialog box, type the menu command in the **Find what** box.
- 5 Click **Find next**.

To reset menus to the default setting

- 1 Click **Tools** ► **Customization**.
- 2 In the **Customization** list of categories, click **Command bars**.
- 3 Choose **Menu bar** from the list.
- 4 Click **Reset**.

Customizing toolbars

You can customize toolbar position and display. For example, you can move or resize a toolbar, and you can choose to hide or display a toolbar.

Toolbars can be either docked or floating. Docking a toolbar attaches it to the edge of the application window. Undocking a toolbar pulls it away from the edge of the application window, so it floats and can be easily moved around.

You can create, delete, and rename custom toolbars. You can customize toolbars by adding, removing, and arranging toolbar items. You can adjust toolbar appearance by resizing buttons; and displaying images, captions, or both. You can also edit toolbar button images.

When moving, docking, and undocking toolbars, you use the grab area of the toolbar.

For a

The grab area is

Docked and unlocked toolbar

Identified by a dotted line at the top or left edge of the toolbar



Floating toolbar

The title bar. If the title is not displayed, the grab area is identified by a dotted line at the top or left edge of the toolbar.

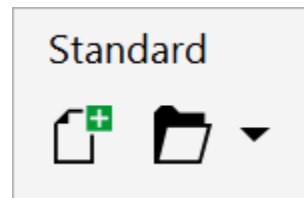

If you do not want to move docked toolbars by mistake, you can lock them. Locked toolbars do not have a dotted line along their left edge.



A locked toolbar

To customize toolbar position and display

To

Do the following

Move a toolbar

Unlock the toolbar, click the toolbar's grab area, and drag the toolbar to a new position.

To

Dock a toolbar

Do the following

Click the toolbar's grab area, and drag the toolbar to any edge of the application window.

Undock a toolbar

Unlock the toolbar, click the toolbar's grab area, and drag the toolbar away from the edge of the application window.

Resize a floating toolbar

Point to the edge of the toolbar and, using the two-directional arrow, drag the edge of the toolbar.

Hide or display a toolbar

Click **Tools** ► **Customization**. In the **Customization** list of categories, click **Command bars**, and disable or enable the check box next to the toolbar name.

Reset a toolbar to its default setting

Click **Tools** ► **Customization**. In the **Customization** list of categories, click **Command bars**, click a toolbar, and click **Reset**.



Docked toolbars cannot be moved when they are locked. For information about unlocking toolbars, see [“To lock or unlock toolbars” on page 866](#).

To add, delete, or rename a custom toolbar

To

Do the following

Add a custom toolbar

Click **Tools** ► **Customization**. In the **Customization** list of categories, click **Command bars**, click **New**, and type a name in the **Command bars** list. Holding down **Alt + Ctrl**, drag a tool or button in the application window to the new toolbar. You can also drag commands from the **Commands** list (**Tools** ► **Customization** ► **Commands**).

Delete a custom toolbar

Click **Tools** ► **Customization**. In the **Customization** list of categories, click **Command bars**, click a toolbar, and click **Delete**.

Rename a custom toolbar

Click **Tools** ► **Customization**. In the **Customization** list of categories, click **Command bars**, click a toolbar name twice, and type a new name.

To add or remove an item on a toolbar

- 1 Click **Tools** ► **Customization**.
- 2 In the **Customization** list of categories, click **Commands**.
- 3 Choose a command category from the top list box.

- 4 Drag a toolbar item from the list to a toolbar in the application window.

If you want to remove an item from a toolbar, drag the toolbar item off the toolbar.

To arrange toolbar items

- 1 Click **Tools** ► **Customization**.
- 2 In the **Customization** list of categories, click **Commands**.
- 3 On the toolbar in the application window, drag the toolbar item to a new position.

If you want to move a toolbar item to another toolbar, drag the toolbar item icon from one toolbar to the other.



You can copy a toolbar item to another toolbar by holding down **Ctrl** while dragging a toolbar item. If the **Options** dialog box is not open, you must hold down **Alt+Ctrl**.

To modify toolbar appearance

- 1 Click **Tools** ► **Customization**.
- 2 In the **Customization** list of categories, click **Command bars**.
- 3 Click a toolbar name in the list.
If you want to choose multiple toolbars, hold down **Ctrl**, and click the other toolbar names.
- 4 Choose a size from the **Button** list box.
- 5 From the **Default button appearance** list box, choose one of the following:
 - **Caption only**
 - **Caption to right of image**
 - **Default**
 - **Image only**

If you want to hide the title when the toolbar is floating, disable the **Show title when toolbar is floating** check box.



You can reset a built-in toolbar to its default settings by clicking **Reset**.

To edit a toolbar button image

- 1 Click **Tools** ► **Customization**.
- 2 In the **Customization** list of categories, click **Commands**.
- 3 Choose a command category from the top list box.
- 4 Click a toolbar command.
- 5 Click the **Appearance** tab.
- 6 Edit the button image using the options in the **Imagearea**.



When you choose either **Small** or **Medium** in the **Size** list box, you edit the small or medium versions of a particular button image. You cannot edit the large version of a button image. For information about how to display all buttons as small, medium, or large, see [“To modify toolbar appearance” on page 865](#).



You can reset toolbar button images to the default settings by clicking **Restore defaults**.

To lock or unlock toolbars

- Click **Windows** ► **Toolbars** ► **Lock toolbars**.

The **Lock toolbars** command is enabled when a check mark appears beside it. When you launch the application for the first time, the toolbars are locked by default.



Floating toolbars cannot be locked.



You can also lock or unlock toolbars by right-clicking a toolbar and clicking **Lock toolbars**.

Customizing the toolbox

You can add or remove tools from the toolbox. If you modify the toolbox, you can reset the default settings at any time.

To customize the toolbox

- 1 On the toolbox, click the **Quick customize** button .
- 2 Enable or disable any of the check boxes.

You can also

Reset the toolbox

Click the **Reset toolbar** button.

Customize the toolbox

Click the **Customize** button.

Customizing the property bar

You have control over the placement and content of the property bar. You can move the property bar anywhere on screen. Placing it inside the application window creates a floating property bar. Placing it on any of the four sides of the application window docks it, making it part of the window border.

When moving, docking, or undocking the property bar, you use the grab area of the property bar, which is the same as the grab area of a toolbar. For more information about the grab area, see [“Customizing toolbars” on page 863](#).

You can also customize the property bar by adding or removing tools. This lets you customize what appears on the property bar when you choose various tools. For example, when the **Text** tool is active, you can have the property bar display additional commands for text-related tasks such as increasing or decreasing font size, or changing case. You can also reset the property bar to its default settings.

To position the property bar

To

Move the property bar

Do the following

Unlock the property bar, click the property bar's grab area, and drag the property bar to a new position.

Undock the property bar

Click the property bar's grab area, and drag the property bar away from the edge of the application window.

Dock the property bar

Click the property bar's grab area, and drag the property bar to any edge of the application window.

To add or remove a toolbar item on the property bar

- 1 On the property bar, click the **Quick customize** button .
- 2 Enable or disable the check boxes next to the items that you want to add or remove.

You can also

Reset the toolbox

Click the **Reset toolbar** button.

Customize the toolbox

Click the **Customize** button.



The new item is displayed on the property bar for the active tool or task. When the property bar content changes, the item is not displayed. The new item is displayed again when the related tool or task is activated.



You can also customize the property bar by clicking **Tools** ► **Customization**. In the **Customization** list of categories, click **Commands**, choose a command category from the top list box, and then drag a toolbar item from the list to the property bar. If you want to remove an item from the property bar, drag the toolbar item icon off the property bar.

To rearrange toolbar items on the property bar

- 1 Click **Tools** ► **Customization**.
- 2 In the **Customization** list of categories, click **Commands**.
- 3 Drag the toolbar item icon to a new position on the property bar.

Customizing the status bar

The status bar displays information about selected **objects**, such as color, **fill** type, and outline. The status bar also shows the current cursor position and relevant commands. In addition, it displays document color information, such as the document color profile and color proofing status. You can customize the status bar by changing the information that is displayed and by resizing it. You can also customize the status bar by adding, removing, and resizing toolbar items. In addition, you can restore the status bar to its default settings. You can also place the status bar at the top of the application window to see the displayed information more easily.

To change the information the status bar displays

- Click the flyout  button next to the displayed information and choose one of the following options:
 - Cursor position
 - Object details
 - Color information
 - Information about selected tool

To resize the status bar

- 1 Click **Tools** ► **Customization**.
- 2 In the **Customization** list of categories, click **Command bars**.
- 3 Click **Status bar**, and enable the check box.
- 4 Type 1 or 2 in the **Number of lines when docked** box.

To add or remove a toolbar item on the status bar

- 1 Click **Tools** ► **Customization**.
- 2 In the **Customization** list of categories, click **Commands**.
- 3 Choose a command category from the top list box.
- 4 Drag a toolbar item from the list to the status bar.

If you want to remove a toolbar item from the status bar, drag the item off the status bar.

To resize toolbar items on the status bar

- 1 Click **Tools** ► **Customization**.
- 2 In the **Customization** list of categories, click **Command bars**.
- 3 Click **Status bar**, and enable the check box.
- 4 Choose one of the following options from the **Button** list box:
 - Small
 - Medium
 - Large



Only toolbar items you have added to the status bar are affected by resizing. The size of the default icons remains unchanged.

To change the position of the status bar

- Right-click the status bar, click **Customize** ► **Status bar** ► **Position**, and click **Top** or **Bottom**.

To restore the status bar default settings

- Right-click the status bar, and click **Customize** ► **Status bar** ► **Reset to default**.

Customizing filters

Filters are used to convert files from one format to another. They are organized into four types: [raster](#), [vector](#), [animation](#), and text. You can customize filter settings by adding or removing filters so that only the filters you need are loaded. You can also change the order of the list of filters and reset filters to the default setting.

To add a filter

- 1 Click **Tools** ► **Options**.
- 2 In the list of categories, double-click **Global**, and double-click **Filters**.
- 3 Double-click a type of filter in the **Available file types** list.
- 4 Click a **filter**.
- 5 Click **Add**.

To remove a filter

- 1 Click **Tools** ► **Options**.
- 2 In the list of categories, double-click **Global**, and click **Filters**.
- 3 Click a **filter** in the **List of active filters**.
- 4 Click **Remove**.

To change the order of the list of filters

- 1 Click **Tools** ► **Options**.
- 2 In the list of categories, double-click **Global**, and click **Filters**.
- 3 Click a **filter** in the **List of active filters**.
- 4 Click one of the following:
 - **Move up** — moves the filter up the list
 - **Move down** — moves the filter down the list



You can reset the **List of active filters** to the default setting by clicking **Reset**.

Customizing file associations

You can associate a number of different file types with Corel applications. When you double-click a file you have associated with an application, the application starts and the file opens. When you no longer need a file type association, you can break it.

To associate a file type with CorelDRAW

- 1 Click **Tools** ► **Options**.
- 2 In the list of categories, double-click **Global**, and click **Filters**.
- 3 Click **Associate**.
- 4 In the **Associated file extensions with CorelDRAW** list, enable the check box of the file type you want to associate.



Associating a file type with an application adds the application to the list of recommended programs for opening this file type. To open a file of an associated file type in CorelDRAW while browsing in Windows, you also need to make CorelDRAW the default program. To do this, click the **Start** button on the Windows taskbar, and then click **Default programs**. Next, click **Associate a file type or protocol with a program**. For detailed instructions about how to change the default program for a file type, see the Windows Help.

You can reset file associations by clicking **Reset**.

To break a CorelDRAW file type association

- 1 Click **Tools** ► **Options**.
- 2 In the list of categories, double-click **Global**, and click **Filters**.
- 3 Click **Associate**.
- 4 In the **Associated file extensions with CorelDRAW** list, disable the check box of the file type association you want to break.



You can reset file associations by clicking **Reset**.

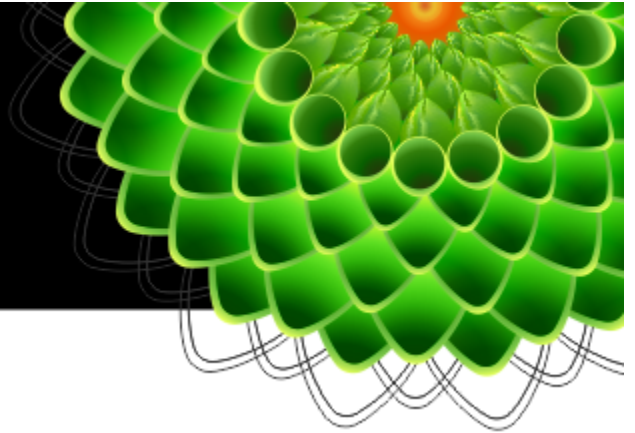

Using macros to automate tasks

You can use macros to speed up repetitive tasks, combine multiple or complex actions, or make an option more easily accessible. You create macros by using the built-in features for Visual Basic for Applications (VBA) or Visual Studio Tools for Applications (VSTA).

Using a macro is similar to using the speed-dialing feature on a phone. On many phones, you can set a frequently dialed number to a speed-dial button; then, the next time you need to dial that number, you can save time by pressing its speed-dial button. Similarly, a macro lets you set the actions that you want to repeat; then, the next time that you need to repeat those actions, you can save time by playing that macro.

This section contains the following topic:

- [“Working with macros” \(page 871\)](#)

Working with macros

You can save time by using a macro to automate a series of repetitive tasks. A macro lets you specify a sequence of actions so that you can quickly repeat those actions later.

You don't need any programming experience to use macros — in fact, the basic tools for working with macros are available within the main application window. However, if you want to have more control over your macros, you can use the following built-in programming environments:

- Microsoft Visual Studio Tools for Applications (VSTA) — the successor to VBA, and an excellent choice for developers and other programming experts. VSTA provides the tools and features that you need to create the most advanced macro projects.
- Microsoft Visual Basic for Applications (VBA) — a subset of the Microsoft Visual Basic (VB) programming environment, and an excellent choice for beginners. You can use VBA to create basic macros for personal use, but you can also use it to create more advanced macro projects.



For detailed information on the differences between VBA and VSTA, please see the programming guide on the [Developer area](#) on the [CorelDRAW community website](#).

Getting started with macros

The macro features for VBA and VSTA are installed with the software by default, but you can manually install these features if necessary. You can specify options for the VBA feature.



To use VSTA macro features with CorelDRAW, you must have Microsoft Visual Studio 2017 installed. To use the VSTA Editor, you must first install Microsoft Visual Studio 2017, Community, Professional, Premium, Ultimate or Enterprise Edition; and then reinstall Microsoft Visual Studio Tools for Applications 2017 from microsoft.com.

If you install Microsoft Visual Studio after installing CorelDRAW Graphics Suite, you must re-install the VSTA macro features by modifying your CorelDRAW Graphics Suite installation. For more information, see [“To manually install the macro features” on page 874](#).

The macro features provide several tools for working with macros in the main application window:

- Macros toolbar — provides easy access to common macro functions
- Macro Manager docker — provides easy access to all available macro projects for VBA, and to basic functions for working with those projects
- Macro Editor (formerly the Visual Basic Editor) — provides advanced functions for creating VBA-based macro projects
- VSTA Editor — provides advanced functions for creating VSTA-based macro projects. The VSTA Editor is accessible only if you have Microsoft Visual Studio 2017 installed.

Corel macros

The macros provided with the application are listed and described in the following table.

Macro	Description
Calendar Wizard	Create a custom calendar on a full page, portion of a page, or inside an object. From multipage calendars with various layouts to one pagers showing the year at a glance, the choices are virtually limitless. Start with a preset layout and size, and create a unique calendar by choosing the language, adding images, marking holidays, customizing text elements, and more.
Color Chart Creator	The Color Chart Creator lets you create grids of colors, known as color charts, from stock or custom color palettes. You can use color charts as a visual reference by displaying them on screen or printing them.
Convert All to Curves	Convert text and graphic objects to curves, and preserve the look of your document when sharing it with others. This macro works inside groups and PowerClip objects.
File Converter	Quickly convert all files in a folder to another file format. You can choose to overwrite the original files or create copies of the files saved to the new file format. In addition, you can select different page sizes for vector files, and you can set the resolution and color mode of bitmaps. The File Converter can handle 20 different file formats.

Creating macros

Macros are stored in modules (also called “code modules”), which are stored in macro projects. The Macro Manager docker lets you view and manage all of the macro projects, modules, and macros that are available to you.

You can use the Macro Manager docker to create macro projects in the form of Global Macro Storage (GMS) files or Corel VSTA Projects (CGSaddon). Using such files is an excellent way to bundle the components of your macro project for sharing with others. You can use the Macro Manager docker to open (or “load”) the macro projects that you create, as well as the macro projects that install with the software or that are otherwise made available to you. You can also use the Macro Manager docker to rename macro projects, as well as to copy and close (or “unload”) GMS-based and VSTA macro projects.



Some macro projects are locked and cannot be modified.



When you create a document, a macro project for that document is automatically added to the Macro Manager docker. Although you can store macros within the macro project for a document — for example, to create an all-in-one template — it is recommended that you instead use GMS files to store your macro projects.

Each macro project contains at least one module. You can use the Macro Manager docker to add a module to a VBA-based macro project, or to open existing modules for editing. You can also use the Macro Manager docker to rename or delete VBA modules.



The editing feature is disabled for some modules.

Finally, you can use the Macro Manager docker to create macros within the available modules. You don’t need any programming experience to create macros; however, if you have programming experience and want to edit VBA macros, you can do so by using the Macro Editor. You can also use the Macro Manager docker to rename and delete VBA macros.

Recording macros

You can record macros and save them for later use.

You can also record temporary macros for actions that you need to repeat only a few times. A temporary macro is accessible until a new temporary macro is recorded.



The recording feature is disabled for some macro projects.



Before recording a macro, make sure that you know exactly which actions you want to record and the order in which you want to record them. When you start recording, the macro recorder captures every change that you make in a drawing. For example, if you create a shape, resize the shape, and then change its color, the macro records all the changes. When you are done making the changes, you must stop recording the macro.

Playing macros

You can perform the actions that are associated with a macro by playing that macro.

You can also play a temporary macro.

Learning more about macros

The [Developer area](#) on the CorelDRAW community website can help you with its wealth of useful resources: a [programming guide](#), detailed [Object Model reference documentation](#) with code samples, object model diagrams, and in-depth programming articles and tutorials.

The Object Model reference documentation, also referred to as API documentation, includes help on every feature and function that can be automated in the applications. (Collectively, these features and functions are called an “object model.”) You can easily access relevant documentation from within the Macro Editor.

The Object Model diagrams provide a hierarchical representation of the features and functions that can be automated in CorelDRAW, Corel PHOTO-PAINT, and Corel DESIGNER.



For more detailed information about VBA and its programming environment, please consult the Microsoft Visual Basic Help from the **Help** menu in the Macro Editor.

For more detailed information about VSTA and its programming environment, please consult the **Help** menu in the VSTA Editor.

To manually install the macro features

- 1 On the Windows Control Panel, click **Uninstall a program**.
- 2 Double-click **CorelDRAW Graphics Suite** on the **Uninstall or change a program** page.
- 3 Enable the **Modify** option in the wizard that appears, and follow the instructions.
- 4 On the **Features** page of the installation wizard, enable the following check boxes in the **Utilities** list box:
 - **Visual Basic for Applications**
 - **Visual Studio Tools for Applications**



The macro features for VBA and VSTA are installed with the software by default.

To specify VBA options

- 1 Click **Tools** ► **Options**.
- 2 In the **Workspace** list of categories, click **VBA**.
- 3 In the **Security** area, specify how to control the risk of running malicious macros by clicking **Security options**.
If you want to bypass this security feature, enable the **Trust all installed GMS modules** check box, and then proceed to step 6.
- 4 On the **Security level** page of the **Security** dialog box, enable one of the following options:
 - **Very high** — allows only macros installed in trusted locations to run. All other signed and unsigned macros are disabled.
 - **High** — allows only signed macros from trusted sources to run. Unsigned macros are automatically disabled.
 - **Medium** — lets you choose which macros run, even if they are potentially harmful
 - **Low (not recommended)** — allows all potentially unsafe macros to run. Enable this setting if you have virus-scanning software installed, or if you check the safety of all documents that you open.
- 5 On the **Trusted publishers** page of the **Security** dialog box, review which macro publishers are trusted. Click **View** to display details on the selected macro publisher, or click **Remove** to delete the selected macro publisher from the list.
If desired, you can enable or disable the **Trust access to Visual Basic project** check box for the selected macro publisher.
- 6 Disable the **Delay load VBA** check box if you want to load the VBA feature at start-up.

To access the macro tools

To	Do the following
Display the Macros toolbar	Click Window ► Toolbars ► Macros . A check mark next to the command indicates that the toolbar is displayed.
Display the Macro Manager docker	Do one of the following: <ul style="list-style-type: none">• Click Tools ► Macros ► Macro Manager.

- Click the **Macro Manager** button  on the **Macros** toolbar.

Display the Macro Editor

Do one of the following:

- Click **Tools** ► **Macros** ► **Macro Editor**.
- Click the **Macro Editor** button  on the **Macros** toolbar.
- Right-click **Visual Basic for Applications** in the **Macro Manager** docker, and then click **Show IDE**.

Display the VSTA Editor

Click **Tools** ► **Macros** ► **VSTA Editor**. (VSTA must be installed on your computer.)

To create a macro project

- In the **Macro Manager** docker, do one of the following:
 - Click **Visual Studio Tools for Applications** in the list, click **New**, and then click **New macro project**.
 - Click **Visual Basic for Applications** in the list, click **New**, and then click **New macro project**.

You can also

Open (or “load”) a macro project

Do one of the following:

- Click **Visual Studio Tools for Applications** in the list, click **Load**, and then choose the project.
- Click **Visual Basic for Applications** in the list, click **Load**, and then choose the project.

Rename a macro project

Right-click the project in the list, and then click **Rename**.

Copy a GMS-based macro project

Right-click the project in the list, click **Copy to**, and then choose the target location for the copied project.

NOTE: You cannot copy a document-based macro project. Such projects are stored within a document and cannot be managed separately from that document.

Display or hide all modules in the list

Click the **Simple mode** button .

Add a module to a VBA macro project

Do one of the following:

- Click the project in the list, click **New**, and then click **New module**.
- Right-click the project in the list, and then click **New module**.

Edit a module in a VBA macro project

Do one of the following:

- Click the module in the list, and then click the **Edit** button .
- Right-click the module in the list, and then click **Edit**.

Rename a module in a macro project

Right-click the module in the list, and then click **Rename**.

Delete a module from a macro project

Do one of the following:

You can also

- Click the module in the list, and then click the **Delete** button .
- Right-click the module in the list, and then click **Delete**.

Close (or “unload”) a GMS-based macro project

Right-click the macro project in the list, and then click **Unload macro project**.

NOTE: You can close a document-based macro project only by closing the document in which it is stored.



Some macro projects are locked and cannot be modified.

To create a macro

- In the **Macro Manager** docker, do one of the following:
 - Click the container you want, click **New**, and then click **New macro**.
 - Right-click the desired container module, and then click **New macro**.

You can also

Edit a macro

Do one of the following:

- Click the macro in the list, and then click the **Edit** button .
- Right-click the macro in the list, and then click **Edit**.

Delete a macro

Do one of the following:

- Click the macro in the list, and then click the **Delete** button .
- Right-click the macro in the list, and then click **Delete**.



Some macro projects are locked and cannot be modified.

To record a macro

- 1 Click **Tools** ► **Macros** ► **Start recording**.
The **Record macro** dialog box appears.
- 2 In the **Macro name** box, type a name for the macro.
Macro names can contain numerals, but they must begin with a letter. Macro names cannot contain spaces or non-alphanumeric characters other than underscores (_).
- 3 Type a description of the macro in the **Description** box, and then click **OK**.
- 4 Perform the actions that you want to record.
The application begins recording your actions. If you want to pause recording, click **Tools** ► **Macros** ► **Pause recording**. Repeat this step to resume recording.
- 5 To stop recording, click **Tools** ► **Macros** ► **Stop recording**.



You cannot record a macro if all available macro projects are locked.

Not all actions can be recorded — some because of their complexity (although many such actions can be manually coded in the Macro Editor). When an action cannot be recorded, a comment is placed in the macro code (“**The recording of this command is not supported.**”), but the recording process continues until you stop it. You can view any comments in the code by opening the macro in the Macro Editor.



By default, macros are recorded in the **GlobalMacros** project so that they can be accessed from other documents. However, you can change the default macro project for recordings by right-clicking another project in the **Macro Manager** docker, and then clicking **Set as recording project**. You cannot specify a locked macro project.

You can cancel recording a macro, and discard any commands recorded thus far, by clicking **Tools ▶ Macros ▶ Cancel recording**.

You can also record, pause, and stop recording a macro by using the **Macros** toolbar or the **Macro Manager** docker (**Tools ▶ Macros ▶ Macro Manager**).

You can also

Save the actions in the **Undo** list as a VBA macro

Click **Edit ▶ Undo manager**, perform the actions that you want to record, and then click the **Save list to a VBA macro** button  in the **Undo manager** docker.

To record a temporary macro

- 1 Click **Tools ▶ Macros ▶ Record temporary macro**.
- 2 Perform the actions that you want to record.

The application begins recording your actions. If you want to pause recording, click **Tools ▶ Macros ▶ Pause recording**. Repeat this step to resume recording.

- 3 To stop recording, click **Tools ▶ Macros ▶ Stop recording**.

The macro is temporarily saved to the default recording project. When the current session is ended, the macro is deleted from that project.



You cannot record a temporary macro if all available macro projects are locked.

Not all actions can be recorded.





By default, macros are recorded in the **GlobalMacros** project so that they can be accessed from other documents. However, you can change the default recording project by right-clicking another project in the **Macro Manager** docker, and then clicking **Set as recording project**. (You cannot specify a locked macro project.) If you want, you can create multiple temporary recordings by assigning each one to its own macro project.

You can cancel recording a macro, and discard any commands recorded thus far, by clicking **Tools ▶ Macros ▶ Cancel recording**.

You can also pause and stop recording a temporary macro by using the **Macros** toolbar or the **Macro Manager** docker (**Tools ▶ Macros ▶ Macro Manager**).

To play a macro

- Do any of the following:

- Click **Tools** ► **Macros** ► **Run macro**, or click the **Run macro** button  on the **Macros** toolbar. From the **Macros in** list box, choose the project or file in which the macro is stored. From the **Macro name** list, choose the macro. Click **Run**.
- In the **Macro Manager** docker, double-click the macro in the list.
- In the **Macro Manager** docker, click the macro in the list, and then click the **Run** button .
- In the **Macro Manager** docker, right-click the macro in the list, and then click **Run**.

To play a temporary macro

- Click **Tools** ► **Macros** ► **Run temporary macro**.



This option is enabled only after you record a temporary macro.



If you have created multiple temporary macros, you must specify which macro project contains the one that you want to run. Right-click the project in the **Macro Manager** docker, and then click **Set as recording project**.

To access Object Model reference documentation from within the Macro Editor

- 1 While in Microsoft Visual Basic for Applications, press **F2** to display the Object Browser.
The Object Browser displays all the features and functions that can be automated in the Macro Editor.
- 2 Choose **VGCore** from the **Library** list box.
The Object Browser is updated to display only the features and functions of CorelDRAW that can be automated in the Macro Editor. Collectively, these features and functions are called an “object model.”
- 3 Click an item in the Object Browser, and press **F1**.



You can also display information for any item in the **Code** window of the Macro Editor by clicking that item and pressing **F1**.

Reference

CorelDRAW for Adobe Illustrator users..... 881

Glossary..... 887

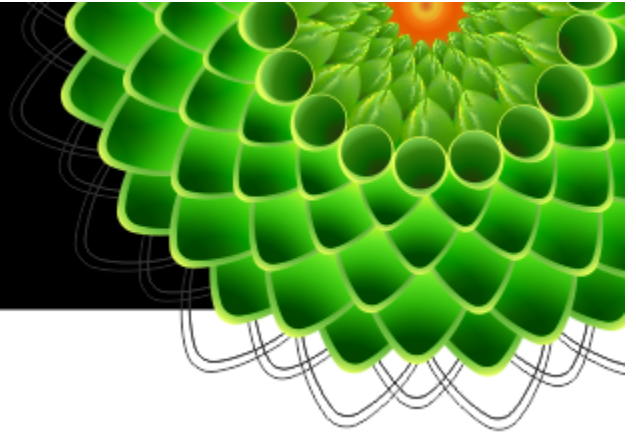

CorelDRAW for Adobe Illustrator users

Adobe Illustrator and CorelDRAW have many similarities, which makes it easy to move from one graphics application to the other. Although they share most basic drawing and design capabilities, Adobe Illustrator and CorelDRAW are distinguished by some differences in both terminology and tools. Understanding these differences lets you make a quick transition to CorelDRAW.

This section contains the following topics:

- [“Comparing terminology” \(page 881\)](#)
- [“Comparing tools” \(page 882\)](#)
- [“Using the Adobe Illustrator workspace” \(page 885\)](#)

Comparing terminology

The terms and concepts in Adobe Illustrator and CorelDRAW differ for some features. Adobe Illustrator terms are listed below with their CorelDRAW equivalents.

Adobe Illustrator term	CorelDRAW term
Actions/Scripts	Macros/Scripts
Anchor points	Nodes
Artwork	Drawing
Clipping mask	PowerClip
Direction points	Control handles
Guides	Guidelines
Smart guides	Dynamic guides

Adobe Illustrator term

Gradient fill

Live Color

Outline view

Panels

Path

Placing files

Rasterizing

Stroke

Swatches panel

CorelDRAW term

Fountain fill

Color styles, color harmonies

Wireframe view

Dockers

Curve

Importing files

Converting to a bitmap

Outline

Color palette

Comparing tools

The following table lists Adobe Illustrator tools and the corresponding CorelDRAW tools. Many of the tools create the same result but operate slightly differently.

Adobe Illustrator tool

Add Anchor Point tool

Area Type tool

Blend tool

Bloat tool

Convert Anchor Point tool

Delete Anchor Point tool

CorelDRAW tool

Shape tool . See "To add or delete a node" on page 194.

Text tool . See "To add paragraph text" on page 479.

Blend tool . See "To blend objects" on page 453.

Envelope tool . See "To apply an envelope" on page 212.

Shape tool . See "To shape a curve object by using cusp, smooth, or symmetrical nodes" on page 195.

Shape tool . See "To add or delete a node" on page 194.

Adobe Illustrator tool

Direct Selection tool

Drop Shadow tool

Gradient tool

Line Segment tool

Live Paint Bucket tool

Live Trace command

Measure tool

Mesh tool

Paintbrush tool

Pan tool

Path Type tool

Pathfinder effects

CorelDRAW tool

Shape tool . See “To select a node” on page 181.

Drop shadow tool . See “To add a drop shadow” on page 447.

Interactive fill tool . See “Applying fountain fills” on page 368.

Freehand tool . See “To draw a curve by using the 3-point curve tool ” on page 135.

Polyline tool . See “Drawing lines” on page 127.

Smart fill tool . See “To apply a fill to an enclosed area” on page 387.

Bitmaps ▶ Quick Trace command

Bitmaps ▶ Centerline Trace command

Bitmaps ▶ Outline Trace command. See “To trace a bitmap by using the Outline Trace method” on page 720.

Dimension tool . See “Drawing connector and callout lines” on page 158.

Mesh fill tool . See “To apply a mesh to an object” on page 384.

Artistic media tool . See “To draw a calligraphic line ” on page 137.

Brush tool . See “Applying brushstrokes” on page 153.

Pan tool . See “To pan in the drawing window” on page 59.

Text tool . See “To fit text to a path” on page 492.

Object ▶ Shaping commands. See “Trimming objects ” on page 224 and “Welding and intersecting objects” on page 228.

Adobe Illustrator tool

Pencil tool

Pucker tool

Reflect tool

Reshape tool

Rotate tool

Rounded Rectangle tool

Save For Microsoft Office command

Scale tool

Scissors tool

Selection tool

Shear tool

Star tool

Symbol Sprayer tool

Twirl tool

Type tool

CorelDRAW tool

Freehand tool . See "To draw a line by using the Freehand tool" on page 130.

Envelope tool . See "To apply an envelope" on page 212.

Mirror buttons. See "To mirror an object" on page 294.

Shape tool . See "To stretch, scale, rotate, or skew nodes" on page 196.

Pick tool . See "To rotate an object" on page 294.

Rectangle tool . See "To draw a rectangle or square with rounded, scalloped, or chamfered corners" on page 169.



File ► Export for ► Office command

Pick tool . See "Sizing and scaling objects" on page 292.

Knife tool . See "To split an object" on page 223.

Pick tool . See "To select objects" on page 255.

Pick tool . See "Skewing and stretching objects" on page 198.

Star  and Complex star  tools. See "To draw a star" on page 172.

Sprayer tool . See "To spray a pattern" on page 156.

Distort tool . See "To distort an object" on page 208.

Text tool . See "To add paragraph text" on page 479 and "To add artistic text" on page 477.

Adobe Illustrator tool

Vertical Type tool

Warp tool

Wrinkle tool

CorelDRAW tool

Paragraph formatting docker. See [“To choose a text orientation for Asian text”](#) on page 527.

Smudge tool . See [“To smudge an object”](#) on page 201.

Envelope tool. See [“Shaping objects by using envelopes”](#) on page 210.

Roughen tool . See [“To roughen an object”](#) on page 203.

Using the Adobe Illustrator workspace

CorelDRAW includes a workspace that has the look and feel of Adobe Illustrator. This workspace can help you find menu commands and tools more easily. For information about changing your workspace, see [“To choose a workspace”](#) on page 97.

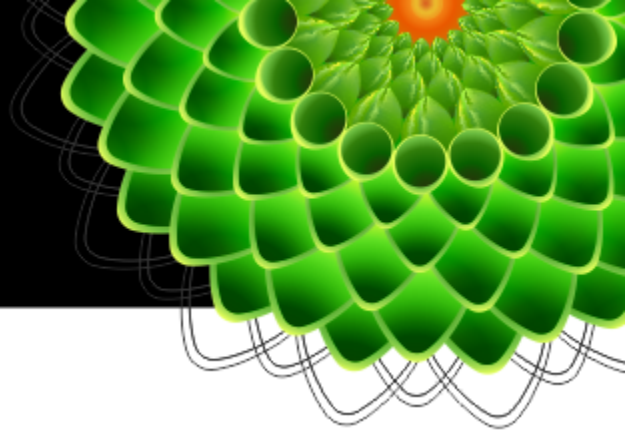

Glossary

A B C D E F G H I J K L M N O P Q R S T U V W Z

A

accelerator table

A file that contains a list of shortcut keys. Different tables are active depending on the task that you are performing.

add-in

A separate module that extends the functionality of an application.

alignment guides

Temporary guidelines that help align objects as you create, resize, or move them in relation to other nearby objects.

anchor point

The point that remains stationary when you stretch, scale, mirror, or skew an object. Anchor points correspond to the eight handles that appear when an object is selected, as well as the center of a selection box marked by an X.

animation file

A file that supports moving images; for example, animated GIF and QuickTime (MOV).

anti-aliasing

A method of smoothing curved and diagonal edges in images. Intermediate pixels along edges are filled to smooth the transition between the edges and the surrounding area.

arrow keys

Direction keys that move or “nudge” selected objects in small increments. You can also use arrow keys to position the cursor when you type or edit text on-screen or in a dialog box.

artistic text

A type of text created with the **Text** tool. Use artistic text to add short lines of text, such as titles, or to apply graphic effects, such as fitting text to a path, creating extrusions and blends, and creating all other special effects. An artistic text object can contain up to 32,000 characters.

aspect ratio

The ratio of the width of an image to its height (expressed mathematically as x:y). For example, the aspect ratio of an image that is 640 x 480 pixels is 4:3.

B

base color

The color of the object that appears under a transparency. The base color and the color of the transparency combine in various ways depending on the merge mode you apply to the transparency.

baseline

An invisible line upon which text characters sit.

baseline grid

A series of evenly spaced horizontal lines that follow the pattern of a ruled notebook and help align text and objects.

baseline shift

The process of moving text characters above or below the baseline.

Bézier line

A straight or curved line made up of segments connected by [nodes](#). Each node has control handles that allow the shape of the line to be modified.

bit depth

The number of binary bits that define the shade or color of each pixel in a bitmap. For example, a pixel in a black-and-white image has a depth of 1 bit, because it can only be black or white. The number of color values that a given bit depth can produce is equal to 2 to the power of the bit depth. For example, a bit depth of 1 can produce two color values ($2^1 = 2$), and a bit depth of 2 can produce 4 color values ($2^2 = 4$).

Bit depth ranges between 1 and 64 bits per pixel (bpp) and determines the [color depth](#) of an image.

bitmap

An image composed of grids of pixels or dots.

See also [vector graphic](#).

black point

A brightness value that is considered black in a bitmap image. In Corel PHOTO-PAINT, you can set the black point to improve the contrast of an image. For example, in a [histogram](#) of an image, with a brightness scale of 0 (dark) to 255 (light), if you set the black point at 5, all pixels with a value greater than 5 are converted to black.

black-and-white color mode

A 1-bit color mode that stores images as two solid colors — black and white — with no gradations. This color mode is useful for line art and simple graphics. To create a black-and-white photo effect, you can use the grayscale color mode.

See also [grayscale](#).

bleed

The part of the printed image that extends beyond the edge of the page. The bleed ensures that the final image goes right to the edge of the paper after binding and trimming.

blend

An effect created by transforming one object into another through a progression of shapes and colors.

bookmark

An indicator for marking an address on the Internet.

bounding box

The invisible box indicated by the eight selection [handles](#) surrounding a selected object.

brightness

The amount of light that is transmitted or reflected from a given pixel. In the HSB color mode, brightness is a measure of how much white a color contains. For example, a brightness value of 0 produces black (or shadow in photos), and a brightness value of 255 produces white (or highlight in photos).

C**calligraphic angle**

The angle that controls the orientation of a pen to the drawing surface, like the slant of the nib on a calligraphy pen. A line drawn at the calligraphic angle has little or no thickness, but widens as its angle gets farther from the calligraphic angle.

cascading style sheet (CSS)

An extension to HTML that allows styles such as color, font, and size to be specified for parts of a hypertext document. Style information can be shared by multiple HTML files.

See also [HTML](#).

center of rotation

The point around which an object rotates.

CGI script

An external application that is executed by an HTTP server in response to an action you perform in a web browser, such as clicking a link, image, or another interactive element of a webpage.

character

A letter, number, punctuation mark, or other symbol.

child color

A color style created as a shade of another color style. For most of the available color models and palettes, child colors share the same hue as the parent, but have different saturation and brightness levels.

See also [parent color](#).

choke

In commercial printing, a form of trapping created by extending the background object into the foreground object.

clipart

Ready-made images that can be imported into Corel applications and edited if required.

Clipboard

An area that is used to temporarily store cut or copied information. The information is stored until new information is cut or copied to the Clipboard, replacing the old.

clone

A copy of an object or an area of an image that is linked to a master object or image area. Most changes made to the master are automatically applied to its clones.

See also [symbol](#).

closed object

An object defined by a path whose start point and end point are connected.

closed path

A path whose start point and end point are connected.

color cast

A color tint that often occurs in photos as a result of lighting conditions or other factors. For example, taking a photo indoors in dim incandescent light can result in a yellow color cast, and taking a photo outdoors in bright sunlight can result in a blue color cast.

color depth

The maximum number of colors an image can contain. Color depth is determined by the [bit depth](#) of an image and the displaying monitor. For example, an 8-bit image can contain up to 256 colors, while a 24-bit image can contain roughly up to 16 million colors. A GIF image is an example of an 8-bit image; a JPEG image is an example of a 24-bit image.

control object or control group

An object or a group of objects to which a special effect, such as an extrusion, blend, drop shadow, or contour, is applied. You can edit the control object or group by changing its shape, color or position or by applying a transformation, thus modifying the overall appearance of the special effect.

With blends, the start and end objects of the blend are the control objects.

CMY

A color mode made up of cyan (C), magenta (M), and yellow (Y). This mode is used in the three-color printing process.

CMYK

A color mode made up of cyan (C), magenta (M), yellow (Y), and black (K). CMYK printing produces true blacks and a wide tonal range. In the CMYK color mode, color values are expressed as percentages; therefore, a value of 100 for an ink means that the ink is applied at full saturation.

code page

A code page is a table in the DOS or Windows operating system that defines which ASCII or ANSI character set is used for displaying text. Different character sets are used for different languages.

color channel

An 8-bit grayscale version of an image. Each channel represents one level of color in the image; for example, RGB has three color channels, while CMYK has four. When all the channels are printed together, they produce the entire range of colors in the image.

See also [RGB](#) and [CMYK](#).

color gamut

The range of colors that can be reproduced or perceived by any device. For example, a monitor displays a different color gamut than a printer, making it necessary to manage colors from original images to final output.

color mode

A system that defines the number and kind of colors that make up an image. Black-and-white, grayscale, RGB, CMYK, and paletted are examples of color modes.

color model

A simple color chart that defines the range of colors displayed in a color mode. RGB (red, green, blue), CMY (cyan, magenta, yellow), CMYK (cyan, magenta, yellow, black), HSB (hue, saturation, brightness), HLS (hue, lightness, saturation), and CIE L*a*b (Lab) are examples of color models.

color palette

A collection of solid colors from which you can choose colors for fills and outlines.

color profile

A description of the color-handling capabilities and characteristics of a device.

color separation

In commercial printing, the process of splitting colors in a composite image to produce a number of separate grayscale images, one for each primary color in the original image. In the case of a CMYK image, four separations (one for cyan, magenta, yellow, and black) must be made.

color space

In electronic color management, a virtual representation of a device or the color gamut of a color model. The boundaries and contours of a device's color space are mapped by color management software.

See also [color gamut](#).

color swatch

A solid-colored patch in a color palette.

color trapping

A printing term used to describe a method of overlapping colors to compensate for misaligned color separations (misregistration). This method avoids white slivers that appear between adjoining colors on a white page.

See also [spread](#), [choke](#), and [overprinting](#).

color value

A set of numbers that define a color in a color mode. For example, in the RGB color mode, color values of 255 for red (R) and zero for both green (G) and blue (B) result in the color red.

combined object

An object created by combining two or more objects and converting them into a single curve object. A combined object takes on the fill and outline attributes of the last selected object. Sections where an even number of objects overlapped have no fill. Sections where an odd number of objects overlapped are filled. The outlines of the original objects remain visible.

compound blend

A blend created by blending the start or end object of one blend with another object.

concave

Hollowed or rounded inward like the inside of a bowl.

content

The object or objects that appear inside a container object when you apply PowerClip effects.

This term is also used to describe graphics resources included with the product such as clipart, photos, symbols, fonts, and objects.

constrain key

A key you hold to constrain drawing and editing to a shape or at an angle. The default key is Ctrl. You can change the default key to Shift, the Windows standard, on the **Pick** tool page of the **Options** dialog box.

contour

An effect created by adding evenly spaced concentric shapes inside or outside the borders of an object. This effect can also be used for creating cuttable outlines for devices, such as plotters, engraving machines, and vinyl cutters.

contrast

The difference in tone between the dark and light areas of an image. Higher contrast values indicate greater differences and fewer gradations between dark and light.

control object

The original object used to create effects such as envelopes, extrusions, drop shadows, contours, and objects created with the **Artistic media** tool. Changes made to the control object control the appearance of the effect.

control handles (CorelDRAW)

The handles that extend from a node along a curve that is being edited with the **Shape** tool. Control handles determine the angle at which the curve passes through the node.

convex

Curved or rounded outwards like the exterior of a sphere or circle.

crop

To cut unwanted areas of an image without affecting the resolution of the part that remains.

curve object

An object that has [nodes](#) and [control handles](#), which you can manipulate to change the object's shape. A curve object can be any shape, including a straight or curved line.

cusp

A point or corner created where two curves meet.

D

desktop

The area in a drawing where you can experiment and create objects for future use. This area is outside the borders of the drawing page. You can drag objects from the desktop area to the drawing page when you decide to use them.

DeviceN

A type of color space and device color model. This color space is multi-component, allowing color to be defined by other than the standard set of three (RGB) and four (CMYK) color components.

diacritical mark

An accent mark above, below, or through a written character; for example, the acute (é) and cedilla (ç) accents.

dimension line

A line that displays the size of objects or the distance or angle between objects.

dithering

A process used to simulate a greater number of colors when only a limited number of colors are available.

document grid

A series of evenly spaced horizontal and vertical lines that are used to help draw and arrange objects.

document navigator

The area at the bottom-left of the application window that contains controls for moving between pages and adding pages. The document navigator also displays the page number of the active page and the total number of pages in a drawing.

dpi (dots per inch)

A measure of a printer's resolution in dots per inch. Typical desktop laser printers print at 600 dpi. Imagesetters print at 1270 or 2540 dpi. Printers with higher dpi capabilities produce smoother and cleaner output. The term dpi is also used to measure scanning resolution and to indicate bitmap resolution.

drawing

A document you create in CorelDRAW.

drawing page

The portion of a drawing window enclosed by a rectangle with a shadow effect.

drawing window

The portion of the application window on which you can create, add, and edit objects.

drop shadow

A three-dimensional shadow effect that gives objects a realistic appearance.

duotone

An image in the duotone color mode is an 8-bit [grayscale](#) image that has been enhanced with one to four additional colors.

dynamic guides

Temporary guidelines that appear from the following snap points in objects — center, node, quadrant, and text baseline.

E

embedding

The process of placing an object created in one application into a document created in a different application. Embedded objects are included entirely in the current document; they are not linked to their source files.

encoding

Determines the character set of text, letting you correctly display text in the appropriate language.

envelope

A closed shape that can be placed around an object to change the object's shape. An envelope consists of segments connected by nodes. After an envelope has been placed around an object, the nodes can be moved to change the shape of the object.

exposure

A photographic term referring to the amount of light used to create an image. If not enough light is permitted to interact with the sensor (in a digital camera) or film (in a traditional camera), the image appears too dark (underexposed). If too much light is permitted to interact with the sensor or film, the image appears too light (overexposed).

extrusion

A feature that lets you apply a three-dimensional perspective by projecting lines from an object to create the illusion of depth.

F**feathering**

The level of sharpness along the edges of a drop shadow.

fill

A color, bitmap, fountain, or pattern applied to an area of an image.

filter

An application that translates digital information from one form to another.

floating object

A bitmap with no background. Floating objects are also referred to as photo objects or cutout images.

font

A set of characters with a single style (such as italic), weight (such as bold), and size (such as 10 point) for a typeface such as Times New Roman.

fountain fill

A smooth progression of two or more colors applied to an area of an image that follow a linear, radial, conical, or square path. Two-color fountain fills have a direct progression from one color to another, while custom fills may have a progression of many colors.

fountain step

The shades of color that make up the appearance of a fountain fill. The more steps in a fill, the smoother the transition from the beginning color to the end color.

freehand marquee select

To marquee select objects or nodes while dragging the **Shape** tool and controlling the shape of the marquee box enclosure as if you were drawing a freehand line.

See also [marquee select](#).

FTP (File Transfer Protocol)

A method of moving files between two computers. Many Internet sites have established repositories of material that can be accessed by using FTP.

G**GIF**

A graphic file format designed to use a minimum of disk space and be easily exchanged between computers. This format is commonly used to publish images of 256 or fewer colors to the Internet.

glyph

Diamond-shaped handles that can be dragged to alter the form of a shape.

glyph (typographic)

A typographic glyph corresponds to a single character of a typeface.

grab area

The area of a command bar that can be dragged. Dragging the grab area moves the bar, while dragging any other area of the bar has no effect. The location of the grab area depends on the operating system you are using, the orientation of the bar, and whether the bar is docked or undocked. Command bars with grab areas include toolbars, the toolbox, and the property bar.

grayscale

A color mode that displays images by using 256 shades of gray. Each color is defined as a value between 0 and 255, where 0 is darkest (black) and 255 is lightest (white). Grayscale images, especially photos, are commonly referred to as "black and white."

greeking

A method of representing text by using either words that have no meaning or a series of straight lines.

grid

A series of evenly spaced horizontal and vertical lines that are used to help draw and arrange objects.

See also [document grid](#).

group

A set of objects that behave as one unit. Operations you perform on a group apply equally to each of its objects.

guideline

A horizontal, vertical, or slanted line that can be placed anywhere in the drawing window to aid in object placement.

gutter

The space between columns of text, also called the alley. In printing, the white space formed by the inside margins of two facing pages.

H

halftone

An image that has been converted from a continuous tone image to a series of dots of various sizes to represent different tones.

handles

A set of eight black squares that appear at the corners and sides of an object when the object is selected. By dragging individual handles, you can scale, resize, or mirror the object. If you click a selected object, the shape of the handles changes to arrows so that you can rotate and skew the object.

highlight, shadow, and midtone

Terms used to describe the brightness of pixels in a bitmap image. Brightness values range from 0 (dark) to 255 (light). Pixels in the first third of the range are considered shadows, pixels in the middle third of the range are considered midtones, and pixels in the last third of the range are considered highlights. You can lighten or darken specific areas in images by adjusting the highlights, shadows, or midtones. A [histogram](#) is an excellent tool for viewing and evaluating the highlights, shadows, and midtones of images.

histogram

A histogram consists of a horizontal bar chart that plots the brightness values of the pixels in your bitmap image on a scale from 0 (dark) to 255 (light). The left part of the histogram represents the shadows of an image, the middle part represents the midtones, and the right part represents the highlights. The height of the spikes indicates the number of pixels at each brightness level. For example, a large number of pixels in the shadows (the left side of the histogram) indicates the presence of image detail in the dark areas of the image.

hotspot

The area of an object that you can click to jump to the address specified by a URL.

hotspotting

The process of adding data to objects or groups of objects so that they respond to events, such as pointing or clicking. For example, you can assign a URL to an object, making it a hyperlink to an external website.

hot zone

The distance from the right margin at which hyphenation begins.

HSB (hue, saturation, brightness)

A color model that defines three components: hue, saturation, and brightness. Hue determines color (yellow, orange, red, and so on); brightness determines perceived intensity (lighter or darker color); and saturation determines color depth (from dull to intense).

HTML

The World Wide Web authoring standard comprised of markup tags that define the structure and components of a document. The tags are used to tag text and integrate resources (such as images, sound, video, and animation) when you create a webpage.

hue

The property of a color that allows it to be classified by its name. For example, blue, green, and red are all hues.

hyperlink

An electronic link that provides access directly from one place in a document to another place in that document or to another document.

I**icon**

A pictorial representation of a tool, object, file, or other application item.

input stroke

A stroke that you make as you sketch with the LiveSketch tool. Input strokes are adjusted and converted to Bézier curves based on the time and distance between them.

image map

A graphic in an HTML document that contains clickable areas that link to locations on the World Wide Web, to other HTML documents, or to graphics.

image resolution

The number of pixels per inch in a bitmap measured in ppi (pixels per inch) or dpi (dots per inch). Low resolutions can result in a grainy appearance of the bitmap; high resolutions can produce smoother images but result in larger file sizes.

imagesetter

A high-resolution device that creates film or film-based paper output used in the production of plates for printing presses.

insert

To import and place a photo image, clipart object, or sound file into a drawing.

intensity

Intensity is a measure of the brightness of the light pixels in a bitmap compared with the darker midtones and dark pixels. An increase in intensity increases the vividness of whites while maintaining true darks.

interlacing

In GIF images, a method that lets you display a web-based image on the screen at a low, blocky resolution. As the image data loads, the image quality improves.

intersection

The point at which one line crosses another.

J

JavaScript

A scripting language used on the web to add interactive functions to HTML pages.

JPEG

A format for photographic images that offers compression with some loss of image quality. Because of their compression (up to 20 to 1) and small file size, JPEG images are widely used in Internet publishing.

JPEG 2000

An improved version of the JPEG file format that features better compression and allows you to attach image information and assign a different compression rate to an image area.

justify

To modify the spacing between characters and words so that the edges on the left, right, or both margins of a block of text are even.

K

kerning

The space between characters, and the adjustment of that space. Often, kerning is used to place two characters closer together than usual, for example WA, AW, TA, or VA. Kerning increases readability and makes letters appear balanced and proportional, especially at larger font sizes.

knockout

A printing term that refers to an area where underlying colors have been removed so that only the top color prints. For example, if you print a small circle on a large circle, the area under the small circle is not printed. This ensures that the color used for the small circle remains true instead of overlapping and mixing with the color used for the large circle.

L

Lab

A color model that contains a luminance (or lightness) component (L) and two chromatic components: "a" (green to red) and "b" (blue to yellow).

layer

A transparent plane on which you can place objects in a drawing.

leader tabs

A row of characters placed between text objects to help the reader follow a line across white space. Leader tabs are often used in place of tab stops, especially before text that is flush right such as in a list or table of contents.

leading

The spacing between lines of text. Leading is important for both readability and appearance.

linking

The process of placing an object created in one application into a document created in a different application. A linked object remains connected with its source file. If you want to change a linked object in a file, you have to modify the source file.

library

A collection of [symbol](#) definitions that are included in a CorelDRAW (CDR) file. To share a library between drawings, you can export it to the Corel Symbol Library (CSL) file format.

ligature

A character consisting of two or more letters joined together.

lightness

The level of brightness that is shared between a transparency and the object to which it is applied. For example, if a transparency is applied to an object whose color appears bright, the transparency color takes on a comparable brightness. The same is true for a transparency that is applied to an object whose color appears dark — the transparency takes on a comparable darkness.

lossless

A kind of file compression that maintains the quality of an image that has been compressed and decompressed.

lossy

A kind of file compression that results in noticeable degradation of image quality.

LZW

A lossless file compression technique that results in smaller file size and faster processing time. LZW compression is commonly used on GIF and TIFF files.

M

marquee select

To select objects or nodes by dragging the **Pick** tool or **Shape** tool diagonally and enclosing objects in a marquee box with a dotted outline.

master object

An object that has been cloned. Most changes you make to the master object are automatically applied to the clone.

master layer

A layer on a [master page](#) whose objects appear on every page of a multipage drawing. A master page can have more than one master layer.

master page

A virtual page that contains global objects, guidelines, and grid settings that apply to all pages in your document.

mesh fill

A type of fill that lets you add patches of color to the inside of a selected object.

metadata

Information about objects. Examples of metadata are names, comments, and cost assigned to objects.

micro nudge

To move an object in small increments.

See also [nudge](#) and [super nudge](#).

midpoint

The point of a Bézier line that divides it into two parts of equal length.

miter limit

A value that determines when two lines that meet at a sharp angle switch from a pointed (mitered) joint to a squared-off (beveled) joint.

moiré pattern

The visual effect of radiating curves created by superimposing two regular patterns. For example, a moiré pattern can result from overlapping two [halftone](#) screens of different angles, dot spacing, and dot size. Moiré patterns are the undesirable result of rescreening an image with a different halftone screen or with the same halftone screen on an angle different from the original.

multiple select

To select multiple objects by using the **Pick** tool, or multiple nodes by using the **Shape** tool.

N

nested group

A group of two or more groups that behaves as one object.

nested PowerClip objects

Containers that hold other containers to form complex PowerClip objects.

nodes

The square points at each end of a line or curve segment. You can change the shape of a line or curve by dragging one or more of its nodes.

noise

In bitmap editing, random pixels on the surface of a bitmap, resembling static on a television screen.

nonprinting characters

Items that appear on the screen but do not print. They include the rulers, guidelines, table gridlines, hidden text, and formatting symbols, such as spaces, hard returns, tabs, and indents.

nudge

To move an object in increments.

See also [micro nudge](#) and [super nudge](#).

O

object (CorelDRAW)

A generic term for any item you create or place in a drawing. Objects include lines, shapes, graphics, and text.

one-point perspective

An effect created by lengthening or shortening one side of an object to create the impression that the object is receding from view in one direction.

opacity

The quality of an object that makes it difficult to see through. If an object is 100 percent opaque, you cannot see through it. Opacity levels under 100 percent increase the transparency of objects.

See also [transparency](#).

open object

An object defined by a path whose start point and end point are not connected.

origin

The point in the drawing window at which the rulers intersect.

output resolution

The number of dots per inch (dpi) that an output device, such as an imagesetter or laser printer, produces.

outline

The line that defines the shape of an object.

overexposure

Excessive light in an image that gives it a washed-out appearance.

See also [exposure](#).

overprinting

Overprinting is achieved by printing one color over another. Depending on the colors you choose, the overprinted colors mix to create a new color, or the top color covers the bottom color. Overprinting a dark color on a light color is often used to avoid registration problems that occur when color separations are not precisely aligned.

See also [color trapping](#), [choke](#), and [spread](#).

P

paletted color mode

An 8-bit color mode that displays images of up to 256 colors. You can convert a complex image to the paletted color mode to reduce file size and to achieve more precise control of the colors used throughout the conversion process.

pan (CorelDRAW)

To move the drawing page around in the drawing window. Panning changes the page view in the same way that scrolling moves the drawing up, down, to the left, or to the right in the drawing window. When working at high magnification levels where not all of the drawing is displayed, you can quickly pan to see parts of the drawing that were previously hidden.

PANOSE font matching

A feature that lets you choose a substitute font if you open a file that contains a font not installed on your computer. You can make a substitution for the current working session only, or you can make a permanent substitution, so that the new font is automatically displayed when you save and reopen the file.

PANTONE process colors

The colors that are available through the PANTONE Process Color System, which is based on the CMYK color model.

paragraph text

A text type that allows you to apply formatting options and directly edit large blocks of text.

parent color

An original color style that you can save and apply to objects in a drawing. You can create child colors from the parent color.

See also [child color](#).

path

The basic component from which objects are constructed. A path can be open (for example, a line) or closed (for example, a circle), and it can be made up of a single line or curve segment or many joined segments.

pattern fill

A fill consisting of a series of repeating vector objects or images.

Perfect Shapes

Predefined shapes, such as basic shapes, arrows, stars, and callouts. Perfect Shapes often have [glyphs](#), which let you modify their appearance.

perpendicular line

A line that intersects another line at a right angle.

pixel

A colored dot that is the smallest part of a bitmap.

See also [resolution](#).

PNG (Portable Network Graphics)

A graphic file format designed for use in online viewing. This format can import 24-bit color graphics.

point

A unit of measure used primarily in typesetting to define type sizes. There are approximately 72 points to an inch and 12 points to a pica.

PostScript fill

A type of texture fill designed using the PostScript language.

PowerClip effect

A way of arranging objects that lets you contain one object inside another.

PowerClip object

An object created by placing objects (contents objects) inside other objects (container objects). If the contents object is larger than the container object, the contents object is automatically cropped. Only the contents that fit inside the container object are visible.

pressure-sensitive pen

A stylus that you can use to access commands and draw your images. To use with CorelDRAW, you must install the pressure-sensitive pen, along with a pressure-sensitive tablet and its corresponding drivers.

process color

In commercial printing, colors that are produced from a blend of cyan, magenta, yellow, and black. This is different from a spot color, which is a solid ink color printed individually (one printing plate is required for each spot color).

progressive

In JPEG images, a method of having the image appear on screen in its entirety, at a low, blocky resolution. As the image data loads, the image quality progressively improves.

Q

QuickCorrect™

A feature that automatically displays the fully worded form for abbreviations or the correct form for errors as you type. You can use QuickCorrect to capitalize words or to correct common spelling and typographic errors automatically; for example, QuickCorrect can replace "asap" with "as soon as possible" and "hte" with "the."

R

radius

As applied to the Dust & Scratch filter, sets the number of pixels surrounding the damaged area that are used to apply the filter.

range sensitivity

A paletted color mode option that lets you specify a focus color for the paletted conversion. You can adjust the color and specify its importance to guide converting.

rasterized image

An image that has been rendered into pixels. When you convert vector graphic files to bitmap files, you create rasterized images.

render

To capture a two-dimensional image from a three-dimensional model.

resample

To change the [resolution](#) and dimensions of a bitmap. Upsampling increases the size of the image; downsampling decreases the size of the image. Resampling with fixed resolution lets you maintain the resolution of the image by adding or subtracting pixels while varying the image size. Resampling with variable resolution keeps the number of pixels unchanged while changing the image size, resulting in lower or higher resolution than that of the original image.

resolution

The amount of detail that an image file contains, or that an input, output, or display device is capable of producing. Resolution is measured in dpi (dots per inch) or ppi (pixels per inch). Low resolutions can result in a grainy appearance; high resolutions can produce higher quality images but result in larger file sizes.

rich text

Rich text supports text formatting, such as bold, italics, and underlining, as well as different fonts, font sizes, and colored text. Rich text documents can also include page formatting options, such as custom page margins, line spacing, and tab widths.

RGB

A color mode in which the three colors of light (red, green, and blue) are combined in varying intensities to produce all other colors. A value between 0 and 255 is assigned to each [channel](#) of red, green, and blue. Monitors, scanners, and the human eye use RGB to produce or detect color.

rollover

An interactive object or group of objects that changes its appearance when you click or point to it.

round-tripping

The conversion of a document saved in one file format, such as Portable Document Format (PDF), to another format, such as Corel DESIGNER (DES) and then back again.

rotate

To reposition and reorient an object by turning it around its center of rotation.

ruler

A horizontal or vertical bar marked off in units and used to determine the size and position of objects. By default, the rulers appear on the left side and along the top of the application window, but they can be hidden or moved.

S**saturation**

The purity or vividness of a color, expressed as the absence of white. A color that has 100 percent saturation contains no white. A color with 0 percent saturation is a shade of gray.

scale

To change an object's horizontal and vertical dimensions proportionally by a specified percentage. For example, scaling a rectangle that is 1 inch high and 2 inches wide by 150 percent results in a rectangle that is 1.5 inches high and 3 inches wide. The aspect ratio of 1:2 (height to width) is maintained.

segment

The line or curve between nodes in a curve object.

selection box

An invisible rectangle with eight visible handles that appears around any object you select using the **Pick** tool.

shape recognition

The ability to recognize and convert hand-drawn shapes into perfect forms. To take advantage of shape recognition, you must use the Smart drawing tool. For example, you can draw four pen strokes to sketch a rectangle, and the application will convert your hand-drawn lines into a perfect rectangle.

simple wireframe view

An outline view of a drawing that hides fills, extrusions, contours, and intermediate blend shapes. Bitmaps are displayed in monochrome.

See also [wireframe view](#).

size

To change an object's horizontal and vertical dimensions proportionally by changing one of the dimensions. For example, a rectangle with a height of 1 inch and a width of 2 inches can be sized by changing the value of the height to 1.5 inches. A width of 3 inches automatically results from the new height value. The aspect ratio of 1:2 (height to width) is maintained.

skew

To slant an object vertically, horizontally, or both.

snap

To force an object that is being drawn or moved to align automatically to a point on the grid, a guideline, or another object.

source object

The object you use to perform a shaping action on another object, such as welding, trimming, or intersecting. The source object receives the fill and outline attributes of the target object.

See also [target object](#).

splash screen

The screen that appears when CorelDRAW starts. It monitors the progress of the startup process and provides information about copyright and registration.

split blend

A single blend that is broken into two or more components to create a compound blend. The object where the blend is split becomes the end object for one component of the blend and start object for the other.

spot color

In commercial printing, a solid ink color that prints individually, one plate per spot color.

spread

In commercial printing, a type of trap that is created by extending the foreground object into the background object.

style

A set of attributes that controls the appearance of a specific type of object. There are three style types: graphic styles, text styles (artistic and paragraph), and color styles.

stylus

A pen device, used in conjunction with a pen tablet, that allows you to draw paint strokes. A pressure-sensitive stylus allows you to vary your strokes with subtle changes in pressure.

subpaths (CorelDRAW)

Subpaths are the basic curves and shapes from which a single curve object is constructed.

subscript

Text characters that are positioned below the baseline of the other characters in a line of text.

subtractive color model

A color model, such as CMYK, that creates color by subtracting wavelengths of light reflected from an object. For example, a colored ink appears blue if it absorbs all colors except blue.

super nudge

To move an object in large increments by pressing Shift and an Arrow key. The super nudge value is multiplied by the nudge value to obtain the distance by which the object is moved.

See also [nudge](#) and [micro nudge](#).

superscript

Text characters that are positioned above the baseline of the other characters in a line of text.

swap disk

Hard drive space used by applications to artificially increase the amount of memory available in your computer.

swatch

One of a series of solid-colored patches used as a sample when selecting color. A printed booklet of swatches is called a swatchbook. Swatch also refers to the colors contained in the color palette.

symbol

A reusable object or group of objects. A symbol is defined once and can be referenced many times in a drawing.

symbol instance

An occurrence of a [symbol](#) in a drawing. A symbol instance automatically inherits any changes made to the symbol. You can also apply unique properties to each instance, including size, position, and uniform transparency.

T

tangent

A straight line that touches a curve or an ellipse at a point, but does not cross the curve or ellipse at that point.

target object

The object you perform a shaping action on, such as welding, trimming, or intersecting with another object. The target object retains its fill and outline attributes while copying these attributes to the source objects used to perform the action.

See also [source object](#).

temperature

A way of describing light in terms of degrees Kelvin — lower values correspond to dim lighting conditions that cause an orange cast, such as candlelight or the light from an incandescent light bulb. Higher values correspond to intense lighting conditions that cause a blue cast, such as sunlight.

template

A predefined set of information that sets the page size, orientation, ruler position, and grid and guideline information. A template may also include graphics and text that can be modified.

text baseline

The imaginary horizontal line that text characters appear to be placed on.

text frame

The rectangle that appears as a series of dashed lines around a block of paragraph text created using the **Text** tool.

text style

A set of attributes that controls the appearance of text. There are two text style types: [artistic text](#) styles and [paragraph text](#) styles.

texture fill

A fractally generated fill that, by default, fills an object or image area with one image instead of with a series of repeating images.

threshold

A level of tolerance for tonal variation in a bitmap.

thumbnail

A miniature, low-resolution version of an image or illustration.

tick

Invisible divisions to which your pointer gravitates.

tiling

The technique of repeating a small image across a large surface. Tiling is often used to create a patterned background for webpages.

tint

In photo editing, a tint often refers to a semitransparent color applied over an image. Also called a [color cast](#).

In printing, a tint refers to a lighter shade of a color created with halftone screening — for example, a spot color.

See also [halftone](#).

tonal range

The distribution of pixels in a bitmap image from dark (a value of zero, indicating no brightness) to light (a value of 255, indicating full brightness). Pixels in the first third of the range are considered shadows, pixels in the middle third of the range are considered midtones, and pixels in the last third of the range are considered highlights. Ideally, the pixels in an image should be distributed across the entire tonal range. A [histogram](#) is an excellent tool for viewing and evaluating the tonal range of images.

tone

The variations in a color or the range of grays between black and white.

transparency

The quality of an object that makes it easy to see through. Setting lower levels of transparency causes higher levels of opacity and less visibility of the underlying items or image.

See also [opacity](#).

trapping

See [color trapping](#).

TrueType fonts

A font specification developed by Apple. TrueType fonts print the way they appear on the screen and can be resized to any height.

TWAIN

By using the TWAIN driver supplied by the manufacturer of the imaging hardware, Corel graphics applications can acquire images directly from a digital camera or scanner.

two-point perspective

An effect created by lengthening or shortening two sides of an object to create the impression that the object is receding from view in two directions.

U

underexposure

Insufficient light in an image.

See also [exposure](#).

uniform fill

A type of fill used to apply one solid color to your image.

See also [fill](#).

Unicode

A character encoding standard that defines character sets for all written languages in the world by using a 16-bit code set and more than 65, 000 characters. Unicode lets you handle text effectively regardless of the language of the text, your operating system, or the application you are using.

URL (Uniform Resource Locator)

A unique address that defines where a webpage is located on the Internet.

V

vanishing point

A marker that appears when you select an extrusion or an object to which perspective has been added. With an extrusion, the vanishing point marker indicates the depth (parallel extrusion) or the point at which the extruded surfaces would meet if extended (perspective extrusion). In both cases, the vanishing point is indicated by an X.

vector graphic

An image generated from mathematical descriptions that determine the position, length, and direction in which lines are drawn. Vector graphics are created as collections of lines rather than as patterns of individual dots or pixels.

See also [bitmap](#).

vector object

A specific object within a drawing that is created as a collection of lines rather than as patterns of individual dots or pixels. Vector objects are generated from mathematical descriptions that determine the position, length, and direction in which lines are drawn.

W

watermark

A small amount of random noise added to the luminance component of the image pixels which carries information about the image. This information survives normal editing, printing, and scanning.

weld

To combine two objects into a single curve object with a single outline. A [source object](#) is welded to a [target object](#) to create a new object that takes on the fill and outline attributes of the target object.

white point

The measurement of white on a color monitor that influences how highlights and contrast appear.

In image correction, the white point determines the brightness value that is considered white in a bitmap image. In Corel PHOTO-PAINT, you can set the white point to improve the contrast of an image. For example, in a [histogram](#) of an image, with a brightness scale of 0 (dark) to 255 (light), if you set the white point at 250, all pixels with a value greater than 250 are converted to white.

Windows Image Acquisition (WIA)

A standard interface and driver, created by Microsoft, for loading images from peripheral devices, such as scanners and digital cameras.

wireframe view

An outline view of a drawing that hides fills but displays extrusions, contour lines, and intermediate blend shapes. Bitmaps are displayed in monochrome.

See also [simple wireframe view](#).

workspace

A configuration of settings that specifies how the various command bars, commands, and buttons are arranged when you open the application.

Z

zoom

To reduce or magnify the view of a drawing. You can zoom in to see details or zoom out for a broader view.

ZIP

A lossless file compression technique that results in smaller file size and faster processing time.