

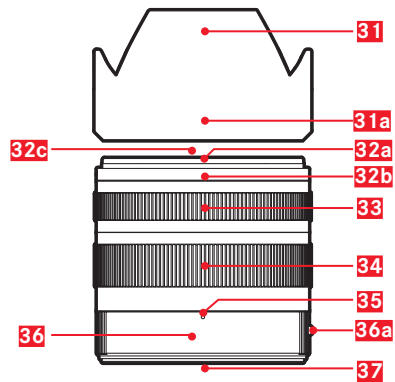

LEICA CL
INSTRUCTIONS

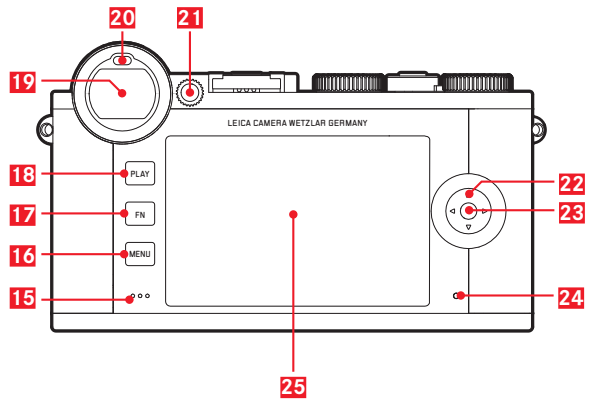
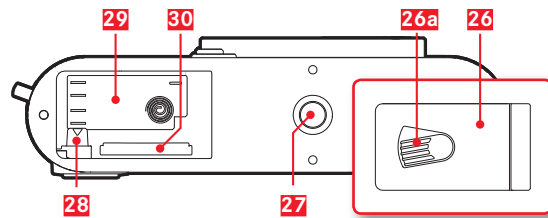
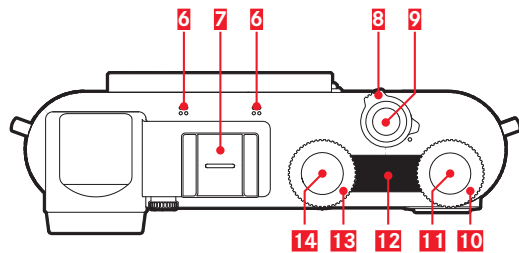
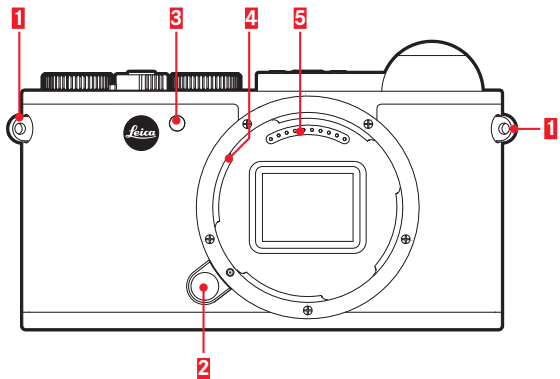

PART DESIGNATIONS

Front view

- 1** Strap lugs
- 2** Lens release button
- 3** Self-timer LED / AF assist lamp
- 4** Bayonet
- 5** Contact strip

Top view

- 6** Microphone
- 7** Accessory shoe
- 8** Main switch
- 9** Shutter button
- 10** Setting wheel
- 11** Setting wheel button
- 12** Top display
- 13** Setting wheel
- 14** Setting wheel button

Rear view

- 15** Speaker
- 16** **MENU** button
- 17** **FN** button
- 18** **PLAY** button
- 19** Viewfinder
- 20** Eye sensor
- 21** Diopter dial

- 22** Directional pad
- 23** Center button
- 24** Status LED
- 25** Screen

Bottom view

- 26** Cover for battery compartment and memory card slot
 - a** Lock/unlock lever
- 27** Tripod thread
- 28** Battery locking latch
- 29** Battery compartment
- 30** Memory card slot

Lens

- 31** Lens hood
 - a** Alignment points
- 32** Front mount
 - a** Male bayonet for lens hood
 - b** Alignment points for lens hood
 - c** Internal thread for filters
- 33** Focus setting ring
- 34** Zoom setting ring
- 35** Alignment point for focal length
- 36** Fixed ring
 - a** Red alignment button for lens change
- 37** Contact strip

FOREWORD

Dear Customer,

We are confident that you will enjoy taking photographs with your new Leica CL. Please read this manual thoroughly to ensure that you familiarize yourself with the full scope of functions your Leica CL has to offer.

The Quick Start Guide introduces the main functions of your new Leica camera only.

SCOPE OF DELIVERY

Please check that you have all of the accessories before using your Leica CL for the first time.

- a. Lithium-ion battery Leica BP-DC12
- b. Battery charger Leica BC-DC12 with replaceable mains cable
- c. Carry strap
- d. Camera bayonet cover
- e. Accessory shoe cover
- f. Registration card

ACCESSORY

Please visit the Leica Camera AG website for information on the extensive range of Leica CL accessories:

www.leica-camera.com

REPLACEMENT PARTS

Order No.

Camera bayonet cover	16 060
Accessory shoe cover	423-116.001-013
Carry strap	439-612.060-000
Lithium-ion battery Leica BP-DC12	19 500
Battery charger Leica BC-DC12	423-116.001-032



Correct disposal of electrical and electronic equipment

(Applies within the EU and for other European countries with active waste separation policies.)

This device contains electrical and/or electronic components which must not be disposed of in general household waste! Make sure to bring this device to a local disposal collection point for recycling. This service is free of charge. Any standard or rechargeable batteries used in this device must be removed and disposed of separately in accordance with local regulations.

Please contact your local authorities, waste disposal collection point or the retailer, from whom you purchased the device for more information on correct waste disposal.

Subject to changes in design and production.

Definition of remarks in this manual:**Note:**

Additional information

Important:

Failure to comply with these instructions may cause damage to the camera, accessories or the photos

Attention:

Failure to observe the instructions may cause personal injury

You will find the manufacturing date of your camera on the stickers in the Guarantee Card and/or on the packaging.

The format is year/month/day.

The specific approvals for this device can be found in the camera menu.

- ▶ Select **Camera Information** in the **Main Menu** (5th screen page)
- ▶ Select **Regulatory Information** in the submenu

LEGAL INFORMATION

- Compliance with copyright laws is mandatory. The recording and publication of pre-recorded media, e.g. tapes, CDs, or other published or broadcast material may be in breach of copyright laws.
- The same applies for all software supplied in the scope of delivery.
- The following applies for all video material created with this camera: This product is governed by the AVC Patent Portfolio license and is meant for private use by a consumer only. The device may furthermore be used for purposes for which the consumer receives no remuneration, e.g. (i) encoding in accordance with the AVC Standard (“AVC Video”) and/or (ii) decoding of AVC Video that was encoded by a consumer in accordance with the AVC Standard within the scope of personal use and/or which the consumer has received from the provider, who is in possession of a license to offer AVC Video. No license is granted or implied for any other use. Any other use, including but not limited to providing AVC video in exchange for remuneration, may require a separate license agreement with MPEG LA, L.L.C. For more information please visit the MPEG LA, L.L.C. website at: www.mpegla.com
- The SD logo is a registered trademark.
- Other names, company and product names mentioned in this manual are trademarks or registered trademarks of their respective companies.

SAFETY REMARKS

- Always store small parts (e.g. the accessory shoe cover) as follows:
 - out of the reach of children
 - in a safe location, where they will not get lost or stolen
- State-of-the-art electronic components are sensitive to static discharge. Since people can easily pick up charges of several 10,000 volts by walking on synthetic carpets, a discharge can occur when you touch the camera, and especially it is placed on a conductive surface. A static discharge on the camera housing poses no risk for the electronics. However, despite built-in safety circuits, avoid direct contact with external camera contacts like those in the accessory shoe.
- Do not use a micro-fiber cloth (synthetic) as used for spectacles; use a cotton or linen cloth instead. Before touching the contacts, you can make sure you discharge any electrostatic charge by deliberately touching a heating or water pipe (conductive, grounded material). Dirt deposits and oxidation on the contacts can be avoided by storing your camera in a dry location with the lens cap and flash shoe/viewfinder cap in place.
- Use only the recommended accessories to prevent faults, short circuits or electric shock.
- Do not attempt to remove parts of the housing (covers) yourself. Repairs must be done at authorized service centers only.
- Do not use your camera in the immediate vicinity of devices with powerful magnetic, electrostatic or electromagnetic fields (e.g. induction ovens, microwave ovens, television sets or computer monitors, video game consoles, cell phones, broadcasting equipment).
- Image recording may be affected if you place the camera on a television set or operate the camera near the television set or mobile phones.
- Strong magnetic fields, e.g. from speakers or large electric motors, can damage the stored image data or impact the image quality.
- Switch off the camera, remove the battery and switch the camera on again if the camera malfunctions due to the effects of electromagnetic fields. Do not use the camera in the immediate vicinity of radio transmitters or high-voltage power lines. Their electromagnetic fields can also interfere with recordings.
- Protect the camera against contact with insect sprays and other aggressive chemicals. Petroleum spirit, thinner and alcohol must not be used for cleaning the camera. Some chemicals and fluids can damage the camera housing or its surface coating.
- Rubber and plastics are known to expel aggressive chemicals and should therefore not be kept in contact with the camera for extended periods of time.
- Prevent any sand or dust penetration into the camera, e.g. on the beach. Be extra careful when inserting or removing the memory card. Sand and dust can damage the camera and the memory card.
- Prevent water penetrating the camera, e.g. during snowfall or rain or on the beach. Moisture can cause malfunctions and irreparable damage to the camera and memory card.
- Wet a soft cloth with tap water, wring it out thoroughly and wipe the camera clean of any salt water spray. Then wipe it down thoroughly with a dry cloth.
- Switch off the camera and leave it to stand at room temperature for approximately an hour if condensation has formed on or in the camera. The condensation will disappear, once the camera temperature has reached room temperature.
- Use the carry straps only for their intended purpose on a camera or on binoculars. Any other use poses the risk of injury and may possibly result in damage to the carry strap and is therefore not permitted.

- Carry straps are usually made of very robust material. You should therefore keep it out of the reach of children. A carry strap is not a toy and poses a strangulation risk.
- Carry straps should also not be used for cameras/binoculars during sports activities with a high risk of getting entangled in the carry strap (e.g. mountain climbing and similar outdoor activities).

Disclaimer

- All data, including personal information can be manipulated or deleted due to incorrect or accidental operation, static discharge, accidents, malfunctions, repairs and other measures.
- Please note that Leica Camera AG will not accept liability for direct or consequential damage due to the manipulation or destruction of data and personal information.

Important

- Only the accessories specified and described in this manual or by Leica Camera AG must be used with the camera.
- Use only the mains cable provided.
- The mains cable provided must only be used in conjunction with the supplied charger and must not be used with any other device.

General remarks about the screen

- Condensation can form on the screen if the camera is exposed to great temperature fluctuations. Wipe the screen carefully with a soft, dry cloth.
- The screen image will initially be slightly darker than normal if the camera is very cold when it is switched on. The normal level of brightness will be reached as soon as the screen warms up.
- Cosmic radiation (e.g. during flights) may cause pixel defects.

The screen is manufactured in a high-precision process to ensure that of the total of around 1,040,000 pixels, more than 99.995% work correctly and only 0.005% remain dark or are always bright. This is not a malfunction and does not impair the picture or video playback.

CONTENT

PART DESIGNATIONS	1	ADJUSTING THE VIEWFINDER EYEPIECE	28
FOREWORD	2	SCREEN/VIEWFINDER SETTINGS	28
SCOPE OF DELIVERY	2	Screen brightness	29
ACCESSORY	2	Top display	29
REPLACEMENT PARTS	2	Auto power off of all displays	29
LEGAL INFORMATION	3	Information displays	29
SAFETY NOTES	4	Selecting additional information and auxiliary displays	30
PREPARATIONS	8	Grid (Grid)	30
ATTACHING THE CARRY STRAP	8	Level display (Horizon)	30
CHARGING THE BATTERY	8	Histogram	31
CHANGING THE BATTERY/MEMORY CARD	11	Clipping	31
CHANGING THE LENS	16	BASIC PICTURE SETTINGS	32
COMPATIBLE LENSES	17	File format	32
CAMERA OPERATION	18	JPG Resolution	32
MAIN SWITCH	18	White balance	32
SHUTTER BUTTON	18	ISO sensitivity	33
SETTING WHEELS/SETTING WHEEL BUTTONS/ TOP DISPLAY	19	JPG image properties (Film Style)	34
LOCKING/UNLOCKING THE SETTING WHEEL FUNCTIONS	19	Using Leica M and R lenses	35
MENU CONTROL	20	Image stabilization	35
Managing the Favorites menu	23	Electronic shutter	36
Direct access to menu function	23	Single/serial exposures	36
GESTURE CONTROL	25	PICTURE MODE	38
BASIC CAMERA SETTINGS	26	DISTANCE SETTING(Focusing)	38
MENU LANGUAGE	26	AUTOFOCUS	38
DATE/TIME	26	LIMITING THE AUTOFOCUS SETTING RANGE	39
AUTOMATIC CAMERA SHUTDOWN	27	AF ASSIST LAMP	40
ACOUSTIC SIGNALS	27	AUTOFOCUS METERING METHODS/OPERATING MODES	40
		Spot (Spot)/Field metering (Field)	40
		Subject tracking (Tracking)	41
		Touch-controlled autofocus (Touch AF)	41
		Multi-field metering (Multi Point)	42
		Face detection	42
		Manual focusing	43
		ASSIST FUNCTION FOR MANUAL FOCUSING	43

EXPOSURE METERING AND CONTROL	45	Selecting/accessing menu items	68
EXPOSURE METERING METHODS	45	Exiting the playback menu	68
EXPOSURE CONTROL	46	Deleting pictures	69
Setting wheel functions in the modes P, S, A and M	47	Automatic review	70
Exposure simulation	47	Start playback	71
Automatic program - P	48	Video playback	71
Scene mode	49	End playback	73
Aperture priority mode - A	52	Adjusting the volume	73
Shutter speed priority - S	53	MISCELLANEOUS	76
Metering memory lock	53	USER PROFILES	76
Exposure compensation	54	CHANGING FILE NAMES	79
Automatic bracketing	54	WIRELESS DATA TRANSMISSION AND REMOTE CONTROL OF THE CAMERA USING A WLAN CONNECTION	80
Manual settings - M	55	TRANSFERRING DATA TO A COMPUTER	84
ADDITIONAL PICTURE FUNCTIONS	56	DATA STRUCTURE ON THE MEMORY CARD	84
Interval shooting	56	FORMATTING	84
Self-timer	58	WORKING WITH RAW DATA (DNG)	84
FLASH PHOTOGRAPHY	59	INSTALLING FIRMWARE UPDATES	85
COMPATIBLE FLASH UNITS	59	CARE & USE INSTRUCTIONS	86
ATTACHING THE FLASH UNIT	59	MENU OVERVIEW	88
FLASH MODES	60	APPENDIX	90
FLASH RANGE	61	DISPLAYS ON SCREEN/IN THE VIEWFINDER	90
SYNCHRONIZATION TIME POINT	61	Picture mode	90
FLASH EXPOSURE COMPENSATION	61	Playback mode	92
VIDEO RECORDING	62	Displays on the top display	93
PLAYBACK MODE	64	TECHNICAL DATA	94
SELECTING/SCROLLING THROUGH PICTURES	65	LEICA SERVICE ADDRESSES	96
ENLARGING PICTURES/SIMULTANEOUS DISPLAY OF MULTIPLE PICTURES	66		
Magnification	66		
Simultaneous display of 12/30 pictures	67		
SELECTING AN IMAGE SECTION	68		
MARKING/UNMARKING PICTURES	68		
PLAYBACK MENU	68		
Accessing the playback menu	68		

PREPARATIONS

ATTACHING THE CARRY STRAP

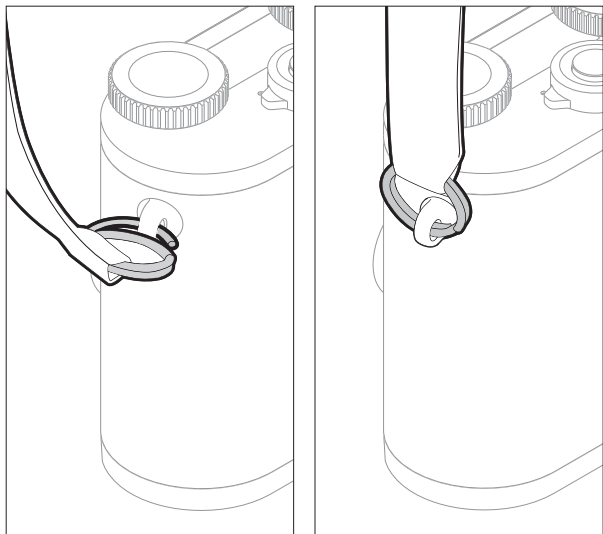

CHARGING THE BATTERY

Your Leica CL is powered by a lithium-ion battery. The battery must be removed from the camera before charging. The battery must be removed from the camera before charging.

Attention

- Only the battery types specified and described in this manual and/or specified and described by Leica Camera AG may be used in this camera.
- This battery must only be used in the devices for which it is designed and must only be charged exactly as described. The use of other chargers not approved by Leica Camera AG can cause damage to the batteries and, in extreme cases, serious or life-threatening injuries.
- Improper use of the batteries or the use of unapproved battery types may result in an explosion.
- Batteries must not be exposed to sunlight, heat, humidity or condensation for extended periods of time. Batteries must not be placed in a microwave oven or in a pressurized container as this may cause an explosion.
- Never throw batteries into a fire as they might explode!
- Damp or wet batteries must not be charged or used in the camera under any circumstances.
- Keep the battery contacts clean and easily accessible.

- Although lithium-ion batteries are secured against short circuits, they should still be protected against contact with metal objects like paper clips or jewelry. A short-circuited battery can get very hot and cause severe burns.
- Check the housing and the contacts immediately for any damage if a battery is accidentally dropped. A damaged battery can damage the camera.
- A battery must be removed from the camera or charger immediately and replaced if it develops noise, becomes discolored, deformed or overheated, or if it shows any sign of leakage. Continued use of a damaged battery may cause overheating and poses a fire and/or explosion hazard.
- Keep batteries away from heat sources if you detect any leakage or a smell of burning, because the fluid is highly flammable.
- The charger supplied should be used exclusively for charging this battery type. Do not attempt to use it for other purposes.
- Connect the charger to a freely accessible power socket.
- Heat is generated during charging. Never charge batteries in small, closed, i.e. unventilated containers.
- Do not open the battery or the charger. Repairs must only be carried out by authorized service centers.
- Keep batteries out of the reach of children. Swallowing batteries may lead to suffocation.

Dispose of used batteries in accordance with the relevant information provided in this manual.

First Aid

- Battery fluid may cause blindness if it comes into contact with the eyes. Rinse the eyes thoroughly with clean water immediately. Avoid rubbing. Seek medical attention immediately.
- Leaked battery fluid poses an injury hazard when it comes in contact with clothing or skin. Rinse the affected areas thoroughly with clean water.

Notes

- Batteries must be charged before use. The battery is supplied partially charged ex works, but it should be fully charged before extended use.
 - The battery must have a temperature between 0 °C and 35 °C (32 °F and 95 °F) for charging, as the charger may otherwise not switch on, or will automatically switch off.
 - Lithium-ion batteries can be charged at any time, regardless of their current charge level. A partially charged battery will charge to full capacity faster than a fully discharged one.
 - Lithium-ion batteries should only be stored partially charged, i.e. not fully depleted or fully charged. For very long storage periods, batteries should be charged for around 15 minutes twice a year to prevent deep discharge.
 - Batteries heat up during the charging process. That is normal and not a malfunction.
 - A new battery only reaches its full capacity after it has been fully charged and – by using it in the camera – depleted 2 to 3 times. This depletion process should be repeated roughly every 25 cycles.
 - Rechargeable lithium-ion batteries generate power by way of internal chemical reactions. These reactions are influenced by ambient temperature and humidity. The service life of the battery will be maximized if exposure to extreme temperatures over extended periods of time is avoided, e.g. in a parked car in summer or winter.
 - However, every battery has a limited service life! After several hundred charging cycles, this limitation will become evident as the operating times get significantly shorter.
- The replaceable battery supplies another back-up battery that is built into the camera. This back-up battery ensures that the date and time settings remain accurate for up to 2 days. Once the back-up battery is depleted, it must be replenished by inserting a charged main battery. The back-up battery will recover its full capacity after approx. 60 hours with the rechargeable battery in place. The camera will not have to be switched on for this process. The date and time settings will, however, have to be corrected.
 - Remove the battery if the camera will not be used for an extended period of time. Make sure to switch the camera off via the main switch before removing the battery. Leaving the battery in the camera will result in a deep discharge after a few weeks. The voltage will drop severely, as the camera still consumes a small amount of idle current to save your settings while the camera is switched off.
 - The date and time need to be reset after a battery that was left in the camera has been exhausted, this is usually after a maximum of 3 months.

PREPARING THE CHARGER

Use the mains cable with the matching regional plug to connect the charger to mains electricity.

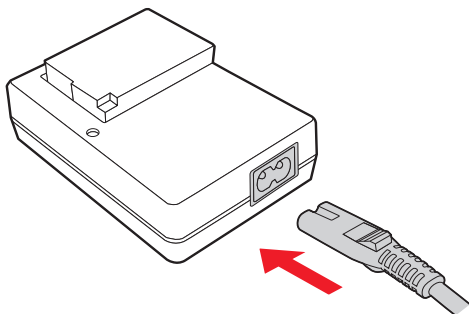

Note

The charger will automatically adapt to the regional mains voltage.

INSERTING THE BATTERY IN THE CHARGER

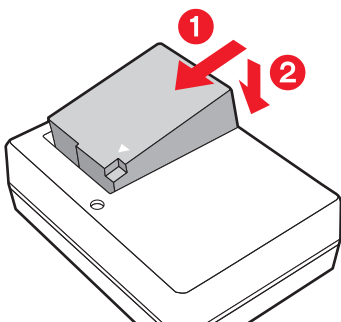

CHARGE STATUS DISPLAY

A green status LED will light up to indicate the charging process has commenced correctly. The battery will be fully charged when the green LED switches off.

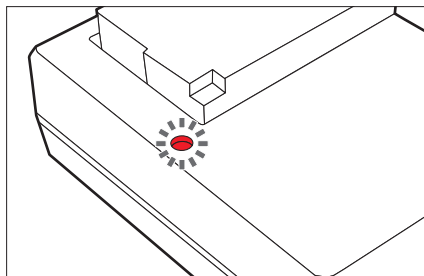

REPLACING THE BATTERY/MEMORY CARD

- ▶ Switch off the camera (see p. 18)

Remove the battery compartment/memory card slot cover

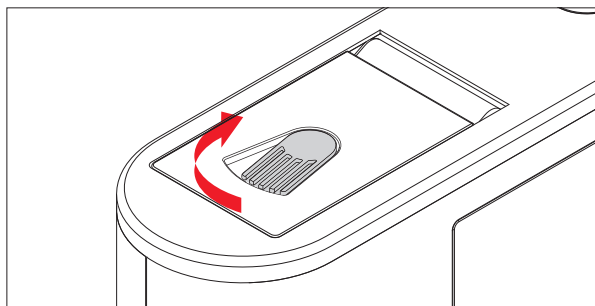

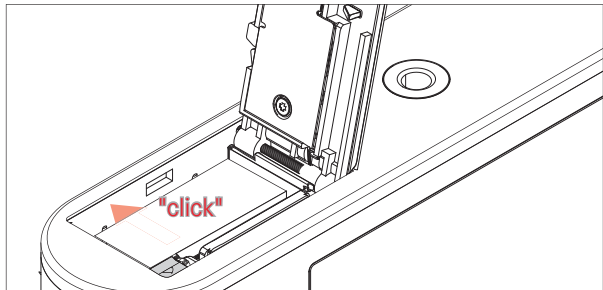
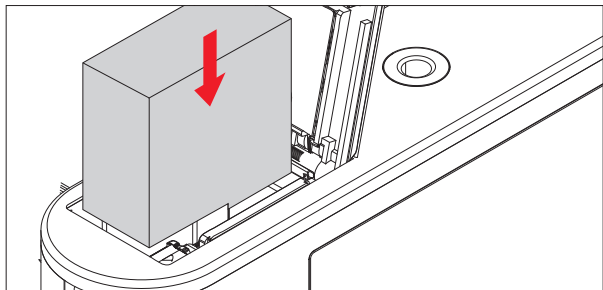
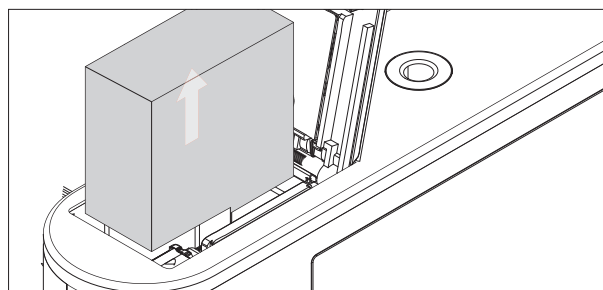
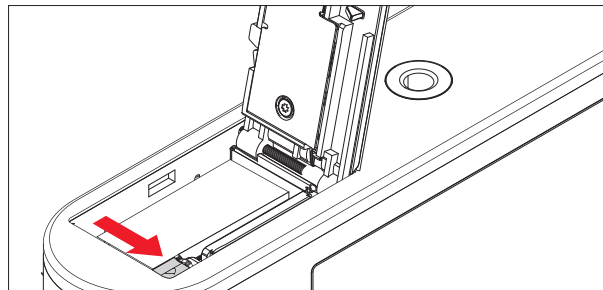
Inserting the battery**Removing the battery****Important**

Removing the battery while the camera is switched on may result in the loss of your camera settings and damage to the memory card.

Charge level display

The battery charge level is displayed on screen.
(see p. 90 "On screen and viewfinder displays")

Inserting the memory card

The Leica CL can accommodate SD, SDHC, or SDXC memory cards.

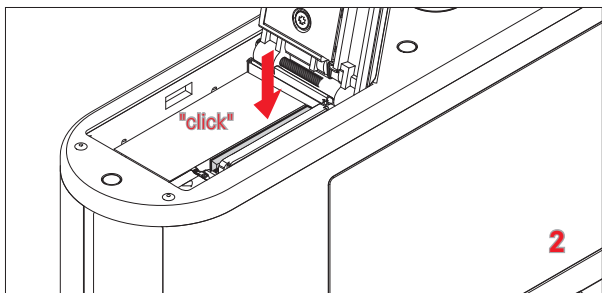
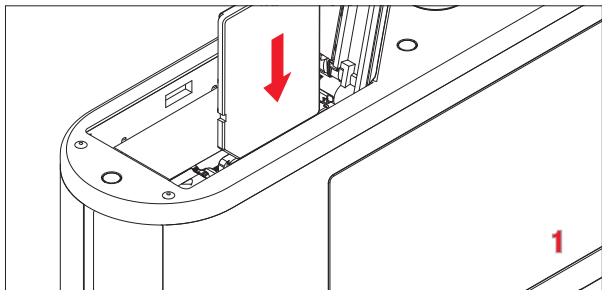

Removing the memory card

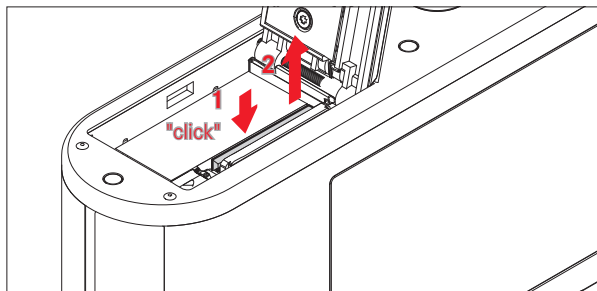

Notes

- Do not touch the memory card contacts.
- Make sure the memory card is aligned correctly if you have difficulties inserting it into the camera.
- The range of available SD/SDHC/SDXC cards on the market is too great for Leica Camera AG to test all types for compatibility and quality. Generally, any type of memory card may be used without any damage to the camera or memory card. As some "no name" cards may not fully comply with the SD/SDHC/SDXC standards, Leica Camera AG cannot provide any guarantee of function.
- Video recordings require a high write speed.
- Do not open the cover or remove the memory card or the battery while the status LED is lit, which indicates memory access. Data on the card may otherwise be destroyed and camera malfunctions may occur.
- We recommend backing up your data on a PC, because electromagnetic fields, static electricity and any memory card or camera defects could result in permanent damage or loss of your data.

- We furthermore recommend storing your memory card in an anti-static container to protect your card and saved data.
- Proper camera function cannot be guaranteed when using WLAN memory cards.
- SD, SDHC, and SDXC memory cards come with a write protection slider to prevent accidental overwriting. This slider is located on the non-beveled side of the card. All data on the card is protected when the slider is set to its lower position, marked LOCK.

Attention

- Keep memory cards out of the reach of children.
- Swallowing a memory card may cause suffocation.

Closing the battery compartment/memory card slot cover

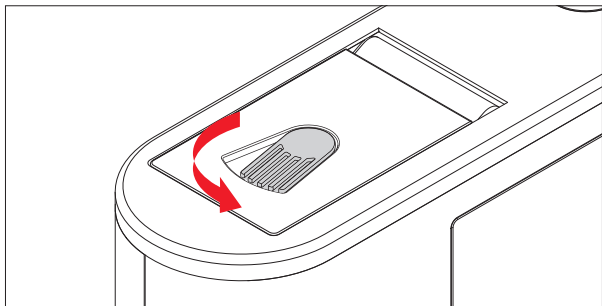

CHANGING THE LENS

Attaching the lens

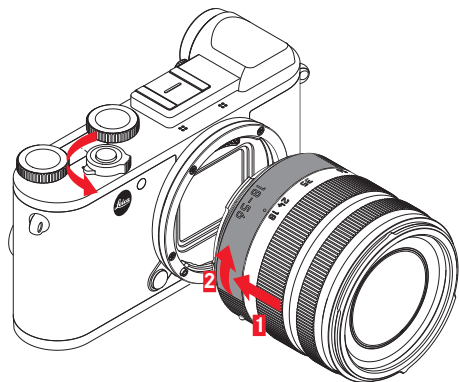

- ▶ Switch off the camera
- ▶ Hold the lens on the fixed ring
- ▶ Position the red alignment button on the lens in line with the release button on the camera housing.
- ▶ Insert the lens in this position
- ▶ Turn the lens clockwise until you hear and feel it click into place

Detaching the lens

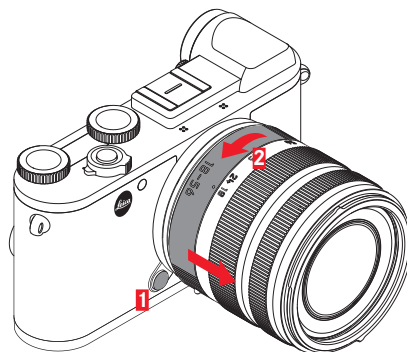

- ▶ Switch off the camera
- ▶ Hold the lens on the fixed ring
- ▶ Press the release button on the camera housing
- ▶ Turn the lens counter-clockwise until the red alignment button is aligned with the release button
- ▶ Remove the lens

Notes

- Make sure to always have a lens or the camera bayonet cover attached to prevent dust or other foreign bodies penetrating the camera.
- That is why you should replace the lens quickly and in a dust-free environment.
- Never store the camera bayonet cover or the rear lens cover in a pants pocket, as they will attract lint and dust, which could then be accidentally be introduced into the camera.

COMPATIBLE LENSES

All Leica TL lenses share the same basic structure: they have an external bayonet fitting for the lens hood, an internal thread for filters, a focus ring, a fixed ring with a red alignment button for lens replacement and a contact strip for the transfer of data and control signals. Leica CL zoom lenses have an additional focal length setting ring with its own index.

In addition to Leica TL lenses, the Leica CL can also accommodate Leica SL lenses with full functionality via the L bayonet. Leica M and R lenses can also be used in conjunction with Leica M/R L adapters.

Depth of field

Leica SL and TL lenses don't come with an aperture ring, which means they don't offer a depth of field scale. Please look up the relevant values on the Leica Camera AG website, where tables with that information are provided.

Exposure metering and exposure control using a Vario lens

Some Leica TL and SL zoom lenses have a variable speed, i.e. the effective aperture opening depends on the configured focal length. Make sure to set the desired focal length before storing the meter value or changing the shutter speed / aperture combination to prevent incorrect exposure. Please read the sections "Exposure metering and exposure control" starting on page 45 for more information on the subject. Make sure that the aperture setting on the flash unit matches the camera aperture if you are using a non-system compatible flash unit.

Lens hood

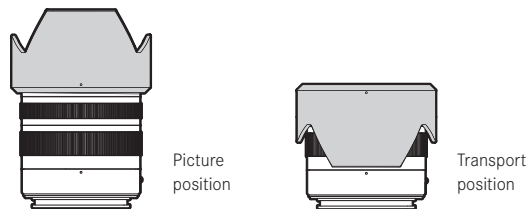

Leica CL lenses are supplied with optimized lens hoods. The symmetrical bayonet fitting can be attached quickly and easily in operational position, as well as in reverse position for space-saving storage.

Lens hoods reduce light scatter and reflection, and protect the front lens against damage and soiling.

Filter

Leica CL lenses can accommodate screw-on filters. Please read the technical information provided in the manual of the relevant lens for the correct filter diameter.

CAMERA OPERATION

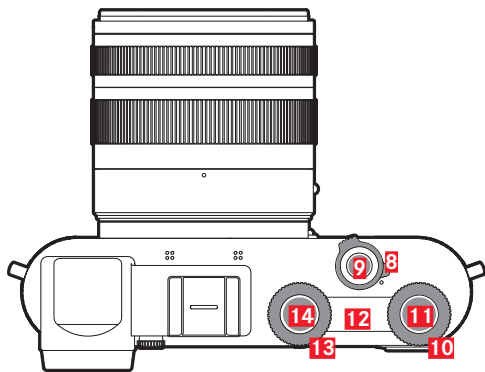

MAIN SWITCH

The main switch **8** switches the Leica CL on and off:

- Red dot visible = Off
- Red dot not visible = On

The screen image appears when the camera is switched on.

Notes

- A welcome video will play on screen when you switch on your camera for the first time or after factory settings have been restored. Next, the **Language** submenu will appear for you to choose your preferred language, followed by the **Date & Time** submenu for additional settings. Once you have completed these basic settings, the picture mode screen will be displayed.
- For the purposes of this manual, all references for the screen image also apply to the viewfinder image, as the relevantly active displays are identical on both.

SHUTTER BUTTON

The shutter button **9** works in two stages. Pressing down half-way will activate Auto focus, exposure metering and exposure control. The relevant settings/values are stored. Pressing the shutter button will activate the camera if it was in standby mode, and the screen image reappears. Pressing the shutter button all the way down takes a picture.

SETTING WHEELS/SETTING WHEEL BUTTONS/ TOP DISPLAY

The two setting wheels **10** and **13** are used

- mainly for exposure control in picture mode (see p. 45)
- and for the setting of various functions in playback mode (see p. 29)
- in menu mode, the right setting wheel is used for menu navigation (see p. 20)

In picture mode, the relevant function of the setting wheel is indicated on screen below the wheel, once the setting wheel is turned to the next position.

A button (**11**, **14**) is located on each setting wheel that allows the assignment of alternative functions to the setting wheels in picture mode.

In menu control mode, the right setting wheel button is used to select and confirm settings.

A top display **12** is located between the two setting wheels. It visualizes a number of items.



Note

Please read the relevant sections of this manual for more information about how to operate the setting wheels and buttons, and about what information is shown in the top display.

LOCKING/UNLOCKING THE SETTING WHEEL FUNCTIONS

Both setting wheels can be locked/unlocked.

Using gesture control

- ▶ Tap the relevant function display until / appears at the center bottom of the screen (after approx. 2 seconds)

Using menu control

- ▶ Select **Wheel Lock in Live View** in the **Main Menu** (4th screen page)
- ▶ Select **Right Wheel** or **Left Wheel** in the submenu
- ▶ Activate or deactivate the wheel function in the relevant submenu

A locked setting wheel is indicated by  on screen.

MENU CONTROL

A variety of camera functions are controlled via menu control. Navigate using the **MENU** button **16**, the center button **23** or the right setting wheel button **11**; alternatively, use the directional pad **22** or the right setting wheel **10**. The **FN** **17** and **PLAY** buttons **18** are also used in some cases. The relevant settings and setting steps are clearly displayed on screen when the camera is switched on.

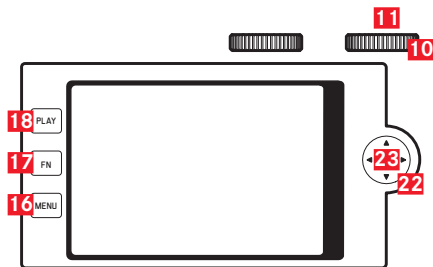

The two menu areas: **Main Menu** and **Favorites**

The **Main Menu** always includes all 37 menu items. Up to 15 of these menu items can be assigned to the customizable **Favorites** menu. That means you can access your most frequently used menu items much quicker and easier. The factory settings of the **Favorites** menu contain 7 menu items. Details about this menu option can be found on the following pages.

The following applies for both menu areas: A screen page can contain max. 8 menu items, which means that the **Favorites** menu will have 1 or 2 screen pages and the **Main Menu** will have 5 screen pages.

Accessing menu control

- ▶ Press the **MENU** button 1x
- The **Favorites** menu will appear first if at least one function was assigned to it. It will be your “home screen” and will allow access to the menu control. The **Main Menu** will appear instead if the **Favorites** menu has no functions assigned.

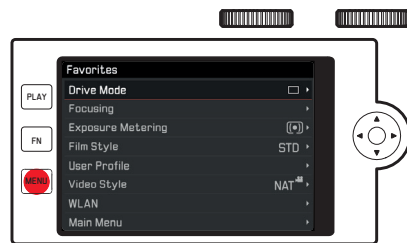

Accessing the **Main Menu** with the **Favorites** menu set up:

- a. Directly
 - ▶ Press the **MENU** button 2x
- b. **Favorites** menu is already open
 - ▶ Press the **MENU** button again 1x (this function is available from within any open menu item) or
 - ▶ Select the **Main Menu** (listed as the last menu item in the **Favorites** menu, which means it may be on the 2nd screen page) with the right setting wheel or by pressing the directional pad up/down

All three options will open the first screen page of the **Main Menu**.

Menu control elements

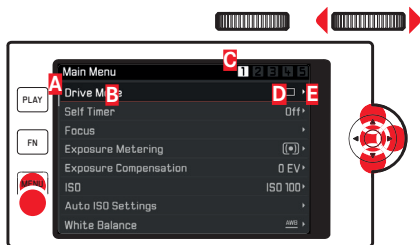

- A** Scrollbar: current position in the menu list
- B** Menu item designation
- C** Number of the accessed screen page
- D** Setting/value of the menu item: The active menu item (white lettering, dark background, underlined in red). This applies to all menu levels
- E** Triangle: additional submenu

Scrolling in the menu list

Line by line:

- ▶ Press the directional pad up/down, or turn the right setting wheel

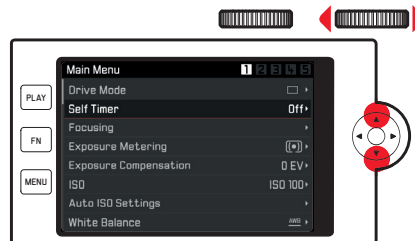

Page by page:

- ▶ Press the **MENU** button (repeatedly) until the desired page appears

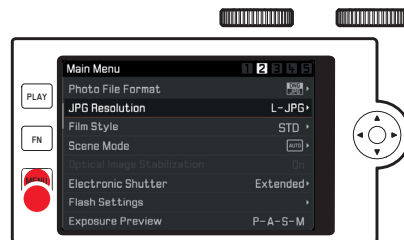



Selecting a setting/value in the submenu

- ▶ Press the directional pad, the center button, the setting wheel on the right or the setting wheel button on the right to select a menu item

In the submenu

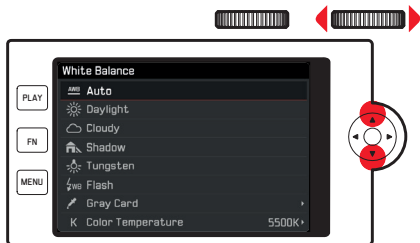
- In a list of settings,
 - ▶ Press the directional pad up/down, or turn the right setting wheel
 The newly selected submenu item is activated.



- In a setting scale
 - ▶ Set the desired value on the scale by
 - turning the right setting wheel
 - pressing the directional pad left or right
 - tapping  the desired value on the row
 - dragging  to the desired value in the row

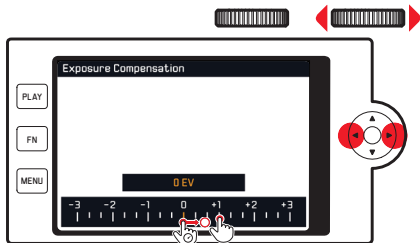

Exiting a submenu with setting confirmation

- ▶ Press the center button or right setting wheel button

The menu list reappears; the confirmed (new) setting is displayed on the right in the active menu item row.

Exiting a submenu without confirming a setting

- ▶ Press the directional pad to the left or press the **MENU** button

The menu list reappears; the unchanged (previous) setting is displayed on the right in the active menu item row.

The directional pad is not available for this function in scale-type submenus.

Or

- ▶ Press the shutter button
- The picture mode screen image appears.

Or

- ▶ Press the **PLAY** button
- The playback screen image appears.

Favorites menu management

For the max. 15 menu items that you can assign to the **Favorites** menu, almost all of the menu options of the **Main Menu** are available (see p. 88 for a complete list).

- ▶ Select **Customize Control** in the **Main Menu** (4th screen page)
- ▶ Select **Edit Favorites** in the submenu
- ▶ Select the desired menu item
- ▶ Pressing the directional pad to the right, pressing the center button or the setting wheel button of the right setting wheel will add the selected menu item to the **Favorites** menu (**On**), or removes the selected menu item (**Off**)

A warning message will appear if the **Favorites** menu already contains 15 items and you are trying to add another.

Note

The **Favorites** menu is activated completely if you deactivate all of its menu items.

Should that be the case, then the **Main Menu** will appear immediately, i. e. when the **MENU** button is pressed for the first time.

Direct access to menu function

You can assign one menu item each to the right setting wheel button **11** and to the **FN** button **17** for extra quick operation via direct access in picture mode.

The factory settings assign **SD** to the setting wheel button on the right, and **Self Timer** to the **FN** button.

Accessing the assigned function

- ▶ Press the relevant button briefly (≤ 0.7 seconds)

Setting the function/menu item accessed via the relevant buttons

Most of the menu items/functions accessed directly can be set using gesture control or the button/setting wheel controls. To make things easy, the setting variants for each of these items are displayed running across the bottom of the screen image like on a conveyor belt.

Other menu items, for which several parameters must be configured, resemble the “standard” menu control in terms of display and operation.

Baseline for additional settings:

The relevant “conveyor belt” submenu is already open (in this example: **White Balance**).

The currently active setting displayed in the center is highlighted in yellow.

Using gesture control

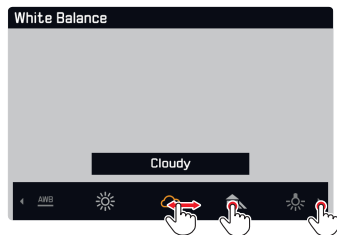

Note

Functions/values initially outside the screen image can be accessed by repeatedly tapping accessible functions/values. Swipe the navigation bar at the outer edge of the screen for bigger navigation steps.

Using button/setting wheel controls

- ▶ Turn the setting wheel on the right or press the directional pad right/left

The selected function requires no confirmation and will be active immediately.

Notes

- “Conveyor belts” are not on endless loops.
- In playback mode, the **FN** button has the “single image delete” function assigned.

Button assignment

You can assign up to 8 menu items/functions to each button via menu control. A variety of menu items is provided in the **Main Menu** for that purpose (see p. 88 for a complete list).

- ▶ Select **Customize Control** in the **Main Menu** (4th screen page)
- ▶ Select **Edit Right Wheel Push in Live View** from the submenu or select **Edit Rear FN Button in Live View**
- ▶ Select from the list by turning the right setting wheel
- ▶ Activate (**On**) or deactivate (**Off**) a function by pressing the directional pad to the right or by pushing the center button or the button on the setting wheel on the right

Note

The available functions are identical for both buttons.

Changing a button function

- ▶ Press and hold the button (≥ 0.7 seconds)
A list of available functions is displayed.
- ▶ Use the setting wheel on the right to select the desired function
- ▶ Confirm the setting by pressing the center or right setting wheel button

Notes

- Selecting a function will automatically deselect the previously selected function.
- Switching the camera off will not affect the settings; A complete camera reset to its factory settings (**Reset**) will negate the settings you have chosen.

GESTURE CONTROL

As mentioned on the previous pages, some Leica CL settings can be controlled using the following gestures on the touch-sensitive screen.

Note

A light touch is enough, do not press down.



Tap briefly

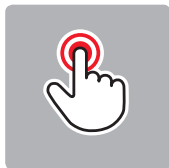

Double tap



*Long touch,
drag and drop*



Swipe



Swipe



Two-finger pinch



Two-finger spread

General remarks on menu control

- Settings for menu items that differ from the above explanations or include additional steps are described in the sections dealing with the relevant options.
- Some menu items may not be available, e.g. because the relevant functions are permanent features of the **Scene Mode**, or because the relevant setting can only be configured on an attached and relevantly equipped flash unit. These menu items are then indicated by gray text (instead of white) and cannot be selected.

BASIC CAMERA SETTINGS

MENU LANGUAGE

- ▶ Select **Language** in the **Main Menu** (5th screen page)
- ▶ Select the desired language

Apart from a few exceptions (button names, short designations), the language will be changed for all information provided.

DATE/TIME

- ▶ Select **Date & Time** in the **Main Menu** (5th screen page)

Setting the date/Selecting the date format

- ▶ Select **Date Setting** in the **Date & Time** submenu

Toggle between the setting options:

- ▶ Press the directional pad to the right/left or turn the setting wheel on the right

Configuring the items:

- ▶ Press the directional pad up/down

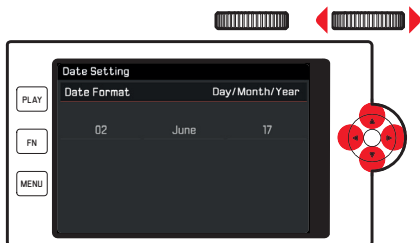

Selecting the time zone

- ▶ Select **Time Zone** in the **Date & Time** submenu
- ▶ Select the desired time zone

Activating/deactivating daylight saving time

- ▶ Select **Daylight Saving Time** in the **Date & Time** submenu
- ▶ Function activation/deactivation

Setting the Time/Selecting the time format

- ▶ Select **Time Setting** in the **Date & Time** submenu

Toggling between the setting options:

- ▶ Press the directional pad to the right/left or turn the setting wheel on the right

Configuring the items:

- ▶ Press the directional pad up/down

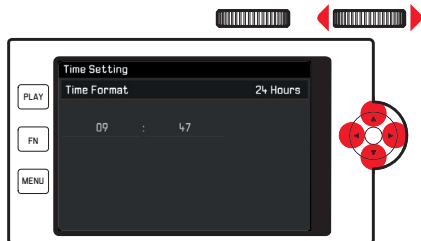

Note

The built in back-up battery will keep the date and time settings intact for a few days even if no battery is in the camera or if the battery is depleted. After that, however, the settings will have to be redone.

AUTOMATIC CAMERA SHUTDOWN

With this function enabled, the camera will switch to standby mode to extend battery life after a preset time.

- ▶ Select **Power Saving** in the **Main Menu** (4th screen page)
- ▶ Select **Auto Power Off** in the submenu
- ▶ Select the desired setting
(**2 min**/**5 min**/**10 min**/**Off**)

Note

The camera can be reactivated from standby mode at any time by pressing the shutter button or by switching the main switch off and on again.

ACOUSTIC SIGNALS

You can choose to have acoustic signals for camera operations or to signal a full memory card – or no acoustic signals to take photographs without additional sounds.

- ▶ Select **Acoustic Signal** in the **Main Menu** (4th screen page)
- ▶ Activate or deactivate the functions for **Electronic Shutter Sound**, **AF Confirmation** and **Acoustic Signals** in the relevant submenus and set the volume in the **Volume** submenu

ADJUSTING THE VIEWFINDER EYEPIECE

The viewfinder can be adjusted from +4 to -4 diopters to match your vision.

- ▶ Pull the setting wheel on the right of the eyepiece backward to unlock
- ▶ While looking through the viewfinder, turn the dial until you can see the image and displayed information clearly.
- ▶ Push the setting wheel back into the locked position

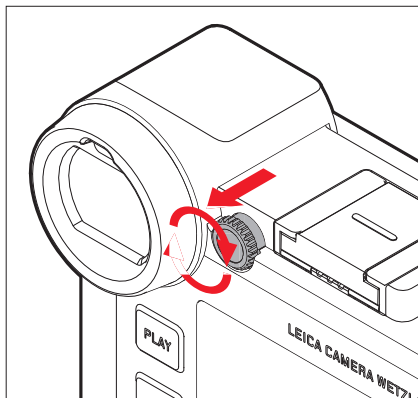

SCREEN/VIEWFINDER SETTINGS

Toggling between screen and viewfinder

The displays appearing on screen and in the viewfinder are identical. You can, however, specify when and where the displays appear. The changeover from screen to viewfinder is automatic in the factory settings (with the proximity sensor in the eyepiece activated). You can also specify to have the displays appear only on screen or only in the viewfinder:

- ▶ Select **Display Settings** in the **Main Menu** (3rd screen page)
- ▶ Select **EVF-LCD** in the submenu
- ▶ Select the desired function
 - **LCD**: Photographs, playback and menu control always on screen
 - **EVF**: Photographs, playback and menu control always in the viewfinder
 - **Auto**: Screen or viewfinder selection activated via proximity sensor
 - **EVF Extended**: Photographs always with viewfinder, playback or menu control always on screen

You can adjust sensor sensitivity to ensure that the changeover functions reliably even if you need to wear glasses:

- ▶ Select **Display Settings** in the **Main Menu** (3rd screen page)
- ▶ Select **Eye Sensor Sensitivity** in the submenu
- ▶ Select the desired setting:
 - Users without glasses can retain the setting **Low**, others should select **Medium high**.

Screen brightness

You can adjust screen brightness for best visibility and various lighting conditions:

- ▶ Select **Display Settings** in the **Main Menu** (3rd screen page)
- ▶ Select **LCD Brightness** in the submenu
- ▶ Select the desired function

With **Auto** activated, brightness is adjusted automatically.

Top display

The top display between the setting wheels can be switched on or off:

- ▶ Select **Display Settings** in the **Main Menu** (3rd screen page)
- ▶ Select **Top Display** in the submenu
- ▶ Select the desired function
 - **On**: always on
 - **Off**: always off
 - **Auto**: automatic control, depending on ambient brightness

Auto power off of all displays

This function allows you to set a time after which the top display, screen and viewfinder are powered down to extend battery life.

- ▶ Select **Power Saving** in the **Main Menu** (4th screen page)
- ▶ Select **All Displays Auto Off** in the submenu
- ▶ Select the desired setting

Information displays

Pressing the center button allows you to adjust the screen displays incrementally in accordance with the level of information you want to see:

In picture mode

Factory setting = none of the two lines

Press 1x = header and footer lines

Press 2x = baseline

In playback mode

Factory setting = header and footer lines

Press 1x = none of the two lines

Press 2x = baseline

The options are arranged in an endless loop, meaning they can be accessed by pressing once or repeatedly.

A detailed listing of the displays can be found on the following pages.

Notes

- The last display used will be shown when the camera is switched to picture mode.
- In video mode, both lines are shown at all times.

Selecting additional information and auxiliary displays

In addition to the information provided in the header and footer lines, you can choose to have additional information and auxiliary displays shown.

For picture mode

- ▶ Select **Capture Assistants** in the **Main Menu** (3rd screen page)
- ▶ Select **Grid**, **Horizon**, **Histogram** or **Clipping** in the submenu
- ▶ Activate or deactivate the functions

For playback mode

The settings for **Clipping** and **Histogram** under the **Main Menu** item **Play Mode Setup** (4th screen page) are done the same way.

Notes

- The grid display will always appear when activated, i.e. no matter whether the information in the header and footer are displayed (see p. 29). With header and footer deactivated, the level display, histogram and clipping displays will not appear.
- Only the histogram display is available for video recordings.

Grid (Grid)

The grid divides the image frame into nine equal sections. It helps with e.g. picture composition and camera orientation.

Level Gauge (Horizon)

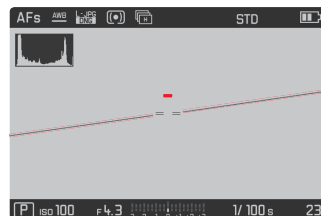

The integrated sensors of the Leica CL allow it to show its alignment. These displays ensure exact camera orientation along the longitudinal and transverse axes of critical subjects, e.g. architecture.

Two long lines to the left and right of the image center indicate the longitudinal axis - green when level, red when tilted. The transverse axis is indicated in level position by two green double-lines immediately left and right of the image center. When the camera is tilted, these lines are white and a short red line appears above or below them.

Note

Display accuracy is $\leq 1^\circ$.

Histogram

The histogram visualizes the brightness distribution in the picture. The horizontal axis represents tone values from black (left) via gray to white (right). The vertical axis corresponds to the number of pixels at each brightness level.

This form of representation – in conjunction with the impression of the picture itself – provides an additional quick and easy assessment of the exposure setting.

The histogram can also be moved to the bottom right corner of the screen image.

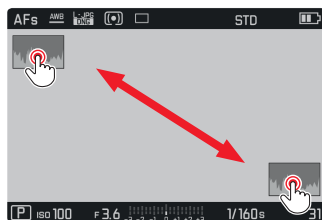

Notes

- In picture mode, the histogram should be seen as a “trend display” and not as an exact representation of the pixel numbers.
- For a picture with flash, the initial histogram cannot represent the final exposure as the flash is fired after the values are displayed.
- The histogram at the time of playback of an image may vary slightly from the values displayed before the picture is taken.
- The histogram function is not available for the simultaneous playback of multiple thumbnails or enlarged pictures.

Clipping

The clipping display marks bright areas in the image lacking definition. These areas will flash in black. The clipping function is therefore a very simple and exact means for checking and adjusting the exposure settings as needed.

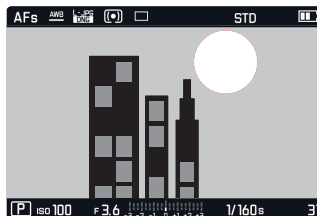

Notes

- The clipping display is not available in video mode.
- The clipping display is available for the playback of the entire picture and for individual cropped sections, but not for the simultaneous playback of 12 or 30 thumbnails.
- The clipping display always refers to the currently shown cropped section of the image.

BASIC PICTURE SETTINGS

File format

You can choose between the JPG format **JPG** and the standardized raw data format **DNG** (= digital negative). They can be used individually or simultaneously.

- ▶ Select **Photo File Format** in the **Main Menu** (2nd screen page)
- ▶ Select the desired setting

JPG Resolution

With the **JPG** format selected, you can take pictures with 3 different resolutions (numbers of pixels). Available are: **L-JPG** (24 MP), **M-JPG** (12 MP) and **S-JPG** (6 MP) (MP = Mega pixel). This allows you to adjust the setting precisely to the intended use or to the memory card capacity available.

- ▶ Select **JPG Resolution** in the **Main Menu** (2nd screen page).
- ▶ Select the desired setting

Note

The **DNG** format always functions at maximum resolution regardless of the **JPG** settings.

White balance

In digital photography, white balance ensures neutral, i.e. natural color reproduction in any light. White balance is based on the camera being preset to reproduce a particular color as white.

You can choose between automatic white balance, various presets, one custom setting based on specific measurements, and a direct setting of the color temperature.

1. **Automatic** (automatic setting)
2. **Daylight** (for outdoor pictures in sunshine)
3. **Cloudy** (for outdoor pictures in cloudy conditions)
4. **Shadow** (for outdoor pictures with the main subject in shadow)
5. **Tungsten** (for indoor illumination with incandescent light bulbs)
6. **Flash** (for illumination with electronic flash)
7. **Gray Card 1** (memory slot for your custom measurements)
8. **Color Temperature** (memory slot for fixed setting)

Fixed presets

- ▶ Select **White Balance** in the **Main Menu** (1st screen page)
- ▶ Select the desired setting

Manual setting based on measurements taken

- ▶ Select **White Balance** in the **Main Menu** (1st screen page)
- ▶ Select **Gray Card 1** in the submenu
- ▶ Select **▶** next to **Gray Card 1** in the submenu

A yellow frame appears in the center of the monitor with an instruction below it.

- ▶ Aim the frame at a uniformly white or gray object that completely fills the frame
- ▶ Press the center button to confirm

The camera shutter is triggered, measurements are taken and stored.

These settings can later be accessed again via **Gray Card 1**.

Direct color temperature setting

- ▶ Select **White Balance** in the **Main Menu** (1st screen page)
- ▶ Select **Color Temperature** in the submenu
- ▶ Select **▶** next to **Color Temperature** in the submenu
- ▶ Select the desired value

ISO sensitivity

The ISO setting specifies the available combinations of shutter speed and aperture at a specific brightness. Higher sensitivities allow faster shutter speeds and/or smaller apertures (for "freezing" rapid movements or to increase the depth of field), although this may also mean more image noise.

- ▶ Select **ISO** in the **Main Menu** (1st screen page)
- ▶ Select the desired setting
(i.e. **Auto ISO** for an automatic setting or one of the eleven fixed settings)

You can limit the sensitivity range to be used (e.g. to control image noise) via the **Auto ISO** option. You can also specify the slowest shutter speed to be used (e.g. to prevent blurred pictures of moving subjects).

- ▶ Select **Auto ISO Settings** in the **Main Menu** (1st screen page)
- ▶ Select **Maximum Exposure Time** and/or **Maximum ISO** in the submenu
- ▶ Select the desired settings

JPG image properties (Film Style)

One of the many advantages of digital photography is that it is very easy to change critical properties of a picture.

Your Leica CL allows you to adjust color rendering, contrast, sharpness and color saturation before taking the picture.

Note

The functions and settings described in this section apply for pictures taken in **JPG** format only. These settings have no effect if the **RAW** file format is selected, because image data will in this case always be saved in its original form.

Color rendering

Choose between **Standard**, **Vivid** – for highly saturated colors – and **Natural** – for slightly less saturated colors and a somewhat softer contrast. Two monochrome settings – **B&W Natural** (natural) and **B&W High Contrast** – are additionally available.

- ▶ Select **Film Style** in the **Main Menu** (2nd screen page)
- ▶ Select the desired setting

Contrast, sharpness, saturation

The following three image properties can also be changed for each color rendering setting:

- Contrast (i.e. the difference between light and dark image sections) determines whether an image comes across “flat” or “brilliant”. Contrast can be therefore influenced by increasing or reducing this difference, i.e. with a brighter rendering of image sections with more light, and a darker rendering of image sections with less light.
 - Image sharpness – at least of the main subject – using the correct distance setting is prerequisite for a great picture. The impression of sharpness in a picture is largely determined by edge sharpness, i.e. by how small the transition between light/dark is at edges in the picture. Expanding or reducing these areas will therefore change the impression of sharpness.
 - The saturation factor in color images determines, whether colors in the picture appear “pale” and pastel-like or “bright” and colorful.
- ▶ Select **Film Style** in the **Main Menu** (2nd screen page)
 - ▶ Select **Film Style Settings** in the submenu

For each of the color rendering variants available in the previous step, you can change three additional image parameters available in further submenus:

- **Contrast**
- **Sharpness**
- **Saturation** (not available for the two B/W settings)

The following gradations are available for all of these: **Low**, **Medium low**, **Standard**, **Medium High** and **High**.

- ▶ Select the desired settings in the relevant submenus
- ▶ Press the center button to confirm

Using Leica M and R lenses

The Leica M and R Adapters L accommodate the use of Leica M and R lenses. There are lens profiles stored in the camera, which allow the following functions:

- The flash exposure and flash reflector controls utilize the stored lens data (see “Compatible flash units”).
- The lens data is furthermore written to the EXIF data of the images. A display of the lens focal length is added to the visualization of the extended image data.

The camera will automatically select the appropriate lens type settings if the Leica M lens has a 6 bit encoding, or the Leica R lens has a ROM contact strip. You will have to enter the lens model manually if the lenses are not relevantly equipped.

- ▶ Select **Lens Profiles** in the **Main Menu** (3rd screen page)
- ▶ Select automatic lens identification (**Auto**) in the submenu, or enter the lens model manually into one of the two lens lists, or deactivate the function altogether.

If you want to enter the lens model yourself:

- ▶ **M-Lenses** or **R-Lenses**

You can shorten the lens lists by deleting all unnecessary lens types to simplify operation:

- ▶ Select **Edit List of M-Lenses** or **Edit List of R-Lenses** in the **M-Lenses** or **R-Lenses** submenu.
- ▶ Activate (**On**) or deactivate (**Off**) the lens types you will be using/not using in the lens lists

Note

This menu item is not available for Leica TL and SL lenses and the relevant item line is marked unavailable in gray lettering.

Image stabilization

When using Leica SL lenses equipped with OIS, your Leica CL can utilize their built-in stabilization function. That means you can achieve sharp pictures at shutter speeds that would otherwise be too slow.

- ▶ Select **Optical Image Stab.** in the **Main Menu** (2nd screen page)
- ▶ Function activation/deactivation

Note

Please read the relevant lens manual for more information about OIS.

Electronic shutter

Your Leica CL comes equipped with a mechanical shutter and a purely electronic shutter function. The completely silent electronic shutter function is a great choice for taking photographs inconspicuously. This function also extends the available shutter speed range. You can choose between three function variants:

- **Off**

Only the mechanical shutter is used. Shutter speed range: 30 s to $\frac{1}{8000}$ s

- **Extended**

You can add in the electronic shutter functions if you need faster shutter speeds than can be achieved with the mechanical shutter. Shutter speed range: 30 s - $\frac{1}{8000}$ s + < $\frac{1}{8000}$ s - $\frac{1}{25000}$ s

- **Always On**

Only the electronic shutter function is used. Shutter speed range: 30 s - $\frac{1}{25000}$ s

- ▶ Select **Electronic Shutter** in the **Main Menu** (2nd screen page)
- ▶ Select the desired setting

Single/serial exposures

The Leica CL allows single and serial exposures. Three speeds are available.

- ▶ Select **Drive Mode** in the **Main Menu** (1st screen page)
- ▶ Select **Continuous Low Speed**, **Continuous Medium Speed**, **Continuous High Speed** for serial exposure, or **Single** for single exposures in the submenu

Notes

- Serial exposures with **Continuous High Speed** are taken at a frequency of up to 10 exposures¹, provided that shutter speeds of $\frac{1}{60}$ s and faster are used.
- Serial exposures are not possible if a flash is used. Only a single picture will be taken if the flash function is activated.
- Serial exposures are not available in combination with the self-timer function. Only a single picture will be taken if the self-timer function is activated.
- The exposure frequency will slow down after max. 33 exposures (**DNG + JPG**). This slow-down is due to the time required to transfer the data from the buffer memory to the card.
- The last picture in the series will be displayed first in playback mode, regardless of how many pictures are taken in the series.

¹ mechanical/electronic shutter

PICTURE MODE

DISTANCE SETTING (focusing)

Your Leica CL allows automatic as well as manual focusing. There are two autofocus modes available: **AFs** (single autofocus) or **AFc** (continuous autofocus).

AUTOFOCUS

- ▶ Select **Focusing** in the **Main Menu** (1st screen page)
- ▶ Select **Focus Mode** in the submenu
- ▶ Select the desired setting

The selected function is displayed on screen.

Use the **AFs** mode if you want to take photos of stationary subjects or subjects with very little movement. Focus on a specific area, while applying light pressure to the shutter button (first pressure point) to create a sharp image. The sharpest focus may no longer be in the desired image area if the subject moves between pressing the shutter button to the first pressure point and the time of exposure.

Use the **AFc** mode if you want to photograph moving subjects. Once again, focus on a specific area, while applying light pressure to the shutter button to the first pressure point. While keeping the shutter button pressed to the first pressure point, the camera will keep the selected focus area sharp until the exposure.

A successful AF setting is displayed as follows:

- The color of the rectangle changes to green
- Up to 49 green rectangles appear with multiple field metering
- An acoustic signal is generated (if activated).

Notes

- You can also use the focus setting ring on the lens to manually change the automatically set focus while the shutter button is pressed to the first pressure point.
- The sharpness setting is saved along with the exposure setting.
- In some situations, the AF system may be unable to set the distance correctly, e.g. when:
 - the distance to the subject you are aiming at is outside the setting range of the attached lens, and/or
 - the subject is not sufficiently illuminated (see next section).These situations and subjects are indicated by:
 - The color of the rectangle changes to red
 - In multiple field metering, the display changes to a single red rectangle
- Only manual focusing is available when using Leica M or R lenses with the optional Leica M or R Adapter L.

Important

The shutter button is not locked, regardless of whether the focusing is correct for the relevant subject.

LIMITING THE AUTOFOCUS SETTING RANGE

The autofocus system takes longer to run through the complete setting range, i.e. from their closest focusing distance to infinity when focusing macro lenses (with typically very short closest focusing distance) or with

lenses with a longer focal length.

Some Leica TL lenses¹ allow a limiting of their setting ranges to speed up focusing. This is advisable if you know that you will only need the close range or only the long range for specific exposures.

Activating the function

- ▶ Select **Focusing** in the **Main Menu** (1st screen page)
- ▶ Select **Focus Limit** in the submenu
- ▶ Function activation/deactivation

Using the function

Whether the **Focus Limit** function should limit automatic focusing to close range or long range depends first of all on the current lens setting. You will still be able to switch between ranges at any time by turning the focus ring. The following table illustrates the correlations.

Lens setting	Focus Limit is activated	Changing the focus range (turning the lens focus ring)
working with shorter ranges	Autofocus applies only for set short range	Focusing "jumps" to long range (Autofocus is limited to long range)
working with longer ranges	Autofocus applies only for set long range	Focusing "jumps" to short range (Autofocus is limited to short range)

Notes

- The **Focus Limit** function is also available for specific Leica SL lenses (see relevant manual), but not for lenses attached via an adapter.
- The **On** setting of the function is reset to **Off** if the lens is changed while the camera is switched on.

¹ Version 31.7.2017: Leica APO-Macro-Elmarit-TL 1:2.8/60 ASPH.,
Leica Vario-Elmar-TL 1:3.5-4.5/55-135 ASPH.

AF ASSIST LAMP

The built-in AF assist lamp extends the operating range of the AF system in poor lighting conditions. This light comes on as soon as the shutter button is pressed, provided the function is activated.

- ▶ Select **Focusing** in the **Main Menu** (1st screen page)
- ▶ Select **AF Assist Lamp** in the submenu
- ▶ Select the desired setting

Note

The AF assist lamp illuminates a range of approximately 4 m.

AUTOFOCUS METERING METHODS/OPERATING MODES

Your Leica CL offers seven AF metering options for optimal adjustment of the AF system to various subjects, situations and your own image composition ideas.

- ▶ Select **Focusing** in the **Main Menu** (1st screen page)
- ▶ Select **AF Mode** in the submenu
- ▶ Select the desired setting

Spot (Spot)/Field metering (Field)

Both metering methods detect only those parts of the subject within the relevant AF frames.

- The metering fields are indicated by a small AF frame.

The very small metering range for spot metering allows focusing on tiny details of the subject.

The slightly larger **Field** metering range is less critical when focusing, and therefore easier to handle while still allowing selective metering.

These metering methods can also be used for serial exposures in which the part of the subject you want to focus on will always be at the same off-center position in the image.

In both metering methods you can move the AF frame – which is usually positioned in the center of the screen – to another position:

- ▶ Press the directional pad left or right as needed

Note

In both cases, the metering fields remain at their last positions set, even if the metering method is changed or the camera is switched off.

Subject tracking (Tracking)

This mode is a variation of **Field** metering that can help to capture a sharp image of a moving subject.

Focusing will be automatic, once you have focused on the subject.

- ▶ Select **Tracking** in the **AF Mode** submenu

Procedure

- ▶ Aim the metering field at the desired subject
- ▶ Press the shutter button to the 1st pressure point

The metering system locks on to the subject.

- ▶ Keep the shutter button at the first pressure point and pan the camera to the desired image section

The AF frame “follows” the saved subject.

- ▶ Fully press the shutter button to take the picture

Notes

- The metering field can be moved just like in **Spot/Field** metering before the subject is saved.
- The tracking function works the same way in **AFs** mode or **AFc** mode.
- Tracking stops when you release the shutter button. The metering field remains at the last position reached.

Touch-controlled autofocus (Touch AF)

In this mode, the AF frame can be moved for each exposure without the need for additional menu settings. The metering characteristics and metering field size match the **Field** metering.

- ▶ Select **Touch AF** in the **AF Mode** submenu

Specifying the metering field position

- ▶ Tap the screen at the desired position in the image field

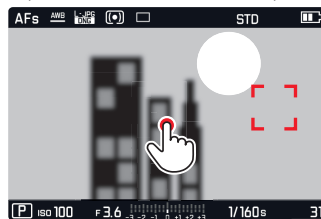

The AF frame “jumps” to the selected position.

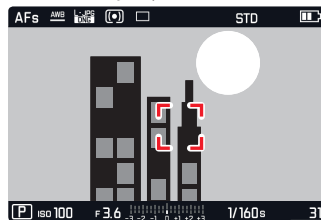

Touch-controlled shutter release (Touch AF + Release)

The **Touch AF + Release** function is a variant of **Touch AF**, allowing touch-controlled focusing and exposure.

- ▶ Select **Touch AF + Release** in the **AF Mode** submenu

Note

In both touch-controlled modes, the focusing process does not start when the shutter button is pressed to the first pressure point, but when the screen is touched instead.

Multiple field metering (Multi Point)

This metering method detects the subject using a total of 49 fields. Focusing is done automatically on the parts of the subject at the shortest distance, ensuring maximum reliability for snapshots. The fields used are indicated by AF frames.

- ▶ Select **Multi Point** in the **AF Mode** submenu

Face detection

Your Leica CL automatically detects faces in the image field in this mode. The focus is set automatically on the faces closest to the camera. Multi-zone metering is used if no faces are detected.

- ▶ Select **Face Detection** in the **AF Mode** submenu

MANUAL FOCUSING

Focusing manually may in some situations be a better choice than autofocus.

Manual focusing is preferable if:

- the same setting is used for several exposures
 - it would take longer to use the metering memory lock function
 - the setting is to be kept at infinity for landscape pictures
 - poor, i.e. very dark lighting conditions prevent AF operation or would slow it down.
- ▶ Select **Focusing** in the **Main Menu** (1st screen page)
 - ▶ Select **Focus Mode** in the submenu
 - ▶ Select **MF**

Manual focusing is done by turning the focus ring on the lens.

The best setting is achieved when the screen image shows the key part(s) of your subject as you want them to appear.

Note

Manual focusing is possible in auto focus mode as well – with the shutter button at the first pressure point.

ASSIST FUNCTION FOR MANUAL FOCUSING

Your Leica CL offers two useful tools to facilitate settings and improve setting accuracy:

- The enlarged display of a central section:
The larger the details of the subject appear on screen, the better you can assess their sharpness.
- Marking of clearly focused subjects (focus peaking): Edges of sharply rendered subject parts are marked in a color, making it easy to identify the best setting.

Both functions are activated as part of the factory settings. You can choose to only activate Focus Peaking, or only the enlargement function – or to deactivate both.

Selecting functions

- ▶ Select **Focusing** in the **Main Menu** (1st screen page)
- ▶ Select **Focus Assist** in the submenu
- ▶ Select the desired setting

You can also select the color to be used for markings in **Focus Peaking** to e.g. ensure visibility in various ambient light situations or for various subject types:

- ▶ Select **Focus Peaking** in the **Focusing** submenu
- ▶ Select the desired color

Focusing

- ▶ Specify an image section
- ▶ Use the focus ring on the lens to focus on the desired subject details

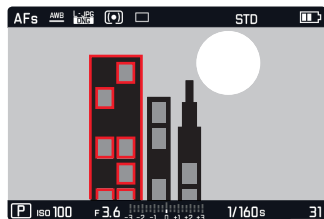

- All subject detail edges in focus are marked in the selected color.

The rule of thumb is:

- maximum contrast = in focus.
- Alternatively or simultaneously (see previous page), the screen image switches to an image section at 3x magnification.
- Another display appears, indicating the current magnification factor (highlighted in white) and the other available magnification factors.
- You can increase magnification to 6x or toggle between the two by pressing the center button. The magnification level displayed first is the one used last. The camera will switch back to the original screen image automatically about 5 s after the focusing ring was last moved. You can also get back to the original screen image at any time by pressing the shutter button to the first pressure point.

Notes

- Focus peaking is based on subject contrast, i.e. on differences between light and dark.
- If you are using the Leica M- or R-Adapter L, the right setting wheel assignment changes to **Focus Assist**, **x3**, **x6** or **Off**.

EXPOSURE METERING AND EXPOSURE CONTROL

EXPOSURE METERING METHODS

Your Leica CL offers three exposure metering methods to adapt to prevalent lighting and other conditions like your working methods or artistic ideas:

- ▶ Select **Exposure Metering** in the **Main Menu** (1st screen page)
- ▶ Select the desired setting

Multi-field metering –

In this metering method, the camera automatically analyzes the brightness differences in the subject and – by comparing them with programmed brightness distribution patterns – arrives at the likely position of the main subject and the relevantly best exposure setting.

This method is particularly suitable for spontaneous, uncomplicated but reliable photography in difficult conditions and therefore a good choice in combination with the automatic mode.

Center-weighted metering –

This metering method allocates the highest weighting to the center of the image field, but also captures all other areas.

When used in conjunction with metering memory lock, this method allows the exposure to be selectively adjusted to specific sections of the subject, while simultaneously taking into account the entire image field.

Spot metering –

This metering method is concentrated exclusively on a small area in the center of the image. It allows exact measurement of tiny details for precise exposure – preferably in conjunction with manual settings.

For backlit pictures, for example, an underexposure of the main subject due to brighter surroundings must be prevented. The much smaller metering field in spot metering ensures a targeted evaluation of these subject details.

EXPOSURE CONTROL

You can choose from four exposure modes for optimized adjustment to the relevant subject or to suit your preferred working method: program (**P**), aperture priority (**A**) and shutter priority mode (**S**), plus manual setting (**M**). These are selected the same way as the video mode and the **Scene Mode Si**.

Setting the modes

- ▶ Press the **left** setting wheel button

The standard information offered in the top display between the setting wheels is replaced by the mode icons. The arrows to the left and right of the larger, central icon indicate how to change modes. The same arrows also appear next to the mode display in the footer of the screen image.

- ▶ Turn the **left** setting wheel to select a mode

The mode display changes in the top display and on screen.

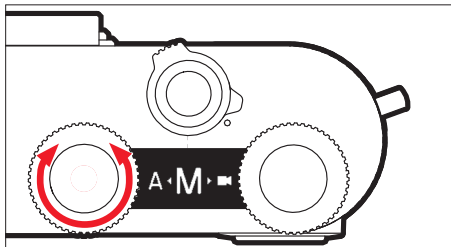

The selected mode will be applied automatically approx. 2 s after the setting wheel is moved the last time.

To set the selected mode immediately:

- ▶ Press the left setting wheel button or the shutter button

Notes

- The modes described above are arranged in an endless loop, i.e. they can be reached by turning the loop in either direction.
- When using Leica M or R lenses with the Leica M Adapter L or the Leica R Adapter L, only **A** and **M** are available, i.e. **P**, **S** or the **Scene Mode** cannot be selected. If **P**, **S** or one of the **Scene Mode** is selected, then the camera will automatically switch to **A** when the adapter is attached. **FD.0** is displayed as the aperture value.
- If a Leica TL or SL lens is attached again later, and you want to use **P**, **S** or a **Scene Mode**, then the desired mode will have to be set again.
- Depending on the lighting conditions, the brightness of the screen image may differ from that of the actual pictures taken. The screen image will be significantly darker than the correctly exposed picture in long exposures of dark subjects. See also "Exposure simulation" on page 47.

Setting wheel functions in the modes P, S, A and M

The two setting wheels are used for setting various functions depending on the exposure mode selected:

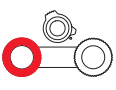
	P	S	A	M
	Mode shift	Shutter speed	Exposure compensation	Shutter speed
	Exposure compensation	Exposure compensation	Aperture	Aperture

In addition to its “primary function”, the right setting wheel can also be used to select other functions (factory setting = ISO sensitivity):

- ▶ Press the right setting wheel button
 - The relevantly set value (instead of the shutter speed) will be displayed for approx. 4 s at the bottom right of the top display between the two setting wheels.
 - The values appear on a “conveyor belt” at the bottom of the screen. The value in the middle, highlighted in yellow, is the currently set value.
- ▶ Turn the right setting wheel

The displays change accordingly. The display switches back to its original status about 4 s after the last operation.

Note

In addition to the factory settings, there are 7 more menu functions available for direct access via the right setting wheel. Please read the section “Direct access to menu functions” on page 23 for more information on the topic and on how to assign specific menu functions to the button.

Exposure simulation

Ex works, the brightness of the screen image in the three automatic exposure modes **P**, **S** and **A** matches the relevant exposure settings¹.

You can now assess and control the effect of the relevant exposure setting on the image before taking the picture.

This function is also available for manual exposure control:

- ▶ Select **Exp. Preview** in the **Main Menu** (2nd screen page)
- ▶ Select **P-A-S** (only in automatic, aperture priority, and shutter priority mode) or **P-A-S-M** (also for manual setting)

¹ This will apply as long as the subject brightness and the set exposure don't result in excessively low or high brightness values, and as long as the internal exposure setting is not greater than $\frac{1}{60}$ s.

Automatic mode – P

The automatic mode facilitates fast and fully automatic photography. The exposure is controlled by an automatic shutter speed and aperture setting.

Taking a picture

▶ Press the shutter button to the first pressure point

The values for shutter speed and aperture are displayed in white. If a completely open or closed aperture combined with the longest shutter speed will result in underexposure, or if a completely closed aperture combined with the shortest shutter speed will result in overexposure, then both values will be displayed in red.

If the automatically set pair of values appears to be appropriate for the intended image composition:

▶ Press the shutter button down to take the picture

Changing the preset shutter speed / Aperture combinations (Shift)

Changing the preset values using the Shift function combines the reliability and speed of fully automatic exposure control with the opportunity to vary the speed/aperture combination selected by the camera at any time to fit in with your own ideas and intentions.

▶ That is done using the right setting wheel. Turn the wheel to the left if you prefer to use faster speeds, e.g. for sports shots. Turn to the right if you prefer a larger depth of field, e.g. for landscape shots and are prepared to accept the resulting slower shutter speeds.

- The overall exposure, i.e. the brightness of the image, remains unchanged. The adjustment range is limited to guarantee correct exposure.
- Shifted pairs of values are indicated by a + next to the shutter speed.
- The values will be reset to those specified by the camera after each picture taken to prevent accidental use and also if exposure metering deactivates automatically after 12 s.

Scene mode

In addition to the “normal” automatic mode **P**, the menu item **Scene Mode** offers nine other automatic options for particularly easy and accurate photography. One of these is an automatic “snapshot” variant for general use: **Auto** (factory setting). Eight are customized for the specific requirements of common types of subjects; another is reserved for camera mounted permanently on a spotting scope.

You will also find another three “special” mode variants under the menu item **Scene Mode**:

Panorama	Automatic creation of panorama pictures
Miniature Effect	Limitation of the sharpness range to one horizontal or vertical strip within the image field
HDR	Simultaneously optimized exposure of very bright and very dark subject elements

You will find details about the **Panorama**, **Miniature Effect** and **HDR** modes on the next few pages.

Selecting the **Scene Mode**

- ▶ Press the **left** setting wheel button
- ▶ Turn the left setting wheel to select **S_i**

The selected mode will be applied approx. 2 s after the last turn of the setting wheel.

To apply the selected mode immediately:

- ▶ Press the left setting wheel button or the shutter button

Setting the Scene Mode

- ▶ Select **Scene Mode** in the **Main Menu** (2nd screen page)
- ▶ Select the desired scene mode

Taking a picture

Same as in “normal” automatic mode

Notes

- All **Scene Mode** variants control a range of automatic functions in addition to shutter speed and aperture.
- The program shift function is not available.
- The two setting wheels have no function in this case.

Panorama pictures

Your Leica CL allows you to create horizontal panorama pictures with this function.

Setting the function

- ▶ Select **Panorama** in the **Scene Mode** submenu.

The following will appear on the screen:

- a white horizontal line in the center of the picture
- a progression and directional display for the function at the bottom

To switch between landscape or portrait orientation for the panorama:

- ▶ Press the directional pad up or down

Creating a panoramic picture

- ▶ Aim the camera so that the planned left edge of the panoramic picture is not quite at the left edge of the screen image,
- ▶ Press the shutter button and hold it down
- ▶ Pan the camera steadily in the direction indicated while using the white line to help keep from drifting up or down too much

Notes

- The camera will stop taking the panoramic picture if it is panned too slowly or too quickly, and a notification will appear on screen.
- The less steady the camera is held along the horizontal line, the smaller will be the overall height of the panorama picture.
- The maximum panning angle is approx. 180°.

Stopping the recording:

- ▶ Release the shutter button
- Pictures are taken in quick succession, once the shutter is pressed.
- When the whole series of pictures is taken, the camera will calculate a single panorama image from the individual pictures.

Notes

- Regardless of the current menu setting, panoramic pictures are always stored in the **JPG** file format.
- Panoramic pictures cannot be taken with a flash.
- The resolution of a panoramic picture depends on the direction of the picture and number of pictures taken. Maximum resolution is approx. 8176x1920 pixels.
- Sharpness, white balance and exposure for all pictures are set to the values of the first picture taken in the series. That is why the final panorama picture may not be in perfect focus or have ideal brightness if the distance between camera and subject, as well as ambient light change while the picture is taken.
- Some subjects in the picture may appear distorted or there may be visual transitions, because the picture is composed of a series of individual exposures.
- Panorama pictures cannot be created in the following situations:
 - At very slow shutter speeds (longer than $\frac{1}{60}$ s)
 - In conjunction with the **Interval** function

- Panorama pictures may not be possible for the following subjects, under the following exposure conditions or transition areas may not be perfect:
 - Single-color subjects or subjects with a uniform pattern (sky, beach, etc.)
 - Moving subjects (people, pets, vehicles, waves, flowers swaying in the wind, etc.)
 - Subjects with changing colors or patterns (e.g. a TV image)
 - Dark locations
 - Subjects illuminated by uneven, flickering light sources (e.g. fluorescent lamps, candle light, etc.)

Miniature effect

This function allows you to select specific parts of the image field you want to have in focus – and most importantly – which should be out of focus. You can limit the focused areas to either a horizontal or vertical stripe. You can change the width as well as the location of this stripe within the image field.

The effect will make the picture look similar to a closeup photo with its characteristically shallow depth of field.

Setting the function

- ▶ Select **Miniature Effect** in the **Scene Mode** submenu

The following will appear on screen:

- A white rectangle outlining the correctly focused area
- In the middle of the rectangle will be the autofocus metering field
- Arrows centered above and below, or to the left and right to indicate how the rectangle can be shifted
- At the top left and right will be displays indicating how the rectangle can be modified using the directional pad and one of the setting wheels

Changing the orientation of the rectangle:

- ▶ Press left or up 1x on the directional pad (depending on the baseline)

Changing the location of the rectangle:

- ▶ Press up as many times as necessary on the directional pad (differs depending on orientation)

Changing the width of the rectangle:

- ▶ Turn (any) setting wheel
to the left = smaller, to the right = larger

HDR

HDR generates a picture in which the “overlay” of three different exposures (-2 EV/0 EV/+2 EV) reproduces an improved image of lighter and darker parts of the subject, i.e. with less overexposure in the highlights and more definition in the darkest areas.

Due to the consecutive exposures, this operating mode is best suited for immobile subjects or those with very little movement, e.g. landscapes. We recommend the use of a tripod for HDR pictures because of the slower shutter speeds and in particular in low ambient light, e.g. for evening or night time pictures.

Setting the function

- ▶ Select **HDR** in the **Scene Mode** submenu

Taking a HDR picture

- ▶ Specify the desired image section
- ▶ Press the shutter button all the way down, hold the camera steady during the three exposures (see above)

Aperture priority mode – A

Aperture priority mode sets the exposure automatically according to the manually selected aperture. This mode is suitable for pictures in which the depth of field is a critical compositional element. By selecting an appropriately low aperture value, you can reduce the depth of field range, for example to make a face “stand out” in sharp focus against an unimportant or distracting background. Conversely, you can use a higher aperture value to increase the depth of field range, so that everything from the foreground to the background will be in full focus in a landscape shot.

Taking a picture

- ▶ Select the desired aperture value with the **right** setting wheel
- ▶ Press the shutter button to the first pressure point

Both the set aperture value and the automatically calculated shutter speed are displayed in white. Both values will be displayed in red if the fastest or slowest shutter speed combined with the set aperture will result in under or overexposure.

If the automatically set shutter speed appears appropriate for the intended composition:

- ▶ Press the shutter button down to take the picture

Shutter priority mode – S

Shutter priority mode sets the exposure automatically depending on the manually selected shutter speed. It is therefore particularly suitable for pictures of moving subjects, where the sharpness of the movement depicted is a critical compositional element.

An appropriately fast shutter speed will avoid undesirable blurring of the movement, i.e. "freeze" your subject, or you can use a slower shutter speed to express the dynamic nature of the movement with a deliberate "blur effect".

Taking a picture

- ▶ Select the desired shutter speed with the left setting wheel
- ▶ Press the shutter button to the first pressure point

The set shutter speed and the automatically controlled aperture value are displayed in white.

Both values are displayed in red if the lowest or highest aperture value combined with the set shutter speed will result in under or overexposure.

If the automatically set aperture value appears to be appropriate for the intended composition:

- ▶ Press the shutter button down to take the picture

Metering memory lock

For reasons of image composition, it may be beneficial not to have the main subject in the center of the picture.

In that case, the metering memory lock function allows a metering of the main subject first, and the relevant settings are retained until you have determined your final picture section and are ready to take the picture. This can be done with the exposure modes **P**, **S** and **A** as well as the AF modes Field and Spot metering, as well as by tapping.

Taking a picture with this function

- ▶ Aim the relevant AF frame at the part of your subject to which you want to adjust the sharpness and exposure.
- ▶ Press the shutter button to the first pressure point to set and store the focus and exposure.
- ▶ Continue holding the shutter button at the first pressure point and pan the camera to specify the final picture section.
- ▶ Press the shutter button down to take the picture

Exposure compensation

Some subjects consist predominantly of areas of above or below average brightness, for example areas of snow or full-format dark subject elements. Using the exposure modes **P**, **S** and **A**, it may be more convenient to set an appropriate exposure compensation instead of using the metering memory lock function for each picture. The same applies if you want to ensure an identical exposure for multiple pictures. Values of + 3 to - 3 EV are available in 1/3 EV increments.

- ▶ Select **Exposure Compensation** in the **Main Menu** (1st screen page)
- ▶ Select the desired compensation value

In modes **P**, **S** and **A**, a compensation value can also be directly entered via one of the setting wheels.

Once a compensation value is set, it is displayed on screen, e.g. as **EV+3**. While setting the value, you can see the effect on the screen image, which becomes darker or lighter.

Notes

- When setting the exposure manually, exposure compensation can only be done via menu control, or if the function for direct access was selected (see p. 23).
- A set exposure compensation remains active after any number of pictures and even after the camera was switched off, until it is reset to ± 0 (= center of scale).

Automatic bracketing

High contrast subjects that have very bright and very dark areas can have very different picture effects depending on exposure. The automatic bracketing function allows you to take a series of three pictures with stepped exposure. You can then select the best picture for further use.

Selecting a menu item

- ▶ Select **Drive Mode** in the **Main Menu** (1st screen page)
- ▶ Select **Exposure Bracketing** in the submenu

Active bracketing is indicated by  on screen. You can watch the effect of the function on screen while the pictures are taken (brighter or darker).

At least two parameters must be set for a bracketing series:

- Number of pictures
- Exposure gradation (in full EV increments = Exposure value steps)

Selecting the number of pictures

- ▶ Select **Frames** in the **Exposure Bracketing** submenu
- ▶ Select  or 

Setting the exposure gradation

- ▶ Select **Aperture/ EV Steps** in the **Exposure Bracketing** submenu
- ▶ Select the desired setting

Two more settings are optionally available:

- “Shift” – moving the complete bracketing series in the direction of underexposure/overexposure
The selected exposure compensation value will be applied to the entire exposure series. This allows you to produce more or only alternatives with higher or lower exposures.
- Release method for the series

Setting an exposure compensation value

- ▶ Select **Exposure Compensation** in the **Exposure Bracketing** submenu
- ▶ Select the desired setting

Setting the release method

- ▶ Select **Automatic** in the **Exposure Bracketing** submenu
- ▶ Select the desired setting

The factory setting **On** will run the entire exposure series after the shutter button is pressed once; when the setting is **Off**, each exposure must be done individually.

Notes

- Depending on the exposure mode chosen, gradations are produced by changing the shutter speed (**P/A/M**) or the aperture (**S**).
- The sequence of the pictures: correct exposure/underexposure/overexposure
- Depending on the available shutter speed/aperture combination, the working range for automatic bracketing may be limited.
- Once set, bracketing remains active after any number of releases and even after the camera was switched off, i.e. until it is reset to ± 0 (= center of scale).

Manual setting – M

A manual setting of shutter speed and aperture may be beneficial if you want to achieve a specific image effect that is possible only with a very specific exposure, or if you want to ensure that several pictures with different image sections have an identical exposure.

Taking a picture

- ▶ Select the desired aperture value with the **right** setting wheel
- ▶ Select the desired shutter speed value with the **left** setting wheel
- ▶ Press the shutter button to the first pressure point

The shutter speed and aperture values are displayed in white. The light balance scale is additionally displayed. It covers a range of ± 3 EV (exposure value) in 1/3 EV increments.

Settings within ± 3 EV are indicated by white lines on the scale, settings outside this range by red lines.

- ▶ Adjust the settings for correct exposure so that the central mark is displayed in white

Once the set values and/or the exposure appear to be appropriate for the intended composition:

- ▶ Press the shutter button down to take the picture

Note

The screen image will show an exposure simulation if **P-A-S-M** is selected in the menu item **Exposure Preview**

ADDITIONAL PICTURE FUNCTIONS

Interval shooting

Your Leica CL allows you to take pictures of motion sequences over a long period of time in the form of picture series. You specify the number of pictures, the intervals between pictures, and the start time of the series.

Setting the function

- ▶ Select **Drive Mode** in the **Main Menu** (1st screen page)
- ▶ Select **Interval** in the submenu
- ▶ Select **Number of Frames** in the **Interval** submenu
- ▶ Select the desired number of pictures (from 1 to a maximum of 9999) in the relevant keypad submenu

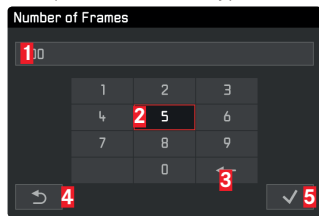

- 1 Input line
- 2 Number pad
- 3 “Delete” button (deletes the last entered character)
- 4 “Back” button (brings you back to the **Interval** submenu level without confirming any settings)
- 5 “Confirm” button (confirms settings)

The keypad can be operated in various ways:

Using gesture control

- ▶ Touch the desired value or “button”

Using button/setting wheel controls

To go left or right (incl. changing lines, endless loop):

- ▶ Turn the setting wheel on the right or press the directional pad right/left

To go up or down (only within the same column):

- ▶ Press the directional pad up/down

To enter a selected number:

- ▶ Press the center button

To confirm a finished setting:

- ▶ Select the “Confirm” button
- ▶ Press the center button

Note

The setting process starts fresh each time the keypad submenu is accessed, i.e. any previously set number of pictures is overwritten.

- ▶ Select **Interval** or **Countdown**
- ▶ Enter the desired times
(between 1 s to a maximum of 59 h 59 min 59 s)

toggling between the units of time:

- ▶ Press the directional pad right/left

To set the units of time:

- ▶ Press the directional pad up/down, or turn the right setting wheel

Creating an interval picture series

The exposure and focus settings are no different from those for normal pictures, but you should remember that the lighting conditions may change during the course of the picture series.

The time until the first picture and the number of pictures to be taken are shown in the upper right corner of the screen image.

Starting interval shooting:

- ▶ Press the shutter button

The remaining number of pictures will be displayed briefly between the pictures and a relevant message will be appear, once the series is complete.



Notes

- The camera may switch off and on again if “Auto power off” is set and no other camera operation occurs between the taking of the individual pictures.
- Interval shooting done over an extended period of time in a cold location or in a place with high temperature and humidity may result in malfunctions.
- Use a sufficiently charged battery.
- Interval shooting will be interrupted or stopped in the following situations:
 - if the battery is depleted
 - if the camera is switched off

You can continue your interval shooting by replacing the battery or the memory card while the camera is switched off and then switching it back on. The pictures taken after the function interruption be stored in a separate group.
- The function remains active after interval shooting is completed, and also after the camera is switched off and on again. You will therefore have to choose the relevant function in the **Drive Mode** submenu if you want to return to a standard picture mode. A prompt will be displayed on screen if the camera is switched off and on again while the interval shooting function active.
- The pictures of an interval shoot are marked with  in playback mode.
- The availability of this function does not mean that the camera is suitable for use as a monitoring device.

Self-timer

You can use the self-timer function to take a picture with a delay of 12 s or 2 s. This is useful for group photographs in which you want to be included or if you want to avoid blurring caused by an unsteady hand.

- ▶ Select **Self Timer** in the **Main Menu** (1st screen page)
 - ▶ Select the desired settings
-  or  will be displayed when the self-timer is activated.

Operation:

- ▶ Press the shutter button down to take the picture
 - Progress is indicated by the flashing self timer LED;
 - 12 s delay: slowly at first, faster for the last 2 s
 - 2 s delay: fast flashing
 - The remaining time is counted down on screen.

Notes

- A time delay in progress can be restarted at any time by pressing the shutter button again. The only way to cancel a delay time in progress is to switch off the camera.
- The self-timer function only accommodates single pictures, i.e. serial exposures and automatic bracketing cannot be combined with the self-timer function.
- In self-timer mode, the focus and exposure are not set until right before the picture is taken, i.e. not when the shutter is pressed to the first pressure point.
- The self-timer function remains active until it is deactivated via the menu or the camera is switched off.

FLASH PHOTOGRAPHY

COMPATIBLE FLASH UNITS

The following flash units offer a TTL flash metering function and – depending on the model – a varying number of the functions described in this manual.

- Leica system flash units SF 40, SF 64 and SF 58
- Other Leica system flash units, except Leica SF 20

Other commercially available flash units with a standard flash foot and positive center contact¹ (X contact) can also be used, as well as studio flash units connected to the central contact via an adapter and sync cable.

We recommend the use of state-of-the-art thyristor-controlled electronic flashunits.

ATTACHING A FLASH UNIT

- ▶ Switch off the camera and flash unit
- ▶ Slide back the cover over the accessory shoe on the camera
- ▶ Slide the foot of the flash unit all the way into the accessory shoe and where available, use the clamping nut to secure it in place. Movement inside the accessory shoe may interrupt the necessary contacts and cause malfunctions.

¹Activate the **WB Flash** setting if you will be using flash units that are not directly compatible with the camera and will therefore not automatically adjust the white balance of the camera.

Set the flash unit to **TTL** mode to allow automatic control of the unit by the camera.

When set to **A**, subjects with above or below average brightness may not be exposed correctly.

When set to **M**, the flash exposure must be controlled by manually setting a flash output level appropriate for the aperture and shutter speed settings determined by the camera.

The display for the set flash mode appears in white (see next pages). The flash mode will blink red if the flash unit is not fully charged and therefore not ready.

The camera determines the necessary flash power by firing one or more ranging flashes, fractions of a second before taking the actual picture. Immediately after, i.e. during the exposure, the main flash is fired. All parameters that influence the exposure (e.g. filters, changed aperture settings) are automatically considered.

Notes

- A flash unit that is not ready to flash may cause incorrect exposures or error messages.
- Serial exposures and automatic bracketing with flash are not available. With the camera set to one of these modes, there will be no flash display on screen even if the flash unit is attached and the flash will not fire.
- A flash unit and the Leica Visoflex electronic viewfinder cannot be used simultaneously.

FLASH MODES

Automatic flash activation

That is the default flash mode. An attached and activated flash unit is fired automatically whenever slower shutter speeds could lead to blurred pictures in poor lighting conditions.

Manual flash activation

This mode is suitable for backlit pictures in which your main subject does not fill the entire frame and is in shadow, or in situations in which you want to moderate high contrasts (e.g. in direct sunlight) with a fill-in flash. As long as this mode is active, an attached and switched on flash unit will fire each time you take a shot, whatever the prevailing lighting conditions. The flash output depends on the metered ambient brightness: in poor light it is the same output as in automatic mode, with output decreasing with increasing brightness. The flash will then work as a fill-in light, e.g. to light up dark shadows in the foreground or backlit subjects, and to create more balanced overall lighting.

Automatic flash activation at slower shutter speeds

This mode generates appropriately lit, i.e. a brighter rendering of dark backgrounds and a fill-in flash for the foreground. Explanation: In the other flash modes the shutter speed is not extended beyond 1/30 s To minimize the risk of blurring. This may mean, however, that pictures with flash exposure can end up with objects in the background not illuminated by the flash and therefore being underexposed. In this mode, the slower shutter speeds required in these situations (up to 30 s) are available to ensure appropriate consideration of ambient light.

Selecting a mode:

- ▶ Select **Flash Settings** in the **Main Menu** (2nd screen page)
- ▶ Select **Flash Mode** in the submenu
- ▶ Select the desired setting

The relevant mode variant can be selected directly via the left setting wheel if the  function is assigned to it.

The selected mode is displayed on screen.

Notes

- This setting is not available and the function is grayed out if no system compatible flash unit is attached.
- Depending on the selected **Auto ISO Settings**, (see p. 33) the camera may not support slower shutter speeds, because an increase in ISO sensitivity takes priority.
- The slowest shutter speed can be selected via **Maximum Exposure Time** (see p. 33).
- Make sure to hold the camera steady, i.e. prop it up or use a tripod to prevent blurring with slow shutter speeds. You can alternatively select a higher sensitivity.

FLASH RANGE

The usable flash range depends on the aperture and sensitivity values set manually or calculated by the camera. It is important to ensure that the subject is within the relevant flash range for sufficient illumination.

SYNCHRONIZATION TIME POINT

Flash photographs are always illuminated by two light sources: ambient light and the light from the flash. The time at which the flash is fired determines where the subject elements illuminated exclusively or predominantly by the flash are shown in the image.

The conventional flash firing point at the start of the exposure – **Start of Exp.** – may cause apparent contradictions, e.g. a vehicle “overtaken” by the light trail from its own tail lights. Your Leica CL allows you to choose between this conventional flash firing point and the end of the exposure – **End of Exp.**:

- ▶ Select **Flash Settings** in the **Main Menu** (2nd screen page)
- ▶ Select **Flash Sync** in the submenu
- ▶ Select the desired setting

In the second option, the light trail from the tail lights will then follow the vehicle as expected. This flash technique gives a more natural impression of movement and dynamics.

Note

When using the flash with faster shutter speeds, there will be hardly any or only a minor difference in fast movements in the image between the two flash firing points.

FLASH EXPOSURE COMPENSATION

This function can be used to selectively reduce or strengthen the flash exposure regardless of the exposure from available light, e.g. in a picture taken in the evening or to brighten the face of a person in the foreground while retaining the same lighting ambiance.

- ▶ Select **Flash Settings** in the **Main Menu** (2nd screen page)
- ▶ Select **Flash Exp. Compensation** in the submenu
- ▶ Select the desired setting

Notes

- Flash exposure compensation changes the range of the flash unit.
- Once set, compensation remains active even after any number of pictures and even after turning off the camera, until it is reset to ± 0 (= center of scale).
- A compensation value previously set via menu control may become void once a relevantly equipped flash unit is attached to the camera, e.g. a Leica SF 64., and a compensation value is entered in that flash unit.

VIDEO RECORDING

Your Leica CL can also record video.

There are two methods for toggling between picture preview and video preview mode:

Using gesture control

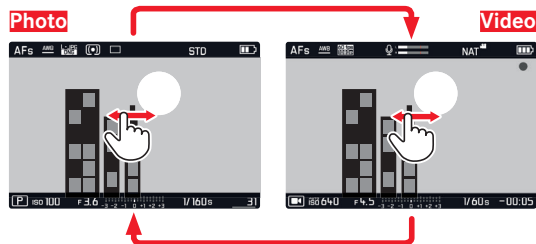

Using button control

- ▶ Press the **left** setting wheel button
- ▶ Turn the **left** setting wheel to select 

The selected mode will be applied approx. 2 s after the last turn of the setting wheel.

To apply the selected mode immediately:

- ▶ Press the left setting wheel button or the shutter button

Notes

- The relevantly effective focal length is increased, because only part of the sensor area is used for video recordings. That means the image sections are reduced accordingly.
- You can record video up to 29 minutes without interruption. The maximum file size is 4 GB. Once a recording exceeds this limit, the overrun will be automatically stored in a new file.

Starting/ending the recording

Start:

- ▶ Press the shutter button
- A flashing red dot indicates active recording mode. The remaining available recording time is also displayed.





End:

- ▶ Press the shutter button again

The following functions are available for video recording:

Resolution

Choose one of three resolution levels, one of which offers two frame rates:

	(3840 x 2160 pixels)
	(1920 x 1080 pixels) – Factory setting
	(1920 x 1080 pixels)
	(1280 x 720 pixels)

- ▶ Select **Video Resolution** in the **Main Menu** (3rd screen page)
- ▶ Select the desired setting

ISO sensitivity

All settings available in the menu.

Focusing

All variants described on pages 38-43.

Exposure metering methods

All options described on page 45.

Exposure control

Exposure control for video recording is completely independent of the exposure mode or the shutter speed and aperture settings for photos.

- **Shutter speed:** Depending on the selected **Video Resolution**
- **Aperture:** Automatic
- ISO sensitivity will be increased automatically if correct exposure cannot be achieved with the largest aperture – no matter what values were set manually.

Note

Automatic exposure control takes into account any fluctuations in brightness. Set the shutter time manually if this is undesirable, e.g. for landscape recordings or panning.

Color rendering and image properties

You can choose between various color rendering variants for video recording, just like for photos (described on page 34). You can additionally change the contrast, saturation and sharpness for each of these variants.

- ▶ Select **Video Style** in the **Main Menu** (3rd screen page)

All other operation is done as described on pages 34.

Note

The stored values differ from those in menu item **Film Style**.

Recording level, wind noise damping, stabilization

Three more settings are bundled under the menu item

Video Settings.

- **Microphone Gain** allows you to adjust the level of the built-in microphone in line with external conditions.
 - **Wind elimination** offers a dampening function to suppress wind noise during sound recording.
 - **Video Stabil.** helps to remedy unsteady hands.
- ▶ Select **Video Settings** in the **Main Menu** (3rd screen page)
 - ▶ Select the desired function in the submenu
 - ▶ Select the desired gain level in the relevant submenu or activate/deactivate the function

Notes

- The image section is reduced slightly when using the video stabilization function.
 - Sound is recorded in stereo via the built-in microphones.
 - Autofocus and focal length adjustments on zoom lenses produce noise that may be picked up in the recording.
- Avoid using either of these functions while recording to prevent unwanted noise or adjust the focus manually and don't change the focal length.

PLAYBACK MODE

PLAYBACK

There are two methods for toggling between recording and playback mode:

Using gesture control

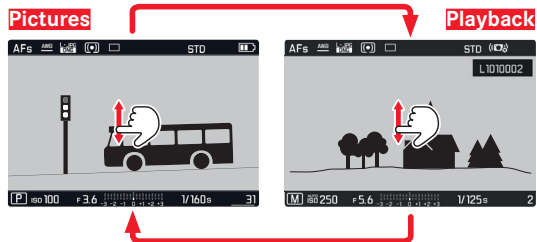

Using button/setting wheel controls

- ▶ Press the **PLAY** button
(1x = playback mode, 2x = back to recording mode)

Notes

- Portrait-format recordings are rendered as shot, i.e. the full screen area will be used.
- You can toggle back from playback mode to recording mode at any time by tapping the shutter button.
- The message **No valid picture to play.** will appear if the memory card contains no image data.
- If you have used the picture series function or automatic bracketing, the last or last saved picture in the series is displayed first – unless the pictures in the series were overwritten by the camera's internal back-up memory in the meantime.
- Files that were not created on this camera may not be renderable on this device. The screen will remain black and only display the file name.

Automatic playback

The **Auto Review** function allows you to view each photo/video right after it was taken:

- ▶ Select **Auto Review** in the **Main Menu** (3rd screen page)
- ▶ Select the desired function or duration

Note

As long as you **keep** the shutter button pressed down completely after the photo/video was taken, The most recent images will be played back, even if **Off**, **1s**, **3s**, or **5s** is set.

SELECTING/SCROLLING THROUGH PICTURES/RECORDINGS

Using gesture control

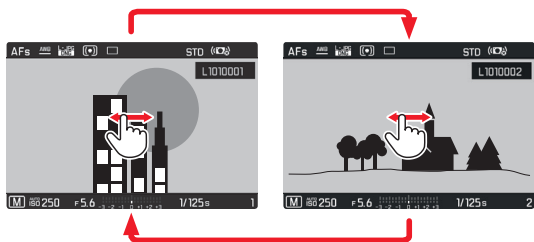

Using button/setting wheel controls

- ▶ Turn the left setting wheel or press the directional pad right/

Notes

- Swiping to the right (gesture), turning the setting wheel or pressing the directional pad will result in a playback of pictures/recordings with higher numbers; the same commands to the left will play back the lower numbers.
- The pictures/recordings are displayed in an endless loop in either direction. Once the last picture/recording is reached, the first will appear again.

ENLARGING PICTURES/SIMULTANEOUS DISPLAY OF MULTIPLE PICTURES

Playing back an enlarged picture will allow you to better assess the sharpness.

Magnification

Using gesture control

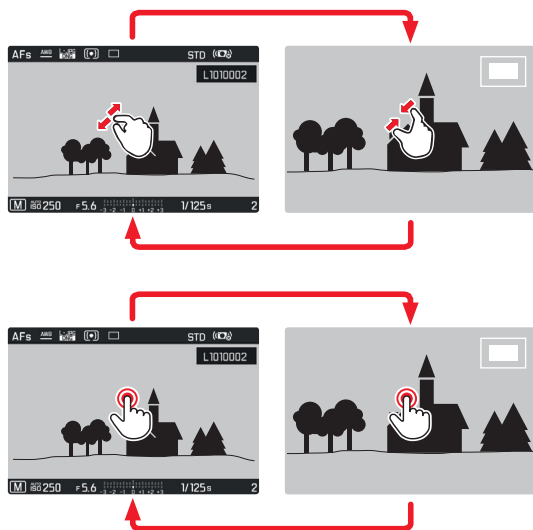

Using button/setting wheel controls

Step by step:

- ▶ Turn the right setting wheel to the right, four click-stops = four magnification levels up to the max. magnification

Accessing the third magnification level directly:

- ▶ Press the right setting wheel button (back to standard view: press again)

Notes

- Incremental magnification is available only in standard view, i.e. not when you have accessed the third magnification level directly by pressing the button.
- At the max. magnification, one picture pixel equals one screen pixel.
- You can decide which part of the picture is should be magnified by tapping the relevant area on screen.

Simultaneous display of 12/30 pictures

Displaying a number of thumbnails will give you a better overview and will allow you to find a specific picture faster.

Using gesture control

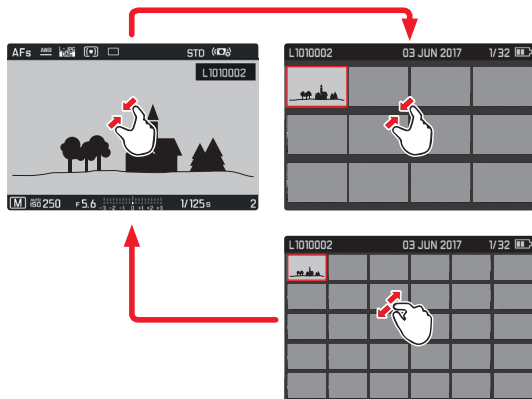

Using Button/Setting wheel controls

- ▶ Turn right setting wheel to the left; one click-stop past standard size = 12 picture display, two click-stops = 30 picture display

The last picture to be shown in standard size is indicated by a red frame.

Notes

- Video recordings cannot be magnified.
- The display with additional information is not accessible during magnification/thumbnaill view.
- It may not be possible to enlarge pictures taken with other camera types.

Selecting thumbnails

- ▶ Press the directional pad left or right to select the desired picture

The selected picture is marked with a red frame.

Exiting the thumbnail view

Using gesture control

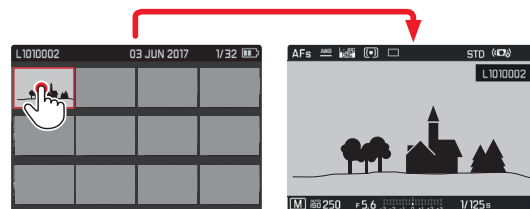

Using Button/Setting wheel controls

- ▶ Turn the right setting wheel to the right; one click-stop past 30 picture display = 12 picture display, two click-stops = standard size

Returning to standard size directly:

- ▶ Press the center or right setting wheel button

SELECTING AN IMAGE SECTION

In a magnified picture, you can move the enlarged section away from the center, e.g. to check subject details outside the center.

Using gesture control



Using Button/Setting wheel controls

- ▶ Press the directional pad right or left in the direction you want to move

The approximate position of the image section is indicated by the rectangle inside the frame.

MARKING PICTURES/UNMARKING PICTURES

You can mark any picture, e.g. to find it again faster or to protect it against accidental deletion:

- ▶ Press the left setting wheel button

After pressing the button for the first time, a marked picture ★ appears in the header on screen on the right. ★ will disappear after the button is pressed a second time.

PLAYBACK MENU

The playback menu contains the five functions **Delete**, **Delete Unrated**, **Delete All**, **Slideshow** and **WLAN**. Please see next pages for details on the first four functions. The **WLAN** submenu is the same that can be accessed via the **Main Menu**. Details on the **WLAN** settings are provided from page 80 onward.

Accessing the playback menu

- ▶ Press the **MENU** button

The playback menu appears

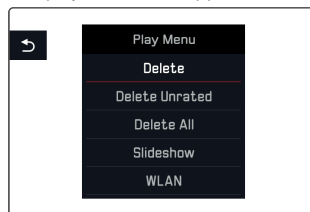

Selecting/accessing menu items

Using gesture control

- ▶ Tap the desired function line

Using button/setting wheel controls

- ▶ Turn one of the setting wheels or press the directional pad up/down
- ▶ Press the center button

Exiting the playback menu

- ▶ Press the **MENU** button again, or press the **PLAY** button marked ↵, or press the directional pad left

Deleting pictures/recordings

Pictures/videos saved on the memory card can be deleted at any time: individually – **Delete**, or all unmarked ones – **Delete Unrated**, or all at once – **Delete All**.

Deleting individual pictures/videos

The following screen appears when **Delete** is selected:



Note

This screen is also directly accessible:

- ▶ Press the **FN** button

Using gesture control

- ▶ Press the **FN** button marked  again and tap 

Using button/setting wheel controls

- ▶ Press the **FN** button marked 

Notes

- The “Scroll” and “Magnify” functions continue to be available when the “Delete” screen is active.
- When a picture/video is deleted, the next one in line appears, or **No valid picture to play** will be shown if no more pictures/videos are available.

Deleting all unmarked/all pictures/videos

When **Delete Unrated** or **Delete All** is selected, a screen message will appear (see example of **Delete Unrated**):

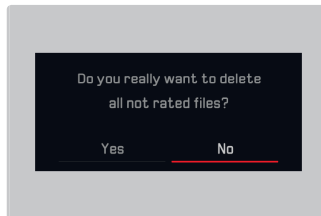

Using gesture control

Yes or **No**

Using button/setting wheel controls

- ▶ Turn the right setting wheel or press the directional pad left/right side to select **Yes** or **No**
- ▶ Press the center button

Note

The message **No valid picture to play** appears after successful deletion. The same picture is displayed again if deletion was unsuccessful. When deleting several or all pictures/recordings, a notification screen may appear for the time needed to process the data.

Important

Once deleted, pictures/videos are no longer retrievable.

Automatic playback

You can set your Leica CL to play back pictures/videos automatically in sequence. Within this **Slideshow** function, you can specify to show all pictures/videos (**Play All**), only pictures (**Pictures only**) or only videos (**Videos only**). You can also select the time span for which each picture/video is displayed (**Duration**). The following screen appears after **Slideshow** is selected:

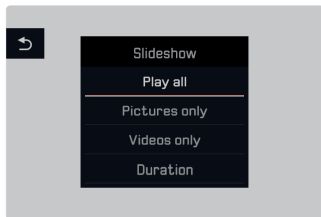

Setting the duration

Using gesture control

- ▶ **Duration**
- ▶ Tap the desired playback duration

Using button/setting wheel controls

- ▶ Turn the right setting wheel or press the directional pad up/down to select **Duration**
- ▶ Press the center button to access the **Duration** submenu
- ▶ Turn the right setting wheel or press the directional pad up/down to select the desired setting
- ▶ Press the center button to confirm your setting

The **Slideshow** menu reappears.

Note

Your settings in **Duration** even after the camera is switched off and on again.

Start playback

Using gesture control

- ▶ Tap the desired mode (**Play All**, **Pictures only** or **Videos only**)

Using button/setting wheel controls

- ▶ Turn the right setting wheel, or press the directional pad up/down to select the desired function
- ▶ Press the center button

An intermediate screen may appear while the data is prepared for playback.

The slide show will then run on an endless loop until you end it.

End playback

- ▶ Press the **PLAY** button or the shutter button

The camera switches to the relevant mode.

Video playback

PLAY > will appear on screen if you have selected a video file for playback.

Start playback

Using gesture control

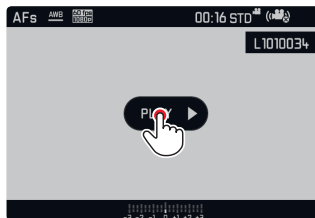

Using button/setting wheel controls

- ▶ Press the center button

Accessing the video and audio control icons

Using gesture control

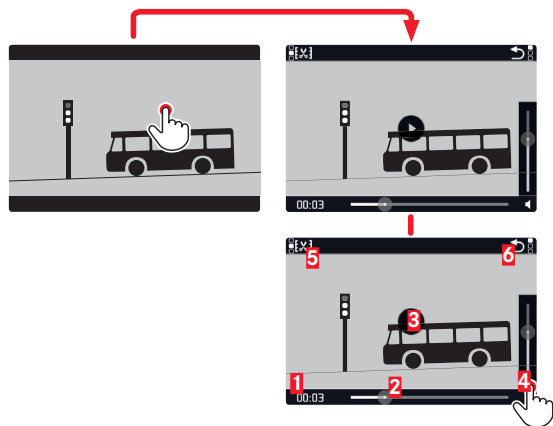

- 1 Elapsed time
- 2 Scroll bar with touch area
- 3 Pause
- 4 Volume
- 5 Shorten video
- 6 Back to beginning of the video

Using button/setting wheel controls

- ▶ Press the center button

Notes

- Accessing the icons will pause playback.
- The icons disappear after approx. 3 s.

Playback from any point in the file

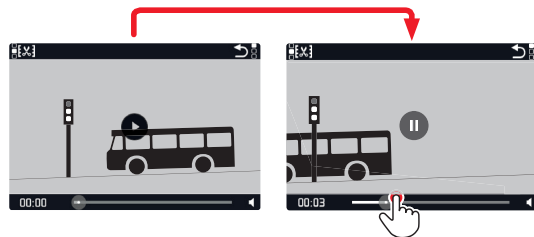

Pause playback

Using gesture control

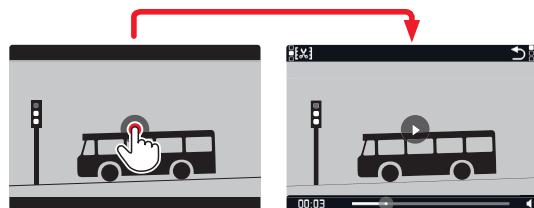

Using button/setting wheel controls

- ▶ Press the center button

End playback

Using gesture control

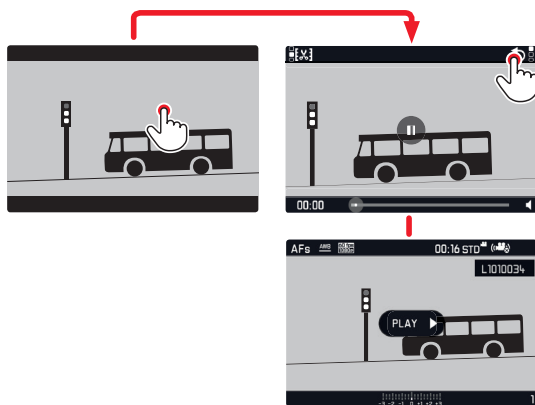

Using button/setting wheel controls

- ▶ Press the **PLAY** button or the center button

Adjusting the volume

Using gesture control

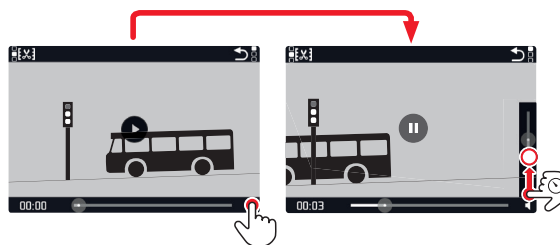

Using Button/Setting wheel controls

- ▶ Press the directional pad up or down

The volume scrollbar appears.

- ▶ Press the directional pad up (louder) or down (quieter)

Note

Sound is switched off at the lowest part of the bar and the volume icon changes to .

Cutting video recordings

Using gesture control

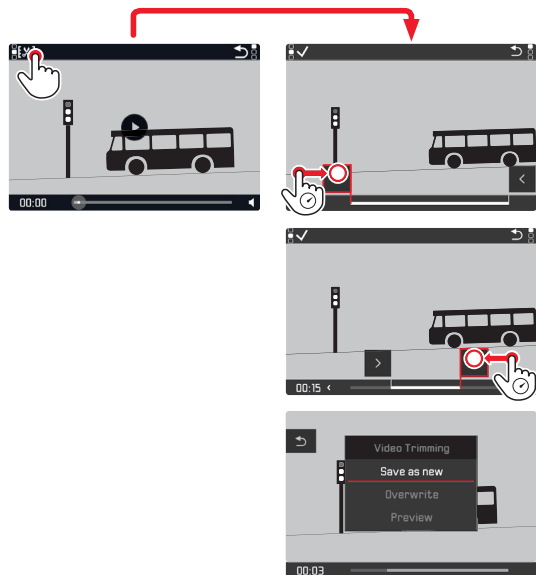

Using button/setting wheel controls

- ▶ Press the **FN** button

The video cutting screen appears, the left cutting mark is highlighted in red (= active).

Changing and moving cutting points

Changing (only available in the two end positions):

- From the beginning (left) to the end (right)
- ▶ Turn the right setting wheel one click-stop to the right
- From the end (right) to the beginning (left)
- ▶ Turn the left setting wheel one click-stop to the left

The selected cutting point is highlighted in red (= active).

Moving:

- ▶ The cutting point on the left is moved with the left setting wheel, the one on the right with the right setting wheel

The relevant time stamp and the still image at the selected start and end points are displayed during the process.

- ▶ Press the **FN** button to confirm your cuts

The video cutting submenu appears.

Note

To exit the video screen without executing the configured cuts:

- ▶ Press the **PLAY** button

The video playback screen reappears.

When cuts were confirmed, further operation will be done by selecting one of the three submenu items. The procedure is identical in each case:

- **Save as new**

The new video is additionally saved, i.e. the original video remains unchanged.

- **Overwrite**

The newly cut video is saved and the original one is deleted.

- **Preview**

The new video is played. The newly cut video is not saved and the original remains unchanged.

In all three cases, a notification screen appears while the data is being processed. When processing is completed, the first scene of the new video is played back.

MISCELLANEOUS

USER PROFILES

Your Leica CL can permanently store any combination of all menu settings, which can be useful, as they will then be quickly and easily accessible for recurring situations/subjects. A total of seven memory slots are available for these combinations. All menu options can be restored to the factory settings (**Default Profile**) at any time:

Creating profiles

- ▶ Set the desired functions in the menu
- ▶ Select **User Profile** in the **Main Menu** (3rd screen page)
- ▶ Select **Manage Profiles** in the **User Profile** submenu
- ▶ Select **Save as Profile** in the **Manage Profiles** submenu
- ▶ Select the desired memory slot for the profile

Applying profiles

- ▶ Select desired memory slot for your profile or **Default Profile** in the **User Profile** submenu

Notes

- **Default Profile** will allow you to access the factory settings at any time, even if menu settings are stored in one or more of the three profiles.
- Unlike the **Reset Camera** function described in “Resetting all custom settings”, your settings for time, date and language will not be reset by selecting **Default Profile**.

Renaming profiles

- ▶ Select **Rename Profiles** in the **Manage Profiles** submenu
- ▶ Select the desired memory slot for the profile
- ▶ Enter the new profile name in the relevant keypad submenu

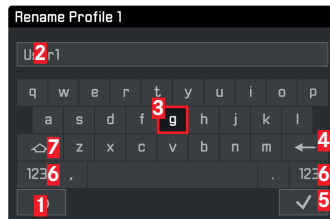

- 1** “Back” button (for returning to the previous menu level without confirming any settings)
- 2** Input line
- 3** Keypad
- 4** “Delete” button (deletes the last character entered)
- 5** “Confirm” button (confirms individual characters and finished settings)
- 6** Changing the character type
- 7** Shift key

The keypad can be operated in various ways:

Using gesture control

- ▶ Tap the desired value or the relevant “button”

Using button/setting wheel controls

To move left or right:

- ▶ Turn the setting wheel on the right or press the directional pad right/left

To go up or down:

- ▶ Press the directional pad up/down

To confirm a value or setting:

- ▶ Press the center button

Transferring profiles to / from a memory card

You can copy the profile memory slots to the memory card or copy them from the memory card to the camera. Both procedures are performed the same way in principal:

- ▶ Select **Manage Profiles** in the **User Profile** submenu
- ▶ Select **Export Profiles** or **Import Profiles** in the submenu
- ▶ Confirm the export/import (**Yes**) or decline (**No**)

Note

All profile memory slots are imported to the memory card, including empty profiles. Any existing profiles stored in the camera will be overwritten, i.e. deleted during the profile import.

RESETTING ALL CUSTOM SETTINGS

This function allows you to reset all menu settings to restore the factory settings. You can choose to leave the user profiles, WLAN settings and/or the reset of the image numbers intact:

- ▶ Select **Reset Camera** in the **Main Menu** (5th screen page)
- ▶ Confirm deletion of profile settings (**Yes**)/ decline (**No**) and/or
- ▶ Confirm deletion of WLAN settings (**Yes**)/decline (**No**) and/or
- ▶ Confirm reset of the image numbers (**Yes**)/decline (**No**)

Notes

- You can alternatively reset the image file numbers via the menu item **Reset Image Numbering**.
- This reset will also affect the settings for **Date & Time** and **Language**. The welcome video will appear the next time the camera is switched on. Please read the sections “Menu language“ (page 26) and “Date / Time“ (page 26) for information about what to do next.

Your Leica CL saves picture/video files with ascending numbers and stores them in automatically created folders. The picture file names are eight digits long: “L” for the (Leica) camera, three numbers to identify the folder and four numbers for the picture/video, e.g. “L1001234”. You can reset this number assignment at any time:

- ▶ Select **Reset Image Numbering** in the **Main Menu** (4th screen page)
- ▶ Confirm (**Yes**) or decline (**No**)

A new folder is created automatically and the numbering starts again if you reset the numbering, or if the current folder contains the picture file number 9999. Example: Last picture/video before the reset “L1009999”, first picture/video after the reset “L1010001”. This can be a useful feature to help you sort picture/video files more clearly.

The folder number will be the next available number; you can have max. 999 folders.

A warning message will be displayed on screen and you will be prompted to reset the numbering when all numbers have been assigned and the count is at “L9999999”.

Notes

- If the memory card used already contains a picture file with a higher number than the last number assigned by the camera, the numbers will then be counted upward from the numbering on the memory card.
- Format the memory card and reset the picture number right after to reset the folder number to 100.

CHANGING FILE NAMES

You can replace the first letter of a picture file name with any other letter:

- ▶ Select **Edit File Name** in the **Main Menu** (4th screen page)
- ▶ Enter the desired letter in the relevant keypad submenu.

The process is basically the same as renaming a profile (see p. 76).

WIRELESS DATA TRANSMISSION AND REMOTE CONTROL OF THE CAMERA VIA WLAN

You can control your Leica CL remotely using a smartphone/tablet or use the smartphone/tablet as an external storage medium. You will have to install the Leica CL app on your smartphone first. This app is available at the Google Play Store™ for Android™ devices and at the Apple App Store™ for iOS™ devices.

Note

In this section, the term "smartphone" refers to smartphones as well as tablets.

WLAN function variants

Your first decision will have to be whether you want to establish a WLAN connection to the camera directly via a smartphone

– **Connect to App** or via a browser – **Web Server**. The function **Backup** will keep the camera permanently connected or will connect automatically to your smartphone when it is switched on. **Off** deactivates the WLAN function. The connections will allow remote picture creation and playback and the storing of image/video files on your smartphone. A connection via browser will additionally allow saving your pictures in DNG format.

- ▶ Select **WLAN** in the **Main Menu** (4th screen page)
- ▶ Select **Function** in the submenu
- ▶ Select the desired setting

Note

There are two methods for establishing a connection to your smartphone (see “Selecting a connection method”).

Other operations via the variant **Connect to App**

- ▶ Establishing a connection with a smartphone
- ▶ Select “Camera Control” in the Leica CL app
- ▶ Taking pictures

Pictures taken are stored in the camera.

The most important settings are available in the Leica CL app.

Other operations via the variant **Web Server**

When **Web Server** is selected in the **Connection** submenu, an information screen with the information you need for the connection will appear.

Open a browser window and type in the URL displayed on the camera to create a connection between your PC or smartphone and the camera within a WLAN network.

Selecting a connection method

There are two methods for establishing a connection between your camera and your smartphone. If you have access to a WLAN network, the **Join WLAN** method is recommended. In this method, the camera and smartphone will be in the same WLAN network.

Establishing a connection via **Create WLAN** may be practical if you don't have access to a WLAN network: In this method, the camera generates an access point (hot spot) via which you can connect to your smartphone.

- ▶ Select **WLAN** in the **Main Menu** (4th screen page)
- ▶ Select **Connection** in the submenu
- ▶ Select **Create WLAN** or **Join WLAN**

Later operation will differ, depending on which option you choose:

Join WLAN

Select a network from a list of available WLAN networks if you want to establish a network connection.

- ▶ Select **WLAN** in the **Main Menu** (4th screen page)
- ▶ Select **Setup** in the submenu
- ▶ Select the desired setting

An intermediate screen appears briefly while the device searches for available networks.

The relevant submenu will appear, once the process is completed. It contains the menu items **Scan** and **Add Network** and lists all networks the camera has found.

Establishing a connection with a smartphone in **Join WLAN** mode

- ▶ Select the desired network from the list

Repeat the search by selecting the menu item **Scan** if the network you are looking for is not listed.

Establishing a connection to an invisible WLAN network

- ▶ **Add Network**
- ▶ Enter the **SSID/Network Name** and the encryption method (**Client Security**) in the relevant submenu

Create WLAN

All settings for this menu item are preset ex works. Proceed as follows if you want to change these settings for some reason:

- ▶ Select **WLAN** in the **Main Menu** (4th screen page)
- ▶ Select **Setup** in the submenu
- ▶ Select **SSID/Network Name**, **Security** or **Password**
- ▶ You can change the camera name within the network via the **SSID/Network Name** keypad submenu.
- ▶ You can also change the password via the keypad submenu **Password**.

The procedure in both keypad submenus is exactly the same as described in the section “Renaming profiles” on page 76.

We recommend leaving the preset **WPA2** encryption method in the **Security** submenu unchanged. Use the variant **Open** only if you are sure that unauthorized access will be impossible.

Establishing a connection to a smartphone in [Create WLAN](#) mode

Establishing a connection via QR code:

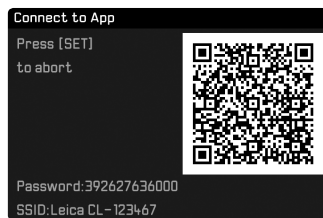

Using an iOS smartphone (with an operating system version no higher than 8.3):

- ▶ Launch the Leica CL app on your smartphone
- ▶ Select “Connect via QR Code”
- ▶ Scan the QR code shown on the camera with the Leica CL app
- ▶ Import the “Leica CL” profile on your smartphone
- ▶ Select “Install”, then “Install” again, and then “Done”

A message will appear in the web browser on the smartphone.

If a passcode is needed to access the smartphone:

- ▶ Enter the passcode
- ▶ Click the “Home” to close the web browser
- ▶ Select and activate “WLAN” under “Settings” on the smartphone
- ▶ Select the SSID displayed on the camera (default: Leica CL)
- ▶ Return to the “Home” screen of your smartphone
- ▶ Launch the Leica CL app

Note

Subject to changes in subsequent versions of the operating system.

Using an Android smartphone:

- ▶ Launch the Leica CL app on your smartphone
- ▶ Select “Connect via QR Code”
- ▶ Scan the QR code shown on the camera with the Leica CL app

The next steps are the same for both smartphone types.

Establishing a connection using SSID and password:

- ▶ Launch the Leica CL app on your smartphone
- ▶ Select “WLAN”
- ▶ Select the SSID displayed on the camera
- ▶ Enter the password shown on this device (only when establishing a connection for the first time)

Notes

- When using devices or computer systems that require more reliable security than WLAN devices, appropriate measures must be taken to ensure security and protection against disruptions to the systems used.
 - Leica Camera AG accepts no liability for damage arising from the use of the camera for purposes other than as a WLAN device.
 - It is assumed that the WLAN function will be used in the countries where this camera is sold. The use in other countries may violate local communications transmission provisions. Leica Camera AG accepts no liability for violations of this kind.
 - Please notice that data transmitted and received wirelessly can be intercepted by third parties. We highly recommend that you activate the encryption in the wireless access point settings to ensure data safety.
- Avoid using the camera in the vicinity of magnetic fields, static electricity or other interferences, e.g. in the vicinity of a microwave oven. The wireless transmissions may otherwise not reach the camera.
 - Using the camera in the vicinity of devices like microwave ovens or cordless telephones using the 2.4 GHz radio frequency wavelength may negatively impact the performance of both devices.
 - Do not connect to wireless networks you are not authorized to use.
 - The device will automatically search for wireless networks when the WLAN function is activated. Some networks you are not authorized to use may appear in the list. Do not attempt to connect to such a network, as this could be construed as unauthorized access.

TRANSFERRING DATA TO A COMPUTER

The picture data on a memory card can be transferred to a computer via a card reader for SD /SDHC/SDXC cards.

DATA STRUCTURE ON THE MEMORY CARD

The transfer of data stored on a card onto a computer occurs in folders, which will be named 100LEICA, 101LEICA, etc.: Each folder can contain up to 9999 pictures.

FORMATTING

Memory cards that have already been in use will usually not require formatting. Formatting will, however, be the first step when you are inserting an unformatted memory card for the first time. The relevant confirmation screen will be displayed automatically.

We recommend formatting memory cards from time to time, because residual data traces (data pertaining to individual pictures) may reduce the card's memory capacity.

- ▶ Select **Format** in the **Main Menu** (4th screen page)
- ▶ Confirm **(Yes)** or decline **(No)**

Notes

- All data stored on a memory card will be lost during formatting.
- We therefore recommend that you make habit of regularly transferring all your pictures to a secure mass storage medium, e.g. the hard drive on your computer.
- Never switch off the camera while data transfer is in progress.
- Make sure to reformat the memory card in your camera if it was originally formatted in another device, e.g. a computer.
- Ask your dealer or the Leica Product Support for advice if the memory card cannot be formatted.
- Formatting will not be prevented by the deletion protection set for individual pictures.

WORKING WITH RAW DATA (DNG)

You will need specific software for editing data in DNG format, e.g. the professional raw data converter Adobe® Photoshop® Lightroom®. This software allows you to convert stored raw data in excellent quality and also offers quality optimized algorithms for digital color processing, which also ensure low noise and astonishingly high picture resolution.

During editing, you can adjust parameters like gradation, sharpness etc. in retrospect to achieve the best possible image quality.

INSTALLING FIRMWARE UPDATES

Leica is continuously working on the further development and optimization of its products. As digital cameras have many functions that are controlled solely electronically, some of these improvements and function enhancements can be installed on the camera at a later date. Leica offers firmware updates at irregular intervals, which you can download from our website.

Leica will notify you of any new updates, once you have registered your camera.

Find out which firmware version is currently installed:

- ▶ Select **Camera Information** in the **Main Menu** (5th screen page)
- ▶ Select **Firmware** in the submenu

Your currently installed firmware version number is shown in the first line of the submenu.

Please visit the “Customer Service” section of our website at <https://owners.leica-camera.com> for more information on how to register, on firmware updates for your camera, how to do an update, plus changes and additions to this manual

Notes

- The warning message **Insufficient battery Update not possible** appears if the battery charge level is insufficient to complete an update. Please charge the battery fully and then repeat the process described above.
- Make sure to follow all the instructions regarding the recommissioning of your camera.
- You will find additional device and country-specific registration marks and numbers in the **Camera Information** submenu.
- Installing a firmware update will revert all camera settings back to the factory settings, which means all your settings will be lost.

INSTRUCTIONS FOR CARE & USE

Camera

- Only clean the camera with a soft, dry cloth. Stubborn dirt should first be moistened with a watered-down detergent and can then be wiped away with a dry cloth.
- Wipe the camera with a clean, lint-free cloth to remove spots and fingerprints. Tougher dirt is hard to reach corners of the camera housing can be removed with a small brush.
- All mechanically operated bearings and sliding surfaces on your camera are lubricated. Please remember the following if the camera has not been used for an extended period of time: Operate the camera a few times in three-month intervals to prevent a hardening of the lubricant. We also recommend repeated adjustment and use of the setting wheels.

Lenses

- A soft hair brush will usually suffice to remove dust from the outer lens. Remove more severe soiling with a very clean, soft cloth that is completely free of foreign matter. Wipe the lens in circular motions from the inside outward. We recommend using microfiber cloths (available from photography retailers and opticians) that are stored in a protective container and are machine-washable up to 40 °C (do not use fabric softener, never iron!). Do not use spectacle lens cleaning cloths, because they are soaked in chemicals, which could damage the lens glass.
- The lens hoods supplied protect the lens against accidental fingerprint smudges and rain.

Battery

Rechargeable lithium-ion batteries generate power by way of internal chemical reactions. These reactions are influenced by ambient temperature and humidity. Very high or very low ambient temperatures reduce the service life of the battery.

- Always remove the battery if the camera will not be used for an extended period of time. Leaving the battery in the camera will result in a deep discharge after a few weeks, which means voltage levels could drop significantly.
- Lithium-ion batteries should only be stored partially charged, i.e. not fully depleted or fully charged. During very long storage periods, the battery should be charged for approx. 15 minutes twice a year to prevent deep discharge. Always keep the battery contacts clean and readily accessible. Although lithium-ion batteries are secured against short circuits, they should still be protected against contact with metal objects like paper clips or jewelry. A short-circuited battery can get very hot and cause severe burns.
- The battery must have a temperature between 0 °C and 35 °C (32 °F and 95 °F) for charging, as the charger may otherwise not switch on, or will automatically switch off.
- Check the housing and the contacts immediately for any damage if a battery is accidentally dropped. A damaged battery can damage the camera.
- Batteries have a limited service life.
- Take your defective batteries to a collection point to ensure correct recycling.
- Never throw batteries into a fire as they might explode!

Charger

- Using the charger in the vicinity of broadcast receivers may interfere with the reception of the device; Ensure a distance of at least 1 m (3 ft) between the charger and the receiver.
- When the charger is in use, it may emit a buzzing sound – this is normal and not a malfunction.
- Disconnect the charger from the mains when it is not in use, because it consumes some (a very small amount) electricity, even when no battery is inserted.
- Always keep the charger contacts clean, and never short circuit them.

Memory cards

- Never remove the memory card during a picture save or card reading process. The camera must not be switched off or be subjected to impact or vibrations.
- Make sure to store memory cards in their anti-static container when not in use.
- Do not store memory cards where they will be exposed to high temperatures, direct sunlight, magnetic fields or static electricity.
- Do not drop or bend memory cards as this will cause damage and result in the loss of the stored data.
- Always remove the memory card if the camera will not be used for an extended period of time.
- Do not touch the connections on the reverse of the memory card and keep them away from dirt, dust and moisture.
- We recommend formatting the memory card from time to time, because fragmented residual data from deleted files may block some of the storage capacity of the memory card.

Storage

- Recommendations if the camera will not be used for an extended period of time:
 - a. Switch it off,
 - b. remove the memory card, and
 - c. remove the battery.
- A camera lens can have the effect of a magnifying glass – especially when exposed to direct frontal sunlight. Never store the camera without lens protection. Using the lens cap and keeping the camera in the shade – ideally in its camera case – will help prevent damage to the interior of the camera.
- Store the camera in a closed and padded container to prevent friction damage and protect it against dust accumulation.
- Store the camera in a dry, sufficiently ventilated place, where it will not be subjected to high temperatures and humidity. When the camera was used in humid conditions, make sure to remove all moisture before storing it.
- Camera bags that have gotten wet during use must be emptied completely to prevent moisture damage to your equipment or damage from tanning agents released.
- To prevent fungal growth during use in tropical climates, the camera equipment should be exposed to the sun and air as often as possible. Storage in airtight containers or cases is recommended only in conjunction with a desiccant like silica gel. The camera should therefore also not be stored in a leather case for extended periods of time.
- Moisture can cause malfunctions and irreparable damage to the camera and memory card.
- Note down the serial number of your Leica CL. This information may be very important in case of loss or theft.

MENU OVERVIEW

	Favorites		Direct access via the FN/right setting wheel button ¹		Page
	Factory settings	Available	Factory settings	Available	
Drive Mode	●	● ²	● ²	● ²	36/54
Self Timer		●	●	●	58
Focusing	●	● ³		● ⁴	38
Exposure Metering	●	●	●	●	45
Exposure Compensation		●		●	54
ISO		●	●	●	33
Autom. ISO setting		●		●	33
White Balance		● ⁵	●	●*	32
Photo File Format		●	●	●	32
JPG Resolution		●		●	32
Film Style	●	●		●	33
Scene Mode		●	●	●	49
Optical Image Stabilization		●		●	35
Electronic Shutter		●		●	36
Flash Settings		●		●	60
Exposure Preview		●		●	46
User Profile	●	●	●	●	76
Video Resolution		●		●	62
Video Settings					63

	Favorites		Direct access via the FN /right setting wheel button ¹		Page
	Factory settings	Available	Factory settings	Available	
Video Style	●	●			63
Capture Assistants					30
Display Settings					28
Auto Review					65
Lens Profiles		●	● ⁷		35
Customize Button assignment		● ¹			23
WLAN	●	●	●		80
Edit File Name					79
Reset Image Numbering					78
Power Saving					29
Acoustic Signals					27
Wheel Lock in Live View		●	●		19
Play Mode Setup					30
Format Card		●			84
Camera Information					85
Date & Time					26
Language					26
Reset Camera					76

¹ In picture mode

² **Drive Mode** menu items **Interval** and **Exposure Bracketing**, also available individually

³ **Focusing** menu items **Focus Mode**, **AF Mode** and **Focus Assist**, also available individually

⁴ **Focusing** menu items **Focus Mode**, **Focus Limit (Macro)**, **AF Mode** and **Focus Assist**, also available individually

⁵ **White Balance** menu item **Gray Card**, also available individually

⁶ **White Balance** menu items **Gray Card** and **Color Temperature**, also available individually

⁷ **Lens Profiles** menu items **M-Lenses** and **R-Lenses**, also available individually

⁸ **Customize Control** menu item **Edit Favorites**, also available individually

APPENDIX

DISPLAYS ON SCREEN/IN THE VIEWFINDER

Picture mode

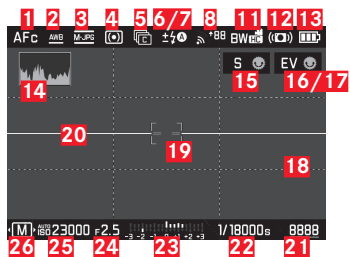

- 1** Focusing mode
- 2** White balance mode
- 3** File format/Video resolution/frame rate
- 4** Exposure metering method
- 5** Pictures
(Single/serial exposures, time-lapse pictures, bracketing)
- 6** Flash exposure mode,
with flash compensation as needed
- 7** Recording level (only in video mode, appears instead of displays **5** and **6**)
- 8** WLAN activated/Signal strength
- 9** Data transmission to smartphone incl. remaining pictures
- 10** **01:20** Video recording time (only in video mode, appears instead of displays **8** and **9**)

- 11** Color Rendering
- 12** Stabilization activated
- 13** Battery charge level
- 14** Histogram
- 15** Function of the left setting wheel (short-term when activated)
- 16** Function of right setting wheel (short-term when activated)
- 17** ● Video recording status (gray = video preview, flashing red = video recording appears instead of display **16**)
- 18** Auxiliary grid
- 19** Autofocus metering field
- 20** Horizon
Long horizontal lines indicate inclination:
- red = tilted
- green = horizontal
Short horizontal line indicates tilting:
- line visible = tilted
- no line = not tilted
- 21** Remaining number of pictures/elapsed video recording time (the flashes as a warning if there is no storage capacity)
- 22** Shutter speed

- 23** Light balance
top = exposure indicator/compensation, white lines = exposure fine or difference of up to 3 EV from standard exposure, red lines = more than 3 EV difference from standard exposure;
bottom = exposure compensation
- 24** Aperture
- 25** ISO sensitivity/setting
- 26** Exposure mode (* = reference to modified shutter speed/aperture combination, appears only in auto mode and after shift)/scene mode
- 27** Indication (only when changing exposure modes/scene mode)

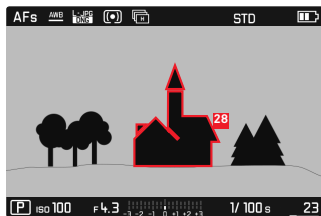

- 28** Marking for in-focus edges
("peaking", color selectable)

Playback mode

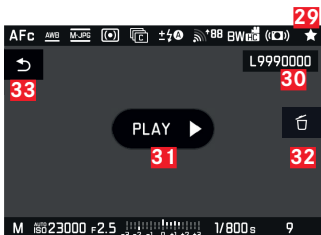

- 29** Indication for marked picture/video
- 30** File number of the picture/video shown
- 31** Indication for video playback
- 32** Indication for the use of the center button to delete individual pictures
- 33** Indication for the use of the PLAY button to hide individual picture deletion

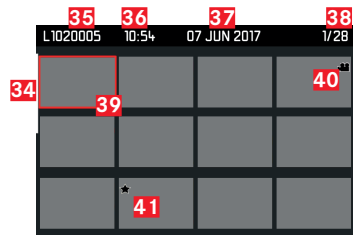

- 34** Scrollbar: for page overview
- 35** File number of the marked picture/video
- 36** Recording time of the marked video
- 37** Recording date of the marked video
- 38** Picture counter, selected picture/total number of pictures
- 39** Indicator for selected pictures/videos
- 40** Video recording
- 41** Indicator for marked pictures/videos

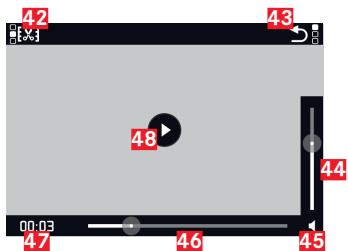

- 42** Icon for accessing the video editing function incl. softkey
- 43** Icon for exiting video playback incl. softkey
- 44** Volume setting bar
- 45** Display for audio playback (🔊 = audio playback deactivated)
- 46** Playback bar
- 47** Elapsed playback time
- 48** Icon for resuming playback (⏮ = playback paused)

Displays in the top display

When the camera is switched on



- 1** Camera name
- 2** Battery status

Standard view



- 3** Aperture
- 4** Exposure mode
- 5** Shutter speed

When changing exposure modes



- 6** Currently set exposure mode
- 7** Arrows for the shift direction

TECHNICAL DATA

Camera name

Leica CL

Camera type

Digital APS-C system camera

Type No.

7323

Order No.

19 301 (black)

Lens mount

Leica L bayonet with contact strip for communication between lens and camera

Compatible lenses

Lenses with Leica L bayonet, Leica M/R lenses using the Leica M Adapter L/Leica R Adapter L

Sensor

APS-C-sized CMOS sensor (23.6 x 15.7 mm) with 24.96/24.24 million pixels (total/effective), aspect ratio: 3:2

Resolution

Overall pixels: 6088 x 4100 pixels (24.96 MP), effective pixels: 6032 x 4032 pixels (24.32 MP), active pixels: 6024 x 4024 pixels (24.24 MP), DNG: 6016 x 4014 pixels (24 MP), JPG: optionally 6000 x 4000 pixels (24 MP), 4272 x 2856 pixels (12 MP) oder 3024 x 2016 pixels (6 MP)

Photo File Format/Compression rate

Optionally: DNG, JPG or DNG + JPG

Video recording format

MP4

Video Resolution/Image Sequence

Selectable: 3840 x 2160 p (4 K) 30 B/s, 1920 x 1080 p (FHD) 60 B/s, 1920 x 1080 p (FHD) 30 fps or 1280 x 720 p (HD) 30 fps

Duration of Video Recording

You can record video up to 29 minutes without interruption, depending on ambient and camera temperature. The maximum file size is 4 GB. Once a recording exceeds this limit, the overrun will be automatically stored in a new file.

Storage Media

UHS-II, UHS-I, SD/SDHC/SDXC memory card

ISO Range

Automatic, ISO 100 to ISO 50000

White Balance

Automatic, presets for daylight, cloud, halogen lighting, shadow, flash, one memory slot for manual settings, manual color temperature settings

Autofocus System

Contrast

Autofocus metering methods

Spot, field, multi-field, face detection, touch-controlled AF function

Exposure modes

Automatic, aperture priority, shutter priority, manual setting, scene modes: fully automatic, sport, portrait, landscape, night portrait, snow/beach, fireworks, candlelight, sunset, digiscope, thumbnail, panorama, HDR

Exposure metering methods

Multi-field, center-weighted, spot

Exposure Compensation

± 3 EV in 1/3 EV increments

Automatic exposure bracketing

Three or five pictures in gradations up to ± 3 EV, adjustable in 1 EV increments

Shutter speed range

30 s to $\frac{1}{25000}$ s (up to $\frac{1}{8000}$ s with mechanical, beyond that with electronic shutter)

Picture series

Max. approx. 10 fps with mechanical shutter, max. approx. 10 fps with electronic shutter, max. approx. 33 pictures (ONG+JPG) at constant exposure frequency, then depending on memory card properties

Flash modes

Configurable with attached, system-compatible flash unit

Flash exposure compensation

± 3 EV in $\frac{1}{3}$ EV increments

Flash sync speed

$\frac{1}{180}$ s

Viewfinder

Resolution: 1024 x 768 pixels (2.36 MP), magnification: 0.74x, aspect ratio: 4:3, exit pupil position: 20 mm, configurable ± 4 dioptres, with eye sensor for automatic toggling between viewfinder and screen

Top display

Resolution: 128 x 58 pixels

Screen

3" TFT LCD, 1.04 MP, touch control available

Self-timer

Configurable delay time 2 or 12 s

WLAN

Complies with the IEEE 802.11b/g/n standard (standard WLAN protocol), channel 1-11, encryption method: WLAN-compatible WPA™/WPA2™, Access method: Infrastructure mode

Interfaces

Accessory shoe with Leica flash interface

Power supply

Leica BP-DC12 lithium-ion battery, rated voltage: 7.2 V \equiv (7.2 V DC), capacity: 1200 mAh, (according to CIPA standard): approx. 220 pictures, charging time (after deep discharge): approx. 140 min, manufacturer: Panasonic Energy (Wuxi) Co., Ltd. Made in China

Charger

Leica BC-DC12, input: AC 100-240 V, 50/60 Hz, automatic switchover, output: DC 8.4 V; 0.65 A, manufacturer: Shin Tech Engineering Ltd., Made in China

Housing

Top and bottom covers: milled and anodized aluminum, front and rear panels: magnesium

Tripod thread

A $\frac{1}{4}$ DIN 4503 ($\frac{1}{4}$ ")

Dimensions (WxHxD)

approx. 131 x 78 x 45 mm

Weight

approx. 403 g/353 g (with/without battery)

Scope of delivery

Camera housing, camera bayonet cover, carry strap, accessory shoe cover, battery (Leica BP-DC12), charger (Leica BC-DC12), mains cable (EU, US, local mains cable)

Software

Leica CL app (remote control and picture transfer, free download from Apple™ App-Store™/Google™ Play Store™)

Subject to changes in design and production.

LEICA SERVICE ADDRESSES

LEICA PRODUCT SUPPORT

The Product Support Department at Leica AG can answer any technical questions relating to Leica products, including support for the supplied software in writing, on the phone or by email. It is also your first point of contact for purchasing advice and manual orders. Alternatively, you can send us your questions using the contact form on the Leica Camera AG website.

Leica Camera AG
Product Support/Software Support
Am Leitz-Park 5
35578 Wetzlar, Germany
Telephone: +49(0)6441-2080-111 /-108
Fax: +49(0)6441-2080-490
info@leica-camera.com / software-support@leica-camera.com

LEICA CUSTOMER CARE

The Leica Camera AG Customer Care department or the repair service provided by authorized Leica agents in your country are available for service, maintenance and repairs of your Leica equipment (visit the Leica Camera AG website for a list of addresses).

Leica Camera AG
Customer Care
Am Leitz-Park 5
35578 Wetzlar, Germany
Tel.: +49(0)6441-2080-189
Fax: +49(0)6441-2080-339
customer.care@leica-camera.com



DAS WESENTLICHE.

Leica Camera AG | Am Leitz-Park 5 | 35578 WETZLAR | DEUTSCHLAND

Telefon +49(0)6441-2080-0 | Telefax +49(0)6441-2080-333 | www.leica-camera.com

93 789 XI/17/LW/D