

C & A

Building Plastics

BIG STOCKS - LOW PRICES - BEST VALUE!



POLYCARBONATE



GLAZING BARS



CORRUGATED



FASCIA & SOFFIT

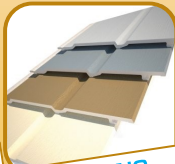

CLADDING



UNDERGROUND



GUTTER & PIPE



**DOOR CANOPIES
PLUS LOTS MORE!**

Over 50 Years supplying a **HUGE** range of plastic building materials **NATIONWIDE!**

SHOP ONLINE NOW!

www.cabp.co.uk

Catalogue Edition 75 075/03/18

NATIONAL SALES

01634 374444

CONTENTS PAGE

02

PAGE	DESCRIPTION	PAGE	DESCRIPTION	PAGE	DESCRIPTION	PAGE	DESCRIPTION
02	CONTENTS PAGE	28	GLAZING BAR KNOW HOW	54	OGEE & BULLNOSE FASCIA—WHITE	80	SUSPENDED CEILING FRAME
03	ABOUT US	29	GLAZING BAR KNOW HOW	55	WOODGRAIN FASCIA & SOFFIT	81	SUSPENDED CEILING TILES
04	4mm SPC* CLEAR & 10mm HAZE	30	3" CORRUGATED SHEET	56	COLORMAX—FASCIA & CAPPIT	82	DOOR CANOPIES—700mm
05	10mm SPC* CLEAR BRONZE AND	31	3" ACCESSORIES + MINI PROFILE	57	COLORMAX—SOFFIT	83	DOOR CANOPIES—900mm
06	16mm SPC* HAZE AND CLEAR	32	BOX CORRUGAED PVC	58	WHITE CLADDING	84	DOOR CANOPIES PREMIER RANGE
07	16mm SPC* BRONZE AND OPAL	33	BIG 6 & MINI PROFILE CORRUGATED	59	170mm FORTEX TEXTURED CLADDING	85	RUBBER ROOFING
08	25mm SPC* CLEAR AND HEAT/OPAL	34	ONDULINE BITUMEN SHEETS	60	300mm FORTEX TEXTURED CLADDING	86	FLAT ROOF DOMES
09	25mm SPC* CLEAR/ BRONZE /OPAL	35	ONDUVILLA	61	333mm FORTEX TEXTURED CLADDING	87	FLAT ROOF DOMES WITH UPSTAND
10	35mm SPC* CLEAR/ BRONZE /OPAL	36	CA32 PLASTIC COATED STEEL	62	FASCIA & CLADDING ACCESSORIES	88	BATH & SHOWER SUITES
11	40mm SPC* CLEAR	37	CA32 STEEL TRIMS	63	TRIMS & WINDOW BOARDS	89	VALUE RANGE
12	MULTIWALL (SPC) KNOW HOW	38	GALVASTEEL	64	DRY VERGE'S	90	SILICONE
13	MULTIWALL (SPC) KNOW HOW	39	15 & 22mm SPEEDFIT	65	ARTIFICIAL GRASS	91	SILICONE & ADHESIVE
14	SPC* ROOF VENTS	40	15 & 22mm COPPER PIPE & FITTINGS	66	DECKING	92	CLEANERS
15	VALE GLAZING BARS	41	15 7 22mm BRASS COMPRESSION	67	DECKING	93	EXPANDING FOAM
16	GLEN GLAZING BARS	42	32, 40 & 50mm SOLVENT WASTE	68	SKIRTING	94	SCREWS & NAILS
17	HAWK GLAZING BARS	43	110mm SOIL PIPE & FITTINGS	69	ORAC COVING	95	CORRUGATED FIXINGS
18	AVON GLAZING BARS	44	110mm UNDERGROUND DRAINAGE	70	VINYL FLOORING	96	TOOLS
19	AVON GLAZING BARS	45	110mm UNDERGROUND DRAINAGE	71	VINYL FLOORING	97	TOOLS
20	PEAK GLAZING BARS	46	GUTTER HALF ROUND & SQUARE	72	INTERNAL WALL PANELS 10mm	98	TERMS & CONDITIONS
21	PEAK GLAZING BARS	47	GUTTER OGEE & FULL FLO	73	INTERNAL WALL PANELS 10mm	99	TERMS & CONDITIONS
22	YORK GLAZING BARS	48	DOWN PIPES	74	INTERNAL WALL PANELS 7mm	100	DELIVERY INFORMATION & MAPS
23	YORK GLAZING BARS	49	GUTTER & PIPE— CAST IRON	75	INTERNAL WALL PANELS 7mm	101	DELIVERY CHARGES
24	GLAZING BAR ACCESSORIES	50	GUTTER ACCESSORIES	76	INTERNAL WALL PANELS 5mm	102	HOW TO ORDER
25	GLAZING BAR ACCESSORIES	51	FASCIA KNOW HOW	77	INTERNAL WALL PANELS 5mm	103	ORDER FORM
26	SANCTUARY CANOPIES	52	SQUARE FASCIA & CAPPIT—WHITE	78	SOLID FLAT SHEET WHITE PVC		
27	SANCTUARY CANOPIES	53	SOFFIT BOARDS—WHITE	79	SOLID FLAT SHEET POLYCARBONATE		

*SPC=Structured Polycarbonate / Multiwall Polycarbonate

C&A Building Plastics

Tel 01634 374444 www.cabp.co.uk



C & A were established in 1968 by the founding couple Charles and Audrey so 2018 is a special year with our golden anniversary. To celebrate our 50th anniversary we are giving away **FREE** gifts throughout 2018 with all qualifying orders so keep an eye out for your **FREE** gifts with all order containing products over the value of £50 nett.

Back in 1968 plastics were a relatively new product for the construction industry but C & A had the vision that these were going to be important building blocks for the future. Coming from a carpentry background, it only made sense that these carpentry skills should be used in conjunction with the new emerging plastic products, and the focus was on canopies and carports. These canopies were made-to-measure, sold as either self-assembly kits or with a complete installation service provided. With a lot of hard work and determination C & A became one of the largest distributors of PVC corrugated sheets in the UK! In the 80's there was a new kid in town in the form of "Multiwall Polycarbonate" C & A could see the advantages of this and within 3 weeks we had sold a full pallet which dumfounded the manufacturer who wanted to know what we had done with it all as they could not believe it was gone already. We could see a great demand for polycarbonate and made this one of our premium products these days it's used in just about everything you come across in everyday life and you probably don't realise. Over the years C&A have become one of the largest independent UK stock holders of polycarbonate sheeting and have continued to stay at the leading edge of this product range. We are often consulted by the manufacturers as to the product's feasibility in the UK market before it goes into full production and is not uncommon for C & A to take part in initial production runs to help launch new product lines to the UK.

It's never easy trying to stay at the front of the market and C & A missed the emergence of the UPVC fascia and soffit market in the early 1990's and were playing catch up for a while. Learning from this experience we are always looking for feedback and suggestions from our customers which has led to our range continuously growing over the years. Part of our continuous innovation has resulted in C & A designing our own range of glazing bars over the years, each with different attributes to suit and range of applications.

C & A today is not too dissimilar to the founding beginnings, it is still a family firm, but we now have a lot more than 2 people! Plastics are still becoming ever more important to the building industry and we take pride in keeping at the cutting edge of this industry.

We are always working hard behind the scenes and 2018 is a year that will see our product range grow even more with our NEW plumbing and Bathroom centre showroom opening at the Gillingham Branch supplying a full range bathroom suites, showers, copper and plastic plumbing fittings

Want to know more then please ensure you keep your records up to date with us, so that you can be the first to hear all about our newest developments, products and special offers!



ABOUT C&A BUILDING PLASTICS

4mm CLEAR

TWINWALL POLYCARBONATE



3.9
"U" VALUE

- ▶ Lightweight
- ▶ Insulating
- ▶ Low cost

0.8
KG/sq.m

**MAX SUNLIGHT
MAX VISION**

GREENHOUSE PACK

Pack of 10 Sheets

SHEET SIZE: 4ft x 2ft (1220mm x 610mm)

4mm Multiwall Polycarbonate sheets are perfect for greenhouse glass replacement as a low cost alternative to glass, giving a long life and they are also easily be trimmed to size.

PART	PRICE
KB41206CL	£39.99

10mm HAZE

TWINWALL POLYCARBONATE

3.1
"U" VALUE

UV PROTECTION

1.5
KG/sq.m

**MIN SUNLIGHT
MIN VISION**

C&A HOME BRAND Offers Quality with affordability



These super value sheets have a high regrind content allowing them to offer dependable roofing at the lowest possible cost. Misty White in-colour to give a clean look, privacy & shade.

Exclusive to
C&A Building Plastics

4mm CLEAR **BONUS**



WIDTH	695mm (2' 3 ^{1/2} "		1047mm (3' 5 ^{1/2} "		2100mm (6' 10 ^{1/2} "	
	PART	PRICE	PART	PRICE	PART	PRICE
1.0M (3' 3")	MB41007CL	£3.99	MB41010CL	£5.97	MB41021CL	£11.97
1.5M (4' 11")	MB41507CL	£6.49	MB41510CL	£9.70	MB41521CL	£19.47
2.0M (6' 6")	MB42007CL	£8.69	MB42010CL	£12.99	MB42021CL	£26.07
2.5M (8' 2")	MB42507CL	£10.79	MB42510CL	£16.13	MB42521CL	£32.37
3.0M (9' 10")	MB43007CL	£12.99	MB43010CL	£19.42	MB43021CL	£38.97
3.5M (11' 6")	MB43507CL	£15.29	MB43510CL	£22.86	MB43521CL	£45.87
4.0M (13' 1")	MB44007CL	£17.39	MB44010CL	£26.00	MB44021CL	£52.17
5.0M (16' 5")	MB45007CL	£22.99	MB45010CL	£34.37	MB45021CL	£68.97
6.0M (19' 8")	MB46007CL	£27.49	MB46010CL	£41.10	MB46021CL	£82.47

BUDGET 10mm HAZE



WIDTH	700mm (2' 3 ^{1/2} "		1047mm (3' 5 ^{1/2} "		2100mm (6' 10 ^{1/2} "	
	PART	PRICE	PART	PRICE	PART	PRICE
1.0M (3' 3")	MHE1007WH	£4.99	MHE1010WH	£7.49	MHE1021WH	£14.99
1.5M (4' 11")	MHE1507WH	£8.43	MHE1510WH	£12.59	MHE1521WH	£25.29
2.0M (6' 6")	MHE2007WH	£11.24	MHE2010WH	£16.79	MHE2021WH	£33.69
2.5M (8' 2")	MHE2507WH	£14.05	MHE2510WH	£20.99	MHE2521WH	£41.99
3.0M (9' 10")	MHE3007WH	£16.86	MHE3010WH	£25.19	MHE3021WH	£50.49
3.5M (11' 6")	MHE3507WH	£19.67	MHE3510WH	£29.39	MHE3521WH	£58.99
4.0M (13' 1")	MHE4007WH	£22.48	MHE4010WH	£33.59	MHE4021WH	£67.49
5.0M (16' 5")	MHE5007WH	£28.10	MHE5010WH	£41.99	MHE5021WH	£83.99
6.0M (19' 8")	MHE6007WH	£34.99	MHE6010WH	£52.49	MHE6021WH	£105.99

SHEET END CLOSURE For 10mm sheets

LENGTH	COLOUR	PART	PRICE	COLOUR	PART	PRICE
1050mm	WHITE	UE10WH	£1.42	BROWN	UE10BR	£1.55
2100mm	WHITE	UE21WH	£2.84	BROWN	UE21BR	£3.10



SEALING BUTTONS

Pack of 10
For 10mm sheets



WHITE		BROWN	
PART	PRICE	PART	PRICE
B10WH	£4.50	B10BR	£4.96

SEALING TAPES

10M roll
For 10mm sheets



Aluminium Tape		Ventilation Tape	
PART	PRICE	PART	PRICE
TA10	£1.35	TV10	£4.93

10mm TWINWALL POLYCARBONATE

C&A HOME BRAND

Offers Quality with affordability

C & A's extremely popular home brand sheeting is a high quality sheeting. Made from pure polycarbonate material and combined with a light weight structure to allow for roofing on a budget but have more rigidity than 4mm twinwall sheets. All the colours admit various levels of light to helping to reduce glare. These sheets are the perfect choice for low cost installations of open sided structures, canopies and gazebos.

UV PROTECTION

3.1 "U" VALUE

1.5 KG/sq.m

MAX SUNLIGHT
MAX VISION

IDEAL FOR CARPORTS & OPEN STRUCTURES

MAX SHADE
LOW VISION

SHADED EFFECT

SOME SUNLIGHT
NO VISION

PEARLESCENT TRANSLUCENT

This Clear sheet offers no real shade and reduces light by a small amount and has subtle rib lines across the width of the sheet

This sheet's gentle bronzed tint gives a good level of shade, reducing the sun's glare for roofs exposed to direct sunlight.

Opal sheets transmit some translucent light, but not sight, so provides privacy for overlooked roofs. It also immediately reflects some of the sun's heat.

WIDTH	CLEAR					BRONZE					OPAL							
	695mm (2' 3 ^{3/8} ")		1045mm (3' 5 ^{1/8} ")		2090mm (6' 10")		695mm (2' 3 ^{3/8} ")		1045mm (3' 5 ^{1/8} ")		2090mm (6' 10")		695mm (2' 3 ^{3/8} ")		1045mm (3' 5 ^{1/8} ")		2090mm (6' 10")	
LENGTH	PART	PRICE	PART	PRICE	PART	PRICE	PART	PRICE	PART	PRICE	PART	PRICE	PART	PRICE	PART	PRICE	PART	PRICE
1.0M (3'3")	MBE1007CL	£6.49	MBE1010CL	£9.70	MBE1021CL	£19.47	MBE1007BR	£6.81	MBE1010BR	£10.19	MBE1021BR	£20.44	MBE1007WH	£7.14	MBE1010WH	£10.67	MBE1021WH	£21.42
1.5M (4'11")	MBE1507CL	£10.59	MBE1510CL	£15.83	MBE1521CL	£31.77	MBE1507BR	£11.12	MBE1510BR	£16.62	MBE1521BR	£33.36	MBE1507WH	£11.65	MBE1510WH	£17.42	MBE1521WH	£34.95
2.0M (6'6")	MBE2007CL	£14.12	MBE2010CL	£21.11	MBE2021CL	£42.36	MBE2007BR	£14.83	MBE2010BR	£22.16	MBE2021BR	£44.48	MBE2007WH	£15.53	MBE2010WH	£23.22	MBE2021WH	£46.60
2.5M (8'2")	MBE2507CL	£17.79	MBE2510CL	£26.60	MBE2521CL	£53.37	MBE2507BR	£18.68	MBE2510BR	£27.93	MBE2521BR	£56.04	MBE2507WH	£19.57	MBE2510WH	£29.26	MBE2521WH	£58.71
3.0M (9'10")	MBE3007CL	£20.99	MBE3010CL	£31.38	MBE3021CL	£62.97	MBE3007BR	£22.04	MBE3010BR	£32.95	MBE3021BR	£66.12	MBE3007WH	£23.09	MBE3010WH	£34.52	MBE3021WH	£69.27
3.5M (11'6")	MBE3507CL	£24.71	MBE3510CL	£36.94	MBE3521CL	£74.13	MBE3507BR	£25.95	MBE3510BR	£38.79	MBE3521BR	£77.84	MBE3507WH	£27.18	MBE3510WH	£40.64	MBE3521WH	£81.54
4.0M (13'1")	MBE4007CL	£28.24	MBE4010CL	£42.22	MBE4021CL	£84.72	MBE4007BR	£29.65	MBE4010BR	£44.33	MBE4021BR	£88.96	MBE4007WH	£31.06	MBE4010WH	£46.44	MBE4021WH	£93.19
5.0M (16'5")	MBE5007CL	£35.49	MBE5010CL	£53.06	MBE5021CL	£106.47	MBE5007BR	£37.26	MBE5010BR	£55.71	MBE5021BR	£111.79	MBE5007WH	£39.04	MBE5010WH	£58.36	MBE5021WH	£117.12
6.0M (19'8")	MBE6007CL	£43.99	MBE6010CL	£65.77	MBE6021CL	£131.97	MBE6007BR	£46.19	MBE6010BR	£69.05	MBE6021BR	£138.57	MBE6007WH	£48.39	MBE6010WH	£72.34	MBE6021WH	£145.17

10mm STRUCTURED POLYCARBONATE

16mm HAZE

TRIPLE-WALL POLYCARBONATE

2.4
"U" VALUE

UV
PROTECTION

2.5
KG/sq.m

MIN
SUNLIGHT
LOW
VISION

These super value sheets have a high regrind content allowing them to offer dependable roofing at the lowest possible cost. Misty White in colour to give a clean look, privacy & shade.

BUDGET BEATING SHEETS

Exclusive to
C&A Building Plastics

BUDGET 16mm HAZE

WIDTH	700mm (2' 3 ^{1/2"})		1047mm (3' 5 ^{1/4"})		2100mm (6' 10 ^{1/2"})	
LENGTH	PART	PRICE	PART	PRICE	PART	PRICE
1.0M (3' 3")	MHT1007WH	£8.49	MHT1010WH	£12.69	MHT1021WH	£25.47
1.5M (4' 11")	MHT1507WH	£13.99	MHT1510WH	£20.92	MHT1521WH	£41.97
2.0M (6' 6")	MHT2007WH	£18.69	MHT2010WH	£27.94	MHT2021WH	£56.07
2.5M (8' 2")	MHT2507WH	£23.35	MHT2510WH	£34.91	MHT2521WH	£70.05
3.0M (9' 10")	MHT3007WH	£27.99	MHT3010WH	£41.85	MHT3021WH	£83.97
3.5M (11' 6")	MHT3507WH	£32.69	MHT3510WH	£48.87	MHT3521WH	£98.07
4.0M (13' 1")	MHT4007WH	£37.36	MHT4010WH	£55.85	MHT4021WH	£112.08
5.0M (16' 5")	MHT5007WH	£46.70	MHT5010WH	£69.82	MHT5021WH	£140.10
6.0M (19' 8")	MHT6007WH	£57.99	MHT6010WH	£86.70	MHT6021WH	£173.97

16mm CLEAR

NINE-WALL POLYCARBONATE

1.8
"U" VALUE

UV
PROTECTION

2.5
KG/sq.m

MAX
SUNLIGHT
MAX
VISION

Lexan* Tough Virtually Unbreakable
Polycarbonate Sheet

OUTSTANDING PERFORMANCE

AFFORDABILITY AND EASE OF USE

16mm CLEAR

WIDTH	980mm (3'2 ^{1/2"})	
LENGTH	PART	PRICE
1.0M (3' 3")	MFT1098CL	£14.99
1.5M (4' 11")	MFT1598CL	£24.79
2.0M (6' 6")	MFT2098CL	£32.99
2.5M (8' 2")	MFT2598CL	£41.29
3.0M (9' 10")	MFT3098CL	£49.55
3.5M (11' 6")	MFT3598CL	£57.81
4.0M (13' 1")	MFT4098CL	£65.99
5.0M (16' 5")	MFT5098CL	£82.58
6.0M (19' 8")	MFT6098CL	£99.99
7.0M (22' 10")	MFT7098CL	£119.99

One of the best value Clear Multiwall sheets on the market.

These sheets have been manufacturer to have an increased rigidity and a high level of heat insulation

These qualities make this sheet ideal for wide span canopies and conservatories that are occasionally heated.

Being a handy 980mm wide sheet helps make for very easy and simple roof construction.

> Glazing bars and their roof timbers can be set exactly 1 metre apart—a simple bar centre measurement. Results in less to trim on the width, which means a quicker easier roof installation.

> Both long edges of the sheet are sealed, because they are unlikely to need cutting.

> Easier to handle due to narrower widths.

+ SHEET FITTINGS

SHEET END CLOSURE

For 16mm sheets
Used as endcaps at both ends of the sheet

COLOUR	WHITE		BROWN	
	PART	PRICE	PART	PRICE
LENGTH				
1050mm	UT10WH	£1.69	UT10BR	£2.08
2100mm	UT21WH	£3.32	UT21BR	£3.74

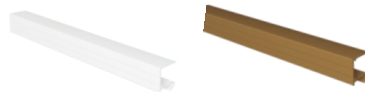

FOR 16mm SHEETS

SEALING BUTTONS

Pack of 10
For 16mm sheets



WHITE

PART	PRICE
B16WH	£4.60

BROWN

PART	PRICE
B16BR	£4.97

SEALING TAPES

10M roll
For 16mm sheets



Aluminium Tape		Ventilation Tape	
PART	PRICE	PART	PRICE
TA16	£1.79	TV16	£7.39

16mm CLEAR / BRONZE / OPAL WHITE NINE-WALL POLYCARBONATE

1.8
"U" VALUE

2.5
KG/sq.m

UV
PROTECTION

With NEW technology from one of the world's biggest brands these sheets provide increased rigidity and a level of heat insulation that was previously considered unobtainable from a 16mm sheet. These qualities make this sheet ideal for wide span canopies and conservatories that are occasionally heated.

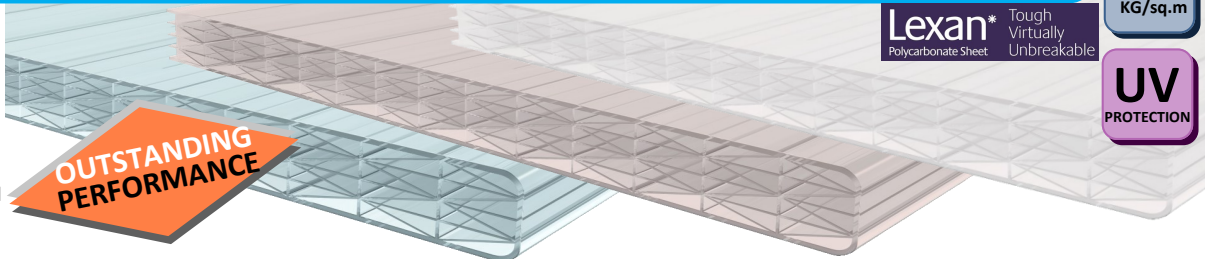

Lexan* Tough Virtually Unbreakable
Polycarbonate Sheet

OUTSTANDING PERFORMANCE

SIZE	FINEST 16mm CLEAR						FINEST 16mm BRONZE						FINEST 16mm OPAL WHITE					
	695mm (2' 3 ^{3/8} ")		1045mm (3' 5 ^{1/8} ")		2090mm (6' 10")		695mm (2' 3 ^{3/8} ")		1045mm (3' 5 ^{1/8} ")		2090mm (6' 10")		695mm (2' 3 ^{3/8} ")		1045mm (3' 5 ^{1/8} ")		2090mm (6' 10")	
WIDTH	PART	PRICE	PART	PRICE	PART	PRICE	PART	PRICE	PART	PRICE	PART	PRICE	PART	PRICE	PART	PRICE	PART	PRICE
1.0M (3'3")	MFT1007CL	£10.49	MFT1010CL	£15.68	MFT1021CL	£31.47	MFT1007BR	£11.01	MFT1010BR	£16.47	MFT1021BR	£33.04	MFT1007WH	£11.54	MFT1010WH	£17.25	MFT1021WH	£34.62
1.5M (4'11")	MFT1507CL	£17.69	MFT1510CL	£26.45	MFT1521CL	£53.07	MFT1507BR	£18.57	MFT1510BR	£27.77	MFT1521BR	£55.72	MFT1507WH	£19.46	MFT1510WH	£29.09	MFT1521WH	£58.38
2.0M (6'6")	MFT2007CL	£23.59	MFT2010CL	£35.27	MFT2021CL	£70.77	MFT2007BR	£24.77	MFT2010BR	£37.03	MFT2021BR	£74.31	MFT2007WH	£25.95	MFT2010WH	£38.79	MFT2021WH	£77.85
2.5M (8'2")	MFT2507CL	£29.48	MFT2510CL	£44.07	MFT2521CL	£88.44	MFT2507BR	£30.95	MFT2510BR	£46.28	MFT2521BR	£92.86	MFT2507WH	£32.43	MFT2510WH	£48.48	MFT2521WH	£97.28
3.0M (9'10")	MFT3007CL	£35.38	MFT3010CL	£52.89	MFT3021CL	£106.14	MFT3007BR	£37.15	MFT3010BR	£55.54	MFT3021BR	£111.45	MFT3007WH	£38.92	MFT3010WH	£58.18	MFT3021WH	£116.75
3.5M (11'6")	MFT3507CL	£41.28	MFT3510CL	£61.71	MFT3521CL	£123.84	MFT3507BR	£43.34	MFT3510BR	£64.80	MFT3521BR	£130.03	MFT3507WH	£45.41	MFT3510WH	£67.88	MFT3521WH	£136.22
4.0M (13'1")	MFT4007CL	£46.99	MFT4010CL	£70.25	MFT4021CL	£140.97	MFT4007BR	£49.34	MFT4010BR	£73.76	MFT4021BR	£148.02	MFT4007WH	£51.69	MFT4010WH	£77.28	MFT4021WH	£155.07
5.0M (16'5")	MFT5007CL	£58.97	MFT5010CL	£88.16	MFT5021CL	£176.91	MFT5007BR	£61.92	MFT5010BR	£92.57	MFT5021BR	£185.76	MFT5007WH	£64.87	MFT5010WH	£96.98	MFT5021WH	£194.60
6.0M (19'8")	MFT6007CL	£72.99	MFT6010CL	£109.12	MFT6021CL	£218.97	MFT6007BR	£76.64	MFT6010BR	£114.58	MFT6021BR	£229.92	MFT6007WH	£80.29	MFT6010WH	£120.03	MFT6021WH	£240.87

16mm STRUCTURED POLYCARBONATE

25mm CLEAR

NINEWALL POLYCARBONATE

1.4
"U" VALUE

UV PROTECTION
Both sides

3.0
KG/sq.m

MAX SUNLIGHT
MAX VISION

25mm HEATGUARD OPAL

SEVENWALL POLYCARBONATE

1.6
"U" VALUE

UV PROTECTION

3.1
KG/sq.m

HEAT SHIELD PROTECTION

Exclusive to
C&A Building Plastics

SUPER SHEET

This unique sheet is ideal for south-facing conservatories. Manufactured using a high quality dual-extrusion process resulting in two layers of polycarbonate. The metalised top layer provides shade and reflect solar heat, whilst the bottom Opal tinted layer provides evenly diffused light below and reflects artificial light.

980mm

With Insulation Values better than some 35mm sheets, this sheet is also extremely rigid allowing wider spans between glazing bars. It also has an anti-UV coating on BOTH sides of the sheet so it does not matter which way up the sheet is laid on the roof.

At a handy 980mm wide size these sheets make for very easy and simple roof construction.

> Glazing bars and their roof timbers can be set exactly 1 metre apart—a simple bar centre measurement.

> Both long edges of the sheet are sealed, because they are unlikely to need cutting.

> Less need to trim and cut to size, which means a quicker easier roof installation.

Lexan* Tough Virtually Unbreakable
Polycarbonate Sheet

WIDTH	980mm (3' 2 1/2")	
LENGTH	PART	PRICE
1.0M (3' 3")	MFQ1098CL	£17.99
1.5M (4' 11")	MFQ1598CL	£29.49
2.0M (6' 6")	MFQ2098CL	£39.32
2.5M (8' 2")	MFQ2598CL	£49.15
3.0M (9' 10")	MFQ3098CL	£58.98
3.5M (11' 6")	MFQ3598CL	£68.81
4.0M (13' 1")	MFQ4098CL	£78.64
5.0M (16' 5")	MFQ5098CL	£98.30
6.0M (19' 8")	MFQ6098CL	£119.99
7.0M (22' 10")	MFQ7098CL	£139.99

BONUS HEATGUARD OPAL

WIDTH	700mm (2' 3 1/2")		1047mm (3' 5 1/4")		2100mm (6' 10 1/2")	
LENGTH	PART	PRICE	PART	PRICE	PART	PRICE
1.0M (3' 3")	MBQ1007H0	£17.49	MBQ1010H0	£26.15	MBQ1021H0	£52.47
1.5M (4' 11")	MBQ1507H0	£26.99	MBQ1510H0	£40.35	MBQ1521H0	£80.97
2.0M (6' 6")	MBQ2007H0	£35.99	MBQ2010H0	£53.81	MBQ2021H0	£107.97
2.5M (8' 2")	MBQ2507H0	£44.99	MBQ2510H0	£67.26	MBQ2521H0	£134.97
3.0M (9' 10")	MBQ3007H0	£53.99	MBQ3010H0	£80.72	MBQ3021H0	£161.97
3.5M (11' 6")	MBQ3507H0	£62.99	MBQ3510H0	£94.17	MBQ3521H0	£188.97
4.0M (13' 1")	MBQ4007H0	£71.99	MBQ4010H0	£107.63	MBQ4021H0	£215.97
5.0M (16' 5")	MBQ5007H0	£91.49	MBQ5010H0	£136.78	MBQ5021H0	£274.47
6.0M (19' 8")	MBQ6007H0	£109.99	MBQ6010H0	£164.44	MBQ6021H0	£329.97

+ SHEET FITTINGS

SHEET END CLOSURE

For 25mm sheets
Used as endcaps at both ends of the sheet

COLOUR	WHITE		BROWN	
	PART	PRICE	PART	PRICE
LENGTH				
1050mm	UQ10WH	£2.37	UQ10BR	£2.59
2100mm	UQ21WH	£4.28	UQ21BR	£4.75

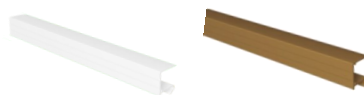

FOR 25mm SHEETS

SEALING BUTTONS

Pack of 10
For 25mm sheets



WHITE		BROWN	
PART	PRICE	PART	PRICE
B25WH	£4.73	B25BR	£4.98

SEALING TAPES

10M roll
For 25mm sheets



Aluminium Tape		Ventilation Tape	
PART	PRICE	PART	PRICE
TA25	£1.97	TV25	£8.67

25mm CLEAR / BRONZE / OPAL WHITE NINE-WALL POLYCARBONATE

1.4
"U" VALUE

3.0
KG/sq.m

UV
PROTECTION
Both sides

**GREAT FOR
CONSERVATORIES**

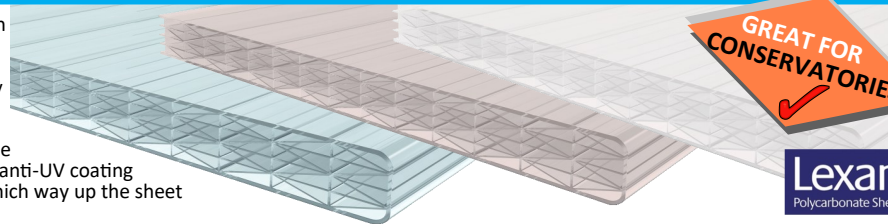

C&A are proud to introduce these 25mm sheets with their new cutting-edge technology. With Insulation Values better than some 35mm sheets, the number of finely divided cells also adds to the sheet's rigidity allowing wider spans between glazing bars.

Another great factor to our 25mm sheet is, unlike the majority of multiwall polycarbonate sheeting, it has anti-UV coating on BOTH SIDES of the sheet so it does not matter which way up the sheet is laid on the roof.

Lexan* Tough Virtually Unbreakable
Polycarbonate Sheet

SIZE	FINEST 25mm CLEAR						FINEST 25mm BRONZE						FINEST 25mm OPAL WHITE					
	695mm (2' 3 ^{3/8} ")		1045mm (3' 5 ^{1/8} ")		2090mm (6' 10")		695mm (2' 3 ^{3/8} ")		1045mm (3' 5 ^{1/8} ")		2090mm (6' 10")		695mm (2' 3 ^{3/8} ")		1045mm (3' 5 ^{1/8} ")		2090mm (6' 10")	
WIDTH ▶	PART	PRICE	PART	PRICE	PART	PRICE	PART	PRICE	PART	PRICE	PART	PRICE	PART	PRICE	PART	PRICE	PART	PRICE
1.0M (3'3")	MFQ1007CL	£12.99	MFQ1010CL	£19.42	MFQ1021CL	£38.97	MFQ1007BR	£13.64	MFQ1010BR	£20.39	MFQ1021BR	£40.92	MFQ1007WH	£14.29	MFQ1010WH	£21.36	MFQ1021WH	£42.87
1.5M (4'11")	MFQ1507CL	£20.99	MFQ1510CL	£31.38	MFQ1521CL	£62.97	MFQ1507BR	£22.04	MFQ1510BR	£32.95	MFQ1521BR	£66.12	MFQ1507WH	£23.09	MFQ1510WH	£34.52	MFQ1521WH	£69.27
2.0M (6'6")	MFQ2007CL	£27.99	MFQ2010CL	£41.85	MFQ2021CL	£83.97	MFQ2007BR	£29.39	MFQ2010BR	£43.94	MFQ2021BR	£88.17	MFQ2007WH	£30.79	MFQ2010WH	£46.03	MFQ2021WH	£92.37
2.5M (8'2")	MFQ2507CL	£34.99	MFQ2510CL	£52.31	MFQ2521CL	£104.97	MFQ2507BR	£36.74	MFQ2510BR	£54.93	MFQ2521BR	£110.22	MFQ2507WH	£38.49	MFQ2510WH	£57.54	MFQ2521WH	£115.47
3.0M (9'10")	MFQ3007CL	£41.99	MFQ3010CL	£62.78	MFQ3021CL	£125.97	MFQ3007BR	£44.09	MFQ3010BR	£65.91	MFQ3021BR	£132.27	MFQ3007WH	£46.19	MFQ3010WH	£69.05	MFQ3021WH	£138.57
3.5M (11'6")	MFQ3507CL	£48.98	MFQ3510CL	£73.23	MFQ3521CL	£146.94	MFQ3507BR	£51.43	MFQ3510BR	£76.89	MFQ3521BR	£154.29	MFQ3507WH	£53.88	MFQ3510WH	£80.55	MFQ3521WH	£161.63
4.0M (13'1")	MFQ4007CL	£55.98	MFQ4010CL	£83.69	MFQ4021CL	£167.94	MFQ4007BR	£58.78	MFQ4010BR	£87.87	MFQ4021BR	£176.34	MFQ4007WH	£61.58	MFQ4010WH	£92.06	MFQ4021WH	£184.73
5.0M (16'5")	MFQ5007CL	£69.97	MFQ5010CL	£104.61	MFQ5021CL	£209.91	MFQ5007BR	£73.47	MFQ5010BR	£109.84	MFQ5021BR	£220.41	MFQ5007WH	£76.97	MFQ5010WH	£115.07	MFQ5021WH	£230.90
6.0M (19'8")	MFQ6007CL	£84.99	MFQ6010CL	£127.06	MFQ6021CL	£254.97	MFQ6007BR	£89.24	MFQ6010BR	£133.41	MFQ6021BR	£267.72	MFQ6007WH	£93.49	MFQ6010WH	£139.77	MFQ6021WH	£280.47
7.0M (22'10")	MFQ7007CL	£99.49	MFQ7010CL	£148.74	MFQ7021CL	£298.47	FOR 7M SHEETS IN BRONZE AND OPAL PLEASE CALL 01634 374444 FOR PRICES AND AVAILABILITY											

25mm STRUCTURED POLYCARBONATE

35mm CLEAR - BRONZE - OPAL WHITE SEVEN-WALL POLYCARBONATE

1.2
"U" VALUE

3.8
KG/sq.m

UV
PROTECTION

Our range of 35mm sheets have excellent Insulation Values and are all manufactured to an extremely high specification. With CLEAR, BRONZE and OPAL WHITE options, we offer the best choices to suit the majority of Conservatories—part-shaded, overlooked or in full sunlight.



SUITABLE FOR USE WITH:

- ▶ AVON Glazing Bars
- ▶ YORK Glazing Bars
- ▶ VALE Glazing Bars

SIZE	BONUS 35mm CLEAR						BONUS 35mm BRONZE						BONUS 35mm OPAL WHITE					
	700mm (2' 3 ^{1/2} ")		1047mm (3' 5 ^{1/2} ")		2100mm (6' 10 ^{1/2} ")		700mm (2' 3 ^{1/2} ")		1047mm (3' 5 ^{1/2} ")		2100mm (6' 10 ^{1/2} ")		700mm (2' 3 ^{1/2} ")		1047mm (3' 5 ^{1/2} ")		2100mm (6' 10 ^{1/2} ")	
WIDTH ▶	PART	PRICE	PART	PRICE	PART	PRICE	PART	PRICE	PART	PRICE	PART	PRICE	PART	PRICE	PART	PRICE	PART	PRICE
1.0M (3'3")	MBK1007CL	£19.99	MBK1010CL	£29.89	MBK1021CL	£59.97	MBK1007BR	£20.99	MBK1010BR	£31.38	MBK1021BR	£62.97	MBK1007WH	£21.99	MBK1010WH	£32.87	MBK1021WH	£65.97
1.5M	MBK1507CL	£29.99	MBK1510CL	£44.84	MBK1521CL	£89.97	MBK1507BR	£31.49	MBK1510BR	£47.08	MBK1521BR	£94.47	MBK1507WH	£32.99	MBK1510WH	£49.32	MBK1521WH	£98.97
2.0M (6'6")	MBK2007CL	£39.99	MBK2010CL	£59.79	MBK2021CL	£119.97	MBK2007BR	£41.99	MBK2010BR	£62.77	MBK2021BR	£125.97	MBK2007WH	£43.99	MBK2010WH	£65.76	MBK2021WH	£131.97
2.5M (8'2")	MBK2507CL	£49.99	MBK2510CL	£74.74	MBK2521CL	£149.97	MBK2507BR	£52.49	MBK2510BR	£78.47	MBK2521BR	£157.47	MBK2507WH	£54.99	MBK2510WH	£82.21	MBK2521WH	£164.97
3.0M	MBK3007CL	£59.99	MBK3010CL	£89.69	MBK3021CL	£179.97	MBK3007BR	£62.99	MBK3010BR	£94.17	MBK3021BR	£188.97	MBK3007WH	£65.99	MBK3010WH	£98.65	MBK3021WH	£197.97
3.5M	MBK3507CL	£69.99	MBK3510CL	£104.64	MBK3521CL	£209.97	MBK3507BR	£73.49	MBK3510BR	£109.87	MBK3521BR	£220.47	MBK3507WH	£76.99	MBK3510WH	£115.10	MBK3521WH	£230.97
4.0M	MBK4007CL	£79.99	MBK4010CL	£119.59	MBK4021CL	£239.97	MBK4007BR	£83.99	MBK4010BR	£125.56	MBK4021BR	£251.97	MBK4007WH	£87.99	MBK4010WH	£131.54	MBK4021WH	£263.97
5.0M	MBK5007CL	£99.99	MBK5010CL	£149.49	MBK5021CL	£299.97	MBK5007BR	£104.99	MBK5010BR	£156.96	MBK5021BR	£314.97	MBK5007WH	£109.99	MBK5010WH	£164.43	MBK5021WH	£329.97
6.0M	MBK6007CL	£119.99	MBK6010CL	£179.39	MBK6021CL	£359.97	MBK6007BR	£125.99	MBK6010BR	£188.35	MBK6021BR	£377.97	MBK6007WH	£131.99	MBK6010WH	£197.32	MBK6021WH	£395.97

+ SHEET FITTINGS
FOR 35mm SHEETS

SHEET END CLOSURE FOR 35mm SHEETS

COLOUR ▶	WHITE		BROWN	
	PART	PRICE	PART	PRICE
1.2M	UK12WH	£3.12	UK12BR	£3.50
2.1M	UK21WH	£5.46	UK21BR	£5.99



SEALING BUTTONS

Pack of 10 for 35mm

WHITE		BROWN	
PART	PRICE	PART	PRICE
B35WH	£5.30	B35BR	£5.50

SEALING TAPES

10m Roll for 35mm

Aluminium		Ventilation	
PART	PRICE	PART	PRICE
TA40	£2.25	TV40	£9.48



40mm CLEAR

NINE WALL POLYCARBONATE

1.1 "U" VALUE	4.3 KG/sq.m	UV PROTECTION	SOME SUNLIGHT MIN VISION
-------------------------	-----------------------	-------------------------	---

SUITABLE FOR USE WITH:

- ▶ **AVON** Frame Supported System
- ▶ **YORK** Self-Supporting System

THE ULTIMATE SHEET

FINEST CLEAR 		
WIDTH	1200mm (3' 11 ^{1/4} ")	
LENGTH	PART	PRICE
1.0M (3' 3")	MFN1012CL	£36.99
1.5M (4' 11")	MFN1512CL	£59.99
2.0M (6' 6")	MFN2012CL	£79.99
2.5M (8' 2")	MFN2512CL	£99.99
3.0M (9' 10")	MFN3012CL	£119.98
3.5M (11' 6")	MFN3512CL	£139.97
4.0M (13' 1")	MFN4012CL	£159.97
5.0M (16' 5")	MFN5012CL	£199.97
6.0M (19' 8")	MFN6012CL	£239.96
7.0M (22' 10")	MFN7012CL	£284.99

Only UK STOCKIST

SOUND PROOFING

The multi-celled, braced construction of 40mm 'X' Form Sheets, not only gives the highest insulation, but also acts as an efficient barrier to intrusive exterior airborne noise, making it the ideal sheet to roof conservatories sited near Airports, Motorways and Industrial Sites.



The advanced cell structure of these 40mm polycarbonate sheets provides increased sheet rigidity and the highest Insulation Value of all our Multiwall Polycarbonate range.

THE RESULT — 40mm sheets are capable of spanning far wider distances between Glazing Bars, reducing both material costs and construction time. They also have the best sheet properties to help reduce Winter Fuel Costs, due to its superior insulation properties.

Lexan* Tough Virtually Unbreakable
Polycarbonate Sheet

+ SHEET FITTINGS FOR 40mm SHEETS

SHEET END CLOSURE FOR 40mm SHEETS

COLOUR	WHITE		BROWN	
	PART	PRICE	PART	PRICE
1.2M	UN12WH	£3.65	UN12BR	£4.10
2.1M	UN21WH	£6.40	UN21BR	£7.20

SEALING BUTTONS

Pack of 10 for 40mm

WHITE		BROWN	
PART	PRICE	PART	PRICE
B40WH	£5.70	B40BR	£5.90

SEALING TAPES

10m Roll for 40mm

Aluminium		Ventilation	
PART	PRICE	PART	PRICE
TA40	£2.25	TV40	£9.48

40mm STRUCTURED POLYCARBONATE

MULTIWALL POLYCARBONATE INFORMATION & KNOW-HOW

This information is a broad overview for a working knowledge on Multiwall sheeting, Each sheet will be slightly different due to its structure and resin composition and individual data sheets should be consulted if any doubt of the product's suitability for use.

Multiwall Polycarbonate sheeting is a versatile, easy to cut, lightweight, high-impact resistant, insulating and fire resistant product (most have an AA Fire Rating to BSI Standard 476 or its equivalent in the country of origin). Ideal for roofing or vertical wall cladding applications, and used in many other applications such as set design.

SHEET SPECIFICATIONS

3.1
"U" VALUE

INSULATION—The U Value is the measure of heat transfer through the sheet. The lower the number, the less heat is transferred—better insulation and lower fuel bills!

UV
PROTECTION

UV PROTECTION —The outer face of the sheet has a special coating to prevent degradation by natural UV sunlight. UV stabilised increases a product's life span.

1.5
KG/sq.m

WEIGHT—Shown per 1M²
As the weight of the sheet increases, generally the level of insulation will also increase.

MIN
SUNLIGHT
MIN
VISION

SUNLIGHT AND VISION — A summary of the sheet's amount of sunlight penetration and the amount of vision it allows through the sheet.

HEAT
SHIELD
PROTECTION

HEAT SHIELDING — Sheets with this symbol have a special coating designed to reduce heat, providing a cooler space below the sheet.



LIGHT TRANSMISSION —Manufacturer's measure the light that passes through their sheets. However, they use different tests in different laboratories and so real world comparison between them is difficult. This symbol is our own indicator as to the shading we feel they provide. Official figures can be obtained from the individual product data sheets.

Sheet Storage

> Polycarbonate sheets stored outside in the open must have sheet ends taped up to prevent insects, debris or moisture invading the cells.

> Stacks of polycarbonate sheets should be covered with a light proof sheet to prevent distortion by magnified sunlight.



Handling Sheets

> Polycarbonate sheets have temporary plastic cover films on their surface each side to protect them from marks or scratches.

> Plastic cover films also indicate which face is the upper side with the UV protection—this will normally be the film printed with writing.

> As it is almost impossible to otherwise tell the two sides apart, **DO NOT REMOVE** the cover film until the sheet is being laid on the roof.



Cutting Sheets

> Polycarbonate sheets can be easily trimmed using a fine bladed/ toothed handsaw. Power saws should be used with caution and are generally not recommended unless experienced in working with plastics.

> When cutting, support both sides of the cut and saw at a shallow angle with light pressure.

> For long cuts, overlay the approximate cut line with masking tape so an accurate line can be marked.

> Sheet debris from cutting can be removed from the cells with compressed air or a quality vacuum cleaner.

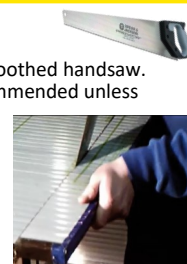

Sheet Expansion

> Polycarbonate roof sheets must be fitted with a gap that allows them to expand with temperature changes.

> **AT THE TOP**—Allow a 3mm gap for each metre of the sheets length (this will be covered by a wall flashing).

> **AT THE SIDES**—Allow a 3mm gap between the sheet edge and the centre ribs of the Glazing Bar on both sides (An average bar centre spacing is 20mm wider than the sheet itself. However a 980mm wide sheet allows bars to be set at 1M centres).

EXAMPLE. 3M x 980mm SHEET

9mm expansion allowance for the top edge (3x3)

3mm expansion allowance each side

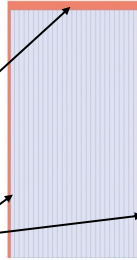

Typical Sheet Usage

THICKNESS

4mm
6mm
10mm

16mm

25mm
35mm
40mm

NORMAL AREA OF USE

Basic Horticulture
Heavy Duty Horticulture
Premium Horticulture
Basic Open Structures

Open Structures
Basic Enclosed Structures

Enclosed Structures

Heavy Duty Enclosed Structures
Prestigious Structures



Online Resources www.cabp.co.uk

Getting better information has become easier due to the Internet, so why not have a look at the great features and additional information our website has to offer using your PC, Tablet or Smart Phone, with just a few simple clicks!

> **DATA SHEETS**—There is a wealth of additional information about our products, including Multiwall Polycarbonate sheeting, that can be found online on our website. Our data sheets can be found under a product's **Specification** tab shown on each product's page. This will provide any further product details that we often have direct from the manufacturers themselves.

> **COMPONENT CALCULATORS**—You have decided that you want to build a polycarbonate roof, whether it is an open lean-to, or an enclosed structure such as a conservatory. You have not built one before so you are a little unsure of what the components are and where they go. Don't worry, we have been helping people get it right for a long time!

We have created some easy-to-use online calculators to ensure that you get all the components you need for your roof.

Simply visit the link to the webpage www.cabp.co.uk/Calculators.htm

> **PRODUCT VIDEOS**—In addition to the product information we have written online, we also have devised a collection of helpful videos that explain our products or how we recommend using them, to guide you in your building projects. They can be found under an individual product's information, under the **Video** tab.

+ WE ARE HERE TO HELP!
Simply call us on 01634 374444 and we will try to help there and then on the phone. It's not always easy, as a picture says a thousand words, so we may ask for further information, but most queries can be resolved in a single phone call.

AVON Bar Component calculator

Please enter data into the **Orange** boxes to calculate your requirements.
This form will calculate the stock size materials required to cover the area entered. This is not a cut to size service.



Enter distance along host wall in meters

 Selected projection/ fall of roof in meters

 Select Polycarbonate thickness in mm

 Select Polycarbonate colour

 Select Glaz Bar & Accessory Colour

Please Note: These bars are for timber or metal supporting frameworks
 Sheet width selected based on max span without purfin support



SHEETS & ACCESSORIES	PART	QTY
2.5M x 1.05M x 25mm Clear	MFQ2510CL	5
Vault tape for 25mm sheets 10M	TV25	1
All laps for 25mm sheets 10M	TA25	1
25mm Sheet endcourse 2.1M White	UQ21WH	6
White fixing buttons pack of 10 for 25mm	PF25WH	2
Avon eaves retainer 2.1M White	AER21WH	3
BAR & ACCESSORIES		
2.5M Avon 1625mm bar White	ATQ25WH	6
Glaz and Avon bar endcap White	GAC2WH	6
2.5M End bar (with) 20mm White	ES20WH	2
1" SS Screws Pack of 25	SR18	2
Silopane White	STWH	1
White Rubber Gasket	TRM	1
Pack of 10 plugs and screws 30mm White	SPP30WH	2
3.0M PVC Wall Flashing White	PF30WH	1
2.0M PVC Wall Flashing White	PF20WH	1

<http://www.cabp.co.uk>

ROOF VENTILATION FOR POLYCARBONATE ROOFS

Without roof ventilation many conservatories, especially south-facing, can build up such high levels of solar heat that they can become uninhabitable. It is recommended that roofs in direct sunlight have a roof vent for every 6M² of roof area, and shaded roofs have a roof vent for every 12M² of roof area.

SOLAR POWERED VENTS

	MODEL	PART	PRICE
 BOOST 300 MODEL 	BOOST 300 Includes Directional fan button & Boost button to turn on without sunlight using an in-built rechargeable battery.	SV300	£69.10
	INSTALLATION KIT Includes Hole saw & Arbour Saw to cut a neat circular hole in the roof sheet & Clear Stixall.	SVKIT	£25.00

Ideal for conservatories: These fans work efficiently as they can be permanently switched on. This means that when the sun shines the fan will automatically extract hot air without the concern that a room will overheat (which could cause damage or worry that a window may have been left open accidentally). In full sunlight these vents will disperse 25M³ of hot air per hour through the roof.

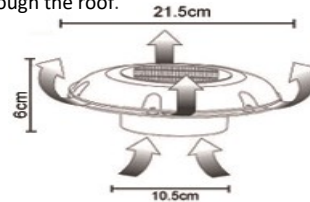

UPVC ROOF VENT WINDOWS

White UPVC Frames With Chrome Worm Screw
 W. 550mm x L. 750mm (1' 9^{1/2}" x 2' 5^{1/2}")

DESCRIPTION	PART	PRICE
FOR 16mm SHEETS	VP16WH	£155.50
FOR 25mm SHEETS	VP25WH	£159.50
OPTIONAL LONG HANDLE	VLH	£49.15

These complete kits are designed for retrofitting existing roofs or new installations.

A rectangular hole is cut out of the sheet, using the window frame as a template. Pre-welded Roof Vent Windows come ready to install.

Simply cut out the polycarbonate, using the templates supplied with the vent. The section of sheet that has been removed is used to glaze the window, ensuring a perfect match on the sheet every time.

Then using the sealant and gaskets supplied, fit to your existing roof sheet.



VALE GLAZING BAR

THE SIMPLE SOLUTION FOR ALL FLAT SHEET ROOFING

- ▶ C&A 's own design
- ▶ One-Size-Fits-All design
- ▶ Use with ALL flat sheet glazing roofing materials
- ▶ In **WHITE** or **BROWN**

The **VALE** Glazing Bar is a simple yet hugely popular product allowing users to join ANY glazing sheet material of ANY thickness, with a strong Aluminium Core and plastic capping. Initially designed for joining Glass panels on lean-to roofs, this bar has also proven very popular with the use of polycarbonate sheeting.

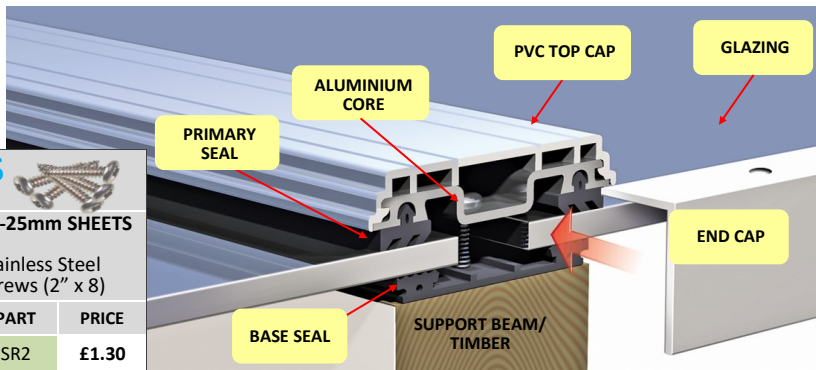

VALE GLAZING BARS

COMPRISING:
1x PVC Cover Cap, 1x Aluminium Core, 2x Primary Top Seals and 1x Base Seal

COLOUR	WHITE		BROWN		
	LENGTH	PART	PRICE	PART	PRICE
2.0M (6' 6")	VB20WH	£12.49	VB20BR	£14.36	
3.0M (9' 10")	VB30WH	£18.32	VB30BR	£20.99	
4.0M (13' 1")	VB40WH	£24.57	VB40BR	£28.39	
6.0M (19' 8")	VB60WH	£38.32	VB60BR	£43.95	
BAR END CAP	VECWH	£1.39	VECBR	£1.55	

BAR FIXINGS

Pack of 25

0-10mm SHEETS 10-25mm SHEETS

Stainless Steel
Screws (1^{1/2}" x 8)

Stainless Steel
Screws (2" x 8)

PART	PRICE	PART	PRICE
SR15	£1.04	SR2	£1.30

USE WITH ANY THICKNESS

The **VALE** Bar can accept any thickness sheet — all that is needed is a long enough screw! The **draw back** to this is care needs to be taken to ensure that the **VALE** Bar is not over-tightened which may cause damage to the glazing sheets. Once secured the PVC Cover Cap clips on ensuring that water can not enter the fixing channel or leak through the roof.

FIXING VALE BARS DOWN

Frames should be flat and stable, made of timber or metal and be at least 45mm wide. The Aluminium Core is screwed on top of the Base Seal every 400mm. At the lower (gutter) end of the roof, bars can overhang the Support Beam by 50mm.

BARREL VAULTED ROOFS

The **VALE** bar is ideal for use in Barrel Vaulted roofs where the structural frame is shaped to a curve. This is because the bar can be pulled to the correct curvature using the fixing screws to a minimum 3 metre radius curve.

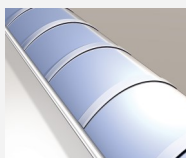

RUBBER SEALS/ GASKETS

The **VALE** Bar is C&A's only Frame Supported Bar which uses rubber Gaskets. The bar consists of a Base Seal which is glued to the supporting beam/ timber, then the screwed down Aluminium Core which houses a further two Primary Seals.

ROOF EDGES/ END BARS

Due to the **VALE** Bar's ability to accept any thickness sheet, we do not supply an End Bar Infill as with our other Glazing Bar Systems. Instead, a packing piece (normally made of timber) is required on the open side of the end bar the same thickness as the glazing material to ensure the end bar is stable and rigid (Fig 1). If polycarbonate is being used the sheet can span across the entire bar, which can be fastened through the sheet itself (Fig 2).



Figure 1. End Bar when using glass sheet



Figure 2. End Bar when using polycarbonate sheet

GLEN GLAZING BAR

ALL UPVC

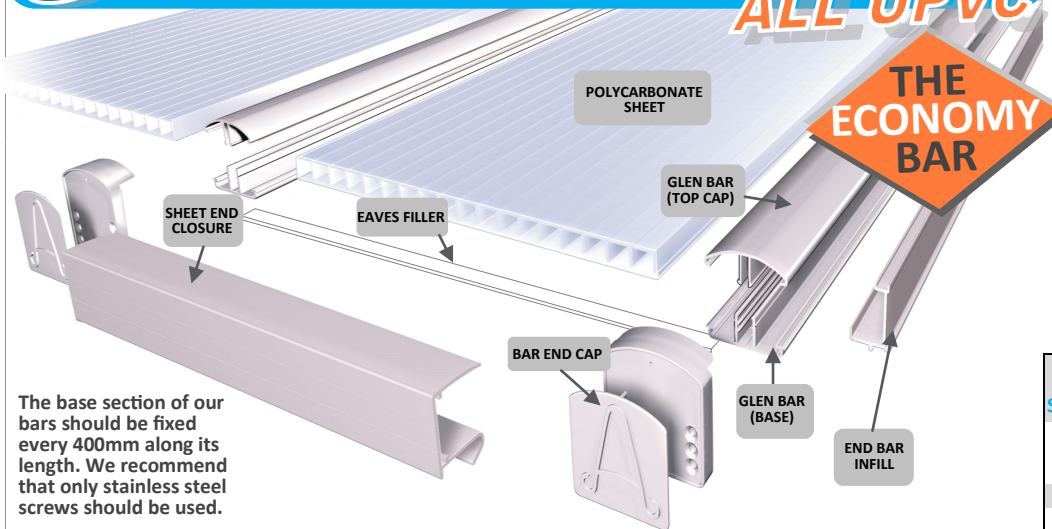

The base section of our bars should be fixed every 400mm along its length. We recommend that only stainless steel screws should be used.

- ▶ C&A's own design
- ▶ Frame Supported
- ▶ For 10mm Polycarbonate sheets

Our Budget Frame Supported Glazing Bar System for Multiwall Polycarbonate sheets, the GLEN Bar is specially designed to be a **LOW COST** choice.

Manufactured entirely of UPVC, the GLEN bar has an oversized end cap and includes drainage channels and a separate fixing cavity that other competitors' systems fail to provide.

Easy to assemble and install, this system push fits together and is simply secured to supporting timbers with screws.

GLEN Bars are 58mm wide providing greater sheet cutting tolerance.

SHEET ACCESSORIES

Sheet End Closure	LENGTH	PART	PRICE
10mm White	1.05M	UE10WH	£1.42
	2.1M	UE21WH	£2.84
Sealing Tapes			
Aluminium	10M	TA10	£1.35
	Vent	10M	TV10

GLEN GLAZING BARS

COLOUR	WHITE	
LENGTH	PART	PRICE
2.0M (6' 6")	GB20WH	£6.65
2.5M (8' 2")	GB25WH	£8.32
3.0M (9' 10")	GB30WH	£9.97
3.5M (11' 6")	GB35WH	£11.65
4.0M (13' 1")	GB40WH	£13.32
6.0M (19' 8")	GB60WH	£19.95

END BAR INFILL 10mm

COLOUR	WHITE	
LENGTH	PART	PRICE
2.0M (6' 6")	EE20WH	£2.10
2.5M (8' 2")	EE25WH	£2.63
3.0M (9' 10")	EE30WH	£3.15
3.5M (11' 6")	EE35WH	£3.68
4.0M (13' 1")	EE40WH	£4.20
6.0M (19' 8")	EE60WH	£6.30

GLEN BAR ENDCAP

Includes fixings

WHITE		
PART	PRICE	
GAECWH	£1.32	

SEALING BUTTONS Pack of 10

FOR 10mm SHEETS

WHITE		
PART	PRICE	
B10WH	£4.50	

EAVES FILLER

PART	PRICE	
1M foam strips 10Pk	GAEF	£7.90

BAR FIXINGS

PART	PRICE	
1" Round Head Screws	SR1	£0.94

Hawk GLAZING BAR

- ▶ C&A's own design
- ▶ Frame Supported
- ▶ For 10mm, 16mm, 25mm Polycarbonate sheets

The Glazing Bar aimed for the Trade, the **HAWK Bar's** design is simple yet strong with an Aluminium Base section.

The **HAWK Bar** is easy to install and visually unobtrusive with a slim 48mm wide base section and low profile PVC top cap.

C&A's well proven design of drainage channels and sealed centre sections for leak-proof fixings within the Aluminium Core are great features of the **HAWK Bar**.

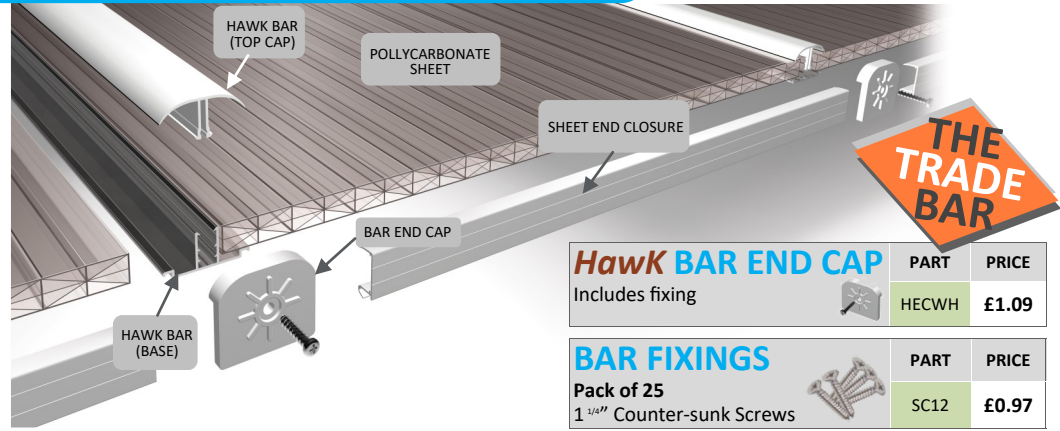

+ ROOF ACCESSORIES

- > Sealing Buttons
- > Sealing Tapes
- > Sheet Enclosures
- > Wall Flashing

SEE PAGES
24-25

Hawk BAR END CAP

Includes fixing



PART	PRICE
HECWH	£1.09

BAR FIXINGS

Pack of 25

1 1/4" Counter-sunk Screws



PART	PRICE
SC12	£0.97

Hawk GLAZING BARS

AVAILABLE IN WHITE ONLY

LENGTH	PART	PRICE
2.0M (6' 6")	HB20WH	£7.99
3.0M (9' 10")	HB30WH	£11.99
4.0M (13' 1")	HB40WH	£15.99
6.0M (19' 8")	HB60WH	£24.99

The base section should be fixed every 400mm along its length.

Hawk END BAR INFILLS

Universal trim fits into the gap in the End Bar's outer edge

LENGTH	PART	PRICE
2.0M (6' 6")	HBE20WH	£4.96
3.0M (9' 10")	HBE30WH	£7.44
4.0M (13' 1")	HBE40WH	£9.92
6.0M (19' 8")	HBE60WH	£14.88

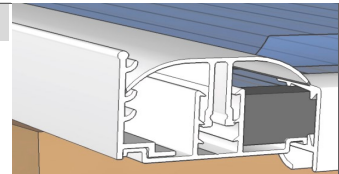

Hawk MUNTING BAR

FOR 16mm SHEETS ONLY

Joining piece to connect 16mm sheets together along their LENGTH.

LENGTH	PART	PRICE
2.1M (6' 10 1/2")	HMT21WH	£9.99

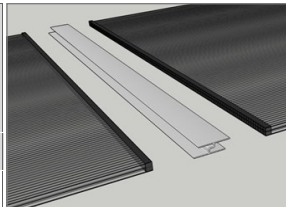

F TRIM

To frame/seal roof edges

SHEET SIZE	10mm		16mm		25mm	
	LENGTH	PART	PRICE	PART	PRICE	PART
2.0M (6' 6")	FE20WH	£4.76	FT20WH	£4.89	FQ20WH	£4.99
3.0M (9' 10")	FE30WH	£7.14	FT30WH	£7.33	FQ30WH	£7.48
4.0M (13' 1")	FE40WH	£9.49	FT40WH	£9.76	FQ40WH	£9.98
6.0M (19' 8")	FE60WH	£14.76	FT60WH	£14.87	FQ60WH	£14.99

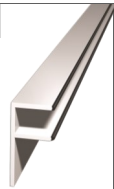

HAWK GLAZING BAR

AVON

ALUMINIUM CORED

GLAZING BAR

- ▶ C-A's own design
- ▶ Frame Supported
- ▶ For 16mm, 25mm, 35mm and 40mm Sheets
- ▶ In WHITE or BROWN

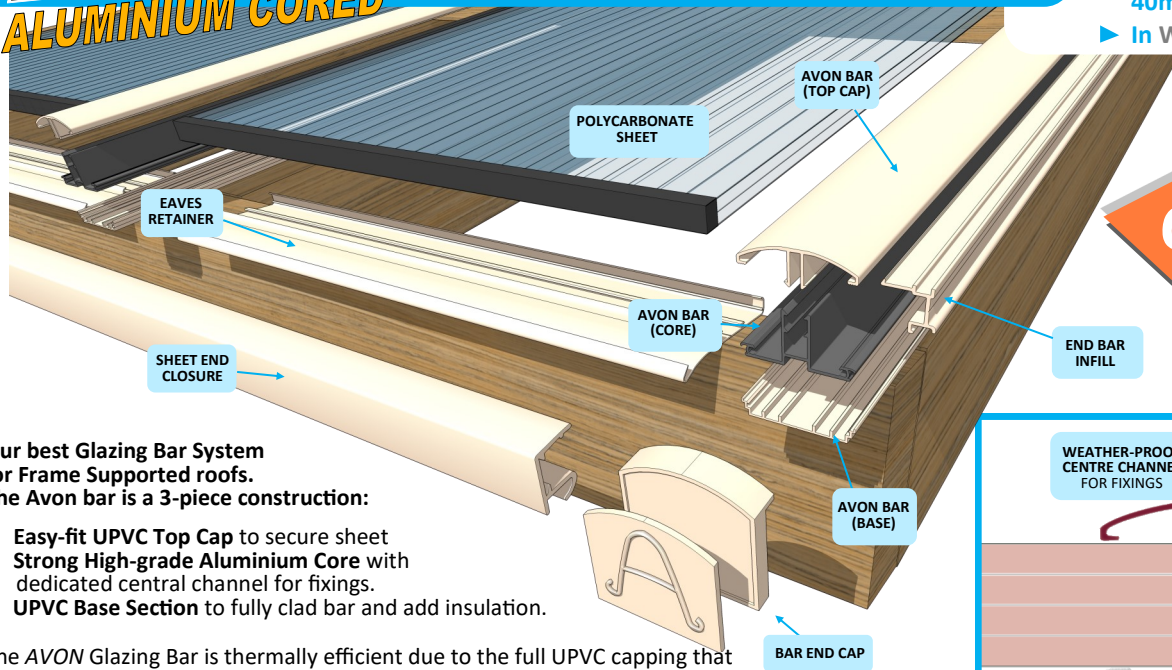

Our best Glazing Bar System for Frame Supported roofs. The Avon bar is a 3-piece construction:

1. Easy-fit UPVC Top Cap to secure sheet
2. Strong High-grade Aluminium Core with dedicated central channel for fixings.
3. UPVC Base Section to fully clad bar and add insulation.

The AVON Glazing Bar is thermally efficient due to the full UPVC capping that includes an insulating air gap in the base section. The bar also has wide side channels to drain moisture away, making this bar a top choice for roofing projects such as conservatories.

The AVON Bar is 58mm wide to ensure wide fluted sheets are correctly secured and are available with two different cores for a range of sheet acceptance:

16mm & 25mm and **35mm & 40mm** sheets.

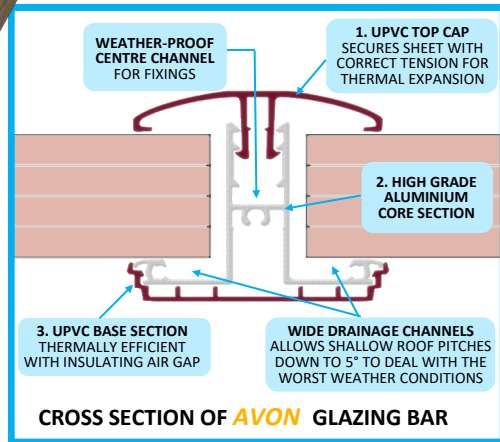

AVON GLAZING BARS

FOR 16mm & 25mm SHEETS
58mm Wide

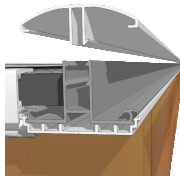

COLOUR ▶	WHITE		BROWN		
	LENGTH ▼	PART	PRICE	PART	PRICE
	2.0M (6' 6")	ATQ20WH	£12.49	ATQ20BR	£13.74
	2.5M (8' 2")	ATQ25WH	£15.69	ATQ25BR	£17.26
	3.0M (9' 10")	ATQ30WH	£18.99	ATQ30BR	£20.89
	3.5M (11' 6")	ATQ35WH	£21.99	ATQ35BR	£24.19
	4.0M (13' 1")	ATQ40WH	£24.99	ATQ40BR	£27.49
	6.0M (19' 8")	ATQ60WH	£37.49	ATQ60BR	£41.24

AVON BAR END CAPS

FOR 16mm & 25mm SHEETS

Includes fixings



COLOUR	WHITE		BROWN	
	PART	PRICE	PART	PRICE
	GAECWH	£1.32	GAECBR	£1.45

BAR FIXINGS FOR 16mm & 25mm SHEETS



1/4" Round-headed Screws
Pack of 25

PART	PRICE
SR12	£0.97

AVON GLAZING BARS

FOR 35mm & 40mm SHEET
58mm Wide

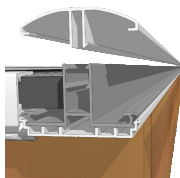

COLOUR ▶	WHITE		BROWN		
	LENGTH ▼	PART	PRICE	PART	PRICE
	2.0M (6' 6")	AKN20WH	£14.49	AKN20BR	£15.94
	2.5M (8' 2")	AKN25WH	£17.99	AKN25BR	£19.79
	3.0M (9' 10")	AKN30WH	£21.49	AKN30BR	£23.64
	3.5M (11' 6")	AKN35WH	£24.99	AKN35BR	£27.49
	4.0M (13' 1")	AKN40WH	£28.49	AKN40BR	£31.34
	6.0M (19' 8")	AKN60WH	£42.99	AKN60BR	£47.29

AVON BAR END CAPS

FOR 35mm & 40mm SHEETS

Includes fixings



COLOUR	WHITE		BROWN	
	PART	PRICE	PART	PRICE
	AKNECWH	£1.63	AKNECBR	£1.77

BAR FIXINGS FOR 35mm & 40mm SHEETS



2" Round-headed Screws
Pack of 25

PART	PRICE
SR2	£1.30

AVON EAVES RETAINER

Screw to the front beam with 32mm stainless steel screws, to lock Sheet End Closures in place and seal the gap between the front beam & the sheet.

COLOUR ▶	WHITE		BROWN		
	LENGTH ▼	PART	PRICE	PART	PRICE
	0.98M (3' 3")	AER98WH	£2.70	AER98BR	£2.98
	2.1M (6' 10")	AER21WH	£5.82	AER21BR	£6.45

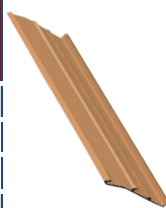

+ ROOF ACCESSORIES

- > Sealing Buttons
- > Sealing Tapes
- > Sheet Enclosures
- > End Bar Infills
- > Wall Flashing

SEE PAGES
24-25

PEAK 100 GLAZING BAR

C&A's proven own design
 Self Supporting up to 4M*
 For 16mm and 25mm
 Polycarbonate sheets

The **PEAK 100** Self-Supporting Glazing Bar System is capable of spanning an impressive 4 metres and is also one of C&A's most complete designs with full UPVC capping, plus additional trims, flashing and structural components.

PEAK 100 Bars have a load-bearing high quality Aluminium Core, allowing the length of mono-pitch roofs to extend up to approximately 4 metres (*see spanning table on Page 29 for details). Other Aluminium components of this system, such as the Wall Plate and Beams/ Posts, also aid to its strength and durability and are concealed behind UPVC capping, which not only improves thermal insulation but that also make this roofing system visually attractive. Using the **PEAK 130** Wall Plate, the bars are connected to the host building with Pivot Mounts, whilst fixed at the other end to the **PEAK 60** Beam /Post.

SELF-SUPPORTS UP TO 4 METRES*

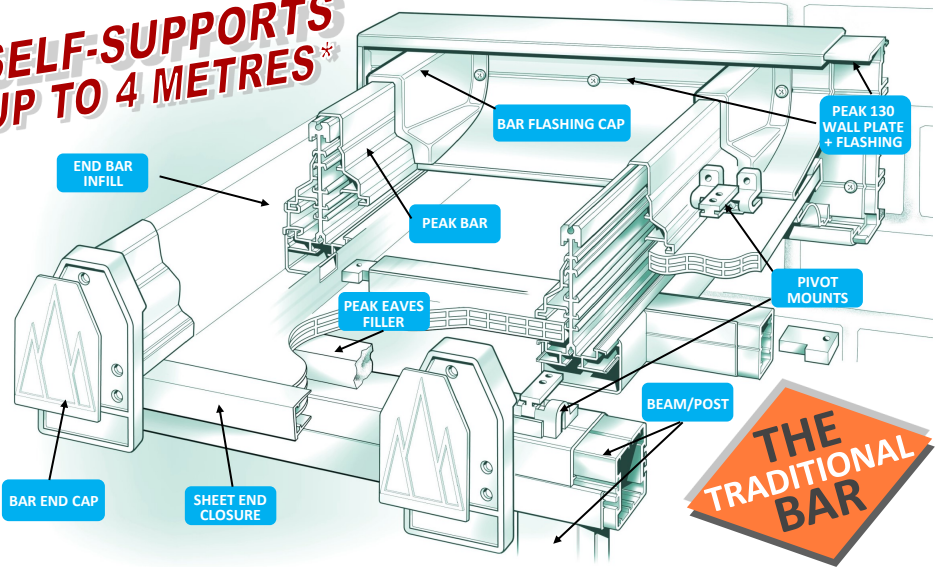

PEAK 100 GLAZING BARS

COLOUR	WHITE	
LENGTH	PART	PRICE
2.0M (6' 6")	P120WH	£31.49
2.5M (8' 2")	P125WH	£38.49
3.0M (9' 10")	P130WH	£46.49
3.5M (11' 6")	P135WH	£53.49
4.0M (13' 1")	P140WH	£60.99
6M BARS ARE NOT SELF-SUPPORTING		
6.0M (19' 8")	P160WH	£91.99

PEAK 100 PIVOT MOUNTS
 PACK OF 2
 Includes fixings

WHITE	
PART	PRICE
PM2WH	£3.48

PEAK 100 BAR FLASHING CAPS
 Includes fixings

WHITE	
PART	PRICE
PFCWH	£3.35

PEAK 100 BAR END CAPS
 Includes fixings

WHITE	
PART	PRICE
PECWH	£1.66

PEAK 130 WALL PLATE

SIZE: 130mm HIGH x 25mm THICK when fitted

Each plate comprises: An Aluminium Core, Core Plastic covers, UPVC Sheet Flashings and a UPVC Bottom Seal Trim.

COLOUR	WHITE	
LENGTH	PART	PRICE
2.0M (6' 6")	PW20WH	£33.33
3.0M (9' 10")	PW30WH	£49.99
4.0M (13' 1")	PW40WH	£66.66
END COVERS Pack of x2	PWEWH	£2.30

WALL PLATE FIXINGS

STAINLESS STEEL FIXINGS

DESCRIPTION	PART	PRICE
4 Drills + 10x 50mm Screws + Wall plugs	PWFK	£5.43
Pack of 10 Screws + Wall plugs	PWF	£2.26

WALL FLASHING FIXINGS

DECORATIVE COLOUR MATCHING SCREWS

18mm Plastic Headed
Stainless Steel Screws
PACK OF 10

	WHITE	
	PART	PRICE
	SP18WH	£2.87

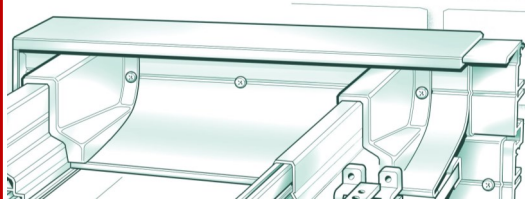

PEAK 60 SUPPORT BEAM/ POST

ALUMINIUM WITH UPVC CAPPING

Used as horizontal Support Beams or as vertical Support Posts/ pillars.

COLOUR	WHITE	
LENGTH	PART	PRICE
2.5M (8' 2")	PB25WH	£32.49
3.0M (9' 10")	PB30WH	£37.49
4.0M (13' 1")	PB40WH	£51.66
BEAM END COVERS Pack of x2	PBEWH	£1.89

BEAM CONNECTORS

Aluminium joining parts.

DESCRIPTION	PART	PRICE
POST TO BEAM CONNECTOR	PBEC	£3.33
STRAIGHT CONNECTOR	PBESC	£4.58

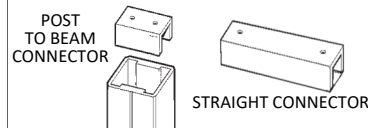

PEAK 100 EAVES FILLER

1M foam strips 10 pack

PART

PRICE

PEF

£7.49

Fills any gaps between the underside of the polycarbonate sheets and the roof frame, reducing draughts & bowing on sheets.

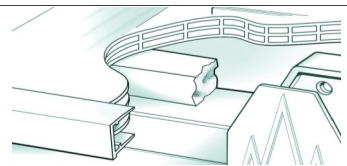

END BAR INFILLS

To fill the gap in the end glazing bar.

SHEET SIZE	FOR 16mm SHEETS		FOR 25mm SHEETS	
COLOUR	WHITE		WHITE	
LENGTH	PART	PRICE	PART	PRICE
2.0M (6' 6")	ET20WH	£3.15	EQ20WH	£4.20
2.5M (8' 2")	ET25WH	£3.94	EQ25WH	£5.25
3.0M (9' 10")	ET30WH	£4.73	EQ30WH	£6.30
3.5M (11' 6")	ET35WH	£5.51	EQ35WH	£7.35
4.0M (13' 1")	ET40WH	£6.30	EQ40WH	£8.40
6.0M (19' 8")	ET60WH	£9.45	EQ60WH	£12.60

**+ MORE
ROOF
ACCESSORIES**

SEE PAGES 24-25

> Sealing Buttons

> Sealing Tapes

> Sheet Enclosures

YORK GLAZING BAR

SELF-SUPPORTS
UP TO 4 METRE SPANS*

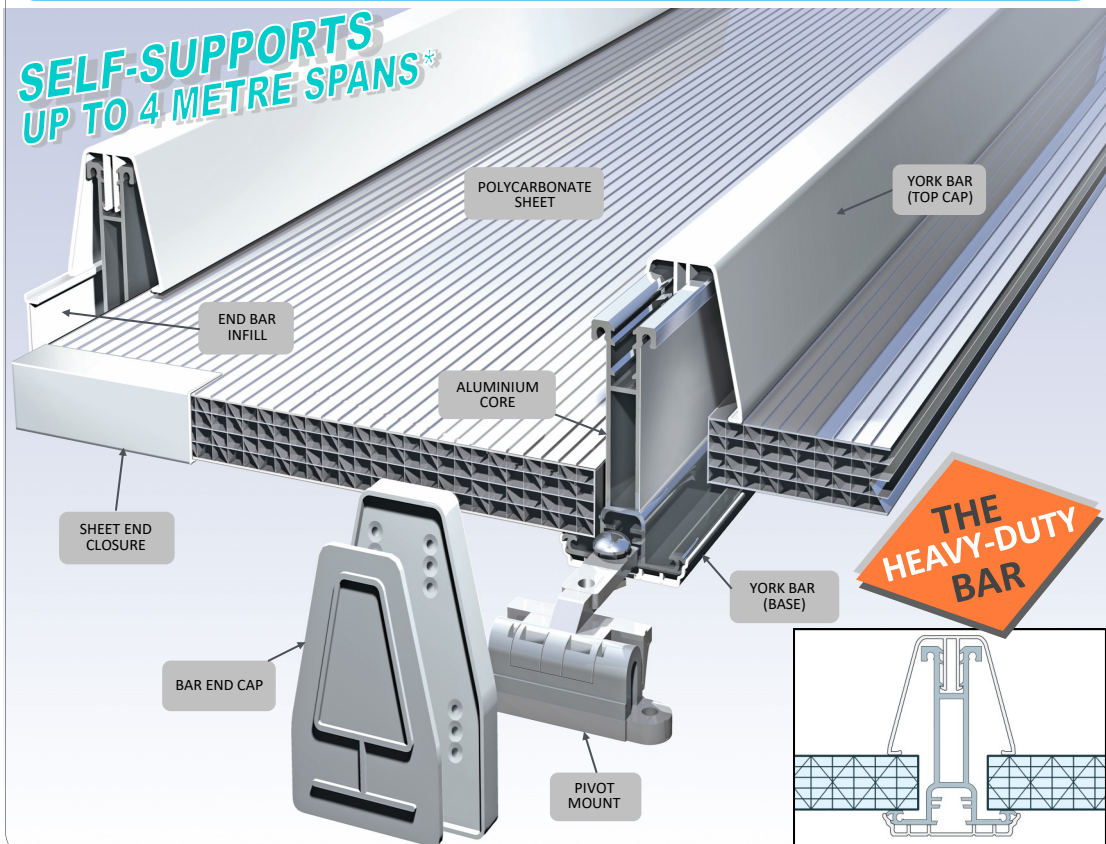

- ▶ C&A's own proven design
- ▶ Self Supporting up to 4M*
- ▶ For 16/25/35/40mm Polycarbonate sheets

Designed to satisfy a recent demand for thicker polycarbonate roof sheets that have the highest insulation standards.

These Self Supporting bars are strong enough to hold their own weight without any timbers underneath each bar, using the Pivot Mounts to attach the Glazing Bars to a Wall Plate fitted on to the host wall, and fix the other (gutter) end to the front beam.

YORK Glazing Bars are available up to 6M in length for better optimisation when cutting to size, these are not self supporting.

The YORK system has been designed to cater for a wide variety of demands, from small span roofs where a lighter aluminium can be used to reduce cost, to large heavy duty aluminium for larger spans and thicker sheets.

> The System 7

Suitable for roofs with spans of up to 3M with 70mm high Aluminium Core.

> The System 8

Suitable for roofs with spans of up to 4M with 84mm high Aluminium Core.

*See spanning tables on Page 29.

YORK GLAZING BARS

SYSTEM 7

FOR 16mm, 25mm & 40mm SHEETS

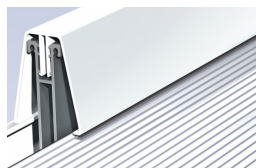

SIZE	FOR 16mm SHEETS				FOR 25mm & 40mm SHEETS			
	COLOUR	WHITE		BROWN		WHITE		BROWN
LENGTH	PART	PRICE	PART	PRICE	PART	PRICE	PART	PRICE
2.0M (6' 6")	Y7L20WH	£23.99	Y7L20BR	£26.39	Y7S20WH	£23.49	Y7S20BR	£25.84
2.5M (8' 2")	Y7L25WH	£29.99	Y7L25BR	£32.99	Y7S25WH	£29.49	Y7S25BR	£32.44
3.0M (9' 10")	Y7L30WH	£35.49	Y7L30BR	£39.04	Y7S30WH	£34.99	Y7S30BR	£38.49

YORK GLAZING BARS

SYSTEM 8

FOR 25mm, 35mm & 40mm SHEETS

For refurbishing or spares, plastic capping is available separately, Please contact us for information.

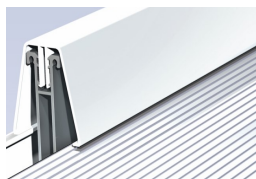

SIZE	FOR 25mm & 35mm SHEETS				FOR 40mm SHEETS				
	COLOUR	WHITE		BROWN		WHITE		BROWN	
LENGTH	PART	PRICE	PART	PRICE	PART	PRICE	PART	PRICE	
2.0M (6' 6")	Y8L20WH	£25.99	Y8L20BR	£26.57	Y8S20WH	£25.49	Y8S20BR	£28.04	
2.5M (8' 2")	Y8L25WH	£32.49	Y8L25BR	£32.99	Y8S25WH	£31.99	Y8S25BR	£35.19	
3.0M (9' 10")	Y8L30WH	£38.99	Y8L30BR	£40.33	Y8S30WH	£38.49	Y8S30BR	£42.34	
3.5M (11' 6")	Y8L35WH	£45.49	Y8L35BR	£46.74	Y8S35WH	£44.99	Y8S35BR	£49.49	
4.0M (13' 1")	Y8L40WH	£51.99	Y8L40BR	£54.08	Y8S40WH	£50.99	Y8S40BR	£56.09	
▼ *6M BARS ARE NOT SELF-SUPPORTING* ▼									
6.0M (19' 8")	Y8L60WH	£77.99	Y8L60BR	£85.79	Y8S60WH	£76.49	Y8S60BR	£84.14	

YORK

PIVOT MOUNTS/BAR FIXINGS

Used to fix the glazing bars into place at the top & bottom of bar SOLD IN PACKS OF 2

Includes fixings 1 to attach to a Wall Plate and 1 to the Front Beam.

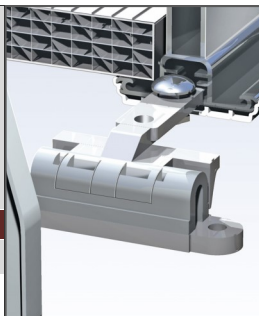

WHITE		BROWN	
PART	PRICE	PART	PRICE
YM2WH	£4.57	YM2BR	£4.91

YORK

GLAZING BAR END CAP

Includes fixings.

Large front face endcap to fit all York Glazing bars (16/25/35/40mm)



WHITE		BROWN	
PART	PRICE	PART	PRICE
YECWH	£1.58	YECBR	£1.74

+ ROOF ACCESSORIES

SEE PAGES 24-25

- > Eaves Filler
- > Sealing Buttons
- > Sealing Tapes
- > Sheet Enclosures
- > End Bar Infills
- > Wall Flashing

ROOF ACCESSORIES FOR POLYCARBONATE ROOFS

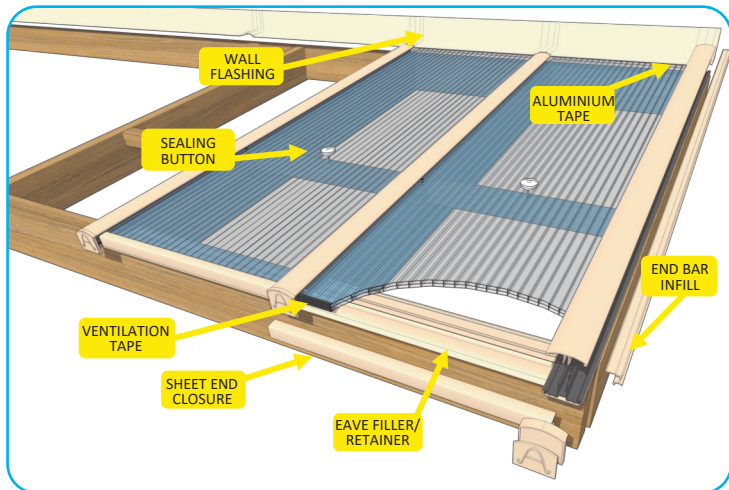

SEALING BUTTONS

Pack of 10

For use on Polycarbonate, to secure sheets into place. Whilst allowing for sheet expansion.

COLOUR ▶	WHITE		BROWN		
	FOR SHEET SIZE ▼	PART	PRICE	PART	PRICE
6mm		B6WH	£4.25	-	-
10mm		B10WH	£4.50	B10BR	£4.96
16mm		B16WH	£4.60	B16BR	£4.97
25mm		B25WH	£4.73	B25BR	£4.98
35mm		B35WH	£5.30	B35BR	£5.50
40mm		B40WH	£5.70	B40BR	£5.90

SEALING TAPES

10M ROLL

Seals over the ends of polycarbonate sheets. Use Ventilation Tape on the lower end and Aluminium Tape on the top End.



TYPE OF TAPE ▶	ALUMINIUM		VENTILATION	
FOR SHEET SIZE ▼	PART	PRICE	PART	PRICE
4mm/6mm/10mm	TA10	£1.35	TV10	£4.93
16mm	TA16	£1.79	TV16	£7.39
25mm	TA25	£1.97	TV25	£8.67
35mm/40mm	TA40	£2.25	TV40	£9.48

SHEET END CLOSURE

U-section trim that push-fits over the ends of sheets (and tapes) between glazing bars. Available in white or

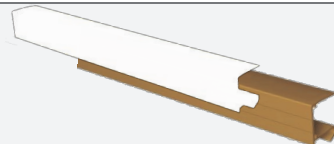

SHEET THICKNESS ▼	COLOUR ▶	WHITE		BROWN		
		LENGTH ▼	PART	PRICE	PART	PRICE
6mm	1.05M		U610WH	£1.39	U610BR	£1.45
			U621WH	£2.78	U621BR	£2.99
10mm	1.05M		UE10WH	£1.42	UE10BR	£1.55
			UE21WH	£2.84	UE21BR	£3.10
16mm	1.05M		UT10WH	£1.69	UT10R	£2.08
			UT21WH	£3.32	UT21BR	£3.74
25mm	1.05M		UQ10WH	£2.37	UQ10BR	£2.59
			UQ21WH	£4.28	UQ21BR	£4.75
35mm	0.98M		UK98WH	£2.58	UK98BR	£2.84
			UK12WH	£3.12	UK12BR	£3.43
			UK21WH	£5.46	UK21BR	£5.99
40mm	1.2M		UN12WH	£3.65	UN12BR	£3.99
			UN21WH	£6.40	UN21BR	£7.20

END BAR INFILL COMPATIBLE WITH *GLEN, AVON, YORK & PEAK 100* BARS (SEE BELOW FOR *Hawk* BARS)

Push fits into the gap in the End Bar's outer edge where there is no sheet to finish the roof end.

SHEET SIZE	6mm/10mm SHEETS				16mm SHEETS				25mm SHEETS				35mm SHEETS				40mm SHEETS			
COLOUR ▶	WHITE		BROWN		WHITE		BROWN		WHITE		BROWN		WHITE		BROWN		WHITE		BROWN	
LENGTH ▼	PART	PRICE	PART	PRICE	PART	PRICE	PART	PRICE	PART	PRICE	PART	PRICE	PART	PRICE	PART	PRICE	PART	PRICE	PART	PRICE
2.0M (6' 6")	EE20WH	£2.10	EE20BR	£2.20	ET20WH	£3.15	ET20BR	£3.47	EQ20WH	£4.20	EQ20BR	£4.62	EK20WH	£5.25	EK20BR	£5.78	EN20WH	£6.30	EN20BR	£6.93
2.5M (8' 2")	EE25WH	£2.63	EE25BR	£2.75	ET25WH	£3.94	ET25BR	£4.34	EQ25WH	£5.25	EQ25BR	£5.78	EK25WH	£6.56	EK25BR	£7.22	EN25WH	£7.88	EN25BR	£8.66
3.0M (9' 10")	EE30WH	£3.15	EE30BR	£3.30	ET30WH	£4.73	ET30BR	£5.20	EQ30WH	£6.30	EQ30BR	£6.93	EK30WH	£7.88	EK30BR	£8.66	EN30WH	£9.45	EN30BR	£10.40
3.5M (11' 6")	EE35WH	£3.68	EE35BR	£3.85	ET35WH	£5.51	ET35BR	£6.07	EQ35WH	£7.35	EQ35BR	£8.09	EK35WH	£9.19	EK35BR	£10.11	EN35WH	£11.03	EN35BR	£12.13
4.0M (13' 1")	EE40WH	£4.20	EE40BR	£4.40	ET40WH	£6.30	ET40BR	£6.93	EQ40WH	£8.40	EQ40BR	£9.24	EK40WH	£10.50	EK40BR	£11.55	EN40WH	£12.60	EN40BR	£13.86
6.0M (19' 8")	EE60WH	£6.30	EE60BR	£6.60	ET60WH	£9.45	ET60BR	£10.40	EQ60WH	£12.60	EQ60BR	£13.86	EK60WH	£15.75	EK60BR	£17.33	EN60WH	£18.90	EN60BR	£20.79

END BAR INFILL

COMPATIBLE WITH *Hawk* BARS Only

FOR 10mm/16mm/25mm

WHITE ONLY		
LENGTH	PART	PRICE
2.0M (6' 6")	HBE20WH	£4.96
3.0M (9' 10")	HBE30WH	£7.44
4.0M (13' 1")	HBE40WH	£9.92
6.0M (19' 8")	HBE60WH	£14.88

EAVES RETAINER

FOR *AVON* BARS Only

Screw to the front beam to lock Sheet End Closures in place and seal the gap between the front beam & the sheet.

COLOUR ▶	WHITE		BROWN	
LENGTH ▼	PART	PRICE	PART	PRICE
0.98M (3' 3")	AER98WH	£2.70	AER98BR	£2.98
2.1M (6' 10")	AER21WH	£5.82	AER21BR	£6.45

PVC WALL FLASHING

For *GLEN, AVON, Hawk* Bars.

Upvc section to seal the roof to the host wall & can be trimmed to fit around glazing bars. Seal with Silicone mastic.

COLOUR ▶	WHITE		BROWN	
LENGTH ▼	PART	PRICE	PART	PRICE
2.0M (6' 6")	PF20WH	£5.00	PF20BR	£5.50
3.0M (9' 10")	PF30WH	£7.50	PF30BR	£8.25
4.0M (13' 1")	PF40WH	£10.00	PF40BR	£11.00

30mm PLASTIC HEADED SCREWS + WALL PLUGS

PACK OF 10

Use to screw the PVC Wall Flashing to wall.

WHITE		BROWN	
PART	PRICE	PART	PRICE
SPP30WH	£3.65	SPP30BR	£3.85

SILICONE MASTIC

Use to seal the PVC Wall Flashing to wall.

WHITE		BROWN	
PART	PRICE	PART	PRICE
SMWH	£3.365	SMBR	£3.65

STANDARD EAVES FILLERS

For *GLEN, AVON, Hawk* Bars
L 1000mm x W 20mm x D 12mm

PACK OF 10
1M FOAM STRIPS

PART	PRICE
GAEF	£7.90



PEAK EAVES FILLERS

For *PEAK 100* & also *YORK* Bars
L 1000mm x W 32mm x D 23mm

PACK OF 10
1M FOAM STRIPS

PART	PRICE
PEF	£7.49



SANCTUARY CANOPY SYSTEM *COMPLETE KITS*



- ▶ Verandas
- ▶ Carports
- ▶ Walkways
- ▶ Smoking shelters
- ▶ And more!

- ✓ Strong All-Aluminium framework construction.
 - Plain Aluminium is used for painting on site.
 - Gloss white is pre painted ready to install.
- ✓ Durable 16mm HAZE Polycarbonate sheets giving weather protection and shade.
- ✓ Hidden integral gutter within front beam and support posts that:
 - Minimise the space required for the structure.
 - Cut costs - no need for additional guttering.
 - Reduce risk of damage - no pipes to knock.
- ✓ Cavities in the bar, to allow for electrics to be concealed inside.
- ✓ Simple fixing system for speed and ease of installation.
- ✓ Kits come complete with Bolts, Screws, Rivets, Drill bits, Sealants, Installation guide and Rivet gun.



Additional Cost options:

- Alternative frame and sheet colours available to order. Call 01634 374444

Frame: PLAIN ALUMINIUM		Roof Sheets: 16mm HAZE KITS					
ROOF WIDTH ▶	3.20M		4.25M		5.30M		
PROJECTION ▼	PART	PRICE	PART	PRICE	PART	PRICE	
2.0M (6' 6")	SC2032PA	£362.90	SC2042PA	£469.15	SC2053PA	£554.16	
2.5M (8' 2")	SC2532PA	£394.15	SC2542PA	£517.15	SC2553PA	£614.15	
3.0M (9' 10")	SC3032PA	£441.65	SC3042PA	£569.99	SC3053PA	£679.99	
3.5M (11' 6")	SC3532PA	£479.16	SC3542PA	£624.99	SC3553PA	£737.49	
4.0M (13' 1")	SC4032PA	£524.99	SC4042PA	£676.65	SC4053PA	£799.99	

Frame: GLOSS WHITE		Roof Sheets: 16mm HAZE KITS					
ROOF WIDTH ▶	3.20M		4.25M		5.30M		
PROJECTION ▼	PART	PRICE	PART	PRICE	PART	PRICE	
2.0M (6' 6")	SC2032WH	£441.66	SC2042WH	£566.66	SC2053WH	£665.82	
2.5M (8' 2")	SC2532WH	£485.82	SC2542WH	£621.24	SC2553WH	£734.99	
3.0M (9' 10")	SC3032WH	£529.16	SC3042WH	£683.33	SC3053WH	£816.65	
3.5M (11' 6")	SC3532WH	£574.16	SC3542WH	£741.66	SC3553WH	£874.99	
4.0M (13' 1")	SC4032WH	£616.66	SC4042WH	£791.66	SC4053WH	£944.99	

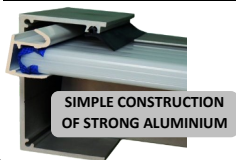

Installation Guide & Assembly Video Online

SANCTUARY CANOPY Installation Guide 5:55

SANCTUARY COMPONENTS

- ▶ Make customised configurations
- ▶ Buy spare/ replacement parts
- ▶ Gloss White or Plain Aluminium
You can leave it plain or paint it yourself

The Sanctuary System can be configured to suit your needs. This can include changing the glazing sheet options, extending to make larger widths, fixing back to back to make double pitched roofs (tie bars/wire may be required), pitching towards each other into a valley formation, or even used vertically in a fencing application.

BARS

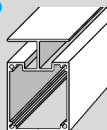

Endcaps sold separately

FINISH	▶	PLAIN ALUMINIUM		GLOSS WHITE		
		LENGTH ▼	PART	PRICE	PART	PRICE
		2.0M (6' 6")	SCB20PA	£20.99	SCB20WH	£25.65
		2.5M (8' 2")	SCB25PA	£26.49	SCB25WH	£32.07
		3.0M (9' 10")	SCB30PA	£31.49	SCB30WH	£38.48
		3.5M (11' 6")	SCB35PA	£36.99	SCB35WH	£44.90
		4.0M (13' 1")	SCB40PA	£42.49	SCB40WH	£51.32

SUPPORT POSTS

2.5M LONG

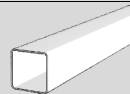

PART	PRICE	PLAIN ALUMINIUM		GLOSS WHITE	
		PART	PRICE	PART	PRICE
SCP25PA	£21.49	SCP25WH	£30.24		

GLASS CLEAR 6mm SOLID POLYCARBONATE SHEET

Glass clear polycarbonate roof panels are a maximum of 3M long and used with the bar gasket. This required to hold the sheets in place. These sheets give that glass like appearance.

	PART	PRICE
3.0M x 600mm 6MM SOLID PC	SCS63006CL	£99.95
6mm PC BAR GASKET (1.0M)	SCG6STOCK	£2.89
6mm SHEET END CLOSURE	U621WH	£2.78

WALL PLATE

Gasket sold separately
The gasket is priced per 1M



To order the gasket calculate how many metres you require and then order that amount.

FINISH	▶	PLAIN ALUMINIUM		GLOSS WHITE		
		LENGTH ▼	PART	PRICE	PART	PRICE
		3.20M (10' 6")	SCW32PA	£32.08	SCW32WH	£39.40
		4.25M (13' 11 ^{1/3} ")	SCW42PA	£42.15	SCW42WH	£53.15
		5.30M (17' 4 ^{2/3} ")	SCW53PA	£52.24	SCW53WH	£65.99
		1.0M Gasket	SCWGSTOCK	£1.49	SCWGSTOCK	£1.49

FIXINGS AND ACCESSORIES

COMPONENT	PART	PRICE
POST CONNECTOR SET	SCPESET	£8.24
WALLPLATE FIXINGS (10PK)	TFF8100	£6.04
RIVETS (100PK)	TR4812	£5.99
WHITE PAINT TOUCH UP	SCPAINT	£14.99
HAND RIVET GUN	THRG	£4.99
5mm ALI DRILLBIT	DH55	£1.32
8mm ALI DRILL BIT	DH58	£1.32
8mm SDS MASONARY BIT	TSDS8	£2.09
12mm SDS MASONARY BIT	TSDS12	£2.50
S/S ENDCAP SCREWS (50PK)	SR63	£1.69
WHITE SCREW CAPS (25PK)	SCSWH	£0.99
CLEAR SILICONE	SMCL	£3.65

FRONT BEAM



Endcaps sold separately

FINISH	▶	PLAIN ALUMINIUM		GLOSS WHITE		
		LENGTH ▼	PART	PRICE	PART	PRICE
		3.20M (10' 6")	SCF32PA	£54.49	SCF32WH	£77.90
		4.25M (13' 11 ^{1/3} ")	SCF42PA	£71.99	SCF42WH	£104.49
		5.30M (17' 4 ^{2/3} ")	SCF53PA	£89.99	SCF53WH	£130.15

END PLATES

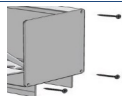

	FRONTBEAM		GLAZING BAR		WALLPLATE	
FINISH	PART	PRICE	PART	PRICE	PART	PRICE
PLAIN ALUMINIUM	SCFEPPA	£3.84	SCBEPPA	£2.19	SCWEPPA	£2.74
GLOSS WHITE	SCFEPWH	£5.49	SCBEPWH	£2.94	SCWEPWH	£3.49

MULTIWALL POLYCARBONATE

See Pages 6 & 7 For 16mm Sheets

COMPONENT	PART	PRICE
16mm SHEET END CLOSURE	UT21WH	£3.32

C&A can powder coat framework to any RAL colour for you. Please contact us for a quote. Special coating increases delivery time scales.



Need Advice Then CALL!
01634 374444

GLAZING BAR KNOW-HOW

Securing Frame-Supported Glazing Bars

GLEN, HAWK & AVON Glazing Bars utilise Snap-down Top Caps. The Base Section should be screwed down every 600mm along the length through the sealed Centre Channel provided for fixings. This allows any water that may ingress under the Top Cap to run down the Drainage Channels on the sides of the bars.

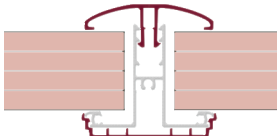

The **GLEN & HAWK** bars must have structural support under their entire length, whilst the **AVON** with stronger aluminium core can span across purlins that are no greater than 600mm (approx. 2ft) apart. This makes them ideal as a replacement to corrugated roofs as the structure should not need changing if originally built correct and in good order.

Once the Base Sections are fastened to the support structure, the sheets are placed in position, ensuring the expansion gaps are included and that a vertical rib of the sheet will be encapsulated by the bar. The Top Cap is then pushed down into the Base Section and a set of retaining hooks holds the top cap in place. This can be done with a firm hand or by gently tapping with a rubber mallet. To ensure a seal, the Top Cap must have pressure on both sides to stop it from toppling over. Therefore if there is no sheet on one side, then a Bar End Infill must be used in its place.

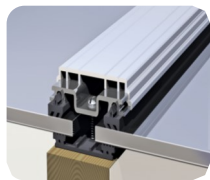

VALE Glazing Bars have a screw down Top Cap that is intended for the sealing (but not retaining) of glass units or solid polycarbonate. These consist of a rubber base gasket that need to be secured to the structural supports. The glazing is then placed on the Base Gasket and secured with a Retainer. The Aluminium Core Section with rubber seals is then placed along the joint and fastened through the middle into the supporting structure every 300mm with the appropriate length stainless steel screw.

This should only be tightened until the gaskets are under a small amount of compression. Once fastened the PVC Top Cover can be snapped onto the Aluminium Core, providing a thermal break and seal over the fixings. These Bars can also be fastened to pre-rolled steel box section for the fabrication of barrel vaults.

Timbers for Frame Supported Glazing Bars

The size of the timbers will depend on many factors, including the weather conditions the roof is going to be subjected to and the quality of the timber used. **TABLE A** is a guide only. You must ensure that the support provided is suitable for your application.

TABLE A	LENGTH OF BAR ▼	SIZE OF TIMBER SUPPORT ▼	
		WIDTH	DEPTH
Timber rafter size guide (when at 1M centres)	2.0M (6' 6")	50mm (2")	100mm (4")
	3.0M (9' 10")	50mm (2")	125mm (5")
	4.0M (13' 1")	50mm (2")	150mm (6")
	5.0M (16' 4")	50mm (2")	200mm (8")

Sheet Width & Glazing Bar Spacing

The Polycarbonate sheet widths available (up to 2.1M) are much wider than they can span unsupported, but are available for better sheet optimisation when cutting. The distance between the timber supports for the sheets will depend on the sheet thickness, sheet structure, and the sheet's typical environment (this information can be found in the manufacturer's data sheets). **TABLE B** is a guide only for normal operating environments.

TABLE B	SHEET THICKNESS ▶	6mm	10mm	16mm	25mm+
	MAX SPAN ▼				
Sheet spanning guide for Frame Supported Bars	Without Purlins	600mm	700mm	1000mm	1200mm
	Purlins at 600mm	1000mm	1000mm	1500mm	1500mm

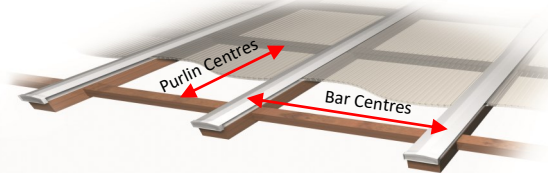

Cutting Bars & Securing Capping/ Beading

It is recommend to use hand tools when cutting our Glazing bars. The Aluminium and PVC sections can both be cut with a fine tooth hacksaw.

When installing secure the PVC glazing caps/ beads by hand wherever possible. A rubber mallet can be used, but should be used with caution as to not cause damage.

Self Supporting Bars

PEAK 100 Bars for 16mm &, 25mm polycarbonate sheets on spans of up to 4M.

Designed for mono-pitch roofs with spans up to 4M, this very well proven Glazing Bar system has PVC capping on both the inside and outside for an attractive appearance and thermal insulation. An Aluminium reinforced Wall Plate is used to secure the roof to the host building, whilst a PVC clad Aluminium **PEAK 60** Beam with optional posts support the roof at the lower end. All fixings are Stainless Steel and where these are exposed to view, the fixings have colour matched plastic heads.

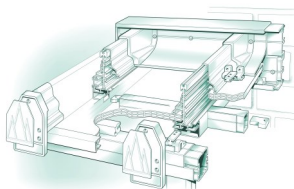

YORK Bars for 16, 25, 35 & 40mm polycarbonate sheets on spans of up to 4M.

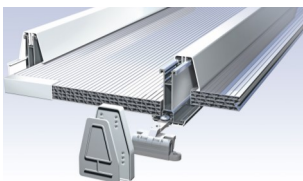

Designed for mono-pitched roofs, **YORK** Glazing Bars are available in two grades – The System 7 bar will carry 16, 25 and 40mm polycarbonate roof sheets up to spans of 3 metres, whilst the heavier gauge System 8 bar will carry 25, 35 and 40mm polycarbonate roof sheets up to spans of 4 metres. Designed to be quick to install with fewer components needed for each bar.

SANCTUARY Bars for 16mm polycarbonate sheets on spans up to 4M.

All-Aluminium construction, these bars are designed to be used with the dedicated Wall Plate and Front Beam of the system. These are then all riveted together to create a substantial framework.



TABLE C Bar spanning guide for Self Supporting Bars	PROJECTION ▼	MAXIMUM BAR SPACING			
		YORK 7	YORK 8	PEAK 100	Sanctuary
	2.0M	1200mm	1200mm	1200mm	1200mm
	2.5M	1100mm	1100mm	1100mm	1200mm
	3.0M	1000mm	1000mm	1000mm	1100mm
	3.5M	N/A	900mm	900mm	1050mm
	4.0M	N/A	700mm	700mm	1050mm

Bar Drainage Channels

C&A bar systems specifically for polycarbonate sheets have a sheet retention system that secures the roof sheets and prevents the ingress of water without restricting the essential thermal expansion. Apart from the **VALE** Bar, all our Glazing Bars do not need rubber seals/ gaskets, which can weather over time and restrict sheet expansion. In extreme weather conditions strong winds may force small amounts of rainwater into the joint between the sheet and the bar's Top Cap which is why these bars have drainage channels immediately behind the joint leading down to the gutter.

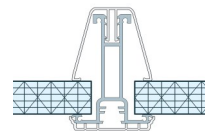

Pivot fixings for Self Supporting Bars

Because of the Drainage system designed in all of C&A's Glazing Bars, the **PEAK** and **YORK** Bars have dedicated Pivot Mounting systems to secure the bars without compromising the drainage.

The head of the Pivot Mount is slid up the bar and secured from underneath, ensuring the channels are unaffected. The base is fastened to the Wall Plate or front beam, through the designated holes, and the two parts are linked together with a stainless steel pin.

By being assembled round the pivoting action of the pin, the bars can be set at any angle up to 45°. It should be noted that low pitch roofs can suffer from standing water and the water blow back, increasing the chance of water penetration. It is recommended that roofs should try to be set with a minimum 15° pitch wherever possible to minimise this.

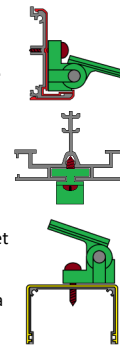

Stainless Steel Fixings

When fixing to Aluminium it is important that the correct type of fixing is chosen. Stainless Steel has high strength and is very resistant to corrosion making it an ideal choice for any screws, nuts, bolts or pins - C&A mostly supply these.

Untreated Steel will rust and weaken over time and although Zinc-plated Steel has a protective coating to help protect it from rusting, it unfortunately also reacts with Aluminium, causing weakness. Aluminium fixings do not suffer corrosion or reaction, but are not as strong as Stainless Steel.



CLEAR 3" CEMENT PROFILE PVC

3" profile sheeting is commonly used for a wide variety of roles in modern DIY. Uses include carports, greenhouses, chicken coops & garden covering - the list can go on.

Available in 2 thicknesses **0.8mm Economy Grade** and **1.3mm Thickness Trade Grade**. The thicker Trade Grade has increased strength and durability. This should allow the trade grade sheets to out live their thinner economy counterparts. All corrugated sheets are available from stock with a full range of accessories.

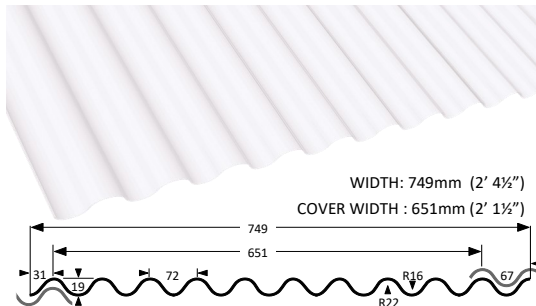

LENGTH	ECONOMY GRADE 0.8mm Thick		TRADE GRADE 1.3mm Thick	
	PART	PRICE	PART	PRICE
1.82M (6ft)	R56CL	£6.52	R106CL	£10.26
2.13M (7ft)	R57CL	£7.62	R107CL	£11.97
2.44M (8ft)	R58CL	£8.69	R108CL	£13.68
2.74M (9ft)	R59CL	£9.78	R109CL	£15.39
3.04M (10ft)	R510CL	£10.88	R1010CL	£17.10
3.64M (12ft)	R512CL	£13.99	R1012CL	£21.99

3" CEMENT PROFILE GRP FIBRE GLASS

Fibreglass roof sheets have great strength and durability. They are commonly used as roof lights in agricultural and commercial buildings. Class 3, 1.83kg Grade is designed for domestic or light commercial use. These sheets admit light but not sight and are easily trimmed to size with a fine-toothed saw. Higher grade sheeting is available for use on industrial or commercial areas.

N.B. Class 1 & Class 0 sheets can be supplied to order.



CLASS 3 (1.83Kg/M²)



LENGTH	PART	PRICE
1.82 (6ft)	RF336	£26.78
2.44 (8ft)	RF338	£35.71
3.04 (10ft)	RF3310	£44.64

CLEAR 3" IRON PROFILE POLYCARBONATE

One of the first stockists in the UK

Manufactured using Polycarbonate Resin giving an extremely tough durable corrugated sheet. The ideal choice for residential, commercial, industrial and agricultural projects.

ADVANTAGES OVER PVC:

- Vastly stronger than standard PVC sheets
- UV Coated, Blocking up to 99% of harmful UV
- Withstands higher temperatures up to 130°C (PVC: 60°C)
- Improved lifespan compared to PVC sheets
- Easier to install than standard PVC sheets
- Wider cover width
- Profile matched to our Galvanised sheets - see page 38 for more information

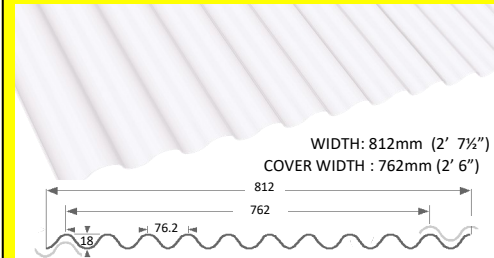

LENGTH	SUPER GRADE 1.0mm Thick	
	PART	PRICE
1.82M (6ft)	RG106CL	£14.09
2.44M (8ft)	RG108CL	£18.79
3.04M (10ft)	RG1010CL	£23.49

ACCESSORIES & KNOW HOW

Know How

Recommended Purlin Centres

Profile	Fixing Centre	Economy	Trade/Super Grade	Cover Width
3" Profile	180mm	610mm	914mm	651mm



How many fixing do I need?

Step 1 Divide the overall roof width by fixing centre (eg $4860\text{mm} / 180\text{mm} = 27$)

Step 2 Divide the roof length by the Purlin centres and add 1 (eg $2440\text{mm} / 610\text{mm} = 4 + 1 = 5$)

Step 3 Multiply these two numbers together ($27 \times 5 = 135$): Approx. number of fixings needed.

The actual amount may vary depending on overlaps and purlin centres

TYPE	PART	PRICE	PACKS OF 10
Zinc Plated Steel	RFS	£0.99	
Stainless Steel	RFX	£1.49	Inc spacers 

Do I Need Foam Fillers? Fillers should be used under the sheets at all support positions to prevent roof 'chatter' and to support the sheets when fixed.

3" Profile Foam Eaves Filler

Pack of 10

PROFILE	LENGTH	PART	PRICE
3" CEMENT	As sheet width	REF3	£4.95
3" IRON	As sheet width	RGEF3	£4.95

How to Cut Sheets:

Sheets should overhang the roof by 60mm to allow water run-off.

When cutting, use an angle grinder with a metal slitting blade or a fine tooth saw at a shallow angle applying light pressure. **A good tip** when cutting, is to sandwich the sheet between other sheets with the part to be cut off protruding.

Pre-drill sheets before fixing. Holes for fixings must be drilled typically 4mm larger than the fixing diameter to allow for expansion. Drill sheets singularly with a masonry bit on a low speed and use light pressure. Support the sheet securely under each hole position when drilling. There should be at least 5 fixings across the width of each sheet which are to be fixed into the purlins and rafters.

RIDGES & FLASHINGS



Clear 3" Profile PVC Ridge

PROFILE	LENGTH	PART	PRICE
3"	660mm(2' 2")	RR3CL	£7.99



Clear Profile PVC Wall Flashing

PROFILE	LENGTH	PART	PRICE
3" CEMENT	660mm (2' 2")	RWF3CL	£4.49
3" IRON	660mm (2' 2")	RWFG3CL	£4.49
1 1/4" MINI	660mm (2' 2")	RWFMCL	£4.49



Lap Sealing

PART	LENGTH	PART	PRICE
Lap Tape	10M	RLT	£1.99
Clear Silicone	Up To 11M Bead	SMCL	£3.65

WHITE 1 1/4" PROFILE PVC

Solid White PVC sheets are most commonly used as a wall liner. PVC is water-resistant and very easy to keep clean.

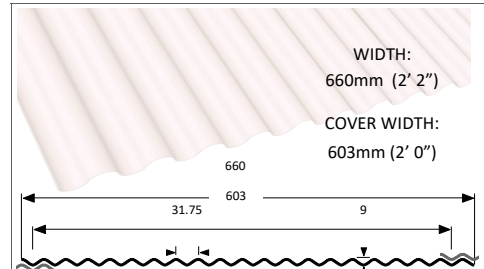

LENGTH	PART	PRICE
3.04M (10ft)	R210WH	£11.94

TYPE	SHEET	PART	PRICE	PACKS OF 10
Plated Steel	1 1/4"	RFM	£0.33	

Mini Profile Foam Filler

Pack of 10

PROFILE	LENGTH	PART	PRICE
1 1/4"	As sheet width	REFM	£3.85

CORRUGATED SHEETS

SUPERBOX 70/18 GRECCA PROFILE SOLID COLOUR PVC CORRUGATED

1.1mm thick sheets are lightweight and surprisingly strong. Ideal for use in many areas.

- Roofing
- Garden Pavilions
- Carports
- Sheds
- Chicken runs
- Bin sheds



Each sheet provides a full metre width of coverage, resulting in less sheets to handle and fix and a faster project completion time.

N.B. These sheets are not suitable for over-roofing substrates, such as plywood or chipboard.

Dark colours are not suitable for use in locations where temperatures over 40°C can occur.

WIDTH: 1095mm
COVER: 1050mm

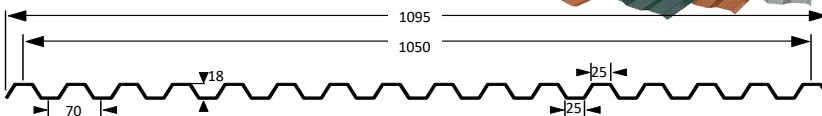

Box profile coloured sheets are a solid colour which means no light will pass through.



Soft Sheen



Soft Sheen

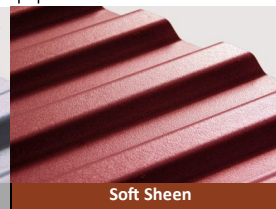

Soft Sheen

LENGTH	PART	PRICE	PART	PRICE	PART	PRICE
1.82M (6ft)	RB6GR	£17.36	RB6LG	£17.56	RB6TC	£17.56
2.44M (8ft)	RB8GR	£23.04	RB8LG	£23.24	RB8TC	£23.24
3.04M (10ft)	RB10GR	£28.72	RB10LG	£28.92	RB10TC	£28.92

ACCESSORIES

Clear PVC Wall Flashing



PROFILE	LENGTH	PART	PRICE
BOX	660mm (2' 6")	RWFBCL	£4.49

Eaves Filler

Pack of 10



PROFILE	LENGTH	PART	PRICE
BOX	1050mm (3' 5")	REFB	£4.99

SHEET FIXING

TYPE	PART	PRICE	PACKS OF 10
Plated Steel	RFS	£0.99	
Stainless Steel	RFX	£1.49	Inc spacers



Lap Sealing

PART	LENGTH	PART	PRICE
Lap Tape	10M	RLT	£1.99
Clear Silicone	Up To 11M Bead	SMCL	£3.65

+ Alternative fixings available See Page 94

LIGHTING SHEETS

Translucent sheets allow light but restrict sight.

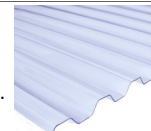

Clear sheets allow light and have no restriction on sight.



LENGTH	NATURAL TRANSLUCENT BLUE		GLASS-CLEAR	
	PART	PRICE	PART	PRICE
1.82M (6ft)	RB6NT	£16.97	RB6CL	£16.67
2.44M (8ft)	RB8NT	£22.62	RB8CL	£22.32
3.04M (10ft)	RB10NT	£28.27	RB10CL	£27.97

BIG 6 CORRUGATED SHEETS

This traditional high top corrugated sheet can be used for a wide variety of projects from:

- Porches
- Carports
- Roof lights
- Greenhouses
- Cloches and cold frames
- Side cladding
 - Sheds
 - Walkways

With its glass clear clarity this sheeting can provide up to 3 times more natural light than vertical glazing, creating a bright environment below. This sheeting is strong but light-weight making them easy to handle and install. The size of these sheets gives a larger cover area resulting in a faster installation time.

CLEAR BIG 6 PROFILE PVC

WIDTH: 1086mm (3' 6½")

COVER WIDTH: 1016mm (3' 3½")

1.3mm Thickness

LENGTH	PART	PRICE
1.82M (6ft)	R1066CL	£16.99
2.44M (8ft)	R1068CL	£22.49
3.04M (10ft)	R10610CL	£28.49

SHEET FIXING

Eaves Filler
Pack of 10

PROFILE	LENGTH	PART	PRICE
BIG 6	1086mm (3' 6½")	REF6	£5.99

Lap Sealing

PART	LENGTH	PART	PRICE
Lap Tape	10M	RLT	£1.99
Clear Silicone	Up To 11M Bead	SMCL	£3.65

Big 6 Fixings

SHEET PROFILE	PART	PRICE	PACKS OF 10
Galvanised 6"	RF6	£4.98	

BIG 6 PROFILE GRP CLASS 3 1.83Kg/M²

Manufactured from Glass Reinforced Polyester resin (GRP) with unique light diffusing additives which scatter light passing through. These sheets provide effective daylight without hot spots or excessive glare. Can be used in single skin and double skin site assembled applications. Can also be used for insulating intermediate layers to provide improved insulation levels for compliance with current legislation. With excellent impact resistance and a highly durable UV resistant polyester film on the weather face which extends the durable working life of the sheet and helps to prevent the sheets from discolouring under normal conditions. Sheet life should exceed **30 years!**

Did You Know?

This type of sheeting is also available in over 900 different profiles, to match all current and most discontinued asbestos cement and metal roofing profiles. If you require a non standard profile, please contact us for a quote.

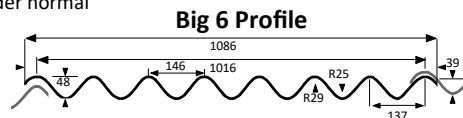

Available in various weights including 1.83kg/m², 2.44kg/m² & 3.06kg/m² to order

BIG 6 PROFILE
WIDTH: 1086mm (3' 6½")
COVER: 1016mm (3' 3½")

CLASS 3 1.83Kg/M²

LENGTH	PART	PRICE
1.82M (6ft)	RF636	£37.48
2.44M (8ft)	RF638	£49.76
3.04M (10ft)	RF6310	£64.90

ONDULINE Classic®



- ✓ Professional grade roofing
- ✓ Proven durability
- ✓ Easy to handle

Onduline is an extremely tough, lightweight, corrugated roofing and wall cladding material, manufactured utilising a base board produced from recycled cellulose fibres which is saturated with bitumen under intense pressure and heat. Onduline sheets are finished with a colour pigment and resin impregnation process which "stains" the colour into the sheet to provide excellent colour retention properties and enhanced U.V. resistance. Onduline Classic sheets are ideal for a wide range of applications reflecting the materials unrivalled versatility for use on agricultural, industrial, DIY and environmental projects.

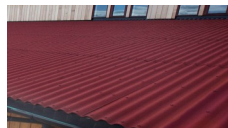

(for more details see the product PDF downloads @ www.cabp.co.uk)

Follow these simple steps to design and construct a durable, long lasting roof.

1 Select roof slope: 15° degrees and over (Gradient: 1 in 4 or higher)

2 To support sheet: Fix to purlins at 610mm (24") Centres (max).

3 To fix sheet: Sheet side lap: 170mm

Sheet side lap: 1 Corrugation

Nails per sheet: 20

1 Select roof slope: 10° to 15° to degrees (Gradient: 1 in 4 to 1 in 6)

2 To support sheet: Fix to purlins at 450mm (18") Centres (max).

3 To fix sheet: Sheet side lap: 200mm

Sheet side lap: 1 Corrugation

Nails per sheet: 25

1 Select roof slope: 5° to 10° degrees (Gradient: 1 in 6 to 1 in 10)

2 To support sheet: Fix to decked or close boarding roof.

3 To fix sheet: Fully supporting roof deck fixed @ 610mm centres. Sheet side lap: 300mm

Sheet side lap: 2 Corrugation

Nails per sheet: 20

Note: At the eaves allow a 50 to 70mm sheet overhang.

STANDARD ONDULINE SHEETS

2M X 950mm x 3mm (6.4Kg) Coverage width 855mm

COLOUR	PART	PRICE
BLACK	ROB2BK	£10.99
RED	ROB2RD	£13.95
GREEN	ROB2GR	£13.99
CLEAR PVC	ROB2CL	£13.29

ONDULINE Nails

COLOUR CODED HEADS 73mm

It is recommended that each Onduline sheet uses 25 nails.

COLOUR	10 PACK		400 BOX	
	PART	PRICE	PART	PRICE
BLACK	ROBNBK	£1.49	ROBNBK	£16.99
RED	ROBNRD	£1.49	ROBNRD	£16.99
GREEN	ROBNGR	£1.49	ROBNGR	£16.99

ONDULINE RIDGES 1M Width (830mm Coverage allowing overlap)

COLOUR	PART	PRICE
BLACK	RORBK	£7.45
RED	RORRD	£7.75
GREEN	RORGR	£7.95

ONDULINE VERGE 1.1M x 200mm x 200mm

COLOUR	PART	PRICE
BLACK	ROVBK	£7.45
RED	ROVRD	£7.75
GREEN	ROVGR	£7.95

ONDULINE FLASHING BLACK APRON FLASHING 930mm

PART	PRICE
ROBWF BK	£9.99

ONDULINE EAVES FILLER 5 TOP and 5 BOTTOM

PART	PRICE
ROBEF	£6.95

+ Bitumen and Steel sheets can be insulated to help prevent condensation and heat loss unlike the PVC sheets.

ONDUVILLA by Onduline

The **Onduvilla** range has been designed at Onduline's Italian design studio with a unique three tone colour shaded finish in Red and Green, creating warm natural colours normally only associated with expensive and heavy clay roofing products. This attractive colour finish combined with the Mediterranean bold roll profile results in an exciting and exclusive roof covering that bestows an attractive aesthetic roof finish to any structure.

The practical design aspects of the **Onduvilla** tile strip range have not been overlooked with an innovative tile lapping system utilising a grooved lap joint to provide enhanced weathering performance. The tiles form an attractive, durable and light-weight roof covering that can either be laid on a roof decking or close boarding. The system is ideal for a wide variety of applications. A full installation PDF guide can be downloaded from www.cabp.co.uk



ONDUVILLA TILES

1.06M X 400mm
Max Cover Width 1M x 300mm

COLOUR	PART	PRICE
BLACK	ROVTBK	£3.59
GREEN	ROVTGR	£3.59
RED	ROVTRD	£3.59

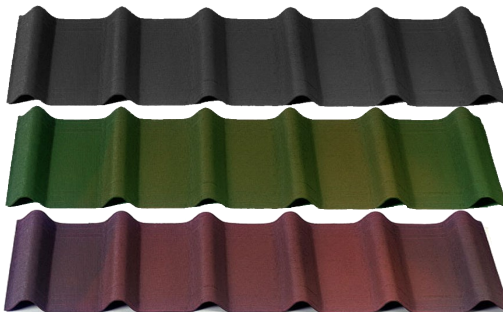

Onduvilla ridges are used to form a weather seal over the ridge of pitched roofs and are fixed into place using the same fixings as the Onduvilla tiles

ONDUVILLA RIDGES

900MM X 500mm (ALLOW FOR OVERLAP)

COLOUR	PART	PRICE
BLACK	ROVRBK	£4.95
GREEN	ROVRGR	£4.95
RED	ROVRRD	£4.95



ONDUVILLA FLASHING

1.02M (ALLOW FOR OVERLAP)

COLOUR	PART	PRICE
BLACK	ROVFBK	£3.95
GREEN	ROVFGR	£3.95
RED	ROVFRD	£3.95

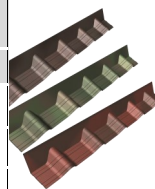

ONDULINE / ONDUVILLA NAILS

COLOUR CODED HEADS 73mm

	PACK OF 10		BOX OF 400	
COLOUR	PART	PRICE	PART	PRICE
BLACK	ROBNBK	£1.49	ROBNBBK	£16.99
GREEN	ROBNGR	£1.49	ROBNBGR	£16.99
RED	ROBNRD	£1.49	ROBNBRD	£16.99



Verge Trims are designed to provide a neat weatherproof seal at the edge of the roof. Can be used for both sides right / left.

ONDUVILLA VERGE

1.00M (ALLOW FOR OVERLAP)

COLOUR	PART	PRICE
BLACK	ROVVBK	£3.69
GREEN	ROVVGR	£3.69
RED	ROVVRD	£3.69

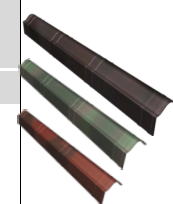

CA32/1000 PROFILE - 1080mm WIDE SHEET - 1M FULL COVER USED IN INDUSTRIAL ROOFING AND CLADDING

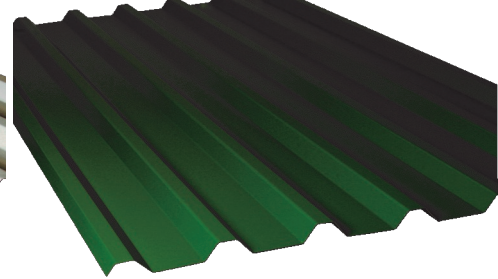
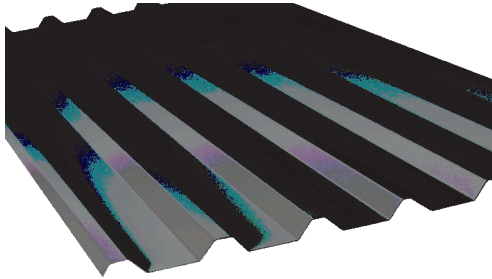

MERLIN GREY

LENGTH	PART	PRICE
2.0M (6' 6")	R3220MG	£34.49
2.5M (8' 2")	R3225MG	£43.65
3.0M (9' 10")	R3230MG	£51.79

GOOSEWING GREY

LENGTH	PART	PRICE
2.0M (6' 6")	R3220GG	£35.70
2.5M (8' 2")	R3225GG	£44.69
3.0M (9' 10")	R3230GG	£53.65

OLIVE GREEN

LENGTH	PART	PRICE
2.0M (6' 6")	R3220OG	£35.79
2.5M (8' 2")	R3225OG	£44.75
3.0M (9' 10")	R3230OG	£53.79

GRP/FIBRE GLASS ROOFLIGHTS SHEETS

LENGTH	PART	PRICE
2.0M (6' 6")	RF3220	£40.39
2.5M (8' 2")	RF3225	£50.49
3.0M (9' 10")	RF3230	£60.59

+ Steel and Bitumen sheets can be insulated to help prevent condensation and heat loss, unlike corrugated PVC sheets.

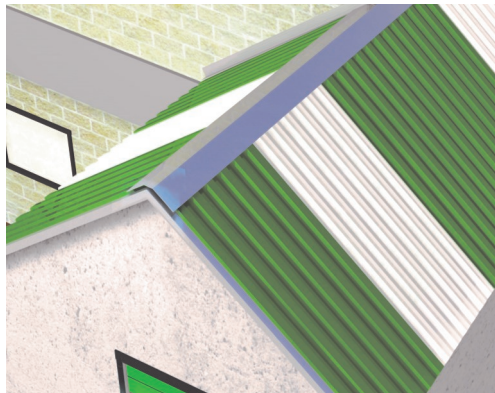

GRP Translucent sheets allow light but not sight. Matching the size and profile of Colour-coat Plastisol sheets they provide daylight through the roof.

Stocked in Class 3 Fire Rating, but Class 1 and Class 0 available on quotation.

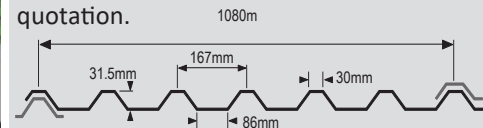

STEEL TRIMS AND ACCESSORIES

FLASHING TRIM 3M

COLOUR	PART	PRICE
MERLIN GREY	R3FMG	£20.70
GOOSEWING GREY	R3FGG	£21.10
OLIVE GREEN	R3FOG	£21.50

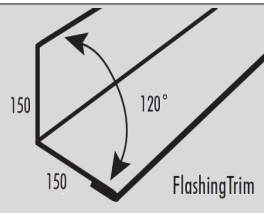

RIDGE TRIM 3M

COLOUR	PART	PRICE
MERLIN GREY	R3RMG	£21.60
GOOSEWING GREY	R3RGG	£21.90
OLIVE GREEN	R3ROG	£21.95

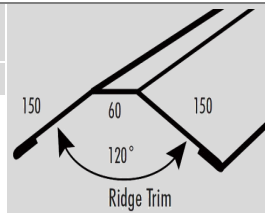

DRILLFIX



PACKS OF 10

SIZE	PART	PRICE
20mm	FSD20	£1.98
38mm	FSD38	£2.39
50mm	FSD50	£2.63
70mm	FSD70	£2.99

8mm Hex Head

Drillfix and Tapfix screws are zinc plated to help prevent corrosion, and come with sealing washers. Don't forget to buy your colour coded caps.

TAPFIX



PACKS OF 10

SIZE	PART	PRICE
38mm	FST38	£2.48
50mm	FST50	£2.69
75mm	FST75	£2.89

Easy to fasten with a nut driver (TS516)

The 20mm stitcher is used to secure trim overlaps and to the profile roofing sheeting.

NOTE—Tapfix need a predrilled hole

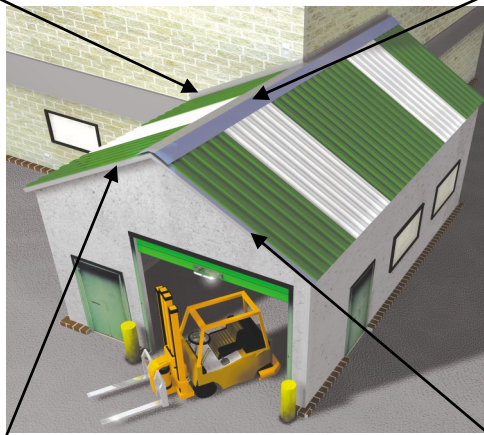

COLOUR CODED CAPS (10PK)

COLOUR	PART	PRICE
MERLIN GREY	FCCMG	£0.49
GOOSEWING	FCCGG	£0.52
OLIVE GREEN	FCCOG	£0.53

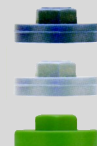

LAP TAPE 10M ROLL

PART	PRICE
RLT	£1.99

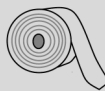

EAVES FILLER 5 TOP & 5 BOTTOM

PART	PRICE
REF32	£6.69



90° ANGLE TRIM 3M

COLOUR	PART	PRICE
MERLIN GREY	R3AMG	£21.30
GOOSEWING GREY	R3AGG	£21.70
OLIVE GREEN	R3AOG	£21.89

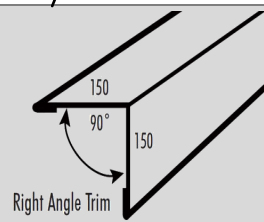

EDGE TRIM 3M

COLOUR	PART	PRICE
MERLIN GREY	R3EMG	£20.69
GOOSEWING GREY	R3EGG	£20.95
OLIVE GREEN	R3EOG	£21.10

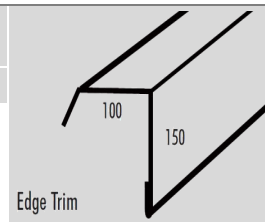

STEEL ROOF ACCESSORIES

GALVANISED STEEL SHEETS TRADITIONAL LOW COST SHEET

Galvanised steel sheets have been around for a very long time and are a very strong and secure roofing and cladding material. These are often used by emergency repair companies to temporarily secure properties before permanent repairs are made.

The steel sheet is coated in zinc, which is more reactive to oxygen than the iron and causes a white oxidation coating to take place. Once all the zinc has been used up in this type of reaction then the iron in the steel will react and this is when the sheets will rust. These sheets are primarily used as a temporary covering, but to increase their lifespan they should be coated / painted to provide a barrier between the steel and the oxygen, to prevent rusting.

Width: 790mm (2' 7⁷/₆₄") / Lap: 50mm (2") / Cover: 740mm (2' 5⁹/₆₄")

CORRUGATED FITTINGS

HOOK BOLTS, CAPS AND WASHERS

DESCRIPTION	PART	PRICE
60 x 6mm J-BOLT & NUT	FJ60	£1.99
80 x 6mm J-BOLT & NUT	FJ80	£2.25
100 x 6mm J-BOLT & NUT	FJ100	£2.44
140 x 6mm J-BOLT & NUT	FJ140	£2.75
90 x 8mm SCAFFOLD-BOLT & NUT	FJS90	£3.79
150 x 8mm SCAFFOLD-BOLT & NUT	FJS150	£8.37
28mm PVC WASHER	W28	£0.96
28mm STANDARD CAP	WC28	£0.78
28mm DEEP CAP	WDC28	£0.99



GALVANISED STEEL SHEETS 3" IRON PROFILE

WARNING STEEL SHEETS HAVE SHARP EDGES!

LENGTH	PART	PRICE
1.82M (6')	RG6	£11.99
2.43M (8')	RG8	£15.98
3.04M (10')	RG10	£19.98
3.64m (12')	RG12	£23.97

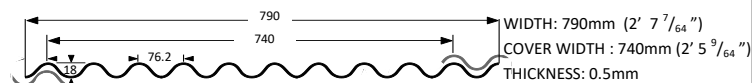
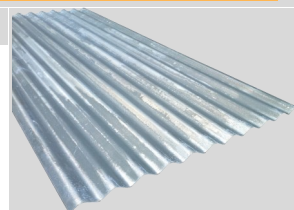

For clear sheets and filler please see pages 30 & 31

SCREWS WITH CAPS AND WASHERS

PACK OF 10

DESCRIPTION	PART	PRICE
ZINK PLATE	RFS	£0.99
S/S & SPACER	RFX	£1.49



HEX HEAD SCREWS & WASHERS

PACK OF 10

	DRILLFIX			TAPFIX	
	LENGTH	PART	PRICE	PART	PRICE
These screws are zinc plated to protect against corrosion. Supplied with 19mm sealing washers. Easy to fasten with nut driver.	38mm	FSD38	£2.39	FST38	£2.48
	50mm	FSD50	£2.63	FST50	£2.69
	70mm	FSD70	£2.99	N/A	N/A
	75mm	N/A	N/A	FST75	£2.89



Speedfit®



JG Speedfit is a push-fit system suitable for the plumbing of domestic hot and cold water services and central heating applications, including pressurised and combi systems.

The System is approved by the Water Regulations Advisory Scheme. Speedfit 'PEM' fittings and PEX and Polybutylene

Barrier Pipe are Kitemarked to BS7291 Parts 1, 2 and 3 Class S Licence No KM39767.

Performance specifications are well within those required for most central heating and water supply systems including:

- Mains fed and indirect cold water systems
- Vented and unvented hot water systems
- Vented central heating systems
- Sealed central heating systems provided temperatures and pressures comply with BS7291 Parts 1, 2 and 3 Class S
- Underfloor heating

Extensive tests have shown that Speedfit products will withstand temperatures and pressures well in excess of normal working conditions.

Speedfit should be installed to conform with good plumbing practice.

15mm SpeedFit

PRODUCT	SINGLES		PACKS		
	SINGLE	SINGLE	PACK	Qty	PACKS
15mm 3Mtr Pipe	SFP13	£3.65	SFPB13	20	£67.19
15mm 25Mtr Pipe Coil	SFP125	£31.99	SFPB125	8	£236.36
15mm Straight Connector	SFSC1	£1.24	SFSCB1	10	£11.10
15mm Equal Elbow	SFEE1	£1.47	SFEEB1	10	£13.26
15mm Equal Tee	SFET1	£2.12	SFETB1	5	£9.58
15mm Pipe Inserts	SFSS1	£0.26	SFSSB1	50	£11.53
15mm Appliance Tee	SFAT1	£6.13	SFATB1	5	£28.49
15mm Service Valve	SFPSV1	£4.78	SFPSVB1	5	£22.19



22mm SpeedFit

22mm 3Mtr Pipe	SFP23	£6.88	SFPB23	20	£132.84
22mm 25Mtr Pipe Coil	SFP225	£65.98	SFPB225	6	£354.60
22mm Straight Connector	SFSC2	£2.19	SFSCB2	5	£10.58
22mm Equal Elbow	SFEE2	£2.35	SFEEB2	5	£10.90
22mm Equal Tee	SFET2	£3.57	SFETB2	5	£14.62
22mm Pipe Inserts	SFSS2	£0.52	SFSSB2	25	£11.13
15-22mm Straight Reducer	SFRC	£3.91	SFRCB	5	£16.91



PRODUCT	SINGLES	
	PART No	PRICE
15mm Double Check Valve	SFDCS1	£9.68
15mm x 1/2" Straight Tap Connector	SFST1	£2.62
15mm x 3/4" Straight Tap Connector	SFST13	£2.86
22mm x 3/4" Straight Tap Connector	SFST2	£3.36
15mm x 1/2" Bent Tap Connector	SFBTC1	£3.24
15mm x 1/2" 300mm Flex Tap Connector	SFTC13	£5.13
15mm x 3/4" 300mm Flex Tap Connector	SFTC133	£6.49
22mm x 1/2" 300mm Flex Tap Connector	SFTC23	£7.99
Standard Pipe Cutter	SFPC	£27.98



15mm & 22mm SPEEDFIT



15 & 22mm Copper Pipe, Fittings & Accessories

Stocked At Our Gillingham Branch National Delivery Available

Manufactured to BS EN 1254-1:1998 Copper end feed and solder ring fittings (also known by the trademarked name Yorkshire fittings) are available from stock in sizes 15mm & 22mm. These fittings are suitable for use in solder joints with copper tube to manufactured to EN1057. Our comprehensive range of high quality copper end feed and solder ring fittings are for use in hot and cold water plumbing and heating systems. All our Solder Ring Fittings are **LEAD FREE** pre-soldered capillary connectors for joining copper pipes. These are ideal when fitting in confined spaces and where single handed fitting is required.

PRODUCT	15mm		22mm	
	PART No	PRICE	PART No	PRICE
3M Copper Tube	VCT31	£5.80	VCT32	£11.49
45Deg Copper End Feed	VEF145	£0.25	VEF245	£0.64
45deg Bend Copper Solder Ring	VSR145	£0.59	VSR245	£1.19
90Deg Copper End Feed	VEF190	£0.19	VEF290	£0.59
90deg Bend Copper Solder Ring	VSR190	£0.46	VSR290	£1.19
Copper Olive	VCO1	£0.19	VCO2	£0.24
Coupler Copper End Feed	VEFCO1	£0.15	VEFCO2	£0.36
Coupler Copper Solder Ring	VSRCO1	£0.35	VSRCO2	£0.79
Equal T Copper End Feed	VEFT1	£0.42	VEFT2	£0.99
Equal T Solder Ring	VSRT1	£0.84	VSRT2	£1.99
Link Lock Pipe Clip	VPC1	£0.09	VPC2	£0.12
Saddle Clip Copper	VSC1	£0.17	VSC2	£0.23
1/2" Tap Connector Copper End Feed	VEFTC112	£0.69	N/A	
1/2" Tap Connector Copper Solder Ring	VSRTC112	£1.89	N/A	
3/4" Tap Connector Copper End Feed	VEFTC134	£1.19	VEFTC234	£1.29
3/4" Tap Connector Copper Solder Ring	VSRTC134	£2.99	VSRTC234	£2.69



Types of Fitting

“End Feed” are plain/smooth fittings

“Solder Ring” has a raised Lead Free ring

PRODUCT	PART No	PRICE
22mm - 15mm Reducing Coupler Copper End Feed	VEFRC21	£0.59
22mm - 15mm Reducing Coupler Copper Solder Ring	VSRRC21	£1.24
22mm x 15mm x 15mm Reducing T Copper End Feed	VEFT211	£3.99
22mm x 15mm x 15mm Reducing T Solder Ring	VSRT211	£2.49
22mm x 22mm x 15mm Reducing T Copper End Feed	VEFT221	£0.89
22mm x 22mm x 15mm Reducing T Solder Ring	VSRT221	£1.69
28mm x 1" Cylinder Union Copper End Feed	VEFCU281	£2.99
250gram Real Solder Leaded	VSL25	£4.95
500gram Real Solder Leaded	VSL50	£7.49
250gram Real Solder Lead Free	VSLF25	£11.49
500gram Real Solder Lead Free	VSLF50	£17.99
200gram Steel Wool	VSW20	£2.99



Can't Find the item you require? CALL US more items held in stock

NEW!

15 & 22mm Brass Compression Fittings

Stocked At Our
Gillingham Branch
National Delivery
Available

Manufactured to BS EN 1254-2:1998 Compression fittings are available from stock in sizes 15mm & 22mm.

These fittings are suitable for use when creating joints with copper tube to EN1057 and are ideal where the use of flames is not possible or permitted. Compression fittings offer a quick and convenient way to build systems or carry out emergency repairs when the use of soldered joints is not possible.



PRODUCT	15mm		22mm	
	PART No	PRICE	PART No	PRICE
3M Copper Tube	VCT31	£5.80	VCT32	£11.49
90Deg Brass Compression Fitting	VBC190	£0.99	VBC290	£1.92
Coupler Brass Compression Fitting	VBCCO1	£0.99	VBCCO2	£1.59
End Cap Brass Compression Fitting	VBCEC1	£0.79	VBCEC2	£1.19
Equal T Brass Compression	VBCET1	£1.49	VBCET2	£2.89
1/2" Tap Connector Brass Compression	VBCTC112	£1.29	N/A	N/A
3/4" Tap Connector Brass Compression	VBCTC134	£1.69	VBCTC234	£2.99
22mm - 15mm Reducing Coupler Brass	N/A	N/A	VBCCO21	£1.79
22mm x 22mm x 15mm Reducing T	N/A	N/A	VBCRT221	£2.39
Brass Stop Cock	VBCSC1	£3.79	VBCSC2	£5.99
CU Red-Blue L B V	VBCRBV1	£3.99	VBCRBV2	£5.29
Isolating Valve Brass Compression	VBCIV1	£1.29	VBCIV2	£3.29
Tank Connector Brass Compression	VBCTC1	£1.69	VBCTC2	£2.79
Copper Olive	VCO1	£0.19	VCO2	£0.24



PRODUCT	PART No	PRICE
PTFE Tape	VPTFE	£0.49
PTFE Gas Tape	VPTFEG	£0.89
250gram Real Solder Leaded	VSL25	£4.95
500gram Real Solder Leaded	VSL50	£7.49
250gram Real Solder Lead Free	VSLF25	£11.49
500gram Real Solder Lead Free	VSLF50	£17.99
200gram Steel Wool	VSW20	£2.99
3 - 22mm Standard Copper Pipe Cutter	VPCS	£2.49
3 - 30mm Standard Copper Pipe Cutter	VPCL	£3.99
Auto Start Blow Torch EN417 Connection	VASBT	£19.99
350G Butane Gas Cartridge	VBG35	£5.99
399G Butane Gas Cartridge CGA600	VBG39	£14.99
Fixed Basin Wrench	VFBW	£2.49
Adjustable Basin Wrench	VABW	£4.29



Cant Find the item you require? CALL US more items held in stock

BLACK & WHITE SOLVENT WASTE 32mm 40mm & 50mm

Stocked At Our
Gillingham Branch
National Delivery
Available



At **C&A** we are always adding products to our range and in this

latest catalogue edition we are excited to bring you 32mm 40mm & 50mm Solvent waste pipe and fittings in **BLACK & WHITE**.

This easy to assemble product range that requires only the most basic of tools gives you a bond in seconds. The end result is a perfect seal and professional finish to every job.

Solvent Cement waste systems give that solid connection avoiding the problem of moving pipes and joints that can come apart resulting in unwanted floods.

All our waste products are manufactured to the following British Standards

BS 5255:1989

BS 4514:1983

BS 3943:1988

BS EN 1451:2000

and BBA approved



PRODUCT	32mm		40mm		50mm	
	PART No	PRICE	PART No	PRICE	PART No	PRICE
3M Long Pipe	WGP33*	£2.99	WGP43*	£3.77	WGP53*	£5.17
Coupler	WG3C*	£0.64	WG4C*	£0.75	WG5C*	£1.07
90° Bend	WG3B90*	£0.64	WG4B90*	£0.75	WG5B90*	£1.07
92.5° Bend	WG3B92*	£0.64	WG5B92*	£0.75	WG5B92*	£1.07
135° Bend	WG3B13*	£0.64	WG4B13*	£0.75	WG5B13*	£1.07
90° T Branch	WG3T*	£0.96	WG4T*	£0.96	WG5T*	£1.61
135° Y Branch	WG3Y*	£0.96	WG4Y*	£1.07	WG5Y*	£1.61
Pipe Clip / Bracket	WG3PC*	£0.42	WG4PC*	£0.49	WG5PC*	£0.64
Access Plug	WG3AP*	£0.64	WG4AP*	£0.75	WG5AP*	£1.07



Replace ALL asterisks * with colour code
WHITE = WH / BLACK = BK



PRODUCT	PART No	PRICE
Solvent Cement 125ml	WGSC12	£2.49
Solvent Cement 250ml	WGSC25	£4.49
40-32mm Reducer	WGR43	£0.59
50-32mm Reducer	WGR53	£0.79
50-40mm Reducer	WGR54	£0.79



Cant Find the item you require? CALL US more items held in stock

For a full range of tools, screws, fixings and sealants see pages 89—97

110mm

Soil pipe and fittings using Forsheda Seals to ensure ease of installation and a long life all made to British Standards



110mm Soil Pipe and Fittings are compatible with all standard 110mm soil and underground

systems in the UK. Kalsi 110mm Soil waste system compliments our 110mm underground system and our 32mm, 40mm and 50mm solvent weld waste system. The complete system consists of extruded pipe sections and



injection moulded fittings and provides an efficient way to convey sanitary waste from all types of buildings. The components in these systems enable the construction of Soil and Waste installations complying with the requirements of BS EN 12056-2:2000, and with The Building Regulations 2002. Building Standards (Scotland) Regulations 1990.

Building Regulations (Northern Ireland) 1990

WASTE ADAPTOR ACCESSORIES

110mm Strap On Boss	WSSOB	£3.77
32mm Rubber Waste Adaptor	WSRA32	£2.80
40mm Rubber Waste Adaptor	WSRA40	£2.91
50mm Rubber Waste Adaptor	WSRA50	£3.01
4" Clay to 110mm PVC Coupler	WU44CP	£5.93
4" Cast Iron to 110mm PVC	WS44CIP	£5.93



PRODUCT	PART No	PRICE
3M Long Pipe Plain	WS30P	£12.41
3M Long Pipe Single Socket	WS30S	£12.95
Coupler Double Socket	WSCD	£3.77
92.5° Bend Single Socket	WSB92S	£5.39
92.5° Bend Double Socket	WSB92D	£5.93
92.5° Access Bend Double Socket	WSAB9	£16.73
135° Bend Single Socket	WSB13S	£5.39
135° Bend Double Socket	WSB13D	£6.04
0—90° Adjustable Bend	WSABD	£14.57
92.5° Branch Double Socket	WST92D	£8.09
92.5° Branch Triple Socket	WST92T	£8.63
135° Branch Double Socket	WSY13D	£8.09
135° Branch Triple Socket	WSY13T	£8.63
92.5° Access Branch Triple Socket	WSAT92T	£16.73
92.5 Double T Branch	WSDT92	£43.15
110mm Soil Pipe Bracket	WSPB	£1.61
110mm Soil Pipe Vent Cowl	WSVC	£4.85



Can't Find the item you require?
CALL US more items held in stock

BS 3943:1988: Specification for plastic waste traps. BS 4514:1983: Specification for unplasticised PVC soil and ventilating pipes, fittings and accessories. BS EN 1451:2000 Plastics piping systems for soil and waste discharge within the building structure – polypropylene. BS 5255:1989: Specification for thermoplastics waste pipe and fittings. .

110mm SOIL

110mm Underground drainage pipe and fittings using Forsheda Seals to ensure ease of installation and all made to BS standards

110mm Underground Pipe and Fittings are compatible with all standard 110mm soil and underground systems in the UK. Kalsi 110mm Underground systems compliments our 110mm soil and our 32mm, 40mm and 50mm solvent weld waste system. The complete system consists of extruded pipe sections and injection moulded fittings and provides an efficient way to convey sanitary waste from all types of buildings.

The components in these systems enable the construction of Soil and Waste installations complying with the requirements of BS EN 12056-2:2000, and with The Building Regulations 2002. Building Standards (Scotland) Regulations 1990. Building Regulations (Northern Ireland) 1990



PRODUCT	PART No	PRICE
3M Long Pipe Single Socket	WU30S	£7.94
6M Long Pipe Single Socket	WU60S	£18.89
Coupler Double Socket	WUCD	£2.15
Slip Coupler Double Socket	WUSCD	£2.15
15° Bend Single Socket	WUB1S	£3.23
15° Bend Double Socket	WUB1D	£3.66
30° Bend Single Socket	WUB3S	£3.23
30° Bend Double Socket	WUB3D	£3.66
45° Bend Single Socket	WUB4S	£3.23
45° Bend Double Socket	WUB4D	£3.66
87.5° Bend Single Socket	WUB8S	£3.23
87.5° Bend Double Socket	WUB8D	£3.66

PRODUCT	PART No	PRICE
87.5° Rest Bend Single Socket	WURB8S	£9.71
87.5° Rest Bend Double Socket	WURB8D	£10.79
45° Long Radius Bend	WULRB4S	£15.65
87.5° Long Radius Bend	WULRB8S	£16.19
0—90° Adjustable Bend	WUABD	£12.95
45° Branch Double Socket	WUY4D	£6.25
45° Branch Triple Socket	WUY4T	£6.47
87.5° Branch Double Socket	WUT8D	£6.25
87.5° Branch Triple Socket	WUT8T	£6.47

Can't find the item you require?
CALL US more items held in stock

Manufactured to BS EN 1401-1: Plastic piping systems for 1998 (SN4) non-pressure underground drainage and sewerage. PVCu - Part 1: Specifications for pipes, fittings and system. BS4660: 1989 Specification for plasticized. PVC pipes and fittings of sizes 110mm for below ground drainage. BS5481: 1997 (1989) Specification for plasticized. PVC pipes and fittings for gravity

110mm Underground drainage pipe and fittings using Forsheda Seals to ensure ease of installation and all made to BS standards

With a selection of fittings covering most applications including drainage chamber bases, risers and drain covers. Compatible with our range of soil and solvent waste systems to give you a complete range of products. The components in these systems enable the construction of Soil and Waste installations complying with the requirements of BS EN 12056-2:2000, and with The Building Regulations 2002. Building Standards (Scotland) Regulations 1990. Building Regulations (Northern Ireland) 1990 .



PRODUCT	PART No	PRICE	
Square Hopper	WUSH	£9.17	
Integral Hopper	WUIH	£10.25	
Plain Bottle Gully	WUPERG	£9.17	
Back Inlet Roddable Gully	WUBIRG	£9.17	
Low Trap	WULT	£10.79	
Low Back P Trap	WULBPT	£9.71	
Aluminium Rodding Eye	WUARE	£14.57	
Access Plug	WUAP	£3.77	
Socket Plug	WUSP	£2.15	

PRODUCT	PART No	PRICE	
320mm Chamber Base 185mm Invert	WU32CB	£18.35	
320mm Raising Piece 140mm	WU32RP	£10.79	
320mm Round Plastic Cover & Frame	WU32RC	£18.35	
320mm Square Plastic Cover & Frame	WU32SC	£22.67	
470mm Chamber Base 225mm Invert	WU47CB	£34.55	
470mm Raising Piece 235mm	WU47RP	£14.57	
470mm Round Plastic Cover & Frame	WU47RC	£20.51	
470mm Square Plastic Cover & Frame	WU47SC	£35.63	
600x450 Block Paving Manhole Cover	WUMHC	£42.11	
1ltr Soluble Lubricant	WUSL1	£8.63	
4" Clay to 110mm PVC Coupler	WU44CP	£5.93	
4" Cast Iron to 110mm PVC	WS44CIP	£5.93	

Can't find the item you require?
CALL US more items held in stock

Manufactured to BS EN 1401-1: Plastic piping systems for 1998 (SN4) non-pressure underground drainage and sewerage. PVCu - Part 1: Specifications for pipes, fittings and system. BS4660: 1989 Specification for plasticized. PVC pipes and fittings of sizes 110mm for below ground drainage. BS5481: 1997 (1989) Specification for plasticized. PVC pipes and fittings for gravity sewers.

110mm UNDERGROUND

GUTTERING

Four guttering systems available, ranging from low cost 112mm for garden buildings to high capacity for large roofs, and elegant Square and Ogee profiles for house renovations.

HALF ROUND

Width: 112mm (4 ³/₈"")
Depth: 52mm (2 ¹/₁₆"")
BS EN 4576

BLACK - WHITE - BROWN - ANTHRACITE

PRODUCT	COLOUR/PART				PRICE	
	BLACK	WHITE	BROWN	ANTHRACITE GREY		
Gutter 2M Long	GR20BK	GR20WH	GR20BR	GR20AG	£3.08	
Gutter 4M Long	GR40BK	GR40WH	GR40BR	GR40AG	£5.45	
90° Angle	GR9BK	GR9WH	GR9BR	GR9AG	£2.15	
135° Angle	GR35BK	GR35WH	GR35BR	GR35AG	£2.76	
150° Angle	GR50BK	GR50WH	GR50BR	N/A	£2.86	
Joint Bracket	GRJBBK	GRJBWH	GRJBBR	GRJBAG	£1.53	
Support Bracket	GRSBBK	GRSBWH	GRSBBR	GRSBSAG	£0.71	
Running Outlet	GRROBK	GRROWH	GRROBR	GRROAG	£1.80	
Stopend Outlet	GRSOBK	GRSOWH	GRSOBR	GRSOAG	£2.77	
Stopend External	GRSEBK	GRSEWH	GRSEBR	GRSEAG	£1.18	
Stopend Internal	GRSIBK	GRSIWH	GRSIBR	GRSIAG	£1.02	

SQUARE

Width: 114mm (4 ¹/₂"")
Depth: 57mm (2 ¹/₄"")
BS EN 607

BLACK - WHITE - BROWN

PRODUCT	COLOUR/PART			PRICE	
	BLACK	WHITE	BROWN		
Gutter 2M Long	GS20BK	GS20WH	GS20BR	£3.08	
Gutter 4M Long	GS40BK	GS40WH	GS40BR	£5.45	
90° Angle	GS9BK	GS9WH	GS9BR	£2.15	
135° Angle	GS35BK	GS35WH	GS35BR	£2.87	
150° Angle	GS50BK	GS50WH	GS50BR	£2.97	
Joint Bracket	GSJBBK	GSJBWH	GSJBBR	£1.59	
Support Bracket	GSSBBK	GSSBWH	GSSBBR	£0.71	
Running Outlet	GSROBK	GSROWH	GSROBR	£1.80	
Stopend Outlet	GSSOBK	GSSOWH	GSSOBR	£2.77	
Stopend External	GSSEBK	GSSEWH	GSSEBR	£1.18	
Stopend Internal	GSSIBK	GSSIWH	GSSIBR	£1.02	

FOR DOWN PIPES SEE PAGE 48







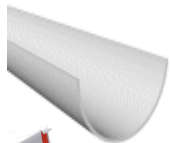

FULL-FLO

Width: 116mm (4 9/16")
Depth: 77mm (3 1/16")
BSEN 607

BLACK - WHITE-ANTHRACITE

HIGH CAPACITY

PRODUCT	COLOUR / PART			PRICE
	BLACK	WHITE	ANTHRACITE GREY	
Gutter 4m Long	GF40BK	GF40WH	GF40AG	£9.74
90° Angle	GF9BK	GF9WH	GF9AG	£3.18
135° Angle	GF35BK	GF35WH	GF35AG	£3.34
Gutter Joint Bracket	GFJBBK	GFJBWH	GFJBAG	£2.56
Running Outlet	GFROBK	GFROWH	GFROAG	£3.58
Stopend External	GFSEBK	GFSEWH	GFSEAG	£1.74
Stopend Internal	GFSIBK	GFSIWH	GFSIAG	£1.38
Fascia Bracket	GFSBBK	GFSBWH	GFSBAG	£1.02

Freeflow

+ DOWN PIPES SEE PAGE 48

+ ACCESSORIES & FITTINGS SEE PAGE 50

OGEE

Width: 135mm (5 5/16")
Depth: 77mm (3 1/16")
BSEN 607

BLACK - WHITE - CAMEL

HIGH CAPACITY

PRODUCT	COLOUR / PART			PRICE
	BLACK	WHITE	CAMEL	
Gutter 4m Long	GO40BK	GO40WH	GO40CM	£10.29
90° Angle	GO9BK	GO9WH	GO9CM	£3.90
135° Angle	GO35BK	GO35WH	GO35CM	£4.10
150° Angle	GO50BK	GO50WH	GO50CM	£4.26
Gutter Joint Bracket	GOJBBK	GOJBWH	GOJBCM	£2.66
Running Outlet	GOROBK	GOROWH	GOROCM	£3.80
Stopend Outlet	GOSOBK	GOSOWH	GOSOCM	£3.89
Stopend External	GOSEBK	GOSEWH	GOSECM	£1.91
Stopend Internal	GOSIBK	GOSIWH	GOSICM	£1.49
Fascia Bracket	GOSBBK	GOSBWH	GOSBCM	£1.02











DOWN PIPE

Round and Square Down Pipes, in a range of colours, compatible with our range and other manufacturers guttering systems.

ROUND PIPE

Diameter: 68mm (2 11/16")
BSEN 12200

BLACK - WHITE - BROWN - ANTHRACITE

PRODUCT	PART NUMBER				PRICE
	BLACK	WHITE	BROWN	ANTHRACITE GREY	
Pipe 2.7m Long	GRP27BK	GRP27WH	GRP27BR	GRP27AG	£4.07
Pipe 4m Long	GRP40BK	GRP40WH	GRP40BR	GRP40AG	£6.13
Pipe 5.5m Long	GRP55BK	GRP55WH	GRP55BR	GRP55AG	£9.22
Pipe Connector	GRPCBK	GRPCWH	GRPCBR	GRPCAG	£1.02
Pipe Bracket	GRPBK	GRPBWH	GRPBR	GRPBAG	£0.81
Pipe Bend 92½°	GRPB9BK	GRPB9WH	GRPB9BR	GRPB9AG	£2.14
Pipe Bend 112½°	GRPB2BK	GRPB2WH	GRPB2BR	GRPB2AG	£1.64
Shoe Outlet Spout	GRPSBK	GRPSWH	GRPSBR	GRPSAG	£1.73
Pipe Branch 112½°	GRPYBK	GRPYWH	GRPYBR	GRPYAG	£3.86
Shallow Offset Bend	GRPOBK	GRPOWH	GRPOBR	N/A	£2.76
Rainwater Head	GHBK	GHWH	GHBR	GHAG	£5.55

SQUARE PIPE

Square Size 65mm (2 9/16")
BSEN 12200

BLACK - WHITE - BROWN - CAMEL

PRODUCT	PART NUMBERS				PRICE
	BLACK	WHITE	BROWN	CAMEL	
Pipe 2.7m Long	GSP27BK	GSP27WH	GSP27BR	GSP27CM	£4.07
Pipe 4m Long	GSP40BK	GSP40WH	GSP40BR	GSP40CM	£6.13
Pipe 5.5m Long	GSP55BK	GSP55WH	GSP55BR	GSP55CM	£9.22
Pipe Connector	GSPCBK	GSPCWH	GSPCBR	GSPCCM	£1.02
Pipe Bracket	GSPBK	GSPBWH	GSPBR	GSPBCM	£0.81
Pipe Bend 92½°	GSPB9BK	GSPB9WH	GSPB9BR	GSPB9CM	£2.15
Pipe Bend 112½°	GSPB2BK	GSPB2WH	GSPB2BR	GSPB2CM	£1.64
Shoe Outlet Spout	GSPSBK	GSPSWH	GSPSBR	GSPSCM	£1.73
Pipe Branch 112½°	GSPYBK	GSPYWH	GSPYBR	GSPYCM	£3.86
Shallow Offset Bend	GSPOBK	GSPOWH	GSPOBR	N/A	£2.76
Rainwater Head	GHBK	GHWH	GHBR	GHCM	£5.55

CAST IRON EFFECT GUTTER & PIPE

CAST IRON EFFECT GUTTERING

This unique Cast Iron effect guttering system has been designed to provide you with the authentic look and feel of traditional gutters, using long-lasting uPVC. The mottled effect finish helps to maintain the look and feel of period properties while allowing you to benefit from the low maintenance, fitter-friendly materials available today.

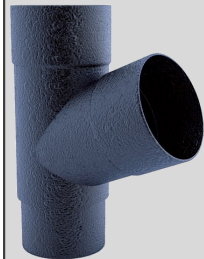
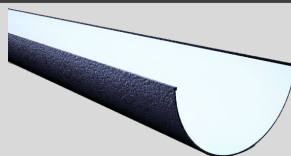

Whilst there is a continuing emphasis on building energy efficient homes, the external design and detailing of many new build developments remains traditional. Cast iron style guttering offers specifiers and property developers the ideal solution for a stylish traditional look giving homeowners a low maintenance long lasting system. The range also allows builders and renovators of period properties the option to update with modern materials without losing the charm and appeal of authentic features.



The Freeflow rainwater system is co-extruded with a white interior to reduce heat absorption and expansion of gutters and

features long-life advanced red compressible seals for ease of fitting and water-tight joints to ensure a leak-free performance.

This high quality product is also available in high capacity 116mm Full-Flo, Please contact us to request a quotation and lead times.



HALF ROUND CAST EFFECT

Width: 112mm (4 5/16")
Depth: 52mm (2 1/16")

PRODUCT	BLACK	PRICE	Image	
Gutter 4M Long	GR40CE	£19.99		
90° Angle	GR9CE	£8.99		
135° Angle	GR35CE	£9.99		
Joint Bracket	GRJBCE	£5.99		
Support Bracket	GRSBCE	£1.49		
Running Outlet	GRROCE	£8.99		
Stopend Outlet	GRSOCE	£9.99		
Stopend External	GRSECE	£4.99		
Pipe 2.7m Long	GRP27CE	£19.99		
Pipe 5.5m Long	GRP55CE	£34.99		
Pipe Clip	GRPBCE	£7.80		
Pipe Clip Collar	GRPCCE	£9.99		
Pipe Bend 92½°	GRPB9CE	£10.49		
Pipe Bend 112½°	GRPB2CE	£10.99		
Shoe Outlet Spout	GRPSCE	£12.99		
Pipe Branch 112½°	GRPYCE	£16.99		

GUTTER ACCESSORIES

HEDGEHOGTM STOPS GUTTER CLUTTER!

- ▶ Prevents gutters from blocking
- ▶ Simple, quick and easy to fit
- ▶ Durable - will last for years
- ▶ Flexible to fit all shapes and bends of guttering
- ▶ Compatible with almost every type of gutter

PRODUCT	PART	PRICE
BLACK 4M Hedgehog	GHHBK	£16.79
BROWN 4M Hedgehog	GHHBR	£16.79
WHITE 4M Hedgehog	GHHWH	£16.79
Holding Clip (Single)	GHHGC1	£0.63
Holding Clips (20 Pack)	GHHGC20	£9.40

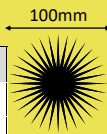

Colour choice is the colour of the brush. The gutter clips are Clear



GUTTER GRID

Colour refers to clips the grid only comes in black

PRODUCT	PART	PRICE
BLACK 10M LONG (Includes 23 Clips)	GMGBK	£29.95
WHITE 10M LONG (Includes 23 Clips)	GMGWH	£29.95
BROWN 10M LONG (Includes 23 Clips)	GMGBR	£29.95

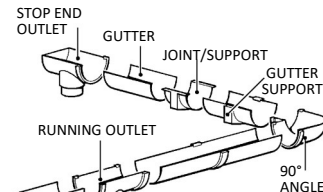
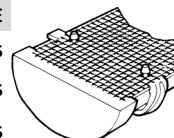

GUTTER & PIPE ADAPTORS

PRODUCT	BLACK	WHITE	BROWN	PRICE
SQUARE to ROUND PIPE ADAPTOR	GSRPABK	GSRPAWH	GSRPABR	£2.10
SQUARE to HALF ROUND GUTTER ADAPTOR	GSRABK	GSRAWH	GSRABR	£5.25
OGEE to SQUARE GUTTER ADAPTOR	GOSABK	GOSAWH	GOSABR	£7.34
OGEE to HALF ROUND GUTTER ADAPTOR	GORABK	GORAWH	GORABR	£7.34

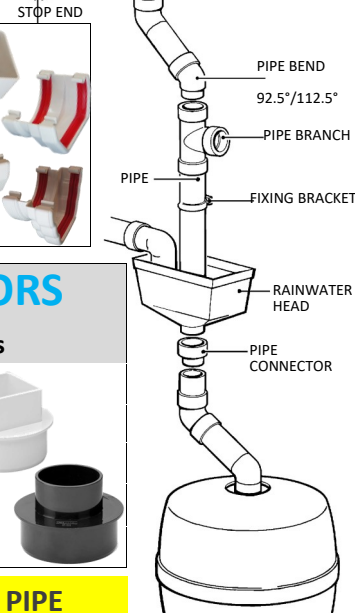

DOWN PIPE to 110mm ADAPTORS

Fits inside standard 110mm Underground & Soil Sockets

PRODUCT	PART	PRICE
68mm ROUND to 110mm CONNECTOR WHITE	WURPAWH	£3.99
68mm SQUARE to 110mm CONNECTOR WHITE	WUSPAWH	£3.99
68mm ROUND to 110mm CONNECTOR BLACK	WURPABK	£3.99
68mm SQUARE to 110mm CONNECTOR BLACK	WUSPABK	£3.99



+ 10 YEAR GUARANTEE ON GUTTERING & PIPE

FASCIA & SOFFIT THE BASICS

Freefoam



CAP-OVER or FULL REPLACEMENT?

10mm Thick boards are for capping over existing timber boards

These must be in good condition and any mild damage or rot should be treated first with a very high grade wood preservative. Before capping, check the Roof Felt has a sufficient overhang to reach the top of the new UPVC board as well as the existing timber one. Over Felt Replacement sections should be fitted to cover the gap.



18mm Thick boards are for use on New builds and for full replacement on existing buildings

Timber sub-structures should first be examined for damage and rot, which should be treated with a high grade wood preservative or in severe cases cut out and new timber sections scarfed in.

Freefoam
LIFETIME
Guarantee

FASCIA & SOFFIT FIXINGS

FIXINGS Use colour-matching plastic headed pins and nails to fix boards into place.

CENTRES Fixing Centers vary, but should never exceed 600mm for white boards, 300mm for black boards and 400mm for other colour and wood grain boards.

For more detailed information please visit the product page and click on the specifications tab on our website www.cabp.co.uk

FURTHER INFORMATION ON FASCIA & SOFFIT

Roof Ventilation should be considered, either by using Vented Soffit boards, Vent Disks or Over Fascia Vents. *See pages 52, 53 and 62.*

Plastic headed pins and nails should be used to fix the boards in place fixing centers vary, but should not exceed 600mm for white boards-

we supply colour-matching heads *See page 62 for all colours.*

Gable end covers can be made by cutting a wide Capping board to size. Use a 400mm or 600mm board, and fix into position. *See page 52*

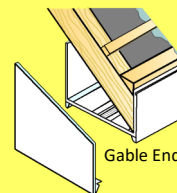

CLADDING THE BASICS

Freefoam

PREPARING WALLS FOR CLADDING

Cladding boards should be fixed horizontally over timber battens,

CENTRES set at a maximum of **400mm apart** upon the host wall.

To protect the battens, a breathable membrane must be lightly tacked over the entire area before the cladding is fitted on top.

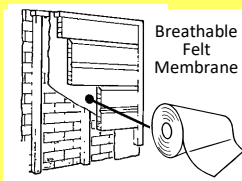

For more detailed information please visit the product page and click on the specifications tab on our website www.cabp.co.uk

FIXING CLADDING BOARDS

Begin at the bottom of the host wall by fixing Starter Trims with Barb Nails through the back of the trim, ensuring the cladding board is located inside the Starter Trim so the fixings will be hidden by the overlap of boards.

At the sides and corners, fix Edge Trims/ Corner Trims as required. Fix any External Corners as you progress upwards, to allow for some movement when fitting the boards into place.

Allow a 5mm gap at each end of the board as they are designed to expand and contract with weather changes so it is important they are cut with some space allowance, which will be covered by the finishing trims.

When fitting the last board, it is likely its depth will need to be altered to fit into the available space, and depending on how much board is trimmed away it may be necessary to fix an additional batten behind to ensure it sits correctly. The last board must fit so it pushes up inside the trim's top edge and also sits correctly on the cladding board below.

WHITE CAP-OVER & REPLACEMENT FASCIA



10mm CAP-OVER/REVEAL LINER FASCIA BOARD

LENGTH WIDTH	2.5M		5.0M		For covering existing timber fascia boards that are in adequate condition.
	PART	PRICE	PART	PRICE	
150mm (5 7/8")	LC215WH	£4.90	LC515WH	£9.08	
175mm (6 7/8")	LC217WH	£6.36	LC517WH	£11.81	
200mm (7 7/8")	LC220WH	£8.67	LC520WH	£14.73	
225mm (9")	LC222WH	£9.25	LC522WH	£15.82	
250mm (9 7/8")	LC225WH	£10.29	LC525WH	£18.00	
300mm (11 3/4")	LC230WH	£12.72	LC530WH	£22.37	
400mm (15 3/4")	LC240WH	£16.77	LC540WH	£30.56	
605mm*(23 13/16")	LC260WH	£27.77	LC560WH	£49.67	

* 605mm Boards Are Double Lipped

18mm FULL REPLACEMENT FASCIA BOARD

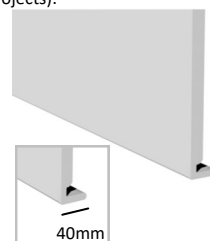
LENGTH WIDTH	2.5M		5.0M		For fully replacing fascia boards (new-builds and restoration projects).
	PART	PRICE	PART	PRICE	
150mm (5 7/8")	LF215WH	£9.27	LF515WH	£18.19	
175mm (6 7/8")	LF217WH	£12.55	LF517WH	£22.92	
200mm (7 7/8")	LF220WH	£14.18	LF520WH	£26.19	
225mm (9")	LF222WH	£16.91	LF522WH	£29.47	
250mm (9 7/8")	LF225WH	£17.46	LF525WH	£31.65	
300mm (11 3/4")	LF230WH	£24.01	LF530WH	£44.75	
410mm *(16 9/64")	LF240WH	£30.01	LF540WH	£52.40	

* 410mm Boards Are Double Lipped

TRIMS FOR 10 & 18mm BOARDS

DESCRIPTION	PART	PRICE
Centre Joint	LCJ3WH	£1.99
90° Internal Corner	LCI93WH	£2.05
90° External Corner	LCC93WH	£2.10
135° External Corner	LCC33WH	£3.70
135° Internal Corner	LCI33WH	£3.70
600mm Double Ended Centre	LCI6WH	£4.23
600mm Double Ended Corner	LCC96WH	£4.19
300mm Large End Cap	LCECWH	£2.49
Fascia (Apex) Finial	LCFWH	£3.87
Decorative Moulding	LCDMWH	£9.96

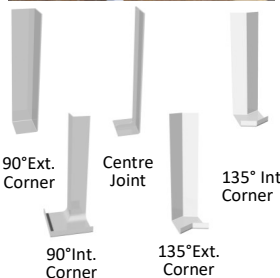

FASCIA BOARD ACCESSORIES

OVER FASCIA VENT

0.5M long



PART	SIZE	PRICE
LOFV10	10mm	£1.29
LOFV25	25mm	£1.59

Fix on to the top of Fascia boards to provide an air gap for ventilation.

UPVC FELT REPLACEMENT

1.5M long

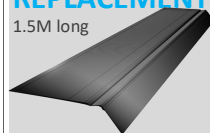

PART	PRICE
LFR	£1.99

Fits below the existing roof felt under the bottom row of tiles, overlapping the top of the fascia board.

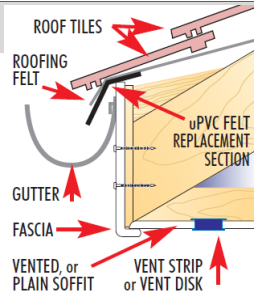

+ MORE ACCESSORIES & FIXINGS
SEE PAGE 62

+ 50 YEAR GUARANTEE ON WHITE BOARDS

Freefoam
LIFETIME
Guarantee



WHITE SOFFIT BOARDS SQUARE EDGE



10mm SOLID SOFFIT MULTIPURPOSE BOARDS

LENGTH	2.5M		5.0M	
	PART	PRICE	PART	PRICE
100mm (3 7/8")	LM210WH	£4.90	LM510WH	£8.18
150mm (5 7/8")	LM215WH	£5.99	LM515WH	£10.91
175mm (6 7/8")	LM217WH	£7.09	LM517WH	£13.07
225mm (9")	LM222WH	£9.26	LM522WH	£16.91
250mm (9 7/8")	LM225WH	£9.77	LM525WH	£19.04
300mm (11 3/4")	LM230WH	£12.00	LM530WH	£21.62
405mm (15 3/4")	LM240WH	£17.46	LM540WH	£30.56
605mm (23 13/16")	LM260WH	£28.38	LM560WH	£52.94

Soffit Vent Strip or Disks available. See Page 62.



10mm VENTED SOFFIT PROVIDES VENTILATION

LENGTH	2.5M		5.0M	
	PART	PRICE	PART	PRICE
100mm (3 7/8")	LV210WH	£8.18	LV510WH	£14.73
150mm (5 7/8")	LV215WH	£9.82	LV515WH	£18.53
175mm (6 7/8")	LV217WH	£10.91	LV517WH	£20.19
225mm (9")	LV222WH	£13.09	LV522WH	£24.56
250mm (9 7/8")	LV225WH	£15.27	LV525WH	£27.80
300mm (11 3/4")	LV230WH	£16.91	LV530WH	£29.86
405mm (15 3/4")	LV240WH	£20.59	LV540WH	£38.75
605mm (23 13/16")	LV260WH	£37.66	LV560WH	£68.77

5M Roll Insect Mesh LVM £4.29



Insect mesh applied over the vents on the internal face

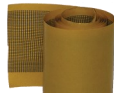

TRIMS

	LENGTH	2.5M		5.0M	
		DESCRIPTION	PART	PRICE	PART
For 10mm Boards in White	J Trim (Edge Trim)	LH2JWH	£2.94	LH5JWH	£5.34
	H Trim (Joiner strip)	LH2HWH	£3.48	LH5HWH	£6.50
	F Trim (Corner Finishing Trim)	LH2FWH	£3.48	LH5FWH	£6.50
	Y Trim (External Corner)	LH2YWH	£5.41	LH5YWH	£9.77



J Trim

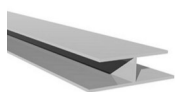

H Trim

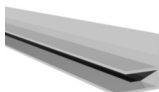

F-Trim



Y-Trim

+ FIXINGS & ACCESSORIES
SEE PAGE 62

Freefoam
LIFETIME
Guarantee

10mm HOLLOW 'V' GROOVED HOLLOW SOFFIT BOARDS

LENGTH	2.5M		5.0M	
	PART	PRICE	PART	PRICE
100mm (3 7/8")	LH210WH	£3.92	LH510WH	£6.87
300mm (11 3/4")	LH230WH	£5.78	LH530WH	£10.29



16mm FLAT BOARD MULTIPURPOSE BOARDS

LENGTH	2.5M		5.0M	
	PART	PRICE	PART	PRICE
150mm (5 7/8")	LT215WH	£12.00	LT515WH	£21.28
200mm (7 7/8")	LT220WH	£16.37	LT520WH	£29.47
250mm (9 7/8")	LT225WH	£19.56	LT525WH	£36.57

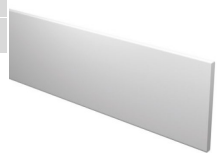

OGEE FASCIA



BULLNOSE FASCIA

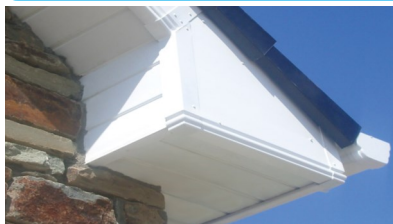

The **Ogee** fascia system is a traditional 's' curved style which includes the 10mm thick Cappit board and 18mm thick fascia board complete with corners and centre joints to give a neat stylish finish.



The **Bullnose** fascia system is a traditional full curved style 18mm thick fascia board that can also be used for internal window sill, complete with corners, centre joints and end caps when using this product for an internal ceil.

10mm OGEE FASCIA CAPPING BOARD

LENGTH	2.5M		5.0M		
WIDTH	PART	PRICE	PART	PRICE	
150mm (5 7/8")	LE215WH	£7.63	LE515WH	£14.18	
175mm (6 7/8")	LE217WH	£9.26	LE517WH	£16.37	
200mm (7 7/8")	LE220WH	£10.29	LE520WH	£19.04	
250mm (9 7/8")	LE225WH	£12.35	LE525WH	£23.46	
300mm (11 3/4")	LE230WH	£15.27	LE530WH	£28.31	

18mm OGEE FASCIA REPLACEMENT BOARD

LENGTH	2.5M		5.0M		
WIDTH	PART	PRICE	PART	PRICE	
150mm (5 7/8")	LG215WH	£13.09	LG515WH	£21.83	
200mm (7 7/8")	LG220WH	£17.46	LG520WH	£29.47	
250mm (9 7/8")	LG225WH	£20.73	LG525WH	£38.20	

TRIMS FOR OGEE BOARDS

DESCRIPTION	PART	PRICE	
600mm Double-ended External Corner	LGC96WH	£4.36	
600mm Double-ended Centre Joint	LGJ6WH	£4.03	Centre

18mm BULLNOSE FASCIA REPLACEMENT BOARD

LENGTH	2.5M		5.0M		
WIDTH	PART	PRICE	PART	PRICE	
150mm (5 7/8")	LB215WH	£12.35	LB515WH	£21.28	
200mm (7 7/8")	LB220WH	£16.37	LB520WH	£28.83	
250mm (9 7/8")	LB225WH	£20.59	LB525WH	£36.02	
405mm (15 3/4")	LB240WH	£32.74	LB540WH	£59.49	

TRIMS FOR BULLNOSE FASCIA

White

DESCRIPTION	PART	PRICE		
300mm End Cap	LBEC6WH	£2.46		End cap
600mm Double-ended External Corner	LBC96WH	£3.81		Corner
600mm Double-ended Centre Joint	LBJ6WH	£3.81		Centre



+ FOR PLAIN & VENTED SOFFIT BOARDS SEE PAGE 53

WOODGRAIN EFFECT FASCIA & SOFFIT

+ 10 YEAR GUARANTEE



Woodgrain effect boards are PVC foiled boards that come in 4 industry standard colours and available from stock. With a semi-gloss lightly textured finish these boards are made to Freefoam® high standards. Designed to cover or replace existing timber boards or for brand new installations these boards will give the look and feel of expensive real wood materials. Woodgrain products come with a 10 year manufacturers guarantee (details available online).

IRISH OAK

*IO

Irish Oak Available To Order
Call 01634 374444 For Prices

ROSEWOOD

*RW

GOLDEN OAK

*GO

MAHOGANY

*MH

BLACK ASH

*BA

10mm CAP-OVER FASCIA BOARD

LENGTH	2.5M		5.0M		
	PART	PRICE	PART	PRICE	
150m (5 7/8")	LC215*	£14.73	LC515*	£28.38	
175m (6 7/8")	LC217*	£16.91	LC517*	£31.65	
200m (7 7/8")	LC220*	£20.19	LC520*	£37.11	
250m (9 7/8")	LC225*	£21.28	LC525*	£42.57	
400m (15 3/4")	LC240*	£33.29	LC540*	£64.41	

18mm FULL REPLACEMENT FASCIA BOARD

LENGTH	2.5M		5.0M		
	PART	PRICE	PART	PRICE	
150mm (5 7/8")	LF215*	£19.10	LF515*	£34.93	
175mm (6 7/8")	LF217*	£21.28	LF517*	£39.29	
200mm (7 7/8")	LF220*	£23.46	LF520*	£43.66	
250mm (9 7/8")	LF225*	£27.83	LF525*	£53.49	
400mm (15 3/4")	LF240*	£43.12	LF540*	£85.15	

10mm SOLID SOFFIT MULTIPURPOSE BOARDS

LENGTH	2.5M		5.0M		
	PART	PRICE	PART	PRICE	
150mm (5 7/8")	LM215*	£15.82	LM515*	£28.38	
175mm (6 7/8")	LM217*	£16.91	LM517*	£31.65	
225mm (8 7/8")	LM222*	£21.28	LM522*	£39.29	
300mm (11 3/4")	LM230*	£27.83	LM530*	£50.21	

SQUARE FASCIA ACCESSORIES

ITEM	PART	PRICE	
300mm External Corner	LCC93*	£6.54	
300mm Centre Joint	LCJ3*	£6.50	
Fascia Finial	LCF*	£5.99	

10mm HOLLOW 'V' GROOVED HOLLOW SOFFIT BOARDS

LENGTH	2.5M		5.0M		
	PART	PRICE	PART	PRICE	
300mm (11 3/4")	LH230*	£20.18	LH530*	£36.02	

TRIMS FOR 10mm BOARDS

LENGTH	2.5M		5.0M		
	PART	PRICE	PART	PRICE	
H Trim	LH2H*	£7.61	LH5H*	£11.83	
J Trim	LH2J*	£7.71	LH5J*	£12.35	

+ FOR COLOURED PLASTIC HEADED PINS AND NAILS SEE PAGE 62

COLORMAX™ COLOUR RANGE

Replace asterisk *
in the part number to
specify colour

ANTHRACITE GREY
*AG
RAL 7016

BLACK
*BK
RAL 9005

BROWN
*BR
RAL 8017

PALE GOLD
*PG
RAL 1013

STORM GREY
*SG
RAL 7045



10mm SQUARE CAPPIT BOARDS CAP-OVER BOARDS

LENGTH	2.5M		5.0M	
	PART	PRICE	PART	PRICE
175mm (6 7/8")	LC217*	£12.00	LC517*	£21.28
200mm (7 7/8")	LC220*	£14.18	LC520*	£25.10
225mm (9)	LC222*	£15.27	LC522*	£26.74
410mm (15 3/4")	LC240*	£27.80	LC540*	£50.21

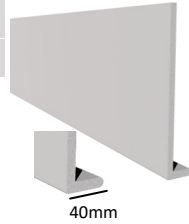

605mm (23' 5") Capping Available to special

605mm Boards Are Double Lipped

18mm SQUARE FASCIA REPLACEMENT BOARDS

LENGTH	2.5M		5M	
	PART	PRICE	PART	PRICE
150mm (5 7/8")	LF215*	£15.44	LF515*	£28.38
175mm (6 7/8")	LF217*	£16.91	LF517*	£31.65
225mm (9)	LF222*	£21.28	LF522*	£41.48
250mm (9 7/8")	LF225*	£25.65	LF525*	£46.94
410mm (15 3/4")	LF240*	£39.84	LF540*	£73.12

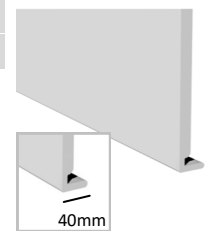

TRIMS 300mm & 600mm LONG

PRODUCT	PART	PRICE
External Corner	LCC93*	£2.72
Centre Joint	LCJ3*	£2.72
90° Internal Corner	LCI93*	£3.27
Finial	LCF*	£5.45
600mm Double Ended Centre	LCJ6*	£5.99
600mm Double Ended Corner	LCC96*	£5.99

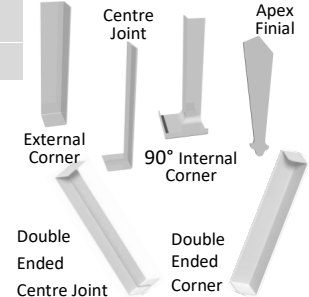

COLORMAX™ COLOUR RANGE

10mm SOFFIT / MULTIPURPOSE **FLAT BOARDS**

LENGTH ▶	2.5M		5.0M	
WIDTH ▼	PART	PRICE	PART	PRICE
150mm (5 7/8")	LM215*	£11.32	LM515*	£20.59
200mm (7 7/8")	LM220*	£14.73	LM520*	£27.28
250mm (9 7/8")#	LM225*	£19.56	LM525*	£35.47
300mm (11 3/4")	LM230*	£29.86	LM530*	£46.34
405mm (15 3/4")	LM240*	£33.29	LM540*	£59.73

605mm (23' 5") Soffit Available to order call for prices



10mm HOLLOW 'V' GROOVED HOLLOW SOFFIT BOARDS

LENGTH ▶	2.5M		5M	
WIDTH ▼	PART	PRICE	PART	PRICE
300mm (11 3/4")	LH230*	£12.00	LH530*	£21.62

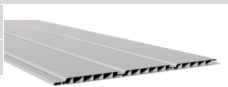

Replace ALL asterisks * with letter code to specify colour

ANTHRACITE GREY

*AG
RAL 7016

BLACK

*BK
RAL 9005

BROWN

*BR
RAL 8017

PALE GOLD

*PG
RAL 1013

STORM GREY

*SG
RAL 7045

+ COLOURED PLASTIC
HEADED PINS & NAILS
SEE PAGE 62

+ OTHER COLOURS AVAILABLE
Call for availability and cost

VENTILATION STRIP **FOR 10mm SOFFIT**

LENGTH ▶	2.5M		5M	
COLOUR ▼	PART	PRICE	PART	PRICE
BLACK	LHV2BK	£11.96	LHV5BK	£21.62
BROWN	LHV2BR	£11.96	LHV5BR	£21.62
ANTHRACITE GREY	LHV2AG	£16.33	LHV5AG	£31.61

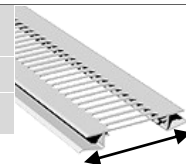

80mm Overall width
(55mm Install width)

TRIMS **FOR 10mm SOFFIT & CAPPIT BOARD**

LENGTH ▶	2.5M		5M	
PRODUCT ▼	PART	PRICE	PART	PRICE
H Trim	LH2H*	£4.36	LH5H*	£7.63
J Trim	LH2J*	£3.27	LH5J*	£5.45

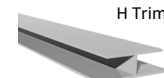

H Trim



J Trim

WHITE GLOSS CLADDING BOARDS



Gloss White 100mm V-Groove & 150mm Shiplap Cladding

uPVC Cladding is the best alternative to traditional wood cladding. This maintenance free product is perfect for today's busy life styles. No more rubbing down and painting. Freefoam's durable cladding products provide not only a decorative but also a protective facing on building exteriors, and act as an additional thermal insulation agent. We offer standard 'V' Groove and traditional Shiplap styles in white. The popular Fortex® textured cladding in a choice of styles, sizes and colours *can be seen on page 59*. Woodgrain finished cladding is also available to special order. All cladding products come with related trims to ensure a neat and professional installation.



+ For fitting information please see page 51



BREATHABLE FELT MEMBRANE 100gsm 1M wide x 20M

- * Highly Breathable
- * Easy-Trim Cutting Grid
- * BBA Certificated no 10/4753
- * UV Stable (3 months exposure)
- * High Tensile and Tear Strength
- * Long Term Durability
- * Multipurpose and Lightweight



PART	PRICE
LFM	£24.99

V-GROOVE CLADDING 100mm cover width

2.5M		5.0M	
PART	PRICE	PART	PRICE
LSV210WH	£5.45	LSV510WH	£9.77
JOINER & STARTER TRIM FOR V-GROOVE			
BUTT JOINT	LSVJWH	£0.99	
3M STARTER TRIM	LSUSTWH	£5.49	

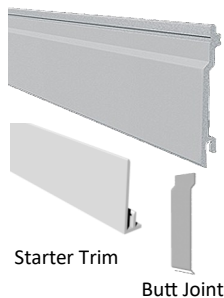

SHIPLAP CLADDING 150mm cover width

2.5M		5.0M	
PART	PRICE	PART	PRICE
LSS215WH	£7.20	LSS515WH	£13.38
JOINER & STARTER TRIM FOR SHIPLAP			
BUTT JOINT	LSSJWH	£1.09	
3M STARTER TRIM	LSUSTWH	£5.49	

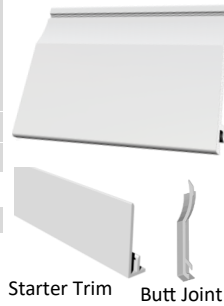

CLADDING TRIMS For V-GROOVE & SHIPLAP CLADDING

DESCRIPTION	PART	PRICE
3.0M Corner Trim	LSUCTWH	£26.50
3.0M Edge Trim	LSUETWH	£16.95
3M H-Trim	LS23HWH	£8.99

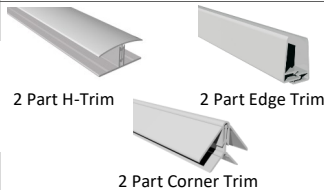

FIXINGS

BARB NAILS
Stainless Steel
30mm x 14g

PACK OF 25		BOX OF 200	
PART	PRICE	PART	PRICE
SN30	£1.02	SNB30	£5.14



FORTEX™ 170mm FEATHER EDGE

NEW COLOURS
ADDED FOR 2018

FORTEX is a range of innovative cladding products that merge the benefits of low-maintenance and long life PVC with an authentic look and feel of real timber. These abstract, Textured wood-grain effect boards are available in a choice of colours.

- ✓ UV & weather resistant
- ✓ Easy to maintain & keep clean
- ✓ 10 Year Guarantee
- ✓ Attractive timber-effect finish in a range of shades to revitalize your home
- ✓ Help to protect your house from cracks, leaks and damp, increasing the insulation
- ✓ Reduce household energy bills & help lower CO² emissions for the environment.

Freefoam
**10 YEAR
GUARANTEE**

FEATHER EDGE 170mm Cover Width

FROM
£21.80 Sq/M

LENGTH	2.5M		5M	
COLOUR	PART	PRICE	PART	PRICE
WHITE	LSF217WH	£10.29	LSF517WH	£18.53
SAND	LSF217SD	£10.29	LSF517SD	£18.53
ARGYLE BROWN	LSF217AB	£12.86	LSF517AB	£20.59
COLONIAL BLUE	LSF217CB	£12.86	LSF517CB	£20.59
MISTY GREY	LSF217MG	£12.86	LSF517MG	£20.59
STORM GREY	LSF217SG	£12.86	LSF517SG	£20.59
SLATE GREY	LSF217SL	£12.86	LSF517SL	£20.59
GREY GREEN #	LSF217GG	£12.86	LSF517GG	£20.59
TORX FIXING		Pk50	Box 500 incl T15 bit	
SCREWS (T15)	SF30	£2.49	SFB30	£16.99
FEATHER EDGE BUTT JOINT			LSFBJ*	£2.05

GREY GREEN DUE MID APRIL 2018

Butt Joint

Torx Screw



Typical Installation Sequence

1. Fix a Suitable Breather Membrane to surface.
2. Fix 25mm x 50mm vertical battens at 400mm spacing Start 20mm from the ground and allow 10mm gap at the top.
3. Fix starter trim along the base and top of area to be clad.
4. Fix first part of 2 part Edge, Corner and Reveal trims as needed. Do not cut second parts of trims yet.
5. Fit first cladding plank into starter trims and screw top of cladding to batten. If needed join the ends of boards with Butt joints.
6. Interlock next cladding plank to the first plank and screw into batten. Repeat until area is clad.
7. Finally cut the second part of 2 part trim to size and clip into place.



FORTEX™ TRIMS		
3 METER TRIMS	PART	PRICE
25mm Vented Starter Trim	LSUSV25	£9.84
External Corner Trim	LSUCT*	£27.30
Edge Trim	LSUET*	£17.46
Reveal Liner	LSECR*	£19.56

125mm

REPLACE ASTERISK * IN THE PART NUMBER WITH THE COLOUR LETTER CODE

170mm FORTEX CLADDING

FORTEX™ STANDARD RANGE 300mm Cover Width

DOUBLE SHIPLAP

300mm Cover Width

LENGTH

2.5M		5M	
PART	PRICE	PART	PRICE
LSD230*	£15.95	LSD530*	£28.83
DOUBLE SHIPLAP BUTT JOINT used to cover the joint between two boards		LSDBJ*	£3.08



Butt Joint

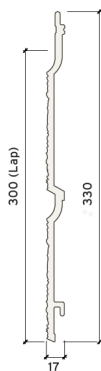

WHITE
* WH



SAND
* SD

Freefoam
10 YEAR
GUARANTEE

FROM
£19.22 Sq/M

REPLACE ASTERISK * IN THE PART NUMBER WITH THE COLOUR LETTER CODE



TORX FIXING	pk50	Box 500 incl T15 bit
SCREWS (T15)	SF30 £2.49	SFB30 £16.99



BREATHABLE FELT MEMBRANE 100gsm 1M wide x 20M

Breathable membrane is used between the host wall and cladding to provide a barrier against water but allow the walls to breathe and help prevent cold damp spots on internal walls

- Highly Breathable
- UV Stable (3 months exposure)
- High Tensile and Tear Strength
- BBA Certified no 10/4753
- Long Term Durability
- Easy-Trim Cutting Grid
- Multipurpose and Lightweight



PART	PRICE
LFM	£24.99

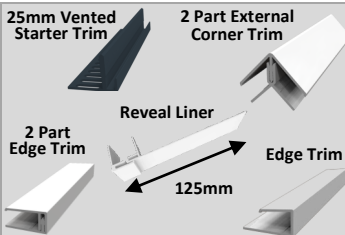

FORTEX TRIMS

3M TRIMS	PART	PRICE
25mm Vented Starter Trim	LSUSV25	£9.84
2 Part External Corner Trim	LSUCT*	£27.30
2 Part Edge Trim	LSUET*	£17.46
Reveal Liner	LSECR*	£19.56
Edge Trim	LSJT*	£15.40



FORTEX™ PROFESSIONAL RANGE 333mm Cover Width



DOUBLE SHIPLAP 333mm Cover Width

2.5M		5M	
PART	PRICE	PART	PRICE
LSD233*	£18.53	LSD533*	£34.99
DOUBLE SHIPLAP BUTT JOINT		LSDBJ*	£3.08



Butt Joint

**FROM
£20.41 Sq/M**

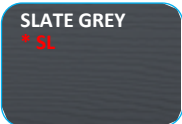
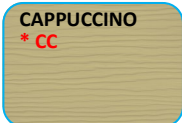
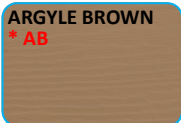

**Freefoam
10 YEAR
GUARANTEE**

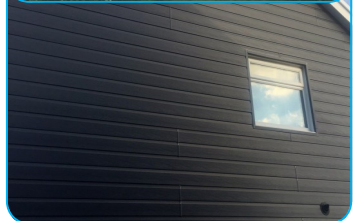

REPLACE ASTERISK * IN THE PART NUMBER WITH THE COLOUR LETTER CODE

TORX FIXING	pk50	Box 500 incl T15 bit
SCREWS (T15)	SF30 £2.49	SFB30 £16.99



BREATHABLE FELT MEMBRANE 100gsm 1M wide x 20M

Breathable membrane is used between the host wall and cladding to provide a barrier against water but allow the walls to breathe and help prevent cold damp spots internally

- Highly Breathable
- UV Stable (3 months exposure)
- High Tensile and Tear Strength
- BBA Certificated no 10/4753
- Long Term Durability
- Easy-Trim Cutting Grid
- Multipurpose and Lightweight



PART	PRICE
LFM	£24.99

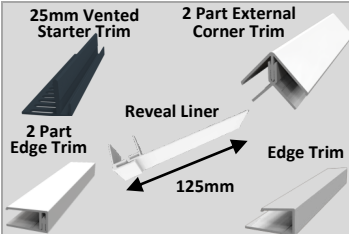

FORTEX™ TRIMS

3 METER TRIMS		PART	PRICE
25mm Vented Starter Trim		LSUSV25	£9.84
2 Part External Corner Trim		LSUCT*	£27.30
2 Part Edge Trim		LSUET*	£17.46
Reveal Liner		LSECR*	£19.56
Edge Trim		LSJT*	£15.40



FORTEX CLADDING

PINS & NAILS

WHITE HEADED PINS (14 Gauge)

SIZE	QTY	PART	PRICE
30mm	25	PP30WH	£1.85
	200	PPB30WH	£8.95
40mm	25	PP40WH	£1.89
	200	PPB40WH	£8.99

WHITE HEADED NAILS (10 Gauge)

SIZE	QTY	PART	PRICE
50mm	25	PP50WH	£2.79
	100	PPB50WH	£8.95
65mm	25	PP65WH	£2.85
	100	PPB65WH	£8.99

COLOUR MATCHED PINS & NAILS

COLOUR CODE

ANTHRACITE GREY	*=AG
BLACK	*=BK
CARAMEL	*=CM
DARK BROWN	*=BR
PALE GOLD	*=PG
STORM GREY	*=SG
REPLACE ALL * WITH CODE	



SIZE	QTY	PART	PRICE
30mm	25	PP30*	£1.95
	200	PPB30*	£11.95
40mm	25	PP40*	£1.99
	200	PPB40*	£11.99
50mm	25	PP50*	£3.95
	100	PPB50*	£11.95
65mm	25	PP65*	£3.99
	100	PPB65*	£11.99

DENTIL MOULDING

Authentic looking moulding ideal for any home, to replace existing crumbling stonework or for just giving your house a face lift. A choice of square tooth or scalloped.

DESCRIPTION	PART	PRICE
1.2M SQUARE DENTIL	EDQWH	£28.95
1.2M SCALLOPED DENTIL	EDSWH	£28.99
External Corner	EDECWH	£12.95
Internal Corner	EDICWH	£12.95
End Caps (pair)	EDEMWH	£21.95



Square Dentil Moulding



Scalloped Dentil Moulding

VENTILATION

Ventilation of the roof space is a requirement to ensure a healthy home. There are various ways to improve ventilation in the roof space. The easiest way for new installations is to use vented soffit boards, plain boards and a ventilation strip or over fascia vents. For existing installations the use of ventilation disks is the easiest method.

VENTILATION STRIP FOR 10mm BOARDS

LENGTH	2.5M		5.0M	
COLOUR	PART	PRICE	PART	PRICE
WHITE	LHV2WH	£13.34	LHV5WH	£24.67
BLACK	LHV2BK	£11.83	LHV5BK	£21.58
BROWN	LHV2BR	£11.83	LHV5BR	£21.58
ANTHRACITE GREY	LHV2AG	£16.98	LHV5AG	£30.85



80mm (55mm width when fixed)

FASCIA & SOFFIT VENTILATION

70mm VENT DISKS

COLOUR	PART	PRICE
ANTHRACITE GREY	LVDAG	£0.61
BLACK	LVDBK	£0.61
BROWN	LVD BR	£0.61
CARAMEL	LVD CM	£0.61
WHITE	LVD WH	£0.61



INSECT MESH

SELF-ADHESIVE INSECT MESH

Applied to the internal side of vented soffit boards or similar applications

PART	PRICE
LVM	£4.29

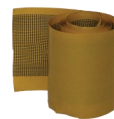

OVER FASCIA VENTS

0.5M long











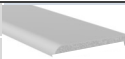



SIZE	PART	PRICE
10mm	LOFV10	£1.29
25mm	LOFV25	£1.59

+ FOR A FULL RANGE OF SILICONES & GLUE
SEE PAGES 90 ONWARDS

TRIMS

WHITE TRIMS

LENGTH	2.5M		5.0M			
DESCRIPTION	PART	PRICE	PART	PRICE		
40mm Architrave	LA240WH	£1.95	LA540WH	£3.29		40mm Architrave
60mm Architrave	LA260WH	£2.46	LA560WH	£4.01		60mm Architrave
90mm Architrave	LA290WH	£3.04	LA590WH	£5.24		90mm Architrave
15mm Quadrant	LQ215WH	£1.08	LQ515WH	£1.95		Quadrant
19mm Quadrant	LQ219WH	£1.60	LQ519WH	£2.36		
20mm Cloak	LQ220WH	£1.29	LQ520WH	£1.95		Cloaking Fillet
28mm D Mould	LD228WH	£1.60	LD528WH	£2.46		D Mould
28mm Rectangular	LR228WH	£1.60	LR528WH	£2.46		
15x15mm Square	LST215WH	£2.05	LST515WH	£3.80		Rectangular
30mm Angle	LA230WH	£5.45	LA530WH	£8.19		Angle
50mm Angle	LA250WH	£8.74	LA550WH	£14.72		
100mm Angle	LA210WH	£19.56	LA510WH	£35.42		Hollow Angle
80x100mm Angle	LHA210WH	£8.74	LHA510WH	£15.95		

WOODGRAIN TRIMS

LENGTH	2.5M		5.0M			
WIDTH	PART	PRICE	PART	PRICE		
40mm Architrave	LA240*	£5.96	LA540*	£9.26		Architrave
60mm Architrave	LA260*	£7.10	LA560*	£11.53		Quadrant
90mm Architrave	LA290*	£8.13	LA590*	£13.65		'D' Mould
19mm Quadrant	LQ219*	£5.45	LQ519*	£8.74		Angle
20mm Cloak	LQ220*	£5.45	LQ520*	£8.74		
28mm D Mould	LD228*	£5.45	LD528*	£8.74		
30mm Angle #	LA230*	£9.47	LA530*	£17.09		# Not Available in Anthracite or Chartwell Green

WINDOW BOARD

10mm WINDOW BOARD HOCKEY or "J" NOSE

LENGTH	2.5M		5.0M		For covering old or damaged internal windowsills.
DESCRIPTION	PART	PRICE	PART	PRICE	
200mm (7 7/8")	LJ220WH	£13.17	LJ520WH	£21.83	
250mm (9 7/8")	LJ225WH	£16.37	LJ525WH	£27.28	

END CAPS FOR WINDOW BOARDS

DESCRIPTION	PART	PRICE
Single 380mm Double-ended End Cap (glue-on)	LJLECWH	£2.39
Set of 2x 60mm End Caps—Left & Right (glue-on)	LJECWH	£1.69

GLOSS ANTHRACITE GREY TRIMS

LENGTH	2.5M		5.0M		
DESCRIPTION	PART	PRICE	PART	PRICE	
40mm Architrave	LA240GAG	£5.45	LA540GAG	£9.26	
60mm Architrave	LA260GAG	£6.54	LA560GAG	£11.53	
90mm Architrave	LA290GAG	£7.71	LA590GAG	£13.69	
28mm D Mould	LD228GAG	£4.62	LD528GAG	£8.74	

ANTHRACITE GREY
RAL 7016

+ FOR A FULL RANGE OF SILICONES & GLUE SEE PAGES 90 ONWARDS

ROSEWOOD *=RW

BLACK ASH *=BA

GOLDEN OAK *=GO

ANTHRACITE *=AG

MAHOGANY *=MH

CHARTWELL *=CG

The Ultimate universal, high speed, high quality easy install dry verge. Left and right handed units are no longer required as Easy Verge U is truly universal. The unique design is quick and easy to install on any tile type and has exceptional holding qualities. A tight secure fit is easily achieved ensuring roof tiles are held firmly in place and not vulnerable to wind dislodgement.

The unique starter unit includes a verge-end closure and a blanking cap to ensure a secure, infestation free and aesthetically pleasing finish. For use in both new build and refurbishment application. UV stable in a choice of Brown, Grey or Terracotta



Dry Verge Universal System

Dry Verge Starter & End Cap

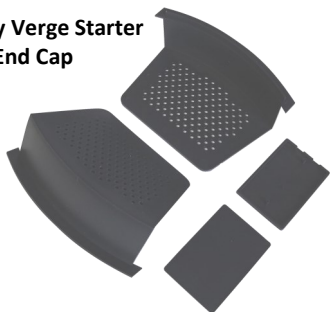

Dry Verge Half Round Ridge Cap



Dry Verge "A" Ridge Cap

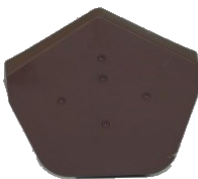

GREY		PART	PRICE
Dry Verge Universal System Grey	DVUSGR	£1.79	
Dry Verge Half Round Ridge Cap c/w Flatcap Grey	DVRRGR	£4.25	
Dry Verge A Ridge Cap c/w Flatcap Grey	DVARGR	£4.25	
Dry Verge Starter & End Cap Pack of 2 Grey	DVSEGR	£4.49	
TERRACOTTA		PART	PRICE
Dry Verge Universal System Terracotta	DVUSTC	£1.79	
Dry Verge Half Round Ridge Cap c/w Flatcap Terracotta	DVRRTC	£4.25	
Dry Verge A Ridge Cap c/w Flatcap Terracotta	DVARTC	£4.25	
Dry Verge Starter & End Cap Pack of 2 Terracotta	DVSETC	£4.49	
BROWN		PART	PRICE
Dry Verge Universal System Brown	DVUSBR	£1.79	
Dry Verge Half Round Ridge Cap c/w Flatcap Brown	DVRRBR	£4.25	
Dry Verge A Ridge Cap c/w Flatcap Brown	DVARBR	£4.25	
Dry Verge Starter & End Cap Pack of 2 Brown	DVSEBR	£4.49	

Nam GRASS

LIKE REAL GRASS ONLY BETTER

We'd all love an immaculately manicured lawn. But unless you've got a full time gardener, it's not going to happen. Fear not. With Artificial Grass from C & A your lawn's always perfect, no matter what the kids, pets or weather have been up to. Handy if you want to throw an impromptu garden party or just spend more time relaxing and enjoying your garden.

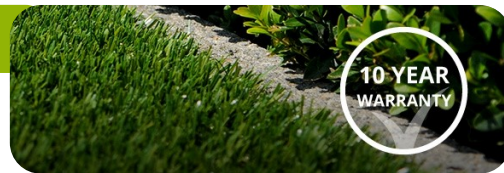

Available in 2M & 4M width rolls

What are the benefits of Artificial Grass?

- No more fussing, digging or mowing.
- Kids can play without creating a mud bath.
- A perfect-looking lawn every day of the year.
- It looks and feels like real grass.
- There's a 10-year warranty with Namgrass
- Perfect for dogs and other pets as it's easy to clean.
- Great if you're allergic to grass pollen.
- Your garden is always ready for entertaining or relaxing.

GREEN VISION



GREEN MEADOW



ECLIPSE 2017



GREEN ELISE



Recommended For	RATING
Lawns & Balconies	✓✓✓✓
Dogs & Pets	✓✓✓✓
Schools & Play Areas	✓✓✓✓
Sports Surface	✓



Recommended For	RATING
Lawns & Balconies	✓✓✓✓
Dogs & Pets	✓✓✓✓
Schools & Play Areas	✓✓✓✓
Sports Surface	✓✓✓✓



Recommended For	RATING
Lawns & Balconies	✓✓✓✓
Dogs & Pets	✓✓✓✓
Schools & Play Areas	✓✓✓✓
Sports Surface	✓✓✓✓



Recommended For	RATING
Lawns & Balconies	✓✓✓✓
Dogs & Pets	✓✓✓✓
Schools & Play Areas	✓✓✓✓
Sports Surface	✓✓✓✓

Green Vision - In Stock Roll Sizes		
SIZE	PART	PRICE
4m x 2m	NGV4020	£141.31
5m x 2m	NGV5020	£175.26
6m x 2m	NGV6020	£210.32

Larger sizes available and delivered direct from manufacturers.
Delivery is normally 2-3 days direct to site.

STYLE	PART	PRICE Per Sq/M
GREEN VISION	NGVSQ	£18.33
GREEN MEADOW	NGMSQ	£22.49
ECLIPSE 2017	NELSQ	£24.16
GREEN ELISE	NGESQ	£24.99



Love your garden Range brings you Composite decking

Composite decking is perfect for gardens, patios, pool areas and holiday homes. Its recycled wood polymer construction makes Composite Wood so much more durable than timber. Whatever's thrown at it - children, bicycles, barbecues, party-goers, paddling pools or garden furniture - it can withstand it all and keep its natural beauty.

ALL Decking planks are reversible with a finish on both sides in fine rib effect or large rib effect.

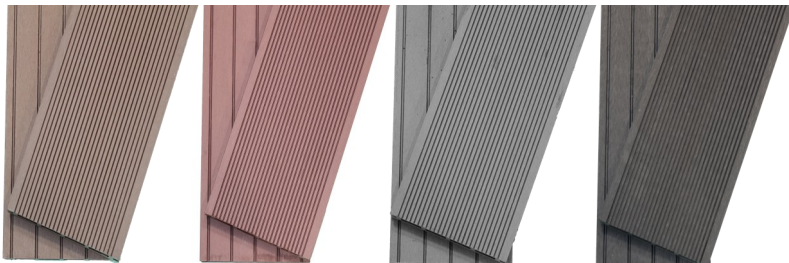

Antique Ash
***AA**

Wild Brown
***WB**

Salt Lake Silver
***SL**

Ancient Black
***AB**

Decking plank size:
146mm x 3660mm x 25mm
Covering 0.53 Sq/M per plank

DECKING PLANKS

PART	PRICE
CDP*	£23.99

FROM
£45.27 Sq/M

DECKING FIXINGS / JOINTING CLIPS

STYLE	PART	PRICE
STARTER CLIP	CDSC	£0.55
JOINING CLIP	CDJC	£0.45

Starter Clip



Joining Clip



Number of fixings required is 12 per board for both starter and joining clips

Life-proof
Durable against:

- kids
- pets
- party-goers
- bicycles and
- barbecues!

Natural Wood Effect

Our decking now comes in a natural wood effect finish creating a traditional wood effect look.

Low Maintenance

No need for painting, sealing or staining - **EVER!** And our products are all colour stabilised so UV rays have little effect.

Weather and environment proof

All of our range is completely water resistant making it ideal for marinas and waterways, as well as holiday homes near the sea or pool areas.

Quick Installation

Our concealed joining system means our products are quick and easy to install. And our 48 hour lead times will keep your project moving.

Safe from the first step

Mould and algae resistant **AND** splinter free, making ever step (with or without shoes) completely safe.

UV

Better colour stabilised and durability

Responsibly sourced products

We only use wood sourced from timber mills and wood workshops which means they haven't been stained or mistreated. Just natural wood goes into all of our Composite Wood products.

Strength

High impact and better scratch resistance.

Installation

Smart, quick and concealed fixings

Splinter free

Warm and soft to touch.



DECKING EDGING & TRIMS

STEP & EDGE NOSING 98 x 45mm x 3660mm

PART	PRICE
CDSE*	£43.99



Step & Edge Nosing

(COMPOSITE FINE RIB)

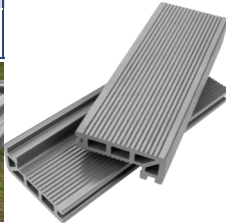

EDGE TRIM 50mm x 40mm x 3660mm

PART	PRICE
CDET*	£10.95

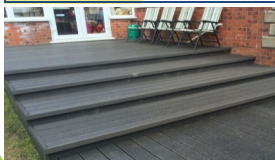

Edge Trim

(Aluminium Colour Matched)

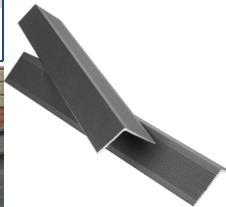

**25Year
Guarantee On All
Composite
Decking and
Balustrades**



Splinter
proof



Choice of
colours



Waterproof



Slip
Resistant



Hard-
Wearing



BALUSTRADES / RAILING

Railing Kit 1500 x 720mm

RAILINGS KIT

PART	PRICE
CDRK*	£84.99



Railing Kit Contains:

Rails 2 Qty
Baluster 9 Qty
Black Plastic Connectors 22 Qty
Railing End Cover Inserts 20 Qty
Railing End Cover 2 Qty
Bottom Rail steel x1

(POST'S NOT INCLUDED)

POST MOUNT 800mm

PART	PRICE
CDPSTPM	£39.99



2.4MTR POST 120mm x 120mm

PART	PRICE
CDPST*	£34.99

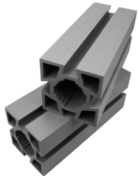

POST TOPCAP

PART	PRICE
CDPSTC*	£3.99

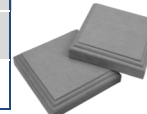

BOTTOM SKIRT

PART	PRICE
CDPSTSK*	£4.99

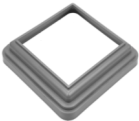

Antique Ash
*AA

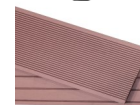

Wild Brown
*WB

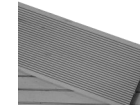

Salt Lake Silver
*SL



Ancient Black
*AB

COMPOSITE DECKING

- Made from **DURABLE** Extruded Polystyrene.
- All the benefits of wood such as it **CUTS** and **JOINS** just like wood.
- None of the disadvantages of wood such as **SPLITTING**, **WARPING** or **WOODWORM**.
- There are **NO IMPERFECTIONS**.
- High **QUALITY** and **CONSISTENT** finish on every length due to foil finish.
- **MOISTURE RESISTANT** and can be used in areas of high humidity.
- **COMPETITIVELY** priced when compared to the equivalent quality and finish of natural wooden products.
- Paintable
- Light weight and easy to handle
- Made in the UK



FIXING KNOW HOW:

- All surfaces should be clean and dry.
- Mitre the moulding the same way as if it were wood for a perfect cut. Cuts the same as wood, so why treat it any differently?
- Most customers are unaware that this product does not normally require gluing. But may be fixed this way.

2.20M x 55mm x 19mm Torus Architrave

COLOUR	PART NO	PRICE	
WHITE	IAT255WH	£7.49	
LIGHT OAK	IAT255LO	£7.99	

2.92M x 100mm x 14mm Ogee Skirting Board

COLOUR	PART NO	PRICE	
WHITE	ISO210WH	£8.99	
LIGHT OAK	ISO210LO	£9.49	

2.20M x 55mm x 14mm Ogee Architrave

COLOUR	PART NO	PRICE	
WHITE	IAO255WH	£4.99	
LIGHT OAK	IAO255LO	£5.49	

2.92M x 140mm x 17mm Torus Skirting Board

COLOUR	PART NO	PRICE	
WHITE	IST214WH	£15.99	
LIGHT OAK	IST214LO	£16.49	

2M x 18mm SCOTIA TRIM

COLOUR	PART NO	PRICE	
WHITE	ISS218WH	£2.99	
LIGHT OAK	ISS218LO	£3.29	

C & A now stock the Orac decorative internal mouldings range. Here are a selection of cornice / covings from the standard ridged to flexible with led lighting apertures.

Orac Decofix Hydro 290ml



- Long-lasting seal between mouldings and the wall or ceiling
- Remove with soap solution
- Paintable after hardening (min. 24 hours)
- 290ml > 7 to 8m

Orac Decofix Extra 310ml



- Remove excess glue before hardening (max. 1 hour and repeat after 2-3 hours)
- Clean with acetone or synth thinner
- Can be painted after 24 hours
- 310ml > min. 80m.

Orac Mitre Box

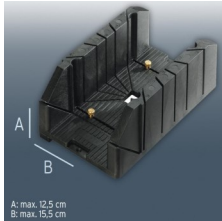

Specialist mitre box for coving, dado, skirting up to 12.5 cm deep x 15.5cm projection.

A: max. 12.5 cm
B: max. 15.5 cm

DISCRIPTION	PART	PRICE
HYDRO	SOCHWH	£8.97
DECOFIX EXTRA	SOCX	£16.04
MITRE BOX	TOCMB	£29.80



CX123-2600 Cornice

A best-seller which has been very successful for a number of years. This cornice is affordable yet elegant and durable.

2.6Mtr x 80 x 80mm

DISCRIPTION	PART	PRICE
CX123 CORNICE	OCX123	£14.77

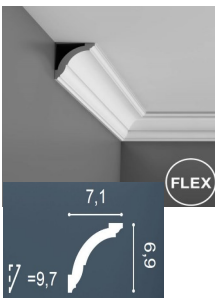

CX100-2600 Cornice

A timeless model to suit all decoration styles. This cornice is affordable yet elegant and durable.

2.6Mtr x 71 x 69mm

DISCRIPTION	PART	PRICE
CX100 CORNICE	OCX100	£13.78



CX127-2600 Cornice

Bigger brother to the CX100. This cornice is affordable yet elegant and durable.

2.6Mtr x 94 x 94mm

DISCRIPTION	PART	PRICE
CX127 CORNICE	OCX127	£18.70

Coving for LED light strips.



C362-2000 Cornice

Inspired by the 1930's, simple circular form allows the 'Curve' to be present without being intrusive. LED lighting can be installed.

2.0Mtr x 50 x 50mm

DISCRIPTION	PART	PRICE
C362 CORNICE	OCL362	£29.34



C373-2000 Cornice

Designed by top designer Ulf Moritz, to be a modernist profile and made of a higher density Purotouch[®], these are not only suitable for walls and ceilings but also as a skirting board.

2.0Mtr x 50 x 80mm

DISCRIPTION	PART	PRICE
C373 MULTI USE	OCL373	£40.65

FLEX

This symbol shows that the coving is manufactured from the flexible profile that are ideal for the curved walls and contours of modern designs. Allowing for an easier to install and superior finish than available from traditional timber products.

Cornice / Coving Sample Box

- See the quality for yourself.
- 100mm length of all 5 cornices for £9.99.
- Part Code: OCSAMPLE

INTERLOCKING LUXURY VINYL FLOORING



Understanding that you want to spend less time installing and more time enjoying your new floor, without compromising on style and durability. This collection brings a unique textured flooring system, each of the wood and stone designs come with a micro bevel effect on all four sides for seamless joints. A strong **0.3mm Wear layer** allows this product to carry a **10 Year residential and commercial warranty** and it is **compatible with underfloor heating**, it is **Water resistant** & has an **R10 slip rating**. All These floorings are 4mm in thickness overall.

CAMARO LOC WOOD LARGE PLANK.

Detailing and natural beauty of wood planks, the realistic timber variations, grains and surface textures combined with reproduced tones give each plank an authentic appearance.



Other shades available please call for samples or information: 01634 374444

Specifications
1212mm (length) x 177mm (width)
9 Planks per pack | 1.94m² per pack

WOOD RANGE LARGE PLANK (9 Planks Per Pack)		
COLOUR	PART	PRICE
SMOKE LIMED OAK	CLPSLO	£42.68
EVERGREEN OAK	CLPEO	£42.68
TAN LIMED OAK	CLPTLO	£42.68



Installation Method:
Simple interlocking click system that requires no adhesive.

VINYL LOC UNDERLAY 10m²



Designed to prevent the planks sliding or becoming damaged due to uneven subfloors, Vinyl Loc Underlay also acts as a light shock-absorber, and is ideal for use in apartments and bedrooms to reduce noise to neighbouring rooms. Suitable for use over underfloor heating and should be laid if underfloor heating is to be installed. Each pack covers 10 square meters.

DISCRIPTION	PART	PRICE
VINYL LOC UNDERLAY	CLUND	£53.95

CAMARO LOC WOOD SMALL PLANK.



VINTAGE TIMBER

£21.55 per Sq/M



GREY MOUNTAIN ASH

£21.55 per Sq/M



WHITE LIME OAK

£21.55 per Sq/M



Specifications
 906mm (length) x 145mm (width)
 15 Planks per pack 1.98m² per pack

WOOD RANGE SMALL PLANK (15 Planks Per Pack)

COLOUR	PART	PRICE
VINTAGE TIMBER	CLPVT	£42.68
GREY MOUNTAIN ASH	CLPGMA	£42.68
WHITE LIME OAK	CLPWLO	£42.68

Other shades available please call
 for samples or information:
 01634 374444

Specifications
 603mm (length) x 298mm (width)
 11 tiles per pack | 1.98m² per pack

STONE RANGE (11 Tiles Per Pack)

COLOUR	PART	PRICE
CLASSIC YORKSTONE	CLTCY	£43.54
GREY FLAGSTONE	CLTGF	£43.54
BLACK SHADOW SLATE	CLTBSS	£43.54

CAMARO LOC STONE RANGE



CLASSIC YORKSTONE

£21.99 per Sq/M



GREY FLAGSTONE

£21.99 per Sq/M



BLACK SLATE

£21.99 per Sq/M

GEO panel INTERNAL INTERLOCKING WALL CLADDING

Large Panel Size. 10mm thick
2400mm X 1000mm Covers(2.4m²)

Internal panelling system available in a range of finishes, ideal for bathroom & kitchen walls.

EASY TO USE

- ✓ Perfect alternative to tiling
- ✓ Cover over any existing surface
- ✓ Simple tongue & groove system
- ✓ No training needed
- ✓ Super fast installation
- ✓ Range of trims available

BENEFITS

- ✓ 100% Waterproof PVC core
- ✓ No grouting to discolour/ leak
- ✓ Mould-free material
- ✓ Hygienic wipe-clean surface
- ✓ Insulation for walls & ceilings
- ✓ Sound proofing

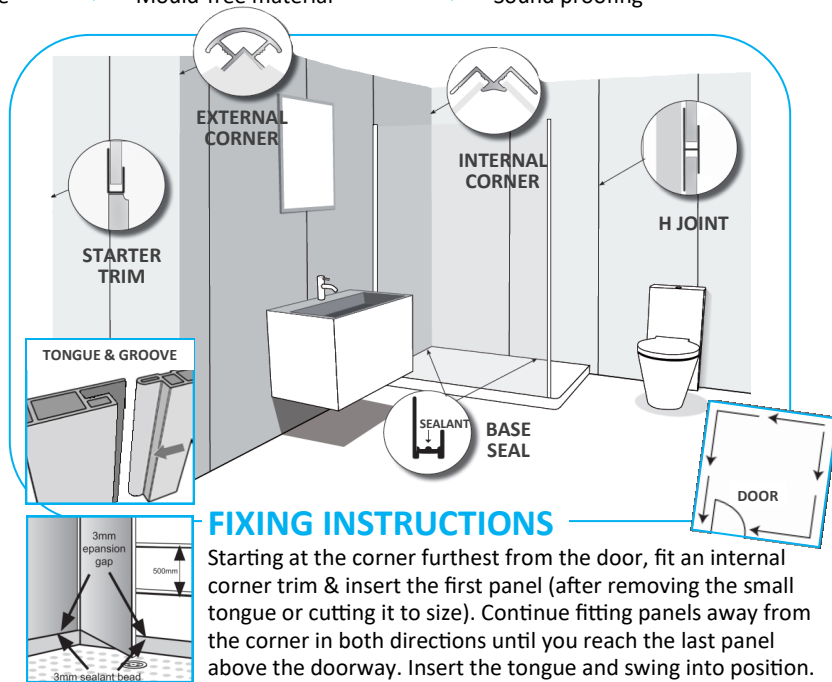

FIXING INSTRUCTIONS

Starting at the corner furthest from the door, fit an internal corner trim & insert the first panel (after removing the small tongue or cutting it to size). Continue fitting panels away from the corner in both directions until you reach the last panel above the doorway. Insert the tongue and swing into position.

▼ OUR RANGE OF FINISHES - panels sold individually ▼

BEIGE MARBLE

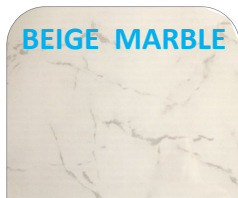

Gloss finish

PART	PRICE
IGPLBE	£61.82

PERGAMON MARBLE

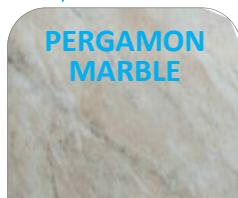

Gloss finish

PART	PRICE
IGPLPM	£61.82

ARCTIC SPARKLE

NEW



Gloss finish

PART	PRICE
IGPLAS	£74.99

WHITE DIAMOND



Gloss finish

PART	PRICE
IGPLWD	£74.99

BLACK DIAMOND

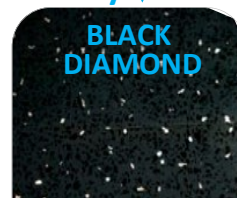

Gloss finish

PART	PRICE
IGPLBD	£74.99

BLACK MARBLE



Gloss finish

PART	PRICE
IGPLBM	£61.82

WHITE MARBLE



Gloss finish

PART	PRICE
IGPLBM	£61.82

WHITE RIPPLE

NEW



Gloss finish

PART	PRICE
IGPLWR	£74.99

BLACK RIPPLE

NEW



Gloss finish

PART	PRICE
IGPLBR	£74.99

BLUE MARBLE

CLEARANCE



Gloss finish

PART	PRICE
IGPLBL	£49.99

LIGHT GREY MARBLE



Gloss finish

PART	PRICE
IGPLGM	£61.82

GLOSS WHITE

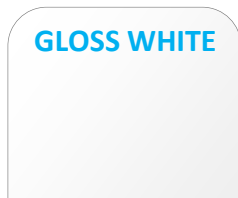

Gloss finish

PART	PRICE
IGPLGW	£74.99

CONCRETE GREY

NEW



Matt finish

PART	PRICE
IGPLCG	£74.99

CONCRETE BEIGE

NEW



Matt finish

PART	PRICE
IGPLCB	£74.99

GREEN MARBLE

CLEARANCE



Gloss finish

PART	PRICE
IGPLGR	£49.99

TRIMS 2.4M Long

Edge/Starter		
COLOUR	PART	PRICE
SILVER	IGPUSI	£6.45
WHITE	IGPUWH	£4.95
External Corner		
SILVER	IGPESI	£9.79
WHITE	IGPEWH	£7.79
Internal Corner		
SILVER	IGPISI	£9.45
WHITE	IGPIWH	£7.59
Base Seal		
SILVER	IGPBSI	£10.99
WHITE	IGPBWH	£7.95
H-Joint		
SILVER	IGPHSI	£7.99
WHITE	IGPHWH	£6.45

GEO panel INTERNAL INTERLOCKING WALL CLADDING

Medium Panels Size. 7mm thick
Pack of 2 panels 2400mm X 600mm
Covers(2.88m²)

NEW!

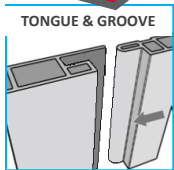

Internal paneling system available in a range of Modern matt finishes, ideal for bathroom & kitchen walls.

Due to the growing popularity of the geo panel range, we are now proud to introduce a NEW range of matt finish wall panels. These panels are sold in **packs of 2**. Each board measures **2400mm x 600mm** and are available in a wide range of stunning modern colours.

EASY TO USE

- ✓ Perfect alternative to tiling
- ✓ Cover over any existing surface
- ✓ Simple tongue & groove system
- ✓ No training needed
- ✓ Super fast installation
- ✓ Range of trims available

BENEFITS

- ✓ 100% Waterproof PVC core
- ✓ No grouting to discolour/ leak
- ✓ Mould-free material
- ✓ Hygienic wipe-clean surface
- ✓ Insulation for walls & ceilings
- ✓ Sound proofing

LARGE TILE EFFECT

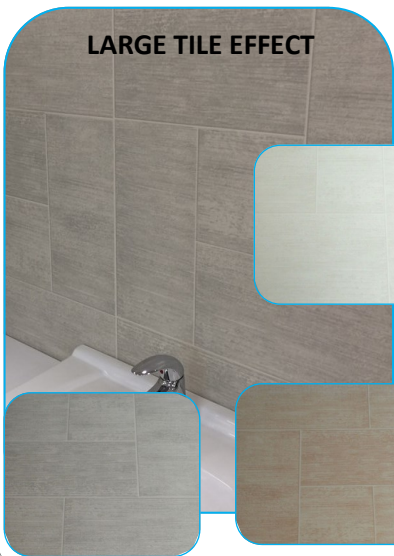

SLATE EFFECT



RETRO METAL EFFECT



SMALL TILE EFFECT



OUR RANGE OF FINISHES - Sold in packs of 2 Measuring 2400mm x 600mm each panel

LARGE TILE EFFECT

LARGE TILE WHITE

PART	PRICE
IGPMLW	£57.40

SMALL TILE EFFECT

SMALL TILE WHITE

PART	PRICE
IGPMSW	£57.40

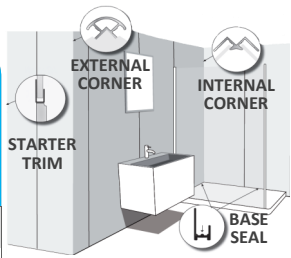

ALUMINIUM TRIMS
For use with 7mm panels

Made from solid aluminium and available in 2 different colours, **Bright silver** or **Plain white**. These trims are made to accept the 7mm panels and are **2400mm** long. Made from aluminium there's no rusting resulting in a long life span

RETRO METAL EFFECT

LARGE TILE BEIGE

PART	PRICE
IGPMLB	£57.40

SMALL TILE BEIGE

PART	PRICE
IGPMSB	£57.40

COPPER RETRO METALLIC

PART	PRICE
IGPMCM	£52.99

SLATE EFFECT RANGE

SLATE BEIGE

PART	PRICE
IGPMSBE	£52.99

LARGE TILE LIGHT GREY

PART	PRICE
IGPMLL	£57.40

SMALL TILE LIGHT GREY

PART	PRICE
IGPMSL	£57.40

SILVER RETRO METALLIC

PART	PRICE
IGPMSM	£52.99

SLATE BLACK

PART	PRICE
IGPMSBK	£52.99

2.4Mtr Aluminium Base Seal		
COLOUR	PART	PRICE
SILVER	IGPMBSI	£24.99
WHITE	IGPMBWH	£16.69

2.4Mtr Aluminium Starter/Edge		
COLOUR	PART	PRICE
SILVER	IGPMUSI	£9.29
WHITE	IGPMUWH	£5.99

2.4Mtr Aluminium External Corner		
COLOUR	PART	PRICE
SILVER	IGPMESI	£23.99
WHITE	IGPMEWH	£15.79

2.4Mtr Aluminium Internal Corner		
COLOUR	PART	PRICE
SILVER	IGPMISI	£17.99
WHITE	IGPMIWH	£12.29

Samples Available—please call for a sample of any of these panels. Please note colour may be slightly different to the printed image.

7mm MEDIUM INTERNAL DECORATIVE PVC PANELS

GEO panel SMALL PANELS Size 5mm thick 2700mm X 250mm (covers 2.7m²)

Interlocking internal paneling system available in a range of finishes, ideal for bathroom & kitchen walls & ceilings

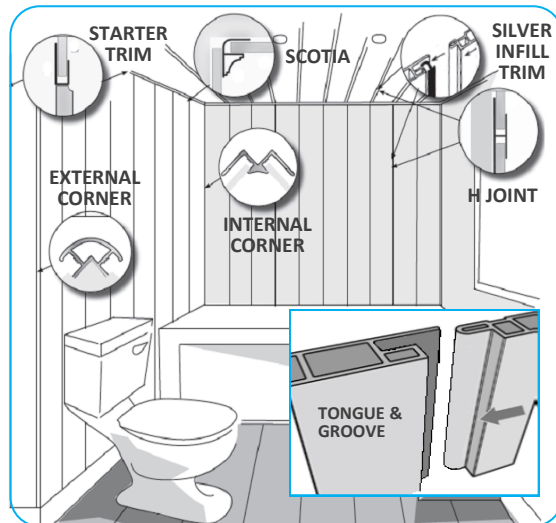
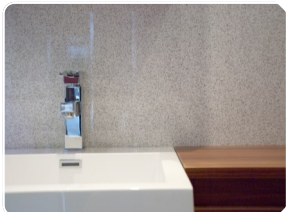

EASY TO USE

- ✓ Perfect alternative to tiling
- ✓ No training needed
- ✓ Cover over any existing surface
- ✓ Super fast installation
- ✓ Simple tongue & groove system
- ✓ Range of trims available

BENEFITS

- ✓ 100% Waterproof PVC core
- ✓ Hygienic wipe-clean surface
- ✓ No grouting to discolour/ leak
- ✓ Insulation for walls & ceilings
- ✓ Mould-free material
- ✓ Sound proofing

FIXING INSTRUCTIONS

Fitting is easy, with no specialist tools or training required. The panels simply interlock forming a watertight finish without grouting or drying time. The best alternative to standard tiling.

GEO panel CEILING PANELS

Gloss White with Silver trim panels, available in packs of 5, ideal for cladding ceilings to give a modern and attractive clean finish. Manageable panel size for easy installation. Geo panel design interlocks sections together using a simple tongue and groove system. A range of trims is also available for a professional finish.

EACH PANEL SIZE. 5mm thick x 2700mm x 200mm

ALSO AVAILABLE IN 4000mm x 200mm pack of 5 ASK FOR INFORMATION



PER PACK OF x5	
PART	PRICE
CIGPSWH	£42.99

▼ **HUGE RANGE OF STYLES** - Available in packs of 4 panels each 2700mm x 250mm (Covers 2.7Sq mtrs)

PACK OF x4

Now also Available in 4M
call for information

GLOSS WHITE	PART	PRICE
A clean, shiny plain white.	IGPSGW	£37.49

PACK OF x4

LIGHT GREY MARBLE	PART	PRICE
A traditional light marble colour.	IGPSGM	£37.49

PACK OF x4

BLACK MARBLE	PART	PRICE
A traditional Black marble colour.	IGPSBM	£37.49

PACK OF x4

PERGAMON MARBLE	PART	PRICE
A traditional marble colour.	IGPSPM	£37.49

PACK OF x4

WHITE DIAMOND	PART	PRICE
A trendy light sparkly colour.	IGPSWD	£39.99

PACK OF x4

BLACK DIAMOND	PART	PRICE
A trendy dark sparkly colour.	IGPSBD	£39.99

Also available in larger 2400mm x 1000mm 10mm Thick single panels
SEE PAGE 72

+ SILICONES & ADHESIVES
SEE PAGE 90 ONWARDS

GEO-PANEL CLEANER





PART	PRICE
IGPCS	£4.25

A powerful cleaning agent designed specifically for cleaning geopanel

500ml SPRAY BOTTLE

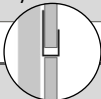

▶ **TRIMS**
2.7M Long

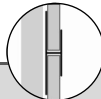
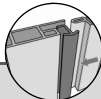
												
	Starter/Edge		External corner		Internal corner		Scotia		H-Joint		Infill Trim	
COLOUR	PART	PRICE	PART	PRICE	PART	PRICE	PART	PRICE	PART	PRICE	PART	PRICE
SILVER	IGPSUSI	£4.49	IGPSESI	£5.29	IGPSISI	£4.99	IGPSSSI	£5.49	IGPSHSI	£4.59	IGPSFSI	£5.49
WHITE	IGPSUWH	£3.69	IGPSEWH	£4.59	IGPSIWH	£4.49	IGPSSWH	£4.59	IGPSHWH	£3.79	N/A	N/A

IDEAL FOR: Bathrooms, Food preparation areas, Clean Rooms & Easy to clean areas

WHITE PVC PANELS

POPULAR HYGIENE LINER

Chemically resistant with a **Class 1 Fire Rating**. These 2440mm x 1220mm (8' x 4') panels are impervious to water and when installed correctly are compliant with statutory regulations for wall coverings in areas of food preparation and packaging. If the area you wish to apply the sheets to isn't smooth and flat then the 3mm should be used for it's increased rigidity.

APPROX DIMENSIONS		2mm Thick	
Millimetres	Inches	PART	PRICE
2440 x 1220	(96" x 48")	FP22412WH	£29.99
		3mm Thick	
2440 x 1220	(96" x 48")	FP32412WH	£44.50



When used in areas of food preparation, it is important that all joints are made using the appropriate trim section, which is treated at the edges with clean room silicone. FDA Approved Food Compatibility. Prevents the formation of most common germs.

PART	PRICE
SCRWH	£4.55



Available in 2.5mm Thickness 2500 x 1220mm Cover

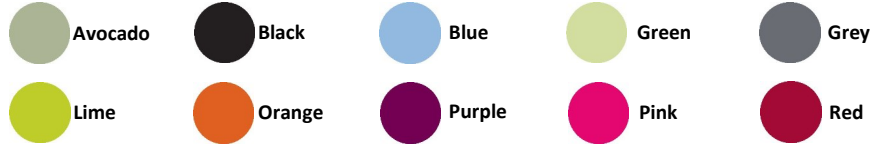

Coloured sheets available with matching trims. Call 01634 374444 for more information or see online for more details www.cabp.co.uk

APPROX DIMENSIONS		2.5mm Thick	
Millimetres	Inches	PART	PRICE
2500 x 1220	(98" x 48")	FP22512*	£67.99

MULTI-TRIM WHITE

2.44M (8ft)

ONE TRIM FOR ALL JOBS

The MULTI-TRIM has been specifically designed for use with the 2-3mm white PVC sheets. This clever design allows one trim to do the job of 4 others. Featuring a flexible co-extrusion this trim can accommodate any angle from 90°-270°. Having this one trim means you will never have the wrong trim on site again!

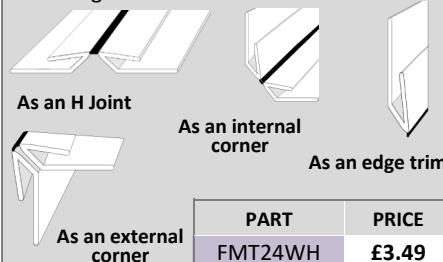

EDGE TRIM WHITE

PART	PRICE	Size 2.4M (8ft) Usable with 2 & 3mm
FTE2WH	£2.99	

JOINTING TRIM WHITE

PART	PRICE	Size 2.4M (8ft) Usable with 2 & 3mm
FTH2WH	£3.99	

EXTERNAL CORNER WHITE

PART	PRICE	Size 2.4M (8ft) Usable with 2 & 3mm
FTEC2WH	£4.49	

LARGE INTERNAL CORNER TRIM

PART	PRICE	Size 2.4M (8ft) Usable with 2 & 3mm
FTLC2WH	£5.99	

SMALL INTERNAL CORNER TRIM

PART	PRICE	Size 2.4M (8ft) Usable with 2 & 3mm
FTSC2WH	£2.99	

HIGHLY VERSATILE SOLID CLEAR POLYCARBONATE

IDEAL FOR:
 > Greenhouses.
 > Secondary Glazing.
 > Security Glazing.



† Solid Polycarbonate is 200 times stronger than glass and can be used in many everyday applications. Common uses include re-glazing sheds, greenhouse glazing, secondary glazing, plus 1000's of other uses around home and work.

CLEAR SOLID POLYCARB

UV Protected both sides

This highly versatile product is totally glass clear, with an impact resistance 200 times greater than that of glass. All of our sheets have a UV coating on both sides to stop UV deterioration, ensure longer life and eliminate the chance of installing the wrong way around. These sheets are extremely easy to cut and drill making them an ideal DIY friendly glazing alternative.

APPROX DIMENSIONS	2mm Thick		3mm Thick		4mm Thick		6mm Thick		
	Millimetres	Inches	PART	PRICE	PART	PRICE	PART	PRICE	PART
1220 x 610	48" x 24"	FC21206CL	£11.99	FC31206CL	£17.98	FC41206CL	£23.99	FC61206CL	£35.96
1220 x 1220	48" x 48"	FC21212CL	£23.99	FC31212CL	£35.97	FC41212CL	£47.98	FC61212CL	£71.93
2440 x 1220	96" x 48"	FC22412CL	£47.98	FC32412CL	£71.94	FC42412CL	£95.96	FC62412CL	£143.87
1000 x 750	39" x 29 ^{1/2} "	FC21007CL	£12.58	FC31007CL	£18.86	FC41007CL	£25.15	FC61007CL	£37.72
1500 x 1000	59" x 39"	FC21510CL	£25.15	FC31510CL	£37.72	FC41510CL	£50.31	FC61510CL	£75.43
2050 x 750	78 ^{3/4} " x 29 ^{1/2} "	FC22007CL	£25.21	FC32007CL	£37.80	FC42007CL	£50.37	FC62007CL	£75.49
2050 x 1500	78 ^{3/4} " x 59"	FC22015CL	£50.31	FC32015CL	£75.44	FC42015CL	£100.62	FC62015CL	£150.87
3050x 2050	118" x 78 ^{3/4} "	FC23020CL	£100.63	FC33020CL	£150.88	FC43020CL	£201.25	FC63020CL	£301.75

SECONDARY GLAZING STRIP

2.44M (8ft) WHITE

Easy to install, 2.4M long strips will accept 2mm or 3mm panels. The strip is in 2 sections, the inner section is pushed around the edge of the sheeting and then screwed into the frame, then the top screw cover is pushed into place to hide the fixings.

PART	PRICE
FT24WH	£5.99



SECONDARY MAGNET GLAZING

5M (16' 4") Per Roll

Two self-adhesive strips, one part is magnetised, the other steel. Applied by sticking one part to the framework and the other to the sheeting. Once installed it will be magnetically held into position making it easy to remove for cleaning or access.

PART	PRICE
MG5	£23.90



SUSPENDED CEILINGS



Armstrong suspended ceilings are designed for maximum effect with modest cost and fast installation times. The professional steel framing interlocks for rigidity and is fully Fire Rated for areas with public access. An easy to assemble system that gives you a neat and clean finish to any ceiling.

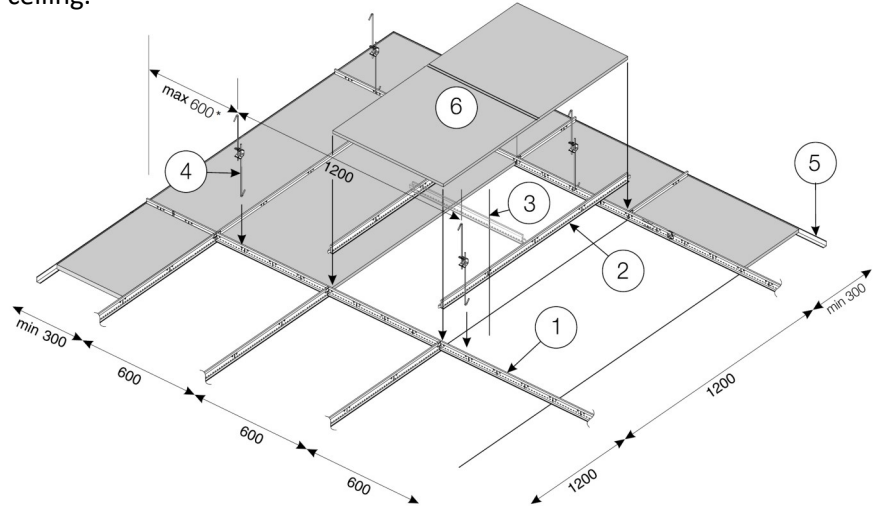

ITEM NO	DESCRIPTION	PART NO	PRICE
1	Main "T" 3.6M (11' 9")	CFT36	£6.84
2	Spacer "T" 1.2M (3' 11 1/4")	CFT12	£2.28
3	Spacer "T" 0.6M (1' 11 1/2")	CFT06	£1.14
4	Suspension Wire 10M	CW10	£1.99
4	Suspension Wire 100M	CW100	£16.99
5	Wall Angle 3M (9' 10")	CWF3	£5.10

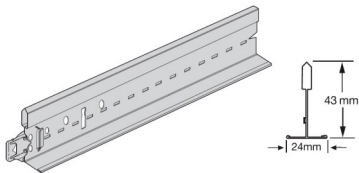

The white-faced, galvanised, steel interlocking frame is fast and easy to install. An angle section is fitted around the walls, then the main 'T' sections rest on these and reach across the room. The spacer 'T's are then fitted to create the desired tile space.



CEILING TILES Prismatic, Fissured & Sandgrain

PRISMATIC Panels

Prismatic panels are translucent allowing light to pass through them into the space below, two versions are available in both the Oblong and Square sizes. Clear panels have a diamond pattern on the lower surface and transmit the most light, whilst the Opal panels diffuse the light to reduce shadows.

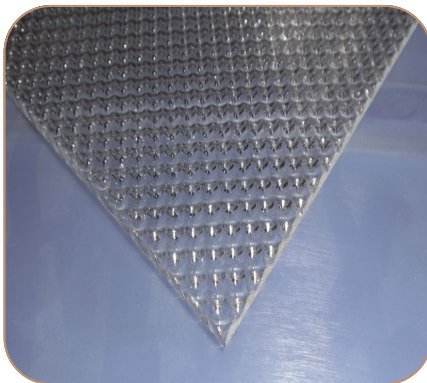

PANEL TYPE		595mm X 595mm		1195mm X 595mm	
DESCRIPTION	COLOUR	PART NO	PRICE	PART NO	PRICE
PRISMATIC	CLEAR	CP66CL	£4.99	CP126CL	£9.49
PRISMATIC	OPAL	CP66WH	£5.99	CP126WH	£12.99
FISSURED	WHITE	CF66	£3.29	CF126	£5.99
DUNE SANDGRAIN	WHITE	CSF66	£5.49	N/A	N/A

All our ceiling tiles are designed to fit standard ceiling systems that accept 595mm x 595mm or 595mm x 1195 tiles.

For our online guides and parts list calculator please see our website www.cabp.co.uk

HAVING TROUBLE?

We can help calculate the materials required

FISSURED Tiles

The non-directional FINE FISSURED surface is easy to install and effective for sound absorption. Ideal for use in circulation areas, meeting rooms, cinemas etc.

Fissured face tiles meet the EEA Euro class A2-S1 Fire Rating standard. With excellent sound and heat insulation properties, they have a pale surface that reflects 75% of ambient light and are easy to cut and fit.



DUNE SANDGRAIN Tiles

The non-directional Dune tile has a fine sand grain finish with a lipped edge so the tile sits below the framework rather than on it, to create a 3 dimensional ceiling. Ideal for use in schools and offices.

Meeting the EEA Euro class A2-S1 Fire Rating standard, it has high sound and heat insulation properties with the further advantages of being highly resistant to humidity and water with a surface that reflects 85% of ambient light.



Combo Canopy

Easy-fit Door Canopies are ideal to cover doorways, balconies, walkways and waiting areas, to give just a few suggestions. Our canopies are sold as kits and are quick to install and only require a small amount of assembly.

The support brackets on each side are made from weather-proof engineering-grade plastic and each one requires only two wall fixings (supplied in kit). These canopies can be installed individually, or back-to-back and side-to-side to give cover over a larger area. We have a range of sizes available, with Grey, Off White or Black brackets, and a choice of Bronze, Opal or Clear Multiwall polycarbonate, or Solid Clear Polycarbonate glazing.

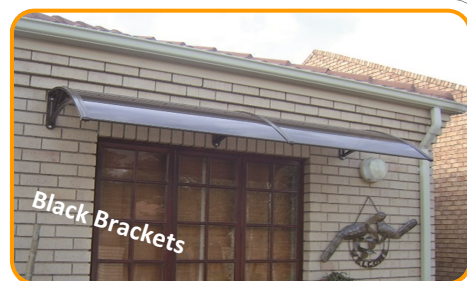

700mm Projection X 1000mm Width				
Sheet Type	Sheet Colour	Bracket Colour	PART NO	PRICE
Multiwall	CLEAR	BLACK	DCB710TC	£29.99

700mm Projection X 1200mm Width				
Sheet Type	Sheet Colour	Bracket Colour	PART NO	PRICE
Multiwall	CLEAR	BLACK	DCB712TC	£34.99
Multiwall	BRONZE	BLACK	DCB712TB	£44.99
Multiwall	CLEAR	WHITE	DCW712TC	£39.95
Multiwall	OPAL	WHITE	DCW712WH	£49.95
Multiwall	CLEAR	GREY	DCG712TC	£49.99
Solid	CLEAR	GREY	DCG712SC	£59.99



See Page 84 for our Premier Range of Canopies and custom colour options

CANOPY INSTALL KIT

This handy kit contains all the bits you will need to help install your canopy.

Consists of:

- 1 x Clear Silicone
- 1 x Screw Driver
- 1 x 10mm SDS Bit
- 1 x Spanner



PART	PRICE
TCIK	£4.99

Combo Canopy

900mm Projection Easy-fit Door Canopies

The support brackets on each side are made from weather-proof engineering-grade plastic and each one requires only two wall fixings (supplied in the kit). The combo canopy can be installed individually, or back-to-back and side-to-side to give cover over a larger area. With a choice of colours, with Grey, White and Black brackets, and choice sheet colours in Bronze, Opal or Clear Multiwall polycarbonate, or Solid Glass Clear Polycarbonate.

Easy to install for both the DIY enthusiast or the trade

920mm Projection X 1200mm Width

Sheet Type	Sheet Colour	Bracket Colour	PART NO	PRICE
Multiwall	CLEAR	BLACK	DCB912TC	£64.99
Multiwall	BRONZE	BLACK	DCB912TB	£75.99
Solid	CLEAR	BLACK	DCB912SC	£98.99
Solid	CLEAR	GREY	DCG912SC	£99.99

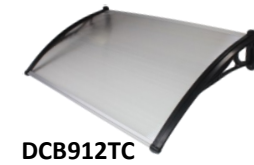
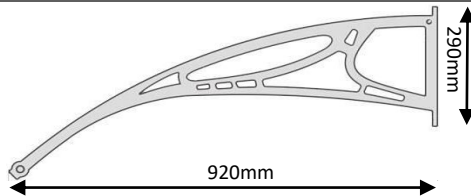

DCB912TC



DCB912SC

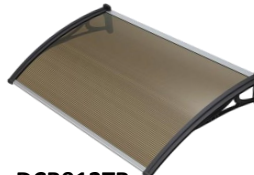

DCB912TB



DCG912TC

CANOPY INSTALL KIT

This handy kit contains all the bits you will need to help install your canopy.

Consists of:

- 1 x Clear Silicone
- 1 x Screw Driver
- 1 x 10mm SDS Bit
- 1 x Spanner



PART	PRICE
TCIK	£4.99

MAX Series Canopy



Our MAX Series Canopies are manufactured from quality materials for strength and durability. With aluminium arms and solid polycarbonate sheets they are built to last. Easy to install by both the DIY or Trade and the option to join multiple canopies to produce a continuous run

when you need to cover long walkways or side passageways



MAX Series Canopy

900mm Projection x 1200mm Width

Sheet Type	Sheet Colour	Bracket Colour	PART NO	PRICE
Solid Polycarbonate	CLEAR	BLACK	DCMB912SC	£129.00
Solid Polycarbonate	CLEAR	SILVER	DCMS912SC	£139.00

This series is joinable along its width allowing for increased coverage and presents a lower pitch making it more suitable for use with outward opening doors.

Combo Canopy Premier Range



The Premier door canopy made with solid polycarbonate clear sheet and steel arms finished on silver is a robust yet stylish canopy allowing plenty of light with its glass clear sheet and easy to install design its suitable for both the DIY and Trade

These sleek, Modern, Easy to install Door Canopies are the ideal solution for covering doorways, balconies, walkways and waiting areas. Their simple clean design makes these the perfect choice for making that instant wow impact on your home.

The brackets and frame are made from aluminium making them lightweight, strong and extremely durable. The sheets are made from Solid Polycarbonate which is UV coated and with a very high impact resistance. This provides all the benefits of glass but at a fraction of the cost. We have a range of styles available, with Silver or Black brackets, and a choice of Bronze or Clear polycarbonate, meaning there is a canopy for almost every job. Supplied in kits complete with instructions and all the Fixings.

Premium Canopy 900mm Projection x 1400mm Wide			
Sheet Type	Bracket	PART NO	PRICE
Solid Clear Polycarbonate	Aluminium	DCE914	£99.00



White and Grey canopies have a satin finish to the following RAL Colours

WHITE = RAL 9910

ANTHRACITE GREY = RAL 7016

We can custom finish to a RAL colour of your choice please call 01634 374444 for prices

J Series Canopies 900mm Projection x 1500mm Width				
Sheet Type	Sheet Colour	Bracket Colour	PART NO	PRICE
Solid Polycarbonate	CLEAR	SILVER	DCJ915CL	£119.00
Solid Polycarbonate	BRONZE	SILVER	DCJ915BR	£139.00
Solid Polycarbonate	CLEAR	WHITE	DCJWH912CL	£199.95
Solid Polycarbonate	CLEAR	ANTHRACITE	DCJAG912CL	£199.95





ClassicBond EPDM flat roofing system has been awarded the British Board of Agreement certificate, No. 11/4853, with an service life in excess of 35 years. The BBA carries out assessment, testing, approval and certification of products and systems for the construction industry against national requirements,

- ◆ Standard 1.2mm membrane is nearly 10% thicker than leading competitors
- ◆ Only EPDM with 50 year history
- ◆ Large sizes no or few joints
- ◆ Excellent resistance to extremes of temperature, UV & ageing
- ◆ High puncture resistance - will not tear, split or crack
- ◆ Quick & clean to install • Choice of 1.2mm or Premium 1.5mm thicknesses



ClassicBond EPDM Membranes Professional grade EPDM membranes are all BBA approved Available in 3.0M, 4.5M, 6.0M, 7.6M & 9.1M widths and up to 30M long.



Deck Adhesive is a high strength, low odour water based acrylic adhesive is specifically designed for use with ClassicBond EPDM roofing membrane and timber deck surfaces. Designed to be roller applied to flat roof surfaces.



152mm Pressure Sensitive Overlayment Strip is used for butt jointing of membrane, seaming in metal edging, drip edges and fastening plates. This EPDM tape has a semi cured top surface with a Pressure Sensitive underside. Resists tearing, cracking and abrasion in all weather conditions.

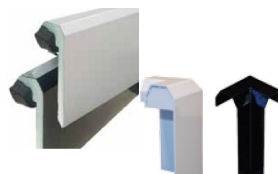

Sure Edge PVC Perimeter Trim is a high quality, durable roof edge trim ready to install straight out of the box. Providing a neat, simple and fast finishing detail for the edge of any flat roof. Supplied in 2.5m lengths and finished with

internal and external corner trims, with a water seal and

Use our online calculator for an instant price or call 01634 374444

- 1 Roof Size
Please enter the actual size of your roof (not the membrane size) in Metric or Imperial
- 2 Edges
A: Kerb
B: Kerb
C: Gutter
D: Kerb
- 3 Your Kit
£346.22
6415.464 inc VAT

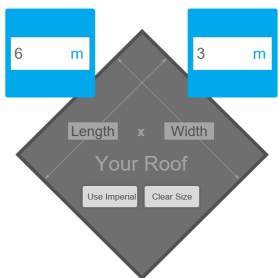

As little as
£15.95 sq/M
Including all trims,

CONTINUE ▶

For an instant quote visit rr.cabp.co.uk enter your size and edging requirements for a quick list of parts and price. Save it for later and when your ready to order simply call us with your reference number and providing you order before 1pm you should receive your completed order the next day



DOMES WITHOUT UPSTAND or KERB

Question &

Q: What is a roof dome?

A: Roof domes are basically windows in flat roofs.

Q: Where do I use a roof dome?

A: On any flat or low pitched roofs that do not exceed 15 degrees

Q: What size do I need?

A: This depends on the size of the hole you have or wish to make. See tables for guide.

For hole sizes
subtract 140mm from the Overall size quoted
(example: a 600mm x 600mm dome would have internal sizes of 460mm x 460mm).

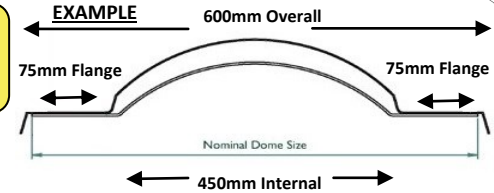

A range of glazing only units designed specifically for refurbishment projects where the glazing only needs to be replaced. These units are supplied with a fixing kit including weathertight washers and cover plugs. Manufactured from Marlon FSX Longlife polycarbonate, these glazing units are up to 200 times stronger than glass. The high resistance to breakage and adverse weather conditions means Mardome Reflex is very safe and reliable.



AVAILABLE COLOURS
BRONZE, OPAL & PRIVACY TEXTURED GLAZED DOMES

- Dome or pyramid option
- Can be mechanically fixed to existing kerbs
- Single, double and triple skin units available
- Available with standard 70mm or 100mm wide flange options to accommodate varying upstand sizes
- 20 Year Manufacturer's weather failure guarantee

Non-Stock Items
Made To Order
Delivered Direct



PLEASE NOTE All Domes Are Made To Order and Can Not Be Returned

STANDARD DOME LIDS ONLY

KERB DIMENSION		SQUARE DOMES	DOUBLE GLAZED		TRIPLE GLAZED	
MIN	MAX	OVERALL SIZE	PART	PRICE	PART	PRICE
460mm	500mm	600x600mm (23½" x 23½")	DRD0606CL	£130.00	DRT0606CL	£171.00
610mm	650mm	750x750mm (29½" x 29½")	DRD0707CL	£166.00	DRT0707CL	£218.00
760mm	800mm	900x900mm (35½" x 35½")	DRD0909CL	£188.00	DRT0909CL	£245.00
910mm	950mm	1050x1050mm (41¼" x 41¼")	DRD1010CL	£219.00	DRT1010CL	£287.00
1060mm	1100mm	1200x1200mm (47¼" x 47¼")	DRD1212CL	£295.00	DRT1212CL	£400.00

KERB DIMENSION		RECTANGULAR DOMES	DOUBLE GLAZED		TRIPLE GLAZED	
MIN	MAX	OVERALL SIZE	PART	PRICE	PART	PRICE
460mm x 760mm	500mm x 800mm	600x900mm (23½" x 35½")	DRD0609CL	£159.00	DRT0609CL	£208.00
610mm x 760mm	650mm x 800mm	750x900mm (29½" x 35½")	DRD0709CL	£181.00	DRT0709CL	£239.00
460mm x 1060mm	500mm x 1100mm	600x1200mm (23½" x 47¼")	DRD0612CL	£210.00	DRT0612CL	£283.00
760mm x 1060mm	800mm x 1100mm	900x1200mm (35½" x 47¼")	DRD0912CL	£294.00	DRT0912CL	£399.00

Thermal Efficiency	U-Value (W/m² k)	Tint	Lighting Effect	Light Transmission (%)	
Double Skin Polycarbonate	2.7	Clear	High Visibility	Double Skin	85%
Triple Skin Polycarbonate	1.8	Clear	High Visibility	Triple Skin	78%

Mardome Trade a standard specification dome. These units come complete with a host of features and benefits as standard to satisfy a range of projects and budgets.

Maximum daylight

- Side walls of the kerb are designed with a steep slope to allow a larger glazing unit to be fitted for maximum daylight area

Easy to install

- Delivered to site complete and ready to fit
- A large kerb foot radius makes for easier application of roof covering to the termination point without the need for timber fillets



Available Options:

- Electric Opening
- High Security
- Smoke Clearance
- Access Opening
- Other sizes also available



ADD ONS:

Vented Upgrade option for all Trade kerbs:

Simply pick the dome size you need then add this item to have your domes kerb include 2 Hit & Miss trickle vents. **Please Note:** This option can only be added at time of order



NON-OPENING DOMES NON-VENTED (WITH KERB)

STRUCTURAL ROOF OPENING		SQUARE DOMES		DOUBLE GLAZED		TRIPLE GLAZED	
MAX	OVERALL SIZE	PART	PRICE	PART	PRICE	PART	PRICE
600x600mm	600x600mm (23½" x 23½")	DUD0606CL	£203.00	DUT0606CL	£263.00		
750x750mm	750x750mm (29½" x 29½")	DUD0707CL	£254.00	DUT0707CL	£330.00		
900x 900mm	900x900mm (35½" x 35½")	DUD0909CL	£294.00	DUT0909CL	£381.00		
1050x1050mm	1050x1050mm (41¼" x 41¼")	DUD1010CL	£338.00	DUT1010CL	£435.00		
1200x1200mm	1200x1200mm (47¼" x 47¼")	DUD1212CL	£428.00	DUT1212CL	£557.00		
RECTANGULAR DOMES				DOUBLE GLAZED		TRIPLE GLAZED	
MAX	OVERALL SIZE	PART	PRICE	PART	PRICE	PART	PRICE
600x900mm	600x900mm (23½" x 35½")	DUD0609CL	£256.00	DUT0609CL	£330.00		
750x900mm	750x900mm (29½" x 35½")	DUD0709CL	£284.00	DUT0709CL	£368.00		
600x1200mm	600x1200mm (23½" x 47¼")	DUD0612CL	£321.00	DUT0612CL	£414.00		
900x1200mm	900x1200mm (35½" x 47¼")	DUD0912CL	£417.00	DUT0912CL	£542.00		

OPENING DOMES LINEAR OPENING(WITH KERB)

STRUCTURAL ROOF OPENING		SQUARE DOMES		DOUBLE GLAZED		TRIPLE GLAZED	
MAX	OVERALL SIZE	PART	PRICE	PART	PRICE	PART	PRICE
600x600mm	600x600mm (23½" x 23½")	DLD0606CL	£358.00	DLT0606CL	£388.00		
750x750mm	750x750mm (29½" x 29½")	DLD0707CL	£431.00	DLT0707CL	£471.00		
900x 900mm	900x900mm (35½" x 35½")	DLD0909CL	£496.00	DLT0909CL	£539.00		
1050x1050mm	1050x1050mm (41¼" x 41¼")	DLD1010CL	£548.00	DLT1010CL	£660.00		
1200x1200mm	1200x1200mm (47¼" x 47¼")	DLD1212CL	£792.00	DLT1212CL	£872.00		
RECTANGULAR DOMES				DOUBLE GLAZED		TRIPLE GLAZED	
MAX	OVERALL SIZE	PART	PRICE	PART	PRICE	PART	PRICE
600x900mm	600x900mm (23½" x 35½")	DLD0609CL	£448.00	DLT0609CL	£483.00		
750x900mm	750x900mm (29½" x 35½")	DLD0709CL	£479.00	DLT0709CL	£524.00		
600x1200mm	600x1200mm (23½" x 47¼")	DLD0612CL	£667.00	DLT0612CL	£717.00		
900x1200mm	900x1200mm (35½" x 47¼")	DLD0912CL	£772.00	DLT0912CL	£852.00		

TRICKLE VENT UPGRADE		
DESCRIPTION	PART	PRICE
HIT AND MISS VENTS ON 2 EDGES	DTVA	£35.00

All Domes Are Made To Order and Can Not Be Returned

COMING SOON

Our NEW bath and shower room opening Spring 2018 at our Gillingham Branch
Featuring a comprehensive range of bathroom and shower suites for new build, refurbishment or commercial applications, including Doc M, with an extensive range of furniture and accessories



VALUE RANGE

BATH & KITCHEN SEALANT

High quality, acrylic based sealant that provides an effective, yet economical seal but is still easy to use.

COLOUR	PART	PRICE
WHITE	SBKSWH	£1.35

C3 Cartridge

ONE HOUR CAULK

Fast drying decorators filler and sealant that remains permanently flexible. Can be over painted with most types of paint.

COLOUR	PART	PRICE
WHITE	SOHCWH	£1.35

C3 Cartridge

EXTERNAL FRAME SEALANT

A high quality acrylic based sealant that provides a long lasting, permanently flexible seal that can be painted over.

COLOUR	PART	PRICE
WHITE	SEFWH	£1.59
BROWN	SEFBR	£1.59
STONE	SEFST	£1.59

C3 Cartridge

ROOF & GUTTER SEALANT

Quality butyl based sealant and adhesive, provides instant & permanent weatherproofing to a wide variety of roofing applications.

COLOUR	PART	PRICE
BLACK	SRGSBK	£1.89

C3 Cartridge

CARTRIDGE ACCESSORIES

TRADE MASTIC GUN

Heavy duty traders frame style mastic gun. Designed to accept both C3 & C4 Cartridges

PART	PRICE
STMG	£5.69

PRO MASTIC GUN

Heavy duty frame for use on C3 & C4 cartridges.

PART	PRICE
SMGP	£10.59

CARTRIDGE CUTTER

A unique cartridge opening and nozzle trimming tool.

PART	PRICE
SSCC	£4.49

SUPERGLUE RANGE

INDUSTRIAL SUPERGLUE 20gm

Medium viscosity formula. For use on surfaces where fast set is required. Bonds non porous surfaces such as most plastics, metals, glass, PVCu & rubber. Set time 5 to 15 seconds.

PART	PRICE
SG20	£1.39

MITRE FAST GLUE & ACTIVATOR KITS

Twin pack adhesive system of glue & aerosol activator. Can be used in various applications where its instant bonding properties will dramatically reduce assembly time.

SIZE	PART	PRICE
STD	SMFK	£5.99
LRG	SMFKX	£12.99

QUICK KEY



QUICK DRY



ANTI-FUNGAL



GAP FILLING



SOLVENT BASED



BITUMEN-COMPATIBLE



INTERNAL USE ONLY



WATERPROOF



PAINTABLE



SOLVENT FREE



LEAD COMPATIBLE

ACCESSORIES

SILICONES

200 LMA SILICONE

For general glazing, weatherproofing & sanitary use. Can be used both inside and out and is easy to tool down.

Multi Saver
5 for 4

C3 Cartridge



COLOUR	SINGLE			PACK OF 5	
	PART	PRICE	PART	PRICE	
WHITE	SGSWH	£2.29	SGSBWH	£9.16	
CLEAR	SGSCL	£2.29	SGSBCL	£9.16	
BLACK	SGSBK	£2.29	SGSBBK	£9.16	
BROWN	SGSBR	£2.29	SGSBBR	£9.16	

SX CONTRACTORS LMN SILICONE

Colour Range. A one component neutral cure silicone which can be used for sealing most building, construction and glazing joints. Almost odourless and cures with atmospheric moisture to form a durable rubber seal.

C3 Cartridge

Multi Saver
5 for 4



COLOUR	SINGLE			PACK OF 5	
	PART	PRICE	PART	PRICE	
WHITE	SLMNWH	£2.75	SLMNBWH	£11.00	
CLEAR	SLMNCL	£2.75	SLMNBCL	£11.00	
BLACK	SLMNBK	£2.75	SLMNBK	£11.00	
BROWN	SLMNBR	£2.89	SLMNBRR	£11.56	
ANTRACITE	SLMNAG	£2.89	SLMNBAG	£11.56	
OAK	SLMNOK	£2.89	SLMNBOK	£11.56	

PREMIER 450 SILICONE

A High Quality low modulus non-corrosive neutral cure silicone sealant that adheres to virtually all substrates, both porous and non-porous.

C3 Cartridge

Multi Saver
5 for 4



COLOUR	SINGLE			PACK OF 5	
	PART	PRICE	PART	PRICE	
WHITE	SMWH	£3.65	SMBWH	£14.60	
CLEAR	SMCL	£3.65	SMBCL	£14.60	
BLACK	SMBK	£3.65	SMBBK	£14.60	
BROWN	SMBR	£3.65	SMBBR	£14.60	
BUFF	SMBF	£3.99	SMBBF	£15.96	

FOREVER WHITE SILICONE

Forever White is a superior silicone sealant that is permanently waterproof and flexible and ideal for sealing: shower bases and cubicles, wetrooms, around baths, sinks and basins. With Mould Shield anti-bacterial solution integrated into the manufacturing process, Forever White is guaranteed to stop black mould growth for 10 years.

C3 Cartridge

COLOUR	PART	PRICE
WHITE	SFWH	£5.69



CLEAN ROOM SILICONE

Advanced neutral curing hygienic sealant that combines a powerful anti-bacterial compound with FDA Approved Food Compatibility. Prevents most common germs forming on its surface. Offers outstanding adhesion to most surfaces.

COLOUR	PART	PRICE
WHITE	SCRWH	£4.55

C3 Cartridge



SEALANTS

LEAD SEALANT

Specially formulated as an alternative to mortaring lead flashing into brick, stone and concrete. Provides a fully waterproof joint that will not crack or shrink.

COLOUR	PART	PRICE
GREY	SLMS	£2.59



C3 Cartridge

ALL WEATHER SEALANT

A universal co-polymer sealant that can be used for emergency building and roofing repairs. Usable in wet weather or damp conditions. Provides superior adhesion to most surfaces. Over paintable with most paints and stains.

COLOUR	PART	PRICE
WHITE	SAWWH	£3.65
CLEAR	SAWCL	£3.65
BLACK	SAWBK	£3.65



C3 Cartridge

For more detailed specifications visit www.cabp.co.uk

SEALANTS & ADHESIVES

GUN & NAIL EXTRA

A high strength, gap filling adhesive providing extra bond strength and quick curing time.

Multi Saver
5 for 4



		SINGLE		PACK OF 5	
COLOUR	PART	PRICE	PART	PRICE	
BEIGE	SGAX	£2.89	SGABX	£11.56	

C3 Cartridge

PINKGRIP WHITE

Solvent free, white version of PinkGrip. It has all the benefits and will stick just about anything on a building site & also has a no-slump formula.

Multi Saver
5 for 4



		SINGLE		PACK OF 5	
COLOUR	PART	PRICE	PART	PRICE	
WHITE	SPGWH	£2.99	SPGBWH	£11.96	

C4 Cartridge

MIGHTY STRENGTH GRIP & GRAB ADHESIVE

Instant grab adhesive that has initial bond strength double that of most other grab adhesives. For use internally or externally and even on damp or wet surfaces. This adhesive is solvent free, cures quickly and is water and weather proof. Suitable for bonding most materials but in particular for the fixing of large panels, wall boards and mirrors.



Multi Saver
5 for 4

C3 Cartridge

STIXALL

The ultimate combination of building adhesive and sealant, with the most extreme power to both bond and seal virtually EVERYTHING to ANYTHING in almost all conditions, even in wet weather, on wet surfaces or even underwater.

Multi Saver
5 for 4



		SINGLE		PACK OF 5	
COLOUR	PART	PRICE	PART	PRICE	
CLEAR	STXCL	£7.99	STXBCL	£31.96	
WHITE	STXWH	£6.99	STXBWH	£27.96	
BROWN	STXBR	£6.99	STXBRR	£27.96	

TRADERS MIGHTY STRENGTH SEAL & FIX

An all-round durable, flexible adhesive and sealant based on MS Polymer technology. Has excellent adhesion to non-porous surfaces, will bond to damp surfaces and is paintable with most paints. Is odourless, neutral and free of isocyanates.

Multi Saver
5 for 4



		SINGLE		PACK OF 5	
COLOUR	PART	PRICE	PART	PRICE	
WHITE	SMSPWH	£5.49	SMSPBWH	£21.96	
CLEAR	SMSPCL	£5.49	SMSPBCL	£21.96	
BLACK	SMSPBK	£5.49	SMSPBBK	£21.96	
BROWN	SMSPBR	£5.49	SMSPBBR	£21.96	

C3 Cartridge



MULTI-PURPOSE SEALANT/ADHESIVE

The ultimate sealant and adhesive in one tube

One-stop, multi-purpose, waterproof, hybrid polymer sealant and adhesive. Sticks to almost any surface without the need for additional fixings, can be used in damp or wet conditions, can even be applied under water! Countless possibilities for use with CT1 sealant & adhesive.

- Food safe - conforms to ISE-GA Standards
- Anti-fungal and has excellent resistance to chemicals
- Bonding of Glass, Mirrors, Wood, Polystyrene, metals (Inc. lead)
- Can be over-painted
- Can be used in all salt-water environments so perfect for marine and boating applications.



C3 Cartridge



MULTISOLVE The perfect tooling partner for CT1

A material remover in an easy to use handheld spray can. A cost-effective solution for a variety of jobs.

- Fully compatible with CT1 sealant & adhesive
- Safely removes wax, paraffin, printing ink, adhesives, sealants, grease, oil & more
- Excellent as a pre-treatment for paints & adhesives
- Used in large number of trades from plumbers to stonemasons
- Leaves no oily residue



300ml Spray can (Std)
500ml Spray can (Large)

SIZE	PART	PRICE
STD	SCTMSS	£6.99
LARGE	SCTMSL	£9.99

SEALANTS & GUNABLE ADHESIVES

PLASTIC, GLASS & HAND CLEANERS



INTERNAL & EXTERNAL USE



SAFE NEXT TO INSULATED GLASS



SOLVENT FREE



SOLVENT BASED



QUICK DRY



PVCu SOLVENT CLEANER

This solvent based product is formulated to remove ingrained dirt from PVCu and most plastics. Also suitable to restore old windows and plastic garden furniture as good as new.

PART PRICE
SAPC £3.99

1 Litre

PAPER GLASS WIFE

Made of extra strong, soft 2-ply paper for effective cleaning of plastic and glass around the home, onsite or at the work place.

SIZE PART PRICE
LARGE 150M (30M²) SGWL £4.79
X-LARGE 280M (80M²) SGWXL £10.79

WONDER WIPES

Specially formulated to clean hands, tools and surfaces from wet and semi-cured paint, sealant, adhesive, bitumen, expanding foam, oil, grease and even silicone.

TUB SIZE PART PRICE
100 Wipes SWW £6.69
300 Wipes SWWGT £14.49

VALUE CLEANING KIT

The complete value kit to cover almost all standard jobs

Consists of:

- 1 x 1lt Solvent Cleaner
- 1 x 1ltr Glass Cleaner
- 1 x Large Paper Tissue

PART PRICE
SVCK £10.69

TRADERS CLEANER KIT

The complete all in one kit covers almost all cleaning jobs

Consists of:

- 1 x 1lt Solvent Cleaner
- 1 x 1ltr Cream Cleaner
- 1 x 1ltr Glass Cleaner
- 1 x Extra Large Paper Tissue

PART PRICE
STCK £18.29

CREAM CLEANER

A solvent-free formulation designed to remove ingrained dirt and stains from PVCu window frames without scratching. Buffs to a deep sheen.

PART PRICE
SCC £2.69

1 Litre

GLASS CLEANER

A powerful glass cleaning agent containing a high level of detergents and solvents for a rapidly drying, smear and static free finish. May also be used on tiling, VDUs, TV screens and chrome.

PART PRICE
SEGC £2.49

1 Litre

POLYCARBONATE CLEANER

Designed to deal with dirt & grime on polycarbonate roofs whilst protecting the external coatings of the sheet. Diluting can produce 20 times more!

PART PRICE
PRCC £9.99

1 Litre

GEO PANEL CLEANER

A powerful cleaning agent designed specifically for cleaning geopanel 500ml SPRAY BOTTLE

PART PRICE
IGPCS £4.25

LUBRICATION SPRAYS

MULTI-PURPOSE SPRAY

Has 100's of uses around the home, garage, workshop and in industry.

Penetrates rusted parts and fastenings to assist dismantling & lubricating. 400ml

PART PRICE
SMPS £2.99

SILICON SPRAY

Ideal for lubricating rubber seals and 'o' rings on guttering, plumbing plus 100's of uses around the home, workshop and business.

400ml
PART PRICE
SS £2.99

EXPANDING FOAMS

FIX & FILL (HANDHELD)

Quick setting foam which expands greatly on application and yields up to 50 times original can contents. Can be cut, sawn, plastered and sealed over.
700ml



PART	PRICE
SFF7	£4.19



GUN GRADE FOAM

Quick setting foam which expands greatly on application and yields up to 50 times original can contents. Can be cut, sawn, plastered and sealed over.
700ml



PART	PRICE
SFFG	£4.29



FOAM CLEANER

Removes wet and uncured foam. Attaches to the Foam Gun for precise cleaning or attach the included spray nozzle for hand-held use.
700ml



PART	PRICE
SFFC	£3.89



FOAM GUN

Gives greater foam application in hard to reach places.

Ensure gun is cleaned after use with SFFC

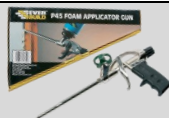

PART	PRICE
SFFPG	£22.99

FOAM EATER

A paste designed to safely remove cured PU foam from most surfaces. Its consistency makes it suitable for both vertical and horizontal use.



PART	PRICE
SFE	£9.99



For more detailed specifications visit www.cabp.co.uk

WT1

WT1 PAINT ON ROOF REPAIR, SEALING & WATERPROOFER.

COVERAGE	PART	PRICE
Up to 10sq/M	SWT1	£85.00

WT1 is a complete new formulated compound with a combined polymer and polyurethane union, which forms a 100% waterproof membrane and remains stable with weather fluctuations, without shrinking or cracking. It is ideal for the quick repair of flat and sloping roofs, and for tanking, with one application straight from the container. It is also used on concrete terraces, balconies and floors, and under ideal conditions, can be rendered or plastered.



FLASHING TAPES & PRIMER

SELF ADHESIVE FLASHING

A strong self-adhesive flashing tape comprising of an aluminium foil and a bitumen rubber adhesive. The adhesive forms a strong waterproof seal by the simply pressing the tape into place by hand.

Benefits

- Replaces need for lead flashing.
- Self-adhesive - requires no separate glue.

Surface Preparation

All surfaces must be dry, sound and free from oil, grease and dust Remove all loose material by scraper or wire brush. Porous surfaces, such as concrete or brick, should be primed using FLASHING PRIMER and allowed to dry.

WIDTH	PART	PRICE
75mm (3")	SFR3	£8.49
100mm (4")	SFR4	£9.49
150mm (6")	SFR6	£13.99
225mm (9")	SFR9	£19.49
300mm (12")	SFR12	£29.49



FLASHING PRIMER

Bitumen and Flashing Primer is a thin black primer used to give a key prior to applying bitumen paints, roof coatings and flashing.



SIZE	PART	PRICE
1 LITRE	SFRP	£5.49

EXPANDING FOAM/ADHESIVES & FLASHING

PLASTIC HEAD PINS & NAILS

Plastic head pins & nails are used most commonly with UPVC fascia, soffits & trim installations, but can be used with virtually any job.

These fixings are made out of stainless steel and have colour matching caps on their head.

Available in two different grades:

- 14 Gauge (30mm & 40mm long pins) ideally used with nothing thicker than 10mm
- 10 Gauge (50mm & 65mm long nails) Ideally used with any of thicker products (10mm+)

WHITE HEADED PINS (14 Gauge)			
SIZE	QTY	PART	PRICE
30mm	25	PP30WH	£1.85
	200	PPB30WH	£8.95
40mm	25	PP40WH	£1.89
	200	PPB40WH	£8.99

WHITE HEADED NAILS (10 Gauge)			
SIZE	QTY	PART	PRICE
50mm	25	PP50WH	£2.79
	100	PPB50WH	£8.95
65mm	25	PP65WH	£2.85
	100	PPB65WH	£8.99

COLOUR MATCHED PINS & NAILS

COLOUR CODE

BLACK	*=BK
CARAMEL	*=CM
DARK BROWN	*=BR
STORM GREY	*=SG
ANTHRACITE GREY	*=AG
PALE GOLD	*=PG

REPLACE ALL * WITH CODE

ANTHRACITE GREY PINS ARE NOT AVAILABLE IN 30mm & 50mm LENGTHS

SIZE	QTY	PART	PRICE
30mm	25	PP30*	£1.95
	200	PPB30*	£11.95
40mm	25	PP40*	£1.99
	200	PPB40*	£11.99
50mm	25	PP50*	£3.95
	100	PPB50*	£11.95
65mm	25	PP65*	£3.99
	100	PPB65*	£11.99

BARBED NAILS

30mm **BARBED NAILS STAINLESS STEEL** 

Designed to be used as a hidden fixing with most cladding ranges & many other applications.

25 PACK		200 BOX	
PART	PRICE	PART	PRICE
SN30	£0.89	SNB30	£4.99

SCREWS & CAPS

PLASTIC SCREW CAPS

For use with No 8 screws the cap size is 13mm diameter and supplied in packs of 25



COLOUR	PART	PRICE	
WHITE	SCSWH	£0.99	
BROWN	SCSBR	£1.99	
BLACK	SCSBK	£1.99	
CARAMEL	SCSCM	£1.99	
Extra Large Caps 18mm Diameter Pack of 25	WHITE	SCLWH	£2.49

PLASTIC HEADED SCREWS

Supplied in packs of 10

18mm x 8g			30mm x 8g		
COLOUR	PART	PRICE	PART	PRICE	
WHITE	SP18WH	£2.87	SP30WH	£3.25	
BROWN	SP18BR	£2.98	SP30BR	£3.65	

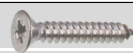

STAINLESS STEEL SCREWS

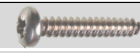

SCREW SIZE	COUNTER SUNK HEAD				ROUND HEAD 'PAN'			
	PACK 25		BOX 250		PACK 25		BOX 250	
	PART	PRICE	PART	PRICE	PART	PRICE	PART	PRICE
¾" x 8	SC3	£0.83	SCB3	£5.95	N/A	N/A	N/A	N/A
1" x 8	SC1	£0.94	SCB1	£7.92	SR1	£0.94	SRB1	£7.92
1¼" x 8	SC12	£0.97	SCB12	£8.50	SR12	£0.97	SRB12	£8.50
1½" x 8	SC15	£1.04	SCB15	£8.95	SR15	£1.04	SRB15	£8.95
2" x 8	SC2	£1.30	SCB2	£9.99	SR2	£1.30	SRB2	£9.99

STEEL SHEET FIXINGS

DRILLFIX PACK OF 10

SIZE	PART	PRICE
20mm	FSD20	£1.98
38mm	FSD38	£2.39
50mm	FSD50	£2.63
70mm	FSD70	£2.99

Self-drilling 5.5mm with 8mm hexagonal head & rubberized sealing washer



*Colour matching caps available

TAPFIX PACK OF 10

SIZE	PART	PRICE
38mm	FST38	£2.48
50mm	FST50	£2.69
75mm	FST75	£2.89

Self-tapping 6.5mm with 8mm hexagonal head & rubberized sealing washer. *Pre drilled holes required*



*Colour matching caps available

COLOURED CAPS FOR FIXINGS

PACK OF 10

COLOUR	PART	PRICE
MERLIN GREY	FCCMG	£0.49
GOOSEWING GREY	FCCGG	£0.52
OLIVE GREEN	FCCOG	£0.53



For covering tops of an 8mm hex head fixing.

BIG 6 PROFILE SHEET FIXINGS

Supplied for use with Big 6 Profile corrugated sheets & also any Fibre Cement sheets.

8mm hexagonal head and sealing washer
6.5 x 130mm

PACK OF 10

PART	PRICE
RF6	£4.98



ONDULINE/ONDUVILLA FIXINGS

73mm ONDULINE/ONDUVILLA NAILS

COLOUR	10 PACK		400 BOX	
	PART	PRICE	PART	PRICE
BLACK	ROBNBK	£1.49	ROBNBBK	£16.99
GREEN	ROBNGR	£1.49	ROBNBGR	£16.99
RED	ROBNRD	£1.49	ROBNBRD	£16.99



CORRUGATED SHEET FIXINGS

PACK OF 10

USED WITH	TYPE	PART	PRICE
1 ¼" SHEETS	PLATED STEEL	RFM	£0.33
3" SHEETS	PLATED STEEL	RFS	£0.99
3" SHEETS	STAINLESS STEEL	RFX	£1.49

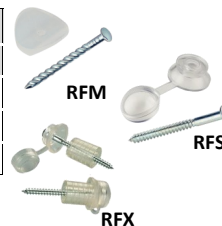

All supplied with washers

(Please note **RFX** fixings include Spacers)

J BOLTS & WASHERS

PACK OF 10 (BOLTS INCLUDE NUTS)

DESCRIPTION	SIZE	PART	PRICE
J HOOK BOLTS	60 x 6mm	FJ60	£1.99
J HOOK BOLTS	80 x 6mm	FJ80	£2.25
J HOOK BOLTS	100 x 6mm	FJ100	£2.44
J HOOK BOLTS	140 x 6mm	FJ140	£2.75
SCAFFOLD BOLTS	90 x 8mm	FJS90	£3.79
SCAFFOLD BOLTS	150 x 8mm	FJS150	£8.37
PVC WASHER	28mm	W28	£0.96
STD CAP (clear)	28mm	WC28	£0.78
DEEP CAP (clear)	28mm	WDC28	£0.99

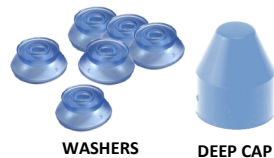

CORRUGATED SHEET FIXINGS

PREDATOR SAWS

LEVELING & MEASURING



UPVC

For use with Plastic boards, trims, plastic pipes & Multiwall sheets.

CUT	PART	PRICE
FINE	TPVPRE	£7.99



SPIRIT LEVELS

Made to last from aluminium with rubber stoppers.

SIZE	PART	PRICE
450mm	TSL4	£5.49
600mm	TSL6	£6.99
900mm	TSL9	£8.99
1200mm	TSL12	£11.99
1800mm	TSL18	£17.99



UNIVERSAL

For use with Timber planks, hardwood and MDF.

CUT	PART	PRICE
COARSE	TUNPRE	£8.49



POST LEVELS

Accurate & easy to use.

PART	PRICE
TPS	£2.46



FIRST FIX

For use with Rough sawn timber, garden posts & joists.

CUT	PART	PRICE
MED	TFIPRE	£8.49



5M TAPE MEASURE

Made from flexible steel.

PART	PRICE
TT5	£1.49



SECOND FIX

For use with Planed wood & skirting.

CUT	PART	PRICE
MED	TSEPRE	£8.49



FITTERS FRIENDS

PREDATOR X

Cuts on both strokes & can be used with almost all wood and plastics except polycarbonate

CUT	PART	PRICE
MED	TXPRE	£9.99



CLAW HAMMER

8 Oz hammer with fiberglass Shaft.

PART	PRICE
TH8	£3.99



FLAT PRY BAR

Ideal for use on fascias

PART	PRICE
TFB	£3.89



600mm QUICK CLAMP

Light weight & easy to use

PART	PRICE
TQC6	£8.45



150mm JUNIOR HACKSAW

PART	PRICE
TJH	£1.19



CLOSE QUARTER SAW

Designed to use new or damaged hacksaw blades.

PART	PRICE
TTQH	£4.49



RUBBER Mallet

Made from WHITE rubber designed to leave no marks on coloured surfaces.

PART	PRICE
TMWH	£3.29



CHISEL SET 5 piece

Forged, bevel-edged chisels. Hardened, tempered and sharpened. Polypropylene handles. Sizes 6, 13, 19, 25 and 32mm. Supplied with blade guards

PART	PRICE
TC5	£10.65



HOLE CUTTERS & ARBOUR

Ideal for use with our circular vent disks.

ITEM	PART	PRICE
ARBOUR	THSA	£4.95
70mm CUTTER	THS70	£7.99
114mm CUTTER	THS114	£14.95



GENERAL ACCESSORIES

CHALK LINE SET

3pce

Includes Hi-Vis 16m chalk line, 115g of blue chalk in airtight container and a handy line level. For accurate line marking

PART	PRICE
TCLS	£4.49



PACKERS

Each pack has 100 packers ranging in size from 1,2,3,5 & 6mm



PART	PRICE
TWP	£5.99

5/16" NUT DRIVER

For use with Drill fast & Tap fix fixing range



PART	PRICE
TS516	£1.99

SDS MASONRY BITS

Sensibly priced 210mm long.



SIZE	PART	PRICE
6mm	TSDS6	£1.69
6.5mm	TSDS65	£1.75
8mm	TSDS8	£2.09
10mm	TSDS10	£2.29
12mm	TSDS12	£2.50

PVC TRIM CUTTER

Comes with a Multi angled base 45-90 degree & Cushion grip handles for extra comfort & safety.



PART	PRICE
TPVCC	£19.95

RIVET GUN

For use with 2.4, 3.2,4.0 & 4.8mm



PART	PRICE
THRG	£4.99

DOME HEAD RIVETS

Pack of 100 4.8 x 12mm



PART	PRICE
TR4812	£5.99

RUBBLE SACKS

Supplied in packs of 10, these are tear resistant and fully reusable.



PART	PRICE
TRS	£3.99

TARPAULINS

Long lasting, Water tight & tear resistant.



SIZE	PART	PRICE
3 x 3.6M	TTP3	£5.40
6 x 3.6M	TTP6	£11.99

DUST SHEETS

100% Cotton
Ideal for covering carpets furniture and all general areas of work.



SIZE	PART	PRICE
3.5 x 2.6M	TDS	£9.99

CARGO LASHES

750kg rated, weather-resistant straps quick release



DESC	PART	PRICE
SINGLE	TCL9	£4.79
4 PACK	TCLS9	£17.99

DOUBLE SIDED TAPE



SIZE	PART	PRICE
25mm x 35M	TDT25	£4.49

Powerful bond, for internal or external use.

FOAM DOUBLE SIDED TAPE



SIZE	PART	PRICE
10mm x 50M	TDST50	£6.39

As used by traders. Ideal for sticking trims and an essential for window fitters.

DUCT TAPE



SIZE	PART	PRICE
50mm x 50M	TGT50	£4.79

Tough, durable, with high Quality adhesive.

STRAPPING TAPE



SIZE	PART	PRICE
50mm x 25M	TST50	£3.99

Clear & Strong, ideal for securing bundles & sheets.

BUILDERS TAPE



SIZE	PART	PRICE
50mm x 33M	TBT50	£2.89

PVC Tape ideal jointing PVC and polythene sheets and membranes.

MASKING TAPES



SIZE	PART	PRICE
25mm x 50M	TMT25	£1.39
50mm x 50M	TMT50	£2.29

General purpose trade quality tape for masking.

TERMS & CONDITIONS

In these terms and conditions – "C & A Building Plastics" means, C & A Supplies Ltd and any other connected organisation that supplies the goods ordered by you and any successor to its business; "We and Us" means C & A Supplies Ltd either alone or together with you, as the context requires; "Working day" means every day of the year except weekends, and English statutory and public holidays; "You" means the person ordering goods subject to these terms and conditions.

C & A Supplies Ltd
Courtney Road
Gillingham
Kent ME8 0EZ

Registered in England under no 3895992
VAT Registration no. GB 248096048

To contact us by telephone, please ring 01634 374444

Please see the website for

> Trade counters opening times
> Updated Terms and Conditions
> Delivery Information

You can always contact us using the Contact Us Form online or emailing cs@cabp.co.uk.

Privacy – C & A Supplies Ltd are committed to protecting your privacy, we will only use your information lawfully in accordance with the data protection act 1998. The information we collect about you enables us to service your needs, but in order to do so we may pass your contact details on to a third party for delivery purposes, and by placing an order with us you are consenting to this.

Your Order—You will have an opportunity to check and correct any errors on your order up until the point at which you submit and pay for your order. All orders made by you through cabp.co.uk are subject to acceptance by us. We may choose not to accept your order for any reason and will not be liable to you or to anyone else in those circumstances. After submitting an order to us we will send you an order acknowledgement email with your order number and details of the goods that you have ordered. Please note this email is an acknowledgement and is not an acceptance of your order. Stock availability information is not available on cabp.co.uk. If you order goods which are not available from stock, we will contact you by email or by telephone to discuss how you wish to proceed. You will have the option to wait until the goods are available from stock or cancel your order in accordance with our returns policy. Unless we have notified

you that we do not accept your order or you have cancelled it in accordance with our returns policy, we accept your order 7 days after the date of order or when the goods are delivered, whichever is earlier.

Liability – We shall not be liable to you where performance of any of our obligations to you is prevented, frustrated or impeded by reason of acts of God, war and other hostilities, civil commotion, strikes, accident, lock outs, trade disputes, acts or restraints of Government, imposition or restrictions of imports or exports or any other cause not within the reasonable control of C & A Supplies Ltd. If any part of these Terms and Conditions is found to be unenforceable as a matter of law, all other parts of these Terms and Conditions shall not be affected and shall remain in force. All sizes quoted are approximate. Where C & A Supplies Ltd agrees to provide a specifically designed plan, the Customer agrees to check the accuracy and suitability of the plan. C & A Supplies Ltd cannot advise on planning permission or building regulation issues. Asbestos may be found in some older properties. If you have any concerns about the presence of asbestos you should seek advice from a licensed asbestos company. The Customer is responsible for obtaining all necessary planning permission and local authority consents and permissions for any work to be carried out. Any plan drawn by C & A Supplies Ltd is, and remains, its property and may not be reproduced in whole or in part without its previous written consent. To the extent permitted by law, C & A Supplies Ltd accepts no liability for any loss, damage or injury arising as a consequence of the advice provided.

Law – These Terms and Conditions and any contract between us shall be governed by and construed in accordance with English law and the English Courts shall have jurisdiction over any disputes.

Prices – The prices of the product are clearly shown with and without VAT online and without VAT in our catalogue. Prices do not include delivery charges. On occasion, the prices payable in respect of goods advertised on cabp.co.uk may differ from those prices payable at the same time in C & A Supplies Ltd branches. We are under no obligation to honour any cabp.co.uk prices in the event that they differ from those in branch. Similarly, we are under no obligation to honour in-branch prices in the event that they differ from those on cabp.co.uk. Prices that are reduced for sales and promotions are only valid for the specified period and that branch offering those items. We reserve the right to adjust prices, offers, goods and specifications of goods on cabp.co.uk at our discretion at any time before (but not after) we accept your order. Although we endeavour to ensure that all pricing information on cabp.co.uk is accurate, occasionally an error may

occur and goods may be mispriced. If we discover a pricing error we will, at our discretion, either contact you or ask you whether you wish to continue with the order at the correct price or notify you that we have cancelled your order. We will not be obliged to supply goods at the incorrect price.

Discounts – May be withdrawn at any time and are subject to change and are given at C & A Supplies Ltd.'s discretion.

Product availability – C&A reserves the right to alter published prices and specifications and withdraw products and services without notice. We will not be held responsible for any costs incurred by a customer when a price, specification, product or service is withdrawn. Where a customer has placed an order based on an obsolete price, specification or service, C&A will inform the customer and wait for further instruction. If payment has already been made for such goods or service, the customer shall be entitled to a full refund for all items that are not then required.

Property – Property of the goods shall not pass to the customer until payment is made in full. If the customer defaults in punctual payment of any sum due we shall be entitled to repossess any goods that remain our property.

Payment – The total cost of your order is the price of the goods and delivery charges as set out in our delivery information. Payment can be made by most major credit or debit cards, PayPal, bank transfer or cash. You must confirm that the credit/debit card being used is yours, all credit/debit card holders are subject to validation checks and authorisation by the card issuer. If the issuer of your card refuses to authorise payment we will not accept your order and we will not be liable for any delay or non-delivery and we are not obliged to inform you of the reason for the refusal. We are not responsible for your card issuer or bank charging you as a result of our processing of your credit/debit card payment in accordance with your order. PayPal payment orders will only be accepted for orders that are for delivery and are subject to PayPal's confirmation of funds. This can in some circumstances take several days. Bank transfers are manually checked and verified, and although you can have instant transfers this does not mean that we are able to instantly check and validate the payment. This process can take a few minutes or a couple of days and no agent should be sent to collect an order until after you receive your order acknowledgment. Cash will be checked to verify its legitimacy and legality, cash will not be accepted if it is not legal tender or if we have any suspicion as to its legitimacy.

TERMS & CONDITIONS

CONTINUED FROM PAGE 90

Colour – Due to batch production C&A cannot guarantee a colour match between materials ordered and supplied on separate orders or products of different dimensions.

Fitness of goods - No goods are sold as fit for any particular purpose. All hints, tips and work practice advice published by C&A in its catalogue, web site and advertising are given without detailed knowledge of the customer's application and cannot be relied upon. Customers must satisfy themselves that materials ordered meet the building regulations and codes relevant to the purpose for the intended use.

Faulty Products – If the product you purchase is faulty we may offer a repair, exchange or refund as appropriate in accordance with your consumer rights. Please call us on 0845 165 165 8 or emailing cs@cabp.co.uk

Delivery - The products that C & A deliver are often large in dimension, therefore optimised routing of specialist vehicles is often undertaken to perform the deliveries. This often means that accurate dates are not available at the time of placing the order and often an estimated timeframe is given. We make 98% of all deliveries within 10 days however it is suggested that you allow up to 30 days if your project is time sensitive. For this reason, delivery time is not considered of essence of the contract unless specifically set out in writing with special delivery charges and acceptance. C & A will do all that it reasonably can to meet the date given for delivery. In the case of unforeseen circumstances beyond the reasonable control of C & A, we cannot be held responsible. In such circumstances C & A will contact the Customer and agree an alternative date. The Customer will also do all that he/she reasonably can to enable the delivery to take place on the given date. In the case of unforeseen circumstances beyond the reasonable control of the Customer they must contact C & A and agree an alternative date. The delivery service is for delivery to the sites kerb side only, C & A are not responsible for placement into gardens, and building sites etc. and the customer should ensure that suitable labour is provided for this at the time of delivery. As soon as C & A has delivered the goods, the Customer will be responsible for their safekeeping and C & A will not be responsible for any damage or fault arising from incorrect storage. If the Customer delays a delivery, C & A's responsibility for everything other than damage due to its negligence will end on the date C & A agreed to deliver the order as set out in the contract. Ownership of the goods shall remain with C & A and shall not pass to the Customer until the agreed price for them, together with all other sums due from the Customer to C & A, have been paid in full.

Damaged or missing items collected - It is the customer's responsibility when collecting goods from our premises to check

they have all the items ordered and that they are in good condition. C&A cannot accept responsibility for damage or shortages once collected goods have left our premises. Where a customer has arranged for a third party to collect goods on their behalf, the same conditions apply as it is your responsibility that your agent undertakes this.

Damaged or missing items delivered - You must contact us within 72 hours with details of the damage, we may ask you to send photos to better understand which items are damaged. Notification after this time will result in claims being rejected. Deliveries by our own transport must be checked with our driver at the time of delivery and any damage must be clearly noted on the paperwork before you sign. Deliveries by carrier that have arrived damaged should not be accepted unless the carrier accepts the damage and can provide written confirmation to that effect. Signing "unchecked" or similar is agreeing to accept the delivery damaged or otherwise. C&A will not be liable for any costs or compensation for missing or incorrectly delivered items.

Returns Policy - C & A Building Plastics are proud of the products we supply and want our customers to be happy with the products they purchase. To this end we offer a 14 calendar day returns period where we will accept return of our standard products that are in resalable condition, even if it's just because you would prefer a different colour, you can return to either branch. This is for standard products and excludes nonstandard products that are customised to your requirements; for examples domes are manufactured to your requirements from specific specification criteria and so are custom made to your requirements. The entire product that you purchased must be returned, we cannot accept a component of the product on its own. Simply contact us within 14 days and inform us in writing that you wish to return the product and then return the item with a copy of your acknowledgment / invoice that includes the products being returned within 30 days from your request to return. Upon return we will inspect the items to ensure they are in acceptable condition. Those that are damaged, dirty or otherwise deemed to be in an unsalable condition will not be accepted for refund. If the returned items are part of an order with multiple items on it and not all items are returned then the delivery charge will not be refunded as it will be associated with the items not returned. If the entire order is returned then the standard delivery charge that would be applicable to the items will be refunded. The additional value for premium service will not be refunded for example express services. It is your responsibility to return the items to us, you are responsible for their safe transit and the costs incurred in their transportation. If you are returning the product to a branch we must be notified which branch this is when you notify us in writing. If you are unable to return the items yourself, we can arrange for

the return transportation. Due to the various different products we supply and their varying degrees of difficulty in transportation we are unable to give the exact costs here for the products return, however we will estimate these costs at the time of applying for the return of the items and these do not normally exceed £100. Delivery charges are normally subsidised by the products and do not reflect the true economic costs involved in their dispatch, to this extent, the cost of return deliveries are therefore not subsidised and can be higher than those charged for dispatch. Goods can only be collected from the site at which we made delivery. We will attempt to make the collection within 30 days from the agreement. The driver is not responsible for checking the condition of the materials. Checking the returned materials takes place when received back at the depot and their condition is assessed. If your order qualified for a bulk discount then it is deemed that all the items within this order were discounted proportionally to achieve this discount, your returned item will be refunded at the value that you paid for them. For example an order of £750 with a list price of 10% has a product returned of the value of £100 bulk price, proportionally this item was discounted by £10 to achieve the bulk discount and so the price paid for the item was in fact £90. Refunds are made in the same format as the payment was made unless otherwise specifically agreed and will be made within 14 days of receiving the returned items.

Legislation - These terms and conditions are in accordance with current business and consumer legislation and do not affect your statutory rights, you can find more from the Citizen's Advice Bureau on the following link: http://www.adviceguide.org.uk/england/consumer_e.htm

Please see your order Acknowledgment for the latest Terms & Conditions

Please see the website for

- > Trade counters opening times
- > Updated Terms and Conditions
- > Delivery Information

<https://www.cabp.co.uk/>

YOUR CONSUMER RIGHTS ARE NOT AFFECTED For further information please see the following website pages. <http://www.tradingstandards.gov.uk/>

A larger print version is available on our website

<https://www.cabp.co.uk/Terms-And-Conditions.htm>
Alternatively we can email or print a copy



GILLINGHAM BRANCH
 Courteney Road
 Gillingham
 ME8 0EZ

Tel: 01634 37 44 44
 Fax: 01634 36 66 44

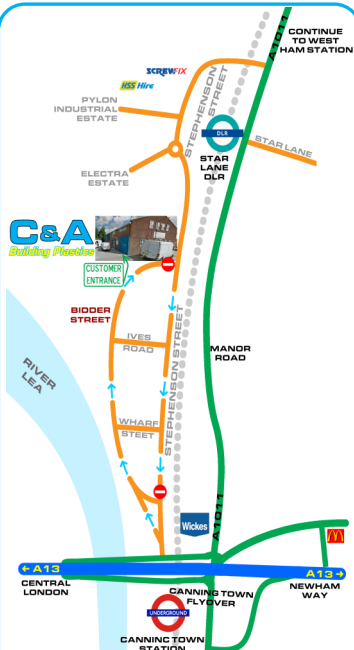

LONDON BRANCH
 Bidder Street
 Canning Town
 E16 4ST

Tel: 0207 474 0474
 Fax: 0207 474 5055

ONLINE: www.cabp.co.uk
POST: Send to either branch

OUR DELIVERY SERVICE

The sheer size of many of the products dictates that special care with handling and transportation is required. For these, C & A deliver most products directly to the customer using our custom-built vehicles operated by our own employees. The route planning for these vehicles is dependent on the areas from which new orders are received and is calculated on a daily basis, but we aim to visit all areas of the UK at least once every 10 working days. Please note that whilst we try to maintain a 10 day rota, there are many factors beyond our control that prevent us offering any guarantee of any delivery dates (Floods, Snow, Road Closures etc) We will always try our best to make every delivery but should we ever have to abort then we will always contact you. When your order has been dispatched we will send an email and a text message. Please note this message is only to advise you that your order is on its way. We always ring the customers the day before delivery, this is normally the driver and they will provide you with an expected delivery time scale. If there are any unforeseen delays whilst on route we will contact you with an update.



SMALL ITEMS—Orders for small items will normally be sent by carrier or post as this maybe the fastest method of delivery, customers will need to sign for these deliveries. Customers with very specific build dates are advised to order at least 28 days in advance and should be prepared to store the materials on site. Urgent orders can sometimes be sent by carrier on a next day delivery service but you will need to contact us directly to ascertain the feasibility of the products you require and the cost of doing so.

DIRECT TO CUSTOMER— Some products are delivered "Direct-To-Customer" as they are shipped from the manufacturer. These deliveries are normally an AM or PM delivery time and date and we will always advise the customer of this as soon as we have the information. This is normally the day before the delivery.

SPECIAL / URGENT GOODS— It may be possible to load special or urgent deliveries onto a C & A vehicle that is scheduled to cover a different area or arrange for another driver to make the special delivery. Customers wishing to enquire about Special / Urgent delivery should contact us for availability and cost, but should bear in mind that vehicle running costs are £275 a day and our delivery schedules deal with a volume of customers all over the UK, therefore we cannot delay a vehicle that already has a full load of orders and which is ready to depart. For both C&A transportation and carrier, remote areas of the UK may incur a higher delivery cost than those listed, in which case the customer will be advised of the delivery cost before order acceptance.



STANDARD DELIVERY CHARGES

White, Grey & Dark Grey Zones

Here at C & A Building Plastics we supply a wide range of materials of all different shapes and sizes, many of which are very large and require extra-large vehicles for the transportation. We only charge one set delivery charge, regardless of the quantity or mix of materials ordered, and these delivery charges often do not cover the cost involved. We welcome customers who wish to organise their own transport to collect materials; but we understand this is not possible for everyone and so offer this delivery service.

These charges are for deliver to the site kerb side, or nearest permitted available parking position, on our standard delivery service (you need to ensure that suitable labour is available on site for the handling of the materials purchased.). Additional services are available such as two man delivery, express delivery, specific date delivery, but these are subject to availability and are by quotation only, if you are interested in these services you should call 01634 374444 for a quote.

With the wide variety of products, some materials are more difficult to transport than others; so we have colour coded the products to help represent this and charge different delivery prices accordingly. Below is our delivery charge table detailing the standard delivery prices:

DELIVERY CHARGE GRID for Standard Delivery		
Product Colour Code:		Price:
S	GREEN	£4.95
M	TURQUOISE	£9.95
M/L	YELLOW	£19.95
L	PURPLE	£24.95
X/L	BROWN	£39.95

Dark Blue Zones: Due to the locations of these zones and the specific logistic issues they represent, delivery charges and timescales are by quotation only. Please call us on 01634 374444 for a personalised quote.

STANDARD DELIVERY TIMESCALES

White, Grey & Dark Grey Zones

The timescales quoted here are for our standard delivery and are subject to the materials being in stock at the delivering depot at the time of the order being placed. 98% of all orders are delivered within the times scales quoted below and most are delivered within only a few days. The table below is for guidance only, and not as a guarantee.

We always notify you before delivery is due to ensure someone is available. If you require a specific date delivery you should call us on: 01634 374444 for a quote

STANDARD DELIVERY TIMESCALE	
Postcode Colour Code:	Normally Within The Following Number of Working Days
WHITE	5
LIGHT GREY	10
DARK GREY	15
DARK BLUE	BY QUOTATION

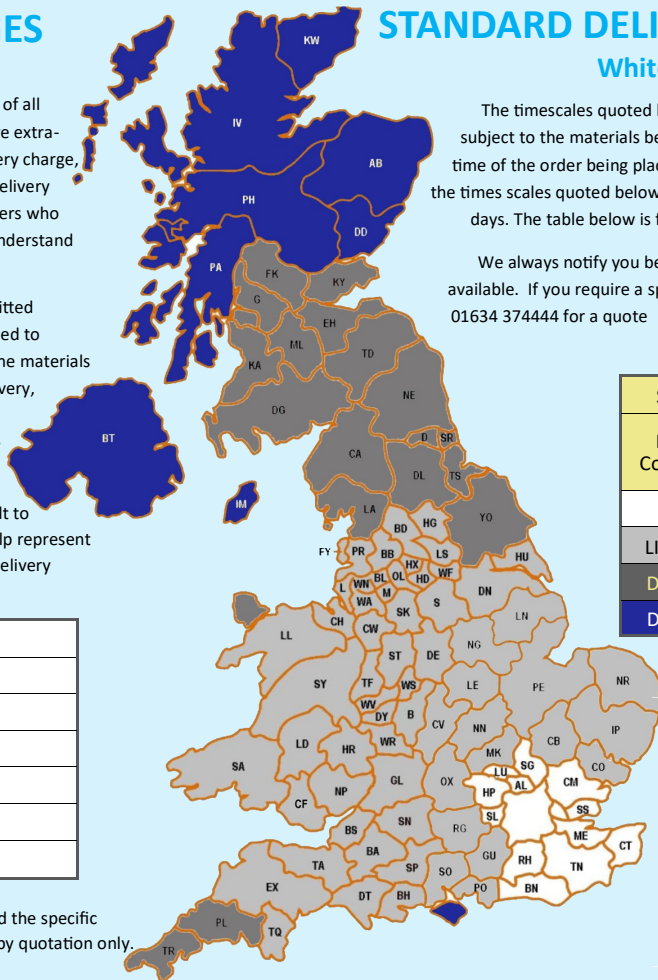

LONDON & SURROUNDING

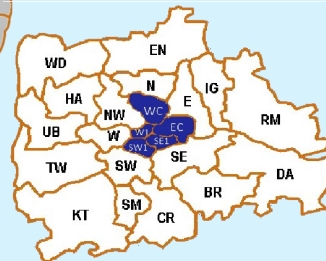



HOW TO ORDER

> **ONLINE** – Go to www.cabp.co.uk

Our Online Shop is open all day, everyday, 365 days of the year. You will find all our products listed online, plus any special offers we currently have running. With our fast and secure servers you can be confident that all of your information is securely encrypted. Our automated shopping cart calculates your bulk order discounts for you so getting quotes and placing orders are fast and easy.

> **BY PHONE** – Call 0845 165 165 8 - 01634 374444 - 0207 474 0474

Our sales team are on hand to provide advice on materials and to put together quotes and orders for you based on your requirements. With payment by card, orders will be processed immediately with a detailed Order Acknowledgement sent immediately for confirmation. For cheque payment, your order will be prepared and processed as soon as the cheque has cleared. **By phone our sales team are available 7:30am – 4:40pm Mon – Fri, 8.30am – 12 noon Saturdays.**

> **BY POST** – C & A Building Plastics, Courteney Road Gillingham Kent ME8 0EZ or Bidder Street, London E16 4ST

Use the Order Form at the back of this catalogue should you wish to order by post. If ordering on your own stationery, please list your requirements in the following order; PRODUCT/ PART No/ UNIT PRICE /QUANTITY/ TOTAL COST. Total the cost of your materials, subtract any bulk order discount applicable, add the delivery cost, and then add VAT. Send your order with payment in full by cheque, made out to *C&A Supplies Ltd.*

> **BY FAX** – Fax 0845 165 165 9 - 01634 366644 - 0207 474 5055

Please see the "By Post" section for details of how to list your requirements and calculate costs and discounts. Where payment is made by card, orders will be processed immediately. Where payment is made by cheque, the order will be prepared and processed as soon as payment is received.

> **OVER THE SALES COUNTER**— See website for branch opening times www.cabp.co.uk

Cash and card payments are accepted we do not accept cheques for trade counter orders. **PLEASE NOTE:** Payment over the phone for collection and cash on delivery facilities are NOT available. Ledger accounts will be considered for regular customers.



DISCOUNTS

If you are working on any form of building project then you want to save as much money as you can. At **C&A** we recognise that money does not grow on trees and to keep costs as low as possible we have a simple discount structure that gives generous discounts based on your order value.

Goods Value

DISCOUNT

Excluding VAT

Over £1000.00

10%

*example :- £1000 nett will get
£100 discount*

TRANSPORT & STORAGE

All plastic building materials should be kept flat during transport and storage. If stacked, materials must then be covered with a light-proof sheet to prevent direct sunlight overheating the interior of the stack, with all products flat and level without excessive weight on the bottom layers.

**NEW SHOWROOM
OPENING SOON!**



**BATH & PLUMBING
CENTRE**

SEE PAGE 88



**15 & 22mm
PLUMBING**

SEE PAGES 39-40

**50th Anniversary
FREE Gifts**



FREE GIFTS

**With all orders
over £50 nett**

SEE WEBSITE

NATIONAL SALES 01634 37 44 44



... NATIONWIDE DELIVERY SERVICE...

Delivering service & quality across the UK

