

**LED**

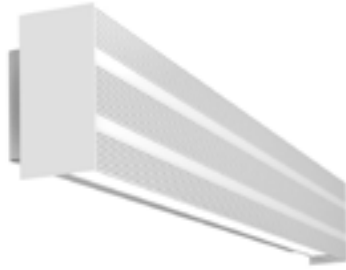

**INTERACTIVE MENU**

- Ordering Guide
- Product Availability Tables
- Photometric Data
- Dimensional Data

**HUBBELL CONTROL SOLUTIONS**

- SpectraSync™ Overview
- SpectraSync Product Availability Tables
- NX™ SpectraSync Solution Guide
- NX In-Fixture Solution Guide

**EXTERNAL LINKS**

- NX Distributed Intelligence Brochure
- SpectraSync Brochure

**PROJECT INFORMATION**

Project Name \_\_\_\_\_

Type \_\_\_\_\_

Catalog No. \_\_\_\_\_

Date \_\_\_\_\_

**COMPATIBLE WITH:**



**FEATURES**

- Simplistic modular design with interchangeable lenses and end caps
- The direct/indirect CWM is intended for ambient illumination such as corridors, overbed, and vanity applications. Available in both semi-recessed and flush mount configurations
- Direct/Indirect version comes available with multiple fascia styles including a straight, round, and optional custom 3form inserts
- Four LED color choices and 84 CRI
- Long-life LEDs 60,000 hours at L80 with projected life over 86,000 hours for reduced life cycle maintenance costs
- Easy removal of lens allows access to electrical components for modular replaceability
- Luminaire installs in three easy steps without disassembling the fixture
- Slender profile meets ADA requirements for wall mounted product
- Optional SpectraSync™ offers three modes of tunable white solutions and integrates seamlessly into a variety of control systems
- NX Distributed Intelligence™ provides options for standalone and networked integrated sensor with wired or wireless connectivity for NX system deployments
- CSA listed and suitable for damp locations
- 5 Year Warranty (Terms and Conditions apply)



**CWM DIRECT/INDIRECT**

**CONSTRUCTION**

The luminaire chassis is designed from anodized extruded aluminum. End caps are die cast for a finished appearance and provide smooth edges for ease of handling. Fixture provides easy access to electrical components via removal of lens and chassis.

**SHIELDING**

High efficiency acrylic lens for high performance and even illumination on vertical surfaces. Optional 1/8" 3form material can be added as a decorative element or to match existing 3form features in various applications. For custom selections please consult factory.

**PERFORMANCE**

CWM provides best in class efficacy, reduced wattage, as well as a wide lumen offering for a variety of ambient wall mount applications including corridor, overbed, and vanity. CWM provides excellent energy savings compared to legacy fluorescent products with exceptional lighting quality.

**MOUNTING**

CWM is available with either a semi recessed mounting or surface mounting option for various applications. Semi recessed mounting option requires the use of a 4-gang junction box for proper mounting and assembly. A Snap-Tite conduit adapter is recommended for conduit installation to surface mount option.

**CERTIFICATION**

All luminaires are built to UL 1598 and 2108 standards, and bear appropriate CSA labels. Damp location labeling is standard. Emergency equipped fixtures labeled UL924. Adheres to LM79, LM80, and TM21 industry standards. NX is available in U.S., Canada and Mexico. For other locations consult factory.

**WARRANTY**

Five year-warranty standard. (Terms and Conditions Apply). Additional terms negotiable.

**ORDERING INFORMATION**

EXAMPLE CWM4-40MLSR-DIS-EDU

YOUR ORDER **CWM** - - - **U** -

CWM		SIZE	CRI	COLOR TEMPERATURE	LUMEN OUTPUT	MOUNTING TYPE
<b>MODEL</b>	CWM Contemporary LED Wall Mount	<b>2</b> 2' <b>4</b> 4'	<b>Blank</b> >80	<b>30</b> 3000K <b>35</b> 3500K <b>40</b> 4000K <b>50</b> 5000K <b>2750T</b> 2700K-5000K SpectraSync™ Tunable White <sup>1</sup> <b>2765T</b> 2700K-6500K SpectraSync™ Tunable White <sup>1</sup>	<b>XW</b> Extra Low Watt <sup>2</sup> <b>VW</b> Very Low Watt <b>MW</b> Medium Low Watt <b>LW</b> Low Watt <b>ML</b> Medium Lumen <sup>3</sup>	<b>SM</b> Surface Mount <b>SR</b> Semi Recessed

See Product Availability Table on following pages.

LENS	DRIVER	VOLTAGE	OPTIONS	CONTROL OPTIONS
<b>DIS</b> Direct/Indirect Straight Aluminum Lens <b>DISB</b> Direct/Indirect Straight Aluminum Lens with Bamboo Insert <b>DISF</b> Direct/Indirect Straight Aluminum Lens with Fabric Insert <b>DIC</b> Direct/Indirect Curved Aluminum Lens <b>DICB</b> Direct/Indirect Curved Aluminum Lens with Bamboo Insert <b>DICF</b> DICF Direct/Indirect Curved Aluminum Lens with Fabric Insert <b>DISC</b> DISC Direct/Indirect Straight Aluminum Lens with Custom 3form Insert <b>DICC</b> DICC Direct/Indirect Curved Aluminum Lens with Custom 3form Insert ** SC Will be custom requested material from 3form by the customer	<b>E</b> Fixed Output <sup>4</sup> <b>ED</b> 0-10V Dimming <b>ED1</b> 0-10V 1% Dimming	<b>U</b> 120V-277V	<b>ELL14</b> Emergency Battery Pack, 1400 Lumens <sup>4,9</sup> <b>GLR</b> Fast Blow Fuse	<b>NXE</b> NX Enabled, Dual SmartPorts <sup>7,8,9</sup> <b>HFU</b> High Frequency Ultra-sonic Occupancy Sensor <sup>4,6,7</sup> <b>OW</b> Occupancy Sensor, Wattstopper <sup>4,5,6,7</sup>

OPTIONAL INTEGRAL SENSORS				
Cat# Suffix	Sensor Manufacturer	Sensor Function	Dim-To-Off Daylighting	Powerpack included in luminaire housing
<b>OW</b>	Wattstopper	Occupancy Sensor	No	Yes
<b>HFU</b>	Wattstopper	High Frequency Ultrasonic Occupancy	No	Yes

<sup>1</sup> Available with ED driver only, N/A with ELL14 (2') or SR (2'&4') options

<sup>2</sup> XW Only available on 4ft

<sup>3</sup> ML Only available in 2ft

<sup>4</sup> Only available with Surface Mount (SM) Option

<sup>5</sup> Not recommended for stairwell applications

<sup>6</sup> HFU and OW only available with SM mounting option

<sup>7</sup> NX controls can only be used with NX Sensor options.

<sup>8</sup> NX is available with ED and ED1 drivers only.

<sup>9</sup> NX is not available with ELL14.

For questions about configuration options, contact Hubbell Representative.

CWM2-30VW	DIS	1344	15	94.0
CWM2-35VW	DIS	1390	15	97.2
CWM2-40VW	DIS	1411	15	98.7
CWM2-50VW	DIS	1449	15	101.3
CWM2-30VW	DISF	1336	14	93.4
CWM2-35VW	DISF	1381	14	96.6
CWM2-40VW	DISF	1403	14	98.1
CWM2-50VW	DISF	1440	14	101.4
CWM2-30VW	DISB	1333	14	93.2
CWM2-35VW	DISB	1378	14	96.4
CWM2-40VW	DISB	1400	14	97.9
CWM2-50VW	DISB	1437	14	101.2
CWM2-30VW	DIC	1010	15	70.6
CWM2-35VW	DIC	1044	15	73.0
CWM2-40VW	DIC	1061	15	74.2
CWM2-50VW	DIC	1089	15	76.1
CWM2-30VW	DICF	1004	14	70.2
CWM2-35VW	DICF	1038	14	72.6
CWM2-40VW	DICF	1054	14	73.7
CWM2-50VW	DICF	1082	14	76.2
CWM2-30VW	DICB	1011	14	70.7
CWM2-35VW	DICB	1045	14	73.1
CWM2-40VW	DICB	1062	14	74.2
CWM2-50VW	DICB	1090	14	76.8
CWM2-30MW	DIS	1810	19	94.8
CWM2-35MW	DIS	1872	19	98.0
CWM2-40MW	DIS	1901	19	99.5
CWM2-50MW	DIS	1951	19	102.2
CWM2-30MW	DISF	1799	19	94.2
CWM2-35MW	DISF	1860	19	97.4
CWM2-40MW	DISF	1889	19	98.9
CWM2-50MW	DISF	1939	19	101.5
CWM2-30MW	DISB	1794	19	93.9
CWM2-35MW	DISB	1855	19	97.1
CWM2-40MW	DISB	1883	19	98.6
CWM2-50MW	DISB	1934	19	101.2
CWM2-30MW	DIC	1363	19	71.0
CWM2-35MW	DIC	1409	19	73.4
CWM2-40MW	DIC	1431	19	74.5
CWM2-50MW	DIC	1469	19	76.5
CWM2-30MW	DICF	1355	19	70.6
CWM2-35MW	DICF	1401	19	73.0
CWM2-40MW	DICF	1423	19	74.1
CWM2-50MW	DICF	1460	19	76.1
CWM2-30MW	DICB	1351	19	70.4
CWM2-35MW	DICB	1397	19	72.7
CWM2-40MW	DICB	1418	19	73.9
CWM2-50MW	DICB	1456	19	75.8
CWM2-30LW	DIS	2360	25	93.3
CWM2-35LW	DIS	2440	25	96.5

Product Availability 80 CRI				
Lumen Package	Lens	Lumens	Input Watts	LPW
CWM2-40LW	DIS	2478	25	97.9
CWM2-50LW	DIS	2544	25	100.6
CWM2-30LW	DISF	2346	25	92.7
CWM2-35LW	DISF	2426	25	95.9
CWM2-40LW	DISF	2463	25	97.4
CWM2-50LW	DISF	2529	25	100.0
CWM2-30LW	DISB	2339	25	87.1
CWM2-35LW	DISB	2418	25	90.1
CWM2-40LW	DISB	2456	25	97.1
CWM2-50LW	DISB	2521	25	99.7
CWM2-30LW	DIC	1774	25	69.8
CWM2-35LW	DIC	1834	25	72.2
CWM2-40LW	DIC	1863	25	73.3
CWM2-50LW	DIC	1912	25	75.3
CWM2-30LW	DICF	1763	25	69.4
CWM2-35LW	DICF	1823	25	71.8
CWM2-40LW	DICF	1852	25	72.9
CWM2-50LW	DICF	1901	25	71.7
CWM2-30LW	DICB	1758	25	69.2
CWM2-35LW	DICB	1818	25	71.6
CWM2-40LW	DICB	1846	25	72.7
CWM2-50LW	DICB	1895	25	74.6
CWM2-30ML	DIS	3166	37	86.7
CWM2-35ML	DIS	3274	37	89.7
CWM2-40ML	DIS	3324	37	91.1
CWM2-50ML	DIS	3413	37	93.5
CWM2-30ML	DISF	3180	37	87.4
CWM2-35ML	DISF	3288	37	90.3
CWM2-40ML	DISF	3339	37	91.7
CWM2-50ML	DISF	3428	37	94.2
CWM2-30ML	DISB	3180	37	87.1
CWM2-35ML	DISB	3288	37	90.1
CWM2-40ML	DISB	3339	37	91.5
CWM2-50ML	DISB	3428	37	93.9
CWM2-30ML	DIC	2387	36	65.8
CWM2-35ML	DIC	2468	36	68.0
CWM2-40ML	DIC	2506	36	69.0
CWM2-50ML	DIC	2573	36	70.9
CWM2-30ML	DICF	2422	36	66.5
CWM2-35ML	DICF	2504	36	68.8
CWM2-40ML	DICF	2543	36	69.9
CWM2-50ML	DICF	2611	36	71.7
CWM2-30ML	DICB	2409	36	66.4
CWM2-35ML	DICB	2491	36	68.6
CWM2-40ML	DICB	2529	36.3	69.7
CWM2-50ML	DICB	2597	36.3	71.5
CWM4-30XW	DIS	2378	24	101.2
CWM4-35XW	DIS	2459	24	104.6

Product Availability 80 CRI				
Lumen Package	Lens	Lumens	Input Watts	LPW
CWM4-40XW	DIS	2497	24	106.3
CWM4-50XW	DIS	2563	24	109.1
CWM4-30XW	DISF	2372	24	100.5
CWM4-35XW	DISF	2453	24	103.9
CWM4-40XW	DISF	2491	24	105.5
CWM4-50XW	DISF	2557	24	108.3
CWM4-30XW	DISB	2359	24	99.5
CWM4-35XW	DISB	2439	24	102.9
CWM4-40XW	DISB	2477	24	104.5
CWM4-50XW	DISB	2543	24	107.3
CWM4-30XW	DIC	1806	24	76.2
CWM4-35XW	DIC	1867	24	78.8
CWM4-40XW	DIC	1896	24	80.0
CWM4-50XW	DIC	1947	24	82.1
CWM4-30XW	DICF	1746	24	74.0
CWM4-35XW	DICF	1805	24	76.5
CWM4-40XW	DICF	1833	24	77.7
CWM4-50XW	DICF	1882	24	79.8
CWM4-30XW	DICB	1780	24	75.4
CWM4-35XW	DICB	1841	24	78.0
CWM4-40XW	DICB	1869	24	79.2
CWM4-50XW	DICB	1919	24	81.3
CWM4-30VW	DIS	3105	32	98.6
CWM4-35VW	DIS	3211	32	101.9
CWM4-40VW	DIS	3260	32	103.5
CWM4-50VW	DIS	3347	32	106.3
CWM4-30VW	DISF	3086	32	98.0
CWM4-35VW	DISF	3191	32	101.3
CWM4-40VW	DISF	3241	32	102.9
CWM4-50VW	DISF	3327	32	105.6
CWM4-30VW	DISB	3077	32	97.7
CWM4-35VW	DISB	3182	32	101.0
CWM4-40VW	DISB	3231	32	102.6
CWM4-50VW	DISB	3317	32	105.3
CWM4-30VW	DIC	2355	32	74.1
CWM4-35VW	DIC	2435	32	76.6
CWM4-40VW	DIC	2473	32	77.8
CWM4-50VW	DIC	2539	32	79.8
CWM4-30VW	DICF	2341	32	73.6
CWM4-35VW	DICF	2420	32	76.1
CWM4-40VW	DICF	2458	32	77.3
CWM4-50VW	DICF	2523	32	79.4
CWM4-30VW	DICB	2334	32	73.4
CWM4-35VW	DICB	2413	32	75.9
CWM4-40VW	DICB	2450	32	77.1
CWM4-50VW	DICB	2516	32	79.1
CWM4-30MW	DIS	3657	38	96.5
CWM4-35MW	DIS	3781	38	100.0

Product Availability 80 CRI				
Lumen Package	Lens	Lumens	Input Watts	LPW
CWM4-40MW	DIS	3840	38	101.6
CWM4-50MW	DIS	3941	38	104.3
CWM4-30MW	DISF	3635	38	96.2
CWM4-35MW	DISF	3759	38	97.2
CWM4-40MW	DISF	3817	38	101.0
CWM4-50MW	DISF	3919	38	103.7
CWM4-30MW	DISB	3624	38	95.9
CWM4-35MW	DISB	3747	38	99.1
CWM4-40MW	DISB	3805	38	100.7
CWM4-50MW	DISB	3907	38	103.4
CWM4-30MW	DIC	2767	38	72.8
CWM4-35MW	DIC	2861	38	75.3
CWM4-40MW	DIC	2905	38	76.5
CWM4-50MW	DIC	2983	38	78.5
CWM4-30MW	DICF	2750	38	72.4
CWM4-35MW	DICF	2844	38	74.8
CWM4-40MW	DICF	2888	38	76.0
CWM4-50MW	DICF	2965	38	78.0
CWM4-30MW	DICB	2742	38	72.2
CWM4-35MW	DICB	2835	38	74.6
CWM4-40MW	DICB	2879	38	75.8
CWM4-50MW	DICB	2956	38	77.8
CWM4-30LW	DIS	4089	43	94.4
CWM4-35LW	DIS	4228	43	97.6
CWM4-40LW	DIS	4293	43	99.2
CWM4-50LW	DIS	4408	43	101.8
CWM4-30LW	DISF	4071	43	94.0
CWM4-35LW	DISF	4209	43	97.2
CWM4-40LW	DISF	4275	43	98.7
CWM4-50LW	DISF	4389	43	101.4
CWM4-30LW	DISB	4069	43	93.8
CWM4-35LW	DISB	4207	43	96.9
CWM4-40LW	DISB	4272	43	98.4
CWM4-50LW	DISB	4386	43	101.1
CWM4-30LW	DIC	3102	43	71.6
CWM4-35LW	DIC	3207	43	74.1
CWM4-40LW	DIC	3257	43	75.2
CWM4-50LW	DIC	3344	43	77.2
CWM4-30LW	DICF	3126	43	72.2
CWM4-35LW	DICF	3232	43	74.6
CWM4-40LW	DICF	3282	43	75.8
CWM4-50LW	DICF	3370	43	77.8
CWM4-30LW	DICB	3017	43	69.7
CWM4-35LW	DICB	3120	43	72.0
CWM4-40LW	DICB	3168	43	73.2
CWM4-50LW	DICB	3252	43.3	75.1

**PHOTOMETRIC DATA**

Test #17826 Test Date 3/7/2017

**LUMINAIRE DATA**

Luminaire	CWM2-35LWxx-DIS-EDU CWM Contemporary Wall Mount, Surface 2ft Direct-Indirect Wall Mount with Frosted Lens
Ballast	XI025C100V054DSM5
Ballast Factor	1.00
Lamp	LED
Fixture Lumens	2443
Watts	25.30
Mounting	Wall Mount
Shielding Angle	0° = 90 90° = 90
Spacing Criterion	0° = N/A 90° = N/A
Luminous Opening in Feet	Length: 0.13 Width: 1.92 Height: 0.50

**ZONAL LUMEN SUMMARY**

Zone	Lumens	% Lamp	% Fixt.
0-30	437	17.9	17.9
0-40	672	27.5	27.5
0-60	1034	42.3	42.3
0-90	1211	49.6	49.6
0-180	2443	100.0	100.0

**ENERGY DATA**

Total Luminaire Efficiency	100.0%
Total Lumens per Watt	97
Comparative Yearly Lighting Energy Cost per 1000 Lumens	\$2.45 based on 3000 hrs. and \$.08 per KWH

**INDOOR CANDELA PLOT**

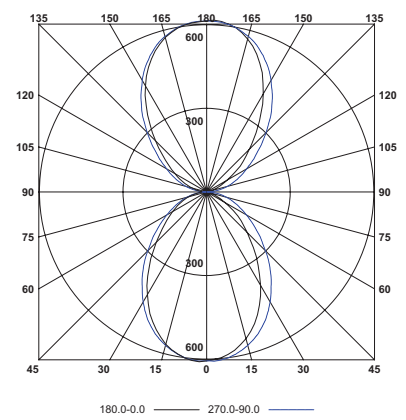

Test #17817 Test Date 3/22/2017

**LUMINAIRE DATA**

Luminaire	CWM4-35LWxx-DIS-EDU CWM Contemporary Wall Mount, Surface 4ft Direct-Indirect Wall Mount with Frosted Lens
Ballast	OT40W/PRG1400C
Ballast Factor	1.00
Lamp	LED
Fixture Lumens	4233
Watts	43.40
Mounting	Wall Mount
Shielding Angle	0° = 90 90° = 90
Spacing Criterion	0° = N/A 90° = N/A
Luminous Opening in Feet	Length: 0.13 Width: 3.92 Height: 0.50

**ZONAL LUMEN SUMMARY**

Zone	Lumens	% Lamp	% Fixt.
0-30	755	17.8	17.8
0-40	1159	27.4	27.4
0-60	1785	42.2	42.2
0-90	2091	49.4	49.4
0-180	4233	100.0	100.0

**ENERGY DATA**

Total Luminaire Efficiency	100.0%
Total Lumens per Watt	98
Comparative Yearly Lighting Energy Cost per 1000 Lumens	\$2.45 BASED ON 3000 HRS. AND \$.08 PER KWH

**INDOOR CANDELA PLOT**

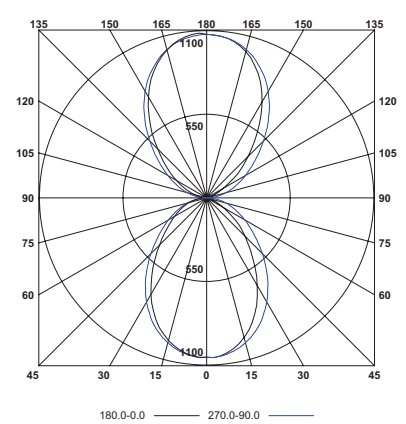

Test #17841 Test Date 3/14/2017

**LUMINAIRE DATA**

Luminaire	CWM4-35LWxx-DIC-EDU CWM Contemporary Wall Mount, Surface 4ft Direct-Indirect Wall Mount with Frosted Lens
Ballast	OT40W/PRG1400C
Ballast Factor	1.00
Lamp	LED
Fixture Lumens	3211
Watts	43.30
Mounting	Wall Mount
Shielding Angle	0° = 90 90° = 90
Spacing Criterion	0° = N/A 90° = N/A
Luminous Opening in Feet	Length: 0.08 Width: 3.92 Height: 0.55

**ZONAL LUMEN SUMMARY**

Zone	Lumens	% Lamp	% Fixt.
0-30	640	19.9	19.9
0-40	935	29.1	29.1
0-60	1360	42.4	42.4
0-90	1620	50.5	50.5
0-180	3211	100.0	100.0

**ENERGY DATA**

Total Luminaire Efficiency	100.0%
Total Lumens per Watt	74
Comparative Yearly Lighting Energy Cost per 1000 Lumens	\$3.20 BASED ON 3000 HRS. AND \$.08 PER KWH

**INDOOR CANDELA PLOT**

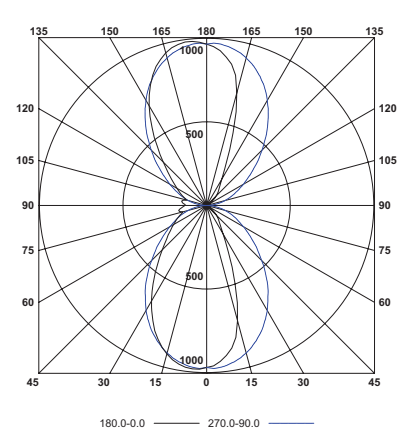

## DIMENSIONAL DATA — SURFACE MOUNT

Surface Mount, Front View, 4'

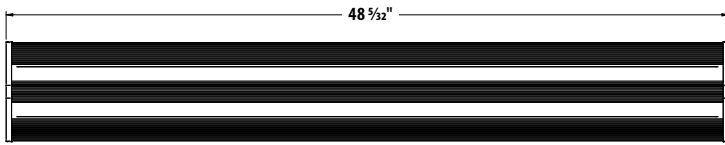

Surface Mount, Cross Section, 4'

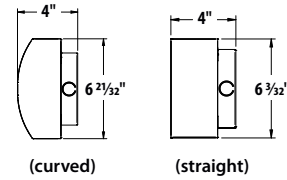

Surface Mount, Front View, 2'

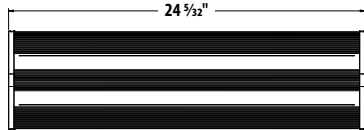

Surface Mount, Cross Section, 2'

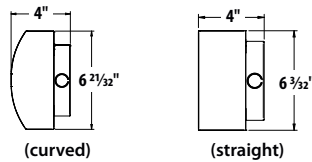

Surface Mount Fixture on Surface (curved lens option shown)

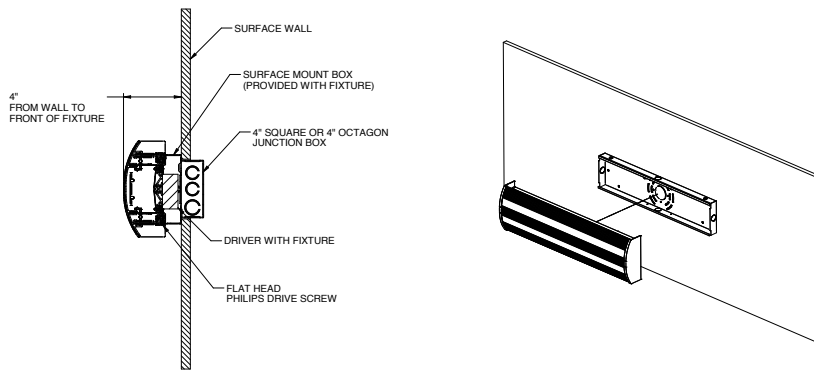

## DIMENSIONAL DATA — SEMI-RECESSED

Semi-Recessed, Front View, 4'

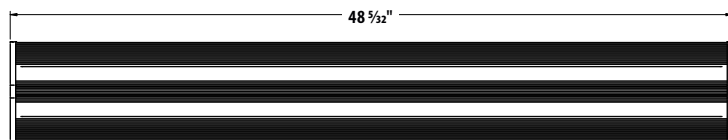

Semi-Recessed, Cross Section, 4'

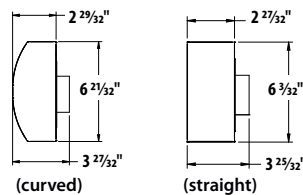

Semi-Recessed, Front View, 2'

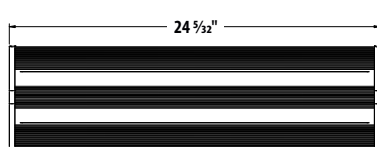

Semi-Recessed, Cross Section, 2'

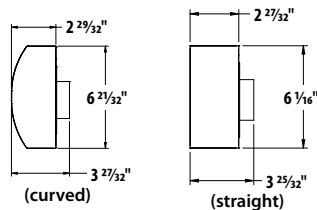

Semi-Recessed Fixture in Drywall (curved lens option shown)

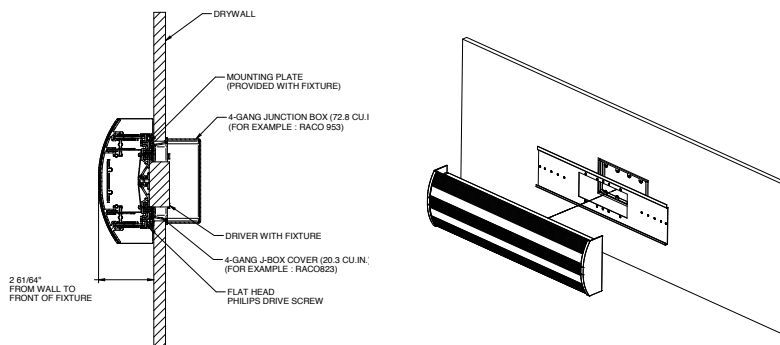



**SPECTRASYNCTM COLOR TUNING TECHNOLOGY**

Control your space based on the needs of the application, specific activities throughout the day and preferences of the occupants with distinct SpectraSync Color Tuning Technologies.

**Dim to Warm**

Dim to Warm mimics the familiar warming effect that occurs with traditional incandescent sources as they are dimmed. (Available with 2200K-3000K)

**Tunable White**

Tunable White offers users the ability to tailor CCT to their personal preference, enhancing task visibility, material and colors, or the aesthetics of the space. (Available with 2700K-5000K or 2700K-6500K)

**Scheduled White**

Scheduled White creates an environment that mimics the rhythms of natural light throughout the day, enhancing occupant's mood and well-being. (Available with 2700K-5000K or 2700K-6500K)

**SPECTRASYNCTUNABLE WHITE**

**2750T OR 2765T- SPECTRASYNCTUNABLE WHITE, 2700K-5000K OR 2700K-6500K**

Requires (2) 0-10V controllers, (1) for intensity and (1) for CCT. Minimum 5% dimming.

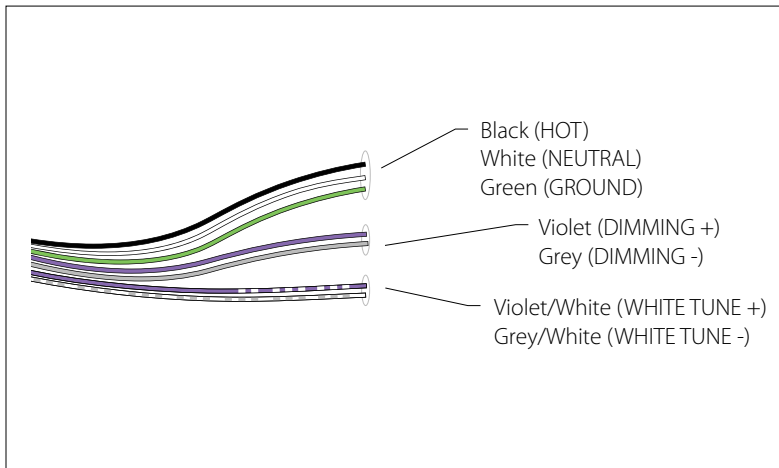

SpectraSync tunable white luminaires are provided with (2) 0-10V circuits. The violet and grey circuit is for wiring to any qualified 0-10V controller for dimming. The violet/white and grey/white circuit is for wiring to any qualified 0-10V controller for tunable white CCT control.

**CONTROLLER MANUFACTURER DATA**

**Suggested controllers to be used with SpectraSync:**

SpectraSync tunable white was designed to be used with sinking style dimmers (provided by others) and is compatible with:

- Hubbell Control Solutions (HCS): NX Distributed Intelligence Room Controllers (NXRC) and In-fixture Controllers (NXFM)
- Lutron: DDTV, DVSTV, and NFTV dimmers
- Wattstopper: ADF120277 and CD4BL (Titan) dimmers

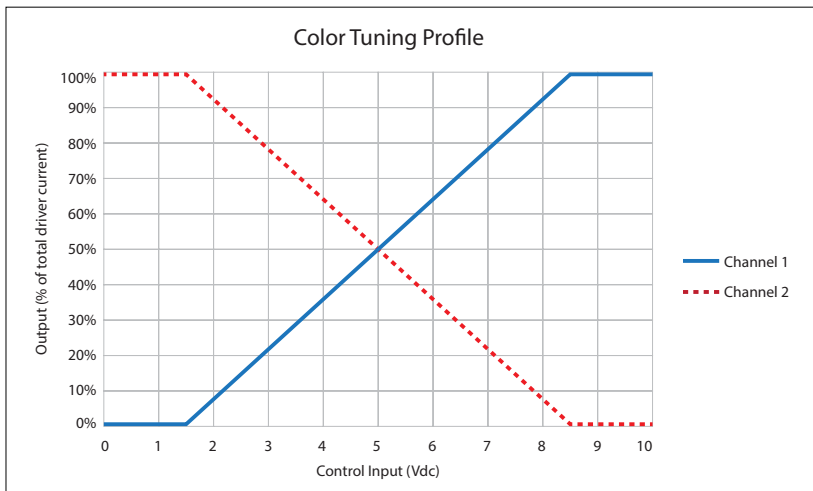

To enable scheduling and for use with NX wall control preset stations please refer to Hubbell Control Solutions NX SpectraSync technical sheet.

<b>2 ft.</b>	DIS	VW	15	1286	89	1344	93	1368	94	1386	96	1431	99	1410	97
		MW	19	1732	91	1810	95	1843	97	1866	98	1928	101	1899	100
		LW	25	2259	89	2360	93	2402	95	2433	96	2513	99	2476	98
		ML	37	3030	83	3166	87	3223	88	3264	89	3372	92	3321	91
	DISF	VW	14	1279	89	1336	93	1360	94	1377	96	1423	99	1401	97
		MW	19	1722	90	1799	94	1831	96	1855	97	1916	100	1887	99
		LW	25	2245	89	2346	93	2388	94	2419	96	2498	99	2461	97
		ML	37	3043	83	3180	87	3237	89	3279	90	3387	93	3336	91
	DISB	VW	14	1276	89	1333	93	1357	94	1374	95	1420	99	1398	97
		MW	19	1717	90	1794	94	1826	96	1850	97	1911	101	1882	99
		LW	25	2238	91	2339	95	2381	97	2412	98	2491	102	2454	100
		ML	37	3043	83	3180	87	3237	88	3279	90	3387	93	3336	91
	DIC	VW	15	967	66	1010	69	1028	70	1041	71	1076	74	1059	73
		MW	19	1304	68	1363	71	1388	72	1405	73	1452	76	1430	74
		LW	25	1698	67	1774	70	1806	71	1829	72	1889	75	1861	74
		ML	36	2284	63	2387	66	2430	67	2461	68	2542	71	2504	70
	DICF	VW	14	961	67	1004	70	1022	71	1035	72	1069	74	1053	73
		MW	19	1297	68	1355	71	1379	73	1397	74	1443	76	1421	75
		LW	25	1687	67	1763	70	1795	71	1818	72	1878	75	1849	73
		ML	36	2318	64	2422	67	2466	68	2497	69	2579	71	2541	70
DICB	VW	14	968	68	1011	71	1029	72	1042	73	1077	75	1061	74	
	MW	19	1293	67	1351	70	1375	72	1393	73	1439	75	1417	74	
	LW	25	1682	69	1758	72	1790	73	1812	74	1872	76	1844	75	
	ML	36	2305	63	2409	66	2452	67	2484	68	2566	70	2527	69	
<b>4 ft.</b>	DIS	XW	24	2276	96	2378	101	2421	103	2452	104	2533	107	2495	106
		VW	32	2971	94	3105	99	3161	100	3201	102	3307	105	3257	103
		MW	38	3500	93	3657	97	3723	99	3770	100	3895	103	3836	102
		LW	43	3913	90	4089	94	4163	96	4216	97	4355	100	4289	99
	DISF	XW	24	2270	96	2372	101	2415	102	2446	104	2526	107	2488	105
		VW	32	2953	94	3086	98	3142	100	3182	101	3287	104	3237	103
		MW	38	3479	92	3635	96	3700	97	3748	99	3871	102	3813	100
		LW	43	3896	90	4071	94	4144	96	4197	97	4336	100	4270	99
	DISB	XW	24	2258	95	2359	99	2401	101	2432	102	2512	106	2475	104
		VW	32	2945	93	3077	98	3132	99	3172	101	3277	104	3228	102
		MW	38	3468	92	3624	96	3689	98	3736	99	3860	102	3802	101
		LW	43	3894	90	4069	94	4142	95	4195	97	4333	100	4268	98
	DIC	XW	24	1728	74	1806	77	1839	78	1862	79	1923	82	1894	81
		VW	32	2254	70	2355	74	2397	75	2428	76	2508	78	2470	77
		MW	38	2648	70	2767	73	2817	74	2853	75	2947	78	2903	76
		LW	43	2969	69	3102	72	3158	73	3198	74	3304	77	3254	76
	DICF	XW	24	1671	71	1746	74	1777	75	1800	76	1859	78	1832	77
		VW	32	2240	71	2341	74	2383	75	2414	76	2493	79	2456	77
		MW	38	2632	69	2750	72	2800	74	2835	75	2929	77	2885	76
		LW	43	2992	69	3126	72	3182	73	3223	74	3329	77	3279	76
DICB	XW	24	1703	72	1780	75	1812	77	1835	78	1896	80	1867	79	
	VW	32	2234	70	2334	73	2376	74	2406	75	2486	78	2448	77	
	MW	38	2624	69	2742	72	2791	73	2827	74	2920	77	2876	76	
	LW	43	2887	67	3017	70	3071	71	3111	72	3213	75	3165	74	

**NX™ SOLUTION GUIDE FOR SPECTRASync™ COLOR TUNING TECHNOLOGY**

When paired with SpectraSync™ enabled luminaires, NX Distributed Intelligence lighting control delivers a comprehensive color control solution, simplifying setup and code compliance through self-configuration and an optional Bluetooth® interface with mobile application.

- Complete control solutions using SpectraSync color tuning technology
- Device auto-configuration and plug-n-play connectivity
- Intuitive app interface and user-friendly wall stations

NX™ Distributed Intelligence Accessories for SpectraSync Control	
CATALOG NUMBER	DESCRIPTOR
NXAC-120	NX Area Controller, NEMA 1, HubbNET, BACnet™, 120 Volt
NXHNB	NX Network Bridge Module
NXRC-2RD-UNV	NX Room Controller, 2 Relay, 0-10V Dimming, Universal Voltage
NXSW-CCT-xx	NX Digital CCT Scene Switch, 6 Buttons, 4 Presets, Raise/Lower
NXSW-SS-xx	NX Digital Scene Switch, 6 Buttons, 4 Presets, Raise/Lower
NXSW-ORLO-xx	NX Digital Switch Station, On/Raise/Lower/Off
NXSW-RL-xx	NX Digital Switch Station, 2 Buttons, Raise/Lower
NXSW-OO-xx	NX Digital Switch Station, On/Off
NXSW-TO-xx	NX Digital Switch Station, Timed-On, Pilot

Order as separate catalog number. Visit [www.hubbellcontrolsolutions.com](http://www.hubbellcontrolsolutions.com)

Note: 'xx' = color; Black (BK), Gray (GY), Ivory (IV), Light Almond (LA), Red (RD), White (blank).

**NX USER INTERFACES**



Wall stations for personalized control of light and color



NX mobile app offers user-friendly configuration tool



Area Controller GUI provides simple and intuitive programming

Android



Free Bluetooth® enabled mobile app for ease of configuration

Apple



**TYPICAL NX DISTRIBUTED INTELLIGENCE™ LAYOUT FOR STAND-ALONE OR NETWORKED ROOM CONTROL**

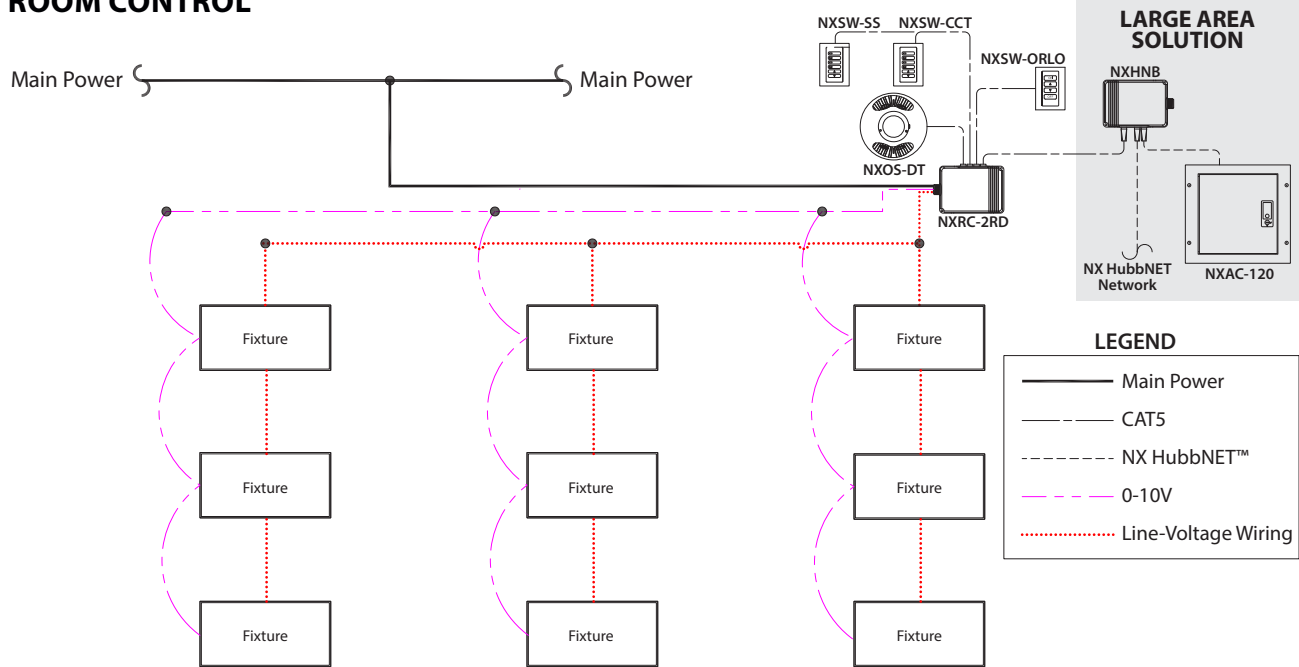

**NX DISTRIBUTED INTELLIGENCE™ IN-FIXTURE SOLUTION GUIDE**

NX Distributed Intelligence enables Hubbell's portfolio of commercial, industrial and architectural luminaires to further reduce energy consumption and total cost of ownership for simple to complex control environments.

NX-enabled luminaires provides you the breadth and flexibility to address all your project requirements today and in the future. For a complete list of luminaires with integrated NX options please visit our website.

NX Distributed Intelligence™ In-Fixture Options			
NX CONTROL OPTIONS	DESCRIPTOR	CONNECTIVITY	APPLICATION SPACE
NXSP14F	NX, PIR Occupancy Sensor, Dimming Daylight Harvesting, 14'	Standalone	Both
NXSPL	NX, PIR Occupancy Sensor, Dimming Daylight Harvesting, Low Mount	Standalone	Indoor
NXOS	NX, PIR Occupancy Sensor, Dimming Daylight Harvesting, OMNI	Standalone	Indoor
NXS	NX, PIR Occupancy Sensor, Dimming Daylight Harvesting	Standalone	Indoor
NXSPH	NX, PIR Occupancy Sensor, Dimming Daylight Harvesting, High Mount	Standalone	Indoor
NXSP30F	NX, PIR Occupancy Sensor, Dimming Daylight Harvesting, 30'	Standalone	Outdoor
NXEPL	NX Enabled, PIR Occupancy Sensor, Dimming Daylight Harvesting, Low Mount	Wired	Indoor
NXE	NX Enabled, Dual SmartPorts	Wired	Indoor
NXEOS	NX Enabled, PIR Occupancy Sensor, Dimming Daylight Harvesting, OMNI	Wired	Indoor
NXES	NX Enabled, PIR Occupancy Sensor, Dimming Daylight Harvesting	Wired	Indoor
NXESPH	NX Enabled, PIR Occupancy Sensor, Dimming Daylight Harvesting, High Mount	Wired	Indoor
NXSPW14F	NX Wireless, PIR Occupancy Sensor, Dimming Daylight Harvesting, 14'	Wireless	Both
NXWE	NX Wireless Enabled	Wireless	Both
NXSPWL	NX Wireless, PIR Occupancy Sensor, Dimming Daylight Harvesting, Low Mount	Wireless	Indoor
NXOSW	NX Wireless, PIR Occupancy Sensor, Dimming Daylight Harvesting, OMNI	Wireless	Indoor
NXSPWH	NX Wireless, PIR Occupancy Sensor, Dimming Daylight Harvesting, High Mount	Wireless	Indoor
NXSW	NX Wireless, PIR Occupancy Sensor, Dimming Daylight Harvesting	Wireless	Indoor
NXSPW30F	NX Wireless, PIR Occupancy Sensor, Dimming Daylight Harvesting, 30'	Wireless	Outdoor

Visit [www.hubbellcontrolsolutions.com](http://www.hubbellcontrolsolutions.com) for additional information on the NX platform. For information on NX options available with specific Hubbell Lighting luminaires please reference specification sheets.

NX Distributed Intelligence™ Accessories	
CATALOG NO.	DESCRIPTOR
NXAC-120	NX Area Controller, NEMA 1, HubbNET, BACnet, 120 Volt
NXHNB	NX Network Bridge Module
NXRC-2RD-UNV	NX Room Controller, 2 Relay, 0 - 10V Dimming, Power Monitoring, Universal Voltage
NXOFM-1R1D-UNV	On-fixture Module (7-pin), On / Off / Dim, Daylight Sensor with HubbNET Radio and Bluetooth® Radio, 120-480VAC
NXSW-CCT-xx	NX Digital CCT Scene Switch, 6 Buttons, 4 Presets, Raise/Lower
NXSW-SS-xx	NX Digital Scene Switch, 6 Buttons, 4 Presets, Raise/Lower
NXSW-ORLO-xx	NX Digital Switch Station, On/Raise/Lower/Off
NXSW-RL-xx	NX Digital Switch Station, 2 Buttons, Raise/Lower
NXSW-OO-xx	NX Digital Switch Station, On/Off
NXSW-TO-xx	NX Digital Switch Station, Timed-On, Pilot

Note: 'xx' = color; Black (BK), Gray (GY), Ivory (IV), Light Almond (LA), Red (RD), White (blank).

**NX USER INTERFACES**



Wall stations for personalized control of light and color



NX mobile app offers user-friendly configuration tool



Area Controller GUI provides simple and intuitive programming

Android



Free Bluetooth® enabled mobile app for ease of configuration

Apple



**TYPICAL NX DISTRIBUTED INTELLIGENCE™ LAYOUT FOR WIRELESS OR WIRED NETWORKED IN-FIXTURE CONTROL**

**Vertical Market:** Education  
**Application:** Classroom  
**Connectivity:** Wired

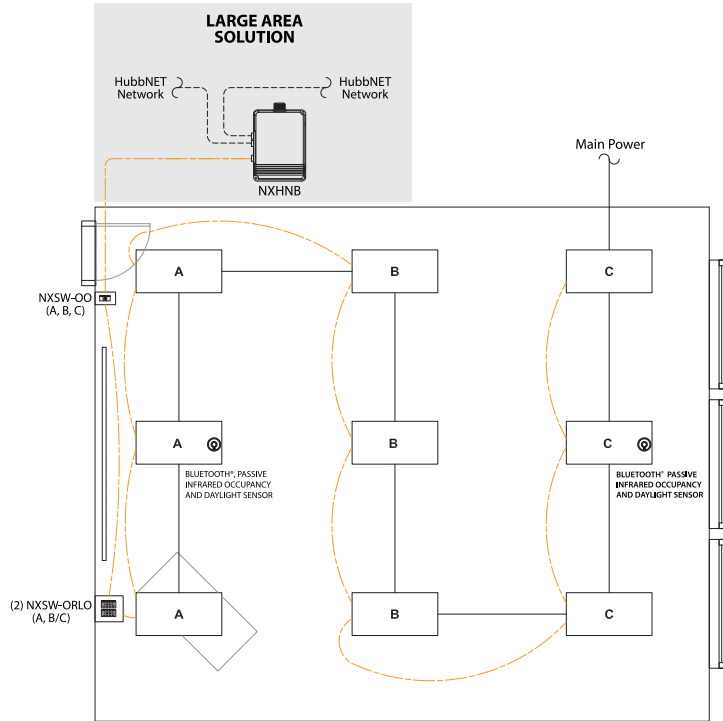
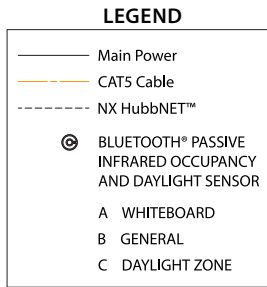

**Vertical Market:** Education  
**Application:** Classroom  
**Connectivity:** Wireless

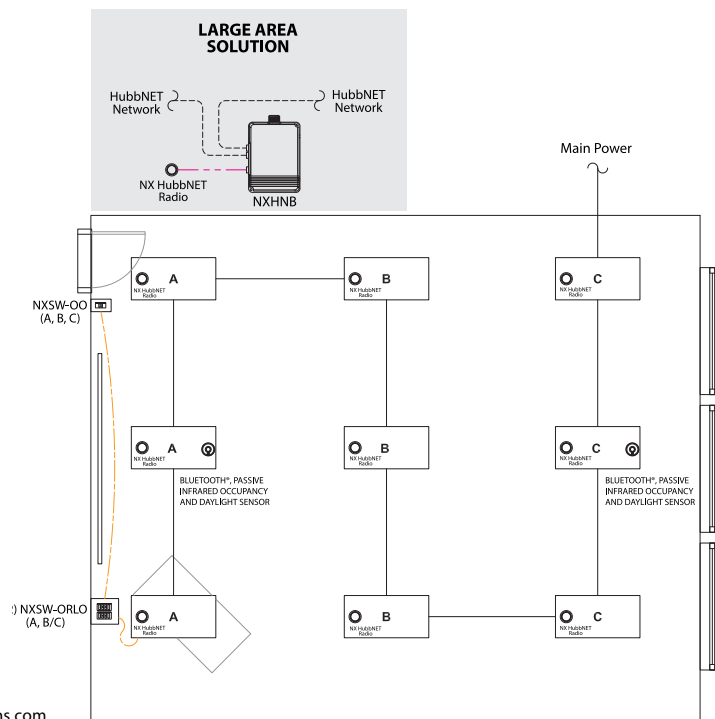
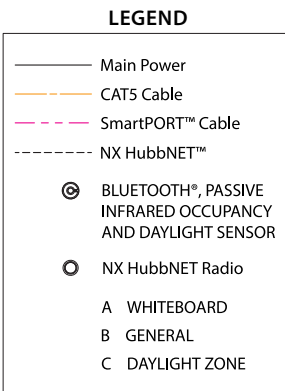

For additional solutions possible with NX please visit [www.hubbellcontrolsolutions.com](http://www.hubbellcontrolsolutions.com) to view our Vertical Market Application Guides.