

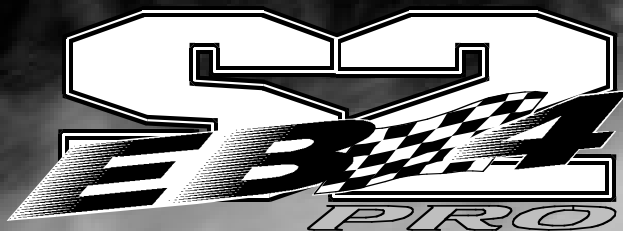

PARTS CATALOG FOR EB-4 S2 PRO SC CAR

NO.6226-F



**1/8 4WD OFF-ROAD
PRO VERSION COMPETITION BUGGY**

Manufactured by **THUNDER TIGER CORPORATION**

<http://www.thundertiger.com>

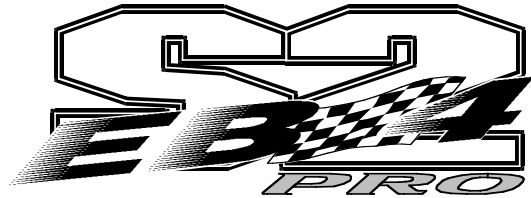

1/8 4WD OFF-ROAD PRO VERSION COMPETITION BUGGY

Features:

- 100% Assembled
- 2-Channel Radio Installed
- High Torque Steering Servo
- Printed Body With Decals
- Race-proven Suspension Geometry
- Durable Gear Differential System
- Double High-Density Annular Foams Air Filter
- Strong Fiberglass Reinforced Composite Parts
- Sturdy Alum. Chassis
- Alum Front Shock Tower
- Alum Rear Shock Tower
- Alum Steering Slider
- Alum Center Diff Top Plate
- Thunder Tiger PRO-21BX-R Engine With Pull Start
- High Performance Rubber Tire
- Adjustable Alum. Large Volume, Competition Shocks
- Front Ball Type Universal Drive Shaft
- Ventilated Flywheel
- High performance Tuned Pipe And Manifold
- Adjustable Toe-In / Camber / Caster Angle



3 Sets of gear diff & Full ball bearings (18pcs)
Included



NO.6226-F



SURFACE OR PISTOL STYLE
FOR CHOICES

REAR ASSEMBLY

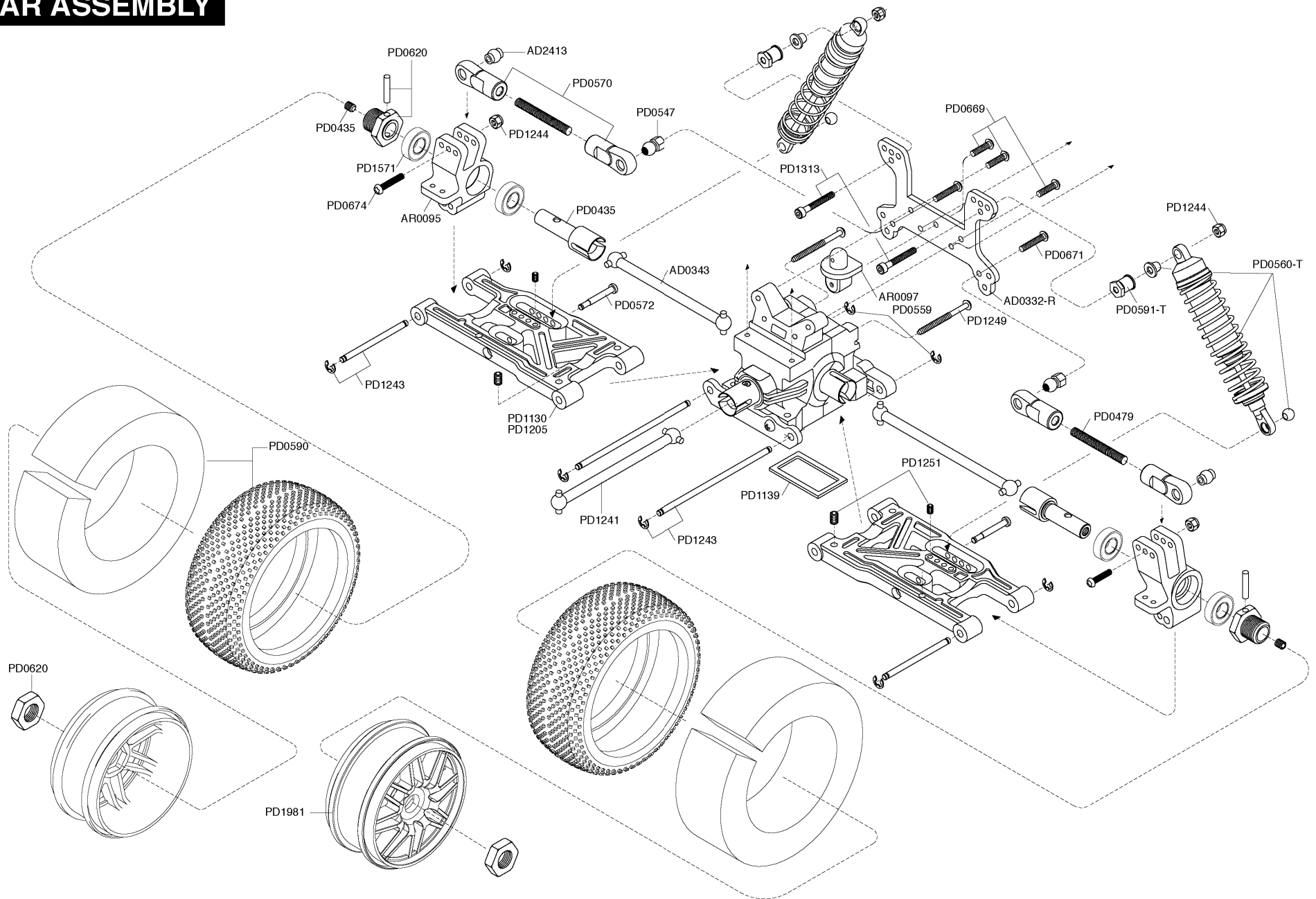

CHASSIS ASSEMBLY

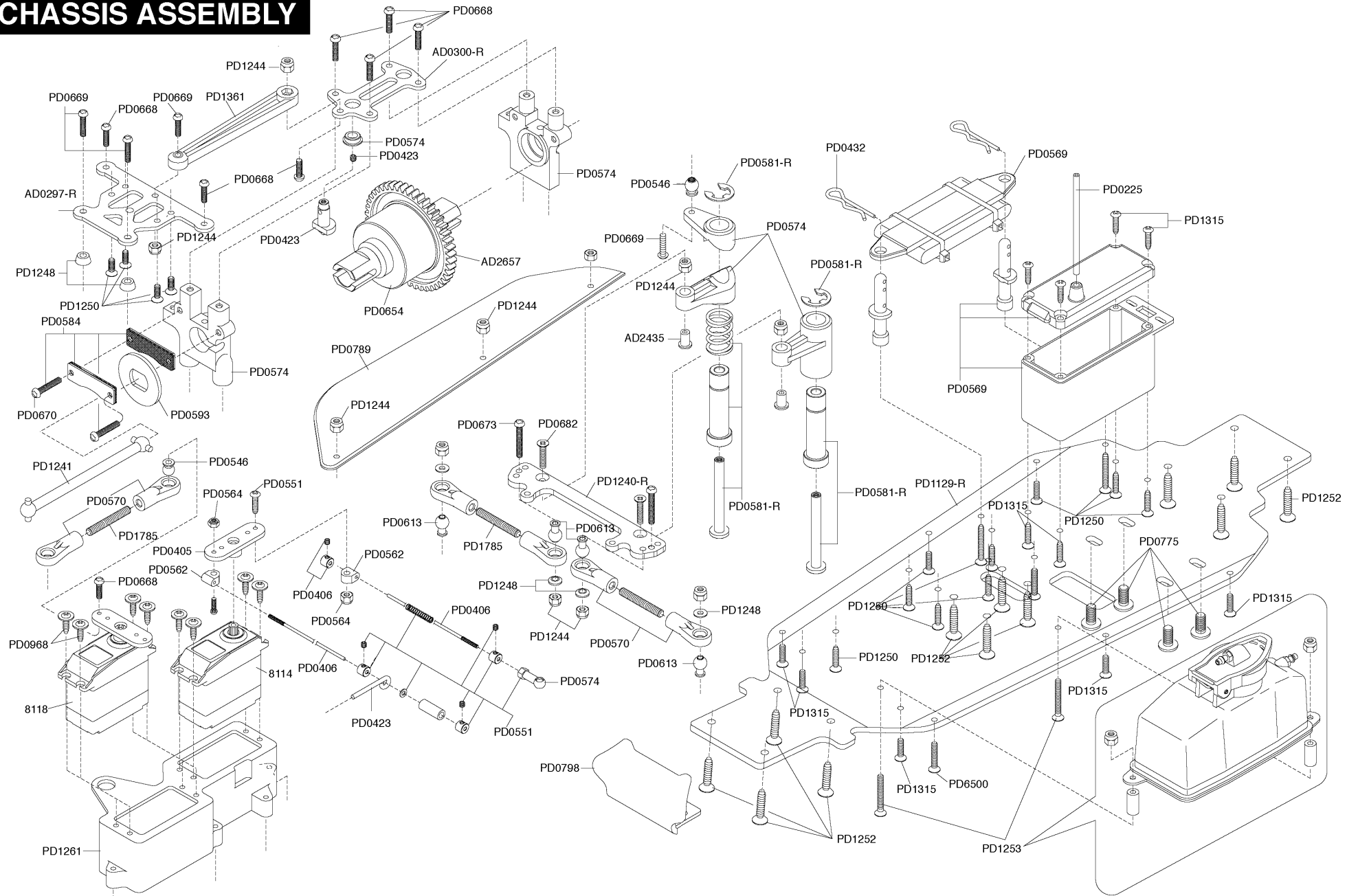

DIFF. ASSEMBLY

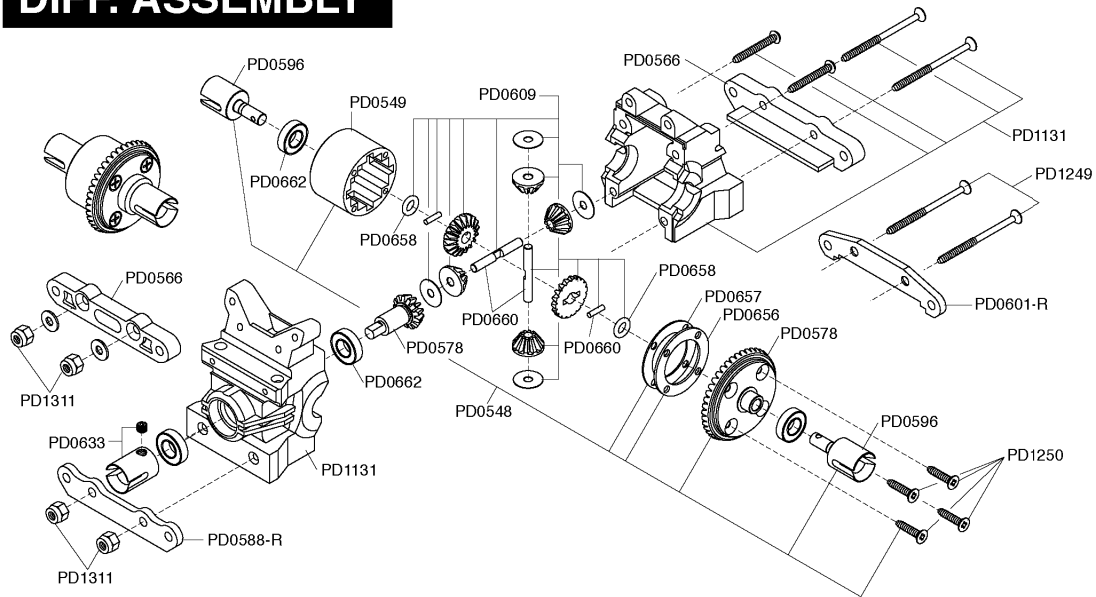

ENGINE & CLUTCH ASSEMBLY

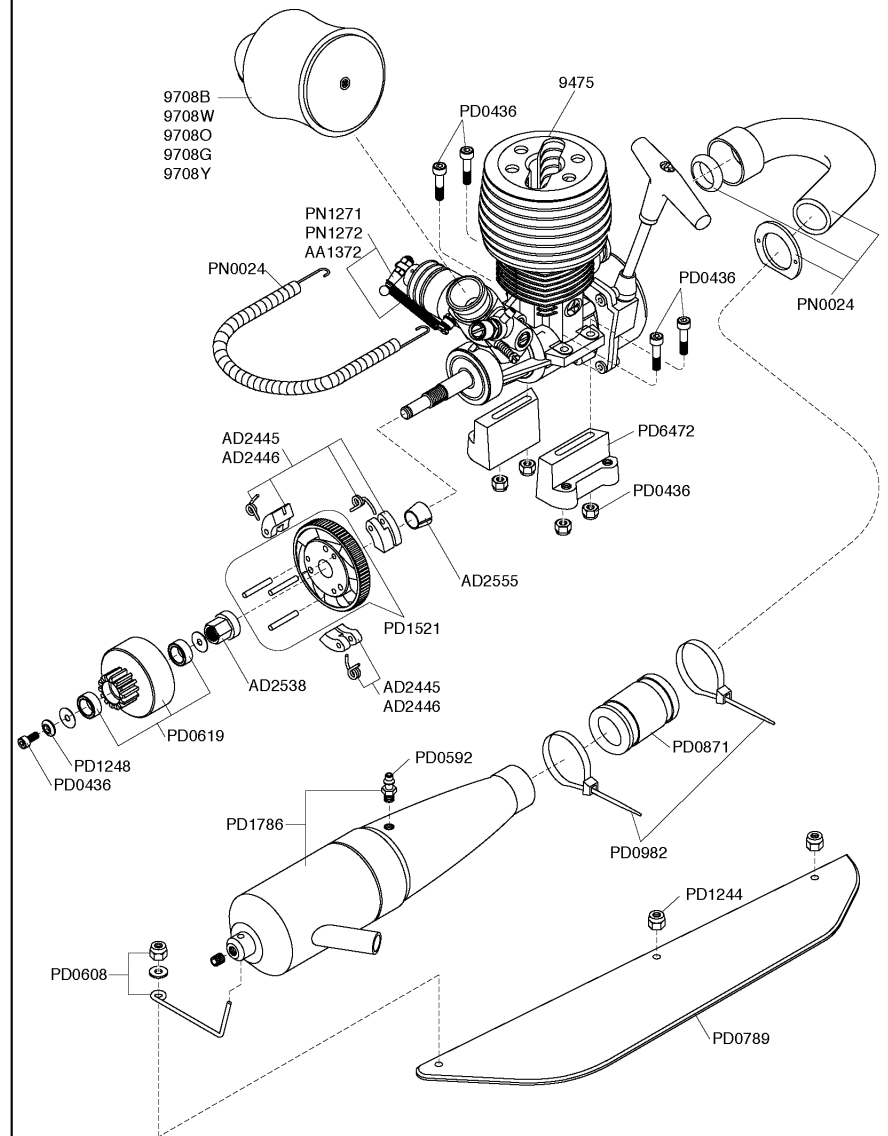

TAIL WING ASSEMBLY

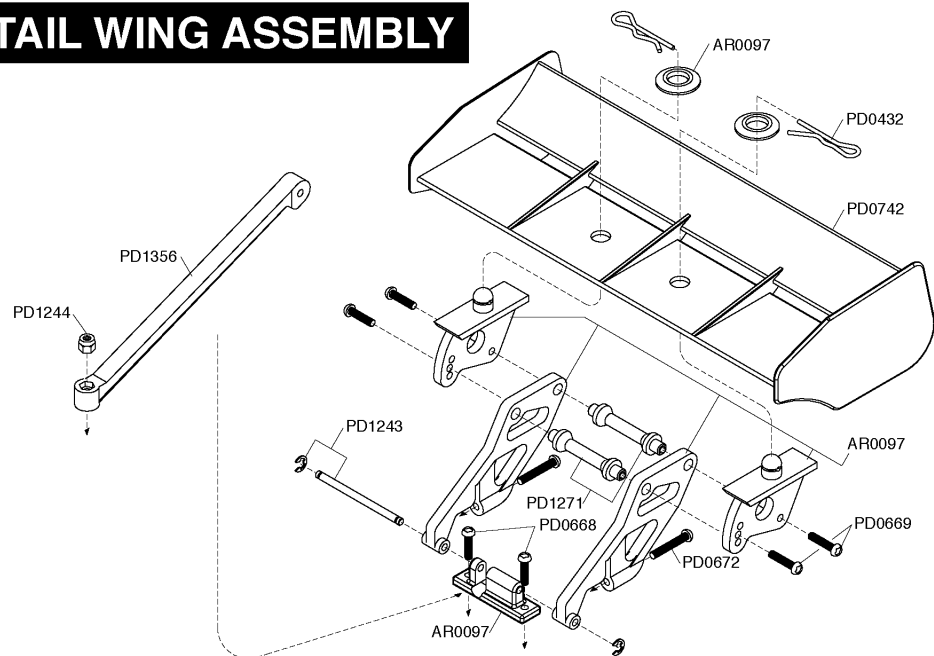

EB-4 S2 SE PARTS LIST

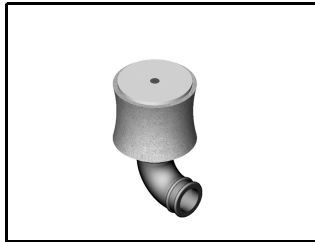

9708B AIR FILTER, 1/8 BLACK
9708O AIR FILTER, 1/8 ORANGE
9708G AIR FILTER, 1/8 GREEN

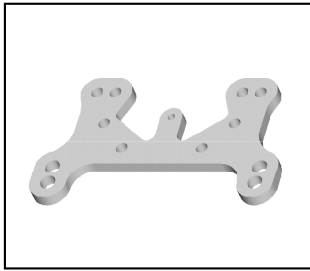

AD0287-R FRONT SHOCK TOWER

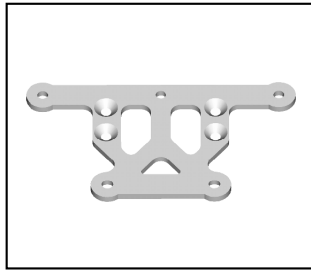

AD0297-R SERVO SAVER TOP PLATE

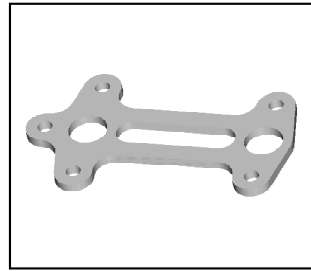

AD0300-R CENTER DIFF TOP PLATE

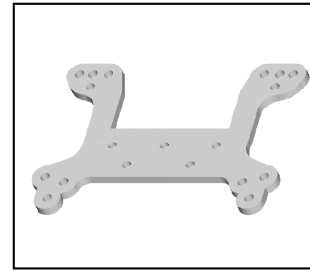

AD0332-R REAR SHOCK TOWER

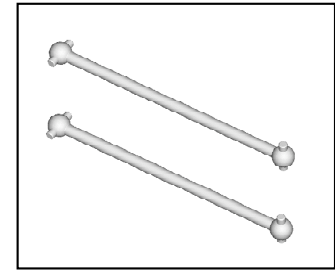

AD0343 REAR DRIVE SHAFT

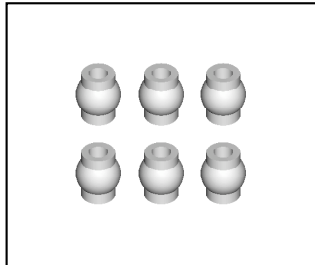

AD2413 PIVOT BALL(6), 4MM

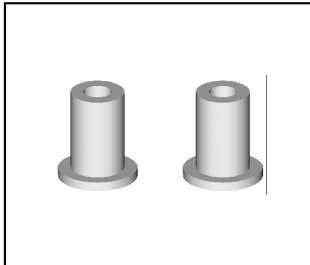

AD2435 SERVO SAVER BUSHING

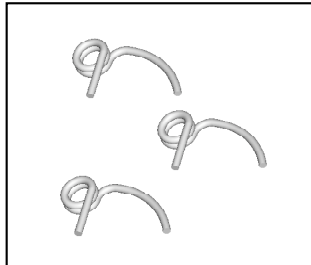

AD2445 1/8 CLUTCH SPR. (3)

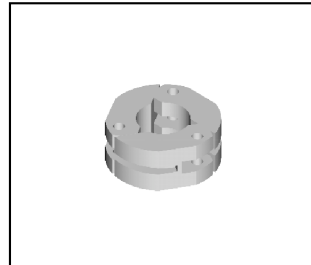

AD2446 1/8 CLUTCH SHOE (3)

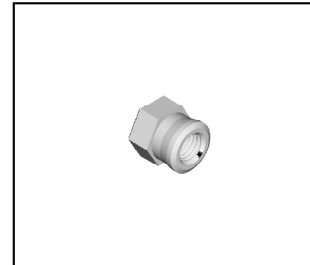

AD2538 1/8 CLUTCH NUT

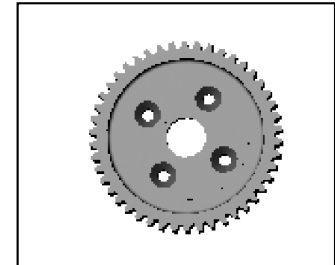

AD2657 METAL MAIN GEAR, 46T



AJD1112 DECAL

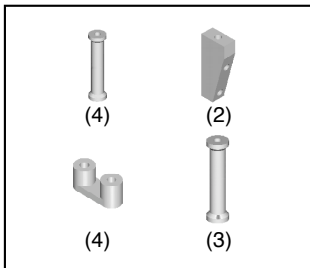

AR0080 SERVO MOUNT / PLASTIC POST

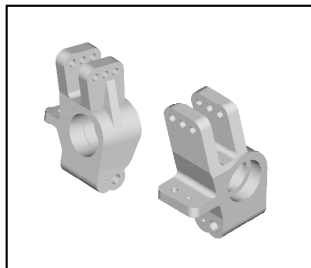

AR0095 REAR HUB CARRIER

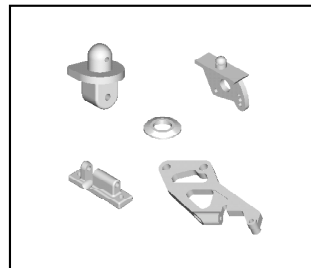

AR0097 BODY / WING MOUNT

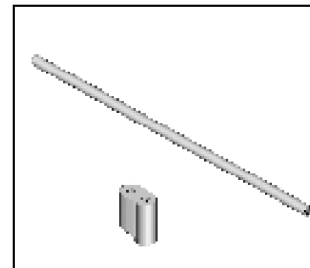

PD0225 ANTENNA BAG

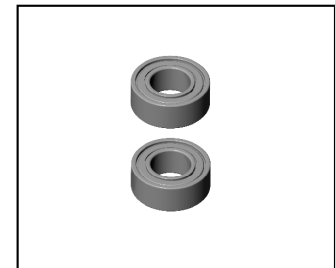

PD0416 BALL BEARING (2), 5 X 10 X 4MM

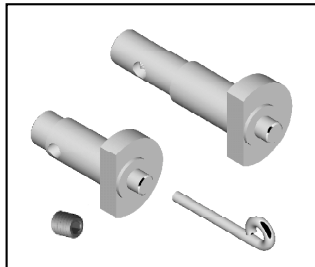

PD0423 BRAKE CAM / LEVER

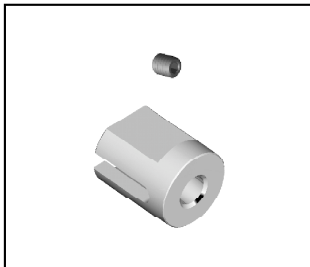

PD0425 CTR RIGID AXLE OUTDRIVE

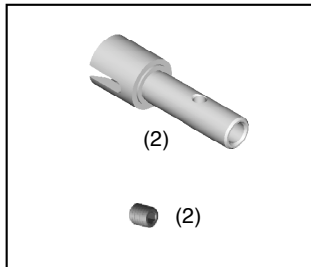

PD0435 REAR AXLE

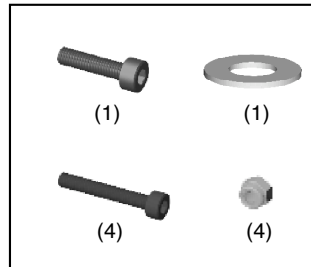

PD0436 SCREW BAG

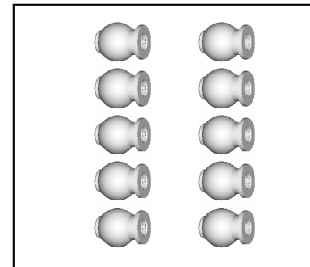

PD0546 STANDOFF BALL (10), SMALL 4MM

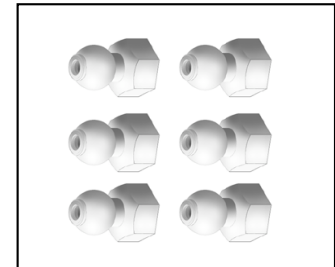

PD0547 STANDOFF BALL (6), LARGE 4MM

EB-4 S2 PRO SC PARTS LIST

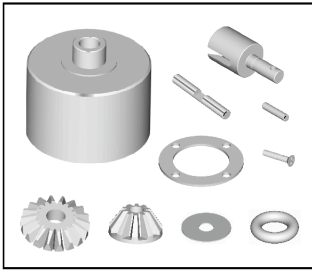

PD0548 FR / RR DIFFERENTIAL SET

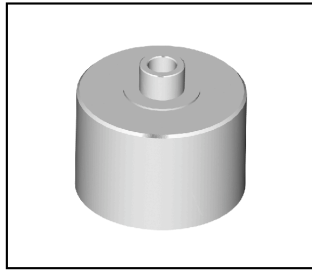

PD0549 DIFFERENTIAL CASE

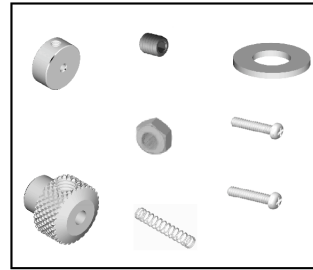

PD0551 THROTTLE / BRAKE HARDWARE SET

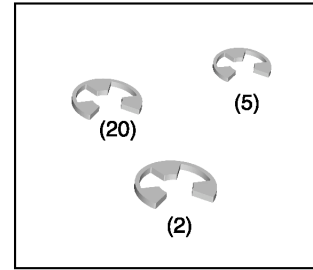

PD0559-T ASSORTED E-CLIPS

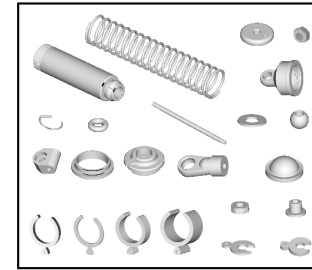

PD0560-T REAR SHOCK SET

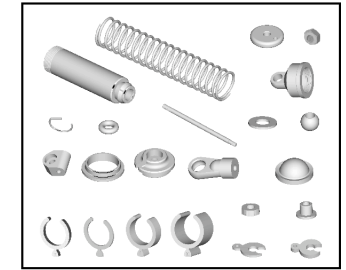

PD0561 FRONT SHOCK SET

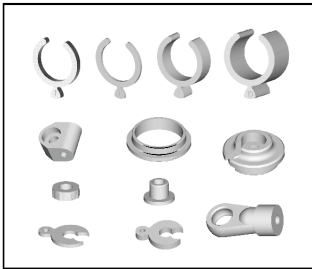

PD0562 SHOCK PLASTIC PARTS

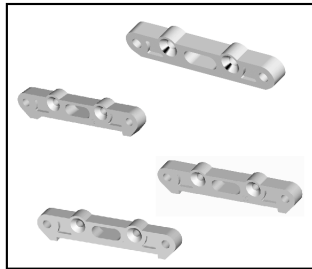

PD0566 LOWER ARM REAR HINGE PLATES

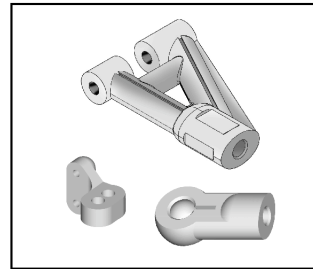

**PD0567 FR UPPER ARM/MT/END
PD1204 FR UPPER ARM/MT/END, COLD TEMP**

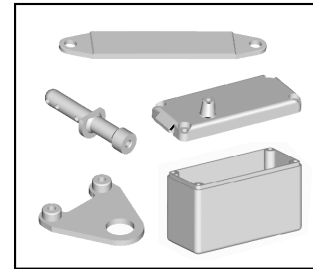

PD0569 RX BOX / BATT POST

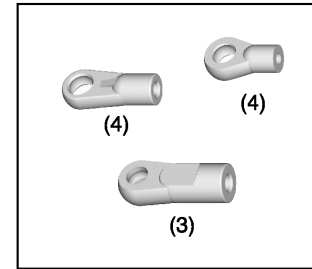

PD0570 TIE-END SET

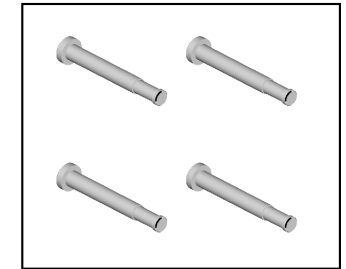

PD0572 LOWER SHOCK PIN(4)

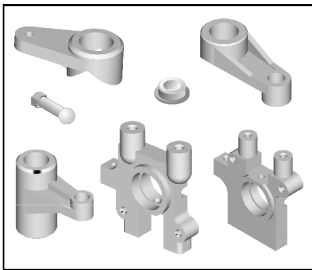

PD0574 CTR DIFF. MOUNT & SERVO SAVER

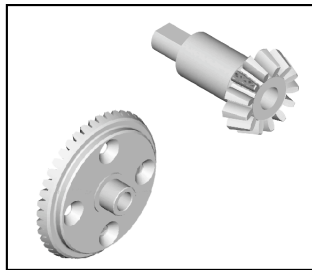

PD0578 DIFF BEVEL / DRIVE GEAR

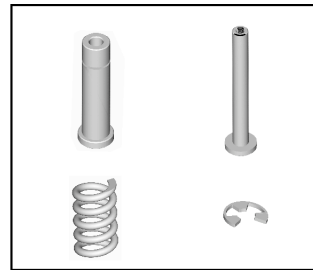

PD0581-R SERVO SAVER METAL PARTS

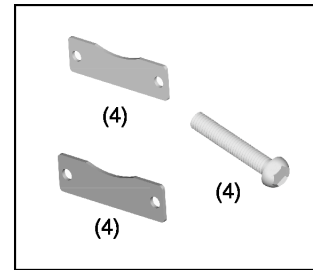

PD0584 BRAKE PAD SET

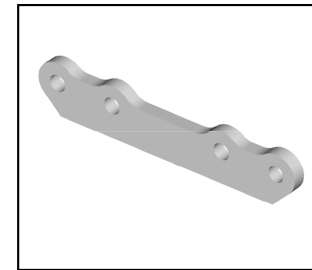

PD0588-R FR SUSP PLATE RR TRANS

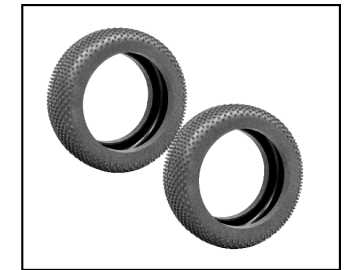

PD0590 1/8 TIRE W/FOAM, CUBIC

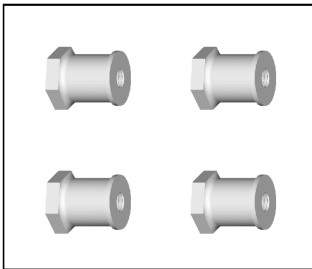

PD0591-T SHOCK STANDOFF (4)

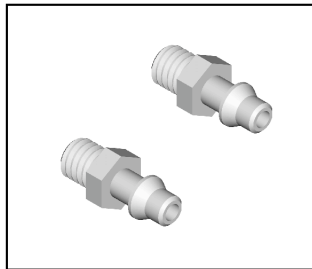

PD0592 PRESSURE FITTING

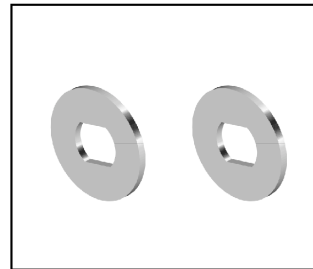

PD0593 STEEL BRAKE DISC(2)

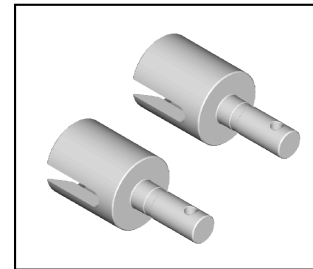

PD0596 FR/RR DIFF OUTDRIVE

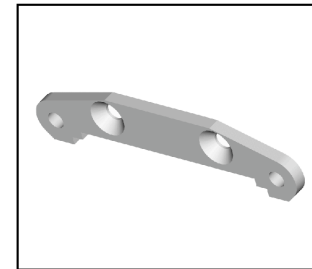

PD0601-R FR SUSP PLATE FR TRANS

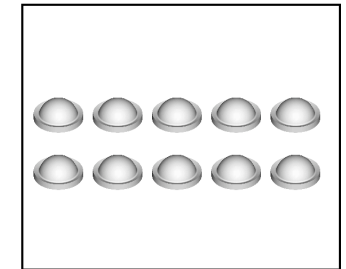

PD0602 1/8 SHOCK DIAPHRAGM (10)

EB-4 S2 PRO SC PARTS LIST

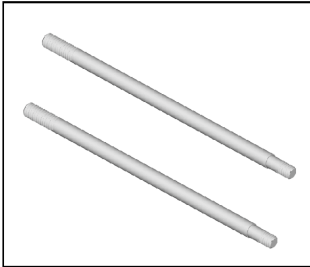

PD0603 RR SHOCK SHAFT (2)

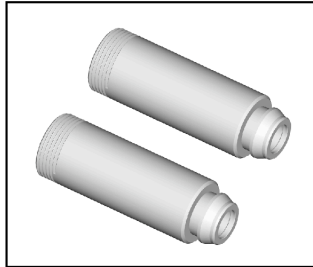

PD0604-T FR SHOCK BODY (2)

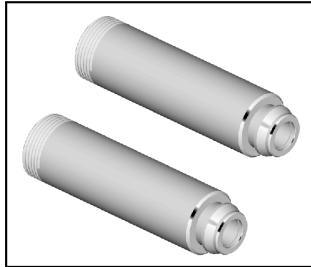

PD0605-T RR SHOCK BODY (2)

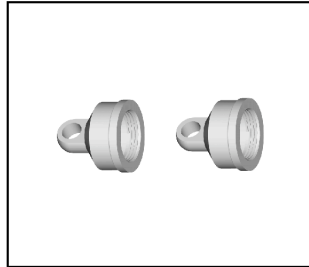

PD0606-T SHOCK CAP (2)

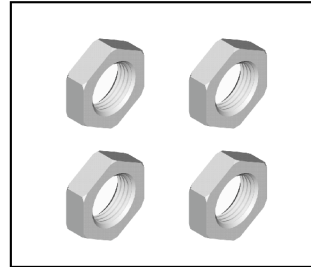

PD0607 ALUM NUT (4), 17MM

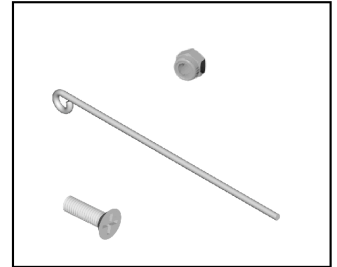

PD0608 TUNED PIPE WIRE

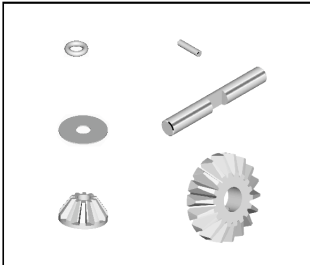

PD0609 DIFF INNER GEARS & PARTS

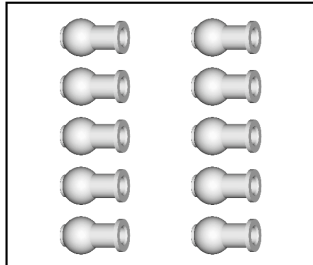

PD0613 STANDOFF BALL (10), MEDIUM 4MM

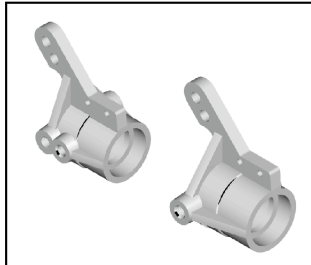

PD0617 FRONT KNUCKLE (2)

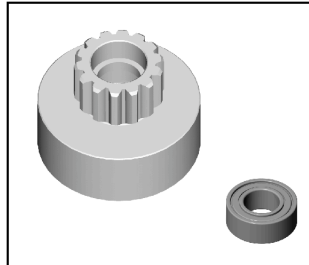

PD0619 1/8 CLUTCH BELL, 26MM 14T

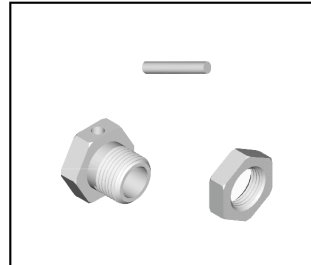

PD0620 17MM HEX WHEEL ADAPTER SET

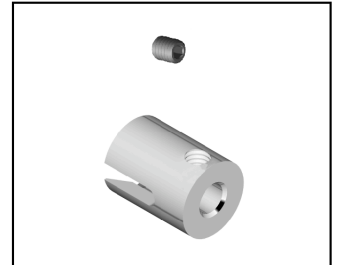

PD0633 DRIVE CUP (2)

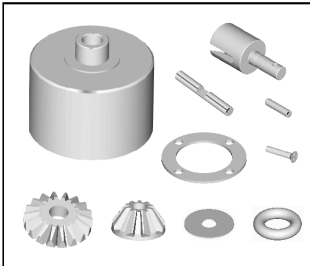

PD0654 CENTER DIFFERENTIAL SET

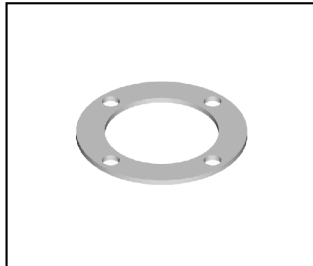

PD0655 DIFF GASKET (10), 0.5MM

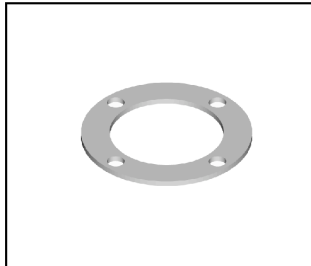

PD0656 DIFF GASKET (10), 0.2MM

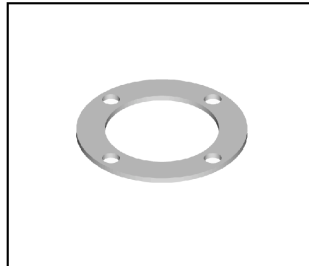

PD0657 DIFF GASKET (10), 0.8MM

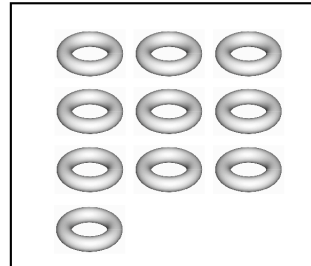

PD0658 O-RINGS (10), 3.2 X 1.4MM

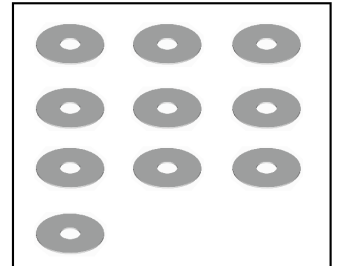

PD0659 WASHER (10), 3.6 X 12 X 0.2MM

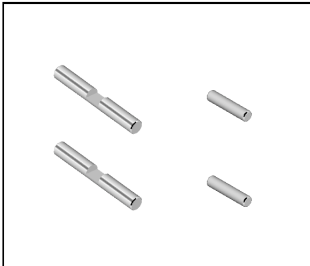

PD0660 DIFF INNER SHAFTS

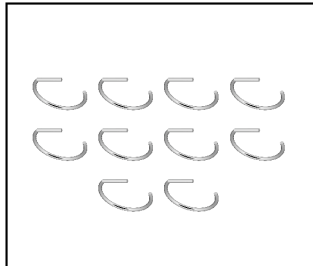

PD0661 G-CLIPS (10), 7MM



PD0662 BALL BEARING (10), SEALED 8x16x5MM

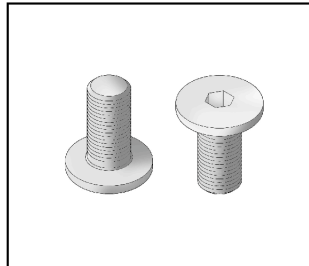

PD0775 FLAT HEAD SOCKET SCREW(10), 5 X 10MM

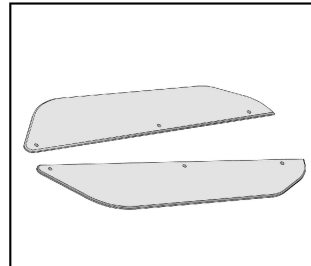

PD0789 FLAT CHASSIS SIDE GUARD



PD0798 SHORT BUMPER

EB-4 S2 PRO SC PARTS LIST

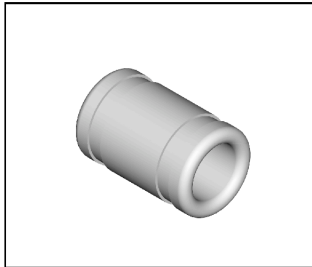

PD0871 TUNED PIPE COUPLER

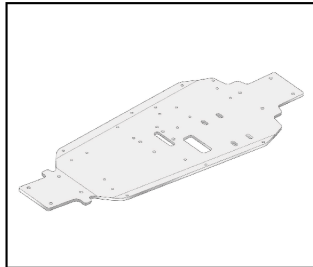

PD1129-R MAIN CHASSIS, TYPE B

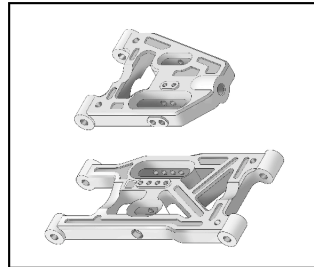

PD1130 LOWER SUSPENSION ARM SET
PD1205 LOWER SUSPENSION ARM SET, COLD TEMP

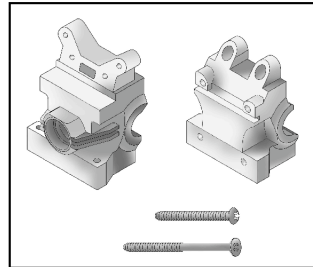

PD1131 TRANS CASE / BULKHEAD

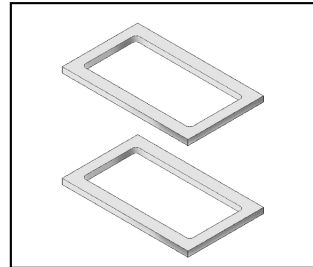

PD1139 CASE / BULKHEAD BOTTOM SEAL

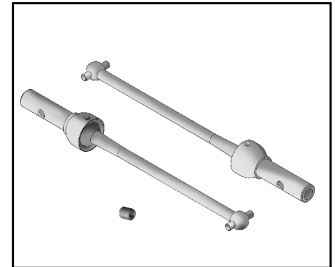

PD1230 BALL UNIVERSAL, FR
PD1231 BALL UNIVERSAL, RR

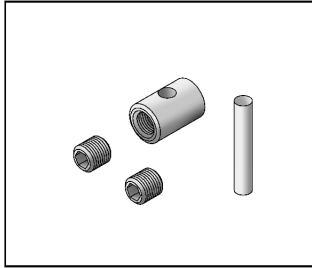

PD1232 BALL UNIVERSAL JOINT

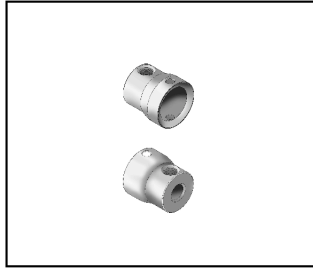

PD1233 BALL UNIVERSAL AXLE, CTR



PD1234 BALL UNIVERSAL AXLE, FR / RR



PD1235 BALL UNIVERSAL BONE, CTR FR
PD1236 BALL UNIVERSAL BONE, CTR RR
PD1237 BALL UNIVERSAL BONE, FR
PD1238 BALL UNIVERSAL BONE, RR

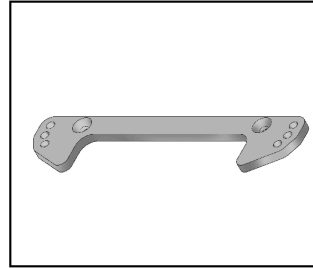

PD1240 -R STEERING SLIDER

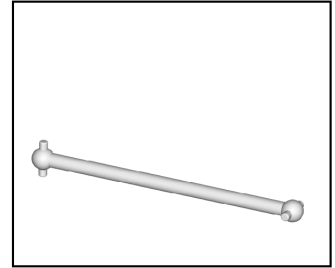

PD1241 CENTER DRIVE SHAFTS, FR / RR

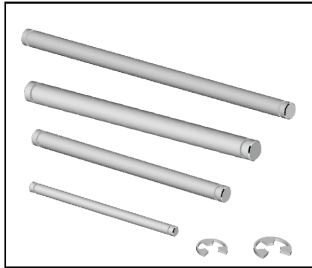

PD1243 HINGE PIN SET

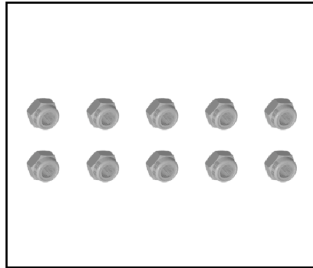

PD1244 LOCK NUT (10), BLACK 3MM

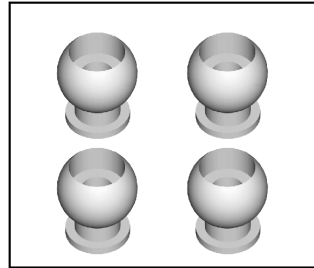

PD1246 FRONT KNUCKLE BALL SET (4)

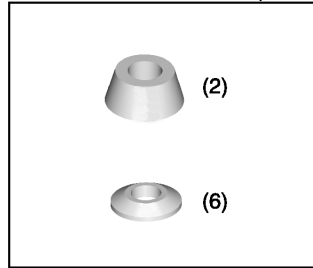

PD1248 WASHER SET

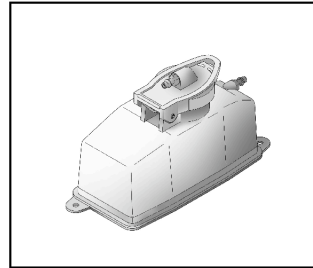

PD1253 FUEL TANK

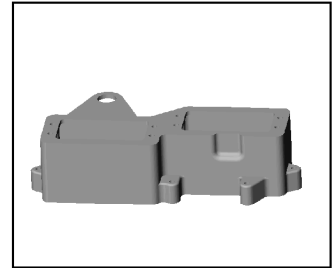

PD1261 PLASTIC SERVO TRAY

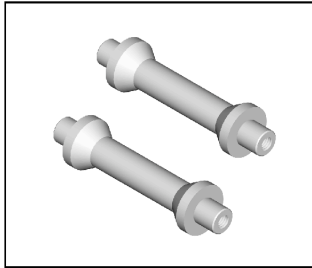

PD1271 WING MOUNT BRACE

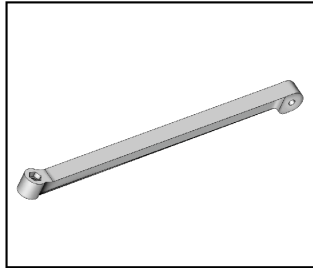

PD1356 RR PLASTIC TORQUE ROD

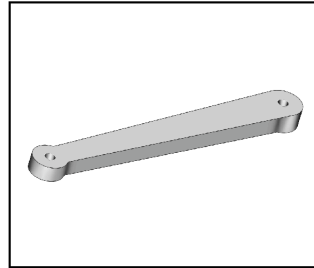

PD1361 FR PLASTIC TORQUE ROD

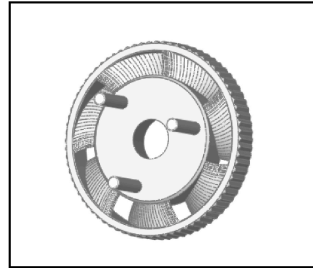

PD1521 1/8 3-SHOE FLYWHEEL

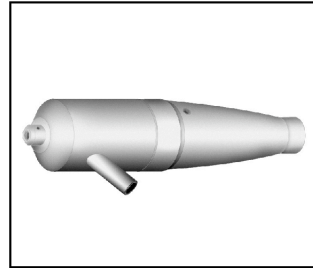

PD1786 1/8 TUNED PIPE



PD1981-O 1/8 5-SPOKE WHEEL, 17mm ORANGE
PD1981-B 1/8 5-SPOKE WHEEL, 17mm BLACK
PD1981-G 1/8 5-SPOKE WHEEL, 17mm GREEN

EB-4 S2 PRO SC PARTS LIST

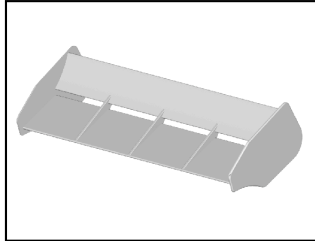

PD1903-O 1/8 REAR WING, ORANGE
 PD1903-B 1/8 REAR WING, BLACK
 PD1903-G 1/8 REAR WING, GREEN



PD6472 1/8 ENGINE MOUNT, PULL START



PD6837 1/8 PRINTED BODY, ORANGE S2
 PD6795 1/8 PRINTED BODY, BLUE S2
 PD6790 1/8 PRINTED BODY, SILVER S2

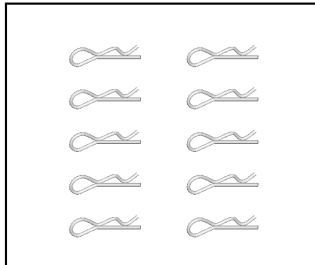

PD0432 1/8 BODY CLIPS (10)

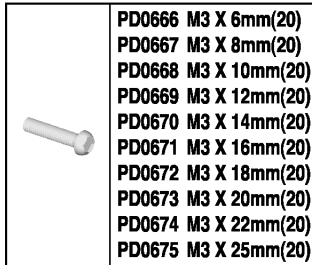

BT MACHINE SCREW

- PD0666 M3 X 6mm(20)
- PD0667 M3 X 8mm(20)
- PD0668 M3 X 10mm(20)
- PD0669 M3 X 12mm(20)
- PD0670 M3 X 14mm(20)
- PD0671 M3 X 16mm(20)
- PD0672 M3 X 18mm(20)
- PD0673 M3 X 20mm(20)
- PD0674 M3 X 22mm(20)
- PD0675 M3 X 25mm(20)

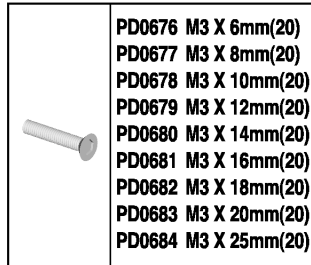

CT MACHINE SCREW

- PD0676 M3 X 6mm(20)
- PD0677 M3 X 8mm(20)
- PD0678 M3 X 10mm(20)
- PD0679 M3 X 12mm(20)
- PD0680 M3 X 14mm(20)
- PD0681 M3 X 16mm(20)
- PD0682 M3 X 18mm(20)
- PD0683 M3 X 20mm(20)
- PD0684 M3 X 25mm(20)

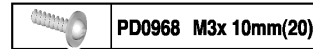

PD0968 M3x 10mm(20)
 BTW PHILLIP TAP SCREW

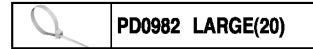

PD0982 LARGE(20)
 NYLON STRAP

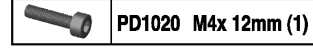

PD1020 M4x 12mm (1)
 SOCKET HEAD MACHINE SCREW

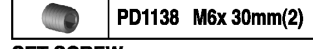

PD1138 M6x 30mm(2)
 SET SCREW

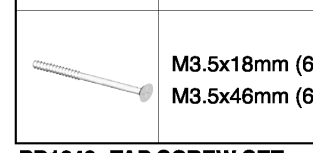
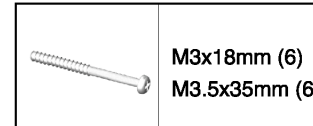

PD1249 TAP SCREW SET

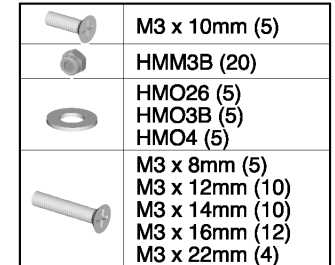

PD1250 HARDWARE SET

- M3 x 10mm (5)
- HMM3B (20)
- HMO26 (5)
- HMO3B (5)
- HMO4 (5)
- M3 x 8mm (5)
- M3 x 12mm (10)
- M3 x 14mm (10)
- M3 x 16mm (12)
- M3 x 22mm (4)

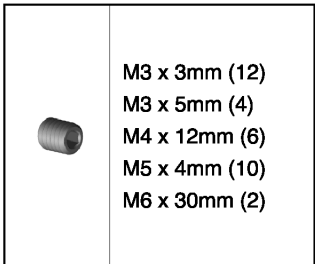

PD1251 SET SCREW SET

- M3 x 3mm (12)
- M3 x 5mm (4)
- M4 x 12mm (6)
- M5 x 4mm (10)
- M6 x 30mm (2)

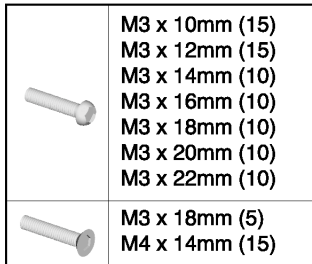

PD1252 HEX SCREW SET

- M3 x 10mm (15)
- M3 x 12mm (15)
- M3 x 14mm (10)
- M3 x 16mm (10)
- M3 x 18mm (10)
- M3 x 20mm (10)
- M3 x 22mm (10)
- M3 x 18mm (5)
- M4 x 14mm (15)



PD1313 SCREW BAG

- M3 x 25mm (6)
- M4 x 14mm (4)
- M4 x 6mm (5)
- M3 x 10mm (5)
- M3 x 12mm (5)
- M35 x 10mm (5)
- M3 x 8mm (5)
- M4 x 25mm (5)

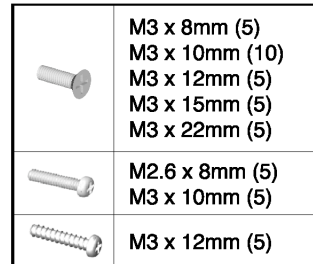

PD1315 CROSS SCREW SET

- M3 x 8mm (5)
- M3 x 10mm (10)
- M3 x 12mm (5)
- M3 x 15mm (5)
- M3 x 22mm (5)
- M2.6 x 8mm (5)
- M3 x 10mm (5)
- M3 x 12mm (5)

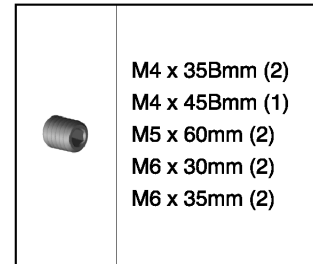

PD1785 SET SCREW SET

- M4 x 35Bmm (2)
- M4 x 45Bmm (1)
- M5 x 60mm (2)
- M6 x 30mm (2)
- M6 x 35mm (2)

EB-4 S2 PRO SC OPTIONAL PARTS LIST

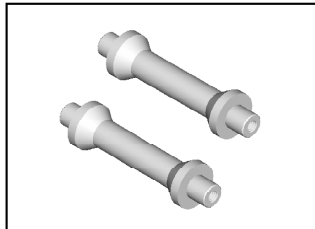

AD2537 WING MOUNT BRACE

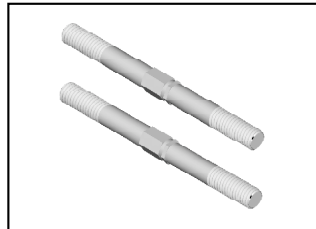

PD0479 TURNBUCKLE (2),
5 X 60MM

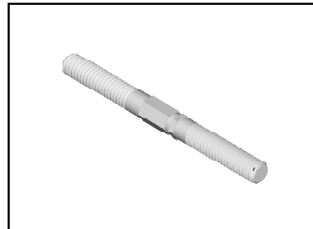

PD0579 TURNBUCKLE (1),
4 x 45MM

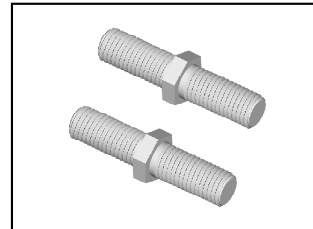

PD0586 TURNBUCKLE (2),
6 x 32MM

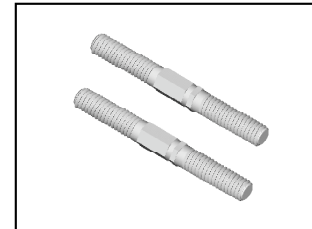

PD0587 TURNBUCKLE (2),
4 x 36MM



PD0748 CARBIDE FR UPPER
ARM PIN



PD0749 CARBIDE RR HUB PIN



PD0573 TORQUE ROD SET,
4x52mm 5x90mm

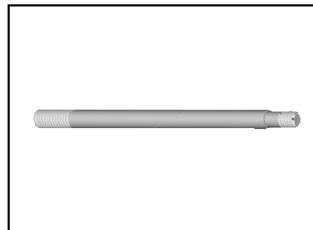

PD1256 CARBIDE SHOCK SHAFT, FR (2)
PD1257 CARBIDE SHOCK SHAFT, RR (2)



PD0780 TITANIUM TURNBUCKLE
5x57MM

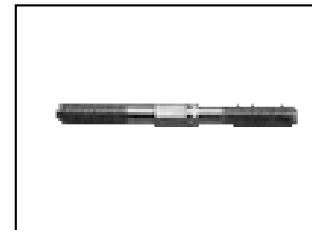

PD0781 TITANIUM TURNBUCKLE
4x45MM

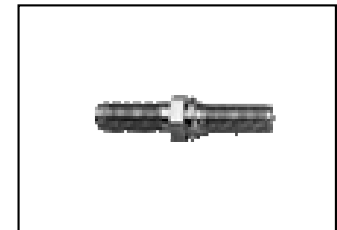

PD0782 TITANIUM TURNBUCKLE
6x32MM

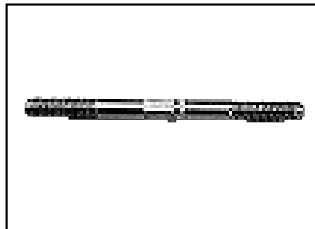

PD0783 TITANIUM TURNBUCKLE 4x52mm
PD1245 TITANIUM TURNBUCKLE 4x36mm

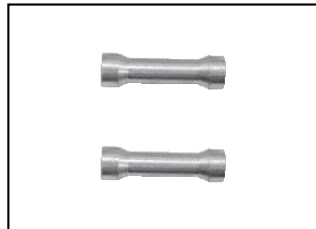

PD0582 ALUMINUM SERVO
TRAY POST

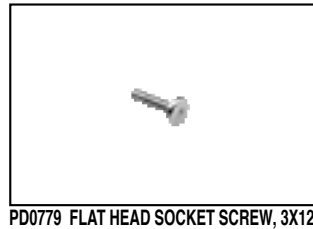

PD0779 FLAT HEAD SOCKET SCREW, 3X12MM
PD0895 FLAT HEAD SOCKET SCREW, 3X8MM
PD1195 FLAT HEAD SOCKET SCREW, 3X5MM

EB-4 S2 PRO SC SPARE PARTS LIST

PART#	DESCRIPTION	NOTE
9708O	AIR FILTER, 21 ORANGE	
9708B	AIR FILTER, 21 BLACK	
9708G	AIR FILTER, 21 GREEN	
AD0287-R	FR SHOCK TOWER	
AD0297-R	SERVO SAVER TOP PLATE	
AD0300-R	CTR DIFF TOP PLATE	
AD0332-R	RR SHOCK TOWER	
AD0343	RR DRIVE SHAFT	

PART#	DESCRIPTION	NOTE
AD2413	PIVOT BALL, 4mm	
AD2435	SERVO SAVER BUSHING	
AD2445	1/8 CLUTCH SPRING (3)	
AD2446	1/8 CLUTCH SHOE (3)	
AD2538	1/8 CLUTCH NUT	
AD2657	METAL MAIN GEAR, 46T	
AJD1112	DECAL	
AR0080	SERVO MOUNT / PLASTIC POST	

PART#	DESCRIPTION	NOTE
AR0095	REAR HUB CARRIER	
AR0097	BODY / WING MOUNT	
PD0225	ANTENNA	
PD0416	BALL BEARING(2), 5X10X4mm	
PD0423	BRAKE CAM / LEVER	
PD0425	CTR RIGID AXLE OUTDRIVE	
PD0432	1/8 BODY CLIPS (10)	
PD0435	REAR AXLE	



EB-4 S2 PRO SC SPARE PARTS LIST

PART#	DESCRIPTION	NOTE
PD0436	SCREW BAG	
PD0546	STANDOFF BALL, SMALL 4mm	
PD0547	STANDOFF BALL, LARGE 4mm	
PD0548	FR/RR DIFFERENTIAL SET	
PD0549	DIFFERENTIAL CASE	
PD0551	THROTTLE / BRAKE HARDWARE	
PD0559	ASSORTED E-CLIPS	
PD0560-T	REAR SHOCK SET	
PD0561-T	FRONT SHOCK SET	
PD0562	SHOCK PLASTIC PARTS	
PD0566	LOWER ARM REAR HINGE PLATES	
PD0567	FR UPPER ARM / MT / END	
PD0569	RX BOX /BATT POST	
PD0570	TIE-END SET	
PD0572	LOWER SHOCK PIN	
PD0574	CTR DIFF MOUNT & SERVO SAVER	
PD0578	DIFF BEVEL & DRIVE GEAR	
PD0581-R	SERVO SAVER METAL PARTS	
PD0584	BRAKE PAD SET	
PD0588-R	FR SUSP PLATE RR TRANS	
PD0590	1/8 TIRE W/ FOAM, CUBIC	
PD0591-T	ALUM SHOCK STANDOFF(4)	
PD0592	PRESSURE FITTING	
PD0593	STEEL BRAKE DISC	
PD0596	FR/RR DIFF OUTDRIVE	
PD0601-R	FR SUSP PLATE FR TRANS	
PD0602	SHOCK DIAPHRAGM(10)	
PD0603	REAR SHOCK SHAFT(2)	
PD0604-T	FRONT ALUM SHOCK BODY(2)	
PD0605-T	REAR ALUM SHOCK BODY(2)	
PD0606-T	SHOCK CAP(2)	
PD0607	ALUM NUT, 17mm	
PD0608	TUNED PIPE WIRE	
PD0609	DIFF INNER GEARS & PARTS	
PD0613	STANDOFF BALL, MEDIUM 4mm	
PD0617	FRONT KNUCKLE	
PD0619	1/8 CLUTCH BELL, 26mm 14T	
PD0620	17mm HEX WHEEL ADAPTER SET	
PD0633	DRIVE CUP	
PD0654	CTR DIFFERENTIAL SET	

PART#	DESCRIPTION	NOTE
PD0655	DIFF GASKET, 0.5mm	
PD0656	DIFF GASKET, 0.2mm	
PD0657	DIFF GASKET, 0.8mm	
PD0658	O-RINGS, 3.2X1.4mm	
PD0659	WASHER, 3.6X12X0.2mm	
PD0660	DIFF INNER SHAFTS	
PD0661	G-CLIPS(10),7mm	
PD0662	BALL BEARING, SEALED 8X16X5mm	
PD0666	BT MACHINE SCREW, 3X6mm	
PD0667	BT MACHINE SCREW, 3X8mm	
PD0668	BT MACHINE SCREW, 3X10mm	
PD0669	BT MACHINE SCREW, 3X12mm	
PD0670	BT MACHINE SCREW, 3X14mm	
PD0671	BT MACHINE SCREW, 3X16mm	
PD0672	BT MACHINE SCREW, 3X18mm	
PD0673	BT MACHINE SCREW, 3X20mm	
PD0674	BT MACHINE SCREW, 3X22mm	
PD0675	BT MACHINE SCREW, 3X25mm	
PD0676	CT MACHINE SCREW, 3X6mm	
PD0677	CT MACHINE SCREW, 3X8mm	
PD0678	CT MACHINE SCREW, 3X10mm	
PD0679	CT MACHINE SCREW, 3X12mm	
PD0680	CT MACHINE SCREW, 3X14mm	
PD0681	CT MACHINE SCREW, 3X16mm	
PD0682	CT MACHINE SCREW, 3X18mm	
PD0683	CT MACHINE SCREW, 3X20mm	
PD0684	CT MACHINE SCREW, 3X25mm	
PD0775	FLAT HEAD SOCKET SCREW, 5X10mm	
PD0789	FLAT CHASSIS SIDE GUARDS	
PD0798	SHORT BUMPER	
PD0800	LEXAN BODY	
PD0871	TUNED PIPE COUPLER T	
PD0968	BTW PHILLIP TAP SCREW, 3X10mm	
PD0982	NYLON STRAP, LARGE	
PD1020	SOCKET HEAD MECHINE SCREW, 4X12mm	
PD1129-R	MAIN CHASSIS, TYPE B	
PD1130	LOWER SUSPENSION ARM SET	
PD1131	TRANS CASE / BULKHEAD	
PD1138	SET SCREW, 6X30mm	
PD1139	CASE / BULKHEAD BOTTOM SEAL	

PART#	DESCRIPTION	NOTE
PD1230	BALL UNIVERSAL, FR	
PD1231	BALL UNIVERSAL, RR	
PD1232	BALL UNIVERSAL JOINT	
PD1233	BALL UNIVERSAL AXLE, CTR	
PD1234	BALL UNIVERSAL AXLE, FR/RR	
PD1235	BALL UNIVERSAL BONE, CTR FR	
PD1236	BALL UNIVERSAL BONE, CTR RR	
PD1237	BALL UNIVERSAL BONE, FR	
PD1238	BALL UNIVERSAL BONE, RR	
PD1240-R	STEERING SLIDER	
PD1241	CENTER DRIVE SHAFTS, FR/RR	
PD1243	HINGE PIN SET	
PD1244	LOCK NUT, BLACK 3mm	
PD1246	FRONT KNUCKLE BALL SET	
PD1248	WASHER SET	
PD1249	TAP SCREW SET	
PD1250	HARDWARE SET	
PD1251	SET SCREW SET	
PD1252	HEX SCREW SET	
PD1253	FUEL TANK	
PD1261	PLASTIC SERVO TRAY	
PD1271	WING MOUNT BRACE,EK S2	
PD1313	SCREW SET, EB S2	
PD1315	CROSS SCREW SET, EB S2	
PD1356	RR PLASTIC TORQUE ROD	
PD1361	FR PLASTIC TORQUE ROD	
PD1521	1/8 3-SHOE FLYWHEEL	
PD1785	SCREW SET	
PD1786	1/8 TUNED PIPE	
PD1903-O	1/8 REAR WING, ORANGE	
PD1903-B	1/8 REAR WING, BLACK	
PD1903-G	1/8 REAR WING, GREEN	
PD6472	ENGINE MOUNT, PS	
PD6790	1/8 PRINTED BODY, SILVER S2	
PD6795	1/8 PRINTED BODY, BLUE S2	
PD6837	1/8 PRINTED BODY, ORANGE S2	



EB-4 S2 PRO SC OPTIONAL PARTS LIST

PART#	DESCRIPTION	NOTE
1165P	FUEL FILTER, 2cc	
1166P	PISTON LOCK TOOL	
9708Y	AIR FILTER 21 YELLOW	
9708P	AIR FILTER 21 PINK	
9708W	AIR FILTER 21 WHITE	
9796	3-CHAMBER TUNED PIPE(L), EFRA 2035	
9796-1	3-CHAMBER TUNED PIPE(L), W/ MANIFOLD EFRA 2035	
9797	3-CHAMBER TUNED PIPE(S), EFRA 2039	
9797-1	3-CHAMBER TUNED PIPE(S), W/ MANIFOLD EFRA 2039	
AD2537	WING MOUNT BRACE	
PD0141	BALL BEARING(2), FLANGE 3X7X3mm	
PD0143	BALL BEARING(2), 5X8X2.5mm	
PD0418	1/8 TUNED PIPE, C2A	
PD0470	1/8 CLUTCH BELL, 15T	
PD0479	TURNBUCKLE (2), 5X60mm	
PD0552	RR SWAY BAR, 2.5mm LT PURPLE	
PD0564	SHOCK PISTON, 1-HOLE	
PD0573	TORQUE ROD SET, 4X52mm / 5X90mm	
PD0576	1/8 REAR WING, YELLOW	
PD0579	TURNBUCKLE(1), 4X45mm	
PD0582	ALUM SERVO TRAY POST	
PD0583	FR SWAY BAR, 2.3mm LT AOUA	
PD0586	TURNBUCKLE(2), 6X32mm	
PD0587	TURNBUCKLE(2), 4X36mm	
PD0610	STEERING SLIDER W/BB	
PD0611	SELF COOLING BRAKE DISK	
PD0612	SERVO SAVER POSTS W/BB	
PD0615	1/8 FR SPRING, 1.5mm YELLOW	
PD0689	1/8 MULTI-SPOKE WHEEL, 17mm WHITE	
PD0748	CARBIDE FR UPPER ARM PIN	
PD0749	CARBIDE RR HUB PIN	
PD0751	1/8 RR SPRING, 1.4mm WHITE	
PD0752	1/8 RR SPRING, 1.6mm BLUE	
PD0753	1/8 FR SPRING, 1.4mm WHITE	
PD0754	1/8 FR SPRING, 1.6mm BLUE	
PD0756	BALL BEARING, FLANGE 5X8X2.5mm	
PD0757	ERGal FR KNUCKLE	
PD0758	ERGal FR UPPER ARM MT	
PD0760	ERGal BATTERY POST	
PD0761	ERGal HEAT-SINK ENGINE MOUNT	

PART#	DESCRIPTION	NOTE
PD0762	ERGal FR PLATE FR TRANS	
PD0763	ERGal RR PLATE FR TRANS	
PD0766	ERGal FR PLATE RR TRANS	
PD0767	ERGal RR TOE-IN BLOCK, 2°	
PD0769	ERGal RR TOE-IN BLOCK, 3°	
PD0770	CARBON SERVO TRAY	
PD0771	CARBON BATT PLATE	
PD0772	ERGal SERVO SAVER TOP PLATE	
PD0776	FR SWAY BAR,2.6mm PINK	
PD0777	RR SWAY BAR,2.7mm LT BLUE	
PD0778	RR SWAY BAR,3.0mm LT GREEN	
PD0779	FLAT HEAD SOCKET SCREW 3X12mm	
PD0780	TITANIUM TURNBUCKLE 5X57mm	
PD0781	TITANIUM TURNBUCKLE 4X45mm	
PD0782	TITANIUM TURNBUCKLE 6X32mm	
PD0783	TITANIUM TURNBUCKLE 4X52mm	
PD0784	TITANIUM TURNBUCKLE 5X90mm	
PD0785	ERGal FRONT SHOCK TOWER	
PD0786	ERGal RR SHOCK TOWER	
PD0787	ERGal DECOMPOSABLE CENTER DIFF MOUNT	
PD0790	1/8 SHOCK BOOT, SHORT	
PD1903-Y	1/8 REAR WING, YELLOW	
PD1903-P	1/8 REAR WING, PINK	
PD1903-W	1/8 REAR WING, WHITE	
PD0895	FLAT HEAD SOCKET SCREW, 3X8mm	
PD0996	1/8 3-SHOE CLUTCH, TYPE A	
PD0998	1/8 4-SHOE CLUTCH, TYPE A	
PD1000	1/8 CLUTCH NUT ONLY, TYPE A	
PD1195	FLAT HEAD SOCKET SCREW, 3X5mm	
PD1203	CARBIDE LOWER ARM PIN	
PD1215	1/8 3 CLUTCH SHOE & SPRING ONLY, TYPE A	
PD1218	1/8 4 CLUTCH SHOE & SPRING ONLY, TYPE A	
PD1228	BALL UNIVERSAL, CTR FR	
PD1229	BALL UNIVERSAL, CTR RR	
PD1230	BALL UNIVERSAL, FR	
PD1231	BALL UNIVERSAL, RR	
PD1239	FRONT KNUCKLE BALL W/CONE RETAINER	
PD1242	1/8 CLUTCH BELL, 13T	
PD1245	TIANIUM TURNBUCKLE, 4X36mm	
PD1247	ERGal LITE CHASSIS, TYPE B	

PART#	DESCRIPTION	NOTE
PD1256	CARBIDE SHOCK SHAFT, FR	
PD1257	CARBIDE SHOCK SHAFT, RR	
PD1946-W	5-SPOKE WHL,17mm 1/8(W)	
PD1946-Y	5-SPOKE WHL,17mm 1/8(Y)	
PD1946-B	5-SPOKE WHL,17mm 1/8(B)	
PD1946-G	5-SPOKE WHL,17mm 1/8(G)	
PD1946-P	5-SPOKE WHL,17mm 1/8(P)	
PD1946-O	5-SPOKE WHL,17mm 1/8(O)	
PD1981-W	MULTI-SPOKE WHL, WHITE, 1/8	
PD1981-P	MULTI-SPOKE WHL, PINK, 1/8	
PD1981-Y	MULTI-SPOKE WHL, YELLOW, 1/8	
PD6602-Y	VELOCITY WHEEL (2), YELLOW, 1/8	
PD6602-W	VELOCITY WHEEL (2), WHITE, 1/8	
PD6602-B	VELOCITY WHEEL (2), BLACK, 1/8	
PD6602-G	VELOCITY WHEEL (2), GREEN, 1/8	
PD6602-P	VELOCITY WHEEL (2), PINK, 1/8	
PD6602-O	VELOCITY WHEEL (2), ORANGE, 1/8	

EB-4 S2 PRO SC OPTIONAL PARTS LIST

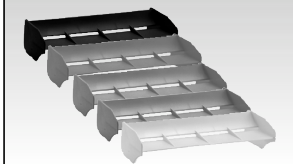

PD1903-Y REAR WING, YELLOW, 1/8
 PD1903-P REAR WING, PINK, 1/8
 PD1903-W REAR WING, WHITE, 1/8



PD1946-Y 5-SPOKE WHL, 17mm YELLOW, 1/8
 PD1946-B 5-SPOKE WHL, 17mm BLACK, 1/8
 PD1946-G 5-SPOKE WHL, 17mm GREEN, 1/8
 PD1946-P 5-SPOKE WHL, 17mm PINK, 1/8
 PD1946-O 5-SPOKE WHL, 17mm ORANGE, 1/8

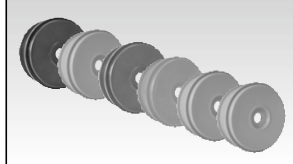

PD6602-Y VELOCITY WHL, YELLOW, 1/8
 PD6602-W VELOCITY WHL, WHITE, 1/8
 PD6602-B VELOCITY WHL, BLACK, 1/8
 PD6602-G VELOCITY WHL, GREEN, 1/8
 PD6602-P VELOCITY WHL, PINK, 1/8
 PD6602-O VELOCITY WHL, ORANGE, 1/8



9708P AIR FILTER .21 PINK
 9708W AIR FILTER .21 WHITE
 9708Y AIR FILTER .21 YELLOW



PD1981-W MULTI-SPOKE WHL, WHITE, 1/8
 PD1981-Y MULTI-SPOKE WHL, YELLOW, 1/8
 PD1981-P MULTI-SPOKE WHL, PINK, 1/8



9796 3-CHAMBER TUNED PIPE(L), EFRA 2035
 9796-1 3-CHAMBER TUNED PIPE(L),
 W/ MANIFOLD EFRA 2035



9797 3-CHAMBER TUNED PIPE(S), EFRA 2039
 9797-1 3-CHAMBER TUNED PIPE(S),
 W/ MANIFOLD EFRA 2039



PD0141 BALL BEARING, FLANGE 3x7x3MM
 PD0143 BALL BEARING, 5x8x2.5MM
 PD0756 BALL BEARING, FLANGE 5x8x2.5MM



PD0470 1/8 CLUTCH BALL, 15T
 PD1242 1/8 CLUTCH BALL, 13T

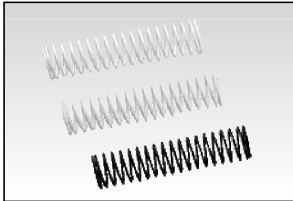

PD0614 1/8 RR SPRING, 1.5MM YELLOW
 PD0751 1/8 RR SPRING, 1.4MM WHITE
 PD0752 1/8 RR SPRING, 1.6MM BLUE

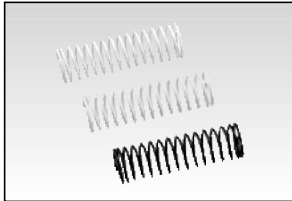

PD0615 1/8 FR SPRING, 1.5MM YELLOW
 PD0753 1/8 FR SPRING, 1.4MM WHITE
 PD0754 1/8 FR SPRING, 1.6MM BLUE



PD0611 SELF COOLING
 BRAKE DISK



PD1228 CENTER BALL UNIVERSAL, FR
 PD1229 CENTER BALL UNIVERSAL, RR



PD1203 CARBIDE LOWER
 ARM PIN



PD1230 BALL UNIVERSAL, FR
 PD1231 BALL UNIVERSAL, RR



PD0784 TITANIUM TURNBUCKLE
 5X90MM

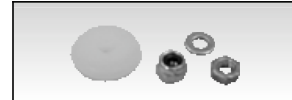

PD0564 SHOCK PISTON(4),
 1-HOLE



PD1239 FRONT KNUCKLE BALL
 W/ CONE RETAINER SET (4)

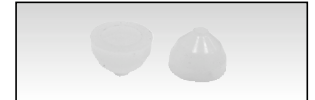

PD0790 1/8 SHOCK BOOT,
 SHORT



PD0552 RR SWAY BAR, 2.5MM LT PURPLE
 PD0777 RR SWAY BAR, 2.7MM LT BLUE
 PD0778 RR SWAY BAR, 3.0MM LT GREEN



PD0583 FR SWAY BAR, 2.3MM LT AQUA
 PD0776 FR SWAY BAR, 2.6MM PINK

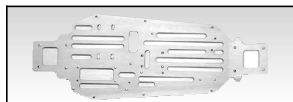

PD1247 ERGAL LITE CHASSIS,
 TYPE B

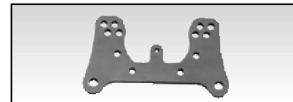

PD0785 ERGAL FR
 SHOCK TOWER

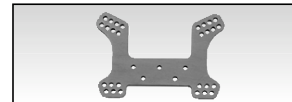

PD0786 ERGAL RR
 SHOCK TOWER

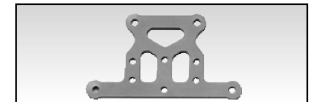

PD0772 ERGAL SERVO SAVER
 TOP PLATE

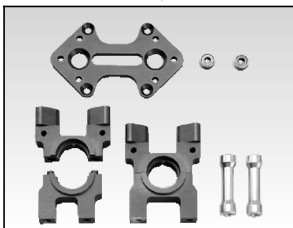

PD0787 ERGAL DECOMPOSABLE
 CENTER DIFF. MOUNT



PD0762 ERGAL FR PLATE
 FR TRANS



PD0763 ERGAL RR PLATE
 FR TRANS



PD0766 ERGAL FR PLATE
 RR TRANS



PD0767 ERGAL RR TOE-IN BLOCK, 2°
 PD0769 ERGAL RR TOE-IN BLOCK, 3°



PD0610 STEERING SLIDER W/BB



1165P FUEL FILTER, 2CC.

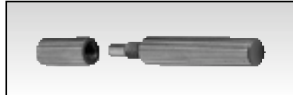

1166P PISTON LOCK TOOL



PD0757 ERGAL FR KNUCKLE



PD0612 SERVO SAVER
 POSTS W/BB



PD0758 ERGAL FR UPPER
 ARM MT



PD0770 CARBON SERVO TRAY



PD0771 CARBON BATT PLATE



PD0761 ERGAL HEAT-SINK
 ENGINE MOUNT

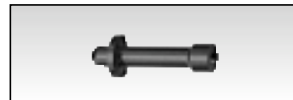

PD0760 ERGAL BATTERY POST



PD0996 1/8 3-SHOE CLUTCH, TYPE A
 PD1215 1/8 3 CLUTCH SHOE & SPR ONLY
 , TYPE A



PD0998 1/8 4-SHOE CLUTCH, TYPE A
 PD1000 1/8 CLUTCH NUT, ONLY TYPE A
 PD1218 1/8 4 CLUTCH SHOE & SPR,
 ONLY TYPE A

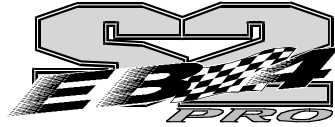

1/8 4WD OFF-ROAD PRO VERSION COMPETITION BUGGY

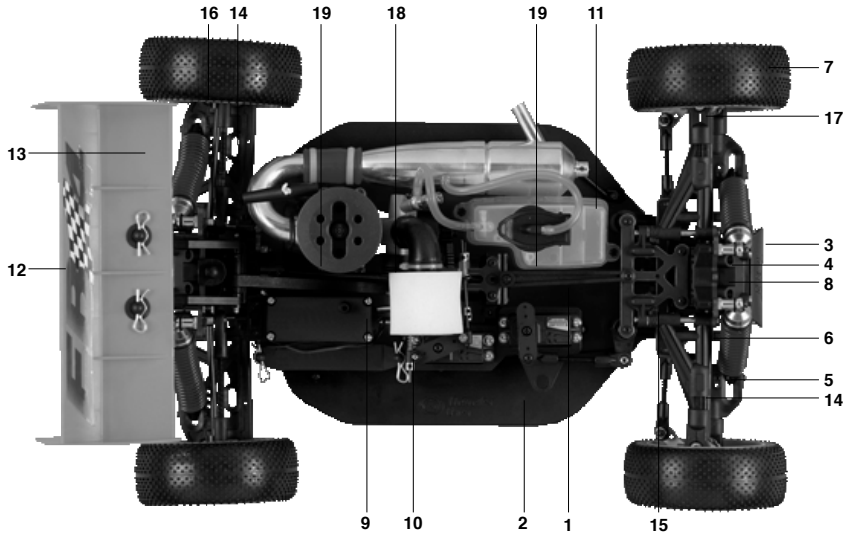

- 1) Rigid, narrow chassis with front and side kick-up
 - 2) Flat chassis side guards
 - 3) Short bumper
 - 4) Small transmission case with bottom seal
 - 5) Narrow, light weight suspension arms
 - 6) Improved front upper arms
 - 7) High performance rubber tire
 - 8) Durable differentials
 - 9) Sealed, large receiver box
 - 10) Quick change receiver battery clip
 - 11) 125cc, low CG fuel tank
 - 12) Adjustable rear toe-in plates
 - 13) Adjustable rear wing
 - 14) Adjustable front/ rear camber
 - 15) Adjustable front caster
 - 16) Adjustable wheelbase
 - 17) Front ball type universal drive shaft
 - 18) Shaft driven 4WD drivetrain
 - 19) Front and rear chassis stiffeners
- Includes ventilated flywheel, 3 shoe clutch, and 14T bell (not pictured) all aluminum parts are red anodized

Specification:

Wheel Base:	Adjustable from 315mm to 320mm
Front Track Width:	Adjustable from 295mm to 305mm
Rear Track Width:	300mm
Front Kick-Up:	5°
Front Caster:	adjustable from 18° to 25°
Rear Anti-Dive:	2°
Rear Toe-In:	1°, 2°, or 2.5°
Weight:	3100g w/ engine, tuned pipe, servos



ACCESSORIES RECOMMENDED



Super Torque Digital Servo

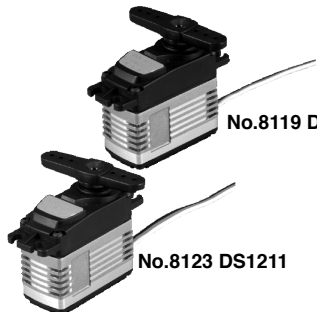

No.8119 DS1013

No.8123 DS1211



Glow Starters

- No.2150 1.8AH Long Glow Starter w/110V 2P
- No.2151 1.8AH Long Glow Starter w/230V 2P
- No.2152 1.8AH Long Glow Starter w/230V 3P



- No.1261
600cc Fuel Bottle
- No.1266
300cc Fuel Bottle

No.9477 PRO-28BX-R

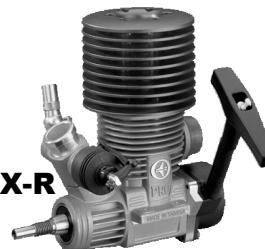

No.1116 5-Way Wrench



No.2409



No.1103 Hex Driver Set

PRO Starter box

