

BR-6478Gn

User Manual

03-2012 / v1.0



COPYRIGHT

Copyright © Edimax Technology Co., Ltd. all rights reserved. No part of this publication may be reproduced, transmitted, transcribed, stored in a retrieval system, or translated into any language or computer language, in any form or by any means, electronic, mechanical, magnetic, optical, chemical, manual or otherwise, without the prior written permission from Edimax Technology Co., Ltd.

Edimax Technology Co., Ltd. makes no representations or warranties, either expressed or implied, with respect to the contents hereof and specifically disclaims any warranties, merchantability, or fitness for any particular purpose. Any software described in this manual is sold or licensed as is. Should the programs prove defective following their purchase, the buyer (and not this company, its distributor, or its dealer) assumes the entire cost of all necessary servicing, repair, and any incidental or consequential damages resulting from any defect in the software. Edimax Technology Co., Ltd. reserves the right to revise this publication and to make changes from time to time in the contents hereof without the obligation to notify any person of such revision or changes.

The product you have purchased and the setup screen may appear slightly different from those shown in this QIG. For more information about this product, please refer to the user manual on the CD-ROM. The software and specifications are subject to change without notice. Please visit our website www.edimax.com for updates. All brand and product names mentioned in this manual are trademarks and/or registered trademarks of their respective holders.

Notice According to GNU General Public License Version 2

This product includes software that is subject to the GNU General Public License version 2. The program is free software and distributed without any warranty of the author. We offer, valid for at least three years, to give you, for a charge no more than the costs of physically performing source distribution, a complete machine-readable copy of the corresponding source code.

The GNU GPL and GNU LGPL software codes used in Edimax products are distributed without any warranty and are subject to the copyrights of their respective authors. The firmware files for this product can be found under the “Download” page at the Edimax website (www.edimax.com).

CONTENTS

CHAPTER I: PRODUCT INFORMATION	4
1-1 Package Contents	4
1-2 Getting Familiar with Your New Wireless Broadband Router	4
CHAPTER II: SYSTEM AND NETWORK SETUP	6
2-1 Establishing a Network Connection.....	6
2-2 Setting Client Computers to Obtain IP Addresses Automatically.....	7
2-2-1 Windows 95/98/Me IP Address Setup	7
2-2-2 Windows 2000 IP Address Setup.....	8
2-2-3 Windows XP IP Address Setup.....	9
2-2-4 Windows Vista IP Address Setup.....	10
2-3 Connecting to Broadband Router via Web Browser	12
2-4 Using “iQ Setup”	15
2-5 Using “iQoS”	19
CHAPTER III: GENERAL SETUP	21
3-1 System.....	21
3-1-1 Time Zone	22
3-1-2 Password Settings.....	23
3-1-3 Remote Management.....	24
3-2 WAN.....	24
3-2-1 Dynamic IP.....	25
3-2-2 Static IP	26
3-2-3 PPPoE.....	27
3-2-4 PPTP.....	29
3-2-5 L2TP	31
3-2-6 WISP.....	34
3-3 LAN.....	35
3-3-1 LAN IP.....	35
3-3-2 DHCP Server.....	36
3-3-3 Static DHCP Leases	36
3-4 Wireless	38
3-4-1 Wireless Settings	38
3-4-1-1 AP Mode.....	39
3-4-1-2 Station-Infrastructure	40
3-4-1-3 AP Bridge—Point to Point	42
3-4-1-4 AP Bridge—Point to Multi-Point	43
3-4-1-5 AP Bridge—WDS.....	44
3-4-1-6 Universal Repeater	46
3-4-2 Security Settings	48
3-4-2-1 Disabled.....	48
3-4-2-2 WEP	48

3-4-2-3 WPA Pre-Shared Key	49
3-4-2-4 WPA RADIUS.....	50
3-4-3 MAC Address Filtering	51
3-4-4 WPS (Wi-Fi Protected Setup) Settings.....	52
3-5 Advanced Settings	53
3-5-1 QoS	54
3-5-2 DDNS.....	56
3-5-3 Port Forwarding.....	58
3-5-4 DMZ	59
3-6 NAT	60
3-6-1 Virtual Server.....	60
3-6-2 Special Applications.....	62
3-6-3 UPnP Settings	63
3-6-4 ALG Settings.....	63
3-6-5 Static Routing.....	64
3-7 Firewall.....	65
3-7-1 Access Control	66
3-7-2 URL Blocking	68
3-7-3 DoS.....	69
3-8 Parental Control.....	71
CHAPTER IV: STATUS, TOOLS & LANGUAGE	73
4-1 Status	73
4-1-1 Internet Connection	73
4-1-2 Device Status	73
4-1-3 System Log.....	74
4-1-4 Security Log	74
4-1-5 Active DHCP Client.....	75
4-1-6 Statistics.....	75
4-2 Tools.....	75
4-2-1 Configuration Tools	76
4-2-2 Firmware Upgrade.....	77
4-2-3 Restart	77
4-3 Language.....	78

CHAPTER I: PRODUCT INFORMATION

1-1 Package Contents



Before you start using this router, please check if there is anything missing in the package, and contact your dealer to claim the missing item(s):

- Broadband router (1 pcs)
- Quick installation guide (1 pcs)
- 3dBi antenna (2 pcs)
- CD with multi-language QIG and user manual (1 pcs)
- 12V DC power adapter (1 pcs)
- Ethernet cable (1 pcs)
- Power adapter (1 pcs)
- Vertical stand (1 pcs)
- Accessory kit (1 pcs)

1-2 Getting Familiar with Your New Wireless Broadband Router

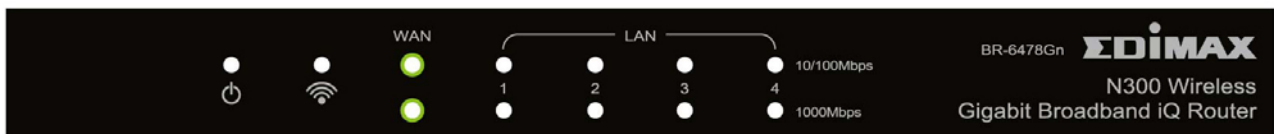
Front Panel



LED Name	Light Status	Description
PWR 	On	Router switched on and correctly powered
	Off	Router not powered or not correctly powered
Wireless 	On	Wireless connectivity activated
	Off	Wireless connectivity not activated
	Flashing	Wireless LAN activity (transferring data)
WAN	On	WAN port connected
	Off	WAN port not connected
	Flashing	WAN activity (transferring data)
LAN (1-4)	On	LAN port connected
	Off	LAN port not connected
	Flashing	LAN activity (transferring data)

Back Panel

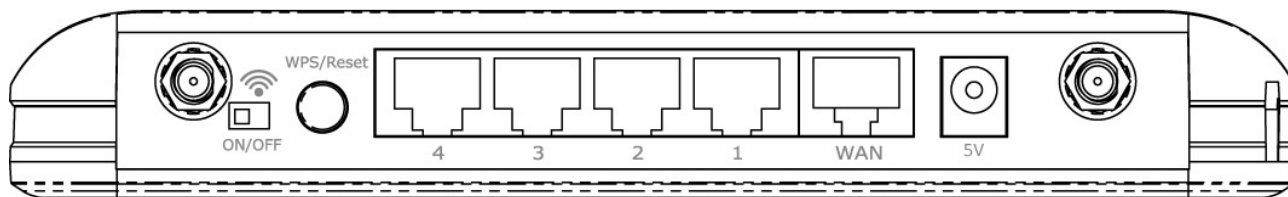

Item Name	Description
Antenna connector(s)	Connects to the supplied antenna(s)
Wi-Fi on/off switch	Switches on/off the Wi-Fi signal
WPS/Reset Button	Resets the router to factory default settings or starts WPS function (press this button and hold for 20 seconds to clear all settings or press this button for 2-5 seconds to activate WPS function)
1-4 (LAN Ports)	Connects to computer or other web devices
WAN Port	Connects to cable/xDSL modems
Power Connector	Connects to the supplied power adapter

CHAPTER II: SYSTEM AND NETWORK SETUP

2-1 Establishing a Network Connection

Please follow the following instructions to build a network connection between your new broadband router, computers, and other network devices:

1. Connect your xDSL or cable modem to the router's "WAN" port with an Ethernet cable.

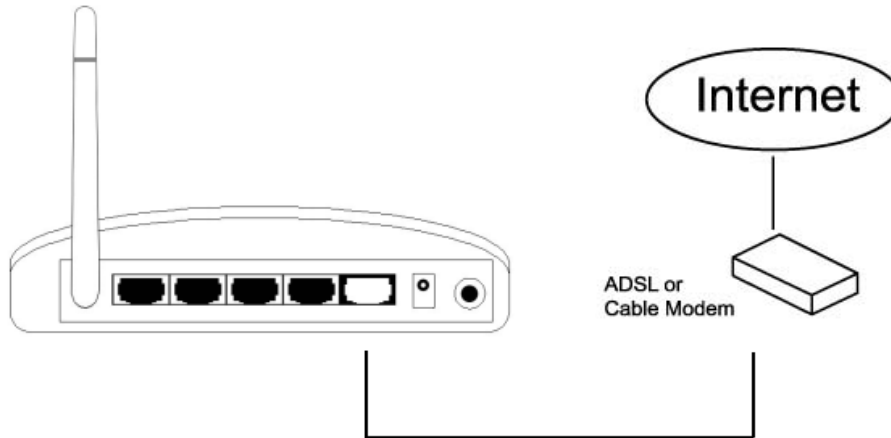

2. Connect your computer to one of the router's "LAN" ports with an Ethernet cable.

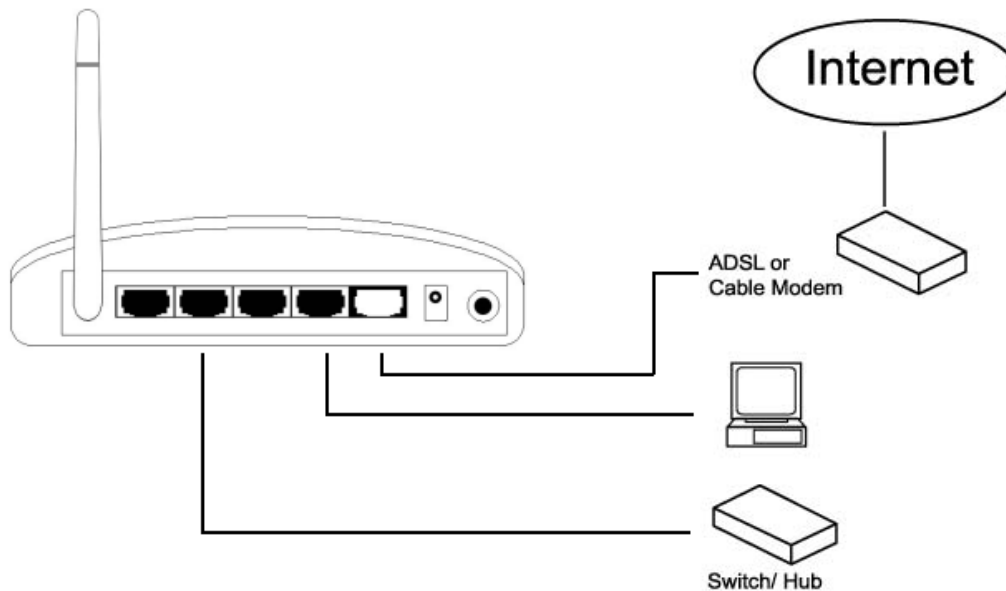

3. Connect the power adapter to the wall socket, and then connect it to the "12V" socket on the back panel of the router.

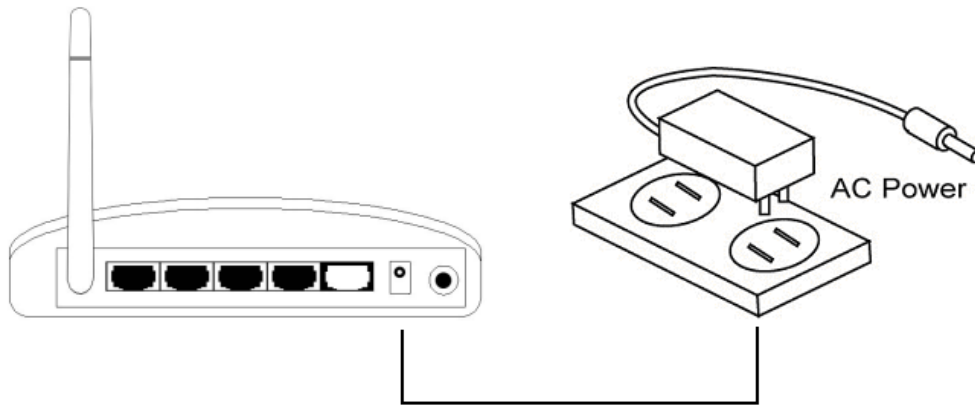

4. Please check all the LEDs on the front panel. The “PWR” and “WAN” LEDs should be on. The “LAN” LED should be on if the computer is connected and correctly powered. If you encounter any problems, please make sure that all your devices are connected and powered correctly.

2-2 Setting Client Computers to Obtain IP Addresses Automatically

Before you start configuration procedures, your computer must be able to get an IP address automatically (set to use dynamic IP addresses). If your computer is set to use a static IP address, or if you are unsure, please follow the following instructions to configure your computer to use dynamic IP addresses:

- Windows 95/98/Me (see section 2-2-1)
- Windows 2000 (see section 2-2-2)
- Windows XP (see section 2-2-3)
- Windows Vista (see section 2-2-4)

2-2-1 Windows 95/98/Me IP Address Setup

1. Click the “Start” button (it should be located at the lower-left corner of your screen), then click “Control Panel”. Double-click the “Network” icon, and the “Network” window will appear. Select “TCP/IP”, and then click “Properties”.

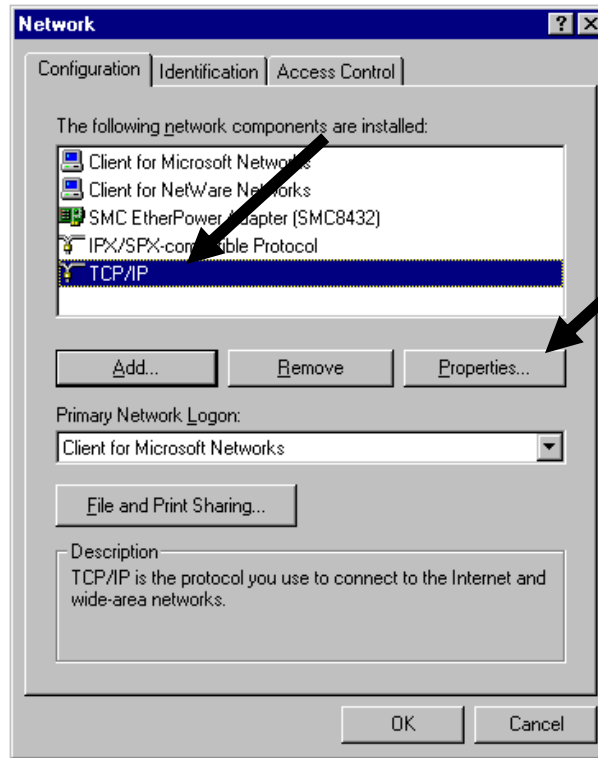

2. Select “Obtain an IP address from a DHCP server”, then click “OK”.

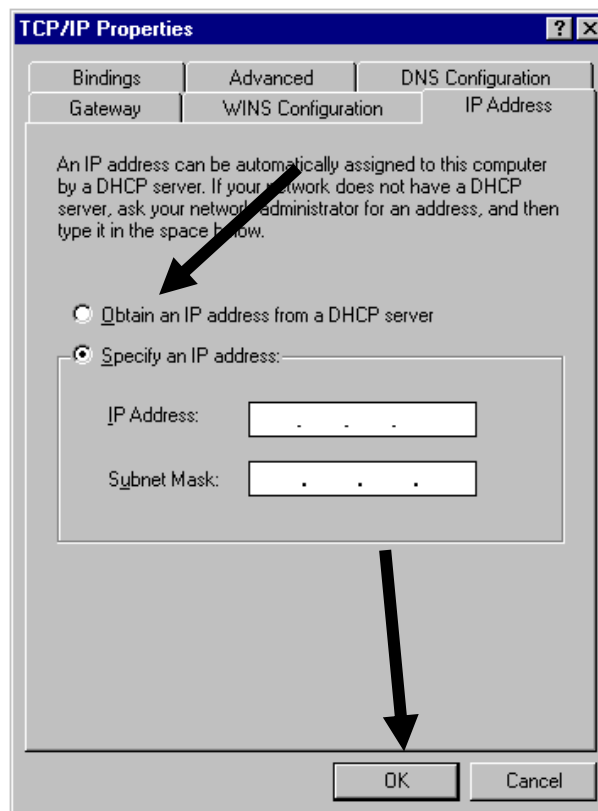

2-2-2 Windows 2000 IP Address Setup

1. Click the “Start” button (it should be located at the lower-left corner of your screen), then click “Control Panel”. Double-click the “Network and Dial-up Connections” icon, and then double-click “Local Area Connection”. When the

“Local Area Connection Properties” window appears, select “Internet Protocol (TCP/IP)”, and then click “Properties”.

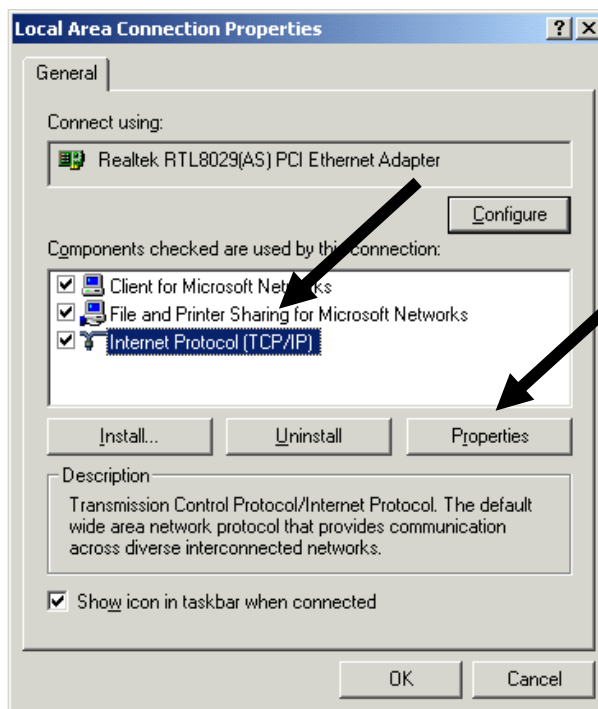

2. Select “Obtain an IP address automatically” and “Obtain DNS server address automatically”, then click “OK”.

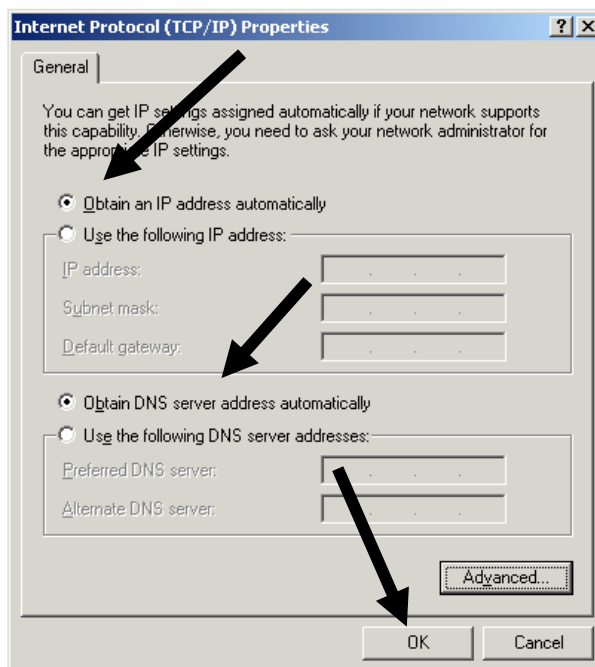

2-2-3 Windows XP IP Address Setup

1. Click the “Start” button (it should be located at the lower-left corner of your screen), then click “Control Panel”. Double-click the “Network and Internet Connections” icon, click “Network Connections”, then double-click “Local Area

Connection". When the "Local Area Connection Properties" window appears, click "Properties".

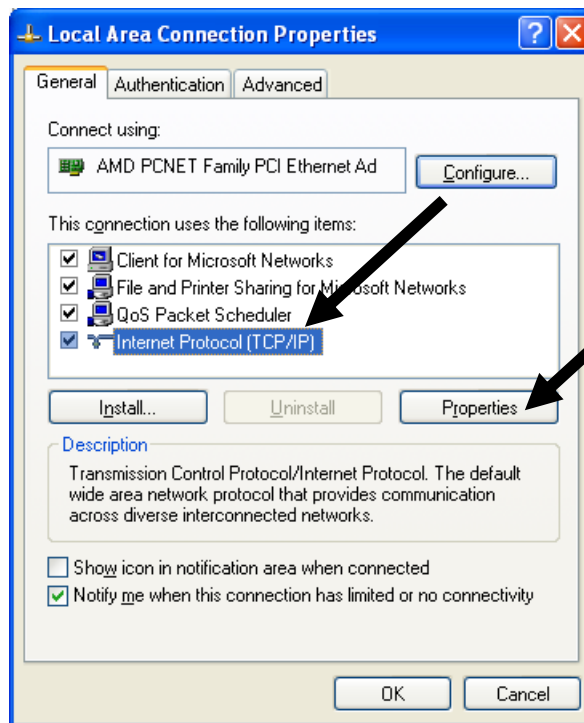

2. Select "Obtain an IP address automatically" and "Obtain DNS server address automatically", then click "OK".

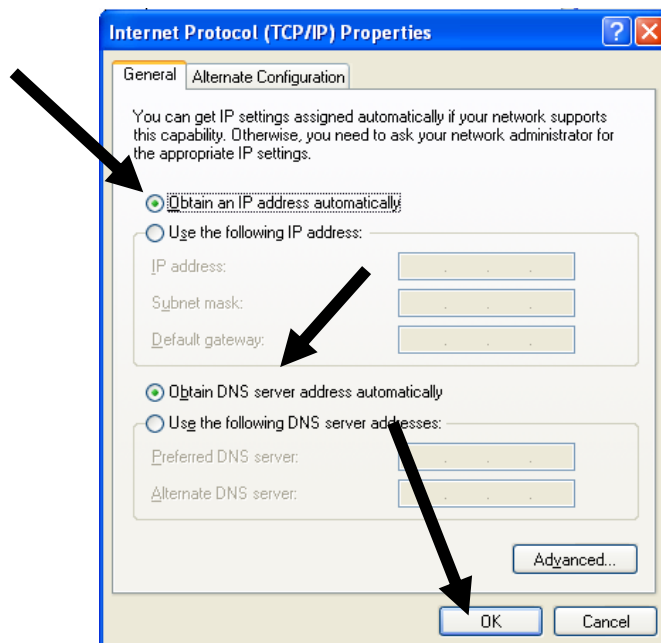

2-2-4 Windows Vista IP Address Setup

1. Click the "Start" button (it should be located at the lower-left corner of your screen), then click "Control Panel". Click "View Network Status and Tasks", and then click "Manage Network Connections". Right-click "Local Area Network", then

select “Properties”. When the “Local Area Connection Properties” window appears, select “Internet Protocol Version 4 (TCP/IPv4)” and then click “Properties”.

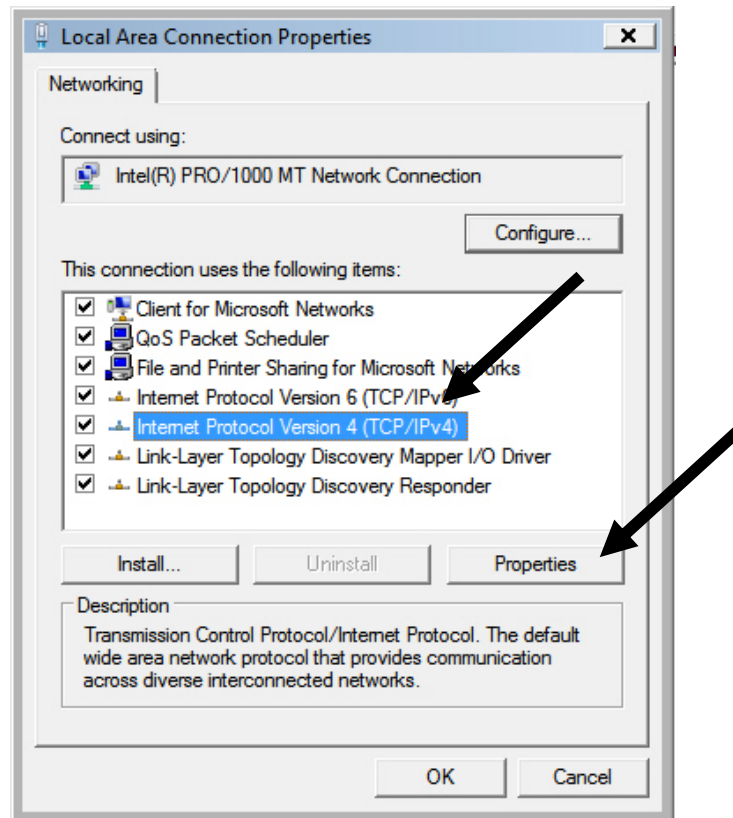

2. Select “Obtain an IP address automatically” and “Obtain DNS server address automatically”, then click “OK”.

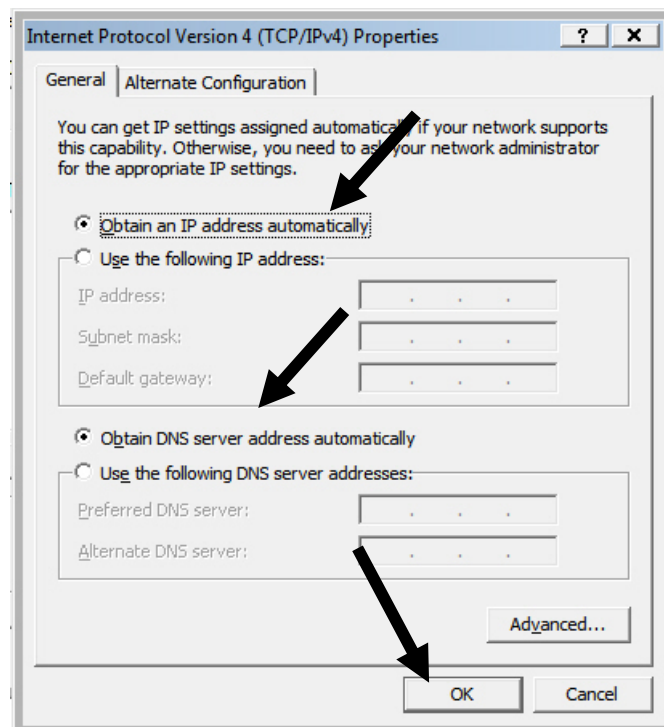

2-3 Connecting to Broadband Router via Web Browser

You can access the broadband router's web-based configuration interface via any connected computer with a web browser (Internet Explorer 5.x or above, Firefox, Opera, or Safari).

1. Please input "192.168.2.1" in the web browser's address bar and press "Enter".

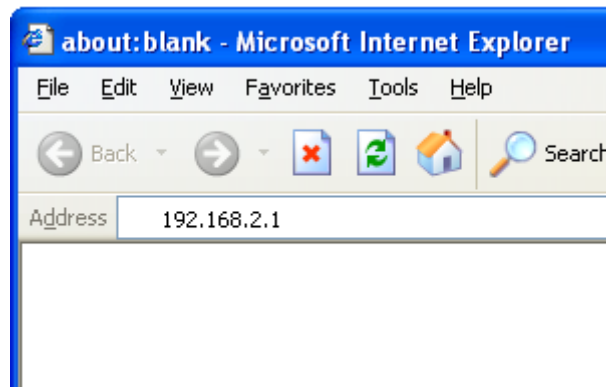

2. You should see the following authentication window:



NOTE: If you cannot access the broadband router's web-based configuration interface, the IP address you have inputted may be incorrect. If you have previously changed the router's IP address, please input the one you have designated.

3. Please input "admin" in the "Username" field and "1234" in the "Password" field. Click the "OK" button to enter the web configuration interface.

4. The first page you see after logging in is “Home”. You can see all the current settings and other system information here.

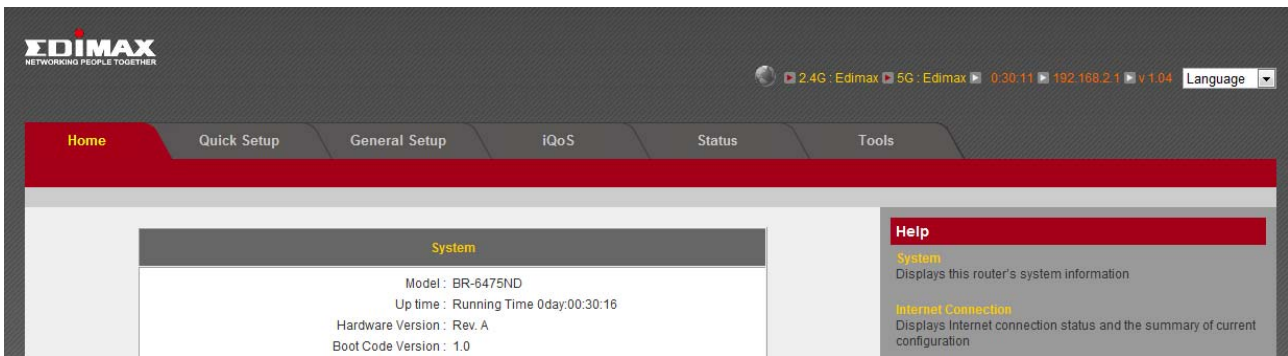

System

Model	Displays this broadband router’s model name (useful when you need technical service)
Up Time	Displays the amount of time this router has been switched on
Hardware Version	Displays this broadband router’s hardware version (useful when you need technical service)
Boot Code Version	Displays this broadband router’s boot code version (useful when you need technical service)
Runtime Code Version	Displays this broadband router’s runtime code version (useful when you need technical service)

Internet Connection

IP Address Mode	Displays how this broadband router currently obtains IP addresses
IP Address	Displays the IP address of the WAN connection
Subnet Mask	Displays the subnet mask of the WAN connection
Default Gateway	Displays the IP address of the WAN connection’s default gateway
MAC Address	Displays the physical address of the WAN port
Primary DNS	Displays the IP address of the first DNS server
Secondary DNS	Displays the IP address of the second (backup) DNS server

Wireless Configuration

Mode	Displays the operation mode of the wireless access point
ESSID	Displays the name of the access point
Channel Number	Displays the channel number of the wireless network

Security	Displays the security authentication mode of the access point
----------	---

LAN Connection

IP Address	Displays the IP address of the LAN connection
Subnet Mask	Displays the subnet mask of the LAN connection
DHCP Server	Displays the status of the internal DHCP server
MAC Address	Displays the physical address of the LAN port

The SSID, the up time, the IP address of the LAN connection, and the runtime code is always displayed on the top of the webpage.

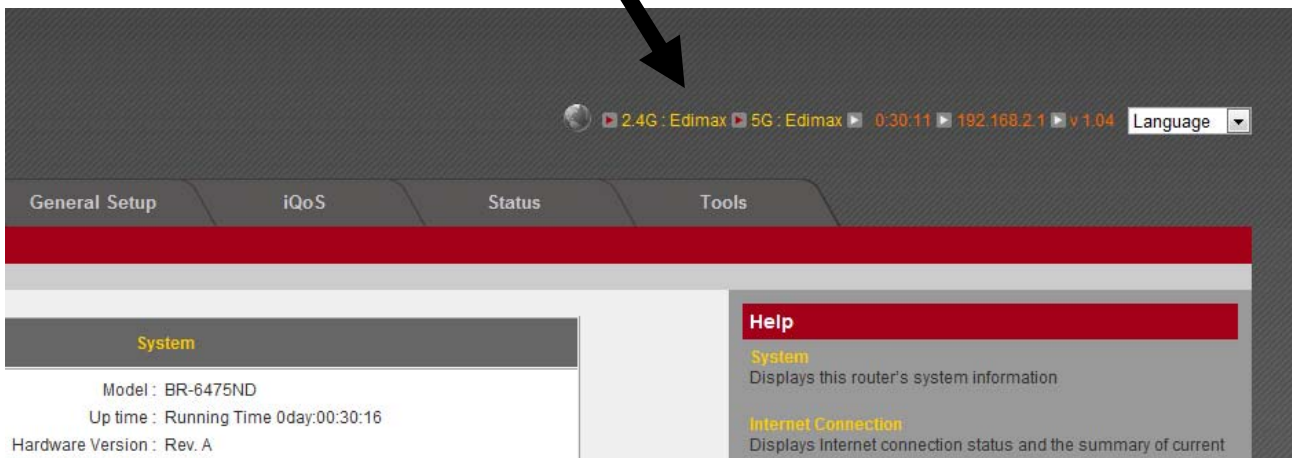

If this router's DHCP server function is enabled, please follow the following instructions to find this router's IP address:

1. Click the "Start" button, then click "Run".



2. Input “cmd”, and then click “OK”.

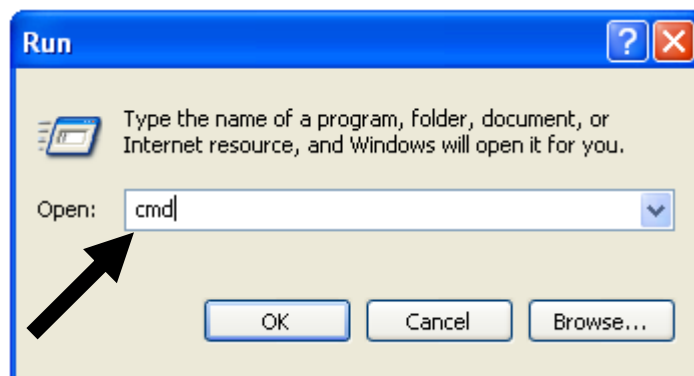

3. Input “ipconfig”, then press “Enter”. Use the IP address following “Default Gateway” to access this router’s web-based configuration interface. Please note that the IP address you find may be different from this illustrated example.

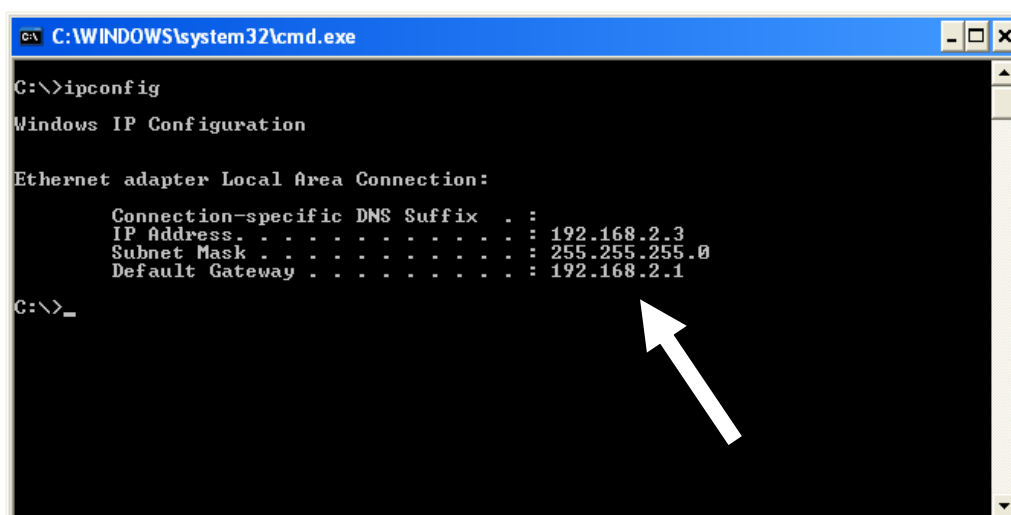

NOTE: If there is no IP address following “Default Gateway”, or if the address following “IP Address” begins with “169”, please try the following procedures:

- Recheck the cable connection between the computer and the router.
- Go to the beginning of this chapter and recheck every step of the setup procedure.
- If both of the above fails, reset the broadband router.

2-4 Using “iQ Setup”

This broadband router’s “iQ Setup” feature allows you to set up basic parameters in a few simple steps.

1. Click “Quick Setup” after logging in.

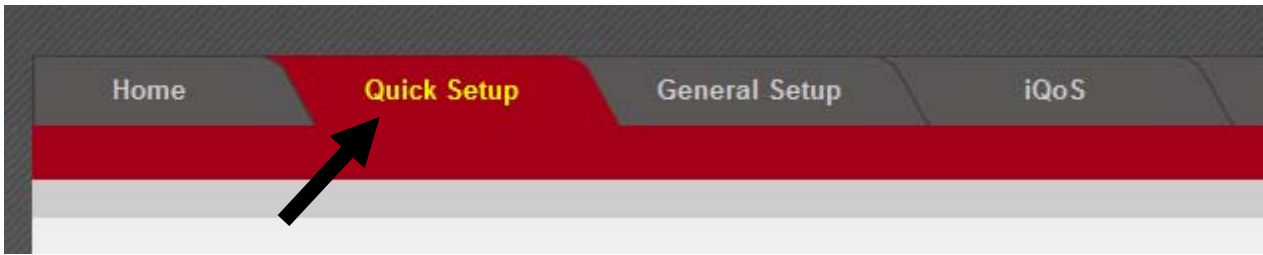

2. The following will appear.

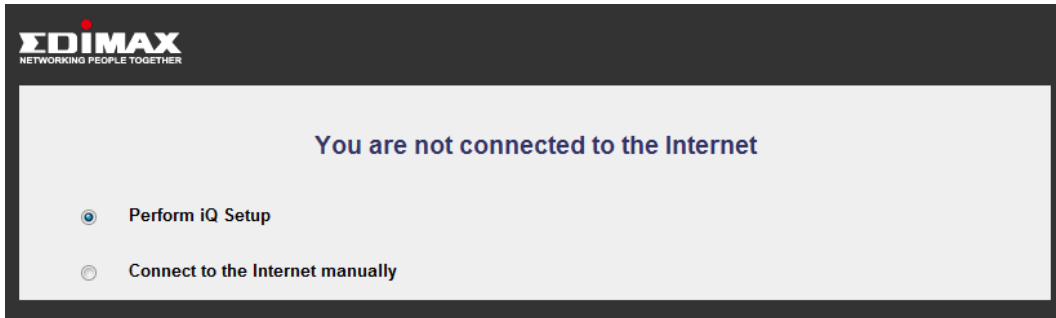

3. Click “Perform iQ Setup” and it will start detecting your Internet service type.

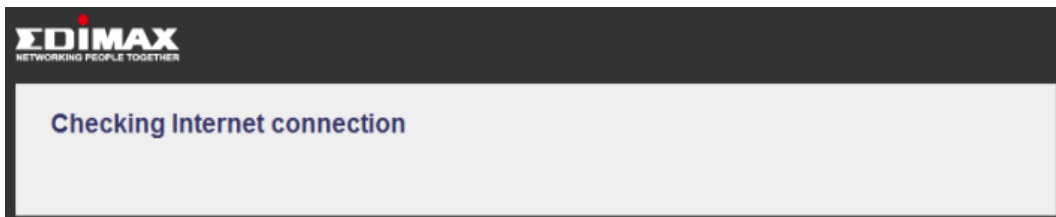

Note: Your computer or iPhone can also use iQ Setup with a Wi-Fi connection. Please make sure you have connected to the correct Wi-Fi network. The router’s default SSID is “Edimax”.



Dynamic IP

If your Internet connection type is dynamic IP, you will see the following:

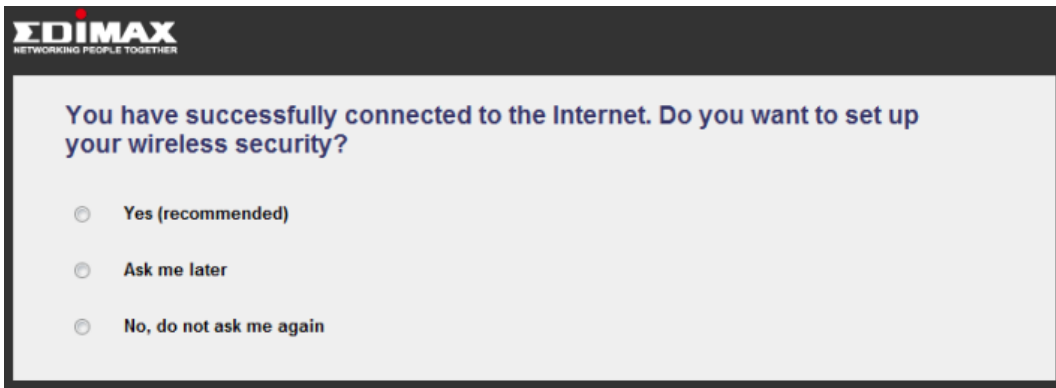

Note: For security reasons, Edimax suggests that you set up the wireless security.

If you click "Yes (recommended)", you will be asked to enter an SSID and a password (at least 8 digits).

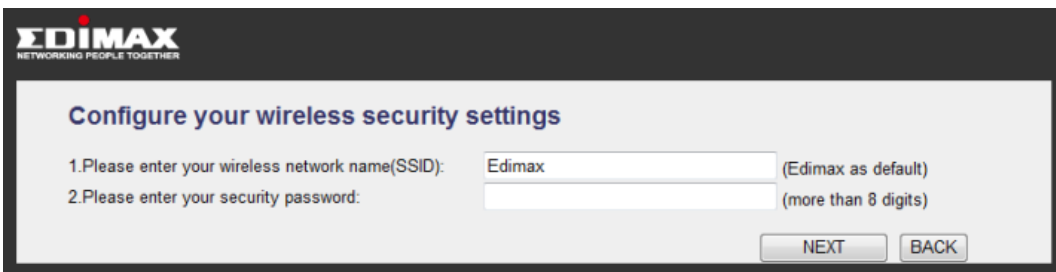

Note: Please remember your password or you will not be able to use the Wi-Fi connection.

PPPoE

If your Internet connection type is PPPoE, you will see the following:

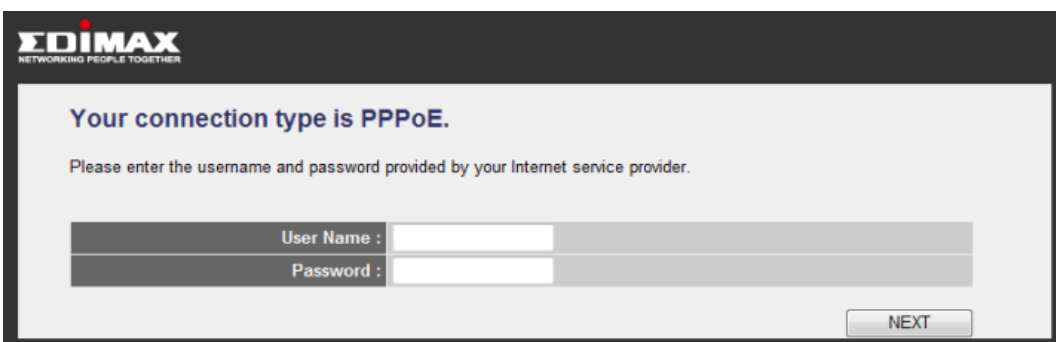

Please enter the username and password provided by your ISP (usernames and passwords are case-sensitive). Click "Next" and the following will appear:

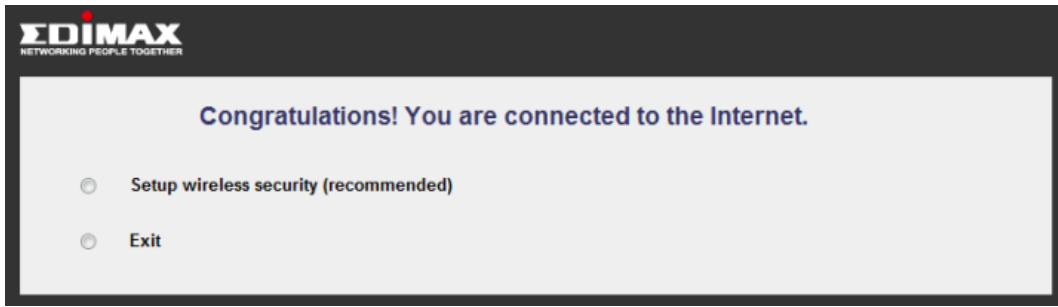

Note: For security reasons, Edimax suggests that you set up the wireless security.

If you click “Setup wireless security (recommended)”, you will be asked to enter an SSID and a password (at least 8 digits).

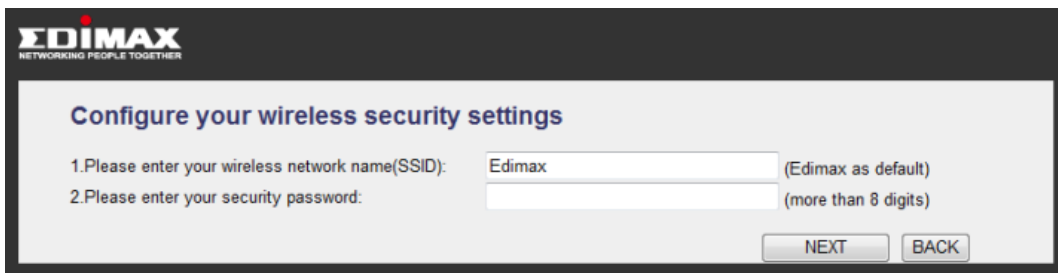

Note: Please remember your password or you will not be able to use the Wi-Fi connection.

If your PPPoE connection is invalid, you will see the following:

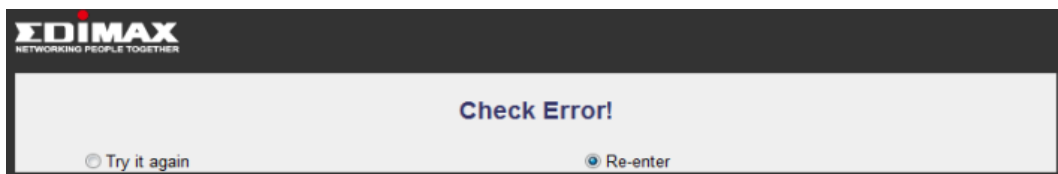

Click “Try it again” and the wizard will try to connect to the Internet again with the current information. Clicking “Re-enter” will take you to the previous page and let you enter the username and password again.

If your connection type is none of the above or if the auto-detection has failed, you will see the following page. Please select your connection type and enter the information accordingly.



Please select and configure your Internet connect type

Dynamic IP : Select "Dynamic IP" if your Internet service provider gives you IP address automatically(e.g. cable Internet providers).

Static IP : Select "Static IP" if your Internet service provider has given you a fixed IP address.

PPPoE : Select "PPPoE" if you are using ADSL(username and password required).

PPTP : If your PPTP service provider gives you dynamic IP addresses, select "Obtain an IP address automatically". If your IP address is fixed, input the one provided by your ISP(username and password required).

L2TP : If your L2TP service provider gives you dynamic IP addresses, select "Obtain an IP address automatically". If your IP address is fixed, input the one provided by your ISP(username and password required).

Telstra Big Pond : Telstra Big Pond is a Internet service is provided in Australia.

2-5 Using "iQoS"

iQoS is Edimax's answer to the need for a quick and easy way to manage internet bandwidth. Its intuitive and friendly user interface allows you to arrange your bandwidth priorities in a few simple steps.

1. First, click "iQoS" to access the iQoS user interface.



2. Check the "Enable iQoS" box to enable the function.

iQoS





Enable iQoS

Total Download Bandwidth : kbits

Total Upload Bandwidth : kbits

Current iQoS Table :

High	Low





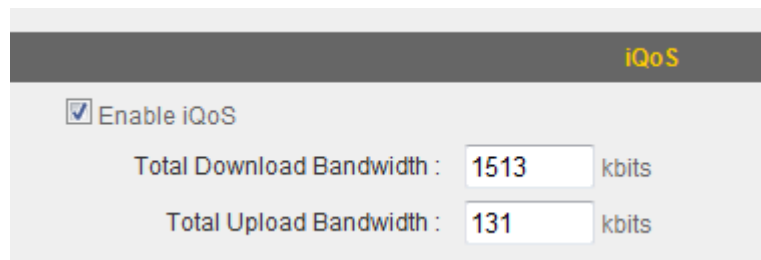

3. Enter your upload and download bandwidth values in the “Total Download Bandwidth” and “Total Upload Bandwidth” fields.

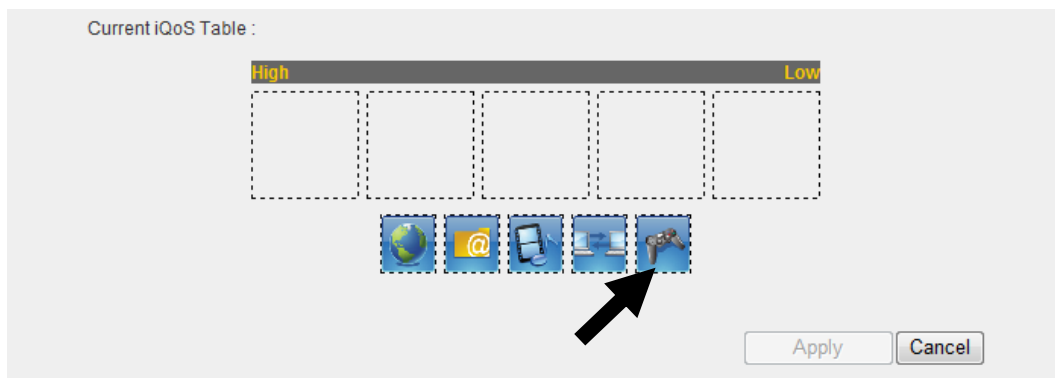

Note: Please check with your ISP for details, or conduct a speed test at a website like www.speedtest.net.

4. The icons near the bottom show the current priority order for various application types (from left to right). Re-arrange the priority by clicking the icons in the order that suits your needs.



5. After you have arranged your application priorities, click the “Apply” button to enable it. The icons will be shown in the order of your preference after the device has restarted.

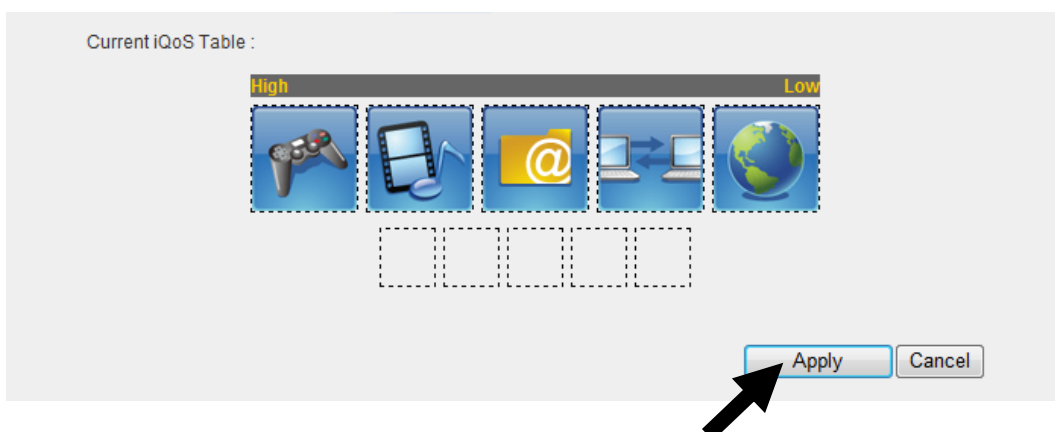

CHAPTER III: GENERAL SETUP

You can perform advanced configuration of this broadband router in “General Setup”.

1. Click “General Setup” after logging in.

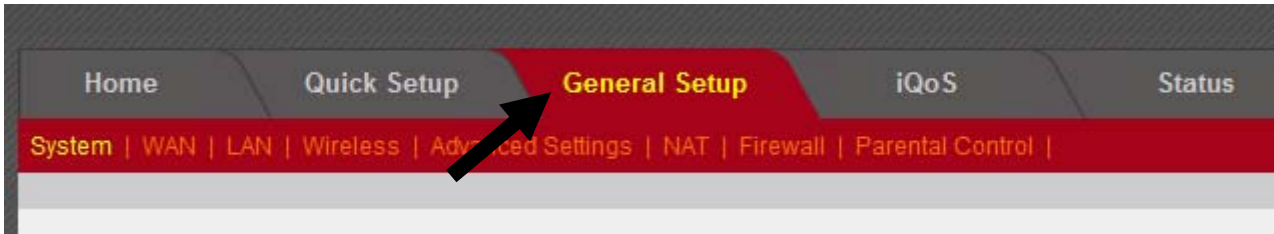

2. All available setup items will appear under the “General Setup” tab.



3. Refer to the following list for further instructions:

- System (See section 3-1)
- WAN (See section 3-2)
- LAN (See section 3-3)
- Wireless (See section 3-4)
- Advance Settings (See section 3-5)
- NAT (See section 3-6)
- Firewall (See section 3-7)
- Parental Control (See section 3-8)

3-1 System

You can set up basic system settings under “System”.

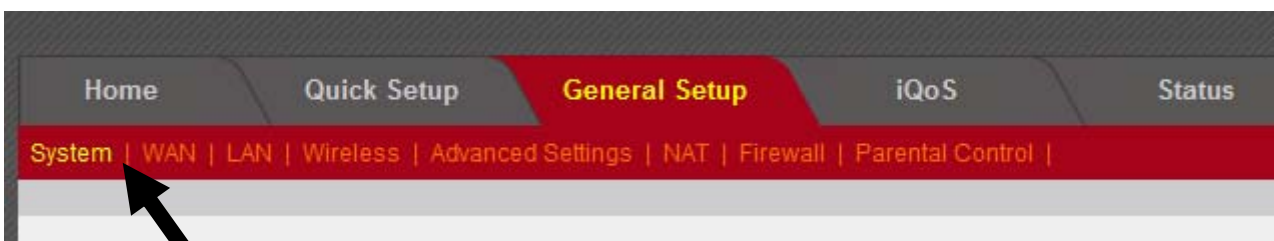

You can configure your time zone, password, and remote management settings here. After you have completed the configurations, click “Apply” to save the changes.

3-1-1 Time Zone

You can configure the time zone settings here.

Item Name	Description
Set Time Zone	Please select the time zone of your country or region. If you cannot find your country/region, please select another country/region whose time zone is the same as yours.
Time Server Address	This router supports NTP (Network Time Protocol) for automatic time and date setup. Input the host name or IP address of the NTP server here. If you do not know the host name, please ask the network administrator or use “pool.ntp.org”.
Daylight Saving	If your country/region uses daylight saving time, please check the “Enable Function” box, and select the start and end date.

Click “Apply” to save the changes. After you have clicked “Apply”, you will see the following message:

Save settings successfully!

You may press CONTINUE button to continue configuring other settings or press APPLY button to restart the system to make the changes take effect.

CONTINUE

APPLY

Click “Apply” to save the changes and restart the broadband router. It takes about 60 seconds for the broadband router to restart. Click “Continue” to configure other settings.

3-1-2 Password Settings

You can change the router’s default login password (“1234”) here. It is advised to do so to prevent others from logging in to your router without permission.

● Password Settings

Current Password :

New Password :

Confirmed Password :

Cancel Apply

Item Name	Description
Current Password	Input the current password here. The default value is “1234”.
New Password	Input your new password here.
Confirm Password	Input your new password again for confirmation.

Click “Apply” to save the changes. After you have clicked “Apply”, you will see the following message:

Save settings successfully!

You may press CONTINUE button to continue configuring other settings or press APPLY button to restart the system to make the changes take effect.

CONTINUE

APPLY

Click “Apply” to save the changes and restart the broadband router. It takes about 60 seconds for the broadband router to restart. Click “Continue” to configure other settings.

3-1-3 Remote Management

Setting up the “Remote Management” function allows you to manage this broadband router from outside your local area network (from the Internet).

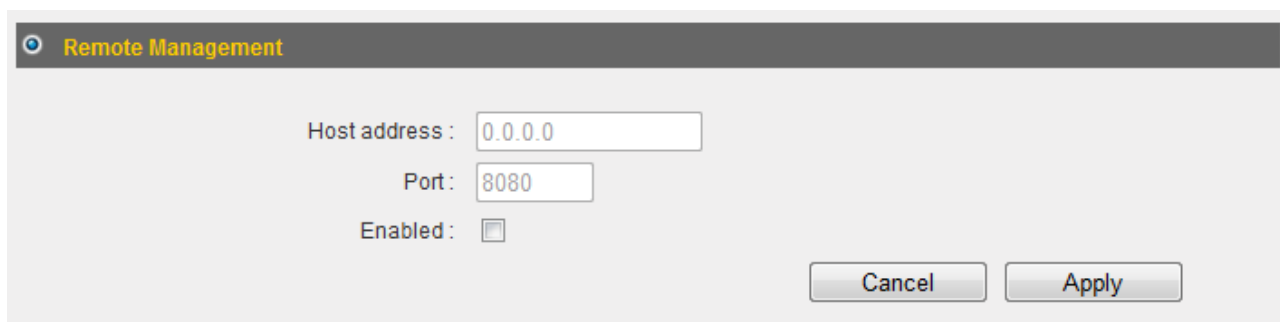

Remote Management

Host address : 0.0.0.0

Port : 8080

Enabled :

Cancel Apply

Item Name	Description
Host Address	Assign an IP address with which to access this router remotely.
Port	Assign a port number with which to access this router remotely. The default value is “8080”. You can use any integer between 1 and 65534.
Enabled	Check this box to enable the “Remote Management” function.

Click “Apply” to save the changes. After you have clicked “Apply”, you will see the following message:

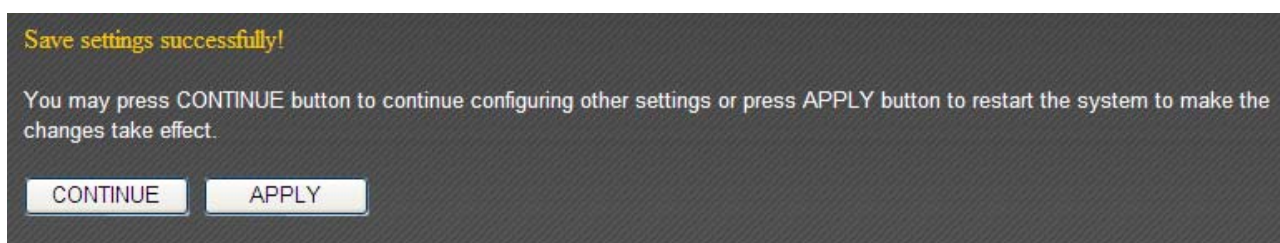

Save settings successfully!

You may press CONTINUE button to continue configuring other settings or press APPLY button to restart the system to make the changes take effect.

CONTINUE APPLY

Click “Apply” to save the changes and restart the broadband router. It takes about 60 seconds for the broadband router to restart. Click “Continue” to configure other settings.

3-2 WAN

You can set up your Internet or WAN (Wide Area Network) connection under “WAN”.

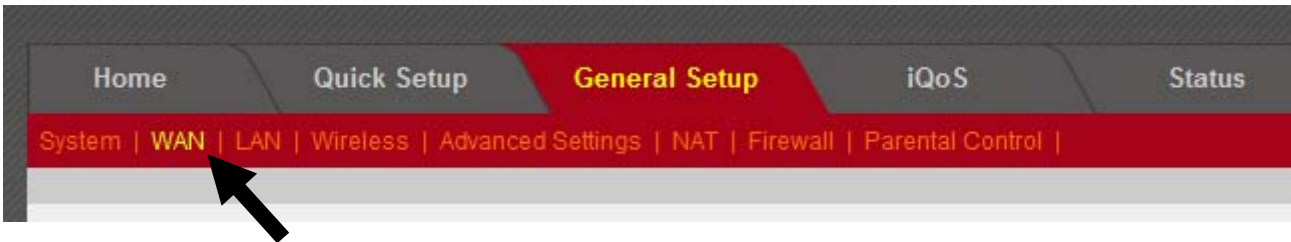

Select a connection type and proceed with the setup; then click “Apply” to save the changes. If you are not sure which connection type you should use, please contact your Internet service provider for help.

A screenshot of the 'Dynamic IP' configuration page in a router's web interface. The page has a dark header with 'Dynamic IP' selected. Below the header, there are several fields and options: 'Host Name' with an empty text box; 'MAC address' with a text box containing '000000000000' and a 'Clone Mac address' button; 'DNS address' with two radio buttons: 'Obtain an IP address automatically' (selected) and 'Use the following IP address'; 'DNS1 address' with a text box containing '0.0.0.0'; 'DNS2 address' with a text box containing '0.0.0.0'; and 'TTL' with two radio buttons: 'Disable' (selected) and 'Enable'. At the bottom of the page, there are five radio buttons for different connection types: 'Dynamic IP' (selected), 'Static IP', 'PPPoE', 'PPTP', 'L2TP', and 'WISP'. An 'Apply' button is located at the bottom right of the page.

3-2-1 Dynamic IP

If your Internet service provider assigns IP addresses to you automatically through DHCP (Dynamic Host Configuration Protocol), select “Dynamic IP”.

Item Name	Description
Host Name	Input the host name of your computer here. This is optional and only required if your ISP asks you to do so.
MAC Address	If your ISP only permits computers with certain MAC addresses to access the Internet, input your computer’s MAC address here. Press “Clone Mac address” to fill the MAC address field with your computer’s MAC address automatically.
DNS Address	Select “Use the following IP address” if your ISP requires that you do so.
DNS Address 1 and 2	Enter the primary and secondary DNS addresses assigned by your ISP here.
TTL	Enable the “TTL” function if your ISP requires you to do so.

Click “Apply” to save the changes. After you have clicked “Apply”, you will see the following message:

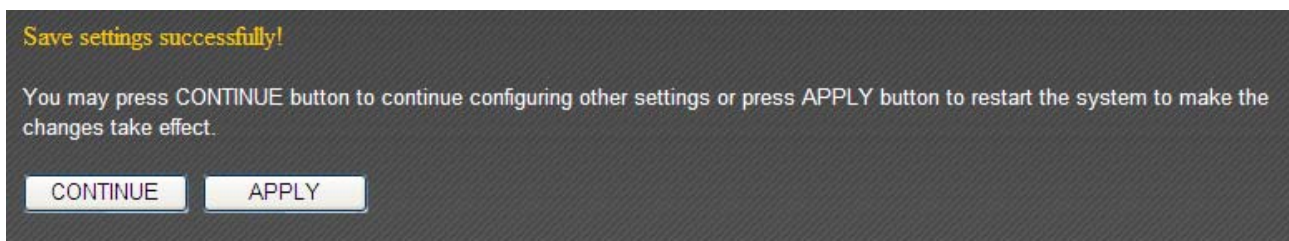

Click “Apply” to save the changes and restart the broadband router. It takes about 60 seconds for the broadband router to restart. Click “Continue” to configure other settings.

3-2-2 Static IP

If your ISP is providing you Internet access via a fixed IP address, select “Static IP”. Generally, your ISP will provide you with such information as IP address, subnet mask, gateway address, and DNS address.

Static IP

Fixed IP Address :

Subnet Mask :

DNS1 address :

DNS2 address :

Default Gateway :

TTL : Disable Enable

Item Name	Description
Fixed IP Address	Input the IP address assigned by your ISP here.
Subnet Mask	Input the subnet mask assigned by your ISP here.
DNS Address 1 and 2	Enter the primary and secondary DNS addresses assigned by your ISP here.
Default Gateway	Input the default gateway assigned by your ISP here. Some ISPs may call this "Default Route".
TTL	Enable the "TTL" function if your ISP requires you to do so.

NOTE: You must use the addresses provided by your ISP. Inputting incorrect values will cause malfunction.

Click "Apply" to save the changes. After you have clicked "Apply", you will see the following message:

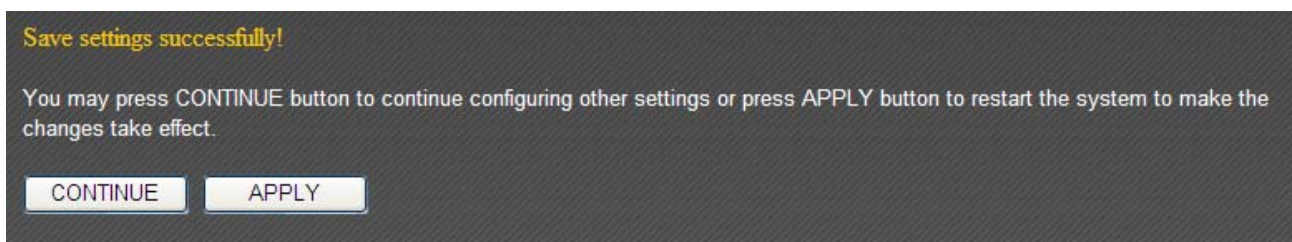

Click "Apply" to save the changes and restart the broadband router. It takes about 60 seconds for the broadband router to restart. Click "Continue" to configure other settings.

3-2-3 PPPoE

If your ISP is providing you Internet access via PPPoE (Point-to-Point Protocol over Ethernet), select "PPPoE".

PPPoE

User Name :

Password :

MAC address :

DNS address : Obtain an IP address automatically
 Use the following IP address

DNS1 address :

DNS2 address :

TTL : Disable Enable

Service Name :

MTU : (512<=MTU Value<=1492)

Connection Type :

Idle Time Out : (1-1000 minutes)

Enable Dual Wan Access :

Item Name	Description
User Name	Input the user name assigned by your ISP here.
Password	Input the password assigned by your ISP here.
MAC Address	If your ISP only permits computers with certain MAC addresses to access the Internet, input your computer's MAC address here. Press "Clone Mac address" to fill the MAC address field with your computer's MAC address automatically.
DNS Address	Select "Use the following IP address" if your ISP requires that you do so.
DNS Address 1 and 2	Enter the primary and secondary DNS addresses assigned by your ISP here.
TTL	Enable the "TTL" function if your ISP requires you to do so.
Service Name	Give this Internet service a name (optional).
MTU	Input the MTU value of your network connection here. If you do not know, use the default value.
Connection Type	Please specify a connection type here. There are 3 options: <ol style="list-style-type: none"> 1. "Continuous" keeps the Internet connection alive all the time. 2. "Connect on Demand" only connects to the Internet when you initiate Internet connection. 3. "Manual" connects to the Internet only when the "Connect" button on this page is clicked, and disconnects when the "Disconnect" button is clicked.

Idle Time Out	Specify the amount of time the router waits before shutting down an idle connection. This option is only available when “Connect on Demand” is selected.
Enable Dual-WAN Access	Check the “Enable Dual-WAN Access” box if your ISP requires you to do so.

Click “Apply” to save the changes. After you have clicked “Apply”, you will see the following message:

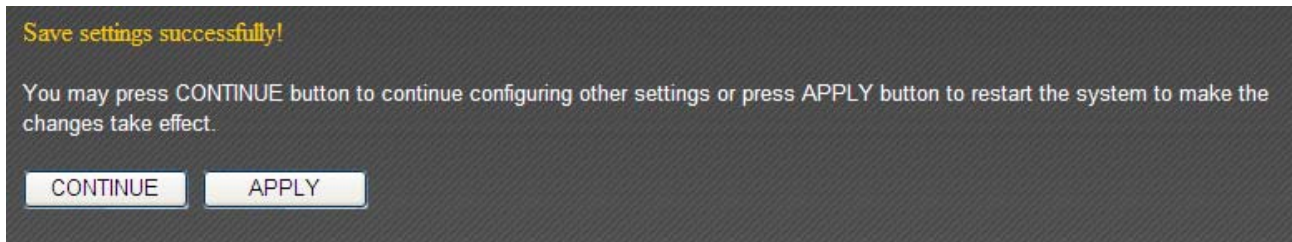

Click “Apply” to save the changes and restart the broadband router. It takes about 60 seconds for the broadband router to restart. Click “Continue” to configure other settings.

3-2-4 PPTP

Select “PPTP” if your ISP is providing you Internet access via PPTP (Point-to-Point Tunneling Protocol).

If your ISP is providing you dynamic IP addresses, select “Obtain an IP address automatically”. If your ISP is providing you a static IP address, select “Use the following IP address”.

Item Name	Description
Host Name	Input the host name of your computer here. This is optional and only required if your ISP asks you to do so.
MAC Address	If your ISP only permits computers with certain MAC addresses to access the Internet, input your computer's MAC address here. Press "Clone Mac address" to fill the MAC address field with your computer's MAC address automatically.
IP Address	Input the IP address assigned by your ISP here.
Subnet Mask	Input the subnet mask assigned by your ISP here.
Default Gateway	Input the default gateway assigned by your ISP here. Some ISPs may call this "Default Route".
MAC Address	If your ISP only permits computers with certain MAC addresses to access the Internet, input your computer's MAC address here. Press "Clone Mac address" to fill the MAC address field with your computer's MAC address automatically.
DNS Address	Select "Use the following IP address" if your ISP requires that you do so.
DNS Address 1 and 2	Enter the primary and secondary DNS addresses assigned by your ISP here.
Enable Dual-WAN Access	Check the "Enable Dual-WAN Access" box if your ISP requires you to do so.

NOTE: These settings must be configured according to your Internet service. Please contact your Internet service provider if you are not sure what to select.

Configure the "PPTP Settings" section.

PPTP Settings :

User ID :

Password :

PPTP Gateway :

Connection ID : (Optional)

MTU : (512<=MTU Value<=1492)

BEZEQ-ISRAEL : Enable (for BEZEQ network in ISRAEL use only)

Connection Type :

Idle Time Out : (1-1000 minutes)

Item Name	Description
User ID	Input the user name assigned by your ISP here.
Password	Input the password assigned by your ISP here.
PPTP Gateway	Input the PPTP gateway assigned by your ISP here.
Connection ID	Give this connection a name (optional).
MTU	Input the MTU value of your network connection here. If you do not know, use the default value.
BEZEQ-ISRAEL	Check the “Enable” box if you are in Israel and using BEZEQ network services.
Connection Type	<p>Please specify a connection type here. There are 3 options:</p> <ol style="list-style-type: none"> 1. “Continuous” keeps the Internet connection alive all the time. 2. “Connect on Demand” only connects to the Internet when you initiate Internet connection. 3. “Manual” connects to the Internet only when the “Connect” button on this page is clicked, and disconnects when the “Disconnect” button is clicked.
Idle Time Out	Specify the amount of time the router waits before shutting down an idle connection. This option is only available when “Connect on Demand” is selected.

Click “Apply” to save the changes. After you have clicked “Apply”, you will see the following message:

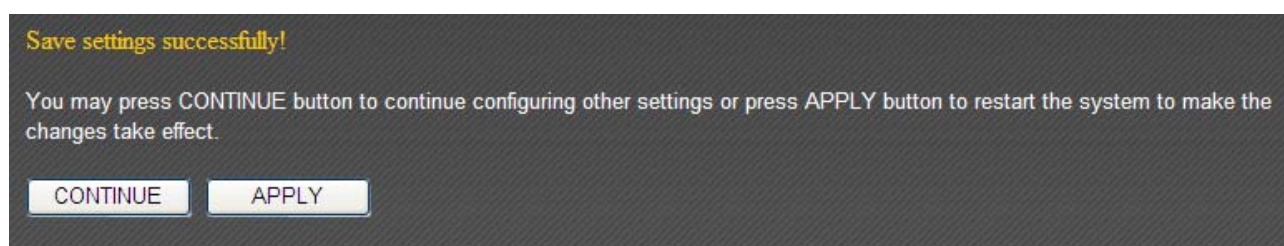

Click “Apply” to save the changes and restart the broadband router. It takes about 60 seconds for the broadband router to restart. Click “Continue” to configure other settings.

3-2-5 L2TP

Select “L2TP” if your ISP is providing you Internet access via L2TP (Layer-2 Tunneling Protocol).

If your ISP is providing you dynamic IP addresses, select “Obtain an IP address automatically”. If your ISP is providing you a static IP address, select “Use the following IP address”.

L2TP

Obtain an IP address automatically :

Host Name :

MAC address :

Use the following IP address :

IP address :

Subnet Mask :

Default Gateway :

DNS address : Obtain an IP address automatically
 Use the following IP address

DNS1 address :

DNS2 address :

Enable Dual Wan Access :

Item Name	Description
Host Name	Input the host name of your computer here. This is optional and only required if your ISP asks you to do so.
MAC Address	If your ISP only permits computers with certain MAC addresses to access the Internet, input your computer's MAC address here. Press "Clone Mac address" to fill the MAC address field with your computer's MAC address automatically.
IP Address	Input the IP address assigned by your ISP here.
Subnet Mask	Input the subnet mask assigned by your ISP here.
Default Gateway	Input the default gateway assigned by your ISP here. Some ISPs may call this "Default Route".
DNS Address	Select "Use the following IP address" if your ISP requires that you do so.
DNS Address 1 and 2	Enter the primary and secondary DNS addresses assigned by your ISP here.
Enable Dual-WAN Access	Check the "Enable Dual-WAN Access" box if your ISP requires you to do so.

NOTE: These settings must be configured according to your Internet service. Please contact your Internet service provider if you are not sure what to select.

Configure the "L2TP Settings" section.

L2TP Settings

User ID :

Password :

L2TP Gateway :

MTU : (512<=MTU Value<=1492)

Connection Type :

Idle Time Out : (1-1000 minutes)

Item Name	Description
User ID	Input the user name assigned by your ISP here.
Password	Input the password assigned by your ISP here.
L2TP Gateway	Input the L2TP gateway assigned by your ISP here.
MTU	Input the MTU value of your network connection here. If you do not know, use the default value.
Connection Type	<p>Please specify a connection type here. There are 3 options:</p> <ol style="list-style-type: none"> 1. "Continuous" keeps the Internet connection alive all the time. 2. "Connect on Demand" only connects to the Internet when you initiate Internet connection. 3. "Manual" connects to the Internet only when the "Connect" button on this page is clicked, and disconnects when the "Disconnect" button is clicked.
Idle Time Out	Specify the amount of time the router waits before shutting down an idle connection. This option is only available when "Connect on Demand" is selected.

Click "Apply" to save the changes. After you have clicked "Apply", you will see the following message:

Save settings successfully!

You may press CONTINUE button to continue configuring other settings or press APPLY button to restart the system to make the changes take effect.

Click "Apply" to save the changes and restart the broadband router. It takes about 60 seconds for the broadband router to restart. Click "Continue" to configure other settings.

3-2-6 WISP

If your Internet service provider is providing you Internet service wirelessly, select “WISP”.

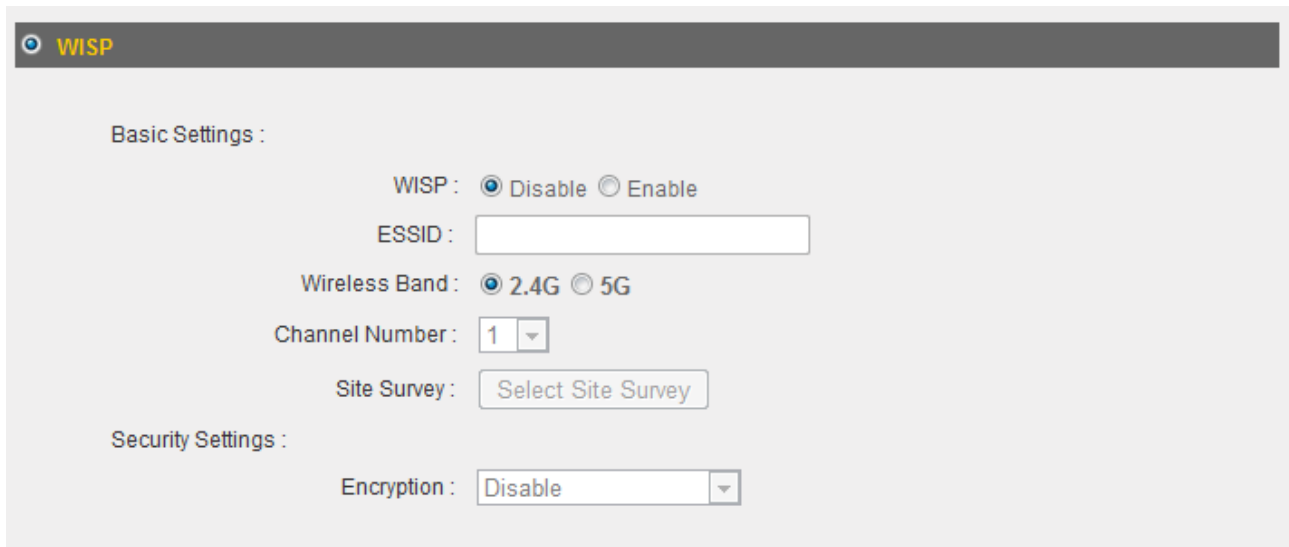

Item Name	Description
WISP	Enable or disable the WISP function.
ESSID	Input the name of your Internet service provider’s wireless access point here.
Wireless Band	Set the wireless frequency range in accordance with your Internet service provider’s requirements.
Channel Number	Select the channel number that corresponds to that of your Internet service provider’s wireless access point.
Site Survey	Click “Select Site Survey” and a pop-up window will appear. All reachable wireless access points will be shown in the window. Select a wireless access point from the list, and click “Done” to establish a connection. Clicking “Refresh” will renew the list.
Security Settings	Configure the security settings in accordance to your Internet service provider’s requirements.

Click “Apply” to save the changes. After you have clicked “Apply”, you will see the following message:

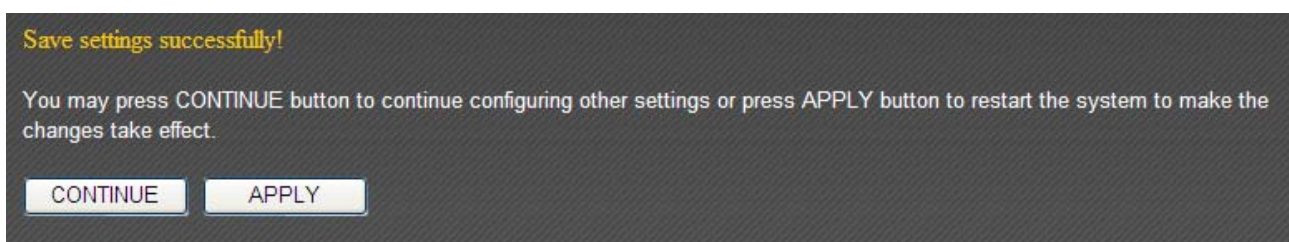

Click “Apply” to save the changes and restart the broadband router. It takes about 60 seconds for the broadband router to restart. Click “Continue” to configure other settings.

3-3 LAN

You can configure your local area network under “LAN”.



Refer to the following list for further instructions:

- LAN IP (See section 3-3-1)
- DHCP Server (See section 3-3-2)
- Static DHCP Leases (See section 3-3-3)

3-3-1 LAN IP

You can assign the LAN interface’s IP address under “LAN IP”.

LAN IP

IP address :

Subnet Mask :

802.1d Spanning Tree :

DHCP Server :

Lease Time :

Item Name	Description
IP Address	Assign the LAN interface’s IP address here.
Subnet Mask	Please input a subnet mask value for this network.
802.1d Spanning Tree	If you wish to activate the 802.1d spanning tree function, select “Enabled”.
DHCP Server	If you wish to activate the DHCP server function, select “Enabled”.
Lease Time	Select a lease time for the DHCP leases here. The DHCP client will be forced to obtain a new IP address after the period expires. You can select “Forever” if you are using this

	broadband router with less than 30 computers.
--	---

If you are not sure what to fill, here are some recommended values:

- IP Address: "192.168.1.254"
- Subnet Mask: "255.255.255.0"
- 802.1d Spanning Tree: "Disabled"
- DHCP Server: "Enabled"
- Lease Time: "Two Weeks" or "Forever"

3-3-2 DHCP Server

You can set the range of IP address leases under "DHCP Server".

The screenshot shows a configuration window titled "DHCP Server". It contains four input fields: "Start IP" with the value "192.168.2.100", "End IP" with the value "192.168.2.200", "Domain Name" which is empty, and "Default Gateway Address" which is also empty.

Item Name	Description
Start IP	Enter the start IP address for the DHCP server's IP assignment.
End IP	Enter the end IP address for the DHCP server's IP assignment.
Domain Name	You can input a domain name for your network (optional).
Default Gateway Address	You can assign a default gateway here (optional).

If you are not sure what to fill, here are some recommended values:

- Start IP: "192.168.1.1"
- End IP: "192.168.1.200"
- Domain Name: (blank)
- Default Gateway Address: (blank)

3-3-3 Static DHCP Leases

You can set the router to assign a static IP address to specified computers/devices under "Static DHCP Leases".

Static DHCP Leases Table

This allows only 16 sets of addresses.

NO.	MAC address	IP address	Select

Enable Static DHCP Leases

New
 MAC address :
 IP address :

Item Name	Description
Enable Static DHCP Leases	Check this box to enable the function.
MAC Address	Input the specified computer's MAC address here.
IP Address	Assign a fixed IP address for the specified computer here.
Add	After you have entered the MAC address and the IP address, click "Add" to add the information to the "Static DHCP Leases Table".
Clear	Click "Clear" to clear the MAC address and IP address fields.

All the assigned entries will be listed as follows:

Static DHCP Leases Table

This allows only 16 sets of addresses.

NO.	MAC address	IP address	Select
1	11:22:33:44:55:66	192.168.2.200	<input type="checkbox"/>
2	aa:bb:cc:dd:ee:ff	192.168.2.100	<input type="checkbox"/>

Enable Static DHCP Leases

New
 MAC address :
 IP address :

Click "Apply" to save the changes. After you have clicked "Apply", you will see the following message:

Save settings successfully!

You may press CONTINUE button to continue configuring other settings or press APPLY button to restart the system to make the changes take effect.

CONTINUE

APPLY

Click “Apply” to save the changes and restart the broadband router. It takes about 60 seconds for the broadband router to restart. Click “Continue” to configure other settings.

3-4 Wireless

You can set up the 2.4GHz wireless LAN connection under “Wireless”.

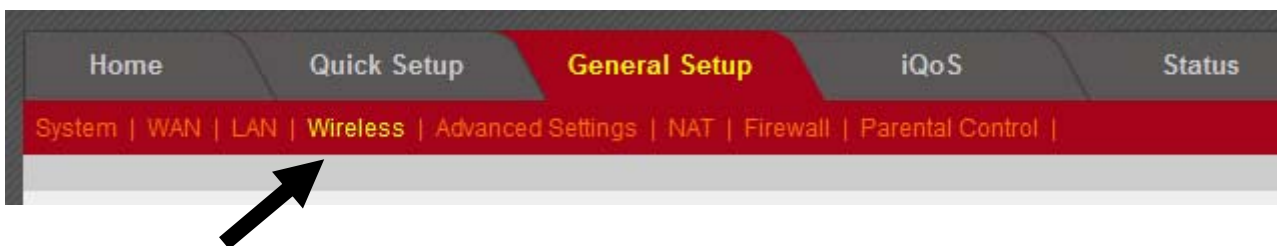

3-4-1 Wireless Settings

Basic 2.4GHz wireless settings can be configured here.

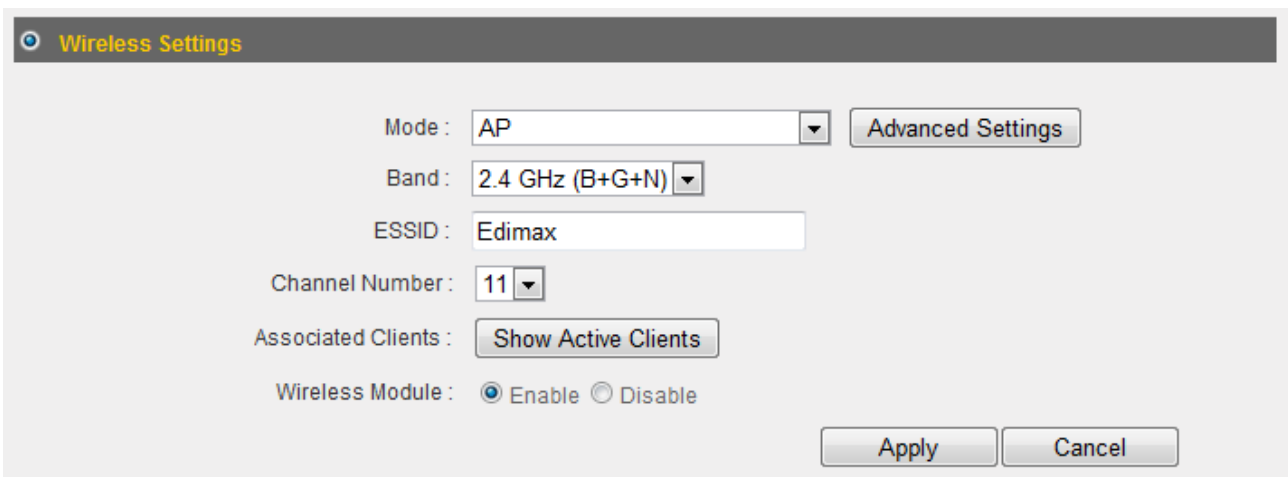

This router can operate in 6 different modes:

- AP: Wireless access point
- Station-Infrastructure: Acts as both wireless communication client and server
- AP Bridge—Point to Point: Connects this router with another broadband router
- AP Bridge—Point to Multi-Point: Connects this router with up to 4 other broadband routers

- AP Bridge—WDS: Connects this router with up to 4 WDS-capable broadband routers
- Universal Repeater: Repeats another wireless access point’s signal to extend its wireless signal coverage

3-4-1-1 AP Mode

The following settings will appear in “AP” mode:

Item Name	Description
Band	<p>Select from one of the following options:</p> <p>2.4GHz (B): Allows 802.11b wireless network clients to connect to this router.</p> <p>2.4GHz (N): Allows 802.11n wireless network clients to connect to this router.</p> <p>2.4GHz (B+G): Allows 802.11b and 802.11g wireless network clients to connect to this router.</p> <p>2.4GHz (G): Allows 802.11g wireless network clients to connect to this router.</p> <p>2.4GHz (B+G+N): Allows 802.11b, 802.11g, and 802.11n wireless clients to connect to this router (recommended).</p>
ESSID	This is the name of your router. You can type any alphanumerical character here (maximum 32 characters).
Channel Number	Select a channel from the dropdown menu. You can

	select the channel of your preference (1 to 13).
Associated Clients	Click “Show Active Clients” for the list of all connected wireless clients. Click “Refresh” in the new window to renew the list, and click “Close” to close the window. Note: If you have a pop-up blocker installed, you may have to disable it, or set it to allow the pop-up window to show up.
Wireless Module	Select “Enable” to turn on the 2.4GHz wireless signal and select “Disable” to turn it off.

Click “Apply” to save the changes, or click “Cancel” to discard the changes. After you have clicked “Apply”, you will see the following message:

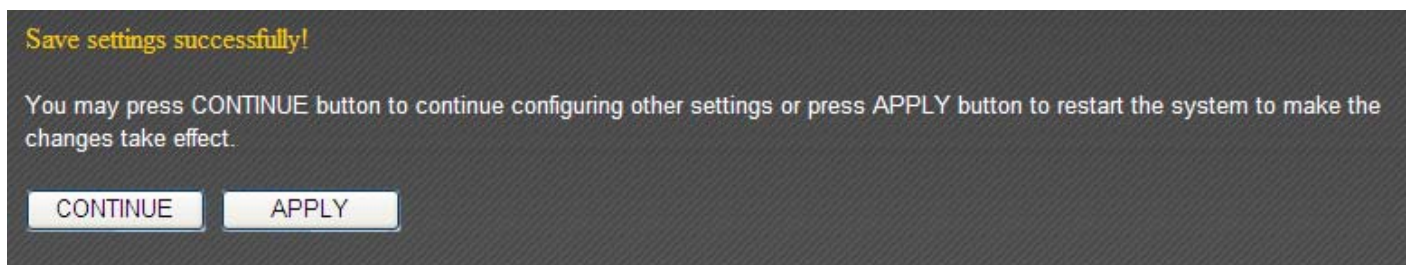

Click “Apply” to save the changes and restart the broadband router. It takes about 60 seconds for the broadband router to restart. Click “Continue” to configure other settings.

3-4-1-2 Station-Infrastructure

In “Station-Infrastructure” mode, the router acts as both a wireless communication client and a wireless communication server. The following settings will appear in “Station-Infrastructure” mode:

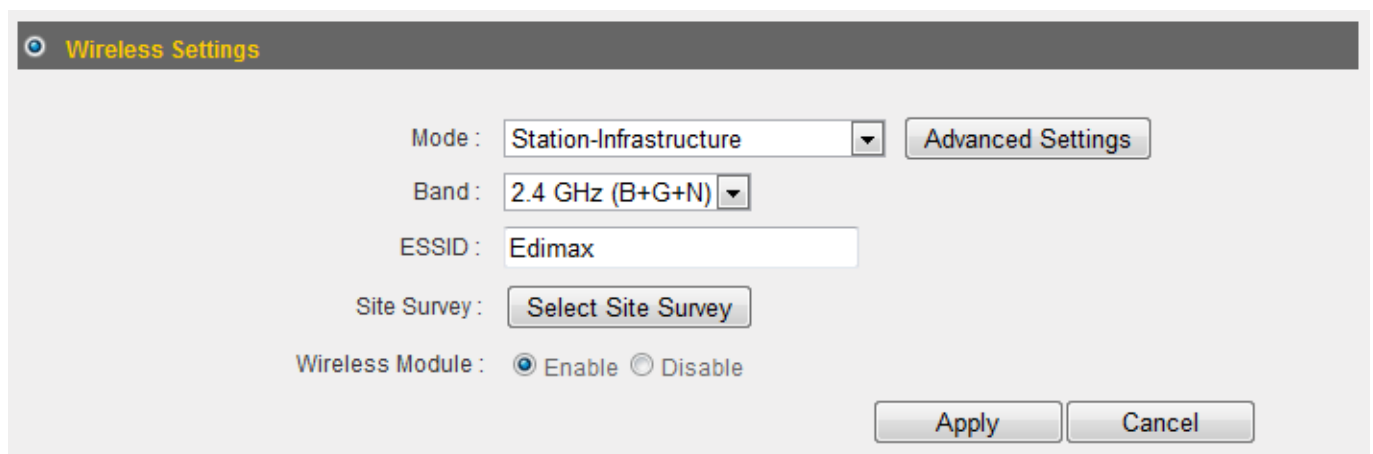

Item Name	Description
Band	<p>Select from one of the following options:</p> <p>2.4GHz (B): Allows 802.11b wireless network clients to connect to this router.</p> <p>2.4GHz (N): Allows 802.11n wireless network clients to connect to this router.</p> <p>2.4GHz (B+G): Allows 802.11b and 802.11g wireless network clients to connect to this router.</p> <p>2.4GHz (G): Allows 802.11g wireless network clients to connect to this router.</p> <p>2.4GHz (B+G+N): Allows 802.11b, 802.11g, and 802.11n wireless clients to connect to this router (recommended).</p>
ESSID	This is the name of your router. You can type any alphanumeric character here (maximum 32 characters).
Site Survey	Click "Select Site Survey" and a pop-up window will appear. All reachable wireless access points will be shown in the window. Select a wireless access point from the list, and click "Done" to establish a connection. Clicking "Refresh" will renew the list.
Wireless Module	Select "Enable" to turn on the 2.4GHz wireless signal and select "Disable" to turn it off.

Click "Apply" to save the changes, or click "Cancel" to discard the changes. After you have clicked "Apply", you will see the following message:

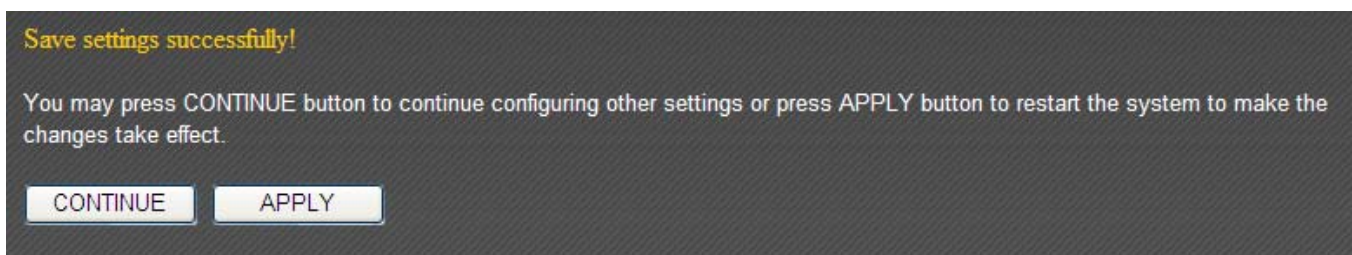

Click "Apply" to save the changes and restart the broadband router. It takes about 60 seconds for the broadband router to restart. Click "Continue" to configure other settings.

3-4-1-3 AP Bridge—Point to Point

“AP Bridge—Point to Point” mode connects this router to another router and allows all the computers connected to the LAN ports of both routers to communicate with each other.

Please note that when you select this mode, this broadband router will act as a wireless bridge only. It will not accept other wireless clients. If you wish to use this function with a wireless access point that supports WDS, please select “AP Bridge—WDS” mode.

Item Name	Description
Band	<p>Select from one of the following options:</p> <p>2.4GHz (B): Allows 802.11b wireless network clients to connect to this router.</p> <p>2.4GHz (N): Allows 802.11n wireless network clients to connect to this router.</p> <p>2.4GHz (B+G): Allows 802.11b and 802.11g wireless network clients to connect to this router.</p> <p>2.4GHz (G): Allows 802.11g wireless network clients to connect to this router.</p> <p>2.4GHz (B+G+N): Allows 802.11b, 802.11g, and 802.11n wireless clients to connect to this router (recommended).</p>
Channel Number	Select a channel from the dropdown menu. Both access points must use the same channel (1 to 13).
MAC Address 1	Input the MAC address of the wireless access point with which you wish to connect.
Wireless Module	Select “Enable” to turn on the 2.4GHz wireless

signal and select “Disable” to turn it off.

Click “Apply” to save the changes, or click “Cancel” to discard the changes. After you have clicked “Apply”, you will see the following message:

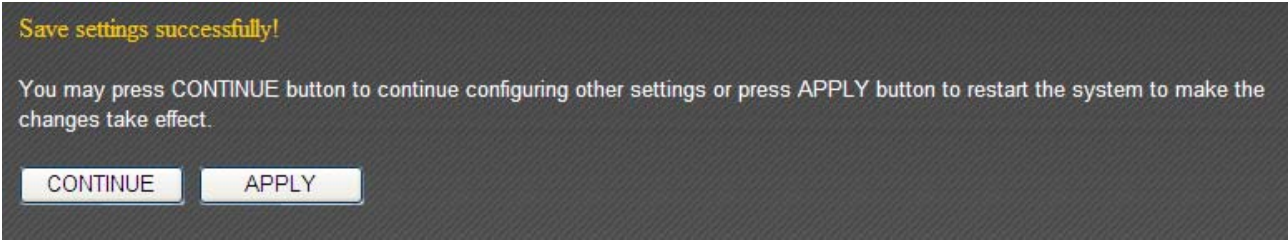

Click “Apply” to save the changes and restart the broadband router. It takes about 60 seconds for the broadband router to restart. Click “Continue” to configure other settings.

3-4-1-4 AP Bridge—Point to Multi-Point

“AP Bridge—Point to Multi-Point” mode connects this router to up to 4 other routers and allows the computers connected to the LAN ports of every router to communicate with each other.

Please note that when you select this mode, this broadband router will act as a wireless bridge only. It will not accept other wireless clients. If you wish to use this function with a wireless access point that supports WDS, please select “AP Bridge—WDS” mode.

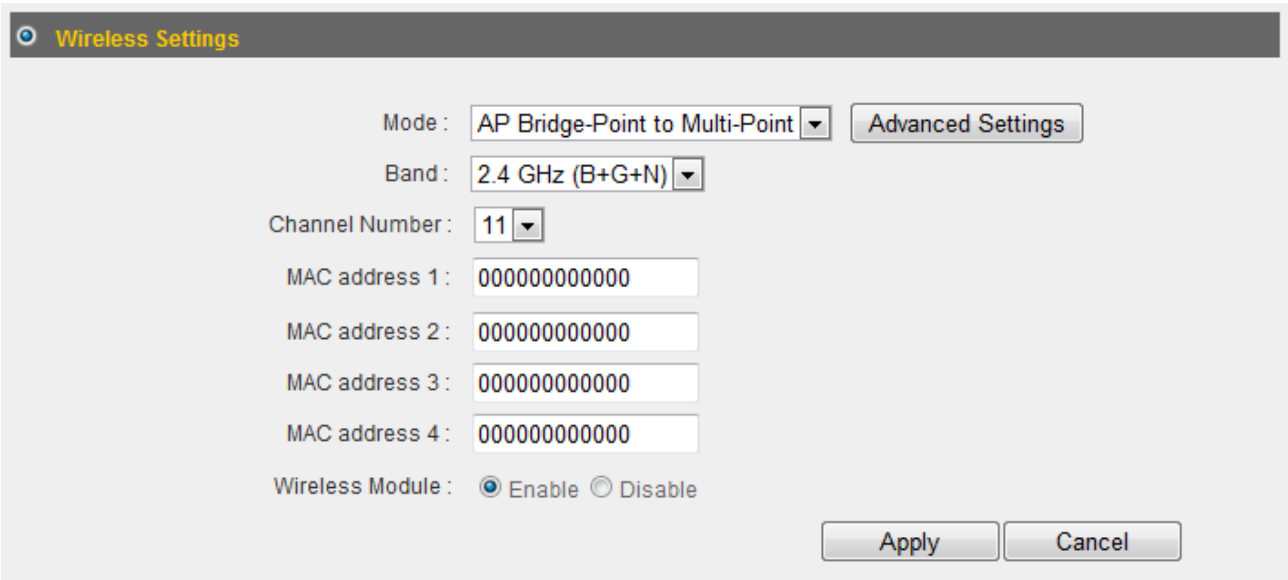

Item Name	Description
Band	Select from one of the following options: 2.4GHz (B): Allows 802.11b wireless network clients

	<p>to connect to this router.</p> <p>2.4GHz (N): Allows 802.11n wireless network clients to connect to this router.</p> <p>2.4GHz (B+G): Allows 802.11b and 802.11g wireless network clients to connect to this router.</p> <p>2.4GHz (G): Allows 802.11g wireless network clients to connect to this router.</p> <p>2.4GHz (B+G+N): Allows 802.11b, 802.11g, and 802.11n wireless clients to connect to this router (recommended).</p>
Channel Number	Select a channel from the dropdown menu. All access points must use the same channel (1 to 13).
MAC Address 1 to 4	Input the MAC addresses of the wireless access points with which you wish to connect.
Wireless Module	Select "Enable" to turn on the 2.4GHz wireless signal and select "Disable" to turn it off.

Click "Apply" to save the changes, or click "Cancel" to discard the changes. After you have clicked "Apply", you will see the following message:

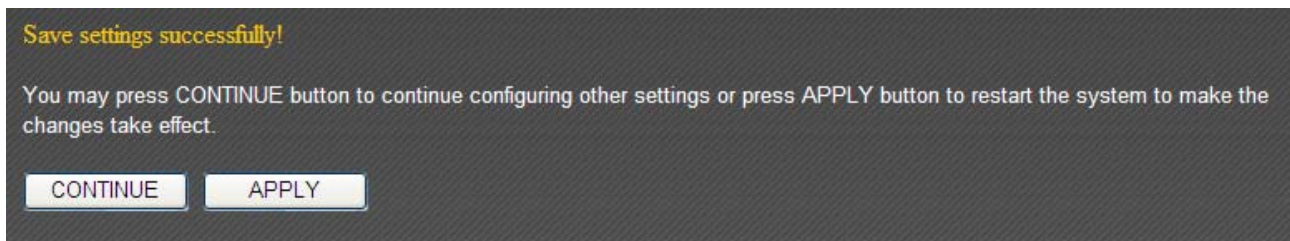

Click "Apply" to save the changes and restart the broadband router. It takes about 60 seconds for the broadband router to restart. Click "Continue" to configure other settings.

3-4-1-5 AP Bridge—WDS

In "AP Bridge—WDS" mode, this broadband router acts as both a wireless communication bridge and a wireless access point. This router can connect to up to 4 WDS-compatible wireless access points and allows the computers connected every AP to communicate with each other.

Wireless Settings

Mode:

Band:

ESSID:

Channel Number:

Associated Clients:

MAC address 1:

MAC address 2:

MAC address 3:

MAC address 4:

Wireless Module: Enable Disable

Item Name	Description
Band	<p>Select from one of the following options:</p> <p>2.4GHz (B): Allows 802.11b wireless network clients to connect to this router.</p> <p>2.4GHz (N): Allows 802.11n wireless network clients to connect to this router.</p> <p>2.4GHz (B+G): Allows 802.11b and 802.11g wireless network clients to connect to this router.</p> <p>2.4GHz (G): Allows 802.11g wireless network clients to connect to this router.</p> <p>2.4GHz (B+G+N): Allows 802.11b, 802.11g, and 802.11n wireless clients to connect to this router (recommended).</p>
ESSID	This is the name of your router. You can type any alphanumerical character here (maximum 32 characters).
Channel Number	Select a channel from the dropdown menu. All access points must use the same channel (1 to 13).
Associated Clients	Click "Show Active Clients" for the list of all connected wireless clients. Click "Refresh" in the new window to renew the list, and click "Close" to

	close the window. Note: If you have a pop-up blocker installed, you may have to disable it, or set it to allow the pop-up window to show up.
MAC address 1 to 4	Input the MAC addresses of the wireless access points with which you wish to connect.
Wireless Module	Select "Enable" to turn on the 2.4GHz wireless signal and select "Disable" to turn it off.

Click "Apply" to save the changes, or click "Cancel" to discard the changes. After you have clicked "Apply", you will see the following message:

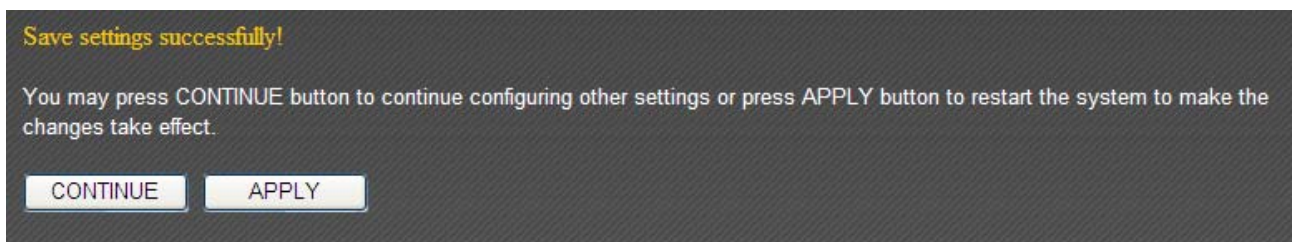

Click "Apply" to save the changes and restart the broadband router. It takes about 60 seconds for the broadband router to restart. Click "Continue" to configure other settings.

3-4-1-6 Universal Repeater

In "Universal Repeater" mode, this broadband router acts as a wireless signal repeater to extend the wireless coverage of the specified wireless access point.

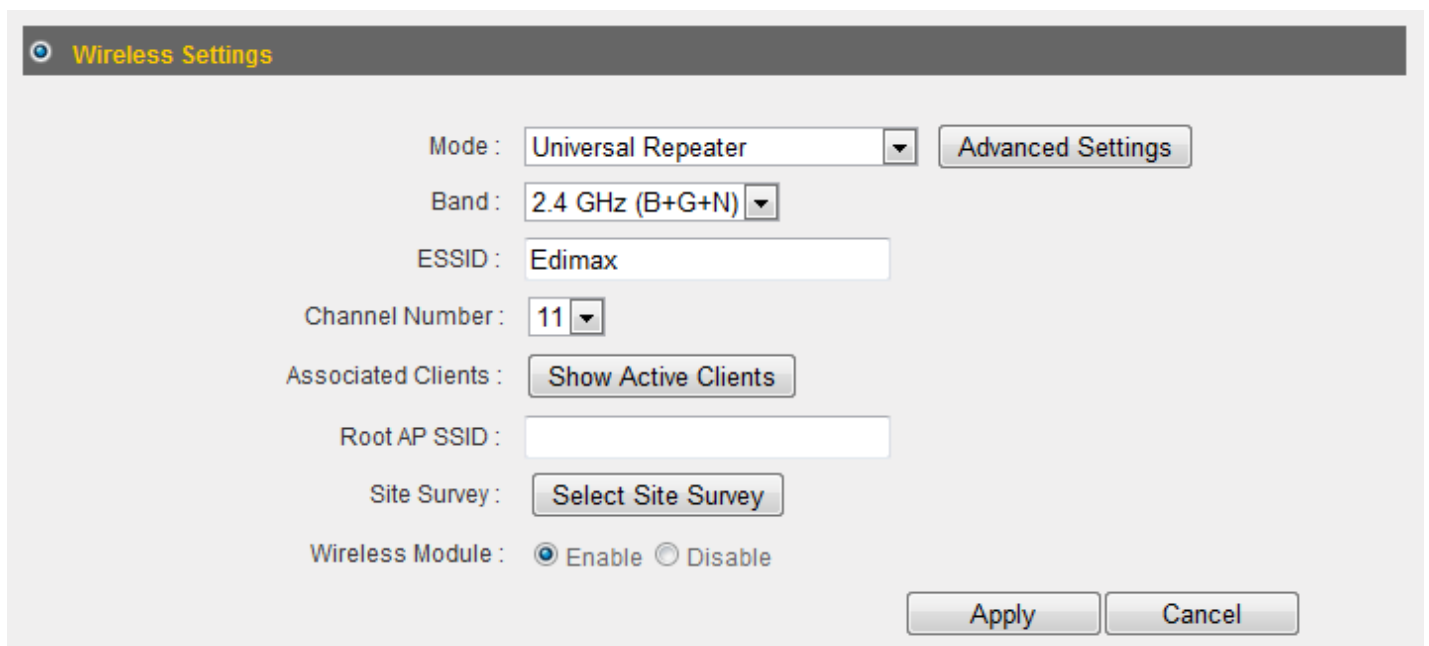

Item Name	Description
Band	<p>Select from one of the following options:</p> <p>2.4GHz (B): Allows 802.11b wireless network clients to connect to this router.</p> <p>2.4GHz (N): Allows 802.11n wireless network clients to connect to this router.</p> <p>2.4GHz (B+G): Allows 802.11b and 802.11g wireless network clients to connect to this router.</p> <p>2.4GHz (G): Allows 802.11g wireless network clients to connect to this router.</p> <p>2.4GHz (B+G+N): Allows 802.11b, 802.11g, and 802.11n wireless clients to connect to this router (recommended).</p>
ESSID	<p>This is the name of your router. You can type any alphanumeric character here (maximum 32 characters).</p>
Channel Number	<p>Select a channel from the dropdown menu. All access points must use the same channel (1 to 13).</p>
Associated Clients	<p>Click "Show Active Clients" for the list of all connected wireless clients. Click "Refresh" in the new window to renew the list, and click "Close" to close the window.</p> <p>Note: If you have a pop-up blocker installed, you may have to disable it, or set it to allow the pop-up window to show up.</p>
Root AP SSID	<p>Input the SSID of the wireless access point with which you wish to connect.</p>
Site Survey	<p>Click "Select Site Survey" and a pop-up window will appear. All reachable wireless access points will be shown in the window. Select a wireless access point from the list, and click "Done" to establish a connection. Clicking "Refresh" will renew the list.</p>
Wireless Module	<p>Select "Enable" to turn on the 2.4GHz wireless signal and select "Disable" to turn it off.</p>

Click “Apply” to save the changes, or click “Cancel” to discard the changes. After you have clicked “Apply”, you will see the following message:

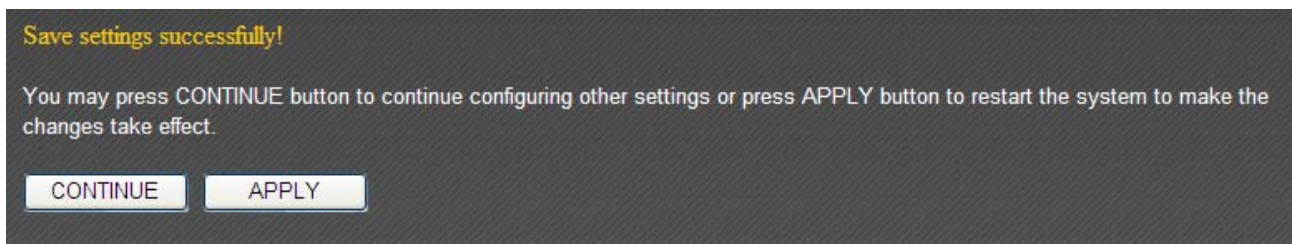

Click “Apply” to save the changes and restart the broadband router. It takes about 60 seconds for the broadband router to restart. Click “Continue” to configure other settings.

3-4-2 Security Settings

Advanced security settings are available in certain modes to enhance connection security.

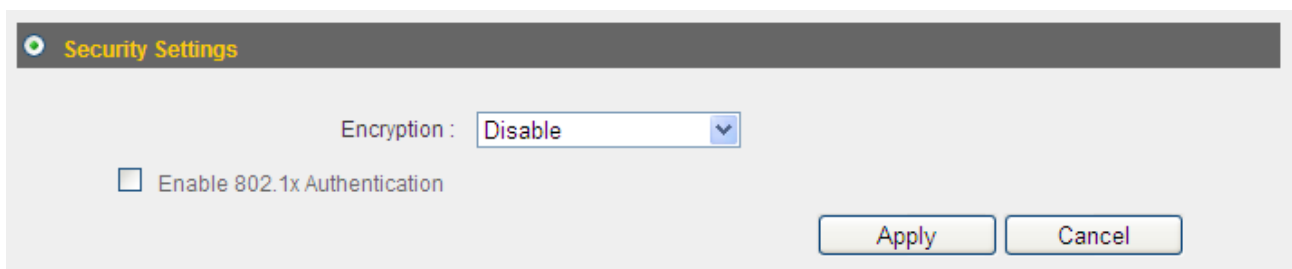

3-4-2-1 Disabled

Connection encryption is disabled under this mode (not recommended).

3-4-2-2 WEP

Selecting “WEP” enables WEP (Wired Equivalent Privacy) encryption.

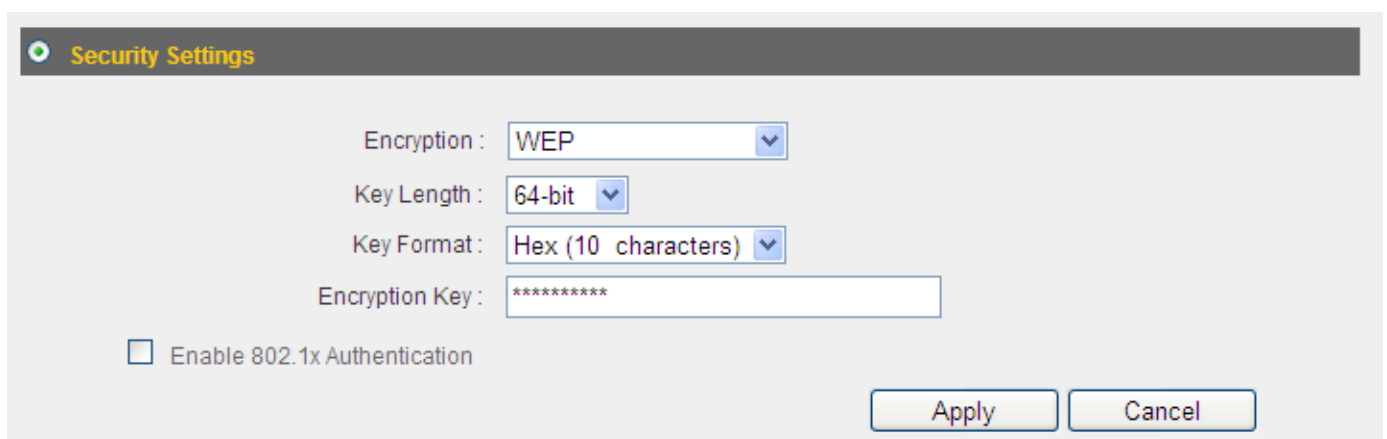

Item Name	Description
Key Length	Two types of key lengths are available: 64-bit and 128-bit.
Key Format	Two types of key formats are available: ASCII and Hex. The number of characters your encryption key can use will be shown here.
Encryption Key	Input an encryption key here. In “ASCII” mode, you can use any alphanumerical character (0-9, a-z, and A-Z). In “Hex” mode, you can use 0-9, a-f, and A-F.
Enable 802.1x Authentication	Check this box to enable the 802.1x authentication function. You need a RADIUS server to perform 802.1x authentication.
RADIUS Server IP address	Input the RADIUS server’s IP address here.
RADIUS Server Port	Input the RADIUS server port here. Generally, it is “1812”.
RADIUS Server Password	Input the password of the RADIUS server here.

Click “Apply” to save the changes, or click “Cancel” to discard the changes. After you have clicked “Apply”, you will see the following message:

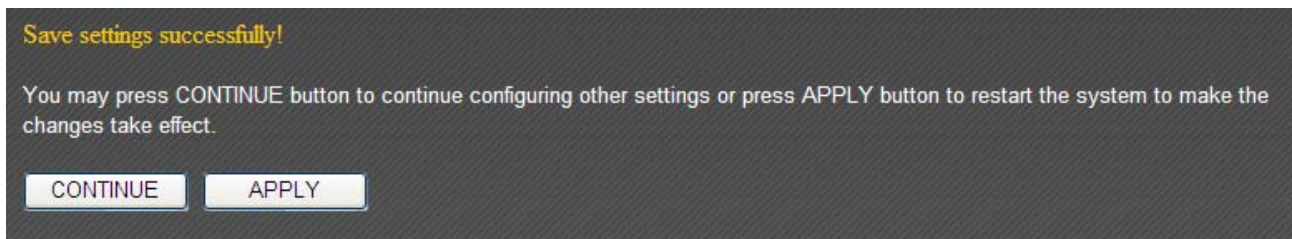

Click “Apply” to save the changes and restart the broadband router. It takes about 60 seconds for the broadband router to restart. Click “Continue” to configure other settings.

3-4-2-3 WPA Pre-Shared Key

WPA (Wi-Fi Protected Access) is a safer encryption mode than WEP (recommended).

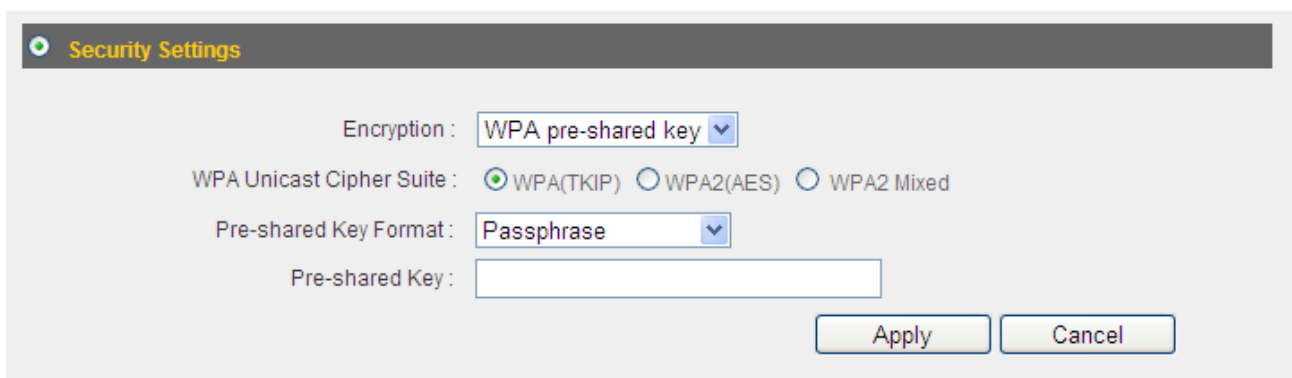

Item Name	Description
WPA Unicast Cipher Suite	Please select a WPA cipher suite supported by your wireless client. Available options are “WPA (TKIP)”, “WPA2 (AES)”, and “WPA2 Mixed”.
Pre-Shared Key Format	Select a pre-shared key format here. “Passphrase” allows you to use 8 or more alphanumerical characters (up to 63). “Hex” allows you to use up to 64 characters within the ranges of 0-9, a-f, and A-F.
Pre-shared Key	Input the WPA key here.

Click “Apply” to save the changes, or click “Cancel” to discard the changes. After you have clicked “Apply”, you will see the following message:

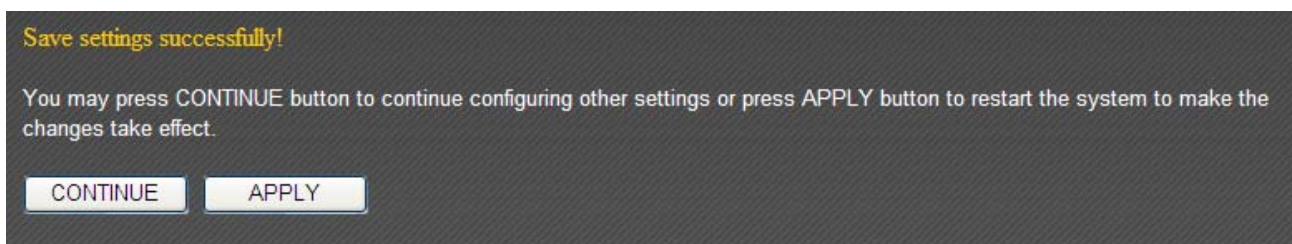

Click “Apply” to save the changes and restart the broadband router. It takes about 60 seconds for the broadband router to restart. Click “Continue” to configure other settings.

3-4-2-4 WPA RADIUS

If you have a RADIUS server on your local network, you can authenticate wireless clients via the RADIUS server’s user database.

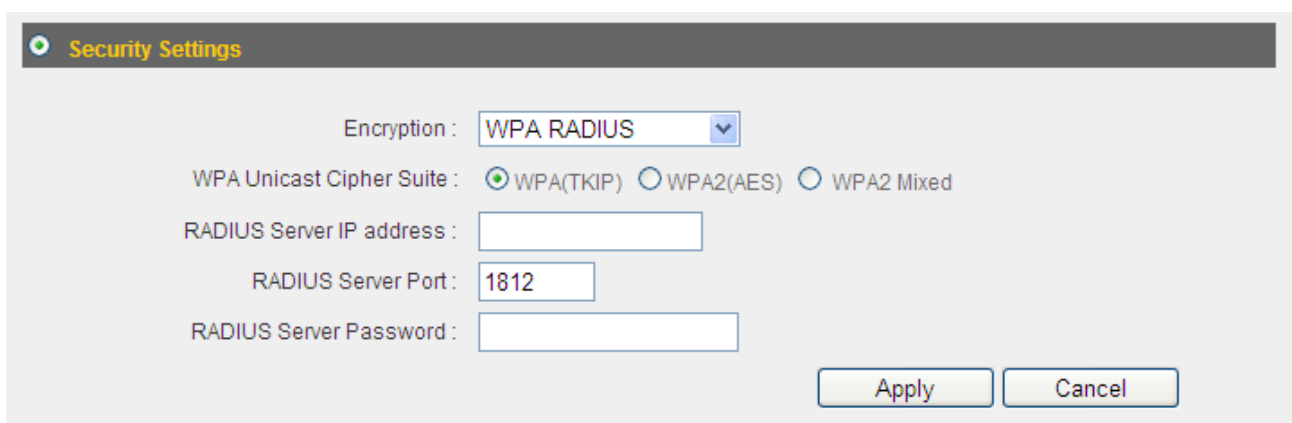

Item Name	Description
WPA Unicast Cipher Suite	Please select a WPA cipher suite supported by your wireless client. Available options are “WPA (TKIP)”, “WPA2 (AES)”, and “WPA2 Mixed”.
RADIUS Server IP address	Input the RADIUS server’s IP address here.

RADIUS Server Port	Input the RADIUS server port here. Generally, it is "1812".
RADIUS Server Password	Input the password of the RADIUS server here.

Click "Apply" to save the changes, or click "Cancel" to discard the changes. After you have clicked "Apply", you will see the following message:

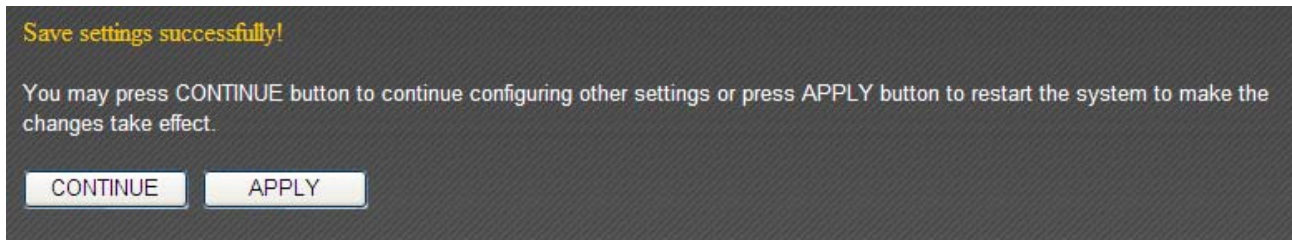

Click "Apply" to save the changes and restart the broadband router. It takes about 60 seconds for the broadband router to restart. Click "Continue" to configure other settings.

3-4-3 MAC Address Filtering

This function will help you prevent unauthorized users from connecting to your wireless router. Only those wireless devices whose MAC address matches the ones you have assigned here can gain access to your wireless router. Up to 20 MAC addresses can be assigned.

To enable MAC address filtering, check the "Enable Wireless Access Control" box.

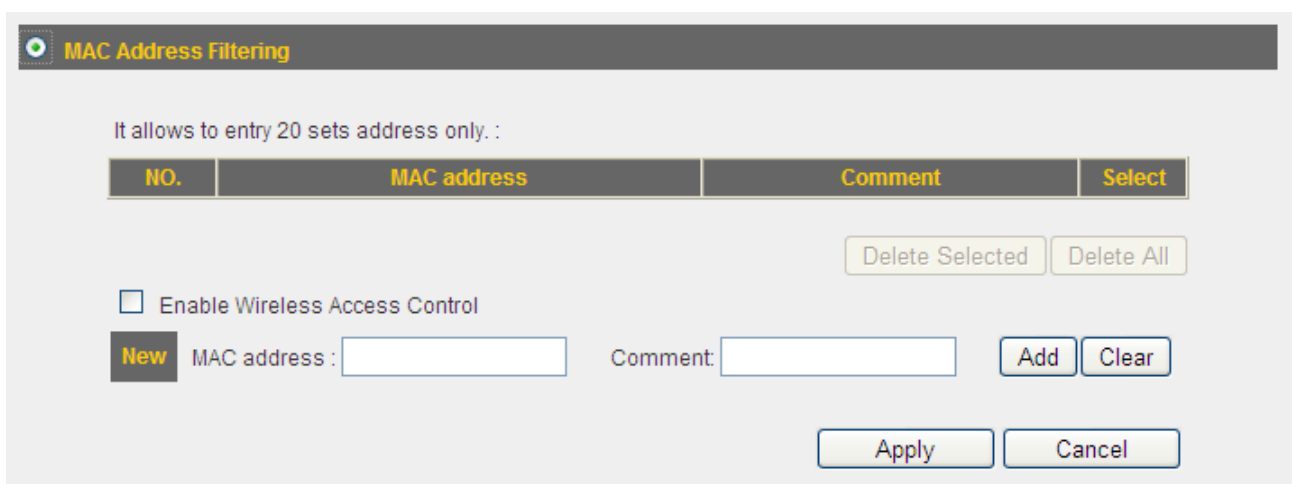

Item Name	Description
MAC Address	Input the MAC address you wish to add here.
Comment	You can input up to 16 alphanumeric characters describing the MAC address here (optional).
Add	Click "Add" to add the MAC address and associated comment to the MAC address list.

Clear	Click “Clear” to remove everything in the MAC address and comment fields.
-------	---

All MAC address entries will be listed in the following table:

NO.	MAC address	Comment	Select
1	11:22:33:44:55:66	John's Computer	<input type="checkbox"/>
2	aa:bb:cc:dd:ee:ff	Mary's Computer	<input type="checkbox"/>

To delete one or more entries, please check the box of the corresponding entry (under “Select”), and click “Delete Selected”. If you wish to delete all the entries, click “Delete All”.

Click “Apply” to save the changes, or click “Cancel” to discard the changes. After you have clicked “Apply”, you will see the following message:

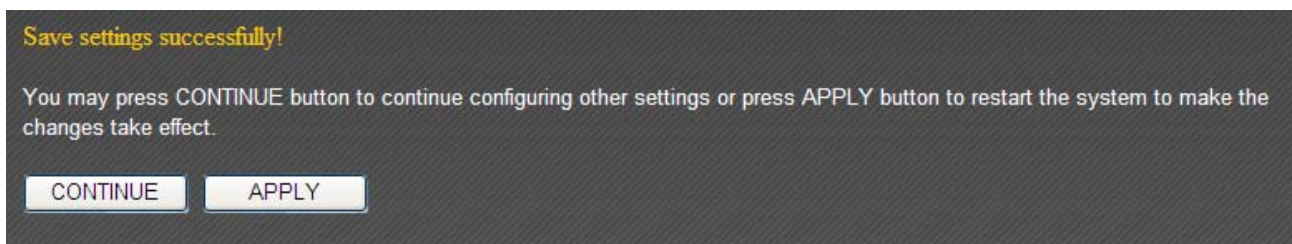

Click “Apply” to save the changes and restart the broadband router. It takes about 60 seconds for the broadband router to restart. Click “Continue” to configure other settings.

3-4-4 WPS (Wi-Fi Protected Setup) Settings

WPS (Wi-Fi Protected Setup) is a convenient way to establish a secure connection between this broadband router and WPS-compatible wireless clients.

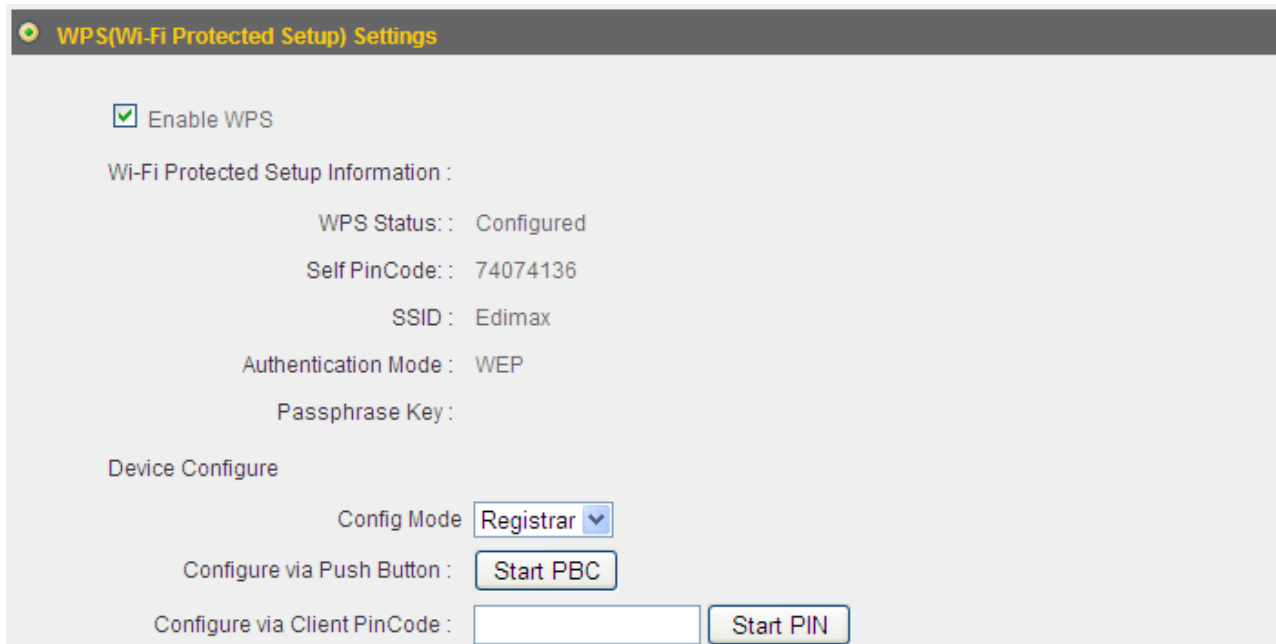

Item Name	Description
Enable WPS	Check this box to enable the WPS function.
WPS Status	The status of the WPS configuration is displayed here.
Self PIN Code	This router's WPS PIN code is displayed here.
SSID	This router's SSID is displayed here.
Authentication Mode	This router's wireless security authentication mode is displayed here.
Passphrase Key	The WPA passphrase key is displayed as asterisk here.
Config Mode	Select this router's WPS configuration role here. Registrar: This broadband router will act as the WPS registrar and wait for the wireless client's WPS configuration request. Enrollee: This broadband router will act as the WPS enrollee and send WPS configuration requests to other WPS registrars.
Configure via Push-Button	Click "Start PBC" to start push-button WPS configuration. You can also use the "WPS/Reset" button located at the back of this router.
Configure via Client PIN Code	Input the WPS-enabled wireless client's PIN code and click "Start PIN" to establish a WPS connection.

3-5 Advanced Settings

You can configure such advanced networking functions like QoS, DDNS, port forwarding, and DMZ under "Advanced Settings".

QoS

DDNS

Dynamic DNS : Enabled Disabled

Provider :

Domain Name :

Account / E-Mail :

Password / Key :

Port Forwarding

DMZ(Demilitarized Zone)

3-5-1 QoS

Quality of Service (QoS) is a means for computers on the network to share Internet bandwidth with guaranteed bandwidth quality for each device. Without QoS, all devices on the network will compete for Internet bandwidth, so applications that require higher bandwidth (like video streaming and network telephone) will suffer from network latency issues.

QoS

Enable QoS

Total Download Bandwidth : kbps

Total Upload Bandwidth : kbps

Current QoS Table :

Priority	Rule Name	Upload Bandwidth	Download Bandwidth	Select

QoS Rules Table :

Rule Name :

Bandwidth : Kbps

Local IP Address : -

Local Port Range :

Remote IP Address : -

Remote Port Range :

Traffic Type :

Protocol :

Item Name	Description
Enable QoS	Check this box to enable the QoS function.
Total Download Bandwidth	You can set a limit to the total download bandwidth here. To disable download bandwidth limitation, input "0" here.
Total Upload Bandwidth	You can set a limit to the total upload bandwidth here. To disable upload bandwidth limitation, input "0" here.
Rule Name	Input a name for this QoS rule for identification purposes.
Bandwidth	<p>Set the speed limitation for this QoS rule here:</p>  <p style="text-align: center;"> 1 2 3 </p> <ol style="list-style-type: none"> 1. Select the direction of data transfer for this rule 2. Input the maximum data rate for this QoS rule 3. Define the data rate value as "Guarantee" (guaranteed bandwidth) or "Max" (maximum bandwidth allowed)
Local IP Address	Set the IP address range that will be affected by this QoS rule. If only one IP address is involved, input the IP address in the left field only.
Local Port Range	Set the port range that will activate this QoS rule. If only one port is involved, input a single number here (1 to 65535). If multiple ports are involved, input the starting and ending port numbers in x-y format (e.g. 10-20).
Remote IP Address	Set the remote IP address range that will be affected by this QoS rule. If only one remote IP address is involved, input the IP address in the left field only.
Remote Port Range	Set the remote port range that will activate this QoS rule. If only one remote port is involved, input a single number here (1 to 65535). If multiple remote ports are involved, input the starting and ending port numbers in x-y format (e.g. 10-20).
Traffic Type	If you are creating a QoS rule for a specific type of traffic, you can define it here. You do not need to fill in any port range information (above) for this type of QoS rule.

Protocol	Define the protocol type here (TCP or UDP).
Add	Click the “add” button to add new QoS rules to the table.
Reset	Click “Reset” to erase all the values you have just entered.
Edit	Select a rule in the QoS table and click “Edit” to modify the contents of a specific rule. Only one rule can be edited at a time.
Delete Selected	Select the rule(s) you want to delete and click “Delete Selected” to perform the task.
Delete All	Click “Delete All” to delete all the rules listed in the QoS table.
Move Up	The “Move Up” button moves a selected rule up in the list, giving it a higher priority.
Move Down	The “Move Down” button moves a selected rule down in the list, giving it a lower priority.

Click “Apply” to save the changes, or click “Cancel” to discard the changes. After you have clicked “Apply”, you will see the following message:

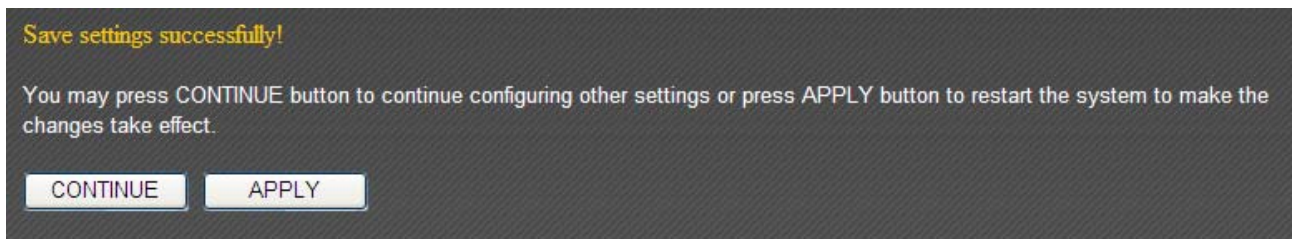

Click “Apply” to save the changes and restart the broadband router. It takes about 60 seconds for the broadband router to restart. Click “Continue” to configure other settings.

3-5-2 DDNS

DDNS (Dynamic DNS) is an IP-to-hostname mapping service for users who do not have a static (fixed) IP address and need to provide services to other users over the Internet.

This router supports the following DDNS service providers:

- DHS (<http://www.dhs.org>)
- Dyn (<http://dyn.com>)
- ODS (<http://ods.org>)
- TZO (<http://www.tzo.com>)
- GnuDIP (<http://gnudip2.sourceforge.net>)
- DyNS (<http://www.dyns.cx>)

- ZoneEdit (<http://www.zoneedit.com>)
- DHIS (<http://www.dhis.org>)
- CyberGate (<http://cybergate.planex.co.jp/ddns>)

Please go to one of the DDNS service provider’s website and get a DDNS account. After that, you can configure the DDNS settings here:

Item Name	Description
Dynamic DNS	Enables or disables the DDNS function.
Provider	Select your DDNS service provider here.
Domain Name	Input the domain name you have obtained from the DDNS service provider.
Account/Email	Input your DDNS account or email of registration.
Password/Key	Input DDNS service password.

The following are the settings for a DHIS DDNS account:

Item Name	Description
HostID	Input the HostID provided by DHIS here.
ISAddr	Input the ISAddr provided by DHIS here.
Authentication Type	Select the authentication type from the dropdown menu (password or QRC).
HostPass	Input the HostPass provided by DHIS here. (This field appears only when the authentication type is “Password”).

AuthP/AuthQ	Input the AuthP/AuthQ provided by DHIS here. (This field appears only when the authentication type is "QRC").
-------------	--

Click "Apply" to save the changes, or click "Cancel" to discard the changes. After you have clicked "Apply", you will see the following message:

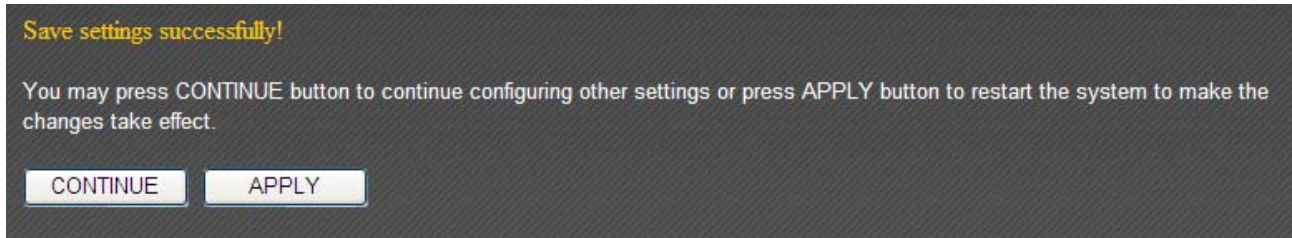

Click "Apply" to save the changes and restart the broadband router. It takes about 60 seconds for the broadband router to restart. Click "Continue" to configure other settings.

3-5-3 Port Forwarding

The port forwarding function allows you to redirect the ports of an Internet IP address to corresponding ports of an IP address in the local network. The port number(s) of the Internet IP address and the local IP address must be identical. If not, please use the virtual server function.

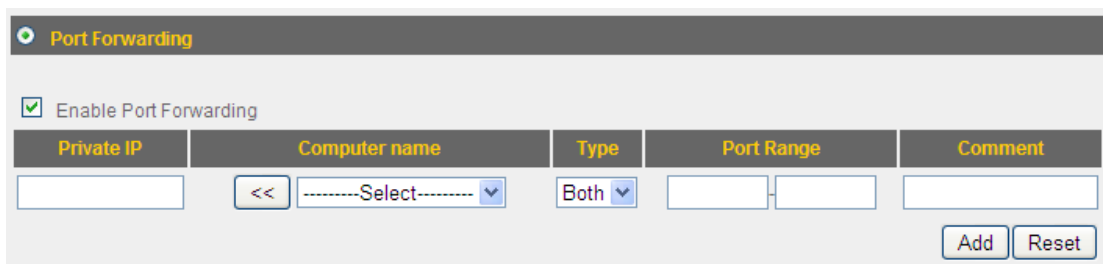

Item Name	Description
Enable Port Forwarding	Check this box to enable the port forwarding function.
Private IP	Input the IP address of the computer in the local network that provides the Internet service.
Computer Name	Computer names found in the local network are listed here. You can select a computer name and click the "<<" button to add the selected computer's IP address to the "Private IP" field.
Type	Select the connection type (TCP or UDP) here. If you are not sure, please select "Both".
Port Range	Input the starting port number in the left field and the

	ending port number in the right field. If only one port number is to be redirected, fill that port number in the left field.
Comment	You can add an optional note in the “Comment” field. Up to 16 alphanumerical characters are supported.
Add	Click “Add” to add the settings to the port forwarding table.
Reset	Click “Reset” to clear all the settings.

Click “Apply” to save the changes, or click “Cancel” to discard the changes. After you have clicked “Apply”, you will see the following message:

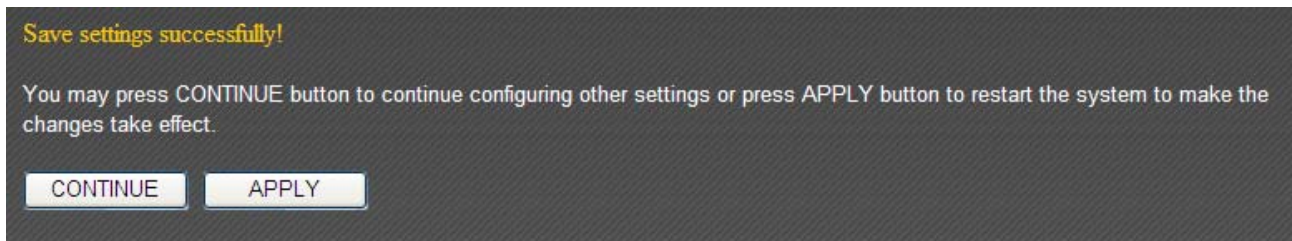

Click “Apply” to save the changes and restart the broadband router. It takes about 60 seconds for the broadband router to restart. Click “Continue” to configure other settings.

3-5-4 DMZ

Adding a device with a private IP address to the DMZ (demilitarized zone) will map the device’s private IP to an Internet IP, so users will be able to access that device over the Internet.

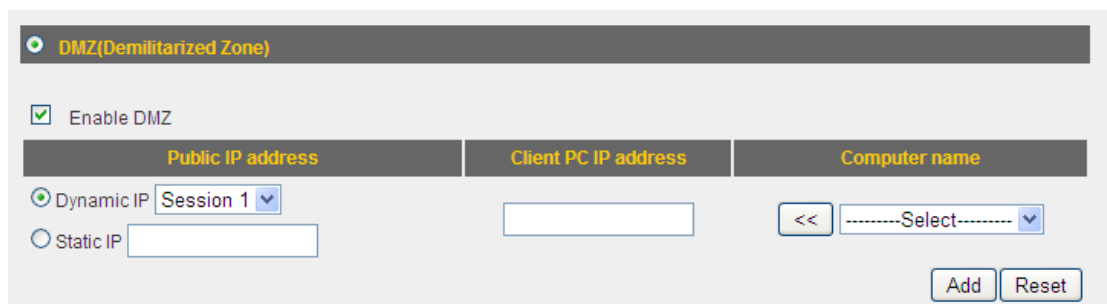

Item Name	Description
Enable DMZ	Check this box to enable the DMZ function.
Public IP Address	If you select “Dynamic IP”, you need to designate a connection session from the dropdown menu. If you select “Static IP”, please input the Internet IP address to which you want to map the private IP address.
Client PC IP Address	Please input the private IP address of the device in the

	local network here.
Computer Name	Computer names found in the local network are listed here. You can select a computer name and click the “<<” button to add the selected computer’s private IP address to the “Client PC IP Address” field.
Add	Click “Add” to add the settings to the DMZ table.
Reset	Click “Reset” to clear the settings.

NOTE: Each public IP address can be mapped to one client PC IP address only.

All DMZ entries are displayed in “Current DMZ Table”:

Current DMZ Table :

NO.	Computer name	Public IP address	Client PC IP address	Select
1	OFFLINE	---	192.168.98.205	<input type="checkbox"/>

Click “Apply” to save the changes, or click “Cancel” to discard the changes. After you have clicked “Apply”, you will see the following message:

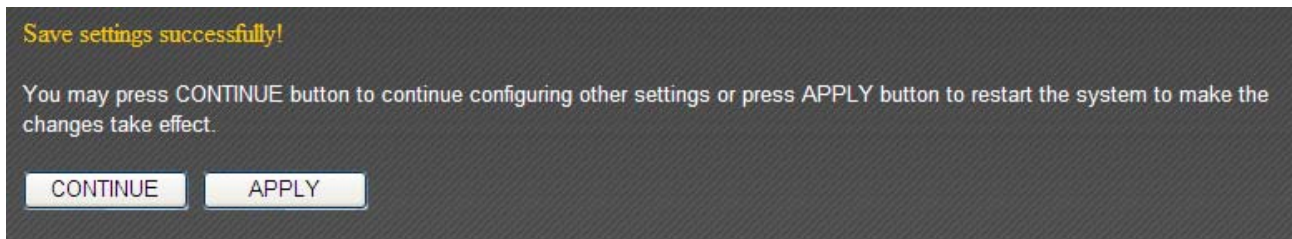

Click “Apply” to save the changes and restart the broadband router. It takes about 60 seconds for the broadband router to restart. Click “Continue” to configure other settings.

3-6 NAT

This broadband router supports four types of NAT functions. See the following for instructions.

3-6-1 Virtual Server

This function allows you to redirect a port of an Internet IP address to a specified port of a private IP address, so you can set up an Internet service on the computer in the local network without exposing it to the Internet directly.

Item Name	Description
Enable Virtual Server	Check this box to enable the virtual server function.
Private IP	Please input the private IP address of the device in the local network here.
Computer Name	Computer names found in the local network are listed here. You can select a computer name and click the “<<” button to add the selected computer’s private IP address to the “Private IP” field.
Private Port	Input the port number of the private IP address here.
Type	Select the connection type (TCP or UDP) here. If you are not sure, please select “Both”.
Public Port	Input the port number of the Internet IP address here.
Comment	You can add an optional note in the “Comment” field. Up to 16 alphanumerical characters are supported.
Add	Click “Add” to add the settings to the virtual server table.
Reset	Click “Reset” to clear all the settings.

Click “Apply” to save the changes, or click “Cancel” to discard the changes. After you have clicked “Apply”, you will see the following message:

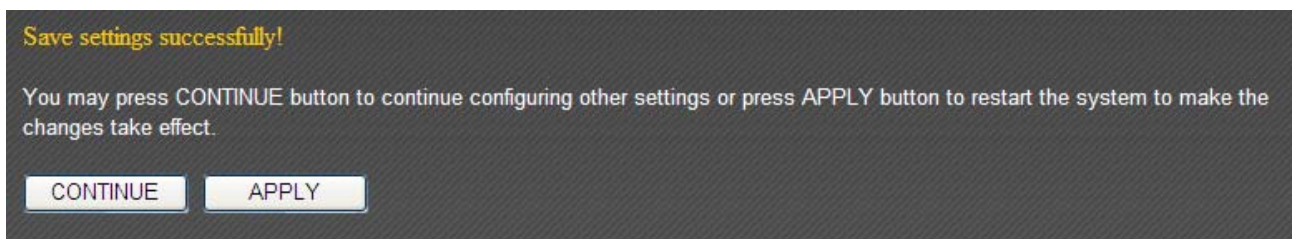

Click “Apply” to save the changes and restart the broadband router. It takes about 60 seconds for the broadband router to restart. Click “Continue” to configure other settings.

3-6-2 Special Applications

Some applications require multiple simultaneous connections, which cannot be set up with simple NAT rules. You can configure the “Special Applications” feature for such applications.

Item Name	Description
Enable Special Applications	Check this box to enable the special applications function.
IP Address	Input the IP address of the computer in the local network that provides the Internet service.
Computer Name	Computer names found in the local network are listed here. You can select a computer name and click the “<<” button to add the selected computer’s IP address to the “IP Address” field.
TCP Port to Open	Input the TCP port number(s) here. The port number can be a single value, or a range (e.g. “20-50”). If you need to input multiple, non-contiguous port numbers, separate each number with a comma (“,”). If the application does not use TCP ports, leave it blank.
UDP Port to Open	Input the UDP port number(s) here. The port number can be a single value, or a range (e.g. “20-50”). If you need to input multiple, non-contiguous port numbers, separate each number with a comma (“,”). If the application does not use UDP ports, leave it blank.
Comment	You can add an optional note in the “Comment” field.
Popular Applications	Here is a list of port mapping settings for numerous network games. Select a game from the dropdown menu and click “Add” to add the settings to the respective fields.
Add	Click “Add” to add the settings to the table.
Reset	Click “Reset” to clear all the settings.

Click “Apply” to save the changes, or click “Cancel” to discard the changes. After you have clicked “Apply”, you will see the following message:

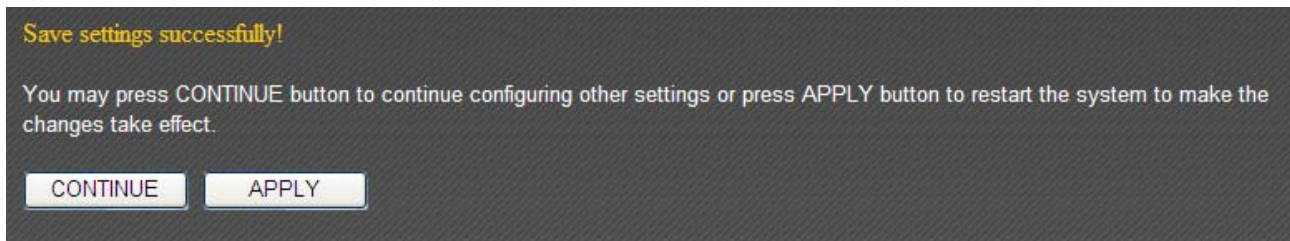

Click “Apply” to save the changes and restart the broadband router. It takes about 60 seconds for the broadband router to restart. Click “Continue” to configure other settings.

3-6-3 UPnP Settings

The UPnP (Universal Plug and Play) feature allows other network devices to communicate with this broadband router.

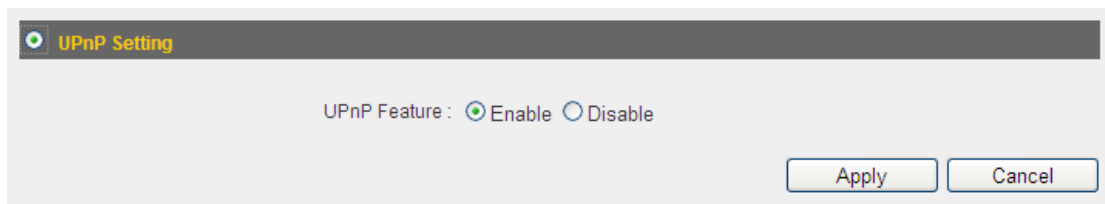

Click “Apply” to save the changes, or click “Cancel” to discard the changes. After you have clicked “Apply”, you will see the following message:

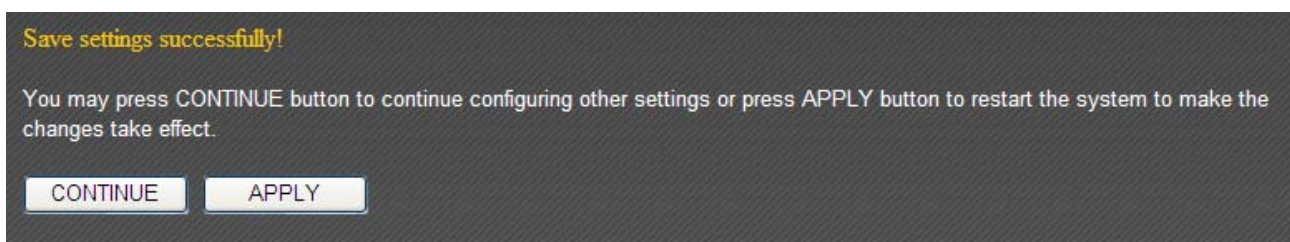

Click “Apply” to save the changes and restart the broadband router. It takes about 60 seconds for the broadband router to restart. Click “Continue” to configure other settings.

3-6-4 ALG Settings

The ALG (application layer gateway) feature is a kind of network connectivity support for applications like network gaming and instant online chatting.

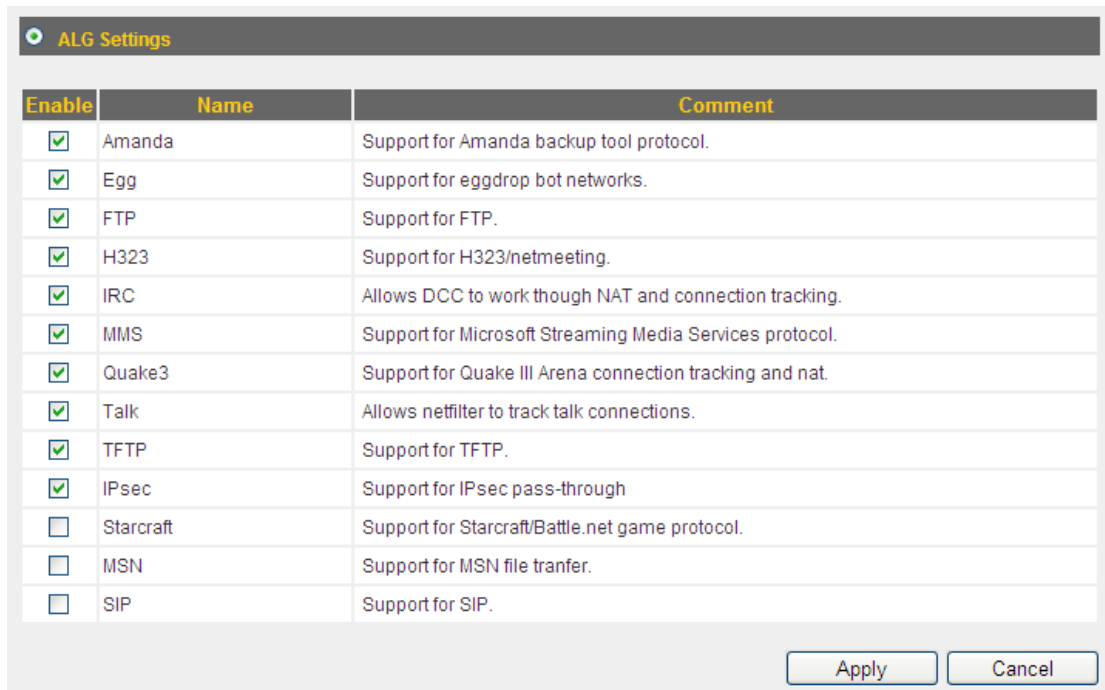

All ALG requiring applications that are compatible with this broadband router is listed here. Check the applications you will be using.

Click "Apply" to save the changes, or click "Cancel" to discard the changes. After you have clicked "Apply", you will see the following message:

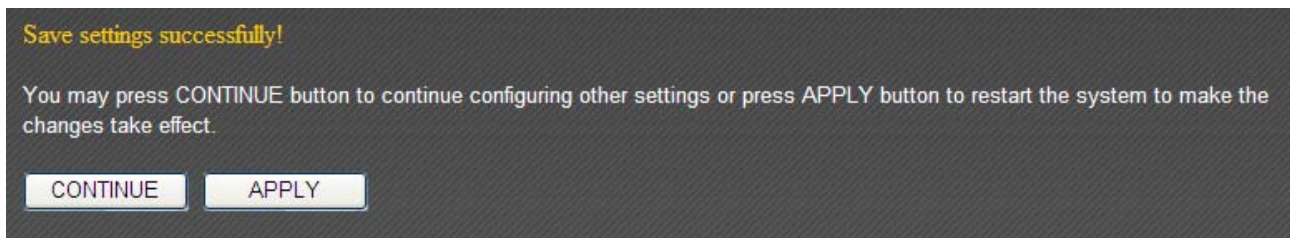

Click "Apply" to save the changes and restart the broadband router. It takes about 60 seconds for the broadband router to restart. Click "Continue" to configure other settings.

3-6-5 Static Routing

In most cases, all the computers in the local network will use a default gateway (generally provided by your ISP) to access the Internet. However, if you have a preferred network route, you can use this function to bypass the default gateway.

Item Name	Description
Enable Static Routing	Check this box to enable the function.
Destination LAN IP	Input the destination LAN IP here.
Subnet Mask	Input the subnet mask of the destination network here.
Default Gateway	Input the gateway IP address that leads to the specified network.
Hop Count	Input the hop count (the distance between the destination network and this broadband router) here.
Interface	Select the interface that leads to the destination network (LAN or WAN).
Add	Click “Add” to add the settings to the table.
Reset	Click “Reset” to clear all the settings.

Click “Apply” to save the changes, or click “Cancel” to discard the changes. After you have clicked “Apply”, you will see the following message:

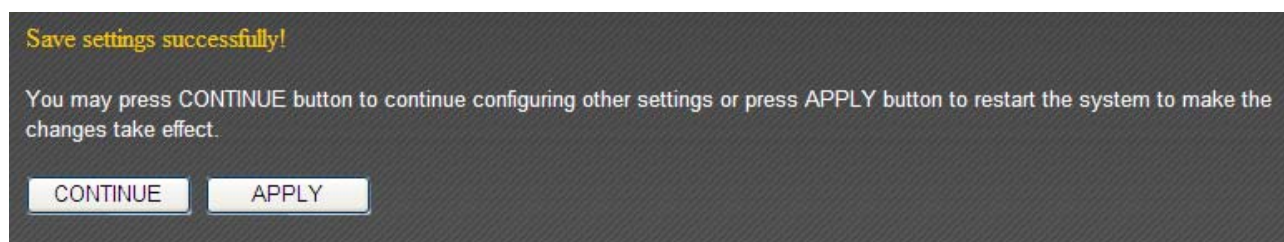

Click “Apply” to save the changes and restart the broadband router. It takes about 60 seconds for the broadband router to restart. Click “Continue” to configure other settings.

3-7 Firewall

You can configure the firewall functions under “Firewall” to protect your network and computer.

3-7-1 Access Control

You can allow or deny computers with certain MAC addresses access to the network.

Item Name	Description
Enable MAC Filtering	Check this box to enable MAC address filtering, and select “Deny” or “Allow” to deny or allow network access to the computer(s) in the list.
Client PC MAC Address	Please input the MAC address of a computer here. Dashes (“-”) and colons (“:”) are not required.
Computer Name	Computer names found in the local network are listed here. You can select a computer name and click the “<<” button to add the selected computer’s MAC address to the “Client PC MAC Address” field.
Comment	You can add an optional note in the “Comment” field. Up to 16 alphanumerical characters are supported.
Add	Click “Add” to add the settings to the table.
Reset	Click “Reset” to clear all the settings.

If you wish to set up IP address filtering, use the “IP Filtering Table” on this page:

Item Name	Description
Enable IP Filtering	Check this box to enable IP address filtering, and select “Deny” or “Allow” to deny or allow network access to the IP address(es) in the list.
Add PC	Click “Add PC” to add an entry to the list.

Access Control Add PC

Client PC Description:

Client PC IP address : -

Client PC Service

Service Name	Detail Description	Select
WWW	HTTP, TCP Port 80, 3128, 8000, 8080, 8081	<input type="checkbox"/>
E-mail Sending	SMTP, TCP Port 25	<input type="checkbox"/>
News Forums	NNTP, TCP Port 119	<input type="checkbox"/>
E-mail Receiving	POP3, TCP Port 110	<input type="checkbox"/>
Secure HTTP	HTTPS, TCP Port 443	<input type="checkbox"/>
File Transfer	FTP, TCP Port 21	<input type="checkbox"/>
MSN Messenger	TCP Port 1863	<input type="checkbox"/>
Telnet Service	TCP Port 23	<input type="checkbox"/>
AIM	AOL Instant Messenger, TCP Port 5190	<input type="checkbox"/>
NetMeeting	H.323, TCP Port 389,522,1503,1720,1731	<input type="checkbox"/>
DNS	UDP Port 53	<input type="checkbox"/>
SNMP	UDP Port 161, 162	<input type="checkbox"/>
VPN-PPTP	TCP Port 1723	<input type="checkbox"/>
VPN-L2TP	UDP Port 1701	<input type="checkbox"/>
TCP	All TCP Port	<input type="checkbox"/>
UDP	All UDP Port	<input type="checkbox"/>

User Define Service

Protocol:

Port Range:

Item Name	Description
Client PC Description	Input a description for the IP address here. Up to 16 alphanumerical characters are supported.
Client PC IP Address	Input the starting IP address in the left field and the ending IP address in the right field. If only one IP address is to be redirected, fill that IP address in the left field.
Client PC Service	Select the Internet services that will apply to this access control rule.

If the service you wish to deny or allow is not listed, you can use the “User Defined Service” settings.

Item Name	Description
Protocol	Select the protocol type (TCP or UDP) here. If you are not sure, please select “Both”.

Port Range	Input the port number(s) here. The port number can be a single value, or a range (e.g. "20-50"). If you need to input multiple, non-contiguous port numbers, separate each number with a comma (",").
------------	---

Click "Apply" to save the changes, or click "Cancel" to discard the changes. After you have clicked "Apply", you will see the following message:

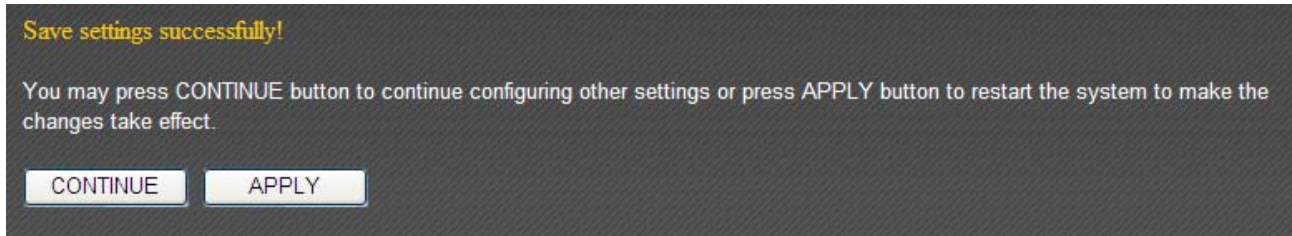

Click "Apply" to save the changes and restart the broadband router. It takes about 60 seconds for the broadband router to restart. Click "Continue" to configure other settings.

3-7-2 URL Blocking

Use the "URL Blocking" function to prevent computers in the local network from accessing certain websites.



Item Name	Description
Enable URL Blocking	Check this box to enable the function.
URL/Keyword	Input the URL of the website or the keyword contained in the URL here.
Add	Click "Add" to add the settings to the table.
Reset	Click "Reset" to clear all the settings.

Click "Apply" to save the changes, or click "Cancel" to discard the changes. After you have clicked "Apply", you will see the following message:

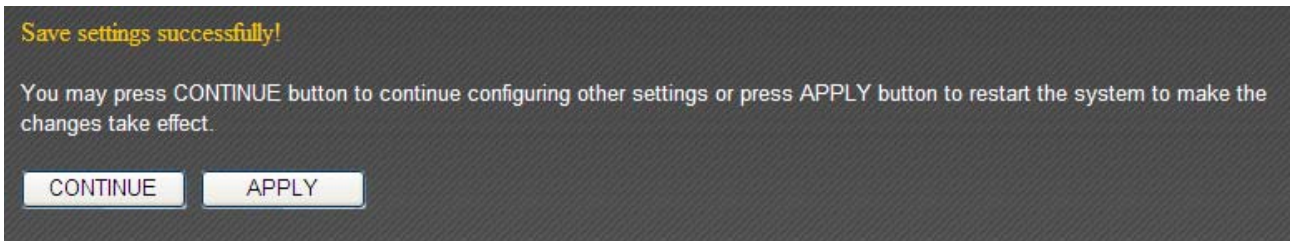

Click “Apply” to save the changes and restart the broadband router. It takes about 60 seconds for the broadband router to restart. Click “Continue” to configure other settings.

3-7-3 DoS

The denial-of-service attack (DoS attack) is a common attack that paralyzes your Internet connection. Configure the DoS function to prevent such attacks.

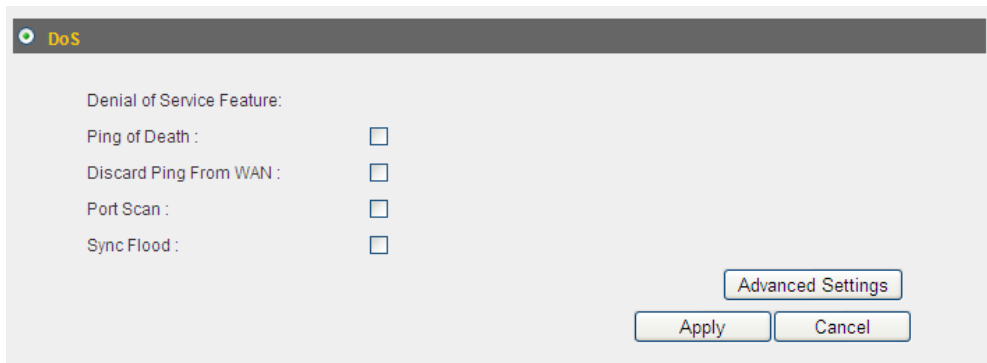

Item Name	Description
Ping of Death	Check this box to filter out malicious ping packets that causes computers to stop responding.
Discard Ping from WAN	Check this box to ignore all inbound ping requests when malicious intruders try to paralyze your Internet connection with many ping requests.
Port Scan	Check this box to block attempts of a malicious intruder trying to scan for open ports on your Internet IP address.
Sync Flood	Check this box to filter out fake connection requests trying to drain the memory of your server.
Advanced Settings	Click “Advanced Settings” to configure details of the DoS function.

Denial of Service

The Broadband router's firewall can block common hacker attacks, including DoS, Port Scan, and discard Ping from WAN.

Denial of Service Feature

Ping of Death : Ping of Death Packet(S) Per Burst

Discard Ping From WAN :

NMAP FIN / URG / PSH

Xmas tree

Another Xmas tree

Port Scan :

Null scan

SYN / RST

SYN / FIN

SYN (only unreachable port)

Sync Flood : Packet(S) Per Burst

Item Name	Description
Ping of Death	Set the threshold for this defense mechanism to be activated here. Check the “Ping of Death” box and input the frequency of the threshold. You can also input the burst value, which activates the mechanism when the number of ping of death packets exceeds the defined number in the specified duration of time.
Discard Ping from WAN	Check this box to ignore inbound ping requests when malicious intruders try to paralyze your Internet connection with many ping requests.
Port Scan	Check the “Port Scan” box to block attempts of a malicious intruder trying to scan for open ports on your Internet IP address. Then check one or more port scanning methods that you would like to block.
Sync Flood	Set the threshold for this defense mechanism to be activated here. Check the “Sync Flood” box and input the frequency of the threshold. You can also input the burst value, which activates the mechanism when the number of connection requests exceeds the defined number in the specified duration of time.

Click “Apply” to save the changes, or click “Cancel” to discard the changes. After you have clicked “Apply”, you will see the following message:

Save settings successfully!

You may press CONTINUE button to continue configuring other settings or press APPLY button to restart the system to make the changes take effect.

Click “Apply” to save the changes and restart the broadband router. It takes about 60 seconds for the broadband router to restart. Click “Continue” to configure other settings.

3-8 Parental Control

You can control when your child is able to access the Internet under “Parental Control”.

To enable the parental control function, check “Enable Parental Control”. This router will only allow Internet access to other computers when your computer is present. By default, your computer’s MAC address will be listed here automatically. You can also input another computer’s MAC address manually in the “MAC Address of Parental PC” field.

NOTE: You do not need to enter the punctuation marks in the MAC address. Just enter the 12 hexadecimal numbers (as shown above).

You also have the option of setting up a parental control schedule.

Item Name	Description
MAC	Input the MAC address of the computer you want to control (i.e. your child’s computer) in the “MAC” field. You can also select a computer in the “Select” dropdown list, and copy it by clicking “<<”.
Weekdays	Select the days that will be affected by the parental control rule.

Time Start/Time Stop	Select the starting/ending time the parental control rule will take effect.
Add	Click “Add” to add the parental control rule to the list.
Reset	Click “Reset” to clear all fields.

To delete one or more entries in the list, please check the box of the corresponding entry (under “Select”), and click “Delete”. If you wish to delete all the entries, click “Delete All”.

Click “Apply” to save the changes, or click “Cancel” to discard the changes. After you have clicked “Apply”, you will see the following message:

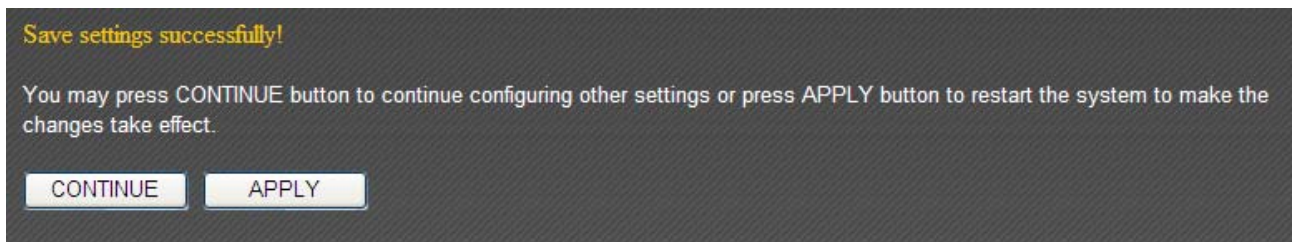

Click “Apply” to save the changes and restart the broadband router. It takes about 60 seconds for the broadband router to restart. Click “Continue” to configure other settings.

CHAPTER IV: STATUS, TOOLS & LANGUAGE

4-1 Status

You can check how your router is currently operating under “Status”.

1. Click the “Status” tab.

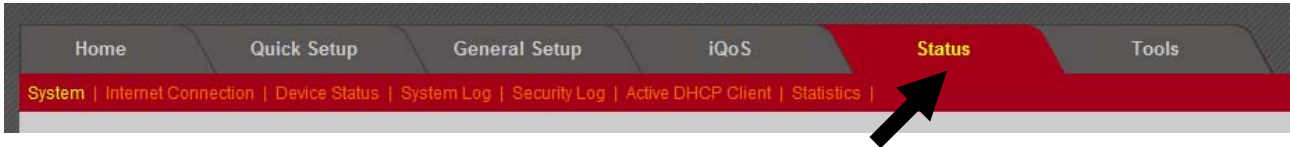

2. Basic system information will be shown under “System”. More information can be found in the other subpages under “System”.

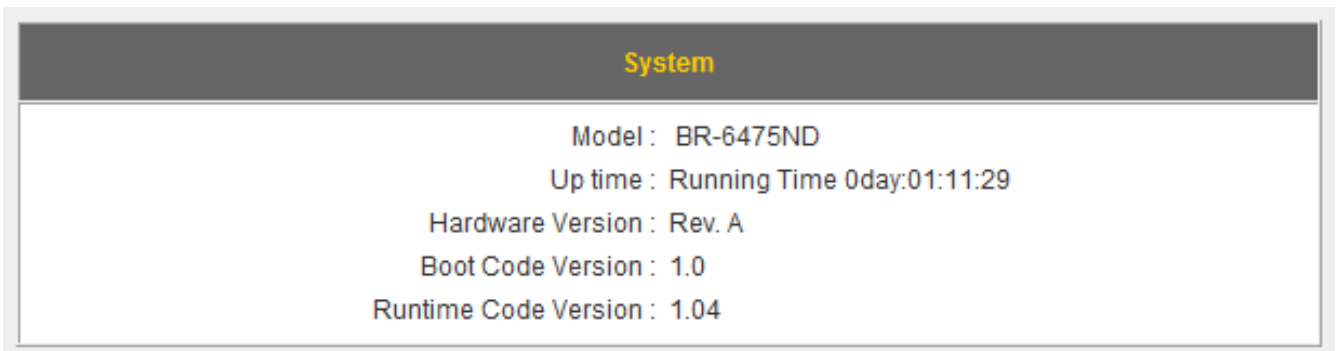

4-1-1 Internet Connection

This page shows the status of your Internet connection.

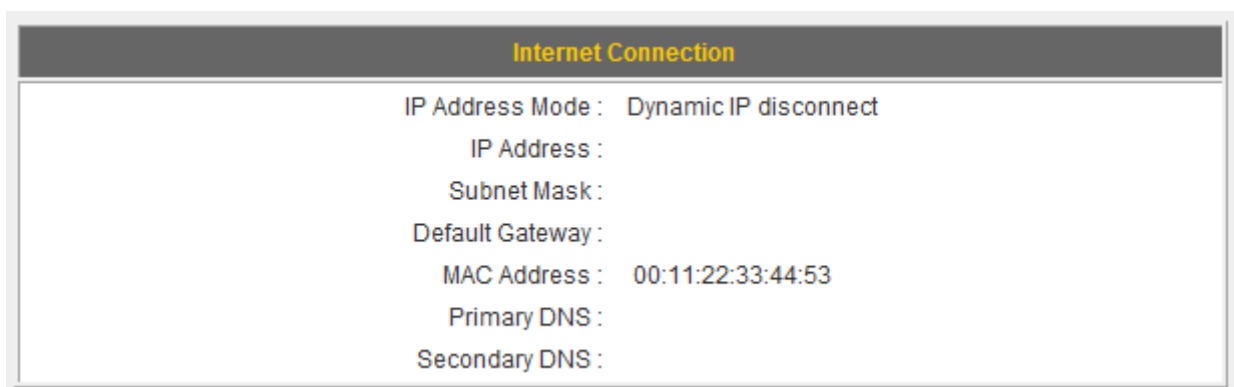

4-1-2 Device Status

This page shows the current settings of your wired and wireless LAN.

The screenshot displays three sections of network configuration settings:

- Wireless Configuration-2.4G:**
 - Wireless Module : Enable
 - Mode : AP
 - ESSID : Edimax
 - Channel Number : 11
 - Security : Disable
 - MAC Address : 00:11:22:33:44:50
- Wireless Configuration-5G:**
 - Wireless Module : Enable
 - Mode : AP
 - ESSID : Edimax
 - Channel Number : 36
 - Security : Disable
 - MAC Address : 00:11:22:33:44:52
- LAN Configuration:**
 - IP Address : 192.168.2.1
 - Subnet Mask : 255.255.255.0
 - DHCP Server : Enable
 - MAC Address : 00:11:22:33:44:50

4-1-3 System Log

This page shows all logged system information. You can click “Save” to download the log file to your computer. You can also click “Clear” to remove all logs, or click “Refresh” to reload the logs.

The screenshot shows a log window with the following entry:

```
Jan 1 00:00:00 (none) syslog.info syslogd started: BusyBox v1.15.2
```

Below the log window are three buttons: **Save**, **Clear**, and **Refresh**.

4-1-4 Security Log

This page shows all logged security-related information. You can click “Save” to download the log file to your computer. You can also click “Clear” to remove all logs, or click “Refresh” to reload the logs.

```

[2000-01-01 00:01:05]: start Dynamic IP
[2000-01-01 00:32:13]: [SNTP]: connect to TimeServer 192.43.244.18 ...
[2000-01-01 00:32:13]: [SNTP]: connect fail!!

```

Save Clear Refresh

4-1-5 Active DHCP Client

This page shows all current DHCP clients. You can click “Refresh” to reload the list.

IP Address	MAC Address	Time Expired(sec)
192.168.2.100	00:1a:a0:ff:7e:5b	forever
192.168.2.101	24:ab:81:9b:45:d4	forever
192.168.2.102	dc:2b:61:7e:22:ac	forever

Refresh

4-1-6 Statistics

This page shows the statistical information of each network interface and the total system up time.

Wireless LAN	Sent Packets	8235
	Received Packets	93125
Ethernet LAN	Sent Packets	11625
	Received Packets	6875
Ethernet WAN	Sent Packets	816
	Received Packets	0
Running Time		Restart

Refresh

4-2 Tools

This broadband router comes with several tools that help you backup the settings, upgrade the firmware, and restart the device.

1. Click the “Tools” tab.

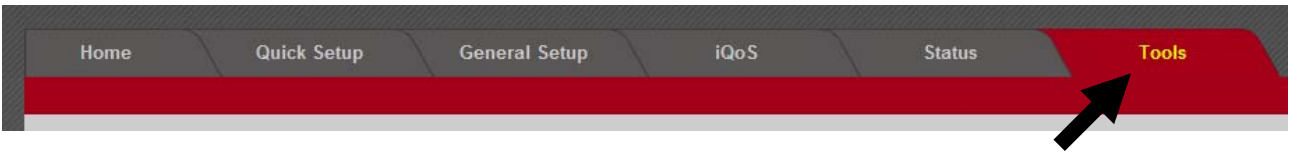

2. You will be able to access the configuration tools, upgrade your firmware, or restart the router here.

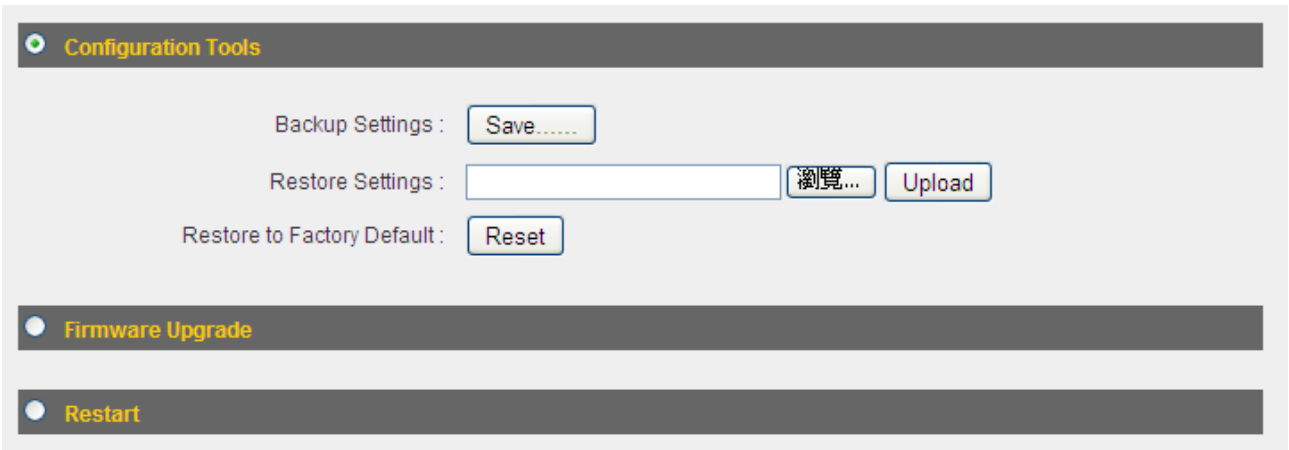

4-2-1 Configuration Tools

You can backup and restore your system configurations here. You can also reset all settings to the factory default.

1. Click “Configuration Tools”.



Item Name	Description
Backup Settings	Click the “Save...” button to save the current settings on your computer as a “config.bin” file.
Restore Settings	Click the “Browse...” button to select a previously saved “config.bin” file from your computer, then click “Upload” to replace the current settings with the settings in the “config.bin” file.

Restore to Factory Default	Click “Reset” to restore the settings to the factory default. A pop-up message window will appear and ask you to confirm the reset.
----------------------------	---

2. Click “Apply” to save the changes. If you wish to go back to the previous page, click “Previous”.

4-2-2 Firmware Upgrade

You can upgrade your firmware in the “Firmware Upgrade” section.

1. Download the firmware file from our company’s website and save it on your computer.



2. Click “Browse...” to find the firmware file saved on your computer, then click “Apply” to start firmware upload. The broadband router will restart after the file is uploaded. All your current settings will be lost after the firmware is upgraded.

NOTE: It is recommended that you use a wired Ethernet connection and not a wireless connection to upload the firmware file. Do not switch the broadband router or computer off while performing firmware upgrade. This will cause the broadband router to malfunction.

4-2-3 Restart

If your broadband router is not functioning properly or responding slowly, restarting the broadband router may solve the problem.

1. Select “Reset”.

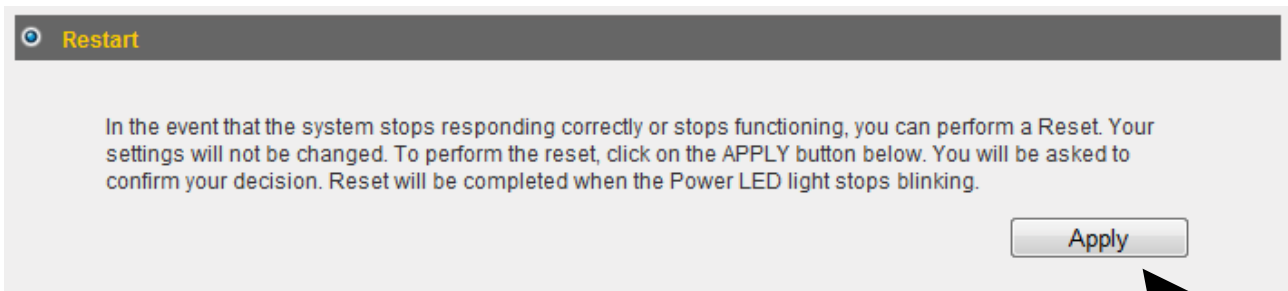

2. Click the “Apply” button to restart the broadband router.
3. When you are prompted to confirm the restart, click “OK”.

4-3 Language

This broadband router’s web-based user interface supports several languages. You can change the display language with the “Language” dropdown menu at the upper-right corner of the user interface.

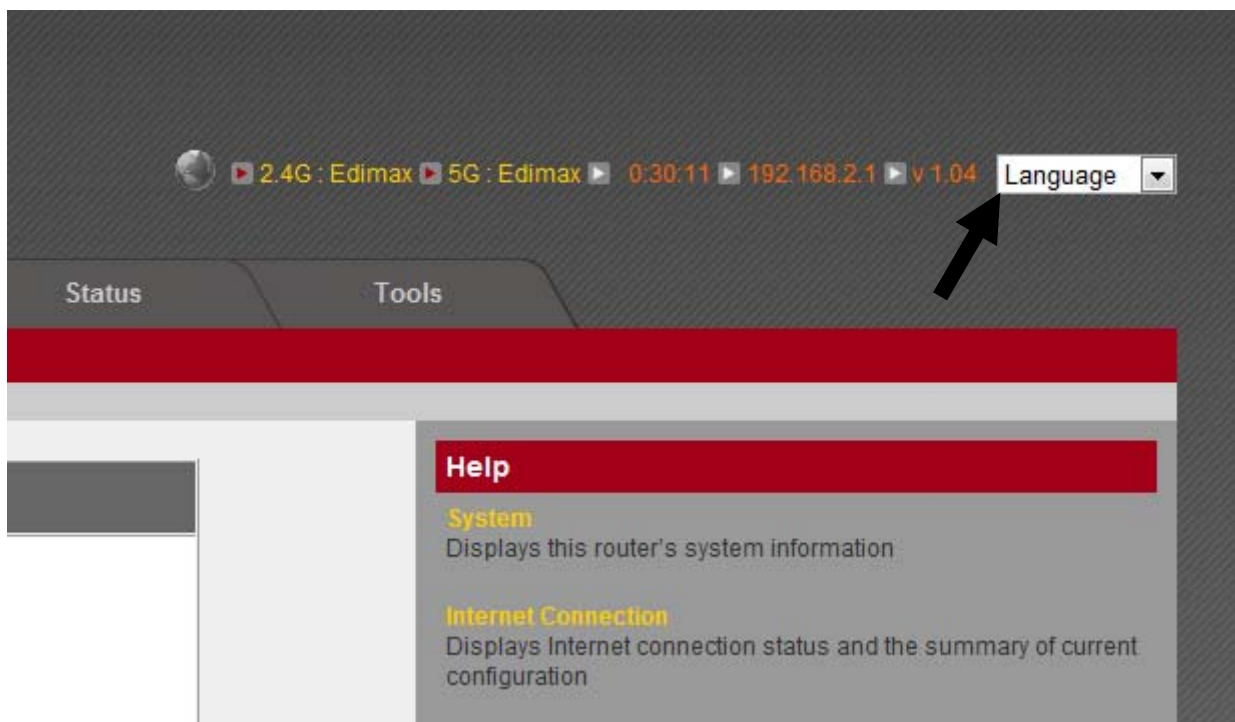



ΣDIMAX
NETWORKING PEOPLE TOGETHER

Edimax Technology Co., Ltd.
No.3, Wu-Chuan 3rd Road, Wu-Gu,
New Taipei City 24891, Taiwan

Edimax Technology Europe B.V.
Nijverheidsweg 25 5683 CJ Best
The Netherlands

Edimax Computer Company
3350 Scott Blvd., Bldg.15 Santa Clara,
CA 95054, USA

www.edimax.com