

# C & A

## Building Plastics

**BIG STOCKS - LOW PRICES - BEST VALUE!**

This edition's  
**SPECIAL OFFER!**

**4M Square & Half  
Round Gutter**

ONLY **£4.99** +VAT



**POLYCARBONATE**



**FASCIA & SOFFIT**



**CLADDING**



**BOARDS & TRIMS**

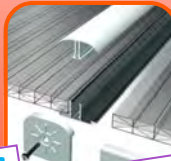

**GLAZING BARS**



**TOOLS & FIXINGS**



**GUTTER & PIPE**



**CORRUGATED SHEETS**

**PLUS LOTS MORE!**



**Over 45 Years supplying a HUGE range of plastic building materials NATIONWIDE!**

**SHOP ONLINE NOW!**  
**[www.cabp.co.uk](http://www.cabp.co.uk)**

**National Lo-cal Rate: 0845 165 165 8**

**Gillingham Depot: 01634 37 44 44**

**London Depot: 0207 474 0474**

# CONTENTS PAGE

02

PAGE	DESCRIPTION	PAGE	DESCRIPTION	PAGE	DESCRIPTION	PAGE	DESCRIPTION
02	CONTENTS PAGE	24	YORK GLAZING BARS	46	GUTTER ACCESSORIES	68	SMALL INTERNAL DECORATIVE PVC
03	ABOUT US	25	YORK GLAZING BARS	47	FASCIA/CLADDING KNOW HOW	69	SMALL INTERNAL DECORATIVE PVC
04	4mm SPC*	26	GLAZING BAR ACCESSORIES	48	SQUARE FASCIA—WHITE	70	SUSPENDED CEILINGS FRAME
05	6mm SPC*	27	GLAZING BAR ACCESSORIES	49	SOFFIT BOARDS—WHITE	71	SUSPENDED CEILING TILES
06	10mm SPC* CLEAR AND HAZE	28	SANCTUARY COMPONENTS	50	OGEE/ BULLNOSE FASCIA—WHITE	72	SKIRTING
07	10mm SPC* BRONZE AND OPAL	29	SANCTUARY KITS	51	WOODGRAIN FASCIA & SOFFIT	73	VALUE RANGE
08	16mm SPC* HAZE AND CLEAR	30	GLAZING BAR KNOW HOW	52	COLORMAX FASCIA & SOFFIT	74	SILICON
09	16mm SPC* BRONZE AND OPAL	31	GLAZING BAR KNOW HOW	53	COLORMAX FASCIA & SOFFIT	75	SILICON & ADHESIVE
10	25mm SPC* CLEAR AND HEAT/OPAL	32	3" CORRUGATED SHEET	54	ACCESSORIES & VENTILATION	76	CLEANERS
11	25mm SPC* CLEAR/ BRONZE /OPAL	33	3" ACCESSORIES + MINI PROFILE	55	WHITE GLOSS PVC CLADDING	77	EXPANDING FOAM
12	35mm SPC* CLEAR/ BRONZE /OPAL	34	BOX CORRUGAED PVC	56	FORTEX TEXTURED CLADDING	78	SCREWS & NAILS
13	40mm SPC* CLEAR	35	BIG 6 & MINI PROFILE CORRUGATED	57	TRIMS & WINDOW BOARDS	79	CORRUGATED FIXINGS
14	MULTIWALL (SPC) KNOW HOW	36	ONDULINE BITUMEN SHEETS	58	DOOR CANOPIES	80	TOOLS
15	MULTIWALL (SPC) KNOW HOW	37	ONDUVILLA	59	DOOR CANOPIES	81	TOOLS
16	SPC* ROOF VENTS	38	CA32 PLASTIC COATED STEEL	60	ILLUMI-THERM FLAT ROOF LIGHT	82	TERMS & CONDITIONS
17	VALE GLAZING BAR	39	CA32 STEEL TRIMS	61	ILLUMI-THERM CONVEX	83	TERMS & CONDITIONS
18	GLEN GLAZING BAR	40	GALVASTEEL	62	FLAT ROOF DOMES	84	DELIVERY INFORMATION & MAPS
19	HAWK GLAZING BAR	41	110mm UNDERGROUND DRAINAGE	63	FLAT ROOF DOMES WITH UPSTAND	85	DELIVERY CHARGES
20	AVON GLAZING BAR	42	ROUND AND SQUARE GUTTERS	64	FLAT SHEET POLYCARBONATE	86	HOW TO ORDER
21	AVON GLAZING BAR	43	OGEE AND FULL FLO GUTTERS	65	FLAT SHEET WHITE PVC AND TRIMS	87	ORDER FORM
22	PEAK GLAZING BARS	44	CAST IRON GUTTER	66	LARGE INTERNAL DECORATIVE PVC		
23	PEAK GLAZING BARS	45	GUTTER DOWNPIPES	67	LARGE INTERNAL DECORATIVE PVC		

\*SPC=Structured Polycarbonate

C & A were established in 1968 by the founding couple Charles and Audrey. Back then, plastics were a relatively new product for the construction industry but C & A had the vision that these were going to be important building blocks for the future. Coming from a carpentry background, it only made sense that these carpentry skills should be used in conjunction with the new emerging plastic products, and the focus was on canopies and carports. These canopies were made-to-measure, sold as either self-assembly kits or with a complete installation service provided. With their success, C & A became one of the largest distributors of PVC corrugated sheets in the UK! Then came the new kid in town — "Multiwall Polycarbonate". Over the years, C & A have become one of the largest independent UK stock holders of polycarbonate sheeting and have continued to stay at the leading edge of this product range. We are often consulted by the manufacturers as to the product's feasibility in the UK market before it goes into full production and is not uncommon for C & A to take part in initial production runs to help launch new product lines to the UK.

It's never easy trying to stay at the front of the market. C & A missed the emergence of the UPVC fascia and soffit market in the 1990's and were playing catch up for a while, therefore we now always encourage feedback and suggestions to help insure that we do not miss these sorts of opportunities in future. Part of our continuous innovation has resulted in C & A designing our own range of glazing bars over the years, each with different attributes. For example, the Avon is 58mm wide to make for easier installation on wide fluted sheets, but the Hawk bar is 48mm wide and fits neatly on 2" timber rafters. We try to offer products to suit every project and this has resulted in the development of products that are fundamentally using the same concept, but offering varying designs to cater for most applications, to certainly try to please everyone.

C & A today is not too dissimilar to the founding beginnings - it is still a family firm, but we now have a lot more than 2 people! We still see plastics as becoming ever more important to the building industry and we take pride in keeping at the leading edge of the industry. With regular talks to industry experts, helping us to look at ways to improve products, service and value for money. Recently, we have renewed our website to give a far better customer experience with order history lookup, plus many other benefits. The site now boasts more and ever growing product video collections, designed to help customers understand the products. These are just the improvements that are visible to you the customer, but rest assured we work just as hard behind the scenes too. Please ensure you keep your records up to date with us, so that you can be the first to hear all about our newest developments, products and special offers!





## THE LARGEST RANGE OF MULTIWALL POLYCARBONATE SHEETS IN THE UK

C & A are not only one of the biggest stock-holders of plastic roofing materials in the UK. We are one of the very few suppliers with their own Transport Delivery service to safely deliver materials of up to 7 metres long, anywhere in the UK mainland. We also offer a range of Glazing Bar Systems for both Frame Supported and Self Supporting roofs, all designed and developed over the years in-house by C & A.

# 4mm CLEAR

TWINWALL POLYCARBONATE

**3.9**  
"U" VALUE  
MAX SUNLIGHT  
MAX VISION

**0.8**  
KG/sq.m

- ▶ Lightweight
- ▶ High light transmission
- ▶ Insulating
- ▶ Low cost
- ▶ Virtually impossible to shatter



*C&A BRAND OFFERS QUALITY WITH AFFORDABILITY*

## BONUS

### 4mm CLEAR



WIDTH ▶	695mm (2' 3 <sup>1/2</sup> "		1047mm (3' 5 <sup>1/2</sup> "		2100mm (6' 10 <sup>1/2</sup> "	
LENGTH ▼	PART	PRICE	PART	PRICE	PART	PRICE
1.0M (3' 3")	MB41007CL	£3.34	MB41010CL	£4.90	MB41021CL	£10.30
1.5M (4' 11")	MB41507CL	£5.25	MB41510CL	£7.73	MB41521CL	£16.18
2.0M (6' 6")	MB42007CL	£6.67	MB42010CL	£9.81	MB42021CL	£20.60
2.5M (8' 2")	MB42507CL	£8.75	MB42510CL	£12.87	MB42521CL	£26.97
3.0M (9' 10")	MB43007CL	£10.01	MB43010CL	£14.71	MB43021CL	£30.89
3.5M (11' 6")	MB43507CL	£12.24	MB43510CL	£18.02	MB43521CL	£37.76
4.0M (13' 1")	MB44007CL	£13.34	MB44010CL	£19.61	MB44021CL	£41.19
5.0M (16' 5")	MB45007CL	£17.49	MB45010CL	£25.75	MB45021CL	£53.94
6.0M (19' 8")	MB46007CL	£20.01	MB46010CL	£29.42	MB46021CL	£61.79

## SEALING TAPES

For 4mm sheets (10M roll)  
To seal open edges of sheets

DESCRIPTION	PART	PRICE
Aluminium Tape	TA10	£1.35
Ventilation Tape	TV10	£4.93

Tapes protect the interior of the sheet from moisture, debris and insects.

Use Vent Tape on the lower edges (nearest gutter) and Ali Tape on the top edges of a Roof, and on any other cut edges.

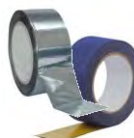

## GREENHOUSE PACK

# BARGAIN

### Pack of 10 Sheets

SHEET SIZE: 4ft x 2ft (1220mm x 610mm)

4mm Multiwall Polycarbonate sheets are perfect for greenhouse glass replacement as a low cost alternative to glass, giving a long life to any greenhouse that can also easily be trimmed to size.

PART	PRICE
KB41206CL	£39.99

# 6mm CLEAR

TWINWALL POLYCARBONATE

<b>3.7</b> "U" VALUE	<b>UV</b> PROTECTION
<b>1.3</b> KG/sq.m	<b>MAX</b> SUNLIGHT <b>MAX</b> VISION

- ▶ Rigid lightweight material
- ▶ Improved insulation
- ▶ Excellent light transmission
- ▶ Impact resistance 200 times greater than glass
- ▶ Low cost economical choice for porches & small canopies



Offers Quality with affordability

SUITABLE FOR  
**GLEN**  
GLAZING BARS  
SEE PAGE 18

**BONUS**

6mm CLEAR



WIDTH	695mm (2' 3 <sup>1/2</sup> " )		1047mm (3' 5 <sup>1/2</sup> " )		2100mm (6' 10 <sup>1/2</sup> " )	
LENGTH	PART	PRICE	PART	PRICE	PART	PRICE
1.0M (3' 3")	MB61007CL	£4.97	MB61010CL	£7.31	MB61021CL	£15.35
1.5M (4' 11")	MB61507CL	£7.82	MB61510CL	£11.51	MB61521CL	£24.12
2.0M (6' 6")	MB62007CL	£9.94	MB62010CL	£14.62	MB62021CL	£30.70
2.5M (8' 2")	MB62507CL	£13.03	MB62510CL	£19.18	MB62521CL	£40.20
3.0M (9' 10")	MB63007CL	£14.91	MB63010CL	£21.92	MB63021CL	£46.05
3.5M (11' 6")	MB63507CL	£18.25	MB63510CL	£26.86	MB63521CL	£56.28
4.0M (13' 1")	MB64007CL	£19.89	MB64010CL	£29.24	MB64021CL	£61.40
5.0M (16' 5")	MB65007CL	£26.07	MB65010CL	£38.38	MB65021CL	£80.41
6.0M (19' 8")	MB66007CL	£29.82	MB66010CL	£43.86	MB66021CL	£92.10

## SEALING TAPES

For 6mm sheets  
10M roll

Aluminium Tape		Ventilation Tape	
PART	PRICE	PART	PRICE
TA10	£1.35	TV10	£4.93

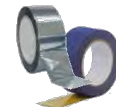

SEALING TAPES—To seal the open edges of sheets.

## SEALING BUTTONS

Pack of 10

For 6mm sheets

WHITE

PART	PRICE
B6WH	£4.25



## SEALING BUTTONS

To secure sheet down along the front edge.

## SHEET END CLOSURE

For 6mm sheets  
Used as endcaps at the end of sheets

COLOUR	WHITE		BROWN		
	PART	PRICE	PART	PRICE	
LENGTH	1050mm	U610WH	£1.39	U610BR	£1.45
	2100mm	U621WH	£2.78	U621BR	£2.99



SHEET END CLOSURE—U-section trim to push fit over Sealing Tapes.

# 6mm STRUCTURED POLYCARBONATE

## 10mm HAZE

TWINWALL POLYCARBONATE

**3.1**  
"U" VALUE

**UV**  
PROTECTION

**1.5**  
KG/sq.m

**MIN**  
SUNLIGHT  
**MIN**  
VISION

**BUDGET**  
**BEATING**  
**SHEETS**

These super value sheets have a high regrid content allowing them to offer dependable roofing at the lowest possible cost. Misty White in colour to give a clean look, privacy & shade.

Exclusive to  
**C&A Building Plastics**

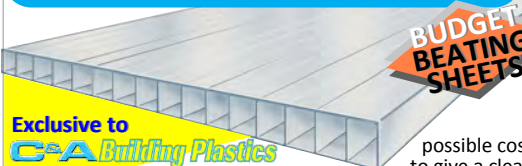

## 10mm CLEAR

TWINWALL POLYCARBONATE

**3.1**  
"U" VALUE

**UV**  
PROTECTION

**1.5**  
KG/sq.m

**MAX**  
SUNLIGHT  
**MAX**  
VISION

**C&A**  
**HOME**

Offers Quality with affordability

**IDEAL FOR**  
**CARPORTS &**  
**OPEN STRUCTURES**

C & A Home Brand sheeting offers this extremely popular high quality sheeting. Made from pure material and a light weight structure to allow for roofing on a budget but still admitting high levels of light to pass through.



### BUDGET

#### 10mm HAZE



WIDTH	700mm (2' 3 <sup>1/2</sup> " )		1047mm (3' 5 <sup>1/2</sup> " )		2100mm (6' 10 <sup>1/2</sup> " )	
LENGTH	PART	PRICE	PART	PRICE	PART	PRICE
1.0M (3' 3")	MHE1007WH	£4.84	MHE1010WH	£7.24	MHE1021WH	£14.90
1.5M (4' 11")	MHE1507WH	£7.26	MHE1510WH	£10.86	MHE1521WH	£22.35
2.0M (6' 6")	MHE2007WH	£9.68	MHE2010WH	£14.48	MHE2021WH	£29.80
2.5M (8' 2")	MHE2507WH	£12.92	MHE2510WH	£19.55	MHE2521WH	£39.91
3.0M (9' 10")	MHE3007WH	£14.52	MHE3010WH	£21.72	MHE3021WH	£44.370
3.5M (11' 6")	MHE3507WH	£17.90	MHE3510WH	£26.59	MHE3521WH	£54.80
4.0M (13' 1")	MHE4007WH	£19.36	MHE4010WH	£28.96	MHE4021WH	£59.61
5.0M (16' 5")	MHE5007WH	£25.84	MHE5010WH	£38.92	MHE5021WH	£79.82
6.0M (19' 8")	MHE6007WH	£28.99	MHE6010WH	£43.44	MHE6021WH	£89.44

### BONUS

#### 10mm CLEAR



WIDTH	700mm (2' 3 <sup>1/2</sup> " )		1047mm (3' 5 <sup>1/2</sup> " )		2100mm (6' 10 <sup>1/2</sup> " )	
LENGTH	PART	PRICE	PART	PRICE	PART	PRICE
1.0M (3' 3")	MBE1007CL	£5.32	MBE1010CL	£7.98	MBE1021CL	£16.46
1.5M (4' 11")	MBE1507CL	£7.98	MBE1510CL	£11.97	MBE1521CL	£24.69
2.0M (6' 6")	MBE2007CL	£10.64	MBE2010CL	£15.96	MBE2021CL	£32.92
2.5M (8' 2")	MBE2507CL	£14.36	MBE2510CL	£21.54	MBE2521CL	£44.44
3.0M (9' 10")	MBE3007CL	£15.96	MBE3010CL	£23.94	MBE3021CL	£49.38
3.5M (11' 6")	MBE3507CL	£19.68	MBE3510CL	£29.52	MBE3521CL	£60.90
4.0M (13' 1")	MBE4007CL	£21.28	MBE4010CL	£31.92	MBE4021CL	£65.84
5.0M (16' 5")	MBE5007CL	£28.72	MBE5010CL	£42.96	MBE5021CL	£88.88
6.0M (19' 8")	MBE6007CL	£31.92	MBE6010CL	£47.88	MBE6021CL	£98.76

**+ SHEET**  
**FITTINGS**

#### SHEET END CLOSURE

For 10mm sheets  
Used as endcaps at the end of sheets

COLOUR

WHITE

BROWN

LENGTH

PART

PRICE

PART

PRICE

1050mm

UE10WH

£1.42

UE10BR

£1.55

2100mm

UE21WH

£2.84

UE21BR

£3.10

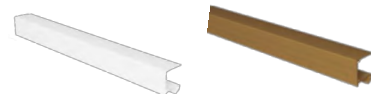

## FOR 10mm SHEETS

## SEALING BUTTONS

Pack of 10  
For 10mm sheets



### WHITE

PART	PRICE
B10WH	£4.50

### BROWN

PART	PRICE
B10BR	£4.96

## SEALING TAPES

10M roll  
For 10mm sheets



### Aluminium Tape

PART	PRICE
TA10	£1.35

### Ventilation Tape

PART	PRICE
TV10	£4.93

# 10mm BRONZE

## TWINWALL POLYCARBONATE

UV PROTECTION

MAX SHADE MIN VISION

3.1 "U" VALUE

1.5 KG/sq.m

C&A BRAND

Offers Quality with affordability

SHADED EFFECT



This sheet's gentle bronzed tint gives a good level of shade, reducing the sun's glare for roofs exposed to direct sunlight.

## BONUS 10mm BRONZE



WIDTH	700mm (2' 3 <sup>1/2</sup> "		1047mm (3' 5 <sup>1/2</sup> "		2100mm (6' 10 <sup>1/2</sup> "	
LENGTH	PART	PRICE	PART	PRICE	PART	PRICE
1.0M (3' 3")	MBE1007BR	£5.68	MBE1010BR	£8.44	MBE1021BR	£17.20
1.5M (4' 11")	MBE1507BR	£8.52	MBE1510BR	£12.66	MBE1521BR	£25.80
2.0M (6' 6")	MBE2007BR	£11.36	MBE2010BR	£16.88	MBE2021BR	£34.40
2.5M (8' 2")	MBE2507BR	£15.34	MBE2510BR	£22.72	MBE2521BR	£46.44
3.0M (9' 10")	MBE3007BR	£17.04	MBE3010BR	£25.32	MBE3021BR	£51.60
3.5M (11' 6")	MBE3507BR	£20.99	MBE3510BR	£31.32	MBE3521BR	£63.64
4.0M (13' 1")	MBE4007BR	£22.70	MBE4010BR	£33.76	MBE4021BR	£68.80
5.0M (16' 5")	MBE5007BR	£30.68	MBE5010BR	£45.44	MBE5021BR	£92.88
6.0M (19' 8")	MBE6007BR	£33.99	MBE6010BR	£50.64	MBE6021BR	£103.20

# 10mm OPAL WHITE

## TWINWALL POLYCARBONATE

UV PROTECTION

SOME SUNLIGHT NO VISION

3.1 "U" VALUE

1.5 KG/sq.m

C&A BRAND

Offers Quality with affordability

PEARLESCENT TRANSLUCENT

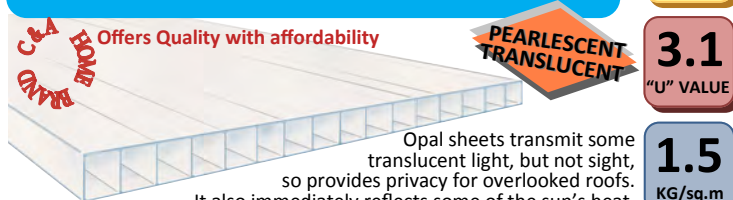

Opal sheets transmit some translucent light, but not sight, so provides privacy for overlooked roofs. It also immediately reflects some of the sun's heat.

## BONUS 10mm OPAL WHITE



WIDTH	700mm (2' 3 <sup>1/2</sup> "		1047mm (3' 5 <sup>1/2</sup> "		2100mm (6' 10 <sup>1/2</sup> "	
LENGTH	PART	PRICE	PART	PRICE	PART	PRICE
1.0M (3' 3")	MBE1007WH	£5.62	MBE1010WH	£8.36	MBE1021WH	£16.96
1.5M (4' 11")	MBE1507WH	£8.43	MBE1510WH	£12.54	MBE1521WH	£25.44
2.0M (6' 6")	MBE2007WH	£11.24	MBE2010WH	£16.72	MBE2021WH	£33.92
2.5M (8' 2")	MBE2507WH	£15.18	MBE2510WH	£22.49	MBE2521WH	£45.79
3.0M (9' 10")	MBE3007WH	£16.48	MBE3010WH	£24.99	MBE3021WH	£50.88
3.5M (11' 6")	MBE3507WH	£20.79	MBE3510WH	£30.92	MBE3521WH	£62.75
4.0M (13' 1")	MBE4007WH	£22.48	MBE4010WH	£33.44	MBE4021WH	£67.84
5.0M (16' 5")	MBE5007WH	£30.36	MBE5010WH	£44.98	MBE5021WH	£91.58
6.0M (19' 8")	MBE6007WH	£33.72	MBE6010WH	£50.26	MBE6021WH	£101.76

# 10mm STRUCTURED POLYCARBONATE

## 16mm HAZE

TRIPLE-WALL POLYCARBONATE



Exclusive to **C&A Building Plastics**

**2.4**  
"U" VALUE

**UV**  
PROTECTION

**2.5**  
KG/sq.m

**MIN**  
SUNLIGHT  
**LOW**  
VISION

These super value sheets have a high regrind content allowing them to offer dependable roofing at the lowest possible cost. Misty White in colour to give a clean look, privacy & shade.

## 16mm CLEAR

W-FORM POLYCARBONATE



**2.4**  
"U" VALUE

**UV**  
PROTECTION

**2.2**  
KG/sq.m

**MAX**  
SUNLIGHT  
**MAX**  
VISION

**C&A BUDGET BEATING SHEETS** Offers Quality with affordability

**AFFORDABILITY AND EASE OF USE**

### BUDGET 16mm HAZE

WIDTH	700mm (2' 3 <sup>1/2</sup> " <sup>n</sup> )		1047mm (3' 5 <sup>1/4</sup> " <sup>n</sup> )		2100mm (6' 10 <sup>1/2</sup> " <sup>n</sup> )	
LENGTH	PART	PRICE	PART	PRICE	PART	PRICE
1.0M (3' 3")	MHT1007WH	£7.94	MHT1010WH	£11.86	MHT1021WH	£23.78
1.5M (4' 11")	MHT1507WH	£11.91	MHT1510WH	£17.79	MHT1521WH	£35.67
2.0M (6' 6")	MHT2007WH	£15.82	MHT2010WH	£23.72	MHT2021WH	£47.56
2.5M (8' 2")	MHT2507WH	£21.44	MHT2510WH	£31.98	MHT2521WH	£64.16
3.0M (9' 10")	MHT3007WH	£23.82	MHT3010WH	£35.58	MHT3021WH	£71.34
3.5M (11' 6")	MHT3507WH	£29.48	MHT3510WH	£43.88	MHT3521WH	£87.98
4.0M (13' 1")	MHT4007WH	£31.76	MHT4010WH	£47.44	MHT4021WH	£94.99
5.0M (16' 5")	MHT5007WH	£42.88	MHT5010WH	£63.96	MHT5021WH	£128.32
6.0M (19' 8")	MHT6007WH	£47.64	MHT6010WH	£71.16	MHT6021WH	£142.68

### W-FORM 16mm CLEAR

WIDTH	980mm (3' 2 <sup>1/2</sup> " <sup>n</sup> )	
LENGTH	PART	PRICE
1.0M (3' 3")	MWT1098CL	£12.49
1.5M (4' 11")	MWT1598CL	£18.74
2.0M (6' 6")	MWT2098CL	£24.98
2.5M (8' 2")	MWT2598CL	£33.72
3.0M (9' 10")	MWT3098CL	£37.47
3.5M (11' 6")	MWT3598CL	£46.22
4.0M (13' 1")	MWT4098CL	£49.86
5.0M (16' 5")	MWT5098CL	£67.44
6.0M (19' 8")	MWT6098CL	£74.94

**One of the best value Clear Multiwall sheets on the market.**  
The special W structure of this sheet improves strength to produce a very light-weight yet strong cost-effective sheet.

- Being a handy 980mm wide sheet helps make for very easy and simple roof construction.
- > Glazing bars and their roof timbers can be set exactly 1 metre apart—a simple bar centre measurement.
- > Both long edges of the sheet are sealed, because they are unlikely to need cutting.
- > Easy to handle as a smaller width.
- > Less need to trim and cut to size, which means a quicker easier roof installation.

### + SHEET FITTINGS

### SHEET END CLOSURE

For 16mm sheets  
Used as endcaps at the end of sheets

COLOUR	WHITE		BROWN	
	PART	PRICE	PART	PRICE
LENGTH				
980mm	UT98WH	£1.59	UT98BR	£1.75
2100mm	UT21WH	£3.32	UT21BR	£3.74

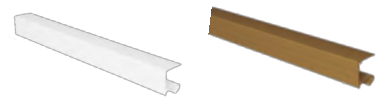



## FOR 16mm SHEETS

## SEALING BUTTONS

Pack of 10  
For 16mm sheets



### WHITE

PART	PRICE
B16WH	£4.60

### BROWN

PART	PRICE
B16BR	£4.97

## SEALING TAPES

10M roll  
For 16mm sheets



### Aluminium Tape

PART	PRICE
TA16	£1.79

### Ventilation Tape

PART	PRICE
TV16	£7.39

# 16mm CLEAR / BRONZE / OPAL WHITE NINE-WALL POLYCARBONATE

1.8  
"U" VALUE

2.5  
KG/sq.m

UV  
PROTECTION

With NEW technology from one of the world's biggest brands

These sheets provide increased rigidity and a level of heat insulation that was previously considered unobtainable from a 16mm sheet.

These qualities make this sheet ideal for wide span canopies and conservatories that are occasionally heated.

Offers Quality with affordability

OUTSTANDING PERFORMANCE

Lexan® Tough Virtually Unbreakable Polycarbonate Sheet

SIZE	FINEST 16mm CLEAR						FINEST 16mm BRONZE						FINEST 16mm OPAL WHITE					
	695mm (2' 3 <sup>3/8</sup> ")		1045mm (3' 5 <sup>1/8</sup> ")		2090mm (6' 10")		695mm (2' 3 <sup>3/8</sup> ")		1045mm (3' 5 <sup>1/8</sup> ")		2090mm (6' 10")		695mm (2' 3 <sup>3/8</sup> ")		1045mm (3' 5 <sup>1/8</sup> ")		2090mm (6' 10")	
WIDTH ▶	PART	PRICE	PART	PRICE	PART	PRICE	PART	PRICE	PART	PRICE	PART	PRICE	PART	PRICE	PART	PRICE	PART	PRICE
LENGTH ▼	1.0M (3'3")		1.5M (4'11")		2.0M (6'6")		2.5M (8'2")		3.0M (9'10")		3.5M (11'6")		4.0M (13'1")		5.0M (16'5")		6.0M (19'8")	
	MFT1007CL	£9.41	MFT1010CL	£13.84	MFT1021CL	£29.09	MFT1007BR	£9.90	MFT1010BR	£14.71	MFT1021BR	£30.85	MFT1007WH	£9.62	MFT1010WH	£14.94	MFT1021WH	£29.91
	MFT1507CL	£14.13	MFT1510CL	£20.77	MFT1521CL	£43.63	MFT1507BR	£14.84	MFT1510BR	£22.06	MFT1521BR	£46.27	MFT1507WH	£14.42	MFT1510WH	£21.67	MFT1521WH	£49.85
	MFT2007CL	£18.83	MFT2010CL	£27.19	MFT2021CL	£58.18	MFT2007BR	£19.79	MFT2010BR	£29.40	MFT2021BR	£61.68	MFT2007WH	£19.26	MFT2010WH	£28.89	MFT2021WH	£59.71
	MFT2507CL	£25.41	MFT2510CL	£37.38	MFT2521CL	£78.53	MFT2507BR	£26.71	MFT2510BR	£39.70	MFT2521BR	£83.27	MFT2507WH	£25.92	MFT2510WH	£38.88	MFT2521WH	£80.74
	MFT3007CL	£28.25	MFT3010CL	£41.53	MFT3021CL	£87.26	MFT3007BR	£29.69	MFT3010BR	£44.11	MFT3021BR	£92.53	MFT3007WH	£28.78	MFT3010WH	£43.33	MFT3021WH	£89.72
	MFT3507CL	£34.84	MFT3510CL	£51.23	MFT3521CL	£107.61	MFT3507BR	£36.61	MFT3510BR	£54.41	MFT3521BR	£114.11	MFT3507WH	£35.62	MFT3510WH	£53.45	MFT3521WH	£110.52
	MFT4007CL	£37.67	MFT4010CL	£55.39	MFT4021CL	£116.35	MFT4007BR	£39.58	MFT4010BR	£58.81	MFT4021BR	£123.37	MFT4007WH	£38.50	MFT4010WH	£57.78	MFT4021WH	£118.63
	MFT5007CL	£50.83	MFT5010CL	£74.77	MFT5021CL	£157.06	MFT5007BR	£53.43	MFT5010BR	£79.40	MFT5021BR	£166.54	MFT5007WH	£51.83	MFT5010WH	£77.77	MFT5021WH	£161.40
	MFT6007CL	£56.50	MFT6010CL	£84.07	MFT6021CL	£174.52	MFT6007BR	£59.77	MFT6010BR	£89.25	MFT6021BR	£186.06	MFT6007WH	£58.76	MFT6010WH	£87.98	MFT6021WH	£182.74

## 16mm STRUCTURED POLYCARBONATE

## 25mm CLEAR

### NINEWALL POLYCARBONATE

**1.4**  
"U" VALUE

**UV**  
PROTECTION  
Both sides

**3.0**  
KG/sq.m

**MAX**  
SUNLIGHT  
**MAX**  
VISION

## 25mm HEATGUARD OPAL

### SEVENWALL POLYCARBONATE

**1.6**  
"U" VALUE

**UV**  
PROTECTION

**3.1**  
KG/sq.m

**HEAT SHIELD**  
PROTECTION

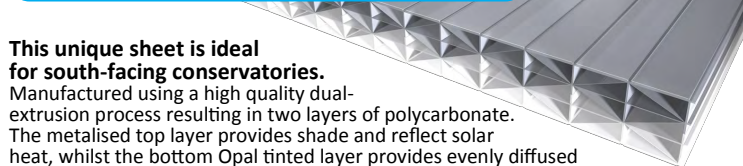

**980mm** 

WIDTH	980mm (3' 2 <sup>1/2</sup> ")	
LENGTH	PART	PRICE
1.0M (3' 3")	MFQ1098CL	£15.54
1.5M (4' 11")	MFQ1598CL	£23.32
2.0M (6' 6")	MFQ2098CL	£31.08
2.5M (8' 2")	MFQ2598CL	£41.88
3.0M (9' 10")	MFQ3098CL	£46.63
3.5M (11' 6")	MFQ3598CL	£55.94
4.0M (13' 1")	MFQ4098CL	£62.17
5.0M (16' 5")	MFQ5098CL	£83.75
6.0M (19' 8")	MFQ6098CL	£95.64
7.0M (22' 10")	MFQ7098CL	£111.92

With Insulation Values better than some 35mm sheets, this sheet is also extremely rigid allowing wider spans between glazing bars. It also has an anti-UV coating on BOTH sides of the sheet so it does not matter which way up the sheet is laid on the roof.

At a handy 980mm wide size these sheets make for very easy and simple roof construction.

> Glazing bars and their roof timbers can be set exactly 1 metre apart—a simple bar centre measurement.

> Both long edges of the sheet are sealed, because they are unlikely to need cutting.

> Less need to trim and cut to size, which means a quicker easier roof installation.



This unique sheet is ideal for south-facing conservatories. Manufactured using a high quality dual-extrusion process resulting in two layers of polycarbonate. The metalised top layer provides shade and reflect solar heat, whilst the bottom Opal tinted layer provides evenly diffused light below and reflects artificial light.

**BONUS HEATGUARD OPAL** 

WIDTH	700mm (2' 3 <sup>1/2</sup> ")		1047mm (3' 5 <sup>1/4</sup> ")		2100mm (6' 10 <sup>1/2</sup> ")	
LENGTH	PART	PRICE	PART	PRICE	PART	PRICE
1.0M (3' 3")	MBQ1007HO	£15.31	MBQ1010HO	£22.72	MBQ1021HO	£46.85
1.5M (4' 11")	MBQ1507HO	£22.89	MBQ1510HO	£34.08	MBQ1521HO	£70.27
2.0M (6' 6")	MBQ2007HO	£30.62	MBQ2010HO	£45.44	MBQ2021HO	£93.70
2.5M (8' 2")	MBQ2507HO	£41.33	MBQ2510HO	£61.34	MBQ2521HO	£126.53
3.0M (9' 10")	MBQ3007HO	£45.93	MBQ3010HO	£68.17	MBQ3021HO	£140.55
3.5M (11' 6")	MBQ3507HO	£56.55	MBQ3510HO	£83.96	MBQ3521HO	£172.96
4.0M (13' 1")	MBQ4007HO	£61.24	MBQ4010HO	£90.89	MBQ4021HO	£187.40
5.0M (16' 5")	MBQ5007HO	£82.64	MBQ5010HO	£122.64	MBQ5021HO	£252.53
6.0M (19' 8")	MBQ6007HO	£93.39	MBQ6010HO	£136.46	MBQ6021HO	£286.23

## + SHEET FITTINGS

### SHEET END CLOSURE

For 25mm sheets  
Used as endcaps at the end of sheets

COLOUR	WHITE		BROWN	
	PART	PRICE	PART	PRICE
LENGTH				
980mm	UQ98WH	£1.99	UQ98BR	£2.22
2100mm	UQ21WH	£4.28	UQ21BR	£4.75

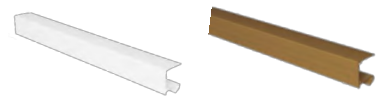

## FOR 25mm SHEETS

## SEALING BUTTONS

Pack of 10  
For 25mm sheets



### WHITE

PART	PRICE
B25WH	£4.73

### BROWN

PART	PRICE
B25BR	£4.98

## SEALING TAPES

10M roll  
For 25mm sheets



### Aluminium Tape

PART	PRICE
TA25	£1.97

### Ventilation Tape

PART	PRICE
TV25	£8.67

# 25mm CLEAR / BRONZE / OPAL WHITE NINE-WALL POLYCARBONATE

1.4  
"U" VALUE

3.0  
KG/sq.m

UV  
PROTECTION  
Both sides

C&A are proud to introduce these 25mm sheets with their new cutting-edge technology. With Insulation Values better than some 35mm sheets, the number of finely divided cells also adds to the sheet's rigidity allowing wider spans between glazing bars.

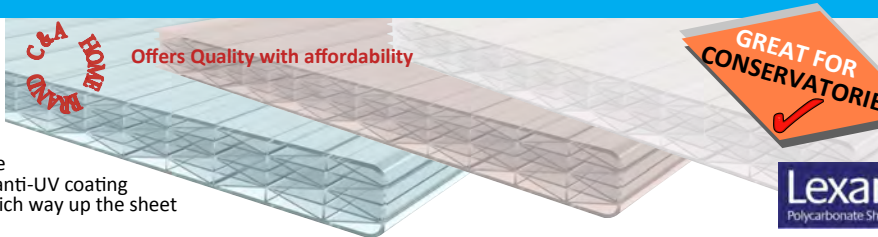

**GREAT FOR CONSERVATORIES**

**Lexan\*** Tough Virtually Unbreakable  
Polycarbonate Sheet

Another great factor to our 25mm sheet is, unlike the majority of multiwall polycarbonate sheeting, it has anti-UV coating on BOTH SIDES of the sheet so it does not matter which way up the sheet is laid on the roof.

SIZE	FINEST 25mm CLEAR						FINEST 25mm BRONZE						FINEST 25mm OPAL WHITE					
	WIDTH ▶ 695mm (2' 3 <sup>3/8</sup> " <sub>RU</sub> )		1045mm (3' 5 <sup>1/8</sup> " <sub>RU</sub> )		2090mm (6' 10")		695mm (2' 3 <sup>3/8</sup> " <sub>RU</sub> )		1045mm (3' 5 <sup>1/8</sup> " <sub>RU</sub> )		2090mm (6' 10")		695mm (2' 3 <sup>3/8</sup> " <sub>RU</sub> )		1045mm (3' 5 <sup>1/8</sup> " <sub>RU</sub> )		2090mm (6' 10")	
LENGTH ▼	PART	PRICE	PART	PRICE	PART	PRICE	PART	PRICE	PART	PRICE	PART	PRICE	PART	PRICE	PART	PRICE	PART	PRICE
1.0M (3'3")	MFQ1007CL	£11.30	MFQ1010CL	£16.62	MFQ1021CL	£34.89	MFQ1007BR	£11.79	MFQ1010BR	£17.66	MFQ1021BR	£37.11	MFQ1007WH	£11.55	MFQ1010WH	£17.32	MFQ1021WH	£36.37
1.5M (4'11")	MFQ1507CL	£16.94	MFQ1510CL	£24.93	MFQ1521CL	£52.35	MFQ1507BR	£17.70	MFQ1510BR	£26.50	MFQ1521BR	£55.66	MFQ1507WH	£17.32	MFQ1510WH	£25.97	MFQ1521WH	£54.54
2.0M (6'6")	MFQ2007CL	£22.58	MFQ2010CL	£33.24	MFQ2021CL	£69.79	MFQ2007BR	£23.58	MFQ2010BR	£35.31	MFQ2021BR	£74.21	MFQ2007WH	£23.10	MFQ2010WH	£34.64	MFQ2021WH	£72.74
2.5M (8'2")	MFQ2507CL	£30.49	MFQ2510CL	£43.22	MFQ2521CL	£94.20	MFQ2507BR	£31.83	MFQ2510BR	£47.68	MFQ2521BR	£99.46	MFQ2507WH	£31.20	MFQ2510WH	£46.76	MFQ2521WH	£98.19
3.0M (9'10")	MFQ3007CL	£33.88	MFQ3010CL	£49.86	MFQ3021CL	£104.68	MFQ3007BR	£35.37	MFQ3010BR	£52.99	MFQ3021BR	£111.32	MFQ3007WH	£34.66	MFQ3010WH	£51.85	MFQ3021WH	£109.11
3.5M (11'6")	MFQ3507CL	£41.77	MFQ3510CL	£59.83	MFQ3521CL	£129.10	MFQ3507BR	£43.60	MFQ3510BR	£65.34	MFQ3521BR	£137.29	MFQ3507WH	£42.73	MFQ3510WH	£64.06	MFQ3521WH	£134.57
4.0M (13'1")	MFQ4007CL	£45.16	MFQ4010CL	£66.48	MFQ4021CL	£139.57	MFQ4007BR	£47.16	MFQ4010BR	£70.62	MFQ4021BR	£148.43	MFQ4007WH	£46.21	MFQ4010WH	£69.26	MFQ4021WH	£145.47
5.0M (16'5")	MFQ5007CL	£60.97	MFQ5010CL	£86.44	MFQ5021CL	£188.33	MFQ5007BR	£63.64	MFQ5010BR	£95.36	MFQ5021BR	£199.10	MFQ5007WH	£62.41	MFQ5010WH	£93.51	MFQ5021WH	£196.38
6.0M (19'8")	MFQ6007CL	£68.93	MFQ6010CL	£101.40	MFQ6021CL	£213.05	MFQ6007BR	£72.48	MFQ6010BR	£106.21	MFQ6021BR	£228.33	MFQ6007WH	£71.53	MFQ6010WH	£104.50	MFQ6021WH	£223.84
7.0M (22'10")	MFQ7007CL	£81.30	MFQ7010CL	£122.66	MFQ7021CL	£252.23	- BY QUOTATION -						- BY QUOTATION -					

## 25mm STRUCTURED POLYCARBONATE

# 35mm CLEAR - BRONZE - OPAL WHITE SEVEN-WALL POLYCARBONATE

**1.2**  
"U" VALUE

**3.8**  
KG/sq.m

**UV**  
PROTECTION

Our range of 35mm sheets have excellent Insulation Values and are all manufactured to an extremely high specification. With CLEAR, BRONZE and OPAL WHITE options, we offer the best choices to suit the majority of Conservatories—part-shaded, overlooked or in full sunlight.



SUITABLE FOR USE WITH:

- ▶ AVON Glazing Bars
- ▶ YORK Glazing Bars
- ▶ VALE Glazing Bars

SIZE	<b>BONUS</b> 35mm CLEAR						<b>BONUS</b> 35mm BRONZE						<b>BONUS</b> 35mm OPAL WHITE					
	700mm (2' 3 <sup>1/2</sup> " )		1047mm (3' 5 <sup>1/2</sup> " )		2100mm (6' 10 <sup>1/2</sup> " )		700mm (2' 3 <sup>1/2</sup> " )		1047mm (3' 5 <sup>1/2</sup> " )		2100mm (6' 10 <sup>1/2</sup> " )		700mm (2' 3 <sup>1/2</sup> " )		1047mm (3' 5 <sup>1/2</sup> " )		2100mm (6' 10 <sup>1/2</sup> " )	
WIDTH ▶	PART	PRICE	PART	PRICE	PART	PRICE	PART	PRICE	PART	PRICE	PART	PRICE	PART	PRICE	PART	PRICE	PART	PRICE
1.0M (3'3")	MBK1007CL	£14.63	MBK1010CL	£21.52	MBK1021CL	£45.18	MBK1007BR	£15.51	MBK1010BR	£22.81	MBK1021BR	£47.89	MBK1007WH	£15.22	MBK1010WH	£22.37	MBK1021WH	£47.00
1.5M (4'11")	MBK1507CL	£23.02	MBK1510CL	£33.89	MBK1521CL	£71.01	MBK1507BR	£24.40	MBK1510BR	£35.92	MBK1521BR	£75.26	MBK1507WH	£23.95	MBK1510WH	£35.24	MBK1521WH	£73.85
2.0M (6'6")	MBK2007CL	£29.26	MBK2010CL	£43.04	MBK2021CL	£90.37	MBK2007BR	£31.01	MBK2010BR	£45.61	MBK2021BR	£95.79	MBK2007WH	£30.43	MBK2010WH	£44.76	MBK2021WH	£93.98
2.5M (8'2")	MBK2507CL	£38.37	MBK2510CL	£56.48	MBK2521CL	£118.34	MBK2507BR	£40.67	MBK2510BR	£59.87	MBK2521BR	£125.44	MBK2507WH	£39.91	MBK2510WH	£58.74	MBK2521WH	£123.07
3.0M (9'10")	MBK3007CL	£43.89	MBK3010CL	£64.55	MBK3021CL	£135.55	MBK3007BR	£46.52	MBK3010BR	£68.42	MBK3021BR	£143.69	MBK3007WH	£45.66	MBK3010WH	£67.13	MBK3021WH	£140.98
3.5M (11'6")	MBK3507CL	£53.71	MBK3510CL	£79.07	MBK3521CL	£165.68	MBK3507BR	£56.94	MBK3510BR	£83.81	MBK3521BR	£175.61	MBK3507WH	£55.87	MBK3510WH	£82.23	MBK3521WH	£172.31
4.0M (13'1")	MBK4007CL	£58.53	MBK4010CL	£86.06	MBK4021CL	£180.73	MBK4007BR	£62.04	MBK4010BR	£91.23	MBK4021BR	£191.58	MBK4007WH	£60.87	MBK4010WH	£89.51	MBK4021WH	£187.97
5.0M (16'5")	MBK5007CL	£76.74	MBK5010CL	£112.96	MBK5021CL	£236.67	MBK5007BR	£81.34	MBK5010BR	£119.75	MBK5021BR	£250.88	MBK5007WH	£79.80	MBK5010WH	£117.48	MBK5021WH	£246.14
6.0M (19'8")	MBK6007CL	£87.78	MBK6010CL	£129.10	MBK6021CL	£271.10	MBK6007BR	£93.05	MBK6010BR	£136.85	MBK6021BR	£287.36	MBK6007WH	£91.30	MBK6010WH	£134.25	MBK6021WH	£281.94

**+ SHEET FITTINGS FOR 35mm SHEETS**

**SHEET END CLOSURE FOR 35mm SHEETS**

COLOUR ▶	WHITE		BROWN	
	PART	PRICE	PART	PRICE
1.2M	UK12WH	£3.12	UK12BR	£3.50
2.1M	UK21WH	£5.46	UK21BR	£5.99

**SEALING BUTTONS**  
Pack of 10 for 35mm

WHITE		BROWN	
PART	PRICE	PART	PRICE
B35WH	£5.30	B35BR	£5.50

**SEALING TAPES**  
10m Roll for 35mm

Aluminium		Ventilation	
PART	PRICE	PART	PRICE
TA40	£2.25	TV40	£9.48

# 40mm CLEAR

## NINE WALL POLYCARBONATE

<b>1.1</b> "U" VALUE	<b>4.3</b> KG/sq.m	<b>UV</b> PROTECTION	<b>SOME</b> SUNLIGHT <b>MIN</b> VISION
-------------------------	-----------------------	-------------------------	---

SUITABLE FOR USE WITH:

- ▶ **AVON** Frame Supported System
- ▶ **YORK** Self-Supporting System

THE  
ULTIMATE  
SHEET

**FINEST CLEAR** 

WIDTH ▶	1200mm (3' 11 <sup>1/4"</sup> )	
LENGTH ▼	PART	PRICE
1.0M (3' 3")	MFN1012CL	£31.98
1.5M (4' 11")	MFN1512CL	£47.97
2.0M (6' 6")	MFN2012CL	£63.96
2.5M (8' 2")	MFN2512CL	£83.95
3.0M (9' 10")	MFN3012CL	£95.94
3.5M (11' 6")	MFN3512CL	£115.60
4.0M (13' 1")	MFN4012CL	£127.92
5.0M (16' 5")	MFN5012CL	£167.40
6.0M (19' 8")	MFN6012CL	£191.88
7.0M (22' 10")	MFN7012CL	£223.86

Only UK STOCKIST

### SOUND PROOFING

The multi-celled, braced construction of 40mm 'X' Form Sheets, not only gives the highest insulation, but also acts as an efficient barrier to intrusive exterior airborne noise, making it the ideal sheet to roof conservatories sited near Airports, Motorways and Industrial Sites.



The advanced cell structure of these 40mm polycarbonate sheets provides increased sheet rigidity and the highest Insulation Value of all our Multiwall Polycarbonate range.

**THE RESULT** — 40mm sheets are capable of spanning far wider distances between Glazing Bars, reducing both material costs and construction time. They also have the best sheet properties to help reduce Winter Fuel Costs, due to its superior insulation properties.



### + SHEET FITTINGS FOR 40mm SHEETS

#### SHEET END CLOSURE FOR 40mm SHEETS

COLOUR ▶	WHITE		BROWN	
	PART	PRICE	PART	PRICE
1.2M	UN12WH	£3.65	UN12BR	£4.10
2.1M	UN21WH	£6.40	UN21BR	£7.20



#### SEALING BUTTONS

Pack of 10 for 40mm



WHITE		BROWN	
PART	PRICE	PART	PRICE
B40WH	£5.70	B40BR	£5.90

#### SEALING TAPES

10m Roll for 40mm



Aluminium		Ventilation	
PART	PRICE	PART	PRICE
TA40	£2.25	TV40	£9.48

## 40mm STRUCTURED POLYCARBONATE

## MULTIWALL POLYCARBONATE INFORMATION & KNOW-HOW

This information is a broad overview for a working knowledge on Multiwall sheeting, Each sheet will be slightly different due to its structure and resin composition and individual data sheets should be consulted if any doubt of the product's suitability for use.

Multiwall Polycarbonate sheeting is a versatile, easy to cut, lightweight, high-impact resistant, insulating and fire resistant product (most have an AA Fire Rating to BS1 Standard 476 or its equivalent in the country of origin). Ideal for roofing or vertical wall cladding applications, and used in many other applications such as set design.

### SHEET SPECIFICATIONS

**3.1**  
"U" VALUE

**INSULATION**—The U Value is the measure of heat transfer through the sheet. The lower the number, the less heat is transferred—better insulation and lower fuel bills!

**UV**  
PROTECTION

**UV PROTECTION** —The outer face of the sheet has a special coating to prevent degradation by natural UV sunlight. UV stabilised increases a product's life span.

**1.5**  
KG/sq.m

**WEIGHT**—Shown per 1M<sup>2</sup>  
As the weight of the sheet increases, generally the level of insulation will also increase.

**MIN**  
SUNLIGHT  
**MIN**  
VISION

**SUNLIGHT AND VISION** — A summary of the sheet's amount of sunlight penetration and the amount of vision it allows through the sheet.

**HEAT**  
**SHIELD**  
PROTECTION

**HEAT SHIELDING** — Sheets with this symbol have a special coating designed to reduce heat, providing a cooler space below the sheet.



**LIGHT TRANSMISSION** —Manufacturer's measure the light that passes through their sheets . However, they use different tests in different laboratories and so real world comparison between them is difficult. This symbol is our own indicator as to the shading we feel they provide. Official figures can be obtained from the individual product data sheets.

### Sheet Storage

> Polycarbonate sheets stored outside in the open must have sheet ends taped up to prevent insects, debris or moisture invading the cells.

> Stacks of polycarbonate sheets should be covered with a light proof sheet to prevent distortion by magnified sunlight.

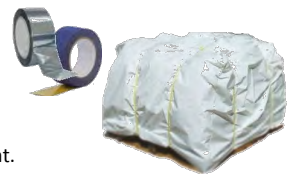

### Handling Sheets

> Polycarbonate sheets have temporary plastic cover films on their surface each side to protect them from marks or scratches.

> Plastic cover films also indicate which face is the upper side with the UV protection—this will normally be the film printed with writing.

> As it is almost impossible to otherwise tell the two sides apart, **DO NOT REMOVE** the cover film until the sheet is being laid on the roof.



### Cutting Sheets

> Polycarbonate sheets can be easily trimmed using a fine bladed/ toothed handsaw. Power saws should be used with caution and are generally not recommended unless experienced in working with plastics.

> When cutting, support both sides of the cut and saw at a shallow angle with light pressure.

> For long cuts, overlay the approximate cut line with masking tape so an accurate line can be marked.

> Sheet debris from cutting can be removed from the cells with compressed air or a quality vacuum cleaner.

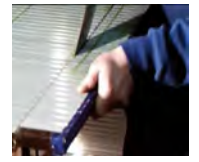

## Sheet Expansion

> Polycarbonate roof sheets must be fitted with a gap that allows them to expand with temperature changes.

> **AT THE TOP**—Allow a 3mm gap for each metre of the sheets length (this will be covered by a wall flashing).

> **AT THE SIDES**—Allow a 3mm gap between the sheet edge and the centre ribs of the Glazing Bar on both sides (An average bar centre spacing is 20mm wider than the sheet itself. However a 980mm wide sheet allows bars to be set at 1M centres).

EXAMPLE. 3M x 980mm SHEET

9mm expansion allowance for the top edge (3x3)

3mm expansion allowance each side



## Typical Sheet Usage

### THICKNESS

4mm  
6mm  
10mm  
  
16mm  
  
25mm  
35mm  
40mm

### NORMAL AREA OF USE

Basic Horticulture  
Heavy Duty Horticulture  
Premium Horticulture  
Basic Open Structures  
  
Open Structures  
Basic Enclosed Structures  
  
Enclosed Structures  
Heavy Duty Enclosed Structures  
Prestigious Structures



## Online Resources

[www.cabp.co.uk](http://www.cabp.co.uk)

Getting better information has become easier due to the Internet, so why not have a look at the great features and additional information our website has to offer using your PC, Tablet or Smart Phone, with just a few simple clicks!

> **DATA SHEETS**—There is a wealth of additional information about our products, including Multiwall Polycarbonate sheeting, that can be found online on our website. Our data sheets can be found under a product's **Specification** tab shown on each product's page. This will provide any further product details that we offer direct from the manufacturers themselves.

> **COMPONENT CALCULATORS**—You have decided that you want to build a polycarbonate roof, whether it is an open lean-to, or an enclosed structure such as a conservatory. You have not built one before so you are a little unsure of what the components are and where they go. Don't worry, we have been helping people get it right for a long time!

We have created some easy-to-use online calculators to ensure that you get all the components you need for your roof.

Simply visit the link to the webpage [www.cabp.co.uk/Calculators.htm](http://www.cabp.co.uk/Calculators.htm)

> **PRODUCT VIDEOS**—In addition to the product information we have written online, we also have devised a collection of helpful videos that explain our products or how we recommend using them, to guide you in your building projects. They can be found under an individual product's information, under the **Video** tab.

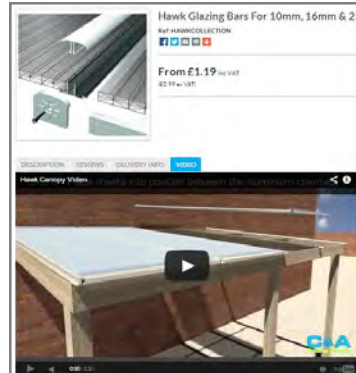

**+ WE ARE HERE TO HELP!**  
Simply call us on 08451651658 and we will try to help there and then on the phone. It's not always easy, as a picture says a thousand words, so we may ask for further information, but most queries can be resolved in a single phone call.

## AVON Bar Component calculator

Please enter data into the **Orange** boxes to calculate your requirements  
This form will calculate the stock size materials required to cover the area entered. This is not a cut to size service.



Enter distance along host wall in meters

Select projection: fall of roof in meters

Select Polycarbonate thickness in mm

Select Clear, Bronze, Opal or Heat GL

Select Polycarbonate colour

Select Glazing Bar & Accessory Colour



Please Note: These bars are for timber or metal supporting framework.  
Sheet width selected based on max span without gullin support

SHEETS & ACCESSORIES	PART	QTY
2.8M x 1.05M x 25mm Clear	MPQ2510CL	8
Stand bars for 25mm sheets 1051	TV25	1
Alu tape for 25mm sheets 1051	TA25	2
25mm Sheet endcap 2.1M White	QD2510W	2
White fixing subtile pack of 50 for 25mm	BE2510W	1
Avon areas material 2.1M White	ABR210W	3
GLAZING & ACCESSORIES		
2.8M Avon 19-25mm bar White	ATQ2510W	6
Clear and Avon bar endcap White	SAC2510	6
3.5M End bar 19-25mm White	EQ2510W	2
1.8" BS Square Prof of 25	SR15	3
Silicone White	ST01W	1
White Rubber Mallet	TRAV	1
Pack of 10 glue and screws 30mm White	SPP301W	2
3.05 PVC Wall Flashing White	PF301W	1
2.0M PVC Wall Flashing White	PF201W	1

## ROOF VENTILATION FOR POLYCARBONATE ROOFS

Without roof ventilation many conservatories, especially south-facing, can build up such high levels of solar heat that they can become inhabitable. It is recommended that roofs in direct sunlight have a roof vent for every 6M<sup>2</sup> of roof area, and shaded roofs have a roof vent for every 12M<sup>2</sup> of roof area.

### SOLAR POWERED VENTS

BASIC 100 MODEL	MODEL	PART	PRICE
	<b>BASIC 100</b> Simple On/Off button only.	SV100	<b>£49.95</b>
	<b>BOOST 300</b> Includes Directional fan button & Boost button to turn on without sunlight using an in-built rechargeable battery.	SV300	<b>£69.10</b>
	<b>INSTALLATION KIT</b> Includes Hole saw & Arbour Saw to cut a neat circular hole in the roof sheet & Clear Stixall.	SVKIT	<b>£25.00</b>

**Ideal for conservatories:** These fans work efficiently as they can be permanently switched on. This means that when the sun shines the fan will automatically extract hot air without the concern that a room will overheat (which could cause damage or worry that a window may have been left open accidentally). In full sunlight these vents will disperse 25M<sup>3</sup> of hot air per hour through the roof.



### UPVC ROOF VENT WINDOWS

White UPVC Frames With Chrome Worm Screw  
W. 550mm x L. 750mm (1' 9<sup>1/2</sup>" x 2' 5<sup>1/2</sup>" )

**These complete kits are designed for retrofitting existing roofs or new installations.**

A rectangular hole is cut out of the sheet, using the window frame as a template. Pre-welded Roof Vent Windows come ready to install.

Simply cut out the polycarbonate, using the templates supplied with the vent. The section of sheet that has been removed is used to glaze the window, ensuring a perfect match on the sheet every time.

Then using the sealant and gaskets supplied, fit to your existing roof sheet.

DESCRIPTION	PART	PRICE
<b>FOR 16mm SHEETS</b>	VP16WH	<b>£145.99</b>
<b>FOR 25mm SHEETS</b>	VP25WH	<b>£145.99</b>
<b>FOR 35mm SHEETS</b>	VP35WH	<b>£175.99</b>
<b>OPTIONAL LONG HANDLE</b>	VLH	<b>£38.75</b>





# VALE GLAZING BAR

## THE SIMPLE SOLUTION FOR ALL FLAT SHEET ROOFING

- ▶ C&A's own design
- ▶ One-Size-Fits-All design
- ▶ Use with ALL flat sheet glazing roofing materials
- ▶ In **WHITE** or **BROWN**

The **VALE** Glazing Bar is a simple yet hugely popular product allowing users to join ANY glazing sheet material of ANY thickness, with a strong Aluminium Core and plastic capping. Initially designed for joining Glass panels on lean-to roofs, this bar has also proven very popular with the use of polycarbonate sheeting.

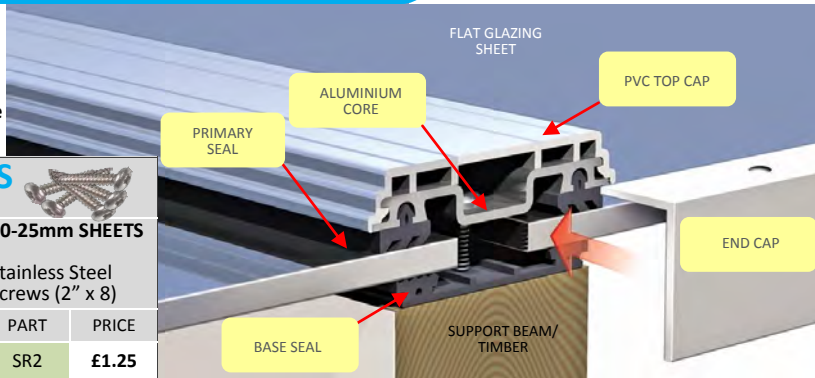

### VALE GLAZING BARS

**COMPRISING:**  
1x PVC Cover Cap, 1x Aluminium Core, 2x Primary Top Seals and 1x Base Seal

COLOUR	WHITE		BROWN	
	LENGTH	PART	PRICE	PART
2.0M (6' 6")	VB20WH	£11.96	VB20BR	£13.98
3.0M (9' 10")	VB30WH	£17.94	VB30BR	£20.82
4.0M (13' 1")	VB40WH	£23.92	VB40BR	£27.76
6.0M (19' 8")	VB60WH	£35.98	VB60BR	£41.84

BAR END CAP	PART	PRICE	PART	PRICE
	VECWH	£1.30	VECBR	£1.43

### BAR FIXINGS

Pack of 25

#### 0-10mm SHEETS

Stainless Steel Screws (1<sup>1/2</sup>" x 8)

PART	PRICE
SR15	£0.99

#### 10-25mm SHEETS

Stainless Steel Screws (2" x 8)

PART	PRICE
SR2	£1.25

### USE WITH ANY THICKNESS

The **VALE** Bar can accept any thickness sheet—all that is needed is a long enough screw! The **draw back** to this is care needs to be taken to ensure that the **VALE** Bar is not over-tightened which may cause damage to the glazing sheets. Once secured the PVC Cover Cap clips on ensuring that water can not enter the fixing channel or leak through the roof.

### FIXING VALE BARS DOWN

Frames should be flat and stable, made of timber or metal and be at least 45mm wide. The Aluminium Core is screwed on top of the Base Seal every 400mm. At the lower (gutter) end of the roof, bars can overhang the Support Beam by 50mm.

### BARREL VAULTED ROOFS

The **VALE** bar is ideal for the use in Barrel Vaulted roofs where the structural frame is shaped to a curve. This is because the bar can be pulled to the correct curvature using the fixing screws to a minimum 3 metre radius curve.

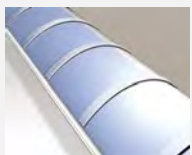

### RUBBER SEALS/ GASKETS

The **VALE** Bar is C&A's only Frame Supported Bar which uses rubber Gaskets. The bar consists of a Base Seal which is glued to the supporting beam/ timber, then the screwed down Aluminium Core which houses a further two Primary Seals.

### ROOF EDGES/ END BARS

Due to the **VALE** Bar's ability to accept any thickness sheet, we do not supply an End Bar Infill as with our other Glazing Bar Systems. Instead, a packing piece (normally made of timber) is required on the open side of the end bar the same thickness as the glazing material to ensure the end bar is stable and rigid (Fig 1). If polycarbonate is being used the sheet can span across the entire bar, which can be fastened through the sheet itself (Fig 2).



Figure 1. End Bar when using glass sheet

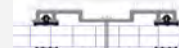
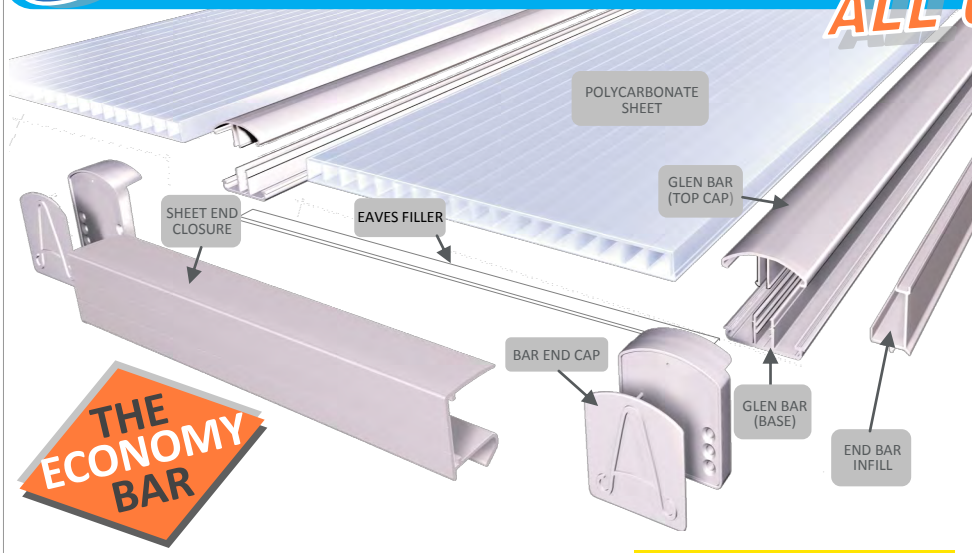

Figure 2. End Bar when using polycarbonate sheet

# GLEN GLAZING BAR

## ALL UPVC

- ▶ C&A's own design
- ▶ Frame Supported
- ▶ For 6mm and 10mm Polycarbonate sheets
- ▶ In WHITE or BROWN



**THE ECONOMY BAR**

Our Budget Frame Supported Glazing Bar System for Multiwall Polycarbonate sheets, the GLEN Bar is specially designed to be a **LOW COST** choice.

Manufactured entirely of UPVC, the GLEN bar has an oversized end cap and includes drainage channels and a separate fixing cavity that other competitors' systems fail to provide.

Easy to assemble and install, this system push fits together and is simply secured to supporting timbers with screws.

GLEN Bars are 58mm wide providing greater sheet cutting tolerance.

### GLEN GLAZING BARS

COLOUR ▶	WHITE		BROWN	
	PART	PRICE	PART	PRICE
LENGTH ▼				
2.0M (6' 6")	GB20WH	£6.65	GB20BR	£7.48
2.5M (8' 2")	GB25WH	£8.32	GB25BR	£9.35
3.0M (9' 10")	GB30WH	£9.97	GB30BR	£11.22
3.5M (11' 6")	GB35WH	£11.65	GB35BR	£13.20
4.0M (13' 1")	GB40WH	£13.32	GB40BR	£14.96
6.0M (19' 8")	GB60WH	£19.95	GB60BR	£22.44

### GLEN BAR END CAP

Includes fixings

	WHITE		BROWN	
	PART	PRICE	PART	PRICE
	GAECWH	£1.32	GAECBR	£1.45

**+ ROOF ACCESSORIES**

SEE PAGES 26-27

- > Sealing Buttons
- > Sealing Tapes
- > Sheet Enclosures
- > End Bar Infill's
- > Wall Flashing

### BAR FIXINGS

	PART	PRICE
 1" Round Head Screws Pack of 25	SR1	£0.89

### EAVES FILLER

	PART	PRICE
 1M foam strips 10Pk	GAEF	£7.90

The base section of our bars should be fixed every 400mm along it's length. We recommend that only stainless steel screws should be used.

# Hawk GLAZING BAR

- ▶ C&A's own design
- ▶ Frame Supported
- ▶ For 10mm, 16mm, 25mm Polycarbonate sheets

The Glazing Bar aimed for the Trade, the **HAWK Bar's design is simple yet strong with an Aluminium Base section.**

The **HAWK Bar** is easy to install and visually unobtrusive with a slim 48mm wide base section and low profile PVC top cap.

C&A's well proven design of drainage channels and sealed centre sections for leak-proof fixings within the Aluminium Core are great features of the **HAWK Bar**.

**+ ROOF ACCESSORIES**

- > Sealing Buttons
- > Sealing Tapes
- > Sheet Enclosures
- > Wall Flashing

**SEE PAGES 26-27**

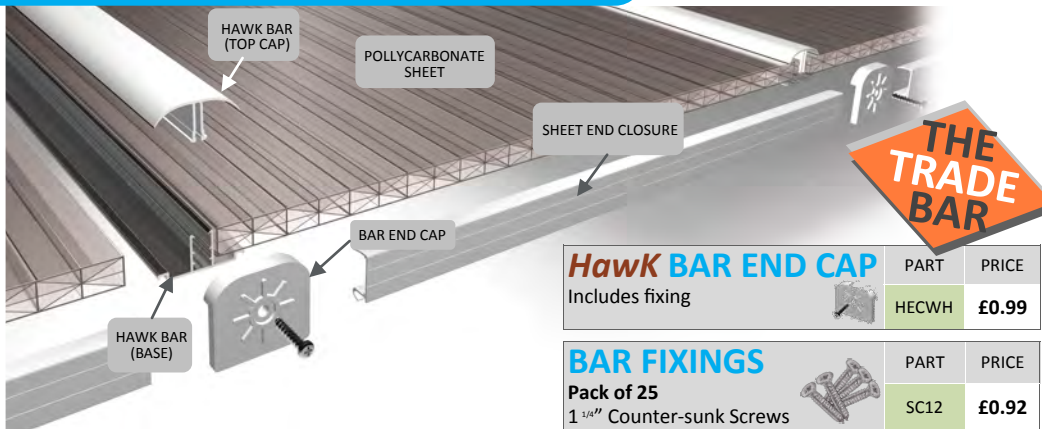

<b>Hawk BAR END CAP</b>	PART	PRICE
Includes fixing	HECWH	£0.99

<b>BAR FIXINGS</b>	PART	PRICE
Pack of 25 1 3/16" Counter-sunk Screws	SC12	£0.92

## Hawk GLAZING BARS

AVAILABLE IN WHITE ONLY

The base section should be fixed every 400mm along it's length.

LENGTH	PART	PRICE
2.0M (6' 6")	HB20WH	£7.96
3.0M (9' 10")	HB30WH	£11.94
4.0M (13' 1")	HB40WH	£15.92
6.0M (19' 8")	HB60WH	£23.98

## Hawk END BAR INFILLS

Universal trim fits into the gap in the End Bar's outer edge

LENGTH	PART	PRICE
2.0M (6' 6")	HBE20WH	£4.96
3.0M (9' 10")	HBE30WH	£7.44
4.0M (13' 1")	HBE40WH	£9.92
6.0M (19' 8")	HBE60WH	£14.88

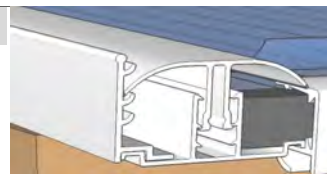

## Hawk MUNTING BAR

FOR 16mm SHEETS ONLY

Joining piece to connect 16mm sheets together along their LENGTH.

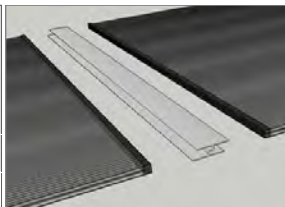

LENGTH	PART	PRICE
2.1M (6' 10 1/2")	HMT21WH	£9.99

## F TRIM

To frame/seal roof edges

SHEET SIZE	10mm		16mm		25mm	
	LENGTH	PART	PRICE	PART	PRICE	PART
2.0M (6' 6")	FE20WH	£4.76	FT20WH	£4.89	FQ20WH	£4.99
3.0M (9' 10")	FE30WH	£7.14	FT30WH	£7.33	FQ30WH	£7.48
4.0M (13' 1")	FE40WH	£9.49	FT40WH	£9.76	FQ40WH	£9.98
6.0M (19' 8")	FE60WH	£14.76	FT60WH	£14.87	FQ60WH	£14.99

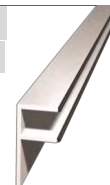

# AVON ALUMINIUM CORED

# GLAZING BAR

- ▶ C&A's own design
- ▶ Frame Supported
- ▶ For 16mm, 25mm, 35mm and 40mm Sheets
- ▶ In **WHITE** or **BROWN**

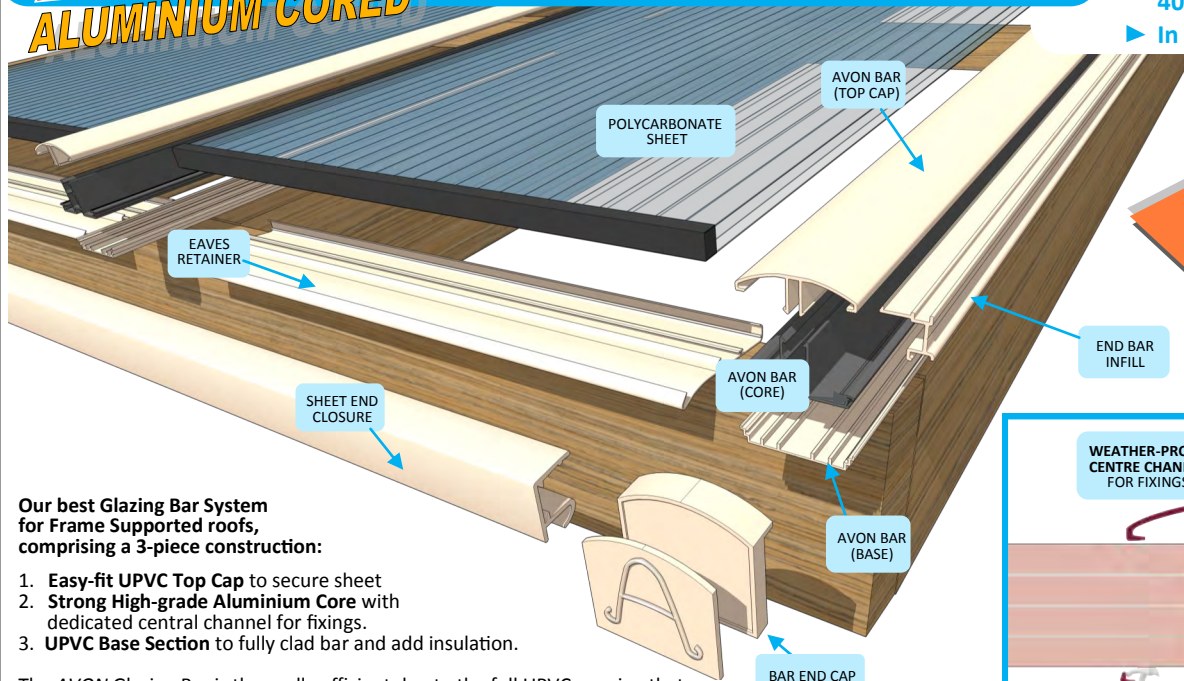

**Our best Glazing Bar System for Frame Supported roofs, comprising a 3-piece construction:**

1. **Easy-fit UPVC Top Cap** to secure sheet
2. **Strong High-grade Aluminium Core** with dedicated central channel for fixings.
3. **UPVC Base Section** to fully clad bar and add insulation.

The AVON Glazing Bar is thermally efficient due to the full UPVC capping that includes an insulating air gap in the base section. The bar also has wide side channels to drain moisture away, making this bar a top choice for roofing projects such as conservatories.

The AVON Bar is 58mm wide to ensure wide fluted sheets are correctly secured and are available with two different cores for a range of sheet acceptance:

**16mm & 25mm** and **35mm & 40mm** sheets.

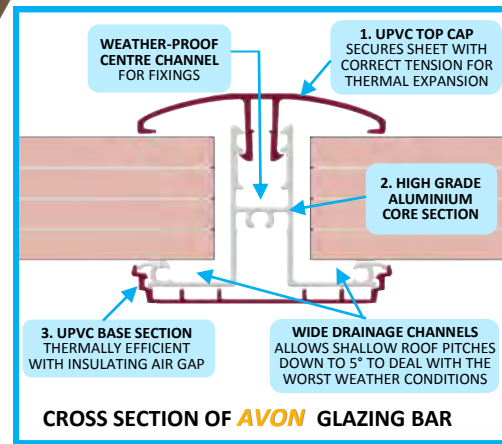

**CROSS SECTION OF AVON GLAZING BAR**

# AVON GLAZING BARS

FOR 16mm & 25mm SHEETS  
58mm Wide



COLOUR ▶	WHITE		BROWN	
	PART	PRICE	PART	PRICE
LENGTH ▼				
2.0M (6' 6")	ATQ20WH	£10.70	ATQ20BR	£11.64
2.5M (8' 2")	ATQ25WH	£13.40	ATQ25BR	£14.55
3.0M (9' 10")	ATQ30WH	£15.99	ATQ30BR	£17.46
3.5M (11' 6")	ATQ35WH	£18.74	ATQ35BR	£20.38
4.0M (13' 1")	ATQ40WH	£21.40	ATQ40BR	£23.30
6.0M (19' 8")	ATQ60WH	£32.20	ATQ60BR	£34.92

## AVON BAR END CAPS

FOR 16mm & 25mm SHEETS

Includes fixings



COLOUR	WHITE		BROWN	
	PART	PRICE	PART	PRICE
GAECWH	£1.32	GAECBR	£1.45	

## BAR FIXINGS FOR 16mm & 25mm SHEETS



1 1/4" Round-headed Screws  
Pack of 25

PART	PRICE
SR12	£0.92

# AVON GLAZING BARS

FOR 35mm & 40mm SHEET  
58mm Wide

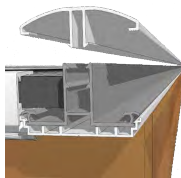

COLOUR ▶	WHITE		BROWN	
	PART	PRICE	PART	PRICE
LENGTH ▼				
2.0M (6' 6")	AKN20WH	£12.64	AKN20BR	£13.96
2.5M (8' 2")	AKN25WH	£15.80	AKN25BR	£17.45
3.0M (9' 10")	AKN30WH	£18.96	AKN30BR	£20.94
3.5M (11' 6")	AKN35WH	£22.20	AKN35BR	£24.43
4.0M (13' 1")	AKN40WH	£25.28	AKN40BR	£27.92
6.0M (19' 8")	AKN60WH	£37.92	AKN60BR	£41.88

## AVON BAR END CAPS

FOR 35mm & 40mm SHEETS

Includes fixings



COLOUR	WHITE		BROWN	
	PART	PRICE	PART	PRICE
AKNECWH	£1.63	AKNECBR	£1.77	

## BAR FIXINGS FOR 35mm & 40mm SHEETS



2" Round-headed Screws  
Pack of 25

PART	PRICE
SR2	£1.25

# AVON EAVES RETAINER

Screw to the front beam with 32mm stainless steel screws, to lock Sheet End Closures in place and seal the gap between the front beam & the sheet.

COLOUR ▶	WHITE		BROWN	
	PART	PRICE	PART	PRICE
LENGTH ▼				
0.98M (3' 3")	AER98WH	£2.70	AER98BR	£2.98
2.1M (6' 10")	AER21WH	£5.82	AER21BR	£6.45



## + ROOF ACCESSORIES

- > Sealing Buttons
- > Sealing Tapes
- > Sheet Enclosures
- > End Bar Infill's
- > Wall Flashing

SEE PAGES  
26-27

# PEAK 100 GLAZING BAR

- C&A's proven own design
- Self Supporting up to 4M\*
- For 16mm and 25mm Polycarbonate sheets

The **PEAK 100 Self-Supporting Glazing Bar System** is capable of spanning an impressive **4 metres** and is also one of C&A's most complete designs with full UPVC capping, plus additional trims, flashing and structural components.

PEAK 100 Bars have a load-bearing high quality Aluminium Core, allowing the length of mono-pitch roofs to extend up to approximately 4 metres (\*see spanning table on Page 31 for details). Other Aluminium components of this system, such as the Wall Plate and Beams/ Posts, also aid to its strength and durability and are concealed behind UPVC capping, which not only improves thermal insulation but that also make this roofing system visually attractive. Using the **PEAK 130 Wall Plate**, the bars are connected to the host building with **Pivot Mounts**, whilst fixed at the other end to the **PEAK 60 Beam/Post**.

**SELF-SUPPORTS UP TO 4 METRES\***

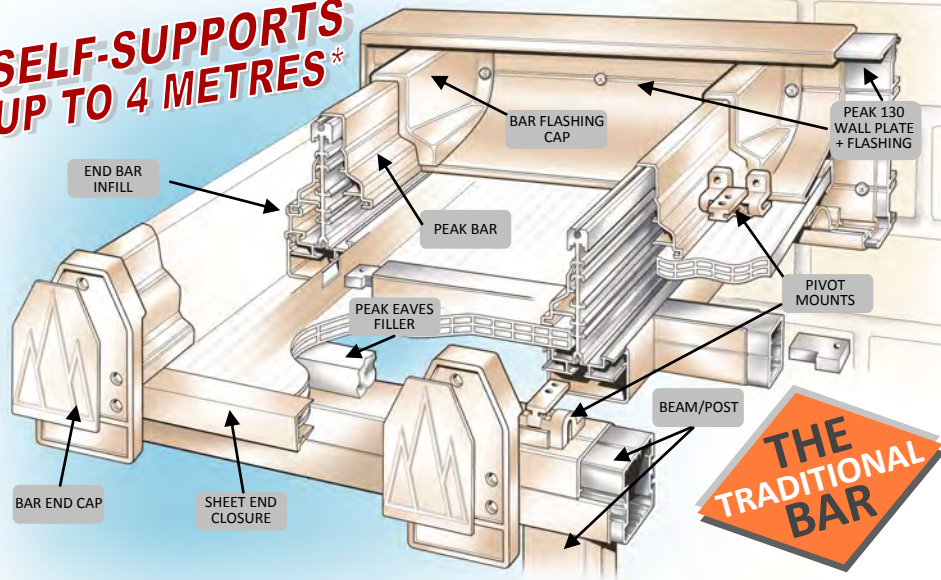

PEAK 100 GLAZING BARS				
COLOUR	WHITE		BROWN	
LENGTH	PART	PRICE	PART	PRICE
2.0M (6' 6")	P120WH	£28.65	P120BR	£30.60
2.5M (8' 2")	P125WH	£35.80	P125BR	£38.25
3.0M (9' 10")	P130WH	£42.96	P130BR	£45.82
3.5M (11' 6")	P135WH	£49.99	P135BR	£53.56
4.0M (13' 1")	P140WH	£57.28	P140BR	£61.20
▼ 6M BARS ARE NOT SELF-SUPPORTING ▼				
6.0M (19' 8")	P160WH	£85.92	P160BR	£91.80

PEAK 100 PIVOT MOUNTS					
		WHITE		BROWN	
		PART	PRICE	PART	PRICE
<b>PACK OF 2</b>					
Includes fixings		PM2WH	£3.48	PM2BR	£3.75

PEAK 100 BAR FLASHING CAPS					
		WHITE		BROWN	
		PART	PRICE	PART	PRICE
Includes fixings		PFCWH	£3.35	PFCBR	£3.55

PEAK 100 BAR END CAPS					
		WHITE		BROWN	
		PART	PRICE	PART	PRICE
Includes fixings		PECWH	£1.66	PECBR	£1.99

## PEAK 130 WALL PLATE

SIZE: 130mm HIGH x 25mm THICK when fitted

Each plate comprises: An Aluminium Core, Core Plastic covers, UPVC Sheet Flashings and a UPVC Bottom Seal Trim.

COLOUR	WHITE		BROWN	
	PART	PRICE	PART	PRICE
LENGTH				
2.0M (6' 6")	PW20WH	£33.33	PW20BR	£37.49
3.0M (9' 10")	PW30WH	£49.99	PW30BR	£54.16
4.0M (13' 1")	PW40WH	£66.66	PW40BR	£74.98
<b>END COVERS</b> Pack of x2	PWEWH	£2.30	PWEBR	£2.50

## WALL PLATE FIXINGS

### STAINLESS STEEL FIXINGS

DESCRIPTION	PART	PRICE
4 Drills + 10x 50mm Screws + Wall plugs	PWFK	£5.43
Pack of 10 Screws + Wall plugs	PWF	£2.26

## WALL FLASHING FIXINGS

### DECORATIVE COLOUR MATCHING SCREWS

18mm Plastic Headed Stainless Steel Screws PACK OF 10	WHITE		BROWN	
	PART	PRICE	PART	PRICE
	SP18WH	£2.47	SP18BR	£2.68



## PEAK 60 SUPPORT BEAM/ POST

### ALUMINIUM WITH UPVC CAPPING

Used as horizontal Support Beams or as vertical Support Posts/ pillars.

COLOUR	WHITE		BROWN	
	PART	PRICE	PART	PRICE
LENGTH				
2.5M (8' 2")	PB25WH	£32.49	PB25BR	£35.82
3.0M (9' 10")	PB30WH	£37.49	PB30BR	£40.82
4.0M (13' 1")	PB40WH	£51.66	PB40BR	£54.99
<b>BEAM END COVERS</b> Pack of x2	PBEWH	£1.89	PBEBR	£2.05

## BEAM CONNECTORS

Aluminium joining parts.

DESCRIPTION	PART	PRICE
<b>POST TO BEAM CONNECTOR</b>	PBEC	£3.33
<b>STRAIGHT CONNECTOR</b>	PBESC	£4.58

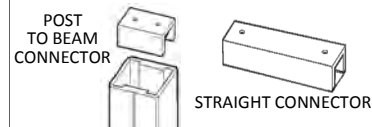

## PEAK 100 EAVES FILLER

1M foam strips 10 pack

PART	PRICE
PEF	£7.49

Fills any gaps between the underside of the polycarbonate sheets and the roof frame, reducing draughts & bowing on sheets.

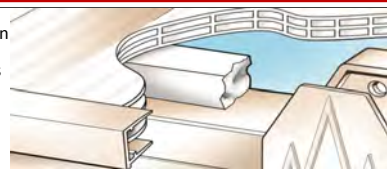

## END BAR INFILLS

To fill the gap in the end glazing bar.

SHEET SIZE	FOR 16mm SHEETS				FOR 25mm SHEETS			
	WHITE		BROWN		WHITE		BROWN	
COLOUR	PART	PRICE	PART	PRICE	PART	PRICE	PART	PRICE
LENGTH								
2.0M (6' 6")	ET20WH	£3.15	ET20BR	£3.47	EQ20WH	£4.20	EQ20BR	£4.62
2.5M (8' 2")	ET25WH	£3.94	ET25BR	£4.34	EQ25WH	£5.25	EQ25BR	£5.78
3.0M (9' 10")	ET30WH	£4.73	ET30BR	£5.20	EQ30WH	£6.30	EQ30BR	£6.93
3.5M (11' 6")	ET35WH	£5.51	ET35BR	£6.07	EQ35WH	£7.35	EQ35BR	£8.09
4.0M (13' 1")	ET40WH	£6.30	ET40BR	£6.93	EQ40WH	£8.40	EQ40BR	£9.24
6.0M (19' 8")	ET60WH	£9.45	ET60BR	£10.40	EQ60WH	£12.60	EQ60BR	£13.86

**+ MORE  
ROOF  
ACCESSORIES**

SEE PAGES 26-27

> Sealing Buttons

> Sealing Tapes

> Sheet Enclosures

# YORK GLAZING BAR

SELF-SUPPORTS  
UP TO 4 METRE SPANS\*

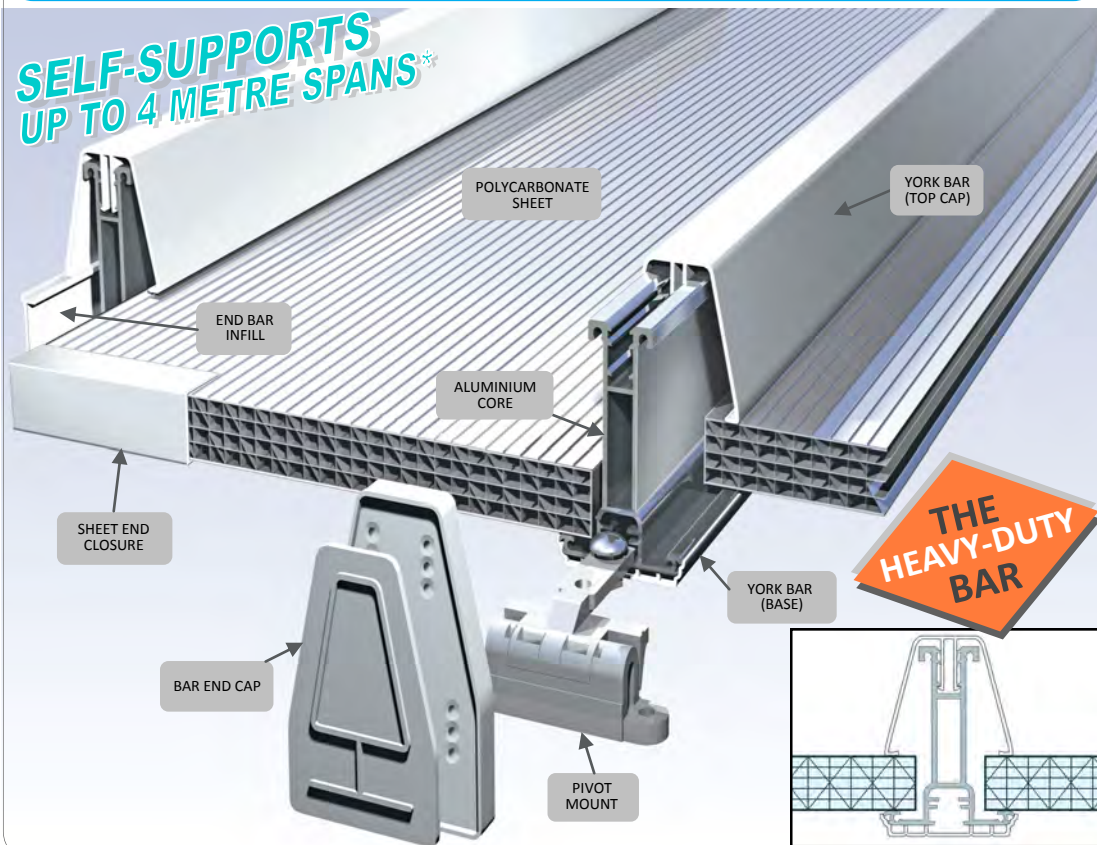

- ▶ **C&A**'s own proven design
- ▶ Self Supporting up to 4M\*
- ▶ For 16/25/35/40mm Polycarbonate sheets

Designed to satisfy a recent demand for thicker polycarbonate roof sheets that have the highest insulation standards.

These Self Supporting bars are strong enough to hold their own weight without any timbers underneath each bar, using the Pivot Mounts to attach the Glazing Bars to a Wall Plate fitted on to the host wall, and fix the other (gutter) end to the front beam.

YORK Glazing Bars are available up to 6M in length for better optimisation when cutting to size, these are not self supporting.

The YORK system has been designed to cater for a wide variety of demands, from small span roofs where a lighter aluminium can be used to reduce cost, to large heavy duty aluminium for larger spans and thicker sheets.

### > The System 7

Suitable for roofs with spans of up to 3M with 70mm high Aluminium Core.

### > The System 8

Suitable for roofs with spans of up to 4M with 84mm high Aluminium Core.

\*See spanning tables on Page 31.



# YORK GLAZING BARS

## SYSTEM 7

FOR 16mm, 25mm & 40mm SHEETS

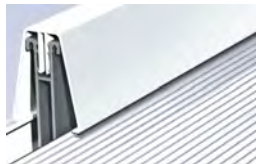

SIZE	FOR 16mm SHEETS				FOR 25mm & 40mm SHEETS			
	WHITE		BROWN		WHITE		BROWN	
COLOUR	WHITE		BROWN		WHITE		BROWN	
LENGTH	PART	PRICE	PART	PRICE	PART	PRICE	PART	PRICE
2.0M (6' 6")	Y7L20WH	£20.82	Y7L20BR	£22.49	Y7S20WH	£19.99	Y7S20BR	£21.66
2.5M (8' 2")	Y7L25WH	£25.82	Y7L25BR	£27.49	Y7S25WH	£24.99	Y7S25BR	£27.08
3.0M (9' 10")	Y7L30WH	£30.82	Y7L30BR	£33.32	Y7S30WH	£29.99	Y7S30BR	£32.91

# YORK GLAZING BARS

## SYSTEM 8

FOR 25mm, 35mm & 40mm SHEETS

For refurbishing or spares plastic capping is available separately, Please contact us for information.

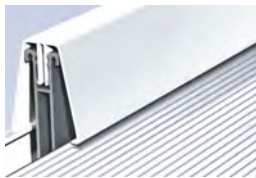

SIZE	FOR 25mm & 35mm SHEETS				FOR 40mm SHEETS			
	WHITE		BROWN		WHITE		BROWN	
COLOUR	WHITE		BROWN		WHITE		BROWN	
LENGTH	PART	PRICE	PART	PRICE	PART	PRICE	PART	PRICE
2.0M (6' 6")	Y8L20WH	£22.91	Y8L20BR	£24.15	Y8S20WH	£22.49	Y8S20BR	£23.74
2.5M (8' 2")	Y8L25WH	£28.74	Y8L25BR	£29.99	Y8S25WH	£28.32	Y8S25BR	£29.57
3.0M (9' 10")	Y8L30WH	£34.16	Y8L30BR	£36.66	Y8S30WH	£33.32	Y8S30BR	£36.24
3.5M (11' 6")	Y8L35WH	£39.99	Y8L35BR	£42.49	Y8S35WH	£39.16	Y8S35BR	£41.66
4.0M (13' 1")	Y8L40WH	£45.82	Y8L40BR	£49.16	Y8S40WH	£44.99	Y8S40BR	£48.32
▼ *6M BARS ARE NOT SELF-SUPPORTING* ▼								
6.0M (19' 8")	Y8L60WH	£69.16	Y8L60BR	£73.31	Y8S60WH	£68.32	Y8S60BR	£72.91

## YORK

### PIVOT MOUNTS/BAR FIXINGS

Used to fix the glazing bars into place at the top & bottom of bar  
**SOLD IN PACKS OF 2**  
 Includes fixings  
 1 to attach to a Wall Plate and 1 to the Front Beam.

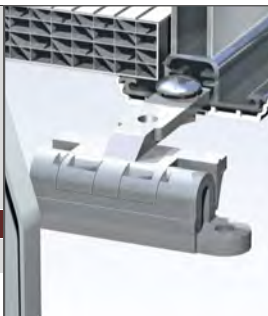

WHITE		BROWN	
PART	PRICE	PART	PRICE
YM2WH	£4.57	YM2BR	£4.91

## YORK

### GLAZING BAR END CAP

Includes fixings.

Large front face endcap to fit all York Glazing bars (16/25/35/40mm)



WHITE		BROWN	
PART	PRICE	PART	PRICE
YECWH	£1.58	YECBR	£1.74

## + ROOF ACCESSORIES

SEE PAGES 26-27

- > Eaves Filler
- > Sealing Buttons
- > Sealing Tapes
- > Sheet Enclosures
- > End Bar Infill's
- > Wall Flashing

## ROOF ACCESSORIES FOR POLYCARBONATE ROOFS

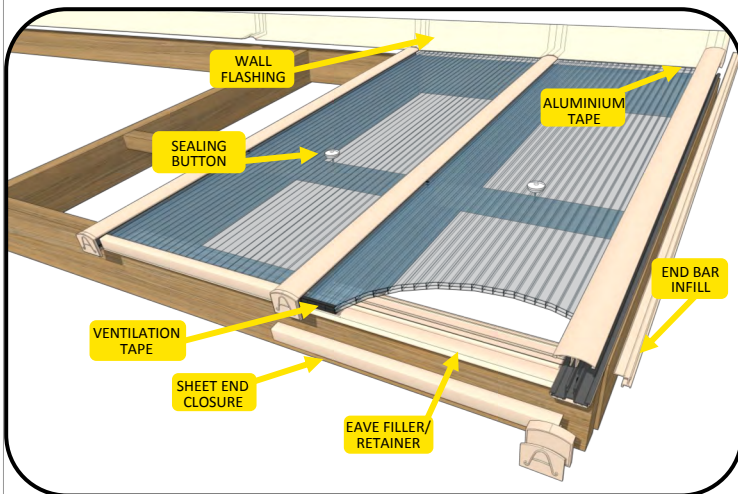

### SEALING BUTTONS

Pack of 10

For use on Polycarbonate, to secure sheets into place. Whilst allowing for sheet expansion.

COLOUR	WHITE		BROWN	
	PART	PRICE	PART	PRICE
FOR SHEET SIZE				
6mm	B6WH	£4.25	-	-
10mm	B10WH	£4.50	B10BR	£4.96
16mm	B16WH	£4.60	B16BR	£4.97
25mm	B25WH	£4.73	B25BR	£4.98
35mm	B35WH	£5.30	B35BR	£5.50
40mm	B40WH	£5.70	B40BR	£5.90

### SEALING TAPES 10M ROLL

Seals over the ends of polycarbonate sheets. Use Ventilation Tape on the lower end and Aluminium Tape on the top end/all other edges.

TYPE OF TAPE	ALUMINIUM		VENTILATION	
	PART	PRICE	PART	PRICE
FOR SHEET SIZE				
4mm/6mm/10mm	TA10	£1.35	TV10	£4.93
16mm	TA16	£1.79	TV16	£7.39
25mm	TA25	£1.97	TV25	£8.67
35mm/40mm	TA40	£2.25	TV40	£9.48

### SHEET END CLOSURE

U-section trim that push-fits over the ends of sheets (and tapes) between glazing bars. Available in white or brown, for all our sheet sizes.

SHEET THICKNESS	COLOUR	WHITE		BROWN	
		PART	PRICE	PART	PRICE
LENGTH					
6mm	1.05M	U610WH	£1.39	U610BR	£1.45
	2.1M	U621WH	£2.78	U621BR	£2.99
10mm	1.05M	UE10WH	£1.42	UE10BR	£1.55
	2.1M	UE21WH	£2.84	UE21BR	£3.10
16mm	0.98M	UT98WH	£1.59	UT98BR	£1.75
	2.1M	UT21WH	£3.32	UT21BR	£3.74
25mm	0.98M	UQ98WH	£1.99	UQ98BR	£2.22
	2.1M	UQ21WH	£4.28	UQ21BR	£4.75
35mm	0.98M	UK98WH	£2.58	UK98BR	£2.84
	1.2M	UK12WH	£3.12	UK12BR	£3.43
	2.1M	UK21WH	£5.46	UK21BR	£5.99
40mm	1.2M	UN12WH	£3.65	UN12BR	£3.99
	2.1M	UN21WH	£6.40	UN21BR	£7.20

## END BAR INFILL COMPATIBLE WITH *GLEN, AVON, YORK & PEAK 100* BARS (SEE BELOW FOR *Hawk* BARS)

Push fits into the gap in the End Bar's outer edge where there is no sheet to finish the roof end.

SHEET SIZE	6mm/10mm SHEETS				16mm SHEETS				25mm SHEETS				35mm SHEETS				40mm SHEETS			
	WHITE		BROWN		WHITE		BROWN		WHITE		BROWN		WHITE		BROWN		WHITE		BROWN	
COLOUR ▶	PART	PRICE	PART	PRICE	PART	PRICE	PART	PRICE	PART	PRICE	PART	PRICE	PART	PRICE	PART	PRICE	PART	PRICE	PART	PRICE
LENGTH ▼																				
2.0M (6' 6")	EE20WH	£2.10	EE20BR	£2.20	ET20WH	£3.15	ET20BR	£3.47	EQ20WH	£4.20	EQ20BR	£4.62	EK20W	£5.25	EK20BR	£5.78	EN20WH	£6.30	EN20BR	£6.93
2.5M (8' 2")	EE25WH	£2.63	EE25BR	£2.75	ET25WH	£3.94	ET25BR	£4.34	EQ25WH	£5.25	EQ25BR	£5.78	EK25W	£6.56	EK25BR	£7.22	EN25WH	£7.88	EN25BR	£8.66
3.0M (9' 10")	EE30WH	£3.15	EE30BR	£3.30	ET30WH	£4.73	ET30BR	£5.20	EQ30WH	£6.30	EQ30BR	£6.93	EK30W	£7.88	EK30BR	£8.66	EN30WH	£9.45	EN30BR	£10.40
3.5M (11' 6")	EE35WH	£3.68	EE35BR	£3.85	ET35WH	£5.51	ET35BR	£6.07	EQ35WH	£7.35	EQ35BR	£8.09	EK35W	£9.19	EK35BR	£10.11	EN35WH	£11.03	EN35BR	£12.13
4.0M (13' 1")	EE40WH	£4.20	EE40BR	£4.40	ET40WH	£6.30	ET40BR	£6.93	EQ40WH	£8.40	EQ40BR	£9.24	EK40W	£10.50	EK40BR	£11.55	EN40WH	£12.60	EN40BR	£13.86
6.0M (19' 8")	EE60WH	£6.30	EE60BR	£6.60	ET60WH	£9.45	ET60BR	£10.40	EQ60WH	£12.60	EQ60BR	£13.86	EK60W	£15.75	EK60BR	£17.33	EN60WH	£18.90	EN60BR	£20.79

### END BAR INFILL

COMPATIBLE WITH *Hawk* BARS Only

FOR 10mm/16mm/25mm

WHITE ONLY			
LENGTH	PART	PRICE	
2.0M (6' 6")	HBE20WH	£4.96	
3.0M (9' 10")	HBE30WH	£7.44	
4.0M (13' 1")	HBE40WH	£9.92	
6.0M (19' 8")	HBE60WH	£14.88	

### EAVES RETAINER

FOR *AVON* BARS Only

Screw to the front beam to lock Sheet End Closures in place and seal the gap between the front beam & the sheet.

COLOUR ▶	WHITE		BROWN	
LENGTH ▼	PART	PRICE	PART	PRICE
0.98M (3' 3")	AER98WH	£2.70	AER98BR	£2.98
2.1M (6' 10")	AER21WH	£5.82	AER21BR	£6.45

### PVC WALL FLASHING

For *GLEN, AVON, Hawk* Bars.

Upvc section to seal the roof to the host wall & can be trimmed to fit around glazing bars. Seal with Silicone mastic.

COLOUR ▶	WHITE		BROWN	
LENGTH ▼	PART	PRICE	PART	PRICE
2.0M (6' 6")	PF20WH	£5.00	PF20BR	£5.50
3.0M (9' 10")	PF30WH	£7.50	PF30BR	£8.25
4.0M (13' 1")	PF40WH	£10.00	PF40BR	£11.00

### 30mm PLASTIC HEADED SCREWS + WALL PLUGS

PACK OF 10

Use to screw the PVC Wall Flashing to wall.

	WHITE		BROWN	
	PART	PRICE	PART	PRICE
SPP30WH	£3.20	SPP30BR	£3.45	

### SILICONE MASTIC

Use to seal the PVC Wall Flashing to wall.

	WHITE		BROWN	
	PART	PRICE	PART	PRICE
SMWH	£3.29	SMBR	£3.39	

### STANDARD EAVES FILLERS

For *GLEN, AVON, Hawk* Bars  
L 1000mm x W 20mm x D 12mm

PACK OF 10  
1M FOAM STRIPS

PART	PRICE
GAEF	£7.90



### PEAK EAVES FILLERS

For *PEAK 100* & also *YORK* Bars  
L 1000mm x W 32mm x D 23mm

PACK OF 10  
1M FOAM STRIPS

PART	PRICE
PEF	£7.49



## SANCTUARY COMPONENTS

- ▶ Make customised configurations
- ▶ Buy spare/ replacement parts
- ▶ Gloss White or Plain Aluminium  
*You can leave it plain or paint it yourself*

The Sanctuary System can be configured to suit your needs. This can include changing the glazing sheet options, extending to make larger widths, fixing back to back to make double pitched roofs (tie bars/wire may be required), pitching towards each other into a valley formation, or even used vertically in a fencing application.

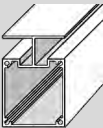
BARS	FINISH	PLAIN ALUMINIUM		GLOSS WHITE	
		LENGTH	PART	PRICE	PART
 Endcaps sold separately	2.0M (6' 6")	SCB20PA	£16.65	SCB20WH	£23.32
	2.5M (8' 2")	SCB25PA	£20.82	SCB25WH	£29.15
	3.0M (9' 10")	SCB30PA	£24.98	SCB30WH	£34.98
	3.5M (11' 6")	SCB35PA	£29.16	SCB35WH	£40.82
	4.0M (13' 1")	SCB40PA	£33.32	SCB40WH	£46.65



FIXINGS AND ACCESSORIES		
COMPONENT	PART	PRICE
POST CONNECTOR SET	SCPECSET	£7.49
WALLPLATE FIXINGS (10PK)	TFE8100	£5.49
RIVETS (100PK)	TR4812	£1.99
WHITE PAINT TOUCH UP	SCPAINT	£13.99
HAND RIVET GUN	THRG	£4.99
5mm ALI DRILLBIT	DHS5	£1.20
8mm ALI DRILL BIT	DHS8	£1.20
8mm SDS MASONARY BIT	TSDS8	£1.75
12mm SDS MASONARY BIT	TSDS12	£2.50
1" S/S SCREWS (25PK)	SR1	£0.85
WHITE SCREW CAPS (25PK)	SCSWH	£0.99
CLEAR SILICONE	SMCL	£3.35

WALL PLATE	FINISH	PLAIN ALUMINIUM		GLOSS WHITE	
		LENGTH	PART	PRICE	PART
Gasket sold separately The gasket is priced per 1M. To order the gasket calculate how many meters your require and then order that amount.	3.20M (10' 6")	SCW32PA	£29.16	SCW32WH	£35.82
	4.25M (13' 11 <sup>3/8</sup> ")	SCW42PA	£38.32	SCW42WH	£48.32
	5.30M (17' 4 <sup>2/3</sup> ")	SCW53PA	£47.49	SCW53WH	£59.99
	1.0M Gasket	SCWGSTOCK	£0.99	SCWGSTOCK	£0.99



FRONT BEAM	FINISH	PLAIN ALUMINIUM		GLOSS WHITE	
		LENGTH	PART	PRICE	PART
Endcaps sold separately	3.20M (10' 6")	SCF32PA	£47.49	SCF32WH	£70.82
	4.25M (13' 11 <sup>3/8</sup> ")	SCF42PA	£63.32	SCF42WH	£94.99
	5.30M (17' 4 <sup>2/3</sup> ")	SCF53PA	£78.32	SCF53WH	£118.32

GLASS CLEAR 6mm SOLID POLYCARBONATE SHEET			
	PART	PRICE	
Glass clear polycarbonate roof panels are a maximum of 3M long and used with the bar gasket to replace of 16mm multiwall sheets. These sheets give that glass like appearance.	3.0M x 600mm 6MM SOLID PC	SCS63006CL	£79.95
	6mm PC BAR GASKET (1.0M)	SCG6STOCK	£2.19
	6mm SHEET END CLOSURE	U621WH	£2.78

**Need Advice Then Call! 01634 374444**

END PLATES	FINISH	PLAIN ALUMINIUM		GLOSS WHITE	
		COMPONENT	PART	PRICE	PART
	FOR BAR	SCBEPPA	£1.99	SCBEPWH	£2.49
	FOR WALL PLATE	SCWEPPA	£2.49	SCWEPWH	£2.99
	FOR FRONT BEAM	SCFEPPA	£3.49	SCFEPWH	£4.99



SUPPORT POSTS 2.5M LONG	PLAIN ALUMINIUM		GLOSS WHITE	
	PART	PRICE	PART	PRICE
	SCP25PA	£16.66	SCP25WH	£27.49

MULTIWALL POLYCARBONATE		
<i>See Pages 8 &amp; 9 For 16mm Sheets</i>		
COMPONENT	PART	PRICE
16mm SHEET END CLOSURE (2.1M)	UT21WH	£3.32

C&A can powder coat framework to any RAL colour for you. Please contact us for a quote. (Special coating increases delivery time scales).

# SANCTUARY

# CANOPY SYSTEM

**LEAN TO KIT**

- ▶ Verandas
- ▶ Carports
- ▶ Walkways
- ▶ Smoking shelters
- ▶ And more!

## C & A's GUTTER-INTEGRATED CANOPY SYSTEM

- ✓ Strong All-Aluminium framework construction.
- ✓ Durable 16mm HAZE Polycarbonate sheets giving weather protection and shade.
- ✓ Hidden integral gutter within beams and support posts that:
  - minimise the space required for the structure.
  - cut costs - no need for additional guttering.
  - reduce risk of damage - no pipes to knock.
- ✓ Beams can be used both as support structures and as box gutters against a wall.
- ✓ Cavities in the bar, to allow for electrics to be concealed inside.
- ✓ Bars have greater torsional strength than similar systems.
- ✓ Simple fixing system for speed and ease of installation.
- ✓ Wall plates that can be bolted together to create a ridge section, ideal for freestanding structures.
- ✓ Eaves Beams that can be bolted together to form valley gutters, ideal for freestanding structures.
- ✓ **CHOICE OF FINISH**

**GLOSS WHITE or PLAIN ALUMINIUM** Which you can choose to leave plain or paint in a colour of your choice.

Sanctuary kits come with 16mm HAZE polycarbonate sheets as standard.

All kits come complete with Bolt, Screws, Rivets, Drill bits, Installation guide and Rivet gun.



INTEGRAL BEAM & GUTTER

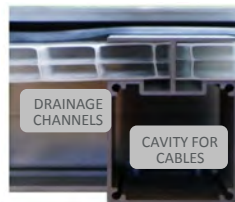

DRAINAGE CHANNELS

CAVITY FOR CABLES

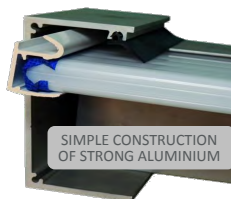

SIMPLE CONSTRUCTION OF STRONG ALUMINIUM

## SANCTUARY CANOPY KITS

Frame: <b>PLAIN ALUMINIUM</b>		Roof Sheets: <b>16mm HAZE</b>				
ROOF WIDTH ▶	3.20M		4.25M		5.30M	
PROJECTION ▼	PART	PRICE	PART	PRICE	PART	PRICE
2.0M (6' 6")	SC2032PA	£320.82	SC2042PA	£408.32	SC2053PA	£491.66
2.5M (8' 2")	SC2532PA	£358.32	SC2542PA	£458.32	SC2553PA	£558.32
3.0M (9' 10")	SC3032PA	£383.32	SC3042PA	£499.99	SC3053PA	£599.99
3.5M (11' 6")	SC3532PA	£424.99	SC3542PA	£549.99	SC3553PA	£658.32
4.0M (13' 1")	SC4032PA	£449.99	SC4042PA	£583.32	SC4053PA	£699.99

Frame: <b>GLOSS WHITE</b>		Roof Sheets: <b>16mm HAZE</b>				
ROOF WIDTH ▶	3.20M		4.25M		5.30M	
PROJECTION ▼	PART	PRICE	PART	PRICE	PART	PRICE
2.0M (6' 6")	SC2032WH	£416.66	SC2042WH	£533.32	SC2053WH	£629.16
2.5M (8' 2")	SC2532WH	£458.32	SC2542WH	£591.66	SC2553WH	£699.99
3.0M (9' 10")	SC3032WH	£491.66	SC3042WH	£633.32	SC3053WH	£749.99
3.5M (11' 6")	SC3532WH	£541.66	SC3542WH	£691.66	SC3553WH	£833.32
4.0M (13' 1")	SC4032WH	£574.99	SC4042WH	£733.32	SC4053WH	£899.99

### BULK ORDER DISCOUNT EXAMPLE

PART: SC3553WH LIST PRICE: £833.32 ORDER OVER £800 DISCOUNT: **-£90.00**

**ACTUAL COST £743.32 + VAT**

**CANNOT SEE YOUR SIZE? We can compile a custom list of components to meet your own job requirements CALL FOR A QUOTE**

## GLAZING BAR KNOW-HOW

### Securing Frame-Supported Glazing Bars

**GLEN, HAWK & AVON** Glazing Bars utilise Snap-down Top Caps. The Base Section should be screwed down every 600mm along the length through the sealed Centre Channel provided for fixings. This allows any water that may ingress under the Top Cap to run down the Drainage Channels on the sides of the bars.

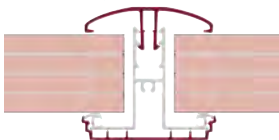

The **GLEN & HAWK** bars must have structural support under their entire length, whilst the **AVON** with stronger aluminium core can span across purlins that are no greater than 600mm (approx. 2ft) apart. This makes them ideal as a replacement to corrugated roofs as the structure should not need changing if originally built correct and in good order.

Once the Base Sections are fastened to the support structure, the sheets are placed in position, ensuring the expansion gaps are included and that a vertical rib of the sheet will be encapsulated by the bar. The Top Cap is then pushed down into the Base Section and a set of retaining hooks holds the top cap in place. This can be done with a firm hand or by gently tapping with a rubber mallet. To ensure a seal, the Top Cap must have pressure on both sides to stop it from toppling over. Therefore if there is no sheet on one side, then a Bar End Infill must be used in its place.



**VALE** Glazing Bars have a screw down Top Cap that is intended for the sealing (but not retaining) of glass units or solid polycarbonate. These consist of a rubber base gasket that need to be secured to the structural supports. The glazing is then placed on the Base Gasket and secured with a Retainer. The Aluminium Core Section with rubber seals is then placed along the joint and fastened through the middle into the supporting structure every 300mm with the appropriate length stainless steel screw.

This should only be tightened until the gaskets are under a small amount of compression. Once fastened the PVC Top Cover can be snapped onto the Aluminium Core, providing a thermal break and seal over the fixings. These Bars can also be fastened to pre-rolled steel box section for the fabrication of barrel vaults.

### Timbers for Frame Supported Glazing Bars

The size of the timbers will depend on many factors, including the weather conditions the roof is going to be subjected to and the quality of the timber used. **TABLE A** is a guide only. You must ensure that the support provided is suitable for your application.

TABLE A Timber rafter size guide (when at 1M centres)	LENGTH OF BAR ▼	SIZE OF TIMBER SUPPORT ▼	
		WIDTH	DEPTH
	2.0M (6' 6")	50mm (2")	100mm (4")
	3.0M (9' 10")	50mm (2")	125mm (5")
	4.0M (13' 1")	50mm (2")	150mm (6")
	5.0M (16' 4")	50mm (2")	200mm (8")

### Sheet Width & Glazing Bar Spacing

The Polycarbonate sheet widths available (up to 2.1M) are much wider than they can span unsupported, but are available for better sheet optimisation when cutting. The distance between the timber supports for the sheets will depend on the sheet thickness, sheet structure, and the sheet's typical environment (this information can be found in the manufacturer's data sheets). **TABLE B** is a guide only for normal operating environments.

TABLE B Sheet spanning guide for Frame Supported Bars	SHEET THICKNESS ▶	6mm	10mm	16mm	25mm+
	MAX SPAN ▼				
	Without Purlins	600mm	700mm	1000mm	1200mm
	Purlins at 600mm	1000mm	1000mm	1500mm	1500mm

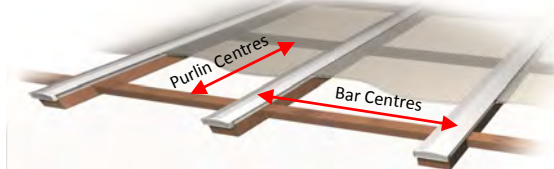

### Cutting Bars & Securing Capping/ Beading

It is recommend to use hand tools when cutting our Glazing bars. The Aluminium and PVC sections can both be cut with a fine tooth hacksaw. When installing secure the PVC glazing caps/ beads by hand wherever possible. A rubber mallet can be used, but should be used with caution as to not cause damage.

## Self Supporting Bars

**PEAK 100 Bars for 16mm &, 25mm polycarbonate sheets on spans up to 4M.**

Designed for mono-pitch roofs with spans up to 4M, this very well proven Glazing Bar system has PVC capping on both the inside and outside for an attractive appearance and thermal insulation. An Aluminium reinforced Wall Plate is used to secure the roof to the host building, whilst a PVC clad Aluminium **PEAK 60** Beam with optional posts support the roof at the lower end. All fixings are Stainless Steel and where these are exposed to view, the fixings have colour matched plastic heads.

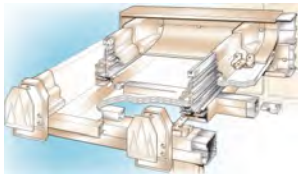

**YORK Bars for 16, 25, 35 & 40mm polycarbonate sheets on spans up to 4M.**



Designed for mono-pitched roofs, **YORK** Glazing Bars are available in two grades – The System 7 bar will carry 16, 25 and 40mm polycarbonate roof sheets up to spans of 3 metres, whilst the heavier gauge System 8 bar will carry 25, 35 and 40mm polycarbonate roof sheets up to spans of 4 metres. Designed to be quick to install with fewer components needed for each bar.

**SANCTUARY Bars for 16mm polycarbonate sheets on spans up to 4M.**

All-Aluminium construction, these bars are designed to be used with the dedicated Wall Plate and Front Beam of the system. These are then all riveted together to create a substantial framework.



TABLE C Bar spanning guide for Self Supporting Bars	PROJECTION ▼	MAXIMUM BAR SPACING			
		YORK 7	YORK 8	PEAK 100	Sanctuary
	2.0M	1200mm	1200mm	1200mm	1200mm
	2.5M	1100mm	1100mm	1100mm	1200mm
	3.0M	1000mm	1000mm	1000mm	1100mm
	3.5M	N/A	900mm	900mm	1050mm
	4.0M	N/A	700mm	700mm	1050mm

## Bar Drainage Channels

C&A bar systems specifically for polycarbonate sheets have a sheet retention system that secures the roof sheets and prevents the ingress of water without restricting the essential thermal expansion. Apart from the **VALE** Bar, all our Glazing Bars do not need rubber seals/ gaskets, which can weather over time and restrict sheet expansion. In extreme weather conditions strong winds may force small amounts of rainwater into the joint between the sheet and the bar's Top Cap which is why these bars have drainage channels immediately behind the joint leading down to the gutter.



## Pivot fixings for Self Supporting Bars

Because of the Drainage system designed in all of C&A's Glazing Bars, the **PEAK** and **YORK** Bars have dedicated Pivot Mounting systems to secure the bars without compromising the drainage.

The head of the Pivot Mount is slid up the bar and secured from underneath, ensuring the channels are unaffected. The base is fastened to the Wall Plate or front beam, through the designated holes, and the two parts are linked together with a stainless steel pin.

By being assembled round the pivoting action of the pin, the bars can be set at any angle up to 45°. It should be noted that low pitch roofs can suffer from standing water and the water blow back, increasing the chance of water penetration. It is recommended that roofs should try to be set with a minimum 15° pitch wherever possible to minimise this.

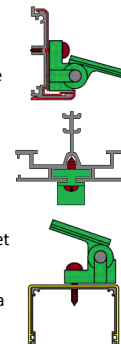

## Stainless Steel Fixings

When fixing to Aluminium it is important that the correct type of fixing is chosen. Stainless Steel has high strength and is very resistant to corrosion making it an ideal choice for any screws, nuts, bolts or pins - C&A mostly supply these.

Untreated Steel will rust and weaken over time and although Zinc-plated Steel has a protective coating to help protect it from rusting, it unfortunately also reacts with Aluminium, causing weakness. Aluminium fixings do not suffer corrosion or reaction, but are not as strong as Stainless Steel.



## CLEAR 3" CEMENT PROFILE PVC

**3" profile sheeting** is commonly used for a wide variety of roles in modern DIY. Uses include carports, greenhouses, chicken coops & garden covering - the list can go on.

Available in 2 thicknesses **0.8mm** Economy Grade and **1.3mm** Thickness Trade Grade. The thicker Trade Grade has increased strength and durability. This should allow the trade grade sheets to out live their thinner economy counterparts. All corrugated sheets are available from stock with a full range of accessories.

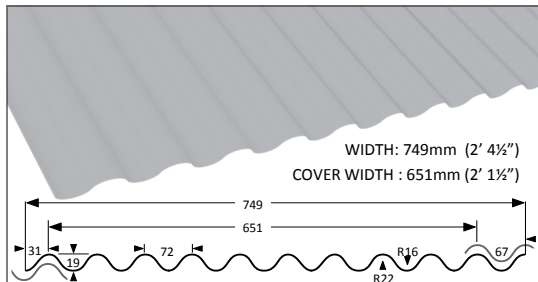

LENGTH	ECONOMY GRADE 0.8mm Thick		TRADE GRADE 1.3mm Thick	
	PART	PRICE	PART	PRICE
1.82M (6ft)	R56CL	£5.69	R106CL	£9.99
2.13M (7ft)	R57CL	£6.65	R107CL	£11.49
2.44M (8ft)	R58CL	£7.49	R108CL	£12.99
2.74M (9ft)	R59CL	£8.32	R109CL	£14.99
3.04M (10ft)	R510CL	£9.49	R1010CL	£16.49
3.64M (12ft)	R512CL	£12.95	R1012CL	£21.99

## 3" CEMENT PROFILE GRP FIBRE GLASS

**Fibreglass roof sheets** have great strength and durability. They are commonly used as roof lights in agricultural and commercial buildings. Class 3, 1.83kg Grade is designed for domestic, light commercial use. These sheets admit light but not sight and are easily trimmed to size with a fine-toothed saw. Higher grade sheeting is available for use on industrial or commercial areas.

**N.B. Class 1 & Class 0 sheets can be supplied to order.**



### CLASS 3 (1.83Kg/M<sup>2</sup>)

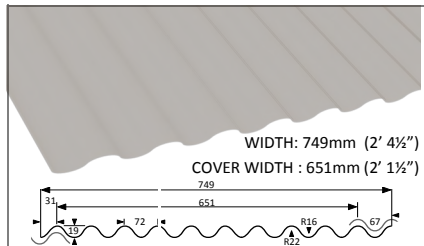

LENGTH	PART	PRICE
1.82 (6ft)	RF336	£24.99
2.44 (8ft)	RF338	£32.99
3.04 (10ft)	RF3310	£40.99

## CLEAR 3" IRON PROFILE POLYCARBONATE NEW!

### One of the first stockists in the UK

Manufactured using Polycarbonate Resin to deliver leading performance & proven durability. The ideal choice for residential, commercial, industrial and agricultural projects.

### ADVANTAGES OVER PVC:

- Vastly stronger than standard PVC sheets
- UV Coated, Blocking up to 99% of harmful UV
- Withstands higher temperatures up to 130°C (PVC: 60°C)
- Improved lifespan compared to PVC sheets
- Easier to work with and install than standard PVC sheets
- Wider cover width
- Profile matched to our Galvanised sheets - see page 40 for more information

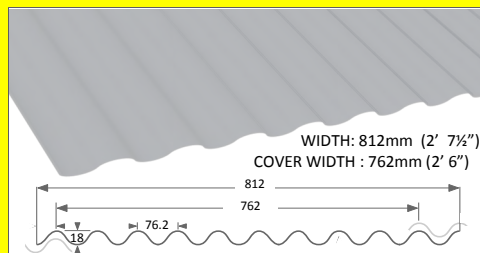

LENGTH	SUPER GRADE 1.0mm Thick	
	PART	PRICE
1.82M (6ft)	RG106CL	£11.99
2.44M (8ft)	RG108CL	£16.99
3.04M (10ft)	RG1010CL	£19.99



# ACCESSORIES & KNOW HOW

## Know How

### Recommended Purlin Centres

Profile	Fixing Centre	Economy	Trade/Super Grade	Cover Width
3" Profile	180mm	610mm	914mm	651mm

### How many fixing do I need?

**Step 1** Divide the overall roof width by fixing centre (eg  $4860\text{mm} / 180\text{mm} = 27$ )

**Step 2** Divide the roof length by the Purlin centres and add 1 (eg  $2440\text{mm} / 610\text{mm} = 4 + 1 = 5$ )

**Step 3** Multiply these two numbers together ( $27 \times 5 = 135$ ): Approx. number of fixing needed.



*The actual amount may vary depending on overlaps and purlin centres*

### How to Cut Sheets:

Sheets should overhang the roof by 60mm to allow water run-off. When cutting, use an angle grinder with a metal slitting blade or a fine tooth saw at a shallow angle applying light pressure. **A good tip** when cutting, is to sandwich the sheet between other sheets with the part to be cut off protruding.

**Pre-drill sheets before fixing.** Holes for fixings must be drilled typically 4mm larger than the fixing diameter to allow for expansion. Drill sheets singularly with a masonry bit on a low speed and use light pressure. Support the sheet securely under each hole position when drilling. There should be at least 5 fixings across the width of the each sheet fixed into purlins frame.

## RIDGES & FLASHINGS

TYPE	PART	PRICE	PACKS OF 10
Zinc Plated Steel	RFS	£0.99	
Stainless Steel	RFX	£1.56	Inc spacers 

**DO I Need Foam Fillers?** Fillers should be used under the sheets at all support positions to prevent roof 'chatter' and to support the sheets when fixed.

### 3" Profile Foam Eaves Filler

Pack of 10

PROFILE	LENGTH	PART	PRICE
3" CEMENT	As sheet width	REF3	£4.95
3" IRON	As sheet width	RGEF3	£4.95

### Clear 3" Profile PVC Ridge

PROFILE	LENGTH	PART	PRICE
3"	660mm(2' 2")	RR3CL	£7.50

### Clear 3" Profile PVC Wall Flashing

PROFILE	LENGTH	PART	PRICE
3"	660mm (2' 2")	RWF3CL	£4.49
1½"	660mm (2' 2")	RWFMLCL	£4.49



### Lap Sealing

PART	LENGTH	PART	PRICE
Lap Tape	10M	RLT	£1.99
Clear Silicone	Up To 11M Bead	SMCL	£3.35

## WHITE 1¼" PROFILE PVC

Solid White PVC sheets are most commonly used as a wall liner. PVC is water-resistant and very easy to keep clean.

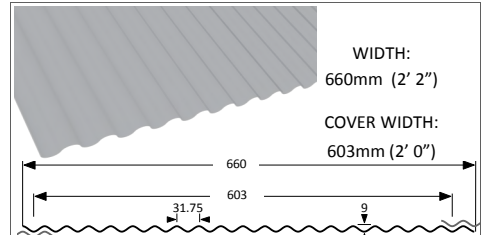

LENGTH	PART	PRICE
3.04M (10ft)	R210WH	£11.94

TYPE	SHEET	PART	PRICE	PACKS OF 10
Plated Steel	1¼"	RFM	£0.33	

### Mini Profile Foam Filler

Pack of 10

PROFILE	LENGTH	PART	PRICE
1¼"	As sheet width	REFM	£3.85

+ BULK ORDER DISCOUNTS AVAILABLE! See page 87

# CORRUGATED SHEETS

## SUPERBOX 70/18 GRECCA PROFILE SOLID COLOUR PVC CORRUGATED

1.1mm thick sheets are lightweight and surprisingly strong. Ideal for use in many areas.

- Roofing
- Garden Pavilions
- Carports
- Sheds
- Chicken runs
- Bin sheds



Each sheet provides a full metre width of coverage, resulting in less sheets to handle and fix and a faster project completion time.

**N.B. These sheets are not suitable for over-roofing substrates, such as plywood or chipboard.**

**Dark colours are not suitable for use in locations where temperatures over 40°C can occur.**

WIDTH: 1095mm  
COVER: 1050mm

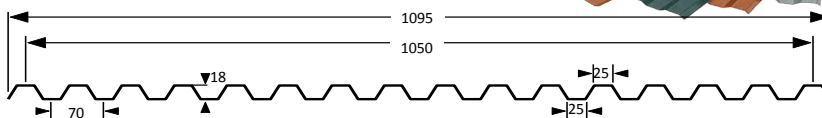

Box profiles coloured sheets are a solid coloured which means no light will pass through.



**Soft Sheen GREEN**

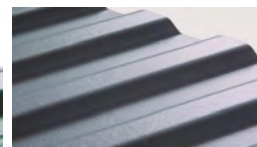

**Soft Sheen LIGHT GREY**

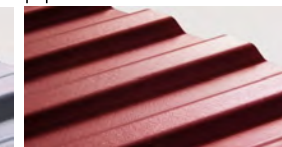

**Soft Sheen TERRACOTTA**

LENGTH	Soft Sheen GREEN		Soft Sheen LIGHT GREY		Soft Sheen TERRACOTTA	
	PART	PRICE	PART	PRICE	PART	PRICE
1.82M (6ft)	RB6GR	£11.59	RB6LG	£11.99	RB6TC	£11.99
2.44M (8ft)	RB8GR	£15.49	RB8LG	£15.99	RB8TC	£15.99
3.04M (10ft)	RB10GR	£19.49	RG10LG	£19.99	RB10TC	£19.99

### ACCESSORIES

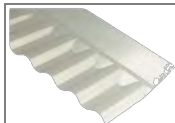

**Clear PVC Wall Flashing**

PROFILE	LENGTH	PART	PRICE
BOX	660mm (2' 6")	RWFBCL	£3.99

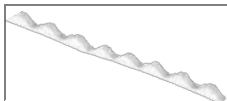

**Eaves Filler**  
Pack of 10

PROFILE	LENGTH	PART	PRICE
BOX	1050mm (3' 5")	REFB	£4.99

### SHEET FIXING

TYPE	PART	PRICE	PACKS OF 10
Plated Steel	RFS	£0.99	
Stainless Steel	RFX	£1.59	Inc spacers



**Lap Sealing**

PART	LENGTH	PART	PRICE
Lap Tape	10M	RLT	£1.99
Clear Silicone	Up To 11M Bead	SMCL	£3.35

**+ BULK ORDER DISCOUNTS AVAILABLE! See Page 87**

### LIGHTING SHEETS

Translucent sheets allows light but restricts sight.

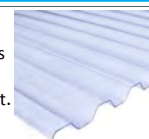

Clear sheets allows light and has no restriction on sight.



LENGTH	NATURAL TRANSLUCENT BLUE		GLASS-CLEAR	
	PART	PRICE	PART	PRICE
1.82M (6ft)	RB6NT	£11.79	RB6CL	£11.95
2.44M (8ft)	RB8NT	£15.65	RB8CL	£15.95
3.04M (10ft)	RB10NT	£19.49	RB10CL	£19.95

# BIG 6 CORRUGATED SHEETS

This traditional high top corrugated sheet can be used for a wide variety of projects from:

- Porches
- Carports
- Roof lights
- Greenhouses
- Cloches and cold frames
- Side cladding
  - Sheds
  - Walkways

With its glass clear clarity this sheeting can provide up to 3 times more natural light than vertical glazing, creating a bright environment below. This sheeting is strong but light-weight making them easy to handle and install. The size of these sheets gives a larger cover area resulting in a faster installation time.

## CLEAR BIG 6 PROFILE PVC

**WIDTH:**  
1086mm (3' 6½")

**COVER WIDTH:**  
1016mm (3' 3½")

**1.3mm Thickness**

LENGTH	PART	PRICE
1.82M (6ft)	R1066CL	£16.99
2.44M (8ft)	R1068CL	£22.49
3.04M (10ft)	R10610CL	£28.49

## SHEET FIXING

**Eaves Filler**  
Pack of 10

PROFILE	LENGTH	PART	PRICE
BIG 6	1086mm (3' 6½")	REF6	£5.49

**Lap Sealing**

DISCRIPTION	LENGTH	PART	PRICE
Lap Tape	10M	RLT	£1.99
Clear Silicone	Up To 11M Bead	SMCL	£3.35

**Big 6 Fixings**

SHEET PROFILE	PART	PRICE	PACKS OF 10
Galvanised 6"	RF6	£4.98	

## BIG 6 PROFILE GRP CLASS 3 1.83Kg/M<sup>2</sup>

Manufactured from Glass Reinforced Polyester resin (GRP) with unique light diffusing additives which scatter light passing through. These sheets provide effective daylight without hot spots or excessive glare. Can be used in single skin and double skin site assembled applications. Can also be used for insulating intermediate layers to provide improved insulation levels for compliance with current legislation. With excellent impact resistance and a highly durable UV resistant polyester film to the weather face to extend the durable working life of the sheet and to prevent sheets discolouring under normal conditions, sheet life should exceed **30 years!**

### Did You Know?

Available in various weights including 1.83kg/m<sup>2</sup>, 2.44kg/m<sup>2</sup> & 3.06kg/m<sup>2</sup> to order

This type of sheeting is also available in over 900 different profiles, to match all current and most discontinued asbestos cement and metal roofing profiles. If you require a non standard profile, please contact us for a quote.

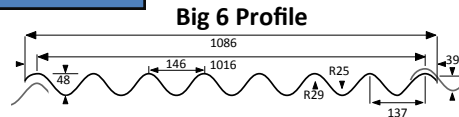

**BIG 6 PROFILE**  
WIDTH: 1086mm (3' 6½")  
COVER: 1016mm (3' 3½")  
**CLASS 3 1.83Kg/M<sup>2</sup>**

LENGTH	PART	PRICE
1.82M (6ft)	RF636	£37.48
2.44M (8ft)	RF638	£49.76
3.04M (10ft)	RF6310	£64.90

## Onduline

**IDEAL FOR SHEDS, GARAGES, FARM BUILDINGS, AVERIES ETC**

**Onduline** Bituminous Corrugated Roofing is an extremely tough, lightweight, corrugated roofing and wall cladding material. Manufactured utilising a base board produced from recycled cellulose fibres which is saturated with bitumen under intense pressure and heat. *Onduline* sheets are finished with a colourful pigment and resin impregnation process which 'stains' the colour into the sheet to provide excellent colour retention properties and enhanced UV resistance.

### LIGHT WEIGHT ONDULINE

These **LIGHT WEIGHT** Bitumen sheets are in keeping with the lower grade specification that is primarily offered in the UK DIY market. The same profile as the standard grade but 2.6mm thick. All flashings and fixings are the same as the standard sheet.

#### LIGHT WEIGHT BITUMEN

2M X 950mm x 2.6mm 5.6kg

COLOUR	PART	PRICE
BLACK	ROLB2BK	£9.99

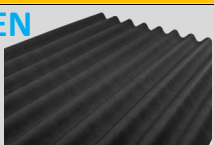

### STANDARD ONDULINE SHEETS

2M X 950mm x 3mm (6.4Kg) Coverage width 855mm

COLOUR	PART	PRICE
BLACK	ROB2BK	£10.79
RED	ROB2RD	£13.95
GREEN	ROB2GR	£13.99
CLEAR PVC	ROB2CL	£13.29

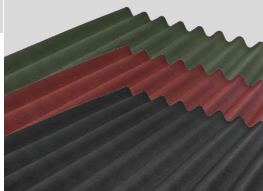

### ONDULINE RIDGES

1M Width (830mm Coverage allowing overlap)

COLOUR	PART	PRICE
BLACK	RORBK	£6.95
RED	RORRD	£7.65
GREEN	RORGR	£7.99

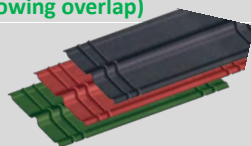

The *Onduline* range is ideal for a wide variety of applications reflecting the materials unrivalled versatility being used for agricultural, industrial, light domestic and environmental projects and is the only bituminous corrugated sheet suitable for use on many different applications. Originally developed in Europe over 60 years ago, *Onduline* is now extensively used worldwide in over 130 countries from the Tropics to the Arctic Circle. (for more details see the product PDF downloads at [www.cabp.co.uk](http://www.cabp.co.uk)).

**+ Bitumen and Steel sheets can be insulated to help prevent condensation and heat loss unlike the PVC sheets.**

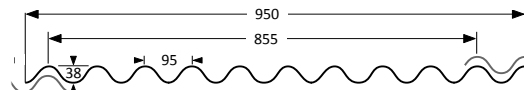

### ONDULINE / ONDUVILLA NAILS

COLOUR CODED HEADS 73mm

	10 PACK		400 BOX	
COLOUR	PART	PRICE	PART	PRICE
BLACK	ROBNBK	£1.49	ROBNBBK	£16.99
RED	ROBNRD	£1.49	ROBNBRD	£16.99
GREEN	ROBNGR	£1.49	ROBNBGR	£16.99



It is recommended that each Onduline sheet uses 25 nails.

### ONDULINE FLASHING

BLACK APRON FLASHING 930mm

PART	PRICE
ROBWF BK	£9.99



### ONDULINE EAVES FILLER

5 TOP and 5 BOTTOM

PART	PRICE
ROBEF	£6.95

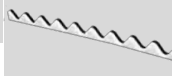

### ONDULINE VERGE

1.1M x 200mm x 200mm

COLOUR	PART	PRICE
BLACK	ROVBK	£7.45
RED	ROVRD	£7.65
GREEN	ROVGR	£7.90



# ONDUVILLA by Onduline

The **Onduvilla** range has been designed at Onduline's Italian design studio with a unique three tone colour shaded finish in Red and Green, creating warm natural colours normally only associated with expensive and heavy clay roofing products. This attractive colour finish combined with the Mediterranean bold roll profile results in an exciting and exclusive roof covering that bestows an attractive aesthetic roof finish to any structure.

The practical design aspects of the **Onduvilla** tile strip range have not been overlooked with an innovative tile lapping system utilising a grooved lap joint to provide enhanced weathering performance. The tiles form an attractive, durable and light-weight roof covering that can either be laid on a roof decking or close boarding. The system is ideal for a wide variety of applications. A full installation PDF guide can be downloaded from [www.cabp.co.uk](http://www.cabp.co.uk)



## ONDUVILLA TILES

1.06M X 400mm (ALLOW FOR OVERLAP)

COLOUR	PART	PRICE
BLACK	ROVTBK	£3.59
GREEN	ROVTGR	£3.59
RED	ROVTRD	£3.59

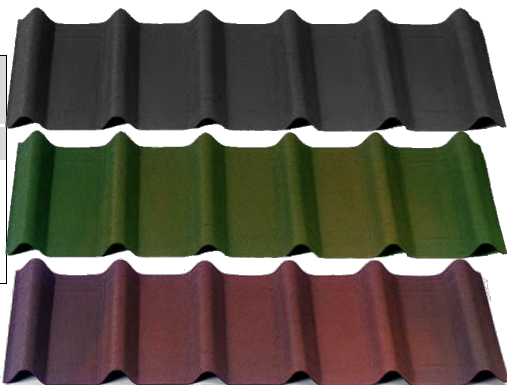

Onduvilla ridges are used to form a weather seal over the ridge of pitched roofs and are fixed into place using the same fixings as the Onduvilla tiles

## ONDUVILLA RIDGES

900MM X 500mm (ALLOW FOR OVERLAP)

COLOUR	PART	PRICE
BLACK	ROVRBK	£4.95
GREEN	ROVRGR	£4.95
RED	ROVRRD	£4.95

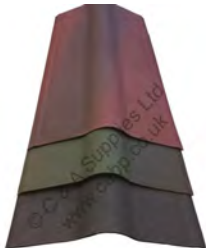

## ONDUVILLA FLASHING

1.02M (ALLOW FOR OVERLAP)

COLOUR	PART	PRICE
BLACK	ROVFBK	£3.95
GREEN	ROVFGGR	£3.95
RED	ROVFRD	£3.95

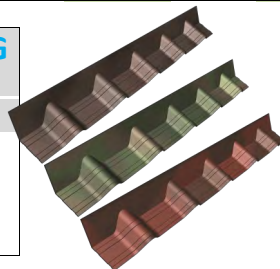

## ONDULINE / ONDUVILLA NAILS

COLOUR CODED HEADS 73mm

	PACK OF 10		BOX OF 400	
COLOUR	PART	PRICE	PART	PRICE
BLACK	ROBNBK	£1.49	ROBNBBK	£16.99
GREEN	ROBNGR	£1.49	ROBNBGR	£16.99
RED	ROBNRD	£1.49	ROBNBRD	£16.99



Onduvilla flashings have the same profile as the tile and are used to form a weather-seal up against a host wall or building. Fixed through the overlap into the tiles using the same fixings as the Onduvilla tiles. Additional fixing to the host wall will be required.

# PLASTISOL STEEL SHEETS CA32 PROFILE

**CA32/1000 PROFILE - 1080mm WIDE SHEET - 1M FULL COVER** USED IN INDUSTRIAL ROOFING AND CLADDING

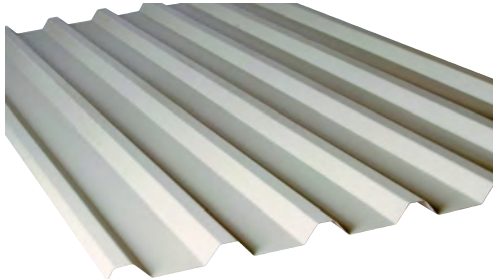

## MERLIN GREY

LENGTH	PART	PRICE
2.0M (6' 6")	R3220MG	<b>£34.49</b>
2.5M (8' 2")	R3225MG	<b>£43.65</b>
3.0M (9' 10")	R3230MG	<b>£51.79</b>

## GOOSEWING GREY

LENGTH	PART	PRICE
2.0M (6' 6")	R3220GG	<b>£35.70</b>
2.5M (8' 2")	R3225GG	<b>£44.69</b>
3.0M (9' 10")	R3230GG	<b>£53.65</b>

## OLIVE GREEN

LENGTH	PART	PRICE
2.0M (6' 6")	R3220OG	<b>£35.79</b>
2.5M (8' 2")	R3225OG	<b>£44.75</b>
3.0M (9' 10")	R3230OG	<b>£53.79</b>

## GRP/FIBRE GLASS ROOFLIGHTS SHEETS

LENGTH	PART	PRICE
2.0M (6' 6")	RF3220	<b>£40.39</b>
2.5M (8' 2")	RF3225	<b>£50.49</b>
3.0M (9' 10")	RF3230	<b>£60.59</b>

**+ Steel and Bitumen sheets can be insulated to help prevent condensation and heat loss, unlike corrugated PVC sheets.**

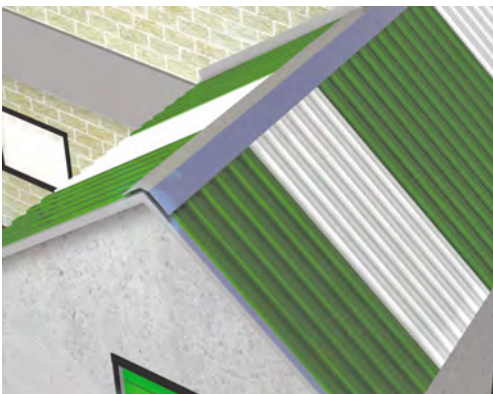

**GRP Translucent sheets** allow light but not sight. Matching the size and profile of Colour-coat Plastisol sheets they provide daylight through the roof.

Stocked in Class 3 Fire Rating, but Class 1 and Class 0 available on quotation.

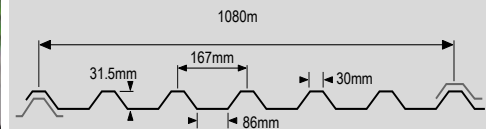

# STEEL TRIMS AND ACCESSORIES

## FLASHING TRIM 3M

COLOUR	PART	PRICE
MERLIN GREY	R3FMG	£20.70
GOOSEWING GREY	R3FGG	£21.10
OLIVE GREEN	R3FOG	£21.50

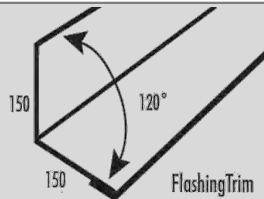

## RIDGE TRIM 3M

COLOUR	PART	PRICE
MERLIN GREY	R3RMG	£21.60
GOOSEWING GREY	R3RGG	£21.90
OLIVE GREEN	R3ROG	£21.95

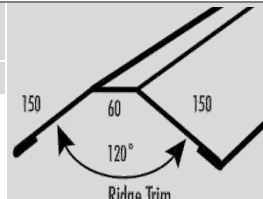

## DRILLFIX

PACKS OF 10



8mm Hex Head

Drillfix and Tapfix screws are zinc plated to help prevent corrosion, and come with sealing washers. Don't forget to buy your colour coded caps.

SIZE	PART	PRICE
20mm	FSD20	£1.98
38mm	FSD38	£2.39
50mm	FSD50	£2.63
70mm	FSD70	£2.99

## TAPFIX

PACKS OF 10



Easy to fasten with a nut driver (TS516)

The 20mm is a stitcher and used to secure trim overlaps and to the profile roofing sheeting.

NOTE—Tapfix need a predrilled hole

SIZE	PART	PRICE
38mm	FST38	£2.48
50mm	FST50	£2.69
75mm	FST75	£2.89

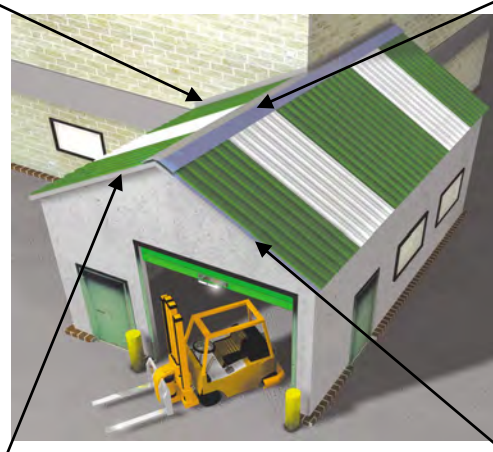

## COLOUR CODED CAPS (10PK)

COLOUR	PART	PRICE
MERLIN GREY	FCCMG	£0.49
GOOSEWING	FCCGG	£0.52
OLIVE GREEN	FCCOG	£0.53



## LAP TAPE 10M ROLL

PART	PRICE
RLT	£1.99

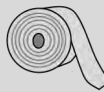

## EAVES FILLER 5 TOP & 5 BOTTOM

PART	PRICE
REF32	£6.69

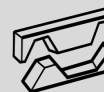

## 90° ANGLE TRIM 3M

COLOUR	PART	PRICE
MERLIN GREY	R3AMG	£21.30
GOOSEWING GREY	R3AGG	£21.70
OLIVE GREEN	R3AOG	£21.89

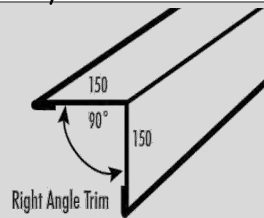

## EDGE TRIM 3M

COLOUR	PART	PRICE
MERLIN GREY	R3EMG	£20.69
GOOSEWING GREY	R3EGG	£20.95
OLIVE GREEN	R3EOG	£21.10

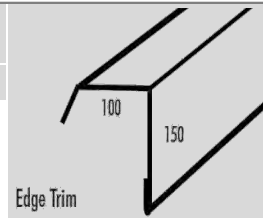

# STEEL ROOF ACCESSORIES

## GALVA STEEL SHEETS TRADITIONAL LOW COST SHEET

Galvanised steel sheets have been around for a very long time and are a very strong and secure roofing and cladding material. These are often used by emergency repair companies to temporarily secure properties before permanent repairs are made. The steel sheet is coated in zinc, which is more reactive to oxygen than the iron and causes a white oxidation coating to take place. Once all the zinc has been used up in this type of reaction then the iron in the steel will react and this is when the sheets will rust. These sheets are primarily used as a temporary covering, but to increase their lifespan they should be coated / painted to provide a barrier between the steel and the oxygen, to prevent rusting.

**Width: 812mm (2' 7½") / Lap: 50mm (2") / Cover: 762mm (2' 6")**

### GALVA STEEL SHEETS 3" IRON PROFILE

**+ WARNING STEEL SHEETS HAVE SHARP EDGES!**

LENGTH	PART	PRICE
1.82M (6')	RG6	<b>£11.99</b>
2.43M (8')	RG8	<b>£15.98</b>
3.04M (10')	RG10	<b>£19.98</b>
3.64m (12')	RG12	<b>£23.97</b>

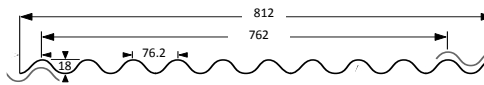
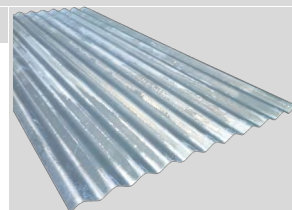

WIDTH: 812mm (2' 7½")  
COVER WIDTH : 762mm (2' 6")  
THICKNESS: 0.5mm

**For clear sheets and filler please see pages 32 & 33**

## CORRUGATED FITTINGS

### HOOK BOLTS, CAPS AND WASHERS

DESCRIPTION	PART	PRICE
60 x 6mm J-BOLT & NUT	FJ60	<b>£1.99</b>
80 x 6mm J-BOLT & NUT	FJ80	<b>£2.25</b>
100 x 6mm J-BOLT & NUT	FJ100	<b>£2.44</b>
140 x 6mm J-BOLT & NUT	FJ140	<b>£2.75</b>
90 x 8mm SCAFFOLD-BOLT & NUT	FJS90	<b>£3.79</b>
150 x 8mm SCAFFOLD-BOLT & NUT	FJS150	<b>£5.37</b>
28mm PVC WASHER	W28	<b>£0.96</b>
28mm STANDARD CAP	WC28	<b>£0.78</b>
28mm DEEP CAP	WDC28	<b>£0.99</b>



### SCREWS WITH CAPS AND WASHERS

**PACK OF 10**

DESCRIPTION	PART	PRICE
ZINK PLATE	RFS	<b>£0.99</b>
S/S & SPACER	RFX	<b>£1.56</b>



### HEX HEAD SCREWS & WASHERS

**PACK OF 10**

	LENGTH	DRILLFIX		TAPFIX	
		PART	PRICE	PART	PRICE
These screws are zinc plated to protect against corrosion. Supplied with 19mm sealing washers. Easy to fasten with nut driver.	38mm	FSD38	<b>£2.39</b>	FST38	<b>£2.48</b>
	50mm	FSD50	<b>£2.63</b>	FST50	<b>£2.69</b>
	70mm	FSD70	<b>£2.99</b>	N/A	<b>N/A</b>
	75mm	N/A	<b>N/A</b>	FST75	<b>£2.89</b>





# NEW 110mm Underground drainage pipe and fittings using Forsheda Seals to ensure ease of installation and all made to BS standards.



Stocked At Our  
Gillingham Branch  
National Delivery  
Available

PRODUCT	PART No	PRICE
3M Long Pipe Single Socket	WU3S	£6.35
Coupler Double Socket	WUCD	£1.99
15° Bend Single Socket	WUB1S	£2.89
15° Bend Double Socket	WUB1D	£3.19
30° Bend Single Socket	WUB3S	£2.89
30° Bend Double Socket	WUB3D	£3.19
45° Bend Single Socket	WUB4S	£2.89
45° Bend Double Socket	WUB4D	£3.19
87.5° Bend Single Socket	WUB8S	£2.89
87.5° Bend Double Socket	WUB8D	£3.19
87.5° Rest Bend Single Socket	WURB8S	£8.49
87.5° Rest Bend Double Socket	WURB8D	£8.99
45° Long Radius Bend	WULRB4S	£13.49
87.5° Long Radius Bend	WULRB8S	£13.99
0—90° Adjustable Bend	WUABD	£10.99
45° Branch Double Socket	WUY4D	£5.29
45° Branch Triple Socket	WUY4T	£5.69
87.5° Branch Double Socket	WUT8D	£5.29
87.5° Branch Triple Socket	WUT8T	£5.69



PRODUCT	PART No	PRICE
Square Hopper	WUSH	£7.99
Integral Hopper	WUIH	£8.99
Back Inlet Roddable Gully	WUBIRG	£7.99
Low Trap	WULT	£9.99
Low Back P Trap	WULBPT	£7.99
Access Plug	WUAP	£2.99
Aluminium Rodding Eye	WUARE	£13.49
Socket Plug	WUSP	£1.79
320mm Chamber Base 185mm Invert	WU32CB	£15.99
320mm Raising Piece 140mm	WU32RP	£8.99
320mm Round Plastic Cover & Frame	WU32RC	£15.99
320mm Square Plastic Cover & Frame	WU32SC	£19.99
470mm Chamber Base 225mm Invert	WU47CB	£30.99
470mm Raising Piece 235mm	WU47RP	£13.49
470mm Round Plastic Cover & Frame	WU47RC	£17.99
470mm Square Plastic Cover & Frame	WU47SC	£30.99
600x450 Block Paving Manhole Cover	WUMHC	£33.99
1ltr Soluble Lubricant	WUSL1	£7.49
4" Clay to 4" PVC Coupler	WU44CP	£4.99



Cant Find the item you require?  
CALL US more items held in stock

Manufactured to BS EN 1401-1: Plastic piping systems for 1998 (SN4) non-pressure underground drainage and sewerage. PVCu - Part 1: Specifications for pipes, fittings and system. BS4660: 1989 Specification for plasticized. PVC pipes and fittings of sizes 110mm for below ground drainage. BS5481: 1997 (1989) Specification for plasticized. PVC pipes and fittings for gravity sewers.

## 110mm UNDERGROUND DRAINAGE

# GUTTERING

Four guttering systems available, ranging from low cost 112mm for garden buildings to high capacity for large roofs, and elegant Square and Ogee profiles for house renovations.

## HALF ROUND

**BLACK - WHITE - BROWN**

Width: 112mm ( $4 \frac{3}{8}$ "")  
Depth: 52mm ( $2 \frac{1}{16}$ "")  
BS EN 4576

PRODUCT	COLOUR/PART			PRICE	
	BLACK	WHITE	BROWN		
Gutter 2M Long	GR2BK	GR2WH	GR2BR	£2.89	
Gutter 4M Long	GR4BK	GR4WH	GR4BR	£4.99	
90° Angle	GR9BK	GR9WH	GR9BR	£1.99	
135° Angle	GR35BK	GR35WH	GR35BR	£2.68	
150° Angle	GR50BK	GR50WH	GR50BR	£2.78	
Joint Bracket	GRJBBK	GRJBWH	GRJBBR	£1.42	
Support Bracket	GRSBBK	GRSBWH	GRSBBR	£0.65	
Running Outlet	GRROBK	GRROWH	GRROBR	£1.66	
Stopend Outlet	GRSOBK	GRSOWH	GRSOBR	£2.47	
Stopend External	GRSEBK	GRSEWH	GRSEBR	£0.99	
Stopend Internal	GRSIBK	GRSIWH	GRSIBR	£0.89	

## SQUARE

**BLACK - WHITE - BROWN**

Width: 114mm ( $4 \frac{1}{2}$ "")  
Depth: 57mm ( $2 \frac{1}{4}$ "")  
BS EN 607

PRODUCT	COLOUR/PART			PRICE	
	BLACK	WHITE	BROWN		
Gutter 2M Long	GS2BK	GS2WH	GS2BR	£2.89	
Gutter 4M Long	GS4BK	GS4WH	GS4BR	£4.99	
90° Angle	GS9BK	GS9WH	GS9BR	£1.99	
135° Angle	GS35BK	GS35WH	GS35BR	£2.68	
150° Angle	GS50BK	GS50WH	GS50BR	£2.78	
Joint Bracket	GSJBBK	GSJBWH	GSJBBR	£1.42	
Support Bracket	GSSBBK	GSSBWH	GSSBBR	£0.65	
Running Outlet	GSROBK	GSROWH	GSROBR	£1.66	
Stopend Outlet	GSSOBK	GSSOWH	GSSOBR	£2.47	
Stopend External	GSSEBK	GSSEWH	GSSEBR	£0.99	
Stopend Internal	GSSIBK	GSSIWH	GSSIBR	£0.89	

# OGEE

## BLACK - WHITE - CARAMEL

Width: 135mm (5 5/16")  
Depth: 77mm (3 1/16")  
BSEN 607

HIGH CAPACITY

PRODUCT	COLOUR/ PART			PRICE	
	BLACK	WHITE	CARAMEL		
Gutter 4m Long	GO4BK	GO4WH	GO4CM	£9.99	
90° Angle	GO9BK	GO9WH	GO9CM	£3.63	
135° Angle	GO35BK	GO35WH	GO35CM	£3.87	
150° Angle	GO50BK	GO50WH	GO50CM	£3.99	
Gutter Joint Bracket	GOJBBK	GOJBWH	GOJBCM	£2.49	
Running Outlet	GOROBK	GOROWH	GOROCM	£3.56	
Stopend Outlet	GOSOBK	GOSOWH	GOSOCM	£3.66	
Stopend External	GOSEBK	GOSEWH	GOSECM	£1.77	
Stopend Internal	GOSIBK	GOSIWH	GOSICM	£1.35	
Fascia Bracket	GOSBBK	GOSBWH	GOSBCM	£0.99	

# FULL-FLO

## BLACK - WHITE

Width: 116mm (4 9/16")  
Depth: 77mm (3 1/16")  
BSEN 607

HIGH CAPACITY

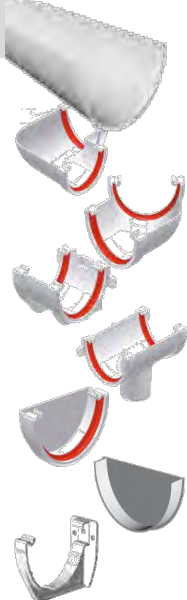
PRODUCT	COLOUR/ PART		PRICE	
	BLACK	WHITE		
Gutter 4m Long	GF4BK	GF4WH	£9.46	
90° Angle	GF9BK	GF9WH	£2.95	
135° Angle	GF35BK	GF35WH	£3.14	
Gutter Joint Bracket	GFJBBK	GFJBWH	£2.40	
Running Outlet	GFROBK	GFROWH	£3.32	
Stopend External	GFSEBK	GFSEWH	£1.56	
Stopend Internal	GFSIBK	GFSIWH	£1.25	
Fascia Bracket	GFSBBK	GFSBWH	£0.99	

**+ DOWN PIPES** SEE PAGE 44

**+ ACCESSORIES & FITTINGS**

SEE PAGE 46

Freeflow

# GUTTER SYSTEMS

## DOWN PIPE

Both Round and Square Down Pipes, in a range of colours, compatible with our guttering.

### ROUND PIPE

Diameter: 68mm (2 11/16")  
BSEN 12200

BLACK - WHITE - BROWN

PRODUCT	PART NUMBERS			PRICE
	BLACK	WHITE	BROWN	
Pipe 2.7m Long	GRP27BK	GRP27WH	GRP27BR	£3.95
Pipe 4m Long	GRP4BK	GRP4WH	GRP4BR	£5.95
Pipe 5.5m Long	GRP55BK	GRP55WH	GRP55BR	£8.95
Pipe Connector	GRPCBK	GRPCWH	GRPCBR	£0.99
Pipe Bracket	GRPBK	GRPBWH	GRPBR	£0.74
Pipe Bend 92½°	GRPB9BK	GRPB9WH	GRPB9BR	£1.99
Pipe Bend 112½°	GRPB2BK	GRPB2WH	GRPB2BR	£1.46
Shoe Outlet Spout	GRPSBK	GRPSWH	GRPSBR	£1.52
Pipe Branch 112½°	GRPYBK	GRPYWH	GRPYBR	£3.62
Shallow Offset Pipe	GRPOBK	GRPOWH	GRPOBR	£2.59
Rainwater Head	GHBK	GHWH	GHBR	£5.24

### SQUARE PIPE

Square Size 65mm (2 9/16")  
BSEN 12200

BLACK - WHITE - BROWN - CAMEL

PRODUCT	PART NUMBERS				PRICE
	BLACK	WHITE	BROWN	CAMEL	
Pipe 2.7m Long	GSP27BK	GSP27WH	GSP27BR	GSP27CM	£3.95
Pipe 4m Long	GSP4BK	GSP4WH	GSP4BR	GSP4CM	£5.95
Pipe 5.5m Long	GSP55BK	GSP55WH	GSP55BR	GSP55CM	£8.95
Pipe Connector	GSPCBK	GSPCWH	GSPCBR	GSPCCM	£0.99
Pipe Bracket	GSPBK	GSPBWH	GSPBR	GSPBCM	£0.76
Pipe Bend 92½°	GSPB9BK	GSPB9WH	GSPB9BR	GSPB9CM	£2.09
Pipe Bend 112½°	GSPB2BK	GSPB2WH	GSPB2BR	GSPB2CM	£1.48
Shoe Outlet Spout	GSPSBK	GSPSWH	GSPSBR	GSPSCM	£1.56
Pipe Branch 112½°	GSPYBK	GSPYWH	GSPYBR	GSPYCM	£3.66
Rainwater Head	GHBK	GHWH	GHBR	GHCM	£5.24

# CAST IRON EFFECT GUTTER & PIPE

**NEW!**

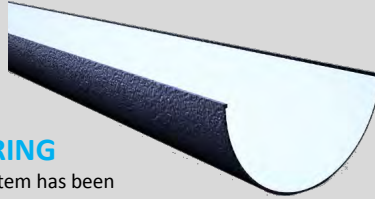

## CAST IRON EFFECT GUTTERING

This unique cast iron effect guttering system has been designed to provide you with the authentic look and feel of traditional gutters, using long-lasting uPVC. The mottled effect finish helps to maintain the look and feel of period properties while allowing you to benefit from the low maintenance, fitter-friendly materials available today.



Whilst there is a continuing emphasis on building energy efficient homes the external design and detailing of many new build developments remains traditional. Cast iron style guttering offers specifiers and property developers the ideal solution for a stylish traditional look giving homeowners a low maintenance long lasting system. The range also allows builders and renovators of period properties the option to update with modern materials without losing the charm and appeal of authentic features.

The Freeflow rainwater system is co-extruded with a white interior to reduce heat absorption and expansion of gutters and features long-life advanced red compressible seals for ease of fitting and water-tight joints to ensure a leak-free performance.

This high quality product is also available in high capacity 116mm Full-Flo, Please contact us to request a quotation and lead times.



## HALF ROUND CAST EFFECT

Width: 112mm (4 <sup>6</sup>/<sub>16</sub>"")

Depth: 52mm (2 <sup>1</sup>/<sub>16</sub>"")

BS EN 4576

PRODUCT	BLACK	PRICE		
Gutter 4M Long	GR4CE	£19.99		
90° Angle	GR9CE	£8.99		
135° Angle	GR35CE	£9.99		
Joint Bracket	GRJBCE	£5.99		
Support Bracket	GRSBCE	£1.49		
Running Outlet	GRROCE	£8.99		
Stopend Outlet	GRSOCE	£9.99		
Stopend External	GRSECE	£4.99		
Stopend Internal	GRSICE	£4.49		
Pipe 2.7m Long	GRP27CE	£19.99		
Pipe 5.5m Long	GRP55CE	£34.99		
Pipe Clip	GRPCCE	£7.80		
Pipe Clip Collar	GRPBCE	£9.99		
Pipe Bend 92½°	GRPB9CE	£10.49		
Pipe Bend 112½°	GRPB2CE	£10.99		
Shoe Outlet Spout	GRPSCE	£12.99		
Pipe Branch 112½°	GRPYCE	£16.99		

## GUTTER ACCESSORIES

# HEDGEHOG™

## STOPS GUTTER CLUTTER!

- ▶ Prevents gutters from blocking
- ▶ Simple, quick and easy to fit
- ▶ Durable - will last for years
- ▶ Flexible to fit all shapes and bends of guttering
- ▶ Compatible with almost every type of gutter

PRODUCT	PART	PRICE
<b>BLACK</b> 4M Hedgehog	GHHBK	£16.79
<b>BROWN</b> 4M Hedgehog	GHHBR	£16.79
<b>WHITE</b> 4M Hedgehog	GHHWH	£16.79
Holding Clip (Single)	GHHGC1	£0.63
Holding Clips (20 Pack)	GHHGC20	£9.40

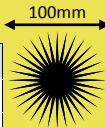

Colour choice is the colour of the brush. The gutter clips are Clear



### GUTTER GRID

Colour refers to clips the grid only comes in black

PRODUCT	PART	PRICE
<b>BLACK</b> 10M LONG (Includes 23 Clips)	GMGBK	£29.95
<b>WHITE</b> 10M LONG (Includes 23 Clips)	GMGWH	£29.95
<b>BROWN</b> 10M LONG (Includes 23 Clips)	GMGBR	£29.95

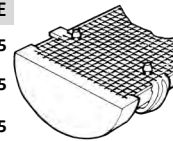

### GUTTER & PIPE ADAPTORS

PRODUCT	BLACK	WHITE	BROWN	PRICE
SQUARE to ROUND PIPE ADAPTOR	GSRPABK	GSRPAWH	GSRPABR	£2.10
SQUARE to HALF ROUND GUTTER ADAPTOR	GSRABK	GSRAWH	GSRABR	£5.25
OGEE to SQUARE GUTTER ADAPTOR	GOSABK	GOSAWH	GOSABR	£7.34
OGEE to ROUND GUTTER ADAPTOR	GORABK	GORAWH	GORABR	£7.34

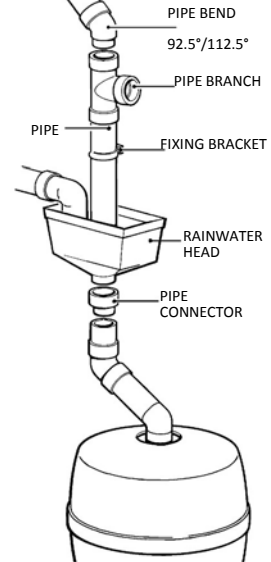
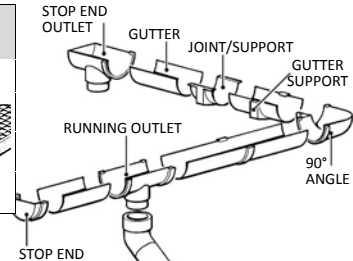

### About Our Guttering

All our Freeflow® gutter systems are manufactured by Freefoam®. The high quality PVC-U rainwater systems have an innovative design which results in a co-extruded gutter which has a white interior and coloured exterior. This innovative solution helps to reduce the problems associated with rapid heat absorption and expansion of traditional guttering. The Freeflow® range has been designed to ensure both reliable, leak-free performance and quick installation.

**+ 10 YEAR  
GUARANTEE**



## CAP-OVER or FULL REPLACEMENT?

**10mm Thick boards** are for capping over existing timber boards

These must be in good condition and any mild damage or rot should be treated first with a very high grade wood preservative. Before capping, check the Roof Felt has a sufficient overhang to reach the top of the new UPVC board as well as the existing timber one. Over Felt Replacement sections should be fitted to cover the gap.



**18mm Thick boards** are for use on New builds and for full replacement on existing buildings

Timber sub-structures should first be examined for damage and rot, which should be treated with a high grade wood preservative or in severe cases cut out and new timber sections scarfed in.

## FASCIA & SOFFIT FIXINGS

**FIXINGS** Use colour-matching plastic headed pins and nails to fix boards into place.

**CENTRES** Fixing Centers vary, but should never exceed 600mm for white boards, 300mm for black boards and 400mm for other colour and wood grain boards.

For more detail information please visit the product page and click on the specifications tab on our website [www.cabp.co.uk](http://www.cabp.co.uk)

## FURTHER INFORMATION ON FASCIA & SOFFIT

**Roof Ventilation** should be considered, either by using Vented Soffit boards, Vent Disks or Over Fascia Vents. *See pages 48, 49 and 54.*

**Plastic headed pins and nails** should be used to fix the boards in place fixing centers vary, but should not exceed 600mm for white boards-

we supply colour-matching heads *See page 54 for all colours.*

**Gable end covers** can be made by cutting a wide Capping board to size. Use a 400mm or 600mm board, and fix into position. *See page 48.*

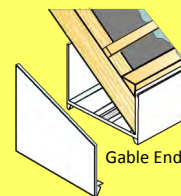

# CLADDING THE BASICS

## PREPARING WALLS FOR CLADDING

Cladding boards should be fixed horizontally over timber battens,

**CENTRES** set at a maximum of 400mm apart upon the host wall. To protect the battens, a breathable membrane must be lightly tacked over the entire area before the cladding is fitted on top.

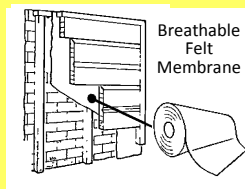

For more detail information please visit the product page and click on the specifications tab on our website [www.cabp.co.uk](http://www.cabp.co.uk)

## FIXING CLADDING BOARDS

**Begin at the bottom of the host wall** by fixing Starter Trims with Barb Nails through the back of the trim, ensuring the cladding board is located inside the Starter Trim so the fixings will be hidden by the overlap of boards.

**At the sides and corners**, fix Edge Trims/ Corner Trims as required. Fix any External Corners as you progress upwards, to allow for some movement when fitting the boards into place.

**Allow a 5mm gap at each end of board** as they are designed to expand and contract with weather changes so it is important they are cut with some space allowance, which will be covered by the finishing trims.

**When fitting the last board**, It is likely it's depth will need to be altered to fit into the available space, and depending on how much board is trimmed away it may be necessary to fix an additional batten behind to ensure it sits correctly. The last board must fit so it pushes up inside the trim's top edge and also sits correctly on the cladding board below.

## WHITE CAP-OVER & REPLACEMENT FASCIA



### 10mm CAP-OVER/REVEAL LINER FASCIA BOARD

LENGTH	2.5M		5.0M		For covering existing timber fascia boards that are in adequate condition.
WIDTH	PART	PRICE	PART	PRICE	
150mm (5 7/8")	LC215WH	£4.49	LC515WH	£8.32	
175mm (6 7/8")	LC217WH	£5.49	LC517WH	£10.82	
200mm (7 7/8")	LC220WH	£7.49	LC520WH	£13.49	
225mm (9")	LC222WH	£7.99	LC522WH	£14.49	
250mm (9 7/8")	LC225WH	£8.99	LC525WH	£16.49	
300mm (11 3/4")	LC230WH	£10.99	LC530WH	£20.49	
400mm (15 3/4")	LC240WH	£14.49	LC540WH	£27.99	
605mm*(23 13/16")	LC260WH	£23.99	LC560WH	£45.49	

\* 605mm Boards Are Double Lipped

### 18mm FULL REPLACEMENT FASCIA BOARD

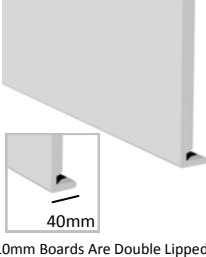
LENGTH	2.5M		5.0M		For fully replacing fascia boards (new-builds and restoration projects).
WIDTH	PART	PRICE	PART	PRICE	
150mm (5 7/8")	LF215WH	£8.49	LF515WH	£16.66	
175mm (6 7/8")	LF217WH	£11.49	LF517WH	£20.99	
200mm (7 7/8")	LF220WH	£12.99	LF520WH	£23.99	
225mm (9")	LF222WH	£15.49	LF522WH	£26.99	
250mm (9 7/8")	LF225WH	£15.99	LF525WH	£28.99	
300mm (11 3/4")	LF230WH	£21.99	LF530WH	£40.99	
410mm*(16 9/64")	LF240WH	£27.49	LF540WH	£47.99	

\* 410mm Boards Are Double Lipped

### TRIMS FOR 10 & 18mm BOARDS

DESCRIPTION	PART	PRICE
Centre Joint	LCJ3WH	£1.89
90° Internal Corner	LCI93WH	£1.95
90° External Corner	LCC93WH	£1.99
135° External Corner	LCC33WH	£3.49
135° Internal Corner	LCI33WH	£3.49
600mm Double Ended Centre	LCJ6WH	£3.99
600mm Double Ended Corner	LCC96WH	£3.95
300mm Large End Cap	LCECWH	£2.35
Fascia (Apex) Finial	LCFWH	£3.65
Decorative Moulding	LCDMW	£9.40

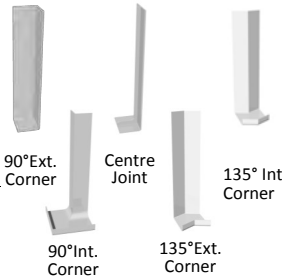

### FASCIA BOARD ACCESSORIES

#### OVER FASCIA VENT

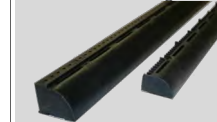

PART	SIZE	PRICE
LOFV10	10mm	£2.57
LOFV25	25mm	£3.10

Fix on to the top of Fascia boards to provide an air gap for ventilation.

#### UPVC FELT REPLACEMENT

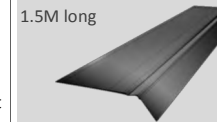

PART	PRICE
LFR	£1.99

Fits below the existing roof felt under the bottom row of tiles, overlapping the top of the fascia board.

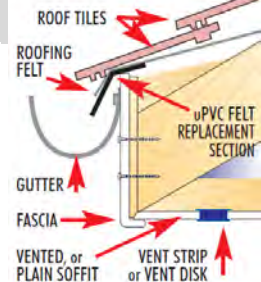

**+ MORE ACCESSORIES & FIXINGS SEE PAGE 54**

**+ 50 YEAR GUARANTEE ON WHITE BOARDS**



# WHITE SOFFIT BOARDS SQUARE EDGE



## 10mm SOLID SOFFIT MULTIPURPOSE BOARDS

LENGTH	2.5M		5.0M	
	PART	PRICE	PART	PRICE
100mm (3 7/8")	LM210WH	£4.49	LM510WH	£7.49
150mm (5 7/8")	LM215WH	£5.49	LM515WH	£9.99
175mm (6 7/8")	LM217WH	£6.49	LM517WH	£11.99
225mm (9")	LM222WH	£8.49	LM522WH	£15.49
250mm (9 7/8")	LM225WH	£8.99	LM525WH	£17.49
300mm (11 3/4")	LM230WH	£10.99	LM530WH	£19.99
405mm (15 3/4")	LM240WH	£15.99	LM540WH	£27.99
605mm (23' 5")	LM260WH	£25.99	LM560WH	£48.49



Soffit Vent Strip or Disks available. See Page 54.

## 10mm VENTED SOFFIT PROVIDES VENTILATION

LENGTH	2.5M		5.0M	
	PART	PRICE	PART	PRICE
100mm (3 7/8")	LV210WH	£7.49	LV510WH	£13.49
150mm (5 7/8")	LV215WH	£8.99	LV515WH	£16.99
175mm (6 7/8")	LV217WH	£9.99	LV517WH	£18.49
225mm (9")	LV222WH	£11.99	LV522WH	£22.49
250mm (9 7/8")	LV225WH	£13.99	LV525WH	£25.49
300mm (11 3/4")	LV230WH	£15.49	LV530WH	£27.49
405mm (15 3/4")	LV240WH	£18.99	LV540WH	£35.49
605mm (23' 5")	LV260WH	£34.49	LV560WH	£62.99



For insect mesh See Page 54.

## TRIMS

	LENGTH	2.5M		5.0M	
		DESCRIPTION	PART	PRICE	PART
For 10mm Boards in White	J Trim (Edge Trim)	LH2JWH	£2.69	LH5JWH	£4.89
	H Trim (Joiner strip)	LH2HWH	£3.19	LH5HWH	£5.95
	F Trim (Corner Finishing Trim)	LH2FWH	£3.19	LH5FWH	£5.95
	Y Trim (External Corner)	LH2YWH	£4.95	LH5YWH	£8.95

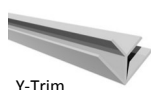
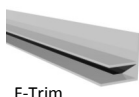
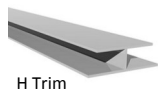
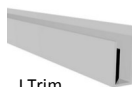

## 10mm HOLLOW 'V' GROOVED HOLLOW SOFFIT BOARDS

LENGTH	2.5M		5.0M	
	PART	PRICE	PART	PRICE
100mm (3 7/8")	LH210WH	£3.59	LH510WH	£6.29
300mm (11 3/4")	LH230WH	£5.29	LH530WH	£9.49



## 16mm FLAT BOARD MULTIPURPOSE BOARDS

LENGTH	2.5M		5.0M	
	PART	PRICE	PART	PRICE
150mm (5 7/8")	LT215WH	£10.99	LT515WH	£19.49
200mm (7 7/8")	LT220WH	£14.99	LT520WH	£26.99
250mm (9 7/8")	LT225WH	£17.99	LT525WH	£33.49



**+ FIXINGS & ACCESSORIES**  
SEE PAGE 54

- > Plastic-headed pins & nails
- > Ventilation accessories
- > Insect Mesh

## OGEE FASCIA



## BULLNOSE FASCIA



The **Ogee** fascia system is a traditional 's' curved style which includes the 10mm thick Cappit board and 18mm thick fascia board complete with corners and centre joints to give a neat stylish finish.

### 10mm OGEE FASCIA CAPPING BOARD

LENGTH	2.5M		5.0M	
	PART	PRICE	PART	PRICE
150mm (5 7/8")	LE215WH	£6.99	LE515WH	£12.99
175mm (6 7/8")	LE217WH	£8.49	LE517WH	£14.99
200mm (7 7/8")	LE220WH	£9.49	LE520WH	£17.49
250mm (9 7/8")	LE225WH	£11.49	LE525WH	£21.49
300mm (11 3/4")	LE230WH	£13.99	LE530WH	£25.99



### 18mm OGEE FASCIA REPLACEMENT BOARD

LENGTH	2.5M		5.0M	
	PART	PRICE	PART	PRICE
150mm (5 7/8")	LG215WH	£11.99	LG515WH	£19.99
200mm (7 7/8")	LG220WH	£15.99	LG520WH	£26.99
250mm (9 7/8")	LG225WH	£18.99	LG525WH	£34.99



### TRIMS FOR OGEE BOARDS

DESCRIPTION	PART	PRICE
600mm Double-ended External Corner	LGC96WH	£3.99
600mm Double-ended Centre Joint	LGJ6WH	£3.69

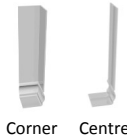

**+ 50 YEAR GUARANTEE ON ALL WHITE BOARDS**



The **Bullnose** fascia system is a traditional full curved style 18mm thick fascia board that can also be used for internal window ceils complete with corners, centre joints and end caps when using this product for an internal ceil.

### 18mm BULLNOSE FASCIA REPLACEMENT BOARD

LENGTH	2.5M		5.0M	
	PART	PRICE	PART	PRICE
150mm (5 7/8")	LB215WH	£11.49	LB515WH	£19.49
200mm (7 7/8")	LB220WH	£14.99	LB520WH	£26.49
250mm (9 7/8")	LB225WH	£18.99	LB525WH	£32.99
405mm (15 3/4")	LB240WH	£29.99	LB540WH	£54.49



### TRIMS FOR BULLNOSE FASCIA

In White

DESCRIPTION	PART	PRICE
300mm End Cap	LBECWH	£2.25
600mm Double-ended External Corner	LBC96WH	£3.49
600mm Double-ended Centre Joint	LBJ6WH	£3.49

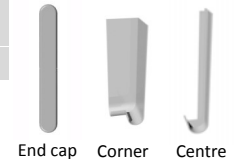

**+ FOR PLAIN & VENTED SOFFIT BOARDS SEE PAGE 49**

# WOODGRAIN EFFECT FASCIA & SOFFIT

Replace ALL asterisks \*  
with the colour code



Woodgrain effect boards are PVC foiled boards that come in 4 industry standard colours and available from stock. With a semi-gloss lightly textured finish these boards are made to Freefoam® high standards. Designed to cover or replace existing timber boards or for brand new installations these boards will give the look and feel of expensive real wood materials. Woodgrain products come with a 10year manufacturers guarantee (details available online).

**+ 10 YEAR  
GUARANTEE**



**MAHOGANY** \*=MH

**GOLDEN OAK** \*=GO



**ROSEWOOD** \*=RW

**BLACK ASH** \*=BA

## 10mm CAP-OVER FASCIA BOARD

LENGTH	2.5M		5.0M		
WIDTH	PART	PRICE	PART	PRICE	
150mm (5 7/8")	LC215*	£14.49	LC515*	£26.99	
175mm (6 7/8")	LC217*	£16.49	LC517*	£29.99	
200mm (7 7/8")	LC220*	£18.49	LC520*	£33.99	
250mm (9 7/8")	LC225*	£22.49	LC525*	£40.99	
400mm (15 3/4")	LC240*	£33.49	LC540*	£61.99	

## 10mm SOLID SOFFIT MULTIPURPOSE BOARDS

LENGTH	2.5M		5.0M		
WIDTH	PART	PRICE	PART	PRICE	
150mm (5 7/8")	LM215*	£14.49	LM515*	£25.99	
175mm (6 7/8")	LM217*	£15.49	LM517*	£28.99	
225mm (8 7/8")	LM222*	£19.49	LM522*	£35.99	
300mm (11 3/4")	LM230*	£25.49	LM530*	£45.99	

## 10mm HOLLOW 'V' GROOVED HOLLOW SOFFIT BOARDS

LENGTH	2.5M		5.0M		
WIDTH	PART	PRICE	PART	PRICE	
300mm (11 3/4")	LH230*	£18.49	LH530*	£32.99	

## 18mm FULL REPLACEMENT FASCIA BOARD

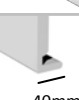
LENGTH	2.5M		5.0M		
WIDTH	PART	PRICE	PART	PRICE	
150mm (5 7/8")	LF215*	£18.49	LF515*	£33.99	
175mm (6 7/8")	LF217*	£21.49	LF517*	£38.99	
200mm (7 7/8")	LF220*	£23.49	LF520*	£43.99	
250mm (9 7/8")	LF225*	£26.49	LF525*	£49.99	
400mm (15 3/4")	LF240*	£45.49	LF540*	£81.99	

## SQUARE FASCIA ACCESSORIES

ITEM	PART	PRICE	
300mm External Corner	LCC93*	£5.99	
300mm Centre Joint	LCJ3*	£5.95	
Fascia Finial	LCF*	£5.49	

## TRIMS FOR 10mm BOARDS

LENGTH	2.5M		5.0M		
ITEM	PART	PRICE	PART	PRICE	
H Trim	LH2H*	£6.99	LH5H*	£10.99	H Trim
J Trim	LH2J*	£6.99	LH5J*	£11.49	

+ FOR COLOURED PLASTIC HEADED PINS AND NAILS SEE PAGE 54

# WOODGRAIN FASCIA & SOFFIT

# COLOURED FASCIA & SOFFIT COLORMAX



The innovative COLORMAX Technology provides a ground-breaking new range of Fascia and Soffit boards in a variety of colour fast shades. With a 10 Year Guarantee, they not only perform to the highest standards in function but also add a long-lasting coloured finish to any roofline project.

## Freefoam is the colour specialist

Using the most technologically advanced colour PVC-U and PVC-UE fascia and soffit ranges and the unique patented Colormax® technology provides ground breaking colour variety, colour matching and colourfastness.

## Colour available 'off the shelf'

The Colormax® technology includes an advanced master-batching process where a special blend of natural PVC compound is dosed on-line with specific concentrations of pigment enabling the company to produce high quality colours easily and quickly. This means C & A can offer many colour products with NO LEAD TIME – a significant advantage to many customers.



**SEE BELOW FOR  
Coloured Fascia & Soffit**

## UPVC A GREAT CHOICE

Our UPVC products are the best option for capping or replacing Fascia and Soffit boards. They are maintenance-free, unlike timber, they do not rot and do not ever need painting. They remain fresh, clean and hard wearing for years, with a manufacturer back **Guarantee** giving peace of mind. They are also easy to fit and you only need simple tools and basic joinery skills.

## INSTALLATION GUIDELINES

**FIXINGS** Use colour-matching plastic headed pins and nails to fix boards into place.

**CENTRES** Fixing Centers vary, but should never exceed 600mm for white boards, 300mm for black boards and 400mm for other colour and wood grain boards.

**TEMPERATURE** Products should not be installed where ambient temperatures are likely to exceed 40°C, such as in close proximity to boiler flues or where there is reflected or radiated solar or other sources of heat. External air temperature is acceptable between 0°-30° C. Temperature changes due to the time of day, season and weather should also be allowed for. Hollow rigid products should be installed only in areas shaded from direct sunlight.

**HANDLING & STORAGE** Coloured products should be stored internally away from direct sunlight in their protective sleeving until just before installation. Remove the protective film immediately after installation. Never store coloured products externally or on top of vans for any length of time as heat distortion may occur.



# COLORMAX™ COLOUR RANGE

PALE GOLD  
\*PG

ANTHRACITE GREY  
\*AG

BROWN  
\*BR

BLACK  
\*BK

LIGHT GREY  
\*LG



## 10mm SQUARE CAPPIT BOARDS CAP-OVER BOARDS

LENGTH	2.5M		5.0M	
	PART	PRICE	PART	PRICE
175mm (6 7/8")	LC217*	£10.99	LC517*	£19.49
225mm (9)	LC222*	£13.99	LC522*	£24.49
410mm (15 3/4")	LC240*	£25.49	LC540*	£45.99



Replace ALL asterisks \* with letter code to specify colour

## 18mm SQUARE FASCIA REPLACEMENT BOARDS

LENGTH	2.5M		5M	
	PART	PRICE	PART	PRICE
175mm (6 7/8")	LF217*	£15.49	LF517*	£28.99
225mm (9)	LF222*	£19.49	LF522*	£37.99
410mm (15 3/4")	LF240*	£36.49	LF540*	£66.99



## 10mm SOFFIT/ MULTIPURPOSE FLAT BOARDS

LENGTH	2.5M		5.0M	
	PART	PRICE	PART	PRICE
150mm (5 7/8")	LM215*	£10.49	LM515*	£18.99
200mm (7 7/8")	LM220*	£13.49	LM520*	£24.99



## 10mm HOLLOW 'V' GROOVED HOLLOW SOFFIT BOARDS

LENGTH	2.5M		5M	
	PART	PRICE	PART	PRICE
300mm (11 3/4")	LH230*	£10.99	LH530*	£19.99



## TRIMS 300mm LONG

PRODUCT	PART	PRICE
External Corner	LCC93*	£2.49
Centre Joint	LCJ3*	£2.49
90° Internal Corner	LCI93*	£2.99
Finial	LCF*	£4.99

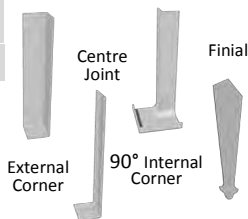

+ COLOURED PLASTIC  
HEADED PINS &  
NAILS

SEE PAGE 54

+ OTHER COLOURS  
AVAILABLE

Call for availability and  
cost

## TRIMS FOR 10mm SOFFIT & CAPPIT BOARD

LENGTH	2.5M		5M	
	PART	PRICE	PART	PRICE
H Trim	LH2H*	£3.99	LH5H*	£6.99
J Trim	LH2J*	£2.99	LH5J*	£4.99

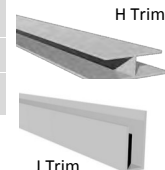

# COLOURED FASCIA & SOFFIT

## PINS & NAILS

### WHITE HEADED PINS (14 Gauge)

SIZE	QTY	PART	PRICE
30mm	25	PP30WH	£1.75
	200	PPB30WH	£8.95
40mm	25	PP40WH	£1.79
	200	PPB40WH	£8.99

### WHITE HEADED NAILS (10 Gauge)

SIZE	QTY	PART	PRICE
50mm	25	PP50WH	£2.75
	100	PPB50WH	£8.95
65mm	25	PP65WH	£2.79
	100	PPB65WH	£8.99

## COLOUR MATCHED PINS & NAILS

COLOUR	CODE
BLACK	*=BK
CARAMEL	*=CM
DARK BROWN	*=BR
LIGHT GREY	*=LG
ANTHRACITE GREY	*=AG
PALE GOLD	*=PG

REPLACE ALL \* WITH CODE



SIZE	QTY	PART	PRICE
30mm	25	PP30*	£1.95
	200	PPB30*	£11.95
40mm	25	PP40*	£1.99
	200	PPB40*	£11.99
50mm	25	PP50*	£3.95
	100	PPB50*	£11.95
65mm	25	PP65*	£3.99
	100	PPB65*	£11.99

ANTHRACITE GREY PINS ARE NOT AVAILABLE IN 30mm & 50mm LENGTHS

## DENTIL MOULDING

Authentic looking moulding ideal for any home, to replace existing crumbling stonework or for just giving your house a face lift. A choice of square tooth or scalloped.

DESCRIPTION	PART	PRICE
1.2M SQUARE DENTIL	EDQWH	£28.95
1.2M SCALLOPED DENTIL	EDSWH	£28.99
External Corner	EDECWH	£12.95
Internal Corner	EDICWH	£12.95
End Caps (pair)	EDEMWH	£21.95

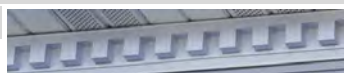

Square Dentil Moulding

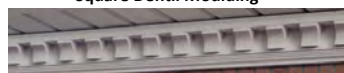

Scalloped Dentil Moulding

## VENTILATION

Ventilation of the roof space is a requirement to ensure a healthy home. There are various ways to improve ventilation in the roof space. The easiest way for new installations is to use vented soffit boards, plain boards and a ventilation strip or over fascia vents. For existing installations then the use of ventilation disks is the easiest method.

### VENTILATION STRIP FOR 10mm BOARDS

LENGTH	2.5M		5.0M	
	PART	PRICE	PART	PRICE
WHITE	LHV2WH	£11.95	LHV5WH	£22.95
BLACK	LHV2BK	£10.95	LHV5BK	£19.95
BROWN	LHV2BR	£10.95	LHV5BR	£19.95
ANTHRACITE GREY	LHV2AG	£14.95	LHV5AG	£28.95



### FASCIA & SOFFIT VENTILATION

#### 70mm VENT DISKS

COLOUR	PART	PRICE
WHITE	LVDWH	£0.59
BROWN	LVDDBR	£0.59
CARAMEL	LVDPCM	£0.59
BLACK	LVDDBK	£0.59



#### OVER FASCIA VENTS

	SIZE	PART	PRICE
1.0M long	10mm	LOFV10	£2.57
	25mm	LOFV25	£3.10



### INSECT MESH

#### SELF-ADHESIVE INSECT MESH

Applied to the internal side of vented soffit boards or similar applications

PART	PRICE
LVM	£4.29

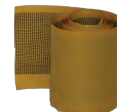

+ FOR A FULL RANGE OF SILICONES & GLUE

SEE PAGES 73 ONWARDS

# WHITE GLOSS CLADDING BOARDS



## Gloss White 100mm V-Groove & 150mm Shiplap Cladding

uPVC Cladding is the best alternative to traditional wood cladding. This maintenance free product is perfect for today's busy life styles. No more rubbing down and painting. Freefoam's durable cladding products provide not only a decorative but also a protective facing on building exteriors, and act as an additional thermal insulation agent. We offer standard 'V' Groove and traditional Shiplap styles in white. The popular Fortex® textured cladding is a choice of styles, sizes and colours *can be seen on page 56*.

Woodgrain finished cladding is also available to special order. All cladding products come with related trims to ensure a neat and professional installation.

**For fitting information please see page 47**

## uPVC A GREAT CHOICE

Our uPVC products are the best option for replacing old wooden cladding or new installations. They will remain fresh, clean and hard wearing for years, with a **Lifetime Guarantee**.

## V-GROOVE CLADDING 100mm cover width

2.5M		5.0M	
PART	PRICE	PART	PRICE
LSV210WH	£4.99	LSV510WH	£8.49
<b>JOINER &amp; STARTER TRIM FOR V-GROOVE</b>			
BUTT JOINT		LSVJWH	£0.95
3M STARTER TRIM		LSUSTWH	£4.99

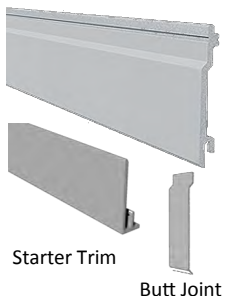

## SHIPLAP CLADDING 150mm cover width

2.5M		5.0M	
PART	PRICE	PART	PRICE
LSS215WH	£6.49	LSS515WH	£11.99
<b>JOINER &amp; STARTER TRIM FOR SHIPLAP</b>			
BUTT JOINT		LSSJWH	£1.05
5M STARTER TRIM		LSSTWH	£5.99



## BREATHABLE FELT MEMBRANE 100gsm 1M wide x 20M

- \* Highly Breathable
- \* Easy-Trim Cutting Grid
- \* BBA Certificated no 10/4753
- \* UV Stable (3 months exposure)
- \* High Tensile and Tear Strength
- \* Long Term Durability
- \* Multipurpose and Lightweight



PART	PRICE
LFM	£24.99

## CLADDING TRIMS For V-GROOVE & SHIPLAP CLADDING

DESCRIPTION	PART	PRICE
3.0M Corner Trim	LSUCTWH	£19.43
3.0M Edge Trim	LSUETWH	£14.91
2.5M H-Trim	LS22HWH	£4.41
5.0M H-Trim	LS52HWH	£8.35

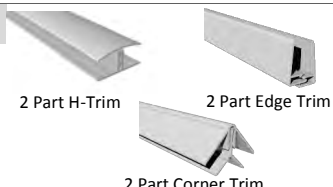

## FIXINGS BARB NAILS

Stainless Steel  
30mm x 14g

PACK OF 25		BOX OF 200	
PART	PRICE	PART	PRICE
SN30	£0.79	SNB30	£4.65



# EXTERIOR WALL CLADDING

# FORTEX™

FORTEX is a range of innovative cladding products that merge the benefits of low-maintenance and long life PVC with an authentic look and feel of real timber. These abstract, textured wood-grain effect boards are available in a choice of colours.

**Freefoam**  
**10 YEAR**  
**GUARANTEE**



- ✓ UV & weather resistant
- ✓ Easy to maintain & keep clean
- ✓ 10 Year Guarantee
- ✓ Attractive timber-effect finish in a range of shades to revitalise your home
- ✓ Help to protect your house from cracks, leaks and damp, increasing the insulation
- ✓ Reduce household energy bills & help lower CO<sup>2</sup> emissions for the environment.

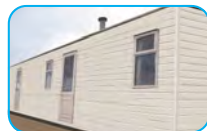

REPLACE ASTERISK \* IN THE PART NUMBER WITH THE COLOUR LETTER CODE



## FORTEX PROFESSIONAL RANGE

### FEATHER EDGE 170mm Cover Width

LENGTH	2.5M		5M	
COLOUR	PART	PRICE	PART	PRICE
ARGYLE BROWN	LSF217AB	£12.49	LSF517AB	£21.99
COLONIAL BLUE	LSF217CB	£12.49	LSF517CB	£21.99
FEATHER EDGE BUTT JOINT			LSFBJ*	£1.99



### DOUBLE SHIPLAP 333mm Cover Width

ARGYLE BROWN	LSD233AB	£18.49	LSD533AB	£34.99
COLONIAL BLUE	LSD233CB	£18.49	LSD533CB	£34.99
STORM GREY	LSD233SG	£18.49	LSD533SG	£34.99
DOUBLE SHIPLAP BUTT JOINT			LSDBJ*	£1.99
3.0M External Corner Trim			LSUCT*	£24.99
3.0M Edge Trim			LSUET*	£15.99

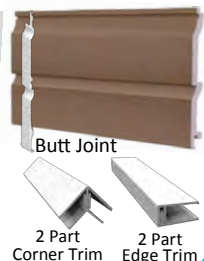

## FORTEX STANDARD RANGE

### FEATHER EDGE 170mm Cover Width

LENGTH	2.5M		5M	
COLOUR	PART	PRICE	PART	PRICE
WHITE	LSF217WH	£10.49	LSF517WH	£18.99
SAND	LSF217SD	£10.49	LSF517SD	£18.99
FEATHER EDGE BUTT JOINT			LSFBJ*	£1.99

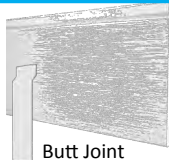

### DOUBLE SHIPLAP 300mm Cover Width

WHITE	LSD230WH	£15.49	LSD530WH	£27.99
SAND	LSD230SD	£15.49	LSD530SD	£27.99
DOUBLE SHIPLAP BUTT JOINT			LSDBJ*	£1.99
3.0M Ext Corner Trim			LSUCT*	£19.99
3.0M Edge Trim			LSUET*	£12.99



## ACCESSORIES

	PART	PRICE		
3.0M Universal Starter Trim	LSUSTWH	£4.99		
<b>FIXINGS BARB NAILS</b>	PACK OF 25	BOX OF 200		
	PART	PRICE	PART	PRICE
Stainless Steel 30mm x 14g	SN30	£0.79	SNB30	£4.65











**MORE COLOURS AVAILABLE TO ORDER— CALL 01634 37 44 44**

Cappuccino
Misty Grey
Pale Blue
Pale Gold







# TRIMS

## WHITE TRIMS

LENGTH	2.5M		5.0M		
DESCRIPTION	PART	PRICE	PART	PRICE	
40mm Architrave	LA240WH	£1.79	LA540WH	£2.99	 40mm Arc
60mm Architrave	LA260WH	£2.29	LA560WH	£3.69	 60mm Arc
90mm Architrave	LA290WH	£2.79	LA590WH	£4.79	 90mm Arc
15mm Quadrant	LQ215WH	£1.00	LQ515WH	£1.79	 Quadrant
19mm Quadrant	LQ219WH	£1.49	LQ519WH	£2.19	
20mm Cloak	LQ220WH	£1.19	LQ520WH	£1.79	 Cloak
28mm D Mould	LD228WH	£1.49	LD528WH	£2.29	 D Mould
28mm Rectangular	LR228WH	£1.49	LR528WH	£2.29	 Rectangular
30mm Angle	LA230WH	£4.99	LA530WH	£7.49	
50mm Angle	LA250WH	£7.99	LA550WH	£13.49	
100mm Angle	LA210WH	£17.99	LA510WH	£32.49	
15x15mm Square	LST215WH	£1.99	LST515WH	£3.49	 Angle

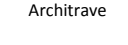
## WOODGRAIN TRIMS

LENGTH	2.5M		5.0M		
WIDTH	PART	PRICE	PART	PRICE	
40mm Architrave	LA240*	£5.49	LA540*	£8.49	 Architrave
60mm Architrave	LA260*	£6.49	LA560*	£10.49	 Quadrant
90mm Architrave	LA290*	£7.49	LA590*	£12.49	
19mm Quadrant	LQ219*	£4.99	LQ519*	£7.99	
20mm Cloak	LQ220*	£4.99	LQ520*	£7.99	 Cloaking Fillet
28mm D Mould	LD228*	£4.99	LD528*	£7.99	 Angle
30mm Angle	LA230*	£8.89	LA530*	£15.69	 'D' Mould

# WINDOW BOARD

## 10mm WINDOW BOARD HOCKEY or "J" NOSE

LENGTH	2.5M		5.0M		For covering old or damaged internal windowsills.
WIDTH	PART	PRICE	PART	PRICE	
200mm (7 7/8")	LJ220WH	£11.99	LJ520WH	£19.99	
250mm (9 7/8")	LJ225WH	£14.99	LJ525WH	£24.99	

## END CAPS FOR WINDOW BOARDS

DESCRIPTION	PART	PRICE	
Single 380mm Double-ended End Cap (glue-on)	LJLECWH	£2.29	
Set of 2x 60mm End Caps—Left & Right (glue-on)	LJECWH	£1.59	

## PREMIER 450 SILICONE

Quality low modulus non-corrosive neutral cure silicone sealant that adheres to virtually all substrates, both porous and non-porous.

C3 Cartridge



COLOUR	PART	PRICE
WHITE	SMWH	£3.29
CLEAR	SMCL	£3.35
BROWN	SMBR	£3.39
GREY	SMLG	£3.45
BLACK	SMBK	£3.49
BUFF	SMBF	£3.59

**MAHOGANY** \*=MH

**BLACK ASH** \*=BA

**GOLDEN OAK** \*=GO

**ANTHRACITE** \*=AG

**ROSEWOOD** \*=RW

**CHARTWELL** \*=CG

# Combo Canopy

Easy-fit Door Canopies are ideal to cover doorways, balconies, walkways and waiting areas, to give just a few suggestions. Our canopies are sold as kits and are quick to install and only require a small amount of assembly.

The support brackets on each side are made from weather-proof engineering-grade plastic and each one requires only two wall fixings (supplied in kit). As illustrated, they can be installed individually, or back-to-back and side-to-side to give cover over a larger area. We have a range of sizes available, with Grey or Black brackets, and a choice of Bronze or Clear Multiwall polycarbonate, or Solid Clear Polycarbonate glazing.



700mm Projection X 1000mm Width				
Sheet Type	Sheet Colour	Bracket Colour	PART NO	PRICE
Multiwall	CLEAR	BLACK	DCB710TC	£29.99

700mm Projection X 1200mm Width				
Sheet Type	Sheet Colour	Bracket Colour	PART NO	PRICE
Multiwall	CLEAR	BLACK	DCB712TC	£34.99
Multiwall	BRONZE	BLACK	DCB712TB	£44.99
Solid	CLEAR	BLACK	DCB712SC	£64.99
Multiwall	CLEAR	GREY	DCG712TC	£49.99
Solid	CLEAR	GREY	DCG712SC	£59.99

## CANOPY INSTALL KIT

This handy kit contains all the bits you will need to help install your canopy.



PART	PRICE
TCIK	£4.99

Consists of:  
 1 x Clear Silicone  
 1 x Screw Driver  
 1 x 10mm SDS Bit  
 1 x Spanner



920mm Projection X 1200mm Width				
Sheet Type	Sheet Colour	Bracket Colour	PART NO	PRICE
Multiwall	CLEAR	BLACK	DCB912TC	£64.99
Multiwall	BRONZE	BLACK	DCB912TB	£75.99
Solid	CLEAR	BLACK	DCB912SC	£98.99
Solid	CLEAR	GREY	DCG912SC	£99.99

## PANEL UPGRADES

700mm Projection x 1200mm Width				
Sheet Type	Sheet Colour	PART NO	PRICE	
Multiwall	GREEN	D4712GR	£29.99	
Multiwall	AQUA	D4712AQ	£29.99	
Multiwall	PURPLE	D4712PU	£29.99	

920mm Projection x 1200mm Width				
Sheet Type	Sheet Colour	PART NO	PRICE	
Multiwall	GREEN	D4912GR	£39.99	
Multiwall	AQUA	D4912AQ	£39.99	
Multiwall	PURPLE	D4912PU	£39.99	



# Combo Canopy

## Premier Range

These sleek, Modern, Easy to install Door Canopies are the ideal solution for covering doorways, balconies, walkways and waiting areas. Their simple clean design makes these the perfect choice for making that instant wow impact on your home.

The brackets and frame are made using finished Aluminium giving them strength and making them extremely durable. The sheeting is made from Solid Polycarbonate which is UV coated and has massive impact resistance. This provides all the benefits of glass but at a fraction of the cost. We have a range of styles available, with Silver or Black brackets, and a choice of Bronze or Clear polycarbonate, meaning there is a canopy for almost every job. Supplied in kits complete with instructions and all the Fixings.



	Premium Canopy 900mm Projection x 1400mm Wide			
	Sheet Type	Bracket	PART NO	PRICE
	Solid Clear Polycarbonate	Aluminium	DCE914	£99.00

J Series Canopies 900mm Projection x 1500mm Width					
Sheet Type	Sheet Colour	Bracket Colour	PART NO	PRICE	
Solid Polycarbonate	CLEAR	SILVER	DCJ915CL	£119.00	
Solid Polycarbonate	BRONZE	SILVER	DCJ915BR	£139.00	

MAX Series Canopy 900mm Projection x 1200mm Width				
Sheet Type	Sheet Colour	Bracket Colour	PART NO	PRICE
Solid Polycarbonate	CLEAR	BLACK	DCM912SC	£129.00

This series is joinable along its width allowing for an increased coverage and presents a lower pitch making it more suitable for use with outward opening doors.



## FLAT ROOF LIGHTING

## ILLUMI-THERM FLAT ROOF LIGHT

### 25mm ILLUMI-THERM

Includes fixings

SHEET COLOUR	SIZE	PART	PRICE
CLEAR	980mm x 980mm	DIQ9898CL	£75.00
BRONZE	980mm x 980mm	DIQ9898BR	£75.00
OPAL WHITE	980mm x 980mm	DIQ9898WH	£75.00
CLEAR	1000mm x 2000mm	DIQ1020CL	£99.00
BRONZE	1000mm x 2000mm	DIQ1020BR	£99.00
OPAL WHITE	1000mm x 2000mm	DIQ1020WH	£99.00



CLEAR

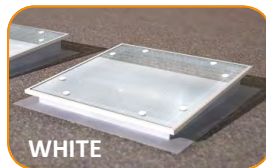

WHITE

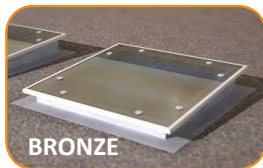

BRONZE

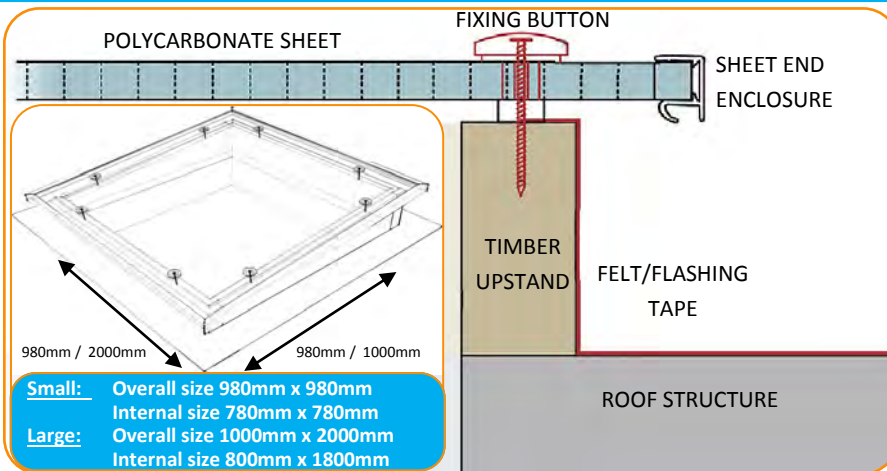

**This product does not come with an upstand, customers will need to construct their own**

- ◆ Extremely high impact; polycarbonate is the material bullet proof glass is made from.
- ◆ Available in Clear, Bronze or Opal White for different diffusion/ambience requirements.
- ◆ High light transmission levels (light transmission will vary on thickness and tint).
- ◆ Greater insulation levels than traditional dome moulded roof lights.
- ◆ Fire resistance to BS476/7.
- ◆ Adjustable on site to meet your actual opening size.



# FLAT ROOF LIGHTING

## ILLUMI-THERM CONVEX

### ILLUMI-THERM CONVEX

Includes fixings

SHEET COLOUR	SIZE*	PART	PRICE
WHITE	600mm x 600mm	DIX0606WH	£75.00
WHITE	900mm x 900mm	DIX0909WH	£145.00
WHITE	1200mm x 1200mm	DIX1212WH	£180.00

This product does not come with an up-stand / kerb as Customers will need to construct their own or purchase one as an additional extra.

\*Sizes are internal framework opening size eg a 600mm x 600mm dome has an overall size of 800mm x 800mm

Multiwall Polycarbonate for improved insulation to weight ratio.

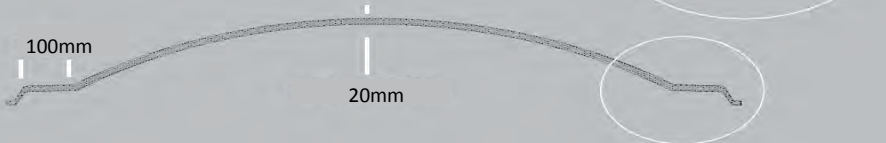

Constructed from multi-chambered polycarbonate sheeting which is formed into a convex dome shape, for ease of installation onto a standard kerb / up-stand. This design gives great insulation & strength while keeping the weight & cost down. Manufactured in a WHITE finish to allow light to pass through while still reflecting some of the heat and giving privacy. We are proud to be the first to offer this cutting edge technology product in the UK.

**NEW!**

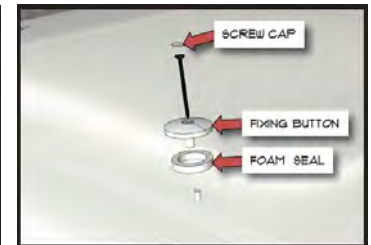
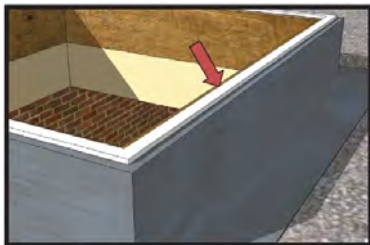

## ILLUMI-THERM CONVEX FLAT ROOF LIGHT

## DOMES WITHOUT UPSTAND or KERB

### Our range of roof domes are supplied in two types:

Without an upstand or kerb for use where direct fixing is needed, or with a fully integrated and contemporary upstand/kerb for new installations.

- ◆ Includes 70mm wide flange
- ◆ Fixing kit included
- ◆ New look profile
- ◆ Manufactured from 3mm Marlon FSX long-life polycarbonate
- ◆ Options for Single, Double and Triple skin
- ◆ 20 Year Manufacturer's weather failure guarantee



For Internal Dome sizes subtract 140mm from the Overall size quoted (example: a 600mm x 600mm dome would have internal sizes of 460mm x 460mm).

**Non-Stock Items  
Manufactured To Order  
Delivered Direct**

### Security Fixings

- Fixing secured with tamper-proof caps

### Membrane Clamp

- Factory-fitted to kerb.
- Holds roofing felt and membranes in place to prevent peel-back.

### Multiwall PVC Kerb

- Thermally efficient Robust and durable.
- Sloped foot allows roof covering to be finished without need for timber filllets.

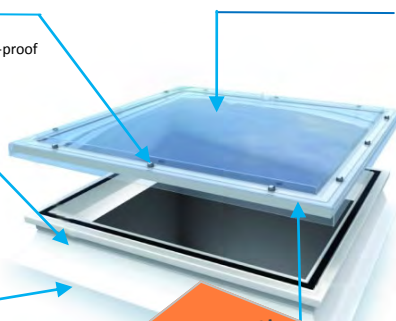

### Glazing

- Low-rise polycarbonate glazing profile
- Dual-sided UV protection and 200 times stronger than glass
- Triple and Quad skin glazing meets and exceeds Part L
- Heat gain and solar glare control options
- 25mm polycarbonate inner glazing option for improved thermal performance

### Glazing Cassette

- Holds glazing in Triple and Quad skins
- Reduces risk of condensation

**BRONZE & OPAL  
SINGLE & QUADRUPLE  
GLAZED DOMES  
Supplied to order**

## NON-OPENING DOMES

SQUARE DOMES OVERALL SIZE	DOUBLE GLAZED		TRIPLE GLAZED	
	PART	PRICE	PART	PRICE
600x600mm (23½" x 23½")	DRD0606CL	£162.00	DRT0606CL	£213.00
750x750mm (29½" x 29½")	DRD0707CL	£206.00	DRT0707CL	£271.00
900x900mm (35½" x 35½")	DRD0909CL	£233.00	DRT0909CL	£305.00
1050x1050mm (41¾" x 41¾")	DRD1010CL	£272.00	DRT1010CL	£356.00
1200x1200mm (47¾" x 47¾")	DRD1212CL	£366.00	DRT1212CL	£496.00

Other sizes also available to order

RECTANGULAR DOMES OVERALL SIZE	DOUBLE GLAZED		TRIPLE GLAZED	
	PART	PRICE	PART	PRICE
600x900mm (23½" x 35½")	DRD0609CL	£198.00	DRT0609CL	£258.00
750x900mm (29½" x 35½")	DRD0709CL	£224.00	DRT0709CL	£296.00
600x1200mm (23½" x 47¾")	DRD0612CL	£260.00	DRT0612CL	£351.00
900x1200mm (35½" x 47¾")	DRD0912CL	£365.00	DRT0912CL	£495.00

# DOMES COMPLETE WITH UPSTANDS

These domes are supplied with high grade upstand/kerb.



## Available Options:

- Electric Opening
- High Security
- Smoke Clearance
- Access Opening
- Other sizes also available

BRONZE & OPAL  
SINGLE & QUADRUPLE  
GLAZED DOMES  
Supplied to order

## OPENING DOMES LINEAR OPENING

SQUARE DOMES	DOUBLE GLAZED		TRIPLE GLAZED	
	OVERALL SIZE	PART	PRICE	PART
600x600mm (23½" x 23½")	DLD0606CL	<b>£443.00</b>	DLT0606CL	<b>£480.00</b>
750x750mm (29½" x 29½")	DLD0707CL	<b>£534.00</b>	DLT0707CL	<b>£584.00</b>
900X900mm (35½" x 35½")	DLD0909CL	<b>£594.00</b>	DLT0909CL	<b>£668.00</b>
1050x1050mm (41¼" x 41¼")	DLD1010CL	<b>£679.00</b>	DLT1010CL	<b>£744.00</b>
1200x1200mm (47¼" x 47¼")	DLD1212CL	<b>£982.00</b>	DLT1212CL	<b>£1081.00</b>

RECTANGULAR DOMES	DOUBLE GLAZED		TRIPLE GLAZED	
	OVERALL SIZE	PART	PRICE	PART
600x900mm (23½" x 35½")	DLD0609CL	<b>£555.00</b>	DLT0609CL	<b>£599.00</b>
750x900mm (29½" x 35½")	DLD0709CL	<b>£594.00</b>	DLT0709CL	<b>£649.00</b>
600X1200mm (23½" x 47¼")	DLD0612CL	<b>£827.00</b>	DLT0612CL	<b>£888.00</b>
900x1200mm (35½" x 47¼")	DLD0912CL	<b>£957.00</b>	DLT0912CL	<b>£1056.00</b>

Opening Poles sold separately

## NON-OPENING DOMES NON-VENTED

SQUARE DOMES	DOUBLE GLAZED		TRIPLE GLAZED	
	OVERALL SIZE	PART	PRICE	PART
600x600mm (23½" x 23½")	DUD0606CL	<b>£251.00</b>	DUT0606CL	<b>£327.00</b>
750x750mm (29½" x 29½")	DUD0707CL	<b>£315.00</b>	DUT0707CL	<b>£409.00</b>
900X900mm (35½" x 35½")	DUD0909CL	<b>£365.00</b>	DUT0909CL	<b>£472.00</b>
1050x1050mm (41¼" x 41¼")	DUD1010CL	<b>£419.00</b>	DUT1010CL	<b>£539.00</b>
1200x1200mm (47¼" x 47¼")	DUD1212CL	<b>£530.00</b>	DUT1212CL	<b>£691.00</b>

RECTANGULAR DOMES	DOUBLE GLAZED		TRIPLE GLAZED	
	OVERALL SIZE	PART	PRICE	PART
600x900mm (23½" x 35½")	DUD0609CL	<b>£317.00</b>	DUT0609CL	<b>£409.00</b>
750x900mm (29½" x 35½")	DUD0709CL	<b>£351.00</b>	DUT0709CL	<b>£456.00</b>
600X1200mm (23½" x 47¼")	DUD0612CL	<b>£398.00</b>	DUT0612CL	<b>£513.00</b>
900x1200mm (35½" x 47¼")	DUD0912CL	<b>£516.00</b>	DUT0912CL	<b>£672.00</b>

## NON-OPENING DOMES TRICKLE VENTED

SQUARE DOMES	DOUBLE GLAZED		TRIPLE GLAZED	
	OVERALL SIZE	PART	PRICE	PART
600x600mm (23½" x 23½")	DTD0606CL	<b>£285.00</b>	DTT0606CL	<b>£360.00</b>
750x750mm (29½" x 29½")	DTD0707CL	<b>£349.00</b>	DTT0707CL	<b>£443.00</b>
900X900mm (35½" x 35½")	DTD0909CL	<b>£399.00</b>	DTT0909CL	<b>£506.00</b>
1050x1050mm (41¼" x 41¼")	DTD1010CL	<b>£452.00</b>	DTT1010CL	<b>£573.00</b>
1200x1200mm (47¼" x 47¼")	DTD1212CL	<b>£564.00</b>	DTT1212CL	<b>£724.00</b>

RECTANGULAR DOMES	DOUBLE GLAZED		TRIPLE GLAZED	
	OVERALL SIZE	PART	PRICE	PART
600x900mm (23½" x 35½")	DTD0609CL	<b>£351.00</b>	DTT0609CL	<b>£443.00</b>
750x900mm (29½" x 35½")	DTD0709CL	<b>£385.00</b>	DTT0709CL	<b>£489.00</b>
600X1200mm (23½" x 47¼")	DTD0612CL	<b>£431.00</b>	DTT0612CL	<b>£546.00</b>
900x1200mm (35½" x 47¼")	DTD0912CL	<b>£550.00</b>	DTT0912CL	<b>£706.00</b>

# FLAT ROOF DOMES WITH UPSTANDS

## HIGHLY VERSATILE SOLID CLEAR POLYCARBONATE SHEETS

- IDEAL FOR:**
- > Greenhouses.
  - > Secondary Glazing.
  - > Security Glazing.

✦ Solid Polycarbonate is 200 times stronger than glass and can be used in many everyday applications. Common uses include re-glazing sheds, greenhouse glazing, secondary glazing, plus 1000's of other uses around home and works.



## CLEAR SOLID POLYCARB

### UV Protected both sides

This highly versatile product is totally glass clear, with an impact resistance 200 times greater than that of glass. All of our sheets have a UV coating on both sides to stop UV deterioration, ensure longer life and eliminate the chance of installing the wrong way around. These sheets are extremely easy to cut and drill making them an ideal DIY friendly glazing alternative.

	APPROX DIMENSIONS		2mm Thick		3mm Thick		4mm Thick		6mm Thick	
	Millimetres	Inches	PART	PRICE	PART	PRICE	PART	PRICE	PART	PRICE
	1220 x 610	48" x 24"	FC21206CL	£9.99	FC31206CL	£15.41	FC41206CL	£20.41	FC61206CL	£31.08
	1220 x 1220	48" x 48"	FC21212CL	£20.84	FC31212CL	£31.26	FC41212CL	£41.60	FC61212CL	£62.48
	2440 x 1220	96" x 48"	FC22412CL	£41.66	FC32412CL	£62.49	FC42412CL	£83.30	FC62412CL	£124.90
	1000 x 750	39" x 29 <sup>1/2</sup> "	FC21007CL	£9.99	FC31007CL	£15.68	FC41007CL	£20.83	FC61007CL	£31.33
	1500 x 1000	59" x 39"	FC21510CL	£20.90	FC31510CL	£31.36	FC41510CL	£41.80	FC61510CL	£62.60
	2050 x 750	78 <sup>3/4</sup> " x 29 <sup>1/2</sup> "	FC22007CL	£20.96	FC32007CL	£31.44	FC42007CL	£41.90	FC62007CL	£62.85
	2050 x 1500	78 <sup>3/4</sup> " x 59"	FC22015CL	£41.98	FC32015CL	£62.98	FC42015CL	£83.96	FC62015CL	£125.94
	3050 x 2050	118" x 78 <sup>3/4</sup> "	FC23020CL	£83.80	FC33020CL	£125.70	FC43020CL	£166.60	FC63020CL	£249.80

## SECONDARY GLAZING STRIP

### 2.44M (8ft) WHITE

Easy to install, 2.4M long strips will accept 2mm, or 3mm panel. The strip is in 2 sections, the inner section is pushed around the edge of the sheeting and then screwed into the frame, then the top screw cover is pushed into place to hide the fixings.

PART	PRICE
FT24WH	£5.99



## SECONDARY MAGNET GLAZING

### 5M (16' 4") Per Roll

Two self-adhesive strips, one is part is magnetised, the other steel. Applied by sticking one part to the framework and the other to the sheeting. Once installed it will be magnetically held into position making it easy to remove for cleaning or access.

PART	PRICE
MG5	£23.90





# IDEAL FOR: Bathrooms, Food preparation areas, Clean Rooms & Easy to clean areas

## WHITE PVC PANELS

### POPULAR HYGIENE LINER

Chemically resistant with **Class 1 Fire Rating**. These 2440mm x 1220mm (8' x 4') panels are impervious to water and when installed correctly are compliant with statutory regulations for wall coverings in areas of food preparation and packaging. If the area you wish to apply the sheets to isn't smooth and flat then the 3mm should be used for its increased rigidity.

APPROX	2mm Thick		3mm Thick	
	PART	PRICE	PART	PRICE
2440 x 1220 (96"x 48")	FP22412WH	£29.99	FP32412WH	£44.50

**FOOD HYGIENE:** When used in areas of food preparation, it is important that all joints are made using the appropriate trim section, which is treated at the edges with clean room silicone.

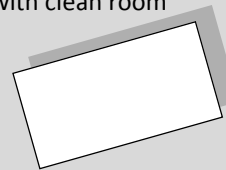

## MULTI-TRIM WHITE

### 2.44M (8ft)

#### ONE TRIM FOR ALL JOBS

The MULTI-TRIM has been specifically designed for the use with the 2-3mm white PVC sheets. This clever design allows one trim to do the job of 4 others. Featuring a flexible co-extrusion this trim can accommodate any angle from 90°-270°. Having this one trim means you will never have the wrong trim on site again!

PART	PRICE
FMT24WH	£3.49

As an edge trim

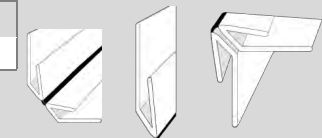

As an internal corner

As an external corner

As an H Joint

## EDGE TRIM WHITE

PART	PRICE
FTE2WH	£2.99

Size 2.4M (8ft)  
Usable with 2 & 3mm

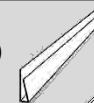

## JOINTING TRIM WHITE

PART	PRICE
FTH2WH	£3.99

Size 2.4M (8ft)  
Usable with 2 & 3mm

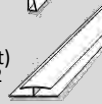

## EXTERNAL CORNER WHITE

PART	PRICE
FTEC2WH	£4.49

Size 2.4M (8ft)  
Usable with 2 & 3mm



## LARGE INTERNAL CORNER TRIM

PART	PRICE
FTLC2WH	£5.99

Size 2.4M (8ft)  
Usable with 2 & 3mm



## SMALL INTERNAL CORNER TRIM

PART	PRICE
FTSC2WH	£2.99

Size 2.4M (8ft)  
Usable with 2 & 3mm



## CLEAN ROOM SILICONE

Advanced neutral curing hygienic sealant that combines a powerful Anti-Bacterial compound with FDA Approved Food Compatibility. Prevents the formation of most common germs.

#### C3 Cartridge

PART	PRICE
SCRWH	£3.99



## STIXALL

Combination of building adhesive and sealant, With power to both bond and seal virtually EVERYTHING.

#### C3 Cartridge

PART	PRICE
STXWH	£5.99



# LARGE WHITE PVC SHEETS & ACCESSORIES

## GEO panel INTERNAL INTERLOCKING WALL CLADDING

Large Panel Size. 10mm thick  
2400mm X 1000mm Covers(2.4m<sup>2</sup>)

Internal paneling system available in a range of finishes, ideal for bathroom & kitchen walls.

### EASY TO USE

- ✓ Perfect alternative to tiling
- ✓ Cover over any existing surface
- ✓ Simple tongue & groove system
- ✓ No training needed
- ✓ Super fast installation
- ✓ Range of trims available

### BENEFITS

- ✓ 100% Waterproof PVC core
- ✓ No grouting to discolour/ leak
- ✓ Mould-free material
- ✓ Hygienic wipe-clean surface
- ✓ Insulation for walls & ceilings
- ✓ Sound proofing

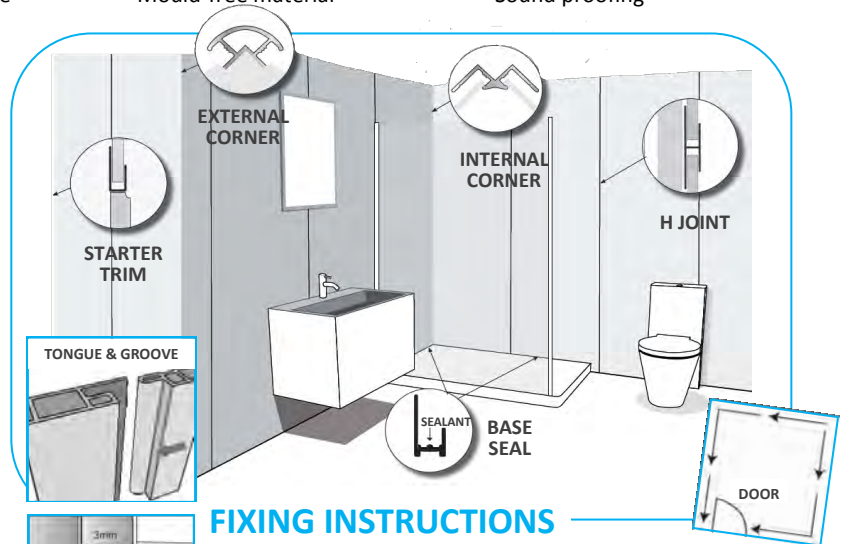
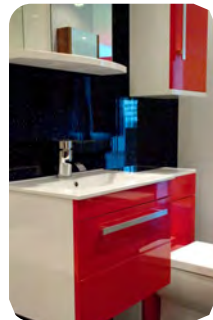

### FIXING INSTRUCTIONS

Starting at the corner furthest from the door, fit an internal corner trim & insert the first panel (after removing the small tongue or cutting it to size). Continue fitting panels away from the corner in both directions until you reach the last panel above the doorway. Insert the tongue and swing into position.

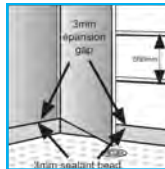

## ▼ OUR RANGE OF FINISHES - panels sold individually

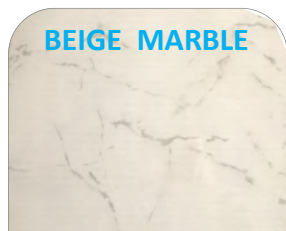

BEIGE MARBLE

PART	PRICE
IGPLBE	£58.32



WHITE MARBLE

PART	PRICE
IGPLWM	£58.32



BLUE MARBLE

PART	PRICE
IGPLBL	£58.32

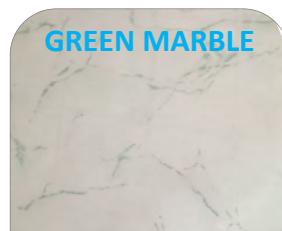

GREEN MARBLE

PART	PRICE
IGPLGR	£58.32



LIGHT GREY MARBLE

PART	PRICE
IGPLGM	£58.32

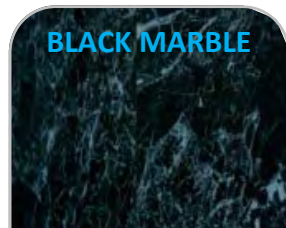

BLACK MARBLE

PART	PRICE
IGPLBM	£58.32



PERGAMON MARBLE

PART	PRICE
IGPLPM	£58.32



GLOSS WHITE

PART	PRICE
IGPLGW	£70.82





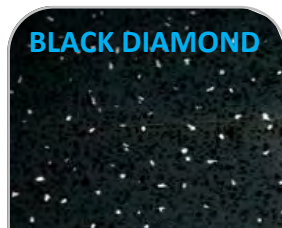

WHITE DIAMOND

PART	PRICE
IGPLWD	£70.82

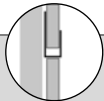

BLACK DIAMOND

PART	PRICE
IGPLBD	£70.82

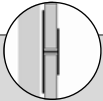
TRIMS 2.4M long	 Starter/Edge		 External Corner		 Internal Corner		 Base Seal		 H-Joint		
	COLOUR	PART	PRICE	PART	PRICE	PART	PRICE	PART	PRICE	PART	PRICE
	SILVER	IGPUSI	£5.95	IGPESI	£8.95	IGPISI	£7.99	IGPBSI	£9.29	IGPHSI	£7.49
WHITE	IGPUWH	£4.65	IGPEWH	£6.95	IGPIWH	£6.39	IGPBWH	£7.45	IGPHWH	£5.95	

### GEOPANEL CLEANER

A powerful cleaning agent designed specifically for cleaning geopanel

500ml SPRAY BOTTLE



PART	PRICE
IGPCS	£3.99

+ SILICONES & ADHESIVES SEE PAGE 73 ONWARDS

# LARGE INTERNAL DECORATIVE PVC

## GEO panel SMALL PANELS

Size: 5mm thick  
2700mm X 250mm (covers 2.7m<sup>2</sup>)

**PACK OF x4**

Interlocking internal paneling system available in a range of finishes, ideal for bathroom & kitchen walls & ceilings

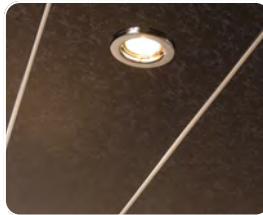
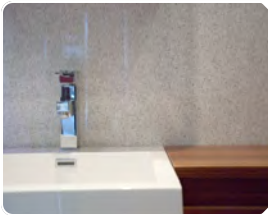

### EASY TO USE

- ✓ Perfect alternative to tiling
- ✓ No training needed
- ✓ Cover over any existing surface
- ✓ Super fast installation
- ✓ Simple tongue & groove system
- ✓ Range of trims available

### BENEFITS

- ✓ 100% Waterproof PVC core
- ✓ Hygienic wipe-clean surface
- ✓ No grouting to discolour/ leak
- ✓ Insulation for walls & ceilings
- ✓ Mould-free material
- ✓ Sound proofing

### FIXING INSTRUCTIONS

Fitting is easy, with no specialist tools or training required. The panels simply interlock forming a watertight finish without grouting or drying time. The best alternative to standard tiling.

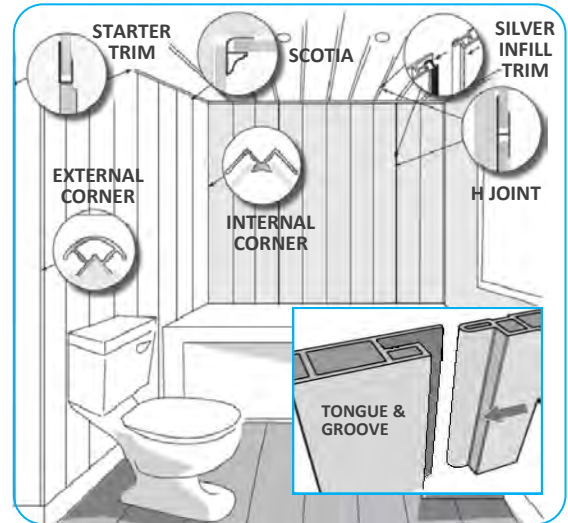

## GEO panel CEILING PANELS

Gloss White with Silver trim panels, available in packs of 5, ideal for cladding ceilings to give a modern and attractive clean finish. Manageable panel size for easy installation. Geo panel design interlocks sections together using a simple tongue and groove system. A range of trims is also available for a professional finish.

**EACH PANEL SIZE. 5mm thick x 2700mm x 200mm**

**PACK OF x5**

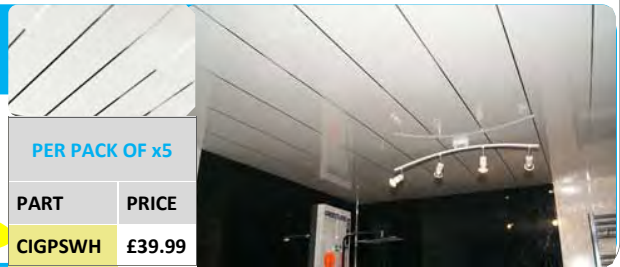

PER PACK OF x5	
PART	PRICE
CIGPSWH	£39.99

▼ **HUGE RANGE OF STYLES** - Available in packs of 4 panels each 2700mm x 250mm (Covers 2.7Sq mtrs)

**PACK OF x4**



<b>GLOSS WHITE</b> A clean, shiny plain white.	PART	PRICE
	<b>IGPSGW</b>	<b>£34.99</b>

**PACK OF x4**



<b>LIGHT GREY MARBLE</b> A traditional light marble colour.	PART	PRICE
	<b>IGPSGM</b>	<b>£34.99</b>

**PACK OF x4**



<b>BLACK MARBLE</b> A traditional Black marble colour.	PART	PRICE
	<b>IGPSBM</b>	<b>£34.99</b>

**PACK OF x4**



<b>PERGAMON MARBLE</b> A traditional marble colour.	PART	PRICE
	<b>IGPSPM</b>	<b>£34.99</b>

**PACK OF x4**



<b>WHITE DIAMOND</b> A trendy light sparkly colour.	PART	PRICE
	<b>IGPSWD</b>	<b>£36.99</b>

**PACK OF x4**



<b>BLACK DIAMOND</b> A trendy dark sparkly colour.	PART	PRICE
	<b>IGPSBD</b>	<b>£36.99</b>

Also available in larger  
2400mm x 1000mm  
10mm Thick single panels  
**SEE PAGE 66**

**+ SILICONES & ADHESIVES**  
**SEE PAGE 74 ONWARDS**



**GEO-PANEL CLEANER**

PART	PRICE
<b>IGPCS</b>	<b>£3.99</b>

A powerful cleaning agent designed specifically for cleaning geopanel

**500ml SPRAY BOTTLE**

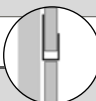

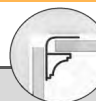
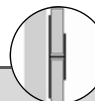
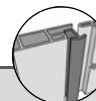
<b>▶ TRIMS</b> <b>2.7M Long</b>													
		Starter/Edge		External corner		Internal corner		Scotia		H-Joint		Infill Trim	
	COLOUR	PART	PRICE	PART	PRICE	PART	PRICE	PART	PRICE	PART	PRICE	PART	PRICE
	SILVER	<b>IGPSUSI</b>	<b>£3.99</b>	<b>IGPSESI</b>	<b>£4.69</b>	<b>IGPSISI</b>	<b>£4.59</b>	<b>IGPSSSI</b>	<b>£4.95</b>	<b>IGPSHSI</b>	<b>£3.89</b>	<b>IGPSFSI</b>	<b>£4.49</b>
WHITE	<b>IGPSUWH</b>	<b>£3.25</b>	<b>IGPSEWH</b>	<b>£3.69</b>	<b>IGPSIWH</b>	<b>£4.15</b>	<b>IGPSSWH</b>	<b>£4.29</b>	<b>IGPSHWH</b>	<b>£3.15</b>	<b>N/A</b>	<b>N/A</b>	

## SUSPENDED CEILINGS



Armstrong suspended ceilings are designed for maximum effect with modest cost and fast installation times. The professional steel framing interlocks for rigidity and is fully Fire Rated for areas with public access. An easy to assemble system that gives you a neat and clean finish to any ceiling.

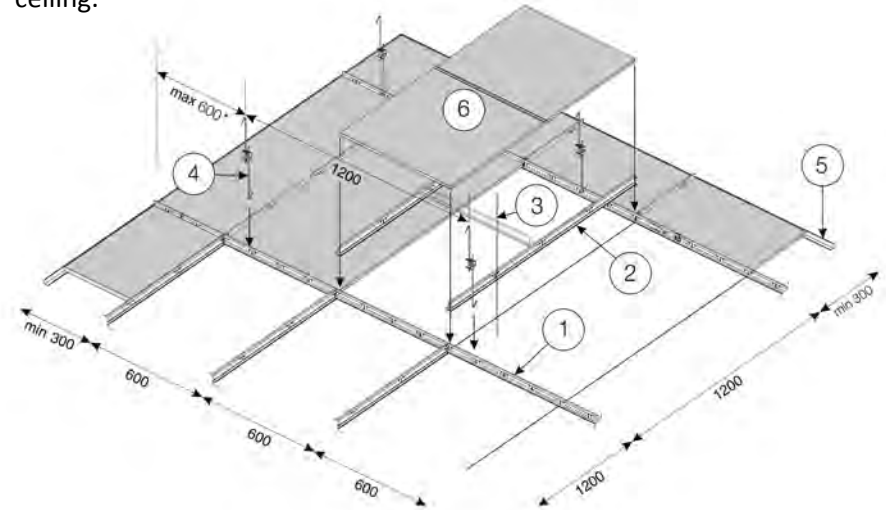

ITEM NO	DESCRIPTION	PART NO	PRICE
1	Main "T" 3.6M (11' 9")	CFT36	£6.84
2	Spacer "T" 1.2M (3' 11¼")	CFT12	£2.28
3	Spacer "T" 0.6M (1' 11 ½")	CFT06	£1.14
4	Suspension Wire 10M	CW10	£1.99
4	Suspension Wire 100M	CW100	£16.99
5	Wall Angle 3M (9' 10")	CWF3	£5.10

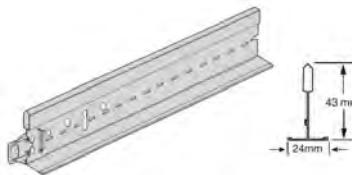

The white-faced, galvanised, steel interlocking frame is fast and easy to install. An angle section is fitted around the walls, then the main 'T' sections rest on these and reach across the room. The spacer 'T's are then fitted to create the desired tile space.



# CEILING TILES Prismatic Fissured & Sandgrain

## PRISMATIC Panels

Prismatic panels are translucent allowing light to pass through them into the space below, two versions are available in both the Oblong and Square sizes. Clear panels have a diamond pattern on the lower surface and transmit the most light, whilst the Opal panels diffuse the light to reduce shadows.

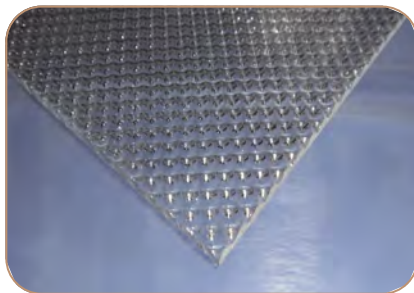

PANEL TYPE		595mm X 595mm		1195mm X 595mm	
DESCRIPTION	COLOUR	PART NO	PRICE	PART NO	PRICE
PRISMATIC	CLEAR	CP66CL	£4.99	CP126CL	£9.49
PRISMATIC	OPAL	CP66WH	£5.99	CP126WH	£12.99
FISSURED	WHITE	CF66	£3.29	CF126	£5.99
DUNE SANDGRAIN	WHITE	CSF66	£5.49	N/A	N/A

All our ceiling tiles are designed to fit standard ceiling systems that accept 595mm x 595mm or 595mm x 1195 tiles.

For our online guides and parts list calculator please see our website [www.cabp.co.uk](http://www.cabp.co.uk)

## HAVING TROUBLE?

We can help calculate the materials required

## FISSURED Tiles

The non-directional FINE FISSURED surface is easy to install and effective for sound absorption. Ideal for use in circulation areas, meeting rooms, cinemas etc. Fissured face tiles meet the EEA Euro class A2-S1 Fire Rating standard. With excellent sound and heat insulation properties, they have a pale surface that reflects 75% of ambient light and are easy to cut and fit.



## DUNE SANDGRAIN Tiles

The non-directional Dune tile has a fine sand grain finish with a lipped edge so the tile sits below the framework rather than on it, to create a 3 dimensional ceiling. Ideal for use in schools and offices. Meeting the EEA Euro class A2-S1 Fire Rating standard, it has high sound and heat insulation properties with the further advantages of being highly resistant to humidity and water with a surface that reflects 85% of ambient light.

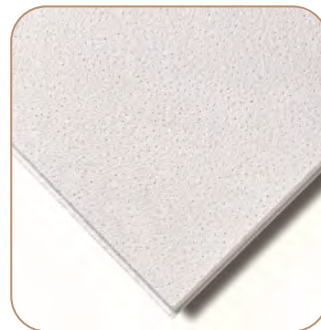

- Made from **DURABLE** Extruded Polystyrene.
- All the benefits of wood such as it **CUTS** and **JOINS** just like wood.
- None of the disadvantages of wood such as **SPLITTING, WARPING** or **WOODWORM**.
- There are **NO IMPERFECTIONS**.
- High **QUALITY** and **CONSISTENT** finish on every length due to foil finish.
- **MOISTURE RESISTANT** and can be used in areas of high humidity.
- **COMPETITIVELY** priced against wood. Sometimes wood can be cheaper, but that is normally only be achieved with the use very low grade wood.
- **Over paintable**
- **Light weight** and easy to handle
- **Made in the UK**



## FIXING KNOW HOW:

- All surfaces should be clean and dry.
- Mitre the moulding the same way as if it is wood. For a perfect cut. Cuts the same as wood, so why treat it any differently?
- Most customers are unaware of this product does not normally require gluing. But you may be fixed this way.

## 2.20M x 55mm x 19mm Torus Architrave

COLOUR	PART NO	PRICE	
WHITE	IAT255WH	<b>£6.49</b>	
LIGHT OAK	IAT255LO	<b>£6.99</b>	

## 2.92M x 100mm x 14mm Ogee Skirting Board

COLOUR	PART NO	PRICE	
WHITE	ISO210WH	<b>£8.59</b>	
LIGHT OAK	ISO210LO	<b>£9.29</b>	

## 2.20M x 55mm x 14mm Ogee Architrave

COLOUR	PART NO	PRICE	
WHITE	IAO255WH	<b>£4.49</b>	
LIGHT OAK	IAO255LO	<b>£5.49</b>	

## 2.92M x 140mm x 17mm Torus Skirting Board

COLOUR	PART NO	PRICE	
WHITE	IST214WH	<b>£15.99</b>	
LIGHT OAK	IST214LO	<b>£18.49</b>	

## 2M x 18mm SCOTIA TRIM

COLOUR	PART NO	PRICE	
WHITE	ISS218WH	<b>£2.99</b>	
LIGHT OAK	ISS218LO	<b>£3.29</b>	



# VALUE RANGE

	<b>BATH &amp; KITCHEN SEALANT</b>	<b>COLOUR</b>	<b>PART</b>	<b>PRICE</b>
	High quality, acrylic based sealant that provides an effective, yet economical seal but is still easy to use.	WHITE	SBKSWH	<b>£1.19</b>
	<b>C3 Cartridge</b>			

	<b>ONE HOUR CAULK</b>	<b>COLOUR</b>	<b>PART</b>	<b>PRICE</b>
	Fast drying decorators filler and sealant that remains permanently flexible. Can be over painted with most types of paint.	WHITE	SOHCWH	<b>£1.19</b>
	<b>C3 Cartridge</b>			

	<b>EXTERNAL FRAME SEALANT</b>	<b>COLOUR</b>	<b>PART</b>	<b>PRICE</b>
	A high quality acrylic based sealant that provides a long lasting, permanently flexible seal that can be painted over.	WHITE	SEFWH	<b>£1.29</b>
		BROWN	SEFBR	<b>£1.29</b>
		STONE	SEFST	<b>£1.29</b>
<b>C3 Cartridge</b>				

	<b>ROOF &amp; GUTTER SEALANT</b>	<b>COLOUR</b>	<b>PART</b>	<b>PRICE</b>
	Quality butyl based sealant and adhesive, provides instant & permanent weatherproofing to a wide variety of roofing applications.	BLACK	SRGSBK	<b>£1.49</b>
	<b>C3 Cartridge</b>			

## ▼ QUICK KEY ▼



QUICK DRY



ANTI-FUNGAL



GAP FILLING



SOLVENT BASED



BITUMEN-COMPATIBLE



INTERNAL USE ONLY

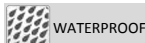

WATERPROOF



PAINTABLE

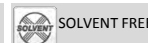

SOLVENT FREE

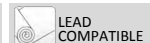

LEAD COMPATIBLE

# CARTRIDGE ACCESSORIES

## PRO MASTIC GUN

Heavy duty traders frame style mastic gun. Designed to accept both C3 and C4 Cartridges

<b>PART</b>	<b>PRICE</b>
STMGM	<b>£5.49</b>

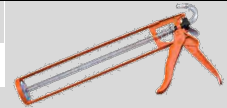

## PRO MASTIC GUN

Heavy duty frame for use on C3 & C4 cartridges.

<b>PART</b>	<b>PRICE</b>
SMGP	<b>£9.99</b>



## CARTRIDGE CUTTER

A unique cartridge opening and nozzle trimming tool.

<b>PART</b>	<b>PRICE</b>
SSCC	<b>£4.49</b>



# SUPERGLUE RANGE

## INDUSTRIAL SUPERGLUE 20gsm

Medium viscosity formula. For use on surfaces where fast set is required. Bonds non porous surfaces such as most plastics, metals, glass, PVCu & rubber. Set time 5 to 15 seconds.

<b>PART</b>	<b>PRICE</b>
SG20	<b>£1.29</b>



## MITRE FAST GLUE & ACTIVATOR KITS

Twin pack adhesive system of glue & aerosol activator. Can be used in various applications where its instant bonding properties will dramatically reduce assembly time.



<b>SIZE</b>	<b>PART</b>	<b>PRICE</b>
STD	SMFK	<b>£5.99</b>
LRG	SMFKX	<b>£11.99</b>



# ACCESSORIES

## SILICONE



### 200 LMA SILICONE

For general glazing, weatherproofing & sanitary use. Can be used both inside and out and is easy to tool down.



COLOUR	PART	PRICE
WHITE	SGSWH	£1.99
CLEAR	SGSCL	£1.99
BLACK	GSGBK	£1.99
BROWN	GSGBR	£1.99

C3 Cartridge



### SX LMN 2001 SILICONE

A low modulus one part versatile silicone which can be used for sealing most building, construction and glazing joints. This silicone is neutral cure and almost odourless and cures with atmospheric moisture to form a durable rubber seal.



COLOUR	PART	PRICE
WHITE	SLMNWH	£2.69
CLEAR	SLMNCL	£2.70
BLACK	SLMNBK	£2.75
BROWN	SLMNBR	£2.75

C3 Cartridge



### PREMIER 450 SILICONE

A High Quality low modulus non-corrosive neutral cure silicone sealant that adheres to virtually all substrates, both porous and non-porous.



COLOUR	PART	PRICE
WHITE	SMWH	£3.29
CLEAR	SMCL	£3.35
BLACK	SMBK	£3.45
BROWN	SMBR	£3.49
BUFF	SMBF	£3.59

C3 Cartridge

### CLEAN ROOM SILICONE

Advanced neutral curing hygienic sealant that combines a powerful anti-bacterial compound with FDA Approved Food Compatibility. Prevents most common germs forming on its surface. Offers outstanding adhesion to most surfaces.

COLOUR	PART	PRICE
WHITE	SCRWH	£3.99



C3 Cartridge



### SILICONE 825

Low modulus, best used for perimeter pointing around PVCu, wood and powder coated aluminium. Also used for expansion joints to stone, brick, concrete, composite panels and weather proofing sealing to most external applications.

COLOUR	PART	PRICE
MAGNOLIA	S8MA	£3.19
ANTHRACITE	S8AG	£3.29



C4 Cartridge



## SEALANTS

### LEAD SEALANT

Specially formulated as an alternative to mortaring lead flashing into brick, stone and concrete. Provides a fully waterproof joint that will not crack or shrink.

COLOUR	PART	PRICE
GREY	SLMS	£2.49



C3 Cartridge



### ALL WEATHER SEALANT

A universal co-polymer sealant that can be used for emergency building and roofing repairs. Usable in wet weather or damp conditions. Provides superior adhesion to most surfaces such as glass, aluminium, lead and zinc. Over paintable with most paints and stains.

COLOUR	PART	PRICE
WHITE	SAWWH	£3.49
CLEAR	SAWCL	£3.49
BLACK	SAWBK	£3.49



C3 Cartridge

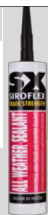

For more detailed specifications visit [www.cabp.co.uk](http://www.cabp.co.uk)

#### KEY

INTERNAL & EXTERNAL USE	INTERNAL USE ONLY	AQUARIA SAFE	ANTI-FUNGAL	FLEXIBLE	PAINTABLE	SAFE NEXT TO INSULATED GLASS	SOLVENT BASED	FOR USE WITH POLYCARBONATE	BITUMEN COMPATIBLE
INTERNAL USE ONLY	EXTERNAL USE ONLY	FOOD SAFE	WATERPROOF	QUICK DRY	LEAD COMPATIBLE	ANTI-SLUMP	SOLVENT FREE	GAP FILLING	CHEMICALLY RESISTANT

# SEALANTS & ADHESIVES

## TRADERS MIGHTY STRENGTH MS POLYMER



An all-round durable, flexible adhesive and sealant based on MS Polymer technology. Has excellent adhesion to non-porous surfaces, will bond to damp surfaces and is paintable with most paints. Is odourless, neutral and free of isocyanates.

COLOUR	PART	PRICE
WHITE	SMSPPWH	£4.99
CLEAR	SMSPPCL	£4.99
BLACK	SMSPPBK	£4.99
BROWN	SMSPPBR	£4.99



C3 Cartridge

## STIXALL



The ultimate combination of building adhesive and sealant, with the most extreme power to both bond and seal virtually EVERYTHING to ANYTHING in almost all conditions, even in wet weather, on wet surfaces or even underwater.

COLOUR	PART	PRICE
WHITE	STXWH	£5.99
CLEAR	STXCL	£6.99
BROWN	STXBR	£5.99



C3 Cartridge

**GUN & NAIL EXTRA** A high strength, gap filling adhesive providing extra bond strength and quick curing time.

C3 Cartridge



**PINKGRIP WHITE** Solvent free, white version of PinkGrip. It has all the benefits and will stick just about anything on a building site & also has a no-slump formula.

C4 Cartridge



**For our range of super glues please see pages 73**

## MIGHTY STRENGTH GRIP & GRAB ADHESIVE

Instant grab adhesive that has initial bond strength double that of most other grab adhesives. For use internally or externally and even on damp or wet surfaces. This adhesive is solvent free, cures quickly and is water and weather proof. Suitable for bonding most materials but in particular for fixing of large panels, wall boards and mirrors.



COLOUR	PART	PRICE
WHITE	SMSGG	£5.69



Unaided holds up to

**35Kg**  
C3 Cartridge

## CT-1

### MULTI-PURPOSE SEALANT/ADHESIVE

The ultimate sealant and adhesive in one tube

One-stop, multi-purpose, waterproof, hybrid polymer sealant and adhesive. Sticks to almost any surface without the need for additional fixings, can be used in damp or wet conditions, can even be applied under water! Countless possibilities for use with CT1 sealant & adhesive.

- Food safe - conforms to ISEGA Standards
- Anti-fungal and has excellent resistance to chemicals
- Bonding of Glass, Mirrors, Wood, Polystyrene, metals (Inc. lead)
- Can be over-painted
- Can be used in all salt-water environments so perfect for marine and boating applications.



COLOUR	PART	PRICE
WHITE	SCT1WH	£9.99
BROWN	SCT1BR	£9.99
BLACK	SCT1BK	£9.99
GREY	SCT1GR	£9.99
BEIGE	SC1BE	£9.99
OAK	SCT1OK	£9.99
CLEAR	SCT1CL	£10.99
SILVER	SCT1SI	£10.99

C3 Cartridge



300ml Spray can (Std)  
500ml Spray can (Large)

### MULTISOLVE The perfect tooling partner for CT1

A material remover in an easy to use handheld spray can. A cost-effective solution for a variety of jobs.

- Fully compatible with CT1 sealant & adhesive
- Safely removes wax, paraffin, printing ink, adhesives, sealants, grease, oil & more
- Excellent as a pre-treatment for paints & adhesives
- Used in large number of trades from plumbers to stonemasons
- Leaves no oily residue



SIZE	PART	PRICE
STD	SCTMSS	£6.99
LARGE	SCTMSL	£9.99

# SEALANTS & GUNABLE ADHESIVES

## PLASTIC, GLASS & HAND CLEANERS



### PVCu SOLVENT CLEANER

This solvent based product is formulated to remove ingrained dirt from PVCu and most plastics. Also suitable to restore old windows and plastic garden furniture as good as new.

PART	PRICE
SAPC	£3.99



1 Litre



### CREAM CLEANER

A solvent-free formulation designed to remove ingrained dirt and stains from PVCu window frames without scratching. Buffs to a deep sheen.

PART	PRICE
SCC	£2.49



1 Litre



### GLASS CLEANER

A powerful glass cleaning agent containing a high level of detergents and solvents for a rapidly drying, smear and static free finish. May also be used on tiling, VDUs, TV screens and chrome.

PART	PRICE
SEGC	£2.49



1 Litre

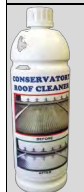

### POLYCARBONATE CLEANER

Designed to deal with dirt & grime on polycarbonate roofs whilst protecting the external coatings of the sheet. Diluting can produce 20 times more!

PART	PRICE
PRCC	£9.99



1 Litre

### PAPER GLASS WIFE

Made of extra strong, soft 2-ply paper for effective cleaning of plastic and glass around the home, onsite or at the work place.



SIZE	PART	PRICE
LARGE 150M (30M <sup>2</sup> )	SGWL	£4.49
X-LARGE 280M (80M <sup>2</sup> )	SGWXL	£10.49

### WONDER WIPES

Specially formulated to clean hands, tools and surfaces from wet and semi-cured paint, sealant, adhesive, bitumen, expanding foam, oil, grease and even silicone.



TUB SIZE	PART	PRICE
100 Wipes	SWW	£5.95
300 Wipes	SWWGT	£13.95



### KEY



SAFE NEXT TO INSULATED GLASS



SOLVENT FREE



INTERNAL & EXTERNAL USE



SOLVENT BASED



QUICK DRY

### VALUE CLEANING KIT

The complete value kit to covers almost all standard jobs

#### Consists of:

- 1 x 1lt Solvent Cleaner
- 1 x 1ltr Glass Cleaner
- 1 x Large Paper Tissue



PART	PRICE
SVCK	£9.99

### TRADERS CLEANER KIT

The complete all in one kit covers almost all cleaning jobs

#### Consists of:

- 1 x 1lt Solvent Cleaner
- 1 x 1ltr Cream Cleaner
- 1 x 1ltr Glass Cleaner
- 1 x Extra Large Paper Tissue



PART	PRICE
STCK	£17.49

### GEPANEL CLEANER

A powerful cleaning agent designed specifically for cleaning geopanel  
500ml SPRAY BOTTLE



PART	PRICE
IGPCS	£3.99

## LUBRICATION SPRAYS

### MULTI-PURPOSE SPRAY

Has 100's of uses around the home, garage, workshop and in industry. Penetrates rusted parts and fastenings to assist dismantling & lubricating.



400ml

PART	PRICE
SMPS	£2.99

### SILICON SPRAY

Ideal for lubricating rubber seals and 'o' rings on guttering, plumbing plus 100's of uses around the home, workshop and business.



400ml

PART	PRICE
SS	£2.99

## EXPANDING FOAMS

### FIX & FILL (HANDHELD)

Quick setting foam which expands greatly on application and yields up to 50 times original can contents. Can be cut, sawn, plastered and sealed over. 700ml



PART	PRICE
SFF7	£3.79

SFF7	£3.79
------	-------



### GUN GRADE FOAM

Quick setting foam which expands greatly on application and yields up to 50 times original can contents. Can be cut, sawn, plastered and sealed over. 700ml



PART	PRICE
SFFG	£3.99

SFFG	£3.99
------	-------



### FOAM CLEANER

Removes wet and uncured foam. Attaches to the Foam Gun for precise cleaning or attach the included spray nozzle for hand-held use. 700ml



PART	PRICE
SFFC	£3.49

SFFC	£3.49
------	-------



### FOAM GUN

Gives greater foam application in hard to reach places. Insure gun is clean after use.

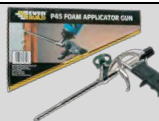

PART	PRICE
SFFPG	£19.49

SFFPG	£19.49
-------	--------

### FOAM EATER

A paste designed to safely remove cured PU foam from most surfaces. Its consistency makes it suitable for both vertical and horizontal use.



PART	PRICE
SFE	£8.99

SFE	£8.99
-----	-------



For more detailed specifications visit [www.cabp.co.uk](http://www.cabp.co.uk)

## ADHESIVES/ FILLERS

### HARD PLASTIC ADHESIVE

Strong, clear, quick drying adhesive suitable for bonding most hard plastics such as rigid PVC, acrylic & polycarbonate.



PART	PRICE
SHPA	£1.59

SHPA	£1.59
------	-------



### SX SMALL GAP SEALER TUBE

A fast setting adhesive that will bond uPVC, polycarbonate and most plastics. This adhesive has high gap filling properties, is tack free in seconds and cures quickly.



COLOUR	PART	PRICE
WHITE	SGSTWH	£4.45

WHITE	SGSTWH	£4.45
-------	--------	-------



80ml Injector Tube

## FLASHING TAPES & PRIMER

### SELF ADHESIVE FLASHING

A strong self-adhesive flashing tape comprising of an aluminum foil and a bitumen rubber adhesive. The adhesive forms a strong waterproof seal by the simply pressing the tape into place by hand.

#### Benefits

- Replaces need for lead flashing.
- Self-adhesive - requires no separate glue.

#### Surface Preparation

All surfaces must be dry, sound and free from oil, grease and dust. Remove all loose material by scraper or wire brush. Porous surfaces, such as concrete or brick, should be primed using FLASHING PRIMER and allowed to dry.

WIDTH	PART	PRICE
75mm (3")	SFR3	£7.99
100mm (4")	SFR4	£9.49
150mm (6")	SFR6	£12.99
225mm (9")	SFR9	£19.49
300mm (12")	SFR12	£28.99



### FLASHING PRIMER

Bitumen and Flashing Primer is a thin black primer used to give a key prior to applying bitumen paints, roof coatings and flashing.

SIZE	PART	PRICE
1 LITRE	SFRP	£4.99

## PLASTIC HEAD PINS & NAILS

Plastic head pins & nails are used mostly commonly with UPVC fascia's, soffit's & trim's installations, but can be used really with any job. These fixings are made out of stainless steel and have colour matching caps on there head.

**Available in two different grades:**

- 14 Gauge (30mm & 40mm long pins ) ideally used with nothing thicker than 10mm
- 10 Gauge (50mm & 65mm long nails ) Ideally used with any of thicker products (10mm+)

### WHITE HEADED PINS (14 Gauge)

SIZE	QTY	PART	PRICE
30mm	25	PP30WH	£1.75
	200	PPB30WH	£8.95
40mm	25	PP40WH	£1.79
	200	PPB40WH	£8.99

### WHITE HEADED NAILS (10 Gauge)

SIZE	QTY	PART	PRICE
50mm	25	PP50WH	£2.75
	100	PPB50WH	£8.95
65mm	25	PP65WH	£2.79
	100	PPB65WH	£8.99

## COLOUR MATCHED PINS & NAILS

COLOUR	CODE	SIZE	QTY	PART	PRICE
BLACK	*=BK	30mm	25	PP30*	£1.95
CARAMEL	*=CM		200	PPB30*	£11.95
DARK BROWN	*=BR	40mm	25	PP40*	£1.99
LIGHT GREY	*=LG		200	PPB40*	£11.99
ANTHRACITE GREY	*=AG	50mm	25	PP50*	£3.95
PALE GOLD	*=PG		100	PPB50*	£11.95
		65mm	25	PP65*	£3.99
			100	PPB65*	£11.99

REPLACE ALL \* WITH CODE

ANTHRACITE GREY PINS ARE NOT AVAILABLE IN 30mm & 50mm LENGTHS

## BARBED NAILS

### 30mm BARBED NAILS STAINLESS STEEL



Designed to be used as a hidden fixing with most cladding ranges & many other applications.

25 PACK		200 BOX	
PART	PRICE	PART	PRICE
SN30	£0.79	SNB30	£4.65

## SCREWS & CAPS

### PLASTIC SCREW CAPS

For use with No 8 screws the cap size is 13mm diameter and supplied in packs of 25



COLOUR	PART	PRICE	
WHITE	SCSWH	£0.99	
BROWN	SCSBR	£1.99	
BLACK	SCSBK	£1.99	
CARAMEL	SCSCM	£1.99	
Extra Large Caps 18mm Diameter Pack of 25	WHITE	SCLWH	£2.49

### PLASTIC HEADED SCREWS

Supplied in packs of 10

COLOUR	18mm x 8g		30mm x 8g	
	PART	PRICE	PART	PRICE
WHITE	SP18WH	£2.35	SP30WH	£2.95
BROWN	SP18BR	£2.55	SP30BR	£3.35

## STAINLESS STEEL SCREWS

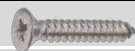

SCREW	COUNTER SUNK HEAD				ROUND HEAD 'PAN'			
	PACK 25		BOX 250		PACK 25		BOX 250	
	SIZE	PART	PRICE	PART	PRICE	PART	PRICE	
3/4" x 8	SC3	£0.78	SCB3	£5.95	N/A	N/A	N/A	N/A
1" x 8	SC1	£0.85	SCB1	£7.92	SR1	£0.89	SRB1	£7.90
1 1/4" x 8	SC12	£0.92	SCB12	£8.25	SR12	£0.92	SRB12	£8.50
1 1/2" x 8	SC15	£0.99	SCB15	£8.75	SR15	£0.99	SRB15	£8.95
2" x 8	SC2	£1.25	SCB2	£9.95	SR2	£1.25	SRB2	£9.99

## STEEL SHEET FIXINGS

### DRILLFIX PACK OF 10

SIZE	PART	PRICE
20mm	FSD20	£1.98
38mm	FSD38	£2.39
50mm	FSD50	£2.63
70mm	FSD70	£2.99

**Self-drilling** 5.5mm with 8mm hexagonal head & rubberized sealing washer



\*Colour matching caps available

### TAPFIX PACK OF 10

SIZE	PART	PRICE
38mm	FST38	£2.48
50mm	FST50	£2.69
75mm	FST75	£2.89

**Self-tapping** 6.5mm with 8mm hexagonal head & rubberized sealing washer.  
*Pre drilled holes required*



\*Colour matching caps available

## COLOURED CAPS FOR FIXINGS

### PACK OF 10

COLOUR	PART	PRICE
MERLIN GREY	FCCMG	£0.49
GOOSEWING GREY	FCCGG	£0.52
OLIVE GREEN	FCCOG	£0.53



For covering tops of an 8mm hex head fixing.

## BIG 6 PROFILE SHEET FIXINGS

Supplied for use with Big 6 Profile corrugated sheets & also any Fibre Cement sheets.

8mm hexagonal head and sealing washer  
6.5 x 130mm

### PACK OF 10

PART	PRICE
RF6	£4.98



## ONDULINE/ONDUVILLA FIXINGS

### 73mm ONDULINE/ONDUVILLA NAILS

COLOUR	10 PACK		400 BOX	
	PART	PRICE	PART	PRICE
BLACK	ROBNBK	£1.49	ROBNBBK	£16.99
GREEN	ROBNGR	£1.49	ROBNBGR	£16.99
RED	ROBNRD	£1.49	ROBNBRD	£16.99



## CORRUGATED SHEET FIXINGS

### PACK OF 10

USED WITH	TYPE	PART	PRICE
1 ¼" SHEETS	PLATED STEEL	RFM	£0.47
3" SHEETS	PLATED STEEL	RFS	£1.10
3" SHEETS	STAINLESS STEEL	RFX	£1.66

All supplied with washers

(Please note **RFX** fixings include Spacers)



## J BOLTS & WASHERS

### PACK OF 10 (BOLTS INCLUDE NUTS)

DESCRIPTION	SIZE	PART	PRICE
J HOOK BOLTS	60 x 6mm	FJ60	£1.99
J HOOK BOLTS	80 x 6mm	FJ80	£2.25
J HOOK BOLTS	100 x 6mm	FJ100	£2.44
J HOOK BOLTS	140 x 6mm	FJ140	£2.75
SCAFFOLD BOLTS	90 x 8mm	FJS90	£3.79
SCAFFOLD BOLTS	150 x 8mm	FJS150	£5.37
PVC WASHER	28mm	W28	£0.96
STD CAP (clear)	28mm	WC28	£0.78
DEEP CAP (clear)	28mm	WDC28	£0.99

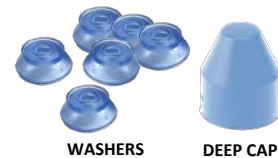
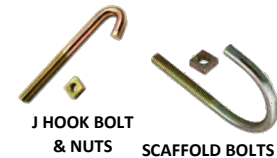

## CORRUGATED SHEET FIXINGS

**NEW!**

## PREDATOR SAWS

## LEVELING & MEASURING

**SPEAR & JACKSON**

**SILVERLINE**

### UPVC

For use with Plastic boards, trims, plastic pipes & Multiwall sheets.

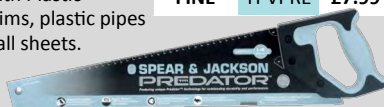

CUT	PART	PRICE
FINE	TPVPRE	£7.99

### UNIVERSAL

For use with Timber planks, hardwood and MDF.



CUT	PART	PRICE
COARSE	TUNPRE	£8.49

### FIRST FIX

For use with Rough sawn timber, garden posts & joists.



CUT	PART	PRICE
MED	TFIPRE	£8.49

### SECOND FIX

For use with Planed wood & skirting.

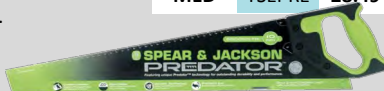

CUT	PART	PRICE
MED	TSEPRE	£8.49

### PREDATOR X

Cuts on both strokes & can be use with anything (except Polycarbonate sheets).



CUT	PART	PRICE
MED	TXPRE	£9.99

### SPIRIT LEVELS

Made to last from aluminium with rubber stoppers.



SIZE	PART	PRICE
450mm	TSL4	£5.49
600mm	TSL6	£6.99
900mm	TSL9	£8.99
1200mm	TSL12	£11.99
1800mm	TSL18	£17.99

### POST LEVELS

Accurate & easy to use.



PART	PRICE
TPS	£2.46

### 5M TAPE MEASURE

Made from flexible steel.



PART	PRICE
TT5	£1.49

## FITTERS FRIENDS

### CLAW HAMMER

8 Oz hammer with fiberglass Shaft.



PART	PRICE
TH8	£3.99

### FLAT PRY BAR

Ideal for use on fascia's.

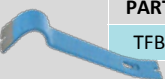

PART	PRICE
TFB	£3.49

### 600mm QUICK CLAMP

Light weight & easy to use.

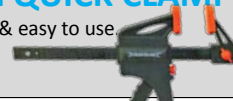

PART	PRICE
TQC6	£7.45

### 150mm JUNIOR HACKSAW



PART	PRICE
TJH	£0.99

### CLOSE QUARTER SAW

Designed to use new or damaged hacksaw blades.



PART	PRICE
TTQH	£4.49

### RUBBER Mallet

Made from WHITE rubber designed to leave no marks on coloured surfaces.

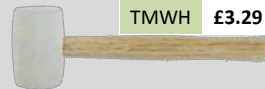

PART	PRICE
TMWH	£3.29

### CHISEL SET 5 piece

Forged, bevel-edged chisels. Hardened, tempered and sharpened. Polypropylene handles. Sizes 6, 13, 19, 25 and 32mm. Supplied with blade guards



PART	PRICE
TC5	£9.95

### HOLE CUTTERS & ARBOUR

Ideal for use with our circular vent disks.



ITEM	PART	PRICE
ARBOUR	THSA	£4.95
70mm CUTTER	THS70	£7.99
114mm CUTTER	THS114	£12.50



## SEAL RITE WIZARD

A multi-function sealant tool with:

- ◆ Two points/edges to cut away old sealant.
- ◆ A blade to cut the sealant cartridge thread & nozzle.
- ◆ A flexible rubber blade to smooth down new sealant.



PART	PRICE
SSRWT	£6.49

## PVC TRIM CUTTER

Comes with a Multi angled base 45-90 degree & Cushion grip handles for extra comfort & safety.



PART	PRICE
TPVCC	£5.99

## RIVET GUN

For use with 2.4, 3.2,4.0 & 4.8mm



PART	PRICE
THRG	£4.99

## DOME HEAD RIVETS

Pack of 100 4.8 x 12mm



PART	PRICE
TR4812	£1.99

## RUBBLE SACKS

Supplied in packs of 10, these are Tear resistant and fully reusable.



PART	PRICE
TRS	£3.99

## TARPAULINS

Long lasting, Water tight & Tear resistant.



SIZE	PART	PRICE
3 x 3.6M	TTP3	£5.40
6 x 3.6M	TTP6	£11.99

## DUST SHEETS

100% Cotton  
Ideal for covering carpets furniture and all general areas of work.



SIZE	PART	PRICE
3.5 x 2.6M	TDS	£9.99

## CARGO LASH'S

900kg rated, weather-resistant straps quick release

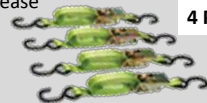

DESC	PART	PRICE
SINGLE	TCL9	£4.49
4 PACK	TCLS9	£15.99

## DOUBLE SIDED TAPE



SIZE	PART	PRICE
25mm x 35M	TDT25	£4.49

Powerful bond, for internal or external use.

## FOAM DOUBLE SIDED TAPE

SIZE	PART	PRICE
10mm x 50M	TDST50	£6.39

As used by traders. Ideal for sticking trims and an essential for window fitters.



## DUCT TAPE

SIZE	PART	PRICE
50mm x 50M	TGT50	£4.79

Tough, durable, with high Quality adhesive.



## STRAPPING TAPE

SIZE	PART	PRICE
50mm x 25M	TST50	£3.99

Clear & Strong, ideal for securing bundles & sheets.



## BUILDERS TAPE

SIZE	PART	PRICE
50mm x 33M	TBT50	£2.89

PVC Tape ideal jointing PVC and polythene sheets and membranes.



## MASKING TAPES

SIZE	PART	PRICE
25mm x 50M	TMT25	£1.39
50mm x 50M	TMT50	£2.29

General purpose trade quality tape for masking.



## GENERAL ACCESSORIES

### PACKERS

Each pack has 100 packers ranging in size from 1,2,3,5 & 6mm



PART	PRICE
TWP	£5.99

### 5/16" NUT DRIVER

For use with Drill fast & Tap fix fixing range



PART	PRICE
TSS16	£1.99

### SDS MASONRY BITS

Sensibly priced 210mm long.



SIZE	PART	PRICE
6mm	TSDS6	£1.49
6.5mm	TSDS65	£1.55
8mm	TSDS8	£1.75
10mm	TSDS10	£1.99
12mm	TSDS12	£2.50

## TERMS & CONDITIONS

**In these terms and conditions** – "C & A Building Plastics" means, C & A Supplies Ltd and any other connected organisation that supplies the goods ordered by you and any successor to its business; "We and Us" means C & A Supplies Ltd either alone or together with you, as the context requires; "Working day" means every day of the year except weekends, and English statutory and public holidays; "You" means the person ordering goods subject to these terms and conditions.

C & A Supplies Ltd  
Courtney Road  
Gillingham  
Kent ME8 0EZ

Registered in England under no 3895992  
VAT Registration no. GB 248096048

To contact us by telephone, please ring 01634 374444

### Please see the website for

- > Trade counters opening times
- > Updated Terms and Conditions
- > Delivery Information

You can always contact us using the Contact Us Form online or emailing [cs@cabbp.co.uk](mailto:cs@cabbp.co.uk).

**Privacy** - C & A Supplies Ltd are committed to protecting your privacy, we will only use your information lawfully in accordance with the data protection act 1998. The information we collect about you enables us to service your needs, but in order to do so we may pass your contact details on to a third party for delivery purposes, and by placing an order with us you are consenting to this.

**Your Order**—You will have an opportunity to check and correct any errors on your order up until the point at which you submit and pay for your order. All orders made by you through [cabbp.co.uk](http://cabbp.co.uk) are subject to acceptance by us. We may choose not to accept your order for any reason and will not be liable to you or to anyone else in those circumstances. After submitting an order to us we will send you an order acknowledgement email with your order number and details of the goods that you have ordered. Please note this email is an acknowledgement and is not an acceptance of your order. Stock availability information is not available on [cabbp.co.uk](http://cabbp.co.uk). If you order goods which are not available from stock, we will contact you by email or by telephone to discuss how you wish to proceed. You will have the option to wait until the goods are available from stock or cancel your order in accordance with our returns policy. Unless we have notified

you that we do not accept your order or you have cancelled it in accordance with our returns policy, we accept your order 7 days after the date of order or when the goods are delivered, whichever is earlier.

**Liability** – We shall not be liable to you where performance of any of our obligations to you is prevented, frustrated or impeded by reason of acts of God, war and other hostilities, civil commotion, strikes, accident, lock outs, trade disputes, acts or restraints of Government, imposition or restrictions of imports or exports or any other cause not within the reasonable control of C & A Supplies Ltd. If any part of these Terms and Conditions is found to be unenforceable as a matter of law, all other parts of these Terms and Conditions shall not be affected and shall remain in force. All sizes quoted are approximate. Where C & A Supplies Ltd agrees to provide a specifically designed plan, the Customer agrees to check the accuracy and suitability of the plan. C & A Supplies Ltd cannot advise on planning permission or building regulation issues. Asbestos may be found in some older properties. If you have any concerns about the presence of asbestos you should seek advice from a licensed asbestos company. The Customer is responsible for obtaining all necessary planning permission and local authority consents and permissions for any work to be carried out. Any plan drawn by C & A Supplies Ltd is, and remains, its property and may not be reproduced in whole or in part without its previous written consent. To the extent permitted by law, C & A Supplies Ltd accepts no liability for any loss, damage or injury arising as a consequence of the advice provided. These Terms and Conditions and any contract between us shall be governed by and construed in accordance with English law and the English Courts shall have jurisdiction over any disputes.

**Law** - These Terms and Conditions and any contract between us shall be governed by and construed in accordance with English law and the English Courts shall have jurisdiction over any disputes.

**Prices** – The prices of the product are clearly shown with and without VAT online and without VAT in our catalogue. Prices do not include delivery charges. On occasion, the prices payable in respect of goods advertised on [cabbp.co.uk](http://cabbp.co.uk) may differ from those prices payable at the same time in C & A Supplies Ltd branches. We are under no obligation to honour any [cabbp.co.uk](http://cabbp.co.uk) prices in the event that they differ from those in branch. Similarly, we are under no obligation to honour in-branch prices in the event that they differ from those on [cabbp.co.uk](http://cabbp.co.uk). Prices that are reduced for sales and promotions are only valid for the specified period and that branch offering those items. We reserve the right to adjust prices, offers, goods and specifications of goods on [cabbp.co.uk](http://cabbp.co.uk) at

our discretion at any time before (but not after) we accept your order. Although we endeavour to ensure that all pricing information on [cabbp.co.uk](http://cabbp.co.uk) is accurate, occasionally an error may occur and goods may be mispriced. If we discover a pricing error we will, at our discretion, either contact you or ask you whether you wish to continue with the order at the correct price or notify you that we have cancelled your order. We will not be obliged to supply goods at the incorrect price.

**Discounts** – May be withdrawn at any time and are subject to change and are given at C & A Supplies Ltd.'s discretion.

**Product availability** - C&A reserves the right to alter published prices and specifications and withdraw products and services without notice and is not responsible for any costs incurred by a customer when a price, specification, product or service is withdrawn. Where a customer has placed an order based on an obsolete price, specification or service, C&A will inform the customer and wait for further instruction. If payment has already been made for such goods or service, the customer shall be entitled to a full refund for all items that are not then required.

**Property** – Property of the goods shall not pass to the customer until payment is made in full. If the customer defaults in punctual payment of any sum due we shall be entitled to repossess any goods that remain our property.

**Payment** - The total cost of your order is the price of the goods and delivery charges as set out in our delivery information. Payment can be made by most major credit or debit cards, PayPal, bank transfer or cash. You must confirm that the credit/debit card being used is yours, all credit/debit card holders are subject to validation checks and authorisation by the card issuer. If the issuer of your card refuses to authorise payment we will not accept your order and we will not be liable for any delay or non-delivery and we are not obliged to inform you of the reason for the refusal. We are not responsible for your card issuer or bank charging you as a result of our processing of your credit/debit card payment in accordance with your order. PayPal payment orders will only be accepted for orders that are for delivery and are subject to PayPal's confirmation of funds this can in some circumstances take several days. Bank transfers are manually checked and verified, and although you can have instant transfers this does not mean that we are able to instantly check and validate the payment. This process can take a few minutes or a couple of days and no agent should be sent to collect an order until after you receive your order acknowledgment. Cash will be checked to verify its legitimacy and legality, cash will not be accepted if it is not legal tender or if we have any suspicion as to its legitimacy.

**CONTINUED ON PAGE 83**

# TERMS & CONDITIONS

## CONTINUED FROM PAGE 82

**Colour** – Due to batch production C&A cannot guarantee a colour match between materials ordered and supplied on separate orders or products of different dimensions.

**Fitness of goods** - No goods are sold as fit for any particular purpose. All hints, tips and work practice advice published by C&A in its catalogue, web site and advertising are given without detailed knowledge of the customer's application and cannot be relied upon. Customers must satisfy themselves that materials ordered meet the building regulations and codes relevant to the purpose for the intended use.

**Faulty Products** – If the product you purchase is faulty we may offer a repair, exchange or refund as appropriate in accordance with your consumer rights. Please call us on 0845 165 165 8 or emailing [cs@cabp.co.uk](mailto:cs@cabp.co.uk)

**Delivery** - The products that C & A deliver are often large in dimension, and so careful routing of specialist vehicles is often undertaken to perform the deliveries this often means that accurate dates are not available at the time of placing the order and often an estimated timeframe is given, it is suggested that on extreme circumstances you allow up to 30 days. For this reason delivery time is not considered of essence of the contract unless specifically set out in writing with special delivery charges and acceptance. C & A will do all that it reasonably can to meet the date given for delivery. In the case of unforeseen circumstances beyond the reasonable control of C & A, we cannot be held responsible. In such circumstances C & A will contact the Customer and agree an alternative date. The Customer will also do all that he/she reasonably can to enable the delivery to take place on the given date. In the case of unforeseen circumstances beyond the reasonable control of the Customer they must contact C & A and agree an alternative date. The delivery service is for delivery to the sites kerb side only, C & A are not responsible for placement into gardens, and building sites etc. and the customer should ensure that suitable labour is provided for this at the time of delivery. As soon as C & A has delivered the goods, the Customer will be responsible for their safekeeping and C & A will not be responsible for any damage or fault arising from incorrect storage. If the Customer delays a delivery, C & A's responsibility for everything other than damage due to its negligence will end on the date C & A agreed to deliver the order as set out in the contract. Ownership of the goods shall remain with C & A and shall not pass to the Customer until the agreed price for them, together with all other sums due from the Customer to C & A, have been paid in full.

**Damaged or missing items collected** - It is the customer's responsibility when collecting goods from our premises to check they have all the items ordered and that they are in good condition. C&A cannot accept responsibility for damage or shortages once collected goods have left our premises. Where a customer has arranged for a third party to collect goods on their behalf, the same conditions apply as it is your responsibility that your agent undertakes this.

**Damaged or missing items delivered** - You must contact us within 72 hours with details of the damage, we may ask you to send photos to better understand which items are damaged. Notification after this time will result in claims being rejected. Deliveries by our own transport must be checked with our driver at the time of delivery and any damage must be clearly noted on the paperwork before you sign. Deliveries by carrier that have arrived damaged should not be accepted unless the carrier accepts it. Damaged and can provide written confirmation to that effect. Signing "unchecked" or similar is agreeing to accept the delivery damaged or otherwise.

**Returns Policy** - C & A Building Plastics are proud of the products we supply and want our customers to be happy with the products they purchase. To this end we offer a 14 day returns period where we will accept return of our standard products that are in resalable condition, even if it's just because you would prefer a different colour. This is for standard products and excludes nonstandard products that are customised to your requirements; for examples domes are manufactured to your requirements from specific specification criteria and so are custom made to your requirements. The entire product that you purchased must be returned, we cannot accept a component of the product on its own. Simply contact us within 14 days and inform us in writing that you wish to return the product and then return the item with a copy of your acknowledgment / invoice that included the products being returned. Upon return we will inspect the items to ensure they are in acceptable condition, those that are damaged, dirty or otherwise deemed to be in an unsalable condition will not be accepted for refund. If the returned items are part of an order with multiple items on it and not all items are returned then the delivery charge will not be refunded as it will be associated with the items not returned. If the entire order is returned then the standard delivery charge that would be applicable to the items will be refunded, the additional value for premium service will not be refunded for example express services. It is your responsibility to return the items to us, you are responsible for their safe transit and the costs incurred in their transportation. If you are returning the product to a branch we must be notified which branch this is when you notify us in writing. If you are unable to return the items yourself, we can arrange for the return transportation. Due to the various different products we supply and their varying degrees of difficulty in

transportation we are unable to give the exact costs here for the products return, however we will estimate these costs at the time of applying for the return of the items and these do not normally exceed £100. Delivery charges are normally subsidised by the products and do not reflect the true economic costs involved in their despatch, to this extent the cost of return deliveries are therefore not subsidised and can be higher than those charged for dispatch. Goods can only be collected from the site at which we made delivery and will be attempted within 30 days from agreement, the driver is not responsible for checking the condition of the materials at site this function takes place when back at the depot and their condition is assessed on their return to the depot. If your order qualified for a bulk discount then it is deemed that all the items within this order were discounted proportionally to achieve this discount, your returned item will be refunded with the bulk discount you paid for them. For example an order of £750 with a bulk discount of 10% has a product returned of the value of £100 list, proportionally this item was discounted by £10 to achieve the bulk discount and so the price paid for the item was in fact £90. Refunds are made in the same format as the payment was made unless otherwise specifically agreed and will be made within 14 days of receiving the returned items.

**Legislation** - These terms and conditions are in accordance to current business and consumer legislation and do not affect your statutory rights, you can find more from the Citizen's Advice on the following link: [http://www.adviceguide.org.uk/england/consumer\\_e.htm](http://www.adviceguide.org.uk/england/consumer_e.htm)

**Please see the website for**

- > Trade counters opening times
- > Updated Terms and Conditions
- > Delivery Information

<https://www.cabp.co.uk/>

YOUR CONSUMER RIGHTS ARE NOT AFFECTED For further information please see the following website pages. <http://www.tradingstandards.gov.uk/>

**A larger print version is available on our website**  
<https://www.cabp.co.uk/Terms-And-Conditions.htm>  
**Alternatively we can email or print a copy for you**



**GILLINGHAM BRANCH**  
 Courteney Road  
 Gillingham  
 ME8 0EZ  
 Tel: 01634 37 44 44  
 Fax: 01634 36 66 44

**LONDON BRANCH**  
 Bidder Street  
 Canning Town  
 E16 4ST  
 Tel: 0207 474 0474  
 Fax: 0207 474 5055

**ONLINE:** [www.cabp.co.uk](http://www.cabp.co.uk)  
**POST:** Send to either branch

## OUR DELIVERY SERVICE

The sheer size of many of the products dictates that special care with handling and transportation is required. For these C & A deliver most products directly to the customer using our custom-built vehicles, operated by our own employees. The route planning for these vehicles is dependent on the areas from which new orders are received and is calculated on a daily basis, but we aim to visit all areas of the UK at least once every 10 working days. Please note that whilst we try to maintain a 10 day rota, there are many factors beyond our control that prevent us offering any guarantee of any delivery dates (Floods, Snow, Road Closures etc) We will always try our best to make every delivery but should we ever have to abort then we will always contact you. When your order has been dispatched we will send an email and a text message please note this message is only to advise you that your order is on its way. We always ring the customers the day before delivery, this is normally the driver and they will provide you with an expected delivery time scale. If there are any unforeseen delays whilst on route we will contact you with an update.



**SMALL ITEMS**—Orders for small items will normally be sent by carrier or post as this maybe the fastest method of delivery, customers will need to sign for these deliveries. Customers with very specific build dates are advised to order at least 28 days in advance and should be prepared to store the materials on site. Urgent orders can sometimes be sent by carrier on a next day delivery service but you will need to contact us directly to ascertain the feasibility of the products you require and the cost of doing so.

**DIRECT TO CUSTOMER**— Some products are delivered “Direct-To-Customer” as they are shipped from the manufacturer. These deliveries are normally an AM or PM delivery time and date and we will always advise the customer of this as soon as we have the information. This is normally the day before the delivery.

**SPECIAL / URGENT GOODS**— It may be possible to load special or urgent deliveries onto a C & A vehicle that is scheduled to cover a different area or arrange for another driver to make the special delivery. Customers wishing to enquire about Special / Urgent delivery should contact us for availability and cost, but should bear in mind that vehicle running costs are £275 a day and our delivery schedules deal with a volume of customers all over the UK, therefore we cannot delay a vehicle that already has a full load of orders and which is ready to depart. For both C&A transportation and carrier, remote areas of the UK may incur a higher delivery cost than those listed, in which case the customer will be advised of the delivery cost before order acceptance.



# DELIVERY CHARGES

## STEP 1—Check the Colour codes on your products

Every product has a Colour Code that is defined by the background colour of the Part Number throughout the catalogue—see the table in the Example opposite. The Colour Codes generally relate to the overall size of the product. The colours are Green, Turquoise, Yellow, Purple and Brown. Check the colour against the Delivery Charge Grid (see below). If an order has multiple products, the overriding Colour Code to use will be the largest item, i.e. the row furthest down the table. For example, an order with products colour coded Purple and Brown would come under the Brown row.

## STEP 2—Check your Regional Zone

Every region of the UK (primarily defined by post codes) has a Regional Zone letter and an assigned colour, ranging from White, Grey and Black—see map to the right. Using this map you can obtain the Zone colour for your delivery postcode. Check the colour against the Delivery Charge Grid (see below). This map is available online at [www.cabp.co.uk/Delivery-Information.htm](http://www.cabp.co.uk/Delivery-Information.htm)

## STEP 3—Obtain your delivery charge

Using the Delivery Charge Grid below, find the Product Colour Code (from Step 1) and cross reference across the table to the correct column for the Regional postcode Zone (from Step 2) to obtain the delivery charge for your product/order.

DELIVERY CHARGE GRID for Standard Delivery				
Product Colour Code		Regional Zone		
		ZONE A	ZONE B	ZONE C
S	GREEN	£4.95	£4.95	£4.95
M	TURQUOISE	£9.95	£14.95	POA *
M/L	YELLOW	£17.95	£19.95	POA *
L	PURPLE	£19.95	£24.95	POA *
X/L	BROWN	£29.95	£34.95	POA *

**NOTE.** Delivery charges are irrespective of quantity—they are based on the largest item and delivery zone. Delivery charges are plus VAT.

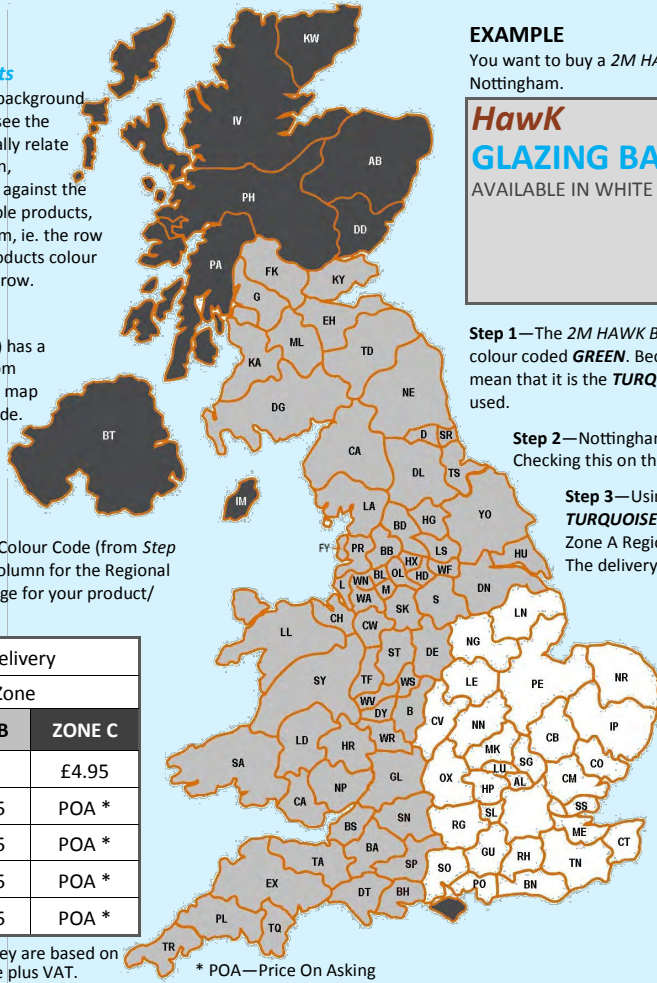

## EXAMPLE

You want to buy a *2M HAWK BAR* and *END CAP* and have it delivered to Nottingham.

<b>Hawk</b>	LENGTH	PART	PRICE
<b>GLAZING BARS</b> AVAILABLE IN WHITE ONLY	2.0M (6' 6")	HB20WH	£7.96
	3.0M (9' 10")	HB30WH	£11.94
	4.0M (13' 1")	HB40WH	£15.92
	6.0M (19' 8")	HB60WH	£23.98
	END CAP	HECWH	£0.99

**Step 1**—The *2M HAWK BAR* is colour coded TURQUOISE and the *END CAP* is colour coded GREEN. Because the *2M HAWK BAR* is the largest item this will mean that it is the **TURQUOISE** row in the Delivery Charge Grid that should be used.

**Step 2**—Nottingham is an NG postcode which on the Map is WHITE. Checking this on the Delivery Charge Grid, this is Regional Zone A.

**Step 3**—Using the Delivery Charge Grid, cross reference the **TURQUOISE** row in the Product Colour Code column across to the Zone A Regional Zone column.

The delivery charge listed is £9.95 (+VAT)

## LONDON & SURROUNDING AREA

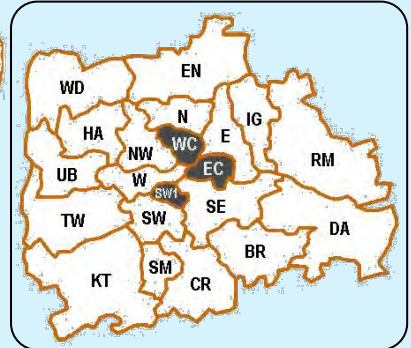

\* POA—Price On Asking

# DELIVERY INFORMATION



## HOW TO ORDER

> **ONLINE** – Go to [www.cabp.co.uk](http://www.cabp.co.uk)

Our Online Shop is open all day, everyday, 365 days of the year. You will find all our products listed online, plus any special offers we currently have running. With our fast and secure servers you can be confident that all of your information is securely encrypted. Our automated shopping cart calculates your bulk order discounts for you so getting quotes and placing orders are fast and easy.

> **BY PHONE** – Call 0845 165 165 8 - 01634 374444 - 0207 474 0474

Our sales team are on hand to provide advice on materials and to put together quotes and orders for you based on your requirements. With payment by card, orders will be processed immediately with a detailed Order Acknowledgement sent immediately for confirmation. For cheque payment, your order will be prepared and processed as soon as the cheque has cleared. **By phone our sales team are available 7:30am – 4:40pm Mon – Fri, 8.30am – 12 noon Saturdays.**

> **BY POST** – C & A Building Plastics, Courteney Road Gillingham Kent ME8 0EZ or Bidder Street, London E16 4ST

Use the Order Form at the back of this catalogue should you wish to order by post. If ordering on your own stationery, please list your requirements in the following order; PRODUCT/ PART No/ UNIT PRICE /QUANTITY/ TOTAL COST. Total the cost of your materials, subtract any bulk order discount applicable, add the delivery cost, and then add VAT. Send your order with payment in full by cheque, made out to *C&A Supplies Ltd.*

> **BY FAX** – Fax 0845 165 165 9 - 01634 366644 - 0207 474 5055

Please see the "By Post" section for details of how to list your requirements and calculate costs and discounts. Where payment is made by card, orders will be processed immediately. Where payment is made by cheque, the order will be prepared and processed as soon as payment is received.

> **OVER THE SALES COUNTER** – See [website for branch opening times](http://www.cabp.co.uk) [www.cabp.co.uk](http://www.cabp.co.uk)

**PLEASE NOTE:** Payment over the phone for collection and Cash On Delivery facilities are NOT available. Ledger accounts will be considered for regular customers.



## BULK ORDER DISCOUNTS

If you are working on any form of building project then you want to save as much money as you can. At **C&A** we recognise that money does not grow on trees and to keep costs as low as possible we have a simple discount structure that gives generous discounts based on your order value.

Goods Value	DISCOUNT
Excluding VAT	
£200.00 and above	-£15.00
£400.00 and above	-£35.00
£600.00 and above	-£60.00
£800.00 and above	-£90.00
£1000.00 and above	-£120.00
£1250.00 and above	-£160.00
£1500.00 and above	-£220.00
<b>£75 discount for every additional £500 spent</b>	
<i>example :- £2500 nett will get £370 discount</i>	

## TRANSPORT & STORAGE

All plastic building materials should be kept flat during transport and storage. If stacked, materials must then be covered with a light-proof sheet to prevent direct sunlight overheating the interior of the stack, with all products flat and level without excessive weight on the bottom layers.

**Invoice Address**

Name \_\_\_\_\_

Address \_\_\_\_\_

\_\_\_\_\_ Post Code \_\_\_\_\_

Telephone Number \_\_\_\_\_

Mobile Number \_\_\_\_\_ (At least one number is required)

ITEM DESCRIPTION	PART NUMBER	PRICE EACH	QUANTITY	LINE TOTAL
<b>EXAMPLE</b> 4M Square White Gutter	GS+WH	4.99	2	9.98

**Delivery Address**

Name \_\_\_\_\_

Address \_\_\_\_\_

\_\_\_\_\_ Post Code \_\_\_\_\_

Telephone Number \_\_\_\_\_

Mobile Number \_\_\_\_\_ (At least one number is required)

**Additional Information/ Delivery Instructions**

If your address does not have a house number or is hard to find then please provide us with additional information that will assist our drivers in making the delivery. If we are unable to contact you or our driver cannot locate the delivery address then we may abort the delivery and have to reschedule it for a later date.

---



---



---

**DELIVERY CHARGES**

Delivery is charged on all orders and is calculated using two pieces of information.

- 1) The physical size of the item
- 2) The area/zone it is being delivered to

You are only charged for the largest item on your order and not separately for each item.

**For full details please see page 85**

**BULK ORDER DISCOUNTS**

Good Value Exl VAT	DISCOUNT
£200.00 and above	-£15.00
£400.00 and above	-£35.00
£600.00 and above	-£60.00
£800.00 and above	-£90.00
£1000.00 and above	-£120.00
£1250.00 and above	-£160.00
£1500.00 and above	-£220.00
£75 discount for every additional £500 spent	
<i>example :- £2500 nett will get £370 discount</i>	

The following credit & debit cards are accepted



Cash     Cheque     Credit Card

Please provide a contact number if paying by credit card \_\_\_\_\_



Total Goods Value	_____
Less Bulk Order Discount	_____
Total	_____
(see page 85) Delivery	_____
Total	_____
Add VAT @ 20%	_____
Total	_____

# **C&A Building Plastics** FEATURED PRODUCTS! .....



**Combo Canopy**  
**DOOR CANOPIES**

**SEE PAGES 58 & 59**



**110mm**  
**UNDERGROUND**  
**DRAINAGE**

**SEE PAGE 41**



**ROOF SYSTEMS**  
**SANCTUARY CANOPY**

**SEE PAGE 29**

**Lo-Cal Rate: 0845 165 165 8 Gillingham Depot: 01634 37 44 44 London Depot: 0207 474 0474**



**... NATIONWIDE DELIVERY SERVICE ...**  
delivering service & quality across the UK

