

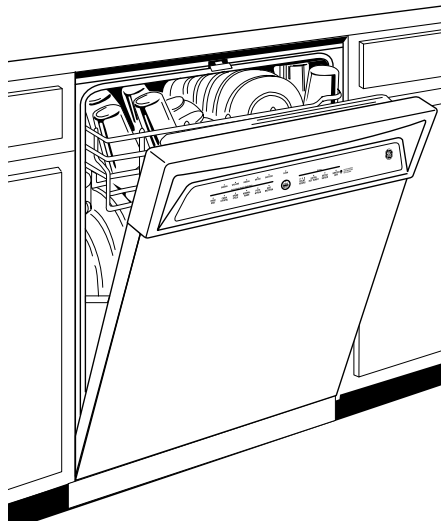

TECHNICAL SERVICE GUIDE

Triton XL Dishwashers



MODEL SERIES:

EDW4000 PDW7300
EDW4060 PDW7700
GSD6200 PDW7800
GSD6300 PDW7880
GSD6600
GSD6660
GSD6700





IMPORTANT SAFETY NOTICE

The information in this service guide is intended for use by individuals possessing adequate backgrounds of electrical, electronic, and mechanical experience. Any attempt to repair a major appliance may result in personal injury and property damage. The manufacturer or seller cannot be responsible for the interpretation of this information, nor can it assume any liability in connection with its use.

WARNING

To avoid personal injury, disconnect power before servicing this product. If electrical power is required for diagnosis or test purposes, disconnect the power immediately after performing the necessary checks.

RECONNECT ALL GROUNDING DEVICES

If grounding wires, screws, straps, clips, nuts, or washers used to complete a path to ground are removed for service, they must be returned to their original position and properly fastened.

GE Consumer Home Services Training
Technical Service Guide
Copyright © 2001

All rights reserved. This service guide may not be reproduced in whole or in part in any form without written permission from the General Electric Company.

Table of Contents

Introduction	2
Nomenclature	3
Control Panel Features	
Profile Models	4
GE Models	6
Component Locator Views	9
Dishwasher Components	
Door Components	13
Escutcheon Keypad Assembly	13
Control Module	14
Detergent/Rinse Module	14
Stainless Steel Bowed Panel (on some models)	15
Door Interlock Switch	16
Bottom Door Seal	17
Drain System	17
Circulation System	18
Fill Funnel	20
Calrod® Heating Element	20
Turbidity Sensor	21
Water Valve and Flood Switch	22
Active Vent	23
Flashing Display Lights	24
Service Mode	25
Factory Test Mode	26
Washability Complaints	27
Cycle Progression Charts	28
Wiring Diagram	29
Parts List	30
Review	38
Warranty	
Profile Models	39
GE Models	40

Introduction

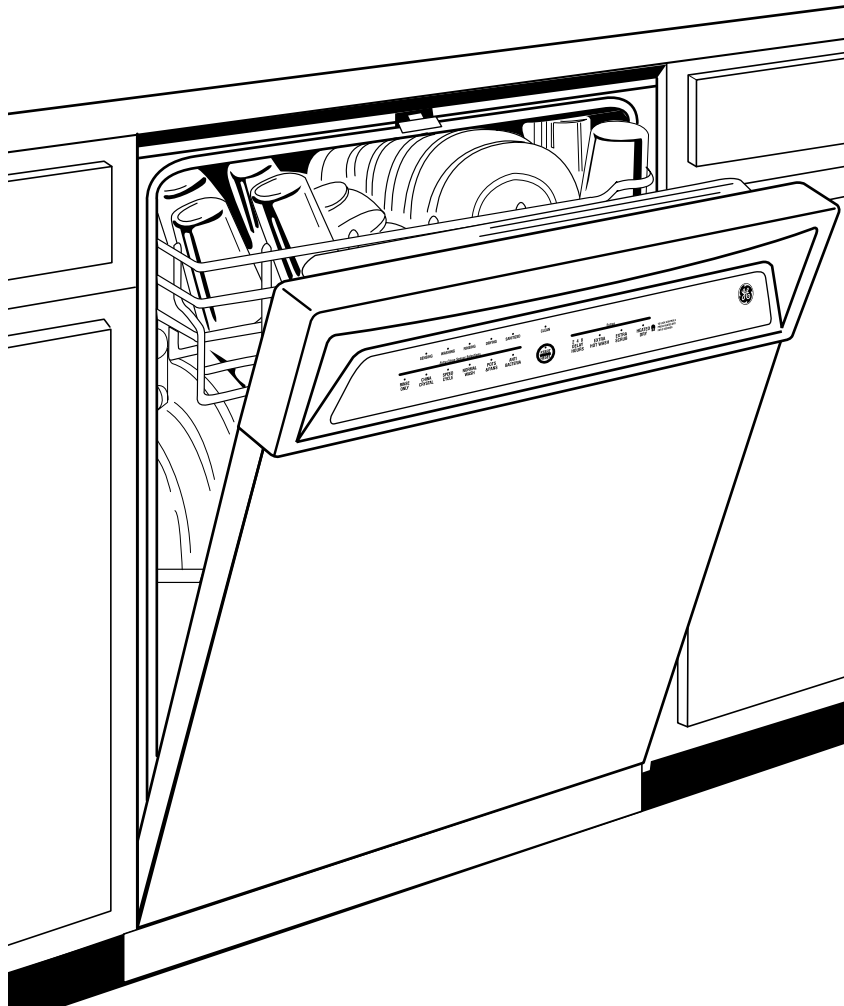

The new Triton XL Dishwashers are packed with features to get your dishes cleaner, pots and pans spotless, and keep your kitchen quieter... and with a power usage of 477 kWhr/yr, they have an “EnergyStar” rating.

The Triton XL Dishwashers have 3 wash arms that provide complete coverage, eliminating pre-rinsing, soaking, and scrubbing. The ExtraClean™ sensor incorporates a thermistor Auto Temp control and measures the water turbidity in 5 levels of cleanliness. The 100% triple-water filtration, with extra fine filter, eliminates recirculating

food particles. The Piranha™ hard food disposer grinds and pulverizes any other food particles.

Triton XL Dishwashers run quieter thanks to our QuietPower™ motor, PermaTuf® tub, and the QuietPower IV sound insulation, Thinstall.

The dual wattage Calrod® heater draws 835 W when it is wet to heat the water faster and, during the drying cycle, drops to 700 W for gentler drying.

The information on the following pages will help you service these new Triton XL Dishwashers effectively and efficiently.

Nomenclature

Model Number

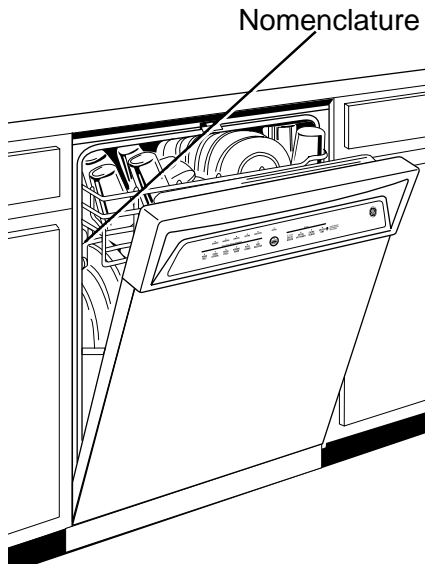
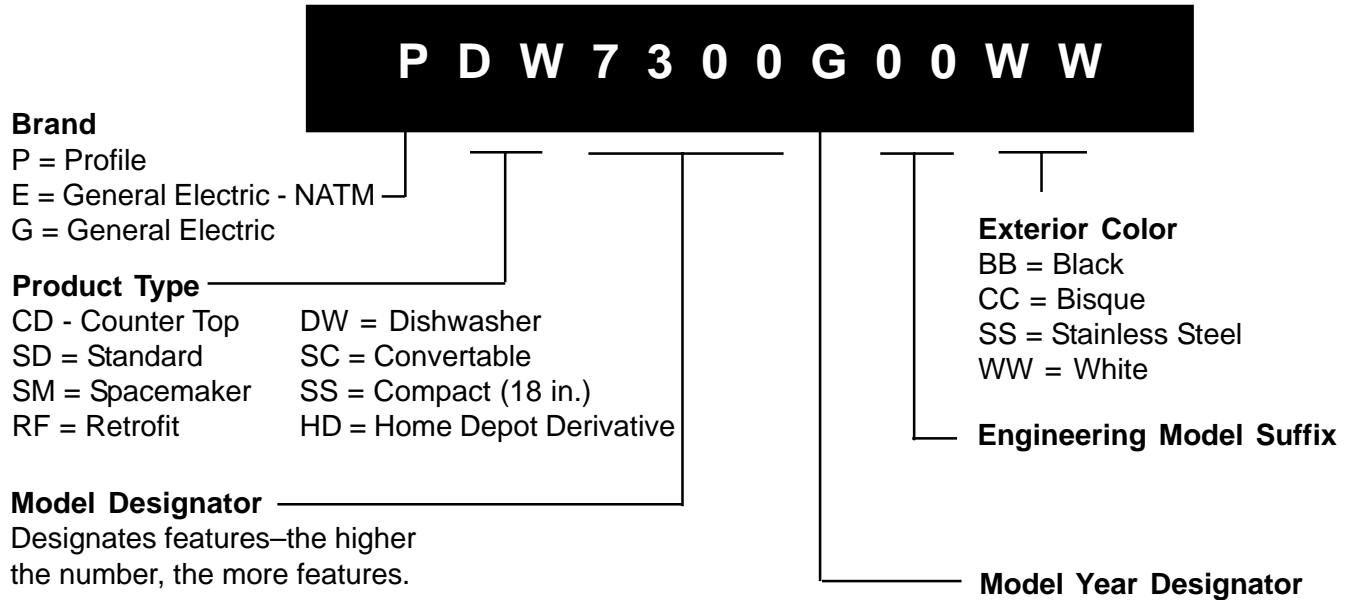

The serial plate of your dishwasher is located on the tub wall just inside the door.

Serial Number

The first two characters of the serial number identify the month and year of manufacture.

Example: **AA**123456S = January, 2001

A - JAN	2005 - H
D - FEB	2004 - G
F - MAR	2003 - F
G - APR	2002 - D
H - MAY	2001 - A
L - JUN	2000 - Z
M - JUL	1999 - V
R - AUG	1998 - T
S - SEP	1997 - S
T - OCT	1996 - R
V - NOV	1995 - M
Z - DEC	1994 - L

The letter designating the year repeats every 12 years.

Example:

- T - 1974
- T - 1986
- T - 1998

Note: The service information sheet is located under the control panel.

Control Panel Features

Profile Models

Throughout this manual, features and appearance may vary from your model.

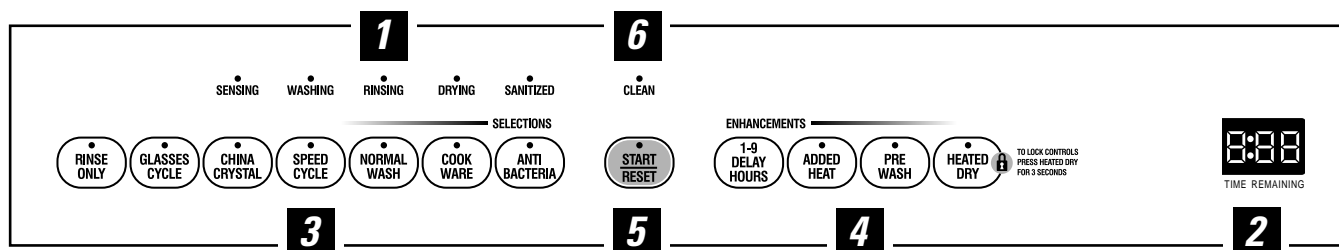

Control Settings

1 Status Indicator Lights

The Status display tells you what's happening while the dishwasher is in operation and may flash, indicating a malfunction (see page 8). The lights will come **ON** indicating the sequence of operation the dishwasher is in.

SENSING Displayed while the ExtraClean™ Sensor is measuring the amount of soil and temperature of water. The dishwasher will adjust the selected cycle to achieve optimal performance.

WASHING Displayed during prewash and main wash periods.

RINSING Displayed during rinse periods.

DRYING Displayed during **HEATED DRY**.

SANITIZED Displayed when cycle has met sanitization conditions. Light remains **ON** until door is opened.

CLEAN Displayed when a wash cycle is complete. The light will remain **ON** until door is opened.

2 Time Remaining Display (on some models)

Displays the minutes remaining until the cycle is complete. The display may adjust the remaining time while the Sensing light is on.

3 Selections

The light above the selected pad will be **ON** to indicate which **WASH CYCLE** has been selected.

ANTI-BACTERIA Heavy 10.0 gal., 93 min.
Medium 8.6 gal., 90 min.
Light 7.2 gal., 90 min.

This cycle raises the water temperature in the final rinse to sanitize your dishware. The cycle length will vary depending on the temperature of your inlet water.

NOTE: The Anti-Bacteria cycle is monitored for sanitization requirements. If the cycle is interrupted during or after the main wash portion or if the incoming water temperature is so low that adequate water heating cannot be achieved, the sanitizing conditions may not be met. In these cases, the sanitized light will not illuminate at the end of the cycle.

NOTE: NSF certified residential dishwashers are not intended for licensed food establishments.

COOK WARE **Heavy** 11.4 gal., 95 min.
Medium 10.0 gal., 71 min.
Light 10.0 gal., 66 min.

This cycle is meant for heavily soiled dishes or cookware with dried-on or baked-on soils. This cycle may not remove burned-on foods. Everyday dishes are safe to be used in this cycle.

NORMAL WASH **Heavy** 9.9 gal., 74 min.
Medium 7.0 gal., 61 min.
Light 5.6 gal., 48 min.

This cycle is for medium/heavily soiled dishes and glassware.

SPEED CYCLE **Heavy** 9.3 gal., 36 min.
Medium 7.2 gal., 36 min.
Light 5.7 gal., 33 min.

This cycle is for everyday dishes and glassware.

CHINA CRYSTAL **Heavy** 10.0 gal., 49 min.
Medium 7.2 gal., 36 min.
Light 7.2 gal., 36 min.

This cycle is for lightly soiled china and crystal.

GLASSES **Heavy** 10.0 gal., 45 min.
(on some models) **Medium** 7.2 gal., 33 min.
Light 7.2 gal., 32 min.

This cycle is specifically designed for glasses.

RINSE ONLY **Heavy** 2.9 gal., 7 min.
Light 1.4 gal., 3 min.

For rinsing partial loads that will be washed later. Do not use detergent with this cycle.

NOTE: This dishwasher is equipped with an ExtraClean™ Sensor with automatic temperature control; therefore cycle length and time may vary depending on soil and temperature conditions.

NOTE: Only the Anti-Bacteria cycle has been designed to meet the requirements of Section 6, NSF 184 for soil removal and sanitization efficacy.

4 Enhancements

*The light above the selected pad will be ON to indicate which **ENHANCEMENT** has been selected.*

PRE WASH For use with heavily soiled and/or dried-on, baked-on soils. This option **MUST** be selected **PRIOR** to starting the cycle. *This option adds 16 minutes to the cycle time.* **NOTE:** Cannot be selected with **RINSE ONLY** cycle.

HEATED DRY Shuts off the drying heat option. Dishes air dry naturally and energy is saved. For faster air dry, *Light OFF* you can prop the door open after the **CLEAN** light illuminates.

HEATED DRY Turns the heater on for fast drying. This will extend the time to your wash cycle by 8 minutes *Light ON* for the **SPEED CYCLE** and 20 minutes for all other cycles. **NOTE:** Cannot be selected with **RINSE ONLY** cycle.

LOCK  *You can lock the controls to prevent any selections from being made. Or you can lock the controls after you have started a cycle.*

Children cannot accidentally start dishwasher by touching pads with this option selected.

To unlock the dishwasher controls, press and hold the **HEATED DRY** pad for 3 seconds. To lock the dishwasher, press and hold the **HEATED DRY** pad for 3 seconds. The light above the **LOCK** pad will turn off.

ADDED HEAT When selected, the **NORMAL WASH** cycle will run longer with heating elements on to improve both wash and dry performance. **NOTE:** Cannot be selected with **RINSE ONLY** cycle.

DELAY HOURS You can delay the start of a wash cycle for up to 9 hours (on some models). Press the **DELAY HOURS** pad to choose the number of hours you want to delay the start of the cycle, then press **START/RESET**. The machine will count down and start automatically at the correct time. **Pressing START/RESET a second time will cancel the DELAY START selection.**
NOTE: If you forget to fully close the door a reminder signal will beep until you do so.

RESET To change a cycle after washing starts, touch the **START/RESET** pad to cancel the cycle. The **START/RESET** light will flash while the water is pumped out if needed. This takes approximately 90 seconds. When the light stops flashing, the dishwasher can be reprogrammed and restarted.

5 Start

Close the dishwasher door and select the cycle and desired enhancements. Touch the **START/RESET** pad to begin the cycle. Water fill begins, and approximately 60 seconds later the wash action begins.

NOTE: The dishwasher remembers your last cycle so you don't have to reprogram each time. When the dishwasher door is fully closed, the control panel lights will display the last settings you selected.

If you don't want to change any of the settings, simply touch the **START/RESET** pad to begin the cycle.

If the door is closed the indicator lights will turn off if the **START/RESET** pad is not selected within two minutes. To activate the display, open and close the door or press any pad.

Also, if a power failure occurs, **NORMAL** and **HEATED DRY** will automatically be programmed. Make any new selections and touch the **START/RESET** pad to begin the cycle.

6 Clean

The **CLEAN** light is illuminated when a wash cycle is complete. The light will stay **ON** until the door is opened.

GE Models

You can locate your model number on the tub wall just inside the door. Throughout this manual, features and appearance may vary from your model.

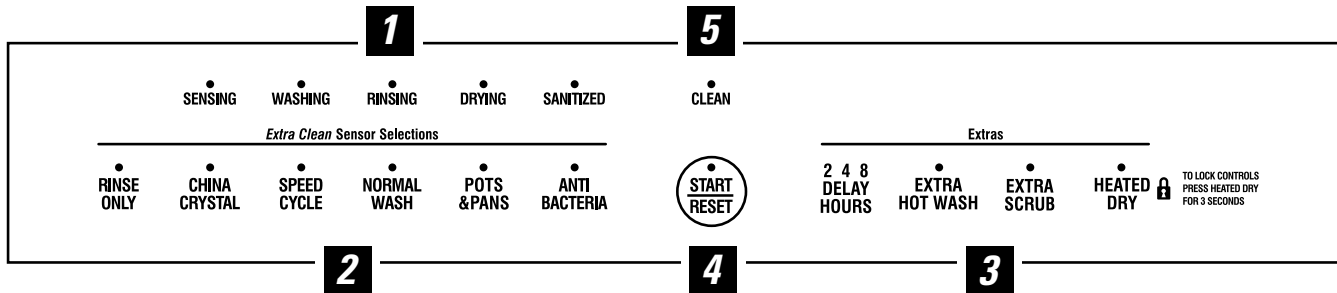

Control Settings

1 Status Indicator Lights

The Status display tells you what's happening while the dishwasher is in operation and may flash, indicating a malfunction (see page 8). The lights will come **ON** indicating the sequence of operation the dishwasher is in.

SENSING Displayed while the ExtraClean™ Sensor is measuring the amount of soil and temperature of water. (on some models) The dishwasher will adjust the selected cycle to achieve optimal performance.

WASHING Displayed during prewash and main wash periods. (on some models)

RINSING Displayed during rinse periods. (on some models)

DRYING Displayed during **HEATED DRY**. (on some models)

SANITIZED Displayed when cycle has met sanitization conditions. Light remains **ON** until door is opened.

CLEAN Displayed when a wash cycle is complete. The light will remain **ON** until door is opened.

2 **ExtraClean™ Sensor Selections**

The light above the selected pad will be **ON** to indicate which **ExtraClean™ Sensor Selection** has been selected.

ANTI-BACTERIA Heavy 10.0 gal., 93 min.

Medium 8.6 gal., 90 min.

Light 7.2 gal., 90 min.

This cycle raises the water temperature in the final rinse to sanitize your dishware. The cycle length will vary depending on the temperature of your inlet water.

NOTE: The Anti-Bacteria cycle is monitored for sanitization requirements. If the cycle is interrupted during or after the main wash portion or if the incoming water temperature is so low that adequate water heating cannot be achieved, the sanitizing conditions may not be met. In these cases, the sanitized light will not illuminate at the end of the cycle.

NOTE: NSF certified residential dishwashers are not intended for licensed food establishments.

POTS Heavy 11.4 gal., 95 min.

& PANS Medium 10.0 gal., 71 min.

Light 10.0 gal., 66 min.

This cycle is meant for heavily soiled dishes or cookware with dried-on or baked-on soils. This cycle may not remove burned-on foods. Everyday dishes are safe to be used in this cycle.

NORMAL WASH Heavy 9.9 gal., 74 min.

Medium 7.0 gal., 61 min.

Light 5.6 gal., 48 min.

This cycle is for medium/heavily soiled dishes and glassware.

SPEED CYCLE Heavy 9.3 gal., 36 min.

or Medium 7.2 gal., 36 min.

SPEED WASH Light 5.7 gal., 33 min.

This cycle is for everyday dishes and glassware.

CHINA CRYSTAL Heavy 10.0 gal., 49 min.

(on some models) **Medium** 7.2 gal., 36 min.

Light 7.2 gal., 36 min.

This cycle is for lightly soiled china and crystal.

RINSE ONLY Heavy 2.9 gal., 7 min.

Light 1.4 gal., 3 min.

For rinsing partial loads that will be washed later. Do not use detergent with this cycle.

NOTE: This dishwasher is equipped with an ExtraClean™ Sensor with automatic temperature control; therefore cycle length and time may vary depending on soil and temperature conditions.

NOTE: Only the Anti-Bacteria cycle has been designed to meet the requirements of Section 6, NSF 184 for soil removal and sanitization efficacy.

3 **Extras**

The light above the selected pad will be **ON** to indicate which **EXTRA** has been selected.

EXTRA For use with heavily soiled and/or dried-on, baked-on soils. This option **MUST** be selected

SCRUB PRIOR to starting the cycle. *This option adds 16 minutes to the cycle time.* **NOTE:** Cannot (on some models) be selected with **RINSE ONLY** cycle.

HEATED DRY Light OFF Shuts off the drying heat option. Dishes air dry naturally and energy is saved. For faster air dry, you can prop the door open after the **CLEAN** light illuminates.

HEATED DRY Light ON Turns the heater on for fast drying. This will extend the time to your wash cycle by 8 minutes for the **SPEED CYCLE** and 20 minutes for all other cycles. **NOTE:** Cannot be selected with **RINSE ONLY** cycle.

LOCK  You can lock the controls to prevent any selections from being made. Or you can lock the controls after you have started a cycle.

Children cannot accidentally start dishwasher by touching pads with this option selected.

To unlock the dishwasher controls, press and hold the **HEATED DRY** pad for 3 seconds. To lock the dishwasher, press and hold the **HEATED DRY** pad for 3 seconds. The light above the **LOCK** pad will turn off.

EXTRA HOT WASH When selected, the **NORMAL WASH** cycle will run longer with heating elements on to improve both wash and dry performance. **NOTE:** Cannot be selected with **RINSE ONLY** cycle.

DELAY HOURS You can delay the start of a wash cycle for up to 8 hours (on some models). Press the **DELAY HOURS** pad to choose the number of hours you want to delay the start of the cycle, then press **START/RESET**. The machine will count down and start automatically at the correct time. **Pressing START/RESET a second time will cancel the DELAY START selection.** **NOTE:** If you forget to fully close the door a reminder signal will beep until you do so.

RESET To change a cycle after washing starts, touch the **START/RESET** pad to cancel the cycle. The **START/RESET** light will flash while the water is pumped out if needed. This takes approximately 90 seconds. When the light stops flashing, the dishwasher can be reprogrammed and restarted.

4 Start
Close the dishwasher door and select the cycle and desired enhancements. Touch the **START/RESET** pad to begin the cycle. Water fill begins, and approximately 60 seconds later the wash action begins.

NOTE: The dishwasher remembers your last cycle so you don't have to reprogram each time. When the dishwasher door is fully closed, the control panel lights will display the last settings you selected.

5 Clean
The **CLEAN** light is illuminated when a wash cycle is complete. The light will stay **ON** until the door is opened.

If you don't want to change any of the settings, simply touch the **START/RESET** pad to begin the cycle.

If the door is closed the indicator lights will turn off if the **START/RESET** pad is not selected within two minutes. To activate the display, open and close the door or press any pad.

Also, if a power failure occurs, **NORMAL** and **HEATED DRY** will automatically be programmed. Make any new selections and touch the **START/RESET** pad to begin the cycle.

FLASHING DISPLAY LIGHTS

Status Indicator Lights	What It Means
START/RESET	Cycle has been interrupted by pressing the START/RESET keypad. Light will quit flashing after the dishwasher automatically drains out the water.
CLEAN	Unit has no water. Check the water supply. If water is turned on call for service.

Component Locator Views

Door View (Panel and Escutcheon Removed)

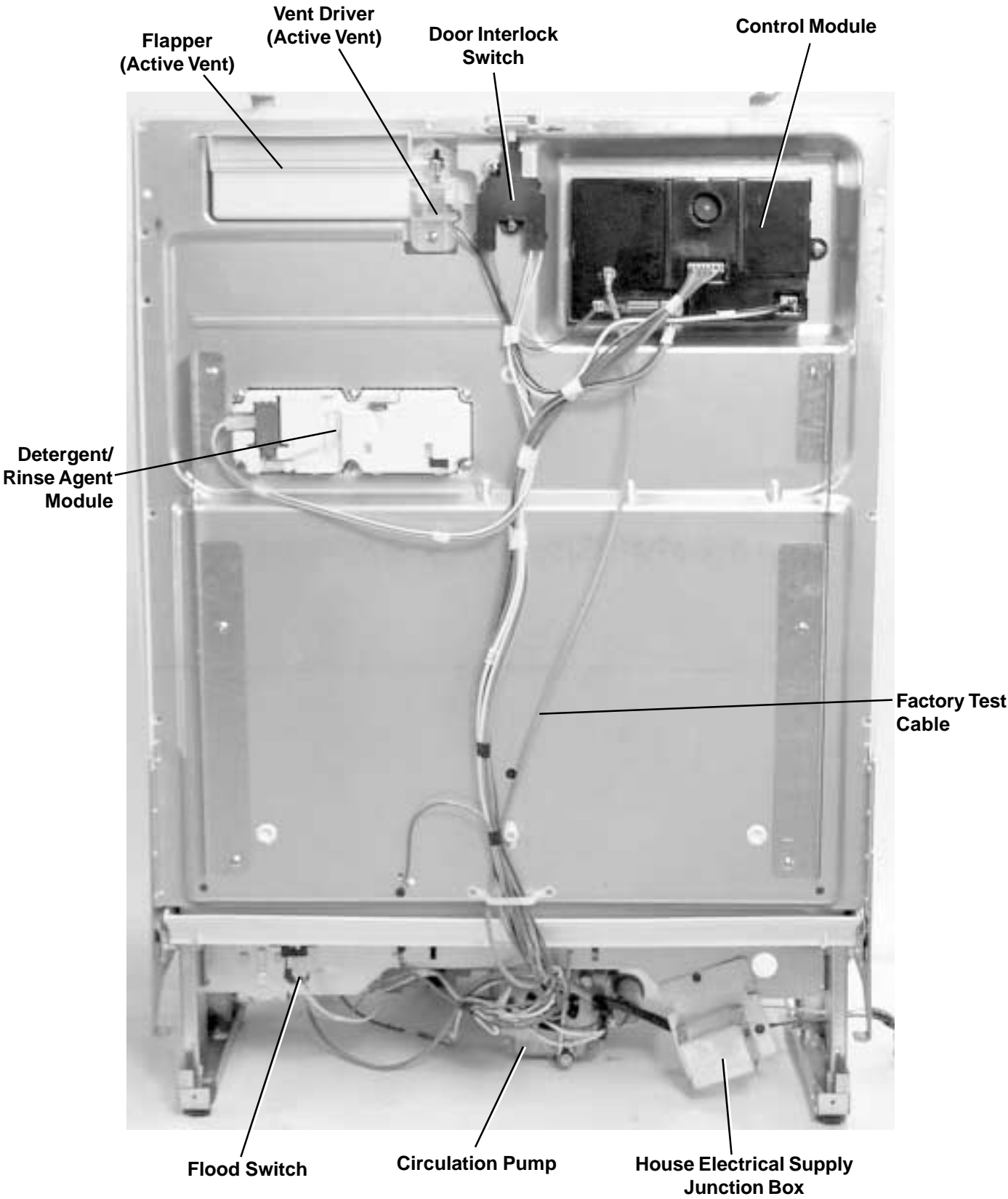

**Door View
(Front Panel ONLY Removed)**

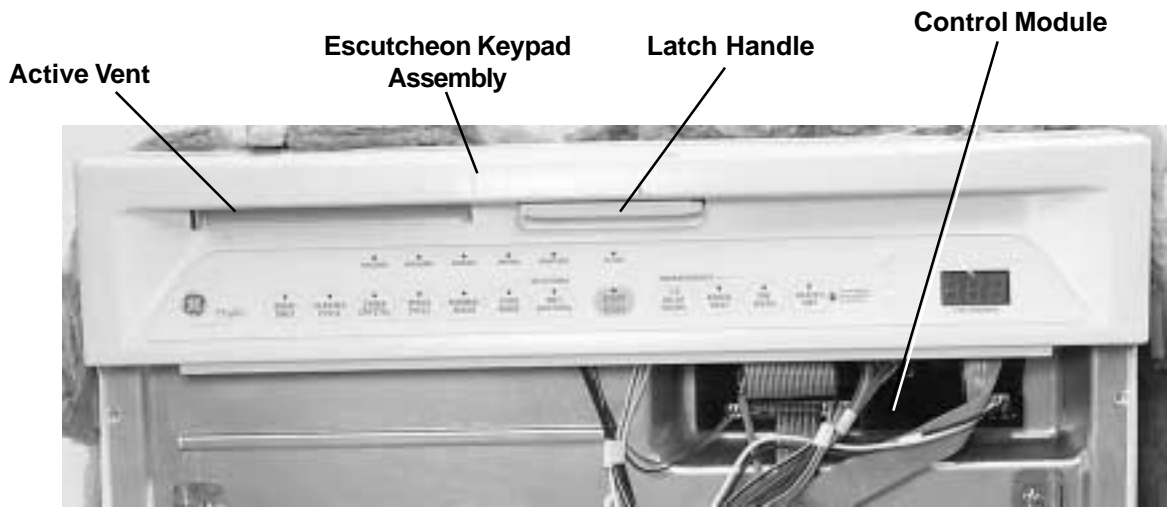

Bottom View

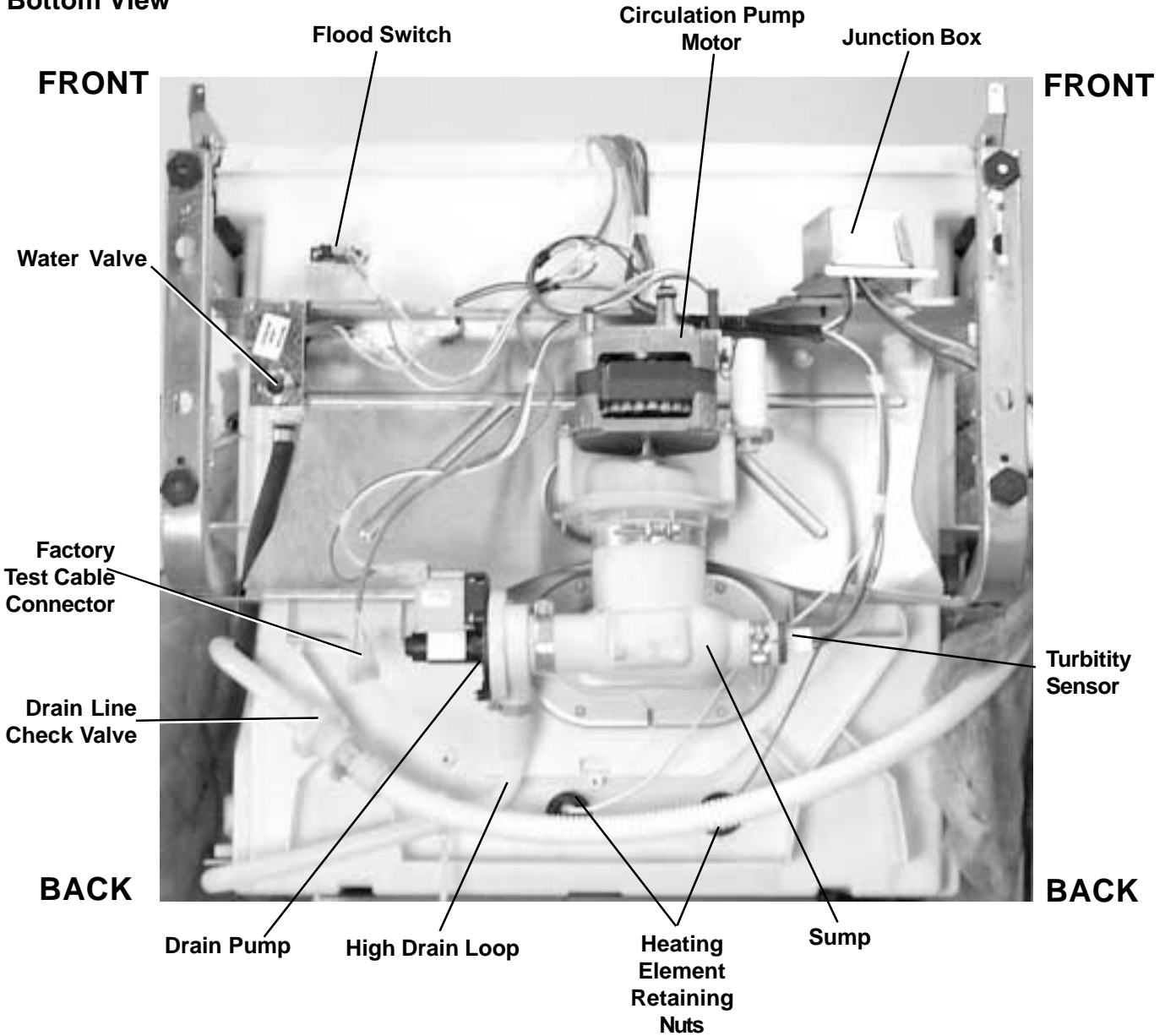

Inside View

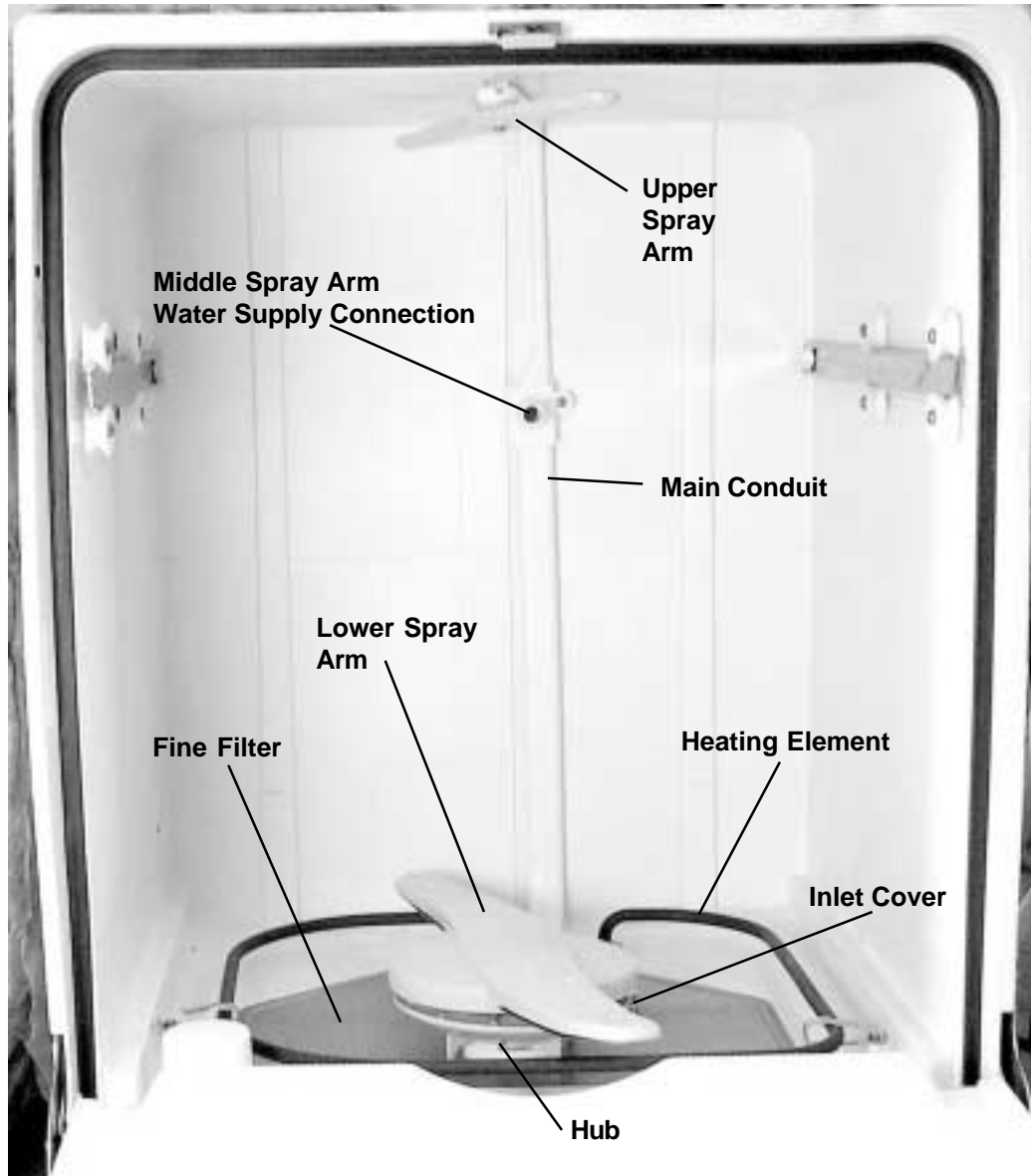

Inside Door View

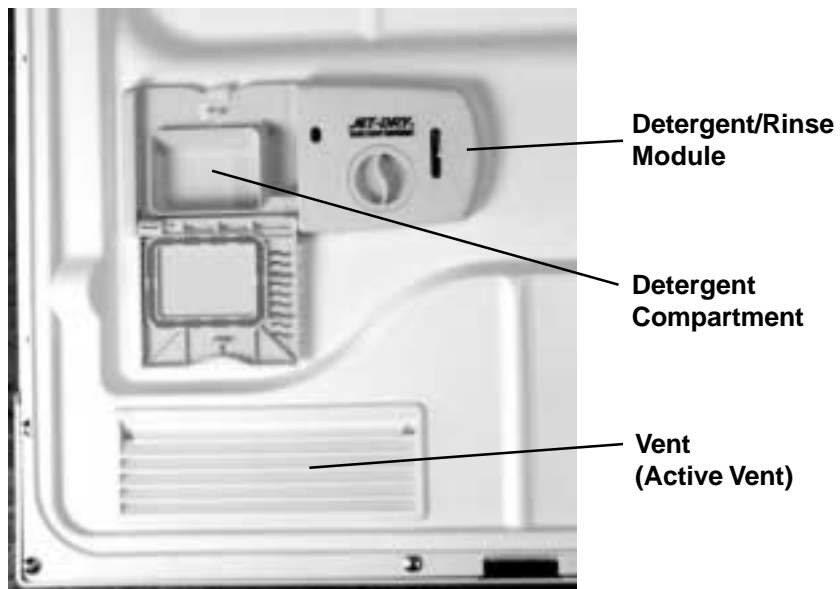

P0003687

Side View

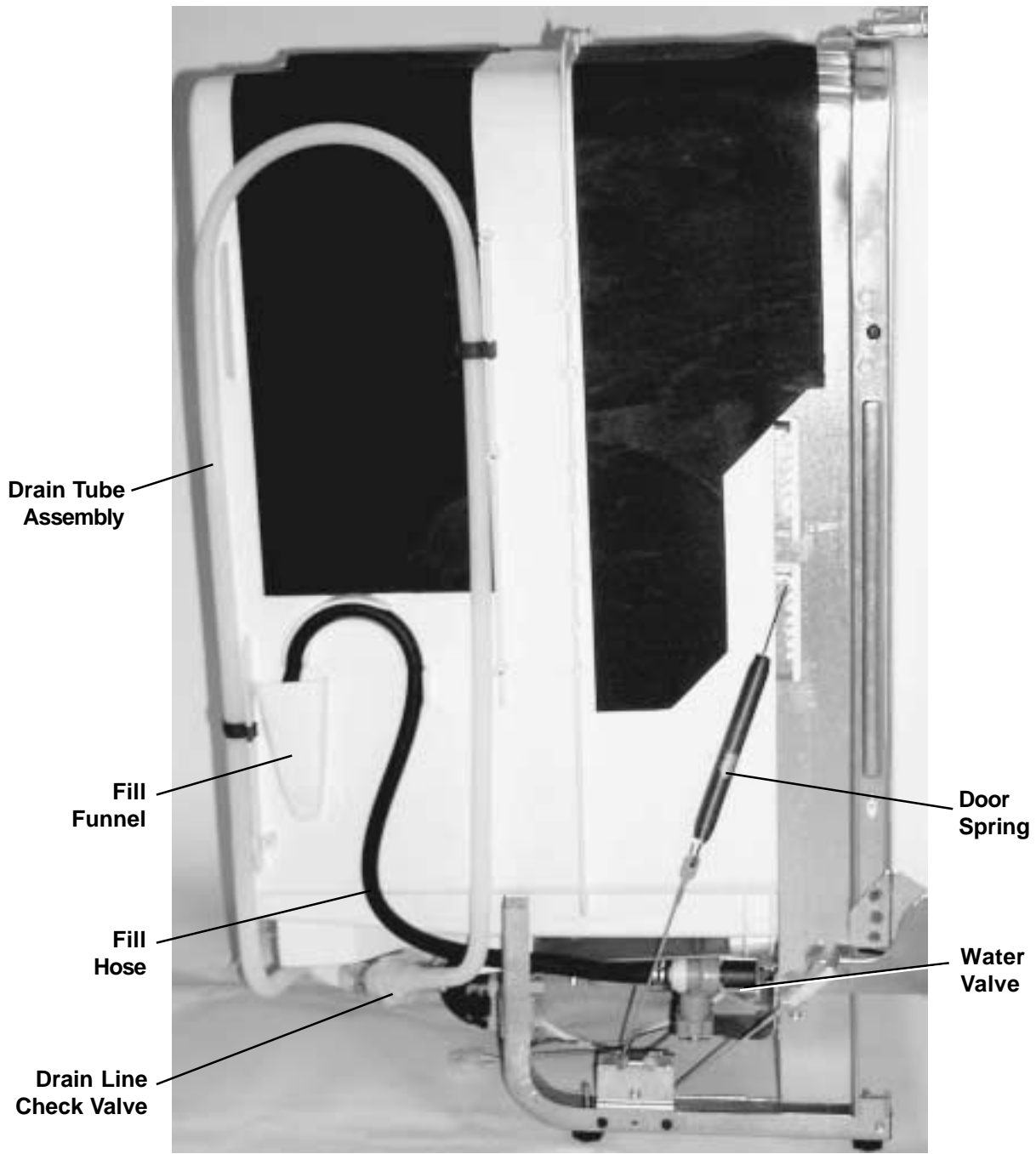

Dishwasher Components

Door Components

The door components are accessible by removing 3 Phillips screws from each side of inner door and 2 T20 torx screws from the bottom of the door. Carefully separate the inner door panel from the outer door panel. To access the active vent, flapper, and door interlock switch, the escutcheon keypad assembly must be removed.

Escutcheon Keypad Assembly

The keypad and 2 ribbon cables are a permanent part of the escutcheon and are replaced as a unit.

Disassembly

Caution: After removing the screws from the escutcheon keypad assembly, the assembly is **still attached** to the control module by 2 ribbon cables. Dropping or rough handling of the escutcheon will cause the ribbon cable to tear, and the entire escutcheon keypad assembly will need to be replaced.

1. Remove the outer door panel (see **Door Components**).
2. Open the door, **support the escutcheon keypad assembly**, and remove 6 screws from the back side of the escutcheon keypad assembly.
3. Remove the 2 ribbon cable connectors from the control module and remove the escutcheon keypad assembly.

Assembly

IMPORTANT: When reassembling, the active vent flapper must be closed before the escutcheon keypad assembly is installed. Close the active vent flapper by turning the worm gear by hand. Failure to do so will cause a misalignment and an increase in noise level.

1. While supporting the escutcheon keypad assembly, connect the 2 ribbon cable connectors to the control module.
2. Open the door. Align the escutcheon and install 6 screws from the back side of the escutcheon keypad assembly.
3. Install the outer door panel (see **Door Components**).

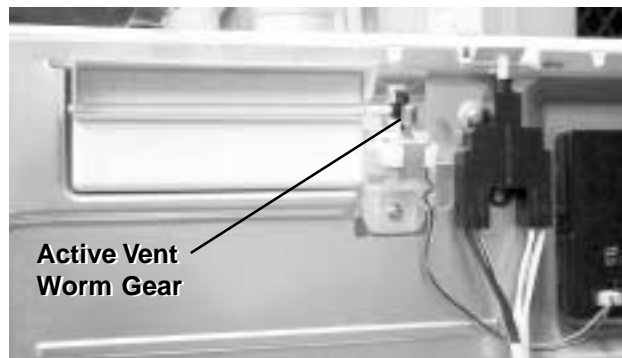
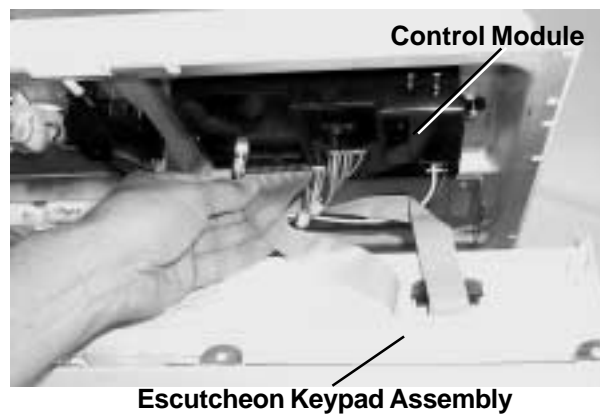
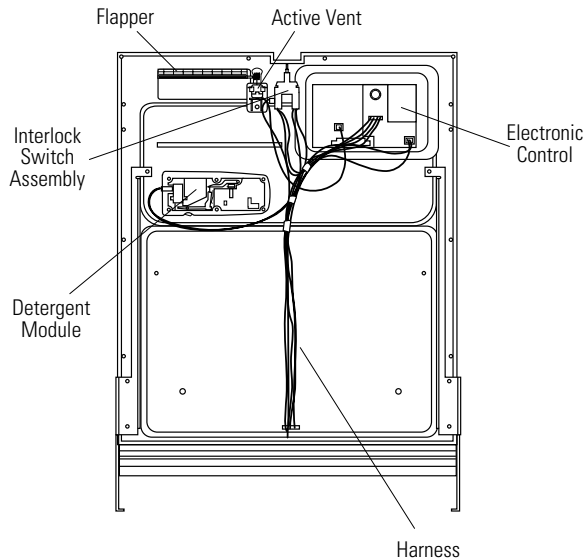

Control Module

Removal

1. Remove the outer door panel (see **Door Components**).
2. Open the door and remove the 3 screws from the back on the right side of the escutcheon keypad assembly.
3. Remove 1 screw from the right side of the control module and slide the module out.
4. Unplug the connectors from the module.

Installation

Note: The gray cable is a factory test cable (see photo) and may be removed when servicing control module.

1. Plug connectors into control module.
2. Insert the tabs on the left side of the control module into the slots on the inner door panel and secure the module with 1 screw.
3. Install 3 screws on the right side of the escutcheon and replace the outer door panel (see **Door Components**).

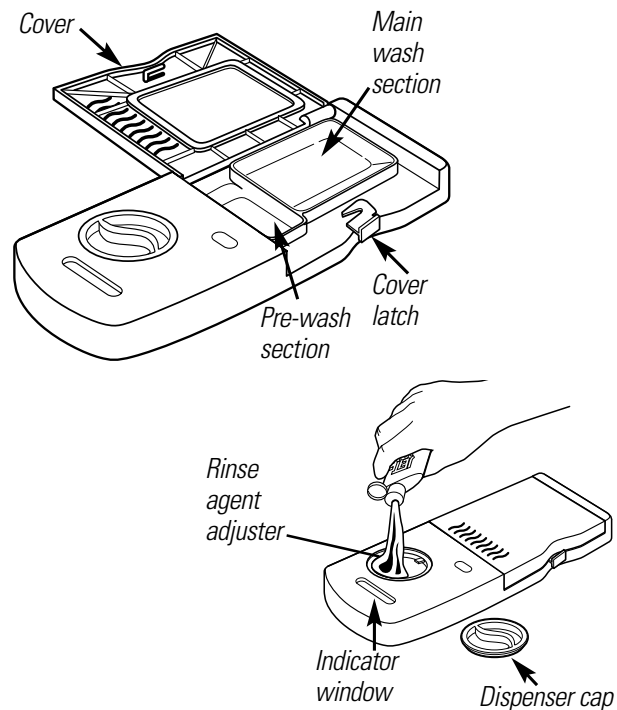
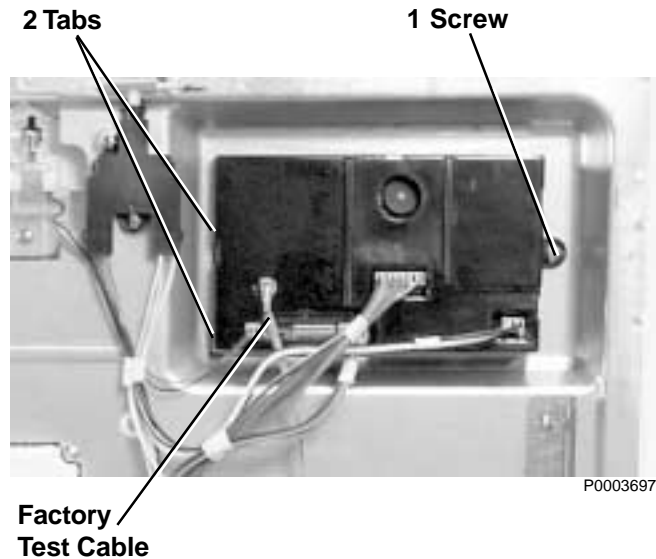

Detergent/Rinse Module

The door panel must be removed to access the detergent/rinse module. Refer to the **Door Component** section.

The detergent/rinse module can be activated using service mode. Refer to the **Service Mode** chapter.

The detergent/rinse module automatically dispenses both the detergent and the rinse agent at the appropriate times. The module is activated 2 times during a wash cycle.

The first time the module is activated (1), the lever slides up the right-hand path of the connecting rod. This action releases the detergent cover. When deactivated (2), the lever returns down the left-hand path and comes to rest under the notch in the center of the connecting rod. At the second activation (3), the lever lifts the connecting rod by the notch. This action lifts the rinse dispenser plunger and releases the rinse agent. When deactivated, the lever returns to its original starting position.

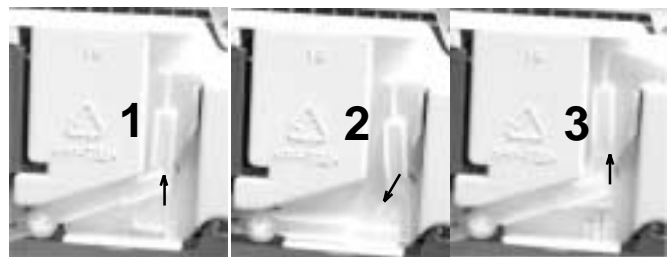

L1 Voltage from J2-6



Stainless Steel Bowed Panel (On Some Models)

Disassembly

1. Open the dishwasher door to the fully open (89 degrees open) position.
2. Remove 8 screws (4 screws per side) which hold the outer panel to the door assembly. Be careful not to remove the 2 screws which hold the escutcheon to the door assembly.
3. Slowly close the door.
4. Once the door is closed, remove the 2 screws that connect the bottom of the outer panel to the hinge arms.
5. While holding the outer panel against the door assembly, slowly open the door to about 15 degrees open so the top of the outer panel is in front of the kitchen countertop. If the dishwasher is not installed, the door does not have to be opened.
6. Rotate the bottom of the outer panel out such that the panel is now vertical.
7. Lift up on the stainless steel outer panel such that top corner flanges lift up over the corner cutouts in the escutcheon. Move the panel forward and over the escutcheon so that the panel is totally separated from the door. (See photos of escutcheon and outer panel below.)

Assembly

1. Open the door to about 15 degrees open so that the top of the outer panel is in front of the kitchen countertop. If the dishwasher is not installed, the door does not have to be opened.
2. Lift the outer panel up in the vertical position and hang the outer panel over top of the escutcheon. Take care to ensure that the stainless steel panel corner flanges go over and around the escutcheon corner cutouts.
3. While holding the outer panel to the escutcheon, slowly close the door.
4. With the panel hanging over the escutcheon, rotate the bottom of the stainless steel outer panel back so it is flush with the door assembly. Make sure that the sides of the outer panel fit around the hinge arms.
5. Look at the fit between the escutcheon and the stainless steel outer panel front opening. Make

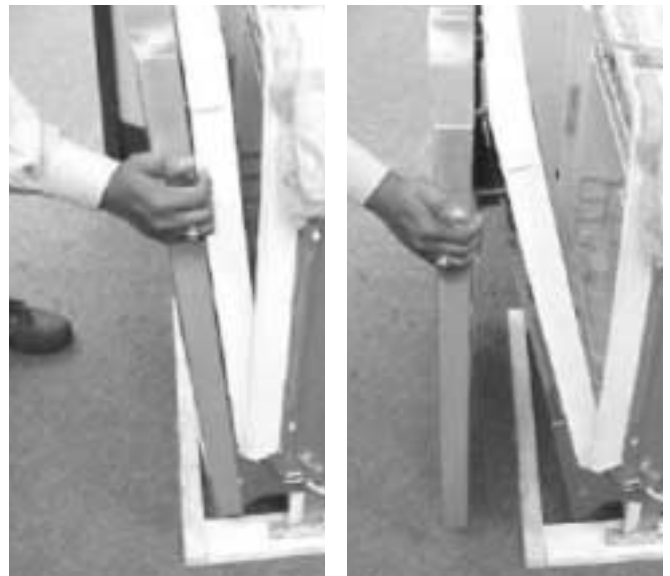
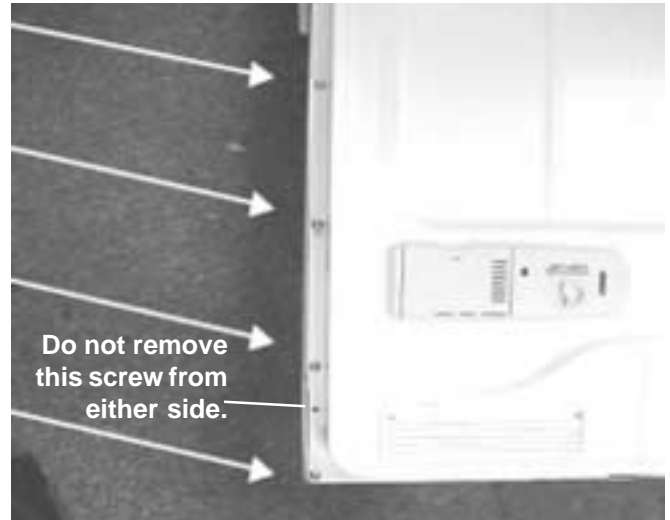

sure that the protruding ribs from the escutcheon fit inside the stainless steel front opening. Adjust the position of the outer panel up or down, left or right to center the panel with the escutcheon.

6. Once the panel is centered, install the 2 screws in the bottom of the panel to connect the stainless steel outer panel to the hinge arms. Recheck to make sure the escutcheon ribs are protruding through the panel opening.
7. While holding the outer panel against the door assembly, slowly open the door to about 45 degrees open so that the remaining 8 panel screws can be installed (4 screws on each side).

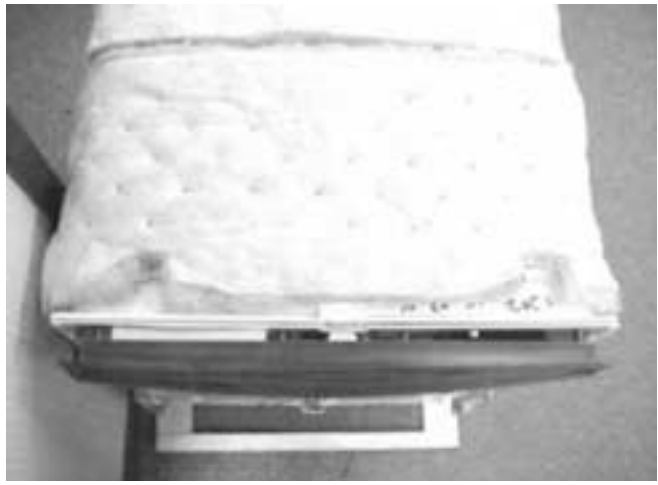

Door Interlock Switch

The door interlock switch opens the L1 circuit and Neutral circuit when the door is open.

Caution: After removing the screws from the escutcheon keypad assembly, the assembly is **still attached** to the control module by 2 ribbon cables. Dropping or rough handling of the escutcheon will cause the ribbon cable to tear, and the entire escutcheon keypad assembly will need to be replaced.

1. Remove the escutcheon keypad assembly (see *Escutcheon Keypad Assembly*).
2. Remove 2 screws and the switch from the door.
3. Carefully remove the cover from the switch and unplug the blade connectors.

Note: The wire color code is on the switch cover.

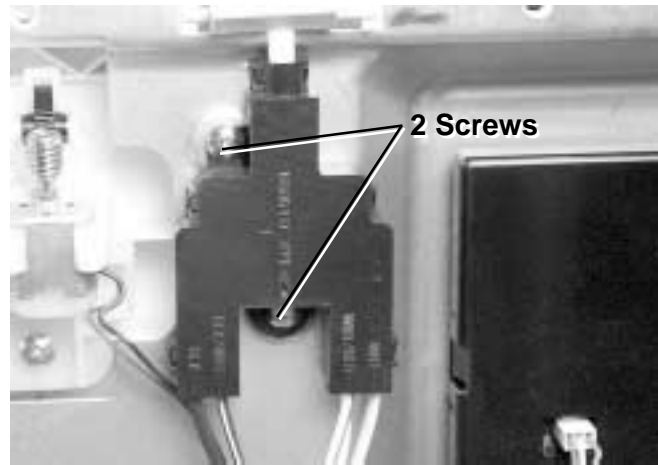

P0003703



P0003705

DOOR INTERLOCK SWITCH

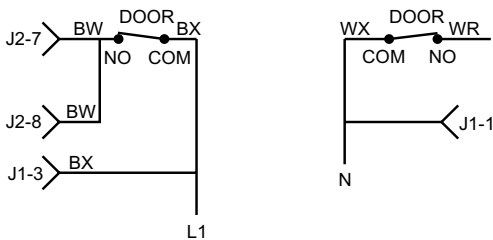

Bottom Door Seal

The bottom door seal is replaceable by removing the outer door panel (see **Door Components**). With the door closed, insert a flat-blade screwdriver under the bottom of the door into the channel and twist to break the bead. Open the door and pull the seal from the channel. To install the seal, snap the seal into the channel, working from one side of the door to the other, until the entire bead is complete and the seal slides freely in the channel.

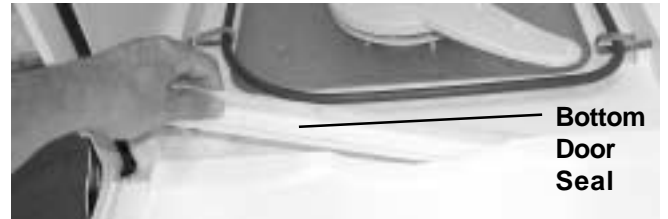
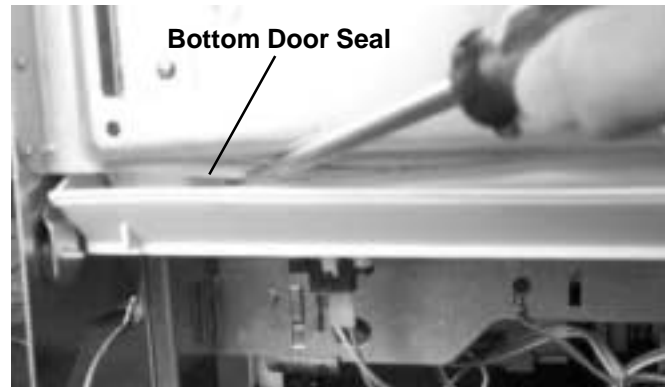

Drain System

The drain system consists of the following components:

- Inlet cover
- Sump
- Drain pump (includes motor and one-way check valve)
- Drain pipe
- Check valve (in line with drain pipe)

The inlet cover prevents large particles from entering the sump. Water entering the drain pump is not filtered by the fine filter (metal) or by the sump filter (plastic). The drain pump is mounted on the sump and contains a one-way check valve. The drain pump is controlled by the control module and can be activated using service mode (refer to the **Service Mode** chapter). The drain pump pushes the drain water out into the drainpipe. The drainpipe contains a one-way check valve.

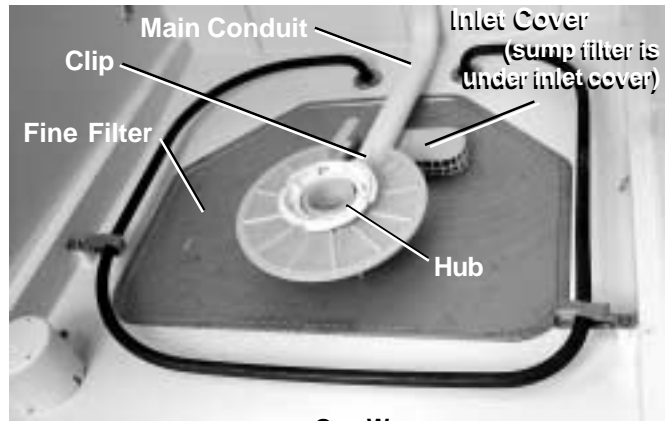

Inlet Cover and Sump

Caution: Use care to avoid breaking the clip on the hub when removing the main conduit from hub.

Remove the lower wash arm and main conduit to gain access to the inlet cover and sump.

Drain Pump

The dishwasher must be removed from its installation to gain access to the drain pump. The drain pump can be activated using service mode (refer to the **Service Mode** chapter). The drain pump contains a one way check valve. Refer to schematic or strip circuit for motor resistance value.

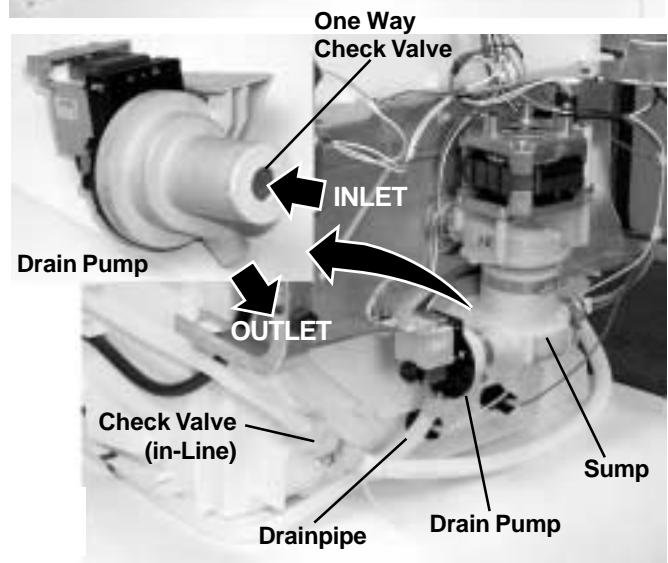

Drain Pipe and Check Valve

The dishwasher must be removed from its installation to gain access to the check valve that is in-line with the drainpipe.

L1 Output from J2-5

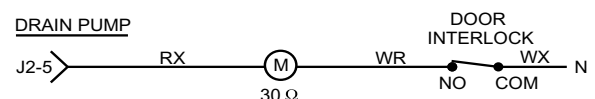

Dishwasher Doesn't Drain

L1 Output from J2-5

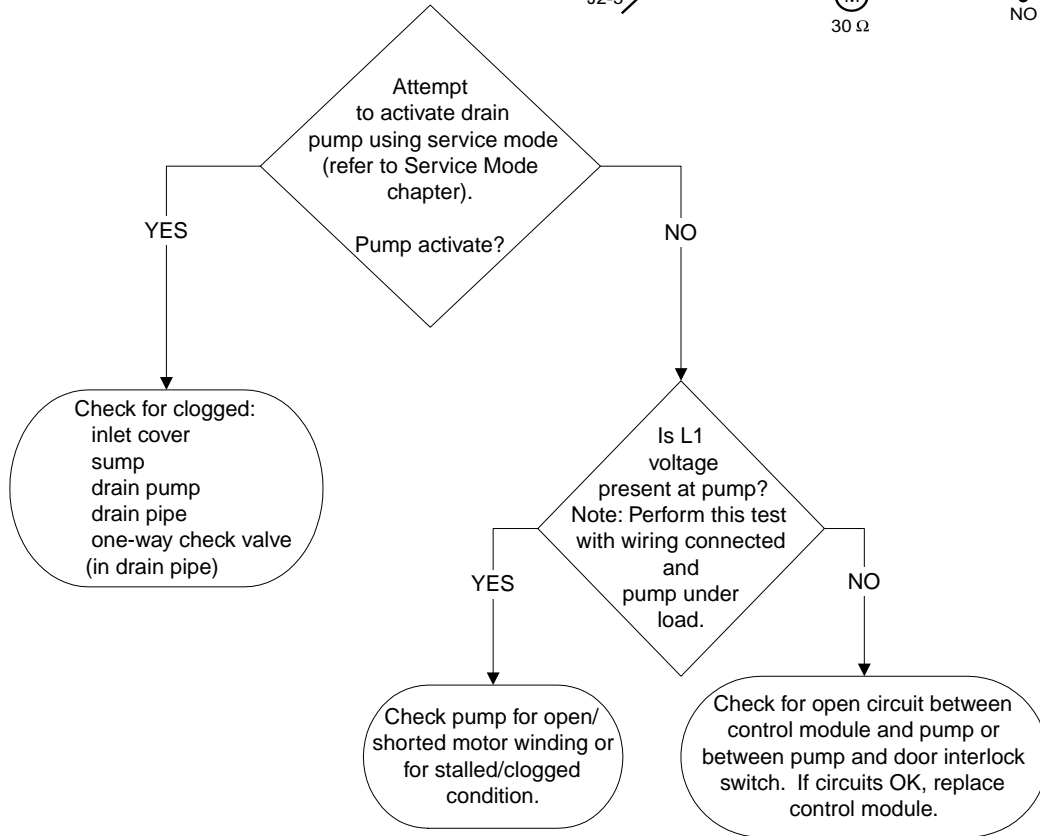
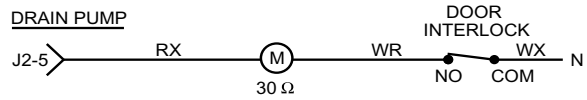

Circulation System

The circulation system consists of the following components:

- Inlet Cover
- Fine filter and sump filter
- Sump
- Circulation pump
- Hub
- Lower spray arm
- Main conduit
- Middle spray arm
- Upper Spray arm

The inlet cover prevents large particles from entering the sump. The fine filter (metal) and sump filter (plastic) prevent fine particles from entering the circulation-pump part of the sump (water entering the drain pump is not filtered by the fine filter or by the sump filter). The circulation pump is controlled by the control module and can be activated using service mode (refer to **Service Mode** chapter). The pump pushes water up

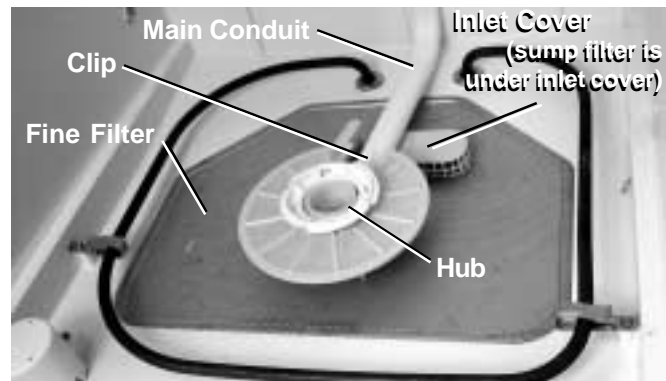
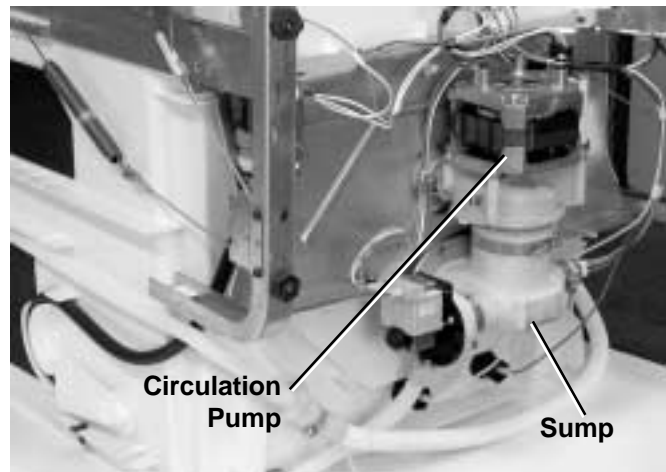

through the hub to the lower spray arm and to the main conduit. The main conduit supplies water to the middle and upper spray arms.

Inlet Cover

Caution: Use care to avoid breaking the clip on the hub when removing the main conduit from hub.

Remove the lower wash arm and main conduit to gain access to the inlet cover and sump.

Fine Filter, Sump Filter, and Sump

The dishwasher must be removed from its installation to gain access to the sump. The sump must be removed to allow removal of the fine filter and sump filter.

Circulation Pump

Note: It is extremely important that the self-tapping ground-wire screw on the circulation pump is tightened securely.

The dishwasher must be removed from its installation to gain access to the circulation pump. The circulation pump can be activated using service mode (refer to the **Service Mode** chapter). Refer to schematic or strip circuit for motor resistance value.

Lower Wash Arm

Lift and rotate (ccw) the lower spray arm to remove it from the hub. Clean the screen on the water return if necessary.

Middle Wash Arm

Refer to illustration for disassembly.

Upper Wash Arm

Remove screw, plastic bearing, and upper wash arm.

L1 Output from J2-1

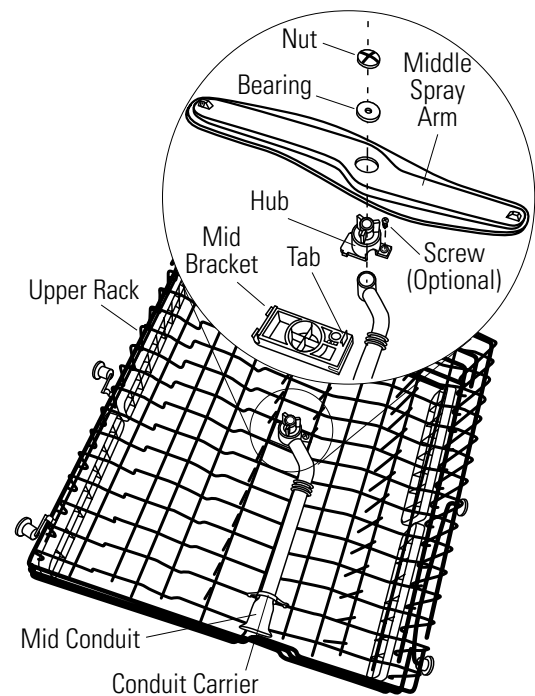
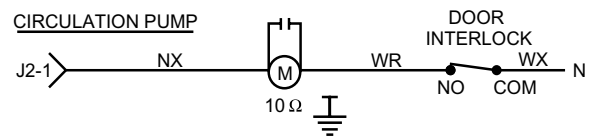

No Water Circulation

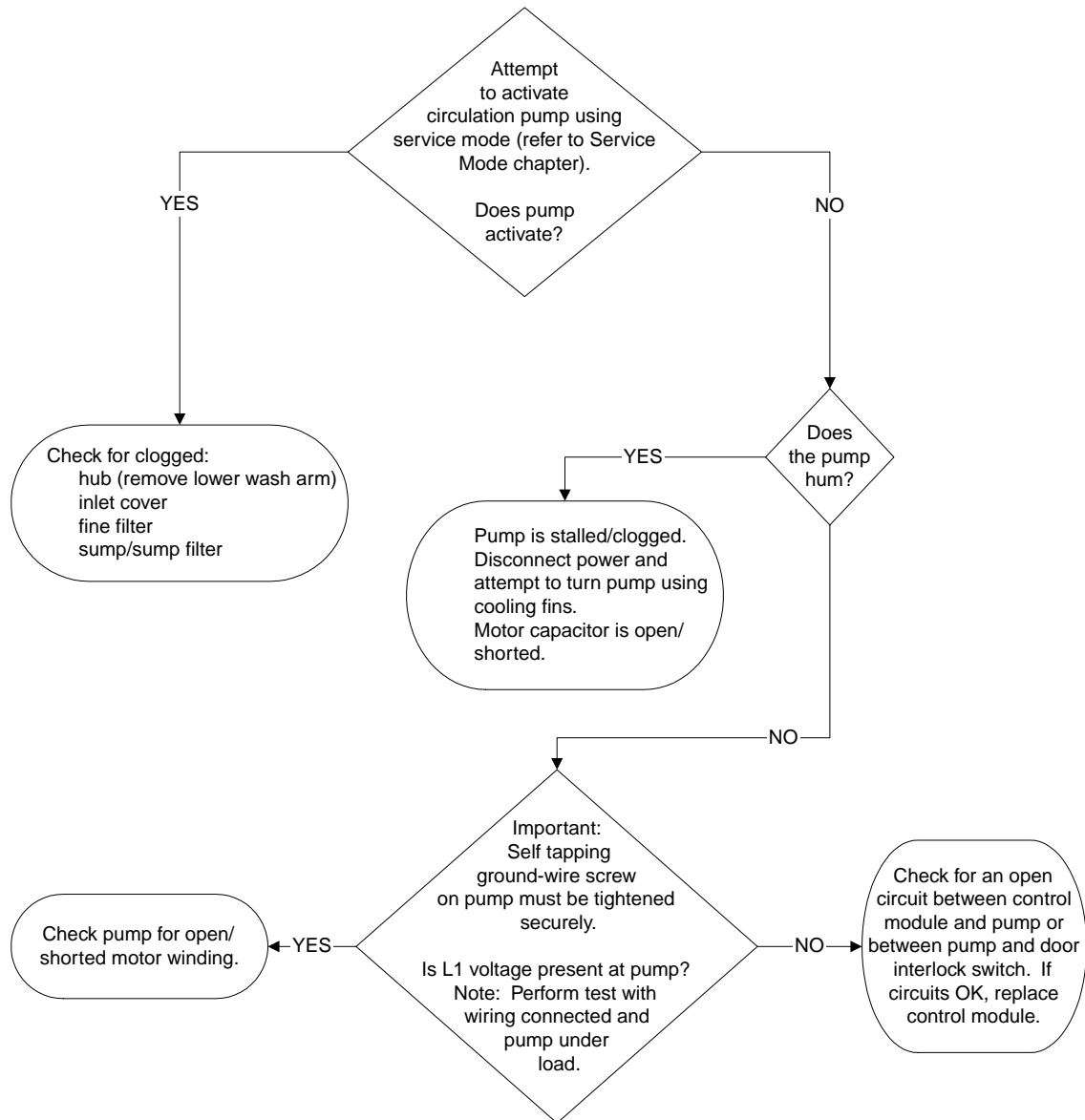

L1 Output from J2-1

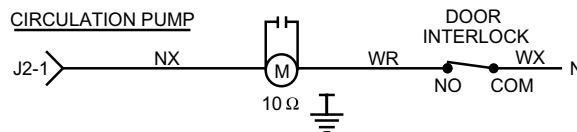

Fill Funnel

The fill funnel is removable with a quarter turn clockwise. There is an O-ring seal between the fill funnel and the dishwasher tub.

Calrod® Heating Element

The heating element can be activated using service mode. Refer to the **Service Mode** chapter.

The dual wattage Calrod® heating element draws 835 W when it is wet to heat the water faster and,

Rotate clockwise 1/4 turn to remove.

O-ring

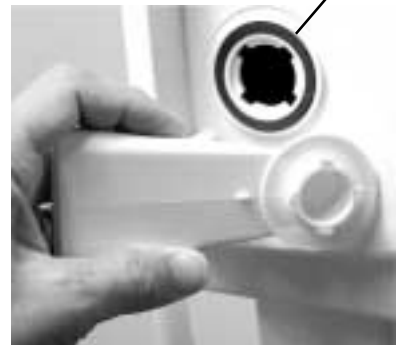

during the drying cycle, drops to 700 W for gentler drying.

Water inlet temperature must be at least 120 °F for proper drying. Low water inlet temperature will prevent proper convection air movement and increase drying time substantially.

If the complaint is the dishes are not drying correctly, don't overlook the rinse agent. A rinse agent will improve the water sheeting action and drying performance.

Replacement

Note: The heating element nuts are located on the underside of the washer, near the back. Ample force is required to remove the nuts. Removing the dishwasher from installation may be required.

1. Disconnect power and remove wire leads from heating element.
2. Unscrew 2 heating element nuts.
3. Remove 2 screws, 2 heating element supports, and the heating element.

Turbidity Sensor

The turbidity sensor measures the amount of suspended particles in the wash water in the sump. As the sump water lays between the 1/4- to 3/8-inch gap between the LED transmitter and the receptor during the first fill, the baseline reading is taken. Successive turbidity measurements are supplied to the control module and used to determine whether any prewash or rinse cycles can be skipped. Decisions are based on a comparison of clean water measurements at the beginning of the first fill, measurements taken at selected fills, and water temperature. By measuring the turbidity level, the control module can conserve energy on lightly soiled loads by skipping unnecessary cycles.

Note: If the turbidity sensor circuit fails open or shorted, the sensing LED on the control panel will **not** light and the unit will operate for the maximum amount of time, using the maximum number of wash and rinse fills for the selected cycle.

The turbidity sensor also contains the thermistor for automatic temperature control.

Turbidity Sensor Test

Factory test mode is the most accurate way to test the turbidity sensor circuit (circuit contains control module, wiring, and turbidity sensor). Refer to the **Factory Test Mode** chapter.

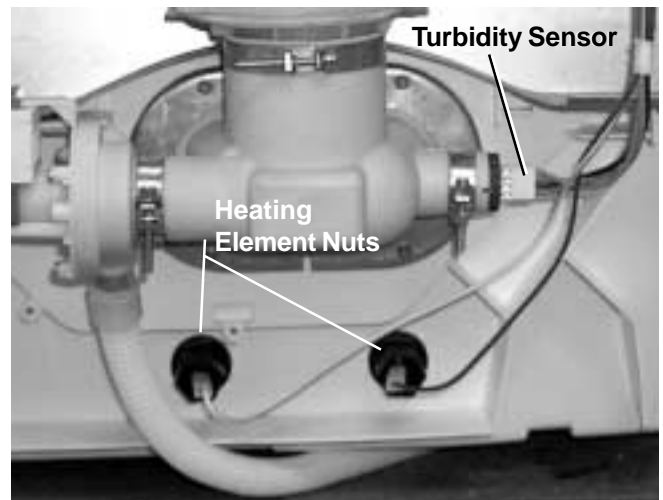
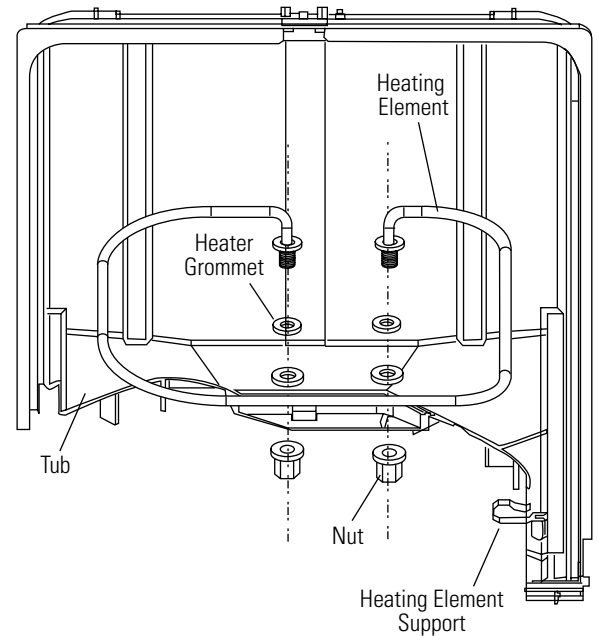
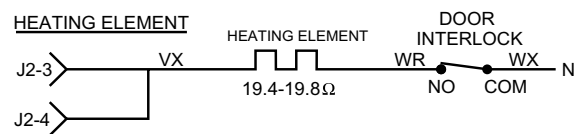

(Bottom View)

TURBIDITY SENSOR

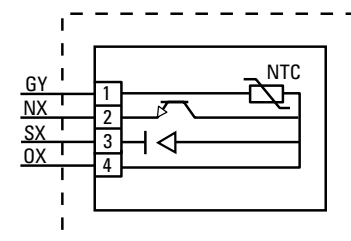

Refer to **Wiring Diagram** for voltages and pin-outs.

Replacement

To remove the turbidity sensor from the side of the sump, loosen the screw and slide the retaining clamp back. Remove turbidity sensor from the sump and unplug connector from the turbidity sensor.

Note: When installing the turbidity sensor, align the key on the sensor with the keyway on the sump.

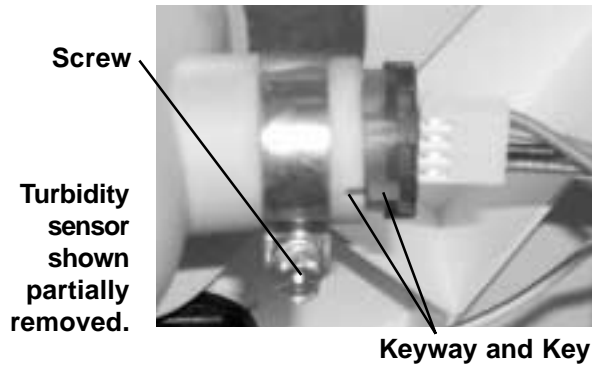

Water Valve and Flood Switch

The water valve is a 120 VAC (L1) solenoid valve that is switched on/off by the control module. The flood switch acts as a safety switch only and does not control normal operation of the water valve. The flood switch opens the L1 side of the water valve circuit.

Water Valve Replacement

The water valve can be replaced with the dishwasher installed.

WARNING: Disconnect power to dishwasher before proceeding.

1. Turn off water supply to dishwasher.
2. Remove toekick.
3. Disconnect house plumbing from dishwasher.
4. Remove 2 screws and valve from dishwasher frame.
5. Disconnect connector.
6. Move clamp up, away from valve, and remove valve from hose.

Note: To prevent leaks after installation, ensure that hose-to-valve connection is good and that clamp is in place.

Water Valve Test

1. Attempt to activate water valve using service mode (see **Service Mode** chapter). Pump out water as necessary using service mode. If an intermittent failure is suspected, activate water valve 5 times using service mode. Water valve should stay on for 50 - 71 seconds per activation and should not turn on and off during the 50 - 71 second activation time.
2. If the water valve is not operating properly or

WATER VALVE AND FLOOD SWITCH

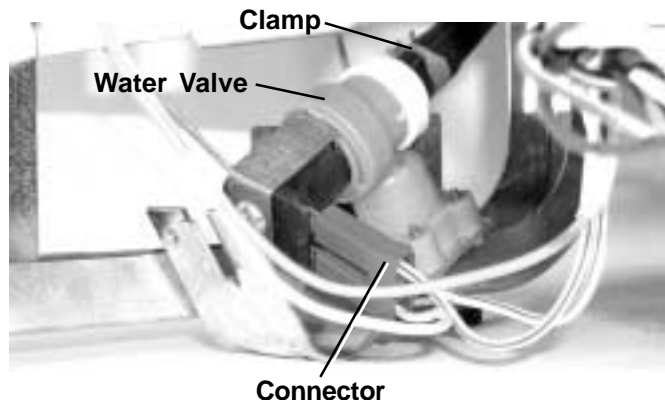
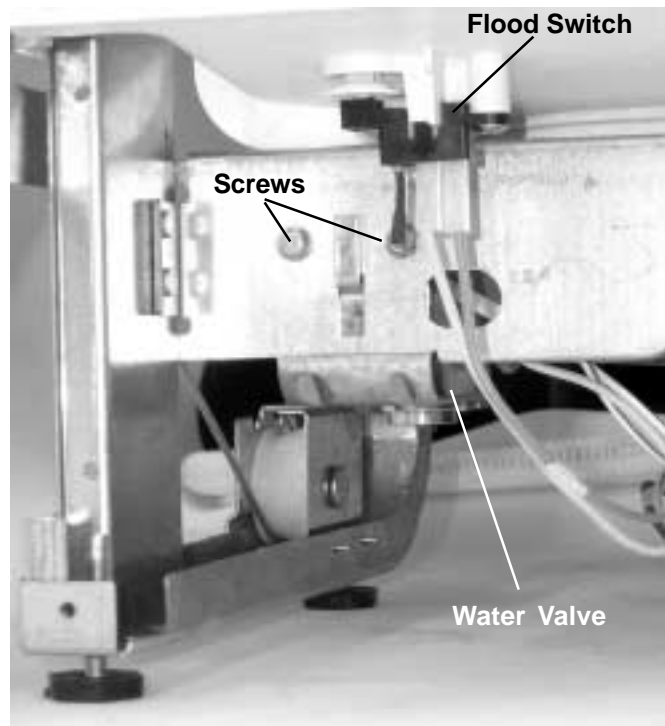
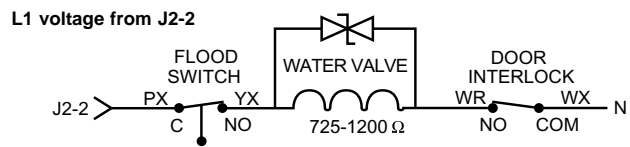

water level is low, check the following:

- Flood switch, flood switch float, and float stem - Flood switch should open when water level is approximately 1/4 in. above the base (bottom) of the float dome.
- Resistance through the water valve solenoid coil - Check from yellow wire at flood switch to white/red wire at door interlock switch (Escutcheon keypad assembly must be removed, refer to **Escutcheon Keypad Assembly** section).
- Clogged screen in water valve.

Caution: After removing the screws from the escutcheon keypad assembly, the assembly is **still attached** to the control module by 2 ribbon cables. Dropping or rough handling of the escutcheon will cause the ribbon cable to tear, and the entire escutcheon keypad assembly will need to be replaced.

Active Vent

The active vent helps to reduce the noise level and heat loss when in the closed position. The control module supplies +/- 12 VDC to the motor. The control module reverses polarity to drive the motor in a clockwise or counterclockwise (open or closed) direction. The vent is closed during the wash cycle and open during the drying cycle (heated and non-heated) and when the unit is not in use. If the vent is closed and the door is opened during the wash cycle, the vent will open. When the door is closed again, the vent will remain open for seven (7) seconds, then close again to finish the cycle.

It is normal for steam to come through the active vent during the dry cycle.

The active vent can be opened and closed using the service mode. Refer to the **Service Mode** chapter.

The active vent can be accessed by removing the escutcheon keypad assembly (see **Escutcheon Keypad Assembly** section).

IMPORTANT: When reassembling, the active vent flapper must be closed before the escutcheon keypad assembly is installed. Close the active vent flapper by turning the worm gear by hand. Failure to do so will cause a misalignment and an increase in noise level.

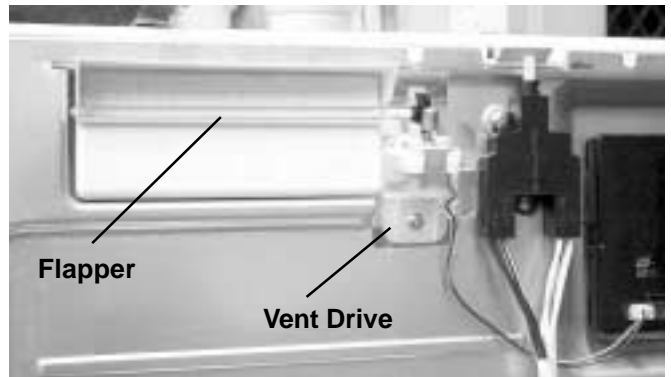
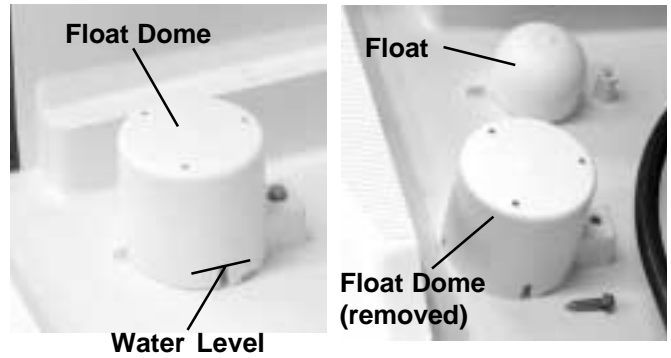

ACTIVE VENT

+ or - 12 VDC at J5-1
+ or - 12 VDC at J5-2

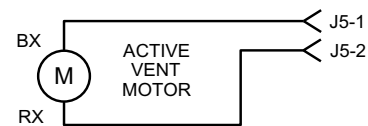

Flashing Display Lights

The status display tells you what's happening while the dishwasher is in operation and may flash, indicating a malfunction. The lights will come on indicating the sequence of operation the dishwasher is in.

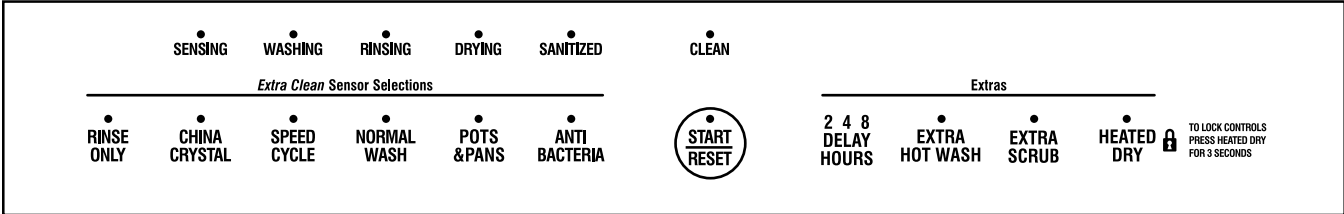

FLASHING DISPLAY LIGHTS

<i>Status Indicator Lights</i>	<i>What It Means</i>
START/RESET	Cycle has been interrupted by pressing the START/RESET keypad. Light will quit flashing after the dishwasher automatically drains out the water.
CLEAN	Unit has no water. Check the water supply. If water is turned on call for service.

Service Mode

THIS DISHWASHER IS PROGRAMMED WITH A SERVICE MODE TO AID THE TECHNICIAN IN TROUBLESHOOTING THE DISHWASHER. EACH COMPONENT MAY BE CYCLED TO DETECT IF IT IS FUNCTIONING CORRECTLY. COMPONENTS ARE CYCLED BY PRESSING KEYPADS TO THE RIGHT OR LEFT OF THE START/RESET KEYPAD. DETERMINE WHICH TYPE OF CONTROL PANEL IS PRESENT (FLAT OR BOWED) AND THEN USE THE MATRIX BELOW TO DETERMINE HOW TO CYCLE EACH COMPONENT.

FLAT PANEL

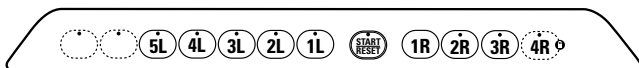

○ Indicates Keypad Used Only on Some Models

BOWED PANEL

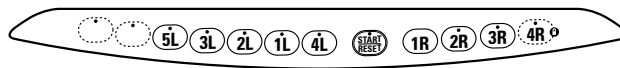

○ Indicates Keypad Used Only on Some Models

TO ENTER SERVICE MODE :

PRESS THE COOKWARE (POTS & PANS ON SOME MODELS) AND THE HEATED DRY KEYPAD SIMULTANEOUSLY FOR 3 SECONDS.

TO EXIT SERVICE MODE :

PRESS THE START/RESET KEYPAD AT ANYTIME TIME TO EXIT.

TRITON XL SERVICE MODE TEST MATRIX *

KEYPAD		DESCRIPTION	TIME in seconds**
PAD	CONTROL TYPE		
Keypads to the left of the Start/Reset keypad (Selections)			
1L	FLAT	Activates Drain Pump	75
	BOWED	Activates Detergent Module	
2L	FLAT	Activates Detergent Module	60
	BOWED	Activates Main Pump	
3L	FLAT	Activates Main Pump	75
	BOWED	Activates Heating Element	
4L	FLAT	Activates Heating Element	300
	BOWED	Activates Drain Pump	
5L	FLAT	Activates Water Valve (Length of time is model dependent)	50 or 71
	BOWED		
START/RESET Used to EXIT Service Mode			
Keypads to the right of the Start/Reset keypad (Enhancement/Extras)			
1R	FLAT	Activates the following in order: Status LEDs; Wash LEDs; Start/Reset and Option LEDs; finally "888" will be shown on the 3 digit display (some models)	3 seconds each cycle
	BOWED		
2R	FLAT	Opens Active Vent	
	BOWED		
3R	FLAT	Closes Active Vent	
	BOWED		

*NOTE : Service mode may be used for 30 minutes maximum. After 30 minutes the service mode will automatically turn off.

**NOTE : Component will be activated for indicated time. Component may be deactivated by pressing the same keypad that was pressed to activate the component.

Factory Test Mode

Factory test mode is the most accurate way to test the turbidity sensor circuit (circuit contains control module, wiring, and turbidity sensor). Factory test mode will test the thermistor (used for Automatic Temperature Control) that is contained in the turbidity sensor and will test the transmitter that is contained in the turbidity sensor.

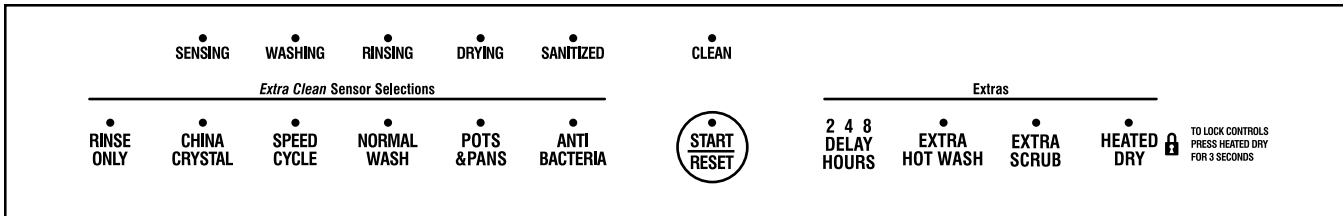

Entering Factory Test Mode

Note: This mode can only be entered within the first 2 minutes after power-up. After 2 minutes, factory test mode is unavailable.

1. Disconnect power from dishwasher. Wait 10 seconds and connect power to dishwasher.
2. Press the NORMAL WASH keypad and POTS & PANS (or COOK WARE) keypad at the same time for 5 seconds (This step must be performed within 2 minutes of power-up).
3. The following sequence should occur:
 - a. All LEDs illuminate for a short period of time.
 - b. Water valve activates. The dishwasher will fill for the appropriate amount of time.
 - c. Circulation pump activates. The dishwasher will circulate for approximately 1 minute.
 - d. Turbidity sensor check. The control module will check the thermistor circuit, the turbidity (transmitter) circuit, and calibrate itself to the turbidity sensor (transmitter). The turbidity sensor check lasts for 20 to 30 seconds.
 - If the turbidity sensor check fails, the control

module will beep continuously and the Lock LED will be illuminated. The control module, wiring, and turbidity sensor are suspect if the turbidity sensor check fails. Press any keypad to stop the control module beeping and move to the next step in the factory test mode sequence.

- If the turbidity sensor check passes, the control module will automatically move to the next step in the factory test mode sequence.
- e. Drain pump activates. Allow the dishwasher to pump out all water (approximately 75 seconds). After the water has been pumped out, the dishwasher will begin to fill again. Press the START/RESET keypad while the dishwasher is filling. The dishwasher will then pump out for approximately 2 minutes and then return to normal operation. The dishwasher will automatically exit factory test mode 1 hour and 10 minutes after the test was initiated if the START/RESET keypad is not pressed to exit.

Washability Complaints

Hot Water – Ample supply of water at a minimum temperature of **120 °F** is necessary. Do **not** use dishwasher soon after using clothes washer or filling bath tub.

Loading – Consult Owner's Manual on loading procedures.

Amount of Water – Make sure dishwasher is level. Check water level, allowing dishwasher to fill normally for first fill. **The water level should be to the base (bottom) of the float dome.** If water level is low, check for clogged screen in water valve and check flood switch. Refer to the **Water Valve and Flood Switch** section.

Detergent/Rinse Module Leakage – Some moisture in cup is normal. Detergent must not be soaking wet, oozing out and down the inner door panel. If a leak is detected, check the detergent/rinse module door lid, latch operation, and gasket seal. Also refer to the **Detergent/Rinse Module** section.

Proper Amount of Detergent – Use full detergent cup of fresh detergent in hard water. Use only enough detergent to get good wash performance in soft water.

Rinse Agent – Use rinse agent if spotting or drying is a problem. A rinse agent will improve the water sheeting action and drying performance.

Water Valve – Refer to the **Water Valve and Flood Switch** section.

Spray Arm – Check to be sure all 3 spray arms spin freely and jets are not clogged. Check to be sure the middle spray arm water conduit is connecting properly to the main conduit.

Drying – Water inlet temperature must be at least 120 °F for proper drying. Low water inlet temperature will prevent proper convection air movement and increase drying time substantially.

A rinse agent will improve the water sheeting action and drying performance.

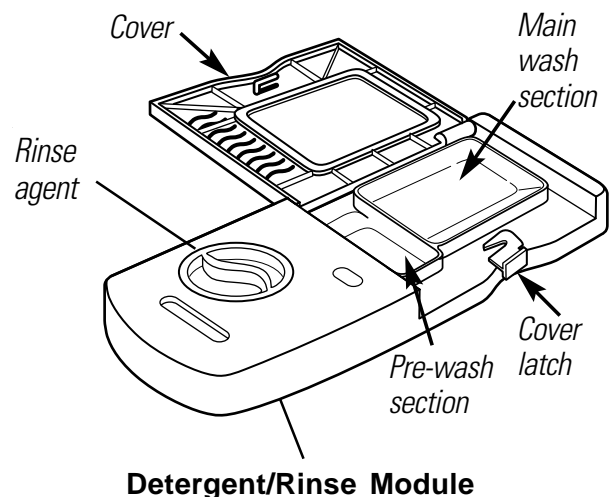
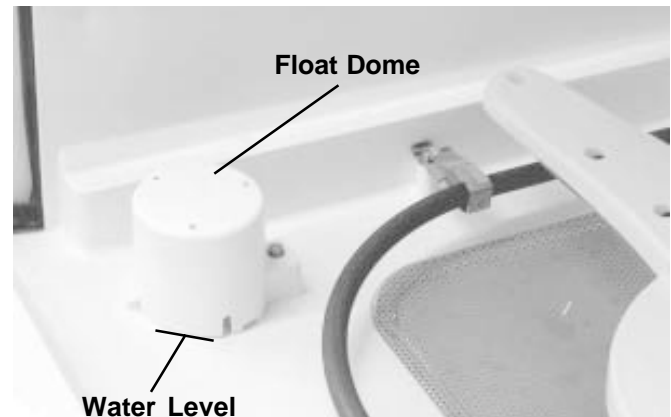

Cycle Progression Chart

	NORMAL WASH (CLEAN) (DIRTY)		SPEED CYCLE	GLASSES CYCLE	CHINA CRYSTAL	POTS & PANS	ANTI- BACTERIA	RINSE ONLY
	140 °F*	140 °F*	140 °F*	130 °F*	130 °F*	145 °F*	160 °F*	-
MAX TEMP								
	fill time	49 / 70 sec	49 / 70 sec	50 / 71sec	50 / 71sec	50 / 71sec	50 / 71sec	50 / 71sec
	fill quantity	1.4 gal	1.4 gal	1.43 gal	1.43 gal	1.43 gal	1.43 gal	1.43 gal
	detergent cup	after 3 minutes	no	no	no	no	no	no
	calrod	after 3 minutes	no	yes	yes	yes	yes	no
cycle time	19 minutes	1 - 8 minutes	1 - 2 minutes	1 - 2 minutes	1 minute	1 - 8 minutes	1 minute	1 minute
FIRST FILL	fill time	49 / 70 sec	49-50 / 70-71	50 / 71 sec	49-50 / 70-71	49-50 / 70-71	50 / 71 sec	50 / 71 sec
	fill quantity	1.4 gal	1.4 - 1.43 gal	1.43 gal	1.4 - 1.43 gal	1.4 - 1.43 gal	1.43 gal	1.43 gal
	detergent cup	no	no	no	no	no	no	no
	calrod	no	no	yes	yes	yes	yes	no
	cycle time	5 minutes	1 - 8 minutes	1 - 2 minutes	1 - 8 minutes	1 - 8 minutes	1 - 8 minutes	1 minute
SECOND FILL	fill time	49 / 70 sec	49 / 70	50 / 71 sec	49-50 / 70-71	49-50 / 70-71	50 / 71 sec	50 / 71 sec
	fill quantity	1.4 gal	1.4 gal	1.43 gal	1.4 - 1.43 gal	1.4 - 1.43 gal	1.43 gal	1.43 gal
	detergent cup	no	no	no	no	no	no	no
	calrod	no	no	yes	yes	yes	yes	no
	cycle time	5 minutes	1 - 8 minutes	1 - 2 minutes	1 - 8 minutes	1 - 8 minutes	1 - 8 minutes	1 minute
THIRD FILL	fill time	49 / 70 sec	49 / 70	50 / 71 sec	49-50 / 70-71	49-50 / 70-71	50 / 71 sec	50 / 71 sec
	fill quantity	1.4 gal	1.4 gal	1.43 gal	1.4 - 1.43 gal	1.4 - 1.43 gal	1.43 gal	1.43 gal
	detergent cup	no	no	no	no	no	no	no
	calrod	no	no	yes	yes	yes	yes	no
	cycle time	5 minutes	1 - 8 minutes	1 - 2 minutes	1 - 8 minutes	1 - 8 minutes	1 - 8 minutes	1 - 8 minutes
FOURTH FILL	fill time	49 / 70 sec	-	-	-	-	50 / 71 sec	-
	fill quantity	1.4 gal	-	-	-	-	1.43 gal	-
	detergent cup	(rinse aid)	-	-	-	-	no	-
	calrod	yes	-	-	-	-	yes	-
	cycle time	9 minutes	-	-	-	-	1 - 10 minutes	-
POWER PRE-SOAK OPTION	fill time	#	50 / 71 sec	50 / 71 sec	50 / 71 sec	50 / 71 sec	50 / 71 sec	50 / 71 sec
	fill quantity	#	1.43 gal	1.43 gal	1.43 gal	1.43 gal	1.43 gal	1.43 gal
	detergent cup	#	no	no	no	no	no	no
	calrod	#	yes	yes	yes	yes	yes	yes
	cycle time	#	13 minutes	13 minutes	13 minutes	13 minutes	13 minutes	13 minutes
MAIN WASH	fill time	-	49-50 / 70-71	50 / 71 sec	50 / 71 sec	50 / 71 sec	50 / 71 sec	50 / 71 sec
	fill quantity	-	1.4 - 1.43 gal	1.43 gal	1.43 gal	1.43 gal	1.43 gal	1.43 gal
	detergent cup	-	yes	yes	yes	yes	yes	yes
	calrod	-	yes	yes	yes	yes	yes	yes
	cycle time	-	15 - 30 minutes	15 - 10 minutes	5 minutes	5 minutes	20 - 40 minutes	5 minutes
MW EXTEND	if temp not reached, main wash enters extend time	-	130 F	-	-	110 F	140 F	130 F
		-	15 minutes	-	-	10 minutes	15 minutes	15 minutes
		-	15 minutes	-	-	10 minutes	15 minutes	15 minutes
FIRST RINSE	fill time	-	49 / 70 sec	50 / 71 sec	50 / 71 sec	50 / 71 sec	50 / 71 sec	50 / 71 sec
	fill quantity	-	1.4 gal	1.43 gal	1.43 gal	1.43 gal	1.43 gal	1.43 gal
	detergent cup	-	no	no	no	no	no	no
	calrod	-	no	yes	yes	yes	yes	yes
	cycle time	-	5 minutes	5 minutes	6 minutes	6 minutes	5 minutes	5 minutes
SECOND RINSE	fill time	-	49 / 70 sec	50 / 71 sec	50 / 71 sec	50 / 71 sec	50 / 71 sec	50 / 71 sec
	fill quantity	-	1.4 gal	1.43 gal	1.43 gal	1.43 gal	1.43 gal	1.43 gal
	detergent cup	-	no	no	no	no	no	no
	calrod	-	no	yes	yes	yes	yes	yes
	cycle time	-	5 minutes	5 minutes	2 minutes	5 minutes	5 minutes	5 minutes
THIRD RINSE	fill time	-	49 / 70 sec	-	50 / 71 sec	50 / 71 sec	50 / 71 sec	50 / 71 sec
	fill quantity	-	1.4 gal	-	1.43 gal	1.43 gal	1.43 gal	1.43 gal
	rinse aid	-	yes	-	yes	yes	yes	yes
	calrod	-	yes	-	yes	yes	yes	yes
	cycle time	-	9 minutes	-	8 minutes	9 minutes	9 minutes	1 - 60 minutes
HI-TEMP OPTION	cycle time	fourth fill extended to 25 minutes	extended rinse extended to 25 minutes	second rinse extended to 14 minutes	third rinse extended to 22 minutes	third rinse extended to 25 minutes	third rinse extended to 25 minutes	no effect, third rinse run time is determined by sanitation requirements
DRY		30 minutes**	30 minutes**	8 minutes**	30 minutes**	30 minutes**	30 minutes**	15 minutes cool & 15 minutes dry**

* When maximum temperature is reached and the calrod is on the calrod will be cycled on and off.

**Heater is on for the first 6 minutes then cycles.

The CLEAN NORMAL run will insert the pre-soak after 3 minutes into the first fill. The cycle will be a NORMAL with dirty water where the first fill is 3 minutes, and the second and third fills are skipped.

Wiring Diagram

WARNING: Power **must** be disconnected before servicing the appliance.

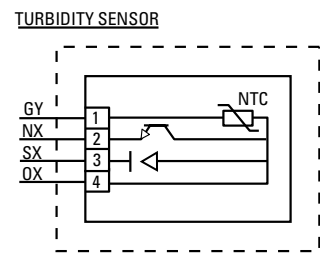
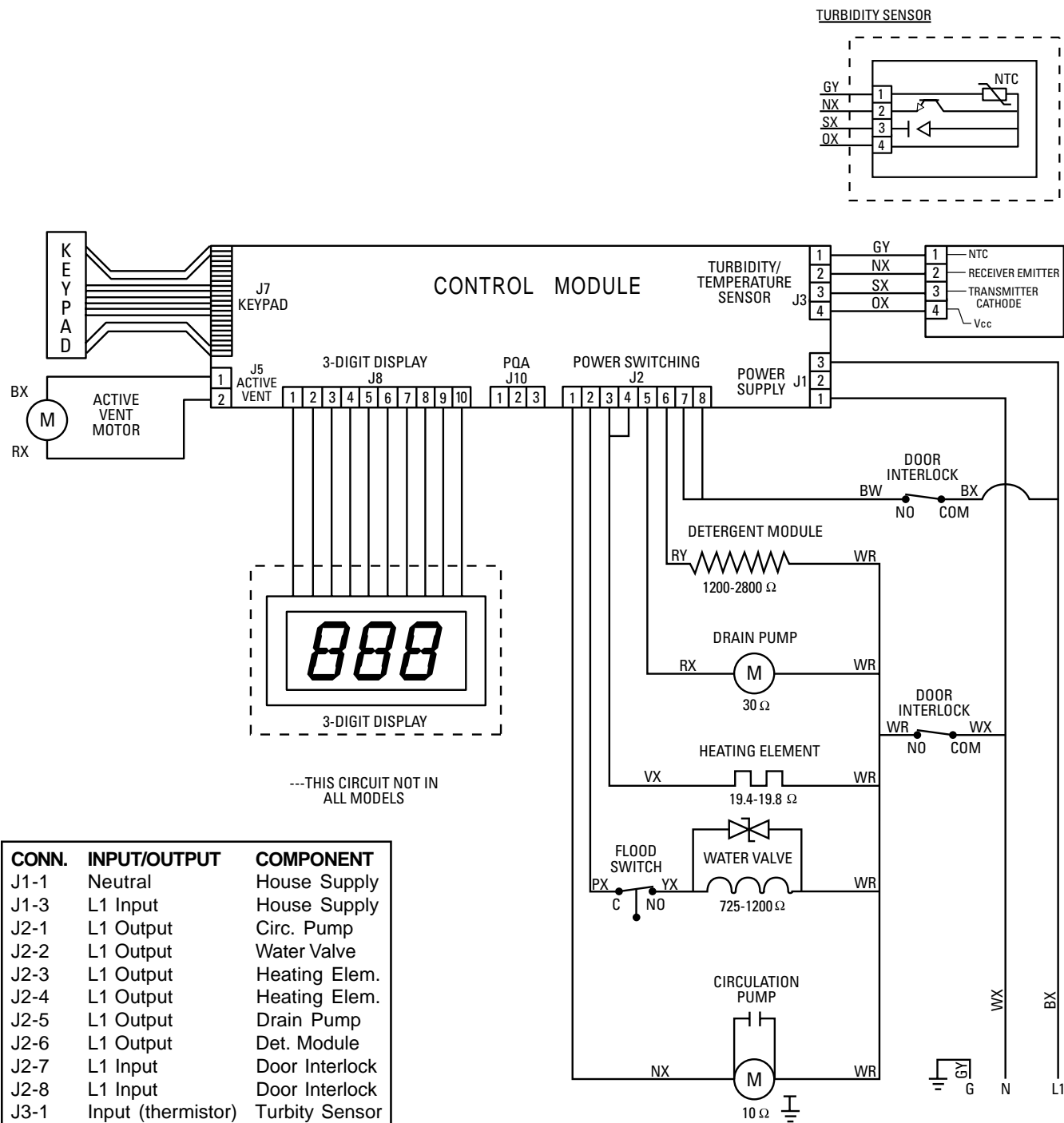

---THIS CIRCUIT NOT IN ALL MODELS

CONN.	INPUT/OUTPUT	COMPONENT
J1-1	Neutral	House Supply
J1-3	L1 Input	House Supply
J2-1	L1 Output	Circ. Pump
J2-2	L1 Output	Water Valve
J2-3	L1 Output	Heating Elem.
J2-4	L1 Output	Heating Elem.
J2-5	L1 Output	Drain Pump
J2-6	L1 Output	Det. Module
J2-7	L1 Input	Door Interlock
J2-8	L1 Input	Door Interlock
J3-1	Input (thermistor)	Turbidity Sensor
J3-2	Input (turbidity)	Turbidity Sensor
J3-3	0 to 5 VDC output*	Turbidity Sensor
J3-4	5 VDC output*	Turbidity Sensor
J5-1	+ or - 12 VDC*	Active Vent
J5-2	+ or - 12 VDC*	Active Vent

*Measure voltage with black test lead connected to J10-1.

COLOR CODE			
LETTERS	COLOR	LETTERS	COLOR
AX	LT. BLUE	RX	RED
BX	BLACK	SX	GRAY
CX	BROWN	TX	TAN
NX	DK. BLUE	VX	PURPLE
OX	ORANGE	WX	WHITE
PX	PINK	YX	YELLOW

THE "X" INDICATES ONE SOLID COLOR- NO TRACER. WIRES WITH TRACER SHOW BOTH COLORS. EXAMPLE -WR IS WHITE WITH RED TRACER.

Parts List

Door

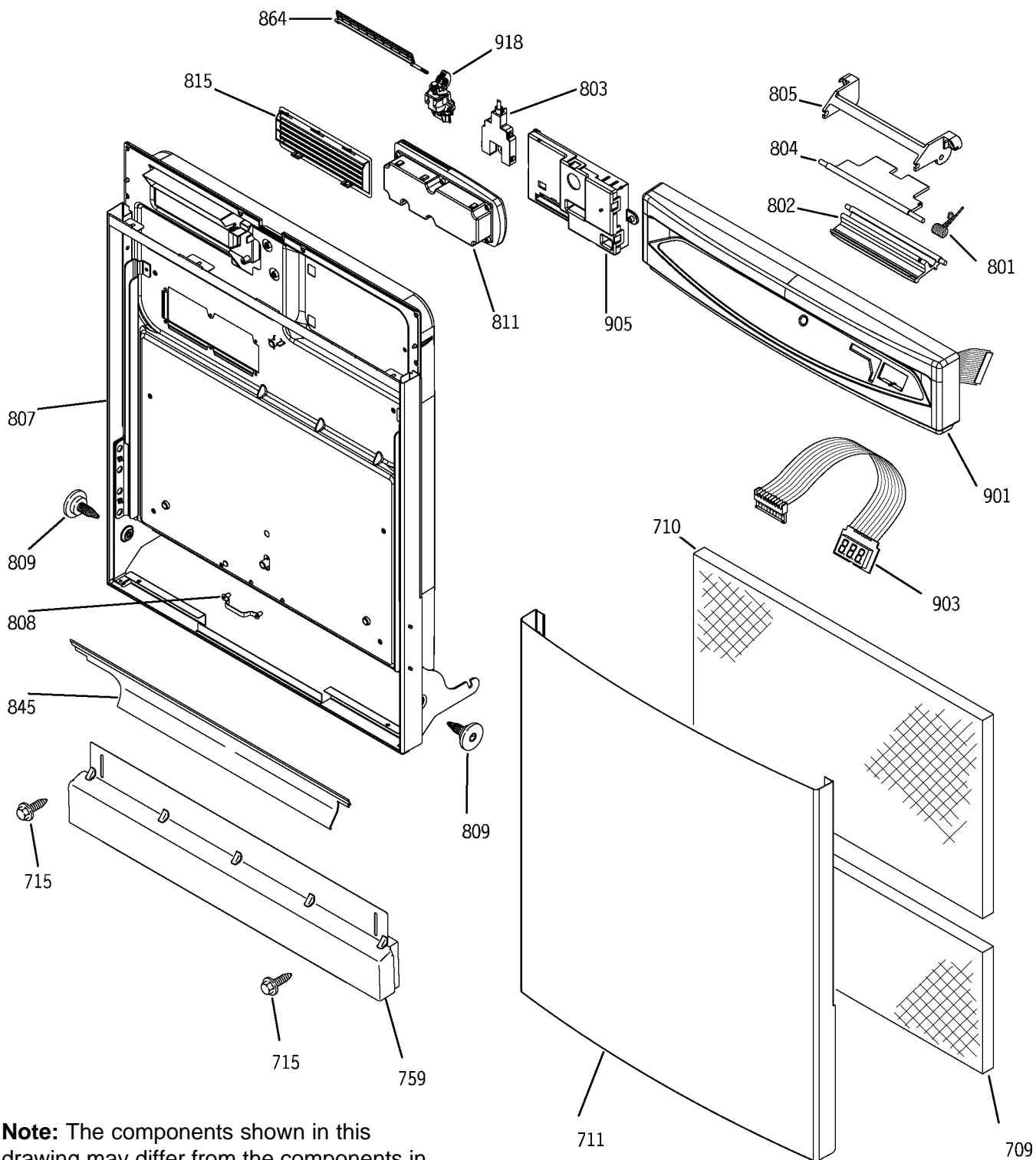

Note: The components shown in this drawing may differ from the components in your unit. Refer to the microfiche or GEA IPC for the component and part number for your unit.

Body Parts

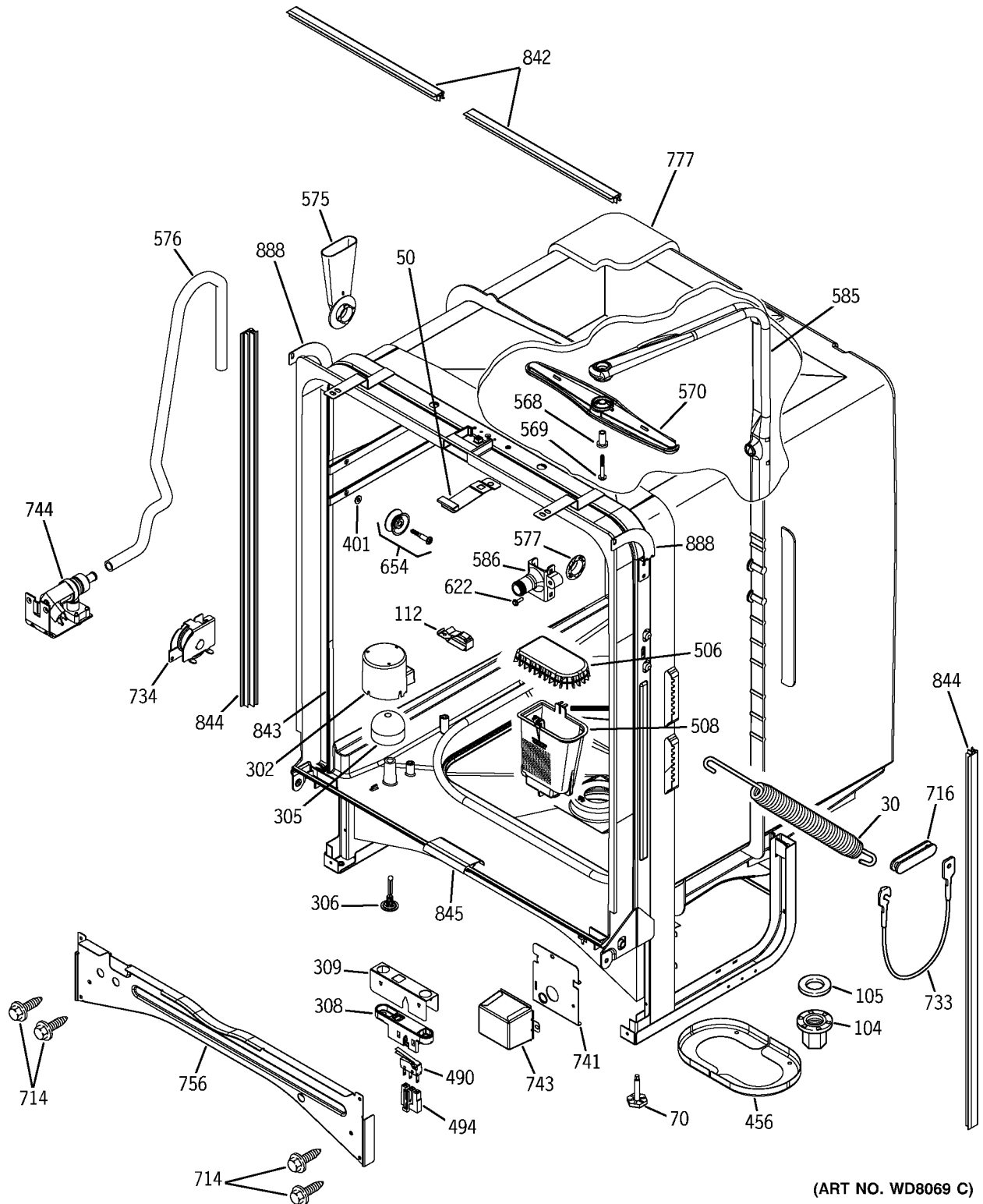

(ART NO. WD8069 C)

Note: The components shown in this drawing may differ from the components in your unit. Refer to the microfiche or GEA IPC for the component and part number for your unit.

Upper Rack

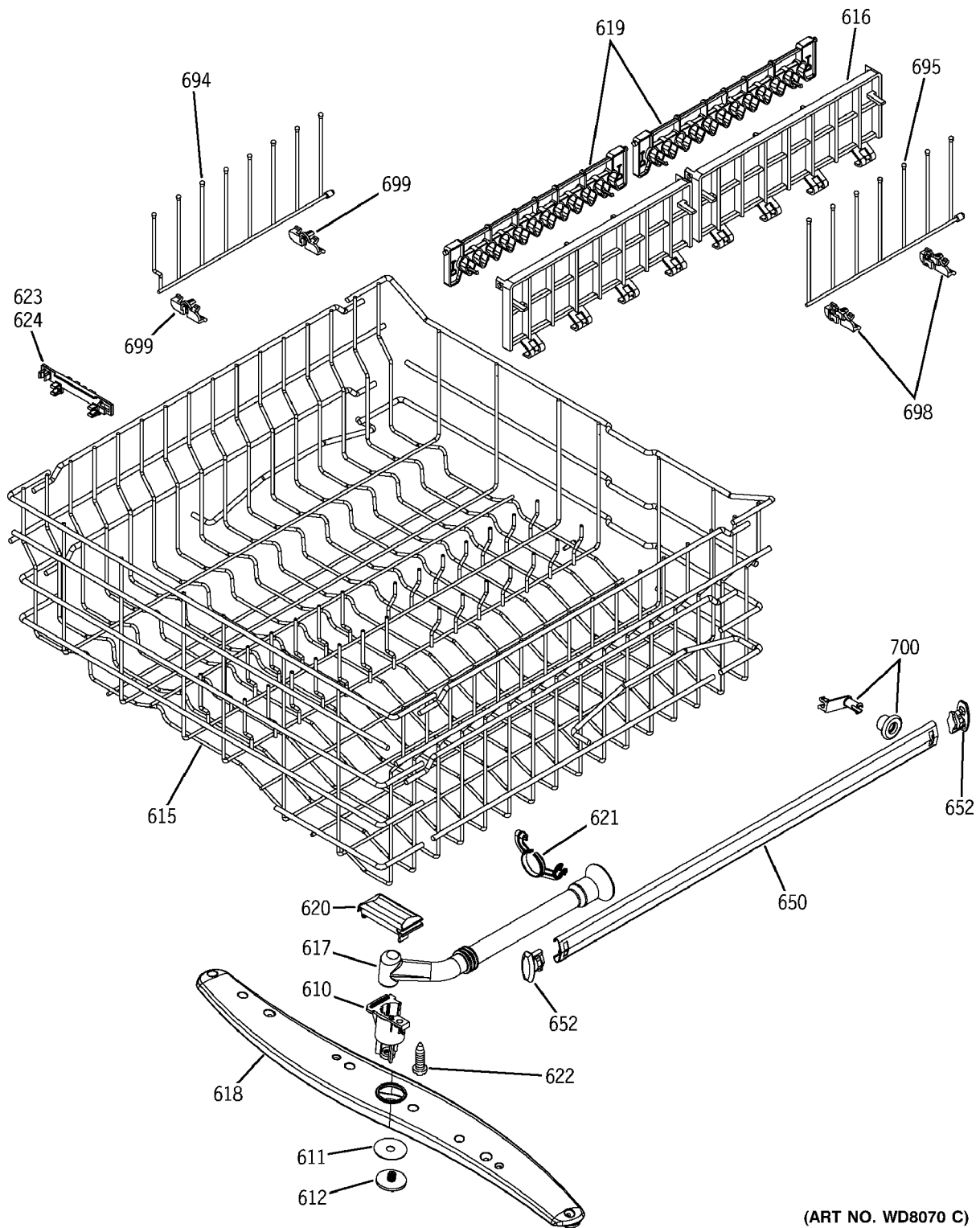

(ART NO. WD8070 C)

Note: The components shown in this drawing may differ from the components in your unit. Refer to the microfiche or GEA IPC for the component and part number for your unit.

Lower Rack

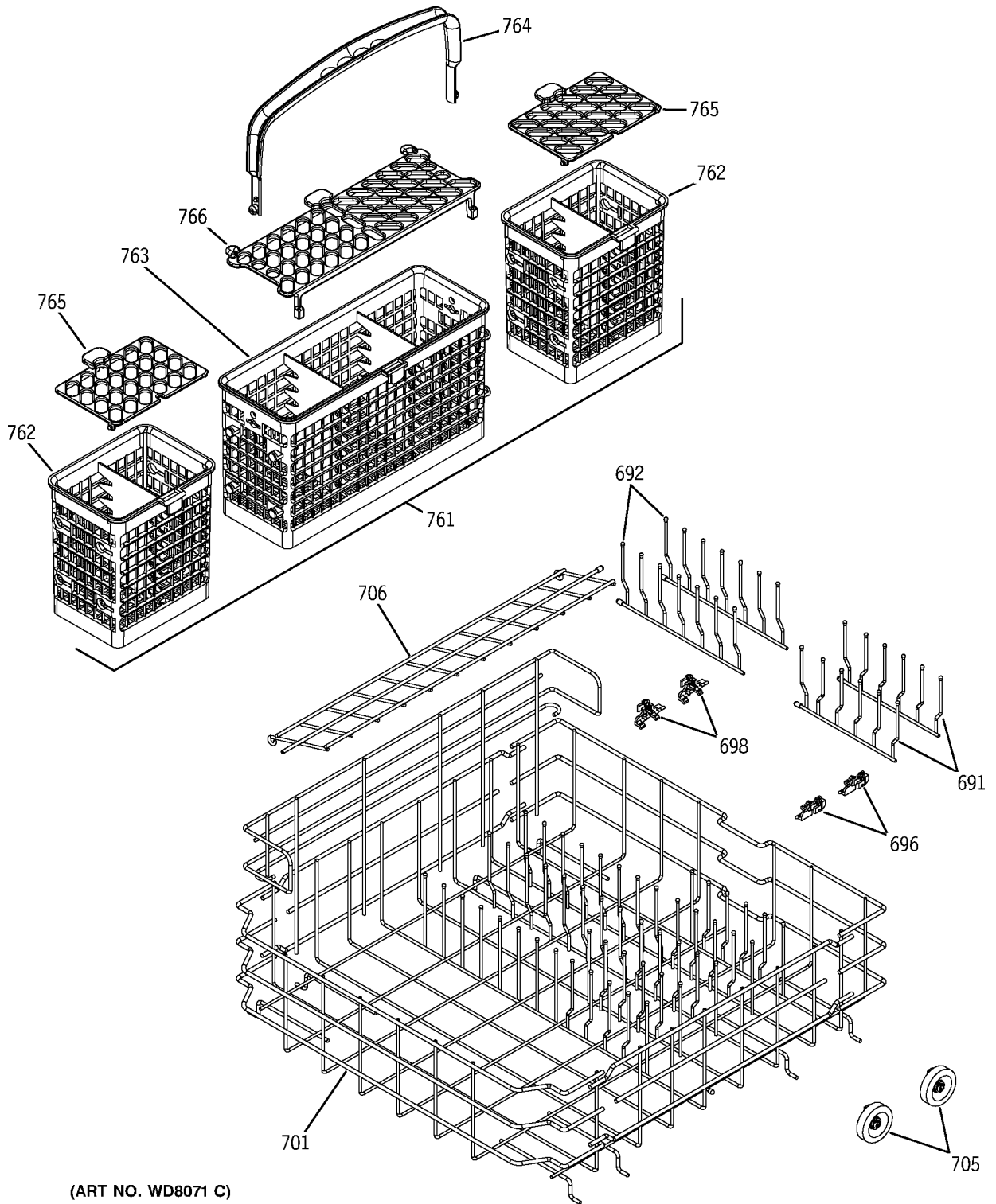

(ART NO. WD8071 C)

Note: The components shown in this drawing may differ from the components in your unit. Refer to the microfiche or GEA IPC for the component and part number for your unit.

Pumps and Filters

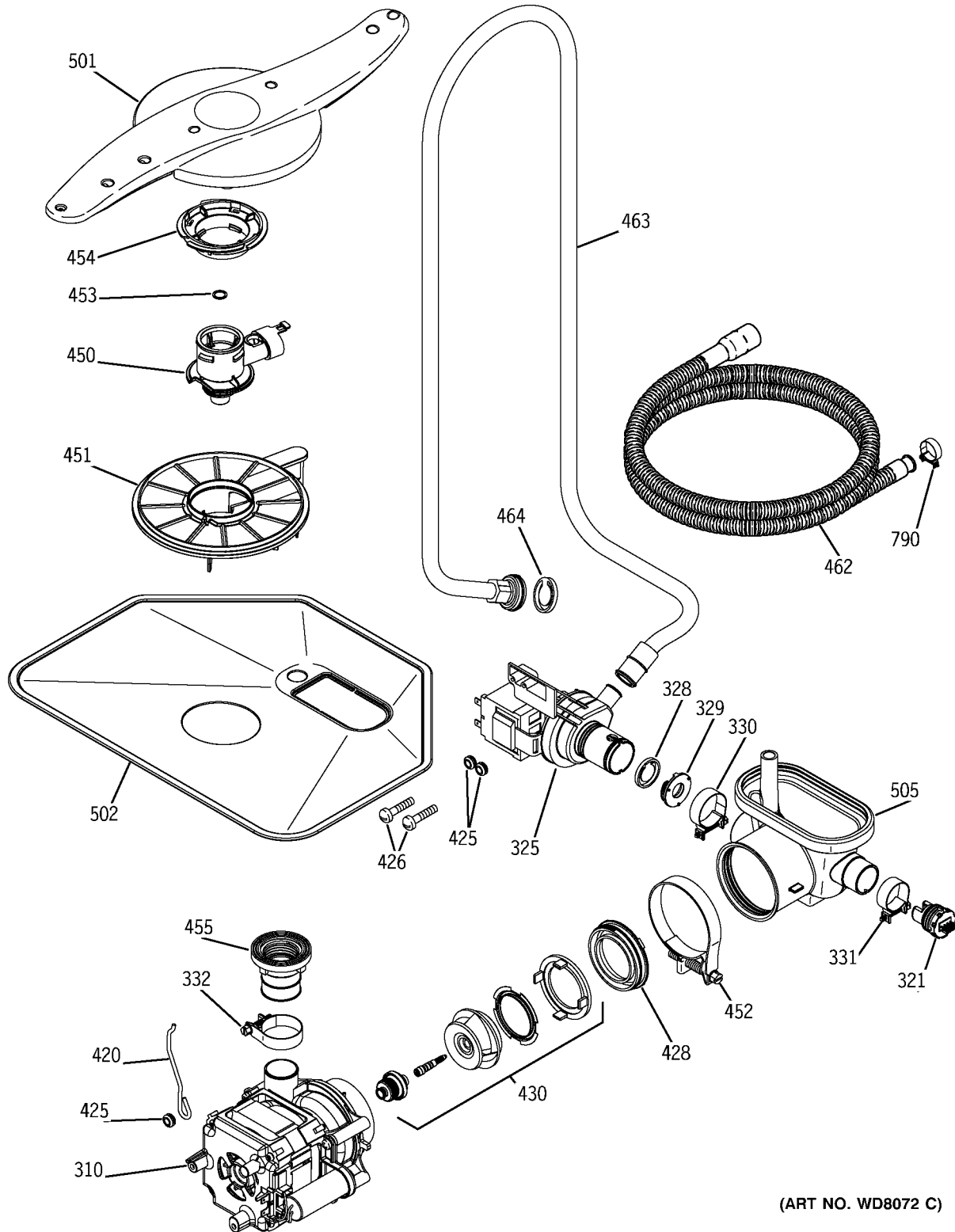

(ART NO. WD8072 C)

Note: The components shown in this drawing may differ from the components in your unit. Refer to the microfiche or GEA IPC for the component and part number for your unit.

Note: The components shown in this drawing may differ from the components in your unit. Refer to the microfiche or GEA IPC for the component and part number for your unit.

Ref #	Part #	Description	Qty
1	31-30365	PM SHEET MINI MANUAL	1
1	31-30530	PM INSTRUCTION INSTALL	1
1	49-5908	PM MANUAL USE & CARE	1
30	WD03X10014	SPRING	2
42	WZ4X376D	SCR 10-16X3/4 #8 HX SSTL	3
50	WD13X10006	KEEPER LATCH ASM	1
51	WD02X10066	SCR 10-24X1/2 TT TRR S	1
70	WD02X0320	SCREW LEVEL	4
101	WD05X10005	ELEMENT HEATING ASM	1
104	WD01X10097	NUT TOWER HEATER	2
109	WD01X10094	GROMMET HEATER	2
112	WD01X10098	SUPPORT HEATER	2
302	WD12X10051	DOME FLOAT	1
305	WD12X10047	FLOAT	1
306	WD12X10048	STEM FLOAT	1
308	WD12X10043	HOUSING FLOOD SWITCH	1
309	WD12X10058	SHIELD FLOOD SW	1
310	WD26X10015	MECHANISM ASM	1
321	WD21X10118	SENSOR TURBIDITY	1
325	WD26X10016	PUMP DRAIN ASM	1
330	WD01X10103	CLAMP	1
331	WD01X10104	CLAMP	1
332	WD01X10105	CLAMP	1
401	WD03X0767	WASHER ST STL	8
414	WD02X0444	SCREW MECH HANGER	4
420	WD01X10093	HANGER MECH ASM	1
425	WD01X10101	GROMMET	3
428	WD12X10060	RING SUCTION	1
429	WD19X10032	KIT IMPELLER ASM	1
450	WD18X10009	HUB VENTURI ASM	1
452	WD01X1392	CLAMP, SUMP	1
453	WD01X10107	BEARING SPRAY ARM LOW	1
454	WD12X10061	NUT HUB FINE FILTER	1
455	WD18X10010	CONNECTOR PUMP ASM	1
456	WD01X10106	RING SUMP	2
462	WD24X10014	HOSE DRAIN	1
463	WD24X10020	TUBE DRAIN ASM	1
490	WD21X10119	SWITCH FLOOD	1
494	WD01X10088	HOUSING SPECIAL -DRAIN	1
501	WD22X10030	ARM SPRAY LOW ASM	1
502	WD22X10029	FILTER COARSE	1
505	WD18X10008	SUMP INLET	1
506	WD12X10049	COVER INLET	1
507	WD12X10050	FILTER FINE ASM	1
508	WD22X10028	FILTER SUMP	1
568	WD01X10108	BEARING SPRAY ARM MID	1
569	WD02X10068	SCR 8-16 B HXW 1.08 SS	1
570	WD22X10027	ARM SPRAY UPPER ASM	1
575	WD12X10056	FUNNEL FILL	1
576	WD24X10019	HOSE FILL	1
577	WD08X10020	GASKET FUNNEL FILL	1

Note: The components shown in this drawing may differ from the components in your unit. Refer to the microfiche or GEA IPC for the component and part number for your unit.

Ref #	Part #	Description	Qty
585	WD12X10057	CONDUIT MAIN	1
586	WD12X10059	CONE DOCKING	1
610	WD12X10066	HUB SPRAY ARM MID	1
611	WD01X10102	BEARING SPRAY ARM UP	1
612	WD01X10109	NUT HUB MID	1
615	WD28X10074	RACK UPPER ROLL ASM	1
616	WD28X10012	SHELF MULTI PURPOSE	2
617	WD12X10052	CONDUIT SPRAY ARM MID	1
618	WD22X10031	ARM SPRAY MID ASM	1
619	WD28X10013	GRIPPER STEMWARE	2
620	WD12X10053	BRACKET SPRAY ARM MID	1
621	WD12X10054	CONDUIT CARRIER MID	1
622	WD02X10067	SCR 8-16 HXW 1/2 SS	1
623	WD12X10062	FINGER INDEXER	1
650	WD30X0098	RACK SLIDE	2
652	WD12X0344	RACK SLIDE END CAP	4
654	WD12X0332	ROLLER STUD ASM	8
692	WD28X10064	COMB LOWER RACK ASM	2
694	WD28X10060	COMB UPPER RACK ASM	1
695	WD28X10061	COMB UPPER RACK ASM	1
698	WD28X10062	RETAINER COMB	6
699	WD28X10063	RETAINER COMB	2
701	WD28X10073	RACK LOW ROLL ASM	1
705	WD12X10065	ROLLER SIDE	4
709	WD01X10113	INSULATION PANEL FRONT	1
710	WD01X10095	INSULATION	1
710	WD01X10100	INSULATION	1
710	WD01X10114	INSULATION PANEL	1
711	WD31X10029	PANEL FRONT BOWED WH	1
714	WD02X10083	SCR 8-18 B HXW .480 S	4
715	WD02X10086	SCR 8-18 B 1HW 1/2 S N	2
716	WD14X10009	LINK HINGE ARM	2
733	WD16X10009	PULLEY BRACKET ASM	1
741	WD12X10055	BRACKET J BOX ASM	1
743	WD12X448	COVER JUCTION BOX	1
744	WD15X10004	VALVE WATER INLET	1
746	WD2X248D	SCR 10-24X3/8 TT HEX	2
755	WZ4X44D	SCREW	4
756	WD34X10566	BRACE TOEKICK WH	1
759	WD27X10086	TOEKICK ASM WH	1
761	WD28X10058	BASKET 7 PC ASM	1
762	WD28X10038	BASKET SILVERWARE END	2
763	WD28X10037	BASKET SILVERWARE MIDDLE	1
764	WD28X10039	HANDLE BASKET	1
765	WD28X10066	LID BASKET	1
766	WD28X10067	LID BASKET	1
767	WD28X10068	LID BASKET	1
775	WD02X10055	SCREW 10-16 X 5/8 HXW	2
775	WD02X5166	SCR 10-16X1/2 AB HXW S	2
776	WZ5X222D	SCR 10-32 T HEX 7/16 S	3
777	WD01X10089	INSULATION TUB BLANKET	1

Note: The components shown in this drawing may differ from the components in your unit. Refer to the microfiche or GEA IPC for the component and part number for your unit.

Ref #	Part #	Description	Qty
790	WD01X10065	CLAMP HOSE	1
790	WH01X2036	CLAMP HOSE	1
801	WR02X10585	SPRING RECESS DOOR	1
802	WD13X10010	HANDLE LATCH WH	1
803	WD21X10121	SWITCH INTERLOCK ASM	1
804	WD13X10008	ACTUATOR HANDLE	1
805	WD13X10009	RETAINER HANDLE	1
807	WD31X10027	INNER DOOR & HINGE ASM	1
808	WD01X10110	CLIP HARNESS	1
809	WD02X10084	SCR 10-32GX FLT25 .615 S	2
810	WD02X0322	SCR 8-18X7/8 BT	6
811	WD12X10046	MODULE RINSE ASM	1
815	WD12X10045	VENT	1
817	WD01X0550	SCR 8-32 PNT 1/2 S	2
817	WD02X0445	SCR 10-32 T HEX .7 S	1
833	WD01X10099	CABLE PULLEY ASM	2
833	WD02X0295	SCR 8-16X2 SS	4
842	WD08X10023	TRIM TUB FLANGE WH	2
843	WD08X10018	GASKET TUB	1
844	WD08X10024	TRIM TUB FLANGE	2
845	WD08X10019	SEAL SHORT BOT DOOR	1
864	WD12X10067	FLAPPER VENT	1
888	WD01X10090	BRACKET COUNTER SIDE RH	1
888	WD01X10091	BRACKET COUNTER SIDE LH	1
901	WD34X10565	ESCUTCHEON KEYPAD ASM WH	1
905	WD21X10017	MODULE CONTROL ASM	1
905	WD35X10015	MODULE CONTROL ASM	1
905	WD21X10131	MODULE CONTROL ASM	1
918	WD21X10120	VENT DRIVER ASM	1
943	WZ5X219D	SCREW ESCUTCHEON	1

Review

- The incoming water temperature must be _____.
- The dishwasher has a _____ year parts warranty.
The electronic module has a _____ year _____ warranty.
- The dishwasher has a _____ year labor warranty.
- If the bearing washer (item #611) on the top rack, bottom wash arm is left out, then:
 - washability can be affected.
 - glassware can be broken.
 - excessive wear will occur.
 - all of the above will occur.
 - none of the above will occur, the part is really not needed.
- Circle the button(s) which must be pushed to enter Service Mode.

FLAT PANEL

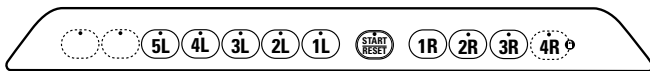

○ Indicates Keypad Used Only on Some Models

BOWED PANEL

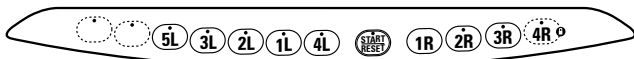

○ Indicates Keypad Used Only on Some Models

- The high drain loop, mounted on the side of the tub, can be removed if needed.
T or F
- A blinking START/RESET keypad light indicates:
 - Sequence switch problem.
 - Cycle was interrupted and dishwasher will drain and stop.
 - There is a problem with the heater circuit.
 - There is a problem with the water valve circuit.
- A blinking Clean light indicates:
 - The unit has no water.
 - There is a problem with the turbidity sensor circuit.
 - The water was not heated properly on sani-cycle models.
 - Dishwasher is in Extended Wash Mode.

- The detergent/rinse agent dispenser is activated with _____ volts _____ times during the cycle.

- If the turbidity sensor fails, the dishwasher stops, beeps, drains, and terminates the cycle.

T or F

Warranty

Profile Models



All warranty service provided by our Factory Service Centers, or an authorized Customer Care® technician. To schedule service, on-line, 24 hours a day, visit us at GEAppliances.com, or call 800.GE.CARES (800.432.2737).

Staple your receipt here.
Proof of the original purchase date is needed to obtain service under the warranty.

For The Period Of:	GE Will Replace:
One Year From the date of the original purchase	Any part of the dishwasher which fails due to a defect in materials or workmanship. During this full one-year warranty , GE will also provide, free of charge , all labor and in-home service to replace the defective part.
Second Year From the date of the original purchase	Any part of the dishwasher which fails due to a defect in materials or workmanship. During this second-year limited warranty , you will be responsible for any labor or in-home service costs.
Five Years From the date of the original purchase	The dishwasher rack (nylon coated only—not vinyl coated) , if it should rust, or the electronic control module if it should fail due to a defect in materials or workmanship. During this five-year limited warranty , you will be responsible for any labor or in-home service costs.
Lifetime of Product	The PermaTuf® tub or door liner , if it fails to contain water due to a defect in materials or workmanship. During this full warranty , GE will also provide, free of charge , all labor and in-home service to replace the defective part.

What GE Will Not Cover:

- Service trips to your home to teach you how to use the product.
- Improper installation.
- Failure of the product if it is abused, misused, or used for other than the intended purpose or used commercially.
- Replacement of house fuses or resetting of circuit breakers.
- Damage to the product caused by accident, fire, floods or acts of God.
- Incidental or consequential damage caused by possible defects with this appliance.
- Cleaning or servicing of the air gap device in the drain line.

This warranty is extended to the original purchaser and any succeeding owner for products purchased for home use within the USA. Proof of original purchase date is needed to obtain service under the warranty. In Alaska, the warranty excludes the cost of shipping or service calls to your home.

Some states do not allow the exclusion or limitation of incidental or consequential damages. This warranty gives you specific legal rights, and you may also have other rights which vary from state to state. To know what your legal rights are, consult your local or state consumer affairs office or your state's Attorney General.

Warrantor: General Electric Company, Louisville, KY 40225

GE Models



All warranty service provided by our Factory Service Centers, or an authorized Customer Care[®] technician. To schedule service, on-line, 24 hours a day, visit us at GEAppliances.com, or call 800.GE.CARES (800.432.2737).

Staple your receipt here.
Proof of the original purchase date is needed to obtain service under the warranty.

For The Period Of:	GE Will Replace:
One Year From the date of the original purchase	Any part of the dishwasher which fails due to a defect in materials or workmanship. During this full one-year warranty , GE will also provide, free of charge , all labor and in-home service to replace the defective part.
Second Year From the date of the original purchase	Any part of the dishwasher which fails due to a defect in materials or workmanship. During this second-year limited warranty , you will be responsible for any labor or in-home service costs.
Five Years From the date of the original purchase	The dishwasher rack (nylon coated only—not vinyl coated) , if it should rust, or the electronic control module if it should fail due to a defect in materials or workmanship. During this five-year limited warranty , you will be responsible for any labor or in-home service costs.
Ten Years	The PermaTuf[®] tub or door liner , if it fails to contain water due to a defect in materials or workmanship. During this full warranty , GE will also provide, free of charge , all labor and in-home service to replace the defective part.

What GE Will Not Cover:

- Service trips to your home to teach you how to use the product.
- Improper installation.
- Failure of the product if it is abused, misused, or used for other than the intended purpose or used commercially.
- Replacement of house fuses or resetting of circuit breakers.
- Damage to the product caused by accident, fire, floods or acts of God.
- Incidental or consequential damage caused by possible defects with this appliance.
- Cleaning or servicing of the air gap device in the drain line.

This warranty is extended to the original purchaser and any succeeding owner for products purchased for home use within the USA. Proof of original purchase date is needed to obtain service under the warranty. In Alaska, the warranty excludes the cost of shipping or service calls to your home.

Some states do not allow the exclusion or limitation of incidental or consequential damages. This warranty gives you specific legal rights, and you may also have other rights which vary from state to state. To know what your legal rights are, consult your local or state consumer affairs office or your state's Attorney General.

Warrantor: General Electric Company, Louisville, KY 40225

