

# Geotech Sipper

## Installation and Operation Manual





# Table of Contents

DOCUMENTATION CONVENTIONS .....	2
Section 1: System Description .....	5
Section 2: System Installation .....	7
Section 3: Timer/Cycle Settings and Display Descriptions .....	16
Section 4: System Operation .....	24
Section 5: System Maintenance.....	27
Section 6: System Troubleshooting .....	32
Section 7: System Specifications .....	35
Section 8: System Schematics.....	37
Section 9: Parts and Accessories .....	41
The Warranty.....	45

# DOCUMENTATION CONVENTIONS

This manual uses the following conventions to present information:



## WARNING

An exclamation point icon indicates a **WARNING** of a situation or condition that could lead to personal injury or death. You should not proceed until you read and thoroughly understand the **WARNING** message.



## CAUTION

A raised hand icon indicates **CAUTION** information that relates to a situation or condition that could lead to equipment malfunction or damage. You should not proceed until you read and thoroughly understand the **CAUTION** message.



## NOTE

A note icon indicates **NOTE** information. Notes provide additional or supplementary information about an activity or concept.

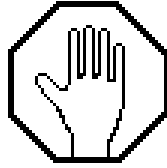

**In order to ensure your Solar Sipper has a long service life and operates properly, adhere to the following cautions and read this manual before use.**

- **Controller power input source must not exceed specified ratings.**
- **Controller may not operate properly with wiring not supplied by manufacturer.**
- **Avoid spraying fluid directly at controller.**
- **Never submerge controller.**
- **Avoid pulling on wires to unplug controller wiring.**
- **Avoid using a controller with obvious physical damage.**
- **To prevent damage, DO NOT drop the controller.**



**WARNING**

Do not operate this equipment if it has visible signs of significant physical damage other than normal wear and tear.



**Notice for consumers in Europe:**

This symbol indicates that this product is to be collected separately.

The following applies only to users in European countries:

- This product is designated for separate collection at an appropriate collection point. Do not dispose of as household waste.
- For more information, contact the seller or the local authorities in charge of waste management.

## Section 1: System Description

### Function and Theory

The Geotech Solar Sipper (Sipper) is a unique solar powered hydrocarbon recovery system used for operating an active downwell remediation pump with an attached Skimmer. It is designed for applications where electrical power is not available or not economically feasible. Electrical power used to run the Solar Sipper is generated on-site by solar panels. The internal compressor is capable of producing up to 20-inches Hg vacuum and 100 psig pressure. This alternating vacuum/pressure process allows the user to recover a wide range of fluids, from very viscous to ultra light Non-Aqueous Phase Liquid (NAPL), from depths as deep as 180 feet below ground surface. Optional multiple channel controllers can operate up to eight pumps in separate recovery wells.



In this manual, a stainless steel pump with Skimmer, or any other downwell assembly used with a Sipper system, will be referred to as a pump. A chart containing a range of viscous products can be found in Section 4.

The standard Solar Sipper uses a 12VDC, 75 amp hour battery that is charged with an attached 85 Watt solar panel. Systems can be expanded to utilize several solar panels and larger capacity batteries. Multiple channel controllers can be implemented in areas where there are multiple recovery wells within close proximity of each other. Up to eight separate wells can be operated per controller.

In general, Geotech recommends a maximum distance of 500 feet (including the well depth) between the Sipper controller and the pump. Longer runs can be accommodated but are not recommended. Careful consideration must be given to additional power requirements as well as protecting the tubing from damage. In certain situations, multiple controllers with separate solar panels and batteries may be a better solution on sites of a relatively larger area. The optional AC Sipper is designed for locations where line voltage is readily available.

### Ease of Deployment

The Solar Sipper can reduce overall project costs and dramatically improve deployment as follows:

- Reduces the time and cost for a power line to be run to a site.
- Eliminates the need for electricians to do install work and permitting.
- The simple and safe low voltage system can be installed without special training or licensing and requires minimal experience.
- No trenching or transformer equipment is required.
- Relocating equipment to follow a plume or to adjust to new site characterization information is fast and easy.

### Sipper Operation

The Sipper controller has an integrated programmable cycle timer for controlling the internal compressor vacuum, pressure, and the time between cycles. This allows the user to calibrate the Sipper to run at its most efficient rate based on the downwell product recharge rate, product viscosity, and Skimmer depth.

During the vacuum timer cycle, vacuum is applied to the air line tubing, stainless steel pump, and intake; helping the product to flow through the oleophilic/hydrophobic mesh screen and into the pump cavity. When the programmed vacuum time expires, the system initiates the pressure timer cycle. During the pressure timer cycle, air is compressed into the air line tubing, evacuating the product from the pump. Once the programmed pressure time has expired the compressor shuts down and the system initiates the programmed delay timer. Upon expiration of the delay timer the process is repeated.

On multiple channel Sippers the vacuum, pressure, and delay cycles are set individually per well. This accommodates recharge and recovery rates unique to individual wells on the same site. A variety of timer setups can be implemented to maximize recovery. For example; different wells can be pumped more or less often than others to maximize recovery. The programming prioritizes the pumps so one pump is operational at a time.

The Sipper controller has several feedback data recording mechanisms that can be used to gauge effectiveness of the remediation system. Two cycle counter screens are available, one records the total lifetime cycles of the controller, the other counter is resettable by the user for monitoring purposes. These cycle counts can be compared with total recovered fluid to determine how much fluid is being recovered per pump cycle. There is also a runtime clock which only increments when the battery is charged and when the system is operating. This clock can be compared with actual recorded deployment time to determine if more solar panels are required to keep the system up and running. More on this can be found within the troubleshooting section of this manual.

The Solar Sipper Controller is dependent upon the annual average solar resources, which can vary from region to region. Geotech can assist in determining how much potential recovery can be expected depending on where the site is and how many solar panels will be required. More information about solar panel location can be found in Section 2.

## **Recovery Rates**

The available solar energy and number of solar panels will determine how quickly available product can potentially be recovered. Recovery will ultimately be limited by the recharge rate of the product layer in the well. Repeatedly removing the entire product layer can reduce fluid conductivity to the well and in turn reduce recovery rates overall.

When the product layer is completely depleted, air is invited into the well screen and surrounding sub surface soil or strata. This air can act to block fluid conductivity as well as to promote bacteria growth and breakdown of the product being recovered. This will eventually 'clog' the fluid path to the well and so reduce the product layer recharge rate. Geotech recommends recovering smaller amounts of product more frequently. This will promote continued fluid conductivity to the well.

In the event that the intake screen, discharge line or check valve should get blocked, remove the Skimmer and clean the intake cartridge and connections as described within the System Maintenance Section of the Geotech Pump and Skimmer Assembly Manual.

Geotech offers a variety of tools and training to provide you with information on properly maintaining your Sipper system and on obtaining a recharge rate. Contact Geotech to discuss your specific application in detail.



## Section 2: System Installation



The standard Geotech Sipper is designed for installation and operation in a non-hazardous, non-classified location with intrinsically safe extension into a hazardous classified location. Geotech does not determine classification of a location. Classification of location is subject to local jurisdiction enforcement of NFPA regulations. All installations should be performed in accordance with NEC.

FPN: NEC 2008 section 500.5 (A) classification of locations says: Through the exercise of ingenuity in the layout of electrical installations for hazardous (classified) locations, it is frequently possible to locate much of the equipment in an unclassified location and, thus, to reduce the amount of special equipment required. FPNs are informational only and are not enforceable as requirements of the NEC.



Sipper installations are to be performed by qualified personnel. If you are not familiar with electrical power equipment, contact a qualified technician to assist you with your installation.

Solar Sipper systems can be modularized and delivered on pallets that can be quickly and easily deployed. This can simplify deployment where existing concrete pads or other infrastructure, which could serve as a mounting base for the equipment, do not already exist. It is more efficient to have the equipment ready for immediate deployment upon delivery. Geotech also offers training on proper installation of your Sipper system at its Denver, Colorado manufacturing headquarters.

### Installation of the Solar Sipper



**AC Sipper Controller** - Ensure the main line is turned off at the breaker and that the ON/OFF switch for the control panel is in the OFF position before proceeding with ANY external or internal wiring.

Because the solar array and battery have live voltage, caution should be exercised when dealing with either item. Special attention is required to ensure that the correct polarity is observed when making connections to the battery and solar panels. Even though the system runs on a safe low voltage, the battery is capable of storing very large amounts of energy from a low impedance source. This can pose a fire and burn hazard.

Special care must be taken to avoid shorting out (making contact between both positive and negative terminals) the battery with any tool or bare grounding wire. Leave protective caps in place and only terminate a wire when you have verified it is the correct polarity (positive or negative.) The system can tolerate reverse polarity connections as long as the ON/OFF switch remains in the OFF position.

### Solar Panel Location

The annual average solar resources will vary from region to region. Geotech can assist you in determining how much recovery you can expect (depending on where the site is located in the world) and how many solar panels will be required. The site latitude will determine seasonal differences in recovery rate. For example, in the northern hemisphere recovery rates will decline over the winter months and increase during the summer months.

Other location specific information must be considered as well. Large objects like trees or building structures can block sunlight from reaching the solar panels. In such cases the solar panels can be mounted atop poles or other available structures to maximize sun exposure. Other unpredictable factors, such as more or less cloud cover, must also be considered when estimating potential recovery rates.

Pick a location with a maximum exposure to sunlight. Avoid shadows, especially during the middle of the day. Orient the module so that the surface will receive the maximum sun exposure over the year for your particular site. The general guideline for positioning is as follows:

- Solar panels should face south in the northern hemisphere and north in the southern hemisphere.
- A solar panel's angle should be set to the equivalent of your location's latitude; plus 15 degrees during the winter or minus 15 degrees in the summer.

For example; Denver, Colorado's latitude is around 39 degrees. In winter the panel should be raised to 54 degrees (from 0°) for optimum sun. For permanent installations, setting the panel angle equal to your latitude will suffice.

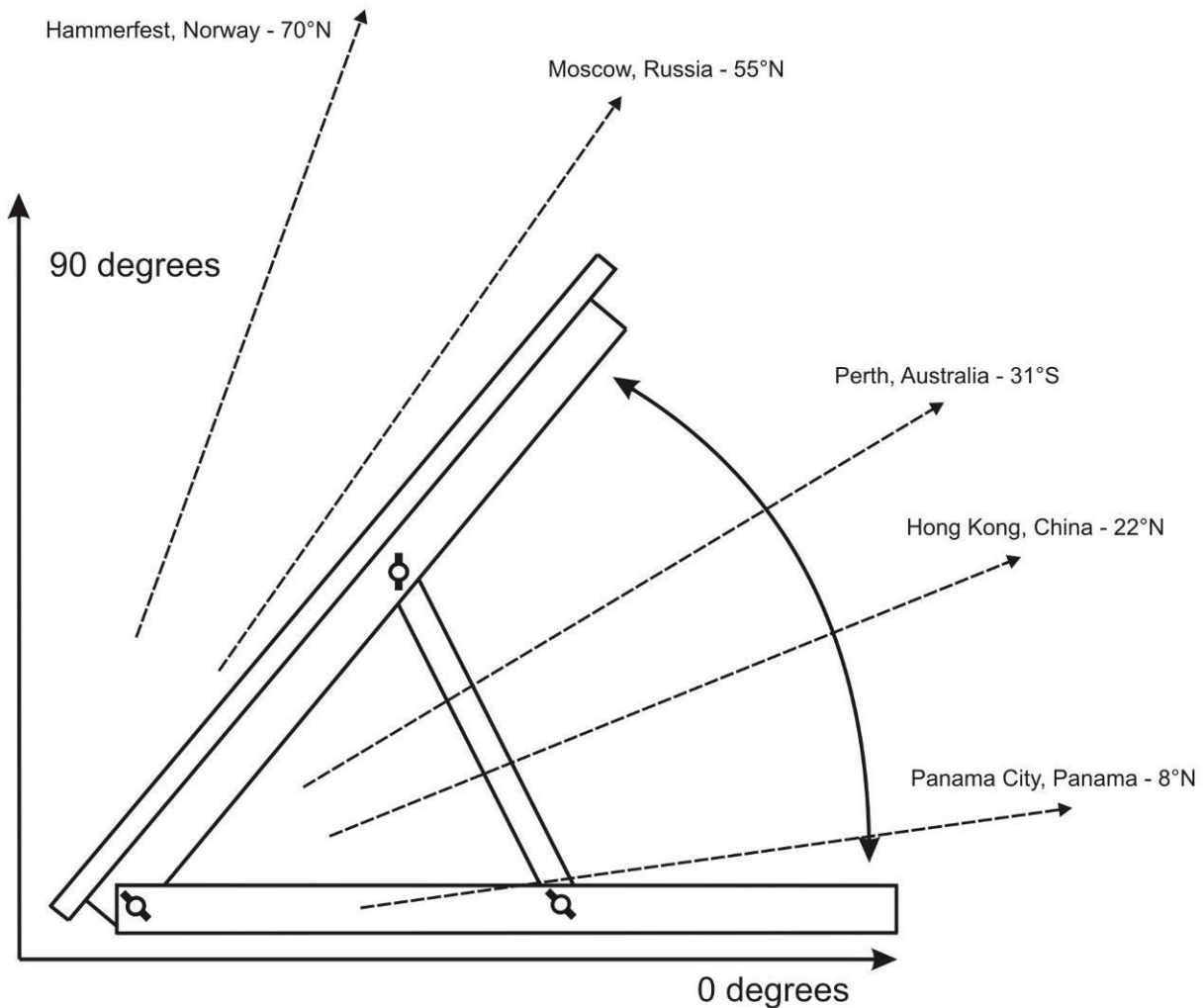

Figure 2-1 – Side view of solar panel assembly.

## Mounting the Control Panel

The enclosure for the Solar Sipper allows the customer the option to place the control panel in a convenient and accessible location. If possible, it is recommended the control panel enclosure be placed out of the direct path of weather and sun light whenever possible. If power is to be plumbed to the enclosure, then all conduit runs are to be rigid metal and grounded to an equipment conductor common for non-current carrying metal parts.

The enclosure also needs to be elevated above the height of the well heads to prevent kinks to the exhaust line and the various air lines to the pumps. When selecting a location for your Sipper controller, consider the placement of air lines to and from the unit to prevent kinks, damage, or the buildup of fluid in sagging lines.

Figure 2-2 is an example of a Sipper control panel mounted to a back panel with 2" u-bolts. Using a back panel will support the enclosure while giving you the ability to pole mount the unit.



**NEVER** drill mounting holes from, or through the inside of the enclosure when attaching the controller to another surface. It is advised that you mount the enclosure to a strong back panel, using the brackets supplied, before attaching the unit to a pole or other surface.

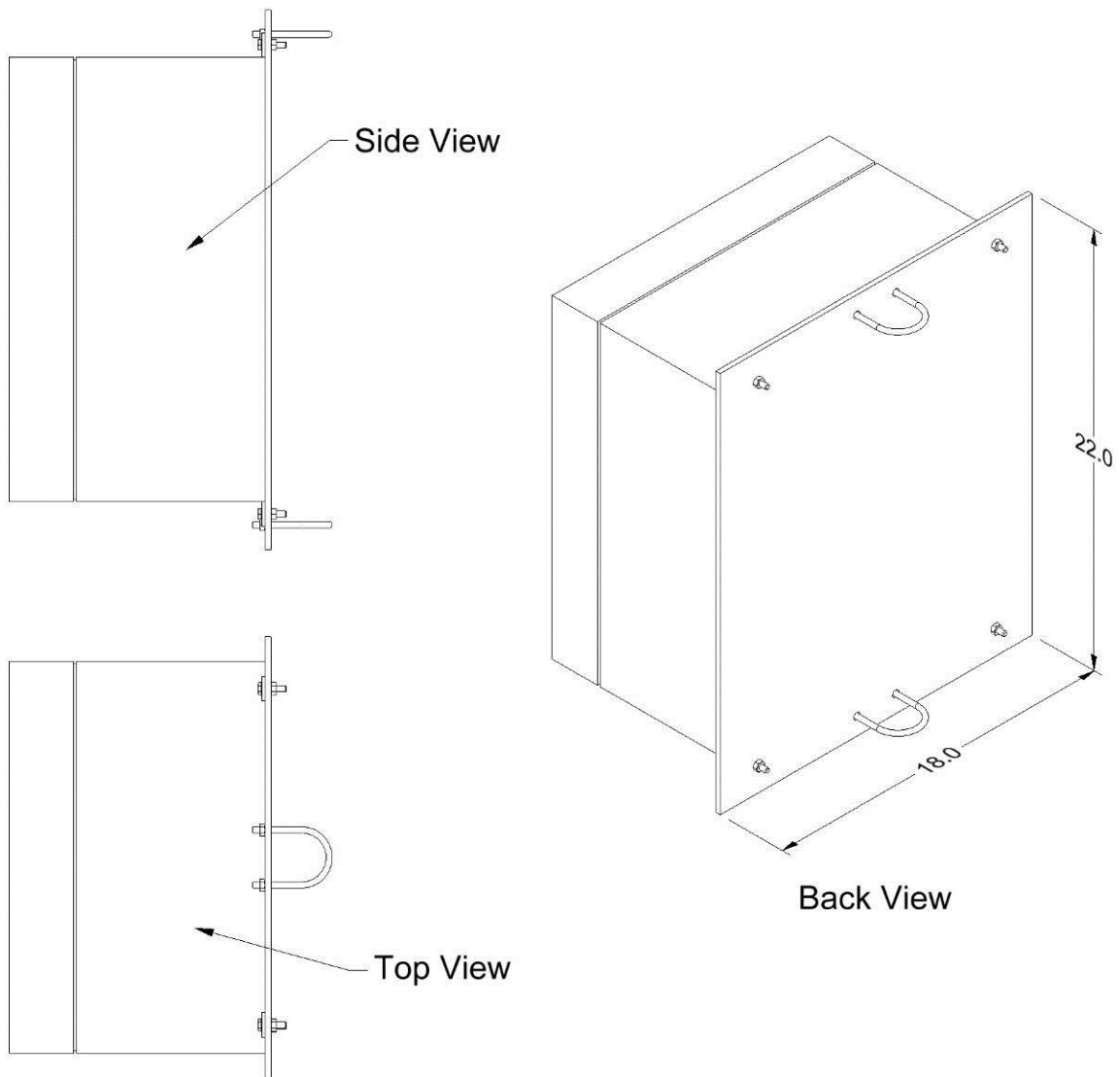

Figure 2-2 – Example of Sipper enclosure mounted to back panel with additional u-bolts for pole attachment.



Diagram is an example only. Mounting hardware shown is available through Geotech – see Section 9: Parts and Accessories . Always avoid drilling through the enclosure body.

## Solar Sipper Wiring



A full size, internal wiring diagram accompanies new Sipper controllers when delivered (pg. 39 or 40). Also, operational flow charts are affixed to the inside door of each controller (pg. 22). Contact Geotech for a replacement wiring diagram as



Before installing the solar panel for the Solar Sipper controller, cover the array with an opaque material before making your wiring connections. This will prevent the modules from producing electricity while making the connections and reduce the risk of sparks. Observe safe electrical practices at all times. Make connections in well-ventilated areas free from flammable gas vapors and open flames.

Solar Sipper systems are supplied with 25 feet of 4 conductor 14 AWG cable. DO NOT extend or add to the length of this power cable. After ensuring the power switch on the controller is set to OFF, make all external power connections as shown in Figure 2-3.

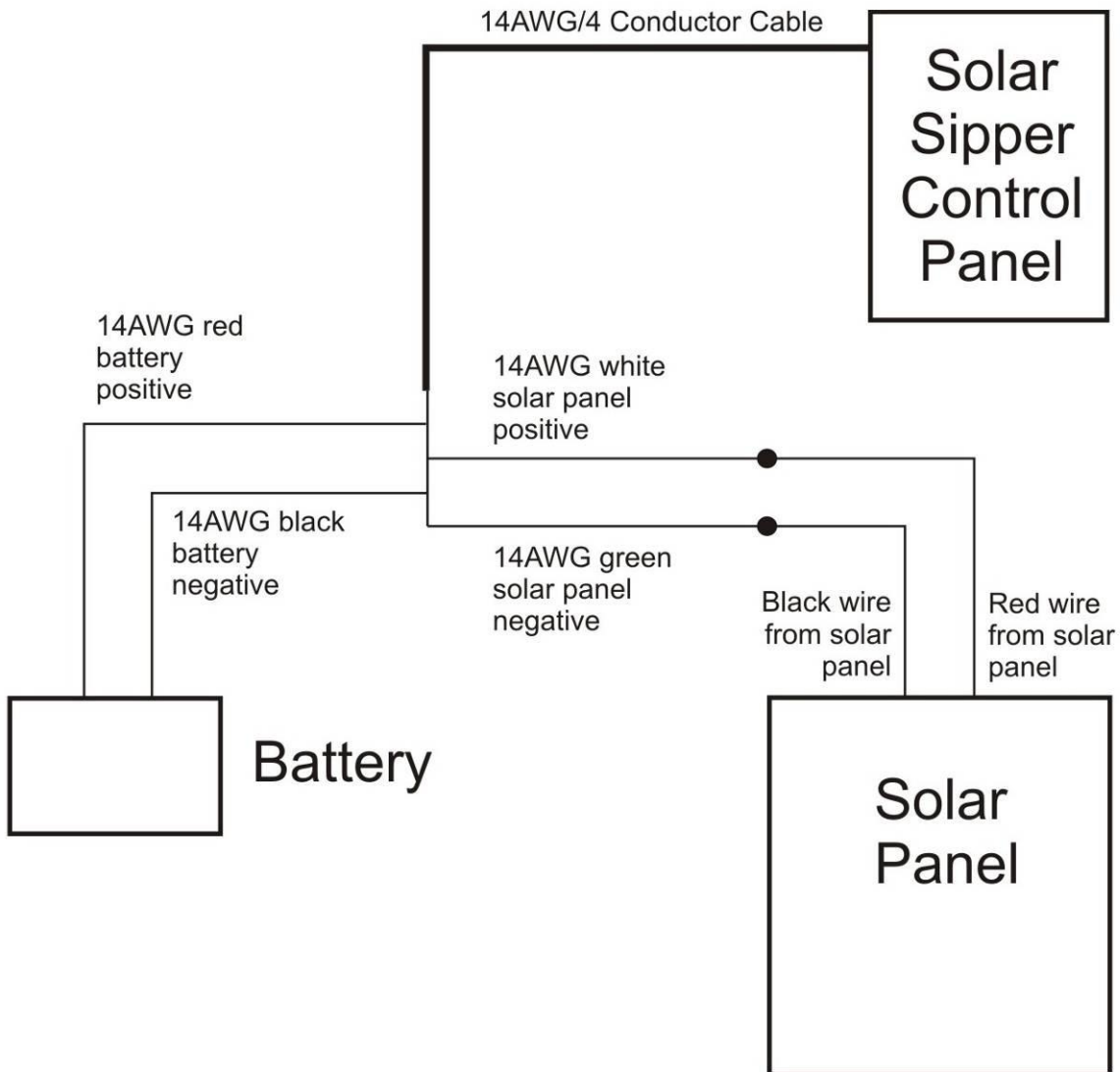

Figure 2-3 – Example of external wiring for a Solar Sipper system.



A brand new or replacement battery may not be fully charged. This will cause the Solar Sipper to go into low voltage shutdown when initially powered up. Allowing the battery to fully charge before deployment will accelerate initial startup. Otherwise, the system could take several days to begin operating depending on the number of solar panels used and the amount of sun exposure. If freeze conditions exist, insulate your battery. A frozen battery will not charge until it is thawed. See Section 3 for minimum voltage requirements.

### Adding Additional Panels

During the winter months when the sunlight decreases, additional solar panels can easily be added to the Solar Sipper system. The addition of one or two more panels will boost production during the winter months, with fewer hours of sunlight, and the excess energy will not be used in the summer. As a general guideline, up to 4 – 80W panels may be connected to the Solar Sipper System.

To wire an additional panel to the system configuration, use the wiring diagram shown in Figure 2-3. Using insulated wire nuts, connect all red wires (positive) from the solar panel(s) to the white wire on the Sipper controller, then connect all black wires (negative) from the solar panel to the green wire on the Sipper controller.

### AC Sipper Wiring

AC Sipper systems are supplied with 25 feet of 3 conductor 12 AWG cable. DO NOT extend or add to the length of this power cord. After ensuring that the power switch is set to OFF, make the power connections using the following wiring diagram:

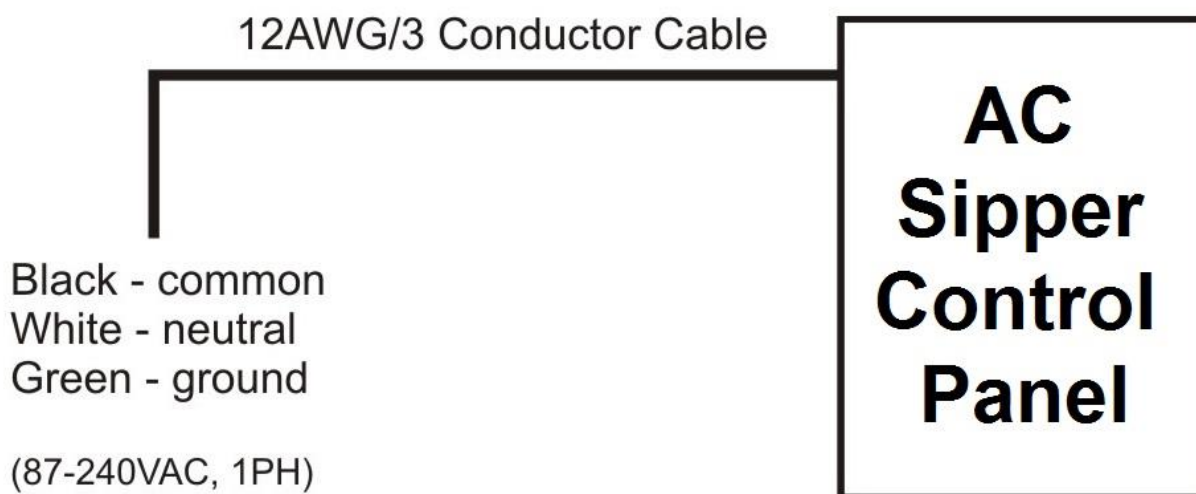

Figure 2-4 – Example of external wiring for a AC Sipper system.



Dangerous shock and fire hazard will exist with any line/mains voltage wiring termination. Sipper installations are to be performed by qualified personnel. If you are not familiar with electrical power equipment, contact a qualified electrician to assist you with your installation.

Always double-check that live voltage is not present at terminals to be worked on. Shut off all circuit breakers and disconnects and use a volt meter or voltage detector to verify power has been removed. Verify the meter is functional by turning the power on and off once or twice before proceeding. Only proceed wiring to AC power terminals when you are certain it is safe.

## Grounding

If no earth ground terminal is available, then a ground spike must be installed. Connect all non-current carrying metal parts to the common ground. An earth ground terminal can be purchased from Geotech with your Sipper. See Section 9 for a complete listing of available accessories.

## Connect All Tubing Runs

Lay out all tubing lengths to the well heads and secure the ends to the hose barbs using adequate clamps. Geotech can supply your Sipper system with a variety of tubing and clamp choices. See Section 9 for a list of available parts.

When installing your tubing runs, DO NOT hang or situate air lines in such a way that they are left sagging with low points in which fluid can collect. Avoid sharp bends which can kink your line.

It is recommended that air lines and hoses be protected. Conduit or PVC pipe can provide protection. However, check local and state regulations regarding fuel transmission lines before installing the product discharge lines.



If there is a chance the Sipper system will be exposed to freezing conditions (see temperature range in Section 7, System Specifications), then it is suggested all discharge lines, including the battery, be insulated or your system be kept within a temperature controlled shelter during operation.

The last line connected will be from the compressor air intake and exhaust port, on the side of the Sipper controller, to the top of the recovery tank. The Sipper controller will use this line as an air source and as a failsafe should product be vacuumed into the compressor and solenoids.

## Deploy the Stainless Steel Pump and Skimmer



Read User Manual “Geotech Pump and Skimmer Assembly” (P/N 16550181) for more information on Skimmers, their parts, and functions.

The oleophilic/hydrophobic mesh screen discriminates between water and product when it is properly “conditioned”. To condition (or prime) a cartridge, use a soft brush and coat the mesh screen with the same or a like product found in the well. DO NOT use baby oil, lamp oil or other similar dyed, perfumed or hydrogenated oils.



Special care must be taken not to damage the float or screened intake before or during deployment. Use a scrap piece of plywood or card board (something that can be properly disposed of if contaminated) on which to set the pump and Skimmer assembly on instead of the ground.

Good site characterization is important for successfully placing the pump and Skimmer assembly at the optimal level in the well. If seasonal or tidal fluctuations in the groundwater table exceed the travel of the Skimmer, periodic manual adjustment may be required. Otherwise, and in most cases, the Skimmer should be placed such that its center of travel is at the nominal ground water level (refer to Figures 8-1 and 8-2.) If the groundwater table level is unknown, Geotech can provide you with an oil/water interface probe to determine the current water level and product layer thickness. Contact Geotech for more information on this important device for site characterization.

Using a separate measuring tape, measure from the middle of the center rod on the Skimmer (also the center of vertical travel of the Skimmer intake float) to where the discharge tubing will exit the well cap. Using contrasting tape or chalk, mark the discharge tubing at this point. The lower end of the Skimmer assembly will displace fluid in the well causing the fluid level to rise initially. The float travel will accommodate this rise in fluid level. The fluid level will take some time to return to normal depending on permeability/hydraulic conductivity of the formation surrounding the well.



Read User Manual “Geotech Pump and Skimmer Assembly” (P/N 16550181) for more information on Skimmer operation, float travel, and other dimensions.

In some cases the initial displacement of fluid can ‘displace’ the product layer from the well and back into the formation. This can happen especially where there is low fluid conductivity surrounding the well. It’s best to trust the site characterization data and test with a Geotech oil/water interface probe to verify that the float is at the expected level within the well. If you cannot access an oil/water interface probe, or are deploying pumps in a 2” well without enough clearance for the probe, you can judge productivity by how much product is in the recovery tank.



Simply guessing or feeling for placement of the Skimmer within the well column is a recipe for failure. Use a Geotech oil/water interface probe to measure water level and product layer thickness, then record this information to your remediation/characterization log.

Implementing the use of a Geotech oil/water interface probe and keeping a record of the water level and product layer thickness is recommended for maintaining optimal system performance.

## Product Recovery Tank

A product recovery tank is not provided with the Solar Sipper system. A tank, preferably a 55 gallon drum or larger, must be provided by the customer with the following attributes:

- A ¾” or 2” threaded bung opening in which the Tankfull probe will be attached.
- A product inlet opening for the system discharge hose.
- A vent opening.
- A fluid discharge fitting for draining.

A Tankfull probe, shown in Figure 2-5, is provided with new Solar Sipper systems. Additional probes can be ordered from Geotech. See Section 9, Parts and Accessories.



Ensure that the compressor air intake and exhaust air line is secured to the top of the recovery tank prior to turning on the Sipper controller. Do not allow the end of this tubing to reach the product already collected.



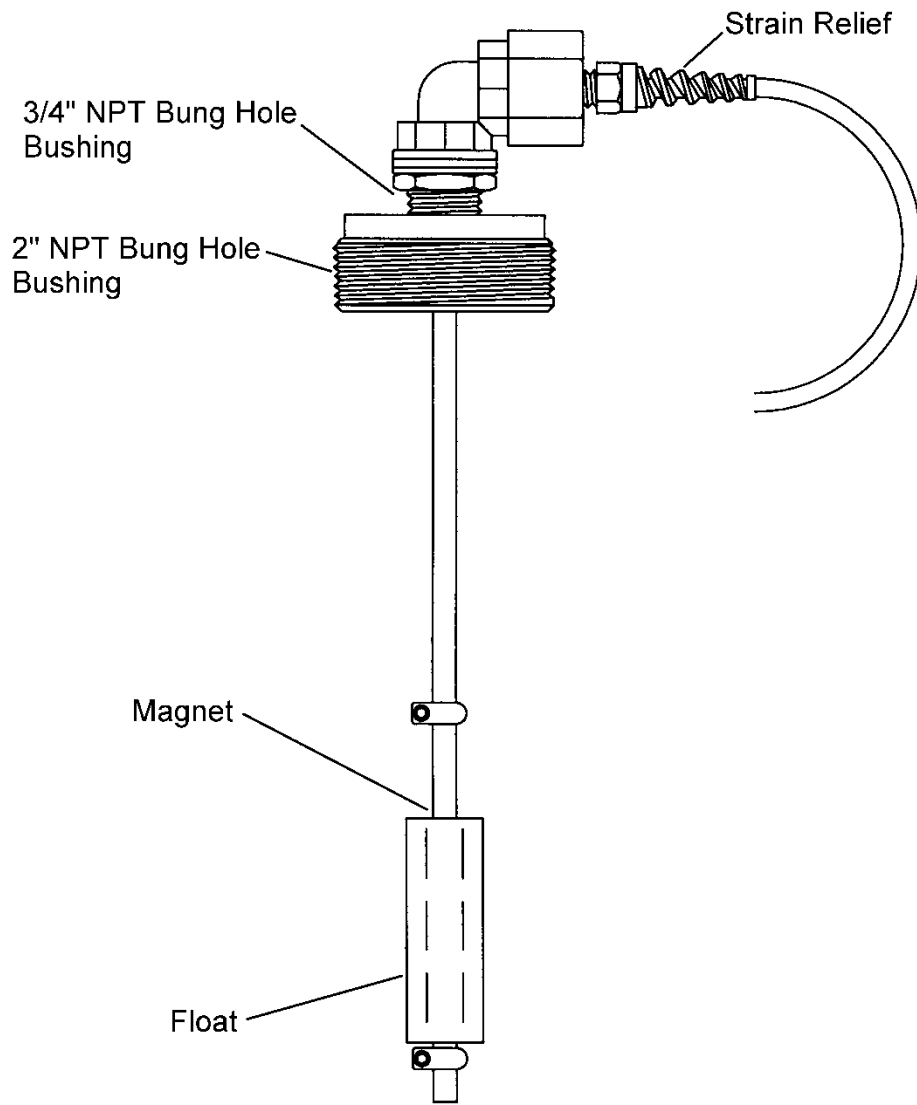

Figure 2-5 – Example of Tankfull Probe

## Section 3: Timer/Cycle Settings and Display Descriptions

This section describes the display functions and the operation of the Sipper controller. Each controller comes with a User Interface Flowchart (shown in Figure 3-1) inside the enclosure lid. The flowchart, used in conjunction with the arrow buttons on the control panel (shown in Figure 3-2) is designed to provide the following operator functions:

- Setting the cycle time (vacuum, pressure, and delay) for each pump and Skimmer assembly.
- Initiating the run time for Sipper system.
- Accessing system status and diagnostic displays.

The following pages show examples of all controller displays and a brief description of their function. Contact Geotech Technical Sales for any assistance in operating your Sipper controller.

### Setup Displays

Once the Sipper system has been installed and all wiring to the controller is complete, turn on the main power switch to the Sipper controller. The unit will perform a quick internal self check and memory configuration, after which the Main Menu will appear on the display as follows:

```
Geotech Sipper
L=Setup  R=Start
```

If the internal self check fails then the screen will display the appropriate alarm condition. See Alarm (condition) and Fault Displays on page 21.

The first task will be to set your timer/cycle settings using the Setup displays. The Setup displays allow you to select each pump individually and assign a unique cycle time (vacuum, pressure, and delay) for the pump based on the performance of the well it resides. (See Section 4 on System Operation for more information on evaluating the appropriate cycle time.) The cycle time range for each function is as follows:

Vacuum	0 second minimum to a 30 second maximum.
Pressure	30 second minimum to a 4 minute maximum.
Delay	30 second minimum to a maximum of 24 hours.



Factory default for all timer settings, for each pump installed, are: 1 second of vacuum, 30 seconds of pressure, 5 minutes of delay. Please set timers based on site requirements.

To access the Setup displays, press the left arrow button. The following display will appear:

```
Select Well
n  L=Main Menu           where n = the well number
```

Using the up and down arrow buttons, select the well number for which cycle time you wish to set (the number of wells per Sipper controller can be between 1 and 8, depending on the configuration.) After selecting a well number, press the right arrow. The Vacuum display will appear:

```
Set Vacuum mm:ss
00:10
```

Using the up and down arrow buttons, scroll to the time required for the vacuum phase of the cycle, then press the right arrow button. The Pressure display will appear:

```
Set Pres   mm:ss  
00:30
```

Using the up and down arrow buttons, scroll to the time required for the pressure phase of the cycle, then press the right arrow button. The Delay display will appear:

```
Set Del hh:mm:ss  
00:05:00
```

Using the up and down arrow buttons, scroll to the time required for the delay time of the cycle, then press the right arrow button one more time. The system will return you to the Select Well display from which you can set the cycle time for any remaining wells.



If the left arrow button is pressed at any time while setting the vacuum, pressure, and delay times, the new or adjusted setting entered will not be retained. To lock in the cycle time entered, press the right arrow button.

After all cycle times have been entered, press the left arrow button (while on the Select Well display) to return to the Main Menu.

### **Start (Runtime) Displays**

The Start (Runtime) displays allow you to:

- Reset the cycle count and runtime (see also “Runtime” display under System Status).
- Turn ON/OFF the low temperature shutoff.
- Set the well number to start pumping with.
- Start and activate the preset cycle times for all the pumps attached.

Once the Sipper has been started (Runtime activated for all pumps), you can do one of two things:

- Press the down arrow button (to review and page through the System Status displays).
- Press the left arrow button (which will complete the current pump’s cycle time, then return you to the Main Menu).

To start the Solar Sipper and activate the runtime to all pumps attached, proceed as follows:

From the Main Menu, press the right arrow button. The following display will appear:

```
Reset Timer?  
YES
```

The Reset Timer display allows you to clear the cycle count and runtime shown in both the system Runtime and the Status Runtime displays. Use the up and down arrow buttons to change this setting to YES or NO then press the right arrow button for the next screen.

Low Temp ShutOff  
OFF

The Low Temp Shutoff display (when enabled), will shutdown the Sipper controller at 0°C (32°F). Since the Sipper system primarily operates above ground, this feature prevents the controller from operating during a time when product lines could freeze. The Sipper will automatically restart at a temperature of 3.3°C (38°F). Use the up and down arrow buttons to change this setting to ON or OFF.

Start with Well  
n

Where n = the number of well (between 1 and 8).

The Start with Well display allows the user to choose the well to pump first upon startup. The well number selection is limited by the number of channels in use. Use the up and down arrow buttons to change the well number to start with.



The Sipper system is now ready for Start up (Runtime). However, before proceeding, thoroughly read Section 4 on System Operation to better understand the required timer adjustments needed for the product being recovered.

Once all cycle times have been entered and the previous three screens have been entered, press the right arrow button one more time to start the Sipper. The Sipper controller will begin cycling the first pump in the series and give you the following Runtime display:

00:00:00 nn  
0000:00:00:00 wf

Where nn = the total number of cycles since activation (1 to 99999)  
w = the well number currently activated  
f = the pump function currently in progress (V for vacuum, P for pressure, D for Delay)

After verifying all pumps are running, you can re-verify the System Status at any time by pressing the down arrow button during operation. After viewing the status displays, leave the last display as is and the system will automatically return to the Runtime display.

### Stopping Sipper Operation (Runtime)

If further adjustments are needed to the cycle time of a particular pump or when the Sipper controller needs to be shut down, press the left arrow button once during the Runtime mode. If the Sipper is currently in the middle of a pump's cycle time, it will give you the following display:

Please wait for  
Main Menu mm:ss

This display will show how much time is left with the current well. Once the pressure phase of the cycle completes, the unit will stop all processes and display the Main Menu. Further adjustments can then be made to the pump cycle times, information retrieved from the Status Displays, or the unit can be turned off for service.

## System Status and Diagnostic Displays



The value “nn” within this section can represent a count anywhere from 1 to 99999.

While at the Main Menu, system Status Displays can be viewed by pressing the up and down arrow buttons. These displays contain a variety of information which can be used to record important activity to your Solar Sipper system. These displays can also be viewed during the system’s Runtime by pressing the up or down arrow buttons at any time during operation. After viewing a status display, leave the system as is. Within 20 seconds the Main Menu (or Runtime display) will reappear.

The following status displays (as shown on the Interface Flowchart) will appear with each press of the down arrow button. The following pages will show you an example of each status display (as they appear) followed by a definition and use of the display.

```
Runtime: nn  
0000:00:00:00
```

The Runtime display shows the number of completed cycles (for all pumps attached) along with the total runtime of the Sipper system since the controller was last reset. These values can be cleared with the Reset Timer display during initial startup.

```
Lifetime: nn  
0000:00:00:00
```

The Lifetime display shows the total number of completed cycles (for all pumps attached) along with the total runtime of the Sipper system since the unit was first put into service. Lifetime values cannot be cleared. Many of the status displays will retrieve their time stamps from this display when something occurs, such as the last time there was a low battery, the last time a tankfull alarm was activated, the last time a low temp shutoff occurred, etc.

```
Well n Delay:  
hh:mm:ss
```

Where n = the Delay time for the well number shown (between 1 and 8) followed by the time.

The Well Delay display shows how much delay time is left for each well assigned to the Sipper. Use the down arrow button to page through all eight displays. Channels not in use will have a display value of 0.

```
Power Ons: nn  
0000:00:00:00
```

The Power Ons display shows the total number of times the unit has been powered ON/OFF (since being put into service) along with a time record of when the unit was last powered on.

```
Tankfulls: nn  
0000:00:00:00
```

The Tankfulls display shows the total number of times the tankfull alarm has been activated (since being put into service), due to a full recovery tank, along with a time record of when the unit last had a tankfull alarm. This display can be used to determine how long it takes the recovery tank to fill or if a larger tank is required.

```
Low Batts: nn  
0000:00:00:00
```

The Low Batts display shows the total number of times the unit has experienced a low battery condition (since being put into service) along with a time record of when the unit last had a low battery condition. This display can help in evaluating battery usage (in comparison to how much product is being recovered) showing the need for either a cycle adjustment or the need for additional solar panels. It can also help in determining if the battery is losing its ability to maintain a charge.

The Solar Sipper controller is designed to shut itself down when the battery voltage reaches 11.4V and will resume operation when the battery charge reaches 12.1V. The Solar Sipper is designed to charge the battery to a maximum of 14.5V. The system will also display a low battery condition when the battery becomes frozen. Allow the battery to thaw prior to re-charging.

```
Low Temps: nn  
0000:00:00:00
```

The Low Temps display (when Low Temp Shutoff is enabled during the Start up process) shows the total number of times the unit has experienced a low temperature condition (since being put into service) along with a time record of when the unit last had a low temperature condition. A low temperature shutoff (when enabled) will occur at 0°C (32°F).

```
Temperature:  
nnC xxx
```

The Temperature display shows the current temperature of the unit in Celsius followed by a diagnostic number.

```
Battery Voltage:  
nn.nV xxxx
```

The Battery Voltage display shows the current battery voltage for the Sipper system followed by a diagnostic number.

```
Ver: v.v Wls: n  
ID: iii SS: sss
```

This final display contains the following information for the Sipper controller:

Where v.v = software version  
n = number of wells for which the unit was designed (1 thru 8)  
iii = controller ID  
SS = Signal Strength (used on wireless Sippers)  
sss = signal strength in a numeric value (used on wireless Sippers)

## Alarm (Condition) and Fault Displays

Besides low battery, low temperature, a blown fuse, or no battery connection, only a few other conditions will cause the Sipper controller to shut down. The following display alarms will require attention from the user before the system can be restarted:

TANKFULL  
L=Main Menu

The TANKFULL display will appear when the recovery tank becomes full or when there is damage to the tankfull probe cable. When this display appears the Sipper controller will stop all activity until the alarm is addressed. To clear the alarm and restart the Sipper controller, press the left arrow button (to obtain the Main Menu), then initiate the Start up process.

INTAKE OVERRIDE  
L=Main Menu

The INTAKE OVERRIDE display will appear when the float on the Intake Float Switch (located on the side of the control box) rises. This will usually happen when product is pulled through the air line from the well (due to an excessive vacuum time or when a directional solenoid becomes stuck on the compressor) or from an accumulation of moisture during operation. See Section 6, Trouble Shooting procedures, for information on resolving an Intake Float Switch alarm.

When the INTAKE OVERRIDE display appears, the Sipper controller will stop all activity until the alarm is addressed. After draining the Intake Float Switch and clearing all effected lines, clear the alarm and restart the Sipper controller by pressing the left arrow button (to obtain the Main Menu), then initiate the Start up process.



You may also need to clear the air line by setting the vacuum to 0 and allowing the pressure cycle to push any residual fluid out of the line and into the pump reservoir. See Section 6, Trouble Shooting, for more information.

Battery Fault  
Check Cables

The Battery Fault display will appear when the voltage on the battery cables is 14.7VDC or greater. This may occur if the solar panel has been miss-wired to the battery input cables. This display will also appear if an overcharged battery has been installed. In any case, when this display is shown, turn the unit off and disconnect all voltage sources immediately. Review Solar Sipper Wiring on page 11. Contact Geotech with any questions on wiring and installation.

## PCB Damage

On rare occasions the following display may appear:

Bad display val:

The Bad Display Value message will only appear when damage has occurred to the PCB within the Sipper controller. Should this display appear, contact Geotech about the fault. Inform the Geotech Technical Sales Representative of all conditions (weather, temperature, vibration, etc.) and when the fault occurred. A fault message of this kind will usually require the unit be sent to Geotech for diagnostics and repair.

# Geotech Sipper User Interface Flow Chart

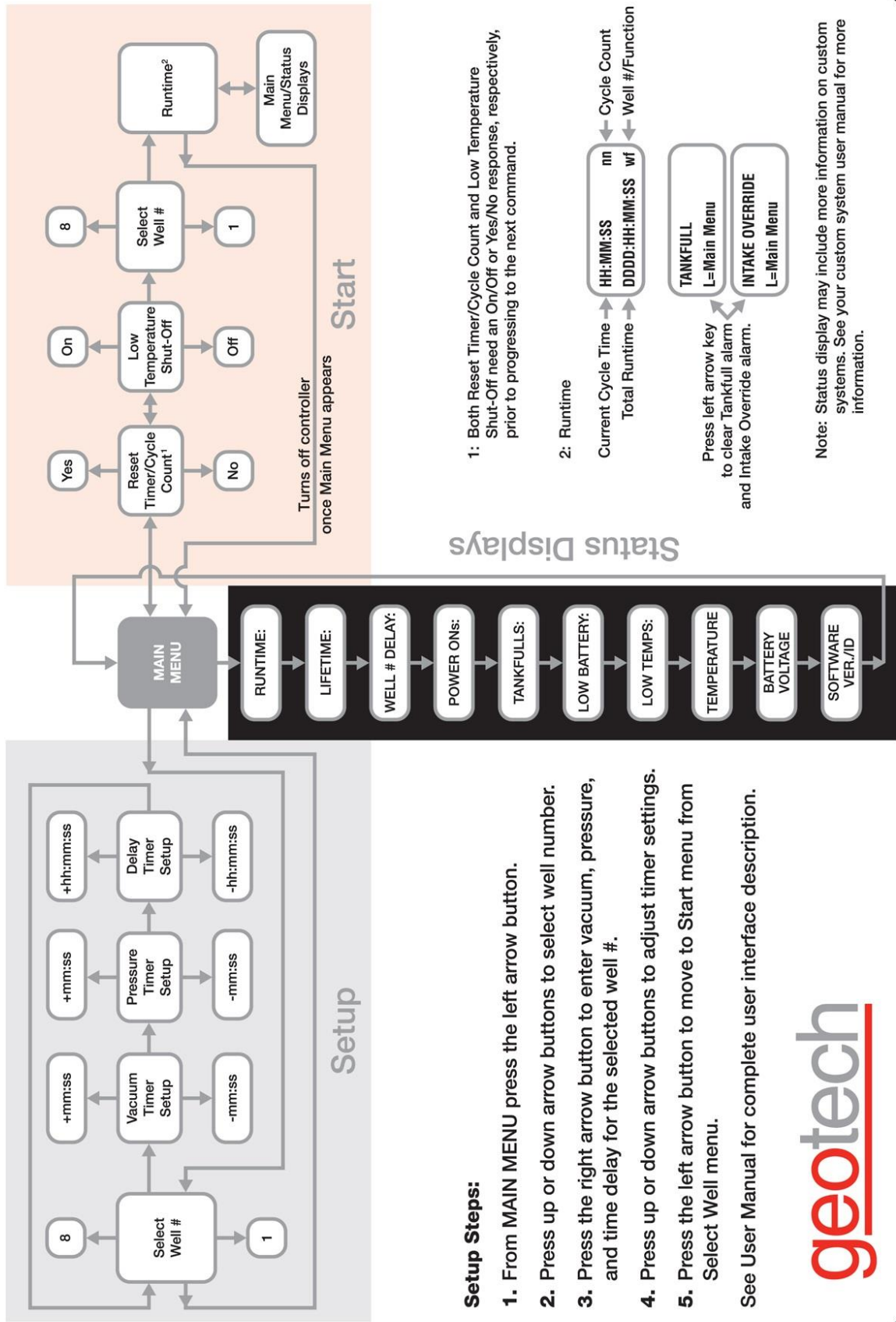

- Setup Steps:**
1. From MAIN MENU press the left arrow button.
  2. Press up or down arrow buttons to select well number.
  3. Press the right arrow button to enter vacuum, pressure, and time delay for the selected well #.
  4. Press up or down arrow buttons to adjust timer settings.
  5. Press the left arrow button to move to Start menu from Select Well menu.
- See User Manual for complete user interface description.



Figure 3-1 – Flowchart of User Interface Label





Figure 3-2 – Example of Solar Sipper front panel.

## Section 4: System Operation



If Sipper system is to be deployed in humid conditions, it is recommended to install the optional Desiccant Dryer to prevent frequent solenoid maintenance. See Section 9: Parts and Accessories for part information.

### Establishing the Product Recovery Cycle Time

The first thing to consider will be a product recovery rate target. The maximum product amount that can be recovered is determined by the recharge rate of each individual well. You can size and adjust your system for optimal recovery rate potential based on the parameters obtained from the well.

The best measure of success is the average measured recovery of fluid in the recovery tank, over a specific time frame, compared to the recovery rate target. Due to seasonal and weather related variability in available solar energy it may be very difficult to schedule site visits to coincide with the system pumping product. If observation of the system in action is desired, schedule a visit in the mid afternoon. Otherwise, record your cycle counter value and total run time and compare these with the amount of product recovered.

The vacuum cycle pulls the product into the pump housing. The system compressor will then switch to pressure mode. The compressor is capable of providing up to 100 PSIG pressure to the pump and the discharge line. The pressure cycle pushes the intake valve shut and forces the product past the discharge valve and up the discharge line to the surface.

It is important that you verify that all product is being pushed out of the pump housing before the next vacuum cycle begins. If the vacuum time interval is set too long, or the pressure cycle set for too short of a period, it is possible for the pump to overfill and for the product to be pulled up the air line and into the Intake Float Switch. If this happens, set the vacuum time back to 0 seconds and the pressure to 30 seconds and evacuate all the fluid from the float switch housing. After the system is clear of excess fluid, try setting the vacuum time to a lower setting and increase your pressure time to a higher setting for better operation. It's better to start with a higher pressure and lower vacuum setting and adjust over time.

The standard stainless steel pump is capable of holding .2 gallons (750 ml) or 46 cubic inches of fluid per cycle. That translates into over 14 inches of product layer in a 2 inch well and about 3.5 inches of product layer in a 4" well. This represents the minimum product layer thickness required to achieve one full pump housing of product per cycle. Even if there is that much product in the well, it is not advisable to pump the product layer all the way down. See Recovery Rates (pg. 6) in Section 1 for further explanation.

## Initiating the Sipper Runtime

Once Runtime has been started, the Solar Sipper system will initiate the vacuum cycle for well number one (or whichever well is selected to start), complete that well's cycle, then continue on through any remaining wells as per the individual user input settings.



The vacuum timer limits are 0 seconds minimum, 30 second maximum.

The pressure timer limits are 30 seconds minimum, 4 minutes maximum.

Custom timer settings outside of these min/max parameters can be adjusted through restricted access menus (contact Geotech for more information.) Timer settings outside of the default min/max warrant special consideration to avoid damage to the equipment and otherwise unsatisfactory performance of the system.

As mentioned before, the amount of product per cycle will depend on how much product is in the well. Also, depending on the viscosity of the fluid and temperature, the product layer could have a somewhat slower recharge rate. This can make it difficult to determine what the best cycle times should be for a particular site.

If you have a less than one gallon per hour recharge rate, then simply increase the delay time proportionally. For example; if your product recharge rate is  $\frac{1}{2}$  gallon per hour, double the delay time.

- After you account for more or less recharge rate, you can account for additional tubing and depth to fluid.
- Add 2 seconds per 25 feet of tubing for vacuum and 3 seconds per 25 feet of tubing for pressure.
- Add an additional 2 seconds per 25 feet depth to product vacuum (the product only needs to be lifted at most to the top of the pump housing).
- Add an additional 3 seconds per 25 feet depth to product pressure to start. You will have to adjust this setting to account to the specific viscosity of the product and the amount of product in the discharge tubing.

It is tempting to want to see product at the recovery tank end of the discharge tube but it is not necessary to empty the entire length of discharge tubing per cycle. It will be a waste of energy to pump air through the lines when it isn't acting to move product. If you observe air flow from the discharge line after the product has stopped flowing, reduce your pressure time by approximately the same amount of time as the extra air flow.

Example: You have a pressure time of 50 seconds; it takes 20 seconds for product to reach the exit end of the discharge tube, product flows for only 20 seconds then air flows freely for 10 seconds. You can reduce your pressure time by 10 seconds. That's an immediate 20% reduction in pressure time. This will increase your battery life and, in turn, improve your recovery potential.

## Fluid Viscosity

The following chart has been compiled based on lab testing as well as real world Sipper deployments. It is impossible to account for the many site specific variables in this manual. If you have a higher recharge rate and require higher production rates than those shown below, then please contact Geotech so that we can determine if more solar panels or batteries are necessary. In some cases, such as in the southwest United States, the standard Solar Sipper can easily outperform the rates shown in the following chart.



The viscosity range shown is based on an average ground water temperature of 50° to 70° F.

Depth to Fluid (feet)	Intake Type	Air Line Length (feet)	Product Weight/ Viscosity (SSU) @ 70° F	Product Recharge Rate (GPH)	Vacuum Time (mm:ss)	Pressure Time (mm:ss)	Delay Time (hh:mm:ss)
10	100 mesh	25	Gasoline - Light/27.7	1	0:00:15	0:00:30	0:11:00
10	100 mesh	25	Transformer Oil - Light/80	2	0:00:15	0:00:30	0:05:00
10	60 mesh	25	No. 4 Fuel Oil - Medium/170	1	0:00:30	0:01:00	0:11:00
10	60 mesh	25	Hydraulic Oil - Medium/200	2	0:00:30	0:01:00	0:05:00
10	Heavy oil	25	SAE 30 Oil - Heavy/1000	1	0:01:30*	0:03:00*	0:11:00
10	Heavy oil	25	SAE 50 Oil - Heavy/3000	2	0:01:30*	0:03:00*	0:05:00

\*Contact Geotech for instructions on how to enable timer settings beyond the standard limits. The standard limits are in place to protect against accidentally setting vacuum or pressure times that could reduce system up time and potentially damage the equipment.

## Recovery Tank is Full

When the tankfull probe detects a full recovery tank, the Sipper will complete the current cycle before shutting the Sipper controller off. The following message will appear:

```
TANKFULL
L=Main Menu
```

During this time the unit will continue to charge the battery, and if enabled, monitor the temperature. Once the recovery tank is emptied, press the left arrow button for the Main Menu and restart the unit as described in the beginning of Section 3.

## Section 5: System Maintenance



Sipper controllers must be returned to Geotech for internal repairs or service.

### Sipper Controller

#### Weekly Maintenance

- Turn the Sipper controller off and drain the Intake Float Switch (if needed).
- Record the level of the recovery tank (depending on the recovery rate).
- Visually inspect all air lines and power cords for damage.

#### Monthly Maintenance

- Rinse debris off the solar panel with clean water – DO NOT use anything abrasive on the panel surface. Clean the front surface of the solar panel and controller enclosure as needed with mild soap and water and a soft cloth.
- Inspect the product pump and Skimmer. Visually inspect the Skimmer, making sure that the coiled hose is not tangled and that the intake assembly moves freely over its travel range.
- Inspect the Intake Float Switch assembly and clean it as needed using the methods described within your Geotech Pump and Skimmer Assembly User Manual.
- Visually inspect the vent plugs in the bottom of the controller enclosure. Clean if obstructed with debris.
- Record the uptime counter from the Lifetime display monthly during the first year. This information can be used to schedule yearly maintenance for the least productive times of the year (due to local variations in the weather and solar exposure).
- Record the level of the recovery tank (depending on the recovery rate).
- Check to see if wildlife (insects, birds, mice, etc.) have not taken up residence in the controller or battery enclosures. Nests and debris can result in vent plug blockage in the battery box, allowing hazardous and explosive gas to build up. Build-up on the controls can result in overheating the electronics and possible failure of components.
- Verify fluid levels in the well using a Geotech Interface Probe. Make sure the pump and Skimmer are set at the correct interval for collection of product.
- Verify pump vacuum, pressure, and delay settings. Make sure the cycling rate of the system is correct for the amount of product available. If the well is slow to recharge and/or there is only a small volume of product to pump, the pumping rate should be decreased to conserve air and minimize controller and battery wear. Consult Geotech Technical Sales and this User Manual for guidance on how to properly set these times. DO NOT adjust if unsure.
- If using the optional Desiccant Dryer for the Sipper system, check the saturation of the desiccant packs and replace packs if necessary.

#### Quarterly Maintenance

- Verify fluid (or air flow if no product in the well) is being discharged into the recovery tank to ensure pump check valves and tubing are free from blockage and that the discharge hose is not kinked or cut.
- Verify that the Tankfull and Intake Switch floats move freely and operate to shut off the Sipper controller when activated.

- Inspect the exterior of the controller for loose fittings. Over time, vibration may cause some fittings to loosen and air leaks to develop. If uncorrected, excess air consumption and shortened controller life will result.
- Verify that your solar panel is correctly positioned for maximum sunlight. Panels can be out of place from either the wind, shade from tall structures near the panel, or sun position due to the time of the year.

### Yearly Maintenance

- Turn off Sipper controller.
- Remove and test the battery. Replace it if needed.
- Replace the inline particle filters on the air lines if needed.
- Contact Geotech for solar panel warranty confirmation and extension.

For technical assistance, call Geotech Environmental Equipment, Inc. at 1-800-833-7958.

### Stainless Steel Pump and Skimmer

In order to provide a full and long service life, keep the Skimmer intake cartridge clear of debris or bio growth. The floating intake cartridge on the Skimmer is the heart of the Sipper system. Therefore, the intake cartridge (oleophilic/hydrophobic screen, float, float shaft, flexible intake hose and clamps) should receive periodic thorough inspections. The floating height of the intake screen should always stay above the waterline. The intake cartridge screen will not pass water unless:

1. The intake cartridge has risen to the top of its travel allowing water to rise above the top of the cartridge (thus indicating that the system should be raised to a height at which the intake is floating within its 12" to 24" of working travel).
2. An inordinate amount of debris is allowed to build up on the surface of the screen.
3. A detergent (surfactant) contacts the screen. (A detergent will "wet" the screen and allow water to pass.)

If the screen is found to be clogged with debris or has been submerged in water, a gentle rinsing in kerosene or gasoline is recommended. When the presence of detergents is suspected, samples should be taken and tested.

Since the pump and Skimmer assembly must be removed from the well to perform maintenance on the intake screen, such occasions should be used to carry out a general inspection of the entire assembly.

Use the maintenance procedures found in the Geotech Pump and Skimmer Assembly User Manual to properly care for your pump and Skimmer assemblies.

### Solar Panel

On Solar Sipper applications, it is important to keep all debris, dust and dirt from accumulating on the solar panel surface. Clean the front surface of the solar panel as needed with mild soap and water. **DO NOT use abrasive cleaners, solvents or pads.** Simply rinsing off the panel with clean, clear water will usually suffice.

## Solenoid Maintenance (Stuck Solenoid)

The following procedure outlines how to remove, dis-assemble, and clean a stuck solenoid plunger.

1. Remove plug on solenoid with Phillips screwdriver (do not lose the gasket for the plug) (Figure 5-1).

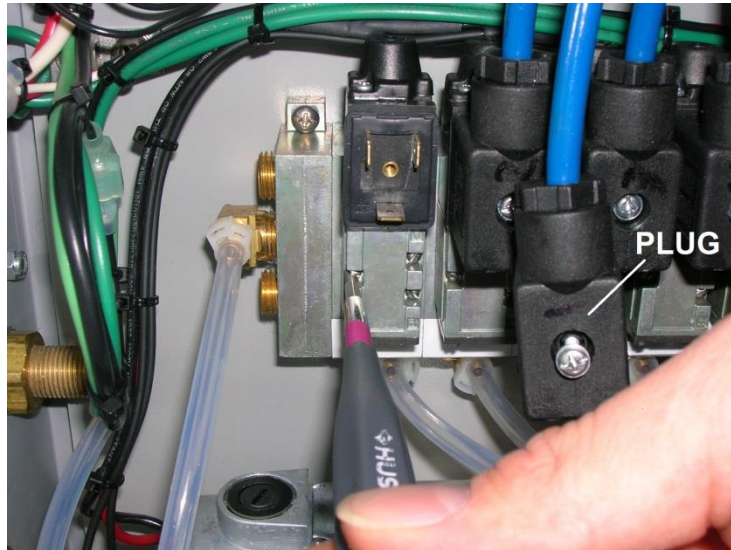

Figure 5-1

2. Remove the three screws and solenoid with a small flathead screwdriver (Figure 5-1). Note the black gasket on the underside Figure 5-2). **Do not lose or damage this gasket.**

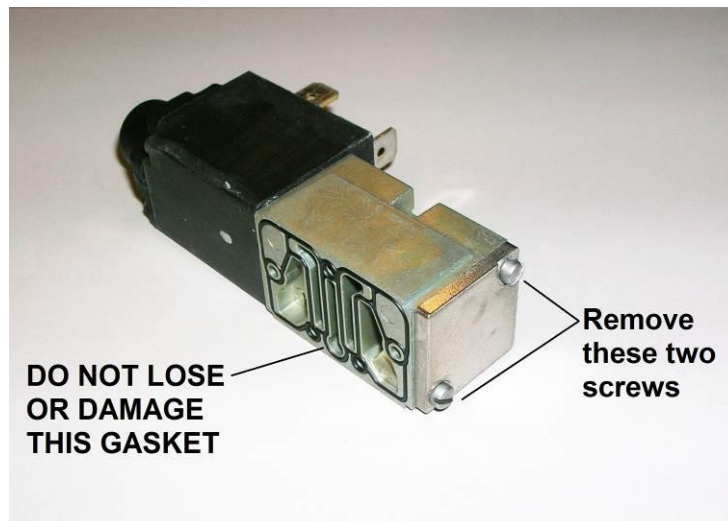

Figure 5-2

3. Using the small flathead screwdriver, remove the two screws to the square metal cap (Figure 5-2). Carefully remove the spring, the o-ring, the bushing, and the plunger (Figure 5-3). Clean the plunger and plunger cavity with a spray lubricant and cotton swab (silicon based or aerosol lubricant OK).

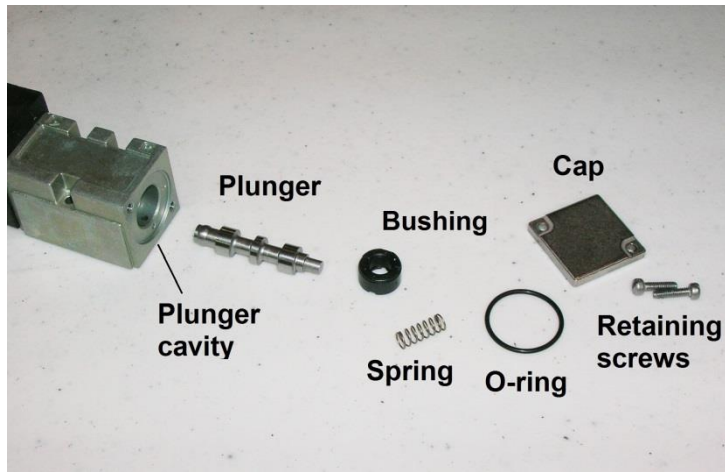

Figure 5-3

4. Orient and insert the plunger as shown in Figure 5-4. Place the o-ring and bushing back into the opening (no orientation needed) followed by the spring (Figure 5-5).

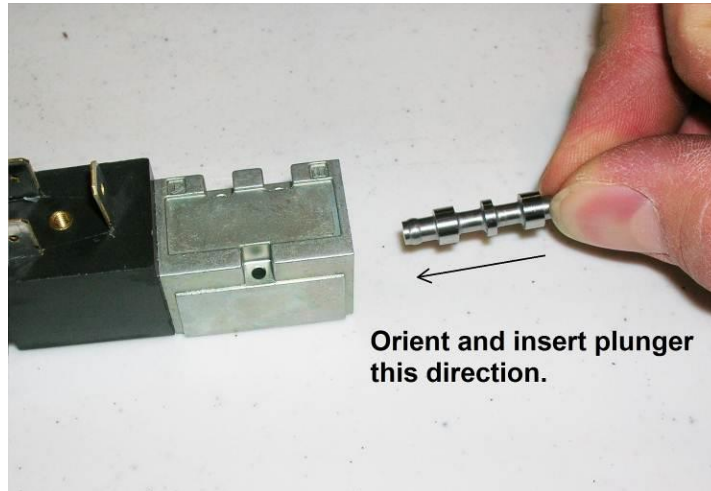

Figure 5-4



Figure 5-5



5. Carefully place the square cap onto the end, compressing the spring, and re-attach the two screws. Make the connection snug but do not over-tighten (Figure 5-6).

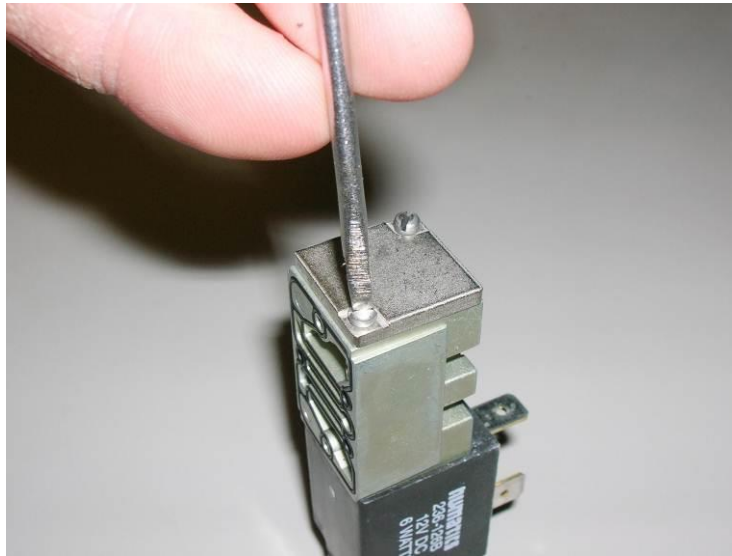

Figure 5-6

6. Verify that the plunger will move easily by depressing the small black button on the other end of the solenoid with a small Phillips screwdriver.
7. After verifying the solenoid gasket is in place, re-attach the solenoid with the three screws (be very careful not to lose or allow the gasket to fall out of place and get crushed.) After securing the solenoid, re-attach the plug with gasket to the solenoid.

**If this procedure does not resolve a suspected vacuum/pressure problem, then please call Geotech Technical Sales for further troubleshooting advice @ 1-800-833-7953.**

## Section 6: System Troubleshooting

### Problem:

No product is being recovered but system cycles and gauge indicates vacuum and pressure generation.

### Solution:

- Inspect product hose for kinks and blockage. Replace if needed. If freezing conditions have occurred check the discharge lines for frozen product.
- Remove and inspect the check valve at the top of the stainless steel pump. If the check ball is stuck in the up position, clean and gently dislodge the ball. (Periodic replacement of the check valve may be required depending on duty cycle.)
- The check valve in the top of the pump may have been re-installed upside down. The arrow on the check valve should point away from the pump and toward the discharge tubing.
- The directional solenoid plumbed directly to the compressor could be stuck. If it is locked up it may be cleared by depressing the small button on the black end of the solenoid using a small Phillips screwdriver or paper clip to actuate the solenoid manually. If this doesn't work, remove the small plate at the other end of the solenoid and clean the plunger and plunger cavity using the procedure found in Section 5.
- Visually inspect the wiring connections to see that they are not loose or otherwise compromised.

### Problem:

System cycles but gauge does not indicate vacuum or pressure generation.

### Solution:

- Verify the valve on the intake float assembly is closed.
- Inspect product hose for abrasion, cuts or open connections. Replace if needed.
- Make sure the air line connection goes to the pump and that the vent connection (the exhaust) is plumbed to the recovery tank.
- Verify that there is product in the well. If so, verify that the Skimmer intake is at the correct level in the well so that product is able to be recovered.
- Open the controller panel and verify that all air line connections are intact.

### Problem:

A pump is stuck in either vacuum or pressure.

### Solution:

- Inspect the solenoid for residue or debris. If it is locked up it may be cleared by depressing the small button on the black end of the solenoid using a small Phillips screwdriver or paper clip to actuate the solenoid manually. If this doesn't work, remove the small plate at the other end of the solenoid and clean the plunger and plunger cavity using the procedure found in Section 5.
- Visually inspect the wiring connections to see that they are not loose or otherwise compromised.

### Problem:

Solenoid continues to stick, even with frequent cleaning (as per Section 5 – Solenoid Maintenance).

### Solution:

- System is operating in humid conditions which can cause residue or debris to accumulate within the solenoid. System may be installed with optional Desiccant Dryers. See Section 9: Parts and Accessories for Desiccant Dryer information, or contact Geotech Technical Sales for assistance.

**Problem:**

The screen is blank.



**DO NOT TURN THE SIPPER SWITCH OFF AND ON AGAIN TO FORCE A CYCLE.**

**Solution:**

- Press the up arrow button. If the system is currently in a low voltage shut down, a low voltage display will be present. If all equipment is functional, then allow the unit time to recharge. See also the low battery definition in Section 3.
- Check for loose or damaged battery connections and solar panel connections.
- Use a volt meter to test the battery voltage. If it is below 10 volts remove the battery and charge it on a separate charger to verify that a charge can be retained. Reconnect the battery and test the system. Otherwise, when the solar panel is exposed to enough sun, the battery will eventually recharge and the system will automatically resume normal operation.
- Turn off the power and check the main fuse.

**Problem:**

The screen shows unintelligible characters.

**Solution:**

- Use a volt meter and ensure the battery voltage is over 12.1 volts, if not, remove the battery and charge it on a separate charger. Otherwise, when the solar panel is exposed to enough sun the battery will eventually recharge and the system will automatically resume normal operation.
- The screen display has no effect on the other hardware functions. If the voltage is over 12.1 volts, turn the ON/OFF switch to OFF and wait 60 seconds before switching on again.

**Problem:**

System is displaying a Battery Fault Check Cables alarm.

**Solution:**

- Disconnect all voltage sources (battery, solar panel) and check Figure 2-3 and re-wire the solar panel and battery to the correct terminals.
- The fuse may have blown, check the fuse with a Multimeter and replace if necessary.
- Battery may have been overcharged by another charging system and may need to be replaced. Verify battery voltage with a volt meter.
- Visually inspect the wiring connections to see that they are not loose or otherwise compromised.

**Problem:**

System is displaying a TANKFULL alarm.

**Solution:**

- Recovery tank is full. Empty and restart the system.
- Tankfull probe is disconnected or cable is damaged. Inspect probe and cable. Replace if needed.
- Verify the tankfull float is not stuck in the up position.
- If the tankfull alarm will not clear then contact Geotech for assistance.

**Problem:**

System is displaying an INTAKE OVERRIDE alarm.

**Solution:**

- The float on the Intake Float Switch is high. This is caused when product or moisture is pulled through the air line due to:
  1. Too long of vacuum time in the cycle.
  2. The directional solenoid on the compressor is stuck.
  3. An accumulation of moisture in the air line during operation.

Drain the intake and restart the system. Allow the system to clear product out of the manifold and past the air filter. Disconnect the line and use a standalone air source (with no more than 100 PSI of pressure) to finish evacuating the air line of product.

Temporarily set the vacuum to 0 and the pressure to 30 or more seconds and allow the Sipper controller to force the line to empty, after which you can restore (or adjust) the vacuum and pressure to previous settings.

**Problem:**

A pump and Skimmer assembly is not functioning, or has been removed from service, on a multiple pump system.

**Solution:**

- Set the vacuum, pressure, and delay for the inoperable pump to the lowest setting possible. Then disconnect the air line at the air filter on the side of the Sipper enclosure. The unit will continue to run all pumps in sequence with minimal use of battery power on the out of service pump.

**Problem:**

Controller displays a low battery condition and the battery will not recharge.

**Solution:**

- If the system experienced freezing conditions, then the battery may be frozen. Place the battery in a warm spot and allow it time to thaw, then reconnect and let it re-charge as normal.
- Battery may need to be replaced. See wiring schematics in Section 2.
- Additional solar panels may be required to keep the system up and running.
- Turn unit off and back on to rest the clock crystal.

**Problem:**

Counters running slow.

**Solution:**

- Turn unit off and back on to reset the clock crystal.

**If your solution cannot be found within this section, please call Geotech Technical Sales for expert troubleshooting advice @ 1-800-833-7958.**

## Section 7: System Specifications

Applications	2" (5.8cm) or larger recovery wells
Recovery Rate	.2 gallons (.750 ml) per cycle
Max. Operating Depth	180 feet (54.86m)
Max. Pressure	100 PSIG (7 bar)
Max. Vacuum	20" Hg @ MSL
Oil/Water Separation	Oleophilic/hydrophobic mesh screen

### Power

Power Maximums	(AC Sipper) 87 to 240VAC, 2.7 to 1 Amp(s) (Solar Sipper) 12-15VDC input @ up to 14.5 Amps 90 ~240 Watts continuous
----------------	--



**Power usage will vary depending on application.**

### Controller

Operating Temperature	0° to 40° C (32° to 104° F)
Storage Temperature Range	-29° to 66° C (-20° to 150° F)
Humidity	90% non-condensing (max)
Size	10" D x 18" T x 16" W (25cm D x 46cm T x 40.5cm W)
Rating	NEMA 3R
Approximate Weight	35 lbs (single channel AC Sipper)
Approximate Weight	34 lbs (single channel Solar Sipper)
Approximate Weight	51 lbs (eight channel AC Sipper)
Approximate Weight	49 lbs (eight channel Solar Sipper)



**Additional customizations and accessories could add more weight.**

### Pump Assembly

Size:	23.5"L x 1.75" OD (60cm L x 4.5cm OD)
Weight:	4.5 lbs. (2 kg)
Materials:	303 and 304 SS, flexible rubber tubing, PVC, Brass

### Skimmer Assembly

	<b>2" Model</b>	<b>4" Model</b>
Effective travel range:	12"	24"
Size:	35.5" L x 1.75" OD	35.5" L x 3.75" OD
Weight:	1.75 lbs. (.8 kg)	2.25 lbs. (1 kg)
Operating Temperature:	0° to 40° C (32° to 104° F)	
Storage Temperature:	-29° to 66° C (-20° to 150° F)	
Materials:	304 SS, Polyethylene, PVC, Polypropylene, Brass	
Tubing - Air:	.17" ID x .25" OD (4.32mm ID x 6.35mm OD)	
Tubing - Discharge:	.375" ID x .5" OD (9.53mm ID x 12.7mm OD)	

**Solar Panel:**

Rated Power	100 Watts (standard unit)
Operating Voltage	17.4 VDC
Maximum Voltage	21.5 VDC
Operating Amperage	4.88 Amps (standard unit)
Maximum Amperage	5.8 Amps
Size:	41.2" H x 27.5" W (105 cm H x 70 cm W)
Approx. Weight:	23.3 lbs (10.5 kg)

**Mounting System:**

Module Tilt Range	15 to 65 degrees
Pole Size	2", 4", and 6"
Max Wind Speed	90
Module Orientation	Landscape/Portrait
Wind Exposure	Category B & C
Materials	5052-H32 Aluminum Powder Coated Steel Stainless Steel Fasteners

## Section 8: System Schematics

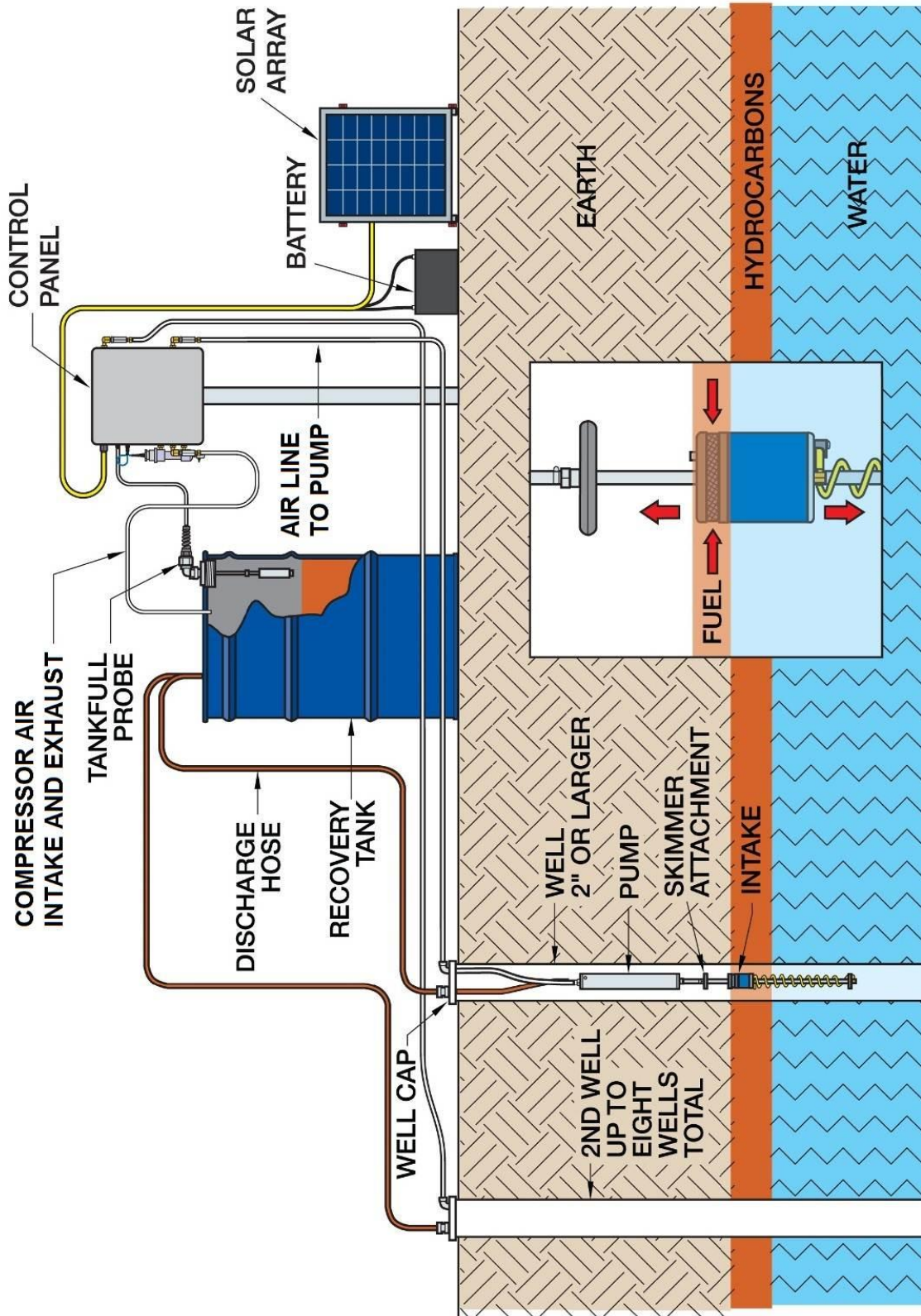

Figure 8-1 - Solar Sipper Schematic

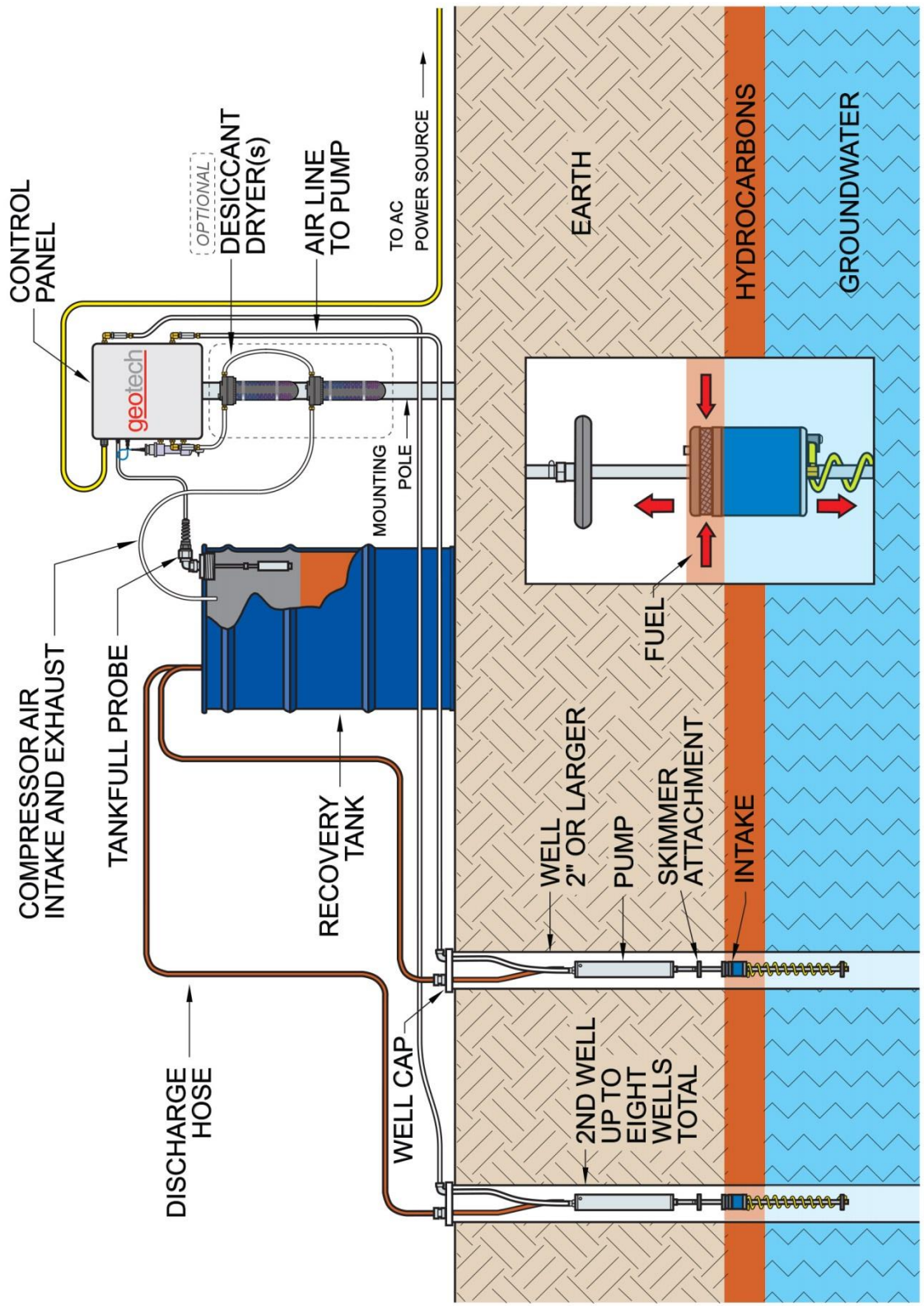

Figure 8-2 - AC Sipper Schematic, shown with optional Desiccant Dryers



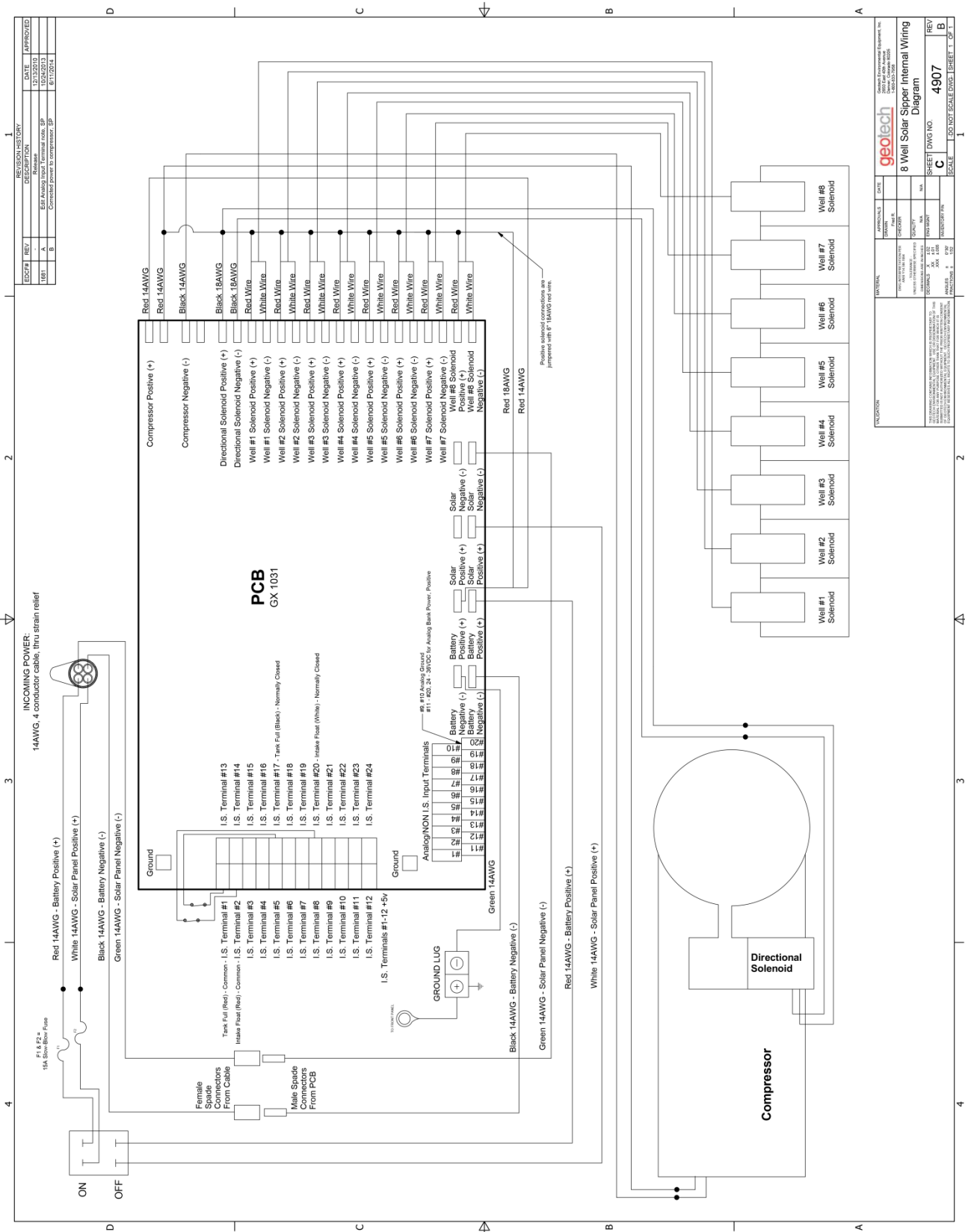

Figure 8-3 – 3 Well Solar Sipper Internal Wiring Diagram

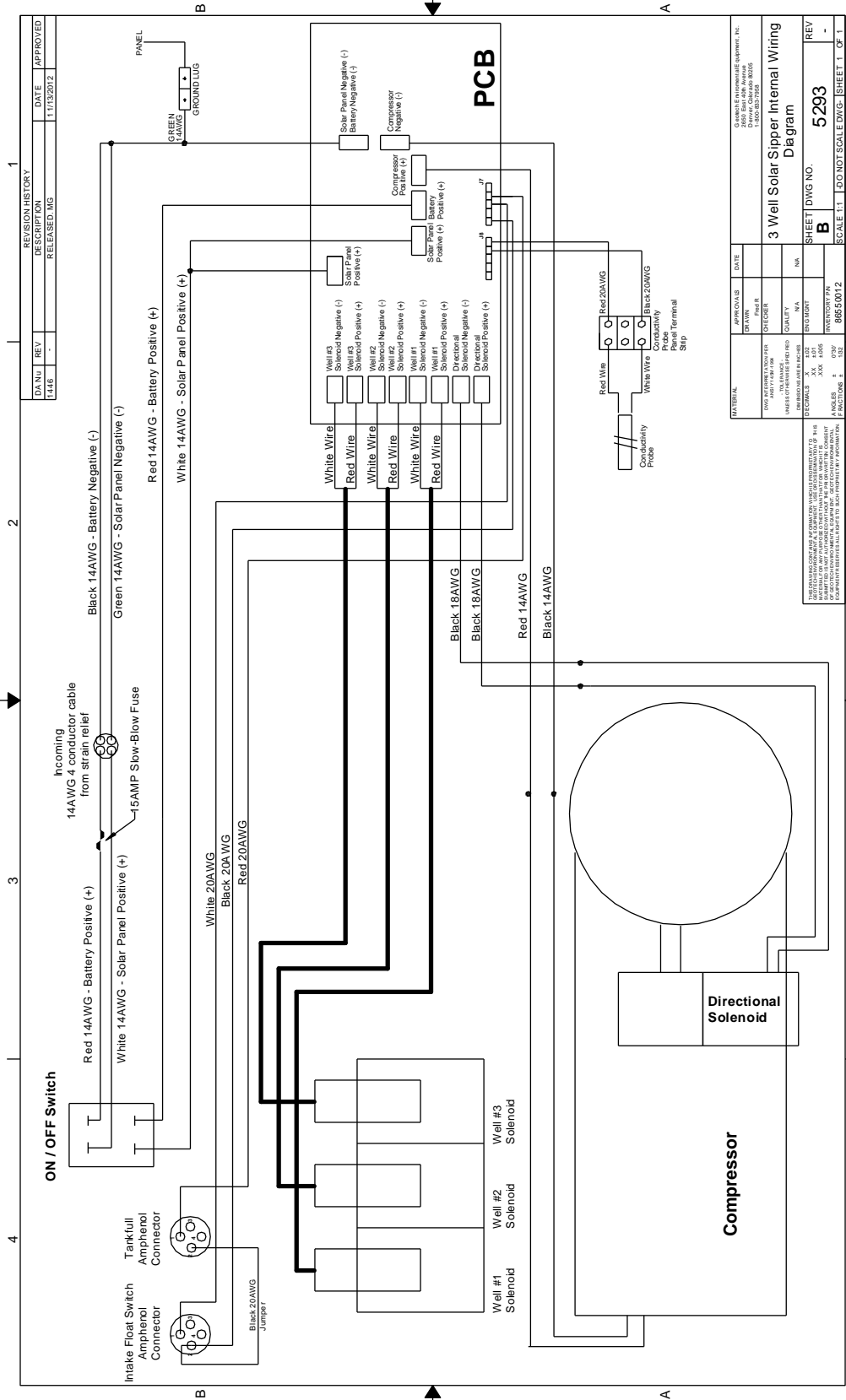

Figure 8-4 – 8 Well Solar Sipper Internal Wiring Diagram

## Section 9: Parts and Accessories

Description	Part Number
MANUAL, SOLAR SIPPER	16550176
MANUAL, SIPPER PUMP & SKIMMER ASSEMBLY	16550181
MOUNTING HARDWARE TABS (FEET)	16110181
FUSE,15A,MDL TYPE	PPE011035
FUSE HOLDER ASSEMBLY	2010029
COMPRESSOR,PRO,SIPPER	11150325
SOL/SPRING,2POS,12VDC,1/8"NPT 031SA4004000060	16550262
SOLENOID,GEOCONTROL PRO	11150249
<b>AC Sipper</b>	
CABLE,MOTORLEAD,12/3,SEOPRENE SEOOW,YELLOW	17050002
POWER SUPPLY,12V,100W, CE APPROVED,GEOCONTROL PRO	11150010
<b>Solar Sipper</b>	
CABLE,SEO,14/4,YELLOW	10014
<b>Solar Panel</b>	
SOLAR PANEL WITH FRAME,100 WATT	86550007
SOLAR PANEL,100 WATT	16550251
MOUNTING RACK,SOLAR PANEL	16550252
CABLE,THW,12AWG SUBMERSIBLE PUMP,BLACK/RED,RIBBON	11200479
BATTERY,SOLAR AGM,104 AH,12V	16550253
<b>Float Switch Assemblies</b>	
SOLAR SIPPER INTAKE FLOAT SWITCH	86600095
PROBE, TANKFULL, SOLAR SIPPER 25'	56650100
<b>Sipper Well Cap and Tubing Accessories</b>	
WELL CAP,2",SLIP W/ CMPRSN FTG SIPPER	86600061
WELL CAP,4",SLIP W/ CMPRSN FTG SIPPER	86600062
<b>Sipper Tubing (Air) – available by the foot or in 500' rolls.</b>	
TUBING,PE,.170x1/4,FT POLYETHYLENE	87050501
TUBING,TLPE,.170x1/4,FT FEP LINED POLYETHYLENE	87050529
TUBING,FEP,.170x1/4,FT FEP	87050509
<b>Sipper Tubing (Discharge) – available by the foot or in 500' rolls.</b>	
TUBING,RBR,3/8x5/8,FT PRODUCT DISHCARGE	16600019
TUBING,TLPE,3/8x1/2,FT FEP LINED POLYETHYLENE	87050506
TUBING,FEP,3/8x1/2,FT FEP	87050511

**Tubing Clamps**

CLAMP,NYL,1/4" SNAPPER	11150259
CLAMP,SS,STEPLESS EAR,17MM	16600004
CLAMP,SS6,WORM,7/32-5/8"	16600063

**Optional Parts and Accessories**

REBUILD KIT, COMPRESSOR, SIPPER PRO	11150334
DESICCANT DRYER, SIPPER	56550048
SILICA GEL, DESICCANT DRYER REFILL, 8 PACK	16600323

**Sipper Pump and Skimmer Parts and Accessories**

See "Geotech Pump and Skimmer Assembly Installation and Operation Manual" (P/N 16550181), for a complete description and listing of available pumps, skimmers, and their accessories.

## Installation Guide: Desiccant Dryer Kit for Geotech Sipper (Solar or AC)

If operating in humid environments, it is recommended to install a desiccant dryer kit with the Geotech Sipper (Solar or AC) to minimize the amount of moisturized air that enters the pneumatic system. This will minimize solenoid maintenance and optimize compressor performance.

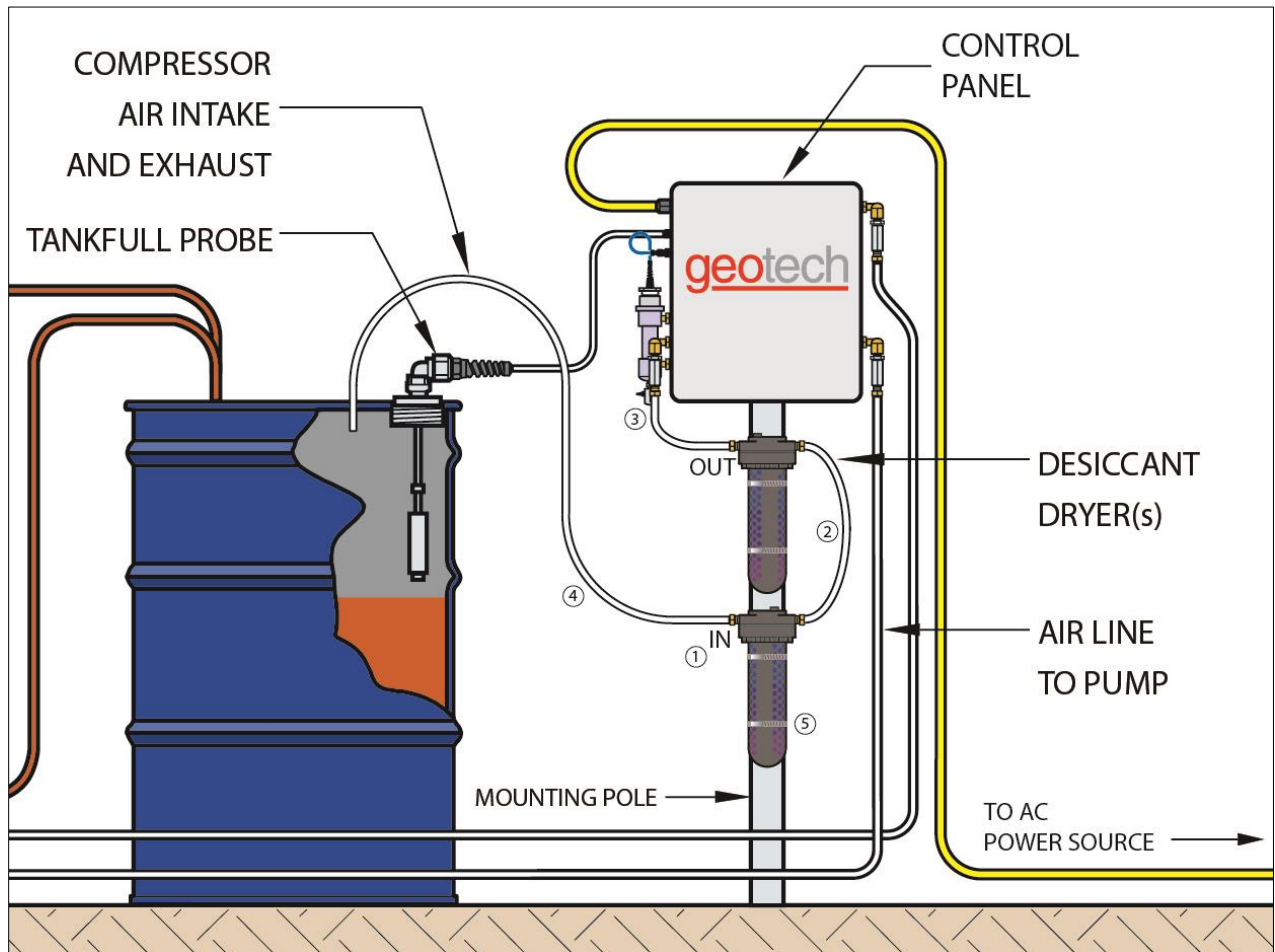

Install the desiccant dryers on the Compressor Air Intake and Exhaust line;

1. Locate the "IN" and "OUT" ports on the dryers.
2. Stack the two dryer's together by connecting an "OUT" port on one dryer to an "IN" port on the other dryer using .17" ID tubing.
3. Connect the remaining "OUT" port to the Intake/Exhaust fitting on the Sipper Enclosure using .17" ID tubing.
4. Connect the .17" ID tubing to the remaining "IN" port on the dryer. The end of this tubing will terminate to the recovery tank (position above tankfull probe), or to where site requirements permit.
5. Mount the desiccant dryers to a pole using the provided worm-drive clamps. Desiccant dryers should remain vertical for optimal moisture recovery.

The Desiccant Dryer's silicone beads will change from blue to pink as the dryer is saturated. Replace desiccant as necessary.

<b>DOCUMENT REVISIONS</b>		
<b>EDCF#</b>	<b>DESCRIPTION</b>	<b>REV/DATE</b>
-	Previous Release	02/15/2013
1583	Added Compressor Repair Kit to Replacement Parts List. Added Revision History Table - SP	05/24/2013
1713	Edited Section 9: Parts and Accessories – Solar Panel now 100 Watts (was 85 Watts), updated Solar Panel Specs - SP	12/18/2013
1725	Edited Section 3: Timer/Cycle Settings and Display Descriptions – Factory Default timers will be set to 0 seconds for vacuum, pressure, and delay – SP	1/10/2014
Project 1377	Added Desiccant Dryer Kit details to Section 4: System Operation, Section 6: System Troubleshooting, and Section 9: Parts and Accessories – SP	1/10/2014
Project 1411	Edited Section 3: Timer/Cycle Settings and Display Descriptions – Factory Default timers will be set to 1 second of vacuum, 30 seconds of pressure, 5 minutes of delay – SP	3/21/14
-	Added Desiccant Dryer Installation Guide, updated 8- well wiring diagram (rev B), SP	1/5/2014

## The Warranty

For a period of one (1) year from date of first sale, product is warranted to be free from defects in materials and workmanship. Geotech agrees to repair or replace, at Geotech's option, the portion proving defective, or at our option to refund the purchase price thereof. Geotech will have no warranty obligation if the product is subjected to abnormal operating conditions, accident, abuse, misuse, unauthorized modification, alteration, repair, or replacement of wear parts. User assumes all other risk, if any, including the risk of injury, loss, or damage, direct or consequential, arising out of the use, misuse, or inability to use this product. User agrees to use, maintain and install product in accordance with recommendations and instructions. User is responsible for transportation charges connected to the repair or replacement of product under this warranty.

## Equipment Return Policy

A Return Material Authorization number (RMA #) is required prior to return of any equipment to our facilities, please call our 800 number for appropriate location. An RMA # will be issued upon receipt of your request to return equipment, which should include reasons for the return. Your return shipment to us must have this RMA # clearly marked on the outside of the package. Proof of date of purchase is required for processing of all warranty requests.

This policy applies to both equipment sales and repair orders.

FOR A RETURN MATERIAL AUTHORIZATION,  
PLEASE CALL OUR SERVICE DEPARTMENT AT 1-800-833-7958

Model Number: \_\_\_\_\_

Serial Number: \_\_\_\_\_

Date of Purchase: \_\_\_\_\_

## Equipment Decontamination

Prior to return, all equipment must be thoroughly cleaned and decontaminated. Please make note on RMA form, the use of equipment, contaminants equipment was exposed to, and decontamination solutions/methods used.

Geotech reserves the right to refuse any equipment not properly decontaminated. Geotech may also choose to decontaminate equipment for a fee, which will be applied to the repair order invoice.

**Geotech Environmental Equipment, Inc**  
2650 East 40<sup>th</sup> Avenue Denver, Colorado 80205  
(303) 320-4764 • **(800) 833-7958** • FAX (303) 322-7242  
email: [sales@geotechenv.com](mailto:sales@geotechenv.com) website: [www.geotechenv.com](http://www.geotechenv.com)