

ICOM

INSTRUCTION MANUAL

**HF ALL BAND TRANSCEIVER
GENERAL COVERAGE RECEIVER**

IC-761



Icom Inc.

FOREWORD

ICOM's new, multi-function **IC-761** all solid state HF transceiver is designed to answer the increasing demand of today's Amateur radio operators for higher precision, sophisticated radio communications. The **IC-761** incorporates the latest in ICOM engineering advances in solid state transceiver design such as a higher dynamic range for receiving and greater quality final amplifier circuits.

In the past, ICOM HF transceivers have been used on various DX-peditions in many countries. Their performances on those occasions have helped establish their reputation for excellence among Amateur radio operators all over the world today. An added benefit of these DX-peditions has been the positive response from Amateur users to ICOM's advanced HF automatic antenna tuners which provide comprehensive, uncomplicated antenna tuning operations on the HF bands. Feedback to ICOM from Amateur users everywhere has therefore been very instrumental in the design effort to provide the finest HF equipment available to Amateurs.

The result of this feedback is the **IC-761**, an all mode, multi-purpose base station HF transceiver with general coverage and advanced HF automatic antenna tuning capability.

To thoroughly understand the capabilities of your new **IC-761**, please study this instruction manual carefully before attempting operation. If you have additional questions regarding the operation or capabilities of the **IC-761**, feel free to contact your nearest ICOM Dealer or Service Center.

UNPACKING

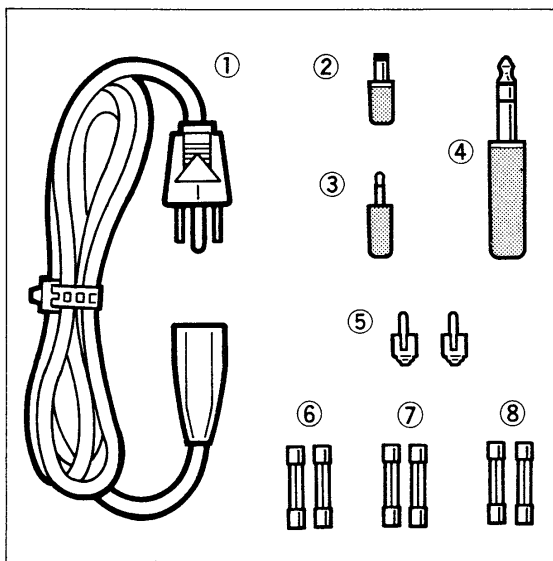

Accessories included with the IC-761:	Qty.
① AC cord	1
② DC power plug	1
③ External speaker plug	1
④ CW key plug	1
⑤ Pin plugs (RCA plugs)	2
⑥ Spare fuses for AC line (See below).	2
⑦ Spare fuses for DC line (5A)	2
⑧ Spare fuses for 13.8V DC OUTPUT (2A)	2

120V AC type : 10A
220 ~ 240V AC type : 5A

TABLE OF CONTENTS

1. PRECAUTIONS AND PREPARATIONS	1	9. MEMORY AND SCANNING OPERATION	48
2. FEATURES	2	9-1 MEMORY CHANNEL AND VFO SELECTION	48
3. CONTROL FUNCTIONS	3	9-2 PROGRAMMING MEMORY CHANNELS	49
3-1 FRONT PANEL	6	9-3 MEMORY CLEARING	50
3-2 FREQUENCY DISPLAY	15	9-4 SCANNING OPERATION	51
3-3 REAR PANEL	16	10. CIRCUIT DESCRIPTION	53
4. INSTALLATION	19	10-1 RECEIVER CIRCUITS	53
4-1 UNPACKING	19	10-2 TRANSMITTER CIRCUITS	54
4-2 PLANNING	19	10-3 ANTENNA TUNER	54
4-3 ANTENNA	19	10-4 PLL CIRCUIT	55
4-4 GROUNDING	19	11. MAINTENANCE AND ADJUSTMENTS	56
4-5 REAR PANEL CONNECTIONS	20	11-1 MAINTENANCE	56
5. SYSTEM INTERCONNECTIONS	21	11-2 ADJUSTMENTS	57
5-1 EXTERNAL LINEAR AMPLIFIER	21	12. OPTIONS INSTALLATIONS	59
5-2 EXTERNAL ANTENNA TUNER	22	12-1 IC-EX310 VOICE SYNTHESIZER UNIT	59
5-3 RTTY TERMINAL UNIT	23	12-2 UT-30 PROGRAMMABLE TONE ENCODER UNIT	60
5-4 AFSK TERMINAL UNIT	23	12-3 FILTERS	60
5-5 SSTV UNIT	24	12-4 OPTIONS	62
5-6 MIC CONNECTOR INFORMATION	24	13. INSIDE VIEWS	63
5-7 ACCESSORY SOCKET INFORMATION	24	13-1 TOP VIEW (REGULATOR AND TUNER UNITS)	63
5-8 REMOTE CONTROL JACK (CI-V) INFORMATION	26	13-2 BOTTOM VIEW (MAIN AND RF UNITS)	64
6. GENERAL OPERATION	27	14. BLOCK DIAGRAMS	65
6-1 INITIAL SETTINGS	27	15. SPECIFICATIONS	67
6-2 FREQUENCY SETTINGS	27	SCHEMATIC DIAGRAMS	SEPARATE
6-3 MODE SELECTION	28		
6-4 SSB OPERATION	29		
6-5 CW OPERATION	31		
6-6 RTTY OPERATION	33		
6-7 AM OPERATION	34		
6-8 FM OPERATION	35		
6-9 GENERAL COVERAGE RECEIVER	36		
7. ANTENNA TUNER OPERATION	37		
7-1 PRESETTINGS	37		
7-2 AUTO-TUNING FAILS TO OPERATE	38		
8. FUNCTIONS OPERATION	39		
8-1 RIT/ Δ TX OPERATION	39		
8-2 FILTER SWITCH OPERATION	41		
8-3 MONITOR OPERATION	42		
8-4 PREAMP/ATT SWITCH OPERATION	42		
8-5 AGC SWITCH OPERATION	42		
8-6 SPEECH COMPRESSOR OPERATION	43		
8-7 NOISE BLANKER (NB) OPERATION	43		
8-8 VOX OPERATION	44		
8-9 PASSBAND/IF SHIFT OPERATION	45		
8-10 NOTCH FILTER OPERATION	46		
8-11 SWR READING	46		
8-12 SPLIT (DUPLEX) OPERATION	47		

1. PRECAUTIONS AND PREPARATIONS

■ INSTALLATION PRECAUTIONS

1. Avoid using the **IC-761** in the following situations:
 - a. Where temperatures under -10°C or over $+60^{\circ}\text{C}$ are encountered. For example, **DO NOT** use the **IC-761** in areas exposed to direct sunlight or near heat-producing devices such as heaters or ranges.
 - b. In humid or moist places including bathrooms.
2. **DO NOT** run the antenna feedline near electronic instruments or magnetic compasses.
3. **DO NOT** place the transceiver within the reach of babies or small children when turning the transceiver ON.
4. **DO NOT** place any liquids on or near the transceiver as spilling could result in fire risk or electric shocks.
5. An extension cord should not be used unless absolutely necessary. Use of improper extension cords could result in fire risk or electric shocks.
6. **DO NOT** let metal strips, wire, etc., come into contact with internal components in the transceiver.

■ GROUNDING

To prevent electrical shocks, TVI, BCI and other problems, be sure to ground the transceiver through the **GROUND TERMINAL**. For best results, use the heaviest gauge wire or strap available and make the connection as short as possible.

ONLY use a city water pipe as a good earth point if the pipe is well grounded and made of metal. **NEVER** use a gas pipe or electrical conduit pipe for grounding.

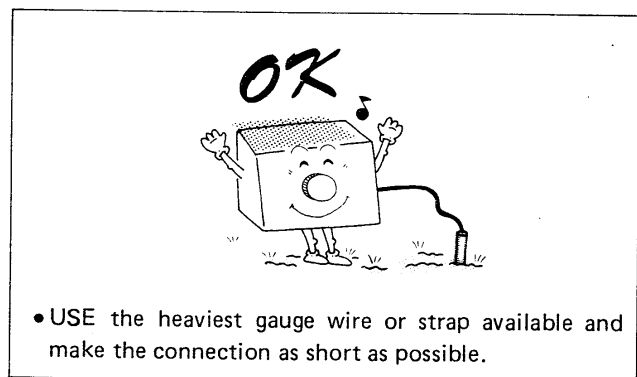
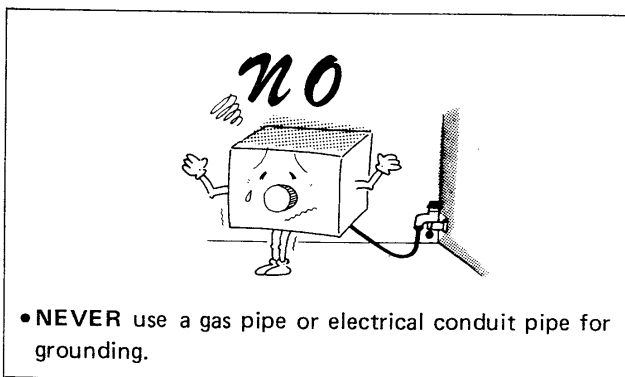

■ ANTENNA

Antennas play a very important role in radio communication. If the antenna is inferior, your transceiver cannot give you the best performance. A well-matched 50Ω antenna and feedline will provide the desired performance.

2. FEATURES

■ COMPLETE HF TRANSCEIVER

- BUILT-IN AUTOMATIC ANTENNA TUNER

The IC-761 is equipped with an advanced HF antenna tuner system for quick, complete, and well matched antenna performance.

- FULL BREAK-IN FUNCTION

Full break-in as well as semi break-in operation are provided for smooth, fast, and natural CW conversations.

- BUILT-IN ELECTRONIC KEYSER FUNCTION

Automatic keying is possible in the IC-761 with the simple connection of an iambic paddle. The number of dots and dashes can be controlled by the operator with the result that CW operation is easier and more enjoyable.

- BUILT-IN HIGH STABILITY CRYSTAL UNIT

The IC-761 has a built-in high stability crystal unit which incorporates a temperature-compensating oven heater, resulting in a frequency stability of less than $\pm 100\text{Hz}$ at $-10^{\circ}\text{C} \sim +60^{\circ}\text{C}$.

■ OUTSTANDING RECEIVER PERFORMANCE

- GENERAL COVERAGE RECEIVER

The IC-761 features general coverage receive capability with a tuning range from 100kHz to 30MHz. This wide range is accomplished by means of up-conversion using a high side IF and a CPU control system.

- ICOM'S DFM SYSTEM

The ICOM DFM (Direct Feed Mixer) feeds the incoming signals directly into a high level first mixer developed by ICOM. This advanced system produces a higher spurious response rejection ratio, a higher receiver sensitivity and a wider dynamic range.

- 105dB DYNAMIC RANGE

The IC-761 has a 105dB dynamic range. Even with the PREAMP switched ON, the dynamic range is approximately 100dB.

■ LARGE MEMORY CAPACITY CPU INSTALLED

- 32 MEMORIES

Thirty-two programmable memories are provided to store mode and frequency, and the CPU is backed up by an internal lithium battery to maintain the memories for up to ten years.

- ADVANCED REMOTE CONTROL SYSTEM

Full communications using a personal computer equipped with an RS-232C jack are possible by using the serial port mounted on the rear panel of the IC-761. The computer controls frequency, mode, VFO A/B selection, and memories when an appropriate interface is used. The serial port uses a standard 1200bps data rate.

- SCANNING VERSATILITY

The IC-761 incorporates a total of four separate scanning functions for easy access to a wide range of frequencies.

3. CONTROL FUNCTIONS

FRONT PANEL

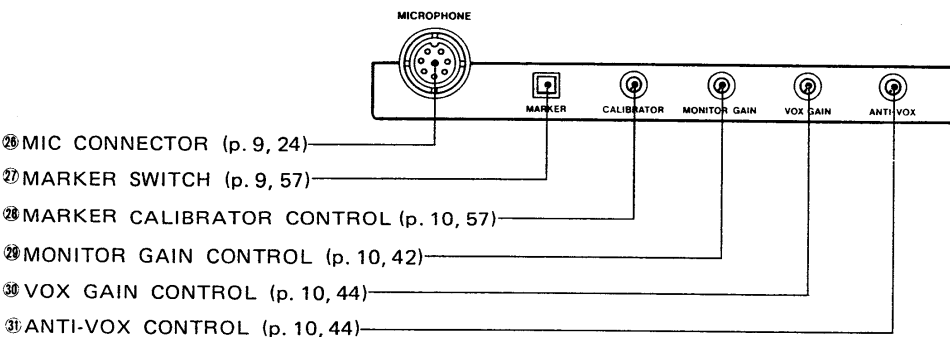
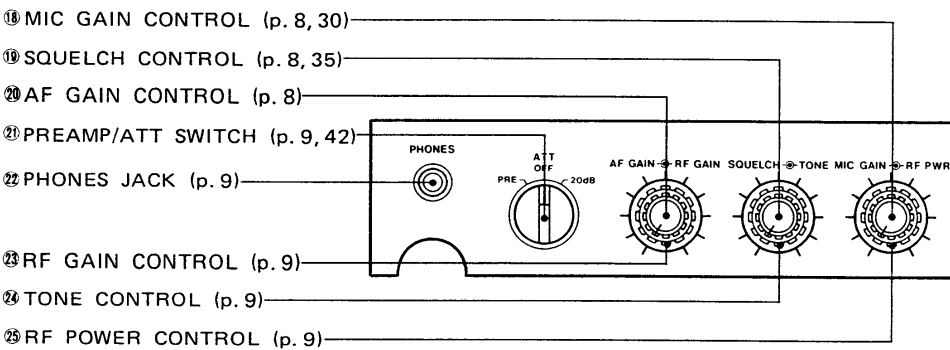
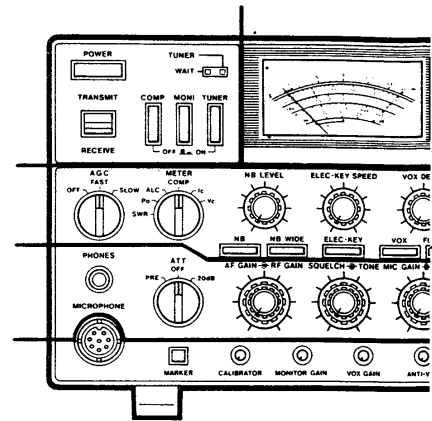
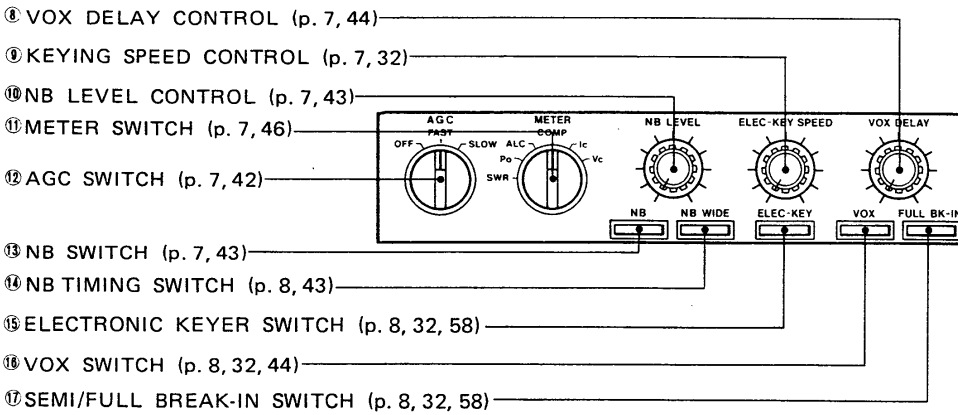
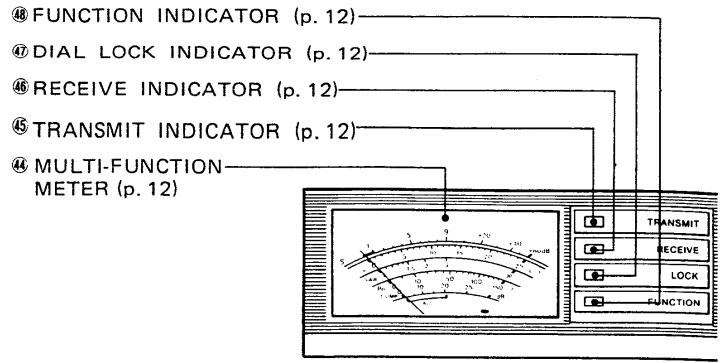
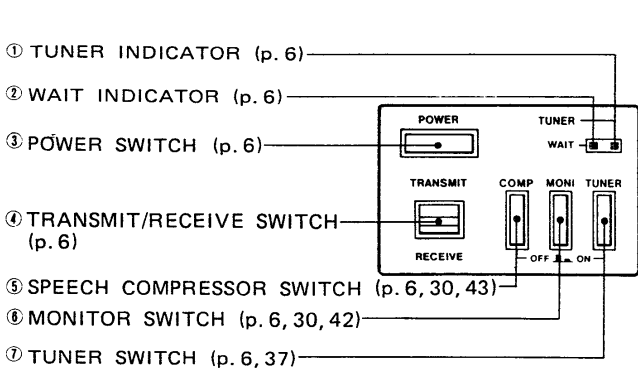

④ FREQUENCY DISPLAY (p. 13, 15, 16)

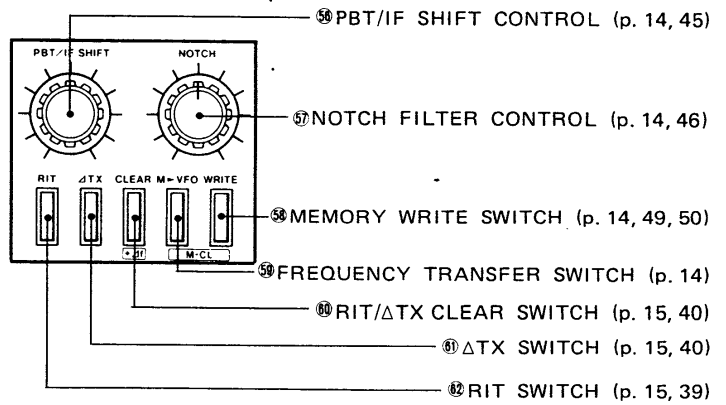
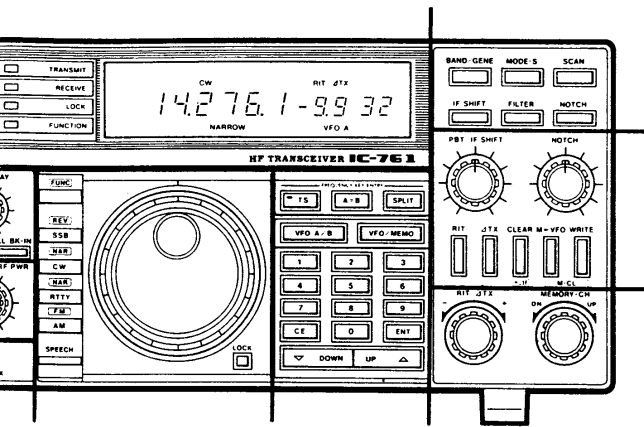
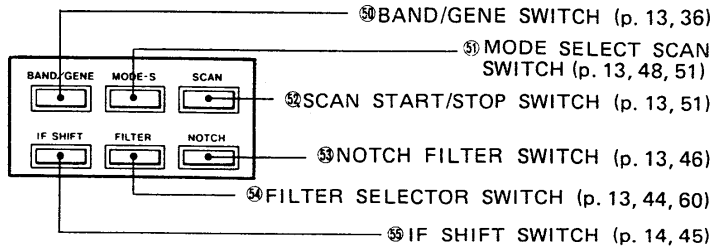
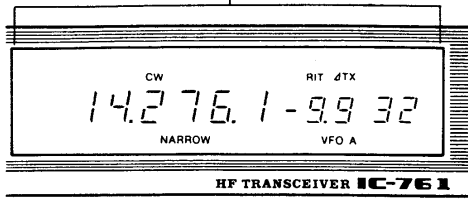

⑱ FUNCTION SWITCH (p. 10, 11)

⑲ MODE SWITCHES (p. 11, 28)

⑳ SPEECH SWITCH (p. 11, 59)

㉑ TUNING CONTROL (p. 10)

㉒ DIAL LOCK SWITCH (p. 10)

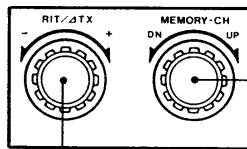
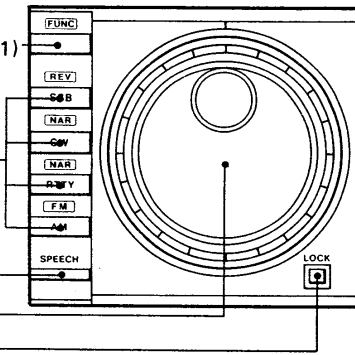

㉓ MEMORY-CH SELECTOR CONTROL (p. 15, 48, 49)

㉔ RIT/ΔTX TUNING CONTROL (p. 15, 39)

㉕ TUNING SPEED SWITCH (p. 11)

㉖ VFO EQUALIZING SWITCH (p. 11)

㉗ SPLIT (DUPLX) SWITCH (p. 12, 47)

㉘ VFO/MEMORY SWITCH (p. 12, 48)

㉙ VFO A/B SWITCH (p. 11, 47, 48)

㉚ KEYBOARD (p. 12, 28)

㉛ UP/DOWN SWITCHES (p. 12, 27)

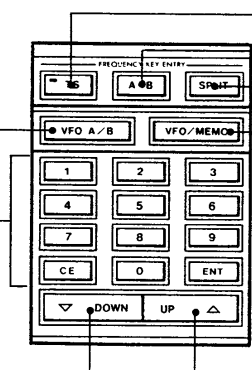

■ FREQUENCY DISPLAY

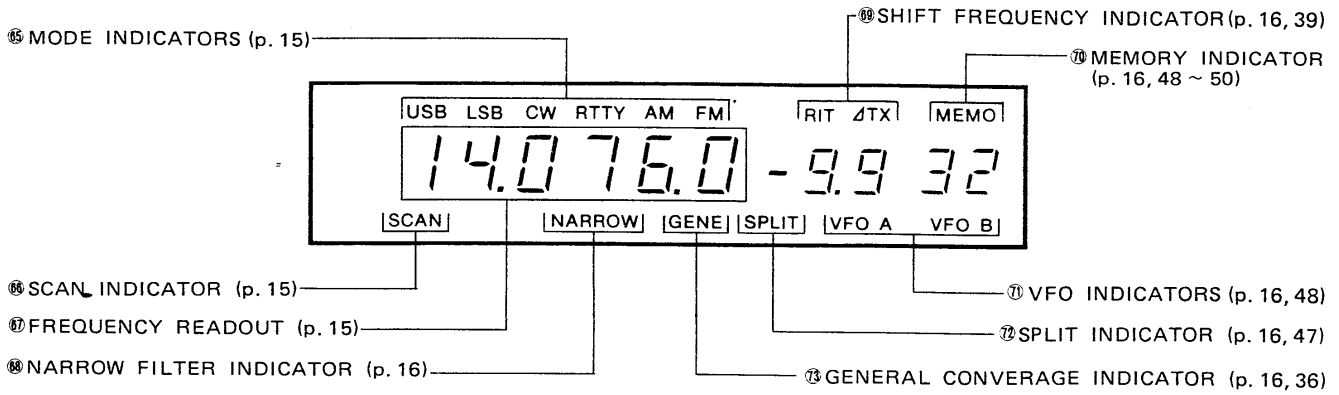

■ REAR PANEL

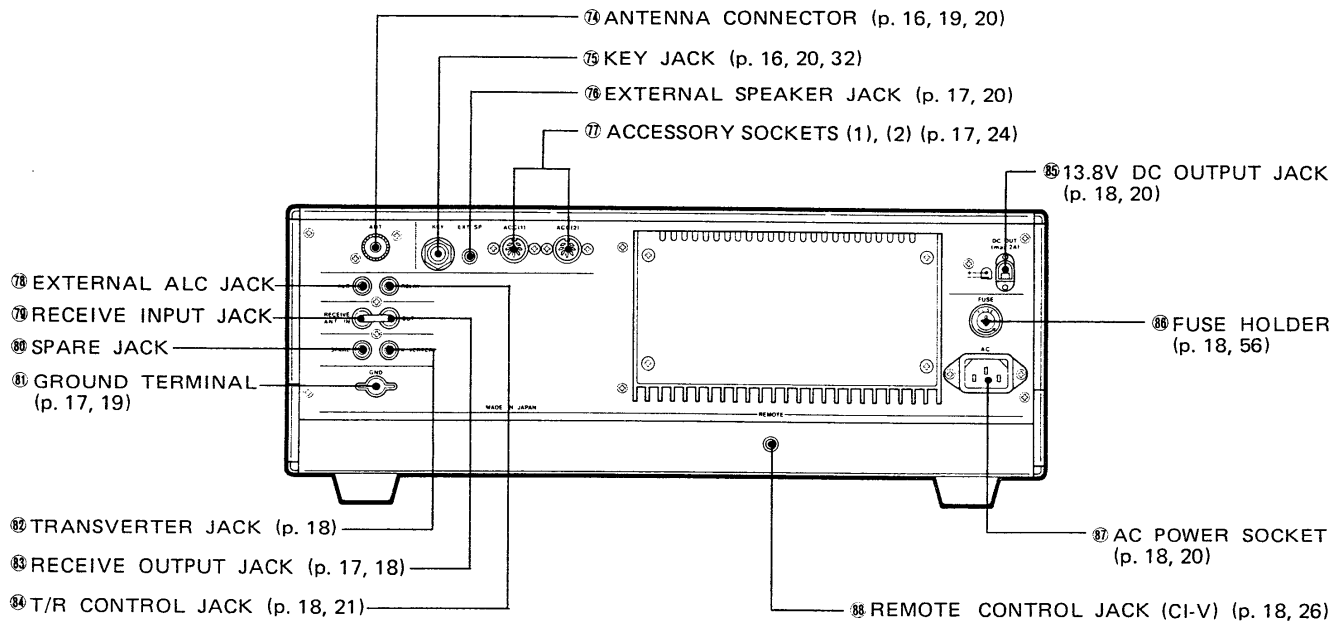

3-1 FRONT PANEL

① TUNER INDICATOR [TUNER]

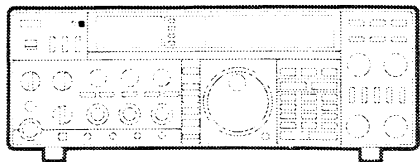

Lights up when the built-in antenna tuner is turned ON.

② WAIT INDICATOR [WAIT]

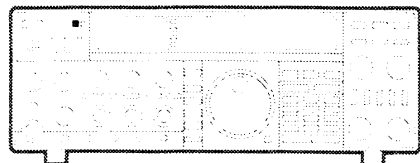

Lights up while the tuning capacitors in the antenna tuner move to preset positions.

③ POWER SWITCH [POWER]

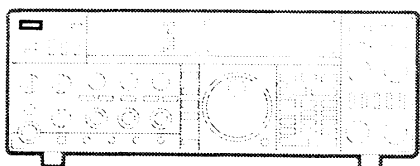

This is a push-lock switch which controls the input AC power to the IC-761.

④ TRANSMIT/RECEIVE SWITCH

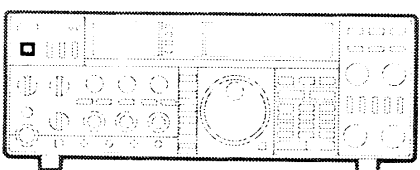

This switch is used to manually switch the transceiver from transmit to receive mode and vice versa.

⑤ SPEECH COMPRESSOR SWITCH [COMP] (p. 30, 43)

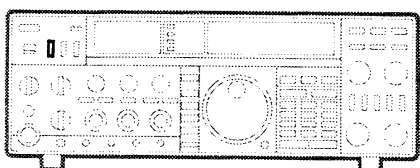

This switch turns the built-in speech compressor circuit ON and OFF.

⑥ MONITOR SWITCH [MONI] (p. 30, 42)

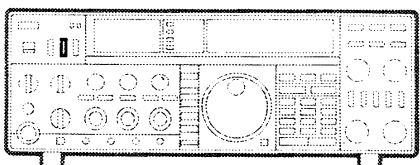

This switch turns the monitor circuit ON and OFF.

⑦ TUNER SWITCH [TUNER] (p. 37)

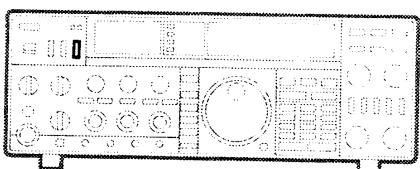

This switch turns the built-in antenna tuner ON and OFF.

- Output power bypasses the built-in antenna tuner when the [TUNER] SWITCH is in OUT (OFF) position.

⑧ VOX DELAY CONTROL [VOX DELAY]
(p. 44)

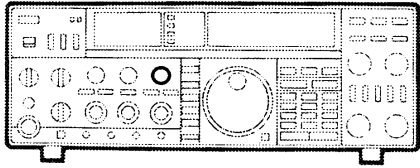

This control changes the transmit to receive switching time. Adjust it so transmit to receive switching occurs during pauses in your speech or CW transmission.

⑨ ELECTRONIC KEYSPEED CONTROL [ELEC-KEY SPEED]
(p. 32)

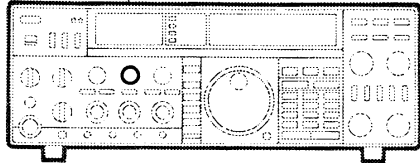

This control varies the keying speed between 5 and 45wpm when operating in CW mode with the [ELEC-KEY] turned ON.
(See item ⑮)

⑩ NOISE BLANKER LEVEL CONTROL [NB LEVEL] (p. 43)

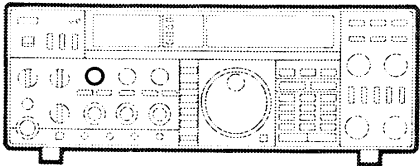

This control varies the threshold level of the noise blanker. Adjust to remove the noise without adding distortion to the received signal.

⑪ METER SWITCH [METER] (p. 46)

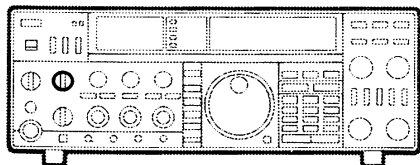

In transmit mode, the front panel meter has six functions.

V_c	Indicates the collector voltage of the final transistors.
I_c	Indicates the collector current of the final transistors.
COMP	Indicates the compression level when the speech compressor is in use.
ALC	Indicates the ALC level. The ALC circuit begins to function when the RF output power reaches a preset level.
P_o	Indicates the approximate output power.
SWR	Indicates the SWR of the antenna system.

⑫ AUTOMATIC GAIN CONTROL SWITCH [AGC] (p. 42)

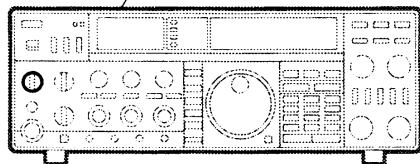

This switch changes the time constant of the AGC circuit.

⑬ NOISE BLANKER SWITCH [NB] (p. 43)

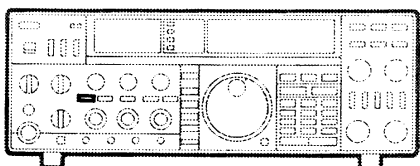

This switch turns ON the noise blanker circuit to reduce pulse-type noise such as that generated by automobile ignition systems.

Use this switch with the NOISE BLANKER LEVEL CONTROL described in item ⑩.

⑭ NOISE BLANKER TIMING SWITCH [NB WIDE] (p. 43)

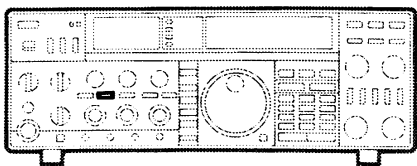

The blanking time of the noise blanker circuit may be set for NORMAL or WIDE with this switch. Use this switch with the NOISE BLANKER LEVEL CONTROL described in item ⑩

- To activate the [NB WIDE] SWITCH, push IN the [NB] SWITCH.

⑮ ELECTRONIC KEYSwitch [ELEC-KEY] (p. 32, 58)

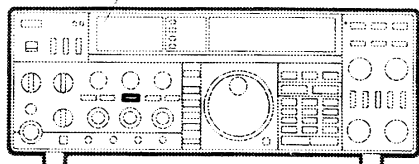

This key turns the electronic keyer function ON and OFF when operating in CW mode. Manual CW operation only is possible when the switch is OFF.

⑯ VOX SWITCH [VOX] (p. 32, 44)

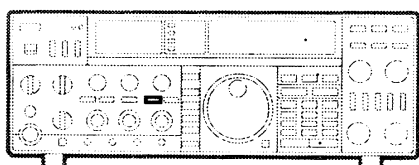

This switch turns the VOX circuit ON and OFF. The automatic T/R switching VOX circuit functions in the PHONE and CW modes when the switch is IN. In CW mode, semi break-in or full break-in operation is possible.

⑰ SEMI/FULL BREAK-IN SWITCH [FULL BK-IN] (p. 32, 58)

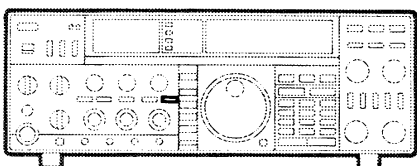

This switch selects semi or full break-in operation for CW operating purposes when CW mode is selected.

⑱ MIC GAIN CONTROL [MIC GAIN] (p. 30)

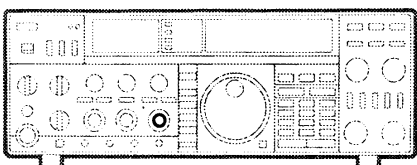

Adjust this control for a suitable modulation level while speaking into the microphone using your normal voice level. Rotate the control clockwise to increase the gain.

⑲ SQUELCH CONTROL [SQUELCH] (p. 35)

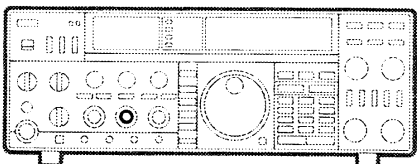

This control sets the squelch threshold level. To turn OFF the squelch function, rotate this control completely counterclockwise. To set the threshold level higher, rotate the control clockwise.

Adjust this control clockwise until the green [RECEIVE] INDICATOR just goes out while no signal is being received.

⑳ AF GAIN CONTROL [AF GAIN]

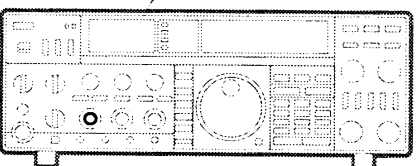

This control varies the audio output level in receive mode. Clockwise rotation increases the level.

⑳ PREAMP/ATT SWITCH [ATT] (p. 42)

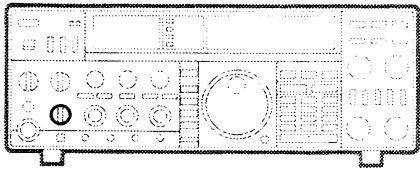

This switch selects the RF preamplifier to amplify weak receive signals or the RF attenuator (20dB) to prevent overloading of the receiver.

㉑ PHONES JACK [PHONES]

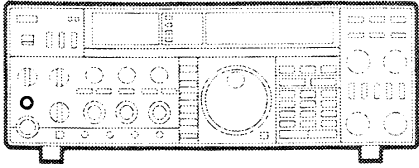

This jack accepts a standard 1/4 inch plug from headphones with an impedance of 4 ~ 16Ω. Stereo headphones may be used without modification.

㉒ RF GAIN CONTROL [RF GAIN]

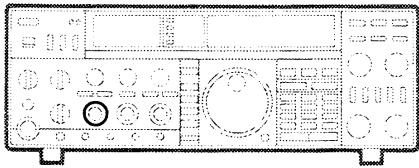

This control varies the gain of the RF stage when the transceiver is in receive mode. Rotate the control fully clockwise for maximum gain. When tuning in SSB or CW mode, the S-meter needle rises as the control is rotated counterclockwise and only those signals stronger than the level indicated by the needle are heard.

㉓ TONE CONTROL [TONE]

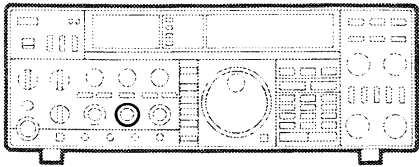

This control varies the receive audio tone. Adjust the control to provide the clearest, most pleasing audio.

㉔ RF POWER CONTROL [RF PWR]

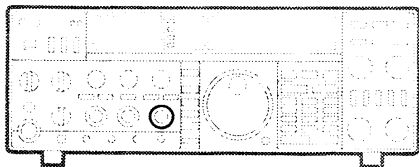

This control varies the RF output power from 10W to maximum.

- SSB : 100W PEP
- CW, RTTY, FM : 100W
- AM : 4W ~ 40W

Rotate the control clockwise to increase the output power. Use the minimum power necessary for reliable communication.

㉕ MIC CONNECTOR [MICROPHONE] (p. 24)

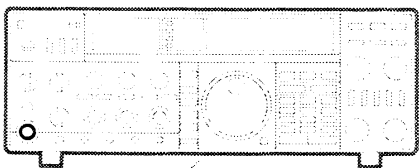

Connect a suitable microphone to this connector. The optional HM-36 HAND MICROPHONE, SM-8 or SM-10 DESK MICROPHONE may be used.

㉖ MARKER SWITCH [MARKER] (p. 57)

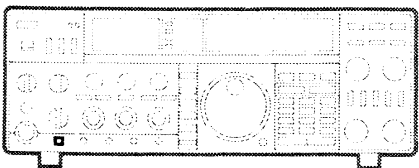

This switch turns the MARKER circuit ON and OFF. A calibration marker is generated every 10kHz when the circuit is activated.

⑳ **MARKER CALIBRATOR CONTROL**
[CALIBRATOR] (p. 57)

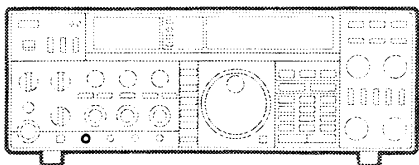

This control varies the marker frequency. Use an accurate standard frequency source such as radio station WWV/WWVH to calibrate the marker generator.

㉑ **MONITOR GAIN CONTROL**
[MONITOR GAIN] (p. 42)

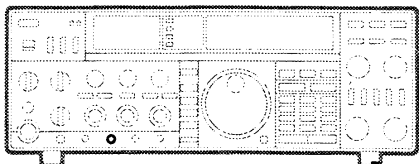

This control changes the audio level of the monitor circuit when the [MONI] SWITCH is turned ON. Adjust the control for the desired monitor volume.

㉒ **VOX GAIN CONTROL [VOX GAIN]**
(p. 44)

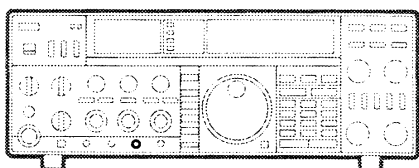

This control increases and decreases the sensitivity of the VOX circuit. When operating in the SSB, AM or FM mode, adjust the control so the VOX circuit activates at a normal speech level.

㉓ **ANTI-VOX CONTROL [ANTI-VOX]**
(p. 44)

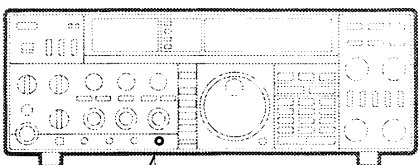

When using the VOX function, sound from the speaker may cause unwanted switching of the T/R relay. Adjust this control in conjunction with the [VOX GAIN] CONTROL so the T/R relay switches only from the operator's voice and not from the speaker audio.

㉔ **FUNCTION SWITCH [FUNC]** (p.11)

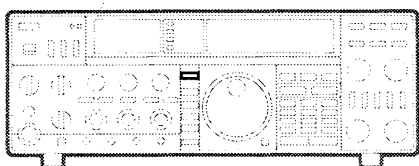

This switch activates the secondary switch functions on the front panel as indicated by the reverse-image lettering (white letters on a black background).

㉕ **TUNING CONTROL**

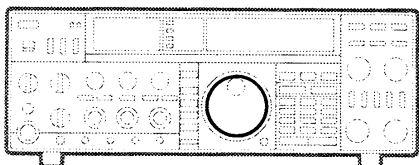

Rotate this control to change the frequency.

TUNING CONTROL	FREQUENCY STEP	
	Slow rotation	10Hz step
Rapid rotation	50Hz step	25kHz/rotation
[TS] SWITCH : ON	1kHz step	500kHz/rotation

㉖ **DIAL LOCK [LOCK]**

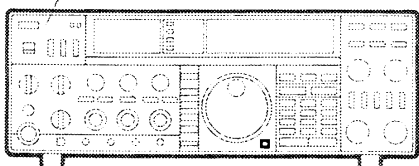

This switch electronically locks the IC-761 on the currently displayed frequency and deactivates the TUNING CONTROL.

35 SPEECH SWITCH [SPEECH] (p. 59)

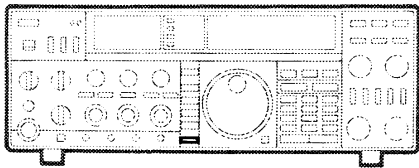

This switch activates the optional IC-EX310 SPEECH SYNTHESIZER UNIT which announces the displayed frequency in English.

36 MODE SWITCHES (p. 28)

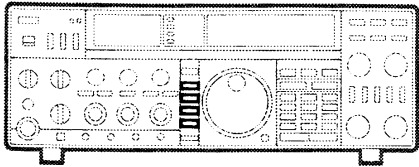

These switches select any of the eight operating modes.

MODE	SWITCH OPERATION
SSB	Push SSB SWITCH
SSB REVERSE	Push FUNC + SSB SWITCHES
CW	Push CW SWITCH
CW NARROW (NAR)	Push FUNC + CW SWITCHES
RTTY	Push RTTY SWITCH
RTTY NARROW (NAR)	Push FUNC + RTTY SWITCHES
AM	Push AM SWITCH
FM	Push FUNC + AM SWITCHES

37 VFO A/B SWITCH [VFO A/B] (p. 47, 48)

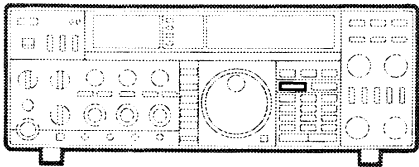

This switch selects VFO A or VFO B for tuning purposes. Each push of this switch selects one of the two VFOs alternately.

38 TUNING SPEED SWITCH [TS]

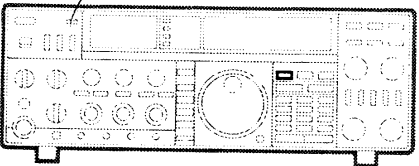

Push this switch to increase the tuning rate to 1kHz while in any operating mode. The 100Hz digit on the FREQUENCY DISPLAY clears to "0" simultaneously.

39 VFO EQUALIZING SWITCH [A = B]

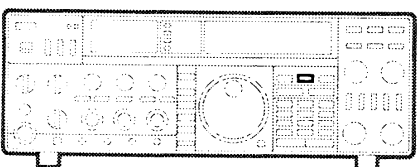

This switch instantly matches the frequency and mode of operation of the two VFOs. The display does not change when this switch is pushed. However, confirmation of the equalizing process is possible by pushing the [VFO A/B] SWITCH to check the frequency and mode of the opposite VFO.

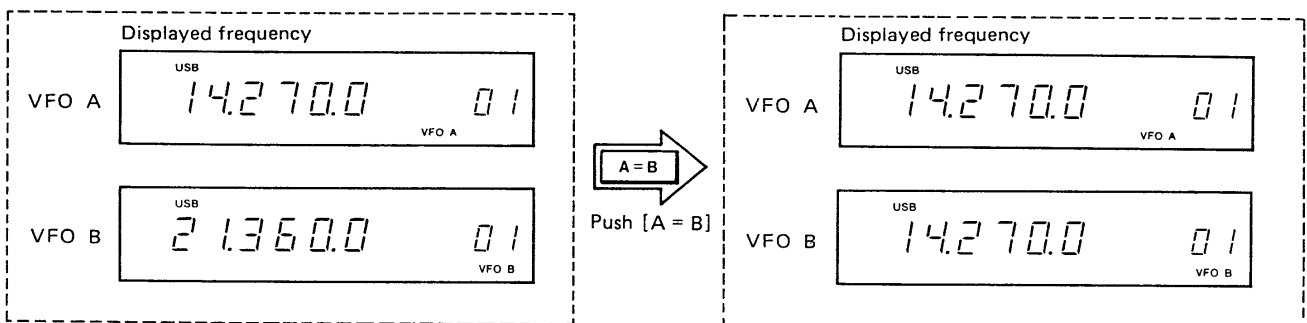

④① SPLIT SWITCH [SPLIT] (p. 47)

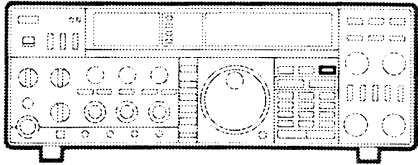

This switch selects the relationship of the two VFO frequencies. In the IN position, one VFO is for receive while the other VFO is for transmit. Each alternate push of this switch chooses the simplex and duplex modes.

④② VFO/MEMORY SWITCH [VFO/MEMO] (p. 48)

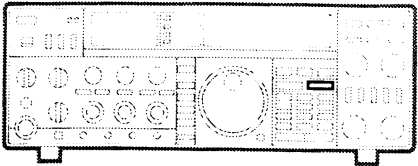

This switch selects either the VFO or MEMORY CHANNEL mode for tuning purposes.

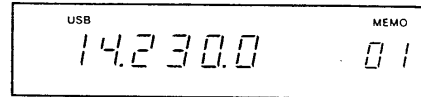
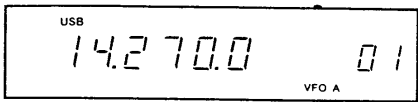

Push [VFO/MEMO] SWITCH.

④③ KEYBOARD (p. 28)

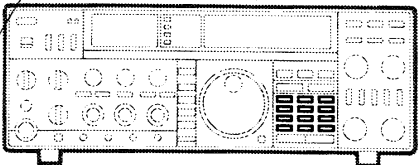

The KEYBOARD directly sets the operating frequency in VFO or memory modes.

④④ UP/DOWN SWITCHES [UP] [DOWN] (p. 27)

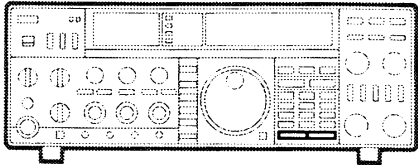

Each push increases or decreases the operating band. Less significant digits do not change.

④⑤ MULTI-FUNCTION METER

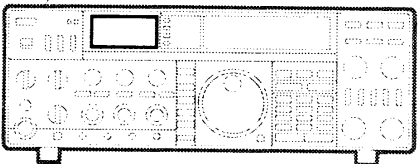

In receive mode, the IC-761 front panel meter acts as an S-meter (signal strength meter). In transmit mode, the meter has six different functions as stated in item ① [METER] SWITCH.

④⑥ TRANSMIT INDICATOR

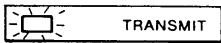

This indicator lights up when the IC-761 is in transmit mode.

④⑦ RECEIVE INDICATOR

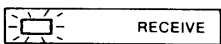

This indicator lights up when the IC-761 is in receive mode.

④⑧ DIAL LOCK INDICATOR

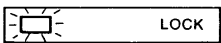

This indicator lights up when the DIAL LOCK function is activated.

④⑨ FUNCTION INDICATOR

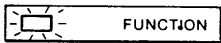

This indicator lights up when the FUNCTION SWITCH is pushed.

④⑨ FREQUENCY DISPLAY (p. 15, 16)

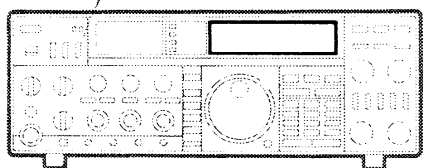

The IC-761 FREQUENCY DISPLAY gives an easy-to-read, comprehensive display of operating mode, functions, frequencies and memory channels. See items ⑥⑤ to ⑦③ for more information.

⑤⑩ HAM BAND/GENERAL COVERAGE SWITCH [BAND/GENE] (p. 36)

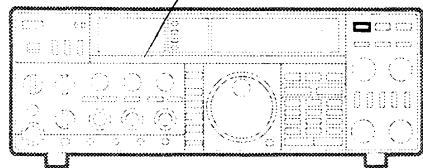

This switch changes the IC-761 between the HAM BAND and GENERAL COVERAGE modes.

HAM BAND MODE:

The transceiver functions on any of the HF amateur bands from 1.8 to 28MHz.

GENERAL COVERAGE MODE:

The transceiver functions on all frequencies from 0.1 to 30MHz. The IC-761 does not transmit while in the GENERAL COVERAGE mode.

⑤⑪ MODE SELECT SCAN SWITCH [MODE-S] (p. 48, 51)

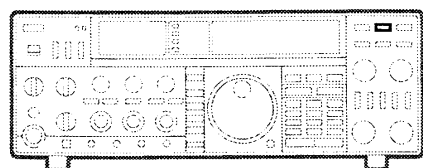

This switch turns the selective mode function ON and OFF. If the switch is IN:

- Only memory channels with the same mode as displayed before the switch was pushed can be selected by the [MEMORY-CH] CONTROL.
- Only memory channels with the same mode as displayed before the switch was pushed can be scanned during MEMORY SCAN operation.

⑤⑫ SCAN START/STOP SWITCH [SCAN] (p. 51)

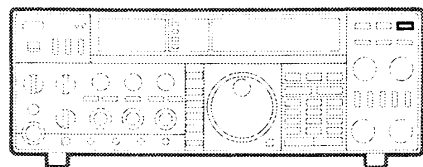

This switch starts and stops all scan functions. When the scan restarts, it begins from the frequency the scan halted on while in programmed scan mode, or from the highest memory channel while in memory mode.

⑤⑬ NOTCH FILTER SWITCH [NOTCH] (p. 46)

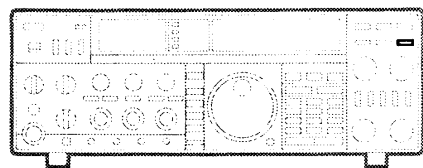

This switch turns the NOTCH FILTER circuit ON and OFF. Adjust the [NOTCH] CONTROL (described in item ⑤⑦) to reduce interference.

⑤⑭ FILTER SELECTOR SWITCH [FILTER] (p. 41, 60)

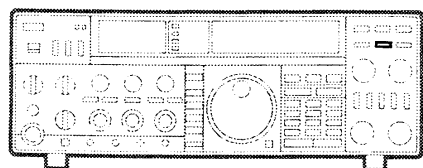

This switch selects a different combination of the second IF (9MHz) filter and the third IF (455kHz) filter to vary the overall selectivity.

⑤⑤ IF SHIFT SWITCH [IF SHIFT] (p. 45)

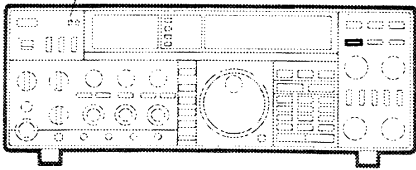

This switch turns the IF SHIFT function ON and OFF. Adjust the [PBT/IF SHIFT] CONTROL (described in item ⑤⑥) to reduce interference from adjacent frequency signals.

⑤⑥ PBT/IF SHIFT CONTROL [PBT/IF SHIFT] (p. 45)

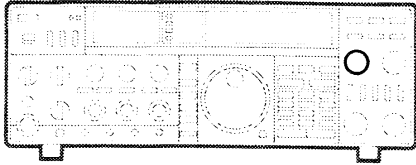

This control allows continuous tuning of the receive selectivity when using the SSB, CW or RTTY mode. The IF SHIFT function works when the [IF SHIFT] SWITCH is ON. Either the PBT or IF SHIFT function works at the same time.

⑤⑦ NOTCH FILTER CONTROL [NOTCH] (p. 46)

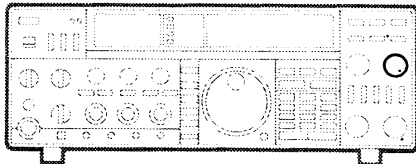

This control shifts the notch filter frequency when the [NOTCH] SWITCH is ON. Adjust the control to minimize interference.

⑤⑧ MEMORY WRITE SWITCH [WRITE] (p. 49, 50)

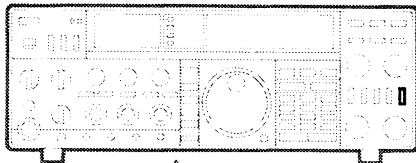

This switch stores the displayed operating frequency and mode information in the memory channel indicated on the FREQUENCY DISPLAY. Memory writing is possible in either VFO or MEMORY CHANNEL mode.

⑤⑨ FREQUENCY TRANSFER SWITCH [M ▶ VFO]

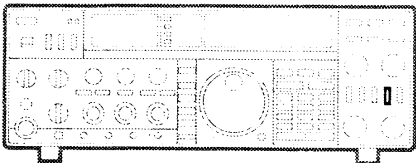

This switch operates differently depending on which mode the IC-761 is in.

- In VFO mode, the frequency and mode stored in the memory channel displayed transfer to the selected VFO.
- In MEMORY CHANNEL mode, the displayed frequency and mode transfer to the VFO used immediately prior to changing to MEMORY CHANNEL mode.

• In VFO mode

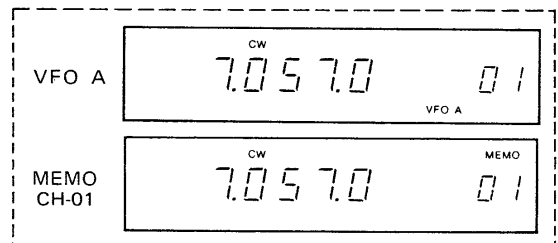
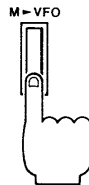
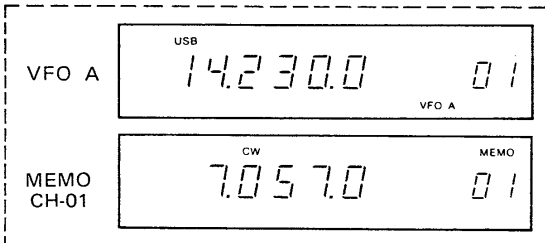

• In MEMORY CHANNEL mode

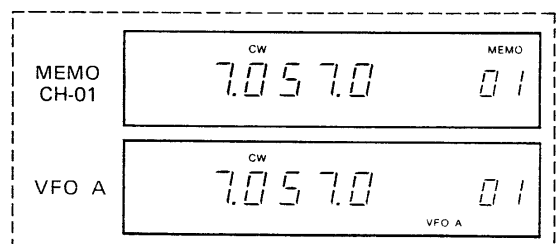
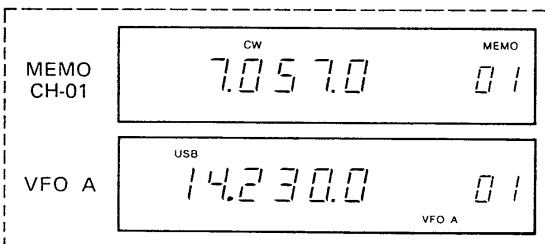

⑥⑩ RIT/ Δ TX CLEAR SWITCH [CLEAR]
(p. 39)

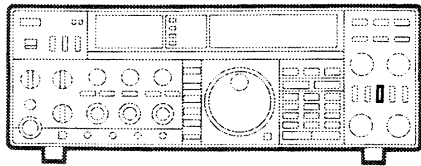

This switch clears the memory which contains the frequency shift information as set with the [RIT/ Δ TX] CONTROL and resets the small incremental tuning display to "0.0".

Push the [FUNC] SWITCH first, then this switch in order to add the shifted frequency to the frequency on the main FREQUENCY DISPLAY.

⑥⑪ Δ TX SWITCH [Δ TX] (p. 40)

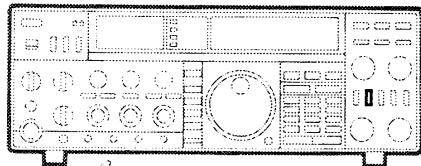

This switch turns the variable transmit frequency circuit ON and OFF. When the circuit is activated, the " Δ TX" INDICATOR on the front panel lights up and the amount of shift is indicated.

⑥⑫ RIT SWITCH [RIT] (p. 39)

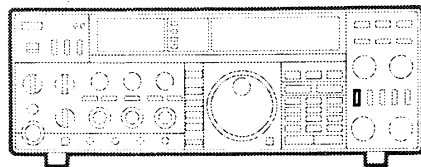

This switch turns the variable receive frequency circuit ON and OFF. When the circuit is activated, the letters "RIT" on the front panel light up and the amount of shift is indicated.

⑥⑬ MEMORY CHANNEL SELECTOR CONTROL [MEMORY-CH] (p. 48, 49)

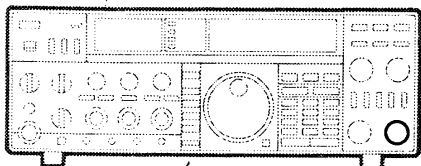

This control is used for selecting memory channels.

⑥⑭ INCREMENTAL TUNING CONTROL [RIT/ Δ TX] (p.39)

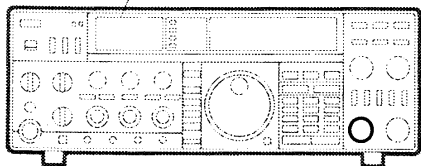

This control shifts the receive or transmit frequency by up to 9.9kHz to either side of the frequency indicated on the main FREQUENCY DISPLAY.

3-2 FREQUENCY DISPLAY

⑥⑮ MODE INDICATORS



This area of the FREQUENCY DISPLAY shows the operating mode currently selected. The modes available are FM, AM, CW, USB, LSB and RTTY.

⑥⑯ SCAN INDICATOR "SCAN"



"SCAN" lights up whenever a scan function is selected.

⑥⑰ FREQUENCY READOUT



This readout shows the operating frequency using 6 digits and 100Hz resolution.

**68 NARROW FILTER INDICATOR
"NARROW"**



"NARROW" lights up when the narrow CW or narrow RTTY filter is selected.

**69 SHIFT FREQUENCY INDICATOR
"RIT" "ΔTX" (p. 39)**



"RIT" or "ΔTX" lights up when the receive or transmit incremental tuning function is activated, respectively. The direction and quantity of the shift is also shown. Both functions may be activated simultaneously if desired.

**70 MEMORY INDICATOR "MEMO"
(p. 48 ~ 50)**



"MEMO" lights up when the memory mode is selected. A selected memory channel number from 01 to 32 is also shown.

**71 VFO INDICATOR "VFO A" "VFO B"
(p.48)**



"VFO A" or "VFO B" lights up to indicate which VFO is currently selected.

**72 SPLIT INDICATOR "SPLIT"
(p. 47)**



"SPLIT" lights up when separate VFOs are used for the transmit and receive frequencies. This allows operation with a transmit frequency which is different from the receive frequency.

**73 GENERAL COVERAGE INDICATOR
"GENE" (p. 36)**



"GENE" lights up when the IC-761 is in GENERAL COVERAGE mode. When "GENE" does not light up, the transceiver is in HAM BAND mode.

3-3 REAR PANEL

**74 ANTENNA CONNECTOR [ANT]
(p. 19, 20)**

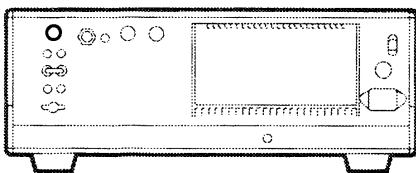

Connect a 50Ω impedance antenna to this connector. The connector mates with a PL-259 plug.

75 KEY JACK [KEY] (p. 20, 32)

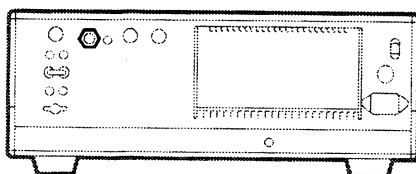

For CW operation, connect a CW key using the supplied standard 1/4 inch, 3-conductor plug. The terminal voltage from external electronic keyers must be less than 0.4V DC.

When using the built-in electronic keyer function connect an iambic keyer paddle using the supplied 1/4 inch, 3-conductor plug.

⑦⑥ EXTERNAL SPEAKER JACK [EXT SP]
(p. 20)

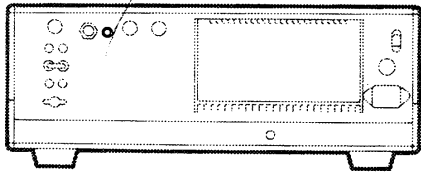

Connect an external speaker to this jack, if required. Use a speaker with an impedance of $4 \sim 16\Omega$ and remember the built-in speaker does not function when using the EXTERNAL SPEAKER JACK.

⑦⑦ ACCESSORY SOCKETS (1), (2)
[ACC (1)] [ACC (2)] (p. 24)

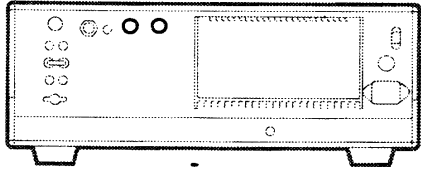

This connector provides signals such as T/R switching, receiver output, ALC input, etc.

⑦⑧ EXTERNAL ALC JACK [ALC]

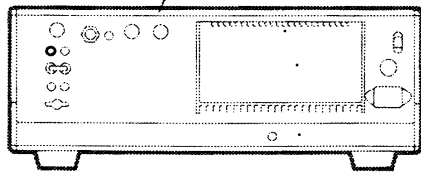

This jack accepts an automatic level control signal from an external amplifier or transverter. The ALC voltage must be in the range of $0 \sim -3V$.

⑦⑨ RECEIVE INPUT JACK
[RECEIVE ANT IN]

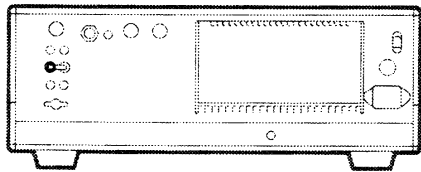

- This is an input jack which connects to the receiver RF stage. An attenuator or preamplifier may be connected between the RECEIVE INPUT JACK and RECEIVE ANTENNA OUTPUT JACK.

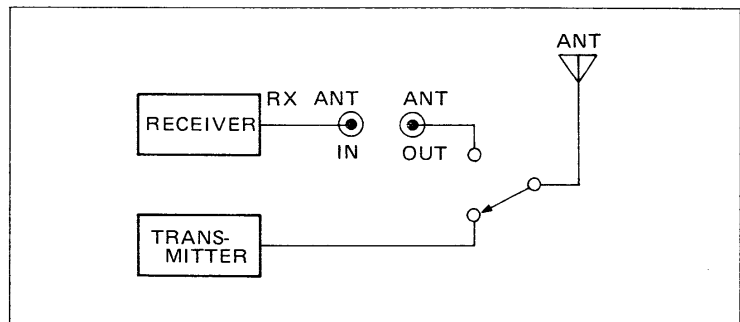

⑧⑩ SPARE JACK [SPARE]

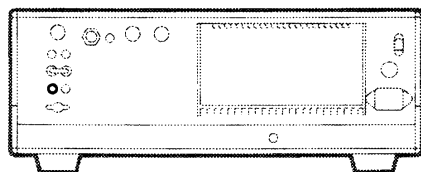

This jack is not used. It may be useful for connecting a personal accessory.

⑧⑪ GROUND TERMINAL [GND] (p.19)

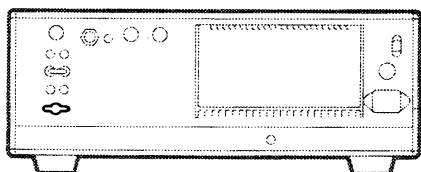

To prevent electrical shocks, TVI, BCI and other problems, be sure to ground the equipment through the GROUND TERMINAL. For best results, use the heaviest gauge wire or strap available and make the connection as short as possible.

⑧② TRANSVERTER JACK [X-VERTER]

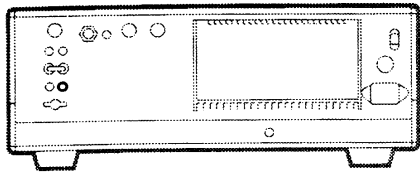

Connect a suitable transverter to this jack for operation on VHF/UHF frequencies. The output is approximately 30mV.

-20dBm

⑧③ RECEIVE ANTENNA OUTPUT JACK [RECEIVE ANT OUT]

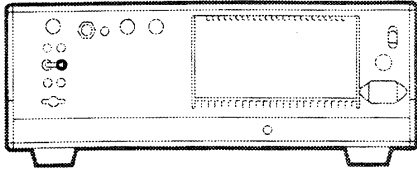

The receive signals from the ANTENNA CONNECTOR pass through the transmit/receive antenna switching circuit to this jack. Normally, the receiver IN and OUT jacks are connected together with a jumper. The ANTENNA OUTPUT JACK is useful when operating with a separate receiver or an external preamplifier.

⑧④ T/R CONTROL JACK [RELAY] (p. 21)

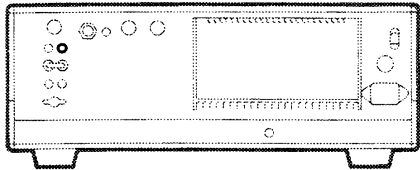

This jack goes to ground level when the IC-761 is in transmit mode and controls the TX/RX switching of an external amplifier or transverter.

DO NOT attempt greater than 30V DC, 1A (100V AC, 0.5A).

⑧⑤ 13.8V DC OUTPUT JACK [DC OUT] (p. 20)

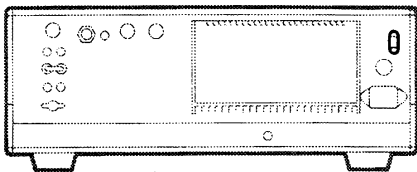

This jack provides 13.8V DC, 2A.

⑧⑥ FUSE HOLDER [FUSE] (p. 56)

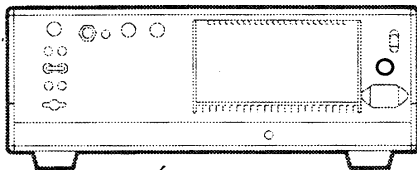

This holder contains the fuses for AC power supply. Use the spare fuses provided to replace an old or damaged fuse.

- 120V AC type : 10A
- 220 ~ 240V AC type : 5A

⑧⑦ AC POWER SOCKET [AC] (p. 20)

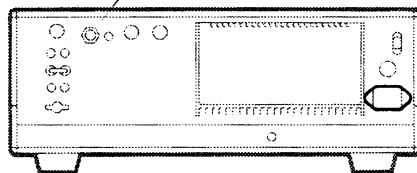

The AC POWER SOCKET connects the IC-761 to AC outlets via the supplied AC cord.

⑧⑧ REMOTE CONTROL JACK (CI-V) [REMOTE] (p. 26)

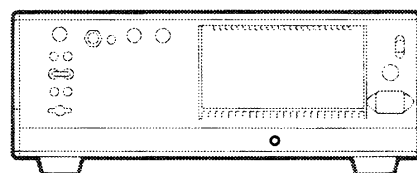

This is a communications port designed for use with a personal computer for remote operation of transceiver functions.

4. INSTALLATION

4-1 UNPACKING

Carefully remove your transceiver from the packing carton and examine it for signs of shipping damage. Should any be apparent, notify the delivering carrier or dealer immediately, stating the full extent of the damage. It is recommended you keep the shipping cartons.

See the diagram and description on the FOREWORD page of this manual for accessory equipment included with the IC-761.

4-2 PLANNING

Select a location for your transceiver which allows free access to the front controls, good air circulation and rear clearance for access to the cable connectors.

4-3 ANTENNA

CAUTION: Protect your transceiver from LIGHTNING by using a lightning arresstor.

Antennas play a very important role in radio communications. If the antenna is inferior, your transceiver cannot deliver optimum performance. A well-matched 50Ω antenna and feedline will provide the desired effect. The transmission line should be a coaxial cable. The antenna system should show a VSWR of less than 1:1.5 when using a 50Ω coaxial transmission line.

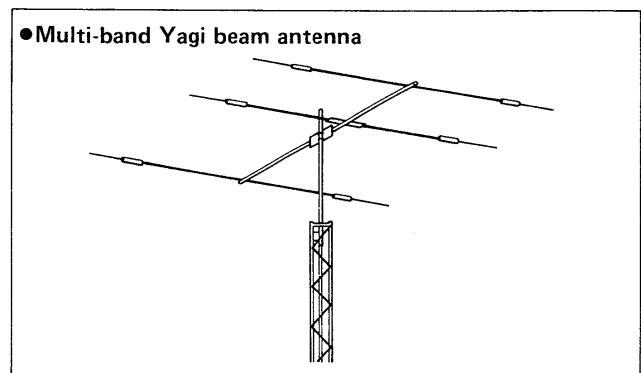
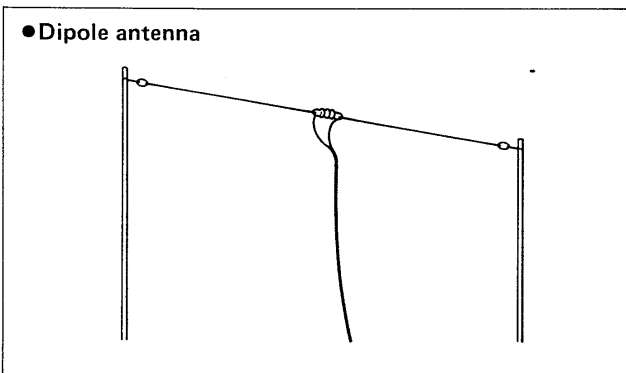

●PL-259 connector installation

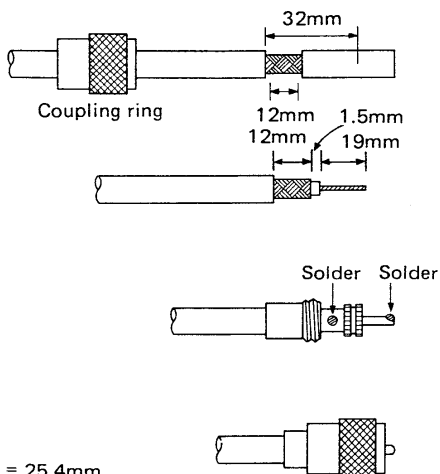

- 1) Slide the coupling ring over the coaxial cable.
- 2) Strip the cable as in the figure, and tin about 13mm (1/2") of the shield conductor. Remove the outer plastic casing and strip the center conductor insulation as in the figure. Tin the center conductor.
- 3) Slide the connector body onto the cable and solder.
- 4) Screw the coupling ring onto the connector body.

4-4 GROUNDING

To prevent electrical shocks, TVI, BCI and other problems, be sure to ground the transceiver through the GROUND TERMINAL. For best results, use the heaviest gauge wire or strap available and make the connection as short as possible. (See page 1)

4-5 REAR PANEL CONNECTIONS

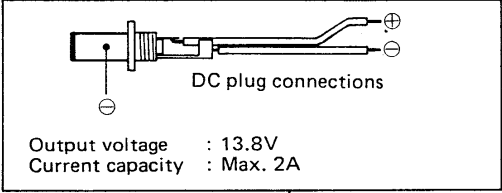
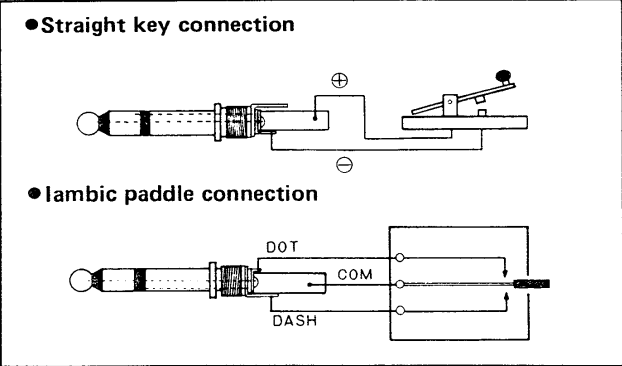
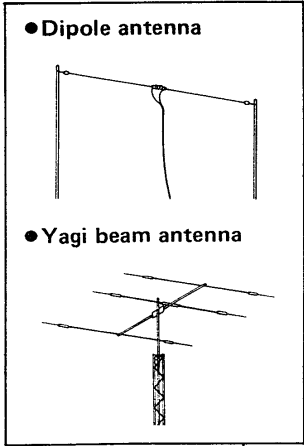

See page 24.

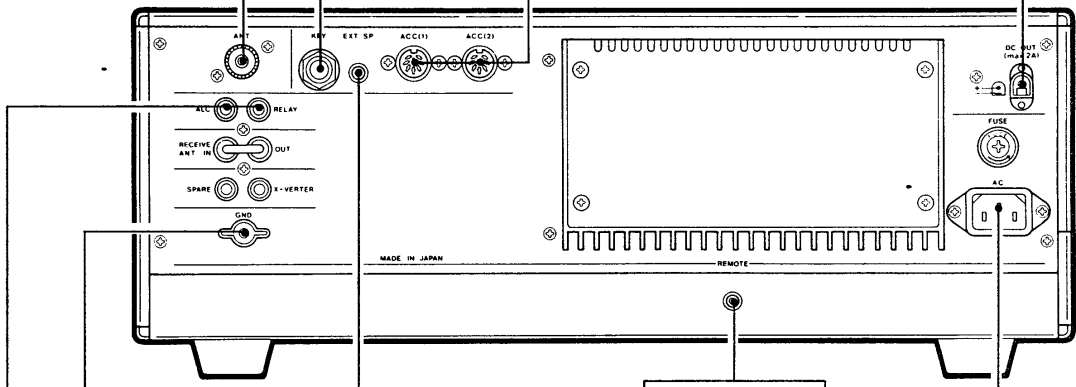

See page 26.

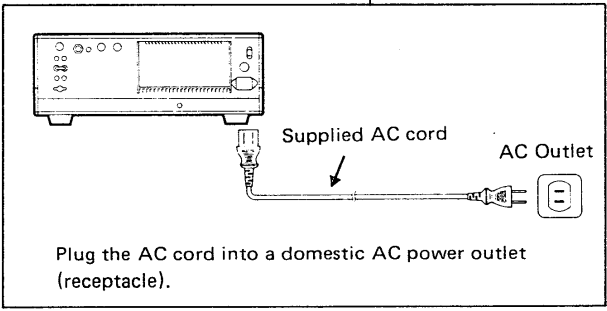
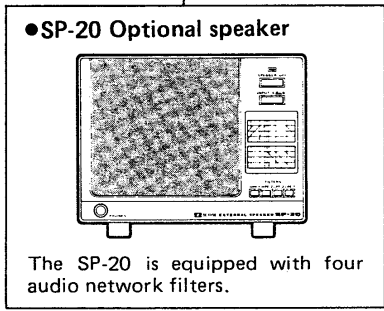

See page 1 for detailed grounding information.

For use with an external linear amplifier. See page 21.

5. SYSTEM INTERCONNECTIONS

5-1 EXTERNAL LINEAR AMPLIFIER

The IC-761 is designed to operate into a load with 50Ω impedance. Therefore, any amplifier used must have 50Ω input impedance for best efficiency.

(1) USING THE ICOM IC-2KL LINEAR AMPLIFIER

The optional 500W, solid-state IC-2KL LINEAR AMPLIFIER may be easily connected to the IC-761 with the cables supplied with the amplifier in the same way as other ICOM transceivers. Refer to the IC-2KL instruction manual for details.

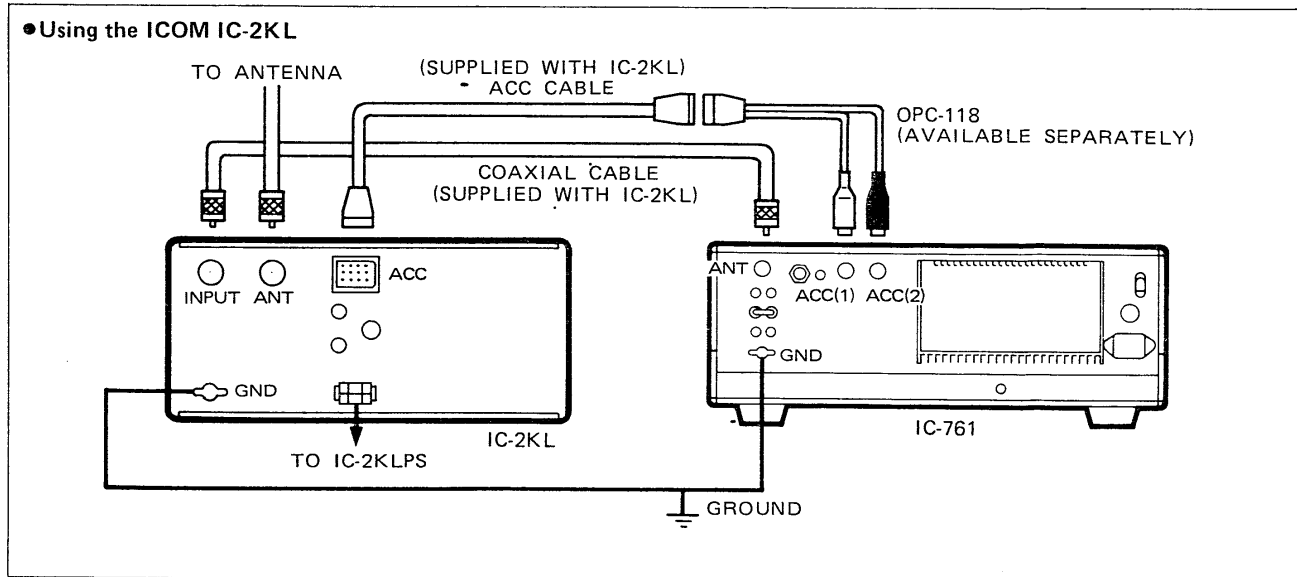

(2) USING NON-ICOM EXTERNAL AMPLIFIERS

The [RELAY] JACK on the rear panel of the IC-761 supplies an output from a built-in keying relay for an external amplifier. The [ALC] JACK is an input for the automatic level control signal from an external amplifier.

The specification for the keying relay is 30V DC, 1A (100V AC, 0.5A) maximum. **DO NOT** exceed this limit.

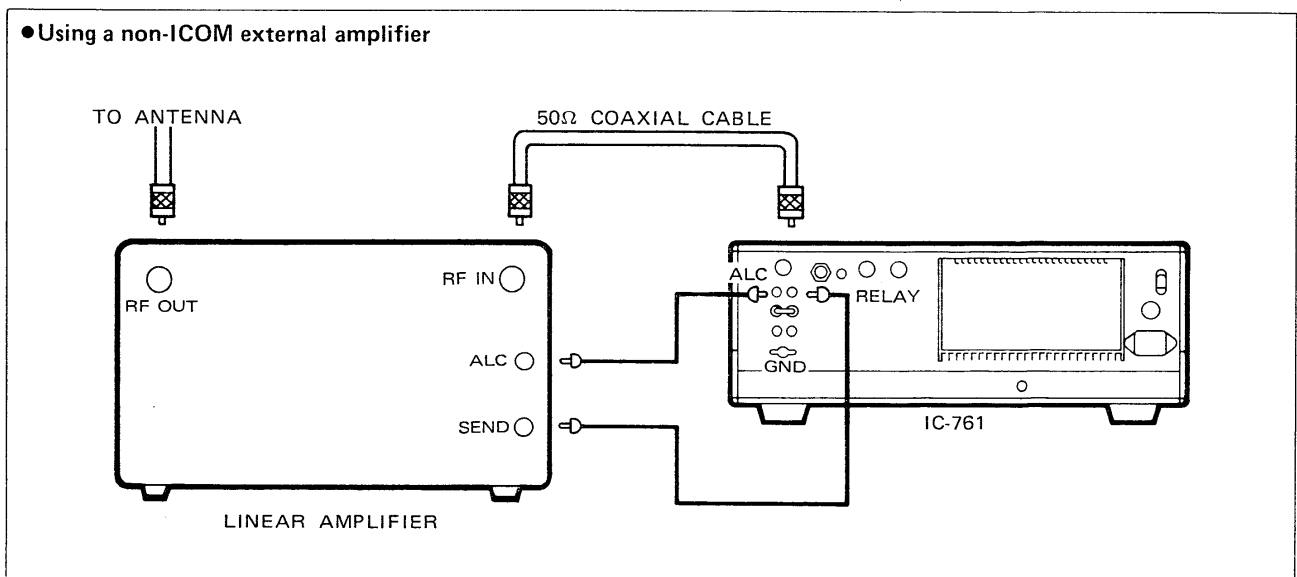

5-2 EXTERNAL ANTENNA TUNER

It is recommended that the ICOM IC-AT500 HF AUTOMATIC ANTENNA TUNER be used between the IC-2KL LINEAR AMPLIFIER and the antenna system for maximum transceiver performance.

(1) USING THE IC-AT500

When using the ICOM IC-2KL with the IC-761, it is not necessary to turn the IC-761 built-in antenna tuner ON.

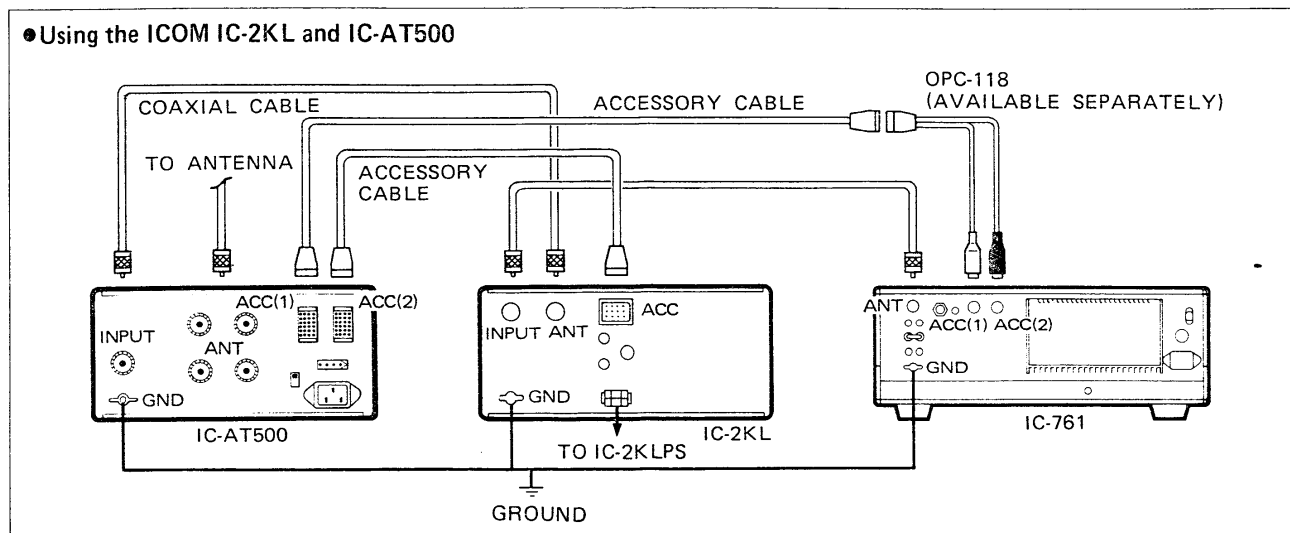

(2) USING THE AH-2

The AH-2 HF ALL BAND ANTENNA TUNER is equipped with a serial bus line and may be connected to the IC-761 and used in conjunction with the ICOM CI-V System.

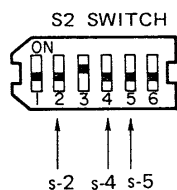

1) Connect cables as shown in the diagram.

2) Set s-2, s-4 and s-5 on the S2 SWITCH in the OFF position. See page 64 for the exact location of S2 in the IC-761.

3) Turn OFF (OUT) the [TUNER] SWITCH on the IC-761 front panel while operating the AH-2.

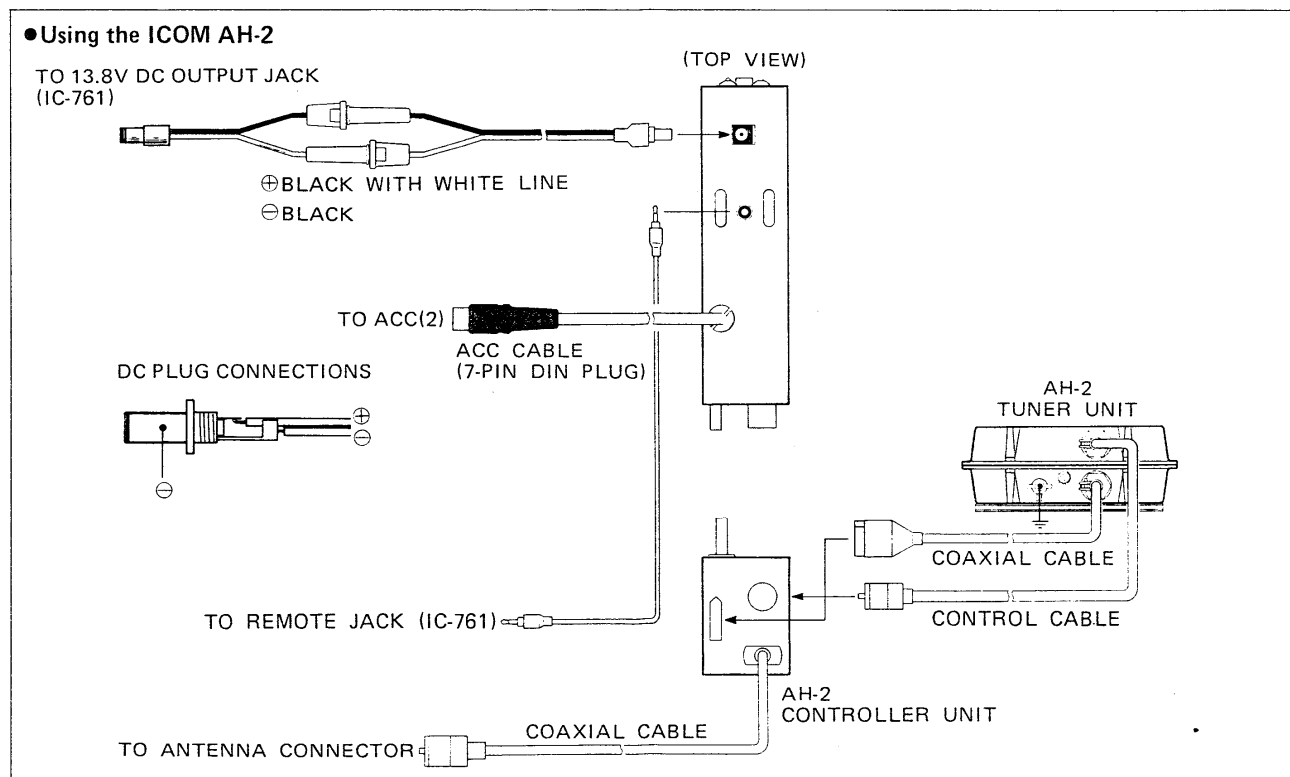

5-3 RTTY TERMINAL UNIT

When operating RTTY, connect the ACC(1) SOCKET pin 1 and pin 2 (ground) via a high speed relay or through a level converter for conversion to TTL level to your teletypewriter. The audio tones for your terminal are available from pin 5 and pin 2 (ground). The AF output level is about 300mVp-p for an S9 signal.

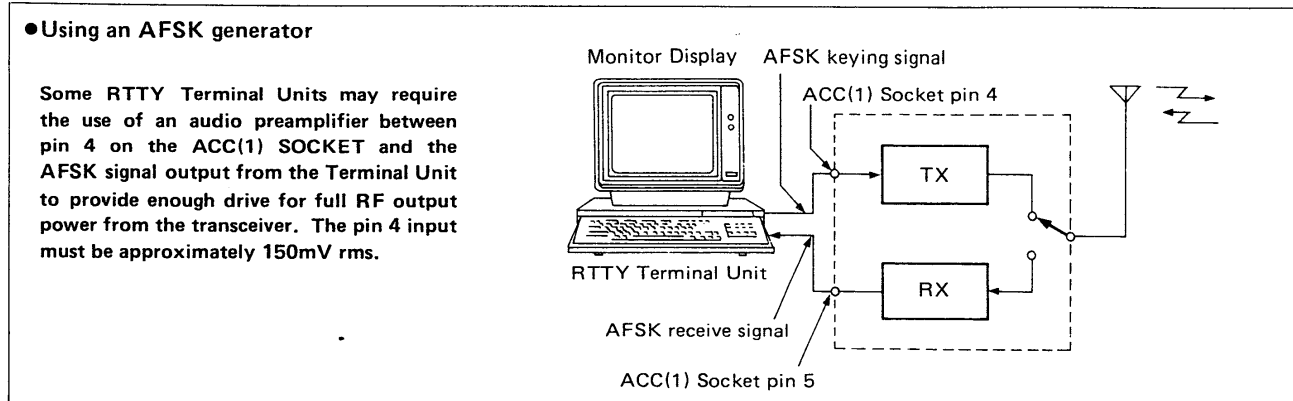
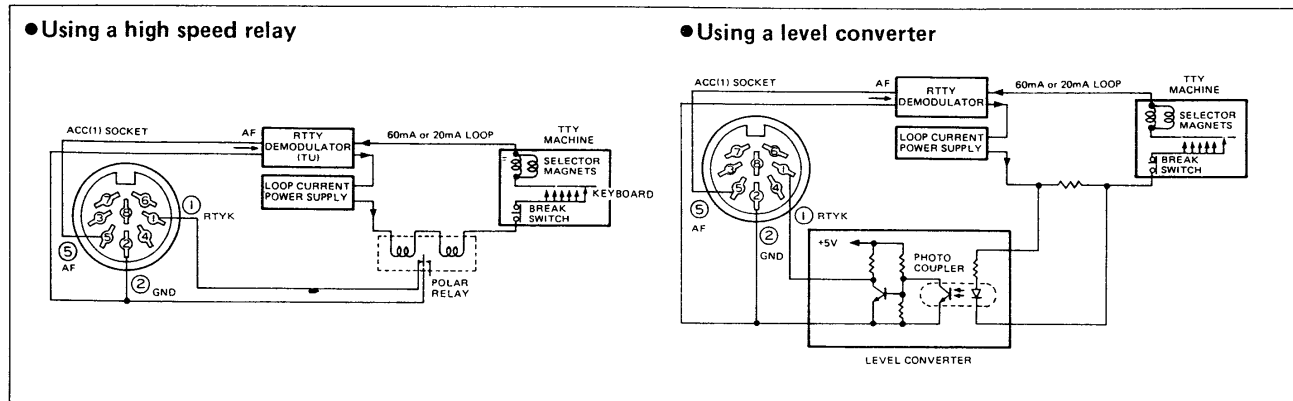

5-4 AFSK TERMINAL UNIT

When operating an AFSK such as RTTY, AMTOR or PACKET, connect the ACC(1) as in the diagram below:

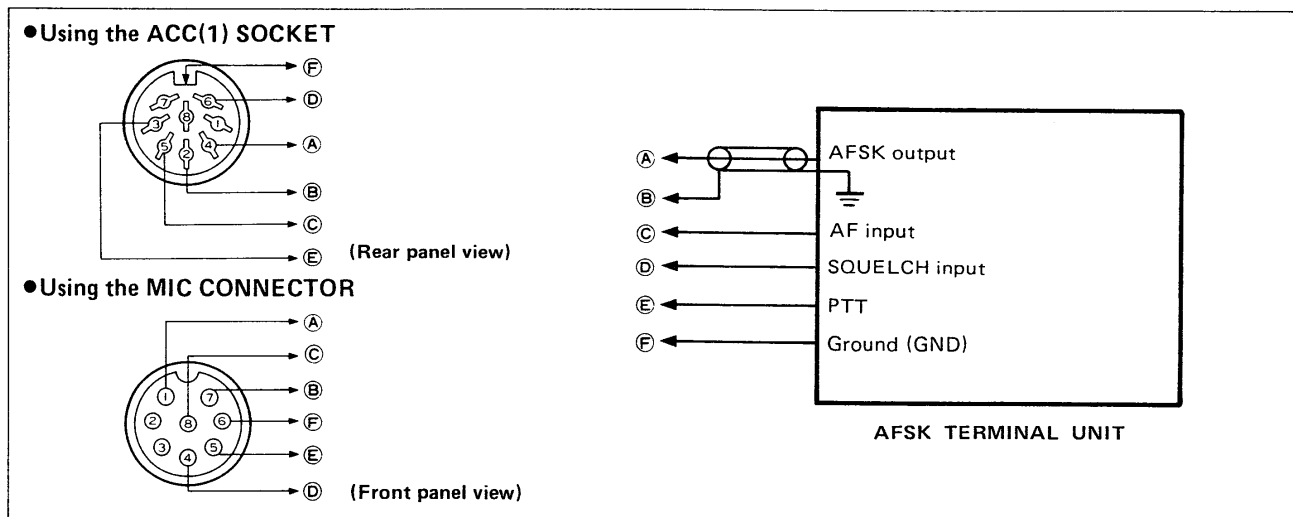

5-5 SSTV UNIT

SSTV (Slow Scan Television) operation is also possible with the IC-761.

- Connect the CAMERA OUTPUT on your SSTV Unit to pin 4 in the ACC(1) SOCKET or pin 1 in the MIC CONNECTOR.
- An audio output signal is available from pin 5 and pin 2 (GROUND). See page 25 for ACC(1) SOCKET information.

5-6 MIC CONNECTOR INFORMATION

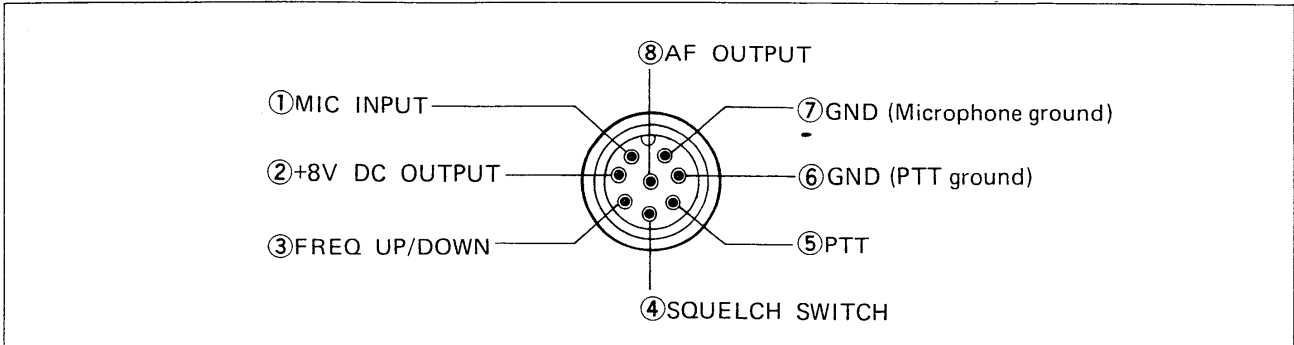

PIN NO.	FUNCTION	DESCRIPTION
②	+8V DC OUTPUT	Max. 10mA
③	FREQ UP	Ground
	FREQ DOWN	Ground through a 470Ω resistor
④	SQL OPEN	"LOW" level
	SQL CLOSE	"HIGH" level

CAUTION: DO NOT short pin 2 to GROUND as this can damage the inside 8V regulator.

5-7 ACCESSORY SOCKET INFORMATION

- ACC(1) SOCKET (Rear panel view)

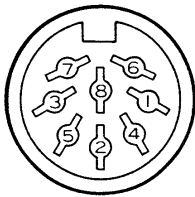

- ACC(2) SOCKET (Rear panel view)

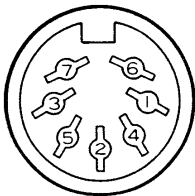

The DIN type ACCESSORY SOCKETS are installed on the rear panel of the IC-761. The function of each socket is as follows:

ACC(1): Connects a phone patch, RTTY, AFSK, and Terminal Units or other equipment. (See page 25)

ACC(2): Connects an ICOM IC-AT500 HF AUTOMATIC ANTENNA TUNER or IC-2KL HF LINEAR AMPLIFIER. (See page 25)

●ACC(1) SOCKET INFORMATION

PIN NO.	PIN NAME	DESCRIPTION	SPECIFICATION
1	RTYK	This terminal is for control of RTTY keying.	“H” level : More than 2.4V “L” level : Less than 0.6V Less than 2mA
2	GND	This terminal connects to GROUND.	Connected in parallel with ACC(2) pin 2.
3	SEND	The transceiver switches to transmit mode when this terminal is grounded. It is grounded when the [TRANSMIT/RECEIVE] SWITCH is placed in the [TRANSMIT] position.	Bi-directional terminal Ground level : -0.5 ~ +0.8V Output current : Less than 20mA Connected in parallel with ACC(2) pin 3.
4	MOD	This is a modulator input terminal, and is connected in the modulator circuit.	Input imp. : 10kΩ Input level : Approx. 100mV rms
5	AF	Output from the receiver detector stages.	Output imp. : 4.7kΩ Output level : 100 ~ 300mV
6	SQLS	This terminal goes to ground level when the SQUELCH opens.	SQL open : Less than 0.3V SQL closed : More than 6.0V
7	13.8V	13.8V DC output is switched by the [POWER] SWITCH on the front panel.	Output current: Max. 1A Connected in parallel with ACC(2) pin 7.
8	ALC	Input for external ALC voltage.	Control voltage : -3 ~ 0V Input imp. : More than 10kΩ Connected in parallel with ACC(2) pin 5.

●ACC(2) SOCKET INFORMATION

PIN NO.	PIN NAME	DESCRIPTION	SPECIFICATION
1	8V	Output reference voltage for band switching.	
2	GND	Ground	
3	SEND	Same as ACC(1) pin 3.	Connected in parallel with ACC(1) pin 3.
4	BAND	Output for external band switching.	
5	ALC	Same as ACC(1) pin 8.	Connected in parallel with ACC(1) pin 8.
6	TRV	Input for controlling power amplifier in the transceiver. This terminal is used when operating with a transverter.	Input voltage : 2 ~ 13.8V DC Input imp. : More than 10kΩ
7	13.8V	Same as ACC(1) pin 7.	Connected in parallel with ACC(1) pin 7.

5-8 REMOTE CONTROL JACK (CI-V) INFORMATION

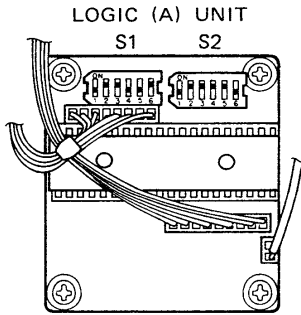

●CT-17 CONNECTION

ICOM has introduced a new remote control Local Area Network, the ICOM Communication Interface-V (CI-V) System using the CSMA (Carrier Sense Multiple Access with Collision Detection) standard.

Transmitters and receivers using the ICOM CI-V System exchange serial information in the PACKET format. The contents of a data PACKET can be changed by using the S1 and S2 SWITCHES on the LOGIC (A) UNIT as shown in the diagram.

- A serial data bus carries all control data. Operation is possible using an optional CT-17 LEVEL CONVERTER with a personal computer equipped with an RS-232C serial port.

Up to four ICOM CI-V transceivers can be connected to a personal computer via the CT-17.

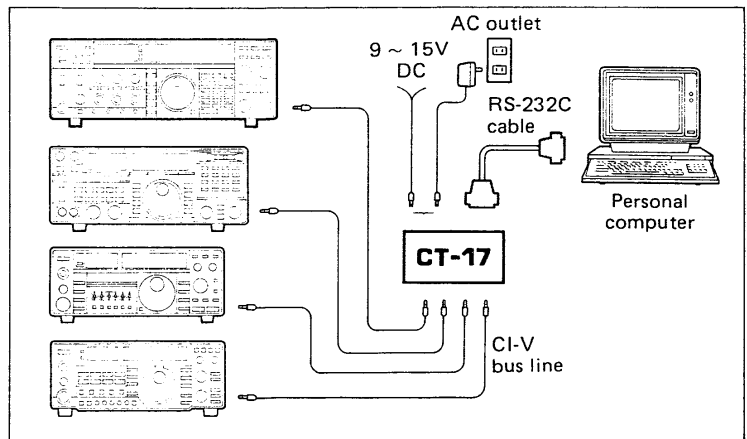

(1) SETTING BAUD RATE

The baud rate (data transfer rate) can be changed using s-1 and s-2 on the S1 SWITCH. The baud rate is set for 1200bps of the standard ICOM CI-V baud rate.

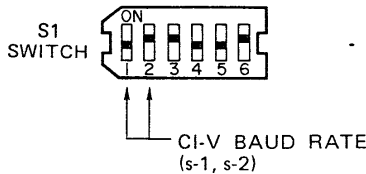

Baud rate	S1	
	s-1	s-2
---	OFF	OFF
9600	ON	OFF
1200	OFF	ON
300	ON	ON

NOTE:
The standard ICOM CI-V baud rate is 1200bps.

(2) SETTING TRANSCEIVE FLAG

Transceive operation is possible using the IC-761 with another transceiver such as the IC-735 HF TRANSCEIVER. Either transceiver can be used as the transmitter or receiver.

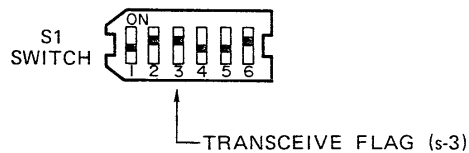

(3) SETTING FREQUENCY BAND

These switches determine the frequency band of the transceiver. The switches must be set as in the diagram.

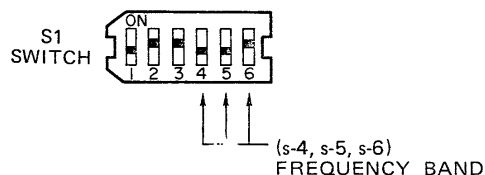

(4) SETTING AN ADDRESS WITH A TRANSCEIVER

The ON position of one of the six switches sets an independent address for your IC-761.

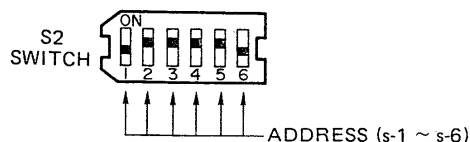

6. GENERAL OPERATION

6-1 INITIAL SETTINGS

After all INSTALLATION instructions have been followed in SECTION 4, including connecting an antenna system, set the controls and switches as shown in the diagram below.

- 1) Make sure the [POWER] SWITCH is OFF, then plug the AC cord into a domestic AC power outlet.
- 2) An antenna must be connected to the ANTENNA CONNECTOR.

CAUTION: Transmitting without an antenna may damage the transceiver.

• See page 37 for operating the built-in antenna tuner if needed.

- 3) A ground connection must be made through the GROUND TERMINAL. See page 1 for detailed information.

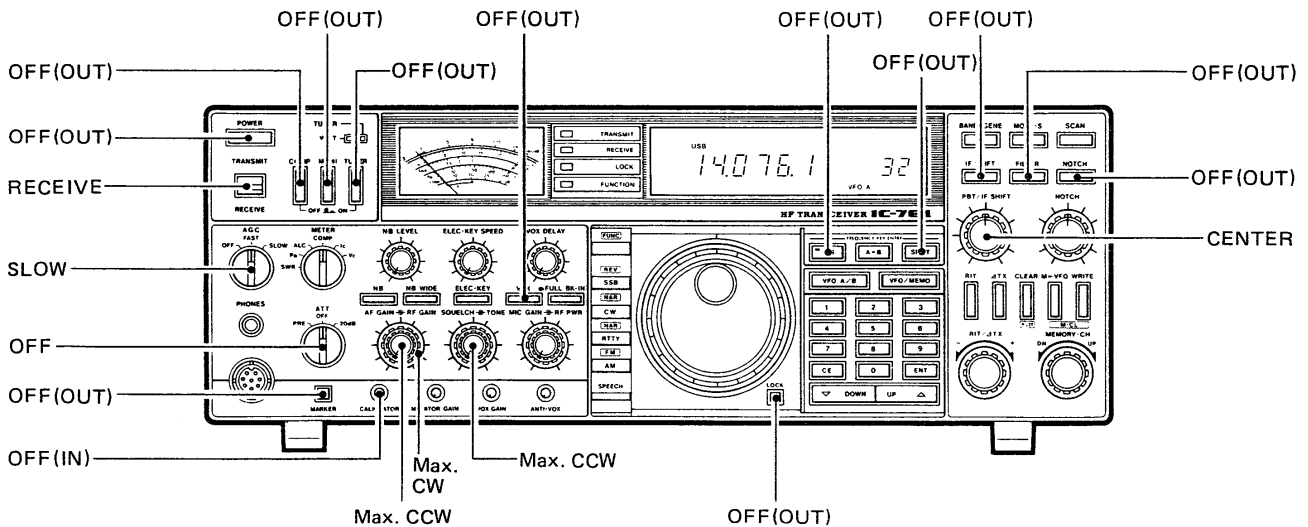

6-2 FREQUENCY SETTINGS

(1) USING THE TUNING CONTROL

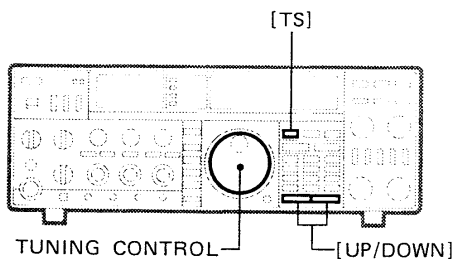

1) TUNING CONTROL:

Rotate the TUNING CONTROL to change the frequency in 10Hz steps while in any operating mode. Turning the TUNING CONTROL faster automatically shifts the tuning increments to 50Hz.

2) TUNING SPEED SWITCH [TS]:

When the [TS] SWITCH is pushed IN, the operating frequency shifts in 1kHz increments while in any operating mode as the TUNING CONTROL is turned.

3) BAND UP/DOWN SWITCH [UP] [DOWN]:

Push these switches to change the operating frequency bands. In HAM BAND mode, the VFO frequencies selected on each band are the initialization frequencies. In GENERAL COVERAGE mode, only the 10 and 1MHz digits of the FREQUENCY DISPLAY change.

(2) Using the KEYBOARD

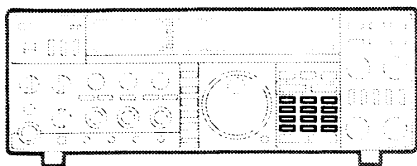

- 1) When setting the desired frequency, the displayed frequency already visible disappears.
- 2) The keyed-in figure for a new frequency is displayed with numbers moving toward the left edge of the FREQUENCY DISPLAY from the right.
- 3) Zeroes ("0") to the right of the 1MHz digit can be keyed in by pressing the [ENT] KEY.

(EXAMPLE 1) Setting frequency at 14.0000MHz.

Push keys   

(EXAMPLE 2) Setting frequency at 21.3600MHz

Push keys       

6-3 MODE SELECTION

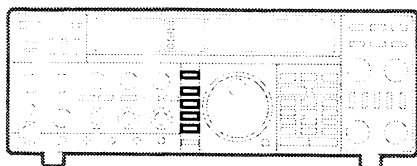

The various modes are selected by using the MODE SWITCHES and the [FUNC] SWITCH.

(1) SSB

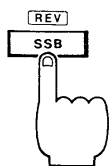

Push the [SSB] SWITCH to automatically select the USB mode on the 10MHz band and above, and LSB mode on the 7MHz band and below. Push the [FUNC] SWITCH, then the [SSB] SWITCH to select the opposite mode.

See page 29 for SSB operation.

(2) CW

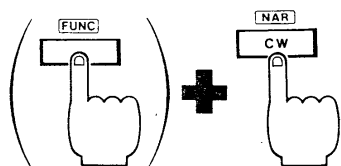

Push the [CW] SWITCH to select CW mode, or push the [FUNC] SWITCH then the [CW] SWITCH to select CW NARROW mode.

See page 31 for CW operation.

(3) RTTY

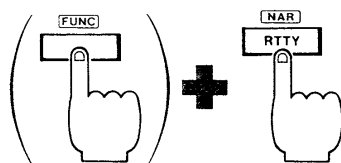

Push the [RTTY] SWITCH to select RTTY mode, or push the [FUNC] SWITCH then the [RTTY] SWITCH to select RTTY NARROW mode.

See page 33 for RTTY operation.

(4) AM

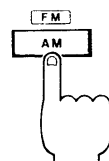

Push the [AM] SWITCH to select AM mode.

See page 34 for AM operation.

(5) FM

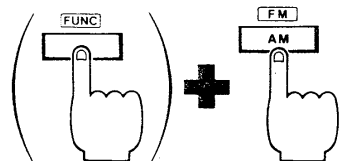

Push the [FUNC] SWITCH then the [AM] SWITCH to select FM mode. Push the [AM] SWITCH again to return to AM mode.

See page 35 for FM operation.

6-4 SSB OPERATION

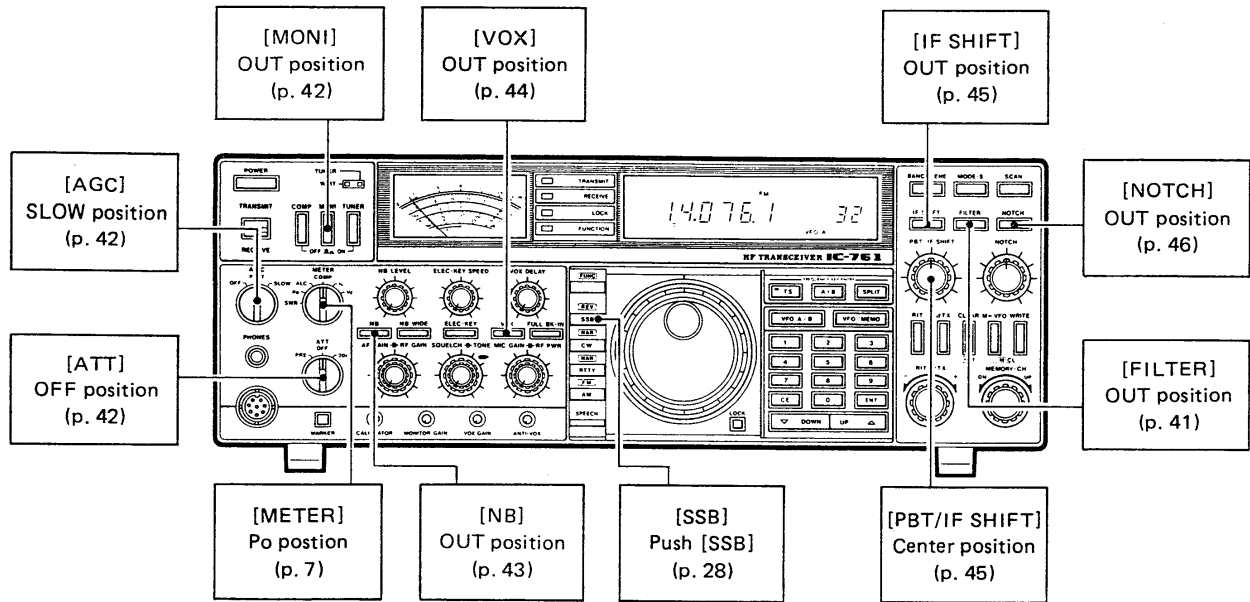

(1) SSB RECEIVING

1) Set all controls and switches.

1) Set all controls and switches as described on page 27.

2) Push IN [POWER] SWITCH.

2) Push IN the [POWER] SWITCH.

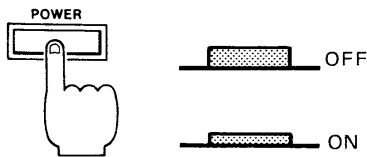

3) Push [UP/DOWN] SWITCHES.

3) Push the BAND [UP/DOWN] SWITCHES to select the desired band of operation.

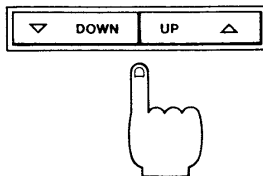

4) Adjust [AF GAIN] CONTROL.

4) Adjust the [AF GAIN] CONTROL for the desired volume.

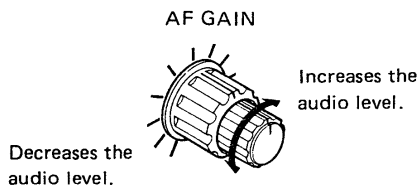

5) Rotate TUNING CONTROL and search for a signal.

5) Rotate the TUNING CONTROL and search for a signal. Tune across the signal to peak the meter needle while listening for the most intelligible audio.

6) Use Passband Tuning or IF Shift Tuning.

6) Passband Tuning or IF Shift Tuning is very useful for improving receiver selectivity, especially when receiving a signal with interference. (See page 45)

(2) SSB TRANSMITTING

NOTE: Listen carefully before transmitting to be sure your transmission will not interfere with any other communications.

- 1) Select transmit mode.

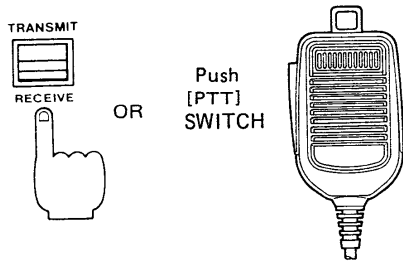

- 1) Select transmit mode using either the [TRANSMIT/RECEIVE] SWITCH or the [PTT] SWITCH.

- 2) Set [METER] SWITCH to [Po] position.

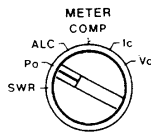

- 2) Set the [METER] SWITCH to the [Po] position. Speak into the microphone using your normal voice level. The meter movement indicates that a signal is being transmitted.

- 3) [TRANSMIT] INDICATOR lights up.

[TRANSMIT] INDICATOR lights up.

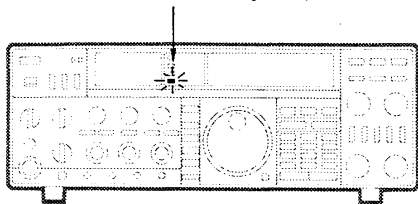

- 3) The [TRANSMIT] INDICATOR lights up whenever the IC-761 is placed in transmit mode. However, an RF signal is only transmitted when the selected operating frequency is within an Amateur band.

- 4) Set [METER] SWITCH to [ALC] position, and adjust [MIC GAIN] CONTROL.

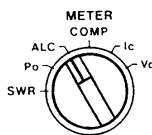

- 4) Set the [METER] SWITCH to the [ALC] position, and adjust the [MIC GAIN] CONTROL for a meter reading within the ALC zone on voice peaks.

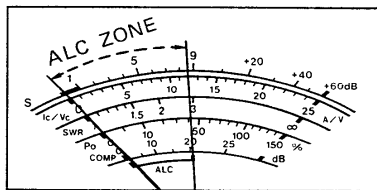

- 5) Use the Speech compressor function.

- 5) Use the Speech compressor function for greater talk power. (See page 43.)

- 6) Use the Monitor function.

- 6) To monitor your transmission signals, use the Monitor function. (See page 42.)

6-5 CW OPERATION

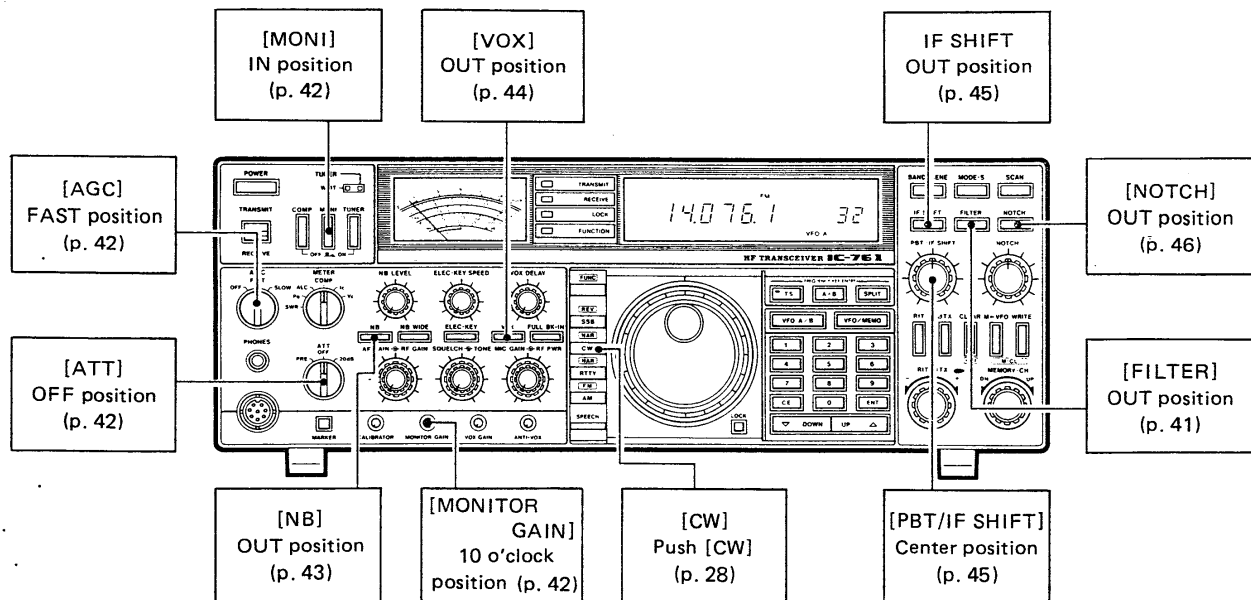

(1) CW RECEIVING

1) Push IN [POWER] SWITCH.

1) Push IN the [POWER] SWITCH.

2) Push [CW] SWITCH.

2) Push the [CW] SWITCH.

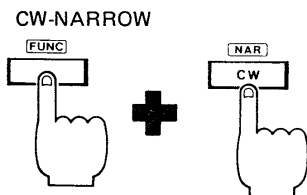

For CW-NARROW receiving, push the [FUNC] SWITCH, then, the [CW] SWITCH.

3) Push [UP/DOWN] SWITCHES.

3) Push the BAND [UP/DOWN] SWITCHES to select the desired band of operation.

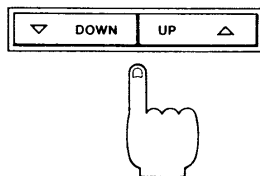

4) Adjust [AF GAIN] CONTROL.

4) Adjust the [AF GAIN] CONTROL for a suitable volume.

5) Rotate TUNING CONTROL.

5) Rotate the TUNING CONTROL and search for a signal. Tune across the signal to peak the needle while listening for the most intelligible tone.

(2) CW TRANSMITTING

1) Insert CW key.

1) Insert the CW key plug into the [KEY] JACK on the rear panel of the IC-761.

2) Select transmit mode.

2) Select transmit mode with the [TRANSMIT/RECEIVE] SWITCH.

3) Operate CW key.

3) Operate the CW key. The meter movement indicates that a signal is being transmitted.

●SEMI BREAK-IN OPERATION
USING A STRAIGHT KEY

Wiring for a straight key.

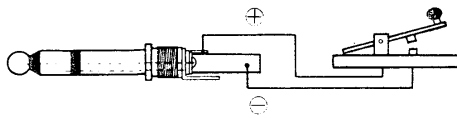

●SEMI BREAK-IN OPERATION WITH
AUTOMATIC KEYING USING AN
IAMBIC PADDLE

Wiring for an iambic paddle.

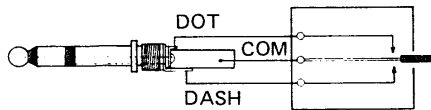

NOTE: The CW WEIGHT CONTROL is installed on the electronic keyer circuit. (See p. 58)

●FULL BREAK-IN OPERATION WITH
AUTOMATIC KEYING USING AN
IAMBIC PADDLE

Wiring for an iambic paddle.

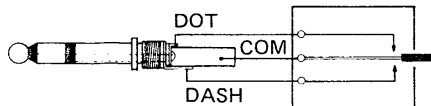

NOTE: The CW WEIGHT CONTROL is installed on the electronic keyer circuit. (See p. 58)

1) Set the controls and switches as shown in the table.

SWITCH/CONTROL	POSITION
MODE	CW OR CW-NARROW
VOX	ON (IN)
VOX DELAY	10 O'CLOCK
TRANSMIT/RECEIVE	RECEIVE

2) Operate the CW key.

3) Set the transmit release delay time to suit your keying speed by adjusting the [VOX DELAY] CONTROL while keying. Rotate the control clockwise to increase the delay.

4) Begin sending with the CW key and the transmitter will switch between transmit and receive automatically.

Automatic keying is possible simply by connecting an iambic paddle. The operator merely controls the number of dots or dashes transmitted without regard to spaces between the elements, or the timing of the elements, within a character. When used correctly, the resulting CW is generally easier and more enjoyable to copy at the receiving end.

1) Set the switches and controls as shown in the table.

SWITCH/CONTROL	POSITION
MODE	CW OR CW-NARROW
VOX	ON (IN)
ELEC-KEY SPEED	12 O'CLOCK
VOX DELAY	10 O'CLOCK
ELEC-KEY	ON (IN)
TRANSMIT/RECEIVE	RECEIVE

2) Operate the CW key.

3) Adjust the [KEY SPEED] CONTROL for a suitable keying speed.

4) Set the transmit release delay time to suit your keying speed by adjusting the [VOX DELAY] CONTROL while keying. Rotate the control clockwise to increase the delay.

5) Transmit/receive switching is automatically performed by the transceiver.

1) Set the switches and controls as shown in the table.

SWITCH/CONTROL	POSITION
MODE	CW OR CW-NARROW
VOX	ON (IN)
ELEC-KEY SPEED	12 O'CLOCK
VOX DELAY	10 O'CLOCK
FULL BK-IN	ON (IN)
ELEC-KEY	ON (IN)
TRANSMIT/RECEIVE	RECEIVE

2) Operate the CW key.

3) Adjust the [KEY SPEED] CONTROL for a suitable keying speed.

4) Transmit/receive switching is automatically performed by the transceiver.

6-6 RTTY OPERATION

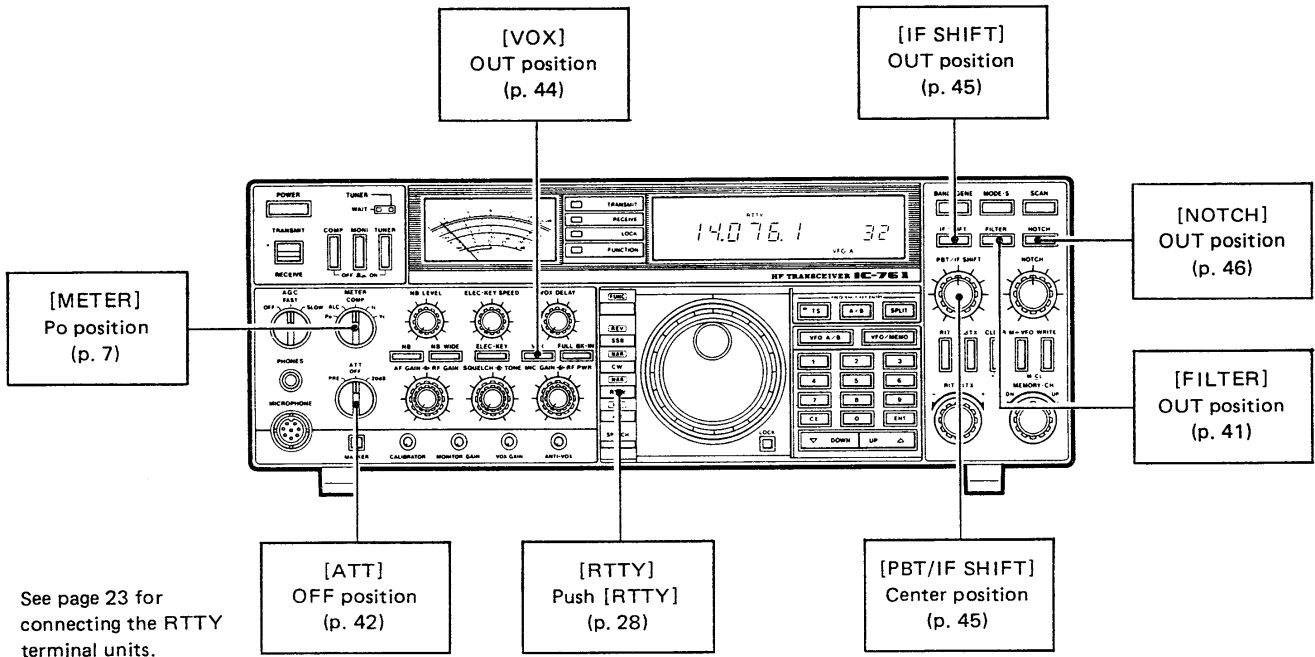

See page 23 for connecting the RTTY terminal units.

(1) RTTY RECEIVING

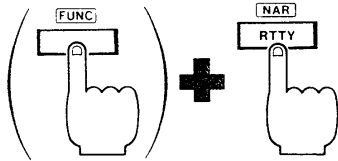

1) For RTTY operation, a teletypewriter or keyboard and a demodulator (terminal unit) which is operational with audio input are required. See page 23 for system interconnections.

2) Push the [RTTY] SWITCH to select RTTY operating mode. For RTTY-NARROW receiving, push the [FUNC] SWITCH then the [RTTY] SWITCH.

3) Tune in an RTTY signal using the tuning indicator of the terminal unit or the cross pattern of an oscilloscope to center the receiver on the signal. Mark frequency is 2125Hz and space frequency is 2295Hz.

(2) RTTY TRANSMITTING

Inside MAIN UNIT (See p. 64)

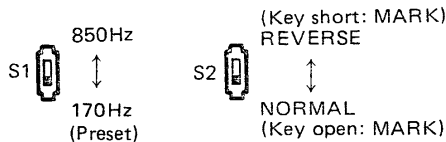
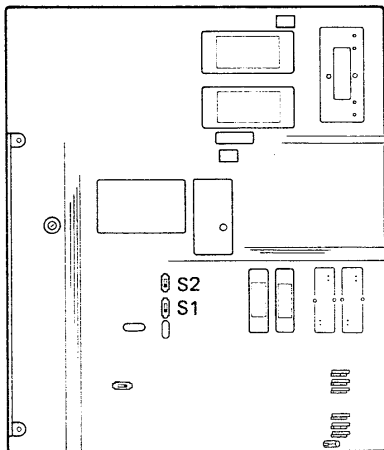

1) Set the [METER] SWITCH to the [Po] position.

2) Set the [TRANSMIT/RECEIVE] SWITCH to the [TRANSMIT] position. The meter indicates the strength of the transmitted carrier wave.

3) Type keys on the RTTY keyboard to transmit RTTY signals.

4) In the AFSK operation, there is a difference between display frequency and the actual operating frequency.

Assuming the demodulator mark frequency is 2125Hz and the space frequency is 2295Hz in receive mode,

$$\left(\begin{array}{l} \text{Transmit frequency} \\ \text{of contacted station} \end{array} \right) = \left(\begin{array}{l} \text{Displayed} \\ \text{frequency} \end{array} \right) - 2125\text{Hz}$$

Assuming the AFSK generator mark frequency is 2125Hz and the space frequency is 2295Hz in transmit mode,

$$\left(\begin{array}{l} \text{Transmit frequency} \\ \text{of your station} \end{array} \right) = \left(\begin{array}{l} \text{Displayed} \\ \text{frequency} \end{array} \right) - 2125\text{Hz}$$

6-7 AM OPERATION

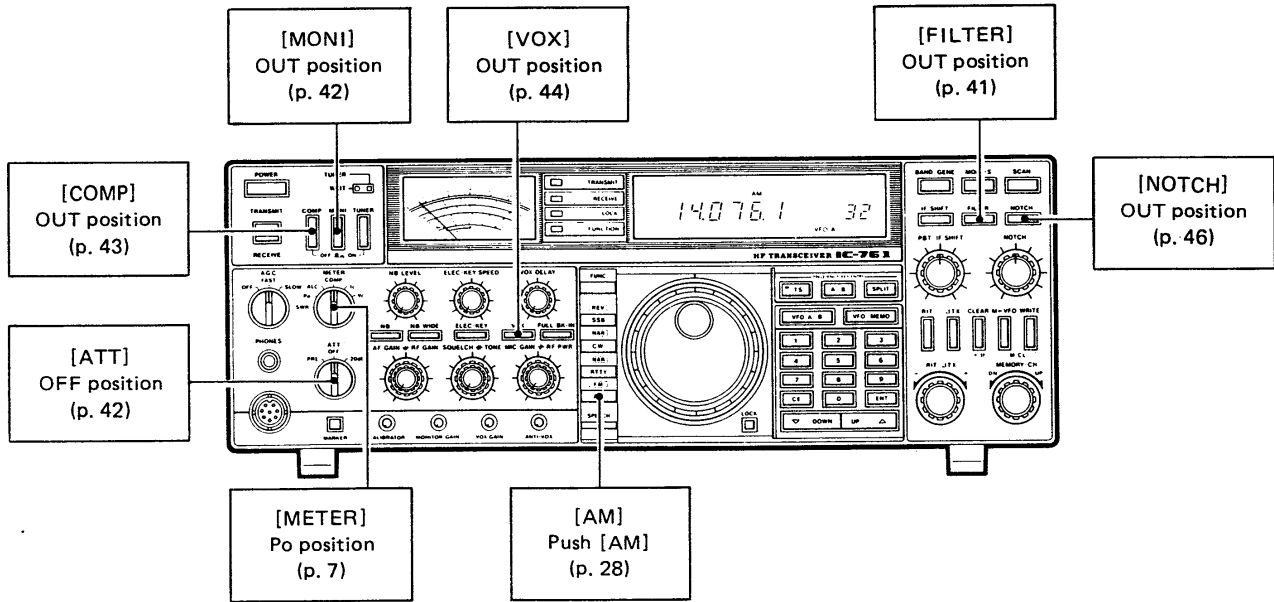

(1) AM RECEIVING

- 1) Push IN the [POWER] SWITCH.
- 2) Select the desired band of operation.
- 3) Push the [AM] SWITCH.
- 4) Adjust the [AF GAIN] CONTROL for a suitable listening level.
- 5) Tune in an AM signal with the TUNING CONTROL using the meter to peak the signal.
- 6) Push the [FILTER] SWITCH to select narrow receive selectivity.

FILTER SWITCH	BANDWIDTH
ON (IN)	2.6kHz
OFF (OUT)	6kHz

NOTE: The [PBT] CONTROL (passband tuning) has no effect in AM mode.

(2) AM TRANSMITTING

- 1) Select transmit mode with either the [TRANSMIT/RECEIVE] SWITCH or the [PTT] SWITCH on the microphone.
- 2) Turn the [RF PWR] CONTROL maximum clockwise or set it to obtain the desired output power.
- 3) Set the [METER] SWITCH to the [Po] position.
- 4) Adjust the [MIC GAIN] CONTROL for a slight indication of the meter needle while speaking into the microphone using your normal voice level.
- 5) The speech compressor [COMP] SWITCH should be turned OFF to prevent overmodulation or distortion.

6-8 FM OPERATION

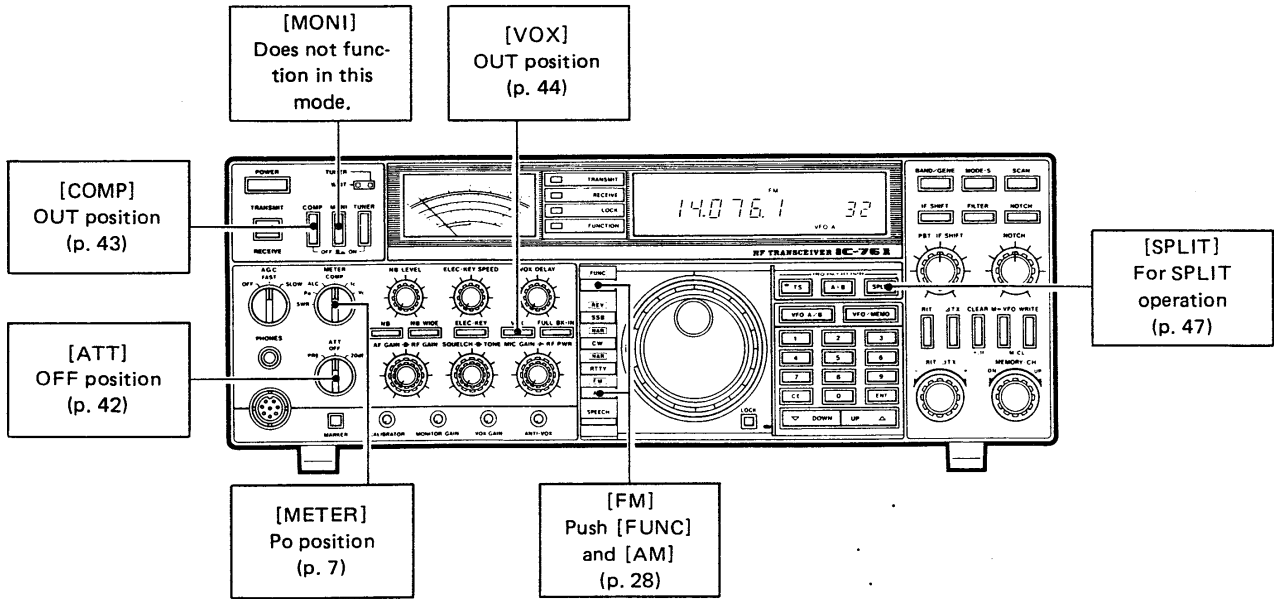

(1) FM RECEIVING

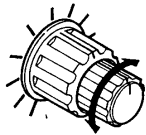

Raises the squelch threshold level.

Decreases the squelch threshold level.

- 1) Push the [FUNC] SWITCH then the [AM] SWITCH.
- 2) Adjust the [VOLUME] CONTROL for a suitable listening level.
- 3) Adjust the [SQUELCH] CONTROL to quiet noise from the speaker.
- 4) When tuning an FM signal, tune for maximum signal strength as indicated on the meter with the clearest audio.

(2) FM TRANSMITTING

- 1) Set the [MIC GAIN] CONTROL to the center position.
- 2) Select transmit mode with either the [TRANSMIT/RECEIVE] SWITCH or the [PTT] SWITCH on the microphone.
- 3) Speak into the microphone using your normal voice level. The meter needle indicates the carrier power when the [METER] SWITCH is in the [Po] position, however the meter does not move in time with your voice modulation in this mode.

● FM REPEATER OPERATION

[FUNCTION] INDICATOR lights up while a tone signal is being transmitted.

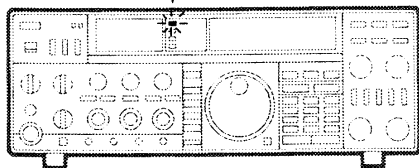

A tone encoder is often required to access HF FM repeaters. The optional UT-30 PROGRAMMABLE TONE ENCODER is designed for this purpose. See page 60 for UT-30 installation information.

- 1) When operating through repeaters, program the transmit and receive frequencies in VFO A and VFO B.

See page 47 for information.

- 2) The encoder tone is transmitted when the [FUNC] SWITCH is pushed while transmitting. In addition, the [FUNCTION] INDICATOR lights up.

6-9 GENERAL COVERAGE RECEIVER

NOTE: In GENERAL COVERAGE mode, it is not possible to transmit on any frequency, including the Amateur band frequencies.

1) Set controls and switches.

1) Set the controls and switches as stated on page 27. Other controls are unrelated to operation in this mode.

2) Push IN [POWER] SWITCH.

2) Push IN the [POWER] SWITCH.

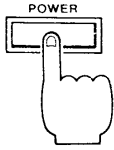

- The built-in antenna tuner does not function in GENERAL COVERAGE mode.

3) Push [BAND/GENE] SWITCH.

3) Select GENERAL COVERAGE mode by pushing the [BAND/GENE] SWITCH.

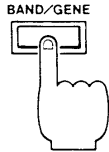

- If the transceiver does not display "GENE", push the [BAND/GENE] SWITCH again.

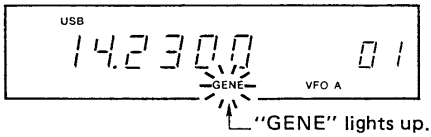

4) Push desired mode switch.

4) Push the desired mode switch.

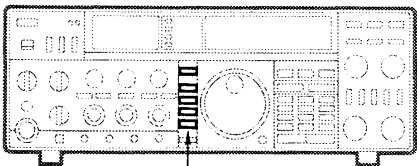

Mode switches
(See page 11)

- When SSB mode is chosen, USB is automatically selected on the 10MHz band and above, and LSB is selected on the 9MHz band and below.
- Once either USB or LSB mode is automatically selected, this mode is maintained regardless of frequency or band changes. To change to the opposite sideband, push the [FUNC] SWITCH then the [SSB] SWITCH again.

5) Select desired band and frequency.

5) Push the [UP/DOWN] SWITCHES then turn the TUNING CONTROL to select the desired band of operation. Push and release the [UP/DOWN] SWITCHES again, and turn the TUNING CONTROL until a signal is located.

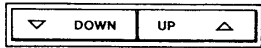

- The KEYBOARD on the front panel is also useful for setting the desired frequency. (See page 28).
- The display on the left shows the frequency of a typical standard time station.



6) Adjust [AF GAIN] CONTROL.

6) Adjust the [AF GAIN] CONTROL for a comfortable audio level.

- The multifunction meter indicates the signal strength of the received signal, therefore tune for the highest reading on the meter with the clearest audio.

7. ANTENNA TUNER OPERATION

NOTE: The built-in antenna tuner does not function in GENERAL COVERAGE mode or during scanning operation.

The built-in automatic antenna tuner allows antenna matching with an impedance of 16.7 ~ 150Ω (VSWR 1:3).

When first using the built-in antenna tuner or when changing the antenna system, observe the following preset procedures.

7-1 PRESETTINGS

These controls are located under the hatch cover on the top cover.

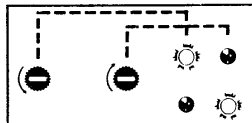
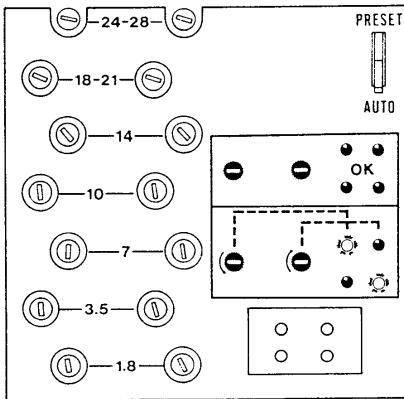

Adjust each PRESET CONTROL as shown in the diagram.

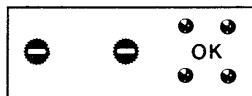

Adjustment correct.

- 1) Connect an antenna to the ANTENNA CONNECTOR with SWR set as low as possible.
- 2) Push IN the [POWER] SWITCH.
- 3) Push the [RTTY] MODE SWITCH.
- 4) Verify that the frequency band selected on the transceiver is the same as the area of the band on which you plan to operate.
- 5) Set the [METER] SWITCH to the [SWR] position.
- 6) Set the [AUTO/PRESET] SWITCH located under the hatch cover to the [AUTO] position. See the diagram at left.
- 7) Push IN the [TUNER] SWITCH to turn the tuner ON.
- 8) Adjust the [RF PWR] CONTROL on the front panel to the 9 o'clock (15W) position.
- 9) Transmit for a couple seconds. Confirm the auto-tuning function operates correctly resulting in a low SWR. Stop transmitting.
 - If the auto-tuning function does not operate, see SECTION 7-2 AUTO-TUNING FAILS TO OPERATE.
- 10) Adjust the two PRESET CONTROLS located under the hatch cover corresponding to the selected band until all four red indicators under the hatch cover go out. This completes presetting for this band.
- 11) Perform the same steps on each frequency band you plan to operate in.

7-2 AUTO-TUNING FAILS TO OPERATE

- The antenna system SWR exceeds 1:3.

The auto-tuning function may not always operate correctly as shown in step 9) above. Reasons for this are listed below.

The antenna needs to be adjusted to bring the SWR below 1:3. The following procedure may allow the tuner to operate correctly:

- 1) Set the [AUTO/PRESET] SWITCH located under the hatch cover in the [PRESET] position.
- 2) Adjust the two PRESET CONTROLS alternately to obtain a minimum SWR reading (1:1 if possible) while transmitting a steady carrier using RTTY mode.
- 3) Stop transmitting. The tuning capacitors are now set at the optimum position for the frequency selected.
- 4) Reset the [AUTO/RESET] SWITCH in the [AUTO] position.

- Lower transmit output power occurs.

- 1) Set the [AUTO/PRESET] SWITCH located under the hatch cover in the [PRESET] position.
- 2) Adjust the two PRESET CONTROLS alternately while transmitting a steady carrier using RTTY mode.
- 3) Tune for maximum output power while watching the relative power meter on the transceiver.
- 4) Stop transmitting.
- 5) Reset the [AUTO/PRESET] SWITCH in the [AUTO] position.

• Additional preset information

(Top view)

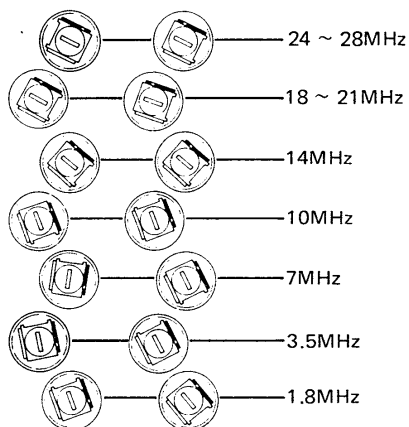

Approximate positions of the PRESET CONTROLS for a 50Ω antenna system.

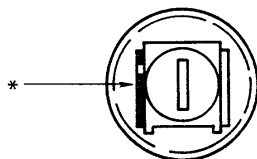

Note (*) the position of the marker when setting each PRESET CONTROL.

8. FUNCTIONS OPERATION

8-1 RIT/ Δ TX OPERATION

(1) RIT OPERATION

1) Push [RIT] SWITCH.

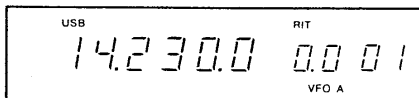

Receive : 14.2300MHz
Transmit : 14.2300MHz

2) Turn [RIT/ Δ TX]

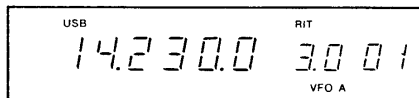

Receive : 14.2330MHz
Transmit : 14.2300MHz

3) Push [RIT] SWITCH again to turn OFF.

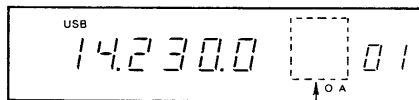

"RIT" and the shift frequency disappear.

4) Push [RIT] SWITCH again to turn ON.

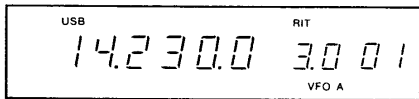

5) Push [CLEAR] SWITCH to clear the RIT.

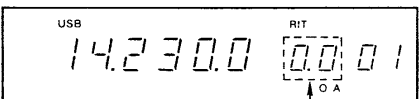

The shift frequency resets to "0.0".

6) Push [FUNC] SWITCH and [CLEAR] SWITCH.

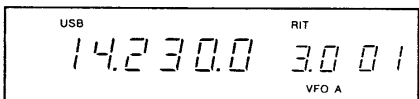

Push [FUNC]
and [CLEAR]

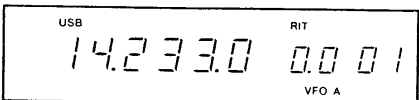

(14.2300MHz + 3.0kHz = 14.2330MHz)

When using the RIT function, it is possible to shift the receive frequency up to 9.9kHz on either side of the transmit frequency without moving the transmit frequency. This is useful for fine tuning stations which call off frequency or for compensating for frequency drift.

1) Push the [RIT] SWITCH to turn the RIT function ON.

- "RIT" and the amount of the shift frequency appear on the FREQUENCY DISPLAY.

2) Turn the [RIT/ Δ TX] to change the receive frequency.

3) Push the [RIT] SWITCH again to turn OFF the RIT function.

- "RIT" and the amount of shift frequency disappear.
- When the RIT function is OFF, RIT shift frequency is stored in a memory for later use.

4) Push the [RIT] SWITCH again to turn ON the RIT function.

- "RIT" and the stored shift frequency appear.

5) Push the [CLEAR] SWITCH to clear the RIT shift frequency.

- The shift frequency resets to "0.0" and the receive and transmit frequencies become the same.

6) Push the [FUNC] SWITCH then the [CLEAR] SWITCH to add the RIT shift frequency to the displayed frequency.

(2) ΔTX OPERATION

- 1) Push [ΔTX] SWITCH.

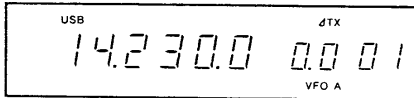

Receive : 14.2300MHz
Transmit : 14.2300MHz

- 2) Turn [RIT/ΔTX] CONTROL.

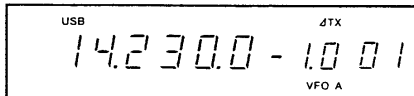

Receive : 14.2300MHz
Transmit : 14.2290MHz

- 3) Push [ΔTX] SWITCH again to turn OFF.

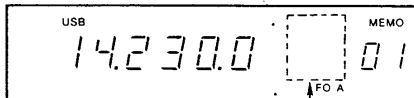

"ΔTX" and the shift frequency disappear.

- 4) Push [ΔTX] SWITCH again to turn ON.

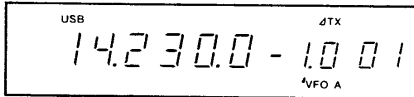

- 5) Push [CLEAR] SWITCH.

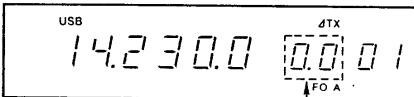

The shift frequency resets to "0.0".

- 6) Push [FUNC] SWITCH and [CLEAR] SWITCH.

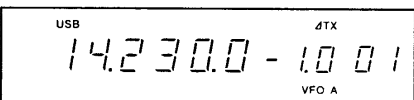

Push [FUNC] and [CLEAR].

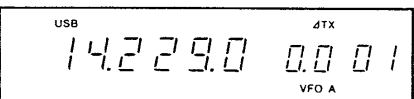

(14.2300MHz - 1.0kHz = 14.2290MHz)

- 7) Same receive and transmit frequencies when RIT and ΔTX are turned ON.

"RIT" and "ΔTX" appear.

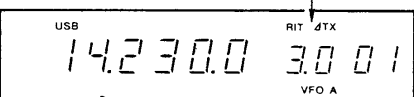

The ΔTX function allows the transmit frequency to be shifted up to 9.9kHz on either side of the receive frequency without moving the receive frequency. This is similar in operation to the RIT function.

- 1) Push the [ΔTX] SWITCH to turn ON the ΔTX function.

- "ΔTX" and the amount of shift frequency appear on the FREQUENCY DISPLAY.

- 2) Turn the [RIT/ΔTX] CONTROL to change the transmit frequency.

- 3) Push the [ΔTX] SWITCH again to turn OFF the ΔTX function.

- "ΔTX" and the amount of the shift frequency are no longer displayed.

- When the ΔTX function is OFF, ΔTX shift frequency is stored in a memory for later use.

- 4) Push the [ΔTX] SWITCH again to turn ON the ΔTX function.

- "ΔTX" and the stored shift frequency appear.

- 5) Push the [CLEAR] SWITCH to clear the ΔTX shift frequency.

- The shift frequency resets to "0.0" and the receive and transmit frequencies become the same.

- 6) Push the [FUNC] SWITCH and then the [CLEAR] SWITCH to add the ΔTX shift frequency to the displayed frequency.

- 7) If the RIT and ΔTX functions are both activated, the receive and transmit frequencies will be equal but shifted from the displayed frequency by the shift value.

- Varying the [RIT/ΔTX] CONTROL changes the receive and transmit frequencies simultaneously.

8-2 FILTER SWITCH OPERATION

(1) FILTER COMBINATIONS

This switch selects the different combinations of the internal 2nd IF (9MHz) and 3rd IF (455kHz) receive filters.

MODE	FILTER SWITCH	9MHz FILTER	455kHz FILTER	STANDARD BANDWIDTH	PASSBAND TUNING	IF SHIFT
SSB	OUT	FL-80	CFJ455K5	2.6kHz	YES	YES
	IN	FL-80	FL-44A	2.4kHz	YES	YES
CW RTTY	OUT	FL-80	FL-44A	2.4kHz	YES	YES
	IN	FL-32A	FL-52A	500Hz	YES	YES
CW RTTY (NARROW)	OUT	FL-32A	FL-52A	500Hz	YES	YES
	IN	FL-32A (FL-101)	FL-52A (FL-53A)	500Hz (250Hz)	YES	YES
AM	OUT	THROUGH (FL-102)	CFW455HT	6kHz	NO	NO
	IN	THROUGH (FL-102)	CFJ455K5	2.6kHz	NO	NO
FM	OUT	THROUGH	CFW455E	15kHz	NO	NO
	IN	THROUGH	CFW455E	15kHz	NO	NO

1) Bracketed filters are options.

2) Standard bandwidth is shown at -6dB point.

(2) FILTER REVERSE SWITCHES

MAIN UNIT (See p. 64)

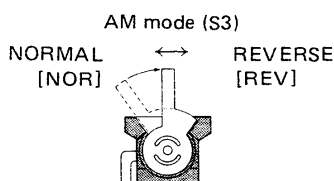
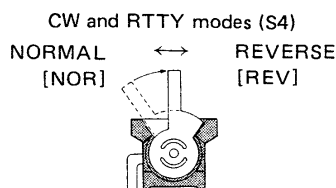
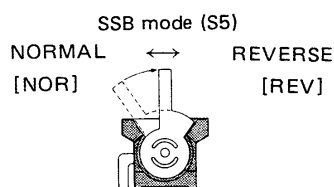
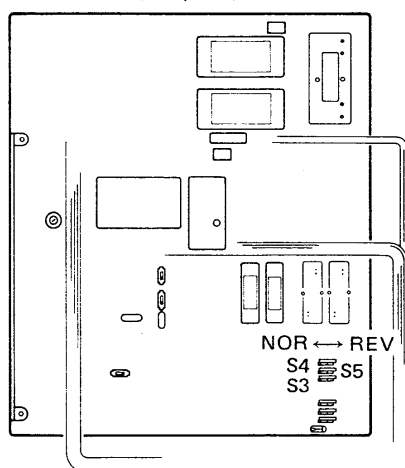

The [FILTER] SWITCH on the front panel selects between two receive filter systems for SSB, CW, RTTY or AM mode when it is switched between the IN and OUT positions. The IN/OUT relationship of the [FILTER] SWITCH may be reversed by using the internal FILTER REVERSE SWITCHES. (See page 64)

In SSB mode:

Internal preset switch S5 reverses these normal and narrow filters.

FILTER SWITCH POSITION	REVERSE SWITCH (S5)	
	NORMAL [NOR]	REVERSE [REV]
OUT	2.6kHz	2.4kHz
IN	2.4kHz	2.6kHz

In CW and RTTY modes:

Internal preset switch S4 reverses these wide and narrow filters.

FILTER SWITCH POSITION	REVERSE SWITCH (S4)	
	NORMAL [NOR]	REVERSE [REV]
OUT	2.4kHz	500Hz
IN	500Hz	2.4kHz

In CW-NARROW and RTTY-NARROW modes:

Internal preset switch S4 reverses these narrow and super-narrow filters.

FILTER SWITCH POSITION	REVERSE SWITCH (S4)	
	NORMAL [NOR]	REVERSE [REV]
OUT	500Hz	500Hz (250Hz)
IN	500Hz (250Hz)	500Hz

() : Optional super-narrow filter bandwidth.

In AM mode:

Internal preset switch S3 reverses these wide and narrow filters.

FILTER SWITCH POSITION	REVERSE SWITCH (S3)	
	NORMAL [NOR]	REVERSE [REV]
OUT	6kHz	2.6kHz
IN	2.6kHz	6kHz

8-3 MONITOR OPERATION

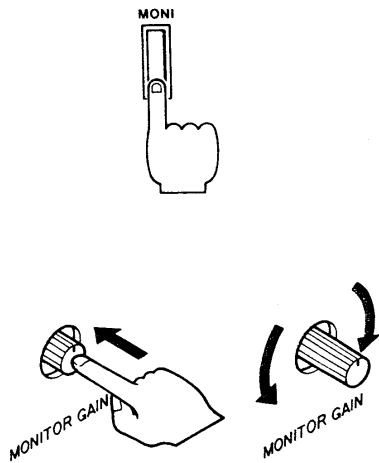

The transmit IF signal may be monitored while operating in SSB, CW, RTTY or AM mode if desired. This circuit is included to allow checking of the quality of the transmitted signal, especially useful when using the RF speech compressor.

- 1) Push IN the [MONI] SWITCH.
- 2) Adjust the [MONITOR GAIN] CONTROL on the front panel for a comfortable audio level.
- 3) Wear headphones while using the monitor function to prevent howling sounds caused by feedback.

8-4 PREAMP/ATT SWITCH OPERATION

• PREAMP



Place the [ATT] SWITCH on the top panel to the [PRE] position when receiving weak signals. An RF preamplifier is inserted in the receive path which increases receiver sensitivity.

• ATTENUATOR

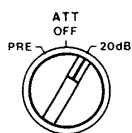

Place the [ATT] SWITCH in the [20dB] position when receiving very strong signals. In the [ATT] position, the RF preamplifier is removed from the receive path and a 20dB attenuator is inserted. This helps to reduce interference.

• FOR NORMAL OPERATION

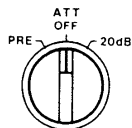

Leave the [ATT] SWITCH in the [OFF] position for normal operation.

8-5 AGC SWITCH OPERATION

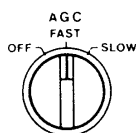

The IC-761 has a fast attack/slow release AGC system which maintains the peak voltage of the rectified IF signal from the IF amplifier circuit for a brief period of time. This circuit keeps irritating background noise from being heard during the short pauses in speech. The damping effect of the AGC therefore allows accurate S-meter readings to be taken of peak IF signal strength.

- 1) For normal SSB or AM reception, select the [SLOW] position.
- 2) For CW reception, or for SSB reception with short interval fading, select the [FAST] position. In the [FAST] position, the time constant of the circuit is shortened.
- 3) In the [OFF] position, the AGC circuit is deactivated and the S-meter gives no signal strength readings. In this case, the [RF GAIN] CONTROL is useful to reduce the receiver gain when strong signals are received.

8-6 SPEECH COMPRESSOR OPERATION

1) Set the switches and controls.

2) Switch to transmit and speak into mic.

3) Adjust [MIC GAIN] CONTROL.

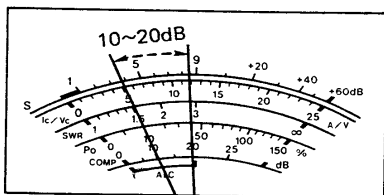

The IC-761 has a low distortion, RF speech compressor circuit which provides greater talk power by improving the intelligibility of the transmitted signal over long distances.

1) Set the switches and controls as shown in the table.

SWITCH/CONTROL	POSITION
MIC GAIN	CENTER
RF POWER	MAX. CCW
COMP	ON (IN)
METER	COMP

2) Switch to transmit and turn the [RF PWR] CONTROL clockwise while speaking into the microphone until the desired RF peak output of approximately 10 ~ 100W is obtained.

3) Adjust the [MIC GAIN] CONTROL for a meter reading between 10dB and 20dB on the COMPRESSOR [COMP] scale.

4) For the best transmit audio, leave the compressor OFF, or use a low mic gain setting with the compressor ON. However, when in contact with DX stations, or under weak signal conditions, the compressor will improve the readability of your signal when it is turned ON and adjusted correctly.

NOTE: Misadjustment of the speech compressor may cause interference to other stations.

8-7 NOISE BLANKER (NB) OPERATION

[NB LEVEL] CONTROL

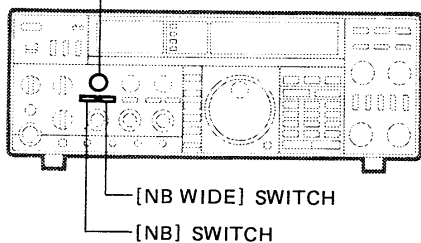

The IC-761 noise blanker function effectively reduces interference when pulse-type noise (such as ignition noise from vehicles) makes receiving difficult.

1) Push the [NB] SWITCH IN.

2) Rotate the [NB LEVEL] CONTROL clockwise. Noise is suppressed and weak signals can be received.

3) The noise blanker function removes long duration pulse-type noise such as "woodpecker noise" when the [NB WIDE] SWITCH is set in the WIDE (IN) position.

NOTE: The noise blanker function may not work as well when strong signals are on nearby frequencies, or when noise is continuous rather than pulse-type.

If the desired receive signal becomes distorted by the action of the noise blanker, set the [NB WIDE] SWITCH in the OUT position, or reduce the [NB LEVEL] CONTROL (turn counterclockwise) until the signal is clear.

8-8 VOX OPERATION

(1) IN SSB, AM AND FM MODES

- 1) Set the switch and controls.

- 2) Set the [TRANSMIT/RECEIVE] SWITCH in the [RECEIVE] position.

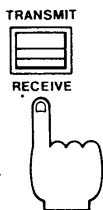

- 3) Adjust [VOX GAIN] CONTROL.

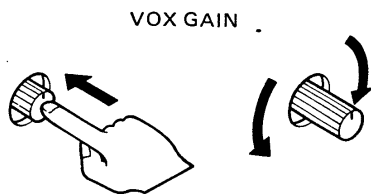

- 4) Adjust [VOX DELAY] CONTROL.



- 5) Adjust [ANTI-VOX] CONTROL.

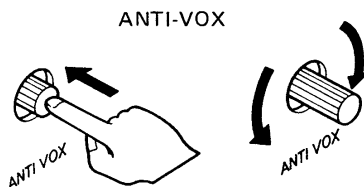

(2) IN CW MODE

The IC-761 has a built-in VOX (voice-operated relay) circuit which allows automatic transmit/receive switching by using the operator's speech modulation.

- 1) Set the switch and controls as shown in the table.

SWITCH/CONTROL	POSITION
VOX	ON (IN)
VOX GAIN	MAX. CCW
VOX DELAY	CENTER
MIC GAIN	CENTER

- 2) Set the [TRANSMIT/RECEIVE] SWITCH in the [RECEIVE] position. It is not necessary to push the [PTT] SWITCH on the microphone.

- 3) Rotate the [VOX GAIN] CONTROL clockwise while speaking into the microphone until the transmit/receive switching circuit is activated.

- 4) Rotate the [VOX DELAY] CONTROL counterclockwise to reduce the time delay after you stop speaking and before the transceiver changes back to receive mode. Set the control to allow for short pauses in normal speech without having the IC-761 change to receive mode.

- 5) Rotate the [ANTI-VOX] CONTROL clockwise while receiving a signal until the audio from the speaker no longer activates the VOX circuit.

In CW mode, break-in operation is possible using the VOX function.

See page 32 for CW break-in operation information.

8-9 PASSBAND/IF SHIFT OPERATION

(1) PASSBAND OPERATION

Passband Tuning is a system designed to electronically narrow the bandwidth (selectivity) of frequencies that pass through the receive crystal filter.

- 1) The [PBT/IF SHIFT] CONTROL has a detent at the center (12 o'clock) position. This position provides the widest bandwidth, and the control should normally be left here.
- 2) Rotate the [PBT/IF SHIFT] CONTROL either clockwise or counterclockwise to eliminate interference.

NOTE: The Passband Tuning does not function when the transceiver is in AM or FM mode.

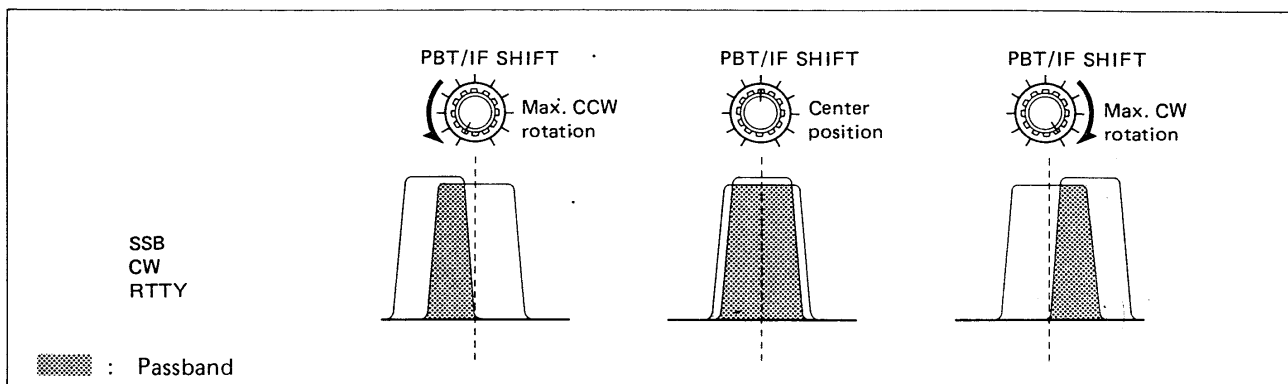

(2) IF SHIFT OPERATION

IF Shift Tuning is a system designed to electronically shift the passband of frequencies that pass through the receive crystal filter.

- 1) Push the [IF SHIFT] SWITCH IN to turn ON the IF Shift Tuning circuit.
- 2) Rotate the [PBT/IF SHIFT] CONTROL either clockwise or counterclockwise to eliminate interference.

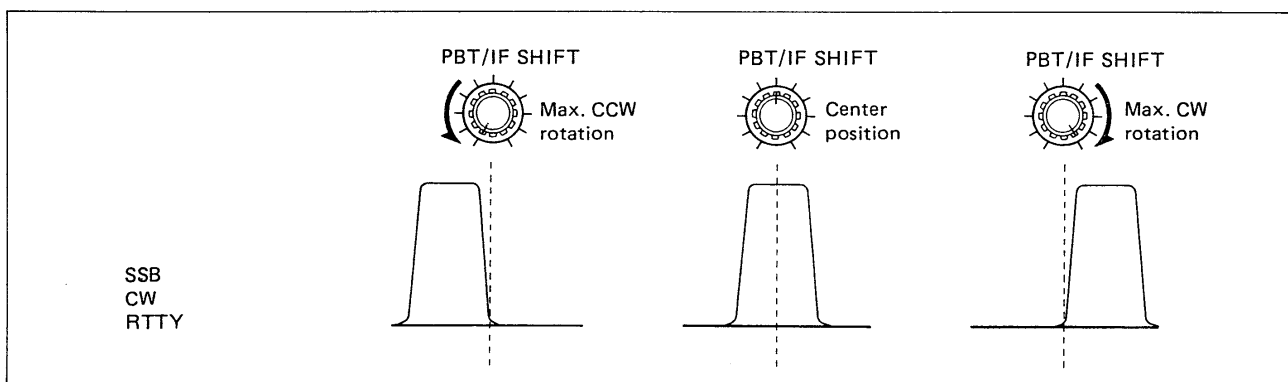

NOTE: IF Shift Tuning does not function when the transceiver is in AM or FM mode.

Passband Tuning and IF Shift Tuning do not function simultaneously.

8-10 NOTCH FILTER OPERATION

- 1) Push [NOTCH] FILTER SWITCH.

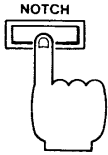

- 2) Adjust [NOTCH] FILTER CONTROL.

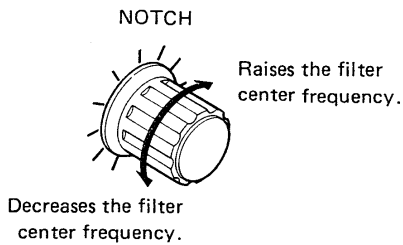

This circuit provides high attenuation at one particular frequency in the IF passband. It may be used to reduce or eliminate interfering heterodyne signals that fall within the passband of the receiver.

- 1) Push the [NOTCH] FILTER SWITCH to the ON position (IN).

- 2) Adjust the [NOTCH] FILTER CONTROL to minimize interference.

NOTCH FILTER CHARACTERISTICS

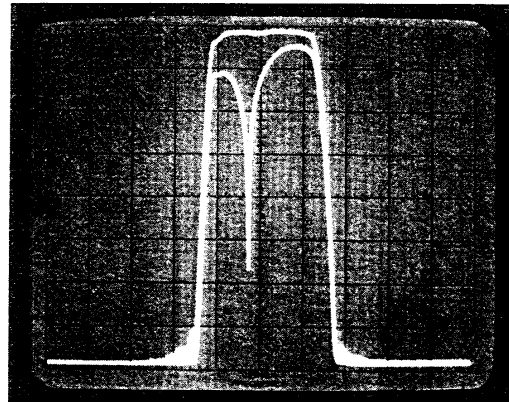

CENTER: 9.0115MHz
 SPAN : 10kHz
 SWP : 500ms
 RBW : 300Hz
 VBW : 3kHz
 REF : 10dB/div

8-11 SWR READING

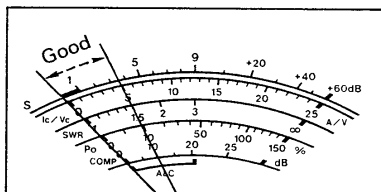
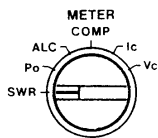

The built-in, highly advanced SWR meter in the IC-761 is designed to operate in any mode, even during SSB operation when transceiver output power does not remain at a steady and constant level.

NOTE: The [TUNER] SWITCH must be turned OFF when measuring SWR.

- 1) Turn the [RF PWR] CONTROL clockwise past the center position to output 30W of power or more.
- 2) Set the [METER] SWITCH in the [SWR] position.
- 3) Set the [TRANSMIT/RECEIVE] SWITCH in the [TRANSMIT] position.

- When operating in SSB mode, whistle for a couple seconds into the mic to measure the SWR.

- 4) Read the SWR on the SWR scale.

- Antenna matching is fine if the reading is 1.5 or less. Check your antenna system if the reading is more than 1.5.

8-12 SPLIT (DUPLEX) OPERATION

- 1) Set VFO A mode and program.

VFO A : 7.0570MHz/CW

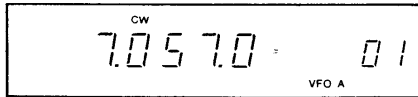

- 2) Set VFO B mode and program.

VFO B : 7.2550MHz/LSB

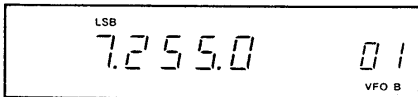

- 3) Return to VFO A mode.



- 4) Push [SPLIT] SWITCH.

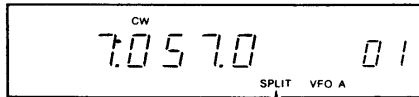

"SPLIT" appears.

- 5) Transmit.

- 6) Receiving : 7.0570MHz in CW mode
Transmitting : 7.2550MHz in LSB mode

• FM REPEATER OPERATION

The purpose of the split function is to allow an operator the option of transmitting on a frequency different than the receive frequency.

Duplex operation is possible using the contents of VFO A and VFO B. Following is an example for 7.0570MHz/CW for receiving and 7.2550MHz/LSB for transmitting on split (duplex) operation.

- 1) Push the [VFO A/B] SWITCH to set the transceiver in VFO A mode and set a receive frequency of 7.0570MHz with the TUNING CONTROL.

- 2) Push the [VFO A/B] SWITCH to set the transceiver in VFO B mode and set a transmit frequency of 7.2550MHz with the TUNING CONTROL.

- 3) Push the [VFO A/B] SWITCH again to return to VFO A mode.

- 4) Push the [SPLIT] SWITCH to enter split frequency operation.

- "SPLIT" appears on the FREQUENCY DISPLAY.

- 5) Push either the [TRANSMIT/RECEIVE] or [PTT] SWITCH to transmit.

- 6) You are now receiving on 7.0570MHz/CW and transmitting on 7.2550MHz/LSB. Push the [VFO A/B] SWITCH once again to receive on 7.2550MHz/LSB and transmit on 7.0570MHz/CW.

Each VFO stores the operating mode in addition to the operating frequency. This allows crossmode contacts to be easily made.

When operating in FM mode using the SPLIT operation, a tone encoder is often required to access FM repeaters. See pages 35 and 60 for more information.

NOTE: Most countries only allow FM operation on 28MHz or higher.

9. MEMORY AND SCANNING OPERATION

The IC-761 has thirty-two memory channels. One frequency, the operating mode, HAM BAND/GENERAL COVERAGE mode VFO A/B, and the split condition may be assigned to each memory channel whether the transceiver is in VFO mode or MEMORY CHANNEL mode.

Remember the following when storing frequencies in memories:

MEMO 01, 02: These channels are used as band limits for the PROGRAMMED SCAN function.

9-1 MEMORY CHANNEL AND VFO SELECTION

- 1) Push [VFO/MEMO] SWITCH.

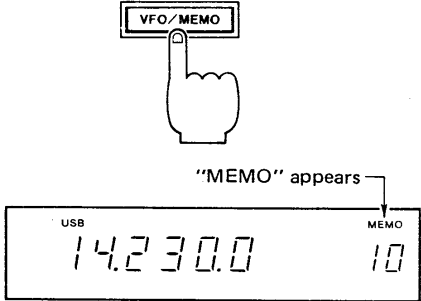

- 2) Rotate [MEMO-CH] SELECTOR CONTROL

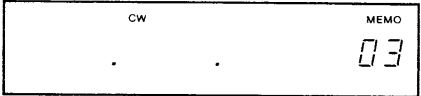

- 3) Push [VFO/MEMO] SWITCH again.

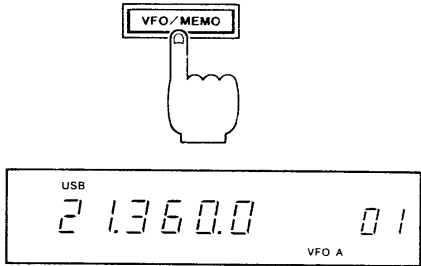

- 4) Push [VFO A/B] SWITCH to select VFO A or VFO B mode.

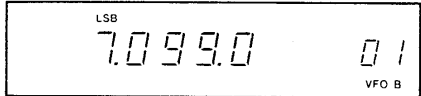

- 1) Push the [VFO/MEMO] SWITCH to select MEMORY CHANNEL mode.

- "MEMO" appears on the FREQUENCY DISPLAY.

- 2) Rotate the [MEMO-CH] SELECTOR CONTROL to select any of the memory channels.

- When memory channels not yet programmed are selected, only the decimal points appear on the FREQUENCY DISPLAY.

NOTE: If the [MODE-S] SWITCH is pushed IN, only memory channels with the same operating mode as displayed just prior to pushing the switch are selected when the [MEMO-CH] CONTROL is used.

- 3) Push the [VFO/MEMO] SWITCH again to return to VFO A or VFO B mode selection.

- 4) Push the [VFO A/B] SWITCH to select VFO A or VFO B mode.

9-2 PROGRAMMING MEMORY CHANNELS

(1) IN VFO MODE

- 1) Select VFO mode.

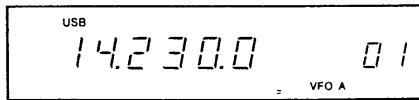

- 2) Select GENERAL COVERAGE mode.

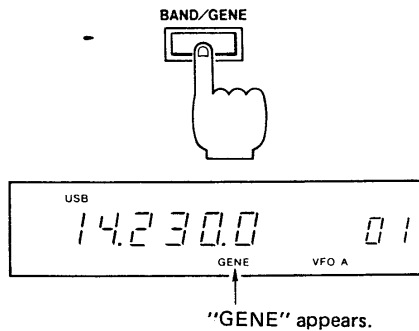

- 3) Push [RTTY] SWITCH.

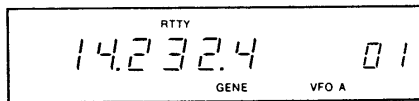

- 4) Set the frequency for 15.7250MHz.

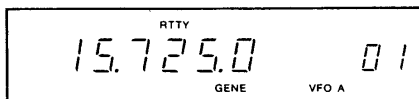

- 5) Select Memory Channel 20.



- 6) Push [WRITE] SWITCH.

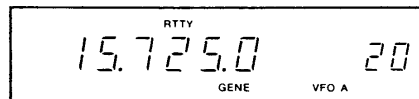

- 7) Push [VFO/MEMO] SWITCH to check contents.

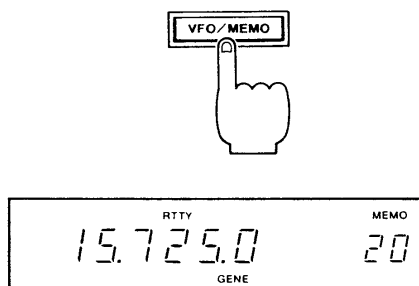

Any frequency, operating mode, HAM BAND/GENERAL COVERAGE mode, VFO A/B, or split condition may be memorized in any memory channel.

Following are instructions for programming 15.7250MHz and RTTY mode into MEMO 20 in GENERAL COVERAGE mode.

- 1) Select VFO A or VFO B mode.

- If the FREQUENCY DISPLAY shows "MEMO", push the [VFO/MEMO] SWITCH to select VFO mode.

- 2) Select GENERAL COVERAGE mode using the [BAND/GENE] SWITCH.

- "GENE" appears on the FREQUENCY DISPLAY.

- 3) Push the [RTTY] SWITCH to select RTTY mode.

- 4) Set the frequency for 15.7250MHz using the [UP/DOWN] SWITCHES and TUNING CONTROL.

- 5) Select Memory Channel 20 by rotating the [MEMORY-CH] SELECTOR CONTROL.

- 6) Push the [WRITE] SWITCH to program all the above information into Memory Channel 20.

- 7) To check the memory channel contents, push the [VFO/MEMO] SWITCH.

- The contents of the selected memory channel are displayed.

(2) IN MEMORY CHANNEL MODE

- 1) Push [VFO/MEMO] SWITCH.

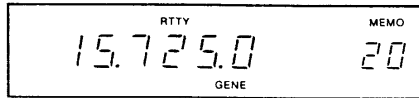

- 2) Select MEMO 10.



- 3) Select GENERAL COVERAGE mode.

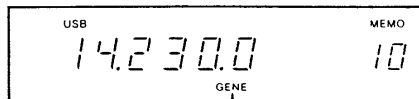

"GENE" appears.

- 4) Push [AM] SWITCH.

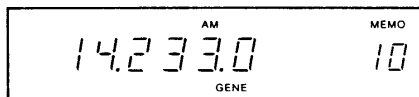

- 5) Set the frequency for 15.350MHz.

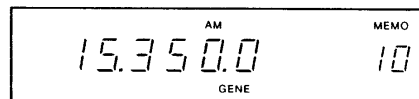

- 6) Push [WRITE] SWITCH.

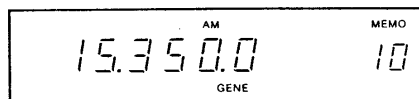

Following are instructions for programming 15.350MHz and AM mode into memory channel 10 (MEMO 10) GENERAL COVERAGE mode.

- 1) Push the [VFO/MEMO] SWITCH to select MEMORY CHANNEL mode.

- "MEMO" appears on the FREQUENCY DISPLAY.

- 2) Select MEMO 10 by rotating the [MEMORY-CH] SELECTOR CONTROL.

- Previously memorized frequency and the other information appear on the FREQUENCY DISPLAY.

- 3) Select GENERAL COVERAGE mode using the [BAND/GENE] SWITCH.

- "GENE" appears on the FREQUENCY DISPLAY.

- 4) Push the [AM] SWITCH to select AM mode.

- 5) Set the frequency for 15.350MHz using the [UP/DOWN] SWITCHES and TUNING CONTROL.

- 6) Push the [WRITE] SWITCH to program the above information into MEMO 10.

9-3 MEMORY CLEARING

- 1) Push [VFO/MEMO] SWITCH.



- 3) Push [FUNC] SWITCH, then push [M▶VFO] or [WRITE] SWITCH.

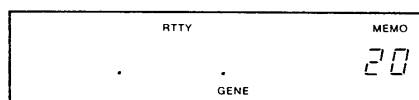

This function clears the information in each memory channel.

- 1) Push the [VFO/MEMO] SWITCH to select MEMORY CHANNEL mode.

- "MEMO" appears on the FREQUENCY DISPLAY.

- 2) Select a memory channel to be cleared (erased).

- 3) Push the [FUNC] SWITCH, then push the [M▶VFO] or [WRITE] SWITCH.

- The memory channel is now vacant.

9-4 SCANNING OPERATION

The IC-761 is equipped with four scan functions, providing tremendous scanning versatility at the touch of just a few switches.

SCAN TYPE	OPERATION
PROGRAMMED SCAN	Repeatedly scans between two user-PROGRAMMED frequencies in the scan range using MEMO 01 and MEMO 02 for storing frequency data.
MEMORY CHANNEL SCAN	Scans all MEMORY CHANNELS containing information while skipping memories in blank status.
SELECTED MODE MEMORY SCAN	Repeatedly scans all memory channels containing frequencies in the same MODE as the displayed frequency.

(1) PROGRAMMED SCAN

- 1) Store the HIGH and LOW frequency limits.

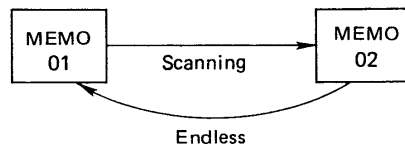
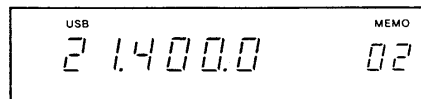
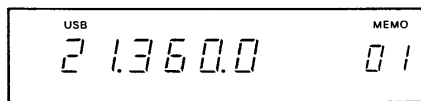

- 2) Push [VFO/MEMO] SWITCH.
- 3) Select a desired mode.
- 4) Adjust [SQUELCH] CONTROL.



[RECEIVE] INDICATOR goes OFF.

- 5) Push [SCAN] SWITCH.
- 6) The scan stops when the transceiver receives a signal.
- 7) Push [SCAN] SWITCH or turn TUNING CONTROL.

- 1) Store the HIGH and LOW frequency limits of the desired scanning range in MEMO 01 and 02. Refer to page 49 for memory channel programming information.

- The scan begins from the LOW limit of the range regardless of which channel has the lower frequency stored.

NOTE: Store both scanning limits in MEMO 01 and MEMO 02 using HAM BAND or GENERAL COVERAGE mode. The programming MUST be used in the same band when using HAM BAND mode.

- 2) Push the [VFO/MEMO] SWITCH to select VFO mode.
- 3) Select a desired mode such as SSB or AM mode.
- 4) Adjust the [SQUELCH] CONTROL to quiet noise output from the speaker.
 - The green [RECEIVE] INDICATOR goes OFF.
- 5) Push the [SCAN] SWITCH to start the scan.
 - "SCAN" appears on the FREQUENCY DISPLAY.
- 6) The scan stops for approximately 10 seconds after a receive signal opens the squelch, then resumes scanning.
 - See page 52 for scan resumption information.
- 7) Push the [SCAN] SWITCH or turn the TUNING CONTROL to stop the scan.
 - "SCAN" disappears.

(2) MEMORY CHANNEL SCAN

- 1) Program the desired frequencies.
- 2) Push [VFO/MEMO] SWITCH.
- 3) Adjust [SQUELCH] CONTROL.
- 4) Push [SCAN] SWITCH.

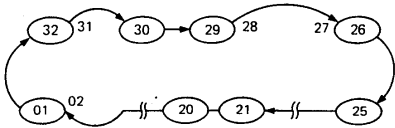

(3) SELECTED MODE MEMORY SCAN

- 1) Program the desired frequencies.
- 2) Push [VFO/MEMO] SWITCH.
- 3) Select a desired mode.
- 4) Adjust [SQUELCH] CONTROL.
- 5) Push [MODE-S] SWITCH.
- 6) Push [SCAN] SWITCH.

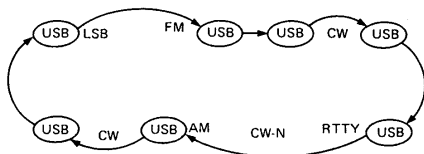

(4) SCAN RESUMPTION

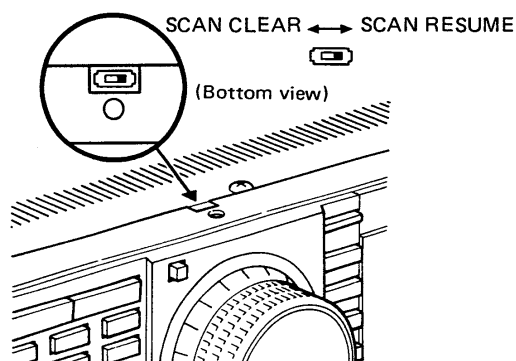

- 1) Program the desired frequencies into memory channels. Refer to page 49 for programming memory channels.
- 2) Push the [VFO/MEMO] SWITCH to select MEMORY CHANNEL mode if the transceiver is in VFO mode.
 - "MEMO" appears on the FREQUENCY DISPLAY.
- 3) Adjust the [SQUELCH] CONTROL to quiet noise output from the speaker.
 - The green [RECEIVE] INDICATOR goes OFF.
- 4) Push the [SCAN] SWITCH to start the scan.
 - "SCAN" appears on the FREQUENCY DISPLAY.
 - Push the [SCAN] SWITCH or turn the TUNING CONTROL to stop the scan.
 - See item (4) SCAN RESUMPTION below.

- 1) Program the desired frequencies into memory channels. Refer to page 49 for memory channel programming information.
- 2) Push the [VFO/MEMO] SWITCH to select MEMORY CHANNEL mode if the transceiver is in VFO mode.
 - "MEMO" appears on the FREQUENCY DISPLAY.
- 3) Select a desired mode such as SSB or AM mode.
- 4) Adjust the [SQUELCH] CONTROL to quiet noise output from the speaker.
 - The green [RECEIVE] INDICATOR goes OFF.
- 5) Push the [MODE-S] SWITCH IN to select SELECTED MODE MEMORY SCAN.
- 6) Push the [SCAN] SWITCH to start the scan.
 - "SCAN" appears on the FREQUENCY DISPLAY.
 - Push the [SCAN] SWITCH or turn the TUNING CONTROL to stop the scan.
 - See item (4) SCAN RESUMPTION below.

Scanning resumes after approximately 10 seconds after the scan stops on a receive signal. However, the switch shown in the diagram may be used to override this feature. (See page 64)

In the SCAN CLEAR position:

The scan function automatically clears when a receive signal opens the squelch.

In the SCAN RESUME position:

The scan stops for approximately 10 seconds after a receive signal opens the squelch, then resumes scanning.

10. CIRCUIT DESCRIPTION

10-1 RECEIVER CIRCUITS

(1) RF CIRCUIT

Incoming signals to the RF UNIT are switched by RL1 and applied to an L-type 20dB attenuator (R92, R93) or bypass the attenuator. Signals are then fed to one of the bandpass filters or low-pass filters depending on the frequency of the signal that is controlled by IC1 and IC2.

Signals from the bandpass filters are fed to an L-type attenuator which consists of R28 and PIN diodes D10 and D11 which are controlled by AGC voltage. Signals are then fed to the preamp (Q6, Q7) or bypass the preamp and enter the 1st mixer. Signals from low-pass filters are fed to the 1st mixer directly.

(2) IF CIRCUIT

Q9 and Q10 create a double-balanced mixer which uses low-noise FETs (2SK125) and is driven by 13.8V to provide an excellent noise figure. Multi-signal receiving characteristics are determined by the 1st mixer circuit. The double-balanced mixer has a high interception point and reduces spurious characteristics in signals. The IC-761 has a very high dynamic range (100dB in SSB mode and 104 ~ 105dB in CW mode).

1st IF signals are filtered (F11), amplified (Q8) and mixed at IC3 with 2nd LO signals from the PLL UNIT for conversion into 2nd IF signals (9.0115MHz) and are then applied to the MAIN UNIT.

(3) PASSBAND TUNING

High quality 9MHz and 455kHz filters are necessary to operate Passband Tuning. The IC-761 therefore has high shape filters in this circuit. The PBT oscillator circuit oscillates local frequency signals for mixers IC10 and IC11 which are located at both the input and output terminals of the 455kHz filter. The center frequency of the 455kHz filter appears to change when the local oscillator frequency is changed $\pm 1.7\text{kHz}$ by the [PBT] CONTROL.

(4) NOISE BLANKER

The noise components of 2nd IF signals to the MAIN UNIT are amplified with wide dynamic range at Q8, Q9, and Q10, are detected at D17 and D18, and control the noise blanker gate by using the NB switching circuit (Q15).

Q12 controls the blanking time for setting 10msec. when the [NB WIDE] SWITCH is pushed IN and for 1 ~ 2msec. when the [NB WIDE] SWITCH is OUT. This results in a distortion-free audio signal. The limits of blanking time are determined by D16, R56, R57, C39 and C40.

(5) NOTCH CIRCUIT

The notch circuit uses a bridge-type notch filter and achieves very sharp attenuation and stability using a crystal unit. Notch frequency can be altered by a capacitance change of varicap D110 which is installed in series with crystal X2. Monolithic filter F17 is connected to the next stage of the notch circuit and eliminates spurious signals emitted from mixer IC11.

(6) AF CIRCUIT

Audio signals from IC20 or Q76 are amplified at IC19(b), are tone controlled by R394, C258 and the [TONE] CONTROL, and pass through the [AF GAIN] CONTROL and are then power amplified at IC18 to more than 3W.

10-2 TRANSMITTER CIRCUITS

(1) AF CIRCUIT

An audio signal from the MIC CONNECTOR is amplified at Q2 in the AF VR UNIT, passes through the [MIC GAIN] CONTROL, and is then amplified again at Q34 and Q35. The tone control circuit is installed between Q34 and Q35, and varies the frequency response of the mic amplifier.

(2) IF CIRCUIT

IC9 is a double-balanced mixer which generates DSB or AM signals using BFO signals. A DSB signal is applied to FI2, a 9MHz filter, creating the SSB signal. An AM signal bypasses the filter. Signals are buffer-amplified at Q84 and then converted into 2nd IF frequency signals of 455kHz at IC10.

A 2nd IF signal is fed into the compressor circuit or bypasses it and then is applied to Q38 depending on the [COMP] SWITCH position. A 455kHz filter, buffer-amplifier Q42, and mixer IC11 are commonly used with the receive circuit, so 455kHz 2nd IF signals are reconverted to 9MHz 3rd IF signals, are amplified at Q1, and are then applied to the RF UNIT.

3rd IF signals to the RF UNIT are converted to 70.4515MHz at IC3, amplified at Q11, and are then fed to the mixer circuit (Q12, Q13) for conversion to the desired frequency (same as on the FREQUENCY DISPLAY).

(3) MONITOR CIRCUIT

The transmitter monitor circuit is not simply a modulation monitor: it also receives signals at the point where the transmit signals are amplified by Q49 and detected by IC15 and fed to IC19(a). The monitor circuit is turned ON and OFF by the power source of Q49.

(4) RF CIRCUIT

Converted signals pass through one of nine bandpass filters and are then applied to the PA UNIT.

Signals from the RF UNIT are amplified at Q1 (a class A amplifier), are amplified at Q2 and Q3 (class AB push-pull amplifiers), and are then amplified at final transistors Q4 and Q5 (class AB push-pull amplifiers) to provide 100W of output power.

10-3 ANTENNA TUNER

(1) MATCHING CIRCUIT

Variable capacitors C3 and C4 are connected to their respective motors and additional condensers are parallel connected to C3 and C4 when the transceiver operates in the 1.8 ~ 3.5MHz range. The taps of the coils on L1 and L2 are automatically selected by the bands designated by relays RL7 ~ RL12. By using two separate motors, the IC-761 obtains a faster overall tuning speed.

(2) DETECTOR CIRCUIT

Resistance components are detected by L1, D1, and D2 on the DET UNIT. If an antenna impedance is higher than 50Ω , positive detected voltage appears; if lower than 50Ω , negative voltage appears.

Reaction components are detected from the RF current and RF voltage using phase detection. RF current is detected by L1 and R5, and RF voltage is detected by C3 ~ C5. Both detector voltages are buffer amplified and are then applied to phase comparators IC1 ~ IC3.

10-4 PLL CIRCUIT

The PLL UNIT in the IC-761 is equipped with a reversed heterodyne 1st mixer and a normal heterodyne 2nd mixer, so PLL output has very accurate oscillation.

The PLL loop generates a 1st LO frequency (F_v) that is given as:

$$F_v = F_{Lo} + N \times F_{ref}$$

F_{Lo} : F_{sub} (generated by the sub loop) + F_{ref}

N : Driven by N-data

F_{ref} : Reference frequency

The reference frequency (F_{ref}) is 10kHz, and the VCO is controlled in 10kHz steps by changing the dividing ratio N of the programmable divider. A frequency between this step (less than 10kHz) is obtained by F_{Lo} , which controls the VCO output frequency. Note that F_{Lo} can be changed in 10Hz steps over the 9.99kHz range, and in this way the entire 30MHz range of the PLL can be varied in 10Hz steps.

(1) MAIN LOOP

The output of the VCO is separated into two parts after passing through the Q22 buffer-amplifier. One part is amplified by Q23, and, after being impedance matched by Q25, is output to the RF UNIT as 1st LO frequency (output level is 0dBm/50Ω). The other part of the VCO is fed back to the PLL loop through Q26, a buffer amplifier.

The VCO signal is mixed with the in-loop LO (F_{Lo}) by IC3 and is down mixed. The output is then amplified by Q16 and Q17 (a cascade amplifier), and is input to IC2 to divide the phase detector with F_{ref} .

(2) SUB LOOP

The reference frequency is 5kHz and the VCO can be locked within a frequency range of 115.00 ~ 119.995MHz. The output signal of the 4.995MHz bandwidth with a 5kHz resolution is divided in a 1/500 ratio by IC204 and IC203, providing output ranging from 230.00 to 239.99kHz in 10Hz steps. This output is fed to the main loop.

[MAIN LOOP]

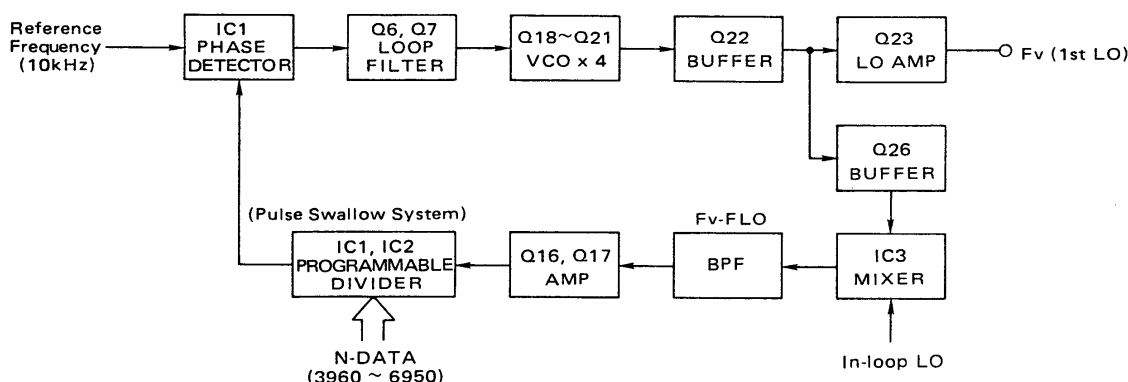

[MARKER GENERATOR]

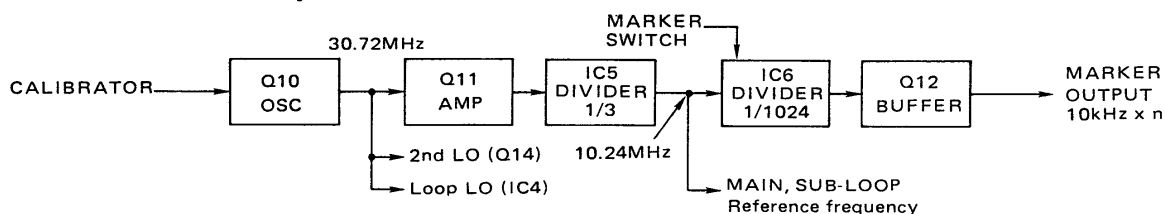

11. MAINTENANCE AND ADJUSTMENTS

11-1 MAINTENANCE

(1) RESETTING THE INTERNAL CPU

The FREQUENCY DISPLAY may occasionally display erroneous information during operation or when first applying power. This may be due to an external cause such as static electricity.

If this sort of problem occurs, turn OFF power to the IC-761, wait for a few seconds and turn ON power again. If the problem continues, perform the following procedure.

NOTE: All information programmed in memory channels will be cleared if the transceiver is reset.

- 1) Push the [POWER] SWITCH OFF (OUT).
- 2) Push and hold the [WRITE] SWITCH and push the [POWER] SWITCH ON (IN).
- 3) The IC-761 is now reset, and displays the following information:

- Frequency : 7.100.0MHz
- Mode : LSB
- VFO : VFO A

(2) FUSE REPLACEMENT

If the fuse blows or the transceiver stops functioning, track down the source of the problem if possible, and replace the damaged fuse with a new, rated fuse.

WARNING: DISCONNECT THE AC CORD FROM THE AC OUTLET (RECEPTACLE) TO PREVENT ELECTRIC SHOCKS WHEN CHANGING THE FUSE.

Rear panel AC line fuse : 10A for 120V AC
5A for 220 ~ 240V AC

Inside DC line fuses : 5A for inside units
2A for external 13.8V DC

The AC line fuse is located on the rear panel and the DC line fuses are located in the transceiver.

- 1) Remove the top cover.
- 2) The fuse holders are located near the POWER SUPPLY UNIT. See the diagrams below.

This fuse (5A) is connected on the line that supplies 13.8V to each unit in the IC-761.

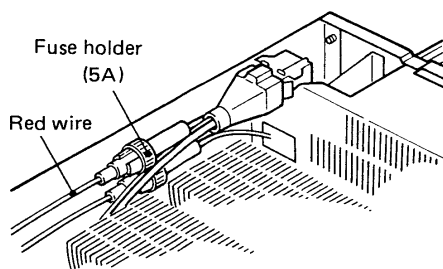

This fuse (2A) is connected on the other line that supplies 13.8V to the [DC OUT] JACK on the rear panel.

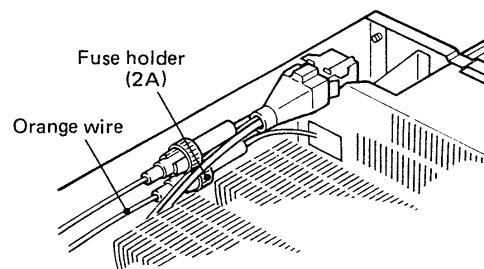

(3) BACKUP BATTERY

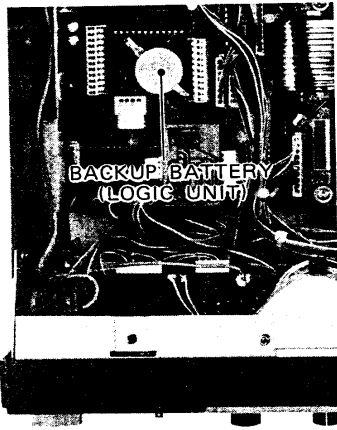

(4) CLEANING

11-2 ADJUSTMENTS

(1) BRAKE ADJUSTMENT

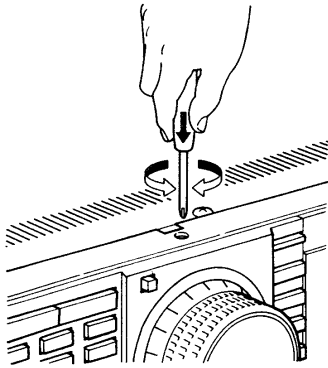

(2) SIMPLE FREQUENCY ADJUSTMENT

NOTE: This adjustment calibrates the reference oscillator, therefore it is unnecessary to calibrate each band.

The IC-761 uses an advanced, highly reliable microprocessor chip. The purpose of the battery is to provide power to the microprocessor so it retains all memory information during power failures, or when the unit is unplugged or turned OFF.

- The usual life of the lithium backup battery should be five years. It is advisable to monitor the battery carefully and replace it if there are repeated cases of display malfunction.
- The transceiver transmits and receives normally if the backup battery is exhausted but the transceiver cannot memorize frequencies.

NOTE: Battery replacement should be done by an authorized ICOM Dealer or ICOM Service Center.

If the transceiver becomes dusty or dirty, wipe it clean with a dry, soft cloth. Avoid the use of strong cleaning agents such as benzine or alcohol as they may damage the surfaces.

TUNING CONTROL tension may be adjusted to suit the operator's preference.

- 1) The screw adjustment is located on the bottom side of the transceiver cabinet below the TUNING CONTROL.
- 2) Turn the brake adjustment screw either CW or CCW to comfortable tension level while turning the TUNING CONTROL continuously and smoothly in one direction.

A very accurate frequency counter is required to align the frequency of the IC-761. However, a simple check may be performed by receiving radio station WWV, WWVH or other standard frequency signals.

- 1) Push the [BAND/GENE] SELECTOR SWITCH to select GENERAL COVERAGE mode.
- 2) Push the [USB] SWITCH to select USB mode.
- 3) Set the FREQUENCY DISPLAY to the exact frequency of the standard frequency station minus 1kHz.

- **EXAMPLE:** When using WWV (10.000.00MHz), adjust the operating frequency 9.999.00MHz.
 $10.000.00\text{MHz} - 0.001.00\text{MHz (1kHz)} = 9.999.00\text{MHz}$

- 4) Push the [MARKER] SWITCH IN (ON).
- 5) Push and pop up the [CALIBRATOR] CONTROL then adjust the control for zero beat.

- Zero beat means that two signals are on exactly the same frequency, resulting in a single audio tone being emitted.

- 6) Push the [CALIBRATION] CONTROL IN and push the [MARKER] SWITCH to turn OFF the marker function.

(3) ELECTRONIC KEYS WEIGHT CONTROL

ELECTRONIC KEYS UNIT
(TOP COVER SIDE)

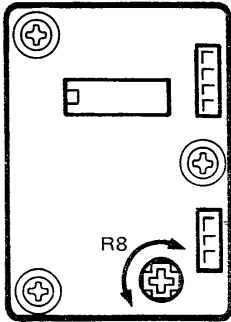

- 1) Connect a CW iambic paddle to the [KEY] JACK on the rear panel.
- 2) Push the [CW] and [ELEC-KEY] SWITCHES.
- 3) Close the CW key and adjust R8 to suit your weight length.

• The R8 WEIGHT CONTROL is set at the factory for the DOT: SPACE: DASH ratio at 1:1:3. DOTS and DASHES increase in length if R8 is turned clockwise.

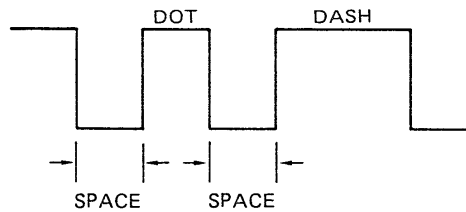

(4) CW SIDETONE FREQUENCY ADJUSTMENT

- 1) This control is factory set for a 700Hz tone.
- 2) Connect a CW key to the [KEY] JACK on the rear panel.
- 3) Push the [CW] SWITCH to select CW mode.
- 4) Close the CW key and adjust R374 on the MAIN UNIT for a suitable tone. Refer to page 64 for the adjustment location.

(5) BFO ADJUSTMENT

Connect a frequency counter to CP1 on the MAIN UNIT. Refer to page 64 for the CP1 location.

MODE	FREQUENCY (MHz)		ADJUSTMENT
	RECEIVE	TRANSMIT	
USB	9.01300	9.01300	C202
LSB	9.01000	9.01000	L33
CW	9.00990	NO SIGNAL	L34
RTTY	9.008475	9.008475	L35
AM	NO SIGNAL	9.01000	L33
FM	NO SIGNAL	NO SIGNAL	-----

(6) TRANSMIT AUDIO ADJUSTMENT

The bass and treble response of your transmitted signal may be altered with the R155 adjustment on the MAIN UNIT. Refer to page 64 for the R155 location.

(7) OTHER ADJUSTMENTS

See page 64 for information regarding other adjustments.

12. OPTIONS INSTALLATIONS

WARNING: TO PREVENT ELECTRIC SHOCKS, DISCONNECT THE AC CORD FROM THE AC OUTLET (RECEPTACLE) BEFORE PERFORMING ANY WORK ON THE TRANSCEIVER.

12-1 IC-EX310 VOICE SYNTHESIZER UNIT

(1) INSTALLATION

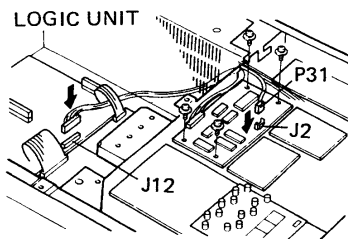
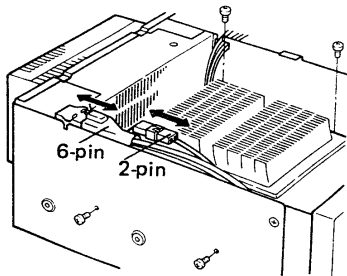

(2) ADJUSTMENT

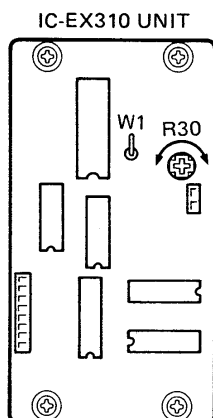

After being installed, the voice synthesizer announces the displayed frequency when the [SPEECH] SWITCH on the front panel is pushed.

- 1) Remove the top and bottom covers.
- 2) Disconnect the 6-pin and 2-pin connectors as shown in the diagram.
- 3) Unscrew the two side panel screws and two inside screws as shown in the diagram and remove the power supply unit installed with a metal plate.
- 4) Connect the 2-pin plug into J2 of the IC-EX310 and connect the 8-pin plug from the IC-EX310 into J12 on the LOGIC UNIT.
- 5) Install the unit correctly using the supplied screws as shown in the diagram.
- 6) Re-assemble the power supply unit and connectors correctly.
- 7) Adjusting the volume and speech speed is necessary before the covers are replaced. The procedure is described below.

- 1) Connect an AC cord between the transceiver and the AC outlet (receptacle).
- 2) Push the [POWER] SWITCH-IN to turn power ON and push the [SPEECH] SWITCH on the front panel.
 - The speaker announces the displayed frequency in English.
- 3) The speech volume and speech speed can be adjusted as follows:
 - **Volume of the announcement** : Turn R30
 - **Faster speech speed** : Cut W1 jumper wire
- 4) Replace the top and bottom covers after finishing the adjustments.

12-2 UT-30 PROGRAMMABLE TONE ENCODER UNIT

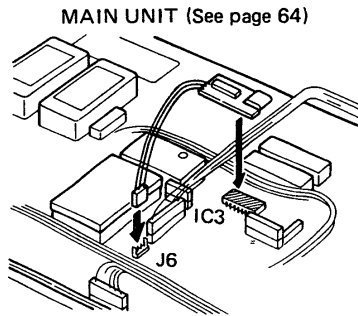

The tone encoder allows access to repeater stations that require sub-audible tones superimposed on the transmit signal. The optional UT-30 has 38 kinds of tones available, and is programmable.

- 1) Remove the top and bottom covers.
- 2) Install the unit where IC3 is located on the MAIN UNIT using the double-sided tape. See page 64 for the location.
- 3) Plug the 3-pin connector from the UT-30 into J6 on the MAIN UNIT.
- 4) Program the unit for the frequency required using the programming chart. The UT-30 is factory programmed for 88.5Hz.
- 5) Replace the top and bottom covers.
- 6) Refer to page 35 for instructions regarding operation.

12-3 FILTERS

(1) FILTER CHARACTERISTICS

FILTER	MODE	CHARACTERISTICS		
		CENTER FREQ.	-6dB POINT	-60dB POINT
FL-53A	CW/RTTY	455kHz	250Hz	480Hz
FL-101	CW/RTTY	9.0106MHz	250Hz	800Hz
FL-102	AM	9.0100MHz	6kHz	20kHz

(2) INSTALLATIONS

● FL-53A installation

CW 455kHz (S9)

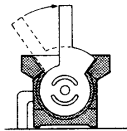

This is a 455kHz filter for use with the CW-Narrow or RTTY-Narrow mode.

- 1) Insert the optional FL-53A into the position shown in the diagram on page 61.

- No soldering is required for the installation.

- 2) Set S9 on the MAIN UNIT in the vertical position as shown in the diagram at left.

● FL-101 installation

CW 9MHz (S7)

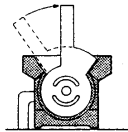

This is a 9MHz narrow filter for CW and RTTY mode.

- 1) Insert the optional FL-101 into the position shown in the diagram on page 61.

- No soldering is required for the installation.

- 2) Set S7 on the MAIN UNIT in the vertical position as shown in the diagram at left.

● FL-102 installation

AM 9MHz (S6)

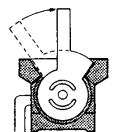

This is a 9MHz filter for AM mode.

- 1) Insert the optional FL-102 into the position shown in the diagram on page 61.

- No soldering is required for the installation.

- 2) Set S6 on the MAIN UNIT in the vertical position as shown in the diagram at left.

(3) INSTALLATION LOCATIONS

MAIN UNIT

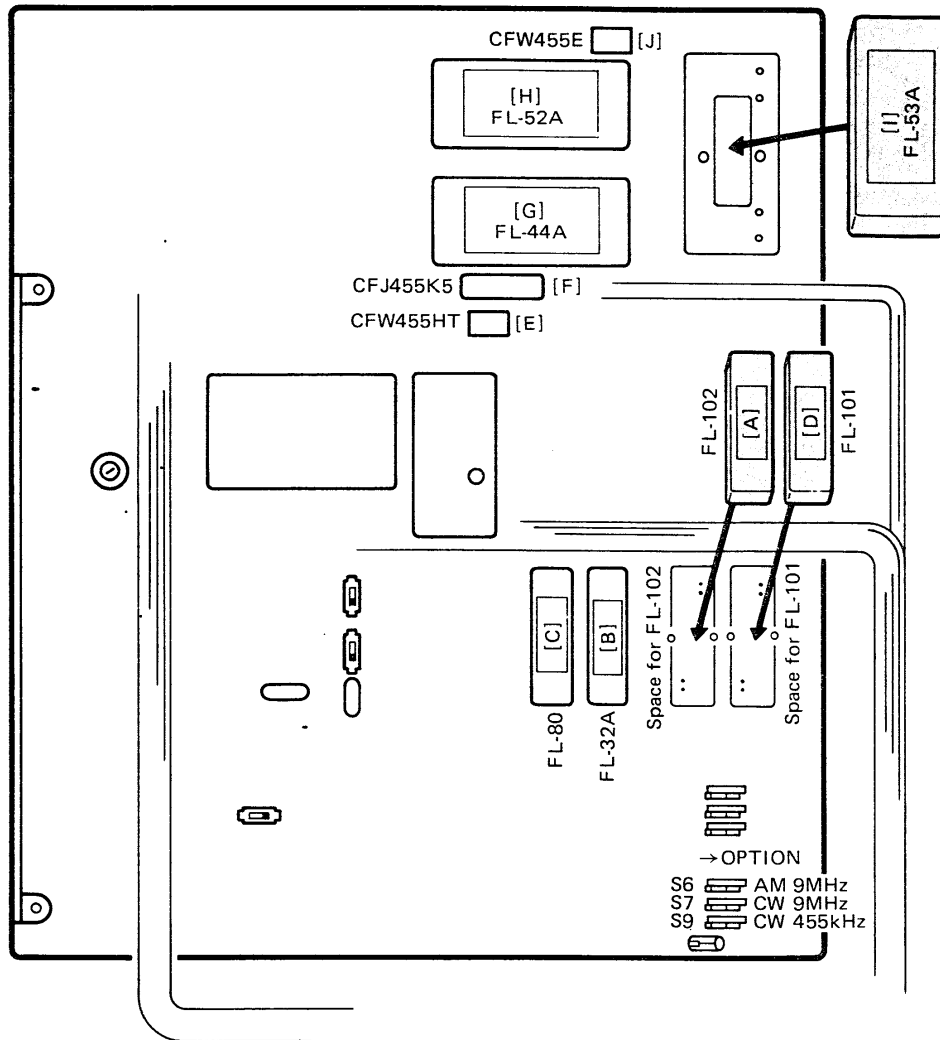

(4) FILTER SYSTEM

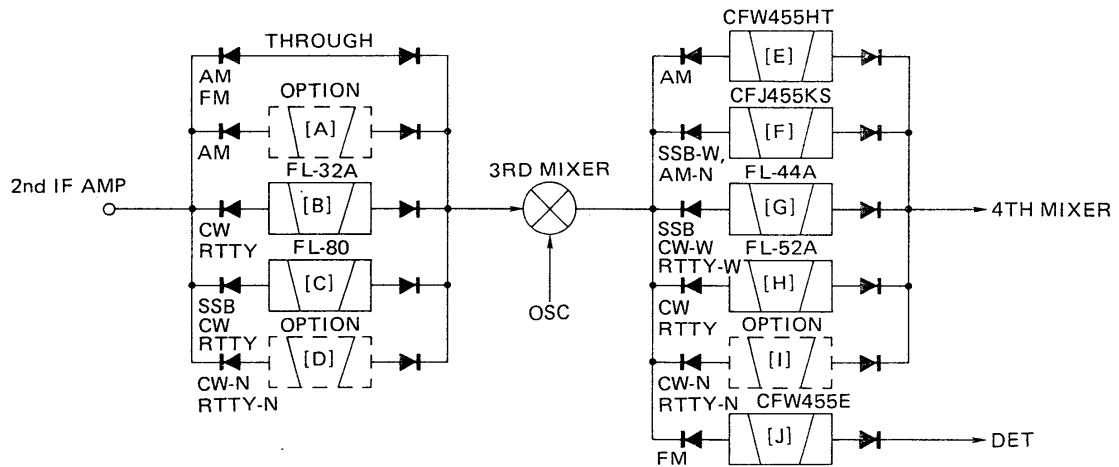

[A] : FL-102
 [D] : FL-101
 [I] : FL-53A

NOTE: 9MHz filters, [A] [D] are bypassed when the [IF SHIFT] SWITCH is pushed IN.

12-4 OPTIONS

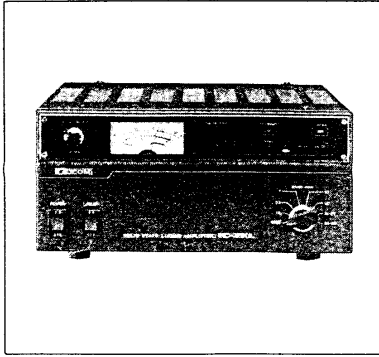

IC-2KL
500W LINEAR AMPLIFIER

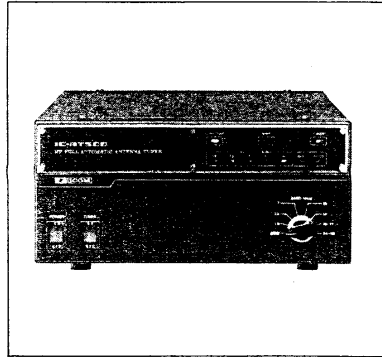

IC-AT500
500W AUTOMATIC
ANTENNA TUNER

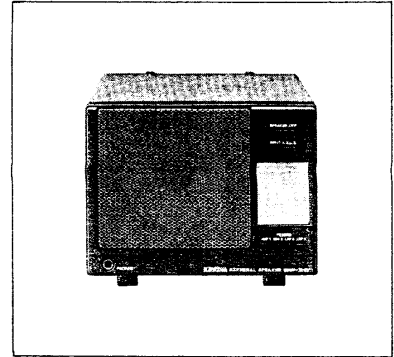

SP-20
EXTERNAL SPEAKER
WITH AUDIO FILTERS

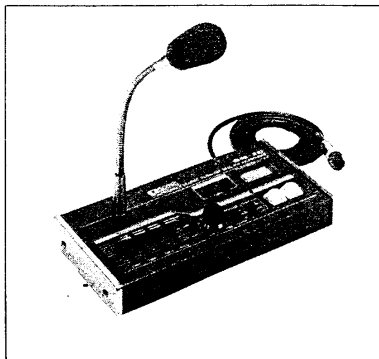

SM-10
COMPRESSOR/GRAPHIC
EQUALIZER DESK TOP
MICROPHONE

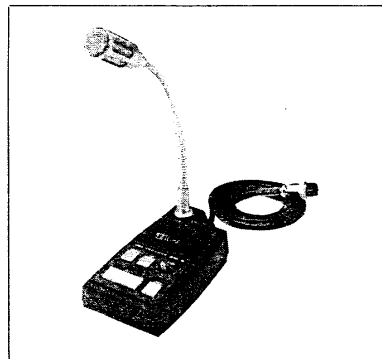

SM-8
DESK MICROPHONE

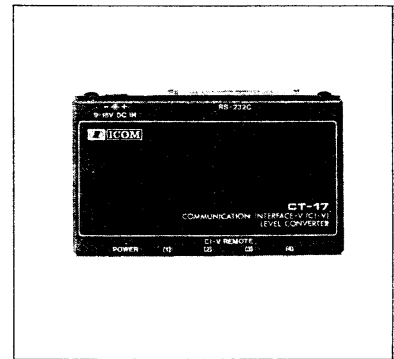

CT-17
CI-V LEVEL CONVERTER

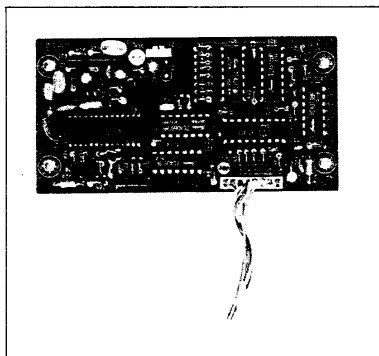

IC-EX310
VOICE SYNTHESIZER UNIT

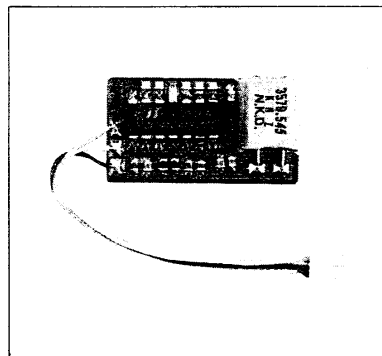

UT-30
PROGRAMMABLE TONE
ENCODER UNIT

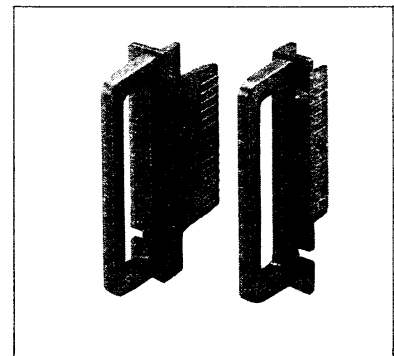

MB-19
RACK MOUNTING
HANDLES

FL-53A	455kHz CW and RTTY Super-narrow Filter (250Hz/−6dB)
FL-101	9MHz CW and RTTY Super-narrow Filter (250Hz/−6dB)
FL-102	9MHz AM Filter (6kHz/−6dB)
CT-16	Satellite Interface Unit
HP-2	Communication Headphones

13. INSIDE VIEWS

13-1 TOP VIEW (REGULATOR AND TUNER UNITS)

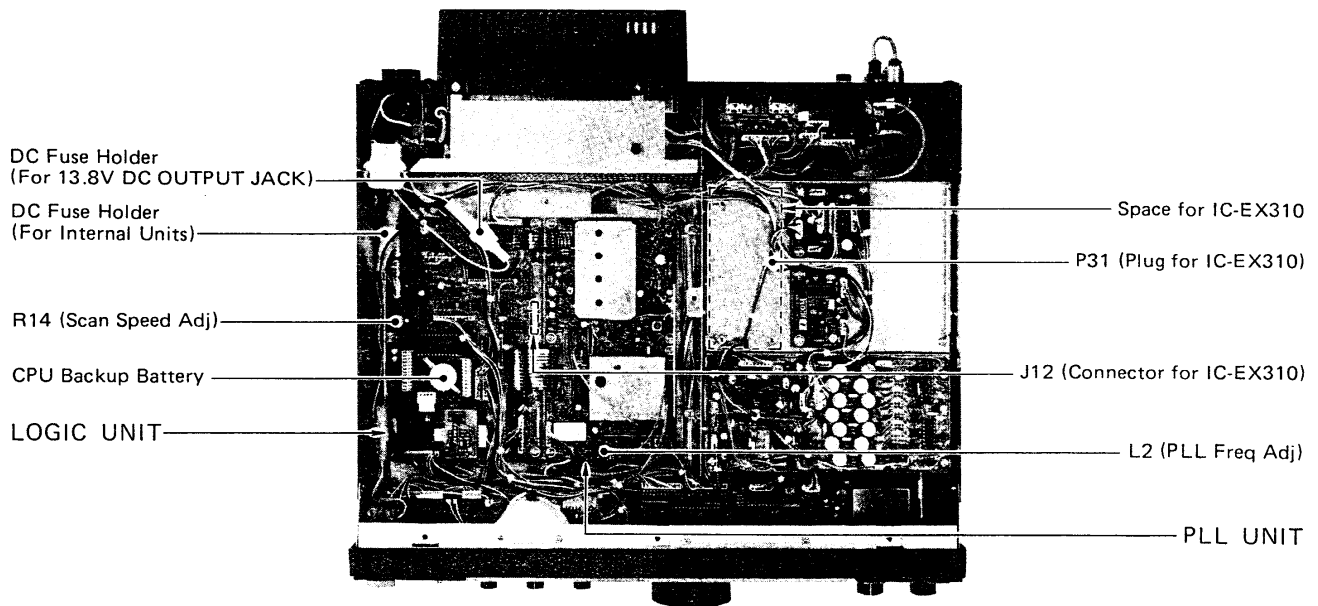
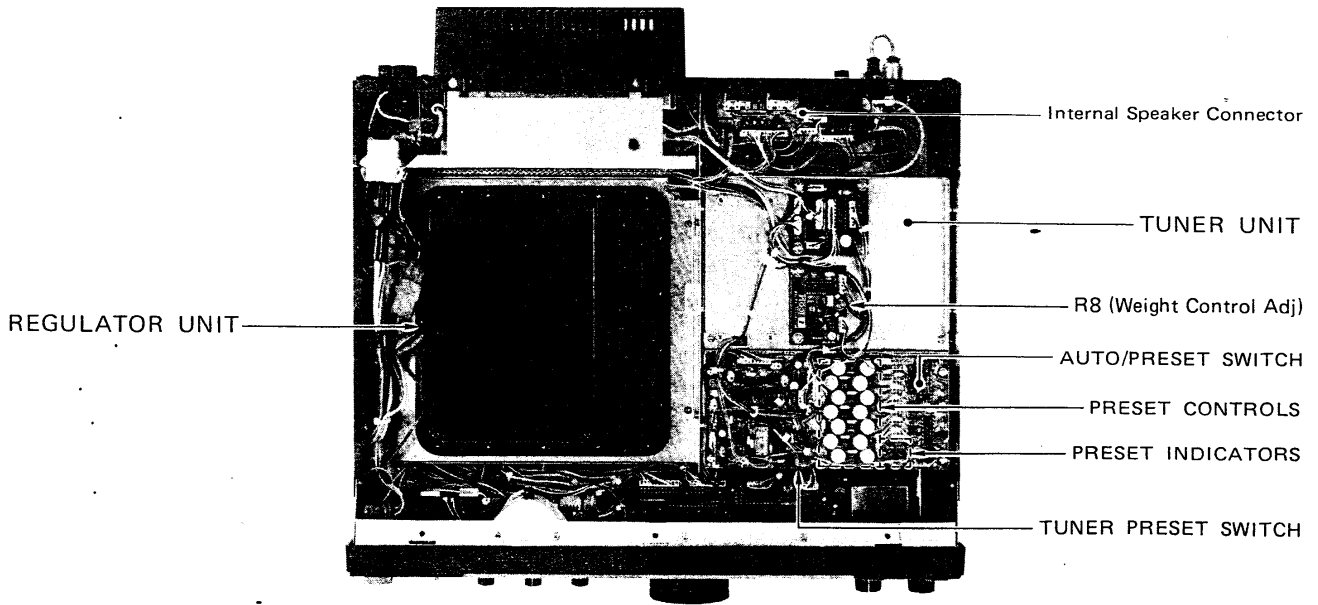

13-2 BOTTOM VIEW (MAIN AND RF UNITS)

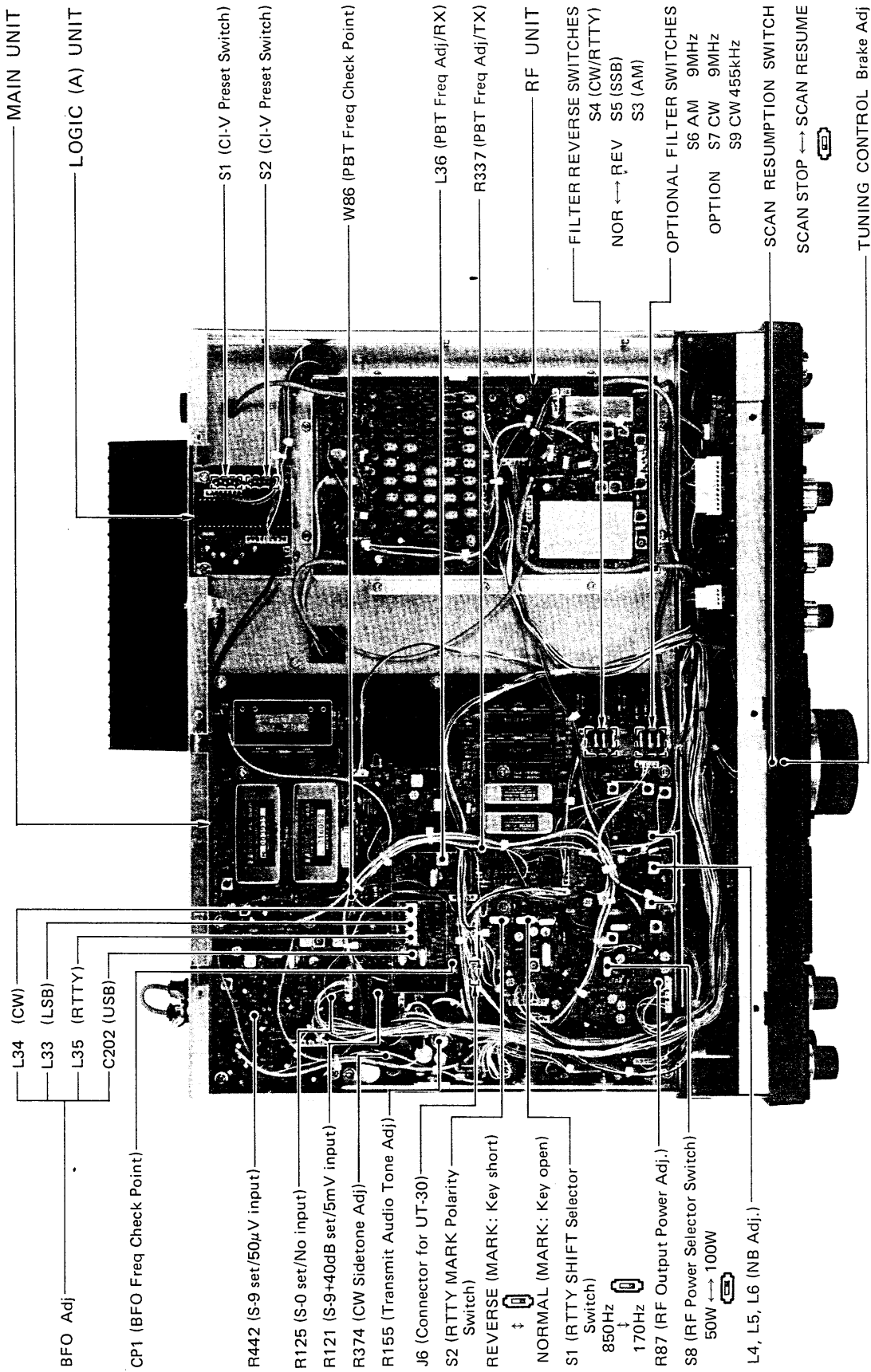

14. BLOCK DIAGRAMS

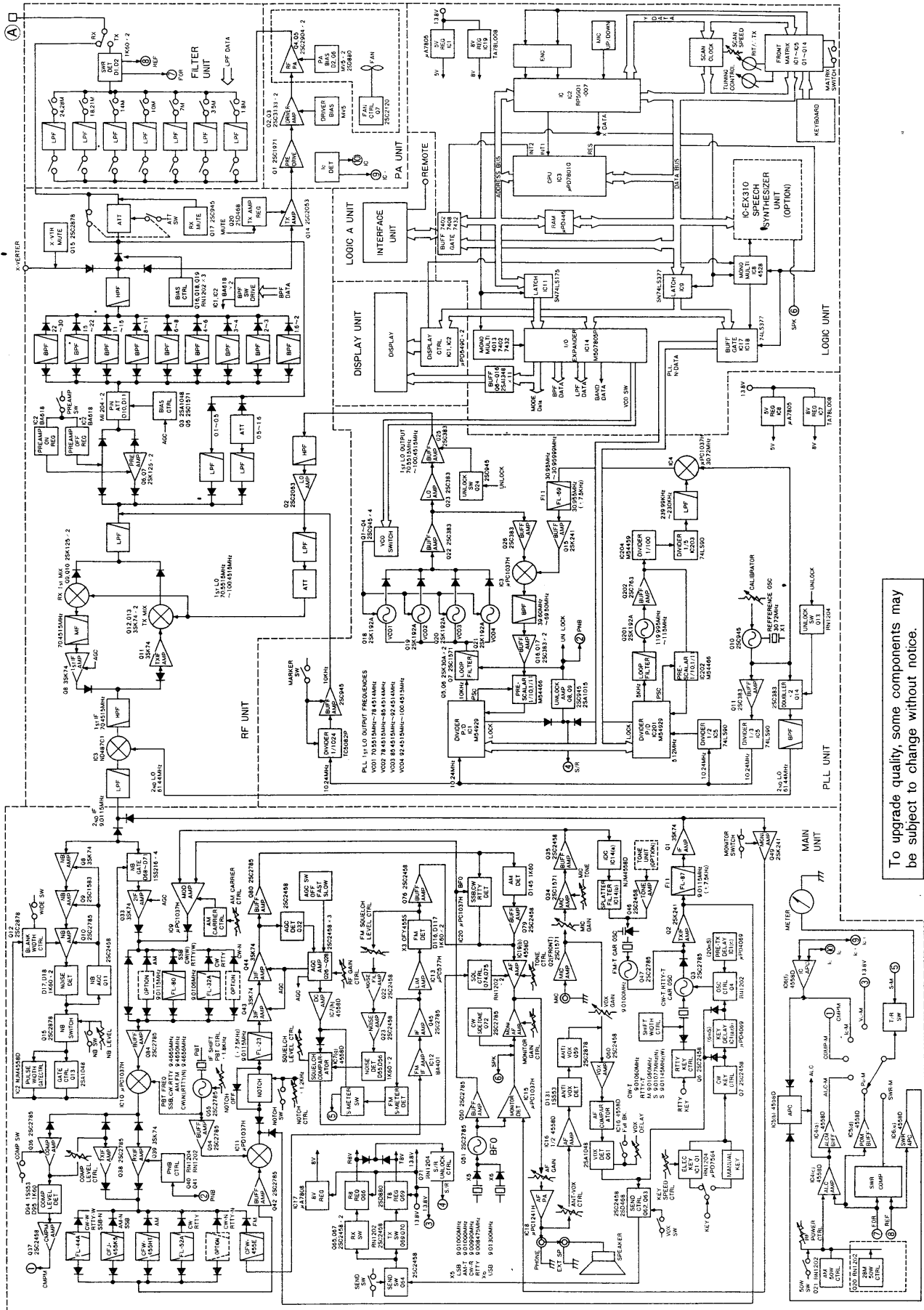

To upgrade quality, some components may be subject to change without notice.

TUNER UNIT

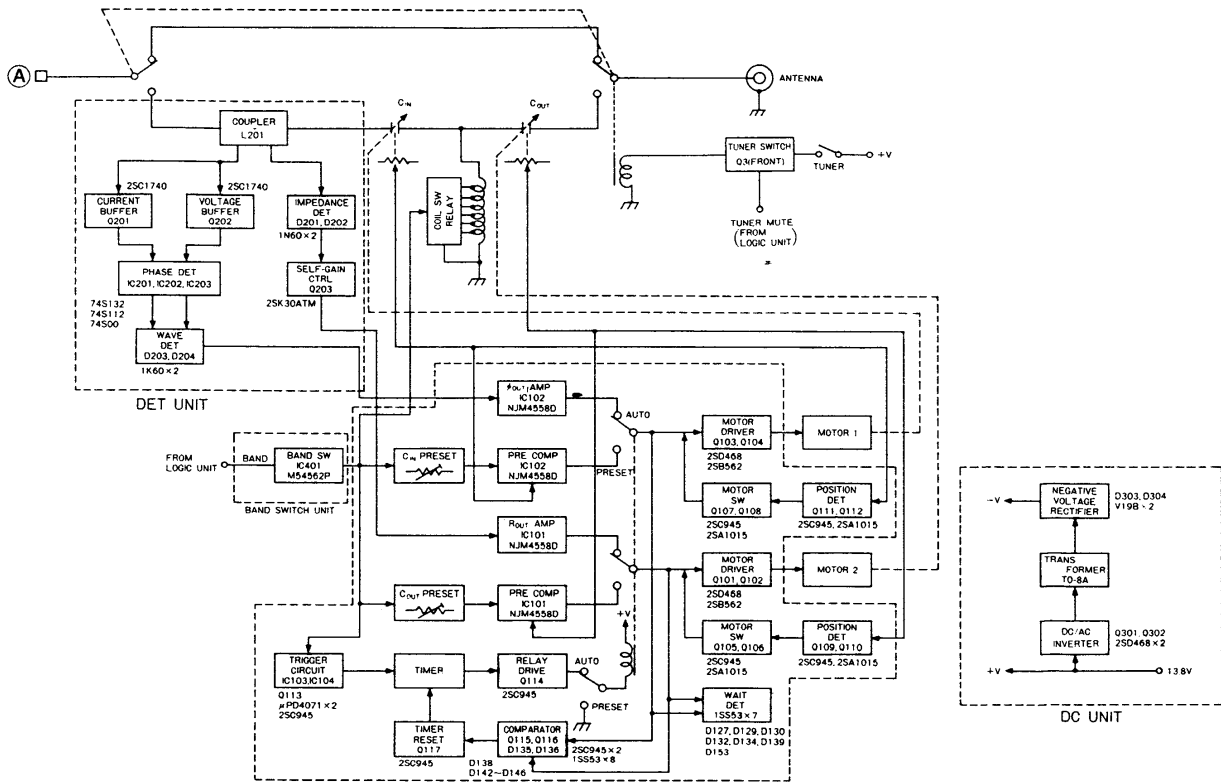

REGULATOR UNIT

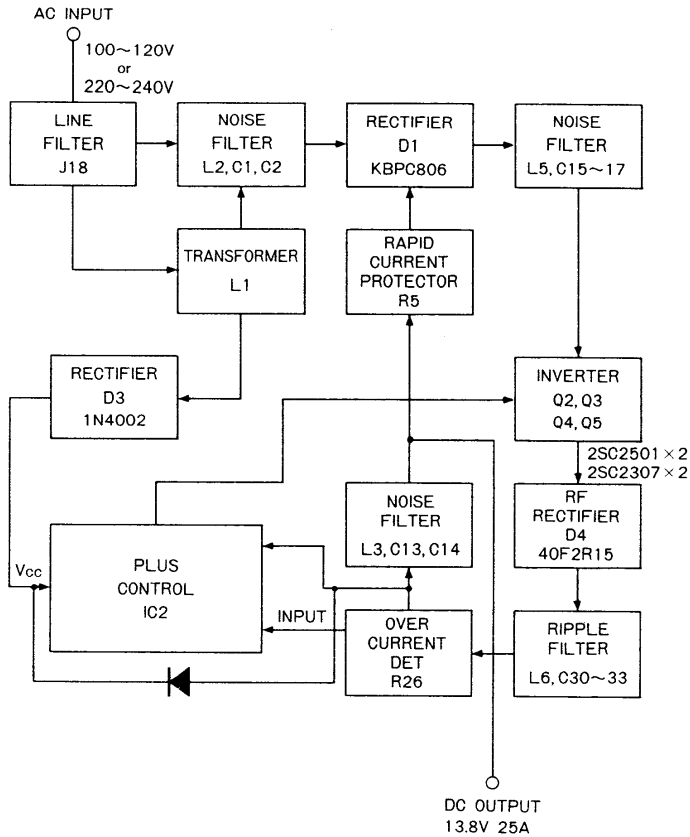

15. SPECIFICATIONS

■ GENERAL

- Frequency coverage : Receive 0.1MHz ~ 30.0MHz
Transmit 160m band 1.8MHz ~ 2.0MHz
80m band 3.45MHz ~ 4.1MHz
40m band 6.95MHz ~ 7.5MHz
30m band 9.95MHz ~ 10.5MHz
20m band 13.95MHz ~ 14.5MHz
17m band 17.95MHz ~ 18.5MHz
15m band 20.95MHz ~ 21.5MHz
12m band 24.45MHz ~ 25.1MHz
10m band 27.95MHz ~ 30.0MHz
- Modes : SSB (A3J), CW (A1), FM (F3), RTTY (F1), AM (A3)
- Frequency control : CPU-based 10Hz step digital PLL synthesizer
- Frequency stability : $\pm 100\text{Hz}$ in the range of $-10^{\circ}\text{C} \sim +60^{\circ}\text{C}$
($+14^{\circ}\text{F} \sim +140^{\circ}\text{F}$)
- Antenna impedance : 50Ω (when TUNER SWITCH is OFF)
 $16.7 \sim 150\Omega$ (with TUNER SWITCH ON)
- Power supply requirement : U.S.A. version AC 100 ~ 120V
Australia, Europe, France versions AC 200 ~ 240V
- Power consumption : Max. 650VA transmitting
Max. 80VA receiving
- Dimensions : 424mm(W) x 150mm(H) x 390mm(D)
(Projections not included)
- Weight : 17.5kg

■ TRANSMITTER

- Output power : SSB Max. 100W PEP
CW, RTTY, FM Max. 100W
AM Max. 40W
- Modulation : SSB Balanced modulation
FM Reactance modulation
AM Low level modulation
- Max. frequency deviation : $\pm 5\text{kHz}$
- RTTY shift width : 170Hz, 850Hz
- Spurious emissions : Less than -60dB
- Carrier suppression : Less than -40dB
- Unwanted sideband : Less than -55dB with 1000Hz modulation
- Microphone impedance : 600Ω

RECEIVER

- **Receive system** : SSB, CW, RTTY, AM Quadruple-conversion
FM Triple-conversion

- **Intermediate frequencies** : 1st All modes 70.4515MHz
2nd SSB 9.0115MHz
CW, RTTY 9.0106MHz
FM, AM 9.0100MHz
3rd All modes 455kHz
4th SSB 9.0115MHz
CW, RTTY 9.0106MHz
AM 9.0100MHz

- **Sensitivity (PREAMP SWITCH ON)** : SSB, CW, RTTY
0.1 ~ 0.5MHz Less than 0.5 μ V for 10dB S/N
0.5 ~ 1.6MHz Less than 1 μ V for 10dB S/N
1.6 ~ 30MHz Less than 0.15 μ V for 10dB S/N
AM (NARROW FILTER selected)
0.1 ~ 0.5MHz Less than 3 μ V for 10dB S/N
0.5 ~ 1.6MHz Less than 6 μ V for 10dB S/N
1.6 ~ 30MHz Less than 1 μ V for 10dB S/N
FM
28 ~ 30MHz Less than 0.3 μ V for 12dB SINAD

- **Squelch sensitivity** : Less than 0.3 μ V

- **Selectivity** : SSB (FILTER SWITCH ON) 2.4kHz/−6dB
3.8kHz/−60dB
CW, RTTY (FILTER SWITCH ON) 500Hz/−6dB
1kHz/−60dB
AM 6kHz/−6dB
18kHz/−50dB
FM 15kHz/−6dB
30kHz/−50dB

- **Audio output power** : More than 2.6W at 10% distortion with 8 Ω load

- **Notch filter attenuation** : More than 45dB

- **RIT variable range** : \pm 9.9kHz

ANTENNA TUNER

- **Output matching range** : 16.7 ~ 150 Ω unbalanced (when TUNER SWITCH is ON).

- **Minimum input power** : 8W

- **Band switching time** : 3 seconds or less

- **Auto tuning time** : 3 seconds or less

- **Auto tuning accuracy** : VSWR 1.2:1 or less

- **Insertion loss** : 0.5dB or less (after tuning)

* All stated specifications are subject to change without notice or obligation.

Count on us!

