

ICOM

INSTRUCTION MANUAL

**HF ALL BAND TRANSCEIVER
GENERAL COVERAGE RECEIVER**

IC-781

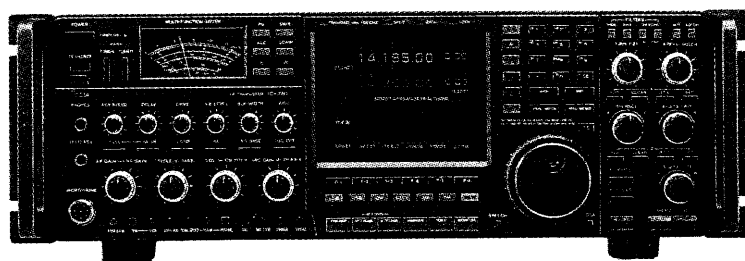

FOREWORD

CONGRATULATIONS! You are the owner of the world's most advanced HF transceiver—IC-781—the first amateur radio transceiver with a built-in CRT DISPLAY. IC-781 is the top of the line, an amateur's dream-rig.

The SPECTRUM SCOPE, TWIN PASSBAND TUNING, and DDS (Direct Digital Synthesizer) are unique to the market. With 105dB DYNAMIC RANGE and 150W OUTPUT POWER you can work the world.

We are grateful to the great number of amateurs throughout the years for their suggestions. In response, we have designed IC-781. ICOM's successful DXpeditions have also contributed to the development of IC-781. IC-781 is the choice of amateurs the world over.

To fully enjoy the advanced features of IC-781, please read this instruction manual carefully before operating. Should you have questions about IC-781, feel free to contact your nearest authorized ICOM dealer or service center.

UNPACKING

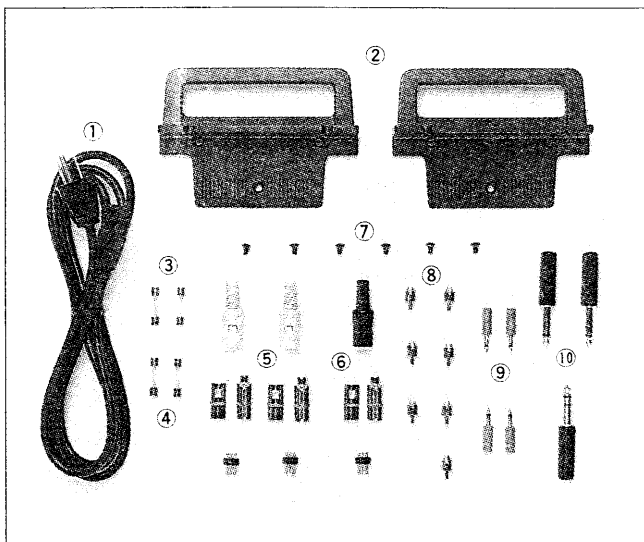

Accessories included with the IC-781:	Qty.
① AC cord	1
② Rack mounting handles	1set
③ Spare fuses for DC line (2A)	2
④ Spare fuses for AC line (see below)	2
⑤ DIN plugs (8-pin)	2sets
⑥ DIN plug (7-pin)	1set
⑦ Screws for rack mounting handle	6
⑧ Pin plugs (RCA plugs)	7
⑨ Two-conductor 1/8 inch mini plugs	4
⑩ Three-conductor 1/4 inch plugs	3
120V AC type	: 10A
220 ~ 240V AC type	: 5A

TABLE OF CONTENTS

1. PRECAUTIONS AND PREPARATIONS	1	9. FUNCTIONS OPERATION	53
2. FEATURES	2	9- 1 FILTER SWITCHES OPERATION	53
3. CONTROL FUNCTIONS	4	9- 2 TWIN PBT OPERATION	54
3-1 FRONT PANEL	4	9- 3 NOTCH FILTER OPERATION	54
3-2 CRT DISPLAY	15	9- 4 AGC OPERATION	55
3-3 REAR PANEL	16	9- 5 NOISE BLANKER OPERATION	55
4. CRT DISPLAY SCREEN MENU	17	9- 6 DUAL WATCH OPERATION	56
4- 1 SCREEN MENU CONSTRUCTION	17	9- 7 RIT/ Δ TX OPERATION	57
4- 2 MENU 1 SCREEN	20	9- 8 SPLIT (DUPLEX) OPERATION	59
4- 3 MENU 2 SCREEN	20	9- 9 VOX OPERATION	59
4- 4 SCAN OPERATION SCREEN	21	9-10 MONITOR OPERATION	59
4- 5 SCAN CONDITION SCREEN	22	9-11 SPEECH COMPRESSOR OPERATION	60
4- 6 MEMORY LIST SCREEN	22	9-12 SWR READING	60
4- 7 MEMORY NOTE WRITE SCREEN	23	10. MEMORY AND SCANNING OPERATION	61
4- 8 SPECTRUM SCOPE SCREEN	23	10- 1 MEMORY CHANNELS	61
4- 9 CLOCK & TIMER SCREEN	24	10- 2 MEMORY LIST SCREEN	62
4-10 SLEEP TIMER SCREEN	24	10- 3 MEMORY WRITING	63
4-11 DAILY TIMER SET (1) SCREEN	25	10- 4 MEMORY CLEARING	66
4-12 DAILY TIMER SET (2) SCREEN	25	10- 5 MEMORY TRANSFERRING	67
4-13 CLOCK ADJUSTMENT (1) SCREEN	26	10- 6 SCANNING OPERATION	68
4-14 CLOCK ADJUSTMENT (2) SCREEN	26	10- 7 PROGRAMMED SCAN	69
4-15 TERMINAL MONITOR SCREEN	27	10- 8 Δ F SCAN	71
4-16 DATA FORMAT SCREEN	27	10- 9 MEMORY SCAN	73
4-17 CI-V CONDITION SCREEN	28	10-10 SELECTED MEMORY CHANNEL SCAN	73
4-18 FILTER SELECTION SCREEN	29	11. CLOCK AND TIMER OPERATION	75
4-19 BAND KEY PRESET SCREEN	29	11-1 CLOCK ADJUSTMENT	75
5. INSTALLATION	30	11-2 SLEEP TIMER	76
5-1 UNPACKING	30	11-3 DAILY TIMER	77
5-2 PLANNING	30	12. CIRCUIT DESCRIPTION	79
5-3 ANTENNA	30	12-1 RECEIVER CIRCUITS	79
5-4 GROUNDING	30	12-2 TRANSMITTER CIRCUITS	79
5-5 FRONT PANEL	31	12-3 ANTENNA TUNER	81
5-6 REAR PANEL	32	12-4 PLL CIRCUITS	81
6. SYSTEM INTERCONNECTIONS	33	13. MAINTENANCE	83
6-1 LINEAR AMPLIFIER CONNECTION	33	13-1 TROUBLESHOOTING	83
6-2 IC-AT500 CONNECTION	34	13-2 CPU RESETTING	85
6-3 TAPE RECORDER CONNECTION	34	13-3 FUSE REPLACEMENT	86
6-4 RTTY TERMINAL UNIT	35	13-4 CLEANING	86
6-5 DATA COMMUNICATIONS	36	14. ADJUSTMENT	87
6-6 MONITOR DISPLAY CONNECTION	37	14-1 SIMPLE FREQUENCY CALIBRATION	87
6-7 MIC CONNECTOR INFORMATION	37	14-2 BREAK ADJUSTMENT	87
6-8 ACCESSORY SOCKET INFORMATION	37	14-3 TRANSCEIVER DISASSEMBLY	88
6-9 REMOTE JACK INFORMATION	39	14-4 ELECTRONIC KEYS WEIGHT CONTROL	88
7. BASIC OPERATION	40	14-5 DIAL LOCK SWITCH FUNCTION	89
7-1 PRE-OPERATION SET UP	40	14-6 MAIN DIAL ROTATION	89
7-2 KEYBOARD OPERATION	41	14-7 BFO ADJUSTMENT	89
7-3 VFO A AND B SELECTION	42	14-8 TONE FREQUENCY SETTING	90
7-4 SSB OPERATION	43	14-9 OPTIONAL UNIT INSTALLATION	90
7-5 CW OPERATION	45	15. INSIDE VIEWS	91
7-6 RTTY OPERATION	47	16. SPECIFICATIONS	93
7-7 FM OPERATION	49	17. OPTIONS	95
7-8 AM OPERATION	50	8. ANTENNA TUNER OPERATION	51
8. ANTENNA TUNER OPERATION	51	8-1 PRESETTING	51
8-1 PRESETTING	51	8-2 UNSUCCESSFUL TUNING	52
8-2 UNSUCCESSFUL TUNING	52		

SCHEMATIC DIAGRAMS/BLOCK DIAGRAM
..... SEPARATE

1. PRECAUTIONS AND PREPARATIONS

■ INSTALLATION PRECAUTIONS

1. **AVOID** using the IC-781 in the following situations:
 - In temperatures under -10°C and over $+60^{\circ}\text{C}$. DO NOT expose the IC-781 to direct sunlight or heat-producing devices such as a heater or stove.
 - In humid or moist places, such as a bathroom.
2. **DO NOT** run the antenna feedline near electronic instruments or magnetic compasses.
3. **DO NOT** place the transceiver within the reach of babies or children when the transceiver is ON.
4. **DO NOT** place liquids on or near the transceiver. Spilling may cause fires and electric shocks.
5. **DO NOT** use extension cords unless absolutely necessary. Improper use of extension cords may cause fires and electric shocks.
6. **DO NOT** touch metal strips, wires, etc., to anything inside the transceiver.

■ GROUNDING

To prevent electrical shocks, TVI, BCI and other problems, be sure to ground the transceiver through the **GROUND TERMINAL**. For best results, use the heaviest gauge wire or strap available, and make the connection as short as possible.

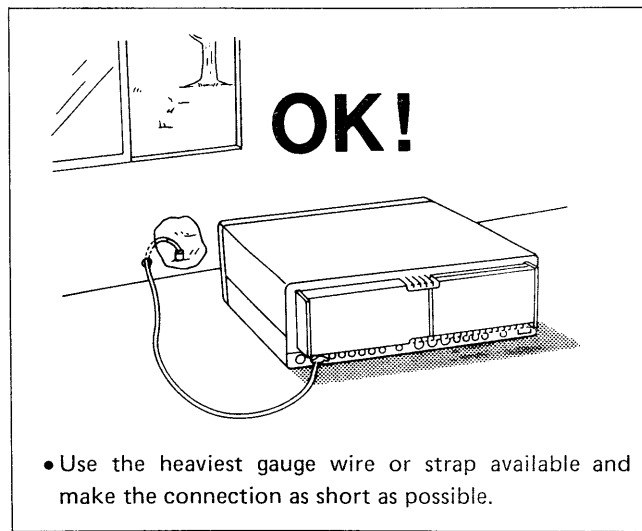
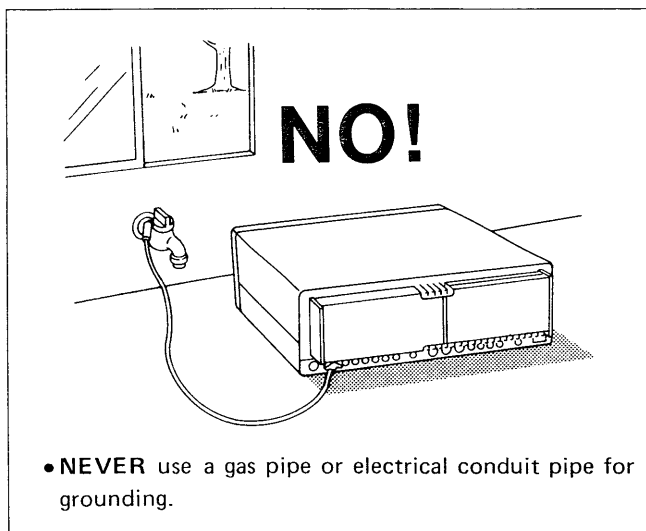

■ ANTENNA

Antennas play a very important role in radio communication. If the antenna is poor your transceiver cannot give you the best performance. A well-matched 50Ω antenna and feedline will provide the desired performance.

■ MULTI-FUNCTIONAL CRT DISPLAY

● BUILT-IN SPECTRUM SCOPE

The multi-functional 5 inch CRT displays the frequencies of VFO A and VFO B, the contents of the MEMORY, two MENU SCREENS and seventeen OPERATIONAL SCREENS. Fine resolution of 94 letters, numbers, punctuation marks and symbols. The soft amber display makes reading easy.

● MEMORY CHANNEL LIST

The CRT's advanced spectrum scope displays the relative strength of signals around a center frequency. The span can be set to 50kHz, 100kHz and 200kHz. Ideal for monitoring band conditions in an instant.

● SLEEP AND DAILY TIMERS

The CRT displays the contents of 99 memory channels, two programmed scan edge frequencies and a note of up to ten characters per channel.

● BUILT-IN CLOCKS

The IC-781 is equipped with selectable Sleep Timers and five Daily Timers which turn the transceiver ON and OFF. Using the timers and the [RECORDER REMOTE] jack, you can record a signal at any time. Especially useful for recording your favorite shortwave program when sleeping or at work.

● TERMINAL MONITOR

The IC-781 is equipped with two clocks, one for local time, and the other for UTC or any other time. The Sub Clock stores a note of up to six characters.

■ COMPLETE HF TRANSCEIVER

● BUILT-IN AUTOMATIC ANTENNA TUNER

ASCII (RS-232C level) code data is displayed on the CRT DISPLAY through the [DATA IN] jack. When using an external terminal unit, the screen displays RTTY, PACKET, AMTOR, etc.

● DDS (DIRECT DIGITAL SYNTHESIZER)

Built-in preset/auto-tuning antenna tuner matches the IC-781 to the antenna when the SWR is less than 3:1. Maximizes radiated output power.

● FULL BREAK-IN

Newly developed frequency synthesizer system, the ICOM DDS (Direct Digital Synthesizer) unit provides rapid lockup time. One of the fastest transmit/receive switching times on the market, it makes the IC-781 ideal for PACKET and AMTOR communications.

● DUAL WATCH

Choose full or semi break-in CW operation at the touch of a switch.

● FINE SCANNING

Two PLL circuits let you monitor two frequencies simultaneously. Ideal for DX contests, traffic-handling and net control work.

The fine scan slowly tunes through a signal without stopping. This innovative feature is especially useful for monitoring SSB or CW mode.

2. FEATURES

- **TWIN PBT**

Selects sections of the 455kHz and 9MHz IF filters separately or in tandem for clear reception of a signal in heavy interference. Useful for DX pile-ups, contests, nets, and other crowded band conditions.
- **150W OUTPUT POWER**

30V-DC (approx.) applied to the final transistors provide 150W output power and low IMD (Inter Modulation Distortion). The inner-type line flow fan ensures continuously stable operation under full power.
- **NOISE BLANKER**

Built-in noise-trigger type noise blanker removes pulse-type noise, such as that from engine ignition sparks. Ideal for city operation. Maximum 15msec blank-width removes longer pulse width noise such as the "woodpecker" and the key clicks of strong CW signals.
- **105dB DYNAMIC RANGE**

Provides excellent sound reproduction of faint and strong signals without distortion (IF band width 500Hz).
- **BAND STACKING REGISTER**

Enables you to store an amateur band frequency, switch bands, and return to the stored frequency. Especially convenient when switching bands during contests and for quick monitoring of propagation conditions on other bands.
- **MULTI-FUNCTION KEYBOARD**

The KEYBOARD enables you to instantly enter a frequency accurate to 10Hz, to switch amateur bands easily without the use of clumsy knobs, and to instantly call up any of the 99 memory channels.
- **HIGH-PERFORMANCE FILTERS**

The high shape factor of the 9 filters provides excellent selectivity characteristics. The 455kHz and 9MHz filters can be separately selected in CW or RTTY mode. Filters may be conveniently preset for each operating mode on the CRT DISPLAY FILTER SELECTION screen.
- **CW PITCH CONTROL**

CW audio pitch may be adjusted without affecting the operating frequency.
- **SEPARATE CONTROLS FOR "A" AND "B" SECTION RIT/ΔTX**

RIT (Receiver Incremental Tuning) and ΔTX (Transmitter Incremental Tuning) for each frequency display section can be separately controlled. Especially useful when operating in duplex and dual watch.
- **AUDIO PEAK FILTER**

The APF (Audio Peak Filter) attenuates the unwanted audio frequency components in CW. Your desired audio frequency between 500Hz and 1000Hz is floated for interference-free receiving.

CONTROL FUNCTIONS 3.

3-1 FRONT PANEL

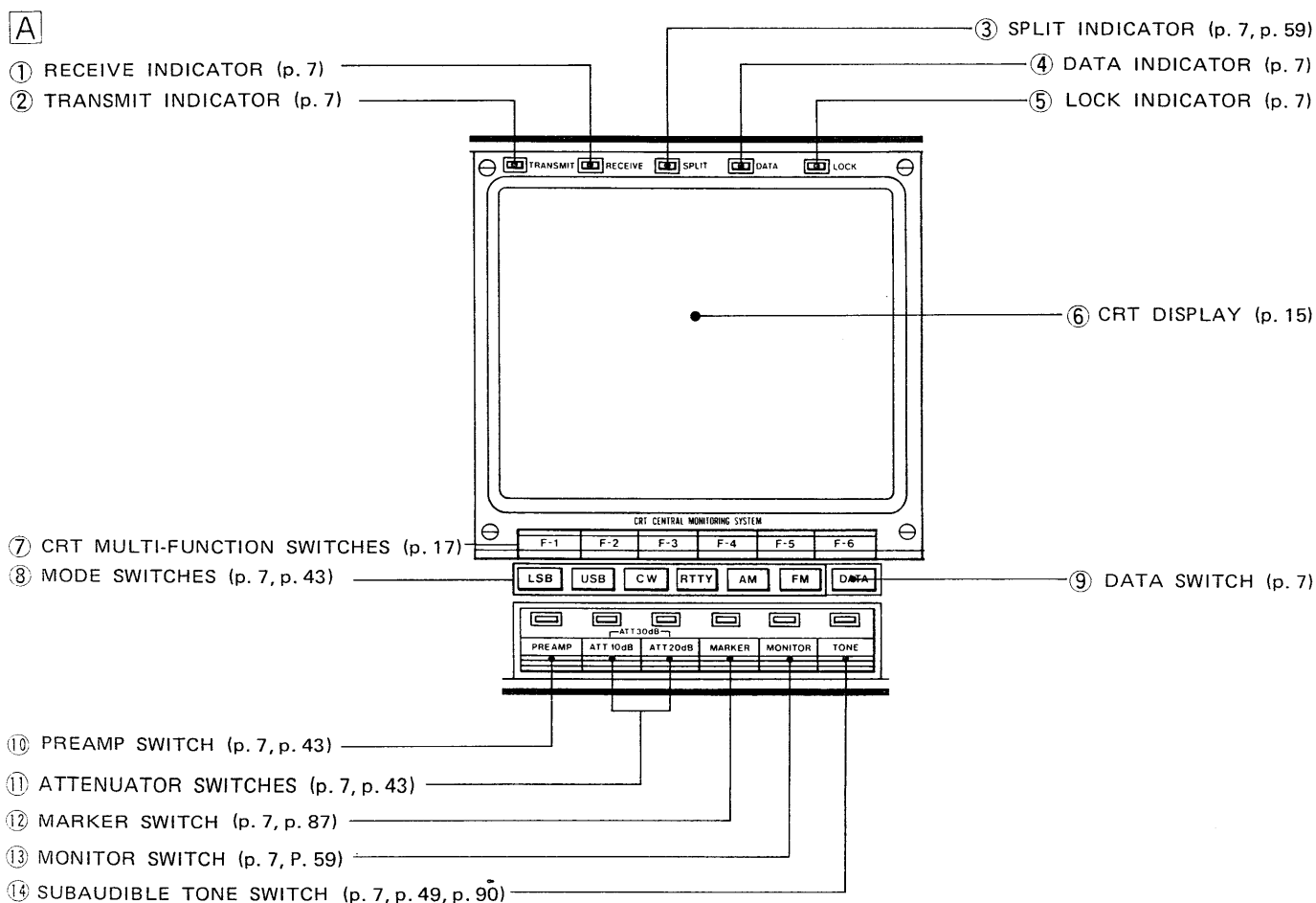
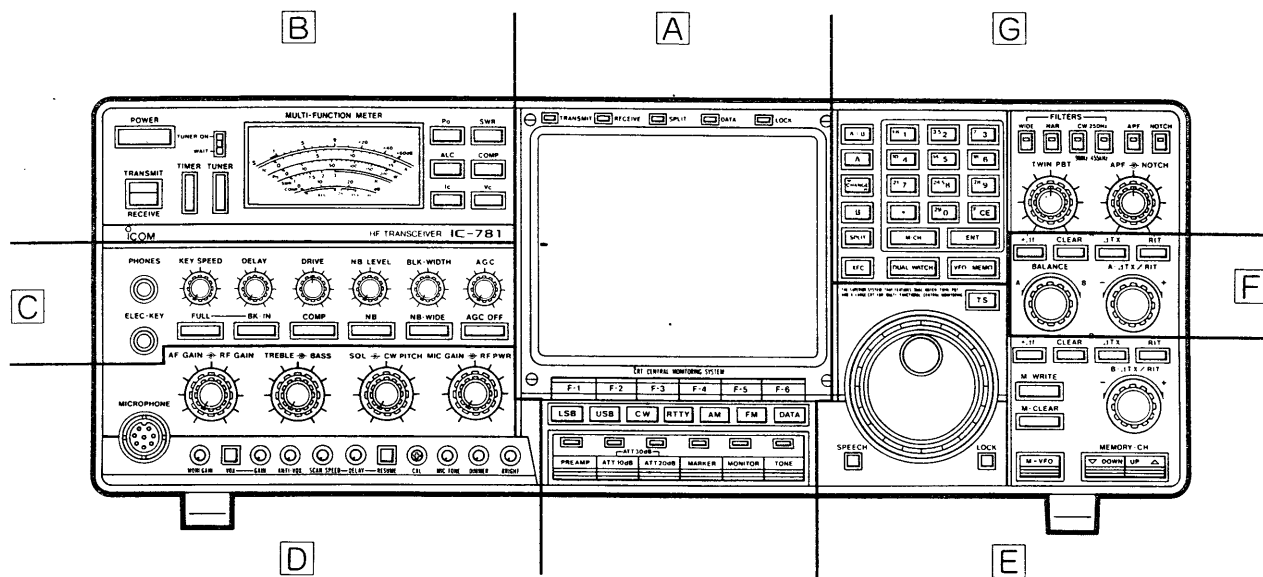

3. CONTROL FUNCTIONS

B

- ⑮ METER FUNCTION SWITCHES (p. 7)
- ⑯ MULTI-FUNCTION METER (p. 8)
- ⑰ WAIT INDICATOR (p. 8)
- ⑱ TUNER INDICATOR (p. 8)
- ⑲ POWER SWITCH (p. 8)
- ⑳ TRANSMIT/RECEIVE SWITCH (p. 8)
- ㉑ TIMER SWITCH (p. 8, p. 76)
- ㉒ TUNER SWITCH (p. 8, p. 51)

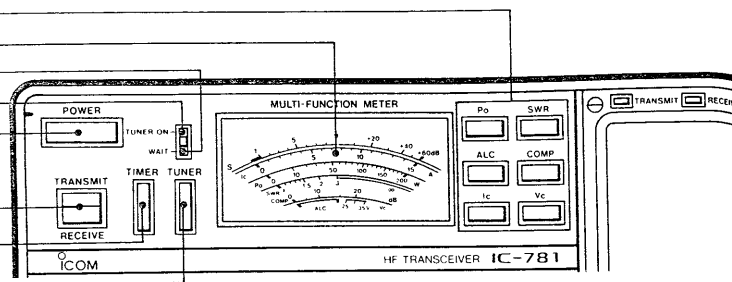

C

- ⑳ AGC CONTROL (p. 9, p. 55)
- ㉘ NOISE BLANK-WIDTH CONTROL (p. 8, p. 55)
- ㉗ NOISE BLANKER LEVEL CONTROL (p. 8, p. 55)
- ㉖ DRIVE CONTROL (p. 8, p. 48, p. 60)
- ㉕ VOX, SEMI BREAK-IN DELAY CONTROL (p. 8, p. 46, p. 59)
- ㉔ ELECTRONIC KEYSPEED CONTROL (p. 8, p. 46)
- ㉓ HEADPHONE JACK (p. 8, p. 31)
- ㉒ ELECTRONIC KEYSPEED JACK (p. 9, p. 46)
- ㉑ SEMI/FULL BREAK-IN SWITCH (p. 9, p. 46)
- ㉐ BREAK-IN SWITCH (p. 9, p. 46)
- ㉏ SPEECH COMPRESSOR SWITCH (p. 9, p. 60)
- ㉍ NOISE BLANKER SWITCH (p. 9, p. 55)
- ㉌ NOISE BLANKER WIDE SWITCH (p. 9, p. 55)
- ㉋ AGC OFF SWITCH (p. 9, p. 55)

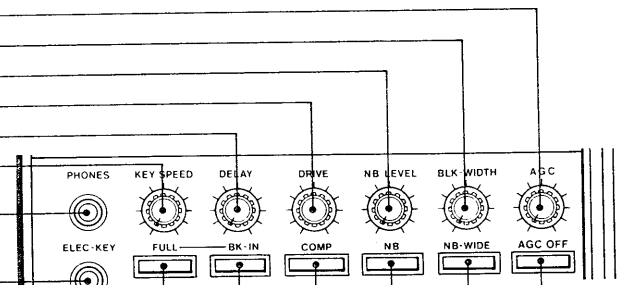

D

- ㉑ RF POWER CONTROL (p. 10, p. 44)
- ㉐ MIC GAIN CONTROL (p. 10, p. 44)
- ㉏ CW PITCH CONTROL (p. 10, p. 45)
- ㉍ SQUELCH CONTROL (p. 10, p. 43)
- ㉌ BASS RESPONSE CONTROL (p. 10)
- ㉋ TREBLE RESPONSE CONTROL (p. 10)
- ㉒ RF GAIN CONTROL (p. 10)
- ㉑ AF GAIN CONTROL (p. 9, p. 43)
- ㉐ MIC CONNECTOR (p. 10, p. 37)
- ㉏ MONITOR GAIN CONTROL (p. 10, p. 59)
- ㉍ VOX SWITCH (p. 11, p. 59)
- ㉌ VOX GAIN CONTROL (p. 11, p. 59)
- ㉋ ANTI-VOX CONTROL (p. 11, p. 59)
- ㉒ SCAN SPEED CONTROL (p. 11, p. 70)
- ㉑ SCAN DELAY CONTROL (p. 11, p. 70)
- ㉐ SCAN RESUME SWITCH (p. 11, p. 70)
- ㉏ MARKER CALIBRATOR POT (p. 12, p. 87)
- ㉍ MIC TONE CONTROL (p. 12, p. 44)
- ㉌ DIMMER CONTROL (p. 12)
- ㉋ BRIGHTNESS CONTROL (p. 12)

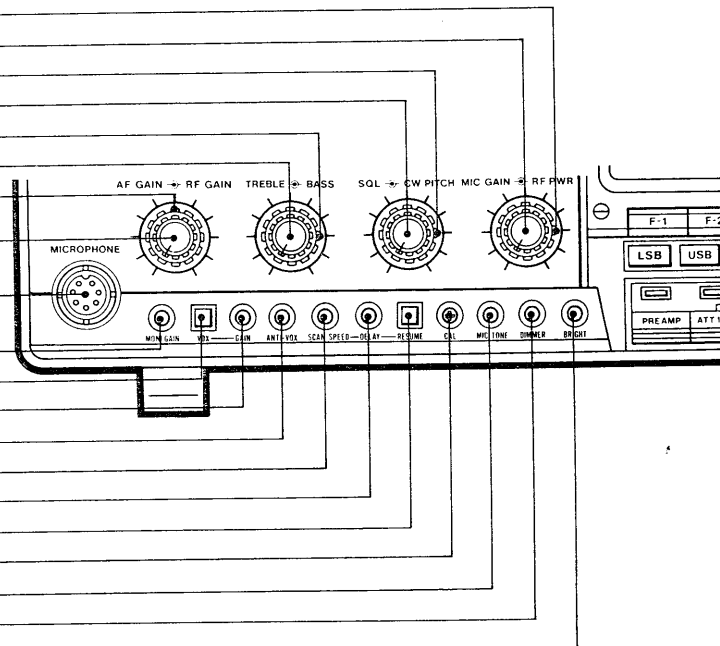

G

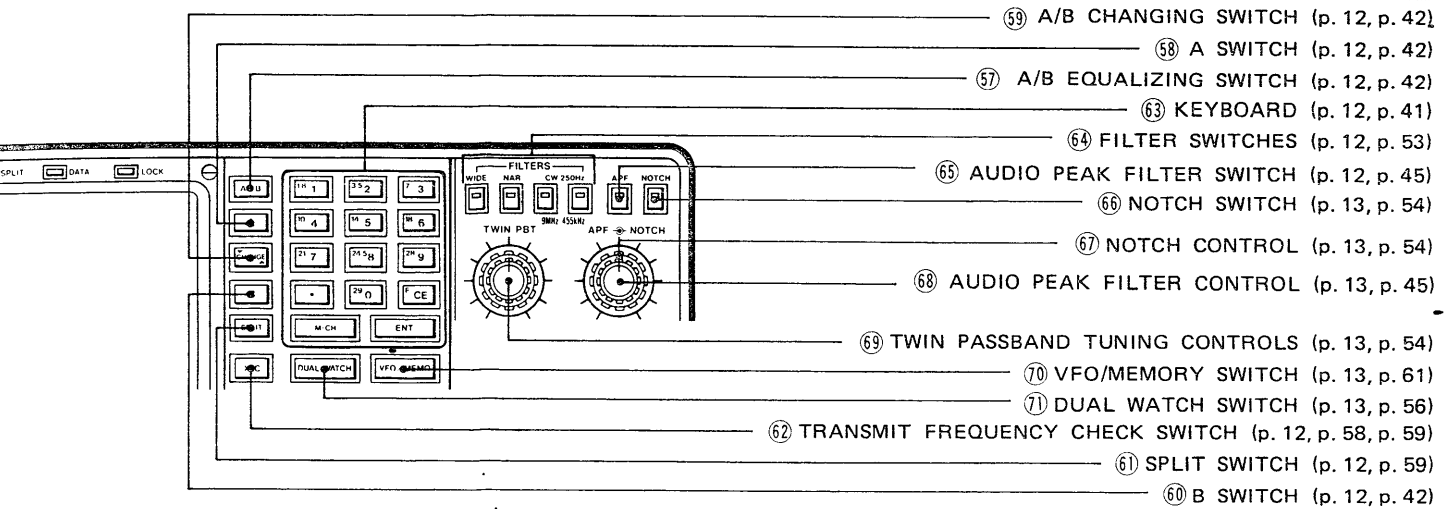

F

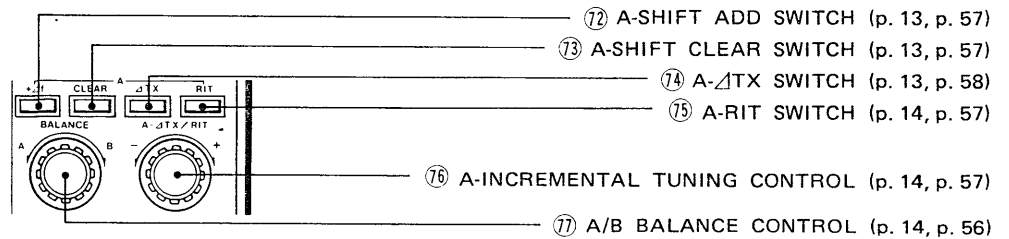

E

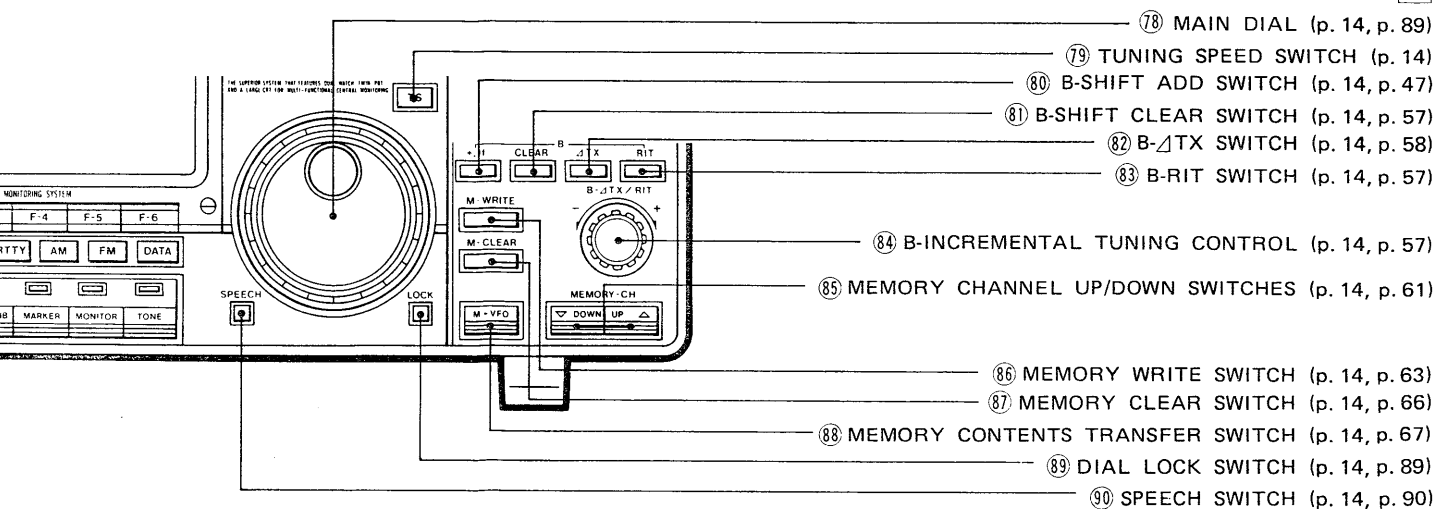

3. CONTROL FUNCTIONS

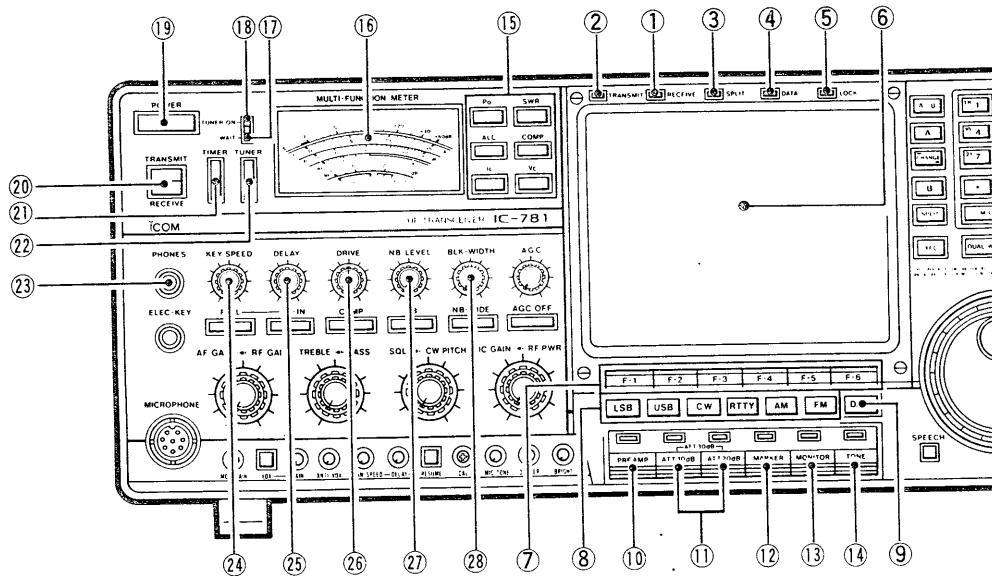

- ① **RECEIVE INDICATOR [RECEIVE]**
Indicates that the squelch is open.
- ② **TRANSMIT INDICATOR [TRANSMIT]**
Indicates a signal is being transmitted.
- ③ **SPLIT INDICATOR [SPLIT] (p. 59)**
Indicates the [SPLIT] switch (item ⑩) is ON.
- ④ **DATA INDICATOR [DATA]**
Indicates the [DATA] switch (item ⑨) is ON.
- ⑤ **LOCK INDICATOR [LOCK]**
Indicates the [LOCK] switch (item ⑧) is ON.
- ⑥ **CRT DISPLAY (p. 15)**
Refer to section 3 - 2 for details.
- ⑦ **CRT MULTI-FUNCTION SWITCHES (p. 17)**
Selects CRT DISPLAY menu functions (see section 4).

F-1	F-2	F-3	F-4	F-5	F-6
-----	-----	-----	-----	-----	-----

- ⑧ **MODE SWITCHES (p. 43)**
Push the switch for the desired mode.

LSB	USB	CW	RTTY	AM	FM
-----	-----	----	------	----	----

- ⑨ **DATA SWITCH [DATA]**
Inhibits microphone input except when the microphone PTT switch is pushed.

- ⑩ **PREAMP SWITCH [PREAMP] (p. 43)**
Activates the built-in 10dB gain RF preamplifier.
- ⑪ **ATTENUATOR SWITCHES (p. 43)**
Selects 10dB, 20dB or 30dB RF attenuation to prevent front end overload.
 - To select 30dB attenuation, push both [ATT 10dB] and [ATT 20dB].
- ⑫ **MARKER SWITCH [MARKER] (p. 87)**
Generates calibration markers every 25kHz.
- ⑬ **MONITOR SWITCH [MONITOR] (p. 59)**
Allows you to hear your transmitted IF signal.

Note: CW sidetone monitor always functions.
- ⑭ **SUBAUDIBLE TONE SWITCH [TONE] (p. 49, p. 90)**
Activates the 88.5Hz tone encoder to produce subaudible tones required to open some HF repeaters.
- ⑮ **METER FUNCTION SWITCHES**
Push the switch corresponding to the measurement you wish to view.

SWITCH	MEASUREMENT
[Po]	Relative output power in watts.
[ALC]	ALC level. The ALC circuit functions when the RF output power reaches a preset level.
[Ic]	Collector current of the final transistors.
[SWR]	SWR over the transmission line.
[COMP]	Speech compressor compression level.
[Vc]	Collector voltage of the final transistors.

⑩ MULTI-FUNCTION METER

Shows strength of signal received. For transmitter meter readings, see item ⑮.

⑪ WAIT INDICATOR

Indicates the antenna tuner is tuning. The light goes out when an antenna match is made.

⑫ TUNER INDICATOR

Indicates the antenna tuner is ON.

⑬ POWER SWITCH [POWER]

Turns ON main power.

⑭ TRANSMIT/RECEIVE SWITCH

Selects transmit or receive.

⑮ TIMER SWITCH [TIMER] (p. 76)

Activates timer functions.

 : Sleep timer and Daily timer

 : OFF

⑯ TUNER SWITCH [TUNER] (p. 51)

Activates the built-in antenna tuner.

 : Tuner ON

 : Tuner is bypassed

⑰ HEADPHONE JACK [PHONES] (p. 31)

Accepts a standard 1/4 inch plug from 4 ~ 16Ω mono or stereo headphones.

⑱ ELECTRONIC KEYSER SPEED CONTROL [KEY SPEED] (p. 46)

Adjusts built-in keyer speed.

To activate, plug an iambic paddle into the front panel key jack.

KEY SPEED

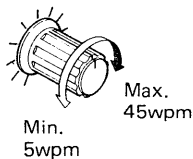

⑳ VOX, SEMI BREAK-IN DELAY CONTROL [DELAY] (p. 46, p. 59)

Adjusts the transmit to receive switching delay time for VOX or CW semi break-in operation.

To activate, push [BK-IN] (item ⑳) or [VOX] (item ⑳).

DELAY

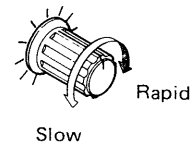

㉑ DRIVE CONTROL [DRIVE] (p. 48, p. 60)

Adjusts the output level of the transmitter's drive stage. Activated in CW, RTTY; and in SSB with [COMP] ON.

DRIVE

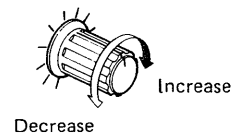

㉒ NOISE BLANKER LEVEL CONTROL [NB LEVEL] (p. 55)

Adjusts the noise blanker threshold level. Suppresses noise without signal distortion.

To activate, push [NB] (item ㉒).

NB LEVEL

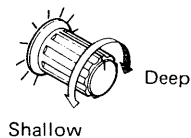

㉓ NOISE BLANK-WIDTH CONTROL [BLK-WIDTH] (p. 55)

Adjusts the noise blanker circuit's blank-width. Adjust this control to remove wide pulse-type noise.

To activate, push [NB] (item ㉒) and [NB-WIDE] (item ㉓).

BK-WIDTH

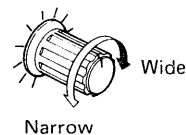

3. CONTROL FUNCTIONS

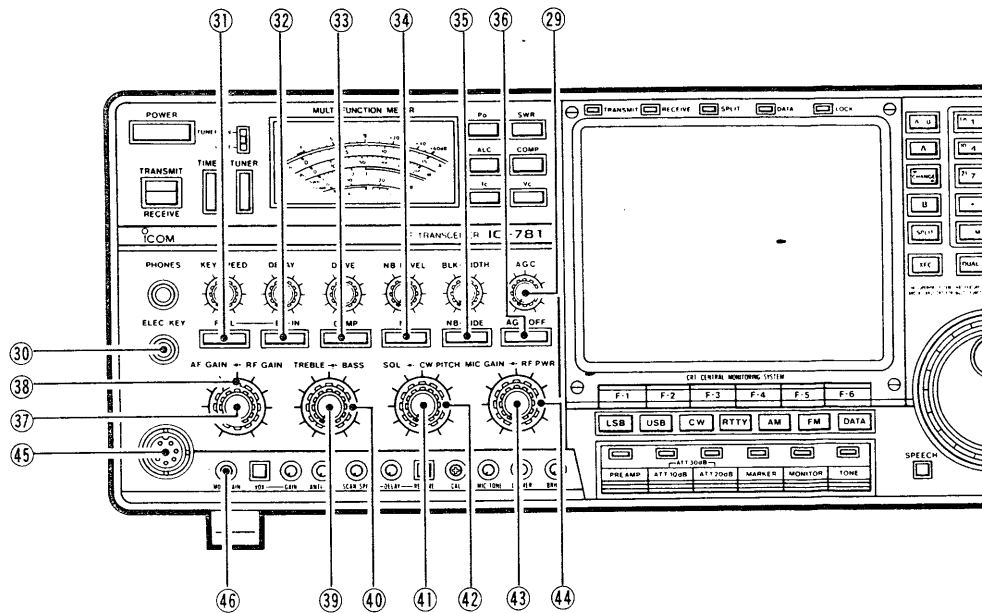

- 29 AGC CONTROL [AGC] (p. 55)**
Adjusts the AGC circuit time constant.

To activate, set [AGC OFF] (item 36) to the OUT position.

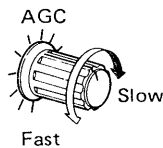

- 34 NOISE BLANKER SWITCH [NB] (p.55)**
Activates the noise blanker circuit.

Use with [NB LEVEL] (item 27).

: ON

: OFF

- 35 NOISE BLANKER WIDE SWITCH [NB-WIDE] (p. 55)**
Removes wide pulse-type noise. Use with [BLK-WIDTH] (item 28).

To activate, push [NB] (item 34).

: For wide pulse-type noise

: For regular pulse-type noise

- 36 AGC OFF SWITCH [AGC OFF] (p. 55)**
Disables the AGC circuit.

: AGC disabled

: AGC activated

- 37 AF GAIN CONTROL [AF GAIN] (p. 43)**
Adjusts audio output level.

AF GAIN

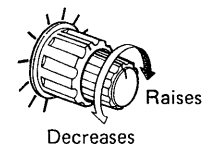

- 30 ELECTRONIC KEYS JACK [ELEC-KEY] (p. 46)**
This jack accepts an iambic keyer paddle with a standard 1/4 inch conductor plug (supplied). It does not accept the output of an electronic keyer.

- 31 SEMI/FULL BREAK-IN SWITCH [FULL] (p. 46)**
CW semi or full break-in selection. See item 32.

- 32 BREAK-IN SWITCH [BK-IN] (p. 46)**
Activates CW break-in functions (semi and full).

[FULL]	[BK-IN]	Break-in
<input type="checkbox"/>	<input type="checkbox"/>	Manual
<input type="checkbox"/>	<input type="checkbox"/>	Semi break-in
<input type="checkbox"/>	<input type="checkbox"/>	Full break-in

- 33 SPEECH COMPRESSOR SWITCH [COMP] (p. 60)**
Activates the RF speech compressor.

: ON

: OFF

③⑧ RF GAIN CONTROL [RF GAIN]

Adjusts gain at the receiver RF stage.

- The S-meter needle rises as the control is rotated counterclockwise.
- Only those signals stronger than the level indicated by the needle will be heard.

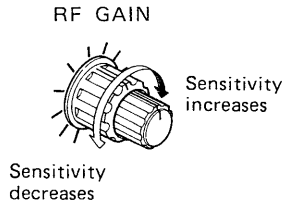

③⑨ TREBLE RESPONSE CONTROL [TREBLE]

Adjusts the treble response of the audio.

- Adjust together with the [BASS] control (item ④①) for the most pleasing tone.

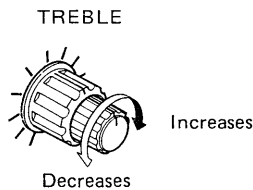

④① BASS RESPONSE CONTROL [BASS]

Adjusts the bass response of the audio.

- Adjust together with the [TREBLE] control (item ③⑨) for the most pleasing tone.

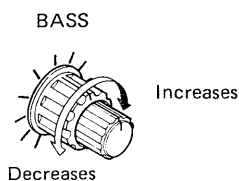

④① SQUELCH CONTROL [SQL] (p. 43)

Adjusts the squelch threshold level.

- To close the squelch, adjust this control clockwise until the green [RECEIVE] INDICATOR goes out.
- When the [RF GAIN] control (item ③⑧) is rotated counterclockwise to exceed the squelch threshold level, the squelch circuit opens.

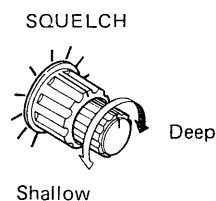

④② CW PITCH CONTROL [CW PITCH] (p. 45)

Adjusts the received or monitored CW audio tone without changing the displayed frequency.

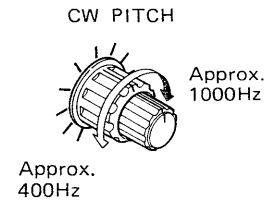

④③ MIC GAIN CONTROL [MIC GAIN] (p. 44)

Adjusts microphone input gain. Speak into the microphone naturally, and adjust as needed.

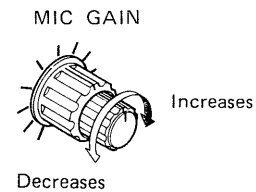

④④ RF POWER CONTROL [RF PWR] (p. 44)

Adjusts RF output power.

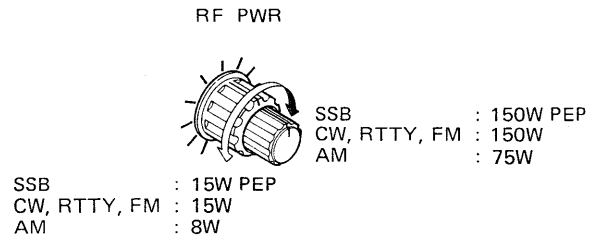

④⑤ MIC CONNECTOR [MICROPHONE] (p. 37)

Accepts ICOM hand microphones and desk microphones. Refer to section 17, OPTIONS.

④⑥ MONITOR GAIN CONTROL [MONI GAIN] (p. 59)

Adjusts the audio level of the transmitted signal monitor.

To activate, push [MONITOR] (item ⑬).

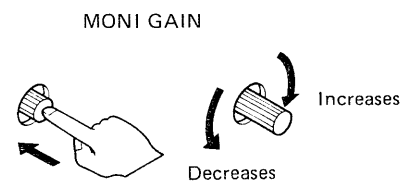

3. CONTROL FUNCTIONS

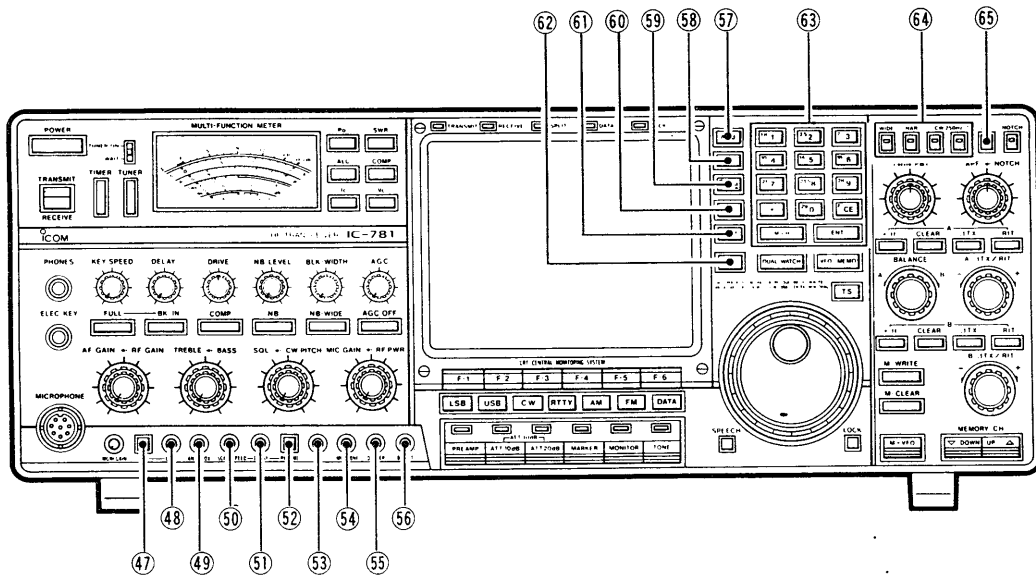

- ④⑦ **VOX SWITCH [VOX]** (p. 59)
Activates the VOX function.

 : ON

 : OFF

- ④⑧ **VOX GAIN CONTROL [-GAIN]** (p. 59)
Adjusts VOX circuit sensitivity.

To activate, push [VOX] (item ④⑦).

-GAIN

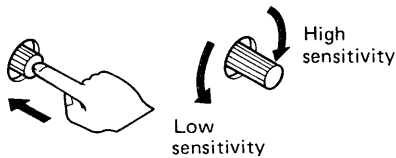

- ④⑨ **ANTI-VOX CONTROL [ANTI-VOX]** (p. 59)
Adjusts the VOX circuit cut-off to prevent tripping the speaker.

- Activate the VOX circuit with your voice and adjust [ANTI-VOX] as necessary.

- To activate, push [VOX] (item ④⑦).

ANTI-VOX

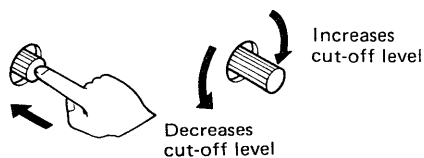

- ⑤⑩ **SCAN SPEED CONTROL [SCAN SPEED]** (p. 70)
Adjusts scanning speed.

SCAN SPEED

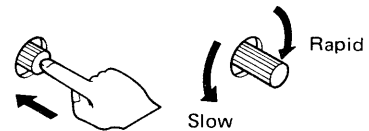

- ⑤① **SCAN DELAY CONTROL [-DELAY-]** (p. 70)
Adjusts time delay between "scan stop" to "scan restart".

To activate, push [-RESUME] IN (item ⑤②).

-DELAY-

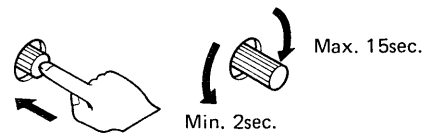

- ⑤② **SCAN RESUME SWITCH [-RESUME]** (p. 70)
Selects scan cancel or restart after a signal has been received.

 : Scan restart

 : Scan cancel

⑤③ MARKER CALIBRATOR POT [CAL] (p. 87)

Adjusts the reference oscillator frequency.

Use together with [MARKER] (item ⑫) and an accurate standard frequency source such as time station WWV.

⑤④ MIC TONE CONTROL [MIC TONE] (p. 44)

Adjusts microphone audio tone.

- This control does not change the audio tone of an external modulation unit connected through [ACC(1)] (rear panel).

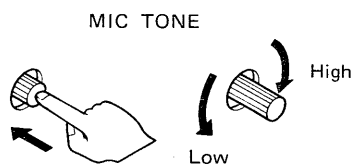
**⑤⑤ DIMMER CONTROL [DIMMER]**

Adjusts the intensity of all indicators and meter lighting.

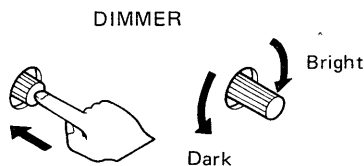
**⑤⑥ BRIGHTNESS CONTROL [BRIGHT]**

Adjusts the intensity of the CRT DISPLAY. Set this control to the 2 o'clock position.

Note: Great intensity will shorten the life of the CRT DISPLAY.

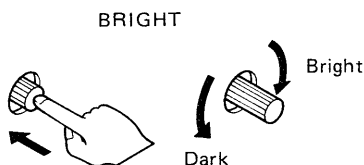
**⑤⑦ A/B EQUALIZING SWITCH [A=B] (p. 42)**

Equalizes upper and lower displayed frequency.

⑤⑧ A SWITCH [A] (p. 42)

Selects upper displayed frequency (VFO A or MEMORY).

⑤⑨ A/B CHANGING SWITCH [CHANGE] (p. 42)

Exchanges the contents of upper displayed frequency for lower displayed frequency.

⑥① B SWITCH [B] (p. 42)

Selects lower displayed frequency (VFO B or MEMORY).

Even when lower displayed frequency is selected with this switch, signals are transmitted and received on upper displayed frequency.

⑥① SPLIT SWITCH [SPLIT] (p. 59)

Selects split operation. The upper displayed frequency holds the receiver frequency and the lower displayed frequency holds the transmitter frequency.

⑥② TRANSMIT FREQUENCY CHECK SWITCH [XFC] (p. 58, p. 59)

Push this switch during split or Δ TX operation to monitor the transmit frequency.

⑥③ KEYBOARD (p. 41)

Sets the operating frequency, memory channel, and amateur band.

- **DIGIT KEYS [0] ~ [9] and [.] :**

- Enter the operating frequency or memory channel number when the KEYBOARD is lighted.
- Select the amateur band when the KEYBOARD is unlighted.

- **[F CE] :**

- During frequency input, clears an entry and retrieves the previous frequency.
- Switches amateur band selection (KEYBOARD unlighted) to direct frequency entry (KEYBOARD lighted).

- **[M-CH] :**

- Selects a memory channel after the memory channel numbers have been entered. Functions in both VFO and MEMORY modes.

- **[ENT] :**

- Stores the entered numbers as the operating frequency. Functions in both VFO and MEMORY modes.

⑥④ FILTER SWITCHES [FILTERS] (p. 53)

Selects various IF filters. Disabled in FM.

⑥⑤ AUDIO PEAK FILTER SWITCH [APF] (p. 45)

Activates the audio peak filter function in CW.

Use with the [APF] control (item ⑥⑧).

3. CONTROL FUNCTIONS

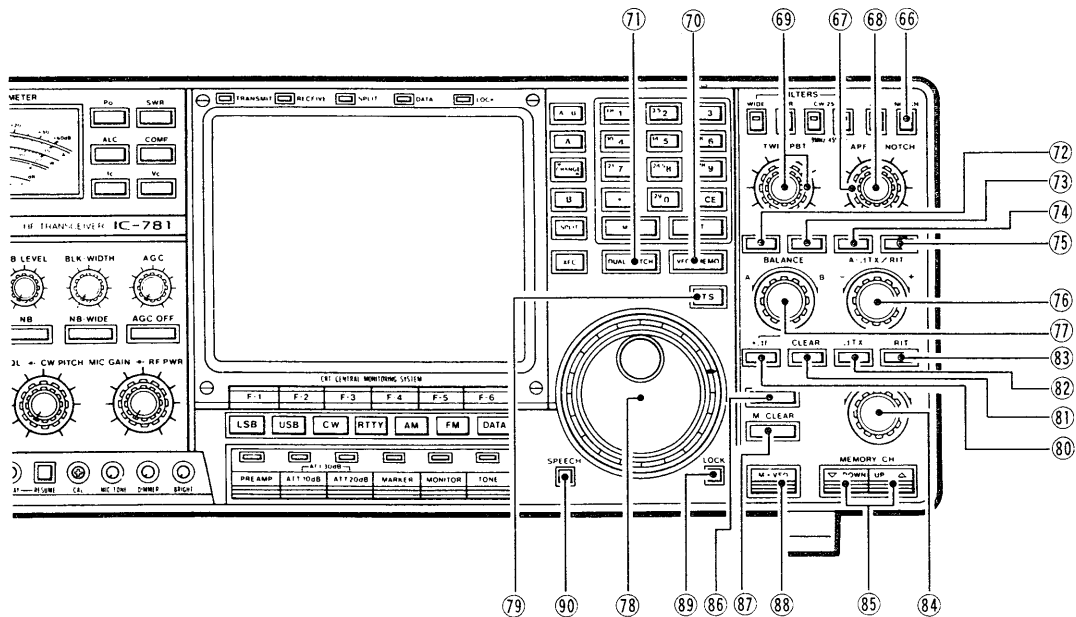

- ⑥⑥ **NOTCH SWITCH [NOTCH]** (p. 54)
Activates the notch filter circuit.

- To reduce interference around the received signal, adjust the [NOTCH] control (item ⑥⑦).

- ⑥⑦ **NOTCH CONTROL [NOTCH]** (p. 54)
Shifts the notch filter frequency. Reduces interference.

To activate, push the [NOTCH] switch (item ⑥⑥).

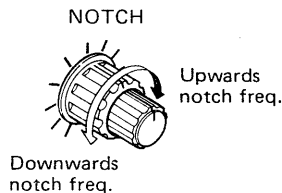

Note: Disabled in FM.

- ⑥⑧ **AUDIO PEAK FILTER CONTROL [APF]** (p. 45)
Adjusts the peak frequency of the audio peak filter circuit to pick out a CW signal in interference.

To activate, push the [APF] switch (item ⑥⑤).

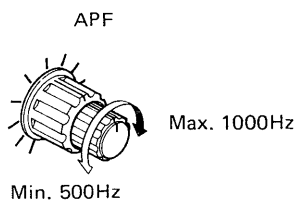

- ⑥⑨ **TWIN PASSBAND TUNING CONTROLS [TWIN PBT]** (p. 54)
Increases selectivity by narrowing the passband.

TWIN PBT

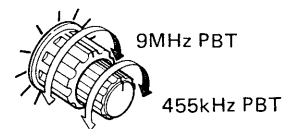

Note: Disabled in FM.

- ⑦⑩ **VFO/MEMORY SWITCH [VFO/MEMO]** (p. 61)
Selects VFO or MEMORY mode.
- ⑦⑪ **DUAL WATCH SWITCH [DUAL WATCH]** (p. 56)
Permits monitoring the upper displayed and lower displayed frequencies simultaneously on the same band in the same mode.
- ⑦⑫ **A-SHIFT ADD SWITCH [+Δf]** (p. 57)
Adds the ΔTX or RIT shift frequency to the upper displayed frequency.
- ⑦⑬ **A-SHIFT CLEAR SWITCH [CLEAR]** (p. 57)
Clears the ΔTX or RIT shift frequency for the upper displayed frequency.
- ⑦⑭ **A-ΔTX SWITCH [ΔTX]** (p. 58)
Activates the variable transmit frequency function for the upper displayed frequency.

The CRT displays "ΔTX" and the shift frequency.

⑦⑤ **A-RIT SWITCH [RIT] (p. 57)**
Shifts the receive frequency of the upper displayed frequency.

The CRT displays "RIT" and the shift frequency.

⑦⑥ **A-INCREMENTAL TUNING CONTROL [A-ΔTX/RIT] (p. 57)**

Shifts the receive or transmit frequency of the upper displayed frequency by ±9.99kHz.

To activate, push A-[RIT] (item ⑦⑤) or A-[ΔTX] (item ⑦④).

⑦⑦ **A/B BALANCE CONTROL [BALANCE] (p. 56)**
Adjusts the receive gain balance of the upper displayed and lower displayed frequencies.

To activate, push [DUAL WATCH] (item ⑦①).

⑦⑧ **MAIN DIAL (p. 89)**
Rotation of this dial changes the frequency as below.

MAIN DIAL	FREQUENCY STEP
Slow rotation	10Hz step 5kHz/rotation*
Rapid rotation	10Hz step 10kHz/rotation
[TS] switch: ON	1kHz step 500kHz/rotation

*5kHz/rotation can be switched to 2.5kHz/rotation. See p. 89.

⑦⑨ **TUNING SPEED SWITCH [TS]**
Selects tuning rate in 10Hz or 1kHz steps.

⑧① **B-SHIFT ADD SWITCH [+Δf] (p. 57)**
Adds the ΔTX or RIT shift frequency to the lower displayed frequency.

⑧② **B-SHIFT CLEAR SWITCH [CLEAR] (p. 57)**
Clears the ΔTX or RIT shift frequency for the lower displayed frequency.

⑧③ **B-ΔTX SWITCH [ΔTX] (p. 58)**
Activates the variable transmit function for the lower displayed frequency.

The CRT displays "ΔTX" and the shift frequency.

⑧④ **B-RIT SWITCH [RIT] (p. 57)**
Shifts the receive frequency of the lower displayed frequency.

The CRT displays "RIT" and the shift frequency.

⑧⑤ **B-INCREMENTAL TUNING CONTROL [B-ΔTX/RIT] (p. 57)**
Shifts the receive or transmit frequency of the lower displayed frequency by ±9.99kHz.

To activate, push B-[RIT] (item ⑧③) or B-[ΔTX] (item ⑧②).

⑧⑥ **MEMORY CHANNEL UP/DOWN SWITCHES [▼DOWN] [UP▲] (p. 61)**
Changes memory channels.

⑧⑦ **MEMORY WRITE SWITCH [M-WRITE] (p. 63)**
In VFO mode, stores the selected VFO contents in the selected memory channel.

In MEMORY mode, the selected contents are stored again when the displayed memory contents change.

⑧⑧ **MEMORY CLEAR SWITCH [M-CLEAR] (p. 66)**
Clears the contents of the selected memory channel. Functions in MEMORY mode or on the MEMORY LIST screen.

⑧⑨ **MEMORY CONTENTS TRANSFER SWITCH [M▶VFO] (p. 67)**
Transfers a selected memory channel to VFO A or VFO B.

Note: Disabled when a selected memory channel is blank.

⑧⑩ **DIAL LOCK SWITCH [LOCK] (p. 89)**
Deactivates the MAIN DIAL.

⑨① **SPEECH SWITCH [SPEECH] (p. 90)**
Activates the UT-36 VOICE SYNTHESIZER UNIT (optional) to announce the selected frequency.

The UT-36 announces the operating mode each time the MODE SWITCHES are pushed.

3. CONTROL FUNCTIONS

3-2 CRT DISPLAY

The upper half of the CRT displays VFO and MEMORY information. The lower half displays the multi-function screens.

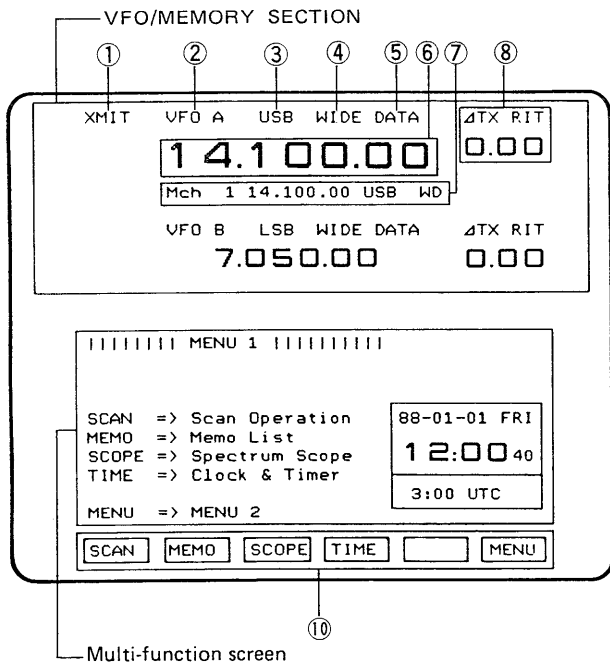

"A" section selected during VFO mode.

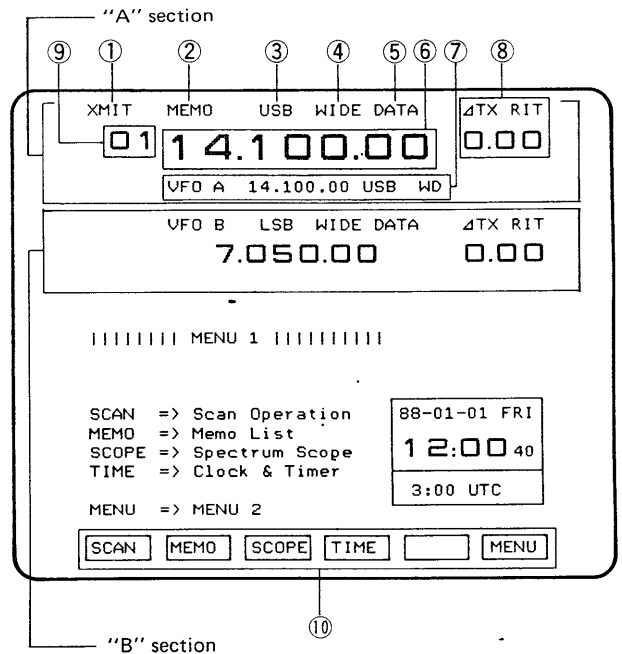

"A" section selected during MEMORY mode.

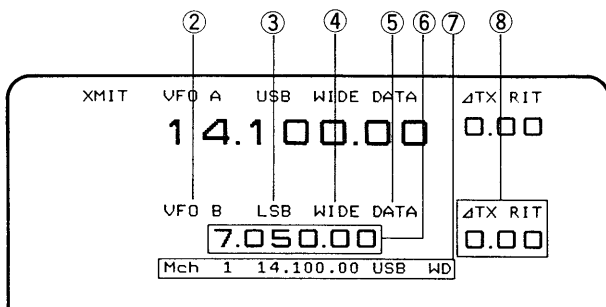

"B" section selected during VFO mode.

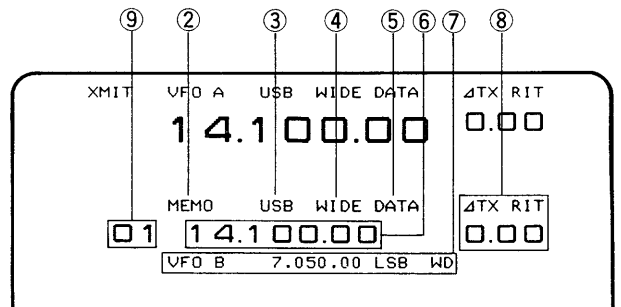

"B" section selected during MEMORY mode.

- ① **XMIT INDICATOR (p. 59)**
Indicates the transmitter section.
- ② **VFO/MEMO INDICATOR (p. 63)**
Indicates VFO or MEMORY mode operation.
- ③ **MODE INDICATOR**
Indicates the operating mode.
- ④ **WIDE/NARROW INDICATOR (p. 53)**
Indicates IF filter wide or narrow is being used.
- ⑤ **DATA INDICATOR**
Indicates the [DATA] switch is ON when lighted.
- ⑥ **FREQUENCY READOUT**
Displays the operating frequency from the 10Hz unit to the 10MHz unit in 7 digits.
- ⑦ **MEMORY READOUT (p. 61)**
Displays memory channel contents.

In the MEMORY mode, this area shows VFO A or B contents.
- ⑧ **ΔTX/RIT READOUT (p. 57)**
Appears when ΔTX or RIT functions are selected, and shows shift frequency up to ±9.99kHz.
- ⑨ **MEMORY CHANNEL NUMBER INDICATOR (p. 61)**
Displays the selected memory channel number during MEMORY mode operation.
- ⑩ **FUNCTION SWITCHES GUIDE (p. 17)**
Explains the operation of the CRT MULTI-FUNCTION SWITCHES.

3-3 REAR PANEL

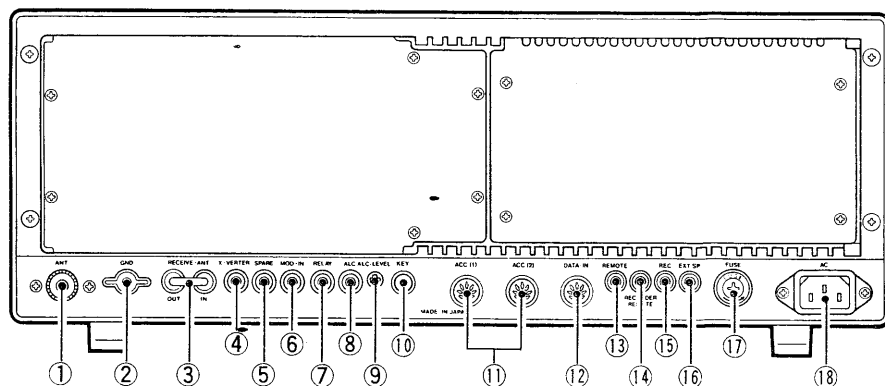

① ANTENNA CONNECTOR [ANT] (p. 32)

Connects a 50Ω antenna with a PL-259 plug.

② GROUND TERMINAL [GND] (p. 30)

To prevent electrical shocks, TVI, BCI and other problems, connect this terminal to ground.

③ RECEIVE ANTENNA [RECEIVE-ANT]

Located between the transmit/receive switching circuit and receiver's RF stage.

Connects an external preamplifier or RF filter, if desired.

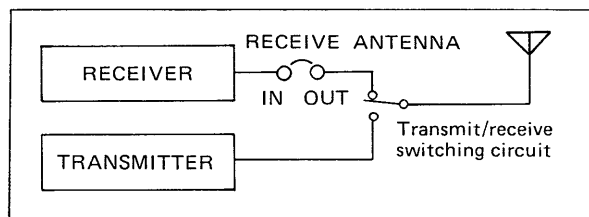

④ TRANSVERTER JACK [X-VERTER]

External transverter IN/OUT (30mV) jack. Activated by voltage applied to [ACC(2)] pin 5.

⑤ SPARE JACK [SPARE]

No connection.

⑥ MODULATION INPUT JACK [MOD-IN]

Accepts modulation input from an RTTY or DATA communication terminal. Same as [ACC(1)] pin 4.

⑦ T/R CONTROL JACK [RELAY] (p. 33)

Goes to ground when transmitting to control an external unit.

NOTE: T/R control voltage and current must be under 30V DC, 1A or 100V AC, 0.5A.

⑧ ALC INPUT JACK [ALC] (p. 33)

Connects to the ALC input of a non-ICOM linear amplifier.

⑨ ALC LEVEL POT [ALC-LEVEL] (p. 33)

Adjusts [ALC] (item ⑧) input level. No adjustment is necessary when the ALC output level of a linear amplifier is 0 ~ -4V DC.

⑩ KEY JACK [KEY] (p. 46)

Accepts a straight key or electronic keyer with standard 1/4 inch conductor plug.

⑪ ACCESSORY SOCKETS (1), (2) [ACC(1), ACC(2)] (p. 37)

Input and output connections for external RTTY and PACKET equipment.

⑫ DATA INPUT SOCKET [DATA-IN] (p. 37)

Accepts ASCII with RS-232C level input for display on the CRT DISPLAY terminal monitor screen. Contains CRT monitor output pins.

⑬ CI-V REMOTE CONTROL JACK [REMOTE] (p. 39)

When controlling the transceiver with a personal computer, connect computer output to this jack.

⑭ RECORDER REMOTE JACK [RECORDER REMOTE] (p. 34)

Connects to the remote jack of a tape recorder. When the squelch opens, this jack shorts.

⑮ RECORDER OUTPUT JACK [REC] (p. 34)

Audio output jack for a tape recorder. The fixed audio output level is set for a tape recorder AUX jack.

⑯ EXTERNAL SPEAKER JACK [EXT SP] (p. 32)

Connect a 4 ~ 16Ω speaker to this jack, if required.

⑰ FUSE HOLDER [FUSE] (p. 86)

Holds the following fuses for the AC power supply:

• 120V AC : 10A, 220 ~ 240V AC : 5A

⑱ AC POWER SOCKET [AC] (p. 32)

Connects the supplied AC cord to an AC outlet.

4. CRT DISPLAY SCREEN MENU

4-1 SCREEN MENU CONSTRUCTION

The 17 multi-function screens of the CRT DISPLAY are used together with the MULTI-FUNCTION SWITCHES. Choose the desired screen using these charts.

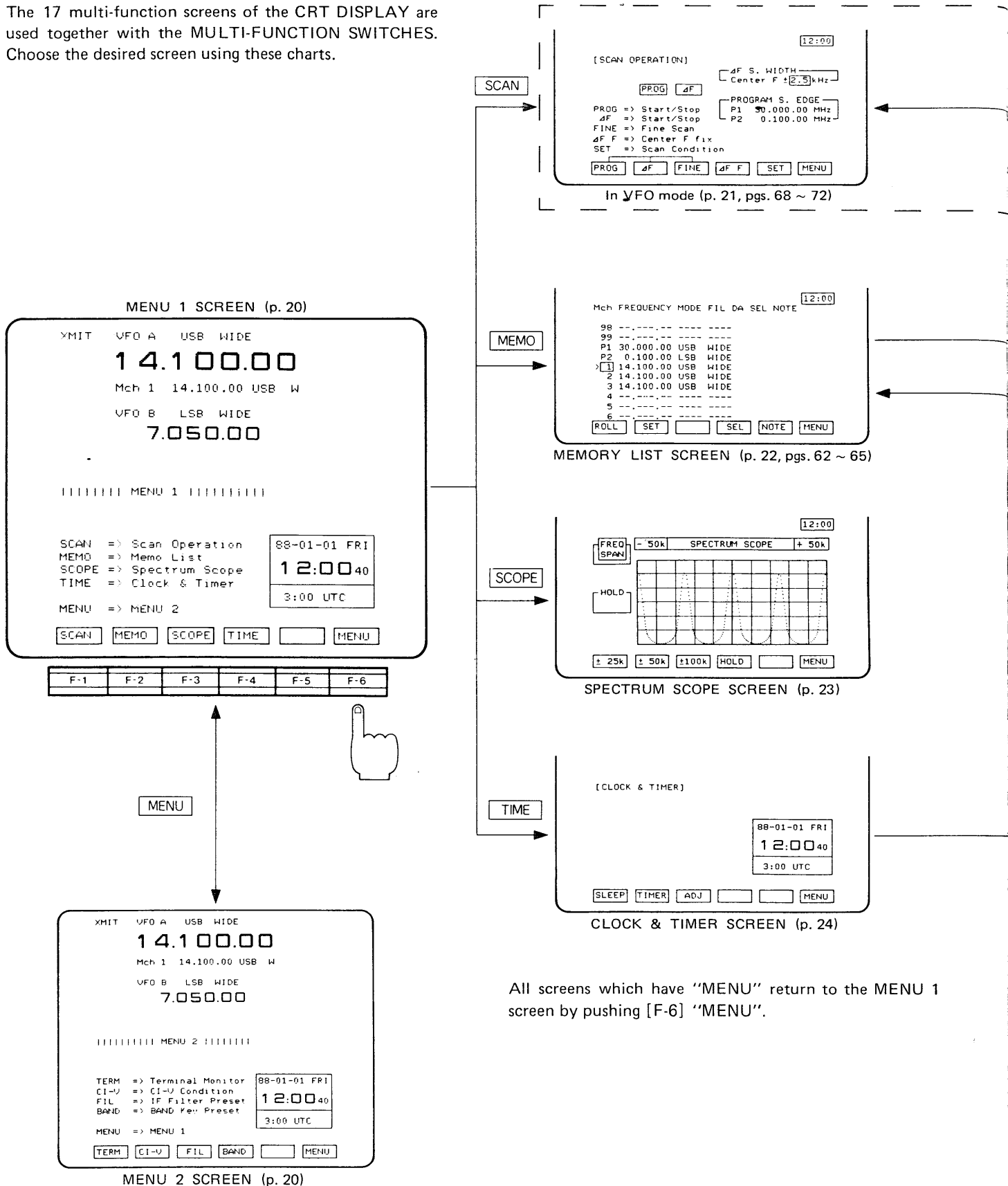

All screens which have "MENU" return to the MENU 1 screen by pushing [F-6] "MENU".

VFO/MEMO

[SCAN OPERATION] 12:00

MEMO MEMO ΔF

MEMO => Start/Stop
 ΔF => Start/Stop
 SEL/F => SEL/Fine Scan
 ΔF F => Center F fix
 SET => Scan Condition

ΔF S. WIDTH Center F ±2.5kHz
 SELECT MEMO S. SEL-No. = *1

MEMO ΔF SEL/F ΔF F SET MENU

In MEMORY mode (p. 21, pgs. 71 ~ 74)

SCAN OPERATION SCREEN

SET

[SCAN CONDITION] 12:00

with MAIN DIAL

ΔF S. WIDTH Center F ±2.5kHz

ΔF W => 10 2.5 5

PROG => Enter Ten-Key PROGRAM S. EDGE
 P1 30.000.00 MHz
 P2 0.100.00 MHz

SELM => SEL-No. SELECT MEMO S. SEL-No. = *1

ΔF W PROG SEL M SET

SCAN CONDITION SCREEN (p. 22, pgs. 69 ~ 73)

NOTE

SET or CE

Mch FREQUENCY MODE FIL DA SEL NOTE 12:00

98 -----
 99 -----
 P1 30.000.00 USB WIDE
 P2 0.100.00 LSB WIDE
 >1 14.100.00 USB WIDE
 2 14.100.00 USB WIDE
 3 14.100.00 USB WIDE
 4 -----
 5 -----
 6 -----

ENT <-- >-- SPACE CE SET

MEMORY NOTE WRITE SCREEN (p. 23, p. 65)

SLEEP

[SLEEP SET] with MAIN DIAL

SLP 1 SLP 2 88-01-01 FRI
 90 min 12:00 40
 OFF TIME 3:00 UTC

- 10 OFF SLP 2 MENU

SLEEP TIMER SCREEN (p. 24, p. 76)

TIMER

[DAILY TIMER SET] with MAIN DIAL

CH	SEL	DAY	ON	OFF	Mch
A	---	---	0:00	0:00	88-01-01 FRI
B	---	---	0:00	0:00	12:00 40
C	---	---	0:00	0:00	3:00 UTC
D	---	---	0:00	0:00	
E	---	---	0:00	0:00	

CH SEL SET MENU

DAILY TIMER SET (1) SCREEN (p. 25, p. 77)

SET

SET

[DAILY TIMER SET] with MAIN DIAL

CH	SEL	DAY	ON	OFF	Mch
A	---	---	0:00	0:00	88-01-01 FRI
B	---	---	0:00	0:00	12:00 40
C	---	---	0:00	0:00	3:00 UTC
D	---	---	0:00	0:00	
E	---	---	0:00	0:00	

DAY ON OFF Mch BLANK SET

DAILY TIMER SET (2) SCREEN (p. 25, p. 77)

ADJ

[CLOCK ADJUST] with MAIN DIAL

YEAR => Year
 DATE => Month & Date
 DAY => Day
 CLK1 => Hour & Min & 0ADJ
 CLK2 => Hour & Min
 NOTE => Comment Write

88-01-01 FRI
 12:00 40
 3:00 UTC

YEAR DATE DAY CLK 1 CLK 2 NOTE MENU

CLOCK ADJUSTMENT (1) SCREEN (p. 26, p. 75)

NOTE

SET or CE

[CLOCK ADJUST] with MAIN DIAL

YEAR => Year
 DATE => Month & Date
 DAY => Day
 CLK1 => Hour & Min & 0ADJ
 CLK2 => Hour & Min
 NOTE => Comment Write

88-01-01 FRI
 12:00 40
 3:00 UTC

ENT <-- >-- SPACE CE SET

CLOCK ADJUSTMENT (2) SCREEN (p. 26, p. 75)

4. CRT DISPLAY SCREEN MENU

All screens which have "MENU" return to the MENU 1 screen by pushing [F-6] "MENU".

MENU 2 SCREEN (p. 20)

```

XMIT  UFO A  USB WIDE
      14.100.00
Mch 1  14.100.00 USB W
      UFO B  LSB WIDE
      7.050.00

||||| MENU 2 |||||

TERM => Terminal Monitor
CI-V => CI-V Condition
FIL  => IF Filter Preset
BAND => BAND Key Preset

MENU => MENU 1
    
```

88-01-01 FRI
12:00:40
3:00 UTC

TERM CI-V FIL BAND [] MENU

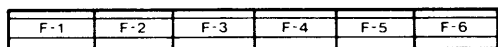

MENU

MENU 1 SCREEN (p. 20)

```

XMIT  UFO A  USB WIDE
      14.100.00
Mch 1  14.100.00 USB W
      UFO B  LSB WIDE
      7.050.00

||||| MENU 1 |||||

SCAN => Scan Operation
MEMO => Memo List
SCOPE => Spectrum Scope
TIME  => Clock & Timer

MENU => MENU 2
    
```

88-01-01 FRI
12:00:40
3:00 UTC

SCAN MEMO SCOPE TIME [] MENU

MENU 1 SCREEN (p. 20)

TERMINAL MONITOR SCREEN (p. 27, p. 36)

[TERMINAL MONITOR] 8 bit 300B

This is a Terminal Monitor Demonstration

<< DATA FORMAT >>

Start bit + 7 or 8 bit DATA + Stop bit

<< BAUD RATE >>

300B , 600B , 1200B or 2400B

!*%&`()*+,-./0123456789:;<=>?@ABCDEFGHI

HOLD CLEAR FORMT [] [] MENU

FORMT

SET

[TERMINAL MONITOR]

[DATA FORMAT SET] with MAIN DIAL

BIT => Data bit 7 bit 8 bit

BAUD => Baud Rate 300B 600B 1200B 2400B

CODE => CR & LF Code CR only CR + LF

BIT BAUD CODE [] [] SET

DATA FORMAT SCREEN (p. 27, p. 36)

[CI-V REMOTE CONTROL CONDITION] 12:00

with MAIN DIAL

DE/U => Default or User SET	DEFT	USER
ADDR => My Address (01H-7FH)	26H	04H
BAUD => Baud Rate	1200	1200
TRCV => Transceive Function	ON	ON
731 => Transceive with IC-731/735	---	WITH

DE/U ADDR BAUD TRCV 731 MENU

CI-V CONDITION SCREEN (p. 28, p. 36)

[IF FILTER PRESET] 12:00

NAR NAR NAR NAR NAR

WIDE WIDE WIDE WIDE WIDE

LSB USB CW RTTY AM MENU

FILTER SELECTION SCREEN (p. 29)

[BAND KEY PRESET] 12:00

[BAND KEY PRESET]

Band Stacking Register

ON => Auto Write

OFF => Fixed

ON/OFF [] [] [] [] MENU

BAND KEY PRESET SCREEN (p. 29)

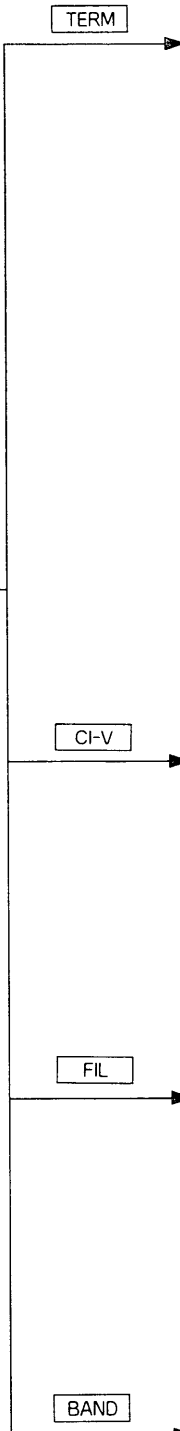

4-2 MENU 1 SCREEN

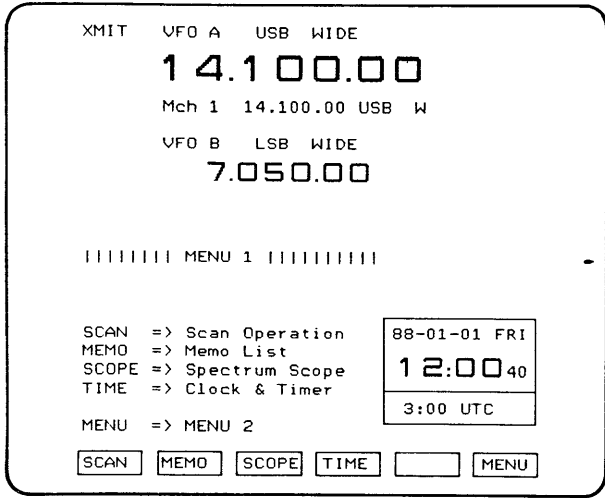

All operational screens below are accessed from the MENU 1 screen. Push the switch below the displayed screen name you wish to access.

NAME	ACCESSED SCREEN	SWITCH
"SCAN"	SCAN OPERATION	[F-1]
"MEMO"	MEMORY LIST	[F-2]
"SCOPE"	SPECTRUM SCOPE	[F-3]
"TIME"	CLOCK & TIMER	[F-4]
"MENU"	MENU 2	[F-6]

4-3 MENU 2 SCREEN

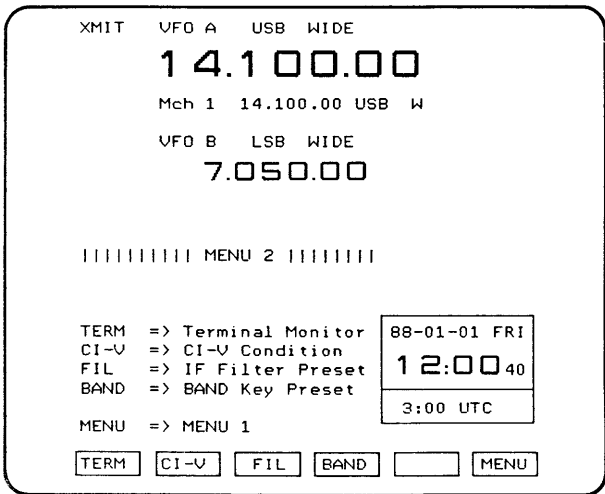

All operational screens below are accessed from the MENU 2 screen. Push the switch below the displayed screen name you wish to access.

NAME	ACCESSED SCREEN	SWITCH
"TERM"	TERMINAL MONITOR	[F-1]
"CI-V"	CI-V CONDITION	[F-2]
"FIL"	IF FILTER PRESET	[F-3]
"BAND"	BAND KEY PRESET	[F-4]
"MENU"	MENU 1	[F-6]

4. CRT DISPLAY SCREEN MENU

4-4 SCAN OPERATION SCREEN

■ SCAN OPERATION SCREEN IN VFO MODE

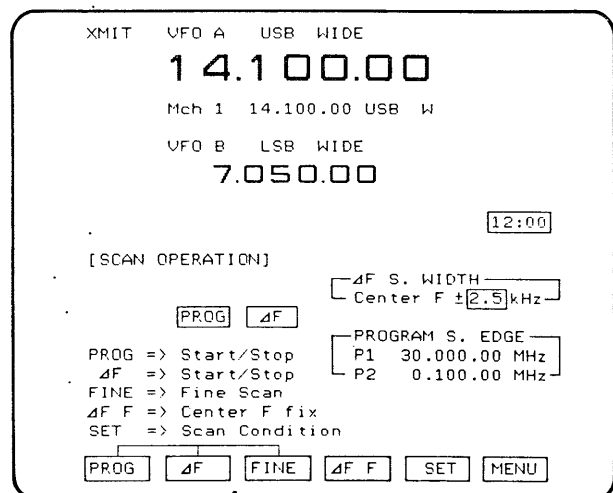

To access this screen from MENU 1, push [F-1] during VFO mode.

To operate scanning, access the SCAN OPERATION screen. Push [VFO/MEMO] to select scanning in VFO mode or scanning in MEMORY mode.

Operates the programmed scan, fine programmed scan, ΔF scan and fine ΔF scan.

NAME	FUNCTION
"PROG" [F-1]	Starts and stops the programmed scan.
" ΔF " [F-2]	Starts and stops the ΔF scan.
"FINE" [F-3]	Switches to fine programmed scan or fine ΔF scan. Push this switch after pushing "PROG" or " ΔF ".
" $\Delta F F$ " [F-4]	Sets the center frequency of the ΔF scan. Pushing this switch stores or releases the displayed frequency as the ΔF scan center frequency.
"SET" [F-5]	Accesses the SCAN CONDITION screen.
"MENU" [F-6]	Accesses MENU 1.

■ SCAN OPERATION SCREEN IN MEMORY MODE

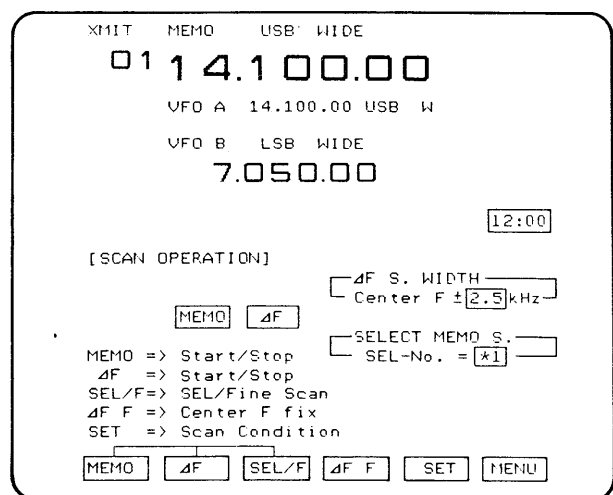

To access this screen from MENU 1, push [F-1] "SCAN" during MEMORY mode.

Operates the memory scan, selected memory scan, ΔF scan and fine ΔF scan.

NAME	FUNCTION
"MEMO" [F-1]	Starts and stops the memory scan.
" ΔF " [F-2]	Starts and stops the ΔF scan.
"SEL/F" [F-3]	Switches to selected memory scan or fine ΔF scan. Push this switch after pushing "MEMO" or " ΔF ".
" $\Delta F F$ " [F-4]	Sets the center frequency of the ΔF scan. Push to store or release the displayed frequency as the center frequency.
"SET" [F-5]	Accesses the SCAN CONDITION screen.
"MENU" [F-6]	Accesses MENU 1.

4-5 SCAN CONDITION SCREEN

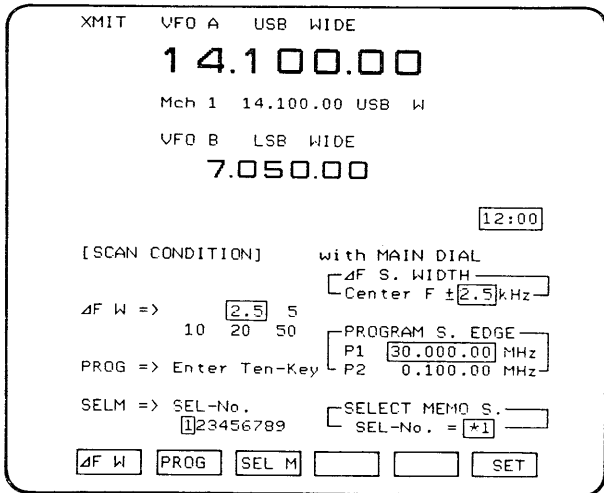

To access this screen from MENU 1, push [F-1] "SCAN" then push [F-5] "SET".

Sets the scanning conditions.

NOTE: When this screen is selected, the KEYBOARD does not change the VFO frequency.

NAME	FUNCTION
"ΔF W" [F-1]	Selects the scan width of the ΔF scan. To select the ΔF scan width, push and hold this switch, and rotate the MAIN DIAL.
"PROG" [F-2]	Selects P1 and P2 for programming the scan band edges. To select the scan band edges, push and hold this switch, and rotate the MAIN DIAL. Use the KEYBOARD to input the scan band edge frequencies.
"SEL M" [F-3]	Selects selected memory scan numbers 1 ~ 9. To select the memory scan number, push and hold this switch, and rotate the MAIN DIAL.
"SET" [F-6]	Accesses the SCAN OPERATION screen.

4-6 MEMORY LIST SCREEN

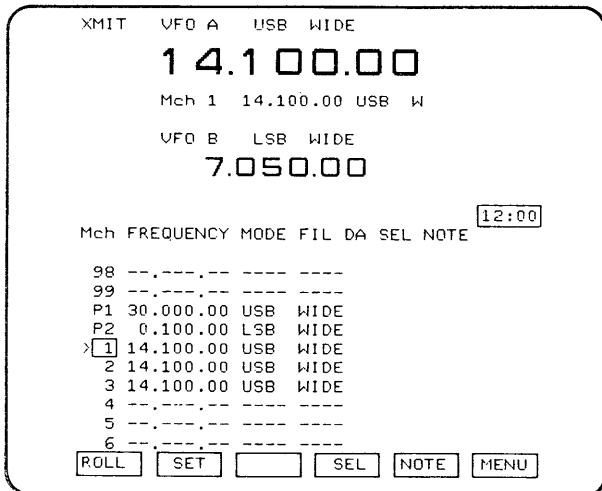

To access this screen from MENU 1, push [F-2] "MEMO".

Lists up to ten memory channels and programs the selected memory scan number.

NAME	FUNCTION
"ROLL" [F-1]	Rolls the memory channel list. To check the list, push and hold this switch, and rotate the MAIN DIAL.
"SET" [F-2]	Selects the memory channel. To select the memory channel, push and hold this switch, and rotate the MAIN DIAL.
"SEL" [F-4]	Programs and erases a selected memory scan number. To renumber, push and hold the switch, and rotate the MAIN DIAL.
"NOTE" [F-5]	Accesses the MEMORY NOTE WRITE screen.
"MENU" [F-6]	Accesses MENU 1.

4. CRT DISPLAY SCREEN MENU

4-7 MEMORY NOTE WRITE SCREEN

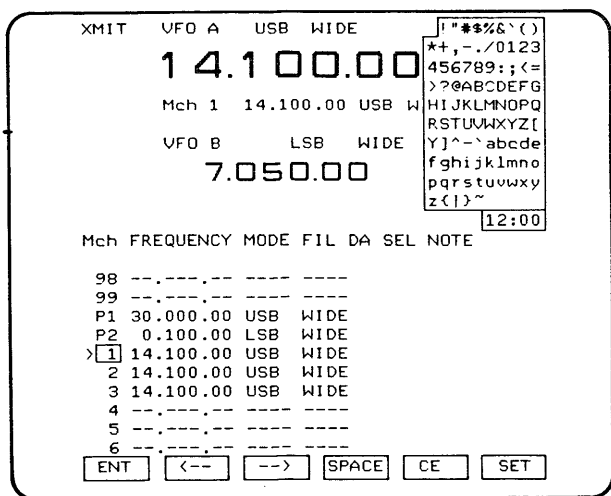

To access this screen from MENU 1, push [F-2] "MEMO" then push [F-5] "NOTE".

Programs a note of up to 10 characters into the memory channel list of your choice. Select characters with the MAIN DIAL.

NAME	FUNCTION
"ENT" [F-1]	Retrieves characters from the character area and enters them into the channel.
"<--" [F-2]	Moves the cursor to the left side.
"-->" [F-3]	Moves the cursor to the right side.
"SPACE" [F-4]	Inputs spaces between characters in the note area.
"CE" [F-5]	Erases entered characters; retrieves the previous note; and then accesses the MEMORY LIST screen.
"SET" [F-6]	Stores the entered characters and then accesses the MEMORY LIST screen.

4-8 SPECTRUM SCOPE SCREEN

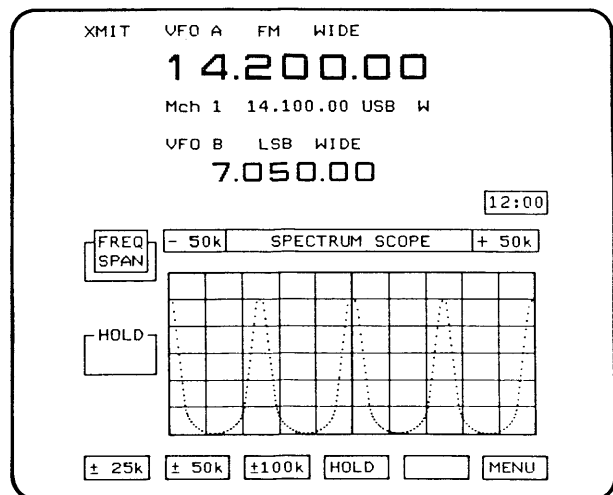

To access this screen from MENU 1, push [F-3] "SCOPE".

Displays the signal spectrum on an 80 x 256 dot spectrum scope.

NAME	FUNCTION
"±25k" [F-1]	Selects a 50kHz spectrum bandwidth.
"±50k" [F-2]	Selects a 100kHz spectrum bandwidth.
"±100k" [F-3]	Selects a 200kHz spectrum bandwidth.
"HOLD" [F-4]	Freezes the displayed spectrum waveform.
"MENU" [F-6]	Accesses MENU 1.

4-9 CLOCK & TIMER SCREEN

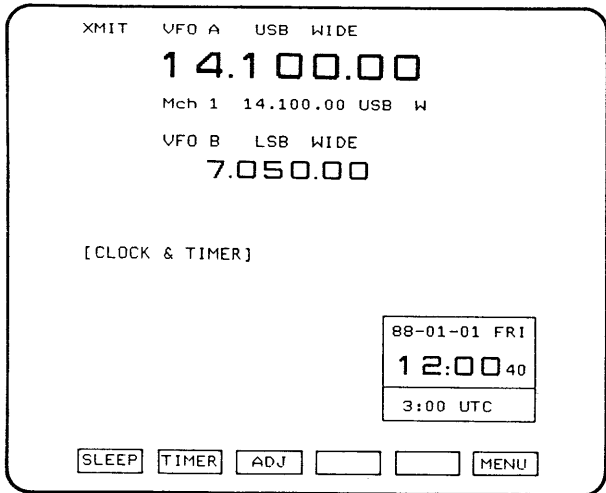

To access this screen from MENU 1, push [F-4] "TIME".

The IC-781 has two clocks, selectable Sleep Timers, and five Daily Timers.

NAME	FUNCTION
"SLEEP" [F-1]	Accesses the SLEEP TIMER screen.
"TIMER" [F-2]	Accesses the DAILY TIMER SET (1) screen.
"ADJ" [F-3]	Accesses the CLOCK ADJUSTMENT (1) screen.
"MENU" [F-6]	Accesses MENU 1.

4-10 SLEEP TIMER SCREEN

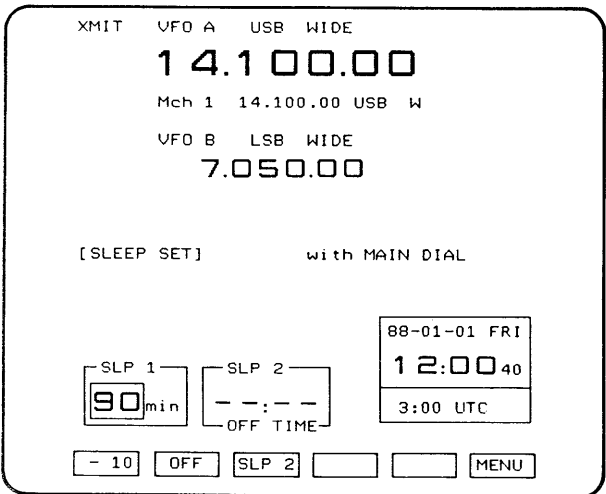

To access this screen from MENU 1, push [F-4] "TIME" then [F-1] "SLEEP".

Displays the SLP 1 (Time-off Timer) and the SLP 2 (Clock Timer). When the [TIMER] switch is OFF, a second alarm sounds at the programmed OFF time.

NAME	FUNCTION
"SLP 1" "-10" [F-1]	Selects and activates the SLP 1. Push to set the time from 10 to 90 minutes in 10 minutes steps.
"OFF" [F-2]	Disables the Sleep Timers (SLP 1 and 2).
"SLP 2" [F-3]	Selects and activates the SLP 2. To set the time, push and hold this switch, and rotate the MAIN DIAL.
"MENU" [F-6]	Accesses MENU 1.

4. CRT DISPLAY SCREEN MENU

4-11 DAILY TIMER SET(1) SCREEN

Selects and programs Daily Timers.

XMIT UFO A USB WIDE
14.100.00
Mch 1 14.100.00 USB W
UFO B LSB WIDE
7.050.00

[DAILY TIMER SET] With MAIN DIAL

CH	SEL	DAY	ON	OFF	Mch
A	---	---	0:00	0:00	--
B	---	---	0:00	0:00	--
C	---	---	0:00	0:00	--
D	---	---	0:00	0:00	--
E	---	---	0:00	0:00	--

88-01-01 FRI
12:00 40
3:00 UTC

CH SEL SET MENU

To access this screen from MENU 1, push [F-4] "TIME" then push [F-2] "TIMER".

NAME	FUNCTION
"CH" [F-1]	Selects one of the five Daily Timers. To set a timer, push and hold this switch, and rotate the MAIN DIAL.
"SEL" [F-2]	Activates and deactivates a selected timer. When a timer is ON, its selected number will be displayed.
"SET" [F-3]	Accesses DAILY TIMER SET (2) screen.
"MENU" [F-6]	Accesses MENU 1.

4-12 DAILY TIMER SET(2) SCREEN

Selects and activates the ON/OFF-time, the day and the memory channel.

XMIT UFO A USB WIDE
14.100.00
Mch 1 14.100.00 USB W
UFO B LSB WIDE
7.050.00

[DAILY TIMER SET] With MAIN DIAL

CH	SEL	DAY	ON	OFF	Mch
A	---	---	0:00	0:00	--
B	---	---	0:00	0:00	--
C	---	---	0:00	0:00	--
D	---	---	0:00	0:00	--
E	---	---	0:00	0:00	--

88-01-01 FRI
12:00 40
3:00 UTC

DAY ON OFF Mch BLANK SET

To access this screen from MENU 1, push [F-4] "TIME" then [F-2] "TIMER" then [F-3] "SET".

NAME	FUNCTION
"DAY" [F-1]	To set the day, push and hold this switch and rotate the MAIN DIAL. To operate the timer every day, push this switch and [F-5] "BLANK" simultaneously.
"ON" [F-2]	To set the power ON time, push and hold this switch, and rotate the MAIN DIAL.
"OFF" [F-3]	To set the power OFF time, push and hold this switch, and rotate the MAIN DIAL. To only turn the power ON with the timer, push this switch and [F-5] "BLANK" simultaneously.
"M ch" [F-4]	To select a memory channel on which the timer turns ON, push and hold this switch, and rotate the MAIN DIAL. To activate a previous frequency, push this switch and [F-5] "BLANK" simultaneously.
"BLANK" [F-5]	To leave a selection blank, push this switch simultaneously with the "DAY", "OFF" or "Mch".
"SET" [F-6]	Accesses the DAILY TIMER SET (1) screen.

4-13 CLOCK ADJUSTMENT(1) SCREEN

Sets Clock 1 and Clock 2.

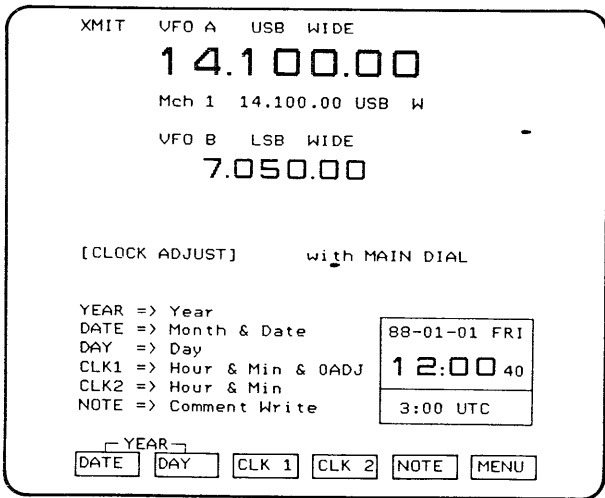

To access this screen from MENU 1, push [F-4] "TIME" then [F-3] "ADJ".

NAME	FUNCTION
"DATE" [F-1]	To set the date of Clock 1, push and hold this switch, and rotate the MAIN DIAL. To set the year of Clock 1, push and hold the "DATE" and "DAY" switches, and rotate the MAIN DIAL.
"DAY" [F-2]	To set the day of Clock 1, push and hold this switch, and rotate the MAIN DIAL.
"CLK 1" [F-3]	Push this switch to set the second at zero. To set the time of Clock 1, push and hold this switch, and rotate the MAIN DIAL.
"CLK 2" [F-4]	To set the time of Clock 2, push and hold this switch, and rotate the MAIN DIAL.
"NOTE" [F-5]	Accesses the CLOCK ADJUSTMENT (2) screen.
"MENU" [F-6]	Accesses MENU 1.

4-14 CLOCK ADJUSTMENT(2) SCREEN

Programs up to six characters on Clock 2. Rotate the MAIN DIAL to choose characters.

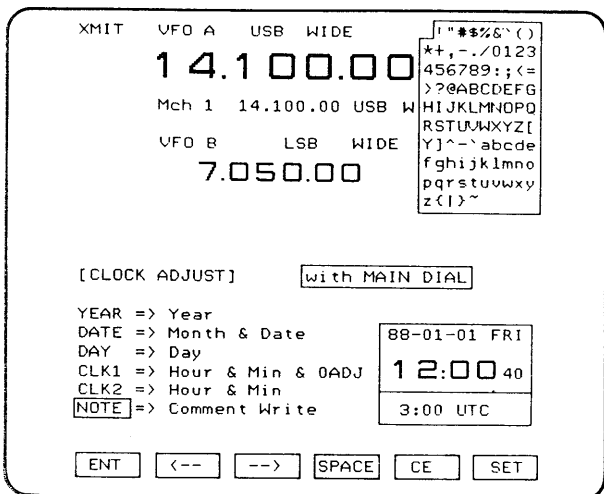

To access this screen from MENU 1, push [F-4] "TIME" then [F-3] "ADJ" then [F-5] "NOTE".

NAME	FUNCTION
"ENT" [F-1]	Enters the chosen character into the note area.
"<--" [F-2]	Moves the cursor to the left.
"-->" [F-3]	Moves the cursor to the right.
"SPACE" [F-4]	Makes a space between characters in the note area.
"CE" [F-5]	Erases the entered note, saves the previous note, and then accesses the CLOCK ADJUSTMENT (1) screen.
"SET" [F-6]	Saves the note and accesses the CLOCK ADJUSTMENT (1) screen.

4. CRT DISPLAY SCREEN MENU

4-15 TERMINAL MONITOR SCREEN

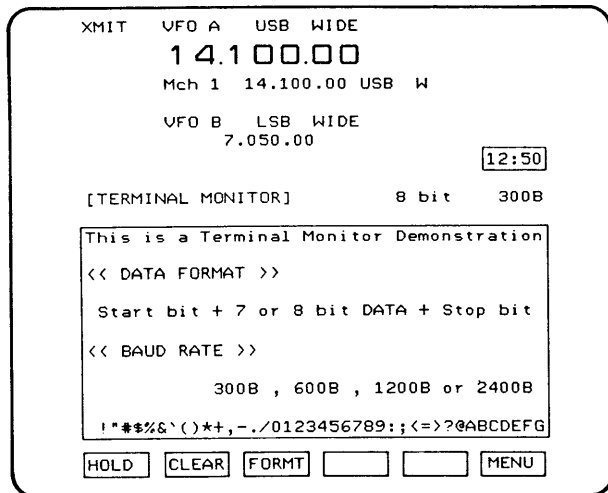

To access this screen from MENU 1, push [F-6] "MENU" then push [F-1] "TERM".

Monitors ASCII input from [DATA-IN] on the rear panel. When no data is input, the screen displays a demonstration of its functions.

NAME	FUNCTION
"HOLD" [F-1]	Freezes the screen.
"CLEAR" [F-2]	Clears the screen.
"FORMT" [F-3]	Accesses the DATA FORMAT screen.
"MENU" [F-6]	Accesses MENU 1.

4-16 DATA FORMAT SCREEN

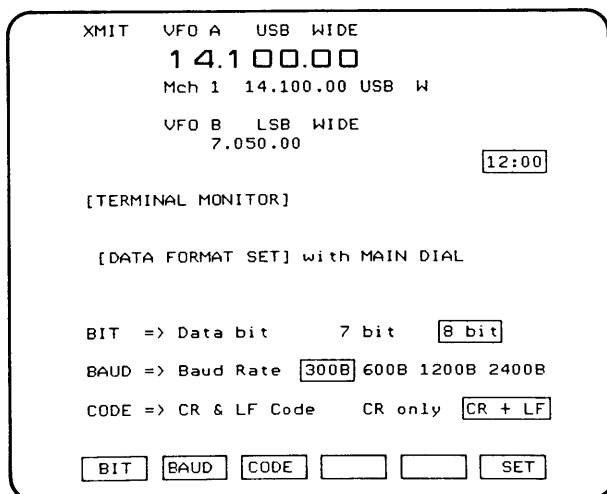

To access this screen from MENU 1, push [F-6] "MENU" then [F-1] "TERM" then [F-3] "FORMT".

Sets the data length, baud rate and line feed command.

NAME	FUNCTION
"BIT" [F-1]	Selects a character length of 7 or 8 bits for the terminal monitor. To change the character length, push and hold the switch, and rotate the MAIN DIAL.
"BAUD" [F-2]	Selects the baud rate for the terminal monitor. To set the baud rate, push and hold this switch, and rotate the MAIN DIAL.
"CODE" [F-3]	Selects the acceptance command for line feed CR (carriage return) only, or for CR + LF (carriage return + line feed). To set the line feed command, push and hold the switch, and rotate the MAIN DIAL.
"SET" [F-6]	Accesses the TERMINAL MONITOR screen.

4-17 CI-V CONDITION SCREEN

Sets the CI-V remote control condition.

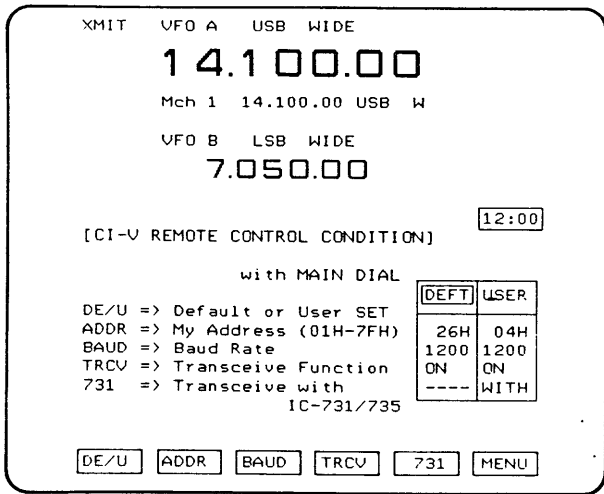

To access this screen from MENU 1, push [F-6] "MENU" then push [F-2] "CI-V".

NAME	FUNCTION
"DE/U" [F-1]	Selects the ICOM standard CI-V default condition and the user programmed condition. To select a default or user setting, push and hold this switch.
"ADDR" [F-2]	Selects the IC-781 address number. To select a user programmable address number from 01H to 7FH, push and hold this switch and rotate the MAIN DIAL.
"BAUD" [F-3]	Selects the baud rate. To select a baud rate, push and hold this switch, and rotate the MAIN DIAL.
"TRCV" [F-4]	Selects the transceive function ON and OFF positions. To select the transceive function, push and hold this switch, and rotate the MAIN DIAL.
"731" [F-5]	Selects frequency data in 5 bytes (----) or 4 bytes (WITH). When using the transceive function with the IC-735, this switch must be set to "WITH" condition. To set transceive data length, push and hold this switch, and rotate the MAIN DIAL.
"MENU" [F-6]	Accesses MENU 1.

4. CRT DISPLAY SCREEN MENU

4-18 FILTER SELECTION SCREEN

Selects filter presettings.

To access this screen from MENU 1, push [F-6] "MENU" then push [F-3] "FIL".

NAME	FILTER SELECTION
"LSB" [F-1]	LSB wide or narrow. Note: The SSB wide filter is an option.
"USB" [F-2]	USB wide or narrow. Note: The SSB wide filter is an option.
"CW" [F-3]	CW wide or narrow.
"RTTY" [F-4]	RTTY wide or narrow.
"AM" [F-5]	AM wide or narrow.
"MENU" [F-6]	Accesses MENU 1 screen.

4-19 BAND KEY PRESET SCREEN

Sets the band stacking register ON and OFF. The band stacking register remains set at the previously used frequency of each band.

To access this screen from MENU 1, push [F-6] "MENU" then push [F-4] "BAND".

NAME	FUNCTION
"ON/OFF" [F-1]	Turns ON and OFF the band stacking register.
"MENU" [F-2]	Accesses MENU 1 screen.

5-1 UNPACKING

After unpacking, immediately and completely describe any damage to the delivering carrier and dealer. Keep the shipping cartons. For a description and a diagram of accessory equipment included with IC-781, see the FOREWORD.

5-2 PLANNING

Select a location for the transceiver with space for thorough air circulation, and access to the front and rear panels. Keep away from extreme heat, cold, vibrations, TV sets, TV antenna elements, radios and electro-magnetic sources.

5-3 ANTENNA

Select an antenna, such as a well-matched 50Ω antenna and feedline. The transmission line should be coaxial cable. VSWR should be less than 1:1.5.

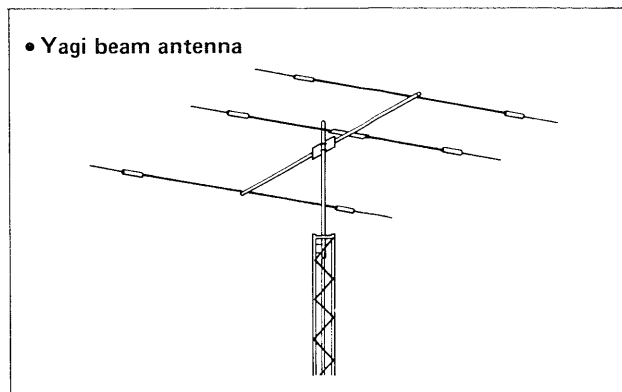
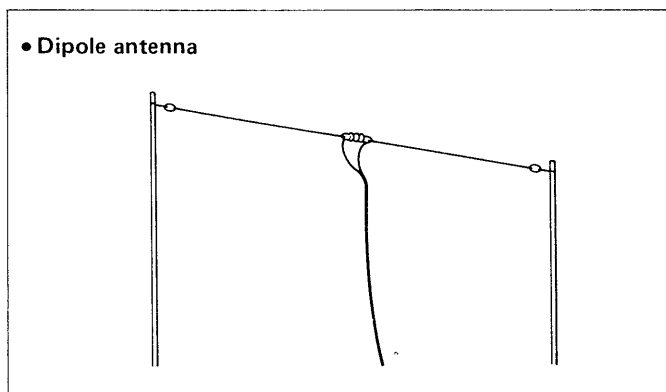

• PL-259 connector installation

- 1) Slide the coupling ring over the coaxial cable.
- 2) Prepare the cable as shown at left. Remove 33mm of the cable jacket. Tin the entire length of the exposed braid. Remove 21mm of the braid. Remove 19mm of the central conductor installation. Tin the center conductor as shown at left.
- 3) Slide the connector body onto the cable and solder it to the outer and center conductors as shown at left.
- 4) Screw the coupling ring onto the connector body.

1 inch = 25.4mm

5-4 GROUNDING

To prevent shocks, TVI, BCI and other problems, ground the transceiver through the [GND] terminal on the rear panel.

For best results, connect heavy gauge wire or strap to a cold water pipe or long earth-sunk copper rod. Make the distance between the [GND] terminal and ground as short as possible.

5. INSTALLATION

5-5 FRONT PANEL

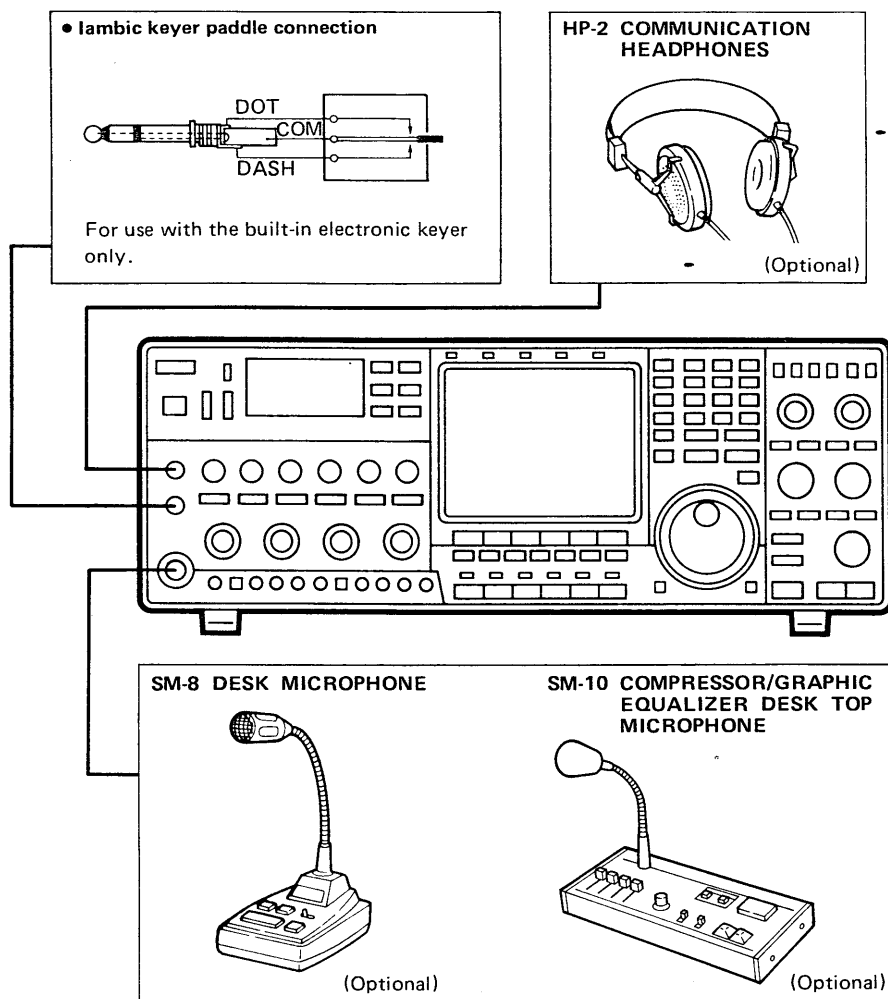

■ RACK MOUNTING HANDLES

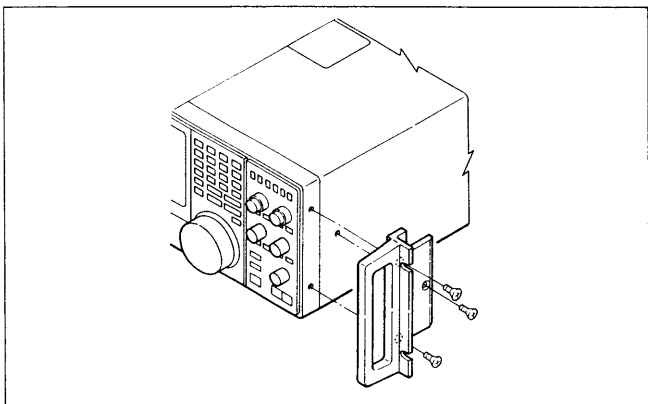

Remove the four screws from both sides of the front panel, then attach the rack mounting handles to the sides of the transceiver using the supplied screws.

■ RUBBER STANDS

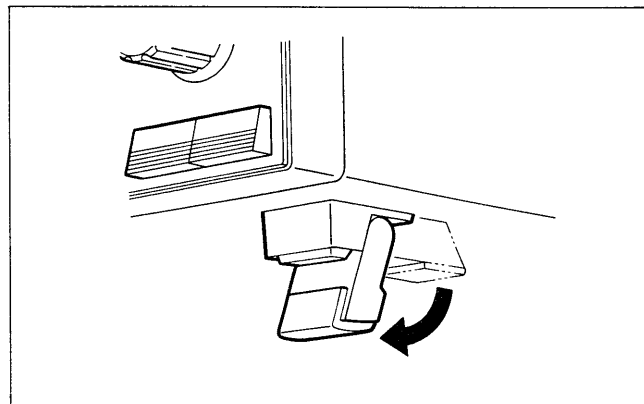

The rubber stands on the bottom of the IC-781 give the transceiver two selectable angles.

5-6 REAR PANEL

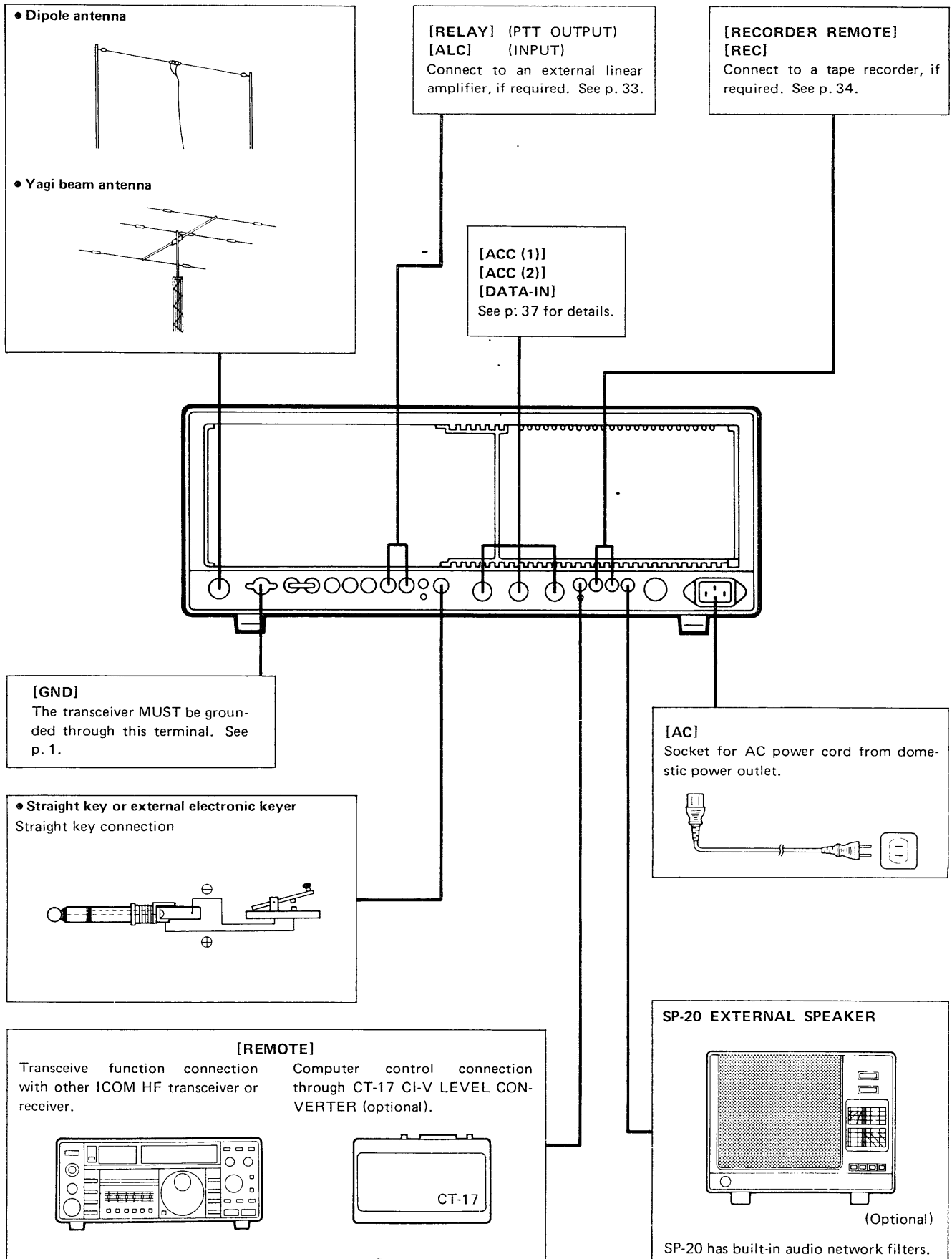

6. SYSTEM INTERCONNECTIONS

6-1 LINEAR AMPLIFIER CONNECTION

(1) CONNECTING IC-2KL

To connect IC-2KL LINEAR AMPLIFIER, refer to the diagram below.

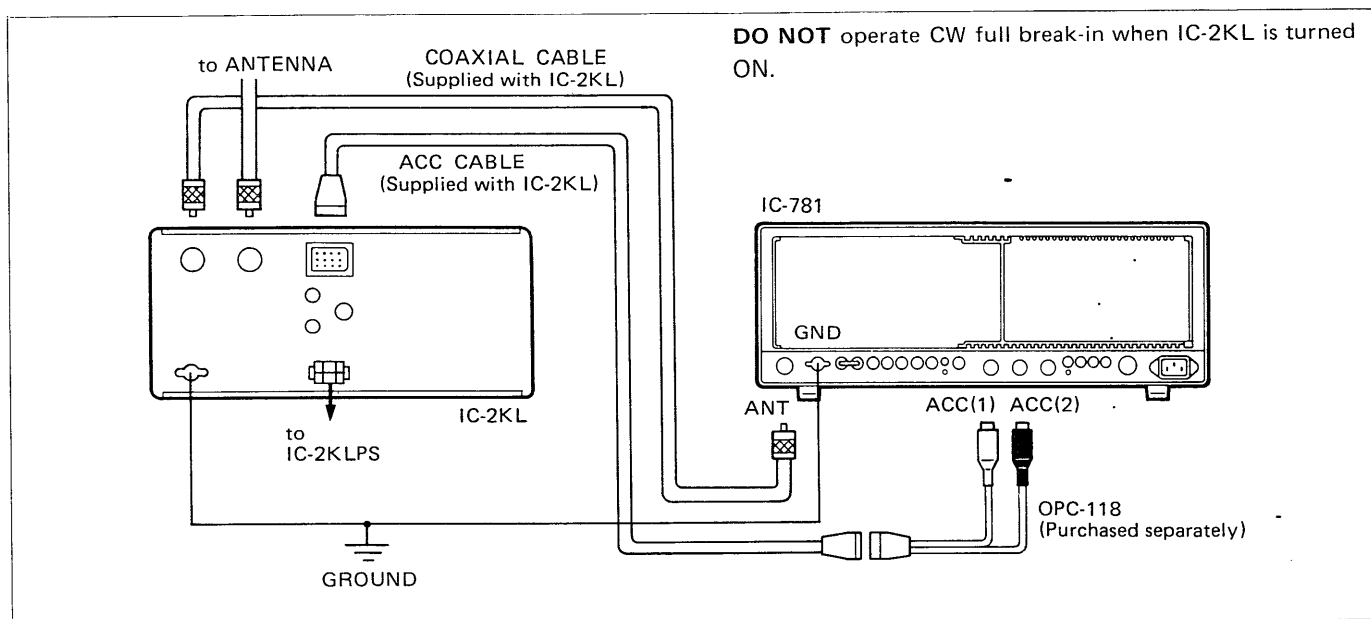

(2) CONNECTING A NON-ICOM LINEAR AMPLIFIERS

To connect a linear amplifier not made by ICOM, refer to the diagram below.

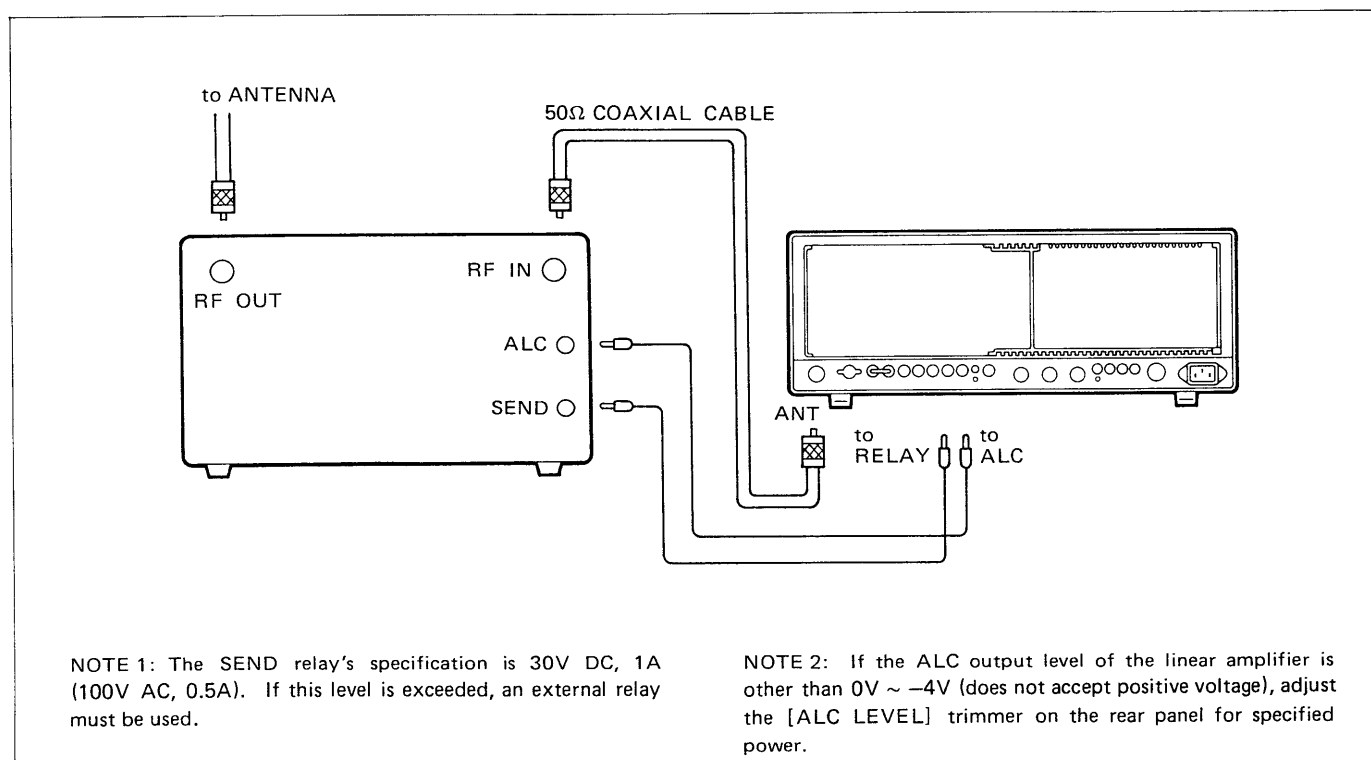

6-2 IC-AT500 CONNECTION

When using IC-2KL LINEAR AMPLIFIER, we recommend connecting IC-AT500 AUTOMATIC ANTENNA TUNER between IC-2KL and the antenna.

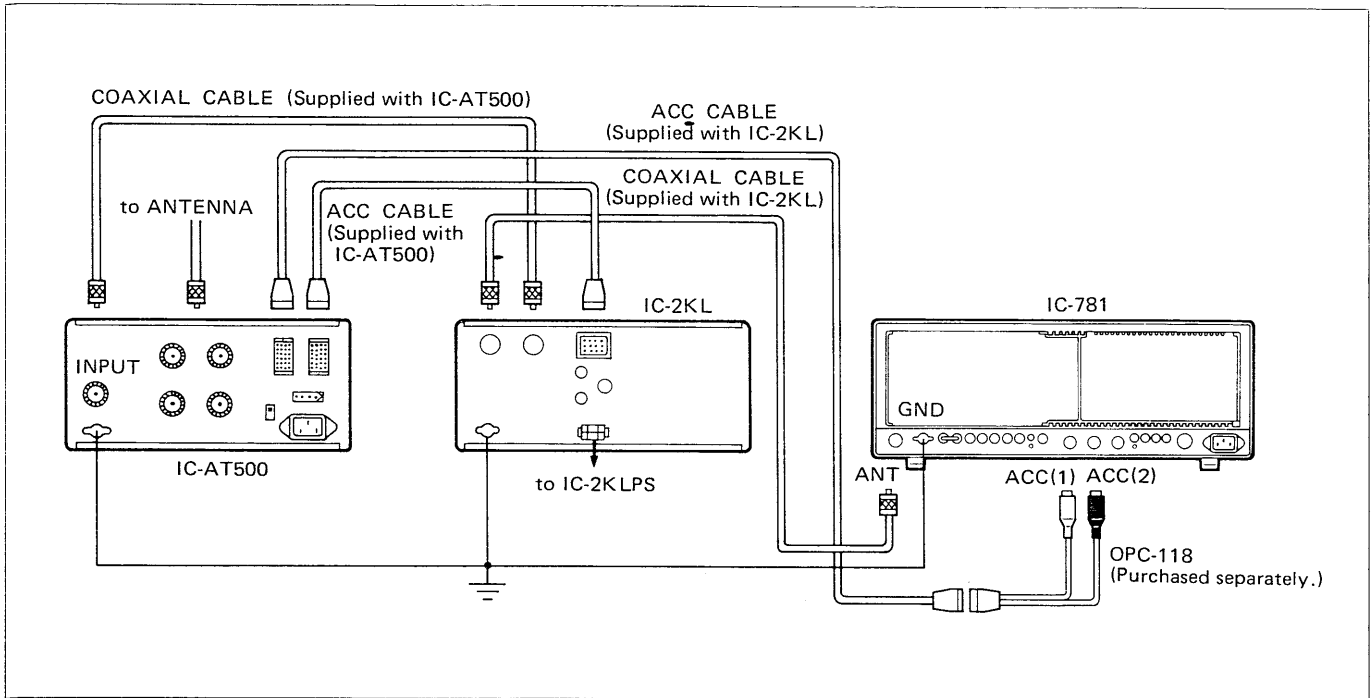

CAUTION:

AH-2 HF ALL BAND ANTENNA TUNER cannot be used with IC-781. AH-2 accepts less than 100W input power.

6-3 TAPE RECORDER CONNECTION

You can record a signal with a tape recorder through the [REC] jack. Audio output level is fixed, regardless of the [AF GAIN] position.

The [RECORDER REMOTE] jack closes when the transceiver is ON and the squelch opens. Activates a tape recorder with IC-781's timers and allows recording only when a signal opens the squelch.

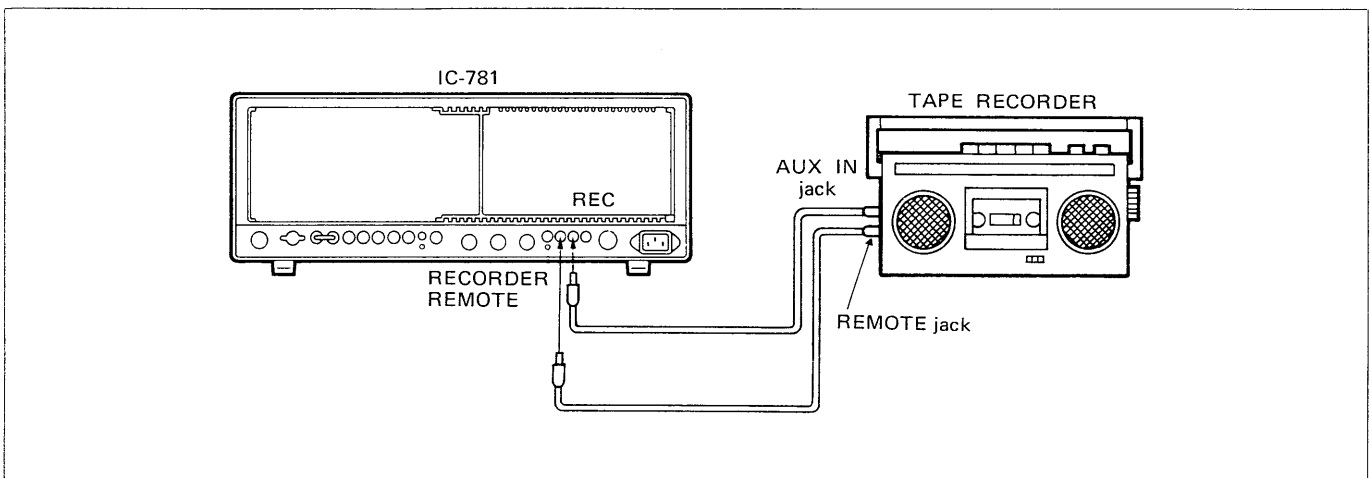

6. SYSTEM INTERCONNECTIONS

6-4 RTTY TERMINAL UNIT

Connect a radioteletype and demodulation unit as shown in the diagram below.

See p. 48 for mark/space frequencies information.

•When using a high-speed relay

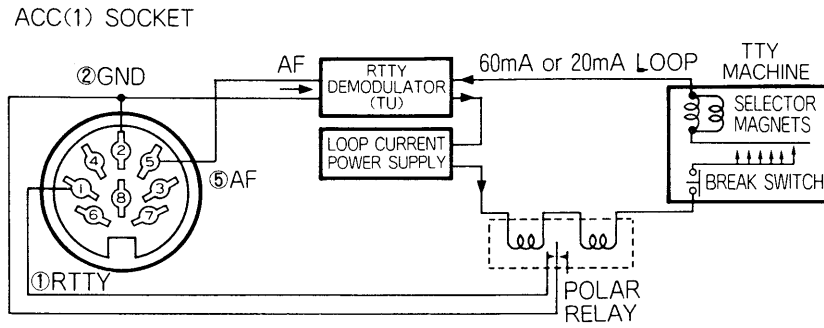

•When using a level converter

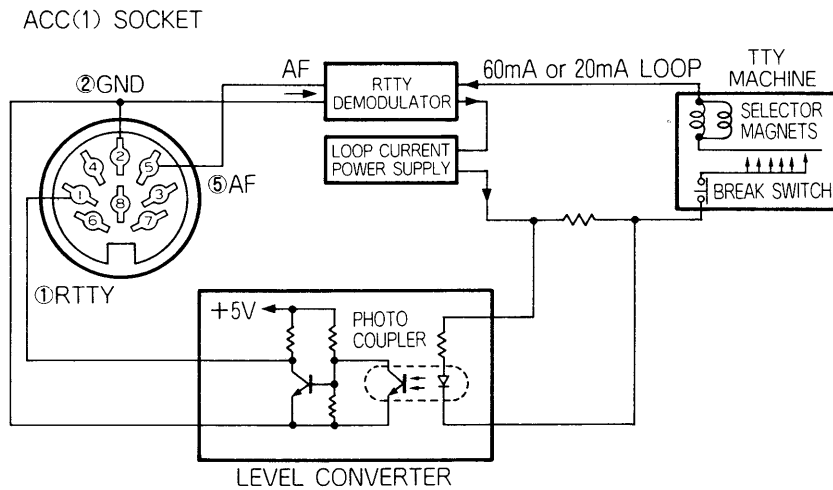

•When using an AFSK generator

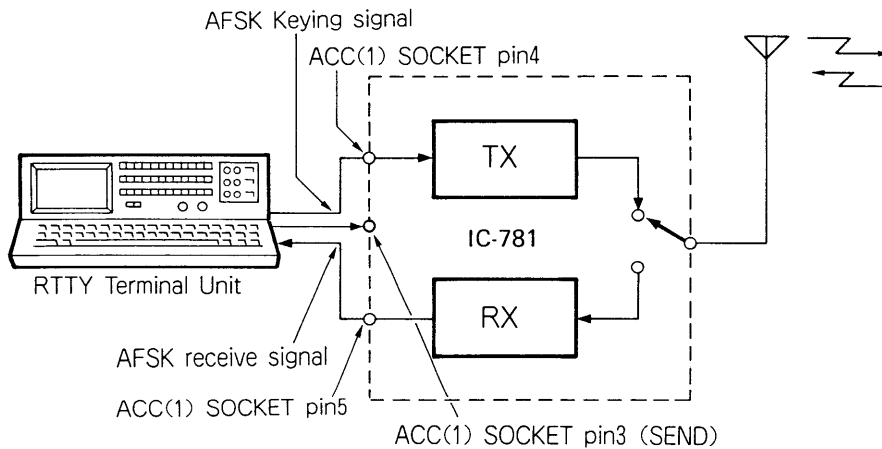

6-5 DATA COMMUNICATIONS

When operating AFSK, AMTOR and PACKET, connect external equipment to [ACC(1)] on the rear panel or [MICROPHONE] on the front panel.

The CRT DISPLAY (the TERMINAL MONITOR screen) can be used as the data communication display. The CRT displays an ASCII code output from an external demodulator.

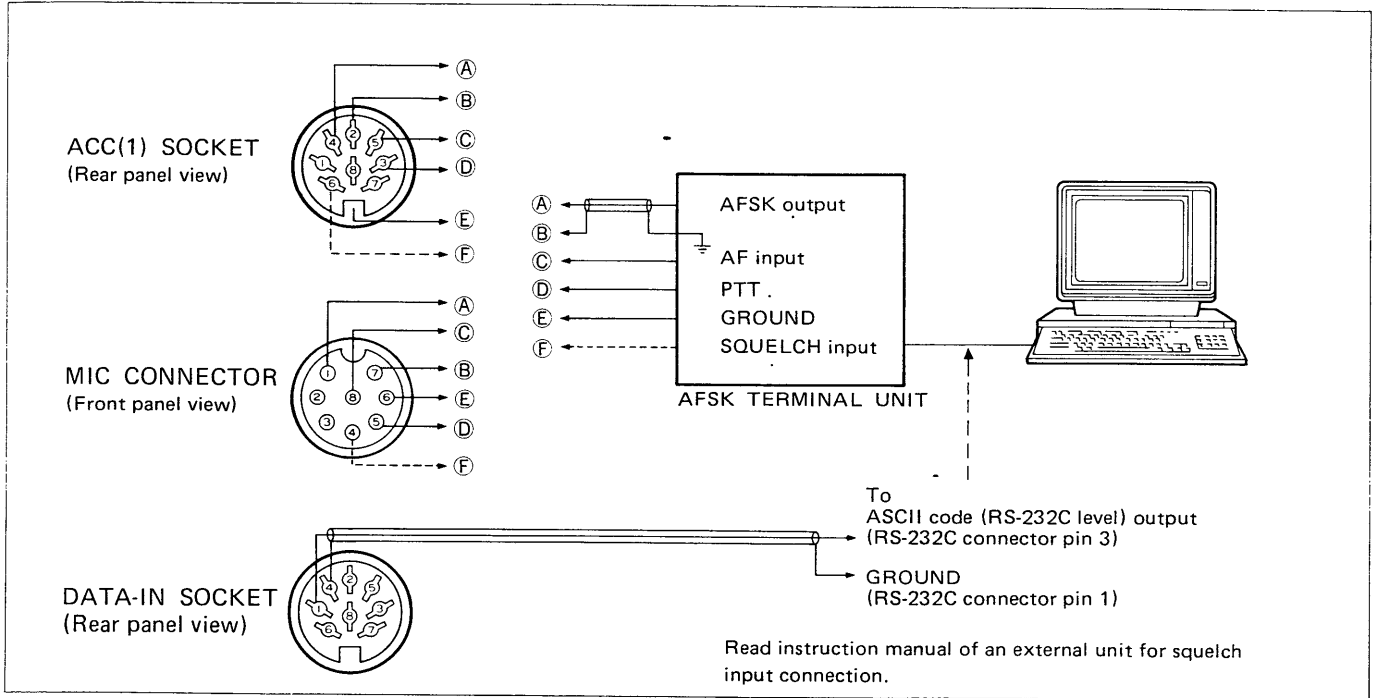

DATA FORMAT SCREEN

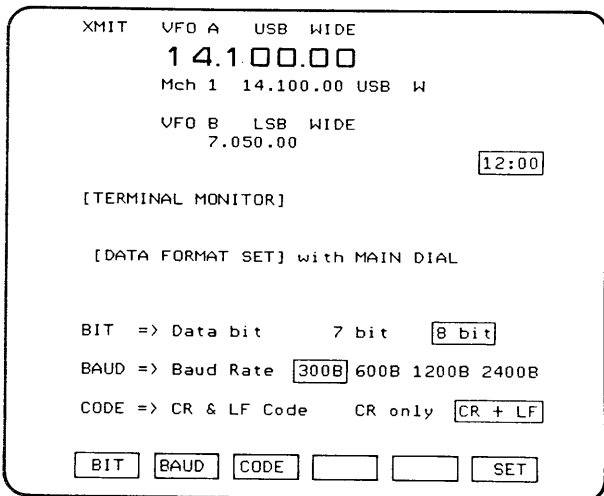

To set data length, baud rate and line feed command for the TERMINAL MONITOR screen, use the DATA FORMAT screen.

- 1) Push [F-6] "MENU" when the CRT displays MENU 1.
- 2) Push [F-1] "TERM".
- 3) Push [F-3] "FORMT".
- 4) To select data bit 7 or 8, push and hold [F-1], and rotate the MAIN DIAL.
- 5) To select the baud rate, push and hold [F-2] "BAUD", and rotate the MAIN DIAL.
- 6) To select the line feed command, push and hold [F-3] "CODE", and rotate the MAIN DIAL.
- 7) To return to the TERMINAL MONITOR screen, push [F-6] "SET".
- 8) When no ASCII code is received, the demonstration operates on the screen. As soon as ASCII code is received, the screen clears, and displays the incoming data.

6. SYSTEM INTERCONNECTIONS

6-6 MONITOR DISPLAY CONNECTION

A monitor display can be connected to IC-781 via the [DATA-IN] SOCKET. You can enjoy using IC-781 with a large-size display.

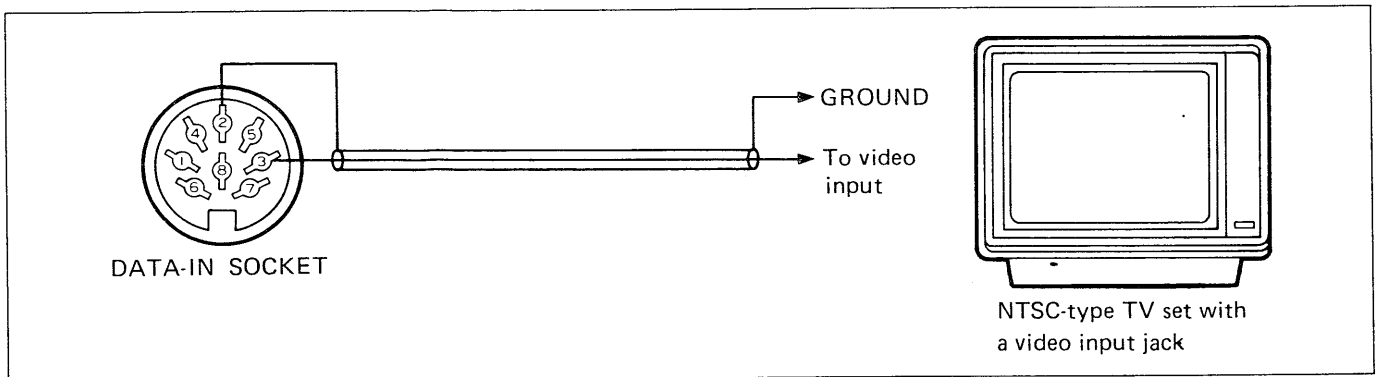

6-7 MIC CONNECTOR INFORMATION

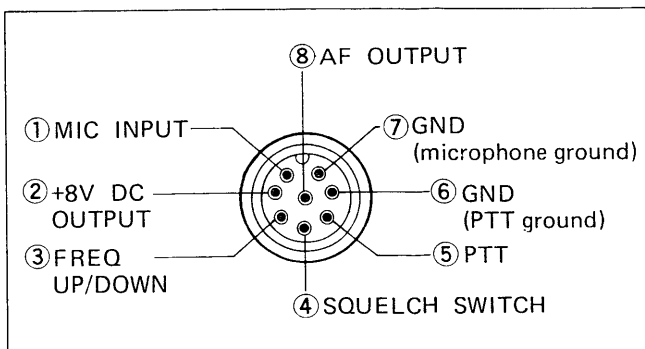

PIN NO.	FUNCTION	DESCRIPTION
2	+8V DC OUTPUT	Max. 10mA
3	FREQ UP	Ground
	FREQ DOWN	Ground through 470Ω
4	SQL OPEN	"LOW" level
	SQL CLOSED	"HIGH" level

CAUTION: DO NOT short pin 2 to ground as this can damage the internal 8V regulator.

6-8 ACCESSORY SOCKET INFORMATION

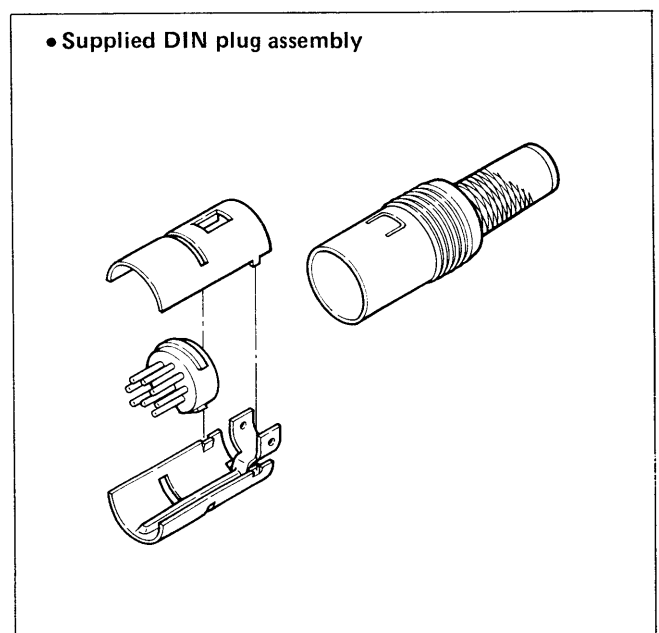
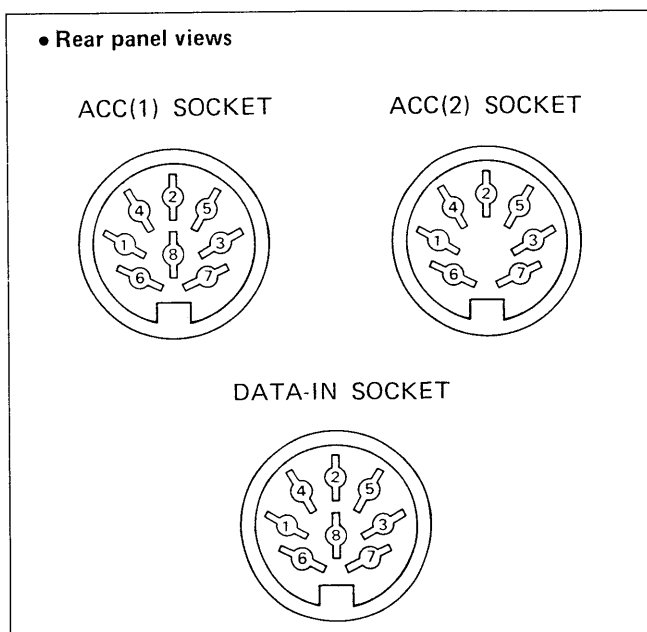

(1) ACC(1) SOCKET

PIN NO.	PIN NAME	DESCRIPTION	SPECIFICATIONS
1	RTTY	Controls RTTY keying.	"HIGH" level : More than 2.4V "LOW" level : Less than 0.6V Output current : Less than 2mA
2	GND	Connects to ground.	Connected in parallel with ACC(2) pin 2.
3	SEND	Input/Output pin. Goes to ground when transmitting. When grounded, transmits.	Grounded level : $-0.5 \sim +0.8V$ Input current : Less than 20mA Connected in parallel with ACC(2) pin 3.
4	MOD	Modulator input. Connects to a modulator.	Input imp. : $10k\Omega$ Input level : Approx. 100mV rms
5	AF	AF detector output. Fixed, regardless of [AF GAIN].	Output imp. : $4.7k\Omega$ Output level : $100 \sim 300mV$ rms
6	SQLS	Squelch output. Goes to ground when SQL opens.	SQL open : Less than $0.3V/5mA$ SQL closed : More than $6.0V/100\mu A$
7	13.8V	13.8V output when power is ON.	Output current : Max. 1A Connected in parallel with ACC(2) pin 7.
8	ALC	ALC voltage input.	Control voltage : $-4 \sim 0V$ Input imp. : More than $10k\Omega$ Connected in parallel with ACC(2) pin 5.

(2) ACC(2) SOCKET

PIN NO.	PIN NAME	DESCRIPTION	SPECIFICATIONS
1	8V	Regulated 8V output	Output voltage : $8V \pm 0.3V$ Output current : Less than 10mA
2	GND	Same as ACC(1) pin 2.	
3	SEND	Same as ACC(1) pin 3.	
4	BAND	Band voltage output (varies with amateur band). Connects to external unit (e.g., antenna tuner)	Output voltage : $0 \sim 8.0V$
5	ALC	Same as ACC(1) pin 8.	
6	TRV	Switching voltage input. Activates [X-VERTER] output/input.	Input imp. : More than $10k\Omega$ Input voltage : $2 \sim 13.8V$
7	13.8V	Same as ACC(1) pin 7.	

(3) DATA-IN SOCKET

PIN NO.	PIN NAME	DESCRIPTION	SPECIFICATIONS
1	DATA IN	ASCII code input for the CRT DISPLAY.	RS-232C level
2	VIDEO GND	Connected to ground.	
3	VIDEO	Video signal output.	Output level : 1Vp-p Output imp. : 75Ω
4	DATA GND	Connected to ground.	
5 ~ 8	NC	No connection	

6. SYSTEM INTERCONNECTIONS

6-9 REMOTE JACK INFORMATION

IC-781 may be connected through CT-17 CI-V LEVEL CONVERTER (optional) to a personal computer with an RS-232C serial port. ICOM COMMUNICATION INTERFACE-V (CI-V) controls frequency, mode, memory channel, etc.

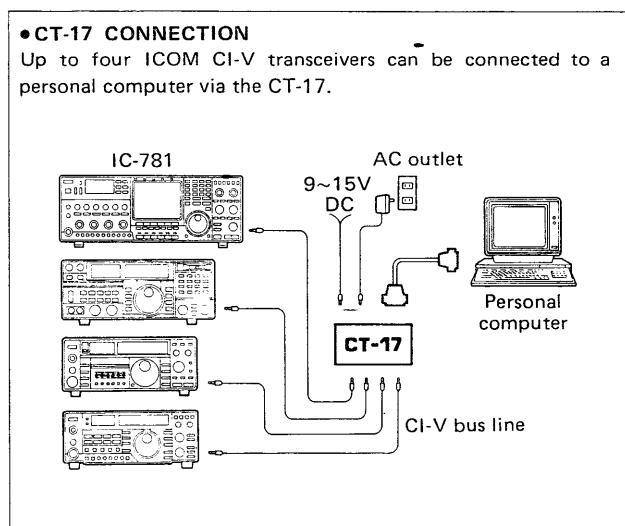

■ CI-V CONDITION SCREEN

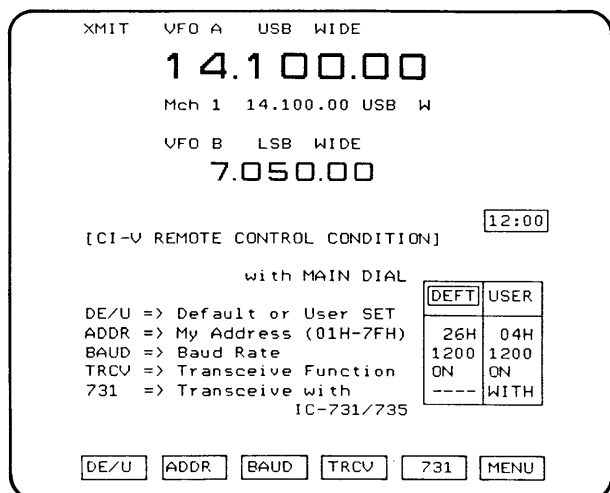

If desired, change the following CI-V data of the transceiver with the CI-V CONDITION screen:

- Address
- Baud rate
- Transceive ON/OFF
- Frequency data length

- 1) Push [F-6] "MENU" when the CRT displays MENU 1.
- 2) Push [F-2] "CI-V".
- 3) To select IC-781 standard CI-V data "DEFT" or variable "USER", push and hold [F-1] "DE/U", and rotate the MAIN DIAL.
- 4) To select the address number 01H ~ 7FH, push and hold [F-2] "ADDR", and rotate the MAIN DIAL.
- 5) To select baud rates of 300, 1200, 4800 and 9600bps, push and hold [F-3] "BAUD", and rotate the MAIN DIAL.
- 6) To select transceive function ON or OFF, push and hold [F-4] "TRCV", and rotate the MAIN DIAL.
- 7) To select 4 byte or 5 byte frequency data length, push and hold [F-5] "731", and rotate the MAIN DIAL.

- Standard ICOM CI-V baud rate is 1200bps.

- "WITH" : 4 byte. Used with IC-735.
- "----" : 5 byte. Used with other radios.

- 8) To return to MENU 1, push [F-6] "MENU".

BASIC OPERATION 7.

7-1 PRE-OPERATION SET UP

NOTE: Follow all instructions in section 5 before operating.

- 1) Turn [POWER] OFF, and plug the AC cord into a domestic AC power outlet.
- 2) Connect an antenna to the ANTENNA CONNECTOR.

WARNING: Transmitting without an antenna may damage the transceiver.

- 3) The transceiver must be grounded at the GROUND TERMINAL.

INITIAL SETTINGS

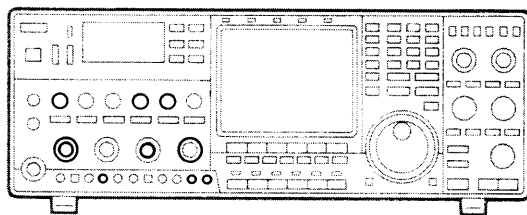
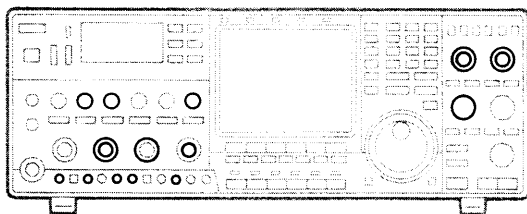
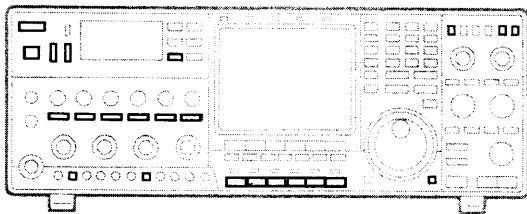

SWITCH	POSITION	SWITCH	POSITION
POWER	OUT	ATT 10dB	OUT
TIMER	OUT	ATT 20dB	OUT
TUNER	OUT	MARKER	OUT
FULL	OUT	MONITOR	OUT
BK-IN	OUT	TONE	OUT
COMP	OUT	FILTERS	WIDE
NB	OUT	APF	OFF
NB-WIDE	OUT	NOTCH	OFF
AGC OFF	OUT	LOCK	OUT
VOX	OUT	TRANSMIT/ RECEIVE	RECEIVE
SCAN RESUME	OUT	METER	IC
PREAMP	OUT		

CONTROL	POSITION	CONTROL	POSITION
DELAY	CENTER	VOX GAIN	CENTER
DRIVE	CENTER	SCAN SPEED	CENTER
AGC	CENTER	SCAN DELAY	CENTER
TREBLE	CENTER	MIC.TONE	CENTER
BASS	CENTER	TWIN PBT	CENTER
CW PITCH	CENTER	APF	CENTER
MIC GAIN	CENTER	NOTCH	CENTER
MONI GAIN	CENTER	BALANCE	CENTER

CONTROL	POSITION	CONTROL	POSITION
KEY SPEED	CCW	SQL	CCW
NB LEVEL	CCW	RF POWER	CW
BLK-WIDTH	CCW	ANTI-VOX	CCW
AF GAIN	CCW	DIMMER	CW
RF GAIN	CW	BRIGHT	2 o'clock

CW: Clockwise

CCW: Counterclockwise

7. BASIC OPERATION

7-2 KEYBOARD OPERATION

(1) AMATEUR BAND SELECTION

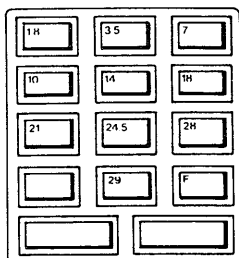

When unlighted.

Select a frequency, an amateur band or a memory channel with the KEYBOARD.

- 1) Push [F/CE] to turn OFF the digit key lighting.
- 2) Push the digit key with the desired amateur band frequency.
- 3) Refer to p. 29 for the band stacking register function.

(2) FREQUENCY SETTING

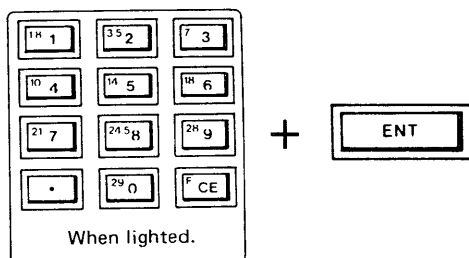

When lighted.

- 1) Push [F/CE] to turn ON the digit key lighting.
- 2) Enter the desired frequency.
 - Push [.] after entering MHz and before entering kHz.
 - The CRT displays the frequency as you enter it.
- 3) If required, push [F/CE] to retrieve the previous frequency and follow item 2) again.
- 4) Push [ENT] to enter the displayed frequency.
- 5) To enter 0 in succession, push [ENT] once.

[EXAMPLES] Check that the digit keys are lighted.

- **Set frequency at 7.000.00MHz.**
Push [7] and [ENT].
- **Set frequency at 7.100.00MHz.**
Push [7] [.] [1] and [ENT].
- **Set frequency at 234kHz (0.23400MHz).**
Push [0] [.] [2] [3] [4] and [ENT].
- **Set frequency at 28.123.45MHz.**
Push [2] [8] [.] [1] [2] [3] [4] [5] and [ENT].
- **Change frequency from 28.123.45MHz to 28.455.00 MHz.**
Push [.] [4] [5] [5] and [ENT].

(3) MEMORY CHANNEL SELECTION

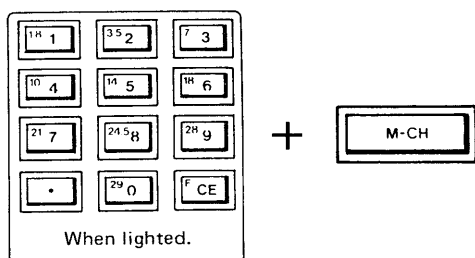

When lighted.

- 1) Push [F/CE] to turn ON the digit key lighting.
- 2) Push digit keys to enter a memory channel number.
- 3) Push [M-CH].
 - You may also select a memory channel with [▼ DOWN], [UP ▲] or the MEMORY LIST screen. See section 10.

7-3 VFO A AND B SELECTION

(1) VFO A AND B MODES

If the large memory channel number appears in the left hand corner of the CRT, push [VFO/MEMO] to select VFO mode.

VFO A:

- frequency is displayed in large characters in the "A" section.
- transmits and receives during normal operations.
- receives only, during SPLIT operation.

VFO B:

- frequency is displayed in small characters in the "B" section.
- frequency is displayed in large characters during dual watch operation.
- does not receive and transmit in normal operation.
- receives during dual watch operation.
- transmits during SPLIT operation.
- does not operate the scans.

(2) "A" AND "B" SECTIONS SELECTION

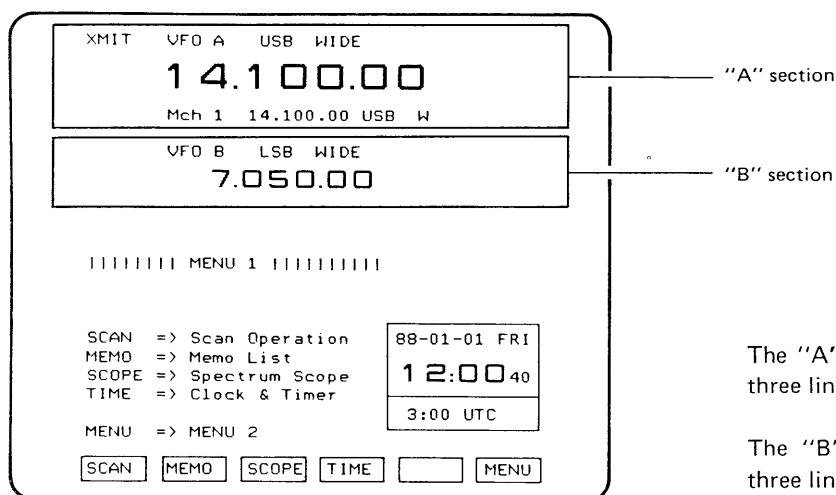

The "A" section of the CRT DISPLAY consists of the top three lines.

The "B" section of the CRT DISPLAY consists of the three lines below the "A" section.

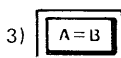
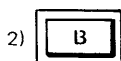
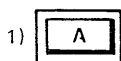

1) Push [A] to select VFO A. The "A" section is brightly lighted.

2) Push [B] to select VFO B. The "B" section is brightly lighted.

- Receiving or transmitting is still operated on VFO A.

3) Push [A=B] to equalize the contents of the two VFOs.

4) Push [CHANGE] to replace the contents of VFO A with the contents of VFO B.

7. BASIC OPERATION

7-4 SSB OPERATION

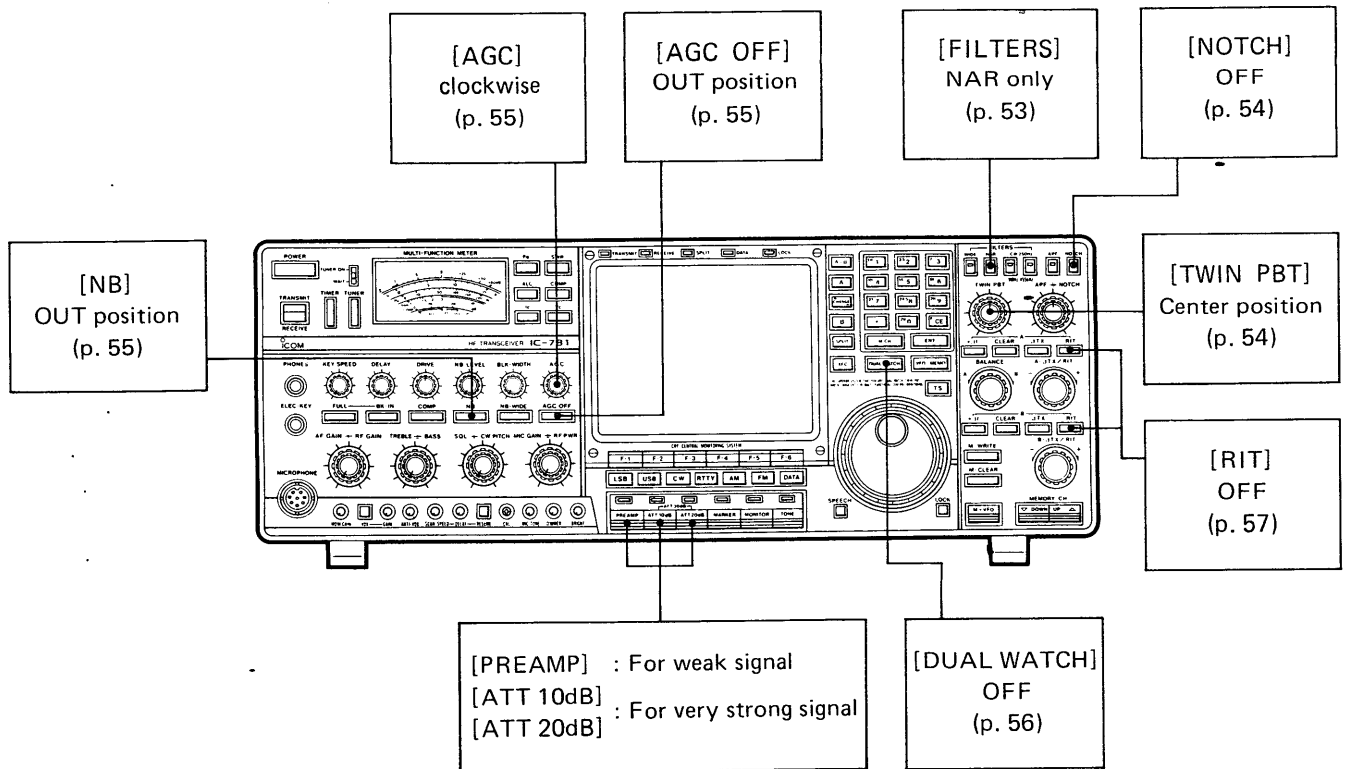

(1) SSB RECEIVING

- 1) Set controls and switches as described on p. 40.
- 2) Push [POWER] ON.
- 3) Push [USB] or [LSB].
 - Amateurs use LSB below 7.5MHz and USB above 10MHz.
- 4) Adjust [AF GAIN] as desired.
- 5) Adjust [SQL] to squelch a signal, if required.
- 6) Push [A], then set the operating frequency with the KEYBOARD and the MAIN DIAL. See p. 41.
- 7) If a received signal is strong enough, the needle of the S-meter moves and the squelch opens.

● INTERFERENCE

Use TWIN PBT and NOTCH to reduce interference. See p. 54.

● FILTER SWITCHES

FILTERS [WIDE] does not function even if the switch lights up.

The FL-103 SSB WIDE FILTER (optional) can be installed in place of FL-102 AM FILTER. See p. 53 for details.

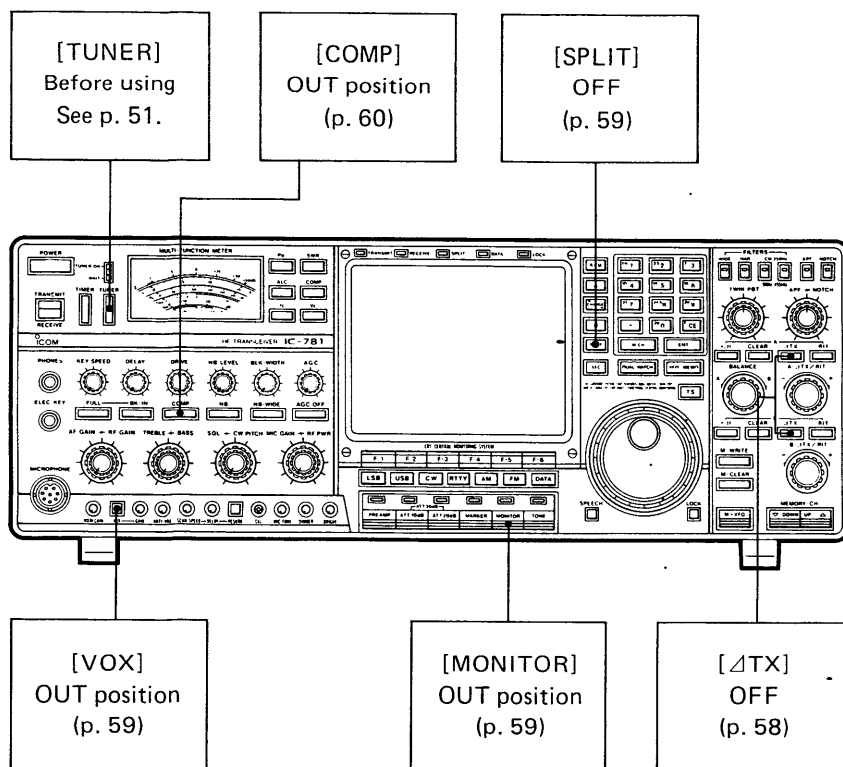

(2) SSB TRANSMITTING

NOTE: Listen before you transmit, and prevent interference.

- 1) Push [Po] to view relative output power on the meter.
- 2) Push [PTT] on your microphone or select [TRANSMIT/RECEIVE] to TRANSMIT.
 - The transceiver transmits on the frequency displayed in the "A" section (VFO A).
 - The [TRANSMIT] INDICATOR above the CRT lights up.
- 3) Speak naturally into the microphone. When you transmit a signal, the meter needle moves.
- 4) Adjust [RF PWR] to the desired output power.
- 5) Push [ALC], and adjust [MIC GAIN]. The meter needle should be held within the ALC zone.

• VOX OPERATION

Push [VOX] IN. Your voice keys the transmitter.

• MONITOR OPERATION

To hear your signal, push [MONITOR]. Useful when adjusting [MIC TONE].

• SPEECH COMPRESSOR

For greater "talk power", push [COMP].

7. BASIC OPERATION

7-5 CW OPERATION

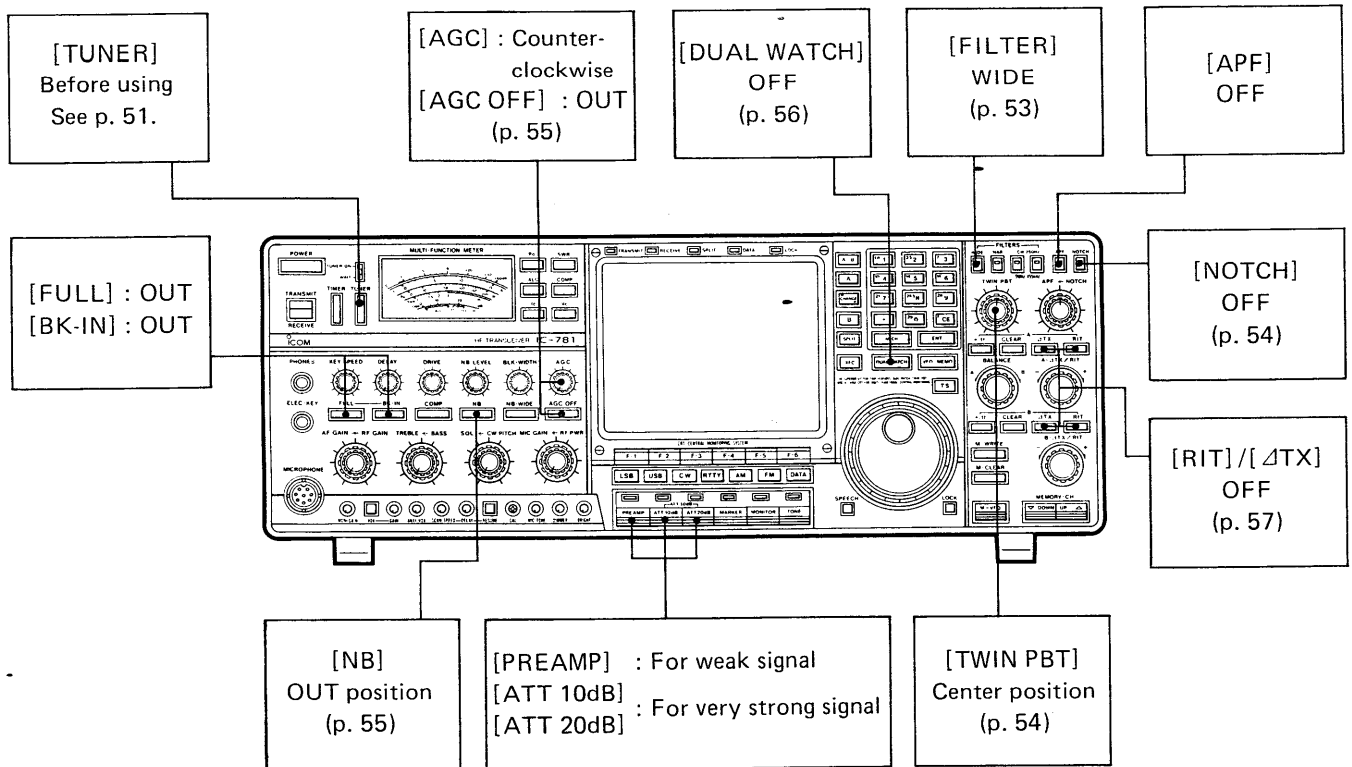

(1) CW RECEIVING

- 1) Set controls and switches as described on p. 40.
- 2) Push [POWER] ON.
- 3) Push [CW].
- 4) Adjust [AF GAIN] as desired.
- 5) Adjust [SQL] to squelch a signal, if required.
- 6) Push [A], then set the operating frequency with the KEYBOARD and the MAIN DIAL. See p. 41.
- 7) If a received signal is strong enough, the needle of the S-meter moves and the squelch opens.

Change the received audio tone with [CW PITCH].

To reduce unwanted audio, push [APF] switch and adjust [APF] control as desired.

TWIN PBT and NOTCH reduce interference. See p. 54.

9MHz and 455kHz IF filters may be separately selected with [CW 250Hz] switches. See p. 53.

●CW PITCH

●AUDIO PEAK FILTER

●INTERFERENCE

●250Hz FILTER

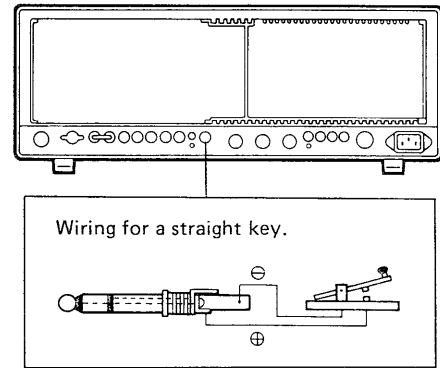
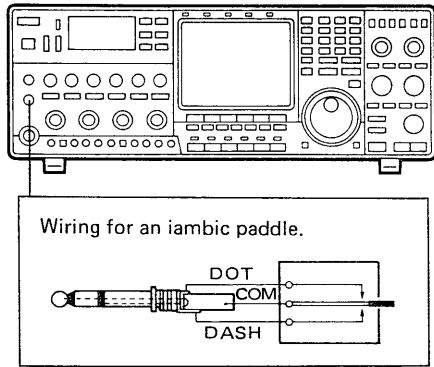

(2) CW TRANSMITTING

•[BK-IN] SWITCH OFF

- 1) Push [Po] to view the relative output power on the meter.
- 2) Select [TRANSMIT/RECEIVE] to TRANSMIT.
- 3) Plug an iambic paddle into [ELEC-KEY] on the front panel; or a straight key or keyer into [KEY] on the rear panel.

- Adjust [KEY SPEED] when using an iambic paddle.

- 4) Operate the CW key, and then adjust [MONI GAIN] to the desired sidetone level.
- 5) Adjust [RF PWR] to the desired output power.

- 6) Push [ALC], and adjust [DRIVE] for a meter reading within the ALC zone.

•[BK-IN] SWITCH ON

- 1) Push [Po] to view the relative output power on the meter.

- 2) Select semi break-in or full break-in:

- Semi break-in: [BK-IN] , [FULL] .

- Full break-in : [BK-IN] , [FULL] .

- 3) For semi break-in operation, adjust [DELAY] to set the break-in delay time.

- 4) Plug an iambic paddle into [ELEC-KEY] on the front panel; or a straight key or keyer into [KEY] on the rear panel.

- Adjust [KEY SPEED] when using an iambic paddle.

- 5) Operate the CW key, and then adjust [MONI GAIN] to the desired sidetone level.

- 6) Adjust [RF PWR] to the desired output power.

- 7) Push [ALC], and adjust [DRIVE] for a meter reading within the ALC zone.

7. BASIC OPERATION

7-6 RTTY OPERATION

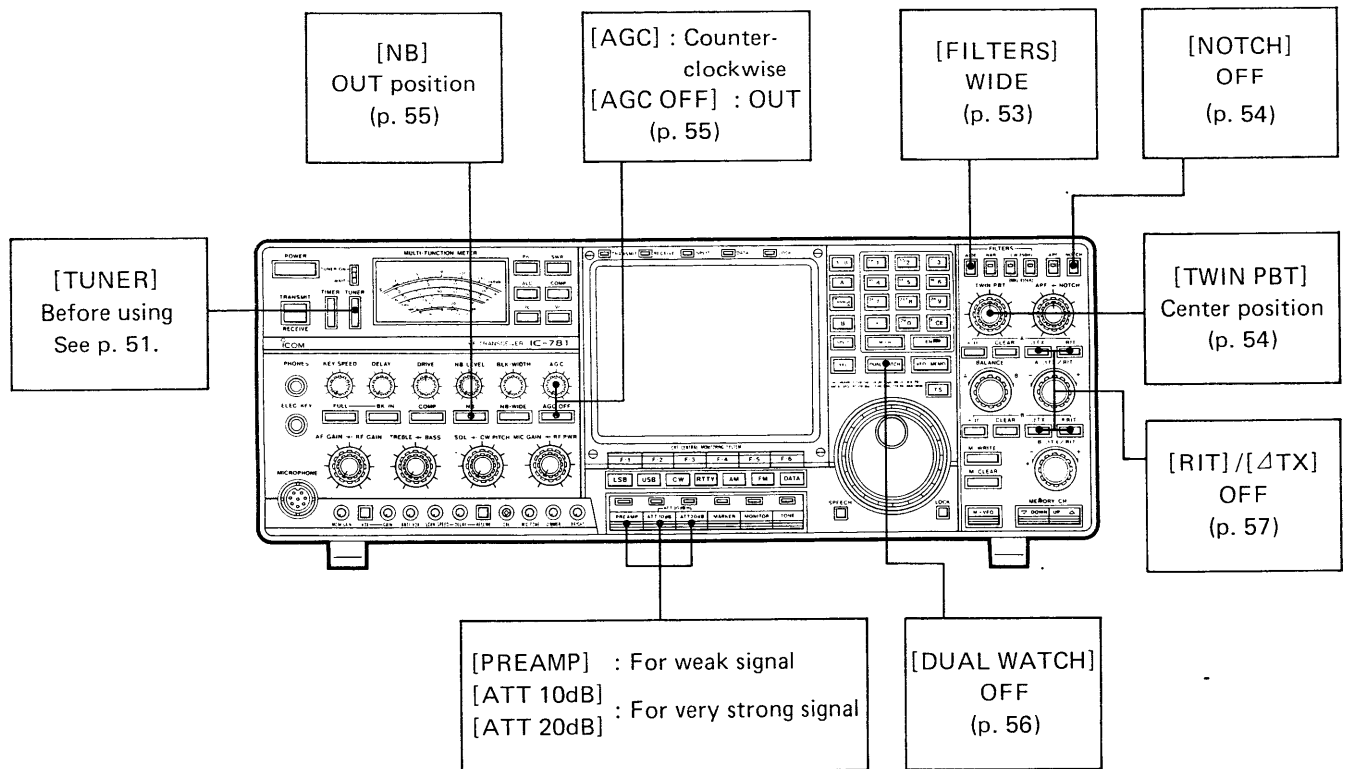

(1) RTTY RECEIVING

- 1) Set controls and switches as described on p. 40.
- 2) Push [POWER] ON.
- 3) Push [RTTY].
- 4) Adjust [AF GAIN] as desired.
- 5) Adjust [SQL] to squelch a signal, if required.
- 6) Push [A], then set the operating frequency with the KEYBOARD and the MAIN DIAL. See p. 41.
- 7) If a received signal is strong enough, the needle of the S-meter moves and the squelch opens.

● TERMINAL MONITOR SCREEN

The CRT displays ASCII code (RS-232C level) input from the [DATA IN] socket on the rear panel.

For RTTY receiving, use an external demodulator (ASCII code output). See p. 27 for the TERMINAL MONITOR screen and p. 36 for connection.

● 250Hz FILTER

9MHz and 455kHz IF filters may be separately selected with the [CW 250Hz] switches. See p. 53.

(2) RTTY TRANSMITTING

RTTY operation requires a teletypewriter, or a keyboard and a demodulator (i.e., terminal unit). See p. 35 for connection.

- 1) Push [Po] to view relative output power on the meter.
- 2) Select [TRANSMIT/RECEIVE] to TRANSMIT.
- 3) Adjust [RF PWR] to the desired output power.
- 4) Push [ALC], and then adjust [DRIVE] control for a meter reading within the ALC zone.
- 5) Type on your RTTY keyboard.

③ Setting RTTY mark/space

The following mark/space frequencies are set at the factory.

- Mark frequency : 2125Hz
- Space frequency : 2295Hz
- Shift/width : 170Hz

- Mark : key open
- Space : key closed

Mark/space frequencies can be selected as shown in the table below.

	Shift width	Mark frequency	Space frequency
HIGH TONE	170Hz	2125Hz	2295Hz
	425Hz	2125Hz	2550Hz
	850Hz	2125Hz	2975Hz
LOW TONE	170Hz	1275Hz	1445Hz

To change mark/space frequencies, follow the table below.

	S2	J17
170Hz shift HIGH TONE		
425Hz shift HIGH TONE		
850Hz shift HIGH TONE		
170Hz shift LOW TONE		

S1 RTTY MARK polarity switch

- Mark : Key open
- Space : Key closed
- Mark : Key closed
- Space : Key open

(Transceiver underside view)

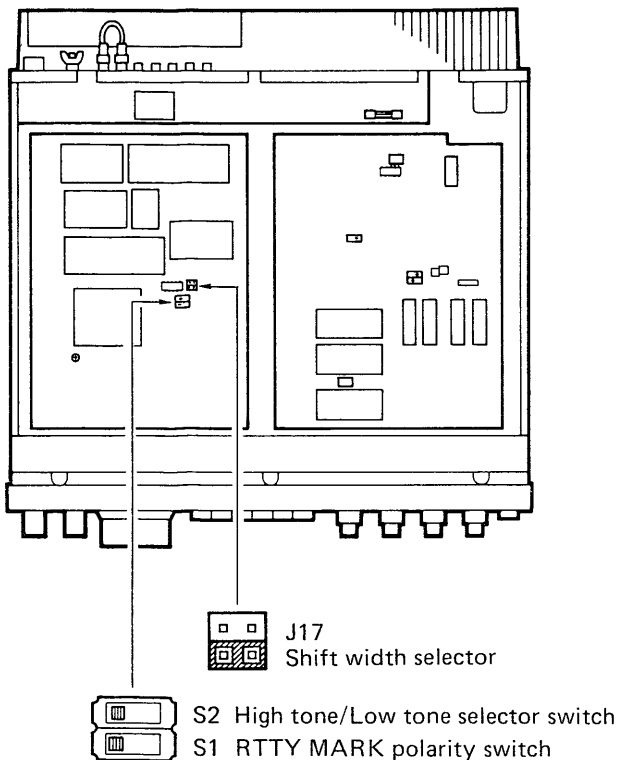

7. BASIC OPERATION

7-7 FM OPERATION

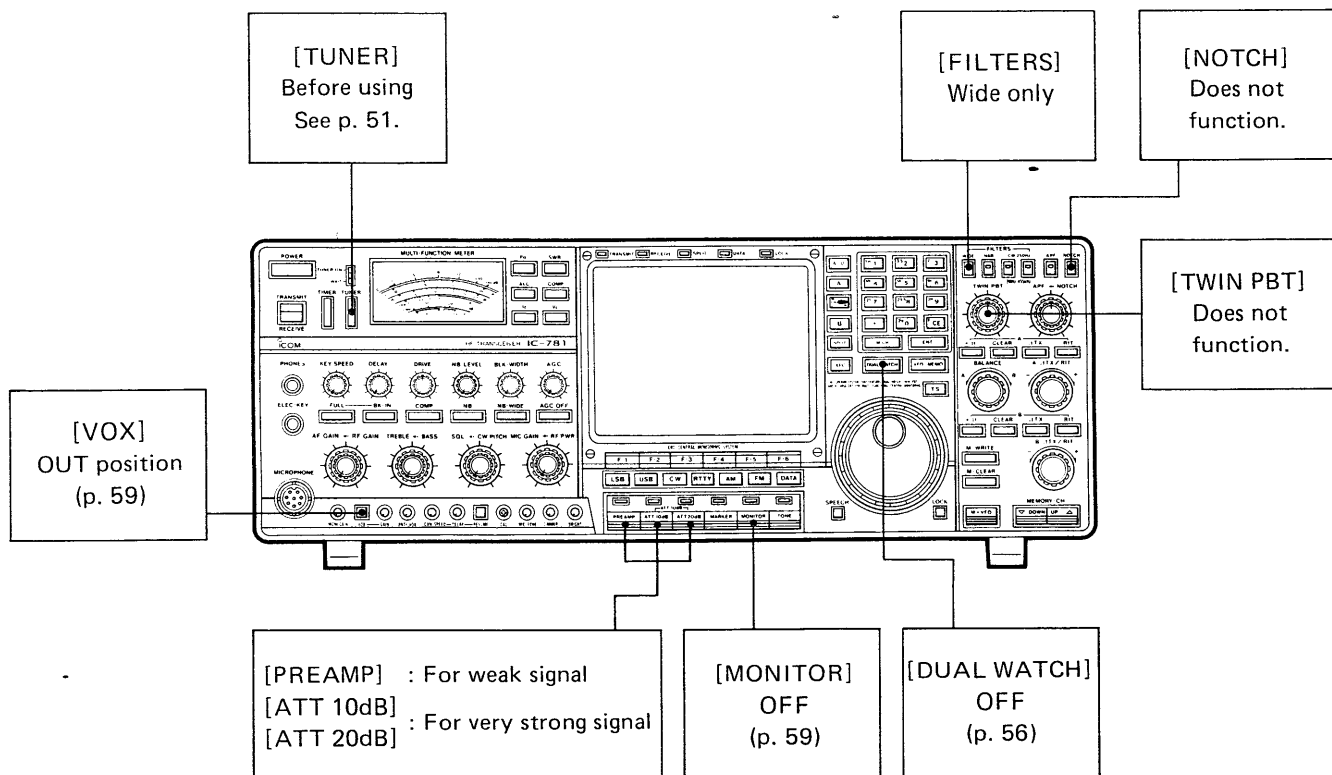

(1) FM RECEIVING

- 1) Set controls and switches as described on p. 40.
- 2) Push [POWER] ON.
- 3) Push [FM].
- 4) Adjust [AF GAIN] as desired.
- 5) Adjust [SQL] to squelch a signal.
- 6) Push [A], then set the operating frequency with the KEYBOARD and the MAIN DIAL. See p. 41.
- 7) If a received signal is strong enough, the needle of the S-meter moves and the squelch opens.

(2) FM TRANSMITTING

■ ACCESSING FM REPEATERS

- 1) Input the receive frequency in VFO A and the transmit frequency in VFO B.
- 2) Push [SPLIT].
- 3) Push [TONE], if a repeater requires a subaudible tone.
- 4) Push [PTT]. IC-781 transmits on the VFO B frequency.
- 5) Push [XFC] to monitor the transmit frequency.

- 1) Push [Po] to view relative output power on the meter.
- 2) Set [MIC GAIN] at 12 o'clock.
- 3) Push [PTT] or select [TRANSMIT/RECEIVE] to TRANSMIT.
- 4) Adjust [RF PWR] to the desired output power.
- 5) Push [ALC]. The meter shows relative modulation.

7-8 AM OPERATION

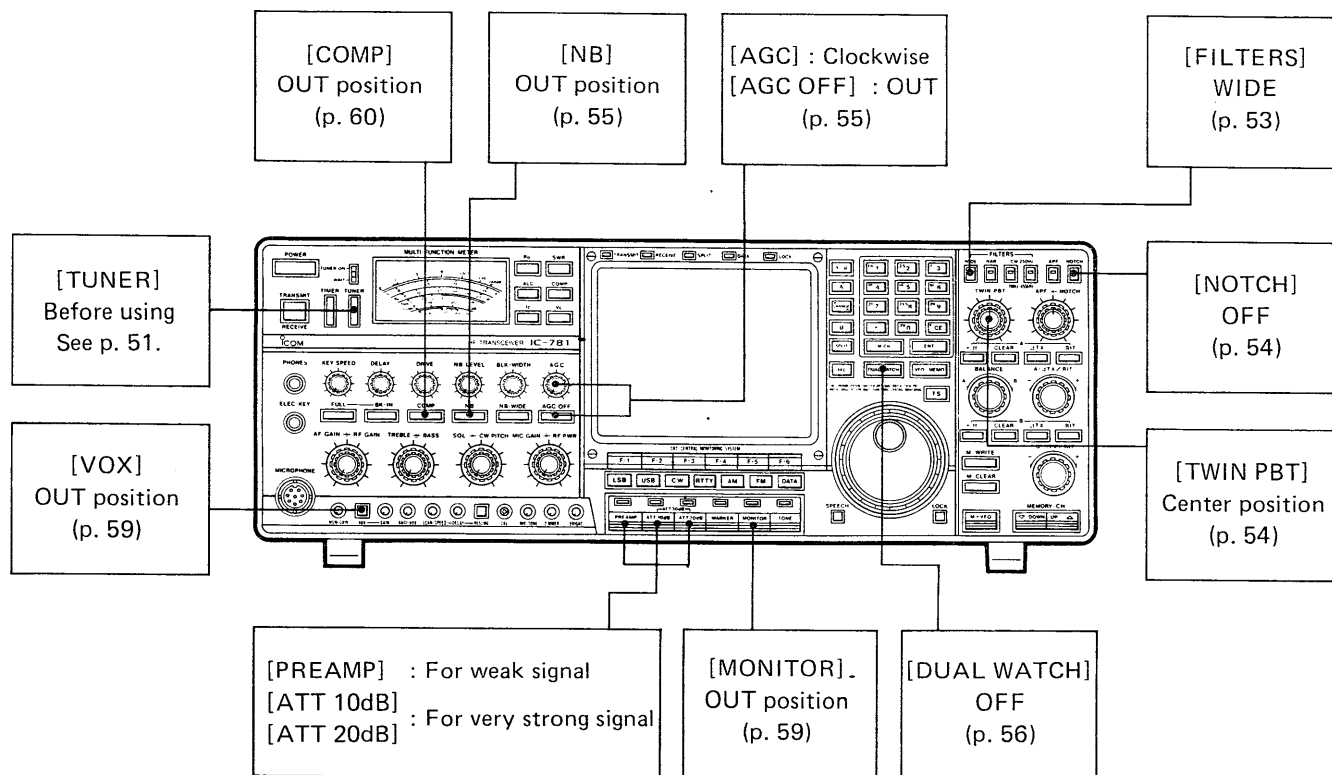

(1) AM RECEIVING

- 1) Set controls and switches as described on p. 40.
- 2) Push [POWER] ON.
- 3) Push [AM].
- 4) Adjust [AF GAIN] as desired.
- 5) Adjust [SQL] to squelch a signal, if required.
- 6) Push [A], then set the frequency with the KEYBOARD and MAIN DIAL. See p. 41.

7) If a signal is strong enough, the S-meter needle moves and the squelch opens.

(2) AM TRANSMITTING

- 1) Push [Po] to view relative output power on the meter.
- 2) Push [PTT] or select [TRANSMIT/RECEIVE] to TRANSMIT.
- 3) Adjust [RF PWR] to the desired output power.
- 4) Push [ALC] and adjust [MIC GAIN] for voice peak readings within the ALC zone.

8. ANTENNA TUNER OPERATION

This tuner matches IC-781 to an antenna when the VSWR is less than 3:1 (impedance $16.7\Omega \sim 150\Omega$).

Follow this section if you are using IC-781 for the first time, or if you have changed the antenna.

NOTE: The antenna tuner functions for the "A" section displayed frequency in simplex operation and for the "B" section in split operation.

8-1 PRESETTING

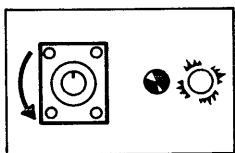
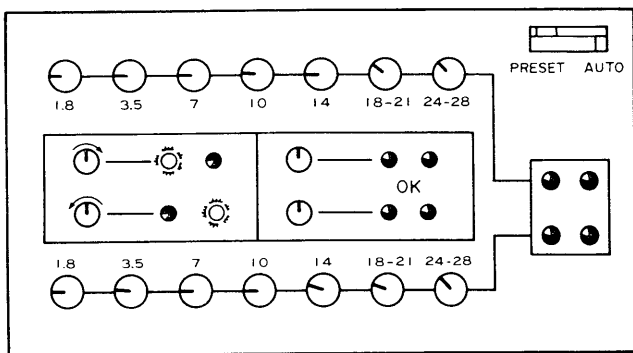

Turn counterclockwise when the right indicator is lighted.

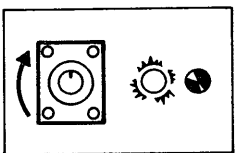

Turn clockwise when the left indicator is lighted.

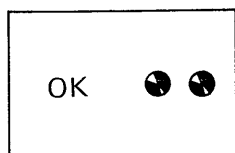

Make both adjustments and four indicators go out on each amateur band.

- 1) Connect an antenna to the ANTENNA CONNECTOR. Make sure that the SWR is low. The antenna tuner cannot make a match when the SWR exceeds 3:1.
- 2) Push [POWER] ON.
- 3) Push [RTTY].
- 4) Tune to the frequency on which you plan to operate.
- 5) Push [SWR].
- 6) Open the top hatch.
- 7) Set [AUTO/PRESET] located under the hatch cover to [AUTO]. See the diagram at left.
- 8) Push [TUNER] ON.
- 9) Adjust [RF PWR] on the front panel to 12 o'clock.
- 10) Transmit for several seconds. Confirm that the auto-tuning lowers the SWR on the meter, then stop transmitting.
- 11) Adjust PRESET CONTROLS until all four red indicators go out. This completes presetting for this band.
 - See the diagram at left. There are two controls for each amateur band (in total there are 14 controls).
- 12) Preset each band as in the above steps.

8-2 UNSUCCESSFUL TUNING

(1) SWR EXCEEDS 3:1

If auto-tuning does not make a match, see below.

1) Push [TUNER] OFF.

2) Adjust your antenna to lower the SWR below 3:1.

CAUTION: DO NOT transmit using an antenna with the SWR over 3:1.

(2) OUTPUT POWER GOES DOWN

When the antenna tuner is preset to the wrong SWR dip, or the antenna SWR is around 3:1, the APC circuit reduces the output power. To operate the antenna tuner, preset it in the following way:

1) Set [AUTO/PRESET] located under the top hatch to [PRESET].

2) Set PRESET CONTROLS as shown in the diagram below.

3) Adjust [RF POWER] to 12 o'clock.

4) Push [SWR].

5) Push [TUNER] ON.

6) Transmit a steady carrier in RTTY mode, and adjust the two [PRESET] controls for your frequency to a low SWR reading, ideally 1:1.

7) Push [Po], rotate [RF POWER] to maximum clockwise, and then confirm that the full 150W power is obtained.

8) Stop transmitting. The tuning capacitors are at their optimum positions for the frequency.

9) Reset [AUTO/PRESET] to [AUTO], then proceed to 8 - 1 PRESETTING.

• PRESET CONTROLS original position

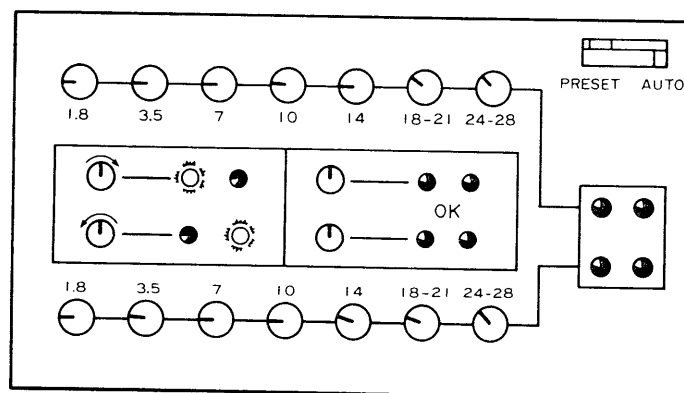

9. FUNCTIONS OPERATION

9-1 FILTER SWITCHES OPERATION

The FILTER SWITCHES select the IF bandwidth as shown in the table below.

In CW and RTTY modes, 2nd IF (9MHz) and 3rd IF (455kHz) filter combinations can be selected with the [CW 250Hz] switches.

Set filter selection with the FILTER SELECTION screen. See p. 29.

• Filter combinations

MODE	FILTER SWITCH	STANDARD BANDWIDTH	9MHz FILTER	455kHz FILTER
SSB	WIDE	2.4kHz	FL-80	FL-96
	NARROW			
CW RTTY	See table below			
FM	WIDE only	15kHz	Through	CFW-455E
	NARROW	2.6kHz	FL-102	FL-96

Standard bandwidth is shown at -6dB.

• CW and RTTY filter combinations

FILTER SWITCH	250Hz FILTER SWITCHES		STANDARD WIDTH	9MHz FILTER	455kHz FILTER
	9MHz	455kHz			
WIDE	---	---	2.4kHz	FL-80	FL-96
NARROW	OFF	OFF	500Hz	FL-100	FL-52A
	ON	OFF	250Hz	FL-101	FL-52A
	OFF	ON	250Hz	FL-100	FL-53A
	ON	ON	250Hz	FL-101	FL-53A

Standard bandwidth is shown at -6dB.

• 9MHz FILTER SELECTION

(Transceiver underside view)

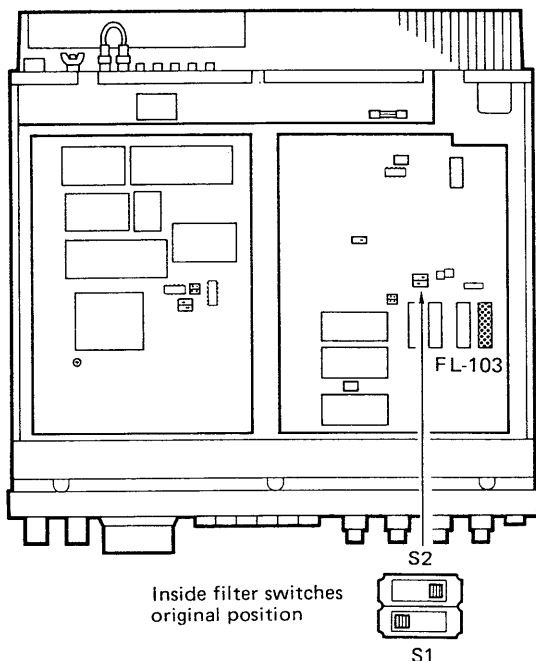

The installed FL-102 AM FILTER can be changed to a FL-103 SSB WIDE FILTER.

When using the FL-103, set the inside filter switches as follows:

S2 AM FILTER SWITCH

OFF ON Set to the OFF position.

S1 SSB FILTER SWITCH

OFF ON Set to the ON position.

NOTE: When the FL-102 is replaced with the FL-103, TWIN PBT does not function on AM.

9-2 TWIN PBT OPERATION

Twin Passband Tuning electronically adjusts 9MHz IF and 455kHz IF filters for through frequencies.

Moving both TWIN PBT controls to the same position shifts the IF.

The [TWIN PBT] controls are normally set at 12 o'clock for the widest bandwidth.

1) Rotate the [TWIN PBT] controls clockwise or counter-clockwise as necessary to eliminate interference.

2) The inner TWIN PBT control adjusts the 455kHz filter. The outer TWIN PBT control adjusts the 9MHz filter.

NOTE: TWIN PBT does not function on FM.

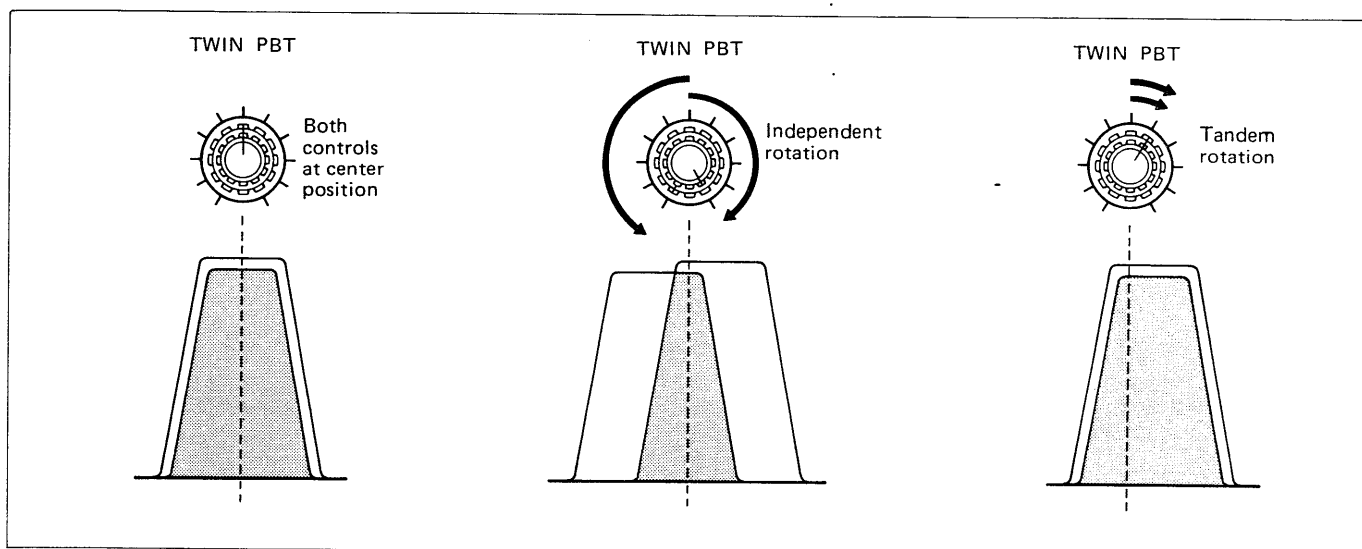

9-3 NOTCH FILTER OPERATION

The NOTCH filter attenuates a particular frequency in the IF passband, such as that of an interfering signal.

1) Push [NOTCH].

2) Adjust the [NOTCH] control to minimize interference.

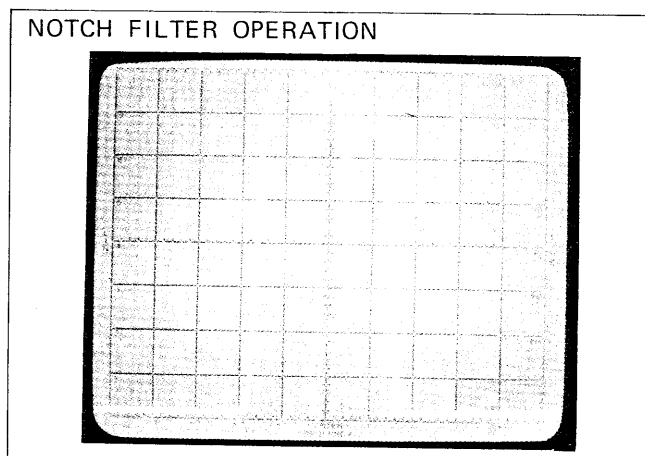
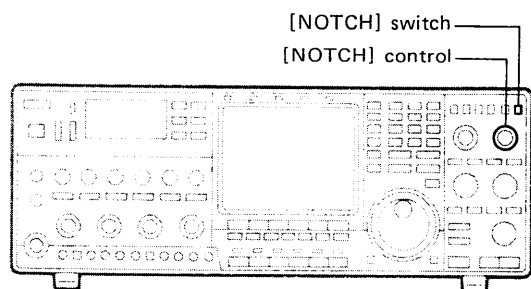

9. FUNCTIONS OPERATION

9-4 AGC OPERATION

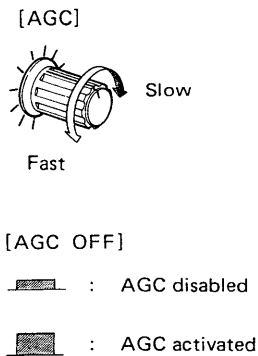

AGC holds audio output constant during fluctuation in signal strength.

1) Adjust AGC as required.

- For SSB or AM : clockwise
- For CW or SSB with quick fading : counterclockwise

2) When receiving weak signals, push [AGC OFF] to deactivate the AGC circuit.

NOTE: The S-meter needle does not move when [AGC OFF] is pushed IN.

9-5 NOISE BLANKER OPERATION

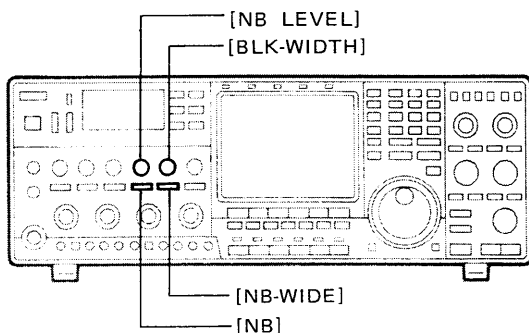

The Noise Blanker clips pulse-type noise such as that from car ignitions and wide pulse-type noise such as the "woodpecker".

1) Push [NB].

2) Adjust [NB LEVEL] as required depending on the noise level.

NOTE: Should the noise blanker distort the audio of a received signal, rotate [NB LEVEL] counterclockwise as necessary.

3) To suppress the "woodpecker" and other wide pulse-type noise, push [NB-WIDE].

- Turn [BLK-WIDTH] counterclockwise.

- [NB-WIDE] automatically adjust the blank-width corresponding to the width of the pulse-type noise.

4) To suppress echo noise from the "woodpecker" adjust [BLK-WIDTH] as desired.

NOTE: When [BLK-WIDTH] is turned to maximum clockwise, it also blanks the audio signal.

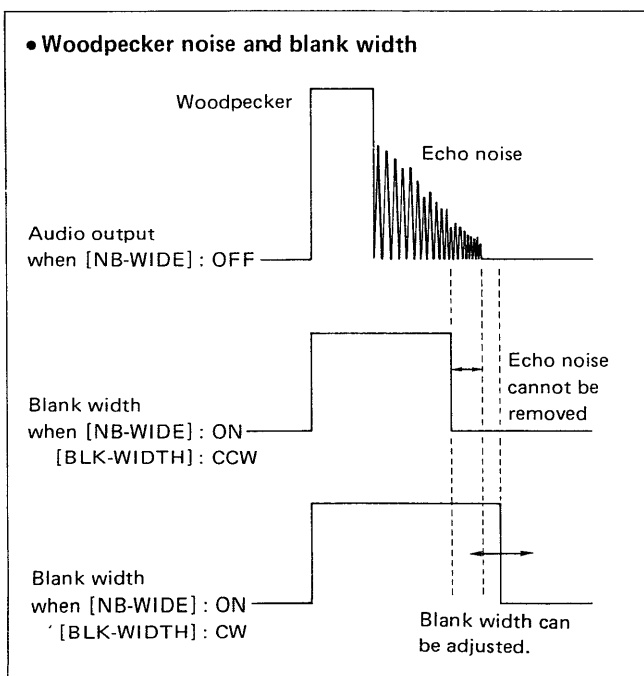

9-6 DUAL WATCH OPERATION

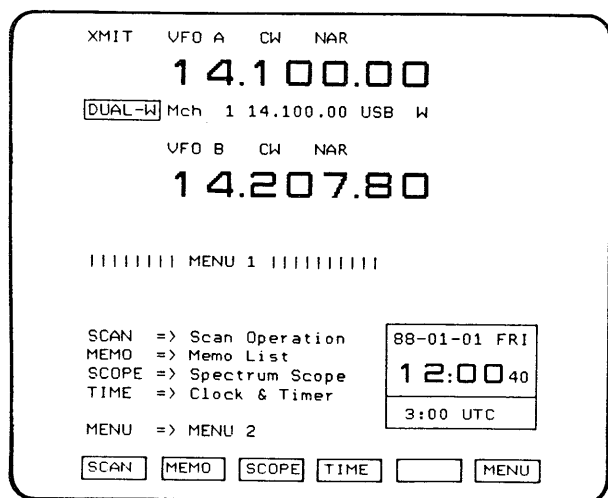
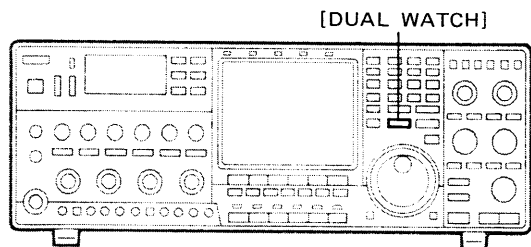

●SCAN OPERATION WITH DUAL WATCH

Dual Watch monitors two frequencies simultaneously.

During Dual Watch, both frequencies should be on the same band because the bandpass filter is selected for the operating frequency displayed in the "A" section of the CRT DISPLAY.

NOTE: In Dual Watch, operating modes and filters of the "A" and "B" are automatically equalized.

- 1) Set an operating frequency in the "A" section of the CRT DISPLAY.
- 2) Set an operating frequency in the "B" section of the CRT DISPLAY.
- 3) Push [DUAL WATCH].
 - "DUAL-W" appears on the CRT DISPLAY, and the "B" frequency is displayed in large characters.
- 4) Adjust [BALANCE] as desired to choose a suitable signal strength balance between the "A" and "B" operating frequencies.
- 5) To transmit on the "B" frequency, push [CHANGE] or [SPLIT].
- 6) RIT circuits function independently on "A" and "B"

Scanning operates only on the "A" section. If you wish to operate during Dual Watch, scan on the "A" section frequency, and use the "B" section frequency for your QSO.

- 1) Push [VFO/MEMO] to select VFO mode.
- 2) Enter the programmed scan edges on the same amateur band in the "B" section. See p. 69 for programming.
- 3) Set an operating frequency in the "B" section of the CRT DISPLAY.
- 4) Push [DUAL WATCH].
- 5) Push [SPLIT].
- 6) Push [F-1] "SCAN" when the CRT displays MENU 1.
- 7) Push [F-1] "PROG" to start the programmed scan in the "A" section.

• Transmitting stops a scan.

NOTE: Make sure that the operating mode and RF bandpass filter stage of the "B" section is the same as that of the "A" section.

9. FUNCTIONS OPERATION

9-7 RIT/ Δ TX OPERATION

(1) RIT OPERATION

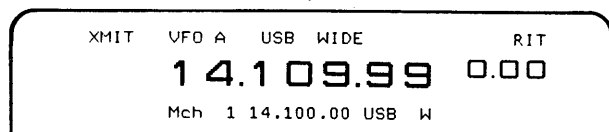
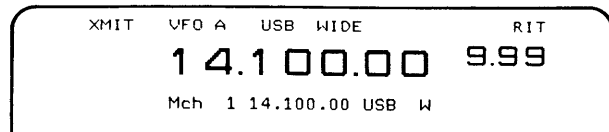
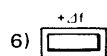
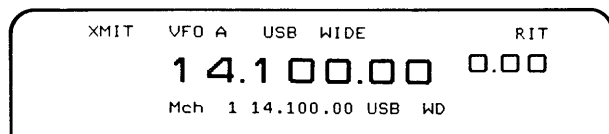
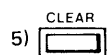
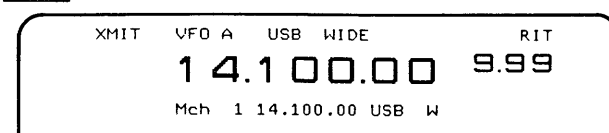
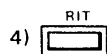
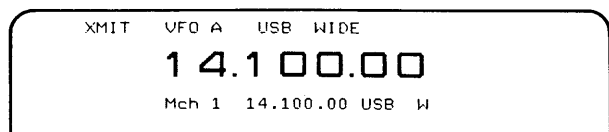
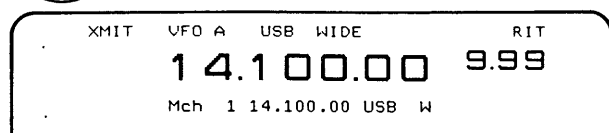
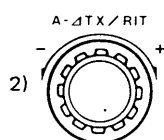
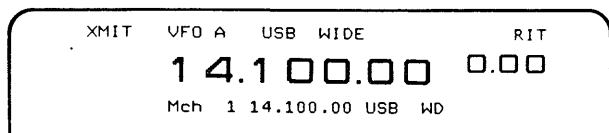
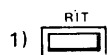

RIT shifts the receive frequency by up to ± 9.99 kHz in 10Hz steps without shifting the transmit frequency.

1) Push A-[RIT].

- "RIT" and the amount of shift frequency appears in the "A" section (upper displayed frequency) of the CRT DISPLAY.

2) To shift the receive frequency in the "A" section, rotate [A- Δ TX/RIT] control.

3) To turn OFF the "A" section RIT function, push the A-[RIT] switch again.

- "RIT" and amount of shift frequency disappear from the CRT DISPLAY.

- When you turn RIT OFF, the final shift frequency displayed on the CRT DISPLAY is stored.

4) Push A-[RIT].

- "RIT" and the stored shift frequency appear on the CRT DISPLAY.

5) Push A-[CLEAR] to clear the RIT shift frequency from the "A" section.

- The CRT displays "0.00" and the receive and transmit frequencies become equal.

6) To add the RIT shift frequency to the "A" section operating frequency, push A-[Δ f] when the shift frequency is displayed.

7) The B-[RIT], B-[CLEAR] and B-[Δ f] switches function for the "B" section of the CRT DISPLAY as above.

- The "B" section RIT function can be programmed in normal operation, but only functions after pushing [CHANGE] or during dual watch.

(2) ΔTX OPERATION

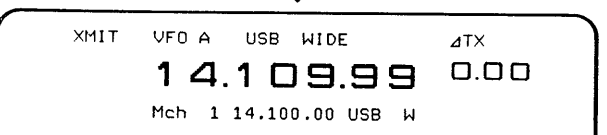
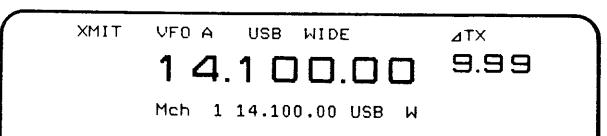
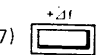
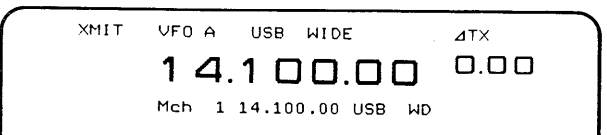
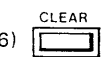
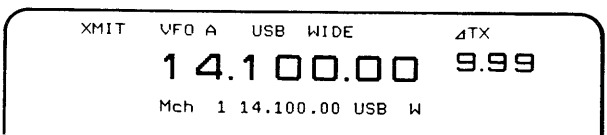
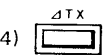
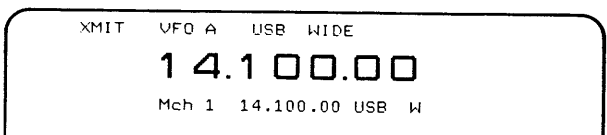
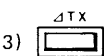
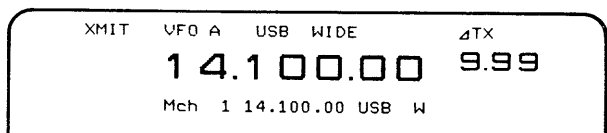
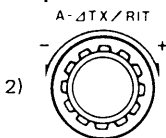
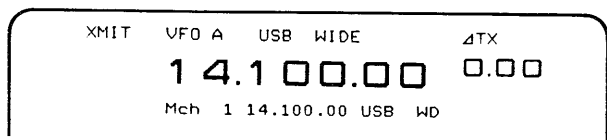
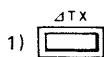

ΔTX shifts the transmit frequency by up to ±9.99kHz in 10Hz steps without shifting the receive frequency.

1) Push A-[ΔTX].

- "ΔTX" and the amount of shift frequency appear in the "A" section of the CRT DISPLAY.

2) Rotate [A-ΔTX/RIT] to shift the transmit frequency.

3) To turn OFF the "A" section ΔTX, push the A-[ΔTX] switch again.

- "ΔTX" and the amount of the shift frequency disappear from the CRT DISPLAY.

- When you turn ΔTX OFF, the final shift frequency displayed on the CRT DISPLAY is stored.

4) To turn ON ΔTX, push A-[ΔTX] again.

- "ΔTX" and the stored shift frequency appear on the CRT DISPLAY.

5) To monitor the transmitter frequency, push [XFC] during receiving.

6) Push A-[CLEAR] to clear the ΔTX shift frequency. The CRT displays "0.00" and the receive and transmit frequencies become equal.

7) To add the ΔTX shift frequency to the displayed frequency, push A-[+Δf] when the shift frequency is displayed.

8) B-[ΔTX], B-[CLEAR] and B-[+Δf] function for the "B" section as above.

- The "B" section ΔTX function can be programmed in normal operation, but only functions after pushing [CHANGE] or during SPLIT operation.

9. FUNCTIONS OPERATION

9-8 SPLIT (DUPLEX) OPERATION

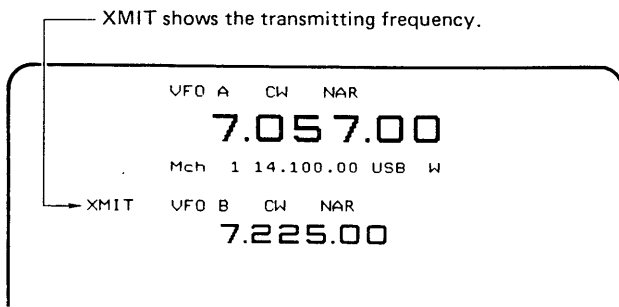
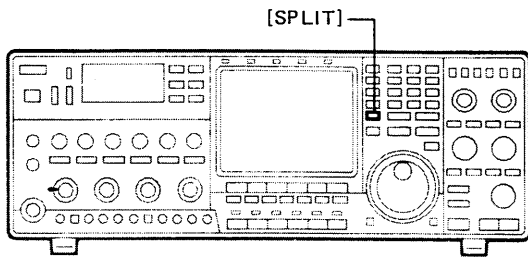

NOTE: During cross band split operation, [TUNER] should be OFF, because the antenna tuner functions for the "B" section frequency and reduces the "A" section sensitivity.

Split (duplex) operation refers to transmitting and receiving on separate frequencies.

[Example]

Set the transmitter for split (duplex) operation on 7.057MHz (receive) and 7.225MHz (transmit).

- 1) Set "A" to 7.057MHz.
- 2) Set "B" to 7.225MHz.
- 3) Push [SPLIT].
 - [SPLIT] indicator lights up.
- 4) To transmit, push either the [PTT] on your microphone or select [TRANSMIT/RECEIVE] to TRANSMIT.
 - Receiving : 7.057MHz
 - Transmitting : 7.225MHz
- 5) To monitor the transmitter frequency, push [XFC].
- 6) To exchange "A" for "B", push [CHANGE].

9-9 VOX OPERATION

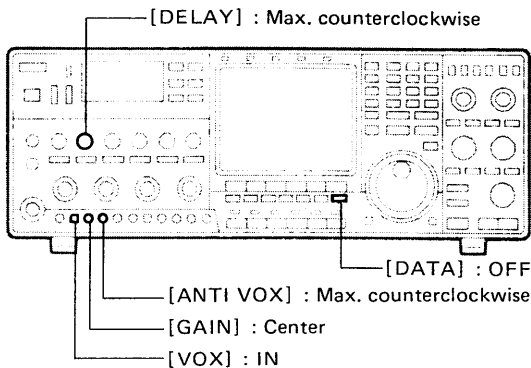

VOX (voice-operated relay) lets you key the transmitter with your voice.

- 1) Set the front panel as shown at left.
- 2) While speaking naturally into the microphone, adjust VOX-[GAIN] clockwise until you key the transmitter.
- 3) To adjust the transmit to receive switching time, adjust [DELAY].
 - A short delay will clip the VOX while you are speaking.
- 4) To prevent speaker audio from tripping the VOX, adjust [ANTI-VOX].

9-10 MONITOR OPERATION

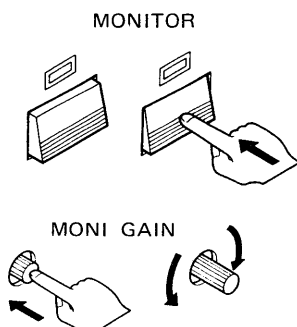

The monitor lets you hear your IF signal in any mode through the speaker.

The CW monitor always functions.

- 1) Push [MONITOR].
- 2) Adjust [MONI GAIN] as desired.

NOTE: Wear headphones to prevent feedback.

9-11 SPEECH COMPRESSOR OPERATION

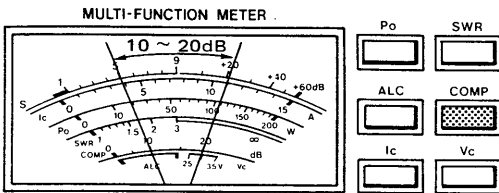
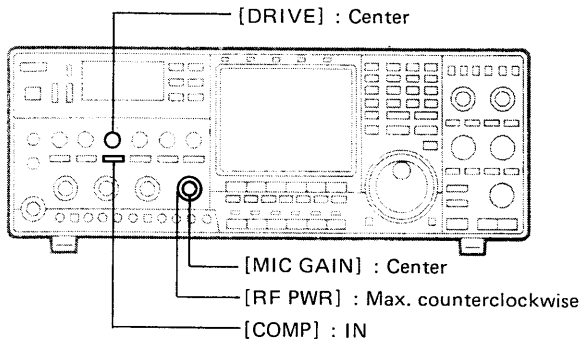

The RF speech compressor increases average output power, improving signal strength and intelligibility.

- 1) Set the front panel as shown at left.
- 2) Push [Po].
- 3) Select [TRANSMIT/RECEIVE] to TRANSMIT. Speak naturally into the microphone.
- 4) Turn the [RF PWR] control clockwise. Peak RF output power is shown on the meter.
- 5) Push [COMP] in the METER FUNCTION SWITCHES.
- 6) Adjust the [MIC GAIN] control for an S-meter COMP scale reading between 10dB and 20dB.
- 7) Push [ALC].
- 8) Adjust [DRIVE] for a meter reading within the ALC zone.

NOTE: DO NOT set [MIC GAIN] and [DRIVE] too high. This will distort your signal and cause QRM.

9-12 SWR READING

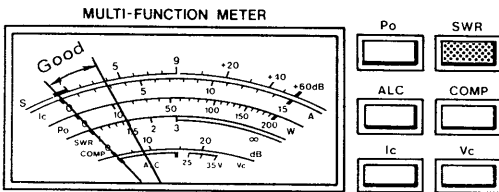

The SWR meter functions in all modes.

- 1) Push [TUNER] OFF.
- 2) Push [Po].
- 3) Turn [RF PWR] clockwise past 12 o'clock for an output of at least 30W.
- 4) Push [SWR].
- 5) Set [TRANSMIT/RECEIVE] to TRANSMIT.
- 6) Read the SWR on the SWR scale.

NOTE: The built-in antenna tuner matches the transmitter to the antenna when the SWR is lower than 1:3.

10. MEMORY AND SCANNING OPERATION

10-1 MEMORY CHANNELS

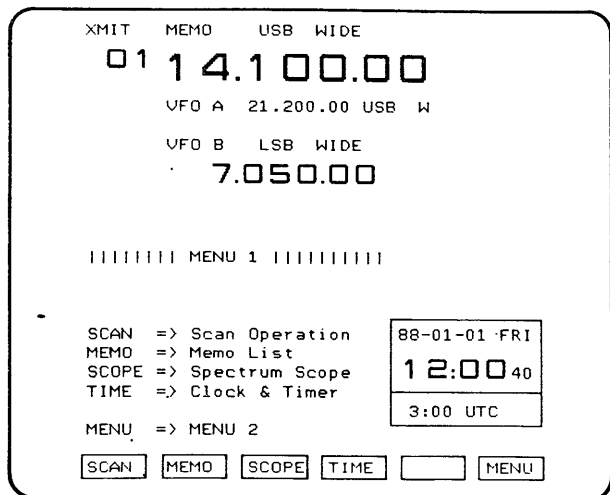

Ninety-nine memory channels store frequency, mode, [DATA] ON/OFF and filter (narrow/wide).

Each memory channel also stores a selected memory channel scan number and a note of up to ten characters.

1) Push [VFO/MEMO] to select MEMORY mode.

- The CRT displays "MEMO" and the memory channel number.

2) There are three ways to select a memory channel:

- Enter the channel number with the KEYBOARD when lighted, and push [M-CH].
- Push [▼ DOWN] or [UP ▲] on the front panel, bottom right.
- Use the MEMORY LIST screen. See section 10 - 2.

3) Push [VFO/MEMO] to return to VFO mode.

- Memory channels can also be changed in VFO mode.

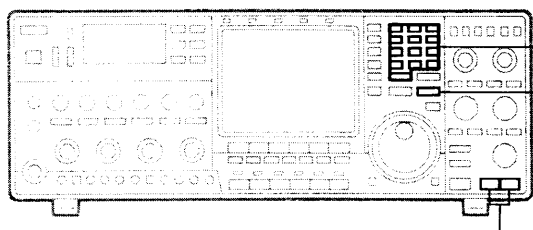

KEYBOARD and [M-CH]

EXAMPLE: Select memory channel 25.

Push [2] [5] and [M-CH] when lighted.

[VFO/MEMO]

[▼DOWN] [UP▲]

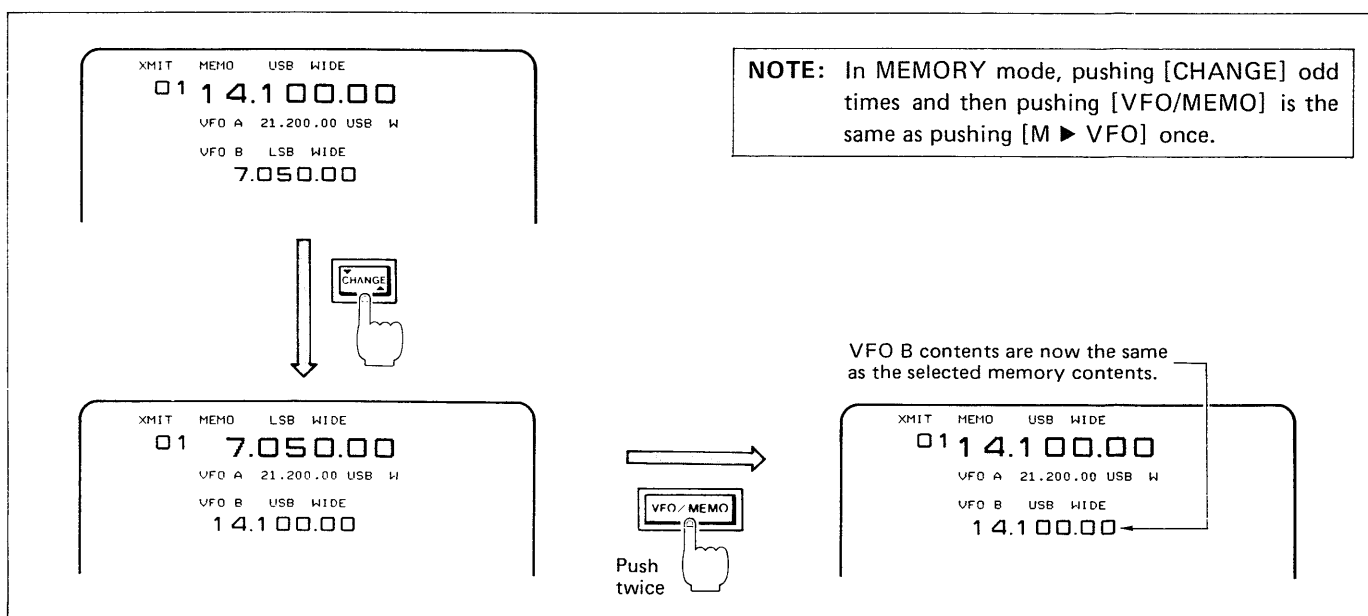

10-2 MEMORY LIST SCREEN

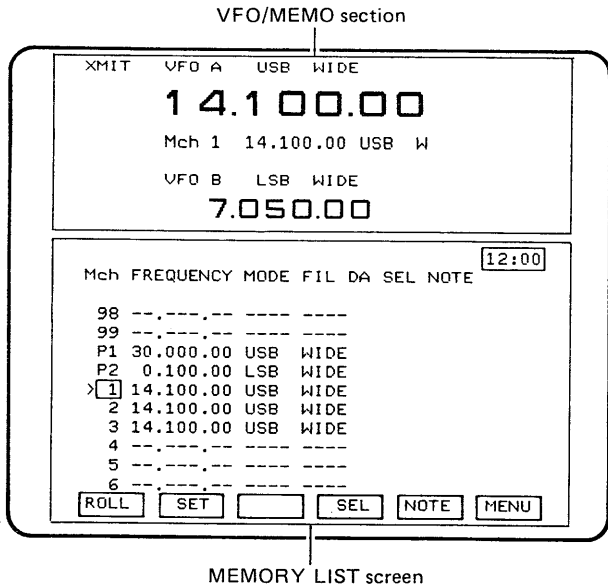

The MEMORY LIST screen displays ten of ninety-nine the memory channels at one time. Roll the screen to view the other channels.

1) To access the MEMORY LIST screen, push [F-2] "MEMO" when the CRT displays MENU 1.

2) To view memory channels, push and hold [F-1] "ROLL" and rotate the MAIN DIAL.

- The memory channel displayed in the VFO/MEMO section does not change.

- Memory writing and clearing can be performed on the MEMORY LIST screen. See p. 63.

3) To select a memory channel, push and hold [F-2] "SET" and rotate the MAIN DIAL.

- The memory channel displayed in the VFO/MEMO section also changes.

4) To return to MENU 1, push [F-6] "MENU".

• "ROLL" and "SET"

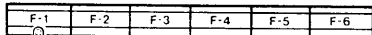
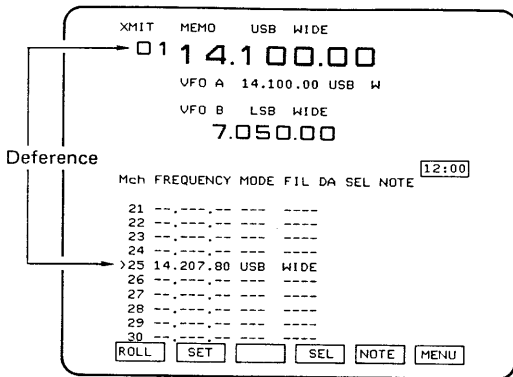

[F-1] "ROLL" + MAIN DIAL

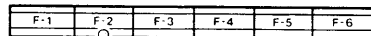
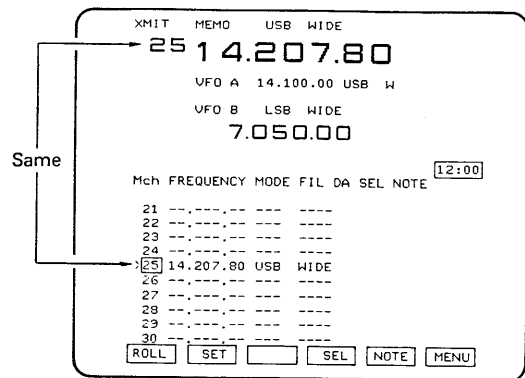

[F-2] "SET" + MAIN DIAL

10. MEMORY AND SCANNING OPERATION

10-3 MEMORY WRITING

(1) MEMORY WRITING

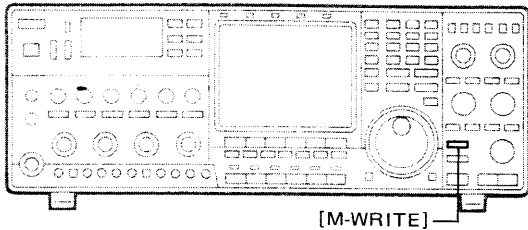

- 1) Select VFO mode with [VFO/MEMO].
- 2) Select the contents you wish to write (frequency, mode, filter wide/narrow, [DATA] ON/OFF).
- 3) Select a memory channel with [▼ DOWN] and [UP▲]; or with the digit keys and [M-CH] on the KEYBOARD.
- 4) Push and hold [M-WRITE] on the right front panel until you hear three beeps.

• Writing a memory channel in one section

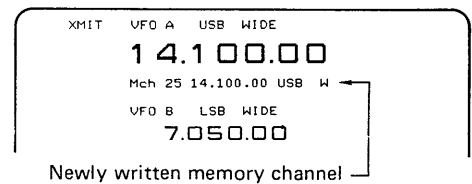
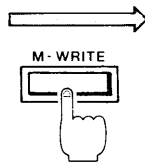
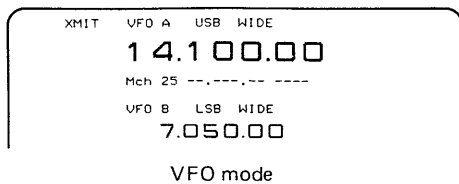

• Writing a memory channel from another section

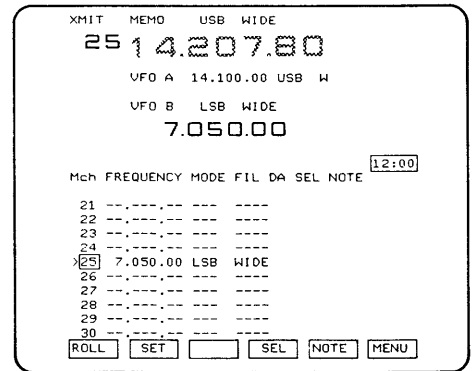
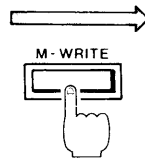
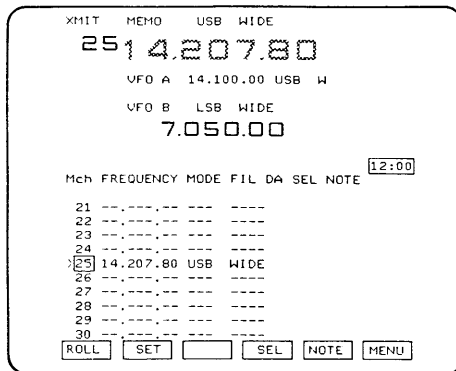

Select MEMORY mode on the "A" section and push [B] for the above screen.

The contents of the memory channel have changed, but the previous contents are still displayed in the "A" section.

• VFO to MEMORY LIST

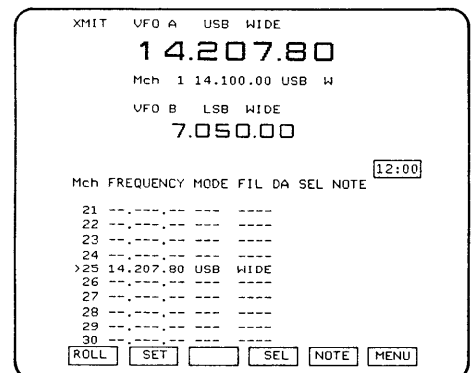
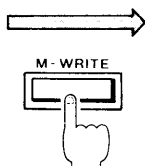
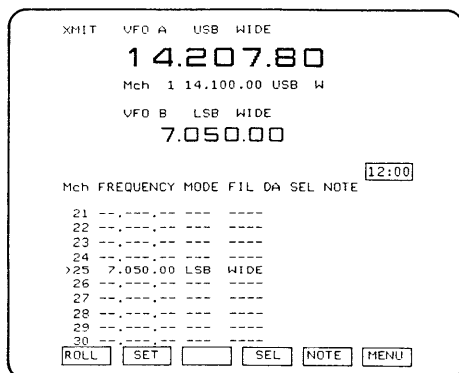

Memory channel selected with "ROLL" and the MAIN DIAL.

The MEMORY LIST has priority over the VFO/MEMO section.

(2) CHANGING MEMORY CONTENTS

- 1) Select MEMORY mode with [VFO/MEMO].
- 2) Select a memory channel you wish to change with [▼DOWN] and [UP▲]; or with digit keys and [M-CH] on the KEYBOARD.
- 3) Select the contents you wish to change (frequency, mode, filter wide/narrow, [DATA] ON/OFF).
- 4) Push and hold [M-WRITE] until you hear three beeps.
 - The contents have been changed.

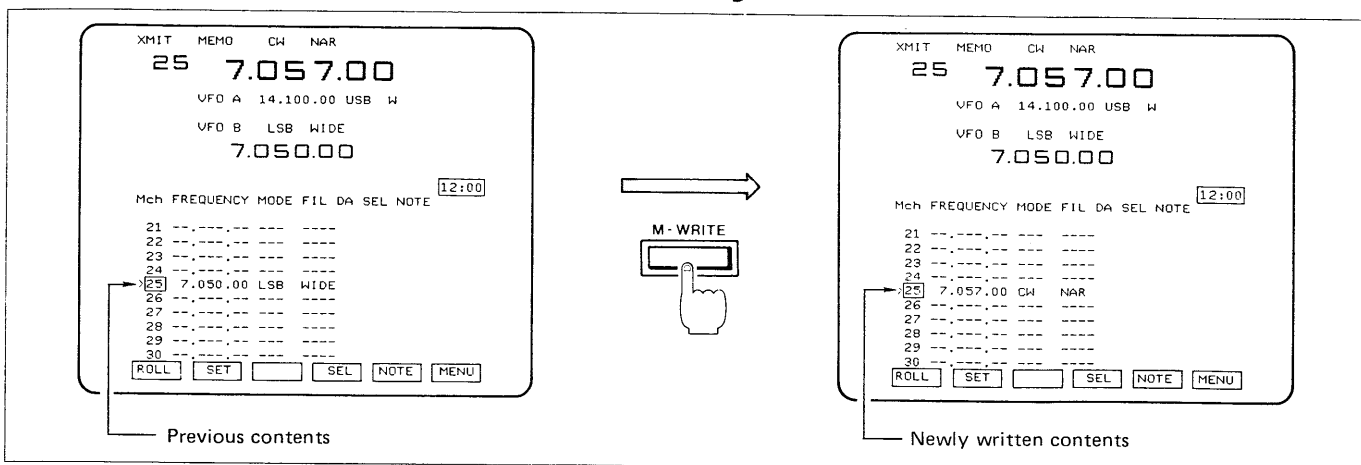

(3) MEMORY CHANNEL TO MEMORY CHANNEL WRITING

This function is useful when you change the memory contents and you wish to keep both the original contents and the changed contents.

- 1) Select MEMORY mode with [VFO/MEMO].
- 2) Select a memory channel.
- 3) Select the contents you wish to change (frequency, mode, filter wide/narrow, [DATA] ON/OFF).
- 4) To access the MEMORY LIST screen, push [F-2] "MEMO" when the CRT displays MENU 1.
- 5) To select the memory channel you wish to write, push and hold [F-1] "ROLL", and rotate the MAIN DIAL.
- 6) Push and hold [M-WRITE] until you hear three beeps.

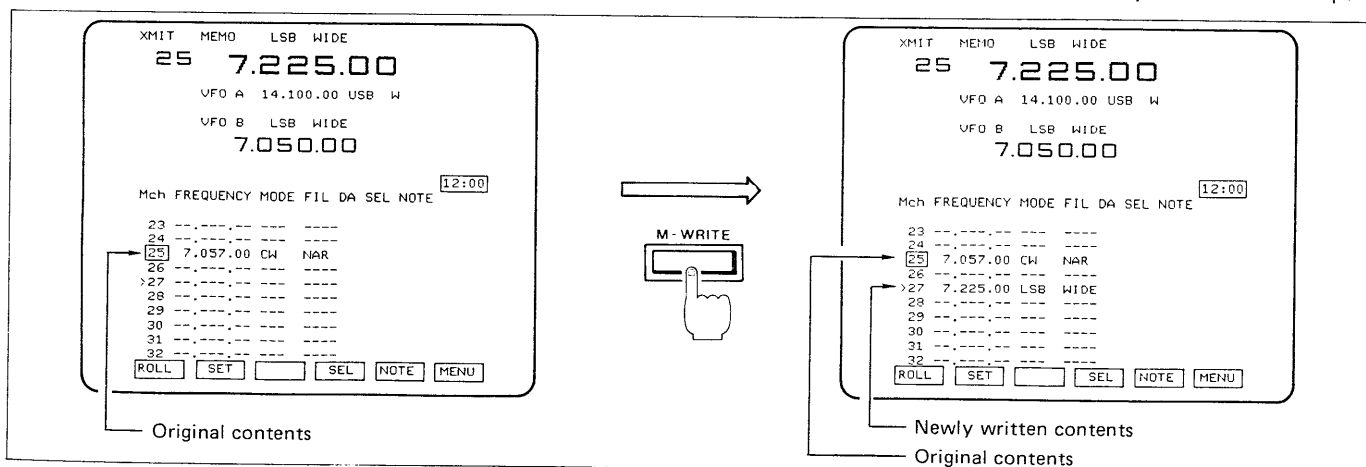

10. MEMORY AND SCANNING OPERATION

(4) SELECTED MEMORY SCAN NUMBER

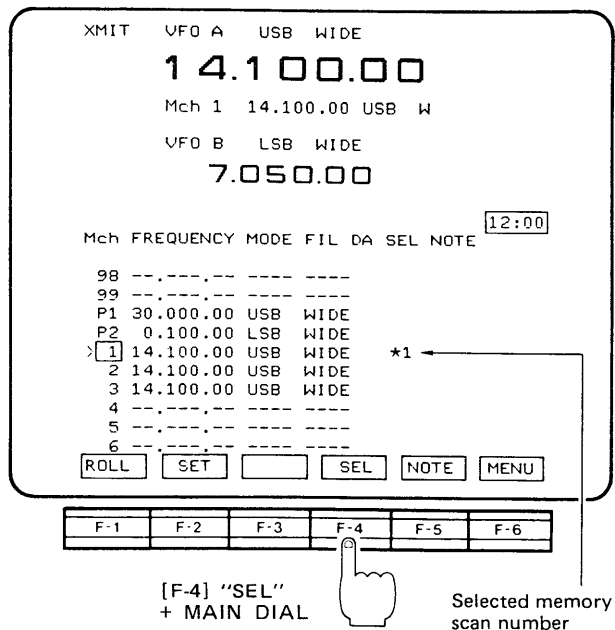

- 1) To access the MEMORY LIST screen, push [F-2] "MEMO" when the CRT displays MENU 1.
- 2) Select the memory channel using "ROLL" or "SET" and the MAIN DIAL; or using [▼DOWN] [UP▲].
- 3) To turn the selected memory scan number ON and OFF, push [F-4] "SEL".
 - The number can hold only memory channels which have already been programmed.
 - See p. 73 for selected memory scan operation.
- 4) To select the selected memory scan number, push and hold [F-4] "SEL" and rotate the MAIN DIAL.
- 5) Program a selected memory scan number in other memory channels (begin with item 2) or push [F-6] "MENU" to return to MENU 1.

NOTE: A selected memory scan number can not be programmed on P1 and P2.

(5) MEMORY NOTE

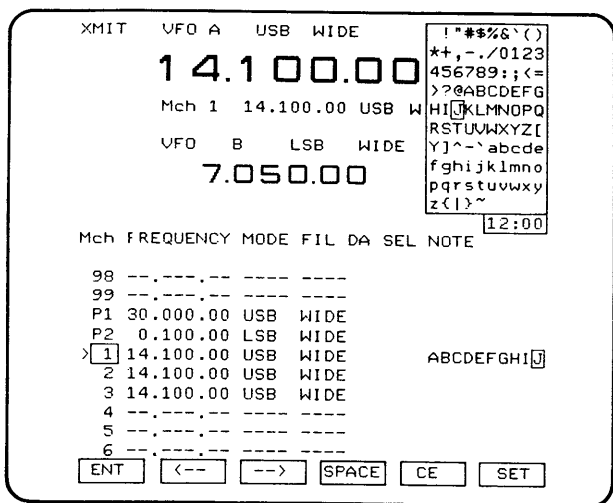

- 1) To select the MEMORY LIST screen, push [F-2] "MEMO" when the CRT displays MENU 1.
- 2) Select the memory channel using "ROLL" or "SET" and the MAIN DIAL; or using [▼DOWN] [UP▲].
- 3) To access the MEMORY NOTE WRITE screen, push [F-5] "NOTE".
- 4) Choose characters with the MAIN DIAL.
- 5) To enter a character in the note area, push [F-1] "ENT".
- 6) Move the cursor with "-->", "<--" and "SPACE".
- 7) To erase an entry and retrieve the previous note, push [F-5] "CE".
 - The CRT returns to the MEMORY LIST screen.
- 8) To store the note and return to the MEMORY LIST screen, push [F-6] "SET".
- 9) To erase a stored note, use "SPACE" on the MEMORY NOTE WRITE screen.
- 10) Program a note on another memory channel (begin with item 2) or push [F-6] "MENU" to return to MENU 1.

10-4 MEMORY CLEARING

(1) IN THE VFO/MEMORY SECTION

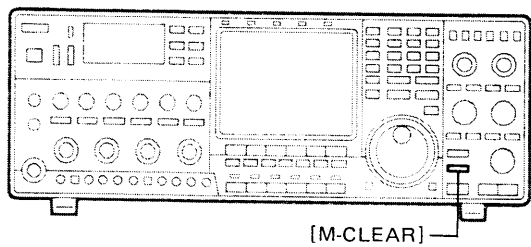

- 1) Select MEMORY mode with [VFO/MEMO].
- 2) Select a memory channel to be cleared.
- 3) Push and hold [M-CLEAR] until three beeps are emitted.

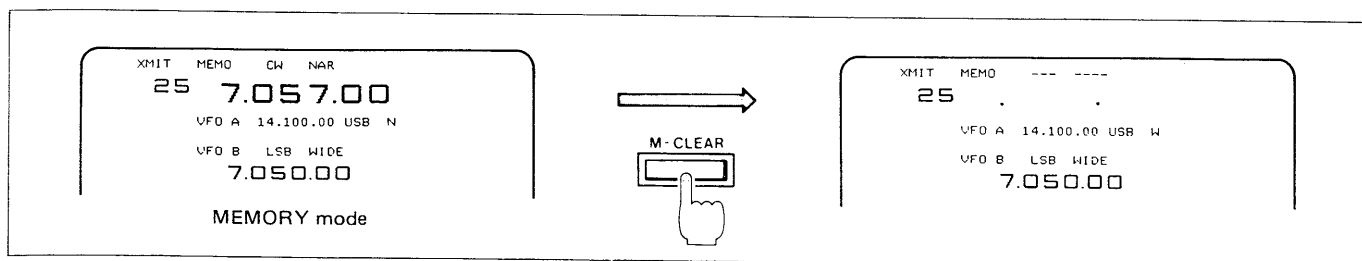

(2) ON THE MEMORY LIST SCREEN

- 1) To access the MEMORY LIST screen, push [F-2] "MEMO" when the CRT displays MENU 1.
- 2) To select the memory channel you wish to clear, push and hold [F-1] "ROLL" or [F-2] "SET", and rotate the MAIN DIAL.
- 3) Push and hold [M-CLEAR] until you hear three beeps.

NOTE: The memory clear function operates in both VFO and MEMORY mode when the MEMORY LIST screen is accessed.

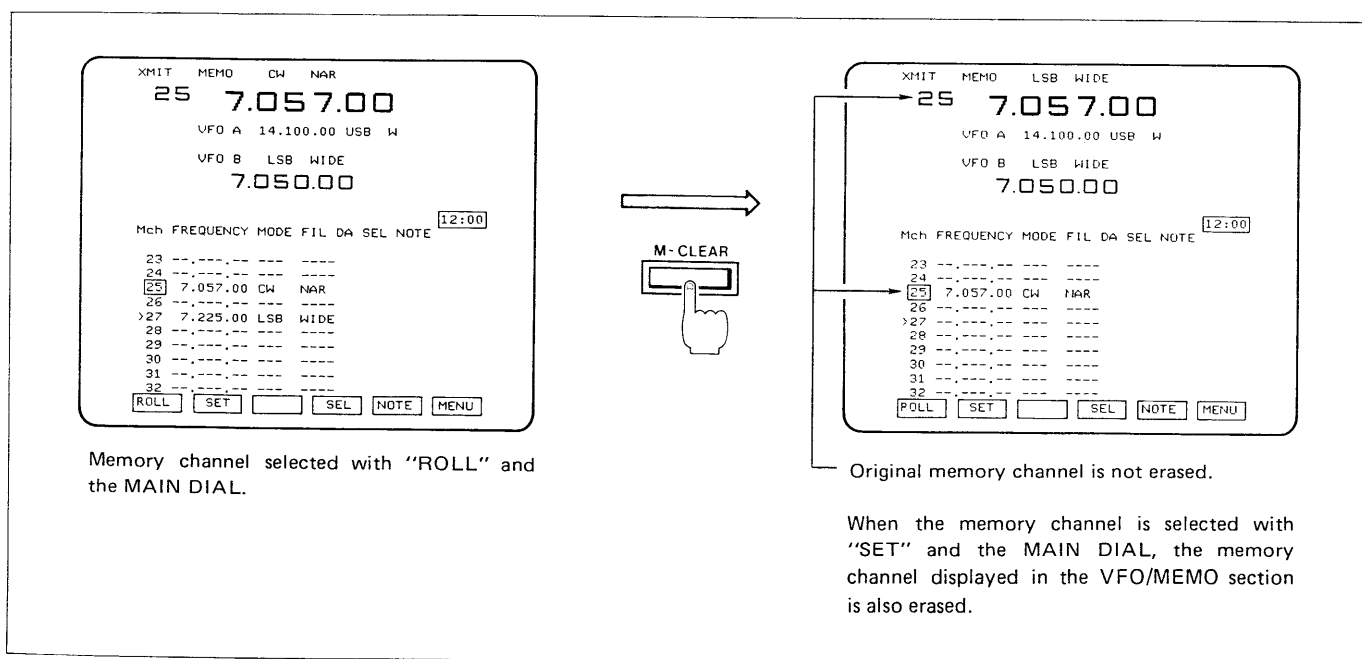

10. MEMORY AND SCANNING OPERATION

10-5 MEMORY TRANSFERRING

Push and hold [M ▶ VFO] until three beeps are emitted to transfer the memory contents to VFO.

(1) IN THE VFO/MEMORY SECTION

The memory transferring function operates in both VFO and MEMORY modes.

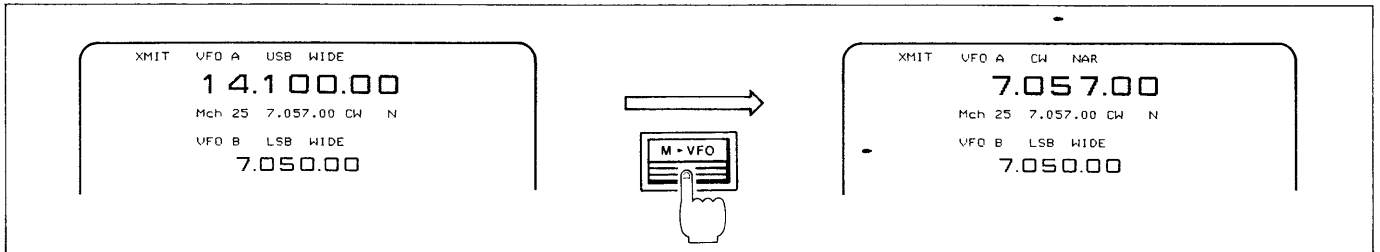

(2) ON THE MEMORY LIST SCREEN

• VFO mode

The selected memory contents on the MEMORY LIST screen are transferred to VFO.

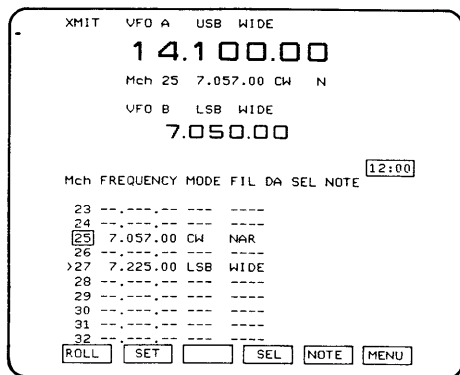

Memory channel selected with "ROLL" and the MAIN DIAL.

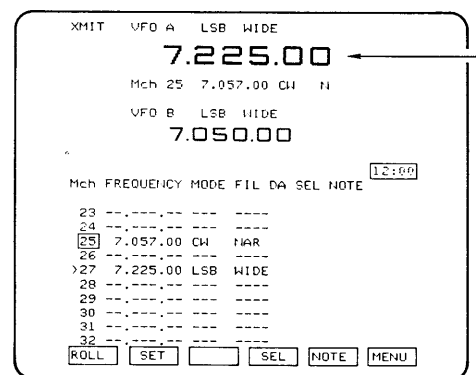
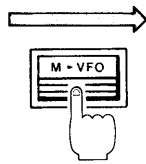

The contents come from the MEMORY LIST screen.

• MEMORY mode

The selected memory contents on the VFO/MEMORY section of the CRT DISPLAY are transferred to VFO.

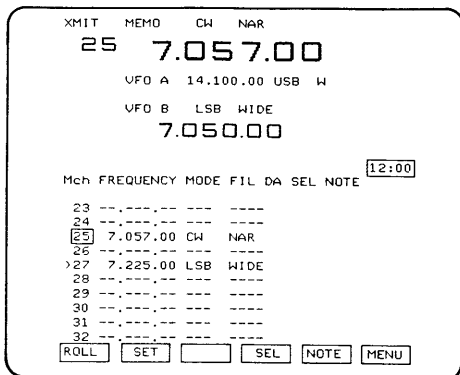

Memory channel selected with "ROLL" and the MAIN DIAL.

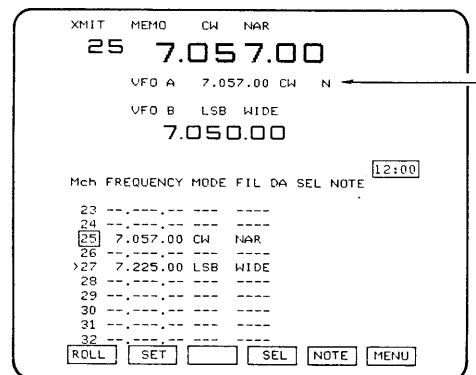
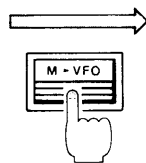

The contents come from the VFO/MEMORY section.

10-6 SCANNING OPERATION

NOTE: Scanning operates only on the "A" section of the CRT DISPLAY.

Operate scanning on the SCAN OPERATION screen.

There are six scanning functions.

SCAN NAME	FUNCTION
PROGRAMMED SCAN	Repeatedly scans between two user-programmed scan edges.
ΔF SCAN	Scans the ΔF scan width around an operating frequency.
MEMORY SCAN	Scans all but blank memory channels.
SELECTED MEMORY CHANNEL SCAN	Scans only those memory channels to which the user has assigned the same selected memory scan number.
FINE PROGRAMMED SCAN	Functions as a programmed scan, but scan speed decreases when the squelch opens and does not stop.
FINE ΔF SCAN	Functions as a ΔF scan, but scan speed decreases when the squelch opens and does not stop.

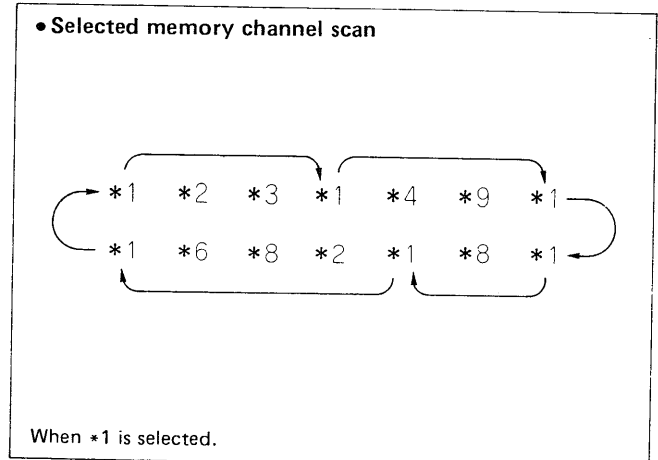
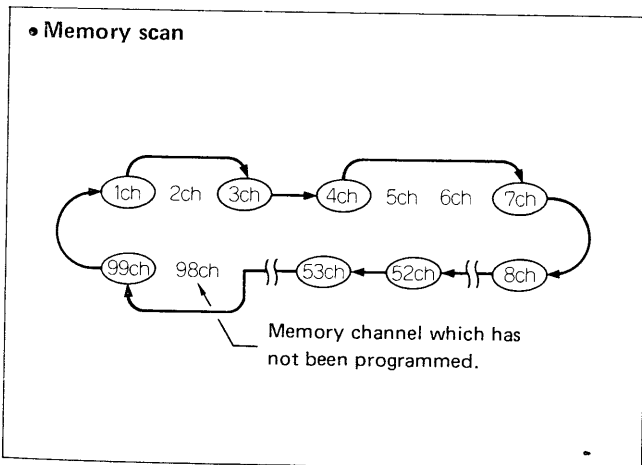
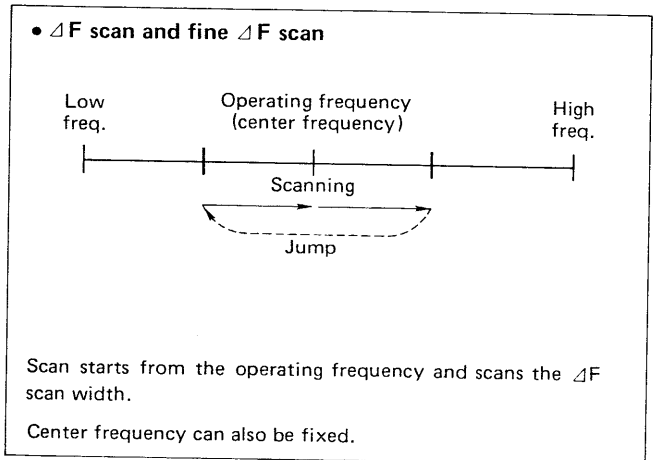
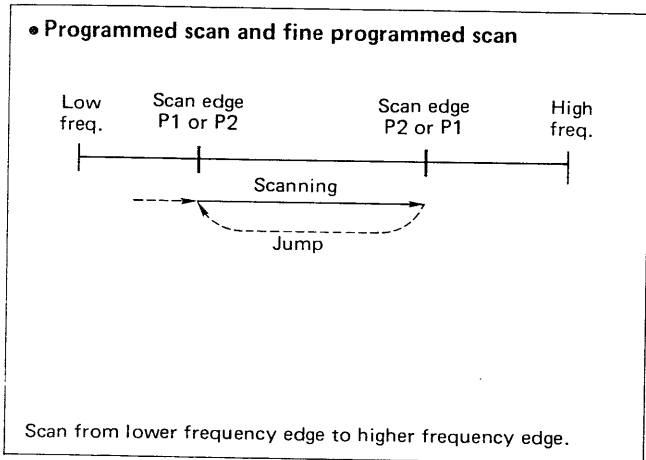

10. MEMORY AND SCANNING OPERATION

10-7 PROGRAMMED SCAN

(1) PROGRAMMING SCAN EDGES

• Using [M-WRITE]

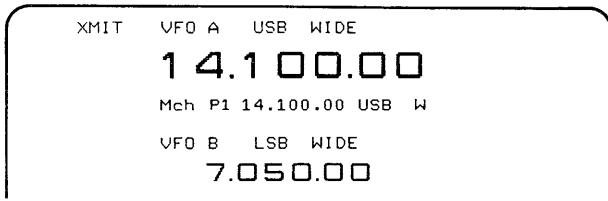

• Using the SCAN CONDITION screen

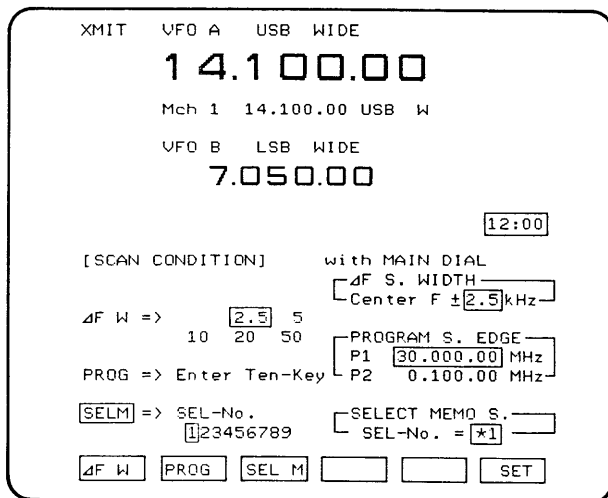

Scan edges may be programmed in two ways:

(1) Program a frequency on memory channels P1 and P2 as you would write a memory channel. See p. 63.

(2) Program a frequency using the SCAN CONDITION screen.

1) Push [F-1] "SCAN" to access the SCAN OPERATION screen when the CRT displays MENU 1.

2) Push [F-5] "SET" to access the SCAN CONDITION screen.

3) Enter P1 scan edge frequency with the KEYBOARD.

4) To select P2, push and hold [F-2] "PROG", and rotate the MAIN DIAL.

5) Enter the P2 scan edge frequency with the KEYBOARD.

6) Push [F-6] "SET" to return to the SCAN OPERATION screen.

NOTE: The displayed frequency in the VFO/MEMO section is not entered when the CRT displays the SCAN CONDITION screen.

(2) PROGRAMMED SCAN OPERATION

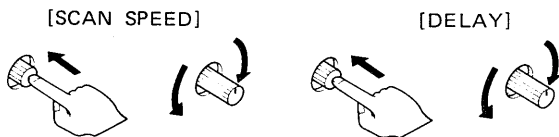
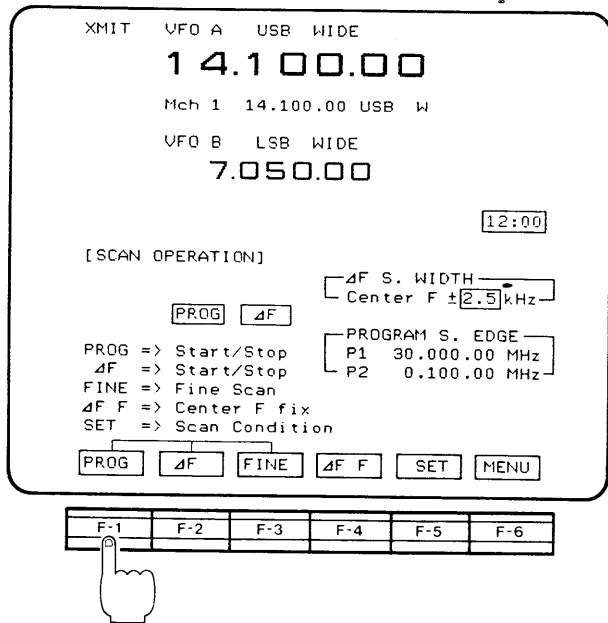

- 1) Push [VFO/MEMO] to select VFO mode.
- 2) Select USB, LSB, AM, FM, CW or RTTY.
- 3) Adjust [SQL] to squelch speaker audio.
 - The green [RECEIVE] indicator goes out.
- 4) Push SCAN [RESUME].
 - IN : Scan stops when a signal is received and then restarts.
 - OUT : Scan stops when a signal is received.
- 5) To access the SCAN OPERATION screen, push [F-1] "SCAN" when CRT displays MENU 1.
- 6) Push [F-1] "PROG" to start the programmed scan.
- 7) Adjust [SCAN SPEED] to the desired scanning speed.
- 8) When [RESUME] is pushed IN, adjust SCAN [DELAY] to the desired stop/restart delay time.
- 9) Push any switch [F-1] ~ [F-6] (except [F-3]) to stop the scan.
 - The MAIN DIAL and KEYBOARD also stop the scan.

(3) FINE PROGRAMMED SCAN OPERATION

[RESUME]

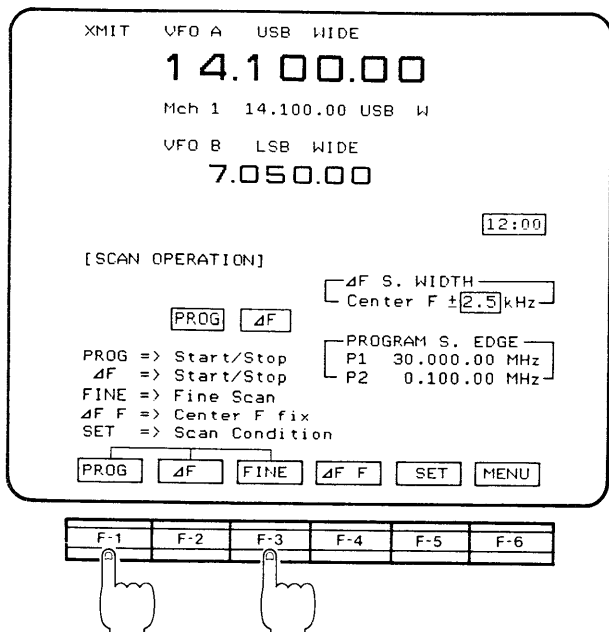
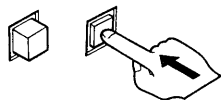

- Fine scanning tunes through a signal which has opened the squelch, but scanning does not stop.
- 1) Push [RESUME] IN.
 - 2) Push [F-1] "PROG" and [F-3] "FINE" simultaneously to start the fine scan when the CRT displays the SCAN OPERATION screen.
 - 3) To cancel the fine scan push [F-3] "FINE".
 - The programmed scan continues to operate.
 - 4) To stop the scan, push any switch [F-1] ~ [F-6] (except [F-3]).
 - The MAIN DIAL and KEYBOARD also stop the scan.

10. MEMORY AND SCANNING OPERATION

10-8 ΔF SCAN

(1) PROGRAMMING THE ΔF SCAN WIDTH

12:00

[SCAN CONDITION] With MAIN DIAL

ΔF S. WIDTH Center F ±2.5kHz

ΔF W => 2.5 5 10 20 50

PROG => Enter Ten-Key

PROGRAM S. EDGE P1 30.000.00 MHz P2 0.100.00 MHz

SELM => SEL-No. 23456789 SELECT MEMO S. SEL-No. = *1

ΔF W PROG SEL M SET

F-1 F-2 F-3 F-4 F-5 F-6

[F-1] "ΔF W" + MAIN DIAL

- 1) To access the SCAN OPERATION screen, push [F-1] "SCAN" when the CRT displays MENU 1.
- 2) To access the SCAN CONDITION screen, push [F-5] "SET".
- 3) To select a ΔF scan width, push and hold [F-1] "ΔF W", and rotate the MAIN DIAL.
 - ΔF SCAN WIDTHS: 2.5, 5, 10, 20, 50kHz to each side of the center frequency.
- 4) Push [F-6] "SET" to return to the SCAN OPERATION screen.

(2) ΔF SCAN OPERATION

[SCAN OPERATION] Variable

ΔF S. WIDTH Center F ±2.5kHz

PROGRAM S. EDGE P1 30.000.00 MHz P2 0.100.00 MHz

PROG => Start/Stop

ΔF => Start/Stop

FINE => Fine Scan

ΔF F => Center F fix

SET => Scan Condition

PROG ΔF FINE ΔF F SET MENU

[SCAN OPERATION] Fixed

ΔF S. WIDTH 14.100.00 ±2.5kHz

PROGRAM S. EDGE P1 30.000.00 MHz P2 0.100.00 MHz

PROG => Start/Stop

ΔF => Start/Stop

FINE => Fine Scan

ΔF F => Center F fix

SET => Scan Condition

PROG ΔF FINE ΔF F SET MENU

- 1) Push [VFO/MEMO] to select VFO mode.
- 2) Select USB, LSB, AM, FM, CW or RTTY.
- 3) Adjust [SQL] to squelch speaker audio.
 - The green [RECEIVE] indicator goes out.
- 4) Push SCAN [RESUME].
 - IN : Scan stops when a signal is received and then restarts.
 - OUT : Scan stops when a signal is received.
- 5) To access the SCAN OPERATION screen, push [F-1] "SCAN" when the CRT displays MENU 1.
- 6) Push [F-4] "ΔF F" to select a fixed or variable ΔF scan center frequency.
 - Fixed: ΔF scan operates around a fixed frequency even if the operating frequency has been changed.
 - Variable: ΔF scan operates around the operating frequency.

NOTE: Fixed center frequency ΔF scan does not operate when the operating frequency is beyond the ΔF scan width.

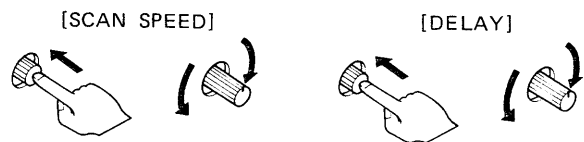
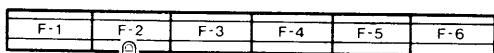
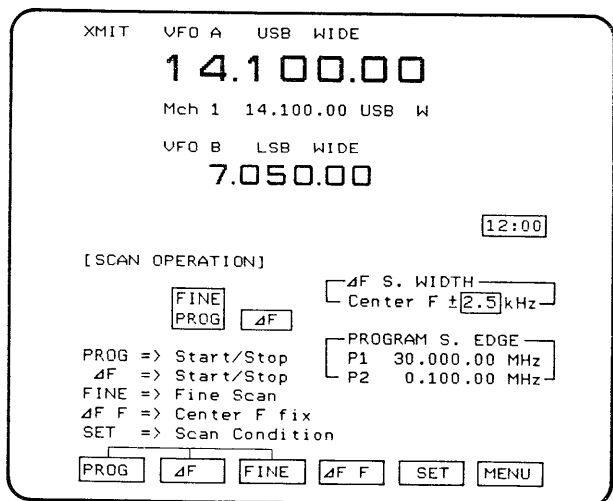

(3) FINE ΔF SCAN OPERATION

[RESUME]

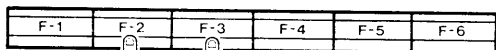
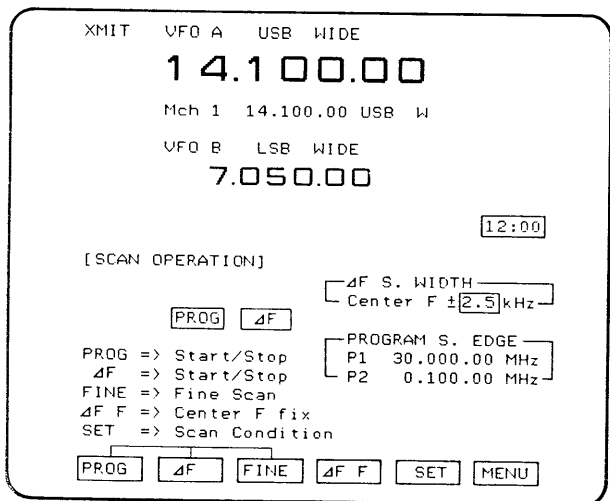
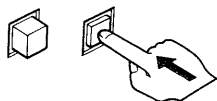

- 7) Push [F-2] "ΔF" to start the ΔF scan.
 - 8) Adjust [SCAN SPEED] to the desired scanning speed.
 - 9) When [RESUME] is pushed IN, adjust SCAN [DELAY] to the desired stop/restart delay time.
 - 10) Push any switch [F-1] ~ [F-6] (except [F-3]) to stop the scan.
- The MAIN DIAL and KEYBOARD also stop the scan.

FINE scanning tunes through a signal which has opened the squelch, but scanning does not stop.

- 1) Push [RESUME] IN.
 - 2) To start the fine ΔF scan, push [F-2] "ΔF" and [F-3] "FINE" simultaneously when the CRT displays the SCAN OPERATION screen.
 - 3) To cancel the fine scan, push [F-3] "FINE".
- The ΔF scan continues to operate.
- 4) To stop the scan, push any switch [F-1] ~ [F-6] (except [F-3]).
- The MAIN DIAL and KEYBOARD also stop the scanning.

10. MEMORY AND SCANNING OPERATION

10-9 MEMORY SCAN

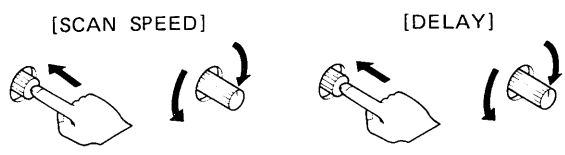
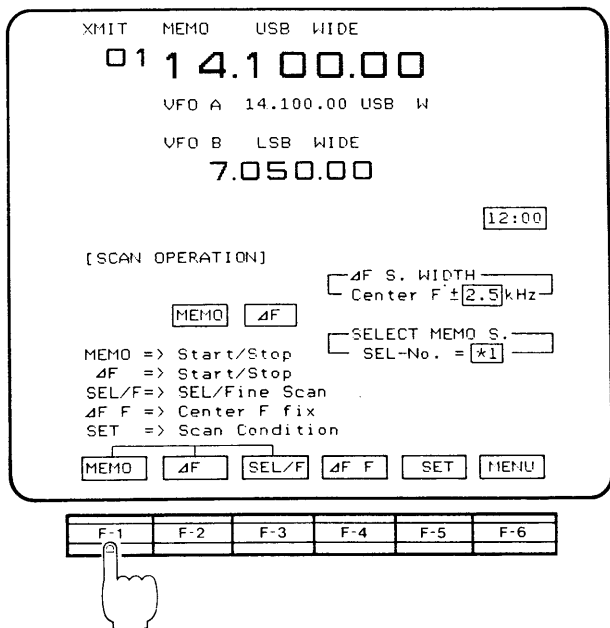

- 1) Program at least two memory channels.
- 2) Push [A], then push [VFO/MEMO] to select MEMORY mode in the "A" section.
 - A memory channel number appears.
- 3) Adjust [SQL] to squelch speaker audio.
 - The green [RECEIVE] INDICATOR goes out.
- 4) Push SCAN [RESUME].
 - IN : Scan stops when a signal is received and then restarts.
 - OUT : Scan stops when a signal is received.
- 5) To access the SCAN OPERATION screen, push [F-1] "SCAN" when the CRT displays MENU 1.
- 6) Push [F-1] "MEMO" to start the memory scan.
- 7) Adjust [SCAN SPEED] to the desired scanning speed.
- 8) When [RESUME] is pushed IN, adjust SCAN [DELAY] to the desired stop/restart delay time.
- 9) To stop the scan, push any switch [F-1] ~ [F-6] (except [F-3]).
 - The MAIN DIAL and KEYBOARD also stop the scan.

10-10 SELECTED MEMORY CHANNEL SCAN

(1) SELECTED MEMORY CHANNEL SCAN NUMBER SELECTION

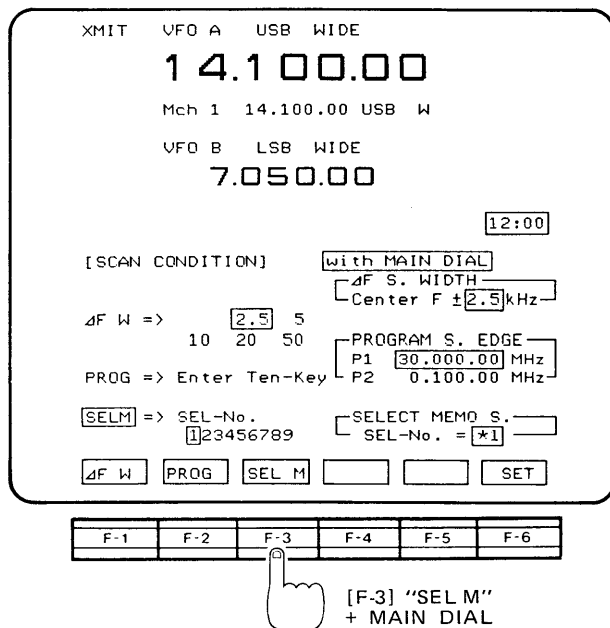

- Each number corresponds to a group of memory channels.
- 1) To access the SCAN OPERATION screen, push [F-1] "SCAN" when the CRT displays MENU 1.
 - 2) To access the SCAN CONDITION screen, push [F-5] "SET".
 - 3) To select the selected memory channel scan number, push and hold [F-3] "SEL M" and rotate the MAIN DIAL.
 - 4) Push [F-6] "SET" to return to the SCAN OPERATION screen.
 - 5) See p. 65 for programming the selected memory scan number in each memory channel.

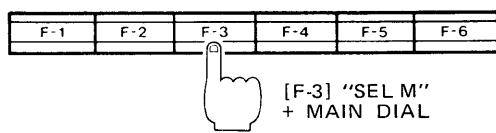

(2) OPERATION

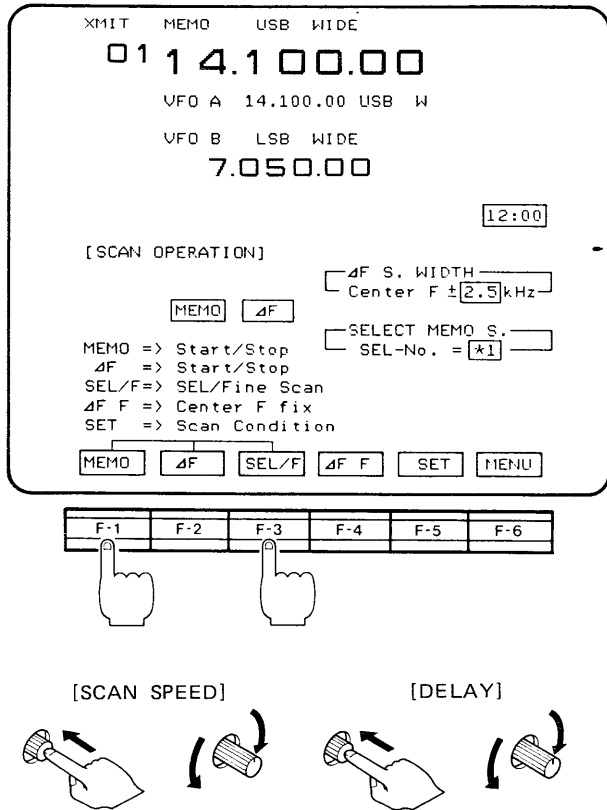

(3) MEMORY MODE ΔF SCAN AND FINE ΔF SCAN

1) Push [A], then push [VFO/MEMO] to select MEMORY mode in the "A" section.

- A memory channel number appears.

2) Adjust [SQL] to squelch speaker audio.

- The green [RECEIVE] INDICATOR goes out.

3) Push SCAN [RESUME].

- IN : Scan stops when a signal is received and then restarts.

- OUT : Scan stops when a signal is received.

4) To access the SCAN OPERATION screen, push [F-1] "SCAN" when CRT displays MENU 1.

5) To start the selected memory channel scan, push [F-1] "MEMO", and then push [F-3] "SEL/F".

6) Adjust [SCAN SPEED] to the desired scanning speed.

7) When [RESUME] is pushed IN, adjust SCAN [DELAY] to the desired stop/restart delay time.

8) To cancel the selected memory channel scan, push [F-3] "SEL/F".

- The memory scan continues to operate.

9) To stop the scan, push any switch [F-1] ~ [F-6] (except [F-3]).

- The MAIN DIAL and KEYBOARD also stop the scan.

The MEMORY mode also has a ΔF scan and fine ΔF scan.

1) Push [VFO/MEMO] to access MEMORY mode.

2) Follow instructions on p. 71.

- In the MEMORY mode, [F-3] appears on the CRT DISPLAY as "SEL/F".

11. CLOCK AND TIMER OPERATION

11-1 CLOCK ADJUSTMENT

(1) MAIN CLOCK (CLK 1)

CLOCK ADJUSTMENT (1) SCREEN

```

XMIT  VFO A  USB  WIDE
14.100.00
Mch 1  14.100.00 USB  W
VFO B  LSB  WIDE
7.050.00

[CLOCK ADJUST]      with MAIN DIAL

YEAR => Year
DATE => Month & Date
DAY  => Day
CLK1 => Hour & Min & 0ADJ
CLK2 => Hour & Min
NOTE => Comment Write
    
```

88-01-01 FRI
12:00 40
3:00 UTC

-YEAR-

[DATE] [DAY] [CLK 1] [CLK 2] [NOTE] [MENU]

(2) SUB CLOCK (CLK 2)

```

[CLOCK ADJUST]      with MAIN DIAL

YEAR => Year
DATE => Month & Date
DAY  => Day
CLK1 => Hour & Min & 0ADJ
CLK2 => Hour & Min
NOTE => Comment Write
    
```

88-01-01 FRI
12:00 40
3:00 UTC

-YEAR-

[DATE] [DAY] [CLK 1] [CLK 2] [NOTE] [MENU]

[F-4] "CLK 2" + MAIN DIAL

CLOCK ADJUSTMENT (2) SCREEN

```

XMIT  VFO A  USB  WIDE
14.100.00
Mch 1  14.100.00 USB  W
VFO B  LSB  WIDE
7.050.00

[CLOCK ADJUST]      with MAIN DIAL

YEAR => Year
DATE => Month & Date
DAY  => Day
CLK1 => Hour & Min & 0ADJ
CLK2 => Hour & Min
NOTE => Comment Write
    
```

88-01-01 FRI
12:00 40
3:00 UTC

[ENT] [←] [→] [SPACE] [CE] [SET]

IC-781 has two clocks: Main Clock and Sub Clock. Main Clock records the year, month, day, hour, minute and second. Sub Clock records the hour, minute and a note of up to six characters.

- 1) To access the CLOCK & TIMER screen, push [F-4] "TIME" when the CRT displays MENU 1.
- 2) Push [F-3] "ADJ" to access the CLOCK ADJUSTMENT (1) screen.
- 3) To set the year, push and hold [F-1] "DATE" and [F-2] "DAY", and rotate the MAIN DIAL.
- 4) To set the month and date, push and hold [F-1] "DATE", and rotate the MAIN DIAL.
- 5) To set the day, push and hold [F-2] "DAY" and rotate the MAIN DIAL.
- 6) To set the time, push and hold [F-3] "CLK 1", and rotate the MAIN DIAL.
- 7) To set the second at 0, push [F-3] "CLK 1" again.
- 8) Push [F-6] "MENU" to return to MENU 1.

- 1) Access the CLOCK ADJUSTMENT (1) screen. See MAIN CLOCK items 1) and 2).

- 2) To set the time of the Sub Clock, push and hold [F-4] "CLK 2", and rotate the MAIN DIAL.
- 3) To select the CLOCK ADJUSTMENT (2) screen, push [F-5] "NOTE".

- If not writing a note, skip to item 9).

- 4) Choose characters with the MAIN DIAL.
- 5) To enter a character in the note area, push [F-1] "ENT".

- 6) Move the cursor with [←], [→] and "SPACE".
- 7) To erase an entry and retrieve the previous note, push [F-5] "CE".

- The screen automatically return to the CLOCK ADJUSTMENT (1) screen.

- 8) To store the note, and return to the CLOCK ADJUSTMENT (1) screen, push [F-6] "SET".
- 9) Push [F-6] "MENU" to return to MENU 1.

11-2 SLEEP TIMER

When the [TIMER] switch is OFF, a 2 second alarm sounds at the programmed OFF time.

(1) SLEEP 1

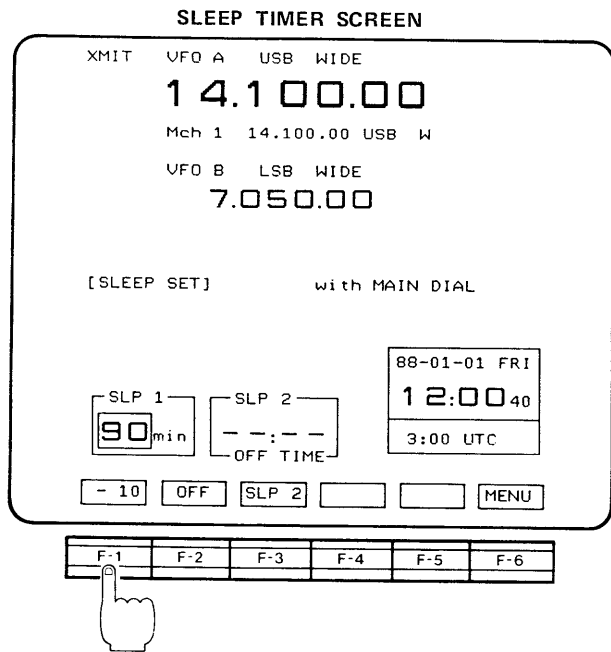

The selectable Sleep Timers, Sleep 1 (Time-off Timer) and Sleep 2 (Clock Timer), shut OFF the transceiver.

Program the Sleep Timer with the SLEEP TIMER screen. Then activate the timer function by pushing the [TIMER] switch.

- 1) To access the CLOCK & TIMER SCREEN, push [F-4] "TIME" when the CRT displays MENU 1.
- 2) To access the SLEEP TIMER screen, push [F-1] "SLEEP".
- 3) To adjust the Sleep 1 time from 0 ~ 90 minutes, push [F-1] "--10" (or "SLP 1").
- 4) Push the [TIMER] switch IN.
- 5) To turn the Sleep Timer OFF, push [F-2] "OFF".
- 6) Push [F-6] "MENU" to return to MENU 1.

[TIMER]

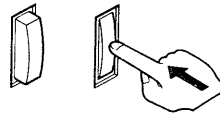

(2) SLEEP 2

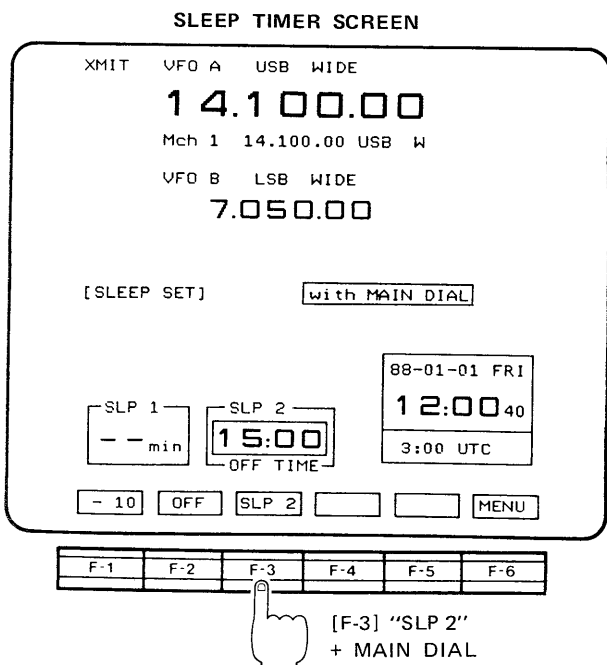

- 1) To access Sleep 2 Timer, push [F-3] "SLP 2" when the SLEEP TIMER screen is displayed.
- 2) Push and hold [F-3] and rotate the MAIN DIAL to the desired shut off time.
- 3) Push the [TIMER] switch IN.
- 4) To turn the Sleep Timer OFF, push [F-2] "OFF".
- 5) Push [F-6] "MENU" to return to MENU 1.

[TIMER]

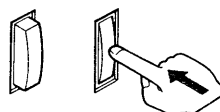

11. CLOCK AND TIMER OPERATION

11-3 DAILY TIMER

DAILY TIMER SET (1) SCREEN

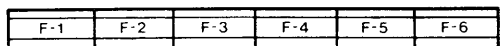
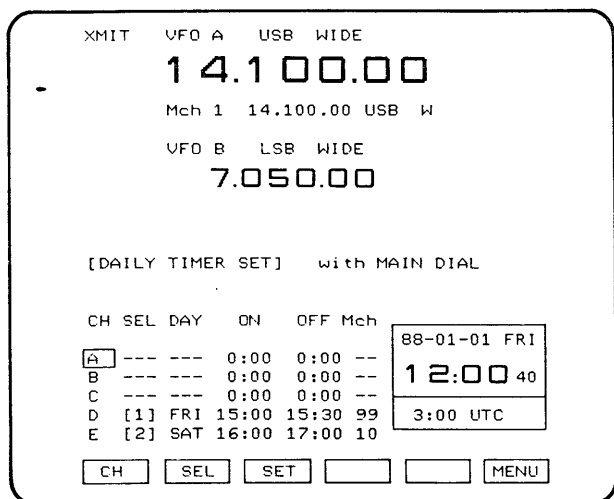

- ↑ Accesses the DAILY TIMER SET(2) Screen
- ↑ Turns ON and OFF the selected Daily Timer.
- ↑ Selects one of Daily Timers (A ~ E) with the MAIN DIAL.

DAILY TIMER SET (2) SCREEN

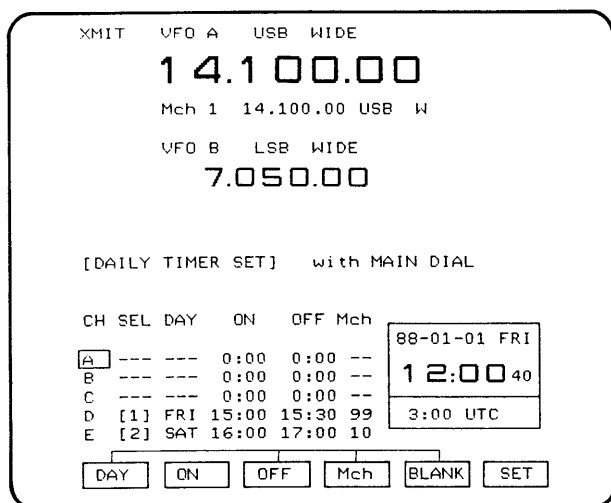

[TIMER]

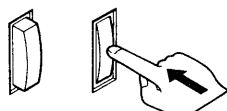

Five programmable Daily Timers turn the transceiver ON and OFF. The programmable contents include the day, ON/OFF time and memory channel.

- 1) To access the CLOCK & TIMER screen, push [F-4] "TIME" when the CRT displays MENU 1.
- 2) To access the DAILY TIMER SET (1) screen, push [F-2] "TIMER".
- 3) Push and hold [F-1] "CH", and select A, B, C, D or E with the MAIN DIAL.

- 4) Push [F-2] "SEL" to turn selected timer ON.

- Selected number shows timer priority.

- 5) To access the DAILY TIMER SET (2) screen, push [F-3] "SET".

- 6) To set the day, push [F-1] "DAY" and adjust the MAIN DIAL.

- To activate the timer every day, push this switch and [F-5] "BLANK" simultaneously.

- 7) To set the timer ON time, push [F-2] "ON" and adjust the MAIN DIAL.

- 8) To set the OFF time, push [F-3] "OFF" and adjust the MAIN DIAL.

- To only turn ON the power with the timer, push this switch and [F-5] "BLANK" simultaneously.

- 9) To select the memory channel number in which you have already stored a frequency, push and hold [F-4] "Mch" and adjust the MAIN DIAL.

- To turn ON the timer at the displayed frequency, push this switch and [F-5] "BLANK" simultaneously.

- 10) Push [F-6] "SET".

- 11) Push the [TIMER] switch IN.

- 12) Program another Daily Timer (begin again from item 3) or push [F-6] "MENU" to access MENU 1.

- 13) Several seconds after you access MENU 1, the power automatically turns OFF, and will turn ON again at the Daily Timer ON time.

NOTE: To operate the Daily Timer together with the Sleep Timer, set the Sleep Timer before pushing IN the [TIMER] switch.

■ DAILY TIMER OPERATION

● CHECKING THE OFF TIME

The OFF time of the activated Daily Timer can be checked on the CLOCK & TIMER screen. To access the CLOCK & TIMER screen, push [F-4] "TIME" when CRT displays MENU 1.

● CHANGING THE OFF TIME

The OFF time can be changed when the timer is ON without changing the programming on the DAILY TIMER SET (2) screen, if desired.

- Select the SLEEP TIMER screen and set the desired OFF time on the Sleep 2 Timer.

- The programmed OFF time of the Daily Timer remains at the original OFF time.

● DAILY TIMER CANCELLING

If you wish to cancel Daily Timer which has been turned ON, and to operate the next programmed timer, turn the [POWER] switch OFF and then ON, one minute after the timer is turned ON.

- The transceiver is turned OFF as soon as the power comes ON.

● SLEEP TIMER CANCELLING

If you wish to cancel the Sleep Timer when you operate the Sleep Timer together with the Daily Timer, turn [POWER] switch OFF and then ON.

- The transceiver is turned OFF as soon as the power comes ON.

■ PROGRAMMING NOTE

(1) When the ON time is the same for 2 programs.

CH	SEL	DAY	ON	OFF	Mch
A	[2]	FRI	13:00	14:00	01
B	[1]	FRI	13:00	15:00	02

The later OFF time program is selected.

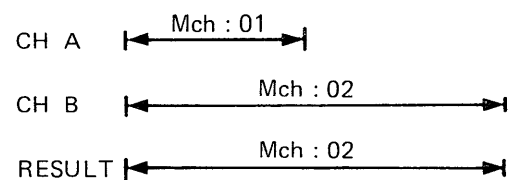

(2) When the OFF time and ON time are the same on 2 programs.

CH	SEL	DAY	ON	OFF	Mch
A	[1]	FRI	13:00	14:00	01
B	[2]	FRI	14:00	15:00	02

The Mch changes.

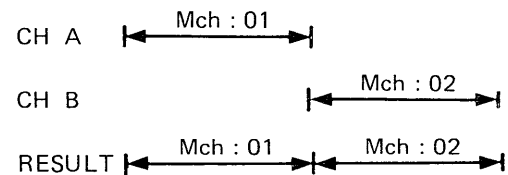

(3) When 2 programs overlap.

CH	SEL	DAY	ON	OFF	Mch
A	[1]	FRI	13:00	14:00	01
B	[2]	FRI	13:30	14:30	02

Only the first program is selected.

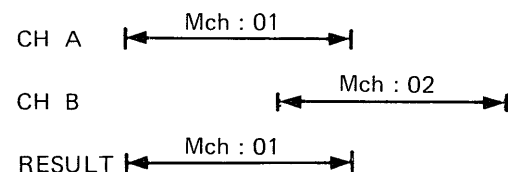

12. CIRCUIT DESCRIPTION

12-1 RECEIVER CIRCUITS

(1) RF CIRCUITS (RF UNIT)

Incoming signals pass through the TUNER UNIT and enter the RF UNIT. The RF UNIT has 9 RF bandpass filters for signals above 1.6MHz and 2 low-pass filters for signals below 1.6MHz. Incoming signals pass through one of bandpass filters or low-pass filters. Signals above 1.6MHz pass through the L-type pin diodes attenuator (D18, D19) and bypass, or are amplified by the preamplifier circuit (Q13, Q14). The preamplifier has 10dB gain for wideband frequency range.

The IC-781 has two mixer circuits for the Dual Watch operation. Signals are separated at L41, amplified at Q304 and Q404* and then enter the 1st mixer circuits (Q302/Q303 and Q402/Q403*) to be converted to 46.5115MHz 1st IF signals. D301~D305* D401~D405* consists of dual π -type attenuator for the [BALANCE] control.

(*Operates during Dual Watch operation)

1st IF signals pass through a high isolation buffer Q7 and Q8*, MCF (Monolithic Crystal Filter) and then enter the IF UNIT via J6 in the RF UNIT.

(2) IF CIRCUITS (IF UNIT)

1st IF signals from the RF UNIT are converted to 9.0115 MHz 2nd IF signals at DBM (Double Balanced Mixer) (IC14). 2nd IF signals pass through D96 (D97 for transmitting) and are then amplified at Q43 in FM or amplified at Q58 in another mode.

Output signals from Q58 pass through the noise blanker filter (F17), noise blanker gate (D92 ~ D95), and are amplified at Q57. Signals are then applied to one of the four 9MHz filters.

Signals from the 9MHz filter pass through the impedance converter (Q74) and are converted to 455kHz 3rd IF signals at IC12. The 3rd IF signals pass through one of four 455kHz filters and then enter the MAIN UNIT via P3 pin 8 in the IF UNIT. The 3rd IF signals are converted to 10.695MHz 4th IF signals at IC29 on the MAIN UNIT.

(3) NOISE BLANKER CIRCUITS (IF UNIT)

The IC-781 uses the noise trigger-type noise blanker circuit. A portion of the signal from F17 is amplified at the noise amplifier (Q59 ~ Q61), detected at the noise detector (D98, D99), and is then separately applied to the noise AGC circuit (Q63) and the noise gate control.

The noise AGC circuit does not operate for pulse-type noise. The noise AGC circuit reduces the gain of the noise amplifier with only normal signal strength by applying the pulse-type noise to the noise gate control.

The noise gate control consists of a pulse amplifier (Q62, Q65), gate drive (Q66) and NB-wide circuits. The threshold level of the pulse amplifier is controlled by the [NB-LEVEL] control.

(4) NOTCH CIRCUITS (MAIN UNIT)

The 3rd IF signals from the IF UNIT are converted to 10.695MHz 4th IF signals at IC29 and then pass through the notch filter (X5). The local oscillator signal for conversion comes from the notch oscillator (Q10, X1). This oscillator signal is also applied to the BFO circuit. Changing the notch oscillator frequency electronically changes the center frequency of the notch filter.

(5) TWIN PBT OSCILLATOR (MAIN UNIT)

The TWIN PBT oscillator circuit consists of two PLL circuits in the MAIN UNIT. A 142MHz band frequency is oscillated at PBT-1 circuit and is divided by 80 to obtain 1.25MHz. These outputs are mixed at IC5 and applied to the 3rd mixer (IC12) in the IF UNIT. PBT-2 outputs are mixed with the notch oscillator, and the resulting signal is applied to the 4th mixer (IC29) in the MAIN UNIT.

(6) BFO OSCILLATOR (MAIN UNIT)

The BFO oscillator circuit also uses the PLL circuit. The BFO oscillator frequency is 91MHz and is divided by 20 at IC15, and divided by 10 at IC16 to obtain 455kHz. This frequency is mixed with the frequency of the notch oscillator circuit to obtain a 10.695MHz BFO frequency and FTC (FM Transmit Carrier) frequency. This frequency is used for the balanced modulator in the IF UNIT via Q15 and Q16 and for the PLL UNIT.

The reference oscillator of the BFO PLL consists of Q18 and X2. The frequency is shifted with the [MODE] switches by D9 ~ D11.

(7) AF CIRCUITS (MAIN UNIT)

The 4th IF signals (SSB, CW and RTTY) are detected at the product detector (IC28). The AM signal is detected at D49 and D66, and FM signal at IC10. The detected signals enter the FRONT UNIT and pass through the [AF GAIN] control and tone control circuit and are then power amplified at IC22 in the MAIN UNIT.

12-2 TRANSMITTER CIRCUITS

(1) MIC AMPLIFIER (MAIN UNIT)

Audio signals from the MIC CONNECTOR are amplified at the mic amplifier (Q1) in the FRONT UNIT, pass through the [MIC GAIN] control, and then enter the MAIN UNIT via J16 pin 3. These signals are amplified at IC23(f), pass through the switching circuit (Q38), and are then applied to the balanced modulator (IC11) in the IF UNIT via J9 pin 2 in the MAIN UNIT. Q38 is turned OFF in CW, RTTY and FM.

• IC-781 frequency construction

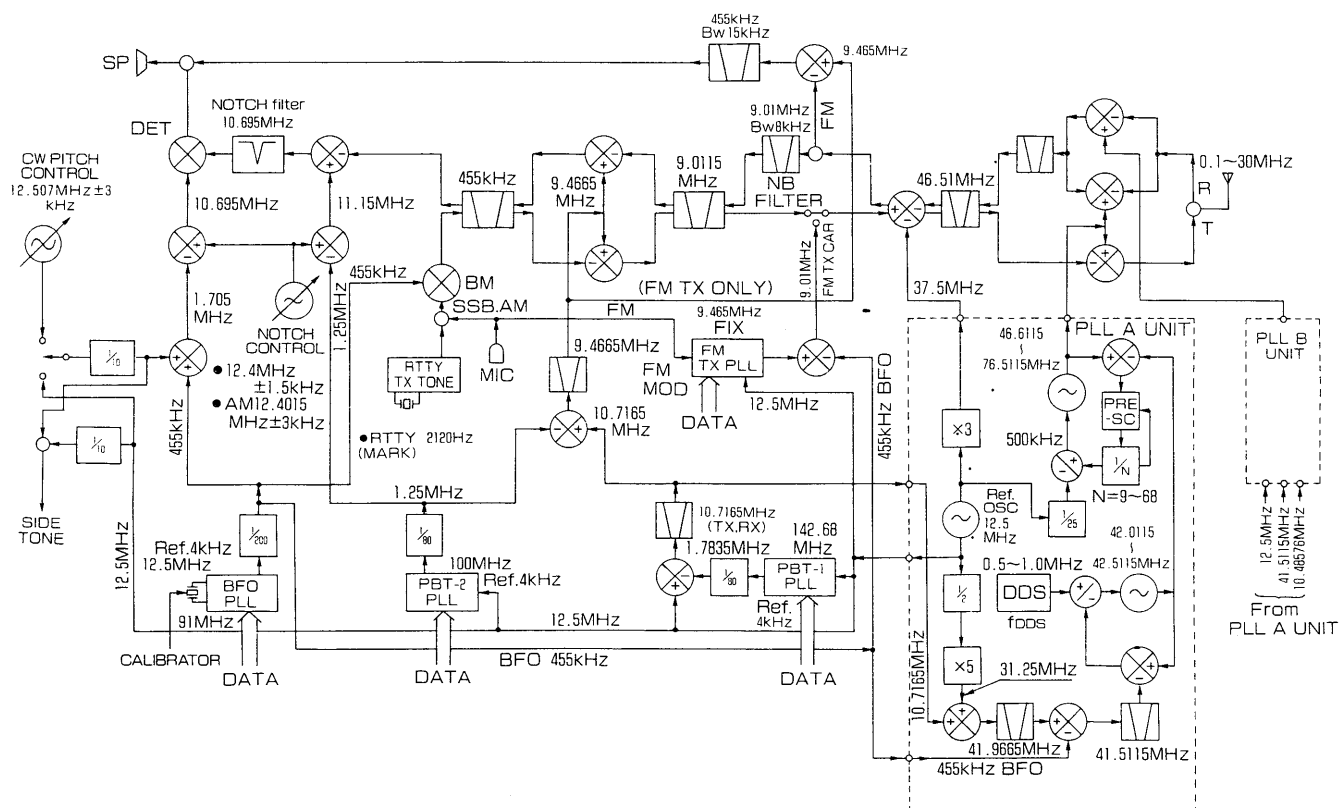

In FM, output signals from IC23(f) are applied to the IDC UNIT and IC23(e). The IDC UNIT limiter amplifies the signals, and IC23(e) amplifies the signal for the deviation meter (ALC meter in another mode).

(2) RTTY SIGNAL GENERATOR (MAIN UNIT)

In the IC-781, RTTY signals are generated from an audio signal to maintain excellent frequency stability, and are applied to the balanced modulator circuit in the IF UNIT.

IC20 consists of a reference oscillator, divider and sine wave converter. IC20 oscillates 3.596MHz signals with a crystal unit (X4) and outputs 2120Hz signals for MARK and 2290Hz signals for SPACE from pin 2. Pins 8 ~ 13 on IC20 are used for dividing data input for the internal divider circuit.

Either 170Hz, 425Hz or 850Hz shift frequency can be selected by a plug, P1, on connector J17.

(3) FM TX OSCILLATOR (MAIN UNIT)

The IC-781 has an exclusive transmit IF circuit. The circuit consists of PLL IC (IC17) and a VCO (Q22). Output signals of the IDC UNIT are applied to the VCO circuit to generate FM signals.

This PLL circuit generates 9.465MHz signals which are applied to the mixer circuit (IC12) via Q23, creating 9.01MHz IF signals for transmitting.

(4) BALANCED MODULATOR (IF UNIT)

Output signals from IC23(f) enter the IF UNIT and are applied to the balanced modulator circuit (IC11) to be converted to 455kHz IF signals. The output signals from IC11 pass through a 455kHz filter to obtain an SSB signal.

R142 and R145 adjust the balance level of IC11 for maximum carrier suppression. In AM, Q45 and R144 upset the balance to obtain carrier signals.

(5) COMPRESSOR CIRCUIT (IF UNIT)

Output signals from the 455kHz filter pass through the impedance converter (Q50) and pass through D59 or D60. When [COMP] switch is ON, or CW or RTTY are selected, signals amplified at Q53 pass through the diode limiter (D65, D66), and are amplified at Q56. The gain of Q56 is controlled by the [DRIVE] control. When the [COMP] switch is OFF in SSB, signals bypass the above circuits via D60 and D61.

12. CIRCUIT DESCRIPTION

(6) IF CIRCUITS (IF AND RF UNITS)

Amplified or bypassed signals from the compressor circuit are converted to 9MHz IF signals at IC13, pass through a 9MHz filter, are amplified at Q39, and are then converted to 46.5115MHz IF signals at IC14. IC14 is also used in receiving. FM signals from the MAIN UNIT are amplified at Q32 and are then applied to IC14.

46.5515MHz IF signals enter the RF UNIT, pass through F11, and are then amplified at Q23. Amplified signals are converted to the displayed frequency at the balanced mixer (Q24, Q25).

(7) RF CIRCUITS (RF AND PA UNITS)

Converted signals from Q24 and Q25 are amplified at Q21. The bias voltage of Q21 (2nd gate) is controlled by the [RF PWR] control. Amplified signals pass through the X-VERTER switching circuit (D49, D50), are amplified at Q20, and are then applied to the PA UNIT. Output level from the RF UNIT is +6dBm max.

Incoming signals from the RF UNIT are amplified at the predriver (Q1), the driver (Q2, Q3) and the power amplifier (Q4, Q5) to obtain stable 150W RF output power. The predriver consists of a class A amplifier with 15V Vcc. and both the driver and the power amplifier consist of a class AB push-pull amplifier with approx. 30V Vcc.

(8) ALC CIRCUIT (IF UNIT)

FOR voltage (detected voltage of the forward signal from the SWR detector circuit in the FILTER UNIT) is applied to IC4(a) and IC5(d) in the IF UNIT. POIF voltage (control voltage from the [RF PWR] control) is also applied to IC4(a) as the reference voltage.

When the FOR voltage exceeds the POIF voltage, IC4(a) controls the IF amplifiers to reduce the output power until the FOR voltage and POIF voltages equalizes. When the FOR voltage is less than the POIF voltage, IC4(a) outputs negative voltage, increasing the output power until FOR and POIF are equalized. Q32 and Q39 in the IF UNIT and Q23 in the RF UNIT are controlled by ALC voltage.

(9) APC CIRCUITS (IF UNIT)

The APC circuits prevent the final transistors from the high SWR and excessive current. REF voltage (detected voltage of the reflection signal from the SWR detector circuit in the FILTER UNIT) is amplified at IC4(b) and IC6(e). The output voltage of IC6(e) controls the ALC circuits.

The output voltage of the IC meter amplifier (IC3) is also applied to IC6(e) to operate the excessive current ALC.

12-3 ANTENNA TUNER

(1) MATCHING CIRCUITS

Variable capacitors C303 and C304 are connected to their respective motors. Additional condensers are connected to C303 and C304 when the transceiver operates in the 1.8 ~ 3.5MHz range. The taps of L210 and additional coils L211 ~ L213 are automatically grounded by the band-designated relays, RL204 ~ RL209. By using two separate motors, the IC-781 obtains a faster overall tuning speed.

(2) DETECTOR CIRCUITS

The antenna tuner has two detector circuits: a resistance components detector and a reactance components detector.

Resistance components are picked up by L6 and detected by D16 and D15 on the DET UNIT. D16 outputs negative voltage and D15 outputs positive voltage. Output voltage of the resistance components detector is added to the voltage output from D16 and D15. When antenna impedance is higher than 50Ω , output voltage is positive; when lower than 50Ω , negative.

Reactance components are detected by L6 and R43. RF voltage is detected by C42 ~ C44. Both detector voltages are buffer amplified at Q13 and Q14, and are then applied to phase comparators IC3 ~ IC5.

12-4 PLL CIRCUITS

The IC-781 has two PLL units (PLL A and PLL B) for the Dual Watch operation. Each PLL UNIT generates the 1st LO (46.5115 ~ 76.5115MHz variable) used in the RF UNIT. The PLL A UNIT generates the 2nd LO (37.5MHz fixed) used in the IF UNIT.

This section explains the PLL A UNIT.

(1) REFERENCE OSCILLATOR CIRCUIT

The IC-781 uses a constant temperature oven-type crystal unit (CR-228) which is stable to $\pm 0.25\text{ppm}$ ($-30^\circ\text{C} \sim +60^\circ\text{C}$). The CR-228 generates the reference frequency for the PLL A UNIT, PLL B UNIT (through P8), and MAIN UNIT PLL circuits (through P9).

(2) 2nd LOCAL OSCILLATOR CIRCUITS

A 2nd local oscillator frequency is used for the 2nd mixer circuit in the IF UNIT. Q33 in the PLL A UNIT is a multiplier circuit that multiplies the reference frequency of 12.5MHz by 3 to 37.5MHz. The 37.5MHz signal is applied to the IF UNIT.

(3) MAIN LOOP

The main loop generates the 1st LO frequency of 46.5115 ~ 76.5115MHz for the RF UNIT.

An oscillated signal at one of 4 VCOs (Q2, Q3, Q13, Q14) is amplified at Q6, Q45, and Q21, and is then mixed with f_{LO} (sub loop output) to obtain a frequency of 4.5 ~ 34.5MHz. The converted frequency is amplified at Q19 and Q20, passes through one of three bandpass filters, and is applied to the prescaler (IC10 and IC11 in EP2).

The prescaler divides the signal by 3 or 4 and is applied to the PLL IC (IC2). IC2 includes a phase detector, programmable divider, and a modulus controller for the dividing ratio in the IC chip. The phase detected signal from IC2 is converted to the lock voltage at the loop filter (IC3), and is then applied to the VCO.

The oscillated signal is obtained by following calculation:

$$f_v = f_{LO} + N_T \times f_{REF}$$

- f_v : Main loop output
- f_{LO} : Sub loop output
- N_T : Dividing ratio from the LOGIC A UNIT
- f_{REF} : Reference frequency (500kHz)

(4) SUB LOOP

The sub loop uses the DDS (Direct Digital Synthesizer) system to generate frequencies of 42.00150 ~ 42.51149 MHz in 10Hz steps.

The generated signal at the VCO (Q24) is amplified at Q25, Q32, and is converted to a frequency of 0.5 ~ 0.99999MHz at IC5 and f_{LO1}. The converted signal is amplified at Q30 and Q31 and is then applied to the DDS UNIT to be converted to the lock voltage using the N-data from the LOGIC A UNIT.

A frequency of f_{LO1} equals 41.5115MHz ± (MODE shift frequency ± PBT1 shift frequency). The reference frequency is divided by 2 at IC8, multiplied by 5 at Q37, and mixed with PLOA frequency at the mixer (IC7). PLOA frequency equals 10.7165MHz ± PBT1 shift frequency, and is generated at the MAIN UNIT.

The mixed signal (41.9665MHz) passes through FI2, and is mixed with the PLOB frequency at the mixer (IC6). PLOB frequency equals 455kHz ± MODE shift frequency, and is generated at the MAIN UNIT. The mixed signal (41.5115MHz) passes through FI1, is amplified at Q35, and is then applied to the sub loop mixer (IC5).

The f_{LO1} signal (output from Q35) is also applied to the PLL B UNIT.

PLL A UNIT construction

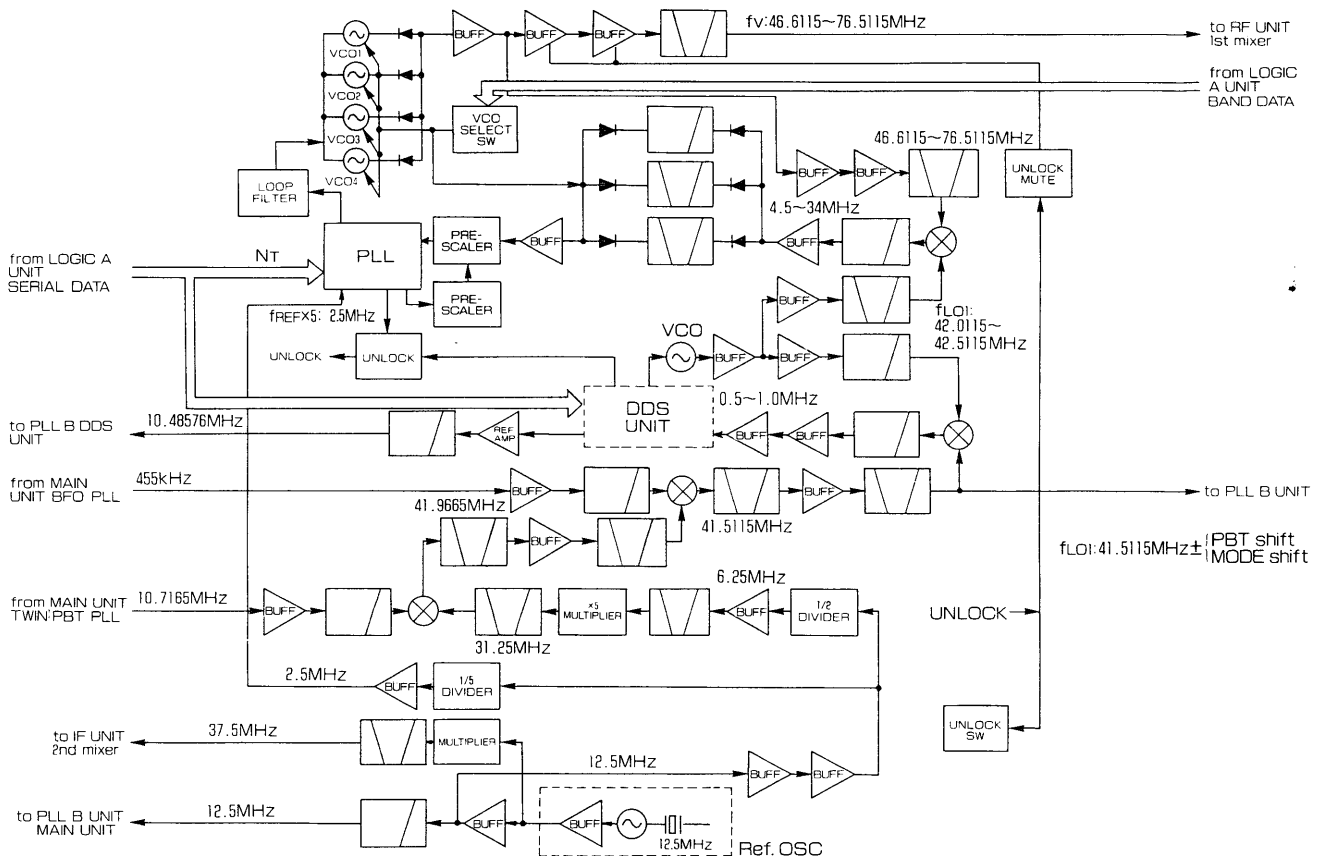

13. MAINTENANCE

13-1 TROUBLESHOOTING

The following chart is designed to help you correct problems which are not equipment malfunctions. If you are unable to locate the cause of the problem or solve it through the use of this chart, contact your nearest ICOM service center or dealer.

RECEIVING AND TRANSMITTING

PROBLEM	POSSIBLE CAUSE	SOLUTION	REF
1. Power does not turn ON.	<ul style="list-style-type: none"> • [TIMER] is pushed IN. • [BRIGHT] and [DIMMER] are rotated too far CCW. • The fuse is blown. 	<ul style="list-style-type: none"> • Turn [TIMER] OFF. • Set [BRIGHT] to the 2 o'clock position and [DIMMER] max. CW. • Check for the cause, then replace the fuse. 	<p>p. 76</p> <p>p. 12</p> <p>p. 86</p>
2. No sound comes from the speaker or volume is too low.	<ul style="list-style-type: none"> • [RF GAIN] is rotated too far CCW. • [SQL] is rotated too far CW. • [TWIN PBT] are rotated to the max opposite poles. • The [TRANSMIT/RECEIVE] switch is set to transmit. 	<ul style="list-style-type: none"> • Rotate [RF GAIN] max. CW. • Rotate [SQL] max. CCW. • Set [TWIN PBT] to 12 o'clock. • Select receive with [TRANSMIT/RECEIVE] or connected external unit. 	<p>p. 10</p> <p>p. 40</p> <p>p. 54</p> <p>p. 44</p>
3. Sensitivity is low.	<ul style="list-style-type: none"> • [RF GAIN] is rotated CCW. • [ATT] is ON. • [TUNER] and [SPLIT] are ON when "A" and "B" frequencies are on different bands. • [BALANCE] is not at 12 o'clock during DUAL WATCH operation. • Different bands are selected during DUAL WATCH operation. 	<ul style="list-style-type: none"> • Rotate [RF GAIN] max. CW. • Turn [ATT] OFF. • Turn [TUNER] or [SPLIT] OFF. • Set [BALANCE] to 12 o'clock. • Set both frequencies in the same band. 	<p>p. 10</p> <p>p. 43</p> <p>p. 59</p> <p>p. 56</p> <p>p. 56</p>
4. S-meter does not move.	<ul style="list-style-type: none"> • [AGC OFF] is pushed IN. 	<ul style="list-style-type: none"> • Push [AGC OFF] OUT. 	<p>p. 55</p>
5. Received audio is unclear or distorted.	<ul style="list-style-type: none"> • [TWIN PBT] are not at 12 o'clock. • [NB] is ON and [NB-LEVEL] is rotated too far CW. • Wrong MODE SWITCH is pushed. • [APF] is ON and [APF] control is not at 12 o'clock in CW mode. • [CW PITCH] is not at 12 o'clock. 	<ul style="list-style-type: none"> • Set [TWIN PBT] to 12 o'clock. • Rotate [NB-LEVEL] CCW. • Push the correct MODE SWITCH. • Set [APF] control to 12 o'clock. • Set [CW PITCH] to 12 o'clock, then adjust frequency again. 	<p>p. 54</p> <p>p. 55</p> <p>p. 43</p> <p>p. 45</p> <p>p. 45</p>
6. No output power or the output power is too low.	<ul style="list-style-type: none"> • The operating frequency is outside an amateur band. • [RF PWR] is rotated too far CCW. • [MIC GAIN] is rotated too far CCW in SSB mode. • [DRIVE] is rotated too far CCW. 	<ul style="list-style-type: none"> • Select an amateur band. • Rotate [RF PWR] CW. • Rotate [MIC GAIN] CW. • Set [DRIVE] to 12 o'clock. 	<p>p. 41</p> <p>p. 44</p> <p>p. 44</p> <p>p. 46</p> <p>p. 60</p>
7. Transmitted signal is unclear or distorted.	<ul style="list-style-type: none"> • [MIC GAIN] is rotated too far CW. • [COMP] is ON and [DRIVE] is rotated too far CW. 	<ul style="list-style-type: none"> • Rotate [MIC GAIN] CCW until the ALC meter (S-meter) needle is within the ALC zone. • Rotate [DRIVE] CCW until the ALC meter (S-meter) needle is within the ALC zone. 	<p>p. 44</p> <p>p. 60</p>
8. Auto tuning does not function (antenna tuner).	<ul style="list-style-type: none"> • Wrong antenna is selected. • AUTO/PRESET switch is selected to the PRESET. • Antenna SWR exceeds 3:1. 	<ul style="list-style-type: none"> • Select the correct antenna for the operating frequency. • Open the hatch on the top cover and select AUTO/PRESET to AUTO. • Adjust your antenna. 	<p>p. 51</p> <p>p. 51</p> <p>p. 51</p>
9. VOX function does not operate.	<ul style="list-style-type: none"> • [DATA] is ON. 	<ul style="list-style-type: none"> • Push [DATA] OFF. 	<p>p. 59</p>

* CW: Clockwise CCW: Counterclockwise

■ FREQUENCY SETTING

PROBLEM	POSSIBLE CAUSE	SOLUTION	REF
1. MAIN DIAL does not function.	• [LOCK] is pushed IN.	• Turn [LOCK] OFF.	p. 89
2. KEYBOARD lighted even when pushing the [F CE] key.	• The SCAN CONDITION screen is selected.	• Push [F-6] "SET" to leave the SCAN CONDITION screen.	p. 22
3. KEYBOARD does not set a frequency.	• KEYBOARD is unlighted. • [.] is not pushed after entering 1MHz digit. • [0] is not pushed before entering 100kHz digit. • The SCAN CONDITION screen is selected.	• Push [F CE]. • Push [.] between entering the 1MHz digit and 100kHz digit. • Push [0] before entering the 100kHz digit. • Push [F-6] "SET" to leave the SCAN CONDITION screen.	p. 41 p. 41 p. 41 p. 22
4. The previously used frequency is lost when bands are changed.	• Band stacking register function is turned OFF.	• Select the BAND KEY PRESET screen and turn ON the band stacking register function.	p. 29

■ SCANNING

PROBLEM	POSSIBLE CAUSE	SOLUTION	REF
1. Scan does not function.	• Squelch opens and [RESUME] is pushed OUT.	• Turn [SQL] CW or push [RESUME] IN.	p. 70
2. Fine scan stops when the squelch opens.	• [RESUME] is pushed OUT.	• Push [RESUME] IN.	p. 70
3. ΔF scan does not function.	• Operating frequency is out of the ΔF scan width (when using center F fix).	• Push [F-4] " ΔF F" to cancel the "center F fix"; or push and hold [F-2] " ΔF " to start the ΔF scan in the ΔF scan width.	p. 71
4. Programmed scan does not function.	• Either P1 or P2 is not programmed.	• Program the scan edge frequency to P1 and P2.	p. 69
5. Selected memory channel scan does not operate.	• The selected memory channel scan number is not same as the selected one.	• Write in the selected memory channel scan number using the MEMORY LIST screen.	p. 65 p. 73

■ MEMORY MODE

PROBLEM	POSSIBLE CAUSE	SOLUTION	REF
1. Wrong contents are memorized.	• MEMORY mode is selected.	• Memory writing is accepted in VFO mode. In MEMORY mode the memory contents can be changed.	p. 63
2. Memory clearing does not function.	• VFO mode is selected.	• Memory can be cleared in MEMORY mode or the MEMORY LIST screen.	p. 66
3. Memory contents clears.	• [M-WRITE] has not been pushed.	• The memory contents can be changed in MEMORY mode; however it is not stored if [M-WRITE] is not pushed.	p. 64

■ CLOCK & TIMER

PROBLEM	POSSIBLE CAUSE	SOLUTION	REF
1. Timer does not function even when the timer is set.	• [TIMER] is not pushed IN. • "SEL" is not pushed on the Daily Timer. • Programmed contents are cleared by CPU resetting.	• Push [TIMER] IN. • Push [F-2] "SEL" when the CRT displays the DAILY TIMER SET (1) screen. • Program the timer again.	p. 76 p. 77 p. 77
2. Second selection timer does not function.	• When the OFF time of the first selection timer is later than the ON time of the second selection timer, the second selection timer does not function.	• Set the time of the Daily Timer again.	p. 78
3. Memory channel appears even though the Daily Timer ON Mch section is blank.	• The timer turns ON to the previous frequency when Mch is blank.	• Select VFO before the timer is turned OFF; or store the required frequency in a memory channel.	p. 77

13. MAINTENANCE

13-2 CPU RESETTING

The CRT DISPLAY may occasionally display erroneous information, e.g., when first applying power. This may be caused externally by static electricity, etc.

If this problem occurs, turn the [POWER] switch OFF. Wait a few seconds, and then turn ON power again. If the problem continues, perform the following procedure.

NOTE: CPU resetting clears all memory information.

- 1) Turn [POWER] OFF.
- 2) Push and hold [M-CLEAR], and turn [POWER] ON.
- 3) The CPU is now reset, and the CRT displays MENU 1.

This screen tests MAIN CPU, SUB CPU and RAM IC chips for correct functioning.

- 1) To access the LOGIC CHECK SCREEN, push and hold [XFC], and turn [POWER] ON.
- 2) Push [F-6] "MENU" to access the MENU 1 screen.

■ LOGIC CHECK SCREEN

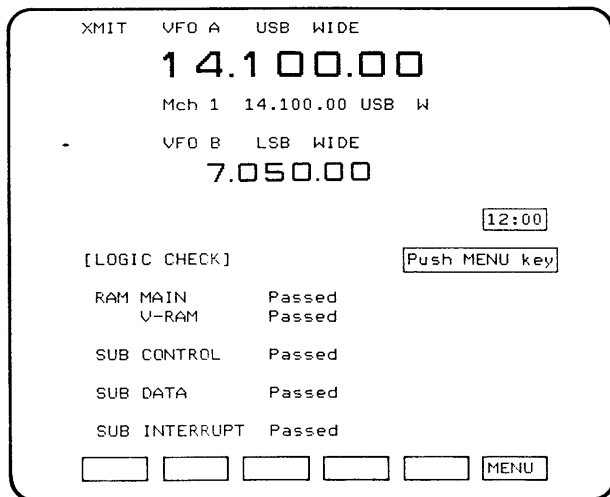

INDICATE	DESCRIPTION
RAM MAIN	8k byte RAM for MAIN CPU.
V-RAM	128k byte V-RAM for CRTIC.
SUB CONTROL	Control line between MAIN CPU and SUB CPU.
SUB DATA	Data transferring between MAIN CPU and SUB CPU.
SUB INTERRUPT	Interrupt data line to SUB CPU.

The above items are checked. The CRT displays "Passed" next to the items which function correctly or "PROGRAM STOP" when there is a problem. If "PROGRAM STOP" appears, the CPU accepts only the MAIN DIAL.

NOTE: When "PROGRAM STOP" is indicated on the LOGIC CHECK screen, the transceiver should be sent to an authorized ICOM dealer or service center.

■ BACKUP BATTERY

● Clock battery

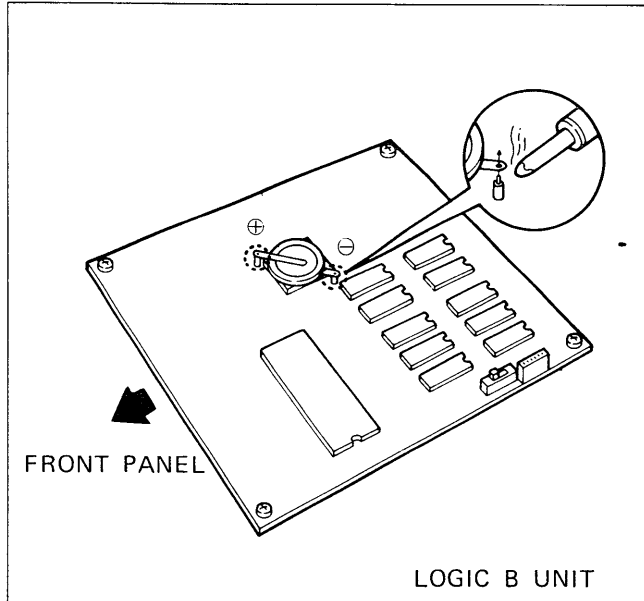

The IC-781 has one lithium backup battery for memory and one for the clocks.

The usual life of the clock battery is two years after shipment from the factory. If the clocks are slow or there is a numbering malfunction, replace the lithium battery (BR2032).

WARNING: DISCONNECT THE AC CORD FROM THE AC OUTLET BEFORE REMOVING THE COVER.

- 1) Remove the top cover. See p. 88.
- 2) Unsolder the battery and remove it.
- 3) Check the positive (+) and negative (-) terminals of the battery and solder them to their original positions.
- 4) Replace the top cover and adjust the clock.

● Memory backup

The usual life of the memory backup battery is five years. It is advisable to monitor the battery carefully and replace it if there are repeated cases of display malfunction.

The transceiver transmits and receives normally when the backup battery is exhausted, but the transceiver cannot retain memory information.

13-3 FUSE REPLACEMENT

If the fuse blows or the transceiver stops functioning, find the source of the problem if possible, and replace the damaged fuse with a new, rated fuse.

WARNING: DISCONNECT THE AC CORD FROM THE AC OUTLET WHEN CHANGING THE FUSE TO PREVENT ELECTRIC SHOCKS.

- Rear panel AC line fuse : 10A for 120V AC
5A for 220 ~ 240V AC

- Inside DC line fuse : 2A

Inside DC line fuse is used for ACC(1) and ACC(2) sockets. See p. 71 for the fuse location.

13-4 CLEANING

If the transceiver becomes dusty or dirty, wipe it clean with a dry, soft cloth. Avoid the use of strong cleaning agents such as benzine or alcohol as they may damage the surface.

14. ADJUSTMENT

14-1 SIMPLE FREQUENCY CALIBRATION

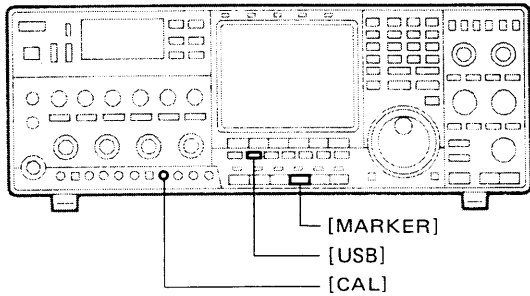

A very accurate frequency counter is required to calibrate the frequency of the IC-781. However, a simple check may be performed by receiving radio station WWV, or other standard frequency signals.

Because this simple calibration adjusts the reference oscillator, it is unnecessary to calibrate each band.

- 1) Push [USB].
- 2) Set the operating frequency to the standard frequency station minus 1kHz.

EXAMPLE:

When using WWV (10.000.00MHz), adjust the operating frequency 9.999.00MHz.

$$10.000.00\text{MHz} - 0.001.00\text{MHz (1kHz)} = 9.999.00\text{MHz}$$

- 3) Push [MARKER] IN.
- 4) Adjust the [CAL] pot for a zero beat.
 - Zero beat means that two signals are exactly the same frequency, resulting in a single audio tone being emitted.

14-2 BRAKE ADJUSTMENT

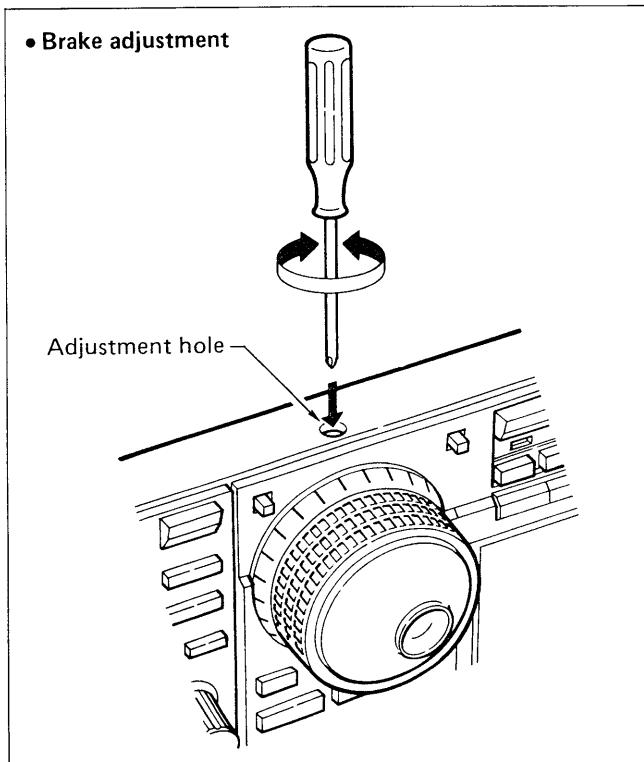

The tension of the MAIN DIAL may be adjusted to suit the operator.

- 1) The brake adjustment screw is located on the bottom side of the transceiver cabinet below the MAIN DIAL.
- 2) Turn the brake adjustment screw clockwise or counter-clockwise to a comfortable tension level while turning the MAIN DIAL continuously and evenly in one direction.

14-3 TRANSCEIVER DISASSEMBLY

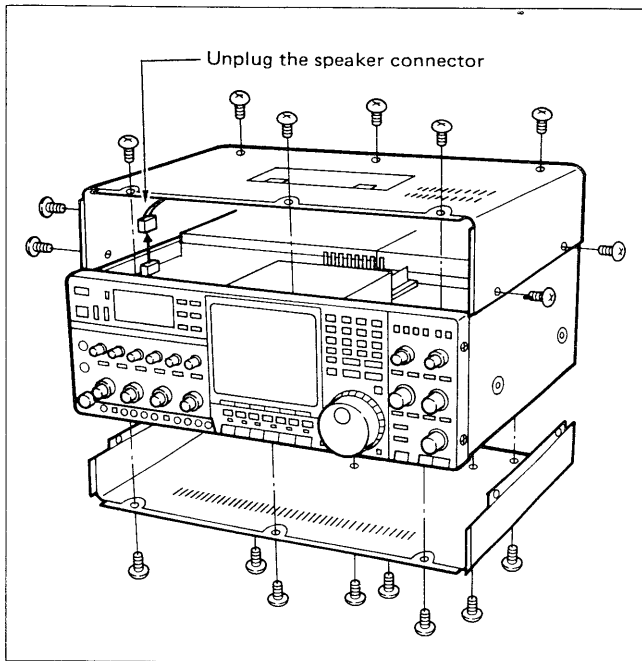

- 1) Turn [POWER] OFF, and disconnect the power cable.
 - 2) Unscrew 10 screws (including 4 on the transceiver sides) from the top cover.
 - 3) Remove the top cover slowly and unplug the speaker connector.
- Be careful. Do not cut the speaker cord.
- 4) Unscrew 8 screws from bottom cover.
 - 5) Remove the bottom cover.

14-4 ELECTRONIC KEYS WEIGHT CONTROL

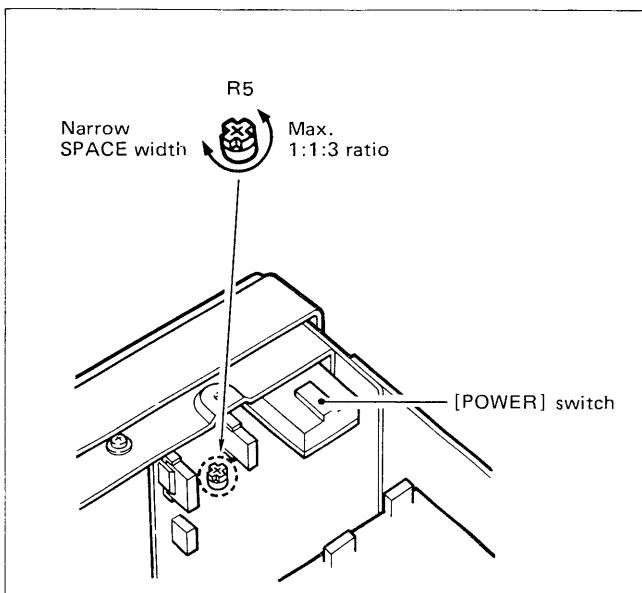

- 1) Open the top cover.
- 2) Connect an iambic keyer paddle to the [ELEC-KEY] jack on the front panel.
- 3) Push [CW] and [BK-IN].
- 4) Close the CW key and adjust R5.

- The R5 WEIGHT CONTROL is set at the factory for a DOT : SPACE : DASH ratio of 1:1:3. R5 changes the width of the SPACE.

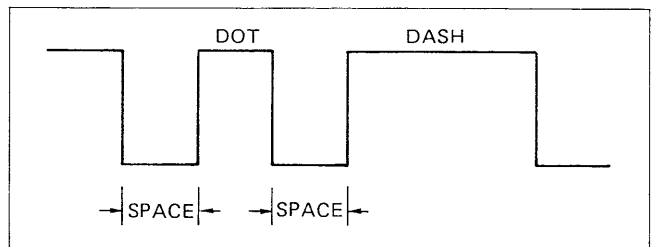

14. ADJUSTMENT

14-5 DIAL LOCK SWITCH FUNCTION

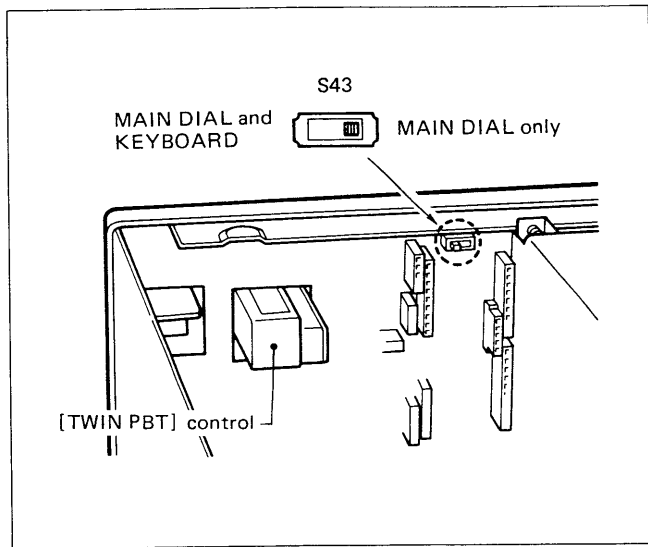

The [LOCK] switch function is selectable as follows:

- Electronically locks only the MAIN DIAL.
- Electronically locks the MAIN DIAL, KEYBOARD and some non-locked switches.

- 1) Open the top cover. See p. 88.
- 2) Set S43 to the desired position at left.

14-6 MAIN DIAL ROTATION

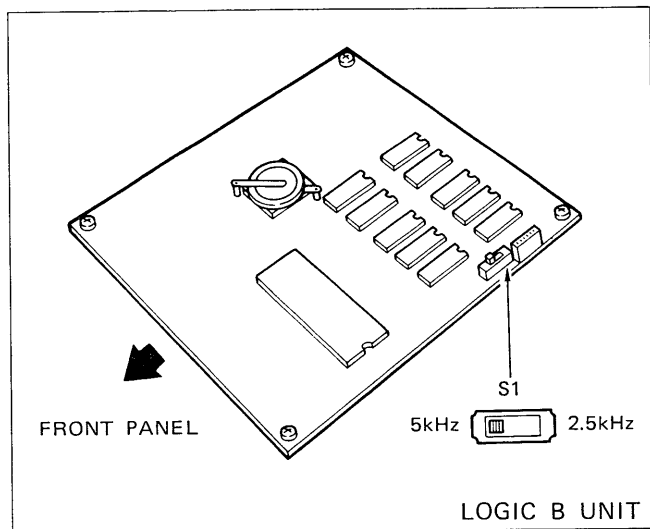

The MAIN DIAL rotation speed is selectable. One slow rotation of the MAIN DIAL (when [TS] is OFF) can be set to 5kHz or 2.5kHz.

- 1) Open the top cover. See p. 88.
- 2) Set S1 to the desired position at left.

14-7 BFO ADJUSTMENT

Connect a frequency counter to L30 on the MAIN UNIT. See p. 92 for location.

MODE	FREQUENCY	ADJUSTMENT
AM	455.0kHz	L36
USB	453.5kHz	C106
LSB	456.5kHz	C107

14-8 TONE FREQUENCY SETTING

The subaudible tone frequency is set at 88.5kHz. This frequency is selectable as shown in the table below.

- 1) Open the top and bottom covers. See p. 88.
- 2) Solder pins (P1 ~ P6) if you require the other subaudible tone frequencies.

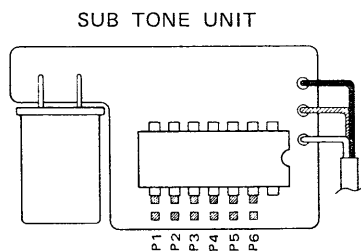

Located on the MAIN UNIT.
See p. 92

• Subaudible tone encoder programming chart

FRE-QUENCY	P1	P2	P3	P4	P5	P6	FRE-QUENCY	P1	P2	P3	P4	P5	P6
67.0	1						131.8			1		1	
71.9		1					136.5	1		1		1	
74.4	1	1					141.3		1	1		1	
77.0			1				146.2	1	1	1		1	
79.7	1		1				151.4				1	1	
82.5		1	1				156.7	1			1	1	
85.4	1	1	1				162.2		1		1	1	
88.5				1			167.9	1	1		1	1	
91.5	1			1			173.8			1	1	1	
94.8		1		1			179.9	1		1	1	1	
97.4	1	1		1			186.2		1	1	1	1	
100.0			1	1			192.8	1	1	1	1	1	
103.5	1		1	1			203.5						1
107.2		1	1	1			210.7	1					1
110.9	1	1	1	1			218.1		1				1
114.8					1		225.7	1	1				1
118.8	1				1		233.6			1			1
123.0		1			1		241.8	1		1			1
127.3	1	1			1		250.3		1	1			1

"1" indicates pins to be soldered to program the SUB TONE UNIT for specific tones.

14-9 OPTIONAL UNIT INSTALLATION

The optional UT-36 VOICE SYNTHESIZER UNIT announces the operating frequency when the [SPEECH] switch is pushed; and the operating mode when the operating mode is changed.

- 1) Open the top cover. See p. 88.
- 2) Remove the protective paper from the back of the UT-36 to expose the adhesive strip, and attach the unit on the LOGIC B UNIT as shown at left.
- 3) Connect P1 (5 pins) from LOGIC B UNIT to J1 on the UT-36.
- 4) Connect P89 (3 pins) from the MAIN UNIT to J2 on the UT-36.
- 5) Replace the top cover and 10 screws.

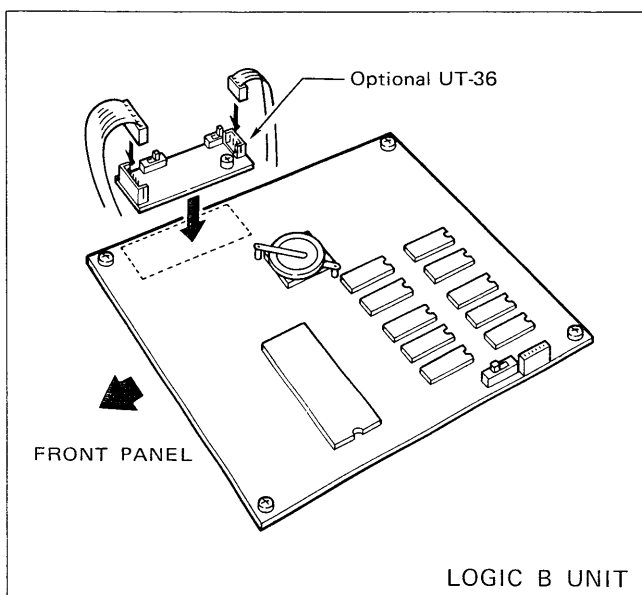

15. INSIDE VIEWS

TOP SIDE VIEW

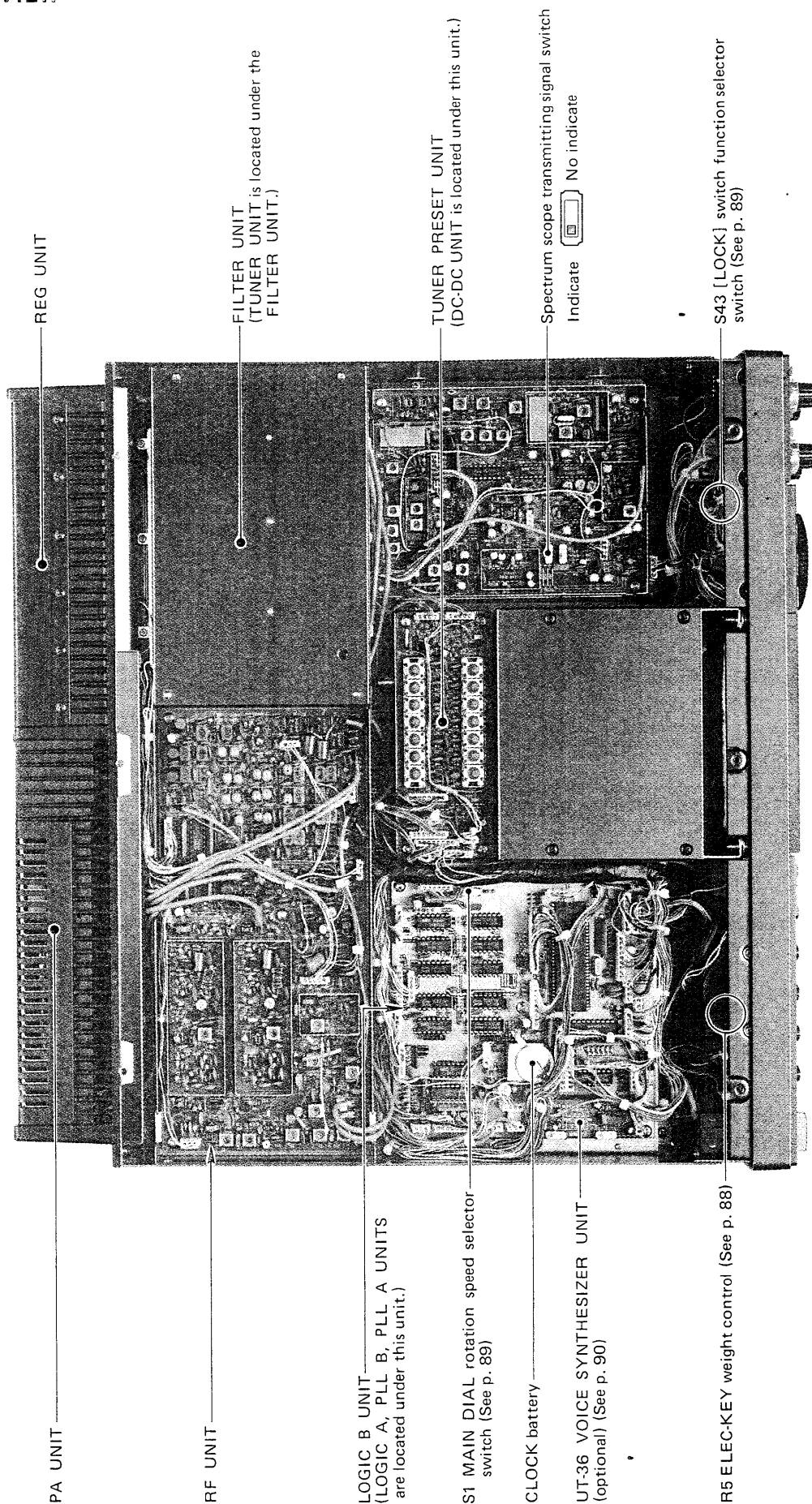

PA UNIT

RF UNIT

LOGIC B UNIT
(LOGIC A, PLL B, PLL A UNITS
are located under this unit.)

S1 MAIN DIAL rotation speed selector
switch (See p. 89)

CLOCK battery

UT-36 VOICE SYNTHESIZER UNIT
(optional) (See p. 90)

R5 ELEC-KEY weight control (See p. 88)

REG UNIT

FILTER UNIT
(TUNER UNIT is located under the
FILTER UNIT.)

TUNER PRESET UNIT
(DC-DC UNIT is located under this unit.)

Spectrum scope transmitting signal switch
Indicate  No indicate

S43 [LOCK] switch function selector
switch (See p. 89)

■ BOTTOM SIDE VIEW

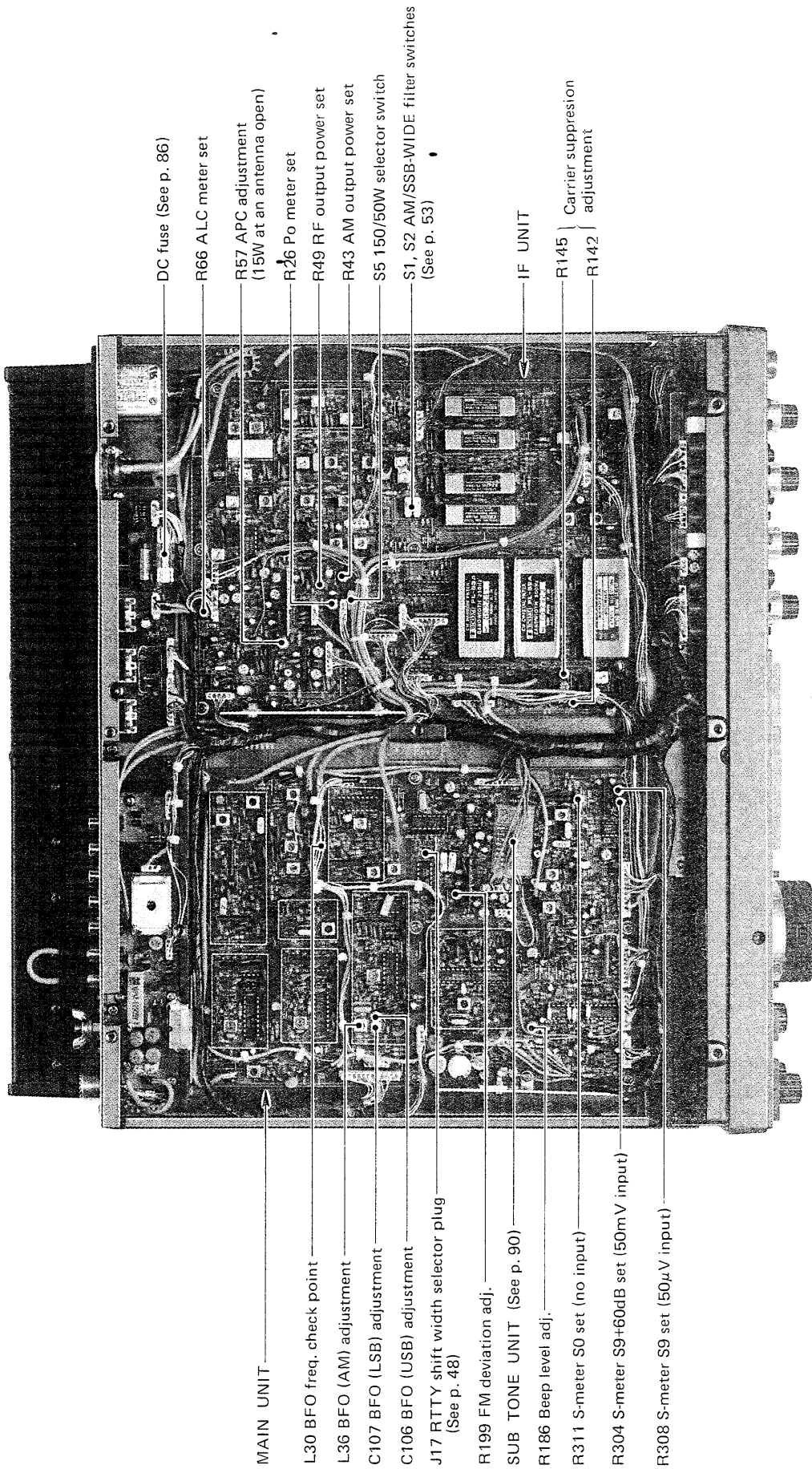

- MAIN UNIT
- L30 BFO freq. check point
- L36 BFO (AM) adjustment
- C107 BFO (LSB) adjustment
- C106 BFO (USB) adjustment
- J17 RTTY shift width selector plug (See p. 48)
- R199 FM deviation adj.
- SUB TONE UNIT (See p. 90)
- R186 Beep level adj.
- R311 S-meter S0 set (no input)
- R304 S-meter S9+60dB set (50mV input)
- R308 S-meter S9 set (50μV input)
- DC fuse (See p. 86)
- R66 ALC meter set
- R57 APC adjustment (15W at an antenna open)
- R26 Po meter set
- R49 RF output power set
- R43 AM output power set
- S5 150/50W selector switch
- S1, S2 AM/SSB-WIDE filter switches (See p. 53)
- IF UNIT
- R145 Carrier suppression adjustment
- R142

16. SPECIFICATIONS

■ GENERAL

• Frequency coverage

Receive	:	0.1000 ~ 30.0000MHz
Transmit	:	160m band 1.8000 ~ 2.0000MHz
		80m band 3.4000 ~ 4.1000MHz
		40m band 6.9000 ~ 7.5000MHz
		30m band 9.9000 ~ 10.5000MHz
		20m band 13.9000 ~ 14.5000MHz
		17m band 17.9000 ~ 18.5000MHz
		15m band 20.9000 ~ 21.5000MHz
		12m band 24.4000 ~ 25.1000MHz
		10m band 27.9000 ~ 30.0000MHz

• Modes

A3J(SSB), A1 (CW), F3 (FM), F1 (RTTY),
A3 (AM)

• Frequency step

10Hz (With [TS] OFF)
1kHz (With [TS] ON)

• Antenna impedance (With [TUNER] OFF)

50Ω unbalanced

• Power supply requirement

100 ~ 120V AC (U.S.A. version)
220 ~ 240V AC (Australia, Europe, France versions)

• Power consumption

Receiving max. audio : 150VA
stand by : 140VA
Transmitting HIGH : 760VA
LOW : 325VA

• Usable temperature range

-10°C ~ +60°C

• Frequency stability

±15Hz (-10°C ~ +60°C)

• Dimensions

425mm(W) x 149mm(H) x 411mm(D)
(Projections not included)

• Weight

23kg

■ TRANSMITTER

• Max. output power

SSB : 150W PEP
CW, RTTY, FM : 150W
AM : 75W

• Modulation

SSB : Balanced modulation
FM RTTY : Reactance modulation
AM : Low level modulation

• Max. frequency deviation

±5kHz

• RTTY shift width

170Hz, 425Hz, 850Hz selectable

• Spurious emissions

Less than -60dB

• Carrier suppression

Less than -40dB

• Unwanted sideband

Less than -55dB (with 1kHz modulation)

• Microphone impedance

600Ω

RECEIVER

Receiving system

SSB, CW, RTTY, AM : Quadruple-conversion
superheterodyne

FM : Triple-conversion
superheterodyne

Intermediate frequencies

	SSB	CW, RTTY	AM	FM
1st	46.5115	46.5106	46.5100	46.5100
2nd	9.0115	9.0106	9.0100	9.0100
3rd	0.4550	0.4550	0.4550	0.4550
4th	10.6950	10.6950	10.6950	---

Unit : MHz

Sensitivity ([PREAMP] ON)

SSB, CW, RTTY (for 10dB S/N):

0.1 ~ 0.5MHz Less than 0.5 μ V

0.5 ~ 1.8MHz Less than 1.0 μ V

1.8 ~ 30MHz Less than 0.16 μ V

AM (for 10dB S/N):

0.1 ~ 0.5MHz Less than 3.2 μ V

0.5 ~ 1.8MHz Less than 6.3 μ V

1.8 ~ 30MHz Less than 1.0 μ V

FM (for 12dB SINAD):

28 ~ 30MHz Less than 0.23 μ V

FM squelch sensitivity

28 ~ 30MHz Less than 0.23 μ V

Selectivity

SSB, CW-W, RTTY-W, AM-N:

More than 2.4kHz/−6dB Less than 3.8kHz/−60dB

CW-N, RTTY-N (With [CM250Hz] OFF):

More than 500Hz/−6dB Less than 1.0kHz/−60dB

CW-N, RTTY-N (With [CW250Hz] ON):

More than 250Hz/−6dB Less than 800Hz/−60dB

AM-W:

More than 6.0kHz/−6dB Less than 15.0kHz/−60dB

FM:

More than 15.0kHz/−6dB Less than 30.0kHz/−50dB

Spurious and image rejection ratio

Image : Less than −80dB IF : Less than −70dB

Audio output

More than 2.6W at 10% distortion with an 8 Ω load.

Notch filter attenuation

More than 45dB

RIT variable range

±9.99kHz

ANTENNA TUNER

Output matching range

16.7 ~ 150 Ω unbalanced.

Minimum input power

15W

Band switching time

Less than 3sec.

Auto tuning time

Less than 3sec.

Auto tuning accuracy

VSWR less than 1.2:1

Insertion loss

Less than 0.5dB (after tuning)

CRT DISPLAY

Output level

Composite video signal : 1Vp-p

Video components : 0.7Vp-p positive

Synchronous components : 0.3Vp-p negative

Output impedance

75 Ω

Usable humidity range

10 ~ 90%

(Keep the transceiver away from moist environments.)

Horizontal frequency

15.75kHz

Vertical frequency

60Hz

All stated specifications are approximate and subject to change without notice or obligation.

17. OPTIONS



IC-2KL
500W LINEAR AMPLIFIER



IC-AT500
500W AUTOMATIC
ANTENNA TUNER

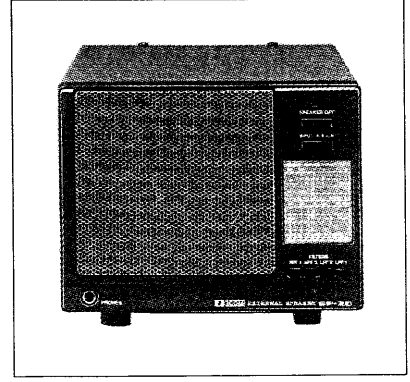

SP-20
EXTERNAL SPEAKER
WITH AUDIO FILTERS

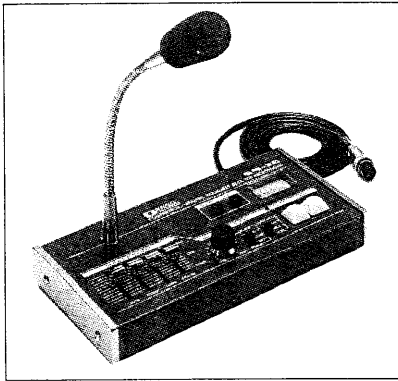

SM-10
COMPRESSOR/GRAPHIC
EQUALIZER DESK TOP
MICROPHONE

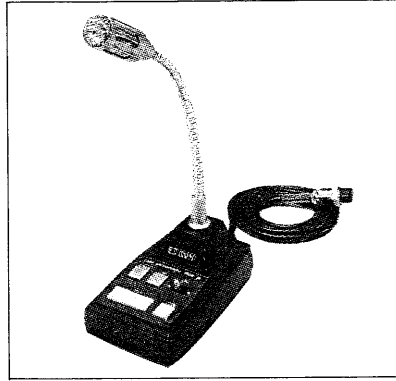

SM-8
DESK MICROPHONE



HP-2
COMMUNICATION
HEADPHONES

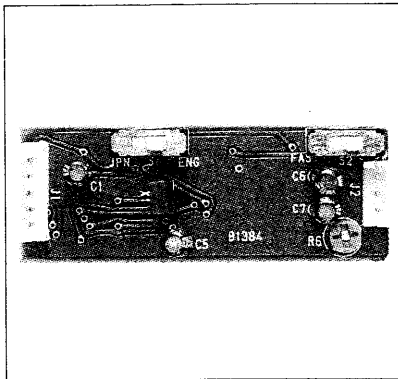

UT-36
VOICE SYNTHESIZER UNIT

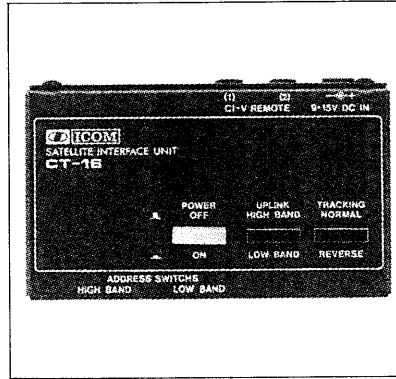

CT-16
SATELLITE INTERFACE UNIT

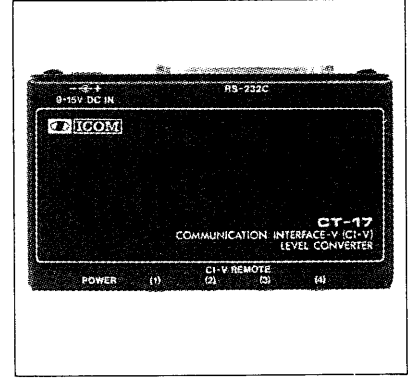

CT-17
CI-V LEVEL CONVERTER

HM-36	HAND MICROPHONE (Up/down switches included)
SM-6	ELECTRET CONDENSER-TYPE DESK MICROPHONE
WR-200	SWR & POWER METER (1.8 ~ 150MHz, max. 200W)
WR-2000	SWR & POWER METER (1.8 ~ 54MHz, max. 2000W)

Please record the serial number of your **IC-781** transceiver below for future servicing reference:

Serial number : _____

Date of purchase : _____

Place where purchased : _____

Count on us!

