

Keysight Infiniium Oscilloscopes

Notices

© Keysight Technologies, Inc. 2007-2017

No part of this manual may be reproduced in any form or by any means (including electronic storage and retrieval or translation into a foreign language) without prior agreement and written consent from Keysight Technologies, Inc. as governed by United States and international copyright laws.

Revision

Version 06.10.00709

Edition

November 2017

Available in electronic format only

Published by:

Keysight Technologies, Inc.
1900 Garden of the Gods Road
Colorado Springs, CO 80907 USA

Warranty

The material contained in this document is provided "as is," and is subject to being changed, without notice, in future editions. Further, to the maximum extent permitted by applicable law, Keysight disclaims all warranties, either express or implied, with regard to this manual and any information contained herein, including but not limited to the implied warranties of merchantability and fitness for a particular purpose. Keysight shall not be liable for errors or for incidental or consequential damages in connection with the furnishing, use, or performance of this document or of any information contained herein. Should Keysight and the user have a separate written agreement with warranty terms covering the material in this document that conflict with these terms, the warranty terms in the separate agreement shall control.

Technology License

The hardware and/or software described in this document are furnished under a license and may be used or copied only in accordance with the terms of such license.

U.S. Government Rights

The Software is "commercial computer software," as defined by Federal Acquisition Regulation ("FAR") 2.101. Pursuant to FAR 12.212 and 27.405-3 and Department of Defense FAR Supplement ("DFARS") 227.7202, the U.S. government acquires commercial computer software under the same terms by which the software is customarily provided to the public. Accordingly, Keysight provides the Software to U.S. government customers under its standard commercial license, which is embodied in its End User License Agreement (EULA), a copy of which can be found at www.keysight.com/find/sweula. The license set forth in the EULA represents the exclusive authority by which the U.S. government may use, modify, distribute, or disclose the Software. The EULA and the license set forth therein, does not require or permit, among other things, that Keysight: (1) Furnish technical information related to commercial computer software or commercial computer software documentation that is not customarily provided to the public; or (2) Relinquish to, or otherwise provide, the government rights in excess of these rights customarily provided to the public to use, modify, reproduce, release, perform, display, or disclose commercial computer software or commercial computer software documentation. No additional government requirements beyond those set forth in the EULA shall apply, except to the extent that those terms, rights, or licenses are explicitly required from all providers of commercial computer software pursuant to the FAR and the DFARS and are set forth specifically in writing elsewhere in the EULA. Keysight shall be under no obligation to update, revise or otherwise modify the Software. With respect to any technical data as defined by FAR 2.101, pursuant to FAR 12.211 and 27.404.2 and DFARS 227.7102, the U.S. government acquires no greater than Limited Rights as defined in FAR 27.401 or DFAR 227.7103-5 (c), as applicable in any technical data.

Safety Notices

CAUTION

A **CAUTION** notice denotes a hazard. It calls attention to an operating procedure, practice, or the like that, if not correctly performed or adhered to, could result in damage to the product or loss of important data. Do not proceed beyond a **CAUTION** notice until the indicated conditions are fully understood and met.

WARNING

A **WARNING** notice denotes a hazard. It calls attention to an operating procedure, practice, or the like that, if not correctly performed or adhered to, could result in personal injury or death. Do not proceed beyond a **WARNING** notice until the indicated conditions are fully understood and met.

In This Book

This book is your guide to programming Infiniium oscilloscopes that have the 5.00 or greater, next-generation user interface software. Supported models include:

- 9000 Series and 9000H Series oscilloscopes.
- S-Series oscilloscopes.
- 90000A Series oscilloscopes.
- 90000 X-Series oscilloscopes.
- V-Series oscilloscopes.
- 90000 Q-Series oscilloscopes.
- Z-Series oscilloscopes.
- N8900A Infiniium Offline oscilloscope analysis software.

In this book, **Chapter 1**, “What's New,” starting on page 41, describes programming command changes in the latest version of oscilloscope software.

Chapter 2, “Setting Up,” starting on page 85, describes the steps you must take before you can control the oscilloscope with remote programs.

The next several chapters give you an introduction to programming the oscilloscopes, along with necessary conceptual information. These chapters describe basic program communications, interface, syntax, data types, and status reporting:

- **Chapter 3**, “Introduction to Programming,” starting on page 93
- **Chapter 4**, “Sequential (Blocking) vs. Overlapped Commands,” starting on page 129
- **Chapter 5**, “LAN, USB, and GPIB Interfaces,” starting on page 131
- **Chapter 6**, “Message Communication and System Functions,” starting on page 143
- **Chapter 7**, “Status Reporting,” starting on page 147
- **Chapter 8**, “Remote Acquisition Synchronization,” starting on page 177
- **Chapter 9**, “Programming Conventions,” starting on page 195

The next chapters describe the commands used to program the oscilloscopes. Each chapter describes the set of commands that belong to an individual subsystem, and explains the function of each command.

- **Chapter 10**, “Acquire Commands,” starting on page 203
- **Chapter 11**, “Analyze Commands,” starting on page 237
- **Chapter 12**, “Bus Commands,” starting on page 275
- **Chapter 13**, “Calibration Commands,” starting on page 287
- **Chapter 14**, “Channel Commands,” starting on page 299
- **Chapter 15**, “Common Commands,” starting on page 401
- **Chapter 16**, “Digital Commands,” starting on page 425

- **Chapter 17**, “Disk Commands,” starting on page 431
 - **Chapter 18**, “Display Commands,” starting on page 449
 - **Chapter 19**, “Function Commands,” starting on page 493
 - **Chapter 20**, “Hardcopy Commands,” starting on page 551
 - **Chapter 21**, “Histogram Commands,” starting on page 557
 - **Chapter 22**, “Hosted Commands,” starting on page 571
 - **Chapter 23**, “InfiniiScan (ISCan) Commands,” starting on page 597
 - **Chapter 24**, “Limit Test Commands,” starting on page 619
 - **Chapter 25**, “Lister Commands,” starting on page 629
 - **Chapter 26**, “Marker Commands,” starting on page 633
 - **Chapter 27**, “Mask Test Commands,” starting on page 653
 - **Chapter 28**, “Measure Commands,” starting on page 721
 - **Chapter 29**, “Pod Commands,” starting on page 979
 - **Chapter 30**, “Root Level Commands,” starting on page 985
 - **Chapter 31**, “Serial Bus Commands,” starting on page 1023
 - **Chapter 32**, “Self-Test Commands,” starting on page 1097
 - **Chapter 33**, “Serial Data Equalization Commands,” starting on page 1101
 - **Chapter 34**, “System Commands,” starting on page 1147
 - **Chapter 35**, “Time Base Commands,” starting on page 1167
 - **Chapter 36**, “Trigger Commands,” starting on page 1181
 - **Chapter 37**, “Waveform Commands,” starting on page 1381
 - **Chapter 38**, “Waveform Memory Commands,” starting on page 1445
 - **Chapter 39**, “Xtalk (Crosstalk Analysis) Commands,” starting on page 1459
- Chapter 40**, “Obsolete and Discontinued Commands,” starting on page 1497, describes obsolete (deprecated) commands that still work but have been replaced by newer commands, and lists discontinued commands that are no longer supported.
- Chapter 41**, “Error Messages,” starting on page 1541, describes error messages.
- Chapter 42**, “Sample Programs,” starting on page 1553, shows example programs in various languages using the VISA COM, VISA, and SICL libraries.
- Finally, **Chapter 43**, “Reference,” starting on page 1689, contains file format descriptions.

See Also

- For more information on using the SICL, VISA, and VISA COM libraries in general, see the documentation that comes with the Keysight IO Libraries Suite.
- For information on controller PC interface configuration, see the documentation for the interface card used (for example, the Keysight 82350A GPIB interface).

- For information on oscilloscope front-panel operation, see the *User's Guide*.
- For detailed connectivity information, refer to the *Keysight Technologies USB/LAN/GPIB Connectivity Guide*. For a printable electronic copy of the *Connectivity Guide*, direct your Web browser to www.keysight.com and search for "Connectivity Guide".
- For the latest versions of this and other manuals, see:
<http://www.keysight.com/find/Infiniium-manuals>

Contents

In This Book / 3

1 What's New

| | |
|----------------------------|------|
| What's New in Version 6.10 | / 42 |
| What's New in Version 6.00 | / 44 |
| What's New in Version 5.75 | / 48 |
| What's New in Version 5.70 | / 49 |
| What's New in Version 5.60 | / 52 |
| What's New in Version 5.52 | / 55 |
| What's New in Version 5.51 | / 56 |
| What's New in Version 5.50 | / 57 |
| What's New in Version 5.30 | / 63 |
| What's New in Version 5.20 | / 65 |
| What's New in Version 5.10 | / 67 |
| What's New in Version 5.00 | / 68 |
| What's New in Version 4.60 | / 72 |
| What's New in Version 4.50 | / 73 |
| What's New in Version 4.30 | / 74 |
| What's New in Version 4.20 | / 75 |
| What's New in Version 4.10 | / 76 |
| What's New in Version 4.00 | / 77 |
| What's New in Version 3.50 | / 78 |
| What's New in Version 3.20 | / 80 |
| What's New in Version 3.11 | / 81 |
| What's New in Version 3.10 | / 82 |

2 Setting Up

| | |
|--|------|
| Step 1. Install Keysight IO Libraries Suite software | / 86 |
|--|------|

| | |
|---|----|
| Step 2. Connect and set up the oscilloscope / | 87 |
| Using the USB (Device) Interface / | 87 |
| Using the LAN Interface / | 87 |
| Step 3. Verify the oscilloscope connection / | 88 |

3 Introduction to Programming

| | |
|--|-----|
| Communicating with the Oscilloscope / | 95 |
| Instructions / | 96 |
| Instruction Header / | 97 |
| White Space (Separator) / | 98 |
| Braces / | 99 |
| Ellipsis / | 100 |
| Square Brackets / | 101 |
| Command and Query Sources / | 102 |
| Program Data / | 103 |
| Header Types / | 104 |
| Simple Command Header / | 104 |
| Compound Command Header / | 104 |
| Combining Commands in the Same Subsystem / | 105 |
| Common Command Header / | 105 |
| Duplicate Mnemonics / | 105 |
| Query Headers / | 106 |
| Program Header Options / | 107 |
| Character Program Data / | 108 |
| Numeric Program Data / | 109 |
| Embedded Strings / | 110 |
| Program Message Terminator / | 111 |
| Common Commands within a Subsystem / | 112 |
| Selecting Multiple Subsystems / | 113 |
| Programming Getting Started / | 114 |
| Referencing the IO Library / | 115 |
| Opening the Oscilloscope Connection via the IO Library / | 116 |

| | |
|---|-----|
| Initializing the Interface and the Oscilloscope / | 117 |
| Autoscale / | 117 |
| Setting Up the Oscilloscope / | 118 |
| Example Program / | 119 |
| Using the DIGitize Command / | 120 |
| Receiving Information from the Oscilloscope / | 122 |
| String Variable Example / | 123 |
| Numeric Variable Example / | 124 |
| Definite-Length Block Response Data / | 125 |
| Multiple Queries / | 126 |
| Oscilloscope Status / | 127 |

4 Sequential (Blocking) vs. Overlapped Commands

5 LAN, USB, and GPIB Interfaces

| | |
|---|-----|
| LAN Interface Connector / | 132 |
| GPIB Interface Connector / | 133 |
| Default Startup Conditions / | 134 |
| Interface Capabilities / | 135 |
| GPIB Command and Data Concepts / | 136 |
| Communicating Over the GPIB Interface / | 137 |
| Interface Select Code / | 137 |
| Oscilloscope Address / | 137 |
| Communicating Over the LAN Interface / | 138 |
| Communicating via Telnet and Sockets / | 139 |
| Telnet / | 139 |
| Sockets / | 139 |
| Bus Commands / | 141 |
| Device Clear / | 141 |
| Group Execute Trigger / | 141 |
| Interface Clear / | 141 |

6 Message Communication and System Functions

| | |
|---------------------|-------|
| Protocols | / 144 |
| Functional Elements | / 144 |
| Protocol Overview | / 144 |
| Protocol Operation | / 145 |
| Protocol Exceptions | / 145 |
| Suffix Multiplier | / 145 |
| Suffix Unit | / 146 |

7 Status Reporting

| | |
|---------------------------------------|-------|
| Status Reporting Data Structures | / 150 |
| Status Byte Register | / 152 |
| Service Request Enable Register | / 154 |
| Message Event Register | / 155 |
| Trigger Event Register | / 156 |
| Standard Event Status Register | / 157 |
| Standard Event Status Enable Register | / 158 |
| Operation Status Register | / 159 |
| Operation Status Enable Register | / 160 |
| Mask Test Event Register | / 161 |
| Mask Test Event Enable Register | / 162 |
| Acquisition Done Event Register | / 163 |
| Process Done Event Register | / 164 |
| Trigger Armed Event Register | / 165 |
| Auto Trigger Event Register | / 166 |
| Error Queue | / 167 |
| Output Queue | / 168 |
| Message Queue | / 169 |
| Clearing Registers and Queues | / 170 |
| Example: Checking for Armed Status | / 172 |

8 Remote Acquisition Synchronization

| | |
|-----------------------------|-------|
| Programming Flow | / 178 |
| Setting Up the Oscilloscope | / 179 |

- Acquiring a Waveform / 180
- Retrieving Results / 181
- Acquisition Synchronization / 182
 - Blocking Synchronization / 182
 - Polling Synchronization With Timeout / 182
 - Example: Blocking and Polling Synchronization / 183
- Single Shot Device Under Test (DUT) / 192
- Averaging Acquisition Synchronization / 193

9 Programming Conventions

- Truncation Rule / 196
- The Command Tree / 197
 - Command Types / 197
 - Tree Traversal Rules / 197
 - Tree Traversal Examples / 198
- Infinity Representation / 200
- Response Generation / 201
- EOI / 202

10 Acquire Commands

- :ACQUIRE:AVERAge / 205
- :ACQUIRE[:AVERAge]:COUNT / 206
- :ACQUIRE:BANDwidth / 207
- :ACQUIRE:BANDwidth:FRAME? / 209
- :ACQUIRE:BANDwidth:TESTLIMITS? / 210
- :ACQUIRE:COMplete / 211
- :ACQUIRE:COMplete:STATe / 213
- :ACQUIRE:HRESolution / 214
- :ACQUIRE:INTERpolate / 215
- :ACQUIRE:MODE / 216
- :ACQUIRE:POINTS[:ANALog] – Memory depth / 218
- :ACQUIRE:POINTS:AUTO / 220
- :ACQUIRE:POINTS:DIGital? / 221
- :ACQUIRE:POINTS:TESTLIMITS? / 222
- :ACQUIRE:REDGe – RealEdge Channel Inputs (90000 Q-Series, Z-Series) / 223
- :ACQUIRE:RESPonse (90000A Series, 90000 X-Series, V-Series, 90000 Q-Series, Z-Series) / 224
- :ACQUIRE:SEGmented:AUTOplay / 225
- :ACQUIRE:SEGmented:COUNT / 226

:ACQUIRE:SEGMENTED:INDEX / 227
:ACQUIRE:SEGMENTED:PLAY / 228
:ACQUIRE:SEGMENTED:PRATE / 229
:ACQUIRE:SEGMENTED:TTAGS / 230
:ACQUIRE:SRATE[:ANALOG] – Analog Sample Rate / 231
:ACQUIRE:SRATE[:ANALOG]:AUTO / 232
:ACQUIRE:SRATE:DIGITAL – Digital Channels Sample Rate / 233
:ACQUIRE:SRATE:DIGITAL:AUTO / 234
:ACQUIRE:SRATE:TESTLIMITS? / 235

11 Analyze Commands

:ANALYZE:AEDGES / 239
:ANALYZE:CLOCK / 240
:ANALYZE:CLOCK:METHOd / 241
:ANALYZE:CLOCK:METHOd:ALIGn / 244
:ANALYZE:CLOCK:METHOd:DEEMphasis / 246
:ANALYZE:CLOCK:METHOd:EDGE / 247
:ANALYZE:CLOCK:METHOd:JTF / 249
:ANALYZE:CLOCK:METHOd:OJTF / 252
:ANALYZE:CLOCK:METHOd:PLLTrack / 255
:ANALYZE:CLOCK:METHOd:SKEW / 256
:ANALYZE:CLOCK:METHOd:SOURce / 257
:ANALYZE:CLOCK:VERTical / 258
:ANALYZE:CLOCK:VERTical:OFFSet / 259
:ANALYZE:CLOCK:VERTical:RANGe / 260
:ANALYZE:SIGNal:DATarate / 261
:ANALYZE:SIGNal:SYMBOLrate / 263
:ANALYZE:SIGNal:MIXer:CABLEloss / 265
:ANALYZE:SIGNal:MMWave:CALibrate / 266
:ANALYZE:SIGNal:MMWave:CFRequency / 267
:ANALYZE:SIGNal:MMWave:CONNect / 268
:ANALYZE:SIGNal:MMWave:LOADdress / 269
:ANALYZE:SIGNal:MMWave:MBANdwidth / 270
:ANALYZE:SIGNal:TYPE / 271
:ANALYZE:VIEW / 273

12 Bus Commands

:BUS:B<N>:TYPE / 276
:BUS:BIT<M> / 278
:BUS:BITS / 279
:BUS:CLEar / 280

:BUS:CLOCK / 281
:BUS:CLOCK:SLOPe / 282
:BUS:DISPlay / 283
:BUS:LABel / 284
:BUS:READout / 285

13 Calibration Commands

:CALibrate:DATE? / 289
:CALibrate:OUTPut / 290
:CALibrate:OUTPut:AUX / 292
:CALibrate:OUTPut:AUX:RTIME / 293
:CALibrate:OUTPut:CAL / 294
:CALibrate:SKEW / 295
:CALibrate:STATus? / 296
:CALibrate:TEMP? / 297

14 Channel Commands

:CHANnel<N>:BWLimit (9000 Series, 9000H Series, S-Series) / 302
:CHANnel<N>:COMMonmode / 303
:CHANnel<N>:DIFFerential / 304
:CHANnel<N>:DIFFerential:SKEW / 305
:CHANnel<N>:DISPlay / 306
:CHANnel<N>:DISPlay:AUTO / 307
:CHANnel<N>:DISPlay:OFFSet / 309
:CHANnel<N>:DISPlay:RANGe / 311
:CHANnel<N>:DISPlay:SCALE / 313
:CHANnel<N>:INPut / 315
:CHANnel<N>:INVert / 316
:CHANnel<N>:ISIM:APPLy / 317
:CHANnel<N>:ISIM:BANDwidth / 318
:CHANnel<N>:ISIM:BWLimit / 320
:CHANnel<N>:ISIM:BWLimit:TYPE / 322
:CHANnel<N>:ISIM:CONVolve / 323
:CHANnel<N>:ISIM:CORRection / 324
:CHANnel<N>:ISIM:DEConvolve / 326
:CHANnel<N>:ISIM:DELay / 327
:CHANnel<N>:ISIM:NORMalize / 328
:CHANnel<N>:ISIM:PEXTraction / 329
:CHANnel<N>:ISIM:SPAN / 331
:CHANnel<N>:ISIM:STATe / 332
:CHANnel<N>:LABel / 333

:CHANnel<N>:OFFSet / 334
:CHANnel<N>:PROBe / 335
:CHANnel<N>:PROBe:ACCAL / 336
:CHANnel<N>:PROBe:ATTenuation / 337
:CHANnel<N>:PROBe:AUTOzero / 338
:CHANnel<N>:PROBe:COUPLing / 339
:CHANnel<N>:PROBe:EADapter / 340
:CHANnel<N>:PROBe:ECOupling / 343
:CHANnel<N>:PROBe:EXTernal / 344
:CHANnel<N>:PROBe:EXTernal:GAIN / 345
:CHANnel<N>:PROBe:EXTernal:OFFSet / 346
:CHANnel<N>:PROBe:EXTernal:UNITs / 347
:CHANnel<N>:PROBe:GAIN / 348
:CHANnel<N>:PROBe:HEAD:ADD / 349
:CHANnel<N>:PROBe:HEAD:DELeTe ALL / 350
:CHANnel<N>:PROBe:HEAD:SELeCt / 351
:CHANnel<N>:PROBe:HEAD:VTErm / 352
:CHANnel<N>:PROBe:ID? / 353
:CHANnel<N>:PROBe:INFO? / 354
:CHANnel<N>:PROBe:MODE / 355
:CHANnel<N>:PROBe:PRECprobe:BANDwidth / 356
:CHANnel<N>:PROBe:PRECprobe:CALibration / 357
:CHANnel<N>:PROBe:PRECprobe:DELAy / 358
:CHANnel<N>:PROBe:PRECprobe:MODE / 359
:CHANnel<N>:PROBe:PRECprobe:ZSRC / 360
:CHANnel<N>:PROBe:PRIMary (9000 Series, 9000H Series, S-Series) / 362
:CHANnel<N>:PROBe:SKEW / 363
:CHANnel<N>:PROBe:STYPe / 364
:CHANnel<N>:RANGe / 365
:CHANnel<N>:SCALe / 366
:CHANnel<N>:SIMulation:AMPLitude / 367
:CHANnel<N>:SIMulation:DATA:LENGth / 368
:CHANnel<N>:SIMulation:DATA:ODD / 369
:CHANnel<N>:SIMulation:DATA:PAM / 370
:CHANnel<N>:SIMulation:DATA:RESeed / 371
:CHANnel<N>:SIMulation:DATA:SELection / 372
:CHANnel<N>:SIMulation:DRATE / 373
:CHANnel<N>:SIMulation:FILTer:ISIM:ADDResS / 374
:CHANnel<N>:SIMulation:FILTer:ISIM:PEXTraction / 375
:CHANnel<N>:SIMulation:FILTer:SELection / 376
:CHANnel<N>:SIMulation:FLOad:ADDResS / 377
:CHANnel<N>:SIMulation:FLOad:LOOP / 378

:CHANnel<N>:SIMulation:FREQuency / 379
 :CHANnel<N>:SIMulation:FUNCTion:SELECTION / 380
 :CHANnel<N>:SIMulation:FUNCTion:SQUare:DCYCLE / 381
 :CHANnel<N>:SIMulation:FUNCTion:SQUare:FTIME / 382
 :CHANnel<N>:SIMulation:FUNCTion:SQUare:RTIME / 383
 :CHANnel<N>:SIMulation:JITTer / 384
 :CHANnel<N>:SIMulation:JITTer:ABUJ / 385
 :CHANnel<N>:SIMulation:JITTer:PERiodic<M>:ENABle / 386
 :CHANnel<N>:SIMulation:JITTer:PERiodic<M>:FREQuency / 387
 :CHANnel<N>:SIMulation:JITTer:PERiodic<M>:MAGNitude / 388
 :CHANnel<N>:SIMulation:JITTer:PERiodic<M>:SHAPE / 389
 :CHANnel<N>:SIMulation:JITTer:RANDom / 390
 :CHANnel<N>:SIMulation:NOISe / 391
 :CHANnel<N>:SIMulation:NOISe:BWLimit / 392
 :CHANnel<N>:SIMulation:NOISe:PERiodic<M>:ENABle / 393
 :CHANnel<N>:SIMulation:NOISe:PERiodic<M>:FREQuency / 394
 :CHANnel<N>:SIMulation:NOISe:PERiodic<M>:MAGNitude / 395
 :CHANnel<N>:SIMulation:NOISe:PERiodic<M>:SHAPE / 396
 :CHANnel<N>:SIMulation:NOISe:RANDom / 397
 :CHANnel<N>:SIMulation:OFFSet / 398
 :CHANnel<N>:SIMulation:WAVEform / 399
 :CHANnel<N>:UNITs / 400

15 Common Commands

*CLS – Clear Status / 403
 *ESE – Event Status Enable / 404
 *ESR? – Event Status Register / 406
 *IDN? – Identification Number / 407
 *LRN? – Learn / 408
 *OPC – Operation Complete / 410
 *OPT? – Option / 411
 *PSC – Power-on Status Clear / 414
 *RCL – Recall / 415
 *RST – Reset / 416
 *SAV – Save / 417
 *SRE – Service Request Enable / 418
 *STB? – Status Byte / 420
 *TRG – Trigger / 422
 *TST? – Test / 423
 *WAI – Wait / 424

16 Digital Commands

:DIGital<N>:DISPlay / 426
:DIGital<N>:LABel / 427
:DIGital<N>:SIZE / 428
:DIGital<N>:THReshold / 429

17 Disk Commands

:DISK:CDIRectory / 432
:DISK:COPIY / 433
:DISK:DELeTe / 434
:DISK:DIRectory? / 435
:DISK:LOAD / 436
:DISK:MDIRectory / 437
:DISK:PWD? / 438
:DISK:SAVE:COMPOSITE / 439
:DISK:SAVE:IMAGe / 440
:DISK:SAVE:JITTer / 441
:DISK:SAVE:LISTing / 442
:DISK:SAVE:MEASurements / 443
:DISK:SAVE:PRECprobe / 444
:DISK:SAVE:SETup / 445
:DISK:SAVE:WAVEform / 446
:DISK:SEGmented / 448

18 Display Commands

:DISPlay:BOOKmark<N>:DELeTe / 451
:DISPlay:BOOKmark<N>:SET / 452
:DISPlay:BOOKmark<N>:VERTical? / 454
:DISPlay:BOOKmark<N>:XPOStion / 455
:DISPlay:BOOKmark<N>:YPOStion / 456
:DISPlay:CGRade / 457
:DISPlay:CGRade:LEVels? / 459
:DISPlay:CGRade:SCHeme / 461
:DISPlay:CONNect / 463
:DISPlay:DATA? / 464
:DISPlay:GRATicule / 465
:DISPlay:GRATicule:AREA<N>:STATe / 466
:DISPlay:GRATicule:INTensity / 467
:DISPlay:GRATicule:NUMBer / 468
:DISPlay:GRATicule:SETGrat / 469
:DISPlay:ISIM:GCOunt / 470

:DISPlay:ISIM:SElectgraph / 471
 :DISPlay:ISIM:SOURce / 472
 :DISPlay:JITTer:GCOunt / 473
 :DISPlay:JITTer:SElectgraph / 474
 :DISPlay:JITTer:THReshold / 476
 :DISPlay:LABel / 477
 :DISPlay:LAYout / 478
 :DISPlay:MAIN / 479
 :DISPlay:NOISe:LEVel / 480
 :DISPlay:PERsistence / 481
 :DISPlay:PROPortion / 483
 :DISPlay:PROPortion:RESults / 484
 :DISPlay:PRECprobe:GCOunt / 485
 :DISPlay:PRECprobe:SElectgraph / 486
 :DISPlay:PRECprobe:SOURce / 487
 :DISPlay:SCOLor / 488
 :DISPlay:STATus:COLumn / 490
 :DISPlay:STATus:ROW / 491
 :DISPlay:WINDow:MAXimize / 492

19 Function Commands

:FUNction<F>? / 496
 :FUNction<F>:ABSolute / 497
 :FUNction<F>:ADD / 498
 :FUNction<F>:ADEMod / 499
 :FUNction<F>:AVERage / 500
 :FUNction<F>:COMMonmode / 501
 :FUNction<F>:DELay – Delay / 502
 :FUNction<F>:DIFF – Differentiate / 503
 :FUNction<F>:DISPlay / 504
 :FUNction<F>:DIVide / 505
 :FUNction<F>:FFT:DETEctor:POINts / 506
 :FUNction<F>:FFT:DETEctor:TYPE / 507
 :FUNction<F>:FFT:FREQuency / 508
 :FUNction<F>:FFT:REFErence / 509
 :FUNction<F>:FFT:RESolution / 510
 :FUNction<F>:FFT:SPAN / 511
 :FUNction<F>:FFT:STOP / 512
 :FUNction<F>:FFT:TDELay / 513
 :FUNction<F>:FFT:VUNits / 514
 :FUNction<F>:FFT:WINDow / 515

:FUNCTION<F>:FFTMagnitude / 517
 :FUNCTION<F>:FFTPHase / 518
 :FUNCTION<F>:GATING – Gating / 519
 :FUNCTION<F>:GATING:START – Gating window start time / 520
 :FUNCTION<F>:GATING:STOP – Gating window stop time / 521
 :FUNCTION<F>:HIGHpass / 522
 :FUNCTION<F>:HORIZONTAL / 523
 :FUNCTION<F>:HORIZONTAL:POSITION / 524
 :FUNCTION<F>:HORIZONTAL:RANGE / 526
 :FUNCTION<F>:INTEGRate / 528
 :FUNCTION<F>:INVERT / 529
 :FUNCTION<F>:LOWPass / 530
 :FUNCTION<F>:MAGNify / 531
 :FUNCTION<F>:MATLab / 532
 :FUNCTION<F>:MATLab:CONTRol<N> / 533
 :FUNCTION<F>:MATLab:OPERator / 534
 :FUNCTION<F>:MAXimum / 535
 :FUNCTION<F>:MHISTogram / 536
 :FUNCTION<F>:MINimum / 537
 :FUNCTION<F>:MLOG / 538
 :FUNCTION<F>:MTRend / 539
 :FUNCTION<F>:MULTiPLY / 540
 :FUNCTION<F>:OFFSet / 541
 :FUNCTION<F>:RANGE / 542
 :FUNCTION<F>:SMOoth / 543
 :FUNCTION<F>:SQRT / 544
 :FUNCTION<F>:SQUare / 545
 :FUNCTION<F>:SUBTract / 546
 :FUNCTION<F>:VERSus / 547
 :FUNCTION<F>:VERTical / 548
 :FUNCTION<F>:VERTical:OFFSet / 549
 :FUNCTION<F>:VERTical:RANGE / 550

20 Hardcopy Commands

:HARDcopy:AREA / 552
 :HARDcopy:DPRinter / 553
 :HARDcopy:FACTors / 554
 :HARDcopy:IMAGe / 555
 :HARDcopy:PRINters? / 556

21 Histogram Commands

- :HISTogram:AXIS / 559
- :HISTogram:HORizontal:BINs / 560
- :HISTogram:MEASurement:BINs / 561
- :HISTogram:MODE / 562
- :HISTogram:SCALE:SIZE / 563
- :HISTogram:VERTical:BINs / 564
- :HISTogram:WINDow:DEFault / 565
- :HISTogram:WINDow:SOURce / 566
- :HISTogram:WINDow:LLIMit / 567
- :HISTogram:WINDow:RLIMit / 568
- :HISTogram:WINDow:BLIMit / 569
- :HISTogram:WINDow:TLIMit / 570

22 Hosted Commands

- :HOSTed:CALibrate:CALibrate / 573
- :HOSTed:CALibrate:CHANnel / 574
- :HOSTed:CALibrate:DESKew:CHANnels / 575
- :HOSTed:CALibrate:DESKew:FRAMES / 576
- :HOSTed:CALibrate:DESKew:SIGNals / 577
- :HOSTed:CALibrate:DESKew:ZERO / 578
- :HOSTed:CALibrate:LEVel / 579
- :HOSTed:CALibrate:PROMpt / 581
- :HOSTed:CALibrate:STATus:CHANnels? / 582
- :HOSTed:CALibrate:STATus:FRAMES? / 583
- :HOSTed:CALibrate:STATus:LEVel? / 584
- :HOSTed:CALibrate:STATus:SIGNals? / 585
- :HOSTed:CALibrate:TREF:DETECT / 586
- :HOSTed:FOLLOWer<N>:ACHannels? / 587
- :HOSTed:FOLLOWer<N>:CONFigure / 588
- :HOSTed:FOLLOWer<N>:CONNect / 589
- :HOSTed:FOLLOWer<N>:DISConnect / 590
- :HOSTed:LEADer:ACHannels? / 591
- :HOSTed:LEADer:CONFigure / 592
- :HOSTed:LEADer:CONNect / 593
- :HOSTed:LEADer:DISConnect / 594
- :HOSTed:NCONnected? / 595
- :HOSTed:PERiodic / 596

23 InfiniiScan (IScan) Commands

- :IScan:DELay / 598

:ISCan:MEASurement:FAIL / 599
:ISCan:MEASurement:LLIMit / 600
:ISCan:MEASurement / 601
:ISCan:MEASurement:ULIMit / 602
:ISCan:MODE / 603
:ISCan:NONMonotonic:EDGE / 604
:ISCan:NONMonotonic:HYSTeresis / 605
:ISCan:NONMonotonic:SOURce / 606
:ISCan:RUNT:HYSTeresis / 607
:ISCan:RUNT:LLEVel / 608
:ISCan:RUNT:SOURce / 609
:ISCan:RUNT:ULEVel / 610
:ISCan:SERial:PATTern / 611
:ISCan:SERial:SOURce / 612
:ISCan:ZONE:HIDE / 613
:ISCan:ZONE:SOURce / 614
:ISCan:ZONE<Z>:MODE / 615
:ISCan:ZONE<Z>:PLACement / 616
:ISCan:ZONE<Z>:SOURce / 617
:ISCan:ZONE<Z>:STATe / 618

24 Limit Test Commands

:LTEST:ADDStats / 620
:LTEST:FAIL / 621
:LTEST:LLIMit – Lower Limit / 623
:LTEST:MEASurement / 624
:LTEST:RESults? / 625
:LTEST:RUMode:SOFailure / 626
:LTEST:TEST / 627
:LTEST:ULIMit – Upper Limit / 628

25 Lister Commands

:LISTer:DATA? / 630
:LISTer:DISPlay / 631

26 Marker Commands

:MARKer:CURSor? / 634
:MARKer:DELTA / 635
:MARKer:MEASurement:MEASurement / 636
:MARKer:MODE / 637
:MARKer:TSTArt / 638

:MARKer:TSTOp / 639
:MARKer:VSTArt / 640
:MARKer:VSTOp / 641
:MARKer:X1Position / 642
:MARKer:X2Position / 643
:MARKer:X1Y1source / 644
:MARKer:X2Y2source / 646
:MARKer:XDELta? / 648
:MARKer:Y1Position / 649
:MARKer:Y2Position / 650
:MARKer:YDELta? / 651

27 Mask Test Commands

:MTEST:ALIGn / 655
:MTEST:AlignFIT / 656
:MTEST:AMASK:CREate / 658
:MTEST:AMASK:SOURce / 659
:MTEST:AMASK:SAVE / 661
:MTEST:AMASK:UNITs / 662
:MTEST:AMASK:XDELta / 663
:MTEST:AMASK:YDELta / 664
:MTEST:AUTO / 665
:MTEST:AVERage / 666
:MTEST:AVERage:COUNT / 667
:MTEST:COUNT:FAILures? / 668
:MTEST:COUNT:FUI? / 669
:MTEST:COUNT:FWAVEforms? / 670
:MTEST:COUNT:MARGin:FAILures? / 671
:MTEST:COUNT:SUI? / 672
:MTEST:COUNT:UI? / 673
:MTEST:COUNT:WAVEforms? / 674
:MTEST:DELeTe / 675
:MTEST:ENABle / 676
:MTEST:FOLDing (Clock Recovery software only) / 677
:MTEST:FOLDing:BITS / 679
:MTEST:FOLDing:COUNT:UI? / 681
:MTEST:FOLDing:COUNT:WAVEforms? / 683
:MTEST:FOLDing:FAST / 685
:MTEST:FOLDing:POSition / 687
:MTEST:FOLDing:SCALe / 689
:MTEST:FOLDing:TPOSition / 691

:MTESt:FOLDing:TSCale / 693
:MTESt:HAMPliTude / 695
:MTESt:IMPedance / 696
:MTESt:INVert / 697
:MTESt:LAMPliTude / 698
:MTESt:LOAD / 699
:MTESt:MARGin:AUTO:HITS / 700
:MTESt:MARGin:AUTO:HRATio / 701
:MTESt:MARGin:AUTO:METHod / 702
:MTESt:MARGin:METHod / 703
:MTESt:MARGin:PERCent / 704
:MTESt:MARGin:STATe / 705
:MTESt:NREGions? / 706
:MTESt:PROBe:IMPedance? / 707
:MTESt:RUMode / 708
:MTESt:RUMode:SOfailure / 709
:MTESt:SCALE:BIND / 710
:MTESt:SCALE:X1 / 711
:MTESt:SCALE:XDELta / 712
:MTESt:SCALE:Y1 / 713
:MTESt:SCALE:Y2 / 714
:MTESt:SOURce / 715
:MTESt:STARt / 716
:MTESt:STOP / 717
:MTESt:STIMe / 718
:MTESt:TITLe? / 719
:MTESt:TRIGger:SOURce / 720

28 Measure Commands

:MEASure:AREA / 731
:MEASure:BER / 732
:MEASure:BERPeracq / 733
:MEASure:BINTErval / 734
:MEASure:BPERiod / 735
:MEASure:BWIDth / 736
:MEASure:CDRRate / 737
:MEASure:CGRade:CROSSing / 738
:MEASure:CGRade:DCDistortion / 739
:MEASure:CGRade:EHEight / 740
:MEASure:CGRade:EWIDth / 742
:MEASure:CGRade:EWINDow / 744

:MEASure:CGRade:JITTer / 746
:MEASure:CGRade:OLEVel / 747
:MEASure:CGRade:QFACTOR / 748
:MEASure:CGRade:ZLEVel / 749
:MEASure:CHARge (9000 Series, 9000H Series, S-Series) / 750
:MEASure:CLear / 751
:MEASure:CROSSing / 752
:MEASure:CTCDutycycle / 753
:MEASure:CTCJitter / 755
:MEASure:CTCNwidth / 757
:MEASure:CTCPwidth / 758
:MEASure:DATarate / 759
:MEASure:DEEMphasis / 760
:MEASure:DELTatime / 762
:MEASure:DELTatime:DEFine / 764
:MEASure:DUTYcycle / 766
:MEASure:EDGE / 767
:MEASure:ERATio / 768
:MEASure:ETOedge / 769
:MEASure:FALLtime / 770
:MEASure:FFT:CPOWer / 772
:MEASure:FFT:DFRequency / 773
:MEASure:FFT:DMAGnitude / 774
:MEASure:FFT:FREQuency / 775
:MEASure:FFT:MAGNitude / 776
:MEASure:FFT:OBW / 777
:MEASure:FFT:PEAK1 / 778
:MEASure:FFT:PEAK2 / 779
:MEASure:FFT:PSD / 780
:MEASure:FFT:THReshold / 781
:MEASure:FREQuency / 782
:MEASure:HISTogram:FWMH / 784
:MEASure:HISTogram:HITS / 785
:MEASure:HISTogram:M1S / 786
:MEASure:HISTogram:M2S / 787
:MEASure:HISTogram:M3S / 788
:MEASure:HISTogram:MAX / 789
:MEASure:HISTogram:MEAN / 790
:MEASure:HISTogram:MEDian / 791
:MEASure:HISTogram:MIN / 792
:MEASure:HISTogram:MODE / 793
:MEASure:HISTogram:PEAK / 794

:MEASure:HISTogram:PP / 795
:MEASure:HISTogram:RESolution / 796
:MEASure:HISTogram:STDDev / 797
:MEASure:HOLDtime / 798
:MEASure:JITTer:HISTogram / 800
:MEASure:JITTer:MEASurement / 801
:MEASure:JITTer:SPECTrum / 802
:MEASure:JITTer:SPECTrum:HORizontal / 803
:MEASure:JITTer:SPECTrum:HORizontal:POSition / 804
:MEASure:JITTer:SPECTrum:HORizontal:RANGe / 805
:MEASure:JITTer:SPECTrum:VERTical / 806
:MEASure:JITTer:SPECTrum:VERTical:OFFSet / 807
:MEASure:JITTer:SPECTrum:VERTical:RANGe / 808
:MEASure:JITTer:SPECTrum:VERTical:TYPE / 809
:MEASure:JITTer:SPECTrum:WINDow / 810
:MEASure:JITTer:TREND / 811
:MEASure:JITTer:TREND:SMOoth / 812
:MEASure:JITTer:TREND:SMOoth:POINts / 813
:MEASure:JITTer:TREND:VERTical / 814
:MEASure:JITTer:TREND:VERTical:OFFSet / 815
:MEASure:JITTer:TREND:VERTical:RANGe / 816
:MEASure:NAME / 817
:MEASure:NCJitter / 818
:MEASure:NOISe / 820
:MEASure:NOISe:ALL? / 821
:MEASure:NOISe:BANDwidth / 823
:MEASure:NOISe:LOCation / 824
:MEASure:NOISe:METHod / 825
:MEASure:NOISe:REPort / 826
:MEASure:NOISe:RN / 827
:MEASure:NOISe:SCOPE:RN / 828
:MEASure:NOISe:STATe / 829
:MEASure:NOISe:UNITs / 830
:MEASure:NPERiod / 831
:MEASure:NPULses / 832
:MEASure:NUI / 833
:MEASure:NWIDth / 834
:MEASure:OMAMplitude / 835
:MEASure:OPOWer / 836
:MEASure:OVERshoot / 837
:MEASure:PAM:ELEVel / 838
:MEASure:PAM:ESKew / 840

:MEASure:PAM:EYE:ELMethod / 842
:MEASure:PAM:EYE:ESTiming / 843
:MEASure:PAM:EYE:PPERcent / 844
:MEASure:PAM:EYE:TIME:LTDefinition / 845
:MEASure:PAM:LEVel / 846
:MEASure:PAM:LRMS / 848
:MEASure:PAM:LTHickness / 850
:MEASure:PAMPlitude / 852
:MEASure:PBASe / 853
:MEASure:PERiod / 854
:MEASure:PHASe / 856
:MEASure:PPContrast / 858
:MEASure:PPULses / 859
:MEASure:PREShoot / 860
:MEASure:PTOP / 861
:MEASure:PWIDth / 862
:MEASure:QUALifier<M>:CONDition / 863
:MEASure:QUALifier<M>:SOURce / 864
:MEASure:QUALifier<M>:STATe / 865
:MEASure:RESults? / 866
:MEASure:RISetime / 869
:MEASure:RJDJ:ALL? / 871
:MEASure:RJDJ:APLength? / 873
:MEASure:RJDJ:BANDwidth / 874
:MEASure:RJDJ:BER / 875
:MEASure:RJDJ:CLOCK / 877
:MEASure:RJDJ:EDGE / 878
:MEASure:RJDJ:INTerpolate / 879
:MEASure:RJDJ:METHod / 880
:MEASure:RJDJ:MODE / 881
:MEASure:RJDJ:PAMThreshold / 882
:MEASure:RJDJ:PLENght / 883
:MEASure:RJDJ:REPort / 884
:MEASure:RJDJ:RJ / 885
:MEASure:RJDJ:SCOPE:RJ / 886
:MEASure:RJDJ:SOURce / 887
:MEASure:RJDJ:STATe / 888
:MEASure:RJDJ:TJRJDJ? / 889
:MEASure:RJDJ:UNITs / 891
:MEASure:SCRatch / 892
:MEASure:SENDvalid / 893
:MEASure:SER / 894

:MEASure:SERPeracq / 895
:MEASure:SETuptime / 896
:MEASure:SLEWrate / 898
:MEASure:SOURce / 899
:MEASure:STATistics / 900
:MEASure:TEDGe / 901
:MEASure:THResholds:ABSolute / 902
:MEASure:THResholds:DISPlay / 903
:MEASure:THResholds:GENauto / 904
:MEASure:THResholds:GENeral:ABSolute / 905
:MEASure:THResholds:GENeral:HYSTeresis / 907
:MEASure:THResholds:GENeral:METHod / 909
:MEASure:THResholds:GENeral:PAMCustom / 911
:MEASure:THResholds:GENeral:PAMAutomatic / 913
:MEASure:THResholds:GENeral:PERCent / 915
:MEASure:THResholds:GENeral:TOPBase:ABSolute / 917
:MEASure:THResholds:GENeral:TOPBase:METHod / 919
:MEASure:THResholds:HYSTeresis / 920
:MEASure:THResholds:METHod / 922
:MEASure:THResholds:PERCent / 923
:MEASure:THResholds:RFALL:ABSolute / 924
:MEASure:THResholds:RFALL:METHod / 926
:MEASure:THResholds:RFALL:PAMAutomatic / 928
:MEASure:THResholds:RFALL:PERCent / 930
:MEASure:THResholds:RFALL:TOPBase:ABSolute / 932
:MEASure:THResholds:RFALL:TOPBase:METHod / 934
:MEASure:THResholds:SERial:ABSolute / 935
:MEASure:THResholds:SERial:HYSTeresis / 937
:MEASure:THResholds:SERial:METHod / 939
:MEASure:THResholds:SERial:PERCent / 940
:MEASure:THResholds:SERial:TOPBase:ABSolute / 942
:MEASure:THResholds:SERial:TOPBase:METHod / 944
:MEASure:THResholds:TOPBase:ABSolute / 945
:MEASure:THResholds:TOPBase:METHod / 946
:MEASure:TIEClock2 / 947
:MEASure:TIEData2 / 949
:MEASure:TIEFilter:SHAPE / 950
:MEASure:TIEFilter:STARt / 951
:MEASure:TIEFilter:STATe / 952
:MEASure:TIEFilter:STOP / 953
:MEASure:TIEFilter:TYPE / 954
:MEASure:TMAX / 955

:MEASure:TMIN / 956
:MEASure:TVOLt / 957
:MEASure:UITouijitter / 958
:MEASure:UNITinterval / 959
:MEASure:VAMPLitude / 960
:MEASure:VAverage / 961
:MEASure:VBASe / 962
:MEASure:VLOWer / 963
:MEASure:VMAX / 964
:MEASure:VMIDdle / 965
:MEASure:VMIN / 966
:MEASure:VOVershoot / 967
:MEASure:VPP / 968
:MEASure:VPReshoot / 969
:MEASure:VRMS / 970
:MEASure:VTIMe / 972
:MEASure:VTOp / 973
:MEASure:VUPPer / 974
:MEASure:WINDow / 975
:MEASurement<N>:NAME / 976
:MEASurement<N>:SOURce / 977

29 Pod Commands

:POD<N>:DISPlay / 980
:POD<N>:PSKew / 981
:POD<N>:THReshold / 982

30 Root Level Commands

:ADER? – Acquisition Done Event Register / 987
:AER? – Arm Event Register / 988
:ASTate? / 989
:ATER? – Auto Trigger Event Register / 990
:AUToscale / 991
:AUToscale:CHANnels / 992
:AUToscale:PLACement / 993
:AUToscale:VERTical / 994
:BEEP / 995
:BLANk / 996
:CDISplay / 997
:DIGitize / 998
:DISable DIGital / 1000

:ENABle DIGital / 1001
 :MODEl? / 1002
 :MTEEnable – Mask Test Enable Register / 1003
 :MTERegister? – Mask Test Event Register / 1004
 :OPEEnable – Operation Status Enable / 1005
 :OPERegister? – Operation Status Register / 1006
 :OVLRegister? / 1007
 :PDER? – Processing Done Event Register / 1008
 :PRINt / 1009
 :RECall:SETup / 1010
 :RSTate? / 1011
 :RUN / 1012
 :SERial – Serial Number / 1013
 :SINGle / 1014
 :STATus? / 1015
 :STOP / 1017
 :STORe:JITTer / 1018
 :STORe:SETup / 1019
 :STORe:WAVEform / 1020
 :TERegister? – Trigger Event Register / 1021
 :VIEW / 1022

31 Serial Bus Commands

General :SBUS<N> Commands / 1024
 :SBUS<N>[:DISPlay] / 1025
 :SBUS<N>:MODE / 1026
 :SBUS<N>:CAN Commands / 1027
 :SBUS<N>:CAN:FDSPoint / 1028
 :SBUS<N>:CAN:SAMPlEpoint / 1029
 :SBUS<N>:CAN:SIGNal:BAUDrate / 1030
 :SBUS<N>:CAN:SIGNal:DEFinition / 1031
 :SBUS<N>:CAN:SIGNal:FDBaudrate / 1032
 :SBUS<N>:CAN:SOURce / 1033
 :SBUS<N>:CAN:TRIGger (9000 Series, 9000H Series, S-Series) / 1034
 :SBUS<N>:CAN:TRIGger:PATTern:DATA (9000 Series, 9000H Series, S-Series) / 1037
 :SBUS<N>:CAN:TRIGger:PATTern:DATA:LENGth (9000 Series, 9000H Series, S-Series) / 1038
 :SBUS<N>:CAN:TRIGger:PATTern:ID (9000 Series, 9000H Series, S-Series) / 1040
 :SBUS<N>:CAN:TRIGger:PATTern:ID:MODE (9000 Series, 9000H Series, S-Series) / 1041
 :SBUS<N>:CAN:TYPE / 1042

- :SBUS<N>:FLEXray Commands / 1043
 - :SBUS<N>:FLEXray:BAUDrate / 1044
 - :SBUS<N>:FLEXray:CHANnel / 1045
 - :SBUS<N>:FLEXray:SOURce / 1046
 - :SBUS<N>:FLEXray:TRIGger / 1047
 - :SBUS<N>:FLEXray:TRIGger:ERRor:TYPE / 1048
 - :SBUS<N>:FLEXray:TRIGger:FRAMe:CCBase / 1049
 - :SBUS<N>:FLEXray:TRIGger:FRAMe:CCRepetition / 1050
 - :SBUS<N>:FLEXray:TRIGger:FRAMe:ID / 1051
 - :SBUS<N>:FLEXray:TRIGger:FRAMe:TYPE / 1052
- :SBUS<N>:HS Commands / 1053
 - :SBUS<N>:HS:DESCramble / 1054
 - :SBUS<N>:HS:FORMat / 1055
 - :SBUS<N>:HS:IDLE / 1056
 - :SBUS<N>:HS:SOURce<S> / 1057
- :SBUS<N>:IIC Commands / 1058
 - :SBUS<N>:IIC:ASIZe / 1059
 - :SBUS<N>:IIC:SOURce:CLOCK / 1060
 - :SBUS<N>:IIC:SOURce:DATA / 1061
 - :SBUS<N>:IIC:TRIGger:PATTern:ADDress (9000 Series, 9000H Series, S-Series) / 1062
 - :SBUS<N>:IIC:TRIGger:PATTern:DATA (9000 Series, 9000H Series, S-Series) / 1064
 - :SBUS<N>:IIC:TRIGger:TYPE (9000 Series, 9000H Series, S-Series) / 1065
- :SBUS<N>:LIN Commands / 1067
 - :SBUS<N>:LIN:SAMPlepoint / 1068
 - :SBUS<N>:LIN:SIGNal:BAUDrate / 1069
 - :SBUS<N>:LIN:SOURce / 1070
 - :SBUS<N>:LIN:STANdard / 1071
 - :SBUS<N>:LIN:TRIGger / 1072
 - :SBUS<N>:LIN:TRIGger:ID / 1073
 - :SBUS<N>:LIN:TRIGger:PATTern:DATA / 1074
 - :SBUS<N>:LIN:TRIGger:PATTern:DATA:LENGth / 1075
- :SBUS<N>:SPI Commands / 1076
 - :SBUS<N>:SPI:BITOrder / 1077
 - :SBUS<N>:SPI:CLOCK:SLOPe / 1078
 - :SBUS<N>:SPI:CLOCK:TIMEout / 1079
 - :SBUS<N>:SPI:FRAMe:STATe / 1080
 - :SBUS<N>:SPI:SOURce:CLOCK / 1081
 - :SBUS<N>:SPI:SOURce:DATA / 1083
 - :SBUS<N>:SPI:SOURce:FRAMe / 1085
 - :SBUS<N>:SPI:SOURce:MISO / 1086

:SBUS<N>:SPI:SOURce:MOSI / 1087
:SBUS<N>:SPI:TRIGger:PATTern:DATA (9000 Series, 9000H Series, S-Series) / 1089
:SBUS<N>:SPI:TRIGger:PATTern:WIDTh (9000 Series, 9000H Series, S-Series) / 1091
:SBUS<N>:SPI:TRIGger:TYPE (9000 Series, 9000H Series, S-Series) / 1093
:SBUS<N>:SPI:TYPE / 1095
:SBUS<N>:SPI:WIDTh / 1096

32 Self-Test Commands

:SELftest:CANCel / 1098
:SELftest:SCOPEtEST / 1099

33 Serial Data Equalization Commands

:SPRocessing:CTLequalizer:ACGain / 1103
:SPRocessing:CTLequalizer:DCGain / 1104
:SPRocessing:CTLequalizer:DISPlay / 1105
:SPRocessing:CTLequalizer:NUMPoles / 1106
:SPRocessing:CTLequalizer:P1 / 1107
:SPRocessing:CTLequalizer:P2 / 1108
:SPRocessing:CTLequalizer:P3 / 1109
:SPRocessing:CTLequalizer:RATE / 1110
:SPRocessing:CTLequalizer:SOURce / 1111
:SPRocessing:CTLequalizer:VERTical / 1112
:SPRocessing:CTLequalizer:VERTical:OFFSet / 1113
:SPRocessing:CTLequalizer:VERTical:RANGe / 1114
:SPRocessing:CTLequalizer:Z1 / 1115
:SPRocessing:CTLequalizer:Z2 / 1116
:SPRocessing:DFEQualizer:NTAPs / 1117
:SPRocessing:DFEQualizer:SOURce / 1118
:SPRocessing:DFEQualizer:STATe / 1119
:SPRocessing:DFEQualizer:TAP / 1120
:SPRocessing:DFEQualizer:TAP:AUTomatic / 1121
:SPRocessing:DFEQualizer:TAP:DELay / 1122
:SPRocessing:DFEQualizer:TAP:GAIN / 1123
:SPRocessing:DFEQualizer:TAP:LTARget / 1124
:SPRocessing:DFEQualizer:TAP:MAX / 1125
:SPRocessing:DFEQualizer:TAP:MIN / 1126
:SPRocessing:DFEQualizer:TAP:UTARget / 1127
:SPRocessing:DFEQualizer:TAP:WIDTh / 1128
:SPRocessing:FFEQualizer:BANDwidth / 1129
:SPRocessing:FFEQualizer:BWMoDe / 1130
:SPRocessing:FFEQualizer:DISPlay / 1131

:SPROcessing:FFEQualizer:NPRecursor / 1132
:SPROcessing:FFEQualizer:NTAPs / 1133
:SPROcessing:FFEQualizer:RATE / 1134
:SPROcessing:FFEQualizer:SOURce / 1135
:SPROcessing:FFEQualizer:TAP / 1136
:SPROcessing:FFEQualizer:TAP:AUTomatic / 1137
:SPROcessing:FFEQualizer:TAP:DELay / 1138
:SPROcessing:FFEQualizer:TAP:PLENght / 1139
:SPROcessing:FFEQualizer:TAP:WIDTh / 1140
:SPROcessing:FFEQualizer:TDELay / 1141
:SPROcessing:FFEQualizer:TDMode / 1142
:SPROcessing:FFEQualizer:VERTical / 1143
:SPROcessing:FFEQualizer:VERTical:OFFSet / 1144
:SPROcessing:FFEQualizer:VERTical:RANGe / 1145

34 System Commands

:SYSTem:DATE / 1148
:SYSTem:DEBUg / 1149
:SYSTem:DONTtabmeas / 1151
:SYSTem:DSP / 1152
:SYSTem:ERRor? / 1153
:SYSTem:GUI / 1154
:SYSTem:HEADer / 1155
:SYSTem:HLED (90000 Q-Series, S-Series, V-Series, Z-Series) / 1156
:SYSTem:LOCK / 1157
:SYSTem:LONGform / 1158
:SYSTem:MENU? / 1159
:SYSTem:PERSONa / 1160
:SYSTem:PRESet / 1161
:SYSTem:SETup / 1163
:SYSTem:TIME / 1165

35 Time Base Commands

:TIMebase:POSition / 1168
:TIMebase:RANGe / 1169
:TIMebase:REFClock / 1170
:TIMebase:REFerence / 1171
:TIMebase:REFerence:PERCent / 1172
:TIMebase:ROLL:ENABLE / 1173
:TIMebase:SCALE / 1174
:TIMebase:VIEW / 1175

:TIMebase:WINDow:DELay / 1176
:TIMebase:WINDow:POSition / 1177
:TIMebase:WINDow:RANGe / 1178
:TIMebase:WINDow:SCALe / 1179

36 Trigger Commands

General Trigger Commands / 1183
:TRIGger:AND:ENABle / 1184
:TRIGger:AND:SOURce / 1185
:TRIGger:HOLDoff / 1186
:TRIGger:HOLDoff:MAX / 1187
:TRIGger:HOLDoff:MIN / 1188
:TRIGger:HOLDoff:MODE / 1189
:TRIGger:HTHReshold / 1190
:TRIGger:HYSteresis / 1191
:TRIGger:LEVel / 1192
:TRIGger:LEVel:FIFTy / 1193
:TRIGger:LTHReshold / 1194
:TRIGger:MODE / 1195
:TRIGger:SWEEp / 1197

Comm Trigger Commands / 1198
:TRIGger:COMM:BWIDth / 1199
:TRIGger:COMM:ENCode / 1200
:TRIGger:COMM:PATTern / 1201
:TRIGger:COMM:POLarity / 1202
:TRIGger:COMM:SOURce / 1203

Delay Trigger Commands / 1204
:TRIGger:DELay:ARM:SOURce / 1205
:TRIGger:DELay:ARM:SLOPe / 1206
:TRIGger:DELay:EDELay:COUNT / 1207
:TRIGger:DELay:EDELay:SOURce / 1208
:TRIGger:DELay:EDELay:SLOPe / 1209
:TRIGger:DELay:MODE / 1210
:TRIGger:DELay:TDELay:TIME / 1211
:TRIGger:DELay:TRIGger:SOURce / 1212
:TRIGger:DELay:TRIGger:SLOPe / 1213

Edge Trigger Commands / 1214
:TRIGger:EDGE:COUPling (9000 Series, 9000H Series, S-Series) / 1215
:TRIGger:EDGE:SLOPe / 1216
:TRIGger:EDGE:SOURce / 1217

GBSerial Trigger Commands / 1218

- :TRIGger:GBSerial:CLOCK (V-Series with HWST Option) / 1219
- :TRIGger:GBSerial:CLOCK:FREQUENCY (V-Series with HWST Option) / 1220
- :TRIGger:GBSerial:DRATE (V-Series with HWST Option) / 1222
- :TRIGger:GBSerial:MODE (V-Series with HWST Option) / 1224
- :TRIGger:GBSerial:PATTERN (V-Series with HWST Option) / 1225
- :TRIGger:GBSerial:POLARITY (V-Series with HWST Option) / 1226
- :TRIGger:GBSerial:PRBS (V-Series with HWST Option) / 1227
- :TRIGger:GBSerial:SOURCE (V-Series with HWST Option) / 1228

Glitch Trigger Commands / 1229

- :TRIGger:GLITCh:POLARITY / 1230
- :TRIGger:GLITCh:SOURCE / 1231
- :TRIGger:GLITCh:WIDTH / 1232

Pattern Trigger Commands / 1233

- :TRIGger:PATTERN:CONDITION / 1234
- :TRIGger:PATTERN:LOGIC / 1235

Pulse Width Trigger Commands / 1236

- :TRIGger:PWIDth:DIRection / 1237
- :TRIGger:PWIDth:POLARITY / 1238
- :TRIGger:PWIDth:SOURCE / 1239
- :TRIGger:PWIDth:TPOint / 1240
- :TRIGger:PWIDth:WIDTH / 1241

Runt Trigger Commands / 1242

- :TRIGger:RUNT:POLARITY / 1243
- :TRIGger:RUNT:QUALified / 1244
- :TRIGger:RUNT:SOURCE / 1245
- :TRIGger:RUNT:TIME / 1246

Sequence Trigger Commands / 1247

- :TRIGger:SEQUence:TERM1 (90000A Series, 90000 X-Series, V-Series, 90000 Q-Series, Z-Series) / 1248
- :TRIGger:SEQUence:TERM2 (90000A Series, 90000 X-Series, V-Series, 90000 Q-Series, Z-Series) / 1249
- :TRIGger:SEQUence:RESet:ENABle (90000A Series, 90000 X-Series, V-Series, 90000 Q-Series, Z-Series) / 1250
- :TRIGger:SEQUence:RESet:TYPE (90000A Series, 90000 X-Series, V-Series, 90000 Q-Series, Z-Series) / 1251
- :TRIGger:SEQUence:RESet:EVENT (90000A Series, 90000 X-Series, V-Series, 90000 Q-Series, Z-Series) / 1252
- :TRIGger:SEQUence:RESet:TIME (90000A Series, 90000 X-Series, V-Series, 90000 Q-Series, Z-Series) / 1253

- :TRIGger:SEQuence:WAIT:ENABle (90000A Series, 90000 X-Series, V-Series, 90000 Q-Series, Z-Series) / 1254
- :TRIGger:SEQuence:WAIT:TIME (90000A Series, 90000 X-Series, V-Series, 90000 Q-Series, Z-Series) / 1255
- Setup and Hold Trigger Commands / 1256
 - :TRIGger:SHOLd:CSourcE / 1257
 - :TRIGger:SHOLd:CSourcE:EDGE / 1258
 - :TRIGger:SHOLd:DSourcE / 1259
 - :TRIGger:SHOLd:HoldTIME (HTIME) / 1260
 - :TRIGger:SHOLd:MODE / 1261
 - :TRIGger:SHOLd:SetupTIME / 1262
- State Trigger Commands / 1263
 - :TRIGger:STATe:CLOCK / 1264
 - :TRIGger:STATe:LOGic / 1265
 - :TRIGger:STATe:LTYPe / 1266
 - :TRIGger:STATe:SLOPe / 1267
- Timeout Trigger Commands / 1268
 - :TRIGger:TIMEout:CONDition / 1269
 - :TRIGger:TIMEout:SOURcE / 1270
 - :TRIGger:TIMEout:TIME / 1271
- Transition Trigger Commands / 1272
 - :TRIGger:TRANSition:DIRection / 1273
 - :TRIGger:TRANSition:SOURcE / 1274
 - :TRIGger:TRANSition:TIME / 1275
 - :TRIGger:TRANSition:TYPE / 1276
- TV Trigger Commands / 1277
 - :TRIGger:TV:LINE / 1278
 - :TRIGger:TV:MODE / 1279
 - :TRIGger:TV:POLarity / 1280
 - :TRIGger:TV:SOURcE / 1281
 - :TRIGger:TV:STANdard / 1282
 - :TRIGger:TV:UDTV:ENUMber / 1283
 - :TRIGger:TV:UDTV:HSYNc / 1284
 - :TRIGger:TV:UDTV:HTIME / 1285
 - :TRIGger:TV:UDTV:PGTHan / 1286
 - :TRIGger:TV:UDTV:POLarity / 1287
- Window Trigger Commands / 1288
 - :TRIGger:WINDow:CONDition / 1289
 - :TRIGger:WINDow:SOURcE / 1290

- :TRIGger:WINDow:TIME / 1291
- :TRIGger:WINDow:TPOint / 1292
- Advanced Comm Trigger Commands / 1293
 - :TRIGger:ADVanced:COMM:BWIDth / 1294
 - :TRIGger:ADVanced:COMM:ENCode / 1295
 - :TRIGger:ADVanced:COMM:LEVel / 1296
 - :TRIGger:ADVanced:COMM:PATTern / 1297
 - :TRIGger:ADVanced:COMM:POLarity / 1298
 - :TRIGger:ADVanced:COMM:SOURce / 1299
- Advanced Pattern Trigger Commands / 1300
 - :TRIGger:ADVanced:PATTern:CONDition / 1302
 - :TRIGger:ADVanced:PATTern:LOGic / 1303
 - :TRIGger:ADVanced:PATTern:THReshold:LEVel / 1304
 - :TRIGger:ADVanced:PATTern:THReshold:POD<N> / 1305
- Advanced State Trigger Commands / 1306
 - :TRIGger:ADVanced:STATe:CLOCK / 1307
 - :TRIGger:ADVanced:STATe:LOGic / 1308
 - :TRIGger:ADVanced:STATe:LTYPe / 1309
 - :TRIGger:ADVanced:STATe:SLOPe / 1310
 - :TRIGger:ADVanced:STATe:THReshold:LEVel / 1311
- Advanced Delay By Event Trigger Commands / 1312
 - :TRIGger:ADVanced:DElay:EDLY:ARM:SOURce / 1314
 - :TRIGger:ADVanced:DElay:EDLY:ARM:SLOPe / 1315
 - :TRIGger:ADVanced:DElay:EDLY:EVENT:DElay / 1316
 - :TRIGger:ADVanced:DElay:EDLY:EVENT:SOURce / 1317
 - :TRIGger:ADVanced:DElay:EDLY:EVENT:SLOPe / 1318
 - :TRIGger:ADVanced:DElay:EDLY:TRIGger:SOURce / 1319
 - :TRIGger:ADVanced:DElay:EDLY:TRIGger:SLOPe / 1320
- Advanced Delay By Time Trigger Commands / 1321
 - :TRIGger:ADVanced:DElay:TDLY:ARM:SOURce / 1323
 - :TRIGger:ADVanced:DElay:TDLY:ARM:SLOPe / 1324
 - :TRIGger:ADVanced:DElay:TDLY:DElay / 1325
 - :TRIGger:ADVanced:DElay:TDLY:TRIGger:SOURce / 1326
 - :TRIGger:ADVanced:DElay:TDLY:TRIGger:SLOPe / 1327
- Advanced Standard TV Trigger Commands / 1328
 - :TRIGger:ADVanced:TV:STV:FIELD / 1330
 - :TRIGger:ADVanced:TV:STV:LINE / 1331
 - :TRIGger:ADVanced:TV:STV:SOURce / 1332
 - :TRIGger:ADVanced:TV:STV:SPOLarity / 1333

Advanced User Defined TV Mode and Commands / 1334

- :TRIGger:ADVanced:TV:UDTV:ENUMber / 1336
- :TRIGger:ADVanced:TV:UDTV:PGTHan / 1337
- :TRIGger:ADVanced:TV:UDTV:POLarity / 1338
- :TRIGger:ADVanced:TV:UDTV:SOURce / 1339

Advanced Violation Trigger Modes / 1340

- :TRIGger:ADVanced:VIOLation:MODE / 1341

Advanced Pulse Width Violation Trigger Commands / 1342

- :TRIGger:ADVanced:VIOLation:PWIDth:DIRection / 1344
- :TRIGger:ADVanced:VIOLation:PWIDth:POLarity / 1345
- :TRIGger:ADVanced:VIOLation:PWIDth:SOURce / 1346
- :TRIGger:ADVanced:VIOLation:PWIDth:WIDTh / 1347

Advanced Setup Violation Trigger Commands / 1348

- :TRIGger:ADVanced:VIOLation:SETup:MODE / 1351
- :TRIGger:ADVanced:VIOLation:SETup:SETup:CSOURce / 1352
- :TRIGger:ADVanced:VIOLation:SETup:SETup:CSOURce:LEVel / 1353
- :TRIGger:ADVanced:VIOLation:SETup:SETup:CSOURce:EDGE / 1354
- :TRIGger:ADVanced:VIOLation:SETup:SETup:DSOURce / 1355
- :TRIGger:ADVanced:VIOLation:SETup:SETup:DSOURce:HTHReshold / 1356
- :TRIGger:ADVanced:VIOLation:SETup:SETup:DSOURce:LTHReshold / 1357
- :TRIGger:ADVanced:VIOLation:SETup:SETup:TIME / 1358
- :TRIGger:ADVanced:VIOLation:SETup:HOLD:CSOURce / 1359
- :TRIGger:ADVanced:VIOLation:SETup:HOLD:CSOURce:LEVel / 1360
- :TRIGger:ADVanced:VIOLation:SETup:HOLD:CSOURce:EDGE / 1361
- :TRIGger:ADVanced:VIOLation:SETup:HOLD:DSOURce / 1362
- :TRIGger:ADVanced:VIOLation:SETup:HOLD:DSOURce:HTHReshold / 1363
- :TRIGger:ADVanced:VIOLation:SETup:HOLD:DSOURce:LTHReshold / 1364
- :TRIGger:ADVanced:VIOLation:SETup:HOLD:TIME / 1365
- :TRIGger:ADVanced:VIOLation:SETup:SHOLd:CSOURce / 1366
- :TRIGger:ADVanced:VIOLation:SETup:SHOLd:CSOURce:LEVel / 1367
- :TRIGger:ADVanced:VIOLation:SETup:SHOLd:CSOURce:EDGE / 1368
- :TRIGger:ADVanced:VIOLation:SETup:SHOLd:DSOURce / 1369
- :TRIGger:ADVanced:VIOLation:SETup:SHOLd:DSOURce:HTHReshold / 1370
- :TRIGger:ADVanced:VIOLation:SETup:SHOLd:DSOURce:LTHReshold / 1371
- :TRIGger:ADVanced:VIOLation:SETup:SHOLd:SetupTIme (STIME) / 1372
- :TRIGger:ADVanced:VIOLation:SETup:SHOLd:HoldTIme (HTIME) / 1373

Advanced Transition Violation Trigger Commands / 1374

- :TRIGger:ADVanced:VIOLation:TRANsition / 1375
- :TRIGger:ADVanced:VIOLation:TRANsition:SOURce / 1376
- :TRIGger:ADVanced:VIOLation:TRANsition:SOURce:HTHReshold / 1377

:TRIGger:ADVanced:VIOLation:TRANSition:SOURce:LTHReshold / 1378
:TRIGger:ADVanced:VIOLation:TRANSition:TYPE / 1379

37 Waveform Commands

:WAVeform:BANDpass? / 1384
:WAVeform:BYTeorder / 1385
:WAVeform:CGRade:HEIGHt? / 1386
:WAVeform:CGRade:WIDTh? / 1387
:WAVeform:COMPLete? / 1388
:WAVeform:COUNt? / 1389
:WAVeform:COUPling? / 1390
:WAVeform:DATA? / 1391
:WAVeform:FORMat / 1413
:WAVeform:POINts? / 1416
:WAVeform:PREamble? / 1417
:WAVeform:SEGmented:ALL / 1421
:WAVeform:SEGmented:COUNt? / 1422
:WAVeform:SEGmented:TTAG? / 1423
:WAVeform:SEGmented:XLISt? / 1424
:WAVeform:SOURce / 1425
:WAVeform:STReaming / 1427
:WAVeform:TYPE? / 1428
:WAVeform:VIEW / 1429
:WAVeform:XDISplay? / 1432
:WAVeform:XINCrement? / 1433
:WAVeform:XORigin? / 1434
:WAVeform:XRANge? / 1435
:WAVeform:XREFerence? / 1436
:WAVeform:XUNits? / 1437
:WAVeform:YDISplay? / 1438
:WAVeform:YINCrement? / 1439
:WAVeform:YORigin? / 1440
:WAVeform:YRANge? / 1441
:WAVeform:YREFerence? / 1442
:WAVeform:YUNits? / 1443

38 Waveform Memory Commands

:WMEMory:TIETimebase / 1446
:WMEMory<R>:CLEar / 1447
:WMEMory<R>:DISPlay / 1448
:WMEMory<R>:LOAD / 1449

:WMEemory<R>:SAVE / 1450
:WMEemory<R>:SEGmented:COUNT? / 1451
:WMEemory<R>:SEGmented:INDEX / 1452
:WMEemory<R>:SEGmented:PLAY / 1453
:WMEemory<R>:XOFFset / 1454
:WMEemory<R>:XRANge / 1455
:WMEemory<R>:YOFFset / 1456
:WMEemory<R>:YRANge / 1457

39 Xtalk (Crosstalk Analysis) Commands

:XTALK:ENABle / 1461
:XTALK:PAADeskew / 1463
:XTALK:PAIFilter / 1464
:XTALK:PAISi / 1465
:XTALK:PASLimit / 1466
:XTALK:PAXFilter / 1467
:XTALK:PAXSi / 1468
:XTALK:PJADeskew / 1469
:XTALK:PJIFilter / 1470
:XTALK:PJISi / 1471
:XTALK:PJSLimit / 1472
:XTALK:PJXFilter / 1473
:XTALK:PJXSi / 1474
:XTALK:RESults? / 1475
:XTALK:SAADeskew / 1477
:XTALK:SAIFilter / 1478
:XTALK:SAISi / 1479
:XTALK:SASLimit / 1480
:XTALK:SAXFilter / 1481
:XTALK:SAXSi / 1482
:XTALK<X>:AENable<X> / 1483
:XTALK<X>:ENABle / 1484
:XTALK<X>:IAGGressor / 1485
:XTALK<X>:IVICTim / 1486
:XTALK<X>:PAUTo / 1487
:XTALK<X>:PLENght / 1488
:XTALK<X>:PTYPe / 1489
:XTALK<X>:RIDeal / 1490
:XTALK<X>:RISI / 1491
:XTALK<X>:ROTHer / 1492
:XTALK<X>:SOURce / 1493

:XTALK<X>:STYPe / 1494

40 Obsolete and Discontinued Commands

:ANALyze:CLOCK:METHOD:PAM:B03 / 1501
:ANALyze:CLOCK:METHOD:PAM:B12 / 1503
:ANALyze:CLOCK:METHOD:PAM:NONSymmetric / 1505
:DISPlay:COLumn / 1507
:DISPlay:LINE / 1508
:DISPlay:ROW / 1509
:DISPlay:STRing / 1510
:DISPlay:TAB / 1511
:DISPlay:TEXT / 1512
:HOSTed:CALibrate:ALIGn (MultiScope) / 1513
:MEASure:CLOCK / 1514
:MEASure:CLOCK:METHOD / 1515
:MEASure:CLOCK:METHOD (deprecated) / 1517
:MEASure:CLOCK:METHOD:ALIGn / 1519
:MEASure:CLOCK:METHOD:DEEMphasis / 1521
:MEASure:CLOCK:METHOD:EDGE / 1522
:MEASure:CLOCK:METHOD:JTF / 1524
:MEASure:CLOCK:METHOD:OJTF / 1526
:MEASure:CLOCK:METHOD:PLLTrack / 1528
:MEASure:CLOCK:METHOD:SOURce / 1529
:MEASure:CLOCK:VERTical / 1530
:MEASure:CLOCK:VERTical:OFFSet / 1531
:MEASure:CLOCK:VERTical:RANGe / 1532
:MEASure:DDPWS – Data Dependent Pulse Width Shrinkage / 1533
:MEASure:JITTer:STATistics / 1535
:MEASure:TIEData / 1536
:MTESt:FOLDing:COUNt? / 1538
:SPROcessing:CTLequalizer:ZERo / 1540

41 Error Messages

Error Queue / 1542
Error Numbers / 1543
Command Error / 1544
Execution Error / 1545
Device- or Oscilloscope-Specific Error / 1546
Query Error / 1547

List of Error Messages / 1548

42 Sample Programs

VISA COM Examples / 1554

VISA COM Example in Visual Basic / 1554

VISA COM Example in C# / 1565

VISA COM Example in Visual Basic .NET / 1575

VISA COM Example in Python / 1584

VISA Examples / 1592

VISA Example in C / 1592

VISA Example in Visual Basic / 1601

VISA Example in C# / 1611

VISA Example in Visual Basic .NET / 1623

VISA Example in Python (PyVISA 1.5 and older) / 1635

VISA Example in Python (PyVISA 1.6 and newer) / 1641

SICL Examples / 1649

SICL Example in C / 1649

SICL Example in Visual Basic / 1658

SCPI.NET Examples / 1668

SCPI.NET Example in C# / 1668

SCPI.NET Example in Visual Basic .NET / 1675

SCPI.NET Example in IronPython / 1682

43 Reference

HDF5 Example / 1690

CSV and TSV Header Format / 1691

BIN Header Format / 1693

File Header / 1693

Waveform Header / 1693

Waveform Data Header / 1695

Example Program for Reading Binary Data / 1695

Index

1 What's New

| | |
|------------------------------|----|
| What's New in Version 6.10 / | 42 |
| What's New in Version 6.00 / | 44 |
| What's New in Version 5.75 / | 48 |
| What's New in Version 5.70 / | 49 |
| What's New in Version 5.60 / | 52 |
| What's New in Version 5.52 / | 55 |
| What's New in Version 5.51 / | 56 |
| What's New in Version 5.50 / | 57 |
| What's New in Version 5.30 / | 63 |
| What's New in Version 5.20 / | 65 |
| What's New in Version 5.10 / | 67 |
| What's New in Version 5.00 / | 68 |
| What's New in Version 4.60 / | 72 |
| What's New in Version 4.50 / | 73 |
| What's New in Version 4.30 / | 74 |
| What's New in Version 4.20 / | 75 |
| What's New in Version 4.10 / | 76 |
| What's New in Version 4.00 / | 77 |
| What's New in Version 3.50 / | 78 |
| What's New in Version 3.20 / | 80 |
| What's New in Version 3.11 / | 81 |
| What's New in Version 3.10 / | 82 |

What's New in Version 6.10

New command descriptions for Version 6.10 of the Infiniium oscilloscope software appear below.

New Commands

| Command | Description |
|---|--|
| :ANALyze:CLOCK:METHOD:SKEW (see page 256) | When clock recovery is being performed on a PAM-4 signal type, this command can be used to center the eye opening at the clock locations by shifting the clocks relative to the data. |
| :DISPlay:JITTer:THReshold (see page 476) | When the ":MEASure:RJDJ:PAMThreshold ALL" command specifies that all PAM-4 thresholds are measured, this command specifies whether a certain threshold level or ALL threshold levels should be displayed in the jitter graphs. |
| :DISPlay:NOISe:LEVel (see page 480) | Specifies which of the noise graphs to display. |
| :HOSTed:NCONnected? (see page 595) | Returns a number that indicates whether in hosted mode, and if in hosted mode, the number of hosted oscilloscope frames connected. |
| :MARKer:DELTA (see page 635) | Turns on or off the checkbox to display deltas on the screen (as opposed to the deltas in the results area and remote queries). |
| :MEASure:PAM:EYE:ELMethod (see page 842) | Selects the basis for determining the location of an eye's center on the waveform. |
| :MEASure:PAM:EYE:ESTiming (see page 843) | Configures the timing for sampling the data. |
| :MEASure:PAM:EYE:PPERcent (see page 844) | Defines the timespan over which an eye's amplitude level is measured. |
| :MEASure:PAM:EYE:TIME:LTDefi nition (see page 845) | Specifies the method used to locate the time at which to measure an eye's level. |
| :MEASure:HISTogram:FWHM (see page 784) | The command installs a Full-Width at Half Max histogram measurement into the user interface's measurement Results pane. The query returns the measured histogram Full-Width at Half Max value. |
| :MEASure:RJDJ:PAMThreshold (see page 882) | Specifies which PAM thresholds to measure for PAM-4 signals. |
| :MEASure:THResholds:DISPlay (see page 903) | When the source is a PAM-4 signal type, this command turns on or off the display of the PAM-4 measurement thresholds. |

Changed
Commands

| Command | Description |
|---|--|
| :ANALyze:SIGNal:TYPE (see page 271) | CPHY has been added as a signal type. |
| :BUS:B<N>:TYPE (see page 276) | Added support for new CPHY (MIPI C-PHY), BRR (BroadR-Reach), SPW (SpaceWire), and MAN (Manchester) protocols. |
| :CALibrate:OUTPut (see page 290) | Added the PRBS7, PRBS15, and PRBS31 options for the Infiniium 90000 X-Series, V-Series, 90000 Q-Series, and Z-Series oscilloscopes. |
| :CHANnel<N>:PROBe:EADapter (see page 340) | Added the CUR0002VA and CUR002VA options for use with the E2697A or N5449A high impedance adapters. |
| :DISK:SAVE:WAVEform (see page 446) | Added the MATLAB format for saving waveforms to MATLAB (.mat) data format files. |
| :MEASure:RJDJ:ALL? (see page 871) | Jitter analysis is supported on PAM-4 signals. When the ":MEASure:RJDJ:PAMThreshold ALL" command setting has been made, the query results include values for multiple threshold levels; otherwise, the query results are for the specific threshold level specified in the :MEASure:RJDJ:PAMThreshold command. |
| :MEASure:RJDJ:TJRJDJ? (see page 889) | Jitter analysis is supported on PAM-4 signals. When the ":MEASure:RJDJ:PAMThreshold ALL" command setting has been made, the query results include values for multiple threshold levels; otherwise, the query results are for the specific threshold level specified in the :MEASure:RJDJ:PAMThreshold command. |
| :MEASure:THResholds:GENeral :PAMCustom (see page 911) | Added an optional <hysteresis> value at the end of the command parameters. |

Obsolete
Commands

| Obsolete Command | Current Command Equivalent | Behavior Differences |
|--|----------------------------|---|
| :ANALyze:CLOCK:METHod:PAM: B03 (see page 1501) | None | The command works and as before, but changing its default (ON) is not necessary. |
| :ANALyze:CLOCK:METHod:PAM: B12 (see page 1503) | None | The command works and as before, but changing its default (ON) is not necessary. |
| :ANALyze:CLOCK:METHod:PAM: NONSymmetric (see page 1505) | None | The command works and as before, but changing its default (OFF) is not necessary. |

What's New in Version 6.00

New command descriptions for Version 6.00 of the Infiniium oscilloscope software appear below.

New Commands

| Command | Description |
|--|---|
| :ACQuire:SEGmented:AUToplay (see page 225) | Specifies whether segments are automatically played after a segmented memory acquisition. |
| :CALibrate:OUTPut:AUX (see page 292) | Enables or disables signal output on the oscilloscope's Aux Out connector. |
| :CALibrate:OUTPut:AUX:RTIME (see page 293) | Specifies the speed of the Aux Out signal's rise time. |
| :CALibrate:OUTPut:CAL (see page 294) | Enables or disables signal output on the oscilloscope's Cal Out connector. |
| :CHANnel<N>:SIMulation:AMP Litude (see page 367) | Specifies the amplitude of the simulated waveform. |
| :CHANnel<N>:SIMulation:DATA :LENGth (see page 368) | Specifies the length exponent of the simulated waveform's PRBS sequence (for the DATA simulated waveform type). |
| :CHANnel<N>:SIMulation:DATA :ODD (see page 369) | Sets the PRBS "odd" control (for the DATA simulated waveform type). |
| :CHANnel<N>:SIMulation:DATA :PAM (see page 370) | Specifies the number of symbols (or levels) in the PAM signal (when the DATA simulated waveform type is selected and the PAM signal type is selected). |
| :CHANnel<N>:SIMulation:DATA :RESeed (see page 371) | Specifies whether to reseed the PRBS generator(s) (for the DATA simulated waveform type). |
| :CHANnel<N>:SIMulation:DATA :SELECTION (see page 372) | Specifies whether the simulated PRBS waveform is a Non Return to Zero (NRZ) signal or a Pulse Amplitude Modulation (PAM) signal (for the DATA simulated waveform type). |
| :CHANnel<N>:SIMulation:DRATE (see page 373) | Specifies the data rate of the simulated waveform (for the DATA simulated waveform type). |
| :CHANnel<N>:SIMulation:FILTer:ISIM:ADDRESS (see page 374) | Specifies the path of an InfiniiSim transfer function file (when an InfiniiSim filter is selected). |
| :CHANnel<N>:SIMulation:FILTer:ISIM:PEXtraction (see page 375) | Specifies the port extraction method for a 4-port InfiniiSim transfer function file. |
| :CHANnel<N>:SIMulation:FILTer:SELECTION (see page 376) | Sets the filter type. |
| :CHANnel<N>:SIMulation:FLOa d:ADDRESS (see page 377) | Specifies the full path string of a .wfm file to use as the simulated waveform (for the FILE simulated waveform type). |

| Command | Description |
|---|---|
| :CHANnel<N>:SIMulation:FLOad:LOOP (see page 378) | Specifies whether the simulated waveform should repeat from the beginning of the file when reaching the end of the file (for the FILE simulated waveform type). |
| :CHANnel<N>:SIMulation:FREQuency (see page 379) | Specifies the frequency of the simulated waveform (for the CLOCK or FUNCtion simulated waveform types). |
| :CHANnel<N>:SIMulation:FUNCtion:SELECTION (see page 380) | Specifies the simulated waveform function type (for the FUNCtion simulated waveform type). |
| :CHANnel<N>:SIMulation:FUNCtion:SQUare:DCYCLE (see page 381) | Specifies the square wave's duty cycle high time percent value (when the FUNCtion simulated waveform type is selected and the SQUare function is selected). |
| :CHANnel<N>:SIMulation:FUNCtion:SQUare:FTIME (see page 382) | Specifies the square wave's high-to-low transition time (when the FUNCtion simulated waveform type is selected and the SQUare function is selected). |
| :CHANnel<N>:SIMulation:FUNCtion:SQUare:RTIME (see page 383) | Specifies the square wave's low-to-high transition time (when the FUNCtion simulated waveform type is selected and the SQUare function is selected). |
| :CHANnel<N>:SIMulation:JITTer (see page 384) | Turns all simulated waveform jitter off or on while saving the values. |
| :CHANnel<N>:SIMulation:JITTer:ABUJ (see page 385) | Specifies the amount of Aperiodic Bounded Uniform Jitter (ABUJ) to apply to the simulated waveform. |
| :CHANnel<N>:SIMulation:JITTer:PERiodic<M>:ENABLE (see page 386) | Turns the periodic jitter for the simulated waveform on or off. |
| :CHANnel<N>:SIMulation:JITTer:PERiodic<M>:FREQuency (see page 387) | Specifies the frequency of the periodic jitter applied to the simulated waveform. |
| :CHANnel<N>:SIMulation:JITTer:PERiodic<M>:MAGNitude (see page 388) | Specifies the magnitude of the periodic jitter applied to the simulated waveform. |
| :CHANnel<N>:SIMulation:JITTer:PERiodic<M>:SHAPE (see page 389) | Specifies the shape of the periodic jitter applied to the simulated waveform. |
| :CHANnel<N>:SIMulation:JITTer:RANDom (see page 390) | Specifies the standard deviation of random jitter to apply. |
| :CHANnel<N>:SIMulation:NOISe (see page 391) | Turns all simulated waveform noise off or on while saving the values. |
| :CHANnel<N>:SIMulation:NOISe:BWLimit (see page 392) | Turns the noise filter on or off. |

| Command | Description |
|--|---|
| :CHANnel<N>:SIMulation:NOIS e:PERiodic<M>:ENABle (see page 393) | Turns the periodic noise for the simulated waveform on or off. |
| :CHANnel<N>:SIMulation:NOIS e:PERiodic<M>:FREQuency (see page 394) | Specifies the frequency of the periodic noise applied to the simulated waveform. |
| :CHANnel<N>:SIMulation:NOIS e:PERiodic<M>:MAGNitude (see page 395) | Specifies the magnitude of the periodic noise applied to the simulated waveform. |
| :CHANnel<N>:SIMulation:NOIS e:PERiodic<M>:SHAPE (see page 396) | Specifies the shape of the periodic noise applied to the simulated waveform. |
| :CHANnel<N>:SIMulation:NOIS e:RANDom (see page 397) | Specifies the standard deviation of random noise to apply. |
| :CHANnel<N>:SIMulation:OFFS et (see page 398) | Specifies the offset of the simulated waveform. |
| :CHANnel<N>:SIMulation:WAV eform (see page 399) | Sets the simulated waveform type. |
| :FUNction<F>:MLOG (see page 538) | Adds a function waveform that is a scrolling record of measurement values over time. |
| :MEASure:THResholds:GENaut o (see page 904) | Automatically sets the general "Custom: thresholds +/- hysteresis" when thresholds apply to individual waveforms. |
| :MTEST:COUNT:SUI? (see page 672) | Returns the total number of samples that have been mask tested in the UI bit time. |
| :SYSTem:HLED (see page 1156) | On Infiniium 90000 Q-Series, S-Series, V-Series, and Z-Series oscilloscopes, this command turns the Turn off Front Panel LEDs user preference on or off. |
| :WAVEform:CGRade:HEIGHt? (see page 1386) | Returns the color grade (pixel) database data height (when the CGRade waveform view is selected). |
| :WAVEform:CGRade:WIDTh? (see page 1387) | Returns the color grade (pixel) database data width (when the CGRade waveform view is selected). |
| :WMEMory<R>:SEGmented:CO UNT? (see page 1451) | When segmented memory acquisitions are saved to waveform memory, this query returns the number of segments in the waveform memory. |
| :WMEMory<R>:SEGmented:IN Dex (see page 1452) | When segmented memory acquisitions are saved to waveform memory, this command command sets the index number for the segment that you want to display on screen. |
| :WMEMory<R>:SEGmented:PL AY (see page 1453) | When segmented memory acquisitions are saved to waveform memory, this command command plays (or stops) the segments. |

Changed Commands

| Command | Description |
|--|--|
| :ANALyze:CLOCK:METHOD:JTf (see page 249) | There are now Third Order PLL options. |
| :ANALyze:CLOCK:METHOD:OJTf (see page 252) | There are now Third Order PLL options. |
| :BUS:B<N>:TYPE (see page 276) | Added support for new SPMI and GENRaw protocols. |
| :FUNction<F>:FFT:DETEctor:TYPE (see page 507) | The RMS detector type has been added. |
| :FUNction<F>:HORizontal:POSition (see page 524) | For functions where the horizontal position cannot be adjusted, this command now gives a -221, "Settings conflict" instead of being accepted without effect. |
| :FUNction<F>:HORizontal:RANGe (see page 526) | For functions where the horizontal position cannot be adjusted, this command now gives a -221, "Settings conflict" instead of being accepted without effect. |
| :HOSTed:FOLLOWer<N>:CONFiGure (see page 588) | Added the ability to configure a "Simulated Instrument" to set up simulated waveforms. |
| :MTEST:SOURce (see page 715) | Waveform memories can now be used as a source for mask testing. |
| :WAVEform:FORMat (see page 1413) | There is now a FLOat option for getting color grade (pixel) database data in single-precision floating-point format (when the CGRade waveform view is selected). |
| :WAVEform:VIEW (see page 1429) | There is now a CGRade option for getting color grade (pixel) database data. |

Discontinued Commands

| Discontinued Command | Current Command Equivalent | Comments |
|--------------------------------------|----------------------------|---|
| :MEASure:THResholds:RFALL:HYSteresis | None | Rise/fall thresholds are no longer set using hysteresis and level values. |

What's New in Version 5.75

New command descriptions for Version 5.75 of the Infiniium oscilloscope software appear below.

New Commands

| Command | Description |
|--|--|
| :SPROcessing:CTLequalizer:Z1 (see page 1115) | Specifies the first zero for 3-pole CTLE. |
| :SPROcessing:CTLequalizer:Z2 (see page 1116) | Specifies the second zero for 3-pole CTLE. |

Changed Commands

| Command | Description |
|---|---|
| :SPROcessing:CTLequalizer:NUMPoles (see page 1106) | Now that you can specify up to two zeros for a 3-pole CTLE, the previous POLE3 option has been replaced by P3Z1 and P3Z2. |
| :MEASure:RJDJ:BER (see page 875) | You can now set J4 and J5 jitter BER levels. |

What's New in Version 5.70

New command descriptions for Version 5.70 of the Infiniium oscilloscope software appear below.

New Commands

| Command | Description |
|--|--|
| :ACQuire:SEGmented:PRATe (see page 229) | Specifies the segmented memory navigation play rate. |
| :CHANnel<N>:INVert (see page 316) | Enables or disables the invert setting for a channel. |
| :CHANnel<N>:ISIM:BWLimit:TYPE (see page 322) | Specifies a channel's band width limit filter response. |
| :CHANnel<N>:PROBE:INFO? (see page 354) | Returns a comma-separated list of probe information. |
| :DISPlay:PROPortion:RESults (see page 484) | Specifies the size of the Results pane in the oscilloscope display. |
| :FUNction<F>:FFT:DETEctor:POINTS (see page 506) | When a detector is used for the FFT magnitude function, this command specifies the maximum number of points (buckets) that detectors should decimate to. |
| :FUNction<F>:FFT:DETEctor:TYPE (see page 507) | Specifies whether a detector is used for the FFT magnitude function. |
| :FUNction<F>:FFT:SPAN (see page 511) | Sets the frequency span for the FFT function. |
| :FUNction<F>:FFT:STOP (see page 512) | Sets the stop frequency for the FFT function. |
| :FUNction<F>:FFT:VUNits (see page 514) | Specifies the vertical units for the FFT magnitude function. |
| :HOSTed:PERiodic (see page 596) | Turns periodic drift correction on or off. |
| :LTEST:ADDStats (see page 620) | Enables or disables the limit test "statistics on passing measurements only" option. |
| :LTEST:RUMode:SOFailure (see page 626) | Enables or disables the limit test "stop on failure" option. |
| :MEASure:CGRade:OLEvel (see page 747) | The command installs an Eye One Level measurement into the user interface's measurement Results pane. The query returns the measured Eye One Level. |
| :MEASure:CGRade:ZLEvel (see page 749) | The command installs an Eye Zero Level measurement into the user interface's measurement Results pane. The query returns the measured Eye Zero Level. |

| Command | Description |
|--|---|
| :MEASure:ERATio (see page 768) | The command installs an Extinction Ratio measurement into the user interface's measurement Results pane. The query returns the measured Extinction Ratio. |
| :MEASure:FFT:CPOWer (see page 772) | The command installs a channel power measurement into the user interface's measurement Results pane. The query returns the measured channel power. |
| :MEASure:FFT:OBW (see page 777) | The command installs an occupied bandwidth measurement into the user interface's measurement Results pane. The query returns the measured occupied bandwidth. |
| :MEASure:FFT:PSD (see page 780) | The command installs a power spectral density measurement into the user interface's measurement Results pane. The query returns the measured power spectral density. |
| :MEASure:OMAMplitude (see page 835) | The command installs an Optical Modulation Amplitude (OMA) measurement into the user interface's measurement Results pane. The query returns the measured Optical Modulation Amplitude (OMA). |
| :MEASure:OPOWer (see page 836) | The command installs an Optical Average Power measurement into the user interface's measurement Results pane. The query returns the measured Optical Average Power. |
| :MTESt:COUNt:MARGIn:FAILure s? (see page 671) | Returns the margin failure count for a specified region. |
| :MTESt:MARGIn:AUTO:HITS (see page 700) | When the automatic margin method is selected, and the hit ratio method is selected, this command specifies the hit count. |
| :MTESt:MARGIn:AUTO:HRATio (see page 701) | When the automatic margin method is selected, and the hit ratio method is selected, this command specifies the hit ratio. |
| :MTESt:MARGIn:AUTO:METHod (see page 702) | When the automatic margin method is selected, this command selects between the hit count and hit ratio and automatic margin methods. |
| :MTESt:MARGIn:METHod (see page 703) | Selects between the manual and automatic margin types. |
| :MTESt:MARGIn:PERCent (see page 704) | When the manual margin method is selected, this command specifies the margin percent. |
| :MTESt:MARGIn:STATe (see page 705) | Enables or disables mask margin testing. |
| :XTALk Commands (see page 1459) | The commands in the XTALK subsystem are used to control the Crosstalk Analysis application. |

Changed Commands

| Command | Description |
|---|--|
| :BUS:B<N>:TYPE (see page 276) | Added support for new A429, M1553, and I3C protocols. |
| :DISPlay:SCOLor (see page 488) | Added the ability to set colors for MMPolygons. |
| :FUNCTion<F>:FFT:RESolution (see page 510) | The command form now lets you set the FFT resolution. |
| :MARKer:MODE (see page 637) | Added XONLY and YONLY options for for the "Manual (X only)" and "Manual (Y only)" marker modes. |
| :MEASure:AREA (see page 731) | Added a RISing or FALLing edge parameter when "Measure All Edges" is set and measuring a single cycle of the waveform. |

What's New in Version 5.60

New command descriptions for Version 5.60 of the Infiniium oscilloscope software appear below.

New Commands

| Command | Description |
|---|---|
| :ACQuire:BA ^N Dwidth:TESTLIMITS? (see page 210) | Returns the oscilloscope's acquisition bandwidth maximum and minimum limits. |
| :ACQuire:POINts:TESTLIMITS? (see page 222) | Returns the oscilloscope's acquisition points maximum and minimum limits. |
| :ACQuire:SEGmented:PLAY (see page 228) | Plays (or stops) acquired segments. |
| :ACQuire:SRATE:TESTLIMITS? (see page 235) | Returns the oscilloscope's acquisition sampling rate maximum and minimum limits. |
| :ANALyze:SIGNal:MIXer:CABLeLoss (see page 265) | Sets the loss of the cable connecting the mixer to the oscilloscope. |
| :ANALyze:SIGNal:MMWave:CALibrate (see page 266) | Initiates a mixer/LO (local oscillator) power calibration. The LO is identified by the :ANALyze:SIGNal:MMWave:LOADdress command. |
| :ANALyze:SIGNal:MMWave:CFRequency (see page 267) | Sets the center frequency for the oscilloscope's FFT math function. |
| :ANALyze:SIGNal:MMWave:CONNect (see page 268) | Sets the connection status for the mixer and LO (local oscillator) assigned to the specified channel. |
| :ANALyze:SIGNal:MMWave:LOADdress (see page 269) | Sets the LO's (local oscillator's) VISA address. |
| :ANALyze:SIGNal:MMWave:MBANdwidth (see page 270) | Sets the measurement bandwidth. This becomes the center frequency for the oscilloscope's FFT math function. |
| :CHANnel<N>:PROBe:PRIMary (see page 362) | For the N2820A/N2821A high-sensitivity current probes only, this command configures the input channel as a zoomed-in (amplified) or zoomed-out channel. |
| :MEASure:BER (see page 732) | When the signal type is PAM, this command installs a cumulative BER (bit error rate) measurement of the specified PAM signal into the user interface's measurement Results pane. The query returns the measured cumulative BER value. |
| :MEASure:BERPeracq (see page 733) | When the signal type is PAM, this command installs a BER (bit error rate) per acquisition measurement of the specified PAM signal into the user interface's measurement Results pane. The query returns the measured BER per acquisition value. |
| :MEASure:PPContrast (see page 858) | Measures the peak-to-peak contrast (also known as Michelson contrast or modulation). |

| Command | Description |
|---|--|
| :MEASure:SER (see page 894) | When the signal type is PAM, this command installs a cumulative SER (symbol error rate) measurement of the specified PAM signal into the user interface's measurement Results pane. The query returns the measured cumulative SER value. |
| :MEASure:SERPeracq (see page 895) | When the signal type is PAM, this command installs a SER (symbol error rate) per acquisition measurement of the specified PAM signal into the user interface's measurement Results pane. The query returns the measured SER per acquisition value. |
| :SBUS<N>:CAN:TYPE (see page 1042) | Selects between standard CAN or Flexible Data Rate CAN (CAN FD) decode types. |
| :SBUS<N>:CAN:FDSPoint (see page 1028) | Sets the point during the bit time where the bit level is sampled to determine whether the bit is dominant or recessive. |
| :SBUS<N>:CAN:SIGNAL:FDBaudrate (see page 1032) | Sets the CAN FD baud rate in the range from 1 Mb/s to 10 Mb/s. |
| :SYSTem:DONTtabmeas (see page 1151) | Turns the Never tab Measurement Results user preference on or off. |

Changed Commands

| Command | Description |
|---|---|
| :ANALyze:CLOCK:METHod (see page 241) | They CPHY and PWM methods have been added. |
| :ANALyze:SIGNAL:TYPE (see page 271) | MMWave has been added as a signal type. |
| :DISPlay:SCOLor (see page 488) | Removed the ability to set colors for MEASurements, STExT, TSCale, and WBACKgrnd. |
| :FUNction<F>:MATLab:CONTRol<N> (see page 533) | Up to 6 user-defined controls supported. |
| :SBUS<N>:CAN:TRIGger (see page 1034) | Additional trigger condition options for CAN FD have been added. |
| :SBUS<N>:CAN:TRIGger:PATtern:DATA:LENGth (see page 1038) | Length can be from 1 to 15 bytes for CAN FD. |

Obsolete
Commands

| Obsolete Command | Current Command Equivalent | Behavior Differences |
|--|----------------------------|---|
| :DISPlay:TAB (see page 1511) | None | This command is not supported in version 5.00 or higher. The query now returns only NONE. |
| :HOSTed:CALibrate:ALIGn (see page 1513) | None | Acquired data is now always aligned, and this command has no effect. |

What's New in Version 5.52

New command descriptions for Version 5.52 of the Infiniium oscilloscope software appear below.

Changed Commands

| Command | Description |
|--|---|
| :MTESt:FOLDing:COUNT:UI? (see page 681) | The <source> parameter is now optional. |
| :MTESt:FOLDing:COUNT:WAVeforms? (see page 681) | The <source> parameter is now optional. |

What's New in Version 5.51

New command descriptions for Version 5.51 of the Infiniium oscilloscope software appear below.

Changed Commands

| Command | Description |
|--|---|
| :BUS:B<N>:TYPE (see page 276) | Added support for new ESPI, USB31, and USBPD protocols. |

What's New in Version 5.50

New command descriptions for Version 5.50 of the Infiniium oscilloscope software appear below.

New Commands

| Command | Description |
|---|---|
| :ANALyze:CLOCK:METHod:PAM:B03 (see page 1501) | When the signal type is PAM-4, this command specifies whether edges from the 0 level to the 3 level and from the 3 level to the 0 level are included in the clock recovery. |
| :ANALyze:CLOCK:METHod:PAM:B12 (see page 1503) | When the signal type is PAM-4, this command specifies whether edges from the 1 level to the 2 level and from the 2 level to the 1 level are included in the clock recovery. |
| :ANALyze:CLOCK:METHod:PAM:NONSymmetric (see page 1505) | When the signal type is PAM-4, this command specifies whether edges that are non-symmetric about the middle threshold are included in the clock recovery. |
| :ANALyze:SIGNAL:DARate (see page 261) | When the signal type is PAM-4, this command specifies the data rate of the signal. |
| :ANALyze:SIGNAL:SYMBOLrate (see page 263) | When the signal type is PAM-4, this command specifies the edge rate of the signal. |
| :ANALyze:SIGNAL:TYPE (see page 271) | Lets you specify whether a channel, function, or waveform memory is a special type of signal, like a PAM-4 signal for example. |
| :DISPlay:ISIM:GCOunt (see page 470) | Sets or returns the number of visible graphs in the InfiniiSim plots window area. |
| :DISPlay:ISIM:SElectgraph (see page 471) | Inserts the specified graph at the first display graph position. |
| :DISPlay:ISIM:SOURce (see page 472) | Sets the source for the InfiniiSim plots graph(s). |
| :DISPlay:JITTer:GCOunt (see page 473) | Sets or returns the number of visible graphs in the Jitter/Noise graphs window area. |
| :DISPlay:JITTer:SElectgraph (see page 474) | Inserts the specified graph at the first display graph position. |
| :DISPlay:PRECprobe:GCOunt (see page 485) | Sets or returns the number of visible graphs in the PrecisionProbe correction and analysis charts window area. |
| :DISPlay:PRECprobe:SElectgraph (see page 486) | Inserts the specified graph at the first display graph position. |
| :DISPlay:PRECprobe:SOURce (see page 487) | Sets the source for the PrecisionProbe correction and analysis chart(s). |
| :DISPlay:WINDow:MAXimize (see page 492) | Will maximize the size of the specified window. |

| Command | Description |
|--|---|
| :HOSTed:CALibrate:ALIGn (see page 1513) | Lets you align acquired data in the MultiScope system. |
| :HOSTed:CALibrate:CALibrate (see page 573) | Performs the MultiScope system time-correlation calibration at the level selected by :HOSTed:CALibrate:LEVel. |
| :HOSTed:CALibrate:CHANnel (see page 574) | Selects the calibration channel or synchronization input where the MultiScope system time-correlation procedures expect to find the calibration signal. |
| :HOSTed:CALibrate:DESKew:FRAMes (see page 576) | Deskews frames in the MultiScope system by measuring only one input channel from each oscilloscope frame. |
| :HOSTed:CALibrate:DESKew:CHANnels (see page 575) | Deskews all channels in the MultiScope system. |
| :HOSTed:CALibrate:DESKew:SIGNals (see page 577) | Aligns the horizontal positions of the closest rising edges of all input signals in the MultiScope system. |
| :HOSTed:CALibrate:DESKew:ZERO (see page 578) | Resets MultiScope system signal skew values to zero. |
| :HOSTed:CALibrate:LEVel (see page 579) | Selects the MultiScope system calibration level. |
| :HOSTed:CALibrate:PROMpt (see page 581) | Specifies whether the user interface software prompts you to make the proper connections while the MultiScope system calibration runs. |
| :HOSTed:CALibrate:STATus:CHANnels? (see page 582) | Returns the MultiScope system calibration status of "Deskew Channels". |
| :HOSTed:CALibrate:STATus:FRAMes? (see page 583) | Returns the MultiScope system calibration status of "Deskew Frames". |
| :HOSTed:CALibrate:STATus:LEVel? (see page 584) | Returns the MultiScope system calibration status of the currently selected calibration level. |
| :HOSTed:CALibrate:STATus:SIGNals? (see page 585) | Returns the MultiScope system calibration status of "Deskew Signals". |
| :HOSTed:CALibrate:TREF:DETECT (see page 586) | Automatically detects the reference clock connection between oscilloscopes in a MultiScope system. |
| :HOSTed:FOLLOWer<N>:ACHannels? (see page 587) | Returns the channel numbers assigned to a Follower oscilloscope in a MultiScope system. |
| :HOSTed:FOLLOWer<N>:CONFigure (see page 588) | Identifies the Follower oscilloscope in a MultiScope system by its VISA address. |
| :HOSTed:FOLLOWer<N>:CONNeCt (see page 589) | Opens the connection to a Follower oscilloscope in a MultiScope system. |
| :HOSTed:FOLLOWer<N>:DISCoNnect (see page 590) | Closes the connection to a Follower oscilloscope in a MultiScope system. |

| Command | Description |
|--|---|
| :HOSTed:LEADer:ACHannels? (see page 591) | Returns the channel numbers assigned to the Leader oscilloscope in a MultiScope system. |
| :HOSTed:LEADer:CONFigure (see page 592) | Identifies the Leader oscilloscope in a MultiScope system by its VISA address. |
| :HOSTed:LEADer:CONNect (see page 593) | Opens the connection to the Leader oscilloscope in a MultiScope system. |
| :HOSTed:LEADer:DISConnect (see page 594) | Closes the connection to the Leader oscilloscope in a MultiScope system. |
| :MEASure:PAM:ELEVel (see page 838) | When the signal type is PAM-4, this command installs a vertical center measurement of the specified PAM-4 eye into the user interface's measurement Results pane. The query returns the measured vertical center value. |
| :MEASure:PAM:ESKew (see page 840) | When the signal type is PAM-4, this command installs a horizontal center skew measurement of the specified PAM-4 eye into the user interface's measurement Results pane. The query returns the measured horizontal center skew value. |
| :MEASure:PAM:LEVel (see page 846) | When the signal type is PAM-4, this command installs a mean voltage measurement of the specified PAM-4 level into the user interface's measurement Results pane. The query returns the measured mean voltage value. |
| :MEASure:PAM:LRMS (see page 848) | When the signal type is PAM-4, this command installs a RMS voltage measurement of the specified PAM-4 level into the user interface's measurement Results pane. The query returns the measured RMS voltage value. |
| :MEASure:PAM:LTHickness (see page 850) | When the signal type is PAM-4, this command installs an eye diagram level thickness measurement of the specified PAM-4 level into the user interface's measurement Results pane. The query returns the measured thickness value. |
| :MEASure:THResholds:GENeral :PAMCustom (see page 911) | When the signal type is PAM-4 and :MEASure:THResholds:GENeral:METHod is set to PAMCustom, this command sets the PAM threshold levels for general measurements to the values you specify. |
| :MEASure:THResholds:GENeral :PAMAutomatic (see page 913) | When the signal type is PAM-4 and :MEASure:THResholds:GENeral:METHod is set to PAMAutomatic, this command specifies whether the PAM threshold levels for general measurements are determined automatically or using the PAM-4 levels you specify. |
| :MEASure:THResholds:RFALL:P AMAutomatic (see page 928) | When the signal type is PAM-4, this command specifies whether the PAM threshold levels for rise/fall measurements are determined automatically or using the PAM-4 levels you specify. |
| :MEASure:TIEData2 (see page 949) | Measures data time interval error. |

| Command | Description |
|--|--|
| :MTESt:FOLDing:COUNT:UI? (see page 681) | Returns the number of unit intervals in the real time eye. |
| :MTESt:FOLDing:COUNT:WAVef orms? (see page 681) | Returns the number of waveforms in the real time eye. |
| :SYSTem:GUI (see page 1154) | Disables or enables the front panel user interface. When disabled, the Remote Operations In Progress dialog box appears on the oscilloscope's screen. NOTE: The :SYSTem:GUI OFF command lets Infiniium oscilloscopes behave like other Keysight instruments by locking out the GUI (graphical user interface) and the front panel while remote scripts are running. On Infiniium oscilloscopes, the GUI and front panel do not lock automatically during remote operation (as most other instruments do) to preserve the integrity and timing of legacy customer scripts. The recommendation is, however, that all scripts begin with :SYSTem:GUI OFF when convenient and possible to run more like other Keysight instruments and likely improve performance. |
| :SYSTem:MENU? (see page 1159) | Returns front panel graphical user interface menu strings. |
| :TRIGger:GBSerial:CLOCK (see page 1219) | Specifies whether an INTERNAL or EXTERNAL reference clock (and internal multipliers) are used to support the selected data rate. External reference clock signals are supplied to a BNC connector on the oscilloscope's hardware serial trigger I/O panel. |
| :TRIGger:GBSerial:CLOCK:FREQ uency (see page 1220) | When an external reference clock is used, this command specifies its frequency. |
| :TRIGger:GBSerial:DRATe (see page 1222) | Specifies the data rate of the serial signal. Common data rates are supported. |
| :TRIGger:GBSerial:MODE (see page 1224) | Selects the hardware serial trigger mode ("generic" sequences, 8b/10b sequences, or PRBS errors). |
| :TRIGger:GBSerial:PATTern (see page 1225) | When triggering on "generic" sequences or 8b/10b sequences, this command specifies the bit pattern to trigger on. |
| :TRIGger:GBSerial:POLarity (see page 1226) | When triggering on PRBS errors, this command specifies the polarity of the selected PRBS pattern. |
| :TRIGger:GBSerial:PRBS (see page 1227) | When triggering on PRBS errors, this command specifies the pattern to check when looking for errors. You can select PRBS 7, 15, 23, or 31 patterns. |
| :TRIGger:GBSerial:SOURce (see page 1228) | Specifies the oscilloscope input channel on which the hardware serial trigger operates. This is always CHANNEL1. |

Changed Commands

| Command | Description |
|--|--|
| :ANALyze:CLOCK:METHOD (see page 241) | When the signal type is PAM-4, a symbol rate (baud) is specified instead of a data rate (b/s). |
| :ANALyze:CLOCK:METHOD:JTF (see page 249) | When the signal type is PAM-4, a symbol rate (baud) is specified instead of a data rate (b/s). |
| :ANALyze:CLOCK:METHOD:OJTF (see page 252) | When the signal type is PAM-4, a symbol rate (baud) is specified instead of a data rate (b/s). |
| :CHANnel<N>:PROBe:HEAD:VTErm (see page 352) | Supports the N7010A active termination adapter (regardless of the attachment/head) as well as the N5444A probe head. |
| :DISPlay:CGRade (see page 457) | When the <source> parameter is not provided, enabling color grade will turn off the main waveform view, and disabling color grade will turn on the main waveform view. |
| :DISK:SAVE:MEASurements (see page 443) | Added the <legacy_save_mode> option to save measurement results in the format used prior to Infiniium version 5.00. |
| :MEASure:CGRade:EHEight (see page 740) | When the signal type is PAM-4, an additional <threshold> parameter is used to specify which eye, and the <algorithm> parameter is ignored. |
| :MEASure:CGRade:EWIDth (see page 742) | When the signal type is PAM-4, an additional <threshold> parameter is used to specify which eye, and the <algorithm> parameter is ignored. |
| :MEASure:FALLtime (see page 770) | With PAM signal types, additional <start_level> and <stop_level> parameters are used to identify the edge to measure. |
| :MEASure:NOISe:ALL? (see page 821) | The parameters TWO and THRee are available for PAM-4 signals. |
| :MEASure:RISetime (see page 869) | With PAM signal types, additional <start_level> and <stop_level> parameters are used to identify the edge to measure. |
| :MEASure:THResholds:GENeral:METHOD (see page 909) | When the signal type is PAM-4, you can choose between PAMCustom and PAMautomatic methods for setting the general measurement thresholds. |
| :MEASure:THResholds:RFALL:METHOD (see page 926) | When the signal type is PAM-4, you can choose between T1090 (10% and 90% of levels) and T2080 (20% and 80% of levels) when setting the rise/fall measurement thresholds. |
| :MTESt:FOLDing (see page 677) | When the <source> parameter is not provided, enabling the real-time eye will turn off the main waveform view, and disabling the real-time eye will turn on the main waveform view. |
| :MTESt:FOLDing:BITS (see page 679) | The <pattern> string can contain characters "2" and "3" when specified for PAM-4 signals. |
| :SPROcessing:CTLequalizer:RATE (see page 1110) | When the signal type is PAM-4, a symbol rate (baud) is specified instead of a data rate (b/s). |
| :SPROcessing:FFEQualizer:RATE (see page 1134) | When the signal type is PAM-4, a symbol rate (baud) is specified instead of a data rate (b/s). |

Obsolete
Commands

| Obsolete Command | Current Command Equivalent | Behavior Differences |
|--|---|--|
| :MEASure:TIEData (see page 1536) | :MEASure:TIEData2 (see page 949) | <p>Clock recovery options have been removed (clock recovery as specified with the :ANALyze:CLOCK:METHod is used).</p> <p>When the signal type is PAM-4, an additional <threshold> parameter is used to specify the threshold at which to make the TIE measurements.</p> |
| :MTESt:FOLDing:COUNT? (see page 1538) | :MTESt:FOLDing:COUNT:UI? (see page 681) :MTESt:FOLDing:COUNT:WAVeforms? (see page 683) | <p>The :MTESt:FOLDing:COUNT? query returns two values for UI count and waveform count. Now, there are separate queries that return those values individually.</p> <p>The UI count returned by :MTESt:FOLDing:COUNT? is now a floating-point value instead of an integer value.</p> |

What's New in Version 5.30

New command descriptions for Version 5.30 of the Infiniium oscilloscope software appear below.

New Commands

| Command | Description |
|---|---|
| :ANALyze Commands (see page 237) | <p>The commands in the ANALyze subsystem are used to:</p> <ul style="list-style-type: none"> ▪ Specify whether to use a single edge or all edges in the acquisition for horizontal measurements (:ANALyze:AEDGes command). ▪ Set up clock recovery (:ANALyze:CLOCK commands). ▪ Specify whether to use the data on screen or the entire acquisition for measurements, functions, and analysis (:ANALyze:VIEW command). |
| :FUNction<F>:GATing:START (see page 520) | Specifies the time, in seconds, where the gating window begins relative to the source waveform. |
| :FUNction<F>:GATing:STOP (see page 521) | Specifies the time, in seconds, where the gating window ends relative to the source waveform. |

Obsolete Commands

| Obsolete Command | Current Command Equivalent | Behavior Differences |
|---|--|---|
| :MEASure:CLOCK (see page 1514) | :ANALyze:CLOCK (see page 240) | There are no differences in behavior. This is just a remapping of commands into a new subsystem. |
| :MEASure:CLOCK:METHod (see page 1515) | :ANALyze:CLOCK:METHod (see page 241) | |
| :MEASure:CLOCK:METHod:ALIGn (see page 1519) | :ANALyze:CLOCK:METHod:ALIGn (see page 244) | |
| :MEASure:CLOCK:METHod:DEEMphasis (see page 1521) | :ANALyze:CLOCK:METHod:DEEMphasis (see page 246) | |
| :MEASure:CLOCK:METHod:EDGE (see page 1522) | :ANALyze:CLOCK:METHod:EDGE (see page 247) | |
| :MEASure:CLOCK:METHod:JTF (see page 1524) | :ANALyze:CLOCK:METHod:JTF (see page 249) | |
| :MEASure:CLOCK:METHod:OJTF (see page 1526) | :ANALyze:CLOCK:METHod:OJTF (see page 252) | |
| :MEASure:CLOCK:METHod:PLLT rack (see page 1528) | :ANALyze:CLOCK:METHod:PLLT rack (see page 255) | |
| :MEASure:CLOCK:METHod:SOURce (see page 1529) | :ANALyze:CLOCK:METHod:SOURce (see page 257) | |
| :MEASure:CLOCK:VERTical (see page 1530) | :ANALyze:CLOCK:VERTical (see page 258) | |
| :MEASure:CLOCK:VERTical:OFFSet (see page 1531) | :ANALyze:CLOCK:VERTical:OFFSet (see page 259) | |
| :MEASure:CLOCK:VERTical:RANGe (see page 1532) | :ANALyze:CLOCK:VERTical:RANGe (see page 260) | |
| :MEASure:JITTer:STATistics (see page 1535) | :ANALyze:AEDGEs (see page 239) | The :ANALyze:AEDGEs command maps to the "Measure All Edges" control in the user interface's Measurement Setup dialog box only. It does not affect jitter modes or statistics. |

What's New in Version 5.20

New command descriptions for Version 5.20 of the Infiniium oscilloscope software appear below.

New Commands

| Command | Description |
|---|---|
| :ACQuire:BA ^N Dwidth:FRAMe? (see page 209) | Returns the maximum band width associated with oscilloscope model. |
| :HISTogram:HORizontal:BINs (see page 560) | Sets the maximum number of bins used for a horizontal waveform histogram. |
| :HISTogram:MEASurement:BINs (see page 561) | Sets the maximum number of bins used for a measurement histogram. |
| :HISTogram:VERTical:BINs (see page 564) | Sets the maximum number of bins used for a vertical waveform histogram. |
| :MEASure:CLOCK:METHOD:SOURce (see page 1529) | Clock recovery methods can now be defined for each waveform source (or for all waveform sources, as before). This command selects the waveform source (or all sources) to which other clock recovery method setup commands apply. |
| :SBUS<N>:FLEXray Commands (see page 1043) | These commands control the FlexRay serial decode bus viewing, mode, and other options. |
| :SBUS<N>:LIN Commands (see page 1067) | These commands control the LIN serial decode bus viewing, mode, and other options. |
| :SYSTem:PERSONa (see page 1160) | Sets the manufacturer string and the model number string returned by the *IDN? query. |

Changed Commands

| Command | Description |
|---|--|
| :CHANnel<N>:PROBE:EADapter (see page 340) | Added the DIV1000, CUR001VA, CUR01VA, CUR1VA, CUR10VA, CURN2893, CUR1147, HIVOLTN2790 options for use with the E2697A or N5449A high impedance adapters. |
| :FUNCTion<F>:MHISTogram (see page 536) | Lets you specify the maximum number of histogram bins along with the measurement source. |
| :SBUS<N>:MODE (see page 1026) | Added the FLEXray and LIN mode options. |

| Command | Description |
|--|--|
| :SBUS<N>:CAN:SOURce (see page 1033) | Added the NONE parameter to make the previously selected channel, waveform memory, or math function available for other decodes (same as selecting "None" for the source in the user interface). |
| :SBUS<N>:IIC:SOURce:CLOCK (see page 1060) | |
| :SBUS<N>:IIC:SOURce:DATA (see page 1061) | |
| :SBUS<N>:SPI:SOURce:CLOCK (see page 1081) | |
| :SBUS<N>:SPI:SOURce:DATA (see page 1083) | |
| :SBUS<N>:SPI:SOURce:FRAME (see page 1085) | |
| :SBUS<N>:SPI:SOURce:MISO (see page 1086) | |
| :SBUS<N>:SPI:SOURce:MOSI (see page 1087) | |

What's New in Version 5.10

New command descriptions for Version 5.10 of the Infiniium oscilloscope software appear below.

New Commands

| Command | Description |
|--|--|
| :MTEST:FOLDing:TPOSITION (see page 691) | Sets the real-time eye horizontal center position in time. |
| :MTEST:FOLDing:TSCale (see page 693) | Sets the real-time eye horizontal scale perdivision in time. |

Changed Commands

| Command | Description |
|--|--|
| :MEASure:CLOCK:METHOD (see page 1515) | The PCIe clock recovery method has been removed. |

What's New in Version 5.00

Version 5.00 of the Infiniium oscilloscope software introduces the new, next-generation Infiniium user interface.

The next-generation Infiniium user interface software gives you much more flexibility in how you can organize data, measurement results, and analysis views. You can size windows however you like, choose stacked, side by side, or tabbed window layouts, and you can even undock tabbed windows and place them anywhere on your monitor(s).

Plus, the next-generation Infiniium user interface software gives you more features to help you document waveforms and measurements, including visible scale values on the waveform grids, visible markers delta values, bookmarks with user-defined callout labels, and measurement values with callout labels. It is easy to capture screen images with all this information. And, you can save waveform data, measurements, analysis, settings, window layouts, and other settings, all to a single composite file. When you open a composite file later, everything is set up just like it was when you saved the file.

New command descriptions for Version 5.00 of the Infiniium oscilloscope software appear below.

New Commands

| Command | Description |
|--|--|
| :DISPlay:BOOKmark<N>:DELet (see page 451) | Deletes a bookmark. |
| :DISPlay:BOOKmark<N>:SET (see page 452) | Sets a bookmark. |
| :DISPlay:BOOKmark<N>:VERTi cal? (see page 454) | Returns a waveform's vertical value at a bookmark's horizontal position. |
| :DISPlay:BOOKmark<N>:XPOSi tion (see page 455) | Sets the horizontal grid position of a bookmark's callout box. |
| :DISPlay:BOOKmark<N>:YPOSi tion (see page 456) | Sets the vertical grid position of a bookmark's callout box. |
| :DISPlay:GRATicule:AREA<N>:S TATE (see page 466) | Enables or disables waveform areas 2-8. Waveform area 1 is always on. |
| :DISPlay:LAYout (see page 478) | Sets the window layout. |
| :DISPlay:MAIN (see page 479) | Turns on or off the main window view for the indicated source. |
| :DISPlay:PROPortion (see page 483) | Specifies the size of the waveform and plot areas. |
| :MTESt:FOLDing:COUNT (see page 1538) | Returns the number of waveforms and unit intervals in the real-time eye. |

| Command | Description |
|--|---|
| :MTESt:FOLDing:POSition (see page 687) | Sets the real-time eye horizontal center position in unit intervals. |
| :MTESt:FOLDing:SCALe (see page 689) | Sets the real-time eye horizontal scale, that is, the number of unit intervals (UIs) shown on screen. |
| :SBUS<N>:HS:DESCramble (see page 1054) | Turns high-speed descrambling on or off if supported by the protocol type. |
| :SBUS<N>:HS:FORMat (see page 1055) | Specifies the high-speed symbol display format. |
| :SBUS<N>:HS:IDLE (see page 1056) | Specifies whether electrical idles are present in the signal. |
| :SBUS<N>:HS:SOURce<S> (see page 1057) | Specifies the signal that is the high-speed data source. |
| :TIMEbase:REFerence:PERCent (see page 1172) | Sets the timebase reference (trigger) position as a percent of screen value. |

Changed Commands

| Command | Description |
|--|---|
| :BUS:B<N>:TYPE (see page 276) | Added support for new protocols. |
| :DISK:SAVE:LISTing (see page 442) | Added the <type> parameter for specifying which display window to save. |
| :DISPlay:CGRade (see page 457) | Added the optional <source> parameter for specifying the waveform on which color grade should be turned on or off. |
| :DISPlay:CGRade:LEVels (see page 459) | This query is unchanged but results are returned only when a single color grade view is on. |
| :DISPlay:CONNect (see page 463) | Added the optional <source> parameter for specifying the waveform on which the setting should be made. |
| :DISPlay:GRATICule:NUMBer (see page 468) | Number of grids can be any number between 1 and 16 (not just 1, 2, 4, 8, or 16). You can also specify which waveform area the number of grids setting is for. |
| :DISPlay:GRATICule:SETGrat (see page 469) | In addition to assigning a waveform to a grid, you can now optionally specify which waveform area the grid is in. Also, you can specify whether the MAIN or CGRade (color grade) view of the waveform will be placed. |
| :DISPlay:PERSistence (see page 481) | Added the optional <source> parameter for specifying the waveform on which the persistence setting should be made. |
| :LISTer:DATA (see page 630) | Added the <type> parameter for specifying which display window to save. |

| Command | Description |
|--|--|
| :MEASure:CGRade:CROSSsing (see page 738) | Added the optional <source> parameter for specifying the waveform on which the color grade crossing level percent is measured. |
| :MEASure:CGRade:DCDistortion (see page 739) | Added the optional <source> parameter for specifying the waveform on which the color grade duty cycle distortion is measured. |
| :MEASure:CGRade:EHEight (see page 740) | Added the optional <source> parameter for specifying the waveform on which the color grade eye height is measured. |
| :MEASure:CGRade:EWIDth (see page 742) | Added the optional <source> parameter for specifying the waveform on which the color grade eye width is measured. |
| :MEASure:CGRade:EWINDow (see page 744) | Added the optional <source> parameter for specifying the waveform on which the color grade eye window is applied. |
| :MEASure:CGRade:JITTer (see page 746) | Added the optional <source> parameter for specifying the waveform on which the color grade jitter is measured. |
| :MEASure:CGRade:QFACTOR (see page 748) | Added the optional <source> parameter for specifying the waveform on which the color grade Q factor is measured. |
| :MEASure:WINDow (see page 975) | Added the CGRade (color grade) view as a measurement window option. |
| :MTESt:FOLDing (see page 677) | Added the optional <source> parameter for specifying the waveform on which to enable/disable the real-time eye. |
| :MTESt:FOLDing:BITS (see page 679) | Added the required <source> parameter to specify the waveform on which to set the real-time eye bit qualification. |
| :MTESt:FOLDing:FAST (see page 685) | Added the optional <source> parameter for specifying the waveform on which to set the fast worst-case option. |
| :TIMEbase:REFerence (see page 1171) | Query can now return PERC when a reference position percent value is being used. |

Obsolete Commands

| Obsolete Command | Current Command Equivalent | Behavior Differences |
|--|--|---|
| :DISPlay:COLumn (see page 1507) | :DISPlay:BOOKmark<N>:XPOSition (see page 455) | Bookmarks are now the method used to place text strings or annotations on screen. |
| :DISPlay:LINE (see page 1508) | :DISPlay:BOOKmark<N>:SET (see page 452) | |
| :DISPlay:ROW (see page 1509) | :DISPlay:BOOKmark<N>:YPOSition (see page 456) | |
| :DISPlay:STRing (see page 1510) | :DISPlay:BOOKmark<N>:SET (see page 452) | |
| :DISPlay:TEXT (see page 1512) | :DISPlay:BOOKmark<N>:DELet (see page 451) | |

Discontinued
Commands

| Discontinued Command | Current Command Equivalent | Comments |
|-------------------------|----------------------------|---|
| :DISPlay:GRATicule:SIZE | None | Graticule sizing is different in the next-generation Infiniium user interface software. |

What's New in Version 4.60

New command descriptions for Version 4.60 of the Infiniium oscilloscope software appear below.

New Commands

| Command | Description |
|--|--|
| :AState? (see page 989) | Returns the acquisition state. |
| :CHANnel<N>:ISIM:NORMALize (see page 328) | Lets you normalize the gain of an InfiniiSim transfer function. |
| :RState? (see page 1011) | Returns the run state. |
| :SBUS<N>:CAN Commands (see page 1027) | These commands control the CAN serial decode bus viewing, mode, and other options. |

Changed Commands

| Command | Description |
|--|------------------------|
| :SBUS<N>:MODE (see page 1026) | Added CAN mode option. |

What's New in Version 4.50

New command descriptions for Version 4.50 of the Infiniium oscilloscope software appear below.

New Commands

| Command | Description |
|--|---|
| :FUNction<F>:ADEMod (see page 499) | Sets the math function to show the amplitude envelope for an amplitude modulated (AM) input signal. |
| :MEASurement<N>:NAME (see page 976) | Lets you give specific names to measurements displayed on the oscilloscope's screen. |
| :MEASurement<N>:SOURce (see page 977) | Changes the source of an existing measurement. |
| :MTEST:FOLDing:FAST (see page 685) | Turns the "Fast, Worst Case Only" real-time eye display option ON or OFF. |

Changed Commands

| Command | Description |
|---|---|
| :DIGital<N>:THReshold (see page 429) | There is now the DIFFerential parameter for specifying the threshold voltage. |
| :DISK:SAVE:WAVEform (see page 446) | There is now the H5INt format parameter which saves waveform data as integers within the H5 file. |
| :POD<N>:THReshold (see page 982) | There is now the DIFFerential parameter for specifying the threshold voltage. |

What's New in Version 4.30

New command descriptions for Version 4.30 of the Infiniium oscilloscope software appear below.

New Commands

| Command | Description |
|--|--|
| :FUNction<F>:DELay (see page 502) | Defines a function waveform that is the source waveform delayed in time. |
| :FUNction<F>:GATing (see page 519) | Defines a horizontal gating function of another waveform (similar to horizontal zoom). Measurements on horizontal gating functions are essentially gated measurements. |
| :MEASure:CLOCK:METHOD:EDG E (see page 1522) | Specifies which edge(s) of the data signal are used to recover a clock. |
| :MEASure:RJDJ:CLOCK (see page 877) | When ON, it forces the pattern to be a clock and sets the jitter for edges not examined to zero (0). |
| :TRIGger:LEVel:FIFTy (see page 1193) | Sets the trigger level to 50%, like pushing the front panel trigger level knob |

Changed Commands

| Command | Description |
|---|--|
| Function Commands (see page 493) | You can now define up to 16 functions. |

What's New in Version 4.20

New command descriptions for Version 4.20 of the Infiniium oscilloscope software appear below.

New Commands

| Command | Description |
|--|---|
| :DISPlay:CGrade:SCHEME (see page 461) | Lets you set the color grade scheme to CLASSic or TEMP. |
| :FUNction<F>:FFT:TDElay (see page 513) | Sets the time delay for the FFT phase function. |
| :MEASure:CHARge (see page 750) | When N2820A/N2821A high-sensitivity current probes are connected, this command/query measures the total current consumption over time with the results listed in ampere-hours (Ah). |
| :MEASure:CLOCK:METHOD:JTF (see page 1524) | Specifies the clock recovery PLL's response in terms of the Jitter Transfer Function's (JTF) 3 dB band width. |
| :MEASure:CLOCK:METHOD:OJTF (see page 1526) | Specifies the clock recovery PLL's response in terms of the Observed Jitter Transfer Function's (OJTF) 3 dB band width. |
| :MEASure:CLOCK:METHOD:PLLT rack (see page 1528) | Turns the Transition Density Dependent setting on or off. |

Changed Commands

| Command | Description |
|--|---|
| :MEASure:CLOCK:METHOD (see page 1515) | The command options for specifying clock recovery PLL options have been moved to the new commands :MEASure:CLOCK:METHOD:JTF and :MEASure:CLOCK:METHOD:OJTF. |

Obsolete Commands

| Obsolete Command | Current Command Equivalent | Description |
|------------------|--|---|
| :MEASure:DDPWS | :MEASure:RJDJ:ALL? (see page 871) | The :MEASure:RJDJ:ALL? query returns all of the RJDJ jitter measurements. |

What's New in Version 4.10

New command descriptions for Version 4.10 of the Infiniium oscilloscope software appear below.

New Commands

| Command | Description |
|--|--|
| :MEASure:NOISe:MEthod (see page 825) | Lets you select the method for random noise (RN) analysis, either the SPECTral method or BOTH the spectral and tail fit methods. |
| :MEASure:NOISe:REPort (see page 826) | When BOTH is selected for :MEASure:NOISe:MEthod, you can select SPECTral or TAILfit to specify which method is used for the reports. |
| :MEASure:RJDJ:MEthod (see page 880) | Lets you select the method for random jitter (RJ) analysis, either the SPECTral method or BOTH the spectral and tail fit methods. |
| :MEASure:RJDJ:REPort (see page 884) | When BOTH is selected for :MEASure:RJDJ:MEthod, you can select SPECTral or TAILfit to specify which method is used for the reports. |
| :MEASure:TIEFilter:SHApe (see page 950) | Specifies the shape of the TIE filter edge(s). |

Changed Commands

| Command | Description |
|--|--|
| :MEASure:NOISe:ALL (see page 821) | New results can be returned depending on the :MEASure:NOISe:MEthod and :MEASure:NOISe:REPort settings. |
| :MEASure:RJDJ:ALL (see page 871) | New results can be returned depending on the :MEASure:RJDJ:MEthod and :MEASure:RJDJ:REPort settings. |

What's New in Version 4.00

New command descriptions for Version 4.00 of the Infiniium oscilloscope software appear below.

New Commands

| Command | Description |
|--|--|
| :ACQUIRE:REDGe (see page 223) | For 50 GHz and 63 GHz band width models of the 90000 Q-Series oscilloscopes, this command enables or disables the RealEdge channel inputs. |
| :DISK:SAVE:PRECprobe (see page 444) | Saves PrecisionProbe/Cable data to a file. |
| :IScan:ZONE:HIDE (see page 613) | Lets you hide or show all InfiniiScan zones on the display. |

Changed Commands

| Command | Description |
|---|---|
| :ACQUIRE:BANDwidth (see page 207) | There is now a MAX option for selecting the maximum band width. |
| :MTEST:FOLDing:BITS (see page 679) | There is now a PATtern option for specifying bit pattern qualification for the real-time eye display. |

What's New in Version 3.50

New command descriptions for Version 3.50 of the Infiniium oscilloscope software appear below.

New Commands

| Command | Description |
|---|---|
| :CHANnel<N>:PROBe:AUTOzero (see page 338) | Initiates the N2893A probe's auto degauss/ offset cal. |
| :CHANnel<N>:PROBe:HEAD:VTERm (see page 352) | Sets the termination voltage for the N5444A probe head. |
| :CHANnel<N>:PROBe:MODE (see page 355) | Sets the N2750A probe's InfiniiMode configuration. |
| :FUNction<F>:MTRend (see page 539) | New Meas Trend math function. |
| :FUNction<F>:MHISTogram (see page 536) | New Meas Histogram math function. |
| :LISTer Commands (see page 629) | For displaying and retrieving data from the serial decode listings. |
| :MEASure:HISTogram:RESolution (see page 796) | The bin width value of one bar in the histogram. |
| :MEASure:NOISe (see page 820) | Adds a Noise measurement to the oscilloscope display (like Measure > Data > Noise from the front panel) or gets the measured noise value. |
| :MEASure:NOISe:ALL (see page 821) | Returns the NOISe measurement results for the "zeros" or "ones" level. |
| :MEASure:NOISe:BANDwidth (see page 823) | Sets the type of filtering used to separate the data dependent noise from the random noise and the periodic noise. |
| :MEASure:NOISe:LOCation (see page 824) | Specifies the noise measurement location within the bit where 0% is the beginning of the bit, 50% is the middle of the bit, and 100% is the end of the bit. |
| :MEASure:NOISe:RN (see page 827) | Specifies a known amount of random noise. |
| :MEASure:NOISe:SCOPE:RN (see page 828) | Specifies the removal of the oscilloscope's calibrated random noise from the reported RN. |
| :MEASure:NOISe:STATe (see page 829) | Enables or disables the NOISe measurements. |
| :MEASure:NOISe:UNITs (see page 830) | Sets the unit of measure for NOISe measurements to volts or unit amplitude. |
| :MEASure:RJDJ:RJ (see page 885) | Specifies a known amount of random jitter. |

| Command | Description |
|--|--|
| :MEASure:RJDJ:SCOPE:RJ (see page 886) | Specifies the removal of the oscilloscope's calibrated random jitter from the reported RJ. |
| :SBUS<N> Commands (see page 1023) | For setting up IIC and SPI serial decode and triggering. |

Changed Commands

| Command | Description |
|---|--|
| :CHANnel<N>:PROBE:HEAD:SElect (see page 351) | Now lets you select probe heads by the labels given with the :CHANnel<N>:PROBE:HEAD:ADD command. |
| :MEASure:HISTogram:HITS (see page 785) | Can now use this command with Meas Histogram math functions. |
| :MEASure:HISTogram:M1S (see page 786) | Can now use this command with Meas Histogram math functions. |
| :MEASure:HISTogram:M2S (see page 787) | Can now use this command with Meas Histogram math functions. |
| :MEASure:HISTogram:M3S (see page 788) | Can now use this command with Meas Histogram math functions. |
| :MEASure:HISTogram:MAX (see page 789) | Can now use this command with Meas Histogram math functions. |
| :MEASure:HISTogram:MEAN (see page 790) | Can now use this command with Meas Histogram math functions. |
| :MEASure:HISTogram:MEDian (see page 791) | Can now use this command with Meas Histogram math functions. |
| :MEASure:HISTogram:MIN (see page 792) | Can now use this command with Meas Histogram math functions. |
| :MEASure:HISTogram:MODE (see page 793) | Can now use this command with Meas Histogram math functions. |
| :MEASure:HISTogram:PEAK (see page 794) | Can now use this command with Meas Histogram math functions. |
| :MEASure:HISTogram:PP (see page 795) | Can now use this command with Meas Histogram math functions. |
| :MEASure:HISTogram:STDDev (see page 797) | Can now use this command with Meas Histogram math functions. |
| :MEASure:RJDJ:ALL (see page 871) | There are two possible additional measurement results, Scope RN(rms) and DDPWS. |
| :TRIGger:MODE (see page 1195) | Added the SBUS1, SBUS2, SBUS3, and SBUS4 selections for triggering on serial buses. |

What's New in Version 3.20

New command descriptions for Version 3.20 of the Infiniium oscilloscope software appear below.

New Commands

| Command | Description |
|---|---|
| :MARKer:MEASurement:MEASurement (see page 636) | Specifies which measurement markers track (when the :MARKer:MODE is set to MEASurement). |
| :MEASure:CLOCK:METHod:ALIGN (see page 1519) | Lets you specify clock edges either center aligned with data or edge aligned with data when using an explicit method of clock recovery. |

What's New in Version 3.11

New command descriptions for Version 3.11 of the Infiniium oscilloscope software appear below.

New Commands

| Command | Description |
|--|---|
| :CHANnel<N>:ISIM:PEXtraction (see page 329) | Selects a channel's InfiniiSim port extraction. |
| :MEASure:HISTogram:MODE (see page 793) | Returns the measurement histogram's Mode value. |

Changed Commands

| Command | Description |
|---|---|
| :BUS:B<N>:TYPE (see page 276) | The MPHY protocol type has been added for the MIPI M-PHY serial decode selection. |
| :FUNction<F>:FFT:WINDow (see page 515) | The HAMMING window mode is now a valid selection. |
| :MEASure:JITTer:SPECTrum:WINDow (see page 810) | The HAMMING window mode is now a valid selection. |

What's New in Version 3.10

New command descriptions for Version 3.10 of the Infiniium oscilloscope software appear below.

New Commands

| Command | Description |
|---|--|
| :ACQuire:BA ^N Dwidth (see page 207) | Changes the bandwidth frequency control for the acquisition system. |
| :CHANnel<N>:PROBe:ACCAl (see page 336) | Sets the type of AC response probe calibration to use. |
| :CHANnel<N>:PROBe:PRECprobe:BA ^N Dwidth (see page 356) | Specifies how the limit of PrecisionProbe or PrecisionCable correction/boosting is determined.. |
| :CHANnel<N>:PROBe:PRECprobe:CALibration (see page 357) | Specifies the name of the PrecisionProbe or PrecisionCable calibration to use for the specified channel and probe. |
| :CHANnel<N>:PROBe:PRECprobe:MODE (see page 359) | Selects between PrecisionProbe or PrecisionCable AC response probe calibration. |
| :CHANnel<N>:PROBe:PRECprobe:ZSRC (see page 360) | Specifies how PrecisionProbe characterizes the time domain and frequency domain response. |
| :DISPlay:STATus:COL (see page 490) | Used to position the real time eye and InfiniiScan Zone Trigger status labels. |
| :DISPlay:STATus:ROW (see page 491) | Used to position the real time eye and InfiniiScan Zone Trigger status labels. |
| :MEASure:DDPWS (see page 1533) | For measuring Data Dependent Pulse Width Shrinkage. |
| :MEASure:EDGE (see page 767) | For measuring the edge time relative to the reference location. |
| :MEASure:JITTer:SPECTrum:VE ^R Tical:TYPE (see page 809) | Lets you select either a LINear or a LOGarithmic vertical scale for the jitter spectrum plot. |
| :MEASure:RJDJ:APLength? (see page 873) | Returns the determined RjDj pattern length. |
| :MEASure:THResholds:GENeral:ABSolute (see page 905) | Sets the upper level, middle level, and lower level voltages for everything except rise/fall measurements and protocol decode. |
| :MEASure:THResholds:GENeral:HYSTeresis (see page 907) | Sets the hysteresis range and level level voltages for everything except rise/fall measurements and protocol decode. |
| :MEASure:THResholds:GENeral:METHod (see page 909) | Specifies the way that the top and base of a waveform are calculated for everything except rise/fall measurements and protocol decode. |

| Command | Description |
|--|---|
| :MEASure:THResholds:GENeral:PERCent (see page 915) | Sets the upper level, middle level, and lower level voltages as a percentage of the top and base voltages for everything except rise/fall measurements and protocol decode. |
| :MEASure:THResholds:GENeral:TOPBase:ABSolute (see page 917) | Sets the top level and base level voltages for everything except rise/fall measurements and protocol decode. |
| :MEASure:THResholds:GENeral:TOPBase:METHod (see page 917) | Determines the way that the top and base of a waveform are derived for everything except rise/fall measurements and protocol decode. |
| :MEASure:THResholds:RFALL:ABSolute (see page 924) | Sets the upper level, middle level, and lower level voltages for rise/fall measurements. |
| :MEASure:THResholds:RFALL:HYSTeresis | Sets the hysteresis range and level level voltages for rise/fall measurements. |
| :MEASure:THResholds:RFALL:METHod (see page 926) | Specifies the way that the top and base of a waveform are calculated for rise/fall measurements. |
| :MEASure:THResholds:RFALL:PERCent (see page 930) | Sets the upper level, middle level, and lower level voltages as a percentage of the top and base voltages for rise/fall measurements. |
| :MEASure:THResholds:RFALL:TOPBase:ABSolute (see page 932) | Sets the top level and base level voltages for rise/fall measurements. |
| :MEASure:THResholds:RFALL:TOPBase:METHod (see page 932) | Determines the way that the top and base of a waveform are derived for rise/fall measurements. |
| :MEASure:THResholds:SERial:ABSolute (see page 935) | Sets the upper level, middle level, and lower level voltages for protocol decode. |
| :MEASure:THResholds:SERial:HYSTeresis (see page 937) | Sets the hysteresis range and level level voltages for protocol decode. |
| :MEASure:THResholds:SERial:METHod (see page 939) | Specifies the way that the top and base of a waveform are calculated for protocol decode. |
| :MEASure:THResholds:SERial:PERCent (see page 940) | Sets the upper level, middle level, and lower level voltages as a percentage of the top and base voltages for protocol decode. |
| :MEASure:THResholds:SERial:TOPBase:ABSolute (see page 942) | Sets the top level and base level voltages for protocol decode. |
| :MEASure:THResholds:SERial:TOPBase:METHod (see page 942) | Determines the way that the top and base of a waveform are derived for protocol decode. |

| Command | Description |
|---|--|
| :SPROcessing:CTLequalizer:NUMPoles (see page 1106) | Selects either a 2 Pole or 3 Pole Continuous Time Linear Equalization. |
| :SPROcessing:CTLequalizer:P3 (see page 1109) | Sets the Pole 3 frequency for the Continuous Time Linear Equalization. |

Changed Commands

| Command | Description |
|--|---|
| :ACQUIRE:INTERpolate (see page 215) | The INT1, INT2, INT4, INT8, INT16 options have been added for specifying the 1, 2, 4, 8, or 16 point Sin(x)/x interpolation ratios. |
| :MEASURE:RJDJ:BER (see page 875) | You can now set J2 and J9 jitter BER levels. |
| :MEASURE:VRMS (see page 970) | The VOLT and DBM parameters have been added for specifying the measurement units. |
| :MEASURE:WINDOW (see page 975) | The short form of the command was changed from :MEAS:WIN to :MEAS:WIND. |

2 Setting Up

Step 1. Install Keysight IO Libraries Suite software / 86

Step 2. Connect and set up the oscilloscope / 87

Step 3. Verify the oscilloscope connection / 88

This chapter explains how to install the Keysight IO Libraries Suite software on a controller PC, connect the oscilloscope to the controller PC, set up the oscilloscope, and verify the oscilloscope connection.

Note that Keysight IO Libraries Suite software comes installed on Infiniium oscilloscopes, and it is possible to control the oscilloscope from programs running on the instrument.

Step 1. Install Keysight IO Libraries Suite software

To install the Keysight IO Libraries Suite software on a controller PC:

- 1** Download the Keysight IO Libraries Suite software from the Keysight web site at:
 - <http://www.keysight.com/find/iolib>
- 2** Run the setup file, and follow its installation instructions.

Note that Keysight IO Libraries Suite software comes installed on Infiniium oscilloscopes.

Step 2. Connect and set up the oscilloscope

Infiniium oscilloscopes can have these interfaces for programming the oscilloscope:

- USB (device port, square connector).
- LAN. To configure the LAN interface, set up the Infiniium oscilloscope on the network as you would any other computer with the Windows operating system.
- GPIB, when the instrument has a GPIB interface connector or when the N4865A GPIB-to-LAN adapter is used.

When installed, these interfaces are always active.

Using the USB (Device) Interface

- 1** Connect a USB cable from the controller PC's USB port to the "USB DEVICE" port on the back of the oscilloscope.

Some oscilloscopes have a USB 2.0 high-speed port; other more recent models have a USB 3.0 super-speed port.

Using the LAN Interface

- 1** If the controller PC is not already connected to the local area network (LAN), do that first.
- 2** Contact your network administrator about adding the oscilloscope to the network.

Setting up an Infiniium oscilloscope on a network is the same as setting up any other computer with the Windows 7 operating system.

- 3** Connect the oscilloscope to the local area network (LAN) by inserting LAN cable into the "LAN" port on the oscilloscope.

Step 3. Verify the oscilloscope connection

NOTE

Make sure the Keysight Infiniium software is running on the oscilloscope. It must be running before you can make a connection.

- 1 On the controller PC, click on the Keysight IO Control icon in the taskbar and choose **Connection Expert** from the popup menu.

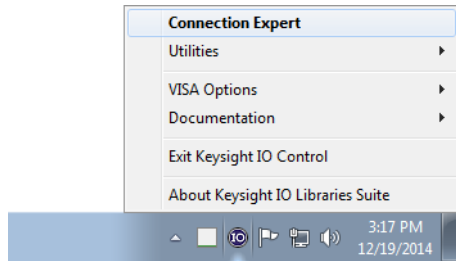

- 2 In the Keysight Connection Expert application, instruments connected to the controller's USB and GPIB interfaces as well as instruments on the same LAN subnet should automatically appear in the Instruments tab.

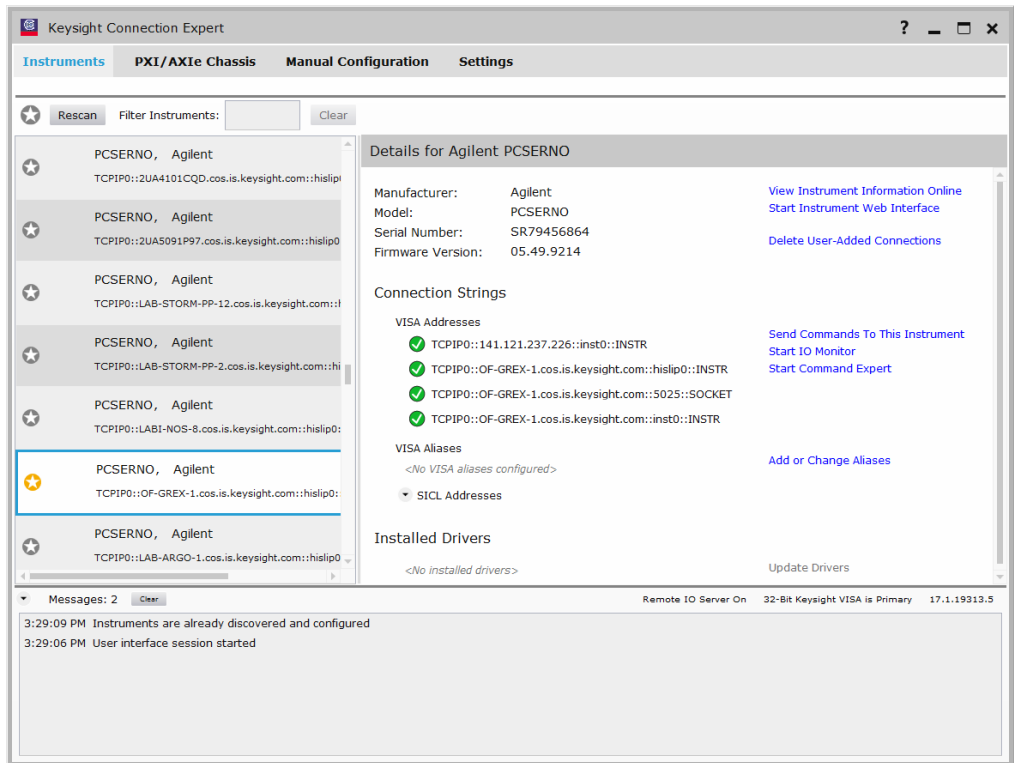

- 3 If your instrument does not appear, you can add it using the Manual Configuration tab.

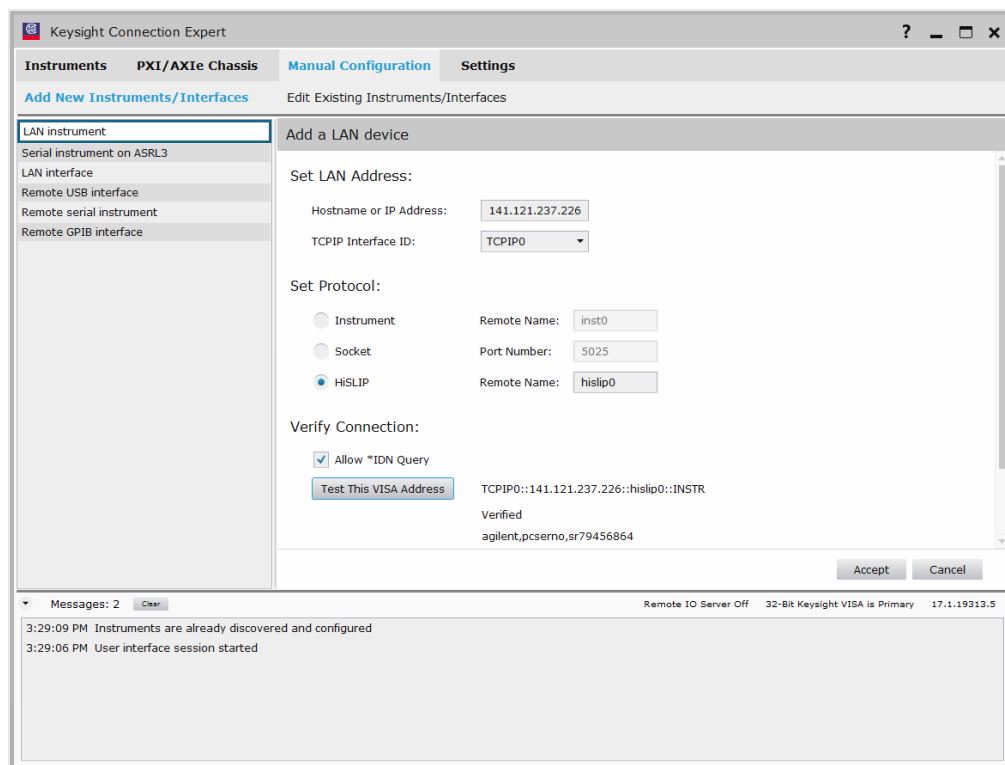

For example, to add a device:

- a Select **LAN instrument** in the list on the left.
- b Enter the oscilloscope's **Hostname** or **IP address**.
- c Select the protocol.
- d Select **HiSLIP** under Set Protocol.

HiSLIP (High-Speed LAN Instrument Protocol) is a protocol for TCP-based instrument control that provides the instrument-like capabilities of conventional test and measurement protocols with minimal impact to performance.

For more information on the HiSLIP protocol, see:

- The Keysight IO Libraries Suite documentation.
- <http://www.lxistandard.org/About/LXI-Device-Support-HiSLIP.aspx>
- <http://www.ivifoundation.org/specifications/>

- e Click **Test This VISA Address** to verify the connection.
- f If the connection test is successful, click **Accept** to add the instrument.

If the connection test is not successful, go back and verify the LAN connections and the oscilloscope setup.

- 4 Test some commands on the instrument:
 - a In the Details for the selected instrument, click **Send Commands To This Instrument**.

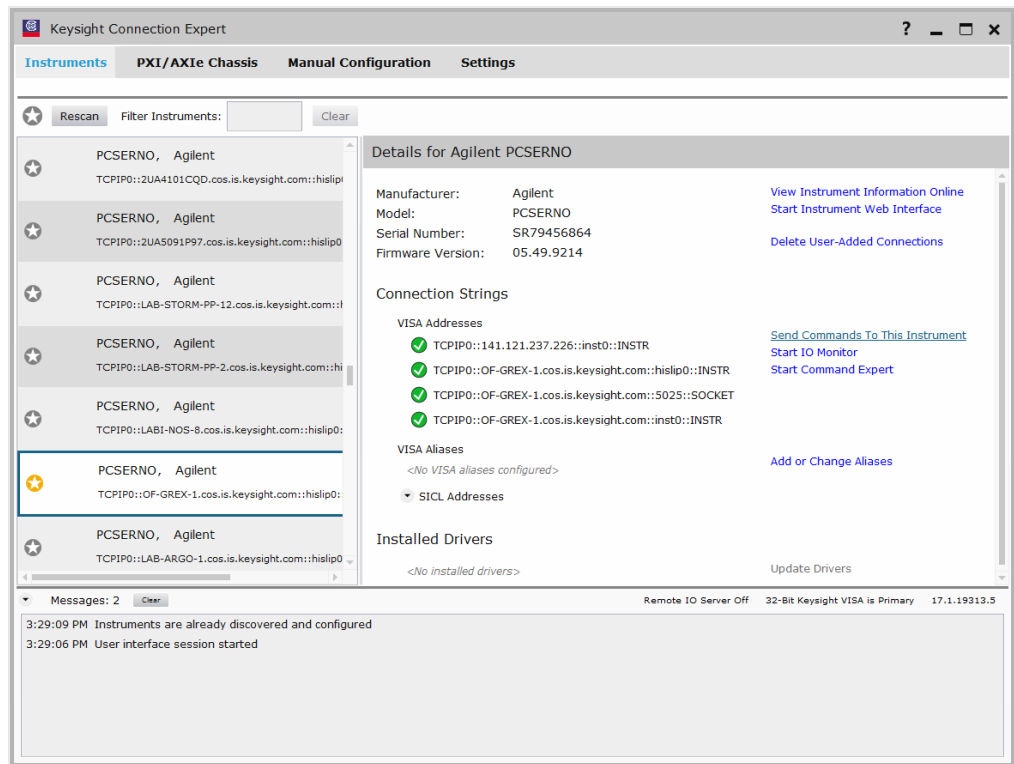

- b In the Keysight Interactive IO application, enter commands in the **Command** field and press **Send Command**, **Read Response**, or **Send & Read**.

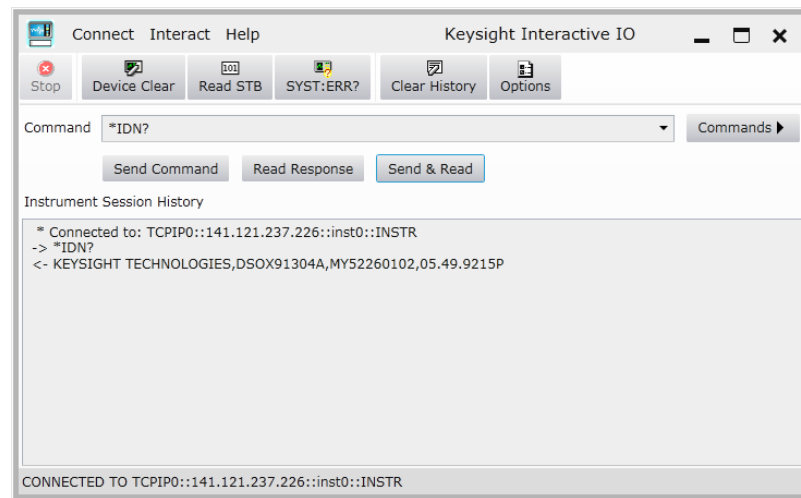

- c Choose **Connect > Exit** from the menu to exit the Keysight Interactive IO application.
- 5 In the Keysight Connection Expert application, choose **File > Exit** from the menu to exit the application.

2 Setting Up

3 Introduction to Programming

| |
|--|
| Communicating with the Oscilloscope / 95 |
| Instructions / 96 |
| Instruction Header / 97 |
| White Space (Separator) / 98 |
| Braces / 99 |
| Ellipsis / 100 |
| Square Brackets / 101 |
| Command and Query Sources / 102 |
| Program Data / 103 |
| Header Types / 104 |
| Query Headers / 106 |
| Program Header Options / 107 |
| Character Program Data / 108 |
| Numeric Program Data / 109 |
| Embedded Strings / 110 |
| Program Message Terminator / 111 |
| Common Commands within a Subsystem / 112 |
| Selecting Multiple Subsystems / 113 |
| Programming Getting Started / 114 |
| Referencing the IO Library / 115 |
| Opening the Oscilloscope Connection via the IO Library / 116 |
| Initializing the Interface and the Oscilloscope / 117 |
| Example Program / 119 |
| Using the DIGitize Command / 120 |
| Receiving Information from the Oscilloscope / 122 |
| String Variable Example / 123 |
| Numeric Variable Example / 124 |
| Definite-Length Block Response Data / 125 |
| Multiple Queries / 126 |
| Oscilloscope Status / 127 |

This chapter introduces the basics for remote programming of an oscilloscope. The programming commands in this manual conform to the IEEE 488.2 Standard Digital Interface for Programmable Instrumentation. The programming commands provide the means of remote control.

Basic operations that you can do with a computer and an oscilloscope include:

- Set up the oscilloscope.
- Make measurements.
- Get data (waveform, measurements, and configuration) from the oscilloscope.
- Send information, such as waveforms and configurations, to the oscilloscope.

You can accomplish other tasks by combining these functions.

NOTE

Example Programs are Written in Visual Basic for Applications (VBA) and C

The programming examples for individual commands in this manual are written in Visual Basic for Applications (VBA) and C.

Communicating with the Oscilloscope

Computers communicate with the oscilloscope by sending and receiving messages over a remote interface, such as a GPIB card (must order the N4865A GPIB-to-LAN adapter) or a Local Area Network (LAN) card. Commands for programming normally appear as ASCII character strings embedded inside the output statements of a "host" language available on your computer. The input commands of the host language are used to read responses from the oscilloscope.

For example, the VISA COM library provides the `WriteString()` method for sending commands and queries. After a query is sent, the response can be read using the `ReadString()` method. The `ReadString()` method passes the value across the bus to the computer and places it in the designated variable.

For the GPIB interface, messages are placed on the bus using an output command and passing the device address, program message, and a terminator. Passing the device address ensures that the program message is sent to the correct GPIB interface and GPIB device.

The following `WriteString()` method sends a command that sets the channel 1 scale value to 500 mV:

```
myScope.WriteString ":CHANnel1:SCALE 500E-3"
```

The VISA COM library setup is explained on the following pages.

NOTE

Use the Suffix Multiplier Instead

Using "mV" or "V" following the numeric voltage value in some commands will cause Error 138 - Suffix not allowed. Instead, use the convention for the suffix multiplier as described in [Chapter 6](#), "Message Communication and System Functions," starting on page 143.

Instructions

Instructions, both commands and queries, normally appear as strings embedded in a statement of your host language, such as Visual Basic for Applications (VBA), Visual Basic .NET, C#, C, etc.

The only time a parameter is not meant to be expressed as a string is when the instruction's syntax definition specifies <block data>, such as with the :SYSTem:SETup command. There are only a few instructions that use block data.

Instructions are composed of two main parts:

- The header, which specifies the command or query to be sent.
- The program data, which provides additional information to clarify the meaning of the instruction.

Instruction Header

The instruction header is one or more command mnemonics separated by colons (:). They represent the operation to be performed by the oscilloscope. See **Chapter 9**, “Programming Conventions,” starting on page 195 for more information.

Queries are formed by adding a question mark (?) to the end of the header. Many instructions can be used as either commands or queries, depending on whether or not you include the question mark. The command and query forms of an instruction usually have different program data. Many queries do not use any program data.

White Space (Separator)

White space is used to separate the instruction header from the program data. If the instruction does not require any program data parameters, you do not need to include any white space. In this manual, white space is defined as one or more spaces. ASCII defines a space to be character 32 in decimal.

Braces

When several items are enclosed by braces, { }, only one of these elements may be selected. Vertical line (|) indicates "or". For example, {ON | OFF} indicates that only ON or OFF may be selected, not both.

Ellipsis

... An ellipsis (trailing dots) indicates that the preceding element may be repeated one or more times.

Square Brackets

Items enclosed in square brackets, [], are optional.

Command and Query Sources

Many commands and queries require that a source be specified. Depending on the command or query and the model number of Infiniium oscilloscope being used, some of the sources are not available. The following is a list of sources:

| | | | |
|----------|-----------|-----------|----------------------|
| CHANnel1 | FUNction1 | WMEMory1 | COMMonmode{3 4} |
| CHANnel2 | FUNction2 | WMEMory2 | DIFFerential{1 2} |
| CHANnel3 | FUNction3 | WMEMory3 | EQUalized |
| CHANnel4 | FUNction4 | WMEMory4 | DIGital0 - DIGital15 |
| CLOCK | MTRend | MSPectrum | HISTogram |

Program Data

Program data is used to clarify the meaning of the command or query. It provides necessary information, such as whether a function should be on or off, or which waveform is to be displayed. Each instruction's syntax definition shows the program data and the values they accept.

When there is more than one data parameter, they are separated by commas (.). You can add spaces around the commas to improve readability.

Header Types

There are three types of headers:

- **"Simple Command Header"** on page 104
- **"Compound Command Header"** on page 104
- **"Common Command Header"** on page 105

- See Also**
- **"Combining Commands in the Same Subsystem"** on page 105
 - **"Duplicate Mnemonics"** on page 105

Simple Command Header

Simple command headers contain a single mnemonic. AUToscale and DIGitize are examples of simple command headers typically used in this oscilloscope. The syntax is:

```
<program mnemonic><terminator>
```

For example:

```
" :AUToscale"
```

When program data must be included with the simple command header (for example, :DIGitize CHANnel1), white space is added to separate the data from the header. The syntax is:

```
<program mnemonic><separator><program data><terminator>
```

For example:

```
" :DIGitize CHANnel1,FUNCTION2"
```

Compound Command Header

Compound command headers are a combination of two program mnemonics. The first mnemonic selects the subsystem, and the second mnemonic selects the function within that subsystem. The mnemonics within the compound message are separated by colons. For example:

To execute a single function within a subsystem:

```
:<subsystem>:<function><separator><program data><terminator>
```

For example:

```
" :CHANnel1:BWLimit ON"
```

Combining Commands in the Same Subsystem

To execute more than one command within the same subsystem, use a semi-colon (;) to separate the commands:

```
:<subsystem>:<command><separator><data>;<command><separator>
<data><terminator>
```

For example:

```
:CHANnel1:INPut DC;BWLimit ON
```

Common Command Header

Common command headers, such as clear status, control the IEEE 488.2 functions within the oscilloscope. The syntax is:

```
*<command header><terminator>
```

No space or separator is allowed between the asterisk (*) and the command header. *CLS is an example of a common command header.

Duplicate Mnemonics

Identical function mnemonics can be used for more than one subsystem. For example, you can use the function mnemonic RANGE to change both the vertical range and horizontal range:

To set the vertical range of channel 1 to 0.4 volts full scale:

```
:CHANnel1:RANGe .4
```

To set the horizontal time base to 1 second full scale:

```
:TIMebase:RANGe 1
```

In these examples, CHANnel1 and TIMebase are subsystem selectors, and determine the range type being modified.

Query Headers

A command header immediately followed by a question mark (?) is a query. After receiving a query, the oscilloscope interrogates the requested subsystem and places the answer in its output queue. The answer remains in the output queue until it is read or until another command is issued. When read, the answer is transmitted across the bus to the designated listener (typically a computer).

For example, with VISA COM library and Visual Basic for Applications (VBA) language, the query:

```
myScope.WriteString ":TIMEbase:RANGe?"
```

places the current time base setting in the output queue.

The computer input statement:

```
varRange = myScope.ReadNumber
```

passes the value across the bus to the computer and places it in the variable varRange.

You can use queries to find out how the oscilloscope is currently configured and to get results of measurements made by the oscilloscope. For example, the query:

```
:MEASure:RISetime?
```

tells the oscilloscope to measure the rise time of your waveform and place the result in the output queue.

The output queue must be read before the next program message is sent. For example, when you send the query :MEASure:RISetime?, you must follow it with an input statement.

With the VISA COM library and Visual Basic for Applications (VBA) language, this is usually done with a ReadString() or ReadNumber() method. These methods read the result of the query and place the result in a specified variable.

NOTE

Handle Queries Properly

If you send another command or query before reading the result of a query, the output buffer is cleared and the current response is lost. This also generates a query-interrupted error in the error queue. If you execute an input statement before you send a query, it will cause the computer to wait indefinitely.

Program Header Options

You can send program headers using any combination of uppercase or lowercase ASCII characters. Oscilloscope responses, however, are always returned in uppercase.

You may send program command and query headers in either long form (complete spelling), short form (abbreviated spelling), or any combination of long form and short form. For example:

":TIMebase:DELay 1E-6" is the long form.

":TIM:DEL 1E-6" is the short form.

The command descriptions in this reference show upper and lowercase characters. For example, ":AUToscale" indicates that the entire command name is ":AUTOSCALE". The short form, ":AUT", is also accepted by the oscilloscope.

NOTE

Using Long Form or Short Form

Programs written in long form are easily read and are almost self-documenting. The short form syntax conserves the amount of computer memory needed for program storage and reduces I/O activity.

The rules for the short form syntax are described in [Chapter 9](#), "Programming Conventions," starting on page 195.

Character Program Data

Character program data is used to convey parameter information as alpha or alphanumeric strings. For example, the `:TIMEbase:REFerence` command can be set to left, center, or right. The character program data in this case may be `LEFT`, `CENTer`, or `RIGHT`. The command `:TIMEbase:REFerence RIGHT` sets the time base reference to right.

The available mnemonics for character program data are always included with the instruction's syntax definition. You may send either the long form of commands, or the short form (if one exists). You may mix uppercase and lowercase letters freely. When receiving responses, uppercase letters are used exclusively.

Numeric Program Data

Some command headers require program data to be expressed numerically. For example, `:TIMEbase:RANGE` requires the desired full-scale range to be expressed numerically.

For numeric program data, you can use exponential notation or suffix multipliers to indicate the numeric value. The following numbers are all equal:

$$28 = 0.28E2 = 280E-1 = 28000m = 0.028K = 28E-3K$$

When a syntax definition specifies that a number is an integer, it means that the number should be whole. Any fractional part is ignored and truncated. Numeric data parameters that accept fractional values are called real numbers.

All numbers are expected to be strings of ASCII characters.

- When sending the number 9, you would send a byte representing the ASCII code for the character "9" (which is 57).
- A three-digit number like 102 would take up three bytes (ASCII codes 49, 48, and 50). The number of bytes is figured automatically when you include the entire instruction in a string.

Embedded Strings

Embedded strings contain groups of alphanumeric characters which are treated as a unit of data by the oscilloscope. An example of this is the line of text written to the advisory line of the oscilloscope with the :SYSTem:DSP command:

```
:SYSTem:DSP ""This is a message."""
```

You may delimit embedded strings with either single (') or double (") quotation marks. These strings are case-sensitive, and spaces are also legal characters.

Program Message Terminator

The program instructions within a data message are executed after the program message terminator is received. The terminator may be either an NL (New Line) character, an EOI (End-Of-Identify) asserted in the GPIB interface, or a combination of the two. Asserting the EOI sets the EOI control line low on the last byte of the data message. The NL character is an ASCII linefeed (decimal 10).

NOTE**New Line Terminator Functions Like EOS and EOT**

The NL (New Line) terminator has the same function as an EOS (End Of String) and EOT (End Of Text) terminator.

Common Commands within a Subsystem

Common commands can be received and processed by the oscilloscope whether they are sent over the bus as separate program messages or within other program messages. If you have selected a subsystem, and a common command is received by the oscilloscope, the oscilloscope remains in the selected subsystem. For example, if the program message

```
" :ACQUIRE: AVERAGE ON; *CLS; COUNT 1024 "
```

is received by the oscilloscope, the oscilloscope turns averaging on, then clears the status information without leaving the selected subsystem.

If some other type of command is received within a program message, you must re-enter the original subsystem after the command. For example, the program message

```
" :ACQUIRE: AVERAGE ON; :AUTOSCALE; :ACQUIRE: AVERAGE: COUNT 1024 "
```

turns averaging on, completes the autoscale operation, then sets the acquire average count. Here, :ACQUIRE must be sent again after AUTOSCALE to re-enter the ACQUIRE subsystem and set the count.

Selecting Multiple Subsystems

You can send multiple program commands and program queries for different subsystems on the same line by separating each command with a semicolon. The colon following the semicolon lets you enter a new subsystem. For example:

```
<program mnemonic><data>;:<program mnemonic><data><terminator>  
:CHANnel1:RANGe 0.4;:TIMebase:RANGe 1
```

NOTE**You can Combine Compound and Simple Commands**

Multiple program commands may be any combination of compound and simple commands.

Programming Getting Started

The remainder of this chapter explains how to set up the oscilloscope, how to retrieve setup information and measurement results, how to digitize a waveform, and how to pass data to the computer. **Chapter 28**, “Measure Commands,” starting on page 721 describes getting measurement data from the oscilloscope.

Referencing the IO Library

No matter which instrument programming library you use (SICL, VISA, or VISA COM), you must reference the library from your program.

In C/C++, you must tell the compiler where to find the include and library files (see the Keysight IO Libraries Suite documentation for more information).

To reference the Keysight VISA COM library in Visual Basic for Applications (VBA, which comes with Microsoft Office products like Excel):

- 1 Choose **Tools > References...** from the main menu.
- 2 In the References dialog, check the "VISA COM 3.0 Type Library".

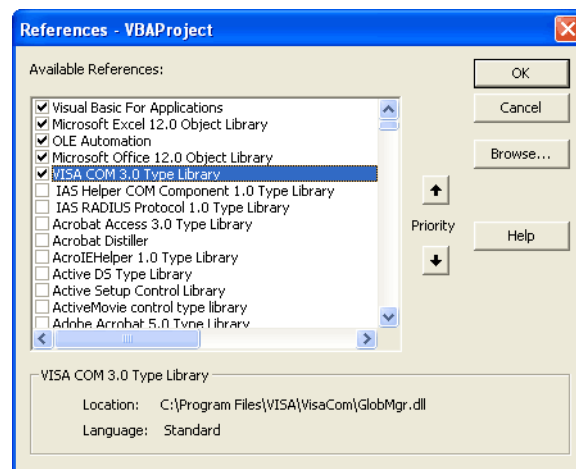

- 3 Click **OK**.

To reference the Keysight VISA COM library in Microsoft Visual Basic 6.0:

- 1 Choose **Project > References...** from the main menu.
- 2 In the References dialog, check the "VISA COM 3.0 Type Library".
- 3 Click **OK**.

Opening the Oscilloscope Connection via the IO Library

PC controllers communicate with the oscilloscope by sending and receiving messages over a remote interface. Once you have opened a connection to the oscilloscope over the remote interface, programming instructions normally appear as ASCII character strings embedded inside write statements of the programming language. Read statements are used to read query responses from the oscilloscope.

For example, when using the Keysight VISA COM library in Visual Basic (after opening the connection to the instrument using the ResourceManager object's Open method), the FormattedIO488 object's WriteString, WriteNumber, WriteList, or WriteIIEEEBlock methods are used for sending commands and queries. After a query is sent, the response is read using the ReadString, ReadNumber, ReadList, or ReadIIEEEBlock methods.

The following Visual Basic statements open the connection and send a command that turns on the oscilloscope's label display.

```
Dim myMgr As VisaComLib.ResourceManager
Dim myScope As VisaComLib.FormattedIO488

Set myMgr = New VisaComLib.ResourceManager
Set myScope = New VisaComLib.FormattedIO488

' Open the connection to the oscilloscope. Get the VISA Address from the
' Keysight Connection Expert (installed with Keysight IO Libraries Suite
').
Set myScope.IO = myMgr.Open("<VISA Address>")

' Send a command.
myScope.WriteString ":DISPlay:LABel ON"
```

The ":DISPlay:LABEL ON" in the above example is called a *program message*. Program messages are explained in more detail in **"Instructions"** on page 96.

Initializing the Interface and the Oscilloscope

To make sure the bus and all appropriate interfaces are in a known state, begin every program with an initialization statement. When using the Keysight VISA COM library, you can use the resource session object's Clear method to clear the interface buffer:

```
Dim myMgr As VisaComLib.ResourceManager
Dim myScope As VisaComLib.FormattedIO488

Set myMgr = New VisaComLib.ResourceManager
Set myScope = New VisaComLib.FormattedIO488

' Open the connection to the oscilloscope. Get the VISA Address from the
' Keysight Connection Expert (installed with Keysight IO Libraries Suite
').
Set myScope.IO = myMgr.Open("<VISA Address>")

' Clear the interface buffer and set the interface timeout to 10 seconds
.
myScope.IO.Clear
myScope.IO.Timeout = 10000
```

When you are using GPIB, CLEAR also resets the oscilloscope's parser. The parser is the program which reads in the instructions which you send it.

After clearing the interface, initialize the instrument to a preset state:

```
myScope.WriteString "*RST"
```

NOTE

Information for Initializing the Instrument

The actual commands and syntax for initializing the instrument are discussed in [Chapter 15, "Common Commands,"](#) starting on page 401.

Refer to the Keysight IO Libraries Suite documentation for information on initializing the interface.

- See Also
- ["Autoscale"](#) on page 117
 - ["Setting Up the Oscilloscope"](#) on page 118

Autoscale

The AUToscale feature of Keysight Technologies digitizing oscilloscopes performs a very useful function on unknown waveforms by automatically setting up the vertical channel, time base, and trigger level of the oscilloscope.

The syntax for the autoscale function is:

```
:AUToscale<terminator>
```

Setting Up the Oscilloscope

A typical oscilloscope setup configures the vertical range and offset voltage, the horizontal range, delay time, delay reference, trigger mode, trigger level, and slope.

A typical example of the commands sent to the oscilloscope are:

```
:CHANnel1:PROBe 10; RANGE 16;OFFSet 1.00<terminator>  
  
:SYSTem:HEADer OFF<terminator>  
  
:TIMebase:RANGe 1E-3;DELay 100E-6<terminator>
```

This example sets the time base at 1 ms full-scale (100 μ s/div), with delay of 100 μ s. Vertical is set to 16 V full-scale (2 V/div), with center of screen at 1 V, and probe attenuation of 10.

Example Program

This program demonstrates the basic command structure used to program the oscilloscope.

```
' Initialize the instrument interface to a known state.
myScope.IO.Clear
myScope.IO.Timeout = 15000    ' Set interface timeout to 15 seconds.

' Initialize the instrument to a preset state.
myScope.WriteString "*RST"

' Set the time base mode to normal with the horizontal time at
' 50 ms/div with 0 s of delay referenced at the center of the
' graticule.
myScope.WriteString ":TIMEbase:RANGe 5E-4"    ' Time base to 500 us/div.
myScope.WriteString ":TIMEbase:DELay 0"      ' Delay to zero.
myScope.WriteString ":TIMEbase:REFerence CENTER"  ' Display ref. at
                                                ' center.

' Set the vertical range to 1.6 volts full scale with center screen
' at -0.4 volts with 10:1 probe attenuation and DC coupling.
myScope.WriteString ":CHANnel:PROBE 1.0"      ' Probe attenuation
                                                ' to 1:1.
myScope.WriteString ":CHANnel:RANGe 1.6"      ' Vertical range
                                                ' 1.6 V full scale.
myScope.WriteString ":CHANnel:OFFSet -0.4"    ' Offset to -0.4.
myScope.WriteString ":CHANnel:INPut DC"      ' Coupling to DC.

' Configure the instrument to trigger at -0.4 volts with normal
' triggering.
myScope.WriteString ":TRIGger:SWEep NORMal"   ' Normal triggering.
myScope.WriteString ":TRIGger:LEVel CHAN1,-0.4"  ' Trigger level to -0.
4.
myScope.WriteString ":TRIGger:MODE EDGE"      ' Edge triggering
myScope.WriteString ":TRIGger:EDGE:SLOPe POSitive" ' Trigger on pos. slo
pe.

' Configure the instrument for normal acquisition.
myScope.WriteString ":ACQuire:MODE RTIME"     ' Normal acquisition.
myScope.WriteString ":SYSTem:HEADer OFF"     ' Turn system headers off.
myScope.WriteString ":DISPlay:GRATICule FRAMe" ' Grid off.
```

Using the DIGitize Command

The DIGitize command is a macro that captures data using the acquisition (ACQUIRE) subsystem. When the digitize process is complete, the acquisition is stopped. You can measure the captured data by using the oscilloscope or by transferring the data to a computer for further analysis. The captured data consists of two parts: the preamble and the waveform data record.

After changing the oscilloscope configuration, the waveform buffers are cleared. Before doing a measurement, you should send the DIGitize command to ensure new data has been collected.

You can send the DIGitize command with no parameters for a higher throughput. Refer to the DIGitize command in [Chapter 30](#), “Root Level Commands,” starting on page 985 for details.

When the DIGitize command is sent to an oscilloscope, the specified channel's waveform is digitized using the current ACQUIRE parameters. Before sending the :WAVEform:DATA? query to download waveform data to your computer, you should specify the WAVEform parameters.

The number of data points comprising a waveform varies according to the number requested in the ACQUIRE subsystem. The ACQUIRE subsystem determines the number of data points, type of acquisition, and number of averages used by the DIGitize command. This lets you specify exactly what the digitized information contains. The following program example shows a typical setup:

```
myScope.WriteString ":SYSTem:HEADer OFF"
myScope.WriteString ":ACQUIRE:MODE RTIME"
myScope.WriteString ":ACQUIRE:COMPLetE 100"
myScope.WriteString ":WAVEform:SOURce CHANnel1"
myScope.WriteString ":WAVEform:FORMat BYTE"
myScope.WriteString ":ACQUIRE:COUNt 8"
myScope.WriteString ":ACQUIRE:POINts 500"
myScope.WriteString ":DIGitize CHANnel1"
myScope.WriteString ":WAVEform:DATA?"
```

This setup places the oscilloscope into the real time sampling mode using eight averages. This means that when the DIGitize command is received, the command will execute until the waveform has been averaged at least eight times.

After receiving the :WAVEform:DATA? query, the oscilloscope will start downloading the waveform information.

Digitized waveforms are passed from the oscilloscope to the computer by sending a numerical representation of each digitized point. The format of the numerical representation is controlled by using the :WAVEform:FORMat command and may be selected as BYTE, WORD, or ASCII.

The easiest method of receiving a digitized waveform depends on data structures, available formatting, and I/O capabilities. You must convert the data values to determine the voltage value of each point. These data values are passed starting with the left most point on the oscilloscope's display. For more information, refer to the chapter, "Waveform Commands."

When using GPIB, you may abort a digitize operation by sending a Device Clear over the bus.

Receiving Information from the Oscilloscope

After receiving a query (a command header followed by a question mark), the oscilloscope places the answer in its output queue. The answer remains in the output queue until it is read or until another command is issued. When read, the answer is transmitted across the interface to the computer.

The input statement for receiving a response message from an oscilloscope's output queue typically has two parameters; the device address and a format specification for handling the response message. For example, with the VISA COM library, to read the result of the query command :CHANnel1:INPut? you would use the ReadString() method:

```
Dim strSetting As String
myScope.WriteString ":CHANnel1:INPut?"
strSetting = myScope.ReadString
```

This would enter the current setting for the channel 1 coupling in the string variable strSetting.

All results for queries sent in a program message must be read before another program message is sent. For example, when you send the query :MEASure:RISETIME?, you must follow that query with an input statement.

NOTE

Handle Queries Properly

If you send another command or query before reading the result of a query, the output buffer will be cleared and the current response will be lost. This will also generate a query-interrupted error in the error queue. If you execute an input statement before you send a query, it will cause the computer to wait indefinitely.

The format specification for handling response messages depends on both the computer and the programming language.

String Variable Example

The output of the oscilloscope may be numeric or character data depending on what is queried. Refer to the specific commands for the formats and types of data returned from queries.

NOTE**Express String Variables Using Exact Syntax**

In Visual Basic, string variables are case sensitive and must be expressed exactly the same each time they are used.

This example shows the data being returned to a string variable:

```
Dim strRang As String
myScope.WriteString ":CHANnel:RANGE?"
strRang = myScope.ReadString
Debug.Print strRang
```

After running this program, the computer displays:

```
+8.00000E-01
```

Numeric Variable Example

This example shows the data being returned to a numeric variable:

```
Dim varRang As Variant  
myScope.WriteString ":CHANnel:RANGe?"  
varRang = myScope.ReadNumber  
Debug.Print "Channel 1 range: " + FormatNumber(varRang, 0)
```

After running this program, the computer displays:

.8

Definite-Length Block Response Data

Definite-length block response data allows any type of device-dependent data to be transmitted over the system interface as a series of 8-bit binary data bytes. This is particularly useful for sending large quantities of data or 8-bit extended ASCII codes. The syntax is a pound sign (#) followed by a non-zero digit representing the number of digits in the decimal integer. After the non-zero digit is the decimal integer that states the number of 8-bit data bytes being sent. This is followed by the actual data.

For example, for transmitting 4000 bytes of data, the syntax would be:

```
#44000 <4000 bytes of data> <terminator>
```

The "4" following the pound sign represents the number of digits in the number of bytes, and "4000" represents the number of bytes to be transmitted.

Multiple Queries

You can send multiple queries to the instrument within a single command string, but you must also read them back as a single query result. This can be accomplished by reading them back into a single string variable, multiple string variables, or multiple numeric variables.

For example, to read the :TIMEbase:RANGe?;DELay? query result into a single string variable, you could use the commands:

```
myScope.WriteString ":TIMEbase:RANGe?;DELay?"
Dim strQueryResult As String
strQueryResult = myScope.ReadString
MsgBox "Timebase range; delay:" + strQueryResult
```

When you read the result of multiple queries into a single string variable, each response is separated by a semicolon. For example, the output of the previous example would be:

```
Timebase range; delay: <range_value>;<delay_value>
```

To read the :TIMEbase:RANGe?;DELay? query result into multiple string variables, you could use the ReadList method to read the query results into a string array variable using the commands:

```
myScope.WriteString ":TIMEbase:RANGe?;DELay?"
Dim strResults() As String
strResults() = myScope.ReadList(ASCIIType_BSTR)
MsgBox "Timebase range: " + strResults(0) + ", delay: " + strResults(1)
```

To read the :TIMEbase:RANGe?;DELay? query result into multiple numeric variables, you could use the ReadList method to read the query results into a variant array variable using the commands:

```
myScope.WriteString ":TIMEbase:RANGe?;DELay?"
Dim varResults() As Variant
varResults() = myScope.ReadList
MsgBox "Timebase range: " + FormatNumber(varResults(0) * 1000, 4) + " _
      " ms, delay: " + FormatNumber(varResults(1) * 1000000, 4) + " us"
```

Oscilloscope Status

Status registers track the current status of the oscilloscope. By checking the oscilloscope status, you can find out whether an operation has completed and is receiving triggers. **Chapter 7**, “Status Reporting,” starting on page 147 explains how to check the status of the oscilloscope.

4 Sequential (Blocking) vs. Overlapped Commands

IEEE 488.2 makes the distinction between sequential and overlapped commands (and queries):

- *Sequential commands*, also known as *blocking commands*, must finish their task before the execution of the next command starts.
- *Overlapped commands* run concurrently. Commands following an overlapped command may be started before the overlapped command is completed.

In the Infiniium oscilloscopes, for the most part, commands and queries operate differently.

- Most commands are overlapped.

Exceptions to this are the :DIGitize command and the :DISK:SAVE commands, which are sequential (blocking).

- Most queries are sequential (blocking).

Exceptions to this are queries, like measurement results (see [Chapter 28](#), “Measure Commands,” starting on page 721), that copy information from the display without having to make acquisitions.

With sequential (blocking) commands and queries, the oscilloscope is expected to stop processing inputs, including additional remote commands and queries as well as front panel knobs, until completed.

Waiting for Overlapped Commands to Complete

With overlapped commands, you can use the *OPC? query to prevent any more commands from being executed until the overlapped command is complete. This may be necessary when a command that follows an overlapped command interferes with the overlapped command's processing or analysis. For example:

```
:WMEmory1:SAVE CHAN1;*OPC?;:WMEmory2:SAVE CHAN2
```

You can also use the *ESR? query to look at the OPC bit (bit 0) in the Standard Event Status Register to determine when an operation is complete.

Using Device Clear to Abort a Sequential (Blocking) Command When sequential (blocking) commands take too long or fail to complete for some reason, you can send a Device Clear over the bus to clear the input buffer and output queue, reset the parser, and clear any pending commands.

- See Also
- **"*OPC – Operation Complete"** on page 410
 - **"*ESR? – Event Status Register"** on page 406
 - **Chapter 8**, "Remote Acquisition Synchronization," starting on page 177

5 LAN, USB, and GPIB Interfaces

- LAN Interface Connector / 132
- GPIB Interface Connector / 133
- Default Startup Conditions / 134
- Interface Capabilities / 135
- GPIB Command and Data Concepts / 136
- Communicating Over the GPIB Interface / 137
- Communicating Over the LAN Interface / 138
- Communicating via Telnet and Sockets / 139
- Bus Commands / 141

There are several types of interfaces that can be used to remotely program the Infiniium oscilloscope including Local Area Network (LAN) interface and GPIB interface. Telnet and sockets can also be used to connect to the oscilloscope.

LAN Interface Connector

The oscilloscope is equipped with a LAN interface RJ-45 connector on the rear panel. This allows direct connect to your network. However, before you can use the LAN interface to program the oscilloscope, the network properties must be configured. Unless you are a Network Administrator, you should contact your Network Administrator to add the appropriate client, protocols, and configuration information for your LAN. This information is different for every company.

GPIB Interface Connector

The oscilloscope is not equipped with a GPIB interface connector. You can, however, order the N4865A GPIB-to-LAN adapter for the 9000A Series oscilloscope.

Default Startup Conditions

The following default conditions are established during power-up:

- The Request Service (RQS) bit in the status byte register is set to zero.
- All of the event registers are cleared.
- The Standard Event Status Enable Register is set to 0xFF hex.
- Service Request Enable Register is set to 0x80 hex.
- The Operation Status Enable Register is set to 0xFFFF hex.
- The Overload Event Enable Register is set to 0xFF hex.
- The Mask Test Event Enable Register is set to 0xFF hex.

You can change the default conditions using the *PSC command with a parameter of 1 (one). When set to 1, the Standard Event Status Enable Register is set 0x00 hex and the Service Request Enable Register is set to 0x00 hex. This prevents the Power On (PON) event from setting the SRQ interrupt when the oscilloscope is ready to receive commands.

Interface Capabilities

The interface capabilities of this oscilloscope, as defined by IEEE 488.1 and IEEE 488.2, are listed in **Table 1**.

Table 1 Interface Capabilities

| Code | Interface Function | Capability |
|------|--------------------|--|
| SH1 | Source Handshake | Full Capability |
| AH1 | Acceptor Handshake | Full Capability |
| T5 | Talker | Basic Talker/Serial Poll/Talk Only Mode/ Unaddress if Listen Address (MLA) |
| L4 | Listener | Basic Listener/ Unaddresses if Talk Address (MTA) |
| SR1 | Service Request | Full Capability |
| RL1 | Remote Local | Complete Capability |
| PP0 | Parallel Poll | No Capability |
| DC1 | Device Clear | Full Capability |
| DT1 | Device Trigger | Full Capability |
| C0 | Computer | No Capability |
| E2 | Driver Electronics | Tri State (1 MB/SEC MAX) |

GPIB Command and Data Concepts

The GPIB interface has two modes of operation: command mode and data mode. The interface is in the command mode when the Attention (ATN) control line is true. The command mode is used to send talk and listen addresses and various interface commands such as group execute trigger (GET).

The interface is in the data mode when the ATN line is false. The data mode is used to convey device-dependent messages across the bus. The device-dependent messages include all of the oscilloscope-specific commands, queries, and responses found in this manual, including oscilloscope status information.

Communicating Over the GPIB Interface

Device addresses are sent by the computer in the command mode to specify who talks and who listens. Because GPIB can address multiple devices through the same interface card, the device address passed with the program message must include the correct interface select code and the correct oscilloscope address.

Device Address = (Interface Select Code * 100) + Oscilloscope Address

- See Also**
- **"Interface Select Code"** on page 137
 - **"Oscilloscope Address"** on page 137

Interface Select Code

Each interface card has a unique interface select code. This code is used by the computer to direct commands and communications to the proper interface. The default is typically "7" for the GPIB interface cards.

Oscilloscope Address

Each oscilloscope on the GPIB must have a unique oscilloscope address between decimal 0 and 30. This oscilloscope address is used by the computer to direct commands and communications to the proper oscilloscope on an interface. The default is typically "7" for this oscilloscope. You can change the oscilloscope address in the Utilities, Remote Interface dialog box.

NOTE

Do Not Use Address 21 for an Oscilloscope Address

Address 21 is usually reserved for the Computer interface Talk/Listen address, and should not be used as an oscilloscope address.

Communicating Over the LAN Interface

The device address used to send commands and receive data using the LAN interface is located in the Remote Setup dialog box (**Utilities > Remote Setup**).

The following C example program shows how to communicate with the oscilloscope using the LAN interface and the Keysight Standard Instrument Control Library (SICL).

```
#include <sicl.h>

#define BUFFER_SIZE 1024

main()
{
  INST Bus;
  int reason;
  unsigned long actualcnt;
  char buffer[ BUFFER_SIZE ];

  /* Open the LAN interface */
  Bus = iopen( "lan[130.29.71.143]:hpib7,7" );
  if( Bus != 0 ) {
    /* Bus timeout set to 20 seconds */
    itimeout( Bus, 20000 );

    /* Clear the interface */
    iclear( Bus );
    /* Query and print the oscilloscope's Id */
    iwrite( Bus, "*IDN?", 5, 1, &actualcnt );
    iread( Bus, buffer, BUFFER_SIZE, &reason, &actualcnt );
    buffer[ actualcnt - 1 ] = 0;

    printf( "%s\\n", buffer );
    iclose( Bus );
  }
}
```

Communicating via Telnet and Sockets

- **"Telnet"** on page 139
- **"Sockets"** on page 139

Telnet

To open a connection to the oscilloscope via a telnet connection, use the following syntax in a command prompt:

```
telnet Oscilloscope_IP_Address 5024
```

5024 is the port number and the name of the oscilloscope can be used in place of the IP address if desired.

After typing the above command line, press enter and a SCPI command line interface will open. You can then use this as you typically would use a command line.

Sockets

Sockets can be used to connect to your oscilloscope on either a Windows or Unix machine.

The sockets are located on port 5025 on your oscilloscope. Between ports 5024 and 5025, only six socket ports can be opened simultaneously. It is, therefore, important that you use a proper close routine to close the connection to the oscilloscope. If you forget this, the connection will remain open and you may end up exceeding the limit of six socket ports.

Some basic commands used in communicating to your oscilloscope include:

- The receive command is: `recv`
- The send command is: `send`

Below is a programming example (for a Windows-based machine) for opening and closing a connection to your oscilloscope via sockets.

```
#include <winsock2.h>

void main ()
{
    WSADATA wsaData;
    SOCKET mysocket = NULL;
    char* ipAddress = "130.29.70.70";
    const int ipPort = 5025;

    //Initialize Winsock
    int iResult = WSStartup(MAKEWORD(2,2), &wsaData);
    if(iResult != NO_ERROR)
    {
        printf("Error at WSStartup()\n");
    }
}
```

```

        return NULL;
    }

    //Create the socket
    mySocket = socket(AF_INET, SOCK_STREAM, IPPROTO_TCP);
    if(mySocket == INVALID_SOCKET)
    {
        printf("Error at socket(): %ld\n", WSAGetLastError());
        WSACleanup();
        return NULL;
    }

    sockaddr_in clientService;
    clientService.sin_family = AF_INET;
    clientService.sin_addr.s_addr = inet_addr(ipAddress);
    clientService.sin_port = htons(ipPort);

    if(connect(mySocket, (SOCKADDR*) &clientService, sizeof(clientService
)))
    {
        printf("Failed to connect.\n");
        WSACleanup();
        return NULL;
    }

    //Do some work here

    //Close socket when finished
    closesocket(mySocket);
}

```

Bus Commands

The following commands are IEEE 488.1 bus commands (ATN true). IEEE 488.2 defines many of the actions that are taken when these commands are received by the oscilloscope.

Device Clear

The device clear (DCL) and selected device clear (SDC) commands clear the input buffer and output queue, reset the parser, and clear any pending commands. If either of these commands is sent during a digitize operation, the digitize operation is aborted.

Group Execute Trigger

The group execute trigger (GET) command arms the trigger. This is the same action produced by sending the RUN command.

Interface Clear

The interface clear (IFC) command halts all bus activity. This includes unaddressing all listeners and the talker, disabling serial poll on all devices, and returning control to the system computer.

6 Message Communication and System Functions

Protocols / 144

This chapter describes the operation of oscilloscopes that operate in compliance with the IEEE 488.2 (syntax) standard. It is intended to give you enough basic information about the IEEE 488.2 standard to successfully program the oscilloscope. You can find additional detailed information about the IEEE 488.2 standard in ANSI/IEEE Std 488.2-1987, "*IEEE Standard Codes, Formats, Protocols, and Common Commands.*"

This oscilloscope series is designed to be compatible with other Keysight Technologies IEEE 488.2 compatible instruments. Oscilloscopes that are compatible with IEEE 488.2 must also be compatible with IEEE 488.1 (GPIB bus standard); however, IEEE 488.1 compatible oscilloscopes may or may not conform to the IEEE 488.2 standard. The IEEE 488.2 standard defines the message exchange protocols by which the oscilloscope and the computer will communicate. It also defines some common capabilities that are found in all IEEE 488.2 oscilloscopes. This chapter also contains some information about the message communication and system functions not specifically defined by IEEE 488.2.

Protocols

The message exchange protocols of IEEE 488.2 define the overall scheme used by the computer and the oscilloscope to communicate. This includes defining when it is appropriate for devices to talk or listen, and what happens when the protocol is not followed.

- **"Functional Elements"** on page 144
- **"Protocol Overview"** on page 144
- **"Protocol Operation"** on page 145
- **"Protocol Exceptions"** on page 145
- **"Suffix Multiplier"** on page 145
- **"Suffix Unit"** on page 146

Functional Elements

Before proceeding with the description of the protocol, you should understand a few system components, as described here.

- Input Buffer** The input buffer of the oscilloscope is the memory area where commands and queries are stored prior to being parsed and executed. It allows a computer to send a string of commands, which could take some time to execute, to the oscilloscope, then proceed to talk to another oscilloscope while the first oscilloscope is parsing and executing commands.
- Output Queue** The output queue of the oscilloscope is the memory area where all output data or response messages are stored until read by the computer.
- Parser** The oscilloscope's parser is the component that interprets the commands sent to the oscilloscope and decides what actions should be taken. "Parsing" refers to the action taken by the parser to achieve this goal. Parsing and execution of commands begins when either the oscilloscope recognizes a program message terminator, or the input buffer becomes full. If you want to send a long sequence of commands to be executed, then talk to another oscilloscope while they are executing, you should send all of the commands before sending the program message terminator.

Protocol Overview

The oscilloscope and computer communicate using program messages and response messages. These messages serve as the containers into which sets of program commands or oscilloscope responses are placed.

A program message is sent by the computer to the oscilloscope, and a response message is sent from the oscilloscope to the computer in response to a query message. A query message is defined as being a program message that contains one or more queries. The oscilloscope will only talk when it has received a valid

query message, and therefore has something to say. The computer should only attempt to read a response after sending a complete query message, but before sending another program message.

NOTE

Remember this Rule of Oscilloscope Communication

The basic rule to remember is that the oscilloscope will only talk when prompted to, and it then expects to talk before being told to do something else.

Protocol Operation

When you turn the oscilloscope on, the input buffer and output queue are cleared, and the parser is reset to the root level of the command tree.

The oscilloscope and the computer communicate by exchanging complete program messages and response messages. This means that the computer should always terminate a program message before attempting to read a response. The oscilloscope will terminate response messages except during a hard copy output.

After you send a query message, the next message should be the response message. The computer should always read the complete response message associated with a query message before sending another program message to the same oscilloscope.

The oscilloscope allows the computer to send multiple queries in one query message. This is called sending a "compound query". Multiple queries in a query message are separated by semicolons. The responses to each of the queries in a compound query will also be separated by semicolons.

Commands are executed in the order they are received.

Protocol Exceptions

If an error occurs during the information exchange, the exchange may not be completed in a normal manner.

Suffix Multiplier

The suffix multipliers that the oscilloscope will accept are shown in **Table 2**.

Table 2 <suffix mult>

| Value | Mnemonic | Value | Mnemonic |
|-------|----------|-------|----------|
| 1E18 | EX | 1E-3 | M |
| 1E15 | PE | 1E-6 | U |
| 1E12 | T | 1E-9 | N |

Table 2 <suffix mult> (continued)

| Value | Mnemonic | Value | Mnemonic |
|-------|----------|-------|----------|
| 1E9 | G | 1E-12 | P |
| 1E6 | MA | 1E-15 | F |
| 1E3 | K | 1E-18 | A |

Suffix Unit

The suffix units that the oscilloscope will accept are shown in [Table 3](#).

Table 3 <suffix unit>

| Suffix | Referenced Unit |
|--------|-----------------|
| V | Volt |
| S | Second |

7 Status Reporting

| | |
|---|------|
| Status Reporting Data Structures / | 150 |
| Status Byte Register / | 152 |
| Service Request Enable Register / | 154 |
| Message Event Register / | 155 |
| Trigger Event Register / | 156 |
| Standard Event Status Register / | 157 |
| Standard Event Status Enable Register / | 158 |
| Operation Status Register / | 159 |
| Operation Status Enable Register / | 160 |
| Mask Test Event Register / | 161 |
| Mask Test Event Enable Register / | 162 |
| Acquisition Done Event Register / | 163 |
| Process Done Event Register / | 164 |
| Trigger Armed Event Register / | 165 |
| Auto Trigger Event Register / | 166 |
| Error Queue / | 1542 |
| Output Queue / | 168 |
| Message Queue / | 169 |
| Clearing Registers and Queues / | 170 |
| Example: Checking for Armed Status / | 172 |

An overview of the oscilloscope's status reporting structure is shown in [Figure 1](#). The status reporting structure shows you how to monitor specific events in the oscilloscope. Monitoring these events lets you determine the status of an operation, the availability and reliability of the measured data, and more.

- To monitor an event, first clear the event, then enable the event. All of the events are cleared when you initialize the oscilloscope.
- To generate a service request (SRQ) interrupt to an external computer, enable at least one bit in the Status Byte Register.

The Status Byte Register, the Standard Event Status Register group, and the Output Queue are defined as the Standard Status Data Structure Model in IEEE 488.2-1987. IEEE 488.2 defines data structures, commands, and common bit definitions for status reporting. There are also oscilloscope-defined structures and bits.

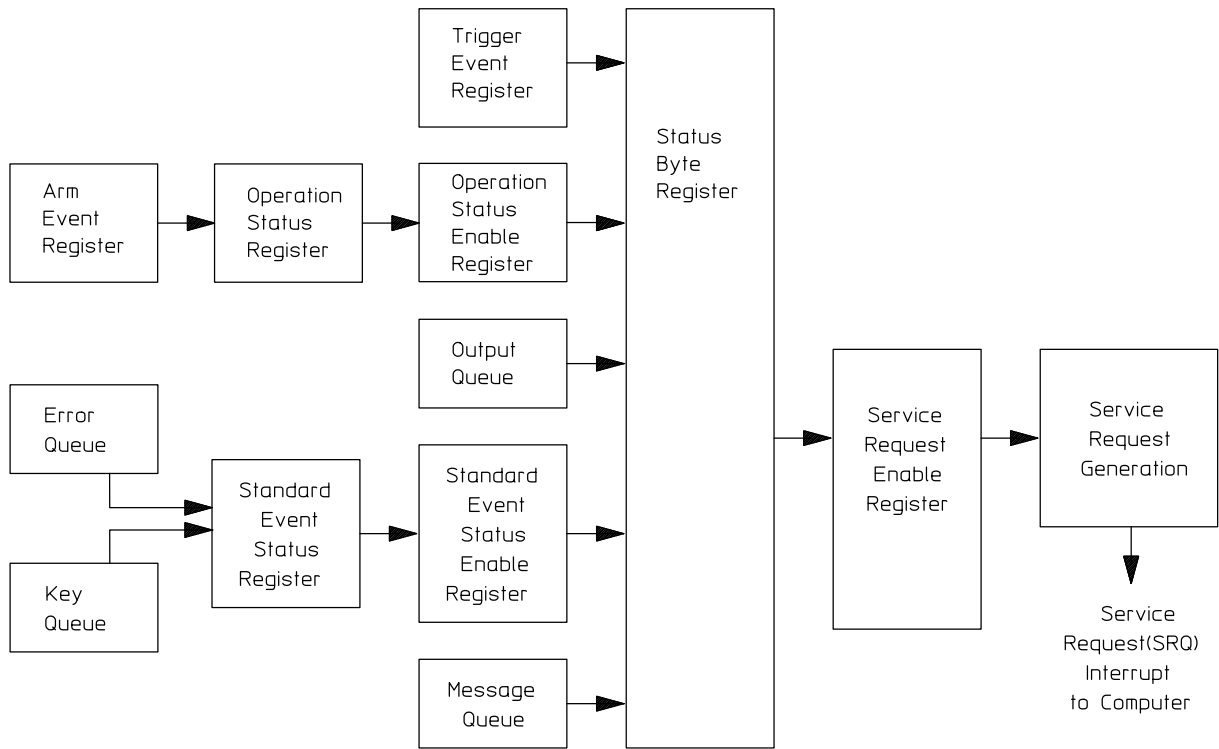

Figure 1 Status Reporting Overview Block Diagram

The status reporting structure consists of the registers shown here.

Table 4 lists the bit definitions for each bit in the status reporting data structure.

Table 4 Status Reporting Bit Definition

| Bit | Description | Definition |
|-----|------------------------|---|
| PON | Power On | Indicates power is turned on. |
| URQ | User Request | Not Used. Permanently set to zero. |
| CME | Command Error | Indicates if the parser detected an error. |
| EXE | Execution Error | Indicates if a parameter was out of range or was inconsistent with the current settings. |
| DDE | Device Dependent Error | Indicates if the device was unable to complete an operation for device-dependent reasons. |

Table 4 Status Reporting Bit Definition (continued)

| Bit | Description | Definition |
|-----------|---------------------------|---|
| QYE | Query Error | Indicates if the protocol for queries has been violated. |
| RQL | Request Control | Indicates if the device is requesting control. |
| OPC | Operation Complete | Indicates if the device has completed all pending operations. |
| OPER | Operation Status Register | Indicates if any of the enabled conditions in the Operation Status Register have occurred. |
| RQS | Request Service | Indicates that the device is requesting service. |
| MSS | Master Summary Status | Indicates if a device has a reason for requesting service. |
| ESB | Event Status Bit | Indicates if any of the enabled conditions in the Standard Event Status Register have occurred. |
| MAV | Message Available | Indicates if there is a response in the output queue. |
| MSG | Message | Indicates if an advisory has been displayed. |
| USR | User Event Register | Indicates if any of the enabled conditions have occurred in the User Event Register. |
| TRG | Trigger | Indicates if a trigger has been received. |
| WAIT TRIG | Wait for Trigger | Indicates the oscilloscope is armed and ready for trigger. |

Status Reporting Data Structures

The different status reporting data structures, descriptions, and interactions are shown in **Figure 2**. To make it possible for any of the Standard Event Status Register bits to generate a summary bit, you must enable the corresponding bits. These bits are enabled by using the *ESE common command to set the corresponding bit in the Standard Event Status Enable Register.

To generate a service request (SRQ) interrupt to the computer, you must enable at least one bit in the Status Byte Register. These bits are enabled by using the *SRE common command to set the corresponding bit in the Service Request Enable Register. These enabled bits can then set RQS and MSS (bit 6) in the Status Byte Register.

For more information about common commands, see the "Common Commands" chapter.

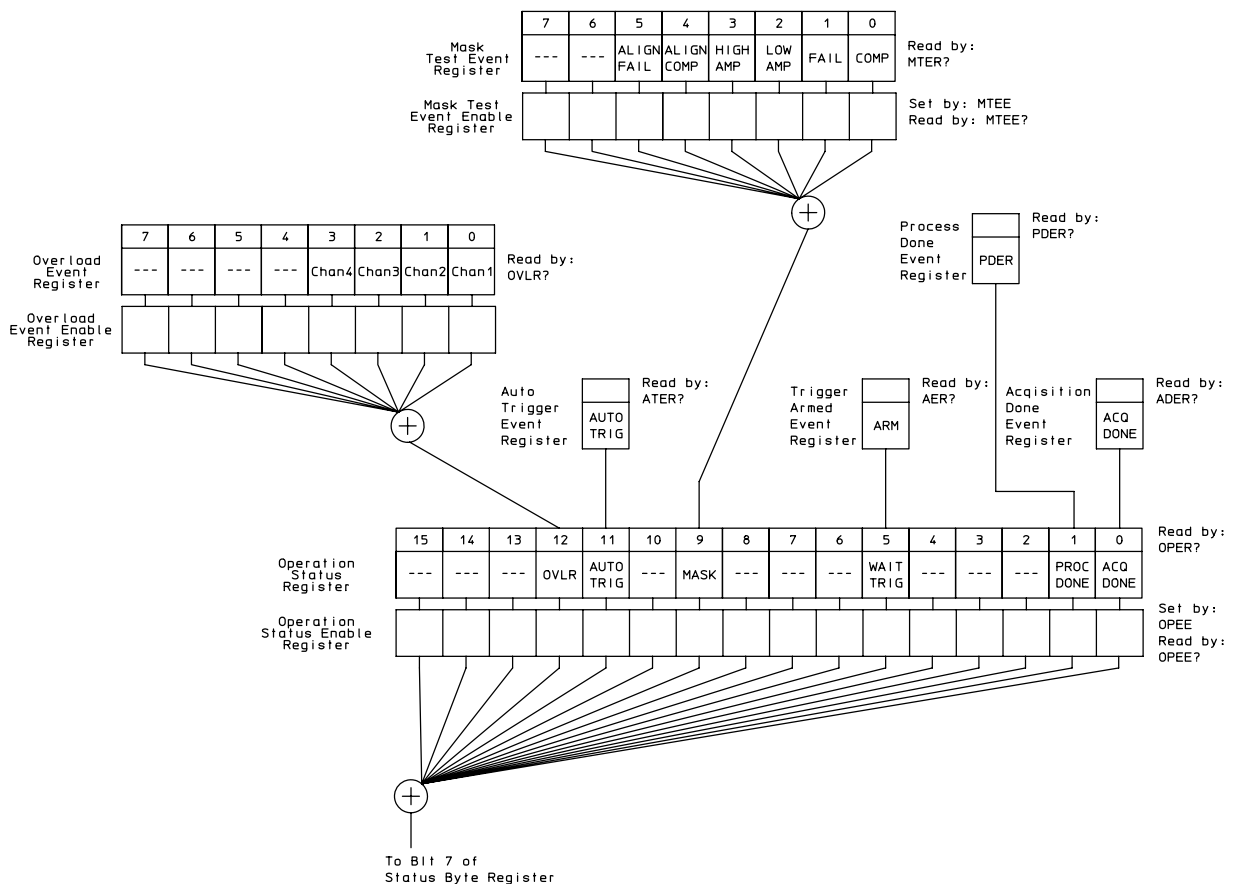

Figure 2 Status Reporting Data Structures

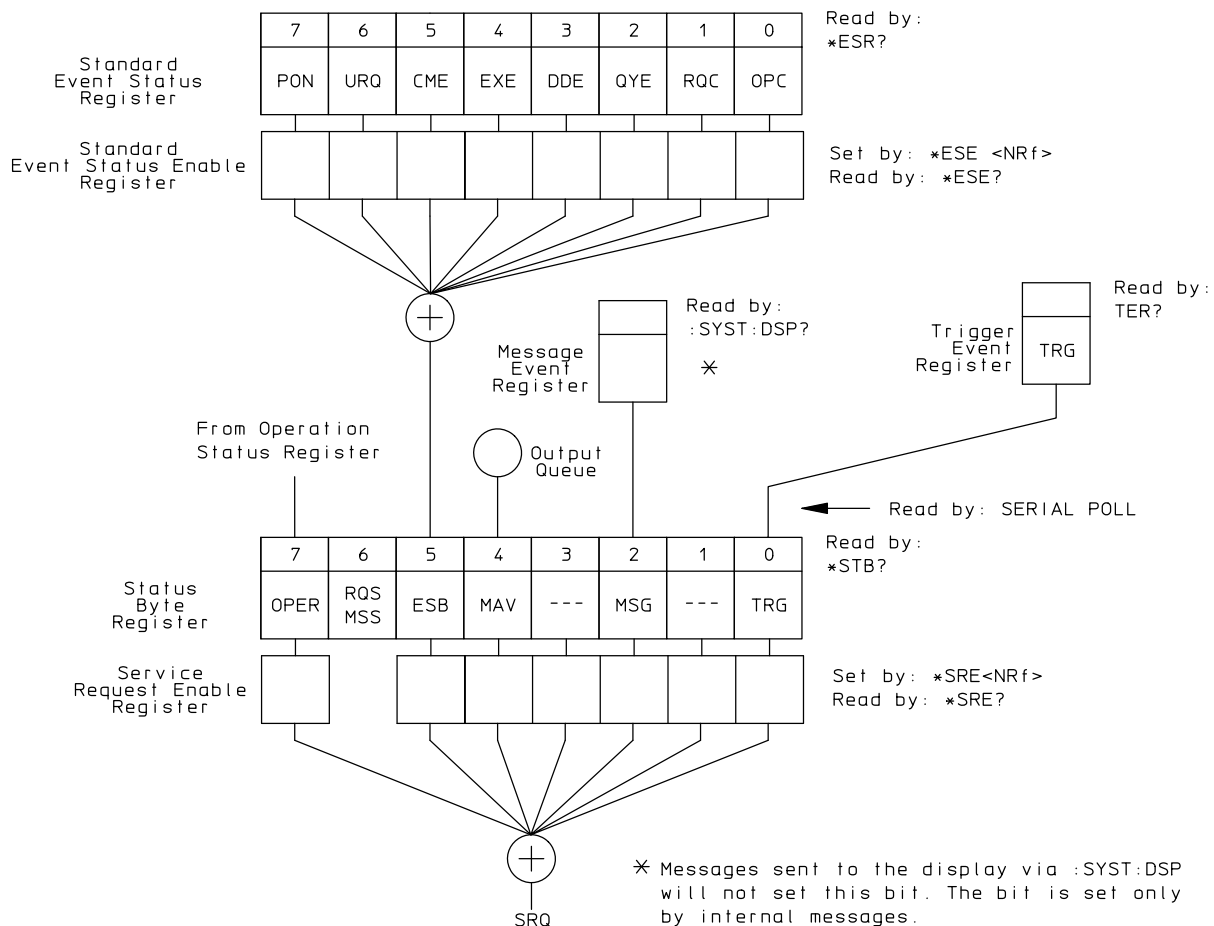

Figure 3 Status Reporting Data Structures (Continued)

Status Byte Register

The Status Byte Register is the summary-level register in the status reporting structure. It contains summary bits that monitor activity in the other status registers and queues. The Status Byte Register is a live register. That is, its summary bits are set and cleared by the presence and absence of a summary bit from other event registers or queues.

If the Status Byte Register is to be used with the Service Request Enable Register to set bit 6 (RQS/MSS) and to generate an SRQ, at least one of the summary bits must be enabled, then set. Also, event bits in all other status registers must be specifically enabled to generate the summary bit that sets the associated summary bit in the Status Byte Register.

You can read the Status Byte Register using either the *STB? common command query or the GPIB serial poll command. Both commands return the decimal-weighted sum of all set bits in the register. The difference between the two methods is that the serial poll command reads bit 6 as the Request Service (RQS) bit and clears the bit which clears the SRQ interrupt. The *STB? query reads bit 6 as the Master Summary Status (MSS) and does not clear the bit or have any effect on the SRQ interrupt. The value returned is the total bit weights of all of the bits that are set at the present time.

The use of bit 6 can be confusing. This bit was defined to cover all possible computer interfaces, including a computer that could not do a serial poll. The important point to remember is that if you are using an SRQ interrupt to an external computer, the serial poll command clears bit 6. Clearing bit 6 allows the oscilloscope to generate another SRQ interrupt when another enabled event occurs.

The only other bit in the Status Byte Register affected by the *STB? query is the Message Available bit (bit 4). If there are no other messages in the Output Queue, bit 4 (MAV) can be cleared as a result of reading the response to the *STB? query.

If bit 4 (weight = 16) and bit 5 (weight = 32) are set, a program would print the sum of the two weights. Since these bits were not enabled to generate an SRQ, bit 6 (weight = 64) is not set.

Example 1 This example uses the *STB? query to read the contents of the oscilloscope's Status Byte Register when none of the register's summary bits are enabled to generate an SRQ interrupt.

```
Dim varStbValue As Variant
myScope.WriteString ":SYSTEM:HEADer OFF;*STB?" 'Turn headers off
varStbValue = myScope.ReadNumber
Debug.Print "Status Byte Register, Read: 0x" + Hex(varStbValue)
```

The next program prints "0x84" and clears bit 6 (RQS) of the Status Byte Register. The difference in the decimal value between this example and the previous one is the value of bit 6 (weight = 64). Bit 6 is set when the first enabled summary bit is set, and is cleared when the Status Byte Register is read by the serial poll command.

Example 2 The following example uses the resource session object's ReadSTB method to read the contents of the oscilloscope's Status Byte Register.

```
varStbValue = myScope.IO.ReadSTB
Debug.Print "Status Byte Register, Serial Poll: 0x" + Hex(varStbValue)
```

NOTE**Use Serial Polling to Read the Status Byte Register**

Serial polling is the preferred method to read the contents of the Status Byte Register because it resets bit 6 and allows the next enabled event that occurs to generate a new SRQ interrupt.

See Also · ["Example: Checking for Armed Status"](#) on page 172

Service Request Enable Register

Setting the Service Request Enable Register bits enables corresponding bits in the Status Byte Register. These enabled bits can then set RQS and MSS (bit 6) in the Status Byte Register.

Bits are set in the Service Request Enable Register using the *SRE command, and the bits that are set are read with the *SRE? query. Bit 6 always returns 0. Refer to the Status Reporting Data Structures shown in [Figure 2](#).

Example The following example sets bit 4 (MAV) and bit 5 (ESB) in the Service Request Enable Register.

```
myScope.WriteString "*SRE " + CStr(CInt("&H30"))
```

This example uses the decimal parameter value of 48, the string returned by `CStr(CInt("&H30"))`, to enable the oscilloscope to generate an SRQ interrupt under the following conditions:

- When one or more bytes in the Output Queue set bit 4 (MAV).
- When an enabled event in the Standard Event Status Register generates a summary bit that sets bit 5 (ESB).

Message Event Register

This register sets the MSG bit in the status byte register when an internally generated message is written to the advisory line on the oscilloscope. The message is read using the :SYSTEM:DSP? query. Note that messages written to the advisory line on the oscilloscope using the :SYSTEM:DSP command does not set the MSG status bit.

Trigger Event Register

This register sets the TRG bit in the status byte register when a trigger event occurs.

The trigger event register stays set until it is cleared by reading the register with the TER? query or by using the *CLS (clear status) command. If your application needs to detect multiple triggers, the trigger event register must be cleared after each one.

If you are using the Service Request to interrupt a computer operation when the trigger bit is set, you must clear the event register after each time it is set.

Standard Event Status Register

The Standard Event Status Register (SESR) monitors the following oscilloscope status events:

- PON - Power On
- CME - Command Error
- EXE - Execution Error
- DDE - Device Dependent Error
- QYE - Query Error
- RQC - Request Control
- OPC - Operation Complete

When one of these events occurs, the corresponding bit is set in the register. If the corresponding bit is also enabled in the Standard Event Status Enable Register, a summary bit (ESB) in the Status Byte Register is set.

You can read the contents of the Standard Event Status Register and clear the register by sending the *ESR? query. The value returned is the total bit weights of all bits set at the present time.

Example The following example uses the *ESR query to read the contents of the Standard Event Status Register.

```
myScope.WriteString ":SYSTem:HEADer OFF"    'Turn headers off
myScope.WriteString "*ESR?"
varQueryResult = myScope.ReadNumber
Debug.print "Standard Event Status Register: 0x" + Hex(varQueryResult)
```

If bit 4 (weight = 16) and bit 5 (weight = 32) are set, the program prints the sum of the two weights.

Standard Event Status Enable Register

For any of the Standard Event Status Register bits to generate a summary bit, you must first enable the bit. Use the *ESE (Event Status Enable) common command to set the corresponding bit in the Standard Event Status Enable Register. Set bits are read with the *ESE? query.

Example Suppose your application requires an interrupt whenever any type of error occurs. The error related bits in the (Standard) Event Status Register are bits 2 through 5 (hexadecimal value 0x3C). Therefore, you can enable any of these bits to generate the summary bit by sending:

```
myScope.WriteString "*ESE " + CStr(CInt("&H3C"))
```

Whenever an error occurs, it sets one of these bits in the (Standard) Event Status Register. Because all the error related bits are enabled, a summary bit is generated to set bit 5 (ESB) in the Status Byte Register.

If bit 5 (ESB) in the Status Byte Register is enabled (via the *SRE command), a service request interrupt (SRQ) is sent to the controller PC.

NOTE

Disabled Standard Event Status Register Bits Respond, but Do Not Generate a Summary Bit

Standard Event Status Register bits that are not enabled still respond to their corresponding conditions (that is, they are set if the corresponding event occurs). However, because they are not enabled, they do not generate a summary bit in the Status Byte Register.

Operation Status Register

This register hosts the following bits:

- ACQ DONE bit 0
- PROC DONE bit 1
- WAIT TRIG bit 5
- MASK bit 9
- AUTO TRIG bit 11
- OVLN bit 12

The ACQ DONE bit is set by the Acquisition Done Event Register.

The PROC DONE bit is set by the Process Done Event Register and indicates that all functions and all math processes are done.

The WAIT TRIG bit is set by the Trigger Armed Event Register and indicates the trigger is armed.

The MASK bit is set whenever at least one of the Mask Test Event Register bits is enabled.

The AUTO TRIG bit is set by the Auto Trigger Event Register.

The OVLN bit is set whenever at least one of the Overload Event Register bits is enabled.

If any of these bits are set, the OPER bit (bit 7) of the Status Byte Register is set. The Operation Status Register is read and cleared with the OPER? query. The register output is enabled or disabled using the mask value supplied with the OPEE command.

See Also • ["Example: Checking for Armed Status"](#) on page 172

Operation Status Enable Register

For any of the Operation Status Register bits to generate a summary bit, you must first enable the bit. Use the OPEE (Operation Event Status Enable) command to set the corresponding bit in the Operation Status Enable Register. Set bits are read with the OPEE? query.

Example Suppose your application requires an interrupt whenever any event occurs in the mask test register. The error status bit in the Operation Status Register is bit 9. Therefore, you can enable this bit to generate the summary bit by sending:

```
myScope.WriteString ":OPEE " + CStr(CInt("&H200"))
```

Whenever an error occurs, the oscilloscope sets this bit in the Mask Test Event Register. Because this bit is enabled, a summary bit is generated to set bit 9 (OPER) in the Operation Status Register.

If bit 7 (OPER) in the Status Byte Register is enabled (via the *SRE command), a service request interrupt (SRQ) is sent to the external computer.

NOTE

Disabled Operation Status Register Bits Respond, but Do Not Generate a Summary Bit

Operation Status Register bits that are not enabled still respond to their corresponding conditions (that is, they are set if the corresponding event occurs). However, because they are not enabled, they do not generate a summary bit in the Status Byte Register.

Mask Test Event Register

This register hosts the following bits:

- Mask Test Complete bit (bit 0)
- Mask Test Fail bit (bit 1)
- Mask Low Amplitude bit (bit 2)
- Mask High Amplitude bit (bit 3)
- Mask Align Complete bit (bit 4)
- Mask Align Fail bit (bit 5)

The Mask Test Complete bit is set whenever the mask test is complete.

The Mask Test Fail bit is set whenever the mask test failed.

The Mask Low Amplitude bit is set whenever the signal is below the mask amplitude.

The Mask High Amplitude bit is set whenever the signal is above the mask amplitude.

The Mask Align Complete bit is set whenever the mask align is complete.

The Mask Align Fail bit is set whenever the mask align failed.

If any of these bits are set, the MASK bit (bit 9) of the Operation Status Register is set. The Mask Test Event Register is read and cleared with the MTER? query. The register output is enabled or disabled using the mask value supplied with the MTEE command.

Mask Test Event Enable Register

For any of the Mask Test Event Register bits to generate a summary bit, you must first enable the bit. Use the MTEE (Mask Test Event Enable) command to set the corresponding bit in the Mask Test Event Enable Register. Set bits are read with the MTEE? query.

Example Suppose your application requires an interrupt whenever a Mask Test Fail occurs in the mask test register. You can enable this bit to generate the summary bit by sending:

```
myScope.WriteString ":MTEE " + CStr(CInt("&H2"))
```

Whenever an error occurs, the oscilloscope sets the MASK bit in the Operation Status Register. Because the bits in the Operation Status Enable Register are all enabled, a summary bit is generated to set bit 7 (OPER) in the Status Byte Register.

If bit 7 (OPER) in the Status Byte Register is enabled (via the *SRE command), a service request interrupt (SRQ) is sent to the external computer.

NOTE

Disabled Mask Test Event Register Bits Respond, but Do Not Generate a Summary Bit

Mask Test Event Register bits that are not enabled still respond to their corresponding conditions (that is, they are set if the corresponding event occurs). However, because they are not enabled, they do not generate a summary bit in the Operation Status Register.

Acquisition Done Event Register

The Acquisition Done Event Register (ACQ DONE) sets bit 0 (ACQ DONE bit) in the Operation Status Register when the oscilloscope acquisition is completed.

The ACQ DONE event register stays set until it is cleared by reading the register by a ADER? query. If your application needs to detect multiple acquisitions, the ACQ DONE event register must be cleared after each acquisition.

See Also · ["Example: Blocking and Polling Synchronization"](#) on page 183

Process Done Event Register

The Process Done Event Register (PDER) sets bit 1 (PROC DONE) of the Operation Status Register when all functions and all math operations are completed. The PDER bit stays set until cleared by a PDER? query.

See Also · ["Example: Blocking and Polling Synchronization"](#) on page 183

Trigger Armed Event Register

The Trigger Armed Event Register (TDER) sets bit 5 (WAIT TRIG) in the Operation Status Register when the oscilloscope becomes armed.

The ARM event register stays set until it is cleared by reading the register with the AER? query. If your application needs to detect multiple triggers, the ARM event register must be cleared after each one.

See Also · ["Example: Checking for Armed Status"](#) on page 172

Auto Trigger Event Register

The Auto Trigger Event Register (AUTO TRIG) sets bit 11 (AUTO TRIG) in the Operation Status Register when an auto trigger event occurs. The AUTO TRIG register stays set until it is cleared by reading the register with the ATER? query. If the application needs to detect multiple auto trigger events, the AUT TRIG register must be cleared after each one.

Error Queue

As errors are detected, they are placed in an error queue. This queue is a first-in, first-out queue. If the error queue overflows, the last error in the queue is replaced with error -350, "Queue overflow." Any time the queue overflows, the oldest errors remain in the queue, and the most recent error is discarded. The length of the oscilloscope's error queue is 30 (29 positions for the error messages, and 1 position for the "Queue overflow" message).

The error queue is read with the :SYSTem:ERRor? query. Executing this query reads and removes the oldest error from the head of the queue, which opens a position at the tail of the queue for a new error. When all the errors have been read from the queue, subsequent error queries return 0, "No error."

The error queue is cleared when any of these events occur:

- When the oscilloscope is powered up.
- When the oscilloscope receives the *CLS common command.
- When the last item is read from the error queue.

For more information on reading the error queue, refer to the :SYSTem:ERRor? query in the System Commands chapter. For a complete list of error messages, refer to the chapter, "Error Messages."

Output Queue

The output queue stores the oscilloscope-to-controller responses that are generated by certain oscilloscope commands and queries. The output queue generates the Message Available summary bit when the output queue contains one or more bytes. This summary bit sets the MAV bit (bit 4) in the Status Byte Register.

When using the Keysight VISA COM library, the output queue may be read with the FormattedIO488 object's ReadString, ReadNumber, ReadList, or ReadIEEEBlock methods.

Message Queue

The message queue contains the text of the last message written to the advisory line on the screen of the oscilloscope. The queue is read with the `:SYSTEM:DSP?` query. Note that messages sent with the `:SYSTEM:DSP` command do not set the MSG status bit in the Status Byte Register.

Clearing Registers and Queues

The *CLS common command clears all event registers and all queues except the output queue. If *CLS is sent immediately following a program message terminator, the output queue is also cleared.

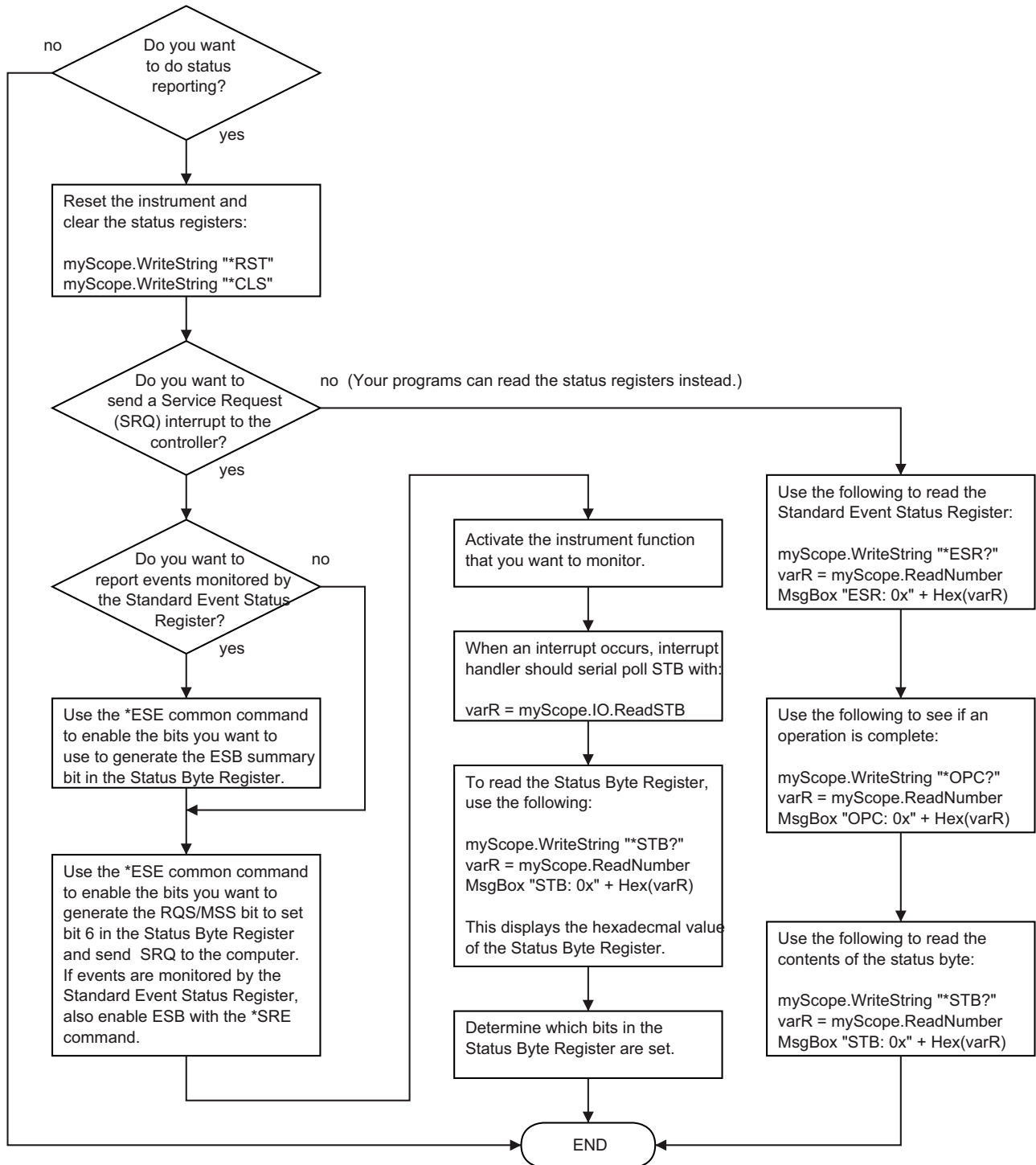

Figure 4 Status Reporting Decision Chart

Example: Checking for Armed Status

```

# -*- coding: utf-8 -*-

# *****
# This script using the Python language (http://www.python.org/) and
# the PyVISA package (http://pyvisa.readthedocs.org/) shows three
# methods to tell whether a Keysight Infiniium oscilloscope is armed.
# *****

# Import modules
# -----
import sys
import visa
import time

# Initialization constants
# -----
# Get VISA address from Keysight IO Libraries Connection Expert
VISA_ADDRESS = "TCPIP0::141.121.228.133::hislip0::INSTR"
GLOBAL_TOUT = 10000 # IO timeout in milliseconds

# Connect and initialize oscilloscope
# -----
# Define VISA Resource Manager & Install directory
rm = visa.ResourceManager('C:\\Windows\\System32\\visa32.dll')

# Define and open the oscilloscope using the VISA address
KsInfiniiumScope = rm.open_resource(VISA_ADDRESS)

# Set the Global Timeout
KsInfiniiumScope.timeout = GLOBAL_TOUT

# Clear the instrument bus
KsInfiniiumScope.clear()

# Reset the oscilloscope.
KsInfiniiumScope.write("*RST")

# Autoscale to set up vertical scale and trigger level on channel 1.
KsInfiniiumScope.write(":AUToscale:CHANnels DISPLAYed")
KsInfiniiumScope.write(":AUToscale")

# Ensure a "long" time to arm (5 seconds) and not trigger immediately.
# -----
# 10 second total capture, with trigger point in the middle = 5s to arm
KsInfiniiumScope.write(":TIMEbase:RANGE 10")
# Prevent Auto trigger.
KsInfiniiumScope.write(":TRIGger:SWEep TRIGgered")

# =====
# Method 1: Query the Armed Event Register with :AER?
# -----
# This method reads the 1-bit Armed Event Register using the :AER?
# query.

```

```

#
# The Armed Event Register bit goes low (0) when it is read using
# :AER? or when a *CLS command is issued.
# =====

# Stop the oscilloscope.
KsInfiniiumScope.query(":STOP;*OPC?")

# Method 1: Initiate capture using :SINGLE
# -----
print "Acquiring signal (Method 1, using :SINGLE)...\n"
now = time.clock()

# Clear all status registers before checking for new events.
KsInfiniiumScope.write("*CLS")

# Because the :AER? query will not work with :DIGitize (which is
# blocking), use the :SINGLE command to start the acquisition.
KsInfiniiumScope.write(":SINGLE")

# Method 1: Determine if armed using :AER? query.
# -----
# Define armed criteria.
ARMED = 1

# Test for armed.
ARMED_STATUS = int(KsInfiniiumScope.query(":AER?"))

# Wait indefinitely until armed.
while ARMED_STATUS != ARMED:
    # Check the status again after small delay.
    time.sleep(0.1) # 100 ms delay to prevent excessive queries.
    ARMED_STATUS = int(KsInfiniiumScope.query(":AER?"))

print "Oscilloscope is armed (method 1, using :AER? query)!"
print "It took " + str(time.clock() - now) + \
      " seconds to arm.\n"

# =====
# Method 2: Read the Status Byte
# -----
# This method reads the Status Byte register's OPER bit (bit 7) using
# the "read status byte" function in VISA, which works during blocking
# commands and can therefore be used with the :DIGitize command.
#
# The Status Byte bits do NOT go low (0) when the register is read.
#
# The *CLS command will clear the Status Byte bits.
# =====

# Stop the oscilloscope.
KsInfiniiumScope.query(":STOP;*OPC?")

# Method 2: Initiate capture using :DIGitize or :SINGLE
# -----
print "Acquiring signal (Method 2, using :DIGitize)...\n"
now = time.clock()

```

```

# Clear all status registers before checking for new events.
KsInfiniiumScope.write("*CLS")

# Mask out all bits in the Operation Status Register except for
# the ARM bit.
KsInfiniiumScope.write(":OPEE 32") # "Unmask" only the arm bit

# Use the :DIGitize command to start the acquisition.
KsInfiniiumScope.write(":DIGitize")

# Method 2: Determine if armed by reading the Status Byte.
# -----
# Define register bit masks for the Status Byte Register
ARM_BIT = 7
# 1 leftshift 7 = 128 (bit 7 in the Status Byte Register)
ARM_MASK = 1 << ARM_BIT

# Define armed criteria.
ARMED = 1 << ARM_BIT # 1 leftshift 7 = 128

# Test for armed.
STATUS_BYTE = int(KsInfiniiumScope.read_stb())
ARMED_STATUS = STATUS_BYTE & ARM_MASK
# Note that you could also do:
# ARMED_STATUS = int(KsInfiniiumScope.query("*STB?"))
# BUT *STB? does not work with the blocking :DIGitize.

# Wait indefinitely until armed.
while ARMED_STATUS != ARMED:
    # Check the status again after small delay.
    time.sleep(0.1) # 100 ms delay to prevent excessive queries.
    STATUS_BYTE = int(KsInfiniiumScope.read_stb())
    ARMED_STATUS = STATUS_BYTE & ARM_MASK

print "Oscilloscope is armed (method 2, using Read STB function)!"
print "It took " + str(time.clock() - now) + \
      " seconds to arm.\n"

# =====
# Method 3: Query the Operation Status Register with :OPER?
# -----
# This method reads the Operation Status Register's Wait Trig bit
# (bit 5) using the :OPER? query.
#
# The Operation Status Register bits do NOT go low (0) when the
# register is read.
#
# Also, the Wait Trig bit does NOT go low (0) when the oscilloscope
# becomes unarmed by starting or stopping another acquisition (before
# the first one finishes) or by changing the time scale.
#
# The Wait Trig bit is cleared by a *CLS command, or by reading the
# Armed Event Register register with the :AER? query.
# =====

# Stop the oscilloscope.

```

```

KsInfiniiumScope.query(":STOP;*OPC?")

# Method 3: Initiate capture using :SINGLE
# -----
print "Acquiring signal (Method 3, using :SINGLE)...\n"
now = time.clock()

# Clear all status registers before checking for new events.
KsInfiniiumScope.write("*CLS")

# Because the :OPER? query will not work with :DIGitize (which is
# blocking), use the :SINGLE command to start the acquisition.
KsInfiniiumScope.write(":SINGLE")

# Method 3: Determine if armed using :OPER? query.
# -----
# Define register bit masks for the Operation Status Register
ARM_BIT = 5
# 1 leftshift 5 = 32 (bit 5 in the Operation Status Register)
ARM_MASK = 1 << ARM_BIT

# Define armed criteria.
ARMED = 1 << ARM_BIT # 1 leftshift 5 = 32

# Test for armed.
STATUS_REGISTER = int(KsInfiniiumScope.query(":OPER?"))
ARMED_STATUS = STATUS_REGISTER & ARM_MASK

# Wait indefinitely until armed.
while ARMED_STATUS != ARMED:
    # Check the status again after small delay.
    time.sleep(0.1) # 100 ms delay to prevent excessive queries.
    STATUS_REGISTER = int(KsInfiniiumScope.query(":OPER?"))
    ARMED_STATUS = STATUS_REGISTER & ARM_MASK

print "Oscilloscope is armed (method 3, using :OPER? query)!"
print "It took " + str(time.clock() - now) + \
      " seconds to arm.\n"

# End of Script
# -----
KsInfiniiumScope.clear() # Clear communications interface
KsInfiniiumScope.close() # Close communications interface
print "All done."

```

8 Remote Acquisition Synchronization

- Programming Flow / 178
- Setting Up the Oscilloscope / 179
- Acquiring a Waveform / 180
- Retrieving Results / 181
- Acquisition Synchronization / 182
- Single Shot Device Under Test (DUT) / 192
- Averaging Acquisition Synchronization / 193

When remotely controlling an oscilloscope with SCPI commands, it is often necessary to know when the oscilloscope has finished the previous operation and is ready for the next SCPI command. The most common example is when an acquisition is started using the `:DIG`, `:RUN`, or `:SINGle` commands. Before a measurement result can be queried, the acquisition must complete. Too often, fixed delays are used to accomplish this wait, but fixed delays often use excessive time or the time may not be long enough. A better solution is to use synchronous commands and status to know when the oscilloscope is ready for the next request.

Programming Flow

Most remote programming follows these three general steps:

- 1** Setup the oscilloscope and device under test
- 2** Acquire a waveform
- 3** Retrieve results

Setting Up the Oscilloscope

Before making changes to the oscilloscope setup, it is best to make sure it is stopped using the :STOP command followed by the *OPC? command.

NOTE

It is not necessary to use the *OPC? command, hard coded waits, or status checking when setting up the oscilloscope.

After the oscilloscope is configured, it is ready for an acquisition.

Acquiring a Waveform

When acquiring a waveform, there are two possible methods used to wait for the acquisition to complete. These methods are blocking and polling. The table below details when each method should be chosen and why.

| | Blocking Wait | Polling Wait |
|---------------|---|--|
| Use When | You know the oscilloscope will trigger based on the oscilloscope setup and device under test. | You know the oscilloscope may or may not trigger based on the oscilloscope setup and device under test. |
| Advantages | <ul style="list-style-type: none"> ▪ No need for polling ▪ Fast method | <ul style="list-style-type: none"> ▪ Remote interface will not timeout ▪ No need for device clear if no trigger |
| Disadvantages | <ul style="list-style-type: none"> ▪ Remote interface may timeout ▪ Device clear only way to get control of oscilloscope if there is no trigger | <ul style="list-style-type: none"> ▪ Slower method ▪ Required polling loop ▪ Required known maximum wait time |

Retrieving Results

Once the acquisition is complete, it is safe to retrieve measurements and statistics.

Acquisition Synchronization

- **"Blocking Synchronization"** on page 182
- **"Polling Synchronization With Timeout"** on page 182
- **"Example: Blocking and Polling Synchronization"** on page 183

Blocking Synchronization

Use the :DIGitize command to start the acquisition. This blocks subsequent queries until the acquisition and processing is complete.

```

Example // Setup
           :TRIGger:MODE EDGE
           :TIMEbase:SCALE 5e-9

           //Acquire
           :DIG

           //Get results
           :MEASure:RISetime?

```

Polling Synchronization With Timeout

This example requires a timeout value so the operation can abort if an acquisition does not occur within the timeout period.

```

Example TIMEOUT = 1000ms
           currentTime = 0ms

           // Setup
           :STOP; *OPC? // if not stopped
           :ADER? // clear ADER event

           // Acquire
           :SINGLE

           while(currentTime <= TIMEOUT)
           {
               if (:ADER? == 1)
               {
                   break;
               }
               else
               {
                   // Use small wait to prevent excessive
                   // queries to the oscilloscope
                   wait (100ms)
                   currentTime += 100ms
               }
           }

           //Get results

```

```

if (currentTime < TIMEOUT)
{
    :MEASure:RISetime?
}

```

Example: Blocking and Polling Synchronization

```

# -*- coding: utf-8 -*-

# *****
# This script using the Python language (http://www.python.org/) and
# the PyVISA package (http://pyvisa.readthedocs.org/) shows the two
# best synchronization methods for Infiniium real-time oscilloscopes.
# Benefits and drawbacks of each method are described. No error
# handling is provided except in the actual synchronization methods.
# *****

# Import modules
# -----
import sys
import visa
import time

# Initialization constants
# -----
# Get VISA address from Keysight IO Libraries Connection Expert
VISA_ADDRESS = "TCPIP0::141.121.228.133::hislip0::INSTR"
GLOBAL_TOUT = 10000 # IO time out in milliseconds

TIME_TO_TRIGGER = 10 # Time in seconds
# -----
# This is the time until the FIRST trigger event.
#
# While the script calculates a general time out for the given setup,
# it cannot know when a trigger event will occur. Thus, you must
# still set this value.
#
# This time is in addition to the calculated minimum timeout... so, if
# an oscilloscope might take say, 1 us to arm and acquire data, the
# signal might take 100 seconds before it occurs... this accounts for
# that.
#
# The SCOPE_ACQUISITION_TIME_OUT calculation pads this by 1.1.
# -----

TIME_BETWEEN_TRIGGERS = 0.025 # Time in seconds - for Average,
# Segmented, and Equivalent Time modes, else set to 0
# -----
# In Average, Segmented, and Equivalent Time modes, the oscilloscope
# makes repeated acquisitions. This is similar to the above
# TIME_TO_TRIGGER, but it is the time BETWEEN triggers. For example,
# it might take 10 seconds for the first trigger event, and then they
# might start occurring regularly at say, 1 ms intervals. In that
# scenario, 15 seconds (a conservative number for 10s) would be good
# for TIME_TO_TRIGGER, and 2 ms (again conservative) would be good for
# TIME_BETWEEN_TRIGGERS.

```

```

#
# The default in this sample script is 0.025 seconds. This is to make
# the sample work for the LINE trigger used in this script when the
# oscilloscope is in Average, Segmented, and Equivalent Time modes to
# force a trigger off of the AC input line (:TRIGger:EDGE:SOURce LINE)
# which runs at 50 or 60 Hz in most of the world (1/50 Hz -> 20 ms, so
# use 25 ms to be conservative).
#
# The SCOPE_ACQUISITION_TIME_OUT calculation pads this by 1.1.
# -----
PROCESSING_TIME = 0 # Time in seconds - this is needed to account
# for additional time after an acquisition to do any processing such
# as FFTs, jitter, etc.
# -----
# When using repetitive modes such as average or segmented mode,
# processing happens only once, at the end, on either the final
# averaged waveform or the last segment, thus this only needs to be
# accounted for once.
#
# This time cannot be known ahead of time. One needs to measure this
# time:
#
# To measure PROCESSING_TIME, a second oscilloscope is ideal.
#
# 1. Connect the trigger output of the oscilloscope to be
#    programmed to an input on a second oscilloscope. It is
#    often best to use peak detect mode, maximize the signal
#    display intensity, and set the trigger sweep to
#    Normal/Triggered, not auto.
#
# 2. Feed the oscilloscope to be programmed a 1 MHz (or faster)
#    sine or square wave or other continuous signal such that the
#    trigger condition is always met and the oscilloscope will
#    trigger as fast as it can.
#
# 3. Set up the oscilloscope to be programmed as it will be used,
#    and put it in the RUNNING state (press the front panel Run
#    key).
#
# 4. Observe and record the delta time (DT) between trigger
#    output pulses. There will be some variation, use the
#    largest observed delta time.
#
# 5. Turn off any processing and again record the smallest delta
#    time of the trigger output pulses.
#
# 6. Calculate PROCESSING_TIME as
#    DT_largest_processing_ON - DT_smallest_processing_OFF
#
# For example, with an S-Series oscilloscope, at 67 MPts and
# 20 GSa/s (~3.35 ms time capture) with sinx/x interpolation
# enabled, it takes on the order of ~10-15 ms per capture to
# capture and display one channel repetitively. Once an FFT
# is enabled, it takes about ~8.2 seconds to repetitively
# capture, calculate the FFT, and display it, repetitively.
# Thus the PROCESSING_TIME should be 8.2 s - 15 ms = ~8.2

```



```

#         seconds. Here, 10 seconds should then be used. (FFTs take a
#         logarithmically long time to compute.)
#
# The SCOPE_ACQUISITION_TIME_OUT calculation pads this by 1.2.
# -----

# =====
# Define a simple and fast function utilizing the blocking :DIGitize
# command in conjunction with *OPC?.
# -----
#
# Benefits of this method:
#
# - Fastest, compact, simple
# - Works for ALL modes including averaging.
# - Don't have to deal with the status registers, which can be
#   confusing.
#
# Drawbacks of this method:
#
# - Requires a well-chosen, hard-set timeout that will cover the
#   time to arm, trigger, finish acquisition AND any processing
#   that is already enabled, for example FFTs, math functions,
#   measurements, jitter separation... The script calculates this
#   timeout.
#
#   Please note that for segmented memory mode, any processing
#   would happen only for the final segment.
#
#   Please note that for average acquisition mode, any processing
#   would happen only for the final averaged waveform.
#
# - Requires Exception handling and a device clear for a possible
#   timeout (no trigger event)
#
# How it works:
#
# - The :DIGitize command is a blocking command, and thus, no
#   other SCPI commands will *execute* until :DIGitize is completely
#   done. This includes any subsequent processing that is already
#   set up, such as math, jitter separation, measurements.
#
# KEY POINT: However, :DIGitize does not prevent additional
# commands from being sent to the queue or cause the remote
# program to wait. For example, if your program does something
# like:
#
#     KsInfiniiumScope.write(":DIGitize")
#     sys.stdout.write("Signal acquired.\n")
#
# The "Signal acquired" message will be written immediately
# after the :DIGitize is sent, not after the acquisition and
# processing is complete.
#
# To pause the program until the :DIGitize is complete, you must
# wait for a query result after the :DIGitize. For example, in

```

```

#         this case:
#
#         query_result = KsInfiniiumScope.query(":DIGitize;*OPC?")
#         sys.stdout.write("Signal acquired.\n")
#
#         The "Signal acquired" message will be written after the
#         acquisition and processing is complete.  The *OPC? query is
#         appended to :DIGitize with a semi-colon (;), which
#         essentially ties it to the same thread in the parser.  It is
#         immediately dealt with once :DIGitize finishes and gives a "1"
#         back to the program (whether the program uses it or not),
#         allowing the program to move on.
#
# Other Notes:
#
# - If you DO NOT know when a trigger will occur, you will need to
#   set a very long time out (that is, TIME_TO_TRIGGER should be
#   very long).
#
# - Because it is essentially impossible to know how long
#   additional processing (for example FFT) will take ahead of
#   time, it CAN be beneficial to turn on such things AFTER the
#   signal is acquired.  Further, because much of this processing
#   is done in the Windows OS and memory space, there CAN be a
#   large variation in the post-acquisition processing time.
#   However, read the comments at PROCESSING_TIME for how to
#   actually measure this, and it can be accounted for.
#
# - The timeout will need to be (should be) adjusted before and
#   after the :DIGitize operation, though this is not absolutely
#   required.
#
# - A :DIGitize can be aborted with a device clear:
#   KsInfiniiumScope.clear()
#
#   The device clear itself can timeout.  Can happen if issued
#   after acquisition done, but scope is still processing a long
#   FFT, for example.  A few (10) seconds is usually plenty.
# =====
def blocking_method():

    KsInfiniiumScope.timeout = SCOPE_ACQUISITION_TIME_OUT
    # Time in milliseconds (PyVisa uses ms) to wait for the
    # oscilloscope to arm, trigger, finish acquisition, and finish
    # any processing.
    #
    # Note that this is a property of the device interface,
    # KsInfiniiumScope
    #
# If doing repeated acquisitions, this should be done BEFORE the
# loop, and changed again after the loop if the goal is to
# achieve the best throughput.

    sys.stdout.write("Acquiring signal(s)...\n")
    # Set up a try/except block to catch a possible timeout and exit.
    try:
        KsInfiniiumScope.query(":DIGitize;*OPC?")

```

```

        # Acquire the signal(s) with :DIGITize (blocking) and wait
        # until *OPC? comes back with a one.
        sys.stdout.write("Signal acquired.\n")
    # Catch a possible timeout and exit.
    except Exception:
        print "The acquisition timed out, most likely due to no " \
              "trigger or improper setup causing no trigger. " \
              "Properly closing the oscilloscope connection and " \
              "exiting script.\n"
        KsInfiniiumScope.clear() # Clear communications interface;
                                # A device clear also aborts digitize.
        KsInfiniiumScope.close() # Close communications interface
        sys.exit("Exiting script.")

    # Reset timeout back to what it was, GLOBAL_TOUT.
    KsInfiniiumScope.timeout = GLOBAL_TOUT

# =====
# Define a function using the non-blocking :SINGLE command and polling
# on the Processing Done Event Register
# -----
#
# Benefits of this method:
#
# - Don't have to worry about interface timeouts.
# - Easy to expand to know when the oscilloscope is armed.
#
# Drawbacks of this method:
#
# - Slow, as you don't want to poll the oscilloscope too fast.
#
# - Still need some maximum timeout (here MAX_TIME_TO_WAIT),
#   ideally, or the script will sit in the while loop forever if
#   there is no trigger event.
#
#   If using :PDER? max time out (here MAX_TIME_TO_WAIT) must also
#   account for any processing done (PROCESSING_TIME).
#
#   Max time out (here MAX_TIME_TO_WAIT) must also account for time
#   to arm the oscilloscope and finish the acquisition.
#
#   The script calculates this MAX_TIME_TO_WAIT as
#   SCOPE_ACQUISITION_TIME_OUT.
#
# - DOES NOT work for Equivalent time mode. MUST use the blocking
#   method.
#
# How it works:
#
# - Basically, clear the status registers with *CLS. Initiate the
#   acquisition with the non-blocking :SINGLE. Poll the
#   oscilloscope until the Processing Done Event Register comes
#   back with a 1, meaning that both the acquisition and any
#   enabled processing (FFTs, Math, jitter...) are done.
#
# Other Notes:

```

```

#
# - Instead of using the Processing Done Event Register, you could
#   use the Acquisition Done Event Register (see :ADER?). The
#   benefit here is that one could potentially determine WHEN a
#   trigger occurred, but only within 100 ms (the poll wait time -
#   also need to know how much time acquired after the trigger...)
#   You could also do :ADER? and then, when that comes back with a
#   1, do :PDER? possibly enabling processing in between...
#
#   Please note that for segmented memory mode, any processing would
#   happen only for the final segment.
#
#   Please note that for average acquisition mode, any processing
#   would happen only for the final averaged waveform.
# =====
def polling_method():

    MAX_TIME_TO_WAIT = SCOPE_ACQUISITION_TIME_OUT
    # Time in seconds to wait for the oscilloscope to arm, trigger,
    # finish acquisition, and finish any processing.
    #
    # Note that this is NOT a property of the device interface,
    # KsInfiniiumScope, but rather some constant in the script to be
    # used later with the Python module "time", and will be used with
    # time.clock().
    #
    # If using ADER (below), set PROCESSING_TIME = 0.

    # Define completion criterion:
    ACQ_DONE = 1
    ACQ_NOT_DONE = 0

    sys.stdout.write("Acquiring signal(s)...\n")
    # Clear all status registers (set them to 0). This could be
    # concatenated with the :SINGLE command two lines below to speed
    # things up a little, like this ->
    # KsInfiniiumScope.write("*CLS;:SINGLE")
    KsInfiniiumScope.write("*CLS")

    # Define acquisition start time. This is in seconds.
    StartTime = time.clock()

    # Begin acquisition with non-blocking :SINGLE command.
    KsInfiniiumScope.write(":SINGLE")
    # KsInfiniiumScope.write("*CLS;:SINGLE")
    # Recommended to concatenate these together for repeated
    # acquisition using this method as it goes slightly faster;
    # consider using method 1 instead if max throughput is desired

    # Immediately ask oscilloscope if it is done with the acquisition
    # and processing.
    Status = int(KsInfiniiumScope.query(":PDER?"))
    # NOTE: :ADER? could also be used, but :ADER does not cover any
    # processing. If using ADER, set PROCESSING_TIME = 0.
    #
    # NOTE: :PDER? not supported on older Infiniiums. Use :ADER?
    # instead.

```

```

# -----
# For Average mode, MUST use :ADER? (and then PDER if needed) -
# see "Other Notes" at bottom of this section.
#
# This needs to be changed in two places, one above here, and one
# below...
# -----

# Poll the oscilloscope until Status (:PDER?) is a one. (This is
# NOT a "Serial Poll.")
while Status == ACQ_NOT_DONE and \
    (time.clock() - StartTime <= MAX_TIME_TO_WAIT):
    # This loop is never entered if the acquisition completes
    # immediately. Exits if Status == 1 or MAX_TIME_TO_WAIT exceeded
    time.sleep(0.1) # Pause 100 ms to prevent excessive queries
    Status = int(KsInfiniiumScope.query(":PDER?")) # Read status
    # Loop exists when Status != NOT_DONE, that is, it exits the
    # loop when it is DONE

if Status == ACQ_DONE: # Acquisition fully completed
    sys.stdout.write("Signal acquired.\n")
else: # Acquisition failed for some reason
    print "Max wait time exceeded."
    print "This can happen if there was not enough time to arm the " \
        "oscilloscope, there was no trigger event, the " \
        "oscilloscope did not finish acquiring, or the " \
        "processing did not finish."
    print "Visually check the oscilloscope for a trigger, adjust " \
        "settings accordingly.\n"
    print "Properly closing the oscilloscope connection and " \
        "exiting the script.\n"

# Always stop the oscilloscope when making any changes.
KsInfiniiumScope.query(":STOP;*OPC?")
KsInfiniiumScope.clear() # Clear communications interface
KsInfiniiumScope.close() # Close communications interface
sys.exit("Exiting script.")

# =====
# Do Something with data... save, export, additional analysis...
# =====
def do_something_with_data():

    # For example, make a peak-peak voltage measurement on channel 1:
    Vpp_Ch1 = \
        str(KsInfiniiumScope.query("MEASure:VPP? CHANnel1")).strip("\n")
    # The result comes back with a newline, so remove it with .strip("\n")
    print "Vpp Ch1 = " + Vpp_Ch1 + " V\n"

# =====
# Main code
# =====

```

```

# Connect and initialize oscilloscope
# -----
# Define VISA Resource Manager & Install directory
rm = visa.ResourceManager('C:\\Windows\\System32\\visa32.dll')

# Define and open the oscilloscope using the VISA address
KsInfiniiumScope = rm.open_resource(VISA_ADDRESS)

# Set the Global Timeout
KsInfiniiumScope.timeout = GLOBAL_TOUT

# Clear the instrument bus
KsInfiniiumScope.clear()

# Clear all status registers and errors
KsInfiniiumScope.write("*CLS")

# Set up the oscilloscope
# -----
# Note that you would normally perform a reset (default setup) if you
# were to create the setup from scratch... But here we will use the
# oscilloscope "as is" for the most part.
# KsInfiniiumScope.query("*RST;*OPC?") # Resets the oscilloscope

# Always stop the oscilloscope when making any changes.
KsInfiniiumScope.query(":STOP;*OPC?")

# For this example, the oscilloscope will be forced to trigger on the
# (AC input power) LINE voltage so something happens.
# Always use normal trigger sweep, never auto.
KsInfiniiumScope.write(":TRIGger:SWEep TRIGgered")
# This line simply gives the oscilloscope something to trigger on.
KsInfiniiumScope.query(":TRIGger:EDGE:SOURce LINE;*OPC?")

# Clear the display (so you can see the waveform being acquired -
# otherwise, there is no need for this).
KsInfiniiumScope.write(":CDISplay")

# Calculate acquisition timeout/wait time by short, overestimate method
# -----

# Need to get some info
HO = float(KsInfiniiumScope.query(":TRIGger:HOLDoff?"))
SR = float(KsInfiniiumScope.query(":ACQuire:SRATe:ANALog?"))
N_SAMPLES = float(KsInfiniiumScope.query(":ACQuire:POINTs:ANALog?"))
# Note that the :WAVEform:POINTs? command will also return interpolated
# values, so it is not useful.
T_RANGE = N_SAMPLES / SR
# Note that using the :TIMEbase:RANGE? command really only tells us
# what the oscilloscope is on screen, but Infiniium can be set up to
# capture off-screen data.
T_POSITION = float(KsInfiniiumScope.query(":TIMEbase:POSition?"))

# Determine if Average mode is on
AVERAGE_MODE_STATE = \
    str(KsInfiniiumScope.query(":ACQuire:AVERAge?").strip("\n"))
if AVERAGE_MODE_STATE == "1":

```

```

    N_AVERAGES = \
        float(KsInfiniiumScope.query(":ACquire:AVERage:COUNT?"))
else:
    N_AVERAGES = 1

# Determine if Segmented Memory or Equivalent time modes are on.
ACQ_MODE = str(KsInfiniiumScope.query(":ACquire:MODE?").strip("\n"))
ETIME_MULTIPLIER = 1 # For Equivalent Time mode.
# This is a multiplier used as Equivalent time mode builds up over
# numerous acquisitions.
if ACQ_MODE == "SEGM" or ACQ_MODE == "SEGH":
    N_SEGMENTS = \
        float(KsInfiniiumScope.query(":ACquire:SEGmented:COUNT?"))
elif ACQ_MODE != "ETIM":
    N_SEGMENTS = 1
elif ACQ_MODE == "ETIM":
    N_SEGMENTS = 1
    ETIME_MULTIPLIER = 5 # Total guess. Few use this mode.
    sys.stdout.write("Timeout calculation of Equivalent time mode "
                    "not thoroughly tested.")

# Calculate timeout from above info.
# Recall that PyVISA timeouts are in ms, so multiply by 1000.
SCOPE_ACQUISITION_TIME_OUT = (float(TIME_TO_TRIGGER)*1.1 +
    float(PROCESSING_TIME)*1.2 +
    (T_RANGE*2.0 + abs(T_POSITION)*2.0 + HO*1.1 +
    float(TIME_BETWEEN_TRIGGERS)*1.1)*N_SEGMENTS*N_AVERAGES*
    ETIME_MULTIPLIER)*1000.0

# Ensure the timeout is no less than 10 seconds
if SCOPE_ACQUISITION_TIME_OUT < 10000.0:
    SCOPE_ACQUISITION_TIME_OUT = 10000.0

# Acquire Signal
# -----
# Choose blocking_method or polling_method. These were defined as
# functions in case you want to use them repeatedly.
blocking_method()
do_something_with_data()

polling_method()
do_something_with_data()

# End of Script
# -----
KsInfiniiumScope.clear() # Clear communications interface
KsInfiniiumScope.close() # Close communications interface
print "All done."

```

Single Shot Device Under Test (DUT)

The examples in the previous section (Acquisition Synchronization) assumed the DUT is continually running and, therefore, the oscilloscope will have more than one opportunity to trigger. With a single shot DUT, there is only one opportunity for the oscilloscope to trigger so it is necessary for the oscilloscope to be armed and ready before the DUT is enabled.

NOTE

The blocking `:DIGitize` command cannot be used for a single shot DUT because once the `:DIGitize` command is issued, the oscilloscope is blocked from any further commands until the acquisition is complete.

This example is the same as the previous example with the addition of checking for the armed event status.

Example

```

TIMEOUT = 1000ms
currentTime = 0ms

// Setup
:STOP; *OPC? // if not stopped
:ADER? // clear ADER event

// Acquire
:SINGLE

while(AER? == 0)
{
    wait(100ms)
}

//oscilloscope is armed and ready, enable DUT here

while(currentTime <= TIMEOUT)
{
    if (:ADER? == 1)
    {
        break;
    }
    else
    {
        // Use small wait to prevent excessive
        // queries to the oscilloscope
        wait (100ms)
        currentTime += 100ms
    }
}

//Get results
if (currentTime < TIMEOUT)
{
    :MEASure:RISetime?
}

```

Averaging Acquisition Synchronization

When averaging, it is necessary to know when the average count has been reached. Since an ADER/PDER event occurs for every acquisition in the average count, these commands cannot be used. The :SINGle command does not average.

If it is known that a trigger will occur, a :DIG will acquire the complete number of averages, but if the number of averages is large, it may cause a timeout on the connection.

The example below acquires the desired number of averages and then stops running.

```

Example  AVERAGE_COUNT = 256

:STOP;*OPC?
:TER?
:ACQ:AVERAge:COUNT AVERAGE_COUNT
:ACQ:AVERAge ON
:RUN

//Assume the oscilloscope will trigger, if not put a check here

while (:WAV:COUNT? < AVERAGE_COUNT)
{
    wait(100ms)
}

:STOP;*OPC?

// Get results

```

9 Programming Conventions

| | |
|---------------------------|-----|
| Truncation Rule / | 196 |
| The Command Tree / | 197 |
| Infinity Representation / | 200 |
| Response Generation / | 201 |
| EOI / | 202 |

This chapter describes conventions used to program the Infiniium-Series Oscilloscopes, and conventions used throughout this manual. A description of the command tree and command tree traversal is also included.

Truncation Rule

The truncation rule is used to produce the short form (abbreviated spelling) for the mnemonics used in the programming headers and parameter arguments.

NOTE

Command Truncation Rule

The mnemonic is the first four characters of the keyword, unless the fourth character is a vowel. Then the mnemonic is the first three characters of the keyword. If the length of the keyword is four characters or less, this rule does not apply, and the short form is the same as the long form.

This document's command descriptions shows how the truncation rule is applied to commands.

Table 5 Mnemonic Truncation

| Long Form | Short Form | How the Rule is Applied |
|-----------|------------|--|
| RANGe | RANG | Short form is the first four characters of the keyword. |
| PATTerN | PATT | Short form is the first four characters of the keyword. |
| DISK | DISK | Short form is the same as the long form. |
| DELaY | DEL | Fourth character is a vowel; short form is the first three characters. |

The Command Tree

The command tree in this document's table of contents shows all of the commands in the Infiniium-Series Oscilloscopes and the relationship of the commands to each other. The IEEE 488.2 common commands are not part of the command tree because they do not affect the position of the parser within the tree.

When a program message terminator (<NL>, linefeed - ASCII decimal 10) or a leading colon (:) is sent to the oscilloscope, the parser is set to the "root" of the command tree.

- **"Command Types"** on page 197
- **"Tree Traversal Rules"** on page 197
- **"Tree Traversal Examples"** on page 198

Command Types

The commands in this oscilloscope can be viewed as three types: common commands, root level commands, and subsystem commands.

- Common commands are commands defined by IEEE 488.2 and control some functions that are common to all IEEE 488.2 instruments. These commands are independent of the tree and do not affect the position of the parser within the tree. *RST is an example of a common command.
- Root level commands control many of the basic functions of the oscilloscope. These commands reside at the root of the command tree. They can always be parsed if they occur at the beginning of a program message or are preceded by a colon. Unlike common commands, root level commands place the parser back at the root of the command tree. AUToscale is an example of a root level command.
- Subsystem commands are grouped together under a common node of the command tree, such as the TIMEbase commands. You may select only one subsystem at a given time. When you turn on the oscilloscope initially, the command parser is set to the root of the command tree and no subsystem is selected.

Tree Traversal Rules

Command headers are created by traversing down the command tree. A legal command header from the command tree would be :TIMEbase:RANGe. This is referred to as a compound header. A compound header is a header made up of two or more mnemonics separated by colons. The compound header contains no spaces. The following rules apply to traversing the tree.

NOTE**Tree Traversal Rules**

A leading colon or a program message terminator (<NL> or EOI true on the last byte) places the parser at the root of the command tree. A leading colon is a colon that is the first character of a program header. Executing a subsystem command places the oscilloscope in that subsystem until a leading colon or a program message terminator is found.

In the command tree, use the last mnemonic in the compound header as a reference point (for example, RANGE). Then find the last colon above that mnemonic (TIMEbase:). That is the point where the parser resides. You can send any command below this point within the current program message without sending the mnemonics which appear above them (for example, REFERENCE).

Tree Traversal Examples

The WriteString() methods in the following examples are written using Visual Basic for Application (VBA) with the VISA COM library.

Example 1 Consider the following command:

```
myScope.WriteString ":CHANnel1:RANGe 0.5;OFFSet 0"
```

The colon between CHANnel1 and RANGe is necessary because :CHANnel1:RANGe is a compound command. The semicolon between the RANGe command and the OFFSet command is required to separate the two commands or operations. The OFFSet command does not need :CHANnel1 preceding it because the :CHANnel1:RANGe command sets the parser to the CHANnel1 node in the tree.

Example 2 Consider the following commands:

```
myScope.WriteString ":TIMEbase:REFerence CENTer;POSition 0.00001"
```

or

```
myScope.WriteString ":TIMEbase:REFerence CENTer"  
myScope.WriteString ":TIMEbase:POSition 0.00001"
```

In the first line of example 2, the "subsystem selector" is implied for the POSITION command in the compound command.

A second way to send these commands is shown in the second part of the example. Because the program message terminator places the parser back at the root of the command tree, you must reselect TIMEBASE to re-enter the TIMEBASE node before sending the POSITION command.

Example 3 Consider the following command:

```
myScope.WriteString ":TIMEbase:REFerence CENTer;;CHANnel1:OFFSet 0"
```

In this example, the leading colon before CHANnel1 tells the parser to go back to the root of the command tree. The parser can then recognize the :CHANnel1:OFFSet command and enter the correct node.

Infinity Representation

The representation for infinity for this oscilloscope is 9.99999E+37. This is also the value returned when a measurement cannot be made.

Response Generation

As defined by IEEE 488.2, query responses may be buffered for these reasons:

- When the query is parsed by the oscilloscope.
- When the computer addresses the oscilloscope to talk so that it may read the response.

This oscilloscope buffers responses to a query when the query is parsed.

EOI

The EOI bus control line follows the IEEE 488.2 standard without exception.

10 Acquire Commands

:ACquire:AVERage / 205
:ACquire[:AVERage]:COUNT / 206
:ACquire:BANDwidth / 207
:ACquire:BANDwidth:FRAME? / 209
:ACquire:BANDwidth:TESTLIMITS? / 210
:ACquire:COMplete / 211
:ACquire:COMplete:STATe / 213
:ACquire:HRESolution / 214
:ACquire:INTerpolate / 215
:ACquire:MODE / 216
:ACquire:POINts[:ANALog] – Memory depth / 218
:ACquire:POINts:AUTO / 220
:ACquire:POINts:DIGital? / 221
:ACquire:POINts:TESTLIMITS? / 222
:ACquire:REDge – RealEdge Channel Inputs (90000 Q-Series, Z-Series) / 223
:ACquire:RESPonse (90000A Series, 90000 X-Series, V-Series, 90000 Q-Series,
Z-Series) / 224
:ACquire:SEGmented:AUTOplay / 225
:ACquire:SEGmented:COUNt / 226
:ACquire:SEGmented:INDex / 227
:ACquire:SEGmented:PLAY / 228
:ACquire:SEGmented:PRATe / 229
:ACquire:SEGmented:TTAGs / 230
:ACquire:SRATe[:ANALog] – Analog Sample Rate / 231
:ACquire:SRATe[:ANALog]:AUTO / 232
:ACquire:SRATe:DIGital – Digital Channels Sample Rate / 233
:ACquire:SRATe:DIGital:AUTO / 234
:ACquire:SRATe:TESTLIMITS? / 235

The ACQUIRE subsystem commands set up conditions for executing a :DIGitize root level command to acquire waveform data. The commands in this subsystem select the type of data, the number of averages, and the number of data points.

:ACQUIRE:AVERAGE

Command :ACQUIRE:AVERAGE {{ON|1} | {OFF|0}}

The :ACQUIRE:AVERAGE command enables or disables averaging. When ON, the oscilloscope acquires multiple data values for each time bucket, and averages them. When OFF, averaging is disabled. To set the number of averages, use the :ACQUIRE:AVERAGE:COUNT command described next.

Averaging is not available in PDETECT mode.

The :MTEST:AVERAGE command performs the same function as this command.

Example This example turns averaging on.

```
myScope.WriteString ":ACQUIRE:AVERAGE ON"
```

Query :ACQUIRE:AVERAGE?

The :ACQUIRE:AVERAGE? query returns the current setting for averaging.

Returned Format [:ACQUIRE:AVERAGE] {1|0}<NL>

Example This example places the current settings for averaging into the string variable, strSetting, then prints the contents of the variable to the computer's screen.

```
Dim strSetting As String ' Dimension variable.
myScope.WriteString ":ACQUIRE:AVERAGE?"
strSetting = myScope.ReadString
Debug.Print strSetting
```

History Legacy command (existed before version 3.10).

:ACQUIRE[:AVERAGE]:COUNT

Command :ACQUIRE[:AVERAGE]:COUNT <count_value>

The :ACQUIRE[:AVERAGE]:COUNT command sets the number of averages for the waveforms. In the AVERAGE mode, the :ACQUIRE[:AVERAGE]:COUNT command specifies the number of data values to be averaged for each time bucket before the acquisition is considered complete for that time bucket.

The :MTEST:AVERAGE:COUNT command performs the same function as this command.

<count_value> An integer, 2 to 65,534, specifying the number of data values to be averaged.

Example This example specifies that 16 data values must be averaged for each time bucket to be considered complete. The number of time buckets that must be complete for the acquisition to be considered complete is specified by the :ACQUIRE:COMPLETE command.

```
myScope.WriteString ":ACQUIRE:COUNT 16"
```

Query :ACQUIRE[:AVERAGE]:COUNT?

The :ACQUIRE[:AVERAGE]:COUNT? query returns the currently selected count value.

Returned Format [:ACQUIRE[:AVERAGE]:COUNT] <value><NL>

<value> An integer, 2 to 65,534, specifying the number of data values to be averaged.

Example This example checks the currently selected count value and places that value in the string variable, strResult. The program then prints the contents of the variable to the computer's screen.

```
Dim strResult As String
myScope.WriteString ":SYSTEM:HEADER OFF"
myScope.WriteString ":ACQUIRE:AVERAGE:COUNT?"
strResult = myScope.ReadString
Debug.Print strResult
```

History Legacy command (existed before version 3.10).

:ACQUIRE:BANDwidth

Command :ACQUIRE:BANDwidth {AUTO | MAX | <bandwidth>}

The :ACQUIRE:BANDwidth command changes the bandwidth frequency control for the acquisition system.

- AUTO – The bandwidth is automatically selected based on the sample rate setting in order to make a good a trade-off between bandwidth, noise, and aliasing.
- MAX – Sets the oscilloscope to the hardware bandwidth limit and disables the bandwidth filter.
- <bandwidth> – a real number representing the bandwidth of the bandwidth filter whose range of values depends on the model number of your oscilloscope.

| Model | Band width Filter Values |
|-----------------------------------|---|
| DSOX/DSAX96204Q, DSAZ/DSOZ634A | The maximum bandwidth down to 1 GHz in 1 GHz increments. |
| DSOX/DSAX95004Q, DSAZ/DSOZ504A | |
| DSOX/DSAX93304Q, DSAZ/DSOZ334A | |
| DSOX/DSAX92504Q, DSAZ/DSOZ254A | |
| DSOX/DSAX92004Q, DSAZ/DSOZ204A | |
| DSOX/DSAX93204A | The maximum bandwidth down to 1 GHz in 1 GHz increments. |
| DSOX/DSAX92804A | |
| DSOX/DSAX92504A | |
| DSOX/DSAX92004A | |
| DSOX/DSAX91604A | |
| DSO/DSA91304A | 13E09, 12E09, 10E09, 8E09, 6E09, 4E09, 3E09, 2.5E09, 2E09, 1E09 |
| DSO/DSA91204A | 12E09, 10E09, 8E09, 6E09, 4E09, 3E09, 2.5E09, 2E09, 1E09 |
| DSO/DSA90804A | 8E09, 6E09, 4E09, 3E09, 2.5E09, 2E09, 1E09 |
| DSO/DSA90604A | 6E09, 4E09, 3E09, 2.5E09, 2E09, 1E09 |
| DSO/DSA90404A | 4E09, 3E09, 2.5E09, 2E09, 1E09 |
| DSO/DSA90254A | 2.5E09, 2E09, 1E09 |

| Model | Band width Filter Values |
|---------------|--|
| DSOS/MSOS804A | The maximum band width down to 500 MHz in 500 MHz increments, 250 MHz. |
| DSOS/MSOS604A | |
| DSOS/MSOS404A | |
| DSOS/MSOS254A | |
| DSOS/MSOS204A | |
| DSOS/MSOS104A | |
| DSOS/MSOS054A | |
| DSO/MSO9404A | 4E09, 3.5E09, 3E09, 2.5E09, 2E09, 1.5E09, 1E09, 5E08 |
| DSO/MSO9254A | 2.5E09, 2E09, 1.5E09, 1E09, 5E08 |
| DSO/MSO9104A | 1E09, 5E08 |
| DSO/MSO9064A | The command is not valid for this model oscilloscope. |

NOTE

The DSO/MSO 9000 Series oscilloscopes do not have AUTO and MAX modes. Sending the :ACQUIRE:BANDwidth command with these parameters disables the global band width limit. Sending the :ACQUIRE:BANDwidth command with specific band width values enables the global band width limit.

Query :ACQUIRE:BANDwidth?

The :ACQUIRE:BANDwidth? query returns the bandwidth setting of the bandwidth control.

Returned Format [:ACQUIRE:BANDwidth] <bandwidth><NL>

History New in version 3.10.

Version 4.00: Added a MAX option for selecting the maximum bandwidth.

:ACQuire:BA NDwidth:FRAMe?

Query :ACQuire:BA NDwidth:FRAMe?

The :ACQuire:BA NDwidth:FRAMe? query returns the maximum bandwidth associated with oscilloscope model.

Returned Format <bandwidth><NL>

<bandwidth> ::= max. BW of oscilloscope model

History New in version 5.20.

:ACQUIRE:BANDWIDTH:TESTLIMITS?

Query :ACQUIRE:BANDWIDTH:TESTLIMITS?

The :ACQUIRE:BANDWIDTH:TESTLIMITS? query returns the oscilloscope's acquisition bandwidth maximum and minimum limits.

Returned Format <num_parms>, <<type>><min>:<max><NL>

<num_parms> Number of parameters, always 1 for this query.

<type> Type of values returned, always "<numeric>" for this query.

<min> Lower bandwidth limit value.

<max> Upper bandwidth limit value.

- See Also**
- [":ACQUIRE:BANDWIDTH"](#) on page 207
 - [":ACQUIRE:BANDWIDTH:FRAME?"](#) on page 209
 - [":ACQUIRE:POINTS:TESTLIMITS?"](#) on page 222
 - [":ACQUIRE:SRATE:TESTLIMITS?"](#) on page 235

History New in version 5.60.

:ACQUIRE:COMPLETE

Command :ACQUIRE:COMPLETE <percent>

The :ACQUIRE:COMPLETE command specifies how many of the data point storage bins (time buckets) in the waveform record must contain a waveform sample before a measurement will be made. For example, if the command :ACQUIRE:COMPLETE 60 has been sent, 60% of the storage bins in the waveform record must contain a waveform data sample before a measurement is made.

- If :ACQUIRE:AVERAGE is set to OFF, the oscilloscope only needs one value per time bucket for that time bucket to be considered full.
- If :ACQUIRE:AVERAGE is set to ON, each time bucket must have n hits for it to be considered full, where n is the value set by :ACQUIRE:AVERAGE:COUNT.

Due to the nature of real time acquisition, 100% of the waveform record bins are filled after each trigger event, and all of the previous data in the record is replaced by new data when :ACQUIRE:AVERAGE is off. Hence, the complete mode really has no effect, and the behavior of the oscilloscope is the same as when the completion criteria is set to 100% (this is the same as in PDETECT mode). When :ACQUIRE:AVERAGE is on, all of the previous data in the record is replaced by new data.

The range of the :ACQUIRE:COMPLETE command is 0 to 100 and indicates the percentage of time buckets that must be full before the acquisition is considered complete. If the complete value is set to 100%, all time buckets must contain data for the acquisition to be considered complete. If the complete value is set to 0, then one acquisition cycle will take place. Completion is set by default setup or *RST to 90%. Autoscale changes it to 100%.

<percent> An integer, 0 to 100, representing the percentage of storage bins (time buckets) that must be full before an acquisition is considered complete.

Example This example sets the completion criteria for the next acquisition to 90%.

```
myScope.WriteString ":ACQUIRE:COMPLETE 90"
```

Query :ACQUIRE:COMPLETE?

The :ACQUIRE:COMPLETE? query returns the completion criteria.

Returned Format [:ACQUIRE:COMPLETE] <percent><NL>

<percent> An integer, 0 to 100, representing the percentage of time buckets that must be full before an acquisition is considered complete.

Example This example reads the completion criteria and places the result in the variable, varPercent. Then, it prints the content of the variable to the computer's screen.

```
myScope.WriteString ":SYSTEM:HEADER OFF"
myScope.WriteString ":ACQUIRE:COMPLETE?"
varPercent = myScope.ReadNumber
Debug.Print FormatNumber(varPercent, 0)
```

History Legacy command (existed before version 3.10).

:ACQUIRE:COMPLETE:STATE

Command :ACQUIRE:COMPLETE:STATE {{ON | 1} | {OFF | 0}}

The :ACQUIRE:COMPLETE:STATE command specifies whether acquisition averaging should complete before measurements are made.

This command maps to the **Wait for channel average to complete for measurements** check box in the front panel user interface's Measurement Setup dialog box, General tab.

NOTE

The :ACQUIRE:COMPLETE:STATE command is used only when the oscilloscope is running and a digitize operation is not being performed. The :DIGITIZE command temporarily overrides the setting of this mode and forces it to ON.

ON When ON, the oscilloscope waits for an acquisition average to complete before measurements are taken. If you have averaging enabled (using the :ACQUIRE:AVERAGE command), setting :ACQUIRE:COMPLETE:STATE ON forces the measurement calculations to wait until the average is computed. This lets you filter out noise in your waveform before measurements are made.

OFF When OFF, the oscilloscope makes measurements without waiting for an acquisition average to complete.

Query :ACQUIRE:COMPLETE:STATE?

The :ACQUIRE:COMPLETE:STATE? query returns the :ACQUIRE:COMPLETE:STATE setting.

History Legacy command (existed before version 3.10).

:ACQUIRE:HRESOLUTION

Command :ACQUIRE:HRESOLUTION {AUTO | BITS9 | BITS10 | BITS11 | BITS12}

When :ACQUIRE:MODE is set to HRESOLUTION or SEGHRes, the :ACQUIRE:HRESOLUTION command sets the desired minimum bit resolution.

- AUTO – the number of bits of vertical resolution is determined by the sampling rate, which can be controlled manually by the :ACQUIRE:SRATE:ANALOG command or automatically when adjusting :TIMEBASE:SCALE (or :TIMEBASE:RANGE).
- BITS9, BITS10, BITS11, BITS12 – selects the desired minimum number of bits of vertical resolution (which can affect the sampling rate).

NOTE

Some of the BITS settings may not be valid in certain 9000H Series models.

Example This example sets the bit resolution setting to a minimum of 11 bits.

```
myScope.WriteString ":ACQUIRE:HRESOLUTION BITS11"
```

Query :ACQUIRE:HRESOLUTION?

The :ACQUIRE:HRESOLUTION? query returns the bit resolution setting.

Returned Format [:ACQUIRE:HRESOLUTION] {AUTO | BITS9 | BITS10 | BITS11 | BITS12}<NL>

Example This example places the current bit resolution setting in the string variable, strBitRes, then prints the contents of the variable to the computer's screen.

```
Dim strBitRes As String ' Dimension variable.
myScope.WriteString ":ACQUIRE:HRESOLUTION?"
strBitRes = myScope.ReadString
Debug.Print strBitRes
```

- See Also**
- **" :ACQUIRE:MODE "** on page 216
 - **" :ACQUIRE:SRATE[:ANALOG] – Analog Sample Rate "** on page 231
 - **" :TIMEBASE:SCALE "** on page 1174
 - **" :TIMEBASE:RANGE "** on page 1169

History Legacy command (existed before version 3.10).

:ACQUIRE:INTERPOLATE

Command :ACQUIRE:INTERPOLATE {{ON | 1} | {OFF | 0} | INT1 | INT2 | INT4 | INT8
| INT16}

The :ACQUIRE:INTERPOLATE command turns the $\sin(x)/x$ interpolation filter on or off when the oscilloscope is in one of the real time sampling modes. You can also specify the 1, 2, 4, 8, or 16 point $\sin(x)/x$ interpolation ratios using INT1, INT2, INT4, INT8, or INT16. When ON, the number of interpolation points is automatically determined.

Query :ACQUIRE:INTERPOLATE?

The :ACQUIRE:INTERPOLATE? query returns the current state of the $\sin(x)/x$ interpolation filter control.

Returned Format [:ACQUIRE:INTERPOLATE] {1 | 0 | INT1 | INT2 | INT4 | INT8 | INT16}<NL>

History Legacy command (existed before version 3.10).

Version 3.10: Added the INT1, INT2, INT4, INT8, INT16 options for specifying the 1, 2, 4, 8, or 16 point $\sin(x)/x$ interpolation ratios.

:ACQuire:MODE

Command :ACQuire:MODE {ETIME | RTIME | PDETECT | HRESolution | SEGmented
| SEGPdetect | SEGHres}

The :ACQuire:MODE command sets the sampling/acquisition mode of the oscilloscope.

NOTE

In the 9000H Series oscilloscopes, HRESolution and SEGHres are the only valid options.

ETIME In Equivalent Time mode, the data record is acquired over multiple trigger events.

RTIME In Real Time Normal mode, the complete data record is acquired on a single trigger event.

PDETECT In Real Time Peak Detect mode, the oscilloscope acquires all of the waveform data points during one trigger event. The data is acquired at the fastest sample rate of the oscilloscope regardless of the horizontal scale setting. The sampling rate control then shows the storage rate into the channel memory rather than the sampling rate. The storage rate determines the number of data points per data region. From each data region, four sample points are chosen to be displayed for each time column. The four sample points chosen from each data region are:

- the minimum voltage value sample
- the maximum voltage value sample
- a randomly selected sample
- an equally spaced sample

The number of samples per data region is calculated using the equation:

$$\text{Number of Samples} = \frac{\text{Sampling Rate}}{\text{Storage Rate}}$$

The remainder of the samples are not used for display purposes.

HRESolution In Real Time High Resolution mode, the oscilloscope acquires all the waveform data points during one trigger event and averages them thus reducing noise and improving voltage resolution. The data is acquired at the fastest sample rate of the oscilloscope regardless of the horizontal scale setting. The sampling rate control then shows the storage rate into the channel memory rather than the sampling rate. The number of samples that are averaged together per data region is calculated using the equation

$$\text{Number of Samples} = \frac{\text{Sampling Rate}}{\text{Storage Rate}}$$

This number determines how many samples are averaged together to form the 16-bit samples that are stored into the channel memories.

To set the desired bits of vertical resolution, see **":ACquire:HRESolution"** on page 214.

SEGmented In this sampling mode you can view waveform events that are separated by long periods of time without capturing waveform events that are not of interest to you.

SEGPdetect Enables Peak Detect Segmented mode.

SEGHres Enables High Resolution Segmented mode.

To set the desired bits of vertical resolution, see **":ACquire:HRESolution"** on page 214.

Example This example sets the acquisition mode to Real Time Normal.

```
myScope.WriteString ":ACquire:MODE RTIME"
```

Query :ACquire:MODE?

The :ACquire:MODE? query returns the current acquisition sampling mode.

Returned Format [:ACquire:MODE] {ETIM | RTIM | PDET | HRES | SEGM | SEGP | SEGH}<NL>

Example This example places the current acquisition mode in the string variable, strMode, then prints the contents of the variable to the computer's screen.

```
Dim strMode As String ' Dimension variable.
myScope.WriteString ":ACquire:MODE?"
strMode = myScope.ReadString
Debug.Print strMode
```

History Legacy command (existed before version 3.10).

:ACQUIRE:POINTS[:ANALOG] – Memory depth

Command :ACQUIRE:POINTS[:ANALOG] {AUTO | <points_value>}

The :ACQUIRE:POINTS[:ANALOG] command sets the requested analog memory depth for an acquisition. Before you download data from the oscilloscope to your computer, always query the points value with the :WAVEFORM:POINTS? query or :WAVEFORM:PREAmble? query to determine the actual number of acquired points.

You can set the points value to AUTO, which allows the oscilloscope to select the optimum memory depth and display update rate.

<points_value> An integer representing the memory depth.

The range of points available for a channel depends on the oscilloscope settings of sampling mode, sampling rate, and trigger sweep.

Interaction between :ACQUIRE:SRATE[:ANALOG] and :ACQUIRE:POINTS[:ANALOG] If you assign a sample rate value with :ACQUIRE:SRATE[:ANALOG] or a points value using :ACQUIRE:POINTS[:ANALOG] the following interactions will occur. "Manual" means you are setting a non-AUTO value for SRATE or POINTS.

| SRATE | POINTS | Result |
|--------|--------|--|
| AUTO | Manual | POINTS value takes precedence (sample rate is limited) |
| Manual | AUTO | SRATE value takes precedence (memory depth is limited) |
| Manual | Manual | SRATE value takes precedence (memory depth is limited) |

Example This example sets the memory depth to 500 points.

```
myScope.WriteString ":ACQUIRE:POINTS:ANALOG 500"
```

Query :ACQUIRE:POINTS[:ANALOG]?

The :ACQUIRE:POINTS[:ANALOG]? query returns the value of the analog memory depth control.

Returned Format [:ACQUIRE:POINTS:ANALOG] <points_value><NL>

Example This example checks the current setting for memory depth and places the result in the variable, varLength. Then the program prints the contents of the variable to the computer's screen.

```
myScope.WriteString ":SYSTEM:HEADER OFF"
myScope.WriteString ":ACQUIRE:POINTS:ANALOG?"
varLength = myScope.ReadNumber
Debug.Print FormatNumber(varLength, 0)
```

See Also • [":WAVEFORM:DATA?"](#) on page 1391

History Legacy command (existed before version 3.10).

:ACQUIRE:POINTS:AUTO

Command :ACQUIRE:POINTS:AUTO {{ON | 1} | {OFF | 0}}

The :ACQUIRE:POINTS:AUTO command enables (automatic) or disables (manual) the automatic memory depth selection control. When enabled, the oscilloscope chooses a memory depth that optimizes the amount of waveform data and the display update rate. When disabled, you can select the amount of memory using the :ACQUIRE:POINTS command.

Example This example sets the automatic memory depth control to off.

```
myScope.WriteString ":ACQUIRE:POINTS:AUTO OFF"
```

Query :ACQUIRE:POINTS:AUTO?

The :ACQUIRE:POINTS:AUTO? query returns the automatic memory depth control state.

Returned Format [:ACQUIRE:POINTS:AUTO] {1 | 0}<NL>

Example This example checks the current setting for automatic memory depth control and places the result in the variable, varState. Then the program prints the contents of the variable to the computer's screen.

```
myScope.WriteString ":SYSTEM:HEADER OFF"
myScope.WriteString ":ACQUIRE:POINTS:AUTO?"
varState = myScope.ReadNumber
Debug.Print FormatNumber(varState, 0)
```

See Also :WAVEFORM:DATA?

History Legacy command (existed before version 3.10).

:ACQUIRE:POINTS:DIGITAL?

Query :ACQUIRE:POINTS:DIGITAL?

The :ACQUIRE:POINTS:DIGITAL query returns the current memory depth for the digital channels (MSO models only).

History Legacy command (existed before version 3.10).

:ACQuire:POINts:TESTLIMITS?

Query :ACQuire:POINts:TESTLIMITS?

The :ACQuire:POINts:TESTLIMITS? query returns the oscilloscope's acquisition points maximum and minimum limits.

Returned Format <num_parms>,<<type>><min>:<max><NL>

<num_parms> Number of parameters, always 1 for this query.

<type> Type of values returned, always "<numeric>" for this query.

<min> Lower points limit value.

<max> Upper points limit value.

- See Also**
- [":ACQuire:POINts\[:ANALog\] – Memory depth"](#) on page 218
 - [":ACQuire:POINts:AUTO"](#) on page 220
 - [":ACQuire:BANDwidth:TESTLIMITS?"](#) on page 210
 - [":ACQuire:SRATe:TESTLIMITS?"](#) on page 235

History New in version 5.60.

:ACQUIRE:REDGe – RealEdge Channel Inputs (90000 Q-Series, Z-Series)

Command

NOTE

This command is available for the 90000 Q-Series and Z-Series models whose bandwidths are greater than 33 GHz.

```
:ACQUIRE:REDGe {{ON | 1} | {OFF | 0}}
```

The :ACQUIRE:REDGe command enables or disables the RealEdge channel inputs.

When RealEdge channel inputs are enabled, the :CHANNEL1 and :CHANNEL3 commands/queries work for the oscilloscope's 1R and 3R channel inputs, and the :CHANNEL2 and :CHANNEL4 commands give "hardware missing" or "undefined header" messages.

Also when RealEdge channel inputs are enabled:

- The sampling rate is fixed at 160 GSa/s.
- Real Time Normal is the only acquisition mode available.

Example This example enables the RealEdge channel inputs.

```
myScope.WriteString ":ACQUIRE:REDGe ON"
```

Query :ACQUIRE:REDGe?

The :ACQUIRE:REDGe? query returns the current setting for RealEdge channel inputs.

Returned Format [:ACQUIRE:REDGe] {1 | 0}<NL>

Example This example places the current setting for RealEdge channel inputs in the string variable, strRealEdge, then prints the contents of the variable to the computer's screen.

```
Dim strRealEdge As String ' Dimension variable.
myScope.WriteString ":ACQUIRE:REDGe?"
strSample = myScope.ReadString
Debug.Print strRealEdge
```

History New in version 4.00.

:ACQUIRE:RESPONSE (90000A Series, 90000 X-Series, V-Series, 90000 Q-Series, Z-Series)

Command :ACQUIRE:RESPONSE {FLATmag | GAUSSsianmag}

The Flat Magnitude filter is the default one and is the filter typically used on Infiniium oscilloscopes. The Gaussian Magnitude filter eliminates all ringing (preshoot or overshoot) caused by the oscilloscope's response. Therefore, any ringing you see in the displayed signal is actually in your signal and is not caused by the oscilloscope. The main drawback to using the Gaussian Magnitude Filter is the decrease in bandwidth. Please consult the Flat Magnitude / Magnitude Magnitude Filters topic in the help system for specific information regarding the decrease in bandwidth.

Example This example turns on the Gaussian Magnitude filter.

```
myScope.WriteString ":ACQUIRE:RESPONSE GAUSSsianmag"
```

Query :ACQUIRE:RESPONSE?

The :ACQUIRE:RESPONSE? query returns the current filter being used.

Returned Format [:ACQUIRE:POINTS:AUTO] {FLATmag | NGAUSSsianmag}<NL>

Example This example checks the current filter setting and places the result in the variable, state. Then the program prints the contents of the variable to the computer's screen.

```
myScope.WriteString ":SYSTEM:HEADER OFF"
myScope.WriteString ":ACQUIRE:RESPONSE?"
varState = myScope.ReadNumber
Debug.Print FormatNumber(varState, 0)
```

History Legacy command (existed before version 3.10).

:ACQUIRE:SEGMENTED:AUTOPLAY

Command :ACQUIRE:SEGMENTED:AUTOPLAY {{0 | OFF} | {1 | ON}}

The :ACQUIRE:SEGMENTED:AUTOPLAY command specifies whether segments are automatically played after a segmented memory acquisition.

Query :ACQUIRE:SEGMENTED:AUTOPLAY?

The :ACQUIRE:SEGMENTED:AUTOPLAY? query returns the segmented memory autoplay setting.

Returned Format <setting><NL>

<setting> ::= {0 | 1}

- See Also**
- **"ACQUIRE:MODE"** on page 216
 - **"ACQUIRE:SEGMENTED:PLAY"** on page 228
 - **"ACQUIRE:SEGMENTED:PRATE"** on page 229
 - **"ACQUIRE:SEGMENTED:COUNT"** on page 226
 - **"ACQUIRE:SEGMENTED:INDEX"** on page 227
 - **"ACQUIRE:SEGMENTED:TTAGS"** on page 230

History New in version 6.00.

:ACQUIRE:SEGMENTED:COUNT

Command :ACQUIRE:SEGMENTED:COUNT <#segments>

The :ACQUIRE:SEGMENTED:COUNT command sets the number of segments to acquire in the segmented memory mode.

<#segments> An integer representing the number of segments to acquire.

Example This example sets the segmented memory count control to 1000.

```
myScope.WriteString ":ACQUIRE:SEGMENTED:COUNT 1000"
```

Query :ACQUIRE:SEGMENTED:COUNT?

The :ACQUIRE:SEGMENTED:COUNT? query returns the number of segments control value.

Returned Format [:ACQUIRE:SEGMENTED:COUNT] <#segments><NL>

Example This example checks the current setting for segmented memory count control and places the result in the variable, varSegments. Then the program prints the contents of the variable to the computer's screen.

```
myScope.WriteString ":SYSTEM:HEADER OFF"
myScope.WriteString ":ACQUIRE:SEGMENTED:COUNT?"
varSegments = myScope.ReadNumber
Debug.Print FormatNumber(varSegments, 0)
```

See Also

- [":ACQUIRE:SEGMENTED:INDEX"](#) on page 227
- [":ACQUIRE:SEGMENTED:PLAY"](#) on page 228
- [":ACQUIRE:SEGMENTED:TTAGS"](#) on page 230

History Legacy command (existed before version 3.10).

:ACQUIRE:SEGMENTED:INDEX

Command :ACQUIRE:SEGMENTED:INDEX <index#>

The :ACQUIRE:SEGMENTED:INDEX command sets the index number for the segment that you want to display on screen in the segmented memory mode. If an index value larger than the total number of acquired segments is sent, an error occurs indicating that the data is out of range and the segment index is set to the maximum segment number.

<index#> An integer representing the index number of the segment that you want to display.

Example This example sets the segmented memory index number control to 1000.

```
myScope.WriteString ":ACQUIRE:SEGMENTED:INDEX 1000"
```

Query :ACQUIRE:SEGMENTED:INDEX?

The :ACQUIRE:SEGMENTED:INDEX? query returns the segmented memory index number control value.

Returned Format [:ACQUIRE:SEGMENTED:INDEX] <index#><NL>

Example This example checks the current setting for segmented memory index number control and places the result in the variable, varIndex. Then the program prints the contents of the variable to the computer's screen.

```
myScope.WriteString ":SYSTEM:HEADER OFF"
myScope.WriteString ":ACQUIRE:SEGMENTED:INDEX?"
varIndex = myScope.ReadNumber
Debug.Print FormatNumber(varIndex, 0)
```

See Also

- [":ACQUIRE:SEGMENTED:COUNT"](#) on page 226
- [":ACQUIRE:SEGMENTED:PLAY"](#) on page 228
- [":ACQUIRE:SEGMENTED:TTAGs"](#) on page 230

History Legacy command (existed before version 3.10).

:ACQUIRE:SEGMENTED:PLAY

Command :ACQUIRE:SEGMENTED:PLAY {{0 | OFF} | {1 | ON}}

The :ACQUIRE:SEGMENTED:PLAY command plays (or stops) acquired segments.

- ON – is the same as clicking the play button in the graphical user interface.
- OFF – is the same as clicking the stop button in the graphical user interface.

Playing acquired segments can take a while depending on the analysis taking place. You can query to determine when playing is complete.

Query :ACQUIRE:SEGMENTED:PLAY?

The :ACQUIRE:SEGMENTED:PLAY? query returns whether segments are currently being played (1) or are stopped (0).

Returned Format [:ACQUIRE:SEGMENTED:PLAY] <setting><NL>

<setting> ::= {0 | 1}

- See Also**
- [":ACQUIRE:SEGMENTED:PRATE"](#) on page 229
 - [":ACQUIRE:SEGMENTED:COUNT"](#) on page 226
 - [":ACQUIRE:SEGMENTED:INDEX"](#) on page 227
 - [":ACQUIRE:SEGMENTED:TTAGS"](#) on page 230

History New in version 5.60.

:ACQUIRE:SEGMENTED:PRATE

Command :ACQUIRE:SEGMENTED:PRATE <time_per_seg>

<time_per_seg> ::= seconds from 0.001 to 1 in NR3 format.

The :ACQUIRE:SEGMENTED:PRATE command specifies the segmented memory navigation play rate.

When playing segments, the current segment through the last segment are displayed at the specified rate. Playing segments lets you collect measurement statistics across all the played-back segments.

Query :ACQUIRE:SEGMENTED:PRATE?

The :ACQUIRE:SEGMENTED:PRATE? query returns segmented memory navigation play rate.

Returned Format <time_per_seg><NL>

See Also · **" :ACQUIRE:SEGMENTED:PLAY "** on page 228

History New in version 5.70.

:ACQUIRE:SEGMENTED:TTAGS

Command :ACQUIRE:SEGMENTED:TTAGS {{ON | 1} | {OFF | 0}}

The :ACQUIRE:SEGMENTED:TTAGS command turns the time tags feature on or off for the segmented memory sampling mode.

Example This example turns the time tags on for segmented memory.

```
myScope.WriteString ":ACQUIRE:SEGMENTED:TTAGS ON"
```

Query :ACQUIRE:SEGMENTED:TTAGS?

The :ACQUIRE:SEGMENTED:TTAGS? query returns the segmented memory time tags control value.

Returned Format [:ACQUIRE:SEGMENTED:TTAGS] {1 | 0}<NL>

Example This example checks the current setting for segmented memory time tags control and places the result in the variable, varTimeTags. Then the program prints the contents of the variable to the computer's screen.

```
myScope.WriteString ":SYSTEM:HEADER OFF"
myScope.WriteString ":ACQUIRE:SEGMENTED:TTAGS?"
varTimeTags = myScope.ReadNumber
Debug.Print FormatNumber(varTimeTags, 0)
```

See Also

- [":ACQUIRE:SEGMENTED:COUNT"](#) on page 226
- [":ACQUIRE:SEGMENTED:INDEX"](#) on page 227
- [":ACQUIRE:SEGMENTED:PLAY"](#) on page 228

History Legacy command (existed before version 3.10).

:ACQUIRE:SRATE[:ANALOG] – Analog Sample Rate

Command :ACQUIRE:SRATE[:ANALOG] {AUTO | MAX | <rate>}

The :ACQUIRE:SRATE[:ANALOG] command sets the analog acquisition sampling rate.

AUTO The AUTO rate allows the oscilloscope to select a sample rate that best accommodates the selected memory depth and horizontal scale.

MAX The MAX rate enables the oscilloscope to select maximum available sample rate.

<rate> A real number representing the sample rate. You can send any value, but the value is rounded to the next fastest sample rate.

Interaction between :ACQUIRE:SRATE[:ANALOG] and :ACQUIRE:POINTS[:ANALOG] If you assign a sample rate value with :ACQUIRE:SRATE[:ANALOG] or a points value using :ACQUIRE:POINTS[:ANALOG] the following interactions will occur. "Manual" means you are setting a non-AUTO value for SRATE or POINTS.

| SRATE | POINTS | Result |
|--------|--------|--|
| AUTO | Manual | POINTS value takes precedence (sample rate is limited) |
| Manual | AUTO | SRATE value takes precedence (memory depth is limited) |
| Manual | Manual | SRATE value takes precedence (memory depth is limited) |

Example This example sets the sample rate to 250 MSa/s.

```
myScope.WriteString ":ACQUIRE:SRATE:ANALOG 250E+6"
```

Query :ACQUIRE:SRATE[:ANALOG]?

The :ACQUIRE:SRATE[:ANALOG]? query returns the current analog acquisition sample rate.

Returned Format [:ACQUIRE:SRATE:ANALOG] {<rate>}<NL>

Example This example places the current sample rate in the string variable, strSample, then prints the contents of the variable to the computer's screen.

```
Dim strSample As String ' Dimension variable.
myScope.WriteString ":ACQUIRE:SRATE:ANALOG?"
strSample = myScope.ReadString
Debug.Print strSample
```

History Legacy command (existed before version 3.10).

:ACQUIRE:SRATE[:ANALOG]:AUTO

Command :ACQUIRE:SRATE[:ANALOG]:AUTO {{ON | 1} | {OFF | 0}}

The :ACQUIRE:SRATE[:ANALOG]:AUTO command enables (ON) or disables (OFF) the automatic analog sampling rate selection control. On the oscilloscope front-panel interface, ON is equivalent to Automatic and OFF is equivalent to Manual.

Example This example changes the sampling rate to manual.

```
myScope.WriteString ":ACQUIRE:SRATE:ANALOG:AUTO OFF"
```

Query :ACQUIRE:SRATE[:ANALOG]:AUTO?

The :ACQUIRE:SRATE[:ANALOG]:AUTO? query returns the current acquisition sample rate.

Returned Format [:ACQUIRE:SRATE:ANALOG:AUTO] {1 | 0}<NL>

Example This example places the current analog sample rate in the variable, varSample, then prints the contents of the variable to the computer's screen.

```
myScope.WriteString ":SYSTEM:HEADER OFF"
myScope.WriteString ":ACQUIRE:SRATE:ANALOG:AUTO?"
varSample = myScope.ReadNumber
Debug.Print FormatNumber(varSample, 0)
```

History Legacy command (existed before version 3.10).

:ACQUIRE:SRATE:DIGITAL – Digital Channels Sample Rate

| | |
|--|---|
| Command | <code>:ACQUIRE:SRATE:DIGITAL {AUTO MAX <rate>}</code> |
| | The <code>:ACQUIRE:SRATE:DIGITAL</code> command sets the digital acquisition sampling rate. |
| AUTO | The AUTO rate allows the oscilloscope to select a sample rate that best accommodates the selected memory depth and horizontal scale. |
| MAX | The MAX rate enables the oscilloscope to select maximum available sample rate. |
| <rate> | A real number representing the digital sample rate. You can send any value, but the value is rounded to the next fastest sample rate. |
| Interaction between :ACQUIRE:SRATE:DIGITAL and :ACQUIRE:POINTS:DIGITAL? | If you assign a sample rate value with <code>:ACQUIRE:SRATE:DIGITAL</code> , the digital memory depth is automatically adjusted and can be seen by using the <code>:ACQUIRE:POINTS:DIGITAL?</code> query. |
| Query | <code>:ACQUIRE:SRATE:DIGITAL?</code> |
| | The <code>:ACQUIRE:SRATE:DIGITAL?</code> query returns the current digital acquisition sample rate. |
| Returned Format | <code>[:ACQUIRE:SRATE:DIGITAL] {<rate>}<NL></code> |
| Example | This example places the current digital channel sample rate in the string variable, <code>strSample</code> , then prints the contents of the variable to the computer's screen. |
| | <pre>Dim strSample As String ' Dimension variable. myScope.WriteString ":ACQUIRE:SRATE:DIGITAL?" strSample = myScope.ReadString Debug.Print strSample</pre> |
| History | Legacy command (existed before version 3.10). |

:ACQUIRE:SRATE:DIGITAL:AUTO

Command :ACQUIRE:SRATE:DIGITAL:AUTO {{ON | 1} | {OFF | 0}}

The :ACQUIRE:SRATE:DIGITAL:AUTO command enables (ON) or disables (OFF) the automatic digital channel sampling rate selection control.

Example This example changes the digital channel sampling rate to manual.

```
myScope.WriteString ":ACQUIRE:SRATE:DIGITAL:AUTO OFF"
```

Query :ACQUIRE:SRATE:DIGITAL:AUTO?

The :ACQUIRE:SRATE:DIGITAL:AUTO? query returns the current digital channel acquisition sample rate.

Returned Format [:ACQUIRE:SRATE:DIGITAL:AUTO] {1 | 0}<NL>

Example This example places the current digital channel sample rate in the variable, varSample, then prints the contents of the variable to the computer's screen.

```
myScope.WriteString ":SYSTEM:HEADER OFF"
myScope.WriteString ":ACQUIRE:SRATE:DIGITAL:AUTO?"
varSample = myScope.ReadNumber
Debug.Print FormatNumber(varSample, 0)
```

History Legacy command (existed before version 3.10).

:ACQuire:SRATe:TESTLIMITS?

Query :ACQuire:SRATe:TESTLIMITS?

The :ACQuire:SRATe:TESTLIMITS? query returns the oscilloscope's acquisition sampling rate maximum and minimum limits.

Returned Format <num_parms>,<<type>><min>:<max><NL>

<num_parms> Number of parameters, always 1 for this query.

<type> Type of values returned, always "<numeric>" for this query.

<min> Lower sample rate limit value.

<max> Upper sample rate limit value.

- See Also**
- [":ACQuire:SRATe\[:ANALog\] – Analog Sample Rate"](#) on page 231
 - [":ACQuire:SRATe\[:ANALog\]:AUTO"](#) on page 232
 - [":ACQuire:BANDwidth:TESTLIMITS?"](#) on page 210
 - [":ACQuire:POINTs:TESTLIMITS?"](#) on page 222

History New in version 5.60.

11 Analyze Commands

:ANALyze:AEDGes / 239
:ANALyze:CLOCK / 240
:ANALyze:CLOCK:METHod / 241
:ANALyze:CLOCK:METHod:ALIGn / 244
:ANALyze:CLOCK:METHod:DEEMphasis / 246
:ANALyze:CLOCK:METHod:EDGE / 247
:ANALyze:CLOCK:METHod:JTF / 249
:ANALyze:CLOCK:METHod:OJTF / 252
:ANALyze:CLOCK:METHod:PLLTrack / 255
:ANALyze:CLOCK:METHod:SKEW / 256
:ANALyze:CLOCK:METHod:SOURce / 257
:ANALyze:CLOCK:VERTical / 258
:ANALyze:CLOCK:VERTical:OFFSet / 259
:ANALyze:CLOCK:VERTical:RANGe / 260
:ANALyze:SIGNal:DATarate / 261
:ANALyze:SIGNal:SYMBOLrate / 263
:ANALyze:SIGNal:MIXer:CABLEloss / 265
:ANALyze:SIGNal:MMWave:CALibrate / 266
:ANALyze:SIGNal:MMWave:CFRequency / 267
:ANALyze:SIGNal:MMWave:CONNect / 268
:ANALyze:SIGNal:MMWave:LOADdress / 269
:ANALyze:SIGNal:MMWave:MBANdwidth / 270
:ANALyze:SIGNal:TYPE / 271
:ANALyze:VIEW / 273

The commands in the ANALyze subsystem are used to:

- Specify whether to use a single edge or all edges in the acquisition for horizontal measurements (:ANALyze:AEDGes command).
- Set up clock recovery (:ANALyze:CLOCK commands).
- Specify a waveform source's signal type:

- The PAM4 signal type sets up a new paradigm for serial data signal analysis with multiple data levels and edges for clock recovery (as compared to high and low level NRZ signals).
- The MMWave signal type supports analysis of millimeter-wave signals that have been down-converted to IF band signals by an external smart mixer and an LO signal from a signal generator.
- Support MMWave millimeter-wave signal analysis.
- Specify whether to use the data on screen or the entire acquisition for measurements, functions, and analysis (:ANALyze:VIEW command).

The :ANALyze:CLOCK commands are available when the High Speed Serial Software or the Jitter Analysis Software is installed.

:ANALyze:AEDGes

Command :ANALyze:AEDGes {{0 | OFF} | {1 | ON}}

The :ANALyze:AEDGes command specifies whether a single edge or all edges in the acquisition are used for horizontal measurements.

The :ANALyze:AEDGes command maps to the "Measure All Edges" control in the user interface's Measurement Setup dialog box only.

When all edges in an acquisition are used for horizontal measurements, the entire acquisition is also used for measurements, functions, and analysis (see :ANALyze:VIEW ALL).

Query :ANALyze:AEDGes?

The :ANALyze:AEDGes? query returns the value that is currently set.

Returned Format [:ANALyze:AEDGes] {0 | 1}<NL>

See Also • [":ANALyze:VIEW"](#) on page 273

History New in version 5.30. This commands replaces the now deprecated command [":MEASure:JITTer:STATistics"](#) on page 1535.

:ANALyze:CLOCK

Command

NOTE

:ANALyze:CLOCK commands are available when clock recovery is used by licensed software (like the E2688A High Speed Serial software or the N5400A/N5401A EZJIT Plus jitter analysis software).

```
:ANALyze:CLOCK {{ON|1}, <source>} | {OFF|0}}
<source> ::= {CHANnel<N> | DIFF<D> | COMMONmode<C> | FUNCTION<F>
             | WMEMory<R>}
```

The :ANALyze:CLOCK command turns the recovered clock display on or off and sets the clock recovery channel source.

<N> An integer, 1-4 in a single oscilloscope, 1-40 in a MultiScope system.

<D>, <C> <D> is an integer, 1-2. <C> is an integer, 3-4.

The DIFF and COMMONmode sources are just aliases that can be used in place of the channel names to apply to differential or common mode signals. These are just aliases - no state change occurs if you refer to a differential channel and you are not in differential mode. DIFF1 refers to the differential signal between channels 1 and 3 (and COMMONmode3 refers to the common mode channel between these same channels). DIFF2 refers to the differential signal between channels 2 and 4 (and COMMONmode4 refers to the common mode channel between these same channels).

<F> An integer, 1-16.

<R> An integer, 1-4.

Example This example turns the recovered clock display on for channel 1.

```
myScope.WriteString ":ANALyze:CLOCK ON, CHANnel1"
```

Query :ANALyze:CLOCK?

The :ANALyze :CLOCK? query returns the state of the recovered clock display.

Returned Format [:ANALyze:CLOCK] {1 | 0}<NL>

Example This example places the current setting of the recovered clock display in the variable varSetting, then prints the contents of the variable to the computer's screen.

```
myScope.WriteString ":SYSTEM:HEADer OFF"
myScope.WriteString ":ANALyze:CLOCK?"
varSetting = myScope.ReadNumber
Debug.Print FormatNumber(varSetting, 0)
```

History New in version 5.30. This command replaces the now deprecated command **":MEASure:CLOCK"** on page 1514.

:ANALyze:CLOCK:METHOD

Command

NOTE

:ANALyze:CLOCK commands are available when clock recovery is used by licensed software (like the E2688A High Speed Serial software or the N5400A/N5401A EZJIT Plus jitter analysis software).

```
:ANALyze:CLOCK:METHOD
  {FC,{FC1063 | FC2125 | FC425}}
  | {EXPLICIT,<source>,{RISING | FALLING | BOTH}[,<multiplier>]}
  | {FIXED,{AUTO | {SEMI[,<data_rate>]} | <data_rate>}}
  | {FLEXR,<baud_rate>}
  | {FLEXT,<baud_rate>}
  | {PWM}
  | {CPHY[,<symbol_rate>[,<setup_UI>]]}
```

The :ANALyze:CLOCK:METHOD command sets the clock recovery method to:

- FC (Fibre Channel).
- EXPLICIT (Explicit Clock).
- FIXED (Constant Frequency).
- FLEXR (FlexRay Receiver).
- FLEXT (FlexRay Transmitter).
- PWM (MIPI M-PHY PWM)
- CPHY (MIPI C-PHY)

This command applies to the clock recovery method being set up for the waveform source selected by the :ANALyze:CLOCK:METHOD:SOURce command.

For setting phase-locked loop (PLL) clock recovery methods in terms of the Observed Jitter Transfer Function (OJTF), see **":ANALyze:CLOCK:METHOD:OJTF"** on page 252.

For setting phase-locked loop (PLL) clock recovery methods in terms of the Jitter Transfer Function (JTF), see **":ANALyze:CLOCK:METHOD:JTF"** on page 249.

<source> {CHANnel<N> | FUNCTION<F> | WMemory<R> | EQUALized}

<N> An integer, 1-4 in a single oscilloscope, 1-40 in a MultiScope system.

<F> An integer, 1-16.

<R> An integer, 1-4.

<data_rate> A real number for the base data rate in Hertz.

When the signal type is PAM-4 (see :ANALyze:SIGNal:TYPE), a symbol rate (baud) is specified instead of a data rate (b/s).

<multiplier> An integer used as the multiplication factor.

- <baud_rate>** A real number used for the baud rate.
- <symbol_rate>** When the signal type is CPHY (see :ANALyze:SIGNal:TYPE), CPHY is automatically selected as the clock recovery method, but you can use the :ANALyze:CLOCK:METHOD CPHY command to specify the nominal a symbol rate in baud.
- <setup_UI>** When the signal type is CPHY (see :ANALyze:SIGNal:TYPE), CPHY is automatically selected as the clock recovery method, but you can use the :ANALyze:CLOCK:METHOD CPHY command to specify the time (in Unit Intervals) used to cluster edges for clock recovery.

Example This example sets the explicit clock recovery method on channel 1, rising edge, with a multiplier of 2.

```
myScope.WriteString ":ANALyze:CLOCK:METHOD EXPLICIT,CHANnel1,RISing,2"
```

Query :ANALyze:CLOCK:METHOD?

The :ANALyze:CLOCK:METHOD? query returns the state of the clock recovery method.

NOTE

You can use the :ANALyze:CLOCK:METHOD? query when phase-locked loop (PLL) clock recovery methods are set up. The format returned will be that of the :ANALyze:CLOCK:METHOD:OJTF? query. See **" :ANALyze:CLOCK:METHOD:OJTF "** on page 252.

Returned Format [:ANALyze:CLOCK:METHOD]
 {FC,{FC1063 | FC2125 | FC425}}
 | {EXPLICIT,<source>,{RISing | FALLing | BOTH},<multiplier>}
 | {FIXed,{AUTO | {SEMI,<data_rate>} | <data_rate>}}
 | {FLEXR,<baud_rate>}
 | {FLEXT,<baud_rate>}
 | {PWM}
 | {CPHY,<symbol_rate>,<setup_UI>}

Example This example places the current setting of the clock recovery method in the variable strSetting, then prints the contents of the variable to the computer's screen.

```
myScope.WriteString ":SYSTEM:HEADer OFF"  
myScope.WriteString ":ANALyze:CLOCK:METHOD?"  
strSetting = myScope.ReadString  
Debug.Print strSetting
```

- See Also**
- **" :ANALyze:CLOCK:METHOD:SOURce "** on page 257
 - **" :ANALyze:CLOCK:METHOD:OJTF "** on page 252
 - **" :ANALyze:CLOCK:METHOD:JTF "** on page 249
 - **" :ANALyze:CLOCK:METHOD:DEEMphasis "** on page 246
 - **" :ANALyze:CLOCK:METHOD:ALIGN "** on page 244

- `":ANALyze:CLOCK:METHod:PLLTrack"` on page 255
- `":ANALyze:CLOCK:METHod:EDGE"` on page 247
- `":ANALyze:SIGNal:TYPE"` on page 271

History New in version 5.30. This command replaces the now deprecated command `":MEASure:CLOCK:METHod"` on page 1515.

Version 5.50: When the signal type is PAM-4, a symbol rate (baud) is specified instead of a data rate (b/s).

Version 5.60: Added the PWM and CPHY methods.

:ANALyze:CLOCK:METHOD:ALIGN**Command****NOTE**

:ANALyze:CLOCK commands are available when clock recovery is used by licensed software (like the E2688A High Speed Serial software or the N5400A/N5401A EZJIT Plus jitter analysis software).

```
:ANALyze:CLOCK:METHOD:ALIGN {CENTer | EDGE}
```

When using an explicit method of clock recovery, the :ANALyze:CLOCK:METHOD:ALIGN command specifies how the clock is aligned with data:

- **CENTer** – Clock edges are aligned with the center of data.
- **EDGE** – Clock edges are aligned with data edges. In this case, Time Interval Error (TIE) is measured directly from the data edge to the clock edge.

This command applies to the clock recovery method being set up for the waveform source selected by the :ANALyze:CLOCK:METHOD:SOURce command.

Example When using an explicit method of clock recovery, this example specifies that clock edges are aligned with the center of data.

```
myScope.WriteString ":ANALyze:CLOCK:METHOD:ALIGN CENTER"
```

Query

```
:ANALyze:CLOCK:METHOD:ALIGN?
```

The :ANALyze:CLOCK:METHOD:ALIGN? query returns the clock recovery method's edge alignment setting.

Returned Format

```
[ :ANALyze:CLOCK:METHOD:ALIGN ] {CENT | EDGE}
```

Example

This example places the current edge alignment setting of the clock recovery method in the variable strSetting, then prints the contents of the variable to the computer's screen.

```
myScope.WriteString ":SYSTEM:HEADer OFF"
myScope.WriteString ":ANALyze:CLOCK:METHOD:ALIGN?"
strSetting = myScope.ReadString
Debug.Print strSetting
```

See Also

- **" :ANALyze:CLOCK:METHOD:SOURce "** on page 257
- **" :ANALyze:CLOCK:METHOD "** on page 241
- **" :ANALyze:CLOCK:METHOD:OJTF "** on page 252
- **" :ANALyze:CLOCK:METHOD:JTF "** on page 249
- **" :ANALyze:CLOCK:METHOD:DEEmphasis "** on page 246
- **" :ANALyze:CLOCK:METHOD:PLLTrack "** on page 255
- **" :ANALyze:CLOCK:METHOD:EDGE "** on page 247

History New in version 5.30. This command replaces the now deprecated command **":MEASure:CLOCK:METHod:ALIGn"** on page 1519.

:ANALyze:CLOCK:METHOD:DEEMphasis

Command

NOTE

:ANALyze:CLOCK commands are available when clock recovery is used by licensed software (like the E2688A High Speed Serial software or the N5400A/N5401A EZJIT Plus jitter analysis software).

```
:ANALyze:CLOCK:METHOD:DEEMphasis {OFF | ON}
```

The :ANALyze:CLOCK:METHOD:DEEMphasis command turns de-emphasis on or off.

This command applies to the clock recovery method being set up for the waveform source selected by the :ANALyze:CLOCK:METHOD:SOURce command.

See the help system for more information on de-emphasis.

Example This example enables de-emphasis.

```
myScope.WriteString ":ANALyze:CLOCK:METHOD:DEEMphasis ON"
```

Query :ANALyze:CLOCK:METHOD:DEEMphasis?

The :ANALyze:CLOCK:METHOD:DEEMphasis? query returns whether or not de-emphasis is turned on.

Returned Format [:ANALyze:CLOCK:METHOD:DEEMphasis] {OFF | ON}

Example This example places the current setting of the de-emphasis mode in the string variable strDeemph, then prints the contents of the variable to the computer's screen.

```
myScope.WriteString ":SYSTEM:HEADER OFF"
myScope.WriteString ":ANALyze:CLOCK:METHOD:DEEMphasis?"
strDeemph = myScope.ReadString
Debug.Print strDeemph
```

- See Also**
- [":ANALyze:CLOCK:METHOD:SOURce"](#) on page 257
 - [":ANALyze:CLOCK:METHOD"](#) on page 241
 - [":ANALyze:CLOCK:METHOD:OJTF"](#) on page 252
 - [":ANALyze:CLOCK:METHOD:JTF"](#) on page 249
 - [":ANALyze:CLOCK:METHOD:ALIGN"](#) on page 244
 - [":ANALyze:CLOCK:METHOD:PLLTrack"](#) on page 255
 - [":ANALyze:CLOCK:METHOD:EDGE"](#) on page 247

History New in version 5.30. This command replaces the now deprecated command [":MEASure:CLOCK:METHOD:DEEMphasis"](#) on page 1521.

:ANALyze:CLOCK:METHod:EDGE

Command

NOTE

:ANALyze:CLOCK commands are available when clock recovery is used by licensed software (like the E2688A High Speed Serial software or the N5400A/N5401A EZJIT Plus jitter analysis software).

```
:ANALyze:CLOCK:METHod:EDGE {RISing | FALLing | BOTH}
```

The :ANALyze:CLOCK:METHod:EDGE command specifies which edge(s) of the data are used to recover a clock. (In the front panel GUI, this control appears in the Advanced Clock Recovery dialog box.) Normally, both edges are used. However, if you are performing clock recovery on a low duty cycle clock signal, for example, you may want to use just the rising or falling edge.

This command applies to the clock recovery method being set up for the waveform source selected by the :ANALyze:CLOCK:METHod:SOURce command.

This command applies to the following clock recovery methods:

- FIXed (Constant Frequency).
- FOPLL (First Order PLL).
- SOPLL (Second Order PLL).
- EXPLICIT (Explicit Clock).
- EXPFOPLL (Explicit First Order PLL).
- EXPSOPLL (Explicit Second Order PLL).
- EQFOPLL (Equalized First Order PLL).
- EQSOPLL (Equalized Second Order PLL).

To measure jitter on only rising (or falling) edges of a clock, you must also set :ANALyze:RJDJ:EDGE to the same RISing or FALLing option, and you must set :ANALyze:RJDJ:CLOCK ON to force the pattern to be a clock and set the jitter for edges not examined to zero (0).

Example This example specifies that both rising and falling edges of the data are used to recover a clock.

```
myScope.WriteString ":ANALyze:CLOCK:METHod:EDGE BOTH"
```

Query :ANALyze:CLOCK:METHod:EDGE?

The :ANALyze:CLOCK:METHod:EDGE? query returns the clock recovery method's edge setting.

Returned Format [:ANALyze:CLOCK:METHod:EDGE] {RIS | FALL | BOTH}

Example This example places the current edge setting of the clock recovery method in the variable strSetting, then prints the contents of the variable to the computer's screen.

```
myScope.WriteString ":SYSTEM:HEADer OFF"  
myScope.WriteString ":ANALyze:CLOCK:METHod:EDGE?"  
strSetting = myScope.ReadString  
Debug.Print strSetting
```

- See Also**
- [":ANALyze:CLOCK:METHod:SOURce"](#) on page 257
 - [":ANALyze:CLOCK:METHod"](#) on page 241
 - [":ANALyze:CLOCK:METHod:OJTF"](#) on page 252
 - [":ANALyze:CLOCK:METHod:JTF"](#) on page 249
 - [":ANALyze:CLOCK:METHod:DEEMphasis"](#) on page 246
 - [":ANALyze:CLOCK:METHod:ALIGN"](#) on page 244
 - [":ANALyze:CLOCK:METHod:PLLTrack"](#) on page 255
 - [":MEASure:RJDJ:EDGE"](#) on page 878
 - [":MEASure:RJDJ:CLOCK"](#) on page 877

History New in version 5.30. This command replaces the now deprecated command [":MEASure:CLOCK:METHod:EDGE"](#) on page 1522.

:ANALyze:CLOCK:METHod:JTF

Command

NOTE

:ANALyze:CLOCK commands are available when clock recovery is used by licensed software (like the E2688A High Speed Serial software or the N5400A/N5401A EZJIT Plus jitter analysis software).

```
:ANALyze:CLOCK:METHod:JTF
  {FOPLL,<data_rate>,<jtf_loop_bandwidth>}
  | {EQFOPLL,<data_rate>,<jtf_loop_bandwidth>}
  | {SOPLL,<data_rate>,<jtf_loop_bandwidth>,<peaking>}
  | {EQSOPLL,<data_rate>,<jtf_loop_bandwidth>,<peaking>}
  | {EXPFOPLL,<source>,{RISing | FALLing | BOTH},
    <multiplier>,<clock_freq>,<jtf_loop_bandwidth>}
  | {EXPSOPLL,<source>,{RISing | FALLing | BOTH},
    <multiplier>,<clock_freq>,<jtf_loop_bandwidth>,<peaking>}
```

The :ANALyze:CLOCK:METHod:JTF command specifies the clock recovery PLL's response in terms of the Jitter Transfer Function's (JTF) 3 dB bandwidth.

This command applies to the clock recovery method being set up for the waveform source selected by the :ANALyze:CLOCK:METHod:SOURce command.

You can set these types of PLL clock recovery methods:

- FOPLL (First Order PLL).
- SOPLL (Second Order PLL).
- EQFOPLL (Equalized First Order PLL).
- EQSOPLL (Equalized Second Order PLL).
- EXPFOPLL (Explicit First Order PLL).
- EXPSOPLL (Explicit Second Order PLL).

The Equalized clock recovery methods are only available if the oscilloscope has the High Speed Serial option and the Serial Data Equalization option installed and the features are enabled.

For setting phase-locked loop (PLL) clock recovery methods in terms of the Observed Jitter Transfer Function (OJTF), see **":ANALyze:CLOCK:METHod:OJTF"** on page 252.

For setting other clock recovery methods, see **":ANALyze:CLOCK:METHod"** on page 241.

<source> {CHANnel<N> | FUNCtion<F> | WMEMory<R> | EQUalized}

<N> An integer, 1-4 in a single oscilloscope, 1-40 in a MultiScope system.

<F> An integer, 1-16.

<R> An integer, 1-4.

- <data_rate>** A real number for the base data rate in bits per second.
When the signal type is PAM-4 (see :ANALyze:SIGNal:TYPE), a symbol rate (baud) is specified instead of a data rate (b/s).
- <peaking>** The peaking value in dB.
- <jtf_loop_bandwidth>** A real number for the cutoff frequency for the PLL to track.
- <multiplier>** An integer used as the multiplication factor.
- <clock_freq>** A real number used for the clock frequency of the PLL.

Example This example sets the clock recovery method to Second Order PLL, a nominal data rate of 4 Gb/s, and a peaking value of 1.25 dB.

```
myScope.WriteString ":ANALyze:CLOCK:METHOD:JTF SOPLL,4E9,3.822E6,1.25"
```

Query :ANALyze:CLOCK:METHOD:JTF?

The :ANALyze:CLOCK:METHOD:JTF? query returns the state of the clock recovery method.

Returned Format [:ANALyze:CLOCK:METHOD:JTF]
 {FOPLL,<data_rate>,<jtf_loop_bandwidth>}
 | {EQFOPLL,<data_rate>,<jtf_loop_bandwidth>}
 | {SOPLL,<data_rate>,<jtf_loop_bandwidth>,<peaking>}
 | {EQSOPLL,<data_rate>,<jtf_loop_bandwidth>,<peaking>}
 | {EXPFOPLL <source>,{RISing | FALLing | BOTH},
 <multiplier>,<clock_freq>,<jtf_loop_bandwidth>}
 | {EXPSOPLL <source>,{RISing | FALLing | BOTH},
 <multiplier>,<clock_freq>,<jtf_loop_bandwidth>,<peaking>}

Example This example places the current setting of the clock recovery method in the variable strSetting, then prints the contents of the variable to the computer's screen.

```
myScope.WriteString ":SYSTEM:HEADER OFF"
myScope.WriteString ":ANALyze:CLOCK:METHOD:JTF?"
strSetting = myScope.ReadString
Debug.Print strSetting
```

- See Also**
- [":ANALyze:CLOCK:METHOD:SOURce"](#) on page 257
 - [":ANALyze:CLOCK:METHOD"](#) on page 241
 - [":ANALyze:CLOCK:METHOD:OJTF"](#) on page 252
 - [":ANALyze:CLOCK:METHOD:DEEMphasis"](#) on page 246
 - [":ANALyze:CLOCK:METHOD:ALIGN"](#) on page 244
 - [":ANALyze:CLOCK:METHOD:PLLTrack"](#) on page 255
 - [":ANALyze:CLOCK:METHOD:EDGE"](#) on page 247
 - [":ANALyze:SIGNal:TYPE"](#) on page 271

History New in version 5.30. This command replaces the now deprecated command **":MEASure:CLOCK:METHod:JTF"** on page 1524.

Version 5.50: When the signal type is PAM-4, a symbol rate (baud) is specified instead of a data rate (b/s).

:ANALyze:CLOCK:METHod:OJTF

Command

NOTE

:ANALyze:CLOCK commands are available when clock recovery is used by licensed software (like the E2688A High Speed Serial software or the N5400A/N5401A EZJIT Plus jitter analysis software).

```
:ANALyze:CLOCK:METHod:OJTF
  {FOPLL,<data_rate>,<ojtf_loop_bandwidth>}
  | {EQFOPLL,<data_rate>,<ojtf_loop_bandwidth>}
  | {SOPLL,<data_rate>,<ojtf_loop_bandwidth>,<damping_factor>}
  | {EQSOPLL,<data_rate>,<ojtf_loop_bandwidth>,<damping_factor>}
  | {TOPLL,<data_rate>,<natural_frequency>,<pole_frequency>,<damping_factor>[,<PLL_settling_time>]}
  | {EQTOPLL,<data_rate>,<natural_frequency>,<pole_frequency>,<damping_factor>[,<PLL_settling_time>]}
  | {EXPFOPPLL,<source>,{RISing | FALLing | BOTH},<multiplier>,<clock_freq>,<ojtf_loop_bandwidth>}
  | {EXPSOPLL,<source>,{RISing | FALLing | BOTH},<multiplier>,<clock_freq>,<ojtf_loop_bandwidth>,<damping_factor>}
  | {EXPTOPLL,<source>,{RISing | FALLing | BOTH},<multiplier>,<clock_freq>,<natural_frequency>,<pole_frequency>,<damping_factor>}
```

The :ANALyze:CLOCK:METHod:OJTF command specifies the clock recovery PLL's response in terms of the Observed Jitter Transfer Function's (OJTF) 3 dB bandwidth.

This command applies to the clock recovery method being set up for the waveform source selected by the :ANALyze:CLOCK:METHod:SOURce command.

You can set these types of PLL clock recovery methods:

- FOPLL (First Order PLL).
- SOPLL (Second Order PLL).
- TOPLL (Third Order PLL).
- EQFOPLL (Equalized First Order PLL).
- EQSOPLL (Equalized Second Order PLL).
- EQTOPLL (Equalized Third Order PLL).
- EXPFOPPLL (Explicit First Order PLL).
- EXPSOPLL (Explicit Second Order PLL).
- EXPTOPLL (Explicit Third Order PLL).

The Equalized clock recovery methods are only available if the oscilloscope has the High Speed Serial option and the Serial Data Equalization option installed and the features are enabled.

For setting phase-locked loop (PLL) clock recovery methods in terms of the Jitter Transfer Function (JTF), see **":ANALyze:CLOCK:METHod:JTF"** on page 249.

For setting other clock recovery methods, see **":ANALyze:CLOCK:METHOD"** on page 241.

- <source>** {CHANnel<N> | FUNCTION<F> | WMEMory<R> | EQUalized}
- <N>** An integer, 1-4 in a single oscilloscope, 1-40 in a MultiScope system.
- <F>** An integer, 1-16.
- <R>** An integer, 1-4.
- <data_rate>** A real number for the base data rate in bits per second.
- When the signal type is PAM-4 (see :ANALyze:SIGNal:TYPE), a symbol rate (baud) is specified instead of a data rate (b/s).
- <damping_factor>** A real number for the damping factor of the PLL.
- <ojtf_loop_bandwidth>** A real number for the cutoff frequency for the PLL to track.
- <natural_frequency>** A real number for the natural frequency of the PLL.
- <pole_frequency>** A real number for the pole frequency of the PLL.
- <PLL_settling_time>** A real number for the PLL settling time.
- <multiplier>** An integer used as the multiplication factor.
- <clock_freq>** A real number used for the clock frequency of the PLL.

Example This example sets the clock recovery method to Second Order PLL, a nominal data rate of 4 Gb/s, and a damping factor of 1.0.

```
myScope.WriteString ":ANALyze:CLOCK:METHOD:OJTF SOPLL,4E9,2.4E6,1.0"
```

Query :ANALyze:CLOCK:METHOD:OJTF?

The :ANALyze:CLOCK:METHOD:OJTF? query returns the state of the clock recovery method.

Returned Format [:ANALyze:CLOCK:METHOD:OJTF]

```
{FOPLL,<data_rate>,<ojtf_loop_bandwidth>}
| {EQFOPLL,<data_rate>,<ojtf_loop_bandwidth>}
| {SOPLL,<data_rate>,<ojtf_loop_bandwidth>,<damping_factor>}
| {EQSOPLL,<data_rate>,<ojtf_loop_bandwidth>,<damping_factor>}
| {TOPLL,<data_rate>,<natural_frequency>,<pole_frequency>,<damping_factor>[,<PLL_settling_time>]}
| {EQTOPLL,<data_rate>,<natural_frequency>,<pole_frequency>,<damping_factor>[,<PLL_settling_time>]}
| {EXPFOPLL <source>,{RISing | FALLing | BOTH},<multiplier>,<clock_freq>,<ojtf_loop_bandwidth>}
| {EXPSOPLL <source>,{RISing | FALLing | BOTH},<multiplier>,<clock_freq>,<ojtf_loop_bandwidth>,<damping_fact>}
| {EXPTOPLL,<source>,{RISing | FALLing | BOTH},
```

```
<multiplier>,<clock_freq>,<natural_frequency>,<pole_frequency>,<damping_factor>}
```

Example This example places the current setting of the clock recovery method in the variable `strSetting`, then prints the contents of the variable to the computer's screen.

```
myScope.WriteString ":SYSTEM:HEADer OFF"
myScope.WriteString ":ANALyze:CLOCK:METHOD:OJTF?"
strSetting = myScope.ReadString
Debug.Print strSetting
```

See Also

- [":ANALyze:CLOCK:METHOD:SOURce"](#) on page 257
- [":ANALyze:CLOCK:METHOD"](#) on page 241
- [":ANALyze:CLOCK:METHOD:JTF"](#) on page 249
- [":ANALyze:CLOCK:METHOD:DEEMphasis"](#) on page 246
- [":ANALyze:CLOCK:METHOD:ALIGN"](#) on page 244
- [":ANALyze:CLOCK:METHOD:PLLTrack"](#) on page 255
- [":ANALyze:CLOCK:METHOD:EDGE"](#) on page 247
- [":ANALyze:SIGNAL:TYPE"](#) on page 271

History New in version 5.30. This command replaces the now deprecated command [":MEASure:CLOCK:METHOD:OJTF"](#) on page 1526.

Version 5.50: When the signal type is PAM-4, a symbol rate (baud) is specified instead of a data rate (b/s).

:ANALyze:CLOCK:METHOD:PLLTrack

Command

NOTE

:ANALyze:CLOCK commands are available when clock recovery is used by licensed software (like the E2688A High Speed Serial software or the N5400A/N5401A EZJIT Plus jitter analysis software).

```
:ANALyze:CLOCK:METHOD:PLLTrack {OFF | ON}
```

The :ANALyze:CLOCK:METHOD:PLLTrack command turns transition density dependence on or off. See the help system for more information on the Transition Density Dependent setting.

This command applies to the clock recovery method being set up for the waveform source selected by the :ANALyze:CLOCK:METHOD:SOURce command.

Example This example enables the Transition Density Dependent setting.

```
myScope.WriteString ":MEASure:CLOCK:METHOD:PLLTrack ON"
```

Query :ANALyze:CLOCK:METHOD:PLLTrack?

The :ANALyze:CLOCK:METHOD:PLLTrack? query returns whether or not the Transition Density Dependent setting is turned on.

Returned Format [:ANALyze:CLOCK:METHOD:PLLTrack] {OFF | ON}

Example This example places the current setting of the Transition Density Dependent setting in the string variable strTDD, then prints the contents of the variable to the computer's screen.

```
myScope.WriteString ":SYSTem:HEADer OFF"
myScope.WriteString ":ANALyze:CLOCK:METHOD:PLLTrack?"
strTDD = myScope.ReadString
Debug.Print strTDD
```

- See Also**
- [":ANALyze:CLOCK:METHOD:SOURce"](#) on page 257
 - [":ANALyze:CLOCK:METHOD"](#) on page 241
 - [":ANALyze:CLOCK:METHOD:OJTF"](#) on page 252
 - [":ANALyze:CLOCK:METHOD:JTF"](#) on page 249
 - [":ANALyze:CLOCK:METHOD:DEEMphasis"](#) on page 246
 - [":ANALyze:CLOCK:METHOD:ALIGN"](#) on page 244
 - [":ANALyze:CLOCK:METHOD:EDGE"](#) on page 247

History New in version 5.30. This command replaces the now deprecated command [":MEASure:CLOCK:METHOD:PLLTrack"](#) on page 1528.

:ANALyze:CLOCK:METhod:SKEW

Command :ANALyze:CLOCK:METhod:SKEW <time>

When clock recovery is being performed on a PAM-4 signal type (see :ANALyze:SIGNal:TYPE), the :ANALyze:CLOCK:METhod:SKEW command can be used to center the eye opening at the clock locations by shifting the clocks relative to the data.

<time> Seconds in NR3 format.

Query :ANALyze:CLOCK:METhod:SKEW?

The :ANALyze:CLOCK:METhod:SKEW? query returns the skew setting.

Returned Format <time><NL>

- See Also**
- [":ANALyze:SIGNal:TYPE"](#) on page 271
 - [":MEASure:THResholds:DISPlay"](#) on page 903
 - [":MEASure:THResholds:GENeral:METhod"](#) on page 909
 - [":MEASure:THResholds:GENeral:PAMCustom"](#) on page 911
 - [":MEASure:THResholds:GENeral:PAMAutomatic"](#) on page 913
 - [":MEASure:THResholds:RFALL:METhod"](#) on page 926
 - [":MEASure:THResholds:RFALL:PAMAutomatic"](#) on page 928

History New in version 6.10.

:ANALyze:CLOCK:METHod:SOURce

Command :ANALyze:CLOCK:METHod:SOURce {ALL | <source>}
 <source> ::= {CHANnel<N> | FUNction<F> | WMEMory<R> | EQUalized}

The :ANALyze:CLOCK:METHod:SOURce command selects the waveform source (or ALL sources) to which other clock recovery method setup commands apply.

Clock recovery methods can be set up for each waveform source (or for all waveform sources).

Query :ANALyze:CLOCK:METHod:SOURce?

The :ANALyze:CLOCK:METHod:SOURce? query returns the waveform source to which other clock recovery method commands currently apply.

Returned Format [:ANALyze:CLOCK:METHod:SOURce] <source><NL>
 <source> ::= {ALL | CHAN<N> | FUNC<F> | WMEM<N> | EQU}

- See Also**
- [":ANALyze:CLOCK:METHod"](#) on page 241
 - [":ANALyze:CLOCK:METHod:OJTF"](#) on page 252
 - [":ANALyze:CLOCK:METHod:JTF"](#) on page 249
 - [":ANALyze:CLOCK:METHod:DEEMphasis"](#) on page 246
 - [":ANALyze:CLOCK:METHod:ALIGN"](#) on page 244
 - [":ANALyze:CLOCK:METHod:PLLTrack"](#) on page 255
 - [":ANALyze:CLOCK:METHod:EDGE"](#) on page 247

History New in version 5.30. This command replaces the now deprecated command [":MEASure:CLOCK:METHod:SOURce"](#) on page 1529.

:ANALyze:CLOCK:VERTical

Command

NOTE

:ANALyze:CLOCK commands are available when clock recovery is used by licensed software (like the E2688A High Speed Serial software or the N5400A/N5401A EZJIT Plus jitter analysis software).

```
:ANALyze:CLOCK:VERTical {AUTO | MANual}
```

The :ANALyze:CLOCK:VERTical command sets the recovered clock vertical scale mode to automatic or manual. In automatic mode, the oscilloscope automatically selects the vertical scaling and offset. In manual mode, you can set your own scaling and offset values.

Example This example sets the recovered clock vertical scale mode to automatic.

```
myScope.WriteString ":ANALyze:CLOCK:VERTical AUTO"
```

Query

```
:ANALyze:CLOCK:VERTical?
```

The :ANALyze:CLOCK:VERTical? query returns the current recovered clock vertical scale mode setting.

Returned Format

```
[ :ANALyze:CLOCK:VERTical ] {AUTO | MANual}
```

Example

This example places the current setting of the recovered clock vertical scale mode in the string variable strSetting, then prints the contents of the variable to the computer's screen.

```
myScope.WriteString ":SYSTEM:HEADer OFF"
myScope.WriteString ":ANALyze:CLOCK:VERTical?"
strSetting = myScope.ReadString
Debug.Print strSetting
```

History

New in version 5.30. This command replaces the now deprecated command **":MEASure:CLOCK:VERTical"** on page 1530.

:ANALyze:CLOCK:VERTical:OFFSet

Command

NOTE

:ANALyze:CLOCK commands are available when clock recovery is used by licensed software (like the E2688A High Speed Serial software or the N5400A/N5401A EZJIT Plus jitter analysis software).

```
:ANALyze:CLOCK:VERTical:OFFSet <offset>
```

The :ANALyze:CLOCK:VERTical:OFFSet command sets the recovered clock vertical offset.

<offset> A real number for the recovered clock vertical offset.

Example This example sets the clock recovery vertical offset to 1 volt.

```
myScope.WriteString ":ANALyze:CLOCK:VERTical:OFFSet 1"
```

Query :ANALyze:CLOCK:VERTical:OFFSet?

The :ANALyze:CLOCK:VERTical:OFFSet? query returns the clock recovery vertical offset setting.

Returned Format [:ANALyze:CLOCK:VERTical:OFFSet] <value><NL>

<value> The clock recovery vertical offset setting.

Example This example places the current value of recovered clock vertical offset in the numeric variable, varValue, then prints the contents of the variable to the computer's screen.

```
myScope.WriteString ":SYSTEM:HEADer OFF" ' Response headers off.
myScope.WriteString ":ANALyze:CLOCK:VERTical:OFFSet?"
varValue = myScope.ReadNumber
Debug.Print FormatNumber(varValue, 0)
```

History New in version 5.30. This command replaces the now deprecated command **":MEASure:CLOCK:VERTical:OFFSet"** on page 1531.

:ANALyze:CLOCK:VERTical:RANGe

Command

NOTE

:ANALyze:CLOCK commands are available when clock recovery is used by licensed software (like the E2688A High Speed Serial software or the N5400A/N5401A EZJIT Plus jitter analysis software).

```
:ANALyze:CLOCK:VERTical:RANGe <range>
```

The :ANALyze:CLOCK:VERTical:RANGe command sets the recovered clock vertical range.

<range> A real number for the full-scale recovered clock vertical range.

Example This example sets the recovered clock vertical range to 16 volts (2 volts times 8 divisions.)

```
myScope.WriteString ":ANALyze:CLOCK:VERTical:RANGe 16"
```

Query :ANALyze:CLOCK:VERTical:RANGe?

The :ANALyze:CLOCK:VERTical:RANGe? query returns the recovered clock vertical range setting.

Returned Format [:ANALyze:CLOCK:VERTical:RANGe] <value><NL>

<value> The recovered clock vertical range setting.

Example This example places the current value of recovered clock vertical range in the numeric variable, varValue, then prints the contents of the variable to the computer's screen.

```
myScope.WriteString ":SYSTem:HEADer OFF" ' Response headers off.
myScope.WriteString ":ANALyze:CLOCK:VERTical:RANGe?"
varValue = myScope.ReadNumber
Debug.Print FormatNumber(varValue, 0)
```

History New in version 5.30. This command replaces the now deprecated command **":MEASure:CLOCK:VERTical:RANGe"** on page 1532.

:ANALyze:SIGNal:DATarate

Command :ANALyze:SIGNal:DATarate <source>,<data_rate>

<source> ::= {CHANnel<N> | DIFF<D> | COMMONmode<C> | FUNCTION<F>
| WMEMory<R>}

When the source signal type is PAM-4 (see :ANALyze:SIGNal:TYPE), the :ANALyze:SIGNal:DATarate command specifies the data rate of the signal.

With PAM-4, the data rate is twice the symbol rate because each voltage level represents two bits of data. Changing the data rate also changes the symbol rate (see :ANALyze:SIGNal:SYMBOLrate) and vice-versa.

<N> An integer, 1-4 in a single oscilloscope, 1-40 in a MultiScope system.

<D>, <C> <D> is an integer, 1-2. <C> is an integer, 3-4.

The DIFF and COMMONmode sources are just aliases that can be used in place of the channel names to apply to differential or common mode signals. These are just aliases - no state change occurs if you refer to a differential channel and you are not in differential mode. DIFF1 refers to the differential signal between channels 1 and 3 (and COMMONmode3 refers to the common mode channel between these same channels). DIFF2 refers to the differential signal between channels 2 and 4 (and COMMONmode4 refers to the common mode channel between these same channels).

<F> An integer, 1-16.

<R> An integer, 1-4.

<data_rate> Bits/second in NR3 format.

Query :ANALyze:SIGNal:DATarate? <source>

The :ANALyze:SIGNal:DATarate? query returns the data rate of the source signal.

Returned Format [:ANALyze:SIGNal:DATarate] <data_rate><NL>

<data_rate> ::= bits/second in NR3 format.

- See Also**
- [":ANALyze:CLOCK:METHod:SKEW"](#) on page 256
 - [":ANALyze:SIGNal:SYMBOLrate"](#) on page 263
 - [":ANALyze:SIGNal:TYPE"](#) on page 271
 - [":MEASure:CGRade:EWIDth"](#) on page 742
 - [":MEASure:CGRade:EHEight"](#) on page 740
 - [":MEASure:FALLtime"](#) on page 770
 - [":MEASure:PAM:ELEVEL"](#) on page 838
 - [":MEASure:PAM:ESKew"](#) on page 840
 - [":MEASure:PAM:LEVEL"](#) on page 846

- **":MEASure:PAM:LRMS"** on page 848
- **":MEASure:PAM:LTHickness"** on page 850
- **":MEASure:RISetime"** on page 869
- **":MEASure:THResholds:DISPlay"** on page 903
- **":MEASure:THResholds:GENeral:METhod"** on page 909
- **":MEASure:THResholds:GENeral:PAMCustom"** on page 911
- **":MEASure:THResholds:GENeral:PAMAutomatic"** on page 913
- **":MEASure:THResholds:RFALL:METhod"** on page 926
- **":MEASure:THResholds:RFALL:PAMAutomatic"** on page 928
- **":MEASure:TIEData2"** on page 949

History New in version 5.50.

:ANALyze:SIGNal:SYMBolrate

Command :ANALyze:SIGNal:SYMBolrate <source>,<symbol_rate>

<source> ::= {CHANnel<N> | DIFF<D> | COMMONmode<C> | FUNction<F>
| WMEMory<R>}

When the source signal type is PAM-4 (see :ANALyze:SIGNal:TYPE), this command specifies the edge rate of the signal. The inverse of this rate is the unit interval (UI).

With PAM-4, the data rate is twice the symbol rate because each voltage level represents two bits of data. Changing the symbol rate also changes the data rate (see :ANALyze:SIGNal:DATarate) and vice-versa.

<N> An integer, 1-4 in a single oscilloscope, 1-40 in a MultiScope system.

<D>, <C> <D> is an integer, 1-2. <C> is an integer, 3-4.

The DIFF and COMMONmode sources are just aliases that can be used in place of the channel names to apply to differential or common mode signals. These are just aliases - no state change occurs if you refer to a differential channel and you are not in differential mode. DIFF1 refers to the differential signal between channels 1 and 3 (and COMMONmode3 refers to the common mode channel between these same channels). DIFF2 refers to the differential signal between channels 2 and 4 (and COMMONmode4 refers to the common mode channel between these same channels).

<F> An integer, 1-16.

<R> An integer, 1-4.

<symbol_rate> Baud in NR3 format.

Query :ANALyze:SIGNal:SYMBolrate? <source>

The :ANALyze:SIGNal:SYMBolrate? query returns the symbol rate for the specified source signal.

Returned Format [:ANALyze:SIGNal:SYMBolrate] <symbol_rate><NL>

<symbol_rate> ::= baud in NR3 format.

- See Also**
- [":ANALyze:CLOCK:METHod:SKEW"](#) on page 256
 - [":ANALyze:SIGNal:DATarate"](#) on page 261
 - [":ANALyze:SIGNal:TYPE"](#) on page 271
 - [":MEASure:CGRade:EWIDth"](#) on page 742
 - [":MEASure:CGRade:EHEight"](#) on page 740
 - [":MEASure:FALLtime"](#) on page 770
 - [":MEASure:PAM:ELEVel"](#) on page 838
 - [":MEASure:PAM:ESKew"](#) on page 840
 - [":MEASure:PAM:LEVel"](#) on page 846

- **":MEASure:PAM:LRMS"** on page 848
- **":MEASure:PAM:LTHickness"** on page 850
- **":MEASure:RISetime"** on page 869
- **":MEASure:THResholds:DISPlay"** on page 903
- **":MEASure:THResholds:GENeral:METhod"** on page 909
- **":MEASure:THResholds:GENeral:PAMCustom"** on page 911
- **":MEASure:THResholds:GENeral:PAMAutomatic"** on page 913
- **":MEASure:THResholds:RFALL:METhod"** on page 926
- **":MEASure:THResholds:RFALL:PAMAutomatic"** on page 928
- **":MEASure:TIEData2"** on page 949

History New in version 5.50.

:ANALyze:SIGNal:MIXer:CABLeLoss

Command :ANALyze:SIGNal:MIXer:CABLeLoss <source>,<loss>

The :ANALyze:SIGNal:MIXer:CABLeLoss command sets the loss of the cable connecting the mixer to the oscilloscope.

<source> {CHANnel<N>}

<loss> The dB cable return loss in NR3 format.

Query :ANALyze:SIGNal:MIXer:CABLeLoss? <source>

The :ANALyze:SIGNal:MIXer:CABLeLoss? query returns the specified cable loss.

Returned Format <loss><NL>

- See Also**
- [":ANALyze:SIGNal:MMWave:CALibrate"](#) on page 266
 - [":ANALyze:SIGNal:MMWave:CFRequency"](#) on page 267
 - [":ANALyze:SIGNal:MMWave:CONNect"](#) on page 268
 - [":ANALyze:SIGNal:MMWave:LOADdress"](#) on page 269
 - [":ANALyze:SIGNal:MMWave:MBANd wid th"](#) on page 270

History New in version 5.60.

:ANALyze:SIGNal:MMWave:CALibrate

Command :ANALyze:SIGNal:MMWave:CALibrate

The :ANALyze:SIGNal:MMWave:CALibrate command initiates a mixer/LO (local oscillator) power calibration.

The LO is identified by the :ANALyze:SIGNal:MMWave:LOADdress command.

The calibration takes about a minute.

You may send additional commands that will not be executed until this command completes. (The command is blocking.)

You may initiate a query (*IDN?, etc.) to wait until the calibration is complete.

- See Also**
- [":ANALyze:SIGNal:MIXer:CABLEloss"](#) on page 265
 - [":ANALyze:SIGNal:MMWave:CFRequency"](#) on page 267
 - [":ANALyze:SIGNal:MMWave:CONNect"](#) on page 268
 - [":ANALyze:SIGNal:MMWave:LOADdress"](#) on page 269
 - [":ANALyze:SIGNal:MMWave:MBANDwidth"](#) on page 270

History New in version 5.60.

:ANALyze:SIGNal:MMWave:CFRequency

Command :ANALyze:SIGNal:MMWave:CFRequency <center_freq>

The :ANALyze:SIGNal:MMWave:CFRequency command sets the center frequency for the oscilloscope's FFT math function.

Because all channels using mmWave share a LO, there is only one center frequency for the oscilloscope.

<center_freq> Center frequency in NR3 format.

Query :ANALyze:SIGNal:MMWave:CFRequency?

The :ANALyze:SIGNal:MMWave:CFRequency? query returns the specified center frequency.

Returned Format <center_freq><NL>

- See Also**
- [":ANALyze:SIGNal:MIXer:CABLeLoss"](#) on page 265
 - [":ANALyze:SIGNal:MMWave:CALibrate"](#) on page 266
 - [":ANALyze:SIGNal:MMWave:CONNect"](#) on page 268
 - [":ANALyze:SIGNal:MMWave:LOADdress"](#) on page 269
 - [":ANALyze:SIGNal:MMWave:MBANd width"](#) on page 270

History New in version 5.60.

:ANALyze:SIGNal:MMWave:CONNect

Command :ANALyze:SIGNal:MMWave:CONNect <source>,{{0 | OFF} | {1 | ON}}

The :ANALyze:SIGNal:MMWave:CONNect command sets the connection status for the mixer and LO (local oscillator) assigned to the specified channel. Use OFF to disconnect.

<source> {CHANnel<N>}

Query :ANALyze:SIGNal:MMWave:CONNect? <source>

The :ANALyze:SIGNal:MMWave:CONNect? query returns the mixer and LO connection status.

Returned Format <status><NL>

<status> ::= {0 | 1}

- See Also**
- [":ANALyze:SIGNal:MIXer:CABLeLoss"](#) on page 265
 - [":ANALyze:SIGNal:MMWave:CALibrate"](#) on page 266
 - [":ANALyze:SIGNal:MMWave:CFRequency"](#) on page 267
 - [":ANALyze:SIGNal:MMWave:LOADdress"](#) on page 269
 - [":ANALyze:SIGNal:MMWave:MBANDwidth"](#) on page 270

History New in version 5.60.

:ANALyze:SIGNal:MMWave:LOADdress

Command :ANALyze:SIGNal:MMWave:LOADdress <string>

The :ANALyze:SIGNal:MMWave:LOADdress command sets the LO's (local oscillator's) VISA address.

The VISA address of the LO can be found in the Keysight Connection Expert.

<string> Quoted VISA address of LO.

Query :ANALyze:SIGNal:MMWave:LOADdress?

The :ANALyze:SIGNal:MMWave:LOADdress? query returns the specified LO VISA address.

Returned Format <string><NL>

- See Also**
- [":ANALyze:SIGNal:MIXer:CABLeLoss"](#) on page 265
 - [":ANALyze:SIGNal:MMWave:CALibrate"](#) on page 266
 - [":ANALyze:SIGNal:MMWave:CFRequency"](#) on page 267
 - [":ANALyze:SIGNal:MMWave:CONNect"](#) on page 268
 - [":ANALyze:SIGNal:MMWave:MBANdwid th"](#) on page 270

History New in version 5.60.

:ANALyze:SIGNal:MMWave:MBANdwidth

Command :ANALyze:SIGNal:MMWave:MBANdwidth <meas_bandwidth>

The :ANALyze:SIGNal:MMWave:MBANdwidth command sets the measurement bandwidth (in Hz).

The specified bandwidth becomes the center frequency for the oscilloscope's FFT math function.

Because all channels using mmWave will share a LO (local oscillator), there is only one measurement bandwidth for the oscilloscope.

<meas_bandwidth
>

Bandwidth in NR3 format.

Query :ANALyze:SIGNal:MMWave:MBANdwidth?

The :ANALyze:SIGNal:MMWave:MBANdwidth? query returns the specified measurement bandwidth.

Returned Format <meas_bandwidth><NL>

- See Also**
- [":ANALyze:SIGNal:MIXer:CABLeLoss"](#) on page 265
 - [":ANALyze:SIGNal:MMWave:CALibrate"](#) on page 266
 - [":ANALyze:SIGNal:MMWave:CFRequency"](#) on page 267
 - [":ANALyze:SIGNal:MMWave:CONNect"](#) on page 268
 - [":ANALyze:SIGNal:MMWave:LOADdress"](#) on page 269

History New in version 5.60.

:ANALyze:SIGNal:TYPE

Command :ANALyze:SIGNal:TYPE <source>, {UNSPecified | PAM4 | MMWave | CHPY}
 <source> ::= {CHANnel<N> | FUNction<F> | WMEMory<R>}

The :ANALyze:SIGNal:TYPE command lets you specify whether a channel, function, or waveform memory is a special type of signal, like a PAM-4 signal for example.

- UNSPecified – When a signal type is unspecified, the oscilloscope's digital signal analysis and measurement features assume a NRZ signal with two levels (high and low).
- PAM4 – When a signal is specified as a PAM-4 (4-level Pulse-Amplitude Modulation) signal:
 - It changes how the oscilloscope determines voltage levels. Three thresholds are used to distinguish between the four voltage levels.
 - It changes how the oscilloscope represents the data rate. Two bits of data are represented by each voltage level.
 - The term *symbol rate* is used to describe the clock edge rate of the signal. The inverse of this rate is the unit interval (UI).
 - There are multiple edges to consider in clock recovery. Clock recovery occurs at the middle threshold, but you can specify which edges to include: 0 level to 3 level edges and opposite, 1 level to 2 level edges and opposite, or non-symmetric edges (about the middle threshold, for example, 1 level to 3 level edges, 2 level to 0 level edges, etc.).
 - It changes how eye measurements, voltage level measurements, and rise/fall time measurements are presented because of the multiple eyes, levels, and edges.
- MMWave – Supports analysis of millimeter-wave signals that have been down-converted to IF band signals by an external smart mixer and an LO signal from a signal generator. The oscilloscope controls the signal generator and external smart mixer and gets correction factors and detector level information from the mixer. The resulting signals can be analyzed using the oscilloscope's FFT spectral analysis and demodulated using the 89600 VSA vector signal analysis software.
- CHPY – Supports decode and analysis of MIPI C-PHY signals.

<N> An integer, 1-4 in a single oscilloscope, 1-40 in a MultiScope system.

<D>, <C> <D> is an integer, 1-2. <C> is an integer, 3-4.

The DIFF and COMMONmode sources are just aliases that can be used in place of the channel names to apply to differential or common mode signals. These are just aliases - no state change occurs if you refer to a differential channel and you are not in differential mode. DIFF1 refers to the differential signal between channels 1 and 3 (and COMMONmode3 refers to the common mode channel between these

same channels). DIFF2 refers to the differential signal between channels 2 and 4 (and COMMONmode4 refers to the common mode channel between these same channels).

<F> An integer, 1-16.

<R> An integer, 1-4.

Query :ANALyze:SIGNal:TYPE? <source>

The :ANALyze:SIGNal:TYPE? query returns a channel, function, or waveform memory's signal type.

Returned Format [:ANALyze:SIGNal:TYPE] <type><NL>

<type> ::= {UNSP | PAM3 | PAM4 | MMW | CPHY}

- See Also**
- [":ANALyze:CLOCK:METHod:SKEW"](#) on page 256
 - [":ANALyze:SIGNal:DATarate"](#) on page 261
 - [":ANALyze:SIGNal:SYMBOLrate"](#) on page 263
 - [":MEASure:CGRade:EWIDth"](#) on page 742
 - [":MEASure:CGRade:EHEight"](#) on page 740
 - [":MEASure:FALLtime"](#) on page 770
 - [":MEASure:PAM:ELEVEL"](#) on page 838
 - [":MEASure:PAM:ESKew"](#) on page 840
 - [":MEASure:PAM:LEVEL"](#) on page 846
 - [":MEASure:PAM:LRMS"](#) on page 848
 - [":MEASure:PAM:LTHickness"](#) on page 850
 - [":MEASure:RISetime"](#) on page 869
 - [":MEASure:THResholds:DISPlay"](#) on page 903
 - [":MEASure:THResholds:GENeral:METHod"](#) on page 909
 - [":MEASure:THResholds:GENeral:PAMCustom"](#) on page 911
 - [":MEASure:THResholds:GENeral:PAMAutomatic"](#) on page 913
 - [":MEASure:THResholds:RFALL:METHod"](#) on page 926
 - [":MEASure:THResholds:RFALL:PAMAutomatic"](#) on page 928
 - [":MEASure:TIEData2"](#) on page 949

History New in version 5.50.

Version 5.60: Added the MMWave signal type.

Version 6.10: Added the CPHY signal type.

:ANALyze:VIEW

Command :ANALyze:VIEW <data>

<data> ::= {ALL | MAIN}

The :ANALyze:VIEW command specify whether to use the data on screen or the entire acquisition for measurements, functions, and analysis.

This command maps to the "Window All Data" control in the user interface's Measurement Setup dialog box.

When all edges in an acquisition are used for horizontal measurements (see :ANALyze:AEDGes), this command's setting becomes "ALL" and the entire acquisition is used for measurements, functions, and analysis.

Query :ANALyze:VIEW?

The :ANALyze:VIEW? query returns the value that is currently set.

Returned Format [:ANALyze:VIEW] <data><NL>

<data> ::= {ALL | MAIN}

See Also • [":ANALyze:AEDGes"](#) on page 239

History New in version 5.30.

12 Bus Commands

:BUS:B<N>:TYPE / 276
:BUS:BIT<M> / 278
:BUS:BITS / 279
:BUS:CLEar / 280
:BUS:CLOCK / 281
:BUS:CLOCK:SLOPe / 282
:BUS:DISPlay / 283
:BUS:LABel / 284
:BUS:READout / 285

NOTE

The :BUS:B<N>:TYPE command applies to oscilloscopes with the serial data analysis option installed. The other :BUS commands apply to mixed-signal oscilloscopes (MSOs).

:BUS:B<N>:TYPE

Command :BUS:B<N>:TYPE {<protocol> | <hs_protocol>}

NOTE

This BUS command only applies to oscilloscopes with the serial data analysis option installed.

The :BUS:B<N>:TYPE command sets the type of protocol being analyzed for a serial bus waveform.

<protocol> {A429 | BRR | CAN | CPHY | DDR | E10GBASEKR | EPSI | FLEXray | GENRaw | I3C | IIC | JTAG | LIN | MAN | M1553 | MIPI | RFFE | SPI | SPMI | SPW | SVID | UART | USB2 | USBPD | XAUI}

<hs_protocol> {CSI3 | DIGRf | DVI | FIBRechannel | {GEN8B10B | GENeric} | HOTLink | INFiniband | JESD204B | LLI | PCI3 | PCIe | SAS | SATA | SSIC | UFS | UNIPro | USB3 | USB31}

<N> An integer, 1-4.

Example This example sets the serial bus waveform number one protocol type to FLEXray.

```
myScope.WriteString ":BUS:B1:TYPE FLEXray"
```

Query :BUS:B<N>:TYPE?

The :BUS:B<N>:TYPE? query returns the name of the protocol being used for the serial bus.

Returned Format [:BUS:B<N>:TYPE] {<protocol> | <hs_protocol>}<NL>

<protocol> {A429 | BRR | CAN | CPHY | DDR | E10GBASEKR | ESPI | FLEX | GENRaw | I3C | IIC | JTAG | LIN | MAN | M1553 | MIPI | RFFE | SPI | SPMI | SPW | SVID | UART | USB2 | USBPD | XAUI}

<hs_protocol> {CSI3 | DIGR | DVI | FC | {USER | USER} | HOTL | INF | JESD204B | LLI | PCI3 | PCIE | SAS | SATA | SSIC | UFS | UNIP | USB3 | USB31}

See Also • [":SBUS<N>:HS Commands"](#) on page 1053

History Legacy command (existed before version 3.10).

Version 3.11: Added the MPHY protocol type for the MIPI M-PHY serial decode selection.

Version 5.00: Added support for new protocols.

Version 5.51: Added support for new ESPI, USB31, and USBPD protocols.

Version 5.70: Added support for new A429, M1553, and I3C protocols.

Version 6.00: Added support for new GENRaw and SPMI protocols.

Version 6.10: Added support for new CPHY (MIPI C-PHY), BRR (BroadR-Reach), SPW (SpaceWire), and MAN (Manchester) protocols.

:BUS:BIT<M>

Command :BUS:BIT<M> {ON | OFF | 1 | 0}

NOTE

The BUS commands only apply to the MSO oscilloscopes.

The :BUS:BIT<M> command includes or excludes the selected bit as part of the definition for the selected bus. If the parameter is a 1 (ON) then the bit is included in the definition. If the parameter is a 0 (OFF) then the bit is excluded from the definition. The digital subsystem must be enabled for this command will work. See ENABLE command in the root subsystem.

<M> An integer, 0-15.

<N> An integer, 1-4.

Example This example includes bit 1 as part of the bus 1 definition.

```
myScope.WriteString ":ENABLE DIGital"
myScope.WriteString ":BUS1:BIT1 ON"
```

Query :BUS:BIT<M>?

The :BUS:BIT<M>? query returns the value indicating whether the specified bit is included or excluded from the specified bus definition.

Returned Format [:BUS:BIT<M>] {1 | 0}<NL>

History Legacy command (existed before version 3.10).

:BUS:BITS

Command :BUS:BITS <channel_list>,{ON | OFF| 1 | 0}

NOTE

The BUS commands only apply to the MSO oscilloscopes.

The :BUS:BITS command includes or excludes the selected bits in the channel list in the definition of the selected bus. If the parameter is a 1 (ON) then the bits in the channel list are included as part of the selected bus definition. If the parameter is a 0 (OFF) then the bits in the channel list are excluded from the definition of the selected bus. The digital subsystem must be enabled for this command will work. See ENABLE command in the root subsystem.

<N> An integer, 1- 4.

<channel_list> The channel range is from 0 to 15 in the following format.

| | |
|------------|--|
| @1,5,7,9) | channels 1, 5, 7, and 9 are turned on. |
| @1:15) | channels 1 through 15 are turned on. |
| @1:5,8,14) | channels 1 through 5, channel 8, and channel 14 are turned on. |

NOTE

The parentheses are part of the expression and are necessary.

Example This example includes bits 1, 2, 4, 5, 6, 7, 8, and 9 as part of the bus 1 definition.

```
myScope.WriteString ":ENABle DIGital"
myScope.WriteString ":BUS1:BITS (@1,2,4:9),ON"
```

Query :BUS:BITS?

The :BUS:BITS? query returns the definition for the specified bus.

Returned Format [:BUS:BITS] <channel_list>,{1 | 0}<NL>

History Legacy command (existed before version 3.10).

:BUS:CLEAr

Command :BUS:CLEAr

NOTE

The BUS commands only apply to the MSO oscilloscopes.

The :BUS:CLEAr command excludes all of the digital channels from the selected bus definition.

<N> An integer, 1-4.

Example This example excludes all the digital channels from the bus 1 definition.

```
myScope.WriteString ":BUS1:CLEAr"
```

History Legacy command (existed before version 3.10).

:BUS:CLOCK

Command :BUS:CLOCK {CHANnel<N> | DIGital<M> | NONE}

NOTE

The BUS commands only apply to the MSO oscilloscopes.

The :BUS:CLOCK command sets the digital or analog channel used as the clock for decoding the bus values.

<M> An integer, 0-15.

<N> An integer, 1-4 in a single oscilloscope, 1-40 in a MultiScope system.

<O> An integer, 1-4.

Example This example sets the clock to channel 1 for bus 1.

```
myScope.WriteString ":ENABLE DIGital"
myScope.WriteString ":BUS1:CLOCK CHANnel1"
```

Query :BUS:CLOCK?

The :BUS:CLOCK query returns the channel being used for the specified bus.

Returned Format [:BUS:CLOCK] {CHANnel<O> | DIGital<M> | NONE}<NL>

History Legacy command (existed before version 3.10).

:BUS:CLOCK:SLOPe

Command :BUS:CLOCK:SLOPe {RISing | FALLing | EITHer}

NOTE

The BUS commands only apply to the MSO oscilloscopes.

The :BUS:CLOCK:SLOPe command sets the clock edge used for decoding the bus values.

<O> An integer, 1-4.

Example This example sets the clock edge to falling for bus 1.

```
myScope.WriteString ":ENABLE DIGital"
myScope.WriteString ":BUS1:CLOCK:SLOPE FALLING"
```

Query :BUS:CLOCK:SLOPe?

The :BUS:CLOCK:SLOPe query returns the clock edge being used for the specified bus.

Returned Format [:BUS:CLOCK:SLOPe] {RISing | FALLing | EITHer}<NL>

History Legacy command (existed before version 3.10).

:BUS:DISPlay

Command :BUS[:DISPlay] {ON | OFF | 1 | 0}

NOTE

The BUS commands only apply to the MSO oscilloscopes.

The :BUS:DISPlay command enables or disables the view of the selected bus. The digital subsystem must be enabled before this command will work. See the ENABLE command in the root subsystem.

<N> An integer, 1- 4.

Example This example enables the viewing of bus 1.

```
myScope.WriteString ":ENABLE DIGital"
myScope.WriteString ":BUS1 ON"
```

Query :BUS[:DISPlay]?

The :BUS[:DISPlay]? query returns the display value of the selected bus.

Returned Format [:BUS] {1 | 0}<NL>

History Legacy command (existed before version 3.10).

:BUS:LABel**Command** :BUS:LABel <quoted_string>**NOTE**

The BUS commands only apply to the MSO oscilloscopes.

The :BUS:LABel command sets the bus label to the quoted string. Setting a label for a bus will also result in the name being added to the label list.

NOTE

Label strings are 16 characters or less, and may contain any commonly used ASCII characters. Labels with more than 16 characters are truncated to 16 characters.

<N> An integer, 1- 4.**<quoted_string>** A series of 6 or less characters as a quoted ASCII string.**Example** This example sets the bus 1 label to Data.

```
myScope.WriteString ":BUS1:LABel "Data""
```

Query :BUS:LABel?

The :BUS:LABel? query returns the name of the specified bus.

Returned Format [:BUS:LABel] <quoted_string><NL>**History** Legacy command (existed before version 3.10).

:BUS:READout

Command :BUS:READout {DECimal | HEX | SIGNed | SYMBol}

NOTE

The BUS commands only apply to the MSO oscilloscopes.

The :BUS:READout command changes the format of the numbers displayed in the bus waveform.

<N> An integer, 1-4.

Example This example sets the bus read out to decimal.

```
myScope.WriteString ":BUS1:READout DECimal"
```

Query :BUS:READout?

The :BUS:READout? query returns the format of the readout control.

Returned Format [:BUS:READout] {DECimal | HEX | SIGNed | SYMBol}<NL>

History Legacy command (existed before version 3.10).

13 Calibration Commands

:CALibrate:DATE? / 289
:CALibrate:OUTPut / 290
:CALibrate:OUTPut:AUX / 292
:CALibrate:OUTPut:AUX:RTIME / 293
:CALibrate:OUTPut:CAL / 294
:CALibrate:SKEW / 295
:CALibrate:STATus? / 296
:CALibrate:TEMP? / 297

This chapter briefly explains the calibration of the oscilloscope. It is intended to give you and the calibration lab personnel an understanding of the calibration procedure and how the calibration subsystem is intended to be used.

The commands in the CALibration subsystem allow you to change the output of the front-panel Aux Out connector, adjust the skew of channels, and check the status of calibration.

These CALibration commands and queries are implemented in the Infiniium oscilloscopes:

This chapter briefly explains the calibration of the oscilloscope. It is intended to give you and the calibration lab personnel an understanding of the calibration procedure and how the calibration subsystem is intended to be used.

Oscilloscope Calibration Oscilloscope calibration establishes calibration factors for the oscilloscope. These factors are stored on the oscilloscope's hard disk.

- Initiate the calibration from the "Utilities Calibration" menu.

You should calibrate the oscilloscope periodically (at least annually), or if the ambient temperature since the last calibration has changed more than ± 5 °C. The temperature change since the last calibration is shown on the calibration status screen which is found under the "Utilities Calibration" dialog. It is the line labeled "Calibration Δ Temp: _ °C."

See also the oscilloscope's *Service Guide* has more details about the calibration.

Probe Calibration Probe calibration establishes the gain and offset of a probe that is connected to a channel of the oscilloscope, and applies these factors to the calibration of that channel.

- Initiate probe calibration from the "Setup > Channel > Probes > Calibrate Probe" menu.

To achieve the specified accuracy ($\pm 2\%$) with a probe connected to a channel, make sure the oscilloscope is calibrated.

- For probes that the oscilloscope can identify through the probe power connector, like the 1158A, the oscilloscope automatically adjusts the vertical scale factors for that channel even if a probe calibration is not performed.
- For nonidentified probes, the oscilloscope adjusts the vertical scale factors only if a probe calibration is performed.
- If you do not perform a probe calibration but want to use an unidentified probe, enter the attenuation factor in the "Setup > Channel > Probes > Configure Probing System > User Defined Probe" menu.
 - If the probe being calibrated has an attenuation factor that allows the oscilloscope to adjust the gain (in hardware) to produce even steps in the vertical scale factors, the oscilloscope will do so.
 - If the probe being calibrated has an unusual attenuation, like 3.75, the oscilloscope may have to adjust the vertical scale factors to an unusual number, like 3.75 V/div.

Typically, probes have standard attenuation factors such as divide by 10, divide by 20, or divide by 100.

:CALibrate:DATE?**Query** :CALibrate:DATE?

The :CALibrate:DATE? query returns two calibration dates and times:

- The date and time of the last regular user calibration.
- The date and time of the last time scale calibration.

Returned Format [:CALibrate:DATE] <user_date_time>,<ts_date_time><NL>

The string returned is formatted like "<day> <month> <year>

<hours>:<minutes>:<seconds>,<day> <month> <year>

<hours>:<minutes>:<seconds>", for example "31 MAY 2013 12:52:45,4 DEC 2012 10:59:52".

History Legacy command (existed before version 3.10).

:CALibrate:OUTPut

Command :CALibrate:OUTPut {AC | TRIGOUT | DC,<dc_value> | ZERO | ONE | DPULse
| SOSC | HFOSC | PRBS7 | PRBS15 | PRBS31}

The :CALibrate:OUTPut command sets the coupling frequency, trigger output pulse, and dc level of the calibrator waveform output through the front-panel Aux Out connector.

Options on all oscilloscopes:

- AC – sets the Aux Out to be the probe compensation square wave (approximately 750 Hz).
- TRIGOUT – outputs a pulse when the trigger event occurs. Use this to trigger other instruments.
- DC,<dc_value> – a DC level value in volts. The <dc_value> is a real number from -2.4 V to +2.4 V dc.

Options on 90000A Series, 90000 X-Series, V-Series, 90000 Q-Series, and Z-Series oscilloscopes:

- ZERO – a -450 mV DV level.
- ONE – a -150 mV DC level.
- DPULse – A double-pulse signal.
- SOSC – The 100 MHz reference clock output.
- HFOSC – A high-frequency oscillator output.

Options on 90000 X-Series, V-Series, 90000 Q-Series, and Z-Series oscilloscopes:

- PRBS7 – Pseudo-Random Binary Sequence with maximum length 2^7-1 bits, and its inverted version.
- PRBS15 – Pseudo-Random Binary Sequence with maximum length $2^{15}-1$ bits, and its inverted version.
- PRBS31 – Pseudo-Random Binary Sequence with maximum length $2^{31}-1$ bits, and its inverted version.

Example This example puts a DC voltage of 2.0 volts on the oscilloscope front-panel Aux Out connector.

```
myScope.WriteString ":CALibrate:OUTPut DC,2.0"
```

Query :CALibrate:OUTPut?

The :CALibrate:OUTPut? query returns the current setup.

Returned Format [:CALibrate:OUTPut] {AC | TRIGOUT | DC,<dc_value> | ZERO | ONE | DPULse
| SOSC | HFOSC | PRBS7 | PRBS15 | PRBS31}

Example This example places the current selection for the DC calibration to be printed in the string variable, strSelection, then prints the contents of the variable to the computer's screen.

```
Dim strSelection As String 'Dimension variable
myScope.WriteString ":CALibrate:OUTPut?"
strSelection = myScope.ReadString
Debug.Print strSelection
```

History Legacy command (existed before version 3.10).

Version 6.10: Added the PRBS7, PRBS15, and PRBS31 options for the Infiniium 90000 X-Series, V-Series, 90000 Q-Series, and Z-Series oscilloscopes.

:CALibrate:OUTPut:AUX

Command :CALibrate:OUTPut:AUX {{0 | OFF} | {1 | ON}}

The :CALibrate:OUTPut:AUX command enables or disables signal output on the oscilloscope's Aux Out connector.

NOTE

On the Infiniium S-Series, 9000 Series, or 90000A Series oscilloscopes, the only valid setting for this command is ON or 1.

Query :CALibrate:OUTPut:AUX?

The :CALibrate:OUTPut:AUX? query returns the Aux Out enable/disable setting.

Returned Format <setting><NL>

<setting> ::= {0 | 1}

- See Also**
- **":CALibrate:OUTPut"** on page 290
 - **":CALibrate:OUTPut:AUX:RTIME"** on page 293
 - **":CALibrate:OUTPut:CAL"** on page 294

History New in version 6.00.

:CALibrate:OUTPut:AUX:RTIME

Command :CALibrate:OUTPut:AUX:RTIME <risetime>

The :CALibrate:OUTPut:AUX:RTIME command specifies the speed of the Aux Out signal's rise time.

<risetime> {FAST | SLOW | RFAST}

NOTE

The RFAST option is available with the 9000 Series oscilloscopes only.

Query :CALibrate:OUTPut:AUX:RTIME?

The :CALibrate:OUTPut:AUX:RTIME? query returns the Aux Out rise time setting.

Returned Format <risetime><NL>

<risetime> ::= {FAST | SLOW | RFAST}

- See Also**
- **":CALibrate:OUTPut"** on page 290
 - **":CALibrate:OUTPut:AUX"** on page 292
 - **":CALibrate:OUTPut:CAL"** on page 294

History New in version 6.00.

:CALibrate:OUTPut:CAL

Command :CALibrate:OUTPut:CAL {{0 | OFF} | {1 | ON}}

The :CALibrate:OUTPut:CAL command enables or disables signal output on the oscilloscope's Cal Out connector.

NOTE

On the Infiniium S-Series, 9000 Series, or 90000A Series oscilloscopes, the only valid setting for this command is OFF or 0 because there is no Cal Out connector.

Query :CALibrate:OUTPut:CAL?

The :CALibrate:OUTPut:CAL? query returns the Cal Out enable/disable setting.

Returned Format <setting><NL>

<setting> ::= {0 | 1}

- See Also**
- **":CALibrate:OUTPut"** on page 290
 - **":CALibrate:OUTPut:AUX"** on page 292
 - **":CALibrate:OUTPut:AUX:RTIME"** on page 293

History New in version 6.00.

:CALibrate:SKEW

Command :CALibrate:SKEW <source>,<skew_value>

<source> ::= {CHANnel<N> | DIFF<D> | COMMONmode<C>}

The :CALibrate:SKEW command sets the channel-to-channel skew factor for a channel. The numeric argument is a real number in seconds, which is added to the current time base position to shift the position of the channel's data in time. Use this command to compensate for differences in the electrical lengths of input paths due to cabling and probes.

<N> An integer, 1-4.

<D>, <C> <D> is an integer, 1-2. <C> is an integer, 3-4.

The DIFF and COMMONmode sources are just aliases that can be used in place of the channel names to apply to differential or common mode signals. These are just aliases - no state change occurs if you refer to a differential channel and you are not in differential mode. DIFF1 refers to the differential signal between channels 1 and 3 (and COMMONmode3 refers to the common mode channel between these same channels). DIFF2 refers to the differential signal between channels 2 and 4 (and COMMONmode4 refers to the common mode channel between these same channels).

<skew_value> A real number, in seconds.

Example This example sets the oscilloscope channel 1 skew to 1 μ s.

```
myScope.WriteString ":CALibrate:SKEW CHANnel1,1E-6"
```

Query :CALibrate:SKEW? <source>

The :CALibrate:SKEW? query returns the current skew value.

Returned Format [:CALibrate:SKEW] <skew_value><NL>

History Legacy command (existed before version 3.10).

:CALibrate:STATus?

Query :CALibrate:STATus?

The :CALibrate:STATus? query returns the calibration status of the oscilloscope. These are ten, comma-separated integers, with 1, 0, or -1. A "1" indicates pass, a "0" indicates fail and a "-1" indicates unused. This matches the status in the Calibration dialog box in the Utilities menu.

Returned Format [:CALibrate:STATus] <status>

<status> <Oscilloscope Frame Status>, <Channel1 Vertical>, <Channel1 Trigger>, <Channel2 Vertical>, <Channel2 Trigger>, <Channel3 Vertical>, <Channel3 Trigger>, <Channel4 Vertical>, <Channel4 Trigger>, <Aux Trigger>

History Legacy command (existed before version 3.10).

:CALibrate:TEMP?

Query :CALibrate:TEMP?

The :CALibrate:TEMP? query returns two delta temperature values in Celsius:

- Between the current temp and the temp of the last time scale calibration.
- Between the current temp and the temp of the last regular user calibration.

Returned Format [:CALibrate:TEMP] <ts_delta_temp>,<user_delta_temp><NL>

For example, the string returned could be "-1,0". A difference in the two delta values of one degree is not uncommon.

History Legacy command (existed before version 3.10).

14 Channel Commands

:CHANnel<N>:BWLimit (9000 Series, 9000H Series, S-Series) / 302
:CHANnel<N>:COMMonmode / 303
:CHANnel<N>:DIFFerential / 304
:CHANnel<N>:DIFFerential:SKEW / 305
:CHANnel<N>:DISPlay / 306
:CHANnel<N>:DISPlay:AUTO / 307
:CHANnel<N>:DISPlay:OFFSet / 309
:CHANnel<N>:DISPlay:RANGe / 311
:CHANnel<N>:DISPlay:SCALe / 313
:CHANnel<N>:INPut / 315
:CHANnel<N>:INVert / 316
:CHANnel<N>:ISIM:APPLy / 317
:CHANnel<N>:ISIM:BANDwidth / 318
:CHANnel<N>:ISIM:BWLimit / 320
:CHANnel<N>:ISIM:BWLimit:TYPE / 322
:CHANnel<N>:ISIM:CONVolve / 323
:CHANnel<N>:ISIM:CORRection / 324
:CHANnel<N>:ISIM:DEConvolve / 326
:CHANnel<N>:ISIM:DELay / 327
:CHANnel<N>:ISIM:NORMAlize / 328
:CHANnel<N>:ISIM:PEXTraction / 329
:CHANnel<N>:ISIM:SPAN / 331
:CHANnel<N>:ISIM:STATe / 332
:CHANnel<N>:LABel / 333
:CHANnel<N>:OFFSet / 334
:CHANnel<N>:PROBe / 335
:CHANnel<N>:PROBe:ACCAL / 336
:CHANnel<N>:PROBe:ATTenuation / 337
:CHANnel<N>:PROBe:AUTOzero / 338
:CHANnel<N>:PROBe:COUPLing / 339
:CHANnel<N>:PROBe:EADapter / 340
:CHANnel<N>:PROBe:ECOupling / 343

:CHANnel<N>:PROBe:EXTErnal / 344
:CHANnel<N>:PROBe:EXTErnal:GAIN / 345
:CHANnel<N>:PROBe:EXTErnal:OFFSet / 346
:CHANnel<N>:PROBe:EXTErnal:UNITs / 347
:CHANnel<N>:PROBe:GAIN / 348
:CHANnel<N>:PROBe:HEAD:ADD / 349
:CHANnel<N>:PROBe:HEAD:DELeTe ALL / 350
:CHANnel<N>:PROBe:HEAD:SELeCt / 351
:CHANnel<N>:PROBe:HEAD:VTErm / 352
:CHANnel<N>:PROBe:ID? / 353
:CHANnel<N>:PROBe:INFO? / 354
:CHANnel<N>:PROBe:MODE / 355
:CHANnel<N>:PROBe:PRECprobe:BANDwidth / 356
:CHANnel<N>:PROBe:PRECprobe:CALibration / 357
:CHANnel<N>:PROBe:PRECprobe:DELay / 358
:CHANnel<N>:PROBe:PRECprobe:MODE / 359
:CHANnel<N>:PROBe:PRECprobe:ZSRC / 360
:CHANnel<N>:PROBe:PRIMary (9000 Series, 9000H Series, S-Series) / 362
:CHANnel<N>:PROBe:SKEW / 363
:CHANnel<N>:PROBe:STYPe / 364
:CHANnel<N>:RANGe / 365
:CHANnel<N>:SCALE / 366
:CHANnel<N>:SIMulation:AMPLitude / 367
:CHANnel<N>:SIMulation:DATA:LENGth / 368
:CHANnel<N>:SIMulation:DATA:ODD / 369
:CHANnel<N>:SIMulation:DATA:PAM / 370
:CHANnel<N>:SIMulation:DATA:RESeed / 371
:CHANnel<N>:SIMulation:DATA:SELeCtion / 372
:CHANnel<N>:SIMulation:DRATE / 373
:CHANnel<N>:SIMulation:FILTer:ISIM:ADDReSS / 374
:CHANnel<N>:SIMulation:FILTer:ISIM:PEXTraction / 375
:CHANnel<N>:SIMulation:FILTer:SELeCtion / 376
:CHANnel<N>:SIMulation:FLOad:ADDReSS / 377
:CHANnel<N>:SIMulation:FLOad:LOOP / 378
:CHANnel<N>:SIMulation:FREQUency / 379
:CHANnel<N>:SIMulation:FUNCTion:SELeCtion / 380
:CHANnel<N>:SIMulation:FUNCTion:SQUare:DCYCLE / 381
:CHANnel<N>:SIMulation:FUNCTion:SQUare:FTIME / 382
:CHANnel<N>:SIMulation:FUNCTion:SQUare:RTIME / 383

```

:CHANnel<N>:SIMulation:JITTer / 384
:CHANnel<N>:SIMulation:JITTer:ABUJ / 385
:CHANnel<N>:SIMulation:JITTer:PERiodic<M>:ENABle / 386
:CHANnel<N>:SIMulation:JITTer:PERiodic<M>:FREQuency / 387
:CHANnel<N>:SIMulation:JITTer:PERiodic<M>:MAGNitude / 388
:CHANnel<N>:SIMulation:JITTer:PERiodic<M>:SHAPE / 389
:CHANnel<N>:SIMulation:JITTer:RANDom / 390
:CHANnel<N>:SIMulation:NOISe / 391
:CHANnel<N>:SIMulation:NOISe:BWLimit / 392
:CHANnel<N>:SIMulation:NOISe:PERiodic<M>:ENABle / 393
:CHANnel<N>:SIMulation:NOISe:PERiodic<M>:FREQuency / 394
:CHANnel<N>:SIMulation:NOISe:PERiodic<M>:MAGNitude / 395
:CHANnel<N>:SIMulation:NOISe:PERiodic<M>:SHAPE / 396
:CHANnel<N>:SIMulation:NOISe:RANDom / 397
:CHANnel<N>:SIMulation:OFFSet / 398
:CHANnel<N>:SIMulation:WAVEform / 399
:CHANnel<N>:UNITs / 400

```

The CHANnel subsystem commands control all vertical (Y axis) functions of the oscilloscope. You may toggle the channel displays on and off with the root level commands :VIEW and :BLANK, or with :CHANnel:DISPlay.

NOTE

In this section, you can specify differential and/or common mode channels using the following convention. If you have differential or common mode channels enabled (using either the :CHANnel<N>:DIFFerential or :CHANnel<N>:COMMonmode commands) then:

- :CHANnel1 would refer to the Channel 1 - Channel 3 differential channel
- :CHANnel2 would refer to the Channel 2 - Channel 4 differential channel
- :CHANnel3 would refer to the Channel 1 + Channel 3 common mode channel
- :CHANnel4 would refer to the Channel 2 + Channel 4 common mode channel

:CHANnel<N>:BWLimit (9000 Series, 9000H Series, S-Series)

Command :CHANnel<N>:BWLimit {{ON | 1} | {OFF | 0}} **for 9000, 9000H Series**
 :CHANnel<N>:BWLimit {{OFF | 0} | 20e6 | 200e6} **for S-Series**

On Infiniium 9000 Series or S-Series oscilloscopes, the :CHANnel<N>:BWLimit command controls the input channel's low-pass filter. When ON (or set to a value), the bandwidth of the specified channel is limited. The bandwidth filter can be used with either AC or DC coupling.

- On Infiniium 9000 Series oscilloscopes, 1M Ω input impedance must be selected before you can turn on the 20 MHz low-pass filter (see **":CHANnel<N>:INPut"** on page 315).
- On Infiniium S-Series oscilloscopes, 20 MHz or 200 MHz low pass filters can be turned on (without a passive probe being connected).

You can enable custom bandwidth limits using the :CHANnel<N>:ISIM:BWLimit command. You can specify the custom bandwidth limit value with the :CHANnel<N>:ISIM:BANDwidth command.

<N> An integer, 1-4.

Example This example sets the internal low-pass filter to "ON" for channel 1.

```
myScope.WriteString ":CHANnel1:BWLimit ON"
```

Query :CHANnel<N>:BWLimit?

The :CHANnel<N>:BWLimit? query returns the current state of the low-pass filter for the specified channel.

Returned Format [:CHANnel<N>:BWLimit] {1 | 0}<NL> **for 9000, 9000H Series**
 [:CHANnel<N>:BWLimit] {0 | 20e6 | 200e6}<NL> **for S-Series**

Example This example places the current setting of the low-pass filter in the variable varLimit, then prints the contents of the variable to the computer's screen.

```
myScope.WriteString ":SYSTem:HEADer OFF"
myScope.WriteString ":CHANnel1:BWLimit?"
varLimit = myScope.ReadNumber
Debug.Print FormatNumber(varLimit, 0)
```

- See Also**
- **":CHANnel<N>:INPut"** on page 315
 - **":CHANnel<N>:ISIM:BWLimit"** on page 320
 - **":CHANnel<N>:ISIM:BANDwidth"** on page 318
 - **":ACQuire:BANDwidth"** on page 207

History Legacy command (existed before version 3.10).

:CHANnel<N>:COMMONmode

Command :CHANnel<N>:COMMONmode {{ON | 1} | {OFF | 0}}

The :CHANnel<N>:COMMONmode command turns on/off common mode for the channel. Channels 2 and 4 may form a common mode channel and Channels 1 and 3 may form a common mode channel.

<N> An integer, 1-4 in a single oscilloscope, 1-40 in a MultiScope system.

Example This example turns channel 1 common mode channel on (channel 1 + channel 3).

```
myScope.WriteString ":CHANnel1:COMMONmode ON"
```

Query :CHANnel<N>:COMMONmode?

The :CHANnel<N>:COMMONmode? query returns whether the channel is in commonmode or not.

Returned Format [:CHANnel<N>:COMMONmode] {1 | 0}<NL>

Example This example places the current common mode setting of the channel 1 display in the variable varComm, then prints the contents of the variable to the computer's screen.

```
myScope.WriteString ":SYSTEM:HEADer OFF"
myScope.WriteString ":CHANnel1:COMMONmode?"
varComm = myScope.ReadNumber
Debug.Print FormatNumber(varComm, 0)
```

History Legacy command (existed before version 3.10).

:CHANnel<N>:DIFFerential

Command :CHANnel<N>:DIFFerential {{ON | 1} | {OFF | 0}}

The :CHANnel<N>:DIFFerential command turns on/off differential mode for the channel. Channels 1 and 3 may form a differential channel and Channels 2 and 4 may form a differential channel.

When differential channel modes are turned on, you can specify the display vertical scale, range, and offsets for the differential or common mode signals (using the :CHANnel<N>:DISPlay:SCALE, :CHANnel<N>:DISPlay:RANGe, or :CHANnel<N>:DISPlay:OFFSet commands), or you can set the display vertical scale, range, and offsets to track the acquisition vertical scale and offset (using the :CHANnel<N>:DISPlay:AUTO command).

<N> An integer, 1-4 in a single oscilloscope, 1-40 in a MultiScope system.

Example This example turns channel 1 differential on (channel 1 - channel 3).

```
myScope.WriteString ":CHANnel1:DIFFerential ON"
```

Query :CHANnel<N>:DIFFerential?

The :CHANnel<N>:DIFFerential? query returns whether the channel is in differential mode or not.

Returned Format [:CHANnel<N>:DIFFerential] {1 | 0}<NL>

Example This example places the current differential setting of the channel 1 display in the variable varDiff, then prints the contents of the variable to the computer's screen.

```
myScope.WriteString ":SYSTem:HEADer OFF"
myScope.WriteString ":CHANnel1:DIFFerential?"
varDiff = myScope.ReadNumber
Debug.Print FormatNumber(varDiff, 0)
```

See Also

- [":CHANnel<N>:DISPlay:AUTO"](#) on page 307
- [":CHANnel<N>:DISPlay:OFFSet"](#) on page 309
- [":CHANnel<N>:DISPlay:RANGe"](#) on page 311
- [":CHANnel<N>:DISPlay:SCALE"](#) on page 313

History Legacy command (existed before version 3.10).

:CHANnel<N>:DIFFerential:SKEW

Command :CHANnel<N>:DIFFerential:SKEW <skew>

The :CHANnel<N>:DIFFerential:SKEW <skew> command sets the skew that is applied to the differential or common mode pair of channels.

<skew> A real number for the skew value

Example This example sets the skew applied to the channel 1 - channel 3 differential channel to 10 μ s.

```
myScope.WriteString ":CHANnel1:DIFFerential:SKEW 10E-6"
```

Query :CHANnel<N>:DIFFerential:SKEW?

The :CHANnel<N>:DIFFerential:SKEW? query returns the skew that is applied to the differential or common mode pair of channels.

Returned Format [:CHANnel<N>:DIFFerential:SKEW] <skew_value><NL>

Example This example places the current skew setting of the channel 1 - channel 3 differential channel in the variable varSkew, then prints the contents of the variable to the computer's screen.

```
myScope.WriteString ":SYSTem:HEADer OFF"
myScope.WriteString ":CHANnel1:DIFFerential:SKEW?"
varSkew = myScope.ReadNumber
Debug.Print FormatNumber(varSkew, 0)
```

History Legacy command (existed before version 3.10).

:CHANnel<N>:DISPlay

Command :CHANnel<N>:DISPlay {{ON | 1} | {OFF | 0}}

The :CHANnel<N>:DISPlay command turns the display of the specified channel on or off.

NOTE

You can specify differential and/or common mode channels using the following convention. If you have differential or common mode channels enabled (using either the :CHANnel<N>:DIFFerential or :CHANnel<N>:COMMonmode commands) then:

- :CHANnel1 would refer to the Channel 1 - Channel 3 differential channel
- :CHANnel2 would refer to the Channel 2 - Channel 4 differential channel
- :CHANnel3 would refer to the Channel 1 + Channel 3 common mode channel
- :CHANnel4 would refer to the Channel 2 + Channel 4 common mode channel

<N> An integer, 1-4 in a single oscilloscope, 1-40 in a MultiScope system.

Example This example sets channel 1 display to on.

```
myScope.WriteString ":CHANnel1:DISPlay ON"
```

Query :CHANnel<N>:DISPlay?

The :CHANnel<N>:DISPlay? query returns the current display condition for the specified channel.

Returned Format [:CHANnel<N>:DISPlay] {1 | 0}<NL>

Example This example places the current setting of the channel 1 display in the variable varDisplay, then prints the contents of the variable to the computer's screen.

```
myScope.WriteString ":SYSTem:HEADer OFF"
myScope.WriteString ":CHANnel1:DISPlay?"
varDisplay = myScope.ReadNumber
Debug.Print FormatNumber(varDisplay, 0)
```

History Legacy command (existed before version 3.10).

:CHANnel<N>:DISPlay:AUTO

Command :CHANnel<N>:DISPlay:AUTO {{ON | 1} | {OFF | 0}}

NOTE

This command only works when differential channel modes are turned on (using the :CHANnel<N>:DIFFerential command).

When differential channel modes are turned on:

- ON – sets the differential and common mode display vertical scale and offset to track the acquisition vertical scale and offset.

In this case, the differential and common mode display vertical scale and offsets are set using the normal :CHANnel<N>:SCALE, :CHANnel<N>:RANGE, or :CHANnel<N>:OFFSet commands.

- OFF – the differential and common mode display vertical scale and offset are set using the the :CHANnel<N>:DISPlay:SCALE, :CHANnel<N>:DISPlay:RANGE, or :CHANnel<N>:DISPlay:OFFSet commands.

<N> An integer, 1-4 in a single oscilloscope, 1-40 in a MultiScope system.

NOTE

You can specify differential and/or common mode channels using the following convention. If you have differential or common mode channels enabled (using either the :CHANnel<N>:DIFFerential or :CHANnel<N>:COMMonmode commands) then:

- :CHANnel1 would refer to the Channel 1 - Channel 3 differential channel
- :CHANnel2 would refer to the Channel 2 - Channel 4 differential channel
- :CHANnel3 would refer to the Channel 1 + Channel 3 common mode channel
- :CHANnel4 would refer to the Channel 2 + Channel 4 common mode channel

Example This example sets the channel 1 - channel 3 differential channel display scale and offset to track the acquisition scale and offset.

```
myScope.WriteString ":CHANnel1:DISPlay:AUTO ON"
```

Query :CHANnel<N>:DISPlay:AUTO?

The :CHANnel<N>:DISPlay:AUTO? query returns whether or not the differential or common mode display scale and offset are tracking the acquisition scale and offset.

Returned Format [:CHANnel<N>:DISPlay:AUTO] {1 | 0}<NL>

Example This example places whether or not the channel 1 - channel 3 differential channel display scale and offset is tracking the acquisition scale and offset in the variable varAuto, then prints the contents of the variable to the computer's screen.

```
myScope.WriteString ":SYSTem:HEADer OFF"
myScope.WriteString ":CHANnel1:DISPlay:AUTO?"
```

```
varAuto = myScope.ReadNumber  
Debug.Print FormatNumber(varAuto, 0)
```

- See Also**
- **":CHANnel<N>:DIFFerential"** on page 304
 - **":CHANnel<N>:DISPlay:OFFSet"** on page 309
 - **":CHANnel<N>:DISPlay:RANGe"** on page 311
 - **":CHANnel<N>:DISPlay:SCALe"** on page 313
 - **":CHANnel<N>:OFFSet"** on page 334
 - **":CHANnel<N>:RANGe"** on page 365
 - **":CHANnel<N>:SCALe"** on page 366

History Legacy command (existed before version 3.10).

:CHANnel<N>:DISPlay:OFFSet

Command :CHANnel<N>:DISPlay:OFFSet <value>

NOTE

This command only works when differential channel modes are turned on (using the :CHANnel<N>:DIFFerential command).

When differential channel modes are turned on, the :CHANnel<N>:DISPlay:OFFSet command sets the display vertical offset of the selected channel.

If the differential and common mode display vertical scale and offset is set to track the acquisition vertical scale and offset (:CHANnel<N>:DISPlay:AUTO ON), using the :CHANnel<N>:DISPlay:OFFSet command turns OFF auto tracking, and the :CHANnel<N>:DISPlay:SCALe, :CHANnel<N>:DISPlay:RANGe, and :CHANnel<N>:DISPlay:OFFSet commands are used to specify the display vertical scale, range, and offsets for the differential or common mode signals.

<value> A real number for the value variable

NOTE

You can specify differential and/or common mode channels using the following convention. If you have differential or common mode channels enabled (using either the :CHANnel<N>:DIFFerential or :CHANnel<N>:COMMonmode commands) then:

- :CHANnel1 would refer to the Channel 1 - Channel 3 differential channel
- :CHANnel2 would refer to the Channel 2 - Channel 4 differential channel
- :CHANnel3 would refer to the Channel 1 + Channel 3 common mode channel
- :CHANnel4 would refer to the Channel 2 + Channel 4 common mode channel

Example This example sets the displayed offset of channel 1 to

```
myScope.WriteString ":CHANnel1:DISPlay:RANGe 10e-6"
```

Query :CHANnel<N>:DISPlay:OFFSet?

The :CHANnel<N>:DISPlay:OFFSet? query returns the displayed offset for the selected channel.

Returned Format [:CHANnel<N>:DISPlay:OFFSet] <value><NL>

Example This example places the displayed offset of channel 1 in the variable varOffset, then prints the contents of the variable to the computer's screen.

```
myScope.WriteString ":SYSTem:HEADer OFF"
myScope.WriteString ":CHANnel1:DISPlay:OFFSet?"
varOffset = myScope.ReadNumber
Debug.Print FormatNumber (varOffset, 0)
```

See Also

- [":CHANnel<N>:DIFFerential"](#) on page 304
- [":CHANnel<N>:DISPlay:AUTO"](#) on page 307

- **":CHANnel<N>:DISPlay:RANGe"** on page 311
- **":CHANnel<N>:DISPlay:SCALe"** on page 313

History Legacy command (existed before version 3.10).

:CHANnel<N>:DISPlay:RANGe

Command :CHANnel<N>:DISPlay:RANGe <range>

NOTE

This command only works when differential channel modes are turned on (using the :CHANnel<N>:DIFFerential command).

When differential channel modes are turned on, the :CHANnel<N>:DISPlay:RANGe command sets the display full scale vertical range of the selected channel.

If the differential and common mode display vertical scale and offset is set to track the acquisition vertical scale and offset (:CHANnel<N>:DISPlay:AUTO ON), using the :CHANnel<N>:DISPlay:RANGe command turns OFF auto tracking, and the :CHANnel<N>:DISPlay:SCALE, :CHANnel<N>:DISPlay:RANGe, and :CHANnel<N>:DISPlay:OFFSet commands are used to specify the display vertical scale, range, and offsets for the differential or common mode signals.

<range> A real number for the range value

NOTE

You can specify differential and/or common mode channels using the following convention. If you have differential or common mode channels enabled (using either the :CHANnel<N>:DIFFerential or :CHANnel<N>:COMMonmode commands) then:

- :CHANnel1 would refer to the Channel 1 - Channel 3 differential channel
- :CHANnel2 would refer to the Channel 2 - Channel 4 differential channel
- :CHANnel3 would refer to the Channel 1 + Channel 3 common mode channel
- :CHANnel4 would refer to the Channel 2 + Channel 4 common mode channel

Example This example sets the display range of the display of channel 1 to

```
myScope.WriteString ":CHANnel1:DISPlay:RANGe 10e-6"
```

Query :CHANnel<N>:DISPlay:RANGe?

The :CHANnel<N>:DISPlay:RANGe? query returns the full scale vertical range of the display for the selected channel.

Returned Format [:CHANnel<N>:DISPlay:RANGe] <range><NL>

Example This example places the range of channel 1 in the variable varRange, then prints the contents of the variable to the computer's screen.

```
myScope.WriteString ":SYSTem:HEADer OFF"
myScope.WriteString ":CHANnel1:DISPlay:RANGe?"
varRange = myScope.ReadNumber
Debug.Print FormatNumber (varRange, 0)
```

See Also

- [":CHANnel<N>:DIFFerential"](#) on page 304
- [":CHANnel<N>:DISPlay:AUTO"](#) on page 307

- **":CHANnel<N>:DISPlay:OFFSet"** on page 309
- **":CHANnel<N>:DISPlay:SCALe"** on page 313

History Legacy command (existed before version 3.10).

:CHANnel<N>:DISPlay:SCALE

Command :CHANnel<N>:DISPlay:SCALE <scale>

NOTE

This command only works when differential channel modes are turned on (using the :CHANnel<N>:DIFFerential command).

When differential channel modes are turned on, the :CHANnel<N>:DISPlay:SCALE command sets the display vertical scale (units per division) of the selected channel.

If the differential and common mode display vertical scale and offset is set to track the acquisition vertical scale and offset (:CHANnel<N>:DISPlay:AUTO ON), using the :CHANnel<N>:DISPlay:SCALE command turns OFF auto tracking, and the :CHANnel<N>:DISPlay:SCALE, :CHANnel<N>:DISPlay:RANGE, and :CHANnel<N>:DISPlay:OFFSet commands are used to specify the display vertical scale, range, and offsets for the differential or common mode signals.

<scale> A real number for the scale value

NOTE

You can specify differential and/or common mode channels using the following convention. If you have differential or common mode channels enabled (using either the :CHANnel<N>:DIFFerential or :CHANnel<N>:COMMONmode commands) then:

- :CHANnel1 would refer to the Channel 1 - Channel 3 differential channel
- :CHANnel2 would refer to the Channel 2 - Channel 4 differential channel
- :CHANnel3 would refer to the Channel 1 + Channel 3 common mode channel
- :CHANnel4 would refer to the Channel 2 + Channel 4 common mode channel

Example This example sets the display scale of channel 1 per division to

```
myScope.WriteString ":CHANnel1:DISPlay:SCALE 10e-6"
```

Query :CHANnel<N>:DISPlay:SCALE?

The :CHANnel<N>:DISPlay:SCALE? query returns the displayed scale of the selected channel per division.

Returned Format [:CHANnel<N>:DISPlay:SCALE] <scale><NL>

Example This example places the display scale of channel 1 in the variable varScale, then prints the contents of the variable to the computer's screen.

```
myScope.WriteString ":SYSTEM:HEADer OFF"
myScope.WriteString ":CHANnel1:DISPlay:SCALE?"
varScale = myScope.ReadNumber
Debug.Print FormatNumber(varScale, 0)
```

See Also • [":CHANnel<N>:DIFFerential"](#) on page 304

- `":CHANnel<N>:DISPlay:AUTO"` on page 307
- `":CHANnel<N>:DISPlay:OFFSet"` on page 309
- `":CHANnel<N>:DISPlay:RANGe"` on page 311

History Legacy command (existed before version 3.10).

:CHANnel<N>:INPut

Command :CHANnel<N>:INPut <parameter>

The :CHANnel<N>:INPut command selects the input coupling, impedance, and LF/HF reject for the specified channel.

<N> An integer, 1-4 in a single oscilloscope, 1-40 in a MultiScope system.

<parameter> On 9000 Series, 9000H Series, and S-Series oscilloscopes:

- DC – DC coupling, 1 M Ω impedance.
- DC50 | DCFifty – DC coupling, 50 Ω impedance.
- AC – AC coupling, 1 M Ω impedance.
- LFR1 | LFR2 – AC 1 M Ω input impedance.

When no probe is attached, the coupling for each channel can be AC, DC, DC50, or DCFifty.

If you have an 1153A probe attached, the valid parameters are DC, LFR1, and LFR2 (low-frequency reject).

On 90000A Series, 90000 X-Series, V-Series, 90000 Q-Series, and Z-Series oscilloscopes:

- DC50 | DCFifty – DC coupling, 50 Ω impedance.

Example This example sets the channel 1 input to DC50.

```
myScope.WriteString ":CHANnel1:INPut DC50"
```

Query :CHANnel<N>:INPut?

The :CHANnel<N>:INPut? query returns the selected channel input parameter.

Returned Format [CHANnel<N>:INPut] <parameter><NL>

Example This example puts the current input for channel 1 in the string variable, strInput. The program then prints the contents of the variable to the computer's screen.

```
myScope.WriteString ":SYSTem:HEADer OFF"
myScope.WriteString ":CHANnel1:INPut?"
strInput = myScope.ReadString
Debug.Print strInput
```

History Legacy command (existed before version 3.10).

:CHANnel<N>:INVert

Command :CHANnel<N>:INVert {{0 | OFF} | {1 | ON}}

The :CHANnel<N>:INVert command enables or disables the invert setting for a channel.

Inverting a channel causes the waveform to be reflected about the 0 V reference point. Inverting a channel can cause the oscilloscope to stop triggering (depending on the trigger level setting) and it can affect math function waveforms that have the channel as an input source.

Query :CHANnel<N>:INVert?

The :CHANnel<N>:INVert? query returns the channel invert setting.

Returned Format <setting><NL>

<setting> ::= {0 | 1}

History New in version 5.70.

:CHANnel<N>:ISIM:APPLy

Command :CHANnel<N>:ISIM:APPLy "<transfer_func_t_file>"

NOTE

This CHANnel command only applies if you have purchased the InfiniiSim software application.

The :CHANnel<N>:ISIM:APPLy command applies a pre-computed transfer function to the waveform. If InfiniiSim is in 2 port mode, the file must be a .tf2 file. If in 4 port mode, the file must be a .tf4 file. Use the ISIM:STATe command to enable InfiniiSim before issuing the APPLy command.

NOTE

You can specify differential and/or common mode channels using the following convention. If you have differential or common mode channels enabled (using either the :CHANnel<N>:DIFFerential or :CHANnel<N>:COMMonmode commands) then:

- :CHANnel1 would refer to the Channel 1 - Channel 3 differential channel
- :CHANnel2 would refer to the Channel 2 - Channel 4 differential channel
- :CHANnel3 would refer to the Channel 1 + Channel 3 common mode channel
- :CHANnel4 would refer to the Channel 2 + Channel 4 common mode channel

<N> An integer, 1-4 in a single oscilloscope, 1-40 in a MultiScope system.

<transfer_func_t_file> The full path to the .tf2 file name (if in 2 port mode) or the .tf4 file (if in 4 port mode).

Example This example applies the example.tf4 file to the waveform on channel 1.

```
myScope.WriteString _
  ":CHANnel1:ISIM:APPLy " + _
  "\"C:\Users\Public\Documents\Infiniium\Filters\example.tf4\""
```

Query :CHANnel<N>:ISIM:APPLy?

The :CHANnel<N>:ISIM:APPLy? query returns the currently selected function file name when 2 port or 4 port mode is enabled.

Returned Format [CHANnel<N>:ISIM:APPLy] <file_name><NL>

Example This example puts the current transfer function file name in the variable strFile. The program then prints the contents of the variable to the computer's screen.

```
myScope.WriteString ":SYSTem:HEADer OFF"
myScope.WriteString ":CHANnel1:ISIM:APPLy?"
strFile = myScope.ReadString
Debug.Print strFile
```

History Legacy command (existed before version 3.10).

:CHANnel<N>:ISIM:BANDwidth

Command :CHANnel<N>:ISIM:BANDwidth <bw_value>

The :CHANnel<N>:ISIM:BANDwidth command lets you set the custom bandwidth limit (cutoff frequency) value. The :CHANnel<N>:ISIM:BWLimit command lets you enable or disable the custom bandwidth limit.

NOTE

- On Infiniium 9000 Series oscilloscopes, you can use the :CHANnel<N>:BWLimit command to enable or disable a 20 MHz low-pass filter on the input channel.
- On Infiniium S-Series oscilloscopes, you can use the :CHANnel<N>:BWLimit command to enable or disable a 20 MHz or 200 MHz low-pass filter on the input channel.

NOTE

You can specify differential and/or common mode channels using the following convention. If you have differential or common mode channels enabled (using either the :CHANnel<N>:DIFFerential or :CHANnel<N>:COMMonmode commands) then:

- :CHANnel1 would refer to the Channel 1 - Channel 3 differential channel
- :CHANnel2 would refer to the Channel 2 - Channel 4 differential channel
- :CHANnel3 would refer to the Channel 1 + Channel 3 common mode channel
- :CHANnel4 would refer to the Channel 2 + Channel 4 common mode channel

<N> An integer, 1-4 in a single oscilloscope, 1-40 in a MultiScope system.

<bw_value> The maximum value is the sample rate / 2. The minimum value is 1000 Hz.

Example This example sets the channel 1 input bandwidth limit cutoff frequency to 2 GHz.

```
myScope.WriteString ":CHANnel1:ISIM:BANDwidth 2e9"
```

Query :CHANnel<N>:ISIM:BANDwidth?

The :CHANnel<N>:ISIM:BANDwidth? query returns the selected channel input's bandwidth limit cutoff frequency.

Returned Format [CHANnel<N>:ISIM:BANDwidth] <parameter><NL>

Example This example puts the current input for channel 1 in the string variable, varBwLimit. The program then prints the contents of the variable to the computer's screen.

```
myScope.WriteString ":SYSTEM:HEADer OFF"
myScope.WriteString ":CHANnel1:ISIM:BANDwidth?"
varBwLimit = myScope.ReadNumber
Debug.Print FormatNumber(varBwLimit, 0)
```

- See Also**
- [":CHANnel<N>:ISIM:BWLimit"](#) on page 320
 - [":CHANnel<N>:BWLimit \(9000 Series, 9000H Series, S-Series\)"](#) on page 302
 - [":ACQuire:BANDwidth"](#) on page 207

History Legacy command (existed before version 3.10).

:CHANnel<N>:ISIM:BWLimit

Command :CHANnel<N>:ISIM:BWLimit {{ON | 1} | {OFF | 0}}

The :CHANnel<N>:ISIM:BWLimit command lets you enable or disable the custom bandwidth limit (cutoff frequency). The CHANnel<N>:ISIM:BANDwidth command sets the value to be used when the custom bandwidth limit is enabled.

NOTE

- On Infiniium 9000 Series oscilloscopes, you can use the :CHANnel<N>:BWLimit command to enable or disable a 20 MHz low-pass filter on the input channel.
- On Infiniium S-Series oscilloscopes, you can use the :CHANnel<N>:BWLimit command to enable or disable a 20 MHz or 200 MHz low-pass filter on the input channel.

NOTE

You can specify differential and/or common mode channels using the following convention. If you have differential or common mode channels enabled (using either the :CHANnel<N>:DIFFerential or :CHANnel<N>:COMMonmode commands) then:

- :CHANnel1 would refer to the Channel 1 - Channel 3 differential channel
- :CHANnel2 would refer to the Channel 2 - Channel 4 differential channel
- :CHANnel3 would refer to the Channel 1 + Channel 3 common mode channel
- :CHANnel4 would refer to the Channel 2 + Channel 4 common mode channel

<N> An integer, 1-4 in a single oscilloscope, 1-40 in a MultiScope system.

Example This example turns on the bandwidth limit feature for channel 1.

```
myScope.WriteString ":CHANnel1:ISIM:BWLimit ON"
```

Query :CHANnel<N>:ISIM:BWLimit?

The :CHANnel<N>:ISIM:BWLimit? query returns the current state of the corresponding channel's bandwidth limiting feature.

Returned Format [CHANnel<N>:ISIM:BWLimit] {1 | 0}<NL>

Example This example puts the current bandwidth limit state for channel 1 in the string variable, varLimit. The program then prints the contents of the variable to the computer's screen.

```
myScope.WriteString ":SYSTem:HEADer OFF"
myScope.WriteString ":CHANnel1:ISIM:BWLimit?"
varLimit = myScope.ReadNumber
Debug.Print FormatNumber(varLimit, 0)
```

- See Also**
- [":CHANnel<N>:ISIM:BWLimit:TYPE"](#) on page 322
 - [":CHANnel<N>:ISIM:BANDwidth"](#) on page 318
 - [":CHANnel<N>:BWLimit \(9000 Series, 9000H Series, S-Series\)"](#) on page 302
 - [":ACQuire:BANDwidth"](#) on page 207

History Legacy command (existed before version 3.10).

:CHANnel<N>:ISIM:BWLimit:TYPE

Command :CHANnel<N>:ISIM:BWLimit:TYPE <filter_type>

<filter_type> ::= {WALL | BESSEL4}

The :CHANnel<N>:ISIM:BWLimit:TYPE command specifies a channel's bandwidth limit filter response:

- WALL – Specifies a Brick-Wall response for the bandwidth limit filter. This response has a sharp roll-off.
- BESSEL4 – Specifies a 4th Order Bessel response for the bandwidth limit filter. This response has a more gradual roll-off.

NOTE

To achieve the 4th Order Bessel response, the maximum band width you can specify is about 2/3 of the maximum band width you could specify with the Brick-Wall filter. Also with the 4th Order Bessel filter, the brick-wall response takes over at what would be the brick-wall filter's maximum band width. Therefore, you can have a combination of roll-off responses with this selection.

Query :CHANnel<N>:ISIM:BWLimit:TYPE?

The :CHANnel<N>:ISIM:BWLimit:TYPE? query returns the bandwidth limit filter response setting.

Returned Format <filter_type><NL>

<filter_type> ::= {WALL | BESSEL4}

See Also • [":CHANnel<N>:ISIM:BWLimit"](#) on page 320

History New in version 5.70.

:CHANnel<N>:ISIM:CONVolve

Command :CHANnel<N>:ISIM:CONVolve "<s_parameter_file>", {OFF | ON}

NOTE

This CHANnel command is available when you have purchased the InfiniiSim software application.

The :CHANnel<N>:ISIM:CONVolve command sets the InfiniiSim 2 Port state (:CHANnel<N>:ISIM:STATe PORT2), automates the creation of a transfer function, and applies the transfer function to the channel waveform. The transfer function is created using the **Add insertion loss of a fixture or cable** application preset's simple one-block circuit model. The S-parameter file defines the simulation circuit of the single block and the measurement circuit is a **Thru**. When the generated transfer function is applied, it performs an embed operation.

This command uses the S-parameter file's S_{21} insertion loss only. If a .s4p file is specified, ports 1 and 2 are used assuming a 1-2, 3-4 port numbering for 4 port files.

Optionally, include ON to flip the port numbering when reading the S-parameter file.

NOTE

You can specify differential and/or common mode channels using the following convention. If you have differential or common mode channels enabled (using either the :CHANnel<N>:DIFFerential or :CHANnel<N>:COMMonmode commands) then:

- :CHANnel1 would refer to the Channel 1 - Channel 3 differential channel
- :CHANnel2 would refer to the Channel 2 - Channel 4 differential channel
- :CHANnel3 would refer to the Channel 1 + Channel 3 common mode channel
- :CHANnel4 would refer to the Channel 2 + Channel 4 common mode channel

| | |
|--------------------|--|
| <N> | An integer, 1-4 in a single oscilloscope, 1-40 in a MultiScope system. |
| <s_parameter_file> | The quoted name of the S-parameter file. |
| Example | This example convolves the S-parameter file example.s2p with the waveform on channel 1. <pre>myScope.WriteString ":CHANnel1:ISIM:CONVolve example.s2p"</pre> |
| See Also | <ul style="list-style-type: none"> • ":CHANnel<N>:ISIM:STATe" on page 332 • ":CHANnel<N>:ISIM:APPLY" on page 317 • ":CHANnel<N>:ISIM:DEConvolve" on page 326 |
| History | Legacy command (existed before version 3.10). |

:CHANnel<N>:ISIM:CORRection

Command :CHANnel<N>:ISIM:CORRection <percent>

NOTE

This CHANnel command only applies if you have purchased the InfiniiSim software application.

The :CHANnel<N>:ISIM:CORRection command sets the amount of linearly scaled correction applied to the non-DC frequency components of the measured signal. This lets you trade off the amount of correction to apply via the transformation function versus the increase in noise it may create at higher frequencies. In other words, you can fine-tune the amount of high-frequency noise versus the sharpness of the step response edge.

<N> An integer, 1-4 in a single oscilloscope, 1-40 in a MultiScope system.

NOTE

You can specify differential and/or common mode channels using the following convention. If you have differential or common mode channels enabled (using either the :CHANnel<N>:DIFFerential or :CHANnel<N>:COMMONmode commands) then:

- :CHANnel1 would refer to the Channel 1 - Channel 3 differential channel
- :CHANnel2 would refer to the Channel 2 - Channel 4 differential channel
- :CHANnel3 would refer to the Channel 1 + Channel 3 common mode channel
- :CHANnel4 would refer to the Channel 2 + Channel 4 common mode channel

<percent> If you are making averaged mode measurements or applying a transfer function that does not magnify the noise, use the full correction by setting this field to 100%.

However, if you are working with eye diagrams or making jitter measurements and the transfer function is magnifying the noise, you may want to limit the correction by selecting a lower percentage.

Example This example sets the channel 1 InfiniiSim correction factor to 80%.

```
myScope.WriteString ":CHANnel1:ISIM:CORRection 80"
```

Query :CHANnel<N>:ISIM:CORRection?

The :CHANnel<N>:ISIM:CORRection? query returns the selected input channel's percent correction factor.

Returned Format [CHANnel<N>:ISIM:CORRection] <percent><NL>

Example This example gets the current channel 1 InfiniiSim correction percentage and places it in the numeric variable, varIsimCorrection. The program then prints the contents of the variable to the computer's screen.

```
myScope.WriteString ":SYSTem:HEADer OFF"  
myScope.WriteString ":CHANnel:ISIM:CORRection?"  
varIsimCorrection = myScope.ReadNumber  
Debug.Print FormatNumber(varBwLimit, 0)
```

History Legacy command (existed before version 3.10).

:CHANnel<N>:ISIM:DEConvolve

Command :CHANnel<N>:ISIM:DEConvolve "<s_parameter_file>", {OFF | ON}

NOTE

This CHANnel command is available when you have purchased the InfiniiSim software application.

The :CHANnel<N>:ISIM:CONVolve command sets the InfiniiSim 2 Port state (:CHANnel<N>:ISIM:STATE PORT2), automates the creation of a transfer function, and applies the transfer function to the channel waveform. The transfer function is created using the **Remove insertion loss of a fixture or cable** application preset's simple one-block circuit model. The S-parameter file defines the measurement circuit of the single block and the simulation circuit is a **Thru**. When the generated transfer function is applied, it performs an de-embed operation.

This command uses the S-parameter file's S_{21} insertion loss only. If a .s4p file is specified, ports 1 and 2 are used assuming a 1-2, 3-4 port numbering for 4 port files.

Optionally, include ON to flip the port numbering when reading the S-parameter file.

NOTE

You can specify differential and/or common mode channels using the following convention. If you have differential or common mode channels enabled (using either the :CHANnel<N>:DIFFerential or :CHANnel<N>:COMMonmode commands) then:

- :CHANnel1 would refer to the Channel 1 - Channel 3 differential channel
- :CHANnel2 would refer to the Channel 2 - Channel 4 differential channel
- :CHANnel3 would refer to the Channel 1 + Channel 3 common mode channel
- :CHANnel4 would refer to the Channel 2 + Channel 4 common mode channel

| | |
|--------------------|---|
| <N> | An integer, 1-4 in a single oscilloscope, 1-40 in a MultiScope system. |
| <s_parameter_file> | The quoted name of the S-parameter file. |
| Example | This example deconvolves the S-parameter file example.s2p with the waveform on channel 1. <pre>myScope.WriteString ":CHANnel1:ISIM:DEConvolve example.s2p"</pre> |
| See Also | <ul style="list-style-type: none"> • " :CHANnel<N>:ISIM:STATE" on page 332 • " :CHANnel<N>:ISIM:APPLY" on page 317 • " :CHANnel<N>:ISIM:CONVolve" on page 323 |
| History | Legacy command (existed before version 3.10). |

:CHANnel<N>:ISIM:DElay

Command :CHANnel<N>:ISIM:DElay {OFF | ON | TRIG}

NOTE

This CHANnel command only applies if you have purchased the InfiniiSim software application.

The :CHANnel<N>:ISIM:DElay command specifies the transfer function filter delay option:

- ON – Includes filter delay.
- OFF – Removes filter delay.
- TRIG – Includes trigger-corrected delay.

Consult the InfiniiSim User's Guide in the Manuals section of the GUI help system for more information.

NOTE

You can specify differential and/or common mode channels using the following convention. If you have differential or common mode channels enabled (using either the :CHANnel<N>:DIFFerential or :CHANnel<N>:COMMonmode commands) then:

- :CHANnel1 would refer to the Channel 1 - Channel 3 differential channel
- :CHANnel2 would refer to the Channel 2 - Channel 4 differential channel
- :CHANnel3 would refer to the Channel 1 + Channel 3 common mode channel
- :CHANnel4 would refer to the Channel 2 + Channel 4 common mode channel

<N> An integer, 1-4 in a single oscilloscope, 1-40 in a MultiScope system.

Example This example applies the transfer function delay in the resultant waveform.

```
myScope.WriteString ":CHANnel1:ISIM:DElay ON"
```

Query :CHANnel<N>:ISIM:DElay?

The :CHANnel<N>:ISIM:DElay? query returns the current state of the transfer function delay feature on the corresponding input channel.

Returned Format [CHANnel<N>:ISIM:DElay] {OFF | ON | TRIG}<NL>

Example This example puts whether or not the transfer function delay is included in the resultant waveform for channel 1 in the string variable, strDelay. The program then prints the contents of the variable to the computer's screen.

```
myScope.WriteString ":SYSTem:HEADer OFF"
myScope.WriteString ":CHANnel1:ISIM:DElay?"
strDelay = myScope.ReadString
Debug.Print strDelay
```

History Legacy command (existed before version 3.10).

:CHANnel<N>:ISIM:NORMAlize

Command :CHANnel<N>:ISIM:NORMAlize {{ON | 1} | {OFF | 0}}

NOTE

This CHANnel command only applies if you have purchased the InfiniiSim software application.

The :CHANnel<N>:ISIM:NORMAlize command activates or deactivates the "Normalize Gain" option. The InfiniiSim normalize gain option removes any DC gain of the transfer function and can be used when modeling probes.

NOTE

You can specify differential and/or common mode channels using the following convention. If you have differential or common mode channels enabled (using either the :CHANnel<N>:DIFFerential or :CHANnel<N>:COMMONmode commands) then:

- :CHANnel1 would refer to the Channel 1 - Channel 3 differential channel
- :CHANnel2 would refer to the Channel 2 - Channel 4 differential channel
- :CHANnel3 would refer to the Channel 1 + Channel 3 common mode channel
- :CHANnel4 would refer to the Channel 2 + Channel 4 common mode channel

<N> An integer, 1-4 in a single oscilloscope, 1-40 in a MultiScope system.

Example This example turns on the InfiniiSim normalize gain option for channel 1.

```
myScope.WriteString ":CHANnel1:ISIM:NORMAlize ON"
```

Query :CHANnel<N>:ISIM:NORMAlize?

The :CHANnel<N>:ISIM:NORMAlize? query returns the current state of the corresponding channel's InfiniiSim normalize gain option.

Returned Format [CHANnel<N>:ISIM:NORMAlize] {1 | 0}<NL>

Example This example puts the current InfiniiSim normalize gain state for channel 1 in the string variable, varNormalizeGain. The program then prints the contents of the variable to the computer's screen.

```
myScope.WriteString ":SYSTem:HEADer OFF"
myScope.WriteString ":CHANnel1:ISIM:NORMAlize?"
varNormalizeGain = myScope.ReadNumber
Debug.Print FormatNumber(varLimit, 0)
```

See Also • [":CHANnel<N>:ISIM:DELAy"](#) on page 327

History New in version 4.60.

:CHANnel<N>:ISIM:PEXtraction

Command :CHANnel<N>:ISIM:PEXtraction {P12 | P32 | P34 | P14 | DIFFerential
| COMMONmode}

NOTE

This CHANnel command only applies if you have purchased the InfiniiSim software application.

The :CHANnel<N>:ISIM:PEXtraction command selects the InfiniiSim port extraction. The selections are:

- P12 – Use ports 1 -> 2.
- P32 – Use ports 3 -> 2.
- P34 – Use ports 3 -> 4.
- P14 – Use ports 1 -> 4.
- DIFFerential – valid for all channels.
- COMMONmode – valid for all channels.

NOTE

You can specify differential and/or common mode channels using the following convention. If you have differential or common mode channels enabled (using either the :CHANnel<N>:DIFFerential or :CHANnel<N>:COMMONmode commands) then:

- :CHANnel1 would refer to the Channel 1 - Channel 3 differential channel
- :CHANnel2 would refer to the Channel 2 - Channel 4 differential channel
- :CHANnel3 would refer to the Channel 1 + Channel 3 common mode channel
- :CHANnel4 would refer to the Channel 2 + Channel 4 common mode channel

<N> An integer, 1-4 in a single oscilloscope, 1-40 in a MultiScope system.

Example This example selects the channel 1 InfiniiSim differential port extraction.

```
myScope.WriteString ":CHANnel1:ISIM:PEXtraction DIFFerential"
```

Query :CHANnel<N>:ISIM:PEXtraction?

The :CHANnel<N>:ISIM:PEXtraction? query returns the current InfiniiSim port extraction selection.

Returned Format [CHANnel<N>:ISIM:PEXtraction] {P12 | P32 | P34 | P14 | DIFF | COMM}<NL>

Example This example puts the current InfiniiSim port extraction selection for channel 1 in the string variable, strMode. The program then prints the contents of the variable to the computer's screen.

```
myScope.WriteString ":SYSTem:HEADer OFF"
myScope.WriteString ":CHANnel1:ISIM:PEXtraction?"
```

```
strMode = myScope.ReadString  
Debug.Print strMode
```

History New in version 3.11.

:CHANnel<N>:ISIM:SPAN

Command :CHANnel<N>:ISIM:SPAN <max_time_span>

NOTE

This CHANnel command only applies if you have purchased the InfiniiSim software application.

The :CHANnel<N>:ISIM:SPAN command sets the maximum time span control in the InfiniiSim Setup dialog box.

NOTE

You can specify differential and/or common mode channels using the following convention. If you have differential or common mode channels enabled (using either the :CHANnel<N>:DIFFerential or :CHANnel<N>:COMMONmode commands) then:

- :CHANnel1 would refer to the Channel 1 - Channel 3 differential channel
- :CHANnel2 would refer to the Channel 2 - Channel 4 differential channel
- :CHANnel3 would refer to the Channel 1 + Channel 3 common mode channel
- :CHANnel4 would refer to the Channel 2 + Channel 4 common mode channel

<N> An integer, 1-4 in a single oscilloscope, 1-40 in a MultiScope system.

<max_time_span> A real number.

Example This example sets the maximum time span control to 100e-9.

```
myScope.WriteString ":CHANnel1:ISIM:SPAN 100e-9"
```

Query :CHANnel<N>:ISIM:SPAN?

The :CHANnel<N>:ISIM:SPAN? query returns the current InfiniiSim filter maximum time span on the corresponding input channel.

Returned Format [CHANnel<N>:ISIM:SPAN] <max_time_span><NL>

Example This example puts the InfiniiSim filter's maximum time span value in the variable varTspan. The program then prints the contents of the variable to the computer's screen.

```
myScope.WriteString ":SYSTem:HEADer OFF"
myScope.WriteString ":CHANnel1:ISIM:SPAN?"
varTspan = myScope.ReadNumber
Debug.Print FormatNumber(varTspan, 0)
```

History Legacy command (existed before version 3.10).

:CHANnel<N>:ISIM:STATe

Command :CHANnel<N>:ISIM:STATe {OFF | PORT2 | PORT4 | PORT41}

NOTE

This CHANnel command only applies if you have purchased the InfiniiSim software application.

The :CHANnel<N>:ISIM:STATe command turns InfiniiSim on or off and sets whether 2 port, 4 port (Channels 1&3), or 4 port (Channel 1) mode is being used (if it is turned on).

NOTE

You can specify differential and/or common mode channels using the following convention. If you have differential or common mode channels enabled (using either the :CHANnel<N>:DIFFerential or :CHANnel<N>:COMMONmode commands) then:

- :CHANnel1 would refer to the Channel 1 - Channel 3 differential channel
- :CHANnel2 would refer to the Channel 2 - Channel 4 differential channel
- :CHANnel3 would refer to the Channel 1 + Channel 3 common mode channel
- :CHANnel4 would refer to the Channel 2 + Channel 4 common mode channel

<N> An integer, 1-4 in a single oscilloscope, 1-40 in a MultiScope system.

Example This example turns on InfiniiSim for channel 1 and puts it in 2 port mode.

```
myScope.WriteString ":CHANnel1:ISIM:STATe PORT2"
```

Query :CHANnel<N>:ISIM:STATe?

The :CHANnel<N>:ISIM:STATe? query returns the current state of InfiniiSim on the corresponding input channel.

Returned Format [CHANnel<N>:ISIM:STATe] {OFF | PORT2 | PORT4 | PORT41}<NL>

Example This example puts the current InfiniiSim state for channel 1 in the string variable, strMode. The program then prints the contents of the variable to the computer's screen.

```
myScope.WriteString ":SYSTem:HEADer OFF"
myScope.WriteString ":CHANnel1:ISIM:STATe?"
strMode = myScope.ReadString
Debug.Print strMode
```

History Legacy command (existed before version 3.10).

:CHANnel<N>:LABel

Command :CHANnel<N>:LABel <string>

The :CHANnel<N>:LABel command sets the channel label to the quoted string.

NOTE

You can specify differential and/or common mode channels using the following convention. If you have differential or common mode channels enabled (using either the :CHANnel<N>:DIFFerential or :CHANnel<N>:COMMonmode commands) then:

- :CHANnel1 would refer to the Channel 1 - Channel 3 differential channel
- :CHANnel2 would refer to the Channel 2 - Channel 4 differential channel
- :CHANnel3 would refer to the Channel 1 + Channel 3 common mode channel
- :CHANnel4 would refer to the Channel 2 + Channel 4 common mode channel

<N> An integer, 1-4 in a single oscilloscope, 1-40 in a MultiScope system.

<string> A series of 16 or less characters as a quoted ASCII string

Example This example sets the channel 1 label to Data.

```
myScope.WriteString ":CHANnel1:LABel "Data""
```

Query :CHANnel<N>:LABel?

The :CHANnel<N>:LABel? query returns the label of the specified channel.

Returned Format [CHANnel<N>:LABel] <string><NL>

History Legacy command (existed before version 3.10).

:CHANnel<N>:OFFSet

Command :CHANnel<N>:OFFSet <offset_value>

The :CHANnel<N>:OFFSet command sets the vertical value that is represented at the center of the display for the selected channel. Offset parameters are probe and vertical scale dependent.

<N> An integer, 1-4 in a single oscilloscope, 1-40 in a MultiScope system.

<offset_value> A real number for the offset value at center screen. Usually expressed in volts, but it can also be in other measurement units, such as amperes, if you have specified other units using the :CHANnel<N>:UNITs command or the CHANnel<N>:PROBE:EXTernal:UNITs command.

Example This example sets the offset for channel 1 to 0.125 in the current measurement units:

```
myScope.WriteString ":CHANnel1:OFFSet 125E-3"
```

Query :CHANnel<N>:OFFSet?

The :CHANnel<N>:OFFSet? query returns the current offset value for the specified channel.

Returned Format [CHANnel<N>:OFFSet] <offset_value><NL>

Example This example places the offset value of the specified channel in the variable, varOffset, then prints the contents of the variable to the computer's screen.

```
myScope.WriteString ":SYSTEM:HEADer OFF"
myScope.WriteString ":CHANnel1:OFFSet?"
varOffset = myScope.ReadNumber
Debug.Print FormatNumber(varOffset, "Scientific")
```

History Legacy command (existed before version 3.10).

:CHANnel<N>:PROBe

Command :CHANnel<N>:PROBe <attenuation_factor>[, {RATio | DECibel}]

The :CHANnel<N>:PROBe command sets the probe attenuation factor and the units (ratio or decibels) for the probe attenuation factor for a user-defined probe.

The DECibel and RATio parameters also set the "mode" for the probe attenuation. These parameters, along with attenuation factor, determine the scaling of the display and affect automatic measurements and trigger levels.

This mode also determines the units (ratio or decibels) that may be used for a subsequent command.

<N> An integer, 1-4

<attenuation_factor> A real number from 0.0001 to 1000 for the RATio attenuation units or from -80 dB to 60 dB for the DECibel attenuation units.

Example This example sets the probe attenuation factor for a 10:1 probe on channel 1 in ratio units.

```
myScope.WriteString ":CHANnel1:PROBe 10,RAT"
```

Query :CHANnel<N>:PROBe?

The :CHANnel<N>:PROBe? query returns the current probe attenuation setting and units for the selected channel.

Returned Format [:CHANnel<N>:PROBe] <attenuation>,{RATio | DECibel}<NL>

Example This example places the current attenuation setting for channel 1 in the string variable, strAtten, then the program prints the contents.

```
Dim strAtten As String ' Dimension variable.
myScope.WriteString ":CHANnel1:PROBe?"
strAtten = myScope.ReadString
Debug.Print strAtten
```

If you use a string variable, the query returns the attenuation value and the factor (decibel or ratio). If you use an integer variable, the query returns the attenuation value. You must then read the attenuation units into a string variable.

History Legacy command (existed before version 3.10).

:CHANnel<N>:PROBe:ACCAL

Command :CHANnel<N>:PROBe:ACCAL {AUTO | OFF | PRECprobe}

The :CHANnel<N>:PROBe:ACCAL command sets the type of AC response probe calibration to use:

- OFF – no AC response probe calibration is used.
- AUTO – the AC response probe calibration is based on the type of probe being used and its general characteristics.
- PRECprobe – PrecisionProbe or PrecisionCable probe calibration is used.

NOTE

You are not able to start a PrecisionProbe or PrecisionCable calibration using remote SCPI commands. However, you can enter SCPI commands to use the results of calibrations performed using the front panel wizards.

<N> An integer, 1–4.

Example This example chooses the PrecisionProbe or PrecisionCable AC response calibration for the probe on channel 1.

```
myScope.WriteString ":CHANnel1:PROBe:ACCAL PRECprobe"
```

Query :CHANnel<N>:PROBe:ACCAL?

The :CHANnel<N>:PROBe:ACCAL? query returns the AC response probe calibration setting for the selected channel.

Returned Format [:CHANnel<N>:PROBe:ACCAL] {AUTO | OFF | PREC}<NL>

- See Also**
- **":CHANnel<N>:PROBe:PRECprobe:MODE"** on page 359
 - **":CHANnel<N>:PROBe:PRECprobe:CALibration"** on page 357
 - **":CHANnel<N>:PROBe:PRECprobe:ZSRC"** on page 360
 - **":CHANnel<N>:PROBe:PRECprobe:BANDwidth"** on page 356

History New in version 3.10.

:CHANnel<N>:PROBe:ATTenuation

Command :CHANnel<N>:PROBe:ATTenuation {DIV1 | DIV10}

NOTE

This command is only valid for the 1154A probe.

The :CHANnel<N>:PROBe:ATTenuation command sets the 1154A probe's input amplifier attenuation. If the 1154A probe is not connected to the channel you will get a settings conflict error.

<N> An integer, 1-4.

Example This example sets the probe attenuation for channel 1 to divide by 10.

```
myScope.WriteString ":CHANnel1:PROBe:ATTenuation DIV10"
```

Query :CHANnel<N>:PROBe:ATTenuation?

The :CHANnel<N>:PROBe:ATTenuation? query returns the current 1154A probe input amplifier attenuation setting for the selected channel.

Returned Format [:CHANnel<N>:PROBe:ATTenuation] {DIV1 | DIV10}<NL>

History Legacy command (existed before version 3.10).

:CHANnel<N>:PROBe:AUTOzero

Command :CHANnel<N>:PROBe:AUTOzero

NOTE

This command is currently only valid for the N2893A probe.

The :CHANnel<N>:PROBe:AUTOzero command initiates the N2893A probe's auto degauss/ offset cal.

If the N2893A probe is not connected to the channel you will get a settings conflict error.

<N> An integer, 1-4.

Example This example performs an auto zero operation for the probe on channel 1.

```
myScope.WriteString ":CHANnel1:PROBe:AUTOzero"
```

History New in version 3.50.

:CHANnel<N>:PROBe:COUPling

Command :CHANnel<N>:PROBe:COUPling {DC | AC}

The :CHANnel<N>:PROBe:COUPling command sets the probe coupling to either AC or DC.

NOTE

This command is for probes only. To set the input channel coupling, see :CHANnel<N>:INPut.

<N> An integer, 1-4.

Example This example sets the probe coupling for channel 1 to AC.

```
myScope.WriteString ":CHANnel1:PROBe:COUPling AC"
```

Query :CHANnel<N>:PROBe:COUPling?

The :CHANnel<N>:PROBe:COUPling? query returns the current probe coupling setting for the selected channel.

Returned Format [:CHANnel<N>:PROBe:COUPling] {DC | AC}<NL>

See Also • [":CHANnel<N>:INPut"](#) on page 315

History Legacy command (existed before version 3.10).

:CHANnel<N>:PROBe:EADapter

Command :CHANnel<N>:PROBe:EADapter {NONE | DIV10 | DIV20 | DIV100 | DIV1000
| CUR0002VA | CUR001VA | CUR002VA | CUR01VA | CUR1VA | CUR10VA
| CURN2893 | CUR1147 | HIVOLTN2790}

NOTE

This command is valid only for the 1153A, 1154A, and 1159A probes and the E2697A and N5449A high impedance adapters.

The :CHANnel<N>:PROBe:EADapter command sets the probe external adapter control. The 1153A, 1154A, and 1159A probes and the E2697A and N5449A high impedance adapters have external adapters that you can attach to the end of your probe. When you attach one of these adapters, you should use the EADapter command to set the external adapter control to match the adapter connected to your probe as follows.

If an 1153A, 1154A, or 1159A probe or E2697A or N5449A high impedance adapter is not connected to the channel you will get a settings conflict error.

With the 1153A,
1154A, and 1159A
probes:

| Parameter | Description |
|-----------|---|
| NONE | Use this setting when there is no adapter connected to the end of your probe. |
| DIV10 | Use this setting when you have a divide by 10 adapter connected to the end of your probe. |
| DIV20 | Use this setting when you have a divide by 20 adapter connected to the end of your probe. (1159A) |
| DIV100 | Use this setting when you have a divide by 100 adapter connected to the end of your probe. (1153A only) |

With the E2697A
and N5449A high
impedance
adapters:

When the :CHANnel<N>:PROBe:EADapter command is used with either the E2697A or N5449A high impedance adapter, the behavior is the same as with the 115x probes; however, there are more parameters available to choose from. The following table describes which probes are available with which adapters and what the parameter string is:

| Probe | Parameter | Compatibility | |
|-------------|-----------|----------------|----------------|
| | | E2697A adapter | N5449A adapter |
| 1:1 probe | NONE | X | X |
| 10:1 probe | DIV10 | X | X |
| 20:1 probe | DIV20 | X | X |
| 100:1 probe | DIV100 | X | X |

| Probe | Parameter | Compatibility | |
|--|-------------|----------------|----------------|
| | | E2697A adapter | N5449A adapter |
| 100:1 probe | DIV1000 | | X |
| 0.002 V/A current probe | CUR0002VA | X | X |
| 0.01 V/A current probe | CUR001VA | X | X |
| 0.02 V/A current probe | CUR002VA | X | X |
| 0.1 V/A current probe | CUR01VA | X | X |
| 1 V/A current probe | CUR1VA | X | X |
| 10 V/A current probe | CUR10VA | X | X |
| N2893A current probe | CURN2893 | | X |
| 1147A/B current probe | CUR1147 | | X |
| N2790A high-voltage differential probe | HIVOLTN2790 | | X |

Lastly, the N5449A adapter has the ability to automatically detect supported probes. If a supported probe (most passive probes) is attached to the N5449A adapter, the :CHANnel<N>:PROBe:EADapter command will not have any effect until the attached probe is removed. If, on the other hand, an unsupported probe (BNC cable, etc.) is attached to the N5449A adapter, the :CHANnel<N>:PROBe:EADapter command will work as normal. The :CHANnel<N>:PROBe:EADapter? query will work in either case.

<N> An integer, 1–4.

Example This example sets the external adapter for channel 1 to divide by 10:

```
myScope.WriteString ":CHANnel1:PROBe:EADapter DIV10"
```

Query :CHANnel<N>:PROBe:EADapter?

The :CHANnel<N>:PROBe:EADapter? query returns the current external adapter value for the specified channel.

Returned Format [CHANnel<N>:PROBe:EADapter] {NONE | DIV10 | DIV20 | DIV100 | DIV1000 | CUR0002VA | CUR001VA | CUR002VA | CUR01VA | CUR1VA | CUR10VA | CURN2893 | CUR1147 | HIVOLTN2790}<NL>

Example This example places the external adapter value of the specified channel in the string variable, strAdapter, then prints the contents of the variable to the computer's screen.

```
Dim strAdapter As String 'Dimension variable
myScope.WriteString ":CHANnel1:PROBe:EADapter?"
strAdapter = myScope.ReadString
Debug.Print strAdapter
```

History Legacy command (existed before version 3.10).

Version 5.20: Added the DIV1000, CUR001VA, CUR01VA, CUR1VA, CUR10VA, CURN2893, CUR1147, HIVOLTN2790 options for use with the E2697A or N5449A high impedance adapters.

Version 6.10: Added the CUR0002VA and CUR002VA options for use with the E2697A or N5449A high impedance adapters.

:CHANnel<N>:PROBe:ECOupling

Command :CHANnel<N>:PROBe:ECOupling {NONE | AC}

NOTE

This command is valid only for the 1153A, 1154A, and 1159A probes.

The :CHANnel<N>:PROBe:ECOupling command sets the probe external coupling adapter control. The 1154A and 1159A probes have external coupling adapters that you can attach to the end of your probe. When you attach one of these adapters, you should use the ECOupling command to set the external coupling adapter control to match the adapter connected to your probe as follows.

| Parameter | Description |
|-----------|---|
| NONE | Use this setting when there is no adapter connected to the end of your probe. |
| AC | Use this setting when you have an ac coupling adapter connected to the end of your probe. |

If an 1153A, 1154A, or 1159A probe is not connected to the channel you will get a settings conflict error.

<N> An integer, 1-4.

Example This example sets the external coupling adapter for channel 1 to ac:

```
myScope.WriteString ":CHANnel1:PROBe:ECOupling AC"
```

Query :CHANnel<N>:PROBe:ECOupling?

The :CHANnel<N>:PROBe:ECOupling? query returns the current external adapter coupling value for the specified channel.

Returned Format [CHANnel<N>:PROBe:ECOupling] {NONE | AC}<NL>

Example This example places the external coupling adapter value of the specified channel in the string variable, strAdapter, then prints the contents of the variable to the computer's screen.

```
Dim strAdapter As String ' Dimension variable.
myScope.WriteString ":CHANnel1:PROBe:ECOupling?"
strAdapter = myScope.ReadString
Debug.Print strAdapter
```

History Legacy command (existed before version 3.10).

:CHANnel<N>:PROBe:EXTeRnal

Command :CHANnel<N>:PROBe:EXTeRnal {{ON | 1} | {OFF | 0}}

The :CHANnel<N>:PROBe:EXTeRnal command sets the external probe mode to on or off.

<N> An integer, 1-4.

Example This example sets channel 1 external probe mode to on.

```
myScope.WriteString ":CHANnel1:PROBe:EXTeRnal ON"
```

Query :CHANnel<N>:PROBe:EXTeRnal?

The :CHANnel<N>:PROBe:EXTeRnal? query returns the current external probe mode for the specified channel.

Returned Format [:CHANnel<N>:PROBe:EXTeRnal] {1 | 0}<NL>

Example This example places the current setting of the external probe mode on channel 1 in the variable varMode, then prints the contents of the variable to the computer's screen.

```
myScope.WriteString ":SYSTem:HEADer OFF"
myScope.WriteString ":CHANnel1:PROBe:EXTeRnal?"
varMode = myScope.ReadNumber
Debug.Print FormatNumber(varMode, 0)
```

History Legacy command (existed before version 3.10).

:CHANnel<N>:PROBe:EXTeRnal:GAIN

Command :CHANnel<N>:PROBe:EXTeRnal:GAIN <gain_factor>[, {RATio | DECibel}]

NOTE

CHANnel<N>:PROBe:EXTeRnal command must be set to ON before issuing this command or query or this command will have no effect.

The :CHANnel<N>:PROBe:EXTeRnal:GAIN command sets the probe external scaling gain factor and, optionally, the units for the probe gain factor. The reference factors that are used for scaling the display are changed with this command, and affect automatic measurements and trigger levels.

The RATio or DECibel also sets the mode for the probe attenuation and also determines the units that may be used for a subsequent command. For example, if you select RATio mode, then the attenuation factor must be given in ratio gain units. In DECibel mode, you can specify the units for the argument as "dB".

<N> An integer, 1-4.

<gain_factor> A real number from 0.001 to 10000 for the RATio gain units, or from -60 dB to 80 dB for the DECibel gain units.

Example This example sets the probe external scaling gain factor for channel 1 to 10.

```
myScope.WriteString ":CHANnel1:PROBe:EXTeRnal ON"
myScope.WriteString ":CHANnel1:PROBe:EXTeRnal:GAIN 10,RATio"
```

Query :CHANnel<N>:PROBe:EXTeRnal:GAIN?

The :CHANnel<N>:PROBe:EXTeRnal:GAIN? query returns the probe external gain setting for the selected channel.

Returned Format [:CHANnel<N>:PROBe:EXTeRnal:GAIN] <gain_factor>,{RAT | DEC}<NL>

Example This example places the external gain value of the probe on the specified channel in the variable, varGain, then prints the contents of the variable to the computer's screen.

```
myScope.WriteString ":CHANnel1:PROBe:EXTeRnal ON"
myScope.WriteString ":CHANnel1:PROBe:EXTeRnal:GAIN?"
varGain = myScope.ReadString
Debug.Print varGain
```

History Legacy command (existed before version 3.10).

:CHANnel<N>:PROBe:EXtErnal:OFFSet

Command :CHANnel<N>:PROBe:EXtErnal:OFFSet <offset_value>

NOTE

CHANnel<N>:PROBe:EXtErnal command must be set to ON before issuing this command or query or this command will have no effect.

The :CHANnel<N>:PROBe:EXtErnal:OFFSet command sets the external vertical value for the probe that is represented at the center of the display for the selected channel. Offset parameters are probe and vertical scale dependent.

When using the 113xA series probes, the CHANnel<N>:PROBe:STYPe command determines how the offset is applied. When CHANnel<N>:PROBe:STYPe SINGLE is selected, the :CHANnel<N>:PROBe:EXtErnal:OFFSet command changes the offset value of the probe amplifier. When CHANnel<N>:PROBe:STYPe DIFFerential is selected, the :CHANnel<N>:PROBe:EXtErnal:OFFSet command changes the offset value of the channel amplifier.

<N> An integer, 1-4.

<offset_value> A real number for the offset value at center screen. Usually expressed in volts, but can be in other measurement units, such as amperes, if you have specified other units using the :CHANnel<N>:PROBe:EXtErnal:UNITs command.

Example This example sets the external offset for the probe on channel 1 to 0.125 in the current measurement units:

```
myScope.WriteString ":CHANnel1:PROBe:EXtErnal ON"
myScope.WriteString ":CHANnel1:PROBe:EXtErnal:OFFSet 125E-3"
```

Query :CHANnel<N>:EXtErnal:PROBe:OFFSet?

The :CHANnel<N>:PROBe:EXtErnal:OFFSet? query returns the current external offset value for the probe on the specified channel.

Returned Format [CHANnel<N>:PROBe:EXtErnal:OFFSet] <offset_value><NL>

Example This example places the external offset value of the probe on the specified channel in the variable, Offset, then prints the contents of the variable to the computer's screen.

```
myScope.WriteString ":SYSTem:HEADer OFF"
myScope.WriteString ":CHANnel1:PROBe:EXtErnal ON"
myScope.WriteString ":CHANnel1:PROBe:EXtErnal:OFFSet?"
varOffset = myScope.ReadNumber
Debug.Print FormatNumber(varOffset, 0)
```

History Legacy command (existed before version 3.10).

:CHANnel<N>:PROBe:EXTErnal:UNITs

Command :CHANnel<N>:PROBe:EXTErnal:UNITs {VOLT | AMPere | WATT | UNKNown}

NOTE

CHANnel<N>:PROBe:EXTErnal command must be set to ON before issuing this command or query or this command will have no effect. UNITs can also be set using the CHANnel<N>:UNITs command.

The :CHANnel<N>:PROBe:EXTErnal:UNITs command sets the probe external vertical units on the specified channel. You can specify Y-axis units of VOLTS, AMPS, WATTS, or UNKNown. The units are implied for other pertinent channel probe external commands and channel commands (such as :CHANnel<N>:PROBe:EXTErnal:OFFSet and :CHANnel<N>:RANGe). See the Probe Setup dialog box for more information.

<N> An integer, 1-4.

Example This example sets the external units for the probe on channel 1 to amperes.

```
myScope.WriteString ":CHANnel1:PROBe:EXTErnal ON"
myScope.WriteString ":CHANnel1:PROBe:EXTErnal:UNITs AMPERE"
```

Query :CHANnel<N>:PROBe:EXTErnal:UNITs?

The :CHANnel<N>:PROBe:EXTErnal:UNITs? query returns the current external units setting for the probe on the specified channel.

Returned Format [:CHANnel<N>:PROBe:EXTErnal:UNITs] {VOLT | AMPere | WATT | UNKNown}<NL>

Example This example places the external vertical units for the probe on the specified channel in the string variable, strUnits, then prints the contents of the variable to the computer's screen.

```
Dim strUnits As String
myScope.WriteString ":CHANnel1:PROBe:EXTErnal ON"
myScope.WriteString ":CHANnel1:PROBe:EXTErnal:UNITs?"
strUnits = myScope.ReadString
Debug.Print strUnits
```

History Legacy command (existed before version 3.10).

:CHANnel<N>:PROBe:GAIN**Command** :CHANnel<N>:PROBe:GAIN {X1 | X10}**NOTE**

This command is valid only for the 1154A probe.

The :CHANnel<N>:PROBe:GAIN command sets the 1154A probe input amplifier gain.

If an 1154A probe is not connected to the channel you will get a settings conflict error.

<N> An integer, 1-4.

Example This example sets the probe gain for channel 1 to times 10.

```
myScope.WriteString ":CHANnel1:PROBe:GAIN X10"
```

Query :CHANnel<N>:PROBe:GAIN?

The :CHANnel<N>:PROBe:GAIN? query returns the current probe gain setting for the selected channel.

Returned Format [:CHANnel<N>:PROBe:GAIN] {X1 | X10}<NL>

History Legacy command (existed before version 3.10).

:CHANnel<N>:PROBe:HEAD:ADD

Command :CHANnel<N>:PROBe:HEAD:ADD "head", ["label"]

The :CHANnel<N>:PROBe:HEAD:ADD command adds an entry to the list of probe heads.

<N> An integer, 1-4.

"head" A quoted string matching the probe head model such as "N5381A", "E2678A", etc.

"label" An optional quoted string for the head label.

Example This example adds the probe head N5381A to the list of probe heads for channel 1.

```
myScope.WriteString ":CHANnel1:PROBe:HEAD:ADD "N5381A" "
```

History Legacy command (existed before version 3.10).

:CHANnel<N>:PROBe:HEAD:DELeTe ALL

Command :CHANnel<N>:PROBe:HEAD:DELeTe ALL

The :CHANnel<N>:PROBe:HEAD:DELeTe ALL command deletes all the nodes in the list of probe heads except for one default probe head which remains after this command is executed.

<N> An integer, 1-4.

Example This example deletes the entire list of probe heads for channel 1 except for the default head.

```
myScope.WriteString ":CHANnel1:PROBe:HEAD:DELeTe ALL"
```

History Legacy command (existed before version 3.10).

:CHANnel<N>:PROBe:HEAD:SElect

Command :CHANnel<N>:PROBe:HEAD:SElect {<int> | <quoted_label_string>}

The :CHANnel<N>:PROBe:HEAD:SElect command selects the probe head being used from a list of possible probe head choices. You can select by the position number in the list of probe heads, or you can select by the label given when the probe head was added.

<N> An integer, 1-4.

<int> Specifies the number of the head (or position) in the configure list. The entry at the top of the list starts at 1.

<quoted_label_string> Specifies the label of the probe head given with the :CHANnel<N>:PROBe:HEAD:ADD command.

Example This example add a couple of probe heads to the list then selects the probe head using a number and a label.

```
myScope.WriteString ":CHANnel1:PROBe:HEAD:ADD 'N5445A:B1.5-2.5S'"
myScope.WriteString ":CHANnel1:PROBe:HEAD:ADD 'N5444A:2.92','foo'"
myScope.WriteString ":CHANnel1:PROBe:HEAD:SElect 1"
myScope.WriteString ":CHANnel1:PROBe:HEAD:SElect 'foo'"
```

Query :CHANnel<N>:PROBe:HEAD:SElect? {MODEl | LABEL}

The :CHANnel<N>:PROBe:HEAD:SElect? query returns a SCPI formatted string of the selected probe head. Optional parameters are:

- MODEl – Returns the model of the probe head.
- LABEL – Returns the label of the probe head. This is the same label given with the :CHANnel<N>:PROBe:HEAD:ADD command and that can also be used with the SElect command.

If no parameter is specified, the MODEl format is returned.

Example This example shows a few queries of the channel 1 probe head selection.

```
Dim strProbeHead As String
myScope.WriteString ":CHANnel1:PROBe:HEAD:SElect?"
strProbeHead = myScope.ReadString
Debug.Print strProbeHead ' Prints "N5444A:2.92".
myScope.WriteString ":CHANnel1:PROBe:HEAD:SElect? LABEL"
strProbeHead = myScope.ReadString
Debug.Print strProbeHead ' Prints "foo".
myScope.WriteString ":CHANnel2:PROBe:HEAD:SElect? MODEl"
strProbeHead = myScope.ReadString
Debug.Print strProbeHead ' Prints "N5444A:2.92".
```

See Also • [":CHANnel<N>:PROBe:HEAD:ADD"](#) on page 349

History Legacy command (existed before version 3.10).

Version 3.50: Added the MPHY protocol type for the MIPI M-PHY serial decode selection.

:CHANnel<N>:PROBe:HEAD:VTERm

Command :CHANnel<N>:PROBe:HEAD:VTERm {FLOating | EXTernal
| {INTernal,<voltage>}}

The :CHANnel<N>:PROBe:HEAD:VTERm command sets the termination voltage for:

- The N5444A probe head.
- The N7010A active termination adapter, regardless of the attachment/head.

<N> An integer, 1-4.

<voltage> A real number for the internal termination voltage setting.

Example To set an internal termination voltage of -1.0 V:

```
myScope.WriteString ":CHANnel1:PROBe:HEAD:VTERm INTernal,-1.0"
```

Query :CHANnel<N>:PROBe:HEAD:VTERm?

The :CHANnel<N>:PROBe:HEAD:VTERm? query returns the termination voltage setting.

Returned Format [:CHANnel<N>:PROBe:HEAD:VTERm] {FLO | EXT | {INT,<voltage>}}<NL>

History New in version 3.50.

Version 5.50: Supports the N7010A active termination adapter (regardless of the attachment/head) as well as the N5444A probe head.

:CHANnel<N>:PROBe:ID?

Query :CHANnel<N>:PROBe:ID?

The :CHANnel<N>:PROBe:ID? query returns the type of probe attached to the specified oscilloscope channel.

<N> An integer, 1-4.

Returned Format [:CHANnel<N>:PROBe:ID] <probe_id>

<probe_id> A string of alphanumeric characters. Some of the possible returned values are:

| | | |
|-----------|---------|--------------------|
| 1131A | 1132A | 1134A |
| 1152A | 1154A | 1156A |
| 1157A | 1158A | 1159A |
| 1163A | 1168A | 1169A |
| AutoProbe | E2621A | E2622A |
| E2695A | E2697A | N5380A |
| N5381A | N5382A | E2695A |
| No Probe | Unknown | User Defined Probe |

Example This example reports the probe type connected to channel 1, if one is connected.

```
myScope.WriteString ":CHANnel1:PROBe:ID?"
```

History Legacy command (existed before version 3.10).

:CHANnel<N>:PROBe:INFO?

Query :CHANnel<N>:PROBe:INFO?

The :CHANnel<N>:PROBe:INFO? query returns a comma-separated list of probe information.

Returned Format [:CHANnel<N>:PROBe:INFO] <info_list><NL>

<info_list> A comma-delimited list of probe information that includes:

- Model number.
- Serial number.
- Probe head model number or "No Head".
- Attenuation calibration date and time (or "1 JAN 1999 00:00:00" if uncalibrated).
- Skew calibration date and time (or "1 JAN 1999 00:00:00" if uncalibrated).
- Specifies whether default attenuation "Default Atten" or calibrated attenuation "Cal Atten" is being used.
- Specifies whether default skew "Default Skew" or calibrated skew "Cal Skew" is being used.
- The first part of the attenuation ratio (<first>:<second>).
- The second part of the attenuation ratio (<first>:<second>).

Example This is an example probe information string.

```
N2751A, US53330101, No Head, 1 JAN 1999 00:00:00, 1 JAN 1999 00:00:00,
Default Atten, Default Skew, 1.9856E+000, 1.0000E+000
```

See Also • **":CHANnel<N>:PROBe:ID?"** on page 353

History New in version 5.70.

:CHANnel<N>:PROBe:MODE

Command :CHANnel<N>:PROBe:MODE {DIFF | SEA | SEB | CM}

NOTE

This command is currently only valid for the N2750A probe.

The :CHANnel<N>:PROBe:MODE command sets the N2750A probe's InfiniiMode configuration.

If the N2750A probe is not connected to the channel you will get a settings conflict error.

<N> An integer, 1-4.

Example This example sets the probe InfiniiMode for channel 1 to common mode.

```
myScope.WriteString ":CHANnel1:PROBe:MODE CM"
```

Query :CHANnel<N>:PROBe:MODE?

The :CHANnel<N>:PROBe:MODE? query returns the current N2750A probe InfiniiMode setting for the selected channel.

Returned Format [:CHANnel<N>:PROBe:MODE] {DIFF | SEA | SEB | CM}<NL>

History New in version 3.50.

:CHANnel<N>:PROBe:PRECprobe:BANDwidth

Command :CHANnel<N>:PROBe:PRECprobe:BANDwidth {AUTO | {MANual, <bandwidth>}
| {BOOSt, <boost_dB>}}

The :CHANnel<N>:PROBe:PRECprobe:BANDwidth command specifies how the limit of PrecisionProbe or PrecisionCable correction/boosting is determined.

<N> An integer, 1-4.

AUTO PrecisionProbe or PrecisionCable normally sets the bandwidth to a value that has a small amount of boosting in the frequency response.

MANual, <bandwidth> Let you manually specify a bandwidth limit at which to stop applying correction.

BOOSt, <boost_dB> Lets you specify a dB limit at which to stop applying correction.

Example This example specifies that, for PrecisionProbe or PrecisionCable on channel 1, correction/boosting should stop being applied at a 3 dB limit.

```
myScope.WriteString ":CHANnel1:PROBe:PRECprobe:BANDwidth BOOSt, 3"
```

Query :CHANnel<N>:PROBe:PRECprobe:BANDwidth?

The :CHANnel<N>:PROBe:PRECprobe:BANDwidth? query returns the current PrecisionProbe or PrecisionCable corrected bandwidth setting for the selected channel.

Returned Format [:CHANnel<N>:PROBe:PRECprobe:BANDwidth] {AUTO | {MANual, <bandwidth>}
| {BOOSt, <boost_dB>}}<NL>

- See Also**
- [":CHANnel<N>:PROBe:ACCAL"](#) on page 336
 - [":CHANnel<N>:PROBe:PRECprobe:MODE"](#) on page 359
 - [":CHANnel<N>:PROBe:PRECprobe:CALibration"](#) on page 357
 - [":CHANnel<N>:PROBe:PRECprobe:ZSRC"](#) on page 360
 - [":CHANnel<N>:PROBe:PRECprobe:DELay"](#) on page 358

History New in version 3.10.

:CHANnel<N>:PROBe:PRECprobe:CALibration

Command :CHANnel<N>:PROBe:PRECprobe:CALibration <cal_string>[,<cal_string2>]

The :CHANnel<N>:PROBe:PRECprobe:CALibration command specifies the name of the PrecisionProbe or PrecisionCable calibration to use for the specified channel and probe.

<N> An integer, 1-4.

<cal_string>[,<cal_string2>] A quoted string that is the name of the PrecisionProbe or Precision Cable calibration. The SMA probe heads can use two independent calibration files.

Example This example says to use the PrecisionProbe or PrecisionCable calibration named "2-8-2" for channel 1.

```
myScope.WriteString ":CHANnel1:PROBe:PRECprobe:CALibration "2-8-2"
```

Query :CHANnel<N>:PROBe:PRECprobe:CALibration?

The :CHANnel<N>:PROBe:PRECprobe:CALibration? query returns the currently specified name for the selected channel's PrecisionProbe or PrecisionCable calibration.

Returned Format [:CHANnel<N>:PROBe:PRECprobe:CALibration] <cal_string>[,<cal_string2>]<NL>

- See Also**
- [":CHANnel<N>:PROBe:ACCAL"](#) on page 336
 - [":CHANnel<N>:PROBe:PRECprobe:MODE"](#) on page 359
 - [":CHANnel<N>:PROBe:PRECprobe:ZSRC"](#) on page 360
 - [":CHANnel<N>:PROBe:PRECprobe:BANDwidth"](#) on page 356
 - [":CHANnel<N>:PROBe:PRECprobe:DELay"](#) on page 358

History New in version 3.10.

:CHANnel<N>:PROBe:PRECprobe:DELAy

Command :CHANnel<N>:PROBe:PRECprobe:DELAy {{ON | 1} | {OFF | 0}}

The :CHANnel<N>:PROBe:PRECprobe:DELAy command specifies whether to include cable delay in a PrecisionCable AC response probe calibration.

<N> An integer, 1-4.

Example This example specifies to include cable delay in the calibration.

```
myScope.WriteString ":CHANnel1:PROBe:PRECprobe:DELAy ON"
```

Query :CHANnel<N>:PROBe:PRECprobe:DELAy?

The :CHANnel<N>:PROBe:PRECprobe:DELAy? query returns the current "include cable delay" selection.

Returned Format [:CHANnel<N>:PROBe:PRECprobe:DELAy] {1 | 0}<NL>

- See Also**
- [":CHANnel<N>:PROBe:ACCAL"](#) on page 336
 - [":CHANnel<N>:PROBe:PRECprobe:MODE"](#) on page 359
 - [":CHANnel<N>:PROBe:PRECprobe:CALibration"](#) on page 357
 - [":CHANnel<N>:PROBe:PRECprobe:ZSRC"](#) on page 360
 - [":CHANnel<N>:PROBe:PRECprobe:BANDwidth"](#) on page 356

History New in version 4.20.

:CHANnel<N>:PROBe:PRECprobe:MODE

Command :CHANnel<N>:PROBe:PRECprobe:MODE {PROBe | CABLE}

The :CHANnel<N>:PROBe:PRECprobe:MODE command chooses between PrecisionProbe or PrecisionCable AC response probe calibration.

<N> An integer, 1-4.

Example This example chooses PrecisionProbe calibration for the probe on channel 1.

```
myScope.WriteString ":CHANnel1:PROBe:PRECprobe:MODE PROBe"
```

Query :CHANnel<N>:PROBe:PRECprobe:MODE?

The :CHANnel<N>:PROBe:PRECprobe:MODE? query returns the current PrecisionProbe/PrecisionCable selection for the selected channel.

Returned Format [:CHANnel<N>:PROBe:PRECprobe:MODE] {PROBe | CABLE}<NL>

- See Also**
- [":CHANnel<N>:PROBe:ACCAL"](#) on page 336
 - [":CHANnel<N>:PROBe:PRECprobe:CALibration"](#) on page 357
 - [":CHANnel<N>:PROBe:PRECprobe:ZSRC"](#) on page 360
 - [":CHANnel<N>:PROBe:PRECprobe:BANDwidth"](#) on page 356
 - [":CHANnel<N>:PROBe:PRECprobe:DELay"](#) on page 358

History New in version 3.10.

:CHANnel<N>:PROBe:PRECprobe:ZSRC

Command :CHANnel<N>:PROBe:PRECprobe:ZSRC {VIN | {VSRC, <impedance>}
| {VSRC, <file_string>}}

The :CHANnel<N>:PROBe:PRECprobe:ZSRC command specifies how PrecisionProbe characterizes the time domain and frequency domain response.

<N> An integer, 1-4.

VIN Selects the VOut/Vin probe transfer function (which characterizes the output of the probe as a function of the input at the probe tips).

Defining the response this way lets you evaluate the probe's accuracy in reproducing the actual signal present in your system with the probe attached. This correction is what you would see with a real band limited probe that has finite input impedance. PrecisionProbe corrects the "VOut/Vin" response to be flat with frequency and phase to your defined bandwidth limit. It does not de-embed the loading effects of the probe. (Keysight's probe corrections are typically defined using Vout/Vin.)

VSRC, <impedance> Selects the VOut/VSrc estimate of probed system response (which corrects the probe as "what would be there if the probe were not present"), and specifies a constant ($Z_0/2$) value (in ohms) as the system source impedance.

One drawback of defining the probe's response in this manner is that if the probe's loading causes your circuit to lose some timing or amplitude margin, you probably want to know that when you make a measurement. VOut/VSource compensation will hide these effects from you. However, this method can be effective if probing at the transmitter.

VSRC, <file_string> Selects the VOut/VSrc estimate of probed system response (which corrects the probe as "what would be there if the probe were not present"), and names an S-parameter file whose S11 is used to specify the system source impedance.

Example This example, for channel 1, tells PrecisionProbe to use the VOut/VSrc characterization and to get the system source impedance from S11 in the "foo.s2p" S-parameter file.

```
myScope.WriteString ":CHANnel1:PROBe:PRECprobe:ZSRC VSRC, "foo.s2p"
```

Query :CHANnel<N>:PROBe:PRECprobe:ZSRC?

The :CHANnel<N>:PROBe:PRECprobe:ZSRC? query returns the current settings for PrecisionProbe time domain and frequency domain response characterization.

Returned Format [:CHANnel<N>:PROBe:PRECprobe:ZSRC] {VIN | {VSRC, <impedance>}
| {VSRC, <file_string>}}<NL>

- See Also**
- **":CHANnel<N>:PROBe:ACCAL"** on page 336
 - **":CHANnel<N>:PROBe:PRECprobe:MODE"** on page 359
 - **":CHANnel<N>:PROBe:PRECprobe:CALibration"** on page 357

- `":CHANnel<N>:PROBe:PRECprobe:BANDwidth"` on page 356
- `":CHANnel<N>:PROBe:PRECprobe:DELay"` on page 358

History New in version 3.10.

:CHANnel<N>:PROBe:PRIMary (9000 Series, 9000H Series, S-Series)

Command :CHANnel<N>:PROBe:PRIMary {ZIN | ZOUT}

<N> is an integer, 1-4.

For the N2820A/N2821A high-sensitivity current probes only, the :CHANnel<N>:PROBe:PRIMary command configures the input channel as a zoomed-in amplified channel (ZIN) or zoomed-out channel (ZOUT). With N2820A probes, the secondary channel will have the other waveform.

Query :CHANnel<N>:PROBe:PRIMary?

The :CHANnel<N>:PROBe:PRIMary? query returns the primary channel output setting.

Returned Format [:CHANnel<N>:PROBe:PRIMary] {ZIN | ZOUT}<NL>

See Also • [":MEASure:CHARge \(9000 Series, 9000H Series, S-Series\)"](#) on page 750

History New in version 5.60.

:CHANnel<N>:PROBe:SKEW

Command :CHANnel<N>:PROBe:SKEW <skew_value>

The :CHANnel<N>:PROBe:SKEW command sets the channel-to-channel skew factor for the specified channel. You can use the oscilloscope's probe skew control to remove timing differences between probes or cables on different channels.

<N> An integer, 1-4.

<skew_value> A real number for the skew value, in the range -1 ms to +1 ms.

Example This example sets the probe skew for channel 1 to 10 μ s.

```
myScope.WriteString ":CHANnel1:PROBe:SKEW 10E-6"
```

Query :CHANnel<N>:PROBe:SKEW?

The :CHANnel<N>:PROBe:SKEW? query returns the current probe skew setting for the selected channel.

Returned Format [:CHANnel<N>:PROBe:SKEW] <skew_value><NL>

History Legacy command (existed before version 3.10).

:CHANnel<N>:PROBe:STYPe**Command** :CHANnel<N>:PROBe:STYPe {DIFFerential | SINGle}**NOTE**

This command is valid only for the 113xA series probes, 1168A probe, and 1169A probe.

The :CHANnel<N>:PROBe:STYPe command sets the channel probe signal type (STYPe) to differential or single-ended when using the 113xA series probes, 1168A probe, and 1169A probe. This setting determines how offset is applied.

When single-ended is selected, the :CHANnel<N>:PROBe:EXtErnal:OFFset command changes the offset value of the probe amplifier. When differential is selected, the :CHANnel<N>:PROBe:EXtErnal:OFFset command changes the offset value of the channel amplifier.

<N> An integer, 1–4.**Example** This example sets the probe mode to single-ended.

```
myScope.WriteString ":CHANnel1:PROBe:STYPe SINGle"
```

Query :CHANnel<N>:PROBe:STYPe?

The :CHANnel<N>:PROBe:STYPe? query returns the current probe mode setting for the selected channel.

Returned Format [:CHANnel<N>:PROBe:STYPe] {DIFFerential | SINGle}<NL>**History** Legacy command (existed before version 3.10).

:CHANnel<N>:RANGe

Command :CHANnel<N>:RANGe <range_value>

The :CHANnel<N>:RANGe command defines the full-scale vertical axis of the selected channel. It sets up acquisition and display hardware to display the waveform at a given range scale. The values represent the full-scale deflection factor of the vertical axis in volts. These values change as the probe attenuation factor is changed.

<N> An integer, 1-4 in a single oscilloscope, 1-40 in a MultiScope system.

<range_value> A real number for the full-scale voltage of the specified channel number.

Example This example sets the full-scale range for channel 1 to 500 mV.

```
myScope.WriteString ":CHANnel1:RANGe 500E-3"
```

Query :CHANnel<N>:RANGe?

The :CHANnel<N>:RANGe? query returns the current full-scale vertical axis setting for the selected channel.

Returned Format [:CHANnel<N>:RANGe] <range_value><NL>

Example This example places the current range value in the number variable, varSetting, then prints the contents of the variable to the computer's screen.

```
myScope.WriteString ":SYSTem:HEADer OFF"      ' Response headers off.
myScope.WriteString ":CHANnel1:RANGe?"
varSetting = myScope.ReadNumber
Debug.Print FormatNumber(varSetting, 0)
```

History Legacy command (existed before version 3.10).

:CHANnel<N>:SCALE

Command :CHANnel<N>:SCALE <scale_value>

The :CHANnel<N>:SCALE command sets the vertical scale, or units per division, of the selected channel. This command is the same as the front-panel channel scale.

<N> An integer, 1-4 in a single oscilloscope, 1-40 in a MultiScope system.

<scale_value> A real number for the vertical scale of the channel in units per division.

Example This example sets the scale value for channel 1 to 500 mV/div.

```
myScope.WriteString ":CHANnel1:SCALE 500E-3"
```

Query :CHANnel<N>:SCALE?

The :CHANnel<N>:SCALE? query returns the current scale setting for the specified channel.

Returned Format [:CHANnel<N>:SCALE] <scale_value><NL>

Example This example places the current scale value in the number variable, varSetting, then prints the contents of the variable to the computer's screen.

```
myScope.WriteString ":SYSTEM:HEADer OFF"      ' Response headers off.
myScope.WriteString ":CHANnel1:SCALE?"
varSetting = myScope.ReadNumber
Debug.Print FormatNumber(varSetting, 0)
```

History Legacy command (existed before version 3.10).

:CHANnel<N>:SIMulation:AMPLitude

Command :CHANnel<N>:SIMulation:AMPLitude <value>

The :CHANnel<N>:SIMulation:AMPLitude command specifies the amplitude of the simulated waveform.

<N> An integer, 1-4 in a single oscilloscope, 1-40 in a MultiScope system.

<value> Simulated waveform vertical value in NR3 format.

Query :CHANnel<N>:SIMulation:AMPLitude?

The :CHANnel<N>:SIMulation:AMPLitude? query returns the simulated waveform's amplitude value.

Returned Format <value><NL>

<value> ::= waveform vertical value in NR3 format

See Also · [":CHANnel<N>:SIMulation:WAVEform"](#) on page 399

History New in version 6.00.

:CHANnel<N>:SIMulation:DATA:LENGth

Command :CHANnel<N>:SIMulation:DATA:LENGth <length_exp>

For the DATA simulated waveform type (see :CHANnel<N>:SIMulation:WAVEform), the :CHANnel<N>:SIMulation:DATA:LENGth command specifies the length exponent of the simulated saveform's PRBS sequence ($2^{\text{length_exp}}$).

<N> An integer, 1-4 in a single oscilloscope, 1-40 in a MultiScope system.

<length_exp> PRBS length exponent from 1 to 15 in NR1 format.

Query :CHANnel<N>:SIMulation:DATA:LENGth?

The :CHANnel<N>:SIMulation:DATA:LENGth? query returns the specified length exponent.

Returned Format <length_exp><NL>

<length_exp> ::= PRBS length exponent from 1 to 15 in NR1 format

- See Also**
- [":CHANnel<N>:SIMulation:WAVEform"](#) on page 399
 - [":CHANnel<N>:SIMulation:DRATE"](#) on page 373
 - [":CHANnel<N>:SIMulation:DATA:SElection"](#) on page 372
 - [":CHANnel<N>:SIMulation:DATA:ODD"](#) on page 369
 - [":CHANnel<N>:SIMulation:DATA:RESeed"](#) on page 371

History New in version 6.00.

:CHANnel<N>:SIMulation:DATA:ODD

Command :CHANnel<N>:SIMulation:DATA:ODD {{0 | OFF} | {1 | ON}}

For the DATA simulated waveform type (see :CHANnel<N>:SIMulation:WAVEform), the :CHANnel<N>:SIMulation:DATA:ODD command sets the PRBS "odd" control. When ON, one is subtracted from the length of the PRBS sequence.

<N> An integer, 1-4 in a single oscilloscope, 1-40 in a MultiScope system.

Query :CHANnel<N>:SIMulation:DATA:ODD?

The :CHANnel<N>:SIMulation:DATA:ODD? query returns the PRBS "odd" control setting.

Returned Format <setting><NL>

<setting> ::= {0 | 1}

- See Also**
- [":CHANnel<N>:SIMulation:WAVEform"](#) on page 399
 - [":CHANnel<N>:SIMulation:DRATE"](#) on page 373
 - [":CHANnel<N>:SIMulation:DATA:SELECTION"](#) on page 372
 - [":CHANnel<N>:SIMulation:DATA:LENGTH"](#) on page 368
 - [":CHANnel<N>:SIMulation:DATA:RESeed"](#) on page 371

History New in version 6.00.

:CHANnel<N>:SIMulation:DATA:PAM

Command :CHANnel<N>:SIMulation:DATA:PAM <num_of_symbols>

When the DATA simulated waveform type is selected (:CHANnel<N>:SIMulation:WAVEform DATA) and PAM is selected as the PRBS signal type (:CHANnel<N>:SIMulation:DATA:SElection PAM), the :CHANnel<N>:SIMulation:DATA:PAM command specifies the number of symbols (or levels) in the PAM signal. For example, for a PAM-4 signal, you specify 4.

<N> An integer, 1-4 in a single oscilloscope, 1-40 in a MultiScope system.

<num_of_symbols> A value from 2 to 255 in NR1 format.

>

Query :CHANnel<N>:SIMulation:DATA:PAM?

The :CHANnel<N>:SIMulation:DATA:PAM? query returns the specified number of symbols in the PAM signal.

Returned Format <num_of_symbols><NL>

<num_of_symbols> ::= 2 to 255 in NR1 format, e.g., 4 = PAM-4

- See Also**
- [":CHANnel<N>:SIMulation:WAVEform"](#) on page 399
 - [":CHANnel<N>:SIMulation:DATA:SElection"](#) on page 372

History New in version 6.00.

:CHANnel<N>:SIMulation:DATA:RESeed

Command :CHANnel<N>:SIMulation:DATA:RESeed {{0 | OFF} | {1 | ON}}

For the DATA simulated waveform type (see :CHANnel<N>:SIMulation:WAVEform), the :CHANnel<N>:SIMulation:DATA:RESeed command specifies whether to reseed the PRBS generator(s). When ON, a new sequence is given on each acquire.

<N> An integer, 1-4 in a single oscilloscope, 1-40 in a MultiScope system.

Query :CHANnel<N>:SIMulation:DATA:RESeed?

The :CHANnel<N>:SIMulation:DATA:RESeed? query returns the PRBS generator(s) reseed setting.

Returned Format <setting><NL>

<setting> ::= {0 | 1}

- See Also**
- [":CHANnel<N>:SIMulation:WAVEform"](#) on page 399
 - [":CHANnel<N>:SIMulation:DRATE"](#) on page 373
 - [":CHANnel<N>:SIMulation:DATA:SELECTION"](#) on page 372
 - [":CHANnel<N>:SIMulation:DATA:LENGTH"](#) on page 368
 - [":CHANnel<N>:SIMulation:DATA:ODD"](#) on page 369

History New in version 6.00.

:CHANnel<N>:SIMulation:DATA:SElection

Command :CHANnel<N>:SIMulation:DATA:SElection <type>

For the DATA simulated waveform type (see :CHANnel<N>:SIMulation:WAVEform), the :CHANnel<N>:SIMulation:DATA:SElection command specifies whether the simulated PRBS waveform is a Non Return to Zero (NRZ) signal or a Pulse Amplitude Modulation (PAM) signal.

<N> An integer, 1-4 in a single oscilloscope, 1-40 in a MultiScope system.

<type> {NRZ | PAM}

Query :CHANnel<N>:SIMulation:DATA:SElection?

The :CHANnel<N>:SIMulation:DATA:SElection? query returns the simulated PRBS waveform signal type selection.

Returned Format <type><NL>

<type> ::= {NRZ | PAM}

- See Also**
- [":CHANnel<N>:SIMulation:WAVEform"](#) on page 399
 - [":CHANnel<N>:SIMulation:DRATe"](#) on page 373
 - [":CHANnel<N>:SIMulation:DATA:LENGth"](#) on page 368
 - [":CHANnel<N>:SIMulation:DATA:ODD"](#) on page 369
 - [":CHANnel<N>:SIMulation:DATA:PAM"](#) on page 370
 - [":CHANnel<N>:SIMulation:DATA:RESeed"](#) on page 371

History New in version 6.00.

:CHANnel<N>:SIMulation:DRATe

Command :CHANnel<N>:SIMulation:DRATe <data_rate>

For the DATA simulated waveform type (see :CHANnel<N>:SIMulation:WAVEform), the :CHANnel<N>:SIMulation:DRATe command specifies the data rate of the simulated waveform.

<N> An integer, 1-4 in a single oscilloscope, 1-40 in a MultiScope system.

<data_rate> Value in NR3 format.

Query :CHANnel<N>:SIMulation:DRATe?

The :CHANnel<N>:SIMulation:DRATe? query returns the specified data rate of the simulated waveform.

Returned Format <data_rate><NL>

<data_rate> ::= value in NR3 format

- See Also**
- [":CHANnel<N>:SIMulation:WAVEform"](#) on page 399
 - [":CHANnel<N>:SIMulation:DATA:SELECTION"](#) on page 372
 - [":CHANnel<N>:SIMulation:DATA:LENGTH"](#) on page 368
 - [":CHANnel<N>:SIMulation:DATA:ODD"](#) on page 369
 - [":CHANnel<N>:SIMulation:DATA:RESEED"](#) on page 371

History New in version 6.00.

:CHANnel<N>:SIMulation:FILTer:ISIM:ADDRess

Command :CHANnel<N>:SIMulation:FILTer:ISIM:ADDRess <file_path>

When the InfiniiSim filter is selected (with the ":CHANnel<N>:SIMulation:FILTer:SELection ISIM" command), the :CHANnel<N>:SIMulation:FILTer:ISIM:ADDRess command specifies the path of an InfiniiSim transfer function file.

<N> An integer, 1-4 in a single oscilloscope, 1-40 in a MultiScope system.

<file_path> Quoted path string of a valid .tf2 or .tf4 file.

Query :CHANnel<N>:SIMulation:FILTer:ISIM:ADDRess?

The :CHANnel<N>:SIMulation:FILTer:ISIM:ADDRess? query returns the path of the selected InfiniiSim transfer function file.

Returned Format <file_path><NL>

<file_path> ::= quoted path string of a valid .tf2 or .tf4 file

- See Also**
- [":CHANnel<N>:SIMulation:FILTer:ISIM:PEXTraction"](#) on page 375
 - [":CHANnel<N>:SIMulation:FILTer:SELection"](#) on page 376

History New in version 6.00.

:CHANnel<N>:SIMulation:FILTer:ISIM:PEXTraction

Command :CHANnel<N>:SIMulation:FILTer:ISIM:PEXTraction <port_extraction>

When a .tf4 4-port InfiniiSim transfer function file is used (see :CHANnel<N>:SIMulation:FILTer:ISIM:ADDRes), the :CHANnel<N>:SIMulation:FILTer:ISIM:PEXTraction command specifies the port extraction method.

<N> An integer, 1-4 in a single oscilloscope, 1-40 in a MultiScope system.

<port_extraction> {P12 | P32 | P34 | P14 | DIFFerential | COMMONmode}

Query :CHANnel<N>:SIMulation:FILTer:ISIM:PEXTraction?

The :CHANnel<N>:SIMulation:FILTer:ISIM:PEXTraction? query returns the selected port extraction method.

Returned Format <port_extraction><NL>

<port_extraction> ::= {P12 | P32 | P34 | P14 | DIFF | COMM}

- See Also**
- **":CHANnel<N>:SIMulation:FILTer:ISIM:ADDRes"** on page 374
 - **":CHANnel<N>:SIMulation:FILTer:SELECTION"** on page 376

History New in version 6.00.

:CHANnel<N>:SIMulation:FILTer:SElection

Command :CHANnel<N>:SIMulation:FILTer:SElection <filter_type>

The :CHANnel<N>:SIMulation:FILTer:SElection command sets the filter type.

<N> An integer, 1-4 in a single oscilloscope, 1-40 in a MultiScope system.

<filter_type> {BWALI | GAUSSian | ISIM | NONE}

NOTE

The InfiniiSim feature must be licensed to make the ISIM selection.

Query :CHANnel<N>:SIMulation:FILTer:SElection?

The :CHANnel<N>:SIMulation:FILTer:SElection? query returns the filter type setting

Returned Format <filter_type><NL>

<filter_type> ::= {BWAL | GAUS | ISIM | NONE}

See Also

- [":CHANnel<N>:SIMulation:FILTer:ISIM:ADDRess"](#) on page 374
- [":CHANnel<N>:SIMulation:FILTer:ISIM:PEXTraction"](#) on page 375

History New in version 6.00.

:CHANnel<N>:SIMulation:FLOad:ADDRESS

Command :CHANnel<N>:SIMulation:FLOad:ADDRESS <load_file_path>

For the FILE simulated waveform type (see :CHANnel<N>:SIMulation:WAVEform), the :CHANnel<N>:SIMulation:FLOad:ADDRESS command specifies the full path string of a .wfm file to use as the simulated waveform.

The string must include the full path and file extension. Only Infiniium waveform data files are supported.

<N> An integer, 1-4 in a single oscilloscope, 1-40 in a MultiScope system.

<load_file_path> Quoted full path string of a .wfm file.

Query :CHANnel<N>:SIMulation:FLOad:ADDRESS?

The :CHANnel<N>:SIMulation:FLOad:ADDRESS? query returns ...

Returned Format <load_file_path><NL>

<load_file_path> ::= quoted full path string of a .wfm file

- See Also**
- [":CHANnel<N>:SIMulation:WAVEform"](#) on page 399
 - [":CHANnel<N>:SIMulation:FLOad:LOOP"](#) on page 378

History New in version 6.00.

:CHANnel<N>:SIMulation:FLOad:LOOP

Command :CHANnel<N>:SIMulation:FLOad:LOOP {{0 | OFF} | {1 | ON}}

For the FILE simulated waveform type (see :CHANnel<N>:SIMulation:WAVEform), the :CHANnel<N>:SIMulation:FLOad:LOOP command specifies whether the simulated waveform should repeat from the beginning of the file when reaching the end of the file.

<N> An integer, 1-4 in a single oscilloscope, 1-40 in a MultiScope system.

Query :CHANnel<N>:SIMulation:FLOad:LOOP?

The :CHANnel<N>:SIMulation:FLOad:LOOP? query returns the loop control setting.

Returned Format <setting><NL>

<setting> ::= {0 | 1}

- See Also**
- [":CHANnel<N>:SIMulation:WAVEform"](#) on page 399
 - [":CHANnel<N>:SIMulation:FLOad:ADDRESS"](#) on page 377

History New in version 6.00.

:CHANnel<N>:SIMulation:FREQuency

Command :CHANnel<N>:SIMulation:FREQuency <freq>

For the CLOCK or FUNCTION simulated waveform types (see :CHANnel<N>:SIMulation:WAVEform), the :CHANnel<N>:SIMulation:FREQuency command specifies the frequency of the simulated waveform.

<N> An integer, 1-4 in a single oscilloscope, 1-40 in a MultiScope system.

<freq> Value in NR3 format.

Query :CHANnel<N>:SIMulation:FREQuency?

The :CHANnel<N>:SIMulation:FREQuency? query returns the specified frequency of the simulated waveform.

Returned Format <freq><NL>

<freq> ::= value in NR3 format

See Also • [":CHANnel<N>:SIMulation:WAVEform"](#) on page 399

History New in version 6.00.

:CHANnel<N>:SIMulation:FUNCTion:SELection

Command :CHANnel<N>:SIMulation:FUNCTion:SELection <type>

For the FUNCTion simulated waveform type (see :CHANnel<N>:SIMulation:WAVEform), the :CHANnel<N>:SIMulation:FUNCTion:SELection command specifies the simulated waveform function type.

<N> An integer, 1-4 in a single oscilloscope, 1-40 in a MultiScope system.

<type> {IMPulse | SAWTooth | SIN | SQUare | TRIangle}

Query :CHANnel<N>:SIMulation:FUNCTion:SELection?

The :CHANnel<N>:SIMulation:FUNCTion:SELection? query returns the selected simulated waveform function type.

Returned Format <type><NL>

<type> ::= {IMP | SAWT | SIN | SQU | TRI}

- See Also**
- [":CHANnel<N>:SIMulation:WAVEform"](#) on page 399
 - [":CHANnel<N>:SIMulation:FREQuency"](#) on page 379
 - [":CHANnel<N>:SIMulation:FUNCTion:SQUare:DCYCLe"](#) on page 381
 - [":CHANnel<N>:SIMulation:FUNCTion:SQUare:RTIME"](#) on page 383
 - [":CHANnel<N>:SIMulation:FUNCTion:SQUare:FTIME"](#) on page 382

History New in version 6.00.

:CHANnel<N>:SIMulation:FUNCTion:SQUare:DCYClE

Command :CHANnel<N>:SIMulation:FUNCTion:SQUare:DCYClE <duty_cycle>

When the FUNCTion simulated waveform type is selected (:CHANnel<N>:SIMulation:WAVEform FUNCTion) and the SQUare function is selected (:CHANnel<N>:SIMulation:FUNCTion:SELECTION SQUare), the :CHANnel<N>:SIMulation:FUNCTion:SQUare:DCYClE command specifies the square wave's duty cycle high time percent value.

<N> An integer, 1-4 in a single oscilloscope, 1-40 in a MultiScope system.

<duty_cycle> The percent high time value in NR1 format.

Query :CHANnel<N>:SIMulation:FUNCTion:SQUare:DCYClE?

The :CHANnel<N>:SIMulation:FUNCTion:SQUare:DCYClE? query returns the specified duty cycle high time percent value.

Returned Format <duty_cycle><NL>

<duty_cycle> ::= percent high time value in NR1 format

- See Also**
- [":CHANnel<N>:SIMulation:WAVEform"](#) on page 399
 - [":CHANnel<N>:SIMulation:FUNCTion:SELECTION"](#) on page 380

History New in version 6.00.

:CHANnel<N>:SIMulation:FUNCTion:SQUare:FTIME

Command :CHANnel<N>:SIMulation:FUNCTion:SQUare:FTIME <fall_time>

When the FUNCTion simulated waveform type is selected (:CHANnel<N>:SIMulation:WAVEform FUNCTion) and the SQUare function is selected (:CHANnel<N>:SIMulation:FUNCTion:SELECTION SQUare), the :CHANnel<N>:SIMulation:FUNCTion:SQUare:FTIME command specifies the square wave's high-to-low transition time.

<N> An integer, 1-4 in a single oscilloscope, 1-40 in a MultiScope system.

<fall_time> The high-to-low transition time value in NR3 format.

Query :CHANnel<N>:SIMulation:FUNCTion:SQUare:FTIME?

The :CHANnel<N>:SIMulation:FUNCTion:SQUare:FTIME? query returns the specified high-to-low transition time.

Returned Format <fall_time><NL>

<fall_time> ::= high-to-low transition time value in NR3 format

- See Also**
- [":CHANnel<N>:SIMulation:WAVEform"](#) on page 399
 - [":CHANnel<N>:SIMulation:FUNCTion:SELECTION"](#) on page 380

History New in version 6.00.

:CHANnel<N>:SIMulation:FUNCTion:SQUare:RTIME

Command :CHANnel<N>:SIMulation:FUNCTion:SQUare:RTIME <rise_time>

When the FUNCTion simulated waveform type is selected (:CHANnel<N>:SIMulation:WAVEform FUNCTion) and the SQUare function is selected (:CHANnel<N>:SIMulation:FUNCTion:SELECTION SQUare), the :CHANnel<N>:SIMulation:FUNCTion:SQUare:RTIME command specifies the square wave's low-to-high transition time.

<N> An integer, 1-4 in a single oscilloscope, 1-40 in a MultiScope system.

<rise_time> The low-to-high transition time value in NR3 format.

Query :CHANnel<N>:SIMulation:FUNCTion:SQUare:RTIME?

The :CHANnel<N>:SIMulation:FUNCTion:SQUare:RTIME? query returns the specified low-to-high transition time.

Returned Format <rise_time><NL>

<rise_time> ::= low-to-high transition time value in NR3 format

- See Also**
- [":CHANnel<N>:SIMulation:WAVEform"](#) on page 399
 - [":CHANnel<N>:SIMulation:FUNCTion:SELECTION"](#) on page 380

History New in version 6.00.

:CHANnel<N>:SIMulation:JITTer

Command :CHANnel<N>:SIMulation:JITTer {{0 | OFF} | {1 | ON}}

The :CHANnel<N>:SIMulation:JITTer command turns all simulated waveform jitter off or on while saving the values.

<N> An integer, 1-4 in a single oscilloscope, 1-40 in a MultiScope system.

Query :CHANnel<N>:SIMulation:JITTer?

The :CHANnel<N>:SIMulation:JITTer? query returns the simulated waveform jitter off/on setting.

Returned Format <setting><NL>

<setting> ::= {0 | 1}

- See Also**
- [":CHANnel<N>:SIMulation:JITTer:ABUJ"](#) on page 385
 - [":CHANnel<N>:SIMulation:JITTer:PERiodic<M>:ENABLE"](#) on page 386
 - [":CHANnel<N>:SIMulation:JITTer:PERiodic<M>:FREQuency"](#) on page 387
 - [":CHANnel<N>:SIMulation:JITTer:PERiodic<M>:MAGNitude"](#) on page 388
 - [":CHANnel<N>:SIMulation:JITTer:PERiodic<M>:SHAPE"](#) on page 389
 - [":CHANnel<N>:SIMulation:JITTer:RANDom"](#) on page 390

History New in version 6.00.

:CHANnel<N>:SIMulation:JITTer:ABUJ

Command :CHANnel<N>:SIMulation:JITTer:ABUJ <magnitude>

The :CHANnel<N>:SIMulation:JITTer:ABUJ command specifies the amount of Aperiodic Bounded Uniform Jitter (ABUJ) to apply to the simulated waveform. The ABUJ follows a uniform distribution between $[-\text{Magnitude}/2, \text{Magnitude}/2]$.

<N> An integer, 1-4 in a single oscilloscope, 1-40 in a MultiScope system.

<magnitude> Value in NR3 format.

Query :CHANnel<N>:SIMulation:JITTer:ABUJ?

The :CHANnel<N>:SIMulation:JITTer:ABUJ? query returns the Aperiodic Bounded Uniform Jitter (ABUJ) value.

Returned Format <magnitude><NL>

<magnitude> ::= value in NR3 format

- See Also**
- [":CHANnel<N>:SIMulation:JITTer"](#) on page 384
 - [":CHANnel<N>:SIMulation:JITTer:PERiodic<M>:ENABle"](#) on page 386
 - [":CHANnel<N>:SIMulation:JITTer:PERiodic<M>:FREQuency"](#) on page 387
 - [":CHANnel<N>:SIMulation:JITTer:PERiodic<M>:MAGNitude"](#) on page 388
 - [":CHANnel<N>:SIMulation:JITTer:PERiodic<M>:SHAPE"](#) on page 389
 - [":CHANnel<N>:SIMulation:JITTer:RANDom"](#) on page 390

History New in version 6.00.

:CHANnel<N>:SIMulation:JITTer:PERiodic<M>:ENABle

Command :CHANnel<N>:SIMulation:JITTer:PERiodic<M>:ENABle {{0 | OFF} | {1 | ON}}

The :CHANnel<N>:SIMulation:JITTer:PERiodic<M>:ENABle command turns the periodic jitter on or off.

<N> An integer, 1-4 in a single oscilloscope, 1-40 in a MultiScope system.

<M> Periodic jitter slot, 1-10.

Query :CHANnel<N>:SIMulation:JITTer:PERiodic<M>:ENABle?

The :CHANnel<N>:SIMulation:JITTer:PERiodic<M>:ENABle? query returns the periodic jitter enable setting.

Returned Format <setting><NL>

<setting> ::= {0 | 1}

- See Also**
- [":CHANnel<N>:SIMulation:JITTer"](#) on page 384
 - [":CHANnel<N>:SIMulation:JITTer:ABUJ"](#) on page 385
 - [":CHANnel<N>:SIMulation:JITTer:PERiodic<M>:FREQuency"](#) on page 387
 - [":CHANnel<N>:SIMulation:JITTer:PERiodic<M>:MAGNitude"](#) on page 388
 - [":CHANnel<N>:SIMulation:JITTer:PERiodic<M>:SHAPE"](#) on page 389
 - [":CHANnel<N>:SIMulation:JITTer:RANDom"](#) on page 390

History New in version 6.00.

:CHANnel<N>:SIMulation:JITTer:PERiodic<M>:FREQuency

Command :CHANnel<N>:SIMulation:JITTer:PERiodic<M>:FREQuency <freq>

The :CHANnel<N>:SIMulation:JITTer:PERiodic<M>:FREQuency command specifies the frequency of the periodic jitter applied to the simulated waveform.

<N> An integer, 1-4 in a single oscilloscope, 1-40 in a MultiScope system.

<M> Periodic jitter slot, 1-10.

<freq> Value in NR3 format.

Query :CHANnel<N>:SIMulation:JITTer:PERiodic<M>:FREQuency?

The :CHANnel<N>:SIMulation:JITTer:PERiodic<M>:FREQuency? query returns the specified frequency of the periodic jitter.

Returned Format <freq><NL>

<freq> ::= value in NR3 format

- See Also**
- [":CHANnel<N>:SIMulation:JITTer"](#) on page 384
 - [":CHANnel<N>:SIMulation:JITTer:ABUJ"](#) on page 385
 - [":CHANnel<N>:SIMulation:JITTer:PERiodic<M>:ENABLE"](#) on page 386
 - [":CHANnel<N>:SIMulation:JITTer:PERiodic<M>:MAGNitude"](#) on page 388
 - [":CHANnel<N>:SIMulation:JITTer:PERiodic<M>:SHAPE"](#) on page 389
 - [":CHANnel<N>:SIMulation:JITTer:RANDom"](#) on page 390

History New in version 6.00.

:CHANnel<N>:SIMulation:JITTer:PERiodic<M>:MAGNitude

Command :CHANnel<N>:SIMulation:JITTer:PERiodic<M>:MAGNitude <magnitude>

The :CHANnel<N>:SIMulation:JITTer:PERiodic<M>:MAGNitude command specifies the magnitude of the periodic jitter applied to the simulated waveform.

This magnitude is a peak-to-peak value similar to amplitude.

<N> An integer, 1-4 in a single oscilloscope, 1-40 in a MultiScope system.

<M> Periodic jitter slot, 1-10.

<magnitude> Value in NR3 format.

Query :CHANnel<N>:SIMulation:JITTer:PERiodic<M>:MAGNitude?

The :CHANnel<N>:SIMulation:JITTer:PERiodic<M>:MAGNitude? query returns the specified magnitude of the periodic jitter.

Returned Format <magnitude><NL>

<magnitude> ::= value in NR3 format

- See Also**
- [":CHANnel<N>:SIMulation:JITTer"](#) on page 384
 - [":CHANnel<N>:SIMulation:JITTer:ABUJ"](#) on page 385
 - [":CHANnel<N>:SIMulation:JITTer:PERiodic<M>:ENABLE"](#) on page 386
 - [":CHANnel<N>:SIMulation:JITTer:PERiodic<M>:FREQuency"](#) on page 387
 - [":CHANnel<N>:SIMulation:JITTer:PERiodic<M>:SHAPE"](#) on page 389
 - [":CHANnel<N>:SIMulation:JITTer:RANDom"](#) on page 390

History New in version 6.00.

:CHANnel<N>:SIMulation:JITTer:PERiodic<M>:SHAPE

Command :CHANnel<N>:SIMulation:JITTer:PERiodic<M>:SHAPE <shape>

The :CHANnel<N>:SIMulation:JITTer:PERiodic<M>:SHAPE command specifies the shape of the periodic jitter applied to the simulated waveform.

<N> An integer, 1-4 in a single oscilloscope, 1-40 in a MultiScope system.

<M> Periodic jitter slot, 1-10.

<shape> {SAWTooth | SIN | SQUARE | TRIangle}

Query :CHANnel<N>:SIMulation:JITTer:PERiodic<M>:SHAPE?

The :CHANnel<N>:SIMulation:JITTer:PERiodic<M>:SHAPE? query returns the specified shape of the periodic jitter.

Returned Format <shape><NL>

<shape> ::= {SAWT | SIN | SQU | TRI}

- See Also**
- [":CHANnel<N>:SIMulation:JITTer"](#) on page 384
 - [":CHANnel<N>:SIMulation:JITTer:ABUJ"](#) on page 385
 - [":CHANnel<N>:SIMulation:JITTer:PERiodic<M>:ENABLE"](#) on page 386
 - [":CHANnel<N>:SIMulation:JITTer:PERiodic<M>:FREQuency"](#) on page 387
 - [":CHANnel<N>:SIMulation:JITTer:PERiodic<M>:MAGNitude"](#) on page 388
 - [":CHANnel<N>:SIMulation:JITTer:RANDom"](#) on page 390

History New in version 6.00.

:CHANnel<N>:SIMulation:JITTer:RANDom

Command :CHANnel<N>:SIMulation:JITTer:RANDom <standard_deviation>

The :CHANnel<N>:SIMulation:JITTer:RANDom command specifies the standard deviation of random jitter to apply. This random jitter follows a normal distribution.

<N> An integer, 1-4 in a single oscilloscope, 1-40 in a MultiScope system.

<standard_deviation>
Value in NR3 format.

Query :CHANnel<N>:SIMulation:JITTer:RANDom?

The :CHANnel<N>:SIMulation:JITTer:RANDom? query returns the random jitter standard deviation value.

Returned Format <standard_deviation><NL>

<standard_deviation> ::= value in NR3 format

- See Also**
- [":CHANnel<N>:SIMulation:JITTer"](#) on page 384
 - [":CHANnel<N>:SIMulation:JITTer:ABUJ"](#) on page 385
 - [":CHANnel<N>:SIMulation:JITTer:PERiodic<M>:ENABLE"](#) on page 386
 - [":CHANnel<N>:SIMulation:JITTer:PERiodic<M>:FREQuency"](#) on page 387
 - [":CHANnel<N>:SIMulation:JITTer:PERiodic<M>:MAGNitude"](#) on page 388
 - [":CHANnel<N>:SIMulation:JITTer:PERiodic<M>:SHAPE"](#) on page 389

History New in version 6.00.

:CHANnel<N>:SIMulation:NOISe

Command :CHANnel<N>:SIMulation:NOISe {{0 | OFF} | {1 | ON}}

The :CHANnel<N>:SIMulation:NOISe command turns all simulated waveform noise off or on while saving the values.

<N> An integer, 1-4 in a single oscilloscope, 1-40 in a MultiScope system.

Query :CHANnel<N>:SIMulation:NOISe?

The :CHANnel<N>:SIMulation:NOISe? query returns the simulated waveform noise off/on setting.

Returned Format <setting><NL>

<setting ::= {0 | 1}

- See Also**
- [":CHANnel<N>:SIMulation:NOISe:BWLimit"](#) on page 392
 - [":CHANnel<N>:SIMulation:NOISe:PERiodic<M>:ENABLE"](#) on page 393
 - [":CHANnel<N>:SIMulation:NOISe:PERiodic<M>:FREQuency"](#) on page 394
 - [":CHANnel<N>:SIMulation:NOISe:PERiodic<M>:MAGNitude"](#) on page 395
 - [":CHANnel<N>:SIMulation:NOISe:PERiodic<M>:SHAPE"](#) on page 396
 - [":CHANnel<N>:SIMulation:NOISe:RANDom"](#) on page 397

History New in version 6.00.

:CHANnel<N>:SIMulation:NOISe:BWLimit

Command :CHANnel<N>:SIMulation:NOISe:BWLimit {{0 | OFF} | {1 | ON}}

The :CHANnel<N>:SIMulation:NOISe:BWLimit command turns the noise filter on or off. This filter is a brick wall filter with a cut-off frequency of 0.4 times the sample rate.

<N> An integer, 1-4 in a single oscilloscope, 1-40 in a MultiScope system.

Query :CHANnel<N>:SIMulation:NOISe:BWLimit?

The :CHANnel<N>:SIMulation:NOISe:BWLimit? query returns the noise filter on/off setting.

Returned Format <setting><NL>

<setting> ::= {0 | 1}

- See Also**
- [":CHANnel<N>:SIMulation:NOISe"](#) on page 391
 - [":CHANnel<N>:SIMulation:NOISe:PERiodic<M>:ENABLE"](#) on page 393
 - [":CHANnel<N>:SIMulation:NOISe:PERiodic<M>:FREQuency"](#) on page 394
 - [":CHANnel<N>:SIMulation:NOISe:PERiodic<M>:MAGNitude"](#) on page 395
 - [":CHANnel<N>:SIMulation:NOISe:PERiodic<M>:SHAPE"](#) on page 396
 - [":CHANnel<N>:SIMulation:NOISe:RANDom"](#) on page 397

History New in version 6.00.

:CHANnel<N>:SIMulation:NOISe:PERiodic<M>:ENABLE

Command :CHANnel<N>:SIMulation:NOISe:PERiodic<M>:ENABLE {{0 | OFF} | {1 | ON}}

The :CHANnel<N>:SIMulation:NOISe:PERiodic<M>:ENABLE command turns the periodic noise on or off.

<N> An integer, 1-4 in a single oscilloscope, 1-40 in a MultiScope system.

<M> Periodic noise slot, 1-10.

Query :CHANnel<N>:SIMulation:NOISe:PERiodic<M>:ENABLE?

The :CHANnel<N>:SIMulation:NOISe:PERiodic<M>:ENABLE? query returns the periodic noise enable setting.

Returned Format <setting><NL>

<setting> ::= {0 | 1}

- See Also**
- [":CHANnel<N>:SIMulation:NOISe"](#) on page 391
 - [":CHANnel<N>:SIMulation:NOISe:BWLimit"](#) on page 392
 - [":CHANnel<N>:SIMulation:NOISe:PERiodic<M>:FREQUENCY"](#) on page 394
 - [":CHANnel<N>:SIMulation:NOISe:PERiodic<M>:MAGNitude"](#) on page 395
 - [":CHANnel<N>:SIMulation:NOISe:PERiodic<M>:SHAPE"](#) on page 396
 - [":CHANnel<N>:SIMulation:NOISe:RANDom"](#) on page 397

History New in version 6.00.

:CHANnel<N>:SIMulation:NOISe:PERiodic<M>:FREQuency

Command :CHANnel<N>:SIMulation:NOISe:PERiodic<M>:FREQuency <freq>

The :CHANnel<N>:SIMulation:NOISe:PERiodic<M>:FREQuency command specifies the frequency of the periodic noise applied to the simulated waveform.

<N> An integer, 1-4 in a single oscilloscope, 1-40 in a MultiScope system.

<M> Periodic noise slot, 1-10.

<freq> Value in NR3 format.

Query :CHANnel<N>:SIMulation:NOISe:PERiodic<M>:FREQuency?

The :CHANnel<N>:SIMulation:NOISe:PERiodic<M>:FREQuency? query returns the specified frequency of the periodic noise.

Returned Format <freq><NL>

<freq> ::= value in NR3 format

- See Also**
- [":CHANnel<N>:SIMulation:NOISe"](#) on page 391
 - [":CHANnel<N>:SIMulation:NOISe:BWLimit"](#) on page 392
 - [":CHANnel<N>:SIMulation:NOISe:PERiodic<M>:ENABLE"](#) on page 393
 - [":CHANnel<N>:SIMulation:NOISe:PERiodic<M>:MAGNitude"](#) on page 395
 - [":CHANnel<N>:SIMulation:NOISe:PERiodic<M>:SHAPE"](#) on page 396
 - [":CHANnel<N>:SIMulation:NOISe:RANDOM"](#) on page 397

History New in version 6.00.

:CHANnel<N>:SIMulation:NOISe:PERiodic<M>:MAGNitude

Command :CHANnel<N>:SIMulation:NOISe:PERiodic<M>:MAGNitude <magnitude>

The :CHANnel<N>:SIMulation:NOISe:PERiodic<M>:MAGNitude command specifies the magnitude of the periodic noise applied to the simulated waveform.

This magnitude is a peak-to-peak value similar to amplitude.

<N> An integer, 1-4 in a single oscilloscope, 1-40 in a MultiScope system.

<M> Periodic noise slot, 1-10.

<magnitude> Value in NR3 format.

Query :CHANnel<N>:SIMulation:NOISe:PERiodic<M>:MAGNitude?

The :CHANnel<N>:SIMulation:NOISe:PERiodic<M>:MAGNitude? query returns the specified magnitude of the periodic noise.

Returned Format <magnitude><NL>

<magnitude> ::= value in NR3 format

- See Also**
- [":CHANnel<N>:SIMulation:NOISe"](#) on page 391
 - [":CHANnel<N>:SIMulation:NOISe:BWLimit"](#) on page 392
 - [":CHANnel<N>:SIMulation:NOISe:PERiodic<M>:ENABLE"](#) on page 393
 - [":CHANnel<N>:SIMulation:NOISe:PERiodic<M>:FREQUENCY"](#) on page 394
 - [":CHANnel<N>:SIMulation:NOISe:PERiodic<M>:SHAPE"](#) on page 396
 - [":CHANnel<N>:SIMulation:NOISe:RANDOM"](#) on page 397

History New in version 6.00.

:CHANnel<N>:SIMulation:NOISe:PERiodic<M>:SHAPE

Command :CHANnel<N>:SIMulation:NOISe:PERiodic<M>:SHAPE <shape>

The :CHANnel<N>:SIMulation:NOISe:PERiodic<M>:SHAPE command specifies the shape of the periodic noise applied to the simulated waveform.

<N> An integer, 1-4 in a single oscilloscope, 1-40 in a MultiScope system.

<M> Periodic noise slot, 1-10.

<shape> {SAWTooth | SIN | SQUARE | TRIangle}

Query :CHANnel<N>:SIMulation:NOISe:PERiodic<M>:SHAPE?

The :CHANnel<N>:SIMulation:NOISe:PERiodic<M>:SHAPE? query returns the specified shape of the periodic noise.

Returned Format <shape><NL>

<shape> ::= {SAWT | SIN | SQU | TRI}

- See Also**
- [":CHANnel<N>:SIMulation:NOISe"](#) on page 391
 - [":CHANnel<N>:SIMulation:NOISe:BWLimit"](#) on page 392
 - [":CHANnel<N>:SIMulation:NOISe:PERiodic<M>:ENABLE"](#) on page 393
 - [":CHANnel<N>:SIMulation:NOISe:PERiodic<M>:FREQuency"](#) on page 394
 - [":CHANnel<N>:SIMulation:NOISe:PERiodic<M>:MAGNitude"](#) on page 395
 - [":CHANnel<N>:SIMulation:NOISe:RANDom"](#) on page 397

History New in version 6.00.

:CHANnel<N>:SIMulation:NOISe:RANDom

Command :CHANnel<N>:SIMulation:NOISe:RANDom <standard_deviation>

The :CHANnel<N>:SIMulation:NOISe:RANDom command specifies the standard deviation of random noise to apply. This random noise follows a normal distribution.

<N> An integer, 1-4 in a single oscilloscope, 1-40 in a MultiScope system.

<standard_deviation>
Value in NR3 format.

Query :CHANnel<N>:SIMulation:NOISe:RANDom?

The :CHANnel<N>:SIMulation:NOISe:RANDom? query returns the random noise standard deviation value.

Returned Format <standard_deviation><NL>

<standard_deviation> ::= value in NR3 format

- See Also**
- [":CHANnel<N>:SIMulation:NOISe"](#) on page 391
 - [":CHANnel<N>:SIMulation:NOISe:BWLimit"](#) on page 392
 - [":CHANnel<N>:SIMulation:NOISe:PERiodic<M>:ENABLE"](#) on page 393
 - [":CHANnel<N>:SIMulation:NOISe:PERiodic<M>:FREQuency"](#) on page 394
 - [":CHANnel<N>:SIMulation:NOISe:PERiodic<M>:MAGNitude"](#) on page 395
 - [":CHANnel<N>:SIMulation:NOISe:PERiodic<M>:SHAPE"](#) on page 396

History New in version 6.00.

:CHANnel<N>:SIMulation:OFFSet

Command :CHANnel<N>:SIMulation:OFFSet <offset_value>

The :CHANnel<N>:SIMulation:OFFSet command specifies the offset of the simulated waveform.

This offset is applied to the simulated waveform and is not to be confused with the channel offset. For example, to specify a simulated waveform that goes from 0 V to 5 V, specify an amplitude of 5 V and an offset of 2.5 V.

<N> An integer, 1-4 in a single oscilloscope, 1-40 in a MultiScope system.

<offset_value> Simulated waveform vertical value in NR3 format.

Query :CHANnel<N>:SIMulation:OFFSet?

The :CHANnel<N>:SIMulation:OFFSet? query returns the simulated waveform's offset value.

Returned Format <offset_value><NL>

<offset_value> ::= waveform vertical value in NR3 format

See Also • [":CHANnel<N>:SIMulation:WAVEform"](#) on page 399

History New in version 6.00.

:CHANnel<N>:SIMulation:WAVeform

Command :CHANnel<N>:SIMulation:WAVeform <type>

The :CHANnel<N>:SIMulation:WAVeform command sets the simulated waveform type.

NOTE

Simulated waveforms become available when the "Simulated Instrument" is added as a follower using the :HOSTed:FOLLOWer<N>:CONFigure and :HOSTed:FOLLOWer<N>:CONNect commands. The channel numbers of the simulated waveforms depend on the follower used (for example, using follower 1 enables simulated waveforms on channels 5 through 8).

<N> An integer, 1-4 in a single oscilloscope, 1-40 in a MultiScope system.

<type> {CLOCK | DATA | FILE | FUNCtion}

- CLOCK – The simulated waveform is a square-wave clock signal.
- DATA – The simulated waveform is a Pseudo-Random Binary Sequence (PRBS) Non Return to Zero (NRZ) or Pulse Amplitude Modulation (PAM) signal.
- FILE – The simulated waveform comes from a saved waveform data file (similar to an arbitrary waveform in a function generator).
- FUNCtion – The simulated waveform is an impulse, sawtooth, sine, square, or triangle function.

Query :CHANnel<N>:SIMulation:WAVeform?

The :CHANnel<N>:SIMulation:WAVeform? query returns the selected simulated waveform type.

Returned Format <type><NL>

<type> ::= {CLOC | DATA | FILE | FUNC}

- See Also**
- [":HOSTed:FOLLOWer<N>:CONFigure"](#) on page 588
 - [":HOSTed:FOLLOWer<N>:CONNect"](#) on page 589
 - [":CHANnel<N>:SIMulation:AMPLitude"](#) on page 367
 - [":CHANnel<N>:SIMulation:OFFSet"](#) on page 398
 - [":CHANnel<N>:SIMulation:FREQuency"](#) on page 379
 - [":CHANnel<N>:SIMulation:DATA:SELECTION"](#) on page 372
 - [":CHANnel<N>:SIMulation:DRATE"](#) on page 373
 - [":CHANnel<N>:SIMulation:FLOad:ADDRes"](#) on page 377
 - [":CHANnel<N>:SIMulation:FUNCTion:SELECTION"](#) on page 380

History New in version 6.00.

:CHANnel<N>:UNITs

Command :CHANnel<N>:UNITs {VOLT | AMPere | WATT | UNKNown}

NOTE

UNITs can also be set using the CHANnel<N>:PROBe:EXternal:UNITs command when CHANnel<N>:PROBe:EXternal command has been set to ON.

The :CHANnel<N>:UNITs command sets the vertical units. You can specify Y-axis units of VOLTS, AMPS, WATTS, or UNKNown. The units are implied for other pertinent channel commands (such as :CHANnel<N>:RANGe and :CHANnel<N>:OFFSet). See the Probe Setup dialog box for more information.

<N> An integer, 1-4 in a single oscilloscope, 1-40 in a MultiScope system.

Example This example sets the units for channel 1 to amperes.

```
myScope.WriteString ":CHANnel1:UNITs AMPere"
```

Query :CHANnel<N>:UNITs?

The :CHANnel<N>:UNITs? query returns the current units setting for the specified channel.

Returned Format [:CHANnel<N>:UNITs] {VOLT | AMPere | WATT | UNKNown}<NL>

Example This example places the vertical units for the specified channel in the string variable, strUnits, then prints the contents of the variable to the computer's screen.

```
Dim strUnits As String
myScope.WriteString ":CHANnel1:UNITs?"
strUnits = myScope.ReadString
Debug.Print strUnits
```

History Legacy command (existed before version 3.10).

15 Common Commands

- *CLS – Clear Status / 403
- *ESE – Event Status Enable / 404
- *ESR? – Event Status Register / 406
- *IDN? – Identification Number / 407
- *LRN? – Learn / 408
- *OPC – Operation Complete / 410
- *OPT? – Option / 411
- *PSC – Power-on Status Clear / 414
- *RCL – Recall / 415
- *RST – Reset / 416
- *SAV – Save / 417
- *SRE – Service Request Enable / 418
- *STB? – Status Byte / 420
- *TRG – Trigger / 422
- *TST? – Test / 423
- *WAI – Wait / 424

Common commands are defined by the IEEE 488.2 standard. They control generic device functions that are common to many different types of instruments. Common commands can be received and processed by the oscilloscope, whether they are sent over the remote interface as separate program messages or within other program messages.

Receiving Common Commands

Common commands can be received and processed by the oscilloscope, whether they are sent over the remote interface as separate program messages or within other program messages. If a subsystem is currently selected and a common command is received by the oscilloscope, the oscilloscope remains in the selected subsystem. For example, if the program message

```
"ACQUIRE:AVERAGE ON;*CLS;COUNT 1024"
```

is received by the oscilloscope, the oscilloscope sets the acquire type, clears the status information, then sets the number of averages without leaving the selected subsystem.

NOTE**Headers and Common Commands.**

Headers are not prepended to common commands.

Status Registers The following two status registers used by common commands have an enable (mask) register. By setting bits in the enable register, you can select the status information for use. Refer to the chapter, "Status Reporting," for a complete discussion of status.

Table 6 Status and Enable Registers

| Status Register | Enable Register |
|-----------------------|---------------------------------|
| Event Status Register | Event Status Enable Register |
| Status Byte Register | Service Request Enable Register |

*CLS – Clear Status

Command *CLS

The *CLS command clears all status and error registers.

Example This example clears the status data structures of the oscilloscope.

```
myScope.WriteString "*CLS"
```

See Also

- [Chapter 7](#), “Status Reporting,” starting on page 147 for a complete discussion of status.
- ["Example: Blocking and Polling Synchronization"](#) on page 183
- ["Example: Checking for Armed Status"](#) on page 172

History Legacy command (existed before version 3.10).

*ESE – Event Status Enable

Command *ESE <mask>

The *ESE command sets the Standard Event Status Enable Register bits.

<mask> An integer, 0 to 255, representing a mask value for the bits to be enabled in the Standard Event Status Register as shown in [Table 7](#).

Example This example enables the User Request (URQ) bit of the Standard Event Status Enable Register. When this bit is enabled and a front-panel key is pressed, the Event Summary bit (ESB) in the Status Byte Register is also set.

```
myScope.WriteString "*ESE 64"
```

Query *ESE?

The *ESE? query returns the current contents of the Standard Event Status Enable Register.

Returned Format <mask><NL>

<mask> An integer, +0 to +255 (the plus sign is also returned), representing a mask value for the bits enabled in the Standard Event Status Register as shown in [Table 7](#).

Example This example places the current contents of the Standard Event Status Enable Register in the numeric variable, varEvent. The value of the variable is printed on the computer's screen.

```
myScope.WriteString "*ESE?"
varEvent = myScope.ReadNumber
Debug.Print FormatNumber(varEvent, 0)
```

The Standard Event Status Enable Register contains a mask value for the bits to be enabled in the Standard Event Status Register. A "1" in the Standard Event Status Enable Register enables the corresponding bit in the Standard Event Status Register. A "0" in the enable register disables the corresponding bit.

Table 7 Standard Event Status Enable Register Bits

| Bit | Weight | Enables | Definition |
|-----|--------|------------------------------|--|
| 7 | 128 | PON - Power On | Indicates power is turned on. |
| 6 | 64 | | Not Used. Permanently set to zero. |
| 5 | 32 | CME - Command Error | Indicates whether the parser detected an error. |
| 4 | 16 | EXE - Execution Error | Indicates whether a parameter was out of range, or was inconsistent with the current settings. |
| 3 | 8 | DDE - Device Dependent Error | Indicates whether the device was unable to complete an operation for device-dependent reasons. |

Table 7 Standard Event Status Enable Register Bits (continued)

| Bit | Weight | Enables | Definition |
|-----|--------|--------------------------|--|
| 2 | 4 | QYE - Query Error | Indicates if the protocol for queries has been violated. |
| 1 | 2 | RQC - Request Control | Indicates whether the device is requesting control. |
| 0 | 1 | OPC - Operation Complete | Indicates whether the device has completed all pending operations. |

See Also Refer to **Chapter 7**, “Status Reporting,” starting on page 147 for a complete discussion of status.

History Legacy command (existed before version 3.10).

*ESR? – Event Status Register

Query *ESR?

The *ESR? query returns the contents of the Standard Event Status Register. Reading this register clears the Standard Event Status Register, as does a *CLS.

Returned Format <status><NL>

<status> An integer, 0 to 255, representing the total bit weights of all bits that are high at the time you read the register.

Example This example places the current contents of the Standard Event Status Register in the numeric variable, varEvent, then prints the value of the variable to the computer's screen.

```
myScope.WriteString "*ESR?"
varEvent = myScope.ReadNumber
Debug.Print FormatNumber(varEvent, 0)
```

Table 8 lists each bit in the Event Status Register and the corresponding bit weights.

Table 8 Standard Event Status Register Bits

| Bit | Bit Weight | Bit Name | Condition (0 = False = Low, 1 = True = High) |
|-----|------------|----------|---|
| 7 | 128 | PON | 1 = OFF to ON transition has occurred. |
| 6 | 64 | | Not Used. Permanently set to zero. |
| 5 | 32 | CME | 0 = no command errors. 1 = a command error has been detected. |
| 4 | 16 | EXE | 0 = no execution error. 1 = an execution error has been detected. |
| 3 | 8 | DDE | 0 = no device-dependent errors. 1 = a device-dependent error has been detected. |
| 2 | 4 | QYE | 0 = no query errors. 1 = a query error has been detected. |
| 1 | 2 | RQC | 0 = request control - NOT used - always 0. |
| 0 | 1 | OPC | 0 = operation is not complete. 1 = operation is complete. |

History Legacy command (existed before version 3.10).

*IDN? – Identification Number

Query *IDN?

The *IDN? query returns the company name, oscilloscope model number, serial number, and software version by returning this string:

```
Keysight Technologies,<Model #>,<USXXXXXXXX>,<Rev #>[,<Options>]
```

<Model #> Specifies the model number of the oscilloscope.

<USXXXXXXXX> Specifies the serial number of the oscilloscope. The first four digits and letter are the serial prefix, which is the same for all identical oscilloscopes. The last five digits are the serial suffix, which is assigned sequentially, and is different for each oscilloscope.

<Rev #> Specifies the software version of the oscilloscope, and is the revision number.

<Options> Comma separated list of the installed options.

Returned Format `Keysight Technologies,DS09404A,USXXXXXXXX,XX.XX.XXXX`

Example This example places the oscilloscope's identification information in the string variable, `strIdentify`, then prints the identification information to the computer's screen.

```
Dim strIdentify As String ' Dimension variable.
myScope.WriteString "*IDN?"
strIdentify = myScope.ReadString
Debug.Print strIdentify
```

History Legacy command (existed before version 3.10).

*LRN? – Learn

Query *LRN?

The *LRN? query returns a block of data that contains the oscilloscope's current setup. You can store the oscilloscope's setup and send it back to the oscilloscope at a later time. This block of setup data should be sent to the oscilloscope just as it is. It works because of its embedded ":SYST:SET" header.

Returned Format :SYST:SET<setup><NL>

<setup> This is a definite-length, arbitrary block response specifying the current oscilloscope setup. The block size is subject to change with different firmware revisions.

Example This Python and PyVISA example saves the *LRN? string to a file and then restores the oscilloscope setup from the file.

```

# *****
# Using the *LRN? string to save and restore the oscilloscope setup.
# *****

# Import modules.
# -----
import visa
import string
import sys

# =====
# Check for instrument errors:
# =====
def check_instrument_errors():

    while True:
        error_string = Infiniium.query(":SYSTem:ERRor? STRing")
        if error_string: # If there is an error string value.

            if error_string.find("0,", 0, 2) == -1: # Not "No error".
                print "ERROR: %s." % error_string
                print "Exited because of error."
                sys.exit(1)

            else: # "No error"
                break

    else: # :SYSTem:ERRor? STRing should always return string.
        print "ERROR: :SYSTem:ERRor? STRing returned nothing."
        print "Exited because of error."
        sys.exit(1)

# =====
# Main program:
# =====

rm = visa.ResourceManager()
Infiniium = rm.open_resource("TCPIP0::141.121.237.226::hislip0::INSTR")

```



```

Infiniium.timeout = 20000
Infiniium.clear()

# Save oscilloscope setup.
values_list = Infiniium.query_binary_values("*LRN?", datatype='s')
sLearn = values_list[0]
check_instrument_errors()

f = open("learn.stp", "wb")
f.write("%s" % sLearn)
f.close()
print "Learn string bytes saved: %d" % len(sLearn)

# Restore the default setup.
Infiniium.write("*RST")

# Set up oscilloscope by loading previously saved learn string.
sLearn = ""
f = open("learn.stp", "rb")
sLearn = f.read()
f.close()

Infiniium.write_binary_values(":SYSTem:SETup ", sLearn, datatype='c')
check_instrument_errors()

print "Learn string bytes restored: %d" % len(sLearn)

```

See Also :SYSTem:SETup command and query. When HEADers is ON and LONGform is OFF, the :SYSTem:SETup command performs the same function as the *LRN? query. However, *LRN and SETup block setup data are not interchangeable.

NOTE

***LRN? Returns Prefix to Setup Block**

The *LRN? query always returns :SYST:SET as a prefix to the setup block. The :SYSTem:HEADer command has no effect on this response.

History Legacy command (existed before version 3.10).

*OPC – Operation Complete

Command *OPC

The *OPC command sets the operation complete bit in the Standard Event Status Register when all pending device operations have finished.

Example This example sets the operation complete bit in the Standard Event Status Register when the DIGitize operation is complete.

```
myScope.WriteString ":DIGitize CHANnel1;*OPC"
```

Query *OPC?

The *OPC? query places an ASCII character "1" in the oscilloscope's output queue when all pending selected device operations have finished.

Returned Format 1<NL>

Example This example places an ASCII character "1" in the oscilloscope's output queue when the AUToscale operation is complete. Then the value in the output queue is placed in the numeric variable var"varComplete."

```
myScope.WriteString ":AUToscale;*OPC?"
varComplete = myScope.ReadNumber
Debug.Print FormatNumber(varComplete, 0)
```

The *OPC? query allows synchronization between the computer and the oscilloscope by using the message available (MAV) bit in the Status Byte or by reading the output queue. Unlike the *OPC command, the *OPC query does not affect the OPC Event bit in the Standard Event Status Register.

History Legacy command (existed before version 3.10).

*OPT? – Option

Query *OPT?

The *OPT? query returns a string with a list of installed options. If no options are installed, the string will have a 0 as the first character.

The length of the returned string may increase as options become available in the future. Once implemented, an option name will be appended to the end of the returned string, delimited by a comma.

Returned Format [002, EZP, EZJ, SDA, LSS, ABD, ABC, ABB, NRD, ERC, AIP, PCI1, ETH, DVI, HDM, B30, CAN, SA1, DDR] <NL>

Table 9 Possible Installed Options and Descriptions

| Installed Option | Description |
|------------------|--|
| AP2 | (U7233A) DDR1 Compliance |
| B30 | (N5416A) USB Compliance |
| CAN | (N5402A) CAN/FlexRay Protocols |
| CFL | (N8803A/B) Basic CAN/FlexRay Protocols |
| D12 | (U7232B) Display Port Compliance |
| DD3 | (U7231A) DDR3 Compliance |
| DD4 | (N6462A) DDR4 Compliance |
| DDR | (N5413A/B) DDR2 Compliance |
| DEA | (N5465A-002) InfiniiSim Advanced |
| DEB | (N5465A-001) InfiniiSim Basic |
| DEQ | (N5461A) Equalization |
| DPT | (U7232A) Display Port Compliance |
| DRF | (N8807A) DIGRF4 Protocol |
| DVI | (N5394A) DVI Compliance |
| EKR | (N8815A) 10GBASE-KR Ethernet Protocol |
| EMC | (N6465A) eMMC Compliance |
| ETH | (N5392A) Gigabit Ethernet Compliance |
| ETN | (U7236A) 10G Ethernet Compliance |
| EZC | (N8813A) EZJIT Complete |
| EZJ | (E2681A) EZJIT |
| EZP | (N5400A) EZJIT Plus |
| FBD | (N5409A) FB DIMM Compliance |

Table 9 Possible Installed Options and Descriptions (continued)

| Installed Option | Description |
|------------------|---------------------------------------|
| FBR | (N5410A) Fibre Channel Compliance |
| GD5 | (U7245A) GDDR5 Compliance |
| H14 | (N5399B) HDMI + HEAC Compliance |
| HDM | (N5399A/B) HDMI Compliance |
| HSI | (U7248A) HSIC Compliance |
| LTP | (N8817A) JTAG Protocol |
| LP2 | (N5413B) LPDDR2 Compliance |
| LPU | (N5413B) LPDDR2 Upgrade |
| LP3 | (U7231B) LPDDR3 Compliance |
| L3U | (U7231B) LPDDR3 Upgrade |
| LSS | (N5391A/B) SPI/I2C Protocols |
| MHL | (N6460A) Mobile HD Link Compliance |
| MPI | (U7238A) MIPI D-PHY Compliance |
| MPH | (U7249A) MIPI M-PHY Compliance |
| MPP | (N8802A) MIPI D-PHY Protocol |
| MYC | (N5467A) User Defined App |
| PCI | (N5393B) PCI Express 1.0a Compliance |
| PC2 | (N5393B) PCI Express 2.0 Compliance |
| PC3 | (N5393C) PCI Express 3.0 Compliance |
| P3U | (N5393C) PCIE 3.0 Upgrade |
| PEP | (N5463A/B) PCI Express Protocol |
| PRN | (N2809A) PrecisionProbe |
| PWR | (U1882A) Power |
| QPI | (U7241A) QPI Compliance |
| RSP | (N5462A/B) RS232/UART Protocol |
| S6G | (N5412B) SAS 6G Compliance |
| S6U | (N5411B) SATA 3 Compliance Upgrade |
| SA1 | (N5411A) SATA 1 Compliance |
| SA6 | (N5411B) SATA 3 Compliance |
| SAS | (N5412A) SAS Compliance |
| SDA | (E2688A, N5384A) Serial Data Analysis |

Table 9 Possible Installed Options and Descriptions (continued)

| Installed Option | Description |
|------------------|---|
| SDC | (U7246A) SD Card Compliance |
| SSU | (N5412B) SAS 6G Upgrade |
| STP | (N8801A) SATA/SAS Protocol |
| SVD | (N8812A) SVID Protocol |
| SWT | (N5414A/B, N5415B) InfiniiScan |
| TBL | (N6463A) Thunderbolt Compliance |
| U3P | (N5464A/B) USB 3.0 Protocol |
| UDF | (N5430A) User Def Fn |
| UH2 | Ultra HS2 SD Compliance |
| U23 | (U7243A-003) Upgrade from USB 2.0 to USB 3.0 Advanced |
| US3 | (U7243A-001) USB 3.0 Compliance Only (Basic) |
| USA | (U7243A-002) USB 2.0 and 3.0 Advanced |
| USU | (U7243A-004) Upgrade from USB 3.0 Compliance Only to USB 3.0 Advanced |
| USP | (N5464A/B) USB 2.0 Protocol |
| VSA | UWB VSA |
| WUB | (U7239A) Wireless USB Compliance |
| XAI | (N5431A) XAUI Compliance |

Example This example places all options into the string variable, strOptions, then prints the option name to the computer's screen.

```
Dim strOptions As String
myScope.WriteString "*OPT?"
strOptions = myScope.ReadString
Debug.Print strOptions
```

History Legacy command (existed before version 3.10).

*PSC – Power-on Status Clear

Command *PSC {{ON|1} | {OFF|0}}

The *PSC command determines whether or not the SRQ line is set upon the completion of the oscilloscope's boot process. When the *PSC flag is set to 1, the Power On (PON) bit of the Standard Event Status Register is 0 during the boot process. When the *PSC flag is set to 0, the PON bit is set to a 1 during the boot process.

When the *PSC flag is set to 0, the Standard Event Status Enable Register must be set to 128 decimal and the Service Request Enable Register must be set to 32 decimal. This allows the Power On (PON) bit to set the SRQ line when the oscilloscope is ready to receive commands.

NOTE

If you are using a LAN interface rather than a GPIB interface, it is not possible to receive the SRQ during the boot process.

Example This example sets the *PSC flag to 0 which sets the SRQ line during the boot process.

```
myScope.WriteString "*PSC 0;*SRE 32;*ESE 128"
```

Query The *PSC? query returns the value of the *PSC flag.

Returned Format 1<NL>

Example This example places the *PSC flag into the integer variable varPscflag.

```
myScope.WriteString "*PSC?"
varPscflag = myScope.ReadNumber
Debug.Print FormatNumber(varPscflag, 0)
```

History Legacy command (existed before version 3.10).

*RCL – Recall

Command *RCL <register>

The *RCL command restores the state of the oscilloscope to a setup previously stored in the specified save/recall register. An oscilloscope setup must have been stored previously in the specified register. Registers 0 through 9 are general-purpose registers and can be used by the *RCL command.

<register> An integer, 0 through 9, specifying the save/recall register that contains the oscilloscope setup you want to recall.

Example This example restores the oscilloscope to the oscilloscope setup stored in register 3.

```
myScope.WriteString "*RCL 3"
```

See Also *SAV (Save). An error message appears on the oscilloscope's display if nothing has been previously saved in the specified register.

History Legacy command (existed before version 3.10).

*RST – Reset

Command *RST

The *RST command performs a default setup which is the same as pressing the oscilloscope front panel **[Default Setup]** key.

Example This example resets the oscilloscope to a known state.

```
myScope.WriteString "*RST"
```

See Also · **":SYSTem:PRESet"** on page 1161 (where the default values for Infiniium oscilloscope controls are described)

History Legacy command (existed before version 3.10).

*SAV – Save

Command *SAV <register>

The *SAV command stores the current state of the oscilloscope in a save register.

<register> An integer, 0 through 9, specifying the register used to save the current oscilloscope setup.

Example This example stores the current oscilloscope setup to register 3.

```
myScope.WriteString "**SAV 3"
```

See Also *RCL (Recall).

History Legacy command (existed before version 3.10).

*SRE – Service Request Enable

Command *SRE <mask>

The *SRE command sets the Service Request Enable Register bits. By setting the *SRE, when the event happens, you have enabled the oscilloscope's interrupt capability. The oscilloscope will then do an SRQ (service request), which is an interrupt.

<mask> An integer, 0 to 255, representing a mask value for the bits to be enabled in the Service Request Enable Register as shown in [Table 10](#).

Example This example enables a service request to be generated when a message is available in the output queue. When a message is available, the MAV bit is high.

```
myScope.WriteString "*SRE 16"
```

Query *SRE?

The *SRE? query returns the current contents of the Service Request Enable Register.

Returned Format <mask><NL>

<mask> An integer, 0 to 255, representing a mask value for the bits enabled in the Service Request Enable Register.

Example This example places the current contents of the Service Request Enable Register in the numeric variable, varValue, then prints the value of the variable to the computer's screen.

```
myScope.WriteString "*SRE?"
varValue = myScope.ReadNumber
Debug.Print FormatNumber(varValue, 0)
```

The Service Request Enable Register contains a mask value for the bits to be enabled in the Status Byte Register. A "1" in the Service Request Enable Register enables the corresponding bit in the Status Byte Register. A "0" disables the bit.

Table 10 Service Request Enable Register Bits

| Bit | Weight | Enables |
|-----|--------|----------------------------------|
| 7 | 128 | OPER - Operation Status Register |
| 6 | 64 | Not Used |
| 5 | 32 | ESB - Event Status Bit |
| 4 | 16 | MAV - Message Available |
| 3 | 8 | Not Used |
| 2 | 4 | MSG - Message |

Table 10 Service Request Enable Register Bits (continued)

| Bit | Weight | Enables |
|-----|--------|---------------------------|
| 1 | 2 | USR - User Event Register |
| 0 | 1 | TRG - Trigger |

History Legacy command (existed before version 3.10).

*STB? – Status Byte

Query *STB?

The *STB? query returns the current contents of the Status Byte, including the Master Summary Status (MSS) bit. See [Table 11](#) for Status Byte Register bit definitions.

Returned Format <value><NL>

<value> An integer, 0 to 255, representing a mask value for the bits enabled in the Status Byte.

Example This example reads the contents of the Status Byte into the numeric variable, varValue, then prints the value of the variable to the computer's screen.

```
myScope.WriteString "*STB?"
varValue = myScope.ReadNumber
Debug.Print FormatNumber(varValue, 0)
```

In response to a serial poll (SPOLL), Request Service (RQS) is reported on bit 6 of the status byte. Otherwise, the Master Summary Status bit (MSS) is reported on bit 6. MSS is the inclusive OR of the bitwise combination, excluding bit 6, of the Status Byte Register and the Service Request Enable Register. The MSS message indicates that the oscilloscope is requesting service (SRQ).

Table 11 Status Byte Register Bits

| Bit | Bit Weight | Bit Name | Condition (0 = False = Low, 1 = True = High) |
|-----|------------|----------|--|
| 7 | 128 | OPER | 0 = no enabled operation status conditions have occurred 1 = an enabled operation status condition has occurred |
| 6 | 64 | RQS/MSS | 0 = oscilloscope has no reason for service 1 = oscilloscope is requesting service |
| 5 | 32 | ESB | 0 = no event status conditions have occurred 1 = an enabled event status condition has occurred |
| 4 | 16 | MAV | 0 = no output messages are ready 1 = an output message is ready |
| 3 | 8 | --- | 0 = not used |
| 2 | 4 | MSG | 0 = no message has been displayed 1 = message has been displayed |

Table 11 Status Byte Register Bits (continued)

| Bit | Bit Weight | Bit Name | Condition (0 = False = Low, 1 = True = High) |
|-----|------------|----------|---|
| 1 | 2 | USR | 0 = no enabled user event conditions have occurred 1 = an enabled user event condition has occurred |
| 0 | 1 | TRG | 0 = no trigger has occurred 1 = a trigger occurred |

History Legacy command (existed before version 3.10).

*TRG – Trigger

Command *TRG

The *TRG command has the same effect as the Group Execute Trigger message (GET) or RUN command. It acquires data for the active waveform display, if the trigger conditions are met, according to the current settings.

Example This example starts the data acquisition for the active waveform display according to the current settings.

```
myScope.WriteString "*TRG"
```

NOTE

Trigger Conditions Must Be Met

When you send the *TRG command in Single trigger mode, the trigger conditions must be met before the oscilloscope will acquire data.

History Legacy command (existed before version 3.10).

*TST? – Test

Query *TST?

The *TST? query causes the oscilloscope to perform a self-test, and places a response in the output queue indicating whether or not the self-test completed without any detected errors. Use the :SYSTEM:ERROR command to check for errors. A zero indicates that the test passed and a non-zero indicates the self-test failed.

NOTE

Disconnect Inputs First

You must disconnect all front-panel inputs before sending the *TST? command.

Returned Format <result><NL>

<result> 0 for pass; non-zero for fail.

Example This example performs a self-test on the oscilloscope and places the results in the numeric variable, varResults. The program then prints the results to the computer's screen.

```
myScope.WriteString "*TST?"
varResults = myScope.ReadNumber
Debug.Print FormatNumber(varResults, 0)
```

If a test fails, refer to the troubleshooting section of the service guide.

NOTE

Expanded Error Reporting

The :SELFtest:SCOPETEST command has expanded error reporting. Instead of using *TST?, Keysight recommends that you use the :SELFtest:SCOPETEST command. In either case, be sure you disconnect all front-panel inputs before sending the *TST? command.

History Legacy command (existed before version 3.10).

*WAI – Wait

Command *WAI

The *WAI command has no function in the oscilloscope, but is parsed for compatibility with other instruments.

Example `myScope.WriteString "*WAI"`

History Legacy command (existed before version 3.10).

16 Digital Commands

:DIGital<N>:DISPlay / 426

:DIGital<N>:LABel / 427

:DIGital<N>:SIZE / 428

:DIGital<N>:THReshold / 429

NOTE

The DIGital commands only apply to the MSO oscilloscopes.

:DIGital<N>:DISPlay

Command

NOTE

The DIGital commands only apply to the MSO oscilloscopes.

```
:DIGital<N>[:DISPlay] {ON | OFF | 1 | 0}
```

The :DIGital<N>:DISPlay command enables or disables the view for the selected digital channel.

<N> An integer, 0–15.

Example This example turns on the display of bit 5 for the digital channels.

```
myScope.WriteString ":DIGital5:DISPlay ON"
```

Query :DIGital<N>[:DISPlay]?

The :DIGital<N>:DISPlay? query returns the value of the display setting for the selected digital channel.

Returned Format [:DIGital<N>:DISPlay] {1 | 0}<NL>

History Legacy command (existed before version 3.10).

:DIGital<N>:LABel

Command

NOTE

The DIGital commands only apply to the MSO oscilloscopes.

```
:DIGital<N>:LABel <quoted_string>
```

The :DIGital<N>:LABel command sets the digital channel label to the quoted string. Setting a label for a digital channel will also result in the name being added to the label list.

NOTE

Label strings are 16 characters or less, and may contain any commonly used ASCII characters. Labels with more than 16 characters are truncated to 16 characters.

<N> An integer, 1-2.

<quoted_string> A series of 16 or less characters as a quoted ASCII string.

Example This example sets the label for bit 7 to Clock.

```
myScope.WriteString ":DIGital7:LABel "Clock""
```

Query :DIGital<N>:LABel?

The :DIGital<N>:LABel? query returns the name of the specified digital channel.

Returned Format [:DIGital<N>:LABel] <quoted_string><NL>

History Legacy command (existed before version 3.10).

:DIGital<N>:SIZE**Command****NOTE**

The DIGital commands only apply to the MSO oscilloscopes.

```
DIGital<N>:SIZE {SMALL | MEDIUM | LARGE}
```

The :DIGital<N>:SIZE command changes the vertical size of all the displayed digital channels. The digital subsystem must be enabled before this command will work. See ENABLE command in the root subsystem.

<N> An integer, 0-15.

Example This example changes the size to medium for all displayed digital channels or buses.

```
myScope.WriteString ":ENABLE DIGital"
myScope.WriteString ":DIGital5:SIZE MEDIUM"
```

Query :DIGital<N>:SIZE?

The :DIGital:CHANnel:SIZE? query returns the size of the displayed digital channels.

Returned Format [:DIGital<N>:SIZE] {SMALL | MEDIUM | LARGE}<NL>

History Legacy command (existed before version 3.10).

:DIGital<N>:THReshold

Command

NOTE

The DIGital commands only apply to the MSO oscilloscopes.

```
:DIGital<N>:THReshold {CMOS50 | CMOS33 | CMOS25 | ECL | PECL | TTL
| DIFFerential | <value>}
```

The :DIGital<N>:THReshold command sets the logic threshold value for a pod. Setting the threshold for digital channels 0 through 7 sets the threshold for pod 1 while setting the threshold for digital channels 8 through 15 sets the threshold for pod 2. This command is equivalent to the POD<N>:THReshold command.

The threshold is used for triggering purposes and for displaying the digital data as high (above the threshold) or low (below the threshold). The voltage values for the predefined thresholds are:

- CMOS50 = 2.5 V
- CMOS33 = 1.65 V
- CMOS25 = 1.25 V
- ECL = -1.3 V
- PECL = 3.7 V
- TTL = 1.4 V
- DIFFerential = 0 V

<N> An integer, 0–15.

<value> A real number representing the voltage value which distinguishes a 1 logic level from a 0 logic level. Waveform voltages greater than the threshold are 1 logic levels while waveform voltages less than the threshold are 0 logic levels.

On 9000 Series, 9000H Series, and S-Series mixed-signal oscilloscopes, the range of the threshold voltage is from -8 volts to 8 volts.

On 90000 X-Series and V-Series mixed-signal oscilloscopes, the range of the threshold voltage is from -3.75 volts to 3.75 volts.

Example This example sets the threshold to 1.8 volts for bits D15 through D8.

```
myScope.WriteString ":DIGital8:THReshold 1.8"
```

Query :DIGital<N>:THReshold?

The :DIGital<N>:THReshold? query returns the threshold value for the specified pod.

Returned Format [:DIGital<N>:THReshold] {CMOS50 | CMOS33 | CMOS25 | ECL | PECL | TTL
| DIFF | <value>}<NL>

History Legacy command (existed before version 3.10).

Version 4.50: Added the DIFFerential parameter for specifying the threshold voltage.

17 Disk Commands

- :DISK:CDIRectory / 432
- :DISK:COPIY / 433
- :DISK:DELeTe / 434
- :DISK:DIRectory? / 435
- :DISK:LOAD / 436
- :DISK:MDIRectory / 437
- :DISK:PWD? / 438
- :DISK:SAVE:COMPOSITE / 439
- :DISK:SAVE:IMAGe / 440
- :DISK:SAVE:JITTer / 441
- :DISK:SAVE:LISTing / 442
- :DISK:SAVE:MEASurements / 443
- :DISK:SAVE:PRECprobe / 444
- :DISK:SAVE:SETup / 445
- :DISK:SAVE:WAVEform / 446
- :DISK:SEGMENTed / 448

The DISK subsystem commands perform the disk operations as defined in the File menu. This allows saving and loading of waveforms and setups, as well as saving screen images to bitmap files.

NOTE

Enclose File Name in Quotation Marks

When specifying a file name, you must enclose it in quotation marks.

NOTE

Filenames are Not Case Sensitive.

The filename that you use is not case sensitive.

:DISK:CDIRectory

Command :DISK:CDIRectory "<directory>"

The :DISK:CDIRectory command changes the present working directory to the designated directory name. An error occurs when the requested directory does not exist. You can then view the error with the :SYSTEM:ERRor? [{NUMBER | STRing}] query.

<directory> A character-quoted ASCII string, which can include the subdirectory designation. You must separate the directory name and any subdirectories with a backslash (\).

Example This example sets the present working directory to C:\Users\Public\Documents\Infiniium.

```
myScope.WriteString ":DISK:CDIRectory "C:\Users\Public\Documents\  
Infiniium" "
```

History Legacy command (existed before version 3.10).

:DISK:COPY

Command :DISK:COPY "<source_file>","<dest_file>"

The :DISK:COPY command copies a source file from the disk to a destination file on the disk. An error is displayed on the oscilloscope screen if the requested file does not exist. Use full directory paths for the source and destination files.

<source_file> A character-quoted ASCII string which can include subdirectories with the name of the file.
<dest_file>

Example This example copies C:\Users\Public\Documents\Infiniium\File1.wfm to C:\Temp\File1b.wfm on the disk.

```
myScope.WriteString ":DISK:COPY "C:\Users\Public\Documents\Infiniium\
File1.wfm" ,"C:\Temp\File1b.wfm"
```

History Legacy command (existed before version 3.10).

:DISK:DELeTe

Command :DISK:DELeTe "<file_name>"

The :DISK:DELeTe command deletes a file from the disk. An error is displayed on the oscilloscope screen if the requested file does not exist. The default path is C:\Users\Public\Documents\Infiniium.

<file_name> A character-quoted ASCII string which can include subdirectories with the name of the file.

Example This example deletes FILE1.SET from the disk.

```
myScope.WriteString ":DISK:DELeTe " "FILE1.SET" ""
```

History Legacy command (existed before version 3.10).

:DISK:DIRectory?

Query :DISK:DIRectory? [<directory>]

The :DISK:DIRectory? query returns the requested directory listing. Each entry is 63 bytes long, including a carriage return and line feed. The default path is C:\Users\Public\Documents\Infiniium.

<directory> The list of filenames and directories.

Returned Format [:DISK:DIRectory] <n><NL><directory>

<n> The specifier that is returned before the directory listing, indicating the number of lines in the listing.

<directory> The list of filenames and directories. Each line is separated by a <NL>.

Example This example displays a number, then displays a list of files and directories in the current directory. The number indicates the number of lines in the listing.

```
Dim varResults As Variant
Dim lngI As Long

myScope.WriteString ":DISK:DIR?"
varResults = myScope.ReadList(ASCIIType_BSTR, vbLf)
Debug.Print FormatNumber(varResults(0), 0)

For lngI = 1 To (varResults(0) - 2)
    Debug.Print CStr(varResults(lngI))
Next lngI
```

History Legacy command (existed before version 3.10).

:DISK:LOAD

Command :DISK:LOAD "<file_name>" [,<destination>]

The :DISK:LOAD command restores from the disk a setup file, composite file, or a waveform file into a waveform memory destination. The type of file is determined by the filename suffix if one is present, or by the destination field if one is not present. You can load .WFM, .CSV, .TSV, .TXT, .BIN, .H5, .SET, and .OSC file types. The destination is only used when loading a waveform memory.

CAUTION

Setups saved from Infiniium software versions prior to 2.00 may not load correctly in software versions 4.30 and greater.

You can remedy this by re-saving any pre-2.00 setups using any version of software from version 2.00 to version 4.20.

Setups saved from software versions between 2.00 and 4.20 should load correctly into version 4.30 and greater.

<file_name> A quoted ASCII string with a maximum of 254 characters including the entire path name, if used. You can use either .WFM, .CSV, .TSV, .TXT, .BIN, .H5, .SET, or .OSC as a suffix after the filename. If no file suffix is specified, the default is .wfm.

The present working directory is assumed, or you can specify the entire path. For example, you can load the standard setup file "SETUP0.SET" using the command:

```
:DISK:LOAD "C:\Users\Public\Documents\Infiniium\Setups\SETUP0.SET"
```

Or, you can use :DISK:CDIRectory to change the present working directory to C:\Users\Public\Documents\Infiniium\Setups, then just use the file name ("SETUP0.SET", for example). The default path is C:\Users\Public\Documents\Infiniium\Setups.

When setup files are loaded, touch screen settings are ignored.

<destination> WMEMory<R>.

Where <R> is an integer from 1-4.

If a destination is not specified, waveform memory 1 is used.

Example This example restores the waveform in FILE1.WFM to waveform memory 1.

```
myScope.WriteString ":DISK:LOAD " "FILE1.WFM" ", WMEM1 "
```

History Legacy command (existed before version 3.10).

:DISK:MDIRectory

Command :DISK:MDIRectory "<directory>"

The :DISK:MDIRectory command creates a directory in the present working directory which has been set by the :DISK:CDIRectory command. If the present working directory has not been set by the :DISK:CDIRectory command, you must specify the full path in the <directory> parameter as shown in Example 1 below.

An error is displayed if the requested subdirectory does not exist.

<directory> A quoted ASCII string which can include subdirectories. You must separate the directory name and any subdirectories with a backslash (\).

Example 1 This example creates the directory CPROGRAMS in the C:\Users\Public\Documents\Infiniium directory.

```
myScope.WriteString _
  ":DISK:MDIRectory " "C:\Users\Public\Documents\Infiniium\CPROGRAMS" "
```

Example 2 This example creates the directory CPROGRAMS in the present working directory set by the :DISK:CDIRectory command.

```
myScope.WriteString ":DISK:MDIRectory " "CPROGRAMS" "
```

You can check your path with the :DISK:DIRectory? query.

History Legacy command (existed before version 3.10).

:DISK:PWD?

Query :DISK:PWD?

The :DISK:PWD? query returns the name of the present working directory (including the full path). If the default path (C:\Users\Public\Documents\Infiniium) has not been changed by the :DISK:CDIRectory command, the :DISK:PWD? query will return an empty string.

Returned Format :DISK:PWD? <present_working_directory><NL>

Example This example places the present working directory in the string variable strWdir, then prints the contents of the variable to the computer's screen.

```
Dim strWdir As String
myScope.WriteString ":DISK:PWD?"
str Wdir = myScope.ReadString
Debug.Print strWdir
```

History Legacy command (existed before version 3.10).

:DISK:SAVE:COMPOSITE

Command :DISK:SAVE:COMPOSITE "<file_name>"

The :DISK:SAVE:COMPOSITE command lets you save oscilloscope composite files to Infiniium's hard disk or to a network drive. Composite files contain setups and waveform data.

The file will have an .osc extension.

<file_name> A quoted ASCII string with a maximum of 254 characters including the entire path name, if used.

The filename assumes the present working directory if a path does not precede the file name.

Example This example saves the oscilloscope's setup and waveform data to a composite file named "C:\Scope\Setup\Comp001.osc".

```
myScope.WriteString ":DISK:SAVE:COMPOSITE " "C:\Scope\Setup\Comp001" ""
```

History New in version 3.50.

:DISK:SAVE:IMAGe

Command :DISK:SAVE:IMAGE "<file_name>" [, <format>
 [, {SCReen | GRATicule}
 [, {ON | 1} | {OFF | 0}
 [, {NORMal | INVert}
 [, {ON | 1} | {OFF | 0}]]]]]

The DISK:SAVE:IMAGe command saves a screen image. The default path is C:\Users\Public\Documents\Infiniium.

<format> The image format can be: BMP, GIF, TIF, PNG, or JPEG. The extension is supplied by the oscilloscope depending on the selected file format.

If you do not include the format in the command, the file is saved in the format shown in the Save Screen dialog box.

<file_name> A quoted ASCII string with a maximum of 254 characters including the entire path name, if used.

(First) ON | OFF ON means that compression is on for the bitmap format (BMP). OFF means compression is off.

(Second) ON | OFF The second ON/OFF selection indicates to save the setup information in the image or not.

<format> {BMP | GIF | TIF | JPEG | PNG}

Examples myScope.WriteString ":DISK:SAVE:IMAGE " "FILE1" ",BMP,SCR,ON,INVERT"

or:

myScope.WriteString ":DISK:SAVE:IMAGE " "FILE1" ",TIF,GRAT,ON"

or:

myScope.WriteString ":DISK:SAVE:IMAGE " "FILE1" ""

History Legacy command (existed before version 3.10).

:DISK:SAVE:JITTer

Command :DISK:SAVE:JITTer "<file_name>"

The DISK:SAVE:JITTer command saves the jitter measurements shown in the RJDJ tab at the bottom of the oscilloscope screen along with the RJDJ graph data in a comma separated variables (CSV) file format. The csv extension is supplied by the oscilloscope. The default path is C:\Users\Public\Documents\Infiniium.

<file_name> A quoted ASCII string with a maximum of 254 characters including the entire path name, if used.

Example myScope.WriteString ":DISK:SAVE:JITTer ""FILE1"""

History Legacy command (existed before version 3.10).

:DISK:SAVE:LISTing

Command `:DISK:SAVE:LISTing [<source>] "<file_name>" [,<format>[,<type>]]`

The DISK:SAVE:LISTing command saves the contents of the bus listing window to a file in either a .csv or .txt format. The default path is C:\Users\Public\Documents\Infiniium.

<source> {SERial<N>} – The default serial bus is the one currently displayed in the listing window.

<N> An integer 1 - 4.

<file_name> A quoted ASCII string with a maximum of 254 characters including the entire path name, if used.

<format> {CSV | TXT}

<type> {PACKets | SYMBols}

Specifies which display window to save.

Example `myScope.WriteString ":DISK:SAVE:LISTing SERIAL3, "FILE1", CSV"`

History Legacy command (existed before version 3.10).

Version 5.00: Added the <type> parameter for specifying which display window to save.

:DISK:SAVE:MEASurements

Command :DISK:SAVE:MEASurements "<file_name>" [,<legacy_save_mode>]

The DISK:SAVE:MEASurements command saves the measurements shown in the measurements tab at the bottom of the oscilloscope screen in a comma separated variables (CSV) file format. The csv extension is supplied by the oscilloscope. The default path is C:\Users\Public\Documents\Infiniium.

<file_name> A quoted ASCII string with a maximum of 254 characters including the entire path name, if used.

<legacy_save_mode> {{ON | 1} | {OFF | 0}}

e>

The <legacy_save_mode> option specifies whether to save measurement results in the format used prior to Infiniium version 5.00. If this option is not used, it is OFF.

Example myScope.WriteString ":DISK:SAVE:MEASurements "FILE1""

History Legacy command (existed before version 3.10).

Version 5.50: Added the <legacy_save_mode> option to save measurement results in the format used prior to Infiniium version 5.00.

:DISK:SAVE:PRECprobe

Command :DISK:SAVE:PRECprobe "<file_name>.csv", {CHAN1 | CHAN2 | CHAN3 | CHAN4}

The DISK:SAVE:PRECprobe command saves PrecisionProbe/Cable data in a comma separated variables (CSV) file format. The default path is C:\Users\Public\Documents\Infiniium.

<file_name> A quoted ASCII string with a maximum of 254 characters including the entire path name, if used.

Example `myScope.WriteString ":DISK:SAVE:PRECprobe "PPch1data.csv"", CHAN1`

History New in version 4.00.

:DISK:SAVE:SETup

Command :DISK:SAVE:SETup "<file_name>"

The :DISK:SAVE:SETup command saves the current oscilloscope setup to a disk. The file will have a .set extension.

<file_name> A quoted ASCII string with a maximum of 254 characters including the entire path name, if used. The filename assumes the present working directory if a path does not precede the file name. The default path is C:\Users\Public\Documents\Infiniium\setups.

Example This example saves the channel 1 waveform to SETUP1 on the disk.

```
myScope.WriteString ":DISK:SAVE:SETup " "SETUP1" ""
```

History Legacy command (existed before version 3.10).

:DISK:SAVE:WAVEform

Command :DISK:SAVE:WAVEform <source>,"<file_name>" [,<format>[,<header>]]

The :DISK:SAVE:WAVEform command saves a waveform to a disk. If the source is ALL, all of the currently displayed waveforms are saved to the file. If you use a file extension as shown below in the <format> variable, then the type of file saved defaults to the extension type. If no format is specified and no extension is used, the file is saved in the INTERNAL format.

NOTE

See the **":WAVEform:VIEW"** on page 1429 command to determine how much data is saved.

NOTE

When an acquisition is made on multiple channels, the data for each channel has the same X origin and the same number of points.

<source> {ALL | CHANnel<N> | CLOCK | FUNCtion<F> | HISTogram | MTRend | MSPectrum | EQUalized | WMEMory<R> | BUS | PODALL | POD1 | POD2}

MTRend and MSPectrum sources are only available if the oscilloscope has the EZJIT option installed and the feature is enabled.

The CLOCK source is only available if the oscilloscope has the High Speed Serial option installed and the feature is enabled.

The EQUalized source is only available if the oscilloscope has the High Speed Serial option and the Serial Data Equalization option installed and the features are enabled. This command uses the Feed-Forward Equalized (FFE) signal as the source.

The BUS sources are can be used with the BIN, CSV, TSV, and TXT formats.

The PODALL source is all digital channels, POD1 is d0-d7, and POD2 is d8-d15.

<N> An integer, 1-4 in a single oscilloscope, 1-40 in a MultiScope system.

<F> An integer, 1-16.

<R> An integer, 1-4.

<file_name> A quoted ASCII string with a maximum of 254 characters including the entire path name, if used. The filename assumes the present working directory if a path does not precede the file name. The default path is C:\Users\Public\Documents\Infiniium.

<format> {BIN | CSV | INTERNAL | TSV | TXT | H5 | H5INT | MATLAB}

The following file name extensions are used for the different formats:

- BIN = file_name.bin

- CSV (comma separated values) = file_name.csv
- INTERNAL = file_name.wfm
- TSV (tab separated values) = file_name.tsv
- TXT = file_name.txt
- H5, H5INT (HDF5) = file_name.h5
- MATLAB (MATLAB data format) = file_name.mat

In the H5 format, data is saved as floats. In the H5INT format, data is saved as integers.

<header> {{ON | 1} | {OFF | 0}}

Example This example saves the channel 1 waveform to FILE1 on the disk in the CSV format with header on.

```
myScope.WriteString ":DISK:SAVE:WAVEform CHANnel1, "FILE1", CSV, ON"
```

History Legacy command (existed before version 3.10).

Version 4.50: Added the H5INT format parameter which saves waveform data as integers within the H5 file.

Version 6.10: Added the MATLAB format for saving waveforms to MATLAB (.mat) data format files.

:DISK:SEGMented

Command :DISK:SEGMented {ALL | CURRent}

The :DISK:SEGMented command sets whether all segments or just the current segment are saved to a file when the :DISK:SAVE:WAVEform command is issued and the source is a channel but not a waveform memory or function. Before segments can be saved, the :ACQUIRE:MODE must be set to the SEGMented mode and segments must be acquired.

Example This example sets the disk segmented memory store method to CURRent.

```
myScope.WriteString ":DISK:SEGMented CURRent"
```

Query :DISK:SEGMented?

The :DISK:SEGMented? query returns disk segmented memory store method value.

Returned Format [:DISK:SEGMented] {ALL | CURRent}<NL>

Example This example places the disk store method in the string variable strMethod, then prints the contents of the variable to the computer's screen.

```
Dim strMethod As String
myScope.WriteString ":DISK:SEGMented?"
strMethod = myScope.ReadString
Debug.Print strMethod
```

History Legacy command (existed before version 3.10).

18 Display Commands

:DISPlay:BOOKmark<N>:DELeTe / 451
:DISPlay:BOOKmark<N>:SEt / 452
:DISPlay:BOOKmark<N>:VERTical? / 454
:DISPlay:BOOKmark<N>:XPOStion / 455
:DISPlay:BOOKmark<N>:YPOStion / 456
:DISPlay:CGRade / 457
:DISPlay:CGRade:LEVels? / 459
:DISPlay:CGRade:SCHeme / 461
:DISPlay:CONNect / 463
:DISPlay:DATA? / 464
:DISPlay:GRATicule / 465
:DISPlay:GRATicule:AREA<N>:STATe / 466
:DISPlay:GRATicule:INTensity / 467
:DISPlay:GRATicule:NUMBer / 468
:DISPlay:GRATicule:SEtGrat / 469
:DISPlay:ISIM:GCOunt / 470
:DISPlay:ISIM:SElectgraph / 471
:DISPlay:ISIM:SOURce / 472
:DISPlay:JITTer:GCOunt / 473
:DISPlay:JITTer:SElectgraph / 474
:DISPlay:JITTer:THReshold / 476
:DISPlay:LABel / 477
:DISPlay:LAYout / 478
:DISPlay:MAIN / 479
:DISPlay:NOISe:LEVel / 480
:DISPlay:PERStence / 481
:DISPlay:PRECprobe:GCOunt / 485
:DISPlay:PRECprobe:SElectgraph / 486
:DISPlay:PRECprobe:SOURce / 487
:DISPlay:PROPortion / 483
:DISPlay:PROPortion:RESults / 484
:DISPlay:SCOLor / 488

```
:DISPlay:STATus:COLumn / 490  
:DISPlay:STATus:ROW / 491  
:DISPlay:WINDow:MAXimize / 492
```

The DISPlay subsystem controls the display of data, text, and graticules, and the use of color.

:DISPlay:BOOKmark<N>:DELeTe

Command :DISPlay:BOOKmark<N>:DELeTe

The :DISPlay:BOOKmark<N>:DELeTe command deletes a bookmark.

<N> An integer, 1-100.

- See Also**
- [":DISPlay:BOOKmark<N>:SET"](#) on page 452
 - [":DISPlay:BOOKmark<N>:VERTical?"](#) on page 454
 - [":DISPlay:BOOKmark<N>:XPOSition"](#) on page 455
 - [":DISPlay:BOOKmark<N>:YPOSition"](#) on page 456

History New in version 5.00.

:DISPlay:BOOKmark<N>:SET

Command :DISPlay:BOOKmark<N>:SET NONE, "label" [, <color>[, "content"]]
 :DISPlay:BOOKmark<N>:SET <source>, "label" [, "content" [, <time>]]

The :DISPlay:BOOKmark<N>:SET command sets a bookmark.

- <N>** An integer, 1-100.
- "label"** A quoted ASCII string. This is the text that appears in the bookmark callout box.
- <color>** Display element color name (see the color names in **":DISPlay:SCOLor"** on page 488). You can set the color only for bookmarks that are not associated with a waveform (that is, when <source> is NONE).
- "content"** A quoted ASCII string. This is the text that pops up when you mouse over a bookmark callout box.
- <source>** {CHANnel<N> | DIFF<D> | COMMONmode<C> | FUNCTION<F> | WMEMory<R> | CLOCK | MTRend | MSPectrum | EQUALized | DIGital<M>}
- MTRend and MSPectrum sources are only available if the oscilloscope has the EZJIT option installed and the feature is enabled.
- The CLOCK source is only available if the oscilloscope has the High Speed Serial option installed and the feature is enabled.
- The EQUALized source is only available if the oscilloscope has the High Speed Serial option and the Serial Data Equalization option installed and the features are enabled. This command uses the Feed-Forward Equalized (FFE) signal as the source.
- <N>** An integer, 1-4 in a single oscilloscope, 1-40 in a MultiScope system.
- <D>, <C>** <D> is an integer, 1-2. <C> is an integer, 3-4.
- The DIFF and COMMONmode sources are just aliases that can be used in place of the channel names to apply to differential or common mode signals. These are just aliases - no state change occurs if you refer to a differential channel and you are not in differential mode. DIFF1 refers to the differential signal between channels 1 and 3 (and COMMONmode3 refers to the common mode channel between these same channels). DIFF2 refers to the differential signal between channels 2 and 4 (and COMMONmode4 refers to the common mode channel between these same channels).
- <F>** An integer, 1-16.
- <R>** An integer, 1-4.
- <time>** A real number time position. Time values are appropriate only for bookmarks associated with waveforms.

See Also • **":DISPlay:BOOKmark<N>:DElete"** on page 451

- `":DISPlay:BOOKmark<N>:VERTical?"` on page 454
- `":DISPlay:BOOKmark<N>:XPOSition"` on page 455
- `":DISPlay:BOOKmark<N>:YPOSition"` on page 456

History New in version 5.00.

:DISPlay:BOOKmark<N>:VERTical?

Query :DISPlay:BOOKmark<N>:VERTical?

The :DISPlay:BOOKmark<N>:VERTical? query returns a waveform's vertical value at a bookmark's horizontal position.

<N> An integer, 1-100.

Returned Format <vertical_value><NL>

<vertical_value> A real number value.

- See Also**
- [":DISPlay:BOOKmark<N>:DELeTe"](#) on page 451
 - [":DISPlay:BOOKmark<N>:SET"](#) on page 452
 - [":DISPlay:BOOKmark<N>:XPOStion"](#) on page 455
 - [":DISPlay:BOOKmark<N>:YPOStion"](#) on page 456

History New in version 5.00.

:DISPlay:BOOKmark<N>:XPOSition

Command :DISPlay:BOOKmark<N>:XPOSition <x_pos>

The :DISPlay:BOOKmark<N>:XPOSition command sets the horizontal grid position of a bookmark's callout box.

<N> An integer, 1-100.

<x_pos> A real number between 0.0 and 1.0 that represents a percentage of the grid width.

Query :DISPlay:BOOKmark<N>:XPOSition?

The :DISPlay:BOOKmark<N>:XPOSition? query returns the horizontal grid position of a bookmark's callout box.

Returned Format [:DISPlay:BOOKmark<N>:XPOSition] <x_pos><NL>

- See Also**
- [":DISPlay:BOOKmark<N>:DELeTe"](#) on page 451
 - [":DISPlay:BOOKmark<N>:SET"](#) on page 452
 - [":DISPlay:BOOKmark<N>:VERTical?"](#) on page 454
 - [":DISPlay:BOOKmark<N>:YPOSition"](#) on page 456

History New in version 5.00.

:DISPlay:BOOKmark<N>:YPOSition

Command `:DISPlay:BOOKmark<N>:YPOSition <y_pos>`

The `:DISPlay:BOOKmark<N>:YPOSition` command sets the vertical grid position of a bookmark's callout box.

<N> An integer, 1-100.

<y_pos> A real number between 0.0 and 1.0 that represents a percentage of the grid height.

Query `:DISPlay:BOOKmark<N>:YPOSition?`

The `:DISPlay:BOOKmark<N>:YPOSition?` query returns the vertical grid position of a bookmark's callout box.

Returned Format `[:DISPlay:BOOKmark<N>:YPOSition] <y_pos><NL>`

- See Also**
- [":DISPlay:BOOKmark<N>:DELeTe"](#) on page 451
 - [":DISPlay:BOOKmark<N>:SET"](#) on page 452
 - [":DISPlay:BOOKmark<N>:VERTical?"](#) on page 454
 - [":DISPlay:BOOKmark<N>:XPOSition"](#) on page 455

History New in version 5.00.

:DISPlay:CGRade

Command :DISPlay:CGRade {{ON | 1} | {OFF | 0}} [, <source>]

The :DISPlay:CGRade command sets the color grade persistence on or off.

When in the color grade persistence mode, all waveforms are mapped into a database and shown with different colors representing varying number of hits in a pixel. "Connected dots" display mode (:DISPlay:CONNect) is disabled when the color grade persistence is on.

The oscilloscope has three features that use a specific database. This database uses a different memory area than the waveform record for each channel. The three features that use the database are:

- Histograms.
- Mask testing.
- Color grade persistence.

When any one of these three features is turned on, the oscilloscope starts building the database. The database is the size of the graticule area and varies in size. Behind each pixel is a 53-bit counter. Each counter is incremented each time a pixel is hit by data from a channel or function. The maximum count (saturation) for each counter is 9,007,199,254,740,991. You can check for counter saturation by using the DISPlay:CGRade:LEVels? query.

The color grade persistence uses colors to represent the number of hits on various areas of the display. The default color-grade state is off.

<source> {CHANnel<N> | DIFF<D> | COMMONmode<C> | FUNCTION<F> | WMEMory<R> | EQUalized | MTRend | MSPectrum}

If <source> is omitted:

- Color grade is enabled/disabled for all sources which are currently on.
- When enabling color grade, the main waveform view is turned off.
- When disabling color grade, the main waveform view is turned on.

<N> An integer, 1-4 in a single oscilloscope, 1-40 in a MultiScope system.

<D>, <C> <D> is an integer, 1-2. <C> is an integer, 3-4.

The DIFF and COMMONmode sources are just aliases that can be used in place of the channel names to apply to differential or common mode signals. These are just aliases - no state change occurs if you refer to a differential channel and you are not in differential mode. DIFF1 refers to the differential signal between channels 1 and 3 (and COMMONmode3 refers to the common mode channel between these same channels). DIFF2 refers to the differential signal between channels 2 and 4 (and COMMONmode4 refers to the common mode channel between these same channels).

<F> An integer, 1-16.

<R> An integer, 1-4.

Example This example sets the color grade persistence on.

```
myScope.WriteString ":DISPlay:CGRade ON"
```

Query :DISPlay:CGRade? [<source>]

The DISPlay:CGRade query returns the current color-grade state.

If <source> is omitted, the query returns ON (1) if any color grade is enabled.

Returned Format [:DISPlay:CGRade] {1 | 0}<NL>

Example This example returns the current color grade state.

```
Dim strCgrade As String ' Dimension variable.
myScope.WriteString ":DISPlay:CGRade?"
strCgrade = myScope.ReadString
Debug.Print strCgrade
```

See Also

- [":DISPlay:CGRade:LEVels?"](#) on page 459
- [":DISPlay:CGRade:SCHEME"](#) on page 461

History Legacy command (existed before version 3.10).

Version 5.00: Added the optional <source> parameter for specifying the waveform on which color grade should be turned on or off.

Version 5.50: When the <source> parameter is not provided, enabling color grade will turn off the main waveform view, and disabling color grade will turn on the main waveform view.

:DISPlay:CGRade:LEVels?

Query :DISPlay:CGRade:LEVels?

The :DISPlay:CGRade:LEVels? query returns the range of hits represented by each color. Fourteen values are returned, representing the minimum and maximum count for each of seven colors. In the CLASsic color grade scheme, the values are returned in the following order:

- Green minimum value
- Green maximum value
- Blue minimum value
- Blue maximum value
- Pink minimum value
- Pink maximum value
- Red minimum value
- Red maximum value
- Orange minimum value
- Orange maximum value
- Yellow minimum value
- Yellow maximum value
- White minimum value
- White maximum value

Returned Format [DISPlay:CGRade:LEVels] <color format><NL>

<color format> <intensity color min/max> is an integer value from 0 to 9,007,199,254,740,991

Example This example gets the range of hits represented by each color and prints it on the computer screen:

```
Dim strSetting As String ' Dimension variable.
myScope.WriteString ":DISPlay:CGRade:LEVels?"
strCgrade = myScope.ReadString
Debug.Print strCgrade
```

In the CLASsic color grade scheme, colors start at green minimum, maximum, then blue, pink, red, orange, yellow, white. The format is a string where commas separate minimum and maximum values. The largest number in the string can be 9,007,199,254,740,991

An example of a possible returned string is as follows:

```
1,414,415,829,830,1658,1659,3316,3317,6633,6634,13267,13268,26535
```

- See Also**
- **":DISPlay:CGRade"** on page 457
 - **":DISPlay:CGRade:SCHeme"** on page 461

History Legacy command (existed before version 3.10).

Version 5.00: This query is unchanged but results are returned only when a single color grade view is on.















:DISPlay:CGRade:SCHEME

Command :DISPlay:CGRade:SCHEME {CLASSic | TEMP}

The :DISPlay:CGRade:SCHEME command sets the color grade scheme to CLASSic or TEMP.

Color grade persistence is displayed in 255 colors grouped into seven color range blocks. The blocks represent the database counts for each color range. In the CLASSic color grade scheme, the counters with the largest counts are displayed using a white pixel while the counters with the smallest counts are displayed using green pixels.

The following table shows the counter range blocks for each color for both the CLASSic and TEMP color grade schemes.

| Color Grade Scheme | | Range |
|---|---|----------------------------------|
| Classic | Temperature | |
|  |  | 50% to 100% of Max counter |
|  |  | 25% to 50% of Max counter |
|  |  | 12.5% to 25% of Max counter |
|  |  | 6.25% to 12.5% of Max counter |
|  |  | 3.125% to 6.25% of Max counter |
|  |  | 1.5625% to 3.125% of Max counter |
|  |  | 1 hit to 1.5625% of Max counter |

Example This example sets the color grade scheme to "classic".

```
myScope.WriteString ":DISPlay:CGRade:SCHEME CLASSic"
```

Query :DISPlay:CGRade:SCHEME?

The :DISPlay:CGRade:SCHEME? query returns the specified color scheme.

Returned Format [DISPlay:CGRade:SCHEME] {CLASSic | TEMP}<NL>

Example This example gets the specified color scheme and prints it on the computer screen:

```
Dim strCgradeScheme As String ' Dimension variable.  
myScope.WriteString ":DISPlay:CGRade:SCHEME?"  
strCgradeScheme = myScope.ReadString  
Debug.Print strCgradeScheme
```

See Also

- [":DISPlay:CGRade"](#) on page 457
- [":DISPlay:CGRade:LEVels?"](#) on page 459

History New in version 4.20.

:DISPlay:CONNect

Command :DISPlay:CONNect {{ON | 1} | {OFF | 0}} [, <source>]

When enabled, :DISPlay:CONNect draws a line between consecutive waveform data points. This is also known as linear interpolation.

<source> {CHANnel<N> | DIFF<D> | COMMONmode<C> | FUNCTION<F> | WMEMory<R> | EQUalized | MTRend | MSPectrum}

If <source> is omitted, connected dots is enabled for all sources.

<N> An integer, 1-4 in a single oscilloscope, 1-40 in a MultiScope system.

<D>, <C> <D> is an integer, 1-2. <C> is an integer, 3-4.

The DIFF and COMMONmode sources are just aliases that can be used in place of the channel names to apply to differential or common mode signals. These are just aliases - no state change occurs if you refer to a differential channel and you are not in differential mode. DIFF1 refers to the differential signal between channels 1 and 3 (and COMMONmode3 refers to the common mode channel between these same channels). DIFF2 refers to the differential signal between channels 2 and 4 (and COMMONmode4 refers to the common mode channel between these same channels).

<F> An integer, 1-16.

<R> An integer, 1-4.

Example This example turns on the connect-the-dots feature.

```
myScope.WriteString ":DISPlay:CONNect ON"
```

Query :DISPlay:CONNect? [<source>]

The :DISPlay:CONNect? query returns the status of the connect-the-dots feature.

If <source> is omitted, the query returns ON (1) if connect the dots is enabled on channel 1.

Returned Format [:DISPlay:CONNect] {1 | 0}<NL>

History Legacy command (existed before version 3.10).

Version 5.00: Added the optional <source> parameter for specifying the waveform on which the setting should be made.

:DISPlay:DATA?

- Query** :DISPlay:DATA? [<type>[,<screen_mode>[,<compression> [,<inversion>]]]]
- The :DISPlay:DATA? query returns information about the captured data. If no options to the query are specified, the default selections are BMP file type, SCReen mode, compression turned ON, and inversion set to NORMAl.
- <type>** The bitmap type: BMP | JPG | GIF | TIF | PNG.
- <screen_mode>** The display setting: SCReen | GRATicule. Selecting GRATicule displays a 10-by-8 (unit) display graticule on the screen. See also :DISPlay:GRATicule.
- <compression>** The file compression feature: ON | OFF.
- <inversion>** The inversion of the displayed file: NORMAl | INVert.
- Returned Format** [:DISPlay:DATA] <binary_block_data><NL>
- <binary_block_data>** Data in the IEEE 488.2 definite block format.
- History** Legacy command (existed before version 3.10).

:DISPlay:GRATicule

Command :DISPlay:GRATicule {GRID | FRAMe}

The :DISPlay:GRATicule command selects the type of graticule that is displayed. Infiniium oscilloscopes have a 10-by-8 (unit) display graticule grid (GRID), a grid line is placed on each vertical and horizontal division. When it is off (FRAMe), a frame with tic marks surrounds the graticule edges.

Example This example sets up the oscilloscope's display background with a frame that is separated into major and minor divisions.

```
myScope.WriteString ":DISPlay:GRATicule FRAMe"
```

Query :DISPlay:GRATicule?

The :DISPlay:GRATicule? query returns the type of graticule currently displayed.

Returned Format [:DISPlay:GRATicule] {GRID | FRAMe}<NL>

Example This example places the current display graticule setting in the string variable, strSetting, then prints the contents of the variable to the computer's screen.

```
Dim strSetting As String ' Dimension variable.
myScope.WriteString ":DISPlay:GRATicule?"
strSetting = myScope.ReadString
Debug.Print strSetting
```

See Also

- [":DISPlay:GRATicule:INTensity"](#) on page 467
- [":DISPlay:GRATicule:NUMBer"](#) on page 468
- [":DISPlay:GRATicule:SETGrat"](#) on page 469

History Legacy command (existed before version 3.10).

:DISPlay:GRATicule:AREA<N>:STATe

Command `:DISPlay:GRATicule:AREA<N>:STATe {{ON | 1} | {OFF | 0}}`

The `:DISPlay:GRATicule:AREA<N>:STATe` command turn a waveform area on or off.

<N> Can be an integer from 2–8. Waveform area 1 is always on.

Example This example turns on waveform area 2.

```
myScope.WriteString ":DISPlay:GRATicule:AREA2:STATe ON"
```

Query `:DISPlay:GRATicule:AREA<N>:STATe?`

The `:DISPlay:GRATicule:AREA<N>:STATe?` query returns whether the waveform area is on or off.

Returned Format `[:DISPlay:GRATicule:AREA<N>:STATe] {1 | 0}<NL>`

Example This example places the status of waveform area 2 in the string variable, `strSetting`, then prints the contents of the variable to the computer's screen.

```
Dim strSetting As String ' Dimension variable.
myScope.WriteString ":DISPlay:GRATicule:AREA2:STATe?"
strSetting = myScope.ReadString
Debug.Print strSetting
```

- See Also**
- [":DISPlay:GRATicule"](#) on page 465
 - [":DISPlay:GRATicule:INTensity"](#) on page 467
 - [":DISPlay:GRATicule:NUMBer"](#) on page 468
 - [":DISPlay:GRATicule:SETGrat"](#) on page 469

History New in version 5.00.

:DISPlay:GRATicule:INTensity

Command :DISPlay:GRATicule:INTensity <intensity_value>

You can dim the grid's intensity or turn the grid off to better view waveforms that might be obscured by the graticule lines using the :DISPlay:GRATicule:INTensity command. Otherwise, you can use the grid to estimate waveform measurements such as amplitude and period.

When printing, the grid intensity control does not affect the hard copy. To remove the grid from a printed hard copy, you must turn off the grid before printing.

<intensity_value> A integer from 0 to 100, indicating the percentage of grid intensity.

Example This example sets the graticule intensity to 50%.

```
myScope.WriteString ":DISPlay:GRATicule:INTensity 50"
```

Query :DISPlay:GRATicule:INTensity?

The :DISPlay:GRATicule:INTensity? query returns the intensity.

Returned Format [:DISPlay:GRATicule:INTensity] <value><NL>

Example This example places the current graticule intensity setting in the string variable, strSetting, then prints the contents of the variable to the computer's screen.

```
Dim strSetting As String ' Dimension variable.
myScope.WriteString ":DISPlay:GRATicule:INTensity?"
strSetting = myScope.ReadString
Debug.Print strSetting
```

- See Also**
- [":DISPlay:GRATicule"](#) on page 465
 - [":DISPlay:GRATicule:NUMBer"](#) on page 468
 - [":DISPlay:GRATicule:SETGrat"](#) on page 469

History Legacy command (existed before version 3.10).

:DISPlay:GRATicule:NUMBER

Command `:DISPlay:GRATicule:NUMBER <grids>[,<area>]`

The `:DISPlay:GRATicule:NUMBER` command specifies the number of grids in a waveform area. Multiple grids let you more easily view multiple waveforms that use the full vertical scale.

<grids> Can be an integer from 1–16.

<area> Can be an integer from 1–8.

If the `<area>` is omitted, the number of grids will be applied to waveform area 1.

Example This example sets up two viewing areas.

```
myScope.WriteString ":DISPlay:GRATicule:NUMBER 2"
```

Query `:DISPlay:GRATicule:NUMBER? [<area>]`

The `:DISPlay:GRATicule:NUMBER?` query returns the the number of grids in a waveform area.

Returned Format `[:DISPlay:GRATicule:NUMBER] {1-16}<NL>`

Example This example places the current number of grids in the string variable, `strSetting`, then prints the contents of the variable to the computer's screen.

```
Dim strSetting As String ' Dimension variable.
myScope.WriteString ":DISPlay:GRATicule:NUMBER?"
strSetting = myScope.ReadString
Debug.Print strSetting
```

- See Also**
- [":DISPlay:GRATicule"](#) on page 465
 - [":DISPlay:GRATicule:INTensity"](#) on page 467
 - [":DISPlay:GRATicule:SETGrat"](#) on page 469
 - [":DISPlay:GRATicule:AREA<N>:STATe"](#) on page 466

History Legacy command (existed before version 3.10).

Version 5.0: Number of grids can be any number between 1 and 16 (not just 1, 2, 4, 8, or 16). You can also specify which waveform area the number of grids setting is for.

:DISPlay:GRATicule:SETGrat

Command :DISPlay:GRATicule:SETGrat
 <DispGratChan>,<grid>[,<area>][,{MAIN | CGRade}]

The :DISPlay:GRATicule:SETGrat command assigns the corresponding waveform to a specific grid and waveform area.

If {MAIN | CGRade} is omitted, the MAIN view will be placed.

<DispGratChan> Can be:

- CHN<N>
- DIFF1, DIFF2
- COMM3, COMM4
- MEM<N> where N is between 1 and 4
- FN<N> where N is between 1 and 16 (function)
- HIST
- D<M> where M is between 0 and 15 (on MSO models with 16 digital channels)
- BUS<Y> where Y is between 1 and 4 (on MSO models)

<grid> Can be an integer from 1-16; this is the number of the grid you want to assign the waveform to.

<area> Can be an integer from 1-8.

If <area> is omitted, the waveform will be placed in waveform area 1.

Example This example assigns the histogram to grid 2 (in waveform area 1).

```
myScope.WriteString ":DISPlay:GRATicule:SETGrat HIST,2"
```

- See Also**
- [":DISPlay:GRATicule"](#) on page 465
 - [":DISPlay:GRATicule:INTensity"](#) on page 467
 - [":DISPlay:GRATicule:NUMBer"](#) on page 468
 - [":DISPlay:GRATicule:AREA<N>:STATe"](#) on page 466

History Legacy command (existed before version 3.10).

Version 5.00: In addition to assigning a waveform to a grid, you can now optionally specify which waveform area the grid is in. Also, you can specify whether the MAIN or CGRade (color grade) view of the waveform will be placed.

:DISPlay:ISIM:GCOunt

Command :DISPlay:ISIM:GCOunt <count>

The :DISPlay:ISIM:GCOunt command sets the number of visible graphs in the InfiniiSim plots window area.

<count> An integer in NR1 format.

Up to three plots can be displayed for each channel source (12 total for all sources).

Query :DISPlay:ISIM:GCOunt?

The :DISPlay:ISIM:GCOunt? query returns the number of visible graphs in the InfiniiSim plots window area.

Returned Format [:DISPlay:ISIM:GCOunt] <count><NL>

- See Also**
- [":DISPlay:ISIM:SElectgraph"](#) on page 471
 - [":DISPlay:ISIM:SOURce"](#) on page 472

History New in version 5.50.

:DISPlay:ISIM:SElectgraph

Command :DISPlay:ISIM:SElectgraph <graph>
<graph> ::= {SPECTrum | IMPulse | STEP | ALL}

The :DISPlay:ISIM:SElectgraph command inserts the specified graph at the first display graph position.

NOTE

Selecting ALL graphs results in all allowed graphs being displayed for the source (see :DISPlay:ISIM:SOURce). If the source is ALL, all graphs will be displayed for all sources. The graph count may change.

See Also · [":DISPlay:ISIM:GCOunt"](#) on page 470
· [":DISPlay:ISIM:SOURce"](#) on page 472

History New in version 5.50.

:DISPlay:ISIM:SOURce

Command :DISPlay:ISIM:SOURce <source>
<source> ::= {CHANnel<N> | ALL}

The :DISPlay:ISIM:SOURce command sets the source for the InfiniiSim plots graph(s).

NOTE

Selecting ALL sources causes the selected graph to be applied to all graph sources. If ALL is the selected graph type, all sources are applied to all graphs. The graph count may change.

<N> An integer, 1-4 in a single oscilloscope, 1-40 in a MultiScope system.

- See Also**
- [":DISPlay:ISIM:GCOunt"](#) on page 470
 - [":DISPlay:ISIM:SElectgraph"](#) on page 471

History New in version 5.50.

:DISPlay:JITTer:GCOunt

Command :DISPlay:JITTer:GCOunt <count>

The :DISPlay:JITTer:GCOunt command sets the number of visible graphs in the Jitter/Noise graphs window area.

<count> An integer in NR1 format.

Query :DISPlay:JITTer:GCOunt?

The :DISPlay:JITTer:GCOunt? query returns the number of visible graphs in the Jitter/Noise graphs window area.

Returned Format [:DISPlay:JITTer:GCOunt] <count><NL>

See Also · [":DISPlay:JITTer:SElectgraph"](#) on page 474

History New in version 5.50.

:DISPlay:JITTer:SElectgraph

Command :DISPlay:JITTer:SElectgraph <graph>

```
<graph> ::= {RPHistogram | TJHistogram | DDJHistogram | JBERbathtub
| DDJVsbIt | JSpectrum | TJComposite | DDJComposite | ISIFilter
| RJPJsep | JTAilbathtub | NBERbathtub | NSpectrum | RNPHistogram
| DDIHistogram | TIHistogram | TIComposite | ISIVsbIt | NSEparation
| NISifilter | RNTailhist | NTAilbathtub | ALL}
```

The :DISPlay:JITTer:SElectgraph command inserts the specified graph at the first display graph position.

NOTE

Selecting ALL graphs results in all allowed graphs being displayed. The graph count may change.

| Graph Option | Description |
|--------------|-------------------------|
| RPHistogram | RjPj Histogram |
| TJHistogram | TJ Histogram |
| DDJHistogram | DDJ Histogram |
| JBERbathtub | Jitter BER Bathtub |
| DDJVsbIt | DDJ vs. Bit |
| JSpectrum | Jitter Spectrum |
| TJComposite | Composite TJ Histogram |
| DDJComposite | Composite DDJ Histogram |
| ISIFilter | Jitter ISI Filter |
| RJPJsep | RJ PJ Separation |
| JTAilbathtub | Jitter Tail Fit Bathtub |
| NBERbathtub | Noise BER Bathtub |
| NSpectrum | Noise Spectrum |
| RNPHistogram | RN PI Histogram |
| DDIHistogram | DDI Histogram |
| TIHistogram | TI Histogram |
| TIComposite | Composite TI Histogram |
| ISIVsbIt | ISI vs. Bit |
| NSEparation | RN PI Threshold |
| NISifilter | Noise ISI Filter |

| Graph Option | Description |
|--------------|-------------------------|
| RNTailhist | RN PI Tailfit Histogram |
| NTailbathtub | Noise Tailfit Bathtub |

See Also · [":DISPlay:JITTer:GCOunt"](#) on page 473

History New in version 5.50.

:DISPlay:JITTer:THReshold

Command :DISPlay:JITTer:THReshold <level>
 <level> ::= {T01 | T12 | T23 | ALL}

When the ":MEASure:RJDJ:PAMThreshold ALL" command specifies that all PAM-4 thresholds are measured, the :DISPlay:JITTer:THReshold command specifies whether a certain threshold level or ALL threshold levels should be displayed in the jitter graphs.

When the ":MEASure:RJDJ:PAMThreshold" command specifies the 0/1, 1/2, or 2/3 PAM-4 thresholds are measured, that level is the one used when displaying jitter graphs.

See Also • [":MEASure:RJDJ:PAMThreshold"](#) on page 882

History New in version 6.10.

:DISPlay:LABel

Command :DISPlay:LABel {{ON | 1} | {OFF | 0}}

The :DISPlay:LABel command turns on or off the display of analog channel labels. Label names can be up to 6 characters long. The label name is assigned by using the CHANnel<n>:LABel command:

Example This example turns on the display of all labels.

```
myScope.WriteString ":DISPlay:LABel ON"
```

Query :DISPlay:LABel?

The :DISPlay:LABel? query returns the current state of the labels.

Returned Format [:DISPlay:LABel] {1 | 0}<NL>

Example This example places the current label state into the string variable, strSetting, then prints the contents of the variable to the computer's screen.

```
Dim strSetting As String ' Dimension variable.
myScope.WriteString ":DISPlay:LABel?"
strSetting = myScope.ReadString
Debug.Print strSetting
```

History Legacy command (existed before version 3.10).

:DISPlay:LAYout

Command :DISPlay:LAYout <layout>

The :DISPlay:LAYout command sets the window layout.

<layout> {CUSTom | SVERTical | SHORizontal}

- CUSTom – Tabbed/custom window layout.
- SVERTical – Stack windows vertically.
- SHORizontal – Stack windows horizontally.

Query :DISPlay:LAYout?

The :DISPlay:LAYout? query returns the window layout setting.

Returned Format [DISPlay:LAYout] <layout><NL>

See Also • [":DISPlay:PROPortion"](#) on page 483

History New in version 5.00.

:DISPlay:MAIN

Command :DISPlay:MAIN {{ON | 1} | {OFF | 0}}[,<source>]

The :DISPlay:MAIN command turns on or off the main window view for the indicated source.

<source> {CHANnel<N> | DIFF<D> | COMMONmode<C> | FUNction<F> | WMEMory<R> | EQUalized | MTRend | MSPectrum}

If <source> is omitted, the main window view is enabled/disabled for all sources that are currently on, except for digital channel sources.

<N> An integer, 1-4 in a single oscilloscope, 1-40 in a MultiScope system.

<D>, <C> <D> is an integer, 1-2. <C> is an integer, 3-4.

The DIFF and COMMONmode sources are just aliases that can be used in place of the channel names to apply to differential or common mode signals. These are just aliases - no state change occurs if you refer to a differential channel and you are not in differential mode. DIFF1 refers to the differential signal between channels 1 and 3 (and COMMONmode3 refers to the common mode channel between these same channels). DIFF2 refers to the differential signal between channels 2 and 4 (and COMMONmode4 refers to the common mode channel between these same channels).

<F> An integer, 1-16.

<R> An integer, 1-4.

Example This example sets the main view on.

```
myScope.WriteString ":DISPlay:MAIN ON"
```

Query :DISPlay:MAIN? [<source>]

The DISPlay:MAIN? returns whether the main window view for the indicated source is on or off.

If <source> is omitted, the query returns ON (1) if any main window view is enabled.

Returned Format [:DISPlay:MAIN] {1 | 0}<NL>

Example This example returns the main window view state.

```
Dim strMain As String ' Dimension variable.
myScope.WriteString ":DISPlay:MAIN?"
strCgrade = myScope.ReadString
Debug.Print strMain
```

See Also • [":DISPlay:CGRade"](#) on page 457

History New in version 5.00.

:DISPlay:NOISe:LEVel

Command :DISPlay:NOISe:LEVel <level>

The :DISPlay:NOISe:LEVel command specifies which of the noise graphs to display.

<level> {0 | 1 | 2 | 3}

For a Non Return to Zero (NRZ) signal, you can display the noise graphs for levels 0 or 1. For a PAM-4 signal, you can you can display the noise graphs for levels 2 or 3 as well.

- See Also**
- [":MEASure:NOISe"](#) on page 820
 - [":MEASure:NOISe:ALL?"](#) on page 821
 - [":MEASure:NOISe:BANDwidth"](#) on page 823
 - [":MEASure:NOISe:LOCation"](#) on page 824
 - [":MEASure:NOISe:METHod"](#) on page 825
 - [":MEASure:NOISe:REPort"](#) on page 826
 - [":MEASure:NOISe:RN"](#) on page 827
 - [":MEASure:NOISe:SCOPE:RN"](#) on page 828
 - [":MEASure:NOISe:STATe"](#) on page 829
 - [":MEASure:NOISe:UNITs"](#) on page 830

History New in version 6.10.

:DISPlay:PERSistence

Command :DISPlay:PERSistence {MINimum | INFinite | <time>} [,<source>]

<time> ::= seconds in in NR3 format from 100E-3 to 200E0

The :DISPlay:PERSistence command sets the display persistence. The parameter for this command can be:

- MINimum – indicates zero persistence.
- INFinite – indicates infinite persistence.
- <time> – for variable persistence, that is, you can specify how long acquisitions remain on the screen.

<source> {CHANnel<N> | DIFF<D> | COMMONmode<C> | FUNCTion<F> | WMEMory<R> | EQUalized | MTRend | MSPectrum}

If <source> is omitted, the persistence is applied to all waveforms.

For the WMEMory<R> source, the only valid persistence value is MINimum.

<N> An integer, 1-4 in a single oscilloscope, 1-40 in a MultiScope system.

<D>, <C> <D> is an integer, 1-2. <C> is an integer, 3-4.

The DIFF and COMMONmode sources are just aliases that can be used in place of the channel names to apply to differential or common mode signals. These are just aliases - no state change occurs if you refer to a differential channel and you are not in differential mode. DIFF1 refers to the differential signal between channels 1 and 3 (and COMMONmode3 refers to the common mode channel between these same channels). DIFF2 refers to the differential signal between channels 2 and 4 (and COMMONmode4 refers to the common mode channel between these same channels).

<F> An integer, 1-16.

<R> An integer, 1-4.

Example This example sets the persistence to infinite.

```
myScope.WriteString ":DISPlay:PERSistence INFinite"
```

Query :DISPlay:PERSistence? [<source>]

The :DISPlay:PERSistence? query returns the current persistence value.

When <source> is omitted, the query returns the persistence mode for channel 1.

Returned Format [:DISPlay:PERSistence] {MINimum | INFinite | <time>}<NL>

Example This example places the current persistence setting in the string variable, strSetting, then prints the contents of the variable to the computer's screen.

```
Dim strSetting As String ' Dimension variable.
myScope.WriteString ":DISPlay:PERSistence?"
```

```
strSetting = myScope.ReadString  
Debug.Print strSetting
```

History Legacy command (existed before version 3.10).

Version 5.00: Added the optional <source> parameter for specifying the waveform on which the persistence setting should be made.

:DISPlay:PROPortion

Command :DISPlay:PROPortion <pane>, <float>

The :DISPlay:PROPortion command specifies the size of the waveform and plot areas.

If the :DISPlay:LAYout is VERTical, this command sets an area's height.

If the :DISPlay:LAYout is HORizontal, this command sets an area's width.

If the :DISPlay:LAYout is CUSTom, this command is not supported.

<pane> {AREA<N> | SERIAL<M> | {JITTer | NOISe} | ISIM | PRECprobe | BUS}

<N> An integer, 1-8.

<M> An integer, 1-4.

<float> A value from 0.0 to 100.0.

Example You should set the proportion of all areas that are displayed such that the sum of the proportions is 100. For example, if you have three areas on: Waveform Area 1, Waveform Area 2, and Jitter graphs, you may want to size them as follows:

```
:DISPlay:PROPortion AREA1, 20.0
:DISPlay:PROPortion AREA2, 20.0
:DISPlay:PROPortion JITTer, 60.0
```

If you set the size of one area only, it may not have the intended effect.

Query :DISPlay:PROPortion? <pane>

The :DISPlay:PROPortion? query returns the proportion value of the specified pane.

The query returns the actual percentage of the specified area's width or height. Note that this may be different than the value passed to the command, particularly if the sum of the values passed to the command forms is not 100.

Returned Format [DISPlay:PROPortion] <float><NL>

See Also • [":DISPlay:PROPortion:RESults"](#) on page 484

• [":DISPlay:LAYout"](#) on page 478

History New in version 5.00.

:DISPlay:PROPortion:RESults

Command :DISPlay:PROPortion:RESults <float>

The :DISPlay:PROPortion:RESults command specifies the size of the Results pane in the oscilloscope display.

<float> A value from 0.0 to 100.0.

Query :DISPlay:PROPortion:RESults?

The :DISPlay:PROPortion:RESults? query returns the Results pane proportion setting.

Returned Format [DISPlay:PROPortion:RESults] <float><NL>

See Also · [":DISPlay:PROPortion"](#) on page 483

History New in version 5.70.

:DISPlay:PRECprobe:GCOunt

Command :DISPlay:PRECprobe:GCOunt <count>

The :DISPlay:PRECprobe:GCOunt command sets the number of visible graphs in the PrecisionProbe correction and analysis charts window area.

<count> An integer in NR1 format.

Up to six charts can be displayed for each channel source (24 total for all sources).

Query :DISPlay:PRECprobe:GCOunt?

The :DISPlay:PRECprobe:GCOunt? query returns the number of visible graphs in the PrecisionProbe correction and analysis charts window area.

Returned Format [:DISPlay:PRECprobe:GCOunt] <count><NL>

See Also

- [":DISPlay:PRECprobe:SElectgraph"](#) on page 486
- [":DISPlay:PRECprobe:SOURce"](#) on page 487

History New in version 5.50.

:DISPlay:PRECprobe:SElectgraph

Command :DISPlay:PRECprobe:SElectgraph <graph>
<graph> ::= {FRPHase | IMAG | IPHase | FFRMag | FFRPhase | MFRMag | ALL}

The :DISPlay:PRECprobe:SElectgraph command inserts the specified graph at the first display graph position.

NOTE

Selecting ALL graphs results in all allowed graphs being displayed for the source (see :DISPlay:PRECprobe:SOURce). If the source is ALL, all graphs will be displayed for all sources. The graph count may change.

- See Also**
- [":DISPlay:PRECprobe:GCOunt"](#) on page 485
 - [":DISPlay:PRECprobe:SOURce"](#) on page 487

History New in version 5.50.

:DISPlay:PRECprobe:SOURce

Command :DISPlay:PRECprobe:SOURce <source>

<source> ::= {CHANnel<N> | ALL}

The :DISPlay:PRECprobe:SOURce command sets the source for the PrecisionProbe correction and analysis chart(s).

NOTE

Selecting ALL sources causes the selected graph to be applied to all graph sources. If ALL is the selected graph type, all sources are applied to all graphs. The graph count may change.

<N> An integer, 1–4.

- See Also**
- [":DISPlay:PRECprobe:GCOunt"](#) on page 485
 - [":DISPlay:PRECprobe:SElectgraph"](#) on page 486

History New in version 5.50.

:DISPlay:SCOLor

Command :DISPlay:SCOLor <color_name>, <hue>, <saturation>, <luminosity>

The :DISPlay:SCOLor command sets the color of the specified display element. The display elements are described in [Table 12](#).

<color_name> {BUS | CGLevel1 - CGLevel7 | CHANnel1 - CHANnel4 | DCHannel | DMEMemory
| FUNction1 - FUNction16 | GRID | HISTogram | MARKers | MTPolygons
| MMPolygons | TINputs | WMEMories | WMEMory1 - WMEMory4}

Table 12 Color Names

| Color Name | Definition |
|------------------------|--|
| BUS | Buses. |
| CGLevel1 - CGLevel7 | Color Grade Level 1 through Level 7 waveform display elements. |
| CHANnel1 - CHANnel4 | Channel 1 through Channel 4 waveform display elements. |
| DCHannel | Digital channels. |
| DMEMemory | Digital waveform memory. |
| FUNction1 - FUNction16 | Function 1 through Function 16 waveform display elements. |
| GRID | Display element for the grid inside the waveform viewing area. |
| HISTogram | Histogram bars. |
| MARKers | Display element for the markers. |
| MTPolygons | Mask test regions. |
| MMPolygons | Mask test margin regions. |
| TINputs | Display element for line and aux trigger colors. |
| WMEMories | Display element for waveform memories (same as WMEMory1). |
| WMEMory1 - WMEMory4 | Waveform Memory 1 through Waveform Memory 4 display elements. |

<hue> An integer from 0 to 100. The hue control sets the color of the chosen display element. As hue is increased from 0%, the color changes from red, to yellow, to green, to blue, to purple, then back to red again at 100% hue. For color examples, see the sample color settings table in the Infiniium Oscilloscope online help file. Pure red is 100%, pure blue is 67%, and pure green is 33%.

<saturation> An integer from 0 to 100. The saturation control sets the color purity of the chosen display element. The saturation of a color is the purity of a color, or the absence of white. A 100% saturated color has no white component. A 0% saturated color is pure white.

<luminosity> An integer from 0 to 100. The luminosity control sets the color brightness of the chosen display element. A 100% luminosity is the maximum color brightness. A 0% luminosity is pure black.

Example This example sets the hue to 50, the saturation to 70, and the luminosity to 90 for the markers.

```
myScope.WriteString ":DISPlay:SCOLor MARKers,50,70,90"
```

Query :DISPlay:SCOLor? <color_name>

The :DISPlay:SCOLor? query returns the hue, saturation, and luminosity for the specified color.

Returned Format [:DISPlay:SCOLor] <color_name>, <hue>, <saturation>, <luminosity><NL>

Example This example places the current settings for the graticule color in the string variable, strSetting, then prints the contents of the variable to the computer's screen.

```
Dim strSetting As String ' Dimension variable.
myScope.WriteString ":DISPlay:SCOLor? GRID"
strSetting = myScope.ReadString
Debug.Print strSetting
```

History Legacy command (existed before version 3.10).

Version 5.60: Removed the ability to set colors for MEASurements, STExT, TSCale, and WBAckgrnd.

Version 5.70: Added the ability to set colors for MMPolygons.

:DISPlay:STATus:COLumn

Command `:DISPlay:STATus:COLumn <column>`

The `:DISPlay:STATus:COLumn` command is used to position the real time eye and InfiniiScan Zone Trigger status labels.

This and the `:DISPlay:STATus:ROW` commands specify the upper left corner of the box relative to the screen.

<column> A value of 0 to 1 may be given for the column where 0 is the far left and 1 the far right.

Example For example, a column of 0.5 will place the upper left of the status label at the center screen.

```
myScope.WriteString ":DISPlay:STATus:COLumn 0.5"
```

Query `:DISPlay:STATus:COLumn?`

The `:DISPlay:STATus:COLumn?` query returns the current value of the status label column location.

Returned Format `[:DISPlay:STATus:COLumn] <column><NL>`

Example This example places the current value for the status label column location in the string variable, `strSetting`, then prints the contents of the variable to the computer's screen.

```
Dim strSetting As String    ' Dimension variable.
myScope.WriteString ":DISPlay:STATus:COLumn?"
strSetting = myScope.ReadString
Debug.Print strSetting
```

History New in version 3.10.

:DISPlay:STATus:ROW

Command :DISPlay:STATus:ROW <row>

The :DISPlay:STATus:ROW command is used to position the real time eye and InfiniiScan Zone Trigger status labels.

This and the :DISPlay:STATus:COL commands specify the upper left corner of the box relative to the screen.

<row> A value of 0 to 1 may be given for the row where 0 is the far top and 1 the far bottom.

Example For example, a row and column of 0.5 will place the upper left of the status label at the center screen.

```
myScope.WriteString ":DISPlay:STATus:ROW 0.5"
```

Query :DISPlay:STATus:ROW?

The :DISPlay:STATus:ROW? query returns the current value of the status label row location.

Returned Format [:DISPlay:STATus:ROW] <row><NL>

Example This example places the current value for the status label row location in the string variable, strSetting, then prints the contents of the variable to the computer's screen.

```
Dim strSetting As String ' Dimension variable.
myScope.WriteString ":DISPlay:STATus:ROW?"
strSetting = myScope.ReadString
Debug.Print strSetting
```

History New in version 3.10.

:DISPlay:WINDow:MAXimize

Command :DISPlay:WINDow:MAXimize <window>

<window> ::= {AREA<N> | SERIAL<M> | {JITTER | NOISE} | ISIM | PRECprobe
| BUS}

The :DISPlay:WINDow:MAXimize command will maximize the size of the specified window.

<N> An integer, 1-8.

<M> An integer, 1-4.

History New in version 5.50.

19 Function Commands

:FUNction<F>? / 496
:FUNction<F>:ABSolute / 497
:FUNction<F>:ADD / 498
:FUNction<F>:ADEMod / 499
:FUNction<F>:AVERage / 500
:FUNction<F>:COMMonmode / 501
:FUNction<F>:DElay – Delay / 502
:FUNction<F>:DIFF – Differentiate / 503
:FUNction<F>:DISPlay / 504
:FUNction<F>:DIVide / 505
:FUNction<F>:FFT:DETEctor:POINts / 506
:FUNction<F>:FFT:DETEctor:TYPE / 507
:FUNction<F>:FFT:FREQuency / 508
:FUNction<F>:FFT:REFErence / 509
:FUNction<F>:FFT:RESolution / 510
:FUNction<F>:FFT:SPAN / 511
:FUNction<F>:FFT:STOP / 512
:FUNction<F>:FFT:TDElay / 513
:FUNction<F>:FFT:VUNits / 514
:FUNction<F>:FFT:WINDow / 515
:FUNction<F>:FFTMagnitude / 517
:FUNction<F>:FFTPHase / 518
:FUNction<F>:GATING – Gating / 519
:FUNction<F>:GATING:STARt – Gating window start time / 520
:FUNction<F>:GATING:STOP – Gating window stop time / 521
:FUNction<F>:HIGHpass / 522
:FUNction<F>:HORizontal / 523
:FUNction<F>:HORizontal:POSition / 524
:FUNction<F>:HORizontal:RANGE / 526
:FUNction<F>:INTegrate / 528
:FUNction<F>:INVert / 529
:FUNction<F>:LOWPass / 530

```

:FUNCTION<F>:MAGNify / 531
:FUNCTION<F>:MATLab / 532
:FUNCTION<F>:MATLab:CONTRol<N> / 533
:FUNCTION<F>:MATLab:OPERator / 534
:FUNCTION<F>:MAXimum / 535
:FUNCTION<F>:MHISTogram / 536
:FUNCTION<F>:MINimum / 537
:FUNCTION<F>:MLOG / 538
:FUNCTION<F>:MTRend / 539
:FUNCTION<F>:MULTiply / 540
:FUNCTION<F>:OFFSet / 541
:FUNCTION<F>:RANGe / 542
:FUNCTION<F>:SMOoth / 543
:FUNCTION<F>:SQRT / 544
:FUNCTION<F>:SQUare / 545
:FUNCTION<F>:SUBTract / 546
:FUNCTION<F>:VERSus / 547
:FUNCTION<F>:VERTical / 548
:FUNCTION<F>:VERTical:OFFSet / 549
:FUNCTION<F>:VERTical:RANGe / 550

```

The FUNCTION subsystem defines functions 1-16. The operands of these functions can be:

- Any of the installed channels in the oscilloscope (see [page 495](#))
- Differential channels or common mode channels (see [page 495](#))
- Waveform memories (see [page 495](#))
- Functions (see [page 495](#))
- A constant (see [page 495](#))
- Jitter measurement trend or jitter spectrum (see [page 495](#))

You can control the vertical scaling and offset functions remotely using the RANGE and OFFSet commands in this subsystem. You can obtain the horizontal scaling and position values of the functions using the :HORizontal:RANGe? and :HORizontal:POSition? queries in this subsystem.

If a channel is not on but is used as an operand, that channel will acquire waveform data.

If the operand waveforms have different memory depths, the function uses the shorter of the two.

If the two operands have the same time scales, the resulting function has the same time scale. If the operands have different time scales, the resulting function has no valid time scale. This is because operations are performed based on the displayed waveform data position, and the time relationship of the data records cannot be considered. When the time scale is not valid, delta time pulse parameter measurements have no meaning, and the unknown result indicator is displayed on the screen.

Constant operands take on the same time scale as the associated waveform operand.

| | |
|--|--|
| Channel Operands | CHANnel<N>, where N is an integer, 1-4 in a single oscilloscope, 1-40 in a MultiScope system. |
| Differential and Common Mode Channel Operands | <p>DIFF<D>, where D is an integer, 1-2.</p> <p>COMMonmode<C>, where C is an integer, 3-4.</p> <p>The COMMONmode and DIFF sources are just aliases that can be used in place of the channel names to apply to differential or common mode signals. These are just aliases - no state change occurs if you refer to a differential channel and you are not in differential mode. DIFF1 refers to the differential signal between channels 1 and 3 (and COMMONmode3 refers to the common mode channel between these same channels). DIFF2 refers to the differential signal between channels 2 and 4 (and COMMONmode4 refers to the common mode channel between these same channels).</p> |
| Waveform Memory Operands | WMEMory<R>, where R is an integer, 1-4. |
| Function Operands | <p>FUNCTion<F>, where F is an integer, 1-16.</p> <p>Another function can be a function's source as long as the other function doesn't use the function being defined. In other words, circular expressions are not allowed.</p> |
| Constant Operands | Constant operands can be a real number from -1E6 to 1E12. |
| Jitter Measurement Trend and Jitter Spectrum Operands | The jitter measurement trend, MTRend, and jitter spectrum, MSPectrum, operands are only available if the oscilloscope has the EZJIT option installed and the feature is enabled. |

:FUNction<F>?**Query** :FUNction<F>?

The :FUNction<F>? query returns the currently defined source(s) for the function.

Returned Format [:FUNction<F>:<operator>] {<operand>[, <operand>]}<NL>

<F> An integer, 1-16, representing the selected function.

<operator> Active math operation for the selected function. For example, ADD, AVERage, COMMONmode, DIFF, DIVide, FFTMagnitude, FFTPhase, HIGHpass, INTegrate, INVert, LOWPass, MAGNify, MAXimum, MINimum, MULTiply, SMOoth, SUBTract, or VERSus.

<operand> Any allowable source for the selected FUNction, including channels, differential channels, common mode channels. waveform memories 1-4, functions 1-4, a constant, jitter measurement trend, and jitter spectrum. If the function is applied to a constant, the source returns the constant.

See the discussion of possible operands in the introduction to [Chapter 19](#), "Function Commands," starting on page 493.**Example** This example returns the currently defined source for function 1.

```
myScope.WriteString ":FUNction1?"
```

If the headers are off (see :SYSTem:HEADer), the query returns only the operands, not the operator.

```
myScope.WriteString ":SYST:HEAD ON"
myScope.WriteString ":FUNC1:ADD CHAN1, CHAN2"
myScope.WriteString ":FUNC1?"
strSettings = myScope.ReadString ' Returns ":FUNC1:ADD CHAN1, CHAN2" .
myScope.WriteString ":SYST:HEAD OFF"
myScope.WriteString ":FUNC1?"
strSettings = myScope.ReadString ' Returns "CHAN1, CHAN2" .
```

History Legacy command (existed before version 3.10).

Version 4.30: Up to 16 functions supported.

:FUNction<F>:ABSolute

Command :FUNction<F>:ABSolute <operand>

The :FUNction<F>:ABSolute command takes the absolute value an operand.

<operand> {CHANnel<N> | DIFF<D> | COMMONmode<C> | FUNction<F> | WMEMory<R> | MTRend | MSPectrum}

See the discussion of possible operands in the introduction to [Chapter 19](#), “Function Commands,” starting on page 493.

Example This example turns on the absolute value command using channel 3.

```
myScope.WriteString ":FUNction1:ABSolute CHANnel3"
```

History Legacy command (existed before version 3.10).

Version 4.30: Up to 16 functions supported.

:FUNCTION<F>:ADD

Command :FUNCTION<F>:ADD <operand>, <operand>

The :FUNCTION<F>:ADD command defines a function that takes the algebraic sum of the two operands.

<F> An integer, 1-16, representing the selected function.

<operand> {CHANnel<n> | DIFF<D> | COMMONmode<C> | FUNCTION<F> | WMEMory<n> | <float_value> | MTRend | MSPectrum}

See the discussion of possible operands in the introduction to [Chapter 19](#), “Function Commands,” starting on page 493.

Example This example sets up function 1 to add channel 1 to channel 2.

```
myScope.WriteString ":FUNCTION1:ADD CHANNEL1,CHANNEL2"
```

History Legacy command (existed before version 3.10).

Version 4.30: Up to 16 functions supported.

:FUNCTION<F>:ADEMod

Command :FUNCTION<F>:ADEMod <source>

The :FUNCTION<F>:ADEMod command sets the math function to show the amplitude envelope for an amplitude modulated (AM) input signal.

This function uses a Hilbert transform to get the real (in-phase, I) and imaginary (quadrature, Q) parts of the input signal and then performs a square root of the sum of the real and imaginary parts to get the demodulated amplitude envelope waveform.

<F> An integer, 1-16, representing the selected function.

<source> {CHANnel<n> | DIFF<D> | COMMONmode<C> | FUNCTION<F> | WMemory<n> | MTRend | MSPectrum}

See the discussion of possible operands in the introduction to [Chapter 19](#), "Function Commands," starting on page 493.

Example This example sets up function 1 to perform the amplitude demodulation function on channel 1.

```
myScope.WriteString ":FUNCTION1:ADEMod CHANnel1"
```

History New in version 4.50.

:FUNCTION<F>:AVERAge

Command :FUNCTION<F>:AVERAge <operand> [, <averages>]

The :FUNCTION<F>:AVERAge command defines a function that averages the operand based on the number of specified averages.

<F> An integer, 1-16, representing the selected function.

<operand> {CHANnel<n> | DIFF<D> | COMMONmode<C> | FUNCTION<F> | WMEMory<n> | <float_value> | MTRend | MSPectrum}

See the discussion of possible operands in the introduction to [Chapter 19](#), “Function Commands,” starting on page 493.

<averages> An integer, 2 to 65534 specifying the number of waveforms to be averaged

Example This example sets up function 1 to average channel 1 using 16 averages.

```
myScope.WriteString ":FUNCTION1:AVERAge CHANnel1,16"
```

History Legacy command (existed before version 3.10).

Version 4.30: Up to 16 functions supported.

:FUNCTION<F>:COMMONmode

Command :FUNCTION<F>:COMMONmode <operand>,<operand>

The :FUNCTION<F>:COMMONmode command defines a function that adds the voltage values of the two operands and divides by 2, point by point.

<F> An integer, 1-16, representing the selected function.

<operand> {CHANnel<n> | DIFF<D> | COMMONmode<C> | FUNCTION<F> | WMemory<n> | <float_value> | MTRend | MSPpectrum}

See the discussion of possible operands in the introduction to [Chapter 19](#), "Function Commands," starting on page 493.

Example This example sets up function 1 to view the common mode voltage value of channel 1 and channel 2.

```
myScope.WriteString ":FUNCTION1:COMMONmode CHANnel1,CHANnel2"
```

History Legacy command (existed before version 3.10).

Version 4.30: Up to 16 functions supported.

:FUNCTION<F>:DElay – Delay

Command :FUNCTION<F>:DElay <operand>, <delay_time>

The :FUNCTION<F>:DElay command adds the provided time to the X origin of the source waveform, effectively shifting the function waveform in time.

<F> An integer, 1-16, representing the selected function.

<operand> {CHANnel<n> | DIFF<D> | COMMONmode<C> | FUNCTION<F> | WMEMory<n> | MTRend | MSPectrum}

See the discussion of possible operands in the introduction to [Chapter 19](#), “Function Commands,” starting on page 493.

<delay_time> Time, in seconds, set for the delay.

Example This example sets function 2 to be the waveform from channel1, delayed by 100 ps.

```
myScope.WriteString ":FUNCTION2:DElay CHANnel1,100E-12"
```

History New in version 4.30.

Version 4.30: Up to 16 functions supported.

:FUNCTION<F>:DIFF – Differentiate

Command :FUNCTION<F>:DIFF <operand>[,<low_pass_phase_align>]

The :FUNCTION<F>:DIFF command defines a function that computes the discrete derivative of the operand.

<F> An integer, 1–16, representing the selected function.

<operand> {CHANnel<n> | DIFF<D> | COMMONmode<C> | FUNCTION<F> | WMEMory<n> | <float_value> | MTRend | MSPectrum}

See the discussion of possible operands in the introduction to [Chapter 19](#), “Function Commands,” starting on page 493.

<low_pass_phase_align> {{ON | 1} | {OFF | 0}}

This parameter turns on or off the low pass and phase align filter.

Example This example sets up function 2 to take the discrete derivative of the waveform on channel 2.

```
myScope.WriteString ":FUNCTION2:DIFF CHANNEL2"
```

History Legacy command (existed before version 3.10).

Version 4.30: Up to 16 functions supported.

:FUNCTION<F>:DISPLAY

Command `:FUNCTION<F>:DISPLAY {{ON|1} | {OFF|0}}`

The `:FUNCTION<F>:DISPLAY` command either displays the selected function or removes it from the display.

<F> An integer, 1-16, representing the selected function.

Example This example turns function 1 on.

```
myScope.WriteString ":FUNCTION1:DISPLAY ON"
```

Query `:FUNCTION<F>:DISPLAY?`

The `:FUNCTION<F>:DISPLAY?` query returns the displayed status of the specified function.

Returned Format `[:FUNCTION<F>:DISPLAY] {1|0}<NL>`

Example This example places the current state of function 1 in the variable, `strSetting`, then prints the contents of the variable to the computer's screen.

```
myScope.WriteString ":SYSTEM:HEADER OFF"
myScope.WriteString ":FUNCTION1:DISPLAY?"
strSetting = myScope.ReadString
Debug.Print strSetting
```

History Legacy command (existed before version 3.10).

Version 4.30: Up to 16 functions supported.

:FUNCTION<F>:DIVide

Command :FUNCTION<F>:DIVide <operand>, <operand>

The :FUNCTION<F>:DIVide command defines a function that divides the first operand by the second operand.

<F> An integer, 1-16, representing the selected function.

<operand> {CHANnel<n> | DIFF<D> | COMMONmode<C> | FUNCTION<F> | WMEMory<n> | <float_value> | MTRend | MSPectrum}

See the discussion of possible operands in the introduction to [Chapter 19](#), "Function Commands," starting on page 493.

Example This example sets up function 2 to divide the waveform on channel 1 by the waveform in waveform memory 4.

```
myScope.WriteString ":FUNCTION2:DIVide CHANnel1,WMEMory4"
```

History Legacy command (existed before version 3.10).

Version 4.30: Up to 16 functions supported.

:FUNCTION<F>:FFT:DETECTOR:POINTS

Command :FUNCTION<F>:FFT:DETECTOR:POINTS <number_of_buckets>
 <number_of_buckets> ::= an integer.

When a detector is used for the FFT magnitude function (see :FUNCTION<F>:FFT:DETECTOR:TYPE), the :FUNCTION<F>:FFT:DETECTOR:POINTS command specifies the maximum number of points (buckets) that detectors should decimate to.

Query :FUNCTION<F>:FFT:DETECTOR:POINTS?

The :FUNCTION<F>:FFT:DETECTOR:POINTS? query returns the specified number of detector points.

Returned Format <number_of_buckets><NL>

- See Also**
- [":FUNCTION<F>:FFT:DETECTOR:TYPE"](#) on page 507
 - [":FUNCTION<F>:FFTMagnitude"](#) on page 517
 - [":FUNCTION<F>:FFT:VUNits"](#) on page 514

History New in version 5.70.

:FUNCTION<F>:FFT:DETECTOR:TYPE

Command :FUNCTION<F>:FFT:DETECTOR:TYPE <type>

```
<type> ::= {OFF | SAMPLE | PPOSITIVE | PNEGATIVE | NORMAL | AVERAGE
            | RMS}
```

The :FUNCTION<F>:FFT:DETECTOR:TYPE command specifies whether a detector is used for the FFT magnitude function.

Detectors decimate the number of points on screen to at most the number of detector points (buckets, see :FUNCTION<F>:FFT:DETECTOR:POINTS). Detectors give you a way of manipulating the acquired data to emphasize different features of the data. The detector types are:

- OFF – No detector is used.
- SAMPLE – Takes the point nearest to the center of every bucket.
- PPOSITIVE – Takes the most positive point in every bucket.
- PNEGATIVE – Takes the most negative point in every bucket.
- NORMAL – Implements a rosenfell algorithm. For details, see the [Spectrum Analysis Basics](#) application note.
- AVERAGE – Takes the average of all points in every bucket.
- RMS – Takes the root mean square of all points in every bucket (average power).

Query :FUNCTION<F>:FFT:DETECTOR:TYPE?

The :FUNCTION<F>:FFT:DETECTOR:TYPE? query returns the selected detector.

Returned Format <type><NL>

```
<type> ::= {OFF | SAMP | PPOS | PNEG | NORM | AVER | RMS}
```

- See Also**
- [":FUNCTION<F>:FFT:DETECTOR:POINTS"](#) on page 506
 - [":FUNCTION<F>:FFTMagnitude"](#) on page 517
 - [":FUNCTION<F>:FFT:VUNITS"](#) on page 514

History New in version 5.70.

:FUNCTION<F>:FFT:FREQUENCY

Command :FUNCTION<F>:FFT:FREQUENCY <center_frequency_value>

The :FUNCTION<F>:FFT:FREQUENCY command sets the center frequency for the FFT when :FUNCTION<F>:FTTMagnitude is defined for the selected function.

<F> An integer, 1-16, representing the selected function.

<center_frequency_value> A real number for the value in Hertz, from -1E12 to 1E12.

Query :FUNCTION<F>:FFT:FREQUENCY?

The :FUNCTION<F>:FFT:FREQUENCY? query returns the center frequency value.

Returned Format [FUNCTION<F>:FFT:FREQUENCY] <center_frequency_value><NL>

- See Also**
- **":FUNCTION<F>:FFT:STOP"** on page 512
 - **":FUNCTION<F>:FFT:SPAN"** on page 511
 - **":FUNCTION<F>:FFT:RESOLUTION"** on page 510

History Legacy command (existed before version 3.10).

Version 4.30: Up to 16 functions supported.

:FUNction<F>:FFT:REfERENCE

Command :FUNction<F>:FFT:REfERENCE {DISPlay | TRIGger}

The :FUNction<F>:FFT:REfERENCE command sets the reference point for calculating the FFT phase function.

<F> An integer, 1-16, representing the selected function.

Example This example sets the reference point to DISPlay.

```
myScope.WriteString ":FUNction1:FFT:REfERENCE DISPlay"
```

Query :FUNction<F>:FFT:REfERENCE?

The :FUNction<F>:FFT:REfERENCE? query returns the currently selected reference point for the FFT phase function.

Returned Format [:FUNction<F>:FFT:REfERENCE] {DISPlay | TRIGger}<NL>

Example This example places the current state of the function 1 FFT reference point in the string variable, strREF, then prints the contents of the variable to the computer's screen.

```
Dim strREF As String
myScope.WriteString ":FUNction1:FFT:REfERENCE?"
strREF = myScope.ReadString
Debug.Print strREF
```

History Legacy command (existed before version 3.10).

Version 4.30: Up to 16 functions supported.

:FUNCTION<F>:FFT:RESolution

Command :FUNCTION<F>:FFT:RESolution <resolution_value>

The :FUNCTION<F>:FFT:RESolution command sets the resolution bandwidth of the FFT function.

If either the memory depth or sampling rate is set to AUTO (see :ACQUIRE:POINTS or :ACQUIRE:SRATE), you can adjust this control. However, if both the memory depth and sampling rate are in manual mode, you cannot set the resolution and can only query it.

The change in resolution bandwidth is achieved by changing the horizontal scale (as with the :TIMEbase:SCALE command). Changes to the horizontal scale will also change the resolution bandwidth.

<F> An integer, 1-16, representing the selected function.

<resolution_value> Resolution bandwidth frequency.

The FFT resolution is determined by the sample rate and memory depth settings. The FFT resolution is calculated using the following equation:

$$\text{FFT Resolution} = \frac{\text{Sample Rate}}{\text{Effective Memory Depth}}$$

The effective memory depth is the highest power of 2 less than or equal to the number of sample points across the display. The memory bar in the status area at the top of the display indicates how much of the actual memory depth is across the display.

Query :FUNCTION<F>:FFT:RESolution?

The :FUNCTION<F>:FFT:RESolution? query returns the current resolution of the FFT function.

Returned Format [FUNCTION<F>:FFT:RESolution] <resolution_value><NL>

- See Also**
- [":ACQUIRE:POINTS\[:ANALog\] – Memory depth"](#) on page 218
 - [":ACQUIRE:SRATE\[:ANALog\] – Analog Sample Rate"](#) on page 231
 - [":FUNCTION<F>:FFT:STOP"](#) on page 512
 - [":FUNCTION<F>:FFT:FREQuency"](#) on page 508
 - [":FUNCTION<F>:FFT:SPAN"](#) on page 511
 - [":TIMEbase:SCALE"](#) on page 1174

History Legacy command (existed before version 3.10).

Version 4.30: Up to 16 functions supported.

Version 5.70: The command form now lets you set the FFT resolution bandwidth.

:FUNction<F>:FFT:SPAN

Command :FUNction<F>:FFT:SPAN <frequency_span>

The :FUNction<F>:FFT:SPAN command sets the frequency span for the FFT function.

<F> An integer, 1-16, representing the selected function.

<frequency_span> Frequency value in NR3 format.

Query :FUNction<F>:FFT:SPAN?

The :FUNction<F>:FFT:SPAN? query returns the frequency span setting.

Returned Format [FUNction<F>:FFT:SPAN] <frequency_span><NL>

- See Also**
- **":FUNction<F>:FFT:STOP"** on page 512
 - **":FUNction<F>:FFT:FREQuency"** on page 508
 - **":FUNction<F>:FFT:RESolution"** on page 510

History New in version 5.70.

:FUNction<F>:FFT:STOP

Command :FUNction<F>:FFT:STOP <stop_frequency>

The :FUNction<F>:FFT:STOP command sets the stop frequency for the FFT function.

<F> An integer, 1-16, representing the selected function.

<stop_frequency> Frequency value in NR3 format.

Query :FUNction<F>:FFT:STOP?

The :FUNction<F>:FFT:STOP? query returns the stop frequency setting.

Returned Format [FUNction<F>:FFT:STOP] <stop_frequency><NL>

- See Also**
- **":FUNction<F>:FFT:FREQuency"** on page 508
 - **":FUNction<F>:FFT:SPAN"** on page 511
 - **":FUNction<F>:FFT:RESolution"** on page 510

History New in version 5.70.

:FUNCTION<F>:FFT:TDELAY

Command :FUNCTION<F>:FFT:TDELAY <time_delay>

The :FUNCTION<F>:FFT:TDELAY command sets the time delay for the FFT phase function.

<time_delay> Time, in seconds, set for the time delay.

Example This example sets the time delay to one millisecond.

```
myScope.WriteString ":FUNCTION1:FFT:TDELAY 1E-3"
```

Query :FUNCTION<F>:FFT:TDELAY?

The :FUNCTION<F>:FFT:TDELAY? query returns the time delay for the FFT phase function.

Returned Format [:FUNCTION<F>:FFT:TDELAY] <time_delay><NL>

Example This example places the FFT phase function's time delay value in the variable, varFftPhaseTimeDelay, then prints the contents of the variable to the computer's screen.

```
Dim varFftPhaseTimeDelay As Variant
myScope.WriteString ":FUNCTION1:FFT:TDELAY?"
varFftPhaseTimeDelay = myScope.ReadNumber
Debug.Print FormatNumber(varFftPhaseTimeDelay, 0)
```

See Also • [":FUNCTION<F>:FFTPhase"](#) on page 518

History New in version 4.20.

Version 4.30: Up to 16 functions supported.

:FUNCTION<F>:FFT:VUNits

Command :FUNCTION<F>:FFT:VUNits <units>

<units> ::= {DB | DBMV | DBUV | WATT | VRMS}

The :FUNCTION<F>:FFT:VUNits command specifies the vertical units for the FFT magnitude function.

Query :FUNCTION<F>:FFT:VUNits?

The :FUNCTION<F>:FFT:VUNits? query returns the FFT magnitude function vertical units setting.

Returned Format <units><NL>

- See Also**
- [":FUNCTION<F>:FFTMagnitude"](#) on page 517
 - [":FUNCTION<F>:FFT:DETECTOR:POINTS"](#) on page 506
 - [":FUNCTION<F>:FFT:DETECTOR:TYPE"](#) on page 507

History New in version 5.70.

:FUNction<F>:FFT:WINDow

Command :FUNction<F>:FFT:WINDow {RECTangular | HANNing | FLATtop
| BHARris | HAMMING}

The :FUNction<F>:FFT:WINDow command sets the window type for the FFT function.

The FFT function assumes that the time record repeats. Unless there is an integral number of cycles of the sampled waveform in the record, a discontinuity is created at the beginning of the record. This introduces additional frequency components into the spectrum about the actual peaks, which is referred to as spectral leakage. To minimize spectral leakage, windows that approach zero smoothly at the beginning and end of the record are employed as filters to the FFTs. Each window is useful for certain classes of input waveforms.

- RECTangular – is essentially no window, and all points are multiplied by 1. This window is useful for transient waveforms and waveforms where there are an integral number of cycles in the time record.
- HANNing – is useful for frequency resolution and general purpose use. It is good for resolving two frequencies that are close together, or for making frequency measurements.
- FLATtop – is best for making accurate amplitude measurements of frequency peaks.
- BHARris – (Blackman-Harris) is best used when you want to look at signals with a strong interference component that is fairly distant from the frequency you want to see. It can be used as a general purpose window as its main lobe is not too wide (decent frequency discrimination) and the side lobes drop off by 90 dB.
- HAMMING – is a "raised cosine" function like the HANNing window but with different coefficients. It has slightly better frequency resolution than the HANNing window.

<F> An integer, 1-16, representing the selected function. This command presently selects all functions, regardless of which integer (1-16) is passed.

Example This example sets the window type for the FFT function to RECTangular.

```
myScope.WriteString ":FUNction1:FFT:WINDow RECTangular"
```

Query :FUNction<F>:FFT:WINDow?

The :FUNction<F>:FFT:WINDow? query returns the current selected window for the FFT function.

Returned Format [:FUNction<F>:FFT:WINDow] {RECTangular | HANNing | FLATtop
| BHARris | HAMMING}<NL>

Example This example places the current state of the function 1 FFT window in the string variable, strWND, then prints the contents of the variable to the computer's screen.

```
Dim strWND As String  
myScope.WriteString ":FUNCTION1:FFT:WINDOW?"  
strWND = myScope.ReadString  
Debug.Print strWND
```

History Legacy command (existed before version 3.10).

Version 3.11: Added the HAMMING window mode selection.

Version 4.30: Up to 16 functions supported.

:FUNction<F>:FFTMagnitude

Command :FUNction<F>:FFTMagnitude <operand>

The :FUNction<F>:FFTMagnitude command computes the Fast Fourier Transform (FFT) of the specified channel, function, or memory. The FFT takes the digitized time record and transforms it to magnitude and phase components as a function of frequency.

<F> An integer, 1-16, representing the selected function.

<operand> {CHANnel<n> | DIFF<D> | COMMONmode<C> | FUNction<F> | WMEMory<n> | <float_value> | MTRend | MSPectrum}

See the discussion of possible operands in the introduction to [Chapter 19](#), "Function Commands," starting on page 493.

Example This example sets up function 1 to compute the FFT of waveform memory 3.

```
myScope.WriteString ":FUNction1:FFTMagnitude WMEMory3"
```

See Also

- [":FUNction<F>:FFT:VUNits"](#) on page 514
- [":FUNction<F>:FFT:DETEctor:TYPE"](#) on page 507
- [":FUNction<F>:FFT:DETEctor:POINts"](#) on page 506

History Legacy command (existed before version 3.10).

Version 4.30: Up to 16 functions supported.

:FUNCTION<F>:FFTPHASE

Command :FUNCTION<F>:FFTPHASE <source>

The :FUNCTION<F>:FFTPHASE command computes the Fast Fourier Transform (FFT) of the specified channel, function, or waveform memory. The FFT takes the digitized time record and transforms it into magnitude and phase components as a function of frequency.

<F> An integer, 1-16, representing the selected function.

<source> {CHANnel<n> | DIFF<D> | COMMONmode<C> | FUNCTION<F> | WMEMory<n> | <float_value> | MTRend | MSPectrum}

See the discussion of possible operands in the introduction to [Chapter 19](#), "Function Commands," starting on page 493.

Example This example sets up function 1 to compute the FFT of waveform memory 3.

```
myScope.WriteString ":FUNCTION1:FFTPHASE WMEMory3"
```

See Also • [":FUNCTION<F>:FFT:TDELay"](#) on page 513

History Legacy command (existed before version 3.10).

Version 4.30: Up to 16 functions supported.

:FUNCTION<F>:GATING – Gating

Command :FUNCTION<F>:GATING <operand> [, <gating_start>, <gating_stop>]

The :FUNCTION<F>:GATING command defines a horizontal gating function of another waveform (similar to horizontal zoom). Measurements on horizontal gating functions are essentially gated measurements.

<F> An integer, 1-16, representing the selected function.

<operand> {CHANnel<n> | DIFF<D> | COMMONmode<C> | FUNCTION<F> | WMemory<n> | MTRend | MSPpectrum}

See the discussion of possible operands in the introduction to [Chapter 19](#), “Function Commands,” starting on page 493.

<gating_start> Time, in seconds, relative to the source waveform that specifies where the gating window begins.

<gating_stop> Time, in seconds, relative to the source waveform that specifies where the gating window ends.

Example This example sets function 4 to be a horizontal gating of the channel1 waveform beginning at -8 ns and ending at -5 ns.

```
myScope.WriteString ":FUNCTION4:GATING CHANNEL1, -8E-9, -5E-9"
```

See Also

- [":FUNCTION<F>:GATING:START – Gating window start time"](#) on page 520
- [":FUNCTION<F>:GATING:STOP – Gating window stop time"](#) on page 521

History New in version 4.30.

Version 4.30: Up to 16 functions supported.

:FUNCTION<F>:GATING:START – Gating window start time

Command `:FUNCTION<F>:GATING:START <gating_start>`

The `:FUNCTION<F>:GATING:START` command specifies the time, in seconds, where the gating window begins relative to the source waveform (see `:FUNCTION<F>:GATING`).

`<F>` An integer, 1-16, representing the selected function.

Example This example sets a -8 ns gating window begin time for function 4.

```
myScope.WriteString ":FUNCTION4:GATING:START -8E-9"
```

The gating window is applied to the source operand specified in the `:FUNCTION4:GATING` command.

Query `:FUNCTION<F>:GATING:START?`

The `::FUNCTION<F>:GATING:START?` query returns the gating window start time.

Returned Format `[:FUNCTION<F>:GATING:START] <gating_start><NL>`

- See Also**
- [":FUNCTION<F>:GATING – Gating"](#) on page 519
 - [":FUNCTION<F>:GATING:STOP – Gating window stop time"](#) on page 521

History New in version 5.30.

:FUNCTION<F>:GATING:STOP – Gating window stop time

Command :FUNCTION<F>:GATING:STOP <gating_stop>

The :FUNCTION<F>:GATING:STOP command specifies the time, in seconds, where the gating window ends relative to the source waveform (see :FUNCTION<F>:GATING).

<F> An integer, 1–16, representing the selected function.

Example This example sets a -5 ns gating window end time for function 4.

```
myScope.WriteString ":FUNCTION4:GATING:STOP -5E-9"
```

The gating window is applied to the source operand specified in the :FUNCTION4:GATING command.

Query :FUNCTION<F>:GATING:STOP?

The ::FUNCTION<F>:GATING:STOP? query returns the gating window stop time.

Returned Format [:FUNCTION<F>:GATING:STOP] <gating_stop><NL>

- See Also**
- [":FUNCTION<F>:GATING – Gating"](#) on page 519
 - [":FUNCTION<F>:GATING:START – Gating window start time"](#) on page 520

History New in version 5.30.

:FUNction<F>:HIGHpass

Command :FUNction<F>:HIGHpass <source>,<bandwidth>

The :FUNction<F>:HIGHpass command applies a single-pole high pass filter to the source waveform. The bandwidth that you set is the 3 dB bandwidth of the filter.

<F> An integer, 1-16, representing the selected function.

<source> {CHANnel<n> | DIFF<D> | COMMONmode<C> | FUNction<F> | WMEMory<n> | MTRend | MSPectrum}

See the discussion of possible operands in the introduction to [Chapter 19](#), "Function Commands," starting on page 493.

<bandwidth> A real number in the range of 50 to 50E9.

Example This example sets up function 2 to compute a high pass filter with a bandwidth of 1 MHz.

```
myScope.WriteString ":FUNction2:HIGHpass CHANnel14,1E6"
```

History Legacy command (existed before version 3.10).

Version 4.30: Up to 16 functions supported.

:FUNCTION<F>:HORIZONTAL

Command :FUNCTION<F>:HORIZONTAL {AUTO | MANUAL}

The :FUNCTION<F>:HORIZONTAL command sets the horizontal tracking to either AUTO or MANUAL.

NOTE

Using the :FUNCTION<F>:HORIZONTAL:RANGE or :FUNCTION<F>:HORIZONTAL:POSITION commands automatically changes the :FUNCTION<F>:HORIZONTAL setting to MANUAL.

<F> An integer, 1-16, representing the selected function.

Query :FUNCTION<F>:HORIZONTAL?

The :FUNCTION<F>:HORIZONTAL? query returns the current horizontal scaling mode of the specified function.

Returned Format [:FUNCTION<F>:HORIZONTAL] {AUTO | MANUAL}<NL>

Example This example places the current state of the function 1 horizontal tracking in the string variable, strSetting, then prints the contents of the variable to the computer's screen.

```
Dim strSetting As String ' Dimension variable.
myScope.WriteString ":FUNCTION1:HORIZONTAL?"
strSetting = myScope.ReadString
Debug.Print strSetting
```

See Also

- [":FUNCTION<F>:HORIZONTAL:POSITION"](#) on page 524
- [":FUNCTION<F>:HORIZONTAL:RANGE"](#) on page 526

History Legacy command (existed before version 3.10).

Version 4.30: Up to 16 functions supported.

:FUNCTION<F>:HORIZONTAL:POSITION

Command :FUNCTION<F>:HORIZONTAL:POSITION <position_value>

The :FUNCTION<F>:HORIZONTAL:POSITION command sets the time value at center screen for the selected function.

Using the :FUNCTION<F>:HORIZONTAL:POSITION command automatically changes the :FUNCTION<F>:HORIZONTAL setting to MANUAL.

When you select :FUNCTION<F>:FFTMagnitude, the horizontal position is equivalent to the center frequency. This also automatically selects manual mode.

NOTE

For some math functions (:FUNCTION<F>:ABSolute, :FUNCTION<F>:ADD, :FUNCTION<F>:ADEMod, :FUNCTION<F>:COMMONmode, :FUNCTION<F>:DIFF, :FUNCTION<F>:DIVide, :FUNCTION<F>:HIGHpass, :FUNCTION<F>:INTEgrate, :FUNCTION<F>:INVert, :FUNCTION<F>:LOWPass, :FUNCTION<F>:MAXimum, :FUNCTION<F>:MTRend, :FUNCTION<F>:MINimum, :FUNCTION<F>:MULTiply, :FUNCTION<F>:SQUare, :FUNCTION<F>:SQRT, :FUNCTION<F>:SUBTract), the waveform's horizontal scaling is tied to the timebase of the source channel waveform(s).

The :FUNCTION<F>:HORIZONTAL:RANGE and :FUNCTION<F>:HORIZONTAL:POSITION commands for these functions give a -221, "Settings conflict" error. Instead, you must use the :TIMEbase:RANGE and :TIMEbase:POSITION commands to make horizontal scale and position changes.

<F> An integer, 1-16, representing the selected function.

<position_value> A real number for the position value in time, in seconds.

Query :FUNCTION<F>:HORIZONTAL:POSITION?

The :FUNCTION<F>:HORIZONTAL:POSITION? query returns the current time value at center screen of the selected function.

Returned Format [:FUNCTION<F>:HORIZONTAL:POSITION] <position><NL>

Example This example places the current horizontal position setting for function 2 in the numeric variable, varValue, then prints the contents to the computer's screen.

```
myScope.WriteString ":SYSTEM:HEADER OFF" ' Response headers off.
myScope.WriteString ":FUNCTION2:HORIZONTAL:POSITION?"
varValue = myScope.ReadNumber
Debug.Print FormatNumber(varValue, 0)
```

See Also

- [":FUNCTION<F>:HORIZONTAL:RANGE"](#) on page 526
- [":FUNCTION<F>:HORIZONTAL"](#) on page 523
- [":TIMEbase:POSITION"](#) on page 1168

History Legacy command (existed before version 3.10).

Version 4.30: Up to 16 functions supported.

Version 6.00: For functions where the horizontal position cannot be adjusted, this command now gives a -221, "Settings conflict" instead of being accepted without effect.

:FUNCTION<F>:HORIZONTAL:RANGE

Command :FUNCTION<F>:HORIZONTAL:RANGE <range_value>

The :FUNCTION<F>:HORIZONTAL:RANGE command sets the current time range for the specified function.

Using the :FUNCTION<F>:HORIZONTAL:RANGE command automatically changes the :FUNCTION<F>:HORIZONTAL setting to MANUAL.

NOTE

For some math functions (:FUNCTION<F>:ABSOLUTE, :FUNCTION<F>:ADD, :FUNCTION<F>:ADEMOD, :FUNCTION<F>:COMMONMODE, :FUNCTION<F>:DIFF, :FUNCTION<F>:DIVIDE, :FUNCTION<F>:HIGHPASS, :FUNCTION<F>:INTEGRATE, :FUNCTION<F>:INVERT, :FUNCTION<F>:LOWPASS, :FUNCTION<F>:MAXIMUM, :FUNCTION<F>:MTRND, :FUNCTION<F>:MINIMUM, :FUNCTION<F>:MULTIPLY, :FUNCTION<F>:SQUARE, :FUNCTION<F>:SQRT, :FUNCTION<F>:SUBTRACT), the waveform's horizontal scaling is tied to the timebase of the source channel waveform(s).

The :FUNCTION<F>:HORIZONTAL:RANGE and :FUNCTION<F>:HORIZONTAL:POSITION commands for these functions give a -221, "Settings conflict" error. Instead, you must use the :TIMEBASE:RANGE and :TIMEBASE:POSITION commands to make horizontal scale and position changes.

<F> An integer, 1-16, representing the selected function.

<range_value> A real number for the width of screen in current X-axis units (usually seconds).

Query :FUNCTION<F>:HORIZONTAL:RANGE?

The :FUNCTION<F>:HORIZONTAL:RANGE? query returns the current time range setting of the specified function.

Returned Format [:FUNCTION<F>:HORIZONTAL:RANGE] <range><NL>

Example This example places the current horizontal range setting of function 2 in the numeric variable, varValue, then prints the contents to the computer's screen.

```
myScope.WriteString ":SYSTEM:HEADER OFF" ' Response headers off.
myScope.WriteString ":FUNCTION2:HORIZONTAL:RANGE?"
varValue = myScope.ReadNumber
Debug.Print FormatNumber(varValue, 0)
```

- See Also**
- [":FUNCTION<F>:HORIZONTAL:POSITION"](#) on page 524
 - [":FUNCTION<F>:HORIZONTAL"](#) on page 523
 - [":TIMEBASE:RANGE"](#) on page 1169

History Legacy command (existed before version 3.10).

Version 4.30: Up to 16 functions supported.

Version 6.00: For functions where the horizontal position cannot be adjusted, this command now gives a -221, "Settings conflict" instead of being accepted without effect.

:FUNCTION<F>:INTEGRATE

Command :FUNCTION<F>:INTEGRATE <operand>

The :FUNCTION<F>:INTEGRATE command defines a function that computes the integral of the specified operand's waveform.

<F> An integer, 1-16, representing the selected function.

<operand> {CHANnel<n> | DIFF<D> | COMMONmode<C> | FUNCTION<F> | WMEMORY<n> | <float_value> | MTRend | MSPectrum}

See the discussion of possible operands in the introduction to [Chapter 19](#), "Function Commands," starting on page 493.

Example This example sets up function 1 to compute the integral of waveform memory 3.

```
myScope.WriteString ":FUNCTION1:INTEGRATE WMEMORY3"
```

History Legacy command (existed before version 3.10).

Version 4.30: Up to 16 functions supported.

:FUNCTION<F>:INVert

Command :FUNCTION<F>:INVert <operand>

The :FUNCTION<F>:INVert command defines a function that inverts the defined operand's waveform by multiplying by -1.

<F> An integer, 1-16, representing the selected function.

<operand> {CHANnel<n> | DIFF<D> | COMMONmode<C> | FUNCTION<F> | WMEMory<n> | <float_value> | MTRend | MSPectrum}

See the discussion of possible operands in the introduction to [Chapter 19](#), "Function Commands," starting on page 493.

Example This example sets up function 2 to invert the waveform on channel 1.

```
myScope.WriteString ":FUNCTION2:INVert CHANnel1"
```

History Legacy command (existed before version 3.10).

Version 4.30: Up to 16 functions supported.

:FUNCTION<F>:LOWPass

Command :FUNCTION<F>:LOWPass <source>, <bandwidth>

The :FUNCTION<F>:LOWPass command applies a 4th order Bessel-Thompson low pass filter to the source waveform. The bandwidth that you set is the 3 dB bandwidth of the filter.

<F> An integer, 1-16, representing the selected function.

<source> {CHANnel<n> | DIFF<D> | COMMONmode<C> | FUNCTION<F> | WMEMORY<n> | MTRend | MSPectrum}

See the discussion of possible operands in the introduction to [Chapter 19](#), "Function Commands," starting on page 493.

<bandwidth> A real number in the range of 50 to 50E9.

Example This example sets up function 2 to compute a low pass filter with a bandwidth of 1 MHz.

```
myScope.WriteString ":FUNCTION2:LOWPass CHANnel4,1E6"
```

History Legacy command (existed before version 3.10).

Version 4.30: Up to 16 functions supported.

:FUNCTION<F>:MAGNify

Command :FUNCTION<F>:MAGNify <operand>

The :FUNCTION<F>:MAGNify command defines a function that is a copy of the operand. The magnify function is a software magnify. No hardware settings are altered as a result of using this function. It is useful for scaling channels, another function, or memories with the RANGE and OFFSET commands in this subsystem.

<F> An integer, 1-16, representing the selected function.

<operand> {CHANNEL<n> | DIFF<D> | COMMONmode<C> | FUNCTION<F> | WMEMORY<n> | <float_value> | MTRend | MSPectrum}

See the discussion of possible operands in the introduction to [Chapter 19](#), "Function Commands," starting on page 493.

Example This example creates a function (function 1) that is a magnified version of channel 1.

```
myScope.WriteString ":FUNCTION1:MAGNify CHANNEL1"
```

History Legacy command (existed before version 3.10).

Version 4.30: Up to 16 functions supported.

:FUNction<F>:MATLab

Command :FUNction<F>:MATLab <operand> [, <operand>]

The :FUNction<F>:MATLab command sets the operand.

<F> An integer, 1-16, representing the selected function.

<operand> {CHANnel<N> | DIFF<D> | COMMONmode<C> | FUNction<F> | WMEMory<R>}

<N> An integer, 1-4 in a single oscilloscope, 1-40 in a MultiScope system.

<D> An integer, 1-2.

<C> An integer, 3-4.

The COMMONmode and DIFF sources are just aliases that can be used in place of the channel names to apply to differential or common mode signals. These are just aliases - no state change occurs if you refer to a differential channel and you are not in differential mode. DIFF1 refers to the differential signal between channels 1 and 3 (and COMMONmode3 refers to the common mode channel between these same channels). DIFF2 refers to the differential signal between channels 2 and 4 (and COMMONmode4 refers to the common mode channel between these same channels).

<R> An integer, 1-4.

<F> An integer, 1-16.

Another function can be a function's source as long as the other function does not use the function being defined. In other words, circular expressions are not allowed.

Example This example sets the operand to channel 3.

```
myScope.WriteString ":FUNction1:MATLab CHANnel3"
```

History Legacy command (existed before version 3.10).

Version 4.30: Up to 16 functions supported.

:FUNCTION<F>:MATLAB:CONTROL<N>

Command :FUNCTION<F>:MATLAB:CONTROL<N> {<value> | <string>}

The :FUNCTION<F>:MATLAB:CONTROL<N> command sets the user-defined control.

<F> An integer, 1-16, representing the selected function.

<N> An integer, 1-6, representing the user-defined control.

<value> A double, integer, or enumerated type value. For an enumerated type, the 1 based index is passed to select the enumeration.

<string> A character array.

Example This example sets control 1 to 3.

```
myScope.WriteString ":FUNCTION1:MATLAB:CONTROL1 3"
```

Query :FUNCTION<F>:MATLAB:CONTROL<N>?

The :FUNCTION<F>:MATLAB:CONTROL<N>? query returns the value or string of the user-defined control.

Returned Format [:FUNCTION<F>:MATLAB:CONTROL<N>] {<value> | <string>}<NL>

Example This example places the current returned value for function 1 control 1 in the string variable, strSelection, then prints the contents of the variable to the computer's screen.

```
Dim strSelection As String ' Dimension variable.
myScope.WriteString ":FUNCTION1:MATLAB:CONTROL1?"
strSelection = myScope.ReadString
Debug.Print strSelection
```

History Legacy command (existed before version 3.10).

Version 4.30: Up to 16 functions supported.

Version 5.60: Up to 6 user-defined controls supported.

:FUNCTION<F>:MATLAB:OPERATOR

Command `:FUNCTION<F>:MATLAB:OPERATOR <string>`

The `:FUNCTION<F>:MATLAB:OPERATOR` command sets the Math dialog box operator.

<F> An integer, 1-16, representing the selected function.

<string> A character array that is the name of the function in the XML file.

Example This example sets function 1 to the Deconvolve operator.

```
myScope.WriteString ":FUNCTION1:MATLAB:OPERATOR 'Deconvolve'"
```

Query `:FUNCTION<F>:MATLAB:OPERATOR?`

The `:FUNCTION<F>:MATLAB:OPERATOR?` query returns the string of the function 1 operator.

Returned Format `[:FUNCTION<F>:MATLAB:OPERATOR] <string><NL>`

Example This example places the current operator string for function 1 in the string variable, `strSelection`, then prints the contents of the variable to the computer's screen.

```
Dim strSelection As String    ' Dimension variable.
myScope.WriteString ":FUNCTION1:MATLAB:OPERATOR?"
strSelection = myScope.ReadString
Debug.Print strSelection
```

History Legacy command (existed before version 3.10).

Version 4.30: Up to 16 functions supported.

:FUNCTION<F>:MAXimum

Command :FUNCTION<F>:MAXimum <operand>

The :FUNCTION<F>:MAXimum command defines a function that computes the maximum of each time bucket for the defined operand's waveform.

<F> An integer, 1-16, representing the selected function.

<operand> {CHANnel<n> | DIFF<D> | COMMONmode<C> | FUNCTION<F> | WMEMory<n> | <float_value> | MTRend | MSPectrum}

See the discussion of possible operands in the introduction to [Chapter 19](#), "Function Commands," starting on page 493.

Example This example sets up function 2 to compute the maximum of each time bucket for channel 4.

```
myScope.WriteString ":FUNCTION2:MAXimum CHANnel4"
```

History Legacy command (existed before version 3.10).

Version 4.30: Up to 16 functions supported.

:FUNCTION<F>:MHISTogram

Command :FUNCTION<F>:MHISTogram {MEAS1 | MEAS2 | MEAS3 | ...
| MEAS20} [, <max_bins>]

The :FUNCTION<F>:MHISTogram command adds a Meas Histogram function that shows a histogram of measurement values. Measurement values are captured and the histogram is updated as new acquisitions are made.

You can display statistics for the histogram in the Measurements tab using the :MEASURE:HISTogram commands and you can get histogram statistics using the :MEASURE:HISTogram queries.

<F> An integer, 1-16, representing the selected function.

<max_bins> An integer from 10-1280.

Example This example sets up a histogram function of the first measurement.

```
myScope.WriteString ":FUNCTION2:MHISTogram MEAS1"
```

- See Also**
- [":MEASURE:HISTogram:HITS"](#) on page 785
 - [":MEASURE:HISTogram:M1S"](#) on page 786
 - [":MEASURE:HISTogram:M2S"](#) on page 787
 - [":MEASURE:HISTogram:M3S"](#) on page 788
 - [":MEASURE:HISTogram:MAX"](#) on page 789
 - [":MEASURE:HISTogram:MEAN"](#) on page 790
 - [":MEASURE:HISTogram:MEDian"](#) on page 791
 - [":MEASURE:HISTogram:MIN"](#) on page 792
 - [":MEASURE:HISTogram:MODE"](#) on page 793
 - [":MEASURE:HISTogram:PEAK"](#) on page 794
 - [":MEASURE:HISTogram:PP"](#) on page 795
 - [":MEASURE:HISTogram:RESolution"](#) on page 796
 - [":MEASURE:HISTogram:STDDev"](#) on page 797

History New in version 3.50.

Version 4.30: Up to 16 functions supported.

Version 5.00: Now 20 measurements to choose from.

Version 5.20: Lets you specify the maximum number of histogram bins along with the measurement source.

:FUNCTION<F>:MINimum

Command :FUNCTION<F>:MINimum <operand>

The :FUNCTION<F>:MINimum command defines a function that computes the minimum of each time bucket for the defined operand's waveform.

<F> An integer, 1-16, representing the selected function.

<operand> {CHANnel<n> | DIFF<D> | COMMONmode<C> | FUNCTION<F> | WMEMory<n> | <float_value> | MTRend | MSPectrum}

See the discussion of possible operands in the introduction to [Chapter 19](#), "Function Commands," starting on page 493.

Example This example sets up function 2 to compute the minimum of each time bucket for channel 4.

```
myScope.WriteString ":FUNCTION2:MINimum CHANnel4"
```

History Legacy command (existed before version 3.10).

Version 4.30: Up to 16 functions supported.

:FUNction<F>:MLOG

Command :FUNction<F>:MLOG {MEAS1 | MEAS2 | MEAS3 | ... | MEAS20}

The :FUNction<F>:MLOG command adds a function waveform that is a scrolling record of measurement values over time.

<F> An integer, 1-16, representing the selected function.

See Also · [":FUNction<F>:MTRend"](#) on page 539

History New in version 6.00.

:FUNCTION<F>:MTRend

Command :FUNCTION<F>:MTRend {MEAS1 | MEAS2 | MEAS3 | ... | MEAS20}

The :FUNCTION<F>:MTRend command adds a Meas Trend function that shows measurement values for a waveform (based on measurement threshold settings) as the waveform progresses across the screen. For every cycle, a measurement is made, and the value is displayed on the screen for the cycle.

If a measurement cannot be made for part of a waveform, the trend function output is a hole (that is, no value) until a measurement can be made.

<F> An integer, 1-16, representing the selected function.

Example This example sets up a trend function of the first measurement.

```
myScope.WriteString ":FUNCTION2:MTRend MEAS1"
```

History New in version 3.50.

Version 4.30: Up to 16 functions supported.

Version 5.00: Now 20 measurements to choose from.

:FUNCTION<F>:MULTIPLY

Command :FUNCTION<F>:MULTIPLY <operand>, <operand>

The :FUNCTION<F>:MULTIPLY command defines a function that algebraically multiplies the first operand by the second operand.

<F> An integer, 1-16, representing the selected function.

<operand> {CHANnel<n> | DIFF<D> | COMMONmode<C> | FUNCTION<F> | WMEMory<n> | <float_value> | MTRend | MSPectrum}

See the discussion of possible operands in the introduction to [Chapter 19](#), "Function Commands," starting on page 493.

Example This example defines a function that multiplies channel 1 by waveform memory 1.

```
myScope.WriteString ":FUNCTION1:MULTIPLY CHANnel1, WMEMory1"
```

History Legacy command (existed before version 3.10).

Version 4.30: Up to 16 functions supported.

:FUNCTION<F>:OFFSet

Command :FUNCTION<F>:OFFSet <offset_value>

The :FUNCTION<F>:OFFSet command sets the voltage represented at the center of the screen for the selected function. This automatically changes the mode from auto to manual.

<F> An integer, 1-16, representing the selected function.

<offset_value> A real number for the vertical offset in the currently selected Y-axis units (normally volts). The offset value is limited to being within the vertical range that can be represented by the function data.

Example This example sets the offset voltage for function 1 to 2 mV.

```
myScope.WriteString ":FUNCTION1:OFFSet 2E-3"
```

Query :FUNCTION<F>:OFFSet?

The :FUNCTION<F>:OFFSet? query returns the current offset value for the selected function.

Returned Format [:FUNCTION<F>:OFFSet] <offset_value><NL>

Example This example places the current setting for offset on function 2 in the numeric variable, varValue, then prints the result to the computer's screen.

```
myScope.WriteString ":SYSTEM:HEADer OFF" ' Response headers off.
myScope.WriteString ":FUNCTION2:OFFSet?"
varValue = myScope.ReadNumber
Debug.Print FormatNumber(varValue, 0)
```

History Legacy command (existed before version 3.10).

Version 4.30: Up to 16 functions supported.

:FUNction<F>:RANGe

Command `:FUNction<F>:RANGe <full_scale_range>`

The `:FUNction<F>:RANGe` command defines the full-scale vertical axis of the selected function. This automatically changes the mode from auto to manual.

<F> An integer, 1-16, representing the selected function.

<full_scale_range> A real number for the full-scale vertical range, from -100E15 to 100E15.

Example This example sets the full-scale range for function 1 to 400 mV.

```
myScope.WriteString ":FUNction1:RANGe 400E-3"
```

Query `:FUNction<F>:RANGe?`

The `:FUNction<F>:RANGe?` query returns the current full-scale range setting for the specified function.

Returned Format `[:FUNction<F>:RANGe] <full_scale_range><NL>`

Example This example places the current range setting for function 2 in the numeric variable "varValue", then prints the contents to the computer's screen.

```
myScope.WriteString ":SYSTem:HEADer OFF"    ' Response headers off.
myScope.WriteString ":FUNction2:RANGe?"
varValue = myScope.ReadNumber
Debug.Print FormatNumber(varValue, 0)
```

History Legacy command (existed before version 3.10).

Version 4.30: Up to 16 functions supported.

:FUNCTION<F>:SMOoth

Command :FUNCTION<F>:SMOoth <operand> [, <points>]

The :FUNCTION<F>:SMOoth command defines a function that assigns the smoothing operator to the operand with the number of specified smoothing points.

<F> An integer, 1-16, representing the selected function.

<operand> {CHANnel<n> | DIFF<D> | COMMONmode<C> | FUNCTION<F> | WMEMory<n> | <float_value> | MTRend | MSPectrum}

See the discussion of possible operands in the introduction to [Chapter 19](#), "Function Commands," starting on page 493.

<points> An integer, odd numbers from 3 to 4001 specifying the number of smoothing points.

Example This example sets up function 1 using assigning smoothing operator to channel 1 using 5 smoothing points.

```
myScope.WriteString ":FUNCTION1:SMOoth CHANnel1,5"
```

History Legacy command (existed before version 3.10).

Version 4.30: Up to 16 functions supported.

:FUNction<F>:SQRT

Command :FUNction<F>:SQRT <operand>

The :FUNction<F>:SQRT command takes the square root of the operand.

<operand> {CHANnel<N> | DIFF<D> | COMMONmode<C> | FUNction<F> | WMEMory<R> | MTRend | MSPectrum}

See the discussion of possible operands in the introduction to [Chapter 19](#), “Function Commands,” starting on page 493.

Example This example turns on the square root function using channel 3.

```
myScope.WriteString ":FUNCTION1:SQRT CHANNEL3"
```

History Legacy command (existed before version 3.10).

Version 4.30: Up to 16 functions supported.

:FUNction<F>:SQUare

Command :FUNction<F>:SQUare <operand>

The :FUNction<F>:SQUare command takes the square value of the operand.

<operand> {CHANnel<N> | DIFF<D> | COMMONmode<C> | FUNction<F> | WMEMory<R> | MTRend | MSPectrum}

See the discussion of possible operands in the introduction to [Chapter 19](#), “Function Commands,” starting on page 493.

Example This example turns on the square value command using channel 3.

```
myScope.WriteString ":FUNction1:SQUare CHANnel3"
```

History Legacy command (existed before version 3.10).

Version 4.30: Up to 16 functions supported.

:FUNCTION<F>:SUBTRACT

Command :FUNCTION<F>:SUBTRACT <operand>, <operand>

The :FUNCTION<F>:SUBTRACT command defines a function that algebraically subtracts the second operand from the first operand.

<F> An integer, 1-16, representing the selected function.

<operand> {CHANNEL<n> | DIFF<D> | COMMONmode<C> | FUNCTION<F> | WMEMORY<n> | <float_value> | MTRend | MSPpectrum}

See the discussion of possible operands in the introduction to [Chapter 19](#), “Function Commands,” starting on page 493.

Example This example defines a function that subtracts waveform memory 1 from channel 1.

```
myScope.WriteString ":FUNCTION1:SUBTRACT CHANNEL1,WMEMORY1"
```

History Legacy command (existed before version 3.10).

Version 4.30: Up to 16 functions supported.

:FUNCTION<F>:VERSUS

Command :FUNCTION<F>:VERSUS <operand>, <operand>

The :FUNCTION<F>:VERSUS command defines a function for an X-versus-Y display. The first operand defines the Y axis and the second defines the X axis. The Y-axis range and offset are initially equal to that of the first operand, and you can adjust them with the RANGE and OFFSET commands in this subsystem.

<F> An integer, 1-16, representing the selected function.

<operand> {CHANNEL<n> | DIFF<D> | COMMONmode<C> | FUNCTION<F> | WMEMORY<n> | <float_value> | MTRend | MSPpectrum}

See the discussion of possible operands in the introduction to [Chapter 19](#), "Function Commands," starting on page 493.

Example This example defines function 1 as an X-versus-Y display. Channel 1 is the X axis and waveform memory 2 is the Y axis.

```
myScope.WriteString ":FUNCTION1:VERSUS WMEMORY2, CHANNEL1"
```

History Legacy command (existed before version 3.10).

Version 4.30: Up to 16 functions supported.

:FUNction<F>:VERTical

Command :FUNction<F>:VERTical {AUTO | MANual}

The :FUNction<F>:VERTical command sets the vertical scaling mode of the specified function to either AUTO or MANual.

This command also contains the following commands and queries:

- OFFset
- RANge

<F> An integer, 1-16, representing the selected function.

Query :FUNction<F>:VERTical?

The :FUNction<F>:VERTical? query returns the current vertical scaling mode of the specified function.

Returned Format [:FUNction<F>:VERTical] {AUTO | MANual}<NL>

Example This example places the current state of the vertical tracking of function 1 in the string variable, strSetting, then prints the contents of the variable to the computer's screen.

```
Dim strSetting As String ' Dimension variable.
myScope.WriteString ":FUNction1:VERTical?"
strSetting = myScope.ReadString
Debug.Print strSetting
```

History Legacy command (existed before version 3.10).

Version 4.30: Up to 16 functions supported.

:FUNCTION<F>:VERTICAL:OFFSET

Command :FUNCTION<F>:VERTICAL:OFFSET <offset_value>

The :FUNCTION<F>:VERTICAL:OFFSET command sets the voltage represented at center screen for the selected function. This automatically changes the mode from auto to manual.

<F> An integer, 1-16, representing the selected function.

<offset_value> A real number for the vertical offset in the currently selected Y-axis units (normally volts). The offset value is limited only to being within the vertical range that can be represented by the function data.

Query :FUNCTION<F>:VERTICAL:OFFSET?

The :FUNCTION<F>:VERTICAL:OFFSET? query returns the current offset value of the selected function.

Returned Format [:FUNCTION<F>:VERTICAL:OFFSET] <offset_value><NL>

Example This example places the current offset setting for function 2 in the numeric variable, varValue, then prints the contents to the computer's screen.

```
myScope.WriteString ":SYSTEM:HEADER OFF" ' Response headers off.
myScope.WriteString ":FUNCTION2:VERTICAL:OFFSET?"
varValue = myScope.ReadNumber
Debug.Print FormatNumber(varValue, 0)
```

History Legacy command (existed before version 3.10).

Version 4.30: Up to 16 functions supported.

:FUNCTION<F>:VERTICAL:RANGE

Command :FUNCTION<F>:VERTICAL:RANGE <full_scale_range>

The :FUNCTION<F>:VERTICAL:RANGE command defines the full-scale vertical axis of the selected function. This automatically changes the mode from auto to manual, if the oscilloscope is not already in manual mode.

<F> An integer, 1-16, representing the selected function.

<full_scale_range> A real number for the full-scale vertical range, from -100E15 to 100E15.

Query :FUNCTION<F>:VERTICAL:RANGE?

The :FUNCTION<F>:VERTICAL:RANGE? query returns the current range setting of the specified function.

Returned Format [:FUNCTION<F>:VERTICAL:RANGE] <range><NL>

Example This example places the current vertical range setting of function 2 in the numeric variable, varValue, then prints the contents to the computer's screen.

```
myScope.WriteString ":SYSTEM:HEADER OFF" ' Response headers off.
myScope.WriteString ":FUNCTION2:VERTICAL:RANGE?"
varValue = myScope.ReadNumber
Debug.Print FormatNumber(varValue, 0)
```

History Legacy command (existed before version 3.10).

Version 4.30: Up to 16 functions supported.

20 Hardcopy Commands

:HARDcopy:AREA / 552

:HARDcopy:DPRinter / 553

:HARDcopy:FACTors / 554

:HARDcopy:IMAGe / 555

:HARDcopy:PRINters? / 556

The HARDcopy subsystem commands set various parameters for printing the screen. The print sequence is activated when the root level command :PRINT is sent.

:HARDcopy:AREA

Command :HARDcopy:AREA {GRATicule | SCReen}

The :HARDcopy:AREA command selects which data from the screen is to be printed. When you select GRATicule, only the graticule area of the screen is printed (this is the same as choosing Waveforms Only in the Configure Printer dialog box). When you select SCReen, the entire screen is printed.

Example This example selects the graticule for printing.

```
myScope.WriteString ":HARDcopy:AREA GRATicule"
```

Query :HARDcopy:AREA?

The :HARDcopy:AREA? query returns the current setting for the area of the screen to be printed.

Returned Format [:HARDcopy:AREA] {GRATicule | SCReen}<NL>

Example This example places the current selection for the area to be printed in the string variable, strSelection, then prints the contents of the variable to the computer's screen.

```
Dim strSelection As String ' Dimension variable.
myScope.WriteString ":HARDcopy:AREA?"
strSelection = myScope.ReadString
Debug.Print strSelection
```

History Legacy command (existed before version 3.10).

:HARDcopy:DPRinter

Command :HARDcopy:DPRinter {<printer_number> | <printer_string>}

The :HARDcopy:DPRinter command selects the default printer to be used.

<printer_number> An integer representing the attached printer. This number corresponds to the number returned with each printer name by the :HARDcopy:PRINTers? query.

<printer_string> A string of alphanumeric characters representing the attached printer.

The :HARDcopy:DPRinter command specifies a number or string for the printer attached to the oscilloscope. The printer string must exactly match the character strings in the File->Print Setup dialog boxes, or the strings returned by the :HARDcopy:PRINTers? query.

Examples This example sets the default printer to the second installed printer returned by the :HARDcopy:PRINTers? query.

```
myScope.WriteString ":HARDcopy:DPRinter 2"
```

This example sets the default printer to the installed printer with the name "HP Laser".

```
myScope.WriteString ":HARDcopy:DPRinter \"HP Laser\""
```

Query :HARDcopy:DPRinter?

The :HARDcopy:DPRinter? query returns the current printer number and string.

Returned Format [:HARDcopy:DPRinter?] {<printer_number>,<printer_string>,DEFAULT}<NL>

Or, if there is no default printer (no printers are installed), only a <NL> is returned.

Example This example places the current setting for the hard copy printer in the string variable, strSetting, then prints the contents of the variable to the computer's screen.

```
Dim strSetting As String ' Dimension variable.
myScope.WriteString ":HARDcopy:DPRinter?"
strSetting = myScope.ReadString
Debug.Print strSetting
```

NOTE

It takes several seconds to change the default printer. Any programs that try to set the default printer must wait (10 seconds is a safe amount of time) for the change to complete before sending other commands. Otherwise, the oscilloscope will become unresponsive.

History Legacy command (existed before version 3.10).

:HARDcopy:FACTors

Command :HARDcopy:FACTors {{ON | 1} | {OFF | 0}}

The :HARDcopy:FACTors command determines whether the oscilloscope setup factors will be appended to screen or graticule images. FACTors ON is the same as choosing Include Setup Information in the Configure Printer dialog box.

Example This example turns on the setup factors.

```
myScope.WriteString ":HARDcopy:FACTors ON"
```

Query :HARDcopy:FACTors?

The :HARDcopy:FACTors? query returns the current setup factors setting.

Returned Format [:HARDcopy:FACTors] {1 | 0}<NL>

Example This example places the current setting for the setup factors in the string variable, strSetting, then prints the contents of the variable to the computer's screen.

```
Dim strSetting As String ' Dimension variable.
myScope.WriteString ":HARDcopy:FACTors?"
strSetting = myScope.ReadString
Debug.Print strSetting
```

History Legacy command (existed before version 3.10).

:HARDcopy:IMAGe

Command :HARDcopy:IMAGe {NORMal | INVert}

The :HARDcopy:IMAGe command prints the image normally, inverted, or in monochrome. IMAGe INVert is the same as choosing Invert Waveform Colors in the Configure Printer dialog box.

Example This example sets the hard copy image output to normal.

```
myScope.WriteString ":HARDcopy:IMAGe NORMal"
```

Query :HARDcopy:IMAGe?

The :HARDcopy:IMAGe? query returns the current image setting.

Returned Format [:HARDcopy:IMAGe] {NORMal | INVert}<NL>

Example This example places the current setting for the hard copy image in the string variable, strSetting, then prints the contents of the variable to the computer's screen.

```
Dim strSetting As String ' Dimension variable.
myScope.WriteString ":HARDcopy:IMAGe?"
strSetting = myScope.ReadString
Debug.Print strSetting
```

History Legacy command (existed before version 3.10).

:HARDcopy:PRINTers?

Query :HARDcopy:PRINTers?

The :HARDcopy:PRINTers? query returns the currently available printers.

Returned Format [:HARDcopy:PRINTers?]
<printer_count><NL><printer_data><NL>[,<printer_data><NL>]

<printer_count> The number of printers currently installed.

<printer_data> The printer number and the name of an installed printer. The word DEFAULT appears next to the printer that is the currently selected default printer.

The <printer_data> return string has the following format:
<printer_number>,<printer_string>{,DEFAULT}

Example This example places the number of installed printers into the variable varCount, loops through it that number of times, and prints the installed printer names to the computer's screen.

```
Dim varResults As Variant
Dim lngI As Long

myScope.WriteString ":HARDcopy:PRINTers?"
varResults = myScope.ReadList(ASCIIType_BSTR, vbLf)
Debug.Print FormatNumber(varResults(0), 0)

For lngI = 1 To varResults(0)
    Debug.Print CStr(varResults(lngI))
Next lngI
```

History Legacy command (existed before version 3.10).

21 Histogram Commands

:HISTogram:AXIS / 559
:HISTogram:HORizontal:BINS / 560
:HISTogram:MEASurement:BINS / 561
:HISTogram:MODE / 562
:HISTogram:SCALE:SIZE / 563
:HISTogram:VERTical:BINS / 564
:HISTogram:WINDow:DEFault / 565
:HISTogram:WINDow:SOURce / 566
:HISTogram:WINDow:LLIMit / 567
:HISTogram:WINDow:RLIMit / 568
:HISTogram:WINDow:BLIMit / 569
:HISTogram:WINDow:TLIMit / 570

The HISTogram commands and queries control the histogram features. A histogram is a probability distribution that shows the distribution of acquired data within a user-definable histogram window.

You can display the histogram either vertically, for voltage measurements, or horizontally, for timing measurements.

The most common use for histograms is measuring and characterizing noise or jitter on displayed waveforms. Noise is measured by sizing the histogram window to a narrow portion of time and observing a vertical histogram that measures the noise on a waveform. Jitter is measured by sizing the histogram window to a narrow portion of voltage and observing a horizontal histogram that measures the jitter on an edge.

Histograms and the database

The histograms, mask testing, and color grade persistence use a specific database that uses a different memory area from the waveform record for each channel. When any of these features are turned on, the oscilloscope starts building the database. The database is the size of the graticule area. Behind each pixel is a 21-bit counter that is incremented each time data from a channel or function hits a pixel. The maximum count (saturation) for each counter is 2,097,151. You can use the DISPlay:CGRade:LEVels command to see if any of the counters are close to saturation.

The database continues to build until the oscilloscope stops acquiring data or all both features (color grade persistence and histograms) are turned off. You can clear the database by turning off all three features that use the database.

The database does not differentiate waveforms from different channels or functions. If three channels are on and the waveform from each channel happens to light the same pixel at the same time, the counter is incremented by three. However, it is not possible to tell how many hits came from each waveform. To separate waveforms, you can position the waveforms vertically with the channel offset. By separating the waveforms, you can avoid overlapping data in the database caused by multiple waveforms. Even if the display is set to show only the most recent acquisition, the database keeps track of all pixel hits while the database is building.

Remember that color grade persistence, mask testing, and histograms all use the same database. Suppose that the database is building because color grade persistence is ON; when mask testing or histograms are turned on, they can use the information already established in the database as though they had been turned on the entire time.

To avoid erroneous data, clear the display after you change oscilloscope setup conditions or DUT conditions and acquire new data before extracting measurement results.

:HISTogram:AXIS

Command :HISTogram:AXIS {VERTical | HORizontal}

The :HISTogram:AXIS command selects the type of histogram. A horizontal histogram can be used to measure time related information like jitter. A vertical histogram can be used to measure voltage related information like noise.

Example This example defines a vertical histogram.

```
myScope.WriteString ":HISTogram:AXIS VERTical"
```

Query :HISTogram:AXIS?

The :HISTogram:AXIS? query returns the currently selected histogram type.

Returned Format [:HISTogram:AXIS] {VERTical | HORizontal}<NL>

Example This example returns the histogram type and prints it to the computer's screen.

```
Dim strAxis As String
myScope.WriteString ":HISTogram:AXIS?"
strAxis = myScope.ReadString
Debug.Print strAxis
```

History Legacy command (existed before version 3.10).

:HISTogram:HORizontal:BINs

Command :HISTogram:HORizontal:BINs <max_bins>

<max_bins> ::= integer from 10-1280

The :HISTogram:HORizontal:BINs command sets the maximum number of bins used for a horizontal waveform histogram.

Query :HISTogram:HORizontal:BINs?

The :HISTogram:HORizontal:BINs? query returns the maximum number of bins setting.

Returned Format <max_bins><NL>

<max_bins> ::= integer from 10-1280

- See Also**
- **":HISTogram:MODE"** on page 562
 - **":HISTogram:AXIS"** on page 559
 - **":HISTogram:MEASurement:BINs"** on page 561
 - **":HISTogram:VERTical:BINs"** on page 564

History New in version 5.20.

:HISTogram:MEASurement:BINs

Command :HISTogram:MEASurement:BINs <max_bins>

<max_bins> ::= integer from 10-1280

The :HISTogram:MEASurement:BINs command sets the maximum number of bins used for a measurement histogram.

Query :HISTogram:MEASurement:BINs?

The :HISTogram:MEASurement:BINs? query returns the maximum number of bins setting.

Returned Format <max_bins><NL>

<max_bins> ::= integer from 10-1280

- See Also**
- **":HISTogram:MODE"** on page 562
 - **":HISTogram:AXIS"** on page 559
 - **":HISTogram:HORizontal:BINs"** on page 560
 - **":HISTogram:VERTical:BINs"** on page 564

History New in version 5.20.

:HISTogram:MODE

Command :HISTogram:MODE {OFF | MEASurement | WAVeforms}

NOTE

The MEASurement parameter is only available when the E2681A Jitter Analysis option is installed.

The :HISTogram:MODE command selects the histogram mode. The histogram may be off, set to track the waveforms, or set to track the measurement when the E2681A Jitter Analysis Software is installed. When the E2681A Jitter Analysis Software is installed, sending the :MEASure:JITTer:HISTogram ON command will automatically set :HISTogram:MODE to MEASurement.

Example This example sets the histogram mode to track the waveform.

```
myScope.WriteString ":HISTogram:MODE WAVeform"
```

Query :HISTogram:MODE?

The :HISTogram:MODE? query returns the currently selected histogram mode.

Returned Format [:HISTogram:MODE] {OFF | MEASurement | WAVeform}<NL>

Example This example returns the result of the mode query and prints it to the computer's screen.

```
Dim strMode As String
myScope.WriteString ":HISTogram:MODE?"
strMode = myScope.ReadString
Debug.Print strMode
```

History Legacy command (existed before version 3.10).

:HISTogram:SCALE:SIZE

Command :HISTogram:SCALE:SIZE <size>

The :HISTogram:SCALE:SIZE command sets histogram size for vertical and horizontal mode.

<size> The size is from 1.0 to 8.0 for the horizontal mode and from 1.0 to 10.0 for the vertical mode.

Example This example sets the histogram size to 3.5.

```
myScope.WriteString ":HISTogram:SCALE:SIZE 3.5"
```

Query :HISTogram:SCALE:SIZE?

The :HISTogram:SCALE:SIZE? query returns the correct size of the histogram.

Returned Format [:HISTogram:SCALE:SIZE] <size><NL>

Example This example returns the result of the size query and prints it to the computer's screen.

```
Dim strSize As String
myScope.WriteString ":HISTogram:SCALE:SIZE?"
strSize = myScope.ReadString
Debug.Print strSize
```

History Legacy command (existed before version 3.10).

:HISTogram:VERTical:BINS

Command :HISTogram:VERTical:BINS <max_bins>

<max_bins> ::= integer from 10-1280

The :HISTogram:VERTical:BINS command sets the maximum number of bins used for a vertical waveform histogram.

Query :HISTogram:VERTical:BINS?

The :HISTogram:VERTical:BINS? query returns the maximum number of bins.

Returned Format <max_bins><NL>

<max_bins> ::= integer from 10-1280

- See Also**
- [":HISTogram:MODE"](#) on page 562
 - [":HISTogram:AXIS"](#) on page 559
 - [":HISTogram:HORizontal:BINS"](#) on page 560
 - [":HISTogram:MEASurement:BINS"](#) on page 561

History New in version 5.20.

:HISTogram:WINDow:DEFault

Command :HISTogram:WINDow:DEFault

The :HISTogram:WINDow:DEFault command positions the histogram markers to a default location on the display. Each marker will be positioned one division off the left, right, top, and bottom of the display.

Example This example sets the histogram window to the default position.

```
myScope.WriteString ":HISTogram:WINDow:DEFault"
```

History Legacy command (existed before version 3.10).

:HISTogram:WINDow:SOURce

Command :HISTogram:WINDow:SOURce {CHANnel<N> | DIFF<D> | COMMONmode<C>
| FUNction<F> | WMEMory<R> | CLOCk | EQUalized | MTRend | MSPectrum}

The :HISTogram:WINDow:SOURce command selects the source of the histogram window. The histogram window will track the source's vertical and horizontal scale.

<N> An integer, 1-4 in a single oscilloscope, 1-40 in a MultiScope system.

<D>, <C> <D> is an integer, 1-2. <C> is an integer, 3-4.

The DIFF and COMMONmode sources are just aliases that can be used in place of the channel names to apply to differential or common mode signals. These are just aliases - no state change occurs if you refer to a differential channel and you are not in differential mode. DIFF1 refers to the differential signal between channels 1 and 3 (and COMMONmode3 refers to the common mode channel between these same channels). DIFF2 refers to the differential signal between channels 2 and 4 (and COMMONmode4 refers to the common mode channel between these same channels).

<F> An integer, 1-16.

<R> An integer, 1-4.

Example This example sets the histogram window's source to Channel 1.

```
myScope.WriteString ":HISTogram:WINDow:SOURce CHANnel1"
```

Query :HISTogram:WINDow:SOURce?

The :HISTogram:WINDow:SOURce? query returns the currently selected histogram window source.

Returned Format [:HISTogram:WINDow:SOURce] {CHAN<N> | DIFF<D> | COMM<C> | FUNC<F>
| WMEM<N> | CLOC | EQU | MTR | MSP}<NL>

Example This example returns the result of the window source query and prints it to the computer's screen.

```
Dim strWinsour As String
myScope.WriteString ":HISTogram:WINDow:SOURce?"
strWinsour = myScope.ReadString
Debug.Print strWinsour
```

History Legacy command (existed before version 3.10).

:HISTogram:WINDow:LLIMit

Command :HISTogram:WINDow:LLIMit <left_limit>

The :HISTogram:WINDow:LLIMit command moves the Ax marker (left limit) of the histogram window. The histogram window determines the portion of the display used to build the database for the histogram. The histogram window markers will track the scale of the histogram window source.

<left_limit> A real number that represents the left boundary of the histogram window.

Example This example sets the left limit position to -200 microseconds.

```
myScope.WriteString ":HISTogram:WINDow:LLIMit -200E-6"
```

Query :HISTogram:WINDow:LLIMit?

The :HISTogram:WINDow:LLIMit? query returns the value of the left limit histogram window marker.

Returned Format [:HISTogram:WINDow:LLIMit] <left_limit><NL>

Example This example returns the result of the left limit position query and prints it to the computer's screen.

```
Dim strLL As String
myScope.WriteString ":HISTogram:WINDow:LLIMit?"
strLL = myScope.ReadString
Debug.Print strLL
```

History Legacy command (existed before version 3.10).

:HISTogram:WINDow:RLIMit

Command : **HISTogram:WINDow:RLIMit** <right_limit>

The :HISTogram:WINDow:RLIMit command moves the Bx marker (right limit) of the histogram window. The histogram window determines the portion of the display used to build the database used for the histogram. The histogram window markers will track the scale of the histogram window source.

<right_limit> A real number that represents the right boundary of the histogram window.

Example This example sets the Bx marker to 200 microseconds.

```
myScope.WriteString ":HISTogram:WINDow:RLIMit 200E-6"
```

Query : **HISTogram:WINDow:RLIMit?**

The :HISTogram:WINDow:RLIMit? query returns the value of the right histogram window marker.

Returned Format [:HISTogram:WINDow:RLIMit] <right_limit><NL>

Example This example returns the result of the Bx position query and prints it to the computer's screen.

```
Dim strRL As String
myScope.WriteString ":HISTogram:WINDow:RLIMit?"
strRL = myScope.ReadString
Debug.Print strRL
```

History Legacy command (existed before version 3.10).

:HISTogram:WINDow:BLIMit

Command :HISTogram:WINDow:BLIMit <bottom_limit>

The :HISTogram:WINDow:BLIMit command moves the Ay marker (bottom limit) of the histogram window. The histogram window determines the portion of the display used to build the database used for the histogram. The histogram window markers will track the scale of the histogram window source.

<bottom_limit> A real number that represents the bottom boundary of the histogram window.

Example This example sets the position of the Ay marker to -250 mV.

```
myScope.WriteString ":HISTogram:WINDow:BLIMit -250E-3"
```

Query :HISTogram:WINDow:BLIMit?

The :HISTogram:WINDow:BLIMit? query returns the value of the Ay histogram window marker.

Returned Format [:HISTogram:WINDow:BLIMit] <bottom_limit><NL>

Example This example returns the result of the Ay position query and prints it to the computer's screen.

```
Dim strBL As String
myScope.WriteString ":HISTogram:WINDow:BLIMit?"
strBL = myScope.ReadString
Debug.Print strBL
```

History Legacy command (existed before version 3.10).

:HISTogram:WINDow:TLIMit

Command :HISTogram:WINDow:TLIMit <top_limit>

The :HISTogram:WINDow:TLIMit command moves the By marker (top limit) of the histogram window. The histogram window determines the portion of the display used to build the database used for the histogram. The histogram window markers will track the scale of the histogram window source.

<top_limit> A real number that represents the top boundary of the histogram window.

Example This example sets the position of the By marker to 250 mV.

```
myScope.WriteString ":HISTogram:WINDow:TLIMit 250E-3"
```

Query :HISTogram:WINDow:TLIMit?

The :HISTogram:WINDow:TLIMit? query returns the value of the By histogram window marker.

Returned Format [:HISTogram:WINDow:TLIMit] <top_limit><NL>

Example This example returns the result of the By position query and prints it to the computer's screen.

```
Dim strTL As String
myScope.WriteString ":HISTogram:WINDow:TLIMit?"
strTL = myScope.ReadString
Debug.Print strTL
```

History Legacy command (existed before version 3.10).

22 Hosted Commands

:HOSTed:CALibrate:CALibrate / 573
:HOSTed:CALibrate:CHANnel / 574
:HOSTed:CALibrate:DESKew:CHANnels / 575
:HOSTed:CALibrate:DESKew:FRAMes / 576
:HOSTed:CALibrate:DESKew:SIGNals / 577
:HOSTed:CALibrate:DESKew:ZERO / 578
:HOSTed:CALibrate:LEVel / 579
:HOSTed:CALibrate:PROMpt / 581
:HOSTed:CALibrate:STATus:CHANnels? / 582
:HOSTed:CALibrate:STATus:FRAMes? / 583
:HOSTed:CALibrate:STATus:LEVel? / 584
:HOSTed:CALibrate:STATus:SIGNals? / 585
:HOSTed:CALibrate:TREF:DETECT / 586
:HOSTed:FOLLower<N>:ACHannels? / 587
:HOSTed:FOLLower<N>:CONFigure / 588
:HOSTed:FOLLower<N>:CONNect / 589
:HOSTed:FOLLower<N>:DISConnect / 590
:HOSTed:LEADer:ACHannels? / 591
:HOSTed:LEADer:CONFigure / 592
:HOSTed:LEADer:CONNect / 593
:HOSTed:LEADer:DISConnect / 594
:HOSTed:NCONnected? / 595
:HOSTed:PERiodic / 596

The commands in the HOSTed subsystem are used to configure and manage the list of oscilloscopes in a MultiScope system.

MultiScope systems can combine up to 10 Infiniium oscilloscopes to create an oscilloscope system with up to 40 time-synchronized channels.

In a MultiScope system, oscilloscopes are connected in daisy-chain configuration where the reference clock output of the Leader oscilloscope is connected to the reference clock input of the Follower 1 oscilloscope and the trigger output of the Leader oscilloscope is connected to the auxiliary trigger input of the Follower 1 oscilloscope, and so on. A calibration signal from one of the Follower 1 oscilloscopes is split and fed into a channel input on all the oscilloscopes to set up time-correlation.

For more information on MultiScope systems, see:

- The *Keysight MultiScope Hardware Configuration Guide*.
- The online help in the Infiniium Offline software.

:HOSTed:CALibrate:CALibrate

Command :HOSTed:CALibrate:CALibrate

The :HOSTed:CALibrate:CALibrate command performs the MultiScope system time-correlation calibration at the level selected by :HOSTed:CALibrate:LEVel.

This command does nothing when the MANual level is selected.

To get the status of the calibration, use the :HOSTed:CALibrate:STATus:LEVel? query.

- See Also**
- [":HOSTed:CALibrate:CHANnel"](#) on page 574
 - [":HOSTed:CALibrate:DESKew:FRAMes"](#) on page 576
 - [":HOSTed:CALibrate:DESKew:CHANnels"](#) on page 575
 - [":HOSTed:CALibrate:DESKew:SIGNals"](#) on page 577
 - [":HOSTed:CALibrate:DESKew:ZERO"](#) on page 578
 - [":HOSTed:CALibrate:LEVel"](#) on page 579
 - [":HOSTed:CALibrate:PROMpt"](#) on page 581
 - [":HOSTed:CALibrate:STATus:CHANnels?"](#) on page 582
 - [":HOSTed:CALibrate:STATus:FRAMes?"](#) on page 583
 - [":HOSTed:CALibrate:STATus:LEVel?"](#) on page 584
 - [":HOSTed:CALibrate:STATus:SIGNals?"](#) on page 585
 - [":HOSTed:CALibrate:TREF:DETECT"](#) on page 586

History New in version 5.50.

:HOSTed:CALibrate:CHANnel

Command :HOSTed:CALibrate:CHANnel <source>

<source> ::= CHANnel<N>

The :HOSTed:CALibrate:CHANnel command selects the calibration channel or synchronization input where the MultiScope system time-correlation procedures expect to find the calibration signal.

This signal comes from the Follower 1 oscilloscope's calibrator output and is split and fed into the calibration channel on each oscilloscope in the MultiScope system.

<N> An integer, 1–4.

Query :HOSTed:CALibrate:CHANnel?

The :HOSTed:CALibrate:CHANnel? query returns the selected the calibration channel or synchronization input.

Returned Format [:HOSTed:CALibrate:CHANnel] <source><NL>

<source> ::= CHAN<N>

- See Also**
- [":HOSTed:CALibrate:CALibrate"](#) on page 573
 - [":HOSTed:CALibrate:DESKew:FRAMes"](#) on page 576
 - [":HOSTed:CALibrate:DESKew:CHANnels"](#) on page 575
 - [":HOSTed:CALibrate:DESKew:SIGNals"](#) on page 577
 - [":HOSTed:CALibrate:DESKew:ZERO"](#) on page 578
 - [":HOSTed:CALibrate:LEVel"](#) on page 579
 - [":HOSTed:CALibrate:PROMpt"](#) on page 581
 - [":HOSTed:CALibrate:STATus:CHANnels?"](#) on page 582
 - [":HOSTed:CALibrate:STATus:FRAMes?"](#) on page 583
 - [":HOSTed:CALibrate:STATus:LEVel?"](#) on page 584
 - [":HOSTed:CALibrate:STATus:SIGNals?"](#) on page 585
 - [":HOSTed:CALibrate:TREF:DETECT"](#) on page 586

History New in version 5.50.

:HOSTed:CALibrate:DESKew:CHANnels

Command :HOSTed:CALibrate:DESKew:CHANnels

The :HOSTed:CALibrate:DESKew:CHANnels command deskews all channels in the MultiScope system. The calibration process prompts you to connect the Leader oscilloscope's Cal Out signal to each of the system's input channels in turn.

To get the status of the calibration, use the :HOSTed:CALibrate:STATus:CHANnels? query.

- See Also**
- [":HOSTed:CALibrate:CALibrate"](#) on page 573
 - [":HOSTed:CALibrate:CHANnel"](#) on page 574
 - [":HOSTed:CALibrate:DESKew:FRAMes"](#) on page 576
 - [":HOSTed:CALibrate:DESKew:SIGNals"](#) on page 577
 - [":HOSTed:CALibrate:DESKew:ZERO"](#) on page 578
 - [":HOSTed:CALibrate:LEVel"](#) on page 579
 - [":HOSTed:CALibrate:PROMpt"](#) on page 581
 - [":HOSTed:CALibrate:STATus:CHANnels?"](#) on page 582
 - [":HOSTed:CALibrate:STATus:FRAMes?"](#) on page 583
 - [":HOSTed:CALibrate:STATus:LEVel?"](#) on page 584
 - [":HOSTed:CALibrate:STATus:SIGNals?"](#) on page 585
 - [":HOSTed:CALibrate:TREF:DETECT"](#) on page 586

History New in version 5.50.

:HOSTed:CALibrate:DESKew:FRAMes

Command :HOSTed:CALibrate:DESKew:FRAMes

The :HOSTed:CALibrate:DESKew:FRAMes command deskews frames in the MultiScope system by measuring only one input channel from each oscilloscope frame. It assumes that the skew of all channels within a single oscilloscope frame is the same since they were deskewed in production.

To get the status of the calibration, use the :HOSTed:CALibrate:STATus:FRAMes? query.

- See Also**
- [":HOSTed:CALibrate:CALibrate"](#) on page 573
 - [":HOSTed:CALibrate:CHANnel"](#) on page 574
 - [":HOSTed:CALibrate:DESKew:CHANnels"](#) on page 575
 - [":HOSTed:CALibrate:DESKew:SIGNals"](#) on page 577
 - [":HOSTed:CALibrate:DESKew:ZERO"](#) on page 578
 - [":HOSTed:CALibrate:LEVel"](#) on page 579
 - [":HOSTed:CALibrate:PROMpt"](#) on page 581
 - [":HOSTed:CALibrate:STATus:CHANnels?"](#) on page 582
 - [":HOSTed:CALibrate:STATus:FRAMes?"](#) on page 583
 - [":HOSTed:CALibrate:STATus:LEVel?"](#) on page 584
 - [":HOSTed:CALibrate:STATus:SIGNals?"](#) on page 585
 - [":HOSTed:CALibrate:TREF:DETECT"](#) on page 586

History New in version 5.50.

:HOSTed:CALibrate:DESKew:SIGNals

Command :HOSTed:CALibrate:DESKew:SIGNals

Given a common edge on configured channels in the MultiScope system, send the :HOSTed:CALibrate:DESKew:SIGNals command to align the horizontal positions of the closest rising edges of all input signals.

This is typically used for demonstration or quick verification purposes, but can also be a quick alternative to the system deskew process if your SUT (signals under test) are already connected and have the necessary rising edges.

To get the status of the calibration, use the :HOSTed:CALibrate:STATus:SIGNals? query.

- See Also**
- [":HOSTed:CALibrate:CALibrate"](#) on page 573
 - [":HOSTed:CALibrate:CHANnel"](#) on page 574
 - [":HOSTed:CALibrate:DESKew:FRAMes"](#) on page 576
 - [":HOSTed:CALibrate:DESKew:CHANnels"](#) on page 575
 - [":HOSTed:CALibrate:DESKew:ZERO"](#) on page 578
 - [":HOSTed:CALibrate:LEVel"](#) on page 579
 - [":HOSTed:CALibrate:PROMpt"](#) on page 581
 - [":HOSTed:CALibrate:STATus:CHANnels?"](#) on page 582
 - [":HOSTed:CALibrate:STATus:FRAMes?"](#) on page 583
 - [":HOSTed:CALibrate:STATus:LEVel?"](#) on page 584
 - [":HOSTed:CALibrate:STATus:SIGNals?"](#) on page 585
 - [":HOSTed:CALibrate:TREF:DETECT"](#) on page 586

History New in version 5.50.

:HOSTed:CALibrate:DESKew:ZERO

Command :HOSTed:CALibrate:DESKew:ZERO

The :HOSTed:CALibrate:DESKew:ZERO command resets MultiScope system signal skew values to zero.

This is provided as a convenience because the skew values are distributed across all channels of all oscilloscope frames and are not changed by setup recall or default setup. Factory default setup does set all skew values to zero, but it must be performed on all oscilloscope frames.

- See Also**
- [":HOSTed:CALibrate:CALibrate"](#) on page 573
 - [":HOSTed:CALibrate:CHANnel"](#) on page 574
 - [":HOSTed:CALibrate:DESKew:FRAMes"](#) on page 576
 - [":HOSTed:CALibrate:DESKew:CHANnels"](#) on page 575
 - [":HOSTed:CALibrate:DESKew:SIGNals"](#) on page 577
 - [":HOSTed:CALibrate:LEVel"](#) on page 579
 - [":HOSTed:CALibrate:PROMpt"](#) on page 581
 - [":HOSTed:CALibrate:STATus:CHANnels?"](#) on page 582
 - [":HOSTed:CALibrate:STATus:FRAMes?"](#) on page 583
 - [":HOSTed:CALibrate:STATus:LEVel?"](#) on page 584
 - [":HOSTed:CALibrate:STATus:SIGNals?"](#) on page 585
 - [":HOSTed:CALibrate:TREF:DETECT"](#) on page 586

History New in version 5.50.

:HOSTed:CALibrate:LEVel

Command :HOSTed:CALibrate:LEVel <level>
 <level> ::= {MANual | BASic | PRECision}

The :HOSTed:CALibrate:LEVel command selects the MultiScope system calibration level:

- **MANual** – No time-correlation calibration is performed. However, you can still:
 - Capture and view signals in the MultiScope system.
 - Phase-lock the timebase reference clocks of the oscilloscopes in the MultiScope system.
 - Input a calibration signal to the oscilloscopes and manually measure the time skew between oscilloscope frames.
 - Manually enter skew values for waveforms to align them in time.
- **BASic** – The time-correlation calibration procedure automates all the time calibration steps you could perform manually.

The calibration output from the Follower 1 oscilloscope is split and fed into the calibration channel on each oscilloscope in the MultiScope system.

After the basic calibration is performed, you can disconnect the calibration channel on each oscilloscope and use it as a normal input channel.

- **PRECision** – Select this calibration level if you want to perform jitter and drift time correction between the oscilloscopes in the MultiScope system. This calibration level gives you the highest time accuracy because jitter and drift calibrations continue to be made as the oscilloscopes acquire data.

For this calibration level, the calibration channel must remain connected during normal operation.

To perform the MultiScope system time-correlation calibration at the BASic or PRECision levels, send the :HOSTed:CALibrate:CALibrate command.

Query :HOSTed:CALibrate:LEVel?

The :HOSTed:CALibrate:LEVel? query returns the selected calibration level.

Returned Format [:HOSTed:CALibrate:LEVel] <level><NL>

<level> ::= {MAN | BAS | PREC}

- See Also**
- [":HOSTed:CALibrate:CALibrate"](#) on page 573
 - [":HOSTed:CALibrate:CHANnel"](#) on page 574
 - [":HOSTed:CALibrate:DESKew:FRAMes"](#) on page 576
 - [":HOSTed:CALibrate:DESKew:CHANnels"](#) on page 575
 - [":HOSTed:CALibrate:DESKew:SIGNals"](#) on page 577
 - [":HOSTed:CALibrate:DESKew:ZERO"](#) on page 578

- `":HOSTed:CALibrate:PROMpt"` on page 581
- `":HOSTed:CALibrate:STATus:CHANnels?"` on page 582
- `":HOSTed:CALibrate:STATus:FRAMes?"` on page 583
- `":HOSTed:CALibrate:STATus:LEVel?"` on page 584
- `":HOSTed:CALibrate:STATus:SIGNals?"` on page 585
- `":HOSTed:CALibrate:TREF:DETECT"` on page 586

History New in version 5.50.

:HOSTed:CALibrate:PROMpt

Command :HOSTed:CALibrate:PROMpt {{0 | OFF} | {1 | ON}}

The :HOSTed:CALibrate:PROMpt command specifies whether the user interface software prompts you to make the proper connections while the MultiScope system calibration runs.

You can select OFF when you know required connections have already been made and you do not want to be prompted to make them.

Query :HOSTed:CALibrate:PROMpt?

The :HOSTed:CALibrate:PROMpt? query returns the setting.

Returned Format [:HOSTed:CALibrate:PROMpt] <setting><NL>
<setting> ::= {0 | 1}

- See Also**
- [":HOSTed:CALibrate:CALibrate"](#) on page 573
 - [":HOSTed:CALibrate:CHANnel"](#) on page 574
 - [":HOSTed:CALibrate:DESKew:FRAMes"](#) on page 576
 - [":HOSTed:CALibrate:DESKew:CHANnels"](#) on page 575
 - [":HOSTed:CALibrate:DESKew:SIGNals"](#) on page 577
 - [":HOSTed:CALibrate:DESKew:ZERO"](#) on page 578
 - [":HOSTed:CALibrate:LEVel"](#) on page 579
 - [":HOSTed:CALibrate:STATus:CHANnels?"](#) on page 582
 - [":HOSTed:CALibrate:STATus:FRAMes?"](#) on page 583
 - [":HOSTed:CALibrate:STATus:LEVel?"](#) on page 584
 - [":HOSTed:CALibrate:STATus:SIGNals?"](#) on page 585
 - [":HOSTed:CALibrate:TREF:DETECT"](#) on page 586

History New in version 5.50.

:HOSTed:CALibrate:STATus:CHANnels?

Query :HOSTed:CALibrate:STATus:CHANnels?

The :HOSTed:CALibrate:STATus:CHANnels? query returns the MultiScope system calibration status of "Deskew Channels" (see :HOSTed:CALibrate:DESKew:CHANnels).

Returned Format <status><NL>

| <status> | Status Description |
|-------------|--|
| UNAVAILABLE | Configuration is incompatible. This could be because: <ul style="list-style-type: none"> ▪ There are insufficient connections ▪ Manual Calibration is selected |
| NOTAPPLIED | The deskew is available, but not currently done. |
| PASSED | Calibration completed and passed. |
| INPROGRESS | Calibration is in progress. |

Nothing is applied for a status result other than PASSED.

- See Also**
- [":HOSTed:CALibrate:CALibrate"](#) on page 573
 - [":HOSTed:CALibrate:CHANnel"](#) on page 574
 - [":HOSTed:CALibrate:DESKew:FRAMes"](#) on page 576
 - [":HOSTed:CALibrate:DESKew:CHANnels"](#) on page 575
 - [":HOSTed:CALibrate:DESKew:SIGNals"](#) on page 577
 - [":HOSTed:CALibrate:DESKew:ZERO"](#) on page 578
 - [":HOSTed:CALibrate:LEVel"](#) on page 579
 - [":HOSTed:CALibrate:PROMpt"](#) on page 581
 - [":HOSTed:CALibrate:STATus:FRAMes?"](#) on page 583
 - [":HOSTed:CALibrate:STATus:LEVel?"](#) on page 584
 - [":HOSTed:CALibrate:STATus:SIGNals?"](#) on page 585
 - [":HOSTed:CALibrate:TREF:DETECT"](#) on page 586

History New in version 5.50.

:HOSTed:CALibrate:STATus:FRAMes?

Query :HOSTed:CALibrate:STATus:FRAMes?

The :HOSTed:CALibrate:STATus:FRAMes? query returns the MultiScope system calibration status of "Deskew Frames" (see :HOSTed:CALibrate:DESKew:FRAMes).

Returned Format <status><NL>

| <status> | Status Description |
|-------------|--|
| UNAVAILABLE | Configuration is incompatible. This could be because: <ul style="list-style-type: none"> ▪ There are insufficient connections ▪ Manual Calibration is selected |
| NOTAPPLIED | The deskew is available, but not currently done. |
| PASSED | Calibration completed and passed. |
| INPROGRESS | Calibration is in progress. |

Nothing is applied for a status result other than PASSED.

- See Also**
- [":HOSTed:CALibrate:CALibrate"](#) on page 573
 - [":HOSTed:CALibrate:CHANnel"](#) on page 574
 - [":HOSTed:CALibrate:DESKew:FRAMes"](#) on page 576
 - [":HOSTed:CALibrate:DESKew:CHANnels"](#) on page 575
 - [":HOSTed:CALibrate:DESKew:SIGNals"](#) on page 577
 - [":HOSTed:CALibrate:DESKew:ZERO"](#) on page 578
 - [":HOSTed:CALibrate:LEVel"](#) on page 579
 - [":HOSTed:CALibrate:PROMpt"](#) on page 581
 - [":HOSTed:CALibrate:STATus:CHANnels?"](#) on page 582
 - [":HOSTed:CALibrate:STATus:LEVel?"](#) on page 584
 - [":HOSTed:CALibrate:STATus:SIGNals?"](#) on page 585
 - [":HOSTed:CALibrate:TREF:DETECT"](#) on page 586

History New in version 5.50.

:HOSTed:CALibrate:STATus:LEVel?

Query :HOSTed:CALibrate:STATus:LEVel?

The :HOSTed:CALibrate:STATus:LEVel? query returns the MultiScope system calibration status of the currently selected calibration level (see :HOSTed:CALibrate:LEVel and :HOSTed:CALibrate:CALibrate).

Returned Format <status><NL>

| <status> | Status Description |
|------------|-----------------------------------|
| FAILED | Calibration completed and failed. |
| PASSED | Calibration completed and passed. |
| INPROGRESS | Calibration is in progress. |

- See Also**
- [":HOSTed:CALibrate:CALibrate"](#) on page 573
 - [":HOSTed:CALibrate:CHANnel"](#) on page 574
 - [":HOSTed:CALibrate:DESKew:FRAMes"](#) on page 576
 - [":HOSTed:CALibrate:DESKew:CHANnels"](#) on page 575
 - [":HOSTed:CALibrate:DESKew:SIGNals"](#) on page 577
 - [":HOSTed:CALibrate:DESKew:ZERO"](#) on page 578
 - [":HOSTed:CALibrate:LEVel"](#) on page 579
 - [":HOSTed:CALibrate:PROMpt"](#) on page 581
 - [":HOSTed:CALibrate:STATus:CHANnels?"](#) on page 582
 - [":HOSTed:CALibrate:STATus:FRAMes?"](#) on page 583
 - [":HOSTed:CALibrate:STATus:SIGNals?"](#) on page 585
 - [":HOSTed:CALibrate:TREF:DETECT"](#) on page 586

History New in version 5.50.

:HOSTed:CALibrate:STATus:SIGNals?

Query :HOSTed:CALibrate:STATus:SIGNals?

The :HOSTed:CALibrate:STATus:SIGNals? query returns the MultiScope system calibration status of "Deskew Signals" (see :HOSTed:CALibrate:DESKew:SIGNals).

Returned Format <status><NL>

| <status> | Status Description |
|-------------|--|
| UNAVAILABLE | Configuration is incompatible. This could be because: <ul style="list-style-type: none"> ▪ There are insufficient connections ▪ Manual Calibration is selected |
| NOTAPPLIED | The deskew is available, but not currently done. |
| PASSED | Calibration completed and passed. |
| INPROGRESS | Calibration is in progress. |

Nothing is applied for a status result other than PASSED.

- See Also**
- [":HOSTed:CALibrate:CALibrate"](#) on page 573
 - [":HOSTed:CALibrate:CHANnel"](#) on page 574
 - [":HOSTed:CALibrate:DESKew:FRAMes"](#) on page 576
 - [":HOSTed:CALibrate:DESKew:CHANnels"](#) on page 575
 - [":HOSTed:CALibrate:DESKew:SIGNals"](#) on page 577
 - [":HOSTed:CALibrate:DESKew:ZERO"](#) on page 578
 - [":HOSTed:CALibrate:LEVel"](#) on page 579
 - [":HOSTed:CALibrate:PROMpt"](#) on page 581
 - [":HOSTed:CALibrate:STATus:CHANnels?"](#) on page 582
 - [":HOSTed:CALibrate:STATus:FRAMes?"](#) on page 583
 - [":HOSTed:CALibrate:STATus:LEVel?"](#) on page 584
 - [":HOSTed:CALibrate:TREF:DETECT"](#) on page 586

History New in version 5.50.

:HOSTed:CALibrate:TREF:DETECT

Command :HOSTed:CALibrate:TREF:DETECT

When the MultiScope system's timebase reference clock status is unlocked, or after you have changed reference clock connections between oscilloscopes, send the :HOSTed:CALibrate:TREF:DETECT command to automatically detect the reference clock connection between oscilloscopes.

Running the BASic or PRECision calibrations (see :HOSTed:CALibrate:LEVel) will automatically detect the timebase reference clock. In the MANual calibration level, you can send the :HOSTed:CALibrate:TREF:DETECT command.

- See Also**
- [":HOSTed:CALibrate:CALibrate"](#) on page 573
 - [":HOSTed:CALibrate:CHANnel"](#) on page 574
 - [":HOSTed:CALibrate:DESKew:FRAMes"](#) on page 576
 - [":HOSTed:CALibrate:DESKew:CHANnels"](#) on page 575
 - [":HOSTed:CALibrate:DESKew:SIGNals"](#) on page 577
 - [":HOSTed:CALibrate:DESKew:ZERO"](#) on page 578
 - [":HOSTed:CALibrate:LEVel"](#) on page 579
 - [":HOSTed:CALibrate:PROMpt"](#) on page 581
 - [":HOSTed:CALibrate:STATus:CHANnels?"](#) on page 582
 - [":HOSTed:CALibrate:STATus:FRAMes?"](#) on page 583
 - [":HOSTed:CALibrate:STATus:LEVel?"](#) on page 584
 - [":HOSTed:CALibrate:STATus:SIGNals?"](#) on page 585

History New in version 5.50.

:HOSTed:FOLLower<N>:ACHannels?**Query** :HOSTed:FOLLower<N>:ACHannels?

The :HOSTed:FOLLower<N>:ACHannels? query returns the channel numbers assigned to a Follower oscilloscope in a MultiScope system. There can be up to 9 Follower oscilloscopes in a MultiScope system.

<N> An integer, 1-9.**Returned Format** <channel_range><NL>

<channel_range> ::= range of channel numbers, for example, 5-8

- See Also**
- [":HOSTed:NCONnected?"](#) on page 595
 - [":HOSTed:FOLLower<N>:CONFigure"](#) on page 588
 - [":HOSTed:FOLLower<N>:CONNect"](#) on page 589
 - [":HOSTed:FOLLower<N>:DISConnect"](#) on page 590
 - [":HOSTed:LEADer:ACHannels?"](#) on page 591
 - [":HOSTed:LEADer:CONFigure"](#) on page 592
 - [":HOSTed:LEADer:CONNect"](#) on page 593
 - [":HOSTed:LEADer:DISConnect"](#) on page 594

History New in version 5.50.

:HOSTed:FOLLower<N>:CONFigure

Command :HOSTed:FOLLower<N>:CONFigure {"<instrument_VISA_string>"
| "Simulated Instrument"}

The :HOSTed:FOLLower<N>:CONFigure command identifies a Follower oscilloscope in a MultiScope system by its VISA address. There can be up to 9 Follower oscilloscopes in a MultiScope system.

You can also configure a "Simulated Instrument" to set up simulated waveforms. For more information, see **":CHANnel<N>:SIMulation:WAVEform"** on page 399.

<N> An integer, 1-9.

Example This example identifies the oscilloscope whose VISA address is "TCPIP0::141.121.237.226::inst0::INSTR" as the Follower 1 oscilloscope.

```
myScope.WriteString ":HOSTed:FOLLower1:CONFigure 'TCPIP0::141.121.237.226::inst0::INSTR' "
```

See Also

- **":HOSTed:FOLLower<N>:ACHannels?"** on page 587
- **":HOSTed:FOLLower<N>:CONNect"** on page 589
- **":HOSTed:FOLLower<N>:DISConnect"** on page 590
- **":HOSTed:LEADer:ACHannels?"** on page 591
- **":HOSTed:LEADer:CONFigure"** on page 592
- **":HOSTed:LEADer:CONNect"** on page 593
- **":HOSTed:LEADer:DISConnect"** on page 594
- **":CHANnel<N>:SIMulation:WAVEform"** on page 399

History New in version 5.50.

Version 6.00: Added the ability to configure a "Simulated Instrument" to set up simulated waveforms.

:HOSTed:FOLLOWer<N>:CONNECT

Command :HOSTed:FOLLOWer<N>:CONNECT

The :HOSTed:FOLLOWer<N>:CONNECT command opens the connection to a Follower oscilloscope in a MultiScope system. There can be up to 9 Follower oscilloscopes in a MultiScope system.

<N> An integer, 1-9.

- See Also**
- [":HOSTed:FOLLOWer<N>:ACHannels?"](#) on page 587
 - [":HOSTed:FOLLOWer<N>:CONFigure"](#) on page 588
 - [":HOSTed:FOLLOWer<N>:DISConnect"](#) on page 590
 - [":HOSTed:LEADer:ACHannels?"](#) on page 591
 - [":HOSTed:LEADer:CONFigure"](#) on page 592
 - [":HOSTed:LEADer:CONNECT"](#) on page 593
 - [":HOSTed:LEADer:DISConnect"](#) on page 594

History New in version 5.50.

:HOSTed:FOLLower<N>:DISConnect

Command :HOSTed:FOLLower<N>:DISConnect

The :HOSTed:FOLLower<N>:DISConnect command closes the connection to a Follower oscilloscope in a MultiScope system. There can be up to 9 Follower oscilloscopes in a MultiScope system.

<N> An integer, 1-9.

- See Also**
- [":HOSTed:FOLLower<N>:ACHannels?"](#) on page 587
 - [":HOSTed:FOLLower<N>:CONFigure"](#) on page 588
 - [":HOSTed:FOLLower<N>:CONNect"](#) on page 589
 - [":HOSTed:LEADer:ACHannels?"](#) on page 591
 - [":HOSTed:LEADer:CONFigure"](#) on page 592
 - [":HOSTed:LEADer:CONNect"](#) on page 593
 - [":HOSTed:LEADer:DISConnect"](#) on page 594

History New in version 5.50.

:HOSTed:LEADer:ACHannels?

Query :HOSTed:LEADer:ACHannels?

The :HOSTed:LEADer:ACHannels? query returns the channel numbers assigned to the Leader oscilloscope in a MultiScope system.

Returned Format <channel_range><NL>

<channel_range> ::= range of channel numbers, for example, 1-4

- See Also**
- [":HOSTed:NCONnected?"](#) on page 595
 - [":HOSTed:LEADer:CONFigure"](#) on page 592
 - [":HOSTed:LEADer:CONNect"](#) on page 593
 - [":HOSTed:LEADer:DISConnect"](#) on page 594
 - [":HOSTed:FOLLower<N>:ACHannels?"](#) on page 587
 - [":HOSTed:FOLLower<N>:CONFigure"](#) on page 588
 - [":HOSTed:FOLLower<N>:CONNect"](#) on page 589
 - [":HOSTed:FOLLower<N>:DISConnect"](#) on page 590

History New in version 5.50.

:HOSTed:LEADer:CONFigure

Command :HOSTed:LEADer:CONFigure "<instrument_VISA_string>"

The :HOSTed:LEADer:CONFigure command identifies the Leader oscilloscope in a MultiScope system by its VISA address.

Example This example identifies the oscilloscope whose VISA address is "TCPIP0::141.121.238.47::inst0::INSTR" as the Leader oscilloscope.

```
myScope.WriteString ":HOSTed:LEADer:CONFigure 'TCPIP0::141.121.238.47::inst0::INSTR'"
```

- See Also**
- [":HOSTed:LEADer:ACHannels?"](#) on page 591
 - [":HOSTed:LEADer:CONNect"](#) on page 593
 - [":HOSTed:LEADer:DISConnect"](#) on page 594
 - [":HOSTed:FOLLower<N>:ACHannels?"](#) on page 587
 - [":HOSTed:FOLLower<N>:CONFigure"](#) on page 588
 - [":HOSTed:FOLLower<N>:CONNect"](#) on page 589
 - [":HOSTed:FOLLower<N>:DISConnect"](#) on page 590

History New in version 5.50.

:HOSTed:LEADer:CONNect

Command :HOSTed:LEADer:CONNect

The :HOSTed:LEADer:CONNect command opens the connection to the Leader oscilloscope in a MultiScope system.

- See Also**
- [":HOSTed:LEADer:ACHannels?"](#) on page 591
 - [":HOSTed:LEADer:CONFigure"](#) on page 592
 - [":HOSTed:LEADer:DISConnect"](#) on page 594
 - [":HOSTed:FOLLower<N>:ACHannels?"](#) on page 587
 - [":HOSTed:FOLLower<N>:CONFigure"](#) on page 588
 - [":HOSTed:FOLLower<N>:CONNect"](#) on page 589
 - [":HOSTed:FOLLower<N>:DISConnect"](#) on page 590

History New in version 5.50.

:HOSTed:LEADer:DISConnect

Command :HOSTed:LEADer:DISConnect

The :HOSTed:LEADer:DISConnect command closes the connection to the Leader oscilloscope in a MultiScope system.

- See Also**
- [":HOSTed:LEADer:ACHannels?"](#) on page 591
 - [":HOSTed:LEADer:CONFigure"](#) on page 592
 - [":HOSTed:LEADer:CONNect"](#) on page 593
 - [":HOSTed:FOLLower<N>:ACHannels?"](#) on page 587
 - [":HOSTed:FOLLower<N>:CONFigure"](#) on page 588
 - [":HOSTed:FOLLower<N>:CONNect"](#) on page 589
 - [":HOSTed:FOLLower<N>:DISConnect"](#) on page 590

History New in version 5.50.

:HOSTed:NCONnected?

Query :HOSTed:NCONnected?

The :HOSTed:NCONnected? query returns a number that indicates whether in hosted mode, and if in hosted mode, the number of hosted oscilloscope frames connected. This query can return:

- 0 – Not in hosted mode. There are no hosted oscilloscope frames connected.
- 1 – One hosted oscilloscope frame is connected, either itself or a remote frame when using Infiniium Offline.
- 2 through 10 – The number of hosted oscilloscope frames connected.

With four analog input channels in each frame, the number returned tells you the potential number of channels in the MultiScope system. If the query returns a 0 or 1, you know there can be up to four channels, if the query returns 2 or more, multiply the returned number by four to get the number of possible channels.

Returned Format <#_of_frames><NL>

<#_of_frames> ::= number of hosted oscilloscope frames connected,
from 0 to 10 in NR1 format

- See Also**
- [":HOSTed:LEADer:ACHannels?"](#) on page 591
 - [":HOSTed:FOLLower<N>:ACHannels?"](#) on page 587

History New in version 6.10.

:HOSTed:PERiodic

Command :HOSTed:PERiodic <drift_corr>
<drift_corr> ::= {OFF | TIME}

The :HOSTed:PERiodic command turns periodic drift correction on (TIME) or off.

Query :HOSTed:PERiodic?

The :HOSTed:PERiodic? query returns the periodic drift correction setting.

Returned Format <drift_corr><NL>
<drift_corr> ::= {OFF | TIME}

See Also • [":HOSTed:PERiodic"](#) on page 596

History New in version 5.70.

23 InfiniiScan (ISCan) Commands

:IScan:DElay / 598
:IScan:MEASurement:FAIL / 599
:IScan:MEASurement:LLIMit / 600
:IScan:MEASurement / 601
:IScan:MEASurement:ULIMit / 602
:IScan:MODE / 603
:IScan:NONMonotonic:EDGE / 604
:IScan:NONMonotonic:HYSteresis / 605
:IScan:NONMonotonic:SOURce / 606
:IScan:RUNT:HYSteresis / 607
:IScan:RUNT:LLEVel / 608
:IScan:RUNT:SOURce / 609
:IScan:RUNT:ULEVel / 610
:IScan:SERial:PATtern / 611
:IScan:SERial:SOURce / 612
:IScan:ZONE:HIDE / 613
:IScan:ZONE:SOURce / 614
:IScan:ZONE<Z>:MODE / 615
:IScan:ZONE<Z>:PLACement / 616
:IScan:ZONE<Z>:SOURce / 617
:IScan:ZONE<Z>:STATe / 618

The ISCan commands and queries control the InfiniiScan feature of the oscilloscope. InfiniiScan provides several ways of searching through the waveform data to find unique events.

:ISCan:DElAy

Command :ISCan:DElAy {OFF | <delay_time>}

The :ISCan:DElAy command sets the delay time from when the hardware trigger occurs and when InfiniiScan tries to find the waveform event that has been defined.

OFF Turns off the delay from the hardware trigger.

<delay_time> Sets the amount of time that the InfiniiScan trigger is delayed from the hardware trigger.

Example The following example causes the oscilloscope to delay by 1 ms.

```
myScope.WriteString ":ISCan:DElAy 1E-06"
```

Query :ISCan:DElAy?

The query returns the current set delay value.

Returned Format [:ISCan:DElAy] {OFF | <delay_time>}<NL>

Example The following example returns the current delay value and prints the result to the controller's screen.

```
myScope.WriteString ":SYSTem:HEADer OFF" ' Response headers off.
myScope.WriteString ":ISCan:DElAy?"
varValue = myScope.ReadNumber
Debug.Print FormatNumber(varValue, 0)
```

History Legacy command (existed before version 3.10).

:IScan:MEASurement:FAIL

Command :IScan:MEASurement:FAIL {INSide | OUTSide}

The :IScan:MEASurement:FAIL command sets the fail condition for an individual measurement. The conditions for a test failure are set on the measurement selected by the :IScan:MEASurement command.

When a measurement failure is detected by the limit test the oscilloscope triggers and the trigger action is executed.

INSide INSide causes the oscilloscope to fail a test when the measurement results are within the parameters set by the :IScan:MEASurement:LIMit and :IScan:MEASurement:ULIMit commands.

OUTSide OUTSide causes the oscilloscope to fail a test when the measurement results exceed the parameters set by the :IScan:MEASurement:LLIMit and the :IScan:MEASurement:ULIMit commands.

Example The following example causes the oscilloscope to trigger when the measurements are outside the lower or upper limits.

```
myScope.WriteString ":IScan:MEASurement:FAIL OUTSide"
```

Query :IScan:MEASurement:FAIL?

The query returns the current set fail condition.

Returned Format [:IScan:MEASurement:FAIL] {INSide | OUTSide}<NL>

Example The following example returns the current fail condition and prints the result to the controller's screen.

```
Dim strFAIL As String
myScope.WriteString ":IScan:MEASurement:FAIL?"
strFAIL = myScope.ReadString
Debug.Print strFAIL
```

History Legacy command (existed before version 3.10).

:ISCan:MEASurement:LLIMit

Command `:ISCan:MEASurement:LLIMit <lower_value>`

The `:ISCan:MEASurement:LLIMit` (lower limit) command sets the lower test limit for the currently selected measurement. The `:ISCan:MEASurement` command selects the measurement used.

<lower_value> A real number.

Example The following example sets the lower test limit to 1.0.

```
myScope.WriteString ":ISCan:MEASurement:LLIMit 1.0"
```

If, for example, you chose to measure volts peak-peak and want the smallest acceptable signal swing to be one volt, you could use the above command, then set the measurement limit to trigger when the signal is outside the specified limit.

Query `:ISCan:MEASurement:LLIMit?`

The query returns the current value set by the command.

Returned Format `[:ISCan:MEASurement:LLIMit]<lower_value><NL>`

Example The following example returns the current lower test limit and prints the result to the controller's screen.

```
myScope.WriteString ":SYSTEM:HEADer OFF"    ' Response headers off.
myScope.WriteString ":ISCan:MEASurement:LLIMit?"
varValue = myScope.ReadNumber
Debug.Print FormatNumber(varValue, 0)
```

History Legacy command (existed before version 3.10).

:ISCan:MEASurement

Command :ISCan:MEASurement {MEAS1 | MEAS2 | MEAS3 | ... | MEAS20}

The :ISCan:MEASurement command selects the current source for Measurement Limit Test Trigger. It selects one of the active measurements as referred to by their position in the Measurement tab area at the bottom of the screen. Measurements are numbered from left to right in the Measurements tab area of the screen.

Example The following example selects the first measurement as the source for the limit testing commands.

```
myScope.WriteString ":ISCan:MEASurement MEAS1"
```

Query :ISCan:MEASurement?

The query returns the currently selected measurement source.

Returned Format [:ISCan:MEASurement] {MEAS1 | MEAS2 | MEAS3 | ... | MEAS20}<NL>

Example The following example returns the currently selected measurement source for the limit testing commands.

```
Dim strSOURCE As String
myScope.WriteString ":ISCan:MEASurement?"
strSOURCE = myScope.ReadString
Debug.Print strSOURCE
```

See Also Measurements are started by the commands in the Measurement Subsystem.

History Legacy command (existed before version 3.10).

Version 5.00: Now 20 measurements to choose from.

:ISCan:MEASurement:ULIMit

Command :ISCan:MEASurement:ULIMit <upper_value>

The :ISCan:MEASurement:ULIMit (upper limit) command sets the upper test limit for the active measurement currently selected by the :ISCan:MEASurement command.

<upper_value> A real number.

Example The following example sets the upper limit of the currently selected measurement to 500 mV.

```
myScope.WriteString ":ISCan:MEASurement:ULIMit 500E-3"
```

Suppose you are measuring the maximum voltage of a signal with Vmax, and that voltage should not exceed 500 mV. You can use the above program and set the :ISCan:MEASurement:FAIL OUTside command to specify that the oscilloscope will trigger when the voltage exceeds 500 mV.

Query :ISCan:MEASurement:ULIMit?

The query returns the current upper limit of the limit test.

Returned Format [:ISCan:MEASurement:ULIMit] <upper_value><NL>

Example The following example returns the current upper limit of the limit test and prints the result to the controller's screen.

```
myScope.WriteString ":SYSTem:HEADer OFF" ' Response headers off.
myScope.WriteString ":ISCan:MEASurement:ULIMit?"
varValue = myScope.ReadNumber
Debug.Print FormatNumber(varValue, 0)
```

History Legacy command (existed before version 3.10).

:IScan:MODE

Command :IScan:MODE {OFF | MEASurement | NONMonotonic | RUNT | SERial | ZONE}

The :IScan:MODE command selects the type of InfiniiScan trigger mode:

- OFF – Turns off the InfiniiScan trigger mode.
- MEASurement – Sets the Measurement limit trigger mode.
- NONMonotonic – Sets the Non-monotonic Edge trigger mode.
- RUNT – Sets the Runt trigger mode.
- SERial – Sets the General Serial trigger mode.
- ZONE – Sets the Zone Qualify trigger mode.

Example The following example selects the runt trigger.

```
myScope.WriteString ":IScan:MODE RUNT"
```

Query :IScan:MODE?

The query returns the currently selected InfiniiScan trigger mode.

Returned Format [:IScan:MEASurement] {OFF | MEAS | NONM | RUNT | SER | ZONE}<NL>

Example The following example returns the currently selected InfiniiScan trigger mode.

```
Dim strMODE As String
myScope.WriteString ":IScan:MODE?"
strMODE = myScope.ReadString
Debug.Print strMODE
```

History Legacy command (existed before version 3.10).

:IScan:NONMonotonic:EDGE

Command `:IScan:NONMonotonic:EDGE {EITHer | FALLing | RISing}`

The `:IScan:NONMonotonic:EDGE` command selects the rising edge, the falling edge, or either edge for the Non-monotonic edge trigger mode.

EITHer Sets the edge used by the Non-monotonic edge trigger to both rising and falling edges.

FALLing Sets the edge used by the Non-monotonic edge trigger to falling edges.

RISing Sets the edge used by the Non-monotonic edge trigger to rising edges.

Example The following example selects the falling edge non-monotonic trigger.

```
myScope.WriteString ":IScan:NONMonotonic:EDGE FALLing"
```

Query `:IScan:NONMonotonic:EDGE?`

The query returns the currently selected edge type for the Non-Monotonic Edge trigger.

Returned Format `[:IScan:NONMonotonic:EDGE]{EITHer | FALLing | RISing}<NL>`

Example The following example returns the currently selected edge type used for the Non-monotonic Edge trigger mode.

```
Dim strSOURCE As String
myScope.WriteString ":IScan:NONMonotonic:EDGE?"
strSOURCE = myScope.ReadString
Debug.Print strSOURCE
```

History Legacy command (existed before version 3.10).

:IScan:NONMonotonic:HYSteresis

Command :IScan:NONMonotonic:HYSteresis <value>

The :IScan:NONMonotonic:HYSteresis command sets the hysteresis value used for the Non-monotonic Edge trigger.

<value> is a real number for the hysteresis.

Example The following example sets the hysteresis value used by the Non-monotonic trigger mode to 10 mV.

```
myScope.WriteString ":IScan:NONMonotonic:HYSteresis 1E-2"
```

Query :IScan:NONMonotonic:HYSteresis?

The query returns the hysteresis value used by the Non-monotonic Edge trigger mode.

Returned Format [:IScan:NONMonotonic:HYSteresis]<value><NL>

Example The following example returns and prints the value of the hysteresis.

```
myScope.WriteString ":SYSTem:HEADer OFF" ' Response headers off.
myScope.WriteString ":IScan:NONMonotonic:HYSteresis?"
varValue = myScope.ReadNumber
Debug.Print FormatNumber(varValue, 0)
```

History Legacy command (existed before version 3.10).

:IScan:NONMonotonic:SOURce

Command `:IScan:NONMonotonic:SOURce CHANnel<N>`

The `:IScan:NONMonotonic:SOURce` command sets the source used for the Non-monotonic Edge trigger.

`<N>` is an integer from 1-4.

Example The following example sets the source used by the Non-monotonic trigger mode to channel 1.

```
myScope.WriteString ":IScan:NONMonotonic:SOURce CHANnel1"
```

Query `:IScan:NONMonotonic:SOURce?`

The query returns the source used by the Non-monotonic Edge trigger mode.

Returned Format `[:IScan:NONMonotonic:SOURce] CHANnel<N><NL>`

Example The following example returns the currently selected source for the Non-monotonic Edge trigger mode.

```
Dim strSOURCE As String
myScope.WriteString ":IScan:NONMonotonic:SOURce?"
strSOURCE = myScope.ReadString
Debug.Print strSOURCE
```

History Legacy command (existed before version 3.10).

:IScan:RUNT:HYSTeresis

Command :IScan:RUNT:HYSTeresis <value>

The :IScan:RUNT:HYSTeresis command sets the hysteresis value used for the Runt trigger.

<value> is a real number for the hysteresis.

Example The following example sets the hysteresis value used by the Runt trigger mode to 10 mV.

```
myScope.WriteString ":IScan:RUNT:HYSTeresis 1E-2"
```

Query :IScan:RUNT:HYSTeresis?

The query returns the hysteresis value used by the Runt trigger mode.

Returned Format [:IScan:RUNT:HYSTeresis] <value><NL>

Example The following example returns and prints the value of the hysteresis.

```
myScope.WriteString ":SYSTEM:HEADer OFF" ' Response headers off.
myScope.WriteString ":IScan:RUNT:HYSTeresis?"
varValue = myScope.ReadNumber
Debug.Print FormatNumber(varValue, 0)
```

History Legacy command (existed before version 3.10).

:ISCan:RUNT:LLEVel

Command `ISCan:RUNT:LLEVel <lower_level>`

The `:ISCan:RUNT:LLEVel` (lower level) command sets the lower level limit for the Runt trigger mode.

<lower_level> A real number.

Example The following example sets the lower level limit to 1.0 V.

```
myScope.WriteString ":ISCan:RUNT:LLEVel 1.0"
```

Query `:ISCan:RUNT:LLEVel?`

The query returns the lower level limit set by the command.

Returned Format `[:ISCan:RUNT:LLEVel] <lower_level><NL>`

Example The following example returns the current lower level used by the Runt trigger and prints the result to the controller's screen.

```
myScope.WriteString ":SYSTem:HEADer OFF" ' Response headers off.
myScope.WriteString ":ISCan:RUNT:LLEVel?"
varValue = myScope.ReadNumber
Debug.Print FormatNumber(varValue, 0)
```

History Legacy command (existed before version 3.10).

:IScan:RUNT:SOURce

Command :IScan:RUNT:SOURce CHANnel<N>

The :IScan:RUNT:SOURce command sets the source used for the Runt trigger.

<N> is an integer from 1-4.

Example The following example sets the source used by the Runt trigger mode to channel 1.

```
myScope.WriteString ":IScan:RUNT:SOURce CHANnel1"
```

Query :IScan:RUNT:SOURce?

The query returns the source used by the Runt trigger mode.

Returned Format [:IScan:RUNT:SOURce] CHANnel<N><NL>

Example The following example returns the currently selected source for the Runt trigger mode.

```
Dim strSOURCE As String
myScope.WriteString ":IScan:RUNT:SOURce?"
strSOURCE = myScope.ReadString
Debug.Print strSOURCE
```

History Legacy command (existed before version 3.10).

:IScan:RUNT:ULEVel

Command :IScan:RUNT:ULEVel <upper_level>

The :IScan:RUNT:ULEVel (upper level) command sets the upper level limit for the Runt trigger mode.

<upper_level> A real number.

Example The following example sets the upper level value used by the Runt trigger mode to 500 mV.

```
myScope.WriteString ":IScan:RUNT:ULEVel 500E-3"
```

Query :IScan:RUNT:ULEVel?

The query returns the current upper level value used by the Runt trigger.

Returned Format [:IScan:RUNT:ULEVel] <upper_level><NL>

Example The following example returns the current upper level used by the Runt trigger and prints the result to the controller's screen.

```
myScope.WriteString ":SYSTem:HEADer OFF" ' Response headers off.
myScope.WriteString ":IScan:RUNT:ULEVel?"
varValue = myScope.ReadNumber
Debug.Print FormatNumber(varValue, 0)
```

History Legacy command (existed before version 3.10).

:IScan:SERial:PATtern

Command :IScan:SERial:PATtern "<pattern>"

The :IScan:SERial:PATtern command sets the pattern used for the Serial trigger.

<pattern> is a 1, 0, or X binary character string of up to 80 characters. The pattern can only be expressed in the binary format.

Example The following example sets the pattern used by the Serial trigger to 101100.

```
myScope.WriteString ":IScan:SERial:PATtern "101100""
```

Query :IScan:SERial:PATtern?

The query returns the pattern used by the Serial trigger mode.

Returned Format [:IScan:SERial:PATtern] <pattern><NL>

Example The following example returns the currently selected pattern for the Serial trigger mode.

```
Dim strPATTERN As String
myScope.WriteString ":IScan:SERial:PATtern?"
strPATTERN = myScope.ReadString
Debug.Print strPATTERN
```

History Legacy command (existed before version 3.10).

:IScan:SERial:SOURce

Command :IScan:SERial:SOURce CHANnel<N>

The :IScan:SERial:SOURce command sets the source used for the Serial trigger.

<N> is an integer from 1-4.

Example The following example sets the source used by the Serial trigger mode to channel 1.

```
myScope.WriteString ":IScan:SERial:SOURce CHANnel1"
```

Query :IScan:SERial:SOURce?

The query returns the source used by the Serial trigger mode.

Returned Format [:IScan:SERial:SOURce] CHANnel<N><NL>

Example The following example returns the currently selected source for the Serial trigger mode.

```
Dim strSOURCE As String
myScope.WriteString ":IScan:SERial:SOURce?"
strSOURCE = myScope.ReadString
Debug.Print strSOURCE
```

History Legacy command (existed before version 3.10).

:IScan:ZONE:HIDE

Command :IScan:ZONE:HIDE {{ON | 1} | {OFF | 0}}

The :IScan:ZONE:HIDE command lets you hide or show all InfiniiScan zones on the display.

Example The following example hides all InfiniiScan zones on the display.

```
myScope.WriteString ":IScan:ZONE:HIDE ON"
```

Query :IScan:ZONE:HIDE?

The query returns the current zone hide setting.

Returned Format [:IScan:ZONE:HIDE] {1 | 0}<NL>

Example The following example returns the current zone hide setting.

```
Dim strHide As String
myScope.WriteString ":IScan:ZONE:HIDE?"
strHide = myScope.ReadString
Debug.Print strHide
```

- See Also**
- [":IScan:ZONE:SOURce"](#) on page 614
 - [":IScan:ZONE<Z>:MODE"](#) on page 615
 - [":IScan:ZONE<Z>:PLACement"](#) on page 616
 - [":IScan:ZONE<Z>:SOURce"](#) on page 617
 - [":IScan:ZONE<Z>:STATe"](#) on page 618

History New in version 4.00.

:IScan:ZONE:SOURce

Command `:IScan:ZONE:SOURce CHANnel<N>`

The `:IScan:ZONE:SOURce` command sets the source for all zones used in the zone qualify trigger.

<N> An integer from 1-4.

Example The following example sets the source used by all zones in the zone qualify trigger to channel 1.

```
myScope.WriteString ":IScan:ZONE:SOURce CHANnel1"
```

Query `:IScan:ZONE:SOURce?`

The query returns the source used for all zones in the zone qualify trigger.

Returned Format `[:IScan:ZONE:SOURce] CHANnel<N><NL>`

Example The following example returns the currently selected source for all zones in the zone qualify trigger.

```
Dim strSOURCE As String
myScope.WriteString ":IScan:ZONE:SOURce?"
strSOURCE = myScope.ReadString
Debug.Print strSOURCE
```

- See Also**
- [":IScan:ZONE:HIDE"](#) on page 613
 - [":IScan:ZONE<Z>:MODE"](#) on page 615
 - [":IScan:ZONE<Z>:PLACement"](#) on page 616
 - [":IScan:ZONE<Z>:SOURce"](#) on page 617
 - [":IScan:ZONE<Z>:STATe"](#) on page 618

History Legacy command (existed before version 3.10).

:IScan:ZONE<Z>:MODE

Command :IScan:ZONE<Z>:MODE {INTERsect | NOTintersect | OINTERsect | ONOT}

The :IScan:ZONE<Z>:MODE command sets the Zone Qualify trigger mode. For the INTERsect mode, the waveform must enter the zone region to qualify as a valid waveform. For NOTintersect mode, the waveform cannot enter a zone region to qualify as a valid waveform.

<Z> An integer from 1-8.

Example The following example sets the mode to intersect for zone 1.

```
myScope.WriteString ":IScan:ZONE1:MODE INTERsect"
```

Query :IScan:ZONE<Z>:MODE?

The query returns the mode used by zone 1.

Returned Format [:IScan:ZONE<Z>:MODE] {INT | NOT | OINT | ONOT}<NL>

Example The following example returns the currently selected mode for zone 1.

```
Dim strMODE As String
myScope.WriteString ":IScan:ZONE1:MODE?"
strMODE = myScope.ReadString
Debug.Print strMODE
```

- See Also**
- [":IScan:ZONE:HIDE"](#) on page 613
 - [":IScan:ZONE:SOURce"](#) on page 614
 - [":IScan:ZONE<Z>:PLACement"](#) on page 616
 - [":IScan:ZONE<Z>:SOURce"](#) on page 617
 - [":IScan:ZONE<Z>:STATe"](#) on page 618

History Legacy command (existed before version 3.10).

:ISCan:ZONE<Z>:PLACement

Command :ISCan:ZONE<Z>:PLACement <width>,<height>,<x_center>,<y_center>

The :ISCan:ZONE<Z>:PLACement command sets the location and size of a zone for the zone qualify trigger mode.

<Z> An integer from 1-8.

<width> A real number defining the width of a zone in seconds.

<height> A real number defining the height of a zone in volts.

<x_center> A real number defining the x coordinate of the center of the zone in seconds.

<y_center> A real number defining the y coordinate of the center of the zone in volts.

Example The following example sets the size of zone 1 to be 500 ps wide and 0.5 volts high and centered about the xy coordinate of 1.5 ns and 1 volt.

```
myScope.WriteString ":ISCan:ZONE1:PLACement 500e-12,0.5,1.5e-9,1"
```

Query :ISCan:ZONE<Z>:PLACement?

The query returns the placement values used by zone 1.

Returned Format [:ISCan:ZONE<Z>:PLACement] <width>,<height>,<x_center>,<y_center><NL>

Example The following example returns the current placement values for zone 1.

```
Dim strPLACEMENT As String
myScope.WriteString ":ISCan:ZONE1:PLACement?"
strPLACEMENT = myScope.ReadString
Debug.Print strPLACEMENT
```

- See Also**
- [":ISCan:ZONE:HIDE"](#) on page 613
 - [":ISCan:ZONE:SOURce"](#) on page 614
 - [":ISCan:ZONE<Z>:MODE"](#) on page 615
 - [":ISCan:ZONE<Z>:SOURce"](#) on page 617
 - [":ISCan:ZONE<Z>:STATe"](#) on page 618

History Legacy command (existed before version 3.10).

:IScan:ZONE<Z>:SOURce

Command :IScan:ZONE<Z>:SOURce CHANnel<N>

The :IScan:ZONE<Z>:SOURce command sets the source used for a particular zone in the zone qualify trigger.

<Z> An integer from 1-8.

<N> An integer from 1-4.

Example The following example sets the source used by zone 1 to channel 1.

```
myScope.WriteString ":IScan:ZONE1:SOURce CHANnel1"
```

Query :IScan:ZONE<Z>:SOURce?

The query returns the source used by the particular zone.

Returned Format [:IScan:ZONE<Z>:SOURce] CHANnel<N><NL>

Example The following example returns the currently selected source for zone 1.

```
Dim strSOURCE As String
myScope.WriteString ":IScan:ZONE1:SOURce?"
strSOURCE = myScope.ReadString
Debug.Print strSOURCE
```

- See Also**
- [":IScan:ZONE:HIDE"](#) on page 613
 - [":IScan:ZONE:SOURce"](#) on page 614
 - [":IScan:ZONE<Z>:MODE"](#) on page 615
 - [":IScan:ZONE<Z>:PLACement"](#) on page 616
 - [":IScan:ZONE<Z>:STATe"](#) on page 618

History Legacy command (existed before version 3.10).

:IScan:ZONE<Z>:STATe

Command :IScan:ZONE<Z>:STATe {{ON | 1} | {OFF | 0}}

The :IScan:ZONE<Z>:STATe command turns a zone off or on for the zone qualify trigger.

<Z> An integer from 1-8.

Example The following example turns on zone 2.

```
myScope.WriteString ":IScan:ZONE2:STATe ON"
```

Query :IScan:ZONE<Z>:STATe?

The query returns the state value for a zone.

Returned Format [:IScan:ZONE<Z>:STATe] {1 | 0}<NL>

Example The following example returns the current state value for zone 2.

```
Dim strSTATE As String
myScope.WriteString ":IScan:ZONE2:STATe?"
strSTATE = myScope.ReadString
Debug.Print strSTATE
```

- See Also**
- **" :IScan:ZONE:HIDE "** on page 613
 - **" :IScan:ZONE:SOURce "** on page 614
 - **" :IScan:ZONE<Z>:MODE "** on page 615
 - **" :IScan:ZONE<Z>:PLACement "** on page 616
 - **" :IScan:ZONE<Z>:SOURce "** on page 617

History Legacy command (existed before version 3.10).

24 Limit Test Commands

:LTEST:ADDStats / 620
:LTEST:FAIL / 621
:LTEST:LLIMit – Lower Limit / 623
:LTEST:MEASurement / 624
:LTEST:RESults? / 625
:LTEST:RUMode:SOFailure / 626
:LTEST:TEST / 627
:LTEST:ULIMit – Upper Limit / 628

The Limit Test commands and queries control the limit test features of the oscilloscope. Limit testing automatically compares measurement results with pass or fail limits. The limit test tracks up to 20 measurements. The action taken when the test fails is also controlled with commands in this subsystem.

:LTEST:ADDStats

Command :LTEST:ADDStats {{0 | OFF} | {1 | ON}}

The :LTEST:ADDStats command enables or disables the limit test "statistics on passing measurements only" option.

When ON, statistics are compiled on passing measurements only.

Query :LTEST:ADDStats?

The :LTEST:ADDStats? query returns the "statistics on passing measurements only" setting.

Returned Format <setting><NL>

<setting> ::= {0 | 1}

See Also • [":LTEST:RUMode:SOFailure"](#) on page 626

History New in version 5.70.

:LTEST:FAIL

Command :LTEST:FAIL {{INSide | OUTSide} | {COUNT | RANGE}}

For the active measurement currently selected by the :LTEST:MEASUREMENT command, the :LTEST:FAIL command sets the fail condition for the measurement.

When a measurement failure is detected by the limit test, the fail action conditions are executed, and there is the potential to generate an SRQ.

INSide, OUTSide These are the fail condition options for most measurements.

- **INSide** – causes the oscilloscope to fail a test when the measurement results are within the parameters set by the :LTEST:LLIMIT and :LTEST:ULIMIT commands.
- **OUTSide** – causes the oscilloscope to fail a test when the measurement results exceed the parameters set by :LTEST:LLIMIT and :LTEST:ULIMIT commands.

COUNT, RANGE When performing limit test on the BER (Per Acq) measurement (:MEASURE:BERPERACQ), the fail condition options are COUNT and RANGE instead of INSIDE and OUTSIDE.

- **COUNT** – causes the oscilloscope to fail a test when the BER (Bit Error Ratio) fail count occurs. In this case, the count is specified by the :LTEST:LLIMIT command (and the :LTEST:ULIMIT command does not apply).
- **RANGE** – causes the oscilloscope to fail a test when the BER (Bit Error Ratio) fail count occurs within a certain number of bits. In this case, the count is specified by the :LTEST:LLIMIT command and the range of bits is specified by the :LTEST:ULIMIT command. This option is useful for finding burst errors.

Example The following example causes the oscilloscope to fail a test when the measurements are outside the lower and upper limits.

```
myScope.WriteString ":LTEST:FAIL OUTSide"
```

Query :LTEST:FAIL?

The query returns the currently set fail condition.

Returned Format [:LTEST:FAIL] {INSide | OUTSide}<NL>

Example The following example returns the current fail condition and prints the result to the controller's screen.

```
Dim strFAIL As String
myScope.WriteString ":LTEST:FAIL?"
strFAIL = myScope.ReadString
Debug.Print strFAIL
```

- See Also**
- **" :LTEST:LLIMIT – Lower Limit "** on page 623
 - **" :LTEST:MEASUREMENT "** on page 624
 - **" :LTEST:RESULTS? "** on page 625
 - **" :LTEST:TEST "** on page 627

- **":LTEST:ULIMit – Upper Limit"** on page 628
- **":MEASure:BERPeracq"** on page 733

History Legacy command (existed before version 3.10).

:LTEST:LLIMit – Lower Limit

Command :LTEST:LLIMit <lower_value>

For the active measurement currently selected by the :LTEST:MEASurement command, the :LTEST:LLIMit (Lower LIMit) command sets the lower test limit.

<lower_value> A real number.

Example The following example sets the lower test limit to 1.0.

```
myScope.WriteString ":LTEST:LLIMit 1.0"
```

If, for example, you chose to measure volts peak-peak and want the smallest acceptable signal swing to be one volt, you could use the above command, then set the limit test to fail when the signal is outside the specified limit.

Query :LTEST:LLIMit?

The query returns the current value set by the command.

Returned Format [:LTEST:LLIMit]<lower_value><NL>

Example The following example returns the current lower test limit and prints the result to the controller's screen.

```
Dim strLLIM As String
myScope.WriteString ":LTEST:LLIMit?"
strLLIM = myScope.ReadString
Debug.Print strLLIM
```

- See Also**
- **" :LTEST:FAIL "** on page 621
 - **" :LTEST:MEASurement "** on page 624
 - **" :LTEST:RESults? "** on page 625
 - **" :LTEST:TEST "** on page 627
 - **" :LTEST:ULIMit – Upper Limit "** on page 628

History Legacy command (existed before version 3.10).

:LTEST:MEASurement

Command :LTEST:MEASurement {MEAS<N>}

The :LTEST:MEASurement command selects the measurement source for the FAIL, LLIMit, ULIMit, and TEST commands. It selects one of the active measurements by its number, where MEAS1 is the most recently added measurement.

<N> An integer, 1-20.

Example The following example selects the first measurement as the source for the limit testing commands.

```
myScope.WriteString ":LTEST:MEASurement MEAS1"
```

Query :LTEST:MEASurement?

The query returns the currently selected measurement source.

Returned Format [:LTEST:MEASurement] {MEAS<N>} <NL>

Example The following example returns the currently selected measurement source for the limit testing commands.

```
Dim strSOURCE As String
myScope.WriteString ":LTEST:MEASurement?"
strSOURCE = myScope.ReadString
Debug.Print strSOURCE
```

See Also Measurements are started in the :MEASure subsystem.

- See Also**
- **":LTEST:FAIL"** on page 621
 - **":LTEST:LLIMit – Lower Limit"** on page 623
 - **":LTEST:RESults?"** on page 625
 - **":LTEST:TEST"** on page 627
 - **":LTEST:ULIMit – Upper Limit"** on page 628

History Legacy command (existed before version 3.10).

:LTEST:RESults?

Query :LTEST:RESults? {MEAS<N>}

The query returns the measurement results for selected measurement.

When :LTEST:TEST is ON, the :LTEST:RESults? query returns the failed minimum value (Fail Min), the failed maximum value (Fail Max), and the total number of measurements made (# of Meas).

When :LTEST:TEST is OFF, the :LTEST:RESults? query returns nothing.

<N> An integer, 1-20.

Returned Format [:LTEST:RESults] <fail_min>,<fail_max>,<num_meas><NL>

<fail_min> A real number representing the total number of measurements that have failed the minimum limit.

<fail_max> A real number representing the total number of measurements that have failed the maximum limit.

<num_meas> A real number representing the total number of measurements that have been made.

Example The following example returns the values for the limit test of measurement 1.

```
Dim strRESULTS As String
myScope.WriteString ":LTEST:RESults? MEAS1"
strRESULTS = myScope.ReadString
Debug.Print strRESULTS
```

See Also Measurements are started in the Measurement Subsystem.

- See Also**
- **" :LTEST:FAIL "** on page 621
 - **" :LTEST:LLIMit – Lower Limit "** on page 623
 - **" :LTEST:MEASurement "** on page 624
 - **" :LTEST:TEST "** on page 627
 - **" :LTEST:ULIMit – Upper Limit "** on page 628

History Legacy command (existed before version 3.10).

:LTEST:RUMode:SOFailure

Command :LTEST:RUMode:SOFailure {{0 | OFF} | {1 | ON}}

The :LTEST:RUMode:SOFailure command enables or disables the limit test "stop on failure" option.

When ON, the oscilloscope acquisition system stops once a limit failure is detected. If more than one measurement limit test is enabled, a failure of any of the measurements stops the oscilloscope from acquiring new waveforms.

Query :LTEST:RUMode:SOFailure?

The :LTEST:RUMode:SOFailure? query returns the "stop on failure" setting.

Returned Format <setting><NL>

<setting> ::= {0 | 1}

See Also • [":LTEST:ADDStats"](#) on page 620

History New in version 5.70.

:LTEST:TEST

Command :LTEST:TEST {{ON | 1} {OFF | 0}}

For the active measurement currently selected by the :LTEST:MEASUREMENT command, the LTEST:TEST command enables or disables the limit test function on that measurement.

When any measurement has its limit test function enabled, the overall Limit Test feature is enabled.

The :LTEST:RESULTS? query returns nothing when :LTEST:TEST is OFF.

Example The following example turns off the limit test function for the active measurement currently selected by the :LTEST:MEASUREMENT command.

```
myScope.WriteString ":LTEST:TEST OFF"
```

Query :LTEST:TEST?

The query returns the state of the TEST control for the active measurement currently selected by the :LTEST:MEASUREMENT command.

Returned Format [:LTEST:TEST] {1 | 0} <NL>

Example The following example returns the current state of the limit test and prints the result to the controller's screen.

```
Dim strTEST As String
myScope.WriteString ":LTEST:TEST?"
strTEST = myScope.ReadString
Debug.Print strTEST
```

- See Also**
- **" :LTEST:FAIL "** on page 621
 - **" :LTEST:LLIMIT – Lower Limit "** on page 623
 - **" :LTEST:MEASUREMENT "** on page 624
 - **" :LTEST:RESULTS? "** on page 625
 - **" :LTEST:ULIMIT – Upper Limit "** on page 628

History Legacy command (existed before version 3.10).

:LTEST:ULIMit – Upper Limit

Command :LTEST:ULIMit <upper_value>

For the active measurement currently selected by the :LTEST:MEASurement command, the :LTEST:ULIMit (Upper LIMit) command sets the upper test limit.

<upper_value> A real number.

Example The following example sets the upper limit of the currently selected measurement to 500 mV.

```
myScope.WriteString ":LTEST:ULIMit 500E-3"
```

Suppose you are measuring the maximum voltage of a signal with Vmax, and that voltage should not exceed 500 mV. You can use the above program and set the LTEST:FAIL OUTside command to specify that the limit subsystem will fail a measurement when the voltage exceeds 500 mV.

Query :LTEST:ULIMit?

The query returns the current upper limit of the limit test.

Returned Format [:LTEST:ULIMit] <upper_value><NL>

Example The following example returns the current upper limit of the limit test and prints the result to the controller's screen.

```
Dim strULIM As String
myScope.WriteString ":LTEST:ULIMit?"
strULIM = myScope.ReadString
Debug.Print strULIM
```

- See Also**
- **" :LTEST:FAIL "** on page 621
 - **" :LTEST:LLIMit – Lower Limit "** on page 623
 - **" :LTEST:MEASurement "** on page 624
 - **" :LTEST:RESults? "** on page 625
 - **" :LTEST:TEST "** on page 627

History Legacy command (existed before version 3.10).

25 Lister Commands

:LISTer:DATA? / 630

:LISTer:DISPlay / 631

The LISTer subsystem is used to turn on/off the serial decode Lister display and return data from the Lister display.

:LISTer:DATA?

Query :LISTer:DATA? [{SBUS1 | SBUS2 | SBUS3 | SBUS4} [,<type>]]

The :LISTer:DATA? query returns the lister data.

<type> {PACKets | SYMBols}

Specifies which display window to save.

Returned Format <binary_block><NL>

<binary_block> ::= comma-separated data with newlines at the end of each row

See Also • [":LISTer:DISPlay"](#) on page 631

History New in version 3.50.

Version 5.00: Added the <type> parameter for specifying which display window to save.

:LISTer:DISPlay

Command :LISTer:DISPlay <value>

<value> ::= {OFF | ON | SBUS1 | SBUS2 | SBUS3 | SBUS4}

The :LISTer:DISPlay command configures which of the serial buses to display in the Lister, or whether the Lister is off. "ON" or "1" is the same as "SBUS1".

When set to "ALL", the decode information for different buses is interleaved in time.

Serial bus decode must be on before it can be displayed in the Lister.

Query :LISTer:DISPlay?

The :LISTer:DISPlay? query returns the Lister display setting.

Returned Format <value><NL>

<value> ::= {OFF | ON | SBUS1 | SBUS2 | SBUS3 | SBUS4}

- See Also**
- **":SBUS<N>[:DISPlay]"** on page 1025
 - **":LISTer:DATA?"** on page 630

History New in version 3.50.

26 Marker Commands

:MARKer:CURSor? / 634
:MARKer:DELTA / 635
:MARKer:MEASurement:MEASurement / 636
:MARKer:MODE / 637
:MARKer:TSTArt / 638
:MARKer:TSTOp / 639
:MARKer:VSTArt / 640
:MARKer:VSTOp / 641
:MARKer:X1Position / 642
:MARKer:X2Position / 643
:MARKer:X1Y1source / 644
:MARKer:X2Y2source / 646
:MARKer:XDELta? / 648
:MARKer:Y1Position / 649
:MARKer:Y2Position / 650
:MARKer:YDELta? / 651

The commands in the MARKer subsystem specify and query the settings of the time markers (X axis) and current measurement unit markers (volts, amps, and watts for the Y axis). You typically set the Y-axis measurement units using the :CHANnel:UNITs command.

NOTE

Guidelines for Using Queries in Marker Modes

In Track Waveforms mode, use :MARKer:CURSor? to track the position of the waveform. In Manual Markers and Track Measurements Markers modes, use other queries, such as the X1Position? and X2Position?, and VSTArt? and VSTOp? queries. If you use :MARKer:CURSor? when the oscilloscope is in either Manual Markers or Track Measurements Markers modes, it will put the oscilloscope in Track Waveforms mode, regardless of the mode previously selected. In addition, measurement results may not be what you expected.

:MARKer:CURSor?

Query :MARKer:CURSor? {DELTA | START | STOP}

The :MARKer:CURSor? query returns the time and current measurement unit values of the specified marker (if markers are in Track Waveforms mode) as an ordered pair of time and measurement unit values.

- If DELTA is specified, the value of delta Y and delta X are returned.
- If START is specified, marker A's x-to-y positions are returned.
- If STOP is specified, marker B's x-to-y positions are returned.

CAUTION

The :MARKer:CURSor? query may change marker mode and results.

In Track Waveforms mode, use :MARKer:CURSor? to track the position of the waveform. In Manual Markers and Track Measurements Markers modes, use other marker queries, such as the X1Position? and X2Position?, and VStart? and VStop? queries.

If you use :MARKer:CURSor? when the oscilloscope is in either Manual Markers or Track Measurements Markers modes, it will put the oscilloscope in Track Waveforms mode, regardless of the mode previously selected. In addition, measurement results may not be what you expected. In addition, measurement results may not be what you expected.

Returned Format [:MARKer:CURSor] {DELTA | START | STOP}
{<Ax, Ay> | <Bx, By> | <deltaX, deltaY>}<NL>

Example This example returns the current position of the X cursor and measurement unit marker 1 to the string variable, strPosition. The program then prints the contents of the variable to the computer's screen.

```
Dim strPosition As String    ' Dimension variable.
myScope.WriteString ":MARKer:CURSor? START"
strPosition = myScope.ReadString
Debug.Print strPosition
```

History Legacy command (existed before version 3.10).

:MARKer:DELTA

Command :MARKer:DELTA {{0 | OFF} | {1 | ON}}

The :MARKer:DELTA command turns on or off the graphical user interface's **Delta Markers** check box setting to display deltas on the screen (as opposed to the deltas in the results area and remote queries).

Query :MARKer:DELTA?

The :MARKer:DELTA? query returns the graphical user interface's **Delta Markers** check box setting (in the Markers dialog box).

Returned Format <setting><NL>

<setting> ::= {0 | 1}

- See Also**
- [":MARKer:XDELTA?"](#) on page 648
 - [":MARKer:YDELTA?"](#) on page 651

History New in version 6.10.

:MARKer:MEASurement:MEASurement

Command :MARKer:MEASurement:MEASurement {MEASurement<N>}

The :MARKer:MEASurement:MEASurement command specifies which measurement markers track. This setting is only used when the :MARKer:MODE is set to MEASurement.

<N> An integer, 1-20.

NOTE

When <N> is 10-20, the long form of the mnemonic, MEASurement<N>, is too long. In this case, you must use the short form, MEAS<N>.

Example This example sets the markers to track the fourth measurement.

```
myScope.WriteString ":MARKer:MEASurement:MEASurement MEASurement4"
```

Query :MARKer:MEASurement:MEASurement?

The :MARKer:MEASurement:MEASurement? query returns the currently specified measurement for marker tracking.

Returned Format [:MARKer:MEASurement:MEASurement] {MEAS<N>}<NL>

Example This example places the current marker mode in the string variable, strTrackMeas, then prints the contents of the variable to the computer's screen.

```
Dim strTrackMeas As String ' Dimension variable.
myScope.WriteString ":MARKer:MEASurement:MEASurement?"
strTrackMeas = myScope.ReadString
Debug.Print strTrackMeas
```

See Also • [":MARKer:MODE"](#) on page 637

History New in version 3.20.

Version 5.00: Up to 20 measurements are supported.

:MARKer:MODE

Command :MARKer:MODE {OFF | MANual | WAVeform | MEASurement | XONLy | YONLy}

The :MARKer:MODE command sets the marker mode:

- OFF – Removes the marker information from the display.
- MANual – Enables manual placement of both X (horizontal) and Y (vertical) markers.
- XONLy – Enables manual placement of X (horizontal) markers.
- YONLy – Enables manual placement of Y (vertical) markers.
- WAVeform – Tracks the current waveform.
- MEASurement – Tracks the most recent measurement.

Example This example sets the marker mode to waveform.

```
myScope.WriteString ":MARKer:MODE WAVeform"
```

Query :MARKer:MODE?

The :MARKer:MODE? query returns the current marker mode.

Returned Format [:MARKer:MODE] {OFF | MAN | WAV | MEAS | XONL | YONL}<NL>

Example This example places the current marker mode in the string variable, strSelection, then prints the contents of the variable to the computer's screen.

```
Dim strSelection As String ' Dimension variable.
myScope.WriteString ":MARKer:MODE?"
strSelection = myScope.ReadString
Debug.Print strSelection
```

History Legacy command (existed before version 3.10).

Version 5.00: The FFTPeak mode was removed.

Version 5.70: Added XONLy and YONLy options for for the "Manual (X only)" and "Manual (Y only)" marker modes.

:MARKer:TSTArt

Command :MARKer:TSTArt <Ax_position>

The :MARKer:TSTArt command sets the Ax marker position. The :MARKer:X1Position command described in this chapter also sets the Ax marker position.

NOTE

Use :MARKer:X1Position Instead of :MARKer:TSTArt

The :MARKer:TSTArt command and query perform the same function as the :MARKer:X1Position command and query. The :MARKer:TSTArt command is provided for compatibility with programs written for previous oscilloscopes. You should use :MARKer:X1Position for new programs.

<Ax_position> A real number for the time at the Ax marker, in seconds.

Example This example sets the Ax marker at 90 ns. Notice that this example uses the X1Position command instead of TSTArt.

```
myScope.WriteString ":MARKer:X1Position 90E-9"
```

Query :MARKer:TSTArt?

The :MARKer:TSTArt? query returns the time at the Ax marker.

Returned Format [:MARKer:TSTArt] <Ax_position><NL>

Example This example places the current setting of the Ax marker in the numeric variable, varSetting, then prints the contents of the variable to the computer's screen. Notice that this example uses the :MARKer:X1Position? query instead of the :MARKer:TSTArt? query.

```
myScope.WriteString ":SYSTem:HEADer OFF" ' Response headers off.
myScope.WriteString ":MARKer:X1Position?"
varSetting = myScope.ReadNumber
Debug.Print FormatNumber(varSetting, 0)
```

NOTE

Do Not Use TST as the Short Form of TSTArt and TSTOp

The short form of the TSTArt command and query does not follow the defined convention for short form commands. Because the short form, TST, is the same for TSTArt and TSTOp, sending TST produces an error. Use TSTA for TSTArt.

History Legacy command (existed before version 3.10).

:MARKer:TSTOp

Command :MARKer:TSTOp <Bx_position>

The :MARKer:TSTOp command sets the Bx marker position. The :MARKer:X2Position command described in this chapter also sets the Bx marker position.

NOTE**Use :MARKer:X2Position Instead of :MARKer:TSTOp**

The :MARKer:TSTOp command and query perform the same function as the :MARKer:X2Position command and query. The :MARKer:TSTOp command is provided for compatibility with programs written for previous oscilloscopes. You should use :MARKer:X2Position for new programs.

<Bx_position> A real number for the time at the Bx marker, in seconds.

Example This example sets the Bx marker at 190 ns. Notice that this example uses the X2Position command instead of TSTOp.

```
myScope.WriteString ":MARKer:X2Position 190E-9"
```

Query :MARKer:TSTOp?

The :MARKer:TSTOp? query returns the time at the Bx marker position.

Returned Format [:MARKer:TSTOp] <Bx_position><NL>

Example This example places the current setting of the Bx marker in the numeric variable, varSetting, then prints the contents of the variable to the computer's screen. Notice that this example uses the :MARKer:X2Position? query instead of the :MARKer:TSTOp? query.

```
myScope.WriteString ":SYSTem:HEADer OFF" ' Response headers off.
myScope.WriteString ":MARKer:X2Position?"
varSetting = myScope.ReadNumber
Debug.Print FormatNumber(varSetting, 0)
```

NOTE**Do Not Use TST as the Short Form of TSTArt and TSTOp**

The short form of the TSTOp command and query does not follow the defined convention for short form commands. Because the short form, TST, is the same for TSTArt and TSTOp, sending TST produces an error. Use TSTO for TSTOp.

History Legacy command (existed before version 3.10).

:MARKer:VSTArt

Command :MARKer:VSTArt <Ay_position>

The :MARKer:VSTArt command sets the Ay marker position and moves the Ay marker to the specified measurement unit value on the specified source. The :MARKer:Y1Position command described in this chapter does also.

NOTE**Use :MARKer:Y1Position Instead of :MARKer:VSTArt**

The :MARKer:VSTArt command and query perform the same function as the :MARKer:Y1Position command and query. The :MARKer:VSTArt command is provided for compatibility with programs written for previous oscilloscopes. You should use :MARKer:Y1Position for new programs.

<Ay_position> A real number for the current measurement unit value at Ay (volts, amps, or watts).

Example This example sets Ay to -10 mV. Notice that this example uses the Y1Position command instead of VSTArt.

```
myScope.WriteString ":MARKer:Y1Position -10E-3"
```

Query :MARKer:VSTArt?

The :MARKer:VSTArt? query returns the current measurement unit level of Ay.

Returned Format [:MARKer:VSTArt] <Ay_position><NL>

History Legacy command (existed before version 3.10).

:MARKer:VSTOp

Command :MARKer:VSTOp <By_position>

The :MARKer:VSTOp command sets the By marker position. The :MARKer:Y2Position command described in this chapter also sets the By marker position.

NOTE**Use :MARKer:Y2Position Instead of :MARKer:VSTOp**

The :MARKer:VSTOp command and query perform the same function as the :MARKer:Y2Position command and query. The :MARKer:VSTOp command is provided for compatibility with programs written for previous oscilloscopes. You should use :MARKer:Y2Position for new programs.

<By_position> A real number for the time at the By marker, in seconds.

Example This example sets the By marker at 10 mV. Notice that this example uses the Y2Position command instead of VSTOp.

```
myScope.WriteString ":MARKer:Y2Position 10E-3"
```

Query :MARKer:VSTOp?

The :MARKer:VSTOp? query returns the time at the By marker position.

Returned Format [:MARKer:VSTOp] <By_position><NL>

Example This example places the current setting of the By marker in the numeric variable, varSetting, then prints the contents of the variable to the computer's screen. Notice that this example uses the :MARKer:Y2? query instead of the :MARKer:VSTOp? query.

```
myScope.WriteString ":SYSTem:HEADer OFF" ' Response headers off.
myScope.WriteString ":MARKer:Y2Position?"
varSetting = myScope.ReadNumber
Debug.Print FormatNumber(varSetting, 0)
```

History Legacy command (existed before version 3.10).

:MARKer:X1Position

Command :MARKer:X1Position <Ax_position>

The :MARKer:X1Position command sets the Ax marker position, and moves the Ax marker to the specified time with respect to the trigger time.

<Ax_position> A real number for the time at the Ax marker in seconds.

Example This example sets the Ax marker to 90 ns.

```
myScope.WriteString ":MARKer:X1Position 90E-9"
```

Query :MARKer:X1Position?

The :MARKer:X1Position? query returns the time at the Ax marker position.

Returned Format [:MARKer:X1Position] <Ax_position><NL>

Example This example returns the current setting of the Ax marker to the numeric variable, varValue, then prints the contents of the variable to the computer's screen.

```
myScope.WriteString ":SYSTem:HEADer OFF" ' Response headers off.
myScope.WriteString ":MARKer:X1Position?"
varValue = myScope.ReadNumber
Debug.Print FormatNumber(varValue, 0)
```

See Also :MARKer:TSTArt

History Legacy command (existed before version 3.10).

:MARKer:X2Position

Command :MARKer:X2Position <Bx_position>

The :MARKer:X2Position command sets the Bx marker position and moves the Bx marker to the specified time with respect to the trigger time.

<Bx_position> A real number for the time at the Bx marker in seconds.

Example This example sets the Bx marker to 90 ns.

```
myScope.WriteString ":MARKer:X2Position 90E-9"
```

Query :MARKer:X2Position?

The :MARKer:X2Position? query returns the time at Bx marker in seconds.

Returned Format [:MARKer:X2Position] <Bx_position><NL>

Example This example returns the current position of the Bx marker to the numeric variable, varValue, then prints the contents of the variable to the computer's screen.

```
myScope.WriteString ":SYSTem:HEADer OFF" ' Response headers off.
myScope.WriteString ":MARKer:X2Position?"
varValue = myScope.ReadNumber
Debug.Print FormatNumber(varValue, 0)
```

History Legacy command (existed before version 3.10).

:MARKer:X1Y1source

Command :MARKer:X1Y1source {CHANnel<N> | DIFF<D> | COMMONmode<C>
| FUNction<F> | WMEMory<R> | CLOCk | MTRend | MSPectrum | EQUalized
| HISTogram | DIGital<M> | BUS}

The :MARKer:X1Y1source command sets the source for the Ax and Ay markers. The channel you specify must be enabled for markers to be displayed. If the channel, function, or waveform memory that you specify is not on, an error message is issued and the query will return channel 1.

MTRend and MSPectrum sources are only available if the oscilloscope has the EZJIT option installed and the feature is enabled.

The CLOCk source is only available if the oscilloscope has the High Speed Serial option installed and the feature is enabled.

The EQUalized source is only available if the oscilloscope has the High Speed Serial option and the Serial Data Equalization option installed and the features are enabled. This command uses the Feed-Forward Equalized (FFE) signal as the source.

<N> An integer, 1-4 in a single oscilloscope, 1-40 in a MultiScope system.

<F> An integer, 1-16.

<R> An integer, 1-4.

<D>, <C> <D> is an integer, 1-2. <C> is an integer, 3-4.

The DIFF and COMMONmode sources are just aliases that can be used in place of the channel names to apply to differential or common mode signals. These are just aliases - no state change occurs if you refer to a differential channel and you are not in differential mode. DIFF1 refers to the differential signal between channels 1 and 3 (and COMMONmode3 refers to the common mode channel between these same channels). DIFF2 refers to the differential signal between channels 2 and 4 (and COMMONmode4 refers to the common mode channel between these same channels).

<M> An integer, 0-15. Digital channels are available on mixed-signal oscilloscopes.

 An integer, 1-4. Buses are available on mixed-signal oscilloscopes.

Example This example selects channel 1 as the source for markers Ax and Ay.

```
myScope.WriteString ":MARKer:X1Y1source CHANnel1"
```

Query :MARKer:X1Y1source?

The :MARKer:X1Y1source? query returns the current source for markers Ax and Ay.

Returned Format [:MARKer:X1Y1source] {CHANnel<N> | DIFF<D> | COMMONmode<C>
| FUNction<F> | WMEMory<R> | CLOCk | MTRend | MSPectrum | EQUalized
| HISTogram | DIGital<M> | BUS}<NL>

Example This example returns the current source selection for the Ax and Ay markers to the string variable, strSelection, then prints the contents of the variable to the computer's screen.

```
Dim strSelection As String ' Dimension variable.  
myScope.WriteString ":MARKer:X1Y1source?"  
strSelection = myScope.ReadString  
Debug.Print strSelection
```

History Legacy command (existed before version 3.10).

:MARKer:X2Y2source

Command :MARKer:X2Y2source {CHANnel<N> | DIFF<D> | COMMONmode<C>
 | FUNction<F> | WMEMory<R> | CLOCk | MTRend | MSPectrum | EQUalized
 | HISTogram | DIGital<M> | BUS}

The :MARKer:X2Y2source command sets the source for the Bx and By markers. The channel you specify must be enabled for markers to be displayed. If the channel, function, or waveform memory that you specify is not on, an error message is issued and the query will return channel 1.

MTRend and MSPectrum sources are only available if the oscilloscope has the EZJIT option installed and the feature is enabled.

The CLOCk source is only available if the oscilloscope has the High Speed Serial option installed and the feature is enabled.

The EQUalized source is only available if the oscilloscope has the High Speed Serial option and the Serial Data Equalization option installed and the features are enabled. This command uses the Feed-Forward Equalized (FFE) signal as the source.

<N> An integer, 1-4 in a single oscilloscope, 1-40 in a MultiScope system.

<D>, <C> <D> is an integer, 1-2. <C> is an integer, 3-4.

The DIFF and COMMONmode sources are just aliases that can be used in place of the channel names to apply to differential or common mode signals. These are just aliases - no state change occurs if you refer to a differential channel and you are not in differential mode. DIFF1 refers to the differential signal between channels 1 and 3 (and COMMONmode3 refers to the common mode channel between these same channels). DIFF2 refers to the differential signal between channels 2 and 4 (and COMMONmode4 refers to the common mode channel between these same channels).

<F> An integer, 1-16.

<R> An integer, 1-4.

<M> An integer, 0-15. Digital channels are available on mixed-signal oscilloscopes.

 An integer, 1-4. Buses are available on mixed-signal oscilloscopes.

Example This example selects channel 1 as the source for markers Bx and By.

```
myScope.WriteString ":MARKer:X2Y2source CHANnel1"
```

Query :MARKer:X2Y2source?

The :MARKer:X2Y2source? query returns the current source for markers Bx and By.

Returned Format [:MARKer:X2Y2source] {CHANnel<N> | DIFF<D> | COMMONmode<C>
 | FUNction<F> | WMEMory<R> | CLOCk | MTRend | MSPectrum | EQUalized
 | HISTogram | DIGital<M> | BUS}<NL>

Example This example returns the current source selection for the Bx and By markers to the string variable, strSelection, then prints the contents of the variable to the computer's screen.

```
Dim strSelection As String ' Dimension variable.  
myScope.WriteString ":MARKer:X2Y2source?"  
strSelection = myScope.ReadString  
Debug.Print strSelection
```

History Legacy command (existed before version 3.10).

:MARKer:XDELta?

Query :MARKer:XDELta?

The :MARKer:XDELta? query returns the time difference between Ax and Bx time markers.

Xdelta = time at Bx - time at Ax

Returned Format [:MARKer:XDELta] <time><NL>

<time> Time difference between Ax and Bx time markers in seconds.

Example This example returns the current time between the Ax and Bx time markers to the numeric variable, varTime, then prints the contents of the variable to the computer's screen.

```
myScope.WriteString ":SYSTEM:HEADer OFF" ' Response headers off.
myScope.WriteString ":MARKer:XDELta?"
varTime = myScope.ReadNumber
Debug.Print FormatNumber(varTime, 0)
```

History Legacy command (existed before version 3.10).

:MARKer:Y1Position

Command :MARKer:Y1Position <Ay_position>

The :MARKer:Y1Position command sets the Ay marker position on the specified source.

<Ay_position> A real number for the current measurement unit value at Ay (volts, amps, or watts).

Example This example sets the Ay marker to 10 mV.

```
myScope.WriteString ":MARKer:Y1Position 10E-3"
```

Query :MARKer:Y1Position?

The :MARKer:Y1Position? query returns the current measurement unit level at the Ay marker position.

Returned Format [:MARKer:Y1Position] <Ay_position><NL>

Example This example returns the current setting of the Ay marker to the numeric variable, varValue, then prints the contents of the variable to the computer's screen.

```
myScope.WriteString ":SYSTem:HEADer OFF" ' Response headers off.
myScope.WriteString ":MARKer:Y1Position?"
varValue = myScope.ReadNumber
Debug.Print FormatNumber(varValue, 0)
```

History Legacy command (existed before version 3.10).

:MARKer:Y2Position

Command :MARKer:Y2Position <By_position>

The :MARKer:Y2Position command sets the By marker position on the specified source.

<By_position> A real number for the current measurement unit value at By (volts, amps, or watts).

Example This example sets the By marker to -100 mV.

```
myScope.WriteString ":MARKer:Y2Position -100E-3"
```

Query :MARKer:Y2Position?

The :MARKer:Y2Position? query returns the current measurement unit level at the By marker position.

Returned Format [:MARKer:Y2Position] <By_position><NL>

Example This example returns the current setting of the By marker to the numeric variable, varValue, then prints the contents of the variable to the computer's screen.

```
myScope.WriteString ":SYSTem:HEADer OFF" ' Response headers off.
myScope.WriteString ":MARKer:Y2Position?"
varValue = myScope.ReadNumber
Debug.Print FormatNumber(varValue, 0)
```

History Legacy command (existed before version 3.10).

:MARKer:YDELta?

Query :MARKer:YDELta?

The :MARKer:YDELta? query returns the current measurement unit difference between Ay and By.

Ydelta = value at By - value at Ay

Returned Format [:MARKer:YDELta] <value><NL>

<value> Measurement unit difference between Ay and By.

Example This example returns the voltage difference between Ay and By to the numeric variable, varVolts, then prints the contents of the variable to the computer's screen.

```
myScope.WriteString ":SYSTEM:HEADer OFF" ' Response headers off.
myScope.WriteString ":MARKer:YDELta?"
varVolts = myScope.ReadNumber
Debug.Print FormatNumber(varVolts, 0)
```

History Legacy command (existed before version 3.10).

27 Mask Test Commands

:MTESt:ALIGn / 655
:MTESt:AlignFIT / 656
:MTESt:AMASk:CREate / 658
:MTESt:AMASk:SOURce / 659
:MTESt:AMASk:SAVE / 661
:MTESt:AMASk:UNITs / 662
:MTESt:AMASk:XDELta / 663
:MTESt:AMASk:YDELta / 664
:MTESt:AUTO / 665
:MTESt:AVERage / 666
:MTESt:AVERage:COUNT / 667
:MTESt:COUNt:FAILures? / 668
:MTESt:COUNt:FUI? / 669
:MTESt:COUNt:FWAVEforms? / 670
:MTESt:COUNt:MARGin:FAILures? / 671
:MTESt:COUNt:SUI? / 672
:MTESt:COUNt:UI? / 673
:MTESt:COUNt:WAVEforms? / 674
:MTESt:DELeTe / 675
:MTESt:ENABLE / 676
:MTESt:FOLDing (Clock Recovery software only) / 677
:MTESt:FOLDing:BITS / 679
:MTESt:FOLDing:COUNt:UI? / 681
:MTESt:FOLDing:COUNt:WAVEforms? / 683
:MTESt:FOLDing:FAST / 685
:MTESt:FOLDing:POSition / 687
:MTESt:FOLDing:SCALE / 689
:MTESt:FOLDing:TPOSition / 691
:MTESt:FOLDing:TSCale / 693
:MTESt:HAMPliTude / 695
:MTESt:IMPedance / 696
:MTESt:INVert / 697

:MTESt:LAMPlitude / 698
:MTESt:LOAD / 699
:MTESt:MARGIn:AUTO:HITS / 700
:MTESt:MARGIn:AUTO:HRATio / 701
:MTESt:MARGIn:AUTO:METHod / 702
:MTESt:MARGIn:METHod / 703
:MTESt:MARGIn:PERCent / 704
:MTESt:MARGIn:STATe / 705
:MTESt:NREGions? / 706
:MTESt:PROBe:IMPedance? / 707
:MTESt:RUMode / 708
:MTESt:RUMode:SOFailure / 709
:MTESt:SCALe:BIND / 710
:MTESt:SCALe:X1 / 711
:MTESt:SCALe:XDELta / 712
:MTESt:SCALe:Y1 / 713
:MTESt:SCALe:Y2 / 714
:MTESt:SOURce / 715
:MTESt:START / 716
:MTESt:STOP / 717
:MTESt:STIME / 718
:MTESt:TITLe? / 719
:MTESt:TRIGger:SOURce / 720

The MTESt subsystem commands and queries control the mask test features. Mask Testing automatically compares measurement results with the boundaries of a set of polygons that you define. Any waveform or sample that falls within the boundaries of one or more polygons is recorded as a failure.

The FOLDing command is only available when the E2688A Clock Recovery Software is installed.

:MTEST:ALIGN

Command :MTEST:ALIGN

The :MTEST:ALIGN command automatically aligns and scales the mask to the current waveform on the display. The type of mask alignment performed depends on the current setting of the Use File Setup When Aligning control. See the :MTEST:AUTO command for more information.

Example This example aligns the current mask to the current waveform.

```
myScope.WriteString ":MTEST:ALIGN"
```

History Legacy command (existed before version 3.10).

:MTEST:AlignFIT

Command :MTEST:AlignFIT {EYEAMI | EYECMI | EYENRZ | FANWidth | FAPeriod
| FAPWidth | FYNWidth | FYPWidth | NONE | NWidth
| PWidth | TMAX | TMIN}

The :MTEST:AlignFIT command specifies the alignment type for aligning a mask to a waveform. The pulse mask standard has rules that determine which controls the oscilloscope can adjust or change during the alignment process. In the following table of alignment types, an X in a column indicates that the control can be adjusted.

Table 13 Available Alignment Types

| Alignment Type | Waveform Type | Horizontal Position | 0 Level Voltage | 1 Level Voltage | Vertical Offset | Invert Waveform |
|----------------|---------------------|---------------------|-----------------|-----------------|-----------------|-----------------|
| EYEAMI | AMI | X | X | X | | |
| EYECMI | CMI | X | X | X | | |
| EYENRZ | NRZ | X | X | X | | |
| FANWidth | Negative | X | | | X | X |
| FAPeriod | Full Period | X | X | | | |
| FAPWidth | Positive | X | | | X | X |
| FYNWidth | Negative | X | X | | | X |
| FYPWidth | Positive | X | X | | | X |
| NONE | Automask | | | | | |
| NWidth | Negative Pulse | X | X | X | | X |
| PWidth | Positive Pulse | X | X | X | | X |
| TMAX | Positive Sine Pulse | X | X | X | | X |
| TMIN | Negative Sine Pulse | X | X | X | | X |

Example This example specifies the alignment type to be EYEAMI.

```
myScope.WriteString ":MTEST:AlignFIT EYEAMI"
```

Query :MTEST:AlignFIT?

The :MTEST:AlignFIT? query returns the alignment type used for the mask.

Returned Format [:MTEST:AlignFIT] {EYEAMI | EYECMI | EYENRZ | FANwidth | FAPeriod
| FAPwidth | FYNwidth | FYPwidth | NONE | Nwidth
| Pwidth | TMAX | TMIN}<NL>

History Legacy command (existed before version 3.10).

:MTESt:AMASk:CREate

Command :MTESt:AMASk:CREate

The :MTESt:AMASk:CREate command automatically constructs a mask around the current selected channel, using the tolerance parameters defined by the AMASk:XDELta, AMASk:YDELta, and AMASk:UNITs commands. The mask only encompasses the portion of the waveform visible on the display, so you must ensure that the waveform is acquired and displayed consistently to obtain repeatable results.

The :MTESt:SOURce command selects the channel and should be set before using this command.

Example This example creates an automask using the current XDELta and YDELta units settings.

```
myScope.WriteString ":MTESt:AMASk:CREate"
```

History Legacy command (existed before version 3.10).

:MTEST:AMASK:SOURce

Command :MTEST:AMASK:SOURce {CHANnel<N> | DIFF<D> | COMMONmode<C>
| FUNCTion<F> | WMEMory<R> | CLOCK | EQUalized
| MTRend | MSPectrum}

The :MTEST:AMASK:SOURce command selects the source for the interpretation of the AMASK:XDELta and AMASK:YDELta parameters when AMASK:UNITs is set to CURRent. When UNITs are CURRent, the XDELta and YDELta parameters are defined in terms of the channel units, as set by the :CHANnel:UNITs command, of the selected source. Suppose that UNITs are CURRent and that you set SOURce to CHANnel1, which is using units of volts. Then you can define AMASK:XDELta in terms of volts and AMASK:YDELta in terms of seconds.

The EQUalized source is only available if the oscilloscope has the High Speed Serial option and the Serial Data Equalization option installed and the features are enabled. This command uses the Feed-Forward Equalized (FFE) signal as the source.

<N> An integer, 1-4 in a single oscilloscope, 1-40 in a MultiScope system.

<D>, <C> <D> is an integer, 1-2. <C> is an integer, 3-4.

The DIFF and COMMONmode sources are just aliases that can be used in place of the channel names to apply to differential or common mode signals. These are just aliases - no state change occurs if you refer to a differential channel and you are not in differential mode. DIFF1 refers to the differential signal between channels 1 and 3 (and COMMONmode3 refers to the common mode channel between these same channels). DIFF2 refers to the differential signal between channels 2 and 4 (and COMMONmode4 refers to the common mode channel between these same channels).

<F> An integer, 1-16.

<R> An integer, 1-4.

Example This example sets the automask source to Channel 1.

```
myScope.WriteString ":MTEST:AMASK:SOURce CHANnel1"
```

Query :MTEST:AMASK:SOURce?

The :MTEST:AMASK:SOURce? query returns the currently set source.

Returned Format [:MTEST:AMASK:SOURce] {CHANnel<N> | DIFF<D> | COMMONmode<C>
| WMEMory<R> | FUNCTion<F> | CLOCK | EQUalized
| MTRend | MSPectrum}<NL>

Example This example gets the source setting for automask and prints the result on the computer display.

```
Dim strAmask_source As String
myScope.WriteString ":MTEST:AMASK:SOURce?"
strAmask_source = myScope.ReadString
Debug.Print strAmask_source
```

History Legacy command (existed before version 3.10).

:MTEST:AMASK:SAVE

Command :MTEST:AMASK:{SAVE | STORE} "<filename>"

NOTE

The :MTEST:AMASK:STORE command is equivalent to the :MTEST:AMASK:SAVE command.

The :MTEST:AMASK:SAVE command saves the automask generated mask to a file. If an automask has not been generated, an error occurs.

<filename> An MS-DOS compatible name of the file, a maximum of 254 characters long (including the path name, if used). The filename assumes the present working directory if a path does not precede the file name. The default save path is C:\Users\Public\Documents\Infiniium\masks. The filename must have a .msk or .MSK extension or the command will fail.

Example This example saves the automask generated mask to a file named "FILE1.MSK".

```
myScope.WriteString ":MTEST:AMASK:SAVE" "FILE1.MSK" ""
```

History Legacy command (existed before version 3.10).

:MTEST:AMASK:UNITs

Command :MTEST:AMASK:UNITs {CURRENT | DIVisions}

The :MTEST:AMASK:UNITs command alters the way the mask test subsystem interprets the tolerance parameters for automasking as defined by AMASK:XDELta and AMASK:YDELta commands.

CURRENT When set to CURRENT, the mask test subsystem uses the units as set by the :CHANnel:UNITs command, usually time for ΔX and voltage for ΔY .

DIVisions When set to DIVisions, the mask test subsystem uses the graticule as the measurement system, so tolerance settings are specified as parts of a screen division. The mask test subsystem maintains separate XDELta and YDELta settings for CURRENT and DIVisions. Thus, XDELta and YDELta are not converted to new values when the UNITs setting is changed.

Example This example sets the measurement units for automasking to the current :CHANnel:UNITs setting.

```
myScope.WriteString ":MTEST:AMASK:UNITs CURRENT"
```

Query :MTEST:AMASK:UNITs?

The AMASK:UNITs query returns the current measurement units setting for the mask test automask feature.

Returned Format [:MTEST:AMASK:UNITs] {CURRENT | DIVision}<NL>

Example This example gets the automask units setting, then prints the setting on the screen of the computer.

```
Dim strAutomask_units As String
myScope.WriteString ":MTEST:AMASK:UNITs?"
strAutomask_units = myScope.ReadString
Debug.Print strAutomask_units
```

History Legacy command (existed before version 3.10).

:MTEST:AMASK:XDELta

Command :MTEST:AMASK:XDELta <xdelta_value>

The :MTEST:AMASK:XDELta command sets the tolerance in the X direction around the waveform for the automasking feature. The absolute value of the tolerance will be added and subtracted to horizontal values of the waveform to determine the boundaries of the mask.

<xdelta_value> A value for the horizontal tolerance. This value is interpreted based on the setting specified by the AMASK:UNITs command; thus, if you specify 250-E3, the setting for AMASK:UNITs is CURRent, and the current setting specifies time in the horizontal direction, the tolerance will be ± 250 ms. If the setting for AMASK:UNITs is DIVISIONs, the same xdelta_value will set the tolerance to ± 250 millidivisions, or 1/4 of a division.

Example This example sets the units to divisions and sets the ΔX tolerance to one-eighth of a division.

```
myScope.WriteString ":MTEST:AMASK:UNITs DIVISIONs"
myScope.WriteString ":MTEST:AMASK:XDELta 125E-3"
```

Query :MTEST:AMASK:XDELta?

The AMASK:XDELta? query returns the current setting of the ΔX tolerance for automasking. If your computer program will interpret this value, it should also request the current measurement system using the AMASK:UNITs query.

Returned Format [:MTEST:AMASK:XDELta] <xdelta_value><NL>

Example This example gets the measurement system units and ΔX settings for automasking from the oscilloscope and prints the results on the computer screen.

```
Dim strAutomask_units As String
Dim strAutomask_xdelta As String
myScope.WriteString ":MTEST:AMASK:UNITs?"
strAutomask_units = myScope.ReadString
myScope.WriteString ":MTEST:AMASK:XDELta?"
strAutomask_xdelta = myScope.ReadString
Debug.Print strAutomask_units
Debug.Print strAutomask_xdelta
```

History Legacy command (existed before version 3.10).

:MTEST:AMASK:YDELta

Command :MTEST:AMASK:YDELta <ydelta_value>

The :MTEST:AMASK:YDELta command sets the vertical tolerance around the waveform for the automasking feature. The absolute value of the tolerance will be added and subtracted to vertical values of the waveform to determine the boundaries of the mask.

This command requires that mask testing be enabled, otherwise a settings conflict error message is displayed. See :MTEST:ENABLE for information on enabling mask testing.

<ydelta_value> A value for the vertical tolerance. This value is interpreted based on the setting specified by the AMASK:UNITS command; thus, if you specify 250-E3, the setting for AMASK:UNITS is CURRENT, and the current setting specifies voltage in the vertical direction, the tolerance will be ± 250 mV. If the setting for AMASK:UNITS is DIVISIONS, the same ydelta_value will set the tolerance to ± 250 millidivisions, or 1/4 of a division.

Example This example sets the units to current and sets the ΔY tolerance to 30 mV, assuming that the current setting specifies volts in the vertical direction.

```
myScope.WriteString ":MTEST:AMASK:UNITS CURRENT"
myScope.WriteString ":MTEST:AMASK:YDELta 30E-3"
```

Query :MTEST:AMASK:YDELta?

The AMASK:YDELta? query returns the current setting of the ΔY tolerance for automasking. If your computer program will interpret this value, it should also request the current measurement system using the AMASK:UNITS query.

Returned Format [:MTEST:AMASK:YDELta] <ydelta_value><NL>

Example This example gets the measurement system units and ΔY settings for automasking from the oscilloscope and prints the results on the computer screen.

```
Dim strAutomask_units As String
Dim strAutomask_ydelta As String
myScope.WriteString ":MTEST:AMASK:UNITS?"
strAutomask_units = myScope.ReadString
myScope.WriteString ":MTEST:AMASK:YDELta?"
strAutomask_ydelta = myScope.ReadString
Debug.Print strAutomask_units
Debug.Print strAutomask_ydelta
```

History Legacy command (existed before version 3.10).

:MTEST:AUTO

Command :MTEST:AUTO {{ON | 1} | {OFF | 0}}

The :MTEST:AUTO command enables (ON) or disables (OFF) the Use File Setup When Aligning control. This determines which type of mask alignment is performed when the :MTEST:ALIGN command is sent. When enabled, the oscilloscope controls are changed to the values which are determined by the loaded mask file. This alignment guarantees that the aligned mask and any subsequent mask tests meet the requirements of the standard.

When disabled, the alignment is performed using the current oscilloscope settings. This may be useful when troubleshooting problems during the design phase of a project.

Example This example enables the Use File Settings When Aligning control.

```
myScope.WriteString ":MTEST:AUTO ON"
```

Query :MTEST:AUTO?

The :MTEST:AUTO? query returns the current value of the Use File Setup When Aligning control.

Returned Format [:MTEST:AUTO] {1 | 0} <NL>

Example

```
myScope.WriteString ":MTEST:AUTO?"
varValue = myScope.ReadNumber
Debug.Print FormatNumber(varValue, 0)
```

History Legacy command (existed before version 3.10).

:MTEST:AVERage

Command :MTEST:AVERage {{ON | 1} | {OFF | 0}}

The :MTEST:AVERage command enables or disables averaging. When ON, the oscilloscope acquires multiple data values for each time bucket, and averages them. When OFF, averaging is disabled. To set the number of averages, use the :MTEST:AVERage:COUNT command described next.

The :ACQUIRE:AVERage command performs the same function as this command.

Averaging is not available in PDETECT mode.

Example This example turns averaging on.

```
myScope.WriteString ":MTEST:AVERage ON"
```

Query :MTEST:AVERage?

The :MTEST:AVERage? query returns the current setting for averaging.

Returned Format [:MTEST:AVERage] {1 | 0} <NL>

Example This example places the current settings for averaging into the string variable, strSetting, then prints the contents of the variable to the computer's screen.

```
Dim strSetting As String ' Dimension variable.
myScope.WriteString ":MTEST:AVERage?"
strSetting = myScope.ReadString
Debug.Print strSetting
```

History Legacy command (existed before version 3.10).

:MTEST:AVERAge:COUNT

Command :MTEST:AVERAge:COUNT <count_value>

The :MTEST:AVERAge:COUNT command sets the number of averages for the waveforms. In the AVERAge mode, the :MTEST:AVERAge:COUNT command specifies the number of data values to be averaged for each time bucket before the acquisition is considered complete for that time bucket.

The :ACQUIRE:AVERAge:COUNT command performs the same function as this command.

<count_value> An integer, 2 to 65534, specifying the number of data values to be averaged.

Example This example specifies that 16 data values must be averaged for each time bucket to be considered complete. The number of time buckets that must be complete for the acquisition to be considered complete is specified by the :MTEST:COMplete command.

```
myScope.WriteString ":MTEST:AVERAge:COUNT 16"
```

Query :MTEST:AVERAge:COUNT?

The :MTEST:AVERAge:COUNT? query returns the currently selected count value.

Returned Format [:MTEST:AVERAge:COUNT] <value><NL>

<value> An integer, 2 to 65534, specifying the number of data values to be averaged.

Example This example checks the currently selected count value and places that value in the string variable, varResult. The program then prints the contents of the variable to the computer's screen.

```
myScope.WriteString ":SYSTem:HEADer OFF"
myScope.WriteString ":MTEST:AVERAge:COUNT?"
varResult = myScope.ReadNumber
Debug.Print FormatNumber(varResult, 0)
```

History Legacy command (existed before version 3.10).

:MTEST:COUNT:FAILures?

Query :MTEST:COUNT:FAILures? REGION<number>

The MTEST:COUNT:FAILures? query returns the number of failures that occurred within a particular mask region.

The value 9.999E37 is returned if mask testing is not enabled or if you specify a region number that is unused.

<number> An integer, 1 through 8, designating the region for which you want to determine the failure count.

Returned Format [:MTEST:COUNT:FAILures] REGION<number><number_of_failures> <NL>

<number_of_failures> The number of failures that have occurred for the designated region.

Example This example determines the current failure count for region 3 and prints it on the computer screen.

```
Dim strMask_failures As String
myScope.WriteString ":MTEST:COUNT:FAILures? REGION3"
strMask_failures = myScope.ReadString
Debug.Print strMask_failures
```

History Legacy command (existed before version 3.10).

:MTEST:COUNT:FUI?

- Query** :MTEST:COUNT:FUI?
- The MTEST:COUNT:FUI? query returns the number of unit interval failures that have occurred.
- Returned Format** [:MTEST:COUNT:FUI?] <unit_interval_failures> <NL>
- <unit_interval_failures>
res>
- Example** This example determines the current number of unit interval failures and prints it to the computer screen.
- ```
Dim strFailures As String
myScope.WriteString ":MTEST:COUNT:FUI?"
strFailures = myScope.ReadString
Debug.Print strFailures
```
- See Also**
- [":MTEST:COUNT:UI?"](#) on page 673
  - [":MTEST:COUNT:SUI?"](#) on page 672
  - [":MTEST:COUNT:WAVEforms?"](#) on page 674
  - [":MTEST:COUNT:FWAVEforms?"](#) on page 670
- History** Legacy command (existed before version 3.10).

## :MTEST:COUNT:FWAVEforms?

**Query** :MTEST:COUNT:FWAVEforms?

The :MTEST:COUNT:FWAVEforms? query returns the total number of failed waveforms in the current mask test run. This count is for all regions and all waveforms, so if you wish to determine failures by region number, use the COUNT:FAILures? query.

This count may not always be available. It is available only when the following conditions are true:

- Mask testing was turned on before the histogram or color grade persistence, and
- No mask changes have occurred, including scaling changes, editing, or new masks.

The value 9.999E37 is returned if mask testing is not enabled, or if you have modified the mask.

**Returned Format** [:MTEST:COUNT:FWAVEforms] <number\_of\_failed\_waveforms><NL>

<number\_of\_failed\_waveforms> The total number of failed waveforms for the current test run.

**Example** This example determines the number of failed waveforms and prints the result on the computer screen.

```
myScope.WriteString ":SYSTEM:HEADER OFF"
myScope.WriteString ":MTEST:COUNT:FWAVEforms?"
strMask_fwaveforms = myScope.ReadString
Debug.Print strMask_fwaveforms
```

- See Also**
- [":MTEST:COUNT:UI?"](#) on page 673
  - [":MTEST:COUNT:FUI?"](#) on page 669
  - [":MTEST:COUNT:SUI?"](#) on page 672
  - [":MTEST:COUNT:WAVEforms?"](#) on page 674

**History** Legacy command (existed before version 3.10).

## :MTEST:COUNT:MARGIN:FAILURES?

**Query** :MTEST:COUNT:MARGIN:FAILURES? REGION<number>

<number> ::= an integer, 1-8.

The :MTEST:COUNT:MARGIN:FAILURES? query returns the margin failure count for a specified region.

**Returned Format** <failures><NL>

<failures> ::= number of failures in NR3 format.

- See Also**
- [":MTEST:MARGIN:STATE"](#) on page 705
  - [":MTEST:MARGIN:METHod"](#) on page 703
  - [":MTEST:MARGIN:PERCent"](#) on page 704
  - [":MTEST:MARGIN:AUTO:METHod"](#) on page 702
  - [":MTEST:MARGIN:AUTO:HITS"](#) on page 700
  - [":MTEST:MARGIN:AUTO:HRATio"](#) on page 701

**History** New in version 5.70.

**:MTEST:COUNT:SUI?****Query** :MTEST:COUNT:SUI?

The :MTEST:COUNT:SUI? query returns the total number of samples that have been mask tested in the UI bit time.

This count is valid only when mask testing a real-time eye.

**Returned Format** [:MTEST:COUNT:SUI?] <samples\_tested><NL>

&lt;samples\_tested&gt; The total number of samples that have been mask tested in the UI bit time.

- See Also**
- **":MTEST:COUNT:UI?"** on page 673
  - **":MTEST:COUNT:FUI?"** on page 669
  - **":MTEST:COUNT:WAVEforms?"** on page 674
  - **":MTEST:COUNT:FWAVEforms?"** on page 670

**History** New in version 6.00.



## :MTEST:COUNT:UI?

- Query** :MTEST:COUNT:UI?
- The MTEST:COUNT:UI? query returns the number of unit intervals that have been mask tested.
- Returned Format** [:MTEST:COUNT:UI?] <unit\_intervals\_tested> <NL>
- <unit\_intervals\_tested> The number of unit intervals tested.
- Example** This example determines the current number of unit intervals tested and prints it to the computer screen.
- ```
Dim strUnit_intervals As String
myScope.WriteString ":MTEST:COUNT:UI?"
strUnit_intervals = myScope.ReadString
Debug.Print strUnit_intervals
```
- See Also**
- [":MTEST:COUNT:FUI?"](#) on page 669
 - [":MTEST:COUNT:SUI?"](#) on page 672
 - [":MTEST:COUNT:WAVEforms?"](#) on page 674
 - [":MTEST:COUNT:FWAVEforms?"](#) on page 670
- History** Legacy command (existed before version 3.10).

:MTEST:COUNT:WAVEforms?

Query :MTEST:COUNT:WAVEforms?

The :MTEST:COUNT:WAVEforms? query returns the total number of waveforms acquired in the current mask test run. The value 9.999E37 is returned if mask testing is not enabled.

Returned Format [:MTEST:COUNT:WAVEforms] <number_of_waveforms><NL>

<number_of_waveforms> The total number of waveforms for the current test run.

Example This example determines the number of waveforms acquired in the current test run and prints the result on the computer screen.

```
myScope.WriteString ":SYSTEM:HEADER OFF"
myScope.WriteString ":MTEST:COUNT:WAVEforms?"
varMask_waveforms = myScope.ReadNumber
Debug.Print FormatNumber(varMask_waveforms, 0)
```

- See Also**
- [":MTEST:COUNT:UI?"](#) on page 673
 - [":MTEST:COUNT:FUI?"](#) on page 669
 - [":MTEST:COUNT:SUI?"](#) on page 672
 - [":MTEST:COUNT:FWAVEforms?"](#) on page 670

History Legacy command (existed before version 3.10).

:MTESt:DELeTe

Command :MTESt:DELeTe

The :MTESt:DELeTe command clears the currently loaded mask.

Example This example clears the currently loaded mask.

```
myScope.WriteString ":MTESt:DELeTe"
```

History Legacy command (existed before version 3.10).

:MTEST:ENABle

Command :MTEST:ENABle {{ON | 1} | {OFF | 0}}

The :MTEST:ENABle command enables or disables the mask test features.

ON Enables the mask test features.

OFF Disables the mask test features.

Example This example enables the mask test features.

```
myScope.WriteString ":MTEST:ENABle ON"
```

Query :MTEST:ENABle?

The :MTEST:ENABle? query returns the current state of mask test features.

Returned Format [MTEST:ENABle] {1 | 0}<NL>

Example This example places the current value of the mask test state in the numeric variable varValue, then prints the contents to the computer's screen.

```
myScope.WriteString ":SYSTEM:HEADer OFF"
myScope.WriteString ":MTEST:ENABle?"
varValue = myScope.ReadNumber
Debug.Print FormatNumber(varValue, 0)
```

History Legacy command (existed before version 3.10).

:MTEST:FOLDing (Clock Recovery software only)

Command

NOTE

This command is only available when the E2688A Clock Recovery Software is installed.

```
:MTEST:FOLDing {{ON | 1} | {OFF | 0}} [, <source>]
```

The :MTEST:FOLDing command enables (ON) or disables (OFF) the display of the real-time eye.

Color grade must be enabled before enabling the real-time eye.

Refer to the :MEASure:CLOCK commands for clock recovery.

<source> {CHANnel<N> | DIFF<D> | COMMONmode<C> | FUNCTION<F> | WMEMory<R> | EQUalized}

If <source> is omitted:

- The real-time eye is enabled for all sources which currently have a color grade view on.
- When enabling real-time eye, the main waveform view is turned off.
- When disabling real-time eye, the main waveform view is turned on.

<N> An integer, 1-4 in a single oscilloscope, 1-40 in a MultiScope system.

<D>, <C> <D> is an integer, 1-2. <C> is an integer, 3-4.

The DIFF and COMMONmode sources are just aliases that can be used in place of the channel names to apply to differential or common mode signals. These are just aliases - no state change occurs if you refer to a differential channel and you are not in differential mode. DIFF1 refers to the differential signal between channels 1 and 3 (and COMMONmode3 refers to the common mode channel between these same channels). DIFF2 refers to the differential signal between channels 2 and 4 (and COMMONmode4 refers to the common mode channel between these same channels).

<F> An integer, 1-16.

<R> An integer, 1-4.

Example This example enables the display of the real-time eye.

```
myScope.WriteString ":MTEST:FOLDing ON"
```

Query :MTEST:FOLDing? [<source>]

The :MTEST:FOLDing? query returns the current state of clock recovery folding.

If <source> is omitted, the query returns ON (1) if any source has real-time eye enabled.

Returned Format [:MTEST:FOLDing] {1 | 0} <NL>

Example

```
myScope.WriteString ":MTEST:FOLDing?"
varValue = myScope.ReadNumber
Debug.Print FormatNumber(varValue, 0)
```

- See Also**
- [":MTEST:FOLDing:BITS"](#) on page 679
 - [":MTEST:FOLDing:FAST"](#) on page 685
 - [":MTEST:FOLDing:COUNT:UI?"](#) on page 681
 - [":MTEST:FOLDing:COUNT:WAVEforms?"](#) on page 683
 - [":MTEST:FOLDing:POSition"](#) on page 687
 - [":MTEST:FOLDing:TPOSition"](#) on page 691
 - [":MTEST:FOLDing:SCALe"](#) on page 689
 - [":MTEST:FOLDing:TSCale"](#) on page 693
 - [":ANALyze:CLOCK"](#) on page 240
 - [":ANALyze:CLOCK:METHod"](#) on page 241
 - [":ANALyze:CLOCK:METHod:ALIGN"](#) on page 244
 - [":ANALyze:CLOCK:METHod:DEEMphasis"](#) on page 246
 - [":ANALyze:CLOCK:METHod:EDGE"](#) on page 247
 - [":ANALyze:CLOCK:METHod:JTF"](#) on page 249
 - [":ANALyze:CLOCK:METHod:OJTF"](#) on page 252

History Legacy command (existed before version 3.10).

Version 5.00: Added the optional <source> parameter for specifying the waveform on which to enable/disable the real-time eye.

Version 5.50: When the <source> parameter is not provided, enabling the real-time eye will turn off the main waveform view, and disabling the real-time eye will turn on the main waveform view.

:MTEST:FOLDing:BITS

Command

NOTE

This command is only available when the E2688A Clock Recovery Software is installed.

```
:MTEST:FOLDing:BITS <source>,{BOTH | DEEMphasis | TRANSition
| PATtern, "<pattern>", <cursor>}
```

The :MTEST:FOLDing:BITS command determines the type of data bits used to create the eye pattern. The transition bits are greater in amplitude than the deemphasis bits. The PCI Express standard requires that compliance mask testing be done for both bit types.

<source> {CHANnel<N> | DIFF<D> | COMMONmode<C> | FUNction<F> | WMEMory<R> | EQUalized}

<N> An integer, 1-4 in a single oscilloscope, 1-40 in a MultiScope system.

<D>, <C> <D> is an integer, 1-2. <C> is an integer, 3-4.

The DIFF and COMMONmode sources are just aliases that can be used in place of the channel names to apply to differential or common mode signals. These are just aliases - no state change occurs if you refer to a differential channel and you are not in differential mode. DIFF1 refers to the differential signal between channels 1 and 3 (and COMMONmode3 refers to the common mode channel between these same channels). DIFF2 refers to the differential signal between channels 2 and 4 (and COMMONmode4 refers to the common mode channel between these same channels).

<F> An integer, 1-16.

<R> An integer, 1-4.

<pattern> An eight character string of level values. For typical NRZ (non-return-to-zero) signals, the levels are "1", "0", or "X" (for example, "101XX010"). For PAM-4 (four-level) signals, the levels are "3", "2", "1", "0", or "X" (for example, "01230X03").

<cursor> A value from 0 to 7 representing which bit is bit 0 from the LSB.

Example This example sets bit type to transition bits on the CHANnel1 real-time eye.

```
myScope.WriteString ":MTEST:FOLDing:BITS CHANnel1,TRANSition"
```

Query :MTEST:FOLDing:BITS? <source>

The :MTEST:FOLDing:BITS? query returns the current setting of the real time eye bits.

Returned Format [:MTEST:FOLDing:BITS] {BOTH | DEEMphasis | TRANSition
| PATT,<pattern>,<cursor>} <NL>

Example

```
myScope.WriteString ":MTEST:FOLDing:BITS? CHANnel1"  
strSetting = myScope.ReadString  
Debug.Print strSetting
```

- See Also**
- [":MTEST:FOLDing \(Clock Recovery software only\)"](#) on page 677
 - [":MTEST:FOLDing:FAST"](#) on page 685
 - [":MTEST:FOLDing:COUNT:UI?"](#) on page 681
 - [":MTEST:FOLDing:COUNT:WAVEforms?"](#) on page 683
 - [":MTEST:FOLDing:POSition"](#) on page 687
 - [":MTEST:FOLDing:TPOSition"](#) on page 691
 - [":MTEST:FOLDing:SCALe"](#) on page 689
 - [":MTEST:FOLDing:TSCale"](#) on page 693

History Legacy command (existed before version 3.10).

Version 4.00: Added a PATTern option for specifying bit pattern qualification for the real-time eye display.

Version 5.00: Added the required <source> parameter to specify the waveform on which to set the real-time eye bit qualification.

Version 5.50: The <pattern> string can contain characters "2" and "3" when specified for PAM-4 signals.

:MTESt:FOLDing:COUNT:UI?

Query :MTESt:FOLDing:COUNT:UI? [<source>]

The :MTESt:FOLDing:COUNT:UI? query returns the number of unit intervals in the real time eye.

<source> {CHANnel<N> | DIFF<D> | COMMONmode<C> | FUNCTION<F> | WMEMory<R> | EQUalized}

<N> An integer, 1-4 in a single oscilloscope, 1-40 in a MultiScope system.

<D>, <C> <D> is an integer, 1-2. <C> is an integer, 3-4.

The DIFF and COMMONmode sources are just aliases that can be used in place of the channel names to apply to differential or common mode signals. These are just aliases - no state change occurs if you refer to a differential channel and you are not in differential mode. DIFF1 refers to the differential signal between channels 1 and 3 (and COMMONmode3 refers to the common mode channel between these same channels). DIFF2 refers to the differential signal between channels 2 and 4 (and COMMONmode4 refers to the common mode channel between these same channels).

If the <source> is not specified, the :MTESt:FOLDing:COUNT? query returns the results of the first real-time eye that is on. Sources are ordered by channels, memories, and then functions.

<F> An integer, 1-16.

<R> An integer, 1-4.

Returned Format [:MTESt:FOLDing:COUNT:UI] <UI_count><NL>

The UI count returned is a floating-point value.

Example

```
myScope.WriteString ":MTESt:FOLDing:COUNT:UI? CHANNEL1"
varUiCount = myScope.ReadNumber
Debug.Print FormatNumber(varUiCount, 0)
```

- See Also**
- [":MTESt:FOLDing \(Clock Recovery software only\)"](#) on page 677
 - [":MTESt:FOLDing:BITS"](#) on page 679
 - [":MTESt:FOLDing:FAST"](#) on page 685
 - [":MTESt:FOLDing:COUNT:WAVEforms?"](#) on page 683
 - [":MTESt:FOLDing:POSition"](#) on page 687
 - [":MTESt:FOLDing:TPOSition"](#) on page 691
 - [":MTESt:FOLDing:SCALE"](#) on page 689
 - [":MTESt:FOLDing:TSCale"](#) on page 693

History New in version 5.50. This query replaces part of the now deprecated query [":MTESt:FOLDing:COUNT?"](#) on page 1538.

Version 5.52: The <source> parameter is now optional.

:MTESt:FOLDing:COUNT:WAVEforms?

Query :MTESt:FOLDing:COUNT:WAVEforms? [<source>]

The :MTESt:FOLDing:COUNT:WAVEforms? query returns the number of waveforms in the real time eye.

<source> {CHANnel<N> | DIFF<D> | COMMONmode<C> | FUNction<F> | WMEMory<R> | EQUalized}

<N> An integer, 1-4 in a single oscilloscope, 1-40 in a MultiScope system.

<D>, <C> <D> is an integer, 1-2. <C> is an integer, 3-4.

The DIFF and COMMONmode sources are just aliases that can be used in place of the channel names to apply to differential or common mode signals. These are just aliases - no state change occurs if you refer to a differential channel and you are not in differential mode. DIFF1 refers to the differential signal between channels 1 and 3 (and COMMONmode3 refers to the common mode channel between these same channels). DIFF2 refers to the differential signal between channels 2 and 4 (and COMMONmode4 refers to the common mode channel between these same channels).

If the <source> is not specified, the :MTESt:FOLDing:COUNT? query returns the results of the first real-time eye that is on. Sources are ordered by channels, memories, and then functions.

<F> An integer, 1-16.

<R> An integer, 1-4.

Returned Format [:MTESt:FOLDing:COUNT:WAVEforms] <Wfm_count><NL>

The Wfm count returned is an integer.

Example

```
myScope.WriteString ":MTESt:FOLDing:COUNT:WAVEforms? CHANnel1"
strWfmCount = myScope.ReadString
Debug.Print strWfmCount
```

- See Also**
- [":MTESt:FOLDing \(Clock Recovery software only\)"](#) on page 677
 - [":MTESt:FOLDing:BITS"](#) on page 679
 - [":MTESt:FOLDing:FAST"](#) on page 685
 - [":MTESt:FOLDing:COUNT:UI?"](#) on page 681
 - [":MTESt:FOLDing:POSition"](#) on page 687
 - [":MTESt:FOLDing:TPOSition"](#) on page 691
 - [":MTESt:FOLDing:SCALE"](#) on page 689
 - [":MTESt:FOLDing:TSCale"](#) on page 693

History New in version 5.50. This query replaces part of the now deprecated query [":MTESt:FOLDing:COUNT?"](#) on page 1538.

Version 5.52: The <source> parameter is now optional.

:MTEST:FOLDing:FAST

Command :MTEST:FOLDing:FAST {{ON | 1} | {OFF | 0}} [, <source>]

The :MTEST:FOLDing:FAST command turns the "Fast, Worst Case Only" real-time eye display option ON or OFF.

When ON, the oscilloscope performs a fast real-time eye display by showing only the worst case bits and other bits that surround them.

This option can be used to speed up the real-time eye display when the oscilloscope is using deep memory.

Worst case bits are evaluated using these 8 points inside the eye:

- Left and right of the eye at the threshold level.
- Left and right of the eye at the threshold + hysteresis level.
- Left and right of the eye at the threshold - hysteresis level.
- Top and bottom of the eye at the center.

For each bit that represents the worst case at one of the evaluated points, the 1,000 bits that surround that bit are also displayed. So, up to 8,000 bits per acquisition can contribute to the real-time eye display. Keep in mind that one bit can represent the worst case at multiple points or that the 1,000 bits surrounding the worst case bits can overlap, so there can be fewer than 8,000 bits displayed per acquisition.

<source> {CHANnel<N> | DIFF<D> | COMMONmode<C> | FUNCTION<F> | WMEMORY<R> | EQUALized}

If <source> is omitted, fast worst-case real-time eye is enabled for all sources which currently have a color grade view on.

<N> An integer, 1-4 in a single oscilloscope, 1-40 in a MultiScope system.

<D>, <C> <D> is an integer, 1-2. <C> is an integer, 3-4.

The DIFF and COMMONmode sources are just aliases that can be used in place of the channel names to apply to differential or common mode signals. These are just aliases - no state change occurs if you refer to a differential channel and you are not in differential mode. DIFF1 refers to the differential signal between channels 1 and 3 (and COMMONmode3 refers to the common mode channel between these same channels). DIFF2 refers to the differential signal between channels 2 and 4 (and COMMONmode4 refers to the common mode channel between these same channels).

<F> An integer, 1-16.

<R> An integer, 1-4.

Example This example turns on the "Fast, Worst Case Only" real-time eye display option.

```
myScope.WriteString ":MTEST:FOLDing:FAST ON"
```

Query `:MTESt:FOLDing:FAST? [<source>]`

The `:MTESt:FOLDing:FAST?` query returns the current setting.

If `<source>` is omitted, the query returns ON (1) if any source has fast real time eye enabled.

Returned Format `[:MTESt:FOLDing:FAST] {1 | 0} <NL>`

Example

```
myScope.WriteString ":MTESt:FOLDing:FAST?"
strSetting = myScope.ReadString
Debug.Print strSetting
```

- See Also**
- [":MTESt:FOLDing \(Clock Recovery software only\)"](#) on page 677
 - [":MTESt:FOLDing:BITS"](#) on page 679
 - [":MTESt:FOLDing:COUNT:UI?"](#) on page 681
 - [":MTESt:FOLDing:COUNT:WAVEforms?"](#) on page 683
 - [":MTESt:FOLDing:POSition"](#) on page 687
 - [":MTESt:FOLDing:TPOSition"](#) on page 691
 - [":MTESt:FOLDing:SCALe"](#) on page 689
 - [":MTESt:FOLDing:TSCale"](#) on page 693

History New in version 4.50.

Version 5.00: Added the optional `<source>` parameter for specifying the waveform on which to set the fast worst-case option.

:MTEST:FOLDing:POSition

Command :MTEST:FOLDing:POSition <UI_position> [,<source>]

The :MTEST:FOLDing:POSition command sets the real-time eye horizontal center position in unit intervals.

<source> {CHANnel<N> | DIFF<D> | COMMONmode<C> | FUNCTION<F> | WMEMory<R> | EQUalized}

If <source> is omitted, this command sets the position for all sources.

<N> An integer, 1-4 in a single oscilloscope, 1-40 in a MultiScope system.

<D>, <C> <D> is an integer, 1-2. <C> is an integer, 3-4.

The DIFF and COMMONmode sources are just aliases that can be used in place of the channel names to apply to differential or common mode signals. These are just aliases - no state change occurs if you refer to a differential channel and you are not in differential mode. DIFF1 refers to the differential signal between channels 1 and 3 (and COMMONmode3 refers to the common mode channel between these same channels). DIFF2 refers to the differential signal between channels 2 and 4 (and COMMONmode4 refers to the common mode channel between these same channels).

<F> An integer, 1-16.

<R> An integer, 1-4.

Example This example sets the real-time eye horizontal center position to -0.300 UI.

```
myScope.WriteString ":MTEST:FOLDing:POSition -0.300"
```

Query :MTEST:FOLDing:POSition? [<source>]

The :MTEST:FOLDing:POSition? query returns the real-time eye horizontal center position.

If <source> is omitted, the query returns the position for the first real-time eye.

Returned Format [:MTEST:FOLDing:POSition] <UI_position> <NL>

Example

```
myScope.WriteString ":MTEST:FOLDing:POSition?"
strUiPosition = myScope.ReadString
Debug.Print strUiPosition
```

- See Also**
- [":MTEST:FOLDing:TPOSition"](#) on page 691
 - [":MTEST:FOLDing \(Clock Recovery software only\)"](#) on page 677
 - [":MTEST:FOLDing:BITS"](#) on page 679
 - [":MTEST:FOLDing:FAST"](#) on page 685
 - [":MTEST:FOLDing:COUNT:UI?"](#) on page 681
 - [":MTEST:FOLDing:COUNT:WAVEforms?"](#) on page 683

- **":MTEST:FOLDing:SCALe"** on page 689
- **":MTEST:FOLDing:TSCale"** on page 693

History New in version 5.00.

:MTEST:FOLDing:SCALE

Command :MTEST:FOLDing:SCALE <UI_scale> [, <source>]

The :MTEST:FOLDing:SCALE command sets the real-time eye horizontal scale, that is, the number of unit intervals (UIs) shown on screen.

<source> {CHANnel<N> | DIFF<D> | COMMONmode<C> | FUNCTION<F> | WMEMory<R> | EQUalized}

If <source> is omitted, this command sets the number of unit intervals for all sources.

<N> An integer, 1-4 in a single oscilloscope, 1-40 in a MultiScope system.

<D>, <C> <D> is an integer, 1-2. <C> is an integer, 3-4.

The DIFF and COMMONmode sources are just aliases that can be used in place of the channel names to apply to differential or common mode signals. These are just aliases - no state change occurs if you refer to a differential channel and you are not in differential mode. DIFF1 refers to the differential signal between channels 1 and 3 (and COMMONmode3 refers to the common mode channel between these same channels). DIFF2 refers to the differential signal between channels 2 and 4 (and COMMONmode4 refers to the common mode channel between these same channels).

<F> An integer, 1-16.

<R> An integer, 1-4.

Example This example sets the real-time eye horizontal scale to 2.0 UI.

```
myScope.WriteString ":MTEST:FOLDing:SCALE 2.0"
```

Query :MTEST:FOLDing:SCALE? [<source>]

The :MTEST:FOLDing:SCALE? query returns the current real-time eye horizontal scale.

If <source> is omitted, the query returns the number of unit intervals for the first real-time eye.

Returned Format [:MTEST:FOLDing:SCALE] <UI_scale><NL>

Example

```
myScope.WriteString ":MTEST:FOLDing:SCALE?"
strUiScale = myScope.ReadString
Debug.Print strUiScale
```

- See Also**
- [":MTEST:FOLDing:TSCale"](#) on page 693
 - [":MTEST:FOLDing \(Clock Recovery software only\)"](#) on page 677
 - [":MTEST:FOLDing:BITS"](#) on page 679
 - [":MTEST:FOLDing:FAST"](#) on page 685
 - [":MTEST:FOLDing:COUNT:UI?"](#) on page 681

- `":MTEST:FOLDing:COUNT:WAVeforms?"` on page 683
- `":MTEST:FOLDing:POSition"` on page 687
- `":MTEST:FOLDing:TPOSition"` on page 691

History New in version 5.00.

:MTEST:FOLDing:TPOsition

Command :MTEST:FOLDing:TPOsition <position> [,<source>]

The :MTEST:FOLDing:TPOsition command sets the real-time eye horizontal center position in time.

<source> {CHANnel<N> | DIFF<D> | COMMONmode<C> | FUNction<F> | WMEMory<R> | EQUalized}

If <source> is omitted, this command sets the position for all sources.

<N> An integer, 1-4 in a single oscilloscope, 1-40 in a MultiScope system.

<D>, <C> <D> is an integer, 1-2. <C> is an integer, 3-4.

The DIFF and COMMONmode sources are just aliases that can be used in place of the channel names to apply to differential or common mode signals. These are just aliases - no state change occurs if you refer to a differential channel and you are not in differential mode. DIFF1 refers to the differential signal between channels 1 and 3 (and COMMONmode3 refers to the common mode channel between these same channels). DIFF2 refers to the differential signal between channels 2 and 4 (and COMMONmode4 refers to the common mode channel between these same channels).

<F> An integer, 1-16.

<R> An integer, 1-4.

Example This example sets the real-time eye horizontal center position to -0.300 ns.

```
myScope.WriteString ":MTEST:FOLDing:TPOsition -0.300E-09"
```

Query :MTEST:FOLDing:TPOsition? [<source>]

The :MTEST:FOLDing:TPOsition? query returns the real-time eye horizontal center position.

If <source> is omitted, the query returns the position for the first real-time eye.

Returned Format [:MTEST:FOLDing:TPOsition] <position> <NL>

Example

```
myScope.WriteString ":MTEST:FOLDing:TPOsition?"
strTimePosition = myScope.ReadString
Debug.Print strTimePosition
```

- See Also**
- [":MTEST:FOLDing:POsition"](#) on page 687
 - [":MTEST:FOLDing \(Clock Recovery software only\)"](#) on page 677
 - [":MTEST:FOLDing:BITS"](#) on page 679
 - [":MTEST:FOLDing:FAST"](#) on page 685
 - [":MTEST:FOLDing:COUNT:UI?"](#) on page 681
 - [":MTEST:FOLDing:COUNT:WAVEforms?"](#) on page 683

- **":MTESt:FOLDing:TSCale"** on page 693
- **":MTESt:FOLDing:SCALe"** on page 689

History New in version 5.10.

:MTEST:FOLDing:TSCale

Command :MTEST:FOLDing:TSCale <scale> [,<source>]

The :MTEST:FOLDing:TSCale command sets the real-time eye horizontal scale per division in time.

<source> {CHANnel<N> | DIFF<D> | COMMONmode<C> | FUNCTION<F> | WMEMory<R> | EQUalized}

If <source> is omitted, this command sets the number of unit intervals for all sources.

<N> An integer, 1-4 in a single oscilloscope, 1-40 in a MultiScope system.

<D>, <C> <D> is an integer, 1-2. <C> is an integer, 3-4.

The DIFF and COMMONmode sources are just aliases that can be used in place of the channel names to apply to differential or common mode signals. These are just aliases - no state change occurs if you refer to a differential channel and you are not in differential mode. DIFF1 refers to the differential signal between channels 1 and 3 (and COMMONmode3 refers to the common mode channel between these same channels). DIFF2 refers to the differential signal between channels 2 and 4 (and COMMONmode4 refers to the common mode channel between these same channels).

<F> An integer, 1-16.

<R> An integer, 1-4.

Example This example sets the real-time eye horizontal scale to 2.0 microseconds.

```
myScope.WriteString ":MTEST:FOLDing:TSCale 2.0E-06"
```

Query :MTEST:FOLDing:TSCale? [<source>]

The :MTEST:FOLDing:TSCale? query returns the current real-time eye horizontal scale.

If <source> is omitted, the query returns the number of unit intervals for the first real-time eye.

Returned Format [:MTEST:FOLDing:TSCale] <scale><NL>

Example

```
myScope.WriteString ":MTEST:FOLDing:TSCale?"
strTimeScale = myScope.ReadString
Debug.Print strTimeScale
```

- See Also**
- **" :MTEST:FOLDing:SCALE "** on page 689
 - **" :MTEST:FOLDing (Clock Recovery software only) "** on page 677
 - **" :MTEST:FOLDing:BITS "** on page 679
 - **" :MTEST:FOLDing:FAST "** on page 685
 - **" :MTEST:FOLDing:COUNT:UI? "** on page 681

- `":MTEST:FOLDing:COUNT:WAVeforms?"` on page 683
- `":MTEST:FOLDing:TPOStion"` on page 691
- `":MTEST:FOLDing:POStion"` on page 687

History New in version 5.10.

:MTESt:HAMPlitude

Command :MTESt:HAMPlitude <upper_limit>

The :MTESt:HAMPlitude command sets the maximum pulse amplitude value that passes the pulse standard. For some of the pulse communications standards, a pulse has a range of amplitude values and still passes the standard. This command sets the upper limit used during mask testing.

<upper_limit> A real number that represents the maximum amplitude in volts of a pulse as allowed by the pulse standard.

Example This example sets the maximum pulse amplitude to 3.6 volts.

```
myScope.WriteString ":MTESt:HAMPlitude 3.6"
```

Query :MTESt:HAMPlitude?

The :MTESt:HAMPlitude? query returns the current value of the maximum pulse amplitude.

Returned Format [MTESt:HAMPlitude] <upper_limit><NL>

<upper_limit> A real number that represents the maximum amplitude in volts of a pulse as allowed by the pulse standard.

Example This example returns the current upper pulse limit and prints it to the computer's screen.

```
myScope.WriteString ":SYSTem:HEADer OFF"      ' Response headers off.
myScope.WriteString ":MTESt:HAMPlitude?"
varULimit = myScope.ReadNumber
Debug.Print FormatNumber(varULimit, 0)
```

History Legacy command (existed before version 3.10).

:MTESt:IMPedance

Command :MTESt:IMPedance {NONE | IMP75 | IMP100 | IMP110 | IMP120}

The :MTESt:IMPedance command sets the desired probe impedance of the channel being used for mask testing. This impedance value is used when starting a mask test to determine whether or not the correct Infiniium probe is connected and in the case of the E2621A if the switch is set to the correct impedance value.

Infiniium has an AutoProbe interface that detects probes that have Probe ID resistors. If one of these probes is connected to the channel being mask tested and is not the correct probe for the selected impedance, a warning dialog box appears when the mask test is started from the human interface.

This command is meant to be used in the setup section of a mask file.

NONE Disables the probe impedance check.

IMP75 Enables the probe impedance check for the E2622A probe.

IMP100 Enables the probe impedance check for the E2621A probe with the switch set to the 100 ohm position.

IMP110 Enables the probe impedance check for the E2621A probe with the switch set to the 110 ohm position.

IMP120 Enables the probe impedance check for the E2621A probe with the switch set to the 120 ohm position.

Example This example sets the probe impedance of the channel being used for mask testing to 100 ohms.

```
myScope.WriteString ":MTESt:IMPedance IMP100"
```

Query :MTESt:IMPedance?

The :MTESt:IMPedance? query returns the current value of the mask test impedance.

Returned Format [:MTESt:IMPedance] {NONE | IMP75 | IMP100 | IMP110 | IMP120}<NL>

Example This example returns the current value of the mask test impedance and prints the result to the computer screen.

```
myScope.WriteString ":SYSTEM:HEADer OFF" ' Response headers off.
myScope.WriteString ":MTESt:IMPedance?"
strImpedance = myScope.ReadString
Debug.Print strImpedance
```

History Legacy command (existed before version 3.10).

:MTESt:INVert

Command :MTESt:INVert {{ON | 1} | {OFF | 0}}

The :MTESt:INVert command inverts the mask for testing negative-going pulses. The trigger level and mask offset are also adjusted. Not all masks support negative-going pulse testing, and for these masks, the command is ignored.

Example This example inverts the mask for testing negative-going pulses.

```
myScope.WriteString ":MTESt:INVert ON"
```

Query :MTESt:INVert?

The :MTESt:INVert? query returns the current inversion setting.

Returned Format [:MTESt:INVert] {1 | 0}<NL>

History Legacy command (existed before version 3.10).

:MTESt:LAMPlitude

Command :MTESt:LAMPlitude <lower_limit>

The :MTESt:LAMPlitude command sets the minimum pulse amplitude value that passes the pulse standard. For some of the pulse communications standards, a pulse has a range of amplitude values and still passes the standard. This command sets the lower limit used during mask testing.

<lower_limit> A real number that represents the minimum amplitude in volts of a pulse as allowed by the pulse standard.

Example This example sets the minimum pulse amplitude to 2.4 volts.

```
myScope.WriteString ":MTESt:LAMPlitude 2.4"
```

Query :MTESt:LAMPlitude?

The :MTESt LAMPlitude? query returns the current value of the minimum pulse amplitude.

Returned Format [:MTESt:LAMPlitude] <lower_limit><NL>

<lower_limit> A real number that represents the minimum amplitude in volts of a pulse as allowed by the pulse standard.

Example This example returns the current lower pulse limit and prints it to the computer's screen.

```
myScope.WriteString ":SYSTem:HEADer OFF ! Response headers off.
myScope.WriteString ":MTESt:LAMPlitude?"
varULimit = myScope.ReadNumber
Debug.Print FormatNumber(varULimit, 0)
```

History Legacy command (existed before version 3.10).

:MTEST:LOAD

Command :MTEST:LOAD "<filename>"

The :MTEST:LOAD command loads the specified mask file. The default path for mask files is C:\Users\Public\Documents\Infiniium\masks. To use a different path, specify the complete path and file name.

<filename> An MS-DOS compatible name of the file, a maximum of 254 characters long (including the path name, if used).

Example This example loads the mask file named "140md_itu_1.msk".

```
myScope.WriteString _
":MTEST:LOAD " "C:\Users\Public\Documents\Infiniium\masks\
140md_itu_1.msk" " "
```

History Legacy command (existed before version 3.10).

:MTEST:MARGIN:AUTO:HITS

Command :MTEST:MARGIN:AUTO:HITS <hit_count>

<hit_count> ::= an integer.

When the automatic margin method is selected, and the hit ratio method is selected, the :MTEST:MARGIN:AUTO:HITS command specifies the hit count.

Query :MTEST:MARGIN:AUTO:HITS?

The :MTEST:MARGIN:AUTO:HITS? query returns the hit count setting.

Returned Format <hit_count><NL>

- See Also**
- [":MTEST:MARGIN:STATE"](#) on page 705
 - [":MTEST:MARGIN:METHod"](#) on page 703
 - [":MTEST:MARGIN:PERCent"](#) on page 704
 - [":MTEST:MARGIN:AUTO:METHod"](#) on page 702
 - [":MTEST:MARGIN:AUTO:HRATio"](#) on page 701
 - [":MTEST:COUNT:MARGIN:FAILures?"](#) on page 671

History New in version 5.70.

:MTEST:MARGIN:AUTO:HRATIO

Command :MTEST:MARGIN:AUTO:HRATIO <hit_ratio>

<hit_ratio> ::= a floating-point number from 0.1 to 1E-12.

When the automatic margin method is selected, and the hit ratio method is selected, the :MTEST:MARGIN:AUTO:HRATIO command specifies the hit ratio.

Query :MTEST:MARGIN:AUTO:HRATIO?

The :MTEST:MARGIN:AUTO:HRATIO? query returns the hit ratio setting.

Returned Format <hit_ratio><NL>

- See Also**
- [":MTEST:MARGIN:STATE"](#) on page 705
 - [":MTEST:MARGIN:METHod"](#) on page 703
 - [":MTEST:MARGIN:PERCent"](#) on page 704
 - [":MTEST:MARGIN:AUTO:METHod"](#) on page 702
 - [":MTEST:MARGIN:AUTO:HITS"](#) on page 700
 - [":MTEST:COUNT:MARGIN:FAILures?"](#) on page 671

History New in version 5.70.

:MTEST:MARGIN:AUTO:METHOD

Command :MTEST:MARGIN:AUTO:METHOD <method>

<method> ::= {HITS | HRATIO}

When the automatic margin method is selected, the :MTEST:MARGIN:AUTO:METHOD command selects between the hit count and hit ratio and automatic margin methods:

- HITS – With the hit count automatic margin method, you specify the hit count with :MTEST:MARGIN:AUTO:HITS.
- HRATIO – With the hit ratio automatic margin method, you specify the hit ratio with :MTEST:MARGIN:AUTO:HRATIO.

Query :MTEST:MARGIN:AUTO:METHOD?

The :MTEST:MARGIN:AUTO:METHOD? query returns the automatic margin method setting.

Returned Format <method><NL>

<method> ::= {HITS | HRATIO}

- See Also**
- [":MTEST:MARGIN:STATE"](#) on page 705
 - [":MTEST:MARGIN:METHOd"](#) on page 703
 - [":MTEST:MARGIN:PERCent"](#) on page 704
 - [":MTEST:MARGIN:AUTO:HITS"](#) on page 700
 - [":MTEST:MARGIN:AUTO:HRATIO"](#) on page 701
 - [":MTEST:COUNT:MARGIN:FAILures?"](#) on page 671

History New in version 5.70.

:MTEST:MARGIN:METHod

Command :MTEST:MARGIN:METHod <method>

<method> ::= {MANual | AUTO}

The :MTEST:MARGIN:METHod command selects between the manual and automatic margin methods:

- **MANual** – With the manual margin method, you specify a margin percent using :MTEST:MARGIN:PERCent.
- **AUTO** – With the automatic margin method, you specify the auto margin method using :MTEST:MARGIN:AUTO:METHod.

Query :MTEST:MARGIN:METHod?

The :MTEST:MARGIN:METHod? query returns the margin type setting.

Returned Format <method><NL>

<method> ::= {MANual | AUTO}

- See Also**
- [":MTEST:MARGIN:STATE"](#) on page 705
 - [":MTEST:MARGIN:PERCent"](#) on page 704
 - [":MTEST:MARGIN:AUTO:METHod"](#) on page 702
 - [":MTEST:MARGIN:AUTO:HITS"](#) on page 700
 - [":MTEST:MARGIN:AUTO:HRATio"](#) on page 701
 - [":MTEST:COUNt:MARGIN:FAILures?"](#) on page 671

History New in version 5.70.

:MTESt:MARGin:PERCent

Command :MTESt:MARGin:PERCent <percent>

<percent> ::= an integer from -100 to 100.

When the manual margin method is selected, the :MTESt:MARGin:PERCent command specifies the margin percent.

Query :MTESt:MARGin:PERCent?

The :MTESt:MARGin:PERCent? query returns the margin percent setting.

Returned Format <percent><NL>

- See Also**
- [":MTESt:MARGin:STATe"](#) on page 705
 - [":MTESt:MARGin:METHod"](#) on page 703
 - [":MTESt:MARGin:AUTO:METHod"](#) on page 702
 - [":MTESt:MARGin:AUTO:HITS"](#) on page 700
 - [":MTESt:MARGin:AUTO:HRATio"](#) on page 701
 - [":MTESt:COUNT:MARGin:FAILures?"](#) on page 671

History New in version 5.70.

:MTEST:MARGIN:STATE

Command :MTEST:MARGIN:STATE {{0 | OFF} | {1 | ON}}

The :MTEST:MARGIN:STATE command enables or disables mask margin testing.

To enable mask margin testing, there must be a real-time eye and you must load a mask file that has a margin definition (*.mskx).

Query :MTEST:MARGIN:STATE?

The :MTEST:MARGIN:STATE? query returns the mask margin testing state.

Returned Format <setting><NL>

<setting ::= {0 | 1}

- See Also**
- [":MTEST:MARGIN:METHod"](#) on page 703
 - [":MTEST:MARGIN:PERCent"](#) on page 704
 - [":MTEST:MARGIN:AUTO:METHod"](#) on page 702
 - [":MTEST:MARGIN:AUTO:HITS"](#) on page 700
 - [":MTEST:MARGIN:AUTO:HRATio"](#) on page 701
 - [":MTEST:COUNt:MARGIN:FAILures?"](#) on page 671

History New in version 5.70.

:MTEST:NREGions?**Query** :MTEST:NREGions?

The :MTEST:NREGions? query returns the number of regions that define the mask.

Returned Format [:MTEST:NREGions] <regions><NL>

<regions> An integer from 0 to 8.

Example This example returns the number of mask regions.

```

myScope.WriteString ":SYSTEM:HEADer OFF"
myScope.WriteString ":MTEST:NREGions?"
varRegions = myScope.ReadNumber
Debug.Print FormatNumber(varRegions, 0)

```

History Legacy command (existed before version 3.10).

:MTEST:PROBE:IMPedance?

Query :MTEST:PROBE:IMPedance?

The :MTEST:PROBE:IMPedance? query returns the impedance setting for the E2621A and E2622A probes for the current mask test channel.

Returned Format [:MTEST:PROBE:IMPedance] <impedance><NL>

<impedance> An unquoted string: 75, 100, 110, 120, or NONE

Example This example returns the impedance setting for the probe.

```
Dim strImpedance As String
myScope.WriteString ":SYSTEM:HEADer OFF"
myScope.WriteString ":MTEST:PROBE:IMPedance?"
strImpedance = myScope.ReadString
Debug.Print strImpedance
```

History Legacy command (existed before version 3.10).

:MTEST:RUMode

Command :MTEST:RUMode {FOREver | TIME, <time> | {WAVEforms, <number_of_waveforms>}}

The :MTEST:RUMode command determines the termination conditions for the mask test. The choices are FOREver, TIME, or WAVEforms.

If WAVEforms is selected, a second parameter is required indicating the number of failures that can occur or the number of samples or waveforms that are to be acquired.

FOREver FOREver runs the Mask Test until the test is turned off. This is used when you want a measurement to run continually and not to stop after a fixed number of failures. For example, you may want the Mask Test to run overnight and not be limited by a number of failures.

TIME TIME sets the amount of time in minutes that a mask test will run before it terminates.

<time> A real number: 0.1 to 1440.0

WAVEforms WAVEforms sets the maximum number of waveforms that are required before the mask test terminates.

<number_of_waveforms> An integer: 1 to 1,000,000,000.

Example This example sets the mask test subsystem run until mode to continue testing until 500,000 waveforms have been gathered.

```
myScope.WriteString ":MTEST:RUMode WAVEforms,500E3"
```

Query :MTEST:RUMode?

The query returns the currently selected termination condition and value.

Returned Format [:MTEST:RUMode] {FOREver | TIME,<time> | {WAVEforms, <number_of_waveforms>}}<NL>

Example This example gets the current setting of the mask test run until mode from the oscilloscope and prints it on the computer screen.

```
Dim strMTEST_Runmode As String
myScope.WriteString ":MTEST:RUMode?"
strMTEST_Runmode = myScope.ReadString
Debug.Print strMTEST_Runmode
```

History Legacy command (existed before version 3.10).

:MTESt:RUMode:SOFailure

Command :MTESt:RUMode:SOFailure {{ON | 1} | {OFF | 0}}

The :MTESt:RUMode:SOFailure command enables or disables the Stop On Failure run until criteria. When a mask test is run and a mask violation is detected, the mask test is stopped and the acquisition system is stopped.

Example This example enables the Stop On Failure run until criteria.

```
myScope.WriteString ":MTESt:RUMode:SOFailure ON"
```

Query :MTESt:SOFailure?

The :MTESt:SOFailure? query returns the current state of the Stop on Failure control.

Returned Format [:MTESt:SOFailure] {1 | 0}<NL>

History Legacy command (existed before version 3.10).

:MTEST:SCALE:BIND

Command :MTEST:SCALE:BIND {{ON | 1} | {OFF | 0}}

The :MTEST:SCALE:BIND command enables or disables Bind 1 & 0 Levels (Bind -1 & 0 Levels for inverted masks) control. If the Bind 1 & 0 Levels control is enabled, the 1 Level and the 0 Level controls track each other. Adjusting either the 1 Level or the 0 Level control shifts the position of the mask up or down without changing its size. If the Bind 1 & 0 Levels control is disabled, adjusting either the 1 Level or the 0 Level control changes the vertical height of the mask.

If the Bind -1 & 0 Levels control is enabled, the -1 Level and the 0 Level controls track each other. Adjusting either the -1 Level or the 0 Level control shifts the position of the mask up or down without changing its size. If the Bind -1 & 0 Levels control is disabled, adjusting either the -1 Level or the 0 Level control changes the vertical height of the mask.

Example This example enables the Bind 1 & 0 Levels control.

```
myScope.WriteString ":MTEST:SCALE:BIND ON"
```

Query :MTEST:SCALE:BIND?

The :MTEST:SCALE:BIND? query returns the value of the Bind 1&0 control (Bind -1&0 for inverted masks).

Returned Format [:MTEST:SCALE:BIND?] {1 | 0}<NL>

History Legacy command (existed before version 3.10).

:MTEST:SCALE:X1

Command :MTEST:SCALE:X1 <x1_value>

The :MTEST:SCALE:X1 command defines where X=0 in the base coordinate system used for mask testing. The other X-coordinate is defined by the SCALE:XDELta command. Once the X1 and XDELta coordinates are set, all X values of vertices in the mask regions are defined with respect to this value, according to the equation:

$$X = (X \times \Delta X) + X1$$

Thus, if you set X1 to 100 ms, and XDELta to 100 ms, an X value of 0.100 is a vertex at 110 ms.

The oscilloscope uses this equation to normalize vertices. This simplifies reprogramming to handle different data rates. For example, if you halve the period of the waveform of interest, you need only to adjust the XDELta value to set up the mask for the new waveform.

<x1_value> A time value specifying the location of the X1 coordinate, which will then be treated as X=0 for mask regions coordinates.

Example This example sets the X1 coordinate at 150 ms.

```
myScope.WriteString ":MTEST:SCALE:X1 150E-3"
```

Query :MTEST:SCALE:X1?

The :MTEST:SCALE:X1? query returns the current X1 coordinate setting.

Returned Format [:MTEST:SCALE:X1] <x1_value><NL>

Example This example gets the current setting of the X1 coordinate from the oscilloscope and prints it on the computer screen.

```
Dim strScale_x1 As String
myScope.WriteString ":MTEST:SCALE:X1?"
strScale_x1 = myScope.ReadString
Debug.Print strScale_x1
```

History Legacy command (existed before version 3.10).

:MTEST:SCALE:XDELta

Command :MTEST:SCALE:XDELta <xdelta_value>

The :MTEST:SCALE:XDELta command defines the position of the X2 marker with respect to the X1 marker. In the mask test coordinate system, the X1 marker defines where X=0; thus, the X2 marker defines where X=1.

Because all X vertices of the regions defined for mask testing are normalized with respect to X1 and ΔX , redefining ΔX also moves those vertices to stay in the same locations with respect to X1 and ΔX . Thus, in many applications, it is best if you define XDELta as a pulse width or bit period. Then a change in data rate without corresponding changes in the waveform can easily be handled by changing ΔX .

The X-coordinate of polygon vertices is normalized using this equation:

$$X = (X \times \Delta X) + X1$$

<xdelta_value> A time value specifying the distance of the X2 marker with respect to the X1 marker.

Example Assume that the period of the waveform you wish to test is 1 ms. Then the following example will set ΔX to 1 ms, ensuring that the waveform's period is between the X1 and X2 markers.

```
myScope.WriteString ":MTEST:SCALE:XDELta 1E-6:
```

Query :MTEST:SCALE:XDELta?

The :MTEST:SCALE:XDELta? query returns the current value of ΔX .

Returned Format [:MTEST:SCALE:XDELta] <xdelta_value><NL>

Example This example gets the value of ΔX from the oscilloscope and prints it on the computer screen.

```
Dim strScale_xdelta As String
myScope.WriteString ":MTEST:SCALE:XDELta?"
strScale_xdelta = myScope.ReadString
Debug.Print strScale_xdelta
```

History Legacy command (existed before version 3.10).

:MTEST:SCALE:Y1

Command :MTEST:SCALE:Y1 <y_value>

The :MTEST:SCALE:Y1 command defines where Y=0 in the coordinate system for mask testing. All Y values of vertices in the coordinate system are defined with respect to the boundaries set by SCALE:Y1 and SCALE:Y2 according to the equation:

$$Y = (Y \times (Y2 - Y1)) + Y1$$

Thus, if you set Y1 to 100 mV, and Y2 to 1 V, a Y value of 0.100 in a vertex is at 190 mV.

<y1_value> A voltage value specifying the point at which Y=0.

Example This example sets the Y1 marker to -150 mV.

```
myScope.WriteString ":MTEST:SCALE:Y1 -150E-3"
```

Query :MTEST:SCALE:Y1?

The SCALE:Y1? query returns the current setting of the Y1 marker.

Returned Format [:MTEST:SCALE:Y1] <y1_value><NL>

Example This example gets the setting of the Y1 marker from the oscilloscope and prints it on the computer screen.

```
Dim strScale_y1 As String
myScope.WriteString ":MTEST:SCALE:Y1?"
strScale_y1 = myScope.ReadString
Debug.Print strScale_y1
```

History Legacy command (existed before version 3.10).

:MTEST:SCALE:Y2

Command :MTEST:SCALE:Y2 <y2_value>

The :MTEST:SCALE:Y2 command defines the Y2 marker in the coordinate system for mask testing. All Y values of vertices in the coordinate system are defined with respect to the boundaries defined by SCALE:Y1 and SCALE:Y2 according to the following equation:

$$Y = (Y \times (Y2 - Y1)) + Y1$$

Thus, if you set Y1 to 100 mV, and Y2 to 1 V, a Y value of 0.100 in a vertex is at 190 mV.

<y2_value> A voltage value specifying the location of the Y2 marker.

Example This example sets the Y2 marker to 2.5 V.

```
myScope.WriteString ":MTEST:SCALE:Y2 2.5"
```

Query :MTEST:SCALE:Y2?

The SCALE:Y2? query returns the current setting of the Y2 marker.

Returned Format [:MTEST:SCALE:Y2] <y2_value><NL>

Example This example gets the setting of the Y2 marker from the oscilloscope and prints it on the computer screen.

```
Dim strScale_y2 As String
myScope.WriteString ":MTEST:SCALE:Y2?"
strScale_y2 = myScope.ReadString
Debug.Print strScale_y2
```

History Legacy command (existed before version 3.10).

:MTEST:SOURce

Command :MTEST:SOURce {CHANnel<N> | FUNCtion<F> | EQUalized | WMEMory<R>}

The :MTEST:SOURce command selects the channel which is configured by the commands contained in a mask file when it is loaded.

The EQUalized source is only available if the oscilloscope has the High Speed Serial option and the Serial Data Equalization option installed and the features are enabled. This command uses the Feed-Forward Equalized (FFE) signal as the source.

<N> An integer, 1-4 in a single oscilloscope, 1-40 in a MultiScope system.

<F> An integer, 1-16.

<R> An integer, 1-4.

Example This example selects channel 1 as the mask test source.

```
myScope.WriteString ":MTEST:SOURce CHANnel1"
```

Query :MTEST:SOURce?

The :MTEST:SOURce? query returns the channel which is configured by the commands contained in the current mask file.

Returned Format [:MTEST:SOURce] {CHAN<N> | FUNC<F> | EQU | WMEM<R>}<NL>

Example This example gets the mask test source setting and prints the result on the computer display.

```
Dim strAmask_source As String
myScope.WriteString ":MTEST:SOURce?"
strAmask_source = myScope.ReadString
Debug.Print strAmask_source
```

History Legacy command (existed before version 3.10).

Version 6.00: Waveform memories can now be used as a source for mask testing.

:MTEST:START

Command `:MTEST:START`

The `:MTEST:START` command starts the mask test. The `:MTEST:START` command also starts the oscilloscope acquisition system.

Example This example starts the mask test and acquisition system.

```
myScope.WriteString ":MTEST:START"
```

History Legacy command (existed before version 3.10).

:MTEST:STOP

Command :MTEST:STOP

The :MTEST:STOP command stops the mask test. The :MTEST:STOP command does not stop the acquisition system.

Example This example stops the mask test.

```
myScope.WriteString ":MTEST:STOP"
```

History Legacy command (existed before version 3.10).

:MTEST:STIME

Command :MTEST:STIME <timeout>

The :MTEST:STIME command sets the timeout value for the Autoalign feature. If the oscilloscope is unable to align the mask to your waveform within the specified timeout value, it will stop trying to align and will report an alignment failure.

<timeout> An integer from 1 to 120 seconds representing the time between triggers (not the time that it takes to finish the alignment.)

Example This example sets the timeout value for the Autoalign feature to 10 seconds.

```
myScope.WriteString ":MTEST:STIME 10"
```

Query :MTEST:STIME?

The query returns timeout value for the Autoalign feature.

Returned Format [:MTEST:STIME] <timeout><NL>

Example This example gets the timeout setting and prints the result on the computer display.

```
myScope.WriteString ":MTEST:STIME?"
varValue = myScope.ReadNumber
Debug.Print FormatNumber(varValue, 0)
```

History Legacy command (existed before version 3.10).

:MTEST:TITLe?

Query :MTEST:TITLe?

The :MTEST:TITLe? query returns the mask title which is a string of up to 23 characters. The title is displayed in the mask test dialog box and mask test tab when a mask file is loaded.

Returned Format [:MTEST:TITLe] <mask_title><NL>

<mask_title> A string of up to 23 ASCII characters which is the mask title.

Example This example places the mask title in the string variable and prints the contents to the computer's screen.

```
Dim strTitle As String
myScope.WriteString ":MTEST:TITLe?"
strTitle = myScope.ReadString
Debug.Print strTitle
```

History Legacy command (existed before version 3.10).

:MTEST:TRIGger:SOURce

Command :MTEST:TRIGger:SOURce CHANnel<N>

The :MTEST:TRIGger:SOURce command sets the channel or function to use as the trigger. Mask testing must be enabled before using this command.

<N> An integer, 1-4.

Example This example sets the mask trigger source to channel 1.

```
myScope.WriteString ":MTEST:TRIGger:SOURce CHANnel1"
```

Query :MTEST:TRIGger:SOURce?

The query returns the currently selected mask test trigger source.

Returned Format [:MTEST:TRIGger:SOURce] CHANnel<N><NL>

Example This example gets the trigger source setting and prints the result on the computer display.

```
Dim strAmask_source As String
myScope.WriteString ":MTEST:TRIGger:SOURce?"
strAmask_source = myScope.ReadString
Debug.Print strAmask_source
```

History Legacy command (existed before version 3.10).

28 Measure Commands

:MEASure:AREA / 731
:MEASure:BER / 732
:MEASure:BERPeracq / 733
:MEASure:BINterval / 734
:MEASure:BPERiod / 735
:MEASure:BWIDth / 736
:MEASure:CDRRate / 737
:MEASure:CGRade:CROSSing / 738
:MEASure:CGRade:DCDistortion / 739
:MEASure:CGRade:EHEight / 740
:MEASure:CGRade:EWIDth / 742
:MEASure:CGRade:EWINDow / 744
:MEASure:CGRade:JITTer / 746
:MEASure:CGRade:OLEVel / 747
:MEASure:CGRade:QFACTOR / 748
:MEASure:CGRade:ZLEVel / 749
:MEASure:CHARge (9000 Series, 9000H Series, S-Series) / 750
:MEASure:CLEar / 751
:MEASure:CROSSing / 752
:MEASure:CTCDutycycle / 753
:MEASure:CTCJitter / 755
:MEASure:CTCNwidth / 757
:MEASure:CTCPwidth / 758
:MEASure:DATarate / 759
:MEASure:DEEMphasis / 760
:MEASure:DELTatime / 762
:MEASure:DELTatime:DEFine / 764
:MEASure:DUTYcycle / 766
:MEASure:EDGE / 767
:MEASure:ERATio / 768
:MEASure:ETOedge / 769
:MEASure:FALLtime / 770

```

:MEASure:FFT:CPOWer / 772
:MEASure:FFT:DFRequency / 773
:MEASure:FFT:DMAGNitude / 774
:MEASure:FFT:FREQuency / 775
:MEASure:FFT:MAGNitude / 776
:MEASure:FFT:OBW / 777
:MEASure:FFT:PEAK1 / 778
:MEASure:FFT:PEAK2 / 779
:MEASure:FFT:PSD / 780
:MEASure:FFT:THReshold / 781
:MEASure:FREQuency / 782
:MEASure:HISTogram:FWMH / 784
:MEASure:HISTogram:HITS / 785
:MEASure:HISTogram:M1S / 786
:MEASure:HISTogram:M2S / 787
:MEASure:HISTogram:M3S / 788
:MEASure:HISTogram:MAX / 789
:MEASure:HISTogram:MEAN / 790
:MEASure:HISTogram:MEdian / 791
:MEASure:HISTogram:MIN / 792
:MEASure:HISTogram:MODE / 793
:MEASure:HISTogram:PEAK / 794
:MEASure:HISTogram:PP / 795
:MEASure:HISTogram:RESolution / 796
:MEASure:HISTogram:STDDev / 797
:MEASure:HOLDtime / 798
:MEASure:JITTer:HISTogram / 800
:MEASure:JITTer:MEASurement / 801
:MEASure:JITTer:SPECtrum / 802
:MEASure:JITTer:SPECtrum:HORizontal / 803
:MEASure:JITTer:SPECtrum:HORizontal:POSition / 804
:MEASure:JITTer:SPECtrum:HORizontal:RANGe / 805
:MEASure:JITTer:SPECtrum:VERTical / 806
:MEASure:JITTer:SPECtrum:VERTical:OFFSet / 807
:MEASure:JITTer:SPECtrum:VERTical:RANGe / 808
:MEASure:JITTer:SPECtrum:VERTical:TYPE / 809
:MEASure:JITTer:SPECtrum:WINDow / 810
:MEASure:JITTer:TRENd / 811
:MEASure:JITTer:TRENd:SMOoth / 812

```

:MEASure:JITTer:TREnd:SMOoth:POINts / 813
:MEASure:JITTer:TREnd:VERTical / 814
:MEASure:JITTer:TREnd:VERTical:OFFSet / 815
:MEASure:JITTer:TREnd:VERTical:RANGe / 816
:MEASure:NAME / 817
:MEASure:NCJitter / 818
:MEASure:NOISe / 820
:MEASure:NOISe:ALL? / 821
:MEASure:NOISe:BANDwidth / 823
:MEASure:NOISe:LOCation / 824
:MEASure:NOISe:METHod / 825
:MEASure:NOISe:REPort / 826
:MEASure:NOISe:RN / 827
:MEASure:NOISe:SCOPE:RN / 828
:MEASure:NOISe:STATe / 829
:MEASure:NOISe:UNITs / 830
:MEASure:NPERiod / 831
:MEASure:NPULses / 832
:MEASure:NUI / 833
:MEASure:NWIDth / 834
:MEASure:OMAMplitude / 835
:MEASure:OPOWer / 836
:MEASure:OVERshoot / 837
:MEASure:PAM:ELEVel / 838
:MEASure:PAM:ESKew / 840
:MEASure:PAM:EYE:ELMethod / 842
:MEASure:PAM:EYE:ESTiming / 843
:MEASure:PAM:EYE:PPERcent / 844
:MEASure:PAM:EYE:TIME:LTDefinition / 845
:MEASure:PAM:LEVel / 846
:MEASure:PAM:LRMS / 848
:MEASure:PAM:LTHickness / 850
:MEASure:PAMPLitude / 852
:MEASure:PBASe / 853
:MEASure:PERiod / 854
:MEASure:PHASe / 856
:MEASure:PPContrast / 858
:MEASure:PPULses / 859
:MEASure:PREShoot / 860

:MEASure:PTOP / 861
:MEASure:PWIDth / 862
:MEASure:QUALifier<M>:CONDition / 863
:MEASure:QUALifier<M>:SOURce / 864
:MEASure:QUALifier<M>:STATe / 865
:MEASure:RESults? / 866
:MEASure:RISetime / 869
:MEASure:RJDJ:ALL? / 871
:MEASure:RJDJ:APLength? / 873
:MEASure:RJDJ:BANDwidth / 874
:MEASure:RJDJ:BER / 875
:MEASure:RJDJ:CLOCK / 877
:MEASure:RJDJ:EDGE / 878
:MEASure:RJDJ:INTerpolate / 879
:MEASure:RJDJ:METHod / 880
:MEASure:RJDJ:MODE / 881
:MEASure:RJDJ:PAMThreshold / 882
:MEASure:RJDJ:PLENght / 883
:MEASure:RJDJ:REPort / 884
:MEASure:RJDJ:RJ / 885
:MEASure:RJDJ:SCOPE:RJ / 886
:MEASure:RJDJ:SOURce / 887
:MEASure:RJDJ:STATe / 888
:MEASure:RJDJ:TJRJDJ? / 889
:MEASure:RJDJ:UNITs / 891
:MEASure:SCRatch / 892
:MEASure:SENDvalid / 893
:MEASure:SER / 894
:MEASure:SERPeracq / 895
:MEASure:SETuptime / 896
:MEASure:SLEWrate / 898
:MEASure:SOURce / 899
:MEASure:STATistics / 900
:MEASure:TEDGe / 901
:MEASure:THResholds:ABSolute / 902
:MEASure:THResholds:DISPlay / 903
:MEASure:THResholds:GENauto / 904
:MEASure:THResholds:GENeral:ABSolute / 905
:MEASure:THResholds:GENeral:HYSteresis / 907

:MEASure:THResholds:GENeral:METhod / 909
:MEASure:THResholds:GENeral:PAMCustom / 911
:MEASure:THResholds:GENeral:PAMAutomatic / 913
:MEASure:THResholds:GENeral:PERCent / 915
:MEASure:THResholds:GENeral:TOPBase:ABSolute / 917
:MEASure:THResholds:GENeral:TOPBase:METhod / 919
:MEASure:THResholds:HYSteresis / 920
:MEASure:THResholds:METhod / 922
:MEASure:THResholds:PERCent / 923
:MEASure:THResholds:RFAl:ABSolute / 924
:MEASure:THResholds:RFAl:METhod / 926
:MEASure:THResholds:RFAl:PAMAutomatic / 928
:MEASure:THResholds:RFAl:PERCent / 930
:MEASure:THResholds:RFAl:TOPBase:ABSolute / 932
:MEASure:THResholds:RFAl:TOPBase:METhod / 934
:MEASure:THResholds:SEriAl:ABSolute / 935
:MEASure:THResholds:SEriAl:HYSteresis / 937
:MEASure:THResholds:SEriAl:METhod / 939
:MEASure:THResholds:SEriAl:PERCent / 940
:MEASure:THResholds:SEriAl:TOPBase:ABSolute / 942
:MEASure:THResholds:SEriAl:TOPBase:METhod / 944
:MEASure:THResholds:TOPBase:ABSolute / 945
:MEASure:THResholds:TOPBase:METhod / 946
:MEASure:TIEClock2 / 947
:MEASure:TIEData2 / 949
:MEASure:TIEFilter:SHApe / 950
:MEASure:TIEFilter:STARt / 951
:MEASure:TIEFilter:STATe / 952
:MEASure:TIEFilter:STOP / 953
:MEASure:TIEFilter:TYPE / 954
:MEASure:TMAX / 955
:MEASure:TMIN / 956
:MEASure:TVOLt / 957
:MEASure:UITouijitter / 958
:MEASure:UNITinterval / 959
:MEASure:VAMPLitude / 960
:MEASure:VAverage / 961
:MEASure:VBASe / 962
:MEASure:VLOWer / 963

```

:MEASure:VMAX / 964
:MEASure:VMIDdle / 965
:MEASure:VMIN / 966
:MEASure:VOVershoot / 967
:MEASure:VPP / 968
:MEASure:VPReshoot / 969
:MEASure:VRMS / 970
:MEASure:VTIMe / 972
:MEASure:VTOp / 973
:MEASure:VUPPer / 974
:MEASure:WINDow / 975
:MEASurement<N>:NAME / 976
:MEASurement<N>:SOURce / 977

```

The commands in the MEASure subsystem are used to make parametric measurements on displayed waveforms.

E2688A High Speed Serial Software Commands

The following MEASure commands are available when the E2688A High Speed Serial Software is installed.

- **":MEASure:TIEData2"** on page 949
- **":MEASure:TIEFilter:SHAPE"** on page 950
- **":MEASure:TIEFilter:START"** on page 951
- **":MEASure:TIEFilter:STATE"** on page 952
- **":MEASure:TIEFilter:STOP"** on page 953
- **":MEASure:TIEFilter:TYPE"** on page 954
- Also see the **":MTESt:FOLDing (Clock Recovery software only)"** on page 677 command in the mask test system.

E2681A EZJIT Jitter Analysis Software Commands

The following MEASure commands are available when the E2681A EZJIT Jitter Analysis Software is installed.

- **":MEASure:CTCDutycycle"** on page 753
- **":MEASure:CTCJitter"** on page 755
- **":MEASure:CTCNwidth"** on page 757
- **":MEASure:CTCPwidth"** on page 758
- **":MEASure:DATarate"** on page 759
- **":MEASure:HOLDtime"** on page 798
- **":MEASure:JITTer:HISTogram"** on page 800

- **":MEASure:JITTer:MEASurement"** on page 801
- **":MEASure:JITTer:SPECTrum"** on page 802
- **":MEASure:JITTer:TREND"** on page 811
- **":MEASure:NCJitter"** on page 818
- **":MEASure:NPERiod"** on page 831
- **":MEASure:NUI"** on page 833
- **":MEASure:SETuptime"** on page 896
- **":MEASure:TIEClock2"** on page 947
- **":MEASure:TIEData2"** on page 949
- **":MEASure:UITouijitter"** on page 958
- **":MEASure:UNITinterval"** on page 959

**N5400A and
N5401A Jitter
Analysis Software
Commands**

The following MEASure commands are available when the N5400A or N5401A Jitter Analysis Software is installed.

- **":MEASure:CTCDutycycle"** on page 753
- **":MEASure:CTCJitter"** on page 755
- **":MEASure:CTCNwidth"** on page 757
- **":MEASure:CTCPwidth"** on page 758
- **":MEASure:DATarate"** on page 759
- **":MEASure:HOLDtime"** on page 798
- **":MEASure:JITTer:HISTogram"** on page 800
- **":MEASure:JITTer:MEASurement"** on page 801
- **":MEASure:JITTer:SPECTrum"** on page 802
- **":MEASure:JITTer:TREND"** on page 811
- **":MEASure:NCJitter"** on page 818
- **":MEASure:RJDJ:ALL?"** on page 871
- **":MEASure:RJDJ:APLength?"** on page 873
- **":MEASure:RJDJ:BER"** on page 875
- **":MEASure:RJDJ:CLOCK"** on page 877
- **":MEASure:RJDJ:EDGE"** on page 878
- **":MEASure:RJDJ:INTerpolate"** on page 879
- **":MEASure:RJDJ:PLENght"** on page 883
- **":MEASure:RJDJ:SOURce"** on page 887
- **":MEASure:RJDJ:STATE"** on page 888
- **":MEASure:RJDJ:TJRJDJ?"** on page 889
- **":MEASure:RJDJ:UNITs"** on page 891

- **":MEASure:SETuptime"** on page 896
- **":MEASure:TIEClock2"** on page 947
- **":MEASure:TIEData2"** on page 949
- **":MEASure:UNITinterval"** on page 959

FFT Commands The :MEASure:FFT commands control the FFT measurements that are accessible through the Measure subsystem.

Measurement Sources Measurements are made on the displayed waveforms specified by the :MEASure:SOURce command. The :MEASure:SOURce command lets you specify two sources. Most measurements are only made on a single source. Some measurements, such as the DELTatime measurement, require two sources.

Most :MEASure commands also let you specify the source(s) using a <source> parameter:

```
<source> ::= {CHANnel<N> | DIFF<D> | COMMonmode<C> | WMEMory<R>
             | FUNcTion<F> | CLOck | EQUalized | MTRend | MSPectrum | DIGital<M>}
```

where:

| | |
|------------------------|--|
| CHANnel<N> | <N> is an integer, 1-4 in a single oscilloscope, 1-40 in a MultiScope system. |
| DIFF<D>, COMMonmode<C> | <D> is an integer, 1-2. <C> is an integer, 3-4. The DIFF and COMMonmode sources are just aliases that can be used in place of the channel names to apply to differential or common mode signals. These are just aliases - no state change occurs if you refer to a differential channel and you are not in differential mode. DIFF1 refers to the differential signal between channels 1 and 3 (and COMMonmode3 refers to the common mode channel between these same channels). DIFF2 refers to the differential signal between channels 2 and 4 (and COMMonmode4 refers to the common mode channel between these same channels). |
| WMEMory<R> | <R> is an integer, 1-4. |
| FUNcTion<F> | <F> is an integer, 1-16. |
| CLOck | The CLOck source is available only if the oscilloscope has the High Speed Serial option installed and the recovered clock is displayed. |
| EQUalized | The EQUalized source is available only if the oscilloscope has the High Speed Serial option and the Serial Data Equalization option installed and the features are enabled. This command uses the linearly equalized (FFE/CTLE) signal as the source. |
| MTRend, MSPectrum | MTRend and MSPectrum sources are available only if the oscilloscope has the EZJIT option installed and the feature is enabled. |

| | |
|------------|--|
| HISTogram | HISTogram sources are available in commands that measure Meas Histogram math functions, the histogram waveform, or memories containing histograms. |
| DIGital<M> | <M> is an integer, 0-15. Digital channels are available on mixed-signal oscilloscopes. |

- Measurement Setup** To make a measurement, the portion of the waveform required for that measurement must be displayed on the oscilloscope.
- For a period or frequency measurement, at least one and a half complete cycles must be displayed.
 - For a pulse width measurement, the entire pulse must be displayed.
 - For a rise time measurement, the leading (positive-going) edge of the waveform must be displayed.
 - For a fall time measurement, the trailing (negative-going) edge of the waveform must be displayed.

In jitter mode with jitter statistics enabled, measurements are made on all data regardless of what is on screen.

- User-Defined Thresholds** If you choose to set user-defined thresholds, they must be set before actually sending the measurement command or query.

- Measurement Error** If a measurement cannot be made because of a lack of data, because the source waveform is not displayed, the requested measurement is not possible (for example, a period measurement on an FFT waveform), or for some other reason, the following results are returned:
- 9.99999E+37 is returned as the measurement result.
 - If SENDvalid is ON, the error code is also returned as well as the questionable value.

- Making Measurements** If more than one period, edge, or pulse is displayed, time measurements are made on the first, left-most portion of the displayed waveform.

When any of the defined measurements are requested, the oscilloscope first determines the top (100%) and base (0%) voltages of the waveform. From this information, the oscilloscope determines the other important voltage values (10%, 90%, and 50% voltage values) for making measurements.

The 10% and 90% voltage values are used in the rise time and fall time measurements when standard thresholds are selected. The 50% voltage value is used for measuring frequency, period, pulse width, and duty cycle with standard thresholds selected.

You can also make measurements using user-defined thresholds instead of the standard thresholds.

When the command form of a measurement is used, the oscilloscope is placed in the continuous measurement mode. The measurement result will be displayed on the front panel. There may be a maximum of 5 measurements running continuously. Use the SCRAatch command to turn off the measurements.

When the query form of the measurement is used, the measurement is made one time, and the measurement result is returned.

- If the current acquisition is complete, the current acquisition is measured and the result is returned.
- If the current acquisition is incomplete and the oscilloscope is running, acquisitions will continue to occur until the acquisition is complete. The acquisition will then be measured and the result returned.
- If the current acquisition is incomplete and the oscilloscope is stopped, the measurement result will be 9.99999e+37 and the incomplete result state will be returned if SENDvalid is ON.

All measurements are made using the entire display, except for VAVerage and VRMS which allow measurements on a single cycle. Therefore, if you want to make measurements on a particular cycle, display only that cycle on the screen.

If the waveform is clipped, the measurement result may be questionable. In this case, the value returned is the most accurate value that can be made using the current scaling. You might be able to obtain a more accurate measurement by adjusting the vertical scale to prevent the waveform from being clipped.

Note that you can concatenate measurement queries for much faster throughput. For example:

```
:MEASure:VPP? CHANnel1;:MEASure:FREQuency? CHANnel2
```

When you do this, however, values are returned as a single query result, separated by semicolons.

:MEASure:AREA

Command :MEASure:AREA [CYCLe[, <source>[, <direction>]]]
 :MEASure:AREA [DISPlay[, <source>]]

The :MEASure:AREA command turns on the area measurement. The area measurement measures between the waveform, or a selected cycle of the waveform, and the waveform ground.

When measuring Area, it is sometimes useful to use the Subtract Math Operator to remove any dc offset from a waveform you want to measure.

<source> {CHANnel<N> | FUNcTION<F> | WMEMory<R>}

For more information on <source> parameters, see "[Measurement Sources](#)" on page 728.

<direction> {RISing | FALLing}

Specifies direction of edge to start measurement. When <direction> is specified, the <source> parameter is required.

Using the <direction> parameter will set the "Measure All Edges" mode if it is not currently set. You can use the :ANALyze:AEDGes command to turn the "Measure All Edges" mode off (or on again). See "[:ANALyze:AEDGes](#)" on page 239.

Example This example turns on the area measurement which measures between the waveform and ground. Only that portion of the waveform which is in the waveform viewing area is measured.

```
myScope.WriteString ":MEASure:AREA DISPlay"
```

Query :MEASure:AREA? [CYCLe[, <source>[, <direction>]]]
 :MEASure:AREA? [DISPlay[, <source>]]

The :MEASure:AREA? query returns the area measurement.

Returned Format [:MEASure:AREA] <value>[, <result_state>]<NL>

Example This example places the current selection for the area to be measured in the string variable, strSelection, then prints the contents of the variable to the computer's screen.

```
Dim strSelection As String
myScope.WriteString ":MEASure:AREA?"
strSelection = myScope.ReadString
Debug.Print strSelection
```

History Legacy command (existed before version 3.10).

Version 5.70: Added a RISing or FALLing edge parameter when measuring a single cycle of the waveform.

:MEASure:BER

Command :MEASure:BER <source>, {AUTO | <pattern_length>}

<source> ::= {CHANnel<N> | FUNction<F> | WMEMory<R>}

<N> is an integer, 1-4 in a single oscilloscope, 1-40 in a MultiScope system.

<F> is an integer, 1-16.

<R> is an integer, 1-4.

<pattern_length> ::= integer number of symbols.

The :MEASure:BER command installs a cumulative bit error rate (BER) measurement of the specified PAM waveform into the user interface's measurement Results pane.

Query :MEASure:BER? <source>, {AUTO | <pattern_length>}

The :MEASure:BER? query returns the measured cumulative bit error rate value.

Returned Format [:MEASure:BER] <value><NL>

<value> ::= the cumulative BER value in NR3 format.

- See Also**
- [":MEASure:BERPeracq"](#) on page 733
 - [":MEASure:SER"](#) on page 894
 - [":MEASure:SERPeracq"](#) on page 895

History New in version 5.60.

:MEASure:BERPeracq

Command :MEASure:BERPeracq <source>, {AUTO | <pattern_length>}

<source> ::= {CHANnel<N> | FUNction<F> | WMEMory<R>}

<N> is an integer, 1-4 in a single oscilloscope, 1-40 in a MultiScope system.

<F> is an integer, 1-16.

<R> is an integer, 1-4.

<pattern_length> ::= integer number of symbols.

The :MEASure:BERPeracq command installs a bit error rate (BER) per acquisition measurement of the specified PAM waveform into the user interface's measurement Results pane.

Query :MEASure:BERPeracq? <source>, {AUTO | <pattern_length>}

The :MEASure:BERPeracq? query returns the measured bit error rate per acquisition value.

Returned Format [:MEASure:BERPeracq] <value><NL>

<value> ::= the BER per acquisition value in NR3 format.

- See Also**
- [":MEASure:BER"](#) on page 732
 - [":MEASure:SER"](#) on page 894
 - [":MEASure:SERPeracq"](#) on page 895

History New in version 5.60.

:MEASure:BINTErval

Command :MEASure:BINTErval <source>, <idle time>

The :MEASure:BINTErval command measures the amount of time between the end of a burst and beginning of the next burst. The idle time is the minimum time between bursts.

<source> {CHANnel<N> | FUNCTion<F> | WMEMory<R>}

For more information on <source> parameters, see "[Measurement Sources](#)" on page 728.

<idle time> Minimum amount of idle time between bursts.

Example This example measures the burst interval between two bursts on channel 4 (and with an idle time of 5 microseconds)

```
myScope.WriteString ":MEASure:BINTErval CHAN4, 5e-6"
```

Query :MEASure:BINTErval? <source>, <idle time>

The :MEASure:BINTErval? query returns the burst interval time.

History Legacy command (existed before version 3.10).

:MEASure:BPERiod

Command :MEASure:BPERiod <source>, <idle time>

The :MEASure:BPERiod command measures the time between the beginning of a burst and the beginning of the next burst. The idle time is the minimum time between bursts.

<source> {CHANnel<N> | FUNCTion<F> | WMEMory<R>}

For more information on <source> parameters, see "[Measurement Sources](#)" on page 728.

<idle time> Minimum amount of idle time between bursts.

Example This example measures the burst period between two bursts on channel 4 (and with an idle time of 5 microseconds)

```
myScope.WriteString ":MEASure:BPERiod CHAN4, 5e-6"
```

Query :MEASure:BPERiod? <source>, <idle time>

The :MEASure:BPERiod? query returns the burst period time.

History Legacy command (existed before version 3.10).

:MEASure:BWIDth

Command :MEASure:BWIDth <source>,<idle_time>

The :MEASure:BWIDth command measures the width of bursts in your waveform. The idle time is the minimum time between bursts.

<source> {CHANnel<N> | DIFF<D> | COMMONmode<C> | FUNction<F> | WMEMory<R> | CLOCk | MSPectrum | MTRend | EQUalized}

For more information on <source> parameters, see "**Measurement Sources**" on page 728.

<idle_time> Amount of idle time between bursts.

Example This example measures the width of bursts for the waveform on channel one and sets the idle time to 1 microsecond.

```
myScope.WriteString ":MEASure:BWIDth CHANnel1,1E-6"
```

Query :MEASure:BWIDth? <source>,<idle_time>

The :MEASure:BWIDth? query returns the width of the burst being measured.

Returned Format [:MEASure:BWIDth]<burst_width><NL>

Example This example returns the width of the burst being measured, in the string variable, strBurstwidth, then prints the contents of the variable to the computer's screen.

```
Dim strBurstwidth As String
myScope.WriteString ":MEASure:BWIDth? CHANnel1,1E-6"
strBurstwidth = myScope.ReadString
Debug.Print strBurstwidth
```

History Legacy command (existed before version 3.10).

:MEASure:CDRRate

Command :MEASure:CDRRate <source>

The :MEASure:CDRRate command determines the data rate (clock recovery rate) from the clock recovery method being used. It yields one data point per acquisition so trending cannot be performed on this measurement.

<source> {CHANnel<N> | DIFF<D> | COMMONmode<C> | FUNCTION<F> | WMEMory<R> | CLOCK | MSPectrum | MTRend | EQUALized}

For more information on <source> parameters, see "[Measurement Sources](#)" on page 728.

Example This example measures the clock recovery rate of channel 1.

```
myScope.WriteString ":MEASure:CDRRate CHANnel1"
```

Query :MEASure:CDRRate? <source>

The :MEASure:CDRRate? query returns the data rate (clock recovery rate) for the source waveform.

Returned Format [:MEASure:CDRRate] <cdr_rate><NL>

Example This example places the current data rate of the channel 1 waveform in the numeric variable, varValue, then prints the contents of the variable to the computer's screen.

```
myScope.WriteString ":SYSTEM:HEADer OFF" ' Response headers off.
myScope.WriteString ":MEASure:CDRRate? CHANnel1"
varValue = myScope.ReadNumber
Debug.Print FormatNumber(varValue, 0)
```

History Legacy command (existed before version 3.10).

:MEASure:CGRade:CROSSing

Command :MEASure:CGRade:CROSSing [<source>]

The :MEASure:CGRade:CROSSing command enables the crossing level percent measurement on the current eye pattern. Before using this command or query, you must use the :DISPlay:CGRade command to enable the color grade persistence feature. Also, there must be a full eye diagram on screen before a valid measurement can be made.

<source> {CHANnel<N> | DIFF<D> | COMMONmode<C> | WMEMory<R> | FUNCTion<F> | CLOCK | EQUalized | MTRend | MSPectrum}

If <source> is omitted, the crossing level measurement will be performed on the first waveform that has color grade enabled.

For more information on <source> parameters, see "[Measurement Sources](#)" on page 728.

Example This example measures the crossing level.

```
myScope.WriteString ":MEASure:CGRade:CROSSing"
```

Query :MEASure:CGRade:CROSSing? [<source>]

The :MEASure:CGRade:CROSSing? query returns the crossing level percent measurement of the current eye diagram on the color grade display. Before using this command or query, you must use the :DISPlay:CGRade command to enable the color grade persistence feature.

Returned Format [:MEASure:CGRade:CROSSing] <value> [, <result_state>] <NL>

<value> The crossing level.

<result_state> If SENDVALID is ON, the result state is returned with the measurement result. Refer to the MEASure:RESuLts command, for a list of the result states.

Example This example places the current crossing level in the numeric variable, varValue, then prints the contents of the variable to the computer's screen.

```
myScope.WriteString ":SYSTem:HEADer OFF" ' Response headers off.
myScope.WriteString ":MEASure:CGRade:CROSSing?"
varValue = myScope.ReadNumber
Debug.Print FormatNumber(varValue, 0)
```

History Legacy command (existed before version 3.10).

Version 5.00: Added the optional <source> parameter for specifying the waveform on which the color grade crossing level percent is measured.

:MEASure:CGRade:DCDistortion

Command :MEASure:CGRade:DCDistortion <format> [, <source>]

The :MEASure:CGRade:DCDistortion command enables the duty cycle distortion measurement on the current eye pattern. The parameter specifies the format for reporting the measurement. Before using this command or query, you must use the :DISPlay:CGRade command to enable the color grade persistence feature. Also, there must be a full eye diagram on screen before a valid measurement can be made.

<format> {TIME | PERCent}

<source> {CHANnel<N> | DIFF<D> | COMMONmode<C> | WMEMory<R> | FUNCTion<F> | CLOCk | EQUalized | MTRend | MSPectrum}

If <source> is omitted, the duty cycle distortion measurement will be performed on the first waveform that has color grade enabled.

For more information on <source> parameters, see "[Measurement Sources](#)" on page 728.

Example This example measures the duty cycle distortion.

```
myScope.WriteString ":MEASure:CGRade:DCDistortion TIME"
```

Query :MEASure:CGRade:DCDistortion? <format> [, <source>]

The :MEASure:CGRade:DCDistortion query returns the duty cycle distortion measurement of the color grade display. Before using this command or query, you must use the :DISPlay:CGRade command to enable the color grade persistence feature.

Returned Format [:MEASure:CGRade:DCDistortion] <value> [, <result_state>] <NL>

<value> The duty cycle distortion.

<result_state> If SENDVALID is ON, the result state is returned with the measurement result. Refer to the MEASure:RESults command, for a list of the result states.

Example This example places the current duty cycle distortion in the numeric variable, varValue, then prints the contents of the variable to the computer's screen.

```
myScope.WriteString ":SYSTEM:HEADer OFF"
myScope.WriteString ":MEASure:CGRade:DCDistortion? PERCent"
varValue = myScope.ReadNumber
Debug.Print FormatNumber(varValue, 0)
```

History Legacy command (existed before version 3.10).

Version 5.00: Added the optional <source> parameter for specifying the waveform on which the color grade duty cycle distortion is measured.

:MEASure:CGRade:EHEight

Command :MEASure:CGRade:EHEight <algorithm>[,<source>[,<threshold>]]

The :MEASure:CGRade:EHEight command enables the eye height measurement on the current eye pattern. Before using this command or query, you must use the :DISPlay:CGRade command to enable the color grade persistence feature. Also, there must be a full eye diagram on screen before a valid measurement can be made.

<algorithm> {MEASured | EXTRapolated} EXTRapolated is optional because it is the default if you do not specify an algorithm.

MEASured will measure the eye height within the window (see CGRade:EWINDow) of the current data. The smallest eye height is reported. Extrapolated will estimate the eye height based upon the mean and standard deviation of the eye top and base.

<source> {CHANnel<N> | DIFF<D> | COMMONmode<C> | WMEMory<R> | FUNCTion<F> | CLOCk | EQUalized | MTRend | MSPectrum}

If <source> is omitted, the eye height measurement will be performed on the first waveform that has color grade enabled.

For more information on <source> parameters, see "[Measurement Sources](#)" on page 728.

<threshold> When the signal type is PAM-4 (see :ANALyze:SIGNal:TYPE), the <threshold> parameter is an integer that specifies which eye to measure, and the <algorithm> parameter is ignored. For PAM-4, the <threshold> may be from 0-2.

Example This example enables the eye height measurement.

```
myScope.WriteString ":MEASure:CGRade:EHEight "
```

Query :MEASure:CGRade:EHEight? <algorithm>[,<source>[,<threshold>]]

The :MEASure:CGRade:EHEight? query returns the eye height measurement of the color grade display. Before using this command or query, you must use the :DISPlay:CGRade command to enable the color grade persistence feature.

Returned Format [:MEASure:CGRade:EHEight] <value>[,<result_state>]<NL>

<value> The eye height.

<result_state> If SENDVALID is ON, the result state is returned with the measurement result. Refer to the MEASure:RESults command, for a list of the result states.

Example This example places the current eye height in the numeric variable, varValue, then prints the contents of the variable to the computer's screen.

```
myScope.WriteString ":SYSTem:HEADer OFF" ' Response headers off.
myScope.WriteString ":MEASure:CGRade:EHEight?"
varValue = myScope.ReadNumber
Debug.Print FormatNumber(varValue, 0)
```

See Also · **":ANALyze:SIGNal:TYPE"** on page 271

History Legacy command (existed before version 3.10).

Version 5.00: Added the optional <source> parameter for specifying the waveform on which the color grade eye height is measured.

Version 5.50: When the signal type is PAM-4, an additional <threshold> parameter is used to specify which eye, and the <algorithm> parameter is ignored.

:MEASure:CGRade:EWIDth

Command :MEASure:CGRade:EWIDth <algorithm>[,<source>[,<threshold>]]

The :MEASure:CGRade:EWIDth command enables the eye width measurement on the current eye pattern. Before using this command or query, you must use the :DISPlay:CGRade command to enable the color grade persistence feature. Also, there must be a full eye diagram on screen before a valid measurement can be made.

<algorithm> {MEASured | EXTRapolated} EXTRapolated is optional because it is the default if you do not specify an algorithm.

MEASured will measure the eye width measurement within the window (see CGRade:EWINDow) of the current data. The smallest eye width is reported. Extrapolated will estimate the eye width based upon the mean and standard deviation of the crossings.

<source> {CHANnel<N> | DIFF<D> | COMMONmode<C> | WMEMory<R> | FUNCTion<F> | CLOCk | EQUalized | MTRend | MSPectrum}

If <source> is omitted, the eye width will be performed on the first waveform that has color grade enabled.

For more information on <source> parameters, see "[Measurement Sources](#)" on page 728.

<threshold> When the signal type is PAM-4 (see :ANALyze:SIGNal:TYPE), the <threshold> parameter is an integer that specifies which eye to measure, and the <algorithm> parameter is ignored. For PAM-4, the <threshold> may be from 0-2.

Example This example measures the eye width.

```
myScope.WriteString ":MEASure:CGRade:EWIDth"
```

Query :MEASure:CGRade:EWIDth? <algorithm>[,<source>[,<threshold>]]

The :MEASure:CGRade:EWIDth? query returns the eye width measurement of the color grade display. Before using this command or query, you must use the :DISPlay:CGRade command to enable the color grade persistence feature.

Returned Format [:MEASure:CGRade:EWIDth] <value>[,<result_state>] <NL>

<value> The eye width.

<result_state> If SENDVALID is ON, the result state is returned with the measurement result. Refer to the MEASure:RESults command, for a list of the result states.

Example This example places the current eye width in the numeric variable, varValue, then prints the contents of the variable to the computer's screen.

```
myScope.WriteString ":SYSTem:HEADer OFF" ' Response headers off.
myScope.WriteString ":MEASure:CGRade:EWIDth?"
varValue = myScope.ReadNumber
Debug.Print FormatNumber(varValue, 0)
```

See Also · **":ANALyze:SIGNal:TYPE"** on page 271

History Legacy command (existed before version 3.10).

Version 5.00: Added the optional <source> parameter for specifying the waveform on which the color grade eye width is measured.

Version 5.50: When the signal type is PAM-4, an additional <threshold> parameter is used to specify which eye, and the <algorithm> parameter is ignored.

:MEASure:CGRade:EWINDow

Command :MEASure:CGRade:EWINDow <start>,<stop>[,<start_after>][,<source>]

The :MEASure:CGRade:EWINDow command is used to change the starting point and the stopping point of the window used to make the eye pattern measurements of eye height, eye crossing %, and eye q-factor. In addition, the number of waveform hits can be set to ensure that enough data has been collected to make accurate measurements.

<start> An integer from 1 to 100 for horizontal starting point. (Default value is 40%.)

<stop> An integer from 1 to 100 for horizontal stopping point. (Default value is 60%.)

<start_after> An integer from 1 to 63,488 for number of hits to acquire before making measurements. (Default value is 1.)

<source> {CHANnel<N> | DIFF<D> | COMMONmode<C> | WMEMory<R> | FUNCtion<F> | CLOCK | EQUalized | MTRend | MSPectrum}

If <source> is omitted, the eye window will be applied to all sources.

For more information on <source> parameters, see "[Measurement Sources](#)" on page 728.

Example This example sets the eye window starting point to 2%, the stopping point to 75% and the start after to 5,000 hits.

```
myScope.WriteString ":SYSTEM:HEADer OFF" ' Response headers off.
myScope.WriteString ":MEASure:CGRade:EWINDow 2,75,5000"
```

Query :MEASure:CGRade:EWINDow? [<source>]

The :MEASure:CGRade:EWINDow query returns the starting point, the ending point, and the start after setting for the eye pattern measurements.

On the query, the eye window of channel 1 will be returned.

Returned Format [:MEASure:CGRade:EWINDow] <start>,<stop>,<start_after> <NL>

The following example returns the values for the eye window.

Example

```
myScope.WriteString ":SYSTEM:HEADer OFF" ' Response headers off.
myScope.WriteString ":MEASure:CGRade:EWINDow?"
varStart,Stop,Startafter = myScope.ReadNumber
Debug.Print FormatNumber(varStart,Stop,Startafter, 0)
```

NOTE**Turn Off Headers**

When receiving numeric data into numeric variables, turn off the headers. Otherwise, the headers may cause misinterpretation of returned data.

History Legacy command (existed before version 3.10).

Version 5.00: Added the optional <source> parameter for specifying the waveform on which the color grade eye window is applied.

:MEASure:CGRade:JITTer

Command :MEASure:CGRade:JITTer <format> [, <source>]

The :MEASure:CGRade:JITTer measures the jitter at the eye diagram crossing point. The parameter specifies the format, peak-to-peak or RMS, of the returned results. Before using this command or query, you must use the :DISPlay:CGRade command to enable the color grade persistence feature.

<format> {PP | RMS}

<source> {CHANnel<N> | DIFF<D> | COMMONmode<C> | WMEMory<R> | FUNctIon<F> | CLOCK | EQUalized | MTRend | MSPectrum}

If <source> is omitted, the jitter will be performed on the first waveform that has color grade enabled.

For more information on <source> parameters, see "[Measurement Sources](#)" on page 728.

Example This example measures the jitter.

```
myScope.WriteString ":MEASure:CGRade:JITTer RMS"
```

Query :MEASure:CGRade:JITTer? <format> [, <source>]

The :MEASure:CGRade:JITTer? query returns the jitter measurement of the color grade display. Before using this command or query, you must use the :DISPlay:CGRade command to enable the color grade persistence feature.

Returned Format [:MEASure:CGRade:JITTer] <value> [, <result_state>] <NL>

<value> The jitter.

<result_state> If SENDVALID is ON, the result state is returned with the measurement result. Refer to the MEASure:RESults command, for a list of the result states.

Example This example places the current jitter in the numeric variable, varValue, then prints the contents of the variable to the computer's screen.

```
myScope.WriteString ":SYSTEM:HEADer OFF" ' Response headers off.
myScope.WriteString ":MEASure:CGRade:JITTer? RMS"
varValue = myScope.ReadNumber
Debug.Print FormatNumber(varValue, 0)
```

History Legacy command (existed before version 3.10).

Version 5.00: Added the optional <source> parameter for specifying the waveform on which the color grade jitter is measured.

:MEASure:CGRade:OLEVel

Command :MEASure:CGRade:OLEVel [<source>]

The :MEASure:CGRade:OLEVel command installs an Eye One Level measurement into the user interface's measurement Results pane. Eye one level is a measure of the mean value of the logical 1 of an eye diagram.

Before using this command or query, you must use the :DISPlay:CGRade command to enable the color grade persistence feature. Also, there must be a full eye diagram on screen before a valid measurement can be made.

<source> {CHANnel<N> | DIFF<D> | COMMONmode<C> | FUNction<F> | WMEMory<R> | CLOCk | MTRend | MSPectrum | EQUalized}

If <source> is omitted, the Q-factor will be performed on the first waveform that has color grade enabled.

For more information on <source> parameters, see "[Measurement Sources](#)" on page 728.

Query :MEASure:CGRade:OLEVel? [<source>]

The :MEASure:CGRade:OLEVel? query returns the measured Eye One Level.

Returned Format [:MEASure:CGRade:OLEVel] <value>[, <result_state>] <NL>

<value> The measured Eye One Level value.

<result_state> If SENDvalid is ON, the result state is returned with the measurement result. See the :MEASure:RESults table in this chapter for a list of the result states.

- See Also**
- "[:MEASure:CGRade:ZLEVel](#)" on page 749
 - "[:MEASure:ERATio](#)" on page 768
 - "[:MEASure:OPOWer](#)" on page 836
 - "[:MEASure:OMAMplitude](#)" on page 835

History New in version 5.70.

:MEASure:CGRade:QFACTOR

Command :MEASure:CGRade:QFACTOR [<source>]

The :MEASure:CGRade:QFACTOR command measures the Q factor. Before using this command or query, you must use the :DISPlay:CGRade command to enable the color grade persistence feature. Also, there must be a full eye diagram on screen before a valid measurement can be made.

<source> {CHANnel<N> | DIFF<D> | COMMONmode<C> | WMEMory<R> | FUNCTion<F> | CLOCk | EQUalized | MTRend | MSPectrum}

If <source> is omitted, the Q-factor will be performed on the first waveform that has color grade enabled.

For more information on <source> parameters, see "[Measurement Sources](#)" on page 728.

Example This example measures the Q factor.

```
myScope.WriteString ":MEASure:CGRade:QFACTOR"
```

Query :MEASure:CGRade:QFACTOR? [<source>]

The :MEASure:CGRade:QFACTOR? query returns the Q factor measurement of the color grade display. Before using this command or query, you must use the :DISPlay:CGRade command to enable the color grade persistence feature.

Returned Format [:MEASure:CGRade:QFACTOR] <value> [, <result_state>] <NL>

<value> The Q factor.

<result_state> If SENDVALID is ON, the result state is returned with the measurement result. Refer to the MEASure:RESuLts command, for a list of the result states.

Example This example places the Q factor in the numeric variable, varValue, then prints the contents of the variable to the computer's screen.

```
myScope.WriteString ":SYSTEM:HEADer OFF" ' Response headers off.
myScope.WriteString ":MEASure:CGRade:QFACTOR"
varValue = myScope.ReadNumber
Debug.Print FormatNumber(varValue, 0)
```

History Legacy command (existed before version 3.10).

Version 5.00: Added the optional <source> parameter for specifying the waveform on which the color grade Q factor is measured.

:MEASure:CGRade:ZLEVel

Command :MEASure:CGRade:ZLEVel [<source>]

The :MEASure:CGRade:ZLEVel command installs an Eye Zero Level measurement into the user interface's measurement Results pane. Eye zero level is a measure of the mean value of the logical 0 of an eye diagram.

Before using this command or query, you must use the :DISPlay:CGRade command to enable the color grade persistence feature. Also, there must be a full eye diagram on screen before a valid measurement can be made.

<source> {CHANnel<N> | DIFF<D> | COMMONmode<C> | FUNction<F> | WMEMory<R> | CLOCk | MTRend | MSPectrum | EQUalized}

If <source> is omitted, the Q-factor will be performed on the first waveform that has color grade enabled.

For more information on <source> parameters, see "[Measurement Sources](#)" on page 728.

Query :MEASure:CGRade:ZLEVel? [<source>]

The :MEASure:CGRade:ZLEVel? query returns the measured Eye Zero Level.

Returned Format [:MEASure:CGRade:ZLEVel] <value>[, <result_state>] <NL>

<value> The measured Eye Zero Level value.

<result_state> If SENDvalid is ON, the result state is returned with the measurement result. See the :MEASure:RESults table in this chapter for a list of the result states.

- See Also**
- "[:MEASure:CGRade:OLEVel](#)" on page 747
 - "[:MEASure:ERATio](#)" on page 768
 - "[:MEASure:OPOWer](#)" on page 836
 - "[:MEASure:OMAMplitude](#)" on page 835

History New in version 5.70.

:MEASure:CHARge (9000 Series, 9000H Series, S-Series)

Command :MEASure:CHARge [<primary_channel_source>]

When N2820A/N2821A high-sensitivity current probes are connected, the :MEASure:CHARge command adds the Charge measurement to the Measurements tab.

This measurement determines the total current consumption over time with the results listed in ampere-hours (Ah).

When both the primary and secondary cables of a N2820A probe are used, the measurement includes the area under the curve across both Zoomed-In and Zoomed-Out waveforms.

<primary_channel_source> {CHANnel<N>}

<N> An integer, 1-4, and should be the primary channel of the N2820A/N2821A probe.

Example This example turns on the Charge measurement and adds it to the Measurements tab.

```
myScope.WriteString ":MEASure:CHARge CHANnel1"
```

Query :MEASure:CHARge?

The :MEASure:CHARge? query returns the measured Charge value in Amp-hours.

Returned Format [:MEASure:CHARge] <value> [, <result_state>] <NL>

Example This example places the measured Charge value in the string variable, strCharge, then prints the contents of the variable to the computer's screen.

```
Dim strCharge As String
myScope.WriteString ":MEASure:CHARge?"
strCharge = myScope.ReadString
Debug.Print strCharge
```

See Also

- [":MEASure:WINDow"](#) on page 975
- [":CHANnel<N>:PROBE:PRIMary \(9000 Series, 9000H Series, S-Series\)"](#) on page 362

History New in version 4.20.

:MEASure:CLEar

Command :MEASure:{CLEar | SCRatch}

The :MEASure:CLEar command clears the measurement results from the screen and disables all previously enabled measurements.

Example This example clears the current measurement results from the screen.

```
myScope.WriteString ":MEASure:CLEar"
```

History Legacy command (existed before version 3.10).

:MEASure:CROSSing

Command :MEASure:CROSSing <source1>,<source2>

The :MEASure:CROSSing command adds the crossing measurement to the screen. The crossing measurement is the voltage where two signals cross (uses edges closest to the center of the screen)

<source1>,<source2> {CHANnel<N> | DIFF<D> | COMMONmode<C> | FUNction<F> | WMEMory<R>}

For more information on <source> parameters, see "**Measurement Sources**" on page 728.

<hysteresis> a real number

Example This example measures the voltage where channel 1 and 2 cross.

```
myScope.WriteString ":MEASure:CROSSing CHANnel1, CHANnel2"
```

Query :MEASure:CROSSing? [<source1>, <source2>]

The :MEASure:CROSSing? query returns the crossing measurement value.

If the <source> parameters are not specified, the two sources specified by the :MEASure:SOURce command are used.

Returned Format [:MEASure:CROSSing] <value><NL>

<value> The voltage value where the signals cross.

Example This example places the crossing voltage value in the numeric variable, varValue, then prints the contents of the variable to the computer's screen.

```
myScope.WriteString ":SYSTem:HEADer OFF" ' Response headers off.
myScope.WriteString ":MEASure:CROSSing? CHANnel1, CHANnel2"
varValue = myScope.ReadNumber
Debug.Print FormatNumber(varValue, 0)
```

See Also • "**:MEASure:SOURce**" on page 899

History Legacy command (existed before version 3.10).

:MEASure:CTCDutycycle

Command

NOTE

This command is only available when the E2681A Jitter Analysis Software or the N5400A/N5401A Software is installed.

```
:MEASure:CTCDutycycle <source>,<direction>
```

The :MEASure:CYCDutycycle command measures the cycle-to-cycle duty cycle jitter (%) of the waveform. Another name for this measurement is "duty cycle - duty cycle".

<source> {CHANnel<N> | DIFF<D> | COMMONmode<C> | FUNCTION<F> | WMEMory<R> | CLOCK | MTRend | MSPectrum | EQUalized}

For more information on <source> parameters, see "[Measurement Sources](#)" on page 728.

<direction> {RISing | FALLing}

Specifies direction of waveform edge to make measurement.

Example This example measures the cycle-to-cycle duty cycle on the rising edge of channel 1.

```
myScope.WriteString ":MEASure:CTCDutycycle CHANnel1,RISing"
```

Query :MEASure:CTCDutycycle? <source>,<direction>

The :MEASure:CTCDutycycle? query returns the cycle-to-cycle duty cycle jitter (%) measurement.

Returned Format [:MEASure:CTCDutycycle <value>[,<result_state>]<NL>

<value> The cycle-to-cycle duty cycle jitter (%) of the waveform.

<result_state> If SENDVALID is ON, the result state is returned with the measurement result. Refer to the MEASure:RESults command, for a list of the result states.

Example This example places the cycle-to-cycle duty cycle of channel 1 in the numeric variable, varValue, then prints the contents of the variable to the computer's screen.

```
myScope.WriteString ":SYSTem:HEADer OFF" ' Response headers off.
myScope.WriteString ":MEASure:CTCDutycycle CHANnel1,RISing"
varValue = myScope.ReadNumber
Debug.Print FormatNumber(varValue, 0)
```

- See Also**
- "[:MEASure:TIEClock2](#)" on page 947
 - "[:MEASure:CTCJitter](#)" on page 755
 - "[:MEASure:NCJitter](#)" on page 818
 - "[:MEASure:CTCPwidth](#)" on page 758

- **":MEASure:CTCNwidth"** on page 757

History Legacy command (existed before version 3.10).

:MEASure:CTCJitter

Command

NOTE

This command is only available when the E2681A Jitter Analysis Software or the N5400A/N5401A Software is installed.

```
:MEASure:CTCJitter <source>,<direction>
```

The :MEASure:CTCJitter command measures the cycle-to-cycle jitter of the waveform. Another name for this measurement is "period-period", where the number of cycles is one.

<source> {CHANnel<N> | DIFF<D> | COMMONmode<C> | FUNCTION<F> | WMEMORY<R> | CLOCK | MTRend | MSPectrum | EQUalized}

For more information on <source> parameters, see "[Measurement Sources](#)" on page 728.

<direction> {RISing | FALLing}

Specifies direction of waveform edge to make measurement.

Example This example measures the cycle-to-cycle jitter on the rising edge of channel 1.

```
myScope.WriteString ":MEASure:CTCJitter CHANnel1,RISing"
```

Query :MEASure:CTCJitter? <source>,<direction>

The :MEASure:CTCJitter? query returns the cycle-to-cycle jitter time measurement.

Returned Format [:MEASure:CTCJitter <value>[,<result_state>] <NL>

<value> The cycle-to-cycle jitter time of the waveform.

<result_state> If SENDVALID is ON, the result state is returned with the measurement result. Refer to the MEASure:RESults command, for a list of the result states.

Example This example places the cycle-to-cycle jitter of channel 1 in the numeric variable, varValue, then prints the contents of the variable to the computer's screen.

```
myScope.WriteString ":SYSTEM:HEADer OFF" ' Response headers off.
myScope.WriteString ":MEASure:CTCJitter CHANnel1,RISing"
varValue = myScope.ReadNumber
Debug.Print FormatNumber(varValue, 0)
```

See Also

- "[:MEASure:TIEClock2](#)" on page 947
- "[:MEASure:NCJitter](#)" on page 818
- "[:MEASure:CTCPwidth](#)" on page 758
- "[:MEASure:CTCNwidth](#)" on page 757
- "[:MEASure:CTCDutycycle](#)" on page 753

History Legacy command (existed before version 3.10).

:MEASure:CTCNwidth

Command

NOTE

This command is only available when the E2681A Jitter Analysis Software or the N5400A/N5401A Software is installed.

```
:MEASure:CTCNwidth [<source>]
```

The :MEASure:CTCNwidth command measures the cycle-to-cycle -width jitter of the waveform. Another name for this measurement is "-width - -width".

<source> {CHANnel<N> | DIFF<D> | COMMONmode<C> | FUNCtion<F> | WMEMory<R> | CLOCK | MTRend | MSPectrum | EQUalized}

For more information on <source> parameters, see "[Measurement Sources](#)" on page 728.

Example This example measures the cycle-to-cycle -width of channel 1.

```
myScope.WriteString ":MEASure:CTCNwidth CHANnel1"
```

Query :MEASure:CTCNwidth? [<source>]

The :MEASure:CTCNwidth? query returns the cycle-to-cycle -width jitter measurement.

Returned Format [:MEASure:CTCNwidth <value>[,<result_state>] <NL>

<value> The cycle-to-cycle - width jitter of the waveform.

<result_state> If SENDVALID is ON, the result state is returned with the measurement result. Refer to the MEASure:RESults command, for a list of the result states.

Example This example places the cycle-to-cycle - width of channel 1 in the numeric variable, varValue, then prints the contents of the variable to the computer's screen.

```
myScope.WriteString ":SYSTem:HEADer OFF" ' Response headers off.
myScope.WriteString ":MEASure:CTCNwidth CHANnel1"
varValue = myScope.ReadNumber
Debug.Print FormatNumber(varValue, 0)
```

See Also

- "[:MEASure:TIEClock2](#)" on page 947
- "[:MEASure:CTCJitter](#)" on page 755
- "[:MEASure:NCJitter](#)" on page 818
- "[:MEASure:CTCPwidth](#)" on page 758
- "[:MEASure:CTCDutycycle](#)" on page 753

History Legacy command (existed before version 3.10).

:MEASure:CTCPwidth

Command

NOTE

This command is only available when the E2681A Jitter Analysis Software or the N5400A/N5401A Software is installed.

```
:MEASure:CTCPwidth [<source>]
```

The :MEASure:CTCPwidth command measures the cycle-to-cycle +width jitter of the waveform. Another name for this measurement is "+width - +width".

<source> {CHANnel<N> | DIFF<D> | COMMONmode<C> | FUNCtion<F> | WMEMory<R> | CLOCK | MTRend | MSPectrum | EQUALized}

For more information on <source> parameters, see "[Measurement Sources](#)" on page 728.

Example This example measures the cycle-to-cycle +width of channel 1.

```
myScope.WriteString ":MEASure:CTCPwidth CHANnel1"
```

Query :MEASure:CTCPwidth? [<source>]

The :MEASure:CTCPwidth? query returns the cycle-to-cycle +width jitter measurement.

Returned Format [:MEASure:CTCPwidth <value>[,<result_state>]<NL>

<value> The cycle-to-cycle +width jitter of the waveform.

<result_state> If SENDVALID is ON, the result state is returned with the measurement result. Refer to the MEASure:RESults command, for a list of the result states.

Example This example places the cycle-to-cycle + width of channel 1 in the numeric variable, varValue, then prints the contents of the variable to the computer's screen.

```
myScope.WriteString ":SYSTem:HEADer OFF" ' Response headers off.
myScope.WriteString ":MEASure:CTCPwidth CHANnel1"
varValue = myScope.ReadNumber
Debug.Print FormatNumber(varValue, 0)
```

See Also

- "[:MEASure:TIEClock2](#)" on page 947
- "[:MEASure:CTCJitter](#)" on page 755
- "[:MEASure:NCJitter](#)" on page 818
- "[:MEASure:CTCNwidth](#)" on page 757
- "[:MEASure:CTCDutycycle](#)" on page 753

History Legacy command (existed before version 3.10).

:MEASure:DATarate

Command

NOTE

This command is only available when the E2681A Jitter Analysis Software or the N5400A/N5401A Software is installed.

```
:MEASure:DATarate <source>[, {AUTO | (SEMI, <data_rate>)}]
```

The :MEASure:DATarate command measures the data rate in bits per second for the selected source. Use the :MEASure:UNITinterval command/query to measure the unit interval of the source

<source> {CHANnel<N> | DIFF<D> | COMMONmode<C> | FUNCTion<F> | WMEMory<R> | CLOCK | MTRend | MSPectrum | EQUalized}

For more information on <source> parameters, see "[Measurement Sources](#)" on page 728.

<data_rate> A real number specifying the data rate.

Example This example measures the data rate of channel 1.

```
myScope.WriteString ":MEASure:DATarate CHANnel1"
```

Query :MEASure:DATarate? <source>[, {Auto | (SEMI, <data_rate>)}]

The :MEASure:DATarate? query returns the measured data rate.

Returned Format [:MEASure:DATarate] <value>[, <result_state>]<NL>

<value> Data rate frequency in bits per second for the selected source.

<result_state> If SENDvalid is ON, the result state is returned with the measurement result. See the :MEASure:RESults table in this chapter for a list of the result states.

Example This example places the current data rate of the channel 1 waveform in the numeric variable, varValue, then prints the contents of the variable to the computer's screen.

```
myScope.WriteString ":SYSTem:HEADer OFF" ' Response headers off.
myScope.WriteString ":MEASure:DATarate? CHANnel1"
varValue = myScope.ReadNumber
Debug.Print FormatNumber(varValue, 0)
```

History Legacy command (existed before version 3.10).

:MEASure:DEEMphasis

Command :MEASure:DEEMphasis [<source>]

When the EZJIT Complete application is licensed, the Deemphasis serial data measurement becomes available.

The :MEASure:DEEMphasis command adds the deemphasis measurement.

The de-emphasis measurement relies on the clock recovery to recover a clock for each bit in the data waveform. You need to configure clock recovery appropriately for your signal.

Sources are specified with the :MEASure:SOURce command or with the optional parameter following the :MEASure:DEEMphasis command.

<source> {CHANnel<N> | DIFF<D> | COMMONmode<C> | FUNCTion<F> | WMEMory<R> | CLOCK | MTRend | MSPectrum | EQUalized}

For more information on <source> parameters, see "[Measurement Sources](#)" on page 728.

Example This example adds the deemphasis measurement on the channel 1 source.

```
myScope.WriteString ":MEASure:DEEMphasis CHANnel1"
```

Query :MEASure:DEEMphasis? [<source>]

The :MEASure:DEEMphasis? query returns the measured deemphasis value of the specified source.

Due to random noise, many bits need to be averaged together to average out the noise. Therefore, the current value has little importance and the mean should be used. See "[:MEASure:STATistics](#)" on page 900.

Returned Format [:MEASure:DEEMphasis] <value> [, <result_state>] <NL>

<value> For every de-emphasis bit in the waveform, a value is computed using:

$$20 * \log_{10}(\text{de-emphasis voltage} / \text{transition voltage})$$

Where:

- Transition voltage is the voltage at the clock location of the preceding transition bit.
- De-emphasis voltage is the voltage at the clock location of de-emphasis bits following a transition bit.

<result_state> If SENDvalid is ON, the result state is returned with the measurement result. See the :MEASure:RESults table in this chapter for a list of the result states.

Example This example places the current value for deemphasis in the numeric variable, varValue, then prints the contents of the variable to the computer's screen.

```
myScope.WriteString ":SYSTEM:HEADer OFF" ' Response headers off.  
myScope.WriteString ":MEASure:DEEMphasis? CHANnel1"  
varValue = myScope.ReadNumber  
Debug.Print FormatNumber(varValue, 0)
```

History Legacy command (existed before version 3.10).

:MEASure:DELTatime

Command :MEASure:DELTatime [<source>[,<source>]]

The :MEASure:DELTatime command measures the delta time between two edges. If one source is specified, the delta time from the leading edge of the specified source to the trailing edge of the specified source is measured. If two sources are specified, the delta time from the leading edge on the first source to the trailing edge on the second source is measured.

Sources are specified with the :MEASure:SOURce command or with the optional parameter following the :MEASure:DELTatime command. The rest of the parameters for this command are specified with the :MEASure:DEFine command.

The necessary waveform edges must be present on the display. The query will return 9.99999E+37 if the necessary edges are not displayed.

<source> {CHANnel<N> | DIFF<D> | COMMONmode<C> | FUNCTion<F> | DIGital<M> | WMEMory<R> | CLOCK | MTRend | MSPectrum | EQUalized}

For more information on <source> parameters, see "[Measurement Sources](#)" on page 728.

Example This example measures the delta time between channel 1 and channel 2.

```
myScope.WriteString ":MEASure:DELTatime CHANnel1,CHANnel2"
```

Query :MEASure:DELTatime? [<source>[,<source>]]

The :MEASure:DELTatime? query returns the measured delta time value.

Returned Format [:MEASure:DELTatime] <value>[,<result_state>]<NL>

<value> Delta time from the first specified edge on one source to the next specified edge on another source.

<result_state> If SENDvalid is ON, the result state is returned with the measurement result. See the :MEASure:RESults table in this chapter for a list of the result states.

Example This example places the current value of delta time in the numeric variable, varValue, then prints the contents of the variable to the computer's screen. This example assumes the source was set using :MEASure:SOURce.

```
myScope.WriteString ":SYSTEM:HEADer OFF" ' Response headers off.
myScope.WriteString ":MEASure:DELTatime?"
varValue = myScope.ReadNumber
Debug.Print FormatNumber(varValue, 0)
```

NOTE**Turn Off Headers**

When receiving numeric data into numeric variables, turn off the headers. Otherwise, the headers may cause misinterpretation of returned data.

History Legacy command (existed before version 3.10).

:MEASure:DELTatime:DEFine

Command :MEASure:DELTatime:DEFine <start_edge_direction>,<start_edge_number>,<start_edge_position>,<stop_edge_direction>,<stop_edge_number>,<stop_edge_position>

The :MEASure:DELTatime:DEFine command sets the type of direction, the number of the edge, and the edge position for the delta time measurement.

<start_edge_direction> {RISing | FALLing | EITHer} for start directions.

<start_edge_number> An integer from 1 to 65534 for start edge numbers.

<start_edge_position> {UPPer | MIDDle | LOWer} for start edge positions.

<stop_edge_direction> {RISing | FALLing | EITHer} for stop directions.

<stop_edge_number> An integer from 1 to 65534 for stop edge numbers.

<stop_edge_position> {UPPer | MIDDle | LOWer} for stop edge positions.

Example This example sets the delta time starting edge to a rising edge on the 5th edge at the middle position and the stopping edge to falling on the 50th edge at the lower position.

```
myScope.WriteString ":SYSTem:HEADer OFF" ' Response headers off.
myScope.WriteString _
    ":MEASure:DELTatime:DEFine RISing,5,MIDDle,FALLing,50,LOWer"
```

Query :MEASure:DELTatime:DEFine?

The :MEASure:DELTatime:DEFine? query returns the measured delta time value.

Returned Format [:MEASure:DELTatime:DEFine] <start_edge_direction>,<start_edge_number>,<start_edge_position>,<stop_edge_direction>,<stop_edge_number>,<stop_edge_position><NL>

Example This example places the current value of delta time definition in the string variable, strValue, then prints the contents of the variable to the computer's screen. This example assumes the source was set using :MEASure:SOURce.

```
Dim strValue As String ' Dimension variable.
myScope.WriteString ":SYSTem:HEADer OFF" ' Response headers off.
myScope.WriteString ":MEASure:DELTatime:DEFine?"
strValue = myScope.ReadString
Debug.Print strValue
```

NOTE**Turn Off Headers**

When receiving numeric data into numeric variables, turn off the headers. Otherwise, the headers may cause misinterpretation of returned data.

History Legacy command (existed before version 3.10).

:MEASure:DUTYcycle

Command :MEASure:DUTYcycle [<source>[,<direction>]]

The :MEASure:DUTYcycle command measures the ratio (%) of the positive pulse width to the period.

Sources are specified with the :MEASure:SOURce command or with the optional <source> parameter following the :MEASure:DUTYcycle command.

<source> {CHANnel<N> | DIFF<D> | COMMONmode<C> | FUNCTION<F> | DIGital<M> | WMemory<R> | CLOCK | MTRend | MSPectrum | EQUalized}

For more information on <source> parameters, see "[Measurement Sources](#)" on page 728.

<direction> {RISing | FALLing}

Specifies direction of edge to start measurement. When <direction> is specified, the <source> parameter is required.

Using the <direction> parameter will set the "Measure All Edges" mode if it is not currently set. You can use the :ANALyze:AEDGes command to turn the "Measure All Edges" mode off (or on again). See "[:ANALyze:AEDGes](#)" on page 239.

Example This example measures the duty cycle of the channel 1 waveform.

```
myScope.WriteString ":MEASure:DUTYcycle CHANnel1"
```

Query :MEASure:DUTYcycle? [<source>],<direction>

The :MEASure:DUTYcycle? query returns the measured duty cycle (%) of the specified source.

Returned Format [:MEASure:DUTYcycle] <value>[,<result_state>]<NL>

<value> The ratio (%) of the positive pulse width to the period.

<result_state> If SENDvalid is ON, the result state is returned with the measurement result. See the :MEASure:RESults table in this chapter for a list of the result states.

Example This example places the current duty cycle of the channel 1 waveform in the numeric variable, varValue, then prints the contents of the variable to the computer's screen.

```
myScope.WriteString ":SYSTem:HEADer OFF" ' Response headers off.
myScope.WriteString ":MEASure:DUTYcycle? CHANnel1"
varValue = myScope.ReadNumber
Debug.Print FormatNumber(varValue, 0)
```

History Legacy command (existed before version 3.10).

:MEASure:EDGE

Command :MEASure:EDGE [<source>[,<direction>]]

The :MEASure:EDGE command measures the time of the edge, relative to the reference location.

Sources are specified with the :MEASure:SOURce command or with the optional <source> parameter following the :MEASure:DUTYcycle command.

<source> {CHANnel<N> | DIFF<D> | COMMONmode<C> | FUNCTION<F> | DIGital<M> | WMemory<R> | CLOCK | MTRend | MSPectrum | EQUalized}

For more information on <source> parameters, see "[Measurement Sources](#)" on page 728.

<direction> {RISing | FALLing | BOTH}

Specifies direction of edge to start measurement. When <direction> is specified, the <source> parameter is required.

Using the <direction> parameter will set the "Measure All Edges" mode if it is not currently set. You can use the :ANALyze:AEDGes command to turn the "Measure All Edges" mode off (or on again). See "[:ANALyze:AEDGes](#)" on page 239.

Example This example measures the duty cycle of the channel 1 waveform.

```
myScope.WriteString ":MEASure:EDGE CHANnel1"
```

Query :MEASure:EDGE? [<source>[,<direction>]]

The :MEASure:EDGE? query returns the measured edge time of the specified source.

Returned Format [:MEASure:DUTYcycle] <value>[,<result_state>]<NL>

<value> The measured edge time.

<result_state> If SENDvalid is ON, the result state is returned with the measurement result. See the :MEASure:RESuLts table in this chapter for a list of the result states.

Example This example places the current duty cycle of the channel 1 waveform in the numeric variable, varValue, then prints the contents of the variable to the computer's screen.

```
myScope.WriteString ":SYSTem:HEADer OFF"      ' Response headers off.
myScope.WriteString ":MEASure:EDGE? CHANnel1"
varValue = myScope.ReadNumber
Debug.Print FormatNumber(varValue, 0)
```

History New in version 3.10.

:MEASure:ERATio

Command :MEASure:ERATio [<source>[, {RATio | DB | PERCent}]]

The :MEASure:ERATio command measures the ratio of the one level and the zero level of an eye diagram of an optical signal.

<source> {CHANnel<N> | DIFF<D> | COMMONmode<C> | FUNCTion<F> | WMEMory<R> | CLOCK | MTRend | MSPectrum | EQUalized}

For more information on <source> parameters, see "**Measurement Sources**" on page 728.

{RATio | DB | PERCent} Specifies the extinction-ratio correction factor units in Ratio, Decibel, or percentage.

Query :MEASure:ERATio? [<source>[, {RATio | DB | PERCent}]]

The :MEASure:ERATio? query returns the measured Extinction Ratio.

Returned Format [:MEASure:ERATio] <value>[, <result_state>] <NL>

<value> The measured Extinction Ratio value.

NOTE

The Extinction Ratio measurement will give a question mark ("?") result if:

- The dark calibration has not been performed at all.
- The vertical sensitivity, offset, or sample rate has changed since the dark calibration was run.
- The probe temperature has changed by > 2 degrees C.

<result_state> If SENDvalid is ON, the result state is returned with the measurement result. See the :MEASure:RESults table in this chapter for a list of the result states.

- See Also**
- "**:MEASure:OMAMplitude**" on page 835
 - "**:MEASure:OPOWER**" on page 836
 - "**:MEASure:CGRade:OLEVel**" on page 747
 - "**:MEASure:CGRade:ZLEVel**" on page 749

History New in version 5.70.

:MEASure:ETOEge

Command :MEASure:ETOEge <source_1>,<direction_1>,<position_1>,<next_prev>,<relative_edge_number>,<source_2>,<direction_2>,<position_2>

The :MEASure:ETOEge command measures the delta time between two edges. It is similar to the delta time measurement, but can be applied to the measurement trend. It also enables you to set whether the measurement is between an edge before or after a specific edge and the number of edges to move forward or backwards.

The necessary waveform edges must be present on the display. The query will return 9.99999E+37 if the necessary edges are not displayed.

<source_1>,<source_2> {CHANnel<N> | DIFF<D> | COMMONmode<C> | FUNCTion<F> | WMEMory<R> | CLOCK | MTRend | MSPectrum | EQUALized}

For more information on <source> parameters, see "[Measurement Sources](#)" on page 728.

<direction_1>,<direction_2> May be RISing, FALLing, or BOTH

<position_1>,<position_2> May be UPPer, MIDDle, or LOWer

<next_prev> May be NEXT or PREVIOUS

<relative_edge_number> An integer that is the relative number of the second edge.

Query :MEASure:ETOEge? <source_1>,<direction_1>,<position_1>,<next_prev>,<relative_edge_number>,<source_2>,<direction_2>,<position_2>

The :MEASure:ETOEge? query returns the delta time between the two specified edges.

Returned Format [:MEASure:ETOEge] <value>[,<result_state>]<NL>

<value> The measured delta time between two edges value.

<result_state> If SENDvalid is ON, the result state is returned with the measurement result. See the :MEASure:RESults table in this chapter for a list of the result states.

Example This example places the current value for delta time in the numeric variable, varValue, then prints the contents of the variable to the computer's screen.

```
myScope.WriteString ":SYSTEM:HEADer OFF" ' Response headers off.
myScope.WriteString ":MEASure:ETOEge? CHAN1,RIS,UPP,NEXT,2,CHAN2,RIS,UPP"
varValue = myScope.ReadNumber
Debug.Print FormatNumber(varValue, 0)
```

History Legacy command (existed before version 3.10).

:MEASure:FALLtime

Command :MEASure:FALLtime [<source>[,<start_level>,<stop_level>]]

The :MEASure:FALLtime command measures the time at the upper threshold of the falling edge, measures the time at the lower threshold of the falling edge, then calculates the fall time. Sources are specified with the :MEASure:SOURce command or with the optional parameter following the :MEASure:FALLtime command.

The first displayed falling edge is used for the fall-time measurement. To make this measurement requires 4 or more sample points on the falling edge of the waveform.

Fall time = time at lower threshold point - time at upper threshold point.

<source> {CHANnel<N> | DIFF<D> | COMMONmode<C> | FUNCTION<F> | WMEMory<R> | CLOCK | MTRend | MSPectrum | EQUalized}

For more information on <source> parameters, see "[Measurement Sources](#)" on page 728.

<start_level>,
<stop_level> When the signal type is PAM-4 (see :ANALyze:SIGNal:TYPE), the <start_level> and <stop_level> parameters are integers that identify the edge to measure. For PAM-4, the levels may be from 0-3.

For PAM fall time measurements, "Measure All Edges" must be turned on (see :ANALyze:AEDGes).

Example This example measures the fall time of the channel 1 waveform.

```
myScope.WriteString ":MEASure:FALLtime CHANnel1"
```

Query :MEASure:FALLtime? [<source>[,<start_level>,<stop_level>]]

The :MEASure:FALLtime? query returns the fall time of the specified source.

Returned Format [:MEASure:FALLtime] <value>[,<result_state>]<NL>

<value> Time at lower threshold - time at upper threshold.

<result_state> If SENDvalid is ON, the result state is returned with the measurement result. See the :MEASure:RESuLts table in this chapter for a list of the result states.

Example This example places the current value for fall time in the numeric variable, varValue, then prints the contents of the variable to the computer's screen.

```
myScope.WriteString ":SYSTem:HEADer OFF" ' Response headers off.
myScope.WriteString ":MEASure:FALLtime? CHANnel1"
varValue = myScope.ReadNumber
Debug.Print FormatNumber(varValue, 0)
```

See Also

- "[:ANALyze:SIGNal:TYPE](#)" on page 271
- "[:ANALyze:AEDGes](#)" on page 239

History Legacy command (existed before version 3.10).

Version 5.50: With PAM signal types, additional <start_level> and <stop_level> parameters are used to identify the edge to measure.

:MEASure:FFT:CPOWer

Command :MEASure:FFT:CPOWer <source>, <center_freq>, <meas_bw>

The :MEASure:FFT:CPOWer command installs a channel power measurement into the user interface's measurement Results pane.

The source must be a function that is set to FFT, or a waveform memory that contains an FFT for this command and query to work.

<source> {FUNction<F> | WMEMory<R> | MSPectrum}

For more information on <source> parameters, see "[Measurement Sources](#)" on page 728.

<center_freq> The center frequency used in the measurement in NR3 format.

<meas_bw> The width of FFT band in NR3 format.

Query :MEASure:FFT:CPOWer? <source>, <center_freq>, <meas_bw>

The :MEASure:FFT:CPOWer? query returns the measured channel power.

Returned Format [:MEASure:FFT:CPOWer] <channel_power_value><NL>
<channel_power_value> ::= in dBm in NR3 format.

See Also

- "[:MEASure:FFT:OBW](#)" on page 777
- "[:MEASure:FFT:PSD](#)" on page 780

History New in version 5.70.

:MEASure:FFT:DFRequency

Command :MEASure:FFT:DFRequency [<source>]

The :MEASure:FFT:DFRequency command enables the delta frequency measurement. The source is specified with the :MEASure:SOURce command or with the optional parameter following the :MEASure:FFT:DFR command.

The source must be a function that is set to FFTMagnitude, or a waveform memory that contains an FFT for this command and query to work.

<source> {FUNcTion<F> | WMemOry<R> | ClOck | MTRend | MSPectrum | EQUalized}

For more information on <source> parameters, see "[Measurement Sources](#)" on page 728.

Query :MEASure:FFT:DFRequency? [<source>]

The :MEASure:FFT:DFRequency? query returns the FFT delta frequency of the specified peaks.

Returned Format [:MEASure:FFT:DFRequency] <delta_frequency>[,<result_state>]<NL>

<result_state> If SENDvalid is ON, the result state is returned with the measurement result. See the :MEASure:RESults table in this chapter for a list of the result states.

Related Commands :MEASure:FFT:PEAK1, :MEASure:FFT:PEAK2, :MEASure:FFT:THReshold

Example This example measures the frequency difference between the peaks specified by the :MEAS:FFT:PEAK1 and :MEAS:FFT:PEAK2 for channel 4.

```
myScope.WriteString ":SYSTEM:HEADer OFF"      ' Response headers off.
myScope.WriteString ":FUNC4:FFTM CHAN4"      ' Perform FFT on channel 4.
myScope.WriteString ":FUNC4:DISP ON"         ' Display the FFT.
myScope.WriteString ":MEAS:FFT:THR -47"      ' Set peak threshold at -47 dBm.
myScope.WriteString ":MEAS:FFT:PEAK1 2"      ' Meas between peak 2 and 3.
myScope.WriteString ":MEAS:FFT:PEAK2 3"
myScope.WriteString ":MEAS:FFT:DFR FUNC4"    ' Perform dfrequency meas.
myScope.WriteString ":MEAS:FFT:DFR? FUNC4"    ' Query for measurement.
varFrequency = myScope.ReadNumber
Debug.Print FormatNumber(varFrequency, "Scientific")
```

History Legacy command (existed before version 3.10).

:MEASure:FFT:DMAGnitude

Command :MEASure:FFT:DMAGnitude [<source>]

The :MEASure:FFT:DMAGnitude command enables the delta magnitude measurement. The source is specified with the :MEASure:SOURce command or with the optional parameter following the :MEASure:FFT command.

The source must be a function that is set to FFT, or a waveform memory that contains an FFT for this command and query to work.

<source> {FUNcTion<F> | WMemOry<R> | ClOck | MTRend | MSPectrum | EQualized}

For more information on <source> parameters, see "[Measurement Sources](#)" on page 728.

Query :MEASure:FFT:DMAGnitude? [<source>]

The :MEASure:FFT:DMAGnitude? query returns the delta magnitude of the specified peaks.

Returned Format [:MEASure:FFT:DMAGnitude] <delta_magnitude>[,<result_state>]<NL>

<result_state> If SENDvalid is ON, the result state is returned with the measurement result. See the :MEASure:RESults table in this chapter for a list of the result states.

Related Commands :MEASure:FFT:PEAK1, :MEASure:FFT:PEAK2, :MEASure:FFT:THReshold

Example This example measures the magnitude difference between the peaks specified by the :MEAS:FFT:PEAK1 and :MEAS:FFT:PEAK2 for channel 4.

```
myScope.WriteString ":SYSTEM:HEADer OFF"      ' Response headers off.
myScope.WriteString ":FUNC4:FFTM CHAN4"      ' Perform FFT on channel 4.
myScope.WriteString ":FUNC4:DISP ON"         ' Display the FFT.
myScope.WriteString ":MEAS:FFT:THR -47"      ' Set peak threshold at -47 d
Bm.
myScope.WriteString ":MEAS:FFT:PEAK1 2"      ' Meas between peak 2 and 3.
myScope.WriteString ":MEAS:FFT:PEAK2 3"
myScope.WriteString ":MEAS:FFT:DMAG FUNC4"   ' Perform magnitude meas.
myScope.WriteString ":MEAS:FFT:DMAG? FUNC4"  ' Query for measurement.
varMagnitude = myScope.ReadNumber
Debug.Print FormatNumber(varMagnitude, "Scientific")
```

History Legacy command (existed before version 3.10).

:MEASure:FFT:FREQuency

Command :MEASure:FFT:FREQuency [<source>]

The :MEASure:FFT:FREQuency command enables the frequency measurement. The source is specified with the :MEASure:SOURce command or with the optional parameter following the :MEASure:FFT command.

The source must be a function that is set to FFT, or a waveform memory that contains an FFT for this command and query to work.

<source> {FUNction<F> | WMemory<R> | CLock | MTRend | MSPectrum | EQualized}

For more information on <source> parameters, see "[Measurement Sources](#)" on page 728.

Query :MEASure:FFT:FREQuency? [<source>]

The :MEASure:FFT:FREQuency? query returns the frequency measurement.

Returned Format [:MEASure:FFT:FREQuency] <frequency>[,<result_state>]<NL>

<result_state> If SENDvalid is ON, the result state is returned with the measurement result. See the :MEASure:RESults table in this chapter for a list of the result states.

Example This example measures the frequency the peak specified by the :MEAS:FFT:PEAK1 for channel 4.

```
myScope.WriteString ":SYSTEM:HEADER OFF"      ' Response headers off.
myScope.WriteString ":FUNC4:FFTM CHAN4"        ' Perform FFT on channel 4.
myScope.WriteString ":FUNC4:DISP ON"           ' Display the FFT.
myScope.WriteString ":MEAS:FFT:THR -47"        ' Set peak threshold at -47 dBm.
myScope.WriteString ":MEAS:FFT:PEAK1 2"        ' Meas amplitude of peak 2.
myScope.WriteString ":MEAS:FFT:FREQ FUNC4"     ' Perform frequency meas.
myScope.WriteString ":MEAS:FFT:FREQ? FUNC4"    ' Query for measurement.
varFrequency = myScope.ReadNumber
Debug.Print FormatNumber(varFrequency, "Scientific")
```

History Legacy command (existed before version 3.10).

:MEASure:FFT:MAGNitude

Command :MEASure:FFT:MAGNitude [<source>]

The :MEASure:FFT:MAGNitude command measures the magnitude of the FFT. The source is specified with the :MEASure:SOURce command or with the optional parameter following the :MEASure:FFT command.

The source must be a function that is set to FFT, or a waveform memory that contains an FFT for this command and query to work.

<source> {FUNction<F> | WMEMory<R> | CLOCk | MTRend | MSPectrum | EQUalized}

For more information on <source> parameters, see "[Measurement Sources](#)" on page 728.

Query :MEASure:FFT:MAGNitude?

The :MEASure:FFT:MAGNitude? query returns the magnitude value of the FFT.

Returned Format [:MEASure:FFT:FMAGNitude] <magnitude> [, <result_state>] <NL>

<result_state> If SENDvalid is ON, the result state is returned with the measurement result. See the :MEASure:RESults table in this chapter for a list of the result states.

Example This example measures the magnitude of the peak specified by the :MEAS:FFT:PEAK1 for channel 4.

```
myScope.WriteString ":SYSTEM:HEADer OFF"      ' Response headers off.
myScope.WriteString ":FUNC4:FFTM CHAN4"      ' Perform FFT on channel 4.
myScope.WriteString ":FUNC4:DISP ON"         ' Display the FFT.
myScope.WriteString ":MEAS:FFT:THR -47"      ' Set peak threshold at -47 d
Bm.
myScope.WriteString ":MEAS:FFT:PEAK1 2"      ' Meas magnitude of peak 2.
myScope.WriteString ":MEAS:FFT:MAGN FUNC4"   ' Perform magnitude meas.
myScope.WriteString ":MEAS:FFT:MAGN? FUNC4"  ' Query for measurement.
varMagnitude = myScope.ReadNumber
Debug.Print FormatNumber(varMagnitude, "Scientific")
```

History Legacy command (existed before version 3.10).

:MEASure:FFT:OBW

Command :MEASure:FFT:OBW <source>,<occupied_bw_pct>

The :MEASure:FFT:OBW command installs an occupied bandwidth measurement into the user interface's measurement Results pane.

The source must be a function that is set to FFT, or a waveform memory that contains an FFT for this command and query to work.

<source> {FUNCTION<F> | WMemory<R> | MSPectrum}

For more information on <source> parameters, see "[Measurement Sources](#)" on page 728.

<occupied_bw_pct
> The percentage of the power of the FFT on screen.

Query :MEASure:FFT:OBW? <source>,<occupied_bw_pct>

The :MEASure:FFT:OBW? query returns the measured occupied bandwidth.

Returned Format [:MEASure:FFT:OBW] <bandwidth><NL>

<bandwidth> ::= in Hz in NR3 format.

See Also

- "[:MEASure:FFT:CPOWer](#)" on page 772
- "[:MEASure:FFT:PSD](#)" on page 780

History New in version 5.70.

:MEASure:FFT:PEAK1

Command :MEASure:FFT:PEAK1 <1st_peak_number>

The :MEASure:FFT:PEAK1 command sets the peak number of the first peak for FFT measurements. The source is specified with the :MEASure:SOURce command as FUNCTION<F> or WMEMory<R>.

<1st_peak_number> An integer, 1 to 100 specifying the number of the first peak.

<N> An integer, 1-4.

<F> An integer, 1-16.

<R> An integer, 1-4.

Query :MEASure:FFT:PEAK1?

The :MEASure:FFT:PEAK1? query returns the peak number currently set as the first peak.

Returned Format [:MEASure:FFT:PEAK1] <1st_peak_number><NL>

See Also :MEASure:FFT:THReshold

Also see the example for :MEASure:FFT:DFRequency in this chapter.

History Legacy command (existed before version 3.10).

:MEASure:FFT:PEAK2

Command :MEASure:FFT:PEAK2 <2nd_peak_number>

The :MEASure:FFT:PEAK2 command sets the peak number of the second peak for FFT measurements. The source is specified with the :MEASure:SOURce command as FUNction<F> or WMEMory<R>.

<2nd_peak_number> An integer, 1 to 100 specifying the number of the second peak.

<N> An integer, 1-4.

<F> An integer, 1-16.

<R> An integer, 1-4.

Query :MEASure:FFT:PEAK2?

The :MEASure:FFT:PEAK2? query returns the peak number currently set as the second peak.

Returned Format [:MEASure:FFT:PEAK1] <2nd_peak_number><NL>

See Also :MEASure:FFT:THReshold

Also see the example for :MEASure:FFT:DFRequency in this chapter.

History Legacy command (existed before version 3.10).

:MEASure:FFT:PSD

Command :MEASure:FFT:PSD <source>,<center_freq>,<meas_bw>

The :MEASure:FFT:PSD command installs a power spectral density measurement into the user interface's measurement Results pane.

The source must be a function that is set to FFT, or a waveform memory that contains an FFT for this command and query to work.

<source> {FUNCTION<F> | WMemory<R> | MSPpectrum}

For more information on <source> parameters, see "[Measurement Sources](#)" on page 728.

<center_freq> The center frequency used in the measurement in NR3 format.

<meas_bw> The width of FFT band in NR3 format.

Query :MEASure:FFT:PSD? <source>,<center_freq>,<meas_bw>

The :MEASure:FFT:PSD? query returns the measured power spectral density.

Returned Format [:MEASure:FFT:PSD] <psd_value><NL>
<psd_value> ::= in dBm/Hz in NR3 format.

See Also • "[:MEASure:FFT:CPOWer](#)" on page 772
• "[:MEASure:FFT:OBW](#)" on page 777

History New in version 5.70.

:MEASure:FFT:THReshold

Command :MEASure:FFT:THReshold <threshold_value>

The :MEASure:FFT:THReshold command sets the peak search threshold value in dB. The dB after the threshold value is optional.

<threshold_value> A real number specifying the threshold for peaks.

Query :MEASure:FFT:THReshold?

The :MEASure:FFT:THReshold? query returns the peak search threshold value.

Returned Format [:MEASure:FFT:THReshold] <threshold_value><NL>

These :MEASure commands also operate on FFT functions:

| Measure Command | Measurement Performed |
|-----------------|---|
| :TMAX | The frequency of the maximum value in the spectrum. |
| :TMIN | The frequency of the minimum value in the spectrum. |
| :VMAX | The maximum value in the spectrum. |
| :VMIN | The minimum value in the spectrum. |
| :VPP | The range of values in the spectrum. |
| :VTIM | The value at a specified frequency. |

See Also Also see the example for :MEASure:FFT:DFRequency in this chapter.

History Legacy command (existed before version 3.10).

:MEASure:FREQuency

Command :MEASure:FREQuency [<source>[,<direction>]]

The :MEASure:FREQuency command measures the frequency of the first complete cycle on the screen using the mid-threshold levels of the waveform (50% levels if standard thresholds are selected).

The source is specified with the :MEASure:SOURce command or with the optional parameter following the :MEASure:FREQuency command.

The algorithm is:

```
If the first edge on the screen is rising,
then
    frequency = 1/(second rising edge time - first rising edge time)
else
    frequency = 1/(second falling edge time - first falling edge time)
```

<source> {CHANnel<N> | DIFF<D> | COMMONmode<C> | FUNCTION<F> | DIGital<M> | WMemory<R> | CLOCK | MTRend | MSPectrum | EQUalized}

For more information on <source> parameters, see "[Measurement Sources](#)" on page 728.

<direction> {RISing | FALLing}

Specifies direction of edge for measurement. When <direction> is specified, the <source> parameter is required.

Using the <direction> parameter will set the "Measure All Edges" mode if it is not currently set. You can use the :ANALyze:AEDGes command to turn the "Measure All Edges" mode off (or on again). See "[:ANALyze:AEDGes](#)" on page 239.

Example This example measures the frequency of the channel 1 waveform.

```
myScope.WriteString ":MEASure:FREQuency CHANnel1"
```

Query :MEASure:FREQuency? [<source>[,<direction>]]

The :MEASure:FREQuency? query returns the measured frequency.

Returned Format [:MEASure:FREQuency] <value>[,<result_state>]<NL>

<value> The frequency value in Hertz of the first complete cycle on the screen using the mid-threshold levels of the waveform.

<result_state> If SENDvalid is ON, the result state is returned with the measurement result. See the :MEASure:RESults table in this chapter for a list of the result states.

Example This example places the current frequency of the waveform in the numeric variable, varFreq, then prints the contents of the variable to the computer's screen.

```
myScope.WriteString ":SYSTem:HEADer OFF" ' Response headers off.
myScope.WriteString ":MEASure:FREQuency? CHANnel1"
```

```
varFreq = myScope.ReadNumber  
Debug.Print FormatNumber(varFreq, 0)
```

History Legacy command (existed before version 3.10).

:MEASure:HISTogram:FWHM

Command :MEASure:HISTogram:FWHM

When a histogram is on, the :MEASure:HISTogram:FWHM command installs a "Full-Width at Half Max" histogram measurement into the user interface's measurement Results pane.

Query :MEASure:HISTogram:FWHM?

The :MEASure:HISTogram:FWHM? query returns the measured histogram "Full-Width at Half Max" value.

Returned Format <value><NL>

<value> ::= width of histogram at half max height in NR3 format

- See Also**
- [":MEASure:HISTogram:HITS"](#) on page 785
 - [":MEASure:HISTogram:M1S"](#) on page 786
 - [":MEASure:HISTogram:M2S"](#) on page 787
 - [":MEASure:HISTogram:M3S"](#) on page 788
 - [":MEASure:HISTogram:MAX"](#) on page 789
 - [":MEASure:HISTogram:MEAN"](#) on page 790
 - [":MEASure:HISTogram:MEDian"](#) on page 791
 - [":MEASure:HISTogram:MIN"](#) on page 792
 - [":MEASure:HISTogram:MODE"](#) on page 793
 - [":MEASure:HISTogram:PEAK"](#) on page 794
 - [":MEASure:HISTogram:PP"](#) on page 795
 - [":MEASure:HISTogram:RESolution"](#) on page 796
 - [":MEASure:HISTogram:STDDev"](#) on page 797

History New in version 6.10.

:MEASure:HISTogram:HITS

Command :MEASure:HISTogram:HITS [<source>]

The :MEASure:HISTogram:HITS command places the histogram hits measurement into the Measurements tab of the oscilloscope's user interface.

The source is specified with the :MEASure:SOURce command or with the optional parameter following the command.

The :MEASure:HISTogram commands only apply to Meas Histogram math functions, the histogram waveform, or memories containing histograms.

<source> { FUNCTION<F> | WMEMory<R> | HISTogram}

<F> An integer, 1-16.

<R> An integer, 1-4.

Example This example places into the Measurements tab the number of hits within the histogram stored in WMEMory1.

```
myScope.WriteString ":MEASure:HISTogram:HITS WMEMory1"
```

Query :MEASure:HISTogram:HITS? [<source>]

The :MEASure:HISTogram:HITS? query returns the number of hits within the histogram.

Returned Format [:MEASure:HISTogram:HITS] <value> [, <result_state>] <NL>

<value> The number of hits in the histogram.

<result_state> If SENDVALID is ON, the result state is returned with the measurement result. Refer to the MEASure:RESults command, for a list of the result states.

Example This example returns the number of hits within the current histogram and prints the result to the computer's screen.

```
myScope.WriteString ":SYSTEM:HEADer OFF" ' Response headers off.
myScope.WriteString ":MEASure:HISTogram:HITS? WMEMory1"
varHisthits = myScope.ReadNumber
Debug.Print FormatNumber(varHisthits, 0)
```

See Also

- **" :FUNCTION<F>:MHISTogram "** on page 536
- **" :HISTogram:MODE "** on page 562

History Legacy command (existed before version 3.10).

Version 3.50: Can now use this command with Meas Histogram math functions.

:MEASure:HISTogram:M1S

Command :MEASure:HISTogram:M1S [<source>]

The :MEASure:HISTogram:M1S command places the histogram percentage of points within one standard deviation of the mean measurement into the Measurements tab of the oscilloscope's user interface.

The source is specified with the :MEASure:SOURce command or with the optional parameter following the command.

The :MEASure:HISTogram commands only apply to Meas Histogram math functions, the histogram waveform, or memories containing histograms.

<source> { FUNCTION<F> | WMEMory<R> | HISTogram}

<F> An integer, 1-16.

<R> An integer, 1-4.

Example This example measures the percentage of points that are within one standard deviation of the mean of the histogram of the data stored in waveform memory 3.

```
myScope.WriteString ":MEASure:HISTogram:M1S WMEMory3"
```

Query :MEASure:HISTogram:M1S? [<source>]

The :MEASure:HISTogram:M1S? query returns the measurement of the percentage of points within one standard deviation of the mean of the histogram.

Returned Format [:MEASure:HISTogram:M1S] <value> [, <result_state>] <NL>

<value> The percentage of points within one standard deviation of the mean of the histogram.

<result_state> If SENDVALID is ON, the result state is returned with the measurement result. Refer to the MEASure:RESults command, for a list of the result states.

Example This example returns the percentage of points within one standard deviation of the mean of the current histogram and prints the result to the computer's screen.

```
myScope.WriteString ":SYSTem:HEADer OFF" ' Response headers off.
myScope.WriteString ":MEASure:HISTogram:M1S? WMEMory1"
varHistM1s = myScope.ReadNumber
Debug.Print FormatNumber(varHistM1s, 0)
```

See Also

- [":FUNCTION<F>:MHISTogram"](#) on page 536
- [":HISTogram:MODE"](#) on page 562

History Legacy command (existed before version 3.10).

Version 3.50: Can now use this command with Meas Histogram math functions.

:MEASure:HISTogram:M2S

Command :MEASure:HISTogram:M2S [<source>]

The :MEASure:HISTogram:M2S command places the histogram percentage of points within two standard deviations of the mean measurement into the Measurements tab of the oscilloscope's user interface.

The source is specified with the :MEASure:SOURce command or with the optional parameter following the command.

The :MEASure:HISTogram commands only apply to Meas Histogram math functions, the histogram waveform, or memories containing histograms.

<source> { FUNCTION<F> | WMEMory<R> | HISTogram }

<F> An integer, 1-16.

<R> An integer, 1-4.

Example This example measures the percentage of points that are within two standard deviations of the mean of the histogram whose source is specified using the MEASure:SOURce command.

```
myScope.WriteString ":MEASure:HISTogram:M2S WMEMory1"
```

Query :MEASure:HISTogram:M2S? [<source>]

The :MEASure:HISTogram:M2S? query returns the measurement of the percentage of points within two standard deviations of the mean of the histogram.

Returned Format [:MEASure:HISTogram:M2S] <value> [, <result_state>] <NL>

<value> The percentage of points within two standard deviations of the mean of the histogram.

<result_state> If SENDVALID is ON, the result state is returned with the measurement result. Refer to the MEASure:RESults command, for a list of the result states.

Example This example returns the percentage of points within two standard deviations of the mean of the current histogram and prints the result to the computer's screen.

```
myScope.WriteString ":SYSTem:HEADer OFF" ' Response headers off.
myScope.WriteString ":MEASure:HISTogram:M2S? WMEMory1"
varHism2s = myScope.ReadNumber
Debug.Print FormatNumber(varHism2s, 0)
```

See Also

- [":FUNCTION<F>:MHISTogram"](#) on page 536
- [":HISTogram:MODE"](#) on page 562

History Legacy command (existed before version 3.10).

Version 3.50: Can now use this command with Meas Histogram math functions.

:MEASure:HISTogram:M3S

Command :MEASure:HISTogram:M3S [<source>]

The :MEASure:HISTogram:M2S command places the histogram percentage of points within two standard deviations of the mean measurement into the Measurements tab of the oscilloscope's user interface.

The source is specified with the :MEASure:SOURce command or with the optional parameter following the command.

The :MEASure:HISTogram commands only apply to Meas Histogram math functions, the histogram waveform, or memories containing histograms.

<source> { FUNCTION<F> | WMEMory<R> | HISTogram}

<F> An integer, 1-16.

<R> An integer, 1-4.

Example This example measures the percentage of points that are within three standard deviations of the mean of the histogram.

```
myScope.WriteString ":MEASure:HISTogram:M3S HISTogram"
```

Query :MEASure:HISTogram:M3S? [<source>]

The :MEASure:HISTogram:M3S? query returns the measurement of the percentage of points within three standard deviations of the mean of the histogram.

Returned Format [:MEASure:HISTogram:M3S] <value> [, <result_state>] <NL>

<value> The percentage of points within three standard deviations of the mean of the histogram.

<result_state> If SENDVALID is ON, the result state is returned with the measurement result. Refer to the MEASure:RESults command, for a list of the result states.

Example This example returns the percentage of points within three standard deviations of the mean of the current histogram and prints the result to the computer's screen.

```
myScope.WriteString ":SYSTem:HEADer OFF" ' Response headers off.
myScope.WriteString ":MEASure:HISTogram:M3S? WMEMory1"
varHism3s = myScope.ReadNumber
Debug.Print FormatNumber(varHism3s, 0)
```

See Also • [":FUNCTION<F>:MHISTogram"](#) on page 536

• [":HISTogram:MODE"](#) on page 562

History Legacy command (existed before version 3.10).

Version 3.50: Can now use this command with Meas Histogram math functions.

:MEASure:HISTogram:MAX

Command :MEASure:HISTogram:MAX [<source>]

The :MEASure:HISTogram:MAX command places the histogram maximum value measurement into the Measurements tab of the oscilloscope's user interface.

The source is specified with the :MEASure:SOURce command or with the optional parameter following the command.

The :MEASure:HISTogram commands only apply to Meas Histogram math functions, the histogram waveform, or memories containing histograms.

<source> { FUNCTION<F> | WMEMory<R> | HISTogram }

<F> An integer, 1-16.

<R> An integer, 1-4.

Example This example places into the Measurements tab the maximum value of the histogram stored in WMEMory1.

```
myScope.WriteString ":MEASure:HISTogram:MAX WMEMory1"
```

Query :MEASure:HISTogram:MAX? [<source>]

The :MEASure:HISTogram:MAX? query returns the measurement of the maximum value of the histogram.

Returned Format [:MEASure:HISTogram:MAX] <value> [, <result_state>] <NL>

<value> The maximum value of the histogram.

<result_state> If SENDVALID is ON, the result state is returned with the measurement result. Refer to the MEASure:RESults command, for a list of the result states.

Example This example returns the maximum value of the current histogram and prints the result to the computer's screen.

```
myScope.WriteString ":SYSTEM:HEADer OFF" ' Response headers off.
myScope.WriteString ":MEASure:HISTogram:MAX?"
varHistmax = myScope.ReadNumber
Debug.Print FormatNumber(varHistmax, 0)
```

See Also

- **":FUNCTION<F>:MHISTogram"** on page 536
- **":HISTogram:MODE"** on page 562

History Legacy command (existed before version 3.10).

Version 3.50: Can now use this command with Meas Histogram math functions.

:MEASure:HISTogram:MEAN

Command :MEASure:HISTogram:MEAN [<source>]

The :MEASure:HISTogram:MEAN command places the histogram mean measurement into the Measurements tab of the oscilloscope's user interface.

The source is specified with the :MEASure:SOURce command or with the optional parameter following the command.

The :MEASure:HISTogram commands only apply to Meas Histogram math functions, the histogram waveform, or memories containing histograms.

<source> { FUNCTION<F> | WMEMory<R> | HISTogram }

<F> An integer, 1-16.

<R> An integer, 1-4.

Example This example places into the Measurements tab the mean of the histogram stored in WMEMory1.

```
myScope.WriteString ":MEASure:HISTogram:MEAN WMEMory1"
```

Query :MEASure:HISTogram:MEAN? [<source>]

The :MEASure:HISTogram:MEAN? query returns the measurement of the mean of the histogram.

Returned Format [:MEASure:HISTogram:MEAN] <value> [, <result_state>] <NL>

<value> The mean of the histogram.

<result_state> If SENDVALID is ON, the result state is returned with the measurement result. Refer to the MEASure:RESults command, for a list of the result states.

Example This example returns the mean of the current histogram and prints the result to the computer's screen.

```
myScope.WriteString ":SYSTem:HEADer OFF" ' Response headers off.
myScope.WriteString ":MEASure:HISTogram:MEAN? WMEMory1"
varHistmean = myScope.ReadNumber
Debug.Print FormatNumber(varHistmean, 0)
```

See Also

- **":FUNCTion<F>:MHISTogram"** on page 536
- **":HISTogram:MODE"** on page 562

History Legacy command (existed before version 3.10).

Version 3.50: Can now use this command with Meas Histogram math functions.

:MEASure:HISTogram:MEDian

Command :MEASure:HISTogram:MEDian [<source>]

The :MEASure:HISTogram:MEDian command places the histogram median measurement into the Measurements tab of the oscilloscope's user interface.

The source is specified with the :MEASure:SOURce command or with the optional parameter following the command.

The :MEASure:HISTogram commands only apply to Meas Histogram math functions, the histogram waveform, or memories containing histograms.

<source> { FUNCTION<F> | WMEMory<R> | HISTogram}

<F> An integer, 1-16.

<R> An integer, 1-4.

Example This example places into the Measurements tab the median of the histogram stored in WMEMory1.

```
myScope.WriteString ":MEASure:HISTogram:MEDian WMEMory1"
```

Query :MEASure:HISTogram:MEDian? [<source>]

The :MEASure:HISTogram:MEDian? query returns the measurement of the median of the histogram.

Returned Format [:MEASure:HISTogram:MEDian] <value> [, <result_state>] <NL>

<value> The median of the histogram.

<result_state> If SENDVALID is ON, the result state is returned with the measurement result. Refer to the MEASure:RESults command, for a list of the result states.

Example This example returns the median of the current histogram and prints the result to the computer's screen.

```
myScope.WriteString ":SYSTem:HEADer OFF" ' Response headers off.
myScope.WriteString ":MEASure:HISTogram:MEDian? WMEMory1"
varHistmed = myScope.ReadNumber
Debug.Print FormatNumber(varHistmed, 0)
```

See Also

- **":FUNCTION<F>:MHISTogram"** on page 536
- **":HISTogram:MODE"** on page 562

History Legacy command (existed before version 3.10).

Version 3.50: Can now use this command with Meas Histogram math functions.

:MEASure:HISTogram:MIN

Command :MEASure:HISTogram:MIN [<source>]

The :MEASure:HISTogram:MIN command places the histogram minimum measurement into the Measurements tab of the oscilloscope's user interface.

The source is specified with the :MEASure:SOURce command or with the optional parameter following the command.

The :MEASure:HISTogram commands only apply to Meas Histogram math functions, the histogram waveform, or memories containing histograms.

<source> { FUNCTION<F> | WMEMory<R> | HISTogram }

<F> An integer, 1-16.

<R> An integer, 1-4.

Example This example places into the Measurements tab the minimum the histogram stored in WMEMory1.

```
myScope.WriteString ":MEASure:HISTogram:MIN WMEMory1"
```

Query :MEASure:HISTogram:MIN? [<source>]

The :MEASure:HISTogram:MIN? query returns the measurement of the minimum value of the histogram.

Returned Format [:MEASure:HISTogram:MIN] <value> [, <result_state>] <NL>

<value> The minimum value of the histogram.

<result_state> If SENDVALID is ON, the result state is returned with the measurement result. Refer to the MEASure:RESults command, for a list of the result states.

Example This example returns the minimum value of the current histogram and prints the result to the computer's screen.

```
myScope.WriteString ":SYSTem:HEADer OFF" ' Response headers off.
myScope.WriteString ":MEASure:HISTogram:MIN?"
varHistmin = myScope.ReadNumber
Debug.Print FormatNumber(varHistmin, 0)
```

See Also

- **":FUNCTION<F>:MHISTogram"** on page 536
- **":HISTogram:MODE"** on page 562

History Legacy command (existed before version 3.10).

Version 3.50: Can now use this command with Meas Histogram math functions.

:MEASure:HISTogram:MODE

Command :MEASure:HISTogram:MODE [<source>]

The :MEASure:HISTogram:MODE command places the histogram mode measurement into the Measurements tab of the oscilloscope's user interface.

The source is specified with the :MEASure:SOURce command or with the optional parameter following the command.

The :MEASure:HISTogram commands only apply to Meas Histogram math functions, the histogram waveform, or memories containing histograms.

<source> { FUNCTION<F> | WMEMory<R> | HISTogram}

<F> An integer, 1-16.

<R> An integer, 1-4.

Example This example places into the Measurements tab the mode of the histogram stored in WMEMory1.

```
myScope.WriteString ":MEASure:HISTogram:MODE WMEMory1"
```

Query :MEASure:HISTogram:MODE? [<source>]

The :MEASure:HISTogram:MODE? query returns the measurement histogram's Mode value.

Returned Format [:MEASure:HISTogram:MODE] <value> [, <result_state>] <NL>

<value> The Mode value of the histogram.

<result_state> If SENDVALID is ON, the result state is returned with the measurement result. Refer to the MEASure:RESults command, for a list of the result states.

Example This example returns the Mode value of the current histogram and prints the result to the computer's screen.

```
myScope.WriteString ":SYSTEM:HEADer OFF" ' Response headers off.
myScope.WriteString ":MEASure:HISTogram:MODE? WMEMory1"
varHistMode = myScope.ReadNumber
Debug.Print FormatNumber(varHistMode, 0)
```

See Also

- **" :FUNCTION<F>:MHISTogram "** on page 536
- **" :HISTogram:MODE "** on page 562

History New in version 3.11.

Version 3.50: Can now use this command with Meas Histogram math functions.

:MEASure:HISTogram:PEAK

Command :MEASure:HISTogram:PEAK [<source>]

The :MEASure:HISTogram:PEAK command places the histogram number of hits in the greatest peak measurement into the Measurements tab of the oscilloscope's user interface.

The source is specified with the :MEASure:SOURce command or with the optional parameter following the command.

The :MEASure:HISTogram commands only apply to Meas Histogram math functions, the histogram waveform, or memories containing histograms.

<source> { FUNCTION<F> | WMEMory<R> | HISTogram }

<F> An integer, 1-16.

<R> An integer, 1-4.

Example This example places into the Measurements tab the number of hits in the greatest peak of the histogram stored in WMEMory1.

```
myScope.WriteString ":MEASure:HISTogram:PEAK WMEMory1"
```

Query :MEASure:HISTogram:PEAK? [<source>]

The :MEASure:HISTogram:PEAK? query returns the number of hits in the greatest peak of the histogram measurement.

Returned Format [:MEASure:HISTogram:PEAK] <value> [, <result_state>] <NL>

<value> The number of hits in the histogram peak.

<result_state> If SENDVALID is ON, the result state is returned with the measurement result. Refer to the MEASure:RESults command, for a list of the result states.

Example This example returns the number of hits in the greatest peak of the current histogram and prints the result to the computer's screen.

```
myScope.WriteString ":SYSTem:HEADer OFF" ' Response headers off.
myScope.WriteString ":MEASure:HISTogram:PEAK? WMEMory1"
varHistpeak = myScope.ReadNumber
Debug.Print FormatNumber(varHistpeak, 0)
```

See Also

- **"[:FUNCTION<F>:MHISTogram](#)"** on page 536
- **"[:HISTogram:MODE](#)"** on page 562

History Legacy command (existed before version 3.10).

Version 3.50: Can now use this command with Meas Histogram math functions.

:MEASure:HISTogram:PP

Command :MEASure:HISTogram:PP [<source>]

The :MEASure:HISTogram:PP command places the histogram width measurement into the Measurements tab of the oscilloscope's user interface.

The source is specified with the :MEASure:SOURce command or with the optional parameter following the command.

The :MEASure:HISTogram commands only apply to Meas Histogram math functions, the histogram waveform, or memories containing histograms.

<source> { FUNCTION<F> | WMEMory<R> | HISTogram}

<F> An integer, 1-16.

<R> An integer, 1-4.

Example This example places into the Measurements tab the width of the histogram stored in WMEMory1.

```
myScope.WriteString ":MEASure:HISTogram:PP WMEMory1"
```

Query :MEASure:HISTogram:PP? [<source>]

The :MEASure:HISTogram:PP? query returns the measurement of the width of the histogram.

Returned Format [:MEASure:HISTogram:PP]<value>[,<result_state>]<NL>

<value> The width of the histogram.

<result_state> If SENDVALID is ON, the result state is returned with the measurement result. Refer to the MEASure:RESults command, for a list of the result states.

Example This example returns the width of the current histogram and prints the result to the computer's screen.

```
myScope.WriteString ":SYSTem:HEADer OFF" ' Response headers off.
myScope.WriteString ":MEASure:HISTogram:PP? WMEMory1"
varHistpp = myScope.ReadNumber
Debug.Print FormatNumber(varHistpp, 0)
```

See Also

- **" :FUNCTION<F>:MHISTogram"** on page 536
- **" :HISTogram:MODE"** on page 562

History Legacy command (existed before version 3.10).

Version 3.50: Can now use this command with Meas Histogram math functions.

:MEASure:HISTogram:RESolution

Command :MEASure:HISTogram:RESolution [<source>]

The :MEASure:HISTogram:RESolution command places the histogram bin width measurement into the Measurements tab of the oscilloscope's user interface.

The source is specified with the :MEASure:SOURce command or with the optional parameter following the command.

The :MEASure:HISTogram commands only apply to Meas Histogram math functions, the histogram waveform, or memories containing histograms.

<source> { FUNCTION<F> | WMEMory<R> | HISTogram }

<F> An integer, 1-16.

<R> An integer, 1-4.

Example This example places into the Measurements tab the bin width of the histogram stored in WMEMory1.

```
myScope.WriteString ":MEASure:HISTogram:RESolution WMEMory1"
```

Query :MEASure:HISTogram:RES? [<source>]

The :MEASure:HISTogram:RES? query returns the measurement of the bin width of the histogram.

Returned Format [:MEASure:HISTogram:RES] <value> [, <result_state>] <NL>

<value> The width of the histogram.

<result_state> If SENDVALID is ON, the result state is returned with the measurement result. Refer to the MEASure:RESults command, for a list of the result states.

Example This example returns the width of the current histogram and prints the result to the computer's screen.

```
myScope.WriteString ":SYSTem:HEADer OFF" ' Response headers off.
myScope.WriteString ":MEASure:HISTogram:RESolution? WMEMory1"
varHistpp = myScope.ReadNumber
Debug.Print FormatNumber(varHistpp, 0)
```

See Also

- [":FUNCTION<F>:MHISTogram"](#) on page 536
- [":HISTogram:MODE"](#) on page 562

History New in version 3.50.

:MEASure:HISTogram:STDDev

Command :MEASure:HISTogram:STDDev [<source>]

The :MEASure:HISTogram:STDDev command places the histogram standard deviation measurement into the Measurements tab of the oscilloscope's user interface.

The source is specified with the :MEASure:SOURce command or with the optional parameter following the command.

The :MEASure:HISTogram commands only apply to Meas Histogram math functions, the histogram waveform, or memories containing histograms.

<source> { FUNCTION<F> | WMEMory<R> | HISTogram }

<F> An integer, 1-16.

<R> An integer, 1-4.

Example This example places into the Measurements tab the standard deviation of the histogram stored in WMEMory1.

```
myScope.WriteString ":MEASure:HISTogram:STDDev WMEMory1"
```

Query :MEASure:HISTogram:STDDev? [<source>]

The :MEASure:HISTogram:STDDev? query returns the measurement of standard deviation of the histogram.

Returned Format [:MEASure:HISTogram:STDDev] <value> [, <result_state>] <NL>

<value> The standard deviation of the histogram.

<result_state> If SENDVALID is ON, the result state is returned with the measurement result. Refer to the MEASure:RESults command, for a list of the result states.

Example This example returns the standard deviation of the histogram whose source is specified using the MEASure:SOURce command and prints the result to the computer's screen.

```
myScope.WriteString ":SYSTem:HEADer OFF" ' Response headers off.
myScope.WriteString ":MEASure:HISTogram:STDDEV? WMEMory1"
varHiststtd = myScope.ReadNumber
Debug.Print FormatNumber(varHiststtd, 0)
```

See Also

- **":FUNCTION<F>:MHISTogram"** on page 536
- **":HISTogram:MODE"** on page 562

History Legacy command (existed before version 3.10).

Version 3.50: Can now use this command with Meas Histogram math functions.

:MEASure:HOLDtime

Command

NOTE

This command is only available when the E2681A Jitter Analysis Software or the N5400A/N5401A Software is installed.

```
:MEASure:HOLDtime
  [<data_source>,<data_source_dir>,<clock_source>,<clock_source_dir>]
```

The :MEASure:HOLDtime command measures the hold time between the specified clock and data sources.

This command sets the "Measure All Edges" mode if it is not currently set. You can use the :ANALyze:AEDGes command to turn the "Measure All Edges" mode off (or on again).

<data_source>, {CHANnel<N> | DIFF<D> | COMMONmode<C> | FUNCTION<F> | WMEMory<R> |
<clock_source> CLOCk | MTRend | MSPectrum | EQUalized}

For more information on <source> parameters, see "[Measurement Sources](#)" on page 728.

<data_source_dir> {RISing | FALLing | BOTH}

Selects the direction of the data source edge.

<clock_source_dir> {RISing | FALLing}

Selects the direction of the clock source edge.

Example This example measures the hold time from the rising edge of channel 1 to the rising edge of channel 2.

```
myScope.WriteString ":MEASure:HOLDtime CHAN1,RIS,CHAN2,RIS"
```

Query :MEASure:HOLDtime?

```
[<data_source>,<data_source_dir>,<clock_source>,<clock_source_dir>]
```

The :MEASure:HOLDtime? query returns the measured hold time between the specified clock and data source.

The necessary waveform edges must be present on the display. Also, the "Measure All Edges" mode must be set (use the :ANALyze:AEDGes command or :MEASure:HOLDtime command before the query).

The query will return 9.99999E+37 if the necessary edges are not displayed or if the "Measure All Edges" mode is not currently set.

Returned Format { :MEASure:SETuptime] <value><NL>

<value> Hold time in seconds.

Example This example places the current value of hold time in the numeric variable, varTime, then prints the contents of the variable to the computer's screen.

```
myScope.WriteString ":SYSTEM:HEADer OFF" ' Response headers off.  
myScope.WriteString ":MEASure:HOLDtime? CHAN1,RIS,CHAN2,RIS"  
varTime = myScope.ReadNumber  
Debug.Print FormatNumber(varTime, 0)
```

See Also Refer to the :MEASure:RESults? query for information on the results returned and how they are affected by the SENDvalid command. Refer to the individual measurements for information on how the result state is returned.

See Also • [":ANALyze:AEDGes"](#) on page 239

History Legacy command (existed before version 3.10).

:MEASure:JITTer:HISTogram

Command

NOTE

This command is only available when the E2681A Jitter Analysis Software or the N5400A/N5401A Software is installed.

```
:MEASure:JITTer:HISTogram {{ON|1} | {OFF|0}}
```

The :MEASure:JITTer:HISTogram command turns the measurement histogram display on or off when a jitter measurement is displayed.

Example This example turns the jitter measurement histogram display on.

```
myScope.WriteString ":MEASure:JITTer:HISTogram ON"
```

Query

```
:MEASure:JITTer:HISTogram?
```

The :MEASure :JITTer:HISTogram? query returns the state of measurement histogram display.

Returned Format [:MEASure:JITTer:HISTogram] {1 | 0}

Example This example places the current setting of the jitter spectrum mode in the variable varSetting, then prints the contents of the variable to the computer's screen.

```
myScope.WriteString ":SYSTem:HEADer OFF"
myScope.WriteString ":MEASure:JITTer:HISTogram?"
varSetting = myScope.ReadNumber
Debug.Print FormatNumber(varSetting, 0)
```

History Legacy command (existed before version 3.10).

:MEASure:JITTer:MEASurement

Command

NOTE

This command is only available when the E2681A Jitter Analysis Software or the N5400A/N5401A Software is installed.

```
:MEASure:JITTer:MEASurement {MEASurement<N>}
```

The :MEASure :JITTer:MEASurement command selects which measurement displayed on the oscilloscope you are performing the jitter analysis on. MEASurement1 is the most recently added measurement.

<N> An integer, 1-20.

NOTE

When <N> is 10-20, the long form of the mnemonic, MEASurement<N>, is too long. In this case, you must use the short form, MEAS<N>.

Example This example assigns measurement 2 to the jitter measurement analysis.

```
myScope.WriteString ":MEASure:JITTer:MEASurement MEASurement2"
```

Query :MEASure:JITTer:MEASurement?

The :MEASure :JITTer:MEASurement? query returns the measurement number you are performing the jitter analysis on. If no measurements are being displayed on the oscilloscope, the query will return a null string.

Returned Format [:MEASure:JITTer:MEASurement MEASurement<N>]

Example This example places the current measurement number that you are performing jitter analysis on in the string variable strSetting, then prints the contents of the variable to the computer's screen.

```
myScope.WriteString ":SYSTem:HEADer OFF"
myScope.WriteString ":MEASure:JITTer:MEASurement?"
strSetting = myScope.ReadString
Debug.Print strSetting
```

History Legacy command (existed before version 3.10).

:MEASure:JITTer:SPECTrum

Command

NOTE

This command is only available when the E2681A Jitter Analysis Software or the N5400A/N5401A Software is installed.

```
:MEASure:JITTer:SPECTrum {{ON|1} | {OFF|0}}
```

The :MEASure:JITTer:SPECTrum command turns the jitter spectrum display on or off when a jitter measurement is displayed.

Example This example turns the jitter measurement spectrum display on.

```
myScope.WriteString ":MEASure:JITTer:SPECTrum ON"
```

Query

```
:MEASure:JITTer:SPECTrum?
```

The :MEASure :JITTer:SPECTrum? query returns the state of jitter spectrum display.

Returned Format [:MEASure:JITTer:SPECTrum] {1 | 0}

Example This example places the current setting of the jitter spectrum mode in the variable varSetting, then prints the contents of the variable to the computer's screen.

```
myScope.WriteString ":SYSTem:HEADer OFF"
myScope.WriteString ":MEASure:JITTer:SPECTrum?"
varSetting = myScope.ReadNumber
Debug.Print FormatNumber(varSetting, 0)
```

History Legacy command (existed before version 3.10).

:MEASure:JITTer:SPECTrum:HORizontal

Command

NOTE

This command is only available when the E2681A Jitter Analysis Software or the N5400A/N5401A Software is installed.

```
:MEASure:JITTer:SPECTrum:HORizontal {AUTO | MANual}
```

The :MEASure:JITTer:SPECTrum:HORizontal command sets the jitter spectrum horizontal mode to automatic or manual. In automatic mode, the oscilloscope automatically selects the horizontal scaling and center frequency. In manual mode, you can set your own horizontal scaling and center frequency values.

Example This example sets the jitter spectrum horizontal mode to automatic.

```
myScope.WriteString ":MEASure:JITTer:SPECTrum:HORizontal AUTO"
```

Query :MEASure:JITTer:SPECTrum:HORizontal?

The :MEASure:JITTer:SPECTrum:HORizontal? query returns the current jitter spectrum horizontal mode setting.

Returned Format [:MEASure:JITTer:SPECTrum:HORizontal] {AUTO | MANual}

Example This example places the current setting of the jitter trend horizontal mode in the string variable strSetting, then prints the contents of the variable to the computer's screen.

```
myScope.WriteString ":SYSTem:HEADer OFF"
myScope.WriteString ":MEASure:JITTer:SPECTrum:HORizontal?"
strSetting = myScope.ReadString
Debug.Print strSetting
```

History Legacy command (existed before version 3.10).

:MEASure:JITTer:SPECTrum:HORizontal:POSition

Command

NOTE

This command is only available when the E2681A Jitter Analysis Software or the N5400A/N5401A Software is installed.

```
:MEASure:JITTer:SPECTrum:HORizontal:POSition <position>
```

The :MEASure:JITTer:SPECTrum:HORizontal:POSition command sets the jitter spectrum horizontal center frequency position.

<position> A real number for the center frequency position in Hertz.

Example This example sets the jitter spectrum horizontal center frequency position to 250 kHz.

```
myScope.WriteString ":MEASure:JITTer:SPECTrum:HORizontal:POSition 250E3"
```

Query :MEASure:JITTer:SPECTrum:HORizontal:POSition?

The :MEASure:JITTer:SPECTrum:HORizontal:POSition? query returns the current jitter spectrum horizontal center frequency position setting.

Returned Format [:MEASure:JITTer:SPECTrum:HORizontal:POSition] <value><NL>

<value> The jitter spectrum horizontal center frequency setting.

Example This example places the current setting of the jitter trend horizontal center frequency position in the variable varValue, then prints the contents of the variable to the computer's screen.

```
myScope.WriteString ":SYSTem:HEADer OFF"
myScope.WriteString ":MEASure:JITTer:SPECTrum:HORizontal:POSition?"
varValue = myScope.ReadNumber
Debug.Print FormatNumber(varValue, 0)
```

History Legacy command (existed before version 3.10).

:MEASure:JITTer:SPECTrum:HORizontal:RANGe

Command

NOTE

This command is only available when the E2681A Jitter Analysis Software or the N5400A/N5401A Software is installed.

```
:MEASure:JITTer:SPECTrum:HORizontal:RANGe <range>
```

The :MEASure:JITTer:SPECTrum:HORizontal:RANGe command sets the jitter spectrum horizontal range.

<range> A real number for the horizontal frequency range in Hertz.

Example This example sets the jitter spectrum horizontal range to 10 GHz (1 GHz/div).

```
myScope.WriteString ":MEASure:JITTer:SPECTrum:HORizontal:RANGe 10E9"
```

Query :MEASure:JITTer:SPECTrum:HORizontal:RANGe?

The :MEASure:JITTer:SPECTrum:HORizontal:RANGe? query returns the current jitter spectrum horizontal range setting.

Returned Format [:MEASure:JITTer:SPECTrum:HORizontal:RANGe] <value><NL>

<value> The jitter spectrum horizontal range setting.

Example This example places the current setting of the jitter trend horizontal range in the variable varValue, then prints the contents of the variable to the computer's screen.

```
myScope.WriteString ":SYSTem:HEADer OFF"
myScope.WriteString ":MEASure:JITTer:SPECTrum:HORizontal:RANGe?"
varValue = myScope.ReadNumber
Debug.Print FormatNumber(varValue, 0)
```

History Legacy command (existed before version 3.10).

:MEASure:JITTer:SPECTrum:VERTical

Command

NOTE

This command is only available when the E2681A Jitter Analysis Software or the N5400A/N5401A Software is installed.

```
:MEASure:JITTer:SPECTrum:VERTical {MANual}
```

The :MEASure:JITTer:SPECTrum:VERTical command sets the jitter spectrum vertical mode to manual. The AUTO mode, which automatically selected the vertical scaling and offset, is no longer available.

Example This example sets the jitter spectrum vertical mode to manual.

```
myScope.WriteString ":MEASure:JITTer:SPECTrum:VERTical MANual"
```

Query :MEASure:JITTer:SPECTrum:VERTical?

The :MEASure:JITTer:SPECTrum:VERTical? query returns the current jitter spectrum vertical mode setting.

Returned Format [:MEASure:JITTer:SPECTrum:VERTical] {MANual}

Example This example places the current setting of the jitter spectrum vertical mode in the string variable strSetting, then prints the contents of the variable to the computer's screen.

```
myScope.WriteString ":SYSTem:HEADer OFF"
myScope.WriteString ":MEASure:JITTer:SPECTrum:VERTical?"
strSetting = myScope.ReadString
Debug.Print strSetting
```

See Also

- [":MEASure:JITTer:SPECTrum:VERTical:OFFSet"](#) on page 807
- [":MEASure:JITTer:SPECTrum:VERTical:RANGe"](#) on page 808

History Legacy command (existed before version 3.10).

:MEASure:JITTer:SPECTrum:VERTical:OFFSet

Command

NOTE

This command is only available when the E2681A Jitter Analysis Software or the N5400A/N5401A Software is installed.

```
:MEASure:JITTer:SPECTrum:VERTical:OFFSet <offset>
```

The :MEASure:JITTer:SPECTrum:VERTical:OFFSet command sets the jitter spectrum vertical offset.

<offset> A real number for the vertical offset of the jitter measurement spectrum.

Example This example sets the jitter spectrum vertical offset to 2 ns.

```
myScope.WriteString ":MEASure:JITTer:SPECTrum:VERTical:OFFSet 10E-9"
```

Query :MEASure:JITTer:SPECTrum:VERTical:OFFSet?

The :MEASure:JITTer:SPECTrum:VERTical:OFFSet? query returns the jitter spectrum vertical offset time.

Returned Format [:MEASure:JITTer:SPECTrum:VERTical:OFFSet] <value> [, <result_state>] <NL>

<value> The jitter vertical spectrum offset time setting.

Example This example places the current value of jitter spectrum vertical offset in the numeric variable, varValue, then prints the contents of the variable to the computer's screen.

```
myScope.WriteString ":SYSTem:HEADer OFF" ' Response headers off.
myScope.WriteString ":MEASure:JITTer:SPECTrum:VERTical:OFFSet?"
varValue = myScope.ReadNumber
Debug.Print FormatNumber(varValue, 0)
```

History Legacy command (existed before version 3.10).

:MEASure:JITTer:SPECTrum:VERTical:RANGe

Command

NOTE

This command is only available when the E2681A Jitter Analysis Software or the N5400A/N5401A Software is installed.

```
:MEASure:JITTer:SPECTrum:VERTical:RANGe <range>
```

The :MEASure:JITTer:SPECTrum:VERTical:RANGe command sets the jitter spectrum vertical range.

<range> A real number for the full-scale vertical range for the jitter measurement spectrum.

Example This example sets the jitter spectrum vertical range to 4 ns (500 ps/div X 8 div).

```
myScope.WriteString ":MEASure:JITTer:SPECTrum:VERTical:RANGe 4E-9"
```

Query

```
:MEASure:JITTer:SPECTrum:VERTical:RANGe?
```

The :MEASure:JITTer:SPECTrum:VERTical:RANGe? query returns the jitter spectrum range time setting.

Returned Format

```
[ :MEASure:JITTer:SPECTrum:VERTical:RANGe ] <value> [ ,<result_state> ] <NL>
```

<value> The jitter spectrum vertical range setting.

Example This example places the current value of jitter spectrum vertical range in the numeric variable, varValue, then prints the contents of the variable to the computer's screen.

```
myScope.WriteString ":SYSTem:HEADer OFF" ' Response headers off.
myScope.WriteString ":MEASure:JITTer:SPECTrum:VERTical:RANGe?"
varValue = myScope.ReadNumber
Debug.Print FormatNumber(varValue, 0)
```

History Legacy command (existed before version 3.10).

:MEASure:JITTer:SPECTrum:VERTical:TYPE

Command

NOTE

This command is only available when the E2681A Jitter Analysis Software or the N5400A/N5401A Software is installed.

```
:MEASure:JITTer:SPECTrum:VERTical:TYPE {LINear | LOGarithmic}
```

The :MEASure:JITTer:SPECTrum:VERTical:TYPE command lets you select either a LINear or a LOGarithmic vertical scale for the jitter spectrum plot.

Example This example sets a linear vertical scale for the jitter spectrum plot.

```
myScope.WriteString ":MEASure:JITTer:SPECTrum:VERTical:TYPE LINear"
```

Query

```
:MEASure:JITTer:SPECTrum:VERTical:TYPE?
```

The :MEASure:JITTer:SPECTrum:VERTical:TYPE? query returns the current jitter spectrum plot vertical scale setting.

Returned Format

```
[ :MEASure:JITTer:SPECTrum:VERTical:TYPE ] {LINear | LOGarithmic}
```

Example

This example places the current jitter spectrum plot vertical scale setting in the string variable strType, then prints the contents of the variable to the computer's screen.

```
myScope.WriteString ":SYSTem:HEADer OFF"
myScope.WriteString ":MEASure:JITTer:SPECTrum:VERTical:TYPE?"
strType = myScope.ReadString
Debug.Print strType
```

History

New in version 3.10.

:MEASure:JITTer:SPECTrum:WINDow

Command

NOTE

This command is only available when the E2681A Jitter Analysis Software or the N5400A/N5401A Software is installed.

```
:MEASure:JITTer:SPECTrum:WINDow {RECTangular | HANNing | FLATtop
                                   | BHARris | HAMMING}
```

The :MEASure:JITTer:SPECTrum:WINDow command sets the jitter spectrum window mode. For a description of the window modes, see [":FUNCTion<F>:FFT:WINDow"](#) on page 515.

Example This example sets the jitter spectrum window mode to Hanning.

```
myScope.WriteString ":MEASure:JITTer:SPECTrum:WINDow HANNing"
```

Query

```
:MEASure:JITTer:SPECTrum:WINDow?
```

The :MEASure:JITTer:SPECTrum:WINDow? query returns the current jitter spectrum window mode setting.

Returned Format

```
[ :MEASure:JITTer:SPECTrum:WINDow ] {RECTangular | HANNing | FLATtop
                                       | BHARris | HAMMING}<NL>
```

Example This example places the current setting of the jitter spectrum window mode in the string variable strSetting, then prints the contents of the variable to the computer's screen.

```
myScope.WriteString ":SYSTEM:HEADer OFF"
myScope.WriteString ":MEASure:JITTer:SPECTrum:WINDow?"
strSetting = myScope.ReadString
Debug.Print strSetting
```

History

Legacy command (existed before version 3.10).

Version 3.11: Added the HAMMING window mode selection.

:MEASure:JITTer:TREND

Command

NOTE

This command is only available when the E2681A Jitter Analysis Software or the N5400A/N5401A Software is installed.

```
:MEASure:JITTer:TREND {{ON|1} | {OFF|0}}
```

The :MEASure:JITTer:TREND command turns the jitter measurement trend display on or off. When on, trend plots measurement results time correlated to the waveform being measured.

Example This example turns the jitter measurement trend display on.

```
myScope.WriteString ":MEASure:JITTer:TREND ON"
```

Query :MEASure:JITTer:TREND?

The :MEASure :JITTer:TREND? query returns the state of jitter trend display.

Returned Format [:MEASure:JITTer:TREND] {1 | 0}

Example This example places the current setting of the jitter trend mode in the string variable strSetting, then prints the contents of the variable to the computer's screen.

```
myScope.WriteString ":SYSTem:HEADer OFF"
myScope.WriteString ":MEASure:JITTer:TREND?"
strSetting = myScope.ReadString
Debug.Print strSetting
```

History Legacy command (existed before version 3.10).

:MEASure:JITTer:TREnd:SMOoth

Command

NOTE

This command is only available when the E2681A Jitter Analysis Software or the N5400A/N5401A Software is installed.

```
:MEASure:JITTer:TREnd:SMOoth {{ON|1} | {OFF|0}}
```

The :MEASure:JITTer:TREnd:SMOoth command sets jitter trend smoothing to on or off. When on, smoothing creates a running average smoothed by the number of points set by the :JITTer:TREnd:SMOoth:POINts command.

Example This example sets the jitter trend smoothing mode to on.

```
myScope.WriteString ":MEASure:JITTer:TREnd:SMOoth ON"
```

Query :MEASure:JITTer:TREnd:SMOoth?

The :MEASure:JITTer:TREnd:SMOoth? query returns the current jitter trend smoothing mode setting.

Returned Format [:MEASure:JITTer:TREnd:SMOoth] {1 | 0}

Example This example places the current setting of the jitter trend smoothing mode in the string variable strSetting, then prints the contents of the variable to the computer's screen.

```
myScope.WriteString ":SYSTem:HEADer OFF"
myScope.WriteString ":MEASure:JITTer:TREnd:SMOoth?"
strSetting = myScope.ReadString
Debug.Print strSetting
```

History Legacy command (existed before version 3.10).

:MEASure:JITTer:TREnd:SMOoth:POINts

Command

NOTE

This command is only available when the E2681A Jitter Analysis Software or the N5400A/N5401A Software is installed.

```
:MEASure:JITTer:TREnd:SMOoth:POINts <points>
```

The :MEASure:JITTer:TREnd:SMOoth:POINts command sets the number of points as a set size for the data smoothing feature.

<points> odd integers, 3 to 100001. If out of range, the number will be rounded to nearest lower odd integer.

Example This example sets the jitter trend smoothing points to 7.

```
myScope.WriteString ":MEASure:JITTer:TREnd:SMOoth:POINts 7"
```

Query :MEASure:JITTer:TREnd:SMOoth:POINts?

The :MEASure:JITTer:TREnd:SMOoth:POINts? query returns the current setting for jitter trend smoothing points.

Returned Format [:MEASure:JITTer:TREnd:SMOoth:POINts] <value><NL>

<value> The jitter offset smoothing points setting.

Example This example places the current value of jitter trend smoothing points in the numeric variable, varValue, then prints the contents of the variable to the computer's screen.

```
myScope.WriteString ":SYSTem:HEADer OFF" ' Response headers off.
myScope.WriteString ":MEASure:JITTer:TREnd:SMOoth:POINts?"
varValue = myScope.ReadNumber
Debug.Print FormatNumber(varValue, 0)
```

History Legacy command (existed before version 3.10).

:MEASure:JITTer:TREND:VERTical

Command

NOTE

This command is only available when the E2681A Jitter Analysis Software or the N5400A/N5401A Software is installed.

```
:MEASure:JITTer:TREND:VERTical {AUTO | MANual}
```

The :MEASure:JITTer:TREND:VERTical command sets the jitter trend vertical mode to automatic or manual. In automatic mode, the oscilloscope automatically selects the vertical scaling and offset. In manual mode, you can set your own scaling and offset values.

Example This example sets the jitter trend vertical mode to automatic.

```
myScope.WriteString ":MEASure:JITTer:TREND:VERTical AUTO"
```

Query :MEASure:JITTer:TREND:VERTical?

The :MEASure:JITTer:TREND:VERTical? query returns the current jitter trend vertical mode setting.

Returned Format [:MEASure:JITTer:TREND:VERTical] {AUTO | MANual}

Example This example places the current setting of the jitter trend vertical mode in the string variable strSetting, then prints the contents of the variable to the computer's screen.

```
myScope.WriteString ":SYSTem:HEADer OFF"
myScope.WriteString ":MEASure:JITTer:TREND:VERTical?"
strSetting = myScope.ReadString
Debug.Print strSetting
```

History Legacy command (existed before version 3.10).

:MEASure:JITTer:TREND:VERTical:OFFSet

Command

NOTE

This command is only available when the E2681A Jitter Analysis Software or the N5400A/N5401A Software is installed.

```
:MEASure:JITTer:TREND:VERTical:OFFSet <offset>
```

The :MEASure:JITTer:TREND:VERTical:OFFSet command sets the jitter trend vertical offset.

<offset> A real number for the vertical offset for the jitter measurement trend.

Example This example sets the jitter trend vertical offset to 100 ps.

```
myScope.WriteString ":MEASure:JITTer:TREND:VERTical:OFFSet 100E-12"
```

Query :MEASure:JITTer:TREND:VERTical:OFFSet?

The :MEASure:JITTer:TREND:VERTical:OFFSet? query returns the jitter trend vertical offset setting.

Returned Format [:MEASure:JITTer:TREND:VERTical:OFFSet] <value><NL>

<value> The jitter vertical trend offset setting.

Example This example places the current value of jitter trend vertical offset in the numeric variable, varValue, then prints the contents of the variable to the computer's screen.

```
myScope.WriteString ":SYSTem:HEADer OFF" ' Response headers off.
myScope.WriteString ":MEASure:JITTer:TREND:VERTical:OFFSet?"
varValue = myScope.ReadNumber
Debug.Print FormatNumber(varValue, 0)
```

History Legacy command (existed before version 3.10).

:MEASure:JITTer:TREND:VERTical:RANGe

Command

NOTE

This command is only available when the E2681A Jitter Analysis Software or the N5400A/N5401A Software is installed.

```
:MEASure:JITTer:TREND:VERTical:RANGe <range>
```

The :MEASure:JITTer:TREND:VERTical:RANGe command sets the jitter trend vertical range.

<range> A real number for the full-scale vertical range for the jitter measurement trend.

Example This example sets the jitter trend vertical range to 4 ns (500 ps/div X 8 div).

```
myScope.WriteString ":MEASure:JITTer:TREND:VERTical:RANGe 4E-9"
```

Query :MEASure:JITTer:TREND:VERTical:RANGe?

The :MEASure:JITTer:TREND:VERTical:RANGe? query returns the jitter trend vertical range setting.

Returned Format [:MEASure:JITTer:TREND:VERTical:RANGe] <value><NL>

<value> The jitter trend vertical range setting.

<result_state> If SENDvalid is ON, the result state is returned with the measurement result. See the :MEASure:RESuLts table in this chapter for a list of the result states.

Example This example places the current value of jitter trend vertical range in the numeric variable, varValue, then prints the contents of the variable to the computer's screen.

```
myScope.WriteString ":SYSTem:HEADer OFF" ' Response headers off.
myScope.WriteString ":MEASure:JITTer:TREND:VERTical:RANGe?"
varValue = myScope.ReadNumber
Debug.Print FormatNumber(varValue, 0)
```

History Legacy command (existed before version 3.10).

:MEASure:NAME

Command :MEASure:NAME {MEAS1 | MEAS2 | MEAS3 | ... | MEAS20}, <name>

The :MEASure:NAME commands sets the name of the specified measurement to whatever string is given to <name>. This enables you to give specific names to measurements displayed on the oscilloscope's screen.

<name> a quoted string

Query :MEASure:NAME? {MEAS1 | MEAS2 | MEAS3 | ... | MEAS20}

The :MEASure:NAME? query returns the name of the corresponding measurement.

History Legacy command (existed before version 3.10).

Version 5.00: Now 20 measurements to choose from.

:MEASure:NCJitter

Command

NOTE

This command is only available when the E2681A Jitter Analysis Software or the N5400A/N5401A Software is installed.

```
:MEASure:NCJitter <source>,<direction>,<n>,<start>
```

The :MEASure:NCJitter command measures the N cycle jitter of the waveform. Another name for this measurement is "N period-period", where N is the number of cycles in the period.

<source> {CHANnel<N> | DIFF<D> | COMMONmode<C> | FUNCtion<F> | WMEMory<R> | CLOCK | MTRend | MSPectrum | EQUalized}

For more information on <source> parameters, see "[Measurement Sources](#)" on page 728.

<direction> {RISing | FALLing}, specifies direction of waveform edge to make measurement.

<n> An integer, 1 to 99, the number of cycles in a group.

<start> An integer, 1 to <n> - 1, typically 1, the cycle to start measuring.

Example This example measures the N cycle jitter on channel 1, rising edge, 5 cycles in a group, starting on the first cycle of the waveform.

```
myScope.WriteString ":MEASure:NCJitter CHANnel1,RISing,5,1"
```

Query :MEASure:NCJitter? <source>,<direction>,<n>,<start>

The :MEASure:NCJitter? query returns the measured N cycle jitter time of the waveform.

Returned Format [:MEASure:NCJitter] <value>[,<result_state>]<NL>

<value> The N cycle jitter time of the waveform.

<result_state> If SENDvalid is ON, the result state is returned with the measurement result. See the :MEASure:RESults table in this chapter for a list of the result states.

Example This example places the current value of N cycle jitter in the numeric variable, varValue, then prints the contents of the variable to the computer's screen.

```
myScope.WriteString ":SYSTem:HEADer OFF" ' Response headers off.
myScope.WriteString ":MEASure:NCJitter? CHANnel1,RIS,5,1"
varValue = myScope.ReadNumber
Debug.Print FormatNumber(varValue, 0)
```

See Also

- "[:MEASure:TIEClock2](#)" on page 947
- "[:MEASure:CTCJitter](#)" on page 755
- "[:MEASure:CTCPwidth](#)" on page 758
- "[:MEASure:CTCNwidth](#)" on page 757

- **":MEASure:CTCDutycycle"** on page 753

History Legacy command (existed before version 3.10).

:MEASure:NOISe

Command

NOTE

This command is only available when the EZJIT Complete software is installed.

```
:MEASure:NOISe <source>, {VOLT | UNITamp}, {ZERO | ONE | BOTH}
```

The :MEASure:NOISe command adds a Noise measurement to the oscilloscope display.

The parameters specify the input source to be measured, the units (in volts or unit amplitude), and whether "zeros", "ones", or both "zeros" and "ones" should be measured.

This command is the equivalent of adding a noise measurement via **Measure > Data > Noise** in the front panel user interface.

<source> {CHANnel<N> | DIFF<D> | COMMONmode<C> | FUNCTION<F> | WMEMory<R> | EQUalized}

For more information on <source> parameters, see "[Measurement Sources](#)" on page 728.

Example This example adds a "ones" Noise measurement on channel 1, in volt units, to the oscilloscope display. The measurement results appear in the Measurements tab.

```
myScope.WriteString ":MEASure:NOISe CHANnel1,VOLT,ONE"
```

Query :MEASure:NOISe? <source>, {VOLT | UNIT}, {ZERO | ONE | BOTH}

The :MEASure:NOISe? query returns the measured noise value.

Returned Format [:MEAS:NOIS] <measured_value><NL>

<measured_value> The measured "zeros", "ones", or both noise value in volts or unit amplitude.

Example This example places the measurement result in the varMeasuredNoise variable.

```
myScope.WriteString ":SYSTEM:HEADer OFF" ' Response headers off.
myScope.WriteString ":MEASure:NOISe? CHANnel1,VOLT,ONE"
varMeasuredNoise = myScope.ReadNumber
Debug.Print FormatNumber(varMeasuredNoise, 0)
```

History New in version 3.50.

:MEASure:NOISe:ALL?

Query

NOTE

This command is only available when the EZJIT Complete software is installed.

```
:MEASure:NOISe:ALL? {ZERO | ONE | TWO | THRee}
```

The :MEASure:NOISe:ALL? query returns the NOISe measurement results for the specified level. The parameters TWO and THRee are available for PAM-4 signals.

These values are returned as comma separated values using the following format:

Returned Format

```
[ :MEASure:NOISe:ALL<space>]
TI(<format>),<result>,<state>,
RN(<format>),<result>,<state>,
DI(<format>),<result>,<state>,
PI(<format>),<result>,<state>,
ABUI(<format>),<result>,<state>,
BUI(<format>),<result>,<state>,
ISI(<format>),<result>,<state>,
Count,<number_of_bits>,<state>,
Level,<nominal_level>,<state>,
Eye Height(<format>),<result>,<state>,<NL>
```

NOTE

Whether some of these values are included or not depends on the setting of :MEASure:NOISe:METHod and :MEASure:NOISe:REPort.

For example, when :MEASure:NOISe:REPort or :MEASure:NOISe:METHod is SPECTral, the BUI and ABUI values are not returned, and there are two PI values (one "rms" and one "dd").

- <space> White space (ASCII 32) character.
- <format> The format value tells you something about how the measurement is made. For instance, TI(1E-12) means that the TI measurement was derived using a bit error rate of 1E-12. A format of (rms) means the measurement is a root-mean-square measurement. A format of (dd) means the measurement uses a dual-Dirac delta model to derive the measurement. A format of (pp) means the measurement is a peak-to-peak measurement.
- <result> The measured results for the NOISe measurements. A value of 9.99999E+37 means that the oscilloscope was unable to make the measurement.
- <state> The measurement result state. See [Table 14](#) for a list of values and descriptions of the result state value.
- <number_of_bits> The number of waveform bits that have been measured.
- <nominal_level> The Level line returns the nominal one or zero level. The unit amplitude = the nominal one level – nominal zero level.

Example This example places the noise measurement result for "ones" in the strResults variable and displays it on the computer's screen.

```
Dim strResult As String ' Dimension variable.
myScope.WriteString ":SYSTEM:HEADER OFF" ' Response headers off.
myScope.WriteString ":MEASURE:NOISE:ALL? ONE"
strResults = myScope.ReadString
Debug.Print strResults
```

See Also

- [":MEASURE:NOISE:METHod"](#) on page 825
- [":MEASURE:NOISE:REPort"](#) on page 826

History New in version 3.50.

Version 4.10: New results can be returned depending on the :MEASURE:NOISE:METHod and :MEASURE:NOISE:REPort settings.

Version 5.50: The parameters TWO and THRee are available for PAM-4 signals.

:MEASure:NOISe:BANDwidth

Command

NOTE

This command is only available when the EZJIT Complete software is installed.

```
:MEASure:NOISe:BANDwidth {NARRow | WIDE}
```

The :MEASure:NOISe:BANDwidth command sets the type of filtering used to separate the data dependent noise from the random noise and the periodic noise.

Example This example sets the RN bandwidth to WIDE.

```
myScope.WriteString ":MEASure:NOISe:BANDwidth WIDE"
```

Query

```
:MEASure:NOISe:BANDwidth?
```

The :MEASure:NOISe:BANDwidth? query returns the RN bandwidth filter setting.

Returned Format

```
[ :MEASure:NOISe:BANDwidth ] {NARRow | WIDE} <NL>
```

Example

This example places the RN filter setting the strFilter variable and displays it on the computer's screen.

```
myScope.WriteString ":SYSTEM:HEADer OFF" ' Response headers off.
myScope.WriteString ":MEASure:NOISe:BANDwidth?"
strFilter = myScope.ReadString
Debug.Print strFilter
```

History

New in version 3.50.

:MEASure:NOISe:LOCation

Command

NOTE

This command is only available when the EZJIT Complete software is installed.

```
:MEASure:NOISe:LOCation <location>
```

The :MEASure:NOISe:LOCation command specifies the measurement location within the bit where 0% is the beginning of the bit, 50% is the middle of the bit, and 100% is the end of the bit.

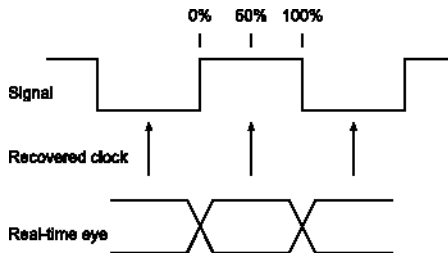

You can specify a location value from 5% to 95%.

Example This example sets the measurement location to 60%.

```
myScope.WriteString ":MEASure:NOISe:LOCation 60"
```

Query :MEASure:NOISe:LOCation?

The :MEASure:NOISe:LOCation? query returns the measurement location setting.

Returned Format [:MEASure:NOISe:LOCation] <location><NL>

Example This example places the measurement location setting the varLocation variable and displays it on the computer's screen.

```
myScope.WriteString ":SYSTem:HEADer OFF" ' Response headers off.
myScope.WriteString ":MEASure:NOISe:LOCation?"
varLocation = myScope.ReadNumber
Debug.Print FormatNumber(varLocation, 0)
```

History New in version 3.50.

:MEASure:NOISe:METhod

Command

NOTE

This command is only available when the EZJIT Complete jitter analysis application is licensed.

```
:MEASure:NOISe:METhod {SPECTral | BOTH}
```

The :MEASure:NOISe:METhod command lets you select the method for random noise (RN) analysis, either the SPECTral method or BOTH the spectral and tail fit methods.

When analyzing noise with crosstalk or ground bounce effects present in your signal, select BOTH. When this option is selected, the deterministic interference (DI) that is uncorrelated to the data pattern, also known as bounded uncorrelated interference (BUI), is separated into periodic interference (PI) and aperiodic bounded uncorrelated interference (ABUI). ABUI is caused by crosstalk and ground bounce effects.

When there are no crosstalk or ground bounce effects present in your signal, you can select the SPECTral method in order to run faster. When this option is selected, the deterministic interference (DI) that is uncorrelated to the data pattern is all reported as periodic interference (PI).

Example This example sets NOISe method to BOTH the spectral and tail fit analysis.

```
myScope.WriteString ":MEASure:NOISe:METhod BOTH"
```

Query :MEASure:NOISe:METhod?

The :MEASure:NOISe:METhod? query returns the selected NOISe method.

Returned Format [:MEASure:NOISe:METhod] {SPEC | BOTH}<NL>

Example This example places the NOISe method setting the strNoiseMethod variable and displays it on the computer's screen.

```
myScope.WriteString ":SYSTem:HEADer OFF" ' Response headers off.
myScope.WriteString ":MEASure:NOISe:METhod?"
strNoiseMethod = myScope.ReadString
Debug.Print strNoiseMethod
```

See Also • [":MEASure:NOISe:REPort"](#) on page 826

History New in version 4.10.

:MEASure:NOISe:REPort**Command****NOTE**

This command is only available when the EZJIT Complete jitter analysis application is licensed.

```
:MEASure:NOISe:REPort {SPEctral | TAILfit}
```

When the :MEASure:NOISe:METhod BOTH command selects both the spectral and tail fit methods for random noise analysis, the :MEASure:NOISe:REPort command specifies which method is used for the reports in the noise graphs / histograms and Noise tab measurements.

Example This example specifies that the NOISe report include measurements from both the spectral and tail fit analysis (including aperiodic bounded uncorrelated interference ABUI measurements).

```
myScope.WriteString ":MEASure:NOISe:REPort TAILfit"
```

Query

```
:MEASure:NOISe:REPort?
```

The :MEASure:NOISe:REPort? query returns the report setting.

Returned Format

```
[ :MEASure:NOISe:REPort ] {SPEC | TAIL}<NL>
```

Example This example places the report setting in the strReportSetting variable and displays it on the computer's screen.

```
myScope.WriteString ":SYSTem:HEADer OFF"      ' Response headers off.
myScope.WriteString ":MEASure:NOISe:REPort?"
strReportSetting = myScope.ReadString
Debug.Print strReportSetting
```

See Also • [":MEASure:NOISe:METhod"](#) on page 825

History New in version 4.10.

:MEASure:NOISe:RN

Command

NOTE

This command is only available when the EZJIT Complete software is installed.

```
:MEASure:NOISe:RN {ON, <RNrms Zero>, <RNrms One> | OFF}
```

The :MEASure:NOISe:RN command can specify a known amount of random noise. When used, the remaining amount of the total noise measured is reported as periodic interference (PI).

This command is used in situations when crosstalk aggressors influence the random noise measured on a signal. If the random noise on a signal is measured without the aggressor signal crosstalk, this known amount of random noise can be specified when measuring the noise again with the crosstalk aggressors.

- ON – Enables a specified amount of random noise.
- <RNrms Zero> – The known amount of "zeros" random noise.
- <RNrms One> – The known amount of "ones" random noise.
- OFF – Disables the specification of random noise amounts.

Specified amounts of "ones" and "zeros" random noise is shown in the noise measurement results (see [page 821](#)) as "RN(rms specified)".

Example This example specifies 100 μ V of known "zeros" random noise and 200 μ V of known "ones" random noise.

```
myScope.WriteString ":MEAS:NOISE:RN ON, 100e-6, 200e-6"
```

Query :MEASure:NOISe:RN?

The :MEASure:NOISe:RN? query returns the specified RN settings.

Returned Format [:MEASure:NOISe:RN] {ON, <RNrms Zero>, <RNrms One> | OFF}<NL>

Example This example places the specified RN settings in the strKnownRandomNoise variable and displays it on the computer's screen.

```
myScope.WriteString ":SYSTEM:HEADer OFF" ' Response headers off.
myScope.WriteString ":MEASure:NOISe:RN?"
strKnownRandomNoise = myScope.ReadString
Debug.Print strKnownRandomNoise
```

History New in version 3.50.

:MEASure:NOISe:SCOPE:RN

Command

NOTE

This command is only available when the EZJIT Complete software is installed.

```
:MEASure:NOISe:SCOPE:RN {ON, <RNrms Zero>, <RNrms One> | OFF}
```

The :MEASure:NOISe:SCOPE:RN command can specify the removal of the oscilloscope's calibrated random noise from the reported RN.

- ON – Enables the removal of the oscilloscope's calibrated random noise from the reported RN.
- <RNrms Zero> – The oscilloscope's "zeros" random noise to remove from the reported RN.
- <RNrms One> – The oscilloscope's "ones" random noise to remove from the reported RN.
- OFF – Disables the removal of the oscilloscope's calibrated random noise from the reported RN.

Running the **Calibrate scope jitter / noise** from the front panel user interface will set <RNrms Zero> and <RNrms One> to the measured values; however, the measures values can be changed by this command.

Example This example specifies 100 μV of oscilloscope "zeros" random noise and 200 μV of oscilloscope "ones" random noise.

```
myScope.WriteString ":MEAS:NOISE:SCOPE:RN ON, 100e-6, 200e-6"
```

Query :MEASure:NOISe:SCOPE:RN?

The :MEASure:NOISe:SCOPE:RN? query returns the oscilloscope RN settings.

Returned Format [:MEASure:NOISe:SCOPE:RN] {ON, <RNrms Zero>, <RNrms One> | OFF}<NL>

Example This example places the oscilloscope RN settings in the strScopeRandomNoise variable and displays it on the computer's screen.

```
myScope.WriteString ":SYSTEM:HEADER OFF" ' Response headers off.
myScope.WriteString ":MEASure:NOISe:SCOPE:RN?"
strScopeRandomNoise = myScope.ReadString
Debug.Print strScopeRandomNoise
```

History New in version 3.50.

:MEASure:NOISe:STATe

Command

NOTE

This command is only available when the EZJIT Complete software is installed.

```
:MEASure:NOISe:STATe {ON | OFF}
```

The :MEASure:NOISe:STATe command enables or disables the NOISe measurements.

Example This example sets the NOISe state to on.

```
myScope.WriteString ":MEASure:NOISe:STATe ON"
```

Query

```
:MEASure:NOISe:STATe?
```

The :MEASure:NOISe:STATe? query returns the state of the NOISe measurements.

Returned Format [:MEASure:NOISe:STATe] {1 | 0}<NL>

Example This example places the current state of the NOISe measurements in the varState variable and displays it on the computer's screen.

```
myScope.WriteString ":SYSTEM:HEADer OFF" ' Response headers off.
myScope.WriteString ":MEASure:NOISe:STATe?"
varState = myScope.ReadNumber
Debug.Print FormatNumber(varState, 0)
```

History New in version 3.50.

:MEASure:NOISe:UNITs

Command

NOTE

This command is only available when the EZJIT Complete software is installed.

```
:MEASure:NOISe:UNITs {VOLT | UNIT}
```

The :MEASure:NOISe:UNITs command sets the unit of measure for NOISe measurements to volts or unit amplitude.

Example This example sets the NOISe units to unit amplitude.

```
myScope.WriteString ":MEASure:NOISe:UNITs UNIT"
```

Query

```
:MEASure:NOISe:UNITs?
```

The :MEASure:NOISe:UNITs? query returns the units of measure being used for the NOISe measurements.

Returned Format [:MEASure:NOISe:UNITs] {VOLT | UNIT}<NL>

Example This example places the current units of measure for the NOISe measurements in the strUnits variable and displays it on the computer's screen.

```
myScope.WriteString ":SYSTem:HEADer OFF" ' Response headers off.
myScope.WriteString ":MEASure:NOISe:UNITs?"
strUnits = myScope.ReadString
Debug.Print strUnits
```

History New in version 3.50.

:MEASure:NPERiod

Command :MEASure:NPERiod <source>, <slope>, <N>

The :MEASure:NPERiod command measures the span of time of N consecutive periods. The measurement then moves over one period and measures the span of time of the next N consecutive periods.

<source> The source on which the measurement is made.

For more information on <source> parameters, see "[Measurement Sources](#)" on page 728.

<slope> {RISing | FALLing}

<N> An integer greater than or equal to 1.

Example This example measures the time span of 3 consecutive periods on channel 1 (rising edge).

```
myScope.WriteString ":MEASure:NPERiod CHANnel1,RISing, 3"
```

Query :MEASure:NPERiod?

History Legacy command (existed before version 3.10).

:MEASure:NPULses

Command :MEASure:NPULses <source>

The :MEASure:NPULses measures the number of negative pulses on the screen.

<source> The source on which the measurement is made.

For more information on <source> parameters, see "[Measurement Sources](#)" on page 728.

Example This example measures the number of negative pulses on channel 1.

```
myScope.WriteString ":MEASure:NPULses CHAN1"
```

Query :MEASure:NPULses?

This query returns the result for the NPULses measurement.

History Legacy command (existed before version 3.10).

:MEASure:NUI

Command :MEASure:NUI <source>, <N>

The :MEASure:NUI command measures N consecutive unit intervals. The measurement then moves over one unit interval and measures the span of time of the next N consecutive unit intervals.

<source> The source on which the measurement is made.

For more information on <source> parameters, see "[Measurement Sources](#)" on page 728.

<N> An integer greater than or equal to 1.

Example This example measures the time span of 3 consecutive unit intervals on channel 1.

```
myScope.WriteString ":MEASure:NUI CHAN1, 3"
```

Query :MEASure:NUI?

History Legacy command (existed before version 3.10).

:MEASure:NWIDth

Command :MEASure:NWIDth [<source>]

The :MEASure:NWIDth command measures the width of the first negative pulse on the screen using the mid-threshold levels of the waveform (50% levels with standard threshold selected). Sources are specified with the :MEASure:SOURce command or with the optional parameter following the :MEASure:NWIDth command.

The algorithm is:

```
If the first edge on the screen is rising,
then
    nwidth = time at the second rising edge - time at the first
    falling edge
else
    nwidth = time at the first rising edge - time at the first
    falling edge
```

<source> {CHANnel<N> | DIFF<D> | COMMONmode<C> | FUNction<F> | DIGital<M> | WMEMory<R> | CLOCK | MTRend | MSPectrum | EQUalized}

For more information on <source> parameters, see "[Measurement Sources](#)" on page 728.

Example This example measures the width of the first negative pulse on the screen.

```
myScope.WriteString ":MEASure:NWIDth CHANnel1"
```

Query :MEASure:NWIDth? [<source>]

The :MEASure:NWIDth? query returns the measured width of the first negative pulse of the specified source.

Returned Format [:MEASure:NWIDth] <value>[,<result_state>] <NL>

<value> The width of the first negative pulse on the screen using the mid-threshold levels of the waveform.

<result_state> If SENDvalid is ON, the result state is returned with the measurement result. See the :MEASure:RESults table in this chapter for a list of the result states.

Example This example places the current width of the first negative pulse on the screen in the numeric variable, varWidth, then prints the contents of the variable to the computer's screen.

```
myScope.WriteString ":SYSTem:HEADer OFF" ' Response headers off.
myScope.WriteString ":MEASure:NWIDth? CHANnel1"
varWidth = myScope.ReadNumber
Debug.Print FormatNumber(varWidth, 0)
```

History Legacy command (existed before version 3.10).

:MEASure:OMAMplitude

Command :MEASure:OMAMplitude [<source>][,{WATT | DBM}]

The :MEASure:OMAMplitude command installs an Optical Modulation Amplitude (OMA) measurement into the user interface's measurement Results pane.

Optical Modulation Amplitude (OMA) is the measure of the difference between the optical power of an NRZ (non-return-to-zero) one pulse and the optical power of an NRZ zero pulse. It requires an NRZ pattern and is designed to be used with a square wave made of consecutive zeros followed by consecutive ones. Be sure to check any relevant standard for one and zero run requirements. All instances are measured if Measure All Edges is selected. Otherwise, the edges closest to the timebase reference are measured.

<source> {CHANnel<N> | DIFF<D> | COMMONmode<C> | FUNCTION<F> | WMEMory<R> | CLOCK | MTRend | MSPectrum | EQUALized}

For more information on <source> parameters, see "[Measurement Sources](#)" on page 728.

{WATT | DBM} Specifies the measurement units in Watts or dBm.

Query :MEASure:OMAMplitude? [<source>][,{WATT | DBM}]

The :MEASure:OMAMplitude? query returns the measured Optical Modulation Amplitude (OMA).

Returned Format [:MEASure:OMAMplitude] <value>[,<result_state>]<NL>

<value> The measured Optical Modulation Amplitude (OMA) value.

<result_state> If SENDvalid is ON, the result state is returned with the measurement result. See the :MEASure:RESults table in this chapter for a list of the result states.

- See Also**
- "[:MEASure:ERATio](#)" on page 768
 - "[:MEASure:OPOWER](#)" on page 836
 - "[:MEASure:CGRade:OLEVel](#)" on page 747
 - "[:MEASure:CGRade:ZLEVel](#)" on page 749

History New in version 5.70.

:MEASure:OPOWer

Command :MEASure:OPOWer [<source>] [, {WATT | DBM}]

The :MEASure:OPOWer command installs an Optical Average Power measurement into the user interface's measurement Results pane.

Optical average power is a measure of the true average component of an optical signal. If markers are tracking this measurement, the marker is placed on the optical power Watts. This measurement is commonly used when identifying the fundamental parameters of a lightwave transmitter. However, it differs from other measurements because it does not rely on the waveform display to determine the measurement. The analog-to-digital converter is in the probe itself, independent of the waveform displayed on the screen. You can measure the optical power of an eye diagram.

<source> {CHANnel<N> | DIFF<D> | COMMONmode<C> | FUNCTION<F> | WMEMory<R> | CLOCK | MTRend | MSPectrum | EQUalized}

For more information on <source> parameters, see "[Measurement Sources](#)" on page 728.

{WATT | DBM} Specifies the measurement units in Watts or dBm.

Query :MEASure:OPOWer? [<source>] [, {WATT | DBM}]

The :MEASure:OPOWer? query returns the measured Optical Average Power.

Returned Format [:MEASure:OMAMplitude] <value> [, <result_state>] <NL>

<value> The measured Optical Average Power value.

<result_state> If SENDvalid is ON, the result state is returned with the measurement result. See the :MEASure:RESuLts table in this chapter for a list of the result states.

- See Also**
- "[:MEASure:ERATio](#)" on page 768
 - "[:MEASure:OMAMplitude](#)" on page 835
 - "[:MEASure:CGRade:OLEVel](#)" on page 747
 - "[:MEASure:CGRade:ZLEVel](#)" on page 749

History New in version 5.70.

:MEASure:OVERshoot

Command :MEASure:OVERshoot [<source>][,<direction>]

The :MEASure:OVERshoot command measures the overshoot of the first edge on the screen. Sources are specified with the :MEASure:SOURce command or with the optional parameter following the :MEASure:OVERshoot command.

The algorithm is:

```
If the first edge on the screen is rising,
then
    overshoot = (Local Vmax - Vtop) / Vamplitude
else
    overshoot = (Vbase - Local Vmin) / Vamplitude
```

<source> {CHANnel<N> | DIFF<D> | COMMONmode<C> | FUNCTION<F> | WMEMory<R> | CLOck | MTRend | MSPectrum | EQUalized}

For more information on <source> parameters, see "[Measurement Sources](#)" on page 728.

<direction> RISing or FALLing

Example This example measures the overshoot of the first edge on the screen.

```
myScope.WriteString ":MEASure:OVERshoot CHANnel1"
```

Query :MEASure:OVERshoot? [<source>][,<direction>]

The :MEASure:OVERshoot? query returns the measured overshoot of the specified source.

Returned Format [:MEASure:OVERshoot] <value>[,<result_state>]<NL>

<value> Ratio of overshoot to amplitude, in percent.

<result_state> If SENDvalid is ON, the result state is returned with the measurement result. See the :MEASure:RESults table in this chapter for a list of the result states.

Example This example places the current value of overshoot in the numeric variable, varValue, then prints the contents of the variable to the computer's screen.

```
myScope.WriteString ":SYSTEM:HEADer OFF" ' Response headers off.
myScope.WriteString ":MEASure:OVERshoot? CHANnel1"
varValue = myScope.ReadNumber
Debug.Print FormatNumber(varValue, 0)
```

History Legacy command (existed before version 3.10).

:MEASure:PAM:ELEVel

Command :MEASure:PAM:ELEVel [`<source>` [, `<threshold>`]]

When the signal type is PAM-4 (see :ANALyze:SIGNal:TYPE), the :MEASure:PAM:ELEVel command installs a vertical center measurement of the specified PAM-4 eye into the user interface's measurement Results pane.

<source> {CHANnel<N> | DIFF<D> | COMMONmode<C> | FUNction<F> | WMEMory<R>}

For more information on `<source>` parameters, see **"Measurement Sources"** on page 728.

<threshold> Specifies eye to measure as an integer. For PAM-4, this may be from 0-2.

Query :MEASure:PAM:ELEVel? [`<source>` [, `<threshold>`]]

The :MEASure:PAM:ELEVel? query returns the measured vertical center value of the specified PAM-4 eye.

Returned Format [:MEASure:PAM:ELEVel] `<value>`<NL>

`<value>` ::= the vertical center value of the specified PAM-4 eye in NR3 format.

- See Also**
- **" :ANALyze:CLOCK:METHod:SKEW "** on page 256
 - **" :ANALyze:SIGNal:DATarate "** on page 261
 - **" :ANALyze:SIGNal:SYMBOLrate "** on page 263
 - **" :ANALyze:SIGNal:TYPE "** on page 271
 - **" :MEASure:CGRade:EWIDth "** on page 742
 - **" :MEASure:CGRade:EHEight "** on page 740
 - **" :MEASure:FALLtime "** on page 770
 - **" :MEASure:PAM:ESKew "** on page 840
 - **" :MEASure:PAM:LEVel "** on page 846
 - **" :MEASure:PAM:LRMS "** on page 848
 - **" :MEASure:PAM:LTHickness "** on page 850
 - **" :MEASure:RISetime "** on page 869
 - **" :MEASure:THResholds:DISPlay "** on page 903
 - **" :MEASure:THResholds:GENeral:METHod "** on page 909
 - **" :MEASure:THResholds:GENeral:PAMCustom "** on page 911
 - **" :MEASure:THResholds:GENeral:PAMAutomatic "** on page 913
 - **" :MEASure:THResholds:RFALL:METHod "** on page 926
 - **" :MEASure:THResholds:RFALL:PAMAutomatic "** on page 928
 - **" :MEASure:TIEData2 "** on page 949

History New in version 5.50.

`:MEASure:PAM:ESKew`

Command `:MEASure:PAM:ESKew [<source>[,<threshold>]]`

When the signal type is PAM-4 (see `:ANALyze:SIGNal:TYPE`), the `:MEASure:PAM:ESKew` command installs a horizontal center skew measurement of the specified PAM-4 eye into the user interface's measurement Results pane.

<source> {CHANnel<N> | DIFF<D> | COMMONmode<C> | FUNCTion<F> | WMEMory<R>}

For more information on <source> parameters, see **"Measurement Sources"** on page 728.

<threshold> Specifies eye to measure as an integer. For PAM-4, this may be from 0-2.

Query `:MEASure:PAM:ESKew? [<source>[,<threshold>]]`

The `:MEASure:PAM:ESKew?` query returns the measured horizontal center skew value of the specified PAM-4 eye.

Returned Format `[:MEASure:PAM:ESKew] <value><NL>`

`<value>` ::= the horizontal center skew value of the specified PAM-4 eye in NR3 format.

- See Also**
- **"`:ANALyze:CLOCK:METHod:SKEW`"** on page 256
 - **"`:ANALyze:SIGNal:DATarate`"** on page 261
 - **"`:ANALyze:SIGNal:SYMBOLrate`"** on page 263
 - **"`:ANALyze:SIGNal:TYPE`"** on page 271
 - **"`:MEASure:CGRade:EWIDth`"** on page 742
 - **"`:MEASure:CGRade:EHEight`"** on page 740
 - **"`:MEASure:FALLtime`"** on page 770
 - **"`:MEASure:PAM:ELEVEL`"** on page 838
 - **"`:MEASure:PAM:LEVEL`"** on page 846
 - **"`:MEASure:PAM:LRMS`"** on page 848
 - **"`:MEASure:PAM:LTHickness`"** on page 850
 - **"`:MEASure:RISetime`"** on page 869
 - **"`:MEASure:THResholds:DISPlay`"** on page 903
 - **"`:MEASure:THResholds:GENeral:METHod`"** on page 909
 - **"`:MEASure:THResholds:GENeral:PAMCustom`"** on page 911
 - **"`:MEASure:THResholds:GENeral:PAMAutomatic`"** on page 913
 - **"`:MEASure:THResholds:RFALL:METHod`"** on page 926
 - **"`:MEASure:THResholds:RFALL:PAMAutomatic`"** on page 928
 - **"`:MEASure:TIEData2`"** on page 949

History New in version 5.50.

:MEASure:PAM:EYE:ELMethod

Command :MEASure:PAM:EYE:ELMethod <method>

The :MEASure:PAM:EYE:ELMethod command selects the basis for determining the location of an eye's center on the waveform.

<method> {MEWidth | MEHeight}

- MEWidth – The eye's center is located at the eye's maximum width midway between the eye's inside left and right edges. This is the default setting.
- MEHeight – The eye's center is located at the eye's maximum height midway between the eye's inside top and bottom edges.

Query :MEASure:PAM:EYE:ELMethod?

The :MEASure:PAM:EYE:ELMethod? query returns the selected method for determining the location of an eye's center.

Returned Format <method><NL>

<method> ::= {MEW | MEH}

- See Also**
- [":MEASure:PAM:EYE:ESTiming"](#) on page 843
 - [":MEASure:PAM:EYE:PPERcent"](#) on page 844
 - [":MEASure:PAM:EYE:TIME:LTDefinition"](#) on page 845

History New in version 6.10.

:MEASure:PAM:EYE:ESTiming

Command :MEASure:PAM:EYE:ESTiming <timing>

The :MEASure:PAM:EYE:ESTiming command configures the timing for sampling the data. Use this setting to match the timing method used by a receiver. For signals with skewed eyes, measurements results will vary depending on this setting.

<timing> {CEYE | PELevel}

- CEYE – Sampling timing is based on the location of the center eye (of the three stacked eyes). This is the default setting.
- PELevel – Sampling timing is independently based on the location of each of the three eyes.

Query :MEASure:PAM:EYE:ESTiming?

The :MEASure:PAM:EYE:ESTiming? query returns the selected "timing for sampling" setting.

Returned Format <timing><NL>

<timing> ::= {CEYE | PEL}

- See Also**
- [":MEASure:PAM:EYE:ELMethod"](#) on page 842
 - [":MEASure:PAM:EYE:PPERcent"](#) on page 844
 - [":MEASure:PAM:EYE:TIME:LTDefinition"](#) on page 845

History New in version 6.10.

:MEASure:PAM:EYE:PPERcent

Command :MEASure:PAM:EYE:PPERcent <percentage>

The :MEASure:PAM:EYE:PPERcent command defines the timespan over which an eye's amplitude level is measured. The timespan is specified as a percentage of the symbol period.

<percentage> Percentage of symbol period in NR3 format. The default setting is 10%.

Query :MEASure:PAM:EYE:PPERcent?

The :MEASure:PAM:EYE:PPERcent? query returns the "eye level width" timespan setting.

Returned Format <percentage><NL>

- See Also**
- [":MEASure:PAM:EYE:ELMethod"](#) on page 842
 - [":MEASure:PAM:EYE:ESTiming"](#) on page 843
 - [":MEASure:PAM:EYE:TIME:LTDefinition"](#) on page 845

History New in version 6.10.

:MEASure:PAM:EYE:TIME:LTDefinition

Command :MEASure:PAM:EYE:TIME:LTDefinition <method>

The :MEASure:PAM:EYE:TIME:LTDefinition command specifies the method used to locate the time at which to measure an eye's level.

<method> {MRMS | ECENter}

- ECENter – The time of a level is the average of the centers of the adjacent eyes. This is the default setting.
- MRMS – The time is located within the eye's level width at the minimum level thickness (RMS values).

Query :MEASure:PAM:EYE:TIME:LTDefinition?

The :MEASure:PAM:EYE:TIME:LTDefinition? query returns the specified method used to locate the time at which to measure an eye's level.

Returned Format <method><NL>

<method> ::= {MRMS | ECEN}

- See Also**
- [":MEASure:PAM:EYE:ELMethod"](#) on page 842
 - [":MEASure:PAM:EYE:ESTiming"](#) on page 843
 - [":MEASure:PAM:EYE:PPERcent"](#) on page 844

History New in version 6.10.

:MEASure:PAM:LEVel

Command :MEASure:PAM:LEVel [`<source>` [, `<level>`]]

When the signal type is PAM-4 (see :ANALyze:SIGNal:TYPE), the :MEASure:PAM:LEVel command installs a mean voltage measurement of the specified PAM-4 level into the user interface's measurement Results pane.

<source> {CHANnel<N> | DIFF<D> | COMMONmode<C> | FUNCTion<F> | WMEMory<R>}

For more information on `<source>` parameters, see **"Measurement Sources"** on page 728.

<level> Specifies the PAM level to measure as an integer. For PAM-4, this may be from 0-3. If omitted, the last specified level is used.

Query :MEASure:PAM:LEVel? [`<source>` [, `<level>`]]

The :MEASure:PAM:LEVel? query returns the measured mean voltage value of the specified PAM-4 level.

Returned Format [:MEASure:PAM:LEVel] `<value>`<NL>

`<value>` ::= the mean voltage value of the specified PAM-4 level in NR3 format.

- See Also**
- **" :ANALyze:CLOCK:METHod:SKEW "** on page 256
 - **" :ANALyze:SIGNal:DATarate "** on page 261
 - **" :ANALyze:SIGNal:SYMBOLrate "** on page 263
 - **" :ANALyze:SIGNal:TYPE "** on page 271
 - **" :MEASure:CGRade:EWIDth "** on page 742
 - **" :MEASure:CGRade:EHEight "** on page 740
 - **" :MEASure:FALLtime "** on page 770
 - **" :MEASure:PAM:ELEVel "** on page 838
 - **" :MEASure:PAM:ESKew "** on page 840
 - **" :MEASure:PAM:LRMS "** on page 848
 - **" :MEASure:PAM:LTHickness "** on page 850
 - **" :MEASure:RISetime "** on page 869
 - **" :MEASure:THResholds:DISPlay "** on page 903
 - **" :MEASure:THResholds:GENeral:METHod "** on page 909
 - **" :MEASure:THResholds:GENeral:PAMCustom "** on page 911
 - **" :MEASure:THResholds:GENeral:PAMAutomatic "** on page 913
 - **" :MEASure:THResholds:RFALL:METHod "** on page 926
 - **" :MEASure:THResholds:RFALL:PAMAutomatic "** on page 928
 - **" :MEASure:TIEData2 "** on page 949

History New in version 5.50.

:MEASure:PAM:LRMS

Command :MEASure:PAM:LRMS [<source>[,<level>]]

When the signal type is PAM-4 (see :ANALyze:SIGNal:TYPE), the :MEASure:PAM:LRMS command installs a RMS voltage measurement of the specified PAM-4 level into the user interface's measurement Results pane.

<source> {CHANnel<N> | DIFF<D> | COMMONmode<C> | FUNCTion<F> | WMEMory<R>}

For more information on <source> parameters, see **"Measurement Sources"** on page 728.

<level> Specifies the PAM level to measure as an integer. For PAM-4, this may be from 0-3. If omitted, the last specified level is used.

Query :MEASure:PAM:LRMS? [<source>[,<level>]]

The :MEASure:PAM:LRMS? query returns the measured RMS voltage value of the specified PAM-4 level.

Returned Format [:MEASure:PAM:LRMS] <value><NL>

<value> ::= the RMS voltage value of the specified PAM-4 level in NR3 format.

- See Also**
- **" :ANALyze:CLOCK:METHod:SKEW "** on page 256
 - **" :ANALyze:SIGNal:DATarate "** on page 261
 - **" :ANALyze:SIGNal:SYMBOLrate "** on page 263
 - **" :ANALyze:SIGNal:TYPE "** on page 271
 - **" :MEASure:CGRade:EWIDth "** on page 742
 - **" :MEASure:CGRade:EHEight "** on page 740
 - **" :MEASure:FALLtime "** on page 770
 - **" :MEASure:PAM:ELEVEL "** on page 838
 - **" :MEASure:PAM:ESKew "** on page 840
 - **" :MEASure:PAM:LEVEL "** on page 846
 - **" :MEASure:PAM:LTHickness "** on page 850
 - **" :MEASure:RISetime "** on page 869
 - **" :MEASure:THResholds:DISPlay "** on page 903
 - **" :MEASure:THResholds:GENeral:METHod "** on page 909
 - **" :MEASure:THResholds:GENeral:PAMCustom "** on page 911
 - **" :MEASure:THResholds:GENeral:PAMAutomatic "** on page 913
 - **" :MEASure:THResholds:RFALL:METHod "** on page 926
 - **" :MEASure:THResholds:RFALL:PAMAutomatic "** on page 928
 - **" :MEASure:TIEData2 "** on page 949

History New in version 5.50.

:MEASure:PAM:LTHickness

Command :MEASure:PAM:LTHickness [<source>[,<level>]]

When the signal type is PAM-4 (see :ANALyze:SIGNal:TYPE), the :MEASure:PAM:LTHickness command installs an eye diagram level thickness measurement of the specified PAM-4 level into the user interface's measurement Results pane.

<source> {CHANnel<N> | DIFF<D> | COMMONmode<C> | FUNCTION<F> | WMEMory<R>}

For more information on <source> parameters, see **"Measurement Sources"** on page 728.

<level> Specifies the PAM level to measure as an integer. For PAM-4, this may be from 0-3. If omitted, the last specified level is used.

Query :MEASure:PAM:LTHickness? [<source>[,<level>]]

The :MEASure:PAM:LTHickness? query returns the measured thickness of the specified PAM-4 level.

Returned Format [:MEASure:PAM:LTHickness] <value><NL>

<value> ::= the thickness value of the specified PAM-4 level in NR3 format.

- See Also**
- **" :ANALyze:CLOCK:METHod:SKEW "** on page 256
 - **" :ANALyze:SIGNal:DATarate "** on page 261
 - **" :ANALyze:SIGNal:SYMBOLrate "** on page 263
 - **" :ANALyze:SIGNal:TYPE "** on page 271
 - **" :MEASure:CGRade:EWIDth "** on page 742
 - **" :MEASure:CGRade:EHEight "** on page 740
 - **" :MEASure:FALLtime "** on page 770
 - **" :MEASure:PAM:ELEVEL "** on page 838
 - **" :MEASure:PAM:ESKew "** on page 840
 - **" :MEASure:PAM:LEVEL "** on page 846
 - **" :MEASure:PAM:LRMS "** on page 848
 - **" :MEASure:RISetime "** on page 869
 - **" :MEASure:THResholds:DISPlay "** on page 903
 - **" :MEASure:THResholds:GENeral:METHod "** on page 909
 - **" :MEASure:THResholds:GENeral:PAMCustom "** on page 911
 - **" :MEASure:THResholds:GENeral:PAMAutomatic "** on page 913
 - **" :MEASure:THResholds:RFALL:METHod "** on page 926
 - **" :MEASure:THResholds:RFALL:PAMAutomatic "** on page 928

- **":MEASure:TIEData2"** on page 949

History New in version 5.50.

:MEASure:PAMplitude

Command :MEASure:PAMplitude [<source>, <width>, <direction>]

The :MEASure:PAMplitude command measures the pulse amplitude around the specified edge. There is only a single width applied to the top and base for the amplitude measurement.

<source> {CHANnel<N> | DIFF<D> | COMMONmode<C> | FUNCTION<F> | WMEMory<R>}

For more information on <source> parameters, see "[Measurement Sources](#)" on page 728.

<width> width to measure at the top and base of the pulse (in percent, 0-100)

<direction> the edge direction to measure (RISing or FALLing). The pulse measured is to the left and right of the specified edge.

Example This example measures the pulse amplitude around a rising edge (width set to 50%)

```
myScope.WriteString ":MEASure:PAMplitude CHAN1, 50, RISing"
```

Query :MEASure:PAMplitude? <source>, <width>, <direction>

The :MEASure:PAMplitude? query returns the pulse amplitude around the specified edge.

History Legacy command (existed before version 3.10).

:MEASure:PBASe

Command :MEASure:PBASe <source>, <pulse width percent>

The :MEASure:PBASe command measures the average of the data of a negative pulse within the pulse window. The pulse window is a range of data centered within the pulse width using the specified percentage of the data as measured as the middle threshold level. For example, a 50% window would not include in the average the first or last 25% of the pulse width as measured at the middle threshold level. A 100% window would measure the average of the entire positive or negative pulse. In measure all edges mode and EZJIT, these measurements can be trended, histogrammed, etc.

<source> {CHANnel<N> | DIFF<D> | COMMONmode<C> | FUNCTion<F> | WMEMory<R>}

For more information on <source> parameters, see "[Measurement Sources](#)" on page 728.

<pulse width percent> pulse width percent to use in average (in percent, 0-100)

Example This example measures the average of the data of a negative pulse within the pulse window (width set to 50%)

```
myScope.WriteString ":MEASure:PBASe CHAN1, 50"
```

Query :MEASure:PBASe? <source>, <pulse width percentage>

The :MEASure:PBASe? query returns the average pulse base of the data of a negative pulse within the specified pulse window.

History Legacy command (existed before version 3.10).

:MEASure:PERiod

Command :MEASure:PERiod [<source>[,<direction>]]

The :MEASure:PERiod command measures the period of the first complete cycle on the screen using the mid-threshold levels of the waveform (50% levels with standard measurements selected).

The source is specified with the :MEASure:SOURce command or with the optional parameter following the :MEASure:PERiod command.

The algorithm is:

```
If the first edge on the screen is rising,
then
    period = second rising edge time - first rising edge time
else
    period = second falling edge time - first falling edge time
```

<source> {CHANnel<N> | DIFF<D> | COMMONmode<C> | FUNCTION<F> | DIGital<M> | WMemory<R> | CLOCK | MTRend | MSPectrum | EQUalized}

For more information on <source> parameters, see "[Measurement Sources](#)" on page 728.

<direction> {RISing | FALLing}

Specifies direction of edge to start measurement. When <direction> is specified, the <source> parameter is required.

Using the <direction> parameter will set the "Measure All Edges" mode if it is not currently set. You can use the :ANALyze:AEDGes command to turn the "Measure All Edges" mode off (or on again). See "[:ANALyze:AEDGes](#)" on page 239.

Example This example measures the period of the waveform.

```
myScope.WriteString ":MEASure:PERiod CHANnel1"
```

Query :MEASure:PERiod? [<source>[,<direction>]]

The :MEASure:PERiod? query returns the measured period of the specified source.

Returned Format [:MEASure:PERiod] <value>[,<result_state>]<NL>

<value> Period of the first complete cycle on the screen.

<result_state> If SENDvalid is ON, the result state is returned with the measurement result. See the :MEASure:RESults table in this chapter for a list of the result states.

Example This example places the current period of the waveform in the numeric variable, varValue, then prints the contents of the variable to the computer's screen.

```
myScope.WriteString ":SYSTem:HEADer OFF" ' Response headers off.
myScope.WriteString ":MEASure:PERiod? CHANnel1"
varValue = myScope.ReadNumber
Debug.Print FormatNumber(varValue, 0)
```

History Legacy command (existed before version 3.10).

:MEASure:PHASe

Command :MEASure:PHASe [<source>[,<source>[,<direction>]]]

The :MEASure:PHASe command measures the phase in degrees between two edges. If two sources are specified, the phase from the specified edge of the first source to the specified edge of the second source is measured. If one source is specified, the phase is always 0.0E0.00°.

This command sets the "Measure All Edges" mode if it is not currently set. You can use the :ANALyze:AEDGes command to turn the "Measure All Edges" mode off (or on again).

<source> {CHANnel<N> | DIFF<D> | COMMONmode<C> | FUNCTion<F> | WMEMory<R> | CLOCK | MTRend | MSPectrum | EQUalized}

For more information on <source> parameters, see "[Measurement Sources](#)" on page 728.

<direction> {RISing | FALLing}

Specifies direction of edge to measure. When <direction> is specified, the <source> parameter is required.

Example This example measures the phase between channel 1 and channel 2.

```
myScope.WriteString ":MEASure:PHASe CHANnel1,CHANnel2"
```

Query :MEASure:PHASe? [<source>[,<source>[,<direction>]]]

The :MEASure:PHASe? query returns the measured phase angle value.

The necessary waveform edges must be present on the display. Also, the "Measure All Edges" mode must be set (use the :ANALyze:AEDGes command or :MEASure:PHASe command before the query).

The query will return 9.99999E+37 if the necessary edges are not displayed or if the "Measure All Edges" mode is not currently set.

Returned Format [:MEASure:PHASe] <value>[,result_state]<NL>

<value> Phase angle from the first edge on the first source to the first edge on the second source.

<result_state> If SENDvalid is ON, the result state is returned with the measurement result. See the :MEASure:RESults table in this chapter for a list of the result states.

Example This example places the current phase angle value between channel 1 and channel 2 in the variable, varValue, then prints the contents of the variable to the computer's screen.

```
myScope.WriteString ":SYSTem:HEADer OFF" ' Response headers off.
myScope.WriteString ":MEASure:PHASe? CHANnel1,CHANnel2"
varValue = myScope.ReadNumber
Debug.Print FormatNumber(varValue, 0)
```

See Also · [":ANALyze:AEDGes"](#) on page 239

History Legacy command (existed before version 3.10).

:MEASure:PPContrast

Command :MEASure:PPContrast [<source>]

The :MEASure:PPContrast command measures the peak-to-peak contrast (also known as Michelson contrast or modulation). This is the relation between the spread and the sum of two luminances.

$$\text{Peak-to-Peak Contrast} = (L_{\text{max}} - L_{\text{min}}) / (L_{\text{max}} + L_{\text{min}})$$

Sources are specified with the :MEASure:SOURce command or with the optional parameter following the :MEASure:PPContrast command.

<source> {CHANnel<N> | DIFF<D> | COMMONmode<C> | FUNCTION<F> | WMEMORY<R> | CLOCK | MTRend | MSPectrum | EQUALized}

For more information on <source> parameters, see "[Measurement Sources](#)" on page 728.

Example This example measures the peak-to-peak contrast of channel 1.

```
myScope.WriteString ":MEASure:PPContrast CHANnel1"
```

Query :MEASure:PPContrast? [<source>]

The :MEASure:PPContrast? query returns the measured peak-to-peak contrast value.

Returned Format [:MEASure:PPContrast] <value>[,<result_state>]<NL>

<value> Peak-to-peak contrast of the selected source.

<result_state> If SENDvalid is ON, the result state is returned with the measurement result. See the :MEASure:RESults table in this chapter for a list of the result states.

Example This example places the current peak-to-peak voltage in the numeric variable, varPPContrast, then prints the contents of the variable to the computer's screen.

```
myScope.WriteString ":SYSTEM:HEADer OFF" ' Response headers off.
myScope.WriteString ":MEASure:PPContrast? CHANnel1"
varPPContrast = myScope.ReadNumber
Debug.Print FormatNumber (varPPContrast, 0)
```

History New in version 5.60.

:MEASure:PPULses

Command :MEASure:PPULses <source>

The :MEASure:PPULses measures the number of positive pulses on the screen.

<source> The source on which the measurement is made.

For more information on <source> parameters, see "[Measurement Sources](#)" on page 728.

Example This example measures the number of positive pulses on channel 1.

```
myScope.WriteString ":MEASure:PPULses CHANnel1"
```

Query :MEASure:PPULses?

This query returns the result for the PPULses measurement.

History Legacy command (existed before version 3.10).

:MEASure:PREShoot

Command :MEASure:PREShoot [<source>]

The :MEASure:PREShoot command measures the preshoot of the first edge on the screen. Sources are specified with the :MEASure:SOURce command or with the optional parameter following the :MEASure:PREShoot command.

The algorithm is:

```
If the first edge on the screen is rising,
then
    preshoot = (Vbase - Local Vmin) / Vamplitude
else
    preshoot = (Local Vmax - Vtop) / Vamplitude
```

<source> {CHANnel<N> | DIFF<D> | COMMONmode<C> | FUNCTion<F> | WMEMory<R> | CLOCk | MTRend | MSPectrum | EQUalized}

For more information on <source> parameters, see "[Measurement Sources](#)" on page 728.

Example This example measures the preshoot of the waveform on the screen.

```
myScope.WriteString ":MEASure:PREShoot CHANnel1"
```

Query :MEASure:PREShoot? [<source>]

The :MEASure:PREShoot? query returns the measured preshoot of the specified source.

Returned Format [:MEASure:PREShoot] <value>[,<result state>]<NL>

<value> Ratio of preshoot to amplitude, in percent.

<result_state> If SENDvalid is ON, the result state is returned with the measurement result. See the :MEASure:RESults table in this chapter for a list of the result states.

Example This example places the current value of preshoot in the numeric variable, varPreshoot, then prints the contents of the variable to the computer's screen.

```
myScope.WriteString ":SYSTem:HEADer OFF" ' Response headers off.
myScope.WriteString ":MEASure:PREShoot? CHANnel1"
varPreshoot = myScope.ReadNumber
Debug.Print FormatNumber(varPreshoot, 0)
```

History Legacy command (existed before version 3.10).

:MEASure:PTOP

Command :MEASure:PTOP <source>, <pulse width percent>

The :MEASure:PTOP command measures the average of the data of a positive pulse within the pulse window. The pulse window is a range of data centered within the pulse width using the specified percentage of the data as measured as the middle threshold level. For example, a 50% window would not include in the average the first or last 25% of the pulse width as measured at the middle threshold level. A 100% window would measure the average of the entire positive or negative pulse. In measure all edges mode and EZJIT, these measurements can be trended, histogrammed, etc.

<source> {CHANnel<N> | DIFF<D> | COMMONmode<C> | FUNCTION<F> | WMemory<R>}

For more information on <source> parameters, see "[Measurement Sources](#)" on page 728.

<pulse width percent> pulse width percent to use in average (in percent, 0-100)

Example This example measures the average of the data of a positive pulse within the pulse window (width set to 50%)

```
myScope.WriteString ":MEASure:PTOP CHANnel1, 50"
```

Query :MEASure:PTOP? <source>, <pulse width percentage>

The :MEASure:PTOP? query returns the average of the data of a positive pulse within the specified pulse window.

History Legacy command (existed before version 3.10).

:MEASure:PWIDth

Command :MEASure:PWIDth [<source>]

The :MEASure:PWIDth command measures the width of the first positive pulse on the screen using the mid-threshold levels of the waveform (50% levels with standard measurements selected). Sources are specified with the :MEASure:SOURce command or with the optional parameter following the :MEASure:PWIDth command.

The algorithm is:

```
If the first edge on the screen is rising,
then
    pwidth = time at the first falling edge - time at the
             first rising edge
else
    pwidth = time at the second falling edge - time at the
             first rising edge
```

<source> {CHANnel<N> | DIFF<D> | COMMONmode<C> | FUNCTion<F> | DIGital<M> | WMEMory<R> | CLOCK | MTRend | MSPectrum | EQUalized}

For more information on <source> parameters, see "[Measurement Sources](#)" on page 728.

Example This example measures the width of the first positive pulse on the screen.

```
myScope.WriteString ":MEASure:PWIDth CHANnel1"
```

Query :MEASure:PWIDth? [<source>]

The :MEASure:PWIDth? query returns the measured width of the first positive pulse of the specified source.

Returned Format [:MEASure:PWIDth] <value>[,<result_state>] <NL>

<value> Width of the first positive pulse on the screen in seconds.

<result_state> If SENDvalid is ON, the result state is returned with the measurement result. See the :MEASure:RESults table in this chapter for a list of the result states.

Example This example places the value of the width of the first positive pulse on the screen in the numeric variable, varWidth, then prints the contents of the variable to the computer's screen.

```
myScope.WriteString ":SYSTem:HEADer OFF" ' Response headers off.
myScope.WriteString ":MEASure:PWIDth? CHANnel1"
varWidth = myScope.ReadNumber
Debug.Print FormatNumber(varWidth, 0)
```

History Legacy command (existed before version 3.10).

:MEASure:QUALifier<M>:CONDition

Command :MEASure:QUALifier<M>:CONDition {HIGH | LOW |
INSide | OUTSide}

The :MEASure:QUALifier<M>:CONDition command sets the condition when valid timing measurements are made

- Above Middle Threshold (HIGH)
- Below Middle Threshold (LOW)
- Between Upper, Lower Thresholds (INSide)
- Not Between Thresholds (OUTSide)

<M> An integer, 1–3.

Example This example sets the level qualifier 2 condition to HIGH.

```
myScope.WriteString ":MEASure:QUALifier2:CONDition HIGH"
```

Query :MEASure:QUALifier<M>:CONDition?

The :MEASure:QUALifier<M>:CONDition? query returns the condition being used of the level qualifier.

Returned Format [:MEASure:QUALifier<M>:CONDition] <source><NL>

Example This example places the current condition of level qualifier for timing measurements in the source variable and displays it on the computer's screen.

```
myScope.WriteString ":SYSTem:HEADer OFF" ' Response headers off.
myScope.WriteString ":MEASure:QUALifier2:CONDition?"
varSource = myScope.ReadNumber
Debug.Print FormatNumber(varSource, 0)
```

History Legacy command (existed before version 3.10).

:MEASure:QUALifier<M>:SOURce**Command****NOTE**

The channel being selected must not be used to make a timing measurement and must be turned on.

```
:MEASure:QUALifier<M>:SOURce <source>
```

The :MEASure:QUALifier<M>:SOURce command sets the source of the level qualify for timing measurements.

<source> CHANnel<N>

<N> An integer, 1-4 in a single oscilloscope, 1-40 in a MultiScope system.

<M> An integer, 1-3.

Example This example sets the level qualifier 2 source to the channel 1 waveform.

```
myScope.WriteString ":MEASure:QUALifier2:SOURce CHANnel1"
```

Query :MEASure:QUALifier<M>:SOURce?

The :MEASure:QUALifier<M>:SOURce? query returns the source being used of the level qualifier for timing measurements.

Returned Format [:MEASure:QUALifier<M>:SOURce] <source><NL>

Example This example places the current source of level qualifier for timing measurements in the source variable and displays it on the computer's screen.

```
myScope.WriteString ":SYSTem:HEADer OFF" ' Response headers off.
myScope.WriteString ":MEASure:QUALifier2:SOURce?"
varSource = myScope.ReadNumber
Debug.Print FormatNumber(varSource, 0)
```

History Legacy command (existed before version 3.10).

:MEASure:QUALifier<M>:STATe

Command :MEASure:QUALifier<M>:STATe {{ON | 1} | {OFF | 0}}

The :MEASure:QUALifier<M>:STATe command enables or disables level qualifying for timing measurements.

<M> An integer, 1-3.

Example This example sets the level qualifier 2 state to ON.

```
myScope.WriteString ":MEASure:QUALifier2:STATe ON"
```

Query :MEASure:QUALifier<M>:STATe?

The :MEASure:QUALifier<M>:STATe? query returns the state of the level qualifier for timing measurements.

Returned Format [:MEASure:QUALifier<M>:SOURce] {1 | 0}<NL>

Example This example places the current state of the level qualifier for timing measurements in the state variable and displays it on the computer's screen.

```
myScope.WriteString ":SYSTem:HEADer OFF" ' Response headers off.
myScope.WriteString ":MEASure:QUALifier2:STATe?"
varstate = myScope.ReadNumber
Debug.Print FormatNumber(varstate, 0)
```

History Legacy command (existed before version 3.10).

:MEASure:RESults?

Query :MEASure:RESults?

The :MEASure:RESults? query returns the results of the continuously displayed measurements. The response to the MEASure:RESults? query is a list of comma-separated values. If SENDvalid is ON, the results state is returned.

If more than one measurement is running continuously, the values in the :MEASure:RESults returned are duplicated for each continuous measurement from the first to last (left to right) result displayed. Each result returned is separated from the previous result by a comma. There is a maximum of five continuous measurements that can be continuously displayed at a time.

Returned Format [:MEASure:RESults] <result_list><NL>

<result_list> A list of the measurement results separated with commas. The following shows the order of values received for a single measurement if :MEASure:STATistics is set to ON.

| Measure ment label | current | result state | min | max | mean | std dev | # of meas |
|--------------------------|---------|-----------------|-----|-----|------|---------|-----------|
| | | | | | | | |

Min, max, mean, std dev, and # of meas are only returned if the :MEASure:STATistics is ON. The result state is only returned if :MEASure:SENDvalid is ON. See [Table 14](#) for the meaning of the result state codes.

If the :MEASure:STATistics is set to CURRENT, MAX, MEAN, MIN, or STDDEV only that particular statistic value is returned for each measurement that is on.

Example This example places the current results of the measurements in the string variable, strResult, then prints the contents of the variable to the computer's screen.

```
Dim strResult As String ' Dimension variable.
myScope.WriteString ":MEASure:RESults?"
strResult = myScope.ReadString
Debug.Print strResult
```

Table 14 Result States

| Code | Description |
|------|---|
| 0 | Result correct. No problem found. |
| 1 | Result questionable but could be measured. |
| 2 | Result less than or equal to value returned. |
| 3 | Result greater than or equal to value returned. |
| 4 | Result returned is invalid. |

Table 14 Result States (continued)

| Code | Description |
|------|--|
| 5 | Result invalid. Required edge not found. |
| 6 | Result invalid. Max not found. |
| 7 | Result invalid. Min not found. |
| 8 | Result invalid. Requested time not found. |
| 9 | Result invalid. Requested voltage not found. |
| 10 | Result invalid. Top and base are equal. |
| 11 | Result invalid. Measurement zone too small. |
| 12 | Result invalid. Lower threshold not on waveform. |
| 13 | Result invalid. Upper threshold not on waveform. |
| 14 | Result invalid. Upper and lower thresholds are too close. |
| 15 | Result invalid. Top not on waveform. |
| 16 | Result invalid. Base not on waveform. |
| 17 | Result invalid. Completion criteria not reached. |
| 18 | Result invalid. Measurement invalid for this type of waveform. |
| 19 | Result invalid. waveform is not displayed. |
| 20 | Result invalid. Waveform is clipped high. |
| 21 | Result invalid. Waveform is clipped low. |
| 22 | Result invalid. Waveform is clipped high and low. |
| 23 | Result invalid. Data contains all holes. |
| 24 | Result invalid. No data on screen. |
| 29 | Result invalid. FFT peak not found. |
| 30 | Result invalid. Eye pattern not found. |
| 31 | Result invalid. No NRZ eye pattern found. |
| 33 | Result invalid. There is more than one source on creating the database. |
| 35 | Signal may be too small to evaluate. |
| 36 | Result invalid. Awaiting completion of averaging. |
| 39 | Result invalid. Need jitter package to make this measurement or must be in jitter mode to make this measurement. |
| 40 | Current measurement is not on screen. |
| 41 | Not enough points available to recover the clock. |
| 42 | The loop band width of the PLL is too high to recover the clock. |

Table 14 Result States (continued)

| Code | Description |
|------|--|
| 43 | RJDJ pattern not found in data. |
| 45 | Clock recovery mode is not permitted. |
| 46 | Too much jitter to make a RJDJ separation. |

History Legacy command (existed before version 3.10).

:MEASure:RISetime

Command :MEASure:RISetime [<source>[,<start_level>,<stop_level>]]

The :MEASure:RISetime command measures the rise time of the first displayed edge by measuring the time at the lower threshold of the rising edge, measuring the time at the upper threshold of the rising edge, then calculating the rise time with the following algorithm:

Rise time = time at upper threshold point - time at lower threshold point.

To make this measurement requires 4 or more sample points on the rising edge of the waveform.

Sources are specified with the :MEASure:SOURce command or with the optional parameter following the RISetime command. With standard thresholds selected, the lower threshold is at the 10% point and the upper threshold is at the 90% point on the rising edge.

<source> {CHANnel<N> | DIFF<D> | COMMONmode<C> | FUNCTION<F> | WMEMory<R> | CLOCK | MTRend | MSPectrum | EQUALized}

For more information on <source> parameters, see "[Measurement Sources](#)" on page 728.

<start_level>,
<stop_level> When the signal type is PAM-4 (see :ANALyze:SIGNal:TYPE), the <start_level> and <stop_level> parameters are integers that identify the edge to measure. For PAM-4, the levels may be from 0-3.

For PAM rise time measurements, "Measure All Edges" must be turned on (see :ANALyze:AEDGes).

Example This example measures the rise time of the channel 1 waveform.

```
myScope.WriteString ":MEASure:RISetime CHANnel1"
```

Query :MEASure:RISetime? [<source>[,<start_level>,<stop_level>]]

The :MEASure:RISetime? query returns the rise time of the specified source.

Returned Format [:MEASure:RISetime] <value>[,<result_state>]<NL>

<value> Rise time in seconds.

<result_state> If SENDvalid is ON, the result state is returned with the measurement result. See the :MEASure:RESults table in this chapter for a list of the result states.

Example This example places the current value of rise time in the numeric variable, varRise, then prints the contents of the variable to the computer's screen.

```
myScope.WriteString ":SYSTem:HEADer OFF" ' Response headers off.
myScope.WriteString ":MEASure:RISetime? CHANnel1"
varRise = myScope.ReadNumber
Debug.Print FormatNumber(varRise, 0)
```

See Also • "[:ANALyze:SIGNal:TYPE](#)" on page 271

- **":ANALyze:AEDGes"** on page 239

History Legacy command (existed before version 3.10).

Version 5.50: With PAM signal types, additional <start_level> and <stop_level> parameters are used to identify the edge to measure.

:MEASure:RJDJ:ALL?

Query

NOTE

This command is only available when the N5400A/N5401A Software is installed.

```
:MEASure:RJDJ:ALL?
```

The :MEASure:RJDJ:ALL? query returns all of the RJDJ jitter measurements. These values are returned as comma separated triples of values using the following format:

Returned Format

```
[ :MEASure:RJDJ:ALL<space>]
TJ(<format>),<result>,<state>,
RJ(<format>),<result>,<state>,
DJ(<format>),<result>,<state>,
PJ(<format>),<result>,<state>,
BUJ(<format>),<result>,<state>,
DDJ(<format>),<result>,<state>,
DCD,<result>,<state>,
ISI(<format>),<result>,<state>,
Transitions,<number_of_transitions>,<transitions_state>,
Scope RJ(<format>),<result>,<state>,
DDPWS,<result>,<state>,
ABUJ(<format>),<result>,<state><NL>
```

NOTE

Whether some of these values are included or not depends on the setting of :MEASure:RJDJ:METHOD and :MEASure:RJDJ:REPort.

For example, when :MEASure:RJDJ:REPort or :MEASure:RJDJ:METHOD is SPECTral, the BUJ and ABUJ values are not returned, and there are two PJ values (one "rms" and one "dd").

With PAM-4 signals, when the ":MEASure:RJDJ:PAMThreshold ALL" command setting has been made, the query results include values for multiple threshold levels. For example:

```
[ :MEASure:RJDJ:ALL<space>]
TJ(<format>) 01,<result>,<state>,
TJ(<format>) 12,<result>,<state>,
TJ(<format>) 23,<result>,<state>,
RJ(<format>) 01,<result>,<state>,
RJ(<format>) 12,<result>,<state>,
RJ(<format>) 23,<result>,<state>,
DJ(<format>) 01,<result>,<state>,
DJ(<format>) 12,<result>,<state>,
DJ(<format>) 23,<result>,<state>,
Transitions 01,<number_of_transitions>,<transitions_state>,
Transitions 12,<number_of_transitions>,<transitions_state>,
Transitions 23,<number_of_transitions>,<transitions_state><NL>
```

Otherwise, the query results are for the specific threshold level specified in the :MEASure:RJDJ:PAMThreshold command.

- <space>** White space (ASCII 32) character.
- <format>** The format value tells you something about how the measurement is made. For instance, TJ(1E-12) means that the TJ measurement was derived using a bit error rate of 1E-12. A format of (rms) means the measurement is a root-mean-square measurement. A format of (dd) means the measurement uses a dual-Dirac delta model to derive the measurement. A format of (pp) means the measurement is a peak-to-peak measurement.
- <result>** The measured results for the RJDJ measurements. A value of 9.99999E+37 means that the oscilloscope was unable to make the measurement.
- <state>** The measurement result state. See [Table 14](#) for a list of values and descriptions of the result state value.
- <number_of_transitions>** The number of waveform transitions that have been measured.

Example This example places the jitter measures in the strResults variable and displays it on the computer's screen.

```
Dim strResult As String ' Dimension variable.
myScope.WriteString ":SYSTEM:HEADer OFF" ' Response headers off.
myScope.WriteString ":MEASure:RJDJ:ALL?"
strResults = myScope.ReadString
Debug.Print strResults
```

- See Also**
- [":MEASure:RJDJ:METHod"](#) on page 880
 - [":MEASure:RJDJ:REPort"](#) on page 884
 - [":MEASure:RJDJ:PAMThreshold"](#) on page 882

History Legacy command (existed before version 3.10).

Version 3.50: There are two possible additional measurement results, Scope RN(rms) and DDPWS.

Version 4.10: New results can be returned depending on the :MEASure:RJDJ:METHod and :MEASure:RJDJ:REPort settings.

Version 6.10: Jitter analysis is supported on PAM-4 signals. When the ":MEASure:RJDJ:PAMThreshold ALL" command setting has been made, the query results include values for multiple threshold levels; otherwise, the query results are for the specific threshold level specified in the :MEASure:RJDJ:PAMThreshold command.

:MEASure:RJDJ:APLength?

Query

NOTE

This command is only available when the N5400A/N5401A Software is installed.

```
:MEASure:RJDJ:APLength?
```

The :MEASure:RJDJ:APLength? query returns the determined RjDj pattern length.

Returned Format [:MEASure:RJDJ:APLength] <value><NL>

<value> The determined RjDj pattern length as a numeric data value. Invalid (9.99999E+37) is returned if there is no data.

Example This example places the calculated pattern length in the strResults variable and displays it on the computer's screen.

```
Dim strResult As String ' Dimension variable.
myScope.WriteString ":SYSTem:HEADer OFF" ' Response headers off.
myScope.WriteString ":MEASure:RJDJ:APLength?"
strResults = myScope.ReadString
Debug.Print strResults
```

History New in version 3.10.

:MEASure:RJDJ:BANDwidth**Command****NOTE**

This command is only available when the N5400A/N5401A Software is installed.

```
:MEASure:RJDJ:BANDwidth {NARRow | WIDE}
```

The :MEASure:RJDJ:BANDwidth command sets the type of filtering used to separate the data dependent jitter from the random jitter and the periodic jitter.

Example This example sets the RJ bandwidth to WIDE.

```
myScope.WriteString ":MEASure:RJDJ:BANDwidth WIDE"
```

Query

```
:MEASure:RJDJ:BANDwidth?
```

The :MEASure:RJDJ:BANDwidth? query returns the RJ bandwidth filter setting.

Returned Format

```
[ :MEASure:RJDJ:BANDwidth ] {NARRow | WIDE}<NL>
```

Example

This example places the RJ filter setting the varFilter variable and displays it on the computer's screen.

```
myScope.WriteString ":SYSTEM:HEADer OFF" ' Response headers off.
myScope.WriteString ":MEASure:RJDJ:BANDwidth?"
varFilter = myScope.ReadNumber
Debug.Print FormatNumber(varFilter, 0)
```

History

Legacy command (existed before version 3.10).

:MEASure:RJDJ:BER

Command

NOTE

This command is only available when the N5400A/N5401A Software is installed.

```
:MEASure:RJDJ:BER {E6 | E7 | E8 | E9 | E10 | E11 | E12 | E13 | E14
                   | E15 | E16 | E17 | E18 | J2 | J4 | J5 | J9}
```

The :MEASure:RJDJ:BER command sets the bit error rate for the Total Jitter (TJ) measurement. The E and J parameters have the following bit error rate meanings:

- E6 = 1E-6
- E7 = 1E-7
- E8 = 1E-8
- E9 = 1E-9
- E10 = 1E-10
- E11 = 1E-11
- E12 = 1E-12
- E13 = 1E-13
- E14 = 1E-14
- E15 = 1E-15
- E16 = 1E-16
- E17 = 1E-17
- E18 = 1E-18
- J2 = 2.5E-3
- J4 = 2.5E-5
- J5 = 2.5E-6
- J9 = 2.5E-10

Example This example sets the bit error rate to E16.

```
myScope.WriteString ":MEASure:RJDJ:BER E16"
```

Query :MEASure:RJDJ:BER?

The :MEASure:RJDJ:BER? query returns the bit error rate setting.

Returned Format [:MEASure:RJDJ:BER] {E6 | E7 | E8 | E9 | E10 | E11 | E12 | E13 | E14
| E15 | E16 | E17 | E18 | J2 | J4 | J5 | J9}<NL>

Example This example places the bit error rate in the varRate variable and displays it on the computer's screen.

```
myScope.WriteString ":SYSTem:HEADer OFF" ' Response headers off.  
myScope.WriteString ":MEASure:RJDJ:BER?"  
varRate = myScope.ReadNumber  
Debug.Print FormatNumber(varRate, 0)
```

History Legacy command (existed before version 3.10).

Version 3.10: Added J2 and J9 jitter BER levels.

Version 5.75: Added J4 and J5 jitter BER levels.

:MEASure:RJDJ:CLOCK

Command

NOTE

This command is available when the EZJIT Plus or EZJIT Complete jitter analysis software is installed.

```
:MEASure:RJDJ:CLOCK {ON | OFF}
```

When the :MEASure:RJDJ:CLOCK command is set to ON, it forces the pattern to be a clock and sets the jitter for edges not examined to zero (0).

To measure jitter on only rising (or falling) edges of a clock, you must also set :MEASure:CLOCK:METHod:EDGE to RISing or FALLing, and you must set :MEASure:RJDJ:EDGE to the same RISing or FALLing option.

Example This example turns on the RJDJ clock option.

```
myScope.WriteString ":MEASure:RJDJ:CLOCK ON"
```

Query

```
:MEASure:RJDJ:CLOCK?
```

The :MEASure:RJDJ:CLOCK? query returns the setting.

Returned Format

```
[ :MEASure:RJDJ:CLOCK] {ON | OFF}<NL>
```

Example This example places the current RJDJ clock setting in the strSetting variable and displays it on the computer's screen.

```
myScope.WriteString ":SYSTEM:HEADer OFF" ' Response headers off.
myScope.WriteString ":MEASure:RJDJ:CLOCK?"
strSetting = myScope.ReadNumber
Debug.Print strSetting
```

See Also

- [":ANALyze:CLOCK:METHod:EDGE"](#) on page 247
- [":MEASure:RJDJ:EDGE"](#) on page 878

History New in version 4.30.

:MEASure:RJDJ:EDGE**Command****NOTE**

This command is only available when the N5400A/N5401A Software is installed.

```
:MEASure:RJDJ:EDGE {RISing | FALLing | BOTH}
```

The :MEASure:RJDJ:EDGE command sets the edge used for the RJDJ measurements.

Example This example sets the RJDJ edge to use both edges.

```
myScope.WriteString ":MEASure:RJDJ:EDGE BOTH"
```

Query

```
:MEASure:RJDJ:EDGE?
```

The :MEASure:RJDJ:EDGE? query returns the edge being used for the RJDJ measurements.

Returned Format

```
[ :MEASure:RJDJ:EDGE ] {RIS | FALL | BOTH} <NL>
```

Example

This example places the current edge being used for RJDJ measurements in the varEdge variable and displays it on the computer's screen.

```
myScope.WriteString ":SYSTem:HEADer OFF"      ' Response headers off.
myScope.WriteString ":MEASure:RJDJ:EDGE?"
varEdge = myScope.ReadNumber
Debug.Print FormatNumber(varEdge, 0)
```

History

Legacy command (existed before version 3.10).

:MEASure:RJDJ:INTerpolate

Command

NOTE

This command is only available when the N5400A/N5401A Software is installed.

```
:MEASure:RJDJ:INTerpolate {LINear | NONE}
```

The :MEASure:RJDJ:INTerpolate command sets the interpolation mode used for the RJDJ measurements.

Example This example sets the RJDJ interpolation to use both linear.

```
myScope.WriteString ":MEASure:RJDJ:INTerpolate LINear"
```

Query :MEASure:RJDJ:INTerpolate?

The :MEASure:RJDJ:INTerpolate? query returns the interpolation mode being used for the RJDJ measurements.

Returned Format [:MEASure:RJDJ:INTerpolate] {LINear | NONE}<NL>

Example This example places the current interpolation mode being used for RJDJ measurements in the interpolate variable and displays it on the computer's screen.

```
myScope.WriteString ":SYSTem:HEADer OFF" ' Response headers off.
myScope.WriteString ":MEASure:RJDJ:INTerpolate?"
varinterpolate = myScope.ReadNumber
Debug.Print FormatNumber(varinterpolate, 0)
```

History Legacy command (existed before version 3.10).

:MEASure:RJDJ:METhod

Command

NOTE

This command is only available when the EZJIT Plus jitter analysis application is licensed.

```
:MEASure:RJDJ:METhod {SPEctral | BOTH}
```

The :MEASure:RJDJ:METhod command lets you select the method for random jitter (RJ) analysis, either the SPEctral method or BOTH the spectral and tail fit methods.

When analyzing jitter with crosstalk or ground bounce effects present in your signal, select BOTH. When this option is selected, the deterministic jitter (DJ) that is uncorrelated to the data pattern, also known as bounded uncorrelated jitter (BUJ), is separated into periodic jitter (PJ) and aperiodic bounded uncorrelated jitter (ABUJ). ABUJ is caused by crosstalk and ground bounce effects.

When there are no crosstalk or ground bounce effects present in your signal, you can select the SPEctral method in order to run faster. When this option is selected, the deterministic jitter (DJ) that is uncorrelated to the data pattern is all reported as periodic jitter (PJ).

Example This example sets the RJDJ method to BOTH the spectral and tail fit analysis.

```
myScope.WriteString ":MEASure:RJDJ:METhod BOTH"
```

Query :MEASure:RJDJ:METhod?

The :MEASure:RJDJ:METhod? query returns the selected RJDJ method.

Returned Format [:MEASure:RJDJ:METhod] {SPEC | BOTH}<NL>

Example This example places the RJDJ method setting the strJitterMethod variable and displays it on the computer's screen.

```
myScope.WriteString ":SYSTem:HEADer OFF" ' Response headers off.
myScope.WriteString ":MEASure:RJDJ:METhod?"
strJitterMethod = myScope.ReadString
Debug.Print strJitterMethod
```

See Also • [":MEASure:RJDJ:REPort"](#) on page 884

History New in version 4.10.

:MEASure:RJDJ:MODE**Command****NOTE**

This command is only available when the N5400A/N5401A Software is installed.

```
:MEASure:RJDJ:MODE {TIE | PERiod | NUI[,<ui>]}
```

The :MEASure:RJDJ:MODE command sets the RJDJ measurement mode. If NUI is selected then <ui> selects the number of unit intervals (for example: :MEASure:RJDJ:MODE NUI,5).

Example This example sets the RJDJ mode to TIE.

```
myScope.WriteString ":MEASure:RJDJ:MODE TIE"
```

Query :MEASure:RJDJ:MODE?

The :MEASure:RJDJ:MODE? query returns the mode of the RJDJ measurements.

History Legacy command (existed before version 3.10).

:MEASure:RJDJ:PAMThreshold

Command :MEASure:RJDJ:PAMThreshold <level>
<level> ::= {T01 | T12 | T23 | ALL}

The :MEASure:RJDJ:PAMThreshold command specifies which PAM thresholds to measure for PAM-4 signals.

Query :MEASure:RJDJ:PAMThreshold?

The :MEASure:RJDJ:PAMThreshold? query returns the PAM threshold setting.

Returned Format <level><NL>

- See Also**
- [":DISPlay:JITTer:THReshold"](#) on page 476
 - [":MEASure:RJDJ:ALL?"](#) on page 871
 - [":MEASure:RJDJ:TJRJDJ?"](#) on page 889

History New in version 6.10.

:MEASure:RJDJ:PLENgtH

Command

NOTE

This command is only available when the N5400A/N5401A Software is installed.

```
:MEASure:RJDJ:PLENgtH {AUTO
| {ARBitrary,<isi_filter_lead>,<isi_filter_lag>}
| <number_of_bits>}
```

The :MEASure:RJDJ:PLENgtH command sets the number of bits used pattern length for the RJDJ measurements.

<isi_filter_lead> An integer number that is less than or equal to 0 that is the number of leading bits that are used to calculate the ISI filter.

<isi_filter_lag> An integer number that is greater than or equal to 0 that is the number of trailing bits used to calculate the ISI filter.

<number_of_bits> An integer number that is the length of pattern from 2 to 1024.

Example This example sets the RJDJ bits to 5.

```
myScope.WriteString ":MEASure:RJDJ:PLENgtH 5"
```

Query :MEASure:RJDJ:PLENgtH?

The :MEASure:RJDJ:PLENgtH? query returns the number of bits being used for the RJDJ measurements when Periodic pattern length is set. For Arbitrary pattern length, the ISI filter lead and filter lag numbers are returned.

Returned Format [MEASure:RJDJ:PLENgtH] {AUTO
| ARBitrary,<isi_filter_lead>,<isi_filter_lag>
| <number_of_bits>}<NL>

Example This example places the current number of bits for RJDJ measurements in the varBits variable and displays it on the computer's screen.

```
myScope.WriteString ":SYSTem:HEADer OFF" ' Response headers off.
myScope.WriteString ":MEASure:RJDJ:PLENgtH?"
varBits = myScope.ReadNumber
Debug.Print FormatNumber(varBits, 0)
```

History Legacy command (existed before version 3.10).

:MEASure:RJDJ:REPort

Command

NOTE

This command is only available when the EZJIT Plus jitter analysis application is licensed.

```
:MEASure:RJDJ:REPort {SPECTral | TAILfit}
```

When the :MEASure:RJDJ:METHOD BOTH command selects both the spectral and tail fit methods for random jitter analysis, the :MEASure:RJDJ:REPort command specifies which method is used for the reports in the jitter graphs/histograms and Jitter tab measurements.

Example This example specifies that the RJDJ report include measurements from both the spectral and tail fit analysis (including aperiodic bounded uncorrelated jitter ABUJ measurements).

```
myScope.WriteString ":MEASure:RJDJ:REPort TAILfit"
```

Query

```
:MEASure:RJDJ:REPort?
```

The :MEASure:RJDJ:REPort? query returns the report setting.

Returned Format

```
[ :MEASure:RJDJ:REPort ] {SPEC | TAIL}<NL>
```

Example This example places the report setting in the strReportSetting variable and displays it on the computer's screen.

```
myScope.WriteString ":SYSTem:HEADer OFF" ' Response headers off.
myScope.WriteString ":MEASure:RJDJ:REPort?"
strReportSetting = myScope.ReadString
Debug.Print strReportSetting
```

See Also · [":MEASure:RJDJ:METHOD"](#) on page 880

History New in version 4.10.

:MEASure:RJDJ:RJ

Command

NOTE

This command is available when the EZJIT Plus software is installed.

```
:MEASure:RJDJ:RJ {ON, <RJrms> | OFF}
```

The :MEASure:RJDJ:RJ command can specify a known amount of random jitter. When used, the remaining amount of the total jitter measured is reported as periodic jitter (PJ).

This command is used in situations when crosstalk aggressors influence the random jitter measured on a signal. If the random jitter on a signal is measured without the aggressor signal crosstalk, this known amount of random jitter can be specified when measuring the jitter again with the crosstalk aggressors.

- ON – Enables a specified amount of random jitter.
- <RJrms> – The known amount of random jitter.
- OFF – Disables the specification of known random jitter.

The amount of random jitter is shown in the jitter measurement results (see [page 871](#)) as "RJ(rms specified)".

Example This example specifies 500 fs of random jitter.

```
myScope.WriteString ":MEAS:RJDJ:RJ ON, 500e-15"
```

Query :MEASure:RJDJ:RJ?

The :MEASure:RJDJ:RJ? query returns the specified RJ settings.

Returned Format [:MEASure:RJDJ:RJ] {ON, <RJrms> | OFF}<NL>

Example This example places the specified RJ settings in the strKnownRandomJitter variable and displays it on the computer's screen.

```
myScope.WriteString ":SYSTem:HEADer OFF" ' Response headers off.
myScope.WriteString ":MEASure:RJDJ:RJ?"
strKnownRandomJitter = myScope.ReadString
Debug.Print strKnownRandomJitter
```

History New in version 3.50.

:MEASure:RJDJ:SCOPE:RJ

Command

NOTE

This command is available when the EZJIT Plus software is installed.

```
:MEASure:RJDJ:SCOPE:RJ {ON, <RJrms> | AUTO | OFF}
```

The :MEASure:RJDJ:SCOPE:RJ command can specify the removal of the oscilloscope's calibrated random jitter from the reported RJ.

- ON – Enables the "manual" removal of a known oscilloscope random jitter from the reported RJ.
- <RJrms> – The known oscilloscope random jitter to remove from the reported RJ.
- AUTO – This option cannot be selected until the scope jitter calibration has been run (use the **Calibrate scope jitter** button in the front panel user interface). When selected, the calculated oscilloscope random jitter is removed from the reported RJ.

The calculated oscilloscope random jitter is shown in the jitter measurement results (see [page 871](#)) as "Scope RJ(rms)".

- OFF – Disables the removal of the oscilloscope's calibrated random jitter from the reported RJ.

Example This example specifies 300 fs of known oscilloscope random jitter.

```
myScope.WriteString ":MEASure:RJDJ:SCOPE:RJ ON, 300e-15"
```

Query :MEASure:RJDJ:SCOPE:RJ?

The :MEASure:RJDJ:SCOPE:RJ? query returns the oscilloscope RJ settings.

Returned Format [:MEASure:RJDJ:SCOPE:RJ] {ON, <RJrms> | OFF}<NL>

Example This example places the oscilloscope RJ settings in the strScopeRJSettings variable and displays it on the computer's screen.

```
myScope.WriteString ":SYSTem:HEADer OFF" ' Response headers off.
myScope.WriteString ":MEASure:RJDJ:SCOPE:RJ?"
strScopeRJSettings = myScope.ReadString
Debug.Print strScopeRJSettings
```

History New in version 3.50.

:MEASure:RJDJ:SOURce

Command

NOTE

This command is only available when the N5400A/N5401A Software is installed.

```
:MEASure:RJDJ:SOURce <source>
```

The :MEASure:RJDJ:SOURce command sets the source for the RJDJ measurements.

<source> {CHANnel<N> | DIFF<D> | COMMONmode<C> | FUNCTion<F> | WMEMory<R> | EQUalized}

For more information on <source> parameters, see "[Measurement Sources](#)" on page 728.

Example This example sets the RJDJ source to the channel 1 waveform.

```
myScope.WriteString ":MEASure:RJDJ:SOURce CHANnel1"
```

Query :MEASure:RJDJ:SOURce?

The :MEASure:RJDJ:SOURce? query returns the source being used for the RJDJ measurements.

Returned Format [:MEASure:RJDJ:SOURce] <source><NL>

Example This example places the current source for RJDJ measurements in the varSource variable and displays it on the computer's screen.

```
myScope.WriteString ":SYSTem:HEADer OFF" ' Response headers off.
myScope.WriteString ":MEASure:RJDJ:SOURce?"
varSource = myScope.ReadNumber
Debug.Print FormatNumber(varSource, 0)
```

History Legacy command (existed before version 3.10).

:MEASure:RJDJ:STATe**Command****NOTE**

This command is only available when the N5400A/N5401A Software is installed.

```
:MEASure:RJDJ:STATe {ON | OFF}
```

The :MEASure:RJDJ:STATe command enables or disables the RJDJ measurements.

Example This example sets the RJDJ state to on.

```
myScope.WriteString ":MEASure:RJDJ:STATe ON"
```

Query

```
:MEASure:RJDJ:STATe?
```

The :MEASure:RJDJ:STATe? query returns the state of the RJDJ measurements.

Returned Format [:MEASure:RJDJ:STATe] {1 | 0}<NL>

Example This example places the current state of the RJDJ measurements in the varState variable and displays it on the computer's screen.

```
myScope.WriteString ":SYSTEM:HEADer OFF" ' Response headers off.
myScope.WriteString ":MEASure:RJDJ:STATe?"
varState = myScope.ReadNumber
Debug.Print FormatNumber(varState, 0)
```

History Legacy command (existed before version 3.10).

:MEASure:RJDJ:TJRJDJ?

Query

NOTE

This command is only available when the N5400A/N5401A Software is installed.

```
:MEASure:RJDJ:TJRJDJ?
```

The :MEASure:RJDJ:TJRJDJ? query returns the Total Jitter (TJ), Random Jitter (RJ), and the Deterministic Jitter (DJ) measurements. These values are returned as comma separated triples of values using the following format:

Returned Format

```
[ :MEASure:RJDJ:TJRJDJ ] TJ(<tj_format>),<tj_result>,<tj_state>,  
RJ(<rj_format>),<rj_result>,<rj_state>,  
DJ(<dj_format>),<dj_result>,<dj_state><NL>
```

With PAM-4 signals, when the ":MEASure:RJDJ:PAMThreshold ALL" command setting has been made, the query results include values for multiple threshold levels. For example:

```
[ :MEASure:RJDJ:TJRJDJ ] TJ(<tj_format>) 01,<tj_result>,<tj_state>,  
TJ(<tj_format>) 12,<tj_result>,<tj_state>,  
TJ(<tj_format>) 23,<tj_result>,<tj_state>,  
RJ(<rj_format>) 01,<rj_result>,<rj_state>,  
RJ(<rj_format>) 12,<rj_result>,<rj_state>,  
RJ(<rj_format>) 23,<rj_result>,<rj_state>,  
DJ(<dj_format>) 01,<dj_result>,<dj_state>,  
DJ(<dj_format>) 12,<dj_result>,<dj_state>,  
DJ(<dj_format>) 23,<dj_result>,<dj_state><NL>
```

Otherwise, the query results are for the specific threshold level specified in the :MEASure:RJDJ:PAMThreshold command.

| | |
|-------------|---|
| <tj_format> | The format value tells you something about how the measurement is made. For instance, TJ(1E-12) means that the TJ measurement was derived using a bit error rate of 1E-12. A format of (rms) means the measurement is a root-mean-square measurement. A format of (d-d) means the measurement uses from a dual-Dirac delta model used to derive the measurement. A format of (p-p) means the measurement is a peak-to-peak measurement. |
| <rj_format> | |
| <dj_format> | |
| <tj_result> | The measured results for the RJDJ measurements. A value of 9.99999E+37 means that the oscilloscope was unable to make the measurement. |
| <rj_result> | |
| <dj_result> | |
| <tj_state> | The measurement result state. See Table 14 for a list of values and descriptions of the result state value. |
| <rj_state> | |
| <dj_state> | |

Example This example places the Total Jitter (TJ), Random Jitter (RJ), and the Deterministic Jitter (DJ) measurements in the strResults variable and displays it on the computer's screen.

```
Dim strResult As String ' Dimension variable.  
myScope.WriteString ":SYSTem:HEADer OFF" ' Response headers off.  
myScope.WriteString ":MEASure:RJDJ:TJRJDJ?"  
strResult = myScope.ReadString  
Debug.Print strResult
```

See Also • [":MEASure:RJDJ:PAMThreshold"](#) on page 882

History Legacy command (existed before version 3.10).

Version 6.10: Jitter analysis is supported on PAM-4 signals. When the ":MEASure:RJDJ:PAMThreshold ALL" command setting has been made, the query results include values for multiple threshold levels; otherwise, the query results are for the specific threshold level specified in the :MEASure:RJDJ:PAMThreshold command.

:MEASure:RJDJ:UNITs

Command

NOTE

This command is only available when the N5400A/N5401A Software is installed.

```
:MEASure:RJDJ:UNITs {SECond | UNITinterval}
```

The :MEASure:RJDJ:UNITs command sets the unit of measure for RJDJ measurements to seconds or unit intervals.

Example This example sets the RJDJ units to unit interval.

```
myScope.WriteString ":MEASure:RJDJ:UNITs UNITinterval"
```

Query

```
:MEASure:RJDJ:UNITs?
```

The :MEASure:RJDJ:UNITs? query returns the units of measure being used for the RJDJ measurements.

Returned Format [:MEASure:RJDJ:UNITs] {SECond | UNITinterval}<NL>

Example This example places the current units of measure for the RJDJ measurements in the varUnits variable and displays it on the computer's screen.

```
myScope.WriteString ":SYSTem:HEADer OFF" ' Response headers off.
myScope.WriteString ":MEASure:RJDJ:UNITs?"
varUnits = myScope.ReadNumber
Debug.Print FormatNumber(varUnits, 0)
```

History Legacy command (existed before version 3.10).

:MEASure:SCRatch

Command :MEASure:{SCRatch | CLear}

The :MEASure:SCRatch command clears the measurement results from the screen. This command performs the same function as :MEASure:CLear.

Example This example clears the current measurement results from the screen.

```
myScope.WriteString ":MEASure:SCRatch"
```

History Legacy command (existed before version 3.10).

:MEASure:SENDvalid

Command :MEASure:SENDvalid {{OFF|0} | {ON|1}}

The :MEASure:SENDvalid command enables the result state code to be returned with the :MEASure:RESults? query and all other measurement queries.

Example This example turns the send valid function on.

```
myScope.WriteString ":MEASure:SENDvalid ON"
```

Query :MEASure:SENDvalid?

The :MEASure:SENDvalid? query returns the state of the send valid control.

Returned Format {:MEASure:SENDvalid] {0 | 1}<NL>

Example This example places the current mode for SENDvalid in the string variable, strMode, then prints the contents of the variable to the computer's screen.

```
Dim strMode As String ' Dimension variable.
myScope.WriteString ":MEASure:SENDvalid?"
strMode = myScope.ReadString
Debug.Print strMode
```

See Also Refer to the :MEASure:RESults? query for information on the results returned and how they are affected by the SENDvalid command. Refer to the individual measurements for information on how the result state is returned.

History Legacy command (existed before version 3.10).

:MEASure:SER

Command :MEASure:SER <source>, {AUTO | <pattern_length>}

<source> ::= {CHANnel<N> | FUNction<F> | WMEMory<R>}

<N> is an integer, 1-4 in a single oscilloscope, 1-40 in a MultiScope system.

<F> is an integer, 1-16.

<pattern_length> ::= integer number of symbols.

<R> is an integer, 1-4.

The :MEASure:SER command installs a cumulative symbol error rate (SER) measurement of the specified PAM waveform into the user interface's measurement Results pane.

With PAM signals, there can be multiple bits per symbol, and symbol error rate is related to bit error rate (BER). For example, with PAM-4 one symbol error can translate to one or two bit errors.

Query :MEASure:SER? <source>, {AUTO | <pattern_length>}

The :MEASure:SER? query returns the measured cumulative symbol error rate value.

Returned Format [:MEASure:SER] <value><NL>

<value> ::= the cumulative SER value in NR3 format.

- See Also**
- [":MEASure:BER"](#) on page 732
 - [":MEASure:BERPeracq"](#) on page 733
 - [":MEASure:SERPeracq"](#) on page 895

History New in version 5.60.

:MEASure:SERPeracq

Command :MEASure:SERPeracq <source>,{AUTO | <pattern_length>}

<source> ::= {CHANnel<N> | FUNction<F> | WMEMory<R>}

<N> is an integer, 1-4 in a single oscilloscope, 1-40 in a MultiScope system.

<F> is an integer, 1-16.

<R> is an integer, 1-4.

<pattern_length> ::= integer number of symbols.

The :MEASure:SERPeracq command installs a symbol error rate (SER) per acquisition measurement of the specified PAM waveform into the user interface's measurement Results pane.

With PAM signals, there can be multiple bits per symbol, and symbol error rate is related to bit error rate (BER). For example, with PAM-4 one symbol error can translate to one or two bit errors.

Query :MEASure:SERPeracq? <source>,{AUTO | <pattern_length>}

The :MEASure:SERPeracq? query returns the measured symbol error rate per acquisition value.

Returned Format [:MEASure:SERPeracq] <value><NL>

<value> ::= the SER per acquisition value in NR3 format.

- See Also**
- [":MEASure:BER"](#) on page 732
 - [":MEASure:BERPeracq"](#) on page 733
 - [":MEASure:SER"](#) on page 894

History New in version 5.60.

:MEASure:SETuptime

Command

NOTE

This command is only available when the E2681A Jitter Analysis Software or the N5400A/5401A Software is installed.

```
:MEASure:SETuptime [<data_source>,<data_source_dir>,  
                   <clock_source>,<clock_source_dir>]
```

The :MEASure:SETuptime command measures the setup time between the specified clock and data source.

This command sets the "Measure All Edges" mode if it is not currently set. You can use the :ANALyze:AEDGes command to turn the "Measure All Edges" mode off (or on again).

<data_source> {CHANnel<N> | FUNction<F> | WMEMory<R> | CLOCK | MTRend | MSPectrum | EQUalized}

MTRend and MSPectrum sources are only available if the oscilloscope has the EZJIT option installed and the feature is enabled.

The CLOCK source is only available if the oscilloscope has the High Speed Serial option installed and the feature is enabled.

The EQUalized source is only available if the oscilloscope has the High Speed Serial option and the Serial Data Equalization option installed and the features are enabled. This command uses the Feed-Forward Equalized (FFE) signal as the source.

<clock_source> {CHANnel<N> | FUNction<F> | DIGital<M> | WMEMory<R> | CLOCK | MTRend | MSPectrum | EQUalized}

MTRend and MSPectrum sources are only available if the oscilloscope has the EZJIT option installed and the feature is enabled.

The CLOCK source is only available if the oscilloscope has the High Speed Serial option installed and the feature is enabled.

The EQUalized source is only available if the oscilloscope has the High Speed Serial option and the Serial Data Equalization option installed and the features are enabled. This command uses the Feed-Forward Equalized (FFE) signal as the source.

<N> An integer, 1-4 in a single oscilloscope, 1-40 in a MultiScope system.

<F> An integer, 1-16.

<M> An integer, 0-15. Digital channels are available on mixed-signal oscilloscopes.

<R> An integer, 1-4.

<data_source_dir> {RISing | FALLing | BOTH}
 Selects the direction of the data source edge. BOTH selects both edges to be measured.

<clock_source_dir> {RISing | FALLing}
 Selects the direction of the clock source edge.

Example This example measures the setup time from the rising edge of channel 1 to the rising edge of channel 2.

```
myScope.WriteString ":MEASure:SETuptime CHAN1,RIS,CHAN2,RIS"
```

Query :MEASure:SETuptime? [<data_source>,<data_source_dir>,<clock_source>,<clock_source_dir>]

The :MEASure:SETuptime query returns the measured setup time between the specified clock and data source.

The necessary waveform edges must be present on the display. Also, the "Measure All Edges" mode must be set (use the :ANALyze:AEDGes command or :MEASure:SETuptime command before the query).

The query will return 9.99999E+37 if the necessary edges are not displayed or if the "Measure All Edges" mode is not currently set.

Returned Format { :MEASure:SETuptime] <value><NL>

<value> Setup time in seconds.

Example This example places the current value of setup time in the numeric variable, varTime, then prints the contents of the variable to the computer's screen.

```
myScope.WriteString ":SYSTem:HEADer OFF" ' Response headers off.
myScope.WriteString ":MEASure:SETuptime? CHAN1,RIS,CHAN2,RIS"
varTime = myScope.ReadNumber
Debug.Print FormatNumber(varTime, 0)
```

See Also • [":ANALyze:AEDGes"](#) on page 239

History Legacy command (existed before version 3.10).

:MEASure:SLEWrate

Command

NOTE

This command is only available when the E2681A Jitter Analysis Software is installed.

```
:MEASure:SLEWrate [<data_source>, <edge_dir>]
```

The :MEASure:SLEWrate command measures the slew rate of the specified data source.

<data_source> {CHANnel<N> | FUNction<F> | WMemory<R> | CLOCK | MTRend | MSPectrum | EQUalized}

MTRend and MSPectrum sources are only available if the oscilloscope has the EZJIT option installed and the feature is enabled.

The CLOCK source is only available if the oscilloscope has the High Speed Serial option installed and the feature is enabled.

The EQUalized source is only available if the oscilloscope has the High Speed Serial option and the Serial Data Equalization option installed and the features are enabled. This command uses the Feed-Forward Equalized (FFE) signal as the source.

<N> An integer, 1-4 in a single oscilloscope, 1-40 in a MultiScope system.

<F> An integer, 1-16.

<R> An integer, 1-4.

<edge_dir> {RISing | FALLing | BOTH}

Example This example measures the slew rate of channel 1.

```
myScope.WriteString ":MEASure:SLEWrate CHANnel1,RISing"
```

Query :MEASure:SLEWrate? [<data_source>, <edge_dir>]

The :MEASure:SLEWrate? query returns the measured slew rate for the specified source.

Returned Format {:MEASure:SLEWrate] <value><NL>

<value> Slew rate in volts per second.

Example This example places the channel 1 value of slew rate in the numeric variable, varTime, then prints the contents of the variable to the computer's screen.

```
myScope.WriteString ":SYSTem:HEADer OFF" ' Response headers off.
myScope.WriteString ":MEASure:SLEWrate? CHANnel1,RISing"
varTime = myScope.ReadNumber
Debug.Print FormatNumber(varTime, 0)
```

History Legacy command (existed before version 3.10).

:MEASure:SOURce

Command :MEASure:SOURce {<source>[,<source>]}

The :MEASure:SOURce command selects the source for measurements. You can specify one or two sources with this command. All measurements except :MEASure:HOLDtime, :MEASure:SETUptime, and :MEASure:DELtatime are made on the first specified source. The delta time measurement uses two sources if two are specified.

<source> {CHANnel<N> | DIFF<D> | COMMONmode<C> | FUNCTION<F> | DIGital<M> | WMEMory<R> | CLOCK | MTRend | MSPectrum | EQUalized}

For more information on <source> parameters, see "[Measurement Sources](#)" on page 728.

Example This example selects channel 1 as the source for measurements.

```
myScope.WriteString ":MEASure:SOURce CHANnel1"
```

Query :MEASure:SOURce?

The :MEASure:SOURce? query returns the current source selection.

Returned Format [:MEASure:SOURce] <source>[,<source>] <NL>

Example This example places the currently specified sources in the string variable, strSource, then prints the contents of the variable to the computer's screen.

```
Dim strSource As String ' Dimension variable.
myScope.WriteString ":MEASure:SOURce?"
strSource = myScope.ReadString
Debug.Print strSource
```

History Legacy command (existed before version 3.10).

:MEASure:STATistics

Command :MEASure:STATistics {{ON | 1} | CURRent | MAXimum | MEAN | MINimum | STDDev}

The :MEASure:STATistics command determines the type of information returned by the :MEASure:RESults? query. ON means all the statistics are on.

Example This example turns all the statistics function on.

```
myScope.WriteString ":MEASure:STATistics ON"
```

Query :MEASure:STATistics?

The :MEASure:STATistics? query returns the current statistics mode.

Returned Format [:MEASure:STATistics] {ON | CURRent | MAXimum | MEAN | MINimum | STDDev}
<NL>

Example This example places the current mode for statistics in the string variable, strMode, then prints the contents of the variable to the computer's screen.

```
Dim strMode As String ' Dimension variable.
myScope.WriteString ":MEASure:STATistics?"
strMode = myScope.ReadString
Debug.Print strMode
```

See Also Refer to the :MEASure:RESults? query for information on the result returned and how it is affected by the STATistics command.

History Legacy command (existed before version 3.10).

:MEASure:TEDGe

Command :MEASure:TEDGe <meas_thres_txt>, [<slope>] <occurrence> [, <source>]

The :MEASure:TEDGe command measures the time interval between the trigger event and the specified edge (threshold level, slope, and transition). Sources are specified with the :MEASure:SOURce command or with the optional parameter following the :MEASure:TEDGe command.

<meas_thres_txt> UPPER, MIDDLE, or LOWER to identify the threshold.

<slope> { - (minus) for falling | + (plus) for rising | <none> (the slope is optional; if no slope is specified, + (plus) is assumed) }

<occurrence> An integer value representing the edge of the occurrence. The desired edge must be present on the display. Edges are counted with 1 being the first edge from the left on the display, and a maximum value of 65534.

<source> {CHANnel<N> | DIFF<D> | COMMONmode<C> | FUNCTION<F> | DIGital<M> | WMemory<R> | CLOCK | MTRend | MSPectrum | EQUalized}

For more information on <source> parameters, see "[Measurement Sources](#)" on page 728.

Query :MEASure:TEDGe? <meas_thres_txt>, <slope> <occurrence> [, <source>]

The :MEASure:TEDGe? query returns the time interval between the trigger event and the specified edge (threshold level, slope, and transition).

Returned Format [:MEASure:TEDGe] <time> [, <result_state>] <NL>

<time> The time interval between the trigger event and the specified voltage level and transition.

<result_state> If SENDvalid is ON, the result state is returned with the measurement result. See the :MEASure:RESults table in this chapter for a list of the result states.

Example This example returns the time interval between the trigger event and the 90% threshold on the second rising edge of the source waveform to the numeric variable, varTime. The contents of the variable are then printed to the computer's screen.

```
myScope.WriteString ":SYSTEM:HEaDer OFF" ' Response headers off.
myScope.WriteString ":MEASure:TEDGe? UPPER,+2,CHANnel1"
varTime = myScope.ReadNumber
Debug.Print FormatNumber(varTime, 0)
```

NOTE**Turn Off Headers**

When receiving numeric data into numeric variables, turn off the headers. Otherwise, the headers may cause misinterpretation of returned data.

History Legacy command (existed before version 3.10).

:MEASure:THResholds:ABSolute

Command :MEASure:THResholds:ABSolute <source>,
<upper_volts>,<middle_volts>,<lower_volts>

The :MEASure:THResholds:ABSolute command sets the upper level, middle level, and lower level voltages that are used to calculate the measurements that use them.

<source> {ALL | CHANnel<N> | FUNction<F> | WMemory<R> | DIGital<M> | CLOck | MTRend | MSPectrum | EQUalized}

Setting the source to ALL does not affect the individual channel settings which is the behavior as the user interface.

For more information on <source> parameters, see "[Measurement Sources](#)" on page 728.

<upper_volts> A real number specifying voltage thresholds.
<middle_volts>
<lower_volts>

Example This example sets the custom voltage thresholds to 0.9 volts for the upper level, 0.5 volts for the middle level and 0.1 volts for the lower level on channel 2.

```
myScope.WriteString ":SYSTem:HEADer OFF" ' Response headers off.
myScope.WriteString ":MEASure:THResholds:ABSolute CHANnel2,0.9,0.5,0.1"
```

Query :MEASure:THResholds:ABSolute? <source>

The :MEASure:THResholds:ABSolute? query returns the current settings for upper level, middle level, and lower level voltages for the custom thresholds.

Returned Format [:MEASure:THResholds:ABSolute] <upper_volts>,<middle_volts>,<lower_volts>
><NL>

Example This example returns the upper level, middle level, and lower level voltages used to calculate the measurements on channel 1.

```
myScope.WriteString ":SYSTem:HEADer OFF" ' Response headers off.
myScope.WriteString ":MEASure:THResholds:ABSolute? CHANnel1"
strThresholds = myScope.ReadString
Debug.Print strThresholds
```

NOTE**Turn Off Headers**

When receiving numeric data into numeric variables, turn off the headers. Otherwise, the headers may cause misinterpretation of returned data.

History Legacy command (existed before version 3.10).

:MEASure:THResholds:DISPlay

Command :MEASure:THResholds:DISPlay <source>,{0 | OFF} | {1 | ON}}

When the source is a PAM-4 signal type (see :ANALyze:SIGNal:TYPE), the :MEASure:THResholds:DISPlay command turns on or off the display of the PAM measurement thresholds. This is the remote command equivalent of the graphical user interface's **Display Thresholds** check box in the Signal Type Setup dialog box.

<source> ::= {CHANnel<N> | FUNction<F> | WMEMory<N> | EQUalized}

Query :MEASure:THResholds:DISPlay? <source>

The :MEASure:THResholds:DISPlay? query returns thresholds display setting.

Returned Format <setting><NL>

<setting> ::= {0 | 1}

- See Also**
- [":ANALyze:SIGNal:TYPE"](#) on page 271
 - [":MEASure:THResholds:GENeral:METhod"](#) on page 909
 - [":MEASure:THResholds:GENeral:PAMCustom"](#) on page 911
 - [":MEASure:THResholds:GENeral:PAMAutomatic"](#) on page 913
 - [":MEASure:THResholds:RFALL:METhod"](#) on page 926
 - [":MEASure:THResholds:RFALL:PAMAutomatic"](#) on page 928

History New in version 6.10.

:MEASure:THResholds:GENauto

Command :MEASure:THResholds:GENauto <source>

The :MEASure:THResholds:GENauto command automatically sets the general "Custom: thresholds +/- hysteresis" when thresholds apply to individual waveforms. This command is the same as pressing the **Auto set thresholds** button in the graphical user interface.

<source> {CHANnel<N> | FUNction<F> | WMEMory<R> | CLOCk | MTRend | MSPectrum | EQUalized}

For more information on <source> parameters, see "[Measurement Sources](#)" on page 728.

See Also

- "[:MEASure:THResholds:GENeral:METHod](#)" on page 909
- "[:MEASure:THResholds:GENeral:HYSTeresis](#)" on page 907

History New in version 6.00.

:MEASure:THResholds:GENeral:ABSolute

Command :MEASure:THResholds:GENeral:ABSolute <source>, <upper_volts>, <middle_volts>, <lower_volts>

The :MEASure:THResholds:GENeral:ABSolute command sets the upper level, middle level, and lower level voltages that are used to calculate the measurements that use them.

NOTE

These general-purpose threshold settings are used for everything except rise/fall measurements and protocol decode.

<source> {ALL | CHANnel<N> | FUNctIon<F> | WMemOry<R> | DIGital<M> | CLOCk | MTRend | MSPectrum | EQUalized}

Setting the source to ALL does not affect the individual channel settings which is the behavior as the user interface.

For more information on <source> parameters, see "[Measurement Sources](#)" on page 728.

<upper_volts> A real number specifying voltage thresholds.
<middle_volts>
<lower_volts>

Example This example sets the custom voltage thresholds to 0.9 volts for the upper level, 0.5 volts for the middle level and 0.1 volts for the lower level on channel 2.

```
myScope.WriteString ":SYSTEM:HEADER OFF" ' Response headers off.
myScope.WriteString ":MEASure:THResholds:GENeral:ABSolute CHANnel2,0.9,0.5,0.1"
```

Query :MEASure:THResholds:GENeral:ABSolute? <source>

The :MEASure:THResholds:GENeral:ABSolute? query returns the current settings for upper level, middle level, and lower level voltages for the custom thresholds.

Returned Format [:MEASure:THResholds:GENeral:ABSolute] <upper_volts>, <middle_volts>, <lower_volts><NL>

Example This example returns the upper level, middle level, and lower level voltages used to calculate the measurements on channel 1.

```
myScope.WriteString ":SYSTEM:HEADER OFF" ' Response headers off.
myScope.WriteString ":MEASure:THResholds:GENeral:ABSolute? CHANnel1"
strThresholds = myScope.ReadString
Debug.Print strThresholds
```

NOTE**Turn Off Headers**

When receiving numeric data into numeric variables, turn off the headers. Otherwise, the headers may cause misinterpretation of returned data.

- See Also**
- [":MEASure:THResholds:ABSolute"](#) on page 902
 - [":MEASure:THResholds:RFALL:ABSolute"](#) on page 924
 - [":MEASure:THResholds:SERial:ABSolute"](#) on page 935

History New in version 3.10.

:MEASure:THResholds:GENeral:HYSTeresis

Command :MEASure:THResholds:GENeral:HYSTeresis <source>,<range>,<level>

The :MEASure:THResholds:GENeral:HYSTeresis command sets the range and level voltages that are used to calculate the measurements that use them. The range is added to the level to determine the upper level voltage for measurements that use it. The range is subtracted from the level to determine the lower level voltage. The level is the middle level voltage.

NOTE

These general-purpose threshold settings are used for everything except rise/fall measurements and protocol decode.

<source> {ALL | CHANnel<N> | FUNCTION<F> | DIGital<M> | WMEMory<R> | CLOCk | MTRend | MSPectrum | EQUalized}

Setting the source to ALL does not affect the individual channel settings which is the behavior as the user interface.

For more information on <source> parameters, see "[Measurement Sources](#)" on page 728.

<range> A real number specifying voltage range for the hysteresis around the level value.

<level> A real number specifying voltage level.

Example This example sets the hysteresis range to 0.9 volts and 0.1 volts for the level on channel 2.

```
myScope.WriteString ":SYSTEM:HEADER OFF" ' Response headers off.
myScope.WriteString ":MEASure:THResholds:GENeral:HYSTeresis CHANnel2,0.9
,0.1"
```

Query :MEASure:THResholds:GENeral:HYSTeresis? <source>

The :MEASure:THResholds:GENeral:HYSTeresis? query returns the current settings for upper level, middle level, and lower level voltages for the custom thresholds.

Returned Format [:MEASure:THResholds:GENeral:HYSTeresis] <range>,<level><NL>

Example This example returns the range and level voltages used to calculate the measurements on channel 1.

```
myScope.WriteString ":SYSTEM:HEADER OFF" ' Response headers off.
myScope.WriteString ":MEASure:THResholds:GENeral:HYSTeresis? CHANnel1"
strRangeLevel = myScope.ReadString
Debug.Print strRangeLevel
```

NOTE

Turn Off Headers

When receiving numeric data into numeric variables, turn off the headers. Otherwise, the headers may cause misinterpretation of returned data.

- See Also
- [":MEASure:THResholds:GENauto"](#) on page 904
 - [":MEASure:THResholds:HYSteresis"](#) on page 920
 - [":MEASure:THResholds:SERial:HYSteresis"](#) on page 937

History New in version 3.10.

:MEASure:THResholds:GENeral:METhod

Command :MEASure:THResholds:GENeral:METhod <source>,{ABSolute | PERCent
| HYSteresis | PAMCustom | PAMAutomatic}

The :MEASure:THResholds:GENeral:METhod command determines the way that the top and base of a waveform are calculated for all of the measurements that use them.

NOTE

These general-purpose threshold settings are used for everything except rise/fall measurements and protocol decode.

When the signal type is PAM-4 (see :ANALyze:SIGNal:TYPE), you can choose between these methods for setting the general measurement thresholds:

- PAMCustom – Then, use the :MEASure:THResholds:GENeral:PAMCustom command to set the PAM threshold levels for general measurements to the values you specify.
- PAMAutomatic – Then, use the :MEASure:THResholds:GENeral:PAMAutomatic command to specify whether the PAM threshold levels for general measurements are determined automatically or using the PAM-4 levels you specify.

<source> {ALL | CHANnel<N> | FUNCTION<F> | DIGital<M> | WMEMory<R> | CLOCk | MTRend | MSPectrum | EQUalized}

Setting the source to ALL does not affect the individual channel settings which is the behavior as the user interface.

For more information on <source> parameters, see "[Measurement Sources](#)" on page 728.

Example This example sets the method used to calculate the top and base of a waveform to hysteresis.

```
myScope.WriteString ":SYSTEM:HEADer OFF" ' Response headers off.
myScope.WriteString ":MEASure:THResholds:GENeral:METhod CHANnel1,HYStere
sis"
```

Query :MEASure:THResholds:GENeral:METhod? <source>

The :MEASure:THResholds:GENeral:METhod? query returns the current method being used to calculate the top and base of a waveform.

Returned Format [:MEASure:THResholds:GENeral:METhod <source>],[ABS | PERC | HYST
| PAMC | PAMA}

Example This example returns the method used to calculate the top and base of a waveform to hysteresis.

```
myScope.WriteString ":SYSTEM:HEADer OFF" ' Response headers off.
myScope.WriteString ":MEASure:THResholds:GENeral:METhod?"
```

```
varMethod = myScope.ReadNumber  
Debug.Print FormatNumber(varMethod, 0)
```

- See Also**
- [":MEASure:THResholds:METhod"](#) on page 922
 - [":MEASure:THResholds:RFALL:METhod"](#) on page 926
 - [":MEASure:THResholds:SERial:METhod"](#) on page 939
 - [":ANALyze:SIGNal:TYPE"](#) on page 271
 - [":MEASure:THResholds:GENeral:PAMCustom"](#) on page 911
 - [":MEASure:THResholds:GENeral:PAMAutomatic"](#) on page 913

History New in version 3.10.

Version 5.50: When the signal type is PAM-4, you can choose between PAMCustom and PAMAutomatic methods for setting the general measurement thresholds.

:MEASure:THResholds:GENeral:PAMCustom

Command :MEASure:THResholds:GENeral:PAMCustom
 <source>,<01_threshold>,<12_threshold>,<23_threshold>[,<hysteresis>]

When the signal type is PAM-4 (see :ANALyze:SIGNal:TYPE) and :MEASure:THResholds:GENeral:METhod is set to PAMCustom, the :MEASure:THResholds:GENeral:PAMCustom command sets the PAM threshold levels for general measurements to the values you specify.

<source> {CHANnel<N> | FUNction<F> | WMEMory<R>}

For more information on <source> parameters, see **"Measurement Sources"** on page 728.

<01_threshold>,&br/>
 <12_threshold>,&br/>
 <23_threshold>

Values for the PAM-4 01, 12, and 23 thresholds in NR3 format.

<hysteresis> Threshold hysteresis value in NR3 format.

Query :MEASure:THResholds:GENeral:PAMCustom? <source>

The :MEASure:THResholds:GENeral:PAMCustom? query returns the currently set PAM custom threshold levels for general measurements.

Returned Format [:MEASure:THResholds:GENeral:PAMCustom]
 <source>,<01_threshold>,<12_threshold>,<23_threshold>,<hysteresis><NL>

- See Also**
- **":ANALyze:CLOCK:METhod:SKEW"** on page 256
 - **":ANALyze:SIGNal:DATarate"** on page 261
 - **":ANALyze:SIGNal:SYMBOLrate"** on page 263
 - **":ANALyze:SIGNal:TYPE"** on page 271
 - **":MEASure:CGRade:EWIDth"** on page 742
 - **":MEASure:CGRade:EHEight"** on page 740
 - **":MEASure:FALLtime"** on page 770
 - **":MEASure:PAM:ELEVEL"** on page 838
 - **":MEASure:PAM:ESKew"** on page 840
 - **":MEASure:PAM:LEVEL"** on page 846
 - **":MEASure:PAM:LRMS"** on page 848
 - **":MEASure:PAM:LTHickness"** on page 850
 - **":MEASure:RISetime"** on page 869
 - **":MEASure:THResholds:DISPlay"** on page 903
 - **":MEASure:THResholds:GENeral:METhod"** on page 909
 - **":MEASure:THResholds:GENeral:PAMAutomatic"** on page 913
 - **":MEASure:THResholds:RFALL:METhod"** on page 926

- **":MEASure:THResholds:RFALL:PAMAutomatic"** on page 928
- **":MEASure:TIEData2"** on page 949

History New in version 5.50.

Version 6.10: Added an optional <hysteresis> value at the end of the command parameters.

:MEASure:THResholds:GENeral:PAMAutomatic

Command :MEASure:THResholds:GENeral:PAMAutomatic
 <source>,{AUTomatic | <0_level>,<1_level>,<2_level>,<3_level>}

When the signal type is PAM-4 (see :ANALyze:SIGNal:TYPE) and :MEASure:THResholds:GENeral:METHod is set to PAMAutomatic, the :MEASure:THResholds:GENeral:PAMAutomatic command specifies whether the PAM threshold levels for general measurements are determined automatically or using the PAM-4 levels you specify.

<source> {CHANnel<N> | FUNction<F> | WMEMory<R>}

For more information on <source> parameters, see **"Measurement Sources"** on page 728.

<0_level>, Voltage values for the PAM-4 0, 1, 2, and 3 levels in NR3 format.
 <1_level>
 <2_level>
 <3_level>

Query :MEASure:THResholds:GENeral:PAMAutomatic? <source>

The :MEASure:THResholds:GENeral:PAMAutomatic? query returns the values used for automatically setting the PAM general threshold levels.

Returned Format [:MEASure:THResholds:GENeral:PAMAutomatic]
 <source>,{AUTomatic | <0_level>,<1_level>,<2_level>,<3_level>}<NL>

- See Also**
- **" :ANALyze:CLOCK:METHod:SKEW "** on page 256
 - **" :ANALyze:SIGNal:DATarate "** on page 261
 - **" :ANALyze:SIGNal:SYMBOLrate "** on page 263
 - **" :ANALyze:SIGNal:TYPE "** on page 271
 - **" :MEASure:CGRade:EWIDth "** on page 742
 - **" :MEASure:CGRade:EHEight "** on page 740
 - **" :MEASure:FALLtime "** on page 770
 - **" :MEASure:PAM:ELEVEL "** on page 838
 - **" :MEASure:PAM:ESKew "** on page 840
 - **" :MEASure:PAM:LEVEL "** on page 846
 - **" :MEASure:PAM:LRMS "** on page 848
 - **" :MEASure:PAM:LTHickness "** on page 850
 - **" :MEASure:RISetime "** on page 869
 - **" :MEASure:THResholds:DISPlay "** on page 903
 - **" :MEASure:THResholds:GENeral:METHod "** on page 909
 - **" :MEASure:THResholds:GENeral:PAMCustom "** on page 911

- **":MEASure:THResholds:RFALL:METhod"** on page 926
- **":MEASure:THResholds:RFALL:PAMAutomatic"** on page 928
- **":MEASure:TIEData2"** on page 949

History New in version 5.50.

:MEASure:THResholds:GENeral:PERCent

Command :MEASure:THResholds:GENeral:PERCent <source>,<upper_pct>,<middle_pct>,<lower_pct>

The :MEASure:THResholds:GENeral:PERCent command sets the upper level, middle level, and lower level voltages as a percentage of the top and base voltages which are used to calculate the measurements that use them.

NOTE

These general-purpose threshold settings are used for everything except rise/fall measurements and protocol decode.

<source> {ALL | CHANnel<N> | FUNction<F> | DIGital<M> | WMEMory<R> | CLOCK | MTRend | MSPectrum | EQUalized}

Setting the source to ALL does not affect the individual channel settings which is the behavior as the user interface.

For more information on <source> parameters, see "[Measurement Sources](#)" on page 728.

<upper_pct> A real number specifying upper percentage from -24.8 to 125.0
<middle_pct> A real number specifying the middle percentage from -24.9 to 124.9.
<lower_pct> A real number specifying the lower percentage from -25.0 to 125.8

Example This example sets the percentage to 100% for the upper level, 50% for the middle level and 0% for the lower level on channel 2.

```
myScope.WriteString ":SYSTEM:HEADer OFF" ' Response headers off.
myScope.WriteString ":MEASure:THResholds:GENeral:PERCent CHANnel2,100,50,0"
```

Query :MEASure:THResholds:GENeral:PERCent? <source>

The :MEASure:THResholds:GENeral:PERCent? query returns the current settings for upper level, middle level, and lower level percentages.

Returned Format [:MEASure:THResholds:GENeral:PERCent] <upper_pct>,<middle_pcts>,<lower_pct><NL>

Example This example returns the upper level, middle level, and lower level percentages used to calculate the measurements on channel 1.

```
myScope.WriteString ":SYSTEM:HEADer OFF" ' Response headers off.
myScope.WriteString ":MEASure:THResholds:GENeral:PERCent? CHANnel1"
strThresholdsPct = myScope.ReadString
Debug.Print strThresholdsPct
```

NOTE**Turn Off Headers**

When receiving numeric data into numeric variables, turn off the headers. Otherwise, the headers may cause misinterpretation of returned data.

- See Also**
- **":MEASure:THResholds:PERCent"** on page 923
 - **":MEASure:THResholds:RFALL:PERCent"** on page 930
 - **":MEASure:THResholds:SERial:PERCent"** on page 940

History New in version 3.10.

:MEASure:THResholds:GENeral:TOPBase:ABSolute

Command :MEASure:TOPBase:THResholds:GENeral:ABSolute <source>,<top_volts>,<base_volts>

The :MEASure:TOPBase:THResholds:GENeral:ABSolute command sets the top level and base level voltages that are used to calculate the measurements that use them.

NOTE

These general-purpose threshold settings are used for everything except rise/fall measurements and protocol decode.

<source> {ALL | CHANnel<N> | FUNction<F> | DIGital<M> | WMEMory<R> | CLOCK | MTRend | MSPectrum | EQUalized}

Setting the source to ALL does not affect the individual channel settings which is the behavior as the user interface.

For more information on <source> parameters, see "[Measurement Sources](#)" on page 728.

<top_volts>
<base_volts> A real number specifying voltage levels. The top voltage level must be greater than the base voltage level.

Example This example sets the voltage level for the top to 0.9 volts and the voltage level for the base to 0.1 volts on channel 2.

```
myScope.WriteString ":SYSTEM:HEADer OFF" ' Response headers off.
myScope.WriteString ":MEASure:THResholds:GENeral:TOPBase:ABSolute CHANne
l2,0.9,0.1"
```

Query :MEASure:THResholds:GENeral:TOPBase:ABSolute? <source>

The :MEASure:THResholds:GENeral:TOPBase:ABSolute? query returns the current settings for top level and base level voltages.

Returned Format [:MEASure:THResholds:GENeral:TOPBase:ABSolute] <top_volts>,<base_volts><NL>

Example This example returns the top level and base level voltages used to calculate the measurements on channel 1.

```
myScope.WriteString ":SYSTEM:HEADer OFF" ' Response headers off.
myScope.WriteString ":MEASure:THResholds:GENeral:TOPBase:ABSolute? CHANn
e11"
strTopBase = myScope.ReadString
Debug.Print strTopBase
```

NOTE**Turn Off Headers**

When receiving numeric data into numeric variables, turn off the headers. Otherwise, the headers may cause misinterpretation of returned data.

- See Also**
- [":MEASure:THResholds:TOPBase:ABSolute"](#) on page 945
 - [":MEASure:THResholds:RFALL:TOPBase:ABSolute"](#) on page 932
 - [":MEASure:THResholds:SERial:TOPBase:ABSolute"](#) on page 942

History New in version 3.10.

:MEASure:THResholds:GENeral:TOPBase:METhod

Command :MEASure:THResholds:GENeral:TOPBase:METhod <source>, {ABSolute | HISTONLY | MINmax | STANdard}

The :MEASure:THResholds:GENeral:TOPBase:METhod command determines the way that the top and base of a waveform are derived for all of the measurements that use them.

NOTE

These general-purpose threshold settings are used for everything except rise/fall measurements and protocol decode.

<source> {ALL | CHANnel<N> | FUNctIon<F> | DIGital<M> | WMEMory<R> | CLOCK | MTRend | MSPectrum | EQUalized}

Setting the source to ALL does not affect the individual channel settings which is the behavior as the user interface.

For more information on <source> parameters, see "[Measurement Sources](#)" on page 728.

Example This example sets the method used to derive the top and base of a waveform to the histogram method.

```
myScope.WriteString ":SYSTem:HEADer OFF" ' Response headers off.
myScope.WriteString ":MEASure:THResholds:GENeral:TOPBase:METhod CHANnel1
,HISTONLY"
```

Query :MEASure:THResholds:GENeral:TOPBase:METhod? <source>

The :MEASure:THResholds:GENeral:TOPBase:METhod? query returns the current method being used to calculate the top and base of a waveform.

Returned Format [:MEASure:THResholds:GENeral:TOPBase:METhod] {ABSolute | HISTONLY | MINmax | STANdard}

Example This example returns the method used to derive the top and base of a waveform for channel 1.

```
myScope.WriteString ":SYSTem:HEADer OFF" ' Response headers off.
myScope.WriteString ":MEASure:THResholds:GENeral:TOPBase:METhod CHANnel1
"
varMethod = myScope.ReadNumber
Debug.Print FormatNumber (varMethod, 0)
```

See Also

- "[:MEASure:THResholds:TOPBase:METhod](#)" on page 946
- "[:MEASure:THResholds:RFALL:TOPBase:METhod](#)" on page 934
- "[:MEASure:THResholds:SERial:TOPBase:METhod](#)" on page 944

History New in version 3.10.

:MEASure:THResholds:HYSTeresis

Command :MEASure:THResholds:HYSTeresis <source>,<range>,<level>

The :MEASure:THResholds:HYSTeresis command sets the range and level voltages that are used to calculate the measurements that use them. The range is added to the level to determine the upper level voltage for measurements that use it. The range is subtracted from the level to determine the lower level voltage. The level is the middle level voltage.

NOTE

This command does not affect Rise/Fall measurement thresholds.

<source> {ALL | CHANnel<N> | FUNCTION<F> | DIGital<M> | WMEMory<R> | CLOCk | MTRend | MSPectrum | EQUalized}

Setting the source to ALL does not affect the individual channel settings which is the behavior as the user interface.

For more information on <source> parameters, see "[Measurement Sources](#)" on page 728.

<range> A real number specifying voltage range for the hysteresis around the level value.

<level> A real number specifying voltage level.

Example This example sets the hysteresis range to 0.9 volts and 0.1 volts for the level on channel 2.

```
myScope.WriteString ":SYSTEM:HEADer OFF" ' Response headers off.
myScope.WriteString ":MEASure:THResholds:HYSTeresis CHANnel2,0.9,0.1"
```

Query :MEASure:THResholds:HYSTeresis? <source>

The :MEASure:THResholds:HYSTeresis? query returns the current settings for upper level, middle level, and lower level voltages for the custom thresholds.

Returned Format [:MEASure:THResholds:HYSTeresis]<range>,<level><NL>

Example This example returns the range and level voltages used to calculate the measurements on channel 1.

```
myScope.WriteString ":SYSTEM:HEADer OFF" ' Response headers off.
myScope.WriteString ":MEASure:THResholds:HYSTeresis? CHANnel1"
strRangeLevel = myScope.ReadString
Debug.Print strRangeLevel
```

NOTE**Turn Off Headers**

When receiving numeric data into numeric variables, turn off the headers. Otherwise, the headers may cause misinterpretation of returned data.

History Legacy command (existed before version 3.10).

:MEASure:THResholds:METhod

Command :MEASure:THResholds:METhod <source>,{ABSolute | PERCent | HYSTeresis}

The :MEASure:THResholds:METhod command determines the way that the top and base of a waveform are calculated for all of the measurements that use them.

NOTE

This command changes the threshold settings used for rise/fall time measurements, protocol decode, and all other general-purpose measurements that use thresholds. To change the settings used for these types of measurements individually, see:

- [":MEASure:THResholds:GENeral:METhod"](#) on page 909
- [":MEASure:THResholds:RFALL:METhod"](#) on page 926
- [":MEASure:THResholds:SERial:METhod"](#) on page 939

<source> {ALL | CHANnel<N> | FUNction<F> | DIGital<M> | WMEMory<R> | CLOCk | MTRend | MSPectrum | EQUalized}

Setting the source to ALL does not affect the individual channel settings which is the behavior as the user interface.

For more information on <source> parameters, see ["Measurement Sources"](#) on page 728.

Example This example sets the method used to calculate the top and base of a waveform to hysteresis.

```
myScope.WriteString ":SYSTem:HEADer OFF" ' Response headers off.
myScope.WriteString ":MEASure:THResholds:METhod CHANnel1,HYSTeresis"
```

Query :MEASure:THResholds:METhod? <source>

The :MEASure:THResholds:METhod? query returns the current method being used to calculate the top and base of a waveform.

Returned Format [:MEASure:THResholds:METhod <source>],[ABSolute | PERCent | HYSTeresis}

Example This example returns the method used to calculate the top and base of a waveform to hysteresis.

```
myScope.WriteString ":SYSTem:HEADer OFF" ' Response headers off.
myScope.WriteString ":MEASure:THResholds:METhod?"
varMethod = myScope.ReadNumber
Debug.Print FormatNumber(varMethod, 0)
```

History Legacy command (existed before version 3.10).

:MEASure:THResholds:PERCent

Command :MEASure:THResholds:PERCent <source>,<upper_pct>,<middle_pct>,<lower_pct>

The :MEASure:THResholds:PERCent command sets the upper level, middle level, and lower level voltages as a percentage of the top and base voltages which are used to calculate the measurements that use them.

<source> {ALL | CHANnel<N> | FUNction<F> | DIGital<M> | WMEMory<R> | CLOCk | MTRend | MSPectrum | EQUalized}

Setting the source to ALL does not affect the individual channel settings which is the behavior as the user interface.

For more information on <source> parameters, see "[Measurement Sources](#)" on page 728.

<upper_pct> A real number specifying upper percentage from -24.8 to 125.0
<middle_pct> A real number specifying the middle percentage from -24.9 to 124.9.
<lower_pct> A real number specifying the lower percentage from -25.0 to 125.8

Example This example sets the percentage to 100% for the upper level, 50% for the middle level and 0% for the lower level on channel 2.

```
myScope.WriteString ":SYSTem:HEADer OFF" ' Response headers off.
myScope.WriteString ":MEASure:THResholds:PERCent CHANnel2,100,50,0"
```

Query :MEASure:THResholds:PERCent? <source>

The :MEASure:THResholds:PERCent? query returns the current settings for upper level, middle level, and lower level percentages.

Returned Format [:MEASure:THResholds:PERCent] <upper_pct>,<middle_pcts>,<lower_pct><NL>

Example This example returns the upper level, middle level, and lower level percentages used to calculate the measurements on channel 1.

```
myScope.WriteString ":SYSTem:HEADer OFF" ' Response headers off.
myScope.WriteString ":MEASure:THResholds:PERCent? CHANnel1"
strThresholdsPct = myScope.ReadString
Debug.Print strThresholdsPct
```

NOTE**Turn Off Headers**

When receiving numeric data into numeric variables, turn off the headers. Otherwise, the headers may cause misinterpretation of returned data.

History Legacy command (existed before version 3.10).

:MEASure:THResholds:RFALL:ABSolute

Command :MEASure:THResholds:RFALL:ABSolute <source>,
<upper_volts>,<middle_volts>,<lower_volts>

The :MEASure:THResholds:RFALL:ABSolute command sets the upper level, middle level, and lower level voltages that are used to calculate the measurements that use them.

NOTE

These threshold settings are used for rise/fall measurements.

<source> {ALL | CHANnel<N> | FUNction<F> | WMemory<R> | DIGital<M> | CLOCK | MTRend | MSPectrum | EQUalized}

Setting the source to ALL does not affect the individual channel settings which is the behavior as the user interface.

For more information on <source> parameters, see "[Measurement Sources](#)" on page 728.

<upper_volts> A real number specifying voltage thresholds.
<middle_volts>
<lower_volts>

Example This example sets the custom voltage thresholds to 0.9 volts for the upper level, 0.5 volts for the middle level and 0.1 volts for the lower level on channel 2.

```
myScope.WriteString ":SYSTEM:HEADer OFF" ' Response headers off.
myScope.WriteString ":MEASure:THResholds:RFALL:ABSolute CHANnel2,0.9,0.5,0.1"
```

Query :MEASure:THResholds:RFALL:ABSolute? <source>

The :MEASure:THResholds:RFALL:ABSolute? query returns the current settings for upper level, middle level, and lower level voltages for the custom thresholds.

Returned Format [:MEASure:THResholds:RFALL:ABSolute] <upper_volts>,<middle_volts>,<lower_volts><NL>

Example This example returns the upper level, middle level, and lower level voltages used to calculate the rise/fall measurements on channel 1.

```
myScope.WriteString ":SYSTEM:HEADer OFF" ' Response headers off.
myScope.WriteString ":MEASure:THResholds:RFALL:ABSolute? CHANnel1"
strThresholds = myScope.ReadString
Debug.Print strThresholds
```

NOTE**Turn Off Headers**

When receiving numeric data into numeric variables, turn off the headers. Otherwise, the headers may cause misinterpretation of returned data.

- See Also**
- **":MEASure:THResholds:ABSolute"** on page 902
 - **":MEASure:THResholds:GENeral:ABSolute"** on page 905
 - **":MEASure:THResholds:SERial:ABSolute"** on page 935

History New in version 3.10.

:MEASure:THResholds:RFALL:METhod

Command :MEASure:THResholds:RFALL:METhod <source>, {ABSolute | PERCent
| HYSteresis | T1090 | T2080}

The :MEASure:THResholds:RFALL:METhod command determines the way that the top and base of a waveform are calculated for all of the measurements that use them.

NOTE

These threshold settings are used for rise/fall measurements.

When the signal type is PAM-4 (see :ANALyze:SIGNal:TYPE), you can choose between T1090 (10% and 90% of levels) and T2080 (20% and 80% of levels) when setting the rise/fall measurement thresholds. Then, use the :MEASure:THResholds:RFALL:PAMAutomatic command to specify whether the PAM threshold levels for rise/fall measurements are determined automatically or using PAM-4 levels you specify.

<source> {ALL | CHANnel<N> | FUNCTION<F> | DIGital<M> | WMEMory<R> | CLOCk | MTRend | MSPectrum | EQUalized}

Setting the source to ALL does not affect the individual channel settings which is the behavior as the user interface.

For more information on <source> parameters, see "[Measurement Sources](#)" on page 728.

Example This example sets the method used to calculate the top and base of a waveform to hysteresis.

```
myScope.WriteString ":SYSTEM:HEADer OFF" ' Response headers off.
myScope.WriteString ":MEASure:THResholds:RFALL:METhod CHANnel1,HYSteresi
s"
```

Query :MEASure:THResholds:RFALL:METhod? <source>

The :MEASure:THResholds:RFALL:METhod? query returns the current method being used to calculate the top and base of a waveform.

Returned Format [:MEASure:THResholds:RFALL:METhod <source>,) {ABS | PERC | HYST
| T1090 | T2080}

Example This example returns the method used to calculate the top and base of a waveform to hysteresis.

```
myScope.WriteString ":SYSTEM:HEADer OFF" ' Response headers off.
myScope.WriteString ":MEASure:THResholds:RFALL:METhod?"
varMethod = myScope.ReadNumber
Debug.Print FormatNumber(varMethod, 0)
```

See Also • "[:MEASure:THResholds:METhod](#)" on page 922

- `":MEASure:THResholds:GENeral:METhod"` on page 909
- `":MEASure:THResholds:SERial:METhod"` on page 939
- `":ANALyze:SIGNal:TYPE"` on page 271
- `":MEASure:THResholds:RFALL:PAMAutomatic"` on page 928

History New in version 3.10.

Version 5.50: When the signal type is PAM-4, you can choose between T1090 (10% and 90% of levels) and T2080 (20% and 80% of levels) when setting the rise/fall measurement thresholds.

:MEASure:THResholds:RFALL:PAMAutomatic

Command :MEASure:THResholds:RFALL:PAMAutomatic
 <source>,{AUTomatic | <0_level>,<1_level>,<2_level>,<3_level>}

When the signal type is PAM-4 (see :ANALyze:SIGNal:TYPE), the :MEASure:THResholds:RFALL:PAMAutomatic command specifies whether the PAM threshold levels for rise/fall measurements are determined automatically or using the PAM-4 levels you specify.

<source> {CHANnel<N> | FUNction<F> | WMEMory<R>}

For more information on <source> parameters, see **"Measurement Sources"** on page 728.

<0_level>,&br/>
 <1_level>,&br/>
 <2_level>,&br/>
 <3_level>

Voltage values for the PAM-4 0, 1, 2, and 3 levels in NR3 format.

Query :MEASure:THResholds:RFALL:PAMAutomatic? <source>

The :MEASure:THResholds:RFALL:PAMAutomatic? query returns the values used for automatically setting the PAM rise/fall threshold levels.

Returned Format [:MEASure:THResholds:RFALL:PAMAutomatic]
 <source>,{AUTomatic | <0_level>,<1_level>,<2_level>,<3_level>}<NL>

- See Also**
- **":ANALyze:CLOCK:METHod:SKEW"** on page 256
 - **":ANALyze:SIGNal:DATarate"** on page 261
 - **":ANALyze:SIGNal:SYMBOLrate"** on page 263
 - **":ANALyze:SIGNal:TYPE"** on page 271
 - **":MEASure:CGRade:EWIDth"** on page 742
 - **":MEASure:CGRade:EHEight"** on page 740
 - **":MEASure:FALLtime"** on page 770
 - **":MEASure:PAM:ELEVEL"** on page 838
 - **":MEASure:PAM:ESKew"** on page 840
 - **":MEASure:PAM:LEVEL"** on page 846
 - **":MEASure:PAM:LRMS"** on page 848
 - **":MEASure:PAM:LTHickness"** on page 850
 - **":MEASure:RISetime"** on page 869
 - **":MEASure:THResholds:DISPlay"** on page 903
 - **":MEASure:THResholds:GENeral:METHod"** on page 909
 - **":MEASure:THResholds:GENeral:PAMCustom"** on page 911
 - **":MEASure:THResholds:GENeral:PAMAutomatic"** on page 913

- `":MEASure:THResholds:RFALL:METhod"` on page 926
- `":MEASure:TIEData2"` on page 949

History New in version 5.50.

:MEASure:THResholds:RFALL:PERCent

Command :MEASure:THResholds:RFALL:PERCent <source>,<upper_pct>,<middle_pct>,<lower_pct>

The :MEASure:THResholds:RFALL:PERCent command sets the upper level, middle level, and lower level voltages as a percentage of the top and base voltages which are used to calculate the measurements that use them.

NOTE

These threshold settings are used for rise/fall measurements.

<source> {ALL | CHANnel<N> | FUNctIon<F> | DIGital<M> | WMEMory<R> | CLOCK | MTRend | MSPectrum | EQUalized}

Setting the source to ALL does not affect the individual channel settings which is the behavior as the user interface.

For more information on <source> parameters, see "[Measurement Sources](#)" on page 728.

<upper_pct> A real number specifying upper percentage from -24.8 to 125.0
<middle_pct> A real number specifying the middle percentage from -24.9 to 124.9.
<lower_pct> A real number specifying the lower percentage from -25.0 to 125.8

Example This example sets the percentage to 100% for the upper level, 50% for the middle level and 0% for the lower level on channel 2.

```
myScope.WriteString ":SYSTEM:HEADer OFF" ' Response headers off.
myScope.WriteString ":MEASure:THResholds:RFALL:PERCent CHANnel2,100,50,0"
"
```

Query :MEASure:THResholds:RFALL:PERCent? <source>

The :MEASure:THResholds:RFALL:PERCent? query returns the current settings for upper level, middle level, and lower level percentages.

Returned Format [:MEASure:THResholds:RFALL:PERCent] <upper_pct>,<middle_pcts>,<lower_pct><NL>

Example This example returns the upper level, middle level, and lower level percentages used to calculate the rise/fall measurements on channel 1.

```
myScope.WriteString ":SYSTEM:HEADer OFF" ' Response headers off.
myScope.WriteString ":MEASure:THResholds:RFALL:PERCent? CHANnel1"
strThresholdsPct = myScope.ReadString
Debug.Print strThresholdsPct
```

NOTE**Turn Off Headers**

When receiving numeric data into numeric variables, turn off the headers. Otherwise, the headers may cause misinterpretation of returned data.

- See Also**
- [":MEASure:THResholds:PERCent"](#) on page 923
 - [":MEASure:THResholds:GENeral:PERCent"](#) on page 915
 - [":MEASure:THResholds:SERial:PERCent"](#) on page 940

History New in version 3.10.

:MEASure:THResholds:RFALL:TOPBase:ABSolute

Command :MEASure:TOPBase:THResholds:RFALL:ABSolute <source>,<top_volts>,<base_volts>

The :MEASure:TOPBase:THResholds:RFALL:ABSolute command sets the top level and base level voltages that are used to calculate the measurements that use them.

NOTE

These threshold settings are used for rise/fall measurements.

<source> {ALL | CHANnel<N> | FUNction<F> | DIGital<M> | WMEMory<R> | CLOCK | MTRend | MSPectrum | EQUalized}

Setting the source to ALL does not affect the individual channel settings which is the behavior as the user interface.

For more information on <source> parameters, see "[Measurement Sources](#)" on page 728.

<top_volts>
<base_volts> A real number specifying voltage levels. The top voltage level must be greater than the base voltage level.

Example This example sets the voltage level for the top to 0.9 volts and the voltage level for the base to 0.1 volts on channel 2.

```
myScope.WriteString ":SYSTEM:HEADER OFF" ' Response headers off.
myScope.WriteString ":MEASure:THResholds:RFALL:TOPBase:ABSolute CHANnel2
,0.9,0.1"
```

Query :MEASure:THResholds:RFALL:TOPBase:ABSolute? <source>

The :MEASure:THResholds:RFALL:TOPBase:ABSolute? query returns the current settings for top level and base level voltages.

Returned Format [:MEASure:THResholds:RFALL:TOPBase:ABSolute] <top_volts>,<base_volts><NL>

Example This example returns the top level and base level voltages used to calculate the rise/fall measurements on channel 1.

```
myScope.WriteString ":SYSTEM:HEADER OFF" ' Response headers off.
myScope.WriteString ":MEASure:THResholds:RFALL:TOPBase:ABSolute? CHANnel
1"
strTopBase = myScope.ReadString
Debug.Print strTopBase
```

NOTE**Turn Off Headers**

When receiving numeric data into numeric variables, turn off the headers. Otherwise, the headers may cause misinterpretation of returned data.

- See Also**
- [":MEASure:THResholds:TOPBase:ABSolute"](#) on page 945
 - [":MEASure:THResholds:GENeral:TOPBase:ABSolute"](#) on page 917
 - [":MEASure:THResholds:SERial:TOPBase:ABSolute"](#) on page 942

History New in version 3.10.

:MEASure:THResholds:RFALL:TOPBase:METhod

Command :MEASure:THResholds:RFALL:TOPBase:METhod <source>, {ABSolute | HISTONLY | MINmax | STANdard}

The :MEASure:THResholds:RFALL:TOPBase:METhod command determines the way that the top and base of a waveform are derived for all of the measurements that use them.

NOTE

These threshold settings are used for rise/fall measurements.

<source> {ALL | CHANnel<N> | FUNctIon<F> | DIGital<M> | WMEMory<R> | CLOCK | MTRend | MSPectrum | EQUalized}

Setting the source to ALL does not affect the individual channel settings which is the behavior as the user interface.

For more information on <source> parameters, see "[Measurement Sources](#)" on page 728.

Example This example sets the method used to derive the top and base of a waveform to the histogram method.

```
myScope.WriteString ":SYSTEM:HEADer OFF" ' Response headers off.
myScope.WriteString ":MEASure:THResholds:RFALL:TOPBase:METhod CHANnel1,HISTONLY"
```

Query :MEASure:THResholds:RFALL:TOPBase:METhod? <source>

The :MEASure:THResholds:RFALL:TOPBase:METhod? query returns the current method being used to calculate the top and base of a waveform.

Returned Format [:MEASure:THResholds:RFALL:TOPBase:METhod] {ABSolute | HISTONLY | MINmax | STANdard}

Example This example returns the method used to derive the top and base of a waveform for channel 1.

```
myScope.WriteString ":SYSTEM:HEADer OFF" ' Response headers off.
myScope.WriteString ":MEASure:THResholds:RFALL:TOPBase:METhod CHANnel1"
varMethod = myScope.ReadNumber
Debug.Print FormatNumber(varMethod, 0)
```

See Also

- "[:MEASure:THResholds:TOPBase:METhod](#)" on page 946
- "[:MEASure:THResholds:GENeral:TOPBase:METhod](#)" on page 919
- "[:MEASure:THResholds:SERial:TOPBase:METhod](#)" on page 944

History New in version 3.10.

:MEASure:THResholds:SERial:ABSolute

Command :MEASure:THResholds:SERial:ABSolute <source>,
<upper_volts>,<middle_volts>,<lower_volts>

The :MEASure:THResholds:SERial:ABSolute command sets the upper level, middle level, and lower level voltages that are used for protocol decode.

NOTE

These serial threshold settings are used for protocol decode.

<source> {ALL | CHANnel<N> | FUNction<F> | WMemory<R> | DIGital<M> | CLock | MTRend | MSPectrum | EQUalized}

Setting the source to ALL does not affect the individual channel settings which is the behavior as the user interface.

For more information on <source> parameters, see "[Measurement Sources](#)" on page 728.

<upper_volts> A real number specifying voltage thresholds.
<middle_volts>
<lower_volts>

Example This example sets the custom voltage thresholds to 0.9 volts for the upper level, 0.5 volts for the middle level and 0.1 volts for the lower level on channel 2.

```
myScope.WriteString ":SYSTem:HEADer OFF" ' Response headers off.
myScope.WriteString ":MEASure:THResholds:SERial:ABSolute CHANnel2,0.9,0.5,0.1"
```

Query :MEASure:THResholds:SERial:ABSolute? <source>

The :MEASure:THResholds:SERial:ABSolute? query returns the current settings for upper level, middle level, and lower level voltages for the custom thresholds.

Returned Format [:MEASure:THResholds:SERial:ABSolute] <upper_volts>,<middle_volts>,<lower_volts><NL>

Example This example returns the upper level, middle level, and lower level voltages used for protocol decode on channel 1.

```
myScope.WriteString ":SYSTem:HEADer OFF" ' Response headers off.
myScope.WriteString ":MEASure:THResholds:SERial:ABSolute? CHANnel1"
strThresholds = myScope.ReadString
Debug.Print strThresholds
```

NOTE**Turn Off Headers**

When receiving numeric data into numeric variables, turn off the headers. Otherwise, the headers may cause misinterpretation of returned data.

- See Also**
- [":MEASure:THResholds:ABSolute"](#) on page 902
 - [":MEASure:THResholds:GENeral:ABSolute"](#) on page 905
 - [":MEASure:THResholds:RFALL:ABSolute"](#) on page 924

History New in version 3.10.

:MEASure:THResholds:SERial:HYSTeresis

Command :MEASure:THResholds:SERial:HYSTeresis <source>,<range>,<level>

The :MEASure:THResholds:SERial:HYSTeresis command sets the range and level voltages that are used for protocol decode. The range is added to the level to determine the upper level voltage. The range is subtracted from the level to determine the lower level voltage. The level is the middle level voltage.

NOTE

These serial threshold settings are used for protocol decode.

<source> {ALL | CHANnel<N> | FUNctIon<F> | DIGital<M> | WMEMory<R> | CLOCk | MTRend | MSPectrum | EQUalized}

Setting the source to ALL does not affect the individual channel settings which is the behavior as the user interface.

For more information on <source> parameters, see "[Measurement Sources](#)" on page 728.

<range> A real number specifying voltage range for the hysteresis around the level value.

<level> A real number specifying voltage level.

Example This example sets the hysteresis range to 0.9 volts and 0.1 volts for the level on channel 2.

```
myScope.WriteString ":SYSTem:HEADer OFF" ' Response headers off.
myScope.WriteString ":MEASure:THResholds:SERial:HYSTeresis CHANnel2,0.9,
0.1"
```

Query :MEASure:THResholds:SERial:HYSTeresis? <source>

The :MEASure:THResholds:SERial:HYSTeresis? query returns the current settings for upper level, middle level, and lower level voltages for the custom thresholds.

Returned Format [:MEASure:THResholds:SERial:HYSTeresis] <range>,<level><NL>

Example This example returns the range and level voltages used for protocol decode on channel 1.

```
myScope.WriteString ":SYSTem:HEADer OFF" ' Response headers off.
myScope.WriteString ":MEASure:THResholds:SERial:HYSTeresis? CHANnel1"
strRangeLevel = myScope.ReadString
Debug.Print strRangeLevel
```

NOTE**Turn Off Headers**

When receiving numeric data into numeric variables, turn off the headers. Otherwise, the headers may cause misinterpretation of returned data.

- See Also**
- [":MEASure:THResholds:HYSteresis"](#) on page 920
 - [":MEASure:THResholds:GENeral:HYSteresis"](#) on page 907

History New in version 3.10.

:MEASure:THResholds:SERial:METhod

Command :MEASure:THResholds:SERial:METhod <source>,{ABSolute | PERCent | HYStere sis}

The :MEASure:THResholds:SERial:METhod command determines the way that the top and base of a waveform are calculated for protocol decode.

NOTE

These serial threshold settings are used for protocol decode.

<source> {ALL | CHANnel<N> | FUNction<F> | DIGital<M> | WMEMory<R> | CLOCk | MTRend | MSPectrum | EQUalized}

Setting the source to ALL does not affect the individual channel settings which is the behavior as the user interface.

For more information on <source> parameters, see "[Measurement Sources](#)" on page 728.

Example This example sets the method used to calculate the top and base of a waveform to hysteresis.

```
myScope.WriteString ":SYSTEM:HEADer OFF" ' Response headers off.
myScope.WriteString ":MEASure:THResholds:SERial:METhod CHANnel1,HYStere sis"
```

Query :MEASure:THResholds:SERial:METhod? <source>

The :MEASure:THResholds:SERial:METhod? query returns the current method being used to calculate the top and base of a waveform.

Returned Format [:MEASure:THResholds:SERial:METhod <source>,) {ABSolute | PERCent | HYStere sis}

Example This example returns the method used to calculate the top and base of a waveform to hysteresis.

```
myScope.WriteString ":SYSTEM:HEADer OFF" ' Response headers off.
myScope.WriteString ":MEASure:THResholds:SERial:METhod?"
varMethod = myScope.ReadNumber
Debug.Print FormatNumber (varMethod, 0)
```

See Also

- "[:MEASure:THResholds:METhod](#)" on page 922
- "[:MEASure:THResholds:GENeral:METhod](#)" on page 909
- "[:MEASure:THResholds:RFALL:METhod](#)" on page 926

History New in version 3.10.

:MEASure:THResholds:SERial:PERCent

Command :MEASure:THResholds:SERial:PERCent <source>,<upper_pct>,<middle_pct>,<lower_pct>

The :MEASure:THResholds:SERial:PERCent command sets the upper level, middle level, and lower level voltages as a percentage of the top and base voltages which are used for protocol decode.

NOTE

These serial threshold settings are used for protocol decode.

<source> {ALL | CHANnel<N> | FUNCTion<F> | DIGital<M> | WMEMory<R> | CLOCk | MTRend | MSPectrum | EQUalized}

Setting the source to ALL does not affect the individual channel settings which is the behavior as the user interface.

For more information on <source> parameters, see "[Measurement Sources](#)" on page 728.

<upper_pct> A real number specifying upper percentage from -24.8 to 125.0
 <middle_pct> A real number specifying the middle percentage from -24.9 to 124.9.
 <lower_pct> A real number specifying the lower percentage from -25.0 to 125.8

Example This example sets the percentage to 100% for the upper level, 50% for the middle level and 0% for the lower level on channel 2.

```
myScope.WriteString ":SYSTEM:HEADer OFF" ' Response headers off.
myScope.WriteString ":MEASure:THResholds:SERial:PERCent CHANnel2,100,50,0"
```

Query :MEASure:THResholds:SERial:PERCent? <source>

The :MEASure:THResholds:SERial:PERCent? query returns the current settings for upper level, middle level, and lower level percentages.

Returned Format [:MEASure:THResholds:SERial:PERCent] <upper_pct>,<middle_pcts>,<lower_pct><NL>

Example This example returns the upper level, middle level, and lower level percentages used for protocol decode on channel 1.

```
myScope.WriteString ":SYSTEM:HEADer OFF" ' Response headers off.
myScope.WriteString ":MEASure:THResholds:SERial:PERCent? CHANnel1"
strThresholdsPct = myScope.ReadString
Debug.Print strThresholdsPct
```

NOTE**Turn Off Headers**

When receiving numeric data into numeric variables, turn off the headers. Otherwise, the headers may cause misinterpretation of returned data.

- See Also**
- [":MEASure:THResholds:PERCent"](#) on page 923
 - [":MEASure:THResholds:GENeral:PERCent"](#) on page 915
 - [":MEASure:THResholds:RFALL:PERCent"](#) on page 930

History New in version 3.10.

:MEASure:THResholds:SERial:TOPBase:ABSolute

Command :MEASure:TOPBase:THResholds:SERial:ABSolute <source>,<top_volts>,<base_volts>

The :MEASure:TOPBase:THResholds:SERial:ABSolute command sets the top level and base level voltages that are used for protocol decode.

NOTE

These serial threshold settings are used for protocol decode.

<source> {ALL | CHANnel<N> | FUNction<F> | DIGital<M> | WMEMory<R> | CLOCK | MTRend | MSPectrum | EQUalized}

Setting the source to ALL does not affect the individual channel settings which is the behavior as the user interface.

For more information on <source> parameters, see "[Measurement Sources](#)" on page 728.

<top_volts> A real number specifying voltage levels. The top voltage level must be greater than the base voltage level.

Example This example sets the voltage level for the top to 0.9 volts and the voltage level for the base to 0.1 volts on channel 2.

```
myScope.WriteString ":SYSTEM:HEADER OFF" ' Response headers off.
myScope.WriteString ":MEASure:THResholds:SERial:TOPBase:ABSolute CHANnel
2,0.9,0.1"
```

Query :MEASure:THResholds:SERial:TOPBase:ABSolute? <source>

The :MEASure:THResholds:SERial:TOPBase:ABSolute? query returns the current settings for top level and base level voltages.

Returned Format [:MEASure:THResholds:SERial:TOPBase:ABSolute] <top_volts>,<base_volts><NL>

Example This example returns the top level and base level voltages used for protocol decode on channel 1.

```
myScope.WriteString ":SYSTEM:HEADER OFF" ' Response headers off.
myScope.WriteString ":MEASure:THResholds:SERial:TOPBase:ABSolute? CHANne
l1"
strTopBase = myScope.ReadString
Debug.Print strTopBase
```

NOTE**Turn Off Headers**

When receiving numeric data into numeric variables, turn off the headers. Otherwise, the headers may cause misinterpretation of returned data.

- See Also**
- [":MEASure:THResholds:TOPBase:ABSolute"](#) on page 945
 - [":MEASure:THResholds:GENeral:TOPBase:ABSolute"](#) on page 917
 - [":MEASure:THResholds:RFALL:TOPBase:ABSolute"](#) on page 932

History New in version 3.10.

:MEASure:THResholds:SERial:TOPBase:MEthod

Command :MEASure:THResholds:SERial:TOPBase:MEthod <source>, {ABSolute | HISTONLY
| MINmax | STANdard}

The :MEASure:THResholds:SERial:TOPBase:MEthod command determines the way that the top and base of a waveform are derived for protocol decode.

NOTE

These serial threshold settings are used for protocol decode.

<source> {ALL | CHANnel<N> | FUNction<F> | DIGital<M> | WMEMory<R> | CLOCk | MTRend
| MSPectrum | EQUalized}

Setting the source to ALL does not affect the individual channel settings which is the behavior as the user interface.

For more information on <source> parameters, see "[Measurement Sources](#)" on page 728.

Example This example sets the method used to derive the top and base of a waveform to the histogram method.

```
myScope.WriteString ":SYSTEM:HEADer OFF" ' Response headers off.
myScope.WriteString ":MEASure:THResholds:SERial:TOPBase:MEthod CHANnel1,
HISTONLY"
```

Query :MEASure:THResholds:SERial:TOPBase:MEthod? <source>

The :MEASure:THResholds:SERial:TOPBase:MEthod? query returns the current method being used to calculate the top and base of a waveform.

Returned Format [:MEASure:THResholds:SERial:TOPBase:MEthod] {ABSolute | HISTONLY | MINmax
| STANdard}

Example This example returns the method used to derive the top and base of a waveform for channel 1.

```
myScope.WriteString ":SYSTEM:HEADer OFF" ' Response headers off.
myScope.WriteString ":MEASure:THResholds:SERial:TOPBase:MEthod CHANnel1"
varMethod = myScope.ReadNumber
Debug.Print FormatNumber (varMethod, 0)
```

See Also

- "[:MEASure:THResholds:TOPBase:MEthod](#)" on page 946
- "[:MEASure:THResholds:GENeral:TOPBase:MEthod](#)" on page 919
- "[:MEASure:THResholds:RFALL:TOPBase:MEthod](#)" on page 934

History New in version 3.10.

:MEASure:THResholds:TOPBase:ABSolute

Command :MEASure:TOPBase:THResholds:ABSolute <source>,<top_volts>,<base_volts>

The :MEASure:TOPBase:THResholds:ABSolute command sets the top level and base level voltages that are used to calculate the measurements that use them.

<source> {ALL | CHANnel<N> | FUNction<F> | DIGital<M> | WMEMory<R> | CLOCk | MTRend | MSPectrum | EQUalized}

Setting the source to ALL does not affect the individual channel settings which is the behavior as the user interface.

For more information on <source> parameters, see "[Measurement Sources](#)" on page 728.

<top_volts> A real number specifying voltage levels. The top voltage level must be greater than the base voltage level.

<base_volts> A real number specifying voltage levels. The top voltage level must be greater than the base voltage level.

Example This example sets the voltage level for the top to 0.9 volts and the voltage level for the base to 0.1 volts on channel 2.

```
myScope.WriteString ":SYSTEM:HEADer OFF" ' Response headers off.
myScope.WriteString ":MEASure:THResholds:TOPBase:ABSolute CHANnel2,0.9,0.1"
```

Query :MEASure:THResholds:TOPBase:ABSolute? <source>

The :MEASure:THResholds:TOPBase:ABSolute? query returns the current settings for top level and base level voltages.

Returned Format [:MEASure:THResholds:TOPBase:ABSolute] <top_volts>,<base_volts><NL>

Example This example returns the top level and base level voltages used to calculate the measurements on channel 1.

```
myScope.WriteString ":SYSTEM:HEADer OFF" ' Response headers off.
myScope.WriteString ":MEASure:THResholds:TOPBase:ABSolute? CHANnel1"
strTopBase = myScope.ReadString
Debug.Print strTopBase
```

NOTE**Turn Off Headers**

When receiving numeric data into numeric variables, turn off the headers. Otherwise, the headers may cause misinterpretation of returned data.

History Legacy command (existed before version 3.10).

:MEASure:THResholds:TOPBase:METhod

Command :MEASure:THResholds:TOPBase:METhod <source>,{ABSolute | HISTONLY
| MINmax | STANdard}

The :MEASure:THResholds:TOPBase:METhod command determines the way that the top and base of a waveform are derived for all of the measurements that use them.

<source> {ALL | CHANnel<N> | FUNction<F> | DIGital<M> | WMEMory<R> | CLOCk | MTRend
| MSPectrum | EQUalized}

Setting the source to ALL does not affect the individual channel settings which is the behavior as the user interface.

For more information on <source> parameters, see "[Measurement Sources](#)" on page 728.

Example This example sets the method used to derive the top and base of a waveform to the histogram method.

```
myScope.WriteString ":SYSTem:HEADer OFF" ' Response headers off.
myScope.WriteString ":MEASure:THResholds:TOPBase:METhod CHANnel1,HISTONL
Y"
```

Query :MEASure:THResholds:TOPBase:METhod? <source>

The :MEASure:THResholds:TOPBase:METhod? query returns the current method being used to calculate the top and base of a waveform.

Returned Format [:MEASure:THResholds:TOPBase:METhod] {ABSolute | HISTONLY | MINmax | STA
Ndard}

Example This example returns the method used to derive the top and base of a waveform for channel 1.

```
myScope.WriteString ":SYSTem:HEADer OFF" ' Response headers off.
myScope.WriteString ":MEASure:THResholds:TOPBase:METhod CHANnel1"
varMethod = myScope.ReadNumber
Debug.Print FormatNumber(varMethod, 0)
```

History Legacy command (existed before version 3.10).

:MEASure:TIEClock2

Command

NOTE

Turn Off Headers

When receiving numeric data into numeric variables, turn off the headers. Otherwise, the headers may cause misinterpretation of returned data.

NOTE

This command is only available when the E2681A Jitter Analysis Software or the N5400A/5401A Software is installed.

```
:MEASure:TIEClock2 <source>,{SECond | UNITinterval},
  <direction>,{AUTO | CUSTOM,<frequency>}
  | {VARiable,<frequency>,<bandwidth>} | CLOck}
```

The :MEASure:TIEClock2 command measures time interval error on a clock. You can set the units of the measurement by selecting SECond (seconds) or UNITinterval. If AUTO is selected, the oscilloscope selects the ideal constant clock frequency. If CUSTOM is selected, you can enter your own ideal clock frequency. If VARiable is selected, a first order PLL clock recovery is used at the give clock frequency and loop bandwidth. If CLOck is given, clock recovery is specified with the :MEASure:CLOCK:METHod command.

<source> {CHANnel<N> | DIFF<D> | COMMONmode<C> | FUNCTion<F> | DIGital<M> | WMEMory<R> | CLOck | MTRend | MSpectrum | EQUalized}

For more information on <source> parameters, see "[Measurement Sources](#)" on page 728.

<direction> {RISing | FALLing | BOTH}

Specifies direction of clock edge. BOTH selects the first edge from the left-hand side of the waveform viewing area.

<frequency> A real number for the ideal clock frequency for clock recovery.

<bandwidth> A real number for the loop bandwidth of the PLL clock recovery method.

Example This example measures the clock time interval error on the rising edge of channel 1, ideal clock frequency set to automatic, units set to seconds.

```
myScope.WriteString ":MEASure:TIEClock2 CHANnel1,SECond,RISing,AUTO"
```

Query :MEASure:TIEClock2? <source>,{SECond | UNITinterval},<direction>,{AUTO | CUSTOM,<frequency> | {VARiable,<frequency>,<bandwidth>} | CLOck}

The :MEASure:TIEClock2? query returns the current value of the clock time interval error.

Returned Format [:MEASure:TIEClock2] <value>[,<result_state>]<NL>

<value> The clock time interval error value.

<result_state> If SENDvalid is ON, the result state is returned with the measurement result. See the :MEASure:RESults table in this chapter for a list of the result states.

Example This example places the current value of the clock time interval error in the variable strValue, then prints the contents of the variable to the computer's screen.

```
myScope.WriteString ":SYSTEM:HEADer OFF"  
myScope.WriteString ":MEASure:TIEClock2? CHANnel1,SECond,FALLing,CUSTOM,  
2.5E9"  
strValue = myScope.ReadString  
Debug.Print strValue
```

- See Also**
- [":MEASure:CTCJitter"](#) on page 755
 - [":MEASure:NCJitter"](#) on page 818
 - [":MEASure:CTCPwidth"](#) on page 758
 - [":MEASure:CTCNwidth"](#) on page 757
 - [":MEASure:CTCDutycycle"](#) on page 753

History Legacy command (existed before version 3.10).

:MEASure:TIEData2

Command

NOTE

This command is only available when the E2681A Jitter Analysis Software, Serial Data Analysis, or the N5400A/5401A Software is installed.

```
:MEASure:TIEData2 <source>,{SECond | UNITinterval}[,<threshold>]
```

The :MEASure:TIEData2 command measures data time interval error. You can set the units of the measurement by selecting SECond (seconds) or UNITinterval.

<source> {CHANnel<N> | DIFF<D> | COMMONmode<C> | FUNCtion<F> | DIGital<M> | WMEMory<R> | CLOCK | MTRend | MSPectrum | EQUalized}

For more information on <source> parameters, see "[Measurement Sources](#)" on page 728.

<threshold> When the signal type is PAM-4 (see :ANALyze:SIGNal:TYPE), the <threshold> parameter is an integer that specifies which PAM threshold to measure. For PAM-4, the <threshold> may be from 0-2.

Example This example measures the data time interval error on channel 1, ideal data rate set to automatic, units set to seconds.

```
myScope.WriteString ":MEASure:TIEData2 CHANnel1,SECond"
```

Query :MEASure:TIEData2? <source>,(SECond | UNITinterval)[,<threshold>]

The :MEASure:TIEData2? query returns the current value of the data time interval error.

Returned Format [:MEASure:TIEData2] <value>[,<result_state>]<NL>

<value> The data time interval error value.

<result_state> If SENDvalid is ON, the result state is returned with the measurement result. See the :MEASure:RESults table in this chapter for a list of the result states.

Example This example places the current value of the data time interval error in the variable strValue, then prints the contents of the variable to the computer's screen.

```
myScope.WriteString ":SYSTem:HEADer OFF"
myScope.WriteString ":MEASure:TIEData2? CHANnel1,SECond"
strValue = myScope.ReadString
Debug.Print strValue
```

See Also • "[:ANALyze:SIGNal:TYPE](#)" on page 271

History New in version 5.50. This command replaces the now deprecated command "[:MEASure:TIEData](#)" on page 1536.

:MEASure:TIEFilter:SHAPE

Command :MEASure:TIEFilter:SHAPE {RECTangular | DB20 | DB40}

The :MEASure:TIEFilter:SHAPE command specifies the shape of the TIE filter edge(s):

- RECTangular – The TIE filter is a brickwall filter.
- DB20 – The TIE filter edge(s) roll off at 20 dB per decade.
- DB40 – The TIE filter edge(s) roll off at 40 dB per decade.

Example This example specifies that the TIE filter edge(s) roll off at 40 dB per decade.

```
myScope.WriteString ":MEASure:TIEFilter:SHAPE DB40"
```

Query :MEASure:TIEFilter:SHAPE?

The :MEASure:TIEFilter:SHAPE? query returns the specified shape of the TIE filter edge(s).

Returned Format [:MEASure:TIEFilter:SHAPE] {RECTangular | DB20 | DB40}<NL>

Example This example places the specified shape of the TIE filter edge(s) in the string variable, strShape, then prints the contents of the variable to the computer's screen.

```
Dim strShape As String ' Dimension variable.
myScope.WriteString ":MEASure:TIEFilter:SHAPE?"
strShape = myScope.ReadString
Debug.Print strShape
```

- See Also**
- [":MEASure:TIEFilter:STATe"](#) on page 952
 - [":MEASure:TIEFilter:TYPE"](#) on page 954
 - [":MEASure:TIEFilter:START"](#) on page 951
 - [":MEASure:TIEFilter:STOP"](#) on page 953

History New in version 4.10.

:MEASure:TIEFilter:START

Command :MEASure:TIEFilter:START <start_frequency>

The :MEASure:TIEFilter:START command sets the starting frequency for the TIE filter.

<start_frequency> A real number.

Query :MEASure:TIEFilter:START?

The :MEASure:TIEFilter:START? query returns the current value of the starting frequency of the TIE filter.

Returned Format [:MEASure:TIEFilter:START] <value><NL>

<value> The start frequency for the TIE filter.

Example This example returns the current value of the starting frequency for the TIE filter then prints the contents of the variable to the computer's screen.

```
myScope.WriteString ":SYSTEM:HEADer OFF" ' Response headers off.
myScope.WriteString ":MEASure:TIEFilter:START?"
varStart = myScope.ReadNumber
Debug.Print FormatNumber(varStart, 0)
```

- See Also**
- [":MEASure:TIEFilter:STATe"](#) on page 952
 - [":MEASure:TIEFilter:TYPE"](#) on page 954
 - [":MEASure:TIEFilter:SHAPE"](#) on page 950
 - [":MEASure:TIEFilter:STOP"](#) on page 953

History Legacy command (existed before version 3.10).

:MEASure:TIEFilter:STATe

Command :MEASure:TIEFilter:STATe {{ON | 1} | {OFF | 0}}

The :MEASure:TIEFilter:STATe command enables the TIE filter for TIE data measurements.

Query :MEASure:TIEFilter:STATe?

The :MEASure:TIEFilter:STATe? query returns the current state of the TIE data filter.

Returned Format [:MEASure:TIEFilter:STATe] {0 | 1}<NL>

Example This example returns the current state of the TIE data filter then prints the contents of the variable to the computer's screen.

```
myScope.WriteString ":SYSTEM:HEADer OFF" ' Response headers off.
myScope.WriteString ":MEASure:TIEFilter:STATe?"
varState = myScope.ReadNumber
Debug.Print FormatNumber(varState, 0)
```

- See Also**
- [":MEASure:TIEFilter:TYPE"](#) on page 954
 - [":MEASure:TIEFilter:SHAPE"](#) on page 950
 - [":MEASure:TIEFilter:START"](#) on page 951
 - [":MEASure:TIEFilter:STOP"](#) on page 953

History Legacy command (existed before version 3.10).

:MEASure:TIEFilter:STOP

Command :MEASure:TIEFilter:STOP <stop_frequency>

The :MEASure:TIEFilter:STOP command sets the stopping frequency for the TIE filter.

<stop_frequency> A real number.

Query :MEASure:TIEFilter:STOP?

The :MEASure:TIEFilter:STOP? query returns the current value of the stopping frequency of the TIE filter.

Returned Format [:MEASure:TIEFilter:STOP] <value><NL>

<value> The stop frequency for the TIE filter.

Example This example returns the current value of the stopping frequency for the TIE filter then prints the contents of the variable to the computer's screen.

```
myScope.WriteString ":SYSTEM:HEADer OFF" ' Response headers off.
myScope.WriteString ":MEASure:TIEFilter:STOP?"
varStop = myScope.ReadNumber
Debug.Print FormatNumber(varStop, 0)
```

- See Also**
- [":MEASure:TIEFilter:STATe"](#) on page 952
 - [":MEASure:TIEFilter:TYPE"](#) on page 954
 - [":MEASure:TIEFilter:SHAPE"](#) on page 950
 - [":MEASure:TIEFilter:START"](#) on page 951

History Legacy command (existed before version 3.10).

:MEASure:TIEFilter:TYPE

Command :MEASure:TIEFilter:TYPE {BANDpass | LOWPass | HIGHpass}

The :MEASure:TIEFilter:TYPE command sets the type of TIE filter to be used.

Example This example sets the TIE filter to highpass.

```
myScope.WriteString ":MEASure:TIEFilter:TYPE HIGHpass"
```

Query :MEASure:TIEFilter:TYPE?

The :MEASure:TIEFilter:TYPE? query returns the current type of TIE filter being used.

Returned Format [:MEASure:TIEFilter:TYPE] {BANDpass | LOWPass | HIGHpass}<NL>

Example This example places the current mode for TIEFilter:TYPE in the string variable, strMode, then prints the contents of the variable to the computer's screen.

```
Dim strMode As String ' Dimension variable.
myScope.WriteString ":MEASure:TIEFilter:TYPE?"
strMode = myScope.ReadString
Debug.Print strMode
```

See Also

- [":MEASure:TIEFilter:STATe"](#) on page 952
- [":MEASure:TIEFilter:SHAPE"](#) on page 950
- [":MEASure:TIEFilter:START"](#) on page 951
- [":MEASure:TIEFilter:STOP"](#) on page 953

History Legacy command (existed before version 3.10).

:MEASure:TMAX

Command :MEASure:TMAX [<source>]

The :MEASure:TMAX command measures the first time at which the maximum voltage of the source waveform occurred. Sources are specified with the :MEASure:SOURce command or with the optional parameter following the :MEASure:TMAX command.

<source> {CHANnel<N> | DIFF<D> | COMMONmode<C> | FUNCTion<F> | WMEMory<R> | CLOCk | MTRend | MSPectrum | EQUalized}

For more information on <source> parameters, see "[Measurement Sources](#)" on page 728.

Query :MEASure:TMAX? [<source>]

The :MEASure:TMAX? query returns the time at which the first maximum voltage occurred.

Returned Format [:MEASure:TMAX] <time> [, <result_state>] <NL>

<time> Time at which the first maximum voltage occurred or frequency where the maximum FFT amplitude occurred.

<result_state> If SENDvalid is ON, the result state is returned with the measurement result. See the :MEASure:RESults table in this chapter for a list of the result states.

Example This example returns the time at which the first maximum voltage occurred to the numeric variable, varTime, then prints the contents of the variable to the computer's screen.

```
myScope.WriteString ":SYSTEM:HEADer OFF" ' Response headers off.
myScope.WriteString ":MEASure:TMAX? CHANnel1"
varTime = myScope.ReadNumber
Debug.Print FormatNumber(varTime, 0)
```

History Legacy command (existed before version 3.10).

:MEASure:TMIN

Command :MEASure:TMIN [<source>]

The :MEASure:TMIN command measures the time at which the first minimum voltage occurred. Sources are specified with the :MEASure:SOURce command or with the optional parameter following the :MEASure:TMIN command.

<source> {CHANnel<N> | DIFF<D> | COMMONmode<C> | FUNCTion<F> | WMEMory<R> | CLOCk | MTRend | MSPectrum | EQUALized}

For more information on <source> parameters, see "[Measurement Sources](#)" on page 728.

Query :MEASure:TMIN? [<source>]

The :MEASure:TMIN? query returns the time at which the first minimum voltage occurred or the frequency where the minimum FFT amplitude occurred.

Returned Format [:MEASure:TMIN] <time> [, <result_state>] <NL>

<time> Time at which the first minimum voltage occurred.

<result_state> If SENDvalid is ON, the result state is returned with the measurement result. See the :MEASure:RESults table in this chapter for a list of the result states.

Example This example returns the time at which the first minimum voltage occurred to the numeric variable, varTime, then prints the contents of the variable to the computer's screen.

```
myScope.WriteString ":SYSTEM:HEADer OFF" ' Response headers off.
myScope.WriteString ":MEASure:TMIN? CHANnel1"
varTime = myScope.ReadNumber
Debug.Print FormatNumber(varTime, 0)
```

History Legacy command (existed before version 3.10).

:MEASure:TVOLt

Command :MEASure:TVOLt <voltage>, [<slope>] <occurrence> [, <source>]

The :MEASure:TVOLt command measures the time interval between the trigger event and the defined voltage level and transition. Sources are specified with the :MEASure:SOURce command or with the optional parameter following the :MEASure:TVOLt command.

The TEDGe command can be used to get the time of edges.

<voltage> Voltage level at which time will be measured.

<slope> The direction of the waveform change when the specified voltage is crossed - rising (+) or falling (-). If no +/- sign is present, + is assumed.

<occurrence> The number of the crossing to be reported (if one, the first crossing is reported; if two, the second crossing is reported, etc.). The desired crossing must be present on the display. Occurrences are counted with 1 being the first occurrence from the left of the display, and a maximum value of 65534.

<source> {CHANnel<N> | DIFF<D> | COMMONmode<C> | FUNCTion<F> | WMEMory<R> | CLOCK | MTRend | MSPectrum | EQUalized}

For more information on <source> parameters, see "[Measurement Sources](#)" on page 728.

Query :MEASure:TVOLt? <voltage>, <slope> <occurrence> [, <source>]

The :MEASure:TVOLt? query returns the time interval between the trigger event and the specified voltage level and transition.

Returned Format [:MEASure:TVOLt] <time> [, <result_state>] <NL>

<time> The time interval between the trigger event and the specified voltage level and transition.

<result_state> If SENDvalid is ON, the result state is returned with the measurement result. See the :MEASure:RESuLts table in this chapter for a list of the result states.

Example This example returns the time interval between the trigger event and the transition through -0.250 Volts on the third rising occurrence of the source waveform to the numeric variable, varTime. The contents of the variable are then printed to the computer's screen.

```
myScope.WriteString ":SYSTEM:HEADer OFF" ' Response headers off.
myScope.WriteString ":MEASure:TVOLt? -0.250,+3,CHANnel1"
varTime = myScope.ReadNumber
Debug.Print FormatNumber(varTime, 0)
```

History Legacy command (existed before version 3.10).

:MEASure:UITouijitter

Command :MEASure:UITouijitter <source>, <N>

The :MEASure:UITouijitter command measures the difference between two consecutive N-UI measurements. The measurement then moves over one unit interval and makes another measurement. When N=1, this is analogous to cycle-cycle jitter, but measures unit intervals instead of periods. When N>1, this is analogous to N-Cycle jitter but measures unit intervals instead of periods.

<source> The source on which the measurement is made.

For more information on <source> parameters, see "[Measurement Sources](#)" on page 728.

<N> An integer greater than or equal to 1.

Example This example measures the UI-UI jitter for 3 consecutive unit intervals on channel 1.

```
myScope.WriteString ":MEASure:UITouijitter CHAN1, 3"
```

Query :MEASure:UITouijitter?

History Legacy command (existed before version 3.10).

:MEASure:UNITinterval

Command

NOTE

This command is only available when the E2681A Jitter Analysis Software or the N5400A/5401A Software is installed.

```
:MEASure:UNITinterval <source>[, {AUTO | (SEMI, <data_rate>)}]
```

The :MEASure:UNITinterval command measures the unit interval value of the selected source. Use the :MEASure:DATarate command/query to measure the data rate of the source

<source> {CHANnel<N> | DIFF<D> | COMMONmode<C> | FUNCTion<F> | DIGital<M> | WMEMory<R> | CLOCK | MTRend | MSPectrum | EQUalized}

For more information on <source> parameters, see "[Measurement Sources](#)" on page 728.

<data_rate> A real number representing the data rate.

Example This example measures the unit interval of channel 1.

```
myScope.WriteString ":MEASure:UNITinterval CHANnel1"
```

Query :MEASure:UNITinterval? <source>[, {AUTO | (SEMI, <data_rate>)}]

The :MEASure:UNITinterval? query returns the measured unit interval.

Returned Format [:MEASure:UNITinterval] <value>[, <result_state>]<NL>

<value> Unit interval of the source.

<result_state> If SENDvalid is ON, the result state is returned with the measurement result. See the :MEASure:RESuLts table in this chapter for a list of the result states.

Example This example places the current unit interval of the channel 1 waveform in the numeric variable, varValue, then prints the contents of the variable to the computer's screen.

```
myScope.WriteString ":SYSTem:HEADer OFF" ' Response headers off.
myScope.WriteString ":MEASure:UNITinterval? CHANnel1"
varValue = myScope.ReadNumber
Debug.Print FormatNumber(varValue, 0)
```

History Legacy command (existed before version 3.10).

:MEASure:VAMPlitude

Command :MEASure:VAMPlitude [<source>]

The :MEASure:VAMPlitude command calculates the difference between the top and base voltage of the specified source. Sources are specified with the :MEASure:SOURce command or with the optional parameter following the :MEASure:VAMPlitude command.

<source> {CHANnel<N> | DIFF<D> | COMMONmode<C> | FUNCTion<F> | WMEMory<R> | CLOCK | MTRend | MSPectrum | EQUalized}

For more information on <source> parameters, see "[Measurement Sources](#)" on page 728.

Example This example calculates the difference between the top and base voltage of the specified source.

```
myScope.WriteString ":MEASure:VAMPlitude CHANnel1"
```

Query :MEASure:VAMPlitude? [<source>]

The :MEASure:VAMPlitude? query returns the calculated difference between the top and base voltage of the specified source.

Returned Format [:MEASure:VAMPlitude] <value>[,<result_state>]<NL>

<value> Calculated difference between the top and base voltage.

<result_state> If SENDvalid is ON, the result state is returned with the measurement result. See the :MEASure:RESuLts table in this chapter for a list of the result states.

Example This example places the current Vamplitude value in the numeric variable, varValue, then prints the contents of the variable to the computer's screen.

```
myScope.WriteString ":SYSTEM:HEADer OFF" ' Response headers off.
myScope.WriteString ":MEASure:VAMPlitude? CHANnel1"
varValue = myScope.ReadNumber
Debug.Print FormatNumber(varValue, 0)
```

History Legacy command (existed before version 3.10).

:MEASure:VAverage

Command :MEASure:VAverage {CYCLE | DISPLAY}[, <source>]

The :MEASure:VAverage command calculates the average voltage over the displayed waveform. Sources are specified with the :MEASure:SOURce command or with the optional parameter following the :MEASure:VAverage command.

CYCLE The CYCLE parameter instructs the average measurement to measure the average voltage across the first period on the display.

DISPlay The DISPlay parameter instructs the average measurement to measure all the data on the display.

<source> {CHANnel<N> | DIFF<D> | COMMONmode<C> | FUNCTION<F> | WMemory<R> | CLOCK | MTRend | MSPectrum | EQUALized}

For more information on <source> parameters, see "[Measurement Sources](#)" on page 728.

Example This example calculates the average voltage over the displayed waveform.

```
myScope.WriteString ":MEASure:VAverage DISPLAY,CHANnel1"
```

Query :MEASure:VAverage? {CYCLE | DISPLAY}[, <source>]

The :MEASure:VAverage? query returns the calculated average voltage of the specified source. Sources are specified with the :MEASure:SOURce command or with the optional parameter following the :MEASure:VAverage command.

Returned Format [:MEASure:VAverage] <value>[, <result_state>]<NL>

<value> The calculated average voltage.

<result_state> If SENDvalid is ON, the result state is returned with the measurement result. See the :MEASure:RESults table in this chapter for a list of the result states.

Example This example places the current average voltage in the numeric variable, varAverage, then prints the contents of the variable to the computer's screen.

```
myScope.WriteString ":SYSTem:HEADer OFF" ' Response headers off.
myScope.WriteString ":MEASure:VAverage? DISPLAY,CHANnel1 CHANnel1"
varAverage = myScope.ReadNumber
Debug.Print FormatNumber(varAverage, 0)
```

History Legacy command (existed before version 3.10).

:MEASure:VBASe

Command :MEASure:VBASe [<source>]

The :MEASure:VBASe command measures the statistical base of the waveform. Sources are specified with the :MEASure:SOURce command or with the optional parameter following the :MEASure:VBASe command.

<source> {CHANnel<N> | DIFF<D> | COMMONmode<C> | FUNCTion<F> | WMEMory<R> | CLOCk | MTRend | MSPectrum | EQUalized}

For more information on <source> parameters, see "[Measurement Sources](#)" on page 728.

Example This example measures the voltage at the base of the waveform.

```
myScope.WriteString ":MEASure:VBASe CHANnel1"
```

Query :MEASure:VBASe? [<source>]

The :MEASure:VBASe? query returns the measured voltage value at the base of the specified source.

Returned Format [:MEASure:VBASe] <value>[,<result_state>]<NL>

<value> Voltage at the base of the waveform.

<result_state> If SENDvalid is ON, the result state is returned with the measurement result. See the :MEASure:RESults table in this chapter for a list of the result states.

Example This example returns the current voltage at the base of the waveform to the numeric variable, varVoltage, then prints the contents of the variable to the computer's screen.

```
myScope.WriteString ":SYSTem:HEADer OFF" ' Response headers off.
myScope.WriteString ":MEASure:VBASe? CHANnel1"
varVoltage = myScope.ReadNumber
Debug.Print FormatNumber(varVoltage, 0)
```

History Legacy command (existed before version 3.10).

:MEASure:VLOWer

Command :MEASure:VLOWer [<source>]

The :MEASure:VLOWer command measures the voltage value at the lower threshold of the waveform. Sources are specified with the :MEASure:SOURce command or with the optional parameter following the :MEASure:VLOWer command.

<source> {CHANnel<N> | DIFF<D> | COMMONmode<C> | FUNCTION<F> | WMEMory<R> | CLOCK | MTRend | MSPectrum | EQUALized}

For more information on <source> parameters, see "[Measurement Sources](#)" on page 728.

Query :MEASure:VLOWer?

The :MEASure:VLOWer? query returns the measured lower threshold of the selected source.

Returned Format [:MEASure:VLOWer] <value>[,<result_state>]<NL>

<value> Voltage value at the lower threshold.

<result_state> If SENDvalid is ON, the result state is returned with the measurement result. See the :MEASure:RESults table in this chapter for a list of the result states.

Example This example returns the measured voltage at the lower threshold of the waveform to the numeric variable, varVlower, then prints the contents of the variable to the computer's screen.

```
myScope.WriteString ":SYSTEM:HEADer OFF" ' Response headers off.
myScope.WriteString ":MEASure:VLOWer? CHANnel1"
varVlower = myScope.ReadNumber
Debug.Print FormatNumber(varVlower, 0)
```

History Legacy command (existed before version 3.10).

:MEASure:VMAX

Command :MEASure:VMAX [<source>]

The :MEASure:VMAX command measures the absolute maximum voltage present on the selected source waveform. Sources are specified with the :MEASure:SOURce command or with the optional parameter following the :MEASure:VMAX command.

<source> {CHANnel<N> | DIFF<D> | COMMONmode<C> | FUNCTion<F> | WMEMory<R> | CLOCK | MTRend | MSPectrum | EQUALized}

For more information on <source> parameters, see "[Measurement Sources](#)" on page 728.

Example This example measures the absolute maximum voltage on the waveform.

```
myScope.WriteString ":MEASure:VMAX CHANnel1"
```

Query :MEASure:VMAX? [<source>]

The :MEASure:VMAX? query returns the measured absolute maximum voltage or maximum FFT amplitude present on the selected source waveform.

Returned Format [:MEASure:VMAX] <value>[, <result_state>]<NL>

<value> Absolute maximum voltage present on the waveform.

<result_state> If SENDvalid is ON, the result state is returned with the measurement result. See the :MEASure:RESuLts table in this chapter for a list of the result states.

Example This example returns the measured absolute maximum voltage on the waveform to the numeric variable, varMaximum, then prints the contents of the variable to the computer's screen.

```
myScope.WriteString ":SYSTem:HEADer OFF" ' Response headers off.
myScope.WriteString ":MEASure:VMAX? CHANnel1"
varMaximum = myScope.ReadNumber
Debug.Print FormatNumber(varMaximum, 0)
```

History Legacy command (existed before version 3.10).

:MEASure:VMIDdle

Command :MEASure:VMIDdle [<source>]

The :MEASure:VMIDdle command measures the voltage level at the middle threshold of the waveform. Sources are specified with the :MEASure:SOURce command or with the optional parameter following the :MEASure:VMIDdle command.

<source> {CHANnel<N> | DIFF<D> | COMMONmode<C> | FUNCTION<F> | WMEMory<R> | CLOCK | MTRend | MSPectrum | EQUALized}

For more information on <source> parameters, see "[Measurement Sources](#)" on page 728.

Query :MEASure:VMIDdle? [<source>]

The :MEASure:VMIDdle? query returns the voltage value at the middle threshold of the waveform.

Returned Format [MEASure:VMIDdle] <value>[,<result_state>]<NL>

<value> The middle voltage present on the waveform.

<result_state> If SENDvalid is ON, the result state is returned with the measurement result. See the :MEASure:RESults table in this chapter for a list of the result states.

Example This example returns the measured middle voltage on the waveform to the numeric variable, varMiddle, then prints the contents of the variable to the computer's screen.

```
myScope.WriteString ":SYSTEM:HEADer OFF" ' Response headers off.
myScope.WriteString ":MEASure:VMIDdle? CHANnel1"
varMiddle = myScope.ReadNumber
Debug.Print FormatNumber(varMiddle, 0)
```

History Legacy command (existed before version 3.10).

:MEASure:VMIN

Command :MEASure:VMIN [<source>]

The :MEASure:VMIN command measures the absolute minimum voltage present on the selected source waveform. Sources are specified with :MEASure:SOURce or with the optional parameter following the :MEASure:VMIN command.

<source> {CHANnel<N> | DIFF<D> | COMMONmode<C> | FUNction<F> | WMEMory<R> | CLOCk | MTRend | MSPectrum | EQUalized}

For more information on <source> parameters, see "[Measurement Sources](#)" on page 728.

Example This example measures the absolute minimum voltage on the waveform.

```
myScope.WriteString ":MEASure:VMIN CHANnel1"
```

Query :MEASure:VMIN? [<source>]

The :MEASure:VMIN? query returns the measured absolute minimum voltage or minimum FFT amplitude present on the selected source waveform.

Returned Format [:MEASure:VMIN] <value>[,<result_state>]<NL>

<value> Absolute minimum voltage present on the waveform.

<result_state> If SENDvalid is ON, the result state is returned with the measurement result. See the :MEASure:RESults table in this chapter for a list of the result states.

Example This example returns the measured absolute minimum voltage on the waveform to the numeric variable, varMinimum, then prints the contents of the variable to the computer's screen.

```
myScope.WriteString ":SYSTem:HEADer OFF" ' Response headers off.
myScope.WriteString ":MEASure:VMIN? CHANnel1"
varMinimum = myScope.ReadNumber
Debug.Print FormatNumber(varMinimum, 0)
```

History Legacy command (existed before version 3.10).

:MEASure:VOVershoot

Command :MEASure:VOVershoot <source>[,<direction>]

The :MEASure:VOVershoot command is similar to the overshoot measurement, but instead of returning the ratio of overshoot voltage to amplitude as a percent, it returns the local voltage of the overshoot.

<source> {CHANnel<N> | DIFF<D> | COMMONmode<C> | FUNCTion<F> | WMEMory<R> | CLOck | MTRend | MSPectrum | EQUalized}

For more information on <source> parameters, see "[Measurement Sources](#)" on page 728.

<direction> RISing or FALLing

Example This example measures the local voltage of the overshoot.

```
myScope.WriteString ":MEASure:VOVershoot CHAN1"
```

Query :MEASure:VOVershoot? <source>[,<direction>]

The :MEASure:VOVershoot? query returns the local voltage of the overshoot.

History Legacy command (existed before version 3.10).

:MEASure:VPP

Command :MEASure:VPP [<source>]

The :MEASure:VPP command measures the maximum and minimum voltages on the selected source, then calculates the peak-to-peak voltage as the difference between the two voltages. Sources are specified with the :MEASure:SOURce command or with the optional parameter following the :MEASure:VPP command.

<source> {CHANnel<N> | DIFF<D> | COMMONmode<C> | FUNCTion<F> | WMEMory<R> | CLOCK | MTRend | MSPectrum | EQUALized}

For more information on <source> parameters, see "[Measurement Sources](#)" on page 728.

Example This example measures the peak-to-peak voltage or FFT amplitude range of the previously selected source.

```
myScope.WriteString ":MEASure:VPP CHANnel1"
```

Query :MEASure:VPP? [<source>]

The :MEASure:VPP? query returns the specified source peak-to-peak voltage.

Returned Format [:MEASure:VPP] <value> [, <result_state>] <NL>

<value> Peak-to-peak voltage of the selected source.

<result_state> If SENDvalid is ON, the result state is returned with the measurement result. See the :MEASure:RESults table in this chapter for a list of the result states.

Example This example places the current peak-to-peak voltage in the numeric variable, varVoltage, then prints the contents of the variable to the computer's screen.

```
myScope.WriteString ":SYSTem:HEADer OFF" ' Response headers off.
myScope.WriteString ":MEASure:VPP? CHANnel1"
varVoltage = myScope.ReadNumber
Debug.Print FormatNumber(varVoltage, 0)
```

History Legacy command (existed before version 3.10).

:MEASure:VPReshoot

Command :MEASure:VPReshoot <source>[,<direction>]

The :MEASure:VPReshoot command is similar to the preshoot measurement, but instead of returning the ratio of preshoot voltage to amplitude as a percent, it returns the local voltage of the preshoot.

<source> {CHANnel<N> | DIFF<D> | COMMONmode<C> | FUNCTion<F> | WMEMory<R> | CLOck | MTRend | MSPectrum | EQUalized}

For more information on <source> parameters, see "[Measurement Sources](#)" on page 728.

<direction> RISing or FALLing

Example This example measures the local voltage of the preshoot.

```
myScope.WriteString ":MEASure:VPReshoot CHAN1"
```

Query :MEASure:VPReshoot? <source>[,<direction>]

History Legacy command (existed before version 3.10).

:MEASure:VRMS

Command :MEASure:VRMS {CYCLe | DISPlay},{AC | DC} [,<source> [, {VOLT | DBM}]]

The :MEASure:VRMS command measures the RMS voltage of the selected waveform by subtracting the average value of the waveform from each data point on the display. Sources are specified with the :MEASure:SOURce command or with the optional parameter following the :MEASure:VRMS command.

CYCLe The CYCLe parameter instructs the RMS measurement to measure the RMS voltage across the first period of the display.

DISPlay The DISPlay parameter instructs the RMS measurement to measure all the data on the display. Generally, RMS voltage is measured across one waveform or cycle, however, measuring multiple cycles may be accomplished with the DISPlay option. The DISPlay parameter is also useful when measuring noise.

AC The AC parameter is used to measure the RMS voltage subtracting the DC component.

DC The DC parameter is used to measure RMS voltage including the DC component.

The AC RMS, DC RMS, and VAVG parameters are related as in this formula:

$$DCVRMS^2 = ACVRMS^2 + VAVG^2$$

<source> {CHANnel<N> | DIFF<D> | COMMONmode<C> | FUNCTION<F> | WMEMory<R> | CLOCK | MTRend | MSPectrum | EQUalized}

For more information on <source> parameters, see "[Measurement Sources](#)" on page 728.

VOLT | DBM Specifies the units of the measurement as either volts or decibels.

Example This example measures the RMS voltage of the previously selected waveform.

```
myScope.WriteString ":MEASure:VRMS CYCLe,AC,CHANnel1"
```

Query :MEASure:VRMS? {CYCLe | DISPlay},{AC | DC} [,<source> [, {VOLT | DBM}]]

The :MEASure:VRMS? query returns the RMS voltage of the specified source.

Returned Format [:MEASure:VRMS] <value> [,<result_state>] <NL>

<value> RMS voltage of the selected waveform.

<result_state> If SENDvalid is ON, the result state is returned with the measurement result. See the :MEASure:RESults table in this chapter for a list of the result states.

Example This example places the current AC RMS voltage over one period of the waveform in the numeric variable, varVoltage, then prints the contents of the variable to the computer's screen.

```
myScope.WriteString ":SYSTEM:HEADer OFF" ' Response headers off.
myScope.WriteString ":MEASure:VRMS? CYCLe,AC,CHANnel1"
```

```
varVoltage = myScope.ReadNumber  
Debug.Print FormatNumber(varVoltage, 0)
```

History Legacy command (existed before version 3.10).

Version 3.10: Added the VOLT and DBM parameters for specifying the measurement units.

:MEASure:VTIME

Command :MEASure:VTIME <time>[,<source>]

The :MEASure:VTIME command measures the voltage at the specified time. The time is referenced to the trigger event and must be on the screen. When an FFT function is the specified source, the amplitude at the specified frequency is measured. Sources are specified with the :MEASure:SOURce command or with the optional parameter following the :MEASure:VTIME command.

<source> {CHANnel<N> | DIFF<D> | COMMONmode<C> | FUNCTION<F> | WMEMory<R> | CLOCK | MTRend | MSPectrum | EQUALized}

For more information on <source> parameters, see "[Measurement Sources](#)" on page 728.

<time> A real number for time from trigger in seconds, or frequency in Hertz for an FFT (when a function is set to FFT or a waveform memory contains an FFT).

Query :MEASure:VTIME? <time>[,<source>]

The :MEASure:VTIME? query returns the measured voltage or amplitude.

Returned Format [:MEASure:VTIME] <value>[,<result_state>]<NL>

<value> Voltage at the specified time. When the source is an FFT function, the returned value is the vertical value at the horizontal setting passed in the VTIME <time> parameter. The time parameter is in Hertz when an FFT function is the source.

<result_state> If SENDvalid is ON, the result state is returned with the measurement result. See the :MEASure:RESults table in this chapter for a list of the result states.

Example This example places the voltage at 500 ms in the numeric variable, varValue, then prints the contents to the computer's screen.

```
myScope.WriteString ":SYSTEM:HEADer OFF" ' Response headers off.
myScope.WriteString ":MEASure:VTIME? 500E-3,CHANnel1"
varValue = myScope.ReadNumber
Debug.Print FormatNumber(varValue, 0)
```

History Legacy command (existed before version 3.10).

:MEASure:VTOP

Command :MEASure:VTOP [<source>]

The :MEASure:VTOP command measures the statistical top of the selected source waveform. Sources are specified with the :MEASure:SOURce command or with the optional parameter following the :MEASure:VTOP command.

<source> {CHANnel<N> | DIFF<D> | COMMONmode<C> | FUNction<F> | WMEMory<R> | CLOCk | MTRend | MSPectrum | EQUalized}

For more information on <source> parameters, see "[Measurement Sources](#)" on page 728.

Example This example measures the voltage at the top of the waveform.

```
myScope.WriteString ":MEASure:VTOP CHANnel1"
```

Query :MEASure:VTOP? [<source>]

The :MEASure:VTOP? query returns the measured voltage at the top of the specified source.

Returned Format [:MEASure:VTOP] <value>[,<result_state>]<NL>

<value> Voltage at the top of the waveform.

<result_state> If SENDvalid is ON, the result state is returned with the measurement result. See the :MEASure:RESults table in this chapter for a list of the result states.

Example This example places the value of the voltage at the top of the waveform in the numeric variable, varValue, then prints the contents of the variable to the computer's screen.

```
myScope.WriteString ":SYSTem:HEADer OFF" ' Response headers off.
myScope.WriteString ":MEASure:VTOP? CHANnel1"
varValue = myScope.ReadNumber
Debug.Print FormatNumber(varValue, 0)
```

History Legacy command (existed before version 3.10).

:MEASure:VUPPer

Command :MEASure:VUPPer [<source>]

The :MEASure:VUPPer command measures the voltage value at the upper threshold of the waveform. Sources are specified with the MEASure:SOURce command or with the optional parameter following the :MEASure:VUPPer command.

<source> {CHANnel<N> | DIFF<D> | COMMONmode<C> | FUNCTion<F> | WMEMory<R> | CLOCK | MTRend | MSPectrum | EQUALized}

For more information on <source> parameters, see "[Measurement Sources](#)" on page 728.

Example This example measures the voltage at the upper threshold of the waveform.

```
myScope.WriteString ":MEASure:VUPPer CHANnel1"
```

Query :MEASure:VUPPer? [<source>]

The :MEASure:VUPPer? query returns the measured upper threshold value of the selected source.

Returned Format [:MEASure:VUPPer] <value>[,<result_state>] <NL>

<value> Voltage at the upper threshold.

<result_state> If SENDvalid is ON, the result state is returned with the measurement result. See the :MEASure:RESults table in this chapter for a list of the result states.

Example This example places the value of the voltage at the upper threshold of the waveform in the numeric variable, varValue, then prints the contents of the variable to the computer's screen.

```
myScope.WriteString ":SYSTEM:HEADer OFF" ' Response headers off.
myScope.WriteString ":MEASure:VUPPer? CHANnel1"
varValue = myScope.ReadNumber
Debug.Print FormatNumber(varValue, 0)
```

History Legacy command (existed before version 3.10).

:MEASure:WINDow

Command :MEASure:WINDow {ZOOM | CGRade | {MAIN | ALL}}, {MEAS<N>}

The :MEASure:WINDow command specifies whether measurements are made in the ZOOM window (measurement gating), the CGRade (color grade) view, or over the entire acquisition (MAIN or ALL). The MAIN and ALL parameters are equivalent.

Not all measurements can be applied to the color grade view.

If MEAS<N> is omitted, the command attempts to apply the selected window to all active measurements.

<N> Can be an integer from 1 – 20.

Example This example gates Measurement 1 to the zoom window.

```
myScope.WriteString ":MEASure:WINDow ZOOM, MEAS1"
```

Query :MEASure:WINDow? {MEASN}

This query returns whether the measurement is being performed on the zoomed portion of the waveform (ZOOM), the color grade view of the waveform (CGR) or the entire acquisition (MAIN or ALL).

If MEAS<N> is omitted on the query, it returns the window of the first measurement.

History Legacy command (existed before version 3.10).

Version 3.10: The short form of the command was changed from :MEAS:WIN to :MEAS:WIND.

Version 5.00: Added the CGRade (color grade) view as a measurement window option.

:MEASurement<N>:NAME

Command :MEASurement<N>:NAME <name>

The :MEASurement<N>:NAME commands sets the name of the specified measurement to whatever string is given to <name>. This lets you give specific names to measurements displayed on the oscilloscope's screen.

<N> An integer, 1-10. This number represents the position of the measurement on screen in the Measurements tab.

<name> A quoted string.

Query :MEASurement<N>:NAME?

The :MEASurement<N>:NAME? query returns the name of the corresponding measurement.

History New in version 4.50.

:MEASurement<N>:SOURce

Command :MEASurement<N>:SOURce <source> [, <source>]

The :MEASurement<N>:SOURce command changes the source of an existing measurement in the Measurements tab of the user interface.

<N> An integer, 1-10. This number represents the position of the measurement on screen in the Measurements tab.

<source> {CHANnel<N> | DIFF<D> | COMMONmode<C> | FUNCTION<F> | DIGital<M> | WMemory<R> | CLOCK | MTRend | MSPectrum | EQUalized}

For more information on <source> parameters, see "[Measurement Sources](#)" on page 728.

Query :MEASurement<N>:SOURce?

The :MEASurement<N>:SOURce? query returns the source(s) of the selected measurement.

Returned Format [:MEASurement<N>:SOURce] <source> [, <source>] <NL>

Example This example places the currently specified measurement 1 source(s) in the string variable, strSource, then prints the contents of the variable to the computer's screen.

```
Dim strSource As String ' Dimension variable.
myScope.WriteString ":MEASurement1:SOURce?"
strSource = myScope.ReadString
Debug.Print strSource
```

See Also • "[:MEASurement<N>:NAME](#)" on page 976

History New in version 4.50.

29 Pod Commands

:POD<N>:DISPlay / 980

:POD<N>:PSKew / 981

:POD<N>:THReshold / 982

NOTE

The POD commands only apply to the MSO oscilloscopes.

:POD<N>:DISPlay**Command****NOTE**

The POD commands only apply to the MSO oscilloscopes.

```
:POD<N>[:DISPlay] {ON | OFF | 1 | 0}
```

The :POD<N>:DISPlay command enables or disables the view for the selected digital channel pod. Pod 1 has the digital channels 0 through 7, and pod 2 has the digital channels 8 through 15.

Displaying a pod automatically enables digital channels. See ENABLE command in the root subsystem.

<N> An integer, 1-2.

Example This example turns on the display of bit 5 for the digital channels.

```
myScope.WriteString ":ENABLE DIGital"
myScope.WriteString ":POD2:DISPlay ON"
```

Query :POD<N>[:DISPlay]?

The :POD<N>:DISPlay? query returns the value of the display setting for the pod.

Returned Format [:POD<N>:DISPlay] {1 | 0}<NL>

See Also

- **":DIGital<N>:DISPlay"** on page 426
- **":ENABLE DIGital"** on page 1001

History Legacy command (existed before version 3.10).

:POD<N>:PSKew

Command :POD<N>:PSKew <skew_value>

The :POD<N>:PSKew command lets you adjust the digital channels with respect to the analog channels when there is a time delay between the analog and digital channels. This can occur when different length cables are used.

<N> An integer, 1-2.

<skew_value> A real number for the skew value, in the range -1 ms to +1 ms.

Example This example sets the probe skew for all digital channels to 10 μ s.

```
myScope.WriteString ":POD1:PSKew 10E-6"
```

Query :POD<N>:PSKew?

The :POD<N>:PSKew? query returns the current probe skew setting for all digital channels.

Returned Format [:POD<N>:PSKew] <skew_value><NL>

History Legacy command (existed before version 3.10).

:POD<N>:THReshold

Command

NOTE

The POD commands only apply to the MSO oscilloscopes.

```
:POD<N>:THReshold {CMOS50 | CMOS33 | CMOS25 | ECL | PECL | TTL
| DIFFerential | <value>}
```

The :POD<N>:THReshold command sets the logic threshold value for a pod. Pod 1 has the digital channels 0 through 7, and pod 2 has the digital channels 8 through 15. This command is equivalent to the :DIGital<N>:THReshold command.

The threshold is used for triggering purposes and for displaying the digital data as high (above the threshold) or low (below the threshold). The voltage values for the predefined thresholds are:

- CMOS50 = 2.5 V
- CMOS33 = 1.65 V
- CMOS25 = 1.25 V
- ECL = -1.3 V
- PECL = 3.7 V
- TTL = 1.4 V
- DIFFerential = 0 V

<N> An integer, 1-2.

<value> A real number representing the voltage value which distinguishes a 1 logic level from a 0 logic level. Waveform voltages greater than the threshold are 1 logic levels while waveform voltages less than the threshold are 0 logic levels.

On 9000 Series, 9000H Series, and S-Series mixed-signal oscilloscopes, the range of the threshold voltage is from -8 volts to 8 volts.

On 90000 X-Series and V-Series mixed-signal oscilloscopes, the range of the threshold voltage is from -3.75 volts to 3.75 volts.

Example This example sets the threshold to 1.8 volts for pod 2 (digital channels D15 through D8).

```
myScope.WriteString ":POD2:THReshold 1.8"
```

Query :POD<N>:THRESHold?

The :POD<N>:THRESHold? query returns the threshold value for the specified pod.

Returned Format [:POD<N>:THReshold] {CMOS50 | CMOS33 | CMOS25 | ECL | PECL | TTL
| DIFF | <value>}<NL>

See Also • [":DIGital<N>:THReshold"](#) on page 429

History Legacy command (existed before version 3.10).

Version 4.50: Added the DIFFerential parameter for specifying the threshold voltage.

30 Root Level Commands

:ADER? – Acquisition Done Event Register / 987
:AER? – Arm Event Register / 988
:AState? / 989
:ATER? – Auto Trigger Event Register / 990
:AUToscale / 991
:AUToscale:CHANnels / 992
:AUToscale:PLACement / 993
:AUToscale:VERTical / 994
:BEEP / 995
:BLANK / 996
:CDISplay / 997
:DIGitize / 998
:DISable DIGital / 1000
:ENABle DIGital / 1001
:MTEEnable – Mask Test Enable Register / 1003
:MTERegister? – Mask Test Event Register / 1004
:MODEl? / 1002
:OPEEnable – Operation Status Enable / 1005
:OPERegister? – Operation Status Register / 1006
:OVLRegister? / 1007
:PDER? – Processing Done Event Register / 1008
:PRINt / 1009
:RECall:SETup / 1010
:RState? / 1011
:RUN / 1012
:SERial – Serial Number / 1013
:SINGle / 1014
:STATus? / 1015
:STOP / 1017
:STORe:JITTer / 1018
:STORe:SETup / 1019
:STORe:WAVEform / 1020

:TERegister? – Trigger Event Register / 1021

:VIEW / 1022

Root level commands control many of the basic operations of the oscilloscope that you can select by pressing the labeled keys on the front panel. These commands are always recognized by the parser if they are prefixed with a colon, regardless of the current tree position. After executing a root level command, the parser is positioned at the root of the command tree.

:ADDER? – Acquisition Done Event Register

Query :ADDER?

The :ADDER? query reads the Acquisition Done Event Register and returns 1 or 0. After the Acquisition Done Event Register is read, the register is cleared. The returned value 1 indicates an acquisition completed event has occurred and 0 indicates an acquisition completed event has not occurred.

Once the Done bit is set, it is cleared only by doing :ADDER? or by sending a *CLS command.

Returned Format {1 | 0}<NL>

See Also · ["Example: Blocking and Polling Synchronization"](#) on page 183

History Legacy command (existed before version 3.10).

:AER? – Arm Event Register

Query :AER?

The :AER? query reads the Arm Event Register and returns 1 or 0. After the Arm Event Register is read, the register is cleared. The returned value 1 indicates a trigger armed event has occurred and 0 indicates a trigger armed has not occurred.

NOTE

Arm Event Returns

:AER? will allow the Arm Event to return either immediately (if you have armed but not triggered) or on the next arm (if you have already triggered). However, *CLS is always required to get an SRQ again.

Once the AER bit is set, it is cleared only by doing :AER? or by sending a *CLS command.

Returned Format {1 | 0}<NL>

See Also · ["Example: Checking for Armed Status"](#) on page 172

History Legacy command (existed before version 3.10).

:AState?

Query :AState?

The :AState? query returns the acquisition state:

- ARM – The trigger is armed and the oscilloscope has acquired all of the pre-trigger data.
- TRIG – The trigger condition has occurred and the oscilloscope is acquiring post trigger data.
- ATRIG – The trigger condition has not been met, but the oscilloscope has auto triggered and is acquiring post trigger data.
- ADONE – The acquisition is done, and the data has been processed and is ready to be unloaded.

The :AState? query result has more meaning when you first know the run state (see **":RState?"** on page 1011).

Returned Format {ARM | TRIG | ATRIG | ADONE}<NL>

See Also • **":RState?"** on page 1011

History New in version 4.60.

:ATER? – Auto Trigger Event Register

Query :ATER?

The :ATER? query reads the Auto Trigger Event Register and returns 1 or 0. After the Auto Trigger Event Register is read, the register is cleared. The returned value 1 indicates an auto trigger event has occurred and 0 indicates an auto trigger event has not occurred.

Returned Format {1 | 0}<NL>

History Legacy command (existed before version 3.10).

:AUToscale

Command :AUToscale

The :AUToscale command causes the oscilloscope to evaluate all input waveforms and find the optimum conditions for displaying the waveform. It searches each of the channels for input waveforms and shuts off channels where no waveform is found. It adjusts the vertical gain and offset for each channel that has a waveform and sets the time base on the lowest numbered input channel that has a waveform.

The trigger is found by searching each channel, starting with channel 4, then channel 3, channel 2, and channel 1, until a trigger waveform is detected. If waveforms cannot be found on any vertical input, the oscilloscope is returned to its former state.

Autoscale sets the following:

- Channel Display, Scale, and Offset
- Trigger Sweep, Mode, Edge, Source, Level, Slope, Hysteresis, and Holdoff
- Acquisition Sampling Rate and Memory Depth
- Time Base Scale and Position
- Marker Mode Set to Measurement
- Resets Acquisition Completion Criteria to 90%

Autoscale turns off the following:

- Measurements on sources that are turned off
- Functions
- Windows
- Memories
- InfiniiSim

Autoscale does not turn off:

- PrecisionProbe/PrecisionCable

No other controls are affected by Autoscale.

Example This example automatically scales the oscilloscope for the input waveform.

```
myScope.WriteString ":AUToscale"
```

History Legacy command (existed before version 3.10).

:AUToscale:CHANnels

Command :AUToscale:CHANnels {ALL | DISPlayed}

The :AUToscale:CHANnels command selects whether to apply autoscale to all of the input channels or just the input channels that are currently displayed.

Example This example automatically scales only the displayed channels.

```
myScope.WriteString ":AUToscale:CHANnels DISPlayed"
```

Query :AUToscale:CHANnels?

The :AUToscale:CHANnels? query returns the selected channels setting.

Returned Format [:AUToscale:CHANnels] {ALL | DISP}<NL>

History Legacy command (existed before version 3.10).

:AUToscale:PLACement

Command :AUToscale:PLACement {STACK | SEParate | OVERlay}

The :AUToscale:PLACement command controls how the waveforms are displayed on the oscilloscope when the autoscale command is used. If Stack is chosen then each waveform's amplitude is decreased and then the waveforms are offset so each takes up a different vertical portion of the screen. This makes it easier to view them, but decreases the accuracy of any measurements performed on the waveforms because they no longer take up the full dynamic range of the ADC (analog to digital converter). If Separate is chosen then the screen is divided into the same number of grids that there are waveforms (for example, if three waveforms are displayed then the screen will be divided into three grids). Each grid represents the full dynamic range of the ADC so this choice maximizes measurement accuracy while still separating the waveforms so they are easy to see. If the Overlay option is chosen then the waveforms are displayed on top of each other. This maximizes measurement accuracy, but can make viewing difficult.

Example This example automatically overlays the waveforms after an autoscale.

```
myScope.WriteString ":AUToscale:OVERlay ON"
```

Query :AUToscale:PLACement?

History Legacy command (existed before version 3.10).

:AUToscale:VERTical

Command :AUToscale:VERTical <source>

The :AUToscale:VERTical command autoscales the vertical position and scaling for the corresponding channel without changing anything else (for example, trigger or timebase settings).

<source> {CHANnel<N> | DIFF<D> | COMMONmode<C>}

<N> An integer, 1-4.

<R> An integer, 1-4.

<D>, <C> <D> is an integer, 1-2. <C> is an integer, 3-4.

The DIFF and COMMONmode sources are just aliases that can be used in place of the channel names to apply to differential or common mode signals. These are just aliases - no state change occurs if you refer to a differential channel and you are not in differential mode. DIFF1 refers to the differential signal between channels 1 and 3 (and COMMONmode3 refers to the common mode channel between these same channels). DIFF2 refers to the differential signal between channels 2 and 4 (and COMMONmode4 refers to the common mode channel between these same channels).

Example This example automatically autoscales the vertical position and scale for the waveform on Channel 1.

```
myScope.WriteString ":AUToscale:VERTical CHAN1"
```

NOTE

If you are using software 2.10 or earlier, the command syntax is (lower-case "t" in "vertical"): AUToscale:VERTical <CHANnel 1 | CHANnel 2 | CHANnel 3 | CHANnel 4>

History Legacy command (existed before version 3.10).

:BEEP

Command :BEEP <frequency>,<duration>

The :BEEP command makes the oscilloscope beep at a defined frequency and duration.

<frequency> A real number representing frequency of beep in Hertz.

<duration> A real number representing duration of beep in milliseconds.

Example This example will create a beep at 1000 Hz for 500 ms.

```
myScope.WriteString ":BEEP 1000,500"
```

History Legacy command (existed before version 3.10).

:BLANK

Command :BLANK {CHANnel<N> | BUS | DIFF<D> | COMMONmode<C>
 | DIGital<M> | FUNCTion<F> | HISTogram | WMEMory<R>
 | MTRend | MSPectrum | EQUalize | POD<P> | ALL}

The :BLANK command turns off an active channel, function, histogram, waveform memory, measurement trend, measurement spectrum, or Feed-Forward Equalized waveform. The :VIEW command turns them on.

<N> An integer, 1-4 in a single oscilloscope, 1-40 in a MultiScope system.

<D>, <C> <D> is an integer, 1-2. <C> is an integer, 3-4.

The DIFF and COMMONmode sources are just aliases that can be used in place of the channel names to apply to differential or common mode signals. These are just aliases - no state change occurs if you refer to a differential channel and you are not in differential mode. DIFF1 refers to the differential signal between channels 1 and 3 (and COMMONmode3 refers to the common mode channel between these same channels). DIFF2 refers to the differential signal between channels 2 and 4 (and COMMONmode4 refers to the common mode channel between these same channels).

<M> An integer, 0-15.

<F> An integer, 1-16.

<R> An integer, 1-4.

<P> An integer, 1-2.

Example This example turns off channel 1.

```
myScope.WriteString ":BLANK CHANnel1"
```

See Also • **":VIEW"** on page 1022

History Legacy command (existed before version 3.10).

:CDISplay

Command :CDISplay

The :CDISplay command clears the display and resets all associated measurements. If the oscilloscope is stopped, all currently displayed data is erased. If the oscilloscope is running, all of the data in active channels and functions is erased; however, new data is displayed on the next acquisition. Waveform memories are not erased.

Example This example clears the oscilloscope display.

```
myScope.WriteString ":CDISplay"
```

History Legacy command (existed before version 3.10).

:DIGitize

Command :DIGitize [CHANnel<N> | DIGital<M> | DIFF<D> | COMMONmode<C>
| POD<P>] [, ...]

The :DIGitize command invokes a special mode of data acquisition that is more efficient than using the :RUN command. This command initializes the selected channels or functions, then acquires them according to the current oscilloscope settings. When all waveforms are completely acquired, the oscilloscope is stopped. The waveform completion criteria is set with the ":ACquire:COMplete" command.

If you specify channel parameters, then these are the only waveforms acquired and the display waveforms of the specified channels are turned off.

NOTE**Full Range of Measurement and Math Operators are Available**

Even though digitized waveforms are not displayed, you may perform the full range of measurement and math operators on them.

NOTE

Channel parameters are not supported in a MultiScope system because acquisitions require at least one channel per connected frame. Only the parameterless version of :DIGitize is supported in a MultiScope system.

If you use the :DIGitize command with no parameters, the digitize operation is performed on the channels that are being displayed in the Infiniium waveform viewing area. In this case, the display state of the acquired waveforms is not changed after the :DIGitize command is completed. Because the command executes more quickly without parameters, this form of the command is useful for repetitive measurement sequences. You can also use this mode if you want to view the digitize results because the display state of the digitized waveforms is not affected.

<N> An integer, 1-4.

<M> An integer, 0-15.

<D>, <C> <D> is an integer, 1-2. <C> is an integer, 3-4.

The DIFF and COMMONmode sources are just aliases that can be used in place of the channel names to apply to differential or common mode signals. These are just aliases - no state change occurs if you refer to a differential channel and you are not in differential mode. DIFF1 refers to the differential signal between channels 1 and 3 (and COMMONmode3 refers to the common mode channel between these same channels). DIFF2 refers to the differential signal between channels 2 and 4 (and COMMONmode4 refers to the common mode channel between these same channels).

Example This example acquires data on channel 1.

```
myScope.WriteString ":DIGitize CHANnel1"
```

The ACQUIRE subsystem commands set up conditions such as COUNT for the next :DIGitize command. The WAVEFORM subsystem commands determine how the data is transferred out of the oscilloscope, and how to interpret the data.

- See Also**
- ["Example: Blocking and Polling Synchronization"](#) on page 183
 - ["Example: Checking for Armed Status"](#) on page 172
 - See the [Chapter 42](#), "Sample Programs," starting on page 1553 for examples of how to use :DIGitize and its related commands.

History Legacy command (existed before version 3.10).

:DISable DIGital

Command `:DISable DIGital`

The `:DISable DIGital` command disables the digital channels 0-15.

Example This example will disable the digital channels.

```
myScope.WriteString ":DISable DIGital"
```

History Legacy command (existed before version 3.10).

:ENABle DIGital

Command `:ENABle DIGital`

The `:ENABle DIGital` command enables the digital channels 0-15.

Example This example will enable the digital channels.

```
myScope.WriteString ":ENABle DIGital"
```

History Legacy command (existed before version 3.10).

:MODEl?

Query :MODEl?

The :MODEl? query returns the model number for the oscilloscope.

Returned Format A six-character alphanumeric model number in quotation marks. Output is determined by header and longform status as in **Table 15**.

Table 15 MODEl? Returned Format

| :SYSTem:HEADer | | :SYSTem:LONGform | | Response (for example) |
|----------------|-----|------------------|-----|------------------------|
| ON | OFF | ON | OFF | |
| | X | | X | DSO90804A |
| | X | X | | DSO90804A |
| X | | | X | :MOD DSO90804A |
| X | | X | | :MODEL DSO90804A |

Example This example places the model number in a string variable, strModel, then prints the contents of the variable on the computer's screen.

```
Dim strModel As String ' Dimension variable.
myScope.WriteString ":MODEl?"
strModel = myScope.ReadString
Debug.Print strModel
```

History Legacy command (existed before version 3.10).

:MTEEnable – Mask Test Enable Register

Command :MTEEnable <enable_mask>

The :MTEEnable command is used to set bits in the Mask Test Enable Register.

<enable_mask> The <enable_mask> is a 16-bit signed decimal value that enables the following bits of the Mask Test Event Register:

| | |
|-----------|---------------------|
| Bit 0 | Mask Test Complete |
| Bit 1 | Mask Test Fail |
| Bit 2 | Mask Low Amplitude |
| Bit 3 | Mask High Amplitude |
| Bit 4 | Mask Align Complete |
| Bit 5 | Mask Align Fail |
| Bits 6-14 | are not used |

Query :MTEEnable?

The :MTEEnable? query returns the value stored in the Mask Test Enable Register.

Returned Format [:MTEEnable] <enable_mask>

Example Suppose your application requires an interrupt whenever a Mask Test Fail occurs in the mask test register. You can enable this bit to generate the summary bit by sending:

```
myScope.WriteString "MTEEnable 2"
```

Whenever an error occurs, the oscilloscope sets the MASK bit in the Operation Status Register. Because the bits in the Operation Status Enable Register are all enabled, a summary bit is generated to set bit 7 (OPER) in the Status Byte Register.

If bit 7 (OPER) in the Status Byte Register is enabled (via the *SRE command), a service request interrupt (SRQ) is sent to the external computer.

History Legacy command (existed before version 3.10).

:MTERegister? – Mask Test Event Register

Query :MTERegister?

The :MTERegister? query returns the value stored in the Mask Test Event Register. The bits stored in the register have the following meanings:

| | |
|-------|---|
| Bit 0 | Mask Test Complete bit is set whenever the mask test is complete. |
| Bit 1 | Mask Test Fail bit is set whenever the mask test failed. |
| Bit 2 | Mask Low Amplitude bit is set whenever the signal is below the mask amplitude. |
| Bit 3 | Mask High Amplitude bit is set whenever the signal is above the mask amplitude. |
| Bit 4 | Mask Align Complete bit is set whenever the mask align is complete. |
| Bit 5 | Mask Align Fail bit is set whenever the mask align failed. |

The Mask Test Event Register is read and cleared by the MTERegister? query. The register output is enabled or disabled using the mask value supplied with the MTEEnable command.

Returned Format 0-63 decimal value.

NOTE

Disabled Mask Test Event Register Bits Respond, but Do Not Generate a Summary Bit

Mask Test Event Register bits that are not enabled still respond to their corresponding conditions (that is, they are set if the corresponding event occurs). However, because they are not enabled, they do not generate a summary bit in the Operation Status Register.

History Legacy command (existed before version 3.10).

:OPEEnable – Operation Status Enable

Command :OPEEnable <mask>

<mask> The decimal weight of the enabled bits.

The :OPEEnable command sets a mask in the Operation Status Enable register. Each bit that is set to a "1" enables that bit to set bit 7 in the status byte register, and potentially causes an SRQ to be generated. Bit 5, Wait for Trig is used. Other bits are reserved.

Query :OPEEnable?

The query returns the current value contained in the Operation Status Enable register as a decimal number.

Returned Format [OPEEnable] <value><NL>

History Legacy command (existed before version 3.10).

:OPERRegister? – Operation Status Register

Query :OPERRegister?

The :OPERRegister? query returns the value contained in the Operation Status Register as a decimal number. This register contains the WAIT TRIG bit (bit 5) and the OVLRL bit (bit 11).

The WAIT TRIG bit is set by the Trigger Armed Event Register and indicates that the trigger is armed. The OVLRL bit is set by the Overload Event Register.

Returned Format <value><NL>

See Also • ["Example: Checking for Armed Status"](#) on page 172

History Legacy command (existed before version 3.10).

:OVLRegister?

Query :OVLRegister?

The :OVLRegister? query returns the value stored in the Overload Event Register.

The integer value returned by this query represents the channels as follows:

- Bit 0 - Channel 1
- Bit 1 - Channel 2
- Bit 2 - Channel 3
- Bit 3 - Channel 4
- Bits 7-4 are not used and are set to zero (0)

Returned Format <value><NL>

History Legacy command (existed before version 3.10).

:PDER? – Processing Done Event Register

Query :PDER?

The :PDER? query reads the Processing Done Event Register and returns 1 or 0. After the Processing Done Event Register is read, the register is cleared. The returned value 1 indicates that all math and measurements are complete and 0 indicates they are not complete. :PDER? is non-blocking.

:PDER? can be used in place of :ADER?.

Returned Format {1 | 0}<NL>

See Also • ["Example: Blocking and Polling Synchronization"](#) on page 183

History Legacy command (existed before version 3.10).

:PRINt

Command :PRINt

The :PRINt command outputs a copy of the screen to a printer or other device destination specified in the HARDcopy subsystem. You can specify the selection of the output and the printer using the HARDcopy subsystem commands.

Example This example outputs a copy of the screen to a printer or a disk file.

```
myScope.WriteString ":PRINt"
```

History Legacy command (existed before version 3.10).

:RECall:SETup

- Command** :RECall:SETup <setup_memory_num>
- <setup_memory_num>** Setup memory number, an integer, 0 through 9.
- The :RECall:SETup command recalls a setup that was saved in one of the oscilloscope's setup memories. You can save setups using either the :STORe:SETup command or the front panel.
- Examples** This command recalls a setup from setup memory 2.
- ```
myScope.WriteString ":RECall:SETup 2"
```
- History** Legacy command (existed before version 3.10).

## :RSTate?

**Query** :RSTate?

The :RSTate? query returns the run state:

- RUN – The oscilloscope is acquiring and displaying new waveforms.
- STOP – The oscilloscope is no longer acquiring new waveforms.
- SING – A single acquisition has been started and the oscilloscope is waiting for the trigger condition to be met.

These are the same run states displayed on the front panel and in the user interface.

**Returned Format** {RUN | STOP | SING}<NL>

**See Also** • [":ASTate?"](#) on page 989

**History** New in version 4.60.

## :RUN

**Command** :RUN

The :RUN command starts the oscilloscope running. When the oscilloscope is running, it acquires waveform data according to its current settings. Acquisition runs repetitively until the oscilloscope receives a :STOP command, or until there is only one acquisition if Trigger Sweep is set to Single. However, the :TRIGger:SWEep SINGle should not be used in new programs. The :SINGle command should be used instead to acquire a single acquisition.

**Example** This example causes the oscilloscope to acquire data repetitively.

```
myScope.WriteString ":RUN"
```

**History** Legacy command (existed before version 3.10).

## :SERial – Serial Number

**Command**    :SERial {<serial\_number>}

The :SERial command sets the serial number of the oscilloscope. A serial number was entered in your oscilloscope by Keysight Technologies before it was shipped to you. Therefore, setting the serial number is not normally required unless the oscilloscope is serialized for a different application.

The oscilloscope's serial number is part of the string returned for the \*IDN? query described in the Common Commands chapter.

<serial\_number>    A ten-character alphanumeric serial number enclosed with quotation marks.

**Example**    This example sets the serial number for the oscilloscope to "US12345678".

```
myScope.WriteString ":SERial ""US12345678"""
```

**Query**    :SERial?

The query returns the current serial number string for the oscilloscope.

**Returned Format**    [:SERial] US12345678

**Example**    This example places the serial number for the oscilloscope in the string variable strSerial, then prints the contents of the variable to the computer's screen.

```
Dim strSerial As String ' Dimension variable.
myScope.WriteString ":SERial?"
strSerial = myScope.ReadString
Debug.Print strSerial
```

**History**    Legacy command (existed before version 3.10).

## :SINGle

**Command**    :SINGle

The :SINGle command causes the oscilloscope to make a single acquisition when the next trigger event occurs. However, this command does not set the :TRIGger:SWEep to SINGle.

**Example**    This example sets up the oscilloscope to make a single acquisition when the next trigger event occurs.

```
myScope.WriteString ":SINGle"
```

**See Also**    • [":TRIGger:SWEep"](#) on page 1197  
              • ["Example: Blocking and Polling Synchronization"](#) on page 183  
              • ["Example: Checking for Armed Status"](#) on page 172

**History**    Legacy command (existed before version 3.10).

## :STATus?

**Query** :STATus? {CHANnel<N> | DIFF<D> | COMMONmode<C> | FUNction<F>  
 | HISTogram | WMEMory<R> | CLOCK | MTRend | MSPectrum  
 | EQUalized | BUS<B> | DIGital<M> | POD<L>}

The :STATus? query shows whether the specified channel, function, wmemory, histogram, measurement trend, measurement spectrum, or equalized waveform is on or off. A return value of 1 means on and a return value of 0 means off.

MTRend and MSPectrum sources are only available if the oscilloscope has the EZJIT option installed and the feature is enabled.

The CLOCK source is only available if the oscilloscope has the High Speed Serial option installed and the feature is enabled.

The EQUalized source is only available if the oscilloscope has the High Speed Serial option and the Serial Data Equalization option installed and the features are enabled. This command uses the Feed-Forward Equalized (FFE) signal as the source.

<N> An integer, 1-4 in a single oscilloscope, 1-40 in a MultiScope system.

<D>, <C> <D> is an integer, 1-2. <C> is an integer, 3-4.

The DIFF and COMMONmode sources are just aliases that can be used in place of the channel names to apply to differential or common mode signals. These are just aliases - no state change occurs if you refer to a differential channel and you are not in differential mode. DIFF1 refers to the differential signal between channels 1 and 3 (and COMMONmode3 refers to the common mode channel between these same channels). DIFF2 refers to the differential signal between channels 2 and 4 (and COMMONmode4 refers to the common mode channel between these same channels).

<F> An integer, 1-16.

<R> An integer, 1-4.

<B> An integer, 1-4

<M> An integer, 0-15.

POD<L> refers to the two digital channel pods - one that includes all of the activated digital channels in the D0-D7 range and the other that includes all of the activated digital channels in the D8-D15 range.

**Returned Format** [:STATus] {0 | 1}<NL>

**Example** This example returns and prints the current status of channel 1.

```
myScope.WriteString ":STATus? CHANnel1"
strCurrent = myScope.ReadString
Debug.Print strCurrent
```

**See Also** • **":BLANK"** on page 996

- **":VIEW"** on page 1022

**History** Legacy command (existed before version 3.10).



## :STOP

**Command** :STOP

The :STOP command causes the oscilloscope to stop acquiring data. To restart the acquisition, use the :RUN or :SINGLE command.

**Example** This example stops the current data acquisition.

```
myScope.WriteString ":STOP"
```

**History** Legacy command (existed before version 3.10).

## :STORe:JITTer

**Command** :STORe:JITTer <file\_name>

The :STORe:JITTer command saves all of the RJ/DJ jitter measurement data to the specified file name. The file that is created has a header section followed by the RJ/DJ measurement results section. After the RJ/DJ measurement results section is the data for each of the measurements. Each data section has a header showing what the measurement data is that follows.

**<file\_name>** A character-quoted ASCII string which can include subdirectories with the name of the file.

**Example** This example stores the RJ/DJ jitter measurements to a file.

```
myScope.WriteString _
":STORe:JITTer " "C:\Users\Public\Documents\Infinium\jitter" "
```

**History** Legacy command (existed before version 3.10).

## :STORe:SETup

- Command** :STORe:SETup <setup\_memory\_num>
- <setup\_memory\_num>** Setup memory number, an integer, 0 through 9.
- The :STORe:SETup command saves the current oscilloscope setup in one of the setup memories.
- Example** This example stores the current oscilloscope setup to setup memory 0.
- ```
myScope.WriteString ":STORe:SETup 0"
```
- History** Legacy command (existed before version 3.10).

:STORe:WAVeform

Command :STORe:WAVeform {{CHANnel<N> | DIFF<D> | COMMONmode<C> | FUNCTION<F>
| WMEMory<R> | MTRend | MSPectrum}, {WMEMory<R>}}

The :STORe:WAVeform command copies a channel, function, stored waveform, measurement trend, or measurement spectrum to a waveform memory. The parameter preceding the comma specifies the source and can be any channel, function, or waveform memory. The parameter following the comma is the destination, and can be any waveform memory.

The :WAVeform:VIEW command determines the view of the data being stored.

MTRend and MSPectrum sources are only available if the oscilloscope has the EZJIT option installed and the feature is enabled.

<N> An integer, 1-4 in a single oscilloscope, 1-40 in a MultiScope system.

<D>, <C> <D> is an integer, 1-2. <C> is an integer, 3-4.

The DIFF and COMMONmode sources are just aliases that can be used in place of the channel names to apply to differential or common mode signals. These are just aliases - no state change occurs if you refer to a differential channel and you are not in differential mode. DIFF1 refers to the differential signal between channels 1 and 3 (and COMMONmode3 refers to the common mode channel between these same channels). DIFF2 refers to the differential signal between channels 2 and 4 (and COMMONmode4 refers to the common mode channel between these same channels).

<F> An integer, 1-16.

Example This example copies channel 1 to waveform memory 3.

```
myScope.WriteString ":STORe:WAVeform CHANnel1,WMEMory3"
```

History Legacy command (existed before version 3.10).

:TERegister? – Trigger Event Register

Query :TERegister?

The :TERegister? query reads the Trigger Event Register. A "1" is returned when an acquisition is complete. A "0" is returned when an acquisition has not completed.

The autotrigger does not set this register.

The register is set to a value of 1 only when the waveform meets the trigger criteria and the acquisition completes.

Returned Format {1 | 0}<NL>

Example This example checks the current status of the Trigger Event Register, places the status in the string variable, strCurrent, then prints the contents of the variable to the computer's screen.

```
Dim strCurrent As String ' Dimension variable.
myScope.WriteString ":TERegister?"
strCurrent = myScope.ReadString
Debug.Print strCurrent
```

Once this bit is set, you can clear it only by reading the register with the :TERegister? query, or by sending a *CLS common command. After the Trigger Event Register is read, it is cleared.

History Legacy command (existed before version 3.10).

:VIEW

Command :VIEW {CHANnel<N> | DIFF<D> | COMMONmode<C> | FUNCTION<F>
| HISTogram | WMEMory<R> | MSTrend | MSPectrum | BUS
| DIGital<M> | POD<P>}

The :VIEW command turns on a channel, function, histogram, or waveform memory. The :BLANK command turns them off.

MTRend and MSPectrum sources are only available if the oscilloscope has the EZJIT option installed and the feature is enabled.

<N> An integer, 1-4 in a single oscilloscope, 1-40 in a MultiScope system.

<D>, <C> <D> is an integer, 1-2. <C> is an integer, 3-4.

The DIFF and COMMONmode sources are just aliases that can be used in place of the channel names to apply to differential or common mode signals. These are just aliases - no state change occurs if you refer to a differential channel and you are not in differential mode. DIFF1 refers to the differential signal between channels 1 and 3 (and COMMONmode3 refers to the common mode channel between these same channels). DIFF2 refers to the differential signal between channels 2 and 4 (and COMMONmode4 refers to the common mode channel between these same channels).

<F> An integer, 1-16.

<R> An integer, 1-4.

 An integer, 1-4.

<M> An integer, 0-15.

<P> An integer, 1-2.

Example This example turns on channel 1.

```
myScope.WriteString ":VIEW CHANnel1"
```

See Also · **":BLANK"** on page 996

History Legacy command (existed before version 3.10).

31 Serial Bus Commands

General :SBUS<N> Commands / 1024

:SBUS<N>:CAN Commands / 1027

:SBUS<N>:FLEXray Commands / 1043

:SBUS<N>:HS Commands / 1053

:SBUS<N>:IIC Commands / 1058

:SBUS<N>:LIN Commands / 1067

:SBUS<N>:SPI Commands / 1076

The :SBUS<N> subsystem commands control the serial decode bus viewing, mode, and other options.

NOTE

These commands are only valid when the corresponding serial decode option has been licensed.

General :SBUS<N> Commands

- **":SBUS<N>[:DISPlay]"** on page 1025
- **":SBUS<N>:MODE"** on page 1026

:SBUS<N>[:DISPlay]

Command :SBUS<N>[:DISPlay] <display>
 <display> ::= {{1 | ON} | {0 | OFF}}

The :SBUS<N>[:DISPlay] command turns displaying of the serial decode bus on or off.

NOTE

This command is only valid when a serial decode option has been licensed.

Query :SBUS<N>[:DISPlay]?

The :SBUS<N>[:DISPlay]? query returns the current display setting of the serial decode bus.

Returned Format [:SBUS<N>[:DISPlay]] <display><NL>
 <display> ::= {0 | 1}

See Also • **":SBUS<N>:MODE"** on page 1026

History New in version 3.50.

:SBUS<N>:MODE**Command** :SBUS<N>:MODE <mode>

<mode> ::= {CAN | IIC | SPI | FLEXray | LIN}

The :SBUS<N>:MODE command determines the decode mode for the serial bus.

NOTE

This command is only valid when a serial decode option has been licensed.

Query :SBUS<N>:MODE?

The :SBUS<n>:MODE? query returns the current serial bus decode mode setting.

Returned Format [:SBUS<N>:MODE] <mode><NL>

<mode> ::= {CAN | IIC | SPI | FLEXray | LIN}

- See Also**
- [":SBUS<N>:CAN Commands"](#) on page 1027
 - [":SBUS<N>:FLEXray Commands"](#) on page 1043
 - [":SBUS<N>:IIC Commands"](#) on page 1058
 - [":SBUS<N>:LIN Commands"](#) on page 1067
 - [":SBUS<N>:SPI Commands"](#) on page 1076

History New in version 3.50.

Version 4.60: Added CAN mode option.

Version 5.20: Added the FLEXray and LIN mode options.

:SBUS<N>:CAN Commands

- **":SBUS<N>:CAN:FDSPoint"** on page 1028
- **":SBUS<N>:CAN:SAMPlEpoint"** on page 1029
- **":SBUS<N>:CAN:SIGNal:BAUDrate"** on page 1030
- **":SBUS<N>:CAN:SIGNal:DEFinition"** on page 1031
- **":SBUS<N>:CAN:SIGNal:FDBaudrate"** on page 1032
- **":SBUS<N>:CAN:SOURce"** on page 1033
- **":SBUS<N>:CAN:TRIGger (9000 Series, 9000H Series, S-Series)"** on page 1034
- **":SBUS<N>:CAN:TRIGger:PATTern:DATA (9000 Series, 9000H Series, S-Series)"** on page 1037
- **":SBUS<N>:CAN:TRIGger:PATTern:DATA:LENGth (9000 Series, 9000H Series, S-Series)"** on page 1038
- **":SBUS<N>:CAN:TRIGger:PATTern:ID (9000 Series, 9000H Series, S-Series)"** on page 1040
- **":SBUS<N>:CAN:TRIGger:PATTern:ID:MODE (9000 Series, 9000H Series, S-Series)"** on page 1041
- **":SBUS<N>:CAN:TYPE"** on page 1042

NOTE

These commands are only valid when the automotive CAN serial decode option has been licensed.

See Also • **":SBUS<N>:MODE"** on page 1026

:SBUS<N>:CAN:FDSPoint

Command :SBUS<N>:CAN:FDSPoint <value>

The :SBUS<N>:CAN:FDSPoint command sets the point during the bit time where the bit level is sampled to determine whether the bit is dominant or recessive. The sample point represents the percentage of time between beginning and end of the bit time.

<value> Percentage values in the range of 30 and 90 in NR3 format. Values are rounded off to nearest 0.5 resolution.

Query :SBUS<n>:CAN:FDSPoint?

The :SBUS<N>:CAN:FDSPoint? query returns the set sample point percentage value

Returned Format <value><NL>

- See Also**
- **":SBUS<N>:CAN:SIGNal:FDbaudrate"** on page 1032
 - **":SBUS<N>:CAN:TYPE"** on page 1042

History New in version 5.60.

:SBUS<N>:CAN:SAMPlEpoint

Command :SBUS<N>:CAN:SAMPlEpoint <value>

<value><NL>

<value> ::= {60 | 62.5 | 65 | 67.5 | 68 | 70 | 72.5 | 75 | 77.5
| 80 | 82.5 | 85 | 87.5} in NR3 format

The :SBUS<N>:CAN:SAMPlEpoint command sets the point during the bit time where the bit level is sampled to determine whether the bit is dominant or recessive. The sample point represents the percentage of time between the beginning of the bit time to the end of the bit time.

<N> An integer, 1-4.

Query :SBUS<N>:CAN:SAMPlEpoint?

The :SBUS<N>:CAN:SAMPlEpoint? query returns the current CAN sample point setting.

Returned Format <value><NL>

<value> ::= {60 | 62.5 | 65 | 67.5 | 68 | 70 | 72.5 | 75 | 77.5
| 80 | 82.5 | 85 | 87.5} in NR3 format

See Also • **":SBUS<N>:MODE"** on page 1026

History New in version 4.60.

:SBUS<N>:CAN:SIGNal:BAUDrate

Command :SBUS<N>:CAN:SIGNal:BAUDrate <baudrate>

<baudrate> ::= a real number from 10E3 to 5E6

The :SBUS<N>:CAN:SIGNal:BAUDrate command sets the standard baud rate of the CAN signal from 10 kb/s to 5 Mb/s.

If the baud rate you select does not match the system baud rate, false triggers may occur.

<N> An integer, 1-4.

Query :SBUS<N>:CAN:SIGNal:BAUDrate?

The :SBUS<N>:CAN:SIGNal:BAUDrate? query returns the current CAN baud rate setting.

Returned Format <baudrate><NL>

<baudrate> ::= a real number from 10E3 to 5E6

- See Also**
- **":SBUS<N>:MODE"** on page 1026
 - **":SBUS<N>:CAN:SIGNal:DEFinition"** on page 1031
 - **":SBUS<N>:CAN:SOURce"** on page 1033

History New in version 4.60.

:SBUS<N>:CAN:SIGNal:DEFinition

Command :SBUS<N>:CAN:SIGNal:DEFinition <value>

<value> ::= {CANH | CANL | DIFFerential | DIFL}

The :SBUS<N>:CAN:SIGNal:DEFinition command sets the CAN signal type when :SBUS<N>:CAN:TRIGger is set to SOF (start of frame). These signals can be set to:

Dominant high signals:

- CANH – the actual CAN_H differential bus signal.

Dominant low signals:

- CANL – the actual CAN_L differential bus signal.
- DIFL – the CAN differential (L-H) bus signal connected to an analog source channel using a differential probe.
- DIFFerential – the CAN differential bus signal connected to an analog source channel using a differential probe. This is the same as DIFL.

<N> An integer, 1-4.

Query :SBUS<N>:CAN:SIGNal:DEFinition?

The :SBUS<N>:CAN:SIGNal:DEFinition? query returns the current CAN signal type.

Returned Format <value><NL>

<value> ::= {CANH | CANL | DIFL}

- See Also**
- **":SBUS<N>:MODE"** on page 1026
 - **":SBUS<N>:CAN:SIGNal:BAUDrate"** on page 1030
 - **":SBUS<N>:CAN:SOURce"** on page 1033

History New in version 4.60.

:SBUS<N>:CAN:SIGNal:FDBaudrate

Command :SBUS<N>:CAN:SIGNal:FDBaudrate <baudrate>

The :SBUS<N>:CAN:SIGNal:FDBaudrate command sets the CAN FD baud rate in the range from 1 Mb/s to 10 Mb/s.

For CAN FD, both the standard rate settings (see :SBUS<n>:CAN:SIGNal:BAUDrate) and the FD rate settings must be set correctly; otherwise, false triggers may occur.

<baudrate> A real number from 1E6 to 10E6

Query :SBUS<n>:CAN:SIGNal:FDBaudrate?

The :SBUS<N>:CAN:SIGNal:FDBaudrate? query returns the CAN FD baud rate setting.

Returned Format <baudrate><NL>

- See Also**
- **":SBUS<N>:CAN:SIGNal:BAUDrate"** on page 1030
 - **":SBUS<N>:CAN:FDSPoint"** on page 1028
 - **":SBUS<N>:CAN:TYPE"** on page 1042

History New in version 5.60.

:SBUS<N>:CAN:SOURce

Command :SBUS<N>:CAN:SOURce <source>

```
<source> ::= { CHANnel<N> | DIFF<D> | COMMONmode<C> | FUNction<F>
              | WMEMory<R> | DIGital<M> | NONE }
```

The :SBUS<N>:CAN:SOURce command sets the source for the CAN signal.

The NONE parameter is the same as selecting "None" for the source in the user interface. It makes the previously selected channel, waveform memory, or math function available for other decodes.

<N> SBUS<N> is an integer, 1-4.

CHANnel<N> is an integer, 1-4 in a single oscilloscope, 1-40 in a MultiScope system.

<D>, <C> <D> is an integer, 1-2. <C> is an integer, 3-4.

The DIFF and COMMONmode sources are just aliases that can be used in place of the channel names to apply to differential or common mode signals. These are just aliases - no state change occurs if you refer to a differential channel and you are not in differential mode. DIFF1 refers to the differential signal between channels 1 and 3 (and COMMONmode3 refers to the common mode channel between these same channels). DIFF2 refers to the differential signal between channels 2 and 4 (and COMMONmode4 refers to the common mode channel between these same channels).

<F> An integer, 1-16.

<R> An integer, 1-4.

<M> An integer, 0-15. Digital channels are available on mixed-signal oscilloscopes.

Query :SBUS<N>:CAN:SOURce?

The :SBUS<N>:CAN:SOURce? query returns the current source for the CAN signal.

Returned Format <source><NL>

- See Also**
- **":SBUS<N>:MODE"** on page 1026
 - **":SBUS<N>:CAN:SIGNal:DEFinition"** on page 1031

History New in version 4.60.

Version 5.20: The NONE parameter was added.

:SBUS<N>:CAN:TRIGger (9000 Series, 9000H Series, S-Series)

Command :SBUS<N>:CAN:TRIGger <condition>

<condition> ::= {SOF | DATA | ERRor | IDData | IDRemote | ALLerrors
| OVERload | ACKerror}

<condition> ::= {FDData | IDFDdata | EBActive | EBPAssive | CRCDbit
| BRsBit | STUFerror | FORMerror | CRCerror | EOF} for CAN FD

NOTE

You must set the proper :SBUS<N>:MODE, :SBUS<N>:CAN:TRIGger, and :SBUS<N>:CAN:TRIGger:PATtern:ID:MODE before setting any other trigger values.

The :SBUS<N>:CAN:TRIGger command sets the CAN "trigger on" condition:

- SOF - will trigger on the Start of Frame (SOF) bit of a Data frame, Remote Transfer Request (RTR) frame, or an Overload frame.
- DATA - will trigger on CAN Data frames matching the specified ID, Data, and the DLC (Data length code).
- ERRor – will trigger on CAN Error frame.
- IDData – will trigger on CAN frames matching the specified ID of a Data frame.
- IDRemote – will trigger on CAN frames matching the specified ID of a Remote frame.
- ALLerrors – will trigger on CAN active error frames and unknown bus conditions.
- OVERload – will trigger on CAN overload frames.
- ACKerror – will trigger on a data or remote frame acknowledge bit that is recessive.

When :SBUS<N>:CAN:TYPE is set to CANFd, the previous IDData condition is no longer valid, and the following "trigger on" conditions are valid:

- FDData – will trigger on CAN FD Data frames matching the specified ID, Data, and the DLC (Data length code).
- IDFDdata – will trigger on CAN FD frames matching the specified ID of a Data frame.
- EBActive – will trigger on ESI bit if set to active.
- EBPAssive – will trigger on ESI bit if set to passive.
- CRCDbit – will trigger on CRC delimiter bit.
- BRsBit – will trigger on BRS bit.
- STUFerror – will trigger on stuff error.
- FORMerror – will trigger on form error.
- CRCerror – will trigger on CRC error.

- EOF – will trigger on EOF.

NOTE

CAN FD triggering is supported on Infiniium S-Series oscilloscopes only.

CAN ID specification is set by the :SBUS<N>:CAN:TRIGger:PATtern:ID and :SBUS<N>:CAN:TRIGger:PATtern:ID:MODE commands.

CAN Data specification is set by the :SBUS<N>:CAN:TRIGger:PATtern:DATA command.

CAN Data Length Code is set by the :SBUS<N>:CAN:TRIGger:PATtern:DATA:LENGth command.

<N> An integer, 1-4.

Example To enable the SBUS1 trigger, set the trigger to CAN Data frame matching the specified Standard ID 0x1f, Data 0x7ffff, and DLC 3.

```
myScope.WriteString ":TRIGger:MODE SBUS1"
myScope.WriteString ":SBUS1:MODE CAN"
myScope.WriteString ":SBUS1:CAN:TRIGger DATA"
myScope.WriteString ":SBUS1:CAN:TRIGger:PATtern:ID:MODE STANdard"
myScope.WriteString ":SBUS1:CAN:TRIGger:PATtern:ID '0x1f'"
myScope.WriteString ":SBUS1:CAN:TRIGger:PATtern:DATA:LENGth 3"
myScope.WriteString ":SBUS1:CAN:TRIGger:PATtern:DATA '0x7ffff'"
```

Query :SBUS<N>:CAN:TRIGger?

The :SBUS<N>:CAN:TRIGger? query returns the current CAN trigger on condition.

Returned Format

```
<condition><NL>
<condition> ::= {SOF | DATA | ERR | IDD | IDE | IDR | ALL | OVER | ACK}
<condition> ::= {FDD | IDFD | EBA | EBP | CRCD | BR SB | STUF | FORM
| CRC | EOF} for CAN FD
```

- See Also**
- **":TRIGger:MODE"** on page 1195
 - **":SBUS<N>:MODE"** on page 1026
 - **":SBUS<N>:CAN:TYPE"** on page 1042
 - **":SBUS<N>:CAN:TRIGger:PATtern:DATA (9000 Series, 9000H Series, S-Series)"** on page 1037
 - **":SBUS<N>:CAN:TRIGger:PATtern:DATA:LENGth (9000 Series, 9000H Series, S-Series)"** on page 1038
 - **":SBUS<N>:CAN:TRIGger:PATtern:ID (9000 Series, 9000H Series, S-Series)"** on page 1040
 - **":SBUS<N>:CAN:TRIGger:PATtern:ID:MODE (9000 Series, 9000H Series, S-Series)"** on page 1041

- **":SBUS<N>:CAN:SIGNal:DEFinition"** on page 1031
- **":SBUS<N>:CAN:SOURce"** on page 1033

History New in version 4.60.

Version 5.60: Additional trigger condition options for CAN FD have been added.

:SBUS<N>:CAN:TRIGger:PATtern:DATA (9000 Series, 9000H Series, S-Series)

Command :SBUS<N>:CAN:TRIGger:PATtern:DATA <string>
 <string> ::= "nn...n" where n ::= {0 | 1 | X | \$}
 <string ::= "0xnn...n" where n ::= {0,...,9 | A,...,F | X | \$}

NOTE

You must set the proper :SBUS<N>:MODE, :SBUS<N>:CAN:TRIGger, and :SBUS<N>:CAN:TRIGger:PATtern:ID:MODE before setting any other trigger values.

The :SBUS<N>:CAN:TRIGger:PATtern:DATA command defines the CAN data pattern resource according to the string parameter. This pattern, along with the data length (set by the :SBUS<N>:CAN:TRIGger:PATtern:DATA:LENGth command), control the data pattern searched for in each CAN message.

If the string parameter starts with "0x", it is a hexadecimal string made up of hexadecimal and X (don't care) characters; otherwise, it is a binary string made up of 0, 1, and X (don't care) characters.

NOTE

If more bits are sent for <string> than specified by the :SBUS<N>:CAN:TRIGger:PATtern:DATA:LENGth command, the most significant bits will be truncated.

<N> An integer, 1-4.

Query :SBUS<N>:CAN:TRIGger:PATtern:DATA?

The :SBUS<N>:CAN:TRIGger:PATtern:DATA? query returns the current settings of the specified CAN data pattern resource in the binary string format.

Returned Format <string><NL> in nondecimal format

- See Also**
- [":TRIGger:MODE"](#) on page 1195
 - [":SBUS<N>:MODE"](#) on page 1026
 - [":SBUS<N>:CAN:TRIGger \(9000 Series, 9000H Series, S-Series\)"](#) on page 1034
 - [":SBUS<N>:CAN:TRIGger:PATtern:ID:MODE \(9000 Series, 9000H Series, S-Series\)"](#) on page 1041
 - [":SBUS<N>:CAN:TRIGger:PATtern:DATA:LENGth \(9000 Series, 9000H Series, S-Series\)"](#) on page 1038
 - [":SBUS<N>:CAN:TRIGger:PATtern:ID \(9000 Series, 9000H Series, S-Series\)"](#) on page 1040

History New in version 4.60.

:SBUS<N>:CAN:TRIGger:PATtern:DATA:LENGth (9000 Series, 9000H Series, S-Series)

Command :SBUS<N>:CAN:TRIGger:PATtern:DATA:LENGth <length>
 <length> ::= integer from 1 to 8 in NR1 format for standard CAN
 <length> ::= integer from 1 to 15 in NR1 format for CAN FD

NOTE

You must set the proper :SBUS<N>:MODE, :SBUS<N>:CAN:TRIGger, and :SBUS<N>:CAN:TRIGger:PATtern:ID:MODE before setting any other trigger values.

The :SBUS<N>:CAN:TRIGger:PATtern:DATA:LENGth command sets the number of 8-bit bytes in the CAN data string.

When ":SBUS<N>:CAN:TYPE CANStandard" is selected, the number of bytes in the string can be anywhere from 1 bytes to 8 bytes (64 bits).

When ":SBUS<N>:CAN:TYPE CANFd" is selected, the number of bytes in the string can be anywhere from 1 bytes to 15 bytes (120 bits).

NOTE

CAN FD triggering is supported on Infiniium S-Series oscilloscopes only.

The value for these bytes is set by the :SBUS<N>:CAN:TRIGger:PATtern:DATA command.

<N> An integer, 1-4.

Query :SBUS<N>:CAN:TRIGger:PATtern:DATA:LENGth?

The :SBUS<N>:CAN:TRIGger:PATtern:DATA:LENGth? query returns the current CAN data pattern length setting.

Returned Format <length><NL>

- See Also**
- **" :TRIGger:MODE "** on page 1195
 - **" :SBUS<N>:MODE "** on page 1026
 - **" :SBUS<N>:CAN:TYPE "** on page 1042
 - **" :SBUS<N>:CAN:TRIGger (9000 Series, 9000H Series, S-Series) "** on page 1034
 - **" :SBUS<N>:CAN:TRIGger:PATtern:ID:MODE (9000 Series, 9000H Series, S-Series) "** on page 1041
 - **" :SBUS<N>:CAN:TRIGger:PATtern:DATA (9000 Series, 9000H Series, S-Series) "** on page 1037
 - **" :SBUS<N>:CAN:SOURce "** on page 1033

History New in version 4.60.

Version 5.60: Length can be from 1 to 15 bytes for CAN FD.

:SBUS<N>:CAN:TRIGger:PATtern:ID (9000 Series, 9000H Series, S-Series)

Command :SBUS<N>:CAN:TRIGger:PATtern:ID <string>
 <string> ::= "nn...n" where n ::= {0 | 1 | X | \$}
 <string ::= "0xnn...n" where n ::= {0,...,9 | A,...,F | X | \$}

NOTE

You must set the proper :SBUS<N>:MODE, :SBUS<N>:CAN:TRIGger, and :SBUS<N>:CAN:TRIGger:PATtern:ID:MODE before setting this value; otherwise, this value is defaulted to "don't care" when the mode is changed.

The :SBUS<N>:CAN:TRIGger:PATtern:ID command defines the CAN identifier pattern resource according to the string parameter. This pattern, along with the identifier mode (set by the :SBUS<N>:CAN:TRIGger:PATtern:ID:MODE command), control the identifier pattern searched for in each CAN message.

If the string parameter starts with "0x", it is a hexadecimal string made up of hexadecimal and X (don't care) characters; otherwise, it is a binary string made up of 0, 1, and X (don't care) characters.

NOTE

The ID pattern resource string size changes based on the :SBUS<N>:CAN:TRIGger:PATtern:ID:MODE setting; it is 11 bits when the mode is STANdard, and it is 29 bits when the mode is EXTended.

A string longer than 29 bits is truncated to 29 bits when setting the ID pattern resource.

<N> An integer, 1-4.

Query :SBUS<N>:CAN:TRIGger:PATtern:ID?

The :SBUS<N>:CAN:TRIGger:PATtern:ID? query returns the current settings of the specified CAN identifier pattern resource in the 29-bit binary string format.

Returned Format <string><NL> in 29-bit binary string format

- See Also**
- **":TRIGger:MODE"** on page 1195
 - **":SBUS<N>:MODE"** on page 1026
 - **":SBUS<N>:CAN:TRIGger (9000 Series, 9000H Series, S-Series)"** on page 1034
 - **":SBUS<N>:CAN:TRIGger:PATtern:ID:MODE (9000 Series, 9000H Series, S-Series)"** on page 1041
 - **":SBUS<N>:CAN:TRIGger:PATtern:DATA (9000 Series, 9000H Series, S-Series)"** on page 1037

History New in version 4.60.

:SBUS<N>:CAN:TRIGger:PATtern:ID:MODE (9000 Series, 9000H Series, S-Series)

Command :SBUS<N>:CAN:TRIGger:PATtern:ID:MODE <value>
 <value> ::= {STANdard | EXTended}

NOTE

You must set the proper :SBUS<N>:MODE, :SBUS<N>:CAN:TRIGger, and :SBUS<N>:CAN:TRIGger:PATtern:ID:MODE before setting any other trigger values.

The :SBUS<N>:CAN:TRIGger:PATtern:ID:MODE command sets the CAN identifier mode. STANdard selects the standard 11-bit identifier. EXTended selects the extended 29-bit identifier. The CAN identifier is set by the :SBUS<N>:CAN:TRIGger:PATtern:ID command.

<N> An integer, 1-4.

Query :SBUS<N>:CAN:TRIGger:PATtern:ID:MODE?

The :SBUS<N>:CAN:TRIGger:PATtern:ID:MODE? query returns the current setting of the CAN identifier mode.

Returned Format <value><NL>

<value> ::= {STAN | EXT}

- See Also**
- [":TRIGger:MODE"](#) on page 1195
 - [":SBUS<N>:MODE"](#) on page 1026
 - [":SBUS<N>:CAN:TRIGger \(9000 Series, 9000H Series, S-Series\)"](#) on page 1034
 - [":SBUS<N>:CAN:TRIGger:PATtern:DATA \(9000 Series, 9000H Series, S-Series\)"](#) on page 1037
 - [":SBUS<N>:CAN:TRIGger:PATtern:DATA:LENGth \(9000 Series, 9000H Series, S-Series\)"](#) on page 1038
 - [":SBUS<N>:CAN:TRIGger:PATtern:ID \(9000 Series, 9000H Series, S-Series\)"](#) on page 1040

History New in version 4.60.

:SBUS<N>:CAN:TYPE

Command :SBUS<N>:CAN:TYPE <cantype>
 <cantype> ::= {CANStandard | CANFd}

The :SBUS<N>:CAN:TYPE command selects between standard CAN or Flexible Data Rate CAN (CAN FD) decode types.

Query :SBUS<n>:CAN:TYPE?

The :SBUS<N>:CAN:TYPE? query returns the selected decode type.

Returned Format <cantype><NL>
 <cantype> ::= {CANS | CANF}

- See Also**
- **":SBUS<N>:CAN:FDSPoint"** on page 1028
 - **":SBUS<N>:CAN:SIGNal:FDbaudrate"** on page 1032
 - **":SBUS<N>:CAN:TRIGger (9000 Series, 9000H Series, S-Series)"** on page 1034

History New in version 5.60.

:SBUS<N>:FLEXray Commands

- **":SBUS<N>:FLEXray:BAUDrate"** on page 1044
- **":SBUS<N>:FLEXray:CHANnel"** on page 1045
- **":SBUS<N>:FLEXray:SOURce"** on page 1046
- **":SBUS<N>:FLEXray:TRIGger"** on page 1047
- **":SBUS<N>:FLEXray:TRIGger:ERRor:TYPE"** on page 1048
- **":SBUS<N>:FLEXray:TRIGger:FRAMe:CCBase"** on page 1049
- **":SBUS<N>:FLEXray:TRIGger:FRAMe:CCRepetition"** on page 1050
- **":SBUS<N>:FLEXray:TRIGger:FRAMe:ID"** on page 1051
- **":SBUS<N>:FLEXray:TRIGger:FRAMe:TYPE"** on page 1052

NOTE

These commands are only valid when the automotive FLEXray serial decode option has been licensed.

-
- See Also • **":SBUS<N>:MODE"** on page 1026

:SBUS<N>:FLEXray:BAUDrate

Command :SBUS<N>:FLEXray:BAUDrate <baudrate>

<baudrate> ::= {2500000 | 5000000 | 10000000}

The :SBUS<n>:FLEXray:BAUDrate command specifies the baud rate as 2.5 Mb/s, 5 Mb/s, or 10 Mb/s.

<N> An integer, 1–4.

Query :SBUS<N>:FLEXray:BAUDrate?

The :SBUS<n>:FLEXray:BAUDrate? query returns the current baud rate setting.

Returned Format <baudrate><NL>

<baudrate> ::= {2500000 | 5000000 | 10000000}

- See Also**
- [":SBUS<N>:FLEXray:CHANnel"](#) on page 1045
 - [":SBUS<N>:FLEXray:SOURce"](#) on page 1046
 - [":SBUS<N>:FLEXray:TRIGger"](#) on page 1047
 - [":SBUS<N>:FLEXray:TRIGger:ERRor:TYPE"](#) on page 1048
 - [":SBUS<N>:FLEXray:TRIGger:FRAMe:CCBase"](#) on page 1049
 - [":SBUS<N>:FLEXray:TRIGger:FRAMe:CCRepetition"](#) on page 1050
 - [":SBUS<N>:FLEXray:TRIGger:FRAMe:ID"](#) on page 1051
 - [":SBUS<N>:FLEXray:TRIGger:FRAMe:TYPE"](#) on page 1052

History New in version 5.20.

:SBUS<N>:FLEXray:CHANnel

Command :SBUS<N>:FLEXray:CHANnel <channel>

<channel> ::= {A | B}

The :SBUS<n>:FLEXray:CHANnel command specifies the bus channel, A or B, of the FlexRay signal.

<N> An integer, 1–4.

Query :SBUS<N>:FLEXray:CHANnel?

The :SBUS<n>:FLEXray:CHANnel? query returns the current bus channel setting.

Returned Format <channel><NL>

<channel> ::= {A | B}

- See Also**
- [":SBUS<N>:FLEXray:BAUDrate"](#) on page 1044
 - [":SBUS<N>:FLEXray:SOURce"](#) on page 1046
 - [":SBUS<N>:FLEXray:TRIGger"](#) on page 1047
 - [":SBUS<N>:FLEXray:TRIGger:ERRor:TYPE"](#) on page 1048
 - [":SBUS<N>:FLEXray:TRIGger:FRAMe:CCBase"](#) on page 1049
 - [":SBUS<N>:FLEXray:TRIGger:FRAMe:CCRepetition"](#) on page 1050
 - [":SBUS<N>:FLEXray:TRIGger:FRAMe:ID"](#) on page 1051
 - [":SBUS<N>:FLEXray:TRIGger:FRAMe:TYPE"](#) on page 1052

History New in version 5.20.

:SBUS<N>:FLEXray:SOURce

Command :SBUS<N>:FLEXray:SOURce <source>

```
<source> ::= { CHANnel<N> | DIFF<D> | COMMONmode<C> | FUNction<F>
              | WMEMory<R> | DIGital<M> | NONE }
```

The :SBUS<N>:FLEXray:SOURce command sets the source for the FlexRay signal.

The NONE parameter is the same as selecting "None" for the source in the user interface. It makes the previously selected channel, waveform memory, or math function available for other decodes.

<N> SBUS<N> is an integer, 1-4.

CHANnel<N> is an integer, 1-4 in a single oscilloscope, 1-40 in a MultiScope system.

<D>, <C> <D> is an integer, 1-2. <C> is an integer, 3-4.

The DIFF and COMMONmode sources are just aliases that can be used in place of the channel names to apply to differential or common mode signals. These are just aliases - no state change occurs if you refer to a differential channel and you are not in differential mode. DIFF1 refers to the differential signal between channels 1 and 3 (and COMMONmode3 refers to the common mode channel between these same channels). DIFF2 refers to the differential signal between channels 2 and 4 (and COMMONmode4 refers to the common mode channel between these same channels).

<F> An integer, 1-16.

<R> An integer, 1-4.

<M> An integer, 0-15. Digital channels are available on mixed-signal oscilloscopes.

Query :SBUS<N>:FLEXray:SOURce?

The :SBUS<n>:FLEXray:SOURce? query returns the source of the FlexRay signal.

Returned Format <source><NL>

- See Also**
- [":SBUS<N>:FLEXray:BAUDrate"](#) on page 1044
 - [":SBUS<N>:FLEXray:CHANnel"](#) on page 1045
 - [":SBUS<N>:FLEXray:TRIGger"](#) on page 1047
 - [":SBUS<N>:FLEXray:TRIGger:ERRor:TYPE"](#) on page 1048
 - [":SBUS<N>:FLEXray:TRIGger:FRAME:CCBase"](#) on page 1049
 - [":SBUS<N>:FLEXray:TRIGger:FRAME:CCRepetition"](#) on page 1050
 - [":SBUS<N>:FLEXray:TRIGger:FRAME:ID"](#) on page 1051
 - [":SBUS<N>:FLEXray:TRIGger:FRAME:TYPE"](#) on page 1052

History New in version 5.20.

:SBUS<N>:FLEXray:TRIGger

Command :SBUS<N>:FLEXray:TRIGger <condition>

<condition> ::= {FRAME | ERROR}

The :SBUS<n>:FLEXray:TRIGger command sets the FLEXray "trigger on" condition:

- FRAME – triggers on specified frames (without errors).
- ERROR – triggers on selected active error frames and unknown bus conditions.

NOTE

The FlexRay trigger is a software-based protocol trigger which operates on data that has acquired (using an available hardware-based trigger) and decoded. In other words, you are triggering on protocol search. Therefore, the :SBUS<n>:FLEXray:TRIGger commands are valid only when protocol decode is turned on.

<N> An integer, 1-4.

Query :SBUS<N>:FLEXray:TRIGger?

The :SBUS<n>:FLEXray:TRIGger? query returns the current FLEXray "trigger on" condition.

Returned Format <condition><NL>

<condition> ::= {FRAM | ERR}

- See Also**
- [":SBUS<N>:FLEXray:BAUDrate"](#) on page 1044
 - [":SBUS<N>:FLEXray:CHANnel"](#) on page 1045
 - [":SBUS<N>:FLEXray:SOURce"](#) on page 1046
 - [":SBUS<N>:FLEXray:TRIGger:ERRor:TYPE"](#) on page 1048
 - [":SBUS<N>:FLEXray:TRIGger:FRAMe:CCBase"](#) on page 1049
 - [":SBUS<N>:FLEXray:TRIGger:FRAMe:CCRepetition"](#) on page 1050
 - [":SBUS<N>:FLEXray:TRIGger:FRAMe:ID"](#) on page 1051
 - [":SBUS<N>:FLEXray:TRIGger:FRAMe:TYPE"](#) on page 1052

History New in version 5.20.

:SBUS<N>:FLEXray:TRIGger:ERRor:TYPE

Command :SBUS<N>:FLEXray:TRIGger:ERRor:TYPE <error_type>

<error_type> ::= {ALL | HCRC | FCRC}

Selects the FlexRay error type to trigger on. The error type setting is only valid when the FlexRay trigger mode is set to ERRor.

- ALL – triggers on ALL errors.
- HCRC – triggers on only Header CRC errors.
- FCRC – triggers on only Frame CRC errors.

<N> An integer, 1–4.

Query :SBUS<N>:FLEXray:TRIGger:ERRor:TYPE?

The :SBUS<n>:FLEXray:TRIGger:ERRor:TYPE? query returns the currently selected FLEXray error type.

Returned Format <error_type><NL>

<error_type> ::= {ALL | HCRC | FCRC}

- See Also**
- [":SBUS<N>:FLEXray:BAUDrate"](#) on page 1044
 - [":SBUS<N>:FLEXray:CHANnel"](#) on page 1045
 - [":SBUS<N>:FLEXray:SOURce"](#) on page 1046
 - [":SBUS<N>:FLEXray:TRIGger"](#) on page 1047
 - [":SBUS<N>:FLEXray:TRIGger:FRAME:CCBase"](#) on page 1049
 - [":SBUS<N>:FLEXray:TRIGger:FRAME:CCRepetition"](#) on page 1050
 - [":SBUS<N>:FLEXray:TRIGger:FRAME:ID"](#) on page 1051
 - [":SBUS<N>:FLEXray:TRIGger:FRAME:TYPE"](#) on page 1052

History New in version 5.20.

:SBUS<N>:FLEXray:TRIGger:FRAME:CCBase

Command :SBUS<N>:FLEXray:TRIGger:FRAME:CCBase <cycle_count_base>
 <cycle_count_base> ::= integer from 0-63

The :SBUS<n>:FLEXray:TRIGger:FRAME:CCBase command sets the base of the FlexRay cycle count (in the frame header) to trigger on. The cycle count base setting is only valid when the FlexRay trigger mode is set to FRAME.

<N> An integer, 1-4.

Query :SBUS<N>:FLEXray:TRIGger:FRAME:CCBase?

The :SBUS<n>:FLEXray:TRIGger:FRAME:CCBase? query returns the current cycle count base setting for the FlexRay frame trigger setup.

Returned Format <cycle_count_base><NL>

<cycle_count_base> ::= integer from 0-63

- See Also**
- [":SBUS<N>:FLEXray:BAUDrate"](#) on page 1044
 - [":SBUS<N>:FLEXray:CHANnel"](#) on page 1045
 - [":SBUS<N>:FLEXray:SOURce"](#) on page 1046
 - [":SBUS<N>:FLEXray:TRIGger"](#) on page 1047
 - [":SBUS<N>:FLEXray:TRIGger:ERRor:TYPE"](#) on page 1048
 - [":SBUS<N>:FLEXray:TRIGger:FRAME:CCRepetition"](#) on page 1050
 - [":SBUS<N>:FLEXray:TRIGger:FRAME:ID"](#) on page 1051
 - [":SBUS<N>:FLEXray:TRIGger:FRAME:TYPE"](#) on page 1052

History New in version 5.20.

:SBUS<N>:FLEXray:TRIGger:FRAME:CCRepetition

Command :SBUS<N>:FLEXray:TRIGger:FRAME:CCRepetition <cycle_count_repetition>

<cycle_count_repetition> ::= {ALL | <rep_#>}

<rep_#> ::= integer values 2, 4, 8, 16, 32, or 64

The :SBUS<n>:FLEXray:TRIGger:FRAME:CCRepetition command sets the repetition number of the FlexRay cycle count (in the frame header) to trigger on. The cycle count repetition setting is only valid when the FlexRay trigger mode is set to FRAME.

<N> An integer, 1-4.

Query :SBUS<N>:FLEXray:TRIGger:FRAME:CCRepetition?

The :SBUS<n>:FLEXray:TRIGger:FRAME:CCRepetition? query returns the current cycle count repetition setting for the FlexRay frame trigger setup.

Returned Format <cycle_count_repetition><NL>

<cycle_count_repetition> ::= {ALL | <rep_#>}

<rep_#> ::= integer values 2, 4, 8, 16, 32, or 64

- See Also**
- [":SBUS<N>:FLEXray:BAUDrate"](#) on page 1044
 - [":SBUS<N>:FLEXray:CHANnel"](#) on page 1045
 - [":SBUS<N>:FLEXray:SOURce"](#) on page 1046
 - [":SBUS<N>:FLEXray:TRIGger"](#) on page 1047
 - [":SBUS<N>:FLEXray:TRIGger:ERRor:TYPE"](#) on page 1048
 - [":SBUS<N>:FLEXray:TRIGger:FRAME:CCBase"](#) on page 1049
 - [":SBUS<N>:FLEXray:TRIGger:FRAME:ID"](#) on page 1051
 - [":SBUS<N>:FLEXray:TRIGger:FRAME:TYPE"](#) on page 1052

History New in version 5.20.

:SBUS<N>:FLEXray:TRIGger:FRAME:ID

Command :SBUS<N>:FLEXray:TRIGger:FRAME:ID <frame_id>

<frame_id> ::= {ALL | <frame_#>}

<frame_#> ::= integer from 1-2047

The :SBUS<n>:FLEXray:TRIGger:FRAME:ID command sets the FlexRay frame ID to trigger on. The frame ID setting is only valid when the FlexRay trigger mode is set to FRAME.

<N> An integer, 1-4.

Query :SBUS<N>:FLEXray:TRIGger:FRAME:ID?

The :SBUS<n>:FLEXray:TRIGger:FRAME:ID? query returns the current frame ID setting for the FlexRay frame trigger setup.

Returned Format <frame_id><NL>

<frame_id> ::= {ALL | <frame_#>}

<frame_#> ::= integer from 1-2047

- See Also**
- [":SBUS<N>:FLEXray:BAUDrate"](#) on page 1044
 - [":SBUS<N>:FLEXray:CHANnel"](#) on page 1045
 - [":SBUS<N>:FLEXray:SOURce"](#) on page 1046
 - [":SBUS<N>:FLEXray:TRIGger"](#) on page 1047
 - [":SBUS<N>:FLEXray:TRIGger:ERRor:TYPE"](#) on page 1048
 - [":SBUS<N>:FLEXray:TRIGger:FRAME:CCBase"](#) on page 1049
 - [":SBUS<N>:FLEXray:TRIGger:FRAME:CCRepetition"](#) on page 1050
 - [":SBUS<N>:FLEXray:TRIGger:FRAME:TYPE"](#) on page 1052

History New in version 5.20.

:SBUS<N>:FLEXray:TRIGger:FRAME:TYPE

Command :SBUS<N>:FLEXray:TRIGger:FRAME:TYPE <frame_type>

<frame_type> ::= {NORMAL | STARTup | NULL | SYNC | NNULL | ALL}

The :SBUS<n>:FLEXray:TRIGger:FRAME:TYPE command sets the FlexRay frame type to trigger on. The frame type setting is only valid when the FlexRay trigger mode is set to FRAME.

- NORMAL – will trigger on only normal (NSTARTup & NNULL & NSYNc) frames.
- STARTup – will trigger on only startup frames.
- NULL – will trigger on only null frames.
- SYNC – will trigger on only sync frames.
- NNULL – will trigger on frames other than null frames.
- ALL – will trigger on all FlexRay frame types.

<N> An integer, 1-4.

Query :SBUS<N>:FLEXray:TRIGger:FRAME:TYPE?

The :SBUS<n>:FLEXray:TRIGger:FRAME:TYPE? query returns the current frame type setting for the FlexRay frame trigger setup.

Returned Format <frame_type><NL>

<frame_type> ::= {NORM | STAR | NULL | SYNC | NNUL | ALL}

- See Also**
- [":SBUS<N>:FLEXray:BAUDrate"](#) on page 1044
 - [":SBUS<N>:FLEXray:CHANnel"](#) on page 1045
 - [":SBUS<N>:FLEXray:SOURce"](#) on page 1046
 - [":SBUS<N>:FLEXray:TRIGger"](#) on page 1047
 - [":SBUS<N>:FLEXray:TRIGger:ERRor:TYPE"](#) on page 1048
 - [":SBUS<N>:FLEXray:TRIGger:FRAME:CCBase"](#) on page 1049
 - [":SBUS<N>:FLEXray:TRIGger:FRAME:CCRepetition"](#) on page 1050
 - [":SBUS<N>:FLEXray:TRIGger:FRAME:ID"](#) on page 1051

History New in version 5.20.

:SBUS<N>:HS Commands

- **":SBUS<N>:HS:DESCramble"** on page 1054
- **":SBUS<N>:HS:FORMat"** on page 1055
- **":SBUS<N>:HS:IDLE"** on page 1056
- **":SBUS<N>:HS:SOURce<S>"** on page 1057

NOTE

These commands are only valid when the high-speed (HS) serial decode type has been licensed and set with the :BUS:B<N>:TYPE command.

See Also • **":BUS:B<N>:TYPE"** on page 276

:SBUS<N>:HS:DESCramble

Command :SBUS<N>:HS:DESCramble {{0 | OFF} | {1 | ON}}

The :SBUS<N>:HS:DESCramble command turns high-speed descrambling on or off if supported by the protocol type.

NOTE

This command is only valid when a serial decode option has been licensed.

Query :SBUS<N>:HS:DESCramble?

The :SBUS<N>:HS:DESCramble? query returns the current descrambling setting of the high-speed serial decode bus.

Returned Format [:SBUS<N>:HS:DESCramble] {0 | 1}<NL>

- See Also**
- **":BUS:B<N>:TYPE"** on page 276
 - **":SBUS<N>:HS:FORMat"** on page 1055
 - **":SBUS<N>:HS:IDLE"** on page 1056
 - **":SBUS<N>:HS:SOURce<S>"** on page 1057

History New in version 5.00.

:SBUS<N>:HS:FORMat

Command :SBUS<N>:HS:FORMat <value>

<value> ::= {KDCoDe | LABe1 | F8Bit | F10Bit}

The :SBUS<N>:HS:FORMat command specifies the high-speed symbol display format.

<N> Is an integer, 1-4.

Example This example sets the K/D Code symbol display format.

```
myScope.WriteString ":SYSTem:HEADer OFF" ' Response headers off.
myScope.WriteString ":SBUS<N>:HS:FORMat KDCoDe"
```

Query :SBUS<N>:HS:FORMat?

The :SBUS<N>:HS:FORMat? query returns the high-speed symbol display format setting.

Returned Format [:SBUS<N>:HS:FORMat] <value><NL>

<value> ::= {KDCoDe | LABe1 | F8Bit | F10Bit}

- See Also**
- **":BUS:B<N>:TYPE"** on page 276
 - **":SBUS<N>:HS:DESCramble"** on page 1054
 - **":SBUS<N>:HS:IDLE"** on page 1056
 - **":SBUS<N>:HS:SOURce<S>"** on page 1057

History New in version 5.00.

:SBUS<N>:HS:IDLE

Command :SBUS<N>:HS:IDLE {{0 | OFF} | {1 | ON}}

The :SBUS<N>:HS:IDLE command specifies whether electrical idles are present in the signal.

NOTE

This command is only valid when a serial decode option has been licensed.

Query :SBUS<N>:HS:IDLE?

The :SBUS<N>:HS:IDLE? query returns the current ".electrical idles are present" setting.

Returned Format [:SBUS<N>:HS:IDLE] {0 | 1}<NL>

- See Also**
- **":BUS:B<N>:TYPE"** on page 276
 - **":SBUS<N>:HS:DESCramble"** on page 1054
 - **":SBUS<N>:HS:FORMat"** on page 1055
 - **":SBUS<N>:HS:SOURce<S>"** on page 1057

History New in version 5.00.

:SBUS<N>:HS:SOURce<S>

Command :SBUS<N>:HS:SOURce<S> <source>

```
<source> ::= {CHANnel<N> | DIFF<D> | COMMONmode<C> | FUNction<F>
             | WMEMory<R> | NONE}
```

The :SBUS<N>:HS:SOURce<S> command specifies the signal that is the high-speed data source.

<N> SBUS<N> is an integer, 1-4.

CHANnel<N> is an integer, 1-4 in a single oscilloscope, 1-40 in a MultiScope system.

<S> Is an integer, 1-4, for the high-speed serial source.

<D>, <C> <D> is an integer, 1-2. <C> is an integer, 3-4.

The DIFF and COMMONmode sources are just aliases that can be used in place of the channel names to apply to differential or common mode signals. These are just aliases - no state change occurs if you refer to a differential channel and you are not in differential mode. DIFF1 refers to the differential signal between channels 1 and 3 (and COMMONmode3 refers to the common mode channel between these same channels). DIFF2 refers to the differential signal between channels 2 and 4 (and COMMONmode4 refers to the common mode channel between these same channels).

<F> An integer, 1-16.

<R> An integer, 1-4.

Example This example specifies channel 2 is the high-speed data source 3 signal.

```
myScope.WriteString ":SYSTEM:HEADer OFF" ' Response headers off.
myScope.WriteString ":SBUS1:HS:SOURce3 CHANnel2"
```

Query :SBUS<N>:HS:SOURce<S>?

The :SBUS<N>:HS:SOURce<S>? query returns the current signal for the high-speed data source.

Returned Format [:SBUS<N>:HS:SOURce<S>] <source><NL>

```
<source> ::= {CHAN<N> | FUNC<F> | WMEM<N> | NONE}
```

- See Also**
- **":BUS:B<N>:TYPE"** on page 276
 - **":SBUS<N>:HS:DESCramble"** on page 1054
 - **":SBUS<N>:HS:FORMat"** on page 1055
 - **":SBUS<N>:HS:IDLE"** on page 1056

History New in version 5.00.

:SBUS<N>:IIC Commands

- **":SBUS<N>:IIC:ASIZE"** on page 1059
- **":SBUS<N>:IIC:SOURce:CLOCK"** on page 1060
- **":SBUS<N>:IIC:SOURce:DATA"** on page 1061
- **":SBUS<N>:IIC:TRIGger:PATtern:ADDRESS (9000 Series, 9000H Series, S-Series)"** on page 1062
- **":SBUS<N>:IIC:TRIGger:PATtern:DATA (9000 Series, 9000H Series, S-Series)"** on page 1064
- **":SBUS<N>:IIC:TRIGger:TYPE (9000 Series, 9000H Series, S-Series)"** on page 1065

NOTE

These commands are only valid when the low-speed IIC and SPI serial decode option has been licensed.

-
- See Also** • **":SBUS<N>:MODE"** on page 1026

:SBUS<N>:IIC:ASIZe

Command :SBUS<N>:IIC:ASIZe <size>

<size> ::= {BIT7 | BIT8}

The :SBUS<N>:IIC:ASIZe command determines whether the Read/Write bit is included as the LSB in the display of the IIC address field of the decode bus.

<N> An integer, 1-4.

Query :SBUS<N>:IIC:ASIZe?

The :SBUS<N>:IIC:ASIZe? query returns the current IIC address width setting.

Returned Format [:SBUS<N>:IIC:ASIZe] <size><NL>

- See Also**
- [":SBUS<N>:IIC:TRIGger:PATtern:ADDRes \(9000 Series, 9000H Series, S-Series\)"](#) on page 1062
 - [":SBUS<N>:MODE"](#) on page 1026

History New in version 3.50.

:SBUS<N>:IIC:SOURce:CLOCK

Command :SBUS<N>:IIC:SOURce:CLOCK <source>

```
<source> ::= { CHANnel<N> | DIFF<D> | COMMONmode<C> | FUNction<F>
              | WMEMory<R> | DIGital<M> | NONE }
```

The :SBUS<N>:IIC:SOURce:CLOCK command sets the source for the IIC serial clock (SCL).

The NONE parameter is the same as selecting "None" for the source in the user interface. It makes the previously selected channel, waveform memory, or math function available for other decodes.

<N> SBUS<N> is an integer, 1-4.

CHANnel<N> is an integer, 1-4 in a single oscilloscope, 1-40 in a MultiScope system.

<D>, <C> <D> is an integer, 1-2. <C> is an integer, 3-4.

The DIFF and COMMONmode sources are just aliases that can be used in place of the channel names to apply to differential or common mode signals. These are just aliases - no state change occurs if you refer to a differential channel and you are not in differential mode. DIFF1 refers to the differential signal between channels 1 and 3 (and COMMONmode3 refers to the common mode channel between these same channels). DIFF2 refers to the differential signal between channels 2 and 4 (and COMMONmode4 refers to the common mode channel between these same channels).

<F> An integer, 1-16.

<R> An integer, 1-4.

<M> An integer, 0-15. Digital channels are available on mixed-signal oscilloscopes.

Example This example selects channel 2 as the source for IIC serial clock.

```
myScope.WriteString ":SBUS1:IIC:SOURce:CLOCK CHANnel2"
```

Query :SBUS<N>:IIC:SOURce:CLOCK?

The :SBUS<N>:IIC:SOURce:CLOCK? query returns the current source for the IIC serial clock.

Returned Format [:SBUS<N>:IIC:SOURce:CLOCK] <source><NL>

See Also

- **":SBUS<N>:IIC:SOURce:DATA"** on page 1061
- **":SBUS<N>:MODE"** on page 1026

History New in version 3.50.

Version 5.20: The NONE parameter was added.

:SBUS<N>:IIC:SOURce:DATA

Command :SBUS<N>:IIC:SOURce:DATA <source>

```
<source> ::= { CHANnel<N> | DIFF<D> | COMMONmode<C> | FUNction<F>
              | WMEMory<R> | DIGital<M> | NONE }
```

The :SBUS<N>:IIC:SOURce:DATA command sets the source for IIC serial data (SDA).

The NONE parameter is the same as selecting "None" for the source in the user interface. It makes the previously selected channel, waveform memory, or math function available for other decodes.

<N> SBUS<N> is an integer, 1-4.

CHANnel<N> is an integer, 1-4 in a single oscilloscope, 1-40 in a MultiScope system.

<D>, <C> <D> is an integer, 1-2. <C> is an integer, 3-4.

The DIFF and COMMONmode sources are just aliases that can be used in place of the channel names to apply to differential or common mode signals. These are just aliases - no state change occurs if you refer to a differential channel and you are not in differential mode. DIFF1 refers to the differential signal between channels 1 and 3 (and COMMONmode3 refers to the common mode channel between these same channels). DIFF2 refers to the differential signal between channels 2 and 4 (and COMMONmode4 refers to the common mode channel between these same channels).

<F> An integer, 1-16.

<R> An integer, 1-4.

<M> An integer, 0-15. Digital channels are available on mixed-signal oscilloscopes.

Example This example selects channel 1 as the source for IIC serial data.

```
myScope.WriteString ":SBUS1:IIC:SOURce:DATA CHANnel1"
```

Query :SBUS<N>:IIC:SOURce:DATA?

The :SBUS<N>:IIC:SOURce:DATA? query returns the current source for IIC serial data.

Returned Format [:SBUS<N>:IIC:SOURce:DATA] <source><NL>

See Also

- **":SBUS<N>:IIC:SOURce:CLOCK"** on page 1060
- **":SBUS<N>:MODE"** on page 1026

History New in version 3.50.

Version 5.20: The NONE parameter was added.

:SBUS<N>:IIC:TRIGger:PATtern:ADDRes (9000 Series, 9000H Series, S-Series)

Command :SBUS<N>:IIC:TRIGger:PATtern:ADDRes <quoted_string>

NOTE

You must set :SBUS<N>:MODE to IIC before you can send other :SBUS<N>:IIC:TRIGger commands.

The :SBUS<n>:IIC:TRIGger:PATtern:ADDRes command specifies the IIC address value to trigger on. The address can be a 7-, 8-, 10-, or 11-bit address depending upon the :SBUS<n>:IIC:TRIGger:TYPE specification and the :SBUS<n>:IIC:ASize setting.

The :SBUS<N>:IIC:TRIGger:TYPE command must select a type that includes an address value before you can use the :SBUS<N>:IIC:TRIGger:PATtern:ADDRes commands.

<N> An integer, 1-4.

<quoted_string> If the quoted string parameter starts with "0x", it is a hexadecimal string made up of hexadecimal and X (don't care) characters (for example, "0x34XF"); otherwise, it is a binary string made up of 0, 1, and X (don't care) characters (for example, "00110100XXXX1111").

Example To enable the SBUS1 trigger, set the trigger type to a 7-bit address frame read, and specify an address value of 0x3F:

```
myScope.WriteString ":CHANnel1:DISPlay ON"
myScope.WriteString ":CHANnel2:DISPlay ON"
myScope.WriteString ":SBUS1:MODE IIC"
myScope.WriteString ":SBUS1:IIC:SOURce:DATA CHANnel1"
myScope.WriteString ":SBUS1:IIC:SOURce:CLOCK CHANnel2"
myScope.WriteString ":TRIGger:MODE SBUS1"
myScope.WriteString ":SBUS1:IIC:TRIGger:TYPE READ7"
myScope.WriteString ":SBUS1:IIC:TRIGger:PATtern:ADDRes '0x3f'"
myScope.WriteString ":SBUS1:IIC:TRIGger:PATtern:DATA '0x7fffffff'"
```

Query :SBUS<N>:IIC:TRIGger:PATtern:ADDRes?

The :SBUS<N>:IIC:TRIGger:PATtern:ADDRes? query returns the current pattern for the IIC address.

Returned Format [:SBUS<N>:IIC:TRIGger:PATtern:ADDRes] <binary_string><NL>

- See Also**
- [":TRIGger:MODE"](#) on page 1195
 - [":SBUS<N>:MODE"](#) on page 1026
 - [":SBUS<N>:IIC:TRIGger:TYPE \(9000 Series, 9000H Series, S-Series\)"](#) on page 1065
 - [":SBUS<N>:IIC:ASize"](#) on page 1059

History New in version 3.50.

:SBUS<N>:IIC:TRIGger:PATtern:DATA (9000 Series, 9000H Series, S-Series)

Command :SBUS<N>:IIC:TRIGger:PATtern:DATA <quoted_string>

NOTE

You must set :SBUS<N>:MODE to IIC before you can send other :SBUS<N>:IIC:TRIGger commands.

The :SBUS<N>:IIC:TRIGger:PATtern:DATA command sets IIC data.

You can specify 1 to 20 bytes of data in binary or hex format.

The :SBUS<N>:IIC:TRIGger:TYPE command must select a type that includes a data value before you can use the :SBUS<N>:IIC:TRIGger:PATtern:DATA commands.

<N> An integer, 1-4.

<quoted_string> If the quoted string parameter starts with "0x", it is a hexadecimal string made up of hexadecimal and X (don't care) characters (for example, "0x34XF"); otherwise, it is a binary string made up of 0, 1, and X (don't care) characters (for example, "00110100XXXX1111").

Example To enable the SBUS1 trigger, set the trigger type to a 7-bit address frame read, and specify a data value of 0x7FFFFFF:

```
myScope.WriteString ":CHANnel1:DISPlay ON"
myScope.WriteString ":CHANnel2:DISPlay ON"
myScope.WriteString ":SBUS1:MODE IIC"
myScope.WriteString ":SBUS1:IIC:SOURce:DATA CHANnel1"
myScope.WriteString ":SBUS1:IIC:SOURce:CLOCK CHANnel2"
myScope.WriteString ":TRIGger:MODE SBUS1"
myScope.WriteString ":SBUS1:IIC:TRIGger:TYPE READ7"
myScope.WriteString ":SBUS1:IIC:TRIGger:PATtern:ADDRESS '0x3f'"
myScope.WriteString ":SBUS1:IIC:TRIGger:PATtern:DATA '0x7ffffff'"
```

Query :SBUS<N>:IIC:TRIGger:PATtern:DATA?

The :SBUS<n>:IIC:TRIGger:PATtern:DATA? query returns the current pattern for IIC data.

Returned Format [:SBUS<N>:IIC:TRIGger:PATtern:DATA] <binary_string><NL>

See Also

- **":TRIGger:MODE"** on page 1195
- **":SBUS<N>:MODE"** on page 1026
- **":SBUS<N>:IIC:TRIGger:TYPE (9000 Series, 9000H Series, S-Series)"** on page 1065

History New in version 3.50.

:SBUS<N>:IIC:TRIGger:TYPE (9000 Series, 9000H Series, S-Series)

Command :SBUS<N>:IIC:TRIGger:TYPE {START | STOP | REStart7 | REStart10 | AACK
| ANACK | READ7 | WRITe7 | WRITe10}

NOTE

You must set :SBUS<N>:MODE to IIC before you can send other :SBUS<N>:IIC:TRIGger commands.

The :SBUS<N>:IIC:TRIGger:TYPE command sets the IIC trigger type:

- START – Start condition.
- STOP – Stop condition.
- REStart7 – Another 7-bit start condition occurs before a stop condition.
- REStart10 – Another 10-bit start condition occurs before a stop condition.
- AACK – Address with acknowledge.
- ANACK – Address with no acknowledge.
- READ7 – 7-bit address frame containing (Start:Address7:Read:Ack:Data).
- WRITe7 – 7-bit address frame containing (Start:Address7:Write:Ack:Data).
- WRITe10 – 10-bit address frame containing (Start:Address
byte1:Write:Ack:Address byte 2:Data).

NOTE

The short form of READ7 (READ7), WRITe7 (WRIT7), WRITe10 (WRIT10), REStart7 (REST7), and REStart10 (REST10) do not follow the defined long form to short form truncation rules.

The :SBUS<N>:IIC:TRIGger:TYPE command must be sent before the :SBUS<N>:IIC:TRIGger:PATtern:ADDRess or :SBUS<N>:IIC:TRIGger:PATtern:DATA commands.

<N> An integer, 1-4.

Example To enable the SBUS1 trigger and set the IIC trigger type to a 7-bit address frame read:

```
myScope.WriteString ":CHANnel1:DISPlay ON"
myScope.WriteString ":CHANnel2:DISPlay ON"
myScope.WriteString ":SBUS1:MODE IIC"
myScope.WriteString ":SBUS1:IIC:SOURce:DATA CHANnel1"
myScope.WriteString ":SBUS1:IIC:SOURce:CLOCK CHANnel2"
myScope.WriteString ":TRIGger:MODE SBUS1"
myScope.WriteString ":SBUS1:IIC:TRIGger:TYPE READ7"
myScope.WriteString ":SBUS1:IIC:TRIGger:PATtern:ADDRess '0x3f'"
myScope.WriteString ":SBUS1:IIC:TRIGger:PATtern:DATA '0x7fffffff'"
```

See Also

- **":TRIGger:MODE"** on page 1195
- **":SBUS<N>:MODE"** on page 1026

- **":SBUS<N>:IIC:TRIGger:PATtern:ADDRes (9000 Series, 9000H Series, S-Series)"** on page 1062
- **":SBUS<N>:IIC:TRIGger:PATtern:DATA (9000 Series, 9000H Series, S-Series)"** on page 1064

History New in version 3.50.

:SBUS<N>:LIN Commands

- **":SBUS<N>:LIN:SAMPlepoint"** on page 1068
- **":SBUS<N>:LIN:SIGNal:BAUDrate"** on page 1069
- **":SBUS<N>:LIN:SOURce"** on page 1070
- **":SBUS<N>:LIN:STANdard"** on page 1071
- **":SBUS<N>:LIN:TRIGger"** on page 1072
- **":SBUS<N>:LIN:TRIGger:ID"** on page 1073
- **":SBUS<N>:LIN:TRIGger:PATTern:DATA"** on page 1074
- **":SBUS<N>:LIN:TRIGger:PATTern:DATA:LENGth"** on page 1075

NOTE

These commands are only valid when the automotive LIN serial decode option has been licensed.

See Also • **":SBUS<N>:MODE"** on page 1026

:SBUS<N>:LIN:SAMPlepoint

Command :SBUS<N>:LIN:SAMPlepoint <value>

<value> ::= {60 | 62.5 | 68 | 70 | 75 | 80 | 87.5} in NR3 format

The :SBUS<n>:LIN:SAMPlepoint command sets the point during the bit time where the bit level is sampled to determine whether the bit is dominant or recessive. The sample point represents the percentage of time between the beginning of the bit time to the end of the bit time.

NOTE

The sample point values are not limited by the baud rate.

<N> An integer, 1–4.

Query :SBUS<N>:LIN:SAMPlepoint?

The :SBUS<n>:LIN:SAMPlepoint? query returns the current LIN sample point setting.

Returned Format <value><NL>

<value> ::= {60 | 62.5 | 68 | 70 | 75 | 80 | 87.5} in NR3 format

- See Also**
- [":SBUS<N>:LIN:SIGNal:BAUDrate"](#) on page 1069
 - [":SBUS<N>:LIN:SOURce"](#) on page 1070
 - [":SBUS<N>:LIN:STANdard"](#) on page 1071
 - [":SBUS<N>:LIN:TRIGger"](#) on page 1072
 - [":SBUS<N>:LIN:TRIGger:ID"](#) on page 1073
 - [":SBUS<N>:LIN:TRIGger:PATtern:DATA"](#) on page 1074
 - [":SBUS<N>:LIN:TRIGger:PATtern:DATA:LENGth"](#) on page 1075

History New in version 5.20.

:SBUS<N>:LIN:SIGNal:BAUDrate

Command :SBUS<N>:LIN:SIGNal:BAUDrate <baudrate>

<baudrate> ::= from 2400 to 625000 in NR3 format

The :SBUS<n>:LIN:SIGNal:BAUDrate command sets the standard baud rate of the LIN signal from 2400 b/s to 625 kb/s.

If you enter a baud rate over 100 kb/s that is not divisible by 10 b/s, the baud rate is set to the nearest baud rate divisible by 10 b/s.

<N> An integer, 1-4.

Query :SBUS<N>:LIN:SIGNal:BAUDrate?

The :SBUS<n>:LIN:SIGNal:BAUDrate? query returns the current LIN baud rate setting.

Returned Format <baudrate><NL>

<baudrate> ::= from 2400 to 625000 in NR3 format

- See Also**
- [":SBUS<N>:LIN:SAMPlepoint"](#) on page 1068
 - [":SBUS<N>:LIN:SOURce"](#) on page 1070
 - [":SBUS<N>:LIN:STANdard"](#) on page 1071
 - [":SBUS<N>:LIN:TRIGger"](#) on page 1072
 - [":SBUS<N>:LIN:TRIGger:ID"](#) on page 1073
 - [":SBUS<N>:LIN:TRIGger:PATTern:DATA"](#) on page 1074
 - [":SBUS<N>:LIN:TRIGger:PATTern:DATA:LENGth"](#) on page 1075

History New in version 5.20.

:SBUS<N>:LIN:SOURce

Command :SBUS<N>:LIN:SOURce <source>

```
<source> ::= {CHANnel<N> | DIFF<D> | COMMONmode<C> | FUNction<F>
             | WMEMory<R> | DIGital<M> | NONE}
```

The :SBUS<n>:LIN:SOURce command sets the source for the LIN signal.

The NONE parameter is the same as selecting "None" for the source in the user interface. It makes the previously selected channel, waveform memory, or math function available for other decodes.

<N> SBUS<N> is an integer, 1-4.

CHANnel<N> is an integer, 1-4 in a single oscilloscope, 1-40 in a MultiScope system.

<D>, <C> <D> is an integer, 1-2. <C> is an integer, 3-4.

The DIFF and COMMONmode sources are just aliases that can be used in place of the channel names to apply to differential or common mode signals. These are just aliases - no state change occurs if you refer to a differential channel and you are not in differential mode. DIFF1 refers to the differential signal between channels 1 and 3 (and COMMONmode3 refers to the common mode channel between these same channels). DIFF2 refers to the differential signal between channels 2 and 4 (and COMMONmode4 refers to the common mode channel between these same channels).

<F> An integer, 1-16.

<R> An integer, 1-4.

<M> An integer, 0-15. Digital channels are available on mixed-signal oscilloscopes.

Query :SBUS<N>:LIN:SOURce?

The :SBUS<n>:LIN:SOURce? query returns the current source for the LIN signal.

Returned Format <source><NL>

- See Also**
- [":SBUS<N>:LIN:SAMPLEpoint"](#) on page 1068
 - [":SBUS<N>:LIN:SIGNal:BAUDrate"](#) on page 1069
 - [":SBUS<N>:LIN:STANdard"](#) on page 1071
 - [":SBUS<N>:LIN:TRIGger"](#) on page 1072
 - [":SBUS<N>:LIN:TRIGger:ID"](#) on page 1073
 - [":SBUS<N>:LIN:TRIGger:PATTern:DATA"](#) on page 1074
 - [":SBUS<N>:LIN:TRIGger:PATTern:DATA:LENGth"](#) on page 1075

History New in version 5.20.

:SBUS<N>:LIN:STANdard

Command :SBUS<N>:LIN:STANdard <std>

<std> ::= {LIN13 | LIN20}

The :SBUS<n>:LIN:STANdard command sets the LIN standard in effect for triggering and decoding to be LIN1.3 or LIN2.0.

<N> An integer, 1–4.

Query :SBUS<N>:LIN:STANdard?

The :SBUS<n>:LIN:STANdard? query returns the current LIN standard setting, which is always LIN20.

When triggering, the oscilloscope looks for both the LIN 1.3 and 2.0 checksum.

Returned Format <std><NL>

<std> ::= LIN20

- See Also**
- [":SBUS<N>:LIN:SAMPlepoint"](#) on page 1068
 - [":SBUS<N>:LIN:SIGNal:BAUDrate"](#) on page 1069
 - [":SBUS<N>:LIN:SOURce"](#) on page 1070
 - [":SBUS<N>:LIN:TRIGger"](#) on page 1072
 - [":SBUS<N>:LIN:TRIGger:ID"](#) on page 1073
 - [":SBUS<N>:LIN:TRIGger:PATTern:DATA"](#) on page 1074
 - [":SBUS<N>:LIN:TRIGger:PATTern:DATA:LENGth"](#) on page 1075

History New in version 5.20.

:SBUS<N>:LIN:TRIGger

Command :SBUS<N>:LIN:TRIGger <condition>

<condition> ::= {ID | DATA | PARityerror | CSUMerror | ALLerrors}

The :SBUS<n>:LIN:TRIGger command sets the LIN trigger condition to be:

- ID – Frame ID.
Use the :SBUS<n>:LIN:TRIGger:ID command to specify the frame ID.
- DATA – Frame ID and Data.
Use the :SBUS<n>:LIN:TRIGger:ID command to specify the frame ID.
Use the :SBUS<n>:LIN:TRIGger:PATtern:DATA:LENGth and :SBUS<n>:LIN:TRIGger:PATtern:DATA commands to specify the data string length and value.
- PARityerror – parity errors.
- CSUMerror – checksum errors.
- ALLerrors – all errors.

<N> An integer, 1–4.

Query :SBUS<N>:LIN:TRIGger?

The :SBUS<n>:LIN:TRIGger? query returns the current LIN trigger value.

Returned Format <condition><NL>

<condition> ::= {ID | DATA | PAR | CSUM | ALL}

- See Also**
- **":SBUS<N>:LIN:SAMPlepoint"** on page 1068
 - **":SBUS<N>:LIN:SIGNal:BAUDrate"** on page 1069
 - **":SBUS<N>:LIN:SOURce"** on page 1070
 - **":SBUS<N>:LIN:STANdard"** on page 1071
 - **":SBUS<N>:LIN:TRIGger:ID"** on page 1073
 - **":SBUS<N>:LIN:TRIGger:PATtern:DATA"** on page 1074
 - **":SBUS<N>:LIN:TRIGger:PATtern:DATA:LENGth"** on page 1075

History New in version 5.20.

:SBUS<N>:LIN:TRIGger:ID

Command :SBUS<N>:LIN:TRIGger:ID <string>

<string> ::= "nn...n" where n ::= {0 | 1 | X | \$}

<string ::= "0xnn...n" where n ::= {0,...,9 | A,...,F | X | \$}

The :SBUS<n>:LIN:TRIGger:ID command defines the LIN identifier searched for in each CAN message when the LIN trigger mode is set to frame ID.

If the string parameter starts with "0x", it is a hexadecimal string made up of hexadecimal and X (don't care) characters; otherwise, it is a binary string made up of 0, 1, and X (don't care) characters.

<N> An integer, 1–4.

Query :SBUS<N>:LIN:TRIGger:ID?

The :SBUS<n>:LIN:TRIGger:ID? query returns the current LIN identifier setting.

Returned Format <string><NL> in 6-bit binary string format

- See Also**
- [":SBUS<N>:LIN:SAMPlEpoint"](#) on page 1068
 - [":SBUS<N>:LIN:SIGNal:BAUDrate"](#) on page 1069
 - [":SBUS<N>:LIN:SOURce"](#) on page 1070
 - [":SBUS<N>:LIN:STANdard"](#) on page 1071
 - [":SBUS<N>:LIN:TRIGger"](#) on page 1072
 - [":SBUS<N>:LIN:TRIGger:PATTern:DATA"](#) on page 1074
 - [":SBUS<N>:LIN:TRIGger:PATTern:DATA:LENGth"](#) on page 1075

History New in version 5.20.

:SBUS<N>:LIN:TRIGger:PATtern:DATA**Command** :SBUS<N>:LIN:TRIGger:PATtern:DATA <string>

<string> ::= "mn...n" where n ::= {0 | 1 | X | \$}

<string ::= "0xn...n" where n ::= {0,...,9 | A,...,F | X | \$}

The :SBUS<N>:LIN:TRIGger:PATtern:DATA command defines the LIN data pattern resource according to the string parameter. This pattern, along with the data length (set by the :SBUS<N>:LIN:TRIGger:PATtern:DATA:LENGth command), control the data pattern searched for in each LIN message.

If the string parameter starts with "0x", it is a hexadecimal string made up of hexadecimal and X (don't care) characters; otherwise, it is a binary string made up of 0, 1, and X (don't care) characters.

NOTE

If more bits are sent for <string> than specified by the :SBUS<N>:LIN:TRIGger:PATtern:DATA:LENGth command, the most significant bits will be truncated.

<N> An integer, 1-4.

Query :SBUS<N>:LIN:TRIGger:PATtern:DATA?

The :SBUS<N>:LIN:TRIGger:PATtern:DATA? query returns the current settings of the specified LIN data pattern resource in the binary string format.

Returned Format <string><NL> in nondecimal format

- See Also**
- **":SBUS<N>:LIN:SAMPlepoint"** on page 1068
 - **":SBUS<N>:LIN:SIGNal:BAUDrate"** on page 1069
 - **":SBUS<N>:LIN:SOURce"** on page 1070
 - **":SBUS<N>:LIN:STANdard"** on page 1071
 - **":SBUS<N>:LIN:TRIGger"** on page 1072
 - **":SBUS<N>:LIN:TRIGger:ID"** on page 1073
 - **":SBUS<N>:LIN:TRIGger:PATtern:DATA:LENGth"** on page 1075

History New in version 5.20.

:SBUS<N>:LIN:TRIGger:PATtern:DATA:LENGth

Command :SBUS<N>:LIN:TRIGger:PATtern:DATA:LENGth <length>

<length> ::= integer from 1 to 8.

The :SBUS<n>:LIN:TRIGger:PATtern:DATA:LENGth command sets the number of 8-bit bytes in the LIN data string. The number of bytes in the string can be anywhere from 1 bytes to 8 bytes (64 bits). The value for these bytes is set by the :SBUS<n>:LIN:TRIGger:PATtern:DATA command.

Query :SBUS<N>:LIN:TRIGger:PATtern:DATA:LENGth?

The :SBUS<n>:LIN:TRIGger:PATtern:DATA:LENGth? query returns the current LIN data pattern length setting.

Returned Format <length><NL>

<length> ::= integer from 1 to 8.

- See Also**
- [":SBUS<N>:LIN:SAMPlepoint"](#) on page 1068
 - [":SBUS<N>:LIN:SIGNal:BAUDrate"](#) on page 1069
 - [":SBUS<N>:LIN:SOURce"](#) on page 1070
 - [":SBUS<N>:LIN:STANdard"](#) on page 1071
 - [":SBUS<N>:LIN:TRIGger"](#) on page 1072
 - [":SBUS<N>:LIN:TRIGger:ID"](#) on page 1073
 - [":SBUS<N>:LIN:TRIGger:PATtern:DATA"](#) on page 1074

History New in version 5.20.

:SBUS<N>:SPI Commands

- **":SBUS<N>:SPI:BITOrder"** on page 1077
- **":SBUS<N>:SPI:CLOCK:SLOPe"** on page 1078
- **":SBUS<N>:SPI:CLOCK:TIMEout"** on page 1079
- **":SBUS<N>:SPI:FRAMe:STATe"** on page 1080
- **":SBUS<N>:SPI:SOURce:CLOCK"** on page 1081
- **":SBUS<N>:SPI:SOURce:DATA"** on page 1083
- **":SBUS<N>:SPI:SOURce:FRAMe"** on page 1085
- **":SBUS<N>:SPI:SOURce:MISO"** on page 1086
- **":SBUS<N>:SPI:SOURce:MOSI"** on page 1087
- **":SBUS<N>:SPI:TRIGger:PATTern:DATA (9000 Series, 9000H Series, S-Series)"** on page 1089
- **":SBUS<N>:SPI:TRIGger:PATTern:WIDTH (9000 Series, 9000H Series, S-Series)"** on page 1091
- **":SBUS<N>:SPI:TRIGger:TYPE (9000 Series, 9000H Series, S-Series)"** on page 1093
- **":SBUS<N>:SPI:TYPE"** on page 1095
- **":SBUS<N>:SPI:WIDTH"** on page 1096

NOTE

These commands are only valid when the low-speed IIC and SPI serial decode option has been licensed.

See Also • **":SBUS<N>:MODE"** on page 1026

:SBUS<N>:SPI:BITOrder

Command :SBUS<N>:SPI:BITOrder <order>

<order> ::= {LSB | MSB}

The :SBUS<N>:SPI:BITOrder command selects the bit order, most significant bit first (MSB) or least significant bit first (LSB), used when displaying data in the serial decode waveform and in the Lister.

<N> An integer, 1-4.

Query :SBUS<N>:SPI:BITOrder?

The :SBUS<N>:SPI:BITOrder? query returns the current SPI decode bit order.

Returned Format [:SBUS<N>:SPI:BITOrder] <order><NL>

See Also • [":SBUS<N>:MODE"](#) on page 1026

History New in version 3.50.

:SBUS<N>:SPI:CLOCK:SLOPe

Command :SBUS<N>:SPI:CLOCK:SLOPe <slope>

<slope> ::= {POSitive | RISing | NEGative | FALLing}

The :SBUS<N>:SPI:CLOCK:SLOPe command specifies the rising edge (POSitive) or falling edge (NEGative) of the SPI clock source that will clock in the data.

<N> An integer, 1-4.

Query :SBUS<N>:SPI:CLOCK:SLOPe?

The :SBUS<N>:SPI:CLOCK:SLOPe? query returns the current SPI clock source slope.

Returned Format [:SBUS<N>:SPI:CLOCK:SLOPe] <slope><NL>

<slope> ::= {RIS | FALL}

- See Also**
- **":SBUS<N>:SPI:CLOCK:TIMEout"** on page 1079
 - **":SBUS<N>:SPI:SOURce:CLOCK"** on page 1081
 - **":SBUS<N>:MODE"** on page 1026

History New in version 3.50.

:SBUS<N>:SPI:CLOCK:TIMEout

Command :SBUS<N>:SPI:CLOCK:TIMEout <time_value>

<time_value> ::= time in seconds in NR3 format

The :SBUS<N>:SPI:CLOCK:TIMEout command sets the SPI signal clock timeout resource in seconds from 100 ns to 10 s when the :SBUS<N>:SPI:FRAMing command is set to TIMEout. The timer is used to frame a signal by a clock timeout.

<N> An integer, 1-4.

Query :SBUS<N>:SPI:CLOCK:TIMEout?

The :SBUS<N>:SPI:CLOCK:TIMEout? query returns current SPI clock timeout setting.

Returned Format [:SBUS<N>:SPI:CLOCK:TIMEout] <time value><NL>

- See Also**
- [":SBUS<N>:SPI:CLOCK:SLOPe"](#) on page 1078
 - [":SBUS<N>:SPI:SOURce:CLOCK"](#) on page 1081
 - [":SBUS<N>:SPI:FRAME:STATe"](#) on page 1080
 - [":SBUS<N>:MODE"](#) on page 1026

History New in version 3.50.

:SBUS<N>:SPI:FRAMe:STATe

Command :SBUS<N>:SPI:FRAMe:STATe <value>

<value> ::= {LOW | HIGH}

The :SBUS<N>:SPI:FRAMe:STATe command sets the SPI trigger frame state.

<N> An integer, 1-4.

Query :SBUS<N>:SPI:FRAMe:STATe?

The :SBUS<N>:SPI:FRAMe:STATe? query returns the current SPI frame state.

Returned Format [:SBUS<N>:SPI:FRAMe:STATe] <value><NL>

- See Also**
- **":SBUS<N>:SPI:SOURce:FRAMe"** on page 1085
 - **":SBUS<N>:MODE"** on page 1026

History New in version 3.50.

:SBUS<N>:SPI:SOURce:CLOCK

Command :SBUS<N>:SPI:SOURce:CLOCK <source>

```
<source> ::= { CHANnel<N> | DIFF<D> | COMMONmode<C> | FUNction<F>
              | WMEMory<R> | DIGital<M> | NONE }
```

The :SBUS<N>:SPI:SOURce:CLOCK command sets the source for the SPI serial clock.

The NONE parameter is the same as selecting "None" for the source in the user interface. It makes the previously selected channel, waveform memory, or math function available for other decodes.

<N> SBUS<N> is an integer, 1-4.

CHANnel<N> is an integer, 1-4 in a single oscilloscope, 1-40 in a MultiScope system.

<D>, <C> <D> is an integer, 1-2. <C> is an integer, 3-4.

The DIFF and COMMONmode sources are just aliases that can be used in place of the channel names to apply to differential or common mode signals. These are just aliases - no state change occurs if you refer to a differential channel and you are not in differential mode. DIFF1 refers to the differential signal between channels 1 and 3 (and COMMONmode3 refers to the common mode channel between these same channels). DIFF2 refers to the differential signal between channels 2 and 4 (and COMMONmode4 refers to the common mode channel between these same channels).

<F> An integer, 1-16.

<R> An integer, 1-4.

<M> An integer, 0-15. Digital channels are available on mixed-signal oscilloscopes.

Query :SBUS<N>:SPI:SOURce:CLOCK?

The :SBUS<N>:SPI:SOURce:CLOCK? query returns the current source for the SPI serial clock.

Returned Format [:SBUS<N>:SPI:SOURce:CLOCK] <source><NL>

- See Also**
- [":SBUS<N>:SPI:CLOCK:SLOPe"](#) on page 1078
 - [":SBUS<N>:SPI:CLOCK:TIMEout"](#) on page 1079
 - [":SBUS<N>:SPI:SOURce:FRAME"](#) on page 1085
 - [":SBUS<N>:SPI:SOURce:MOSI"](#) on page 1087
 - [":SBUS<N>:SPI:SOURce:MISO"](#) on page 1086
 - [":SBUS<N>:SPI:SOURce:DATA"](#) on page 1083
 - [":SBUS<N>:MODE"](#) on page 1026

History New in version 3.50.

Version 5.20: The NONE parameter was added.

:SBUS<N>:SPI:SOURce:DATA

Command :SBUS<N>:SPI:SOURce:DATA <source>

```
<source> ::= { CHANnel<N> | DIFF<D> | COMMONmode<C> | FUNction<F>
              | WMEMory<R> | DIGital<M> | NONE }
```

The :SBUS<N>:SPI:SOURce:DATA command sets the source for the SPI serial MOSI data.

This command is the same as the :SBUS<N>:SPI:SOURce:MOSI command.

The NONE parameter is the same as selecting "None" for the source in the user interface. It makes the previously selected channel, waveform memory, or math function available for other decodes.

<N> SBUS<N> is an integer, 1-4.

CHANnel<N> is an integer, 1-4 in a single oscilloscope, 1-40 in a MultiScope system.

<D>, <C> <D> is an integer, 1-2. <C> is an integer, 3-4.

The DIFF and COMMONmode sources are just aliases that can be used in place of the channel names to apply to differential or common mode signals. These are just aliases - no state change occurs if you refer to a differential channel and you are not in differential mode. DIFF1 refers to the differential signal between channels 1 and 3 (and COMMONmode3 refers to the common mode channel between these same channels). DIFF2 refers to the differential signal between channels 2 and 4 (and COMMONmode4 refers to the common mode channel between these same channels).

<F> An integer, 1-16.

<R> An integer, 1-4.

<M> An integer, 0-15. Digital channels are available on mixed-signal oscilloscopes.

Query :SBUS<N>:SPI:SOURce:DATA?

The :SBUS<N>:SPI:SOURce:DATA? query returns the current source for the SPI serial MOSI data.

Returned Format [:SBUS<N>:SPI:SOURce:DATA] <source><NL>

- See Also**
- **":SBUS<N>:SPI:SOURce:MOSI"** on page 1087
 - **":SBUS<N>:SPI:SOURce:MISO"** on page 1086
 - **":SBUS<N>:SPI:SOURce:CLOCK"** on page 1081
 - **":SBUS<N>:SPI:SOURce:FRAMe"** on page 1085
 - **":SBUS<N>:MODE"** on page 1026

History New in version 3.50.

Version 5.20: The NONE parameter was added.

:SBUS<N>:SPI:SOURce:FRAMe

Command :SBUS<N>:SPI:SOURce:FRAMe <source>

```
<source> ::= { CHANnel<N> | DIFF<D> | COMMONmode<C> | FUNction<F>
              | WMEMory<R> | DIGital<M> | NONE }
```

The :SBUS<N>:SPI:SOURce:FRAMe command sets the frame source.

The NONE parameter is the same as selecting "None" for the source in the user interface. It makes the previously selected channel, waveform memory, or math function available for other decodes.

<N> SBUS<N> is an integer, 1-4.

CHANnel<N> is an integer, 1-4 in a single oscilloscope, 1-40 in a MultiScope system.

<D>, <C> <D> is an integer, 1-2. <C> is an integer, 3-4.

The DIFF and COMMONmode sources are just aliases that can be used in place of the channel names to apply to differential or common mode signals. These are just aliases - no state change occurs if you refer to a differential channel and you are not in differential mode. DIFF1 refers to the differential signal between channels 1 and 3 (and COMMONmode3 refers to the common mode channel between these same channels). DIFF2 refers to the differential signal between channels 2 and 4 (and COMMONmode4 refers to the common mode channel between these same channels).

<F> An integer, 1-16.

<R> An integer, 1-4.

<M> An integer, 0-15. Digital channels are available on mixed-signal oscilloscopes.

Query :SBUS<N>:SPI:SOURce:FRAMe?

The :SBUS<N>:SPI:SOURce:FRAMe? query returns the current frame source for the SPI serial frame.

Returned Format [:SBUS<N>:SPI:SOURce:FRAMe] <source><NL>

- See Also**
- **":SBUS<N>:SPI:SOURce:CLOCK"** on page 1081
 - **":SBUS<N>:SPI:SOURce:MOSI"** on page 1087
 - **":SBUS<N>:SPI:SOURce:MISO"** on page 1086
 - **":SBUS<N>:SPI:SOURce:DATA"** on page 1083
 - **":SBUS<N>:SPI:FRAMe:STATe"** on page 1080
 - **":SBUS<N>:MODE"** on page 1026

History New in version 3.50.

Version 5.20: The NONE parameter was added.

:SBUS<N>:SPI:SOURce:MISO

Command :SBUS<N>:SPI:SOURce:MISO <source>

```
<source> ::= { CHANnel<N> | DIFF<D> | COMMONmode<C> | FUNction<F>
              | WMEMory<R> | DIGital<M> | NONE }
```

The :SBUS<N>:SPI:SOURce:MISO command sets the source for the SPI serial MISO data.

The NONE parameter is the same as selecting "None" for the source in the user interface. It makes the previously selected channel, waveform memory, or math function available for other decodes.

<N> SBUS<N> is an integer, 1-4.

CHANnel<N> is an integer, 1-4 in a single oscilloscope, 1-40 in a MultiScope system.

<D>, <C> <D> is an integer, 1-2. <C> is an integer, 3-4.

The DIFF and COMMONmode sources are just aliases that can be used in place of the channel names to apply to differential or common mode signals. These are just aliases - no state change occurs if you refer to a differential channel and you are not in differential mode. DIFF1 refers to the differential signal between channels 1 and 3 (and COMMONmode3 refers to the common mode channel between these same channels). DIFF2 refers to the differential signal between channels 2 and 4 (and COMMONmode4 refers to the common mode channel between these same channels).

<F> An integer, 1-16.

<R> An integer, 1-4.

<M> An integer, 0-15. Digital channels are available on mixed-signal oscilloscopes.

Query :SBUS<N>:SPI:SOURce:MISO?

The :SBUS<N>:SPI:SOURce:MISO? query returns the current source for the SPI serial MISO data.

Returned Format [:SBUS<N>:SPI:SOURce:MISO] <source><NL>

- See Also**
- **":SBUS<N>:SPI:SOURce:MOSI"** on page 1087
 - **":SBUS<N>:SPI:SOURce:DATA"** on page 1083
 - **":SBUS<N>:SPI:SOURce:CLOCK"** on page 1081
 - **":SBUS<N>:SPI:SOURce:FRAME"** on page 1085
 - **":SBUS<N>:MODE"** on page 1026

History New in version 3.50.

Version 5.20: The NONE parameter was added.

:SBUS<N>:SPI:SOURce:MOSI

Command :SBUS<N>:SPI:SOURce:MOSI <source>

```
<source> ::= { CHANnel<N> | DIFF<D> | COMMONmode<C> | FUNction<F>
              | WMEMory<R> | DIGital<M> | NONE }
```

The :SBUS<N>:SPI:SOURce:MOSI command sets the source for the SPI serial MOSI data.

You can also use the equivalent :SBUS<N>:SPI:SOURce:DATA command to set the MOSI data source.

The NONE parameter is the same as selecting "None" for the source in the user interface. It makes the previously selected channel, waveform memory, or math function available for other decodes.

<N> SBUS<N> is an integer, 1-4.

CHANnel<N> is an integer, 1-4 in a single oscilloscope, 1-40 in a MultiScope system.

<D>, <C> <D> is an integer, 1-2. <C> is an integer, 3-4.

The DIFF and COMMONmode sources are just aliases that can be used in place of the channel names to apply to differential or common mode signals. These are just aliases - no state change occurs if you refer to a differential channel and you are not in differential mode. DIFF1 refers to the differential signal between channels 1 and 3 (and COMMONmode3 refers to the common mode channel between these same channels). DIFF2 refers to the differential signal between channels 2 and 4 (and COMMONmode4 refers to the common mode channel between these same channels).

<F> An integer, 1-16.

<R> An integer, 1-4.

<M> An integer, 0-15. Digital channels are available on mixed-signal oscilloscopes.

Query :SBUS<N>:SPI:SOURce:MOSI?

The :SBUS<N>:SPI:SOURce:MOSI? query returns the current source for the SPI serial MOSI data.

Returned Format [:SBUS<N>:SPI:SOURce:MOSI] <source><NL>

- See Also**
- **":SBUS<N>:SPI:SOURce:DATA"** on page 1083
 - **":SBUS<N>:SPI:SOURce:MISO"** on page 1086
 - **":SBUS<N>:SPI:SOURce:CLOCK"** on page 1081
 - **":SBUS<N>:SPI:SOURce:FRAME"** on page 1085
 - **":SBUS<N>:MODE"** on page 1026

History New in version 3.50.

Version 5.20: The NONE parameter was added.

:SBUS<N>:SPI:TRIGger:PATtern:DATA (9000 Series, 9000H Series, S-Series)

Command :SBUS<N>:SPI:TRIGger:PATtern:DATA <quoted_string>

NOTE

You must set :SBUS<N>:MODE to SPI before you can send other :SBUS<N>:SPI:TRIGger commands.

The :SBUS<N>:SPI:TRIGger:PATtern:DATA command defines the SPI data pattern resource according to the string parameter. This pattern, along with the data width, control the data pattern searched for in the data stream.

The :SBUS<N>:SPI:TRIGger:PATtern:DATA command must receive the number of bytes specified by the :SBUS<N>:SPI:TRIGger:PATtern:WIDTh command.

NOTE

The :SBUS<N>:SPI:TRIGger:PATtern:WIDTh should be set before :SBUS<N>:SPI:TRIGger:PATtern:DATA.

<N> An integer, 1-4.

<quoted_string> If the quoted string parameter starts with "0x", it is a hexadecimal string made up of hexadecimal and X (don't care) characters (for example, "0x34XF"); otherwise, it is a binary string made up of 0, 1, and X (don't care) characters (for example, "00110100XXXX1111").

Example To enable the SBUS1 trigger, set the SPI trigger type to MOSI, set a 32-bit data pattern width, and specify the 0x0080FFFF data pattern:

```
myScope.WriteString ":CHANnel1:DISPlay ON"
myScope.WriteString ":CHANnel2:DISPlay ON"
myScope.WriteString ":CHANnel3:DISPlay ON"
myScope.WriteString ":CHANnel4:DISPlay ON"
myScope.WriteString ":SBUS1:MODE SPI"
myScope.WriteString ":SBUS1:SPI:WIDTh 16"
myScope.WriteString ":SBUS1:SPI:TYPE WIRE4"
myScope.WriteString ":SBUS1:SPI:SOURce:MOSI CHANnel1"
myScope.WriteString ":SBUS1:SPI:SOURce:CLOCK CHANnel2"
myScope.WriteString ":SBUS1:SPI:SOURce:FRAME CHANnel3"
myScope.WriteString ":SBUS1:SPI:SOURce:MISO CHANnel4"
myScope.WriteString ":TRIGger:MODE SBUS1"
myScope.WriteString ":SBUS1:SPI:TRIGger:TYPE MOSI"
myScope.WriteString ":SBUS1:SPI:TRIGger:PATtern:WIDTh 2"
myScope.WriteString ":SBUS1:SPI:TRIGger:PATtern:DATA '0x0080ffff'"
```

Query :SBUS<N>:SPI:TRIGger:PATtern:DATA?

The :SBUS<N>:SPI:TRIGger:PATtern:DATA? query returns the current settings of the specified SPI data pattern resource in the binary string format.

Returned Format [:SBUS<N>:SPI:TRIGger:PATtern:DATA] <binary_string><NL>

- See Also**
- **":TRIGger:MODE"** on page 1195
 - **":SBUS<N>:MODE"** on page 1026
 - **":SBUS<N>:SPI:TRIGger:PATtern:WIDTh (9000 Series, 9000H Series, S-Series)"** on page 1091
 - **":SBUS<N>:SPI:TRIGger:TYPE (9000 Series, 9000H Series, S-Series)"** on page 1093

History New in version 3.50.

:SBUS<N>:SPI:TRIGger:PATtern:WIDTh (9000 Series, 9000H Series, S-Series)

Command :SBUS<N>:SPI:TRIGger:PATtern:WIDTh {1 - 20}

NOTE

You must set :SBUS<N>:MODE to SPI before you can send other :SBUS<N>:SPI:TRIGger commands.

The :SBUS<N>:SPI:TRIGger:PATtern:WIDTh command sets the width of the SPI data pattern. You can specify the width in multiples of the SPI word size up to 20.

NOTE

The :SBUS<N>:SPI:TRIGger:PATtern:WIDTh should be set before :SBUS<N>:SPI:TRIGger:PATtern:DATA.

<N> An integer, 1-4.

Example To enable the SBUS1 trigger, set the SPI trigger type to MOSI, set a 32-bit data pattern width (two 16-bit words), and specify the 0x0080FFFF data pattern:

```
myScope.WriteString ":CHANnel1:DISPlay ON"
myScope.WriteString ":CHANnel2:DISPlay ON"
myScope.WriteString ":CHANnel3:DISPlay ON"
myScope.WriteString ":CHANnel4:DISPlay ON"
myScope.WriteString ":SBUS1:MODE SPI"
myScope.WriteString ":SBUS1:SPI:WIDTh 16"
myScope.WriteString ":SBUS1:SPI:TYPE WIRE4"
myScope.WriteString ":SBUS1:SPI:SOURce:MOSI CHANnel1"
myScope.WriteString ":SBUS1:SPI:SOURce:CLOCK CHANnel2"
myScope.WriteString ":SBUS1:SPI:SOURce:FRAMe CHANnel3"
myScope.WriteString ":SBUS1:SPI:SOURce:MISO CHANnel4"
myScope.WriteString ":TRIGger:MODE SBUS1"
myScope.WriteString ":SBUS1:SPI:TRIGger:TYPE MOSI"
myScope.WriteString ":SBUS1:SPI:TRIGger:PATtern:WIDTh 2"
myScope.WriteString ":SBUS1:SPI:TRIGger:PATtern:DATA '0x0080ffff'"
```

Query :SBUS<N>:SPI:TRIGger:PATtern:WIDTh?

The :SBUS<N>:SPI:TRIGger:PATtern:WIDTh? query returns the current SPI data pattern width setting.

Returned Format [:SBUS<N>:SPI:TRIGger:PATtern:WIDTh] {1 - 20}<NL>

- See Also**
- **" :TRIGger:MODE "** on page 1195
 - **" :SBUS<N>:MODE "** on page 1026
 - **" :SBUS<N>:SPI:WIDTh "** on page 1096
 - **" :SBUS<N>:SPI:TRIGger:TYPE (9000 Series, 9000H Series, S-Series) "** on page 1093

- **":SBUS<N>:SPI:TRIGger:PATtern:DATA (9000 Series, 9000H Series, S-Series)"**
on page 1089

History New in version 3.50.

:SBUS<N>:SPI:TRIGger:TYPE (9000 Series, 9000H Series, S-Series)

Command :SBUS<N>:SPI:TRIGger:TYPE <value>
 <value> ::= {MOSI | MISO}

NOTE

You must set :SBUS<N>:MODE to SPI before you can send other :SBUS<N>:SPI:TRIGger commands.

The :SBUS<N>:SPI:TRIGger:TYPE command specifies whether the SPI trigger will be on the MOSI data or the MISO data.

The data value is specified by the :SBUS<N>:SPI:TRIGger:PATtern:DATA and :SBUS<N>:SPI:TRIGger:PATtern:WIDTh commands.

<N> An integer, 1-4.

Example To enable the SBUS1 trigger and set the SPI trigger type to MOSI:

```
myScope.WriteString ":CHANnel1:DISPlay ON"
myScope.WriteString ":CHANnel2:DISPlay ON"
myScope.WriteString ":CHANnel3:DISPlay ON"
myScope.WriteString ":CHANnel4:DISPlay ON"
myScope.WriteString ":SBUS1:MODE SPI"
myScope.WriteString ":SBUS1:SPI:WIDTh 16"
myScope.WriteString ":SBUS1:SPI:TYPE WIRE4"
myScope.WriteString ":SBUS1:SPI:SOURce:MOSI CHANnel1"
myScope.WriteString ":SBUS1:SPI:SOURce:CLOCK CHANnel2"
myScope.WriteString ":SBUS1:SPI:SOURce:FRAMe CHANnel3"
myScope.WriteString ":SBUS1:SPI:SOURce:MISO CHANnel4"
myScope.WriteString ":TRIGger:MODE SBUS1"
myScope.WriteString ":SBUS1:SPI:TRIGger:TYPE MOSI"
myScope.WriteString ":SBUS1:SPI:TRIGger:PATtern:WIDTh 2"
myScope.WriteString ":SBUS1:SPI:TRIGger:PATtern:DATA '0x0080ffff'"
```

Query :SBUS<N>:SPI:TRIGger:TYPE?

The :SBUS<N>:SPI:TRIGger:TYPE? query returns the trigger type setting.

Returned Format [:SBUS<N>:SPI:TRIGger:TYPE] <value><NL>

- See Also**
- [":TRIGger:MODE"](#) on page 1195
 - [":SBUS<N>:MODE"](#) on page 1026
 - [":SBUS<N>:SPI:SOURce:DATA"](#) on page 1083
 - [":SBUS<N>:SPI:SOURce:MOSI"](#) on page 1087
 - [":SBUS<N>:SPI:SOURce:MISO"](#) on page 1086
 - [":SBUS<N>:SPI:TRIGger:PATtern:DATA \(9000 Series, 9000H Series, S-Series\)"](#) on page 1089
 - [":SBUS<N>:SPI:TRIGger:PATtern:WIDTh \(9000 Series, 9000H Series, S-Series\)"](#) on page 1091

History New in version 3.50.

:SBUS<N>:SPI:TYPE

Command :SBUS<N>:SPI:TYPE <value>

<value> ::= {WIRE2 | WIRE3 | WIRE4}

The :SBUS<N>:SPI:TYPE command specifies whether the type of SPI to decode.

<N> An integer, 1-4.

Example To set the 3-wire SPI decode type:

```
myScope.WriteString ":SBUS1:SPI:TYPE WIRE3 "
```

Query :SBUS<N>:SPI:TYPE?

The :SBUS<N>:SPI:TYPE? query returns the decode type setting.

Returned Format [:SBUS<N>:SPI:TYPE] <value><NL>

- See Also**
- [":SBUS<N>:SPI:BITOrder"](#) on page 1077
 - [":SBUS<N>:SPI:SOURce:CLOCK"](#) on page 1081
 - [":SBUS<N>:SPI:SOURce:DATA"](#) on page 1083
 - [":SBUS<N>:SPI:SOURce:FRAMe"](#) on page 1085
 - [":SBUS<N>:SPI:SOURce:MISO"](#) on page 1086
 - [":SBUS<N>:SPI:SOURce:MOSI"](#) on page 1087
 - [":SBUS<N>:MODE"](#) on page 1026

History New in version 3.50.

:SBUS<N>:SPI:WIDTH

Command :SBUS<N>:SPI:WIDTH <word_width>

<word_width> ::= integer 4-16 in NR1 format

The :SBUS<N>:SPI:WIDTH command determines the number of bits in a word of data for SPI.

<N> An integer, 1-4.

Query :SBUS<N>:SPI:WIDTH?

The :SBUS<N>:SPI:WIDTH? query returns the current SPI decode word width.

Returned Format [:SBUS<N>:SPI:WIDTH] <word_width><NL>

<word_width> ::= integer 4-16 in NR1 format

See Also • **":SBUS<N>:MODE"** on page 1026

History New in version 3.50.

32 Self-Test Commands

:SELFtest:CANCel / 1098
:SELFtest:SCOPETEST / 1099

The SELFtest subsystem commands set up the self-test dialog and run the Infiniium-Series Oscilloscopes Self-Tests.

NOTE

Enclose File Name in Quotation Marks

When specifying a file name, you must enclose it in quotation marks.

:SELFtest:CANCEl

Command `:SELFtest:CANCEl`

The `:SELFtest:CANCEl` command stops the currently running selftest.

Example This example stops the currently running selftest.

```
myScope.WriteString ":SELF:CANC"
```

History Legacy command (existed before version 3.10).

:SELFtest:SCOPETEST

Command :SELFtest:SCOPETEST

The :SELFtest:SCOPETEST command brings up the self-test dialog in customer self-test mode (Service Extensions Off) and runs the test, "Scope Self Tests." Use the :SELFtest:SCOPETEST? query to determine the status of the test.

Example This example brings up the self-test dialog and runs the oscilloscope self-tests.

```
myScope.WriteString ":SELF:SCOPETEST"
```

Query :SELFtest:SCOPETEST?

Returned Format [:SELFtest:SCOPETEST] <test_name>, <test_status>, <time_stamp><NL>

| <test_status> | Status Description |
|---------------|---|
| FAILED | Test completed and failed. |
| PASSED | Test completed and passed. |
| WARNING | Test passed but warning message was issued. |
| CANCELLED | Test was cancelled by user. |
| NODATA | Self-tests have not been executed on this instrument. |
| INPROGRESS | Test is in progress. |

<test_name> A string as follows: "Scope Self Tests".

<time_stamp> The time stamp follows the test name and test status, and is the part of the returned string that includes the date and time, in the format: "20 May 2009 10:13:35".

Example This example places the current status of the self-test in the string variable, strTxt, then prints the contents of the variable to the computer's screen.

```
Dim strTxt As String
myScope.WriteString ":SELF:SCOPETEST?"
strTxt = myScope.ReadString
Debug.Print strTxt
```

History Legacy command (existed before version 3.10).

33 Serial Data Equalization Commands

:SPRocessing:CTLequalizer:ACGain / 1103
:SPRocessing:CTLequalizer:DCGain / 1104
:SPRocessing:CTLequalizer:DISPlay / 1105
:SPRocessing:CTLequalizer:NUMPoles / 1106
:SPRocessing:CTLequalizer:P1 / 1107
:SPRocessing:CTLequalizer:P2 / 1108
:SPRocessing:CTLequalizer:P3 / 1109
:SPRocessing:CTLequalizer:RATE / 1110
:SPRocessing:CTLequalizer:SOURce / 1111
:SPRocessing:CTLequalizer:VERTical / 1112
:SPRocessing:CTLequalizer:VERTical:OFFSet / 1113
:SPRocessing:CTLequalizer:VERTical:RANGE / 1114
:SPRocessing:CTLequalizer:Z1 / 1115
:SPRocessing:CTLequalizer:Z2 / 1116
:SPRocessing:DFEQualizer:NTAPs / 1117
:SPRocessing:DFEQualizer:SOURce / 1118
:SPRocessing:DFEQualizer:STATe / 1119
:SPRocessing:DFEQualizer:TAP / 1120
:SPRocessing:DFEQualizer:TAP:AUTomatic / 1121
:SPRocessing:DFEQualizer:TAP:DELay / 1122
:SPRocessing:DFEQualizer:TAP:GAIN / 1123
:SPRocessing:DFEQualizer:TAP:LTARget / 1124
:SPRocessing:DFEQualizer:TAP:MAX / 1125
:SPRocessing:DFEQualizer:TAP:MIN / 1126
:SPRocessing:DFEQualizer:TAP:UTARget / 1127
:SPRocessing:DFEQualizer:TAP:WIDTH / 1128
:SPRocessing:FFEQualizer:BANDwidth / 1129
:SPRocessing:FFEQualizer:BWMode / 1130
:SPRocessing:FFEQualizer:DISPlay / 1131
:SPRocessing:FFEQualizer:NPRecursor / 1132

:SPRocessing:FFEQualizer:NTAPs / 1133
:SPRocessing:FFEQualizer:RATE / 1134
:SPRocessing:FFEQualizer:SOURce / 1135
:SPRocessing:FFEQualizer:TAP / 1136
:SPRocessing:FFEQualizer:TAP:AUTomatic / 1137
:SPRocessing:FFEQualizer:TAP:DELay / 1138
:SPRocessing:FFEQualizer:TAP:PLENght / 1139
:SPRocessing:FFEQualizer:TAP:WIDTh / 1140
:SPRocessing:FFEQualizer:TDELay / 1141
:SPRocessing:FFEQualizer:TDMode / 1142
:SPRocessing:FFEQualizer:VERTical / 1143
:SPRocessing:FFEQualizer:VERTical:OFFSet / 1144
:SPRocessing:FFEQualizer:VERTical:RANGe / 1145

The N5461A Serial Data Equalization application is used to re-open partially or completely closed real-time eye diagrams. For additional information on equalization, consult the N5461A Infiniium Serial Data Equalization User's Guide.

:SPRocessing:CTLequalizer:ACGain

Command :SPRocessing:CTLequalizer:ACGain <ac_gain>

The :CTLequalizer:ACGain command sets the AC Gain parameter for the Continuous Time Linear Equalization when USB31 is selected for the "# of Poles" option.

<ac_gain> A real number

Example This example sets the CTLE AC Gain parameter to 1.

```
myScope.WriteString ":SPRocessing:CTLequalizer:ACGain 1"
```

Query :SPRocessing:CTLequalizer:ACGain?

The :SPRocessing:CTLequalizer:ACGain? query returns the CTLE's AC Gain parameter setting.

See Also • [":SPRocessing:CTLequalizer:NUMPoles"](#) on page 1106

History New in version 3.10.

:SPRocessing:CTLequalizer:DCGain

Command :SPRocessing:CTLequalizer:DCGain <dc_gain>

The :CTLequalizer:DCGain command sets the DC Gain parameter for the Continuous Time Linear Equalization.

<dc_gain> A real number

Example This example sets the CTLE DC Gain parameter to 1.

```
myScope.WriteString ":SPRocessing:CTLequalizer:DCGain 1"
```

Query :SPRocessing:CTLequalizer:DCGain?

The :SPRocessing:CTLequalizer:DCGain? query returns the CTLE's DC Gain parameter.

History Legacy command (existed before version 3.10).

:SPRocessing:CTLequalizer:DISPlay

Command :SPRocessing:CTLequalizer:DISPlay {(OFF | 0) | (ON | 1)}

The :CTLequalizer:DISPlay command turns the display of a Continuous Time Linear Equalizer (CTLE) waveform on or off. Turning CTLE on automatically turns FFE off (and vice versa).

Example This example turns on the display of a CTLE waveform.

```
myScope.WriteString ":SPRocessing:CTLequalizer:DISPlay ON"
```

Query :SPRocessing:CTLequalizer:DISPlay?

The :SPRocessing:CTLequalizer:DISPlay? query returns whether or not the CTLE waveform is displayed.

History Legacy command (existed before version 3.10).

:SPRoceSSing:CTLequalizer:NUMPoles

Command :SPRoceSSing:CTLequalizer:NUMPoles {POLE2 | P3Z1 | P3Z2 | USB31}

The :SPRoceSSing:CTLequalizer:NUMPoles command selects either a 2 Pole, 3 Pole 1 Zero, 3 Pole 2 Zeros, or USB 3.1 Continuous Time Linear Equalizer (CTLE).

Example This example selects a 2 Pole CTLE.

```
myScope.WriteString ":SPRoceSSing:CTLequalizer:NUMPoles POLE2"
```

Query :SPRoceSSing:CTLequalizer:NUMPoles?

The :SPRoceSSing:CTLequalizer:NUMPoles? query returns the current "number of poles" selection.

- See Also**
- [":SPRoceSSing:CTLequalizer:Z1"](#) on page 1115
 - [":SPRoceSSing:CTLequalizer:Z2"](#) on page 1116
 - [":SPRoceSSing:CTLequalizer:ACGain"](#) on page 1103

History New in version 3.10.

Version 5.75: The previous POLE3 option has been replaced by P3Z1 and P3Z2.

:SPRocessing:CTLequalizer:P1

Command :SPRocessing:CTLequalizer:P1 <pole1_freq>

The :CTLequalizer:P1 command sets the Pole 1 frequency for the Continuous Time Linear Equalization.

<pole1_freq> A real number

Example This example sets the CTLE Pole 1 frequency to 1GHz.

```
myScope.WriteString ":SPRocessing:CTLequalizer:P1 1e9"
```

Query :SPRocessing:CTLequalizer:P1?

The :SPRocessing:CTLequalizer:P1? query returns the CTLE's Pole 1 frequency.

History Legacy command (existed before version 3.10).

:SPRocessing:CTLequalizer:P2

Command :SPRocessing:CTLequalizer:P2 <pole2_freq>

The :CTLequalizer:P1 command sets the Pole 2 frequency for the Continuous Time Linear Equalization.

<pole2_freq> A real number

Example This example sets the CTLE Pole 2 frequency to 4 GHz.

```
myScope.WriteString ":SPRocessing:CTLequalizer:P2 4e9"
```

Query :SPRocessing:CTLequalizer:P2?

The :SPRocessing:CTLequalizer:P2? query returns the CTLE's Pole 2 frequency.

History Legacy command (existed before version 3.10).

:SPRocessing:CTLequalizer:P3

Command :SPRocessing:CTLequalizer:P3 <pole3_freq>

The :CTLequalizer:P1 command sets the Pole 3 frequency for the Continuous Time Linear Equalization.

<pole3_freq> A real number

Example This example sets the CTLE Pole 3 frequency to 4 GHz.

```
myScope.WriteString ":SPRocessing:CTLequalizer:P3 4e9"
```

Query :SPRocessing:CTLequalizer:P3?

The :SPRocessing:CTLequalizer:P3? query returns the CTLE's Pole 3 frequency.

History New in version 3.10.

:SPROcessing:CTLequalizer:RATE

Command :SPROcessing:CTLequalizer:RATE <data_rate>

The :CTLequalizer:RATE command sets the data rate for the CTLE equalizer.

<data_rate> A real number.

When the signal type is PAM-4 (see :ANALyze:SIGNal:TYPE), a symbol rate (baud) is specified instead of a data rate (b/s).

Example This example sets the CTLE data rate to 3e9.

```
myScope.WriteString ":SPROcessing:CTLequalizer:RATE 3e9"
```

Query :SPROcessing:CTLequalizer:RATE?

The :SPROcessing:CTLequalizer:Rate? query returns the CTLE's data rate.

See Also • [":ANALyze:SIGNal:TYPE"](#) on page 271

History Legacy command (existed before version 3.10).

Version 5.50: When the signal type is PAM-4, a symbol rate (baud) is specified instead of a data rate (b/s).

:SPROcessing:CTLequalizer:SOURce

Command :SPROcessing:CTLequalizer:SOURce {CHANnel<N> | FUNction<F> | WMEMory<R>}

The :CTLequalizer:SOURce command sets the source for the Continuous Time Linear Equalization.

<N> An integer, 1-4 in a single oscilloscope, 1-40 in a MultiScope system.

<F> An integer, 1-16.

<R> An integer, 1-4.

Example This example sets the CTLE source to Channel 1.

```
myScope.WriteString ":SPROcessing:CTLequalizer:SOURce CHANnel1"
```

Query :SPROcessing:CTLequalizer:SOURce?

The :SPROcessing:CTLequalizer:SOURce? query returns the CTLE source.

History Legacy command (existed before version 3.10).

:SPROcessing:CTLequalizer:VERTical

Command :SPROcessing:CTLequalizer:VERTical {AUTO | MANual}

The :SPROcessing:CTLequalizer:VERTical command sets the CTLE signal's vertical scale mode to automatic or manual. In automatic mode, the oscilloscope automatically selects the vertical scaling and offset. In manual mode, you can set your own scaling and offset values.

Example This example sets the CTLE signal's vertical scale mode to automatic.

```
myScope.WriteString ":SPROcessing:CTLequalizer:VERTical AUTO"
```

Query :SPROcessing:CTLequalizer:VERTical?

The :SPROcessing:CTLequalizer:VERTical? query returns the current CTLE signal's vertical scale mode setting.

Returned Format [:SPROcessing:CTLequalizer:VERTical] {AUTO | MANual}

Example This example places the current setting of the CTLE signal's vertical scale mode in the string variable strSetting, then prints the contents of the variable to the computer's screen.

```
myScope.WriteString ":SYSTem:HEADer OFF"
myScope.WriteString ":SPROcessing:CTLequalizer:VERTical?"
strSetting = myScope.ReadString
Debug.Print strSetting
```

History Legacy command (existed before version 3.10).

:SPROcessing:CTLequalizer:VERTical:OFFSet

Command :SPROcessing:CTLequalizer:VERTical:OFFSet <offset>

The :SPROcessing:CTLequalizer:VERTical:OFFSet command sets the CTLE signal's vertical offset.

<offset> A real number for the CTLE signal's vertical offset.

Example This example sets the CTLE signal's vertical offset to 1 volt.

```
myScope.WriteString ":SPROcessing:CTLequalizer:VERTical:OFFSet 1"
```

Query :SPROcessing:CTLequalizer:VERTical:OFFSet?

The:SPROcessing:CTLequalizer:VERTical:OFFSet? query returns the CTLE signal's vertical offset setting.

Returned Format [:SPROcessing:CTLequalizer:VERTical:OFFSet] <value><NL>

<value> The CTLE signal's vertical offset setting.

Example This example places the current value of the CTLE signal's vertical offset in the numeric variable, varValue, then prints the contents of the variable to the computer's screen.

```
myScope.WriteString ":SYSTem:HEADer OFF" ' Response headers off.
myScope.WriteString ":SPROcessing:CTLequalizer:VERTical:OFFSet?"
varValue = myScope.ReadNumber
Debug.Print FormatNumber(varValue, 0)
```

History Legacy command (existed before version 3.10).

:SPROcessing:CTLequalizer:VERTical:RANGe

Command :SPROcessing:CTLequalizer:VERTical:RANGe <range>

The :SPROcessing:CTLequalizer:VERTical:RANGe command sets the CTLE signal's vertical range.

<range> A real number for the full-scale CTLE signal's vertical range.

Example This example sets the CTLE signal's vertical range to 16 volts (2 volts times 8 divisions.)

```
myScope.WriteString ":SPROcessing:CTLequalizer:VERTical:RANGe 16"
```

Query :SPROcessing:CTLequalizer:VERTical:RANGe?

The :SPROcessing:CTLequalizer:VERTical:RANGe? query returns the CTLE signal's vertical range setting.

Returned Format [:SPROcessing:CTLequalizer:VERTical:RANGe] <value><NL>

<value> The CTLE signal's vertical range setting.

Example This example places the current value of the CTLE signal's vertical range in the numeric variable, varValue, then prints the contents of the variable to the computer's screen.

```
myScope.WriteString ":SYSTem:HEADer OFF" ' Response headers off.
myScope.WriteString ":SPROcessing:CTLequalizer:VERTical:RANGe?"
varValue = myScope.ReadNumber
Debug.Print FormatNumber(varValue, 0)
```

History Legacy command (existed before version 3.10).

:SPRoceSSing:CTLequalizer:Z1

Command :SPRoceSSing:CTLequalizer:Z1 <zero_freq_1>

The :SPRoceSSing:CTLequalizer:Z1 command sets the first zero frequency for the 3-pole Continuous Time Linear Equalization.

<zero_freq_1> A real number in NR3 format.

Example This example sets the 3-pole CTLE's first zero frequency to 900 MHz.

```
myScope.WriteString ":SPRoceSSing:CTLequalizer:Z1 650e6"
```

Query :SPRoceSSing:CTLequalizer:Z1?

The :SPRoceSSing:CTLequalizer:Z1? query returns the 3-pole CTLE's first zero frequency.

Returned Format <zero_freq_1><NL>

- See Also**
- [":SPRoceSSing:CTLequalizer:Z2"](#) on page 1116
 - [":SPRoceSSing:CTLequalizer:NUMPoles"](#) on page 1106

History New in version 5.75.

:SPRocessing:CTLequalizer:Z2

Command `:SPRocessing:CTLequalizer:Z2 <zero_freq_2>`

The `:SPRocessing:CTLequalizer:Z2` command sets the second zero frequency for the 3-pole Continuous Time Linear Equalization.

<zero_freq_2> A real number in NR3 format.

Example This example sets the 3-pole CTLE's second zero frequency to 4 GHz.

```
myScope.WriteString ":SPRocessing:CTLequalizer:Z2 4e9"
```

Query `:SPRocessing:CTLequalizer:Z2?`

The `:SPRocessing:CTLequalizer:Z2?` query returns the 3-pole CTLE's second zero frequency.

Returned Format `<zero_freq_2><NL>`

- See Also**
- [":SPRocessing:CTLequalizer:Z1"](#) on page 1115
 - [":SPRocessing:CTLequalizer:NUMPoles"](#) on page 1106

History New in version 5.75.

:SPRocessing:DFEQualizer:NTAPs

Command :SPRocessing:DFEQualizer:NTAPs <number>

The :DFEQualizer:NTAPs command sets the number of taps to be used in the DFE algorithm.

DFE tap indices always begin with 1 and extend to the number of taps.

<number> An integer between 1 and 40

Example This example sets the number of DFE taps to 3.

```
myScope.WriteString ":SPRocessing:DFEQualizer:NTAPs 3"
```

Query :SPRocessing:DFEQualizer:NTAPs?

The :SPRocessing:DFEQualizer:NTAPs? query returns the number of DFE taps.

History Legacy command (existed before version 3.10).

:SPROcessing:DFEQualizer:SOURce

Command :SPROcessing:DFEQualizer:SOURce {CHANnel<N> | DIFF<D> | COMMONmode<C>
| FUNction<F> | WMEMory<R> | EQUalized}

The :DFEQualizer:SOURce command sets the source for the Decision Feedback Equalization.

Setting the source to EQUalized means the Feed-Forward Equalized (FFE) waveform is used as the DFE source.

<N> An integer, 1-4 in a single oscilloscope, 1-40 in a MultiScope system.

<D>, <C> <D> is an integer, 1-2. <C> is an integer, 3-4.

The DIFF and COMMONmode sources are just aliases that can be used in place of the channel names to apply to differential or common mode signals. These are just aliases - no state change occurs if you refer to a differential channel and you are not in differential mode. DIFF1 refers to the differential signal between channels 1 and 3 (and COMMONmode3 refers to the common mode channel between these same channels). DIFF2 refers to the differential signal between channels 2 and 4 (and COMMONmode4 refers to the common mode channel between these same channels).

<F> An integer, 1-16.

<R> An integer, 1-4.

Example This example sets the DFE source to Channel 1.

```
myScope.WriteString ":SPROcessing:DFEQualizer:SOURce CHANnel1"
```

Query :SPROcessing:DFEQualizer:SOURce?

The :SPROcessing:DFEQualizer:SOURce? query returns the DFE source.

History Legacy command (existed before version 3.10).

:SPROcessing:DFEQualizer:STATe

Command :SPROcessing:DFEQualizer:STATe {(OFF | 0) | (ON | 1)}

The :DFEQualizer:STATe command turns the Decision Feedback Equalization on or off.

Example This example turns on DFE.

```
myScope.WriteString ":SPROcessing:DFEQualizer:STATe ON"
```

Query :SPROcessing:DFEQualizer:STATe?

The :SPROcessing:DFEQualizer:STATe? query returns whether or not DFE is turned on.

History Legacy command (existed before version 3.10).

:SPRocessing:DFEQualizer:TAP

Command :SPRocessing:DFEQualizer:TAP <tap>, <value>

The :DFEQualizer:TAP command sets the tap value for each DFE tap. For example, when <tap> is equal to 1 then the 1st tap is set to <value>.

DFE tap indices always start at 1 and extend to the number of taps.

<tap> The tap number.

<value> The tap value

Example This example sets the DFE Tap 1 to 0.432.

```
myScope.WriteString ":SPRocessing:DFEQualizer:TAP 1,0.432"
```

Query :SPRocessing:DFEQualizer:TAP? <tap>

The :SPRocessing:DFEQualizer:TAP? query returns the DFE tap values.

See Also · [":SPRocessing:DFEQualizer:NTAPs"](#) on page 1117

History Legacy command (existed before version 3.10).

:SPRocessing:DFEQualizer:TAP:AUTomatic

Command :SPRocessing:DFEQualizer:TAP:AUTomatic

The :DFEQualizer:TAP:AUTomatic command starts the DFE tap optimization. Be sure to first specify the number of taps and the max/min tap values.

Example This example starts the DFE tap optimization.

```
myScope.WriteString ":SPRocessing:DFEQualizer:TAP:AUTomatic"
```

History Legacy command (existed before version 3.10).

:SPRocessing:DFEQualizer:TAP:DELaY

Command :SPRocessing:DFEQualizer:TAP:DELaY <delay>

The :DFEQualizer:TAP:DELaY command specifies the amount of drift the equalized eye diagram has relative to the unequalized one. This drift is then accounted for so the two eyes overlap. For more information on this parameter, refer to the N5461A Infiniium Serial Data Equalization User's Guide.

<delay> A real number

Query :SPRocessing:DFEQualizer:TAP:DELaY?

The :SPRocessing:DFEQualizer:TAP:DELaY? query returns the value for the DFE Delay field.

History Legacy command (existed before version 3.10).

:SPRocessing:DFEQualizer:TAP:GAIN

Command :SPRocessing:DFEQualizer:TAP:GAIN <gain>

The eye diagram drawn after DFE is applied is attenuated. To amplify the eye back to its original size (so you can directly compare the eye at the receiver to the eye at the transmitter), a gain factor needs to be applied. The :DFEQualizer:TAP:GAIN command allows you to set this gain. For more information on this parameter, refer to the N5461A Infiniium Seriald Data Equalization User's Guide.

<gain> A real number

Example This example sets the gain to 3.23.

```
myScope.WriteString ":SPRocessing:DFEQualizer:TAP:GAIN 3.23"
```

Query :SPRocessing:DFEQualizer:TAP:GAIN?

The :SPRocessing:DFEQualizer:TAP:GAIN? query returns the current gain value.

History Legacy command (existed before version 3.10).

:SPRocessing:DFEQualizer:TAP:LTARget

Command :SPRocessing:DFEQualizer:TAP:LTARget <lower_target>

The Lower Target field dictates the logical low value used in the DFE algorithm. For example, in DFE, when a bit is determined to be a logical low, its value will be equal to Lower Target. The :DFEQualizer:TAP:LTARget command allows you to set this value.

<lower_target> A real number

Example This example sets the Lower Target to 1.0.

```
myScope.WriteString ":SPRocessing:DFEQualizer:TAP:LTARget 1.0"
```

Query :SPRocessing:DFEQualizer:TAP:LTARget?

The :SPRocessing:DFEQualizer:TAP:LTARget? query returns the current value for the Lower Target field.

History Legacy command (existed before version 3.10).

:SPRocessing:DFEQualizer:TAP:MAX

Command :SPRocessing:DFEQualizer:TAP:MAX <max_tap_value>

Some standards have upper and lower limits on the tap values. The :DFEQualizer:TAP:MAX command sets the upper limit on taps determined through optimization.

<max_tap_value> A real number

Example This example sets the Upper Limit field to 3.23.

```
myScope.WriteString ":SPRocessing:DFEQualizer:TAP:MAX 3.23"
```

Query :SPRocessing:DFEQualizer:TAP:MAX?

The :SPRocessing:DFEQualizer:TAP:MAX? query returns the Upper Limit used in the DFE tap optimization.

History Legacy command (existed before version 3.10).

:SPRocessing:DFEQualizer:TAP:MIN

Command :SPRocessing:DFEQualizer:TAP:MIN <min_tap_value>

Some standards have upper and lower limits on the tap values. The :DFEQualizer:TAP:MIN command sets the lower limit on taps determined through optimization.

<min_tap_value> A real number

Example This example sets the Lower Limit field to 3.23.

```
myScope.WriteString ":SPRocessing:DFEQualizer:TAP:MIN 3.23"
```

Query :SPRocessing:DFEQualizer:TAP:MIN?

The :SPRocessing:DFEQualizer:TAP:MIN? query returns the Lower Limit used in the DFE tap optimization.

History Legacy command (existed before version 3.10).

:SPRocessing:DFEQualizer:TAP:UTARget

Command :SPRocessing:DFEQualizer:TAP:UTARget <upper_target>

The Upper Target field dictates the logical high value used in the DFE algorithm. For example, in DFE, when a bit is determined to be a logical high, its value will be equal to Upper Target. The :DFEQualizer:TAP:UTARget command allows you to set this value.

<upper_target> A real number

Example This example sets the Upper Target to 1.0.

```
myScope.WriteString ":SPRocessing:DFEQualizer:TAP:UTARget 1.0"
```

Query :SPRocessing:DFEQualizer:TAP:UTARget?

The :SPRocessing:DFEQualizer:TAP:UTARget? query returns the current value for the Upper Target field.

History Legacy command (existed before version 3.10).

:SPROcessing:DFEQualizer:TAP:WIDTh

Command :SPROcessing:DFEQualizer:TAP:WIDTh <width>

The :DFEQualizer:TAP:WIDTh command sets the Eye Width field for the DFE tap optimization. Setting the width to 0.0 means the optimization is only performed at the location of the clock. Setting the width to 1.0 means the entire acquisition is used in the optimization. The default value for DFE is 0.0. For more information on this parameter, refer to the N5461A Infiniium Serial Data Equalization User's Guide.

<width> A real number between 0.0 and 1.0.

Example This example sets the eye width to 0.0.

```
myScope.WriteString ":SPROcessing:DFEQualizer:TAP:WIDTh 0.0"
```

Query :SPROcessing:DFEQualizer:TAP:WIDTh?

The :SPROcessing:DFEQualizer:TAP? query returns the eye width used in the DFE tap optimization.

History Legacy command (existed before version 3.10).

:SPROcessing:FFEQualizer:BANDwidth

Command :SPROcessing:FFEQualizer:BANDwidth <bandwidth>

The :FFEQualizer:BANDwidth command is only needed if the FFEQualizer:BWMode command is set to CUSTom and in this case it sets the bandwidth at which the response generated by equalization rolls off. To understand more about this parameter, consult the N5461A Infiniium Serial Data Equalization User's Guide.

<bandwidth> The bandwidth at which the response generated by equalization rolls off.

Query :SPROcessing:FFEQualizer:BANDwidth?

The :SPROcessing:FFEQualizer:BANDwidth? query returns the current value for the BANDwidth parameter.

History Legacy command (existed before version 3.10).

:SPRocessing:FFEQualizer:BWMode

Command :SPRocessing:FFEQualizer:BWMode {TSBandwidth | TTDelay | CUSTom}

The :FFEQualizer:BWMode command sets the bandwidth at which the response generated by equalization is rolled off. To understand more about this parameter, consult the N5461A Infiniium Serial Data Equalization User's Guide.

Example This example sets the FFE Bandwidth Mode to TTDElay.

```
myScope.WriteString ":SPRocessing:FFEQualizer:BWMode TTDElay"
```

Query :SPRocessing:FFEQualizer:BWMode?

The :SPRocessing:FFEQualizer:BWMode? query returns the FFE Bandwidth Mode.

History Legacy command (existed before version 3.10).

:SPROcessing:FFEQualizer:DISPlay

Command :SPROcessing:FFEQualizer:DISPlay {(OFF | 0) | (ON | 1)}

The :FFEQualizer:DISPlay command turns the display of a Feed-Forward Equalized (FFE) waveform on or off.

Example This example turns on the display of a FFE waveform.

```
myScope.WriteString ":SPROcessing:FFEQualizer:DISPlay ON"
```

Query :SPROcessing:FFEQualizer:DISPlay?

The :SPROcessing:FFEQualizer:DISPlay? query returns whether or not the FFE waveform is displayed.

History Legacy command (existed before version 3.10).

:SPRocessing:FFEQualizer:NPreursor

Command :SPRocessing:FFEQualizer:NPreursor <number>

The :FFEQualizer:NPreursor command sets the number of precursor taps to be used in the FFE algorithm.

<number> An integer between 1 and (NTAPs - 1)

Example This example sets the number of FFE precursor taps to 3.

```
myScope.WriteString ":SPRocessing:FFEQualizer:NPreursor 3"
```

Query :SPRocessing:FFEQualizer:NPreursor?

The :SPRocessing:FFEQualizer:NPreursor? query returns the number of FFE precursor taps.

History Legacy command (existed before version 3.10).

:SPRocessing:FFEQualizer:NTAPs

Command :SPRocessing:FFEQualizer:NTAPs <number>

The :FFEQualizer:NTAPs command sets the number of taps to be used in the FFE algorithm.

The indices of your FFE taps depend on the number of precursor taps being used. For example, if you are using zero precursor taps then your FFE tap indices would range from 0 to (NTAPs - 1). If you are using two precursor taps then your FFE tap indices would range from -2 to (NTAPs - 1 - 2).

<number> an integer between 2 and 40

Example This example sets the number of FFE taps to 3.

```
myScope.WriteString ":SPRocessing:FFEQualizer:NTAPs 3"
```

Query :SPRocessing:FFEQualizer:NTAPs?

The :SPRocessing:FFEQualizer:NTAPs? query returns the number of FFE taps.

History Legacy command (existed before version 3.10).

:SPROcessing:FFEQualizer:RATE

Command :SPROcessing:FFEQualizer:RATE <data_rate>

The :FFEQualizer:RATE command sets the data rate for the FFE equalizer.

<data_rate> A real number.

When the signal type is PAM-4 (see :ANALyze:SIGNal:TYPE), a symbol rate (baud) is specified instead of a data rate (b/s).

Example This example sets the FFE data rate to 3e9.

```
myScope.WriteString ":SPROcessing:FFEQualizer:RATE 3e9"
```

Query :SPROcessing:FFEQualizer:RATE?

The :SPROcessing:FFEQualizer:Rate? query returns the FFE's data rate.

See Also • [":ANALyze:SIGNal:TYPE"](#) on page 271

History Legacy command (existed before version 3.10).

Version 5.50: When the signal type is PAM-4, a symbol rate (baud) is specified instead of a data rate (b/s).

:SPROcessing:FFEQualizer:SOURce

Command :SPROcessing:FFEQualizer:SOURce {CHANnel<N> | DIFF<D> | COMMONmode<C>
| FUNction<F> | WMEMory<R>}

The :FFEQualizer:SOURce command sets the source for the Feed-Forward Equalization.

<N> An integer, 1-4 in a single oscilloscope, 1-40 in a MultiScope system.

<D>, <C> <D> is an integer, 1-2. <C> is an integer, 3-4.

The DIFF and COMMONmode sources are just aliases that can be used in place of the channel names to apply to differential or common mode signals. These are just aliases - no state change occurs if you refer to a differential channel and you are not in differential mode. DIFF1 refers to the differential signal between channels 1 and 3 (and COMMONmode3 refers to the common mode channel between these same channels). DIFF2 refers to the differential signal between channels 2 and 4 (and COMMONmode4 refers to the common mode channel between these same channels).

<F> An integer, 1-16.

<R> An integer, 1-4.

Example This example sets the FFE source to Channel 1.

```
myScope.WriteString ":SPROcessing:FFEQualizer:SOURce CHANnel1"
```

Query :SPROcessing:FFEQualizer:SOURce?

The :SPROcessing:FFEQualizer:SOURce? query returns the FFE source.

History Legacy command (existed before version 3.10).

:SPRocessing:FFEQualizer:TAP

Command :SPRocessing:FFEQualizer:TAP <tap>, <value>

The :FFEQualizer:TAP command sets the tap value for each FFE tap. For example, when <tap> is equal to 0 then the 0th tap is set to <value>.

The indices of your FFE taps depend on the number of precursor taps being used. For example, if you are using zero precursor taps then your FFE tap indices would range from 0 to (NTAPs - 1). If you are using two precursor taps then your FFE tap indices would range from -2 to (NTAPs - 1 - 2).

<tap> The tap number; when <tap> == 0, Tap 0 is set

<value> The tap value

Example This example sets the second FFE tap to -1.432.

```
myScope.WriteString ":SPRocessing:FFEQualizer:TAP 2,-1.432"
```

Query :SPRocessing:FFEQualizer:TAP? <tap>

The :SPRocessing:FFEQualizer:TAP? query returns the FFE tap values.

See Also • [":SPRocessing:FFEQualizer:NTAPs"](#) on page 1133

History Legacy command (existed before version 3.10).

:SPRocessing:FFEQualizer:TAP:AUTomatic

Command :SPRocessing:FFEQualizer:TAP:AUTomatic

The :FFEQualizer:TAP:AUTomatic command starts the FFE tap optimization. Be sure to first specify the number of taps and specify the Pattern and Eye Width parameters.

Example This example starts the FFE tap optimization.

```
myScope.WriteString ":SPRocessing:FFEQualizer:TAP:AUTomatic"
```

History Legacy command (existed before version 3.10).

:SPRocessing:FFEQualizer:TAP:DELay

Command :SPRocessing:FFEQualizer:TAP:DELay <delay>

The :FFEQualizer:TAP:DELay command specifies the amount of drift the equalized eye diagram has relative to the unequalized one. This drift is then accounted for so the two eyes overlap. For more information on this parameter, refer to the N5461A Infiniium Serial Data Equalization User's Guide.

<delay> A real number

Query :SPRocessing:FFEQualizer:TAP:DELay?

The :SPRocessing:FFEQualizer:TAP:DELay? query returns the value for the FFE Delay field.

History Legacy command (existed before version 3.10).

:SPROcessing:FFEQualizer:TAP:PLENgtH

Command :SPROcessing:FFEQualizer:TAP:PLENgtH {CUSTom | PRBS51 | PRBS61 | PRBS71
| PRBS81 | PRBS91 | PRBS101}, <file>

In order for the tap optimization to work, the algorithm must know the input pattern. You can train the oscilloscope to a known pattern and then use the optimized taps on your live traffic. The :FFEQualizer:TAP:PLENgtH command sets the pattern for the FFE tap optimization algorithm.

The file parameter is only used in CUSTom mode.

For more information on this parameter, refer to the *N5461A Infiniium Seriald Data Equalization User's Guide*.

<CUSTom> Allows you to import a known pattern via a .prtn file (save at location <file>)

<PRBSX1> Pseudo-random Binary Sequence of length $2^X - 1$.

Example This example sets the pattern to PRBS $2^8 - 1$.

```
myScope.WriteString ":SPROcessing:FFEQualizer:TAP:PLENgtH PRBS81"
```

Query :SPROcessing:FFEQualizer:TAP:PLENgtH?

The :SPROcessing:FFEQualizer:TAP:PLENgtH? query returns the pattern used in optimizing the FFE tap values.

History Legacy command (existed before version 3.10).

:SPRocessing:FFEQualizer:TAP:WIDTh

Command :SPRocessing:FFEQualizer:TAP:WIDTh <width>

The :FFEQualizer:TAP:WIDTh command sets the Eye Width field for the FFE tap optimization. Setting the width to 0.0 means the optimization is only performed at the location of the clock. Setting the width to 1.0 means the entire acquisition is used in the optimization. The default value for FFE is 0.33. For more information on this parameter, refer to the N5461A Infiniium Serial Data Equalization User's Guide.

<width> A real number between 0.0 and 1.0.

Example This example sets the eye width to 0.0.

```
myScope.WriteString ":SPRocessing:FFEQualizer:TAP:WIDTh 0.0"
```

Query :SPRocessing:FFEQualizer:TAP:WIDTh?

The :SPRocessing:FFEQualizer:TAP:WIDTh? query returns the eye width used in the FFE tap optimization.

History Legacy command (existed before version 3.10).

:SPRocessing:FFEQualizer:TDElay

Command :SPRocessing:FFEQualizer:TDElay <delay_value>

The :FFEQualizer:TDElay command is only needed if the FFEQualizer:TDMODE is set to CUSTOM. To determine what this value should be, use the equation: tap delay = 1/[(data rate)x(# of taps per bit)]. To understand more about this parameter, consult the N5461A Infiniium Serial Data Equalization User's Guide.

<delay_value> A real number

Query :SPRocessing:FFEQualizer:TDElay?

The :SPRocessing:FFEQualizer:TDElay? query returns the current value for the tap delay.

History Legacy command (existed before version 3.10).

:SPRocessing:FFEQualizer:TDMode

Command :SPRocessing:FFEQualizer:TDMode {TBITrate | CUSTom}

The :FFEQualizer:TDMode command sets Tap Delay field to either Track Data Rate or Custom. If you are using one tap per bit, use the TBITrate selection. If you are using multiple taps per bit, use CUSTom and then use the FFEQualizer:TDElay command to set the value. To understand more about this parameter, consult the N5461A Infiniium Serial Data Equalization User's Guide.

Example This example sets the FFE Tap Delay mode to TBITrate.

```
myScope.WriteString ":SPRocessing:FFEQualizer:TDMode TBITrate"
```

Query :SPRocessing:FFEQualizer:TDMode?

The :SPRocessing:FFEQualizer:TDMode? query returns the current Tap Delay mode.

History Legacy command (existed before version 3.10).

:SPROcessing:FFEQualizer:VERTical

Command :SPROcessing:FFEQualizer:VERTical {AUTO | MANual}

The :SPROcessing:FFEQualizer:VERTical command sets the FFE signal's vertical scale mode to automatic or manual. In automatic mode, the oscilloscope automatically selects the vertical scaling and offset. In manual mode, you can set your own scaling and offset values.

Example This example sets the FFE signal's vertical scale mode to automatic.

```
myScope.WriteString ":SPROcessing:FFEQualizer:VERTical AUTO"
```

Query :SPROcessing:FFEQualizer:VERTical?

The :SPROcessing:FFEQualizer:VERTical? query returns the current FFE signal's vertical scale mode setting.

Returned Format [:SPROcessing:FFEQualizer:VERTical] {AUTO | MANual}

Example This example places the current setting of the FFE signal's vertical scale mode in the string variable strSetting, then prints the contents of the variable to the computer's screen.

```
myScope.WriteString ":SYSTem:HEADer OFF"
myScope.WriteString ":SPROcessing:FFEQualizer:VERTical?"
strSetting = myScope.ReadString
Debug.Print strSetting
```

History Legacy command (existed before version 3.10).

:SPRoceSSing:FFEQualizer:VERTical:OFFSet

Command :SPRoceSSing:FFEQualizer:VERTical:OFFSet <offset>

The :SPRoceSSing:FFEQualizer:VERTical:OFFSet command sets the FFE signal's vertical offset.

<offset> A real number for the FFE signal's vertical offset.

Example This example sets the FFE signal's vertical offset to 1 volt.

```
myScope.WriteString ":SPRoceSSing:FFEQualizer:VERTical:OFFSet 1"
```

Query :SPRoceSSing:FFEQualizer:VERTical:OFFSet?

The:SPRoceSSing:FFEQualizer:VERTical:OFFSet? query returns the FFE signal's vertical offset setting.

Returned Format [:SPRoceSSing:FFEQualizer:VERTical:OFFSet] <value><NL>

<value> The FFE signal's vertical offset setting.

Example This example places the current value of the FFE signal's vertical offset in the numeric variable, varValue, then prints the contents of the variable to the computer's screen.

```
myScope.WriteString ":SYSTem:HEADer OFF" ' Response headers off.
myScope.WriteString ":SPRoceSSing:FFEQualizer:VERTical:OFFSet?"
varValue = myScope.ReadNumber
Debug.Print FormatNumber(varValue, 0)
```

History Legacy command (existed before version 3.10).

:SPROcessing:FFEQualizer:VERTical:RANGe

Command :SPROcessing:FFEQualizer:VERTical:RANGe <range>

The :SPROcessing:FFEQualizer:VERTical:RANGe command sets the FFE signal's vertical range.

<range> A real number for the full-scale FFE signal's vertical range.

Example This example sets the FFE signal's vertical range to 16 volts (2 volts times 8 divisions.)

```
myScope.WriteString ":SPROcessing:FFEQualizer:VERTical:RANGe 16"
```

Query :SPROcessing:FFEQualizer:VERTical:RANGe?

The :SPROcessing:FFEQualizer:VERTical:RANGe? query returns the FFE signal's vertical range setting.

Returned Format [:SPROcessing:FFEQualizer:VERTical:RANGe] <value><NL>

<value> The FFE signal's vertical range setting.

Example This example places the current value of the FFE signal's vertical range in the numeric variable, varValue, then prints the contents of the variable to the computer's screen.

```
myScope.WriteString ":SYSTem:HEADer OFF" ' Response headers off.
myScope.WriteString ":SPROcessing:FFEQualizer:VERTical:RANGe?"
varValue = myScope.ReadNumber
Debug.Print FormatNumber(varValue, 0)
```

History Legacy command (existed before version 3.10).

34 System Commands

:SYSTem:DATE / 1148
:SYSTem:DEBUg / 1149
:SYSTem:DONTtabmeas / 1151
:SYSTem:DSP / 1152
:SYSTem:ERRor? / 1153
:SYSTem:GUI / 1154
:SYSTem:HEADer / 1155
:SYSTem:HLED (90000 Q-Series, S-Series, V-Series, Z-Series) / 1156
:SYSTem:LOCK / 1157
:SYSTem:LONGform / 1158
:SYSTem:MENU? / 1159
:SYSTem:PERSONa / 1160
:SYSTem:PRESet / 1161
:SYSTem:SETup / 1163
:SYSTem:TIME / 1165

SYSTem subsystem commands control the way query responses are formatted, send and receive setup strings, and enable reading and writing to the advisory line of the oscilloscope. You can also set and read the date and time in the oscilloscope using the SYSTem subsystem commands.

:SYSTem:DATE

Command `:SYSTem:DATE <day>, <month>, <year>`

The `:SYSTem:DATE` command sets the date in the oscilloscope, and is not affected by the `*RST` common command.

<year> Specifies the year in the format `<yyyy> | <yy>`. The values range from 1992 to 2035.

<month> Specifies the month in the format `<1, 2, . . . 12> | <JAN, FEB, MAR . . .>`.

<day> Specifies the day in the format `<1 . . . 31>`.

Example This example sets the date to December 1, 2002.

```
myScope.WriteString ":SYSTem:DATE 1,12,02"
```

Query `:SYSTem:DATE?`

The `:SYSTem:DATE?` query returns the current date in the oscilloscope.

Returned Format `[:SYSTem:DATE] <day> <month> <year><NL>`

Example This example queries the date.

```
Dim strDate As String
myScope.WriteString ":SYSTem:DATE?"
strDate = myScope.ReadString
Debug.Print strDate
```

History Legacy command (existed before version 3.10).

:SYSTem:DEBUg

Command :SYSTem:DEBUg {{ON|1} [, <output_mode> [, "<file_name>" [, <create_mode>]]] | {OFF|0}}

The :SYSTem:DEBUg command turns the debug mode on and off. This mode enables the tracing of incoming remote commands. If you select CREate mode, a new file is created, and/or an existing file is overwritten. If you select APPend mode, the information is appended to an existing file. The :SYSTem:DEBUg command shows any header and/or parameter errors.

The default create mode is CREate, the default output mode is FileSCReen, and the default file name is "C:\Users\Public\Documents\Infiniium\debug.txt". In debug mode, the File View button lets you view the current debug file, or any other debug file. This is a read-only mode.

<output_mode> {FILE | SCReen | FileSCReen}

<file_name> An MS-DOS compatible name of the file, a maximum of 254 characters long (including the path name, if used). The file name assumes the present working directory if a path does not precede the file name.

<create_mode> {CREate | APPend}

Examples This example turns on the debug/trace mode and creates a debug file.

```
myScope.WriteString ":SYSTem:DEBUG ON,FILE,
"C:\Users\Public\Documents\Infiniium\pacq8xx.txt",CREate"
```

The created file resembles:

```
Debug information file C:\Users\Public\Documents\Infiniium\pacq8xx.txt
Date:  1 DEC 2002
Time:  09:59:35
Model: DSO90804A
Serial#: sn ?
>:syst:err? string$<NL>
<:SYSTem:ERROR 0,"No error"$
>:ACQuire:BEST FLATness$<NL>

?      ^
?-113, Undefined header
>:syst:err? string$<NL>
<:SYSTem:ERROR -113,"Undefined header"$
>:syst:err? string$<NL>
<:SYSTem:ERROR 0,"No error"$
```

This example appends information to the debug file.

```
myScope.WriteString ":SYSTem:DEBUG ON,FILE,
"C:\Users\Public\Documents\Infiniium\pacq8xx.txt",APPend"
```

After appending information, the file resembles:

```
Debug information file C:\Users\Public\Documents\Infiniium\pacq8xx.txt
Date:  1 DEC 2002
Time:  09:59:35
```

```

Model: DSO90804A
Serial#:  sn ?
>:syst:err? string$<NL>
<:SYSTem:ERROR 0,"No error"$
>:ACQuire:BESt FLATness$<NL>

?      ^
?-113, Undefined header
>:syst:err? string$<NL>
<:SYSTem:ERROR -113,"Undefined header"$
>:syst:err? string$<NL>
<:SYSTem:ERROR 0,"No error"$

Debug information file C:\Users\Public\Documents\Infinium\
pacq8xx.txt appended
Date:  1 DEC 2002
Time:  10:10:35
Model: DSO90804A
Serial#:  sn ?
>:syst:err? string$<NL>
<:SYSTem:ERROR 0,"No error"$
>:ACQuire:BESt FLATness$<NL>

?      ^
?-113, Undefined header
>:syst:err? string$<NL>
<:SYSTem:ERROR -113,"Undefined header"$

```

Query :SYSTem:DEBug?

The :SYSTem:DEBug? query returns the current debug mode settings.

Returned Format [:SYSTem:DEBug] {{1,<output_mode>,"<file_name>","<create_mode>} | 0} <NL>

History Legacy command (existed before version 3.10).

:SYSTem:DONTtabmeas

Command :SYSTem:DONTtabmeas {{0 | OFF} | {1 | ON}}

The :SYSTem:DONTtabmeas command enables or disables the **Never tab Measurement Results** user preference.

When this user preference is enabled, and you choose **Display > Windows > Tabbed/Custom Window Layout** in the graphical user interface, the sub panes within the Results pane remain stacked—they are not tabbed as they would have been had this user preference been disabled.

Query :SYSTem:DONTtabmeas?

The :SYSTem:DONTtabmeas? query returns the **Never tab Measurement Results** user preference setting.

Returned Format <setting><NL>

<setting> ::= {0 | 1}

History New in version 5.60.

:SYSTem:DSP

Command :SYSTem:DSP "<string>"

The :SYSTem:DSP command writes a quoted string, excluding quotation marks, to the advisory line of the instrument display. If you want to clear a message on the advisory line, send a null (empty) string.

<string> An alphanumeric character array up to 86 bytes long.

Example This example writes the message, "Test 1" to the advisory line of the oscilloscope.

```
myScope.WriteString ":SYSTem:DSP ""Test 1"""
```

Query :SYSTem:DSP?

The :SYSTem:DSP? query returns the last string written to the advisory line. This may be a string written with a :SYSTem:DSP command, or an internally generated advisory.

The string is actually read from the message queue. The message queue is cleared when it is read. Therefore, the displayed message can only be read once over the bus.

Returned Format [:SYSTem:DSP] <string><NL>

Example This example places the last string written to the advisory line of the oscilloscope in the string variable, strAdvisory. Then, it prints the contents of the variable to the computer's screen.

```
Dim strAdvisory As String ' Dimension variable.
myScope.WriteString ":SYSTem:DSP?"
strAdvisory = myScope.ReadString
Debug.Print strAdvisory
```

History Legacy command (existed before version 3.10).

:SYSTem:ERRor?

Query :SYSTem:ERRor? [{NUMBER | STRing}]

The :SYSTem:ERRor? query outputs the next error number in the error queue over the remote interface. When either NUMBER or no parameter is specified in the query, only the numeric error code is output. When STRing is specified, the error number is output followed by a comma and a quoted string describing the error. **Table 21** lists the error numbers and their corresponding error messages.

Returned Format [:SYSTem:ERRor] <error_number> [, <quoted_string>] <NL>

<error_number> A numeric error code.

<quoted_string> A quoted string describing the error.

Example This example reads the oldest error number and message in the error queue into the string variable, strCondition, then prints the contents of the variable to the computer's screen.

```
Dim strCondition As String    ' Dimension variable.
myScope.WriteString ":SYSTem:ERRor? STRing"
strCondition = myScope.ReadString
Debug.Print strCondition
```

Infiniium Oscilloscopes have an error queue that is 30 errors deep and operates on a first-in, first-out (FIFO) basis. Successively sending the :SYSTem:ERRor? query returns the error numbers in the order that they occurred until the queue is empty. When the queue is empty, this query returns headers of 0, "No error." Any further queries return zeros until another error occurs. Note that front-panel generated errors are also inserted in the error queue and the Event Status Register.

NOTE**Send *CLS Before Other Commands or Queries**

Send the *CLS common command to clear the error queue and Event Status Register before you send any other commands or queries.

See Also The "Error Messages" chapter for more information on error messages and their possible causes.

History Legacy command (existed before version 3.10).

:SYSTem:GUI

Command :SYSTem:GUI {{ON | 1} | {OFF | 0}}

The :SYSTem:GUI OFF command disables the front panel user interface and places a Remote Operations In Progress dialog box on the oscilloscope's screen. The front panel knobs, keys, and graphical user interface are disabled. Graphical user interface updates are also disabled.

NOTE

The :SYSTem:GUI OFF command lets Infiniium oscilloscopes behave like other Keysight instruments by locking out the GUI (graphical user interface) and the front panel while remote scripts are running. On Infiniium oscilloscopes, the GUI and front panel do not lock automatically during remote operation (as most other instruments do) to preserve the integrity and timing of legacy customer scripts. The recommendation is, however, that all scripts begin with :SYSTem:GUI OFF when convenient and possible to run more like other Keysight instruments and likely improve performance.

The :SYSTem:GUI OFF command is similar to the :SYSTem:LOCK ON command, except the :SYSTem:LOCK ON command does not disable the graphical user interface (just the knobs and keys).

The front panel user interface can be re-enabled by:

- Sending the :SYSTem:GUI ON command.
- Clicking **Enable** in the Remote Operations In Progress dialog box.

Example This example disables the oscilloscope's front panel user interface.

```
myScope.WriteString ":SYSTem:GUI OFF"
```

Query :SYSTem:GUI?

The :SYSTem:GUI? query returns the state of the :SYSTem:GUI command.

Returned Format [:SYSTem:GUI] {1 | 0}<NL>

See Also • **":SYSTem:LOCK"** on page 1157

History New in version 5.50.

:SYSTem:HEADer

Command :SYSTem:HEADer {{ON|1} | {OFF|0}}

The :SYSTem:HEADer command specifies whether the instrument will output a header for query responses. When :SYSTem:HEADer is set to ON, the query responses include the command header.

Example This example sets up the oscilloscope to output command headers with query responses.

```
myScope.WriteString ":SYSTem:HEADer ON"
```

Query :SYSTem:HEADer?

The :SYSTem:HEADer? query returns the state of the :SYSTem:HEADer command.

Returned Format [:SYSTem:HEADer] {1|0}<NL>

Example This example prints the system header setting.

```
Dim strSetting As String
myScope.WriteString ":SYSTem:HEADer?"
strSetting = myScope.ReadString
Debug.Print strSetting
```

NOTE**Turn Headers Off when Returning Values to Numeric Variables**

Turn headers off when returning values to numeric variables. Headers are always off for all common command queries because headers are not defined in the IEEE 488.2 standard.

History Legacy command (existed before version 3.10).

:SYSTem:HLED (90000 Q-Series, S-Series, V-Series, Z-Series)**Command** :SYSTem:HLED {{0 | OFF} | {1 | ON}}

The :SYSTem:HLED command turns the "hide front panel LEDs" setting ON or OFF. When ON, all LEDs on the front panel (except the power button LED) will turn off.

You may want to hide front panel LEDs when making measurements in a light-sensitive environment.

Query :SYSTem:HLED?

The :SYSTem:HLED? query returns the hide LEDs setting.

Returned Format <setting><NL>

<setting> ::= {0 | 1}

History New in version 6.00.

:SYSTem:LOCK

Command :SYSTem:LOCK {{ON | 1} | {OFF | 0}}

The :SYSTem:LOCK ON command disables the front panel knobs and keys.

The front panel knobs and keys can be re-enabled by sending the :SYSTem:LOCK OFF command.

This :SYSTem:LOCK ON command is similar to the :SYSTem:GUI OFF command, except the :SYSTem:GUI OFF command also disables the graphical user interface and GUI updates.

Example This example disables the oscilloscope's front panel.

```
myScope.WriteString ":SYSTem:LOCK ON"
```

Query :SYSTem:LOCK?

The :SYSTem:LOCK? query returns the state of the :SYSTem:LOCK command.

Returned Format [:SYSTem:LOCK] {1 | 0}<NL>

See Also • [":SYSTem:GUI"](#) on page 1154

History Legacy command (existed before version 3.10).

:SYSTem:LONGform

Command `:SYSTem:LONGform {{ON | 1} | {OFF | 0}}`

The `:SYSTem:LONGform` command specifies the format for query responses. If the `LONGform` is set to `OFF`, command headers and alpha arguments are sent from the oscilloscope in the short form (abbreviated spelling). If `LONGform` is set to `ON`, the whole word is output.

Example This example sets the format for query responses from the oscilloscope to the short form (abbreviated spelling).

```
myScope.WriteString ":SYSTem:LONGform OFF"
```

Query `:SYSTem:LONGform?`

The `:SYSTem:LONGform?` query returns the current state of the `:SYSTem:LONGform` command.

Returned Format `[:SYSTem:LONGform] {1 | 0}<NL>`

Example This example checks the current format for query responses from the oscilloscope, and places the result in the string variable, `strResult`. Then, it prints the contents of the variable to the computer's screen.

```
Dim strResult As String ' Dimension variable.
myScope.WriteString ":SYSTem:LONGform?"
strResult = myScope.ReadString
Debug.Print strResult
```

NOTE**LONGform Does Not Affect Input Headers and Arguments**

`LONGform` has no effect on input headers and arguments sent to the instrument. You may send headers and arguments to the oscilloscope in either the long form or short form, regardless of the current state of the `:SYSTem:LONGform` command.

History Legacy command (existed before version 3.10).

:SYSTem:MENU?

Query :SYSTem:MENU? <menu_string>
 <menu_string> ::= quoted string

The :SYSTem:MENU? query returns front panel graphical user interface (GUI) menu strings.

NOTE

This query is intended to list GUI menu strings that launch other executable programs. Currently, these appear in the "Analyze" menu only. For other menus, this query may return strings that do not actually appear in the GUI.

Returned Format <items_in_menu><NL>

<items_in_menu> ::= comma-separated list of items in the menu

Example This example shows queries and responses from the Keysight Interactive IO's Instrument Session History:

```
-> :SYSTem:MENU? "Analyze"
<- Histogram..., Mask Test..., Automated Test Apps,
Measurement Analysis (EZJIT)..., Jitter/Noise (EZJIT Complete)...,
RTEye/Clock Recovery (SDA)..., Equalization...
-> :SYSTem:MENU? "Analyze\Automated Test Apps"
<- N8829A 100GBASE-KR4 Test App, N8830A 100GBASE-CR4 Test App
```

History New in version 5.50.0033.

:SYSTem:PERSONa

Command :SYSTem:PERSONa {<manufacturer_string>, <model_string> | <manufacturer_string> | DEFault}

<manufacturer_string> ::= quoted string, 1-31 characters

<model_string> ::= quoted string, 1-10 characters

The :SYSTem:PERSONa command sets the manufacturer string and the model number string returned by the *IDN? query.

Query :SYSTem:PERSONa?

The :SYSTem:PERSONa? query returns the manufacturer string and the model number string.

Returned Format [:SYSTem:PERSONa] <manufacturer_string>, <model_string><NL>

<manufacturer_string> ::= quoted string, 1-31 characters

<model_string> ::= quoted string, 1-10 characters

See Also • ["*IDN? – Identification Number"](#) on page 407

History New in version 5.20.

:SYSTem:PRESet

Command :SYSTem:PRESet [{DEFault | FACTory}]

The :SYSTem:PRESet command initializes the oscilloscope to a known state. You can use these parameters:

- DEFault (or no parameter) – performs a Default Setup just like the oscilloscope's front panel **[Default Setup]** key.

NOTE

On Infiniium Z-Series and 90000 Q-Series oscilloscopes, if Real-Edge channels are turned on when the front panel **[Default Setup]** key is pressed, Real-Edge channels remain on after the default setup. However, with the remote ":SYSTem:PRESet DEFault" command, Real-Edge channels are turned off before the default setup and remain off after.

- FACTory – performs a Factory Default.

Default Setup Default Setup returns Infiniium oscilloscope settings, except user preferences and a few other settings, to their defaults.

- Markers, functions, waveforms, bookmarks, and measurements are all turned off in a default setup.
- Multiple waveform windows are closed, leaving only one waveform window in a default setup.
- These are the default settings for the controls that change:

| Control | Default Setting |
|---------------------|-----------------------|
| Run/Stop | Run |
| Channel 1 | On, 1 V/div, 0 offset |
| Horizontal Scale | 100 ns/ |
| Horizontal Position | 0 s |
| Reference | Center |
| Zoom | Disabled |
| Trigger Mode | Edge |
| Trigger Level | 0 V |
| Trigger Sweep | Auto |
| Edge Trigger Source | Channel 1 |
| Edge Trigger Slope | Rising |

- Default Setup does not change any of the control settings found in the User Preferences dialog box, display color settings, screen options, probe skew, probe external adapter settings for differential probes, or probe internal attenuation and gain settings for differential probes.

Factory Default The Factory Default selection returns the oscilloscope to the settings it had when it left the factory. This places the oscilloscope in a known operating condition. You can use Factory Default when you want to set all values (even the ones not defaulted by Default Setup) back to their default values.

These controls are reset during a factory default (but are not reset during a Default Setup):

- User Preferences dialog box settings
- Customize Multipurpose settings
- Tabbed window layout
- Digital memory size
- Waveform memories
- Channel skew
- Display colors
- Waveform intensity and grid line intensity settings
- Probe skew
- Probe external adapter settings for differential probes
- Probe internal attenuation and gain setting for differential probes
- Lock Display Results (not selected)

Example This example performs an oscilloscope default setup.

```
myScope.WriteString ":SYSTem:PRESet"
```

See Also • **"*RST – Reset"** on page 416

History Legacy command (existed before version 3.10).

:SYSTEM:SETup

Command :SYSTEM:SETup <binary_block_data>

The :SYSTEM:SETup command sets up the oscilloscope as defined by the data in the binary block of data from the computer.

CAUTION

Setups saved from Infiniium software versions prior to 2.00 may not load correctly in software versions 4.30 and greater.

You can remedy this by re-saving any pre-2.00 setups using any version of software from version 2.00 to version 4.20.

Setups saved from software versions between 2.00 and 4.20 should load correctly into version 4.30 and greater.

<binary_block_data> A binary block of data, consisting of bytes of setup information. The number of bytes is a dynamic number that is read and allocated by oscilloscope's software.

Example This example reads setup information from a file and restores it to the oscilloscope.

```
' Read setup from a file:
Dim strPath As String
strPath = "c:\scope\config\setup.dat"
Dim hFile As Long
hFile = FreeFile
Dim varSetup As Variant
Open strPath For Binary Access Read As hFile ' Open file for input.
Get hFile, , varSetup ' Read data.
Close hFile ' Close file.

' Write setup to oscilloscope.
myScope.WriteIEEEBlock ":SYSTEM:SETup", varSetup
Debug.Print "Setup bytes restored: " + CStr(LenB(varSetup))
```

Query :SYSTEM:SETup?

The :SYSTEM:SETup? query outputs the oscilloscope's current setup to the computer in binary block data format as defined in the IEEE 488.2 standard.

Returned Format [:SYSTEM:SETup] #NX...X<setup_data_string><NL>

The first character in the setup data block is a number added for disk operations.

Example This example stores the current oscilloscope setup to the variable, varSetup, and then saves it to a file.

```
' Get setup from the oscilloscope.
Dim varSeup As Variant
myScope.WriteString ":SYSTEM:HEADer OFF" ' Response headers off.
myScope.WriteString ":SYSTEM:SETup?"
varSetup = myScope.ReadIEEEBlock(BinaryType_UI1)

' Output setup string to a file:
```

```
Dim strPath As String
strPath = "c:\scope\config\setup.dat"
Dim hFile As Long
hFile = FreeFile
Open strPath For Binary Access Write Lock Write As hFile
Put hFile, , varSetup ' Write data.
Close hFile ' Close file.
Debug.Print "Setup bytes saved: " + CStr(LenB(varSetup))
```

NOTE**:SYSTem:SETup Can Operate Just Like *LRN?**

When headers and LONGform are on, the :SYSTem:SETup? query operates the same as the *LRN? query in the common commands. Otherwise, *LRN? and :SYSTem:SETup are not interchangeable.

History Legacy command (existed before version 3.10).

:SYSTem:TIME

Command :SYSTem:TIME <hour>,<minute>,<second>

The :SYSTem:TIME command sets the time in the oscilloscope and is not affected by the *RST common command.

<hour> 0...23

<minute> 0...59

<second> 0...59

Example This example sets the oscilloscope time to 10:30:45 a.m.

```
myScope.WriteString ":SYSTem:TIME 10,30,45"
```

Query :SYSTem:TIME?

The :SYSTem:TIME? query returns the current time in the oscilloscope.

Returned Format [:SYSTem:TIME] <hour>,<minute>,<second>

History Legacy command (existed before version 3.10).

35 Time Base Commands

:TIMebase:POSition / 1168
:TIMebase:RANGe / 1169
:TIMebase:REFClock / 1170
:TIMebase:REFerence / 1171
:TIMebase:REFerence:PERCent / 1172
:TIMebase:ROLL:ENABLE / 1173
:TIMebase:SCALe / 1174
:TIMebase:VIEW / 1175
:TIMebase:WINDow:DELay / 1176
:TIMebase:WINDow:POSition / 1177
:TIMebase:WINDow:RANGe / 1178
:TIMebase:WINDow:SCALe / 1179

The TIMebase subsystem commands control the horizontal (X axis) oscilloscope functions.

:TIMebase:POSition

Command :TIMebase:POSition <position_value>

The :TIMebase:POSition command sets the time interval between the trigger event and the delay reference point. The delay reference point is set with the :TIMebase:REFerence command.

<position_value> A real number for the time in seconds from trigger to the delay reference point.

Example This example sets the delay position to 2 ms.

```
myScope.WriteString ":TIMebase:POSition 2E-3"
```

Query :TIMebase:POSition?

The :TIMebase:POSition? query returns the current delay value in seconds.

Returned Format [:TIMebase:POSition] <position_value><NL>

Example This example places the current delay value in the numeric variable, varValue, then prints the contents of the variable to the computer's screen.

```
myScope.WriteString ":SYSTem:HEADer OFF" ' Response headers off.
myScope.WriteString ":TIMebase:POSition?"
varValue = myScope.ReadNumber
Debug.Print FormatNumber(varValue, 0)
```

History Legacy command (existed before version 3.10).

:TIMebase:RANGe

Command :TIMebase:RANGe <full_scale_range>

The :TIMebase:RANGe command sets the full-scale horizontal time in seconds. The range value is ten times the time-per-division value.

<full_scale_range> A real number for the horizontal time, in seconds. The timebase range is 50 ps (5 ps/div) to 200 s (20 s/div).

Example This example sets the full-scale horizontal range to 10 ms.

```
myScope.WriteString ":TIMebase:RANGe 10E-3"
```

Query :TIMebase:RANGe?

The :TIMebase:RANGe? query returns the current full-scale horizontal time.

Returned Format [:TIMebase:RANGe] <full_scale_range><NL>

Example This example places the current full-scale horizontal range value in the numeric variable, varSetting, then prints the contents of the variable to the computer's screen.

```
myScope.WriteString ":SYSTem:HEADer OFF" ' Response headers off.
myScope.WriteString ":TIMebase:RANGe?"
varSetting = myScope.ReadNumber
Debug.Print FormatNumber(varSetting, 0)
```

History Legacy command (existed before version 3.10).

:TIMebase:REFClock

Command :TIMebase:REFClock {{ON | 1} | {OFF | 0} | HFRequency}

The :TIMebase:REFClock command enables or disables the 10 MHz REF IN BNC input (ON or OFF) or the 100 MHz REF IN SMA input (HFRequency or OFF) located on the rear panel of the oscilloscope. The 100 MHz REF IN SMA input is only available on 90000 Q-Series and Z-Series oscilloscopes.

When this feature is enabled, the external reference input is used as a reference clock for the oscilloscope's horizontal scale section instead of the internal reference clock.

Example This example turns on the 10 MHz reference clock mode.

```
myScope.WriteString ":TIMebase:REFClock ON"
```

Query :TIMebase:REFClock?

The :TIMebase:REFClock? query returns the current state of the reference clock mode control.

Returned Format [TIMebase:REFClock] {1 | 0 | HFR}<NL>

Example This example places the current value of the reference clock mode control in the variable, varSetting, then prints the contents of the variable to the computer's screen.

```
myScope.WriteString ":SYSTem:HEADer OFF" ' Response headers off.
myScope.WriteString ":TIMebase:REFClock?"
varSetting = myScope.ReadNumber
Debug.Print FormatNumber(varSetting, 0)
```

History Legacy command (existed before version 3.10).

:TIMebase:REFerence

Command :TIMebase:REFerence {LEFT | CENTER | RIGHT}

The :TIMebase:REFerence command sets the .horizontal reference position to the left, center, or right side of the screen.

Example This example sets the horizontal reference position to the center of the display.

```
myScope.WriteString ":TIMebase:REFerence CENTER"
```

Query :TIMebase:REFerence?

The :TIMebase:REFerence? query returns the current horizontal reference position.

Returned Format [:TIMebase:REFerence] {LEFT | CENTER | RIGHT | PERCent}<NL>

PERC is returned when the horizontal reference position is set to a percent-of-screen location (either in the user interface or with the :TIMebase:REFerence:PERCent command).

Example This example places the current horizontal reference position in the string variable, strSetting, then prints the contents of the variable to the computer's screen.

```
Dim strSetting As String ' Dimension variable.
myScope.WriteString ":TIMebase:REFerence?"
strSetting = myScope.ReadString
Debug.Print strSetting
```

See Also • [":TIMebase:REFerence:PERCent"](#) on page 1172

History Legacy command (existed before version 3.10).

Version 5.00: Query can now return PERC when a reference position percent value is being used.

:TIMebase:REFerence:PERCent

Command :TIMebase:REFerence:PERCent <percent>

The :TIMebase:REFerence:PERCent command sets the horizontal reference position to a percent-of-screen location, from left to right.

<percent> Integer from 0-100.

Example This example sets the horizontal reference position to a 25% of screen location.

```
myScope.WriteString ":TIMebase:REFerence:PERCent 25"
```

Query :TIMebase:REFerence:PERCent?

The :TIMebase:REFerence:PERCent? query returns the current horizontal reference position as a percent-of-screen value.

Returned Format [:TIMebase:REFerence:PERCent] <percent><NL>

Example This example places the current horizontal reference position in the string variable, strSetting, then prints the contents of the variable to the computer's screen.

```
Dim strSetting As String ' Dimension variable.
myScope.WriteString ":TIMebase:REFerence:PERCent?"
strSetting = myScope.ReadString
Debug.Print strSetting
```

See Also · [":TIMebase:REFerence"](#) on page 1171

History New in version 5.00.

:TIMebase:ROLL:ENABLE

Command :TIMebase:ROLL:ENABLE {{ON | 1} | {OFF | 0}}

The :TIMebase:ROLL:ENABLE command enables or disables the roll mode feature.

NOTE

Roll mode is not available when RealEdge channels are enabled in the 90000 Q-Series and Z-Series oscilloscopes.

Example This example turns on the roll mode.

```
myScope.WriteString ":TIMebase:ROLL:ENABLE ON"
```

Query :TIMebase:ROLL:ENABLE?

The :TIMebase:ROLL:ENABLE? query returns the current state of the roll mode enable control.

Returned Format [:TIMebase:ROLL:ENABLE] {1 | 0}<NL>

Example This example places the current value of the roll mode enable control in the variable, varSetting, then prints the contents of the variable to the computer's screen.

```
myScope.WriteString ":SYSTEM:HEADER OFF" ' Response headers off.
myScope.WriteString ":TIMebase:ROLL:ENABLE?"
varSetting = myScope.ReadNumber
Debug.Print FormatNumber(varSetting, 0)
```

History Legacy command (existed before version 3.10).

:TIMebase:SCALE

Command :TIMebase:SCALE <time>

The :TIMebase:SCALE command sets the time base scale. This corresponds to the horizontal scale value displayed as time/div on the oscilloscope screen.

<time> A real number for the time value, in seconds per division. The timebase scale is 5 ps/div to 20 s/div.

Example This example sets the scale to 10 ms/div.

```
myScope.WriteString ":TIMebase:SCALE 10E-3"
```

Query :TIMebase:SCALE?

The :TIMebase:SCALE? query returns the current scale time setting.

Returned Format [:TIMebase:SCALE] <time><NL>

Example This example places the current scale value in the numeric variable, varSetting, then prints the contents of the variable to the computer's screen.

```
myScope.WriteString ":SYSTem:HEADer OFF" ' Response headers off.
myScope.WriteString ":TIMebase:SCALE?"
varSetting = myScope.ReadNumber
Debug.Print FormatNumber(varSetting, 0)
```

History Legacy command (existed before version 3.10).

:TIMEbase:VIEW

Command :TIMEbase:VIEW {MAIN | WINDow}

The :TIMEbase:VIEW command turns the horizontal zoom mode on and off. This is the same as using the front panel **[Zoom]** key.

Example This example turns the horizontal zoom mode on.

```
myScope.WriteString ":TIMEbase:VIEW WINDow"
```

Query :TIMEbase:VIEW?

The :TIMEbase:VIEW? query returns the horizontal zoom mode setting.

Returned Format [:TIMEbase:VIEW] {MAIN | WINDow}<NL>

Example This example places the current view in the string variable, strState, then prints the contents of the variable to the computer's screen.

```
Dim strState As String ' Dimension variable.
myScope.WriteString ":TIMEbase:VIEW?"
strState = myScope.ReadString
Debug.Print strState
```

History Legacy command (existed before version 3.10).

:TIMebase:WINDow:DELay

Command :TIMebase:WINDow:DELay <delay_value>

The :TIMebase:WINDow:DELay sets the horizontal position in the delayed view of the main sweep. The range for this command is determined by the main sweep range and the main sweep horizontal position. The value for this command must keep the time base window within the main sweep range.

NOTE

This Command is Provided for Compatibility

This command is the same as the :TIMebase:WINDow:POSition command, and is provided for compatibility with programs written for previous oscilloscopes. The preferred command for compatibility with Infiniium oscilloscopes is :TIMebase:WINDow:POSition.

<delay_value> A real number for the time in seconds from the trigger event to the delay reference point. The maximum position depends on the main sweep range and the main sweep horizontal position.

Example This example sets the time base window delay position to 20 ns.

```
myScope.WriteString ":TIMebase:WINDow:DELay 20E-9"
```

Query :TIMebase:WINDow:DELay?

The :TIMebase:WINDow:DELay? query returns the current horizontal position in the delayed view.

Returned Format [:TIMebase:WINDow:DELay] <delay_position><NL>

Example This example places the current horizontal position in the delayed view in the numeric variable, varSetting, then prints the contents of the variable to the computer's screen.

```
myScope.WriteString ":SYSTem:HEADer OFF" ' Response headers off.
myScope.WriteString ":TIMebase:WINDow:DELay?"
varSetting = myScope.ReadNumber
Debug.Print FormatNumber(varSetting, 0)
```

See Also The :TIMebase:WINDow:POSition command performs the same function as this command and should be used in new programs.

History Legacy command (existed before version 3.10).

:TIMEbase:WINDow:POSition

Command :TIMEbase:WINDow:POSition <position_value>

The :TIMEbase:WINDow:POSition sets the horizontal position in the delayed view of the main sweep. The range for this command is determined by the main sweep range and the main sweep horizontal position. The value for this command must keep the time base window within the main sweep range.

<position_value> A real number for the time in seconds from the trigger event to the delay reference point. The maximum position depends on the main sweep range and the main sweep horizontal position.

Example This example sets the time base window delay position to 20 ns.

```
myScope.WriteString ":TIMEbase:WINDow:POSition 20E-9"
```

Query :TIMEbase:WINDow:POSition?

The :TIMEbase:WINDow:POSition? query returns the current horizontal position in the delayed view.

Returned Format [:TIMEbase:WINDow:POSition] <position_value><NL>

Example This example places the current horizontal position in the delayed view in the numeric variable, varSetting, then prints the contents of the variable to the computer's screen.

```
myScope.WriteString ":SYSTEM:HEADer OFF" ' Response headers off.
myScope.WriteString ":TIMEbase:WINDow:POSition?"
varSetting = myScope.ReadNumber
Debug.Print FormatNumber(varSetting, 0)
```

History Legacy command (existed before version 3.10).

:TIMEbase:WINDow:RANGe

Command :TIMEbase:WINDow:RANGe <full_scale_range>

The :TIMEbase:WINDow:RANGe command sets the full-scale range of the delayed view. The range value is ten times the time per division of the delayed view. The maximum range of the delayed view is the current main range. The minimum delayed view range is 10 ps (1 ps/div).

<full_scale_range> A real number for the full-scale range of the time base window, in seconds.

Example This example sets the full-scale range of the delayed view to 100 ns.

```
myScope.WriteString ":TIMEbase:WINDow:RANGe 100E-9"
```

Query :TIMEbase:WINDow:RANGe?

The :TIMEbase:WINDow:RANGe? query returns the current full-scale range of the delayed view.

Returned Format [:TIMEbase:WINDow:RANGe] <full_scale_range><NL>

Example This example reads the current full-scale range of the delayed view into the numeric variable, varValue, then prints the contents of the variable to the computer's screen.

```
myScope.WriteString ":SYSTem:HEADer OFF" ' Response headers off.
myScope.WriteString ":TIMEbase:WINDow:RANGe?"
varValue = myScope.ReadNumber
Debug.Print FormatNumber(varValue, 0)
```

History Legacy command (existed before version 3.10).

:TIMebase:WINDow:SCALe

Command :TIMebase:WINDow:SCALe <time>

The :TIMebase:WINDow:SCALe command sets the time/div in the delayed view. This command rescales the horizontal components of displayed waveforms.

<time> A real number for the delayed windows scale.

Example This example sets the scale of the time base window to 2 milliseconds/div.

```
myScope.WriteString ":TIMebase:WINDow:SCALe 2E-3"
```

Query :TIMebase:WINDow:SCALe?

The :TIMebase:WINDow:SCALe? query returns the scaled window time, in seconds/div.

Returned Format [:TIMebase:WINDow:SCALe] <time><NL>

History Legacy command (existed before version 3.10).

36 Trigger Commands

| | |
|---|------|
| General Trigger Commands / | 1183 |
| Comm Trigger Commands / | 1198 |
| Delay Trigger Commands / | 1204 |
| Edge Trigger Commands / | 1214 |
| GBSerial Trigger Commands / | 1218 |
| Glitch Trigger Commands / | 1229 |
| Pattern Trigger Commands / | 1233 |
| Pulse Width Trigger Commands / | 1236 |
| Runt Trigger Commands / | 1242 |
| Sequence Trigger Commands / | 1247 |
| Setup and Hold Trigger Commands / | 1256 |
| State Trigger Commands / | 1263 |
| Timeout Trigger Commands / | 1268 |
| Transition Trigger Commands / | 1272 |
| TV Trigger Commands / | 1277 |
| Window Trigger Commands / | 1288 |
| Advanced Comm Trigger Commands / | 1293 |
| Advanced Pattern Trigger Commands / | 1300 |
| Advanced State Trigger Commands / | 1306 |
| Advanced Delay By Event Trigger Commands / | 1312 |
| Advanced Delay By Time Trigger Commands / | 1321 |
| Advanced Standard TV Trigger Commands / | 1328 |
| Advanced User Defined TV Mode and Commands / | 1334 |
| Advanced Violation Trigger Modes / | 1340 |
| Advanced Pulse Width Violation Trigger Commands / | 1342 |
| Advanced Setup Violation Trigger Commands / | 1348 |
| Advanced Transition Violation Trigger Commands / | 1374 |

The oscilloscope trigger circuitry helps you locate the waveform you want to view. There are several different types of triggering, but the one that is used most often is edge triggering. Edge triggering identifies a trigger condition by looking for the slope (rising or falling) and voltage level (trigger level) on the source you select. Any input channel, auxiliary input trigger, or line can be used as the trigger source.

The commands in the TRIGger subsystem define the conditions for triggering. Many of the commands in the TRIGger subsystem are used in more than one of the trigger modes. The command set has been defined to closely represent the front-panel trigger menus. As a trade-off, there may be less compatibility between Infiniium Oscilloscopes and command sets for previous oscilloscopes. Infiniium Oscilloscopes still accept some commands for compatibility with previous instruments. An alternative command that is accepted by the oscilloscope is noted for a particular command.

**Summary of
Trigger Modes and
Commands**

Make sure the oscilloscope is in the proper trigger mode for the command you want to send. One method of ensuring that the oscilloscope is in the proper trigger mode is to send the :TRIGger:MODE command in the same program message as the parameter to be set.

For example, to place the instrument in the proper triggering mode you select:

```
:TRIGger:MODE <Trigger_mode>
```

<Trigger_mode>

The trigger modes include COMM, DELay, EDGE, GLITch, PATtern, PWIDth, RUNT, SEQuence, SHOLd, STATE, TIMEout, TRANSition, TV, WINDow, SBUS<N>, and ADVanced. Each mode is described with its command set in this chapter.

To place the instrument in the advanced triggering mode you select:

```
:TRIGger:MODE ADVanced
:TRIGger:ADVanced:MODE <Advanced_trigger_mode>
```

**<Advanced
_trigger_mode>**

Advanced trigger modes include COMM, DELay, PATtern, STATE, TV, and VIOLation. Each mode is described with its command set in this chapter.

General Trigger Commands

- `":TRIGger:AND:ENABle"` on page 1184
- `":TRIGger:AND:SOURce"` on page 1185
- `":TRIGger:HOLDoff"` on page 1186
- `":TRIGger:HOLDoff:MAX"` on page 1187
- `":TRIGger:HOLDoff:MIN"` on page 1188
- `":TRIGger:HOLDoff:MODE"` on page 1189
- `":TRIGger:HTHReshold"` on page 1190
- `":TRIGger:HYSteresis"` on page 1191
- `":TRIGger:LEVel"` on page 1192
- `":TRIGger:LEVel:FIFTy"` on page 1193
- `":TRIGger:LTHReshold"` on page 1194
- `":TRIGger:MODE"` on page 1195
- `":TRIGger:SWEep"` on page 1197

:TRIGger:AND:ENABLE

Command :TRIGger:AND[{1 | 2}]:ENABLE {{ON | 1} | {OFF | 0}}

The :TRIGger:AND:ENABLE command enables the ability to further qualify the trigger using other channels.

The optional [{1 | 2}] parameter sets whether the AND qualifier goes with the TERM1 or TERM2 state if sequential triggering is being used.

Query :TRIGger:AND:ENABLE?

The query returns the current state of the AND qualifier.

Returned Format [:TRIGger:AND:ENABLE] {1 | 0}<NL>

History Legacy command (existed before version 3.10).

:TRIGger:AND:SOURce

Command :TRIGger:AND[{1 | 2}]:SOURce CHANnel<N>,{HIGH | LOW | DONTcare}

The :TRIGger:AND:SOURce command sets the logic value used to qualify the trigger for the specified channel. The TRIGger:LEVel command determines what voltage level is considered a HIGH or a LOW logic value. If you set more than one channel to a HIGH or a LOW, then the multiple channels are used to qualify the trigger.

The optional [{1 | 2}] parameter sets whether the AND qualifier goes with the TERM1 or TERM2 state if sequential triggering is being used.

<N> An integer, 1-4.

Query :TRIGger:AND:SOURce? CHANnel<N>

The query returns the logic value for the designated channel.

Returned Format [:TRIGger:AND:SOURce CHANnel<N>] {HIGH | LOW | DONTcare}<NL>

History Legacy command (existed before version 3.10).

:TRIGger:HOLDoff

Command :TRIGger:HOLDoff <holdoff_time>

The :TRIGger:HOLDoff command specifies the amount of time the oscilloscope should wait after receiving a trigger before enabling the trigger again.

<holdoff_time> A real number for the holdoff time, ranging from 100 ns to 10 s.

Query :TRIGger:HOLDoff?

The query returns the current holdoff value for the current mode.

Returned Format [:TRIGger:HOLDoff] <holdoff><NL>

History Legacy command (existed before version 3.10).

:TRIGger:HOLDoff:MAX

Command :TRIGger:HOLDoff:MAX <holdoff_time>

This command is only used when you set the :TRIGger:HOLDoff:MODE command to RANDom. The RANDom mode varies the trigger holdoff from one acquisition to another by randomizing the time values between triggers. The randomized values can be between the values specified by the :TRIGger:HOLDoff:MAX and :TRIGger:HOLDoff:MIN commands.

The Random holdoff mode ensures that the oscilloscope re-arms after each acquisition in a manner that minimizes or eliminates the likelihood of triggering at the beginning of a DDR burst. Randomizing the holdoff increases the likelihood that the oscilloscope will trigger on different data phases of a multiphase (8 data transfer) burst. This mode mixes up the traffic pattern the oscilloscope triggers on and is very effective when used on repeating patterns.

<holdoff_time> A real number for the maximum random holdoff time.

Query :TRIGger:HOLDoff:MAX?

The query returns the current maximum holdoff value for the random holdoff mode.

Returned Format [:TRIGger:HOLDoff:MAX] <holdoff><NL>

History Legacy command (existed before version 3.10).

:TRIGger:HOLDoff:MIN

Command :TRIGger:HOLDoff:MIN <holdoff_time>

This command is only used when you set the :TRIGger:HOLDoff:MODE command to RANDom. The RANDom mode varies the trigger holdoff from one acquisition to another by randomizing the time values between triggers. The randomized values can be between the values specified by the :TRIGger:HOLDoff:MAX and :TRIGger:HOLDoff:MIN commands.

The Random holdoff mode ensures that the oscilloscope re-arms after each acquisition in a manner that minimizes or eliminates the likelihood of triggering at the beginning of a DDR burst. Randomizing the holdoff increases the likelihood that the oscilloscope will trigger on different data phases of a multiphase (8 data transfer) burst. This mode mixes up the traffic pattern the oscilloscope triggers on and is very effective when used on repeating patterns.

<holdoff_time> A real number for the minimum random holdoff time.

Query :TRIGger:HOLDoff:MIN?

The query returns the current minimum holdoff value for the random holdoff mode.

Returned Format [:TRIGger:HOLDoff:MIN] <holdoff><NL>

History Legacy command (existed before version 3.10).

:TRIGger:HOLDoff:MODE

Command :TRIGger:HOLDoff:MAX {FIXed | RANDom}

The Fixed mode sets the amount of time that the oscilloscope waits before re-arming the trigger circuitry. It can be used to stabilize the display of complex waveforms.

The RANDom mode varies the trigger holdoff from one acquisition to another by randomizing the time values between triggers. The randomized values can be between the values specified by the :TRIGger:HOLDoff:MAX and :TRIGger:HOLDoff:MIN commands.

The Random holdoff mode ensures that the oscilloscope re-arms after each acquisition in a manner that minimizes or eliminates the likelihood of triggering at the beginning of a DDR burst. Randomizing the holdoff increases the likelihood that the oscilloscope will trigger on different data phases of a multiphase (8 data transfer) burst. This mode mixes up the traffic pattern the oscilloscope triggers on and is very effective when used on repeating patterns.

Query :TRIGger:HOLDoff:MODE?

The query returns the current holdoff mode.

Returned Format [:TRIGger:HOLDoff:MODE] {FIXed | RANDom}<NL>

History Legacy command (existed before version 3.10).

:TRIGger:HTHReshold

Command :TRIGger:HTHReshold{{CHANnel<N> | AUXiliary},<level>}

This command specifies the high threshold voltage level for the selected trigger source. Set the high threshold level to a value considered to be a high level for your logic family; your data book gives two values, V_{IH} and V_{OH} .

<N> An integer, 1-4.

<level> A real number for the voltage level for the trigger source.

Query :TRIGger:HTHReshold? {CHANnel<N> | AUXiliary}

The query returns the currently defined high threshold voltage level for the trigger source.

Returned Format [:TRIGger:HTHReshold {CHANnel<N> | AUXiliary},] <level><NL>

History Legacy command (existed before version 3.10).

:TRIGger:HYSteresis

Command :TRIGger:HYSteresis {NORMal | NREJect | HSENSitivity}

The :TRIGger:HYSteresis command specifies the trigger hysteresis (noise reject) as:

- NORMal – the typical hysteresis selection.
- NREJect (noise reject) – (available on 9000 Series, 9000H Series, and S-Series oscilloscopes) gives maximum hysteresis but the lowest trigger bandwidth.
- HSENSitivity – (available on 90000A Series, 90000 X-Series, V-Series, 90000 Q-Series, and Z-Series oscilloscopes) lowers the hysteresis of the trigger circuitry and should be used for waveforms of 4 GHz and above.

Query :TRIGger:HYSteresis?

The query returns the current hysteresis setting.

Returned Format [:TRIGger:HYSteresis] {NORMal | NREJect | HSENSitivity}<NL>

History Legacy command (existed before version 3.10).

:TRIGger:LEVel

Command :TRIGger:LEVel {{CHANnel<N> | AUX},<level>}

The :TRIGger:LEVel command specifies the trigger level on the specified channel for the trigger source. Only one trigger level is stored in the oscilloscope for each channel. This level applies to the channel throughout the trigger dialog boxes (Edge, Glitch, and Advanced). This level also applies to all the High Threshold (HTHReshold) values in the Advanced Violation menus.

<N> An integer, 1-4.

<level> A real number for the trigger level on the specified channel or Auxiliary Trigger Input.

Query :TRIGger:LEVel? {CHANnel<N> | AUX}

The query returns the specified channel's trigger level.

Returned Format [:TRIGger:LEVel {CHANnel<N> | AUX},] <level><NL>

History Legacy command (existed before version 3.10).

:TRIGger:LEVel:FIFTy

Command :TRIGger:LEVel:FIFTy

The :TRIGger:LEVel:FIFTy command sets the trigger level to 50%.

This performs the same action as the "push for 50%" front panel trigger level knob.

See Also • [":TRIGger:LEVel"](#) on page 1192

History New in version 4.30.

:TRIGger:LTHReshold

Command :TRIGger:LTHReshold CHANnel<N>,<level>

This command specifies the low threshold voltage level for the selected trigger source. This command specifies the low threshold voltage level for the selected trigger source. Set the low threshold level to a value considered to be a low level for your logic family; your data book gives two values, V_{IL} and V_{OL} .

<N> An integer, 1-4.

<level> A real number for the voltage level for the trigger source.

Query :TRIGger:LTHReshold? CHANnel<N>

The query returns the currently defined low threshold for the trigger source.

Returned Format [:TRIGger:LTHReshold CHANnel<N>,<level><NL>

History Legacy command (existed before version 3.10).

:TRIGger:MODE

Command :TRIGger:MODE {EDGE | GLITCh | PATtern | STATE | DELay | TIMEout | TV
| COMM | RUNT | SEQuence | SHOLd | TRANsition | WINDow
| PWIDth | ADVanced | SBUS<N>}

The :TRIGger:MODE command selects the trigger mode.

Table 16 :TRIGger:MODE Settings

| Mode | Definition |
|------------|--|
| COMM | COMM mode lets you trigger on a serial pattern of bits in a waveform. |
| DELay | Delay by Events mode lets you view pulses in your waveform that occur a number of events after a specified waveform edge. Delay by Time mode lets you view pulses in your waveform that occur a long time after a specified waveform edge. |
| EDGE | Edge trigger mode. |
| GLITCh | Trigger on a pulse that has a width less than a specified amount of time. |
| PATtern | Pattern triggering lets you trigger the oscilloscope using more than one channel as the trigger source. You can also use pattern triggering to trigger on a pulse of a given width. |
| PWIDth | Pulse width triggering lets you trigger on a pulse that is greater than or less than a specified width and of a certain polarity. |
| RUNT | Runt triggering lets you trigger on positive or negative pulses that are smaller in amplitude than other pulses in your waveform. |
| SBUS<N> | Serial triggering on SBUS1, SBUS2, SBUS3, or SBUS4. |
| SEQuence | (Available on 90000A Series, 90000 X-Series, V-Series, 90000 Q-Series, and Z-Series oscilloscopes.) Sequential triggering lets you use multiple events or time/pattern qualifications to define your trigger. |
| SHOLd | Setup and Hold triggering let you trigger on Setup or Hold violations in your circuit. |
| STATE | State triggering lets you set the oscilloscope to use several channels as the trigger source, with one of the channels being used as a clock waveform. |
| TIMEout | Timeout triggering lets you trigger when the waveform remains high too long, low to long, or unchanged too long. |
| TRANsition | Edge Transition triggering lets you trigger on an edge that violates a rise time or fall time specification. |
| TV | TV trigger mode lets you trigger the oscilloscope on one of the standard television waveforms. You can also use this mode to trigger on a custom television waveform that you define. |

Table 16 :TRIGger:MODE Settings (continued)

| Mode | Definition |
|----------|---|
| WINDow | Window triggering lets you define a window on screen and then trigger when the waveform exits the window, enters it, or stays inside/outside the window for too long/short. |
| ADVanced | Allows backward compatibility access to the DELay, PATtern, STATE, TV, and VIOLation modes. When this mode is selected, use the :TRIGger:ADVanced:MODE command to select the advanced trigger mode. |

Table 17 :TRIGger:ADVanced:MODE Settings

| Mode | Definition |
|-----------|--|
| COMM | COMM mode lets you trigger on a serial pattern of bits in a waveform. |
| DELay | Delay by Events mode lets you view pulses in your waveform that occur a number of events after a specified waveform edge. Delay by Time mode lets you view pulses in your waveform that occur a long time after a specified waveform edge. |
| PATtern | Pattern triggering lets you trigger the oscilloscope using more than one channel as the trigger source. You can also use pattern triggering to trigger on a pulse of a given width. |
| STATE | State triggering lets you set the oscilloscope to use several channels as the trigger source, with one of the channels being used as a clock waveform. |
| TV | TV trigger mode lets you trigger the oscilloscope on one of the standard television waveforms. You can also use this mode to trigger on a custom television waveform that you define. |
| VIOLation | Trigger violation modes: Pulse WIDTH, SETup, TRANSition. When this mode is selected, use the :TRIGger:ADVanced:VIOLation:MODE command to select the advanced trigger violation mode. |

Query :TRIGger:MODE?

The query returns the currently selected trigger mode.

Returned Format [:TRIGger:MODE] {EDGE | GLITCh | PATtern | STATE | DELay | TIMEout | TV | COMM | RUNT | SEQuence | SHOLd | TRANSition | WINDow | PWIDth | ADVanced | SBUS<N>}<NL>

History Legacy command (existed before version 3.10).

Version 3.50: Added the SBUS1, SBUS2, SBUS3, and SBUS4 selections for triggering on serial buses.

:TRIGger:SWEep

Command :TRIGger:SWEep {AUTO | TRIGgered | SINGle}

The :TRIGger:SWEep command selects the oscilloscope sweep mode. New programs should use :RUN and :SINGle for run control and this command for AUTO and TRIGgered for sweep control. The SINGle sweep control should not be used.

AUTO When you select AUTO, if a trigger event does not occur within a time determined by the oscilloscope settings, the oscilloscope automatically forces a trigger which causes the oscilloscope to sweep. If the frequency of your waveform is 50 Hz or less, you should not use the AUTO sweep mode because it is possible that the oscilloscope will automatically trigger before your waveform trigger occurs.

TRIGgered When you select TRIGgered, if no trigger occurs, the oscilloscope will not sweep, and the previously acquired data will remain on the screen.

SINGle When you select SINGle, if no trigger occurs, the oscilloscope will not sweep, and the previously acquired data will remain on the screen. Do not use in new programs.

Query :TRIGger:SWEep?

The query returns the specified channel's trigger level.

Returned Format [:TRIGger:SWEep] {AUTO | TRIGgered}<NL>

History Legacy command (existed before version 3.10).

Comm Trigger Commands

- `":TRIGger:COMM:BWIDth"` on page 1199
- `":TRIGger:COMM:ENCode"` on page 1200
- `":TRIGger:COMM:PATtern"` on page 1201
- `":TRIGger:COMM:POLarity"` on page 1202
- `":TRIGger:COMM:SOURce"` on page 1203

:TRIGger:COMM:BWIDth

Command :TRIGger:COMM:BWIDth <bwidth_value>

The :TRIGger:COMM:BWIDth command is used to set the width of a bit for your waveform. The bit width is usually defined in the mask standard for your waveform.

<bwidth_value> A real number that represents the width of a bit.

Query :TRIGger:COMM:BWIDth?

The query returns the current bit width.

Returned Format [:TRIGger:COMM:BWIDth] <bwidth_value><NL>

History Legacy command (existed before version 3.10).

:TRIGger:COMM:ENCode

Command :TRIGger:COMM:ENCode {RZ | NRZ}

This :TRIGger:COMM:ENCode command sets the type of waveform encoding for your waveform. You should use NRZ for CMI type waveforms and RZ for all other type of waveforms.

Query :TRIGger:COMM:ENCode?

The :TRIGger:COMM:ENCode? query returns the current value of encoding

Returned Format [:TRIGger:COMM:ENCode] {RZ | NRZ}<NL>

History Legacy command (existed before version 3.10).

:TRIGger:COMM:PATtern

Command :TRIGger:COMM:PATtern <bit>[,<bit>[,<bit>[,<bit>[,<bit>[,<bit>]]]]

The :TRIGger:COMM:PATtern command sets the pattern used for triggering the oscilloscope when in communication trigger mode. The pattern can be up to 6 bits long. For NRZ type waveforms with positive polarity, there must be at least one logic 0 to logic 1 transition in the pattern. For NRZ waveforms with negative polarity there must be at least one logic 1 to logic 0 transition in the pattern. For RZ type waveforms the pattern must have at least one logic 1 bit for positive polarity. For RZ type waveforms the pattern must have at least one logic -1 bit for negative polarity.

<bit> A 1, -1, or 0.

Query :TRIGger:COMM:PATtern?

The :TRIGger:COMM:PATtern? query returns the current communication trigger pattern.

Returned Format [:TRIGger:COMM:PATtern] <pattern><NL>

<pattern> A string of up to 6 characters.

History Legacy command (existed before version 3.10).

:TRIGger:COMM:POLarity

Command :TRIGger:COMM:POLarity {POSitive | NEGative}

The :TRIGger:COMM:POLarity command directly controls the trigger slope used for communication trigger. When set to a positive value, the rising edge of a pulse or waveform is used to trigger the oscilloscope. When set to a negative value, the falling edge of a pulse or waveform is used.

The polarity setting is also used to check for valid patterns. If you are trying to trigger on an isolated 1 pattern, you should set the polarity to positive. If you are trying to trigger on an isolated -1 pattern, you should set the polarity to negative.

Query :TRIGger:COMM:POLarity?

The :TRIGger:COMM:POLarity? query returns the current setting for polarity.

Returned Format [:TRIGger:COMM:POLarity] {POSitive | NEGative}<NL>

History Legacy command (existed before version 3.10).

:TRIGger:COMM:SOURce

Command :TRIGger:COMM:SOURce CHANnel<N>

The :TRIGger:COMM:SOURce command selects the channel used for the communication trigger.

<N> An integer, 1-4.

Query :TRIGger:COMM:SOURce?

The :TRIGger:COMM:SOURce? query returns the currently selected communication trigger source.

Returned Format [:TRIGger:COMM:SOURce] CHANnel<N><NL>

History Legacy command (existed before version 3.10).

Delay Trigger Commands

- `":TRIGger:DElay:ARM:SOURce"` on page 1205
- `":TRIGger:DElay:ARM:SLOPe"` on page 1206
- `":TRIGger:DElay:EDElay:COUNT"` on page 1207
- `":TRIGger:DElay:EDElay:SOURce"` on page 1208
- `":TRIGger:DElay:EDElay:SLOPe"` on page 1209
- `":TRIGger:DElay:MODE"` on page 1210
- `":TRIGger:DElay:TDElay:TIME"` on page 1211
- `":TRIGger:DElay:TRIGger:SOURce"` on page 1212
- `":TRIGger:DElay:TRIGger:SLOPe"` on page 1213

:TRIGger:DELAy:ARM:SOURce

Command :TRIGger:DELAy:ARM:SOURce {CHANnel<N> | DIGital<M>}

This command sets the Arm On source for arming the trigger circuitry when the oscilloscope is in the Delay trigger mode.

<N> An integer, 1-4.

<M> An integer, 0-15. Digital channels are available on mixed-signal oscilloscopes.

Query :TRIGger:DELAy:ARM:SOURce?

The query returns the currently defined Arm On source for the Delay trigger mode.

Returned Format [:TRIGger:DELAy:EDELAy:ARM:SOURce] {CHANnel<N> | DIGital<M>}<NL>

History Legacy command (existed before version 3.10).

:TRIGger:DELay:ARM:SLOPe

Command :TRIGger:DELay:ARM:SLOPe {NEGative | POSitive}

This command sets a positive or negative slope for arming the trigger circuitry when the oscilloscope is in the Delay trigger mode.

Query :TRIGger:DELay:ARM:SLOPe?

The query returns the currently defined slope for the Delay trigger mode.

Returned Format [:TRIGger:DELay:ARM:SLOPe] {NEGative | POSitive}<NL>

History Legacy command (existed before version 3.10).

:TRIGger:DELay:EDELay:COUNT

Command :TRIGger:DELay:EDELay:COUNT <edge_number>

This command sets the event count for a Delay By Event trigger event.

<edge_num> An integer from 0 to 16,000,000 specifying the number of edges to delay.

Query :TRIGger:DELay:EDELay:COUNT?

The query returns the currently defined number of events to delay before triggering on the next Trigger On condition in the Delay By Event trigger mode.

Returned Format [:TRIGger:DELay:EDELay:COUNT] <edge_number><NL>

History Legacy command (existed before version 3.10).

:TRIGger:DElay:EDELay:SOURce

Command :TRIGger:DElay:EDELay:SOURce {CHANnel<N> | DIGital<M>}

This command sets the Event source for a Delay By Event trigger event.

<N> An integer, 1-4.

<M> An integer, 0-15. Digital channels are available on mixed-signal oscilloscopes.

Query :TRIGger:DElay:EDELay:SOURce?

The query returns the currently defined Event source in the Delay By Event trigger mode.

Returned Format [:TRIGger:DElay:EDELay:SOURce] {CHANnel<N> | DIGital<M>}<NL>

History Legacy command (existed before version 3.10).

:TRIGger:DElay:EDElay:SLOPe

Command :TRIGger:DElay:EDElay:SLOPe {NEGative | POSitive}

This command sets the trigger slope for the Delay By Event trigger event.

Query :TRIGger:DElay:EDElay:SLOPe?

The query returns the currently defined slope for an event in the Delay By Event trigger mode.

Returned Format [:TRIGger:DElay:EDElay:SLOPe] {NEGative | POSitive}<NL>

History Legacy command (existed before version 3.10).

:TRIGger:DElay:MODE

Command :TRIGger:DElay:MODE {EDELay | TDELay}

The :TRIGger:DElay:MODE command selects the type of delay trigger mode to either events or to time.

Query :TRIGger:DElay:MODE?

The query returns the currently selected delay trigger mode.

Returned Format [:TRIGger:DElay:MODE] {EDELay | TDELay}<NL>

History Legacy command (existed before version 3.10).

:TRIGger:DElay:TDElay:TIME

Command :TRIGger:DElay:TDElay:TIME <delay>

This command sets the delay for a Delay By Time trigger event.

<delay> Time, in seconds, set for the delay trigger, from 10 ns to 10 s.

Query :TRIGger:DElay:TDElay:TIME?

The query returns the currently defined time delay before triggering on the next Trigger On condition in the Delay By Time trigger mode.

Returned Format [:TRIGger:DElay:TDElay:TIME] <delay><NL>

History Legacy command (existed before version 3.10).

:TRIGger:DELAy:TRIGger:SOURce

Command :TRIGger:DELAy:TRIGger:SOURce {CHANnel<N> | DIGital<M>}

This command sets the Trigger On source for a Delay trigger event.

<N> An integer, 1-4.

<M> An integer, 0-15. Digital channels are available on mixed-signal oscilloscopes.

Query :TRIGger:DELAy:TRIGger:SOURce?

The query returns the currently defined Trigger On source in the Delay trigger mode.

Returned Format [:TRIGger:DELAy:TRIGger:SOURce] {CHANnel<N> | DIGital<M>}<NL>

History Legacy command (existed before version 3.10).

:TRIGger:DELay:TRIGger:SLOPe

Command :TRIGger:DELay:TRIGger:SLOPe {NEGative | POSitive}

This command sets the trigger slope for the Delay trigger event.

Query :TRIGger:DELay:TRIGger:SLOPe?

The query returns the currently defined slope for an event in the Delay trigger mode.

Returned Format [:TRIGger:DELay:TRIGger:SLOPe] {NEGative | POSitive}<NL>

History Legacy command (existed before version 3.10).

Edge Trigger Commands

- **":TRIGger:EDGE:COUPLing (9000 Series, 9000H Series, S-Series)"** on page 1215
- **":TRIGger:EDGE:SLOPe"** on page 1216
- **":TRIGger:EDGE:SOURce"** on page 1217

:TRIGger:EDGE:COUPling (9000 Series, 9000H Series, S-Series)

Command :TRIGger:EDGE:COUPling {AC | DC | LFReject | HFReject}

The :TRIGger:EDGE:COUPling command sets the trigger coupling when :TRIG:EDGE:SOURce is set to one of the channels.

Query :TRIGger:EDGE:COUPling?

The query returns the currently selected coupling for the specified edge trigger source.

Returned Format [:TRIGger:EDGE:COUPling] {AC | DC | LFReject | HFReject}<NL>

History Legacy command (existed before version 3.10).

:TRIGger:EDGE:SLOPe

Command :TRIGger:EDGE[{1 | 2}]:SLOPe {POSitive | NEGative | EITHer}

The :TRIGger:EDGE:SLOPe command sets the slope of the trigger source previously selected by the :TRIGger:EDGE:SOURce command. The LINE source has no slope.

The optional [{1 | 2}] parameter sets whether the trigger mode goes with the TERM1 or TERM2 state if sequential triggering is being used. Sequential triggering is available on 90000A Series, 90000 X-Series, V-Series, 90000 Q-Series, and Z-Series oscilloscopes.

Query :TRIGger:EDGE:SLOPe?

The query returns the currently selected slope for the specified edge trigger source.

Returned Format [:TRIGger:EDGE:SLOPe] {POSitive | NEGative | EITHer}<NL>

History Legacy command (existed before version 3.10).

:TRIGger:EDGE:SOURce

Command :TRIGger:EDGE[{1 | 2}]:SOURce {CHANnel<N> | DIGital<M> | AUX | LINE}

The :TRIGger:EDGE:SOURce command selects the source for edge mode triggering. This is the source that will be used for subsequent :TRIGger:EDGE:SLOPe commands or queries.

NOTE

The optional [{1 | 2}] parameter sets whether the trigger mode goes with the TERM1 or TERM2 state if sequential triggering is being used. Sequential triggering is available on 90000A Series, 90000 X-Series, V-Series, 90000 Q-Series, and Z-Series oscilloscopes.

NOTE

The LINE parameter is not available with the 90000 Q-Series or Z-Series oscilloscopes.

<N> An integer, 1-4.

<M> An integer, 0-15. Digital channels are available on mixed-signal oscilloscopes.

Query :TRIGger:EDGE:SOURce?

The query returns the currently selected edge mode trigger source.

Returned Format [:TRIGger:EDGE:SOURce] {CHANnel<N> | DIGital<M> | AUX | LINE}<NL>

History Legacy command (existed before version 3.10).

GBSerial Trigger Commands

- [":TRIGger:GBSerial:CLOCK \(V-Series with HWST Option\)"](#) on page 1219
- [":TRIGger:GBSerial:CLOCK:FREQuency \(V-Series with HWST Option\)"](#) on page 1220
- [":TRIGger:GBSerial:DRATe \(V-Series with HWST Option\)"](#) on page 1222
- [":TRIGger:GBSerial:MODE \(V-Series with HWST Option\)"](#) on page 1224
- [":TRIGger:GBSerial:PATTeRn \(V-Series with HWST Option\)"](#) on page 1225
- [":TRIGger:GBSerial:POLarity \(V-Series with HWST Option\)"](#) on page 1226
- [":TRIGger:GBSerial:PRBS \(V-Series with HWST Option\)"](#) on page 1227
- [":TRIGger:GBSerial:SOURce \(V-Series with HWST Option\)"](#) on page 1228

:TRIGger:GBSerial:CLOCK (V-Series with HWST Option)

Command :TRIGger:GBSerial:CLOCK <refclk>
 <refclk> ::= {INTernal | EXTernal}

The :TRIGger:GBSerial:CLOCK command specifies whether an INTernal or EXTernal reference clock (and internal multipliers) are used to support the selected data rate (see :TRIGger:GBSerial:DRATe).

External reference clock signals are supplied to a BNC connector on the oscilloscope's hardware serial trigger I/O panel. When you use an external reference clock, its frequency is specified using the :TRIGger:GBSerial:CLOCK:FREQuency command.

Query :TRIGger:GBSerial:CLOCK?

The :TRIGger:GBSerial:CLOCK? query returns the reference clock selection.

Returned Format [:TRIGger:GBSerial:CLOCK] <refclk><NL>
 <refclk> ::= {INTernal | EXTernal}

- See Also**
- [":TRIGger:GBSerial:CLOCK:FREQuency \(V-Series with HWST Option\)"](#) on page 1220
 - [":TRIGger:GBSerial:DRATe \(V-Series with HWST Option\)"](#) on page 1222
 - [":TRIGger:GBSerial:MODE \(V-Series with HWST Option\)"](#) on page 1224
 - [":TRIGger:GBSerial:PATTern \(V-Series with HWST Option\)"](#) on page 1225
 - [":TRIGger:GBSerial:POLarity \(V-Series with HWST Option\)"](#) on page 1226
 - [":TRIGger:GBSerial:PRBS \(V-Series with HWST Option\)"](#) on page 1227
 - [":TRIGger:GBSerial:SOURce \(V-Series with HWST Option\)"](#) on page 1228

History New in version 5.50.

:TRIGger:GBSerial:CLOCK:FREQUENCY (V-Series with HWST Option)

Command :TRIGger:GBSerial:CLOCK:FREQUENCY <value>

<value> ::= Hertz in NR3 format.

When an external reference clock is used, the :TRIGger:GBSerial:CLOCK:FREQUENCY command specifies its frequency.

In most cases, depending on the serial signal data rate, a single specific reference clock is required. However, for some data rates, multiple reference clock frequencies can be used; in these cases, you use the :TRIGger:GBSerial:CLOCK:FREQUENCY command to specify the frequency of the external reference clock signal.

| Serial Signal Data Rate | Required Reference Clock Frequency |
|-------------------------|------------------------------------|
| 480 Mb/s | 96 MHz |
| 2.5 Gb/s | 100 MHz |
| 4 Gb/s | 200 MHz |
| 5 Gb/s | 100 MHz |
| 6 Gb/s | 75 MHz |
| 8 Gb/s | 100 MHz |
| 10 Gb/s | 100 MHz |
| 10.3125 Gb/s | 103.125 MHz or 156.25 MHz |
| 10.3725 Gb/s | 103.725 MHz |
| 10.75 Gb/s | 107.5 MHz |
| 12 Gb/s | 120 MHz |
| 12.125 Gb/s | 121.25 MHz |
| 12.5 Gb/s | 125 MHz |

Query :TRIGger:GBSerial:CLOCK:FREQUENCY?

The :TRIGger:GBSerial:CLOCK:FREQUENCY? query returns the external reference clock frequency.

Returned Format [:TRIGger:GBSerial:CLOCK:FREQUENCY] <value><NL>

<value> ::= Hertz in NR3 format.

- See Also**
- [":TRIGger:GBSerial:CLOCK \(V-Series with HWST Option\)"](#) on page 1219
 - [":TRIGger:GBSerial:DRATE \(V-Series with HWST Option\)"](#) on page 1222
 - [":TRIGger:GBSerial:MODE \(V-Series with HWST Option\)"](#) on page 1224
 - [":TRIGger:GBSerial:PATTERN \(V-Series with HWST Option\)"](#) on page 1225

- [":TRIGger:GBSerial:POLarity \(V-Series with HWST Option\)"](#) on page 1226
- [":TRIGger:GBSerial:PRBS \(V-Series with HWST Option\)"](#) on page 1227
- [":TRIGger:GBSerial:SOURce \(V-Series with HWST Option\)"](#) on page 1228

History New in version 5.50.

:TRIGger:GBSerial:DRATe (V-Series with HWST Option)

Command :TRIGger:GBSerial:DRATe <bps>

<bps> ::= bits/second in NR3 format.

The :TRIGger:GBSerial:DRATe command specifies the data rate of the serial signal. These common data rate values are supported:

- 480 Mb/s.
- 2.5 Gb/s.
- 4 Gb/s.
- 5 Gb/s.
- 6 Gb/s.
- 8 Gb/s.
- 10 Gb/s.
- 10.3125 Gb/s.
- 10.3725 Gb/s.
- 10.75 Gb/s.
- 12 Gb/s.
- 12.125 Gb/s.
- 12.5 Gb/s.

These data rates are supported in hardware using an internal reference clock and multipliers. You can also supply an external reference clock to a BNC connector on the oscilloscope's hardware serial trigger I/O panel. You can choose between the internal reference clock and an external reference clock using the :TRIGger:GBSerial:CLOCK command. When you use an external reference clock, its frequency is specified using the :TRIGger:GBSerial:CLOCK:FREQUENCY command.

Query :TRIGger:GBSerial:DRATe?

The :TRIGger:GBSerial:DRATe? query returns the specified serial signal data rate.

Returned Format [:TRIGger:GBSerial:DRATe] <bps><NL>

<bps> ::= bits/second in NR3 format.

- See Also**
- [":TRIGger:GBSerial:CLOCK \(V-Series with HWST Option\)"](#) on page 1219
 - [":TRIGger:GBSerial:CLOCK:FREQUENCY \(V-Series with HWST Option\)"](#) on page 1220
 - [":TRIGger:GBSerial:MODE \(V-Series with HWST Option\)"](#) on page 1224
 - [":TRIGger:GBSerial:PATTERN \(V-Series with HWST Option\)"](#) on page 1225
 - [":TRIGger:GBSerial:POLarity \(V-Series with HWST Option\)"](#) on page 1226
 - [":TRIGger:GBSerial:PRBS \(V-Series with HWST Option\)"](#) on page 1227

- [":TRIGger:GBSerial:SOURce \(V-Series with HWST Option\)"](#) on page 1228

History New in version 5.50.

:TRIGger:GBSerial:MODE (V-Series with HWST Option)

Command :TRIGger:GBSerial:MODE <mode>
 <mode> ::= {GENeric | GEN8B10B | PERRor}

The :TRIGger:GBSerial:MODE command selects the hardware serial trigger mode:

- **GENeric** – To trigger on "generic" sequences.
 This mode is used for simple sequences of 1s and 0s (see :TRIGger:GBSerial:PATtern), such as during a power-up sequence where there may be a unique sequence to trigger on.
- **GEN8B10B** – To trigger on 8b/10b sequences.
 In the front panel user interface, you can specify the number of words and choose from K or D codes. In the remote user interface, you are limited to specifying patterns as binary bit sequences, just as in the GENeric mode (see :TRIGger:GBSerial:PATtern)
- **PERRor** – To trigger on PRBS errors.
 This mode lets you select the type of PRBS pattern to compare against (see :TRIGger:GBSerial:PRBS) and its polarity (see :TRIGger:GBSerial:POLarity).

Query :TRIGger:GBSerial:MODE?

The :TRIGger:GBSerial:MODE? query returns the currently selected mode.

Returned Format [:TRIGger:GBSerial:MODE] <mode><NL>
 <mode> ::= {GEN | GEN8B10B | PERR}

- See Also**
- [":TRIGger:GBSerial:CLOCK \(V-Series with HWST Option\)"](#) on page 1219
 - [":TRIGger:GBSerial:CLOCK:FREQuency \(V-Series with HWST Option\)"](#) on page 1220
 - [":TRIGger:GBSerial:DRATe \(V-Series with HWST Option\)"](#) on page 1222
 - [":TRIGger:GBSerial:PATtern \(V-Series with HWST Option\)"](#) on page 1225
 - [":TRIGger:GBSerial:POLarity \(V-Series with HWST Option\)"](#) on page 1226
 - [":TRIGger:GBSerial:PRBS \(V-Series with HWST Option\)"](#) on page 1227
 - [":TRIGger:GBSerial:SOURce \(V-Series with HWST Option\)"](#) on page 1228

History New in version 5.50.

:TRIGger:GBSerial:PATtern (V-Series with HWST Option)

Command :TRIGger:GBSerial:PATtern "<pattern>"

<pattern> ::= binary number string up to 160 bits

When triggering on "generic" sequences or 8b/10b sequences (see :TRIGger:GBSerial:MODE), the :TRIGger:GBSerial:PATtern command specifies the bit pattern to trigger on. The bit pattern can be up to 160 bits.

Query :TRIGger:GBSerial:PATtern?

The :TRIGger:GBSerial:PATtern? query returns the currently specified bit pattern.

Returned Format [:TRIGger:GBSerial:PATtern] "<pattern>"<NL>

<pattern> ::= binary number string up to 160 bits

- See Also**
- [":TRIGger:GBSerial:CLOCK \(V-Series with HWST Option\)"](#) on page 1219
 - [":TRIGger:GBSerial:CLOCK:FREQuency \(V-Series with HWST Option\)"](#) on page 1220
 - [":TRIGger:GBSerial:DRATe \(V-Series with HWST Option\)"](#) on page 1222
 - [":TRIGger:GBSerial:MODE \(V-Series with HWST Option\)"](#) on page 1224
 - [":TRIGger:GBSerial:POLarity \(V-Series with HWST Option\)"](#) on page 1226
 - [":TRIGger:GBSerial:PRBS \(V-Series with HWST Option\)"](#) on page 1227
 - [":TRIGger:GBSerial:SOURce \(V-Series with HWST Option\)"](#) on page 1228

History New in version 5.50.

:TRIGger:GBSerial:POLarity (V-Series with HWST Option)

Command :TRIGger:GBSerial:POLarity <polarity>
 <polarity> ::= {POSitive | NEGative}

When triggering on PRBS errors (see :TRIGger:GBSerial:MODE), the :TRIGger:GBSerial:POLarity command specifies the polarity of the selected PRBS pattern.

Query :TRIGger:GBSerial:POLarity?

The :TRIGger:GBSerial:POLarity? query returns the specified PRBS pattern polarity.

Returned Format [:TRIGger:GBSerial:POLarity] <polarity><NL>
 <polarity> ::= {POSitive | NEGative}

- See Also**
- [":TRIGger:GBSerial:CLOCK \(V-Series with HWST Option\)"](#) on page 1219
 - [":TRIGger:GBSerial:CLOCK:FREQUENCY \(V-Series with HWST Option\)"](#) on page 1220
 - [":TRIGger:GBSerial:DRATE \(V-Series with HWST Option\)"](#) on page 1222
 - [":TRIGger:GBSerial:MODE \(V-Series with HWST Option\)"](#) on page 1224
 - [":TRIGger:GBSerial:PATTERN \(V-Series with HWST Option\)"](#) on page 1225
 - [":TRIGger:GBSerial:PRBS \(V-Series with HWST Option\)"](#) on page 1227
 - [":TRIGger:GBSerial:SOURCE \(V-Series with HWST Option\)"](#) on page 1228

History New in version 5.50.

:TRIGger:GBSerial:PRBS (V-Series with HWST Option)

Command :TRIGger:GBSerial:PRBS <type>

<type> ::= {PRBS7 | PRBS15 | PRBS23 | PRBS31}

When triggering on PRBS errors (see :TRIGger:GBSerial:MODE), the :TRIGger:GBSerial:PRBS command specifies the pattern to check when looking for errors. You can select PRBS 7, 15, 23, or 31 patterns.

Query :TRIGger:GBSerial:PRBS?

The :TRIGger:GBSerial:PRBS? query returns the selected PRBS pattern.

Returned Format [:TRIGger:GBSerial:PRBS] <type><NL>

<type> ::= {PRBS7 | PRBS15 | PRBS23 | PRBS31}

- See Also**
- [":TRIGger:GBSerial:CLOCK \(V-Series with HWST Option\)"](#) on page 1219
 - [":TRIGger:GBSerial:CLOCK:FREQuency \(V-Series with HWST Option\)"](#) on page 1220
 - [":TRIGger:GBSerial:DRATe \(V-Series with HWST Option\)"](#) on page 1222
 - [":TRIGger:GBSerial:MODE \(V-Series with HWST Option\)"](#) on page 1224
 - [":TRIGger:GBSerial:PATTern \(V-Series with HWST Option\)"](#) on page 1225
 - [":TRIGger:GBSerial:POLarity \(V-Series with HWST Option\)"](#) on page 1226
 - [":TRIGger:GBSerial:SOURce \(V-Series with HWST Option\)"](#) on page 1228

History New in version 5.50.

:TRIGger:GBSerial:SOURce (V-Series with HWST Option)

Command :TRIGger:GBSerial:SOURce CHANnel1

The :TRIGger:GBSerial:SOURce command specifies the oscilloscope input channel on which the hardware serial trigger operates. This is always CHANnel1.

Query :TRIGger:GBSerial:SOURce?

The :TRIGger:GBSerial:SOURce? query returns the oscilloscope input channel on which the hardware serial trigger operates. This is always CHANnel1.

Returned Format [:TRIGger:GBSerial:SOURce] <source><NL>
<source> ::= CHANnel1

- See Also**
- [":TRIGger:GBSerial:CLOCK \(V-Series with HWST Option\)"](#) on page 1219
 - [":TRIGger:GBSerial:CLOCK:FREQuency \(V-Series with HWST Option\)"](#) on page 1220
 - [":TRIGger:GBSerial:DRATe \(V-Series with HWST Option\)"](#) on page 1222
 - [":TRIGger:GBSerial:MODE \(V-Series with HWST Option\)"](#) on page 1224
 - [":TRIGger:GBSerial:PATtern \(V-Series with HWST Option\)"](#) on page 1225
 - [":TRIGger:GBSerial:POLarity \(V-Series with HWST Option\)"](#) on page 1226
 - [":TRIGger:GBSerial:PRBS \(V-Series with HWST Option\)"](#) on page 1227

History New in version 5.50.

Glitch Trigger Commands

- `":TRIGger:GLITch:POLarity"` on page 1230
- `":TRIGger:GLITch:SOURce"` on page 1231
- `":TRIGger:GLITch:WIDTh"` on page 1232

:TRIGger:GLITch:POLarity

Command :TRIGger:GLITch[{1 | 2}]:POLarity {POSitive | NEGative}

This command defines the polarity of the glitch as positive or negative. The trigger source must be set using the :TRIGger:GLITch:SOURce command.

The optional [{1 | 2}] parameter sets whether the trigger mode goes with the TERM1 or TERM2 state if sequential triggering is being used. Sequential triggering is available on 90000A Series, 90000 X-Series, V-Series, 90000 Q-Series, and Z-Series oscilloscopes.

Query :TRIGger:GLITch:POLarity?

The query returns the currently selected glitch polarity.

Returned Format [:TRIGger:GLITch:POLarity] {POS | NEG}<NL>

History Legacy command (existed before version 3.10).

:TRIGger:GLITch:SOURce

Command :TRIGger:GLITch[{1 | 2}]:SOURce {CHANnel<N> | DIGital<M>}

This command sets the source for the glitch trigger mode.

The optional [{1 | 2}] parameter sets whether the trigger mode goes with the TERM1 or TERM2 state if sequential triggering is being used. Sequential triggering is available on 90000A Series, 90000 X-Series, V-Series, 90000 Q-Series, and Z-Series oscilloscopes.

<N> An integer, 1-4.

<M> An integer, 0-15. Digital channels are available on mixed-signal oscilloscopes.

Query :TRIGger:GLITch:SOURce?

The query returns the currently selected source for the glitch trigger mode.

Returned Format [:TRIGger:GLITch:SOURce] {CHANnel<N> | DIGital<M>}<NL>

History Legacy command (existed before version 3.10).

:TRIGger:GLITch:WIDTh

Command :TRIGger:GLITch[{1 | 2}]:WIDTh <width>

This command sets the glitch width. The oscilloscope will trigger on a pulse that has a width less than the specified width.

The optional [{1 | 2}] parameter sets whether the trigger mode goes with the TERM1 or TERM2 state if sequential triggering is being used. Sequential triggering is available on 90000A Series, 90000 X-Series, V-Series, 90000 Q-Series, and Z-Series oscilloscopes.

<width> A real number for the glitch width, ranging from the minimum detectable pulse width to 10 s.

Query :TRIGger:GLITch:WIDTh?

The query returns the currently specified glitch width.

Returned Format [:TRIGger:GLITch:WIDTh] <width><NL>

History Legacy command (existed before version 3.10).

Pattern Trigger Commands

- `":TRIGger:PATtern:CONDition"` on page 1234
- `":TRIGger:PATtern:LOGic"` on page 1235

:TRIGger:PATtern:CONDition

Command :TRIGger:PATtern[{1 | 2}]:CONDition {ENTERed | EXITed
 | {GT,<time>[,PEXits|TIMEout]}
 | {LT,<time>}
 | {RANGe,<gt_time>,<lt_time>}}

This command describes the condition applied to the trigger pattern to actually generate a trigger.

The optional [{1 | 2}] parameter sets whether the trigger mode goes with the TERM1 or TERM2 state if sequential triggering is being used. Sequential triggering is available on 90000A Series, 90000 X-Series, V-Series, 90000 Q-Series, and Z-Series oscilloscopes.

<gt_time> The minimum time (greater than time) for the trigger pattern, from 10 ns to 9.999 s.

<lt_time> The maximum time (less than time) for the trigger pattern, from 10.5 ps to 10 s.

<time> The time condition, in seconds, for the pattern trigger, from 100 ps to 10 s.

When using the GT (Present >) parameter, the PEXits (Pattern Exits) or the TIMEout parameter controls when the trigger is generated.

Query :TRIGger:PATtern:CONDition?

The query returns the currently defined trigger condition.

Returned Format [:TRIGger:PATtern:CONDition] {ENTERed|EXITed
 | {GT,<time>[,PEXits|TIMEout]}
 | {LT,<time>}
 | {RANGe,<gt_time>,<lt_time>}}<NL>

History Legacy command (existed before version 3.10).

:TRIGger:PATtern:LOGic

Command :TRIGger:PATtern[{1 | 2}]:LOGic {CHANnel<N> | DIGital<M>},
{HIGH | LOW | DONTcare | RISing | FALLing}

This command defines the logic criteria for a selected channel.

The optional [{1 | 2}] parameter sets whether the trigger mode goes with the TERM1 or TERM2 state if sequential triggering is being used. Sequential triggering is available on 90000A Series, 90000 X-Series, V-Series, 90000 Q-Series, and Z-Series oscilloscopes.

<N> An integer, 1-4.

<M> An integer, 0-15. Digital channels are available on mixed-signal oscilloscopes.

Query :TRIGger:PATtern:LOGic? {CHANnel<N> | DIGital<M>}

The query returns the current logic criteria for a selected channel.

Returned Format [:TRIGger:PATtern:LOGic {CHANnel<N> | DIGital<M>},]
{HIGH | LOW | DONTcare | RISing | FALLing}<NL>

History Legacy command (existed before version 3.10).

Pulse Width Trigger Commands

- `":TRIGger:PWIDth:DIRection"` on page 1237
- `":TRIGger:PWIDth:POLarity"` on page 1238
- `":TRIGger:PWIDth:SOURce"` on page 1239
- `":TRIGger:PWIDth:TPOint"` on page 1240
- `":TRIGger:PWIDth:WIDTh"` on page 1241

:TRIGger:PWIDth:DIRection

Command :TRIGger:PWIDth[{1 | 2}]:DIRection {GTHan | LTHan}

This command specifies whether a pulse must be wider or narrower than the width value to trigger the oscilloscope.

The optional [{1 | 2}] parameter sets whether the trigger mode goes with the TERM1 or TERM2 state if sequential triggering is being used. Sequential triggering is available on 90000A Series, 90000 X-Series, V-Series, 90000 Q-Series, and Z-Series oscilloscopes.

Query :TRIGger:PWIDth:DIRection?

The query returns the currently defined direction for the pulse width trigger.

Returned Format [:TRIGger:PWIDth:DIRection] {GTHan | LTHan}<NL>

History Legacy command (existed before version 3.10).

:TRIGger:PWIDth:POLarity

Command :TRIGger:PWIDth[{1 | 2}]:POLarity {NEGative | POSitive}

This command specifies the pulse polarity that the oscilloscope uses to determine a pulse width violation. For a negative polarity pulse, the oscilloscope triggers when the rising edge of a pulse crosses the trigger level. For a positive polarity pulse, the oscilloscope triggers when the falling edge of a pulse crosses the trigger level.

The optional [{1 | 2}] parameter sets whether the trigger mode goes with the TERM1 or TERM2 state if sequential triggering is being used. Sequential triggering is available on 90000A Series, 90000 X-Series, V-Series, 90000 Q-Series, and Z-Series oscilloscopes.

Query :TRIGger:PWIDth:POLarity?

The query returns the currently defined polarity for the pulse width trigger.

Returned Format [:TRIGger:PWIDth:POLarity] {NEGative | POSitive}<NL>

History Legacy command (existed before version 3.10).

:TRIGger:PWIDth:SOURce

Command :TRIGger:PWIDth[{1 | 2}]:SOURce {CHANnel<N> | DIGital<M>}

This command specifies the channel source used to trigger the oscilloscope with the pulse width trigger.

The optional [{1 | 2}] parameter sets whether the trigger mode goes with the TERM1 or TERM2 state if sequential triggering is being used. Sequential triggering is available on 90000A Series, 90000 X-Series, V-Series, 90000 Q-Series, and Z-Series oscilloscopes.

<N> An integer, 1-4.

<M> An integer, 0-15. Digital channels are available on mixed-signal oscilloscopes.

Query :TRIGger:PWIDth:SOURce?

The query returns the currently defined channel source for the pulse width trigger.

Returned Format [:TRIGger:PWIDth:SOURce] {CHANnel<N> | DIGital<M>}<NL>

History Legacy command (existed before version 3.10).

:TRIGger:PWIDth:TPOint

Command :TRIGger:PWIDth[{1 | 2}]:TPOint {EPULse | TIMEout}

This command specifies whether the pulse width trigger should occur at the end of the pulse or at a specified timeout period. This command is only available if the pulse direction is set to GTHan.

The optional [{1 | 2}] parameter sets whether the trigger mode goes with the TERM1 or TERM2 state if sequential triggering is being used. Sequential triggering is available on 90000A Series, 90000 X-Series, V-Series, 90000 Q-Series, and Z-Series oscilloscopes.

Query :TRIGger:PWIDth:TPOint?

The query returns the currently defined trigger on point for the pulse width trigger.

Returned Format [:TRIGger:PWIDth:TPOint] {EPULse | TIMEout}<NL>

History Legacy command (existed before version 3.10).

:TRIGger:PWIDth:WIDTh

Command :TRIGger:PWIDth[{1 | 2}]:WIDTh <width>

This command specifies how wide a pulse must be to trigger the oscilloscope.

The optional [{1 | 2}] parameter sets whether the trigger mode goes with the TERM1 or TERM2 state if sequential triggering is being used. Sequential triggering is available on 90000A Series, 90000 X-Series, V-Series, 90000 Q-Series, and Z-Series oscilloscopes.

<width> Pulse width, which can range from 250 ps to 10 s.

Query :TRIGger:PWIDth:WIDTh?

The query returns the currently defined width for the pulse.

Returned Format [:TRIGger:PWIDth:WIDTh] <width><NL>

History Legacy command (existed before version 3.10).

Runt Trigger Commands

- **":TRIGger:RUNT:POLarity"** on page 1243
- **":TRIGger:RUNT:QUALified"** on page 1244
- **":TRIGger:RUNT:SOURce"** on page 1245
- **":TRIGger:RUNT:TIME"** on page 1246

:TRIGger:RUNT:POLarity

Command :TRIGger:RUNT[{1 | 2}]:POLarity {POSitive | NEGative}

This command defines the polarity of the runt pulse as positive or negative. The trigger source must be set using the :TRIGger:RUNT:SOURce command.

The optional [{1 | 2}] parameter sets whether the trigger mode goes with the TERM1 or TERM2 state if sequential triggering is being used. Sequential triggering is available on 90000A Series, 90000 X-Series, V-Series, 90000 Q-Series, and Z-Series oscilloscopes.

Query :TRIGger:RUNT:POLarity?

The query returns the currently selected runt pulse polarity.

Returned Format [:TRIGger:RUNT:POLarity] {POSitive | NEGative}<NL>

History Legacy command (existed before version 3.10).

:TRIGger:RUNT:QUALified

Command :TRIGger:RUNT[{1 | 2}]:QUALified {{ON | 1} | {OFF | 0}}

This command enables the time qualified runt pulse feature the polarity of the runt pulse as positive or negative. The trigger source must be set using the :TRIGger:RUNT:SOURce command.

The optional [{1 | 2}] parameter sets whether the trigger mode goes with the TERM1 or TERM2 state if sequential triggering is being used. Sequential triggering is available on 90000A Series, 90000 X-Series, V-Series, 90000 Q-Series, and Z-Series oscilloscopes.

Query :TRIGger:RUNT:QUALified?

The query returns the current state of the time qualified runt pulse feature.

Returned Format [:TRIGger:RUNT:QUALified] {1 | 0}<NL>

History Legacy command (existed before version 3.10).

:TRIGger:RUNT:SOURce

Command :TRIGger:RUNT[{1 | 2}]:SOURce CHANnel<N>

This command sets the source for the runt trigger mode.

The optional [{1 | 2}] parameter sets whether the trigger mode goes with the TERM1 or TERM2 state if sequential triggering is being used. Sequential triggering is available on 90000A Series, 90000 X-Series, V-Series, 90000 Q-Series, and Z-Series oscilloscopes.

<N> An integer, 1-4.

Query :TRIGger:RUNT:SOURce?

The query returns the currently selected source for the runt trigger mode.

Returned Format [:TRIGger:RUNT:SOURce] CHANnel<N><NL>

History Legacy command (existed before version 3.10).

:TRIGger:RUNT:TIME

Command :TRIGger:RUNT[{1 | 2}]:TIME <time>

This command sets the time qualifier. The oscilloscope will trigger on a runt pulse that has a width greater than the specified time.

The optional [{1 | 2}] parameter sets whether the trigger mode goes with the TERM1 or TERM2 state if sequential triggering is being used. Sequential triggering is available on 90000A Series, 90000 X-Series, V-Series, 90000 Q-Series, and Z-Series oscilloscopes.

<time> A real number for the time greater than qualifier, ranging from 250 ps to 30 ns.

Query :TRIGger:RUNT:TIME?

The query returns the currently specified glitch width.

Returned Format [:TRIGger:RUNT:TIME] <time><NL>

History Legacy command (existed before version 3.10).

Sequence Trigger Commands

The sequence trigger commands are available on 90000A Series, 90000 X-Series, V-Series, 90000 Q-Series, and Z-Series oscilloscopes.

- **":TRIGger:SEquence:TERM1 (90000A Series, 90000 X-Series, V-Series, 90000 Q-Series, Z-Series)"** on page 1248
- **":TRIGger:SEquence:TERM2 (90000A Series, 90000 X-Series, V-Series, 90000 Q-Series, Z-Series)"** on page 1249
- **":TRIGger:SEquence:RESet:ENABle (90000A Series, 90000 X-Series, V-Series, 90000 Q-Series, Z-Series)"** on page 1250
- **":TRIGger:SEquence:RESet:TYPE (90000A Series, 90000 X-Series, V-Series, 90000 Q-Series, Z-Series)"** on page 1251
- **":TRIGger:SEquence:RESet:EVENT (90000A Series, 90000 X-Series, V-Series, 90000 Q-Series, Z-Series)"** on page 1252
- **":TRIGger:SEquence:RESet:TIME (90000A Series, 90000 X-Series, V-Series, 90000 Q-Series, Z-Series)"** on page 1253
- **":TRIGger:SEquence:WAIT:ENABle (90000A Series, 90000 X-Series, V-Series, 90000 Q-Series, Z-Series)"** on page 1254
- **":TRIGger:SEquence:WAIT:TIME (90000A Series, 90000 X-Series, V-Series, 90000 Q-Series, Z-Series)"** on page 1255

:TRIGger:SEQuence:TERM1 (90000A Series, 90000 X-Series, V-Series, 90000 Q-Series, Z-Series)

Command :TRIGger:SEQuence:TERM1 { EDGE1 | GLITCh1 | PWIDTh1 | RUNT1 | SHOLd1
| STATe1 | TIMeout1 | TRANsition1 | WINDow1 }

This command specifies the trigger mode for the TERM1 state in the sequential trigger (the Find (A) state in the Trigger Setup dialog box on the oscilloscope).

There are five limitations associated with sequential triggering:

- 1 The Edge followed by Edge and Video trigger modes cannot be used in sequential triggering.
- 2 The AND qualifier cannot be used when the Reset condition is based upon a logical pattern.
- 3 The Pattern/State trigger mode that uses range as the When Pattern selection can only be used for either the Term1 state or the Term2 state, but not both.
- 4 You can only use one long timer (>30 ns). Therefore, trigger modes that use timers greater than 30 ns can only be used for either the Term1 state or the Term2 state, but not both. Some examples of trigger modes where you might use a long timer include Pulse Width, Glitch, Window, Edge Transition, and Timeout.
- 5 The alternating edge trigger mode cannot be used in sequential triggering.

Limitations (3) and (4) deal with extended resources. Extended resources refer to trigger modes or conditions that are only available to either the Term1 state or the Term2 state, but not both at the same time. The oscilloscope will figure out which state has access to these extended resources based upon the conditions you setup in each of these states. If you want Term2 to have a timer longer than 30 ns, you must first change the timer associated with Term1 to be less than 30 ns.

Query :TRIGger:SEQuence:TERM1?

The query returns the currently defined trigger mode for the TERM1 state.

History Legacy command (existed before version 3.10).

:TRIGger:SEQuence:TERM2 (90000A Series, 90000 X-Series, V-Series, 90000 Q-Series, Z-Series)

Command :TRIGger:SEQuence:TERM2 { EDGE2 | GLITCh2 | PWIDth2 | RUNT2 | SHOLd2
| STATE2 | TIMEout2 | TRANsition2 | WINDow2 }

This command specifies the trigger mode for the TERM2 state in the sequential trigger (the Trigger (B) state in the Trigger Setup dialog box on the oscilloscope).

There are five limitations associated with sequential triggering:

- 1 The Edge followed by Edge and Video trigger modes cannot be used in sequential triggering.
- 2 The AND qualifier cannot be used when the Reset condition is based upon a logical pattern.
- 3 The Pattern/State trigger mode that uses range as the When Pattern selection can only be used for either the Term1 state or the Term2 state, but not both.
- 4 You can only use one long timer (>30 ns). Therefore, trigger modes that use timers greater than 30 ns can only be used for either the Term1 state or the Term2 state, but not both. Some examples of trigger modes where you might use a long timer include Pulse Width, Glitch, Window, Edge Transition, and Timeout.
- 5 The alternating edge trigger mode cannot be used in sequential triggering.

Limitations (3) and (4) deal with extended resources. Extended resources refer to trigger modes or conditions that are only available to either the Term1 state or the Term2 state, but not both at the same time. The oscilloscope will figure out which state has access to these extended resources based upon the conditions you setup in each of these states. If you want Term2 to have a timer longer than 30 ns, you must first change the timer associated with Term1 to be less than 30 ns.

Query :TRIGger:SEQuence:TERM2?

The query returns the currently defined trigger mode for the TERM2 state.

History Legacy command (existed before version 3.10).

:TRIGger:SEQuence:RESet:ENABle (90000A Series, 90000 X-Series, V-Series, 90000 Q-Series, Z-Series)

Command :TRIGger:SEQuence:RESet:ENABle {{ON | 1} | {OFF | 0}}

This command turns the Reset feature on or off for the sequential trigger.

The Reset feature allows you to specify a length of time such that if this time is exceeded between when the TERM1 event occurs and when the TERM2 event occurs, the sequential trigger is reset and the oscilloscope returns to looking for the TERM1 event without triggering. If the Delay feature (remote command :WAIT) is used as well then the Reset timer does not start counting down until after the delay period is complete.

You can also base the Reset condition on a logical pattern. If the specified pattern is found between when the TERM1 occurs and the TERM2 event occurs, the sequential trigger resets and goes back to looking for the TERM1 event without triggering. The delay feature does not impact a logical pattern Reset as the pattern is searched for immediately after the TERM1 event occurs regardless of whether or not the Delay period is complete.

If the Reset feature is enabled, the AND qualifier cannot be used for the TERM1 state.

Query :TRIGger:SEQuence:RESet:ENABle?

The query returns whether or not the Reset feature is enabled.

History Legacy command (existed before version 3.10).

:TRIGger:SEQuence:RESet:TYPE (90000A Series, 90000 X-Series, V-Series, 90000 Q-Series, Z-Series)

Command :TRIGger:SEQuence:RESet:TYPE { TIME | EVENT }

This command specifies whether the Reset condition is based upon a length of time or a logical pattern.

The Reset feature allows you to specify a length of time such that if this time is exceeded between when the TERM1 event occurs and when the TERM2 event occurs, the sequential trigger is reset and the oscilloscope returns to looking for the TERM1 event without triggering. If the Delay feature (remote command :WAIT) is used as well then the Reset timer does not start counting down until after the delay period is complete.

You can also base the Reset condition on a logical pattern. If the specified pattern is found between when the TERM1 occurs and the TERM2 event occurs, the sequential trigger resets and goes back to looking for the TERM1 event without triggering. The delay feature does not impact a logical pattern Reset as the pattern is searched for immediately after the TERM1 event occurs regardless of whether or not the Delay period is complete.

Query :TRIGger:SEQuence:RESet:TYPE?

The query returns whether the Reset condition is based upon a length of time or an event.

History Legacy command (existed before version 3.10).

:TRIGger:SEQuence:RESet:EVENT (90000A Series, 90000 X-Series, V-Series, 90000 Q-Series, Z-Series)

Command :TRIGger:SEQuence:RESet:EVENT {CHANnel<N>}, { HIGH | LOW | DONTcare }

This command defines the logical pattern used for an event Reset condition.

You can specify for each channel (1-4) whether you want the value to be high (1), low (0), or you don't care (X).

<N> An integer, 1-4.

Query :TRIGger:SEQuence:RESet:EVENT? {CHANnel<N>}

The query returns the logical pattern used for an event Reset condition.

History Legacy command (existed before version 3.10).

:TRIGger:SEQuence:RESet:TIME (90000A Series, 90000 X-Series, V-Series, 90000 Q-Series, Z-Series)

Command :TRIGger:SEQuence:RESet:TIME <time>

This command defines the length of time to use for the time-based Reset condition.

<time> A length of time in seconds.

Query :TRIGger:SEQuence:RESet:TIME?

The query returns the length of time used for the Reset condition.

History Legacy command (existed before version 3.10).

:TRIGger:SEQuence:WAIT:ENABle (90000A Series, 90000 X-Series, V-Series, 90000 Q-Series, Z-Series)

Command :TRIGger:SEQuence:WAIT:ENABle { {ON|1} | {OFF|0} }

This command turns the Delay feature on or off for the sequential trigger.

The Delay feature allows you to define a length of time for the sequential trigger system to wait after the TERM1 event occurs before it starts searching for the TERM2 event.

Query :TRIGger:SEQuence:WAIT:ENABle?

The query returns whether or not the Delay feature is turned on.

History Legacy command (existed before version 3.10).

:TRIGger:SEQuence:WAIT:TIME (90000A Series, 90000 X-Series, V-Series, 90000 Q-Series, Z-Series)

Command :TRIGger:SEQuence:WAIT:TIME <time>

This command defines the length of time to use for the Delay condition.

<time> A length of time in seconds.

Query :TRIGger:SEQuence:WAIT:TIME?

The query returns the length of time used for the Delay condition.

History Legacy command (existed before version 3.10).

Setup and Hold Trigger Commands

- `":TRIGger:SHOLd:CSource"` on page 1257
- `":TRIGger:SHOLd:CSource:EDGE"` on page 1258
- `":TRIGger:SHOLd:DSource"` on page 1259
- `":TRIGger:SHOLd:HoldTIme (HTIME)"` on page 1260
- `":TRIGger:SHOLd:MODE"` on page 1261
- `":TRIGger:SHOLd:SetupTIme"` on page 1262

:TRIGger:SHOLd:CSOource

Command :TRIGger:SHOLd[{1 | 2}]:CSOource CHANnel<N>

This command specifies the clock source for the clock used for the trigger setup and hold violation. The clock must pass through the voltage level you have set before the trigger circuitry looks for a setup and hold time violation.

The optional [{1 | 2}] parameter sets whether the trigger mode goes with the TERM1 or TERM2 state if sequential triggering is being used. Sequential triggering is available on 90000A Series, 90000 X-Series, V-Series, 90000 Q-Series, and Z-Series oscilloscopes.

<N> An integer, 1-4.

Query :TRIGger:SHOLd:CSOource?

The query returns the currently defined clock source for the trigger setup and hold violation.

Returned Format [:TRIGger:SHOLd:CSOource] CHANnel<N><NL>

History Legacy command (existed before version 3.10).

:TRIGger:SHOLd:CSOurce:EDGE

Command :TRIGger:SHOLd[{1 | 2}]:CSOurce:EDGE {RISing | FALLing}

This command specifies the clock source trigger edge for the clock used for the trigger setup and hold violation. The clock must pass through the voltage level you have set before the trigger circuitry looks for a setup and hold time violation.

The optional [{1 | 2}] parameter sets whether the trigger mode goes with the TERM1 or TERM2 state if sequential triggering is being used. Sequential triggering is available on 90000A Series, 90000 X-Series, V-Series, 90000 Q-Series, and Z-Series oscilloscopes.

Query :TRIGger:SHOLd:CSOurce:EDGE?

The query returns the currently defined clock source edge for the trigger setup and hold violation level for the clock source.

Returned Format [:TRIGger:SHOLd:CSOurce:EDGE] {RISing | FALLing}<NL>

History Legacy command (existed before version 3.10).

:TRIGger:SHOLd:DSOource

Command :TRIGger:SHOLd[{1 | 2}]:DSOource CHANnel<N>

The data source commands specify the data source for the trigger setup and hold violation.

The optional [{1 | 2}] parameter sets whether the trigger mode goes with the TERM1 or TERM2 state if sequential triggering is being used. Sequential triggering is available on 90000A Series, 90000 X-Series, V-Series, 90000 Q-Series, and Z-Series oscilloscopes.

<N> An integer, 1-4.

Query :TRIGger:SHOLd:DSOource?

The query returns the currently defined data source for the trigger setup and hold violation.

Returned Format [:TRIGger:SHOLd:DSOource] CHANnel<N><NL>

History Legacy command (existed before version 3.10).

:TRIGger:SHOLd:HoldTIME (HTIME)

Command :TRIGger:SHOLd[{1 | 2}]:HoldTIME <time>

This command specifies the amount of hold time used to test for both a setup and hold trigger violation. The hold time is the amount of time that the data must be stable and valid after a clock edge.

The optional [{1 | 2}] parameter sets whether the trigger mode goes with the TERM1 or TERM2 state if sequential triggering is being used. Sequential triggering is available on 90000A Series, 90000 X-Series, V-Series, 90000 Q-Series, and Z-Series oscilloscopes.

<time> Hold time, in seconds.

Query :TRIGger:SHOLd:HoldTIME?

The query returns the currently defined hold time for the setup and hold trigger violation.

Returned Format [:TRIGger:SHOLd:HoldTIME] <time><NL>

History Legacy command (existed before version 3.10).

:TRIGger:SHOLd:MODE

Command :TRIGger:SHOLd[{1 | 2}]:MODE {SETup | HOLD | SHOLd}

SETup When using the setup time mode, a time window is defined where the right edge is the clock edge and the left edge is the selected time before the clock edge. The waveform must stay outside of the trigger level thresholds during this time window. If the waveform crosses a threshold during this time window, a violation event occurs and the oscilloscope triggers.

HOLD When using the hold time mode, the waveform must not cross the threshold voltages after the specified clock edge for at least the hold time you have selected. Otherwise, a violation event occurs and the oscilloscope triggers.

SHOLd When using the setup and hold time mode, if the waveform violates either a setup time or hold time, the oscilloscope triggers. The total time allowed for the sum of setup time plus hold time is 24 ns maximum.

The optional [{1 | 2}] parameter sets whether the trigger mode goes with the TERM1 or TERM2 state if sequential triggering is being used. Sequential triggering is available on 90000A Series, 90000 X-Series, V-Series, 90000 Q-Series, and Z-Series oscilloscopes.

Query :TRIGger:SHOLd:MODE?

The query returns the currently selected trigger setup violation mode.

Returned Format [:TRIGger:SHOLd:MODE] {SETup | HOLD | SHOLd}<NL>

History Legacy command (existed before version 3.10).

:TRIGger:SHOLd:SetupTIme

Command :TRIGger:SHOLd[{1 | 2}]:SetupTIme <time>

This command specifies the amount of setup time used to test for both a setup and hold trigger violation. The setup time is the amount of time that the data must be stable and valid before a clock edge.

The optional [{1 | 2}] parameter sets whether the trigger mode goes with the TERM1 or TERM2 state if sequential triggering is being used. Sequential triggering is available on 90000A Series, 90000 X-Series, V-Series, 90000 Q-Series, and Z-Series oscilloscopes.

<time> Setup time, in seconds.

Query :TRIGger:SHOLd:SetupTIme?

The query returns the currently defined setup time for the setup and hold trigger violation.

Returned Format [:TRIGger:SHOLd:SetupTIme] <time><NL>

History Legacy command (existed before version 3.10).

State Trigger Commands

- `":TRIGger:STATe:CLOCK"` on page 1264
- `":TRIGger:STATe:LOGic"` on page 1265
- `":TRIGger:STATe:LTYPe"` on page 1266
- `":TRIGger:STATe:SLOPe"` on page 1267

:TRIGger:STATe:CLOCK

Command :TRIGger:STATe[{1 | 2}]:CLOCK {CHANnel<N> | DIGital<M>}

This command selects the source for the clock waveform in the State Trigger Mode.

The optional [{1 | 2}] parameter sets whether the trigger mode goes with the TERM1 or TERM2 state if sequential triggering is being used. Sequential triggering is available on 90000A Series, 90000 X-Series, V-Series, 90000 Q-Series, and Z-Series oscilloscopes.

<N> An integer, 1-4.

<M> An integer, 0-15. Digital channels are available on mixed-signal oscilloscopes.

Query :TRIGger:STATe:CLOCK?

The query returns the currently selected clock source.

Returned Format [:TRIGger:STATe:CLOCK] {CHANnel<N> | DIGital<M>}<NL>

History Legacy command (existed before version 3.10).

:TRIGger:STATe:LOGic

Command :TRIGger:STATe[{1 | 2}]:LOGic {CHANnel<N> | DIGital<M>},
{LOW | HIGH | DONTcare | RISing | FALLing}

This command defines the logic state of the specified source for the state pattern. The command produces a settings conflict on a channel that has been defined as the clock.

The optional [{1 | 2}] parameter sets whether the trigger mode goes with the TERM1 or TERM2 state if sequential triggering is being used. Sequential triggering is available on 90000A Series, 90000 X-Series, V-Series, 90000 Q-Series, and Z-Series oscilloscopes.

<N> An integer, 1-4.

<M> An integer, 0-15. Digital channels are available on mixed-signal oscilloscopes.

Query :TRIGger:STATe:LOGic? {CHANnel<N> | DIGital<M>}

The query returns the logic state definition for the specified source.

Returned Format [:TRIGger:STATe:LOGic {CHANnel<N> | DIGital<M>},]
{LOW | HIGH | DONTcare | RISing | FALLing}<NL>

History Legacy command (existed before version 3.10).

:TRIGger:STATe:LTYPe

Command :TRIGger:STATe[{1 | 2}]:LTYPe {AND | NAND}

This command defines the state trigger logic type. If the logic type is set to AND, then a trigger is generated on the edge of the clock when the input waveforms match the pattern specified by the :TRIGger:STATe:LOGic command. If the logic type is set to NAND, then a trigger is generated on the edge of the clock when the input waveforms do not match the specified pattern.

The optional [{1 | 2}] parameter sets whether the trigger mode goes with the TERM1 or TERM2 state if sequential triggering is being used. Sequential triggering is available on 90000A Series, 90000 X-Series, V-Series, 90000 Q-Series, and Z-Series oscilloscopes.

Query :TRIGger:STATe:LTYPe?

The query returns the currently specified state trigger logic type.

Returned Format [:TRIGger:STATe:LTYPe] {AND | NAND}<NL>

History Legacy command (existed before version 3.10).

:TRIGger:STATe:SLOPe

Command :TRIGger:STATe[{1 | 2}]:SLOPe {RISing | FALLing | EITHer}

This command specifies the edge of the clock that is used to generate a trigger. The waveform source used for the clock is selected by using the :TRIGger:STATe:CLOCK command.

The optional [{1 | 2}] parameter sets whether the trigger mode goes with the TERM1 or TERM2 state if sequential triggering is being used. Sequential triggering is available on 90000A Series, 90000 X-Series, V-Series, 90000 Q-Series, and Z-Series oscilloscopes.

Query :TRIGger:STATe:SLOPe?

The query returns the currently defined slope for the clock in State Trigger Mode.

Returned Format [:TRIGger:STATe:SLOPe] {RISing | FALLing | EITHer}<NL>

History Legacy command (existed before version 3.10).

Timeout Trigger Commands

- **":TRIGger:TIMEout:CONDition"** on page 1269
- **":TRIGger:TIMEout:SOURce"** on page 1270
- **":TRIGger:TIMEout:TIME"** on page 1271

:TRIGger:TIMEout:CONDition

Command :TRIGger:TIMEout[{1 | 2}]:CONDition {HIGH | LOW | UNCHanged}

The optional [{1 | 2}] parameter sets whether the trigger mode goes with the TERM1 or TERM2 state if sequential triggering is being used. Sequential triggering is available on 90000A Series, 90000 X-Series, V-Series, 90000 Q-Series, and Z-Series oscilloscopes.

This command sets the condition used for the timeout trigger.

HIGH Trigger when the waveform has been high for a period time longer than the time value which is set by the TRIGger:TIMEout:TIME command.

LOW Trigger when the waveform has been low for a period time longer than the time value which is set by the TRIGger:TIMEout:TIME command.

UNCHanged Trigger when the waveform has not changed state for a period time longer than the time value which is set by the TRIGger:TIMEout:TIME command.

Query :TRIGger:TIMEout:CONDition?

The query returns the currently defined trigger condition for the timeout trigger.

Returned Format [:TRIGger:TIMEout:CONDition] {HIGH | LOW | UNCHanged}<NL>

History Legacy command (existed before version 3.10).

:TRIGger:TIMEout:SOURce

Command :TRIGger:TIMEout [{1 | 2}]:SOURce CHANnel<N>

This command specifies the channel source used to trigger the oscilloscope with the timeout trigger.

The optional [{1 | 2}] parameter sets whether the trigger mode goes with the TERM1 or TERM2 state if sequential triggering is being used. Sequential triggering is available on 90000A Series, 90000 X-Series, V-Series, 90000 Q-Series, and Z-Series oscilloscopes.

<N> An integer, 1-4.

Query :TRIGger:TIMEout:SOURce?

The query returns the currently defined channel source for the timeout trigger.

Returned Format [:TRIGger:TIMEout:SOURce] CHANnel<N><NL>

History Legacy command (existed before version 3.10).

:TRIGger:TIMEout:TIME

Command :TRIGger:TIMEout[{1 | 2}]:TIME <time>

This command lets you look for transition violations that are greater than or less than the time specified.

The optional [{1 | 2}] parameter sets whether the trigger mode goes with the TERM1 or TERM2 state if sequential triggering is being used. Sequential triggering is available on 90000A Series, 90000 X-Series, V-Series, 90000 Q-Series, and Z-Series oscilloscopes.

<time> The time for the timeout trigger, in seconds.

Query :TRIGger:TIMEout:TIME?

The query returns the currently defined time for the trigger trigger.

Returned Format [:TRIGger:TIMEout:TIME] <time><NL>

History Legacy command (existed before version 3.10).

Transition Trigger Commands

- **":TRIGger:TRANSition:DIRection"** on page 1273
- **":TRIGger:TRANSition:SOURce"** on page 1274
- **":TRIGger:TRANSition:TIME"** on page 1275
- **":TRIGger:TRANSition:TYPE"** on page 1276

:TRIGger:TRANSition:DIRection

Command :TRIGger:TRANSition[{1 | 2}]:DIRection {GTHan | LTHan}

This command lets you look for transition violations that are greater than or less than the time specified by the :TRIGger:TRANSition:TIME command.

The optional [{1 | 2}] parameter sets whether the trigger mode goes with the TERM1 or TERM2 state if sequential triggering is being used. Sequential triggering is available on 90000A Series, 90000 X-Series, V-Series, 90000 Q-Series, and Z-Series oscilloscopes.

Query :TRIGger:TRANSition:DIRection?

The query returns the currently defined direction for the trigger transition violation.

Returned Format [:TRIGger:TRANSition:DIRection] {GTHan | LTHan}<NL>

History Legacy command (existed before version 3.10).

:TRIGger:TRANSition:SOURce

Command :TRIGger:TRANSition[{1 | 2}]:SOURce CHANnel<N>

The transition source command lets you find any edge in your waveform that violates a rise time or fall time specification. The oscilloscope finds a transition violation trigger by looking for any pulses in your waveform with rising or falling edges that do not cross two voltage levels in the amount of time you have specified.

The optional [{1 | 2}] parameter sets whether the trigger mode goes with the TERM1 or TERM2 state if sequential triggering is being used. Sequential triggering is available on 90000A Series, 90000 X-Series, V-Series, 90000 Q-Series, and Z-Series oscilloscopes.

<N> An integer, 1-4.

Query :TRIGger:TRANSition:SOURce?

The query returns the currently defined transition source for the trigger transition violation.

Returned Format [:TRIGger:TRANSition:SOURce] CHANnel<N><NL>

History Legacy command (existed before version 3.10).

:TRIGger:TRANSition:TIME

Command :TRIGger:TRANSition[{1 | 2}]:TIME <time>

This command lets you look for transition violations that are greater than or less than the time specified.

The optional [{1 | 2}] parameter sets whether the trigger mode goes with the TERM1 or TERM2 state if sequential triggering is being used. Sequential triggering is available on 90000A Series, 90000 X-Series, V-Series, 90000 Q-Series, and Z-Series oscilloscopes.

<time> The time for the trigger violation transition, in seconds.

Query :TRIGger:TRANSition:TIME?

The query returns the currently defined time for the trigger transition violation.

Returned Format [:TRIGger:TRANSition:TIME] <time><NL>

History Legacy command (existed before version 3.10).

:TRIGger:TRANSition:TYPE

Command :TRIGger:TRANSition[{1 | 2}]:TYPE {RISetime | FALLtime}

This command lets you select either a rise time or fall time transition violation trigger event.

The optional [{1 | 2}] parameter sets whether the trigger mode goes with the TERM1 or TERM2 state if sequential triggering is being used. Sequential triggering is available on 90000A Series, 90000 X-Series, V-Series, 90000 Q-Series, and Z-Series oscilloscopes.

Query :TRIGger:TRANSition:TYPE?

The query returns the currently defined transition type for the trigger transition violation.

Returned Format [:TRIGger:TRANSition:TYPE] {RISetime | FALLtime}<NL>

History Legacy command (existed before version 3.10).

TV Trigger Commands

- `":TRIGger:TV:LINE"` on page 1278
- `":TRIGger:TV:MODE"` on page 1279
- `":TRIGger:TV:POLarity"` on page 1280
- `":TRIGger:TV:SOURce"` on page 1281
- `":TRIGger:TV:STANdard"` on page 1282
- `":TRIGger:TV:UDTV:ENUMber"` on page 1283
- `":TRIGger:TV:UDTV:HSYNc"` on page 1284
- `":TRIGger:TV:UDTV:HTIME"` on page 1285
- `":TRIGger:TV:UDTV:PGTHan"` on page 1286
- `":TRIGger:TV:UDTV:POLarity"` on page 1287

:TRIGger:TV:LINE

Command :TRIGger:TV:LINE <line_number>

The :TRIGger:TV:LINE command selects the horizontal line that you want to examine. The allowable line number entry depends on the :TRIGger:TV:MODE selected. Once the vertical sync pulse of the selected field is received, the trigger is delayed by the number of lines specified.

<line_number> Horizontal line number as shown below.

| Video Standard | Field 1 | Field 2 | Alternate Field |
|----------------|----------|------------|-----------------|
| NTSC/PAL-M | 1 to 263 | 1 to 262 | 1 to 262 |
| PAL/SECAM | 1 to 313 | 314 to 625 | 1 to 312 |

| EDTV/HDTV | Line numbers |
|---------------|--------------|
| EDTV 480p/60 | 1 to 525 |
| EDTV 576p/50 | 1 to 625 |
| HDTV 720p/60 | 1 to 750 |
| HDTV 720p/50 | 1 to 750 |
| HDTV 1080i/60 | 1 to 1125 |
| HDTV 1080i/50 | 1 to 1125 |
| HDTV1080p/60 | 1 to 1125 |
| HDTV 1080p/50 | 1 to 1125 |
| HDTV 1080p/30 | 1 to 1125 |
| HDTV 1080p/25 | 1 to 1125 |
| HDTV 1080p/24 | 1 to 1125 |

Query :TRIGger:TV:LINE?

The query returns the current line number.

Returned Format [:TRIGger:TV:LINE] <line_number><NL>

History Legacy command (existed before version 3.10).

:TRIGger:TV:MODE

Command :TRIGger:TV:MODE {AFIElds | ALINes | ALTernate | FIElds1 | FIElds2 | LINE}

The :TRIGger:TV:MODE command determines which portion of the video waveform is used to trigger.

Query :TRIGger:TV:MODE?

The query returns the current TV trigger mode.

Returned Format [:TRIGger:TV:MODE] {AFIElds | ALINes | ALTernate | FIElds1 | FIElds2 | LINE}<NL>

History Legacy command (existed before version 3.10).

:TRIGger:TV:POLarity

Command :TRIGger:TV:POLarity {NEGative | POSitive}

The :TRIGger:TV:POLarity command specifies the vertical sync pulse polarity for the selected field used during TV mode triggering.

Query :TRIGger:TV:POLarity?

The query returns the currently selected sync pulse polarity.

Returned Format [:TRIGger:TV:POLarity] {NEGative | POSitive}<NL>

History Legacy command (existed before version 3.10).

:TRIGger:TV:SOURce

Command :TRIGger:TV:SOURce CHANnel<N>

The :TRIGger:TV:SOURce command selects the source for the TV mode triggering. This is the source that will be used for subsequent :TRIGger:TV commands and queries.

<N> An integer, 1-4.

Query :TRIGger:TV:SOURce?

The query returns the currently selected standard TV trigger mode source.

Returned Format [:TRIGger:TV:SOURce] CHANnel<N>NL>

History Legacy command (existed before version 3.10).

:TRIGger:TV:STANdard

Command :TRIGger:TV:STANdard {I1080L60HZ | I1080L50HZ | L525 | L625 | P480L60HZ
 | P576L50HZ | P720L60HZ | P720L50HZ | P1080L60HZ | P1080L50HZ
 | P1080L30HZ | P1080L25HZ | P1080L24HZ | UDTV}

The TRIGger:TV:STANdard command sets triggering to one of the standard video types. There is also a user defined TV type that can be used to set the triggering to one of the non-standard types of video.

Query :TRIGger:TV:STANdard?

The query returns the currently selected video standard.

Returned Format [:TRIGger:TV:STANdard] {I1080L60HZ | I1080L50HZ | L525 | L625
 | P480L60HZ | P576L50HZ | P720L60HZ | P720L50HZ | P1080L60HZ
 | P1080L50HZ | P1080L40HZ | P1080L30HZ | P1080L25HZ | P1080L24HZ
 | UDTV}<NL>

History Legacy command (existed before version 3.10).

:TRIGger:TV:UDTV:ENUMber

Command :TRIGger:TV:UDTV:ENUMber <count>

The :TRIGger:TV:UDTV:ENUMber command specifies the number of events (horizontal sync pulses) to delay after arming the trigger before looking for the trigger event. Specify conditions for arming the trigger using:

TRIGger:TV:UDTV:PGTHan, and

TRIGger:TV:UDTV:POLarity.

<count> An integer for the number of events to delay. Allowable values range from 1 to 16,000,000.

Query :TRIGger:TV:UDTV:ENUMber?

The query returns the currently programmed count value.

Returned Format [:TRIGger:TV:UDTV:ENUMber] <count><NL>

History Legacy command (existed before version 3.10).

:TRIGger:TV:UDTV:HSYNc

Command :TRIGger:TV:UDTV:HSYNc {ON | 1} | {OFF | 0}

This command enables the horizontal sync mode of triggering.

Query :TRIGger:TV:UDTV:HSYNc?

The query returns the current state of the horizontal sync mode of triggering.

Returned Format [:TRIGger:TV:UDTV:HSYNc] {1 | 0}<NL>

History Legacy command (existed before version 3.10).

:TRIGger:TV:UDTV:HTIME

Command :TRIGger:TV:UDTV:HTIME <time>

The :TRIGger:TV:UDTV:HTIME command sets the time that a sync pulse must be present to be considered a valid sync pulse.

<time> A real number that is the time width for the sync pulse.

Query :TRIGger:TV:UDTV:HTIME?

The query returns the currently defined time for the sync pulse width.

Returned Format [:TRIGger:TV:UDTV:HTIME] <time><NL>

History Legacy command (existed before version 3.10).

:TRIGger:TV:UDTV:PGTHan

Command :TRIGger:TV:UDTV:PGTHan <lower_limit>

The :TRIGger:TV:UDTV:PGTHan (Present Greater THan) command specifies the minimum pulse width of the waveform used to arm the trigger used during user-defined trigger mode.

<lower_limit> Minimum pulse width (time >), from 5 ns to 9.9999999 s.

Query :TRIGger:TV:UDTV:PGTHan?

The query returns the currently selected minimum pulse width.

Returned Format [:TRIGger:TV:UDTV:PGTHan] <lower_limit><NL>

History Legacy command (existed before version 3.10).

:TRIGger:TV:UDTV:POLarity

Command :TRIGger:TV:UDTV:POLarity {NEGative | POSitive}

The :TRIGger:TV:UDTV:POLarity command specifies the polarity for the sync pulse used to arm the trigger in the user-defined trigger mode.

Query :TRIGger:TV:UDTV:POLarity?

The query returns the currently selected UDTV sync pulse polarity.

Returned Format [:TRIGger:TV:UDTV:POLarity] {NEGative | POSitive}<NL>

History Legacy command (existed before version 3.10).

Window Trigger Commands

- **":TRIGger:WINDow:CONDition"** on page 1289
- **":TRIGger:WINDow:SOURce"** on page 1290
- **":TRIGger:WINDow:TIME"** on page 1291
- **":TRIGger:WINDow:TPOint"** on page 1292

:TRIGger:WINDow:CONDition

Command :TRIGger:WINDow[{1 | 2}]:CONDition {ENTer | EXIT
 | INSide [, {GTHan | LTHan}]
 | OUTSide [, {GTHan | LTHan}]}

This command describes the condition applied to the trigger window to actually generate a trigger.

The optional [{1 | 2}] parameter sets whether the trigger mode goes with the TERM1 or TERM2 state if sequential triggering is being used. Sequential triggering is available on 90000A Series, 90000 X-Series, V-Series, 90000 Q-Series, and Z-Series oscilloscopes.

Query :TRIGger:WINDow:CONDition?

The query returns the currently defined trigger condition.

Returned Format [:TRIGger:WINDow:CONDition] {ENTer | EXIT
 | INSide, {GTHan | LTHan}
 | OUTSide, {GTHan | LTHan}}<NL>

History Legacy command (existed before version 3.10).

:TRIGger:WINDow:SOURce

Command :TRIGger:WINDow[{1 | 2}]:SOURce CHANnel<N>

This command specifies the channel source used to trigger the oscilloscope with the window trigger.

The optional [{1 | 2}] parameter sets whether the trigger mode goes with the TERM1 or TERM2 state if sequential triggering is being used. Sequential triggering is available on 90000A Series, 90000 X-Series, V-Series, 90000 Q-Series, and Z-Series oscilloscopes.

<N> An integer, 1-4.

Query :TRIGger:WINDow:SOURce?

The query returns the currently defined channel source for the window trigger.

Returned Format [:TRIGger:WINDow:SOURce] CHANnel<N><NL>

History Legacy command (existed before version 3.10).

:TRIGger:WINDow:TIME

Command :TRIGger:WINDow[{1 | 2}]:TIME <time>

This command lets you look for transition violations that are greater than or less than the time specified.

The optional [{1 | 2}] parameter sets whether the trigger mode goes with the TERM1 or TERM2 state if sequential triggering is being used. Sequential triggering is available on 90000A Series, 90000 X-Series, V-Series, 90000 Q-Series, and Z-Series oscilloscopes.

<time> The time for the trigger violation transition, in seconds.

Query :TRIGger:WINDow:TIME?

The query returns the currently defined time for the trigger window timeout.

Returned Format [:TRIGger:WINDow:TIME] <time><NL>

History Legacy command (existed before version 3.10).

:TRIGger:WINDow:TPOint

Command :TRIGger:WINDow[{1 | 2}]:TPOint {BOUNDary | TIMEout}

This command specifies whether the window trigger should occur at the boundary of the window or at a specified timeout period.

The optional [{1 | 2}] parameter sets whether the trigger mode goes with the TERM1 or TERM2 state if sequential triggering is being used. Sequential triggering is available on 90000A Series, 90000 X-Series, V-Series, 90000 Q-Series, and Z-Series oscilloscopes.

Query :TRIGger:WINDow:TPOint?

The query returns the currently defined trigger on point for the pulse width trigger.

Returned Format [:TRIGger:PWIDth:TPOint] {BOUNDary | TIMEout}<NL>

History Legacy command (existed before version 3.10).

Advanced Comm Trigger Commands

Use the COMM Trigger Mode to find a serial pattern of bits in a waveform. The COMM Trigger Mode is primarily used to find an isolated logically one bit in a waveform for mask testing applications. The pattern is defined by the standards used by the telecommunication and data communication industries. Mask testing is used to verify a waveform meets industrial standards which guarantees that equipment made by different manufacturers will work together.

Set the Mode Before Executing Commands

Before you can execute the :TRIGger:ADVanced:COMMunications commands, mask testing must be enabled at least one time. The :MTEST:ENABLE command enables or disables mask testing. Then you can set the mode by entering:

```
:TRIGger:MODE ADVanced and
:TRIGger:ADVanced:MODE COMM
```

To query the oscilloscope for the advanced trigger mode, enter:

```
:TRIGger:ADVanced:MODE?
```

The :TRIGger:ADVanced:COMM commands define the Communications Trigger Mode. As described in the following commands, you set up the :TRIGger:ADVanced:COMM commands with the following commands and queries.

- **":TRIGger:ADVanced:COMM:BWIDth"** on page 1294
- **":TRIGger:ADVanced:COMM:ENCode"** on page 1295
- **":TRIGger:ADVanced:COMM:LEVel"** on page 1296
- **":TRIGger:ADVanced:COMM:PATtern"** on page 1297
- **":TRIGger:ADVanced:COMM:POLarity"** on page 1298
- **":TRIGger:ADVanced:COMM:SOURce"** on page 1299

:TRIGger:ADVanced:COMM:BWIDth

Command :TRIGger:ADVanced:COMM:BWIDth <bwidth_value>

The :TRIGger:ADVanced:COMM:BWIDth command is used to set the width of a bit for your waveform. The bit width is usually defined in the mask standard for your waveform.

<bwidth_value> A real number that represents the width of a bit.

Query :TRIGger:ADVanced:COMM:BWIDth?

The query returns the current bit width.

Returned Format [:TRIGger:ADVanced:COMM:BWIDth] <bwidth_value><NL>

History Legacy command (existed before version 3.10).

:TRIGger:ADVanced:COMM:ENCode

Command :TRIGger:ADVanced:COMM:ENCode {RZ | NRZ}

This :TRIGger:ADVanced:COMM:ENCode command sets the type of waveform encoding for your waveform. You should use NRZ for CMI type waveforms and RZ for all other type of waveforms.

Query :TRIGger:ADVanced:COMM:ENCode?

The :TRIGger:ADVanced:COMM:ENCode? query returns the current value of encoding

Returned Format [:TRIGger:ADVanced:COMM:ENCode] {RZ | NRZ}<NL>

History Legacy command (existed before version 3.10).

:TRIGger:ADVanced:COMM:LEVel

Command :TRIGger:ADVanced:COMM:LEVel CHANnel<N>, <level>

The :TRIGger:ADVanced:COMM:LEVel command sets the voltage level used to determine a logic 1 from a logic 0 for the communication pattern.

<N> An integer, 1-4.

<level> A real number which is the logic level voltage.

Query :TRIGger:ADVanced:COMM:LEVel? CHANnel<N>

The :TRIGger:ADVanced:COMM:LEVel? query returns the current level for the communication pattern.

Returned Format [:TRIGger:ADVanced:COMM:LEVel CHANnel<N>], <level><NL>

History Legacy command (existed before version 3.10).

:TRIGger:ADVanced:COMM:PATtern

Command :TRIGger:ADVanced:COMM:PATtern <bit>[,<bit>[,<bit>[,<bit>[,<bit>[,<bit>]]]]

The :TRIGger:ADVanced:COMM:PATtern command sets the pattern used for triggering the oscilloscope when in communication trigger mode. The pattern can be up to 6 bits long. For NRZ type waveforms with positive polarity, there must be at least one logic 0 to logic 1 transition in the pattern. For NRZ waveforms with negative polarity there must be at least one logic 1 to logic 0 transition in the pattern. For RZ type waveforms the pattern must have at least one logic 1 bit for positive polarity. For RZ type waveforms the pattern must have at least one logic -1 bit for negative polarity.

<bit> A 1, -1, or 0.

Query :TRIGger:ADVanced:COMM:PATtern?

The :TRIGger:ADVanced:COMM:PATtern? query returns the current communication trigger pattern.

Returned Format [:TRIGger:ADVanced:COMM:PATtern] <pattern><NL>

<pattern> A string of up to 6 characters.

History Legacy command (existed before version 3.10).

:TRIGger:ADVanced:COMM:POLarity

Command :TRIGger:ADVanced:COMM:POLarity {POSitive | NEGative}

The :TRIGger:ADVanced:COMM:POLarity command directly controls the trigger slope used for communication trigger. When set to a positive value, the rising edge of a pulse or waveform is used to trigger the oscilloscope. When set to a negative value, the falling edge of a pulse or waveform is used.

The polarity setting is also used to check for valid patterns. If you are trying to trigger on an isolated 1 pattern, you should set the polarity to positive. If you are trying to trigger on an isolated -1 pattern, you should set the polarity to negative.

Query :TRIGger:ADVanced:COMM:POLarity?

The :TRIGger:ADVanced:COMM:POLarity? query returns the current setting for polarity.

Returned Format [:TRIGger:ADVanced:COMM:POLarity] {1|0}<NL>

History Legacy command (existed before version 3.10).

:TRIGger:ADVanced:COMM:SOURce

Command :TRIGger:ADVanced:COMM:SOURce CHANnel<N>

The :TRIGger:ADVanced:COMM:SOURce command selects the channel used for the communication trigger.

<N> An integer, 1-4.

Query :TRIGger:ADVanced:COMM:SOURce?

The :TRIGger:ADVanced:COMM:SOURce? query returns the currently selected communication trigger source.

Returned Format [:TRIGger:ADVanced:COMM:SOURce] CHANnel<N><NL>

History Legacy command (existed before version 3.10).

Advanced Pattern Trigger Commands

Logic triggering is similar to the way that a logic analyzer captures data. This mode is useful when you are looking for a particular set of ones and zeros on a computer bus or control lines. You determine which channels the oscilloscope uses to form the trigger pattern. Because you can set the voltage level that determines a logic 1 or a logic 0, any logic family that you are probing can be captured.

There are two types of logic triggering: Pattern and State. The difference between pattern and state triggering modes is that state triggering uses one of the oscilloscope channels as a clock.

Use pattern triggering to trigger the oscilloscope using more than one channel as the trigger source. You can also use pattern triggering to trigger on a pulse of a given width.

The Pattern Trigger Mode identifies a trigger condition by looking for a specified pattern. A pattern is a logical combination of the channels. Each channel can have a value of High (H), Low (L) or Don't Care (X). A value is considered a High when your waveform's voltage level is greater than its trigger level, and a Low when the voltage level is less than its trigger level. If a channel is set to Don't Care, it is not used as part of the pattern criteria.

One additional qualifying condition determines when the oscilloscope triggers once the pattern is found. The :PATTern:CONDition command has five possible ways to qualify the trigger:

- Entered** The oscilloscope will trigger on the edge of the source that makes the pattern true.
- Exited** The oscilloscope will trigger on the edge of the source that makes the pattern false.
- Present >** The oscilloscope will trigger when the pattern is present for greater than the time that you specify. An additional parameter allows the oscilloscope to trigger when the pattern goes away or when the time expires.
- Present <** The oscilloscope will trigger when the pattern is present for less than the time that you specify.
- Range** The oscilloscope will trigger on the edge of the waveform that makes the pattern invalid as long as the pattern is present within the range of times that you specify.

Available trigger conditioning includes HOLDoff and HYSTeresis (Noise Reject).

Set the Mode Before Executing Commands

Before you can execute the :TRIGger:ADVanced:PATTern commands, set the mode by entering:

```
:TRIGger:MODE ADVanced and
:TRIGger:ADVanced:MODE PATTern
```

To query the oscilloscope for the advanced trigger mode, enter:

```
:TRIGger:ADVanced:MODE?
```

The `:TRIGger:ADVanced:PATtern` commands define the conditions for the Pattern Trigger Mode. As described in the following commands, you set up the `:TRIGger:ADVanced:PATtern` commands with the following commands and queries:

- `":TRIGger:ADVanced:PATtern:CONDition"` on page 1302
- `":TRIGger:ADVanced:PATtern:LOGic"` on page 1303
- `":TRIGger:ADVanced:PATtern:THReshold:LEVel"` on page 1304
- `":TRIGger:ADVanced:PATtern:THReshold:POD<N>"` on page 1305

:TRIGger:ADVanced:PATtern:CONDition

Command :TRIGger:ADVanced:PATtern:CONDition {ENTERed | EXITed |
 {GT,<time>[,PEXits|TIMEout]} |
 {LT,<time>} |
 {RANGe,<gt_time>,<lt_time>}}

This command describes the condition applied to the trigger pattern to actually generate a trigger.

<gt_time> The minimum time (greater than time) for the trigger pattern, from 10 ns to 9.9999999 s.

<lt_time> The maximum time (less than time) for the trigger pattern, from 15 ns to 10 s.

<time> The time condition, in seconds, for the pattern trigger, from 1.5 ns to 10 s.

When using the GT (Present >) parameter, the PEXits (Pattern Exits) or the TIMEout parameter controls when the trigger is generated.

Query :TRIGger:ADVanced:PATtern:CONDition?

The query returns the currently defined trigger condition.

Returned Format [:TRIGger:ADVanced:PATtern:CONDition] {ENTERed|EXITed |
 {GT,<time>[,PEXits|TIMEout]} | {LT,<time>} | {RANGe,<gt_time>,<lt_time>}
 }><NL>

History Legacy command (existed before version 3.10).

:TRIGger:ADVanced:PATtern:LOGic

Command :TRIGger:ADVanced:PATtern:LOGic {{CHANnel<N> | <channel_list> | DIGital<M>}, {HIGH|LOW|DONTcare|RISing|FALLing}}

This command defines the logic criteria for a selected channel.

<N> An integer, 1-4.

<M> An integer, 0-15. The digital channels are only available on the MSO oscilloscopes or DSO models with the MSO license installed.

<channel_list> The channel range is from 0 to 15 in the following format.

| | |
|-------------|--|
| (@1,5,7,9) | channels 1, 5, 7, and 9 are turned on. |
| (@1:15) | channels 1 through 15 are turned on. |
| (@1:5,8,14) | channels 1 through 5, channel 8, and channel 14 are turned on. |

Query :TRIGger:ADVanced:PATtern:LOGic? {CHANnel<N> | <channel_list> | DIGital<M>}

The query returns the current logic criteria for a selected channel.

Returned Format [:TRIGger:ADVanced:PATtern:LOGic {CHANnel<N>|<channel_list> | DIGital<M>},] {HIGH|LOW|DONTcare|RISing|FALLing}<NL>

History Legacy command (existed before version 3.10).

:TRIGger:ADVanced:PATtern:THReshold:LEVel

Command :TRIGger:ADVanced:PATtern:THReshold:LEVel {CHANnel<N>},<level>

The :TRIGger:ADVanced:PATtern:THReshold:LEVel command specifies the trigger level on the specified channel for the trigger source. Only one trigger level is stored in the oscilloscope for each channel. This level applies to the channel throughout the trigger dialogs (Edge, Glitch, and Advanced). This level also applies to all the High Threshold (HTHReshold) values in the Advanced Violation menus.

<N> An integer, 1-4.

<level> A real number for the trigger level on the specified channel, External Trigger, or Auxilliary Trigger Input.

Query :TRIGger:ADVanced:PATtern:THReshold:LEVel? {CHANnel<N>}

The query returns the specified channel's trigger level.

Returned Format [:TRIGger:ADVanced:PATtern:THReshold:LEVel {CHANnel<N>},] <level><NL>

History Legacy command (existed before version 3.10).

:TRIGger:ADVanced:PATtern:THReshold:POD<N>

Command :TRIGger:ADVanced:PATtern:THReshold:POD<N> {CMOS50 | CMOS30 | CMOS25
| ECL | PECL | TTL | <value>}

NOTE

This command is only valid for the MSO oscilloscopes.

The TRIGger:ADVanced:PATtern:THReshold:POD<N> command sets the logic threshold value for the selected pod. POD1 is digital channels D0 through D7 and POD2 is digital channels D8 through D15. The threshold is used for triggering purposes and for displaying the digital data as high (above the threshold) or low (below the threshold). The voltage values for the predefined thresholds are:

- CMOS50=2.5 V
- CMOS30=1.65 V
- CMOS25=1.25 V
- ECL=-1.3 V
- PECL=3.7 V
- TTL=1.4 V

<N> An integer, 1-2.

<value> A real number representing the voltage value which distinguishes a 1 logic level from a 0 logic level. Waveform voltages greater than the threshold are 1 logic levels while waveform voltages less than the threshold are 0 logic levels.

Query :TRIGger:ADVanced:PATtern:THReshold:POD<N>?

The :TRIGger:ADVanced:PATtern:THReshold:POD<N>? query returns the threshold value for the specified pod.

Returned Format [:TRIGger:ADVanced:PATtern:THReshold:POD<N>] {CMOS50 | CMOS30 | CMOS25
| ECL | PECL | TTL | <value>}<NL>

History Legacy command (existed before version 3.10).

Advanced State Trigger Commands

Logic triggering is similar to the way that a logic analyzer captures data. This mode is useful when you are looking for a particular set of ones and zeros on a computer bus or control lines. You determine which channels the oscilloscope uses to form the trigger pattern. Because you can set the voltage level that determines a logic 1 or a logic 0, any logic family that you are probing can be captured.

There are two types of logic triggering: Pattern and State. The difference between pattern and state triggering modes is that state triggering uses one of the oscilloscope channels as a clock.

Use state triggering when you want the oscilloscope to use several channels as the trigger source, with one of the channels being used as a clock waveform.

The State trigger identifies a trigger condition by looking for a clock edge on one channel and a pattern on the remaining channels. A pattern is a logical combination of the remaining channels. Each channel can have a value of High (H), Low (L) or Don't Care (X). A value is considered a High when your waveform's voltage level is greater than the trigger level and a Low when the voltage level is less than the trigger level. If a channel is set to Don't Care, it is not used as part of the pattern criteria. You can select the clock edge as either rising or falling.

The logic type control determines whether or not the oscilloscope will trigger when the specified pattern is found on a clock edge. When AND is selected, the oscilloscope will trigger on a clock edge when input waveforms match the specified pattern. When NAND is selected, the oscilloscope will trigger when the input waveforms are different from the specified pattern and a clock edge occurs.

Available trigger conditioning includes HOLDoff and HYSTeresis (Noise Reject).

Set the Mode Before Executing Commands

Before you can execute the :TRIGger:ADVanced:STATe commands, set the mode by entering:

```
:TRIGger:MODE ADVanced and
:TRIGger:ADVanced:MODE STATE
```

To query the oscilloscope for the advanced trigger mode, enter:

```
:TRIGger:ADVanced:MODE?
```

The :TRIGger:ADVanced:STATe commands define the conditions for the State Trigger Mode. As described in the following commands, you set up the :TRIGger:ADVanced:STATe commands with the following commands and queries:

- **":TRIGger:ADVanced:STATe:CLOCK"** on page 1307
- **":TRIGger:ADVanced:STATe:LOGic"** on page 1308
- **":TRIGger:ADVanced:STATe:LTYPe"** on page 1309
- **":TRIGger:ADVanced:STATe:SLOPe"** on page 1310
- **":TRIGger:ADVanced:STATe:THReshold:LEVel"** on page 1311

:TRIGger:ADVanced:STATe:CLOCK

Command :TRIGger:ADVanced:STATe:CLOCK {CHANnel<N> | DIGital<M> | DONTcare
| <digital_channel>}

This command selects the source for the clock waveform in the State Trigger Mode.

<N> An integer, 1-2, for two channel Infiniium Oscilloscope. An integer, 1-4, for all other Infiniium Oscilloscope models.

<M> An integer, 0-15. The digital channels are only available on the MSO oscilloscopes or DSO models with the MSO license installed.

Query :TRIGger:ADVanced:STATe:CLOCK?

The query returns the currently selected clock source.

Returned Format [:TRIGger:ADVanced:STATe:CLOCK] {CHANnel<N> | DIGital<M>}<NL>

History Legacy command (existed before version 3.10).

:TRIGger:ADVanced:STATe:LOGic

Command :TRIGger:ADVanced:STATe:LOGic {{CHANnel<N> | <channel_list>
| DIGital<M>},{LOW|HIGH|DONTcare|RISing| FALling}}

This command defines the logic state of the specified source for the state pattern. The command produces a settings conflict on a channel that has been defined as the clock.

<N> An integer, 1-2, for two channel Infiniium Oscilloscope. An integer, 1-4, for all other Infiniium Oscilloscope models.

<channel_list> The channel range is from 0 to 15 in the following format.

| | |
|-------------|--|
| (@1,5,7,9) | channels 1, 5, 7, and 9 are turned on. |
| (@1:15) | channels 1 through 15 are turned on. |
| (@1:5,8,14) | channels 1 through 5, channel 8, and channel 14 are turned on. |

<M> An integer, 0-15. The digital channels are only available on the MSO oscilloscopes or DSO models with the MSO license installed.

Query :TRIGger:ADVanced:STATe:LOGic? {CHANnel<N> | <channel_list> | DIGital<M>}

The query returns the logic state definition for the specified source.

<N> N is the channel number, an integer in the range of 1 - 4.

Returned Format [:TRIGger:ADVanced:STATe:LOGic {CHANnel<N> | <channel_list> | DIGital<M>},,
{LOW | HIGH | DONTcare | RISing | FALling}<NL>

History Legacy command (existed before version 3.10).

:TRIGger:ADVanced:STATe:LTYPe

Command :TRIGger:ADVanced:STATe:LTYPe {AND | NAND}

This command defines the state trigger logic type. If the logic type is set to AND, then a trigger is generated on the edge of the clock when the input waveforms match the pattern specified by the :TRIGger:ADVanced:STATe:LOGic command. If the logic type is set to NAND, then a trigger is generated on the edge of the clock when the input waveforms do not match the specified pattern.

Query :TRIGger:ADVanced:STATe:LTYPe?

The query returns the currently specified state trigger logic type.

Returned Format [:TRIGger:ADVanced:STATe:LTYPe] {AND | NAND}<NL>

History Legacy command (existed before version 3.10).

:TRIGger:ADVanced:STATe:SLOPe

Command :TRIGger:ADVanced:STATe:SLOPe {{RISing | POSitive} | {FALLing | NEGative}}}

This command specifies the edge of the clock that is used to generate a trigger. The waveform source used for the clock is selected by using the :TRIGger:ADVanced:STATe:CLOCK command.

Query :TRIGger:ADVanced:STATe:SLOPe?

The query returns the currently defined slope for the clock in State Trigger Mode.

Returned Format [:TRIGger:ADVanced:STATe:SLOPe] {RIS | FALL}<NL>

History Legacy command (existed before version 3.10).

:TRIGger:ADVanced:STATe:THReshold:LEVel

Command :TRIGger:ADVanced:STATe:THReshold:LEVel {CHANnel<N> | DIGItal<M>},<level>

The :TRIGger:ADVanced:STATe:THReshold:LEVel command specifies the trigger level on the specified channel for the trigger source. Only one trigger level is stored in the oscilloscope for each channel. This level applies to the channel throughout the trigger dialogs (Edge, Glitch, and Advanced). This level also applies to all the High Threshold (HTHReshold) values in the Advanced Violation menus.

<N> An integer, 1-4.

<M> An integer, 0-15. The digital channels are only available on the MSO oscilloscopes or DSO models with the MSO license installed.

<level> A real number for the trigger level on the specified channel, External Trigger, or Auxilliary Trigger Input.

Query :TRIGger:ADVanced:STATe:THReshold:LEVel? {CHANnel<N> | DIGItal<M>}

The query returns the specified channel's trigger level.

Returned Format [:TRIGger:ADVanced:STATe:THReshold:LEVel {CHANnel<N> | DIGItal<M>},] <level><NL>

History Legacy command (existed before version 3.10).

Advanced Delay By Event Trigger Commands

You can set the delay mode to delay by events or time. Use Delay By Event mode to view pulses in your waveform that occur a number of events after a specified waveform edge. Infiniium Oscilloscopes identify a trigger by arming on the edge you specify, counting a number of events, then triggering on the specified edge.

- `":TRIGger:ADVanced:DELay:EDLY:ARM:SOURce"` on page 1314
- `":TRIGger:ADVanced:DELay:EDLY:ARM:SLOPe"` on page 1315
- `":TRIGger:ADVanced:DELay:EDLY:EVENT:DELay"` on page 1316
- `":TRIGger:ADVanced:DELay:EDLY:EVENT:SOURce"` on page 1317
- `":TRIGger:ADVanced:DELay:EDLY:EVENT:SLOPe"` on page 1318
- `":TRIGger:ADVanced:DELay:EDLY:TRIGger:SOURce"` on page 1319
- `":TRIGger:ADVanced:DELay:EDLY:TRIGger:SLOPe"` on page 1320

Arm On Use Arm On to set the source, level, and slope for arming the trigger circuitry. When setting the arm level for your waveform, it is usually best to choose a voltage value that is equal to the voltage value at the mid point of your waveform. For example, if you have a waveform with a minimum value of 0 (zero) volts and a maximum value of 5 volts, then 2.5 volts is the best place to set your arm level. The reason this is the best choice is that there may be some ringing or noise at both the 0volt and 5volt levels that can cause false triggers.

When you adjust the arm level control, a horizontal dashed line with a T on the right-hand side appears showing you where the arm level is with respect to your waveform. After a period of time the dashed line will disappear. To redisplay the line, adjust the arm level control again, or activate the Trigger dialog.

Delay By Event Use Delay By Event to set the source, level, and edge to define an event. When setting the event level for your waveform, it is usually best to choose a voltage value that is equal to the voltage value at the mid point of your waveform. For example, if you have a waveform with a minimum value of 0 (zero) volts and a maximum value of 5 volts, then 2.5 volts is the best place to set your event level. The reason this is the best choice is that there may be some ringing or noise at both the 0volt and 5volt levels that can cause false triggers.

Event Use Event to set the number of events (edges) that must occur after the oscilloscope is armed until it starts to look for the trigger edge.

Trigger On Use Trigger On to set the trigger source and trigger slope required to trigger the oscilloscope. Each source can have only one level, so if you are arming and triggering on the same source, only one level is used.

Set the Mode Before Executing Commands Before you can execute the `:TRIGger:ADVanced:DELay` commands, set the mode by entering:

```
:TRIGger:MODE ADVanced and
:TRIGger:ADVanced:MODE DELay
```

The ADVanced DELay commands define the conditions for the Delay Trigger Mode. The Delay By Events Mode lets you view pulses in your waveform that occur a number of events after a specified waveform edge. After entering the commands above, to select Delay By Events Mode, enter:

```
:TRIGger:ADVanced:DELay:MODE EDLY
```

Then you can use the Event Delay (EDLY) commands and queries for ARM, EVENT, and TRIGger on the following pages.

To query the oscilloscope for the advanced trigger mode or the advanced trigger delay mode, enter:

```
:TRIGger:ADVanced:MODE? or  
:TRIGger:ADVanced:DELay:MODE?
```

:TRIGger:ADVanced:DELAy:EDLY:ARM:SOURce

Command :TRIGger:ADVanced:DELAy:EDLY:ARM:SOURce {CHANnel<N> | DIGital<M>}

This command sets the Arm On source for arming the trigger circuitry when the oscilloscope is in the Delay By Event trigger mode.

<N> An integer, 1-4.

<M> An integer, 0-15. The digital channels are only available on the MSO oscilloscopes or DSO models with the MSO license installed.

Query :TRIGger:ADVanced:DELAy:EDLY:ARM:SOURce?

The query returns the currently defined Arm On source for the Delay By Event trigger mode.

Returned Format [:TRIGger:ADVanced:DELAy:EDLY:ARM:SOURce] {CHANnel<N> | DIGital<M>}<NL>

History Legacy command (existed before version 3.10).

:TRIGger:ADVanced:DELAy:EDLY:ARM:SLOPe

Command :TRIGger:ADVanced:DELAy:EDLY:ARM:SLOPe {NEGative|POSitive}

This command sets a positive or negative slope for arming the trigger circuitry when the oscilloscope is in the Delay By Event trigger mode.

Query :TRIGger:ADVanced:DELAy:EDLY:ARM:SLOPe?

The query returns the currently defined slope for the Delay By Event trigger mode.

Returned Format [:TRIGger:ADVanced:DELAy:EDLY:ARM:SLOPe] {NEGative|POSitive}<NL>

History Legacy command (existed before version 3.10).

:TRIGger:ADVanced:DELAy:EDLY:EVENT:DELAy

Command :TRIGger:ADVanced:DELAy:EDLY:EVENT:DELAy <edge_number>

This command sets the event count for a Delay By Event trigger event.

<edge_num> An integer from 0 to 16,000,000 specifying the number of edges to delay.

Query :TRIGger:ADVanced:DELAy:EDLY:EVENT:DELAy?

The query returns the currently defined number of events to delay before triggering on the next Trigger On condition in the Delay By Event trigger mode.

Returned Format [:TRIGger:ADVanced:DELAy:EDLY:EVENT:DELAy] <edge_number><NL>

History Legacy command (existed before version 3.10).

:TRIGger:ADVanced:DELAy:EDLY:EVENT:SOURce

Command :TRIGger:ADVanced:DELAy:EDLY:EVENT:SOURce {CHANnel<N> | DIGital<M>}

This command sets the Event source for a Delay By Event trigger event.

<N> An integer, 1-2, for two channel Infiniium Oscilloscope. An integer, 1-4, for all other Infiniium Oscilloscope models.

<M> An integer, 0-15. The digital channels are only available on the MSO oscilloscopes or DSO models with the MSO license installed.

Query :TRIGger:ADVanced:DELAy:EDLY:EVENT:SOURce?

The query returns the currently defined Event source in the Delay By Event trigger mode.

Returned Format [:TRIGger:ADVanced:DELAy:EDLY:EVENT:SOURce] {CHANnel<N> | DIGital<M>}<NL>

History Legacy command (existed before version 3.10).

:TRIGger:ADVanced:DELAy:EDLY:EVENT:SLOPe

Command :TRIGger:ADVanced:DELAy:EDLY:EVENT:SLOPe
{NEGAtive|POSitive}

This command sets the trigger slope for the Delay By Event trigger event.

Query :TRIGger:ADVanced:DELAy:EDLY:EVENT:SLOPe?

The query returns the currently defined slope for an event in the Delay By Event trigger mode.

Returned Format [:TRIGger:ADVanced:EDLY:EVENT:SLOPe] {NEGAtive|POSitive}<NL>

History Legacy command (existed before version 3.10).

:TRIGger:ADVanced:DELAy:EDLY:TRIGger:SOURce

Command :TRIGger:ADVanced:DELAy:EDLY:TRIGger:SOURce {CHANnel<N> | DIGital<M>}

This command sets the Trigger On source for a Delay By Event trigger event.

<N> An integer, 1-4.

<M> An integer, 0-15. The digital channels are only available on the MSO oscilloscopes or DSO models with the MSO license installed.

Query :TRIGger:ADVanced:DELAy:EDLY:TRIGger:SOURce?

The query returns the currently defined Trigger On source for the event in the Delay By Event trigger mode.

Returned Format [:TRIGger:ADVanced:DELAy:EDLY:TRIGger:SOURce] {CHANnel<N> | DIGital<M>}<NL>

History Legacy command (existed before version 3.10).

:TRIGger:ADVanced:DElay:EDLY:TRIGger:SLOPe

Command :TRIGger:ADVanced:DElay:EDLY:TRIGger:SLOPe
{NEGative|POSitive}

This command sets the trigger slope for the Delay By Event trigger event.

Query :TRIGger:ADVanced:DElay:EDLY:TRIGger:SLOPe?

The query returns the currently defined slope for an event in the Delay By Event trigger mode.

Returned Format [:TRIGger:ADVanced:DElay:EDLY:TRIGger:SLOPe] {NEGative|POSitive}<NL>

History Legacy command (existed before version 3.10).

Advanced Delay By Time Trigger Commands

You can set the delay mode to delay by events or time. Use Delay By Time mode to view pulses in your waveform that occur a long time after a specified waveform edge. The Delay by Time identifies a trigger condition by arming on the edge you specify, waiting a specified amount of time, then triggering on a specified edge. This can be thought of as two-edge triggering, where the two edges are separated by a selectable amount of time.

It is also possible to use the Horizontal Position control to view a pulse some period of time after the trigger has occurred. The problem with this method is that the further the pulse is from the trigger, the greater the possibility that jitter will make it difficult to view. Delay by Time eliminates this problem by triggering on the edge of interest.

- `":TRIGger:ADVanced:DElay:TDLY:ARM:SOURce"` on page 1323
- `":TRIGger:ADVanced:DElay:TDLY:ARM:SLOPe"` on page 1324
- `":TRIGger:ADVanced:DElay:TDLY:DElay"` on page 1325
- `":TRIGger:ADVanced:DElay:TDLY:TRIGger:SOURce"` on page 1326
- `":TRIGger:ADVanced:DElay:TDLY:TRIGger:SLOPe"` on page 1327

Arm On Use Arm On to set the source, level, and slope for the arming condition. When setting the arm level for your waveform, it is usually best to choose a voltage value that is equal to the voltage value at the mid point of your waveform. For example, if you have a waveform with a minimum value of 0 (zero) volts and a maximum value of 5 volts, then 2.5 volts is the best place to set your arm level. The reason this is the best choice is that there may be some ringing or noise at both the 0-volt and 5-volt levels that can cause false triggers.

When you adjust the arm level control, a horizontal dashed line with a T on the right-hand side appears showing you where the arm level is with respect to your waveform. After a period of time the dashed line will disappear. To redisplay the line, adjust the arm level control again, or activate the Trigger dialog.

Delay By Time Use Delay By Time to set the amount of delay time from when the oscilloscope is armed until it starts to look for the trigger edge. The range is from 30 ns to 160 ms.

Trigger On Use Trigger On to set the source and slope required to trigger the oscilloscope. Trigger On Level is slaved to Arm On Level.

Available trigger conditioning includes HOLDoff and HYSTeresis (Noise Reject).

Set the Mode Before Executing Commands Before you can execute the `:TRIGger:ADVanced:DElay` commands, set the mode by entering:

```
:TRIGger:MODE ADVanced and
:TRIGger:ADVanced:MODE DElay
```

The ADVanced DELay commands define the conditions for the Delay Trigger Mode. The Delay By Time Mode lets you view pulses in your waveform that occur a specified time after a specified waveform edge. After entering the commands above, to select Delay By Time Mode, enter:

```
:TRIGger:ADVanced:DELAy:MODE TDLY
```

Then you can use the Time Delay (TDLY) commands and queries for ARM, DELay, and TRIGger on the following pages.

To query the oscilloscope for the advanced trigger mode or the advanced trigger delay mode, enter:

```
:TRIGger:ADVanced:MODE? or  
:TRIGger:ADVanced:DELAy:MODE?
```

:TRIGger:ADVanced:DELAy:TDLY:ARM:SOURce

Command :TRIGger:ADVanced:DELAy:TDLY:ARM:SOURce {CHANnel<N> | DIGital<M>}

This command sets the Arm On source for arming the trigger circuitry when the oscilloscope is in the Delay By Time trigger mode.

<N> An integer, 1-4.

<M> An integer, 0-15. The digital channels are only available on the MSO oscilloscopes or DSO models with the MSO license installed.

Query :TRIGger:ADVanced:DELAy:TDLY:ARM:SOURce?

The query returns the currently defined channel source for the Delay By Time trigger mode.

Returned Format [:TRIGger:ADVanced:DELAy:TDLY:ARM:SOURce] {CHANnel<N> | DIGital<M>}<NL>

History Legacy command (existed before version 3.10).

:TRIGger:ADVanced:DELay:TDLY:ARM:SLOPe

Command :TRIGger:ADVanced:DELay:TDLY:ARM:SLOPe {NEGative|POSitive}

This command sets a positive or negative slope for arming the trigger circuitry when the oscilloscope is in the Delay By Time trigger mode.

Query :TRIGger:ADVanced:DELay:TDLY:ARM:SLOPe?

The query returns the currently defined slope for the Delay By Time trigger mode.

Returned Format [:TRIGger:ADVanced:DELay:TDLY:ARM:SLOPe] {NEGative|POSitive}<NL>

History Legacy command (existed before version 3.10).

:TRIGger:ADVanced:DELAy:TDLY:DELAy

Command :TRIGger:ADVanced:DELAy:TDLY:DELAy <delay>

This command sets the delay for a Delay By Time trigger event.

<delay> Time, in seconds, set for the delay trigger, from 5 ns to 10 s.

Query :TRIGger:ADVanced:DELAy:TDLY:DELAy?

The query returns the currently defined time delay before triggering on the next Trigger On condition in the Delay By Time trigger mode.

Returned Format [:TRIGger:ADVanced:DELAy:TDLY:DELAy] <delay><NL>

History Legacy command (existed before version 3.10).

:TRIGger:ADVanced:DELAy:TDLY:TRIGger:SOURce

Command :TRIGger:ADVanced:DELAy:TDLY:TRIGger:SOURce {CHANnel<N> | DIGital<M>}

This command sets the Trigger On source for a Delay By Time trigger event.

<N> An integer, 1-4.

<M> An integer, 0-15. The digital channels are only available on the MSO oscilloscopes or DSO models with the MSO license installed.

Query :TRIGger:ADVanced:DELAy:TDLY:TRIGger:SOURce?

The query returns the currently defined Trigger On source in the Delay By Time trigger mode.

Returned Format [:TRIGger:ADVanced:DELAy:TDLY:TRIGger:SOURce] {CHANnel<N> | DIGital<M>}<NL>

History Legacy command (existed before version 3.10).

:TRIGger:ADVanced:DELAy:TDLY:TRIGger:SLOPe

Command :TRIGger:ADVanced:DELAy:TDLY:TRIGger:SLOPe
{NEGative|POSitive}

This command sets the trigger slope for the Delay By Time trigger event.

Query :TRIGger:ADVanced:DELAy:TDLY:TRIGger:SLOPe?

The query returns the currently defined slope for an event in the Delay By Time trigger mode.

Returned Format [:TRIGger:ADVanced:DELAy:TDLY:TRIGger:SLOPe] {NEGative|POSitive}<NL>

History Legacy command (existed before version 3.10).

Advanced Standard TV Trigger Commands

Use TV trigger mode to trigger on one of the standard television waveforms. Also, use this mode to trigger on a custom television waveform that you define, as described in the next section.

There are four types of television (TV) trigger modes: 525 (NTSC or PAL-M), 625 (PAL), and User Defined. The 525 and 625 are predefined video standards used throughout the world. The User Defined TV trigger, described in the next section, lets you trigger on nonstandard TV waveforms.

525 and 625 TV Trigger Modes

- Source** Use the Source control to select one of the oscilloscope channels as the trigger source.
- Level** Use to set the trigger voltage level. When setting the trigger level for your waveform, it is usually best to choose a voltage value that is just below the bottom of burst.

When you adjust the trigger level control, a horizontal dashed line with a T on the right-hand side appears showing you where the trigger level is with respect to your waveform. After a period of time the dashed line will disappear. To redisplay the line, adjust the trigger level control again, or activate the Trigger dialog.

- Positive or Negative Sync** Use the Positive and Negative Sync controls to select either a positive sync pulse or a negative sync pulse as the trigger.

- Field** Use the Field control to select video field 1 or video field 2 as the trigger.

- Line** Use the Line control to select the horizontal line you want to view within the chosen video field.

Available trigger conditioning includes HOLDoff and HYSTeresis (Noise Reject).

- STV Commands** These commands set the conditions for the TV trigger mode using standard, predefined parameters (in STV mode), or user-defined parameters (in UDTV mode). The STV commands are used for triggering on television waveforms, and let you select one of the TV waveform frames and one of the lines within that frame.

- Set the Mode Before Executing Commands** Before executing the :TRIGger:ADVanced:STV commands, set the mode by entering:

```
:TRIGger:MODE ADVanced and
:TRIGger:ADVanced:MODE TV and
```

```
:TRIGger:ADVanced:TV:MODE L525 or
:TRIGger:ADVanced:TV:MODE L625
```

To query the oscilloscope for the advanced trigger mode or the advanced trigger TV mode, enter:

:TRIGger:ADVanced:MODE? or
:TRIGger:ADVanced:TV:MODE?

You set up the :TRIGger:ADVanced:TV:STV commands with the following commands and queries:

- **":TRIGger:ADVanced:TV:STV:FIELD"** on page 1330
- **":TRIGger:ADVanced:TV:STV:LINE"** on page 1331
- **":TRIGger:ADVanced:TV:STV:SOURce"** on page 1332
- **":TRIGger:ADVanced:TV:STV:SPOLarity"** on page 1333

:TRIGger:ADVanced:TV:STV:FIELD

Command :TRIGger:ADVanced:TV:STV:FIELD {1|2}

This command is available in standard TV trigger modes L525 and L626.

The :TRIGger:ADVanced:TV:STV:FIELD command selects which TV waveform field is used during standard TV trigger mode. The line within the selected field is specified using the :TRIGger:ADVanced:TV:STV:LINE <line_number> command.

Query :TRIGger:ADVanced:TV:STV:FIELD?

The query returns the current television waveform field.

Returned Format [:TRIGger:ADVanced:TV:STV:FIELD] {1|2}<NL>

History Legacy command (existed before version 3.10).

:TRIGger:ADVanced:TV:STV:LINE

Command :TRIGger:ADVanced:TV:STV:LINE <line_number>

This command is available in standard TV trigger modes L525 and L626.

The :TRIGger:ADVanced:TV:STV:LINE command selects the horizontal line that the instrument will trigger on. Allowable line_number entry depends on the :TRIGger:ADVanced:TV:STV:FIELD selected. Once the vertical sync pulse of the selected field is received, the trigger is delayed by the number of lines specified.

<line_number> Horizontal line number. Allowable values range from 1 to 625, depending on :TRIGger:ADVanced:TV:STV:FIELD settings as shown below.

| | STV Modes | |
|---------|-----------|------------|
| | 525 | 625 |
| Field 1 | 1 to 263 | 1 to 313 |
| Field 2 | 1 to 262 | 314 to 625 |

Query :TRIGger:ADVanced:TV:STV:LINE?

The query returns the current line number.

Returned Format [:TRIGger:ADVanced:TV:STV:LINE] <line_number><NL>

History Legacy command (existed before version 3.10).

:TRIGger:ADVanced:TV:STV:SOURce

Command :TRIGger:ADVanced:TV:STV:SOURce {CHANnel<N>}

This command is available in standard TV trigger modes L525 and L626.

The :TRIGger:ADVanced:TV:STV:SOURce command selects the source for standard TV mode triggering. This is the source that will be used for subsequent :TRIGger:ADVanced:TV:STV commands and queries.

<N> An integer, 1-4.

Query :TRIGger:ADVanced:TV:STV:SOURce?

The query returns the currently selected standard TV trigger mode source.

Returned Format [:TRIGger:ADVanced:TV:STV:SOURce] {CHANnel<N>|EXTernal}<NL>

History Legacy command (existed before version 3.10).

:TRIGger:ADVanced:TV:STV:SPOLarity

Command :TRIGger:ADVanced:TV:STV:SPOLarity {NEGative|POSitive}

This command is available in standard TV trigger modes L525 and L626.

The :TRIGger:ADVanced:TV:STV:SPOLarity (Sync POLarity) command specifies the vertical sync pulse polarity for the selected field used during standard TV mode triggering.

Query :TRIGger:ADVanced:TV:STV:SPOLarity?

The query returns the currently selected sync pulse polarity.

Returned Format [:TRIGger:ADVanced:TV:STV:SPOLarity] {NEGative|POSitive}<NL>

History Legacy command (existed before version 3.10).

Advanced User Defined TV Mode and Commands

Use TV trigger mode to trigger on one of the standard television waveforms, as described in the previous section, and to trigger on a custom television waveform that you define. The User Defined TV trigger lets you trigger on nonstandard TV waveforms.

User Defined TV Trigger

Source Use the Source control to select one of the oscilloscope channels as the trigger source.

Level Use the Level control to set the trigger voltage level.

When setting the trigger level for your waveform, it is usually best to choose a voltage value that is just below the bottom of burst.

When you adjust the trigger level control, a horizontal dashed line with a T on the right-hand side appears showing you where the trigger level is with respect to your waveform. After a period of time the dashed line will disappear. To redisplay the line, adjust the trigger level control again, or activate the Trigger dialog. A permanent icon with arrow (either T, T_L, or T_H) is also displayed on the right side of the waveform area, showing the trigger level.

Pos or Neg Use the Pos and Neg controls to select either a positive pulse or a negative pulse to arm the trigger circuitry.

Time > Use the Time > control to set the minimum time that the pulse must be present to be considered a valid sync pulse.

Edge Number Use the Edge Number control to select the number of edges you want the oscilloscope to count before triggering.

Available trigger conditioning includes HOLDoff and HYSTeresis (Noise Reject).

UDTV Commands These commands set the conditions for the TV trigger mode using user-defined parameters. They are used for triggering on non-standard television waveforms, and let you define the conditions that must be met before a trigger occurs.

Set the Mode Before Executing Commands Before executing the :TRIGger:ADVanced:TV:UDTV commands, set the mode by entering:

```
:TRIGger:MODE ADVanced and
:TRIGger:ADVanced:MODE TV and
:TRIGger:ADVanced:TV:MODE UDTV
```

To query the oscilloscope for the advanced trigger mode or the advanced trigger TV mode, enter:

```
:TRIGger:ADVanced:MODE? or
:TRIGger:ADVanced:TV:MODE?
```

You set up the :TRIGger:ADVanced:TV:UDTV commands with the following commands and queries:

- **":TRIGger:ADVanced:TV:UDTV:ENUMber"** on page 1336
- **":TRIGger:ADVanced:TV:UDTV:PGTHan"** on page 1337
- **":TRIGger:ADVanced:TV:UDTV:POLarity"** on page 1338
- **":TRIGger:ADVanced:TV:UDTV:SOURce"** on page 1339

When triggering for User Defined TV mode:

- Set the channel or trigger source for the trigger using:
 - :TRIGger:ADVanced:TV:UDTV:SOURce
- Set the conditions for arming the trigger using:
 - :TRIGger:ADVanced:TV:UDTV:PGTHan, and
 - :TRIGger:ADVanced:TV:UDTV:POLarity.
- Set the number of events to delay after the trigger is armed using:
 - :TRIGger:ADVanced:TV:UDTV:ENUMber
- Set the waveform edge that causes the trigger to occur after arming and delay using:
 - :TRIGger:ADVanced:TV:UDTV:EDGE

:TRIGger:ADVanced:TV:UDTV:ENUMber

Command :TRIGger:ADVanced:TV:UDTV:ENUMber <count>

The :TRIGger:ADVanced:TV:UDTV:ENUMber command specifies the number of events (horizontal sync pulses) to delay after arming the trigger before looking for the trigger event. Specify conditions for arming the trigger using:

TRIGger:ADVanced:TV:UDTV:PGTHan, and

TRIGger:ADVanced:TV:UDTV:POLarity.

<count> An integer for the number of events to delay. Allowable values range from 1 to 16,000,000.

Query :TRIGger:ADVanced:TV:UDTV:ENUMber?

The query returns the currently programmed count value.

Returned Format [:TRIGger:ADVanced:TV:UDTV:ENUMber] <count><NL>

History Legacy command (existed before version 3.10).

:TRIGger:ADVanced:TV:UDTV:PGTHan

Command :TRIGger:ADVanced:TV:UDTV:PGTHan <lower_limit>

The :TRIGger:ADVanced:TV:UDTV:PGTHan (Present Greater THan) command specifies the minimum pulse width of the waveform used to arm the trigger used during user-defined trigger mode.

<lower_limit> Minimum pulse width (time >), from 5 ns to 9.9999999 s.

Query :TRIGger:ADVanced:TV:UDTV:PGTHan?

The query returns the currently selected minimum pulse width.

Returned Format [:TRIGger:ADVanced:TV:UDTV:PGTHan] <lower_limit><NL>

History Legacy command (existed before version 3.10).

:TRIGger:ADVanced:TV:UDTV:POLarity

Command :TRIGger:ADVanced:TV:UDTV:POLarity {NEGative|POSitive}

The :TRIGger:ADVanced:TV:UDTV:POLarity command specifies the polarity for the sync pulse used to arm the trigger in the user-defined trigger mode.

Query :TRIGger:ADVanced:TV:UDTV:POLarity?

The query returns the currently selected UDTV sync pulse polarity.

Returned Format [:TRIGger:ADVanced:TV:UDTV:POLarity] {NEGative|POSitive}<NL>

History Legacy command (existed before version 3.10).

:TRIGger:ADVanced:TV:UDTV:SOURce

Command :TRIGger:ADVanced:TV:UDTV:SOURce {CHANnel<N>}

The :TRIGger:ADVanced:TV:UDTV:SOURce command selects the source for user-defined TV mode triggering. This is the source that will be used for subsequent :TRIGger:ADVanced:TV:UDTV commands and queries.

<N> An integer, 1-4.

Query :TRIGger:ADVanced:TV:UDTV:SOURce?

The query returns the currently selected user-defined TV trigger mode source.

Returned Format [:TRIGger:ADVanced:TV:UDTV:SOURce] {CHANnel<N>}<NL>

History Legacy command (existed before version 3.10).

Advanced Violation Trigger Modes

Violation triggering helps you find conditions within your circuit that violate the design rules. There are four types of violation triggering: Pulse Width, Setup and Hold Time, and Transition.

- **":TRIGger:ADVanced:VIOLation:MODE"** on page 1341

| | |
|-------------------|---|
| PWIDth | This mode lets you find pulses that are wider than the rest of the pulses in your waveform. It also lets you find pulses that are narrower than the rest of the pulses in the waveform. |
| SETup | This mode lets you find violations of setup and hold times in your circuit. Use this mode to select setup time triggering, hold time triggering, or both setup and hold time triggering. |
| TRANSition | This mode lets you find any edge in your waveform that violates a rise time or fall time specification. The Infiniium oscilloscope can be set to trigger on rise times or fall times that are too slow or too fast. |

:TRIGger:ADVanced:VIOLation:MODE

Command :TRIGger:ADVanced:VIOLation:MODE {PWIDth | SETup | TRANSition}

After you have selected the advanced trigger mode with the commands :TRIGger:MODE ADVanced and :TRIGger:ADVanced:MODE VIOLation, the :TRIGger:ADVanced:VIOLation:MODE <violation_mode> command specifies the mode for trigger violations. The <violation_mode> is either PWIDth, SETup, or TRANSition.

Query :TRIGger:ADVanced:VIOLation:MODE?

The query returns the currently defined mode for trigger violations.

Returned Format [:TRIGger:ADVanced:VIOLation:MODE] {PWIDth | SETup | TRANSition}<NL>

History Legacy command (existed before version 3.10).

Advanced Pulse Width Violation Trigger Commands

Use Pulse Width Violation Mode to find pulses that are wider than the rest of the pulses in your waveform. You can also use this mode to find pulses that are narrower than the rest of the pulses in the waveform.

The oscilloscope identifies a pulse width trigger by looking for a pulse that is either wider than or narrower than other pulses in your waveform. You specify the pulse width and pulse polarity (positive or negative) that the oscilloscope uses to determine a pulse width violation. For a positive polarity pulse, the oscilloscope triggers when the falling edge of a pulse crosses the trigger level. For a negative polarity pulse, the oscilloscope triggers when the rising edge of a pulse crosses the trigger level.

When looking for narrower pulses, pulse width less than (Width <) trigger is the same as glitch trigger.

- **":TRIGger:ADVanced:VIOLation:PWIDth:DIRection"** on page 1344
- **":TRIGger:ADVanced:VIOLation:PWIDth:POLarity"** on page 1345
- **":TRIGger:ADVanced:VIOLation:PWIDth:SOURce"** on page 1346
- **":TRIGger:ADVanced:VIOLation:PWIDth:WIDTh"** on page 1347

Source Use Source to select the oscilloscope channel used to trigger the oscilloscope.

Level Use the Level control to set the voltage level through which the pulse must pass before the oscilloscope will trigger.

When setting the trigger level for your waveform, it is usually best to choose a voltage value that is equal to the voltage value at the mid point of your waveform. For example, if you have a waveform with a minimum value of 0 (zero) volts and a maximum value of 5 volts, then 2.5 volts is the best place to set your trigger level. The reason this is the best choice is that there may be some ringing or noise at both the 0-volt and 5-volt levels that can cause false triggers.

When you adjust the trigger level control, a horizontal dashed line with a T on the right-hand side appears showing you where the trigger level is with respect to your waveform. After a period of time the dashed line will disappear. To redisplay the line, adjust the trigger level control again, or activate the Trigger dialog. A permanent icon with arrow (either T, T_L, or T_H) is also displayed on the right side of the waveform area, showing the trigger level.

Polarity Use the Polarity control to specify positive or negative pulses.

Direction Use Direction to set whether a pulse must be wider (Width >) or narrower (Width <) than the width value to trigger the oscilloscope.

Width Use the Width control to define how wide of a pulse will trigger the oscilloscope. The glitch width range is from 1.5 ns to 10 s.

Available trigger conditioning includes HOLDoff and HYSTeresis (Noise Reject).

**Set the Mode
Before Executing
Commands**

Before executing the :TRIGger:ADVanced:VIOLation:PWIDth commands, set the mode by entering:

```
:TRIGger:MODE ADVanced and  
:TRIGger:ADVanced:MODE VIOLation and  
:TRIGger:ADVanced:VIOLation:MODE PWIDth
```

To query the oscilloscope for the advanced trigger violation mode, enter:

```
:TRIGger:ADVanced:VIOLation:MODE?
```

:TRIGger:ADVanced:VIOLation:PWIDth:DIRection

Command :TRIGger:ADVanced:VIOLation:PWIDth:DIRection {GTHan | LTHan}

This command specifies whether a pulse must be wider or narrower than the width value to trigger the oscilloscope.

Query :TRIGger:ADVanced:VIOLation:PWIDth:DIRection?

The query returns the currently defined direction for the pulse width trigger.

Returned Format [:TRIGger:ADVanced:VIOLation:PWIDth:DIRection] {GTHan | LTHan}<NL>

History Legacy command (existed before version 3.10).

:TRIGger:ADVanced:VIOLation:PWIDth:POLarity

Command :TRIGger:ADVanced:VIOLation:PWIDth:POLarity {NEGative | POSitive}

This command specifies the pulse polarity that the oscilloscope uses to determine a pulse width violation. For a negative polarity pulse, the oscilloscope triggers when the rising edge of a pulse crosses the trigger level. For a positive polarity pulse, the oscilloscope triggers when the falling edge of a pulse crosses the trigger level.

Query :TRIGger:ADVanced:VIOLation:PWIDth:POLarity?

The query returns the currently defined polarity for the pulse width trigger.

Returned Format [:TRIGger:ADVanced:VIOLation:PWIDth:POLarity] {NEGative | POSitive}<NL>

History Legacy command (existed before version 3.10).

:TRIGger:ADVanced:VIOLation:PWIDth:SOURce

Command :TRIGger:ADVanced:VIOLation:PWIDth:SOURce {CHANnel<N> | DIGital<M>}

This command specifies the channel source used to trigger the oscilloscope with the pulse width trigger.

<N> An integer, 1-2, for two channel Infiniium Oscilloscope. An integer, 1-4, for all other Infiniium Oscilloscope models.

<level> A real number for the voltage through which the pulse must pass before the oscilloscope will trigger.

<M> An integer, 0-15. The digital channels are only available on the MSO oscilloscopes or DSO models with the MSO license installed.

Query :TRIGger:ADVanced:VIOLation:PWIDth:SOURce?

The query returns the currently defined channel source for the pulse width trigger.

Returned Format [:TRIGger:ADVanced:VIOLation:PWIDth:SOURce] {CHANnel<N> | DIGital<M>}<NL>

History Legacy command (existed before version 3.10).

:TRIGger:ADVanced:VIOLation:PWIDth:WIDTh

Command :TRIGger:ADVanced:VIOLation:PWIDth:WIDTh <width>

This command specifies how wide a pulse must be to trigger the oscilloscope.

<width> Pulse width, which can range from 1.5 ns to 10 s.

Query :TRIGger:ADVanced:VIOLation:PWIDth:WIDTh?

The query returns the currently defined width for the pulse.

Returned Format [:TRIGger:ADVanced:VIOLation:PWIDth:WIDTh] <width><NL>

History Legacy command (existed before version 3.10).

Advanced Setup Violation Trigger Commands

Use Setup Violation Mode to find violations of setup and hold times in your circuit.

- `":TRIGger:ADVanced:VIOLation:SETup:MODE"` on page 1351
- `":TRIGger:ADVanced:VIOLation:SETup:SETup:CSOource"` on page 1352
- `":TRIGger:ADVanced:VIOLation:SETup:SETup:CSOource:LEVel"` on page 1353
- `":TRIGger:ADVanced:VIOLation:SETup:SETup:CSOource:EDGE"` on page 1354
- `":TRIGger:ADVanced:VIOLation:SETup:SETup:DSOource"` on page 1355
- `":TRIGger:ADVanced:VIOLation:SETup:SETup:DSOource:HTHReshold"` on page 1356
- `":TRIGger:ADVanced:VIOLation:SETup:SETup:DSOource:LTHReshold"` on page 1357
- `":TRIGger:ADVanced:VIOLation:SETup:SETup:TIME"` on page 1358
- `":TRIGger:ADVanced:VIOLation:SETup:HOLD:CSOource"` on page 1359
- `":TRIGger:ADVanced:VIOLation:SETup:HOLD:CSOource:LEVel"` on page 1360
- `":TRIGger:ADVanced:VIOLation:SETup:HOLD:CSOource:EDGE"` on page 1361
- `":TRIGger:ADVanced:VIOLation:SETup:HOLD:DSOource"` on page 1362
- `":TRIGger:ADVanced:VIOLation:SETup:HOLD:DSOource:HTHReshold"` on page 1363
- `":TRIGger:ADVanced:VIOLation:SETup:HOLD:DSOource:LTHReshold"` on page 1364
- `":TRIGger:ADVanced:VIOLation:SETup:HOLD:TIME"` on page 1365
- `":TRIGger:ADVanced:VIOLation:SETup:SHOLd:CSOource"` on page 1366
- `":TRIGger:ADVanced:VIOLation:SETup:SHOLd:CSOource:LEVel"` on page 1367
- `":TRIGger:ADVanced:VIOLation:SETup:SHOLd:CSOource:EDGE"` on page 1368
- `":TRIGger:ADVanced:VIOLation:SETup:SHOLd:DSOource"` on page 1369
- `":TRIGger:ADVanced:VIOLation:SETup:SHOLd:DSOource:HTHReshold"` on page 1370
- `":TRIGger:ADVanced:VIOLation:SETup:SHOLd:DSOource:LTHReshold"` on page 1371
- `":TRIGger:ADVanced:VIOLation:SETup:SHOLd:SetupTIME (STIME)"` on page 1372
- `":TRIGger:ADVanced:VIOLation:SETup:SHOLd:HoldTIME (HTIME)"` on page 1373

Mode Use MODE to select Setup, Hold, or both Setup and Hold time triggering.

You can have the oscilloscope trigger on violations of setup time, hold time, or both setup and hold time. To use Setup Violation Type, the oscilloscope needs a clock waveform, used as the reference, and a data waveform for the trigger source.

| | |
|---------------------------------|---|
| Setup Time Mode | When using the Setup Time Mode, a time window is defined where the right edge is the clock edge and the left edge is the selected time before the clock edge. The waveform must stay outside of the thresholds during this time window. If the waveform crosses a threshold within the time window, a violation event occurs and the oscilloscope triggers. |
| Hold Time Mode | When using Hold Time Mode, the waveform must not cross the threshold voltages after the specified clock edge for at least the hold time you have selected. Otherwise, a violation event occurs and the oscilloscope triggers. |
| Setup and Hold Time Mode | When using the Setup and Hold Time Mode, if the waveform violates either a setup time or hold time, the oscilloscope triggers. |
| Data Source | Use the data source (DSOURCE) command to select the channel used as the data, the low-level data threshold, and the high-level data threshold. For data to be considered valid, it must be below the lower threshold or above the upper threshold during the time of interest. |
| DSOURCE | Use DSOURCE to select the channel you want to use for the data source. |
| Low Threshold | Use the low threshold (LTHRESHOLD) to set the minimum threshold for your data. Data is valid below this threshold. |
| High Threshold | Use the high threshold (HTHRESHOLD) to set the maximum threshold for your data. Data is valid above this threshold. |
| Clock Source | Use the clock source (CSOURCE) command to select the clock source, trigger level, and edge polarity for your clock. Before the trigger circuitry looks for a setup or hold time violation, the clock must pass through the voltage level you have set. |
| CSOURCE | Use CSOURCE to select the channel you want to use for the clock source. |
| LEVEL | Use LEVEL to set voltage level on the clock waveform as given in the data book for your logic family. |
| RISing or FALLing | Use RISing or FALLing to select the edge of the clock the oscilloscope uses as a reference for the setup or hold time violation trigger. |
| Time | |
| Setup Time | Use SETUP to set the amount of setup time used to test for a violation. The setup time is the amount of time that the data has to be stable and valid prior to a clock edge. The minimum is 1.5 ns; the maximum is 20 ns. |
| Hold Time | Use HOLD to set the amount of hold time used to test for a violation. The hold time is the amount of time that the data has to be stable and valid after a clock edge. The minimum is 1.5 ns; the maximum is 20 ns. |
| Setup and Hold | Use SHOLD (Setup and Hold) to set the amount of setup and hold time used to test for a violation. |

The setup time is the amount of time that the data has to be stable and valid prior to a clock edge. The hold time is the amount of time that the data waveform has to be stable and valid after a clock edge.

The setup time plus hold time equals 20 ns maximum. So, if the setup time is 1.5 ns, the maximum hold time is 18.5 ns.

Available trigger conditioning includes HOLDoff and HYSTeresis (Noise Reject).

**Set the Mode
Before Executing
Commands**

Before executing the :TRIGger:ADVanced:VIOLation:SETup commands, set the mode by entering:

```
:TRIGger:MODE ADVanced and  
:TRIGger:ADVanced:MODE VIOLation and  
:TRIGger:ADVanced:VIOLation:MODE SETup and  
:TRIGger:ADVanced:VIOLation:SETup:MODE <setup_mode>
```

Where <setup_mode> includes SETup, HOLD, and SHOLd.

To query the oscilloscope for the advanced trigger violation setup mode, enter:

```
:TRIGger:ADVanced:VIOLation:SETup:MODE?
```

:TRIGger:ADVanced:VIOLation:SETup:MODE

| | |
|------------------------|--|
| Command | :TRIGger:ADVanced:VIOLation:SETup:MODE {SETup HOLD SHOLd} |
| SETup | When using the setup time mode, a time window is defined where the right edge is the clock edge and the left edge is the selected time before the clock edge. The waveform must stay outside of the trigger level thresholds during this time window. If the waveform crosses a threshold during this time window, a violation event occurs and the oscilloscope triggers. |
| HOLD | When using the hold time mode, the waveform must not cross the threshold voltages after the specified clock edge for at least the hold time you have selected. Otherwise, a violation event occurs and the oscilloscope triggers. |
| SHOLd | When using the setup and hold time mode, if the waveform violates either a setup time or hold time, the oscilloscope triggers. The total time allowed for the sum of setup time plus hold time is 20 ns maximum. |
| Query | :TRIGger:ADVanced:VIOLation:SETup:MODE? The query returns the currently selected trigger setup violation mode. |
| Returned Format | [:TRIGger:ADVanced:VIOLation:SETup:MODE] {SETup HOLD SHOLd}<NL> |
| History | Legacy command (existed before version 3.10). |

:TRIGger:ADVanced:VIOLation:SETup:SETup:CSOource

Command :TRIGger:ADVanced:VIOLation:SETup:SETup:CSOource {CHANnel<N>}

This command specifies the clock source for the clock used for the trigger setup violation. The clock must pass through the voltage level you have set before the trigger circuitry looks for a setup or hold time violation.

<N> An integer, 1-4.

Query :TRIGger:ADVanced:VIOLation:SETup:SETup:CSOource?

The query returns the currently defined clock source for the trigger setup violation.

Returned Format [:TRIGger:ADVanced:VIOLation:SETup:SETup:CSOource]
{CHANnel<N>}<NL>

History Legacy command (existed before version 3.10).

:TRIGger:ADVanced:VIOLation:SETup:SETup:CSOurce:LEVel

Command :TRIGger:ADVanced:VIOLation:SETup:SETup:CSOurce:LEVel {{CHANnel<N>},<level>}

This command specifies the level for the clock source used for the trigger setup violation. The clock must pass through the voltage level you have set before the trigger circuitry looks for a setup or hold time violation.

<N> An integer, 1-4.

<level> A real number for the voltage level for the trigger setup violation clock waveform, and depends on the type of circuitry logic you are using.

Query :TRIGger:ADVanced:VIOLation:SETup:SETup:CSOurce:LEVel? {CHANnel<N>}

The query returns the specified clock source level for the trigger setup violation.

Returned Format [:TRIGger:ADVanced:VIOLation:SETup:SETup:CSOurce:LEVel {CHANnel<N>},] <level><NL>

History Legacy command (existed before version 3.10).

`:TRIGger:ADVanced:VIOLation:SETup:SETup:CSOurce:EDGE`

Command `:TRIGger:ADVanced:VIOLation:SETup:SETup:CSOurce:EDGE {RISing | FALLing}`

This command specifies the edge for the clock source used for the trigger setup violation. The clock must pass through the voltage level you have set before the trigger circuitry looks for a setup or hold time violation.

Query `:TRIGger:ADVanced:VIOLation:SETup:SETup:CSOurce:EDGE?`

The query returns the currently defined clock source edge for the trigger setup violation.

Returned Format `[:TRIGger:ADVanced:VIOLation:SETup:SETup:CSOurce:EDGE] {RIS | FALL}<NL>`

History Legacy command (existed before version 3.10).

:TRIGger:ADVanced:VIOLation:SETup:SETup:DSOurce

Command :TRIGger:ADVanced:VIOLation:SETup:SETup:DSOurce {CHANnel<N>}

The data source commands specify the data source for the trigger setup violation.

<N> An integer, 1-4.

Query :TRIGger:ADVanced:VIOLation:SETup:SETup:DSOurce?

The query returns the currently defined data source for the trigger setup violation.

Returned Format [:TRIGger:ADVanced:VIOLation:SETup:SETup:DSOurce] {CHANnel<N>}<NL>

History Legacy command (existed before version 3.10).

:TRIGger:ADVanced:VIOLation:SETup:SETup:DSource:HTHReshold

Command :TRIGger:ADVanced:VIOLation:SETup:SETup:DSource:HTHReshold {{CHANnel<N>},<level>}

This command specifies the data source for the trigger setup violation, and the high-level data threshold for the selected data source. Data is valid when it is above the high-level data threshold, and when it is below the low-level data threshold.

<N> An integer, 1-4.

<level> A real number for the data threshold level for the trigger setup violation, and is used with the high and low threshold data source commands.

Query :TRIGger:ADVanced:VIOLation:SETup:SETup:DSource:HTHReshold? {CHANnel<N>}

The query returns the specified data source for the trigger setup violation, and the high data threshold for the data source.

Returned Format [:TRIGger:ADVanced:VIOLation:SETup:SETup:DSource:HTHReshold {CHANnel<N>},] <level><NL>

History Legacy command (existed before version 3.10).

:TRIGger:ADVanced:VIOLation:SETup:SETup:DSource:LTHReshold

Command :TRIGger:ADVanced:VIOLation:SETup:SETup:DSource:LTHReshold {{CHANnel<N>},<level>}

This command specifies the data source for the trigger setup violation, and the low-level data threshold for the selected data source. Data is valid when it is above the high-level data threshold, and when it is below the low-level data threshold.

<N> An integer, 1-4.

<level> A real number for the data threshold level for the trigger setup violation, and is used with the high and low threshold data source commands.

Query :TRIGger:ADVanced:VIOLation:SETup:SETup:DSource: LTHReshold? {CHANnel<N>}

The query returns the specified data source for the trigger setup violation, and the low data threshold for the data source.

Returned Format [:TRIGger:ADVanced:VIOLation:SETup:SETup:DSource:LTHReshold {CHANnel<N>},] <level><NL>

History Legacy command (existed before version 3.10).

:TRIGger:ADVanced:VIOLation:SETup:SETup:TIME

Command :TRIGger:ADVanced:VIOLation:SETup:SETup:TIME <time>

This command specifies the amount of setup time used to test for a trigger violation. The setup time is the amount of time that the data must be stable and valid prior to a clock edge.

<time> Setup time, in seconds.

Query :TRIGger:ADVanced:VIOLation:SETup:SETup:TIME?

The query returns the currently defined setup time for the trigger violation.

Returned Format [:TRIGger:ADVanced:VIOLation:SETup:SETup:TIME] <time><NL>

History Legacy command (existed before version 3.10).

:TRIGger:ADVanced:VIOLation:SETup:HOLD:CSOurce

Command :TRIGger:ADVanced:VIOLation:SETup:HOLD:CSOurce {CHANnel<N>}

This command specifies the clock source for the clock used for the trigger hold violation. The clock must pass through the voltage level you have set before the trigger circuitry looks for a setup or hold time violation.

<N> An integer, 1-4.

Query :TRIGger:ADVanced:VIOLation:SETup:HOLD:CSOurce?

The query returns the currently defined clock source for the trigger hold violation.

Returned Format [:TRIGger:ADVanced:VIOLation:SETup:HOLD:CSOurce] {CHANnel<N>}<NL>

History Legacy command (existed before version 3.10).

:TRIGger:ADVanced:VIOLation:SETup:HOLD:CSOurce:LEVel

Command :TRIGger:ADVanced:VIOLation:SETup:HOLD:CSOurce:LEVel {{CHANnel<N>},<level>}

This command specifies the level for the clock source used for the trigger hold violation. The clock must pass through the voltage level you have set before the trigger circuitry looks for a setup or hold time violation.

<N> An integer, 1-4.

<level> A real number for the voltage level for the trigger hold violation clock waveform, and depends on the type of circuitry logic you are using.

Query :TRIGger:ADVanced:VIOLation:SETup:HOLD:CSOurce:LEVel? {CHANnel<N>}

The query returns the specified clock source level for the trigger hold violation.

Returned Format [:TRIGger:ADVanced:VIOLation:SETup:HOLD:CSOurce:LEVel {CHANnel<N>},] <level><NL>

History Legacy command (existed before version 3.10).

:TRIGger:ADVanced:VIOLation:SETup:HOLD:CSOurce:EDGE

Command :TRIGger:ADVanced:VIOLation:SETup:HOLD:CSOurce:EDGE {RISing | FALLing}

This command specifies the edge for the clock source used for the trigger hold violation. The clock must pass through the voltage level you have set before the trigger circuitry looks for a setup or hold time violation.

Query :TRIGger:ADVanced:VIOLation:SETup:HOLD:CSOurce:EDGE?

The query returns the currently defined clock source edge for the trigger hold violation.

Returned Format [:TRIGger:ADVanced:VIOLation:SETup:HOLD:CSOurce:EDGE] {RIS | FALL}<NL>

History Legacy command (existed before version 3.10).

:TRIGger:ADVanced:VIOLation:SETup:HOLD:DSOurce

Command :TRIGger:ADVanced:VIOLation:SETup:HOLD:DSOurce {CHANnel<N>}

The data source commands specify the data source for the trigger hold violation.

<N> An integer, 1-4.

Query :TRIGger:ADVanced:VIOLation:SETup:HOLD:DSOurce?

The query returns the currently defined data source for the trigger hold violation.

Returned Format [:TRIGger:ADVanced:VIOLation:SETup:HOLD:DSOurce] {CHANnel<N>}<NL>

History Legacy command (existed before version 3.10).

:TRIGger:ADVanced:VIOLation:SETup:HOLD:DSOource:HTHReshold

Command :TRIGger:ADVanced:VIOLation:SETup:HOLD:DSOource:HTHReshold {{CHANnel<N>}, <level>}

This command specifies the data source for the trigger hold violation, and the high-level data threshold for the selected data source. Data is valid when it is above the high-level data threshold, and when it is below the low-level data threshold.

<N> An integer, 1–4.

<level> A real number for the data threshold level for the trigger hold violation, and is used with the high and low threshold data source commands.

Query :TRIGger:ADVanced:VIOLation:SETup:HOLD:DSOource:HTHReshold? {CHANnel<N>}

The query returns the specified data source for the trigger hold violation, and the high data threshold for the data source.

Returned Format [:TRIGger:ADVanced:VIOLation:SETup:HOLD:DSOource:HTHReshold {CHANnel<N>},] <level><NL>

History Legacy command (existed before version 3.10).

:TRIGger:ADVanced:VIOLation:SETup:HOLD:DSOurce:LTHReshold

Command :TRIGger:ADVanced:VIOLation:SETup:HOLD:DSOurce:LTHReshold {{CHANnel<N>}, <level>}

This command specifies the data source for the trigger hold violation, and the low-level data threshold for the selected data source. Data is valid when it is above the high-level data threshold, and when it is below the low-level data threshold.

<N> An integer, 1-4.

<level> A real number for the data threshold level for the trigger hold violation, and is used with the high and low threshold data source commands.

Query :TRIGger:ADVanced:VIOLation:SETup:HOLD:DSOurce:LTHReshold? {CHANnel<N>}

The query returns the specified data source for the trigger hold violation, and the low data threshold for the data source.

Returned Format [:TRIGger:ADVanced:VIOLation:SETup:HOLD:DSOurce:LTHReshold {CHANnel<N>},] <level><NL>

History Legacy command (existed before version 3.10).

:TRIGger:ADVanced:VIOLation:SETup:HOLD:TIME

Command :TRIGger:ADVanced:VIOLation:SETup:HOLD:TIME <time>

This command specifies the amount of hold time used to test for a trigger violation. The hold time is the amount of time that the data must be stable and valid after a clock edge.

<time> Hold time, in seconds.

Query :TRIGger:ADVanced:VIOLation:SETup:HOLD:TIME?

The query returns the currently defined hold time for the trigger violation.

Returned Format [:TRIGger:ADVanced:VIOLation:SETup:HOLD:TIME] <time><NL>

History Legacy command (existed before version 3.10).

:TRIGger:ADVanced:VIOLation:SETup:SHOLd:CSource

Command :TRIGger:ADVanced:VIOLation:SETup:SHOLd:CSource: {CHANnel<N>}

This command specifies the clock source for the clock used for the trigger setup and hold violation. The clock must pass through the voltage level you have set before the trigger circuitry looks for a setup and hold time violation.

<N> An integer, 1-4.

Query :TRIGger:ADVanced:VIOLation:SETup:SHOLd:CSource?

The query returns the currently defined clock source for the trigger setup and hold violation.

Returned Format [:TRIGger:ADVanced:VIOLation:SETup:SHOLd:CSource] {CHANnel<N>}<NL>

History Legacy command (existed before version 3.10).

:TRIGger:ADVanced:VIOLation:SETup:SHOLd:CSource:LEVel

Command :TRIGger:ADVanced:VIOLation:SETup:SHOLd:CSource:LEVel {{CHANnel<N>},<level>}

This command specifies the clock source trigger level for the clock used for the trigger setup and hold violation. The clock must pass through the voltage level you have set before the trigger circuitry looks for a setup and hold time violation.

<N> An integer, 1-4.

<level> A real number for the voltage level for the trigger setup and hold violation clock waveform, and depends on the type of circuitry logic you are using.

Query :TRIGger:ADVanced:VIOLation:SETup:SHOLd:CSource:LEVel? {CHANnel<N>}

The query returns the specified clock source level for the trigger setup and hold violation level for the clock source.

Returned Format [:TRIGger:ADVanced:VIOLation:SETup:SHOLd:CSource:LEVel {CHANnel<N>},] <level><NL>

History Legacy command (existed before version 3.10).

:TRIGger:ADVanced:VIOLation:SETup:SHOLd:CSource:EDGE

Command :TRIGger:ADVanced:VIOLation:SETup:SHOLd:CSource:EDGE {RISing | FALLing}

This command specifies the clock source trigger edge for the clock used for the trigger setup and hold violation. The clock must pass through the voltage level you have set before the trigger circuitry looks for a setup and hold time violation.

Query :TRIGger:ADVanced:VIOLation:SETup:SHOLd:CSource:EDGE?

The query returns the currently defined clock source edge for the trigger setup and hold violation level for the clock source.

Returned Format [:TRIGger:ADVanced:VIOLation:SETup:SHOLd:CSource:EDGE] {RIS | FALL}<NL>

History Legacy command (existed before version 3.10).

:TRIGger:ADVanced:VIOLation:SETup:SHOLd:DSOurce

Command :TRIGger:ADVanced:VIOLation:SETup:SHOLd:DSOurce {CHANnel<N>}

The data source commands specify the data source for the trigger setup and hold violation.

<N> An integer, 1-4.

Query :TRIGger:ADVanced:VIOLation:SETup:SHOLd:DSOurce?

The query returns the currently defined data source for the trigger setup and hold violation.

Returned Format [:TRIGger:ADVanced:VIOLation:SETup:SHOLd:DSOurce] {CHANnel<N>}<NL>

History Legacy command (existed before version 3.10).

:TRIGger:ADVanced:VIOLation:SETup:SHOLd:DSource:HTHReshold

Command :TRIGger:ADVanced:VIOLation:SETup:SHOLd:DSource:HTHReshold {{CHANnel<N>},<level>}

This command specifies the data source for the trigger setup and hold violation, and the high-level data threshold for the selected data source. Data is valid when it is above the high-level data threshold, and when it is below the low-level data threshold.

<N> An integer, 1-4.

<level> A real number for the data threshold level for the trigger setup and hold violation, and is used with the high and low threshold data source commands.

Query :TRIGger:ADVanced:VIOLation:SETup:SHOLd:DSource:HTHReshold? {CHANnel<N>}

The query returns the specified data source for the trigger setup and hold violation, and the high data threshold for the data source.

Returned Format [:TRIGger:ADVanced:VIOLation:SETup:SHOLd:DSource:HTHReshold {CHANnel<N>},] <level><NL>

History Legacy command (existed before version 3.10).

:TRIGger:ADVanced:VIOLation:SETup:SHOLd:DSOurce:LTHReshold

Command :TRIGger:ADVanced:VIOLation:SETup:SHOLd:DSOurce:LTHReshold {{CHANnel<N>},<level>}

This command specifies the data source for the trigger setup and hold violation, and the low-level data threshold for the selected data source. Data is valid when it is above the high-level data threshold, and when it is below the low-level data threshold.

<N> An integer, 1–4.

<level> A real number for the data threshold level for the trigger setup and hold violation, and is used with the high and low threshold data source commands.

Query :TRIGger:ADVanced:VIOLation:SETup:SHOLd:DSOurce:LTHReshold? {CHANnel<N>}

The query returns the specified data source for the setup and trigger hold violation, and the low data threshold for the data source.

Returned Format [:TRIGger:ADVanced:VIOLation:SETup:SHOLd:DSOurce:LTHReshold {CHANnel<N>},] <level><NL>

History Legacy command (existed before version 3.10).

:TRIGger:ADVanced:VIOLation:SETup:SHOLd:SetupTIME (STIME)

Command :TRIGger:ADVanced:VIOLation:SETup:SHOLd:SetupTIME <time>

This command specifies the amount of setup time used to test for both a setup and hold trigger violation. The setup time is the amount of time that the data must be stable and valid before a clock edge.

<time> Setup time, in seconds.

Query :TRIGger:ADVanced:VIOLation:SETup:SHOLd:SetupTIME?

The query returns the currently defined setup time for the setup and hold trigger violation.

Returned Format [:TRIGger:ADVanced:VIOLation:SETup:SHOLd:SetupTIME] <time><NL>

History Legacy command (existed before version 3.10).

:TRIGger:ADVanced:VIOLation:SETup:SHOLd:HoldTIME (HTIME)

Command :TRIGger:ADVanced:VIOLation:SETup:SHOLd:HoldTIME <time>

This command specifies the amount of hold time used to test for both a setup and hold trigger violation. The hold time is the amount of time that the data must be stable and valid after a clock edge.

<time> Hold time, in seconds.

Query :TRIGger:ADVanced:VIOLation:SETup:SHOLD:HoldTIME?

The query returns the currently defined hold time for the setup and hold trigger violation.

Returned Format [:TRIGger:ADVanced:VIOLation:SETup:SHOLD:HoldTIME] <time><NL>

History Legacy command (existed before version 3.10).

Advanced Transition Violation Trigger Commands

Use Transition Violation Mode to find any edge in your waveform that violates a rise time or fall time specification. Infiniium Oscilloscopes find a transition violation trigger by looking for any pulses in your waveform with rising or falling edges that do not cross two voltage levels in the amount of time you have specified.

The rise time is measured from the time that your waveform crosses the low threshold until it crosses the high threshold. The fall time is measured from the time that the waveform crosses the high threshold until it crosses the low threshold.

- **":TRIGger:ADVanced:VIOLation:TRANSition"** on page 1375
- **":TRIGger:ADVanced:VIOLation:TRANSition:SOURce"** on page 1376
- **":TRIGger:ADVanced:VIOLation:TRANSition:SOURce:HTHReshold"** on page 1377
- **":TRIGger:ADVanced:VIOLation:TRANSition:SOURce:LTHReshold"** on page 1378
- **":TRIGger:ADVanced:VIOLation:TRANSition:TYPE"** on page 1379

| | |
|---|---|
| Source | Use Source to select the channel used for a transition violation trigger. |
| Low Threshold | Use Low Threshold to set the low voltage threshold. |
| High Threshold | Use High Threshold to set the high voltage threshold. |
| Type | Use Type to select Rise Time or Fall Time violation. |
| Trigger On | Trigger On parameters include > Time and < Time. |
| > Time | Use > Time to look for transition violations that are longer than the time specified. |
| < Time | Use < Time to look for transition violations that are less than the time specified. |
| Time | Use Time to set the amount of time to determine a rise time or fall time violation. |
| | Available trigger conditioning includes HOLDoff and HYSTeresis (Noise Reject). |
| Set the Mode Before Executing Commands | Before executing the :TRIGger:ADVanced:VIOLation:TRANSition commands, set the mode by entering: <pre>:TRIGger:MODE ADVanced and :TRIGger:ADVanced:MODE VIOLation and :TRIGger:ADVanced:VIOLation:MODE TRANSition</pre> |
| | To query the oscilloscope for the advanced trigger violation mode, enter: <pre>:TRIGger:ADVanced:VIOLation:MODE?</pre> |

:TRIGger:ADVanced:VIOLation:TRANSition

Command :TRIGger:ADVanced:VIOLation:TRANSition:{GTHan | LTHan} <time>

This command lets you look for transition violations that are greater than or less than the time specified.

<time> The time for the trigger violation transition, in seconds.

Query :TRIGger:ADVanced:VIOLation:TRANSition:{GTHan | LTHan}?

The query returns the currently defined time for the trigger transition violation.

Returned Format [:TRIGger:ADVanced:VIOLation:TRANSition:{GTHan | LTHan}] <time><NL>

History Legacy command (existed before version 3.10).

:TRIGger:ADVanced:VIOLation:TRANSition:SOURce

Command :TRIGger:ADVanced:VIOLation:TRANSition:SOURce {CHANnel<N>}

The transition source command lets you find any edge in your waveform that violates a rise time or fall time specification. The oscilloscope finds a transition violation trigger by looking for any pulses in your waveform with rising or falling edges that do not cross two voltage levels in the amount of time you have specified.

<N> An integer, 1-4.

Query :TRIGger:ADVanced:VIOLation:TRANSition:SOURce?

The query returns the currently defined transition source for the trigger transition violation.

Returned Format [:TRIGger:ADVanced:VIOLation:TRANSition:SOURce] {CHANnel<N>}<NL>

History Legacy command (existed before version 3.10).

:TRIGger:ADVanced:VIOLation:TRANSition:SOURce:HTHReshold

Command :TRIGger:ADVanced:VIOLation:TRANSition:SOURce:HTHReshold {{CHANnel<N>},<level>}

This command lets you specify the source and high threshold for the trigger violation transition. The oscilloscope finds a transition violation trigger by looking for any pulses in your waveform with rising or falling edges that do not cross two voltage levels in the amount of time you have specified.

<N> An integer, 1–4.

<level> A real number for the voltage threshold level for the trigger transition violation, and is used with the high and low threshold transition source commands.

Query :TRIGger:ADVanced:VIOLation:TRANSition:SOURce:HTHReshold? {CHANnel<N>}

The query returns the specified transition source for the trigger transition high threshold violation.

Returned Format [:TRIGger:ADVanced:VIOLation:TRANSition:SOURce:HTHReshold {CHANnel<N>},<level><NL>

History Legacy command (existed before version 3.10).

:TRIGger:ADVanced:VIOLation:TRANSition:SOURce:LTHReshold

Command :TRIGger:ADVanced:VIOLation:TRANSition:SOURce:LTHReshold {{CHANnel<N>},<level>}

This command lets you specify the source and low threshold for the trigger violation transition. The oscilloscope finds a transition violation trigger by looking for any pulses in your waveform with rising or falling edges that do not cross two voltage levels in the amount of time you have specified.

<N> An integer, 1–4.

<level> A real number for the voltage threshold level for the trigger transition violation, and is used with the high and low threshold transition source commands.

Query :TRIGger:ADVanced:VIOLation:TRANSition:SOURce:LTHReshold? {CHANnel<N>}

The query returns the currently defined transition source for the trigger transition low threshold violation.

Returned Format [:TRIGger:ADVanced:VIOLation:TRANSition:SOURce:LTHReshold {CHANnel<N>},<level><NL>]

History Legacy command (existed before version 3.10).

:TRIGger:ADVanced:VIOLation:TRANSition:TYPE

Command :TRIGger:ADVanced:VIOLation:TRANSition:TYPE {RISetime | FALLtime}

This command lets you select either a rise time or fall time transition violation trigger event.

Query :TRIGger:ADVanced:VIOLation:TRANSition:TYPE?

The query returns the currently defined transition type for the trigger transition violation.

Returned Format [:TRIGger:ADVanced:VIOLation:TRANSition:TYPE] {RISetime | FALLtime}<NL>

History Legacy command (existed before version 3.10).

37 Waveform Commands

:WAVEform:BANDpass? / 1384
:WAVEform:BYTeorder / 1385
:WAVEform:CGRade:HEIGHt? / 1386
:WAVEform:CGRade:WIDTh? / 1387
:WAVEform:COMPLetE? / 1388
:WAVEform:COUNT? / 1389
:WAVEform:COUPLing? / 1390
:WAVEform:DATA? / 1391
:WAVEform:FORMat / 1413
:WAVEform:POINts? / 1416
:WAVEform:PREamble? / 1417
:WAVEform:SEGmented:ALL / 1421
:WAVEform:SEGmented:COUNT? / 1422
:WAVEform:SEGmented:TTAG? / 1423
:WAVEform:SEGmented:XLIST? / 1424
:WAVEform:SOURce / 1425
:WAVEform:STReaming / 1427
:WAVEform:TYPE? / 1428
:WAVEform:VIEW / 1429
:WAVEform:XDISplay? / 1432
:WAVEform:XINCrement? / 1433
:WAVEform:XORigin? / 1434
:WAVEform:XRANge? / 1435
:WAVEform:XREFerence? / 1436
:WAVEform:XUNits? / 1437
:WAVEform:YDISplay? / 1438
:WAVEform:YINCrement? / 1439
:WAVEform:YORigin? / 1440
:WAVEform:YRANge? / 1441
:WAVEform:YREFerence? / 1442
:WAVEform:YUNits? / 1443

The WAVEform subsystem is used to transfer waveform data between a computer and the oscilloscope. It contains commands to set up the waveform transfer and to send or receive waveform records to or from the oscilloscope.

Data Acquisition When data is acquired using the DIGitize command, the data is placed in the channel or function memory of the specified source. After the DIGitize command executes, the oscilloscope is stopped. If the oscilloscope is restarted by your program or from the front panel, the data acquired with the DIGitize command is overwritten.

You can query the preamble, elements of the preamble, or waveform data while the oscilloscope is running, but the data will reflect only the current acquisition, and subsequent queries will not reflect consistent data. For example, if the oscilloscope is running and you query the X origin, the data is queried in a separate command, it is likely that the first point in the data will have a different time than that of the X origin. This is due to data acquisitions that may have occurred between the queries. For this reason, Keysight Technologies does not recommend this mode of operation. Instead, you should use the DIGitize command to stop the oscilloscope so that all subsequent queries will be consistent.

NOTE

Function and channel data are volatile and must be read following a DIGitize command or the data will be lost when the oscilloscope is turned off.

Waveform Data and Preamble The waveform record consists of two parts: the preamble and the waveform data. The waveform data is the actual sampled data acquired for the specified source. The preamble contains the information for interpreting the waveform data, including the number of points acquired, the format of the acquired data, and the type of acquired data. The preamble also contains the X and Y increments, origins, and references for the acquired data.

The values in the preamble are set when you execute the DIGitize command. The preamble values are based on the current settings of the oscilloscope's controls.

Data Conversion Data sent from the oscilloscope must be scaled for useful interpretation. The values used to interpret the data are the X and Y origins and X and Y increments. These values can be read using the :WAVEform:XORigin?, WAVEform:YORigin?, WAVEform:XINCrement?, and WAVEform:YINCrement? queries.

Conversion from Data Values to Units To convert the waveform data values (essentially A/D counts) to real-world units, such as volts, use the following scaling formulas:

$$\begin{aligned} \text{Y-axis Units} &= \text{data value} \times \text{Yincrement} + \text{Yorigin} \quad (\text{analog channels}) \\ \text{X-axis Units} &= \text{data index} \times \text{Xincrement} + \text{Xorigin}, \quad \text{where the data index starts at zero: } 0, 1, 2, \dots, n-1. \end{aligned}$$

The first data point for the time (X-axis units) must be zero, so the time of the first data point is the X origin.

Data Format for Data Transfer There are four types of data formats that you can select using the :WAVEform:FORMat command: ASCii, BYTE, WORD, and BINary. Refer to the FORMat command in this chapter for more information on data formats.

:WAVEform:BANDpass?

Query :WAVEform:BANDpass?

The :WAVEform:BANDpass? query returns an estimate of the maximum and minimum bandwidth limits of the source waveform. The bandwidth limits are computed as a function of the coupling and the selected filter mode. The cutoff frequencies are derived from the acquisition path and software filtering.

Returned Format [:WAVEform:BANDpass] <lower_cutoff>, <upper_cutoff><NL>

<lower_cutoff> Minimum frequency passed by the acquisition system.

<upper_cutoff> Maximum frequency passed by the acquisition system.

Example This example places the estimated maximum and minimum bandwidth limits of the source waveform in the string variable, strBandwidth, then prints the contents of the variable to the computer's screen.

```
Dim strBandwidth As String    ' Dimension variable.
myScope.WriteString ":WAVEform:BANDpass?"
strBandwidth = myScope.ReadString
Debug.Print strBandwidth
```

History Legacy command (existed before version 3.10).

:WAVeform:BYTeorder

Command :WAVeform:BYTeorder {MSBFirst | LSBFirst}

The :WAVeform:BYTeorder command selects the order in which bytes are transferred to and from the oscilloscope using WORD and LONG formats. If MSBFirst is selected, the most significant byte is transferred first. Otherwise, the least significant byte is transferred first. The default setting is MSBFirst.

NOTE

The data transfer rate is faster using the LSBFirst byte order.

MSBFirst is for microprocessors, where the most significant byte resides at the lower address. LSBFirst is for microprocessors, where the least significant byte resides at the lower address.

Example This example sets up the oscilloscope to send the most significant byte first during data transmission.

```
myScope.WriteString ":WAVeform:BYTeorder MSBFirst"
```

Query :WAVeform:BYTeorder?

The :WAVeform:BYTeorder? query returns the current setting for the byte order.

Returned Format [:WAVeform:BYTeorder] {MSBFirst | LSBFirst}<NL>

Example This example places the current setting for the byte order in the string variable, strSetting, then prints the contents of the variable to the computer's screen.

```
Dim strSetting As String ' Dimension variable.
myScope.WriteString ":WAVeform:BYTeorder?"
strSetting = myScope.ReadString
Debug.Print strSetting
```

History Legacy command (existed before version 3.10).

:WAVeform:CGRade:HEIGht?

Query :WAVeform:CGRade:HEIGht?

When the CGRade waveform view is selected (:WAVeform:VIEW CGRade), the :WAVeform:CGRade:HEIGht? query returns the color grade (pixel) database data height.

Returned Format <height><NL>

<height> ::= integer in NR1 format

- See Also**
- ["Getting Color Grade \(Pixel\) Database Count Values"](#) on page 1430
 - [":WAVeform:VIEW"](#) on page 1429
 - [":WAVeform:FORMat"](#) on page 1413
 - [":WAVeform:CGRade:WIDTh?"](#) on page 1387

History New in version 6.00.

:WAVEform:CGRade:WIDTh?

Query :WAVEform:CGRade:WIDTh?

When the CGRade waveform view is selected (:WAVEform:VIEW CGRade), the :WAVEform:CGRade:WIDTh? query returns the color grade (pixel) database data width.

Returned Format <width><NL>

<width> ::= integer in NR1 format

- See Also**
- ["Getting Color Grade \(Pixel\) Database Count Values"](#) on page 1430
 - [":WAVEform:VIEW"](#) on page 1429
 - [":WAVEform:FORMat"](#) on page 1413
 - [":WAVEform:CGRade:HEIGht?"](#) on page 1386

History New in version 6.00.

:WAVeform:COMPLete?

Query :WAVeform:COMPLete?

The :WAVeform:COMPLete? query returns the percent of time buckets that are complete for the currently selected waveform.

For the NORMal, RAW, and INTerpolate waveform types, the percent complete is the percent of the number of time buckets that have data in them, compared to the memory depth.

For the AVERage waveform type, the percent complete is the number of time buckets that have had the specified number of hits divided by the memory depth. The hits are specified by the :ACQuire:AVERage:COUnT command.

For the VERSus waveform type, percent complete is the least complete of the X-axis and Y-axis waveforms.

Returned Format [:WAVeform:COMPLete] <criteria><NL>

<criteria> 0 to 100 percent, rounded down to the closest integer.

Example This example places the current completion criteria in the string variable, strCriteria, then prints the contents of the variable to the computer's screen.

```
Dim strCriteria As String      ' Dimension variable.
myScope.WriteString ":WAVeform:COMPLete?"
strCriteria = myScope.ReadString
Debug.Print strCriteria
```

History Legacy command (existed before version 3.10).

:WAVEform:COUNT?

Query :WAVEform:COUNT?

The :WAVEform:COUNT? query returns the fewest number of hits in all of the time buckets for the currently selected waveform. For the AVERAge waveform type, the count value is the fewest number of hits for all time buckets. This value may be less than or equal to the value specified with the :ACQUIRE:AVERAge:COUNT command.

For the NORMal, RAW, INTERpolate, and VERSus waveform types, the count value returned is one, unless the data contains holes (sample points where no data is acquired). If the data contains holes, zero is returned.

Returned Format [:WAVEform:COUNT] <number><NL>

<number> An integer. Values range from 0 to 1 for NORMal, RAW, or INTERpolate types, and VERSus type. If averaging is on values range from 0 to 65536.

Example This example places the current count field value in the string variable, strCount, then prints the contents of the variable to the computer's screen.

```
Dim strCount As String ' Dimension variable.
myScope.WriteString ":WAVEform:COUNT?"
strCount = myScope.ReadString
Debug.Print strCount
```

History Legacy command (existed before version 3.10).

:WAVEform:COUPling?

Query :WAVEform:COUPling?

The :WAVEform:COUPling? query returns the input coupling of the currently selected source.

Returned Format [:WAVEform:COUPling] {AC | DC | DCFifty | LFReject} <NL>

On 9000 Series, 9000H Series, and Z-Series oscilloscopes, this query can return:

- AC.
- DC.
- DCFifty.
- LFReject.

On 90000A Series, 90000 X-Series, V-Series, 90000 Q-Series, and Z-Series oscilloscopes, this query always returns:

- DC – (and is provided for compatibility with other Infiniium oscilloscopes).

Example This example places the current input coupling of the selected waveform in the string variable, strSetting, then prints the contents of the variable.

```
Dim strSetting As String ' Dimension variable.
myScope.WriteString ":WAVEform:COUPling?"
strSetting = myScope.ReadString
Debug.Print strSetting
```

See Also The :CHANnel<N>:INPut command sets the coupling for a particular channel.

You can use the :WAVEform:SOURce command to set the source for the coupling query.

| Source | Return Value |
|-----------|---|
| CGRade | Coupling of the lowest numbered channel that is on. |
| HISTogram | The coupling of the selected channel. For functions, the coupling of the lowest numbered channel in the function. |
| CHANnel | The coupling of the channel number |
| FUNcTion | The coupling of the lowest numbered channel in the function |
| WMEMory | The coupling value of the source that was loaded into the waveform memory. If channel 1 was loaded, it would be the channel 1 coupling value. |

History Legacy command (existed before version 3.10).

:WAVEform:DATA?

Query :WAVEform:DATA? [<start>[,<size>]]

The :WAVEform:DATA? query outputs waveform data to the computer over the remote interface. The data is copied from a waveform memory, function, channel, bus, pod, or digital channel previously specified with the :WAVEform:SOURce command.

NOTE

The data's returned response depends upon the setting of the :WAVEform:STReaming command. See "**Streaming Off**" on page 1391 or "**Streaming On**" on page 1392 for more detail.

NOTE

If the waveform data is ASCII formatted, no header information indicating the number of bytes being downloaded is included, and the waveform data is separated by commas.

The preamble queries, such as :WAVEform:XINCrement, can be used to determine the vertical scaling, the horizontal scaling, and so on.

NOTE

When an acquisition is made on multiple channels, the data for each channel has the same X origin and the same number of points.

<start> An integer value which is the starting point in the source memory which is the first waveform point to transfer.

<size> An integer value which is the number of points in the source memory to transfer. If the size specified is greater than the amount of available data then the size is adjusted to be the maximum available memory depth minus the <start> value.

Streaming Off The returned waveform data response depends upon the setting of the :WAVEform:STReaming command. When the data format is BYTE and streaming is off, the number of waveform points must be less than 1,000,000,000 or an error occurs and only 999,999,999 bytes of data are sent. When the data format is WORD and streaming is off, the number of waveform points must be less than 500,000,000 or an error occurs and only 499,999,999 words of data are sent.

The returned waveform data in response to the :WAVEform:DATA? query is in the following order.

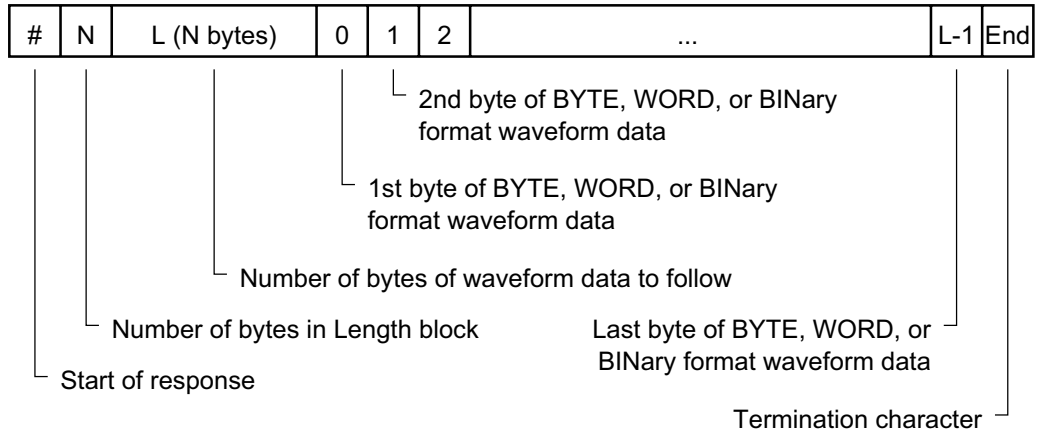

Figure 5 Streaming Off

Streaming On When streaming is on there is no limit on the number of waveform data points that are returned. It is recommended that any new programs use streaming on to send waveform data points. The waveform data response when streaming is on is as follows.

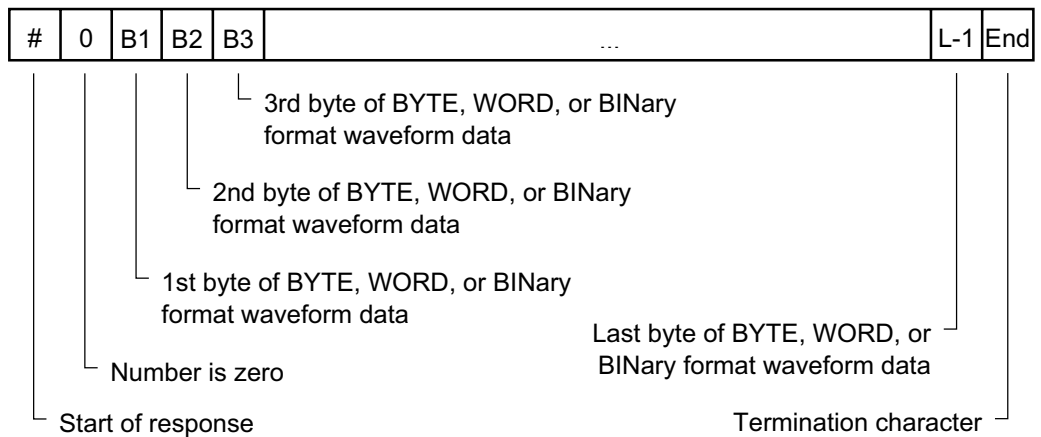

Figure 6 Streaming On

Returned Format [:WAVEform:DATA] <block_data> [, <block_data>] <NL>

Example This example places the current waveform data from channel 1 into the varWavData array in the word format.

```
myScope.WriteString ":SYSTEM:HEADER OFF" ' Response headers off.
myScope.WriteString ":WAVEform:SOURce CHANnel1" ' Select source.
myScope.WriteString ":WAVEform:FORMat WORD" ' Select word format.
myScope.WriteString ":WAVEform:DATA?"
varWavData = myScope.ReadIEEEBlock(BinaryType_I2)
```

The format of the waveform data must match the format previously specified by the :WAVEform:FORMat and :WAVEform:BYTeorder commands.

DATA? Example for Analog Channels

The following C example shows how to transfer WORD formatted waveform data for analog channels to a computer.

```

/* readdata. c */

/* Reading Word format example. This program demonstrates the order
 * of commands suggested for operation of the Infiniium oscilloscope
 * via LAN. This program initializes the oscilloscope, acquires data,
 * transfers data in WORD format, converts the data into time and
 * voltage values, and stores the data in a file as comma-separated
 * ascii values. This format is useful for spreadsheet and MATLAB
 * applications. It requires a waveform which is connected to Channel 1.
 */

#include <stdio.h>      /* location of: printf() */
#include <stdlib.h>     /* location of: atof(), atoi() */
#include <string.h>     /* location of: strlen() */
#include "sicl.h"

/* Prototypes */
int InitIO( void );
void WriteIO( char *buffer );
unsigned long ReadByte( char *buffer, unsigned long BytesToRead);
unsigned long ReadWord( char *buffer, int *reason,
                      unsigned long BytesToRead);
void ReadDouble( double *buffer );
void CloseIO( void );
void AcquireData( void );
void GetVoltageConversionFactors( double *yInc, double *yOrg );
void GetTimeConversionFactors( double *xInc, double *xOrg );
void WriteCsvToFile( unsigned long BytesToRead );
void SetupDataTransfer( void );

/* Defines */
#define MAX_LENGTH 10000000
#define INTERFACE "lan[130.29.70.247]:inst0"
#define TRUE 1
#define FALSE 0
#define IO_TIMEOUT 20000

/* Globals */
INST bus;
INST scope;
char buffer[MAX_LENGTH]; /* Buffer for reading data */
double xOrg=0L, xInc=0L; /* Values used to create time data */
double yOrg=0L, yInc=0L; /* Values used to convert data to volts */

void main( void )
{
    unsigned long BytesToRead;

    if ( !InitIO() )

```

```

    {
        exit( 1 );
    }

    AcquireData();

    WriteIO( ":WAVEform:FORMat WORD" ); /* Setup transfer format */
    WriteIO( ":WAVEform:BYTeorder LSBFirst" ); /* Setup transfer of
                                                LSB first */
    WriteIO( ":WAVEform:SOURce CHANnel1" ); /* Waveform data source
                                                channel 1 */
    WriteIO( ":WAVEform:STReaming 1" ); /* Turn on waveform
                                                streaming of data */

    GetVoltageConversionFactors( &yInc, &yOrg );
    GetTimeConversionFactors( &xInc, &xOrg );
    BytesToRead = MAX_LENGTH;
    SetupDataTransfer();
    WriteCsvToFile( BytesToRead );

    CloseIO( );
}

/*****
* Function name:  InitIO
* Parameters:    none
* Return value:  TRUE if successful otherwise FALSE
* Description:   This routine initializes the SICL environment.
*               It sets up error handling, opens both an interface
*               and device session, sets timeout values, clears
*               the LAN interface card, and clears the
*               oscilloscope's LAN interface by performing a
*               Selected Device Clear.
*****/
int InitIO( void )
{
    ionerror( I_ERROR_EXIT ); /* set-up interface error handling */

    bus = iopen( INTERFACE ); /* open interface session */
    if ( bus == 0 )
    {
        printf( "Bus session invalid\n" );
        return FALSE;
    }

    itimeout( bus, IO_TIMEOUT ); /* set bus timeout */
    iclear( bus ); /* clear the interface */

    scope = bus; /* open the scope device session */

    return TRUE;
}

/*****
* Function name:  WriteIO

```

```

* Parameters: char *buffer which is a pointer to the character
*             string to be output
* Return value: none
* Description: This routine outputs strings to the oscilloscope
*             device session using SICL commands.
*****/

void WriteIO( char *buffer )
{
    unsigned long actualcnt;
    unsigned long BytesToRead;
    int send_end = 1;

    BytesToRead = strlen( buffer );

    iwrite( scope, buffer, BytesToRead, send_end, &actualcnt );
}

/*****
* Function name: ReadByte
* Parameters: char *buffer which is a pointer to the array to
*            store the read bytes
*            unsigned long BytesToRead which indicates the
*            maximum number of bytes to read
* Return value: integer which indicates the actual number of bytes
*            read
* Description: This routine inputs strings from the scope device
*            session using SICL commands.
*****/

unsigned long ReadByte( char *buffer, unsigned long BytesToRead )
{
    unsigned long BytesRead;
    int reason;

    BytesRead = BytesToRead;

    iread( scope, buffer, BytesToRead, &reason, &BytesRead );

    return BytesRead;
}

/*****
* Function name: ReadWord
* Parameters: short *buffer which is a pointer to the word array
*            to store the bytes read
*            int reason which is the reason that the read
*            terminated
*            unsigned long BytesToRead which indicates the
*            maximum number of bytes to read
* Return value: integer which indicates the actual number of
*            bytes read
* Description: This routine inputs an array of short values from
*            the oscilloscope device session using SICL commands.
*****/

```

```

unsigned long ReadWord( char *buffer, int *reason,
                      unsigned long BytesToRead )
{
    long BytesRead;

    iredad( scope, buffer, BytesToRead, reason, &BytesRead );

    return BytesRead;
}

/*****
 * Function name:  ReadDouble
 * Parameters:    double *buffer which is a pointer to the float
 *               value to read
 * Return value: none
 * Description:   This routine inputs a float value from the
 *               oscilloscope device session using SICL commands.
 *****/

void ReadDouble( double *buffer )
{
    iscanf( scope, "%lf", buffer );
}

/*****
 * Function name: close_IO
 * Parameters:    none
 * Return value: none
 * Description:   This routine closes device and interface sessions
 *               for the SICL environment, and calls the routine
 *               _siclcleanup which de-allocates resources
 *               used by the SICL environment.
 *****/

void CloseIO( void )
{
    iclose( scope ); /* close device session */
    iclose( bus );  /* close interface session */

    _siclcleanup(); /* required for 16-bit applications */
}

/*****
 * Function name:  AcquireData
 * Parameters:    none
 * Return value: none
 * Description:   This routine acquires data using the current
 *               oscilloscope settings.
 *****/

void AcquireData( void )
{
    /*
     * The root level :DIGitize command is recommended for
     * acquiring new waveform data. It initializes the

```

```

        * oscilloscope's data buffers, acquires new data,
        * and ensures that acquisition criteria are met before the
        * acquisition is stopped. Note that the display is
        * automatically turned off when you use this form of the
        * :DIGitize command and must be turned on to view the
        * captured data on screen.
*/

WriteIO(":DIGitize CHANnel1");
WriteIO(":CHANnel1:DISPlay ON");

}

/*****
 * Function name: GetVoltageConversionFactors
 * Parameters: double yInc which is the voltage difference
 *             represented by adjacent waveform data digital codes
 *
 *             double yOrg which is the voltage value of digital
 *             code 0.
 * Return value: none
 * Description: This routine reads the conversion factors used to
 *             convert waveform data to volts.
*****/

void GetVoltageConversionFactors( double *yInc, double *yOrg )
{
    /* Read values which are used to convert data to voltage values */

    WriteIO(":WAVEform:YINCrement?");
    ReadDouble( yInc );

    WriteIO(":WAVEform:YORigin?");
    ReadDouble( yOrg );
}

/*****
 * Function name: SetupDataTransfer
 * Parameters: none
 * Return value: none
 * Description: This routine sets up the waveform data transfer and
 *             removes the # and 0 characters.
*****/

void SetupDataTransfer( void )
{
    char cData;

    WriteIO( ":WAVEform:DATA?" ); /* Request waveform data */

    /* Find the # character */

    do
    {
        ReadByte( &cData, 1L );

```

```

    } while ( cData != '#' );

    /* Find the 0 character */

    do
    {
        ReadByte( &cData, 1L );
    } while ( cData != '0' );
}

/*****
* Function name:  GetTimeConversionFactors
* Parameters:    double xInc which is the time between consecutive
*               sample points.
*               double xOrg which is the time value of the first
*               data point.
* Return value:  none
* Description:   This routine transfers the waveform conversion
*               factors for the time values.
*****/

void GetTimeConversionFactors( double *xInc, double *xOrg )
{

    /* Read values which are used to create time values */

    WriteIO(":WAVEform:XINCrement?");
    ReadDouble( xInc );

    WriteIO(":WAVEform:XORigin?");
    ReadDouble( xOrg );

}

/*****
* Function name:  WriteCsvToFile
* Parameters:    unsigned long BytesToRead which is the number of
*               data points to read
* Return value:  none
* Description:   This routine stores the time and voltage
*               information about the waveform as time and
*               voltage separated by commas to a file.
*****/

void WriteCsvToFile( unsigned long BytesToRead )
{
    FILE *fp;
    int done = FALSE;
    int reason = 0;
    unsigned long i;
    unsigned long j = 0;
    unsigned long BytesRead = 0L;
    double Time;
    double Volts;
    short *buff;

    fp = fopen( "pairs.csv", "wb" ); /* Open file in binary mode - clear

```

```

file if it already exists */

if (fp != NULL)
{
while( !done )
{
BytesRead = ReadWord( buffer, &reason, BytesToRead );

switch( reason )
{
case I_TERM_MAXCNT:
done = FALSE;
break;
case I_TERM_END:
done = TRUE;
break;
case I_TERM_CHR:
done = TRUE;
break;
default:
done = TRUE;
break;
};

buff = (short *) buffer;

for( i = 0; i < ((BytesRead - 1)/2); i++)
{
Time = (j * xInc) + xOrg; /* calculate time */
j = j + 1;

Volts = (buff[i] * yInc) + yOrg; /* calculate voltage */

fprintf( fp, "%e,%f\n", Time, Volts );
}
}
fclose( fp );

}
else
{
printf("Unable to open file 'pairs.csv'\n");
}
}

```

DATA? Example for Digital Channels

The following C example shows how to transfer both BYTE and WORD formatted waveform data for digital channels to a computer. There is a file on the Infiniium Oscilloscope Example Programs disk called readdig.c in the c directory that contains this program.

```

/* readdig. c */

/* Reading Byte and Word format Example. This program demonstrates the
order of
commands suggested for operation of the Infiniium oscilloscope by LAN o
r GPIB.

```

```

    This program initializes the scope, acquires data, transfers data in both the
    BYTE and WORD formats, converts the data into hex, octal, binary and time
    values,
    and stores the data in a file as comma-separated values. This format is useful
    for spreadsheet applications.
    */

#include <stdio.h>          /* location of: printf() */
#include <stdlib.h>         /* location of: atof(), atoi() */
#include <string.h>        /* location of: strlen() */
#include "sicl.h"

/* Prototypes */
int InitIO( void );
void WriteIO( char *buffer );
unsigned long ReadByte( char *buffer, unsigned long BytesToRead);
unsigned long ReadWord( short *buffer, unsigned long BytesToRead);
void ReadDouble( double *buffer );
void CloseIO( void );
void AcquireData( void );
void GetTimeConversionFactors( void );
void CreateTimeData( unsigned long AcquiredLength,
                    double *TimeValues );
void WriteCsvToFile( double *TimeValues, unsigned short *wordData,
                   unsigned char *byteData, unsigned long AcquiredLength);
unsigned long SetupDataTransfer( double lTime, double rTime );
int Round( double number );

/* Defines */
#define MAX_LENGTH 8192000

#define LAN

#ifdef LAN
    #define INTERFACE "lan[130.29.71.202]:hpib7,7"
#else
    #define INTERFACE "hpib7"
#endif

#define DEVICE_ADDR "hpib7,7"
#define TRUE 1
#define FALSE 0
#define IO_TIMEOUT 20000

/* Globals */
INST bus;
INST scope;
double TimeValues[MAX_LENGTH];          /* Time value of data */
unsigned short wordData[MAX_LENGTH/2]; /* Buffer for reading word format
data */
unsigned char byteData[MAX_LENGTH];     /* Buffer for reading byte format
data */
double xOrg, xInc;                      /* Values necessary to create time
data */

```



```

int Start;

void main( void )
{
    char Term;
    unsigned long BytesToRead;

    if ( !InitIO() ) {
        exit( 1 );
    }

    AcquireData();

    WriteIO( ":SYStem:HEADer OFF" );
    WriteIO( ":SYStem:LONGform OFF" );
    WriteIO( ":WAVEform:BYTEorder LSBFirst" ); /* Setup byte order */
    WriteIO( ":WAVEform:FORMat WORD" );      /* Setup transfer format */
/
    WriteIO( ":WAVEform:SOURce POD1" );      /* Waveform data source pod
1 */

    GetTimeConversionFactors( );

    BytesToRead = SetupDataTransfer( -25E-6, 25E-6);
    ReadWord( wordData, BytesToRead );
    ReadByte( &Term, 1L );                  /* Read termination character */
/

    WriteIO(":WAVEform:FORMat BYTE");        /* Setup transfer format */

    BytesToRead = SetupDataTransfer( -25E-6, 25E-6);
    ReadByte( byteData, BytesToRead );
    ReadByte( &Term, 1L );                  /* Read termination character */
/

    CreateTimeData( BytesToRead, TimeValues );

    WriteCsvToFile( TimeValues, wordData, byteData, BytesToRead );

    CloseIO( );
}

/*****
*   Function name: InitIO
*   Parameters:    none
*   Return value: none
*   Description:  This routine initializes the SICL environment.  It se
ts up
*                  errorhandling, opens both an interface and device ses
sion,
*                  sets timeout values, clears the GPIB interface card,
and
*                  clears the oscilloscope's GPIB card by performing a
*                  Selected Device Clear.
*****/

```

```

*****
*****/

int InitIO( void )
{
    ionerror( I_ERROR_EXIT ); /* set-up interface error handling */

    bus = iopen( INTERFACE ); /* open interface session */
    if ( bus == 0 ) {
        printf( "Bus session invalid\n" );
        return FALSE;
    }

    itimeout( bus, IO_TIMEOUT ); /* set bus timeout */
    iclear( bus ); /* clear the interface */

#ifdef LAN
    scope = bus;
#else
    scope = iopen( DEVICE_ADDR ); /* open the scope device session */
/
    if ( scope == 0 ) {
        printf( "Scope session invalid\n" );
        iclose( bus ); /* close interface session */
        _siclcleanup(); /* required for 16-bit applications */
        return FALSE;
    }

    itimeout( scope, IO_TIMEOUT ); /* set device timeout */
    iclear( scope ); /* perform Selected Device Clear on oscilloscop
e */
#endif

    return TRUE;
}

/*****
*****
* Function name: WriteIO
* Parameters: char *buffer which is a pointer to the character stri
ng to
* be output
* Return value: none
* Description: This routine outputs strings to the oscilloscope device
* session using SICL commands.
*****
*****/

void WriteIO( char *buffer )
{
    unsigned long actualcnt;
    unsigned long BytesToWrite;
    int send_end = 1;

    BytesToWrite = strlen( buffer );

```

```

        iwrite( scope, buffer, BytesToWrite, send_end, &actualcnt );
    }

/*****
*****
*   Function name: ReadByte
*   Parameters:   char *buffer which is a pointer to the array to store
*                 the read bytes unsigned long BytesToRead which indica
tes
*                 the maximum number of bytes to read
*   Return value: integer which indicates the actual number of bytes re
ad
*   Description: This routine inputs strings from the scope device sessi
on
*                 using SICL commands.
*****
*****/

unsigned long ReadByte( char *buffer, unsigned long BytesToRead )
{
    unsigned long BytesRead=0L;
    int reason;

    BytesRead = BytesToRead;
    ired( scope, buffer, BytesToRead, &reason, &BytesRead );

    return BytesRead;
}

/*****
*****
*   Function name: ReadWord
*   Parameters:   short *buffer which is a pointer to the word array to
store
*                 the bytes read unsigned long BytesToRead which indica
tes
*                 the maximum number of bytes to read
*   Return value: integer which indicates the actual number of bytes re
ad
*   Description: This routine inputs an array of short values from the
*                 oscilloscope device session using SICL commands.
*****
*****/

unsigned long ReadWord( short *buffer, unsigned long BytesToRead )
{
    long BytesRead=0L;
    int reason;

    BytesRead = BytesToRead;
    ired( scope, (char *) buffer, BytesToRead, &reason, &BytesRead );

    return BytesRead;
}

```

```

/*****
*****
*   Function name: ReadDouble
*   Parameters:    double *buffer which is a pointer to the float value
to read
*   Return value: none
*   Description:  This routine inputs a float value from the oscillosco
pe
*
*                   device session using SICL commands.
*****
*****/

void ReadDouble( double *buffer )
{
    int error;
    error = iscanf( scope, "%lf", buffer );
}

/*****
*****
*   Function name: close_IO
*   Parameters:    none
*   Return value: none
*   Description:  This routine closes device and interface sessions for
*
*                   the SICL environment, and calls the routine _siclclean
up
*
*                   which de-allocates resources used by the SICL environm
ent.
*****
*****/

void CloseIO( void )
{

    iclose( scope ); /* close device session */
    iclose( bus ); /* close interface session */

    _siclcleanup(); /* required for 16-bit applications */

}

/*****
*****
*   Function name:  AcquireData
*   Parameters:     none
*   Return value:   none
*   Description:    This routine acquires data using the current
*
*                   oscilloscope settings.
*****
*****/

void AcquireData( void )
{
    /*
    *   The root level :DIGitize command is recommended for acquiring ne
w
    *   waveform data. It initializes the oscilloscope's data buffers,

```

```

*   acquires new data, and ensures that acquisition criteria are met
*   before the acquisition is stopped. Note that the display is
*   automatically turned off when you use this form of the
*   :DIGitize command and must be turned on to view the captured dat
a
*   on screen.
*/

WriteIO(":DIGitize POD1");
WriteIO(":POD1:DISPlay ON");

}

/*****
*****
*   Function name: SetupDataTransfer
*   Parameters:    double lTime which is the time value of the first
*                  waveform memory location of data.
*                  double rTime which is the time value of the last
*                  waveform memory location of data.
*   Return value:  Number of bytes of waveform data to read.
*   Description:   This routine sets up the waveform data transfer and get
S
*                  the number of bytes to be read. The beginning of data
*                  starts with the # character followed by a number which
*                  tells how many bytes to read for the integer which is t
he
*                  total number of data bytes that are being transfered.
*                  Following this is the waveform data. For example, if 1
024
*                  bytes of waveform data is being transfered then this
*                  information will be as follows:
*                  #41024 <1024 data bytes>
*****/

unsigned long SetupDataTransfer( double lTime, double rTime )
{
    unsigned long BytesToRead;
    char header_str[8];
    char cData;
    unsigned long BytesRead;
    int Size;
    char Range[100];

    /* Find the index value of the first data memory location */

    Start = Round((lTime - xOrg)/xInc);
    if (Start < 1) {
        Start = 1;
    }

    /* Find the number of data bytes that you want */

    Size = Round((rTime - lTime)/xInc);

    sprintf( Range, ":WAVEform:DATA? %d,%d", Start, Size);

```

```

WriteIO( Range );                               /* Request waveform data */

/* Find the # character */

do {
    ReadByte( &cData, 1L );
} while ( cData != '#' );

/* Read the next byte which tells how many bytes to read for the number
er
* of waveform data bytes to transfer value.
*/

ReadByte( &cData, 1L );
BytesToRead = cData - '0'; /* Convert to a number */

/* Reads the number of data bytes that will be transferred */

BytesRead = ReadByte( header_str, BytesToRead );
header_str[BytesRead] = '\0';
BytesToRead = atoi( header_str );

return BytesToRead;

}

/*****
*****
*   Function name: GetTimeConversionFactors
*   Parameters:    none
*   Return value:  none
*   Description:   This routine transfers the waveform conversion
*                  factors for the time values.
*****
*****/

Void GetTimeConversionFactors( void )
{

    /* Read values which are used to create time values */

    WriteIO(":WAVEform:XINcrement?");
    ReadDouble( &xInc );

    WriteIO(":WAVEform:XORigin?");
    ReadDouble( &xOrg );

}

/*****
*****
*   Function name: CreateTimeData
*   Parameters:    unsigned long AcquiredLength which is the number of d
ata
*                  points
*                  double TimeValues is a pointer to the array where tim
e

```

```

*           values are stored
*   Return value: none
*   Description: This routine converts the data to time values using
*               the values that describe the waveform.  These values ar
e stored
*               in global variables.
*****/

void CreateTimeData( unsigned long AcquiredLength, double *TimeValues )
{
    unsigned long i;

    for (i = 0; i < AcquiredLength; i++) {
        TimeValues[i] = ((Start + i) * xInc) + xOrg; /* calculate time va
lues */
    }
}

/*****
*****
*   Function name: WriteCsvToFile
*   Parameters:   double *TimeValues which is a pointer to an array of
*               calculated time values
*               unsigned short *wordData which is a pointer to an arr
ay of
*               word format digital values
*               unsigned char *byteData which is a pointer to an arra
y of
*               byte format digital values
*               unsigned long AcquiredLength which is the number of d
ata
*               points read
*   Return value: none
*   Description:  This routine stores the time and digital information
about
*               the waveform as time, word format, and byte format
*               separated by commas to a file.
*****/

void WriteCsvToFile( double *TimeValues, unsigned short *wordData,
                    unsigned char *byteData, unsigned long AcquiredLength )
{
    FILE *fp;
    char Binary[9];
    unsigned long i;
    int j;
    int k;

    fp = fopen( "digital.csv", "wb" ); /* Open file in binary mode - clear
file
                                     if it already exists */

    if (fp != NULL) {

```

```

        fprintf( fp, "Time,Decimal Word Data,Hex Word Data,Hex Byte Data,Bi
nary Byte Data\n");
        Binary[8] = '\0';

        for ( i = 0; i < AcquiredLength; i++ ) {

            // Create the binary formatted byte data
            for ( j = 7, k = 0; j >= 0; j--, k++ ) {
                Binary[k] = ((byteData[i] & ( 1 << j )) >> j) + '0';
            }

            fprintf( fp, "%e,%d,%04X,%02X,%s\
n", TimeValues[i], wordData[i], wordData[i],
                byteData[i], Binary );
        }

        fclose( fp );
    }
    else {
        printf("Unable to open file 'digital.csv'\n");
    }
}

/*****
*   Function name: Round
*   Parameters:   double number which is a floating point number
*                 to be converted.
*   Return value: The rounded integer value for the number parameter.
*   Description:  This routine takes a floating point number and create
s an
*                 integer.
*****/

int Round( double number )
{
    if (number < 0.0f ) {
        return ( (int) (number - 0.5f) );
    }
    else {
        return ( (int) (number + 0.5f) );
    }
}

```

Understanding WORD and BYTE Formats

Before you can understand how the WORD and BYTE downloads work, it is necessary to understand how Infiniium creates waveform data.

Analog-to-digital Conversion Basics

The input channel of every digital sampling oscilloscope contains an analog-to-digital converter (ADC) as shown in **Figure 7**. The 8-bit ADC in some Infiniium oscilloscope models consists of 256 voltage comparators. Each comparator has two inputs. One input is connected to a reference dc voltage level and the other input is connected to the channel input. When the voltage of the waveform on the channel input is greater than the dc level, then the comparator

output is a 1 otherwise the output is a 0. Each of the comparators has a different reference dc voltage. The output of the comparators is converted into an 8-bit integer by the encoder.

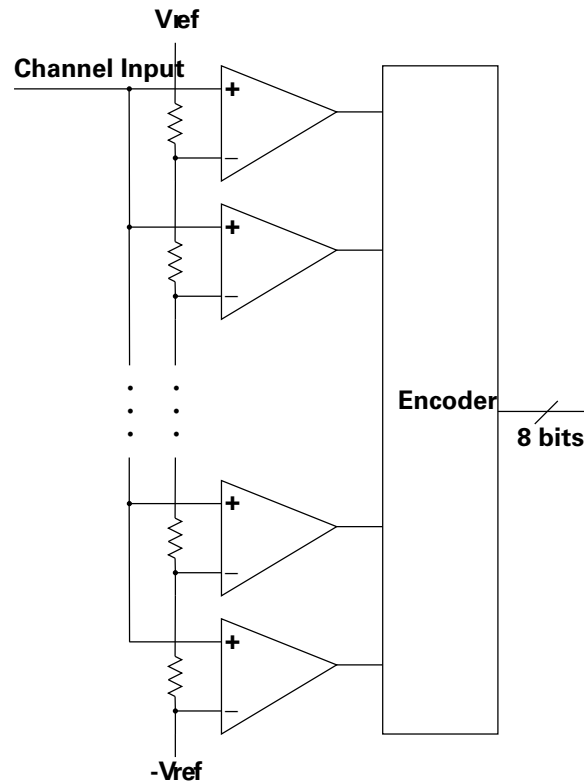

Figure 7 Block Diagram of an ADC

All ADCs have non-linearity errors which, if not corrected, can give less accurate vertical measurement results. For example, the non-linearity error for a 3-bit ADC is shown in the following figure.

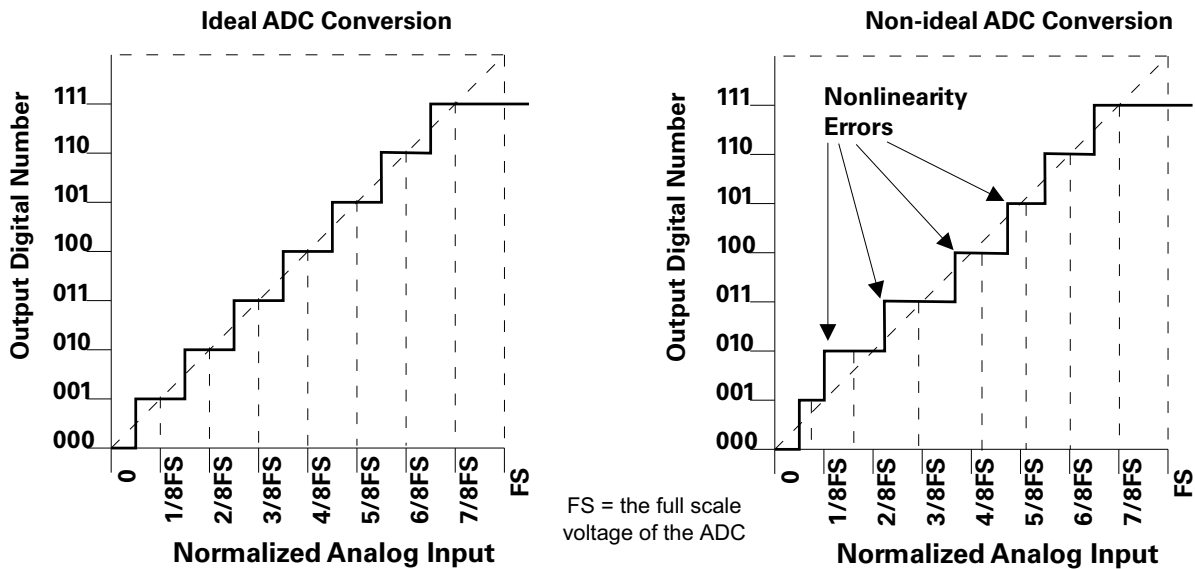

Figure 8 ADC Non-linearity Errors for a 3-bit ADC

The graph on the left shows an ADC which has no non-linearity errors. All of the voltage levels are evenly spaced producing output codes that represent evenly spaced voltages. In the graph on the right, the voltages are not evenly spaced with some being wider and some being narrower than the others.

When you calibrate your Infiniium, the input to each channel, in turn, is connected to the Aux Out connector. The Aux Out is connected to a 16-bit digital-to-analog converter (DAC) whose input is controlled by Infiniium's CPU. There are 65,536 dc voltage levels that are produced by the 16-bit DAC at the Aux Out. At each dc voltage value, the output of the ADC is checked to see if a new digital code is produced. When this happens, a 16-bit correction factor is calculated for that digital code and this correction factor is stored in a Calibration Look-up Table.

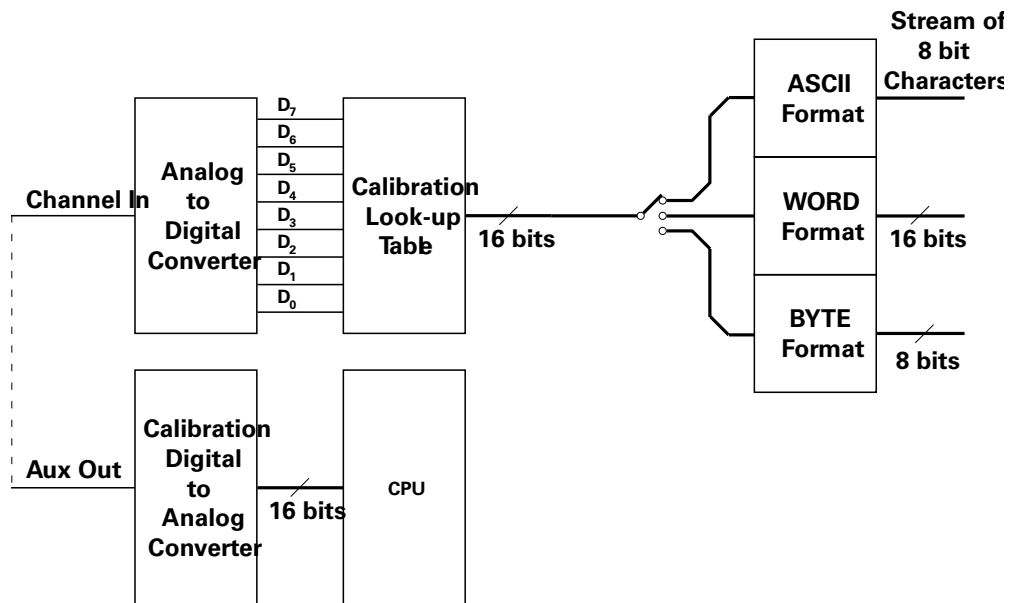

Figure 9 Data Flow in Infiniium

This process continues until all 256 digital codes are calibrated. The calibration process removes most of the non-linearity error of the ADC which yields more accurate vertical voltage values.

During normal operation of the oscilloscope, the output of the ADC is used as an address to the Calibration Look-up Table which produces 16-bit data for the oscilloscope to process and display. The output of the ADC is a signed 8-bit integer and the output of the Calibration Look-up Table is a signed 16-bit integer. If the amplitude of the input waveform is larger than the maximum dc reference level of the ADC, the ADC will output the maximum 8-bit value that it can (255). This condition is called ADC clipping. When the 255 digital code is applied to the Calibration Look-up Table, a 16-bit value, such as 30720 could be produced which represents an ADC clipped value.

Data values for clipped portions of waveforms are the maximum and minimum Q (quantization) values. For 16-bit waveform data, the maximum Q value is 30720 and the minimum Q value is -32736.

WORD and BYTE Data Formats

When downloading the waveform data in WORD format, the 16-bit signed integer value for each data point is sent in two consecutive 8-bit bytes over the remote interface. Whether the least significant byte (LSB) or the most significant byte (MSB) is sent first depends on the byte order determined by the BYTeorder command.

Before downloading the waveform data in BYTE format, each 16-bit signed integer is converted into an 8-bit signed integer. Because there are more possible 16-bit integers than there are 8-bit integers, a range of 16-bit integers is converted into single 8-bit numbers. For example, the following 16-bit numbers are all converted into one 8-bit number.

| 16-Bit Integers | | | 8-Bit Integer | |
|-----------------|--------|-----------------|---------------|---------|
| Decimal | Hex | | Hex | Decimal |
| 26,240 | 0x6680 | Truncated to >> | 0x66 | 102 |
| 26,200 | 0x6658 | | | |
| 26,160 | 0x6630 | | | |
| 26,120 | 0x6608 | | | |

This conversion is what makes the BYTE download format less accurate than the WORD format.

History Legacy command (existed before version 3.10).

:WAVEform:FORMat

Command :WAVEform:FORMat {ASCIi | BINary | BYTE | WORD | FLOat}

The :WAVEform:FORMat command sets the data transmission mode for waveform data output. This command controls how the data is formatted when it is sent from the oscilloscope, and pertains to all waveforms.

The default format is ASCIi.

Table 18 Selecting a Format

| Type | Advantages | Disadvantages |
|--------|---|--|
| ASCIi | <ul style="list-style-type: none"> ▪ Data is returned as voltage values and does not need to be converted. ▪ Is as accurate as WORD format. ▪ Supports HISTogram SOURce. | <ul style="list-style-type: none"> ▪ Very slow data download rate. |
| BYTE | <ul style="list-style-type: none"> ▪ Data download rate is twice as fast as the WORD format. | <ul style="list-style-type: none"> ▪ Data is less accurate than the WORD format for analog channels. ▪ Not compatible with digital bus and pod data. |
| WORD | <ul style="list-style-type: none"> ▪ Data is the most accurate for analog channels. | <ul style="list-style-type: none"> ▪ Data download rate takes twice as long as the BYTE format. |
| BINary | <ul style="list-style-type: none"> ▪ Supports HISTogram SOURce. ▪ Can be used for analog channels. ▪ Can be used for color grade waveform views. | <ul style="list-style-type: none"> ▪ Data download rate takes twice as long as the BYTE format for analog channels. |
| FLOat | <ul style="list-style-type: none"> ▪ Supports color grade waveform view only (:WAVEform:VIEW CGRade). ▪ Supports larger pixel count numbers than BINary with fewer data bytes. | <ul style="list-style-type: none"> ▪ None. |

ASCIi ASCIi-formatted data consists of waveform data values converted to the currently selected units, such as volts, and are output as a string of ASCII characters with each value separated from the next value by a comma. The values are formatted in floating point engineering notation. For example:

```
8.0836E+2,8.1090E+2, . . . , -3.1245E-3
```

NOTE

The ASCIi format does not send out the header information indicating the number of bytes being downloaded.

In ASCII format:

- The value "99.999E+36" represents a hole value. A hole can occur when you are using the equivalent time sampling mode when during a single acquisition not all of the acquisition memory locations contain sampled waveform data. It can take several acquisitions in the equivalent time sampling mode to fill all of the memory locations.

BYTE BYTE-formatted data is formatted as *signed* 8-bit integers. Depending on your programming language and IO library, you may need to create a function to convert these signed bytes to signed integers. In BYTE format:

- The value 125 represents a hole value. A hole can occur when you are using the equivalent time sampling mode when during a single acquisition not all of the acquisition memory locations contain sampled waveform data. It can take several acquisitions in the equivalent time sampling mode to fill all of the memory locations.

The waveform data values are converted from 16-bit integers to 8-bit integers before being downloaded to the computer. For more information, see "[Understanding WORD and BYTE Formats](#)" on page 1408.

WORD WORD-formatted data is transferred as *signed* 16-bit integers in two bytes. If :WAVEform:BYTeorder is set to MSBFirst, the most significant byte of each word is sent first. If the BYTeorder is LSBFirst, the least significant byte of each word is sent first. In WORD format:

- The value 31232 represents a hole level. A hole can occur when you are using the equivalent time sampling mode when during a single acquisition not all of the acquisition memory locations contain sampled waveform data. It can take several acquisitions in the equivalent time sampling mode to fill all of the memory locations.

For more information, see "[Understanding WORD and BYTE Formats](#)" on page 1408.

BINary BINary-formatted data can be used with any SOURce. When a source is any valid source except for HISTogram, the data is returned in WORD format.

When the source is set to HISTogram, the data is transferred as signed 64-bit integers in 8 bytes. There are no hole values in the histogram data.

If :WAVEform:BYTeorder is set to MSBFirst, the most significant byte of each long word is sent first. If the BYTeorder is LSBFirst, the least significant byte of each long word is sent first.

FLOat When the color grade waveform view is selected (:WAVEform:VIEW CGRade), the color grade (pixel) database count values can be queried using these formats only:

- **BINary** – the :WAVEFORM:DATA? query will return a binary block of (8-byte) uint64 values.
- **FLOat** – the :WAVEFORM:DATA? query will return a binary block of (4-byte) single-precision floating-point values.

Example This example selects the WORD format for waveform data transmission.

```
myScope.WriteString ":WAVEform:FORMat WORD"
```

Query :WAVEform:FORMat?

The :WAVEform:FORMat? query returns the current output format for transferring waveform data.

Returned Format [:WAVEform:FORMat] {ASCIi | BINary | BYTE | WORD}<NL>

Example This example places the current output format for data transmission in the string variable, strMode, then prints the contents of the variable to the computer's screen.

```
Dim strMode As String ' Dimension variable.
myScope.WriteString ":WAVEform:FORMat?"
strMode = myScope.ReadString
Debug.Print strMode
```

- See Also**
- [":WAVEform:VIEW"](#) on page 1429
 - [":WAVEform:DATA?"](#) on page 1391
 - [":WAVEform:CGRade:WIDTh?"](#) on page 1387
 - [":WAVEform:CGRade:HEIGht?"](#) on page 1386

History Legacy command (existed before version 3.10).

Version 6.00: Added the FLOat option for getting the color grade (pixel) database data as single-precision floating-point values.

:WAVEform:POINts?

Query :WAVEform:POINts?

The :WAVEform:POINts? query returns the points value in the current waveform preamble. The points value is the number of time buckets contained in the waveform selected with the :WAVEform:SOURce command. If the Sin(x)/x interpolation filter is enabled, the number of points can be larger than the oscilloscope's memory depth setting because the waveform includes the interpolated points.

NOTE

When an acquisition is made on multiple channels, the data for each channel has the same X origin and the same number of points.

With ":WAVEform:VIEW CGRade", the :WAVEform:POINts? query returns the number of count values in the color grade (pixel) database. See "[Getting Color Grade \(Pixel\) Database Count Values](#)" on page 1430.

Returned Format [:WAVEform:POINts] <points><NL>

<points> An integer. See the :ACQUIRE:POINts command for a table of possible values.

Example This example places the current acquisition length in the numeric variable, varLength, then prints the contents of the variable to the computer's screen.

```
myScope.WriteString ":SYSTEM:HEADer OFF" ' Response headers off.
myScope.WriteString ":WAVEform:POINts?"
varLength = myScope.ReadNumber
Debug.Print FormatNumber(varLength, 0)
```

NOTE

Turn Headers Off

When you are receiving numeric data into numeric variables, you should turn the headers off. Otherwise, the headers may cause misinterpretation of returned data.

See Also

- "[:ACQUIRE:POINts\[:ANALog\] – Memory depth](#)" on page 218
- "[:WAVEform:VIEW](#)" on page 1429

History Legacy command (existed before version 3.10).

:WAVeform:PREamble?

Query :WAVeform:PREamble?

The :WAVeform:PREamble? query outputs a waveform preamble to the computer from the waveform source, which can be a waveform memory or channel buffer.

Returned Format [:WAVeform:PREamble] <preamble_data><NL>

The preamble can be used to translate raw data into time and voltage values. The following lists the elements in the preamble.

<preamble_data> <format>, <type>, <points>, <count>, <X increment>, <X origin>, <X reference>, <Y increment>, <Y origin>, <Y reference>, <coupling>, <X display range>, <X display origin>, <Y display range>, <Y display origin>, <date>, <time>, <frame model #>, <acquisition mode>, <completion>, <X units>, <Y units>, <max bandwidth limit>, <min bandwidth limit>[,<segment count>]

Table 19 Waveform Preamble Elements

| Element | Description |
|----------|--|
| <format> | <p>Returned format values can be:</p> <ul style="list-style-type: none"> ▪ 0 – ASCII format ▪ 1 – BYTE format ▪ 2 – WORD format ▪ 3 – LONG format ▪ 4 – LONGLONG format ▪ 5 – FLOat format <p>The format value describes the data transmission mode for waveform data output. This command controls how the data is formatted when it is sent from the oscilloscope. (See ":WAVeform:FORMat" on page 1413.)</p> |
| <type> | <p>Returned type values can be:</p> <ul style="list-style-type: none"> ▪ 1 – RAW ▪ 2 – AVERage ▪ 3 – VHIStogram ▪ 4 – HHIStogram ▪ 5 – not used ▪ 6 – INTerpolate ▪ 7 – not used ▪ 8 – not used ▪ 9 – DIGITAL ▪ 10 – PDEtect <p>This value describes how the waveform was acquired. (See also the ":WAVeform:TYPE?" on page 1428 query.)</p> |

Table 19 Waveform Preamble Elements (continued)

| Element | Description |
|---------------|---|
| <points> | The number of data points or data pairs contained in the waveform data. (See ":ACQUIRE:POINTS:ANALog – Memory depth" on page 218.) |
| <count> | For the AVERAGE waveform type, the count value is the fewest number of hits for all time buckets. This value may be less than or equal to the value requested with the :ACQUIRE:AVERAge:COUNT command. For RAW and INTERpolate waveform types, this value is 0 or 1. The count value is ignored when it is sent to the oscilloscope in the preamble. (See ":WAVEform:TYPE?" on page 1428 and ":ACQUIRE[:AVERAge]:COUNT" on page 206.) |
| <X increment> | The X increment is the duration between data points on the X axis. For time domain waveforms, this is the time between points. If the value is zero then no data has been acquired. (See the ":WAVEform:XINCrement?" on page 1433 query.) |
| <X origin> | The X origin is the X-axis value of the first data point in the data record. For time domain waveforms, it is the time of the first point. This value is treated as a double-precision 64-bit floating-point number. If the value is zero, then no data has been acquired. (See the ":WAVEform:XORigin?" on page 1434 query.) |
| <X reference> | The X reference is the data point associated with the X origin. It is at this data point that the X origin is defined. In this oscilloscope, the value is always zero. (See the ":WAVEform:XREFerence?" on page 1436 query.) |
| <Y increment> | The Y increment is the duration between Y-axis levels. For voltage waveforms, it is the voltage corresponding to one level. If the value is zero, then no data has been acquired. (See the ":WAVEform:YINCrement?" on page 1439 query.) |
| <Y origin> | The Y origin is the Y-axis value at level zero. For voltage waveforms, it is the voltage at level zero. If the value is zero, then no data has been acquired. (See the ":WAVEform:YORigin?" on page 1440 query.) |
| <Y reference> | The Y reference is the level associated with the Y origin. It is at this level that the Y origin is defined. In this oscilloscope, this value is always zero. (See the ":WAVEform:YREFerence?" on page 1442 query.) |
| <coupling> | Returned coupling values can be: <ul style="list-style-type: none"> ▪ 0 – AC coupling ▪ 1 – DC coupling ▪ 2 – DCFIFTY coupling ▪ 3 – LFREJECT coupling The input coupling of the waveform. The coupling value is ignored when sent to the oscilloscope in the preamble. (See the ":WAVEform:COUPling?" on page 1390 query.) |

Table 19 Waveform Preamble Elements (continued)

| Element | Description |
|--------------------|--|
| <X display range> | The X display range is the X-axis duration of the waveform that is displayed. For time domain waveforms, it is the duration of time across the display. If the value is zero, then no data has been acquired. (See the ":WAVeform:XRANge?" on page 1435 query.) |
| <X display origin> | The X display origin is the X-axis value at the left edge of the display. For time domain waveforms, it is the time at the start of the display. This value is treated as a double precision 64-bit floating-point number. If the value is zero, then no data has been acquired. (See the ":WAVeform:XDISplay?" on page 1432 query.) |
| <Y display range> | The Y display range is the Y-axis duration of the waveform which is displayed. For voltage waveforms, it is the amount of voltage across the display. If the value is zero, then no data has been acquired. (See the ":WAVeform:YRANge?" on page 1441 query.) |
| <Y display origin> | The Y-display origin is the Y-axis value at the center of the display. For voltage waveforms, it is the voltage at the center of the display. If the value is zero, then no data has been acquired. (See the ":WAVeform:YDISplay?" on page 1438 query.) |
| <date> | A string containing the date in the format DD MMM YYYY, where DD is the day, 1 to 31; MMM is the month; and YYYY is the year. |
| <time> | A string containing the time in the format HH:MM:SS:TT, where HH is the hour, 0 to 23, MM is the minutes, 0 to 59, SS is the seconds, 0 to 59, and TT is the hundreds of seconds, 0 to 99. |
| <frame model #> | A string containing the model number and serial number of the oscilloscope in the format of MODEL#:SERIAL#. The frame model number is ignored when it is sent to an oscilloscope in the preamble. |
| <acquisition mode> | Returned acquisition mode values can be: <ul style="list-style-type: none"> ▪ 0 – RTIME or HRESolution mode ▪ 1 – ETIME mode ▪ 2 – SEGMENTed or SEGHres mode ▪ 3 – PDETECT or SEGPdetect mode The acquisition sampling mode of the waveform. (See ":ACQUIRE:MODE" on page 216.) |
| <completion> | The completion value is the percent of time buckets that are complete. The completion value is ignored when it is sent to the oscilloscope in the preamble. (See the ":WAVeform:COMPLete?" on page 1388 query.) |

Table 19 Waveform Preamble Elements (continued)

| Element | Description |
|--|--|
| <X units> <Y units> | <p>Returned type values can be:</p> <ul style="list-style-type: none"> ▪ 0 – UNKNOWN units ▪ 1 – VOLT units ▪ 2 – SECOND units ▪ 3 – CONSTANT units ▪ 4 – AMP units ▪ 5 – DECIBEL units <p>The X-axis and Y-axis units of the waveform. (See the ":WAVEform:XUNits?" on page 1437 query and the ":WAVEform:YUNits?" on page 1443 query.)</p> |
| <max band width limit > <min band width limit > | <p>The band pass consists of two values that are an estimation of the maximum and minimum band width limits of the source waveform. The band width limit is computed as a function of the selected coupling and filter mode. (See the ":WAVEform:BANDpass?" on page 1384 query.)</p> |
| <segment count> | <p>When segmented memory acquisitions are turned on, the ":WAVEform:SEGMented:ALL ON" command has been sent, and the waveform source is a channel or pod and has segmented acquisitions, this additional preamble value is returned. It specifies the number of segments in the returned waveform data. (See the ":WAVEform:SEGMented:COUNT?" on page 1422 query.)</p> |

With [":WAVEform:VIEW CGRade"](#), the X increment, X origin, Y increment, and Y origin information returned by the [:WAVEform:PREamble?](#) query have different meanings for the color grade (pixel) database count values. See ["Getting Color Grade \(Pixel\) Database Count Values"](#) on page 1430.

Example This example outputs the current waveform preamble for the selected source to the string variable, strPreamble.

```
Dim strPreamble As String      ' Dimension variable.
myScope.WriteString ":SYSTEM:HEADer OFF"      ' Response headers off.
myScope.WriteString ":WAVEform:PREamble?"
strPreamble = myScope.ReadString
```

See Also

- [":WAVEform:DATA?"](#) on page 1391
- [":WAVEform:VIEW"](#) on page 1429

History Legacy command (existed before version 3.10).

:WAVeform:SEGMENTed:ALL

Command :WAVeform:SEGMENTed:ALL {{ON | 1} | {OFF | 0}}

The :WAVeform:SEGMENTed:ALL command configures the DATA query for rapidly downloading all segments in one query.

The <start> and <size> optional parameters for the DATA query are still supported and represent the start and size of the data for each segment.

Powering on the oscilloscope or performing a Default Setup sets this command to OFF.

There is complete backwards compatibility when this command is set to OFF.

The ON setting applies when channel or pod sources have segmented memory acquisitions. For other sources, such as functions, the DATA query returns the data that corresponds to the current segment.

In segmented acquisition mode, with this command set to ON, the number of segments is appended to end of the waveform preamble.

Example This example turns on this command.

```
myScope.WriteString ":WAVeform:SEGMENTed:ALL ON"
```

Query :WAVeform:SEGMENTed:ALL?

This query returns the status of this command.

History Legacy command (existed before version 3.10).

:WAVEform:SEGMented:COUNT?

Query :WAVEform:SEGMented:COUNT?

The :WAVEform:SEGMented:COUNT? query returns the index number of the last captured segment. A return value of zero indicates that the :ACQUIRE:MODE is not set to SEGMented.

<index_number> An integer number representing the index value of the last segment.

Returned Format [:WAVEform:SEGMented:COUNT] <index_number><NL>

Example This example returns the number of the last segment that was captured in the variable varIndex and prints it to the computer screen.

```
myScope.WriteString ":WAVEform:SEGMented:COUNT?"  
varIndex = myScope.ReadNumber  
Debug.Print FormatNumber(varIndex, 0)
```

History Legacy command (existed before version 3.10).

:WAVeform:SEGMented:TTAG?

Query :WAVeform:SEGMented:TTAG?

The :WAVeform:SEGMented:TTAG? query returns the time difference between the first segment's trigger point and the trigger point of the currently displayed segment.

<delta_time> A real number in exponential format representing the time value difference between the first segment's trigger point and the currently displayed segment.

Returned Format [:WAVeform:SEGMented:TTAG] <delta_time><NL>

Example This example returns the time from the first segment's trigger point and the currently displayed segment's trigger point in the variable varDtime and prints it to the computer screen.

```
myScope.WriteString ":WAVeform:SEGMented:TTAG?"
varDtime = myScope.ReadNumber
Debug.Print FormatNumber(varDtime, 0)
```

History Legacy command (existed before version 3.10).

:WAVEform:SEGMented:XLISt?

Query :WAVEform:SEGMented:XLISt? {RELXorigin | ABSXorigin | TTAG}

The :WAVEform:SEGMented:XLISt? query rapidly downloads x-parameter values for all segments.

RELXorigin = relative X origin for each segment.

ABSXorigin = relative origin + time tag for each segment

TTAG = time tag for each segment

This query uses the DATA query format for the returned data and supports all waveform command options including: BYTeorder, FORmat (only ASCii or BINary (float64 with 8 bytes per value)), SOURce (only CHANnel<N> or POD<N>), STReaming, VIEW.

History Legacy command (existed before version 3.10).

:WAVeform:SOURce

Command :WAVeform:SOURce {CHANnel<N> | DIFF<D> | COMMONmode<C> | FUNCTION<F>
| HISTogram | WMEMory<R> | CLOCK | MTRend | MSPectrum | EQUalized
| BUS | POD1 | POD2 | PODALL}

The :WAVeform:SOURce command selects a channel, function, waveform memory, or histogram as the waveform source.

MTRend and MSPectrum sources are only available if the oscilloscope has the EZJIT option installed and the feature is enabled.

The CLOCK source is only available if the oscilloscope has the High Speed Serial option installed and the feature is enabled.

The EQUalized source is only available if the oscilloscope has the High Speed Serial option and the Serial Data Equalization option installed and the features are enabled. This command uses the Feed-Forward Equalized (FFE) signal as the source.

POD1 is the activated digital channels in the D0-D7 set while POD2 is the activated digital channels in the D8-D15 set. PODALL is all the activated digital channels.

<N> An integer, 1-4 in a single oscilloscope, 1-40 in a MultiScope system.

<D>, <C> <D> is an integer, 1-2. <C> is an integer, 3-4.

The DIFF and COMMONmode sources are just aliases that can be used in place of the channel names to apply to differential or common mode signals. These are just aliases - no state change occurs if you refer to a differential channel and you are not in differential mode. DIFF1 refers to the differential signal between channels 1 and 3 (and COMMONmode3 refers to the common mode channel between these same channels). DIFF2 refers to the differential signal between channels 2 and 4 (and COMMONmode4 refers to the common mode channel between these same channels).

<F> An integer, 1-16.

<R> An integer, 1-4.

 An integer, 1-4.

Example This example selects channel 1 as the waveform source.

```
myScope.WriteString ":WAVeform:SOURce CHANnel1"
```

Query :WAVeform:SOURce?

The :WAVeform:SOURce? query returns the currently selected waveform source.

Returned Format [:WAVeform:SOURce] {CHANnel<N> | DIFF<D> | COMMONmode<C> | FUNCTION<F>
| HISTogram | WMEMory<R> | CLOCK | MTRend | MSPectrum | EQUalized
| BUS | POD1 | POD2 | PODALL}<NL>

Example This example places the current selection for the waveform source in the string variable, `strSelection`, then prints the contents of the variable to the computer's screen.

```
Dim strSelection As String ' Dimension variable.  
myScope.WriteString ":WAVeform:SOURce?"  
strSelection = myScope.ReadString  
Debug.Print strSelection
```

History Legacy command (existed before version 3.10).

:WAVeform:STReaming

Command :WAVeform:STReaming {{ON | 1} | {OFF | 0}}

When enabled, :WAVeform:STReaming allows more than 999,999,999 bytes of data to be transferred from the Infiniium oscilloscope to a PC when using the :WAVeform:DATA? query. See the :WAVeform:DATA? query for information on receiving this much data.

Example This example turns on the streaming feature.

```
myScope.WriteString ":WAVeform:STReaming ON"
```

Query :WAVeform:STReaming?

The :WAVeform:STReaming? query returns the status of the streaming feature.

Returned Format [:WAVeform:STReaming] {1 | 0}<NL>

History Legacy command (existed before version 3.10).

:WAVeform:TYPE?

Query :WAVeform:TYPE?

The :WAVeform:TYPE? query returns the current acquisition data type for the currently selected source. The type returned describes how the waveform was acquired. The waveform type may be:

- RAW – data consists of one data point in each time bucket with no interpolation.
- AVERAge – data consists of the average of the first n hits in a time bucket, where n is the value in the count portion of the preamble. Time buckets that have fewer than n hits return the average of the data they contain. If the :ACQuire:COMPLete parameter is set to 100%, then each time bucket must contain the number of data hits specified with the :ACQuire:AVERAge:COUNT command.
- VHIStogram – data is a vertical histogram. Histograms are transferred using the LONGLONG format. They can be generated using the Histogram subsystem commands.
- HHIStogram – data is a horizontal histogram. Histograms are transferred using the LONGLONG format. They can be generated using the Histogram subsystem commands.
- INTerpolate – In the INTerpolate acquisition type, the last data point in each time bucket is stored, and additional data points between the acquired data points are filled by interpolation.
- DIGITAL – data consists of digital pod or bus values for each time bucket.
- PDETECT – data consists of two data points in each time bucket: the minimum values and the maximum values.

Returned Format [:WAVeform:TYPE] {RAW | AVER | VHIS | HHIS | INT | DIGITAL | PDET}<NL>

Example This example places the current acquisition data type in the string variable, strType, then prints the contents of the variable to the computer's screen.

```
Dim strType As String ' Dimension variable.
myScope.WriteString ":WAVeform:TYPE?"
strType = myScope.ReadString
Debug.Print strType
```

History Legacy command (existed before version 3.10).

:WAVEform:VIEW

Command :WAVEform:VIEW {ALL | MAIN | WINDow | CGRade}

The :WAVEform:VIEW command selects the view of the waveform that is selected for data and preamble queries. You can set the command to ALL, MAIN, WINDow, or CGRade.

The view has different meanings depending upon the waveform source selected.

The default setting for this command is ALL.

The following table summarizes the parameters for this command for each source.

Table 20 Waveform View Parameters

| Source/Parameter | ALL | MAIN | WINDow | CGRade |
|------------------|----------|------------------|------------------|------------------------------|
| CHANnel<N> | All data | Main time base | Zoom | Color grade (pixel) database |
| WMEMory<R> | All data | Memory time base | Memory time base | Color grade (pixel) database |
| FUNCTion<F> | All data | All data | All data | Color grade (pixel) database |

Channels For channels, you may select ALL, MAIN, or WINDow views. If you select ALL, all of the data in the waveform record is referenced. If you select MAIN, only the data in the main time base range is referenced. The first value corresponds to the first time bucket in the main time base range, and the last value corresponds to the last time bucket in the main time base range. If WINDow is selected, only data in the delayed view is referenced. The first value corresponds to the first time bucket in the delayed view and the last value corresponds to the last time bucket in the delayed view.

Memories For memories, if you specify ALL, all the data in the waveform record is referenced. WINDow and MAIN refer to the data contained in the memory time base range for the particular memory. The first value corresponds to the first time bucket in the memory time base range, and the last value corresponds to the last time bucket in the memory time base range.

Functions For functions, ALL, MAIN, and WINDow refer to all of the data in the waveform record.

Example This example sets up the oscilloscope to view all of the data.

```
myScope.WriteString ":WAVEform:VIEW ALL"
```

Getting Color Grade (Pixel) Database Count Values

NOTE

Before you can select the CGRade waveform view, you must enable color grade persistence, color grade view, or a real-time eye for the source waveform.

Getting color grade (pixel) database count values is not supported when segmented memory acquisitions are enabled.

After you select the CGRade waveform view, color grade (pixel) database information is available from the following queries:

| Command | Description |
|---|--|
| :WAVEform:CGRade:HEIGht? (see page 1386) | Returns the color grade (pixel) database data height. |
| :WAVEform:CGRade:WIDTh? (see page 1387) | Returns the color grade (pixel) database data width. |
| :WAVEform:POINts? (see page 1416) | The number of count values in the database (should be the width times the height). |
| :WAVEform:XINCrement? (see page 1433) | The time per column of the color grade database. |
| :WAVEform:XORigin? (see page 1434) | The time at column 0 of the color grade database. |
| :WAVEform:YINCrement? (see page 1439) | The volts per row of the color grade database. |
| :WAVEform:YORigin? (see page 1440) | The volts at row 0 of the color grade database. |
| :WAVEform:PREamble? (see page 1417) | Returns the same points, X increment, X origin, Y increment, and Y origin information as the individual queries. |

To get the color grade (pixel) database count values:

- 1 Use the :WAVEform:FORMat command to specify the format you in which want the database count values returned:
 - Use the ":WAVEform:FORMat BINary" command to get (8-byte) uint64 values.
 - Use the ":WAVEform:FORMat FLOat" command to get (4-byte) single-precision floating-point values.

When getting color grade database values, the only valid formats are BINary and FLOat.

- 2 Send the :WAVEform:DATA? query.

A binary block of values in the selected format is returned.

The order of the returned values is:

- From the row at the top of the display to the bottom of the display (with "height" number of rows).
- Within a row, values are returned from the left of the display to the right of the display (with "width" number of columns).

Query :WAVeform:VIEW?

The :WAVeform:VIEW? query returns the currently selected view.

Returned Format [:WAVeform:VIEW] {ALL | MAIN | WIND | CGR}<NL>

Example This example returns the current view setting to the string variable, strSetting, then prints the contents of the variable to the computer's screen.

```
Dim strSetting As String ' Dimension variable.
myScope.WriteString ":WAVeform:VIEW?"
strSetting = myScope.ReadString
Debug.Print strSetting
```

- See Also**
- [":WAVeform:FORMat"](#) on page 1413
 - [":WAVeform:DATA?"](#) on page 1391
 - [":WAVeform:CGRade:WIDTh?"](#) on page 1387
 - [":WAVeform:CGRade:HEIGht?"](#) on page 1386
 - [":WAVeform:POINts?"](#) on page 1416
 - [":WAVeform:XINCrement?"](#) on page 1433
 - [":WAVeform:XORigin?"](#) on page 1434
 - [":WAVeform:YINCrement?"](#) on page 1439
 - [":WAVeform:YORigin?"](#) on page 1440
 - [":WAVeform:PREamble?"](#) on page 1417

History Legacy command (existed before version 3.10).

Version 6.00: Added the CGRade option for getting the color grade (pixel) database data.

:WAVEform:XDISplay?

Query :WAVEform:XDISplay?

The :WAVEform:XDISplay? query returns the X-axis value at the left edge of the display. For time domain waveforms, it is the time at the start of the display. For VERSus type waveforms, it is the value at the center of the X-axis of the display. This value is treated as a double precision 64-bit floating point number.

NOTE

A "Waveform data is not valid" error occurs when there is no data available for a channel. When this occurs, a zero value is returned.

Returned Format [:WAVEform:XDISplay] <value><NL>

<value> A real number representing the X-axis value at the left edge of the display.

Example This example returns the X-axis value at the left edge of the display to the numeric variable, varValue, then prints the contents of the variable to the computer's screen.

```
myScope.WriteString ":SYSTEM:HEADer OFF"      ' Response headers off.
myScope.WriteString ":WAVEform:XDISplay"
varValue = myScope.ReadNumber
Debug.Print FormatNumber(varValue, 0)
```

History Legacy command (existed before version 3.10).

:WAVeform:XINCrement?

Query :WAVeform:XINCrement?

The :WAVeform:XINCrement? query returns the duration between consecutive data points for the currently specified waveform source. For time domain waveforms, this is the time difference between consecutive data points. For VERSus type waveforms, this is the duration between levels on the X axis. For voltage waveforms, this is the voltage corresponding to one level.

NOTE

A "Waveform data is not valid" error occurs when there is no data available for a channel. When this occurs, a zero value is returned.

With ":WAVeform:VIEW CGRade", the :WAVeform:XINCrement? query returns the time per column of the color grade (pixel) database. See "[Getting Color Grade \(Pixel\) Database Count Values](#)" on page 1430.

Returned Format [:WAVeform:XINCrement] <value><NL>

<value> A real number representing the duration between data points on the X axis.

Example This example places the current X-increment value for the currently specified source in the numeric variable, varValue, then prints the contents of the variable to the computer's screen.

```
myScope.WriteString ":SYSTEM:HEADer OFF" ' Response headers off.
myScope.WriteString ":WAVeform:XINCrement?"
varValue = myScope.ReadNumber
Debug.Print FormatNumber(varValue, 0)
```

See Also

- You can also obtain the X-increment value through the :WAVeform:PREamble? query. See "[:WAVeform:PREamble?](#)" on page 1417.
- [":WAVeform:VIEW"](#) on page 1429

History Legacy command (existed before version 3.10).

:WAVeform:XORigin?

Query :WAVeform:XORigin?

The :WAVeform:XORigin? query returns the X-axis value of the first data point in the data record. For time domain waveforms, it is the time of the first point. For VERSus type waveforms, it is the X-axis value at level zero. For voltage waveforms, it is the voltage at level zero. The value returned by this query is treated as a double precision 64-bit floating point number.

NOTE

A "Waveform data is not valid" error occurs when there is no data available for a channel. When this occurs, a zero value is returned.

NOTE

When an acquisition is made on multiple channels, the data for each channel has the same X origin and the same number of points.

With ":WAVeform:VIEW CGRade", the :WAVeform:XORigin? query returns the time at column 0 of the color grade (pixel) database. See "[Getting Color Grade \(Pixel\) Database Count Values](#)" on page 1430.

Returned Format [:WAVeform:XORigin] <value><NL>

<value> A real number representing the X-axis value of the first data point in the data record.

Example This example places the current X-origin value for the currently specified source in the numeric variable, varValue, then prints the contents of the variable to the computer's screen.

```
myScope.WriteString ":SYSTEM:HEADer OFF" ' Response headers off.
myScope.WriteString ":WAVeform:XORigin?"
varValue = myScope.ReadNumber
Debug.Print FormatNumber(varValue, 0)
```

- See Also**
- You can also obtain the X-origin value through the :WAVeform:PREamble? query. See "[:WAVeform:PREamble?](#)" on page 1417.
 - "[:WAVeform:VIEW](#)" on page 1429

History Legacy command (existed before version 3.10).

:WAVeform:XRANge?

Query :WAVeform:XRANge?

The :WAVeform:XRANge? query returns the X-axis duration of the displayed waveform. For time domain waveforms, it is the duration of the time across the display. For VERSus type waveforms, it is the duration of the waveform that is displayed on the X axis.

NOTE

A "Waveform data is not valid" error occurs when there is no data available for a channel. When this occurs, a zero value is returned.

Returned Format [:WAVeform:XRANge] <value><NL>

<value> A real number representing the X-axis duration of the displayed waveform.

Example This example returns the X-axis duration of the displayed waveform to the numeric variable, varValue, then prints the contents of the variable to the computer's screen.

```
myScope.WriteString ":SYSTEM:HEADer OFF"      ' Response headers off.
myScope.WriteString ":WAVeform:XRANge?"
varValue = myScope.ReadNumber
Debug.Print FormatNumber(varValue, 0)
```

History Legacy command (existed before version 3.10).

:WAVeform:XREFerence?**Query** :WAVeform:XREFerence?

The :WAVeform:XREFerence? query returns the data point or level associated with the X-origin data value. It is at this data point or level that the X origin is defined. In this oscilloscope, the value is always zero.

Returned Format [:WAVeform:XREFerence] 0<NL>

Example This example places the current X-reference value for the currently specified source in the numeric variable, varValue, then prints the contents of the variable to the computer's screen.

```
myScope.WriteString ":SYSTem:HEADer OFF" ' Response headers off.
myScope.WriteString ":WAVeform:XREFerence?"
varValue = myScope.ReadNumber
Debug.Print FormatNumber(varValue, 0)
```

See Also You can obtain the X-reference value through the :WAVeform:PREamble? query.

History Legacy command (existed before version 3.10).

:WAVeform:XUNits?

Query :WAVeform:XUNits?

The :WAVeform:XUNits? query returns the X-axis units of the currently selected waveform source. The currently selected source may be a channel, function, or waveform memory.

Returned Format [:WAVeform:XUNits] {UNKNown | VOLT | SEConD | CONStant | AMP | DECibels | HERTz | WATT}<NL>

Example This example returns the X-axis units of the currently selected waveform source to the string variable, strUnit, then prints the contents of the variable to the computer's screen.

```
Dim strUnit As String ' Dimension variable.
myScope.WriteString ":WAVeform:XUNits?"
strUnit = myScope.ReadString
Debug.Print strUnit
```

History Legacy command (existed before version 3.10).

:WAVEform:YDISplay?

Query :WAVEform:YDISplay?

The :WAVEform:YDISplay? query returns the Y-axis value at the center of the display. For voltage waveforms, it is the voltage at the center of the display.

NOTE

A "Waveform data is not valid" error occurs when there is no data available for a channel. When this occurs, a zero value is returned.

Returned Format [:WAVEform:YDISplay] <value><NL>

<value> A real number representing the Y-axis value at the center of the display.

Example This example returns the current Y-display value to the numeric variable, varValue, then prints the contents of the variable to the computer's screen.

```
myScope.WriteString ":SYSTEM:HEADer OFF" ' Response headers off.
myScope.WriteString "":WAVEform:YDISplay?"
varValue = myScope.ReadNumber
Debug.Print FormatNumber(varValue, 0)
```

History Legacy command (existed before version 3.10).

:WAVeform:YINCrement?

Query :WAVeform:YINCrement?

The :WAVeform:YINCrement? query returns the y-increment voltage value for the currently specified source. This voltage value is the voltage difference between two adjacent waveform data digital codes. Adjacent digital codes are codes that differ by one least significant bit. For example, the digital codes 24680 and 24681 vary by one least significant bit.

- For BYTE and WORD data, and voltage waveforms, it is the voltage corresponding to one least significant bit change.
- For ASCII data format, the YINCrement is the full scale voltage range covered by the A/D converter.

NOTE

A "Waveform data is not valid" error occurs when there is no data available for a channel. When this occurs, a zero value is returned.

With ":WAVeform:VIEW CGRade", the :WAVeform:YINCrement? query returns the volts per row of the color grade (pixel) database. See "[Getting Color Grade \(Pixel\) Database Count Values](#)" on page 1430.

Returned Format [:WAVeform:YINCrement] <real_value><NL>

<real_value> A real number in exponential format.

Example This example places the current Y-increment value for the currently specified source in the numeric variable, varValue, then prints the contents of the variable to the computer's screen.

```
myScope.WriteString ":SYSTem:HEADer OFF" ' Response headers off.
myScope.WriteString ":WAVeform:YINCrement?"
varValue = myScope.ReadNumber
Debug.Print FormatNumber(varValue, 0)
```

- See Also**
- For more information on BYTE and WORD formats, see "[Understanding WORD and BYTE Formats](#)" on page 1408.
 - You can also obtain the Y-increment value through the :WAVeform:PREamble? query. See "[:WAVeform:PREamble?](#)" on page 1417.
 - "[:WAVeform:VIEW](#)" on page 1429

History Legacy command (existed before version 3.10).

:WAVeform:YORigin?

Query :WAVeform:YORigin?

The :WAVeform:YORigin? query returns the y-origin voltage value for the currently specified source. The voltage value returned is the voltage value represented by the waveform data digital code 00000.

- For BYTE and WORD data, and voltage waveforms, it is the voltage at digital code zero.
- For ASCII data format, the YORigin is the Y-axis value at the center of the data range. Data range is returned in the Y increment.

NOTE

A "Waveform data is not valid" error occurs when there is no data available for a channel. When this occurs, a zero value is returned.

With ":WAVeform:VIEW CGRade", the :WAVeform:YORigin? query returns the volts at row 0 of the color grade (pixel) database. See "[Getting Color Grade \(Pixel\) Database Count Values](#)" on page 1430.

Returned Format [:WAVeform:YORigin] <real_value><NL>

<real_value> A real number in exponential format.

Example This example places the current Y-origin value in the numeric variable, varCenter, then prints the contents of the variable to the computer's screen.

```
myScope.WriteString ":SYSTem:HEADer OFF" ' Response headers off.
myScope.WriteString ":WAVeform:YORigin?"
varCenter = myScope.ReadNumber
Debug.Print FormatNumber(varCenter, 0)
```

- See Also**
- For more information on BYTE and WORD formats, see "[Understanding WORD and BYTE Formats](#)" on page 1408.
 - You can also obtain the Y-origin value through the :WAVeform:PREamble? query. See "[:WAVeform:PREamble?](#)" on page 1417.
 - "[:WAVeform:VIEW](#)" on page 1429

History Legacy command (existed before version 3.10).

:WAVeform:YRANge?

Query :WAVeform:YRANge?

The :WAVeform:YRANge? query returns the Y-axis duration of the displayed waveform. For voltage waveforms, it is the voltage across the entire display.

NOTE

A "Waveform data is not valid" error occurs when there is no data available for a channel. When this occurs, a zero value is returned.

Returned Format [:WAVeform:YRANge] <value><NL>

<value> A real number representing the Y-axis duration of the displayed waveform.

Example This example returns the current Y-range value to the numeric variable, varValue, then prints the contents of the variable to the computer's screen.

```
myScope.WriteString ":SYSTem:HEADer OFF" ' Response headers off.
myScope.WriteString ":WAVeform:YRANge?"
varValue = myScope.ReadNumber
Debug.Print FormatNumber(varValue, 0)
```

History Legacy command (existed before version 3.10).

:WAVeform:YREFerence?

Query :WAVeform:YREFerence?

The :WAVeform:YREFerence? query returns the y-reference voltage value for the currently specified source. It is at this level that the Y origin is defined. In this oscilloscope, the value is always zero.

Returned Format [:WAVeform:YREFerence] 0<NL>

Example This example places the current Y-reference value for the currently specified source in the numeric variable, varValue, then prints the contents of the variable to the computer's screen.

```
myScope.WriteString ":SYSTEM:HEADer OFF" ' Response headers off.
myScope.WriteString ":WAVeform:YREFerence?"
varValue = myScope.ReadNumber
Debug.Print FormatNumber(varValue, 0)
```

See Also For more information on BYTE and WORD formats, see ["Understanding WORD and BYTE Formats"](#) on page 1408.

You can obtain the Y-reference value through the :WAVeform:PREamble? query.

History Legacy command (existed before version 3.10).

:WAVeform:YUNits?

Query :WAVeform:YUNits?

The :WAVeform:YUNits? query returns the Y-axis units of the currently selected waveform source. The currently selected source may be a channel, function, or waveform memory.

Returned Format [:WAVeform:YUNits] {UNKNown | VOLT | SEConD | HITS | DECibels | CONStant | AMP}<NL>

Example This example returns the Y-axis units of the currently selected waveform source to the string variable, strUnit, then prints the contents of the variable to the computer's screen.

```
Dim strUnit As String    ' Dimension variable.
myScope.WriteString ":WAVeform:YUNits?"
strUnit = myScope.ReadString
Debug.Print strUnit
```

History Legacy command (existed before version 3.10).

38 Waveform Memory Commands

:WMEMory:TIETimebase / 1446
:WMEMory<R>:CLEar / 1447
:WMEMory<R>:DISPlay / 1448
:WMEMory<R>:LOAD / 1449
:WMEMory<R>:SAVE / 1450
:WMEMory<R>:SEGmented:COUNT? / 1451
:WMEMory<R>:SEGmented:INDex / 1452
:WMEMory<R>:SEGmented:PLAY / 1453
:WMEMory<R>:XOFFset / 1454
:WMEMory<R>:XRANge / 1455
:WMEMory<R>:YOFFset / 1456
:WMEMory<R>:YRANge / 1457

The Waveform Memory Subsystem commands let you save and display waveforms, memories, and functions.

NOTE

<N> in WMEMory<R> Indicates the Waveform Memory Number

In Waveform Memory commands, the <N> in WMEMory<R> represents the waveform memory number (1-4).

:WMEemory:TIETimebase

Command :WMEemory:TIETimebase {{ON | 1} | {OFF | 0}}

The :WMEemory:TIETimebase command specifies whether the waveform memory horizontal scale is tied to the main horizontal time/div setting or can be adjusted separately.

Example This example ties the waveform memory horizontal scale to the main horizontal time/div setting.

```
myScope.WriteString ":WMEemory:TIETimebase ON"
```

Query :WMEemory:TIETimebase?

The :WMEemory:TIETimebase? query returns the state of the "tie to timebase" control.

Returned Format [:WMEemory:TIETimebase] {1 | 0}<NL>

History Legacy command (existed before version 3.10).

:WMEemory<R>:CLEar

Command :WMEemory<R>:CLEar

The :WMEemory<R>:CLEar clears the associated wave memory.

<R> The memory number is an integer from 1 to 4.

Example This example clears the waveform memory 1.

```
myScope.WriteString ":WMEemory1:CLEar"
```

History Legacy command (existed before version 3.10).

:WMEMemory<R>:DISPlay

Command :WMEMemory<R>:DISPlay {{ON | 1} | {OFF | 0}}

The :WMEMemory<R>:DISPlay command enables or disables the viewing of the selected waveform memory.

<R> The memory number is an integer from 1 to 4.

Example This example turns on the waveform memory 1 display.

```
myScope.WriteString ":WMEMemory1:DISPlay ON"
```

Query :WMEMemory<R>:DISPlay?

The :WMEMemory<R>:DISPlay? query returns the state of the selected waveform memory.

Returned Format [:WMEMemory<R>:DISPlay] {1 | 0}<NL>

History Legacy command (existed before version 3.10).

:WMEMemory<R>:LOAD

Command :WMEMemory<R>:LOAD <file_name>

The :WMEMemory<R>:LOAD command loads an oscilloscope waveform memory location with a waveform from a file that has an internal waveform format (extension .wfm), comma separated xypairs, (extension .csv), tab separated xypairs (extension .tsv), and yvalues text (extension .txt). You can load the file from either the c: or a: drive, or any lan connected drive. See the examples below.

The oscilloscope assumes that the default path for waveforms is C:\Users\Public\Documents\Infiniium. To use a different path, specify the path and file name completely.

<R> The memory number is an integer from 1 to 4.

<file_name> A quoted string which specifies the file to load, and has a .wfm, .csv, .tsv, or .txt extension.

Examples This example loads waveform memory 4 with a file.

```
myScope.WriteString _
":WMEMemory4:LOAD " "C:\Users\Public\Documents\Infiniium\waveform.wfm" "
```

This example loads waveform memory 3 with a file that has the internal waveform format and is stored on drive U:.

```
myScope.WriteString ":WMEMemory3:LOAD " "U:\waveform.wfm" "
```

**Related
Commands** :DISK:LOAD
:DISK:STORe

See Also

- [":DISK:LOAD"](#) on page 436
- [":DISK:SAVE:SETup"](#) on page 445
- [":DISK:SAVE:WAVEform"](#) on page 446

History Legacy command (existed before version 3.10).

:WMEMemory<R>:SAVE

Command :WMEMemory<R>:SAVE {CHANnel<N> | DIFF<D> | COMMONmode<C> | CLOCK
| FUNction<F> | MTRend | MSPectrum | WMEMemory<R>}

The :WMEMemory<R>:SAVE command stores the specified channel, waveform memory, or function to the waveform memory. You can save waveforms to waveform memories regardless of whether the waveform memory is displayed or not.

The :WAVEform:VIEW command determines the view of the data being saved.

MTRend and MSPectrum sources are only available if the oscilloscope has the EZJIT option installed and the feature is enabled.

The CLOCK source is only available if the oscilloscope has the High Speed Serial option installed and the feature is enabled.

<N> An integer, 1-4 in a single oscilloscope, 1-40 in a MultiScope system.

<D>, <C> <D> is an integer, 1-2. <C> is an integer, 3-4.

The DIFF and COMMONmode sources are just aliases that can be used in place of the channel names to apply to differential or common mode signals. These are just aliases - no state change occurs if you refer to a differential channel and you are not in differential mode. DIFF1 refers to the differential signal between channels 1 and 3 (and COMMONmode3 refers to the common mode channel between these same channels). DIFF2 refers to the differential signal between channels 2 and 4 (and COMMONmode4 refers to the common mode channel between these same channels).

<F> An integer, 1-16.

<R> An integer, 1-4.

Example This example saves channel 1 to waveform memory 4.

```
myScope.WriteString ":WMEMemory4:SAVE CHANNEL1"
```

History Legacy command (existed before version 3.10).

:WMEMemory<R>:SEGmented:COUNT?

Query :WMEMemory<R>:SEGmented:COUNT?

When segmented memory acquisitions are saved to waveform memory, the :WMEMemory<R>:SEGmented:COUNT? query returns the number of segments in the waveform memory.

Returned Format <#segments><NL>

<#segments> ::= integer in NR1 format

- See Also**
- [":WMEMemory<R>:SEGmented:COUNT?"](#) on page 1451
 - [":WMEMemory<R>:SEGmented:INDEX"](#) on page 1452
 - [":WMEMemory<R>:SEGmented:PLAY"](#) on page 1453

History New in version 6.00.

:WMEMemory<R>:SEGmented:INDEX

Command :WMEMemory<R>:SEGmented:INDEX <number>

When segmented memory acquisitions are saved to waveform memory, the :WMEMemory<R>:SEGmented:INDEX command displays the waveform segment at the specified index.

<number> Segment number in NR1 format.

Query :WMEMemory<R>:SEGmented:INDEX?

The :WMEMemory<R>:SEGmented:INDEX? query returns the index of the waveform segment that is currently being displayed.

Returned Format <number><NL>

<number> ::= segment number in NR1 format

- See Also**
- [":WMEMemory<R>:SEGmented:COUNT?"](#) on page 1451
 - [":WMEMemory<R>:SEGmented:INDEX"](#) on page 1452
 - [":WMEMemory<R>:SEGmented:PLAY"](#) on page 1453

History New in version 6.00.

:WMEMemory<R>:SEGmented:PLAY

Command :WMEMemory<R>:SEGmented:PLAY {{0 | OFF} | {1 | ON}}

When segmented memory acquisitions are saved to waveform memory, the ":WMEMemory<R>:SEGmented:PLAY" command plays (or stops) acquired segments.

- ON – is the similar to clicking the Play button in the graphical user interface, except that the display is not updated while segments are played.
- OFF – is the same as clicking the Stop button in the graphical user interface.

Playing waveform memory segments can take a while depending on the analysis taking place. You can query to determine when playing is complete.

The play rate is the same rate set by :ACQUIRE:SEGmented:PRATE command.

Query :WMEMemory<R>:SEGmented:PLAY?

The :WMEMemory<R>:SEGmented:PLAY? query returns whether segments are currently being played (1) or are stopped (0).

NOTE

The :WMEMemory<R>:SEGmented:PLAY? query is different than the :ACQUIRE:SEGmented:PLAY? query in that it waits until all segments are played before it returns.

Returned Format [:WMEMemory<R>:SEGmented:PLAY] <status><NL>
<status> ::= {0 | 1}

- See Also**
- [":ACQUIRE:SEGmented:PRATE"](#) on page 229
 - [":WMEMemory<R>:SEGmented:COUNT?"](#) on page 1451
 - [":WMEMemory<R>:SEGmented:INDEX"](#) on page 1452

History New in version 6.00.

:WMEMemory<R>:XOFFset

Command :WMEMemory<R>:XOFFset <offset_value>

The :WMEMemory<R>:XOFFset command sets the x-axis, horizontal position for the selected waveform memory's display scale. The position is referenced to center screen.

<R> The memory number is an integer from 1 to 4.

<offset_value> A real number for the horizontal offset (position) value.

Example This example sets the X-axis, horizontal position for waveform memory 3 to 0.1 seconds (100 ms).

```
myScope.WriteString ":WMEMemory3:XOFFset 0.1"
```

Query :WMEMemory<R>:XOFFset?

The :WMEMemory<R>:XOFFset? query returns the current X-axis, horizontal position for the selected waveform memory.

Returned Format [:WMEMemory<R>:XOFFset] <offset_value><NL>

History Legacy command (existed before version 3.10).

:WMEMory<R>:XRANge

Command :WMEMory<R>:XRANge <range_value>

The :WMEMory<R>:XRANge command sets the X-axis, horizontal range for the selected waveform memory's display scale. The horizontal scale is the horizontal range divided by 10.

<R> The memory number is an integer from 1 to 4.

<range_value> A real number for the horizontal range value.

Example This example sets the X-axis, horizontal range of waveform memory 2 to 435 microseconds.

```
myScope.WriteString ":WMEMory2:XRANge 435E-6"
```

Query :WMEMory<R>:XRANge?

The :WMEMory<R>:XRANge? query returns the current X-axis, horizontal range for the selected waveform memory.

Returned Format [:WMEMory<R>:XRANge] <range_value><NL>

History Legacy command (existed before version 3.10).

:WMEMemory<R>:YOFFset

Command :WMEMemory<R>:YOFFset <offset_value>

The :WMEMemory<R>:YOFFset command sets the Y-axis (vertical axis) offset for the selected waveform memory.

<R> The memory number is an integer from 1 to 4.

<offset_value> A real number for the vertical offset value.

Example This example sets the Y-axis (vertical) offset of waveform memory 2 to 0.2V.

```
myScope.WriteString ":WMEMemory2:YOFFset 0.2"
```

Query :WMEMemory<R>:YOFFset?

The :WMEMemory<R>:YOFFset? query returns the current Y-axis (vertical) offset for the selected waveform memory.

Returned Format [:WMEMemory<R>:YOFFset] <offset_value><NL>

History Legacy command (existed before version 3.10).

:WMEMemory<R>:YRANge

Command :WMEMemory<R>:YRANge <range_value>

The :WMEMemory<R>:YRANge command sets the Y-axis, vertical range for the selected memory. The vertical scale is the vertical range divided by 8.

<R> The memory number is an integer from 1 to 4.

<range_value> A real number for the vertical range value.

Example This example sets the Y-axis (vertical) range of waveform memory 3 to 0.2 volts.

```
myScope.WriteString ":WMEMemory3:YRANge 0.2"
```

Query :WMEMemory<R>:YRANge?

The :WMEMemory<R>:YRANge? query returns the Y-axis, vertical range for the selected memory.

Returned Format [:WMEMemory<R>:YRANge] <range_value><NL>

History Legacy command (existed before version 3.10).

39 Xtalk (Crosstalk Analysis) Commands

:XTALK:ENABle / 1461
:XTALK:PAADeskew / 1463
:XTALK:PAIFilter / 1464
:XTALK:PAISi / 1465
:XTALK:PASLimit / 1466
:XTALK:PAXFilter / 1467
:XTALK:PAXSi / 1468
:XTALK:PJADeskew / 1469
:XTALK:PJIFilter / 1470
:XTALK:PJISi / 1471
:XTALK:PJSLimit / 1472
:XTALK:PJXFilter / 1473
:XTALK:PJXSi / 1474
:XTALK:RESults? / 1475
:XTALK:SAADeskew / 1477
:XTALK:SAIFilter / 1478
:XTALK:SAISi / 1479
:XTALK:SASLimit / 1480
:XTALK:SAXFilter / 1481
:XTALK:SAXSi / 1482
:XTALK<X>:AENable<X> / 1483
:XTALK<X>:ENABle / 1484
:XTALK<X>:IAGGressor / 1485
:XTALK<X>:IVICtim / 1486
:XTALK<X>:PAUTo / 1487
:XTALK<X>:PLENght / 1488
:XTALK<X>:PTYPe / 1489
:XTALK<X>:RIDeal / 1490
:XTALK<X>:RISI / 1491
:XTALK<X>:ROTHer / 1492

```
:XTALk<X>:SOURce / 1493
```

```
:XTALk<X>:STYPe / 1494
```

The XTALk commands and queries control the Crosstalk Analysis application. This application helps you troubleshoot and characterize crosstalk on up to four simultaneously-acquired signals.

:XTALK:ENABLE

Command :XTALK:ENABLE {{0 | OFF} | {1 | ON}}

The :XTALK:ENABLE command enables or disables crosstalk analysis.

Query :XTALK:ENABLE?

The :XTALK:ENABLE? query returns whether crosstalk analysis is enabled or disabled.

Returned Format <setting><NL>

<setting> ::= {0 | 1}

- See Also**
- [":XTALK:RESuLts?"](#) on page 1475
 - [":XTALK<X>:AENable<X>"](#) on page 1483
 - [":XTALK<X>:ENABLE"](#) on page 1484
 - [":XTALK<X>:IAGGressor"](#) on page 1485
 - [":XTALK<X>:IVICTim"](#) on page 1486
 - [":XTALK<X>:PAUTo"](#) on page 1487
 - [":XTALK<X>:PLENght"](#) on page 1488
 - [":XTALK<X>:PTYPe"](#) on page 1489
 - [":XTALK<X>:RIDeal"](#) on page 1490
 - [":XTALK<X>:RISI"](#) on page 1491
 - [":XTALK<X>:ROTHer"](#) on page 1492
 - [":XTALK<X>:STYPe"](#) on page 1494
 - [":XTALK<X>:SOURce"](#) on page 1493
 - [":XTALK:SAADeskew"](#) on page 1477
 - [":XTALK:SASLimit"](#) on page 1480
 - [":XTALK:SAISi"](#) on page 1479
 - [":XTALK:SAIFilter"](#) on page 1478
 - [":XTALK:SAXSi"](#) on page 1482
 - [":XTALK:SAXFilter"](#) on page 1481
 - [":XTALK:PAADeskew"](#) on page 1463
 - [":XTALK:PASLimit"](#) on page 1466
 - [":XTALK:PAISi"](#) on page 1465
 - [":XTALK:PAIFilter"](#) on page 1464
 - [":XTALK:PAXSi"](#) on page 1468
 - [":XTALK:PAXFilter"](#) on page 1467
 - [":XTALK:PJADeskew"](#) on page 1469

- [":XTALK:PJSLimit"](#) on page 1472
- [":XTALK:PJISi"](#) on page 1471
- [":XTALK:PJIFilter"](#) on page 1470
- [":XTALK:PJXSi"](#) on page 1474
- [":XTALK:PJXFilter"](#) on page 1473

History New in version 5.70.

:XTALK:PAADeskew

Command `:XTALK:PAADeskew {{0 | OFF} | {1 | ON}}`

The `:XTALK:PAADeskew` command is an advanced configuration option for power supply aggressors (amplitude) that specifies whether auto deskew is enabled or disabled.

When auto deskew is enabled, the Crosstalk Analysis application uses a proprietary cross-correlation method for aligning the waveforms in time. The algorithm searches over a finite range of delays to find the best possible alignment. The search range corresponds to about 1 m of difference in cable length, which is sufficient for most situations.

When auto deskew is disabled, the deskew time limit is specified by the `:XTALK:PASLimit` command.

Query `:XTALK:PAADeskew?`

The `:XTALK:PAADeskew?` query returns the "auto deskew" setting for power supply aggressors (amplitude).

Returned Format `<setting><NL>`

`<setting> ::= {0 | 1}`

- See Also**
- [":XTALK:PASLimit"](#) on page 1466
 - [":XTALK:PAISi"](#) on page 1465
 - [":XTALK:PAIFilter"](#) on page 1464
 - [":XTALK:PAXSi"](#) on page 1468
 - [":XTALK:PAXFilter"](#) on page 1467

History New in version 5.70.

:XTALK:PAIFilter

Command :XTALK:PAIFilter <time_span>

<time_span> ::= time span in seconds in NR3 format.

The :XTALK:PAIFilter command is an advanced configuration option for power supply aggressors (amplitude) that, when auto limit ISI filter time is disabled (:XTALK:PAISi OFF), lets you specify the ISI filter time span.

Query :XTALK:PAIFilter?

The :XTALK:PAIFilter? query returns the specified ISI filter time span.

Returned Format <time_span><NL>

<time_span> ::= time span in seconds in NR3 format.

- See Also**
- **" :XTALK:PAISi "** on page 1465
 - **" :XTALK:PAADeskew "** on page 1463
 - **" :XTALK:PASLimit "** on page 1466
 - **" :XTALK:PAXSi "** on page 1468
 - **" :XTALK:PAXFilter "** on page 1467

History New in version 5.70.

:XTALK:PAISi

Command :XTALK:PAISi {{0 | OFF} | {1 | ON}}

The :XTALK:PAISi command is an advanced configuration option for power supply aggressors (amplitude) that specifies whether auto limit ISI filter time is enabled or disabled.

The ISI filter represents the channel model and can therefore convert an ideal input waveform into the one that is band-limited and containing reflections.

- When auto limit ISI filter time is enabled, the Crosstalk Analysis application uses a proprietary algorithm to automatically determine an ideal ISI filter length for a given situation. The application further tries to optimize the shape of the filter by adaptively placing more taps in areas that are needed.
- When auto limit ISI filter time is disabled, the ISI filter time span is specified by the :XTALK:PAIFilter command.

Query :XTALK:PAISi?

The :XTALK:PAISi? query returns the "auto limit ISI filter time" setting for power supply aggressors (amplitude).

Returned Format <setting><NL>

<setting> ::= {0 | 1}

- See Also**
- [":XTALK:PAIFilter"](#) on page 1464
 - [":XTALK:PAADes skew"](#) on page 1463
 - [":XTALK:PASLimit"](#) on page 1466
 - [":XTALK:PAXSi"](#) on page 1468
 - [":XTALK:PAXFilter"](#) on page 1467

History New in version 5.70.

:XTALK:PASLimit

Command :XTALK:PASLimit <time_limit>

<time_limit> ::= time limit in seconds in NR3 format.

The :XTALK:PASLimit command is an advanced configuration option for power supply aggressors (amplitude) that, when auto deskew is disabled (:XTALK:PAADeskew OFF), lets you specify the deskew time limit (search range).

Notice that the default deskew time limit value is larger for a power supply than for serial data transmission lines. This is because buffers and other circuit components can create delays much larger than the propagation distance. These delays may vary greatly from one circuit to another, so keep in mind that changing the default value may produce better results.

Query :XTALK:PASLimit?

The :XTALK:PASLimit? query returns the specified deskew time limit.

Returned Format <time_limit><NL>

<time_limit> ::= time limit in seconds in NR3 format.

- See Also**
- [":XTALK:PAADeskew"](#) on page 1463
 - [":XTALK:PAISi"](#) on page 1465
 - [":XTALK:PAIFilter"](#) on page 1464
 - [":XTALK:PAXSi"](#) on page 1468
 - [":XTALK:PAXFilter"](#) on page 1467

History New in version 5.70.

:XTALK:PAXFilter

Command :XTALK:PAXFilter <time_span>

<time_span> ::= time span in seconds in NR3 format.

The :XTALK:PAXFilter command is an advanced configuration option for power supply aggressors (amplitude) that, when auto limit XSI filter time is disabled (:XTALK:PAXSi OFF), lets you specify the XSI (crosstalk) filter time span.

Query :XTALK:PAXFilter?

The :XTALK:PAXFilter? query returns the specified XSI (crosstalk) filter time span.

Returned Format <time_span><NL>

<time_span> ::= time span in seconds in NR3 format.

- See Also**
- [":XTALK:PAXSi"](#) on page 1468
 - [":XTALK:PAADeskew"](#) on page 1463
 - [":XTALK:PASLimit"](#) on page 1466
 - [":XTALK:PAISi"](#) on page 1465
 - [":XTALK:PAIFilter"](#) on page 1464

History New in version 5.70.

:XTALK:PAXSi

Command `:XTALK:PAXSi {{0 | OFF} | {1 | ON}}`

The `:XTALK:PAXSi` command is an advanced configuration option for power supply aggressors (amplitude) that specifies whether auto limit XSI filter time is enabled or disabled

Crosstalk filters describe how an aggressor signal is transformed into a crosstalk signal (such as NEXT or FEXT), and what magnitude it will have.

- When auto limit XSI filter time is enabled, the Crosstalk Analysis application uses a proprietary algorithm to automatically determine an ideal crosstalk filter length for a given situation. The application further tries to optimize the shape of the filter by adaptively placing more taps in areas that are needed.
- When auto limit XSI filter time is disabled, the XSI (crosstalk) filter time span is specified by the `:XTALK:PAXFilter` command.

A FEXT filter length should be at least as long as an edge rise time, and a NEXT filter length should be at least twice the propagation delay of the channel.

Query `:XTALK:PAXSi?`

The `:XTALK:PAXSi?` query returns the "auto limit XSI filter time" setting for power supply aggressors (amplitude).

Returned Format `<setting><NL>`

`<setting> ::= {0 | 1}`

- See Also**
- [":XTALK:PAXFilter"](#) on page 1467
 - [":XTALK:PAADeskew"](#) on page 1463
 - [":XTALK:PASLimit"](#) on page 1466
 - [":XTALK:PAISi"](#) on page 1465
 - [":XTALK:PAIFilter"](#) on page 1464

History New in version 5.70.

:XTALK:PJADeskew

Command :XTALK:PJADeskew {{0 | OFF} | {1 | ON}}

The :XTALK:PJADeskew command is an advanced configuration option for power supply aggressors (jitter) that specifies whether auto deskew is enabled or disabled.

When auto deskew is enabled, the Crosstalk Analysis application uses a proprietary cross-correlation method for aligning the waveforms in time. The algorithm searches over a finite range of delays to find the best possible alignment. The search range corresponds to about 1 m of difference in cable length, which is sufficient for most situations.

When auto deskew is disabled, the deskew time limit is specified by the :XTALK:PJSLimit command.

Query :XTALK:PJADeskew?

The :XTALK:PJADeskew? query returns the "auto deskew" setting for power supply aggressors (jitter).

Returned Format <setting><NL>

<setting> ::= {0 | 1}

- See Also**
- [":XTALK:PJSLimit"](#) on page 1472
 - [":XTALK:PJISi"](#) on page 1471
 - [":XTALK:PJIFilter"](#) on page 1470
 - [":XTALK:PJXSi"](#) on page 1474
 - [":XTALK:PJXFilter"](#) on page 1473

History New in version 5.70.

:XTALK:PJIFilter

Command :XTALK:PJIFilter <time_span>

<time_span> ::= time span in seconds in NR3 format.

The :XTALK:PJIFilter command is an advanced configuration option for power supply aggressors (amplitude) that, when auto limit ISI filter time is disabled (:XTALK:PJISi OFF), lets you specify the ISI filter time span.

Query :XTALK:PJIFilter?

The :XTALK:PJIFilter? query returns the specified ISI filter time span.

Returned Format <time_span><NL>

<time_span> ::= time span in seconds in NR3 format.

- See Also**
- [":XTALK:PJISi"](#) on page 1471
 - [":XTALK:PJADeskew"](#) on page 1469
 - [":XTALK:PJSLimit"](#) on page 1472
 - [":XTALK:PJXSi"](#) on page 1474
 - [":XTALK:PJXFilter"](#) on page 1473

History New in version 5.70.

:XTALK:PJISi

Command :XTALK:PJISi {{0 | OFF} | {1 | ON}}

The :XTALK:PJISi command is an advanced configuration option for power supply aggressors (jitter) that specifies whether auto limit ISI filter time is enabled or disabled.

The ISI filter represents the channel model and can therefore convert an ideal input waveform into the one that is band-limited and containing reflections.

- When auto limit ISI filter time is enabled, the Crosstalk Analysis application uses a proprietary algorithm to automatically determine an ideal ISI filter length for a given situation. The application further tries to optimize the shape of the filter by adaptively placing more taps in areas that are needed.
- When auto limit ISI filter time is disabled, the ISI filter time span is specified by the :XTALK:PJIFilter command.

Query :XTALK:PJISi?

The :XTALK:PJISi? query returns the "auto limit ISI filter time" setting for power supply aggressors (jitter).

Returned Format <setting><NL>

<setting> ::= {0 | 1}

- See Also**
- [":XTALK:PJIFilter"](#) on page 1470
 - [":XTALK:PJADeskew"](#) on page 1469
 - [":XTALK:PJSLimit"](#) on page 1472
 - [":XTALK:PJXSi"](#) on page 1474
 - [":XTALK:PJXFilter"](#) on page 1473

History New in version 5.70.

:XTALK:PJSLimit

Command :XTALK:PJSLimit <time_limit>

<time_limit> ::= time limit in seconds in NR3 format.

The :XTALK:PJSLimit command is an advanced configuration option for power supply aggressors (jitter) that, when auto deskew is disabled (:XTALK:PJADes skew OFF), lets you specify the deskew time limit (search range).

Notice that the default deskew time limit value is larger for a power supply than for serial data transmission lines. This is because buffers and other circuit components can create delays much larger than the propagation distance. These delays may vary greatly from one circuit to another, so keep in mind that changing the default value may produce better results.

Query :XTALK:PJSLimit?

The :XTALK:PJSLimit? query returns the specified deskew time limit.

Returned Format <time_limit><NL>

<time_limit> ::= time limit in seconds in NR3 format.

- See Also**
- [":XTALK:PJADes skew"](#) on page 1469
 - [":XTALK:PJSi"](#) on page 1471
 - [":XTALK:PJIFilter"](#) on page 1470
 - [":XTALK:PJSi"](#) on page 1474
 - [":XTALK:PJXFilter"](#) on page 1473

History New in version 5.70.

:XTALK:PJXFilter

Command :XTALK:PJXFilter <time_span>

<time_span> ::= time span in seconds in NR3 format.

The :XTALK:PJXFilter command is an advanced configuration option for power supply aggressors (amplitude) that, when auto limit XSI filter time is disabled (:XTALK:PJSi OFF), lets you specify the XSI (crosstalk) filter time span.

Query :XTALK:PJXFilter?

The :XTALK:PJXFilter? query returns the specified XSI (crosstalk) filter time span.

Returned Format <opt><NL>

<time_span> ::= time span in seconds in NR3 format.

- See Also**
- [":XTALK:PJSi"](#) on page 1474
 - [":XTALK:PJADeskew"](#) on page 1469
 - [":XTALK:PJSLimit"](#) on page 1472
 - [":XTALK:PJISi"](#) on page 1471
 - [":XTALK:PJIFilter"](#) on page 1470

History New in version 5.70.

:XTALK:PJXSi

Command `:XTALK:PJXSi {{0 | OFF} | {1 | ON}}`

The `:XTALK:PJXSi` command is an advanced configuration option for power supply aggressors (jitter) that specifies whether auto limit XSI filter time is enabled or disabled

Crosstalk filters describe how an aggressor signal is transformed into a crosstalk signal (such as NEXT or FEXT), and what magnitude it will have.

- When auto limit XSI filter time is enabled, the Crosstalk Analysis application uses a proprietary algorithm to automatically determine an ideal crosstalk filter length for a given situation. The application further tries to optimize the shape of the filter by adaptively placing more taps in areas that are needed.
- When auto limit XSI filter time is disabled, the XSI (crosstalk) filter time span is specified by the `:XTALK:PJXFilter` command.

A FEXT filter length should be at least as long as an edge rise time, and a NEXT filter length should be at least twice the propagation delay of the channel.

Query `:XTALK:PJXSi?`

The `:XTALK:PJXSi?` query returns the "auto limit XSI filter time" setting for power supply aggressors (jitter).

Returned Format `<setting><NL>`

`<setting> ::= {0 | 1}`

- See Also**
- [":XTALK:PJXFilter"](#) on page 1473
 - [":XTALK:PJADeskew"](#) on page 1469
 - [":XTALK:PJSLimit"](#) on page 1472
 - [":XTALK:PJISi"](#) on page 1471
 - [":XTALK:PJIFilter"](#) on page 1470

History New in version 5.70.

:XTALK:RESults?

Query :XTALK:RESults?

The :XTALK:RESults? query returns the crosstalk analysis results in a comma-separated list of values. The values returned for each victim:aggressor pair in the results are:

| Value | Format | Example |
|--|---|---------|
| Label: | string | c1:c2 |
| Amplitude skew: | floating-point number string in scientific notation | 0.0E+00 |
| Jitter skew: | floating-point number string in scientific notation | 0.0E+00 |
| Volt, Error(rms), for the non victim:victim lines: | floating-point number string in scientific notation | 0.0E+00 |
| Volt, Error(p-p), for the non victim:victim lines: | floating-point number string in scientific notation | 0.0E+00 |
| Time, Error(rms), for the non victim:victim lines: | floating-point number string in scientific notation | 0.0E+00 |
| Time Error(p-p), for the non victim:victim lines: | floating-point number string in scientific notation | 0.0E+00 |
| V high, Error(rms): | floating-point number string in scientific notation | 0.0E+00 |
| V high, Error(p-p): | floating-point number string in scientific notation | 0.0E+00 |
| V low, Error(rms): | floating-point number string in scientific notation | 0.0E+00 |
| V low, Error(p-p): | floating-point number string in scientific notation | 0.0E+00 |
| Volt, Error(rms), for the victim:victim line: | floating-point number string in scientific notation | 0.0E+00 |
| Volt, Error(p-p), for the victim:victim line: | floating-point number string in scientific notation | 0.0E+00 |
| Time, Error(rms), for the victim:victim line: | floating-point number string in scientific notation | 0.0E+00 |
| Time, Error(p-p), for the victim:victim line: | floating-point number string in scientific notation | 0.0E+00 |

Returned Format <results_list><NL>

`<results_list> ::= comma-delimited list of values.`

See Also · [":XTALK:ENABLE"](#) on page 1461

History New in version 5.70.

:XTALK:SAADeskew

Command :XTALK:SAADeskew {{0 | OFF} | {1 | ON}}

The :XTALK:SAADeskew command is an advanced configuration option for serial data aggressors that specifies whether auto deskew is enabled or disabled.

When auto deskew is enabled, the Crosstalk Analysis application uses a proprietary cross-correlation method for aligning the waveforms in time. The algorithm searches over a finite range of delays to find the best possible alignment. The search range corresponds to about 1 m of difference in cable length, which is sufficient for most situations.

When auto deskew is disabled, the deskew time limit is specified by the :XTALK:SASLimit command.

Query :XTALK:SAADeskew?

The :XTALK:SAADeskew? query returns the "auto deskew" setting for serial data aggressors.

Returned Format <setting><NL>

<setting> ::= {0 | 1}

- See Also**
- [":XTALK:SASLimit"](#) on page 1480
 - [":XTALK:SAISi"](#) on page 1479
 - [":XTALK:SAIFilter"](#) on page 1478
 - [":XTALK:SAXSi"](#) on page 1482
 - [":XTALK:SAXFilter"](#) on page 1481

History New in version 5.70.

:XTALK:SAIFilter

Command :XTALK:SAIFilter <time_span>

<time_span> ::= time span in seconds in NR3 format.

The :XTALK:SAIFilter command is an advanced configuration option for serial data aggressors that, when auto limit ISI filter time is disabled (:XTALK:SAISi OFF), lets you specify the ISI filter time span.

Query :XTALK:SAIFilter?

The :XTALK:SAIFilter? query returns the specified ISI filter time span.

Returned Format <time_span><NL>

<time_span> ::= time span in seconds in NR3 format.

- See Also**
- [":XTALK:SAISi"](#) on page 1479
 - [":XTALK:SAADeskew"](#) on page 1477
 - [":XTALK:SASLimit"](#) on page 1480
 - [":XTALK:SAXSi"](#) on page 1482
 - [":XTALK:SAXFilter"](#) on page 1481

History New in version 5.70.

:XTALK:SAISi

Command :XTALK:SAISi {{0 | OFF} | {1 | ON}}

The :XTALK:SAISi command is an advanced configuration option for serial data aggressors that specifies whether auto limit ISI filter time is enabled or disabled.

The ISI filter represents the channel model and can therefore convert an ideal input waveform into the one that is band-limited and containing reflections.

- When auto limit ISI filter time is enabled, the Crosstalk Analysis application uses a proprietary algorithm to automatically determine an ideal ISI filter length for a given situation. The application further tries to optimize the shape of the filter by adaptively placing more taps in areas that are needed.
- When auto limit ISI filter time is disabled, the ISI filter time span is specified by the :XTALK:SAIFilter command.

Query :XTALK:SAISi?

The :XTALK:SAISi? query returns the "auto limit ISI filter time" setting for serial data aggressors.

Returned Format <setting><NL>

<setting> ::= {0 | 1}

- See Also**
- [":XTALK:SAIFilter"](#) on page 1478
 - [":XTALK:SAADeskew"](#) on page 1477
 - [":XTALK:SASLimit"](#) on page 1480
 - [":XTALK:SAXSi"](#) on page 1482
 - [":XTALK:SAXFilter"](#) on page 1481

History New in version 5.70.

:XTALK:SASLimit

Command :XTALK:SASLimit <time_limit>

<time_limit> ::= time limit in seconds in NR3 format.

The :XTALK:SASLimit command is an advanced configuration option for serial data aggressors that, when auto deskew is disabled (:XTALK:SAADeskew OFF), lets you specify the deskew time limit (search range).

Notice that the default deskew time limit value is larger for a power supply than for serial data transmission lines. This is because buffers and other circuit components can create delays much larger than the propagation distance. These delays may vary greatly from one circuit to another, so keep in mind that changing the default value may produce better results.

Query :XTALK:SASLimit?

The :XTALK:SASLimit? query returns the specified deskew time limit.

Returned Format <time_limit><NL>

<time_limit> ::= time limit in seconds in NR3 format.

- See Also**
- [":XTALK:SAADeskew"](#) on page 1477
 - [":XTALK:SAISi"](#) on page 1479
 - [":XTALK:SAIFilter"](#) on page 1478
 - [":XTALK:SAXSi"](#) on page 1482
 - [":XTALK:SAXFilter"](#) on page 1481

History New in version 5.70.

:XTALK:SAXFilter

Command :XTALK:SAXFilter <time_span>

<time_span> ::= time span in seconds in NR3 format.

The :XTALK:SAXFilter command is an advanced configuration option for serial data aggressors that, when auto limit XSI filter time is disabled (:XTALK:SAXSi OFF), lets you specify the XSI (crosstalk) filter time span.

Query :XTALK:SAXFilter?

The :XTALK:SAXFilter? query returns the specified XSI (crosstalk) filter time span.

Returned Format <time_span><NL>

<time_span> ::= time span in seconds in NR3 format.

- See Also**
- [":XTALK:SAXSi"](#) on page 1482
 - [":XTALK:SAADeskew"](#) on page 1477
 - [":XTALK:SASLimit"](#) on page 1480
 - [":XTALK:SAISi"](#) on page 1479
 - [":XTALK:SAIFilter"](#) on page 1478

History New in version 5.70.

:XTALK:SAXSi

Command `:XTALK:SAXSi {{0 | OFF} | {1 | ON}}`

The `:XTALK:SAXSi` command is an advanced configuration option for serial data aggressors that specifies whether auto limit XSI filter time is enabled or disabled

Crosstalk filters describe how an aggressor signal is transformed into a crosstalk signal (such as NEXT or FEXT), and what magnitude it will have.

- When auto limit XSI filter time is enabled, the Crosstalk Analysis application uses a proprietary algorithm to automatically determine an ideal crosstalk filter length for a given situation. The application further tries to optimize the shape of the filter by adaptively placing more taps in areas that are needed.
- When auto limit XSI filter time is disabled, the XSI (crosstalk) filter time span is specified by the `:XTALK:SAXFilter` command.

A FEXT filter length should be at least as long as an edge rise time, and a NEXT filter length should be at least twice the propagation delay of the channel.

Query `:XTALK:SAXSi?`

The `:XTALK:SAXSi?` query returns the "auto limit XSI filter time" setting for serial data aggressors.

Returned Format `<setting><NL>`

`<setting> ::= {0 | 1}`

- See Also**
- [":XTALK:SAXFilter"](#) on page 1481
 - [":XTALK:SAADeskew"](#) on page 1477
 - [":XTALK:SASLimit"](#) on page 1480
 - [":XTALK:SAISi"](#) on page 1479
 - [":XTALK:SAIFilter"](#) on page 1478

History New in version 5.70.

:XTALk<X>:AENable<X>

Command :XTALk<X>:AENable<X> {{0 | OFF} | {1 | ON}}

When the crosstalk analysis signal is a victim (:XTALk<X>:IVICTim ON), the :XTALk<X>:AENable<X> command specifies whether to remove the crosstalk from another signal in the crosstalk analysis.

<X> An integer from 1-4.

Example For example if crosstalk signal1 is a victim, you can specify to remove the crosstalk from the signal3 aggressor with the command:

```
myScope.WriteString ":XTALk1:AENable3 ON"
```

- See Also**
- [":XTALk<X>:ENABLE"](#) on page 1484
 - [":XTALk<X>:IAGGressor"](#) on page 1485
 - [":XTALk<X>:IVICTim"](#) on page 1486
 - [":XTALk<X>:PAUTo"](#) on page 1487
 - [":XTALk<X>:PLENght"](#) on page 1488
 - [":XTALk<X>:PTYPE"](#) on page 1489
 - [":XTALk<X>:RIDeal"](#) on page 1490
 - [":XTALk<X>:RISI"](#) on page 1491
 - [":XTALk<X>:ROTHer"](#) on page 1492
 - [":XTALk<X>:STYPE"](#) on page 1494
 - [":XTALk<X>:SOURce"](#) on page 1493
 - [":XTALk:ENABLE"](#) on page 1461
 - [":XTALk:RESUltS?"](#) on page 1475

History New in version 5.70.

:XTALk<X>:ENABLE

Command :XTALk<X>:ENABle {{0 | OFF} | {1 | ON}}

The :XTALk<X>:ENABle command adds or removes a signal from the crosstalk analysis.

Crosstalk analysis can be performed on up to four simultaneously acquired signals.

<X> An integer from 1-4.

Query :XTALk<X>:ENABle?

The :XTALk<X>:ENABle? query returns whether the signal has been added to the crosstalk analysis.

Returned Format <setting><NL>

<setting> ::= {0 | 1}

- See Also**
- [":XTALk<X>:AENable<X>"](#) on page 1483
 - [":XTALk<X>:IAGGressor"](#) on page 1485
 - [":XTALk<X>:IVICtim"](#) on page 1486
 - [":XTALk<X>:PAUTo"](#) on page 1487
 - [":XTALk<X>:PLENght"](#) on page 1488
 - [":XTALk<X>:PTYPE"](#) on page 1489
 - [":XTALk<X>:RIDeal"](#) on page 1490
 - [":XTALk<X>:RISI"](#) on page 1491
 - [":XTALk<X>:ROTHer"](#) on page 1492
 - [":XTALk<X>:STYPE"](#) on page 1494
 - [":XTALk<X>:SOURce"](#) on page 1493
 - [":XTALk:ENABle"](#) on page 1461
 - [":XTALk:RESults?"](#) on page 1475

History New in version 5.70.

:XTALK<X>:IAGGressor

Command :XTALK<X>:IAGGressor {{0 | OFF} | {1 | ON}}

The :XTALK<X>:IAGGressor command specifies whether the signal is an aggressor.

<X> An integer from 1-4.

Query :XTALK<X>:IAGGressor?

The :XTALK<X>:IAGGressor? query returns the "is aggressor" setting.

Returned Format <setting><NL>

<setting> ::= {0 | 1}

- See Also**
- [":XTALK<X>:AENable<X>"](#) on page 1483
 - [":XTALK<X>:ENABle"](#) on page 1484
 - [":XTALK<X>:IvICTim"](#) on page 1486
 - [":XTALK<X>:PAUTo"](#) on page 1487
 - [":XTALK<X>:PLENgtH"](#) on page 1488
 - [":XTALK<X>:PTYPE"](#) on page 1489
 - [":XTALK<X>:RIDeal"](#) on page 1490
 - [":XTALK<X>:RISI"](#) on page 1491
 - [":XTALK<X>:ROTHer"](#) on page 1492
 - [":XTALK<X>:STYPE"](#) on page 1494
 - [":XTALK<X>:SOURce"](#) on page 1493
 - [":XTALK:ENABle"](#) on page 1461
 - [":XTALK:RESults?"](#) on page 1475

History New in version 5.70.

:XTALK<X>:IVICTim

Command :XTALK<X>:IVICTim {{0 | OFF} | {1 | ON}}

The :XTALK<X>:IVICTim command specifies whether the signal is a victim.

<X> An integer from 1-4.

Query :XTALK<X>:IVICTim?

The :XTALK<X>:IVICTim? query returns the "is victim" setting.

Returned Format <setting><NL>

<setting> ::= {0 | 1}

- See Also**
- [":XTALK<X>:AENable<X>"](#) on page 1483
 - [":XTALK<X>:ENABle"](#) on page 1484
 - [":XTALK<X>:IAGGressor"](#) on page 1485
 - [":XTALK<X>:PAUTo"](#) on page 1487
 - [":XTALK<X>:PLENght"](#) on page 1488
 - [":XTALK<X>:PTYPE"](#) on page 1489
 - [":XTALK<X>:RIDeal"](#) on page 1490
 - [":XTALK<X>:RISI"](#) on page 1491
 - [":XTALK<X>:ROTHer"](#) on page 1492
 - [":XTALK<X>:STYPE"](#) on page 1494
 - [":XTALK<X>:SOURce"](#) on page 1493
 - [":XTALK:ENABle"](#) on page 1461
 - [":XTALK:RESults?"](#) on page 1475

History New in version 5.70.

:XTALK<X>:PAUTO

Command :XTALK<X>:PAUTO {{0 | OFF} | {1 | ON}}

When the crosstalk analysis signal type is DIGital (serial data), the :XTALK<X>:PAUTO command specifies whether the pattern length is automatically determined.

<X> An integer from 1-4.

Query :XTALK<X>:PAUTO?

The :XTALK<X>:PAUTO? query returns the auto length setting.

Returned Format <setting><NL>

<setting> ::= {0 | 1}

- See Also**
- [":XTALK<X>:AENable<X>"](#) on page 1483
 - [":XTALK<X>:ENABLE"](#) on page 1484
 - [":XTALK<X>:IAGGressor"](#) on page 1485
 - [":XTALK<X>:IVICTim"](#) on page 1486
 - [":XTALK<X>:PLENght"](#) on page 1488
 - [":XTALK<X>:PTYPE"](#) on page 1489
 - [":XTALK<X>:RIDeal"](#) on page 1490
 - [":XTALK<X>:RISI"](#) on page 1491
 - [":XTALK<X>:ROTHer"](#) on page 1492
 - [":XTALK<X>:STYPE"](#) on page 1494
 - [":XTALK<X>:SOURce"](#) on page 1493
 - [":XTALK:ENABLE"](#) on page 1461
 - [":XTALK:RESults?"](#) on page 1475

History New in version 5.70.

:XTALk<X>:PLENgtH

Command :XTALk<X>:PLENgtH <number_of_bits>
 <number_of_bits> ::= integer from 2-1024.

When the crosstalk analysis signal type is DIGital (serial data) and the pattern length is not automatically determined (:XTALk<X>:PAUTo OFF), the :XTALk<X>:PLENgtH command specifies the pattern length.

<X> An integer from 1-4.

Query :XTALk<X>:PLENgtH?

The :XTALk<X>:PLENgtH? query returns the pattern length setting.

Returned Format <number_of_bits><NL>
 <number_of_bits> ::= integer from 2-1024.

- See Also**
- [":XTALk<X>:AENable<X>"](#) on page 1483
 - [":XTALk<X>:ENABle"](#) on page 1484
 - [":XTALk<X>:IAGGressor"](#) on page 1485
 - [":XTALk<X>:IVICTim"](#) on page 1486
 - [":XTALk<X>:PAUTo"](#) on page 1487
 - [":XTALk<X>:PTYPE"](#) on page 1489
 - [":XTALk<X>:RIDeal"](#) on page 1490
 - [":XTALk<X>:RISI"](#) on page 1491
 - [":XTALk<X>:ROTHer"](#) on page 1492
 - [":XTALk<X>:STYPE"](#) on page 1494
 - [":XTALk<X>:SOURce"](#) on page 1493
 - [":XTALk:ENABle"](#) on page 1461
 - [":XTALk:RESUltS?"](#) on page 1475

History New in version 5.70.

:XTALK<X>:PTYPE

Command :XTALK<X>:PTYPE <pattern_type>
 <pattern_type> ::= {PERiodic | ARBitrary}

When the crosstalk analysis signal type is DIGital (serial data), the :XTALK<X>:PTYPE command specifies whether the pattern is periodic or arbitrary.

<X> An integer from 1-4.

Query :XTALK<X>:PTYPE?

The :XTALK<X>:PTYPE? query returns the pattern type setting.

Returned Format <pattern_type><NL>
 <pattern_type> ::= {PERiodic | ARBitrary}

- See Also**
- [":XTALK<X>:AENable<X>"](#) on page 1483
 - [":XTALK<X>:ENABle"](#) on page 1484
 - [":XTALK<X>:IAGGressor"](#) on page 1485
 - [":XTALK<X>:IVICTim"](#) on page 1486
 - [":XTALK<X>:PAUTo"](#) on page 1487
 - [":XTALK<X>:PLENght"](#) on page 1488
 - [":XTALK<X>:RIDeal"](#) on page 1490
 - [":XTALK<X>:RISI"](#) on page 1491
 - [":XTALK<X>:ROTHer"](#) on page 1492
 - [":XTALK<X>:STYPE"](#) on page 1494
 - [":XTALK<X>:SOURce"](#) on page 1493
 - [":XTALK:ENABle"](#) on page 1461
 - [":XTALK:RESults?"](#) on page 1475

History New in version 5.70.

:XTALK<X>:RIDeal

Command :XTALK<X>:RIDeal {{0 | OFF} | {1 | ON}}

When the crosstalk analysis signal is a victim (:XTALK<X>:IVICTim ON), the :XTALK<X>:RIDeal command specifies whether to remove the signal's ideal waveform contribution should be removed from the crosstalk-removed waveform.

<X> An integer from 1-4.

Query :XTALK<X>:RIDeal?

The :XTALK<X>:RIDeal? query returns the "remove ideal waveform" setting.

Returned Format <setting><NL>

<setting> ::= {0 | 1}

- See Also**
- [":XTALK<X>:AENable<X>"](#) on page 1483
 - [":XTALK<X>:ENABLE"](#) on page 1484
 - [":XTALK<X>:IAGGressor"](#) on page 1485
 - [":XTALK<X>:IVICTim"](#) on page 1486
 - [":XTALK<X>:PAUTo"](#) on page 1487
 - [":XTALK<X>:PLENght"](#) on page 1488
 - [":XTALK<X>:PTYPE"](#) on page 1489
 - [":XTALK<X>:RISI"](#) on page 1491
 - [":XTALK<X>:ROTHer"](#) on page 1492
 - [":XTALK<X>:STYPE"](#) on page 1494
 - [":XTALK<X>:SOURce"](#) on page 1493
 - [":XTALK:ENABLE"](#) on page 1461
 - [":XTALK:RESults?"](#) on page 1475

History New in version 5.70.

:XTALK<X>:RISI

Command :XTALK<X>:RISI {{0 | OFF} | {1 | ON}}

When the crosstalk analysis signal is a victim (:XTALK<X>:IVICTim ON), the :XTALK<X>:RISI command specifies whether to remove the signal's ISI (inter-symbol interference) contribution should be removed from the crosstalk-removed waveform.

<X> An integer from 1-4.

Query :XTALK<X>:RISI?

The :XTALK<X>:RISI? query returns the "remove ISI" setting.

Returned Format <setting><NL>

<setting> ::= {0 | 1}

- See Also**
- [":XTALK<X>:AENable<X>"](#) on page 1483
 - [":XTALK<X>:ENABLE"](#) on page 1484
 - [":XTALK<X>:IAGGressor"](#) on page 1485
 - [":XTALK<X>:IVICTim"](#) on page 1486
 - [":XTALK<X>:PAUTo"](#) on page 1487
 - [":XTALK<X>:PLENght"](#) on page 1488
 - [":XTALK<X>:PTYPE"](#) on page 1489
 - [":XTALK<X>:RIDeal"](#) on page 1490
 - [":XTALK<X>:ROTHer"](#) on page 1492
 - [":XTALK<X>:STYPE"](#) on page 1494
 - [":XTALK<X>:SOURce"](#) on page 1493
 - [":XTALK:ENABLE"](#) on page 1461
 - [":XTALK:RESUltS?"](#) on page 1475

History New in version 5.70.

:XTALk<X>:ROTHer

Command :XTALk<X>:ROTHer {{0 | OFF} | {1 | ON}}

When the crosstalk analysis signal is a victim (:XTALk<X>:IVICTim ON), the :XTALk<X>:ROTHer command specifies whether to remove the signal's unknown crosstalk and noise contribution should be removed from the crosstalk-removed waveform.

<X> An integer from 1-4.

Query :XTALk<X>:ROTHer?

The :XTALk<X>:ROTHer? query returns the "remove unknown crosstalk and noise" setting.

Returned Format <setting><NL>

<setting> ::= {0 | 1}

- See Also**
- [":XTALk<X>:AENable<X>"](#) on page 1483
 - [":XTALk<X>:ENABle"](#) on page 1484
 - [":XTALk<X>:IAGGressor"](#) on page 1485
 - [":XTALk<X>:IVICTim"](#) on page 1486
 - [":XTALk<X>:PAUTo"](#) on page 1487
 - [":XTALk<X>:PLENght"](#) on page 1488
 - [":XTALk<X>:PTYPE"](#) on page 1489
 - [":XTALk<X>:RIDeal"](#) on page 1490
 - [":XTALk<X>:RISI"](#) on page 1491
 - [":XTALk<X>:STYPE"](#) on page 1494
 - [":XTALk<X>:SOURce"](#) on page 1493
 - [":XTALk:ENABle"](#) on page 1461
 - [":XTALk:RESUltS?"](#) on page 1475

History New in version 5.70.

:XTALK<X>:SOURce

Command :XTALK<X>:SOURce <source>

```
<source> ::= {CHANnel<N> | DIFF<D> | COMMONmode<C> | FUNction<F>
             | WMEMory<N> | EQUalized | MTRend}
```

The :XTALK<X>:SOURce command specifies the source of the crosstalk signal.

<X> An integer from 1-4.

<N> An integer from 1-4.

<D>, <C> <D> is an integer, 1-2. <C> is an integer, 3-4.

The DIFF and COMMONmode sources are just aliases that can be used in place of the channel names to apply to differential or common mode signals. These are just aliases - no state change occurs if you refer to a differential channel and you are not in differential mode. DIFF1 refers to the differential signal between channels 1 and 3 (and COMMONmode3 refers to the common mode channel between these same channels). DIFF2 refers to the differential signal between channels 2 and 4 (and COMMONmode4 refers to the common mode channel between these same channels).

<F> An integer from 1-16.

Query :XTALK<X>:SOURce?

The :XTALK<X>:SOURce? query returns the specified source of the crosstalk signal.

Returned Format <source><NL>

```
<source> ::= {CHAN<N> | FUNC<F> | WMEM<N> | EQU | MTR}
```

- See Also**
- [":XTALK<X>:AENable<X>"](#) on page 1483
 - [":XTALK<X>:ENABle"](#) on page 1484
 - [":XTALK<X>:IAGGressor"](#) on page 1485
 - [":XTALK<X>:IVICTim"](#) on page 1486
 - [":XTALK<X>:PAUTo"](#) on page 1487
 - [":XTALK<X>:PLENght"](#) on page 1488
 - [":XTALK<X>:PTYPE"](#) on page 1489
 - [":XTALK<X>:RIDeal"](#) on page 1490
 - [":XTALK<X>:RISI"](#) on page 1491
 - [":XTALK<X>:ROTHer"](#) on page 1492
 - [":XTALK<X>:STYPE"](#) on page 1494
 - [":XTALK:ENABle"](#) on page 1461
 - [":XTALK:RESults?"](#) on page 1475

History New in version 5.70.

:XTALK<X>:STYPe

Command :XTALK<X>:STYPe <signal_type>
 <signal_type> ::= {POWER | ANALog | DIGital}

The :XTALK<X>:STYPe command specifies the crosstalk analysis signal type:

- POWER – Tells the application to use the specialized algorithms for power supply analysis.

NOTE

You cannot have both a power supply victim and a power supply aggressor in the same setup because these require different algorithms.

- ANALog – For increased accuracy, it is recommended to use clock recovery (DIGital) for all data waveforms whenever possible; however, aggressors that are too noisy for clock recovery can be specified as ANALog, which tells the algorithm to skip clock recovery.

If a victim signal is too noisy for clock recovery, another option is to perform equalization on the waveform before sending it to the Crosstalk Analysis application. This can be done directly on the oscilloscope using the Infiniium Equalization application and then selecting FFE as the signal source for crosstalk analysis.

- DIGital – Tells the application that the input signal represents a digital bit stream (serial data), and that it needs to do a clock recovery.

When the signal type is data DIGital, you need to specify the type of pattern (periodic or arbitrary) and whether the pattern length should be automatically determined or specified with :XTALK<X>:PLENgtH.

<X> An integer from 1–4.

Query :XTALK<X>:STYPe?

The :XTALK<X>:STYPe? query returns the specified signal type.

Returned Format <signal_type><NL>
 <signal_type> ::= {POW | ANAL | DIG}

- See Also**
- **":XTALK<X>:AENable<X>"** on page 1483
 - **":XTALK<X>:ENABle"** on page 1484
 - **":XTALK<X>:IAGGressor"** on page 1485
 - **":XTALK<X>:IVICTim"** on page 1486
 - **":XTALK<X>:PAUTo"** on page 1487
 - **":XTALK<X>:PLENgtH"** on page 1488
 - **":XTALK<X>:PTYPe"** on page 1489

- **":XTALk<X>:RIDeal"** on page 1490
- **":XTALk<X>:RISI"** on page 1491
- **":XTALk<X>:ROTher"** on page 1492
- **":XTALk<X>:SOURce"** on page 1493
- **":XTALk:ENABle"** on page 1461
- **":XTALk:RESulTs?"** on page 1475

History New in version 5.70.

40 Obsolete and Discontinued Commands

Obsolete commands are deprecated, older forms of commands that still work but have been replaced by newer commands.

| Obsolete Command | Current Command Equivalent | Behavior Differences |
|---|--|---|
| :ANALyze:CLOCK:METHOD:PAM:B03 (see page 1501) | None | The command works and as before, but changing its default (ON) is not necessary. |
| :ANALyze:CLOCK:METHOD:PAM:B12 (see page 1503) | None | The command works and as before, but changing its default (ON) is not necessary. |
| :ANALyze:CLOCK:METHOD:PAM:NONSymmetric (see page 1505) | None | The command works and as before, but changing its default (OFF) is not necessary. |
| :DISPlay:COLumn (see page 1507) | :DISPlay:BOOKmark<N>:XPOSITION (see page 455) | Bookmarks are now the method used to place text strings or annotations on screen. |
| :DISPlay:LINE (see page 1508) | :DISPlay:BOOKmark<N>:SET (see page 452) | |
| :DISPlay:ROW (see page 1509) | :DISPlay:BOOKmark<N>:YPOSITION (see page 456) | |
| :DISPlay:STRing (see page 1510) | :DISPlay:BOOKmark<N>:SET (see page 452) | |
| :DISPlay:TAB (see page 1511) | None | This command is not supported in version 5.00 or higher. The query now returns only NONE. |
| :DISPlay:TEXT (see page 1512) | :DISPlay:BOOKmark<N>:DELETE (see page 451) | Bookmarks are now the method used to place text strings or annotations on screen. |

| Obsolete Command | Current Command Equivalent | Behavior Differences |
|---|--|---|
| :HOSTed:CALibrate:ALIGn (see page 1513) | None | Acquired data is now always aligned, and this command has no effect. |
| :MEASure:CLOCK:METHod (see page 1517) | <ul style="list-style-type: none"> ▪ :MEASure:CLOCK:METHod (see page 1515) ▪ :MEASure:CLOCK:METHod:JTF (see page 1524) ▪ :MEASure:CLOCK:METHod:OJTF (see page 1526) | The command options for specifying clock recovery PLL options have been moved to the new commands :MEASure:CLOCK:METHod:JTF and :MEASure:CLOCK:METHod:OJTF. |
| :MEASure:CLOCK (see page 1514) | :ANALyze:CLOCK (see page 240) | There are no differences in behavior. This is just a remapping of commands into a new subsystem. |
| :MEASure:CLOCK:METHod (see page 1515) | :ANALyze:CLOCK:METHod (see page 241) | |
| :MEASure:CLOCK:METHod:ALIGn (see page 1519) | :ANALyze:CLOCK:METHod:ALIGn (see page 244) | |
| :MEASure:CLOCK:METHod:DEEMphasis (see page 1521) | :ANALyze:CLOCK:METHod:DEEMphasis (see page 246) | |
| :MEASure:CLOCK:METHod:EDGE (see page 1522) | :ANALyze:CLOCK:METHod:EDGE (see page 247) | |
| :MEASure:CLOCK:METHod:JTF (see page 1524) | :ANALyze:CLOCK:METHod:JTF (see page 249) | |
| :MEASure:CLOCK:METHod:OJTF (see page 1526) | :ANALyze:CLOCK:METHod:OJTF (see page 252) | |
| :MEASure:CLOCK:METHod:PLLTrack (see page 1528) | :ANALyze:CLOCK:METHod:PLLTrack (see page 255) | |
| :MEASure:CLOCK:METHod:SOURce (see page 1529) | :ANALyze:CLOCK:METHod:SOURce (see page 257) | |
| :MEASure:CLOCK:VERTical (see page 1530) | :ANALyze:CLOCK:VERTical (see page 258) | |
| :MEASure:CLOCK:VERTical:OFFSet (see page 1531) | :ANALyze:CLOCK:VERTical:OFFSet (see page 259) | |
| :MEASure:CLOCK:VERTical:RANGe (see page 1532) | :ANALyze:CLOCK:VERTical:RANGe (see page 260) | |
| :MEASure:DDPWS (see page 1533) | :MEASure:RJDJ:ALL? (see page 871) | The :MEASure:RJDJ:ALL? query returns all of the RJDJ jitter measurements. |

| Obsolete Command | Current Command Equivalent | Behavior Differences |
|---|--|---|
| :MEASure:JITTer:STATistics (see page 1535) | :ANALyze:AEDGes (see page 239) | The :ANALyze:AEDGes command maps to the "Measure All Edges" control in the user interface's Measurement Setup dialog box only. It does not affect jitter modes or statistics. |
| :MEASure:TIEData (see page 1536) | :MEASure:TIEData2 (see page 949) | Clock recovery options have been removed (clock recovery as specified with the :ANALyze:CLOCK:METHod is used). When the signal type is PAM-4, an additional <threshold> parameter is used to specify the threshold at which to make the TIE measurements. |
| :MTESt:FOLDing:COUNT? (see page 1538) | :MTESt:FOLDing:COUNT:UI? (see page 681) :MTESt:FOLDing:COUNT:WAVEforms? (see page 683) | The :MTESt:FOLDing:COUNT? query returns two values for UI count and waveform count. Now, there are separate queries that return those values individually. The UI count returned by :MTESt:FOLDing:COUNT? is now a floating-point value instead of an integer value. |
| :SPROcessing:CTLequalizer:ZERo (see page 1540) | <ul style="list-style-type: none"> ▪ :SPROcessing:CTLequalizer:Z1 (see page 1115) ▪ :SPROcessing:CTLequalizer:Z2 (see page 1116) | Now that you can specify up to two zeros for a 3-pole CTLE, this command has been replaced by two new commands. |

Discontinued Commands

Discontinued commands are commands that were supported in previous versions of the Infiniium oscilloscope software, but are not supported by this version of the Infiniium oscilloscope software. Listed below are the Discontinued commands and the nearest equivalent command available (if any).

| Discontinued Command | Current Command Equivalent | Comments |
|-------------------------|---|--|
| :DISK:STORe | ":DISK:SAVE:SETup" on page 445 ":DISK:SAVE:WAVEform" on page 446 | For saving setups and waveforms to disk. |
| :DISPlay:GRATICule:SIZE | None | Graticule sizing is different in the version 5.00 next-generation Infiniium user interface software. |

:ANALyze:CLOCK:METHod:PAM:B03

Command :ANALyze:CLOCK:METHod:PAM:B03 {{0 | OFF} | {1 | ON}}

When the signal type is PAM-4 (see :ANALyze:SIGNal:TYPE), the :ANALyze:CLOCK:METHod:PAM:B03 command specifies whether edges from the 0 level to the 3 level and from the 3 level to the 0 level are included in the clock recovery.

Remember, with PAM-4 signals, clock recovery is performed individually for each signal source; therefore, this setting applies to the source specified with the :ANALyze:CLOCK:METHod:SOURce command.

Query :ANALyze:CLOCK:METHod:PAM:B03?

The :ANALyze:CLOCK:METHod:PAM:B03? query returns whether 03,30 edges are included in the clock recovery.

Returned Format [:ANALyze:CLOCK:METHod:PAM:B03] <setting><NL>
<setting> ::= {0 | 1}

- See Also**
- [":ANALyze:CLOCK:METHod:SOURce"](#) on page 257
 - [":ANALyze:CLOCK:METHod:PAM:B12"](#) on page 1503
 - [":ANALyze:CLOCK:METHod:PAM:NONSymmetric"](#) on page 1505
 - [":ANALyze:SIGNal:DATarate"](#) on page 261
 - [":ANALyze:SIGNal:SYMBOLrate"](#) on page 263
 - [":ANALyze:SIGNal:TYPE"](#) on page 271
 - [":MEASure:CGRade:EWIDth"](#) on page 742
 - [":MEASure:CGRade:EHEight"](#) on page 740
 - [":MEASure:FALLtime"](#) on page 770
 - [":MEASure:PAM:ELEVel"](#) on page 838
 - [":MEASure:PAM:ESKew"](#) on page 840
 - [":MEASure:PAM:LEVel"](#) on page 846
 - [":MEASure:PAM:LRMS"](#) on page 848
 - [":MEASure:PAM:LTHickness"](#) on page 850
 - [":MEASure:RISetime"](#) on page 869
 - [":MEASure:THResholds:GENeral:METHod"](#) on page 909
 - [":MEASure:THResholds:GENeral:PAMCustom"](#) on page 911
 - [":MEASure:THResholds:GENeral:PAMAutomatic"](#) on page 913
 - [":MEASure:THResholds:RFALL:METHod"](#) on page 926
 - [":MEASure:THResholds:RFALL:PAMAutomatic"](#) on page 928
 - [":MEASure:TIEData2"](#) on page 949

History New in version 5.50.

:ANALyze:CLOCK:METHod:PAM:B12

Command :ANALyze:CLOCK:METHod:PAM:B12 {{0 | OFF} | {1 | ON}}

When the signal type is PAM-4 (see :ANALyze:SIGNal:TYPE), the :ANALyze:CLOCK:METHod:PAM:B12 command specifies whether edges from the 1 level to the 2 level and from the 2 level to the 1 level are included in the clock recovery.

Remember, with PAM-4 signals, clock recovery is performed individually for each signal source; therefore, this setting applies to the source specified with the :ANALyze:CLOCK:METHod:SOURce command.

Query :ANALyze:CLOCK:METHod:PAM:B12?

The :ANALyze:CLOCK:METHod:PAM:B12? query returns whether 12,21 edges are included in the clock recovery.

Returned Format [:ANALyze:CLOCK:METHod:PAM:B12] <setting><NL>
<setting ::= {0 | 1}

- See Also**
- [":ANALyze:CLOCK:METHod:SOURce"](#) on page 257
 - [":ANALyze:CLOCK:METHod:PAM:B03"](#) on page 1501
 - [":ANALyze:CLOCK:METHod:PAM:NONSymmetric"](#) on page 1505
 - [":ANALyze:SIGNal:DATarate"](#) on page 261
 - [":ANALyze:SIGNal:SYMBOLrate"](#) on page 263
 - [":ANALyze:SIGNal:TYPE"](#) on page 271
 - [":MEASure:CGRade:EWIDth"](#) on page 742
 - [":MEASure:CGRade:EHEight"](#) on page 740
 - [":MEASure:FALLtime"](#) on page 770
 - [":MEASure:PAM:ELEVel"](#) on page 838
 - [":MEASure:PAM:ESKew"](#) on page 840
 - [":MEASure:PAM:LEVel"](#) on page 846
 - [":MEASure:PAM:LRMS"](#) on page 848
 - [":MEASure:PAM:LTHickness"](#) on page 850
 - [":MEASure:RISetime"](#) on page 869
 - [":MEASure:THResholds:GENeral:METHod"](#) on page 909
 - [":MEASure:THResholds:GENeral:PAMCustom"](#) on page 911
 - [":MEASure:THResholds:GENeral:PAMAutomatic"](#) on page 913
 - [":MEASure:THResholds:RFALL:METHod"](#) on page 926
 - [":MEASure:THResholds:RFALL:PAMAutomatic"](#) on page 928
 - [":MEASure:TIEData2"](#) on page 949

History New in version 5.50.

:ANALyze:CLOCK:METHOD:PAM:NONSymmetric

Command :ANALyze:CLOCK:METHOD:PAM:NONSymmetric {{0 | OFF} | {1 | ON}}

When the signal type is PAM-4 (see :ANALyze:SIGNal:TYPE), the :ANALyze:CLOCK:METHOD:PAM:NONSymmetric command specifies whether edges that are non-symmetric about the middle threshold (for example, from the 1 level to the 3 level or from the 2 level to the 0 level) are included in the clock recovery.

Remember, with PAM-4 signals, clock recovery is performed individually for each signal source; therefore, this setting applies to the source specified with the :ANALyze:CLOCK:METHOD:SOURce command.

Query :ANALyze:CLOCK:METHOD:PAM:NONSymmetric?

The :ANALyze:CLOCK:METHOD:PAM:NONSymmetric? query returns whether non-symmetric edges are included in the clock recovery.

Returned Format [:ANALyze:CLOCK:METHOD:PAM:NONSymmetric] <setting><NL>
 <setting> ::= {0 | 1}

- See Also**
- [":ANALyze:CLOCK:METHOD:SOURce"](#) on page 257
 - [":ANALyze:CLOCK:METHOD:PAM:B03"](#) on page 1501
 - [":ANALyze:CLOCK:METHOD:PAM:B12"](#) on page 1503
 - [":ANALyze:SIGNal:DATarate"](#) on page 261
 - [":ANALyze:SIGNal:SYMBOLrate"](#) on page 263
 - [":ANALyze:SIGNal:TYPE"](#) on page 271
 - [":MEASure:CGRade:EWIDth"](#) on page 742
 - [":MEASure:CGRade:EHEight"](#) on page 740
 - [":MEASure:FALLtime"](#) on page 770
 - [":MEASure:PAM:ELEVEL"](#) on page 838
 - [":MEASure:PAM:ESKew"](#) on page 840
 - [":MEASure:PAM:LEVEL"](#) on page 846
 - [":MEASure:PAM:LRMS"](#) on page 848
 - [":MEASure:PAM:LTHickness"](#) on page 850
 - [":MEASure:RISetime"](#) on page 869
 - [":MEASure:THResholds:GENeral:METHOD"](#) on page 909
 - [":MEASure:THResholds:GENeral:PAMCustom"](#) on page 911
 - [":MEASure:THResholds:GENeral:PAMAutomatic"](#) on page 913
 - [":MEASure:THResholds:RFALL:METHOD"](#) on page 926
 - [":MEASure:THResholds:RFALL:PAMAutomatic"](#) on page 928

- **":MEASure:TIEData2"** on page 949

History New in version 5.50.

:DISPlay:COLumn

Command

NOTE

This command is deprecated. It is accepted but ignored. Bookmarks are now the method used to place text strings or annotations on screen. The closest command equivalent is **":DISPlay:BOOKmark<N>:XPOsition"** on page 455.

```
:DISPlay:COLumn <column_number>
```

The :DISPlay:COLumn command specifies the starting column for subsequent :DISPlay:STRing and :DISPlay:LINE commands.

<column_number> An integer representing the starting column for subsequent :DISPlay:STRing and :DISPlay:LINE commands. The range of values is 0 to 90.

Example This example sets the starting column for subsequent :DISPlay:STRing and :DISPlay:LINE commands to column 10.

```
myScope.WriteString ":DISPlay:COLumn 10"
```

Query :DISPlay:COLumn?

The :DISPlay:COLumn? query returns the column where the next :DISPlay:LINE or :DISPlay:STRing starts.

Returned Format [:DISPlay:COLumn] <value><NL>

Example This example returns the current column setting to the string variable, strSetting, then prints the contents of the variable to the computer's screen.

```
Dim strSetting As String ' Dimension variable.
myScope.WriteString ":DISPlay:COLumn?"
strSetting = myScope.ReadString
Debug.Print strSetting
```

History Legacy command (existed before version 3.10).
 Obsoleted in version 5.00.

:DISPlay:LINE

Command

NOTE

This command is deprecated. It is accepted but ignored. Bookmarks are now the method used to place text strings or annotations on screen. The closest command equivalent is **":DISPlay:BOOKmark<N>:SET"** on page 452.

```
:DISPlay:LINE "<string_argument>"
```

The :DISPlay:LINE command writes a quoted string to the screen, starting at the location specified by the :DISPlay:ROW and :DISPlay:COLumn commands.

<string_argument>

Any series of ASCII characters enclosed in quotation marks.

Example

This example writes the message "Infiniium Test" to the screen, starting at the current row and column location.

```
myScope.WriteString ":DISPlay:LINE "Infiniium Test""
```

When using the C programming language, quotation marks within a string are escaped using the backslash (\) character as shown in the next example. This example writes the message "Infiniium Test" to the screen.

```
printf("\Infiniium Test\");
```

You may write text up to column 94. If the characters in the string do not fill the line, the rest of the line is blanked. If the string is longer than the space available on the current line, the excess characters are discarded.

In any case, the ROW is incremented and the COLumn remains the same. The next :DISPlay:LINE command will write on the next line of the display. After writing the last line in the display area, the ROW is reset to 0.

History

Legacy command (existed before version 3.10).

Obsoleted in version 5.00.

:DISPlay:ROW

Command

NOTE

This command is deprecated. It is accepted but ignored. Bookmarks are now the method used to place text strings or annotations on screen. The closest command equivalent is **":DISPlay:BOOKmark<N>:YPOSition"** on page 456.

```
:DISPlay:ROW <row_number>
```

The :DISPlay:ROW command specifies the starting row on the screen for subsequent :DISPlay:STRing and :DISPlay:LINE commands. The row number remains constant until another :DISPlay:ROW command is received, or the row is incremented by the :DISPlay:LINE command.

<row_number> An integer representing the starting row for subsequent :DISPlay:STRing and :DISPlay:LINE commands. The range of values is 9 to 23.

Example This example sets the starting row for subsequent :DISPlay:STRing and :DISPlay:LINE commands to 10.

```
myScope.WriteString ":DISPlay:ROW 10"
```

Query :DISPlay:ROW?

The :DISPlay:ROW? query returns the current value of the row.

Returned Format [:DISPlay:ROW] <row_number><NL>

Example This example places the current value for row in the string variable, strSetting, then prints the contents of the variable to the computer's screen.

```
Dim strSetting As String ' Dimension variable.
myScope.WriteString ":DISPlay:ROW?"
strSetting = myScope.ReadString
Debug.Print strSetting
```

History Legacy command (existed before version 3.10).

Obsoleted in version 5.00.

:DISPlay:STRing

Command

NOTE

This command is deprecated. It is accepted but ignored. Bookmarks are now the method used to place text strings or annotations on screen. The closest command equivalent is **":DISPlay:BOOKmark<N>:SET"** on page 452.

```
:DISPlay:STRing "<string_argument>"
```

The :DISPlay:STRing command writes text to the oscilloscope screen. The text is written starting at the current row and column settings. If the column limit is reached, the excess text is discarded. The :DISPlay:STRing command does not increment the row value, but :DISPlay:LINE does.

<string_argument> Any series of ASCII characters enclosed in quotation marks.

Example This example writes the message "Example 1" to the oscilloscope's display starting at the current row and column settings.

```
myScope.WriteString ":DISPlay:STRING "Example 1""
```

History Legacy command (existed before version 3.10).

Obsoleted in version 5.00.

:DISPlay:TAB

Command :DISPlay:TAB <tab>

The :DISPlay:TAB command displays the corresponding tab indicated by the <tab> parameter.

<tab> MEASurement | MARKer | LIMittest | JITTer | NOISe | HISTogram | MASKtest | EYE | COLorgrade | NAVigation | STATus | SCALe

Example This example sets the Status tab as the displayed one.

```
myScope.WriteString ":DISPlay:TAB STATUS"
```

Query :DISPlay:TAB?

The :DISPlay:TAB? query returns the tab that is currently displayed.

Returned Format [:DISPlay:TAB] {MEAS | MARK | LIM | JITT | NOIS | HIST | MASK | EYE | COL | NAV | STAT | SCAL}<NL>

Example This example places the currently displayed tab into the string variable, strTab, then prints the contents of the variable to the computer's screen.

```
Dim strTab As String ' Dimension variable.
myScope.WriteString ":DISPlay:TAB?"
strTab = myScope.ReadString
Debug.Print strTab
```

History Legacy command (existed before version 3.10).

Obsoleted in version 5.00.

:DISPlay:TEXT

Command

NOTE

This command is deprecated. It is accepted but ignored. Bookmarks are now the method used to place text strings or annotations on screen. The closest command equivalent is **":DISPlay:BOOKmark<N>:DELeTe"** on page 451.

```
:DISPlay:TEXT BLANK
```

The :DISPlay:TEXT command blanks the user text area of the screen.

Example This example blanks the user text area of the oscilloscope's screen.

```
myScope.WriteString ":DISPlay:TEXT BLANK"
```

History Legacy command (existed before version 3.10).

Obsoleted in version 5.00.

:HOSTed:CALibrate:ALIGn (MultiScope)

Command :HOSTed:CALibrate:ALIGn {{0 | OFF} | {1 | ON}}

NOTE

As of software version 5.60, acquired data is always aligned, and this command has no effect.

The :HOSTed:CALibrate:ALIGn command lets you align acquired data in the MultiScope system. When ON, a unique time-shifting FIR filter is applied to each output waveform and the waveforms are truncated so that all of them have the same X origin and number of points values.

Setting ":HOSTed:CALibrate:ALIGn ON" causes longer acquisition times.

Query :HOSTed:CALibrate:ALIGn?

The :HOSTed:CALibrate:ALIGn? query returns the align acquired data setting.

Returned Format [:HOSTed:CALibrate:ALIGn] <setting><NL>
<setting> ::= {0 | 1}

- See Also**
- [":HOSTed:CALibrate:CALibrate"](#) on page 573
 - [":HOSTed:CALibrate:CHANnel"](#) on page 574
 - [":HOSTed:CALibrate:DESKew:FRAMes"](#) on page 576
 - [":HOSTed:CALibrate:DESKew:CHANnels"](#) on page 575
 - [":HOSTed:CALibrate:DESKew:SIGNals"](#) on page 577
 - [":HOSTed:CALibrate:DESKew:ZERO"](#) on page 578
 - [":HOSTed:CALibrate:LEVel"](#) on page 579
 - [":HOSTed:CALibrate:PROMpt"](#) on page 581
 - [":HOSTed:CALibrate:STATus:CHANnels?"](#) on page 582
 - [":HOSTed:CALibrate:STATus:FRAMes?"](#) on page 583
 - [":HOSTed:CALibrate:STATus:LEVel?"](#) on page 584
 - [":HOSTed:CALibrate:STATus:SIGNals?"](#) on page 585
 - [":HOSTed:CALibrate:TREF:DETECT"](#) on page 586

History New in version 5.50.

Version 5.60: Acquired data is now always aligned, and this command has no effect.

:MEASure:CLOCK**Command****NOTE**

:MEASure:CLOCK commands are available when clock recovery is used by licensed software (like the E2688A High Speed Serial software or the N5400A/N5401A EZJIT Plus jitter analysis software).

```
:MEASure:CLOCK {{ON|1},CHANnel<N>} | {OFF|0}}
```

The :MEASure:CLOCK command turns the recovered clock display on or off and sets the clock recovery channel source.

<N> An integer, 1-4 in a single oscilloscope, 1-40 in a MultiScope system.

Example This example turns the recovered clock display on for channel 1.

```
myScope.WriteString ":MEASure:CLOCK ON,CHANnel1"
```

Query :MEASure:CLOCK?

The :MEASure:CLOCK? query returns the state of the recovered clock display.

Returned Format [:MEASure:CLOCK] {1 | 0}<NL>

Example This example places the current setting of the recovered clock display in the variable varSetting, then prints the contents of the variable to the computer's screen.

```
myScope.WriteString ":SYSTEM:HEADer OFF"
myScope.WriteString ":MEASure:CLOCK?"
varSetting = myScope.ReadNumber
Debug.Print FormatNumber(varSetting, 0)
```

History Legacy command (existed before version 3.10).

Version 5.30: This command is deprecated, replaced by **:ANALyze:CLOCK** on page 240.

:MEASure:CLOCK:METHOD

Command

NOTE

:MEASure:CLOCK commands are available when clock recovery is used by licensed software (like the E2688A High Speed Serial software or the N5400A/N5401A EZJIT Plus jitter analysis software).

```
:MEASure:CLOCK:METHOD
    {FC,{FC1063 | FC2125 | FC425}}
    | {EXPLICIT,<source>,{RISING | FALLING | BOTH}[,<multiplier>]}
    | {FIXED,{AUTO | {SEMI[,<data_rate>]} | <data_rate>}}
    | {FLEXR,<baud_rate>}
    | {FLEXT,<baud_rate>}
```

The :MEASure:CLOCK:METHOD command sets the clock recovery method to:

- FC (Fibre Channel).
- EXPLICIT (Explicit Clock).
- FIXED (Constant Frequency).
- FLEXR (FlexRay Receiver).
- FLEXT (FlexRay Transmitter).

This command applies to the clock recovery method being set up for the waveform source selected by the :MEASure:CLOCK:METHOD:SOURce command.

For setting phase-locked loop (PLL) clock recovery methods in terms of the Observed Jitter Transfer Function (OJTF), see **":MEASure:CLOCK:METHOD:OJTF"** on page 1526.

For setting phase-locked loop (PLL) clock recovery methods in terms of the Jitter Transfer Function (JTF), see **":MEASure:CLOCK:METHOD:JTF"** on page 1524.

<source> {CHANnel<N> | FUNCTION<F> | WMemory<R>}

<N> An integer, 1–4 in a single oscilloscope, 1–40 in a MultiScope system.

<F> An integer, 1–16.

<R> An integer, 1–4.

<data_rate> A real number for the base data rate in Hertz.

<multiplier> An integer used as the multiplication factor.

<baud_rate> A real number used for the baud rate.

Example This example sets the explicit clock recovery method on channel 1, rising edge, with a multiplier of 2.

```
myScope.WriteString ":MEASure:CLOCK:METHOD EXPLICIT,CHANnel1,RISING,2"
```

Query :MEASure:CLOCK:METHOD?

The `:MEASure:CLOCK:METHOD?` query returns the state of the clock recovery method.

NOTE

You can use the `:MEASure:CLOCK:METHOD?` query when phase-locked loop (PLL) clock recovery methods are set up. The format returned will be that of the `:MEASure:CLOCK:METHOD:OJTF?` query. See [":MEASure:CLOCK:METHOD:OJTF"](#) on page 1526.

Returned Format `[:MEASure:CLOCK:METHOD
 {FC, {FC1063 | FC2125 | FC425}}
 | {EXPLICIT, <source>, {RISING | FALLING | BOTH}, <multiplier>}
 | {FIXED, {AUTO | {SEMI, <data_rate>} | <data_rate>}}
 | {FLEXR, <baud_rate>}
 | {FLEXT, <baud_rate>}`

Example This example places the current setting of the clock recovery method in the variable `strSetting`, then prints the contents of the variable to the computer's screen.

```
myScope.WriteString ":SYSTEM:HEADER OFF"
myScope.WriteString ":MEASure:CLOCK:METHOD?"
strSetting = myScope.ReadString
Debug.Print strSetting
```

- See Also**
- [":MEASure:CLOCK:METHOD:SOURce"](#) on page 1529
 - [":MEASure:CLOCK:METHOD:OJTF"](#) on page 1526
 - [":MEASure:CLOCK:METHOD:JTF"](#) on page 1524
 - [":MEASure:CLOCK:METHOD:DEEMphasis"](#) on page 1521
 - [":MEASure:CLOCK:METHOD:ALIGN"](#) on page 1519
 - [":MEASure:CLOCK:METHOD:PLLTrack"](#) on page 1528
 - [":MEASure:CLOCK:METHOD:EDGE"](#) on page 1522

History Legacy command (existed before version 3.10).

Version 4.20: The command options for specifying clock recovery PLL options moved to the new commands `:MEASure:CLOCK:METHOD:JTF` and `:MEASure:CLOCK:METHOD:OJTF`.

Version 5.10: The PCIE clock recovery method has been removed.

Version 5.30: This command is deprecated, replaced by [":ANALyze:CLOCK:METHOD"](#) on page 241.

:MEASure:CLOCK:METHOD (deprecated)

Command

NOTE

Some of these command options have been deprecated – options for specifying clock recovery PLL options have been moved to the new commands **":MEASure:CLOCK:METHOD:JTF"** on page 1524 and **":MEASure:CLOCK:METHOD:OJTF"** on page 1526. See also **":MEASure:CLOCK:METHOD"** on page 1515.

NOTE

:MEASure:CLOCK commands are available when clock recovery is used by licensed software (like the E2688A High Speed Serial software or the N5400A/N5401A EZJIT Plus jitter analysis software).

```
:MEASure:CLOCK:METHOD {FOPLL,<data_rate>,<loop_bandwidth>}
| {EQFOPLL,<data_rate>,<loop_bandwidth>}
| {SOPLL,<data_rate>,<loop_bandwidth>,<damping_factor>}
| {EQSOPLL,<data_rate>,<loop_bandwidth>,<damping_factor>}
| {FC,{FC1063 | FC2125 | FC425}}
| {EXPFOPLL,<source>,{RISing | FALLing | BOTH},
  <multiplier>,<clock_freq>,<loop_bandwidth>}
| {EXPSOPLL,<source>,{RISing | FALLing | BOTH},
  <multiplier>,<clock_freq>,<loop_bandwidth>,<damping_fact>}
| {EXPLICIT,<source>,{RISing | FALLing | BOTH}[,<multiplier>]}
| {FIXed,{AUTO | {SEMI[,<data_rate>]} | <data_rate>}}
| {FLEXR,<baud_rate>}
| {FLEXT,<baud_rate>}
```

The :MEASure:CLOCK:METHOD command sets the clock recovery method to:

- FOPLL (first order phase-locked loop).
- SOPLL (second order phase-locked loop).
- EQFOPLL (equalized first order phase-locked loop).
- EQSOPLL (equalized second order phase-locked loop).
- FC (Fibre Channel).
- EXPFOPLL (Explicit First Order PLL).
- EXPSOPLL (Explicit Second Order PLL).
- EXPLICIT (Explicit Clock).
- FIXed (Constant Frequency).
- FLEXR (FlexRay Receiver).
- FLEXT (FlexRay Transmitter).

The EQUALized clock recovery methods are only available if the oscilloscope has the High Speed Serial option and the Serial Data Equalization option installed and the features are enabled.

<source> {CHANnel<N> | FUNCTION<N> | WMEMORY<R>}

- <N> An integer, 1-4 in a single oscilloscope, 1-40 in a MultiScope system.
 FUNCTION<N> and WMEMory<R> are:
 An integer, 1-4, representing the selected function or waveform memory.
- <data_rate> A real number for the base data rate in Hertz.
- <damping_factor> A real number for the damping factor of the PLL in bits per second.
- <loop_bandwidth> A real number for the cutoff frequency for the PLL to track.
- <multiplier> An integer used as the multiplication factor.
- <clock_freq> A real number used for the clock frequency of the PLL.
- <track_freq> A real number used for the tracking frequency of the PLL.
- <damping_fact> A real number used for the damping factor of the PLL.
- <baud_rate> A real number used for the baud rate.

Example This example sets the clock recovery method to phase-locked loop.

```
myScope.WriteString ":MEASure:CLOCK:METHOD FOPLL,2E9,1.19E6"
```

Query :MEASure:CLOCK:METHOD?

The :MEASure:CLOCK:METHOD? query returns the state of the clock recovery method.

Returned Format [:MEASure:CLOCK:METHOD] {FOPLL,<data_rate>,<loop_bandwidth>}
 | {EQFOPLL,<data_rate>,<loop_bandwidth>}
 | {SOPLL,<data_rate>,<loop_bandwidth>,<damping_factor>}
 | {EQSOPLL,<data_rate>,<loop_bandwidth>,<damping_factor>}
 | {FC,{FC1063 | FC2125 | FC425}}
 | {EXPFOPLL <source>,{RISing | FALLing | BOTH},
 <multiplier>,<clock_freq>,<track_freq>}
 | {EXPSOPLL <source>,{RISing | FALLing | BOTH},
 <multiplier>,<clock_freq>,<track_freq>,<damping_fact>}
 | {EXPLict,<source>,{RISing | FALLing | BOTH},<multiplier>}
 | {FIXed,{AUTO | {SEMI,<data_rate>} | <data_rate>}}
 | {FLEXR,<baud_rate>}
 | {FLEXT,<baud_rate>}

Example This example places the current setting of the clock recovery method in the variable strSetting, then prints the contents of the variable to the computer's screen.

```
myScope.WriteString ":SYSTEM:HEADER OFF"
myScope.WriteString ":MEASure:CLOCK:METHOD?"
strSetting = myScope.ReadString
Debug.Print strSetting
```

History Legacy command (existed before version 3.10).

Version 5.10: The PCIE clock recovery method has been removed.

:MEASure:CLOCK:METHOD:ALIGN

Command

NOTE

:MEASure:CLOCK commands are available when clock recovery is used by licensed software (like the E2688A High Speed Serial software or the N5400A/N5401A EZJIT Plus jitter analysis software).

```
:MEASure:CLOCK:METHOD:ALIGN {CENTer | EDGE}
```

When using an explicit method of clock recovery, the :MEASure:CLOCK:METHOD:ALIGN command specifies how the clock is aligned with data:

- CENTER – Clock edges are aligned with the center of data.
- EDGE – Clock edges are aligned with data edges. In this case, Time Interval Error (TIE) is measured directly from the data edge to the clock edge.

This command applies to the clock recovery method being set up for the waveform source selected by the :MEASure:CLOCK:METHOD:SOURce command.

Example When using an explicit method of clock recovery, this example specifies that clock edges are aligned with the center of data.

```
myScope.WriteString ":MEASure:CLOCK:METHOD:ALIGN CENTER"
```

Query

```
:MEASure:CLOCK:METHOD:ALIGN?
```

The :MEASure:CLOCK:METHOD:ALIGN? query returns the clock recovery method's edge alignment setting.

Returned Format

```
[ :MEASure:CLOCK:METHOD:ALIGN ] {CENT | EDGE}
```

Example

This example places the current edge alignment setting of the clock recovery method in the variable strSetting, then prints the contents of the variable to the computer's screen.

```
myScope.WriteString ":SYSTEM:HEADER OFF"
myScope.WriteString ":MEASure:CLOCK:METHOD:ALIGN?"
strSetting = myScope.ReadString
Debug.Print strSetting
```

See Also

- [":MEASure:CLOCK:METHOD:SOURce"](#) on page 1529
- [":MEASure:CLOCK:METHOD"](#) on page 1515
- [":MEASure:CLOCK:METHOD:OJTF"](#) on page 1526
- [":MEASure:CLOCK:METHOD:JTF"](#) on page 1524
- [":MEASure:CLOCK:METHOD:DEEMphasis"](#) on page 1521
- [":MEASure:CLOCK:METHOD:PLLTrack"](#) on page 1528
- [":MEASure:CLOCK:METHOD:EDGE"](#) on page 1522

History

New in version 3.20.

Version 5.30: This command is deprecated, replaced by
":ANALyze:CLOCK:METHod:ALIGn" on page 244.

:MEASure:CLOCK:METHOD:DEEMphasis

Command

NOTE

:MEASure:CLOCK commands are available when clock recovery is used by licensed software (like the E2688A High Speed Serial software or the N5400A/N5401A EZJIT Plus jitter analysis software).

```
:MEASure:CLOCK:METHOD:DEEMphasis {OFF | ON}
```

The :MEASure:CLOCK:METHOD:DEEMphasis command turns de-emphasis on or off.

This command applies to the clock recovery method being set up for the waveform source selected by the :MEASure:CLOCK:METHOD:SOURce command.

See the help system for more information on de-emphasis.

Example This example enables de-emphasis.

```
myScope.WriteString ":MEASure:CLOCK:METHOD:DEEMphasis ON"
```

Query :MEASure:CLOCK:METHOD:DEEMphasis?

The :MEASure:CLOCK:METHOD:DEEMphasis? query returns whether or not de-emphasis is turned on.

Returned Format [:MEASure:CLOCK:METHOD:DEEMphasis] {OFF | ON}

Example This example places the current setting of the de-emphasis mode in the string variable strDeemph, then prints the contents of the variable to the computer's screen.

```
myScope.WriteString ":SYSTem:HEADer OFF"
myScope.WriteString ":MEASure:CLOCK:METHOD:DEEMphasis?"
strDeemph = myScope.ReadString
Debug.Print strDeemph
```

See Also

- [":MEASure:CLOCK:METHOD:SOURce"](#) on page 1529
- [":MEASure:CLOCK:METHOD"](#) on page 1515
- [":MEASure:CLOCK:METHOD:OJTF"](#) on page 1526
- [":MEASure:CLOCK:METHOD:JTF"](#) on page 1524
- [":MEASure:CLOCK:METHOD:ALIGN"](#) on page 1519
- [":MEASure:CLOCK:METHOD:PLLTrack"](#) on page 1528
- [":MEASure:CLOCK:METHOD:EDGE"](#) on page 1522

History Legacy command (existed before version 3.10).

Version 5.30: This command is deprecated, replaced by [":ANALyze:CLOCK:METHOD:DEEMphasis"](#) on page 246.

:MEASure:CLOCK:METHOD:EDGE**Command****NOTE**

:MEASure:CLOCK commands are available when clock recovery is used by licensed software (like the E2688A High Speed Serial software or the N5400A/N5401A EZJIT Plus jitter analysis software).

```
:MEASure:CLOCK:METHOD:EDGE {RISing | FALLing | BOTH}
```

The :MEASure:CLOCK:METHOD:EDGE command specifies which edge(s) of the data are used to recover a clock. (In the front panel GUI, this control appears in the Advanced Clock Recovery dialog box.) Normally, both edges are used. However, if you are performing clock recovery on a low duty cycle clock signal, for example, you may want to use just the rising or falling edge.

This command applies to the clock recovery method being set up for the waveform source selected by the :MEASure:CLOCK:METHOD:SOURce command.

This command applies to the following clock recovery methods:

- FIXed (Constant Frequency).
- FOPLL (First Order PLL).
- SOPLL (Second Order PLL).
- EXPLICIT (Explicit Clock).
- EXPFOPLL (Explicit First Order PLL).
- EXP SOPLL (Explicit Second Order PLL).
- EQFOPLL (Equalized First Order PLL).
- EQSOPLL (Equalized Second Order PLL).

To measure jitter on only rising (or falling) edges of a clock, you must also set :MEASure:RJDJ:EDGE to the same RISing or FALLing option, and you must set :MEASure:RJDJ:CLOCK ON to force the pattern to be a clock and set the jitter for edges not examined to zero (0).

Example This example specifies that both rising and falling edges of the data are used to recover a clock.

```
myScope.WriteString ":MEASure:CLOCK:METHOD:EDGE BOTH"
```

Query :MEASure:CLOCK:METHOD:EDGE?

The :MEASure:CLOCK:METHOD:EDGE? query returns the clock recovery method's edge setting.

Returned Format [:MEASure:CLOCK:METHOD:EDGE] {RIS | FALL | BOTH}

Example This example places the current edge setting of the clock recovery method in the variable strSetting, then prints the contents of the variable to the computer's screen.

```

myScope.WriteString ":SYSTem:HEADer OFF"
myScope.WriteString ":MEASure:CLOCK:METhod:EDGE?"
strSetting = myScope.ReadString
Debug.Print strSetting

```

- See Also**
- [":MEASure:CLOCK:METhod:SOURce"](#) on page 1529
 - [":MEASure:CLOCK:METhod"](#) on page 1515
 - [":MEASure:CLOCK:METhod:OJTF"](#) on page 1526
 - [":MEASure:CLOCK:METhod:JTF"](#) on page 1524
 - [":MEASure:CLOCK:METhod:DEEMphasis"](#) on page 1521
 - [":MEASure:CLOCK:METhod:ALIGn"](#) on page 1519
 - [":MEASure:CLOCK:METhod:PLLTrack"](#) on page 1528
 - [":MEASure:RJDJ:EDGE"](#) on page 878
 - [":MEASure:RJDJ:CLOCK"](#) on page 877

History New in version 4.30.

Version 5.30: This command is deprecated, replaced by [":ANALyze:CLOCK:METhod:EDGE"](#) on page 247.

:MEASure:CLOCK:METHod:JTF

Command

NOTE

:MEASure:CLOCK commands are available when clock recovery is used by licensed software (like the E2688A High Speed Serial software or the N5400A/N5401A EZJIT Plus jitter analysis software).

```
:MEASure:CLOCK:METHod:JTF
  {FOPLL,<data_rate>,<jtf_loop_bandwidth>}
  | {EQFOPLL,<data_rate>,<jtf_loop_bandwidth>}
  | {SOPLL,<data_rate>,<jtf_loop_bandwidth>,<peaking>}
  | {EQSOPLL,<data_rate>,<jtf_loop_bandwidth>,<peaking>}
  | {EXPFOPLL,<source>,{RISing | FALLing | BOTH},
    <multiplier>,<clock_freq>,<jtf_loop_bandwidth>}
  | {EXPSOPLL,<source>,{RISing | FALLing | BOTH},
    <multiplier>,<clock_freq>,<jtf_loop_bandwidth>,<peaking>}
```

The :MEASure:CLOCK:METHod:JTF command specifies the clock recovery PLL's response in terms of the Jitter Transfer Function's (JTF) 3 dB bandwidth.

This command applies to the clock recovery method being set up for the waveform source selected by the :MEASure:CLOCK:METHod:SOURce command.

You can set these types of PLL clock recovery methods:

- FOPLL (First Order PLL).
- SOPLL (Second Order PLL).
- EQFOPLL (Equalized First Order PLL).
- EQSOPLL (Equalized Second Order PLL).
- EXPFOPLL (Explicit First Order PLL).
- EXPSOPLL (Explicit Second Order PLL).

The EQUALized clock recovery methods are only available if the oscilloscope has the High Speed Serial option and the Serial Data Equalization option installed and the features are enabled.

For setting phase-locked loop (PLL) clock recovery methods in terms of the Observed Jitter Transfer Function (OJTF), see **":MEASure:CLOCK:METHod:OJTF"** on page 1526.

For setting other clock recovery methods, see **":MEASure:CLOCK:METHod"** on page 1515.

<source> {CHANnel<N> | FUNCtion<F> | WMEMory<R>}

<N> An integer, 1-4 in a single oscilloscope, 1-40 in a MultiScope system.

<F> An integer, 1-16.

<R> An integer, 1-4.

- <data_rate> A real number for the base data rate in bits per second.
- <peaking> The peaking value in dB.
- <jtf_loop_bandwidth> A real number for the cutoff frequency for the PLL to track.
- <multiplier> An integer used as the multiplication factor.
- <clock_freq> A real number used for the clock frequency of the PLL.

Example This example sets the clock recovery method to Second Order PLL, a nominal data rate of 4 Gb/s, and a peaking value of 1.25 dB.

```
myScope.WriteString ":MEASure:CLOCK:METHOD:JTF SOPLL,4E9,3.822E6,1.25"
```

Query :MEASure:CLOCK:METHOD:JTF?

The :MEASure:CLOCK:METHOD:JTF? query returns the state of the clock recovery method.

Returned Format [:MEASure:CLOCK:METHOD:JTF]
 {FOPLL,<data_rate>,<jtf_loop_bandwidth>}
 | {EQFOPLL,<data_rate>,<jtf_loop_bandwidth>}
 | {SOPLL,<data_rate>,<jtf_loop_bandwidth>,<peaking>}
 | {EQSOPLL,<data_rate>,<jtf_loop_bandwidth>,<peaking>}
 | {EXPFOPLL <source>,{RISing | FALLing | BOTH},
 <multiplier>,<clock_freq>,<jtf_loop_bandwidth>}
 | {EXPSOPLL <source>,{RISing | FALLing | BOTH},
 <multiplier>,<clock_freq>,<jtf_loop_bandwidth>,<peaking>}

Example This example places the current setting of the clock recovery method in the variable strSetting, then prints the contents of the variable to the computer's screen.

```
myScope.WriteString ":SYSTEM:HEADER OFF"
myScope.WriteString ":MEASure:CLOCK:METHOD:JTF?"
strSetting = myScope.ReadString
Debug.Print strSetting
```

- See Also**
- [":MEASure:CLOCK:METHOD:SOURce"](#) on page 1529
 - [":MEASure:CLOCK:METHOD"](#) on page 1515
 - [":MEASure:CLOCK:METHOD:OJTF"](#) on page 1526
 - [":MEASure:CLOCK:METHOD:DEEMphasis"](#) on page 1521
 - [":MEASure:CLOCK:METHOD:ALIGN"](#) on page 1519
 - [":MEASure:CLOCK:METHOD:PLLTrack"](#) on page 1528
 - [":MEASure:CLOCK:METHOD:EDGE"](#) on page 1522

History New in version 4.20.

Version 5.30: This command is deprecated, replaced by [":ANALyze:CLOCK:METHOD:JTF"](#) on page 249.

:MEASure:CLOCK:METHod:OJTF

Command

NOTE

:MEASure:CLOCK commands are available when clock recovery is used by licensed software (like the E2688A High Speed Serial software or the N5400A/N5401A EZJIT Plus jitter analysis software).

```
:MEASure:CLOCK:METHod:OJTF
  {FOPLL,<data_rate>,<ojtf_loop_bandwidth>}
  | {EQFOPLL,<data_rate>,<ojtf_loop_bandwidth>}
  | {SOPLL,<data_rate>,<ojtf_loop_bandwidth>,<damping_factor>}
  | {EQSOPLL,<data_rate>,<ojtf_loop_bandwidth>,<damping_factor>}
  | {EXPFOPPLL,<source>,{RISing | FALLing | BOTH},
    <multiplier>,<clock_freq>,<ojtf_loop_bandwidth>}
  | {EXPSOPLL,<source>,{RISing | FALLing | BOTH},
    <multiplier>,<clock_freq>,<ojtf_loop_bandwidth>,<damping_factor>}
```

The :MEASure:CLOCK:METHod:OJTF command specifies the clock recovery PLL's response in terms of the Observed Jitter Transfer Function's (OJTF) 3 dB bandwidth.

This command applies to the clock recovery method being set up for the waveform source selected by the :MEASure:CLOCK:METHod:SOURce command.

You can set these types of PLL clock recovery methods:

- FOPLL (First Order PLL).
- SOPLL (Second Order PLL).
- EQFOPLL (Equalized First Order PLL).
- EQSOPLL (Equalized Second Order PLL).
- EXPFOPLL (Explicit First Order PLL).
- EXPSOPLL (Explicit Second Order PLL).

The Equalized clock recovery methods are only available if the oscilloscope has the High Speed Serial option and the Serial Data Equalization option installed and the features are enabled.

For setting phase-locked loop (PLL) clock recovery methods in terms of the Jitter Transfer Function (JTF), see **":MEASure:CLOCK:METHod:JTF"** on page 1524.

For setting other clock recovery methods, see **":MEASure:CLOCK:METHod"** on page 1515.

<source> {CHANnel<N> | FUNCtion<F> | WMEMory<R>}

<N> An integer, 1-4 in a single oscilloscope, 1-40 in a MultiScope system.

<F> An integer, 1-16.

<R> An integer, 1-4.

- <data_rate> A real number for the base data rate in bits per second.
- <damping_factor> A real number for the damping factor of the PLL.
- <ojtf_loop_bandwidth> A real number for the cutoff frequency for the PLL to track.
- <multiplier> An integer used as the multiplication factor.
- <clock_freq> A real number used for the clock frequency of the PLL.

Example This example sets the clock recovery method to Second Order PLL, a nominal data rate of 4 Gb/s, and a damping factor of 1.0.

```
myScope.WriteString ":MEASure:CLOCK:METHOD:OJTF SOPLL,4E9,2.4E6,1.0"
```

Query :MEASure:CLOCK:METHOD:OJTF?

The :MEASure:CLOCK:METHOD:OJTF? query returns the state of the clock recovery method.

Returned Format [:MEASure:CLOCK:METHOD:OJTF]
 {FOPLL,<data_rate>,<ojtf_loop_bandwidth>}
 | {EQFOPLL,<data_rate>,<ojtf_loop_bandwidth>}
 | {SOPLL,<data_rate>,<ojtf_loop_bandwidth>,<damping_factor>}
 | {EQSOPLL,<data_rate>,<ojtf_loop_bandwidth>,<damping_factor>}
 | {EXPFOPPLL <source>,{RISing | FALLing | BOTH},
 <multiplier>,<clock_freq>,<ojtf_loop_bandwidth>}
 | {EXPSOPLL <source>,{RISing | FALLing | BOTH},
 <multiplier>,<clock_freq>,<ojtf_loop_bandwidth>,<damping_fact>}

Example This example places the current setting of the clock recovery method in the variable strSetting, then prints the contents of the variable to the computer's screen.

```
myScope.WriteString ":SYSTEM:HEADER OFF"
myScope.WriteString ":MEASure:CLOCK:METHOD:OJTF?"
strSetting = myScope.ReadString
Debug.Print strSetting
```

- See Also**
- [":MEASure:CLOCK:METHOD:SOURce"](#) on page 1529
 - [":MEASure:CLOCK:METHOD"](#) on page 1515
 - [":MEASure:CLOCK:METHOD:JTF"](#) on page 1524
 - [":MEASure:CLOCK:METHOD:DEEMphasis"](#) on page 1521
 - [":MEASure:CLOCK:METHOD:ALIGN"](#) on page 1519
 - [":MEASure:CLOCK:METHOD:PLLTrack"](#) on page 1528
 - [":MEASure:CLOCK:METHOD:EDGE"](#) on page 1522

History New in version 4.20.

Version 5.30: This command is deprecated, replaced by [":ANALyze:CLOCK:METHOD:OJTF"](#) on page 252.

:MEASure:CLOCK:METHOD:PLLTrack**Command****NOTE**

:MEASure:CLOCK commands are available when clock recovery is used by licensed software (like the E2688A High Speed Serial software or the N5400A/N5401A EZJIT Plus jitter analysis software).

```
:MEASure:CLOCK:METHOD:PLLTrack {OFF | ON}
```

The :MEASure:CLOCK:METHOD:PLLTrack command turns transition density dependence on or off. See the help system for more information on the Transition Density Dependent setting.

This command applies to the clock recovery method being set up for the waveform source selected by the :MEASure:CLOCK:METHOD:SOURce command.

Example This example enables the Transition Density Dependent setting.

```
myScope.WriteString ":MEASure:CLOCK:METHOD:PLLTrack ON"
```

Query :MEASure:CLOCK:METHOD:PLLTrack?

The :MEASure:CLOCK:METHOD:PLLTrack? query returns whether or not the Transition Density Dependent setting is turned on.

Returned Format [:MEASure:CLOCK:METHOD:PLLTrack] {OFF | ON}

Example This example places the current setting of the Transition Density Dependent setting in the string variable strTDD, then prints the contents of the variable to the computer's screen.

```
myScope.WriteString ":SYSTem:HEADer OFF"
myScope.WriteString ":MEASure:CLOCK:METHOD:PLLTrack?"
strTDD = myScope.ReadString
Debug.Print strTDD
```

- See Also**
- [":MEASure:CLOCK:METHOD:SOURce"](#) on page 1529
 - [":MEASure:CLOCK:METHOD"](#) on page 1515
 - [":MEASure:CLOCK:METHOD:OJTF"](#) on page 1526
 - [":MEASure:CLOCK:METHOD:JTF"](#) on page 1524
 - [":MEASure:CLOCK:METHOD:DEEMphasis"](#) on page 1521
 - [":MEASure:CLOCK:METHOD:ALIGN"](#) on page 1519
 - [":MEASure:CLOCK:METHOD:EDGE"](#) on page 1522

History New in version 4.20.

Version 5.30: This command is deprecated, replaced by [":ANALyze:CLOCK:METHOD:PLLTrack"](#) on page 255.

:MEASure:CLOCK:METHod:SOURce

Command :MEASure:CLOCK:METHod:SOURce {ALL | <source>}
 <source> ::= {CHANnel<N> | DIFF<D> | COMMONmode<C>
 | FUNction<F> | WMEMory<R> | MTRend | MSPectrum | EQUalized
 | DIGital<M>}

The :MEASure:CLOCK:METHod:SOURce command selects the waveform source (or ALL sources) to which other clock recovery method setup commands apply.

Clock recovery methods can be set up for each waveform source (or for all waveform sources).

Query :MEASure:CLOCK:METHod:SOURce?

The :MEASure:CLOCK:METHod:SOURce? query returns the waveform source to which other clock recovery method commands currently apply.

Returned Format [:MEASure:CLOCK:METHod:SOURce] <source><NL>
 <source> ::= {ALL | CHAN<N> | FUNC<F> | WMEM<N> | MTR | MSP | EQU
 | DIG<M>}

- See Also**
- [":MEASure:CLOCK:METHod"](#) on page 1515
 - [":MEASure:CLOCK:METHod:OJTF"](#) on page 1526
 - [":MEASure:CLOCK:METHod:JTF"](#) on page 1524
 - [":MEASure:CLOCK:METHod:DEEMphasis"](#) on page 1521
 - [":MEASure:CLOCK:METHod:ALIGn"](#) on page 1519
 - [":MEASure:CLOCK:METHod:PLLTrack"](#) on page 1528
 - [":MEASure:CLOCK:METHod:EDGE"](#) on page 1522

History New in version 5.20.

Version 5.30: This command is deprecated, replaced by [":ANALyze:CLOCK:METHod:SOURce"](#) on page 257.

:MEASure:CLOCK:VERTical

Command

NOTE

:MEASure:CLOCK commands are available when clock recovery is used by licensed software (like the E2688A High Speed Serial software or the N5400A/N5401A EZJIT Plus jitter analysis software).

```
:MEASure:CLOCK:VERTical {AUTO | MANual}
```

The :MEASure:CLOCK:VERTical command sets the recovered clock vertical scale mode to automatic or manual. In automatic mode, the oscilloscope automatically selects the vertical scaling and offset. In manual mode, you can set your own scaling and offset values.

Example This example sets the recovered clock vertical scale mode to automatic.

```
myScope.WriteString ":MEASure:CLOCK:VERTical AUTO"
```

Query

```
:MEASure:CLOCK:VERTical?
```

The :MEASure:CLOCK:VERTical? query returns the current recovered clock vertical scale mode setting.

Returned Format

```
[ :MEASure:CLOCK:VERTical ] {AUTO | MANual}
```

Example

This example places the current setting of the recovered clock vertical scale mode in the string variable strSetting, then prints the contents of the variable to the computer's screen.

```
myScope.WriteString ":SYSTEM:HEADer OFF"
myScope.WriteString ":MEASure:CLOCK:VERTICAL?"
strSetting = myScope.ReadString
Debug.Print strSetting
```

History

Legacy command (existed before version 3.10).

Version 5.30: This command is deprecated, replaced by **":ANALyze:CLOCK:VERTical"** on page 258.

:MEASure:CLOCK:VERTical:OFFSet

Command

NOTE

:MEASure:CLOCK commands are available when clock recovery is used by licensed software (like the E2688A High Speed Serial software or the N5400A/N5401A EZJIT Plus jitter analysis software).

```
:MEASure:CLOCK:VERTical:OFFSet <offset>
```

The :MEASure:CLOCK:VERTical:OFFSet command sets the recovered clock vertical offset.

<offset> A real number for the recovered clock vertical offset.

Example This example sets the clock recovery vertical offset to 1 volt.

```
myScope.WriteString ":MEASure:CLOCK:VERTICAL:OFFSET 1"
```

Query :MEASure:CLOCK:VERTical:OFFSet?

The :MEASure:CLOCK:VERTical:OFFSet? query returns the clock recovery vertical offset setting.

Returned Format [:MEASure:CLOCK:VERTical:OFFSet] <value><NL>

<value> The clock recovery vertical offset setting.

Example This example places the current value of recovered clock vertical offset in the numeric variable, varValue, then prints the contents of the variable to the computer's screen.

```
myScope.WriteString ":SYSTEM:HEADer OFF" ' Response headers off.
myScope.WriteString ":MEASure:CLOCK:VERTICAL:OFFSET?"
varValue = myScope.ReadNumber
Debug.Print FormatNumber(varValue, 0)
```

History Legacy command (existed before version 3.10).

Version 5.30: This command is deprecated, replaced by **":ANALyze:CLOCK:VERTical:OFFSet"** on page 259.

:MEASure:CLOCK:VERTical:RANGe**Command****NOTE**

:MEASure:CLOCK commands are available when clock recovery is used by licensed software (like the E2688A High Speed Serial software or the N5400A/N5401A EZJIT Plus jitter analysis software).

```
:MEASure:CLOCK:VERTical:RANGe <range>
```

The :MEASure:CLOCK:VERTical:RANGe command sets the recovered clock vertical range.

<range> A real number for the full-scale recovered clock vertical range.

Example This example sets the recovered clock vertical range to 16 volts (2 volts times 8 divisions.)

```
myScope.WriteString ":MEASure:CLOCK:VERTICAL:RANGE 16"
```

Query :MEASure:CLOCK:VERTical:RANGe?

The :MEASure:CLOCK:VERTical:RANGe? query returns the recovered clock vertical range setting.

Returned Format [:MEASure:CLOCK:VERTical:RANGe] <value><NL>

<value> The recovered clock vertical range setting.

Example This example places the current value of recovered clock vertical range in the numeric variable, varValue, then prints the contents of the variable to the computer's screen.

```
myScope.WriteString ":SYSTEM:HEADer OFF" ' Response headers off.
myScope.WriteString ":MEASure:CLOCK:VERTICAL:RANGE?"
varValue = myScope.ReadNumber
Debug.Print FormatNumber(varValue, 0)
```

History Legacy command (existed before version 3.10).

Version 5.30: This command is deprecated, replaced by **":ANALyze:CLOCK:VERTical:RANGe"** on page 260.

:MEASure:DDPWS – Data Dependent Pulse Width Shrinkage

Command

NOTE

This command is deprecated. In its place, use the query **":MEASure:RJDJ:ALL?"** on page 871 which returns all of the RJDJ jitter measurements.

NOTE

This command is only available when the E2681A Jitter Analysis Software or the N5400A/N5401A Software is installed.

```
:MEASure:DDPWS <source>
```

The :MEASure:DDPWS command measures the data dependent pulse width shrinkage for the selected source.

<source> {CHANnel<N> | FUNction<F> | WMemory<R> | CLOCK | MTRend | MSPectrum | EQUalized}

MTRend and MSPectrum sources are only available if the oscilloscope has the EZJIT option installed and the feature is enabled.

The CLOCK source is only available if the oscilloscope has the High Speed Serial option installed and the feature is enabled.

The EQUalized source is only available if the oscilloscope has the High Speed Serial option and the Serial Data Equalization option installed and the features are enabled. This command uses the Feed-Forward Equalized (FFE) signal as the source.

<N> An integer, 1-4 in a single oscilloscope, 1-40 in a MultiScope system.

<F> An integer, 1-16.

<R> An integer, 1-4.

Example This example measures the data rate of channel 1.

```
myScope.WriteString ":MEASure:DDPWS CHANnel1"
```

Query :MEASure:DDPWS? <source>

The :MEASure:DDPWS? query returns the measured data dependent pulse width shrinkage.

Returned Format [:MEASure:DDPWS] <value><NL>

<value> Data dependent pulse width shrinkage in seconds for the selected source.

Example This example places the current data dependent pulse width shrinkage value of the channel 1 waveform in the numeric variable, varValue, then prints the contents of the variable to the computer's screen.

```
myScope.WriteString ":SYSTem:HEADer OFF" ' Response headers off.  
myScope.WriteString ":MEASure:DDPWS? CHANnel1"  
varValue = myScope.ReadNumber  
Debug.Print FormatNumber(varValue, 0)
```

History New in version 3.10.

Version 4.20: Obsoleted, replaced by the :MEASure:RJDJ:ALL? query which returns all of the RJDJ jitter measurements.

:MEASure:JITTer:STATistics

Command :MEASure:JITTer:STATistics {{ON|1} | {OFF|0}}

The :MEASure:JITTer:STATistics command enables or disables jitter mode and allows you to view: measurement histogram (:MEASure:JITTer:HISTogram), measurement trend (:MEASure:JITTer:TREND), and jitter spectrum (:MEASure:JITTer:SPsECtrum) if they are enabled.

The :MEASure:JITTer:STATistics command also turns on or off the ability to measure all edges in the waveform; not just the first edge on screen.

Example This example turns the jitter measurement statistics and the "Measure All Edges" mode on.

```
myScope.WriteString ":MEASure:JITTer:STATistics ON"
```

Query :MEASure:JITTer:STATistics?

The :MEASure:JITTer:STATistics? query returns the state of jitter statistics.

Returned Format [:MEASure:JITTer:STATistics] {1 | 0}

Example This example places the current setting of the jitter statistics mode in the variable varSetting, then prints the contents of the variable to the computer's screen.

```
myScope.WriteString ":SYSTem:HEADer OFF"
myScope.WriteString ":MEASure:JITTer:STATistics?"
varSetting = myScope.ReadNumber
Debug.Print FormatNumber(varSetting, 0)
```

History Legacy command (existed before version 3.10).

Version 5.30: This command is deprecated, replaced by **:ANALyze:AEDGes** on page 239.

:MEASure:TIEData

Command

NOTE

This command is only available when the E2681A Jitter Analysis Software, Serial Data Analysis, or the N5400A/5401A Software is installed.

```
:MEASure:TIEData <source>,{SECond | UNITinterval}, {AUTO
| CUSTOM,<data_rate> | VARIable,<data_rate>,<bandwidth>
| CLOCk}
```

The :MEASure:TIEData command measures data time interval error. You can set the units of the measurement by selecting SECond (seconds) or UNITinterval.

If AUTO is selected, the oscilloscope selects the ideal data rate. If CUSTom is selected, you can enter your own ideal constant data rate. If VARIable is selected, a first order PLL clock recovery is used at a given data rate and loop bandwidth. If CLOCk is given, clock recovery as specified with the :MEASure:CLOCk:METHod is used.

<source> {CHANnel<N> | FUNCTion<F> | DIGital<M> | WMEMory<R> | CLOCk | MTRend | MSPectrum | EQUalized}

MTRend and MSPectrum sources are only available if the oscilloscope has the EZJIT option installed and the feature is enabled.

The CLOCk source is only available if the oscilloscope has the High Speed Serial option installed and the feature is enabled.

The EQUalized source is only available if the oscilloscope has the High Speed Serial option and the Serial Data Equalization option installed and the features are enabled. This command uses the Feed-Forward Equalized (FFE) signal as the source.

<N> An integer, 1-4 in a single oscilloscope, 1-40 in a MultiScope system.

<F> An integer, 1-16.

<M> An integer, 0-15. Digital channels are only available on MSO models.

<R> An integer, 1-4.

<data_rate> A real number for the ideal data rate for clock recovery.

<bandwidth> A real number for the loop bandwidth of the PLL clock recovery method.

Example This example measures the data time interval error on channel 1, ideal data rate set to automatic, units set to seconds.

```
myScope.WriteString ":MEASure:TIEData CHANnel1,SECond,AUTO"
```

Query :MEASure:TIEData? <source>,(SECond | UNITinterval), {AUTO | CUSTom,<frequency> | VARIable,<frequency>,<bandwidth> | CLOCk}

The `:MEASure:TIEData?` query returns the current value of the data time interval error.

Returned Format `[:MEASure:TIEData] <value>[,<result_state>]<NL>`

<value> The data time interval error value.

<result_state> If `SENDvalid` is ON, the result state is returned with the measurement result. See the `:MEASure:RESults` table in this chapter for a list of the result states.

Example This example places the current value of the data time interval error in the variable `strValue`, then prints the contents of the variable to the computer's screen.

```
myScope.WriteString ":SYSTEM:HEADer OFF"
myScope.WriteString ":MEASure:TIEData? CHANnel1,SECond,CUSTOM,1E9"
strValue = myScope.ReadString
Debug.Print strValue
```

History Legacy command (existed before version 3.10).

Version 5.50: This command is deprecated, replaced by `":MEASure:TIEData2"` on page 949.

:MTESt:FOLDing:COUNT?

Query :MTESt:FOLDing:COUNT? [<source>]

The :MTESt:FOLDing:COUNT? query returns the number of waveforms and unit intervals in the real time eye.

<source> {CHANnel<N> | DIFF<D> | COMMONmode<C> | FUNction<F> | WMEMory<R> | EQUalized}

<N> An integer, 1-4 in a single oscilloscope, 1-40 in a MultiScope system.

<D>, <C> <D> is an integer, 1-2. <C> is an integer, 3-4.

The DIFF and COMMONmode sources are just aliases that can be used in place of the channel names to apply to differential or common mode signals. These are just aliases - no state change occurs if you refer to a differential channel and you are not in differential mode. DIFF1 refers to the differential signal between channels 1 and 3 (and COMMONmode3 refers to the common mode channel between these same channels). DIFF2 refers to the differential signal between channels 2 and 4 (and COMMONmode4 refers to the common mode channel between these same channels).

If the <source> is not specified, the :MTESt:FOLDing:COUNT? query returns the results of the first real-time eye that is on. Sources are ordered by channels, memories, and then functions.

<F> An integer, 1-16.

<R> An integer, 1-4.

Returned Format [:MTESt:FOLDing:COUNT] Real Time Eye<NL>
<N> UI<NL>
<N> Wfm<NL>

The UI count returned is a floating-point value. The Wfm count returned is an integer.

Example

```
myScope.WriteString ":MTESt:FOLDing:COUNT? CHANnel1"
strRteCount = myScope.ReadString
Debug.Print strRteCount
```

- See Also**
- [":MTESt:FOLDing \(Clock Recovery software only\)"](#) on page 677
 - [":MTESt:FOLDing:BITS"](#) on page 679
 - [":MTESt:FOLDing:FAST"](#) on page 685
 - [":MTESt:FOLDing:POSition"](#) on page 687
 - [":MTESt:FOLDing:TPOSition"](#) on page 691
 - [":MTESt:FOLDing:SCALe"](#) on page 689
 - [":MTESt:FOLDing:TSCale"](#) on page 693

History New in version 5.00.

Version 5.50: The UI count returned is now a floating-point value instead of an integer value. This command is deprecated, replaced by **":MTESt:FOLDing:COUNt:UI?"** on page 681 and **":MTESt:FOLDing:COUNt:WAVeforms?"** on page 683.

Version 5.52: The <source> parameter is now optional.

:SPRocessing:CTLequalizer:ZERo

Command :SPRocessing:CTLequalizer:ZERo <zero_freq>

The :CTLequalizer:ZERo command sets the zero frequency for the Continuous Time Linear Equalization.

<zero_freq> A real number.

Example This example sets the CTLE zero frequency to 900 MHz.

```
myScope.WriteString ":SPRocessing:CTLequalizer:ZERo 9e6"
```

Query :SPRocessing:CTLequalizer:ZERo?

The :SPRocessing:CTLequalizer:ZERo? query returns the CTLE's zero frequency.

History Legacy command (existed before version 3.10).

Version 5.75: Now that you can specify up to two zeros for a 3-pole CTLE, this command has been replaced by "**:SPRocessing:CTLequalizer:Z1**" on page 1115 and "**:SPRocessing:CTLequalizer:Z2**" on page 1116.

41 Error Messages

| | |
|--|------|
| Error Queue / | 1542 |
| Error Numbers / | 1543 |
| Command Error / | 1544 |
| Execution Error / | 1545 |
| Device- or Oscilloscope-Specific Error / | 1546 |
| Query Error / | 1547 |
| List of Error Messages / | 1548 |

This chapter describes the error messages and how they are generated. The possible causes for the generation of the error messages are also listed in the following table.

Error Queue

As errors are detected, they are placed in an error queue. This queue is first in, first out. If the error queue overflows, the last error in the queue is replaced with error -350, "Queue overflow." Anytime the error queue overflows, the oldest errors remain in the queue, and the most recent error is discarded. The length of the oscilloscope's error queue is 30 (29 positions for the error messages, and 1 position for the "Queue overflow" message).

Reading an error from the head of the queue removes that error from the queue, and opens a position at the tail of the queue for a new error. When all errors have been read from the queue, subsequent error queries return 0, "No error."

The error queue is cleared when any of the following occur:

- the instrument is powered up,
- a *CLS command is sent,
- the last item from the queue is read, or
- the instrument is switched from talk only to addressed mode on the front panel.

Error Numbers

The error numbers are grouped according to the type of error that is detected.

- +0 indicates no errors were detected.
- -100 to -199 indicates a command error was detected
- -200 to -299 indicates an execution error was detected.
- -300 to -399 indicates a device-specific error was detected.
- -400 to -499 indicates a query error was detected.
- +1 to +32767 indicates an oscilloscope specific error has been detected.

Command Error

An error number in the range -100 to -199 indicates that an IEEE 488.2 syntax error has been detected by the instrument's parser. The occurrence of any error in this class sets the command error bit (bit 5) in the event status register and indicates that one of the following events occurred:

- An IEEE 488.2 syntax error was detected by the parser. That is, a computer-to-oscilloscope message was received that is in violation of the IEEE 488.2 standard. This may be a data element that violates the oscilloscope's listening formats, or a data type that is unacceptable to the oscilloscope.
- An unrecognized header was received. Unrecognized headers include incorrect oscilloscope-specific headers and incorrect or unimplemented IEEE 488.2 common commands.
- A Group Execute Trigger (GET) was entered into the input buffer inside of an IEEE 488.2 program message.

Events that generate command errors do not generate execution errors, oscilloscope-specific errors, or query errors.

Execution Error

An error number in the range -200 to -299 indicates that an error was detected by the instrument's execution control block. The occurrence of any error in this class causes the execution error bit (bit 4) in the event status register to be set. It also indicates that one of the following events occurred:

- The program data following a header is outside the legal input range or is inconsistent with the oscilloscope's capabilities.
- A valid program message could not be properly executed due to some oscilloscope condition.

Execution errors are reported by the oscilloscope after expressions are evaluated and rounding operations are completed. For example, rounding a numeric data element will not be reported as an execution error. Events that generate execution errors do not generate command errors, oscilloscope specific errors, or query errors.

Device- or Oscilloscope-Specific Error

An error number in the range of -300 to -399 or +1 to +32767 indicates that the instrument has detected an error caused by an oscilloscope operation that did not properly complete. This may be due to an abnormal hardware or firmware condition. For example, this error may be generated by a self-test response error, or a full error queue. The occurrence of any error in this class causes the oscilloscope-specific error bit (bit 3) in the event status register to be set.

Query Error

An error number in the range-400 to-499 indicates that the output queue control of the instrument has detected a problem with the message exchange protocol. An occurrence of any error in this class should cause the query error bit (bit 2) in the event status register to be set. An occurrence of an error also means one of the following is true:

- An attempt is being made to read data from the output queue when no output is either present or pending.
- Data in the output queue has been lost.

List of Error Messages

Table 21 a list of the error messages that are returned by the parser on this oscilloscope.

Table 21 Error Messages

| | | |
|------|-----------------------------|--|
| 0 | No error | The error queue is empty. Every error in the queue has been read (SYSTEM:ERROR? query) or the queue was cleared by power-up or *CLS. |
| -100 | Command error | This is the generic syntax error used if the oscilloscope cannot detect more specific errors. |
| -101 | Invalid character | A syntactic element contains a character that is invalid for that type. |
| -102 | Syntax error | An unrecognized command or data type was encountered. |
| -103 | Invalid separator | The parser was expecting a separator and encountered an illegal character. |
| -104 | Data type error | The parser recognized a data element different than one allowed. For example, numeric or string data was expected but block data was received. |
| -105 | GET not allowed | A Group Execute Trigger was received within a program message. |
| -108 | Parameter not allowed | More parameters were received than expected for the header. |
| -109 | Missing parameter | Fewer parameters were received than required for the header. |
| -112 | Program mnemonic too long | The header or character data element contains more than twelve characters. |
| -113 | Undefined header | The header is syntactically correct, but it is undefined for the oscilloscope. For example, *XYZ is not defined for the oscilloscope. |
| -121 | Invalid character in number | An invalid character for the data type being parsed was encountered. For example, a "9" in octal data. |
| -123 | Numeric overflow | Number is too large or too small to be represented internally. |
| -124 | Too many digits | The mantissa of a decimal numeric data element contained more than 255 digits excluding leading zeros. |
| -128 | Numeric data not allowed | A legal numeric data element was received, but the oscilloscope does not accept one in this position for the header. |
| -131 | Invalid suffix | The suffix does not follow the syntax described in IEEE 488.2 or the suffix is inappropriate for the oscilloscope. |
| -138 | Suffix not allowed | A suffix was encountered after a numeric element that does not allow suffixes. |
| -141 | Invalid character data | Either the character data element contains an invalid character or the particular element received is not valid for the header. |
| -144 | Character data too long | |

Table 21 Error Messages (continued)

| | | |
|------|-----------------------------|--|
| -148 | Character data not allowed | A legal character data element was encountered where prohibited by the oscilloscope. |
| -150 | String data error | This error can be generated when parsing a string data element. This particular error message is used if the oscilloscope cannot detect a more specific error. |
| -151 | Invalid string data | A string data element was expected, but was invalid for some reason. For example, an END message was received before the terminal quote character. |
| -158 | String data not allowed | A string data element was encountered but was not allowed by the oscilloscope at this point in parsing. |
| -160 | Block data error | This error can be generated when parsing a block data element. This particular error message is used if the oscilloscope cannot detect a more specific error. |
| -161 | Invalid block data | |
| -168 | Block data not allowed | A legal block data element was encountered but was not allowed by the oscilloscope at this point in parsing. |
| -170 | Expression error | This error can be generated when parsing an expression data element. It is used if the oscilloscope cannot detect a more specific error. |
| -171 | Invalid expression | |
| -178 | Expression data not allowed | Expression data was encountered but was not allowed by the oscilloscope at this point in parsing. |
| -200 | Execution error | This is a generic syntax error which is used if the oscilloscope cannot detect more specific errors. |
| -212 | Arm ignored | |
| -213 | Init ignored | |
| -214 | Trigger deadlock | |
| -215 | Arm deadlock | |
| -220 | Parameter error | |
| -221 | Settings conflict | |
| -222 | Data out of range | Indicates that a legal program data element was parsed but could not be executed because the interpreted value is outside the legal range defined by the oscilloscope. |
| -223 | Too much data | Indicates that a legal program data element of block, expression, or string type was received that contained more data than the oscilloscope could handle due to memory or related oscilloscope-specific requirements. |
| -224 | Illegal parameter value | |
| -230 | Data corrupt or stale | |

Table 21 Error Messages (continued)

| | | |
|------|---|--|
| -231 | Data questionable | |
| -240 | Hardware error | |
| -241 | Hardware missing | |
| -250 | Mass storage error | |
| -251 | Missing mass storage | |
| -252 | Missing media | |
| -253 | Corrupt media | |
| -254 | Media full | |
| -255 | Directory full | |
| -256 | File name not found | |
| -257 | File name error | |
| -258 | Media protected | |
| -260 | Expression error | |
| -261 | Math error in expression | |
| -300 | Device specific error | |
| -310 | System error | Indicates that a system error occurred. |
| -311 | Memory error | |
| -312 | PUD memory error | |
| -313 | Calibration memory lost | |
| -314 | Save/recall memory lost | |
| -315 | Configuration memory lost | |
| -321 | Out of memory | |
| -330 | Self-test failed | |
| -350 | Queue overflow | Indicates that there is no room in the error queue and an error occurred but was not recorded. |
| -370 | No sub tests are defined for the selected self test | |
| -371 | Self Test status is corrupt or no self test has been executed | |
| -372 | This product configuration does not support the requested self test | |
| -373 | This product configuration does not support the requested source | |

Table 21 Error Messages (continued)

| | | |
|------|---|----------------------------------|
| -374 | The requested self test log file could not be found | |
| -375 | Attenuator relay actuation counts can only be modified during factory service | |
| -400 | Query error | This is the generic query error. |
| -410 | Query INTERRUPTED | |
| -420 | Query UNTERMINATED | |
| -430 | Query DEADLOCKED | |
| -440 | Query UNTERMINATED after indefinite response | |

42 Sample Programs

VISA COM Examples / 1554

VISA Examples / 1592

SICL Examples / 1649

SCPI.NET Examples / 1668

Example programs are ASCII text files that can be cut from the help file and pasted into your favorite text editor.

VISA COM Examples

- ["VISA COM Example in Visual Basic"](#) on page 1554
- ["VISA COM Example in C#"](#) on page 1565
- ["VISA COM Example in Visual Basic .NET"](#) on page 1575
- ["VISA COM Example in Python"](#) on page 1584

VISA COM Example in Visual Basic

To run this example in Visual Basic for Applications (VBA):

- 1 Start the application that provides Visual Basic for Applications (for example, Microsoft Excel).
- 2 Press ALT+F11 to launch the Visual Basic editor.
- 3 Reference the Keysight VISA COM library:
 - a Choose **Tools>References...** from the main menu.
 - b In the References dialog, check:
 - VISA COM 5.5 Type Library
 - Microsoft Scripting Runtime
 - c Click **OK**.
- 4 Choose **Insert > Module**.
- 5 Cut-and-paste the code that follows into the editor.
- 6 Edit the program to use the VISA address of your oscilloscope, and save the changes.
- 7 Run the program.

```
'
' Keysight VISA COM Example in Visual Basic
' -----
' This program illustrates a few commonly-used programming
' features of your Keysight Infiniium Series oscilloscope.
' -----

Option Explicit

Public myMgr As VisaComLib.ResourceManager
Public myScope As VisaComLib.FormattedIO488
Public varQueryResult As Variant
Public strQueryResult As String

' For Sleep subroutine.
Private Declare Sub Sleep Lib "kernel32" (ByVal dwMilliseconds As Long)

'
' Main Program
' -----
```

```

Sub Main()

    On Error GoTo VisaComError

    ' Create the VISA COM I/O resource.
    Set myMgr = New VisaComLib.ResourceManager
    Set myScope = New VisaComLib.FormattedIO488
    Set myScope.IO = _
        myMgr.Open("TCPIP0::141.121.237.226::hislip0::INSTR")
    myScope.IO.Timeout = 15000 ' Set I/O communication timeout.
    myScope.IO.Clear ' Clear the interface.

    ' Initialize - start from a known state.
    Initialize

    ' Capture data.
    Capture

    ' Analyze the captured waveform.
    Analyze

    Exit Sub

VisaComError:
    MsgBox "VISA COM Error:" + vbCrLf + Err.Description
    End

End Sub

'
' Initialize the oscilloscope to a known state.
' -----

Private Sub Initialize()

    On Error GoTo VisaComError

    ' Clear status.
    DoCommand "*CLS"

    ' Get and display the device's *IDN? string.
    strQueryResult = DoQueryString("*IDN?")
    Debug.Print "Identification string: " + strQueryResult

    ' Load the default setup.
    DoCommand "*RST"

    Exit Sub

VisaComError:
    MsgBox "VISA COM Error:" + vbCrLf + Err.Description
    End

End Sub

'

```

```

' Capture the waveform.
' -----

Private Sub Capture()

    On Error GoTo VisaComError

    ' Set probe attenuation factor.
    DoCommand ":CHANnel1:PROBe 1.0"
    Debug.Print "Channel 1 probe attenuation factor: " + _
        DoQueryString(":CHANnel1:PROBe?")

    ' Use auto-scale to automatically set up oscilloscope.
    ' -----
    Debug.Print "Autoscale."
    DoCommand ":AUToscale"

    ' Set trigger mode.
    DoCommand ":TRIGger:MODE EDGE"
    Debug.Print "Trigger mode: " + _
        DoQueryString(":TRIGger:MODE?")

    ' Set EDGE trigger parameters.
    DoCommand ":TRIGger:EDGE:SOURCe CHANnel1"
    Debug.Print "Trigger edge source: " + _
        DoQueryString(":TRIGger:EDGE:SOURce?")

    DoCommand ":TRIGger:LEVel CHANnel1,-2E-3"
    Debug.Print "Trigger level, channel 1: " + _
        DoQueryString(":TRIGger:LEVel? CHANnel1")

    DoCommand ":TRIGger:EDGE:SLOPe POSitive"
    Debug.Print "Trigger edge slope: " + _
        DoQueryString(":TRIGger:EDGE:SLOPe?")

    ' Save oscilloscope setup.
    ' -----
    varQueryResult = DoQueryIEEEBlock_UI1(":SYSTem:SETup?")

    ' Output setup string to a file:
    Dim strPath As String
    strPath = "c:\scope\config\setup.dat"
    Dim hFile As Long
    hFile = FreeFile
    Open strPath For Binary Access Write Lock Write As hFile
    Put hFile, , varQueryResult ' Write data.
    Close hFile ' Close file.
    Debug.Print "Setup bytes saved: " + CStr(LenB(varQueryResult))

    ' Change oscilloscope settings with individual commands:
    ' -----

    ' Set vertical scale and offset.
    DoCommand ":CHANnel1:SCALe 0.1"
    Debug.Print "Channel 1 vertical scale: " + _
        DoQueryString(":CHANnel1:SCALe?")

```

```

DoCommand ":CHANnel1:OFFSet 0.0"
Debug.Print "Channel 1 vertical offset: " + _
    DoQueryString(":CHANnel1:OFFSet?")

' Set horizontal scale and offset.
DoCommand ":TIMEbase:SCALE 200E-6"
Debug.Print "Timebase scale: " + _
    DoQueryString(":TIMEbase:SCALE?")

DoCommand ":TIMEbase:POSition 0.0"
Debug.Print "Timebase position: " + _
    DoQueryString(":TIMEbase:POSition?")

' Set the acquisition mode.
DoCommand ":ACquire:MODE RTIME"
Debug.Print "Acquire mode: " + _
    DoQueryString(":ACquire:MODE?")

' Or, configure by loading a previously saved setup.
' -----
Dim varSetupString As Variant
strPath = "c:\scope\config\setup.dat"
Open strPath For Binary Access Read As hFile ' Open file for input.
Get hFile, , varSetupString ' Read data.
Close hFile ' Close file.
' Write learn string back to oscilloscope using ":SYSTEM:SETup"
' command:
DoCommandIEEEBlock ":SYSTEM:SETup", varSetupString
Debug.Print "Setup bytes restored: " + CStr(LenB(varSetupString))

' Set the desired number of waveform points,
' and capture an acquisition.
' -----
DoCommand ":ACquire:POINTs 32000"
DoCommand ":DIGitize"

Exit Sub

VisaComError:
MsgBox "VISA COM Error:" + vbCrLf + Err.Description
End

End Sub

'
' Analyze the captured waveform.
' -----

Private Sub Analyze()

On Error GoTo VisaComError

' Make measurements.
' -----
DoCommand ":MEASure:SOURce CHANnel1"
Debug.Print "Measure source: " + _
    DoQueryString(":MEASure:SOURce?")

```

```

DoCommand ":MEASure:FREQuency"
varQueryResult = DoQueryNumber(":MEASure:FREQuency?")
MsgBox "Frequency:" + vbCrLf + _
    FormatNumber(varQueryResult / 1000, 4) + " kHz"

DoCommand ":MEASure:VAMPlitude"
varQueryResult = DoQueryNumber(":MEASure:VAMPlitude?")
MsgBox "Vertical amplitude:" + vbCrLf + _
    FormatNumber(varQueryResult, 4) + " V"

' Download the screen image.
' -----
' Get screen image.
Dim byteData() As Byte
byteData = DoQueryIEEEBlock_UI1(":DISPlay:DATA? PNG")

' Save screen image to a file.
Dim strPath As String
strPath = "c:\scope\data\screen.png"
If Len(Dir(strPath)) Then
    Kill strPath ' Remove file if it exists.
End If

Dim hFile As Long
hFile = FreeFile
Open strPath For Binary Access Write Lock Write As hFile
Put hFile, , byteData ' Write data.
Close hFile ' Close file.
MsgBox "Screen image (" + CStr(UBound(byteData) + 1) + _
    " bytes) written to " + strPath

' Download waveform data.
' -----
' Get the waveform type.
Debug.Print "Waveform type: " + _
    DoQueryString(":WAVEform:TYPE?")

' Get the number of waveform points.
Debug.Print "Waveform points available: " + _
    DoQueryString(":WAVEform:POINTS?")

' Set the waveform source.
DoCommand ":WAVEform:SOURce CHANnel1"
Debug.Print "Waveform source: " + _
    DoQueryString(":WAVEform:SOURce?")

' Choose the format of the data returned:
DoCommand ":WAVEform:FORMat WORD"
Debug.Print "Waveform format: " + _
    DoQueryString(":WAVEform:FORMat?")

' Display the waveform settings from preamble:
Dim Preamble()

```

```

Dim intFormat As Integer
Dim intType As Integer
Dim lngPoints As Long
Dim lngCount As Long
Dim dblXIncrement As Double
Dim dblXOrigin As Double
Dim lngXReference As Long
Dim sngYIncrement As Single
Dim sngYOrigin As Single
Dim lngYReference As Long
Dim intCoupling As Integer
Dim dblXDispRange As Double
Dim dblXDispOrigin As Double
Dim dblYDispRange As Double
Dim dblYDispOrigin As Double
Dim strDate As String
Dim strTime As String
Dim strFrameModel As String
Dim intAcqMode As Integer
Dim intCompletion As Integer
Dim intXUnits As Integer
Dim intYUnits As Integer
Dim dblMaxBwLimit As Double
Dim dblMinBwLimit As Double

Dim dctWavFormat As Scripting.Dictionary
Set dctWavFormat = New Scripting.Dictionary
dctWavFormat.Add 0, "ASCII"
dctWavFormat.Add 1, "BYTE"
dctWavFormat.Add 2, "WORD"
dctWavFormat.Add 3, "LONG"
dctWavFormat.Add 4, "LONGLONG"

Dim dctAcqType As Scripting.Dictionary
Set dctAcqType = New Scripting.Dictionary
dctAcqType.Add 1, "RAW"
dctAcqType.Add 2, "AVERAGE"
dctAcqType.Add 3, "VHISTogram"
dctAcqType.Add 4, "HHISTogram"
dctAcqType.Add 6, "INTERpolate"
dctAcqType.Add 10, "PDETECT"

Dim dctAcqMode As Scripting.Dictionary
Set dctAcqMode = New Scripting.Dictionary
dctAcqMode.Add 0, "RTIME"
dctAcqMode.Add 1, "ETIME"
dctAcqMode.Add 3, "PDETECT"

Dim dctCoupling As Scripting.Dictionary
Set dctCoupling = New Scripting.Dictionary
dctCoupling.Add 0, "AC"
dctCoupling.Add 1, "DC"
dctCoupling.Add 2, "DCFIFTY"
dctCoupling.Add 3, "LFREJECT"

Dim dctUnits As Scripting.Dictionary
Set dctUnits = New Scripting.Dictionary

```

```

dctUnits.Add 0, "UNKNOWN"
dctUnits.Add 1, "VOLT"
dctUnits.Add 2, "SECOND"
dctUnits.Add 3, "CONSTANT"
dctUnits.Add 4, "AMP"
dctUnits.Add 5, "DECIBEL"

Preamble() = DoQueryNumbers(":WAVEform:PREamble?")

intFormat = Preamble(0)
intType = Preamble(1)
lngPoints = Preamble(2)
lngCount = Preamble(3)
dblXIncrement = Preamble(4)
dblXOrigin = Preamble(5)
lngXReference = Preamble(6)
sngYIncrement = Preamble(7)
sngYOrigin = Preamble(8)
lngYReference = Preamble(9)
intCoupling = Preamble(10)
dblXDispRange = Preamble(11)
dblXDispOrigin = Preamble(12)
dblYDispRange = Preamble(13)
dblYDispOrigin = Preamble(14)
strDate = Preamble(15)
strTime = Preamble(16)
strFrameModel = Preamble(17)
intAcqMode = Preamble(18)
intCompletion = Preamble(19)
intXUnits = Preamble(20)
intYUnits = Preamble(21)
dblMaxBwLimit = Preamble(22)
dblMinBwLimit = Preamble(23)

Debug.Print "Waveform format: " + dctWavFormat.Item(intFormat)
Debug.Print "Acquisition type: " + dctAcqType.Item(intType)

Debug.Print "Waveform points desired: " + _
    FormatNumber(lngPoints, 0)

Debug.Print "Waveform average count: " + _
    FormatNumber(lngCount, 0)

Debug.Print "Waveform X increment: " + _
    Format(dblXIncrement, "Scientific")

Debug.Print "Waveform X origin: " + _
    Format(dblXOrigin, "Scientific")

Debug.Print "Waveform X reference: " + _
    FormatNumber(lngXReference, 0)

Debug.Print "Waveform Y increment: " + _
    Format(sngYIncrement, "Scientific")

Debug.Print "Waveform Y origin: " + _
    FormatNumber(sngYOrigin, 0)

```



```

Debug.Print "Waveform Y reference: " + _
    FormatNumber(lngYReference, 0)

Debug.Print "Coupling: " + dctCoupling.Item(intCoupling)

Debug.Print "Waveform X display range: " + _
    Format(dblXDispRange, "Scientific")

Debug.Print "Waveform X display origin: " + _
    Format(dblXDispOrigin, "Scientific")

Debug.Print "Waveform Y display range: " + _
    Format(dblYDispRange, "Scientific")

Debug.Print "Waveform Y display origin: " + _
    Format(dblYDispOrigin, "Scientific")

Debug.Print "Date: " + strDate
Debug.Print "Time: " + strTime
Debug.Print "Frame model: " + strFrameModel
Debug.Print "Acquire mode: " + dctAcqMode.Item(intAcqMode)

Debug.Print "Completion pct: " + _
    FormatNumber(intCompletion, 0)

Debug.Print "Waveform X units: " + dctUnits.Item(intXUnits)
Debug.Print "Waveform Y units: " + dctUnits.Item(intYUnits)

Debug.Print "Max BW limit: " + _
    Format(dblMaxBwLimit, "Scientific")

Debug.Print "Min BW limit: " + _
    Format(dblMinBwLimit, "Scientific")

' Get the waveform data.
DoCommand ":WAVEform:STReaming OFF"
varQueryResult = DoQueryIEEEBlock_I2(":WAVEform:DATA?")
Debug.Print "Number of data values: " + _
    CStr(UBound(varQueryResult) + 1)

' Set up output file:
strPath = "c:\scope\data\waveform_data.csv"

' Open file for output.
Open strPath For Output Access Write Lock Write As hFile

' Output waveform data in CSV format.
Dim lngDataValue As Long
Dim lngI As Long

For lngI = 0 To UBound(varQueryResult)
    lngDataValue = varQueryResult(lngI)

    ' Write time value, voltage value.
    Print #hFile, _
        FormatNumber(dblXOrigin + (lngI * dblXIncrement), 9) + _

```

```

        ", " + _
        FormatNumber((lngDataValue * sngYIncrement) + sngYOrigin)

    Next lngI

    ' Close output file.
    Close hFile ' Close file.
    MsgBox "Waveform format WORD data written to " + _
        "c:\scope\data\waveform_data.csv."

    Exit Sub

VisaComError:
    MsgBox "VISA COM Error:" + vbCrLf + Err.Description
    End

End Sub

Private Sub DoCommand(command As String)

    On Error GoTo VisaComError

    myScope.WriteString command
    CheckInstrumentErrors

    Exit Sub

VisaComError:
    MsgBox "VISA COM Error: " + vbCrLf + CStr(Err.Number) + ", " + _
        Err.Source + ", " + _
        Err.Description, vbExclamation, "VISA COM Error"
    End

End Sub

Private Sub DoCommandIEEEBlock(command As String, data As Variant)

    On Error GoTo VisaComError

    Dim strErrors As String

    myScope.WriteIEEEBlock command, data
    CheckInstrumentErrors

    Exit Sub

VisaComError:
    MsgBox "VISA COM Error: " + vbCrLf + CStr(Err.Number) + ", " + _
        Err.Source + ", " + _
        Err.Description, vbExclamation, "VISA COM Error"
    End

End Sub

Private Function DoQueryString(query As String) As String

    On Error GoTo VisaComError

```

```

myScope.WriteString query
DoQueryString = myScope.ReadString
CheckInstrumentErrors

Exit Function

VisaComError:
MsgBox "VISA COM Error: " + vbCrLf + CStr(Err.Number) + ", " + _
    Err.Source + ", " + _
    Err.Description, vbExclamation, "VISA COM Error"
End

End Function

Private Function DoQueryNumber(query As String) As Variant

    On Error GoTo VisaComError

    myScope.WriteString query
    DoQueryNumber = myScope.ReadNumber
    CheckInstrumentErrors

    Exit Function

VisaComError:
MsgBox "VISA COM Error: " + vbCrLf + CStr(Err.Number) + ", " + _
    Err.Source + ", " + _
    Err.Description, vbExclamation, "VISA COM Error"
End

End Function

Private Function DoQueryNumbers(query As String) As Variant()

    On Error GoTo VisaComError

    Dim strErrors As String

    myScope.WriteString query
    DoQueryNumbers = myScope.ReadList
    CheckInstrumentErrors

    Exit Function

VisaComError:
MsgBox "VISA COM Error: " + vbCrLf + CStr(Err.Number) + ", " + _
    Err.Source + ", " + _
    Err.Description, vbExclamation, "VISA COM Error"
End

End Function

Private Function DoQueryIEEEBlock_UI1(query As String) As Variant

    On Error GoTo VisaComError

```

```

myScope.WriteString query
DoQueryIEEEBlock_UI1 = myScope.ReadIEEEBlock(BinaryType_UI1)
CheckInstrumentErrors

Exit Function

VisaComError:
MsgBox "VISA COM Error: " + vbCrLf + CStr(Err.Number) + ", " + _
    Err.Source + ", " + _
    Err.Description, vbExclamation, "VISA COM Error"
End

End Function

Private Function DoQueryIEEEBlock_I2(query As String) As Variant

On Error GoTo VisaComError

myScope.WriteString query
DoQueryIEEEBlock_I2 = myScope.ReadIEEEBlock(BinaryType_I2)
CheckInstrumentErrors

Exit Function

VisaComError:
MsgBox "VISA COM Error: " + vbCrLf + CStr(Err.Number) + ", " + _
    Err.Source + ", " + _
    Err.Description, vbExclamation, "VISA COM Error"
End

End Function

Private Sub CheckInstrumentErrors()

On Error GoTo VisaComError

Dim strErrVal As String
Dim strOut As String

myScope.WriteString ":SYSTEM:ERROR? STRING" ' Query any errors data.
strErrVal = myScope.ReadString ' Read: Errnum,"Error String".
While Val(strErrVal) <> 0 ' End if find: 0,"No Error".
    strOut = strOut + "INST Error: " + strErrVal
    myScope.WriteString ":SYSTEM:ERROR? STRING" ' Request error message.
    strErrVal = myScope.ReadString ' Read error message.
Wend

If Not strOut = "" Then
    MsgBox strOut, vbExclamation, "INST Error Messages"
    myScope.FlushWrite (False)
    myScope.FlushRead

End If

Exit Sub

VisaComError:

```

```

        MsgBox "VISA COM Error: " + vbCrLf + Err.Description
    End Sub

```

VISA COM Example in C#

To compile and run this example in Microsoft Visual Studio 2008:

- 1 Open Visual Studio.
- 2 Create a new Visual C#, Windows, Console Application project.
- 3 Cut-and-paste the code that follows into the C# source file.
- 4 Edit the program to use the VISA address of your oscilloscope.
- 5 Add a reference to the VISA COM 3.0 Type Library:
 - a Right-click the project you wish to modify (not the solution) in the Solution Explorer window of the Microsoft Visual Studio environment.
 - b Choose **Add Reference...**
 - c In the Add Reference dialog, select the **COM** tab.
 - d Select **VISA COM 5.5 Type Library**; then click **OK**.
- 6 Build and run the program.

For more information, see the VISA COM Help that comes with Keysight IO Libraries Suite 15.

```

/*
 * Keysight VISA COM Example in C#
 * -----
 * This program illustrates a few commonly used programming
 * features of your Keysight Infiniium Series oscilloscope.
 * -----
 */

using System;
using System.IO;
using System.Text;
using System.Collections.Generic;
using Ivi.Visa.Interop;
using System.Runtime.InteropServices;

namespace Infiniium
{
    class VisaComInstrumentApp
    {
        private static VisaComInstrument myScope;

        public static void Main(string[] args)
        {
            try
            {
                myScope = new
                    VisaComInstrument ("TCPIP0::141.121.237.226::hislip0::INSTR");
            }
        }
    }
}

```

```

myScope.SetTimeoutSeconds(10);

// Initialize - start from a known state.
Initialize();

// Capture data.
Capture();

// Analyze the captured waveform.
Analyze();

Console.WriteLine("Press any key to exit");
Console.ReadKey();
}
catch (System.ApplicationException err)
{
    Console.WriteLine("*** VISA COM Error : " + err.Message);
}
catch (System.SystemException err)
{
    Console.WriteLine("*** System Error Message : " + err.Message);
}
catch (System.Exception err)
{
    System.Diagnostics.Debug.Fail("Unexpected Error");
    Console.WriteLine("*** Unexpected Error : " + err.Message);
}
finally
{
    myScope.Close();
}
}

/*
 * Initialize the oscilloscope to a known state.
 * -----
 */
private static void Initialize()
{
    string strResults;

    // Clear status.
    myScope.DoCommand("*CLS");

    // Get and display the device's *IDN? string.
    strResults = myScope.DoQueryString("*IDN?");
    Console.WriteLine("*IDN? result is: {0}", strResults);

    // Load the default setup.
    myScope.DoCommand("*RST");
}

/*
 * Capture the waveform.
 * -----
 */
private static void Capture()

```

```

{
    // Set probe attenuation factor.
    myScope.DoCommand(":CHANnel1:PROBE 1.0");
    Console.WriteLine("Channel 1 probe attenuation factor: {0}",
        myScope.DoQueryString(":CHANnel1:PROBE?"));

    // Use auto-scale to automatically set up oscilloscope.
    myScope.DoCommand(":AUToscale");

    // Set trigger mode.
    myScope.DoCommand(":TRIGger:MODE EDGE");
    Console.WriteLine("Trigger mode: {0}",
        myScope.DoQueryString(":TRIGger:MODE?"));

    // Set EDGE trigger parameters.
    myScope.DoCommand(":TRIGger:EDGE:SOURCe CHANnel1");
    Console.WriteLine("Trigger edge source: {0}",
        myScope.DoQueryString(":TRIGger:EDGE:SOURce?"));

    myScope.DoCommand(":TRIGger:LEVel CHANnel1,-2E-3");
    Console.WriteLine("Trigger level, channel 1: {0}",
        myScope.DoQueryString(":TRIGger:LEVel? CHANnel1"));

    myScope.DoCommand(":TRIGger:EDGE:SLOPe POSitive");
    Console.WriteLine("Trigger edge slope: {0}",
        myScope.DoQueryString(":TRIGger:EDGE:SLOPe?"));

    // Save oscilloscope setup.
    byte[] ResultsArray; // Results array.
    int nLength; // Number of bytes returned from instrument.
    string strPath;

    // Query and read setup string.
    ResultsArray = myScope.DoQueryIEEEBlock_UI1(":SYSTem:SETup?");
    nLength = ResultsArray.Length;

    // Write setup string to file.
    strPath = "c:\\scope\\config\\setup.stp";
    FileStream fStream = File.Open(strPath, FileMode.Create);
    fStream.Write(ResultsArray, 0, nLength);
    fStream.Close();
    Console.WriteLine("Setup bytes saved: {0}", nLength);

    // Change settings with individual commands:

    // Set vertical scale and offset.
    myScope.DoCommand(":CHANnel1:SCALe 0.1");
    Console.WriteLine("Channel 1 vertical scale: {0}",
        myScope.DoQueryString(":CHANnel1:SCALe?"));

    myScope.DoCommand(":CHANnel1:OFFSet 0.0");
    Console.WriteLine("Channel 1 vertical offset: {0}",
        myScope.DoQueryString(":CHANnel1:OFFSet?"));

    // Set horizontal scale and offset.
    myScope.DoCommand(":TIMEbase:SCALe 0.0002");
    Console.WriteLine("Timebase scale: {0}",

```

```

        myScope.DoQueryString(":TIMEbase:SCALE?"));

myScope.DoCommand(":TIMEbase:POSition 0.0");
Console.WriteLine("Timebase position: {0}",
    myScope.DoQueryString(":TIMEbase:POSition?"));

// Set the acquisition mode.
myScope.DoCommand(":ACquire:MODE RTIME");
Console.WriteLine("Acquire mode: {0}",
    myScope.DoQueryString(":ACquire:MODE?"));

// Or, configure by loading a previously saved setup.
byte[] dataArray;
int nBytesWritten;

// Read setup string from file.
strPath = "c:\\scope\\config\\setup.stp";
dataArray = File.ReadAllBytes(strPath);
nBytesWritten = dataArray.Length;

// Restore setup string.
myScope.DoCommandIEEEBlock(":SYSTem:SETup", dataArray);
Console.WriteLine("Setup bytes restored: {0}", nBytesWritten);

// Set the desired number of waveform points,
// and capture an acquisition.
myScope.DoCommand(":ACquire:POINTs 32000");
myScope.DoCommand(":DIGitize");
}

/*
 * Analyze the captured waveform.
 * -----
 */
private static void Analyze()
{
    byte[] resultsArray; // Results array.
    int nLength; // Number of bytes returned from instrument.
    string strPath;

    // Make measurements.
    // -----
    myScope.DoCommand(":MEASure:SOURce CHANnel1");
    Console.WriteLine("Measure source: {0}",
        myScope.DoQueryString(":MEASure:SOURce?"));

    double fResult;
    myScope.DoCommand(":MEASure:FREquency");
    fResult = myScope.DoQueryNumber(":MEASure:FREquency?");
    Console.WriteLine("Frequency: {0:F4} kHz", fResult / 1000);

    myScope.DoCommand(":MEASure:VAMplitude");
    fResult = myScope.DoQueryNumber(":MEASure:VAMplitude?");
    Console.WriteLine("Vertical amplitude: {0:F2} V", fResult);

    // Download the screen image.
    // -----

```



```

// Get the screen data.
ResultsArray =
    myScope.DoQueryIEEEBlock_UI1(":DISPlay:DATA? PNG");
nLength = ResultsArray.Length;

// Store the screen data to a file.
strPath = "c:\\scope\\data\\screen.png";
FileStream fStream = File.Open(strPath, FileMode.Create);
fStream.Write(ResultsArray, 0, nLength);
fStream.Close();
Console.WriteLine("Screen image ({0} bytes) written to {1}",
    nLength, strPath);

// Download waveform data.
// -----

// Get the waveform points mode.
Console.WriteLine("Waveform type: {0}",
    myScope.DoQueryString(":WAVEform:TYPE?"));

// Get the number of waveform points.
Console.WriteLine("Waveform points: {0}",
    myScope.DoQueryString(":WAVEform:POINTs?"));

// Set the waveform source.
myScope.DoCommand(":WAVEform:SOURce CHANnel1");
Console.WriteLine("Waveform source: {0}",
    myScope.DoQueryString(":WAVEform:SOURce?"));

// Choose the format of the data returned:
myScope.DoCommand(":WAVEform:FORMat WORD");
Console.WriteLine("Waveform format: {0}",
    myScope.DoQueryString(":WAVEform:FORMat?"));

// Display the waveform settings from preamble:
Dictionary<string, string> dctWavFormat =
    new Dictionary<string, string>()
    {
        {"0", "ASCIi"},
        {"1", "BYTE"},
        {"2", "WORD"},
        {"3", "LONG"},
        {"4", "LONGLONG"},
    };
Dictionary<string, string> dctAcqType =
    new Dictionary<string, string>()
    {
        {"1", "RAW"},
        {"2", "AVERAge"},
        {"3", "VHIStogram"},
        {"4", "HHIStogram"},
        {"6", "INTerpolate"},
        {"10", "PDETECT"},
    };
Dictionary<string, string> dctAcqMode =
    new Dictionary<string, string>()

```

```

{
    {"0", "RTIME"},
    {"1", "ETIME"},
    {"3", "PDETECT"},
};
Dictionary<string, string> dctCoupling =
    new Dictionary<string, string>()
{
    {"0", "AC"},
    {"1", "DC"},
    {"2", "DCFIFTY"},
    {"3", "LFREJECT"},
};
Dictionary<string, string> dctUnits =
    new Dictionary<string, string>()
{
    {"0", "UNKNOWN"},
    {"1", "VOLT"},
    {"2", "SECOND"},
    {"3", "CONSTANT"},
    {"4", "AMP"},
    {"5", "DECIBEL"},
};
string strPreamble;
string[] strspreamble;

strPreamble = myScope.DoQueryString(":WAVEFORM:PREAmble?");
strspreamble = strPreamble.Split(',');

Console.WriteLine("Waveform format: {0}",
    dctWavFormat[strspreamble[0]]);

Console.WriteLine("Acquire type: {0}",
    dctAcqType[strspreamble[1]]);

Console.WriteLine("Waveform points: {0}", strspreamble[2]);
Console.WriteLine("Waveform average count: {0}", strspreamble[3]);
Console.WriteLine("Waveform X increment: {0}", strspreamble[4]);
Console.WriteLine("Waveform X origin: {0}", strspreamble[5]);
Console.WriteLine("Waveform X reference: {0}", strspreamble[6]);
Console.WriteLine("Waveform Y increment: {0}", strspreamble[7]);
Console.WriteLine("Waveform Y origin: {0}", strspreamble[8]);
Console.WriteLine("Waveform Y reference: {0}", strspreamble[9]);
Console.WriteLine("Coupling: {0}", dctCoupling[strspreamble[10]]);
Console.WriteLine("Waveform X display range: {0}",
    strspreamble[11]);
Console.WriteLine("Waveform X display origin: {0}",
    strspreamble[12]);
Console.WriteLine("Waveform Y display range: {0}",
    strspreamble[13]);
Console.WriteLine("Waveform Y display origin: {0}",
    strspreamble[14]);
Console.WriteLine("Date: {0}", strspreamble[15]);
Console.WriteLine("Time: {0}", strspreamble[16]);
Console.WriteLine("Frame model: {0}", strspreamble[17]);
Console.WriteLine("Acquire mode: {0}",
    dctAcqMode[strspreamble[18]]);

```

```

Console.WriteLine("Completion pct: {0}", strsPreamble[19]);
Console.WriteLine("Waveform X inits: {0}",
    dctUnits[strsPreamble[20]]);
Console.WriteLine("Waveform Y units: {0}",
    dctUnits[strsPreamble[21]]);
Console.WriteLine("Max BW limit: {0}", strsPreamble[22]);
Console.WriteLine("Min BW limit: {0}", strsPreamble[23]);

// Get numeric values for later calculations.
double fXincrement;
fXincrement = myScope.DoQueryNumber(":WAVEform:XINCrement?");
double fXorigin;
fXorigin = myScope.DoQueryNumber(":WAVEform:XORigin?");
double fYincrement;
fYincrement = myScope.DoQueryNumber(":WAVEform:YINCrement?");
double fYorigin;
fYorigin = myScope.DoQueryNumber(":WAVEform:YORigin?");

// Get the waveform data.
myScope.DoCommand(":WAVEform:STReaming OFF");
short[] WordDataArray; // Results array.
WordDataArray = myScope.DoQueryIEEEBlock_I2(":WAVEform:DATA?");
nLength = WordDataArray.Length;
Console.WriteLine("Number of data values: {0}", nLength);

// Set up output file:
strPath = "c:\\scope\\data\\waveform_data.csv";
if (File.Exists(strPath)) File.Delete(strPath);

// Open file for output.
StreamWriter writer = File.CreateText(strPath);

// Output waveform data in CSV format.
for (int i = 0; i < nLength - 1; i++)
    writer.WriteLine("{0:f9}, {1:f6}",
        fXorigin + ((float)i * fXincrement),
        (((float)WordDataArray[i]
            * fYincrement) + fYorigin));

// Close output file.
writer.Close();
Console.WriteLine("Waveform format WORD data written to {0}",
    strPath);
}
}

class VisaComInstrument
{
    private ResourceManagerClass m_ResourceManager;
    private FormattedIO488Class m_IoObject;
    private string m_strVisaAddress;

    // Constructor.
    public VisaComInstrument(string strVisaAddress)
    {
        // Save VISA address in member variable.
        m_strVisaAddress = strVisaAddress;
    }
}

```

```

        // Open the default VISA COM IO object.
        OpenIo();

        // Clear the interface.
        m_IoObject.IO.Clear();
    }

    public void DoCommand(string strCommand)
    {
        // Send the command.
        m_IoObject.WriteString(strCommand, true);

        // Check for inst errors.
        CheckInstrumentErrors(strCommand);
    }

    public void DoCommandIEEEBlock(string strCommand,
        byte[] dataArray)
    {
        // Send the command to the device.
        m_IoObject.WriteIEEEBlock(strCommand, dataArray, true);

        // Check for inst errors.
        CheckInstrumentErrors(strCommand);
    }

    public string DoQueryString(string strQuery)
    {
        // Send the query.
        m_IoObject.WriteString(strQuery, true);

        // Get the result string.
        string strResults;
        strResults = m_IoObject.ReadString();

        // Check for inst errors.
        CheckInstrumentErrors(strQuery);

        // Return results string.
        return strResults;
    }

    public double DoQueryNumber(string strQuery)
    {
        // Send the query.
        m_IoObject.WriteString(strQuery, true);

        // Get the result number.
        double fResult;
        fResult = (double)m_IoObject.ReadNumber(
            IEEEASCIIType.ASCIIType_R8, true);

        // Check for inst errors.
        CheckInstrumentErrors(strQuery);

        // Return result number.
    }

```

```

    return fResult;
}

public double[] DoQueryNumbers(string strQuery)
{
    // Send the query.
    m_JsonObject.WriteString(strQuery, true);

    // Get the result numbers.
    double[] fResultsArray;
    fResultsArray = (double[])m_JsonObject.ReadList(
        IEEEASCIIType.ASCIIType_R8, ",;");

    // Check for inst errors.
    CheckInstrumentErrors(strQuery);

    // Return result numbers.
    return fResultsArray;
}

public byte[] DoQueryIEEEBlock_UI1(string strQuery)
{
    // Send the query.
    m_JsonObject.WriteString(strQuery, true);

    // Get the results array.
    System.Threading.Thread.Sleep(2000); // Delay before reading.
    byte[] ResultsArray;
    ResultsArray = (byte[])m_JsonObject.ReadIEEEBlock(
        IEEEBinaryType.BinaryType_UI1, false, true);

    // Check for inst errors.
    CheckInstrumentErrors(strQuery);

    // Return results array.
    return ResultsArray;
}

public short[] DoQueryIEEEBlock_I2(string strQuery)
{
    // Send the query.
    m_JsonObject.WriteString(strQuery, true);

    // Get the results array.
    System.Threading.Thread.Sleep(2000); // Delay before reading.
    short[] ResultsArray;
    ResultsArray = (short[])m_JsonObject.ReadIEEEBlock(
        IEEEBinaryType.BinaryType_I2, false, true);

    // Check for inst errors.
    CheckInstrumentErrors(strQuery);

    // Return results array.
    return ResultsArray;
}

private void CheckInstrumentErrors(string strCommand)

```

```

{
    // Check for instrument errors.
    string strInstrumentError;
    bool bFirstError = true;

    do    // While not "0,No error".
    {
        m_JsonObject.WriteString(":SYSTEM:ERROR? STRing", true);
        strInstrumentError = m_JsonObject.ReadString();

        if (!strInstrumentError.ToString().StartsWith("0, "))
        {
            if (bFirstError)
            {
                Console.WriteLine("ERROR(s) for command '{0}': ",
                    strCommand);
                bFirstError = false;
            }
            Console.Write(strInstrumentError);
        }
    } while (!strInstrumentError.ToString().StartsWith("0, "));
}

private void OpenIo()
{
    m_ResourceManager = new ResourceManagerClass();
    m_JsonObject = new FormattedIO488Class();

    // Open the default VISA COM IO object.
    try
    {
        m_JsonObject.IO =
            (IMessage)m_ResourceManager.Open(m_strVisaAddress,
                AccessMode.NO_LOCK, 0, "");
    }
    catch (Exception e)
    {
        Console.WriteLine("An error occurred: {0}", e.Message);
    }
}

public void SetTimeoutSeconds(int nSeconds)
{
    m_JsonObject.IO.Timeout = nSeconds * 1000;
}

public void Close()
{
    try
    {
        m_JsonObject.IO.Close();
    }
    catch { }

    try
    {
        Marshal.ReleaseComObject(m_JsonObject);
    }
}

```

```

    }
    catch { }

    try
    {
        Marshal.ReleaseComObject (m_ResourceManager);
    }
    catch { }
}
}
}

```

VISA COM Example in Visual Basic .NET

To compile and run this example in Microsoft Visual Studio 2008:

- 1 Open Visual Studio.
- 2 Create a new Visual Basic, Windows, Console Application project.
- 3 Cut-and-paste the code that follows into the Visual Basic source file.
- 4 Edit the program to use the VISA address of your oscilloscope.
- 5 Add a reference to the VISA COM 3.0 Type Library:
 - a Right-click the project you wish to modify (not the solution) in the Solution Explorer window of the Microsoft Visual Studio environment.
 - b Choose **Add Reference...**
 - c In the Add Reference dialog, select the **COM** tab.
 - d Select **VISA COM 5.5 Type Library**; then click **OK**.
 - e Right-click the project you wish to modify (not the solution) in the Solution Explorer window of the Microsoft Visual Studio environment and choose **Properties**; then, select "Infiniium.VisaComInstrumentApp" as the **Startup object**.
- 6 Build and run the program.

For more information, see the VISA COM Help that comes with Keysight IO Libraries Suite 15.

```

'
' Keysight VISA COM Example in Visual Basic .NET
' -----
' This program illustrates a few commonly used programming
' features of your Keysight Infiniium Series oscilloscope.
' -----

Imports System
Imports System.IO
Imports System.Text
Imports System.Collections.Generic
Imports Ivi.Visa.Interop
Imports System.Runtime.InteropServices

```

```

Namespace Infiniium
Class VisaComInstrumentApp
  Private Shared myScope As VisaComInstrument

  Public Shared Sub Main(ByVal args As String())
    Try
      myScope = New _
        VisaComInstrument("TCPIP0::141.121.237.226::hislip0::INSTR")
      myScope.SetTimeoutSeconds(10)

      ' Initialize - start from a known state.
      Initialize()

      ' Capture data.
      Capture()

      ' Analyze the captured waveform.
      Analyze()

    Catch err As System.ApplicationException
      Console.WriteLine("*** VISA Error Message : " + err.Message)
    Catch err As System.SystemException
      Console.WriteLine("*** System Error Message : " + err.Message)
    Catch err As System.Exception
      System.Diagnostics.Debug.Fail("Unexpected Error")
      Console.WriteLine("*** Unexpected Error : " + err.Message)
    Finally
      myScope.Close()
    End Try
  End Sub

  ' Initialize the oscilloscope to a known state.
  ' -----

  Private Shared Sub Initialize()
    Dim strResults As String

    ' Clear status.
    myScope.DoCommand("*CLS")

    ' Get and display the device's *IDN? string.
    strResults = myScope.DoQueryString("*IDN?")
    Console.WriteLine("*IDN? result is: {0}", strResults)

    ' Load the default setup.
    myScope.DoCommand("*RST")

  End Sub

  ' Capture the waveform.
  ' -----

  Private Shared Sub Capture()

    ' Set probe attenuation factor.
    myScope.DoCommand(":CHANnel1:PROBe 1.0")
    Console.WriteLine("Channel 1 probe attenuation factor: {0}", _

```



```

myScope.DoQueryString(":CHANnel1:PROBE?")

' Use auto-scale to automatically configure oscilloscope.
myScope.DoCommand(":AUToscale")

' Set trigger mode.
myScope.DoCommand(":TRIGger:MODE EDGE")
Console.WriteLine("Trigger mode: {0}", _
    myScope.DoQueryString(":TRIGger:MODE?"))

' Set EDGE trigger parameters.
myScope.DoCommand(":TRIGger:EDGE:SOURCe CHANnel1")
Console.WriteLine("Trigger edge source: {0}", _
    myScope.DoQueryString(":TRIGger:EDGE:SOURce?"))

myScope.DoCommand(":TRIGger:LEVel CHANnel1,-2E-3")
Console.WriteLine("Trigger level, channel 1: {0}", _
    myScope.DoQueryString(":TRIGger:LEVel? CHANnel1"))

myScope.DoCommand(":TRIGger:EDGE:SLOPe POSitive")
Console.WriteLine("Trigger edge slope: {0}", _
    myScope.DoQueryString(":TRIGger:EDGE:SLOPe?"))

' Save oscilloscope configuration.
Dim ResultsArray As Byte() ' Results array.
Dim nLength As Integer ' Number of bytes returned from inst.
Dim strPath As String
Dim fStream As FileStream

' Query and read setup string.
ResultsArray = myScope.DoQueryIEEEBlock_UI1(":SYSTem:SETup?")
nLength = ResultsArray.Length

' Write setup string to file.
strPath = "c:\scope\config\setup.stp"
fStream = File.Open(strPath, FileMode.Create)
fStream.Write(ResultsArray, 0, nLength)
fStream.Close()
Console.WriteLine("Setup bytes saved: {0}", nLength)

' Change settings with individual commands:

' Set vertical scale and offset.
myScope.DoCommand(":CHANnel1:SCALe 0.1")
Console.WriteLine("Channel 1 vertical scale: {0}", _
    myScope.DoQueryString(":CHANnel1:SCALe?"))

myScope.DoCommand(":CHANnel1:OFFSet 0.0")
Console.WriteLine("Channel 1 vertical offset: {0}", _
    myScope.DoQueryString(":CHANnel1:OFFSet?"))

' Set horizontal scale and offset.
myScope.DoCommand(":TIMebase:SCALe 0.0002")
Console.WriteLine("Timebase scale: {0}", _
    myScope.DoQueryString(":TIMebase:SCALe?"))

myScope.DoCommand(":TIMebase:POSition 0.0")

```

```

Console.WriteLine("Timebase position: {0}", _
    myScope.DoQueryString(":TIMEbase:POSition?"))

' Set the acquisition mode.
myScope.DoCommand(":ACquire:MODE RTIME")
Console.WriteLine("Acquire mode: {0}", _
    myScope.DoQueryString(":ACquire:MODE?"))

' Or, configure by loading a previously saved setup.
Dim dataArray As Byte()
Dim nBytesWritten As Integer

' Read setup string from file.
strPath = "c:\scope\config\setup.stp"
dataArray = File.ReadAllBytes(strPath)
nBytesWritten = dataArray.Length

' Restore setup string.
myScope.DoCommandIEEEBlock(":SYSTem:SETup", dataArray)
Console.WriteLine("Setup bytes restored: {0}", nBytesWritten)

' Set the desired number of waveform points,
' and capture an acquisition.
myScope.DoCommand(":ACquire:POINts 32000")
myScope.DoCommand(":DIGitize")

End Sub

' Analyze the captured waveform.
' -----

Private Shared Sub Analyze()

    Dim fResult As Double
    Dim ResultsArray As Byte() ' Results array.
    Dim nLength As Integer ' Number of bytes returned from inst.
    Dim strPath As String

    ' Make measurements.
    ' -----
    myScope.DoCommand(":MEASure:SOURce CHANnel1")
    Console.WriteLine("Measure source: {0}", _
        myScope.DoQueryString(":MEASure:SOURce?"))

    myScope.DoCommand(":MEASure:FREQuency")
    fResult = myScope.DoQueryNumber(":MEASure:FREQuency?")
    Console.WriteLine("Frequency: {0:F4} kHz", fResult / 1000)

    myScope.DoCommand(":MEASure:VAMPlitude")
    fResult = myScope.DoQueryNumber(":MEASure:VAMPlitude?")
    Console.WriteLine("Vertical amplitude: {0:F2} V", fResult)

    ' Download the screen image.
    ' -----

    ' Get the screen data.
    ResultsArray = myScope.DoQueryIEEEBlock_UI1(":DISPlay:DATA? PNG")

```

```

nLength = ResultsArray.Length

' Store the screen data to a file.
strPath = "c:\scope\data\screen.png"
Dim fStream As FileStream
fStream = File.Open(strPath, FileMode.Create)
fStream.Write(ResultsArray, 0, nLength)
fStream.Close()
Console.WriteLine("Screen image ({0} bytes) written to {1}", _
    nLength, strPath)

' Download waveform data.
' -----

' Get the waveform type.
Console.WriteLine("Waveform type: {0}", _
    myScope.DoQueryString(":WAVEform:TYPE?"))

' Get the number of waveform points.
Console.WriteLine("Waveform points: {0}", _
    myScope.DoQueryString(":WAVEform:POINTs?"))

' Set the waveform source.
myScope.DoCommand(":WAVEform:SOURce CHANnel")
Console.WriteLine("Waveform source: {0}", _
    myScope.DoQueryString(":WAVEform:SOURce?"))

' Choose the format of the data returned:
myScope.DoCommand(":WAVEform:FORMat WORD")
Console.WriteLine("Waveform format: {0}", _
    myScope.DoQueryString(":WAVEform:FORMat?"))

' Display the waveform settings from preamble:
Dim dctWavFormat As New Dictionary(Of String, String)
dctWavFormat.Add("0", "ASCIi")
dctWavFormat.Add("1", "BYTE")
dctWavFormat.Add("2", "WORD")
dctWavFormat.Add("3", "LONG")
dctWavFormat.Add("4", "LONGLONG")

Dim dctAcqType As New Dictionary(Of String, String)
dctAcqType.Add("1", "RAW")
dctAcqType.Add("2", "AVERage")
dctAcqType.Add("3", "VHISTogram")
dctAcqType.Add("4", "HHISTogram")
dctAcqType.Add("6", "INTerpolate")
dctAcqType.Add("10", "PDETECT")

Dim dctAcqMode As New Dictionary(Of String, String)()
dctAcqMode.Add("0", "RTIME")
dctAcqMode.Add("1", "ETIME")
dctAcqMode.Add("3", "PDETECT")

Dim dctCoupling As New Dictionary(Of String, String)()
dctCoupling.Add("0", "AC")
dctCoupling.Add("1", "DC")
dctCoupling.Add("2", "DCFIFTY")

```

```

dctCoupling.Add("3", "LFREJECT")

Dim dctUnits As New Dictionary(Of String, String)()
dctUnits.Add("0", "UNKNOWN")
dctUnits.Add("1", "VOLT")
dctUnits.Add("2", "SECOND")
dctUnits.Add("3", "CONSTANT")
dctUnits.Add("4", "AMP")
dctUnits.Add("5", "DECIBEL")

Dim strPreamble As String
Dim strsPreamble As String()

strPreamble = myScope.DoQueryString(":WAVEform:PREamble?")
strsPreamble = strPreamble.Split(",")

Console.WriteLine("Waveform format: {0}", _
    dctWavFormat(strsPreamble(0)))

Console.WriteLine("Acquire type: {0}", _
    dctAcqType(strsPreamble(1)))

Console.WriteLine("Waveform points: {0}", strPreamble(2))
Console.WriteLine("Waveform average count: {0}", strPreamble(3))
Console.WriteLine("Waveform X increment: {0}", strPreamble(4))
Console.WriteLine("Waveform X origin: {0}", strPreamble(5))
Console.WriteLine("Waveform X reference: {0}", strPreamble(6))
Console.WriteLine("Waveform Y increment: {0}", strPreamble(7))
Console.WriteLine("Waveform Y origin: {0}", strPreamble(8))
Console.WriteLine("Waveform Y reference: {0}", strPreamble(9))
Console.WriteLine("Coupling: {0}", dctCoupling(strsPreamble(10)))
Console.WriteLine("Waveform X display range: {0}", _
    strPreamble(11))
Console.WriteLine("Waveform X display origin: {0}", _
    strPreamble(12))
Console.WriteLine("Waveform Y display range: {0}", _
    strPreamble(13))
Console.WriteLine("Waveform Y display origin: {0}", _
    strPreamble(14))
Console.WriteLine("Date: {0}", strPreamble(15))
Console.WriteLine("Time: {0}", strPreamble(16))
Console.WriteLine("Frame model: {0}", strPreamble(17))
Console.WriteLine("Acquire mode: {0}", _
    dctAcqMode(strsPreamble(18)))
Console.WriteLine("Completion pct: {0}", strPreamble(19))
Console.WriteLine("Waveform X inits: {0}", _
    dctUnits(strsPreamble(20)))
Console.WriteLine("Waveform Y units: {0}", _
    dctUnits(strsPreamble(21)))
Console.WriteLine("Max BW limit: {0}", strPreamble(22))
Console.WriteLine("Min BW limit: {0}", strPreamble(23))

' Get numeric values for later calculations.
Dim fXincrement As Double
fXincrement = myScope.DoQueryNumber(":WAVEform:XINcrement?")
Dim fXorigin As Double
fXorigin = myScope.DoQueryNumber(":WAVEform:XORigin?")

```

```

Dim fYincrement As Double
fYincrement = myScope.DoQueryNumber(":WAVEform:YINCrement?")
Dim fYorigin As Double
fYorigin = myScope.DoQueryNumber(":WAVEform:YORigin?")

' Get the waveform data.
myScope.DoCommand(":WAVEform:STReaming OFF")
Dim WordDataArray As Short()
WordDataArray = myScope.DoQueryIEEEBlock_I2(":WAVEform:DATA?")
nLength = WordDataArray.Length
Console.WriteLine("Number of data values: {0}", nLength)

' Set up output file:
strPath = "c:\scope\data\waveform_data.csv"
If File.Exists(strPath) Then
    File.Delete(strPath)
End If

' Open file for output.
Dim writer As StreamWriter = File.CreateText(strPath)

' Output waveform data in CSV format.
For index As Integer = 0 To nLength - 1
    ' Write time value, voltage value.
    writer.WriteLine("{0:f9}, {1:f6}", _
        fXorigin + (CSng(index) * fXincrement), _
        (CSng(WordDataArray(index)) * fYincrement) + fYorigin)
Next

' Close output file.
writer.Close()
Console.WriteLine("Waveform format WORD data written to {0}", _
    strPath)

End Sub

End Class

Class VisaComInstrument
    Private m_ResourceManager As ResourceManagerClass
    Private m_IoObject As FormattedIO488Class
    Private m_strVisaAddress As String

    ' Constructor.
    Public Sub New(ByVal strVisaAddress As String)

        ' Save VISA address in member variable.
        m_strVisaAddress = strVisaAddress

        ' Open the default VISA COM IO object.
        OpenIo()

        ' Clear the interface.
        m_IoObject.IO.Clear()

    End Sub

```

```

Public Sub DoCommand(ByVal strCommand As String)

    ' Send the command.
    m_IoObject.WriteString(strCommand, True)

    ' Check for inst errors.
    CheckInstrumentErrors(strCommand)

End Sub

Public Sub DoCommandIEEEBlock(ByVal strCommand As String, _
    ByVal dataArray As Byte())

    ' Send the command to the device.
    m_IoObject.WriteIEEEBlock(strCommand, dataArray, True)

    ' Check for inst errors.
    CheckInstrumentErrors(strCommand)

End Sub

Public Function DoQueryString(ByVal strQuery As String) As String
    ' Send the query.
    m_IoObject.WriteString(strQuery, True)

    ' Get the result string.
    Dim strResults As String
    strResults = m_IoObject.ReadString()

    ' Check for inst errors.
    CheckInstrumentErrors(strQuery)

    ' Return results string.
    Return strResults
End Function

Public Function DoQueryNumber(ByVal strQuery As String) As Double
    ' Send the query.
    m_IoObject.WriteString(strQuery, True)

    ' Get the result number.
    Dim fResult As Double
    fResult = _
        CDb1(m_IoObject.ReadNumber(IEEEASCIIType.ASCIIType_R8, True))

    ' Check for inst errors.
    CheckInstrumentErrors(strQuery)

    ' Return result number.
    Return fResult
End Function

Public Function DoQueryNumbers(ByVal strQuery As String) As _
    Double()
    ' Send the query.
    m_IoObject.WriteString(strQuery, True)

```

```

' Get the result numbers.
Dim fResultsArray As Double()
fResultsArray = _
    m_IoObject.ReadList(IEEEASCIIType.ASCIIType_R8, ",;")

' Check for inst errors.
CheckInstrumentErrors(strQuery)

' Return result numbers.
Return fResultsArray
End Function

Public _
    Function _
        DoQueryIEEEBlock_UI1(ByVal strQuery As String) As Byte()
' Send the query.
m_IoObject.WriteString(strQuery, True)

' Get the results array.
System.Threading.Thread.Sleep(2000) ' Delay before reading data.
Dim ResultsArray As Byte()
ResultsArray = _
    m_IoObject.ReadIEEEBlock(IEEEBinaryType.BinaryType_UI1, _
        False, True)

' Check for inst errors.
CheckInstrumentErrors(strQuery)

' Return results array.
Return ResultsArray
End Function

Public _
    Function _
        DoQueryIEEEBlock_I2(ByVal strQuery As String) As Short()
' Send the query.
m_IoObject.WriteString(strQuery, True)

' Get the results array.
System.Threading.Thread.Sleep(2000) ' Delay before reading data.
Dim ResultsArray As Short()
ResultsArray = _
    m_IoObject.ReadIEEEBlock(IEEEBinaryType.BinaryType_I2, _
        False, True)

' Check for inst errors.
CheckInstrumentErrors(strQuery)

' Return results array.
Return ResultsArray
End Function

Private Sub CheckInstrumentErrors(ByVal strCommand As String)
' Check for instrument errors.
Dim strInstrumentError As String
Dim bFirstError As Boolean = True
Do ' While not "0,No error".

```

```

    m_IoObject.WriteString(":SYSTEM:ERROR? STRing", True)
    strInstrumentError = m_IoObject.ReadString()

    If Not strInstrumentError.ToString().StartsWith("0,") Then
        If bFirstError Then
            Console.WriteLine("ERROR(s) for command '{0}': ", _
                strCommand)
            bFirstError = False
        End If
        Console.Write(strInstrumentError)
    End If
    Loop While Not strInstrumentError.ToString().StartsWith("0,")
End Sub

Private Sub OpenIo()
    m_ResourceManager = New ResourceManagerClass()
    m_IoObject = New FormattedIO488Class()

    ' Open the default VISA COM IO object.
    Try
        m_IoObject.IO = _
            DirectCast(m_ResourceManager.Open(m_strVisaAddress, _
                AccessMode.NO_LOCK, 0, ""), IMessage)
    Catch e As Exception
        Console.WriteLine("An error occurred: {0}", e.Message)
    End Try
End Sub

Public Sub SetTimeoutSeconds(ByVal nSeconds As Integer)
    m_IoObject.IO.Timeout = nSeconds * 1000
End Sub

Public Sub Close()
    Try
        m_IoObject.IO.Close()
    Catch
    End Try

    Try
        Marshal.ReleaseComObject(m_IoObject)
    Catch
    End Try

    Try
        Marshal.ReleaseComObject(m_ResourceManager)
    Catch
    End Try
End Sub
End Class
End Namespace

```

VISA COM Example in Python

You can use the Python programming language with the "comtypes" package to control Keysight oscilloscopes.

The Python language and "comtypes" package can be downloaded from the web at <http://www.python.org/> and <http://starship.python.net/crew/theller/comtypes/>, respectively.

To run this example with Python and "comtypes":

- 1 Cut-and-paste the code that follows into a file named "example.py".
- 2 Edit the program to use the VISA address of your oscilloscope.
- 3 If "python.exe" can be found via your PATH environment variable, open a Command Prompt window; then, change to the folder that contains the "example.py" file, and enter:

```
python example.py

#
# Keysight VISA COM Example in Python using "comtypes"
# *****
# This program illustrates a few commonly used programming
# features of your Keysight Infiniium Series oscilloscope.
# *****

# Import Python modules.
# -----
import string
import time
import sys
import array

from comtypes.client import GetModule
from comtypes.client import CreateObject

# Run GetModule once to generate comtypes.gen.VisaComLib.
if not hasattr(sys, "frozen"):
    GetModule("C:\Program Files (x86)\IVI Foundation\VISA\VisaCom\
GlobMgr.dll")

import comtypes.gen.VisaComLib as VisaComLib

# Global variables (booleans: 0 = False, 1 = True).
# -----

# =====
# Initialize:
# =====
def initialize():
    # Get and display the device's *IDN? string.
    idn_string = do_query_string("*IDN?")
    print "Identification string '%s'" % idn_string

    # Clear status and load the default setup.
    do_command("*CLS")
    do_command("*RST")
```

```

# =====
# Capture:
# =====
def capture():

    # Set probe attenuation factor.
    do_command(":CHANnel1:PROBe 1.0")
    qresult = do_query_string(":CHANnel1:PROBE?")
    print "Channel 1 probe attenuation factor: %s" % qresult

    # Use auto-scale to automatically set up oscilloscope.
    print "Autoscale."
    do_command(":AUToscale")

    # Set trigger mode.
    do_command(":TRIGger:MODE EDGE")
    qresult = do_query_string(":TRIGger:MODE?")
    print "Trigger mode: %s" % qresult

    # Set EDGE trigger parameters.
    do_command(":TRIGger:EDGE:SOURCe CHANnel1")
    qresult = do_query_string(":TRIGger:EDGE:SOURce?")
    print "Trigger edge source: %s" % qresult

    do_command(":TRIGger:LEVel CHANnel1,-2E-3")
    qresult = do_query_string(":TRIGger:LEVel? CHANnel1")
    print "Trigger level, channel 1: %s" % qresult

    do_command(":TRIGger:EDGE:SLOPe POSitive")
    qresult = do_query_string(":TRIGger:EDGE:SLOPe?")
    print "Trigger edge slope: %s" % qresult

    # Save oscilloscope setup.
    setup_bytes = do_query_ieee_block_UI1(":SYSTem:SETup?")
    nLength = len(setup_bytes)
    f = open("setup.stp", "wb")
    f.write(bytearray(setup_bytes))
    f.close()
    print "Setup bytes saved: %d" % nLength

    # Change oscilloscope settings with individual commands:

    # Set vertical scale and offset.
    do_command(":CHANnel1:SCALe 0.1")
    qresult = do_query_number(":CHANnel1:SCALe?")
    print "Channel 1 vertical scale: %f" % qresult

    do_command(":CHANnel1:OFFSet 0.0")
    qresult = do_query_number(":CHANnel1:OFFSet?")
    print "Channel 1 offset: %f" % qresult

    # Set horizontal scale and offset.
    do_command(":TIMEbase:SCALe 200e-6")
    qresult = do_query_string(":TIMEbase:SCALe?")
    print "Timebase scale: %s" % qresult

```

```

do_command(":TIMEbase:POSition 0.0")
qresult = do_query_string(":TIMEbase:POSition?")
print "Timebase position: %s" % qresult

# Set the acquisition mode.
do_command(":ACQuire:MODE RTIME")
qresult = do_query_string(":ACQuire:MODE?")
print "Acquire mode: %s" % qresult

# Or, configure by loading a previously saved setup.
f = open("setup.stp", "rb")
setup_bytes = f.read()
f.close()
do_command_ieee_block(":SYSTem:SETup", array.array('B', setup_bytes))
print "Setup bytes restored: %d" % len(setup_bytes)

# Set the desired number of waveform points,
# and capture an acquisition.
do_command(":ACQuire:POINts 32000")
do_command(":DIGitize")

# =====
# Analyze:
# =====
def analyze():

    # Make measurements.
    # -----
    do_command(":MEASure:SOURce CHANnel1")
    qresult = do_query_string(":MEASure:SOURce?")
    print "Measure source: %s" % qresult

    do_command(":MEASure:FREQuency")
    qresult = do_query_string(":MEASure:FREQuency?")
    print "Measured frequency on channel 1: %s" % qresult

    do_command(":MEASure:VAMPlitude")
    qresult = do_query_string(":MEASure:VAMPlitude?")
    print "Measured vertical amplitude on channel 1: %s" % qresult

    # Download the screen image.
    # -----
    image_bytes = do_query_ieee_block_UI1(":DISPlay:DATA? PNG")
    nLength = len(image_bytes)
    f = open("screen_image.png", "wb")
    f.write(bytearray(image_bytes))
    f.close()
    print "Screen image written to 'screen_image.png'."

    # Download waveform data.
    # -----

    # Get the waveform type.
    qresult = do_query_string(":WAVEform:TYPE?")
    print "Waveform type: %s" % qresult

```

```

# Get the number of waveform points.
qresult = do_query_string(":WAVEform:POINTs?")
print "Waveform points: %s" % qresult

# Set the waveform source.
do_command(":WAVEform:SOURce CHANnel1")
qresult = do_query_string(":WAVEform:SOURce?")
print "Waveform source: %s" % qresult

# Choose the format of the data returned:
do_command(":WAVEform:FORMat WORD")
print "Waveform format: %s" % do_query_string(":WAVEform:FORMat?")

# Display the waveform settings from preamble:
wav_form_dict = {
    0 : "AScii",
    1 : "BYTE",
    2 : "WORD",
    3 : "LONG",
    4 : "LONGLONG",
}
acq_type_dict = {
    1 : "RAW",
    2 : "AVERage",
    3 : "VHISTogram",
    4 : "HHISTogram",
    6 : "INTErpolate",
    10 : "PDETEct",
}
acq_mode_dict = {
    0 : "RTIME",
    1 : "ETIME",
    3 : "PDETEct",
}
coupling_dict = {
    0 : "AC",
    1 : "DC",
    2 : "DCFIFTY",
    3 : "LFREJECT",
}
units_dict = {
    0 : "UNKNOWN",
    1 : "VOLT",
    2 : "SECOND",
    3 : "CONSTANT",
    4 : "AMP",
    5 : "DECIBEL",
}

preamble_string = do_query_string(":WAVEform:PREAmble?")
(
    wav_form, acq_type, wfmppts, avgcnt, x_increment, x_origin,
    x_reference, y_increment, y_origin, y_reference, coupling,
    x_display_range, x_display_origin, y_display_range,
    y_display_origin, date, time, frame_model, acq_mode,
    completion, x_units, y_units, max_bw_limit, min_bw_limit
) = string.split(preamble_string, ",")

```

```

print "Waveform format: %s" % wav_form_dict[int(wav_form)]
print "Acquire type: %s" % acq_type_dict[int(acq_type)]
print "Waveform points desired: %s" % wfmppts
print "Waveform average count: %s" % avgcnt
print "Waveform X increment: %s" % x_increment
print "Waveform X origin: %s" % x_origin
print "Waveform X reference: %s" % x_reference # Always 0.
print "Waveform Y increment: %s" % y_increment
print "Waveform Y origin: %s" % y_origin
print "Waveform Y reference: %s" % y_reference # Always 0.
print "Coupling: %s" % coupling_dict[int(coupling)]
print "Waveform X display range: %s" % x_display_range
print "Waveform X display origin: %s" % x_display_origin
print "Waveform Y display range: %s" % y_display_range
print "Waveform Y display origin: %s" % y_display_origin
print "Date: %s" % date
print "Time: %s" % time
print "Frame model #: %s" % frame_model
print "Acquire mode: %s" % acq_mode_dict[int(acq_mode)]
print "Completion pct: %s" % completion
print "Waveform X units: %s" % units_dict[int(x_units)]
print "Waveform Y units: %s" % units_dict[int(y_units)]
print "Max BW limit: %s" % max_bw_limit
print "Min BW limit: %s" % min_bw_limit

# Get numeric values for later calculations.
x_increment = do_query_number(":WAVEform:XINCrement?")
x_origin = do_query_number(":WAVEform:XORigin?")
y_increment = do_query_number(":WAVEform:YINCrement?")
y_origin = do_query_number(":WAVEform:YORigin?")

# Get the waveform data.
do_command(":WAVEform:STReaming OFF")
data_words = do_query_ieee_block_I2(":WAVEform:DATA?")
nLength = len(data_words)
print "Number of data values: %d" % nLength

# Open file for output.
strPath = "waveform_data.csv"
f = open(strPath, "w")

# Output waveform data in CSV format.
for i in xrange(0, nLength - 1):
    time_val = x_origin + (i * x_increment)
    voltage = (data_words[i] * y_increment) + y_origin
    f.write("%E, %f\n" % (time_val, voltage))

# Close output file.
f.close()
print "Waveform format WORD data written to %s." % strPath

# =====
# Send a command and check for errors:
# =====
def do_command(command):

```

```

myScope.WriteString("%s" % command, True)
check_instrument_errors(command)

# =====
# Send a command and check for errors:
# =====
def do_command_ieee_block(command, data):
    myScope.WriteIEEEBlock(command, data, True)
    check_instrument_errors(command)

# =====
# Send a query, check for errors, return string:
# =====
def do_query_string(query):
    myScope.WriteString("%s" % query, True)
    result = myScope.ReadString()
    check_instrument_errors(query)
    return result

# =====
# Send a query, check for errors, return string:
# =====
def do_query_ieee_block_UI1(query):
    myScope.WriteString("%s" % query, True)
    result = myScope.ReadIEEEBlock(VisaComLib.BinaryType_UI1, \
        False, True)
    check_instrument_errors(query)
    return result

# =====
# Send a query, check for errors, return string:
# =====
def do_query_ieee_block_I2(query):
    myScope.WriteString("%s" % query, True)
    result = myScope.ReadIEEEBlock(VisaComLib.BinaryType_I2, \
        False, True)
    check_instrument_errors(query)
    return result

# =====
# Send a query, check for errors, return values:
# =====
def do_query_number(query):
    myScope.WriteString("%s" % query, True)
    result = myScope.ReadNumber(VisaComLib.ASCIIType_R8, True)
    check_instrument_errors(query)
    return result

# =====
# Send a query, check for errors, return values:
# =====

```

```

def do_query_numbers(query):
    myScope.WriteString("%s" % query, True)
    result = myScope.ReadList(VisaComLib.ASCIIType_R8, ",;")
    check_instrument_errors(query)
    return result

# =====
# Check for instrument errors:
# =====
def check_instrument_errors(command):

    while True:
        myScope.WriteString(":SYSTem:ERRor? STRing", True)
        error_string = myScope.ReadString()
        if error_string: # If there is an error string value.

            if error_string.find("0,", 0, 2) == -1: # Not "No error".
                print "ERROR: %s, command: '%s'" % (error_string, command)
                print "Exited because of error."
                sys.exit(1)

            else: # "No error"
                break

        else: # :SYSTem:ERRor? STRing should always return string.
            print "ERROR: :SYSTem:ERRor? STRing returned nothing, command: '%s'"
            \
                % command
            print "Exited because of error."
            sys.exit(1)

# =====
# Main program:
# =====
rm = CreateObject("VISA.GlobalRM", \
    interface=VisaComLib.IResourceManager)
myScope = CreateObject("VISA.BasicFormattedIO", \
    interface=VisaComLib.IFormattedIO488)
myScope.IO = \
    rm.Open("TCPIP0::141.121.237.226::hislip0::INSTR")

# Clear the interface.
myScope.IO.Clear
print "Interface cleared."

# Set the Timeout to 15 seconds.
myScope.IO.Timeout = 15000 # 15 seconds.
print "Timeout set to 15000 milliseconds."

# Initialize the oscilloscope, capture data, and analyze.
initialize()
capture()
analyze()

print "End of program"

```

VISA Examples

- ["VISA Example in C"](#) on page 1592
- ["VISA Example in Visual Basic"](#) on page 1601
- ["VISA Example in C#"](#) on page 1611
- ["VISA Example in Visual Basic .NET"](#) on page 1623
- ["VISA Example in Python \(PyVISA 1.5 and older\)"](#) on page 1635
- ["VISA Example in Python \(PyVISA 1.6 and newer\)"](#) on page 1641

VISA Example in C

To compile and run this example in Microsoft Visual Studio 2008:

- 1 Open Visual Studio.
- 2 Create a new Visual C++, Win32, Win32 Console Application project.
- 3 In the Win32 Application Wizard, click **Next >**. Then, check **Empty project**, and click **Finish**.
- 4 Cut-and-paste the code that follows into a file named "example.c" in the project directory.
- 5 In Visual Studio 2008, right-click the Source Files folder, choose **Add > Add Existing Item...**, select the example.c file, and click **Add**.
- 6 Edit the program to use the VISA address of your oscilloscope.
- 7 Choose **Project > Properties....** In the Property Pages dialog, update these project settings:
 - a Under Configuration Properties, Linker, Input, add "visa32.lib" to the Additional Dependencies field.
 - b Under Configuration Properties, C/C++, Code Generation, select Multi-threaded DLL for the Runtime Library field.
 - c Click **OK** to close the Property Pages dialog.
- 8 Add the include files and library files search paths:
 - a Choose **Tools > Options....**
 - b In the Options dialog, under Projects and Solutions, select **VC++ Directories**.
 - c Show directories for **Include files**, and add the include directory (for example, Program Files (x86)\IVI Foundation\VISA\WinNT\Include).
 - d Show directories for **Library files**, and add the library files directory (for example, Program Files (x86)\IVI Foundation\VISA\WinNT\lib\msc).
 - e Click **OK** to close the Options dialog.
- 9 Build and run the program.

```

/*
 * Keysight VISA Example in C
 * -----
 * This program illustrates a few commonly-used programming
 * features of your Keysight Infiniium Series oscilloscope.
 */

#include <stdio.h>           /* For printf(). */
#include <string.h>         /* For strcpy(), strcat(). */
#include <time.h>           /* For clock(). */
#include <visa.h>           /* Keysight VISA routines. */

#define VISA_ADDRESS "TCPIP0::141.121.237.226::hislip0::INSTR"
#define IEEEBLOCK_SPACE 5000000

/* Function prototypes */
void initialize(void);      /* Initialize to known state. */
void capture(void);        /* Capture the waveform. */
void analyze(void);        /* Analyze the captured waveform. */

void do_command(char *command); /* Send command. */
int do_command_ieeeblock(char *command); /* Command w/IEEE block. */
void do_query_string(char *query); /* Query for string. */
void do_query_number(char *query); /* Query for number. */
void do_query_numbers(char *query); /* Query for numbers. */
int do_query_ieeeblock(char *query); /* Query for IEEE byte block. */
int do_query_ieeeblock_words(char *query); /* Query for word block. */
void check_instrument_errors(); /* Check for inst errors. */
void error_handler(); /* VISA error handler. */

/* Global variables */
ViSession defaultRM, vi; /* Device session ID. */
ViStatus err; /* VISA function return value. */
char str_result[256] = {0}; /* Result from do_query_string(). */
double num_result; /* Result from do_query_number(). */
unsigned char ieeeblock_data[IEEBLOCK_SPACE]; /* Result from
do_query_ieeeblock(). */
signed short ieeeblock_data_words[IEEBLOCK_SPACE]; /* Result from
do_query_ieeeblock_words(). */
double dbl_results[10]; /* Result from do_query_numbers(). */

/* Main Program
 * ----- */
void main(void)
{
    /* Open the default resource manager session. */
    err = viOpenDefaultRM(&defaultRM);
    if (err != VI_SUCCESS) error_handler();

    /* Open the session using the oscilloscope's VISA address. */
    err = viOpen(defaultRM, VISA_ADDRESS, VI_NULL, VI_NULL, &vi);
    if (err != VI_SUCCESS) error_handler();

    /* Set the I/O timeout to fifteen seconds. */
    err = viSetAttribute(vi, VI_ATTR_TMO_VALUE, 15000);
    if (err != VI_SUCCESS) error_handler();
}

```

```

/* Clear the interface. */
err = viClear(vi);
if (err != VI_SUCCESS) error_handler();

/* Initialize - start from a known state. */
initialize();

/* Capture data. */
capture();

/* Analyze the captured waveform. */
analyze();

/* Close the vi session and the resource manager session. */
viClose(vi);
viClose(defaultRM);
}

/* Initialize the oscilloscope to a known state.
 * ----- */
void initialize (void)
{
    /* Clear status. */
    do_command("*CLS");

    /* Get and display the device's *IDN? string. */
    do_query_string("*IDN?");
    printf("Oscilloscope *IDN? string: %s\n", str_result);

    /* Load the default setup. */
    do_command("*RST");
}

/* Capture the waveform.
 * ----- */
void capture (void)
{
    int num_values;
    FILE *fp;

    /* Set probe attenuation factor. */
    do_command(":CHANnel1:PROBE 1.0");
    do_query_string(":CHANnel1:PROBE?");
    printf("Channel 1 probe attenuation factor: %s\n", str_result);

    /* Use auto-scale to automatically configure oscilloscope. */
    do_command(":AUToscale");

    /* Set trigger mode. */
    do_command(":TRIGger:MODE EDGE");
    do_query_string(":TRIGger:MODE?");
    printf("Trigger mode: %s\n", str_result);

    /* Set EDGE trigger parameters. */
    do_command(":TRIGger:EDGE:SOURCe CHANnel1");
    do_query_string(":TRIGger:EDGE:SOURce?");
    printf("Trigger edge source: %s\n", str_result);
}

```

```

do_command(":TRIGger:LEVel CHANnel1,-2E-3");
do_query_string(":TRIGger:LEVel? CHANnel1");
printf("Trigger level, channel 1: %s\n", str_result);

do_command(":TRIGger:EDGE:SLOPe POSitive");
do_query_string(":TRIGger:EDGE:SLOPe?");
printf("Trigger edge slope: %s\n", str_result);

/* Save oscilloscope setup. */

/* Read system setup. */
num_values = do_query_ieeeblock(":SYSTem:SETup?");
printf("Read setup string query (%d bytes).\n", num_values);

/* Write setup string to file. */
fp = fopen ("c:\\scope\\config\\setup.stp", "wb");
num_values = fwrite(ieeeblock_data, sizeof(unsigned char), num_values,
    fp);
fclose (fp);
printf("Wrote setup string (%d bytes) to ", num_values);
printf("c:\\scope\\config\\setup.stp.\n");

/* Change settings with individual commands:

/* Set vertical scale and offset. */
do_command(":CHANnel1:SCALE 0.1");
do_query_string(":CHANnel1:SCALE?");
printf("Channel 1 vertical scale: %s\n", str_result);

do_command(":CHANnel1:OFFSet 0.0");
do_query_string(":CHANnel1:OFFSet?");
printf("Channel 1 offset: %s\n", str_result);

/* Set horizontal scale and offset. */
do_command(":TIMEbase:SCALE 0.0002");
do_query_string(":TIMEbase:SCALE?");
printf("Timebase scale: %s\n", str_result);

do_command(":TIMEbase:POSition 0.0");
do_query_string(":TIMEbase:POSition?");
printf("Timebase position: %s\n", str_result);

/* Set the acquisition mode. */
do_command(":ACQuire:MODE RTIME");
do_query_string(":ACQuire:MODE?");
printf("Acquire mode: %s\n", str_result);

/* Or, set up by loading a previously saved setup. */

/* Read setup string from file. */
fp = fopen ("c:\\scope\\config\\setup.stp", "rb");
num_values = fread (ieeeblock_data, sizeof(unsigned char),
    IEEEBLOCK_SPACE, fp);
fclose (fp);
printf("Read setup string (%d bytes) from file ", num_values);
printf("c:\\scope\\config\\setup.stp.\n");

```

```

/* Restore setup string. */
num_values = do_command_ieeeblock(":SYSTem:SETup", num_values);
printf("Restored setup string (%d bytes).\n", num_values);

/* Set the desired number of waveform points,
 * and capture an acquisition. */
do_command(":ACQuire:POINts 32000");
do_command(":DIGitize");
}

/* Analyze the captured waveform.
 * ----- */
void analyze (void)
{
    double wav_format;
    double acq_type;
    double wav_points;
    double avg_count;
    double x_increment;
    double x_origin;
    double y_increment;
    double y_origin;

    FILE *fp;
    int num_values; /* Number of bytes returned from instrument. */
    int i;

    /* Make measurements.
     * ----- */
    do_command(":MEASure:SOURce CHANnel1");
    do_query_string(":MEASure:SOURce?");
    printf("Measure source: %s\n", str_result);

    do_command(":MEASure:FREQuency");
    do_query_number(":MEASure:FREQuency?");
    printf("Frequency: %.4f kHz\n", num_result / 1000);

    do_command(":MEASure:VAMplitude");
    do_query_number(":MEASure:VAMplitude?");
    printf("Vertical amplitude: %.2f V\n", num_result);

    /* Download the screen image.
     * ----- */

    /* Read screen image. */
    num_values = do_query_ieeeblock(":DISPlay:DATA? PNG");
    printf("Screen image bytes: %d\n", num_values);

    /* Write screen image bytes to file. */
    fp = fopen ("c:\\scope\\data\\screen.png", "wb");
    num_values = fwrite(ieeeblock_data, sizeof(unsigned char), num_values,
        fp);
    fclose (fp);
    printf("Wrote screen image (%d bytes) to ", num_values);
    printf("c:\\scope\\data\\screen.bmp.\n");
}

```

```

/* Download waveform data.
 * ----- */

/* Get the waveform type. */
do_query_string(":WAVeform:TYPE?");
printf("Waveform type: %s\n", str_result);

/* Get the number of waveform points. */
do_query_string(":WAVeform:POINTs?");
printf("Waveform points: %s\n", str_result);

/* Set the waveform source. */
do_command(":WAVeform:SOURce CHANnel1");
do_query_string(":WAVeform:SOURce?");
printf("Waveform source: %s\n", str_result);

/* Choose the format of the data returned: */
do_command(":WAVeform:FORMat WORD");
do_query_string(":WAVeform:FORMat?");
printf("Waveform format: %s\n", str_result);

/* Display the waveform settings: */
do_query_number(":WAVeform:XINCrement?");
x_increment = num_result;
printf("Waveform X increment: %e\n", x_increment);

do_query_number(":WAVeform:XORigin?");
x_origin = num_result;
printf("Waveform X origin: %e\n", x_origin);

do_query_number(":WAVeform:YINCrement?");
y_increment = num_result;
printf("Waveform Y increment: %e\n", y_increment);

do_query_number(":WAVeform:YORigin?");
y_origin = num_result;
printf("Waveform Y origin: %e\n", y_origin);

/* Read waveform data. */
num_values = do_query_ieeeblock_words(":WAVeform:DATA?");
printf("Number of data values: %d\n", num_values);

/* Open file for output. */
fp = fopen("c:\\scope\\data\\waveform_data.csv", "wb");

/* Output waveform data in CSV format. */
for (i = 0; i < num_values - 1; i++)
{
    /* Write time value, voltage value. */
    fprintf(fp, "%9f, %6f\n",
        x_origin + ((float)i * x_increment),
        ((float)ieeeblock_data_words[i] * y_increment) + y_origin);
}

/* Close output file. */
fclose(fp);
printf("Waveform format WORD data written to ");

```

```

    printf("c:\\scope\\data\\waveform_data.csv.\n");
}

/* Send a command to the instrument.
 * ----- */
void do_command(command)
char *command;
{
    char message[80];

    strcpy(message, command);
    strcat(message, "\n");
    err = viPrintf(vi, message);
    if (err != VI_SUCCESS) error_handler();

    check_instrument_errors();
}

/* Command with IEEE definite-length block.
 * ----- */
int do_command_ieeeblock(command, num_bytes)
char *command;
int num_bytes;
{
    char message[80];
    int data_length;

    strcpy(message, command);
    strcat(message, " #8%08d");
    err = viPrintf(vi, message, num_bytes);
    if (err != VI_SUCCESS) error_handler();

    err = viBufWrite(vi, ieeeblock_data, num_bytes, &data_length);
    if (err != VI_SUCCESS) error_handler();

    check_instrument_errors();

    return(data_length);
}

/* Query for a string result.
 * ----- */
void do_query_string(query)
char *query;
{
    char message[80];

    strcpy(message, query);
    strcat(message, "\n");

    err = viPrintf(vi, message);
    if (err != VI_SUCCESS) error_handler();

    err = viScanf(vi, "%t", str_result);
    if (err != VI_SUCCESS) error_handler();

    check_instrument_errors();
}

```

```

}

/* Query for a number result.
 * ----- */
void do_query_number(query)
char *query;
{
    char message[80];

    strcpy(message, query);
    strcat(message, "\n");

    err = viPrintf(vi, message);
    if (err != VI_SUCCESS) error_handler();

    err = viScanf(vi, "%lf", &num_result);
    if (err != VI_SUCCESS) error_handler();

    check_instrument_errors();
}

/* Query for numbers result.
 * ----- */
void do_query_numbers(query)
char *query;
{
    char message[80];

    strcpy(message, query);
    strcat(message, "\n");

    err = viPrintf(vi, message);
    if (err != VI_SUCCESS) error_handler();

    err = viScanf(vi, "%,10lf\n", dbl_results);
    if (err != VI_SUCCESS) error_handler();

    check_instrument_errors();
}

/* Query for an IEEE definite-length byte block result.
 * ----- */
int do_query_ieeeblock(query)
char *query;
{
    char message[80];
    int data_length;

    strcpy(message, query);
    strcat(message, "\n");
    err = viPrintf(vi, message);
    if (err != VI_SUCCESS) error_handler();

    data_length = IEEEBLOCK_SPACE;
    err = viScanf(vi, "%#b\n", &data_length, ieeeblock_data);
    if (err != VI_SUCCESS) error_handler();
}

```

```

    if (data_length == IEEEBLOCK_SPACE )
    {
        printf("IEEE block buffer full: ");
        printf("May not have received all data.\n");
    }

    check_instrument_errors();

    return(data_length);
}

/* Query for an IEEE definite-length word block result.
 * ----- */
int do_query_ieeeblock_words(query)
char *query;
{
    char message[80];
    int data_length;

    strcpy(message, query);
    strcat(message, "\n");
    err = viPrintf(vi, message);
    if (err != VI_SUCCESS) error_handler();

    data_length = IEEEBLOCK_SPACE;
    err = viScanf(vi, "%#hb\n", &data_length, ieeeblock_data_words);
    if (err != VI_SUCCESS) error_handler();

    if (data_length == IEEEBLOCK_SPACE )
    {
        printf("IEEE block buffer full: ");
        printf("May not have received all data.\n");
    }

    check_instrument_errors();

    return(data_length);
}

/* Check for instrument errors.
 * ----- */
void check_instrument_errors()
{
    char str_err_val[256] = {0};
    char str_out[800] = "";

    err = viQueryf(vi, ":SYSTem:ERRor? STRing\n", "%t", str_err_val);
    if (err != VI_SUCCESS) error_handler();
    while(strncmp(str_err_val, "0,", 2) != 0 )
    {
        strcat(str_out, ", ");
        strcat(str_out, str_err_val);
        err = viQueryf(vi, ":SYSTem:ERRor? STRing\n", "%t", str_err_val);
        if (err != VI_SUCCESS) error_handler();
    }

    if (strcmp(str_out, "") != 0)

```



```

    {
        printf("INST Error%s\n", str_out);
        err = viFlush(vi, VI_READ_BUF);
        if (err != VI_SUCCESS) error_handler();
        err = viFlush(vi, VI_WRITE_BUF);
        if (err != VI_SUCCESS) error_handler();
    }
}

/* Handle VISA errors.
 * ----- */
void error_handler()
{
    char err_msg[1024] = {0};

    viStatusDesc(vi, err, err_msg);
    printf("VISA Error: %s\n", err_msg);
    if (err < VI_SUCCESS)
    {
        exit(1);
    }
}

```

VISA Example in Visual Basic

To run this example in Visual Basic for Applications:

- 1 Start the application that provides Visual Basic for Applications (for example, Microsoft Excel).
- 2 Press ALT+F11 to launch the Visual Basic editor.
- 3 Add the visa32.bas file to your project:
 - a Choose **File > Import File...**
 - b Navigate to the header file, visa32.bas (installed with Keysight IO Libraries Suite and found in the Program Files (x86)\IVI Foundation\VISA\WinNT\Include), select it, and click **Open**.
- 4 Choose **Insert > Module**.
- 5 Cut-and-paste the code that follows into the editor.
- 6 Edit the program to use the VISA address of your oscilloscope, and save the changes.
- 7 Run the program.

```

'
' Keysight VISA Example in Visual Basic
' -----
' This program illustrates a few commonly-used programming
' features of your Keysight Infiniium Series oscilloscope.
' -----

```

```
Option Explicit
```

```

Public err As Long      ' Error returned by VISA function calls.
Public drm As Long     ' Session to Default Resource Manager.
Public vi As Long      ' Session to instrument.

' Declare variables to hold numeric values returned by
' viVScanf/viVQueryf.
Public dblQueryResult As Double
Public Const ByteArraySize = 5000000
Public Const WordArraySize = 5000000
Public retCount As Long
Public byteArray(ByteArraySize) As Byte
Public wordArray(WordArraySize) As Integer
Public paramsArray(2) As Long
Public Const DblArraySize = 20
Public dblArray(DblArraySize) As Double

' Declare fixed length string variable to hold string value returned
' by viVScanf/viVQueryf.
Public strQueryResult As String * 200

' For Sleep subroutine.
Private Declare Sub Sleep Lib "kernel32" (ByVal dwMilliseconds As Long)

'
' Main Program
' -----

Sub Main()

    ' Open the default resource manager session.
    err = viOpenDefaultRM(drm)
    If (err <> VI_SUCCESS) Then HandleVISAError drm

    ' Open the session using the oscilloscope's VISA address.
    err = viOpen(drm, _
        "TCPIP0::141.121.237.226::hislip0::INSTR", 0, 15000, vi)
    If (err <> VI_SUCCESS) Then HandleVISAError drm

    ' Set the I/O timeout to ten seconds.
    err = viSetAttribute(vi, VI_ATTR_TMO_VALUE, 10000)
    If (err <> VI_SUCCESS) Then HandleVISAError vi

    ' Clear the interface.
    err = viClear(vi)
    If Not (err = VI_SUCCESS) Then HandleVISAError vi

    ' Initialize - start from a known state.
    Initialize

    ' Capture data.
    Capture

    ' Analyze the captured waveform.
    Analyze

    ' Close the vi session and the resource manager session.
    err = viClose(vi)

```

```

    err = viClose(drm)

End Sub

'
' Initialize the oscilloscope to a known state.
' -----

Private Sub Initialize()

    ' Clear status.
    DoCommand "*CLS"

    ' Get and display the device's *IDN? string.
    strQueryResult = DoQueryString("*IDN?")
    MsgBox "*IDN? string: " + strQueryResult, vbOKOnly, "*IDN? Result"

    ' Load the default setup.
    DoCommand "*RST"

End Sub

'
' Capture the waveform.
' -----

Private Sub Capture()

    ' Set probe attenuation factor.
    DoCommand ":CHANnel1:PROBe 1.0"
    Debug.Print "Channel 1 probe attenuation factor: " + _
        DoQueryString(":CHANnel1:PROBe?")

    ' Use auto-scale to automatically configure oscilloscope.
    ' -----
    DoCommand ":AUToscale"

    ' Set trigger mode (EDGE, PULSe, PATtern, etc., and input source.
    DoCommand ":TRIGger:MODE EDGE"
    Debug.Print "Trigger mode: " + _
        DoQueryString(":TRIGger:MODE?")

    ' Set EDGE trigger parameters.
    DoCommand ":TRIGger:EDGE:SOURCe CHANnel1"
    Debug.Print "Trigger edge source: " + _
        DoQueryString(":TRIGger:EDGE:SOURce?")

    DoCommand ":TRIGger:LEVel CHANnel1,-2E-3"
    Debug.Print "Trigger level, channel 1: " + _
        DoQueryString(":TRIGger:LEVel? CHANnel1")

    DoCommand ":TRIGger:EDGE:SLOPe POSitive"
    Debug.Print "Trigger edge slope: " + _
        DoQueryString(":TRIGger:EDGE:SLOPe?")

    ' Save oscilloscope configuration.
    ' -----

```

```

Dim lngSetupStringSize As Long
lngSetupStringSize = DoQueryIEEEBlock_Bytes(":SYSTEM:SETup?")
Debug.Print "Setup bytes saved: " + CStr(lngSetupStringSize)

' Output setup string to a file:
Dim strPath As String
strPath = "c:\scope\config\setup.dat"
If Len(Dir(strPath)) Then
    Kill strPath ' Remove file if it exists.
End If

' Open file for output.
Dim hFile As Long
hFile = FreeFile
Open strPath For Binary Access Write Lock Write As hFile
Dim lngI As Long
For lngI = 0 To lngSetupStringSize - 1
    Put hFile, , byteArray(lngI) ' Write data.
Next lngI
Close hFile ' Close file.

' Change settings with individual commands:
' -----

' Set vertical scale and offset.
DoCommand ":CHANnel1:SCALE 0.1"
Debug.Print "Channel 1 vertical scale: " + _
    DoQueryString(":CHANnel1:SCALE?")

DoCommand ":CHANnel1:OFFSet 0.0"
Debug.Print "Channel 1 vertical offset: " + _
    DoQueryString(":CHANnel1:OFFSet?")

' Set horizontal scale and position.
DoCommand ":TIMEbase:SCALE 0.0002"
Debug.Print "Timebase scale: " + _
    DoQueryString(":TIMEbase:SCALE?")

DoCommand ":TIMEbase:POSition 0.0"
Debug.Print "Timebase position: " + _
    DoQueryString(":TIMEbase:POSition?")

' Set the acquisition mode.
DoCommand ":ACquire:MODE RTIME"
Debug.Print "Acquire mode: " + _
    DoQueryString(":ACquire:MODE?")

' Or, configure by loading a previously saved setup.
' -----
strPath = "c:\scope\config\setup.dat"
Open strPath For Binary Access Read As hFile ' Open file for input.
Dim lngSetupFileSize As Long
lngSetupFileSize = LOF(hFile) ' Length of file.
Get hFile, , byteArray ' Read data.
Close hFile ' Close file.
' Write learn string back to oscilloscope using ":SYSTEM:SETup"
' command:

```

```

Dim lngRestored As Long
lngRestored = DoCommandIEEEBlock(":SYSTEM:SETup", lngSetupFileSize)
Debug.Print "Setup bytes restored: " + CStr(lngRestored)

' Set the desired number of waveform points,
' and capture an acquisition.
' -----
DoCommand ":ACquire:POINTs 32000"
DoCommand ":DIGitize"

End Sub

'
' Analyze the captured waveform.
' -----

Private Sub Analyze()

' Make a couple of measurements.
' -----
DoCommand ":MEASure:SOURce CHANnel1"
Debug.Print "Measure source: " + _
    DoQueryString(":MEASure:SOURce?")

DoCommand ":MEASure:FREQuency"
dblQueryResult = DoQueryNumber(":MEASure:FREQuency?")
MsgBox "Frequency:" + vbCrLf + _
    FormatNumber(dblQueryResult / 1000, 4) + " kHz"

DoCommand ":MEASure:VAMPlitude"
dblQueryResult = DoQueryNumber(":MEASure:VAMPlitude?")
MsgBox "Vertical amplitude:" + vbCrLf + _
    FormatNumber(dblQueryResult, 4) + " V"

' Download the screen image.
' -----

' Get screen image.
Dim lngBlockSize As Long
lngBlockSize = DoQueryIEEEBlock_Bytes(":DISPlay:DATA? PNG")
Debug.Print "Screen image bytes: " + CStr(lngBlockSize)

' Save screen image to a file:
Dim strPath As String
strPath = "c:\scope\data\screen.png"
If Len(Dir(strPath)) Then
    Kill strPath ' Remove file if it exists.
End If
Dim hFile As Long
hFile = FreeFile
Open strPath For Binary Access Write Lock Write As hFile
Dim lngI As Long
For lngI = 0 To lngBlockSize - 1
    Put hFile, , byteArray(lngI) ' Write data.
Next lngI
Close hFile ' Close file.

```

```

MsgBox "Screen image written to " + strPath

' Download waveform data.
' -----

' Get the waveform type.
Debug.Print "Waveform type: " + _
    DoQueryString(":WAVEform:TYPE?")

' Get the number of waveform points.
Debug.Print "Waveform points: " + _
    DoQueryString(":WAVEform:POINTs?")

' Set the waveform source.
DoCommand ":WAVEform:SOURce CHANnel1"
Debug.Print "Waveform source: " + _
    DoQueryString(":WAVEform:SOURce?")

' Choose the format of the data returned:
DoCommand ":WAVEform:FORMat WORD"
Debug.Print "Waveform format: " + _
    DoQueryString(":WAVEform:FORMat?")

' Display the waveform settings:
Dim dblXIncrement As Double
Dim dblXOrigin As Double
Dim dblYIncrement As Double
Dim dblYOrigin As Double

dblXIncrement = DoQueryNumber(":WAVEform:XINCrement?")
Debug.Print "Waveform X increment: " + _
    Format(dblXIncrement, "Scientific")

dblXOrigin = DoQueryNumber(":WAVEform:XORigin?")
Debug.Print "Waveform X origin: " + _
    Format(dblXOrigin, "Scientific")

dblYIncrement = DoQueryNumber(":WAVEform:YINCrement?")
Debug.Print "Waveform Y increment: " + _
    Format(dblYIncrement, "Scientific")

dblYOrigin = DoQueryNumber(":WAVEform:YORigin?")
Debug.Print "Waveform Y origin: " + _
    FormatNumber(dblYOrigin, 0)

' Get the waveform data
DoCommand ":WAVEform:STReaming OFF"
Dim lngNumWords As Long
lngNumWords = DoQueryIEEEBlock_Words(":WAVEform:DATA?")
Debug.Print "Number of data values: " + CStr(lngNumWords)

' Set up output file:
strPath = "c:\scope\data\waveform_data.csv"

' Open file for output.
Open strPath For Output Access Write Lock Write As hFile

```

```

' Output waveform data in CSV format.
For lngI = 0 To lngNumWords - 1

    ' Write time value, voltage value.
    Print #hFile, _
        FormatNumber(dblXOrigin + (lngI * dblXIncrement), 9) + _
        ", " + _
        FormatNumber((wordArray(lngI) * dblYIncrement) + dblYOrigin)

Next lngI

' Close output file.
Close hFile ' Close file.
MsgBox "Waveform format WORD data written to " + _
    "c:\scope\data\waveform_data.csv."

End Sub

Private Sub DoCommand(command As String)

    err = viVPrintf(vi, command + vbCrLf, 0)
    If (err <> VI_SUCCESS) Then HandleVISAError vi

    CheckInstrumentErrors

End Sub

Private Function DoCommandIEEEBlock(command As String, _
    lngBlockSize As Long)

    retCount = lngBlockSize

    Dim strCommandAndLength As String
    strCommandAndLength = command + " %#" + _
        Format(lngBlockSize) + "b"

    err = viVPrintf(vi, strCommandAndLength + vbCrLf, paramsArray(1))
    If (err <> VI_SUCCESS) Then HandleVISAError vi

    DoCommandIEEEBlock = retCount

    CheckInstrumentErrors

End Function

Private Function DoQueryString(query As String) As String

    Dim strResult As String * 200

    err = viVPrintf(vi, query + vbCrLf, 0)
    If (err <> VI_SUCCESS) Then HandleVISAError vi

    err = viVScanf(vi, "%t", strResult)
    If (err <> VI_SUCCESS) Then HandleVISAError vi

    DoQueryString = strResult

```

```

        CheckInstrumentErrors

End Function

Private Function DoQueryNumber(query As String) As Variant

    Dim dblResult As Double

    err = viVPrintf(vi, query + vbLf, 0)
    If (err <> VI_SUCCESS) Then HandleVISAError vi

    err = viVScanf(vi, "%lf" + vbLf, VarPtr(dblResult))
    If (err <> VI_SUCCESS) Then HandleVISAError vi

    DoQueryNumber = dblResult

    CheckInstrumentErrors

End Function

Private Function DoQueryNumbers(query As String) As Long

    Dim dblResult As Double

    ' Send query.
    err = viVPrintf(vi, query + vbLf, 0)
    If (err <> VI_SUCCESS) Then HandleVISAError vi

    ' Set up paramsArray for multiple parameter query returning array.
    paramsArray(0) = VarPtr(retCount)
    paramsArray(1) = VarPtr(dblArray(0))

    ' Set retCount to max number of elements array can hold.
    retCount = DblArraySize

    ' Read numbers.
    err = viVScanf(vi, "%,#lf" + vbLf, paramsArray(0))
    If (err <> VI_SUCCESS) Then HandleVISAError vi

    ' retCount is now actual number of values returned by query.
    DoQueryNumbers = retCount

    CheckInstrumentErrors

End Function

Private Function DoQueryIEEEBlock_Bytes(query As String) As Long

    ' Send query.
    err = viVPrintf(vi, query + vbLf, 0)
    If (err <> VI_SUCCESS) Then HandleVISAError vi

    ' Set up paramsArray for multiple parameter query returning array.
    paramsArray(0) = VarPtr(retCount)
    paramsArray(1) = VarPtr(byteArray(0))

```



```

' Set retCount to max number of elements array can hold.
retCount = ByteArraySize

' Get unsigned integer bytes.
err = viVScanf(vi, "%#b" + vbLf, paramsArray(0))
If (err <> VI_SUCCESS) Then HandleVISAError vi

err = viFlush(vi, VI_READ_BUF)
If (err <> VI_SUCCESS) Then HandleVISAError vi

err = viFlush(vi, VI_WRITE_BUF)
If (err <> VI_SUCCESS) Then HandleVISAError vi

' retCount is now actual number of bytes returned by query.
DoQueryIEEEBlock_Bytes = retCount

CheckInstrumentErrors

End Function

Private Function DoQueryIEEEBlock_Words(query As String) As Long

' Send query.
err = viVPrintf(vi, query + vbLf, 0)
If (err <> VI_SUCCESS) Then HandleVISAError vi

' Set up paramsArray for multiple parameter query returning array.
paramsArray(0) = VarPtr(retCount)
paramsArray(1) = VarPtr(wordArray(0))

' Set retCount to max number of elements array can hold.
retCount = WordArraySize

' Get signed integer words.
err = viVScanf(vi, "%#hb" + vbLf, paramsArray(0))
If (err <> VI_SUCCESS) Then HandleVISAError vi

err = viFlush(vi, VI_READ_BUF)
If (err <> VI_SUCCESS) Then HandleVISAError vi

err = viFlush(vi, VI_WRITE_BUF)
If (err <> VI_SUCCESS) Then HandleVISAError vi

' retCount is now actual number of bytes returned by query.
DoQueryIEEEBlock_Words = retCount

CheckInstrumentErrors

End Function

Private Sub CheckInstrumentErrors()

On Error GoTo ErrorHandler

Dim strErrVal As String * 200
Dim strOut As String

```

```

    err = viVPrintf(vi, ":SYSTEM:ERROR? STRING" + vbLf, 0) ' Query any errors.
    If (err <> VI_SUCCESS) Then HandleVISAError vi

    err = viVScanf(vi, "%t", strErrVal) ' Read: Errnum,"Error String".
    If (err <> VI_SUCCESS) Then HandleVISAError vi

    While Val(strErrVal) <> 0 ' End if find: 0,"No Error".
        strOut = strOut + "INST Error: " + strErrVal

        err = viVPrintf(vi, ":SYSTEM:ERROR? STRING" + vbLf, 0) ' Request error.
        If (err <> VI_SUCCESS) Then HandleVISAError vi

        err = viVScanf(vi, "%t", strErrVal) ' Read error message.
        If (err <> VI_SUCCESS) Then HandleVISAError vi

    Wend

    If Not strOut = "" Then
        MsgBox strOut, vbExclamation, "INST Error Messages"

        err = viFlush(vi, VI_READ_BUF)
        If (err <> VI_SUCCESS) Then HandleVISAError vi

        err = viFlush(vi, VI_WRITE_BUF)
        If (err <> VI_SUCCESS) Then HandleVISAError vi

    End If

    Exit Sub

ErrorHandler:

    MsgBox "*** Error : " + Error, vbExclamation
    End

End Sub

Private Sub HandleVISAError(session As Long)

    Dim strVisaErr As String * 200
    Call viStatusDesc(session, err, strVisaErr)
    MsgBox "*** VISA Error : " + strVisaErr, vbExclamation

    ' If the error is not a warning, close the session.
    If err < VI_SUCCESS Then
        If session <> 0 Then Call viClose(session)
        End
    End If

End Sub

```

VISA Example in C#

To compile and run this example in Microsoft Visual Studio 2008:

- 1 Open Visual Studio.
- 2 Create a new Visual C#, Windows, Console Application project.
- 3 Cut-and-paste the code that follows into the C# source file.
- 4 Edit the program to use the VISA address of your oscilloscope.
- 5 Add Keysight's VISA header file to your project:
 - a Right-click the project you wish to modify (not the solution) in the Solution Explorer window of the Microsoft Visual Studio environment.
 - b Click **Add** and then click **Add Existing Item...**
 - c Navigate to the header file, visa32.cs (installed with Keysight IO Libraries Suite and found in the Program Files (x86)\IVI Foundation\VISA\WinNT\Include directory), select it, but *do not click the Open button*.
 - d Click the down arrow to the right of the **Add** button, and choose **Add as Link**.

You should now see the file underneath your project in the Solution Explorer. It will have a little arrow icon in its lower left corner, indicating that it is a link.

- 6 Build and run the program.

For more information, see the tutorial on using VISA in Microsoft .NET in the VISA Help that comes with Keysight IO Libraries Suite 15.

```

/*
 * Keysight VISA Example in C#
 * -----
 * This program illustrates a few commonly used programming
 * features of your Keysight Infiniium Series oscilloscope.
 * -----
 */

using System;
using System.IO;
using System.Text;
using System.Collections.Generic;

namespace Infiniium
{
    class VisaInstrumentApp
    {
        private static VisaInstrument myScope;

        public static void Main(string[] args)
        {
            try
            {
                myScope = new
                    VisaInstrument("TCPIP0::141.121.237.226::hislip0::INSTR");
            }
        }
    }
}

```

```

        myScope.SetTimeoutSeconds(10);

        // Initialize - start from a known state.
        Initialize();

        // Capture data.
        Capture();

        // Analyze the captured waveform.
        Analyze();

    }
    catch (System.ApplicationException err)
    {
        Console.WriteLine("*** VISA Error Message : " + err.Message);
    }
    catch (System.SystemException err)
    {
        Console.WriteLine("*** System Error Message : " + err.Message);
    }
    catch (System.Exception err)
    {
        System.Diagnostics.Debug.Fail("Unexpected Error");
        Console.WriteLine("*** Unexpected Error : " + err.Message);
    }
    finally
    {
        myScope.Close();
    }
}

/*
 * Initialize the oscilloscope to a known state.
 * -----
 */
private static void Initialize()
{
    StringBuilder strResults;

    // Clear status.
    myScope.DoCommand("*CLS");

    // Get and display the device's *IDN? string.
    strResults = myScope.DoQueryString("*IDN?");
    Console.WriteLine("*IDN? result is: {0}", strResults);

    // Load the default setup.
    myScope.DoCommand("*RST");
}

/*
 * Capture the waveform.
 * -----
 */
private static void Capture()
{
    // Set probe attenuation factor.

```

```

myScope.DoCommand(":CHANnel1:PROBe 1.0");
Console.WriteLine("Channel 1 probe attenuation factor: {0}",
    myScope.DoQueryString(":CHANnel1:PROBE?"));

// Use auto-scale to automatically set up oscilloscope.
myScope.DoCommand(":AUToscale");

// Set trigger mode.
myScope.DoCommand(":TRIGger:MODE EDGE");
Console.WriteLine("Trigger mode: {0}",
    myScope.DoQueryString(":TRIGger:MODE?"));

// Set EDGE trigger parameters.
myScope.DoCommand(":TRIGger:EDGE:SOURCe CHANnel1");
Console.WriteLine("Trigger edge source: {0}",
    myScope.DoQueryString(":TRIGger:EDGE:SOURce?"));

myScope.DoCommand(":TRIGger:LEVel CHANnel1,-2E-3");
Console.WriteLine("Trigger level, channel 1: {0}",
    myScope.DoQueryString(":TRIGger:LEVel? CHANnel1"));

myScope.DoCommand(":TRIGger:EDGE:SLOPe POSitive");
Console.WriteLine("Trigger edge slope: {0}",
    myScope.DoQueryString(":TRIGger:EDGE:SLOPe?"));

// Save oscilloscope configuration.
byte[] ResultsArray; // Results array.
int nLength; // Number of bytes returned from instrument.
string strPath;

// Query and read setup string.
nLength = myScope.DoQueryIEEEBlock_Bytes(":SYSTem:SETup?",
    out ResultsArray);

// Write setup string to file.
strPath = "c:\\scope\\config\\setup.stp";
FileStream fStream = File.Open(strPath, FileMode.Create);
fStream.Write(ResultsArray, 0, nLength);
fStream.Close();
Console.WriteLine("Setup bytes saved: {0}", nLength);

// Change settings with individual commands:

// Set vertical scale and offset.
myScope.DoCommand(":CHANnel1:SCALE 0.1");
Console.WriteLine("Channel 1 vertical scale: {0}",
    myScope.DoQueryString(":CHANnel1:SCALE?"));

myScope.DoCommand(":CHANnel1:OFFSet 0.0");
Console.WriteLine("Channel 1 vertical offset: {0}",
    myScope.DoQueryString(":CHANnel1:OFFSet?"));

// Set horizontal scale and position.
myScope.DoCommand(":TIMEbase:SCALE 0.0002");
Console.WriteLine("Timebase scale: {0}",
    myScope.DoQueryString(":TIMEbase:SCALE?"));

```

```

myScope.DoCommand(":TIMEbase:POSition 0.0");
Console.WriteLine("Timebase position: {0}",
    myScope.DoQueryString(":TIMEbase:POSition?"));

// Set the acquisition mode.
myScope.DoCommand(":ACquire:MODE RTIME");
Console.WriteLine("Acquire mode: {0}",
    myScope.DoQueryString(":ACquire:MODE?"));

// Or, set up by loading a previously saved setup.
byte[] dataArray;
int nBytesWritten;

// Read setup string from file.
strPath = "c:\\scope\\config\\setup.stp";
dataArray = File.ReadAllBytes(strPath);

// Restore setup string.
nBytesWritten = myScope.DoCommandIEEEBlock(":SYSTEM:SETup",
    dataArray);
Console.WriteLine("Setup bytes restored: {0}", nBytesWritten);

// Set the desired number of waveform points,
// and capture an acquisition.
myScope.DoCommand(":ACquire:POINTs 32000");
myScope.DoCommand(":DIGitize");
}

/*
 * Analyze the captured waveform.
 * -----
 */
private static void Analyze()
{
    byte[] resultsArray; // Results array.
    short[] wordResultsArray; // Results array for WORD data.
    int nLength; // Number of bytes returned from instrument.
    string strPath;

    // Make measurements.
    // -----
    myScope.DoCommand(":MEASure:SOURce CHANnel1");
    Console.WriteLine("Measure source: {0}",
        myScope.DoQueryString(":MEASure:SOURce?"));

    double fResult;
    myScope.DoCommand(":MEASure:FREquency");
    fResult = myScope.DoQueryNumber(":MEASure:FREquency?");
    Console.WriteLine("Frequency: {0:F4} kHz", fResult / 1000);

    myScope.DoCommand(":MEASure:VAMplitude");
    fResult = myScope.DoQueryNumber(":MEASure:VAMplitude?");
    Console.WriteLine("Vertical amplitude: {0:F2} V", fResult);

    // Download the screen image.
    // -----

```

```

// Get the screen data.
nLength = myScope.DoQueryIEEEBlock_Bytes(":DISPlay:DATA? PNG",
    out ResultsArray);

// Store the screen data to a file.
strPath = "c:\\scope\\data\\screen.png";
FileStream fStream = File.Open(strPath, FileMode.Create);
fStream.Write(ResultsArray, 0, nLength);
fStream.Close();
Console.WriteLine("Screen image ({0} bytes) written to {1}",
    nLength, strPath);

// Download waveform data.
// -----

// Get the waveform type.
Console.WriteLine("Waveform type: {0}",
    myScope.DoQueryString(":WAVEform:TYPE?"));

// Get the number of waveform points.
Console.WriteLine("Waveform points: {0}",
    myScope.DoQueryString(":WAVEform:POINTs?"));

// Set the waveform source.
myScope.DoCommand(":WAVEform:SOURce CHANnel1");
Console.WriteLine("Waveform source: {0}",
    myScope.DoQueryString(":WAVEform:SOURce?"));

// Choose the format of the data returned:
myScope.DoCommand(":WAVEform:FORMat WORD");
Console.WriteLine("Waveform format: {0}",
    myScope.DoQueryString(":WAVEform:FORMat?"));

// Display the waveform settings from preamble:
Dictionary<string, string> dctWavFormat =
    new Dictionary<string, string>()
    {
        {"0", "ASCIi"},
        {"1", "BYTE"},
        {"2", "WORD"},
        {"3", "LONG"},
        {"4", "LONGLONG"},
    };
Dictionary<string, string> dctAcqType =
    new Dictionary<string, string>()
    {
        {"1", "RAW"},
        {"2", "AVERage"},
        {"3", "VHISTogram"},
        {"4", "HHISTogram"},
        {"6", "INTerpolate"},
        {"10", "PDETECT"},
    };
Dictionary<string, string> dctAcqMode =
    new Dictionary<string, string>()
    {
        {"0", "RTIME"},
    };

```

```

        {"1", "ETIME"},
        {"3", "PDETECT"},
    };
Dictionary<string, string> dctCoupling =
    new Dictionary<string, string>()
    {
        {"0", "AC"},
        {"1", "DC"},
        {"2", "DCFIFTY"},
        {"3", "LFREJECT"},
    };
Dictionary<string, string> dctUnits =
    new Dictionary<string, string>()
    {
        {"0", "UNKNOWN"},
        {"1", "VOLT"},
        {"2", "SECOND"},
        {"3", "CONSTANT"},
        {"4", "AMP"},
        {"5", "DECIBEL"},
    };
string strPreamble;
string[] strsPreamble;

strPreamble =
    myScope.DoQueryString(":WAVEform:PREamble?").ToString();
strsPreamble = strPreamble.Split(',');

Console.WriteLine("Waveform format: {0}",
    dctWavFormat[strsPreamble[0]]);

Console.WriteLine("Acquire type: {0}",
    dctAcqType[strsPreamble[1]]);

Console.WriteLine("Waveform points: {0}", strsPreamble[2]);
Console.WriteLine("Waveform average count: {0}", strsPreamble[3]);
Console.WriteLine("Waveform X increment: {0}", strsPreamble[4]);
Console.WriteLine("Waveform X origin: {0}", strsPreamble[5]);
Console.WriteLine("Waveform X reference: {0}", strsPreamble[6]);
Console.WriteLine("Waveform Y increment: {0}", strsPreamble[7]);
Console.WriteLine("Waveform Y origin: {0}", strsPreamble[8]);
Console.WriteLine("Waveform Y reference: {0}", strsPreamble[9]);
Console.WriteLine("Coupling: {0}", dctCoupling[strsPreamble[10]]);
Console.WriteLine("Waveform X display range: {0}",
    strsPreamble[11]);
Console.WriteLine("Waveform X display origin: {0}",
    strsPreamble[12]);
Console.WriteLine("Waveform Y display range: {0}",
    strsPreamble[13]);
Console.WriteLine("Waveform Y display origin: {0}",
    strsPreamble[14]);
Console.WriteLine("Date: {0}", strsPreamble[15]);
Console.WriteLine("Time: {0}", strsPreamble[16]);
Console.WriteLine("Frame model: {0}", strsPreamble[17]);
Console.WriteLine("Acquire mode: {0}",
    dctAcqMode[strsPreamble[18]]);
Console.WriteLine("Completion pct: {0}", strsPreamble[19]);

```



```

Console.WriteLine("Waveform X units: {0}",
    dctUnits[strsPreamble[20]]);
Console.WriteLine("Waveform Y units: {0}",
    dctUnits[strsPreamble[21]]);
Console.WriteLine("Max BW limit: {0}", strsPreamble[22]);
Console.WriteLine("Min BW limit: {0}", strsPreamble[23]);

// Get numeric values for later calculations.
double fXincrement;
fXincrement = myScope.DoQueryNumber(":WAVEform:XINCrement?");
double fXorigin;
fXorigin = myScope.DoQueryNumber(":WAVEform:XORigin?");
double fYincrement;
fYincrement = myScope.DoQueryNumber(":WAVEform:YINCrement?");
double fYorigin;
fYorigin = myScope.DoQueryNumber(":WAVEform:YORigin?");

// Get the waveform data.
myScope.DoCommand(":WAVEform:STReaming OFF");
nLength = myScope.DoQueryIEEEBlock_Words(":WAVEform:DATA?",
    out WordResultsArray);
Console.WriteLine("Number of data values: {0}", nLength);

// Set up output file:
strPath = "c:\\scope\\data\\waveform_data.csv";
if (File.Exists(strPath)) File.Delete(strPath);

// Open file for output.
StreamWriter writer = File.CreateText(strPath);

// Output waveform data in CSV format.
for (int i = 0; i < nLength - 1; i++)
    writer.WriteLine("{0:f9}, {1:f6}",
        fXorigin + ((float)i * fXincrement),
        ((float)WordResultsArray[i] * fYincrement) + fYorigin);

// Close output file.
writer.Close();
Console.WriteLine("Waveform format WORD data written to {0}",
    strPath);
}
}

class VisaInstrument
{
    private int m_nResourceManager;
    private int m_nSession;
    private string m_strVisaAddress;

    // Constructor.
    public VisaInstrument(string strVisaAddress)
    {
        // Save VISA address in member variable.
        m_strVisaAddress = strVisaAddress;

        // Open the default VISA resource manager.
        OpenResourceManager();
    }
}

```

```

    // Open a VISA resource session.
    OpenSession();

    // Clear the interface.
    int nViStatus;
    nViStatus = visa32.viClear(m_nSession);
}

public void DoCommand(string strCommand)
{
    // Send the command.
    VisaSendCommandOrQuery(strCommand);

    // Check for inst errors.
    CheckInstrumentErrors(strCommand);
}

public int DoCommandIEEEBlock(string strCommand,
    byte[] dataArray)
{
    // Send the command to the device.
    string strCommandAndLength;
    int nViStatus, nLength, nBytesWritten;

    nLength = dataArray.Length;
    strCommandAndLength = String.Format("{0} #8%08d",
        strCommand);

    // Write first part of command to formatted I/O write buffer.
    nViStatus = visa32.viPrintf(m_nSession, strCommandAndLength,
        nLength);
    CheckVisaStatus(nViStatus);

    // Write the data to the formatted I/O write buffer.
    nViStatus = visa32.viBufWrite(m_nSession, dataArray, nLength,
        out nBytesWritten);
    CheckVisaStatus(nViStatus);

    // Check for inst errors.
    CheckInstrumentErrors(strCommand);

    return nBytesWritten;
}

public StringBuilder DoQueryString(string strQuery)
{
    // Send the query.
    VisaSendCommandOrQuery(strQuery);

    // Get the result string.
    StringBuilder strResults = new StringBuilder(1000);
    strResults = VisaGetResultString();

    // Check for inst errors.
    CheckInstrumentErrors(strQuery);
}

```

```

    // Return string results.
    return strResults;
}

public double DoQueryNumber(string strQuery)
{
    // Send the query.
    VisaSendCommandOrQuery(strQuery);

    // Get the result string.
    double fResults;
    fResults = VisaGetResultNumber();

    // Check for inst errors.
    CheckInstrumentErrors(strQuery);

    // Return string results.
    return fResults;
}

public double[] DoQueryNumbers(string strQuery)
{
    // Send the query.
    VisaSendCommandOrQuery(strQuery);

    // Get the result string.
    double[] fResultsArray;
    fResultsArray = VisaGetResultNumbers();

    // Check for inst errors.
    CheckInstrumentErrors(strQuery);

    // Return string results.
    return fResultsArray;
}

public int DoQueryIEEEBlock_Bytes(string strQuery,
    out byte[] ResultsArray)
{
    // Send the query.
    VisaSendCommandOrQuery(strQuery);

    // Get the result string.
    int length; // Number of bytes returned from instrument.
    length = VisaGetResultIEEEBlock_Bytes(out ResultsArray);

    // Check for inst errors.
    CheckInstrumentErrors(strQuery);

    // Return string results.
    return length;
}

public int DoQueryIEEEBlock_Words(string strQuery,
    out short[] ResultsArray)
{
    // Send the query.

```

```

VisaSendCommandOrQuery(strQuery);

// Get the result string.
int length; // Number of bytes returned from instrument.
length = VisaGetResultIEEEBlock_Words(out ResultsArray);

// Check for inst errors.
CheckInstrumentErrors(strQuery);

// Return string results.
return length;
}

private void VisaSendCommandOrQuery(string strCommandOrQuery)
{
    // Send command or query to the device.
    string strWithNewline;
    strWithNewline = String.Format("{0}\n", strCommandOrQuery);
    int nViStatus;
    nViStatus = visa32.viPrintf(m_nSession, strWithNewline);
    CheckVisaStatus(nViStatus);
}

private StringBuilder VisaGetResultString()
{
    StringBuilder strResults = new StringBuilder(1000);

    // Read return value string from the device.
    int nViStatus;
    nViStatus = visa32.viScanf(m_nSession, "%1000t", strResults);
    CheckVisaStatus(nViStatus);

    return strResults;
}

private double VisaGetResultNumber()
{
    double fResults = 0;

    // Read return value string from the device.
    int nViStatus;
    nViStatus = visa32.viScanf(m_nSession, "%lf", out fResults);
    CheckVisaStatus(nViStatus);

    return fResults;
}

private double[] VisaGetResultNumbers()
{
    double[] fResultsArray;
    fResultsArray = new double[10];

    // Read return value string from the device.
    int nViStatus;
    nViStatus = visa32.viScanf(m_nSession, "%,10lf\n",
        fResultsArray);
    CheckVisaStatus(nViStatus);
}

```

```

    return fResultsArray;
}

private int VisaGetResultIEEEBlock_Bytes(out byte[] ResultsArray)
{
    // Results array, big enough to hold a PNG.
    ResultsArray = new byte[5000000];
    int length;    // Number of bytes returned from instrument.

    // Set the default number of bytes that will be contained in
    // the ResultsArray to 5,000,000.
    length = 5000000;

    // Read return value string from the device.
    int nViStatus;
    nViStatus = visa32.viScanf(m_nSession, "%#b", ref length,
        ResultsArray);
    CheckVisaStatus(nViStatus);

    // Write and read buffers need to be flushed after IEEE block?
    nViStatus = visa32.viFlush(m_nSession, visa32.VI_WRITE_BUF);
    CheckVisaStatus(nViStatus);

    nViStatus = visa32.viFlush(m_nSession, visa32.VI_READ_BUF);
    CheckVisaStatus(nViStatus);

    return length;
}

private int VisaGetResultIEEEBlock_Words(out short[] ResultsArray)
{
    // Results array, big enough to hold a PNG.
    ResultsArray = new short[5000000];
    int length;    // Number of words returned from instrument.

    // Set the default number of words that will be contained in
    // the ResultsArray to 5,000,000.
    length = 5000000;

    // Read return value string from the device.
    int nViStatus;
    nViStatus = visa32.viScanf(m_nSession, "%#hb", ref length,
        ResultsArray);
    CheckVisaStatus(nViStatus);

    // Write and read buffers need to be flushed after IEEE block?
    nViStatus = visa32.viFlush(m_nSession, visa32.VI_WRITE_BUF);
    CheckVisaStatus(nViStatus);

    nViStatus = visa32.viFlush(m_nSession, visa32.VI_READ_BUF);
    CheckVisaStatus(nViStatus);

    return length;
}

private void CheckInstrumentErrors(string strCommand)

```

```

{
    // Check for instrument errors.
    StringBuilder strInstrumentError = new StringBuilder(1000);
    bool bFirstError = true;

    do // While not "0,No error"
    {
        VisaSendCommandOrQuery(":SYSTem:ERRor? STRing");
        strInstrumentError = VisaGetResultString();

        if (!strInstrumentError.ToString().StartsWith("0, "))
        {
            if (bFirstError)
            {
                Console.WriteLine("ERROR(s) for command '{0}': ",
                    strCommand);
                bFirstError = false;
            }
            Console.Write(strInstrumentError);
        }
    } while (!strInstrumentError.ToString().StartsWith("0, "));
}

private void OpenResourceManager()
{
    int nViStatus;
    nViStatus =
        visa32.viOpenDefaultRM(out this.m_nResourceManager);
    if (nViStatus < visa32.VI_SUCCESS)
        throw new
            ApplicationException("Failed to open Resource Manager");
}

private void OpenSession()
{
    int nViStatus;
    nViStatus = visa32.viOpen(this.m_nResourceManager,
        this.m_strVisaAddress, visa32.VI_NO_LOCK,
        visa32.VI_TMO_IMMEDIATE, out this.m_nSession);
    CheckVisaStatus(nViStatus);
}

public void SetTimeoutSeconds(int nSeconds)
{
    int nViStatus;
    nViStatus = visa32.viSetAttribute(this.m_nSession,
        visa32.VI_ATTR_TMO_VALUE, nSeconds * 1000);
    CheckVisaStatus(nViStatus);
}

public void CheckVisaStatus(int nViStatus)
{
    // If VISA error, throw exception.
    if (nViStatus < visa32.VI_SUCCESS)
    {
        StringBuilder strError = new StringBuilder(256);
        visa32.viStatusDesc(this.m_nResourceManager, nViStatus,

```

```

        strError);
        throw new ApplicationException(strError.ToString());
    }
}

public void Close()
{
    if (m_nSession != 0)
        visa32.viClose(m_nSession);
    if (m_nResourceManager != 0)
        visa32.viClose(m_nResourceManager);
}
}
}

```

VISA Example in Visual Basic .NET

To compile and run this example in Microsoft Visual Studio 2008:

- 1 Open Visual Studio.
- 2 Create a new Visual Basic, Windows, Console Application project.
- 3 Cut-and-paste the code that follows into the Visual Basic .NET source file.
- 4 Edit the program to use the VISA address of your oscilloscope.
- 5 Add Keysight's VISA header file to your project:
 - a Right-click the project you wish to modify (not the solution) in the Solution Explorer window of the Microsoft Visual Studio environment.
 - b Choose **Add** and then choose **Add Existing Item...**
 - c Navigate to the header file, visa32.vb (installed with Keysight IO Libraries Suite and found in the Program Files (x86)\IVI Foundation\VISA\WinNT\Include directory), select it, but *do not click the Open button*.
 - d Click the down arrow to the right of the **Add** button, and choose **Add as Link**.

You should now see the file underneath your project in the Solution Explorer. It will have a little arrow icon in its lower left corner, indicating that it is a link.

 - e Right-click the project again and choose **Properties**; then, select "Infiniium.VisaInstrumentApp" as the **Startup object**.
- 6 Build and run the program.

For more information, see the tutorial on using VISA in Microsoft .NET in the VISA Help that comes with Keysight IO Libraries Suite 15.

```

'
' Keysight VISA Example in Visual Basic .NET
' -----
' This program illustrates a few commonly-used programming
' features of your Keysight Infiniium Series oscilloscope.
' -----

```

```

Imports System
Imports System.IO
Imports System.Text

Namespace Infiniium
Class VisaInstrumentApp
Private Shared myScope As VisaInstrument

Public Shared Sub Main(ByVal args As String())
Try
myScope = _
New VisaInstrument("TCPIP0::141.121.237.226::hislip0::INSTR")
myScope.SetTimeoutSeconds(10)

' Initialize - start from a known state.
Initialize()

' Capture data.
Capture()

' Analyze the captured waveform.
Analyze()

Catch err As System.ApplicationException
Console.WriteLine("*** VISA Error Message : " + err.Message)
Catch err As System.SystemException
Console.WriteLine("*** System Error Message : " + err.Message)
Catch err As System.Exception
Debug.Fail("Unexpected Error")
Console.WriteLine("*** Unexpected Error : " + err.Message)
Finally
myScope.Close()
End Try
End Sub

'
' Initialize the oscilloscope to a known state.
' -----

Private Shared Sub Initialize()
Dim strResults As StringBuilder

' Clear status.
myScope.DoCommand("*CLS")

' Get and display the device's *IDN? string.
strResults = myScope.DoQueryString("*IDN?")
Console.WriteLine("*IDN? result is: {0}", strResults)

' Load the default setup.
myScope.DoCommand("*RST")

End Sub

'
' Capture the waveform.
' -----

```



```

Private Shared Sub Capture()

    ' Set probe attenuation factor.
    myScope.DoCommand(":CHANnel1:PROBE 1.0")
    Console.WriteLine("Channel 1 probe attenuation factor: {0}", _
        myScope.DoQueryString(":CHANnel1:PROBE?"))

    ' Use auto-scale to automatically set up oscilloscope.
    myScope.DoCommand(":AUToscale")

    ' Set trigger mode.
    myScope.DoCommand(":TRIGger:MODE EDGE")
    Console.WriteLine("Trigger mode: {0}", _
        myScope.DoQueryString(":TRIGger:MODE?"))

    ' Set EDGE trigger parameters.
    myScope.DoCommand(":TRIGger:EDGE:SOURCe CHANnel1")
    Console.WriteLine("Trigger edge source: {0}", _
        myScope.DoQueryString(":TRIGger:EDGE:SOURce?"))

    myScope.DoCommand(":TRIGger:LEVel CHANnel1, -2E-3")
    Console.WriteLine("Trigger edge level: {0}", _
        myScope.DoQueryString(":TRIGger:LEVel? CHANnel1"))

    myScope.DoCommand(":TRIGger:EDGE:SLOPe POSitive")
    Console.WriteLine("Trigger edge slope: {0}", _
        myScope.DoQueryString(":TRIGger:EDGE:SLOPe?"))

    ' Save oscilloscope setup.
    Dim ResultsArray As Byte() ' Results array.
    Dim nLength As Integer ' Number of bytes returned from inst.
    Dim strPath As String
    Dim fStream As FileStream

    ' Query and read setup string.
    nLength = myScope.DoQueryIEEEBlock_Bytes(":SYSTem:SETup?", _
        ResultsArray)

    ' Write setup string to file.
    strPath = "c:\scope\config\setup.stp"
    fStream = File.Open(strPath, FileMode.Create)
    fStream.Write(ResultsArray, 0, nLength)
    fStream.Close()
    Console.WriteLine("Setup bytes saved: {0}", nLength)

    ' Change settings with individual commands:

    ' Set vertical scale and offset.
    myScope.DoCommand(":CHANnel1:SCALe 0.1")
    Console.WriteLine("Channel 1 vertical scale: {0}", _
        myScope.DoQueryString(":CHANnel1:SCALe?"))

    myScope.DoCommand(":CHANnel1:OFFSet 0.0")
    Console.WriteLine("Channel 1 vertical offset: {0}", _
        myScope.DoQueryString(":CHANnel1:OFFSet?"))

```

```

' Set horizontal scale and position.
myScope.DoCommand(":TIMEbase:SCALE 0.0002")
Console.WriteLine("Timebase scale: {0}", _
    myScope.DoQueryString(":TIMEbase:SCALE?"))

myScope.DoCommand(":TIMEbase:POSition 0.0")
Console.WriteLine("Timebase position: {0}", _
    myScope.DoQueryString(":TIMEbase:POSition?"))

' Set the acquisition mode.
myScope.DoCommand(":ACquire:MODE RTIME")
Console.WriteLine("Acquire mode: {0}", _
    myScope.DoQueryString(":ACquire:MODE?"))

' Or, set up by loading a previously saved setup.
Dim dataArray As Byte()
Dim nBytesWritten As Integer

' Read setup string from file.
strPath = "c:\scope\config\setup.stp"
dataArray = File.ReadAllBytes(strPath)

' Restore setup string.
nBytesWritten = myScope.DoCommandIEEEBlock(":SYSTem:SETup", _
    dataArray)
Console.WriteLine("Setup bytes restored: {0}", nBytesWritten)

' Set the desired number of waveform points,
' and capture an acquisition.
myScope.DoCommand(":ACquire:POINts 32000")
myScope.DoCommand(":DIGitize")

End Sub

'
' Analyze the captured waveform.
' -----

Private Shared Sub Analyze()

    Dim fResult As Double
    Dim ResultsArray As Byte() ' Results array.
    Dim WordResultsArray As Short() ' Results array for WORD data.
    Dim nLength As Integer ' Number of bytes returned from inst.
    Dim strPath As String

    ' Make measurements.
    ' -----
    myScope.DoCommand(":MEASure:SOURce CHANnel1")
    Console.WriteLine("Measure source: {0}", _
        myScope.DoQueryString(":MEASure:SOURce?"))

    myScope.DoCommand(":MEASure:FREQuency")
    fResult = myScope.DoQueryNumber(":MEASure:FREQuency?")
    Console.WriteLine("Frequency: {0:F4} kHz", fResult / 1000)

    myScope.DoCommand(":MEASure:VAMPLitude")

```

```

fResult = myScope.DoQueryNumber(":MEASure:VAMplitude?")
Console.WriteLine("Vertical amplitude: {0:F2} V", fResult)

' Download the screen image.
' -----

' Get the screen data.
nLength = myScope.DoQueryIEEEBlock_Bytes(":DISPlay:DATA? PNG", _
    ResultsArray)

' Store the screen data to a file.
strPath = "c:\scope\data\screen.png"
Dim fStream As FileStream
fStream = File.Open(strPath, FileMode.Create)
fStream.Write(ResultsArray, 0, nLength)
fStream.Close()
Console.WriteLine("Screen image ({0} bytes) written to {1}", _
    nLength, strPath)

' Download waveform data.
' -----

' Get the waveform type.
Console.WriteLine("Waveform type: {0}", _
    myScope.DoQueryString(":WAVEform:TYPE?"))

' Get the number of waveform points.
Console.WriteLine("Waveform points: {0}", _
    myScope.DoQueryString(":WAVEform:POINTs?"))

' Set the waveform source.
myScope.DoCommand(":WAVEform:SOURce CHANnel1")
Console.WriteLine("Waveform source: {0}", _
    myScope.DoQueryString(":WAVEform:SOURce?"))

' Choose the format of the data returned:
myScope.DoCommand(":WAVEform:FORMat WORD")
Console.WriteLine("Waveform format: {0}", _
    myScope.DoQueryString(":WAVEform:FORMat?"))

' Display the waveform settings from preamble:
Dim dctWavFormat As New Dictionary(Of String, String)
dctWavFormat.Add("0", "AScii")
dctWavFormat.Add("1", "BYTE")
dctWavFormat.Add("2", "WORD")
dctWavFormat.Add("3", "LONG")
dctWavFormat.Add("4", "LONGLONG")

Dim dctAcqType As New Dictionary(Of String, String)
dctAcqType.Add("1", "RAW")
dctAcqType.Add("2", "AVERage")
dctAcqType.Add("3", "VHISTogram")
dctAcqType.Add("4", "HHISTogram")
dctAcqType.Add("6", "INTerpolate")
dctAcqType.Add("10", "PDETECT")

Dim dctAcqMode As New Dictionary(Of String, String)()

```

```

dctAcqMode.Add("0", "RTIME")
dctAcqMode.Add("1", "ETIME")
dctAcqMode.Add("3", "PDETECT")

Dim dctCoupling As New Dictionary(Of String, String)()
dctCoupling.Add("0", "AC")
dctCoupling.Add("1", "DC")
dctCoupling.Add("2", "DCFIFTY")
dctCoupling.Add("3", "LFREJECT")

Dim dctUnits As New Dictionary(Of String, String)()
dctUnits.Add("0", "UNKNOWN")
dctUnits.Add("1", "VOLT")
dctUnits.Add("2", "SECOND")
dctUnits.Add("3", "CONSTANT")
dctUnits.Add("4", "AMP")
dctUnits.Add("5", "DECIBEL")

Dim strPreamble As String
Dim strsPreamble As String()

strPreamble = _
    myScope.DoQueryString(":WAVEFORM:PREAmble?").ToString()
strsPreamble = strPreamble.Split(",")

Console.WriteLine("Waveform format: {0}", _
    dctWavFormat(strsPreamble(0)))

Console.WriteLine("Acquire type: {0}", _
    dctAcqType(strsPreamble(1)))

Console.WriteLine("Waveform points: {0}", strsPreamble(2))
Console.WriteLine("Waveform average count: {0}", strsPreamble(3))
Console.WriteLine("Waveform X increment: {0}", strsPreamble(4))
Console.WriteLine("Waveform X origin: {0}", strsPreamble(5))
Console.WriteLine("Waveform X reference: {0}", strsPreamble(6))
Console.WriteLine("Waveform Y increment: {0}", strsPreamble(7))
Console.WriteLine("Waveform Y origin: {0}", strsPreamble(8))
Console.WriteLine("Waveform Y reference: {0}", strsPreamble(9))
Console.WriteLine("Coupling: {0}", dctCoupling(strsPreamble(10)))
Console.WriteLine("Waveform X display range: {0}", _
    strsPreamble(11))
Console.WriteLine("Waveform X display origin: {0}", _
    strsPreamble(12))
Console.WriteLine("Waveform Y display range: {0}", _
    strsPreamble(13))
Console.WriteLine("Waveform Y display origin: {0}", _
    strsPreamble(14))
Console.WriteLine("Date: {0}", strsPreamble(15))
Console.WriteLine("Time: {0}", strsPreamble(16))
Console.WriteLine("Frame model: {0}", strsPreamble(17))
Console.WriteLine("Acquire mode: {0}", _
    dctAcqMode(strsPreamble(18)))
Console.WriteLine("Completion pct: {0}", strsPreamble(19))
Console.WriteLine("Waveform X inits: {0}", _
    dctUnits(strsPreamble(20)))
Console.WriteLine("Waveform Y units: {0}", _

```

```

        dctUnits(strsPreamble(21))
    Console.WriteLine("Max BW limit: {0}", strsPreamble(22))
    Console.WriteLine("Min BW limit: {0}", strsPreamble(23))

    ' Get numeric values for later calculations.
    Dim fXincrement As Double
    fXincrement = myScope.DoQueryNumber(":WAVEform:XINcrement?")
    Dim fXorigin As Double
    fXorigin = myScope.DoQueryNumber(":WAVEform:XORigin?")
    Dim fYincrement As Double
    fYincrement = myScope.DoQueryNumber(":WAVEform:YINcrement?")
    Dim fYorigin As Double
    fYorigin = myScope.DoQueryNumber(":WAVEform:YORigin?")

    ' Get the waveform data.
    myScope.DoCommand(":WAVEform:STReaming OFF")
    nLength = myScope.DoQueryIEEEBlock_Words(":WAVEform:DATA?", _
        WordResultsArray)
    Console.WriteLine("Number of data values: {0}", nLength)

    ' Set up output file:
    strPath = "c:\scope\data\waveform_data.csv"
    If File.Exists(strPath) Then
        File.Delete(strPath)
    End If

    ' Open file for output.
    Dim writer As StreamWriter = File.CreateText(strPath)

    ' Output waveform data in CSV format.
    For index As Integer = 0 To nLength - 1
        ' Write time value, voltage value.
        writer.WriteLine("{0:f9}, {1:f6}", _
            fXorigin + (CSng(index) * fXincrement), _
            (CSng(WordResultsArray(index)) * fYincrement) + _
            fYorigin)
    Next

    ' Close output file.
    writer.Close()
    Console.WriteLine("Waveform format WORD data written to {0}", _
        strPath)

End Sub

End Class

Class VisaInstrument
    Private m_nResourceManager As Integer
    Private m_nSession As Integer
    Private m_strVisaAddress As String

    ' Constructor.
    Public Sub New(ByVal strVisaAddress As String)
        ' Save VISA address in member variable.
        m_strVisaAddress = strVisaAddress
    End Sub
End Class

```

```

' Open the default VISA resource manager.
OpenResourceManager()

' Open a VISA resource session.
OpenSession()

' Clear the interface.
Dim nViStatus As Integer
nViStatus = visa32.viClear(m_nSession)
End Sub

Public Sub DoCommand(ByVal strCommand As String)
' Send the command.
VisaSendCommandOrQuery(strCommand)

' Check for inst errors.
CheckInstrumentErrors(strCommand)

End Sub

Public Function DoCommandIEEEBlock(ByVal strCommand As String, _
ByVal dataArray As Byte()) As Integer

' Send the command to the device.
Dim strCommandAndLength As String
Dim nViStatus As Integer
Dim nLength As Integer
Dim nBytesWritten As Integer

nLength = dataArray.Length
strCommandAndLength = [String].Format("{0} #8{1:D8}", _
strCommand, nLength)

' Write first part of command to formatted I/O write buffer.
nViStatus = visa32.viPrintf(m_nSession, strCommandAndLength)
CheckVisaStatus(nViStatus)

' Write the data to the formatted I/O write buffer.
nViStatus = visa32.viBufWrite(m_nSession, dataArray, nLength, _
nBytesWritten)
CheckVisaStatus(nViStatus)

' Check for inst errors.
CheckInstrumentErrors(strCommand)

Return nBytesWritten
End Function

Public Function DoQueryString(ByVal strQuery As String) _
As StringBuilder
' Send the query.
VisaSendCommandOrQuery(strQuery)

' Get the result string.
Dim strResults As New StringBuilder(1000)
strResults = VisaGetResultString()

```

```

    ' Check for inst errors.
    CheckInstrumentErrors(strQuery)

    ' Return string results.
    Return strResults
End Function

Public Function DoQueryNumber(ByVal strQuery As String) As Double
    ' Send the query.
    VisaSendCommandOrQuery(strQuery)

    ' Get the result string.
    Dim fResults As Double
    fResults = VisaGetResultNumber()

    ' Check for inst errors.
    CheckInstrumentErrors(strQuery)

    ' Return string results.
    Return fResults
End Function

Public Function DoQueryNumbers(ByVal strQuery As String) _
    As Double()
    ' Send the query.
    VisaSendCommandOrQuery(strQuery)

    ' Get the result string.
    Dim fResultsArray As Double()
    fResultsArray = VisaGetResultNumbers()

    ' Check for instrument errors (another command and result).
    CheckInstrumentErrors(strQuery)

    ' Return string results.
    Return fResultsArray
End Function

Public Function DoQueryIEEEBlock_Bytes(ByVal strQuery As String, _
    ByRef ResultsArray As Byte()) As Integer
    ' Send the query.
    VisaSendCommandOrQuery(strQuery)

    ' Get the result string.
    Dim length As Integer
    ' Number of bytes returned from instrument.
    length = VisaGetResultIEEEBlock_Bytes(ResultsArray)

    ' Check for inst errors.
    CheckInstrumentErrors(strQuery)

    ' Return string results.
    Return length
End Function

Public Function DoQueryIEEEBlock_Words(ByVal strQuery As String, _

```

```

        ByRef ResultsArray As Short() As Integer
    ' Send the query.
    VisaSendCommandOrQuery(strQuery)

    ' Get the result string.
    Dim length As Integer
    ' Number of bytes returned from instrument.
    length = VisaGetResultIEEEBlock_Words(ResultsArray)

    ' Check for inst errors.
    CheckInstrumentErrors(strQuery)

    ' Return string results.
    Return length
End Function

Private Sub VisaSendCommandOrQuery(ByVal strCommandOrQuery _
    As String)
    ' Send command or query to the device.
    Dim strWithNewline As String
    strWithNewline = [String].Format("{0}" & Chr(10) & "", _
        strCommandOrQuery)
    Dim nViStatus As Integer
    nViStatus = visa32.viPrintf(m_nSession, strWithNewline)
    CheckVisaStatus(nViStatus)
End Sub

Private Function VisaGetResultString() As StringBuilder
    Dim strResults As New StringBuilder(1000)

    ' Read return value string from the device.
    Dim nViStatus As Integer
    nViStatus = visa32.viScanf(m_nSession, "%1000t", strResults)
    CheckVisaStatus(nViStatus)

    Return strResults
End Function

Private Function VisaGetResultNumber() As Double
    Dim fResults As Double = 0

    ' Read return value string from the device.
    Dim nViStatus As Integer
    nViStatus = visa32.viScanf(m_nSession, "%lf", fResults)
    CheckVisaStatus(nViStatus)

    Return fResults
End Function

Private Function VisaGetResultNumbers() As Double()
    Dim fResultsArray As Double()
    fResultsArray = New Double(9) {}

    ' Read return value string from the device.
    Dim nViStatus As Integer
    nViStatus = visa32.viScanf(m_nSession, _
        "%,10lf" & Chr(10) & "", fResultsArray)

```



```

    CheckVisaStatus(nViStatus)

    Return fResultsArray
End Function

Private Function VisaGetResultIEEEBlock_Bytes(ByRef ResultsArray _
    As Byte()) As Integer
    ' Results array, big enough to hold a PNG.
    ResultsArray = New Byte(4999999) {}
    Dim length As Integer
    ' Number of bytes returned from instrument.
    ' Set the default number of bytes that will be contained in
    ' the ResultsArray to 5,000,000.
    length = 5000000

    ' Read return value string from the device.
    Dim nViStatus As Integer
    nViStatus = visa32.viScanf(m_nSession, "%#b", length, _
        ResultsArray)
    CheckVisaStatus(nViStatus)

    ' Write and read buffers need to be flushed after IEEE block?
    nViStatus = visa32.viFlush(m_nSession, visa32.VI_WRITE_BUF)
    CheckVisaStatus(nViStatus)

    nViStatus = visa32.viFlush(m_nSession, visa32.VI_READ_BUF)
    CheckVisaStatus(nViStatus)

    Return length
End Function

Private Function VisaGetResultIEEEBlock_Words(ByRef ResultsArray _
    As Short()) As Integer
    ' Results array, big enough to hold a PNG.
    ResultsArray = New Short(4999999) {}
    Dim length As Integer
    ' Number of bytes returned from instrument.
    ' Set the default number of bytes that will be contained in
    ' the ResultsArray to 5,000,000.
    length = 5000000

    ' Read return value string from the device.
    Dim nViStatus As Integer
    nViStatus = visa32.viScanf(m_nSession, "%#hb", length, _
        ResultsArray)
    CheckVisaStatus(nViStatus)

    ' Write and read buffers need to be flushed after IEEE block?
    nViStatus = visa32.viFlush(m_nSession, visa32.VI_WRITE_BUF)
    CheckVisaStatus(nViStatus)

    nViStatus = visa32.viFlush(m_nSession, visa32.VI_READ_BUF)
    CheckVisaStatus(nViStatus)

    Return length
End Function

```

```

Private Sub CheckInstrumentErrors(ByVal strCommand As String)
    ' Check for instrument errors.
    Dim strInstrumentError As New StringBuilder(1000)
    Dim bFirstError As Boolean = True
    Do ' While not "0,No error"
        VisaSendCommandOrQuery(":SYSTem:ERRor? STRing")
        strInstrumentError = VisaGetResultString()

        If Not strInstrumentError.ToString().StartsWith("0,") Then
            If bFirstError Then
                Console.WriteLine("ERROR(s) for command '{0}': ", _
                    strCommand)
                bFirstError = False
            End If
            Console.Write(strInstrumentError)
        End If
    Loop While Not strInstrumentError.ToString().StartsWith("0,")
End Sub

Private Sub OpenResourceManager()
    Dim nViStatus As Integer
    nViStatus = visa32.viOpenDefaultRM(Me.m_nResourceManager)
    If nViStatus < visa32.VI_SUCCESS Then
        Throw New _
            ApplicationException("Failed to open Resource Manager")
    End If
End Sub

Private Sub OpenSession()
    Dim nViStatus As Integer
    nViStatus = visa32.viOpen(Me.m_nResourceManager, _
        Me.m_strVisaAddress, visa32.VI_NO_LOCK, _
        visa32.VI_TMO_IMMEDIATE, Me.m_nSession)
    CheckVisaStatus(nViStatus)
End Sub

Public Sub SetTimeoutSeconds(ByVal nSeconds As Integer)
    Dim nViStatus As Integer
    nViStatus = visa32.viSetAttribute(Me.m_nSession, _
        visa32.VI_ATTR_TMO_VALUE, nSeconds * 1000)
    CheckVisaStatus(nViStatus)
End Sub

Public Sub CheckVisaStatus(ByVal nViStatus As Integer)
    ' If VISA error, throw exception.
    If nViStatus < visa32.VI_SUCCESS Then
        Dim strError As New StringBuilder(256)
        visa32.viStatusDesc(Me.m_nResourceManager, nViStatus, strError)
        Throw New ApplicationException(strError.ToString())
    End If
End Sub

Public Sub Close()
    If m_nSession <> 0 Then
        visa32.viClose(m_nSession)
    End If
    If m_nResourceManager <> 0 Then

```

```

        visa32.viClose(m_nResourceManager)
    End If
End Sub
End Class
End Namespace

```

VISA Example in Python (PyVISA 1.5 and older)

You can use the Python programming language with the PyVISA package to control Keysight Infiniium Series oscilloscopes.

The Python language and PyVISA package can be downloaded from the web at <http://www.python.org/> and <http://pyvisa.sourceforge.net/>, respectively.

To run this example with Python and PyVISA:

- 1 Cut-and-paste the code that follows into a file named "example.py".
- 2 Edit the program to use the VISA address of your oscilloscope.
- 3 If "python.exe" can be found via your PATH environment variable, open a Command Prompt window; then, change to the folder that contains the "example.py" file, and enter:

```

python example.py

# *****
# This program illustrates a few commonly-used programming
# features of your Keysight Infiniium Series oscilloscope.
# *****

# Import modules.
# -----
import visa
import string
import struct
import sys

# Global variables (booleans: 0 = False, 1 = True).
# -----
debug = 0

# =====
# Initialize:
# =====
def initialize():

    # Clear status.
    do_command("*CLS")

    # Get and display the device's *IDN? string.
    idn_string = do_query_string("*IDN?")
    print "Identification string: '%s'" % idn_string

    # Load the default setup.
    do_command("*RST")

```

```

# =====
# Capture:
# =====
def capture():

    # Set probe attenuation factor.
    do_command(":CHANnel1:PROBe 1.0")
    qresult = do_query_string(":CHANnel1:PROBe?")
    print "Channel 1 probe attenuation factor: %s" % qresult

    # Use auto-scale to automatically set up oscilloscope.
    print "Autoscale."
    do_command(":AUToscale")

    # Set trigger mode.
    do_command(":TRIGger:MODE EDGE")
    qresult = do_query_string(":TRIGger:MODE?")
    print "Trigger mode: %s" % qresult

    # Set EDGE trigger parameters.
    do_command(":TRIGger:EDGE:SOURCe CHANnel1")
    qresult = do_query_string(":TRIGger:EDGE:SOURce?")
    print "Trigger edge source: %s" % qresult

    do_command(":TRIGger:LEVel CHANnel1,-2E-3")
    qresult = do_query_string(":TRIGger:LEVel? CHANnel1")
    print "Trigger level, channel 1: %s" % qresult

    do_command(":TRIGger:EDGE:SLOPe POSitive")
    qresult = do_query_string(":TRIGger:EDGE:SLOPe?")
    print "Trigger edge slope: %s" % qresult

    # Save oscilloscope setup.
    sSetup = do_query_string(":SYSTem:SETup?")
    sSetup = get_definite_length_block_data(sSetup)

    f = open("setup.stp", "wb")
    f.write(sSetup)
    f.close()
    print "Setup bytes saved: %d" % len(sSetup)

    # Change oscilloscope settings with individual commands:

    # Set vertical scale and offset.
    do_command(":CHANnel1:SCALe 0.1")
    qresult = do_query_values(":CHANnel1:SCALe?")[0]
    print "Channel 1 vertical scale: %f" % qresult

    do_command(":CHANnel1:OFFSet 0.0")
    qresult = do_query_values(":CHANnel1:OFFSet?")[0]
    print "Channel 1 offset: %f" % qresult

    # Set horizontal scale and offset.
    do_command(":TIMEbase:SCALe 200e-6")
    qresult = do_query_string(":TIMEbase:SCALe?")

```

```

print "Timebase scale: %s" % qresult

do_command(":TIMEbase:POSition 0.0")
qresult = do_query_string(":TIMEbase:POSition?")
print "Timebase position: %s" % qresult

# Set the acquisition mode.
do_command(":ACQuire:MODE RTIME")
qresult = do_query_string(":ACQuire:MODE?")
print "Acquire mode: %s" % qresult

# Or, set up oscilloscope by loading a previously saved setup.
sSetup = ""
f = open("setup.stp", "rb")
sSetup = f.read()
f.close()
do_command(":SYSTem:SETup #8%08d%s" % (len(sSetup), sSetup), hide_param
s=True)
print "Setup bytes restored: %d" % len(sSetup)

# Set the desired number of waveform points,
# and capture an acquisition.
do_command(":ACQuire:POINts 32000")
do_command(":DIGitize")

# =====
# Analyze:
# =====
def analyze():

    # Make measurements.
    # -----
    do_command(":MEASure:SOURce CHANnel1")
    qresult = do_query_string(":MEASure:SOURce?")
    print "Measure source: %s" % qresult

    do_command(":MEASure:FREQuency")
    qresult = do_query_string(":MEASure:FREQuency?")
    print "Measured frequency on channel 1: %s" % qresult

    do_command(":MEASure:VAMPlitude")
    qresult = do_query_string(":MEASure:VAMPlitude?")
    print "Measured vertical amplitude on channel 1: %s" % qresult

    # Download the screen image.
    # -----
    sDisplay = do_query_string(":DISPlay:DATA? PNG")
    sDisplay = get_definite_length_block_data(sDisplay)

    # Save display data values to file.
    f = open("screen_image.png", "wb")
    f.write(sDisplay)
    f.close()
    print "Screen image written to screen_image.png."

    # Download waveform data.

```

```

# -----

# Get the waveform type.
qresult = do_query_string(":WAVEform:TYPE?")
print "Waveform type: %s" % qresult

# Get the number of waveform points.
qresult = do_query_string(":WAVEform:POINTs?")
print "Waveform points: %s" % qresult

# Set the waveform source.
do_command(":WAVEform:SOURce CHANnel1")
qresult = do_query_string(":WAVEform:SOURce?")
print "Waveform source: %s" % qresult

# Choose the format of the data returned:
do_command(":WAVEform:FORMat BYTE")
print "Waveform format: %s" % do_query_string(":WAVEform:FORMat?")

# Display the waveform settings from preamble:
wav_form_dict = {
    0 : "ASCIi",
    1 : "BYTE",
    2 : "WORD",
    3 : "LONG",
    4 : "LONGLONG",
}
acq_type_dict = {
    1 : "RAW",
    2 : "AVERage",
    3 : "VHISTogram",
    4 : "HHISTogram",
    6 : "INTErpolate",
    10 : "PDETECT",
}
acq_mode_dict = {
    0 : "RTIME",
    1 : "ETIME",
    3 : "PDETECT",
}
coupling_dict = {
    0 : "AC",
    1 : "DC",
    2 : "DCFIFTY",
    3 : "LFREJECT",
}
units_dict = {
    0 : "UNKNOWN",
    1 : "VOLT",
    2 : "SECOND",
    3 : "CONSTANT",
    4 : "AMP",
    5 : "DECIBEL",
}

preamble_string = do_query_string(":WAVEform:PREAmble?")
(

```

```

wav_form, acq_type, wfmppts, avgcnt, x_increment, x_origin,
x_reference, y_increment, y_origin, y_reference, coupling,
x_display_range, x_display_origin, y_display_range,
y_display_origin, date, time, frame_model, acq_mode,
completion, x_units, y_units, max_bw_limit, min_bw_limit
) = string.split(preamble_string, ",")

print "Waveform format: %s" % wav_form_dict[int(wav_form)]
print "Acquire type: %s" % acq_type_dict[int(acq_type)]
print "Waveform points desired: %s" % wfmppts
print "Waveform average count: %s" % avgcnt
print "Waveform X increment: %s" % x_increment
print "Waveform X origin: %s" % x_origin
print "Waveform X reference: %s" % x_reference # Always 0.
print "Waveform Y increment: %s" % y_increment
print "Waveform Y origin: %s" % y_origin
print "Waveform Y reference: %s" % y_reference # Always 0.
print "Coupling: %s" % coupling_dict[int(coupling)]
print "Waveform X display range: %s" % x_display_range
print "Waveform X display origin: %s" % x_display_origin
print "Waveform Y display range: %s" % y_display_range
print "Waveform Y display origin: %s" % y_display_origin
print "Date: %s" % date
print "Time: %s" % time
print "Frame model #: %s" % frame_model
print "Acquire mode: %s" % acq_mode_dict[int(acq_mode)]
print "Completion pct: %s" % completion
print "Waveform X units: %s" % units_dict[int(x_units)]
print "Waveform Y units: %s" % units_dict[int(y_units)]
print "Max BW limit: %s" % max_bw_limit
print "Min BW limit: %s" % min_bw_limit

# Get numeric values for later calculations.
x_increment = do_query_values(":WAVEform:XINCrement?")[0]
x_origin = do_query_values(":WAVEform:XORigin?")[0]
y_increment = do_query_values(":WAVEform:YINCrement?")[0]
y_origin = do_query_values(":WAVEform:YORigin?")[0]

# Get the waveform data.
do_command(":WAVEform:STReaming OFF")
sData = do_query_string(":WAVEform:DATA?")
sData = get_definite_length_block_data(sData)

# Unpack signed byte data.
values = struct.unpack("%db" % len(sData), sData)
print "Number of data values: %d" % len(values)

# Save waveform data values to CSV file.
f = open("waveform_data.csv", "w")

for i in xrange(0, len(values) - 1):
    time_val = x_origin + (i * x_increment)
    voltage = (values[i] * y_increment) + y_origin
    f.write("%E, %f\n" % (time_val, voltage))

f.close()
print "Waveform format BYTE data written to waveform_data.csv."

```

```

# =====
# Send a command and check for errors:
# =====
def do_command(command, hide_params=False):

    if hide_params:
        (header, data) = string.split(command, " ", 1)
        if debug:
            print "\nCmd = '%s'" % header
        else:
            if debug:
                print "\nCmd = '%s'" % command

    Infinium.write("%s\n" % command)

    if hide_params:
        check_instrument_errors(header)
    else:
        check_instrument_errors(command)

# =====
# Send a query, check for errors, return string:
# =====
def do_query_string(query):
    if debug:
        print "Qys = '%s'" % query
    result = Infinium.ask("%s\n" % query)
    check_instrument_errors(query)
    return result

# =====
# Send a query, check for errors, return values:
# =====
def do_query_values(query):
    if debug:
        print "Qyv = '%s'" % query
    results = Infinium.ask_for_values("%s\n" % query)
    check_instrument_errors(query)
    return results

# =====
# Check for instrument errors:
# =====
def check_instrument_errors(command):

    while True:
        error_string = Infinium.ask(":SYSTem:ERRor? STRing\n")
        if error_string: # If there is an error string value.

            if error_string.find("0,", 0, 2) == -1: # Not "No error".

                print "ERROR: %s, command: '%s'" % (error_string, command)

```



```

    print "Exited because of error."
    sys.exit(1)

else: # "No error"
    break

else: # :SYSTem:ERROr? STRing should always return string.
    print "ERROR: :SYSTem:ERROr? STRing returned nothing, command: '%s'"
% command
    print "Exited because of error."
    sys.exit(1)

# =====
# Returns data from definite-length block.
# =====
def get_definite_length_block_data(sBlock):

    # First character should be "#".
    pound = sBlock[0:1]
    if pound != "#":
        print "PROBLEM: Invalid binary block format, pound char is '%s'." % po
und
        print "Exited because of problem."
        sys.exit(1)

    # Second character is number of following digits for length value.
    digits = sBlock[1:2]

    # Get the data out of the block and return it.
    sData = sBlock[int(digits) + 2:]

    return sData

# =====
# Main program:
# =====

Infiniium = visa.instrument("TCPIP0::141.121.237.226::hislip0::INSTR")
Infiniium.timeout = 20
Infiniium.term_chars = ""
Infiniium.clear()

# Initialize the oscilloscope, capture data, and analyze.
initialize()
capture()
analyze()

print "End of program."

```

VISA Example in Python (PyVISA 1.6 and newer)

You can use the Python programming language with the PyVISA package to control Keysight Infiniium Series oscilloscopes.

The Python language and PyVISA package can be downloaded from the web at <http://www.python.org/> and <http://pyvisa.readthedocs.org/>, respectively.

To run this example with Python and PyVISA:

- 1 Cut-and-paste the code that follows into a file named "example.py".
- 2 Edit the program to use the VISA address of your oscilloscope.
- 3 If "python.exe" can be found via your PATH environment variable, open a Command Prompt window; then, change to the folder that contains the "example.py" file, and enter:

```
python example.py

# *****
# This program illustrates a few commonly-used programming
# features of your Keysight Infiniium Series oscilloscope.
# *****

# Import modules.
# -----
import visa
import string
import struct
import sys

# Global variables (booleans: 0 = False, 1 = True).
# -----
debug = 0

# =====
# Initialize:
# =====
def initialize():

    # Clear status.
    do_command("*CLS")

    # Get and display the device's *IDN? string.
    idn_string = do_query_string("*IDN?")
    print "Identification string: '%s'" % idn_string

    # Load the default setup.
    do_command("*RST")

# =====
# Capture:
# =====
def capture():

    # Set probe attenuation factor.
    do_command(":CHANnel1:PROBe 1.0")
    qresult = do_query_string(":CHANnel1:PROBe?")
    print "Channel 1 probe attenuation factor: %s" % qresult
```

```

# Use auto-scale to automatically set up oscilloscope.
print "Autoscale."
do_command(":AUToscale")

# Set trigger mode.
do_command(":TRIGger:MODE EDGE")
qresult = do_query_string(":TRIGger:MODE?")
print "Trigger mode: %s" % qresult

# Set EDGE trigger parameters.
do_command(":TRIGger:EDGE:SOURCe CHANnel1")
qresult = do_query_string(":TRIGger:EDGE:SOURce?")
print "Trigger edge source: %s" % qresult

do_command(":TRIGger:LEVel CHANnel1,330E-3")
qresult = do_query_string(":TRIGger:LEVel? CHANnel1")
print "Trigger level, channel 1: %s" % qresult

do_command(":TRIGger:EDGE:SLOPe POSitive")
qresult = do_query_string(":TRIGger:EDGE:SLOPe?")
print "Trigger edge slope: %s" % qresult

# Save oscilloscope setup.
sSetup = do_query_ieee_block(":SYSTem:SETup?")

f = open("setup.stp", "wb")
f.write(sSetup)
f.close()
print "Setup bytes saved: %d" % len(sSetup)

# Change oscilloscope settings with individual commands:

# Set vertical scale and offset.
do_command(":CHANnel1:SCALe 0.1")
qresult = do_query_number(":CHANnel1:SCALe?")
print "Channel 1 vertical scale: %f" % qresult

do_command(":CHANnel1:OFFSet 0.0")
qresult = do_query_number(":CHANnel1:OFFSet?")
print "Channel 1 offset: %f" % qresult

# Set horizontal scale and offset.
do_command(":TIMEbase:SCALe 200e-6")
qresult = do_query_string(":TIMEbase:SCALe?")
print "Timebase scale: %s" % qresult

do_command(":TIMEbase:POSition 0.0")
qresult = do_query_string(":TIMEbase:POSition?")
print "Timebase position: %s" % qresult

# Set the acquisition mode.
do_command(":ACQuire:MODE RTIME")
qresult = do_query_string(":ACQuire:MODE?")
print "Acquire mode: %s" % qresult

# Or, set up oscilloscope by loading a previously saved setup.
sSetup = ""

```

```

f = open("setup.stp", "rb")
sSetup = f.read()
f.close()
do_command_ieee_block(":SYSTEM:SETup", sSetup)
print "Setup bytes restored: %d" % len(sSetup)

# Set the desired number of waveform points,
# and capture an acquisition.
do_command(":ACQUIRE:POINTS 32000")
do_command(":DIGitize")

# =====
# Analyze:
# =====
def analyze():

    # Make measurements.
    # -----
    do_command(":MEASure:SOURce CHANnel1")
    qresult = do_query_string(":MEASure:SOURce?")
    print "Measure source: %s" % qresult

    do_command(":MEASure:FREQuency")
    qresult = do_query_string(":MEASure:FREQuency?")
    print "Measured frequency on channel 1: %s" % qresult

    do_command(":MEASure:VAMPlitude")
    qresult = do_query_string(":MEASure:VAMPlitude?")
    print "Measured vertical amplitude on channel 1: %s" % qresult

    # Download the screen image.
    # -----
    sDisplay = do_query_ieee_block(":DISPlay:DATA? PNG")

    # Save display data values to file.
    f = open("screen_image.png", "wb")
    f.write(sDisplay)
    f.close()
    print "Screen image written to screen_image.png."

    # Download waveform data.
    # -----

    # Get the waveform type.
    qresult = do_query_string(":WAVEform:TYPE?")
    print "Waveform type: %s" % qresult

    # Get the number of waveform points.
    qresult = do_query_string(":WAVEform:POINTS?")
    print "Waveform points: %s" % qresult

    # Set the waveform source.
    do_command(":WAVEform:SOURce CHANnel1")
    qresult = do_query_string(":WAVEform:SOURce?")
    print "Waveform source: %s" % qresult

```

```

# Choose the format of the data returned:
do_command(":WAVEform:FORMat BYTE")
print "Waveform format: %s" % do_query_string(":WAVEform:FORMat?")

# Display the waveform settings from preamble:
wav_form_dict = {
    0 : "ASCii",
    1 : "BYTE",
    2 : "WORD",
    3 : "LONG",
    4 : "LONGLONG",
}
acq_type_dict = {
    1 : "RAW",
    2 : "AVERage",
    3 : "VHIStogram",
    4 : "HHIStogram",
    6 : "INTErpolate",
    10 : "PDETECT",
}
acq_mode_dict = {
    0 : "RTIME",
    1 : "ETIME",
    3 : "PDETECT",
}
coupling_dict = {
    0 : "AC",
    1 : "DC",
    2 : "DCFIFTY",
    3 : "LFREJECT",
}
units_dict = {
    0 : "UNKNOWN",
    1 : "VOLT",
    2 : "SECOND",
    3 : "CONSTANT",
    4 : "AMP",
    5 : "DECIBEL",
}

preamble_string = do_query_string(":WAVEform:PREamble?")
(
    wav_form, acq_type, wfmppts, avgcnt, x_increment, x_origin,
    x_reference, y_increment, y_origin, y_reference, coupling,
    x_display_range, x_display_origin, y_display_range,
    y_display_origin, date, time, frame_model, acq_mode,
    completion, x_units, y_units, max_bw_limit, min_bw_limit
) = string.split(preamble_string, ",")

print "Waveform format: %s" % wav_form_dict[int(wav_form)]
print "Acquire type: %s" % acq_type_dict[int(acq_type)]
print "Waveform points desired: %s" % wfmppts
print "Waveform average count: %s" % avgcnt
print "Waveform X increment: %s" % x_increment
print "Waveform X origin: %s" % x_origin
print "Waveform X reference: %s" % x_reference # Always 0.
print "Waveform Y increment: %s" % y_increment

```

```

print "Waveform Y origin: %s" % y_origin
print "Waveform Y reference: %s" % y_reference # Always 0.
print "Coupling: %s" % coupling_dict[int(coupling)]
print "Waveform X display range: %s" % x_display_range
print "Waveform X display origin: %s" % x_display_origin
print "Waveform Y display range: %s" % y_display_range
print "Waveform Y display origin: %s" % y_display_origin
print "Date: %s" % date
print "Time: %s" % time
print "Frame model #: %s" % frame_model
print "Acquire mode: %s" % acq_mode_dict[int(acq_mode)]
print "Completion pct: %s" % completion
print "Waveform X units: %s" % units_dict[int(x_units)]
print "Waveform Y units: %s" % units_dict[int(y_units)]
print "Max BW limit: %s" % max_bw_limit
print "Min BW limit: %s" % min_bw_limit

# Get numeric values for later calculations.
x_increment = do_query_number(":WAVEform:XINcrement?")
x_origin = do_query_number(":WAVEform:XORigin?")
y_increment = do_query_number(":WAVEform:YINcrement?")
y_origin = do_query_number(":WAVEform:YORigin?")

# Get the waveform data.
do_command(":WAVEform:STReaming OFF")
sData = do_query_ieee_block(":WAVEform:DATA?")

# Unpack signed byte data.
values = struct.unpack("%db" % len(sData), sData)
print "Number of data values: %d" % len(values)

# Save waveform data values to CSV file.
f = open("waveform_data.csv", "w")

for i in xrange(0, len(values) - 1):
    time_val = x_origin + (i * x_increment)
    voltage = (values[i] * y_increment) + y_origin
    f.write("%E, %f\n" % (time_val, voltage))

f.close()
print "Waveform format BYTE data written to waveform_data.csv."

# =====
# Send a command and check for errors:
# =====
def do_command(command, hide_params=False):

    if hide_params:
        (header, data) = string.split(command, " ", 1)
        if debug:
            print "\nCmd = '%s'" % header
    else:
        if debug:
            print "\nCmd = '%s'" % command

    Infiniium.write("%s" % command)

```

```

if hide_params:
    check_instrument_errors(header)
else:
    check_instrument_errors(command)

# =====
# Send a command and binary values and check for errors:
# =====
def do_command_ieee_block(command, values):
    if debug:
        print "Cmb = '%s'" % command
    Infiniium.write_binary_values("%s " % command, values, datatype='c')
    check_instrument_errors(command)

# =====
# Send a query, check for errors, return string:
# =====
def do_query_string(query):
    if debug:
        print "Qys = '%s'" % query
    result = Infiniium.query("%s" % query)
    check_instrument_errors(query)
    return result

# =====
# Send a query, check for errors, return floating-point value:
# =====
def do_query_number(query):
    if debug:
        print "Qyn = '%s'" % query
    results = Infiniium.query("%s" % query)
    check_instrument_errors(query)
    return float(results)

# =====
# Send a query, check for errors, return binary values:
# =====
def do_query_ieee_block(query):
    if debug:
        print "Qyb = '%s'" % query
    result = Infiniium.query_binary_values("%s" % query, datatype='s')
    check_instrument_errors(query)
    return result[0]

# =====
# Check for instrument errors:
# =====
def check_instrument_errors(command):

    while True:
        error_string = Infiniium.query(":SYSTem:ERRor? STRing")

```

```

if error_string:    # If there is an error string value.

    if error_string.find("0,", 0, 2) == -1:    # Not "No error".

        print "ERROR: %s, command: '%s'" % (error_string, command)
        print "Exited because of error."
        sys.exit(1)

    else:    # "No error"
        break

else:    # :SYSTem:ERror? STRing should always return string.
    print "ERROR: :SYSTem:ERror? STRing returned nothing, command: '%s'"
% command
    print "Exited because of error."
    sys.exit(1)

# =====
# Main program:
# =====

rm = visa.ResourceManager()
Infiniium = rm.open_resource("TCPIP0::141.121.237.226::hislip0::INSTR")

Infiniium.timeout = 20000
Infiniium.clear()

# Initialize the oscilloscope, capture data, and analyze.
initialize()
capture()
analyze()

print "End of program."

```

SICL Examples

- "SICL Example in C" on page 1649
- "SICL Example in Visual Basic" on page 1658

SICL Example in C

To compile and run this example in Microsoft Visual Studio 2008:

- 1 Open Visual Studio.
- 2 Create a new Visual C++, Win32, Win32 Console Application project.
- 3 In the Win32 Application Wizard, click **Next >**. Then, check **Empty project**, and click **Finish**.
- 4 Cut-and-paste the code that follows into a file named "example.c" in the project directory.
- 5 In Visual Studio 2008, right-click the Source Files folder, choose **Add > Add Existing Item...**, select the example.c file, and click **Add**.
- 6 Edit the program to use the SICL address of your oscilloscope.
- 7 Choose **Project > Properties....** In the Property Pages dialog, update these project settings:
 - a Under Configuration Properties, Linker, Input, add "sicl32.lib" to the Additional Dependencies field.
 - b Under Configuration Properties, C/C++, Code Generation, select Multi-threaded DLL for the Runtime Library field.
 - c Click **OK** to close the Property Pages dialog.
- 8 Add the include files and library files search paths:
 - a Choose **Tools > Options....**
 - b In the Options dialog, under Projects and Solutions, select **VC++ Directories**.
 - c Show directories for **Include files**, and add the include directory (for example, Program Files\Agilent\IO Libraries Suite\include).
 - d Show directories for **Library files**, and add the library files directory (for example, Program Files\Agilent\IO Libraries Suite\lib).
 - e Click **OK** to close the Options dialog.
- 9 Build and run the program.

```

/*
 * Keysight SICL Example in C
 * -----
 * This program illustrates a few commonly-used programming
 * features of your Keysight Infiniium Series oscilloscope.
 */

#include <stdio.h>                                /* For printf(). */

```

```

#include <string.h>          /* For strcpy(), strcat(). */
#include <time.h>           /* For clock(). */
#include <sicl.h>           /* Keysight SICL routines. */

#define SICL_ADDRESS       "lan,4880;hislip[141.121.237.226]:hislip0"
#define TIMEOUT           15000
#define IEEEBLOCK_SPACE   5000000

/* Function prototypes */
void initialize(void);      /* Initialize to known state. */
void capture(void);        /* Capture the waveform. */
void analyze(void);        /* Analyze the captured waveform. */

void do_command(char *command); /* Send command. */
int do_command_ieeeblock(char *command); /* Command w/IEEE block. */
void do_query_string(char *query); /* Query for string. */
void do_query_number(char *query); /* Query for number. */
void do_query_numbers(char *query); /* Query for numbers. */
int do_query_ieeeblock(char *query); /* Query for IEEE block. */
int do_query_ieeeblock_words(char *query); /* Query for word data. */
void check_instrument_errors(); /* Check for inst errors. */

/* Global variables */
INST id; /* Device session ID. */
char str_result[256] = {0}; /* Result from do_query_string(). */
double num_result; /* Result from do_query_number(). */
unsigned char ieeeblock_data[IEEBLOCK_SPACE]; /* Result from
do_query_ieeeblock(). */
signed short ieeeblock_data_words[IEEBLOCK_SPACE]; /* Result from
do_query_ieeeblock_words(). */
double dbl_results[10]; /* Result from do_query_numbers(). */

/* Main Program
* ----- */
void main(void)
{
    /* Install a default SICL error handler that logs an error message
    * and exits. On Windows 98SE or Windows Me, view messages with
    * the SICL Message Viewer. For Windows 2000 or XP, use the Event
    * Viewer.
    */
    ionerror(I_ERROR_EXIT);

    /* Open a device session using the SICL_ADDRESS */
    id = iopen(SICL_ADDRESS);

    if (id == 0)
    {
        printf ("Oscilloscope iopen failed!\n");
    }
    else
    {
        printf ("Oscilloscope session opened!\n");
    }

    /* Set the I/O timeout value for this session to 5 seconds. */
    itimeout(id, TIMEOUT);
}

```

```

/* Clear the interface. */
iclear(id);

/* Initialize - start from a known state. */
initialize();

/* Capture data. */
capture();

/* Analyze the captured waveform. */
analyze();

/* Close the device session to the instrument. */
iclose(id);
printf ("Program execution is complete...\n");

/* For WIN16 programs, call _siclcleanup before exiting to release
 * resources allocated by SICL for this application. This call is
 * a no-op for WIN32 programs.
 */
_siclcleanup();
}

/* Initialize the oscilloscope to a known state.
 * ----- */
void initialize (void)
{
    /* Clear status. */
    do_command("*CLS");

    /* Get and display the device's *IDN? string. */
    do_query_string("*IDN?");
    printf("Oscilloscope *IDN? string: %s\n", str_result);

    /* Load the default setup. */
    do_command("*CLS");
    do_command("*RST");
}

/* Capture the waveform.
 * ----- */
void capture (void)
{
    int num_values;
    FILE *fp;

    /* Set probe attenuation factor. */
    do_command(":CHANnel1:PROBe 1.0");
    do_query_string(":CHANnel1:PROBe?");
    printf("Channel 1 probe attenuation factor: %s\n", str_result);

    /* Use auto-scale to automatically configure oscilloscope.
     * ----- */
    do_command(":AUToscale");

    /* Set trigger mode. */

```

```

do_command(":TRIGger:MODE EDGE");
do_query_string(":TRIGger:MODE?");
printf("Trigger mode: %s\n", str_result);

/* Set EDGE trigger parameters. */
do_command(":TRIGger:EDGE:SOURCe CHANnel1");
do_query_string(":TRIGger:EDGE:SOURce?");
printf("Trigger edge source: %s\n", str_result);

do_command(":TRIGger:LEVel CHANnel1, -2E-3");
do_query_string(":TRIGger:LEVel? CHANnel1");
printf("Trigger level, channel 1: %s\n", str_result);

do_command(":TRIGger:EDGE:SLOPe POSitive");
do_query_string(":TRIGger:EDGE:SLOPe?");
printf("Trigger edge slope: %s\n", str_result);

/* Save oscilloscope configuration.
 * ----- */

/* Read system setup. */
num_values = do_query_ieeeblock(":SYSTem:SETUp?");
printf("Read setup string query (%d bytes).\n", num_values);

/* Write setup string to file. */
fp = fopen ("c:\\scope\\config\\setup.stp", "wb");
num_values = fwrite(ieeeblock_data, sizeof(unsigned char), num_values,
    fp);
fclose (fp);
printf("Wrote setup string (%d bytes) to ", num_values);
printf("c:\\scope\\config\\setup.stp.\n");

/* Change settings with individual commands:
 * ----- */

/* Set vertical scale and offset. */
do_command(":CHANnel1:SCALe 0.1");
do_query_string(":CHANnel1:SCALe?");
printf("Channel 1 vertical scale: %s\n", str_result);

do_command(":CHANnel1:OFFSet 0.0");
do_query_string(":CHANnel1:OFFSet?");
printf("Channel 1 offset: %s\n", str_result);

/* Set horizontal scale and position. */
do_command(":TIMEbase:SCALe 0.0002");
do_query_string(":TIMEbase:SCALe?");
printf("Timebase scale: %s\n", str_result);

do_command(":TIMEbase:POSition 0.0");
do_query_string(":TIMEbase:POSition?");
printf("Timebase position: %s\n", str_result);

/* Set the acquisition mode. */
do_command(":ACQuire:MODE RTIME");
do_query_string(":ACQuire:MODE?");
printf("Acquire mode: %s\n", str_result);

```

```

/* Or, configure by loading a previously saved setup.
* ----- */

/* Read setup string from file. */
fp = fopen ("c:\\scope\\config\\setup.stp", "rb");
num_values = fread (ieeeblock_data, sizeof(unsigned char),
    IEEEBLOCK_SPACE, fp);
fclose (fp);
printf("Read setup string (%d bytes) from file ", num_values);
printf("c:\\scope\\config\\setup.stp.\n");

/* Restore setup string. */
num_values = do_command_ieeeblock(":SYSTEM:SETup", num_values);
printf("Restored setup string (%d bytes).\n", num_values);

/* Set the desired number of waveform points,
* and capture an acquisition. */
do_command(":ACQUIRE:POINTS 32000");
do_command(":DIGitize");
}

/* Analyze the captured waveform.
* ----- */
void analyze (void)
{
    double wav_format;
    double acq_type;
    double wav_points;
    double avg_count;
    double x_increment;
    double x_origin;
    double y_increment;
    double y_origin;

    FILE *fp;
    int num_values; /* Number of bytes returned from instrument. */
    int i;

    /* Make measurements.
    * ----- */
    do_command(":MEASure:SOURce CHANnel1");
    do_query_string(":MEASure:SOURce?");
    printf("Measure source: %s\n", str_result);

    do_command(":MEASure:FREQuency");
    do_query_number(":MEASure:FREQuency?");
    printf("Frequency: %.4f kHz\n", num_result / 1000);

    do_command(":MEASure:VAMPlitude");
    do_query_number(":MEASure:VAMPlitude?");
    printf("Vertical amplitude: %.2f V\n", num_result);

    /* Download the screen image.
    * ----- */

    /* Read screen image. */

```

```

num_values = do_query_ieeeblock(":DISPlay:DATA? PNG");
printf("Screen image bytes: %d\n", num_values);

/* Write screen image bytes to file. */
fp = fopen("c:\\scope\\data\\screen.png", "wb");
num_values = fwrite(ieeeblock_data, sizeof(unsigned char), num_values,
    fp);
fclose(fp);
printf("Wrote screen image (%d bytes) to ", num_values);
printf("c:\\scope\\data\\screen.png.\n");

/* Download waveform data.
 * ----- */

/* Get the waveform type. */
do_query_string(":WAVeform:TYPE?");
printf("Waveform type: %s\n", str_result);

/* Get the number of waveform points. */
do_query_string(":WAVeform:POINTs?");
printf("Waveform points: %s\n", str_result);

/* Set the waveform source. */
do_command(":WAVeform:SOURce CHANnel1");
do_query_string(":WAVeform:SOURce?");
printf("Waveform source: %s\n", str_result);

/* Choose the format of the data returned: */
do_command(":WAVeform:FORMat WORD");
do_query_string(":WAVeform:FORMat?");
printf("Waveform format: %s\n", str_result);

/* Display the waveform settings: */
do_query_number(":WAVeform:XINCrement?");
x_increment = num_result;
printf("Waveform X increment: %e\n", x_increment);

do_query_number(":WAVeform:XORigin?");
x_origin = num_result;
printf("Waveform X origin: %e\n", x_origin);

do_query_number(":WAVeform:YINCrement?");
y_increment = num_result;
printf("Waveform Y increment: %e\n", y_increment);

do_query_number(":WAVeform:YORigin?");
y_origin = num_result;
printf("Waveform Y origin: %e\n", y_origin);

/* Read waveform data. */
num_values = do_query_ieeeblock_words(":WAVeform:DATA?");
printf("Number of data values: %d\n", num_values);

/* Open file for output. */
fp = fopen("c:\\scope\\data\\waveform_data.csv", "wb");

/* Output waveform data in CSV format. */

```

```

for (i = 0; i < num_values - 1; i++)
{
    /* Write time value, voltage value. */
    fprintf(fp, "%9f, %6f\n",
        x_origin + ((float)i * x_increment),
        ((float)ieeeblock_data_words[i] * y_increment) + y_origin);
}

/* Close output file. */
fclose(fp);
printf("Waveform format WORD data written to ");
printf("c:\\scope\\data\\waveform_data.csv.\n");
}

/* Send a command to the instrument.
 * ----- */
void do_command(command)
char *command;
{
    char message[80];

    strcpy(message, command);
    strcat(message, "\n");
    fprintf(id, message);

    check_instrument_errors();
}

/* Command with IEEE definite-length block.
 * ----- */
int do_command_ieeeblock(command, num_bytes)
char *command;
int num_bytes;
{
    char message[80];
    int data_length;

    strcpy(message, command);
    strcat(message, " #8%08d");
    fprintf(id, message, num_bytes);
    ifwrite(id, ieeeblock_data, num_bytes, 1, &data_length);

    check_instrument_errors();

    return(data_length);
}

/* Query for a string result.
 * ----- */
void do_query_string(query)
char *query;
{
    char message[80];

    strcpy(message, query);
    strcat(message, "\n");
    fprintf(id, message);
}

```

```

        iscanf(id, "%t\n", str_result);

        check_instrument_errors();
    }

    /* Query for a number result.
     * ----- */
    void do_query_number(query)
    char *query;
    {
        char message[80];

        strcpy(message, query);
        strcat(message, "\n");
        iprintf(id, message);

        iscanf(id, "%lf", &num_result);

        check_instrument_errors();
    }

    /* Query for numbers result.
     * ----- */
    void do_query_numbers(query)
    char *query;
    {
        char message[80];

        strcpy(message, query);
        strcat(message, "\n");
        iprintf(id, message);

        iscanf(id, "%,10lf\n", dbl_results);

        check_instrument_errors();
    }

    /* Query for an IEEE definite-length block result.
     * ----- */
    int do_query_ieeeblock(query)
    char *query;
    {
        char message[80];
        int data_length;

        strcpy(message, query);
        strcat(message, "\n");
        iprintf(id, message);

        data_length = IEEEBLOCK_SPACE;
        iscanf(id, "%#b", &data_length, ieeeblock_data);

        if (data_length == IEEEBLOCK_SPACE )
        {
            printf("IEEE block buffer full: ");
            printf("May not have received all data.\n");
        }
    }

```



```

    }

    check_instrument_errors();

    return(data_length);
}

/* Query for an IEEE definite-length block word data result.
 * ----- */
int do_query_ieeeblock_words(query)
char *query;
{
    char message[80];
    int data_length;

    strcpy(message, query);
    strcat(message, "\n");
    fprintf(id, message);

    data_length = IEEEBLOCK_SPACE;
    iscanf(id, "%#wb", &data_length, ieeeblock_data_words);

    if (data_length == IEEEBLOCK_SPACE )
    {
        printf("IEEE block buffer full: ");
        printf("May not have received all data.\n");
    }

    check_instrument_errors();

    return(data_length);
}

/* Check for instrument errors.
 * ----- */
void check_instrument_errors()
{
    char str_err_val[256] = {0};
    char str_out[800] = "";

    ipromptf(id, ":SYSTem:ERRor? STRing\n", "%t", str_err_val);
    while(strncmp(str_err_val, "0,", 2) != 0 )
    {
        strcat(str_out, ", ");
        strcat(str_out, str_err_val);
        ipromptf(id, ":SYSTem:ERRor? STRing\n", "%t", str_err_val);
    }

    if (strcmp(str_out, "") != 0)
    {
        printf("INST Error%s\n", str_out);
        fflush(id, I_BUF_READ | I_BUF_WRITE);
    }
}

```

SICL Example in Visual Basic

To run this example in Visual Basic for Applications:

- 1 Start the application that provides Visual Basic for Applications (for example, Microsoft Excel).
- 2 Press ALT+F11 to launch the Visual Basic editor.
- 3 Add the sicl32.bas file to your project:
 - a Choose **File > Import File...**
 - b Navigate to the header file, sicl32.bas (installed with Keysight IO Libraries Suite and found in the Program Files\Agilent\IO Libraries Suite\include directory), select it, and click **Open**.
- 4 Choose **Insert > Module**.
- 5 Cut-and-paste the code that follows into the editor.
- 6 Edit the program to use the SICL address of your oscilloscope, and save the changes.
- 7 Run the program.

```
'
' Keysight SICL Example in Visual Basic
' -----
' This program illustrates a few commonly-used programming
' features of your Keysight Infiniium Series oscilloscope.
' -----

Option Explicit

Public id As Integer ' Session to instrument.

' Declare variables to hold numeric values returned by
' ivscanf/ifread.
Public dblQueryResult As Double
Public Const ByteArraySize = 5000000
Public retCount As Long
Public byteArray(ByteArraySize) As Byte

' Declare fixed length string variable to hold string value returned
' by ivscanf.
Public strQueryResult As String * 200

' For Sleep subroutine.
Private Declare Sub Sleep Lib "kernel32" (ByVal dwMilliseconds As Long)

'
' Main Program
' -----

Sub Main()

    On Error GoTo ErrorHandler
```

```

' Open a device session using the SICL_ADDRESS.
id = iopen("lan,4880;hislip[141.121.237.226]:hislip0")
Call itimeout(id, 15000)

' Clear the interface.
Call iclear(id)

' Initialize - start from a known state.
Initialize

' Capture data.
Capture

' Analyze the captured waveform.
Analyze

' Close the vi session and the resource manager session.
Call iclose(id)

Exit Sub

ErrorHandler:

MsgBox "*** Error : " + Error, vbExclamation
End

End Sub

'
' Initialize the oscilloscope to a known state.
' -----

Private Sub Initialize()

On Error GoTo ErrorHandler

' Clear status.
DoCommand "*CLS"

' Get and display the device's *IDN? string.
strQueryResult = DoQueryString("*IDN?")
MsgBox "Result is: " + RTrim(strQueryResult), vbOKOnly, "*IDN? Result"

' Load the default setup.
DoCommand "*RST"

Exit Sub

ErrorHandler:

MsgBox "*** Error : " + Error, vbExclamation
End

End Sub

'
' Capture the waveform.

```

```

' -----
Private Sub Capture()

    On Error GoTo ErrorHandler

    ' Set probe attenuation factor.
    DoCommand ":CHANnel1:PROBe 1.0"
    Debug.Print "Channel 1 probe attenuation factor: " + _
        DoQueryString(":CHANnel1:PROBe?")

    ' Use auto-scale to automatically configure oscilloscope.
    ' -----
    DoCommand ":AUToscale"

    ' Set trigger mode.
    DoCommand ":TRIGger:MODE EDGE"
    Debug.Print "Trigger mode: " + _
        DoQueryString(":TRIGger:MODE?")

    ' Set EDGE trigger parameters.
    DoCommand ":TRIGger:EDGE:SOURCe CHANnel1"
    Debug.Print "Trigger edge source: " + _
        DoQueryString(":TRIGger:EDGE:SOURce?")

    DoCommand ":TRIGger:LEVel CHANnel1,-2E-3"
    Debug.Print "Trigger level, channel 1: " + _
        DoQueryString(":TRIGger:LEVel? CHANnel1")

    DoCommand ":TRIGger:EDGE:SLOPe POSitive"
    Debug.Print "Trigger edge slope: " + _
        DoQueryString(":TRIGger:EDGE:SLOPe?")

    ' Save oscilloscope configuration.
    ' -----
    Dim lngSetupStringSize As Long
    lngSetupStringSize = DoQueryIEEEBlock_Bytes(":SYSTem:SETup?")
    Debug.Print "Setup bytes saved: " + CStr(lngSetupStringSize)

    ' Output setup string to a file:
    Dim strPath As String
    strPath = "c:\scope\config\setup.dat"
    If Len(Dir(strPath)) Then
        Kill strPath ' Remove file if it exists.
    End If

    ' Open file for output.
    Dim hFile As Long
    hFile = FreeFile
    Open strPath For Binary Access Write Lock Write As hFile
    Dim lngI As Long
    For lngI = 0 To lngSetupStringSize - 1
        Put hFile, , byteArray(lngI) ' Write data.
    Next lngI
    Close hFile ' Close file.

    ' Change settings with individual commands:

```

```

' -----
' Set vertical scale and offset.
DoCommand ":CHANnel1:SCALE 0.1"
Debug.Print "Channel 1 vertical scale: " + _
    DoQueryString(":CHANnel1:SCALE?")

DoCommand ":CHANnel1:OFFSet 0.0"
Debug.Print "Channel 1 vertical offset: " + _
    DoQueryString(":CHANnel1:OFFSet?")

' Set horizontal scale and position.
DoCommand ":TIMEbase:SCALE 0.0002"
Debug.Print "Timebase scale: " + _
    DoQueryString(":TIMEbase:SCALE?")

DoCommand ":TIMEbase:POSition 0.0"
Debug.Print "Timebase position: " + _
    DoQueryString(":TIMEbase:POSition?")

' Set the acquisition mode.
DoCommand ":ACQuire:MODE RTIME"
Debug.Print "Acquire mode: " + _
    DoQueryString(":ACQuire:MODE?")

' Or, configure by loading a previously saved setup.
' -----
strPath = "c:\scope\config\setup.dat"
Open strPath For Binary Access Read As hFile ' Open file for input.
Dim lngSetupFileSize As Long
lngSetupFileSize = LOF(hFile) ' Length of file.
Get hFile, , byteArray ' Read data.
Close hFile ' Close file.
' Write setup string back to oscilloscope using ":SYSTEM:SETup"
' command:
Dim lngRestored As Long
lngRestored = DoCommandIEEEBlock(":SYSTEM:SETup", lngSetupFileSize)
Debug.Print "Setup bytes restored: " + CStr(lngRestored)

' Set the desired number of waveform points,
' and capture an acquisition.
' -----
DoCommand ":ACQuire:POINTs 32000"
DoCommand ":DIGitize"

Exit Sub

ErrorHandler:

MsgBox "*** Error : " + Error, vbExclamation
End

End Sub

'
' Analyze the captured waveform.
' -----

```

```

Private Sub Analyze()

    On Error GoTo ErrorHandler

    ' Make measurements.
    ' -----
    DoCommand ":MEASure:SOURce CHANnel1"
    Debug.Print "Measure source: " + _
        DoQueryString(":MEASure:SOURce?")

    DoCommand ":MEASure:FREQuency"
    dblQueryResult = DoQueryNumber(":MEASure:FREQuency?")
    MsgBox "Frequency:" + vbCrLf + _
        FormatNumber(dblQueryResult / 1000, 4) + " kHz"

    DoCommand ":MEASure:VAMPlitude"
    dblQueryResult = DoQueryNumber(":MEASure:VAMPlitude?")
    MsgBox "Vertical amplitude:" + vbCrLf + _
        FormatNumber(dblQueryResult, 4) + " V"

    ' Download the screen image.
    ' -----

    ' Get screen image.
    Dim lngBlockSize As Long
    lngBlockSize = DoQueryIEEEBlock_Bytes(":DISPlay:DATA? PNG")
    Debug.Print "Screen image bytes: " + CStr(lngBlockSize)

    ' Save screen image to a file:
    Dim strPath As String
    strPath = "c:\scope\data\screen.png"
    If Len(Dir(strPath)) Then
        Kill strPath ' Remove file if it exists.
    End If
    Dim hFile As Long
    hFile = FreeFile
    Open strPath For Binary Access Write Lock Write As hFile
    Dim lngI As Long
    ' Skip past header.
    For lngI = CInt(Chr(byteArray(1))) + 2 To lngBlockSize - 1
        Put hFile, , byteArray(lngI) ' Write data.
    Next lngI
    Close hFile ' Close file.
    MsgBox "Screen image written to " + strPath

    ' Download waveform data.
    ' -----

    ' Get the waveform type.
    Debug.Print "Waveform type: " + _
        DoQueryString(":WAVEform:TYPE?")

    ' Get the number of waveform points.
    Debug.Print "Waveform points: " + _
        DoQueryString(":WAVEform:POINTs?")

```

```

' Set the waveform source.
DoCommand ":WAVeform:SOURce CHANnel1"
Debug.Print "Waveform source: " + _
    DoQueryString(":WAVeform:SOURce?")

' Choose the format of the data returned:
DoCommand ":WAVeform:FORMat BYTE"
Debug.Print "Waveform format: " + _
    DoQueryString(":WAVeform:FORMat?")

' Display the waveform settings:
Dim dblXIncrement As Double
Dim dblXOrigin As Double
Dim dblYIncrement As Double
Dim dblYOrigin As Double

dblXIncrement = DoQueryNumber(":WAVeform:XINcrement?")
Debug.Print "Waveform X increment: " + _
    Format(dblXIncrement, "Scientific")

dblXOrigin = DoQueryNumber(":WAVeform:XORigin?")
Debug.Print "Waveform X origin: " + _
    Format(dblXOrigin, "Scientific")

dblYIncrement = DoQueryNumber(":WAVeform:YINcrement?")
Debug.Print "Waveform Y increment: " + _
    Format(dblYIncrement, "Scientific")

dblYOrigin = DoQueryNumber(":WAVeform:YORigin?")
Debug.Print "Waveform Y origin: " + _
    FormatNumber(dblYOrigin, 0)

' Get the waveform data
DoCommand ":WAVeform:STReaming OFF"
Dim lngNumBytes As Long
lngNumBytes = DoQueryIEEEBlock_Bytes(":WAVeform:DATA?")
Debug.Print "Number of data values: " + _
    CStr(lngNumBytes - CInt(Chr(byteArray(1))) - 2)

' Set up output file:
strPath = "c:\scope\data\waveform_data.csv"

' Open file for output.
Open strPath For Output Access Write Lock Write As hFile

' Output waveform data in CSV format.
Dim lngDataValue As Long
Dim byteUnsigned As Byte

' Skip past header.
For lngI = CInt(Chr(byteArray(1))) + 2 To lngNumBytes - 2
    byteUnsigned = byteArray(lngI)
    ' Oscilloscope BYTE format sends signed bytes. VBA Byte is
    ' interpreted as unsigned, so convert the bits to signed value.
    lngDataValue = byteUnsigned - ((byteUnsigned And &H80) * 2)

    ' Write time value, voltage value.

```

```

Print #hFile, _
    FormatNumber(dblXOrigin + (lngI * dblXIncrement), 9) + _
    ", " + _
    FormatNumber((lngDataValue * dblyIncrement) + dblyOrigin)

Next lngI

' Close output file.
Close hFile ' Close file.
MsgBox "Waveform format BYTE data written to " + _
    "c:\scope\data\waveform_data.csv."

Exit Sub

ErrorHandler:

MsgBox "*** Error : " + Error, vbExclamation
End

End Sub

Private Sub DoCommand(command As String)

    On Error GoTo ErrorHandler

    Call ivprintf(id, command + vbLf)

    CheckInstrumentErrors

    Exit Sub

ErrorHandler:

MsgBox "*** Error : " + Error, vbExclamation
End

End Sub

Private Function DoCommandIEEEBlock(command As String, _
    lngBlockSize As Long)

    On Error GoTo ErrorHandler

    ' Send command part.
    Call ivprintf(id, command + " ")

    ' Write definite-length block bytes.
    Call ifwrite(id, byteArray(), lngBlockSize, vbNull, retCount)

    ' retCount is now actual number of bytes written.
    DoCommandIEEEBlock = retCount

    CheckInstrumentErrors

    Exit Function

ErrorHandler:

```



```

    MsgBox "*** Error : " + Error, vbExclamation
End

End Function

Private Function DoQueryString(query As String) As String

    Dim actual As Long

    On Error GoTo ErrorHandler

    Dim strResult As String * 200

    Call ivprintf(id, query + vbLf)
    Call ivscanf(id, "%200t", strResult)
    DoQueryString = strResult

    CheckInstrumentErrors

    Exit Function

ErrorHandler:

    MsgBox "*** Error : " + Error, vbExclamation
End

End Function

Private Function DoQueryNumber(query As String) As Double

    On Error GoTo ErrorHandler

    Dim dblResult As Double

    Call ivprintf(id, query + vbLf)
    Call ivscanf(id, "%lf" + vbLf, dblResult)
    DoQueryNumber = dblResult

    CheckInstrumentErrors

    Exit Function

ErrorHandler:

    MsgBox "*** Error : " + Error, vbExclamation
End

End Function

Private Function DoQueryNumbers(query As String) As Double()

    On Error GoTo ErrorHandler

    Dim dblResults(10) As Double

    Call ivprintf(id, query + vbLf)

```

```

    Call ivscanf(id, "%,10lf" + vbCrLf, dblResults)
    DoQueryNumbers = dblResults

    CheckInstrumentErrors

    Exit Function

ErrorHandler:

    MsgBox "*** Error : " + Error, vbExclamation
    End

End Function

Private Function DoQueryIEEEBlock_Bytes(query As String) As Long

    On Error GoTo ErrorHandler

    ' Send query.
    Call ivprintf(id, query + vbCrLf)

    ' Read definite-length block bytes.
    Call ifread(id, byteArray(), byteArraySize, vbNull, retCount)

    ' Get number of block length digits.
    Dim intLengthDigits As Integer
    intLengthDigits = CInt(Chr(byteArray(1)))

    ' Get block length from those digits.
    Dim strBlockLength As String
    strBlockLength = ""
    Dim i As Integer
    For i = 2 To intLengthDigits + 1
        strBlockLength = strBlockLength + Chr(byteArray(i))
    Next

    ' Return number of bytes in block plus header.
    DoQueryIEEEBlock_Bytes = CLng(strBlockLength) + intLengthDigits + 2

    CheckInstrumentErrors

    Exit Function

ErrorHandler:

    MsgBox "*** Error : " + Error, vbExclamation
    End

End Function

Private Sub CheckInstrumentErrors()

    On Error GoTo ErrorHandler

    Dim strErrVal As String * 200
    Dim strOut As String

```

```

    Call ivprintf(id, ":SYSTEM:ERROR? STRING" + vbLf) ' Query any errors d
ata.
    Call ivscanf(id, "%200t", strErrVal) ' Read: Errnum,"Error String".
    While Val(strErrVal) <> 0 ' End if find: 0,"No Error".
        strOut = strOut + "INST Error: " + strErrVal
        Call ivprintf(id, ":SYSTEM:ERROR? STRING" + vbLf) ' Request error me
ssage.
        Call ivscanf(id, "%200t", strErrVal) ' Read error message.
    Wend

    If Not strOut = "" Then
        MsgBox strOut, vbExclamation, "INST Error Messages"
        Call iflush(id, I_BUF_READ Or I_BUF_WRITE)

    End If

    Exit Sub

ErrorHandler:

    MsgBox "*** Error : " + Error, vbExclamation
    End

End Sub

```

SCPI.NET Examples

These programming examples show how to use the SCPI.NET drivers that come with Keysight's free Command Expert software.

While you can write code manually using SCPI.NET drivers (as described in this section), you can also use the Command Expert software to:

- Connect to instruments and control them interactively using SCPI command sets.
- Quickly prototype and test command sequences.
- Generate C#, VB.NET, or C/C++ code for command sequences.
- Find, download, and install SCPI command sets.
- Browse command trees, search for commands, and view command descriptions.

The Command Expert suite also comes with Add-ons for easy instrument control and measurement data retrieval in NI LabVIEW, Microsoft Excel, Keysight VEE, and Keysight SystemVue.

For more information on Keysight Command Expert, and to download the software, see: <http://www.keysight.com/find/commandexpert>

- "[SCPI.NET Example in C#](#)" on page 1668
- "[SCPI.NET Example in Visual Basic .NET](#)" on page 1675
- "[SCPI.NET Example in IronPython](#)" on page 1682

SCPI.NET Example in C#

To compile and run this example in Microsoft Visual Studio 2008:

- 1 Install the Keysight Command Expert software and the command set for the oscilloscope.
- 2 Open Visual Studio.
- 3 Create a new Visual C#, Windows, Console Application project.
- 4 Cut-and-paste the code that follows into the C# source file.
- 5 Edit the program to use the address of your oscilloscope.
- 6 Add a reference to the SCPI.NET driver:
 - a Right-click the project you wish to modify (not the solution) in the Solution Explorer window of the Microsoft Visual Studio environment.
 - b Choose **Add Reference...**
 - c In the Add Reference dialog, select the **Browse** tab, and navigate to the ScpiNetDrivers folder.

- Windows XP: C:\Documents and Settings\All Users\Agilent\Command Expert\ScpiNetDrivers
 - Windows 7: C:\ProgramData\Agilent\Command Expert\ScpiNetDrivers
- d** Select the .dll file for your oscilloscope, for example **AgInfiniiumAHQSXZ_05_20.dll**; then, click **OK**.

7 Build and run the program.

For more information, see the SCPI.NET driver help that comes with Keysight Command Expert.

```

/*
 * Keysight SCPI.NET Example in C#
 * -----
 * This program illustrates a few commonly used programming
 * features of your Keysight oscilloscope.
 * -----
 */

using System;
using System.IO;
using System.Text;
using System.Collections.Generic;
using Agilent.CommandExpert.Scpinet.AgInfiniiumAHQSXZ_05_20;

namespace Infiniium
{
    class ScpiNetInstrumentApp
    {
        private static AgInfiniiumAHQSXZ myScope;

        static void Main(string[] args)
        {
            try
            {
                string strScopeAddress;
                //strScopeAddress = "141.121.237.226";
                strScopeAddress =
                    "TCPIP0::141.121.237.226::hislip0::INSTR";
                Console.WriteLine("Connecting to oscilloscope...");
                Console.WriteLine();
                myScope = new AgInfiniiumAHQSXZ(strScopeAddress);
                myScope.Transport.DefaultTimeout.Set(10000);

                // Initialize - start from a known state.
                Initialize();

                // Capture data.
                Capture();

                // Analyze the captured waveform.
                Analyze();

                Console.WriteLine("Press any key to exit");
                Console.ReadKey();
            }
            catch { }
        }
    }
}

```

```

    }
    catch (System.ApplicationException err)
    {
        Console.WriteLine("*** SCPI.NET Error : " + err.Message);
    }
    catch (System.SystemException err)
    {
        Console.WriteLine("*** System Error Message : " + err.Message);
    }
    catch (System.Exception err)
    {
        System.Diagnostics.Debug.Fail("Unexpected Error");
        Console.WriteLine("*** Unexpected Error : " + err.Message);
    }
    finally
    {
        //myScope.Dispose();
    }
}

/*
 * Initialize the oscilloscope to a known state.
 * -----
 */
private static void Initialize()
{
    string strResults;

    // Get and display the device's *IDN? string.
    myScope.SCPi.IDN.Query(out strResults);
    Console.WriteLine("*IDN? result is: {0}", strResults);

    // Clear status and load the default setup.
    myScope.SCPi.CLS.Command();
    myScope.SCPi.RST.Command();
}

/*
 * Capture the waveform.
 * -----
 */
private static void Capture()
{
    string strResults;
    double fResult;

    // Use auto-scale to automatically configure oscilloscope.
    myScope.SCPi.AUToscale.Command();

    // Set trigger mode.
    myScope.SCPi.TRIGger.MODE.Command("EDGE");
    myScope.SCPi.TRIGger.MODE.Query(out strResults);
    Console.WriteLine("Trigger mode: {0}", strResults);

    // Set EDGE trigger parameters.
    myScope.SCPi.TRIGger.EDGE.SOURce.Command(1, "CHANnel1");
}

```

```

myScope.SCPi.TRIGger.EDGE.SOURce.Query(1, out strResults);
Console.WriteLine("Trigger edge source: {0}", strResults);

myScope.SCPi.TRIGger.LEVel.Command("CHANnel1", -0.002);
myScope.SCPi.TRIGger.LEVel.Query("CHANnel1", out fResult);
Console.WriteLine("Trigger edge level: {0:F2}", fResult);

myScope.SCPi.TRIGger.EDGE.SLOPe.Command(1, "POSitive");
myScope.SCPi.TRIGger.EDGE.SLOPe.Query(1, out strResults);
Console.WriteLine("Trigger edge slope: {0}", strResults);

// Save oscilloscope setup.
byte[] byteResultsArray; // Results array.
int nLength; // Number of bytes returned from instrument.
string strPath;

// Query and read setup string.
myScope.SCPi.SYSTem.SETUp.Query(out byteResultsArray);
nLength = byteResultsArray.Length;

// Write setup string to file.
strPath = "c:\\scope\\config\\setup.stp";
File.WriteAllBytes(strPath, byteResultsArray);
Console.WriteLine("Setup bytes saved: {0}", nLength);

// Change settings with individual commands:

// Set vertical scale and offset.
myScope.SCPi.CHANnel.SCALe.Command(1, 0.1);
myScope.SCPi.CHANnel.SCALe.Query(1, out fResult);
Console.WriteLine("Channel 1 vertical scale: {0:F4}", fResult);

myScope.SCPi.CHANnel.OFFSet.Command(1, 0.0);
myScope.SCPi.CHANnel.OFFSet.Query(1, out fResult);
Console.WriteLine("Channel 1 vertical offset: {0:F4}", fResult);

// Set horizontal scale and offset.
myScope.SCPi.TIMEbase.SCALe.Command(0.0002);
myScope.SCPi.TIMEbase.SCALe.Query(out fResult);
Console.WriteLine("Timebase scale: {0:F4}", fResult);

myScope.SCPi.TIMEbase.POSition.Command(0.0);
myScope.SCPi.TIMEbase.POSition.Query(out fResult);
Console.WriteLine("Timebase position: {0:F2}", fResult);

// Set the acquisition mode.
myScope.SCPi.ACQuire.MODE.Command("RTIME");
myScope.SCPi.ACQuire.MODE.Query(out strResults);
Console.WriteLine("Acquire mode: {0}", strResults);

// Or, configure by loading a previously saved setup.
byte[] dataArray;
int nBytesWritten;

// Read setup string from file.
strPath = "c:\\scope\\config\\setup.stp";
dataArray = File.ReadAllBytes(strPath);

```

```

nBytesWritten = byteResultsArray.Length;

// Restore setup string.
myScope.SCPi.SYSTem.SETUp.Command(DataArray);
Console.WriteLine("Setup bytes restored: {0}", nBytesWritten);

// Set the desired number of waveform points,
// and capture an acquisition.
myScope.SCPi.ACQuire.POINTs.ANALog.Command(32000);
myScope.SCPi.DIGitize.Command(null);
}

/*
 * Analyze the captured waveform.
 * -----
 */
private static void Analyze()
{
    string strResults;
    double fResult;

    // Make measurements.
    // -----
    myScope.SCPi.MEASure.SOURce.Command("CHANnel1", null);
    myScope.SCPi.MEASure.SOURce.Query(out strResults);
    Console.WriteLine("Measure source: {0}", strResults);

    myScope.SCPi.MEASure.FREQuency.Command("CHANnel1", null);
    myScope.SCPi.MEASure.FREQuency.QuerySendValidOff("CHANnel1",
        null, out fResult);
    Console.WriteLine("Frequency: {0:F4} kHz", fResult / 1000);

    // Use direct command/query when commands not in command set.
    myScope.Transport.Command.Invoke(":MEASure:VAMPlitude CHANnel1");
    myScope.Transport.Query.Invoke(":MEASure:VAMPlitude? CHANnel1",
        out strResults);
    Console.WriteLine("Vertical amplitude: {0} V", strResults);

    // Download the screen image.
    // -----

    // Get the screen data.
    byte[] byteResultsArray; // Results array.
    myScope.SCPi.DISPlay.DATA.Query("PNG", null, null, null,
        out byteResultsArray);
    int nLength; // Number of bytes returned from instrument.
    nLength = byteResultsArray.Length;

    // Store the screen data to a file.
    string strPath;
    strPath = "c:\\scope\\data\\screen.png";
    FileStream fStream = File.Open(strPath, FileMode.Create);
    fStream.Write(byteResultsArray, 0, nLength);
    fStream.Close();
    Console.WriteLine("Screen image ({0} bytes) written to {1}",
        nLength, strPath);
}

```



```

// Download waveform data.
// -----

// Get the waveform points mode.
myScope.SCPi.WAVEform.TYPE.Query(out strResults);
Console.WriteLine("Waveform points mode: {0}", strResults);

// Get the number of waveform points.
int nPointsAvail;
myScope.SCPi.WAVEform.POINTs.Query(out nPointsAvail);
Console.WriteLine("Waveform points: {0}", nPointsAvail);

// Set the waveform source.
myScope.SCPi.WAVEform.SOURce.Command("CHANnel1");
myScope.SCPi.WAVEform.SOURce.Query(out strResults);
Console.WriteLine("Waveform source: {0}", strResults);

// Choose the format of the data returned:
myScope.SCPi.WAVEform.FORMat.Command("WORD");
myScope.SCPi.WAVEform.FORMat.Query(out strResults);
Console.WriteLine("Waveform format: {0}", strResults);

myScope.SCPi.WAVEform.BYTEorder.Command("LSBFirst");
myScope.SCPi.WAVEform.BYTEorder.Query(out strResults);
Console.WriteLine("Waveform byte order: {0}", strResults);

// Display the waveform settings from preamble:
Dictionary<string, string> dctWavFormat =
    new Dictionary<string, string>()
    {
        {"0", "ASCIi"},
        {"1", "BYTE"},
        {"2", "WORD"},
        {"3", "LONG"},
        {"4", "LONGLONG"},
    };
Dictionary<string, string> dctAcqType =
    new Dictionary<string, string>()
    {
        {"1", "RAW"},
        {"2", "AVERAge"},
        {"3", "VHIStogram"},
        {"4", "HHIStogram"},
        {"6", "INTerpolate"},
        {"10", "PDETECT"},
    };
Dictionary<string, string> dctAcqMode =
    new Dictionary<string, string>()
    {
        {"0", "RTIME"},
        {"1", "ETIME"},
        {"3", "PDETECT"},
    };
Dictionary<string, string> dctCoupling =
    new Dictionary<string, string>()
    {
        {"0", "AC"},
    };

```

```

        {"1", "DC"},
        {"2", "DCFIFTY"},
        {"3", "LFREJECT"},
    };
    Dictionary<string, string> dctUnits =
        new Dictionary<string, string>()
    {
        {"0", "UNKNOWN"},
        {"1", "VOLT"},
        {"2", "SECOND"},
        {"3", "CONSTANT"},
        {"4", "AMP"},
        {"5", "DECIBEL"},
    };
    string strPreamble;
    string[] strsPreamble;

    myScope.SCPI.WAVeform.PREamble.Query(out strPreamble);
    strsPreamble = strPreamble.Split(',');

    Console.WriteLine("Waveform format: {0}",
        dctWavFormat[strsPreamble[0]]);

    Console.WriteLine("Acquire type: {0}",
        dctAcqType[strsPreamble[1]]);

    Console.WriteLine("Waveform points: {0}", strsPreamble[2]);
    Console.WriteLine("Waveform average count: {0}", strsPreamble[3]);
    Console.WriteLine("Waveform X increment: {0}", strsPreamble[4]);
    Console.WriteLine("Waveform X origin: {0}", strsPreamble[5]);
    Console.WriteLine("Waveform X reference: {0}", strsPreamble[6]);
    Console.WriteLine("Waveform Y increment: {0}", strsPreamble[7]);
    Console.WriteLine("Waveform Y origin: {0}", strsPreamble[8]);
    Console.WriteLine("Waveform Y reference: {0}", strsPreamble[9]);
    Console.WriteLine("Coupling: {0}", dctCoupling[strsPreamble[10]]);
    Console.WriteLine("Waveform X display range: {0}",
        strsPreamble[11]);
    Console.WriteLine("Waveform X display origin: {0}",
        strsPreamble[12]);
    Console.WriteLine("Waveform Y display range: {0}",
        strsPreamble[13]);
    Console.WriteLine("Waveform Y display origin: {0}",
        strsPreamble[14]);
    Console.WriteLine("Date: {0}", strsPreamble[15]);
    Console.WriteLine("Time: {0}", strsPreamble[16]);
    Console.WriteLine("Frame model: {0}", strsPreamble[17]);
    Console.WriteLine("Acquire mode: {0}",
        dctAcqMode[strsPreamble[18]]);
    Console.WriteLine("Completion pct: {0}", strsPreamble[19]);
    Console.WriteLine("Waveform X inits: {0}",
        dctUnits[strsPreamble[20]]);
    Console.WriteLine("Waveform Y units: {0}",
        dctUnits[strsPreamble[21]]);
    Console.WriteLine("Max BW limit: {0}", strsPreamble[22]);
    Console.WriteLine("Min BW limit: {0}", strsPreamble[23]);

    // Get numeric values for later calculations.

```

```

        double fXincrement;
        myScope.SCPi.WAVEform.XINcrement.Query(out fXincrement);
        double fXorigin;
        myScope.SCPi.WAVEform.XORigin.Query(out fXorigin);
        double fYincrement;
        myScope.SCPi.WAVEform.YINcrement.Query(out fYincrement);
        double fYorigin;
        myScope.SCPi.WAVEform.YORigin.Query(out fYorigin);

        // Get the waveform data.
        myScope.SCPi.WAVEform.STReaming.Command(false);
        short[] WordDataArray; // Results array.
        myScope.SCPi.WAVEform.DATA.QueryWord(null, null, out WordDataArray
    );
        nLength = WordDataArray.Length;
        Console.WriteLine("Number of data values: {0}", nLength);

        // Set up output file:
        strPath = "c:\\scope\\data\\waveform_data.csv";
        if (File.Exists(strPath)) File.Delete(strPath);

        // Open file for output.
        StreamWriter writer = File.CreateText(strPath);

        // Output waveform data in CSV format.
        for (int i = 0; i < nLength - 1; i++)
            writer.WriteLine("{0:f9}, {1:f6}",
                fXorigin + ((float)i * fXincrement),
                (((float)WordDataArray[i]
                * fYincrement) + fYorigin));

        // Close output file.
        writer.Close();
        Console.WriteLine("Waveform format WORD data written to {0}",
            strPath);
    }
}
}

```

SCPI.NET Example in Visual Basic .NET

To compile and run this example in Microsoft Visual Studio 2008:

- 1 Install the Keysight Command Expert software and the command set for the oscilloscope.
- 2 Open Visual Studio.
- 3 Create a new Visual Basic, Windows, Console Application project.
- 4 Cut-and-paste the code that follows into the Visual Basic .NET source file.
- 5 Edit the program to use the VISA address of your oscilloscope.

- 6 Add a reference to the SCPI.NET 3.0 driver:
 - a Right-click the project you wish to modify (not the solution) in the Solution Explorer window of the Microsoft Visual Studio environment.
 - b Choose **Add Reference...**
 - c In the Add Reference dialog, select the **Browse** tab, and navigate to the ScpiNetDrivers folder.
 - Windows XP: C:\Documents and Settings\All Users\Agilent\Command Expert\ScpiNetDrivers
 - Windows 7: C:\ProgramData\Agilent\Command Expert\ScpiNetDrivers
 - d Select the .dll file for your oscilloscope, for example **AgInfiniiumAHQSXZ_05_20.dll**; then, click **OK**.
 - e Right-click the project you wish to modify (not the solution) in the Solution Explorer window of the Microsoft Visual Studio environment and choose **Properties**; then, select "Infiniium.ScpiNetInstrumentApp" as the **Startup object**.
- 7 Build and run the program.

For more information, see the SCPI.NET driver help that comes with Keysight Command Expert.

```
'
' Keysight SCPI.NET Example in Visual Basic .NET
' -----
' This program illustrates a few commonly used programming
' features of your Keysight oscilloscope.
' -----

Imports System
Imports System.IO
Imports System.Text
Imports System.Collections.Generic
Imports Agilent.CommandExpert.ScpiNet.AgInfiniiumAHQSXZ_05_20

Namespace Infiniium
  Class ScpiNetInstrumentApp
    Private Shared myScope As AgInfiniiumAHQSXZ

    Public Shared Sub Main(ByVal args As String())
      Try
        Dim strScopeAddress As String
        'strScopeAddress = "141.121.237.226";
        strScopeAddress = _
          "TCPIP0::141.121.237.226::hislip0::INSTR"
        Console.WriteLine("Connecting to oscilloscope...")
        Console.WriteLine()
        myScope = New AgInfiniiumAHQSXZ(strScopeAddress)
        myScope.Transport.DefaultTimeout.[Set](10000)

        ' Initialize - start from a known state.
        Initialize()
      End Try
    End Sub
  End Class
End Namespace
```

```

    ' Capture data.
    Capture()

    ' Analyze the captured waveform.
    Analyze()

    Console.WriteLine("Press any key to exit")
    Console.ReadKey()
    Catch err As System.ApplicationException
        Console.WriteLine("*** SCPI.NET Error : " & err.Message)
    Catch err As System.SystemException
        Console.WriteLine("*** System Error Message : " & err.Message)
    Catch err As System.Exception
        System.Diagnostics.Debug.Fail("Unexpected Error")
        Console.WriteLine("*** Unexpected Error : " & err.Message)
    'myScope.Dispose();
    Finally
    End Try

End Sub

' Initialize the oscilloscope to a known state.
' -----

Private Shared Sub Initialize()
    Dim strResults As String

    ' Get and display the device's *IDN? string.
    myScope.SCPI.IDN.Query(strResults)
    Console.WriteLine("*IDN? result is: {0}", strResults)

    ' Clear status and load the default setup.
    myScope.SCPI.CLS.Command()
    myScope.SCPI.RST.Command()
End Sub

' Capture the waveform.
' -----

Private Shared Sub Capture()
    Dim strResults As String
    Dim fResult As Double

    ' Use auto-scale to automatically configure oscilloscope.
    myScope.SCPI.AUToscale.Command()

    ' Set trigger mode.
    myScope.SCPI.TRIGger.MODE.Command("EDGE")
    myScope.SCPI.TRIGger.MODE.Query(strResults)
    Console.WriteLine("Trigger mode: {0}", strResults)

    ' Set EDGE trigger parameters.
    myScope.SCPI.TRIGger.EDGE.SOURce.Command(1, "CHANnel1")
    myScope.SCPI.TRIGger.EDGE.SOURce.Query(1, strResults)
    Console.WriteLine("Trigger edge source: {0}", strResults)

```

```

myScope.SCPi.TRIGger.LEVel.Command("CHANnel1", -0.002)
myScope.SCPi.TRIGger.LEVel.Query("CHANnel1", fResult)
Console.WriteLine("Trigger edge level: {0:F2}", fResult)

myScope.SCPi.TRIGger.EDGE.SLOPe.Command(1, "POSitive")
myScope.SCPi.TRIGger.EDGE.SLOPe.Query(1, strResults)
Console.WriteLine("Trigger edge slope: {0}", strResults)

' Save oscilloscope setup.
Dim byteResultsArray As Byte()
' Results array.
Dim nLength As Integer
' Number of bytes returned from instrument.
Dim strPath As String

' Query and read setup string.
myScope.SCPi.SYSTem.SETup.Query(byteResultsArray)
nLength = byteResultsArray.Length

' Write setup string to file.
strPath = "c:\scope\config\setup.stp"
File.WriteAllBytes(strPath, byteResultsArray)
Console.WriteLine("Setup bytes saved: {0}", nLength)

' Change settings with individual commands:

' Set vertical scale and offset.
myScope.SCPi.CHANnel.SCALe.Command(1, 0.1)
myScope.SCPi.CHANnel.SCALe.Query(1, fResult)
Console.WriteLine("Channel 1 vertical scale: {0:F4}", fResult)

myScope.SCPi.CHANnel.OFFSet.Command(1, 0.0)
myScope.SCPi.CHANnel.OFFSet.Query(1, fResult)
Console.WriteLine("Channel 1 vertical offset: {0:F4}", fResult)

' Set horizontal scale and offset.
myScope.SCPi.TIMEbase.SCALe.Command(0.0002)
myScope.SCPi.TIMEbase.SCALe.Query(fResult)
Console.WriteLine("Timebase scale: {0:F4}", fResult)

myScope.SCPi.TIMEbase.POSition.Command(0.0)
myScope.SCPi.TIMEbase.POSition.Query(fResult)
Console.WriteLine("Timebase position: {0:F2}", fResult)

' Set the acquisition mode.
myScope.SCPi.ACQuire.MODE.Command("RTIME")
myScope.SCPi.ACQuire.MODE.Query(strResults)
Console.WriteLine("Acquire mode: {0}", strResults)

' Or, configure by loading a previously saved setup.
Dim dataArray As Byte()
Dim nBytesWritten As Integer

' Read setup string from file.
strPath = "c:\scope\config\setup.stp"
dataArray = File.ReadAllBytes(strPath)
nBytesWritten = dataArray.Length

```

```

' Restore setup string.
myScope.SCPi.SYSTem.SETup.Command(DataArray)
Console.WriteLine("Setup bytes restored: {0}", nBytesWritten)

' Set the desired number of waveform points,
' and capture an acquisition.
myScope.SCPi.ACQuire.POINts.ANALog.Command(32000)
myScope.SCPi.DIGitize.Command(DBNull.Value)
End Sub

' Analyze the captured waveform.
' -----

Private Shared Sub Analyze()
    'Dim strResultsArray As String()
    ' Results array.
    Dim strResults As String
    Dim fResult As Double

    ' Make measurements.
    ' -----
    myScope.SCPi.MEASure.SOURce.Command("CHANnel1", DBNull.Value)
    myScope.SCPi.MEASure.SOURce.Query(strResults)
    Console.WriteLine("Measure source: {0}", strResults)

    myScope.SCPi.MEASure.FREQuency.Command("CHANnel1", DBNull.Value)
    myScope.SCPi.MEASure.FREQuency.QuerySendValidOff("CHANnel1", _
        DBNull.Value, fResult)
    Console.WriteLine("Frequency: {0:F4} kHz", fResult / 1000)

    ' Use direct command/query when commands not in command set.
    myScope.Transport.Command.Invoke(":MEASure:VAMPLitude CHANnel1")
    myScope.Transport.Query.Invoke(":MEASure:VAMPLitude? CHANnel1", _
        strResults)
    Console.WriteLine("Vertical amplitude: {0} V", strResults)

    ' Download the screen image.
    ' -----

    ' Get the screen data.
    Dim byteResultsArray As Byte()
    ' Results array.
    myScope.SCPi.DISPlay.DATA.Query("PNG", DBNull.Value, _
        DBNull.Value, DBNull.Value, byteResultsArray)
    Dim nLength As Integer
    ' Number of bytes returned from instrument.
    nLength = byteResultsArray.Length

    ' Store the screen data to a file.
    Dim strPath As String
    strPath = "c:\scope\data\screen.png"
    Dim fStream As FileStream = File.Open(strPath, FileMode.Create)
    fStream.Write(byteResultsArray, 0, nLength)
    fStream.Close()
    Console.WriteLine("Screen image ({0} bytes) written to {1}", _
        nLength, strPath)

```

```

' Download waveform data.
' -----

' Get the waveform points mode.
myScope.SCOPE.WAVEFORM.TYPE.Query(strResults)
Console.WriteLine("Waveform points mode: {0}", strResults)

' Get the number of waveform points.
Dim nPointsAvail As Integer
myScope.SCOPE.WAVEFORM.POINTS.Query(nPointsAvail)
Console.WriteLine("Waveform points: {0}", nPointsAvail)

' Set the waveform source.
myScope.SCOPE.WAVEFORM.SOURCE.Command("CHANNEL1")
myScope.SCOPE.WAVEFORM.SOURCE.Query(strResults)
Console.WriteLine("Waveform source: {0}", strResults)

' Choose the format of the data returned:
myScope.SCOPE.WAVEFORM.FORMAT.Command("WORD")
myScope.SCOPE.WAVEFORM.FORMAT.Query(strResults)
Console.WriteLine("Waveform format: {0}", strResults)

myScope.SCOPE.WAVEFORM.BYTEORDER.Command("LSBFIRST")
myScope.SCOPE.WAVEFORM.BYTEORDER.Query(strResults)
Console.WriteLine("Waveform byte order: {0}", strResults)

' Display the waveform settings from preamble:
Dim dctWavFormat As New Dictionary(Of String, String)
dctWavFormat.Add("0", "ASCII")
dctWavFormat.Add("1", "BYTE")
dctWavFormat.Add("2", "WORD")
dctWavFormat.Add("3", "LONG")
dctWavFormat.Add("4", "LONGLONG")

Dim dctAcqType As New Dictionary(Of String, String)
dctAcqType.Add("1", "RAW")
dctAcqType.Add("2", "AVERAGE")
dctAcqType.Add("3", "VHISTOGRAM")
dctAcqType.Add("4", "HHISTOGRAM")
dctAcqType.Add("6", "INTERPOLATE")
dctAcqType.Add("10", "PDETECT")

Dim dctAcqMode As New Dictionary(Of String, String)()
dctAcqMode.Add("0", "RTIME")
dctAcqMode.Add("1", "ETIME")
dctAcqMode.Add("3", "PDETECT")

Dim dctCoupling As New Dictionary(Of String, String)()
dctCoupling.Add("0", "AC")
dctCoupling.Add("1", "DC")
dctCoupling.Add("2", "DCFIFTY")
dctCoupling.Add("3", "LFREJECT")

Dim dctUnits As New Dictionary(Of String, String)()
dctUnits.Add("0", "UNKNOWN")
dctUnits.Add("1", "VOLT")

```



```

dctUnits.Add("2", "SECOND")
dctUnits.Add("3", "CONSTANT")
dctUnits.Add("4", "AMP")
dctUnits.Add("5", "DECIBEL")

Dim strPreamble As String
Dim strSPreamble As String()

myScope.SCPi.WAVEform.PREamble.Query(strPreamble)
strSPreamble = strPreamble.Split(",")

Console.WriteLine("Waveform format: {0}", _
    dctWavFormat(strSPreamble(0)))

Console.WriteLine("Acquire type: {0}", _
    dctAcqType(strSPreamble(1)))

Console.WriteLine("Waveform points: {0}", strSPreamble(2))
Console.WriteLine("Waveform average count: {0}", strSPreamble(3))
Console.WriteLine("Waveform X increment: {0}", strSPreamble(4))
Console.WriteLine("Waveform X origin: {0}", strSPreamble(5))
Console.WriteLine("Waveform X reference: {0}", strSPreamble(6))
Console.WriteLine("Waveform Y increment: {0}", strSPreamble(7))
Console.WriteLine("Waveform Y origin: {0}", strSPreamble(8))
Console.WriteLine("Waveform Y reference: {0}", strSPreamble(9))
Console.WriteLine("Coupling: {0}", dctCoupling(strSPreamble(10)))
Console.WriteLine("Waveform X display range: {0}", _
    strSPreamble(11))
Console.WriteLine("Waveform X display origin: {0}", _
    strSPreamble(12))
Console.WriteLine("Waveform Y display range: {0}", _
    strSPreamble(13))
Console.WriteLine("Waveform Y display origin: {0}", _
    strSPreamble(14))
Console.WriteLine("Date: {0}", strSPreamble(15))
Console.WriteLine("Time: {0}", strSPreamble(16))
Console.WriteLine("Frame model: {0}", strSPreamble(17))
Console.WriteLine("Acquire mode: {0}", _
    dctAcqMode(strSPreamble(18)))
Console.WriteLine("Completion pct: {0}", strSPreamble(19))
Console.WriteLine("Waveform X inits: {0}", _
    dctUnits(strSPreamble(20)))
Console.WriteLine("Waveform Y units: {0}", _
    dctUnits(strSPreamble(21)))
Console.WriteLine("Max BW limit: {0}", strSPreamble(22))
Console.WriteLine("Min BW limit: {0}", strSPreamble(23))

' Get numeric values for later calculations.
Dim fXincrement As Double
myScope.SCPi.WAVEform.XINcrement.Query(fXincrement)
Dim fXorigin As Double
myScope.SCPi.WAVEform.XORigin.Query(fXorigin)
Dim fYincrement As Double
myScope.SCPi.WAVEform.YINcrement.Query(fYincrement)
Dim fYorigin As Double
myScope.SCPi.WAVEform.YORigin.Query(fYorigin)

```

```

' Get the waveform data.
myScope.SCPi.WAVEform.STReaming.Command(False)
Dim WorddataArray As Short()
' Results array.
myScope.SCPi.WAVEform.DATA.QueryWord(DBNull.Value, _
    DBNull.Value, WorddataArray)
nLength = WorddataArray.Length
Console.WriteLine("Number of data values: {0}", nLength)

' Set up output file:
strPath = "c:\scope\data\waveform_data.csv"
If File.Exists(strPath) Then
    File.Delete(strPath)
End If

' Open file for output.
Dim writer As StreamWriter = File.CreateText(strPath)

' Output waveform data in CSV format.
For i As Integer = 0 To nLength - 2
    writer.WriteLine("{0:f9}, {1:f6}", _
        fXorigin + (CSng(i) * fXincrement), _
        (CSng(WorddataArray(i)) * fYincrement) + fYorigin)
Next

' Close output file.
writer.Close()
Console.WriteLine("Waveform format WORD data written to {0}", _
    strPath)
End Sub
End Class
End Namespace

```

SCPI.NET Example in IronPython

You can also control Keysight oscilloscopes using the SCPI.NET library and Python programming language on the .NET platform using:

- IronPython (<http://ironpython.codeplex.com/>) which is an implementation of the Python programming language running under .NET.

To run this example with IronPython:

- 1 Install the Keysight Command Expert software and the command set for the oscilloscope.
- 2 Cut-and-paste the code that follows into a file named "example.ipy".
- 3 Edit the program to use the address of your oscilloscope.
- 4 If the IronPython "ipy.exe" can be found via your PATH environment variable, open a Command Prompt window; then, change to the folder that contains the "example.ipy" file, and enter:

```
ipy example.ipy
```

```

#
# Keysight SCPI.NET Example in IronPython
# *****
# This program illustrates a few commonly used programming
# features of your Keysight oscilloscope.
# *****

# Import Python modules.
# -----
import sys
sys.path.append("C:\Python27\Lib") # Python Standard Library.
sys.path.append("C:\ProgramData\Agilent\Command Expert\ScpiNetDrivers")
import string

# Import .NET modules.
# -----
from System import *
from System.IO import *
from System.Text import *
from System.Runtime.InteropServices import *
import clr
clr.AddReference("AgInfiniumAHQSXZ_05_20")
from Agilent.CommandExpert.ScpiNet.AgInfiniumAHQSXZ_05_20 import *

# =====
# Initialize:
# =====
def initialize():

    # Get and display the device's *IDN? string.
    idn_string = scope.SCPI.IDN.Query()
    print "Identification string '%s'" % idn_string

    # Clear status and load the default setup.
    scope.SCPI.CLS.Command()
    scope.SCPI.RST.Command()

# =====
# Capture:
# =====
def capture():

    # Use auto-scale to automatically set up oscilloscope.
    print "Autoscale."
    scope.SCPI.AUToscale.Command()

    # Set trigger mode.
    scope.SCPI.TRIGger.MODE.Command("EDGE")
    qresult = scope.SCPI.TRIGger.MODE.Query()
    print "Trigger mode: %s" % qresult

    # Set EDGE trigger parameters.
    scope.SCPI.TRIGger.EDGE.SOURce.Command(1, "CHANnel1")
    qresult = scope.SCPI.TRIGger.EDGE.SOURce.Query(1)
    print "Trigger edge source: %s" % qresult

```

```

scope.SCPi.TRIGger.LEVel.Command("CHANnel1", -0.002)
qresult = scope.SCPi.TRIGger.LEVel.Query("CHANnel1")
print "Trigger edge level: %s" % qresult

scope.SCPi.TRIGger.EDGE.SLOPe.Command(1, "POSitive")
qresult = scope.SCPi.TRIGger.EDGE.SLOPe.Query(1)
print "Trigger edge slope: %s" % qresult

# Save oscilloscope setup.
setup_bytes = scope.SCPi.SYSTem.SETup.Query()
nLength = len(setup_bytes)
File.WriteAllBytes("setup.stp", setup_bytes)
print "Setup bytes saved: %d" % nLength

# Change settings with individual commands:

# Set vertical scale and offset.
scope.SCPi.CHANnel.SCALe.Command(1, 0.1)
qresult = scope.SCPi.CHANnel.SCALe.Query(1)
print "Channel 1 vertical scale: %f" % qresult

scope.SCPi.CHANnel.OFFSet.Command(1, 0.0)
qresult = scope.SCPi.CHANnel.OFFSet.Query(1)
print "Channel 1 offset: %f" % qresult

# Set horizontal scale and offset.
scope.SCPi.TIMEbase.SCALe.Command(0.0002)
qresult = scope.SCPi.TIMEbase.SCALe.Query()
print "Timebase scale: %f" % qresult

scope.SCPi.TIMEbase.POSition.Command(0.0)
qresult = scope.SCPi.TIMEbase.POSition.Query()
print "Timebase position: %f" % qresult

# Set the acquisition mode.
scope.SCPi.ACQuire.MODE.Command("RTIME")
qresult = scope.SCPi.ACQuire.MODE.Query()
print "Acquire mode: %s" % qresult

# Or, set up oscilloscope by loading a previously saved setup.
setup_bytes = File.ReadAllBytes("setup.stp")
scope.SCPi.SYSTem.SETup.Command(setup_bytes)
print "Setup lines restored: %d" % len(setup_bytes)

# Set the desired number of waveform points,
# and capture an acquisition.
scope.SCPi.ACQuire.POINts.ANALog.Command(32000)
scope.SCPi.DIGitize.Command(None)

# =====
# Analyze:
# =====
def analyze():

    # Make measurements.

```

```

# -----
scope.SCPi.MEASure.SOURce.Command("CHANnel1", None)
qresult = scope.SCPi.MEASure.SOURce.Query()
print "Measure source: %s" % qresult

scope.SCPi.MEASure.FREQuency.Command("CHANnel1", None)
qresult = scope.SCPi.MEASure.FREQuency.QuerySendValidOff("CHANnel1", No
ne)
print "Measured frequency on channel 1: %f" % qresult

# Use direct command/query when commands not in command set.
scope.Transport.Command.Invoke(":MEASure:VAMPlitude CHANnel1")
qresult = scope.Transport.Query.Invoke(":MEASure:VAMPlitude? CHANnel1")
print "Measured vertical amplitude on channel 1: %s" % qresult

# Download the screen image.
# -----
image_bytes = scope.SCPi.DISPlay.DATA.Query("PNG", None, None, None)
nLength = len(image_bytes)
fStream = File.Open("screen_image.png", FileMode.Create)
fStream.Write(image_bytes, 0, nLength)
fStream.Close()
print "Screen image written to screen_image.png."

# Download waveform data.
# -----

# Get the waveform points mode.
qresult = scope.SCPi.WAVeform.TYPE.Query()
print "Waveform points mode: %s" % qresult

# Get the number of waveform points.
qresult = scope.SCPi.WAVeform.POINts.Query()
print "Waveform points: %s" % qresult

# Set the waveform source.
scope.SCPi.WAVeform.SOURce.Command("CHANnel1")
qresult = scope.SCPi.WAVeform.SOURce.Query()
print "Waveform source: %s" % qresult

# Choose the format of the data returned:
scope.SCPi.WAVeform.FORMat.Command("WORD")
qresult = scope.SCPi.WAVeform.FORMat.Query()
print "Waveform format: %s" % qresult

scope.SCPi.WAVeform.BYTEorder.Command("LSBFirst")
qresult = scope.SCPi.WAVeform.BYTEorder.Query()
print "Waveform byte order: %s" % qresult

# Display the waveform settings from preamble:
wav_form_dict = {
    0 : "AScii",
    1 : "BYTE",
    2 : "WORD",
    3 : "LONG",
    4 : "LONGLONG",
}

```

```

acq_type_dict = {
    1 : "RAW",
    2 : "AVERage",
    3 : "VHISTogram",
    4 : "HHISTogram",
    6 : "INTErpolate",
    10 : "PDETECT",
}
acq_mode_dict = {
    0 : "RTIME",
    1 : "ETIME",
    3 : "PDETECT",
}
coupling_dict = {
    0 : "AC",
    1 : "DC",
    2 : "DCFIFTY",
    3 : "LFREJECT",
}
units_dict = {
    0 : "UNKNOWN",
    1 : "VOLT",
    2 : "SECOND",
    3 : "CONSTANT",
    4 : "AMP",
    5 : "DECIBEL",
}

preamble_string = scope.SCPi.WAVEform.PREamble.Query()
(
    wav_form, acq_type, wfmppts, avgcnt, x_increment, x_origin,
    x_reference, y_increment, y_origin, y_reference, coupling,
    x_display_range, x_display_origin, y_display_range,
    y_display_origin, date, time, frame_model, acq_mode,
    completion, x_units, y_units, max_bw_limit, min_bw_limit
) = string.split(preamble_string, ",")

print "Waveform format: %s" % wav_form_dict[int(wav_form)]
print "Acquire type: %s" % acq_type_dict[int(acq_type)]
print "Waveform points desired: %s" % wfmppts
print "Waveform average count: %s" % avgcnt
print "Waveform X increment: %s" % x_increment
print "Waveform X origin: %s" % x_origin
print "Waveform X reference: %s" % x_reference # Always 0.
print "Waveform Y increment: %s" % y_increment
print "Waveform Y origin: %s" % y_origin
print "Waveform Y reference: %s" % y_reference # Always 0.
print "Coupling: %s" % coupling_dict[int(coupling)]
print "Waveform X display range: %s" % x_display_range
print "Waveform X display origin: %s" % x_display_origin
print "Waveform Y display range: %s" % y_display_range
print "Waveform Y display origin: %s" % y_display_origin
print "Date: %s" % date
print "Time: %s" % time
print "Frame model #: %s" % frame_model
print "Acquire mode: %s" % acq_mode_dict[int(acq_mode)]
print "Completion pct: %s" % completion

```

```

print "Waveform X units: %s" % units_dict[int(x_units)]
print "Waveform Y units: %s" % units_dict[int(y_units)]
print "Max BW limit: %s" % max_bw_limit
print "Min BW limit: %s" % min_bw_limit

# Get numeric values for later calculations.
x_increment = scope.SCPi.WAVEform.XINcrement.Query()
x_origin = scope.SCPi.WAVEform.XORigin.Query()
y_increment = scope.SCPi.WAVEform.YINcrement.Query()
y_origin = scope.SCPi.WAVEform.YORigin.Query()

# Get the waveform data.
scope.SCPi.WAVEform.STreaming.Command(False)
data_words = scope.SCPi.WAVEform.DATA.QueryWord(None, None)
nLength = len(data_words)
print "Number of data values: %d" % nLength

# Open file for output.
strPath = "waveform_data.csv"
writer = File.CreateText(strPath)

# Output waveform data in CSV format.
for i in xrange(0, nLength - 1):
    time_val = x_origin + i * x_increment
    voltage = data_words[i] * y_increment + y_origin
    writer.WriteLine("%E, %f" % (time_val, voltage))

# Close output file.
writer.Close()
print "Waveform format WORD data written to %s." % strPath

# =====
# Main program:
# =====
#addr = "141.121.237.226"
addr = "TCPiP0::141.121.237.226::hislip0::INSTR"
scope = AgInfiniiumAHQSXZ(addr)
scope.Transport.DefaultTimeout.Set(10000)

# Initialize the oscilloscope, capture data, and analyze.
initialize()
capture()
analyze()

print "End of program."

# Wait for a key press before exiting.
print "Press any key to exit..."
Console.ReadKey(True)

```

43 Reference

HDF5 Example / 1690

CSV and TSV Header Format / 1691

BIN Header Format / 1693

HDF5 Example

Here is an example of a captured HDF5 file.

```
Channel 1(6576)
Group Size = 1
Number of Attributes = 17
Waveform Type = 1
Start = 1
NumPoints = 1000000
NumSegments = 0
Count = 1
XDispRange = 1.0E-6
XDispOrigin = -5.0E-7
XInc = 5.0E-11
XOrg = -2.4999999E-5
XUnits = Second
YDispRange = 8.0
YDispOrigin = 0.0
YInc = 1.327218738E-4
YOrg = 0.11645629362732
YUnits = Volt
MinBandwidth = 0.0
MaxBandwidth = 6.0E9
```

CSV and TSV Header Format

| | |
|--------------------------|--|
| Revision | Always 0 (zero). |
| Type | How the waveform was acquired: normal, raw, interpolate, average, or versus. When this field is read back into the scope, all modes, except versus, are converted to raw. The default value is raw. |
| Start | Starting point in the waveform of the first data point in the file. This is usually zero. |
| Points | The number of points in the waveform record. The number of points is set by the Memory Depth control. The default value is 1. |
| Count or Segments | <p>For count, it is the number of hits at each time bucket in the waveform record when the waveform was created using an acquisition mode like averaging. For example, when averaging, a count of four would mean every waveform data point in the waveform record has been averaged at least four times. Count is ignored when it is read back into the scope. The default value is 0.</p> <p>Segments is used instead of Count when the data is acquired using the Segmented acquisition mode. This number is the total number of segments that were acquired.</p> |
| XDispRange | The number of X display range columns (n) depends on the number of sources being stored. The X display range is the X-axis duration of the waveform that is displayed. For time domain waveforms, it is the duration of time across the display. If the value is zero then no data has been acquired. |
| XDispOrg | The number of X display origin columns (n) depends on the number of sources being stored. The X display origin is the X-axis value at the left edge of the display. For time domain waveforms, it is the time at the start of the display. This value is treated as a double precision 64-bit floating point number. If the value is zero then no data has been acquired. |
| XInc | The number of X increment columns (n) depends on the number of sources being store. The X increment is the duration between data points on the X axis. For time domain waveforms, this is the time between points. If the value is zero then no data has been acquired. |
| XOrg | The number of X origin columns (n) depends on the number of sources being store. The X origin is the X-axis value of the first data point in the data record. For time domain waveforms, it is the time of the first point. This value is treated as a double precision 64-bit floating point number. If the value is zero then no data has been acquired. |
| XUnits | The number of X units columns (n) depends on the number of sources being store. The X units is the unit of measure for each time value of the acquired data. |

| | |
|-----------------------|--|
| YDispRange | The number of Y display range columns (n) depends on the number of sources being store. The Y display range is the Y-axis duration of the waveform which is displayed. For voltage waveforms, it is the amount of voltage across the display. If the value is zero then no data has been acquired. |
| YDispOrg | The number of Y display origin columns (n) depends on the number of sources being store. The Y-display origin is the Y-axis value at the center of the display. For voltage waveforms, it is the voltage at the center of the display. If the value is zero then no data has been acquired. |
| YInc | The number of Y increment columns (n) depends on the number of sources being store. The Y increment is the duration between Y-axis levels. For voltage waveforms, it is the voltage corresponding to one level. If the value is zero then no data has been acquired. |
| YOrg | The number of Y origin columns (n) depends on the number of sources being store. The Y origin is the Y-axis value at level zero. For voltage waveforms, it is the voltage at level zero. If the value is zero then no data has been acquired. |
| YUnits | The number of Y units columns (n) depends on the number of sources being stored. The Y units is the unit of measure of each voltage value of the acquired waveform. |
| Frame | A string containing the model number and serial number of the scope in the format of MODEL#:SERIAL#. |
| Date | The date when the waveform was acquired. The default value is 27 DEC 1996. |
| Time | The time when the waveform was acquired. The default value is 01:00:00:00. |
| Max band width | An estimation of the maximum bandwidth of the waveform. The default value is 0. |
| Min band width | An estimation of the minimum bandwidth of the waveform. The default value is 0. |
| Time Tags | The Time Tags only occur when the data was acquired using the Segmented acquisition mode with time tags enabled and the file format is YValues. The number of columns depends on the number of Segments being saved. |
| Data | The data values follow this header entry. |

BIN Header Format

- ["File Header"](#) on page 1693
- ["Waveform Header"](#) on page 1693
- ["Waveform Data Header"](#) on page 1695
- ["Example Program for Reading Binary Data"](#) on page 1695

File Header

There is only one file header in a binary file. The file header consists of the following information.

| | |
|----------------------------|--|
| Cookie | Two byte characters, AG, which indicates that the file is in the Keysight Binary Data file format. |
| Version | Two bytes which represent the file version. |
| File Size | An integer (4 byte signed) which is the number of bytes that are in the file. |
| Number of Waveforms | An integer (4 byte signed) which is the number of waveforms that are stored in the file. |

Waveform Header

The waveform header contains information about the type of waveform data that is stored following the waveform data header which is located after each waveform header. Because it is possible to store more than one waveform in the file, there will be a waveform header and a waveform data header for each waveform.

| | |
|-----------------------------------|---|
| Header Size | An integer (4 byte signed) which is the number of bytes in the header. |
| Waveform Type | An integer (4 byte signed) which is the type of waveform that is stored in the file. The follow shows what each value means. <ul style="list-style-type: none"> 0 = Unknown 1 = Normal 2 = Peak Detect 3 = Average 4 = Horizontal Histogram 5 = Vertical Histogram 6 = Logic |
| Number of Waveform Buffers | An integer (4 byte signed) which is the number of waveform buffers required to read the data. This value is one except for peak detect data and digital data. |

| | |
|-------------------------|---|
| Count | An integer (4 byte signed) which is the number of hits at each time bucket in the waveform record when the waveform was created using an acquisition mode like averaging. For example, when averaging, a count of four would mean every waveform data point in the waveform record has been averaged at least four times. The default value is 0. |
| X Display Range | A float (4 bytes) which is the X-axis duration of the waveform that is displayed. For time domain waveforms, it is the duration of time across the display. If the value is zero then no data has been acquired. |
| X Display Origin | A double (8 bytes) which is the X-axis value at the left edge of the display. For time domain waveforms, it is the time at the start of the display. This value is treated as a double precision 64-bit floating point number. If the value is zero then no data has been acquired. |
| X Increment | A double (8 bytes) which is the duration between data points on the X axis. For time domain waveforms, this is the time between points. If the value is zero then no data has been acquired. |
| X Origin | A double (8 bytes) which is the X-axis value of the first data point in the data record. For time domain waveforms, it is the time of the first point. This value is treated as a double precision 64-bit floating point number. If the value is zero then no data has been acquired. |
| X Units | An integer (4 byte signed) which is the number of X units columns (n) depends on the number of sources being stored. The X units is the unit of measure for each time value of the acquired data. X unit definitions are: 0 = Unknown 1 = Volt 2 = Second 3 = Constant 4 = Amp 5 = Decibel |
| Y Units | An integer (4 byte signed) which is the number of Y units columns (n) depends on the number of sources being stored. The Y units is the unit of measure of each voltage value of the acquired waveform. Y units definitions are: 0 = Unknown 1 = Volt 2 = Second 3 = Constant 4 = Amp 5 = Decibel |

| | |
|-----------------------|---|
| Date | A 16 character array which is the date when the waveform was acquired. The default value is 27 DEC 1996. |
| Time | A 16 character array which is the time when the waveform was acquired. The default value is 01:00:00:00. |
| Frame | A 24 character array which is the model number and serial number of the scope in the format of MODEL#:SERIAL#. |
| Waveform Label | A 16 character array which is the waveform label. |
| Time Tags | A double (8 bytes) which is the time tag value of the segment being saved. |
| Segment Index | An unsigned integer (4 byte signed) which is the segment index of the data that follows the waveform data header. |

Waveform Data Header

The waveform data header consists of information about the waveform data points that are stored immediately after the waveform data header.

| | |
|----------------------------------|--|
| Waveform Data Header Size | An integer (4 byte signed) which is the size of the waveform data header. |
| Buffer Type | A short (2 byte signed) which is the type of waveform data that is stored in the file. The following shows what each value means. 0 = Unknown data 1 = Normal 32 bit float data 2 = Maximum float data 3 = Minimum float data 4 = Time float data 5 = Counts 32 bit float data 6 = Digital unsigned 8 bit char data |
| Bytes Per Point | A short (2 byte signed) which is the number of bytes per data point. |
| Buffer Size | An integer (4 byte signed) which is the size of the buffer required to hold the data bytes. |

Example Program for Reading Binary Data

The following is a programming example of reading a Binary Data (.bin) file and converting it to a CSV (.csv) file without a file header.

```
/* bintoascii.c */

/* Reads the binary file format.
   This program demonstrates how to import the Infiniium
```

```

        oscilloscope binary file format and how to export it to an
        ascii comma separated file format.
*/
#pragma pack(4)

#include <stdio.h>                /* location of: printf() */
#include <stdlib.h>               /* location of: atof(), atoi() */
#include <string.h>              /* location of: strlen() */
#include "sicl.h"

/* Defines */
#define MAX_LENGTH 10000000
#define INTERFACE "lan[130.29.70.247]:inst0" /* Change the IP address
                                             * to the one found in
                                             * the Remote Setup
                                             * dialog box.
                                             */

#define TRUE 1
#define FALSE 0
#define IO_TIMEOUT 20000

/* Type definitions */
typedef unsigned _int64 UINT64; /* This defines a 64-bit unsigned
                                * integer for Microsoft platforms.
                                */

/* Structure and Union definitions */
union DATATYPE
{
    char buffer[MAX_LENGTH]; /* Buffer for reading word format data */
    char byte[MAX_LENGTH];
    unsigned short word[MAX_LENGTH/2];
    UINT64 longlong[MAX_LENGTH/4];
};

typedef struct
{
    char Cookie[2];
    char Version[2];
    int FileSize;
    int NumberOfWaveforms;
} FileHeader;

const char COOKIE[2] = {'A', 'G'};
const char VERSION[2] = {'1', '0'};

#define DATE_TIME_STRING_LENGTH 16
#define FRAME_STRING_LENGTH 24
#define SIGNAL_STRING_LENGTH 16

typedef struct
{
    int HeaderSize;
    int WaveformType;
    int NWaveformBuffers;
    int Points;

```



```

    int    Count;
    float  XDisplayRange;
    double XDisplayOrigin;
    double XIncrement;
    double XOrigin;
    int    XUnits;
    int    YUnits;
    char   Date[DATE_TIME_STRING_LENGTH];
    char   Time[DATE_TIME_STRING_LENGTH];
    char   Frame[FRAME_STRING_LENGTH];
    char   WaveformLabel[SIGNAL_STRING_LENGTH];
    double TimeTag;
    unsigned int SegmentIndex;
} WaveformHeader;

typedef struct
{
    int    HeaderSize;
    short  BufferType;
    short  BytesPerPoint;
    int    BufferSize;
} WaveformDataHeader;

typedef enum
{
    PB_UNKNOWN,
    PB_NORMAL,
    PB_PEAK_DETECT,
    PB_AVERAGE,
    PB_HORZ_HISTOGRAM,
    PB_VERT_HISTOGRAM,
    PB_LOGIC
} WaveformType;

typedef enum
{
    PB_DATA_UNKNOWN,
    PB_DATA_NORMAL,
    PB_DATA_MAX,
    PB_DATA_MIN,
    PB_DATA_TIME,
    PB_DATA_COUNTS,
    PB_DATA_LOGIC
} DataType;

/* Prototypes */
void GetTimeConversionFactors( WaveformHeader waveformHeader,
                               double *xInc, double *xOrg );
void OutputNormalWaveform( WaveformHeader waveformHeader );
void OutputPeakDetectWaveform( WaveformHeader waveformHeader );
void OutputHistogramWaveform( WaveformHeader waveformHeader );
void OutputData( FILE *PeakFile,
                 WaveformDataHeader waveformDataHeader );

/* Globals */
double xOrg=0L, xInc=0L; /* Values necessary to create time data */
union DATATYPE WaveFormData; /* Used to input and output data */

```

```

FILE *InputFile = NULL;
FILE *OutputFile;
errno_t err;
char *buffer;
float Volts[MAX_LENGTH];
float MaxVolts[MAX_LENGTH];
float MinVolts[MAX_LENGTH];
UINT64 HistogramData[MAX_LENGTH];

int main( int argc, char **argv )
{
    FileHeader fileHeader;
    WaveformHeader waveformHeader;

    if( argc > 1 )
    {
        InputFile = fopen( argv[1], "rb" );

        if( InputFile )
        {
            OutputFile = fopen( argv[2], "wb" );

            if( OutputFile )
            {
                /* Read the File Header */
                fread( &fileHeader, 1, sizeof( FileHeader ), InputFile );

                /* Make sure that this is a Keysight Binary File */
                if( (fileHeader.Cookie[0] == COOKIE[0]) &&
                    (fileHeader.Cookie[1] == COOKIE[1]) )
                {
                    fread( &waveformHeader, 1,
                        sizeof( WaveformHeader ), InputFile );

                    switch( waveformHeader.WaveformType )
                    {
                        case PB_NORMAL:
                        case PB_AVERAGE:
                            OutputNormalWaveform( waveformHeader );
                            break;
                        case PB_PEAK_DETECT:
                            OutputPeakDetectWaveform( waveformHeader );
                            break;
                        case PB_HORZ_HISTOGRAM:
                        case PB_VERT_HISTOGRAM:
                            OutputHistogramWaveform( waveformHeader );
                            break;
                        default:
                        case PB_UNKNOWN:
                            printf( "Unknown waveform type: %d\n" );
                            break;
                    }
                }
            }
        }
        else
        {
            printf( "Unable to open output file %s\n", OutputFile);
        }
    }
}

```

```

    }
  }
  else
  {
    printf( "Unable to open input file %s\n", argv[1] );
  }

  fclose( InputFile );
  fclose( OutputFile );
}
else
{
  printf( "Usage: bintoascii inputfile outputfile\n" );
}
}

/*****
* Function name:   GetTimeConversionFactors
* Parameters:     double xInc which is the time between consecutive
*                 sample points.
*                 double xOrg which is the time value of the first
*                 data point.
* Return value:  none
* Description:    This routine transfers the waveform conversion
*                 factors for the time values.
*****/
void GetTimeConversionFactors( WaveformHeader waveformHeader,
                              double *xInc, double *xOrg )
{
  /* Read values which are used to create time values */

  *xInc = waveformHeader.XIncrement;
  *xOrg = waveformHeader.XOrigin;
}

/*****
* Function name:   OutputNormalWaveform
* Parameters:     WaveformHeader *waveformHeader which is a structure
*                 that contains the waveform header information.
* Return value:  none
* Description:    This routine stores the time and voltage information
*                 about the waveform as time and voltage separated by
*                 commas to a file.
*****/
void OutputNormalWaveform( WaveformHeader waveformHeader )
{
  WaveformDataHeader waveformDataHeader;
  int done = FALSE;
  unsigned long i;
  unsigned long j = 0;
  size_t BytesRead = 0L;
  double Time;

  BytesRead = fread( &waveformDataHeader, 1,

```

```

        sizeof( WaveformDataHeader ), InputFile );
GetTimeConversionFactors( waveformHeader, &xInc, &xOrg );
while( !done )
{
    BytesRead = fread( (char *) Volts, 1, MAX_LENGTH, InputFile );
    for( i = 0; i < (BytesRead/waveformDataHeader.BytesPerPoint); i++)
    {
        Time = (j * xInc) + xOrg; /* calculate time */
        j = j + 1;
        fprintf( OutputFile, "%e,%f\n", Time, Volts[i] );
    }
    if( BytesRead < MAX_LENGTH )
    {
        done = TRUE;
    }
}

/*****
* Function name: OutputHistogramWaveform
* Parameters:   WaveformHeader *waveformHeader which is a structure
*               that contains the waveform header information.
* Return value: none
* Description:  This routine stores the time and hits information
*               as time and hits separated by commas to a file.
*****/
void OutputHistogramWaveform( WaveformHeader waveformHeader )
{
    WaveformDataHeader waveformDataHeader;
    int done = FALSE;
    unsigned long i;
    unsigned long j = 0;
    size_t BytesRead = 0L;

    fread( &waveformDataHeader, 1,
           sizeof( WaveformDataHeader ), InputFile );
    GetTimeConversionFactors( waveformHeader, &xInc, &xOrg );
    while( !done )
    {
        BytesRead = fread( (char *) HistogramData, 1, MAX_LENGTH,
                           InputFile );

        for( i = 0; i < (BytesRead/waveformDataHeader.BytesPerPoint); i++)
        {
            fprintf( OutputFile, "%d,%u64l\n", j, HistogramData[i] );
            j = j + 1;
        }
        if( BytesRead < MAX_LENGTH )
        {
            done = TRUE;
        }
    }
}

/*****
* Function name: OutputData
* Parameters:   FILE *PeakFile which is the pointer to the file
*****/

```

```

*           to be written.
*           WaveformDataHeader waveformDataHeader
*           which is a structure that contains the waveform
*           header information.
* Return value: none
* Description: This routine stores the time, minimum voltage, and
*             maximum voltage for the peak detect waveform as comma
*             separated values to a file.
*****/
void OutputData( FILE *PeakFile, WaveformDataHeader waveformDataHeader )
{
    int done = FALSE;
    size_t BytesRead = 0L;
    int NumberToRead;

    NumberToRead = waveformDataHeader.BufferSize;

    while( !done )
    {
        BytesRead = fread( (char *) Volts, 1, NumberToRead, InputFile ) +
            BytesRead;

        fwrite( Volts, 1, BytesRead, PeakFile );

        if( BytesRead <= NumberToRead )
        {
            done = TRUE;
        }
    }
}

/*****
* Function name: OutputPeakDetectWaveform
* Parameters:   WaveformHeader waveformHeader which is a
*             structure that contains the waveform header
*             information.
* Return value: none
* Description: This routine stores the time, minimum voltage, and
*             maximum voltage for the peak detect waveform as comma
*             separated values to a file.
*****/
void OutputPeakDetectWaveform( WaveformHeader waveformHeader )
{
    WaveformDataHeader waveformDataHeader;
    int done = FALSE;
    unsigned long i;
    unsigned long j = 0;
    size_t BytesRead = 0L;
    double Time;
    FILE *MaxFile;
    FILE *MinFile;

    fread( &waveformDataHeader, 1,
           sizeof( WaveformDataHeader ), InputFile );
    GetTimeConversionFactors( waveformHeader, &xInc, &xOrg );

    MaxFile = fopen( "maxdata.bin", "wb" );

```

```

MinFile = fopen( "mindata.bin", "wb" );

if( MaxFile && MinFile )
{
    if( waveformDataHeader.BufferType == PB_DATA_MAX )
    {
        OutputData( MaxFile, waveformDataHeader );
        OutputData( MinFile, waveformDataHeader );
    }
    else
    {
        OutputData( MinFile, waveformDataHeader );
        OutputData( MaxFile, waveformDataHeader );
    }

    fclose( MaxFile );
    fclose( MinFile );

    MaxFile = fopen( "maxdata.bin", "rb" );
    MinFile = fopen( "mindata.bin", "rb" );

    while( !done )
    {
        BytesRead = fread( (char *) MaxVolts, 1, MAX_LENGTH, MaxFile );
        fread( (char *) MinVolts, 1, MAX_LENGTH, MinFile );

        for( i = 0; i < BytesRead/4; i++)
        {
            Time = (j * xInc) + xOrg; /* calculate time */
            j = j + 1;
            fprintf( OutputFile, "%9.5e,%f,%f\n", Time, MinVolts[i],
                    MaxVolts[i] );
        }

        if( BytesRead < MAX_LENGTH )
        {
            done = TRUE;
        }
    }

    fclose( MaxFile );
    fclose( MinFile );
}
}

```

Index

Symbols

- :ACQuire:AVERAge command/query, 205
- :ACQuire:AVERAge:COUNT command/query, 206
- :ACQuire:BANdwidth, command/query, 207
- :ACQuire:BANdwidth:FRAME? query, 209
- :ACQuire:BANdwidth:TESTLIMITS? query, 210
- :ACQuire:COMPLete command/query, 211
- :ACQuire:COMPLete:STATE command/query, 213
- :ACQuire:HRESolution command/query, 214
- :ACQuire:INTERpolate command/query, 215
- :ACQuire:MODE command/query, 216
- :ACQuire:POINts:ANALog command/query, 218
- :ACQuire:POINts:AUTO command/query, 220
- :ACQuire:POINts:DIGital? query, 221
- :ACQuire:POINts:TESTLIMITS? query, 222
- :ACQuire:REDGe command/query, 223
- :ACQuire:RESPonse command/query, 224
- :ACQuire:SEGmented:AUTOplay command/query, 225
- :ACQuire:SEGmented:COUNT command/query, 226
- :ACQuire:SEGmented:INDEX command/query, 227
- :ACQuire:SEGmented:PLAY command/query, 228
- :ACQuire:SEGmented:PRATE command/query, 229
- :ACQuire:SEGmented:TTAGs command/query, 230
- :ACQuire:SRATE:ANALog command/query, 231
- :ACQuire:SRATE:ANALog:AUTO command/query, 232
- :ACQuire:SRATE:DIGital command/query, 233
- :ACQuire:SRATE:DIGital:AUTO command/query, 234
- :ACQuire:SRATE:TESTLIMITS? query, 235
- :ADER? query, 987
- :AER? query, 988
- :ANALyze:AEDGes command/query, 239
- :ANALyze:CLOCK command/query, 240
- :ANALyze:CLOCK:METHOD command/query, 241
- :ANALyze:CLOCK:METHOD:ALIGN command/query, 244
- :ANALyze:CLOCK:METHOD:DEEMphasis command/query, 246
- :ANALyze:CLOCK:METHOD:EDGE command/query, 247
- :ANALyze:CLOCK:METHOD:JTF command/query, 249
- :ANALyze:CLOCK:METHOD:OJTF command/query, 252
- :ANALyze:CLOCK:METHOD:PAM:B03 command/query, 1501
- :ANALyze:CLOCK:METHOD:PAM:B12 command/query, 1503
- :ANALyze:CLOCK:METHOD:PAM:NONSymmet ric command/query, 1505
- :ANALyze:CLOCK:METHOD:PLLTrack command/query, 255
- :ANALyze:CLOCK:METHOD:SKEW command/query, 256
- :ANALyze:CLOCK:METHOD:SOURce command/query, 257
- :ANALyze:CLOCK:VERTical command/query, 258
- :ANALyze:CLOCK:VERTical:OFFSet command/query, 259
- :ANALyze:CLOCK:VERTical:RANGE command/query, 260
- :ANALyze:SIGNal:DATarate command/query, 261
- :ANALyze:SIGNal:MIXer:CABLEloss command/query, 265
- :ANALyze:SIGNal:MMWave:CALibrate command, 266
- :ANALyze:SIGNal:MMWave:CFrequency command/query, 267
- :ANALyze:SIGNal:MMWave:CONNect command/query, 268
- :ANALyze:SIGNal:MMWave:LOADdress command/query, 269
- :ANALyze:SIGNal:MMWave:MBANd width command/query, 270
- :ANALyze:SIGNal:SYMBOLrate command/query, 263
- :ANALyze:SIGNal:TYPE command/query, 271
- :ANALyze:VIEW command/query, 273
- :ASTate? query, 989
- :ATER? query, 990
- :AUToscale command, 991
- :AUToscale:CHANnels command, 992
- :AUToscale:PLACement command/query, 993
- :AUToscale:VERTical command, 994
- :BEEP command, 995
- :BLANk command, 996
- :BUS:TYPE command/query, 276
- :BUS:BIT<M> command/query, 278
- :BUS:BITS command/query, 279
- :BUS:CLEar command/query, 280
- :BUS:CLOCK command/query, 281
- :BUS:CLOCK:SLOPe command/query, 282
- :BUS:DISPlay command/query, 283
- :BUS:LABel command/query, 284
- :BUS:READout command/query, 285
- :CALibrate:DATE? query, 289
- :CALibrate:OUTPut command/query, 290
- :CALibrate:OUTPut:AUX command/query, 292
- :CALibrate:OUTPut:AUX:RTIME command/query, 293
- :CALibrate:OUTPut:CAL command/query, 294
- :CALibrate:SKEW command/query, 295
- :CALibrate:STATus? query, 296
- :CALibrate:TEMP? query, 297
- :CDISplay command, 997
- :CHANnel<N>:BWLimit command/query, 302
- :CHANnel<N>:COMMONmode command/query, 303
- :CHANnel<N>:DIFFerential command/query, 304
- :CHANnel<N>:DIFFerential:SKEW command/query, 305
- :CHANnel<N>:DISPlay command/query, 306
- :CHANnel<N>:DISPlay:AUTO command/query, 307
- :CHANnel<N>:DISPlay:OFFSet command/query, 309
- :CHANnel<N>:DISPlay:RANGE command/query, 311
- :CHANnel<N>:DISPlay:SCALE command/query, 313
- :CHANnel<N>:INPut command/query, 315
- :CHANnel<N>:INVert command/query, 316
- :CHANnel<N>:ISIM:APPLY command/query, 317
- :CHANnel<N>:ISIM:BANdwidth command/query, 318
- :CHANnel<N>:ISIM:BWLimit command/query, 320
- :CHANnel<N>:ISIM:BWLimit:TYPE command/query, 322

- :CHANnel<N>:SIM:CONVolve command/query, 323
- :CHANnel<N>:SIM:CORRection command/query, 324
- :CHANnel<N>:SIM:DEConvolve command/query, 326
- :CHANnel<N>:SIM:DELay command/query, 327
- :CHANnel<N>:SIM:NORMalize command/query, 328
- :CHANnel<N>:SIM:PEXTraction command/query, 329
- :CHANnel<N>:SIM:SPAN command/query, 331
- :CHANnel<N>:SIM:STATe command/query, 332
- :CHANnel<N>:LABel command/query, 333
- :CHANnel<N>:OFFSet command/query, 334
- :CHANnel<N>:PROBe command/query, 335
- :CHANnel<N>:PROBe:ACCAL command/query, 336
- :CHANnel<N>:PROBe:ATTenuation command/query, 337
- :CHANnel<N>:PROBe:AUTOzero command/query, 338
- :CHANnel<N>:PROBe:COUPling command/query, 339
- :CHANnel<N>:PROBe:EADapter command/query, 340
- :CHANnel<N>:PROBe:ECOupling command/query, 343
- :CHANnel<N>:PROBe:EXTErnal command/query, 344
- :CHANnel<N>:PROBe:EXTErnal:GAIN command/query, 345
- :CHANnel<N>:PROBe:EXTErnal:OFFSet command/query, 346
- :CHANnel<N>:PROBe:EXTErnal:UNITs command/query, 347
- :CHANnel<N>:PROBe:GAIN command/query, 348
- :CHANnel<N>:PROBe:HEAD:ADD command, 349
- :CHANnel<N>:PROBe:HEAD:DELeTe command, 350
- :CHANnel<N>:PROBe:HEAD:SELeCT command/query, 351
- :CHANnel<N>:PROBe:HEAD:VTErm command/query, 352
- :CHANnel<N>:PROBe:ID? query, 353
- :CHANnel<N>:PROBe:INFO? query, 354
- :CHANnel<N>:PROBe:MODE command/query, 355
- :CHANnel<N>:PROBe:PRECProbe:BANdwidTh command, 356
- :CHANnel<N>:PROBe:PRECProbe:CALibratiOn command, 357
- :CHANnel<N>:PROBe:PRECProbe:DELay command, 358
- :CHANnel<N>:PROBe:PRECProbe:MODE command, 359
- :CHANnel<N>:PROBe:PRECProbe:ZSRC command, 360
- :CHANnel<N>:PROBe:PRIMary command/query, 362
- :CHANnel<N>:PROBe:SKEW command/query, 363
- :CHANnel<N>:PROBe:STYPe command/query, 364
- :CHANnel<N>:RANGe command/query, 365
- :CHANnel<N>:SCALe command/query, 366
- :CHANnel<N>:SIMulation:AMPLitude command/query, 367
- :CHANnel<N>:SIMulation:DATA:LENGTh command/query, 368
- :CHANnel<N>:SIMulation:DATA:ODD command/query, 369
- :CHANnel<N>:SIMulation:DATA:PAM command/query, 370
- :CHANnel<N>:SIMulation:DATA:RESeed command/query, 371
- :CHANnel<N>:SIMulation:DATA:SELection command/query, 372
- :CHANnel<N>:SIMulation:DRATE command/query, 373
- :CHANnel<N>:SIMulation:FILTER:ISIM:ADDRess command/query, 374
- :CHANnel<N>:SIMulation:FILTER:ISIM:PEXTraction command/query, 375
- :CHANnel<N>:SIMulation:FILTER:SELection command/query, 376
- :CHANnel<N>:SIMulation:FLOAd:ADDRess command/query, 377
- :CHANnel<N>:SIMulation:FLOAd:LOOP command/query, 378
- :CHANnel<N>:SIMulation:FREQUency command/query, 379
- :CHANnel<N>:SIMulation:FUNCTion:SELection command/query, 380
- :CHANnel<N>:SIMulation:FUNCTion:SQUare:DCYCLe command/query, 381
- :CHANnel<N>:SIMulation:FUNCTion:SQUare:FTIME command/query, 382
- :CHANnel<N>:SIMulation:FUNCTion:SQUare:RTIME command/query, 383
- :CHANnel<N>:SIMulation:JITTEr command/query, 384
- :CHANnel<N>:SIMulation:JITTEr:ABUJ command/query, 385
- :CHANnel<N>:SIMulation:JITTEr:PERiodic<M>:ENABLe command/query, 386
- :CHANnel<N>:SIMulation:JITTEr:PERiodic<M>:FREQUency command/query, 387
- :CHANnel<N>:SIMulation:JITTEr:PERiodic<M>:MAGNitude command/query, 388
- :CHANnel<N>:SIMulation:JITTEr:PERiodic<M>:SHAPE command/query, 389
- :CHANnel<N>:SIMulation:JITTEr:RANDom command/query, 390
- :CHANnel<N>:SIMulation:NOISe command/query, 391
- :CHANnel<N>:SIMulation:NOISe:BWLimit command/query, 392
- :CHANnel<N>:SIMulation:NOISe:PERiodic<M>:ENABLe command/query, 393
- :CHANnel<N>:SIMulation:NOISe:PERiodic<M>:FREQUency command/query, 394
- :CHANnel<N>:SIMulation:NOISe:PERiodic<M>:MAGNitude command/query, 395
- :CHANnel<N>:SIMulation:NOISe:PERiodic<M>:SHAPE command/query, 396
- :CHANnel<N>:SIMulation:NOISe:RANDom command/query, 397
- :CHANnel<N>:SIMulation:OFFSet command/query, 398
- :CHANnel<N>:SIMulation:WAVEform command/query, 399
- :CHANnel<N>:UNITs command/query, 400
- :DIGital<N>:DISPlay command/query, 426
- :DIGital<N>:LABel command/query, 427
- :DIGital<N>:SIZE command/query, 428
- :DIGital<N>:THReshold command/query, 429
- :DIGitize command, 998
- :DISable DIGital command, 1000
- :DISK:CDIREctory command, 432
- :DISK:COPI command, 433
- :DISK:DELeTe command, 434
- :DISK:DIRectory? query, 435
- :DISK:LOAD command, 436
- :DISK:MDIREctory command, 437
- :DISK:PWD? query, 438
- :DISK:SAVE:COMPOSITE command, 439
- :DISK:SAVE:IMAGe command, 440
- :DISK:SAVE:JITTEr command, 441
- :DISK:SAVE:LISTing command, 442
- :DISK:SAVE:MEASurements command, 443
- :DISK:SAVE:PRECProbe command, 444
- :DISK:SAVE:SETup command, 445
- :DISK:SAVE:WAVEform command, 446
- :DISK:SEGMENTed command/query, 448
- :DISK:STORe command, 1500
- :DISPlay: ROW command query, 1509
- :DISPlay:BOOKmark<N>:DELeTe command, 451
- :DISPlay:BOOKmark<N>:SET command, 452
- :DISPlay:BOOKmark<N>:VERTical? query, 454
- :DISPlay:BOOKmark<N>:XPOSITION command/query, 455
- :DISPlay:BOOKmark<N>:YPOSITION command/query, 456
- :DISPlay:CGRade command/query, 457
- :DISPlay:CGRade:LEVELs? query, 459
- :DISPlay:CGRade:SCHeme command/query, 461
- :DISPlay:COLumn command/query, 1507
- :DISPlay:CONNEct command/query, 463
- :DISPlay:DATA? query, 464
- :DISPlay:GRATICule command/query, 465

- :DISPlay:GRATicule:AREA<N>:STATe command/query, 466
- :DISPlay:GRATicule:INTensity command/query, 467
- :DISPlay:GRATicule:NUMBer command/query, 468
- :DISPlay:GRATicule:SETGrat command, 469
- :DISPlay:GRATicule:SIZE command, 71, 1500
- :DISPlay:ISIM:GCOunt command/query, 470
- :DISPlay:ISIM:SElectgraph command, 471
- :DISPlay:ISIM:SOURce command, 472
- :DISPlay:JITTer:GCOunt command/query, 473
- :DISPlay:JITTer:SElectgraph command, 474
- :DISPlay:JITTer:THReshold command, 476
- :DISPlay:LABel command/query, 477
- :DISPlay:LAYout command/query, 478
- :DISPlay:LINE command, 1508
- :DISPlay:MAIN command/query, 479
- :DISPlay:NOISe:LEVel command, 480
- :DISPlay:PERsistence command/query, 481
- :DISPlay:PRECprobe:GCOunt command/query, 485
- :DISPlay:PRECprobe:SElectgraph command, 486
- :DISPlay:PRECprobe:SOURce command, 487
- :DISPlay:PROPortion command/query, 483
- :DISPlay:PROPortion:RESults command/query, 484
- :DISPlay:SCOLor command/query, 488
- :DISPlay:STATus:COL command query, 490
- :DISPlay:STATus:ROW command query, 491
- :DISPlay:STRing command, 1510
- :DISPlay:TAB command/query, 1511
- :DISPlay:TEXT command, 1512
- :DISPlay:WINDow:MAXimize command, 492
- :ENABle DIGital command, 1001
- :FUNCTion<F>:ABSolute command, 497
- :FUNCTion<F>:ADD command, 498
- :FUNCTion<F>:ADEMMod command, 499
- :FUNCTion<F>:AVERAge command, 500
- :FUNCTion<F>:COMMonmode command, 501
- :FUNCTion<F>:DELay command, 502
- :FUNCTion<F>:DIFF command, 503
- :FUNCTion<F>:DISPlay command/query, 504
- :FUNCTion<F>:DIVide command, 505
- :FUNCTion<F>:FFT:DETECTOR:POINts command/query, 506
- :FUNCTion<F>:FFT:DETECTOR:TYPE command/query, 507
- :FUNCTion<F>:FFT:FREQuency command/query, 508
- :FUNCTion<F>:FFT:REFerence command/query, 509
- :FUNCTion<F>:FFT:RESOLution command/query, 510
- :FUNCTion<F>:FFT:SPAN command/query, 511
- :FUNCTion<F>:FFT:STOP command/query, 512
- :FUNCTion<F>:FFT:TDELay command/query, 513
- :FUNCTion<F>:FFT:VUNits command/query, 514
- :FUNCTion<F>:FFT:WINDow command/query, 515
- :FUNCTion<F>:FFTMagnitude command, 517
- :FUNCTion<F>:FFTPHase command, 518
- :FUNCTion<F>:GATING command, 519
- :FUNCTion<F>:GATING:START command, 520
- :FUNCTion<F>:GATING:STOP command, 521
- :FUNCTion<F>:HIGHpass command, 522
- :FUNCTion<F>:HORizontal command/query, 523
- :FUNCTion<F>:HORizontal:POSItion command/query, 524
- :FUNCTion<F>:HORizontal:RANGE command/query, 526
- :FUNCTion<F>:INTEgrate command, 528
- :FUNCTion<F>:INVert command, 529
- :FUNCTion<F>:LOWPass command, 530
- :FUNCTion<F>:MAGNify command, 531
- :FUNCTion<F>:MATLab command, 532
- :FUNCTion<F>:MATLab:CONTRol<N> command/query, 533
- :FUNCTion<F>:MATLab:OPERator command/query, 534
- :FUNCTion<F>:MAXimum command, 535
- :FUNCTion<F>:MHISTogram command, 536
- :FUNCTion<F>:MINimum command, 537
- :FUNCTion<F>:MLOG command/query, 538
- :FUNCTion<F>:MTRend command, 539
- :FUNCTion<F>:MULTiply command, 540
- :FUNCTion<F>:OFFSet command/query, 541
- :FUNCTion<F>:RANGE command/query, 542
- :FUNCTion<F>:SMOoth command, 543
- :FUNCTion<F>:SQRT command, 544
- :FUNCTion<F>:SQUare command, 545
- :FUNCTion<F>:SUBTRact command, 546
- :FUNCTion<F>:VERSus command, 547
- :FUNCTion<F>:VERTical command/query, 548
- :FUNCTion<F>:VERTical:OFFSet command/query, 549
- :FUNCTion<F>:VERTical:RANGE command/query, 550
- :FUNCTion<F>? query, 496
- :HARDcopy:AREA command/query, 552
- :HARDcopy:DPRinter command/query, 553
- :HARDcopy:FACTors command/query, 554
- :HARDcopy:IMAGe command/query, 555
- :HARDcopy:PRINters? query, 556
- :HISTogram:AXIS command/query, 559
- :HISTogram:HORizontal:BINs command/query, 560
- :HISTogram:MEASurement:BINs command/query, 561
- :HISTogram:MODE command/query, 562
- :HISTogram:SCALE:SIZE command/query, 563
- :HISTogram:VERTical:BINs command/query, 564
- :HISTogram:WINDow:BLIMit command/query, 569
- :HISTogram:WINDow:DEFault command, 565
- :HISTogram:WINDow:LLIMit command/query, 567
- :HISTogram:WINDow:RLIMit command/query, 568
- :HISTogram:WINDow:SOURce command/query, 566
- :HISTogram:WINDow:TLIMit command/query, 570
- :HOSTed:CALibrate:ALIGN command/query, 1513
- :HOSTed:CALibrate:CALibrate command, 573
- :HOSTed:CALibrate:CHANnel command/query, 574
- :HOSTed:CALibrate:DESKew:CHANnels command, 575
- :HOSTed:CALibrate:DESKew:FRAMES command, 576
- :HOSTed:CALibrate:DESKew:SIGNals command, 577
- :HOSTed:CALibrate:DESKew:ZERO command, 578
- :HOSTed:CALibrate:LEVel command/query, 579
- :HOSTed:CALibrate:PROMpt command/query, 581
- :HOSTed:CALibrate:STATus:CHANnels? query, 582
- :HOSTed:CALibrate:STATus:FRAMES? query, 583
- :HOSTed:CALibrate:STATus:LEVel? query, 584
- :HOSTed:CALibrate:STATus:SIGNals? query, 585
- :HOSTed:CALibrate:TREF:DETEct command, 586
- :HOSTed:FOLLOWer<N>:ACHannels? query, 587
- :HOSTed:FOLLOWer<N>:CONFigure command, 588
- :HOSTed:FOLLOWer<N>:CONnect command, 589
- :HOSTed:FOLLOWer<N>:DISConnect command, 590
- :HOSTed:LEADer:ACHannels? query, 591

- :HOSTed:LEADer:CONFigure command, 592
- :HOSTed:LEADer:CONNect command, 593
- :HOSTed:LEADer:DISConnect command, 594
- :HOSTed:NCONNected? query, 595
- :HOSTed:PERiodic command/query, 596
- :ISCan:DELay command/query, 598
- :ISCan:MEASurement command/query, 601
- :ISCan:MEASurement:FAIL command/query, 599
- :ISCan:MEASurement:LLIMit command/query, 600
- :ISCan:MEASurement:ULIMit command/query, 602
- :ISCan:MODE command/query, 603
- :ISCan:NONMonotonic:EDGE command/query, 604
- :ISCan:NONMonotonic:HYSTeresis command/query, 605
- :ISCan:NONMonotonic:SOURce command/query, 606
- :ISCan:RUNT:HYSTeresis command/query, 607
- :ISCan:RUNT:LLEVel command/query, 608
- :ISCan:RUNT:SOURce command/query, 609
- :ISCan:RUNT:ULEVel command/query, 610
- :ISCan:SERial:PATTern command/query, 611
- :ISCan:SERial:SOURce command/query, 612
- :ISCan:ZONE:HIDE command/query, 613
- :ISCan:ZONE:SOURce command/query, 614
- :ISCan:ZONE<Z>:MODE command/query, 615
- :ISCan:ZONE<Z>:PLACement command/query, 616
- :ISCan:ZONE<Z>:SOURce command/query, 617
- :ISCan:ZONE<Z>:STATe command/query, 618
- :LISTer:DATA? query, 630
- :LISTer:DISPlay command/query, 631
- :LTEST:ADDStats command/query, 620
- :LTEST:FAIL command/query, 621
- :LTEST:LLIMit command/query, 623
- :LTEST:MEASurement command/query, 624
- :LTEST:RESults? query, 625
- :LTEST:RUMode:SOFailure command/query, 626
- :LTEST:TEST command/query, 627
- :LTEST:ULIMit command/query, 628
- :MARKer:CURSor? query, 634
- :MARKer:DELTA command/query, 635
- :MARKer:MEASurement:MEASurement command, 636
- :MARKer:MODE command/query, 637
- :MARKer:TSTArt command/query, 638
- :MARKer:TSTOp command/query, 639
- :MARKer:VSTArt command/query, 640
- :MARKer:VSTOp command/query, 641
- :MARKer:X1Position command/query, 642
- :MARKer:X1Y1source command/query, 644
- :MARKer:X2Position command/query, 643
- :MARKer:X2Y2source command/query, 646
- :MARKer:XDELTA? query, 648
- :MARKer:Y1Position command/query, 649
- :MARKer:Y2Position command/query, 650
- :MARKer:YDELTA? query, 651
- :MEASure:AREA command/query, 731
- :MEASure:BER command/query, 732
- :MEASure:BERPeracc command/query, 733
- :MEASure:BINterval command/query, 734
- :MEASure:BPERiod command/query, 735
- :MEASure:BWIDth command/query, 736
- :MEASure:CDRRate command, 737
- :MEASure:CGRade:CROSSing command/query, 738
- :MEASure:CGRade:DCDistortion command/query, 739
- :MEASure:CGRade:EHEight command/query, 740
- :MEASure:CGRade:EWIDth command/query, 742
- :MEASure:CGRade:EWINDow command/query, 744
- :MEASure:CGRade:JITTer command/query, 746
- :MEASure:CGRade:OLEVel command/query, 747
- :MEASure:CGRade:QFACTor command/query, 748
- :MEASure:CGRade:ZLEVel command/query, 749
- :MEASure:CHARge command/query, 750
- :MEASure:CLear command, 751
- :MEASure:CLOCK command/query, 1514
- :MEASure:CLOCK:METHOD command/query, 1515, 1517
- :MEASure:CLOCK:METHOD:ALIGn command/query, 1519
- :MEASure:CLOCK:METHOD:DEEMphasis command/query, 1521
- :MEASure:CLOCK:METHOD:EDGE command/query, 1522
- :MEASure:CLOCK:METHOD:JTF command/query, 1524
- :MEASure:CLOCK:METHOD:OJTF command/query, 1526
- :MEASure:CLOCK:METHOD:PLLTrack command/query, 1528
- :MEASure:CLOCK:METHOD:SOURce command/query, 1529
- :MEASure:CLOCK:VERTical command/query, 1530
- :MEASure:CLOCK:VERTical:OFFSet command/query, 1531
- :MEASure:CLOCK:VERTical:RANGe command/query, 1532
- :MEASure:CROSSing command/query, 752
- :MEASure:CTCDutycycle command/query, 753
- :MEASure:CTC:Jitter command/query, 755
- :MEASure:CTCNwidth command/query, 757
- :MEASure:CTCPwidth command/query, 758
- :MEASure:DATarate command/query, 759
- :MEASure:DDPWS command/query, 75, 1533
- :MEASure:DEEMphasis command/query, 760
- :MEASure:DELTAtime command/query, 762
- :MEASure:DELTAtime:DEFine command/query, 764
- :MEASure:DUTYcycle command/query, 766
- :MEASure:EDGE command/query, 767
- :MEASure:ERATio command/query, 768
- :MEASure:ETOedge command, 769
- :MEASure:FALLtime command/query, 770
- :MEASure:FFT:CPOWer command/query, 772
- :MEASure:FFT:DFRequency command/query, 773
- :MEASure:FFT:DMAGNitude command/query, 774
- :MEASure:FFT:FREQuency command/query, 775
- :MEASure:FFT:MAGNitude command/query, 776
- :MEASure:FFT:OBW command/query, 777
- :MEASure:FFT:PEAK1 command/query, 778
- :MEASure:FFT:PEAK2 command/query, 779
- :MEASure:FFT:PSD command/query, 780
- :MEASure:FFT:THReshold command/query, 781
- :MEASure:FREQuency command/query, 782
- :MEASure:HISTogram:FVWHM command/query, 784
- :MEASure:HISTogram:HITS command/query, 785
- :MEASure:HISTogram:M1S command/query, 786
- :MEASure:HISTogram:M2S command/query, 787
- :MEASure:HISTogram:M3S command/query, 788
- :MEASure:HISTogram:MAX command/query, 789
- :MEASure:HISTogram:MEAN command/query, 790
- :MEASure:HISTogram:MEDIan command/query, 791
- :MEASure:HISTogram:MIN command/query, 792
- :MEASure:HISTogram:MODE command/query, 793
- :MEASure:HISTogram:PEAK command/query, 794
- :MEASure:HISTogram:PP command/query, 795

- :MEASure:HISTogram:RESolution command/query, 796
- :MEASure:HISTogram:STDDev command/query, 797
- :MEASure:HOLDtime command/query, 798
- :MEASure:JITTer:HISTogram command/query, 800
- :MEASure:JITTer:MEASurement command/query, 801
- :MEASure:JITTer:SPECTrum command/query, 802
- :MEASure:JITTer:SPECTrum:HORizontal command/query, 803
- :MEASure:JITTer:SPECTrum:HORizontal:POSITION command/query, 804
- :MEASure:JITTer:SPECTrum:HORizontal:RANGe command/query, 805
- :MEASure:JITTer:SPECTrum:VERTical command/query, 806
- :MEASure:JITTer:SPECTrum:VERTical:OFFSet command/query, 807
- :MEASure:JITTer:SPECTrum:VERTical:RANGe command/query, 808
- :MEASure:JITTer:SPECTrum:VERTical:TYPE command/query, 809
- :MEASure:JITTer:SPECTrum:WINDow command/query, 810
- :MEASure:JITTer:STATistics command/query, 1535
- :MEASure:JITTer:TREND command/query, 811
- :MEASure:JITTer:TREND:SMOoth command/query, 812
- :MEASure:JITTer:TREND:SMOoth:POINTs command/query, 813
- :MEASure:JITTer:TREND:VERTical command/query, 814
- :MEASure:JITTer:TREND:VERTical:OFFSet command/query, 815
- :MEASure:JITTer:TREND:VERTical:RANGe command/query, 816
- :MEASure:NAME command/query, 817
- :MEASure:NCJitter command/query, 818
- :MEASure:NOISe command/query, 820
- :MEASure:NOISe:ALL? query, 821
- :MEASure:NOISe:BANDwidth command/query, 823
- :MEASure:NOISe:LOCation command/query, 824
- :MEASure:NOISe:METHod command/query, 825
- :MEASure:NOISe:REPort command/query, 826
- :MEASure:NOISe:RN command/query, 827
- :MEASure:NOISe:SCOPE:RN command/query, 828
- :MEASure:NOISe:STATE command/query, 829
- :MEASure:NOISe:UNITs command/query, 830
- :MEASure:NPERiod command/query, 831
- :MEASure:NPULses command/query, 832
- :MEASure:NUI command/query, 833
- :MEASure:NWIDth command/query, 834
- :MEASure:OMAMplitude command/query, 835
- :MEASure:OPOWer command/query, 836
- :MEASure:OVERshoot command/query, 837
- :MEASure:PAM:ELEVEL command/query, 838
- :MEASure:PAM:ESKew command/query, 840
- :MEASure:PAM:EYE:ELMethod command/query, 842
- :MEASure:PAM:EYE:ESTiming command/query, 843
- :MEASure:PAM:EYE:PPERcent command/query, 844
- :MEASure:PAM:EYE:TIME:LTDefinition command/query, 845
- :MEASure:PAM:LEVEL command/query, 846
- :MEASure:PAM:LRMS command/query, 848
- :MEASure:PAM:LTHickness command/query, 850
- :MEASure:PAM:PLitude command/query, 852
- :MEASure:PBASe command/query, 853
- :MEASure:PERiod command/query, 854
- :MEASure:PHASe command/query, 856
- :MEASure:PPCcontrast command/query, 858
- :MEASure:PPULses command/query, 859
- :MEASure:PREshoot command/query, 860
- :MEASure:PTOP command/query, 861
- :MEASure:PWIDth command/query, 862
- :MEASure:QUALifier<M>:CONDition command/query, 863
- :MEASure:QUALifier<M>:SOURce command/query, 864
- :MEASure:QUALifier<M>:STATE command/query, 865
- :MEASure:RESults? query, 866
- :MEASure:RISetime command/query, 869
- :MEASure:RJDJ:ALL? query, 871
- :MEASure:RJDJ:APLength? query, 873
- :MEASure:RJDJ:BANDwidth command/query, 874
- :MEASure:RJDJ:BER command/query, 875
- :MEASure:RJDJ:CLOCK command/query, 877
- :MEASure:RJDJ:EDGE command/query, 878
- :MEASure:RJDJ:INTERpolate command/query, 879
- :MEASure:RJDJ:METHod command/query, 880
- :MEASure:RJDJ:MODE command/query, 881
- :MEASure:RJDJ:PAMThreshold command/query, 882
- :MEASure:RJDJ:PLENght command/query, 883
- :MEASure:RJDJ:REPort command/query, 884
- :MEASure:RJDJ:RJ command/query, 885
- :MEASure:RJDJ:SCOPE:RJ command/query, 886
- :MEASure:RJDJ:SOURce command/query, 887
- :MEASure:RJDJ:STATE command/query, 888
- :MEASure:RJDJ:TJRJDJ? query, 889
- :MEASure:RJDJ:UNITs command/query, 891
- :MEASure:SCRatch command, 892
- :MEASure:SENDvalid command/query, 893
- :MEASure:SER command/query, 894
- :MEASure:SERPeracq command/query, 895
- :MEASure:SETuptime command/query, 896
- :MEASure:SLEWrate command/query, 898
- :MEASure:SOURce command/query, 899
- :MEASure:STATistics command/query, 900
- :MEASure:TEDGe command/query, 901
- :MEASure:THResholds:ABSolute command/query, 902
- :MEASure:THResholds:DISPlay command/query, 903
- :MEASure:THResholds:GENAuto command, 904
- :MEASure:THResholds:GENeral:ABSolute command/query, 905
- :MEASure:THResholds:GENeral:HYSTeresis command/query, 907
- :MEASure:THResholds:GENeral:METHod command/query, 909
- :MEASure:THResholds:GENeral:PAMAutomatic command/query, 913
- :MEASure:THResholds:GENeral:PAMCustom command/query, 911
- :MEASure:THResholds:GENeral:PERCent command/query, 915
- :MEASure:THResholds:GENeral:TOPBase:ABSolute command/query, 917
- :MEASure:THResholds:GENeral:TOPBase:METHod command/query, 919
- :MEASure:THResholds:HYSTeresis command/query, 920
- :MEASure:THResholds:METHod command/query, 922
- :MEASure:THResholds:PERCent command/query, 923
- :MEASure:THResholds:RFALL:ABSolute command/query, 924
- :MEASure:THResholds:RFALL:HYSTeresis command, 47
- :MEASure:THResholds:RFALL:METHod command/query, 926
- :MEASure:THResholds:RFALL:PAMAutomatic command/query, 928
- :MEASure:THResholds:RFALL:PERCent command/query, 930
- :MEASure:THResholds:RFALL:TOPBase:ABSolute command/query, 932

- :MEASure:THResholdS:RFAL:TOPBase:MET Hod command/query, 934
- :MEASure:THResholdS:SERial:ABSolute command/query, 935
- :MEASure:THResholdS:SERial:HYSTeresis command/query, 937
- :MEASure:THResholdS:SERial:METhod command/query, 939
- :MEASure:THResholdS:SERial:PERCent command/query, 940
- :MEASure:THResholdS:SERial:TOPBase:ABSolute command/query, 942
- :MEASure:THResholdS:SERial:TOPBase:MET Hod command/query, 944
- :MEASure:THResholdS:TOPBase:ABSolute command/query, 945
- :MEASure:THResholdS:TOPBase:METhod command/query, 946
- :MEASure:TIEClock2 command/query, 947
- :MEASure:TIEData command/query, 1536
- :MEASure:TIEData2 command/query, 949
- :MEASure:TIEFilter:SHApe command/query, 950
- :MEASure:TIEFilter:STARt command/query, 951
- :MEASure:TIEFilter:STATe command/query, 952
- :MEASure:TIEFilter:STOP command/query, 953
- :MEASure:TIEFilter:TYPE command/query, 954
- :MEASure:TMAX command/query, 955
- :MEASure:TMIN command/query, 956
- :MEASure:TVOLt command/query, 957
- :MEASure:UITouijitter command/query, 958
- :MEASure:UNITinterval command/query, 959
- :MEASure:VAMPLitude command/query, 960
- :MEASure:VAverage command/query, 961
- :MEASure:VBASe command/query, 962
- :MEASure:VLOWer command/query, 963
- :MEASure:VMAX command/query, 964
- :MEASure:VMIDdle command/query, 965
- :MEASure:VMIN command/query, 966
- :MEASure:VOVershoot command/query, 967
- :MEASure:VPP command/query, 968
- :MEASure:VPReshoot command/query, 969
- :MEASure:VRMS command/query, 970
- :MEASure:VTIME command/query, 972
- :MEASure:VTOP command/query, 973
- :MEASure:VUPPer command/query, 974
- :MEASure:WINDow command/query, 975
- :MEASurement<N>:NAME command/query, 976
- :MEASurement<N>:SOURce command/query, 977
- :MODEl? query, 1002
- :MTEEnable command/query, 1003
- :MTERegister? query, 1004
- :MTEST:ALIGn command, 655
- :MTEST:AlignFIT command/query, 656
- :MTEST:AMASK:CREate command, 658
- :MTEST:AMASK:SAVE command, 661
- :MTEST:AMASK:SOURce command/query, 659
- :MTEST:AMASK:UNITs command/query, 662
- :MTEST:AMASK:XDELta command/query, 663
- :MTEST:AMASK:YDELta command/query, 664
- :MTEST:AUTO command/query, 665
- :MTEST:AVERage command/query, 666
- :MTEST:AVERage:COUNT command/query, 667
- :MTEST:COUNT:FAILures? query, 668
- :MTEST:COUNT:FUI? query, 669
- :MTEST:COUNT:FWAVEforms? query, 670
- :MTEST:COUNT:MARGin:FAILures? query, 671
- :MTEST:COUNT:SUI? query, 672
- :MTEST:COUNT:UI? query, 673
- :MTEST:COUNT:WAVEforms? query, 674
- :MTEST:DELeTe command, 675
- :MTEST:ENABle command/query, 676
- :MTEST:FOLDing command/query, 677
- :MTEST:FOLDing:BITS command/query, 679
- :MTEST:FOLDing:COUNT query, 1538
- :MTEST:FOLDing:COUNT:UI query, 681
- :MTEST:FOLDing:COUNT:WAVEforms query, 683
- :MTEST:FOLDing:FAST command/query, 685
- :MTEST:FOLDing:POSition command/query, 687
- :MTEST:FOLDing:SCALE command/query, 689
- :MTEST:FOLDing:TPOSition command/query, 691
- :MTEST:FOLDing:TSCale command/query, 693
- :MTEST:HAMPLitude command/query, 695
- :MTEST:IMPedance command/query, 696
- :MTEST:INVert command/query, 697
- :MTEST:LAMPLitude command/query, 698
- :MTEST:LOAD command, 699
- :MTEST:MARGin:AUTO:HITS command/query, 700
- :MTEST:MARGin:AUTO:HRATio command/query, 701
- :MTEST:MARGin:AUTO:METhod command/query, 702
- :MTEST:MARGin:METhod command/query, 703
- :MTEST:MARGin:PERCent command/query, 704
- :MTEST:MARGin:STATe command/query, 705
- :MTEST:NREGions? query, 706
- :MTEST:PROBe:IMPedance? query, 707
- :MTEST:RUMode command/query, 708
- :MTEST:RUMode:SOFailure command/query, 709
- :MTEST:SCALE:BIND command/query, 710
- :MTEST:SCALE:X1 command/query, 711
- :MTEST:SCALE:XDELta command/query, 712
- :MTEST:SCALE:Y1 command/query, 713
- :MTEST:SCALE:Y2 command/query, 714
- :MTEST:SOURce command/query, 715
- :MTEST:STARt command, 716
- :MTEST:STIME command/query, 718
- :MTEST:STOP command, 717
- :MTEST:TITLe? query, 719
- :MTEST:TRIGger:SOURce command/query, 720
- :OPEEnable command/query, 1005
- :OPERRegister? query, 1006
- :OVLRegister? query, 1007
- :PDER? query, 1008
- :POD<N>:DISPlay command/query, 980
- :POD<N>:PSKew command/query, 981
- :POD<N>:THReshold command/query, 982
- :PRINt command, 1009
- :RECall:SETup command, 1010
- :RState? query, 1011
- :RUN command, 1012
- :SBUS<N>:CAN:FDSPoint command/query, 1028
- :SBUS<N>:CAN:SAMPLepoint command/query, 1029
- :SBUS<N>:CAN:SIGNal:BAUDrate command/query, 1030
- :SBUS<N>:CAN:SIGNal:DEFinition command/query, 1031
- :SBUS<N>:CAN:SIGNal:FDBaudrate command/query, 1032
- :SBUS<N>:CAN:SOURce command/query, 1033
- :SBUS<N>:CAN:TRIGger command/query, 1034
- :SBUS<N>:CAN:TRIGger:PATtern:DATA command/query, 1037
- :SBUS<N>:CAN:TRIGger:PATtern:DATA:LEN Gth command/query, 1038
- :SBUS<N>:CAN:TRIGger:PATtern:ID command/query, 1040
- :SBUS<N>:CAN:TRIGger:PATtern:ID:MODE command/query, 1041
- :SBUS<N>:CAN:TYPE command/query, 1042
- :SBUS<N>:FLEXray:BAUDrate command/query, 1044
- :SBUS<N>:FLEXray:CHANnel command/query, 1045
- :SBUS<N>:FLEXray:SOURce command/query, 1046
- :SBUS<N>:FLEXray:TRIGger command/query, 1047
- :SBUS<N>:FLEXray:TRIGger:ERRor:TYPE command/query, 1048

- :SBUS<N>:FLEXray:TRIGger:FRAMe:CCBase
command/query, 1049
- :SBUS<N>:FLEXray:TRIGger:FRAMe:CCRepe
tition command/query, 1050
- :SBUS<N>:FLEXray:TRIGger:FRAMe:ID
command/query, 1051
- :SBUS<N>:FLEXray:TRIGger:FRAMe:TYPE
command/query, 1052
- :SBUS<N>:HS:DESCramble
command/query, 1054
- :SBUS<N>:HS:FORMat
command/query, 1055
- :SBUS<N>:HS:IDLE command/query, 1056
- :SBUS<N>:HS:SOURce<S>
command/query, 1057
- :SBUS<N>:IIC:ASIZe
command/query, 1059
- :SBUS<N>:IIC:SOURce:CLOCK
command/query, 1060
- :SBUS<N>:IIC:SOURce:DATA
command/query, 1061
- :SBUS<N>:IIC:TRIGger:PATtern:ADDReSS
command/query, 1062, 1064
- :SBUS<N>:IIC:TRIGger:TYPE
command, 1065
- :SBUS<N>:LIN:SAMPlepoint
command/query, 1068
- :SBUS<N>:LIN:SIGNal:BAUDrate
command/query, 1069
- :SBUS<N>:LIN:SOURce
command/query, 1070
- :SBUS<N>:LIN:STANDard
command/query, 1071
- :SBUS<N>:LIN:TRIGger
command/query, 1072
- :SBUS<N>:LIN:TRIGger:ID
command/query, 1073
- :SBUS<N>:LIN:TRIGger:PATtern:DATA
command/query, 1074
- :SBUS<N>:LIN:TRIGger:PATtern:DATA:LENG
th command/query, 1075
- :SBUS<N>:SPI:BITorder
command/query, 1077
- :SBUS<N>:SPI:CLOCK:SLOPe
command/query, 1078
- :SBUS<N>:SPI:CLOCK:TIMEout
command/query, 1079
- :SBUS<N>:SPI:FRAMe:STATe
command/query, 1080
- :SBUS<N>:SPI:SOURce:CLOCK
command/query, 1081
- :SBUS<N>:SPI:SOURce:DATA
command/query, 1083
- :SBUS<N>:SPI:SOURce:FRAMe
command/query, 1085
- :SBUS<N>:SPI:SOURce:MISO
command/query, 1086
- :SBUS<N>:SPI:SOURce:MOSI
command/query, 1087
- :SBUS<N>:SPI:TRIGger:PATtern:DATA
command/query, 1089
- :SBUS<N>:SPI:TRIGger:PATtern:WIDTH
command/query, 1091
- :SBUS<N>:SPI:TRIGger:TYPE
command/query, 1093
- :SBUS<N>:SPI:TYPE
command/query, 1095
- :SBUS<N>:SPI:WIDTH
command/query, 1096
- :SELFtest:CANCel command, 1098
- :SELFtest:SCOPEtest
command/query, 1099
- :SERial command/query, 1013
- :SINGle command, 1014
- :SPROcessing:CTLequalizer:ACGain
command/query, 1103
- :SPROcessing:CTLequalizer:DCGain
command/query, 1104
- :SPROcessing:CTLequalizer:DISPlay
command/query, 1105
- :SPROcessing:CTLequalizer:NUMPoles
command/query, 1106
- :SPROcessing:CTLequalizer:P1
command/query, 1107
- :SPROcessing:CTLequalizer:P2
command/query, 1108
- :SPROcessing:CTLequalizer:P3
command/query, 1109
- :SPROcessing:CTLequalizer:RATE
command/query, 1110
- :SPROcessing:CTLequalizer:SOURce
command/query, 1111
- :SPROcessing:CTLequalizer:VERTical
command/query, 1112
- :SPROcessing:CTLequalizer:VERTical:OFFSet
command/query, 1113
- :SPROcessing:CTLequalizer:VERTical:RANGE
command/query, 1114
- :SPROcessing:CTLequalizer:Z1
command/query, 1115
- :SPROcessing:CTLequalizer:Z2
command/query, 1116
- :SPROcessing:CTLequalizer:ZERO
command/query, 1540
- :SPROcessing:DFEQualizer:NTAPs
command/query, 1117
- :SPROcessing:DFEQualizer:SOURce
command/query, 1118
- :SPROcessing:DFEQualizer:STATe
command/query, 1119
- :SPROcessing:DFEQualizer:TAP
command/query, 1120
- :SPROcessing:DFEQualizer:TAP:AUTomatic
command, 1121
- :SPROcessing:DFEQualizer:TAP:DELay
command/query, 1122
- :SPROcessing:DFEQualizer:TAP:GAIN
command/query, 1123
- :SPROcessing:DFEQualizer:TAP:LTARget
command/query, 1124
- :SPROcessing:DFEQualizer:TAP:MAX
command/query, 1125
- :SPROcessing:DFEQualizer:TAP:MIN
command/query, 1126
- :SPROcessing:DFEQualizer:TAP:UTARget
command/query, 1127
- :SPROcessing:DFEQualizer:TAP:WIDTH
command/query, 1128
- :SPROcessing:FFEQualizer:BANDwid th
command/query, 1129
- :SPROcessing:FFEQualizer:BWMMode
command/query, 1130
- :SPROcessing:FFEQualizer:DISPlay
command/query, 1131
- :SPROcessing:FFEQualizer:NPRecursor
command/query, 1132
- :SPROcessing:FFEQualizer:NTAPs
command/query, 1133
- :SPROcessing:FFEQualizer:RATE
command/query, 1134
- :SPROcessing:FFEQualizer:SOURce
command/query, 1135
- :SPROcessing:FFEQualizer:TAP
command/query, 1136
- :SPROcessing:FFEQualizer:TAP:AUTomatic
command, 1137
- :SPROcessing:FFEQualizer:TAP:DELay
command/query, 1138
- :SPROcessing:FFEQualizer:TAP:PLENGth
command/query, 1139
- :SPROcessing:FFEQualizer:TAP:WIDTH
command/query, 1140
- :SPROcessing:FFEQualizer:TDELay
command/query, 1141
- :SPROcessing:FFEQualizer:TDMode
command/query, 1142
- :SPROcessing:FFEQualizer:VERTical
command/query, 1143
- :SPROcessing:FFEQualizer:VERTical:OFFSet
command/query, 1144
- :SPROcessing:FFEQualizer:VERTical:RANGE
command/query, 1145
- :STATus? query, 1015
- :STOP command, 1017
- :STORe:JITTer command, 1018
- :STORe:SETup command, 1019
- :STORe:WAVEform command, 1020
- :SYSTem:DATE command/query, 1148
- :SYSTem:DEBUg command/query, 1149
- :SYSTem:DONTtabmeas
command/query, 1151
- :SYSTem:DSP command/query, 1152
- :SYSTem:ERRor? query, 1153
- :SYSTem:GUI command/query, 1154
- :SYSTem:HEADer command/query, 1155
- :SYSTem:HLED command/query, 1156
- :SYSTem:LOCK command/query, 1157
- :SYSTem:LONGform
command/query, 1158
- :SYSTem:MENU? query, 1159
- :SYSTem:PERSONa command/query, 1160
- :SYSTem:PRESet command, 1161
- :SYSTem:SETup command block data, 96
- :SYSTem:SETup command/query, 1163

- :SYSTem:TIME command/query, 1165
- :TERegister? query, 1021
- :TIMebase:POSition command/query, 1168
- :TIMebase:RANGe command/query, 1169
- :TIMebase:REFClock command/query, 1170
- :TIMebase:REFerence command/query, 1171
- :TIMebase:REFerence:PERCent command/query, 1172
- :TIMebase:ROLL:ENABLE command/query, 1173
- :TIMebase:SCALE command/query, 1174
- :TIMebase:VIEW command/query, 1175
- :TIMebase:WINDow:DELay command/query, 1176
- :TIMebase:WINDow:POSition command/query, 1177
- :TIMebase:WINDow:RANGe command/query, 1178
- :TIMebase:WINDow:SCALE command/query, 1179
- :TRIGger:ADVanced:COMM:BWIDth command/query, 1294
- :TRIGger:ADVanced:COMM:ENCode command/query, 1295
- :TRIGger:ADVanced:COMM:LEVel command/query, 1296
- :TRIGger:ADVanced:COMM:PATtern command/query, 1297
- :TRIGger:ADVanced:COMM:POLarity command/query, 1298
- :TRIGger:ADVanced:COMM:SOURce command/query, 1299
- :TRIGger:ADVanced:DELay:EDLY:ARM:SLOPe command/query, 1315
- :TRIGger:ADVanced:DELay:EDLY:ARM:SOURce command/query, 1314
- :TRIGger:ADVanced:DELay:EDLY:EVENT:DELa y command/query, 1316
- :TRIGger:ADVanced:DELay:EDLY:EVENT:SLOPe command/query, 1318
- :TRIGger:ADVanced:DELay:EDLY:EVENT:SOU Rce command/query, 1317
- :TRIGger:ADVanced:DELay:EDLY:TRIGger:SL OPe command/query, 1320
- :TRIGger:ADVanced:DELay:EDLY:TRIGger:SO URce command/query, 1319
- :TRIGger:ADVanced:DELay:TDLY:ARM:SLOPe command/query, 1324
- :TRIGger:ADVanced:DELay:TDLY:ARM:SOURce command/query, 1323
- :TRIGger:ADVanced:DELay:TDLY:DELay command/query, 1325
- :TRIGger:ADVanced:DELay:TDLY:TRIGger:SL OPe command/query, 1327
- :TRIGger:ADVanced:DELay:TDLY:TRIGger:SO URce command/query, 1326
- :TRIGger:ADVanced:PATtern:CONDition command/query, 1302
- :TRIGger:ADVanced:PATtern:LOGic command/query, 1303
- :TRIGger:ADVanced:PATtern:THReshold:LEV el command/query, 1304
- :TRIGger:ADVanced:PATtern:THReshold:PO D<N> command/query, 1305
- :TRIGger:ADVanced:STATE:CLOCK command/query, 1307
- :TRIGger:ADVanced:STATE:LOGic command/query, 1308
- :TRIGger:ADVanced:STATE:LTYPe command/query, 1309
- :TRIGger:ADVanced:STATE:SLOPe command/query, 1310
- :TRIGger:ADVanced:STATE:THReshold:LEVel command/query, 1311
- :TRIGger:ADVanced:TV:STV:FIELD command/query, 1330
- :TRIGger:ADVanced:TV:STV:LINE command/query, 1331
- :TRIGger:ADVanced:TV:STV:SOURce command/query, 1332
- :TRIGger:ADVanced:TV:STV:SPOLarity command/query, 1333
- :TRIGger:ADVanced:TV:UDTV:ENUMber command/query, 1336
- :TRIGger:ADVanced:TV:UDTV:PGTHan command/query, 1337
- :TRIGger:ADVanced:TV:UDTV:POLarity command/query, 1338
- :TRIGger:ADVanced:TV:UDTV:SOURce command/query, 1339
- :TRIGger:ADVanced:VIOLation:MODE command/query, 1341
- :TRIGger:ADVanced:VIOLation:PWIDth:DIRe ction command/query, 1344
- :TRIGger:ADVanced:VIOLation:PWIDth:POLa rity command/query, 1345
- :TRIGger:ADVanced:VIOLation:PWIDth:SOU Rce command/query, 1346
- :TRIGger:ADVanced:VIOLation:PWIDth:WIDTh command/query, 1347
- :TRIGger:ADVanced:VIOLation:SETup:HOLD: CSORce command/query, 1359
- :TRIGger:ADVanced:VIOLation:SETup:HOLD: CSORce:EDGE command/query, 1361
- :TRIGger:ADVanced:VIOLation:SETup:HOLD: CSORce:LEVel command/query, 1360
- :TRIGger:ADVanced:VIOLation:SETup:HOLD: DSOORce command/query, 1362
- :TRIGger:ADVanced:VIOLation:SETup:HOLD: DSOORce:HTHReshold command/query, 1363
- :TRIGger:ADVanced:VIOLation:SETup:HOLD: DSOORce:LTHReshold command/query, 1364
- :TRIGger:ADVanced:VIOLation:SETup:HOLD: TIME command/query, 1365
- :TRIGger:ADVanced:VIOLation:SETup:MODE command/query, 1351
- :TRIGger:ADVanced:VIOLation:SETup:SETup: CSORce command/query, 1352
- :TRIGger:ADVanced:VIOLation:SETup:SETup: CSORce:EDGE command/query, 1354
- :TRIGger:ADVanced:VIOLation:SETup:SETup: CSORce:LEVel command/query, 1353
- :TRIGger:ADVanced:VIOLation:SETup:SETup: DSOORce command/query, 1355
- :TRIGger:ADVanced:VIOLation:SETup:SETup: DSOORce:HTHReshold command/query, 1356
- :TRIGger:ADVanced:VIOLation:SETup:SETup: DSOORce:LTHReshold command/query, 1357
- :TRIGger:ADVanced:VIOLation:SETup:SETup: TIME command/query, 1358
- :TRIGger:ADVanced:VIOLation:SETup:SHOLd :CSORce command/query, 1366
- :TRIGger:ADVanced:VIOLation:SETup:SHOLd :CSORce:EDGE command/query, 1368
- :TRIGger:ADVanced:VIOLation:SETup:SHOLd :CSORce:LEVel command/query, 1367
- :TRIGger:ADVanced:VIOLation:SETup:SHOLd :DSOORce command/query, 1369
- :TRIGger:ADVanced:VIOLation:SETup:SHOLd :DSOORce:HTHReshold command/query, 1370
- :TRIGger:ADVanced:VIOLation:SETup:SHOLd :DSOORce:LTHReshold command/query, 1371
- :TRIGger:ADVanced:VIOLation:SETup:SHOLd :HoldTIME (HTIME) command/query, 1373
- :TRIGger:ADVanced:VIOLation:SETup:SHOLd :SetupTIME (STIME) command/query, 1372
- :TRIGger:ADVanced:VIOLation:TRANSition command/query, 1375
- :TRIGger:ADVanced:VIOLation:TRANSition:S OURce command/query, 1376
- :TRIGger:ADVanced:VIOLation:TRANSition:S OURce:HTHReshold command/query, 1377
- :TRIGger:ADVanced:VIOLation:TRANSition:S OURce:LTHReshold command/query, 1378
- :TRIGger:ADVanced:VIOLation:TRANSition:TY PE command/query, 1379
- :TRIGger:AND:ENABLE command/query, 1184
- :TRIGger:AND:SOURce command/query, 1185
- :TRIGger:COMM:BWIDth command/query, 1199
- :TRIGger:COMM:ENCode command/query, 1200
- :TRIGger:COMM:PATtern command/query, 1201
- :TRIGger:COMM:POLarity command/query, 1202
- :TRIGger:COMM:SOURce command/query, 1203
- :TRIGger:DELay:ARM:SLOPe command/query, 1206
- :TRIGger:DELay:ARM:SOURce command/query, 1205

- :TRIGger:DElay:EDElay:COUNT
command/query, 1207
- :TRIGger:DElay:EDElay:SLOPe
command/query, 1209
- :TRIGger:DElay:EDElay:SOURce
command/query, 1208
- :TRIGger:DElay:MODE
command/query, 1210
- :TRIGger:DElay:TDElay:TIME
command/query, 1211
- :TRIGger:DElay:TRIGger:SLOPe
command/query, 1213
- :TRIGger:DElay:TRIGger:SOURce
command/query, 1212
- :TRIGger:EDGE:COUPling
command/query, 1215
- :TRIGger:EDGE:SLOPe
command/query, 1216
- :TRIGger:EDGE:SOURce
command/query, 1217
- :TRIGger:GBSerial:CLOCK
command/query, 1219
- :TRIGger:GBSerial:CLOCK:FREQuency
command/query, 1220
- :TRIGger:GBSerial:DRATe
command/query, 1222
- :TRIGger:GBSerial:MODE
command/query, 1224
- :TRIGger:GBSerial:PATtern
command/query, 1225
- :TRIGger:GBSerial:POLarity
command/query, 1226
- :TRIGger:GBSerial:PRBS
command/query, 1227
- :TRIGger:GBSerial:SOURce
command/query, 1228
- :TRIGger:GLITCh:POLarity
command/query, 1230
- :TRIGger:GLITCh:SOURce
command/query, 1231
- :TRIGger:GLITCh:WIDTh
command/query, 1232
- :TRIGger:HOLDoff command/query, 1186
- :TRIGger:HOLDoff:MAX
command/query, 1187
- :TRIGger:HOLDoff:MIN
command/query, 1188
- :TRIGger:HOLDoff:MODE
command/query, 1189
- :TRIGger:HTHReshold
command/query, 1190
- :TRIGger:HYSTeresis
command/query, 1191
- :TRIGger:LEVel command/query, 1192
- :TRIGger:LEVel:FIFTy command, 1193
- :TRIGger:LTHReshold
command/query, 1194
- :TRIGger:MODE command/query, 1195
- :TRIGger:PATtern:CONDition
command/query, 1234
- :TRIGger:PATtern:LOGic
command/query, 1235
- :TRIGger:PWIDth:DIReaction
command/query, 1237
- :TRIGger:PWIDth:POLarity
command/query, 1238
- :TRIGger:PWIDth:SOURce
command/query, 1239
- :TRIGger:PWIDth:TPOint
command/query, 1240
- :TRIGger:PWIDth:WIDTh
command/query, 1241
- :TRIGger:RUNT:POLarity
command/query, 1243
- :TRIGger:RUNT:QUALified
command/query, 1244
- :TRIGger:RUNT:SOURce
command/query, 1245
- :TRIGger:RUNT:TIME
command/query, 1246
- :TRIGger:SEQuence:RESet:ENABle
command/query, 1250
- :TRIGger:SEQuence:RESet:EVENT
command, 1252
- :TRIGger:SEQuence:RESet:TIME
command/query, 1253
- :TRIGger:SEQuence:RESet:TYPE
command/query, 1251
- :TRIGger:SEQuence:TERM1
command/query, 1248
- :TRIGger:SEQuence:TERM2
command/query, 1249
- :TRIGger:SEQuence:WAIT:ENABle
command/query, 1254
- :TRIGger:SEQuence:WAIT:TIME
command/query, 1255
- :TRIGger:SHOLd:CSOURce
command/query, 1257
- :TRIGger:SHOLd:CSOURce:EDGE
command/query, 1258
- :TRIGger:SHOLd:DSOURce
command/query, 1259
- :TRIGger:SHOLd:HoldTIME (HTIME)
command/query, 1260
- :TRIGger:SHOLd:MODE
command/query, 1261
- :TRIGger:SHOLd:SetupTIME
command/query, 1262
- :TRIGger:STATe:CLOCK
command/query, 1264
- :TRIGger:STATe:LOGic
command/query, 1265
- :TRIGger:STATe:LTYPe
command/query, 1266
- :TRIGger:STATe:SLOPe
command/query, 1267
- :TRIGger:SWEep command/query, 1197
- :TRIGger:TIMEout:CONDition
command/query, 1269
- :TRIGger:TIMEout:SOURce
command/query, 1270
- :TRIGger:TIMEout:TIME
command/query, 1271
- :TRIGger:TRANsition:DIReaction
command/query, 1273
- :TRIGger:TRANsition:SOURce
command/query, 1274
- :TRIGger:TRANsition:TIME
command/query, 1275
- :TRIGger:TRANsition:TYPE
command/query, 1276
- :TRIGger:TV:LINE command/query, 1278
- :TRIGger:TV:MODE command/query, 1279
- :TRIGger:TV:POLarity
command/query, 1280
- :TRIGger:TV:SOURce
command/query, 1281
- :TRIGger:TV:STANdard
command/query, 1282
- :TRIGger:TV:UDTV:ENUMber
command/query, 1283
- :TRIGger:TV:UDTV:HSYNc
command/query, 1284
- :TRIGger:TV:UDTV:HTIME
command/query, 1285
- :TRIGger:TV:UDTV:PGTHan
command/query, 1286
- :TRIGger:TV:UDTV:POLarity
command/query, 1287
- :TRIGger:WINDow:CONDition
command/query, 1289
- :TRIGger:WINDow:SOURce
command/query, 1290
- :TRIGger:WINDow:TIME
command/query, 1291
- :TRIGger:WINDow:TPOint
command/query, 1292
- :VIEW command, 1022
- :WAVEform:BANDpass? query, 1384
- :WAVEform:BYTeorder
command/query, 1385
- :WAVEform:CGRade:HEIGht? query, 1386
- :WAVEform:CGRade:WIDTh? query, 1387
- :WAVEform:COMPLete? query, 1388
- :WAVEform:COUNT? query, 1389
- :WAVEform:COUPling? query, 1390
- :WAVEform:DATA? query, 1391
- :WAVEform:FORMat
command/query, 1413
- :WAVEform:POINTs? query, 1416
- :WAVEform:PREamble? query, 1417
- :WAVEform:SEGMENTed:ALL
command/query, 1421
- :WAVEform:SEGMENTed:COUNT?
query, 1422
- :WAVEform:SEGMENTed:TTAG? query, 1423
- :WAVEform:SEGMENTed:XLISt? query, 1424
- :WAVEform:SOURce
command/query, 1425
- :WAVEform:STReaming
command/query, 1427
- :WAVEform:TYPE? query, 1428
- :WAVEform:VIEW command/query, 1429
- :WAVEform:XDISplay? query, 1432
- :WAVEform:XINCrement? query, 1433

:WAVEform:XORigin? query, 1434
 :WAVEform:XRANge? query, 1435
 :WAVEform:XREFerence? query, 1436
 :WAVEform:XUNits? query, 1437
 :WAVEform:YDISplay? query, 1438
 :WAVEform:YINCrement? query, 1439
 :WAVEform:YORigin? query, 1440
 :WAVEform:YRANge? query, 1441
 :WAVEform:YREFerence? query, 1442
 :WAVEform:YUNits? query, 1443
 :WMEemory:TIETimebase
 command/query, 1446
 :WMEemory<R>:CLEar command, 1447
 :WMEemory<R>:DISPlay
 command/query, 1448
 :WMEemory<R>:LOAD command, 1449
 :WMEemory<R>:SAVE command, 1450
 :WMEemory<R>:SEGmented:COUNT?
 query, 1451
 :WMEemory<R>:SEGmented:INDEX
 command/query, 1452
 :WMEemory<R>:SEGmented:PLAY
 command/query, 1453
 :WMEemory<R>:XOFFset
 command/query, 1454
 :WMEemory<R>:XRANge
 command/query, 1455
 :WMEemory<R>:YOFFset
 command/query, 1456
 :WMEemory<R>:YRANge
 command/query, 1457
 :XTALK:ENABle command/query, 1461
 :XTALK:PAADes skew command/query, 1463
 :XTALK:PAIFilter command/query, 1464
 :XTALK:PAISi command/query, 1465
 :XTALK:PASLimit command/query, 1466
 :XTALK:PAXFilter command/query, 1467
 :XTALK:PAXSi command/query, 1468
 :XTALK:PJADes skew command/query, 1469
 :XTALK:PJIFilter command/query, 1470
 :XTALK:PJISi command/query, 1471
 :XTALK:PJSLimit command/query, 1472
 :XTALK:PJXFilter command/query, 1473
 :XTALK:PJXSi command/query, 1474
 :XTALK:RESults? query, 1475
 :XTALK:SAADes skew command/query, 1477
 :XTALK:SAIFilter command/query, 1478
 :XTALK:SAISi command/query, 1479
 :XTALK:SASLimit command/query, 1480
 :XTALK:SAXFilter command/query, 1481
 :XTALK:SAXSi command/query, 1482
 :XTALK<X>:AENable<X> command, 1483
 :XTALK<X>:ENABle command/query, 1484
 :XTALK<X>:IAGGressor
 command/query, 1485
 :XTALK<X>:IVICtim command/query, 1486
 :XTALK<X>:PAUTO command/query, 1487
 :XTALK<X>:PLENght command/query, 1488
 :XTALK<X>:PTYPE command/query, 1489
 :XTALK<X>:RIDeal command/query, 1490
 :XTALK<X>:RISI command/query, 1491
 :XTALK<X>:ROTHer command/query, 1492

:XTALK<X>:SOURce command/query, 1493
 :XTALK<X>:STYPe command/query, 1494
 ..., Ellipsis, 100
 (Event Status Enable (*ESE)
 command/query, 404
 *CLS (Clear Status) command, 403
 *ESE (Event Status Enable)
 command/query, 404
 *ESR? (Event Status Register) query, 129,
 406
 *IDN? (Identification Number) query, 407
 *LRN? (Learn) query, 408
 *LRN?, and SYSTem SETup?[LRN], 1164
 *OP?T (Option) query, 411
 *OPC (Operation Complete)
 command/query, 410
 *OPC (Operation Complete) query, 129
 *PSC (Power-on Status Clear)
 command/query, 414
 *RCL (Recall) command, 415
 *RST (Reset) command, 416
 *SAV (Save) command, 417
 *SRE (Service Request Enable)
 command/query, 418
 *STB? (Status Byte) query, 420
 *TRG (Trigger) command, 422
 *TST? (Test) query, 423
 *WAI (Wait-to-Continue) command, 424
 +width - +width measurement, 758

Numerics

82350A GPIB interface, 4
 9.99999E+37, Infinity Representation, 200

A

Aborting a digitize operation, 141
 aborting a digitize operation, 121
 absolute voltage, and VMAX, 964
 absolute voltage, and VMIN, 966
 ABSolute, :FUNctIon<F>:ABSolute
 command, 497
 ABSolute, :MEASure:THResholds:ABSolute
 command/query, 902
 ABSolute,
 :MEASure:THResholds:GENeral:ABSolute
 command/query, 905
 ABSolute,
 :MEASure:THResholds:GENeral:TOPBas
 e:ABSolute command/query, 917
 ABSolute,
 :MEASure:THResholds:RFALL:ABSolute
 command/query, 924
 ABSolute,
 :MEASure:THResholds:RFALL:TOPBase:A
 BSolute command/query, 932
 ABSolute,
 :MEASure:THResholds:SERial:ABSolute
 command/query, 935
 ABSolute,
 :MEASure:THResholds:SERial:TOPBase:
 ABSolute command/query, 942
 ABSolute,
 :MEASure:THResholds:TOPBase:ABSolu
 te command/query, 945
 ABUJ,
 :CHANnel<N>:SIMulation:JITTer:ABUJ
 command/query, 385
 ACCAL, :CHANnel<N>:PROBe:ACCAL
 command/query, 336
 accuracy and probe calibration, 288
 ACGain, :SPROcessing:CTLequalizer:ACGain
 command/query, 1103
 ACHannels,
 :HOSTed:FOLLower<N>:ACHannels?
 query, 587
 ACHannels, :HOSTed:LEADer:ACHannels?
 query, 591
 Acquire Commands, 203
 Acquire Commands, SRATe, 233
 acquiring a waveform, 180
 acquisition state, 989
 acquisition synchronization, 182
 acquisition, ACQuire AVER and
 completion, 211
 acquisition, points, 218
 acquisition, record length, 218
 acquisition, sample rate, 231, 233
 ADD, :CHANnel<N>:PROBe:HEAD:ADD
 command, 349
 ADD, :FUNctIon<F>:ADD command, 498
 address field size, IIC serial decode, 1059
 ADDRess,
 :CHANnel<N>:SIMulation:FILTer:ISIM:A
 DDRess command/query, 374
 ADDRess,
 :CHANnel<N>:SIMulation:FLOad:ADDR
 ess command/query, 377
 ADDRess,
 :SBUS<N>:IIC:TRIGger:PATtern:ADDR
 ess command/query, 1062
 address, GPIB default, 137
 ADDStats, :LTEST:ADDStats
 command/query, 620
 ADEMod, :FUNctIon<F>:ADEMod
 command, 499
 advanced trigger violation modes, 1340
 advanced trigger violation modes, pulse
 width violation mode, 1342
 advanced trigger violation modes, setup
 violation mode, 1348
 advanced trigger violation modes, transition
 violation mode, 1374
 ADVanced,
 :TRIGger:ADVanced:COMM:BWIDth
 command/query, 1294
 ADVanced,
 :TRIGger:ADVanced:COMM:ENCode
 command/query, 1295
 ADVanced, :TRIGger:ADVanced:COMM:LEVel
 command/query, 1296

- ADVanced,
:TRIGger:ADVanced:COMM:PATtern
command/query, **1297**
- ADVanced,
:TRIGger:ADVanced:COMM:POLarity
command/query, **1298**
- ADVanced,
:TRIGger:ADVanced:COMM:SOURce
command/query, **1299**
- ADVanced,
:TRIGger:ADVanced:DElay:EDLY:ARM:SL
OPe command/query, **1315**
- ADVanced,
:TRIGger:ADVanced:DElay:EDLY:ARM:S
OURce command/query, **1314**
- ADVanced,
:TRIGger:ADVanced:DElay:EDLY:EVENT:
DElay command/query, **1316**
- ADVanced,
:TRIGger:ADVanced:DElay:EDLY:EVENT:
SLOPe command/query, **1318**
- ADVanced,
:TRIGger:ADVanced:DElay:EDLY:EVENT:
SOURce command/query, **1317**
- ADVanced,
:TRIGger:ADVanced:DElay:EDLY:TRIGG
er:SLOPe command/query, **1320**
- ADVanced,
:TRIGger:ADVanced:DElay:EDLY:TRIGG
er:SOURce command/query, **1319**
- ADVanced,
:TRIGger:ADVanced:DElay:TDLY:ARM:SL
OPe command/query, **1324**
- ADVanced,
:TRIGger:ADVanced:DElay:TDLY:ARM:S
OURce command/query, **1323**
- ADVanced,
:TRIGger:ADVanced:DElay:TDLY:DElay
command/query, **1325**
- ADVanced,
:TRIGger:ADVanced:DElay:TDLY:TRIGG
er:SLOPe command/query, **1327**
- ADVanced,
:TRIGger:ADVanced:DElay:TDLY:TRIGG
er:SOURce command/query, **1326**
- ADVanced,
:TRIGger:ADVanced:PATtern:CONDition
command/query, **1302**
- ADVanced,
:TRIGger:ADVanced:PATtern:LOGic
command/query, **1303**
- ADVanced,
:TRIGger:ADVanced:PATtern:THReshold
:LEvel command/query, **1304**
- ADVanced,
:TRIGger:ADVanced:PATtern:THReshold
:POD<N> command/query, **1305**
- ADVanced,
:TRIGger:ADVanced:STATE:CLOCK
command/query, **1307**
- ADVanced,:TRIGger:ADVanced:STATE:LOGic
command/query, **1308**
- ADVanced,:TRIGger:ADVanced:STATE:LTYPe
command/query, **1309**
- ADVanced,
:TRIGger:ADVanced:STATE:SLOPe
command/query, **1310**
- ADVanced,
:TRIGger:ADVanced:STATE:THReshold:L
Evel command/query, **1311**
- ADVanced,
:TRIGger:ADVanced:TV:STV:FIELD
command/query, **1330**
- ADVanced,:TRIGger:ADVanced:TV:STV:LINE
command/query, **1331**
- ADVanced,
:TRIGger:ADVanced:TV:STV:SOURce
command/query, **1332**
- ADVanced,
:TRIGger:ADVanced:TV:STV:SPOlarity
command/query, **1333**
- ADVanced,
:TRIGger:ADVanced:TV:UDTV:ENUMber
command/query, **1336**
- ADVanced,
:TRIGger:ADVanced:TV:UDTV:PGTHan
command/query, **1337**
- ADVanced,
:TRIGger:ADVanced:TV:UDTV:POLarity
command/query, **1338**
- ADVanced,
:TRIGger:ADVanced:TV:UDTV:SOURce
command/query, **1339**
- ADVanced,
:TRIGger:ADVanced:VIOLation:MODE
command/query, **1341**
- ADVanced,
:TRIGger:ADVanced:VIOLation:PWIDth:D
IRectioN command/query, **1344**
- ADVanced,
:TRIGger:ADVanced:VIOLation:PWIDth:P
OLarity command/query, **1345**
- ADVanced,
:TRIGger:ADVanced:VIOLation:PWIDth:S
OURce command/query, **1346**
- ADVanced,
:TRIGger:ADVanced:VIOLation:PWIDth:
WIDTh command/query, **1347**
- ADVanced,
:TRIGger:ADVanced:VIOLation:SETup:H
OLD:CSOURce command/query, **1359**
- ADVanced,
:TRIGger:ADVanced:VIOLation:SETup:H
OLD:CSOURce:EDGE
command/query, **1361**
- ADVanced,
:TRIGger:ADVanced:VIOLation:SETup:H
OLD:CSOURce:LEvel
command/query, **1360**
- ADVanced,
:TRIGger:ADVanced:VIOLation:SETup:H
OLD:DSOURce command/query, **1362**
- ADVanced,
:TRIGger:ADVanced:VIOLation:SETup:H
OLD:DSOURce:HTHReshold
command/query, **1363**
- ADVanced,
:TRIGger:ADVanced:VIOLation:SETup:H
OLD:DSOURce:LTHReshold
command/query, **1364**
- ADVanced,
:TRIGger:ADVanced:VIOLation:SETup:H
OLD:TIME command/query, **1365**
- ADVanced,
:TRIGger:ADVanced:VIOLation:SETup:M
ODE command/query, **1351**
- ADVanced,
:TRIGger:ADVanced:VIOLation:SETup:SE
Tup:CSOURce command/query, **1352**
- ADVanced,
:TRIGger:ADVanced:VIOLation:SETup:SE
Tup:CSOURce:EDGE
command/query, **1354**
- ADVanced,
:TRIGger:ADVanced:VIOLation:SETup:SE
Tup:CSOURce:LEvel
command/query, **1353**
- ADVanced,
:TRIGger:ADVanced:VIOLation:SETup:SE
Tup:DSOURce command/query, **1355**
- ADVanced,
:TRIGger:ADVanced:VIOLation:SETup:SE
Tup:DSOURce:HTHReshold
command/query, **1356**
- ADVanced,
:TRIGger:ADVanced:VIOLation:SETup:SE
Tup:DSOURce:LTHReshold
command/query, **1357**
- ADVanced,
:TRIGger:ADVanced:VIOLation:SETup:SE
Tup:TIME command/query, **1358**
- ADVanced,
:TRIGger:ADVanced:VIOLation:SETup:SH
OLD:CSOURce command/query, **1366**
- ADVanced,
:TRIGger:ADVanced:VIOLation:SETup:SH
OLD:CSOURce:EDGE
command/query, **1368**
- ADVanced,
:TRIGger:ADVanced:VIOLation:SETup:SH
OLD:CSOURce:LEvel
command/query, **1367**
- ADVanced,
:TRIGger:ADVanced:VIOLation:SETup:SH
OLD:DSOURce command/query, **1369**
- ADVanced,
:TRIGger:ADVanced:VIOLation:SETup:SH
OLD:DSOURce:HTHReshold
command/query, **1370**
- ADVanced,
:TRIGger:ADVanced:VIOLation:SETup:SH
OLD:DSOURce:LTHReshold
command/query, **1371**
- ADVanced,
:TRIGger:ADVanced:VIOLation:SETup:SH

- Old:HoldTime (HTIME)
 command/query, **1373**
- ADVanced,
 :TRIGger:ADVanced:VIOLation:SETup:SH
 Old:SetupTime (STIME)
 command/query, **1372**
- ADVanced,
 :TRIGger:ADVanced:VIOLation:TRANSitio
 n command/query, **1375**
- ADVanced,
 :TRIGger:ADVanced:VIOLation:TRANSitio
 n:SOURce command/query, **1376**
- ADVanced,
 :TRIGger:ADVanced:VIOLation:TRANSitio
 n:SOURce:HTHReshold
 command/query, **1377**
- ADVanced,
 :TRIGger:ADVanced:VIOLation:TRANSitio
 n:SOURce:LTHReshold
 command/query, **1378**
- ADVanced,
 :TRIGger:ADVanced:VIOLation:TRANSitio
 n:TYPE command/query, **1379**
- advanced, COMM triggering, **1293**
- advanced, delay trigger modes, **1312**,
1321
- advanced, delay triggering, **1312**, **1321**
- advanced, logic triggering, **1300**, **1306**
- advanced, pattern triggering, **1300**
- advanced, state triggering, **1306**
- advanced, TV commands, **1328**, **1334**
- advisory line, reading and writing to, **1147**
- AEDGes, :ANALyze:AEDGes
 command/query, **239**
- AENable<X>, :XTALK<X>:AENable<X>
 command, **1483**
- algebraic sum of functions, **498**
- ALIGN, :ANALyze:CLOCK:METHod:ALIGN
 command/query, **244**
- ALIGN, :HOSTed:CALibrate:ALIGN
 command/query, **1513**
- ALIGN, :MEASure:CLOCK:METHod:ALIGN
 command/query, **1519**
- ALIGN, :MTEST:ALIGN command, **655**
- AlignFIT, :MTEST:AlignFIT
 command/query, **656**
- all edges, measure, **731**, **766**, **767**, **782**,
798, **854**, **856**, **896**, **1535**
- ALL, :WAVEform:SEGmented:ALL
 command/query, **1421**
- ALL?, :MEASure:NOISe:ALL? query, **821**
- ALL?, :MEASure:RJDJ:ALL? query, **871**
- ALL?, :MEASure:RJDJ:APLength?
 query, **873**
- alphanumeric, characters in embedded
 string, **110**
- alphanumeric, strings, **108**
- AMASK, :MTEST:AMASK:CREate
 command, **658**
- AMASK, :MTEST:AMASK:SAVE
 command, **661**
- AMASK, :MTEST:AMASK:SOURce
 command/query, **659**
- AMASK, :MTEST:AMASK:UNITS
 command/query, **662**
- AMASK, :MTEST:AMASK:XDELta
 command/query, **663**
- AMASK, :MTEST:AMASK:YDELta
 command/query, **664**
- AMPLitude,
 :CHANnel<N>:SIMulation:AMPLitude
 command/query, **367**
- AMPS as vertical units, **347**, **400**
- ANALog, :ACQUIRE:POINTs:ANALog
 command/query, **218**
- ANALog, :ACQUIRE:SRATE:ANALog
 command/query, **231**
- ANALog, :ACQUIRE:SRATE:ANALog:AUTO
 command/query, **232**
- Analyze Commands, **237**
- AND, :TRIGger:AND:ENable
 command/query, **1184**
- AND, :TRIGger:AND:SOURce
 command/query, **1185**
- APPLY, :CHANnel<N>:SIM:APPLY
 command/query, **317**
- AREA, :HARDcopy:AREA
 command/query, **552**
- AREA, :MEASure:AREA
 command/query, **731**
- AREA<N>,
 :DISPlay:GRATICule:AREA<N>:STATE
 command/query, **466**
- ARM,
 :TRIGger:ADVanced:DElay:EDLY:ARM:SL
 OPe command/query, **1315**
- ARM,
 :TRIGger:ADVanced:DElay:EDLY:ARM:S
 OURce command/query, **1314**
- ARM,
 :TRIGger:ADVanced:DElay:TDLy:ARM:SL
 OPe command/query, **1324**
- ARM,
 :TRIGger:ADVanced:DElay:TDLy:ARM:S
 OURce command/query, **1323**
- ARM, :TRIGger:DElay:ARM:SLOPe
 command/query, **1206**
- ARM, :TRIGger:DElay:ARM:SOURce
 command/query, **1205**
- armed status, checking for, **172**
- Arming the trigger, **141**
- ASCII, character 32, **98**
- ASCII, linefeed, **111**
- ASCII, waveform data FORMat, **1413**
- ASIZE, :SBUS<N>:IC:ASIZE
 command/query, **1059**
- attenuation factor for probe, **288**, **335**
- ATTenuation,
 :CHANnel<N>:PROBe:ATTenuation
 command/query, **337**
- AUTO, :ACQUIRE:POINTs:AUTO
 command/query, **220**
- AUTO, :ACQUIRE:SRATE:ANALog:AUTO
 command/query, **232**
- AUTO, :ACQUIRE:SRATE:DIGital:AUTO
 command/query, **234**
- AUTO, :CHANnel<N>:DISPlay:AUTO
 command/query, **307**
- AUTO, :MTEST:AUTO command/query, **665**
- AUTO, :MTEST:MARGIN:AUTO:HITS
 command/query, **700**
- AUTO, :MTEST:MARGIN:AUTO:HRATIO
 command/query, **701**
- AUTO, :MTEST:MARGIN:AUTO:METHod
 command/query, **702**
- AUTomatic,
 :SPROcessing:DFFeQualizer:TAP:AUToma
 tic command, **1121**
- AUTomatic,
 :SPROcessing:FFeQualizer:TAP:AUTomat
 ic command, **1137**
- AUToplay, :ACQUIRE:SEGmented:AUToplay
 command/query, **225**
- AUToscale, during initialization, **117**
- AUTOzero, :CHANnel<N>:PROBe:AUTOzero
 command/query, **338**
- Aux Out connector, **290**
- AUX, :CALibrate:OUTPut:AUX
 command/query, **292**
- AUX, :CALibrate:OUTPut:AUX:RTIME
 command/query, **293**
- availability of measured data, **147**
- AVERage, :ACQUIRE:AVERage
 command/query, **205**
- AVERage, :ACQUIRE:AVERage:COUNT
 command/query, **206**
- AVERage, :FUNCTION<F>:AVERage
 command, **500**
- AVERage, :MTEST:AVERage
 command/query, **666**
- AVERage, :MTEST:AVERage:COUNT
 command/query, **667**
- AVERage, and acquisition completion, **211**
- AVERage, and count, **667**
- AXIS, :HISTogram:AXIS
 command/query, **559**
- ## B
- B<N>, :BUS:B<N>:TYPE
 command/query, **276**
- B03, :ANALyze:CLOCK:METHod:PAM:B03
 command/query, **1501**
- B12, :ANALyze:CLOCK:METHod:PAM:B12
 command/query, **1503**
- BANDpass?, :WAVEform:BANDpass?
 query, **1384**
- bandwidth limit, **1384**
- BANDwidth, :ACQUIRE:BANDwidth,
 command/query, **207**
- BANDwidth, :ACQUIRE:BANDwidth:FRAME?
 query, **209**

- BANDwidth,
 - :ACquire:BANDwidth:TESTLIMITS? query, [210](#)
 - BANDwidth,:CHANnel<N>:ISIM:BANDwidth command/query, [318](#)
 - BANDwidth,
 - :CHANnel<N>:PROBe:PRECprobe:BANDwidth command, [356](#)
 - BANDwidth,:MEASure:NOISe:BANDwidth command/query, [823](#)
 - BANDwidth,:MEASure:RJDJ:BANDwidth command/query, [874](#)
 - BANDwidth,
 - :SPROcessing:FFEQualizer:BANDwidth command/query, [1129](#)
 - basic command structure, [119](#)
 - basic operations, [94](#)
 - baud rate, [1030,1069](#)
 - BAUDrate,:SBUS<N>:CAN:SIGNal:BAUDrate command/query, [1030](#)
 - BAUDrate,:SBUS<N>:FLEXray:BAUDrate command/query, [1044](#)
 - BAUDrate,:SBUS<N>:LIN:SIGNal:BAUDrate command/query, [1069](#)
 - BER,:MEASure:BER command/query, [732](#)
 - BER,:MEASure:RJDJ:BER command/query, [875](#)
 - BERPeracq,:MEASure:BERPeracq command/query, [733](#)
 - BiNary,waveform data FORMat, [1414](#)
 - BIND,:MTEST:SCALe:BIND command/query, [710](#)
 - BINS,:HISTogram:HORizontal:BINS command/query, [560](#)
 - BINS,:HISTogram:MEASurement:BINS command/query, [561](#)
 - BINS,:HISTogram:VERTical:BINS command/query, [564](#)
 - BIInterval,:MEASure:BIInterval command/query, [734](#)
 - Bit Definitions in Status Reporting, [148](#)
 - bit order, SPI decode, [1077](#)
 - BIT<M>,:BUS:BIT<M> command/query, [278](#)
 - BITS,:BUS:BITS command/query, [279](#)
 - BITS,:MTEST:FOLDing:BITS command/query, [679](#)
 - blanking the user text area, [1512](#)
 - BLIMit,:HISTogram:WINDow:BLIMit command/query, [569](#)
 - block data, [96,125](#)
 - block data, in :SYSTem:SETup command, [96](#)
 - Block Diagram, Status Reporting Overview, [148](#)
 - blocking commands, [129](#)
 - blocking synchronization, [182](#)
 - blocking synchronization example, [183](#)
 - BOOKmark<N>,
 - :DISPlay:BOOKmark<N>:DELeTe command, [451](#)
 - BOOKmark<N>,
 - :DISPlay:BOOKmark<N>:SET command, [452](#)
 - BOOKmark<N>,
 - :DISPlay:BOOKmark<N>:VERTical? query, [454](#)
 - BOOKmark<N>,
 - :DISPlay:BOOKmark<N>:XPOSITION command/query, [455](#)
 - BOOKmark<N>,
 - :DISPlay:BOOKmark<N>:YPOSITION command/query, [456](#)
 - BPERiod,:MEASure:BPERiod command/query, [735](#)
 - Braces, [99](#)
 - Brackets, Square, [101](#)
 - brickwall filter, TIE, [950](#)
 - buffer, output, [106,122](#)
 - buffered responses, [201](#)
 - Bus Activity, Halting, [141](#)
 - Bus Commands, [141](#)
 - BWIDth,:MEASure:BWIDth command/query, [736](#)
 - BWIDth,:TRIGger:ADVanced:COMM:BWIDth command/query, [1294](#)
 - BWIDth,:TRIGger:COMM:BWIDth command/query, [1199](#)
 - BWLimit,:CHANnel<N>:BWLimit command/query, [302](#)
 - BWLimit,:CHANnel<N>:ISIM:BWLimit command/query, [320](#)
 - BWLimit,:CHANnel<N>:ISIM:BWLimit:TYPE command/query, [322](#)
 - BWLimit,
 - :CHANnel<N>:SIMulation:NOISe:BWLimit command/query, [392](#)
 - BWMode,
 - :SPROcessing:FFEQualizer:BWMode command/query, [1130](#)
 - BYTE, Understanding the format, [1408](#)
 - BYTE, waveform data FORMat, [1414](#)
 - BYTeorder,:WAVEform:BYTeorder command/query, [1385](#)
 - BYTeorder, and DATA, [1393](#)
- ## C
- C Program, DATA? Analog Channels, [1393](#)
 - C Program, DATA? Digital Channels, [1399](#)
 - C, SICL library example, [1649](#)
 - C, VISA library example, [1592](#)
 - C#, SCPI.NET example, [1668](#)
 - C#, VISA COM example, [1565](#)
 - C#, VISA example, [1611](#)
 - CABLeLoss,
 - :ANALyze:SIGNal:MIXer:CABLeLoss command/query, [265](#)
 - CAL,:CALibrate:OUTPut:CAL command/query, [294](#)
 - CALibrate,
 - :ANALyze:SIGNal:MMWave:CALibrate command, [266](#)
 - CALibrate,:HOSTed:CALibrate:ALIGn command/query, [1513](#)
 - CALibrate,:HOSTed:CALibrate:CALibrate command, [573](#)
 - CALibrate,:HOSTed:CALibrate:CHANnel command/query, [574](#)
 - CALibrate,
 - :HOSTed:CALibrate:DESKew:CHANnels command, [575](#)
 - CALibrate,
 - :HOSTed:CALibrate:DESKew:FRAMES command, [576](#)
 - CALibrate,
 - :HOSTed:CALibrate:DESKew:SIGNals command, [577](#)
 - CALibrate,
 - :HOSTed:CALibrate:DESKew:ZERO command, [578](#)
 - CALibrate,:HOSTed:CALibrate:LEVel command/query, [579](#)
 - CALibrate,:HOSTed:CALibrate:PROMpt command/query, [581](#)
 - CALibrate,
 - :HOSTed:CALibrate:STATus:CHANnels? query, [582](#)
 - CALibrate,
 - :HOSTed:CALibrate:STATus:FRAMES? query, [583](#)
 - CALibrate,
 - :HOSTed:CALibrate:STATus:LEVel? query, [584](#)
 - CALibrate,
 - :HOSTed:CALibrate:STATus:SIGNals? query, [585](#)
 - CALibrate,:HOSTed:CALibrate:TREF:DETECT command, [586](#)
 - Calibration Commands, [287](#)
 - calibration status, [296](#)
 - CALibration,
 - :CHANnel<N>:PROBe:PRECprobe:CALibration command, [357](#)
 - CAN acknowledge, [1029](#)
 - CAN baud rate, [1030](#)
 - CAN serial bus commands, [1027](#)
 - CAN signal definition, [1031](#)
 - CAN source, [1033](#)
 - CAN trigger, [1034,1038](#)
 - CAN trigger data pattern, [1037](#)
 - CAN trigger ID pattern, [1040](#)
 - CAN trigger pattern id mode, [1041](#)
 - CAN,:SBUS<N>:CAN:FDSPoint command/query, [1028](#)
 - CAN,:SBUS<N>:CAN:SAMPlepoint command/query, [1029](#)
 - CAN,:SBUS<N>:CAN:SIGNal:BAUDrate command/query, [1030](#)
 - CAN,:SBUS<N>:CAN:SIGNal:DEFinition command/query, [1031](#)

- CAN, :SBUS<N>:CAN:SIGNal:FDBaudrate command/query, [1032](#)
- CAN, :SBUS<N>:CAN:SOURce command/query, [1033](#)
- CAN, :SBUS<N>:CAN:TRIGger command/query, [1034](#)
- CAN, :SBUS<N>:CAN:TRIGger:PATtern:DATA command/query, [1037](#)
- CAN, :SBUS<N>:CAN:TRIGger:PATtern:DATA:LENGth command/query, [1038](#)
- CAN, :SBUS<N>:CAN:TRIGger:PATtern:ID command/query, [1040](#)
- CAN, :SBUS<N>:CAN:TRIGger:PATtern:ID:MO DE command/query, [1041](#)
- CAN, :SBUS<N>:CAN:TYPE command/query, [1042](#)
- CANCel, :SELFTest:CANCel command, [1098](#)
- CCBase, :SBUS<N>:FLEXray:TRIGger:FRAME:CC Base command/query, [1049](#)
- CCRepetition, :SBUS<N>:FLEXray:TRIGger:FRAME:CC Repetition command/query, [1050](#)
- CDIRectory, :DISK:CDIRectory command, [432](#)
- CDRRate, :MEASure:CDRRate command, [737](#)
- center screen voltage, [334](#), [346](#)
- CFRequency, :ANALyze:SIGNal:MMWave:CFRequency command/query, [267](#)
- CGRade, :DISPlay:CGRade command/query, [457](#)
- CGRade, :DISPlay:CGRade:LEVel? query, [459](#)
- CGRade, :DISPlay:CGRade:SCHEME command/query, [461](#)
- CGRade, :MEASure:CGRade:CROSSing command/query, [738](#)
- CGRade, :MEASure:CGRade:DCDistortion command/query, [739](#)
- CGRade, :MEASure:CGRade:EHEight command/query, [740](#)
- CGRade, :MEASure:CGRade:EWIDth command/query, [742](#)
- CGRade, :MEASure:CGRade:EWINDow command/query, [744](#)
- CGRade, :MEASure:CGRade:JITter command/query, [746](#)
- CGRade, :MEASure:CGRade:OLEVel command/query, [747](#)
- CGRade, :MEASure:CGRade:QFActor command/query, [748](#)
- CGRade, :MEASure:CGRade:ZLEVel command/query, [749](#)
- CGRade, :WAVEform:CGRade:HEIGHt? query, [1386](#)
- CGRade, :WAVEform:CGRade:WIDTh? query, [1387](#)
- Channel Commands, [299](#)
- CHANnel, :HOSTed:CALibrate:CHANnel command/query, [574](#)
- CHANnel, :SBUS<N>:FLEXray:CHANnel command/query, [1045](#)
- CHANnels, :AUToscale:CHANnels command, [992](#)
- CHANnels, :HOSTed:CALibrate:DESKew:CHANnels command, [575](#)
- CHANnels, :HOSTed:CALibrate:STATus:CHANnels? query, [582](#)
- channels, and VIEW, [1429](#)
- channel-to-channel skew factor, [295](#)
- character program data, [108](#)
- CHARge, :MEASure:CHARge command/query, [750](#)
- CLASsic color grade scheme, [461](#)
- Clear method, [117](#)
- Clear Status (*CLS) command, [403](#)
- CLEar, :BUS:CLEar command/query, [280](#)
- CLEar, :MEASure:CLEar command, [751](#)
- CLEar, :WMEMory<R>:CLEar command, [1447](#)
- Clearing, Buffers, [141](#)
- clearing, DONE bit, [163](#)
- clearing, error queue, [167](#), [1542](#)
- Clearing, Pending Commands, [141](#)
- clearing, registers and queues, [170](#)
- clearing, Standard Event Status Register, [157](#), [406](#)
- clearing, status data structures, [403](#)
- clearing, TRG bit, [156](#), [165](#)
- clipped waveform data values, [1411](#)
- clipped waveforms, and measurement error, [730](#)
- clock timeout, SPI, [1079](#)
- CLOCK, :ANALyze:CLOCK command/query, [240](#)
- CLOCK, :ANALyze:CLOCK:METHod command/query, [241](#)
- CLOCK, :ANALyze:CLOCK:METHod:ALIGn command/query, [244](#)
- CLOCK, :ANALyze:CLOCK:METHod:DEEMphasis command/query, [246](#)
- CLOCK, :ANALyze:CLOCK:METHod:EDGE command/query, [247](#)
- CLOCK, :ANALyze:CLOCK:METHod:JTF command/query, [249](#)
- CLOCK, :ANALyze:CLOCK:METHod:OJTF command/query, [252](#)
- CLOCK, :ANALyze:CLOCK:METHod:PAM:B03 command/query, [1501](#)
- CLOCK, :ANALyze:CLOCK:METHod:PAM:B12 command/query, [1503](#)
- CLOCK, :ANALyze:CLOCK:METHod:PAM:NONSy mmetric command/query, [1505](#)
- CLOCK, :ANALyze:CLOCK:METHod:PLLTrack command/query, [255](#)
- CLOCK, :ANALyze:CLOCK:METHod:SKEW command/query, [256](#)
- CLOCK, :ANALyze:CLOCK:METHod:SOURce command/query, [257](#)
- CLOCK, :ANALyze:CLOCK:VERTical command/query, [258](#)
- CLOCK, :ANALyze:CLOCK:VERTical:OFFSet command/query, [259](#)
- CLOCK, :ANALyze:CLOCK:VERTical:RANGE command/query, [260](#)
- CLOCK, :BUS:CLOCK command/query, [281](#)
- CLOCK, :BUS:CLOCK:SLOPe command/query, [282](#)
- CLOCK, :MEASure:CLOCK command/query, [1514](#)
- CLOCK, :MEASure:CLOCK:METHod command/query, [1515](#), [1517](#)
- CLOCK, :MEASure:CLOCK:METHod:ALIGn command/query, [1519](#)
- CLOCK, :MEASure:CLOCK:METHod:DEEMphasis command/query, [1521](#)
- CLOCK, :MEASure:CLOCK:METHod:EDGE command/query, [1522](#)
- CLOCK, :MEASure:CLOCK:METHod:JTF command/query, [1524](#)
- CLOCK, :MEASure:CLOCK:METHod:OJTF command/query, [1526](#)
- CLOCK, :MEASure:CLOCK:METHod:PLLTrack command/query, [1528](#)
- CLOCK, :MEASure:CLOCK:METHod:SOURce command/query, [1529](#)
- CLOCK, :MEASure:CLOCK:VERTical command/query, [1530](#)
- CLOCK, :MEASure:CLOCK:VERTical:OFFSet command/query, [1531](#)
- CLOCK, :MEASure:CLOCK:VERTical:RANGE command/query, [1532](#)
- CLOCK, :MEASure:RJDJ:CLOCK command/query, [877](#)
- CLOCK, :SBUS<N>:IIC:SOURce:CLOCK command/query, [1060](#)
- CLOCK, :SBUS<N>:SPI:BITOrder command/query, [1077](#)
- CLOCK, :SBUS<N>:SPI:CLOCK:SLOPe command/query, [1078](#)
- CLOCK, :SBUS<N>:SPI:CLOCK:TIMEout command/query, [1079](#)
- CLOCK, :SBUS<N>:SPI:SOURce:CLOCK command/query, [1081](#)
- CLOCK, :TRIGger:ADVanced:STATe:CLOCK command/query, [1307](#)
- CLOCK, :TRIGger:GBSerial:CLOCK command/query, [1219](#)
- CLOCK, :TRIGger:GBSerial:CLOCK:FREQuency command/query, [1220](#)
- CLOCK, :TRIGger:STATe:CLOCK command/query, [1264](#)
- CME bit, [404](#), [406](#)

- code, SCPI.NET library example in C#, 1668
- code, SCPI.NET library example in IronPython, 1682
- code, SCPI.NET library example in Visual Basic .NET, 1675
- code, SICL library example in C, 1649
- code, SICL library example in Visual Basic, 1658
- code, VISA COM library example in C#, 1565
- code, VISA COM library example in Python, 1584
- code, VISA COM library example in Visual Basic, 1554
- code, VISA COM library example in Visual Basic .NET, 1575
- code, VISA library example in C, 1592
- code, VISA library example in C#, 1611
- code, VISA library example in Python, 1635, 1641
- code, VISA library example in Visual Basic, 1601
- code, VISA library example in Visual Basic .NET, 1623
- COL, :DISPlay:STATus:COL command query, 490
- color grade (pixel) database count values, getting, 1430
- COLumn, :DISPlay:COLumn command/query, 1507
- combining compound and simple commands, 113
- combining, commands in same subsystem, 105
- combining, long- and short-form headers, 107
- COMM, :TRIGger:ADVanced:COMM:BWIDth command/query, 1294
- COMM, :TRIGger:ADVanced:COMM:ENCode command/query, 1295
- COMM, :TRIGger:ADVanced:COMM:LEVel command/query, 1296
- COMM, :TRIGger:ADVanced:COMM:PATtern command/query, 1297
- COMM, :TRIGger:ADVanced:COMM:POLarity command/query, 1298
- COMM, :TRIGger:ADVanced:COMM:SOURce command/query, 1299
- COMM, :TRIGger:COMM:BWIDth command/query, 1199
- COMM, :TRIGger:COMM:ENCode command/query, 1200
- COMM, :TRIGger:COMM:PATtern command/query, 1201
- COMM, :TRIGger:COMM:POLarity command/query, 1202
- COMM, :TRIGger:COMM:SOURce command/query, 1203
- Command and Data Concepts, GPIB, 136
- Command Error, 1544
- Command Error, Status Bit, 148
- Command Expert, 1668
- Command tree, 197
- Command Types, 197
- Command, DIGitize, 120
- command, execution and order, 145
- Command, GPIB Mode, 136
- command, structure, 119
- Command, TRIGger MODE, 1182
- commands embedded in program messages, 112
- commands, obsolete and discontinued, 1497
- commas and spaces, 103
- Common Command Header, 105
- Common Commands, 401
- Common Commands, Reset (*RST), 416
- Common Commands, within a program message, 401
- commonmode voltage of operands, 501
- COMMONmode, :CHANnel<N>:COMMONmode command/query, 303
- COMMONmode, :FUNctioN<F>:COMMONmode command, 501
- Communicating Over the GPIB Interface, 137
- Communicating Over the LAN Interface, 138
- COMPLETE, :ACQUIRE:COMPLETE command/query, 211
- COMPLETE, :ACQUIRE:COMPLETE:STATE command/query, 213
- COMPLETE?, :WAVEform:COMPLETE? query, 1388
- COMPosite, :DISK:SAVE:COMPosite command, 439
- compound command header, 104
- compound queries, 145
- Computer Code and Capability, 135
- computer control examples, 1553
- concurrent commands, 129
- CONDition, :MEASure:QUALifier<M>:CONDition command/query, 863
- CONDition, :TRIGger:ADVanced:PATtern:CONDition command/query, 1302
- CONDition, :TRIGger:PATtern:CONDition command/query, 1234
- CONDition, :TRIGger:TIMEout:CONDition command/query, 1269
- CONDition, :TRIGger:WINDow:CONDition command/query, 1289
- CONFigure, :HOSTed:FOLLower<N>:CONFigure command, 588
- CONFigure, :HOSTed:LEADer:CONFigure command, 592
- connect oscilloscope, 87
- CONNect, :ANALyze:SIGNal:MMWave:CONNect command/query, 268
- CONNect, :DISPlay:CONNect command/query, 463
- CONNect, :HOSTed:FOLLower<N>:CONNect command, 589
- CONNect, :HOSTed:LEADer:CONNect command, 593
- Connection Expert, 88
- CONTRol<N>, :FUNctioN<F>:MATLab:CONTRol<N> command/query, 533
- conventions of programming, 195
- converting waveform data, from data value to Y-axis units, 1382
- CONVolve, :CHANnel<N>:ISIM:CONVolve command/query, 323
- COPY, :DISK:COPY command, 433
- copying files, 433
- copyright, 2
- CORRection, :CHANnel<N>:ISIM:CORRection command/query, 324
- COUNT, :ACQUIRE:AVERage:COUNT command/query, 206
- COUNT, :ACQUIRE:SEGmented:COUNT command/query, 226
- COUNT, :MTEST:AVERage:COUNT command/query, 667
- COUNT, :MTEST:COUNT:FAILures? query, 668
- COUNT, :MTEST:COUNT:FUI? query, 669
- COUNT, :MTEST:COUNT:FWAVEforms? query, 670
- COUNT, :MTEST:COUNT:MARGIn:FAILures? query, 671
- COUNT, :MTEST:COUNT:SUI? query, 672
- COUNT, :MTEST:COUNT:UI? query, 673
- COUNT, :MTEST:COUNT:WAVEforms? query, 674
- COUNT, :MTEST:FOLDing:COUNT query, 1538
- COUNT, :MTEST:FOLDing:COUNT:UI query, 681
- COUNT, :MTEST:FOLDing:COUNT:WAVEforms query, 683
- COUNT, :TRIGger:DElay:EDElay:COUNT command/query, 1207
- COUNT, :WMEMory<R>:SEGmented:COUNT? query, 1451
- COUNT?, :WAVEform:COUNT? query, 1389
- COUNT?, :WAVEform:SEGmented:COUNT? query, 1422
- COUPLing, :CHANnel<N>:PROBE:COUPLing command/query, 339
- COUPLing, :TRIGger:EDGE:COUPLing command/query, 1215
- coupling, input, 315
- COUPLing?, :WAVEform:COUPLing? query, 1390

- CPOWer**, :MEASure:FFT:CPOWer
 command/query, [772](#)
CREate, :MTEST:AMASK:CREate
 command, [658](#)
CROSSsing, :MEASure:CGRade:CROSSsing
 command/query, [738](#)
CROSSsing, :MEASure:CROSSsing
 command/query, [752](#)
CSOource,
 :TRIGger:ADVanced:VIOLation:SETup:H
 OLD:CSOource command/query, [1359](#)
CSOource,
 :TRIGger:ADVanced:VIOLation:SETup:H
 OLD:CSOource:EDGE
 command/query, [1361](#)
CSOource,
 :TRIGger:ADVanced:VIOLation:SETup:H
 OLD:CSOource:LEVel
 command/query, [1360](#)
CSOource,
 :TRIGger:ADVanced:VIOLation:SETup:SE
 TUp:CSOource command/query, [1352](#)
CSOource,
 :TRIGger:ADVanced:VIOLation:SETup:SE
 TUp:CSOource:EDGE
 command/query, [1354](#)
CSOource,
 :TRIGger:ADVanced:VIOLation:SETup:SE
 TUp:CSOource:LEVel
 command/query, [1353](#)
CSOource,
 :TRIGger:ADVanced:VIOLation:SETup:SH
 OLd:CSOource command/query, [1366](#)
CSOource,
 :TRIGger:ADVanced:VIOLation:SETup:SH
 OLd:CSOource:EDGE
 command/query, [1368](#)
CSOource,
 :TRIGger:ADVanced:VIOLation:SETup:SH
 OLd:CSOource:LEVel
 command/query, [1367](#)
CSOource, :TRIGger:SHOLd:CSOource
 command/query, [1257](#)
CSOource, :TRIGger:SHOLd:CSOource:EDGE
 command/query, [1258](#)
CTCDutycycle, :MEASure:CTCDutycycle
 command/query, [753](#)
CTCJitter, :MEASure:CTCJitter
 command/query, [755](#)
CTCNwidth, :MEASure:CTCNwidth
 command/query, [757](#)
CTCPwidth, :MEASure:CTCPwidth
 command/query, [758](#)
CTLequalizer,
 :SPROcessing:CTLequalizer:ACGain
 command/query, [1103](#)
CTLequalizer,
 :SPROcessing:CTLequalizer:DCGain
 command/query, [1104](#)
CTLequalizer,
 :SPROcessing:CTLequalizer:DISPlay
 command/query, [1105](#)
CTLequalizer,
 :SPROcessing:CTLequalizer:NUMPoles
 command/query, [1106](#)
CTLequalizer, :SPROcessing:CTLequalizer:P1
 command/query, [1107](#)
CTLequalizer, :SPROcessing:CTLequalizer:P2
 command/query, [1108](#)
CTLequalizer, :SPROcessing:CTLequalizer:P3
 command/query, [1109](#)
CTLequalizer,
 :SPROcessing:CTLequalizer:RATE
 command/query, [1110](#)
CTLequalizer,
 :SPROcessing:CTLequalizer:SOURce
 command/query, [1111](#)
CTLequalizer,
 :SPROcessing:CTLequalizer:VERTical
 command/query, [1112](#)
CTLequalizer,
 :SPROcessing:CTLequalizer:VERTical:OF
 FSet command/query, [1113](#)
CTLequalizer,
 :SPROcessing:CTLequalizer:VERTical:RA
 NGe command/query, [1114](#)
CTLequalizer, :SPROcessing:CTLequalizer:Z1
 command/query, [1115](#)
CTLequalizer, :SPROcessing:CTLequalizer:Z2
 command/query, [1116](#)
CTLequalizer,
 :SPROcessing:CTLequalizer:ZERo
 command/query, [1540](#)
CURSor?, :MARKer:CURSor? query, [634](#)
- ## D
- data in a :SYSTem:SETup command, [96](#)
 data in a program, [103](#)
 Data Mode, GPIB, [136](#)
 data pattern length, [1038](#)
 data pattern, CAN trigger, [1037](#)
 data source, SPI trigger, [1083](#)
 Data Structures, and Status Reporting, [150](#)
 data transmission mode, and
 FORMat, [1413](#)
DATA,
 :CHANnel<N>:SIMulation:DATA:LENGth
 command/query, [368](#)
DATA, :CHANnel<N>:SIMulation:DATA:ODD
 command/query, [369](#)
DATA, :CHANnel<N>:SIMulation:DATA:PAM
 command/query, [370](#)
DATA,
 :CHANnel<N>:SIMulation:DATA:RESeed
 command/query, [371](#)
DATA,
 :CHANnel<N>:SIMulation:DATA:SElect
 ion command/query, [372](#)
DATA, :DISPlay:DATA? query, [464](#)
DATA,
 :SBUS<N>:CAN:TRIGger:PATtern:DATA
 command/query, [1037](#)
DATA,
 :SBUS<N>:CAN:TRIGger:PATtern:DATA:
 LENGth command/query, [1038](#)
DATA, :SBUS<N>:IIC:SOURce:DATA
 command/query, [1061](#)
DATA,
 :SBUS<N>:IIC:TRIGger:PATtern:ADDRes
 s command/query, [1064](#)
DATA, :SBUS<N>:LIN:TRIGger:PATtern:DATA
 command/query, [1074](#)
DATA,
 :SBUS<N>:LIN:TRIGger:PATtern:DATA:L
 ENGth command/query, [1075](#)
DATA, :SBUS<N>:SPI:SOURce:DATA
 command/query, [1083](#)
DATA, :SBUS<N>:SPI:TRIGger:PATtern:DATA
 command/query, [1089](#)
 data, acquisition, [1382](#)
 data, conversion, [1382](#)
DATA?, :LISTer:DATA? query, [630](#)
DATA?, :WAVEform:DATA? query, [1391](#)
DATA?, Analog Channels C Program, [1393](#)
DATA?, Digital Channels C Program, [1399](#)
DATArate, :ANALyze:SIGNal:DATArate
 command/query, [261](#)
DATArate, :MEASure:DATArate
 command/query, [759](#)
DATE, :CALibrate:DATE? query, [289](#)
DATE, :SYSTem:DATE
 command/query, [1148](#)
DCDistortion,
 :MEASure:CGRade:DCDistortion
 command/query, [739](#)
DCGain, :SPROcessing:CTLequalizer:DCGain
 command/query, [1104](#)
DCYcle,
 :CHANnel<N>:SIMulation:FUNCTION:SQ
 Uare:DCYcle command/query, [381](#)
DDE bit, [404](#), [406](#)
DDPWS, :MEASure:DDPWS
 command/query, [75](#), [1533](#)
DEBUg, :SYSTem:DEBUg
 command/query, [1149](#)
 decimal 32 (ASCII space), [98](#)
 Decision Chart for Status Reporting, [171](#)
 decode type, SPI, [1095](#)
DEConvolve,
 :CHANnel<N>:ISIM:DEConvolve
 command/query, [326](#)
DEEMphasis,
 :ANALyze:CLOCK:METHod:DEEMphasis
 command/query, [246](#)
DEEMphasis,
 :MEASure:CLOCK:METHod:DEEMphasis
 command/query, [1521](#)
DEEMphasis, :MEASure:DEEMphasis
 command/query, [760](#)
 default setup, [1161](#)
 Default Setup front panel key, [1161](#)
 Default Startup Conditions, [134](#)
DEFault, :HISTogram:WINDow:DEFault
 command, [565](#)

- Default, GPIB Address, [137](#)
- Default, Startup Conditions, [134](#)
- DEFine, :MEASure:DELtAtime:DEFine command/query, [764](#)
- defining functions, [494](#)
- DEFinition,
 - :SBUS<N>:CAN:SIGNal:DEFinition command/query, [1031](#)
- def-length block response data, [125](#)
- delay trigger modes, [1312](#), [1321](#)
- DElay, :CHANnel<N>:ISIM:DElay command/query, [327](#)
- DElay,
 - :CHANnel<N>:PROBe:PREcprobe:DElay command, [358](#)
- DElay, :FUNctIon<F>:DElay command, [502](#)
- DElay, :ISCan:DElay command/query, [598](#)
- DElay,
 - :SPROcessing:DFEQualizer:TAP:DElay command/query, [1122](#)
- DElay, :SPROcessing:FFEQualizer:TAP:DElay command/query, [1138](#)
- DElay, :TIMEbase:WINDow:DElay command/query, [1176](#)
- DElay,
 - :TRIGger:ADVanced:DElay:EDLY:ARM:SLOPe command/query, [1315](#)
- DElay,
 - :TRIGger:ADVanced:DElay:EDLY:ARM:SOURce command/query, [1314](#)
- DElay,
 - :TRIGger:ADVanced:DElay:EDLY:EVENT:DElay command/query, [1316](#)
- DElay,
 - :TRIGger:ADVanced:DElay:EDLY:EVENT:SLOPe command/query, [1318](#)
- DElay,
 - :TRIGger:ADVanced:DElay:EDLY:EVENT:SOURce command/query, [1317](#)
- DElay,
 - :TRIGger:ADVanced:DElay:EDLY:TRIGger:SLOPe command/query, [1320](#)
- DElay,
 - :TRIGger:ADVanced:DElay:EDLY:TRIGger:SOURce command/query, [1319](#)
- DElay,
 - :TRIGger:ADVanced:DElay:TDLY:ARM:SLOPe command/query, [1324](#)
- DElay,
 - :TRIGger:ADVanced:DElay:TDLY:ARM:SOURce command/query, [1323](#)
- DElay,
 - :TRIGger:ADVanced:DElay:TDLY:DElay command/query, [1325](#)
- DElay,
 - :TRIGger:ADVanced:DElay:TDLY:TRIGger:SLOPe command/query, [1327](#)
- DElay,
 - :TRIGger:ADVanced:DElay:TDLY:TRIGger:SOURce command/query, [1326](#)
- DElay, :TRIGger:DElay:ARM:SLOPe command/query, [1206](#)
- DElay, :TRIGger:DElay:ARM:SOURce command/query, [1205](#)
- DElay, :TRIGger:DElay:EDELay:COUNT command/query, [1207](#)
- DElay, :TRIGger:DElay:EDELay:SLOPe command/query, [1209](#)
- DElay, :TRIGger:DElay:EDELay:SOURce command/query, [1208](#)
- DElay, :TRIGger:DElay:MODE command/query, [1210](#)
- DElay, :TRIGger:DElay:TDELay:TIME command/query, [1211](#)
- DElay, :TRIGger:DElay:TRIGger:SLOPe command/query, [1213](#)
- DElay, :TRIGger:DElay:TRIGger:SOURce command/query, [1212](#)
- delay, and WINDow DElay, [1176](#)
- DElete, :CHANnel<N>:PROBe:HEAD:DElete command, [350](#)
- DElete, :DISK:DElete command, [434](#)
- DElete, :DISPlay:BOOKmark<N>:DElete command, [451](#)
- DElete, :MTESt:DElete command, [675](#)
- deleting files, [434](#)
- DELta, :MARKer:DELta command/query, [635](#)
- DELtAtime, :MEASure:DELtAtime command/query, [762](#)
- DELtAtime, :MEASure:DELtAtime:DEFine command/query, [764](#)
- derivative function, [503](#)
- DESCramble, :SBUS<N>:HS:DESCramble command/query, [1054](#)
- DESKew,
 - :HOSTed:CALibrate:DESKew:CHANnels command, [575](#)
- DESKew,
 - :HOSTed:CALibrate:DESKew:FRAMES command, [576](#)
- DESKew,
 - :HOSTed:CALibrate:DESKew:SIGNals command, [577](#)
- DESKew, :HOSTed:CALibrate:DESKew:ZERO command, [578](#)
- DEtect, :HOSTed:CALibrate:TREF:DEtect command, [586](#)
- DEtector,
 - :FUNctIon<F>:FFT:DEtector:POINTs command/query, [506](#)
- DEtector, :FUNctIon<F>:FFT:DEtector:TYPE command/query, [507](#)
- Device Address, GPIB, [137](#)
- Device Address, LAN, [138](#)
- Device Clear (DCL), [141](#)
- Device Clear Code and Capability, [135](#)
- Device Clear to abort a sequential (blocking) command, [130](#)
- Device Dependent Error (DDE), Status Bit, [148](#)
- Device- or Oscilloscope-Specific Error, [1546](#)
- Device Trigger Code and Capability, [135](#)
- device-dependent data, [125](#)
- DFEQualizer,
 - :SPROcessing:DFEQualizer:NTAPs command/query, [1117](#)
- DFEQualizer,
 - :SPROcessing:DFEQualizer:SOURce command/query, [1118](#)
- DFEQualizer,
 - :SPROcessing:DFEQualizer:STATe command/query, [1119](#)
- DFEQualizer, :SPROcessing:DFEQualizer:TAP command/query, [1120](#)
- DFEQualizer,
 - :SPROcessing:DFEQualizer:TAP:AUTomaTic command, [1121](#)
- DFEQualizer,
 - :SPROcessing:DFEQualizer:TAP:DElay command/query, [1122](#)
- DFEQualizer,
 - :SPROcessing:DFEQualizer:TAP:GAIN command/query, [1123](#)
- DFEQualizer,
 - :SPROcessing:DFEQualizer:TAP:LTARget command/query, [1124](#)
- DFEQualizer,
 - :SPROcessing:DFEQualizer:TAP:MAX command/query, [1125](#)
- DFEQualizer,
 - :SPROcessing:DFEQualizer:TAP:MIN command/query, [1126](#)
- DFEQualizer,
 - :SPROcessing:DFEQualizer:TAP:UTARget command/query, [1127](#)
- DFEQualizer,
 - :SPROcessing:DFEQualizer:TAP:WIDTH command/query, [1128](#)
- DFRequency, :MEASure:FFT:DFRequency command/query, [773](#)
- DIFF, :FUNctIon<F>:DIFF command, [503](#)
- DIFFerential, :CHANnel<N>:DIFFerential command/query, [304](#)
- DIFFerential,
 - :CHANnel<N>:DIFFerential:SKEW command/query, [305](#)
- Digital Commands, [425](#)
- DIGital, :ACQuire:POINTs:DIGital? query, [221](#)
- DIGital, :ACQuire:SRATe:DIGital command/query, [233](#)
- DIGital, :ACQuire:SRATe:DIGital:AUTO command/query, [234](#)
- Digitize, Aborting, [141](#)
- Digitize, setting up for execution, [204](#)
- DIRectIon,
 - :TRIGger:ADVanced:VIOLation:PWIDth:DIRectIon command/query, [1344](#)
- DIRectIon, :TRIGger:PWIDth:DIRectIon command/query, [1237](#)

DIRection, :TRIGger:TRANSition:DIRection
 command/query, **1273**
 DIRectory, :DISK:DIRectory? query, **435**
 Disabling Serial Poll, **141**
 DISConnect,
 :HOSTed:FOLLower<N>:DISConnect
 command, **590**
 DISConnect, :HOSTed:LEADer:DISConnect
 command, **594**
 discontinued and obsolete
 commands, **1497**
 discrete derivative function, **503**
 Disk Commands, **431**
 Disk Commands, SEGmented, **448**
 display colors, default setup and, **1162**
 Display Commands, **449**
 display persistence, **481**
 DISPlay, :BUS:DISPlay
 command/query, **283**
 DISPlay, :CHANnel<N>:DISPlay
 command/query, **306**
 DISPlay, :CHANnel<N>:DISPlay:AUTO
 command/query, **307**
 DISPlay, :CHANnel<N>:DISPlay:OFFSet
 command/query, **309**
 DISPlay, :CHANnel<N>:DISPlay:RANGe
 command/query, **311**
 DISPlay, :CHANnel<N>:DISPlay:SCALE
 command/query, **313**
 DISPlay, :DIGital<N>:DISPlay
 command/query, **426**
 DISPlay, :FUNctIon<F>:DISPlay
 command/query, **504**
 DISPlay, :LISTer:DISPlay
 command/query, **631**
 DISPlay, :MEASure:THResholds:DISPlay
 command/query, **903**
 DISPlay, :POD<N>:DISPlay
 command/query, **980**
 DISPlay, :SPROcessing:CTLequalizer:DISPlay
 command/query, **1105**
 DISPlay, :SPROcessing:FFEQualizer:DISPlay
 command/query, **1131**
 DISPlay, :WMEMory<R>:DISPlay
 command/query, **1448**
 display, serial decode bus, **1025**
 DIVide, :FUNctIon<F>:DIVide
 command, **505**
 dividing functions, **505**
 DMAGnitude, :MEASure:FFT:DMAGnitude
 command/query, **774**
 DONTabmeas, :SYSTem:DONTabmeas
 command/query, **1151**
 DPRinter, :HARDcopy:DPRinter
 command/query, **553**
 DRATe, :CHANnel<N>:SIMulation:DRATe
 command/query, **373**
 DRATe, :TRIGger:GBSerial:DRATe
 command/query, **1222**
 Driver Electronics Code and Capability, **135**

DSOurce,
 :TRIGger:ADVanced:VIOLation:SETup:H
 OLD:DSOurce command/query, **1362**
 DSOurce,
 :TRIGger:ADVanced:VIOLation:SETup:H
 OLD:DSOurce:HTHReshold
 command/query, **1363**
 DSOurce,
 :TRIGger:ADVanced:VIOLation:SETup:H
 OLD:DSOurce:LTHReshold
 command/query, **1364**
 DSOurce,
 :TRIGger:ADVanced:VIOLation:SETup:SE
 Tup:DSOurce command/query, **1355**
 DSOurce,
 :TRIGger:ADVanced:VIOLation:SETup:SE
 Tup:DSOurce:HTHReshold
 command/query, **1356**
 DSOurce,
 :TRIGger:ADVanced:VIOLation:SETup:SE
 Tup:DSOurce:LTHReshold
 command/query, **1357**
 DSOurce,
 :TRIGger:ADVanced:VIOLation:SETup:SH
 OLD:DSOurce command/query, **1369**
 DSOurce,
 :TRIGger:ADVanced:VIOLation:SETup:SH
 OLD:DSOurce:HTHReshold
 command/query, **1370**
 DSOurce,
 :TRIGger:ADVanced:VIOLation:SETup:SH
 OLD:DSOurce:LTHReshold
 command/query, **1371**
 DSOurce, :TRIGger:SHOLd:DSOurce
 command/query, **1259**
 DSP, :SYSTem:DSP command/query, **1152**
 duplicate mnemonics, **105**
 duty cycle - duty cycle measurement, **753**
 DUTYcycle, :MEASure:DUTYcycle
 command/query, **766**

E

EADapter, :CHANnel<N>:PROBe:EADapter
 command/query, **340**
 ECOupling, :CHANnel<N>:PROBe:ECOupling
 command/query, **343**
 EDElay, :TRIGger:DElay:EDElay:COUNT
 command/query, **1207**
 EDElay, :TRIGger:DElay:EDElay:SLOPe
 command/query, **1209**
 EDElay, :TRIGger:DElay:EDElay:SOURce
 command/query, **1208**
 edge trigger slope, default setup, **1161**
 edge trigger source, default setup, **1161**
 EDGE, :ANALyze:CLOCK:METHod:EDGE
 command/query, **247**
 EDGE, :ISCan:NONMonotonic:EDGE
 command/query, **604**
 EDGE, :MEASure:CLOCK:METHod:EDGE
 command/query, **1522**
 EDGE, :MEASure:EDGE
 command/query, **767**
 EDGE, :MEASure:RJJD:EDGE
 command/query, **878**
 EDGE,
 :TRIGger:ADVanced:VIOLation:SETup:H
 OLD:CSOurce:EDGE
 command/query, **1361**
 EDGE,
 :TRIGger:ADVanced:VIOLation:SETup:SE
 Tup:CSOurce:EDGE
 command/query, **1354**
 EDGE,
 :TRIGger:ADVanced:VIOLation:SETup:SH
 OLD:CSOurce:EDGE
 command/query, **1368**
 EDGE, :TRIGger:EDGE:COUpling
 command/query, **1215**
 EDGE, :TRIGger:EDGE:SLOPe
 command/query, **1216**
 EDGE, :TRIGger:EDGE:SOURce
 command/query, **1217**
 EDGE, :TRIGger:SHOLd:CSOurce:EDGE
 command/query, **1258**
 edges, measure all, **731, 766, 767, 782,**
 798, 854, 856, 896, 1535
 EDLY,
 :TRIGger:ADVanced:DElay:EDLY:ARM:SL
 OPe command/query, **1315**
 EDLY,
 :TRIGger:ADVanced:DElay:EDLY:ARM:S
 OURce command/query, **1314**
 EDLY,
 :TRIGger:ADVanced:DElay:EDLY:EVENT:
 DElay command/query, **1316**
 EDLY,
 :TRIGger:ADVanced:DElay:EDLY:EVENT:
 SLOPe command/query, **1318**
 EDLY,
 :TRIGger:ADVanced:DElay:EDLY:EVENT:
 SOURce command/query, **1317**
 EDLY,
 :TRIGger:ADVanced:DElay:EDLY:TRIGge
 r:SLOPe command/query, **1320**
 EDLY,
 :TRIGger:ADVanced:DElay:EDLY:TRIGge
 r:SOURce command/query, **1319**
 EHEight, :MEASure:CGRade:EHEight
 command/query, **740**
 ELEVel, :MEASure:PAM:ELEVel
 command/query, **838**
 Ellipsis, ..., **100**
 ELMethod, :MEASure:PAM:EYE:ELMethod
 command/query, **842**
 embedded, commands, **112**
 embedded, strings, **95, 96, 110**
 Enable Register, **402**
 ENABLE,
 :CHANnel<N>:SIMulation:JITTer:PERiod
 ic<M>:ENABLE command/query, **386**

- ENABLE,
 - :CHANnel<N>:SIMulation:NOISe:PERiodic<M>:ENABle command/query, [393](#)
 - ENABLE, :MTESt:ENABle command/query, [676](#)
 - ENABLE, :TIMEbase:ROLL:ENABle command/query, [1173](#)
 - ENABLE, :TRIGger:AND:ENABle command/query, [1184](#)
 - ENABLE, :TRIGger:SEquence:RESet:ENABle command/query, [1250](#)
 - ENABLE, :TRIGger:SEquence:WAIT:ENABle command/query, [1254](#)
 - ENABLE, :XTALK:ENABle command/query, [1461](#)
 - ENABLE, :XTALK<X>:ENABle command/query, [1484](#)
 - ENCode,
 - :TRIGger:ADVanced:COMM:ENCode command/query, [1295](#)
 - ENCode, :TRIGger:COMM:ENCode command/query, [1200](#)
 - End Of String (EOS), [111](#)
 - End Of Text (EOT), [111](#)
 - End-Or-Identify (EOI), [111](#)
 - ENUMber,
 - :TRIGger:ADVanced:TV:UDTV:ENUMber command/query, [1336](#)
 - ENUMber, :TRIGger:TV:UDTV:ENUMber command/query, [1283](#)
 - EOI and IEEE 488.2, [202](#)
 - ERATio, :MEASure:ERATio command/query, [768](#)
 - error messages, [1541](#)
 - Error Messages table, [1548](#)
 - error queue, [1542](#)
 - error queue, and status reporting, [167](#)
 - error queue, overflow, [1542](#)
 - ERRor,
 - :SBUS<N>:FLEXray:TRIGger:ERRor:TYPE command/query, [1048](#)
 - error, in measurements, [729](#)
 - error, numbers, [1543](#)
 - error, query interrupt, [106](#), [122](#)
 - ERRor?, :SYSTem:ERRor? query, [1153](#)
 - errors, exceptions to protocol, [145](#)
 - ESB (Event Status Bit), [149](#), [418](#), [420](#)
 - ESB (Event Summary Bit), [404](#)
 - ESKew, :MEASure:PAM:ESKew command/query, [840](#)
 - ESR (Standard Event Status Register), [157](#)
 - ESTiming, :MEASure:PAM:EYE:ESTiming command/query, [843](#)
 - ETIME acquisition mode, [216](#)
 - ETOedge, :MEASure:ETOedge command, [769](#)
 - event monitoring, [147](#)
 - Event Registers Default, [134](#)
 - Event Status Bit (ESB), [149](#)
 - Event Status Enable (*ESE), Status Reporting, [158](#)
 - Event Status Register (*ESR?) query, [406](#)
 - Event Summary Bit (ESB), [404](#)
 - EVENT,
 - :TRIGger:ADVanced:DElay:EDLY:EVENT:DElay command/query, [1316](#)
 - EVENT,
 - :TRIGger:ADVanced:DElay:EDLY:EVENT:SLOPe command/query, [1318](#)
 - EVENT,
 - :TRIGger:ADVanced:DElay:EDLY:EVENT:SOURce command/query, [1317](#)
 - EVENT, :TRIGger:SEquence:RESet:EVENT command, [1252](#)
 - EWIDth, :MEASure:CGRade:EWIDth command/query, [742](#)
 - EWINDow, :MEASure:CGRade:EWINDow command/query, [744](#)
 - Example Program, [119](#)
 - Example Program, in initialization, [119](#)
 - example programs, [1553](#)
 - exceptions to protocol, [145](#)
 - EXE bit, [404](#), [406](#)
 - executing DIGITIZE, [204](#)
 - Execution Error, [1545](#)
 - Execution Error (EXE), Status Bit, [148](#)
 - execution, errors, and command errors, [1544](#)
 - execution, of commands and order, [145](#)
 - exponential notation, [109](#)
 - exponents, [109](#)
 - EXTernal, :CHANnel<N>:PROBe:EXTernal command/query, [344](#)
 - EXTernal,
 - :CHANnel<N>:PROBe:EXTernal:GAIN command/query, [345](#)
 - EXTernal,
 - :CHANnel<N>:PROBe:EXTernal:OFFSet command/query, [346](#)
 - EXTernal,
 - :CHANnel<N>:PROBe:EXTernal:UNITs command/query, [347](#)
 - eye center location, PAM measurement definition, [842](#)
 - eye level width, PAM measurement definition, [844](#)
 - EYE, :MEASure:PAM:EYE:ELMethod command/query, [842](#)
 - EYE, :MEASure:PAM:EYE:ESTiming command/query, [843](#)
 - EYE, :MEASure:PAM:EYE:PPERcent command/query, [844](#)
 - EYE, :MEASure:PAM:EYE:TIME:LTDefinition command/query, [845](#)
- ## F
- FACTors, :HARDcopy:FACTors command/query, [554](#)
 - FAIL, :ISCan:MEASurement:FAIL command/query, [599](#)
 - FAIL, :LTESt:FAIL command/query, [621](#)
 - FAILures, :MTESt:COUNt:MARGIn:FAILures? query, [671](#)
 - FAILures?, :MTESt:COUNt:FAILures? query, [668](#)
 - fall time measurement setup, [729](#)
 - FALLtime, :MEASure:FALLtime command/query, [770](#)
 - FAST, :MTESt:FOLDing:FAST command/query, [685](#)
 - Fast, Worst Case Only option, [73](#), [685](#)
 - FDBaudrate,
 - :SBUS<N>:CAN:SIGNal:FDBaudrate command/query, [1032](#)
 - FDSPoint, :SBUS<N>:CAN:FDSPoint command/query, [1028](#)
 - FFEQualizer,
 - :SPROcessing:FFEQualizer:Bandwidth command/query, [1129](#)
 - FFEQualizer,
 - :SPROcessing:FFEQualizer:BWMode command/query, [1130](#)
 - FFEQualizer,
 - :SPROcessing:FFEQualizer:DISPlay command/query, [1131](#)
 - FFEQualizer,
 - :SPROcessing:FFEQualizer:NPRecursor command/query, [1132](#)
 - FFEQualizer,
 - :SPROcessing:FFEQualizer:NTAPs command/query, [1133](#)
 - FFEQualizer,
 - :SPROcessing:FFEQualizer:RATE command/query, [1134](#)
 - FFEQualizer,
 - :SPROcessing:FFEQualizer:SOURce command/query, [1135](#)
 - FFEQualizer, :SPROcessing:FFEQualizer:TAP command/query, [1136](#)
 - FFEQualizer,
 - :SPROcessing:FFEQualizer:TAP:AUTomat ic command, [1137](#)
 - FFEQualizer,
 - :SPROcessing:FFEQualizer:TAP:DElay command/query, [1138](#)
 - FFEQualizer,
 - :SPROcessing:FFEQualizer:TAP:PLENgtH command/query, [1139](#)
 - FFEQualizer,
 - :SPROcessing:FFEQualizer:TAP:WIDTh command/query, [1140](#)
 - FFEQualizer,
 - :SPROcessing:FFEQualizer:TDElay command/query, [1141](#)
 - FFEQualizer,
 - :SPROcessing:FFEQualizer:TDMode command/query, [1142](#)
 - FFEQualizer,
 - :SPROcessing:FFEQualizer:VERTical command/query, [1143](#)
 - FFEQualizer,
 - :SPROcessing:FFEQualizer:VERTical:OFF Set command/query, [1144](#)

- FFEQualizer, :SPROcessing:FFEQualizer:VERTical:RANGe command/query, [1145](#)
- FFT Commands, [728](#)
- FFT, :FUNCTION<F>:FFT:DETECTOR:POINTS command/query, [506](#)
- FFT, :FUNCTION<F>:FFT:DETECTOR:TYPE command/query, [507](#)
- FFT, :FUNCTION<F>:FFT:FREQUENCY command/query, [508](#)
- FFT, :FUNCTION<F>:FFT:REFERENCE command/query, [509](#)
- FFT, :FUNCTION<F>:FFT:RESOLUTION command/query, [510](#)
- FFT, :FUNCTION<F>:FFT:SPAN command/query, [511](#)
- FFT, :FUNCTION<F>:FFT:STOP command/query, [512](#)
- FFT, :FUNCTION<F>:FFT:TDELAY command/query, [513](#)
- FFT, :FUNCTION<F>:FFT:VUNITS command/query, [514](#)
- FFT, :FUNCTION<F>:FFT:WINDOW command/query, [515](#)
- FFT, :MEASURE:FFT:CPOWER command/query, [772](#)
- FFT, :MEASURE:FFT:DFREQUENCY command/query, [773](#)
- FFT, :MEASURE:FFT:DMAGNITUDE command/query, [774](#)
- FFT, :MEASURE:FFT:FREQUENCY command/query, [775](#)
- FFT, :MEASURE:FFT:MAGNITUDE command/query, [776](#)
- FFT, :MEASURE:FFT:OBW command/query, [777](#)
- FFT, :MEASURE:FFT:PEAK1 command/query, [778](#)
- FFT, :MEASURE:FFT:PEAK2 command/query, [779](#)
- FFT, :MEASURE:FFT:PSD command/query, [780](#)
- FFT, :MEASURE:FFT:THRESHOLD command/query, [781](#)
- FFTMagnitude, :FUNCTION<F>:FFTMagnitude command, [517](#)
- FFTPhase, :FUNCTION<F>:FFTPhase command, [518](#)
- FIELd, :TRIGGER:ADVANCED:TV:STV:FIELd command/query, [1330](#)
- FILTer, :CHANNEL<N>:SIMULATION:FILTer:ISIM:ADDRESS command/query, [374](#)
- FILTer, :CHANNEL<N>:SIMULATION:FILTer:ISIM:PEXTraction command/query, [375](#)
- FILTer, :CHANNEL<N>:SIMULATION:FILTer:SELECTION command/query, [376](#)
- FLEXray serial bus commands, [1043](#)
- FLEXray, :SBUS<N>:FLEXray:BAUDRate command/query, [1044](#)
- FLEXray, :SBUS<N>:FLEXray:CHANNEL command/query, [1045](#)
- FLEXray, :SBUS<N>:FLEXray:SOURCE command/query, [1046](#)
- FLEXray, :SBUS<N>:FLEXray:TRIGGER command/query, [1047](#)
- FLEXray, :SBUS<N>:FLEXray:TRIGGER:ERROR:TYPE Base command/query, [1048](#)
- FLEXray, :SBUS<N>:FLEXray:TRIGGER:FRAME:CC Base command/query, [1049](#)
- FLEXray, :SBUS<N>:FLEXray:TRIGGER:FRAME:CC Repetition command/query, [1050](#)
- FLEXray, :SBUS<N>:FLEXray:TRIGGER:FRAME:ID command/query, [1051](#)
- FLEXray, :SBUS<N>:FLEXray:TRIGGER:FRAME:TYPE command/query, [1052](#)
- FLOad, :CHANNEL<N>:SIMULATION:FLOad:ADDRESS command/query, [377](#)
- FLOad, :CHANNEL<N>:SIMULATION:FLOad:LOOP command/query, [378](#)
- FLOat, waveform data FORMat, [1414](#)
- flow, programming, [178](#)
- FOLDing, :MTEST:FOLDing command/query, [677](#)
- FOLDing, :MTEST:FOLDing:BITS command/query, [679](#)
- FOLDing, :MTEST:FOLDing:COUNT query, [1538](#)
- FOLDing, :MTEST:FOLDing:COUNT:UI query, [681](#)
- FOLDing, :MTEST:FOLDing:COUNT:WAVEFORMS query, [683](#)
- FOLDing, :MTEST:FOLDing:FAST command/query, [685](#)
- FOLDing, :MTEST:FOLDing:POSITION command/query, [687](#)
- FOLDing, :MTEST:FOLDing:SCALE command/query, [689](#)
- FOLDing, :MTEST:FOLDing:TPOSITION command/query, [691](#)
- FOLDing, :MTEST:FOLDing:TSCALE command/query, [693](#)
- FOLLow<N>, :HOSTED:FOLLow<N>:ACHANNELS? query, [587](#)
- FOLLow<N>, :HOSTED:FOLLow<N>:CONFIGURE command, [588](#)
- FOLLow<N>, :HOSTED:FOLLow<N>:CONNECT command, [589](#)
- FOLLow<N>, :HOSTED:FOLLow<N>:DISCONNECT command, [590](#)
- FORMat, :SBUS<N>:HS:FORMat command/query, [1055](#)
- FORMat, :WAVEform:FORMat command/query, [1413](#)
- FORMat, and DATA, [1393](#)
- FormattedIO488 object, [116](#)
- formatting query responses, [1147](#)
- fractional values, [109](#)
- FRAME, :ACQUIRE:BANDwidth:FRAME? query, [209](#)
- FRAME, :SBUS<N>:FLEXray:TRIGGER:FRAME:CC Base command/query, [1049](#)
- FRAME, :SBUS<N>:FLEXray:TRIGGER:FRAME:CC Repetition command/query, [1050](#)
- FRAME, :SBUS<N>:FLEXray:TRIGGER:FRAME:ID command/query, [1051](#)
- FRAME, :SBUS<N>:FLEXray:TRIGGER:FRAME:TYPE command/query, [1052](#)
- FRAME, :SBUS<N>:SPI:FRAME:STATE command/query, [1080](#)
- FRAME, :SBUS<N>:SPI:SOURCE:FRAME command/query, [1085](#)
- FRAMES, :HOSTED:CALibrate:DESKew:FRAMES command, [576](#)
- FRAMES, :HOSTED:CALibrate:STATUS:FRAMES? query, [583](#)
- frequency measurement setup, [729](#)
- FREQUENCY, :CHANNEL<N>:SIMULATION:FREQUENCY command/query, [379](#)
- FREQUENCY, :CHANNEL<N>:SIMULATION:JITTER:PERIODIC<M>:FREQUENCY command/query, [387](#)
- FREQUENCY, :CHANNEL<N>:SIMULATION:NOISE:PERIODIC<M>:FREQUENCY command/query, [394](#)
- FREQUENCY, :FUNCTION<F>:FFT:FREQUENCY command/query, [508](#)
- FREQUENCY, :MEASURE:FFT:FREQUENCY command/query, [775](#)
- FREQUENCY, :MEASURE:FREQUENCY command/query, [782](#)
- FREQUENCY, :TRIGGER:GBSerial:CLOCK:FREQUENCY command/query, [1220](#)
- FTIME, :CHANNEL<N>:SIMULATION:FUNCTION:SQUARE:FTIME command/query, [382](#)
- FUI?, :MTEST:COUNT:FUI? query, [669](#)
- full-scale vertical axis, [365](#)
- Function Commands, [493](#)
- FUNCTION, :CHANNEL<N>:SIMULATION:FUNCTION:SELECTION command/query, [380](#)

FUNCTION, :CHANnel<N>:SIMulation:FUNCTION:SQUare:DCYCLE command/query, **381**

FUNCTION, :CHANnel<N>:SIMulation:FUNCTION:SQUare:FTIME command/query, **382**

FUNCTION, :CHANnel<N>:SIMulation:FUNCTION:SQUare:RTIME command/query, **383**

function, and vertical scaling, **542**

function, time scale, **495**

functional elements of protocol, **144**

functions, and VIEW, **1429**

functions, combining in instructions, **105**

FWAVEforms?:.MTEST:COUNT:FWAVEforms? query, **670**

FWHM, :MEASURE:HISTogram:FWHM command/query, **784**

G

gain and offset of a probe, **288**

gain factor for user-defined probe, **345**

GAIN, :CHANnel<N>:PROBE:EXTERNAL:GAIN command/query, **345**

GAIN, :CHANnel<N>:PROBE:GAIN command/query, **348**

GAIN, :SPROcessing:DFEQualizer:TAP:GAIN command/query, **1123**

GATING, :FUNCTION<F>:GATING command, **519**

GATING, :FUNCTION<F>:GATING:START command, **520**

GATING, :FUNCTION<F>:GATING:STOP command, **521**

GBSerial, :TRIGGER:GBSerial:CLOCK command/query, **1219**

GBSerial, :TRIGGER:GBSerial:CLOCK:FREQUENCY command/query, **1220**

GBSerial, :TRIGGER:GBSerial:DRATE command/query, **1222**

GBSerial, :TRIGGER:GBSerial:MODE command/query, **1224**

GBSerial, :TRIGGER:GBSerial:PATTERN command/query, **1225**

GBSerial, :TRIGGER:GBSerial:POLarity command/query, **1226**

GBSerial, :TRIGGER:GBSerial:PRBS command/query, **1227**

GBSerial, :TRIGGER:GBSerial:SOURCE command/query, **1228**

GCOunt, :DISPLAY:ISIM:GCOunt command/query, **470**

GCOunt, :DISPLAY:JITTER:GCOunt command/query, **473**

GCOunt, :DISPLAY:PRECprobe:GCOunt command/query, **485**

GENauto, :MEASURE:THRESHolds:GENauto command, **904**

general SBUS<N> commands, **1024**

General, :MEASURE:THRESHolds:General:ABSolute command/query, **905**

General, :MEASURE:THRESHolds:General:HYSTeresis command/query, **907**

General, :MEASURE:THRESHolds:General:METHOD command/query, **909**

General, :MEASURE:THRESHolds:General:PAMAutomatic command/query, **913**

General, :MEASURE:THRESHolds:General:PAMCustom command/query, **911**

General, :MEASURE:THRESHolds:General:PERCent command/query, **915**

General, :MEASURE:THRESHolds:General:TOPBase:ABSolute command/query, **917**

General, :MEASURE:THRESHolds:General:TOPBase:METHOD command/query, **919**

GLITCh, :TRIGGER:GLITCh:POLarity command/query, **1230**

GLITCh, :TRIGGER:GLITCh:SOURCE command/query, **1231**

GLITCh, :TRIGGER:GLITCh:WIDTH command/query, **1232**

GPIB interface, **87**

GPIB, Interface Connector, **133**

GRATICule, :DISPLAY:GRATICule command, **469**

GRATICule, :DISPLAY:GRATICule command/query, **465**

GRATICule, :DISPLAY:GRATICule:AREA<N>:STATE command/query, **466**

GRATICule, :DISPLAY:GRATICule:INTensity command/query, **467**

GRATICule, :DISPLAY:GRATICule:NUMBER command/query, **468**

GRATICule, HARDcopy AREA, **552**

grid line intensity, default setup and, **1162**

Group Execute Trigger (GET), **141**

GUI, :SYSTEM:GUI command/query, **1154**

H

Halting bus activity, **141**

HAMPLitude, :MTEST:HAMPLitude command/query, **695**

Hardcopy Commands, **551**

Hardcopy Commands, AREA, **552**

hardcopy of the screen, **551**

hardcopy output and message termination, **145**

HEAD, :CHANnel<N>:PROBE:HEAD:ADD command, **349**

HEAD, :CHANnel<N>:PROBE:HEAD:DELETE command, **350**

HEAD, :CHANnel<N>:PROBE:HEAD:SELECT command/query, **351**

HEAD, :CHANnel<N>:PROBE:HEAD:VTERM command/query, **352**

HEADer, :SYSTEM:HEADer command/query, **1155**

header, within instruction, **96**

headers, **97**

headers, types, **104**

HEIGHT, :WAVEform:CGRade:HEIGHT? query, **1386**

HIDE, :ISCAN:ZONE:HIDE command/query, **613**

HIGHpass, :FUNCTION<F>:HIGHpass command, **522**

HiSLIP protocol, **89**

Histogram Commands, **557**

HISTogram, :MEASURE:HISTogram:FWHM command/query, **784**

HISTogram, :MEASURE:HISTogram:HITS command/query, **785**

HISTogram, :MEASURE:HISTogram:M1S command/query, **786**

HISTogram, :MEASURE:HISTogram:M2S command/query, **787**

HISTogram, :MEASURE:HISTogram:M3S command/query, **788**

HISTogram, :MEASURE:HISTogram:MAX command/query, **789**

HISTogram, :MEASURE:HISTogram:MEAN command/query, **790**

HISTogram, :MEASURE:HISTogram:MEDIAN command/query, **791**

HISTogram, :MEASURE:HISTogram:MIN command/query, **792**

HISTogram, :MEASURE:HISTogram:MODE command/query, **793**

HISTogram, :MEASURE:HISTogram:PEAK command/query, **794**

HISTogram, :MEASURE:HISTogram:PP command/query, **795**

HISTogram, :MEASURE:HISTogram:RESolution command/query, **796**

HISTogram, :MEASURE:HISTogram:STDDev command/query, **797**

HISTogram, :MEASURE:JITTER:HISTogram command/query, **800**

HITS, :MEASURE:HISTogram:HITS command/query, **785**

HITS, :MTEST:MARGIN:AUTO:HITS command/query, **700**

HLED, :SYSTEM:HLED command/query, **1156**

HOLD, :TRIGGER:ADVanced:VIOLation:SETup:HOLD:CSORce command/query, **1359**

HOLD, :TRIGGER:ADVanced:VIOLation:SETup:H

- OLD:CSOURCE:EDGE
command/query, [1361](#)
- HOLD,
:TRIGGER:ADVANCED:VIOLATION:SETUP:H
OLD:CSOURCE:LEVEL
command/query, [1360](#)
- HOLD,
:TRIGGER:ADVANCED:VIOLATION:SETUP:H
OLD:DSOURCE:COMMAND/query, [1362](#)
- HOLD,
:TRIGGER:ADVANCED:VIOLATION:SETUP:H
OLD:DSOURCE:HTHRESHOLD
command/query, [1363](#)
- HOLD,
:TRIGGER:ADVANCED:VIOLATION:SETUP:H
OLD:DSOURCE:LTHRESHOLD
command/query, [1364](#)
- HOLD,
:TRIGGER:ADVANCED:VIOLATION:SETUP:H
OLD:TIME command/query, [1365](#)
- HOLDoff, :TRIGGER:HOLDoff
command/query, [1186](#)
- HOLDoff, :TRIGGER:HOLDoff:MAX
command/query, [1187](#)
- HOLDoff, :TRIGGER:HOLDoff:MIN
command/query, [1188](#)
- HOLDoff, :TRIGGER:HOLDoff:MODE
command/query, [1189](#)
- HoldTime (HTIME),
:TRIGGER:ADVANCED:VIOLATION:SETUP:SH
OLD:HoldTime (HTIME)
command/query, [1373](#)
- HoldTime (HTIME),
:TRIGGER:SHOLD:HoldTime (HTIME)
command/query, [1260](#)
- HOLDtime, :MEASURE:HOLDtime
command/query, [798](#)
- horizontal position, default setup, [1161](#)
- horizontal scale, default setup, [1161](#)
- horizontal scaling, functions, [494](#)
- HORIZONTAL, :FUNCTION<F>:HORIZONTAL
command/query, [523](#)
- HORIZONTAL,
:FUNCTION<F>:HORIZONTAL:POSITION
command/query, [524](#)
- HORIZONTAL,
:FUNCTION<F>:HORIZONTAL:RANGE
command/query, [526](#)
- HORIZONTAL, :HISTOGRAM:HORIZONTAL:BINS
command/query, [560](#)
- HORIZONTAL,
:MEASURE:JITTER:SPECTRUM:HORIZONTAL
command/query, [803](#)
- HORIZONTAL,
:MEASURE:JITTER:SPECTRUM:HORIZONTAL:
POSITION command/query, [804](#)
- HORIZONTAL,
:MEASURE:JITTER:SPECTRUM:HORIZONTAL:
RANGE command/query, [805](#)
- horizontal, functions, controlling, [1167](#)
- horizontal, offset, and XOFFSET, [1454](#)
- horizontal, range, and XRANGE, [1455](#)
- Host language, [96](#)
- Hosted Commands, [571](#)
- HRATIO, :MTEST:MARGIN:AUTO:HRATIO
command/query, [701](#)
- HRESOLUTION acquisition mode, [216](#)
- HRESOLUTION, :ACQUIRE:HRESOLUTION
command/query, [214](#)
- HS serial bus commands, [1053](#)
- HS, :SBUS<N>:HS:DESCRAMBLE
command/query, [1054](#)
- HS, :SBUS<N>:HS:FORMAT
command/query, [1055](#)
- HS, :SBUS<N>:HS:IDLE
command/query, [1056](#)
- HS, :SBUS<N>:HS:SOURCE<S>
command/query, [1057](#)
- HSYNC, :TRIGGER:TV:UDTV:HSYNc
command/query, [1284](#)
- HTHRESHOLD,
:TRIGGER:ADVANCED:VIOLATION:SETUP:H
OLD:DSOURCE:HTHRESHOLD
command/query, [1363](#)
- HTHRESHOLD,
:TRIGGER:ADVANCED:VIOLATION:SETUP:SE
TUP:DSOURCE:HTHRESHOLD
command/query, [1356](#)
- HTHRESHOLD,
:TRIGGER:ADVANCED:VIOLATION:SETUP:SH
OLD:DSOURCE:HTHRESHOLD
command/query, [1370](#)
- HTHRESHOLD,
:TRIGGER:ADVANCED:VIOLATION:TRANSITIO
N:SOURCE:HTHRESHOLD
command/query, [1377](#)
- HTHRESHOLD, :TRIGGER:HTHRESHOLD
command/query, [1190](#)
- HTIME, :TRIGGER:TV:UDTV:HTIME
command/query, [1285](#)
- hue, [488](#)
- HYSTERESIS,
:ISCAN:NONMONOTONIC:HYSTERESIS
command/query, [605](#)
- HYSTERESIS, :ISCAN:RUNT:HYSTERESIS
command/query, [607](#)
- HYSTERESIS,
:MEASURE:THRESHOLDS:GENERAL:HYSTERE
SIS command/query, [907](#)
- HYSTERESIS,
:MEASURE:THRESHOLDS:HYSTERESIS
command/query, [920](#)
- HYSTERESIS,
:MEASURE:THRESHOLDS:SERIAL:HYSTERE
SIS command/query, [937](#)
- HYSTERESIS, :TRIGGER:HYSTERESIS
command/query, [1191](#)
- I
- IAGGROSSOR, :XTALK<X>:IAGGROSSOR
command/query, [1485](#)
- id mode, [1041](#)
- ID pattern, CAN trigger, [1040](#)
- ID, :CHANNEL<N>:PROBE:ID? query, [353](#)
- ID, :SBUS<N>:CAN:TRIGGER:PATTERN:ID
command/query, [1040](#)
- ID,
:SBUS<N>:CAN:TRIGGER:PATTERN:ID:MO
DE command/query, [1041](#)
- ID, :SBUS<N>:FLEXRAY:TRIGGER:FRAME:ID
command/query, [1051](#)
- ID, :SBUS<N>:LIN:TRIGGER:ID
command/query, [1073](#)
- Identification Number (*IDN?) query, [407](#)
- IDLE, :SBUS<N>:HS:IDLE
command/query, [1056](#)
- IEEE 488.1, [143](#)
- IEEE 488.1, and IEEE 488.2
relationship, [143](#)
- IEEE 488.2, [143](#)
- IEEE 488.2, compliance, [143](#)
- IEEE 488.2, conformity, [94](#)
- IEEE 488.2, Standard, [94](#)
- IEEE 488.2, Standard Status Data Structure
Model, [148](#)
- IIC clock source, [1060](#)
- IIC data source, [1061](#)
- IIC serial decode address field size, [1059](#)
- IIC trigger commands, [1058](#)
- IIC, :SBUS<N>:IIC:ASIZE
command/query, [1059](#)
- IIC, :SBUS<N>:IIC:SOURCE:CLOCK
command/query, [1060](#)
- IIC, :SBUS<N>:IIC:SOURCE:DATA
command/query, [1061](#)
- IIC,
:SBUS<N>:IIC:TRIGGER:PATTERN:ADDR
ES command/query, [1062](#), [1064](#)
- IIC, :SBUS<N>:IIC:TRIGGER:TYPE
command, [1065](#)
- IMAGE, :DISK:SAVE:IMAGE command, [440](#)
- IMAGE, :HARDCOPY:IMAGE
command/query, [555](#)
- IMPEDANCE, :MTEST:IMPEDANCE
command/query, [696](#)
- impedance, input, [315](#)
- IMPEDANCE?, :MTEST:PROBE:IMPEDANCE?
query, [707](#)
- INDEX, :ACQUIRE:SEGMENTED:INDEX
command/query, [227](#)
- INDEX, :WMEMORY<R>:SEGMENTED:INDEX
command/query, [1452](#)
- individual commands language, [94](#)
- InfiniiScan Commands, [597](#)
- Infinity Representation, [200](#)
- INFO, :CHANNEL<N>:PROBE:INFO?
query, [354](#)
- initialization, [117](#)
- initialization, event status, [147](#)
- input buffer, [144](#)
- Input Buffer, Clearing, [141](#)
- input buffer, default condition, [145](#)
- input coupling, and COUPLING?, [1390](#)

- INPut, :CHANnel<N>:INPut command/query, 315
 - instruction headers, 97
 - Instrument Address, GPIB, 137
 - instrument status, 127
 - integer definition, 109
 - INTEgrate, :FUNCTion<F>:INTEgrate command, 528
 - intensity, 467
 - INTensity, :DISPlay:GRATICule:INTensity command/query, 467
 - Interface, Capabilities, 135
 - Interface, Clear (IFC), 141
 - interface, functions, 131
 - Interface, GPIB Select Code, 137
 - INTErpolate, :ACQuire:INTErpolate command/query, 215
 - INTErpolate, :MEASure:RJDJ:INTErpolate command/query, 879
 - interpreting commands, parser, 144
 - interrupted query, 106, 122
 - Introduction to Programming, 93
 - INVert, :CHANnel<N>:INVert command/query, 316
 - INVert, :FUNCTion<F>:INVert command, 529
 - INVert, :MTESt:INVert command/query, 697
 - inverting functions, 529
 - IO library, referencing, 115
 - IronPython, SCPI.NET example, 1682
 - ISIM, :CHANnel<N>:ISIM:APPLY command/query, 317
 - ISIM, :CHANnel<N>:ISIM:BANDwidth command/query, 318
 - ISIM, :CHANnel<N>:ISIM:BWLimit command/query, 320
 - ISIM, :CHANnel<N>:ISIM:BWLimit:TYPE command/query, 322
 - ISIM, :CHANnel<N>:ISIM:CONVolve command/query, 323
 - ISIM, :CHANnel<N>:ISIM:CORRection command/query, 324
 - ISIM, :CHANnel<N>:ISIM:DEConvolve command/query, 326
 - ISIM, :CHANnel<N>:ISIM:DELay command/query, 327
 - ISIM, :CHANnel<N>:ISIM:NORMAlize command/query, 328
 - ISIM, :CHANnel<N>:ISIM:PEXTraction command/query, 329
 - ISIM, :CHANnel<N>:ISIM:SPAN command/query, 331
 - ISIM, :CHANnel<N>:ISIM:STATE command/query, 332
 - ISIM, :CHANnel<N>:SIMulation:FILTer:ISIM:ADDress command/query, 374
 - ISIM, :CHANnel<N>:SIMulation:FILTer:ISIM:PEXTraction command/query, 375
 - ISIM, :DISPlay:ISIM:GCOunt command/query, 470
 - ISIM, :DISPlay:ISIM:SELEctgraph command, 471
 - ISIM, :DISPlay:ISIM:SOURce command, 472
 - IVICTim, :XTALK<X>:IVICTim command/query, 1486
- ## J
- JITTer, :CHANnel<N>:SIMulation:JITTer command/query, 384
 - JITTer, :CHANnel<N>:SIMulation:JITTer:ABUJ command/query, 385
 - JITTer, :CHANnel<N>:SIMulation:JITTer:PERIodic<M>:ENABle command/query, 386
 - JITTer, :CHANnel<N>:SIMulation:JITTer:PERIodic<M>:FREQUency command/query, 387
 - JITTer, :CHANnel<N>:SIMulation:JITTer:PERIodic<M>:MAGNitude command/query, 388
 - JITTer, :CHANnel<N>:SIMulation:JITTer:PERIodic<M>:SHAPE command/query, 389
 - JITTer, :CHANnel<N>:SIMulation:JITTer:RANDom command/query, 390
 - JITTer, :DISK:SAVE:JITTer command, 441
 - JITTer, :DISK:SAVE:LISTing command, 442
 - JITTer, :DISPlay:JITTer:GCOunt command/query, 473
 - JITTer, :DISPlay:JITTer:SELEctgraph command, 474
 - JITTer, :DISPlay:JITTer:THREshold command, 476
 - JITTer, :MEASure:CGRade:JITTer command/query, 746
 - JITTer, :MEASure:JITTer:HISTogram command/query, 800
 - JITTer, :MEASure:JITTer:MEASurement command/query, 801
 - JITTer, :MEASure:JITTer:SPECTrum command/query, 802
 - JITTer, :MEASure:JITTer:SPECTrum:HORizontal command/query, 803
 - JITTer, :MEASure:JITTer:SPECTrum:HORizontal:POSITION command/query, 804
 - JITTer, :MEASure:JITTer:SPECTrum:HORizontal:RANGE command/query, 805
 - JITTer, :MEASure:JITTer:SPECTrum:VERTical command/query, 806
 - JITTer, :MEASure:JITTer:SPECTrum:VERTical:OFFSet command/query, 807
 - JITTer, :MEASure:JITTer:SPECTrum:VERTical:RANGE command/query, 808
 - JITTer, :MEASure:JITTer:SPECTrum:VERTical:TYPE command/query, 809
 - JITTer, :MEASure:JITTer:SPECTrum:WINDow command/query, 810
 - JITTer, :MEASure:JITTer:STATistics command/query, 1535
 - JITTer, :MEASure:JITTer:TREnd command/query, 811
 - JITTer, :MEASure:JITTer:TREnd:SMOoth command/query, 812
 - JITTer, :MEASure:JITTer:TREnd:SMOoth:POINts command/query, 813
 - JITTer, :MEASure:JITTer:TREnd:VERTical command/query, 814
 - JITTer, :MEASure:JITTer:TREnd:VERTical:OFFSet command/query, 815
 - JITTer, :MEASure:JITTer:TREnd:VERTical:RANGE command/query, 816
 - JITTer, :STORe:JITTer command, 1018
 - JTF, :ANALyze:CLOCK:METHod:JTF command/query, 249
 - JTF, :MEASure:CLOCK:METHod:JTF command/query, 1524
- ## K
- Keysight Interactive IO application, 90
 - Keysight IO Control icon, 88
 - Keysight IO Libraries Suite, 4, 85, 89, 115, 117
 - Keysight IO Libraries Suite, installing, 86
- ## L
- LABEL, :BUS:LABEL command/query, 284
 - LABEL, :CHANnel<N>:LABEL command/query, 333
 - LABEL, :DIGital<N>:LABEL command/query, 427
 - LABEL, :DISPlay:LABEL command/query, 477
 - LAMPLitude, :MTESt:LAMPLitude command/query, 698
 - LAN instrument, 89
 - LAN interface, 87, 88
 - language for program examples, 94
 - LAYout, :DISPlay:LAYout command/query, 478

- LEADer, :HOSTed:LEADer:ACHannels? query, [591](#)
 - LEADer, :HOSTed:LEADer:CONFigure command, [592](#)
 - LEADer, :HOSTed:LEADer:CONNect command, [593](#)
 - LEADer, :HOSTed:LEADer:DISConnect command, [594](#)
 - Learn (*LRN?) query, [408](#)
 - LENGth, :CHANnel<N>:SIMulation:DATA:LENGth command/query, [368](#)
 - LENGth, :SBUS<N>:CAN:TRIGger:PATtern:DATA:LENGth command/query, [1038](#)
 - LENGth, :SBUS<N>:LIN:TRIGger:PATtern:DATA:LENGth command/query, [1075](#)
 - LEVel, :DISPlay:NOISe:LEVel command, [480](#)
 - LEVel, :HOSTed:CALibrate:LEVel command/query, [579](#)
 - LEVel, :HOSTed:CALibrate:STATus:LEVel? query, [584](#)
 - LEVel, :MEASure:PAM:LEVel command/query, [846](#)
 - LEVel, :TRIGger:ADVanced:COMM:LEVel command/query, [1296](#)
 - LEVel, :TRIGger:ADVanced:PATtern:THReshold :LEVel command/query, [1304](#)
 - LEVel, :TRIGger:ADVanced:STATE:THReshold:LEVel command/query, [1311](#)
 - LEVel, :TRIGger:ADVanced:VIOLation:SETup:HOLD:CSOURCE:LEVel command/query, [1360](#)
 - LEVel, :TRIGger:ADVanced:VIOLation:SETup:SETup:CSOURCE:LEVel command/query, [1353](#)
 - LEVel, :TRIGger:ADVanced:VIOLation:SETup:SHOLD:CSOURCE:LEVel command/query, [1367](#)
 - LEVel, :TRIGger:LEVel command/query, [1192](#)
 - LEVel, :TRIGger:LEVel:FIFTy command, [1193](#)
 - LEVels, :DISPlay:CGrade:LEVels? query, [459](#)
 - Limit Test Commands, [619](#)
 - LIN acknowledge, [1068](#)
 - LIN baud rate, [1069](#)
 - LIN serial bus commands, [1067](#)
 - LIN source, [1070](#)
 - LIN standard, [1071](#)
 - LIN, :SBUS<N>:LIN:SAMPlepoint command/query, [1068](#)
 - LIN, :SBUS<N>:LIN:SIGNal:BAUDrate command/query, [1069](#)
 - LIN, :SBUS<N>:LIN:SOURce command/query, [1070](#)
 - LIN, :SBUS<N>:LIN:STANdard command/query, [1071](#)
 - LIN, :SBUS<N>:LIN:TRIGger command/query, [1072](#)
 - LIN, :SBUS<N>:LIN:TRIGger:ID command/query, [1073](#)
 - LIN, :SBUS<N>:LIN:TRIGger:PATtern:DATA command/query, [1074](#)
 - LIN, :SBUS<N>:LIN:TRIGger:PATtern:DATA:LENGth command/query, [1075](#)
 - LINE, :DISPlay:LINE command, [1508](#)
 - LINE, :TRIGger:ADVanced:TV:STV:LINE command/query, [1331](#)
 - LINE, :TRIGger:TV:LINE command/query, [1278](#)
 - linefeed, [111](#)
 - List of Error Messages, [1548](#)
 - Listener Code and Capability, [135](#)
 - Listeners, Unaddressing All, [141](#)
 - Lister Commands, [629](#)
 - LLEVel, :ISCan:RUNT:LLEVel command/query, [608](#)
 - LLIMit, :HISTogram:WINDow:LLIMit command/query, [567](#)
 - LLIMit, :ISCan:MEASurement:LLIMit command/query, [600](#)
 - LLIMit, :LTEST:LLIMit command/query, [623](#)
 - LOAD, :DISK:LOAD command, [436](#)
 - LOAD, :MTEST:LOAD command, [699](#)
 - LOAD, :WMEMory<R>:LOAD command, [1449](#)
 - LOADdress, :ANALyze:SIGNal:MMWave:LOADdress command/query, [269](#)
 - loading and saving, [431](#)
 - LOCation, :MEASure:NOISe:LOCation command/query, [824](#)
 - LOCK, :SYSTEM:LOCK command/query, [1157](#)
 - LOGic, :TRIGger:ADVanced:PATtern:LOGic command/query, [1303](#)
 - LOGic, :TRIGger:ADVanced:STATE:LOGic command/query, [1308](#)
 - LOGic, :TRIGger:PATtern:LOGic command/query, [1235](#)
 - LOGic, :TRIGger:STATE:LOGic command/query, [1265](#)
 - long-form headers, [107](#)
 - LONGform, :SYSTEM:LONGform command/query, [1158](#)
 - LOOP, :CHANnel<N>:SIMulation:FLOad:LOOP command/query, [378](#)
 - lowercase, [107](#)
 - lowercase, headers, [107](#)
 - LOWPass, :FUNCTION<F>:LOWPass command, [530](#)
 - LRMS, :MEASure:PAM:LRMS command/query, [848](#)
 - LTARget, :SPProcessing:DFEQualizer:TAP:LTARget command/query, [1124](#)
 - LTDefinition, :MEASure:PAM:EYE:TIME:LTDefinition command/query, [845](#)
 - LTHickness, :MEASure:PAM:LTHickness command/query, [850](#)
 - LTHReshold, :TRIGger:ADVanced:VIOLation:SETup:HOLD:DSOURCE:LTHReshold command/query, [1364](#)
 - LTHReshold, :TRIGger:ADVanced:VIOLation:SETup:SETup:DSOURCE:LTHReshold command/query, [1357](#)
 - LTHReshold, :TRIGger:ADVanced:VIOLation:SETup:SHOLD:DSOURCE:LTHReshold command/query, [1371](#)
 - LTHReshold, :TRIGger:ADVanced:VIOLation:TRANSition:SOURCE:LTHReshold command/query, [1378](#)
 - LTHReshold, :TRIGger:LTHReshold command/query, [1194](#)
 - LTYPE, :TRIGger:ADVanced:STATE:LTYPE command/query, [1309](#)
 - LTYPE, :TRIGger:STATE:LTYPE command/query, [1266](#)
 - luminosity, [489](#)
- ## M
- M1S, :MEASure:HISTogram:M1S command/query, [786](#)
 - M2S, :MEASure:HISTogram:M2S command/query, [787](#)
 - M3S, :MEASure:HISTogram:M3S command/query, [788](#)
 - MAGNify, :FUNCTION<F>:MAGNify command, [531](#)
 - MAGNitude, :CHANnel<N>:SIMulation:JITTER:PERiodic<M>:MAGNitude command/query, [388](#)
 - MAGNitude, :CHANnel<N>:SIMulation:NOISe:PERiodic<M>:MAGNitude command/query, [395](#)
 - MAGNitude, :MEASure:FFT:MAGNitude command/query, [776](#)
 - MAIN, :DISPlay:MAIN command/query, [479](#)
 - making measurements, [729](#)
 - MARGin, :MTEST:COUNT:MARGin:FAILures? query, [671](#)
 - MARGin, :MTEST:MARGin:AUTO:HITS command/query, [700](#)
 - MARGin, :MTEST:MARGin:AUTO:HRATIO command/query, [701](#)

- MARgin, :MTESt:MARgin:AUTO:METhod
command/query, 702
- MARgin, :MTESt:MARgin:METhod
command/query, 703
- MARgin, :MTESt:MARgin:PERCent
command/query, 704
- MARgin, :MTESt:MARgin:STATe
command/query, 705
- Marker Commands, 633
- Mask Test Commands, 653
- Mask Test Commands, DELeTe, 675
- mask, Service Request Enable
Register, 418
- Master Summary Status (MSS), and
*STB, 420
- Master Summary Status (MSS), Status
Bit, 149
- MATLab, :FUNctioN<F>:MATLab
command, 532
- MATLab,
:FUNctioN<F>:MATLab:CONTRol<N>
command/query, 533
- MATLab, :FUNctioN<F>:MATLab:OPERator
command/query, 534
- MAV (Message Available), 149
- MAV (Message Available), bit, 418, 420
- MAX, :MEASure:HISTogram:MAX
command/query, 789
- MAX, :SPRocessing:DFEQualizer:TAP:MAX
command/query, 1125
- MAX, :TRIGger:HOLDoff:MAX
command/query, 1187
- MAXimize, :DISPlay:WINDow:MAXimize
command, 492
- maximum Q value, 16-bit waveform
data, 1411
- MAXimum, :FUNctioN<F>:MAXimum
command, 535
- MBANd wid th,
:ANALyze:SIGNal:MMWave:MBANd wid th
command/query, 270
- MDIRectory, :DISK:MDIRectory
command, 437
- MEAN, :MEASure:HISTogram:MEAN
command/query, 790
- Measure All Edges, 64, 239, 1499
- measure all edges, 731, 766, 767, 782,
798, 854, 856, 896, 1535
- Measure Commands, 721
- Measure Commands, TMAX, 955
- Measure Commands, TMIN, 956
- Measure Commands, TVOLT, 957
- Measure Commands, VMIDdle, 965
- MEASure, RESults and statistics, 900
- MEASurement,
:HISTogram:MEASurement:BINs
command/query, 561
- MEASurement, :ISCan:MEASurement
command/query, 601
- MEASurement, :ISCan:MEASurement:FAIL
command/query, 599
- MEASurement, :ISCan:MEASurement:LLIMit
command/query, 600
- MEASurement, :ISCan:MEASurement:ULIMit
command/query, 602
- MEASurement, :LTEST:MEASurement
command/query, 624
- MEASurement,
:MARKer:MEASurement:MEASurement
command, 636
- MEASurement,
:MEASure:JITTer:MEASurement
command/query, 801
- measurement, error, 729
- measurement, setup, 729
- measurement, sources, 728
- MEASurements, :DISK:SAVE:MEASurements
command, 443
- MEDian, :MEASure:HISTogram:MEDian
command/query, 791
- memories, and VIEW, 1429
- MENU, :SYSTem:MENU?
command/query, 1159
- Message (MSG), Status Bit, 149
- Message Available (MAV), and *OPC, 410
- Message Available (MAV), Status Bit, 149
- Message Communications and System
Functions, 143
- Message Event Register, 155
- message exchange protocols, of IEEE
488.2, 144
- message, queue, 169
- message, termination with hardcopy, 145
- METHod, :ANALyze:CLOCK:METhod
command/query, 241
- METHod, :ANALyze:CLOCK:METhod:ALIGn
command/query, 244
- METHod,
:ANALyze:CLOCK:METhod:DEEMphasis
command/query, 246
- METHod, :ANALyze:CLOCK:METhod:EDGE
command/query, 247
- METHod, :ANALyze:CLOCK:METhod:JTF
command/query, 249
- METHod, :ANALyze:CLOCK:METhod:OJTF
command/query, 252
- METHod,
:ANALyze:CLOCK:METhod:PAM:B03
command/query, 1501
- METHod,
:ANALyze:CLOCK:METhod:PAM:B12
command/query, 1503
- METHod,
:ANALyze:CLOCK:METhod:PAM:NONSy
mmetric command/query, 1505
- METHod,
:ANALyze:CLOCK:METhod:PLLTrack
command/query, 255
- METHod, :ANALyze:CLOCK:METhod:SKEW
command/query, 256
- METHod, :ANALyze:CLOCK:METhod:SOURce
command/query, 257
- METHod, :MEASure:CLOCK:METhod
command/query, 1515, 1517
- METHod, :MEASure:CLOCK:METhod:ALIGn
command/query, 1519
- METHod,
:MEASure:CLOCK:METhod:DEEMphasis
command/query, 1521
- METHod, :MEASure:CLOCK:METhod:EDGE
command/query, 1522
- METHod, :MEASure:CLOCK:METhod:JTF
command/query, 1524
- METHod, :MEASure:CLOCK:METhod:OJTF
command/query, 1526
- METHod,
:MEASure:CLOCK:METhod:PLLTrack
command/query, 1528
- METHod, :MEASure:CLOCK:METhod:SOURce
command/query, 1529
- METHod, :MEASure:NOISe:METhod
command/query, 825
- METHod, :MEASure:RJD:METhod
command/query, 880
- METHod,
:MEASure:THResholds:GENeral:METhod
command/query, 909
- METHod,
:MEASure:THResholds:GENeral:TOPBas
e:METhod command/query, 919
- METHod, :MEASure:THResholds:METhod
command/query, 922
- METHod,
:MEASure:THResholds:RFALL:METhod
command/query, 926
- METHod,
:MEASure:THResholds:RFALL:TOPBase:
METhod command/query, 934
- METHod,
:MEASure:THResholds:SERial:METhod
command/query, 939
- METHod,
:MEASure:THResholds:SERial:TOPBase:
METhod command/query, 944
- METHod,
:MEASure:THResholds:TOPBase:METhod
command/query, 946
- METHod, :MTESt:MARgin:AUTO:METhod
command/query, 702
- METHod, :MTESt:MARgin:METhod
command/query, 703
- MHISTogram, :FUNctioN<F>:MHISTogram
command, 536
- MIN, :MEASure:HISTogram:MIN
command/query, 792
- MIN, :SPRocessing:DFEQualizer:TAP:MIN
command/query, 1126
- MIN, :TRIGger:HOLDoff:MIN
command/query, 1188
- minimum Q value, 16-bit waveform
data, 1411
- MINimum, :FUNctioN<F>:MINimum
command, 537
- MISO data source, SPI, 1086

MISO, :SBUS<N>:SPI:SOURce:MISO
 command/query, **1086**
 MIXer, :ANALyze:SIGNal:MIXer:CABLeLoss
 command/query, **265**
 MLOG, :FUNction<F>:MLOG
 command/query, **538**
 MMWave,
 :ANALyze:SIGNal:MMWave:CALibrate
 command, **266**
 MMWave,
 :ANALyze:SIGNal:MMWave:CFRequency
 command/query, **267**
 MMWave,
 :ANALyze:SIGNal:MMWave:CONNect
 command/query, **268**
 MMWave,
 :ANALyze:SIGNal:MMWave:LOADdress
 command/query, **269**
 MMWave,
 :ANALyze:SIGNal:MMWave:MBANdwidth
 command/query, **270**
 Mnemonic Truncation, **196**
 MODE, :ACQuire:MODE
 command/query, **216**
 MODE, :CHANnel<N>:PROBe:MODE
 command/query, **355**
 MODE,
 :CHANnel<N>:PROBe:PRECProbe:MODE
 command, **359**
 MODE, :HISTogram:MODE
 command/query, **562**
 MODE, :ISCan:MODE command/query, **603**
 MODE, :ISCan:ZONE<Z>:MODE
 command/query, **615**
 MODE, :MARKer:MODE
 command/query, **637**
 MODE, :MEASure:HISTogram:MODE
 command/query, **793**
 MODE, :MEASure:RJDD:MODE
 command/query, **881**
 MODE,
 :SBUS<N>:CAN:TRIGger:PATtern:ID:MO
 DE command/query, **1041**
 MODE, :TRIGger:ADVanced:VIOLation:MODE
 command/query, **1341**
 MODE,
 :TRIGger:ADVanced:VIOLation:SETup:MO
 DE command/query, **1351**
 MODE, :TRIGger:DElay:MODE
 command/query, **1210**
 MODE, :TRIGger:GBSerial:MODE
 command/query, **1224**
 MODE, :TRIGger:HOLDoff:MODE
 command/query, **1189**
 MODE, :TRIGger:MODE
 command/query, **1195**
 MODE, :TRIGger:SHOLD:MODE
 command/query, **1261**
 MODE, :TRIGger:TV:MODE
 command/query, **1279**
 mode, serial decode, **1026**
 monitoring events, **147**

MOSI data source, SPI, **1087**
 MOSI, :SBUS<N>:SPI:SOURce:MOSI
 command/query, **1087**
 MSG bit, **418, 420**
 MSG, bit in the status register, **155**
 MSS bit and *STB, **420**
 MTRend, :FUNction<F>:MTRend
 command, **539**
 Multiple numeric variables, **126**
 multiple, program commands, **113**
 multiple, queries, **126**
 multiple, subsystems, **113**
 MULTIPly, :FUNction<F>:MULTIPly
 command, **540**
 MultiScope system, :DIGitize
 command, **998**

N

N period-period measurement, **818**
 N2750A probe, **355**
 N2893A probe, **338**
 N5444A probe head, **352**
 N7010A active termination adapter, **352**
 NAME, :MEASure:NAME
 command/query, **817**
 NAME, :MEASurement<N>:NAME
 command/query, **976**
 NCJitter, :MEASure:NCJitter
 command/query, **818**
 NCONnected, :HOSTed:NCONnected?
 query, **595**
 Never tab Measurement Results, **1151**
 NL (New Line), **111**
 NOISE, :CHANnel<N>:SIMulation:NOISE
 command/query, **391**
 NOISE,
 :CHANnel<N>:SIMulation:NOISE:BWLim
 it command/query, **392**
 NOISE,
 :CHANnel<N>:SIMulation:NOISE:PERiod
 ic<M>:ENABLE command/query, **393**
 NOISE,
 :CHANnel<N>:SIMulation:NOISE:PERiod
 ic<M>:FREquency
 command/query, **394**
 NOISE,
 :CHANnel<N>:SIMulation:NOISE:PERiod
 ic<M>:MAGNitude
 command/query, **395**
 NOISE,
 :CHANnel<N>:SIMulation:NOISE:PERiod
 ic<M>:SHAPE command/query, **396**
 NOISE,
 :CHANnel<N>:SIMulation:NOISE:RANDo
 m command/query, **397**
 NOISE, :DISPlay:NOISE:LEVel
 command, **480**
 NOISE, :MEASure:NOISE
 command/query, **820**
 NOISE, :MEASure:NOISE:ALL? query, **821**
 NOISE, :MEASure:NOISE:BANDwidth
 command/query, **823**
 NOISE, :MEASure:NOISE:LOCation
 command/query, **824**
 NOISE, :MEASure:NOISE:METHod
 command/query, **825**
 NOISE, :MEASure:NOISE:REPort
 command/query, **826**
 NOISE, :MEASure:NOISE:RN
 command/query, **827**
 NOISE, :MEASure:NOISE:SCOPE:RN
 command/query, **828**
 NOISE, :MEASure:NOISE:STATe
 command/query, **829**
 NOISE, :MEASure:NOISE:UNITs
 command/query, **830**
 NONMonotonic,
 :ISCan:NONMonotonic:EDGE
 command/query, **604**
 NONMonotonic,
 :ISCan:NONMonotonic:HYSTeresis
 command/query, **605**
 NONMonotonic,
 :ISCan:NONMonotonic:SOURce
 command/query, **606**
 NONSymmetric,
 :ANALyze:CLOCK:METHod:PAM:NONSy
 mmetric command/query, **1505**
 NORMalize, :CHANnel<N>:ISIM:NORMalize
 command/query, **328**
 notices, **2**
 NPERiod, :MEASure:NPERiod
 command/query, **831**
 NPRecuror,
 :SPROcessing:FFEQualizer:NPRecuror
 command/query, **1132**
 NPULses, :MEASure:NPULses
 command/query, **832**
 NREGions?, :MTESt:NREGions? query, **706**
 NTAPs, :SPROcessing:DFEQualizer:NTAPs
 command/query, **1117**
 NTAPs, :SPROcessing:FFEQualizer:NTAPs
 command/query, **1133**
 NTSC TV trigger mode, **1328**
 NUI, :MEASure:NUI command/query, **833**
 NUMBer, :DISPlay:GRATicule:NUMBer
 command/query, **468**
 numeric, program data, **109**
 numeric, variable example, **124**
 numeric, variables, **124**
 NUMPoles,
 :SPROcessing:CTLequalizer:NUMPoles
 command/query, **1106**
 NWIDth, :MEASure:NWIDth
 command/query, **834**

O

obsolete and discontinued
 commands, **1497**

OBW, :MEASure:FFT:OBW
command/query, 777

ODD, :CHANnel<N>:SIMulation:DATA:ODD
command/query, 369

offset and gain of a probe, 288

OFFSet, :ANALyze:CLOCK:VERTical:OFFSet
command/query, 259

OFFSet, :CHANnel<N>:DISPlay:OFFSet
command/query, 309

OFFSet, :CHANnel<N>:OFFSet
command/query, 334

OFFSet,
:MEASure:JITTer:SPECTrum:VERTical:OFFSet
command/query, 807

OFFSet,
:MEASure:JITTer:TREND:VERTical:OFFSet
command/query, 815

OFFSet,
:SPROcessing:CTLequalizer:VERTical:OFFSet
command/query, 1113

OFFSet,
:SPROcessing:FFEQualizer:VERTical:OFFSet
command/query, 1144

OJTF, :ANALyze:CLOCK:METHOD:OJTF
command/query, 252

OJTF, :MEASure:CLOCK:METHOD:OJTF
command/query, 1526

OLEVel, :MEASure:CGRade:OLEVel
command/query, 747

OMAMplitude, :MEASure:OMAMplitude
command/query, 835

OPC bit, 405, 406

Open method, 116

OPER bit, 418, 420

operands and time scale, 495

operating the disk, 431

Operation Complete (*OPC)
command/query, 410

Operation Complete (*OPC), Status Bit, 149

operation status, 147

OPERator, :FUNCTion<F>:MATLab:OPERator
command/query, 534

OPOWer, :MEASure:OPOWer
command/query, 836

Option (*OPT?) query, 411

Options, Program Headers, 107

order of commands and execution, 145

oscilloscope connection, opening, 116

oscilloscope connection, verifying, 88

Oscilloscope Default GPIB Address, 137

oscilloscope, connecting, 87

oscilloscope, operation, 5

oscilloscope, setting up, 87

oscilloscope, trigger modes and
commands, 1182

output buffer, 106, 122

output queue, 106, 168

Output Queue, Clearing, 141

output queue, default condition, 145

output queue, definition, 144

OUTPut, :CALibrate:OUTPut
command/query, 290

OUTPut, :CALibrate:OUTPut:AUX
command/query, 292

OUTPut, :CALibrate:OUTPut:AUX:RTIME
command/query, 293

OUTPut, :CALibrate:OUTPut:CAL
command/query, 294

overlapped commands, 129

OVERshoot, :MEASure:OVERshoot
command/query, 837

P

P1, :SPROcessing:CTLequalizer:P1
command/query, 1107

P2, :SPROcessing:CTLequalizer:P2
command/query, 1108

P3, :SPROcessing:CTLequalizer:P3
command/query, 1109

PAADeskew, :XTALK:PAADeskew
command/query, 1463

PAIFilter, :XTALK:PAIFilter
command/query, 1464

PAISi, :XTALK:PAISi command/query, 1465

PAL-M TV trigger mode, 1328

PAM, :ANALyze:CLOCK:METHOD:PAM:B03
command/query, 1501

PAM, :ANALyze:CLOCK:METHOD:PAM:B12
command/query, 1503

PAM,
:ANALyze:CLOCK:METHOD:PAM:NONSy
mmetric command/query, 1505

PAM, :CHANnel<N>:SIMulation:DATA:PAM
command/query, 370

PAM, :MEASure:PAM:ELEVel
command/query, 838

PAM, :MEASure:PAM:ESKew
command/query, 840

PAM, :MEASure:PAM:EYE:ELMethod
command/query, 842

PAM, :MEASure:PAM:EYE:ESTiming
command/query, 843

PAM, :MEASure:PAM:EYE:PPERcent
command/query, 844

PAM, :MEASure:PAM:EYE:TIME:LTDefinition
command/query, 845

PAM, :MEASure:PAM:LEVel
command/query, 846

PAM, :MEASure:PAM:LRMS
command/query, 848

PAM, :MEASure:PAM:LTHickness
command/query, 850

PAMAutomatic,
:MEASure:THResholds:GENeral:PAMAuto
matic command/query, 913

PAMAutomatic,
:MEASure:THResholds:RFALL:PAMAuto
matic command/query, 928

PAMCustom,
:MEASure:THResholds:GENeral:PAMCus
tom command/query, 911

PAMplitude, :MEASure:PAMplitude
command/query, 852

PAMThreshold,
:MEASure:RJJDJ:PAMThreshold
command/query, 882

Parallel Poll Code and Capability, 135

parametric measurements, 726

parser, 144

parser, default condition, 145

Parser, Resetting, 141

PASLimit, :XTALK:PASLimit
command/query, 1466

passing values across the bus, 106

pattern length, 1038

PATtern, :ISCan:SERial:PATtern
command/query, 611

PATtern,
:SBUS<N>:CAN:TRIGger:PATtern:DATA
command/query, 1037

PATtern,
:SBUS<N>:CAN:TRIGger:PATtern:DATA:
LENGth command/query, 1038

PATtern,
:SBUS<N>:CAN:TRIGger:PATtern:ID
command/query, 1040

PATtern,
:SBUS<N>:CAN:TRIGger:PATtern:ID:MO
DE command/query, 1041

PATtern,
:SBUS<N>:IIC:TRIGger:PATtern:ADDRes
s command/query, 1062, 1064

PATtern,
:SBUS<N>:LIN:TRIGger:PATtern:DATA
command/query, 1074

PATtern,
:SBUS<N>:LIN:TRIGger:PATtern:DATA:L
ENGth command/query, 1075

PATtern,
:SBUS<N>:SPI:TRIGger:PATtern:DATA
command/query, 1089

PATtern,
:SBUS<N>:SPI:TRIGger:PATtern:WIDTH
command/query, 1091

PATtern,
:TRIGger:ADVanced:COMM:PATtern
command/query, 1297

PATtern,
:TRIGger:ADVanced:PATtern:CONDition
command/query, 1302

PATtern, :TRIGger:ADVanced:PATtern:LOGic
command/query, 1303

- PATtern, :TRIGger:ADVanced:PATtern:THReshold :LEVel command/query, **1304**
- PATtern, :TRIGger:ADVanced:PATtern:THReshold :POD<N> command/query, **1305**
- PATtern, :TRIGger:COMM:PATtern command/query, **1201**
- PATtern, :TRIGger:GBSerial:PATtern command/query, **1225**
- PATtern, :TRIGger:PATtern:CONDition command/query, **1234**
- PATtern, :TRIGger:PATtern:LOGic command/query, **1235**
- PAUTo, :XTALK<X>:PAUTo command/query, **1487**
- PAXFilter, :XTALK:PAXFilter command/query, **1467**
- PAXSi, :XTALK:PAXSi command/query, **1468**
- PBAsE, :MEASure:PBAsE command/query, **853**
- PDEtect acquisition mode, **216**
- PEAK, :MEASure:HISTogram:PEAK command/query, **794**
- PEAK1, :MEASure:FFT:PEAK1 command/query, **778**
- PEAK2, :MEASure:FFT:PEAK2 command/query, **779**
- peak-to-peak contrast, and PPContrast, **858**
- peak-to-peak voltage, and VPP, **968**
- Pending Commands, Clearing, **141**
- PERCent, :MEASure:THResholds:GENeral:PERCent command/query, **915**
- PERCent, :MEASure:THResholds:PERCent command/query, **923**
- PERCent, :MEASure:THResholds:RFALL:PERCent command/query, **930**
- PERCent, :MEASure:THResholds:SERial:PERCent command/query, **940**
- PERCent, :MTEST:MARGIN:PERCent command/query, **704**
- PERCent, :TIMEbase:REFERENCE:PERCent command/query, **1172**
- period measurement setup, **729**
- PERiod, :MEASure:PERiod command/query, **854**
- PERiodic, :HOSTed:PERiodic command/query, **596**
- PERiodic<M>, :CHANnel<N>:SIMulation:JITTer:PERiodic<M>:ENABle command/query, **386**
- PERiodic<M>, :CHANnel<N>:SIMulation:JITTer:PERiodic<M>:FREQUency command/query, **387**
- PERiodic<M>, :CHANnel<N>:SIMulation:JITTer:PERiodic<M>:MAGNitude command/query, **388**
- PERiodic<M>, :CHANnel<N>:SIMulation:JITTer:PERiodic<M>:SHAPE command/query, **389**
- PERiodic<M>, :CHANnel<N>:SIMulation:NOISE:PERiodic<M>:ENABle command/query, **393**
- PERiodic<M>, :CHANnel<N>:SIMulation:NOISE:PERiodic<M>:FREQUency command/query, **394**
- PERiodic<M>, :CHANnel<N>:SIMulation:NOISE:PERiodic<M>:MAGNitude command/query, **395**
- PERiodic<M>, :CHANnel<N>:SIMulation:NOISE:PERiodic<M>:SHAPE command/query, **396**
- period-period measurement, **755**
- PERsistence, :DISPlay:PERsistence command/query, **481**
- PERsona, :SYSTem:PERsona command/query, **1160**
- PEXTraction, :CHANnel<N>:ISIM:PEXTraction command/query, **329**
- PEXTraction, :CHANnel<N>:SIMulation:FILTter:ISIM:PEXTraction command/query, **375**
- PGTHan, :TRIGger:ADVanced:TV:UDTV:PGTHan command/query, **1337**
- PGTHan, :TRIGger:TV:UDTV:PGTHan command/query, **1286**
- PHAsE, :MEASure:PHAsE command/query, **856**
- PJADeskw, :XTALK:PJADeskw command/query, **1469**
- PJIFilter, :XTALK:PJIFilter command/query, **1470**
- PJISi, :XTALK:PJISi command/query, **1471**
- PJSLimit, :XTALK:PJSLimit command/query, **1472**
- PJXFilter, :XTALK:PJXFilter command/query, **1473**
- PJXSi, :XTALK:PJXSi command/query, **1474**
- PLACement, :AUToscale:PLACement command/query, **993**
- PLACement, :ISCan:ZONE<Z>:PLACement command/query, **616**
- PLAY, :ACQUIRE:SEGmented:PLAY command/query, **228**
- PLAY, :WMEMory<R>:SEGmented:PLAY command/query, **1453**
- PLENght, :MEASure:RJDJ:PLENght command/query, **883**
- PLENght, :SPROcessing:FFEQUalizer:TAP:PLENght command/query, **1139**
- PLENght, :XTALK<X>:PLENght command/query, **1488**
- PLLTrack, :ANALyze:CLOCK:METHod:PLLTrack command/query, **255**
- PLLTrack, :MEASure:CLOCK:METHod:PLLTrack command/query, **1528**
- Pod Commands, **979**
- POD<N>, :TRIGger:ADVanced:PATtern:THReshold :POD<N> command/query, **1305**
- POINts, :ACQUIRE:POINts:ANALog command/query, **218**
- POINts, :ACQUIRE:POINts:AUTO command/query, **220**
- POINts, :ACQUIRE:POINts:DIGital? query, **221**
- POINts, :ACQUIRE:POINts:TESTLIMITS? query, **222**
- POINts, :FUNCTION<F>:FFT:DETECTOR:POINts command/query, **506**
- POINts, :MEASure:JITTer:TREnd:SMOoth:POINts command/query, **813**
- POINts?, :WAVEform:POINts? query, **1416**
- POLarity, :TRIGger:ADVanced:COMM:POLarity command/query, **1298**
- POLarity, :TRIGger:ADVanced:TV:UDTV:POLarity command/query, **1338**
- POLarity, :TRIGger:ADVanced:VIOLation:PWIDth:POLarity command/query, **1345**
- POLarity, :TRIGger:COMM:POLarity command/query, **1202**
- POLarity, :TRIGger:GBSerial:POLarity command/query, **1226**
- POLarity, :TRIGger:GLITCh:POLarity command/query, **1230**
- POLarity, :TRIGger:PWIDth:POLarity command/query, **1238**
- POLarity, :TRIGger:RUNT:POLarity command/query, **1243**
- POLarity, :TRIGger:TV:POLarity command/query, **1280**
- POLarity, :TRIGger:TV:UDTV:POLarity command/query, **1287**
- polling synchronization example, **183**
- polling synchronization with timeout, **182**
- PON bit, **406**
- POSition, :FUNCTION<F>:HORizontal:POSition command/query, **524**
- POSition, :MEASure:JITTer:SPECTrum:HORizontal:POSition command/query, **804**
- POSition, :MTEST:FOLDing:POSition command/query, **687**
- POSition, :TIMEbase:POSition command/query, **1168**
- POSition, :TIMEbase:WINDow:POSition command/query, **1177**

- position, and WINDow POSition, [1177](#)
- pound sign (#) and block data, [125](#)
- Power On (PON) status bit, [148, 404](#)
- Power-on Status Clear (*PSC)
 - command/query, [414](#)
- Power-up Condition, [134](#)
- PP,:MEASure:HISTogram:PP
 - command/query, [795](#)
- PPContrast,:MEASure:PPContrast
 - command/query, [858](#)
- PPERcent,:MEASure:PAM:EYE:PPERcent
 - command/query, [844](#)
- PPULses,:MEASure:PPULses
 - command/query, [859](#)
- PRATe,:ACQuire:SEGmented:PRATe
 - command/query, [229](#)
- PRBS,:TRIGger:GBSerial:PRBS
 - command/query, [1227](#)
- PREamble,:WAVEform:PREamble?
 - query, [1417](#)
- PRECprobe,
 - :CHANnel<N>:PROBe:PRECprobe:BAND width command, [356](#)
- PRECprobe,
 - :CHANnel<N>:PROBe:PRECprobe:CALibration command, [357](#)
- PRECprobe,
 - :CHANnel<N>:PROBe:PRECprobe:DELAy command, [358](#)
- PRECprobe,
 - :CHANnel<N>:PROBe:PRECprobe:MODE command, [359](#)
- PRECprobe,
 - :CHANnel<N>:PROBe:PRECprobe:ZSRC command, [360](#)
- PRECprobe,:DISK:SAVE:PRECprobe
 - command, [444](#)
- PRECprobe,:DISPlay:PRECprobe:GCOUNT
 - command/query, [485](#)
- PRECprobe,
 - :DISPlay:PRECprobe:SElectgraph command, [486](#)
- PRECprobe,:DISPlay:PRECprobe:SOURce
 - command, [487](#)
- PRESet,:SYSTem:PRESet command, [1161](#)
- PREShoot,:MEASure:PREShoot
 - command/query, [860](#)
- PRIMary,:CHANnel<N>:PROBe:PRIMary
 - command/query, [362](#)
- PRINters?,:HARDcopy:PRINters?
 - query, [556](#)
- printing, specific screen data, [552](#)
- printing, the screen, [551](#)
- probe attenuation and gain, default setup and, [1162](#)
- probe attenuation factor, [288](#)
- Probe Calibration, [288](#)
- probe external adapter, default setup and, [1162](#)
- probe skew, default setup and, [1162](#)
- PROBe,:CHANnel<N>:PROBe
 - command/query, [335](#)
- PROBe,:CHANnel<N>:PROBe:ACCAL
 - command/query, [336](#)
- PROBe,:CHANnel<N>:PROBe:ATTenuation
 - command/query, [337](#)
- PROBe,:CHANnel<N>:PROBe:AUTOzero
 - command/query, [338](#)
- PROBe,:CHANnel<N>:PROBe:COUpling
 - command/query, [339](#)
- PROBe,:CHANnel<N>:PROBe:EADapter
 - command/query, [340](#)
- PROBe,:CHANnel<N>:PROBe:ECOupling
 - command/query, [343](#)
- PROBe,:CHANnel<N>:PROBe:EXTernal
 - command/query, [344](#)
- PROBe,
 - :CHANnel<N>:PROBe:EXTernal:GAIN command/query, [345](#)
- PROBe,
 - :CHANnel<N>:PROBe:EXTernal:OFFSet command/query, [346](#)
- PROBe,
 - :CHANnel<N>:PROBe:EXTernal:UNITs command/query, [347](#)
- PROBe,:CHANnel<N>:PROBe:GAIN
 - command/query, [348](#)
- PROBe,:CHANnel<N>:PROBe:HEAD:ADD
 - command, [349](#)
- PROBe,:CHANnel<N>:PROBe:HEAD:DELeTe
 - command, [350](#)
- PROBe,:CHANnel<N>:PROBe:HEAD:SELeCt
 - command/query, [351](#)
- PROBe,:CHANnel<N>:PROBe:HEAD:VTERm
 - command/query, [352](#)
- PROBe,:CHANnel<N>:PROBe:ID?
 - query, [353](#)
- PROBe,:CHANnel<N>:PROBe:INFO?
 - query, [354](#)
- PROBe,:CHANnel<N>:PROBe:MODE
 - command/query, [355](#)
- PROBe,
 - :CHANnel<N>:PROBe:PRECprobe:BAND width command, [356](#)
- PROBe,
 - :CHANnel<N>:PROBe:PRECprobe:CALibration command, [357](#)
- PROBe,
 - :CHANnel<N>:PROBe:PRECprobe:DELAy command, [358](#)
- PROBe,
 - :CHANnel<N>:PROBe:PRECprobe:MODE command, [359](#)
- PROBe,
 - :CHANnel<N>:PROBe:PRECprobe:ZSRC command, [360](#)
- PROBe,:CHANnel<N>:PROBe:PRIMary
 - command/query, [362](#)
- PROBe,:CHANnel<N>:PROBe:SKEW
 - command/query, [363](#)
- PROBe,:CHANnel<N>:PROBe:STYPe
 - command/query, [364](#)
- PROBe,:MTESt:PROBe:IMPedance?
 - query, [707](#)
- program data, [103](#)
- Program example, [119](#)
- Program Header Options, [107](#)
- program message, [116](#)
- program message terminator, [111](#)
- program overview, initialization example, [119](#)
- programming basics, [94](#)
- Programming Conventions, [195](#)
- programming examples, [1553](#)
- programming examples language, [94](#)
- Programming Getting Started, [114](#)
- PROMpt,:HOSTed:CALibrate:PROMpt
 - command/query, [581](#)
- PROPortion,:DISPlay:PROPortion
 - command/query, [483](#)
- PROPortion,:DISPlay:PROPortion:RESulTs
 - command/query, [484](#)
- protocol, exceptions and operation, [144](#)
- PSD,:MEASure:FFT:PSD
 - command/query, [780](#)
- PSKew,:POD<N>:PSKew
 - command/query, [981](#)
- PTOP,:MEASure:PTOP
 - command/query, [861](#)
- PTYPe,:XTALK<X>:PTYPe
 - command/query, [1489](#)
- pulse width measurement setup, [729](#)
- pulse width violation mode, [1342](#)
- PWD,:DISK:PWD? query, [438](#)
- PWIDth,:MEASure:PWIDth
 - command/query, [862](#)
- PWIDth,
 - :TRIGger:ADVanced:VIOLation:PWIDth:DIRrection command/query, [1344](#)
- PWIDth,
 - :TRIGger:ADVanced:VIOLation:PWIDth:POLarity command/query, [1345](#)
- PWIDth,
 - :TRIGger:ADVanced:VIOLation:PWIDth:SOURce command/query, [1346](#)
- PWIDth,
 - :TRIGger:ADVanced:VIOLation:PWIDth:WIDTH command/query, [1347](#)
- PWIDth,:TRIGger:PWIDth:DIRrection
 - command/query, [1237](#)
- PWIDth,:TRIGger:PWIDth:POLarity
 - command/query, [1238](#)
- PWIDth,:TRIGger:PWIDth:SOURce
 - command/query, [1239](#)
- PWIDth,:TRIGger:PWIDth:TPOint
 - command/query, [1240](#)
- PWIDth,:TRIGger:PWIDth:WIDTH
 - command/query, [1241](#)
- Python, VISA COM example, [1584](#)
- Python, VISA example, [1635, 1641](#)
- PyVISA 1.5 and older, [1635](#)
- PyVISA 1.6 and newer, [1641](#)

Q

QFACTOR, :MEASURE:CGRADE:QFACTOR
command/query, 748

QUALIFIED, :TRIGGER:RUNT:QUALIFIED
command/query, 1244

QUALIFIER<M>, :MEASURE:QUALIFIER<M>:CONDITION
command/query, 863

QUALIFIER<M>, :MEASURE:QUALIFIER<M>:SOURCE
command/query, 864

QUALIFIER<M>, :MEASURE:QUALIFIER<M>:STATE
command/query, 865

Query, 97, 106

Query Error, 1547

Query Error, QYE Status Bit, 149

query interrupt, 122

query, headers, 106

query, interrupt, 106

query, response, 122

query, responses, formatting, 1147

question mark, 106

queue, output, 106

quoted strings, 1508

quotes, with embedded strings, 110

QYE bit, 405, 406

R

random jitter, specified, 885

random noise, specified, 827

RANDOM, :CHANNEL<N>:SIMULATION:JITTER:RANDOM
command/query, 390

RANDOM, :CHANNEL<N>:SIMULATION:NOISE:RANDOM
command/query, 397

RANGE, :ANALYZE:CLOCK:VERTICAL:RANGE
command/query, 260

RANGE, :CHANNEL<N>:DISPLAY:RANGE
command/query, 311

RANGE, :CHANNEL<N>:RANGE
command/query, 365

RANGE, :FUNCTION<F>:HORIZONTAL:RANGE
command/query, 526

RANGE, :FUNCTION<F>:RANGE
command/query, 542

RANGE, :FUNCTION<F>:VERTICAL:RANGE
command/query, 550

RANGE, :MEASURE:CLOCK:VERTICAL:RANGE
command/query, 1532

RANGE, :MEASURE:JITTER:SPECTRUM:HORIZONTAL:
RANGE command/query, 805

RANGE, :MEASURE:JITTER:SPECTRUM:VERTICAL:RA
NGE command/query, 808

RANGE, :MEASURE:JITTER:TREND:VERTICAL:RANG
E command/query, 816

RANGE, :SPROCESSING:CTLEQUALIZER:VERTICAL:RA
NGE command/query, 1114

RANGE, :SPROCESSING:FFEQUALIZER:VERTICAL:RA
NGE command/query, 1145

RANGE, :TIMEBASE:RANGE
command/query, 1169

RANGE, :TIMEBASE:WINDOW:RANGE
command/query, 1178

range, and WINDOW RANGE, 1178

RATE, :SPROCESSING:CTLEQUALIZER:RATE
command/query, 1110

RATE, :SPROCESSING:FFEQUALIZER:RATE
command/query, 1134

ReadIEEEBlock method, 116

ReadList method, 116

ReadNumber method, 116

READOUT, :BUS:READOUT
command/query, 285

ReadSTB example, 153

ReadString method, 116

real number definition, 109

real time mode, 216

real time mode, and interpolation, 215

Recall (*RCL) command, 415

receiver sample timing, PAM measurement
definition, 843

Receiving Common Commands, 401

Receiving Information from the
Instrument, 122

REDGE, :ACQUIRE:REDGE
command/query, 223

REFCLOCK, :TIMEBASE:REFCLOCK
command/query, 1170

REFERENCE, :FUNCTION<F>:FFT:REFERENCE
command/query, 509

REFERENCE, :TIMEBASE:REFERENCE
command/query, 1171

REFERENCE, :TIMEBASE:REFERENCE:PERCENT
command/query, 1172

reference, default setup, 1161

register, save/recall, 415, 417

register, Standard Event Status Enable, 158

reliability of measured data, 147

remote control examples, 1553

Remote Local Code and Capability, 135

remote programming basics, 94

REPORT, :MEASURE:NOISE:REPORT
command/query, 826

REPORT, :MEASURE:RJDDJ:REPORT
command/query, 884

representation of infinity, 200

Request Control (RQC), Status Bit, 149

Request Service (RQS), Default, 134

Request Service (RQS), status bit, 149

RESEED, :CHANNEL<N>:SIMULATION:DATA:RESEED
command/query, 371

Reset (*RST) command, 416

RESET, :TRIGGER:SEQUENCE:RESET:ENABLE
command/query, 1250

RESET, :TRIGGER:SEQUENCE:RESET:EVENT
command, 1252

RESET, :TRIGGER:SEQUENCE:RESET:TIME
command/query, 1253

RESET, :TRIGGER:SEQUENCE:RESET:TYPE
command/query, 1251

Resetting the Parser, 141

RESOLUTION, :FUNCTION<F>:FFT:RESOLUTION
command/query, 510

RESOLUTION, :MEASURE:HISTOGRAM:RESOLUTION
command/query, 796

resource session object, 117

ResourceManager object, 116

RESPONSE, :ACQUIRE:RESPONSE
command/query, 224

response, data, 125

response, generation, 201

responses, buffered, 201

result state code, and SENDVALID, 893

RESULTS, :DISPLAY:PROPORTION:RESULTS
command/query, 484

RESULTS, :XTALK:RESULTS? query, 1475

results, retrieving, 181

RESULTS?, :LTEST:RESULTS? query, 625

RESULTS?, :MEASURE:RESULTS? query, 866

Returning control to system computer, 141

RFALL, :MEASURE:THRESHOLDS:RFALL:ABSOLUTE
command/query, 924

RFALL, :MEASURE:THRESHOLDS:RFALL:METH
OD command/query, 926

RFALL, :MEASURE:THRESHOLDS:RFALL:PAMAUT
OMATIC command/query, 928

RFALL, :MEASURE:THRESHOLDS:RFALL:PERCENT
command/query, 930

RFALL, :MEASURE:THRESHOLDS:RFALL:TOPBASE:A
BSOLUTE command/query, 932

RFALL, :MEASURE:THRESHOLDS:RFALL:TOPBASE:
METHOD command/query, 934

RIDEAL, :XTALK<X>:RIDEAL
command/query, 1490

rise time measurement setup, 729

RISETIME, :MEASURE:RISETIME
command/query, 869

RISI, :XTALK<X>:RISI
command/query, 1491

RJ, :MEASURE:RJDDJ:RJ
command/query, 885

RJ, :MEASURE:RJDDJ:SCOPE:RJ
command/query, 886

RJDDJ, :MEASURE:RJDDJ:ALL? query, 871

RJDDJ, :MEASURE:RJDDJ:APLENGTH?
query, 873

- RJDJ, :MEASure:RJDJ:BANDwidth
command/query, **874**
- RJDJ, :MEASure:RJDJ:BER
command/query, **875**
- RJDJ, :MEASure:RJDJ:CLOCK
command/query, **877**
- RJDJ, :MEASure:RJDJ:EDGE
command/query, **878**
- RJDJ, :MEASure:RJDJ:INTERpolate
command/query, **879**
- RJDJ, :MEASure:RJDJ:METHod
command/query, **880**
- RJDJ, :MEASure:RJDJ:MODE
command/query, **881**
- RJDJ, :MEASure:RJDJ:PAMThreshold
command/query, **882**
- RJDJ, :MEASure:RJDJ:PLENgtH
command/query, **883**
- RJDJ, :MEASure:RJDJ:REPort
command/query, **884**
- RJDJ, :MEASure:RJDJ:RJ
command/query, **885**
- RJDJ, :MEASure:RJDJ:SCOPE:RJ
command/query, **886**
- RJDJ, :MEASure:RJDJ:SOURce
command/query, **887**
- RJDJ, :MEASure:RJDJ:STATe
command/query, **888**
- RJDJ, :MEASure:RJDJ:TJRJDJ? query, **889**
- RJDJ, :MEASure:RJDJ:UNITs
command/query, **891**
- RLIMit, :HISTogram:WINDow:RLIMit
command/query, **568**
- RMS voltage, and VRMS, **970**
- RN, :MEASure:NOISE:RN
command/query, **827**
- RN, :MEASure:NOISE:SCOPE:RN
command/query, **828**
- ROLL, :TIMEbase:ROLL:ENABLE
command/query, **1173**
- Root level commands, **985**
- ROTHer, :XTALK<X>:ROTHer
command/query, **1492**
- ROW, :DISPlay: ROW command
query, **1509**
- ROW, :DISPlay:STATus:ROW command
query, **491**
- RQC (Request Control), **149**
- RQC (Request Control), bit, **405, 406**
- RQS (Request Service), **149**
- RQS (Request Service), and *STB, **420**
- RQS (Request Service), Default, **134**
- RQS/MSS bit, **420**
- RTIME acquisition mode, **216**
- RTIME, :CALibrate:OUTPut:AUX:RTIME
command/query, **293**
- RTIME,
:CHANnel<N>:SIMulation:FUNCTion:SQ
Uare:RTIME command/query, **383**
- rule of truncation, **196**
- rules of traversal, **197**
- RUMode, :LTEST:RUMode:SOFailure
command/query, **626**
- RUMode, :MTEST:RUMode
command/query, **708**
- RUMode, :MTEST:RUMode:SOFailure
command/query, **709**
- run state, **1011**
- RUN, and GET relationship, **141**
- Run/Stop, default setup, **1161**
- RUNT, :ISCan:RUNT:HYSTeresis
command/query, **607**
- RUNT, :ISCan:RUNT:LLEVel
command/query, **608**
- RUNT, :ISCan:RUNT:SOURce
command/query, **609**
- RUNT, :ISCan:RUNT:ULEVel
command/query, **610**
- RUNT, :TRIGger:RUNT:POLarity
command/query, **1243**
- RUNT, :TRIGger:RUNT:QUALified
command/query, **1244**
- RUNT, :TRIGger:RUNT:SOURce
command/query, **1245**
- RUNT, :TRIGger:RUNT:TIME
command/query, **1246**
- ## S
- SAADeskew, :XTALK:SAADeskew
command/query, **1477**
- SAIFilter, :XTALK:SAIFilter
command/query, **1478**
- SAISi, :XTALK:SAISi command/query, **1479**
- SAMplepoint, :SBUS<N>:CAN:SAMplepoint
command/query, **1029**
- SAMplepoint, :SBUS<N>:LIN:SAMplepoint
command/query, **1068**
- sampling mode, **216**
- SASLimit, :XTALK:SASLimit
command/query, **1480**
- saturation, **488**
- Save (*SAV) command, **417**
- SAVE, :DISK:SAVE:COMPosite
command, **439**
- SAVE, :DISK:SAVE:IMAGe command, **440**
- SAVE, :DISK:SAVE:JITTer command, **441**
- SAVE, :DISK:SAVE:LISTing command, **442**
- SAVE, :DISK:SAVE:MEASurements
command, **443**
- SAVE, :DISK:SAVE:PRECProbe
command, **444**
- SAVE, :DISK:SAVE:SETup command, **445**
- SAVE, :DISK:SAVE:WAVEform
command, **446**
- SAVE, :MTEST:AMASK:SAVE command, **661**
- SAVE, :WMEMory<R>:SAVE
command, **1450**
- save/recall register, **415, 417**
- saving and loading, **431**
- SAXFilter, :XTALK:SAXFilter
command/query, **1481**
- SAXSi, :XTALK:SAXSi
command/query, **1482**
- SBUS CAN commands, **1027**
- SBUS FLEXray commands, **1043**
- SBUS HS commands, **1053**
- SBUS LIN commands, **1067**
- SBUS<N> commands, general, **1024**
- SCALE, :CHANnel<N>:DISPlay:SCALE
command/query, **313**
- SCALE, :CHANnel<N>:SCALE
command/query, **366**
- SCALE, :HISTogram:SCALE:SIZE
command/query, **563**
- SCALE, :MTEST:FOLDing:SCALE
command/query, **689**
- SCALE, :MTEST:SCALE:BIND
command/query, **710**
- SCALE, :MTEST:SCALE:X1
command/query, **711**
- SCALE, :MTEST:SCALE:XDELta
command/query, **712**
- SCALE, :MTEST:SCALE:Y1
command/query, **713**
- SCALE, :MTEST:SCALE:Y2
command/query, **714**
- SCALE, :TIMEbase:SCALE
command/query, **1174**
- SCALE, :TIMEbase:WINDow:SCALE
command/query, **1179**
- SCHeme, :DISPlay:CGRade:SCHeme
command/query, **461**
- SCOLor, :DISPlay:SCOLor
command/query, **488**
- SCOPE, :MEASure:NOISE:SCOPE:RN
command/query, **828**
- SCOPE, :MEASure:RJDJ:SCOPE:RJ
command/query, **886**
- SCOPETEST, :SELftest:SCOPETEST
command/query, **1099**
- SCPI.NET example in C#, **1668**
- SCPI.NET example in IronPython, **1682**
- SCPI.NET example in Visual Basic
.NET, **1675**
- SCPI.NET examples, **1668**
- SCRatch, :MEASure:SCRatch
command, **892**
- SCReen, HARDcopy AREA, **552**
- SEGHres acquisition mode, **217**
- SEGmented acquisition mode, **217**
- SEGmented, :ACQUIRE:SEGmented:AUTOplay
command/query, **225**
- SEGmented, :ACQUIRE:SEGmented:COUNT
command/query, **226**
- SEGmented, :ACQUIRE:SEGmented:INDEX
command/query, **227**
- SEGmented, :ACQUIRE:SEGmented:PLAY
command/query, **228**
- SEGmented, :ACQUIRE:SEGmented:PRATe
command/query, **229**
- SEGmented, :ACQUIRE:SEGmented:TTAGs
command/query, **230**

- SEGMented, :DISK:SEGMented
command/query, 448
- SEGMented, :WAVeform:SEGMented:ALL
command/query, 1421
- SEGMented,
:WAVeform:SEGMented:COUNT?
query, 1422
- SEGMented, :WAVeform:SEGMented:TTAG?
query, 1423
- SEGMented, :WAVeform:SEGMented:XLIST?
query, 1424
- SEGMented,
:WMEMemory<R>:SEGMented:COUNT?
query, 1451
- SEGMented,
:WMEMemory<R>:SEGMented:INDEX
command/query, 1452
- SEGMented,
:WMEMemory<R>:SEGMented:PLAY
command/query, 1453
- SEGPdetect acquisition mode, 217
- SElect, :CHANnel<N>:PROBe:HEAD:SElect
command/query, 351
- Selected Device Clear (SDC), 141
- SElectgraph, :DISPlay:ISIM:SElectgraph
command, 471
- SElectgraph, :DISPlay:JITTer:SElectgraph
command, 474
- SElectgraph,
:DISPlay:PRECprobe:SElectgraph
command, 486
- Selecting Multiple Subsystems, 113
- SElection,
:CHANnel<N>:SIMulation:DATA:SElecti
on command/query, 372
- SElection,
:CHANnel<N>:SIMulation:FILTer:SElecti
on command/query, 376
- SElection,
:CHANnel<N>:SIMulation:FUNCTion:SEL
ection command/query, 380
- self test, 423
- Self-Test Commands, 1097
- semicolon usage, 105
- sending compound queries, 145
- SENDvalid, :MEASure:SENDvalid
command/query, 893
- separator, 98
- SEquence,
:TRIGger:SEquence:RESet:ENABLE
command/query, 1250
- SEquence, :TRIGger:SEquence:RESet:EVENT
command, 1252
- SEquence, :TRIGger:SEquence:RESet:TIME
command/query, 1253
- SEquence, :TRIGger:SEquence:RESet:TYPE
command/query, 1251
- SEquence, :TRIGger:SEquence:TERM1
command/query, 1248
- SEquence, :TRIGger:SEquence:TERM2
command/query, 1249
- SEquence,
:TRIGger:SEquence:WAIT:ENABLE
command/query, 1254
- SEquence, :TRIGger:SEquence:WAIT:TIME
command/query, 1255
- sequential commands, 129
- SER, :MEASure:SER command/query, 894
- Serial Bus Commands, 1023
- Serial Data Equalization Commands, 1101
- serial decode bus display, 1025
- serial decode mode, 1026
- serial poll, (ReadSTB) in example, 153
- Serial Poll, Disabling, 141
- serial poll, of the Status Byte Register, 153
- serial prefix, reading, 407
- SERial, :ISCan:SERial:PATtern
command/query, 611
- SERial, :ISCan:SERial:SOURce
command/query, 612
- SERial,
:MEASure:THResholds:SERial:ABSolute
command/query, 935
- SERial,
:MEASure:THResholds:SERial:HYSteresi
s command/query, 937
- SERial,
:MEASure:THResholds:SERial:METHod
command/query, 939
- SERial,
:MEASure:THResholds:SERial:PERCent
command/query, 940
- SERial,
:MEASure:THResholds:SERial:TOPBase:
ABSolute command/query, 942
- SERial,
:MEASure:THResholds:SERial:TOPBase:
METHod command/query, 944
- SERPeracq, :MEASure:SERPeracq
command/query, 895
- Service Request Enabl, (*SRE)
command/query, 418
- Service Request Enable, Register
(SRE), 154
- Service Request Enable, Register Bits, 418
- Service Request Enable, Register
Default, 134
- Service Request, Code and Capability, 135
- set up oscilloscope, 87
- SET, :DISPlay:BOOKmark<N>:SET
command, 452
- SETGrat, :DISPlay:GRATicule:SETGrat
command, 469
- setting up, for programming, 114
- setting up, the instrument, 118
- setting, bits in the Service Request Enable
Register, 154
- setting, horizontal tracking, 523
- setting, Standard Event Status Enable
Register bits, 158
- setting, time and date, 1165
- setting, TRG bit, 156
- setting, voltage and time markers, 633
- setup recall, 415
- setup violation mode, 1348
- SETup, :DISK:SAVE:SETup command, 445
- SETup, :RECall:SETup command, 1010
- SETup, :STORe:SETup command, 1019
- SETup, :SYSTem:SETup
command/query, 1163
- SETup,
:TRIGger:ADVanced:VIOLation:SETup:H
OLD:CSORce command/query, 1359
- SETup,
:TRIGger:ADVanced:VIOLation:SETup:H
OLD:CSORce:EDGE
command/query, 1361
- SETup,
:TRIGger:ADVanced:VIOLation:SETup:H
OLD:CSORce:LEVel
command/query, 1360
- SETup,
:TRIGger:ADVanced:VIOLation:SETup:H
OLD:DSORce command/query, 1362
- SETup,
:TRIGger:ADVanced:VIOLation:SETup:H
OLD:DSORce:HTHReshold
command/query, 1363
- SETup,
:TRIGger:ADVanced:VIOLation:SETup:H
OLD:DSORce:LTHReshold
command/query, 1364
- SETup,
:TRIGger:ADVanced:VIOLation:SETup:H
OLD:TIME command/query, 1365
- SETup,
:TRIGger:ADVanced:VIOLation:SETup:M
ODE command/query, 1351
- SETup,
:TRIGger:ADVanced:VIOLation:SETup:SE
Tup:CSORce command/query, 1352
- SETup,
:TRIGger:ADVanced:VIOLation:SETup:SE
Tup:CSORce:EDGE
command/query, 1354
- SETup,
:TRIGger:ADVanced:VIOLation:SETup:SE
Tup:CSORce:LEVel
command/query, 1353
- SETup,
:TRIGger:ADVanced:VIOLation:SETup:SE
Tup:DSORce command/query, 1355
- SETup,
:TRIGger:ADVanced:VIOLation:SETup:SE
Tup:DSORce:HTHReshold
command/query, 1356
- SETup,
:TRIGger:ADVanced:VIOLation:SETup:SE
Tup:DSORce:LTHReshold
command/query, 1357
- SETup,
:TRIGger:ADVanced:VIOLation:SETup:SE
Tup:TIME command/query, 1358

- SETup, :TRIGger:ADVanced:VIOLation:SETup:SHOLd:CSOource command/query, [1366](#)
- SETup, :TRIGger:ADVanced:VIOLation:SETup:SHOLd:CSOource:EDGE command/query, [1368](#)
- SETup, :TRIGger:ADVanced:VIOLation:SETup:SHOLd:CSOource:LEVel command/query, [1367](#)
- SETup, :TRIGger:ADVanced:VIOLation:SETup:SHOLd:DSOource command/query, [1369](#)
- SETup, :TRIGger:ADVanced:VIOLation:SETup:SHOLd:DSOource:HTHReshold command/query, [1370](#)
- SETup, :TRIGger:ADVanced:VIOLation:SETup:SHOLd:DSOource:LTHReshold command/query, [1371](#)
- SETup, :TRIGger:ADVanced:VIOLation:SETup:SHOLd:HoldTIME (HTIME) command/query, [1373](#)
- SETup, :TRIGger:ADVanced:VIOLation:SETup:SHOLd:SetupTIME (STIME) command/query, [1372](#)
- SETup, :TRIGger:SHOLd:CSOource command/query, [1257](#)
- SETup, :TRIGger:SHOLd:CSOource:EDGE command/query, [1258](#)
- SETup, :TRIGger:SHOLd:DSOource command/query, [1259](#)
- SETup, :TRIGger:SHOLd:HoldTIME (HTIME) command/query, [1260](#)
- SETup, :TRIGger:SHOLd:MODE command/query, [1261](#)
- SETup, :TRIGger:SHOLd:SetupTIME command/query, [1262](#)
- Short form, [107](#)
- short-form headers, [107](#)
- short-form mnemonics, [196](#)
- SICL example in C, [1649](#)
- SICL example in Visual Basic, [1658](#)
- SICL examples, [1649](#)
- SIGNal, :ANALyze:SIGNal:DARate command/query, [261](#)
- SIGNal, :ANALyze:SIGNal:MIXer:CABLeLoss command/query, [265](#)
- SIGNal, :ANALyze:SIGNal:MMWave:CALibrate command, [266](#)
- SIGNal, :ANALyze:SIGNal:MMWave:CFrequency command/query, [267](#)
- SIGNal, :ANALyze:SIGNal:MMWave:CONNECT command/query, [268](#)
- SIGNal, :ANALyze:SIGNal:MMWave:LOADdress command/query, [269](#)
- SIGNal, :ANALyze:SIGNal:MMWave:MBANDwidth command/query, [270](#)
- SIGNal, :ANALyze:SIGNal:SYMBOLrate command/query, [263](#)
- SIGNal, :ANALyze:SIGNal:TYPE command/query, [271](#)
- SIGNal, :SBUS<N>:CAN:SIGNal:BAUDrate command/query, [1030](#)
- SIGNal, :SBUS<N>:CAN:SIGNal:DEFinition command/query, [1031](#)
- SIGNal, :SBUS<N>:CAN:SIGNal:FDBaudrate command/query, [1032](#)
- SIGNal, :SBUS<N>:LIN:SIGNal:BAUDrate command/query, [1069](#)
- SIGNals, :HOSTed:CALibrate:DESKew:SIGNals command, [577](#)
- SIGNals, :HOSTed:CALibrate:STATus:SIGNals? query, [585](#)
- simple command header, [104](#)
- SIMulation, :CHANnel<N>:SIMulation:AMPLitude command/query, [367](#)
- SIMulation, :CHANnel<N>:SIMulation:DATA:LENGth command/query, [368](#)
- SIMulation, :CHANnel<N>:SIMulation:DATA:ODD command/query, [369](#)
- SIMulation, :CHANnel<N>:SIMulation:DATA:PAM command/query, [370](#)
- SIMulation, :CHANnel<N>:SIMulation:DATA:RESeed command/query, [371](#)
- SIMulation, :CHANnel<N>:SIMulation:DATA:SElecti on command/query, [372](#)
- SIMulation, :CHANnel<N>:SIMulation:DRATE command/query, [373](#)
- SIMulation, :CHANnel<N>:SIMulation:FILTer:ISIM:ADDRESS command/query, [374](#)
- SIMulation, :CHANnel<N>:SIMulation:FILTer:ISIM:PEXtraction command/query, [375](#)
- SIMulation, :CHANnel<N>:SIMulation:FILTer:SElecti on command/query, [376](#)
- SIMulation, :CHANnel<N>:SIMulation:FLOad:ADDRESS command/query, [377](#)
- SIMulation, :CHANnel<N>:SIMulation:FLOad:LOOP command/query, [378](#)
- SIMulation, :CHANnel<N>:SIMulation:FREQuency command/query, [379](#)
- SIMulation, :CHANnel<N>:SIMulation:FUNCTion:SELECTION command/query, [380](#)
- SIMulation, :CHANnel<N>:SIMulation:FUNCTion:SQUare:DCYCLE command/query, [381](#)
- SIMulation, :CHANnel<N>:SIMulation:FUNCTion:SQUare:FTIME command/query, [382](#)
- SIMulation, :CHANnel<N>:SIMulation:FUNCTion:SQUare:RTIME command/query, [383](#)
- SIMulation, :CHANnel<N>:SIMulation:JITTer command/query, [384](#)

- SIMulation,
:CHANnel<N>:SIMulation:JITTer:ABUJ
command/query, **385**
- SIMulation,
:CHANnel<N>:SIMulation:JITTer:PERiod
ic<M>:ENABle command/query, **386**
- SIMulation,
:CHANnel<N>:SIMulation:JITTer:PERiod
ic<M>:FREQuency
command/query, **387**
- SIMulation,
:CHANnel<N>:SIMulation:JITTer:PERiod
ic<M>:MAGNitude
command/query, **388**
- SIMulation,
:CHANnel<N>:SIMulation:JITTer:PERiod
ic<M>:SHApe command/query, **389**
- SIMulation,
:CHANnel<N>:SIMulation:JITTer:RANDo
m command/query, **390**
- SIMulation, :CHANnel<N>:SIMulation:NOISe
command/query, **391**
- SIMulation,
:CHANnel<N>:SIMulation:NOISe:BWLim
it command/query, **392**
- SIMulation,
:CHANnel<N>:SIMulation:NOISe:PERiod
ic<M>:ENABle command/query, **393**
- SIMulation,
:CHANnel<N>:SIMulation:NOISe:PERiod
ic<M>:FREQuency
command/query, **394**
- SIMulation,
:CHANnel<N>:SIMulation:NOISe:PERiod
ic<M>:MAGNitude
command/query, **395**
- SIMulation,
:CHANnel<N>:SIMulation:NOISe:PERiod
ic<M>:SHApe command/query, **396**
- SIMulation,
:CHANnel<N>:SIMulation:NOISe:RANDo
m command/query, **397**
- SIMulation,
:CHANnel<N>:SIMulation:OFFSet
command/query, **398**
- SIMulation,
:CHANnel<N>:SIMulation:WAVEform
command/query, **399**
- SIZE, :DIGital<N>:SIZE
command/query, **428**
- SIZE, :HISTogram:SCALE:SIZE
command/query, **563**
- SKEW, :ANALyze:CLOCK:METHOD:SKEW
command/query, **256**
- SKEW, :CALibrate:SKEW
command/query, **295**
- SKEW, :CHANnel<N>:DIFFerential:SKEW
command/query, **305**
- SKEW, :CHANnel<N>:PROBe:SKEW
command/query, **363**
- SLEWrate, :MEASure:SLEWrate
command/query, **898**
- SLOPe, :BUS:CLOCK:SLOPe
command/query, **282**
- SLOPe, :SBUS<N>:SPI:CLOCK:SLOPe
command/query, **1078**
- SLOPe,
:TRIGger:ADVanced:DElay:EDLY:ARM:SL
OPe command/query, **1315**
- SLOPe,
:TRIGger:ADVanced:DElay:EDLY:EVENT:
SLOPe command/query, **1318**
- SLOPe,
:TRIGger:ADVanced:DElay:EDLY:TRIGge
r:SLOPe command/query, **1320**
- SLOPe,
:TRIGger:ADVanced:DElay:TDLy:ARM:SL
OPe command/query, **1324**
- SLOPe,
:TRIGger:ADVanced:DElay:TDLy:TRIGge
r:SLOPe command/query, **1327**
- SLOPe, :TRIGger:ADVanced:STATE:SLOPe
command/query, **1310**
- SLOPe, :TRIGger:DElay:ARM:SLOPe
command/query, **1206**
- SLOPe, :TRIGger:DElay:EDelay:SLOPe
command/query, **1209**
- SLOPe, :TRIGger:DElay:TRIGger:SLOPe
command/query, **1213**
- SLOPe, :TRIGger:EDGE:SLOPe
command/query, **1216**
- SLOPe, :TRIGger:STATE:SLOPe
command/query, **1267**
- SMOoth, :FUNctioN<F>:SMOoth
command, **543**
- SMOoth, :MEASure:JITTer:TREnd:SMOoth
command/query, **812**
- SMOoth,
:MEASure:JITTer:TREnd:SMOoth:POINts
command/query, **813**
- SOFailure, :LTEST:RUMode:SOFailure
command/query, **626**
- SOFailure, :MTEST:RUMode:SOFailure
command/query, **709**
- software version, reading, **407**
- source, **1033, 1070**
- SOURce, :ANALyze:CLOCK:METHOD:SOURce
command/query, **257**
- SOURce, :DISPlay:ISIM:SOURce
command, **472**
- SOURce, :DISPlay:PRECProbe:SOURce
command, **487**
- SOURce, :HISTogram:WINDow:SOURce
command/query, **566**
- SOURce, :ISCan:NONMonotonic:SOURce
command/query, **606**
- SOURce, :ISCan:RUNT:SOURce
command/query, **609**
- SOURce, :ISCan:SERial:SOURce
command/query, **612**
- SOURce, :ISCan:ZONE:SOURce
command/query, **614**
- SOURce, :ISCan:ZONE<Z>:SOURce
command/query, **617**
- SOURce, :MEASure:CLOCK:METHOD:SOURce
command/query, **1529**
- SOURce, :MEASure:QUALifier<M>:SOURce
command/query, **864**
- SOURce, :MEASure:RJDJ:SOURce
command/query, **887**
- SOURce, :MEASure:SOURce
command/query, **899**
- SOURce, :MEASurement<N>:SOURce
command/query, **977**
- SOURce, :MTEST:AMASK:SOURce
command/query, **659**
- SOURce, :MTEST:SOURce
command/query, **715**
- SOURce, :MTEST:TRIGger:SOURce
command/query, **720**
- SOURce, :SBUS<N>:CAN:SOURce
command/query, **1033**
- SOURce, :SBUS<N>:FLEXray:SOURce
command/query, **1046**
- SOURce, :SBUS<N>:IIC:SOURce:CLOCK
command/query, **1060**
- SOURce, :SBUS<N>:IIC:SOURce:DATA
command/query, **1061**
- SOURce, :SBUS<N>:LIN:SOURce
command/query, **1070**
- SOURce, :SBUS<N>:SPI:SOURce:CLOCK
command/query, **1081**
- SOURce, :SBUS<N>:SPI:SOURce:DATA
command/query, **1083**
- SOURce, :SBUS<N>:SPI:SOURce:FRAME
command/query, **1085**
- SOURce, :SBUS<N>:SPI:SOURce:MISO
command/query, **1086**
- SOURce, :SBUS<N>:SPI:SOURce:MOSI
command/query, **1087**
- SOURce,
:SPROcessing:CTLequalizer:SOURce
command/query, **1111**
- SOURce,
:SPROcessing:DFFequalizer:SOURce
command/query, **1118**
- SOURce, :SPROcessing:FFEqualizer:SOURce
command/query, **1135**
- SOURce,
:TRIGger:ADVanced:COMM:SOURce
command/query, **1299**
- SOURce,
:TRIGger:ADVanced:DElay:EDLY:ARM:S
OURce command/query, **1314**
- SOURce,
:TRIGger:ADVanced:DElay:EDLY:EVENT:
SOURce command/query, **1317**
- SOURce,
:TRIGger:ADVanced:DElay:EDLY:TRIGge
r:SOURce command/query, **1319**
- SOURce,
:TRIGger:ADVanced:DElay:TDLy:ARM:S
OURce command/query, **1323**
- SOURce,
:TRIGger:ADVanced:DElay:TDLy:TRIGge
r:SOURce command/query, **1326**

- SOURCE, :TRIGGER:ADVANCED:TV:STV:SOURCE command/query, [1332](#)
- SOURCE, :TRIGGER:ADVANCED:TV:UDTV:SOURCE command/query, [1339](#)
- SOURCE, :TRIGGER:ADVANCED:VIOLATION:PWIDTH:SOURCE command/query, [1346](#)
- SOURCE, :TRIGGER:ADVANCED:VIOLATION:TRANSITION:SOURCE command/query, [1376](#)
- SOURCE, :TRIGGER:ADVANCED:VIOLATION:TRANSITION:SOURCE:HTHRESHOLD command/query, [1377](#)
- SOURCE, :TRIGGER:ADVANCED:VIOLATION:TRANSITION:SOURCE:LTHRESHOLD command/query, [1378](#)
- SOURCE, :TRIGGER:AND:SOURCE command/query, [1185](#)
- SOURCE, :TRIGGER:COMM:SOURCE command/query, [1203](#)
- SOURCE, :TRIGGER:DELAY:ARM:SOURCE command/query, [1205](#)
- SOURCE, :TRIGGER:DELAY:EDELAY:SOURCE command/query, [1208](#)
- SOURCE, :TRIGGER:DELAY:TRIGGER:SOURCE command/query, [1212](#)
- SOURCE, :TRIGGER:EDGE:SOURCE command/query, [1217](#)
- SOURCE, :TRIGGER:GBSERIAL:SOURCE command/query, [1228](#)
- SOURCE, :TRIGGER:GLITCH:SOURCE command/query, [1231](#)
- SOURCE, :TRIGGER:PWIDTH:SOURCE command/query, [1239](#)
- SOURCE, :TRIGGER:RUNT:SOURCE command/query, [1245](#)
- SOURCE, :TRIGGER:TIMEOUT:SOURCE command/query, [1270](#)
- SOURCE, :TRIGGER:TRANSITION:SOURCE command/query, [1274](#)
- SOURCE, :TRIGGER:TV:SOURCE command/query, [1281](#)
- SOURCE, :TRIGGER:WINDOW:SOURCE command/query, [1290](#)
- SOURCE, :WAVEFORM:SOURCE command/query, [1425](#)
- SOURCE, :XTALK<X>:SOURCE command/query, [1493](#)
- SOURCE, and measurements, [728](#)
- SOURCE<S>, :SBUS<N>:HS:SOURCE<S> command/query, [1057](#)
- spaces and commas, [103](#)
- SPAN, :CHANNEL<N>:ISIM:SPAN command/query, [331](#)
- SPAN, :FUNCTION<F>:FFT:SPAN command/query, [511](#)
- specified random jitter, [885](#)
- specified random noise, [827](#)
- SPECTRUM, :MEASURE:JITTER:SPECTRUM command/query, [802](#)
- SPECTRUM, :MEASURE:JITTER:SPECTRUM:HORIZONTAL command/query, [803](#)
- SPECTRUM, :MEASURE:JITTER:SPECTRUM:HORIZONTAL:POSITION command/query, [804](#)
- SPECTRUM, :MEASURE:JITTER:SPECTRUM:HORIZONTAL:RANGE command/query, [805](#)
- SPECTRUM, :MEASURE:JITTER:SPECTRUM:VERTICAL command/query, [806](#)
- SPECTRUM, :MEASURE:JITTER:SPECTRUM:VERTICAL:OFFSET command/query, [807](#)
- SPECTRUM, :MEASURE:JITTER:SPECTRUM:VERTICAL:RANGE command/query, [808](#)
- SPECTRUM, :MEASURE:JITTER:SPECTRUM:VERTICAL:TYPE command/query, [809](#)
- SPECTRUM, :MEASURE:JITTER:SPECTRUM:WINDOW command/query, [810](#)
- spelling of headers, [107](#)
- SPI clock slope, [1078](#)
- SPI clock source, [1081](#)
- SPI clock timeout, [1079](#)
- SPI decode bit order, [1077](#)
- SPI decode type, [1095](#)
- SPI decode word width, [1096](#)
- SPI frame source, [1085](#)
- SPI frame state, [1080](#)
- SPI trigger commands, [1076](#)
- SPI trigger data pattern, [1089](#)
- SPI trigger pattern width, [1091](#)
- SPI trigger type, [1093](#)
- SPI, :SBUS<N>:SPI:BITORDER command/query, [1077](#)
- SPI, :SBUS<N>:SPI:CLOCK:SLOPE command/query, [1078](#)
- SPI, :SBUS<N>:SPI:CLOCK:TIMEOUT command/query, [1079](#)
- SPI, :SBUS<N>:SPI:FRAME:STATE command/query, [1080](#)
- SPI, :SBUS<N>:SPI:SOURCE:CLOCK command/query, [1081](#)
- SPI, :SBUS<N>:SPI:SOURCE:DATA command/query, [1083](#)
- SPI, :SBUS<N>:SPI:SOURCE:FRAME command/query, [1085](#)
- SPI, :SBUS<N>:SPI:SOURCE:MISO command/query, [1086](#)
- SPI, :SBUS<N>:SPI:SOURCE:MOSI command/query, [1087](#)
- SPI, :SBUS<N>:SPI:TRIGGER:PATTERN:DATA command/query, [1089](#)
- SPI, :SBUS<N>:SPI:TRIGGER:PATTERN:WIDTH command/query, [1091](#)
- SPI, :SBUS<N>:SPI:TRIGGER:TYPE command/query, [1093](#)
- SPI, :SBUS<N>:SPI:TYPE command/query, [1095](#)
- SPI, :SBUS<N>:SPI:WIDTH command/query, [1096](#)
- SPOLARITY, :TRIGGER:ADVANCED:TV:STV:SPOLARITY command/query, [1333](#)
- SQRT, :FUNCTION<F>:SQRT command, [544](#)
- Square Brackets, [101](#)
- SQUARE, :CHANNEL<N>:SIMULATION:FUNCTION:SQUARE:DCYCLE command/query, [381](#)
- SQUARE, :CHANNEL<N>:SIMULATION:FUNCTION:SQUARE:FTIME command/query, [382](#)
- SQUARE, :CHANNEL<N>:SIMULATION:FUNCTION:SQUARE:RTIME command/query, [383](#)
- SQUARE, :FUNCTION<F>:SQUARE command, [545](#)
- SRATE, :ACQUIRE:SRATE:ANALOG command/query, [231](#)
- SRATE, :ACQUIRE:SRATE:ANALOG:AUTO command/query, [232](#)
- SRATE, :ACQUIRE:SRATE:DIGITAL command/query, [233](#)
- SRATE, :ACQUIRE:SRATE:DIGITAL:AUTO command/query, [234](#)
- SRATE, :ACQUIRE:SRATE:TESTLIMITS? query, [235](#)
- SRE (Service Request Enable Register), [154](#)
- Standard Event Status Enable Register, (SESER), [158](#)
- Standard Event Status Enable Register, Bits, [404](#)
- Standard Event Status Enable Register, Default, [134](#)
- Standard Event Status Register (ESR), [157](#)
- Standard Event Status Register, bits, [406](#)
- Standard Status Data Structure Model, [148](#)
- STANDARD, :SBUS<N>:LIN:STANDARD command/query, [1071](#)
- STANDARD, :TRIGGER:TV:STANDARD command/query, [1282](#)
- standard, LIN, [1071](#)
- START, :FUNCTION<F>:GATING:START command, [520](#)
- START, :MEASURE:TIEFILTER:START command/query, [951](#)
- START, :MTEST:START command, [716](#)
- STATE, :ACQUIRE:COMPLETE:STATE command/query, [213](#)
- STATE, :CHANNEL<N>:ISIM:STATE command/query, [332](#)
- STATE, :DISPLAY:GRATICULE:AREA<N>:STATE command/query, [466](#)
- STATE, :ISCAN:ZONE<Z>:STATE command/query, [618](#)

- STATE, :MEASure:NOISe:STATE
 command/query, **829**
 STATE, :MEASure:QUALifier<M>:STATE
 command/query, **865**
 STATE, :MEASure:RJDJ:STATE
 command/query, **888**
 STATE, :MEASure:TIEFilter:STATE
 command/query, **952**
 STATE, :MTESt:MARGIn:STATE
 command/query, **705**
 STATE, :SBUS<N>:SPI:FRAMe:STATE
 command/query, **1080**
 STATE, :SPROcessing:DFEQualizer:STATE
 command/query, **1119**
 STATE, :TRIGger:ADVanced:STATE:CLOCK
 command/query, **1307**
 STATE, :TRIGger:ADVanced:STATE:LOGic
 command/query, **1308**
 STATE, :TRIGger:ADVanced:STATE:LTYPe
 command/query, **1309**
 STATE, :TRIGger:ADVanced:STATE:SLOPe
 command/query, **1310**
 STATE,
 :TRIGger:ADVanced:STATE:THReshold:L
 Evel command/query, **1311**
 STATE, :TRIGger:STATE:CLOCK
 command/query, **1264**
 STATE, :TRIGger:STATE:LOGic
 command/query, **1265**
 STATE, :TRIGger:STATE:LTYPe
 command/query, **1266**
 STATE, :TRIGger:STATE:SLOPe
 command/query, **1267**
 state, acquisition, **989**
 state, run, **1011**
 STATistics, :MEASure:JITTer:STATistics
 command/query, **1535**
 STATistics, :MEASure:STATistics
 command/query, **900**
 status, **127**
 Status Byte (*STB?) query, **420**
 Status Byte Register, **152**
 Status Byte Register, and serial
 polling, **153**
 Status Byte Register, bits, **420**
 Status Registers, **127, 402**
 Status Reporting, **147**
 Status Reporting Decision Chart, **171**
 Status Reporting, Bit Definitions, **148**
 Status Reporting, Data Structures, **150**
 STATus, :CALibrate:STATus? query, **296**
 STATus, :DISPlay:STATus:COL command
 query, **490**
 STATus, :DISPlay:STATus:ROW command
 query, **491**
 STATus,
 :HOSTed:CALibrate:STATus:CHANnels?
 query, **582**
 STATus,
 :HOSTed:CALibrate:STATus:FRAMes?
 query, **583**
 STATus, :HOSTed:CALibrate:STATus:LEVel?
 query, **584**
 STATus,
 :HOSTed:CALibrate:STATus:SIGNals?
 query, **585**
 status, of an operation, **147**
 STDDDev, :MEASure:HISTogram:STDDDev
 command/query, **797**
 STIME, :MTESt:STIME
 command/query, **718**
 STOP, :FUNCTion<F>:FFT:STOP
 command/query, **512**
 STOP, :FUNCTion<F>:GATing:STOP
 command, **521**
 STOP, :MEASure:TIEFilter:STOP
 command/query, **953**
 STOP, :MTESt:STOP command, **717**
 STReaming, :WAVEform:STReaming
 command/query, **1427**
 string variables, **123**
 string variables, example, **123**
 STRing, :DISPlay:STRing command, **1510**
 string, quoted, **1508**
 strings, alphanumeric, **108**
 STV commands, **1328**
 STV, :TRIGger:ADVanced:TV:STV:FIELD
 command/query, **1330**
 STV, :TRIGger:ADVanced:TV:STV:LINE
 command/query, **1331**
 STV, :TRIGger:ADVanced:TV:STV:SOURce
 command/query, **1332**
 STV, :TRIGger:ADVanced:TV:STV:SPOlarity
 command/query, **1333**
 STYPe, :CHANnel<N>:PROBe:STYPe
 command/query, **364**
 STYPe, :XTALK<X>:STYPe
 command/query, **1494**
 SUBTRact, :FUNCTion<F>:SUBTRact
 command, **546**
 suffix multipliers, **109, 145**
 suffix units, **146**
 SUI, :MTESt:COUnT:SUI? query, **672**
 summary bits, **152**
 SWEEp, :TRIGger:SWEEp
 command/query, **1197**
 SYMBolrate, :ANALyze:SIGNal:SYMBolrate
 command/query, **263**
 synchronization, acquisition, **182**
 syntax error, **1544**
 System Commands, **1147**
 System Computer, Returning control
 to, **141**
 SYSTem:SETup and *LRN, **409**
T
 TAB, :DISPlay:TAB command/query, **1511**
 Talker, Code and Capability, **135**
 Talker, Unaddressing, **141**
 TAP, :SPROcessing:DFEQualizer:TAP
 command/query, **1120**
 TAP,
 :SPROcessing:DFEQualizer:TAP:AUToma
 tic command, **1121**
 TAP, :SPROcessing:DFEQualizer:TAP:DELay
 command/query, **1122**
 TAP, :SPROcessing:DFEQualizer:TAP:GAIN
 command/query, **1123**
 TAP, :SPROcessing:DFEQualizer:TAP:LTARget
 command/query, **1124**
 TAP, :SPROcessing:DFEQualizer:TAP:MAX
 command/query, **1125**
 TAP, :SPROcessing:DFEQualizer:TAP:MIN
 command/query, **1126**
 TAP,
 :SPROcessing:DFEQualizer:TAP:UTARget
 command/query, **1127**
 TAP, :SPROcessing:DFEQualizer:TAP:WIDTh
 command/query, **1128**
 TAP, :SPROcessing:FFEQualizer:TAP
 command/query, **1136**
 TAP,
 :SPROcessing:FFEQualizer:TAP:AUTomat
 ic command, **1137**
 TAP, :SPROcessing:FFEQualizer:TAP:DELay
 command/query, **1138**
 TAP, :SPROcessing:FFEQualizer:TAP:PLENght
 command/query, **1139**
 TAP, :SPROcessing:FFEQualizer:TAP:WIDTh
 command/query, **1140**
 TDELay, :FUNCTion<F>:FFT:TDELay
 command/query, **513**
 TDELay, :SPROcessing:FFEQualizer:TDELay
 command/query, **1141**
 TDELay, :TRIGger:DELay:TDELay:TIME
 command/query, **1211**
 TDLY,
 :TRIGger:ADVanced:DELay:TDLY:ARM:SL
 OPe command/query, **1324**
 TDLY,
 :TRIGger:ADVanced:DELay:TDLY:ARM:S
 OURce command/query, **1323**
 TDLY, :TRIGger:ADVanced:DELay:TDLY:DELay
 command/query, **1325**
 TDLY,
 :TRIGger:ADVanced:DELay:TDLY:TRIGge
 r:SLOPe command/query, **1327**
 TDLY,
 :TRIGger:ADVanced:DELay:TDLY:TRIGge
 r:SOURce command/query, **1326**
 TDMode, :SPROcessing:FFEQualizer:TDMode
 command/query, **1142**
 TEDGe, :MEASure:TEDGe
 command/query, **901**
 TEMP, :CALibrate:TEMP? query, **297**
 temperature and calibration, **287**
 temperature color grade scheme, **461**
 TERM1, :TRIGger:SEquence:TERM1
 command/query, **1248**
 TERM2, :TRIGger:SEquence:TERM2
 command/query, **1249**
 termination of message during
 hardcopy, **145**

- termination voltage for N5444A probe head, [352](#)
- termination voltage for N7010A active termination adapter, [352](#)
- Terminator, [111](#)
- Test (*TST?) query, [423](#)
- TEST, :LTEST:TEST command/query, [627](#)
- TESTLIMITS,
 - :ACQUIRE:BANDWIDTH:TESTLIMITS? query, [210](#)
- TESTLIMITS, :ACQUIRE:POINTS:TESTLIMITS? query, [222](#)
- TESTLIMITS, :ACQUIRE:SRATE:TESTLIMITS? query, [235](#)
- TEXT, :DISPLAY:TEXT command, [1512](#)
- THReshold, :DIGITAL<N>:THReshold command/query, [429](#)
- THReshold, :DISPLAY:JITTER:THReshold command, [476](#)
- THReshold, :MEASURE:FFT:THReshold command/query, [781](#)
- THReshold, :POD<N>:THReshold command/query, [982](#)
- THReshold,
 - :TRIGGER:ADVANCED:PATTERN:THReshold :LEVEL command/query, [1304](#)
- THReshold,
 - :TRIGGER:ADVANCED:PATTERN:THReshold :POD<N> command/query, [1305](#)
- THReshold,
 - :TRIGGER:ADVANCED:STATE:THReshold:LEVEL command/query, [1311](#)
- THResholds,
 - :MEASURE:THResholds:ABSOLUTE command/query, [902](#)
- THResholds, :MEASURE:THResholds:DISPLAY command/query, [903](#)
- THResholds,
 - :MEASURE:THResholds:GENAUTO command, [904](#)
- THResholds,
 - :MEASURE:THResholds:GENERAL:ABSOLUTE command/query, [905](#)
- THResholds,
 - :MEASURE:THResholds:GENERAL:HYS TERESIS command/query, [907](#)
- THResholds,
 - :MEASURE:THResholds:GENERAL:METHOD command/query, [909](#)
- THResholds,
 - :MEASURE:THResholds:GENERAL:PAMAUTOMATIC command/query, [913](#)
- THResholds,
 - :MEASURE:THResholds:GENERAL:PAMCUSTOM command/query, [911](#)
- THResholds,
 - :MEASURE:THResholds:GENERAL:PERCENT command/query, [915](#)
- THResholds,
 - :MEASURE:THResholds:GENERAL:TOPBASE:ABSOLUTE command/query, [917](#)
- THResholds,
 - :MEASURE:THResholds:GENERAL:TOPBASE:METHOD command/query, [919](#)
- THResholds,
 - :MEASURE:THResholds:HYS TERESIS command/query, [920](#)
- THResholds,
 - :MEASURE:THResholds:METHOD command/query, [922](#)
- THResholds,
 - :MEASURE:THResholds:PERCENT command/query, [923](#)
- THResholds,
 - :MEASURE:THResholds:RFALL:ABSOLUTE command/query, [924](#)
- THResholds,
 - :MEASURE:THResholds:RFALL:METHOD command/query, [926](#)
- THResholds,
 - :MEASURE:THResholds:RFALL:PAMAUTOMATIC command/query, [928](#)
- THResholds,
 - :MEASURE:THResholds:RFALL:PERCENT command/query, [930](#)
- THResholds,
 - :MEASURE:THResholds:RFALL:TOPBASE:ABSOLUTE command/query, [932](#)
- THResholds,
 - :MEASURE:THResholds:RFALL:TOPBASE:METHOD command/query, [934](#)
- THResholds,
 - :MEASURE:THResholds:SERIAL:ABSOLUTE command/query, [935](#)
- THResholds,
 - :MEASURE:THResholds:SERIAL:HYS TERESIS command/query, [937](#)
- THResholds,
 - :MEASURE:THResholds:SERIAL:METHOD command/query, [939](#)
- THResholds,
 - :MEASURE:THResholds:SERIAL:PERCENT command/query, [940](#)
- THResholds,
 - :MEASURE:THResholds:SERIAL:TOPBASE:ABSOLUTE command/query, [942](#)
- THResholds,
 - :MEASURE:THResholds:SERIAL:TOPBASE:METHOD command/query, [944](#)
- THResholds,
 - :MEASURE:THResholds:TOPBASE:ABSOLUTE command/query, [945](#)
- THResholds,
 - :MEASURE:THResholds:TOPBASE:METHOD command/query, [946](#)
- TIEClock2, :MEASURE:TIEClock2 command/query, [947](#)
- TIEData, :MEASURE:TIEData command/query, [1536](#)
- TIEData, :MEASURE:TIEData2 command/query, [949](#)
- TIEFilter, :MEASURE:TIEFilter:SHAPE command/query, [950](#)
- TIEFilter, :MEASURE:TIEFilter:START command/query, [951](#)
- TIEFilter, :MEASURE:TIEFilter:STATE command/query, [952](#)
- TIEFilter, :MEASURE:TIEFilter:STOP command/query, [953](#)
- TIEFilter, :MEASURE:TIEFilter:TYPE command/query, [954](#)
- TIETimebase, :WMEMORY:TIETimebase command/query, [1446](#)
- time and date, setting, [1147](#)
- Time Base Commands, [1167](#)
- time buckets, and POINTS?, [1416](#)
- time of level, PAM measurement definition, [845](#)
- time scale, operands and functions, [495](#)
- TIME, :MEASURE:PAM:EYE:TIME:LTDEFINITION command/query, [845](#)
- TIME, :SYSTEM:TIME command/query, [1165](#)
- TIME,
 - :TRIGGER:ADVANCED:VIOLATION:SETUP:HOLD:TIME command/query, [1365](#)
- TIME,
 - :TRIGGER:ADVANCED:VIOLATION:SETUP:SETUP:TIME command/query, [1358](#)
- TIME, :TRIGGER:DELAY:TDELAY:TIME command/query, [1211](#)
- TIME, :TRIGGER:RUN:TIME command/query, [1246](#)
- TIME, :TRIGGER:SEQUENCE:RESET:TIME command/query, [1253](#)
- TIME, :TRIGGER:SEQUENCE:WAIT:TIME command/query, [1255](#)
- TIME, :TRIGGER:TIMEOUT:TIME command/query, [1271](#)
- TIME, :TRIGGER:TRANSITION:TIME command/query, [1275](#)
- TIME, :TRIGGER:WINDOW:TIME command/query, [1291](#)
- TIMEout, :SBUS<N>:SPI:CLOCK:TIMEout command/query, [1079](#)
- TIMEout, :TRIGGER:TIMEout:CONDITION command/query, [1269](#)
- TIMEout, :TRIGGER:TIMEout:SOURCE command/query, [1270](#)
- TIMEout, :TRIGGER:TIMEout:TIME command/query, [1271](#)
- timeout, SPI clock, [1079](#)
- TITLE?, :MTEST:TITLE? query, [719](#)
- TJRJDJ?, :MEASURE:RJDJ:TJRJDJ? query, [889](#)
- TLIMIT, :HISTOGRAM:WINDOW:TLIMIT command/query, [570](#)
- TMAX, :MEASURE:TMAX command/query, [955](#)
- TMIN, :MEASURE:TMIN command/query, [956](#)
- TOPBase,
 - :MEASURE:THResholds:GENERAL:TOPBASE:ABSOLUTE command/query, [917](#)

- TOPBase, :MEASure:THResholds:GENeral:TOPBase:METhod command/query, [919](#)
- TOPBase, :MEASure:THResholds:RFALL:TOPBase:ABSolute command/query, [932](#)
- TOPBase, :MEASure:THResholds:RFALL:TOPBase:METhod command/query, [934](#)
- TOPBase, :MEASure:THResholds:SERial:TOPBase:ABSolute command/query, [942](#)
- TOPBase, :MEASure:THResholds:SERial:TOPBase:METhod command/query, [944](#)
- TOPBase, :MEASure:THResholds:TOPBase:ABSolute command/query, [945](#)
- TOPBase, :MEASure:THResholds:TOPBase:METhod command/query, [946](#)
- TPOint, :TRIGger:PWIDth:TPOint command/query, [1240](#)
- TPOint, :TRIGger:WINDow:TPOint command/query, [1292](#)
- TPOsition, :MTESt:FOLDing:TPOsition command/query, [691](#)
- transferring waveform data, [1382](#)
- transition violation mode, [1374](#)
- TRANSition, :TRIGger:ADVanced:VIOLation:TRANSition command/query, [1375](#)
- TRANSition, :TRIGger:ADVanced:VIOLation:TRANSition:SOURce command/query, [1376](#)
- TRANSition, :TRIGger:ADVanced:VIOLation:TRANSition:SOURce:HTHReshold command/query, [1377](#)
- TRANSition, :TRIGger:ADVanced:VIOLation:TRANSition:SOURce:LTHReshold command/query, [1378](#)
- TRANSition, :TRIGger:ADVanced:VIOLation:TRANSition:TYPE command/query, [1379](#)
- TRANSition, :TRIGger:TRANSition:DIRection command/query, [1273](#)
- TRANSition, :TRIGger:TRANSition:SOURce command/query, [1274](#)
- TRANSition, :TRIGger:TRANSition:TIME command/query, [1275](#)
- TRANSition, :TRIGger:TRANSition:TYPE command/query, [1276](#)
- transmission mode, and FORMat, [1413](#)
- traversal rules, [197](#)
- Tree Traversal, Examples, [198](#)
- Tree Traversal, Rules, [197](#)
- TREF, :HOSTed:CALibrate:TREF:DETECT command, [586](#)
- TREND, :MEASure:JITTer:TREND command/query, [811](#)
- TREND, :MEASure:JITTer:TREND:SMOoth command/query, [812](#)
- TREND, :MEASure:JITTer:TREND:SMOoth:POINts command/query, [813](#)
- TREND, :MEASure:JITTer:TREND:VERTical command/query, [814](#)
- TREND, :MEASure:JITTer:TREND:VERTical:OFFSet command/query, [815](#)
- TREND, :MEASure:JITTer:TREND:VERTical:RANGe command/query, [816](#)
- TRG, bit, [419](#), [421](#)
- TRG, bit in the status byte, [156](#)
- TRG, Event Enable Register, [149](#)
- Trigger (*TRG) command, [422](#)
- trigger armed status, checking for, [172](#)
- Trigger Commands, [1181](#)
- Trigger Event Register (TRG), [156](#)
- TRIGGER IIC commands, [1058](#)
- trigger level, default setup, [1161](#)
- trigger mode, [1182](#)
- trigger mode, ADVanced, [1182](#)
- trigger mode, advanced delay, [1312](#), [1321](#)
- trigger mode, advanced TV, [1328](#), [1334](#)
- trigger mode, COMM, [1293](#)
- trigger mode, default setup, [1161](#)
- trigger mode, delay, [1312](#), [1321](#)
- trigger mode, NTSC TV, [1328](#)
- trigger mode, PAL-M TV, [1328](#)
- trigger mode, pattern, [1300](#)
- trigger mode, state, [1306](#)
- trigger mode, User Defined TV, [1334](#)
- trigger mode, violation types, [1340](#)
- trigger modes, summary, [1182](#)
- trigger other instruments, [290](#)
- TRIGGER SPI commands, [1076](#)
- trigger sweep, default setup, [1161](#)
- trigger type, SPI, [1093](#)
- TRIGGER, :MTESt:TRIGger:SOURce command/query, [720](#)
- TRIGGER, :SBUS<N>:CAN:TRIGger command/query, [1034](#)
- TRIGGER, :SBUS<N>:CAN:TRIGger:PATtern:DATA command/query, [1037](#)
- TRIGGER, :SBUS<N>:CAN:TRIGger:PATtern:DATA:LENGth command/query, [1038](#)
- TRIGGER, :SBUS<N>:CAN:TRIGger:PATtern:ID command/query, [1040](#)
- TRIGGER, :SBUS<N>:CAN:TRIGger:PATtern:ID:MODE command/query, [1041](#)
- TRIGGER, :SBUS<N>:FLEXray:TRIGger command/query, [1047](#)
- TRIGGER, :SBUS<N>:FLEXray:TRIGger:ERRor:TYPE command/query, [1048](#)
- TRIGGER, :SBUS<N>:FLEXray:TRIGger:FRAME:CCBase command/query, [1049](#)
- TRIGGER, :SBUS<N>:FLEXray:TRIGger:FRAME:CCRepetition command/query, [1050](#)
- TRIGGER, :SBUS<N>:FLEXray:TRIGger:FRAME:ID command/query, [1051](#)
- TRIGGER, :SBUS<N>:FLEXray:TRIGger:FRAME:TYPE command/query, [1052](#)
- TRIGGER, :SBUS<N>:IIC:TRIGger:PATtern:ADDRess command/query, [1062](#), [1064](#)
- TRIGGER, :SBUS<N>:IIC:TRIGger:TYPE command, [1065](#)
- TRIGGER, :SBUS<N>:LIN:TRIGger command/query, [1072](#)
- TRIGGER, :SBUS<N>:LIN:TRIGger:ID command/query, [1073](#)
- TRIGGER, :SBUS<N>:LIN:TRIGger:PATtern:DATA command/query, [1074](#)
- TRIGGER, :SBUS<N>:LIN:TRIGger:PATtern:DATA:LENGth command/query, [1075](#)
- TRIGGER, :SBUS<N>:SPI:TRIGger:PATtern:DATA command/query, [1089](#)
- TRIGGER, :SBUS<N>:SPI:TRIGger:PATtern:WIDTH command/query, [1091](#)
- TRIGGER, :SBUS<N>:SPI:TRIGger:TYPE command/query, [1093](#)
- TRIGGER, :TRIGger:ADVanced:DElay:EDLY:TRIGger:SLOPe command/query, [1320](#)
- TRIGGER, :TRIGger:ADVanced:DElay:EDLY:TRIGger:SOURce command/query, [1319](#)
- TRIGGER, :TRIGger:ADVanced:DElay:TDLy:TRIGger:SLOPe command/query, [1327](#)
- TRIGGER, :TRIGger:ADVanced:DElay:TDLy:TRIGger:SOURce command/query, [1326](#)
- TRIGGER, :TRIGger:DElay:TRIGger:SLOPe command/query, [1213](#)
- TRIGGER, :TRIGger:DElay:TRIGger:SOURce command/query, [1212](#)
- Trigger, *TRG status bit, [149](#)
- trigger, CAN, [1034](#)
- trigger, CAN pattern data length, [1038](#)
- trigger, CAN pattern ID mode, [1041](#)
- trigger, CAN sample point, [1029](#)
- trigger, CAN signal baudrate, [1030](#)
- trigger, CAN signal definition, [1031](#)
- trigger, CAN source, [1033](#)
- trigger, IIC signal baudrate, [1069](#)
- trigger, LIN sample point, [1068](#)
- trigger, LIN source, [1070](#)

- triggering, for User Defined TV mode, 1335
- truncating numbers, 109
- Truncation Rule, 196
- TSCale, :MTESt:FOLDing:TSCale
 - command/query, 693
- TSTArT, :MARKEr:TSTArT
 - command/query, 638
- TSTOp, :MARKEr:TSTOp
 - command/query, 639
- TTAG?, :WAVeform:SEGMEnted:TTAG?
 - query, 1423
- TTAGs, :ACQuire:SEGMEnted:TTAGs
 - command/query, 230
- TV, :TRIGger:ADVanced:TV:STV:FIELD
 - command/query, 1330
- TV, :TRIGger:ADVanced:TV:STV:LINE
 - command/query, 1331
- TV, :TRIGger:ADVanced:TV:STV:SOURce
 - command/query, 1332
- TV, :TRIGger:ADVanced:TV:STV:SPOlarity
 - command/query, 1333
- TV, :TRIGger:ADVanced:TV:UDTV:ENUMber
 - command/query, 1336
- TV, :TRIGger:ADVanced:TV:UDTV:PGTHan
 - command/query, 1337
- TV, :TRIGger:ADVanced:TV:UDTV:POLarity
 - command/query, 1338
- TV, :TRIGger:ADVanced:TV:UDTV:SOURce
 - command/query, 1339
- TV, :TRIGger:TV:LINE
 - command/query, 1278
- TV, :TRIGger:TV:MODE
 - command/query, 1279
- TV, :TRIGger:TV:POLarity
 - command/query, 1280
- TV, :TRIGger:TV:SOURce
 - command/query, 1281
- TV, :TRIGger:TV:STANdard
 - command/query, 1282
- TV, :TRIGger:TV:UDTV:ENUMber
 - command/query, 1283
- TV, :TRIGger:TV:UDTV:HSYNc
 - command/query, 1284
- TV, :TRIGger:TV:UDTV:HTIME
 - command/query, 1285
- TV, :TRIGger:TV:UDTV:PGTHan
 - command/query, 1286
- TV, :TRIGger:TV:UDTV:POLarity
 - command/query, 1287
- TVOLT, :MEASure:TVOLT
 - command/query, 957
- TYPE, :ANALyze:SIGNal:TYPE
 - command/query, 271
- TYPE, :BUS:B<N>:TYPE
 - command/query, 276
- TYPE, :CHANnel<N>:ISIM:BWLimit:TYPE
 - command/query, 322
- TYPE, :FUNctioN<F>:FFT:DETEctor:TYPE
 - command/query, 507
- TYPE,
 - :MEASure:JITTer:SPECTrum:VERTical:TYPE
 - command/query, 809
 - :MEASure:TIEFilter:TYPE
 - command/query, 954
 - :SBUS<N>:CAN:TYPE
 - command/query, 1042
 - :SBUS<N>:FLEXray:TRIGger:ERRor:TYPE
 - command/query, 1048
 - :SBUS<N>:FLEXray:TRIGger:FRAME:TYPE
 - command/query, 1052
 - :SBUS<N>:IIC:TRIGger:TYPE
 - command, 1065
 - :SBUS<N>:SPI:TRIGger:TYPE
 - command/query, 1093
 - :SBUS<N>:SPI:TYPE
 - command/query, 1095
 - :TRIGger:ADVanced:VIOLation:TRANSitioN:TYPE
 - command/query, 1379
 - :TRIGger:SEQUence:RESEt:TYPE
 - command/query, 1251
 - :TRIGger:TRANSitioN:TYPE
 - command/query, 1276
 - :WAVeform:TYPE? query, 1428

U

- UDTV commands, 1334
- UDTV,
 - :TRIGger:ADVanced:TV:UDTV:ENUMber
 - command/query, 1336
 - :TRIGger:ADVanced:TV:UDTV:PGTHan
 - command/query, 1337
 - :TRIGger:ADVanced:TV:UDTV:POLarity
 - command/query, 1338
 - :TRIGger:ADVanced:TV:UDTV:SOURce
 - command/query, 1339
 - :TRIGger:TV:UDTV:ENUMber
 - command/query, 1283
 - :TRIGger:TV:UDTV:HSYNc
 - command/query, 1284
 - :TRIGger:TV:UDTV:HTIME
 - command/query, 1285
 - :TRIGger:TV:UDTV:PGTHan
 - command/query, 1286
 - :TRIGger:TV:UDTV:POLarity
 - command/query, 1287
- UI, :MTESt:FOLDing:COUNt:UI query, 681
- UI?, :MTESt:COUNt:UI? query, 673
- UITouijitter, :MEASure:UITouijitter
 - command/query, 958
- ULEVel, :ISCan:RUNT:ULEVel
 - command/query, 610
- ULIMit, :ISCan:MEASurement:ULIMit
 - command/query, 602
- ULIMit, :LTEST:ULIMit
 - command/query, 628
- Unaddressing all listeners, 141
- UNITinterval, :MEASure:UNITinterval
 - command/query, 959
- UNITs, :CHANnel<N>:PROBE:EXTERNAL:UNITs
 - command/query, 347

V

- VAMPLitude, :MEASure:VAMPLitude
 - command/query, 960
- VAVerage, :MEASure:VAVerage
 - command/query, 961
- VBA, 115, 1554
- VBASe, :MEASure:VBASe
 - command/query, 962
- version of software, reading, 407
- VERSus, :FUNctioN<F>:VERSus
 - command, 547
- vertical axis, full-scale, 365
- vertical scaling, functions, 494
- vertical units, 347, 400
- VERTical, :ANALyze:CLOCK:VERTical
 - command/query, 258
- VERTical, :ANALyze:CLOCK:VERTical:OFFSet
 - command/query, 259
- VERTical, :ANALyze:CLOCK:VERTical:RANGe
 - command/query, 260
- VERTical, :AUToscale:VERTical
 - command, 994
- VERTical, :DISPlay:BOOKmark<N>:VERTical?
 - query, 454
- VERTical, :FUNctioN<F>:VERTical
 - command/query, 548
- VERTical, :FUNctioN<F>:VERTical:OFFSet
 - command/query, 549
- VERTical, :FUNctioN<F>:VERTical:RANGe
 - command/query, 550
- VERTical, :HISTogram:VERTical:BINs
 - command/query, 564
- VERTical, :MEASure:CLOCK:VERTical
 - command/query, 1530

- VERTical, :MEASure:CLOCK:VERTical:OFFSet command/query, [1531](#)
- VERTical, :MEASure:CLOCK:VERTical:RANGe command/query, [1532](#)
- VERTical, :MEASure:JITTer:SPECTrum:VERTical command/query, [806](#)
- VERTical, :MEASure:JITTer:SPECTrum:VERTical:OFFSet command/query, [807](#)
- VERTical, :MEASure:JITTer:SPECTrum:VERTical:RANGe command/query, [808](#)
- VERTical, :MEASure:JITTer:SPECTrum:VERTical:TYPE command/query, [809](#)
- VERTical, :MEASure:JITTer:TREnd:VERTical command/query, [814](#)
- VERTical, :MEASure:JITTer:TREnd:VERTical:OFFSet command/query, [815](#)
- VERTical, :MEASure:JITTer:TREnd:VERTical:RANGe command/query, [816](#)
- VERTical, :SPROcessing:CTLequalizer:VERTical command/query, [1112](#)
- VERTical, :SPROcessing:CTLequalizer:VERTical:OFFSet command/query, [1113](#)
- VERTical, :SPROcessing:CTLequalizer:VERTical:RANGe command/query, [1114](#)
- VERTical, :SPROcessing:FFEQualizer:VERTical command/query, [1143](#)
- VERTical, :SPROcessing:FFEQualizer:VERTical:OFFSet command/query, [1144](#)
- VERTical, :SPROcessing:FFEQualizer:VERTical:RANGe command/query, [1145](#)
- vertical, axis control, [301](#)
- vertical, axis offset, and YRANGe, [1456](#)
- vertical, scaling, and YRANGe, [1457](#)
- VIEW and BLANK, [996](#)
- VIEW, :ANALyze:VIEW command/query, [273](#)
- VIEW, :TIMEbase:VIEW command/query, [1175](#)
- VIEW, :WAVEform:VIEW command/query, [1429](#)
- violation modes for trigger, [1340](#)
- VIOLation, :TRIGger:ADVanced:VIOLation:MODE command/query, [1341](#)
- VIOLation, :TRIGger:ADVanced:VIOLation:PWIDth:DIRectioN command/query, [1344](#)
- VIOLation, :TRIGger:ADVanced:VIOLation:PWIDth:POLarity command/query, [1345](#)
- VIOLation, :TRIGger:ADVanced:VIOLation:PWIDth:SOURCE command/query, [1346](#)
- VIOLation, :TRIGger:ADVanced:VIOLation:PWIDth:WIDTH command/query, [1347](#)
- VIOLation, :TRIGger:ADVanced:VIOLation:SETup:HOLD:CSOURCE command/query, [1359](#)
- VIOLation, :TRIGger:ADVanced:VIOLation:SETup:HOLD:CSOURCE:EDGE command/query, [1361](#)
- VIOLation, :TRIGger:ADVanced:VIOLation:SETup:HOLD:CSOURCE:LEVEL command/query, [1360](#)
- VIOLation, :TRIGger:ADVanced:VIOLation:SETup:HOLD:DSOURCE command/query, [1362](#)
- VIOLation, :TRIGger:ADVanced:VIOLation:SETup:HOLD:DSOURCE:HTHReshold command/query, [1363](#)
- VIOLation, :TRIGger:ADVanced:VIOLation:SETup:HOLD:DSOURCE:LTHReshold command/query, [1364](#)
- VIOLation, :TRIGger:ADVanced:VIOLation:SETup:HOLD:TIME command/query, [1365](#)
- VIOLation, :TRIGger:ADVanced:VIOLation:SETup:MODE command/query, [1351](#)
- VIOLation, :TRIGger:ADVanced:VIOLation:SETup:SETup:CSOURCE command/query, [1352](#)
- VIOLation, :TRIGger:ADVanced:VIOLation:SETup:SETup:CSOURCE:EDGE command/query, [1354](#)
- VIOLation, :TRIGger:ADVanced:VIOLation:SETup:SETup:CSOURCE:LEVEL command/query, [1353](#)
- VIOLation, :TRIGger:ADVanced:VIOLation:SETup:SETup:DSOURCE command/query, [1355](#)
- VIOLation, :TRIGger:ADVanced:VIOLation:SETup:SETup:DSOURCE:HTHReshold command/query, [1356](#)
- VIOLation, :TRIGger:ADVanced:VIOLation:SETup:SETup:DSOURCE:LTHReshold command/query, [1357](#)
- VIOLation, :TRIGger:ADVanced:VIOLation:SETup:SETup:TIME command/query, [1358](#)
- VIOLation, :TRIGger:ADVanced:VIOLation:SETup:SHOLD:CSOURCE command/query, [1366](#)
- VIOLation, :TRIGger:ADVanced:VIOLation:SETup:SHOLD:CSOURCE:EDGE command/query, [1368](#)
- VIOLation, :TRIGger:ADVanced:VIOLation:SETup:SHOLD:CSOURCE:LEVEL command/query, [1367](#)
- VIOLation, :TRIGger:ADVanced:VIOLation:SETup:SHOLD:DSOURCE command/query, [1369](#)
- VIOLation, :TRIGger:ADVanced:VIOLation:SETup:SHOLD:DSOURCE:HTHReshold command/query, [1370](#)
- VIOLation, :TRIGger:ADVanced:VIOLation:SETup:SHOLD:DSOURCE:LTHReshold command/query, [1371](#)
- VIOLation, :TRIGger:ADVanced:VIOLation:SETup:SHOLD:HoldTIME (HTIME) command/query, [1373](#)
- VIOLation, :TRIGger:ADVanced:VIOLation:SETup:SHOLD:SetupTIME (STIME) command/query, [1372](#)
- VIOLation, :TRIGger:ADVanced:VIOLation:TRANSitioN command/query, [1375](#)
- VIOLation, :TRIGger:ADVanced:VIOLation:TRANSitioN:SOURCE command/query, [1376](#)
- VIOLation, :TRIGger:ADVanced:VIOLation:TRANSitioN:SOURCE:HTHReshold command/query, [1377](#)
- VIOLation, :TRIGger:ADVanced:VIOLation:TRANSitioN:SOURCE:LTHReshold command/query, [1378](#)
- VIOLation, :TRIGger:ADVanced:VIOLation:TRANSitioN:TYPE command/query, [1379](#)
- VISA COM example in C#, [1565](#)
- VISA COM example in Python, [1584](#)
- VISA COM example in Visual Basic, [1554](#)
- VISA COM example in Visual Basic .NET, [1575](#)
- VISA example in C, [1592](#)
- VISA example in C#, [1611](#)
- VISA example in Python, [1635](#), [1641](#)
- VISA example in Visual Basic, [1601](#)
- VISA example in Visual Basic .NET, [1623](#)
- VISA examples, [1554](#), [1592](#)
- Visual Basic .NET, SCPI.NET example, [1675](#)
- Visual Basic .NET, VISA COM example, [1575](#)
- Visual Basic .NET, VISA example, [1623](#)
- Visual Basic 6.0, [115](#)
- Visual Basic for Applications, [115](#), [1554](#)
- Visual Basic for Applications (VBA), [94](#)

- Visual Basic, SICL library example, [1658](#)
 - Visual Basic, VISA COM example, [1554](#)
 - Visual Basic, VISA example, [1601](#)
 - VLOWer, :MEASure:VLOWer
command/query, [963](#)
 - VMAX, :MEASure:VMAX
command/query, [964](#)
 - VMIDdle, :MEASure:VMIDdle
command/query, [965](#)
 - VMIN, :MEASure:VMIN
command/query, [966](#)
 - voltage at center screen, [334](#), [346](#)
 - VOLTS as vertical units, [347](#), [400](#)
 - VOVershoot, :MEASure:VOVershoot
command/query, [967](#)
 - VPP, :MEASure:VPP command/query, [968](#)
 - VPReshoot, :MEASure:VPReshoot
command/query, [969](#)
 - VRMS, :MEASure:VRMS
command/query, [970](#)
 - VSTArt, :MARKer:VSTArt
command/query, [640](#)
 - VSTOp, :MARKer:VSTOp
command/query, [641](#)
 - VTERm, :CHANnel<N>:PROBe:HEAD:VTERm
command/query, [352](#)
 - VTIME, :MEASure:VTIME
command/query, [972](#)
 - VTOP, :MEASure:VTOP
command/query, [973](#)
 - VUNits, :FUNctioN<F>:FFT:VUNits
command/query, [514](#)
 - VUPPer, :MEASure:VUPPer
command/query, [974](#)
- ## W
- WAIT, :TRIGger:SEQuence:WAIT:ENABLE
command/query, [1254](#)
 - WAIT, :TRIGger:SEQuence:WAIT:TIME
command/query, [1255](#)
 - Wait-to-Continue (*WAI) command, [424](#)
 - warranty, [2](#)
 - WATTS as vertical units, [347](#), [400](#)
 - Waveform Commands, [1381](#)
 - waveform intensity, default setup
and, [1162](#)
 - Waveform Memory Commands, [1445](#)
 - waveform type, and COMPLETE?, [1388](#)
 - waveform type, and COUNT?, [1389](#)
 - WAVEform,
:CHANnel<N>:SIMulation:WAVEform
command/query, [399](#)
 - WAVEform, :DISK:SAVE:WAVEform
command, [446](#)
 - WAVEform, :STORE:WAVEform
command, [1020](#)
 - waveform, acquiring, [180](#)
 - waveform, data and preamble, [1382](#)
 - waveform, saving, [446](#)
 - waveform, view parameters, [1429](#)
 - WAVEforms,
:MTESt:FOLDing:COUNT:WAVEforms
query, [683](#)
 - WAVEforms?, :MTESt:COUNT:WAVEforms?
query, [674](#)
 - waveform data values for clipped
portions, [1411](#)
 - what's new, [41](#)
 - white space (separator), [98](#)
 - width - -width measurement, [757](#)
 - WIDTH,
:SBUS<N>:SPI:TRIGger:PATtern:WIDTH
command/query, [1091](#)
 - WIDTH, :SBUS<N>:SPI:WIDTH
command/query, [1096](#)
 - WIDTH,
:SPRocessing:DFEQualizer:TAP:WIDTH
command/query, [1128](#)
 - WIDTH,
:SPRocessing:FFEQualizer:TAP:WIDTH
command/query, [1140](#)
 - WIDTH,
:TRIGger:ADVanced:VIOLation:PWIDth:
WIDTH command/query, [1347](#)
 - WIDTH, :TRIGger:GLITCh:WIDTH
command/query, [1232](#)
 - WIDTH, :TRIGger:PWIDth:WIDTH
command/query, [1241](#)
 - WIDTH, :WAVEform:CGRade:WIDTH?
query, [1387](#)
 - Window All Data, [273](#)
 - WINDow, :DISPlay:WINDow:MAXimize
command, [492](#)
 - WINDow, :FUNctioN<F>:FFT:WINDow
command/query, [515](#)
 - WINDow, :HISTogram:WINDow:BLIMit
command/query, [569](#)
 - WINDow, :HISTogram:WINDow:DEFault
command, [565](#)
 - WINDow, :HISTogram:WINDow:LLIMit
command/query, [567](#)
 - WINDow, :HISTogram:WINDow:RLIMit
command/query, [568](#)
 - WINDow, :HISTogram:WINDow:SOURce
command/query, [566](#)
 - WINDow, :HISTogram:WINDow:TLIMit
command/query, [570](#)
 - WINDow,
:MEASure:JITTer:SPECTrum:WINDow
command/query, [810](#)
 - WINDow, :MEASure:WINDow
command/query, [975](#)
 - WINDow, :TIMEbase:WINDow:DELay
command/query, [1176](#)
 - WINDow, :TIMEbase:WINDow:POSition
command/query, [1177](#)
 - WINDow, :TIMEbase:WINDow:RANGE
command/query, [1178](#)
 - WINDow, :TIMEbase:WINDow:SCALE
command/query, [1179](#)
 - WINDow, :TRIGger:WINDow:CONDition
command/query, [1289](#)
 - WINDow, :TRIGger:WINDow:SOURce
command/query, [1290](#)
 - WINDow, :TRIGger:WINDow:TIME
command/query, [1291](#)
 - WINDow, :TRIGger:WINDow:TPOint
command/query, [1292](#)
 - word width, SPI decode, [1096](#)
 - WORD, Understanding the format, [1408](#)
 - WORD, waveform data FORMat, [1414](#)
 - WriteEEEEBlock method, [116](#)
 - WriteList method, [116](#)
 - WriteNumber method, [116](#)
 - WriteString method, [116](#)
 - WriteString VISA COM method, [95](#)
 - writing, text to the screen, [1510](#)
- ## X
- x axis, controlling, [1167](#)
 - X vs Y, [547](#)
 - X1, :MTESt:SCALE:X1 command/query, [711](#)
 - X1Position, :MARKer:X1Position
command/query, [642](#)
 - X1Y1source, :MARKer:X1Y1source
command/query, [644](#)
 - X2Position, :MARKer:X2Position
command/query, [643](#)
 - X2Y2source, :MARKer:X2Y2source
command/query, [646](#)
 - x-axis duration, and XRange?, [1435](#)
 - x-axis, offset, and XOFFset, [1454](#)
 - x-axis, range, and XRange, [1455](#)
 - x-axis, units and XUNits, [1437](#)
 - XDELta, :MTESt:AMASK:XDELta
command/query, [663](#)
 - XDELta, :MTESt:SCALE:XDELta
command/query, [712](#)
 - XDELta?, :MARKer:XDELta? query, [648](#)
 - XDISplay?, :WAVEform:XDISplay?
query, [1432](#)
 - XINcrement?, :WAVEform:XINcrement?
query, [1433](#)
 - XLISt?, :WAVEform:SEGmented:XLISt?
query, [1424](#)
 - XOFFset, :WMEMory<R>:XOFFset
command/query, [1454](#)
 - XORigin?, :WAVEform:XORigin?
query, [1434](#)
 - XPOSition,
:DISPlay:BOOKmark<N>:XPOSition
command/query, [455](#)
 - XRANge, :WMEMory<R>:XRANge
command/query, [1455](#)
 - XRANge?, :WAVEform:XRANge?
query, [1435](#)
 - XREFerence?, :WAVEform:XREFerence?
query, [1436](#)
 - XTAlk Commands, [1459](#)
 - XUNits?, :WAVEform:XUNits? query, [1437](#)

Y

Y1, :MTESt:SCALe:Y1 command/query, 713
 Y1Position, :MARKer:Y1Position
 command/query, 649
 Y2, :MTESt:SCALe:Y2 command/query, 714
 Y2Position, :MARKer:Y2Position
 command/query, 650
 Y-axis control, 301
 YDELta, :MTESt:AMASk:YDELta
 command/query, 664
 YDELta?, :MARKer:YDELta? query, 651
 YDISplay?, :WAVEform:YDISplay?
 query, 1438
 YINCrement?, :WAVEform:YINCrement?
 query, 1439
 YOFFset, :WMEMory<R>:YOFFset
 command/query, 1456
 YORigin?, :WAVEform:YORigin?
 query, 1440
 YPOSition,
 :DISPlay:BOOKmark<N>:YPOSition
 command/query, 456
 YRANge, :WMEMory<R>:YRANge
 command/query, 1457
 YRANge?, :WAVEform:YRANge?
 query, 1441
 YREFerence?, :WAVEform:YREFerence?
 query, 1442
 YUNits?, :WAVEform:YUNits? query, 1443

Z

Z1, :SPROcessing:CTLequalizer:Z1
 command/query, 1115
 Z2, :SPROcessing:CTLequalizer:Z2
 command/query, 1116
 ZERO, :HOSTed:CALibrate:DESKew:ZERO
 command, 578
 ZERo, :SPROcessing:CTLequalizer:ZERo
 command/query, 1540
 ZLEVel, :MEASure:CGRade:ZLEVel
 command/query, 749
 ZONE, :ISCan:ZONE:HIDE
 command/query, 613
 ZONE, :ISCan:ZONE:SOURce
 command/query, 614
 ZONE, :ISCan:ZONE<Z>:SOURce
 command/query, 617
 ZONE<Z>, :ISCan:ZONE<Z>:MODE
 command/query, 615
 ZONE<Z>, :ISCan:ZONE<Z>:PLACement
 command/query, 616
 ZONE<Z>, :ISCan:ZONE<Z>:STATe
 command/query, 618
 zoom, default setup, 1161
 ZSRC,
 :CHANnel<N>:PROBe:PRECprobe:ZSRC
 command, 360