



6" LED Surface Mount Cylinder

LD6LED3S

LD6LED4S

Wet Location
120V, 277V

DATE: _____ TYPE: _____

FIRM NAME: _____

PROJECT: _____



For conversion to millimeters,
multiply inches by 25.4
Not to Scale

APPLICATIONS:

LiteForms™ LD6LED3S & LD6LED4S Series is a 6" direct surface mount LED cylinder designed to combine superior brightness control with energy savings and long lamp life. Suitable for a variety of commercial, retail, and institutional applications to achieve illumination patterns on vertical walls or columns. Optical lens options in spot, medium, or wide distribution are ideal for higher ceiling applications such as transportation terminals or atrium areas. Suitable for use in ambient temperatures up to 30°C (86°F) during operation.

HOUSING:

Seamless .058" thick extruded aluminum cylinder body with durable powder coat paint finish in a variety of architectural colors including Prescolite's exclusive Zet, metallic silver.

REFLECTOR:

High purity spun aluminum self-flanged reflector with iridescence suppressed Alzak anodized finish retained by factory installed spring clips and safety cable for ease of maintenance. Provided with integral clear tempered glass lens to protect LEDs.

LED LIGHT ENGINE:

The LED light engines are equipped with (10) high brightness white LEDs (3500K or 4000K) on a metal clad circuit board. Secured to an integral die cast

aluminum heat sink for excellent thermal management. System designed for optimal life and lumen maintenance (50,000 hours at 70% average lumen maintenance*). *LED life calculations are based upon maintaining application LED junction temperatures and drive currents at or below manufacturer's requirements per IESNA-LM-80-08 test data.

Optics: Vacuum metallized injection molded optical reflector features (10) parabolic LED modules with Prescolite's patented (U.S. Patent No. 6,254,256) American Matte™ finish to produce uniform illumination. Optional optical lenses provide a choice of spot, medium, or wide distribution for added versatility.

LED DRIVER:

Energy efficient solid state constant current electronic driver with 50,000 hour minimum anticipated life. Meets UL Class 2, inherent short-circuit protection, self limited, overload protected.

INSTALLATION:

Easy installation onto standard J-Box.

CERTIFICATIONS:

CSA certified to US and Canadian safety standards. Suitable for wet locations.

WARRANTY:

5 year warranty

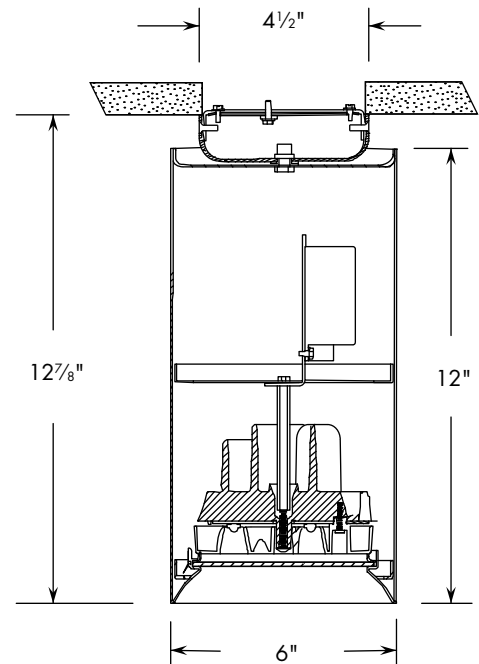

CATALOG NUMBER:

EXAMPLE: LD6LED4SW35K8FL35 277V Z

CYLINDER	LED COLOR	LED COLOR TEMP	CRI	BEAM ANGLE	VOLTAGE	REFLECTOR COLOR	CYLINDER FINISH
<input type="checkbox"/> LD6LED 6" LED cylinder	<input type="checkbox"/> W White	<input type="checkbox"/> 35K 3500 Kelvin	<input type="checkbox"/> 8 Nominal 80+ CRI	<input type="checkbox"/> Blank Vacuum metallized reflector with 45° cutoff	<input type="checkbox"/> Blank 120V only	<input type="checkbox"/> Blank Clear Alzak	<input type="checkbox"/> WH White
<input type="checkbox"/> LED GENERATION		<input type="checkbox"/> 40K 4000 Kelvin		<input type="checkbox"/> FL35 Lensed optic with 35° wide distribution	<input type="checkbox"/> 277V 120/277V	<input type="checkbox"/> CG Champagne Gold Alzak	<input type="checkbox"/> BL Black
<input type="checkbox"/> 3 14W, 700 Lumen LED				<input type="checkbox"/> MD25 Lensed optic with 25° medium distribution	REFLECTOR FINISH	<input type="checkbox"/> BL Black Alzak	<input type="checkbox"/> Z Zet
<input type="checkbox"/> 4 28W, 1100 Lumen LED				<input type="checkbox"/> SP18 Lensed optic with 18° spot distribution	<input type="checkbox"/> Blank Specular	<input type="checkbox"/> WE Wheat Alzak	<input type="checkbox"/> BA Brushed Aluminum
MOUNTING					<input type="checkbox"/> SS Semi-Specular	<input type="checkbox"/> LW Light Wheat Alzak	<input type="checkbox"/> BZ Bronze
<input type="checkbox"/> S Surface						<input type="checkbox"/> PW Pewter Alzak	
						<input type="checkbox"/> WH White Paint	



In a continuing effort to offer the best product possible we reserve the right to change, without notice, specifications or materials that in our opinion will not alter the function of the product.
Web: www.prescolite.com • Tech Support: (888) 777-4832

LFO-LED-012

PHOTOMETRIC DATA

LiteForms™™ - LD6LED - 6" Surface Mount LED Cylinder

DRIVER DATA	LD6LED3	LD6LED3 277V	LD6LED4	LD6LED4 277V
Input Voltage	120V +/- 10%	120/277V	120V +/- 10%	120/277V
Input Frequency	60 Hz	50/60 Hz	50/60 Hz	50/60 Hz
Input Current	0.13A	0.13A/0.07A	0.235A	0.23A/0.13A
Input Power	14W	15W	28W	27.5/28.5W
Constant Current Output	700mA	700mA	1400mA	1400mA
Power Factor	≥0.90	≥0.90	≥0.90	0.98/0.78
THD	<20%	<20%	<20%	<20%
EMI Filtering	FCC 47CFR Part 15, Class A	FCC 47CFR Part 15, Class B	FCC 47CFR Part 15, Class A	FCC 47CFR Part 15, Class B
Operating Temperature	-40°C to 60°C	-30°C to 60°C	-40°C to 60°C	-30°C to 60°C
Dimming	No	No	No	No
Over-voltage, over-current, short-circuit protected				

LD6LED3SW35K7

LED Light Engine: (10) LED Array 3500K Std. CRI
 System Wattage: 13.8
 Fixture delivered lumens: 448
 Fixture Efficacy: 32.4
 Spacing Criteria: 0.8

ZONAL LUMEN SUMMARY

ZONE	LUMENS	%LUMINAIRE
0-30	360	80.3
0-40	424	94.6
0-60	448	100.0
0-90	448	100.0
90-180	0	0.0
0-180	448	100.0

LUMINANCE DATA IN CANDELA/SQ. METER

Angle in Vertical	Average - 0°
45°	3996
55°	170
65°	0
75°	0
85°	0

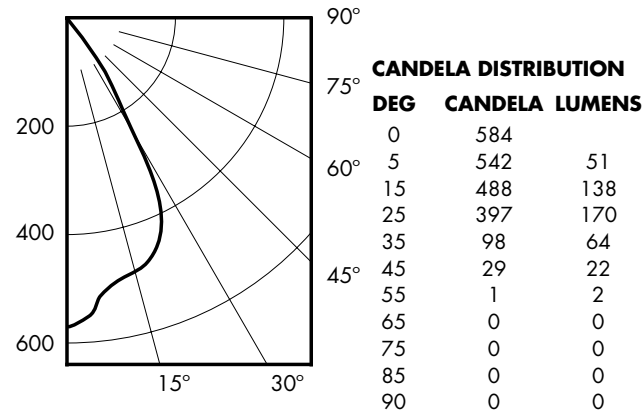

Test No. 2918

Tested at 25°C Ambient in accordance to IESNA LM-79-2008

COEFFICIENTS OF UTILIZATION

Zonal Cavity Method

Room Cavity Ratio	% Effective Floor Cavity Reflectance																
	80%			70%			50%			30%			10%				
	70	50	30	70	50	30	70	50	30	70	50	30	70	50	30		
1	114	111	109	107	111	109	107	105	105	103	102	101	100	99	98	97	96
2	109	104	100	97	106	102	99	96	99	96	94	96	94	92	93	91	90
3	103	97	93	89	102	96	92	88	93	90	87	91	88	85	89	86	84
4	99	91	86	82	97	90	85	82	88	84	81	86	83	80	84	81	79
5	94	86	81	76	92	85	80	76	83	79	75	82	78	75	80	77	74
6	90	81	75	71	88	80	75	71	79	74	71	77	73	70	76	73	70
7	85	77	71	67	84	76	71	67	75	70	66	73	69	66	72	69	66
8	81	72	67	63	80	72	66	63	71	66	62	70	65	62	69	65	62
9	78	69	63	59	77	68	63	59	67	62	59	66	62	59	66	61	59
10	74	65	60	56	73	65	59	56	64	59	56	63	59	56	62	58	55

LD6LED3SW35K7

Test No. 2918

LD6LED3SW35K7FL35

LED Light Engine: (10) LED Array 3500K Std CRI with Flood Lens
 System Wattage: 13.8
 Fixture delivered lumens: 579
 Fixture Efficacy: 41.9
 Spacing Criteria: 0.6

ZONAL LUMEN SUMMARY

ZONE	LUMENS	%LUMINAIRE
0-30	491	84.8
0-40	553	95.5
0-60	578	99.8
0-90	579	100.0

LUMINANCE DATA IN CANDELA/SQ. METER

Angle in Vertical	Average - 0°
45°	3444
55°	849
65°	231
75°	0
85°	0

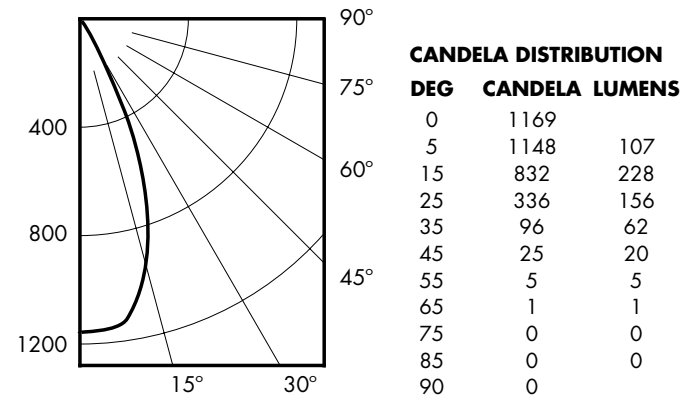

Test No. 2919

Tested at 25°C Ambient in accordance to IESNA LM-79-2008

COEFFICIENTS OF UTILIZATION

Zonal Cavity Method

Room Cavity Ratio	% Effective Floor Cavity Reflectance																
	80%			70%			50%			30%			10%				
	70	50	30	70	50	30	70	50	30	70	50	30	70	50	30		
1	114	112	110	108	112	110	108	106	106	104	103	102	101	100	98	98	97
2	109	105	102	99	107	103	100	98	100	98	95	97	95	93	95	93	91
3	105	99	95	91	103	98	94	91	95	92	89	93	90	88	91	89	87
4	101	94	89	86	99	93	88	85	91	87	84	89	86	83	87	84	82
5	96	89	84	80	95	88	84	80	87	82	79	85	81	79	83	80	78
6	92	85	80	76	91	84	79	76	83	78	75	81	78	75	80	77	74
7	89	81	76	72	88	80	75	72	79	75	71	78	74	71	77	73	71
8	85	77	72	69	84	77	73	68	76	71	68	75	71	68	74	70	68
9	82	74	69	65	81	73	69	65	73	68	65	72	68	65	71	67	65
10	79	71	66	62	78	70	67	62	70	65	62	69	65	62	68	65	62

LD6LED3SW35K7FL35

Test No. 2919

NOTES: Refer to www.prescolite.com for additional photometric tests (IES Files).



PHOTOMETRIC DATA

LD6LED3SW35K7MD25

LED Light Engine: (10) LED Array 3500K Std CRI with Medium Lens
 System Wattage: 13.8
 Fixture delivered lumens: 600
 Fixture Efficacy: 43.5
 Spacing Criteria: 0.4

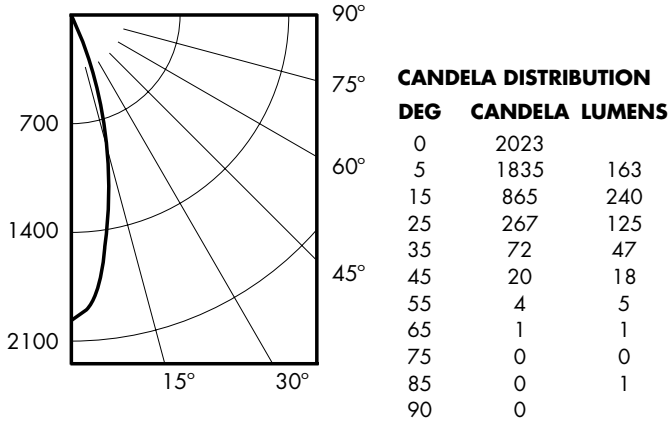

Test No. 2920

Tested at 25°C Ambient in accordance to IESNA LM-79-2008

ZONAL LUMEN SUMMARY

ZONE	LUMENS	%LUMINAIRE
0-30	528	88.0
0-40	575	95.9
0-60	598	99.7
0-90	600	100.0
90-180	0	0.0
0-180	600	100.0

LUMINANCE DATA IN CANDELA/SQ. METER

Angle in Vertical	Average - 0°
45°	2756
55°	679
65°	231
75°	0
85°	0

COEFFICIENTS OF UTILIZATION Zonal Cavity Method

Room Cavity Ratio	% Effective Floor Cavity Reflectance																
	80%					70%					50%						
	20% Effective Floor Cavity Reflectance																
	% Wall Reflectance																
	70	50	30	10	70	50	30	10	50	30	10	50	30	10			
1	114	112	110	108	112	110	108	106	106	105	103	102	101	100	99	98	97
2	110	106	103	100	108	104	101	99	101	99	97	98	96	95	96	94	93
3	106	101	97	93	104	99	96	93	97	94	91	95	92	90	92	90	89
4	102	96	92	88	100	95	91	88	93	89	87	91	88	86	89	87	85
5	98	92	87	84	97	91	87	83	89	85	83	88	84	82	86	83	81
6	95	88	83	80	94	87	83	79	86	82	79	84	81	78	83	80	78
7	92	84	80	76	91	84	79	76	83	79	76	81	78	75	80	77	75
8	89	81	76	73	88	81	76	73	80	76	73	79	75	72	78	75	72
9	86	78	74	70	85	78	73	70	77	73	70	76	72	70	75	72	70
10	83	75	71	68	82	75	71	68	74	70	68	74	70	67	73	70	67

LD6LED3SW35K7MD25

Test No. 2920

LD6LED3SW35K7SP18

LED Light Engine: (10) LED Array 3500K Std CRI with Spot Lens
 System Wattage: 13.8
 Fixture delivered lumens: 640
 Fixture Efficacy: 46.38
 Spacing Criteria: 0.3

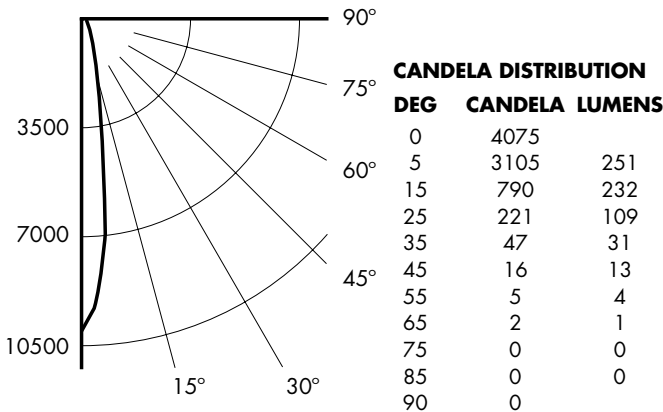

Test No. 2921

Tested at 25°C Ambient in accordance to IESNA LM-79-2008

ZONAL LUMEN SUMMARY

ZONE	LUMENS	%LUMINAIRE
0-30	591	92.3
0-40	622	97.2
0-60	639	99.8
0-90	640	100.0
90-180	0	0.0
0-180	640	100.0

LUMINANCE DATA IN CANDELA/SQ. METER

Angle in Vertical	Average - 0°
45°	2204
55°	849
65°	461
75°	0
85°	0

COEFFICIENTS OF UTILIZATION Zonal Cavity Method

Room Cavity Ratio	% Effective Floor Cavity Reflectance																
	80%					70%					50%						
	20% Effective Floor Cavity Reflectance																
	% Wall Reflectance																
	70	50	30	10	70	50	30	10	50	30	10	50	30	10			
1	115	113	111	109	113	111	109	107	107	105	104	103	102	101	100	99	98
2	111	107	104	102	109	106	103	101	103	101	99	100	98	97	97	96	95
3	108	103	99	96	106	101	98	95	99	96	94	97	94	93	95	93	91
4	104	99	95	92	103	98	94	91	96	93	90	94	91	89	92	90	88
5	101	95	91	88	100	94	90	87	93	89	87	91	88	86	90	87	85
6	98	92	87	84	97	91	87	84	90	86	84	88	85	83	87	85	83
7	95	89	84	82	94	88	84	81	87	84	81	86	83	81	85	82	80
8	93	86	82	79	92	85	82	79	85	81	78	84	81	78	83	80	78
9	90	83	79	77	89	83	79	76	82	79	76	82	78	76	81	78	76
10	88	81	77	74	87	81	77	74	80	77	74	80	76	74	79	76	74

LD6LED3SW35K7SP18

Test No. 2921

NOTES: Refer to www.prescolite.com for additional photometric tests (IES Files).

- 5 year warranty requires product registration. Warranty limited to repair and replacement of defective parts of the LED system and does not include labor or installation after first year. See www.prescolite.com for details.
- Operation in ambient temperatures higher than those specified may shorten life and will void warranty.



Web: www.prescolite.com • Tech Support: (888) 777-4832
 701 Millennium Boulevard • Greenville, SC 29607 U.S.A. • Phone (864) 678-1000
 Copyright ©2015 Prescolite, Inc., a division of Hubbell Lighting, Inc. All Rights Reserved
 Specifications subject to change without notice. • Printed in U.S.A. • IFO-LED-012 • 12/10/15



PHOTOMETRIC DATA

LD6LED4SW35K8

LED Light Engine: (10) LED Array 3500K Mid CRI
 System Wattage: 27.4
 Fixture delivered lumens: 877
 Fixture Efficacy: 32
 Spacing Criteria: 0.8

ZONAL LUMEN SUMMARY

ZONE	LUMENS	%LUMINAIRE
0-30	593	67.7
0-40	748	85.3
0-60	873	99.6
0-90	877	100.0
90-180	0	0.0
0-180	877	100.0

LUMINANCE DATA IN CANDELA/SQ. METER

Angle in Vertical	Average - 0°
45°	17635
55°	5096
65°	692
75°	0
85°	0

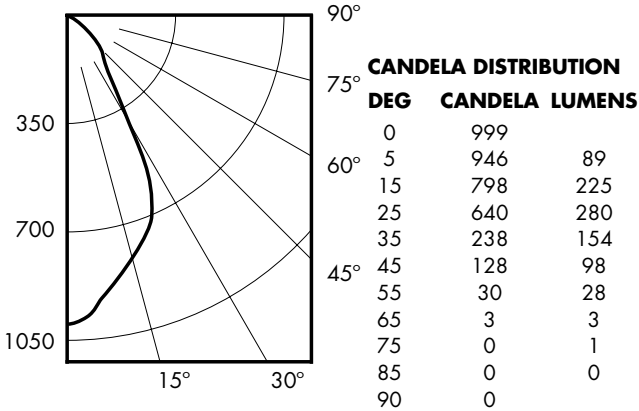

Test No. 2925

Tested at 25°C Ambient in accordance to IESNA LM-79-2008

COEFFICIENTS OF UTILIZATION Zonal Cavity Method

Room Cavity Ratio	% Effective Floor Cavity Reflectance																
	80%		70%		50%		30%		10%								
	70	50	30	10	70	50	30	10	50	30	10						
1	113	110	108	106	111	108	106	104	104	102	101	100	99	98	97	96	95
2	107	102	98	95	105	101	97	93	97	94	91	94	92	99	92	89	88
3	102	95	90	86	100	94	89	85	91	87	84	88	85	82	86	83	81
4	96	88	83	78	94	87	82	78	85	80	77	83	79	76	81	78	75
5	91	82	76	72	89	81	76	71	80	75	71	78	74	70	76	73	69
6	86	77	71	66	85	76	70	66	75	69	66	73	69	65	72	68	65
7	82	72	66	61	80	71	65	61	70	65	61	69	64	61	68	64	60
8	78	68	62	57	76	67	61	57	66	61	57	65	60	57	64	60	56
9	74	64	58	54	73	63	57	53	62	57	53	61	57	53	61	56	53
10	70	60	54	50	69	60	54	50	59	54	50	58	53	50	57	53	50

LD6LED4SW35K8

Test No. 2925

LD6LED4SW35K8FL35

LED Light Engine: (10) LED Array 3500K Mid CRI with Flood Lens
 System Wattage: 27.4
 Fixture delivered lumens: 959
 Fixture Efficacy: 35
 Spacing Criteria: 0.6

ZONAL LUMEN SUMMARY

ZONE	LUMENS	%LUMINAIRE
0-30	826	86.1
0-40	916	95.5
0-60	954	99.5
0-90	959	100.0
90-180	0	0.0
0-180	959	100.0

LUMINANCE DATA IN CANDELA/SQ. METER

Angle in Vertical	Average - 0°
45°	4822
55°	1359
65°	922
75°	376
85°	0

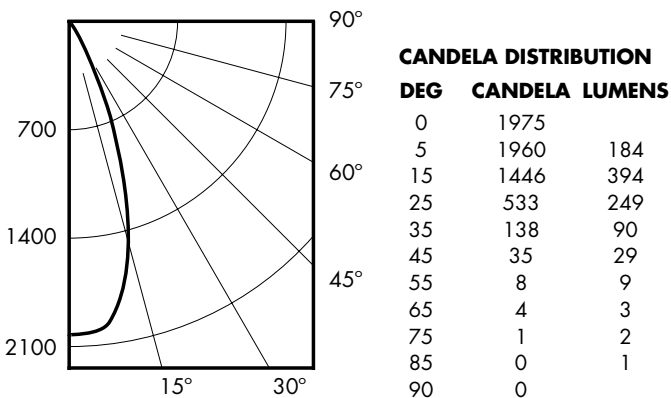

Test No. 2924

Tested at 25°C Ambient in accordance to IESNA LM-79-2008

COEFFICIENTS OF UTILIZATION Zonal Cavity Method

Room Cavity Ratio	% Effective Floor Cavity Reflectance																
	80%		70%		50%		30%		10%								
	70	50	30	10	70	50	30	10	50	30	10						
1	114	112	109	107	112	110	108	106	106	104	103	102	101	99	98	98	97
2	109	105	102	99	107	103	100	98	100	98	95	97	95	93	95	93	91
3	105	99	95	92	103	98	94	91	95	92	89	93	90	88	91	89	87
4	101	94	89	86	99	93	89	85	91	87	84	89	86	83	87	85	82
5	97	89	84	81	95	89	84	80	87	83	80	85	82	79	84	81	78
6	93	85	80	76	91	84	80	76	83	79	76	82	78	75	81	77	75
7	89	81	76	73	88	81	76	72	80	75	72	78	75	72	77	74	71
8	86	78	73	69	85	77	72	69	76	72	69	75	71	69	74	71	68
9	83	75	70	66	82	74	69	66	73	69	66	72	68	66	72	68	65
10	80	72	67	63	79	71	66	63	70	66	63	70	66	63	69	65	63

LD6LED4SW35K8FL35

Test No. 2924

NOTES

Refer to www.prescolite.com for additional photometric tests (IES Files).



PHOTOMETRIC DATA

LiteForms™™ - LD6LED - 6" Surface Mount LED Cylinder

LD6LED4SW35K8MD25

LED Light Engine: (10) LED Array 3500K Mid CRI with Medium Lens
 System Wattage: 27.4
 Fixture delivered lumens: 967
 Fixture Efficacy: 35.2
 Spacing Criteria: 0.4

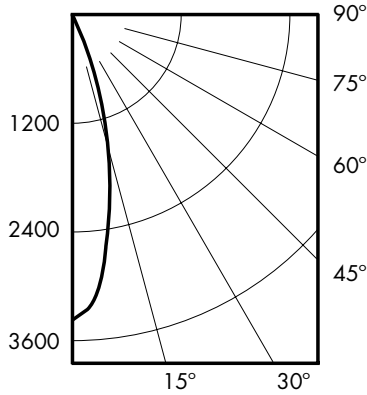

CANDELA DISTRIBUTION

DEG	CANDELA	LUMENS
0	3515	
5	3164	280
15	1399	389
25	404	191
35	108	70
45	33	26
55	9	9
65	2	1
75	0	1
85	0	0
90	0	

Test No. 2923

Tested at 25°C Ambient in accordance to IESNA LM-79-2008

ZONAL LUMEN SUMMARY

ZONE	LUMENS	%LUMINAIRE
0-30	859	88.9
0-40	930	96.2
0-60	965	99.8
0-90	967	100.0
90-180	0	0.0
0-180	967	100.0

LUMINANCE DATA IN CANDELA/SQ. METER

Angle in Vertical	Average - 0°
45°	4547
55°	1529
65°	461
75°	0
85°	0

COEFFICIENTS OF UTILIZATION

Zonal Cavity Method

Room Cavity Ratio	% Effective Floor Cavity Reflectance																
	80%	70%	50%	30%	10%												
	20% Effective Floor Cavity Reflectance																
	% Wall Reflectance																
	70	50	30	10	70	50	30	10	50	30	10						
1	115	112	110	108	112	110	108	107	106	105	103	103	101	100	99	98	97
2	110	106	103	100	108	105	102	99	102	99	97	99	97	95	96	94	93
3	106	101	97	94	104	100	96	93	97	94	92	95	93	90	93	91	89
4	102	97	92	89	101	95	91	88	93	90	87	92	89	86	90	87	85
5	99	92	88	84	97	91	87	84	90	86	83	88	85	83	87	84	82
6	96	89	84	81	94	88	84	80	86	83	80	85	82	79	84	81	79
7	92	85	81	77	91	85	80	77	83	80	77	82	79	76	81	78	76
8	89	82	77	74	88	82	77	74	81	77	74	80	76	74	79	76	73
9	87	79	75	72	86	79	74	71	78	74	71	77	74	71	76	73	71
10	84	77	72	69	83	76	72	69	75	72	69	75	71	69	74	71	69

LD6LED4SW35K8MD25

Test No. 2923

LD6LED4SW35K8SP18

LED Light Engine: (10) LED Array 3500K Mid CRI with Spot Lens
 System Wattage: 27.5
 Fixture delivered lumens: 1108
 Fixture Efficacy: 40.2
 Spacing Criteria: 0.2

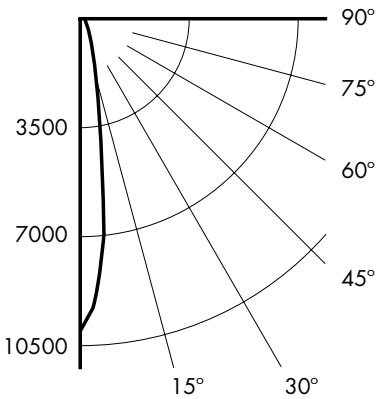

CANDELA DISTRIBUTION

DEG	CANDELA	LUMENS
0	10107	
5	6461	527
15	1283	382
25	295	144
35	52	34
45	19	15
55	6	4
65	1	1
75	0	1
85	0	0
90	0	

Test No. 2922

Tested at 25°C Ambient in accordance to IESNA LM-79-2008

ZONAL LUMEN SUMMARY

ZONE	LUMENS	%LUMINAIRE
0-30	1052	95.0
0-40	1087	98.1
0-60	1106	99.8
0-90	1108	100.0
90-180	0	0.0
0-180	1108	100.0

LUMINANCE DATA IN CANDELA/SQ. METER

Angle in Vertical	Average - 0°
45°	2618
55°	1019
65°	231
75°	0
85°	0

COEFFICIENTS OF UTILIZATION

Zonal Cavity Method

Room Cavity Ratio	% Effective Floor Cavity Reflectance																
	80%	70%	50%	30%	10%												
	20% Effective Floor Cavity Reflectance																
	% Wall Reflectance																
	70	50	30	10	70	50	30	10	50	30	10						
1	115	113	111	108	113	111	110	108	107	106	105	104	103	102	100	99	99
2	112	108	106	102	110	107	104	102	104	102	100	101	99	98	98	97	96
3	109	104	101	97	107	103	100	97	100	98	96	98	96	94	96	94	93
4	106	101	97	94	104	99	96	94	98	95	92	96	93	91	94	92	90
5	103	97	93	90	101	96	93	90	95	92	90	93	91	89	92	90	88
6	100	94	91	88	99	94	90	88	92	89	87	91	89	86	90	88	86
7	98	92	88	85	97	91	88	85	90	87	85	89	86	84	88	86	84
8	95	89	86	83	95	89	85	83	88	85	83	87	84	82	86	84	82
9	93	87	84	81	93	87	83	81	86	83	81	85	83	81	85	82	80
10	91	85	82	79	91	85	82	79	84	81	79	84	81	79	83	81	79

LD6LED4SW35K8SP18

Test No. 2922

NOTES: Refer to www.prescolite.com for additional photometric tests (IES Files).
 1. Operation in ambient temperatures higher than those specified may shorten life and will void warranty.



Web: www.prescolite.com • Tech Support: (888) 777-4832
 701 Millennium Boulevard • Greenville, SC 29607 U.S.A. • Phone (864) 678-1000
 Copyright ©2015 Prescolite, Inc., a division of Hubbell Lighting, Inc. All Rights Reserved
 Specifications subject to change without notice. • Printed in U.S.A. • IFO-LED-012 • 12/10/15

