



AIRBUS

A318/A319/A320/A321

AeroGal
AEROLINEAS GALAPAGOS S.A.

FLIGHT CREW OPERATING MANUAL

The content of this document is the property of Airbus. It is supplied in confidence and commercial security on its contents must be maintained. It must not be used for any purpose other than that for which it is supplied, nor may information contained in it be disclosed to unauthorized persons. It must not be reproduced in whole or in part without permission in writing from the owners of the copyright.

© AIRBUS 2005. All rights reserved.

Intentionally left blank



A318/A319/A320/A321
FLIGHT CREW
OPERATING MANUAL

TRANSMITTAL LETTER

Issue date: 17 OCT 17

This is the FLIGHT CREW OPERATING MANUAL major event publication at issue date 17 OCT 17 for the A318/A319/A320/A321 and replacing last issue dated 05 SEP 17



A318/A319/A320/A321
FLIGHT CREW
OPERATING MANUAL

Intentionally left blank



A318/A319/A320/A321
FLIGHT CREW
OPERATING MANUAL

FILING INSTRUCTIONS

Please incorporate this major event revision as follow:

| Localization Subsection Title | Remove | Insert |
|----------------------------------|--------|-----------|
| | | Rev. Date |

No filing instructions

A318/A319/A320/A321
FLIGHT CREW
OPERATING MANUAL

Intentionally left blank

PRELIMINARY PAGES

Intentionally left blank

PRELIMINARY PAGES
LIST OF EFFECTIVE SECTIONS/SUBSECTIONS

| M⁽¹⁾ | Localization | Subsection Title | Rev. Date |
|------------------------|---------------------|--|------------------|
| | PLP-LESS | LIST OF EFFECTIVE SECTIONS/SUBSECTIONS | 05 SEP 17 |
| | GEN-PLP-LETDU | LIST OF EFFECTIVE TEMPORARY DOCUMENTARY UNITS | 17 OCT 17 |
| | GEN | General Information | 05 SEP 17 |
| | DSC-PLP-LETDU | LIST OF EFFECTIVE TEMPORARY DOCUMENTARY UNITS | 17 OCT 17 |
| | DSC-20-10 | Overview | 12 APR 17 |
| | DSC-20-20 | Description | 12 APR 17 |
| | DSC-20-30 | Ground Handling | 19 JUN 17 |
| | DSC-20-40 | Ground Clearance Diagram | 12 APR 17 |
| | DSC-20-50 | Landing Geometry | 19 JUN 17 |
| | DSC-20-60 | Visual Ground Geometry | 19 JUN 17 |
| | DSC-21-10-10 | General | 12 APR 17 |
| | DSC-21-10-20 | Main Components | 12 APR 17 |
| | DSC-21-10-30 | Temperature and Flow Regulation | 12 APR 17 |
| | DSC-21-10-40 | System Operation under Failure Condition | 12 APR 17 |
| | DSC-21-10-50 | Controls and Indicators | 12 APR 17 |
| | DSC-21-20-10 | General | 12 APR 17 |
| | DSC-21-20-20 | Main Components | 12 APR 17 |
| | DSC-21-20-30 | System Operation | 12 APR 17 |
| | DSC-21-20-40 | Controls and Indicators | 12 APR 17 |
| | DSC-21-30-10 | General | 12 APR 17 |
| | DSC-21-30-20 | Avionics Ventilation | 12 APR 17 |
| | DSC-21-30-40 | Battery Ventilation | 12 APR 17 |
| | DSC-21-30-50 | Lavatory and Galley Ventilation | 12 APR 17 |
| | DSC-21-30-60 | Controls and Indicators | 12 APR 17 |
| | DSC-21-40-10 | General | 12 APR 17 |
| | DSC-21-40-20 | System Operation | 12 APR 17 |
| | DSC-21-40-30 | Controls and Indicators | 12 APR 17 |
| | DSC-21-40-35 | ECAM Cond Page | 12 APR 17 |
| | DSC-22_10-10 | Description | 12 APR 17 |
| | DSC-22_10-20 | System Interface Diagram | 12 APR 17 |
| | DSC-22_10-30 | FMGS Modes of Operation | 12 APR 17 |
| | DSC-22_10-40-05 | Management of the Displays | 12 APR 17 |
| | DSC-22_10-40-10 | MCDU | 12 APR 17 |
| | DSC-22_10-40-20 | FCU | 05 SEP 17 |
| | DSC-22_10-40-30 | Thrust Levers | 12 APR 17 |
| | DSC-22_10-40-40 | Primary Flight Display | 12 APR 17 |
| | DSC-22_10-40-50 | Navigation Display | 12 APR 17 |
| | DSC-22_10-50-10 | General | 12 APR 17 |
| | DSC-22_10-50-20 | Characteristic Speeds | 12 APR 17 |
| | DSC-22_10-50-30 | Limit Speeds | 12 APR 17 |

Continued on the following page

PRELIMINARY PAGES
LIST OF EFFECTIVE SECTIONS/SUBSECTIONS

Continued from the previous page

| M⁽¹⁾ | Localization | Subsection Title | Rev. Date |
|------------------------|---------------------|---|------------------|
| | DSC-22_10-50-40 | Protection Speeds | 12 APR 17 |
| | DSC-22_10-50-50 | Other Speeds | 12 APR 17 |
| | DSC-22_20-10 | General | 12 APR 17 |
| | DSC-22_20-20-05 | General | 12 APR 17 |
| | DSC-22_20-20-10 | Position Computation | 12 APR 17 |
| | DSC-22_20-20-20 | Evaluation of Position Accuracy | 12 APR 17 |
| | DSC-22_20-20-30 | Radio Navigation Tuning | 05 SEP 17 |
| | DSC-22_20-20-40 | Alignment of Inertial Reference System | 12 APR 17 |
| | DSC-22_20-20-50 | Navigation Database | 12 APR 17 |
| | DSC-22_20-30-05 | General | 12 APR 17 |
| | DSC-22_20-30-10-05 | General | 12 APR 17 |
| | DSC-22_20-30-10-15 | FMS2 HONEYWELL | 12 APR 17 |
| | DSC-22_20-30-20-05 | General | 12 APR 17 |
| | DSC-22_20-30-20-25 | FMS2 Honeywell | 12 APR 17 |
| | DSC-22_20-40-10 | Optimization | 12 APR 17 |
| | DSC-22_20-40-20 | Cost Index | 12 APR 17 |
| | DSC-22_20-40-30 | Predictions | 12 APR 17 |
| | DSC-22_20-50-10-25 | FMS2 Honeywell | 05 SEP 17 |
| | DSC-22_20-50-20-35 | FMS2 Honeywell | 12 APR 17 |
| | DSC-22_20-50-30 | MCDU - Data Format List | 12 APR 17 |
| | DSC-22_20-60-10 | Effect of Baro Reference Setting | 12 APR 17 |
| | DSC-22_20-60-20 | Clear Key (Clearing Function) | 12 APR 17 |
| | DSC-22_20-60-30 | How to Execute a Diversion | 12 APR 17 |
| | DSC-22_20-60-40 | Engine Out | 05 SEP 17 |
| | DSC-22_20-60-50 | Secondary Flight Plan | 12 APR 17 |
| | DSC-22_20-60-60 | Pilots/Stored Route Function | 12 APR 17 |
| | DSC-22_20-60-70 | Report Page | 12 APR 17 |
| | DSC-22_20-60-80 | Closest Airports | 12 APR 17 |
| | DSC-22_20-60-90 | Time Marker | 12 APR 17 |
| | DSC-22_20-60-100 | Step ALTS | 12 APR 17 |
| | DSC-22_20-60-110 | Required Time of Arrival (RTA) | 12 APR 17 |
| | DSC-22_20-60-120 | Equitime Point | 12 APR 17 |
| | DSC-22_20-60-130 | MCDU Back Up Navigation | 12 APR 17 |
| | DSC-22_20-60-150 | Descent Profile Optimization (if installed) | 12 APR 17 |
| | DSC-22_20-70 | AOC Functions | 12 APR 17 |
| | DSC-22_20-80 | Print Functions | 12 APR 17 |
| | DSC-22_20-90-10 | FMGC Reset | 12 APR 17 |
| | DSC-22_20-90-20 | "CHECK GW" or "CHECK WEIGHT" Message | 12 APR 17 |
| | DSC-22_20-100-20 | FMS2 HONEYWELL Temporary Abnormal Behaviors | 12 APR 17 |

Continued on the following page

Continued from the previous page

| M⁽¹⁾ | Localization | Subsection Title | Rev. Date |
|------------------------|---------------------|--|------------------|
| | DSC-22_20-100-40 | All FMS Temporary Abnormal Behaviors | 12 APR 17 |
| | DSC-22_30-10 | General | 12 APR 17 |
| | DSC-22_30-20 | Flight Director | 12 APR 17 |
| | DSC-22_30-30 | Autopilot (AP) | 12 APR 17 |
| | DSC-22_30-40 | Speed/Mach Control | 12 APR 17 |
| | DSC-22_30-50 | AP/FD Modes General | 12 APR 17 |
| | DSC-22_30-60 | AP/FD Lateral Modes | 12 APR 17 |
| | DSC-22_30-70-10 | Principles | 12 APR 17 |
| | DSC-22_30-70-20 | Climb Mode | 12 APR 17 |
| | DSC-22_30-70-30 | Open Climb Mode | 12 APR 17 |
| | DSC-22_30-70-50 | Descent Mode | 12 APR 17 |
| | DSC-22_30-70-60 | Open Descent Mode | 12 APR 17 |
| | DSC-22_30-70-65 | Altitude Acquire Mode | 12 APR 17 |
| | DSC-22_30-70-70 | Altitude Hold Mode | 12 APR 17 |
| | DSC-22_30-70-80 | Vertical Speed Mode - Flight Path Angle Mode (V/S - FPA) | 05 SEP 17 |
| | DSC-22_30-70-90 | Expedite | 12 APR 17 |
| | DSC-22_30-75 | Mode Reversions | 12 APR 17 |
| | DSC-22_30-80-10 | General | 12 APR 17 |
| | DSC-22_30-80-20 | Takeoff | 12 APR 17 |
| | DSC-22_30-80-30-05 | General | 12 APR 17 |
| | DSC-22_30-80-30-10 | Precision Approach | 12 APR 17 |
| | DSC-22_30-80-30-20 | Non Precision Approach | 05 SEP 17 |
| | DSC-22_30-80-40 | Go Around (GA) | 12 APR 17 |
| | DSC-22_30-90 | Autothrust | 12 APR 17 |
| | DSC-22_30-100 | Flight Mode Annunciator (FMA) | 12 APR 17 |
| | DSC-22_30-110 | Temporary Abnormal Behaviors | 05 SEP 17 |
| | DSC-22_40-10 | General | 12 APR 17 |
| | DSC-22_40-20 | Yaw Functions | 12 APR 17 |
| | DSC-22_40-30 | Flight Envelope Function | 12 APR 17 |
| | DSC-22_40-40 | Windshear Detection Function | 12 APR 17 |
| | DSC-22_40-50 | Controls and Indicators | 12 APR 17 |
| | DSC-22_45 | Auto Flight - AOC Functions | 12 APR 17 |
| | DSC-22_46 | Auto Flight - Print Interface | 12 APR 17 |
| | DSC-23-10-10 | Introduction | 12 APR 17 |
| | DSC-23-10-20 | Radio Tuning | 12 APR 17 |
| | DSC-23-10-30 | Intercommunication Systems | 12 APR 17 |
| | DSC-23-10-40 | Cockpit Voice Recorder | 12 APR 17 |
| | DSC-23-10-50 | Controls | 12 APR 17 |
| | DSC-23-20-10 | Flight Crew Interphone System | 12 APR 17 |

Continued on the following page

PRELIMINARY PAGES
LIST OF EFFECTIVE SECTIONS/SUBSECTIONS

Continued from the previous page

| M⁽¹⁾ | Localization | Subsection Title | Rev. Date |
|------------------------|---------------------|--------------------------------|------------------|
| | DSC-23-20-20 | Cabin Interphone System | 05 SEP 17 |
| | DSC-23-20-30 | Service Interphone System | 05 SEP 17 |
| | DSC-23-20-40 | Passenger Address | 05 SEP 17 |
| | DSC-23-30-10 | Radio Communication | 05 SEP 17 |
| | DSC-23-40-10 | Emergency Evacuation | 19 JUN 17 |
| | DSC-23-40-30 | Emergency Locator Transmitter | 12 APR 17 |
| | DSC-23-50 | Memo Display | 05 SEP 17 |
| | DSC-24-10-10 | General | 12 APR 17 |
| | DSC-24-10-20 | Generation of Electrical Power | 12 APR 17 |
| | DSC-24-10-30-10 | General | 12 APR 17 |
| | DSC-24-10-30-20 | Normal Configuration | 12 APR 17 |
| | DSC-24-10-30-30 | Abnormal Configurations | 12 APR 17 |
| | DSC-24-10-30-40 | Distribution Table | 12 APR 17 |
| | DSC-24-20 | Controls and Indicators | 12 APR 17 |
| | DSC-25-10-10 | General | 12 APR 17 |
| | DSC-25-10-20 | Cockpit Plan | 12 APR 17 |
| | DSC-25-10-30 | Seats | 12 APR 17 |
| | DSC-25-10-40 | Main Instrument Panels | 12 APR 17 |
| | DSC-25-10-50 | Pedestal | 12 APR 17 |
| | DSC-25-10-60 | Overhead Panel | 12 APR 17 |
| | DSC-25-10-70 | C/B Panels | 12 APR 17 |
| | DSC-25-10-80 | Foot Warmer (If Installed) | 12 APR 17 |
| | DSC-25-20 | Emergency Equipment | 12 APR 17 |
| | DSC-26-10 | General | 12 APR 17 |
| | DSC-26-20-10 | System Description | 05 SEP 17 |
| | DSC-26-20-20 | Controls and Indicators | 12 APR 17 |
| | DSC-26-30-10 | System Description | 12 APR 17 |
| | DSC-26-30-20 | Controls and Indicators | 12 APR 17 |
| | DSC-26-40-10 | System Description | 12 APR 17 |
| | DSC-26-50-10 | System Description | 12 APR 17 |
| | DSC-26-50-20 | Controls and Indicators | 12 APR 17 |
| | DSC-27-10-10 | General | 12 APR 17 |
| | DSC-27-10-20 | Architecture | 12 APR 17 |
| | DSC-27-20-10-10 | General | 12 APR 17 |
| | DSC-27-20-10-20 | Pitch Control | 12 APR 17 |
| | DSC-27-20-10-30 | Lateral Control | 12 APR 17 |
| | DSC-27-20-10-50 | Sideslip Target | 12 APR 17 |
| | DSC-27-20-10-70 | Aircraft Trimming | 12 APR 17 |
| | DSC-27-20-20 | Reconfiguration Control Laws | 12 APR 17 |

Continued on the following page

Continued from the previous page

| M⁽¹⁾ | Localization | Subsection Title | Rev. Date |
|------------------------|---------------------|---|------------------|
| | DSC-27-20-30 | Controls and Indicators | 12 APR 17 |
| | DSC-27-30-10 | Description | 12 APR 17 |
| | DSC-27-30-20 | Controls and Indicators | 12 APR 17 |
| | DSC-28-10-10 | General | 12 APR 17 |
| | DSC-28-10-20 | Tanks | 12 APR 17 |
| | DSC-28-10-30 | Engine Feed | 12 APR 17 |
| | DSC-28-10-50 | APU Feed | 12 APR 17 |
| | DSC-28-10-60 | Fuel Recirculation System | 12 APR 17 |
| | DSC-28-10-70 | Refueling and Defueling | 12 APR 17 |
| | DSC-28-10-80 | Fuel Quantity Indication and Level Sensing | 12 APR 17 |
| | DSC-28-20 | Controls and Indicators | 12 APR 17 |
| | DSC-29-10-10 | General | 12 APR 17 |
| | DSC-29-10-20 | Generation | 12 APR 17 |
| | DSC-29-10-30 | Distribution | 12 APR 17 |
| | DSC-29-20 | Controls and Indicators | 12 APR 17 |
| | DSC-30-10-10 | Description | 12 APR 17 |
| | DSC-30-20-10 | Description | 12 APR 17 |
| | DSC-30-20-20 | Controls And Indicators | 12 APR 17 |
| | DSC-30-30-10 | Description | 12 APR 17 |
| | DSC-30-30-20 | Controls and Indicators | 12 APR 17 |
| | DSC-30-40-10 | Description | 12 APR 17 |
| | DSC-30-40-20 | Controls and Indicators | 12 APR 17 |
| | DSC-30-50-10 | Description | 12 APR 17 |
| | DSC-30-50-20 | Controls and Indicators | 12 APR 17 |
| | DSC-30-60-10 | Description | 19 JUN 17 |
| | DSC-30-60-20 | Controls and Indicators | 12 APR 17 |
| | DSC-30-70-10 | Description | 12 APR 17 |
| | DSC-31-05-10 | Introduction | 12 APR 17 |
| | DSC-31-05-20 | Cockpit Arrangement | 12 APR 17 |
| | DSC-31-05-30 | Architecture | 05 SEP 17 |
| | DSC-31-05-40 | Controls and Switching | 12 APR 17 |
| | DSC-31-05-50 | Reconfiguring the DMC | 12 APR 17 |
| | DSC-31-05-60 | Reconfiguring DUs | 12 APR 17 |
| | DSC-31-10 | ECAM Description | 12 APR 17 |
| | DSC-31-15 | Indications on E/WD | 12 APR 17 |
| | DSC-31-20 | Indications on SD | 12 APR 17 |
| | DSC-31-25-10 | General | 12 APR 17 |
| | DSC-31-25-20 | Example | 12 APR 17 |
| | DSC-31-27 | OEB Reminder | 12 APR 17 |

Continued on the following page

PRELIMINARY PAGES
LIST OF EFFECTIVE SECTIONS/SUBSECTIONS

Continued from the previous page

| M⁽¹⁾ | Localization | Subsection Title | Rev. Date |
|------------------------|---------------------|---|------------------|
| | DSC-31-30 | ECAM Controls | 05 SEP 17 |
| | DSC-31-40 | Indications on PFD | 12 APR 17 |
| | DSC-31-45 | Indications on ND | 12 APR 17 |
| | DSC-31-50 | EFIS Controls | 12 APR 17 |
| | DSC-31-55-10 | General | 12 APR 17 |
| | DSC-31-55-20 | Controls and Indicators | 12 APR 17 |
| | DSC-31-60-10 | Flight Data Recording System | 12 APR 17 |
| | DSC-31-60-20 | Controls and Indicators | 12 APR 17 |
| | DSC-31-60-30 | Aircraft Integrated Data System | 12 APR 17 |
| | DSC-32-10-10 | Description | 12 APR 17 |
| | DSC-32-10-20 | Landing Gear System/Interface | 12 APR 17 |
| | DSC-32-10-30 | Interactions between Landing Gear and Aircraft Systems | 12 APR 17 |
| | DSC-32-10-40 | Controls and Indicators | 12 APR 17 |
| | DSC-32-20-10 | Description | 12 APR 17 |
| | DSC-32-20-20 | Controls and Indicators | 05 SEP 17 |
| | DSC-32-30-10 | Description | 12 APR 17 |
| | DSC-32-30-20 | Controls and Indicators | 12 APR 17 |
| | DSC-33-10-10 | General | 12 APR 17 |
| | DSC-33-10-20 | Description | 12 APR 17 |
| | DSC-33-10-30 | Controls and Indicators | 12 APR 17 |
| | DSC-33-20-10 | General | 12 APR 17 |
| | DSC-33-20-20 | Controls and Indicators | 12 APR 17 |
| | DSC-33-30-10 | Description | 05 SEP 17 |
| | DSC-33-30-20 | Controls and Indicators | 12 APR 17 |
| | DSC-33-40-10 | Controls and Indicators | 12 APR 17 |
| | DSC-34-NAV-10-10 | Description | 12 APR 17 |
| | DSC-34-NAV-10-20 | Controls and Indicators | 12 APR 17 |
| | DSC-34-NAV-15-10 | Description | 12 APR 17 |
| | DSC-34-NAV-20 | Standby Instruments | 12 APR 17 |
| | DSC-34-NAV-30-10 | Tuning | 12 APR 17 |
| | DSC-34-NAV-30-20 | Nav aids | 12 APR 17 |
| | DSC-34-NAV-30-30 | Controls and Indicators | 12 APR 17 |
| | DSC-34-NAV-40-10 | Description | 12 APR 17 |
| | DSC-34-SURV-10-10 | Description | 12 APR 17 |
| | DSC-34-SURV-10-20 | Controls and Indicators | 12 APR 17 |
| | DSC-34-SURV-30-10 | Description | 12 APR 17 |
| | DSC-34-SURV-30-20 | Predictive Windshear System | 12 APR 17 |
| | DSC-34-SURV-30-30 | Controls and Indicators | 12 APR 17 |
| | DSC-34-SURV-40-10 | Description | 12 APR 17 |

Continued on the following page

Continued from the previous page

| M⁽¹⁾ | Localization | Subsection Title | Rev. Date |
|------------------------|---------------------|-------------------------------------|------------------|
| | DSC-34-SURV-40-20 | GPWS Basics Modes | 05 SEP 17 |
| | DSC-34-SURV-40-35 | Predictive GPWS Functions | 12 APR 17 |
| | DSC-34-SURV-40-40 | Controls and Indicators | 19 JUN 17 |
| | DSC-34-SURV-60-10 | Description | 12 APR 17 |
| | DSC-34-SURV-60-20 | Controls and Indicators | 12 APR 17 |
| | DSC-35-10 | General | 12 APR 17 |
| | DSC-35-20-10 | Description | 12 APR 17 |
| | DSC-35-20-20 | Controls and Indicators | 12 APR 17 |
| | DSC-35-30-10 | Description | 12 APR 17 |
| | DSC-35-30-20 | Controls and Indicators | 12 APR 17 |
| | DSC-35-40-10 | Description | 12 APR 17 |
| | DSC-36-10-10 | General | 12 APR 17 |
| | DSC-36-10-20 | Engine Bleed System | 12 APR 17 |
| | DSC-36-10-30 | APU Bleed Air Supply | 12 APR 17 |
| | DSC-36-10-40 | Crossbleed | 12 APR 17 |
| | DSC-36-10-50 | Leak Detection | 12 APR 17 |
| | DSC-36-10-60 | Operation Following Failures | 12 APR 17 |
| | DSC-36-20 | Controls and Indicators | 12 APR 17 |
| | DSC-38-10 | Description | 12 APR 17 |
| | DSC-45-10 | Description | 12 APR 17 |
| | DSC-45-20 | System Operation | 12 APR 17 |
| | DSC-45-25 | Data Loading | 12 APR 17 |
| | DSC-45-30 | Printer | 12 APR 17 |
| | DSC-46-10-10 | General System Description | 12 APR 17 |
| | DSC-46-10-20-10 | General | 12 APR 17 |
| | DSC-46-10-40-30 | MCDU Datalink Pages | 12 APR 17 |
| | DSC-46-10-40-40 | MCDU Scratchpad Messages | 12 APR 17 |
| | DSC-46-10-40-60 | ECAM | 12 APR 17 |
| | DSC-46-10-50 | How To | 12 APR 17 |
| | DSC-46-20-20 | Applications | 05 SEP 17 |
| | DSC-46-30 | Electronic QRH (eQRH) | 12 APR 17 |
| | DSC-46-40-10 | General | 12 APR 17 |
| | DSC-46-40-20 | In Seat Power Supply System | 12 APR 17 |
| | DSC-46-40-30 | Controls and Indicators | 19 JUN 17 |
| | DSC-49-10-10 | General | 12 APR 17 |
| | DSC-49-10-20 | Main Components | 12 APR 17 |
| | DSC-49-20 | Controls and Indicators | 12 APR 17 |
| | DSC-52-10-10 | General | 12 APR 17 |
| | DSC-52-10-20 | Passenger Doors | 12 APR 17 |

Continued on the following page

PRELIMINARY PAGES
LIST OF EFFECTIVE SECTIONS/SUBSECTIONS

Continued from the previous page

| M⁽¹⁾ | Localization | Subsection Title | Rev. Date |
|------------------------|---------------------|---|------------------|
| | DSC-52-10-30 | Emergency Exits | 12 APR 17 |
| | DSC-52-10-40 | Cargo Doors | 12 APR 17 |
| | DSC-52-10-50 | Avionics Compartment Access Door | 12 APR 17 |
| | DSC-52-10-60 | Cockpit Door | 12 APR 17 |
| | DSC-52-10-80 | Escape Slides/Rafts | 12 APR 17 |
| | DSC-52-20 | Controls and Indicators | 12 APR 17 |
| | DSC-52-40-10 | Description | 12 APR 17 |
| | DSC-52-40-20 | Cockpit Door Locking System (CDLS) | 12 APR 17 |
| | DSC-52-40-30 | Cockpit Door Surveillance System (CDSS) | 12 APR 17 |
| | DSC-52-50 | How to | 12 APR 17 |
| | DSC-56-10 | General | 12 APR 17 |
| | DSC-56-20 | Fixed Windows | 12 APR 17 |
| | DSC-56-30 | Sliding Windows | 12 APR 17 |
| | DSC-56-40 | Description | 12 APR 17 |
| | DSC-70-05 | Overview | 12 APR 17 |
| | DSC-70-10 | System Description | 12 APR 17 |
| | DSC-70-20 | FADEC | 12 APR 17 |
| | DSC-70-30-10 | General | 12 APR 17 |
| | DSC-70-30-20 | Thrust Levers | 12 APR 17 |
| | DSC-70-30-30 | Thrust Rating Limit | 12 APR 17 |
| | DSC-70-30-40 | Thrust Control | 12 APR 17 |
| | DSC-70-40 | Fuel System (CFM56) | 12 APR 17 |
| | DSC-70-50 | Oil System | 12 APR 17 |
| | DSC-70-60 | Airbleed System (CFM56) | 12 APR 17 |
| | DSC-70-70 | Thrust Reverser System | 12 APR 17 |
| | DSC-70-80-10 | General | 12 APR 17 |
| | DSC-70-80-20 | Architecture | 12 APR 17 |
| | DSC-70-80-30 | Ignition System | 12 APR 17 |
| | DSC-70-80-40 | Engine Starting System | 12 APR 17 |
| | DSC-70-90-10 | Overhead Panel | 12 APR 17 |
| | DSC-70-90-20 | Pedestal | 12 APR 17 |
| | DSC-70-90-30 | Maintenance Panel | 12 APR 17 |
| | DSC-70-90-40 | Engine Display | 05 SEP 17 |
| | DSC-70-90-50 | Memo Display | 12 APR 17 |
| | PRO-PLP-LETDU | LIST OF EFFECTIVE TEMPORARY DOCUMENTARY UNITS | 05 SEP 17 |
| | PRO-ABN-ABN-00 | INTRODUCTION | 05 SEP 17 |
| | PRO-ABN-ABN-ADV | [ADV] ECAM ADVISORY | 05 SEP 17 |
| | PRO-ABN-ABN-MEM | [MEM] MEMORY ITEMS | 19 JUN 17 |
| | PRO-ABN-ABN-QRH | [QRH] PROCEDURES | 12 APR 17 |

Continued on the following page

Continued from the previous page

| M⁽¹⁾ | Localization | Subsection Title | Rev. Date |
|------------------------|---------------------|---|------------------|
| | PRO-ABN-ABN-RESET | [RESET] SYSTEM RESET | 05 SEP 17 |
| | PRO-ABN-A-ICE | A-ICE | 12 APR 17 |
| | PRO-ABN-AIR | AIR | 12 APR 17 |
| | PRO-ABN-APU | APU | 12 APR 17 |
| | PRO-ABN-APUF | APU FIRE | 12 APR 17 |
| | PRO-ABN-AUTO_FLT | AUTO FLT | 19 JUN 17 |
| | PRO-ABN-AVNCs | AVIONICS SMOKE | 12 APR 17 |
| | PRO-ABN-BLEED | BLEED | 12 APR 17 |
| | PRO-ABN-BRAKES | BRAKES | 12 APR 17 |
| | PRO-ABN-NWS | BRAKES-NWS | 12 APR 17 |
| | PRO-ABN-CAB_PR | CAB PR | 12 APR 17 |
| | PRO-ABN-C_B | C/B | 12 APR 17 |
| | PRO-ABN-COM | COM | 12 APR 17 |
| | PRO-ABN-COND | COND | 12 APR 17 |
| | PRO-ABN-CONFIG | CONFIG | 12 APR 17 |
| | PRO-ABN-DATALINK | DATALINK | 12 APR 17 |
| | PRO-ABN-DOOR | DOOR | 12 APR 17 |
| | PRO-ABN-EIS | EIS | 12 APR 17 |
| | PRO-ABN-ELEC | ELEC | 05 SEP 17 |
| | PRO-ABN-ENG | ENG | 05 SEP 17 |
| | PRO-ABN-F_CTL | F/CTL | 19 JUN 17 |
| | PRO-ABN-FUEL | FUEL | 12 APR 17 |
| | PRO-ABN-FWS | FWS | 12 APR 17 |
| | PRO-ABN-HYD | HYD | 05 SEP 17 |
| | PRO-ABN-LG | L/G | 05 SEP 17 |
| | PRO-ABN-MISC | MISC | 19 JUN 17 |
| | PRO-ABN-NAV | NAV | 19 JUN 17 |
| | PRO-ABN-OVERSPEED | OVERSPEED | 19 JUN 17 |
| | PRO-ABN-RECORDER | RECORDER | 12 APR 17 |
| | PRO-ABN-SMOKE | SMOKE | 05 SEP 17 |
| | PRO-ABN-SURV | SURV | 12 APR 17 |
| | PRO-ABN-VENT | VENT | 12 APR 17 |
| | PRO-ABN-WHEEL | WHEEL | 12 APR 17 |
| | PRO-ABN-W_A_ICE | WING A.ICE | 12 APR 17 |
| | PRO-ABN-90 | Detailed Cabin / Cockpit Evacuation Procedure | 05 SEP 17 |
| | PRO-NOR-SOP-01 | General Information | 19 JUN 17 |
| | PRO-NOR-SOP-02 | Flight Preparation | 12 APR 17 |
| | PRO-NOR-SOP-03 | Safety Exterior Inspection | 12 APR 17 |
| | PRO-NOR-SOP-04 | Preliminary Cockpit Preparation | 05 SEP 17 |

Continued on the following page

PRELIMINARY PAGES
LIST OF EFFECTIVE SECTIONS/SUBSECTIONS

Continued from the previous page

| M⁽¹⁾ | Localization | Subsection Title | Rev. Date |
|------------------------|----------------------|--|------------------|
| | PRO-NOR-SOP-05 | Exterior Walkaround | 05 SEP 17 |
| | PRO-NOR-SOP-06 | Cockpit Preparation | 12 APR 17 |
| | PRO-NOR-SOP-07 | Before Pushback or Start | 19 JUN 17 |
| | PRO-NOR-SOP-08 | Engine Start | 05 SEP 17 |
| | PRO-NOR-SOP-09 | After Start | 12 APR 17 |
| | PRO-NOR-SOP-10 | Taxi | 05 SEP 17 |
| | PRO-NOR-SOP-11 | Before Takeoff | 12 APR 17 |
| | PRO-NOR-SOP-12 | Takeoff | 19 JUN 17 |
| | PRO-NOR-SOP-13 | After Takeoff | 12 APR 17 |
| | PRO-NOR-SOP-14 | Climb | 12 APR 17 |
| | PRO-NOR-SOP-15 | Cruise | 12 APR 17 |
| | PRO-NOR-SOP-16 | Descent Preparation | 19 JUN 17 |
| | PRO-NOR-SOP-17 | Descent | 05 SEP 17 |
| | PRO-NOR-SOP-18-A | Approach General | 12 APR 17 |
| | PRO-NOR-SOP-18-B | Aircraft Configuration Management | 12 APR 17 |
| | PRO-NOR-SOP-18-C | Aircraft Guidance Management | 05 SEP 17 |
| | PRO-NOR-SOP-19 | Landing | 05 SEP 17 |
| | PRO-NOR-SOP-20 | Go-Around | 12 APR 17 |
| | PRO-NOR-SOP-21 | After Landing | 05 SEP 17 |
| | PRO-NOR-SOP-22 | Parking | 05 SEP 17 |
| | PRO-NOR-SOP-23 | Securing the Aircraft | 19 JUN 17 |
| | PRO-NOR-SOP-90 | Standard Callouts | 12 APR 17 |
| | PRO-NOR-SUP-SUP | Supplementary Procedures Menu | 12 APR 17 |
| | PRO-NOR-SUP-ADVWXR | Adverse Weather | 12 APR 17 |
| | PRO-NOR-SUP-COM | Communication | 12 APR 17 |
| | PRO-NOR-SUP-ENG | Engines | 19 JUN 17 |
| | PRO-NOR-SUP-FUEL | Fuel | 05 SEP 17 |
| | PRO-NOR-SUP-LG-LG_DN | Flight with Landing Gear Down | 05 SEP 17 |
| | PRO-NOR-SUP-LG-LG | Operation with Nosewheel Steering Offset | 05 SEP 17 |
| | PRO-NOR-SUP-MISC-D | Pushback with Power Push Unit | 12 APR 17 |
| | PRO-NOR-SUP-MISC-A | High Altitude Airport Operations | 12 APR 17 |
| | PRO-NOR-SUP-MISC-C | Operations at QNH Above 1050 hPa | 12 APR 17 |
| | PRO-NOR-SUP-NAV | Navigation | 12 APR 17 |
| | PRO-NOR-SRP-01-05 | Introduction | 12 APR 17 |
| | PRO-NOR-SRP-01-10 | Cockpit Preparation | 12 APR 17 |
| | PRO-NOR-SRP-01-15 | Before Pushback or Start | 12 APR 17 |
| | PRO-NOR-SRP-01-20 | Taxi | 12 APR 17 |
| | PRO-NOR-SRP-01-30 | Takeoff | 12 APR 17 |
| | PRO-NOR-SRP-01-40 | Climb | 12 APR 17 |

Continued on the following page

Continued from the previous page

| M⁽¹⁾ | Localization | Subsection Title | Rev. Date |
|------------------------|---------------------|--|------------------|
| | PRO-NOR-SRP-01-50 | Cruise | 12 APR 17 |
| | PRO-NOR-SRP-01-60 | Descent | 12 APR 17 |
| | PRO-NOR-SRP-01-70 | Approach | 12 APR 17 |
| | PRO-NOR-SRP-01-80 | Go-Around | 12 APR 17 |
| | PRO-SPO-20 | Flight Without Cabin Pressurization | 12 APR 17 |
| | PRO-SPO-40-10 | General | 12 APR 17 |
| | PRO-SPO-40-20 | Operational Limitations | 12 APR 17 |
| | PRO-SPO-40-30 | Dispatch Consideration | 12 APR 17 |
| | PRO-SPO-40-40 | Diversion During Extended Range Operations | 12 APR 17 |
| | PRO-SPO-40-50 | Procedures | 05 SEP 17 |
| | PRO-SPO-40-60 | Performance | 12 APR 17 |
| | PRO-SPO-45 | Engine Intermix Operations | 19 JUN 17 |
| | PRO-SPO-50 | Reduced Vertical Separation Minimum - RVSM | 12 APR 17 |
| | PRO-SPO-51 | Required Navigation Performance (RNP) | 05 SEP 17 |
| | PRO-SPO-60 | Operations on Narrow Runways | 12 APR 17 |
| | PRO-SPO-85 | ILS PRM Approach | 12 APR 17 |
| | LIM-PLP-LETDU | LIST OF EFFECTIVE TEMPORARY DOCUMENTARY UNITS | 12 APR 17 |
| | LIM-INT | Introduction | 05 SEP 17 |
| | LIM-AG-F_CTL | Flight Maneuvering Load Acceleration Limits | 12 APR 17 |
| | LIM-AG-OPS | Operational Parameters | 05 SEP 17 |
| | LIM-AG-SPD | Speeds | 12 APR 17 |
| | LIM-AG-WGHT | Weights | 12 APR 17 |
| | LIM-AIR | Air Bleed/Cond/Press/Vent | 12 APR 17 |
| | LIM-AFS-10 | General | 05 SEP 17 |
| | LIM-AFS-20 | Automatic Approach, Landing and Rollout | 12 APR 17 |
| | LIM-APU | Auxiliary Power Unit | 05 SEP 17 |
| | LIM-CAB | Cabin Systems | 12 APR 17 |
| | LIM-COM | Communication | 19 JUN 17 |
| | LIM-ENG | Engines | 12 APR 17 |
| | LIM-F_CTL | Flight Controls | 12 APR 17 |
| | LIM-FUEL | Fuel | 12 APR 17 |
| | LIM-ICE_RAIN | Ice and Rain Protection | 12 APR 17 |
| | LIM-LG | Landing Gear | 19 JUN 17 |
| | LIM-NAV | Navigation | 12 APR 17 |
| | LIM-OXY | Oxygen | 12 APR 17 |
| | LIM-SURV | Surveillance | 12 APR 17 |
| | OEB-PLP-LETDU | LIST OF EFFECTIVE TEMPORARY DOCUMENTARY UNITS | 17 OCT 17 |
| | OEB-PLP-LEOEB | LIST OF EFFECTIVE OPERATIONS ENGINEERING BULLETIN | 12 APR 17 |
| | PER-PLP-LETDU | LIST OF EFFECTIVE TEMPORARY DOCUMENTARY UNITS | 17 OCT 17 |

Continued on the following page

PRELIMINARY PAGES
LIST OF EFFECTIVE SECTIONS/SUBSECTIONS

Continued from the previous page

| M⁽¹⁾ | Localization | Subsection Title | Rev. Date |
|------------------------|---------------------|--|------------------|
| | PER-LOD-GEN | GENERAL | 12 APR 17 |
| | PER-LOD-CGO | CARGO LOADING | 12 APR 17 |
| | PER-LOD-FUL | FUEL | 12 APR 17 |
| | PER-LOD-WBA-LTS | LOAD AND TRIM SHEET | 12 APR 17 |
| | PER-LOD-WBA-FIT-10 | FUEL INDEX TABLE | 12 APR 17 |
| | PER-OPD-GEN | GENERAL | 12 APR 17 |
| | PER-OPD-CON-AEO | ALL ENGINES OPERATIVE | 12 APR 17 |
| | PER-OPD-CON-OEI | ONE ENGINE INOPERATIVE | 12 APR 17 |
| | PER-THR-GEN | GENERAL | 12 APR 17 |
| | PER-THR-MTO | MAXIMUM TAKEOFF | 12 APR 17 |
| | PER-THR-MGA | MAXIMUM GO AROUND | 12 APR 17 |
| | PER-THR-FLX | FLEXIBLE TAKEOFF | 12 APR 17 |
| | PER-THR-MCT | MAXIMUM CONTINUOUS | 12 APR 17 |
| | PER-THR-MCL | MAXIMUM CLIMB | 12 APR 17 |
| | PER-THR-MCR | MAXIMUM CRUISE | 12 APR 17 |
| | PER-TOF-THR-FLX-10 | DEFINITION OF FLEXIBLE TAKEOFF | 12 APR 17 |
| | PER-TOF-THR-FLX-20 | USE OF FLEXIBLE TAKEOFF | 12 APR 17 |
| | PER-TOF-THR-FLX-30 | REQUIREMENTS | 12 APR 17 |
| | PER-TOF-THR-FLX-40 | RECOMMENDATION | 12 APR 17 |
| | PER-TOF-TOC-05 | INTRODUCTION | 12 APR 17 |
| | PER-TOF-TOC-10-10 | TAKEOFF PERFORMANCE | 12 APR 17 |
| | PER-TOF-TOC-10-20 | TAKEOFF CHART DESCRIPTION | 12 APR 17 |
| | PER-TOF-TOC-10-30 | ADDITIONAL INFORMATION | 12 APR 17 |
| | PER-TOF-TOC-12-10 | DETERMINATION OF MAXIMUM TAKEOFF WEIGHT AND SPEEDS | 12 APR 17 |
| | PER-TOF-TOC-12-30 | EXTRAPOLATION | 12 APR 17 |
| | PER-TOF-TOC-12-40 | MAXIMUM STRUCTURAL TAKEOFF WEIGHT | 12 APR 17 |
| | PER-TOF-TOC-12-50 | SUMMARY | 12 APR 17 |
| | PER-TOF-TOC-14-10 | DETERMINATION OF FLEXIBLE TAKEOFF TEMPERATURE AND SPEEDS | 12 APR 17 |
| | PER-TOF-TOC-14-20 | FLEXIBLE TAKEOFF NOT POSSIBLE | 12 APR 17 |
| | PER-TOF-TOC-14-25 | FLEXIBLE TAKEOFF POSSIBLE BUT NOT USED | 12 APR 17 |
| | PER-TOF-TOC-14-30 | SUMMARY | 12 APR 17 |
| | PER-TOF-TOC-16-10 | TAKEOFF PERFORMANCE | 12 APR 17 |
| | PER-TOF-TOC-16-20 | TAKEOFF CHART DESCRIPTION | 12 APR 17 |
| | PER-TOF-TOC-16-30 | ADDITIONAL INFORMATION | 12 APR 17 |
| | PER-TOF-TOC-18-10 | DETERMINATION OF MAXIMUM TAKEOFF WEIGHT AND SPEEDS | 12 APR 17 |
| | PER-TOF-TOC-18-20 | EXTRAPOLATION | 12 APR 17 |
| | PER-TOF-TOC-18-30 | MAXIMUM STRUCTURAL TAKEOFF WEIGHT | 12 APR 17 |

Continued on the following page

Continued from the previous page

| M⁽¹⁾ | Localization | Subsection Title | Rev. Date |
|------------------------|---------------------|---|------------------|
| | PER-TOF-TOC-18-40 | SUMMARY | 12 APR 17 |
| | PER-TOF-TOC-20-10 | DETERMINATION OF FLEXIBLE TAKEOFF TEMPERATURE AND SPEEDS | 12 APR 17 |
| | PER-TOF-TOC-20-20 | FLEXIBLE TAKEOFF NOT POSSIBLE | 12 APR 17 |
| | PER-TOF-TOC-20-30 | SUMMARY | 12 APR 17 |
| | PER-TOF-TOD-24 | QNH/BLEEDS CORRECTION | 12 APR 17 |
| | PER-TOF-TOD-25-10 | SPEEDS LIMITED BY VMCG/VMCA | 12 APR 17 |
| | PER-TOF-TOD-25-20 | V2 LIMITED BY VMU/VMCA | 12 APR 17 |
| | PER-TOF-CTA-10 | GENERAL | 12 APR 17 |
| | PER-TOF-CTA-20 | DEFINITIONS | 12 APR 17 |
| | PER-TOF-CTA-30 | OPERATIONAL CONDITIONS | 12 APR 17 |
| | PER-TOF-CTA-40-10 | TAKEOFF PERFORMANCE | 12 APR 17 |
| | PER-TOF-CTA-40-20 | TAKEOFF FROM A WET RUNWAY | 12 APR 17 |
| | PER-TOF-CTA-40-30 | TAKEOFF FROM A CONTAMINATED RUNWAY | 12 APR 17 |
| | PER-TOF-CTA-40-40 | EXAMPLE | 12 APR 17 |
| | PER-FPL-GEN-MFR | MINIMUM RECOMMENDED FUEL REQUIREMENTS | 12 APR 17 |
| | PER-FPL-GEN-FPL | FLIGHT PLAN | 12 APR 17 |
| | PER-FPL-FLP-QFP-10 | INTRODUCTION | 12 APR 17 |
| | PER-FPL-FLP-QFP-20 | CORRECTION FOR DEVIATION FROM REFERENCE LANDING WEIGHT | 12 APR 17 |
| | PER-FPL-FLP-QFP-30 | EXAMPLE | 05 SEP 17 |
| | PER-FPL-FLP-QFP-40 | FLIGHT PLANNING AT A GIVEN MACH NUMBER | 12 APR 17 |
| | PER-FPL-FLP-QFP-50 | FLIGHT PLANNING AT LONG RANGE SPEED | 12 APR 17 |
| | PER-FPL-FLP-ALN-20 | ALL ENGINES OPERATIVE | 12 APR 17 |
| | PER-CLB-GEN | GENERAL | 12 APR 17 |
| | PER-CLB-CLT | CLIMB TABLES | 12 APR 17 |
| | PER-CRZ-ALT-10 | OPTIMUM AND MAXIMUM ALTITUDES | 12 APR 17 |
| | PER-CRZ-ALT-20 | WIND ALTITUDE TRADE FOR CONSTANT SPECIFIC RANGE | 12 APR 17 |
| | PER-CRZ-CRT-10 | GENERAL | 12 APR 17 |
| | PER-CRZ-CRT-20 | CRUISE AT M.78 | 12 APR 17 |
| | PER-CRZ-CRT-30 | CRUISE AT LONG RANGE | 12 APR 17 |
| | PER-CRZ-ICQ-10 | GENERAL | 12 APR 17 |
| | PER-CRZ-ICQ-20 | EXAMPLE | 12 APR 17 |
| | PER-HLD-GEN | GENERAL | 12 APR 17 |
| | PER-HLD-HLD | HOLDING TABLES | 12 APR 17 |
| | PER-DES-GEN | GENERAL | 12 APR 17 |
| | PER-DES-STD | STANDARD | 12 APR 17 |
| | PER-DES-EMG | EMERGENCY | 12 APR 17 |
| | PER-GOA-GEN | GENERAL | 12 APR 17 |

Continued on the following page

PRELIMINARY PAGES
LIST OF EFFECTIVE SECTIONS/SUBSECTIONS

Continued from the previous page

| M⁽¹⁾ | Localization | Subsection Title | Rev. Date |
|------------------------|---------------------|---|------------------|
| | PER-GOA-ACG-NOR | NORMAL | 12 APR 17 |
| | PER-GOA-ACG-CAT | CAT II | 12 APR 17 |
| | PER-LDG-GEN | GENERAL | 19 JUN 17 |
| | PER-LDG-CTA-10 | GENERAL | 12 APR 17 |
| | PER-LDG-CTA-20 | DEFINITIONS | 05 SEP 17 |
| | PER-LDG-DIS-MAT | Runway Condition Assessment Matrix for Landing | 12 APR 17 |
| | PER-LDG-DIS-RLD | REQUIRED LANDING DISTANCES / MANUAL LANDING | 12 APR 17 |
| | PER-LDG-DIS-RLA | REQUIRED LANDING DISTANCES | 12 APR 17 |
| | PER-OEI-GEN | GENERAL | 12 APR 17 |
| | PER-OEI-ALT-10 | CEILINGS | 12 APR 17 |
| | PER-OEI-CRT-10 | STANDARD AND OBSTACLE STRATEGIES | 12 APR 17 |
| | PER-OEI-CRT-20 | FIXED SPEED STRATEGIES | 12 APR 17 |
| | PER-OEI-ICQ-10 | STANDARD STRATEGIES | 12 APR 17 |
| | PER-OEI-ICQ-20 | FIXED SPEED STRATEGIES | 12 APR 17 |
| | PER-OEI-HLD | HOLDING | 12 APR 17 |
| | PER-OEI-DES-10 | STANDARD STRATEGY | 12 APR 17 |
| | PER-OEI-DES-15 | OBSTACLE STRATEGY | 12 APR 17 |
| | PER-OEI-DES-20 | FIXED SPEED STRATEGIES | 12 APR 17 |
| | PER-OEI-DES-30 | DESCENT TO LANDING | 12 APR 17 |

(1) Evolution code : N=New, R=Revised, E=Effectivity, M=Moved

This table gives, for each delivered aircraft, the cross reference between:

- The Manufacturing Serial Number (MSN).
- The Fleet Serial Number (FSN) of the aircraft as known by AIRBUS S.A.S.
- The registration number of the aircraft as known by AIRBUS S.A.S.
- The aircraft model.

| M⁽¹⁾ | MSN | FSN | Registration Number | Model |
|------------------------|------------|------------|----------------------------|--------------|
| | 4100 | | HC-CSF | 320-214 |

(1) Evolution code : N=New, R=Revised



A318/A319/A320/A321
FLIGHT CREW
OPERATING MANUAL

PRELIMINARY PAGES
AIRCRAFT ALLOCATION TABLE

Intentionally left blank

| M⁽¹⁾ | MODIFICATION | Linked SB | Incorp. Date | Title |
|------------------------|---------------------------|------------------|---------------------|---|
| | J0006 | | 20 AUG 10 | FUEL SYSTEM - ADDITIONAL TREATMENT OF CENTRE TANK STRUCTURE AND INSTALLATION OF CENTRE TANK SYSTEM |
| | Applicable to: ALL | | | |
| | J0012 | | 20 AUG 10 | NAVIGATION LIGHTS SYSTEM - INSTALLATION OF A SECOND NAVIGATION LIGHT SYSTEM |
| | Applicable to: ALL | | | |
| | J0022 | | 20 AUG 10 | INSTALLATION OF A FUEL QUANTITY SELECTOR IN THE FLIGHT COMPARTMENT |
| | Applicable to: ALL | | | |
| | J0071 | | 20 AUG 10 | WING STRUCTURE-INTRODUCTION OF A WING TIP INCORPORATING A TIP FENCE FOR 72T MTOW A/C |
| | Applicable to: ALL | | | |
| | J0664 | | 20 AUG 10 | FUEL SYSTEM-TO IMPROVE LOW LEVEL WARNING |
| | Applicable to: ALL | | | |
| | J0689 | | 20 AUG 10 | WING-TO DELETE L/E VENTILATION SYSTEM (PICCOLO TUBE) |
| | Applicable to: ALL | | | |
| | J1255 | | 20 AUG 10 | FUEL - TANK LEVEL SENSING - CHANGE TO LOW PRESSURE WARNING |
| | Applicable to: ALL | | | |
| | J1334 | | 20 AUG 10 | LANDING GEAR-MLG-LGCIU-INTRODUCTION OF A NEW STANDARD FOR IMPROVED PROXIMITY SENSOR FAULT MONITORING FUNCTION |
| | Applicable to: ALL | | | |
| | J1617 | | 20 AUG 10 | FLIGHT CONTROLS - GENERAL - DELETE LAF FEATURE FROM A320 DEFINITION (PRODUCTION SOLUTION) |
| | Applicable to: ALL | | | |
| | J2190 | | 20 AUG 10 | FUEL - MAIN FUEL PUMPS SYSTEMS - CENTRE TANK PUMPS AUTO FEED FAULT.ADAPT PUMP CONTROL LATCH FOR FLIGHT DECK REFUEL CABABILITY |
| | Applicable to: ALL | | | |
| | J2257 | | 20 AUG 10 | FUEL - MANUAL MAGNETIC INDICATORS - ATTITUDE MONITOR DELETION |
| | Applicable to: ALL | | | |
| | J2360 | | 20 AUG 10 | FUEL - QUANTITY INDICATION - INTRODUCE FUEL LEAK DETECTION ASSOCIATED WITH FQIC - 13 - 9 |
| | Applicable to: ALL | | | |

Continued on the following page

Continued from the previous page

| M ⁽¹⁾ | MODIFICATION | Linked SB | Incorp. Date | Title |
|---------------------------|--------------|-----------|--------------|--|
| | J2361 | | 20 AUG 10 | FUEL - QUANTITY INDICATION - REMOVAL OF FUEL LEAK DETECTION FUNCTION ASSOCIATED WITH THE FQIC 13 - 9 |
| Applicable to: ALL | | | | |
| | J2527 | | 20 AUG 10 | FUEL - QUANTITY INDICATING - INTRODUCE NEW STANDARD OF FUEL QTY INDICATING COMPUTER 13-10 |
| Applicable to: ALL | | | | |
| | J2662 | | 15 FEB 13 | FUEL - QUANTITY INDICATING - INTRODUCE NEW STANDARD OF FQIC (P/N SIC5059 14-20) |
| Applicable to: ALL | | | | |
| | J2816 | | 07 APR 11 | WING - FIXED PARTITION - INTRODUCED A STANDARD OF BOX WITHOUT DRY BAY |
| Applicable to: ALL | | | | |
| | J2963 | | 07 APR 11 | REDUCTION IN QUANTITY OF MAGNETIC LEVEL INDICATORS |
| Applicable to: ALL | | | | |
| | K0024 | | 20 AUG 10 | INSTALLATION OF ADDITIONAL CARGO DOOR (BULK DOOR) |
| Applicable to: ALL | | | | |
| | K0026 | | 20 AUG 10 | LIGHTS - LOGOLIGHTS - INSTALLATION OF LOGOLIGHTS SYSTEM |
| Applicable to: ALL | | | | |
| | K0035 | | 20 AUG 10 | FIRE PROTECTION - FWD LOWER HOLD - INSTALLATION OF SMOKE DETECTION SYSTEM |
| Applicable to: ALL | | | | |
| | K0036 | | 20 AUG 10 | FIRE PROTECTION - AFT LOWER HOLD - INSTALLATION OF SMOKE DETECTION SYSTEM |
| Applicable to: ALL | | | | |
| | K0037 | | 20 AUG 10 | FIRE PROTECTION - FWD AND AFT LOWER HOLD INSTALLATION OF A SINGLE SHOT FIRE EXTINGUISHING SYSTEM |
| Applicable to: ALL | | | | |
| | K0052 | | 20 AUG 10 | INSTALLATION OF AN AIDS |
| Applicable to: ALL | | | | |
| | K0064 | | 20 AUG 10 | LIGHTS - INSTALLATION OF STROBE LIGHTS SYNCHRONISED MODE |
| Applicable to: ALL | | | | |
| | K0066 | | 20 AUG 10 | AIR CONDITIONING - VENTILATION SYSTEM FOR FWD CARGO COMPARTMENT |
| Applicable to: ALL | | | | |

Continued on the following page

Continued from the previous page

| M⁽¹⁾ | MODIFICATION | Linked SB | Incorp. Date | Title |
|------------------------|---------------------------|------------------|---------------------|---|
| | K0082 | | 20 AUG 10 | WATER WASTE-INSTALL VACUUM TOILET SYSTEM |
| | Applicable to: ALL | | | |
| | K0151 | | 20 AUG 10 | EQUIPMENT FURNISHINGS ESCAPE FACILITIES INSTALL SLIDE RAFTS (AIRCROISERS) |
| | Applicable to: ALL | | | |
| | K10003 | | 07 APR 11 | AIRBORNE AUXILIARY POWER - CONTROL AND MONITORING INTRODUCE SOFTWARE VERSION 06.00.000 |
| | Applicable to: ALL | | | |
| | K10009 | | 20 AUG 10 | EQUIPMENT/FURNISHINGS - CURTAINS AND PARTITIONS INTRODUCE IMPROVED STRIKES FOR COCKPIT DOOR |
| | Applicable to: ALL | | | |
| | K1014 | | 20 AUG 10 | WATER/WASTE-RELOCATION OF POT.WATER TANK FROM SECTION 18 TO SECTION 15 AND REDESIGN OF POT.WATERSYSTEM |
| | Applicable to: ALL | | | |
| | K10359 | | 20 AUG 10 | LIGHTS - EMERGENCY LIGHTING - DEFINE FLOOR MOUNTED LUFTHANSA TECHNIK 900 SERIES EEPMS |
| | Applicable to: ALL | | | |
| | K10463 | | 25 NOV 11 | AIR CONDITIONING PACK TEMPERATURE CONTROL INTRODUCE IMPROVED AIR CONDITIONING CONTROLLER P/N 1803B0000-02 |
| | Applicable to: ALL | | | |
| | K10494 | | 20 AUG 10 | AIRBORNE AUXILIARY POWER - CHANGE STANDARD APU HONEYWELL GTCP36-300 TO APIC APS3200 |
| | Applicable to: ALL | | | |
| | K11047 | | 20 AUG 10 | COMMUNICATION - ANTI HIJACK CAMERA MONITORING - INSTALL COCKPIT DOOR SURVEILLANCE SYSTEM DISPLAYEDON SD |
| | Applicable to: ALL | | | |
| | K1119 | | 20 AUG 10 | EQUIPMENT FURNISHINGS-C.C-REARRANGE COMPARTMENT 4 INTO TWO ZONES |
| | Applicable to: ALL | | | |
| | K11694 | | 07 APR 11 | EQUIPMENT/FURNISHINGS-MISCELLANEOUS EMERGENCY EQUIPMENT-INSTALLATION OF ELT(406AFN) WITH RCP IN COCKPIT AND NAV PROVISIONS-HONEYWELL |
| | Applicable to: ALL | | | |

Continued on the following page

Continued from the previous page

| M⁽¹⁾ | MODIFICATION | Linked SB | Incorp. Date | Title |
|------------------------|---------------------------|------------------|---------------------|---|
| | K12405 | | 07 APR 11 | COMMUNICATIONS-CIDS-INTRODUCE HANDSET SERIES N40A FROM VENDOR HOLMBERG |
| | Applicable to: ALL | | | |
| | K1420 | | 20 AUG 10 | DOORS-FWD/AFT CARGO DOOR-INTRODUCTION OF LOCKING INDICATION |
| | Applicable to: ALL | | | |
| | K1806 | | 20 AUG 10 | AIR CONDITIONING SYSTEM POWER SUPPLY - MODIFY POWER TO FLOW CONTROL VALVE |
| | Applicable to: ALL | | | |
| | K2335 | | 20 AUG 10 | LAVATORY SMOKE DETECTION - IMPROVEMENT OF SMOKE DETECTION |
| | Applicable to: ALL | | | |
| | K2393 | | 20 AUG 10 | AIR COND.-CABIN PRESSURE CONTROL-IMPROVE CONTROLLER TO ENABLE USE OF EXTERNAL MODE |
| | Applicable to: ALL | | | |
| | K2450 | | 20 OCT 11 | AUXILIARY POWER UNIT - INTRODUCTION OF APIC APS-3000 |
| | Applicable to: ALL | | | |
| | K2938 | | 20 AUG 10 | DOORS - C.C.DOOR HYDRAULIC SYSTEM - INTRODUCE MODIFIED ELECTRICAL (MANUAL) SELECTOR VALVE - |
| | Applicable to: ALL | | | |
| | K2962 | | 20 AUG 10 | HYDRAULIC POWER - MAIN BLUE HYDRAULIC POWER - IMPROVE MAINTENACE STATUS OF BLUE HYDRAULIC RESERVOIR - |
| | Applicable to: ALL | | | |
| | K3118 | | 20 AUG 10 | AUXILIARY POWER UNIT - CONTROL AND MONITORING - INTRODUCTION OF NEW ECB P/N 304817-1 |
| | Applicable to: ALL | | | |
| | K3279 | | 20 AUG 10 | AUXILIARY POWER UNIT - CONTROL AND MONITORING - MODIFIED WIRE HARNESSSES TO NEW ECB |
| | Applicable to: ALL | | | |
| | K3471 | | 20 AUG 10 | GENERAL - INCREASE DESIGN WEIGHT TO 61T MZFW |
| | Applicable to: ALL | | | |
| | K3599 | | 20 AUG 10 | AIR CONDITIONING - COCKPIT AND CABIN TEMPERATURE CONTROL - INTRODUCE IMPROVED ZONE TEMPERATURE CONTROLLER -03 |
| | Applicable to: ALL | | | |

Continued on the following page

Continued from the previous page

| M⁽¹⁾ | MODIFICATION | Linked SB | Incorp. Date | Title |
|------------------------|---------------------------|------------------|---------------------|---|
| | K3901 | | 20 AUG 10 | COMMUNICATIONS - CIDS - MODIFICATION OF DIRECTOR POWER SUPPLY PRINCIPLE |
| | Applicable to: ALL | | | |
| | K4574 | | 20 AUG 10 | AIR CONDITIONING-FLOW CONTROL AND INDICATING- INTRODUCE IMPROVED AIR CONDITIONING PACKAGE FOR FLOW CONTROL |
| | Applicable to: ALL | | | |
| | K4725 | | 06 JUL 16 | DOORS - CARGO COMPARTMENT DOOR FWD AND AFT - MODIFY CARGO DOORS |
| | Applicable to: ALL | | | |
| | K4726 | | 20 AUG 10 | WATER/WASTE-TOILET SYSTEM-INTRODUCE IMPROVED TOILET ASSY |
| | Applicable to: ALL | | | |
| | K4787 | | 20 AUG 10 | LIGHTS - INTRODUCTION OF A COMMON EPSU |
| | Applicable to: ALL | | | |
| | K4793 | | 20 AUG 10 | AIR CONDITIONING-AIR COOLING SYSTEM-INTRODUCE AN IMPROVED RAM OUTLET (RAO) |
| | Applicable to: ALL | | | |
| | K4913 | | 20 AUG 10 | HYDRAULIC POWER - AUXILIARY HYDRAULIC POWER - INSTALL A319 RAM AIR TURBINE ON A320 |
| | Applicable to: ALL | | | |
| | K5157 | | 20 AUG 10 | OXYGEN-PASSENGER OXYGEN-INTRODUCE IMPROVED OPTIONAL CHEMICAL OXYGEN CONTAINER (22 MIN) TO REPLACE "HIGH FLOW" CONTAINER |
| | Applicable to: ALL | | | |
| | K5213 | | 20 AUG 10 | AIR CONDITIONING - PACK TEMPERATURE CONTROL - INTRODUCE IMPROVED PACK TEMPERATURE CONTROLLER |
| | Applicable to: ALL | | | |
| | K5446 | | 20 AUG 10 | INDICATING/RECORDING SYSTEMS - INSTALLATION OF A COMBINED FDIU/DMU |
| | Applicable to: ALL | | | |
| | K5549 | | 20 AUG 10 | OXYGEN - PASSENGER OXYGEN - INTRODUCE CHEMICAL OXYGEN CONTAINER (15MIN) WITH IMPROVED ACTUATOR (VENDOR PURITAN) |
| | Applicable to: ALL | | | |
| | K5801 | | 20 AUG 10 | AIR CONDITIONING-PRESSURE CONTROL AND MONITORING- INTRODUCE MODIFIED PRESSURE CONTROLLER P/N 9022-15702-10 |
| | Applicable to: ALL | | | |

Continued on the following page

Continued from the previous page

| M ⁽¹⁾ | MODIFICATION | Linked SB | Incorp. Date | Title |
|---------------------------|--------------|-----------|--------------|--|
| | K6156 | | 20 AUG 10 | AIR CONDITIONING-PACK TEMPERATURE CONTROL- INTRODUCE MODIFIED PACK TEMPERATURE CONTROLLER |
| Applicable to: ALL | | | | |
| | K6164 | | 20 AUG 10 | GENERAL-INCREASE A320 DESIGN WEIGHTS TO 77,0T MTOW; 66,0T MLW AND 62.5T MZFW |
| Applicable to: ALL | | | | |
| | K6318 | | 20 OCT 11 | APU-CONTROL AND MONITORING-INTRODUCE APIC ECB SOFTWARE VERSION 5 |
| Applicable to: ALL | | | | |
| | K6443 | | 20 AUG 10 | AIR CONDITIONING_AIR COOLING INSTALL A NEW ECS |
| Applicable to: ALL | | | | |
| | K6936 | | 20 AUG 10 | AUXILIARY POWER UNIT (APU)-GENERAL-INCREASE OPERATION ENVELOPE TO 39800 FT. FOR GTCP36-300 |
| Applicable to: ALL | | | | |
| | K7072 | | 20 AUG 10 | LIGHTS-EMERGENCY LIGHTING- EPSU LOAD DISTRIBUTION IMPROVEMENT |
| Applicable to: ALL | | | | |
| | K7755 | | 20 AUG 10 | EQUIPMENT/FURNISHINGS PAX COMPARTMENT INTRODUCE A MODIFIED INTRUSION AND PENETRATION RESISTANCE COCKPIT DOOR |
| Applicable to: ALL | | | | |
| | K7790 | | 20 AUG 10 | DOORS PASSENGER COMPARTMENT FIXED PARTITIONS INTERIOR DOOR-ELECTRICAL COCKPIT DOOR RELEASE SYSTEM |
| Applicable to: ALL | | | | |
| | K7847 | | 25 NOV 11 | EQUIPMENT/FURNISHINGS PASSENGER COMPARTMENT DEFINITION OF A PED POWER SUPPLY SYSTEM PROVIDING 110/60 HZ FROM VENDOR THALES |
| Applicable to: ALL | | | | |
| | K8400 | | 20 AUG 10 | COMMUNICATIONS CABIN INTERCOMMUNICATION MODIFY CABIN INTERCOMMUNICATION DATA SYSTEM ON A319 |
| Applicable to: ALL | | | | |
| | K8734 | | 25 NOV 11 | AIR CONDITIONING - AIR COOLING ADAPT A318 ECS TO A320 |
| Applicable to: ALL | | | | |

Continued on the following page

Continued from the previous page

| M⁽¹⁾ | MODIFICATION | Linked SB | Incorp. Date | Title |
|------------------------|---------------------------|------------------|---------------------|--|
| | K8905 | | 20 AUG 10 | EQUIPMENT/FURNISHINGS -CURTAINS AND PAR INSTALL A DEADBOLT FOR THE REINFORCED COCKPIT DOOR |
| | Applicable to: ALL | | | |
| | K9458 | | 25 NOV 11 | AIR CONDITIONING - PACK TEMPERATURE CONTROL IMPROVED AIR CONDITIONING SYSTEM CONTROLLER P/N 1803B0000-01 |
| | Applicable to: ALL | | | |
| | K9473 | | 20 AUG 10 | AIR CONDITIONING-PRESSURE CONTROL AND MONITORING-INTRODUCE RESIDUAL PRESSURE CONTROL UNIT (RPCU) |
| | Applicable to: ALL | | | |
| | K9877 | | 20 AUG 10 | EQUIPMENT / FURNISHINGS - CURTAINS AND PARTITIONS - MODIFY DEADBOLT FOR REFORCED COCKPIT DOOR |
| | Applicable to: ALL | | | |
| | P0033 | | 07 APR 11 | COMMUNICATIONS - HF1 SYSTEM PROVISION FOR HF1 SYSTEM |
| | Applicable to: ALL | | | |
| | P0034 | | 07 APR 11 | SINGLE HF SYSTEM |
| | Applicable to: ALL | | | |
| | P0040 | | 20 AUG 10 | 4TH OCCUPANT SEAT |
| | Applicable to: ALL | | | |
| | P0091 | | 20 AUG 10 | ALTERNATIVE FLIGHT CREW OXYGEN BOTTLE (77.1CU/FT) IN COMPOSITE MATERIAL FOR FIXED SYSTEM |
| | Applicable to: ALL | | | |
| | P0143 | | 20 AUG 10 | COMMUNICATIONS - INSTALLATION OF A 3RD RMP |
| | Applicable to: ALL | | | |
| | P0147 | | 20 AUG 10 | DESIGN WEIGHT-MTOW 72T-STRUCTURAL REINFORCEMENT |
| | Applicable to: ALL | | | |
| | P0197 | 23-1365 15 | 07 APR 11 | COMMUNICATIONS-SINGLE HF SYSTEM INSTALLATION |
| | Applicable to: ALL | | | |
| | P0287 | | 07 APR 11 | NAVIGATION-REPLACE EXISTING VOR DDRMI WITH A COMBINED VOR ADF DDRMI COLLINS |
| | Applicable to: ALL | | | |
| | P0415 | | 20 AUG 10 | COMMUNICATIONS-HOT MIKE RECORDING |
| | Applicable to: ALL | | | |

Continued on the following page

Continued from the previous page

| M⁽¹⁾ | MODIFICATION | Linked SB | Incorp. Date | Title |
|------------------------|---------------------------|--------------------------|---------------------|--|
| | P10022 | | 07 APR 11 | ENGINE FUEL AND CONTROL FADEC SYSTEM INTRODUCE NEW "5B0" ECU SOFTWARE STD ON CFM56-5B ENGINES - CNF CFM 109B - |
| | Applicable to: ALL | | | |
| | P10098 | 24-1120 04 | 20 AUG 10 | ELECTRICAL POWER AC ESSENTIAL GENERATION SWITCHING INSTALL AUTO SWITCHING SYSTEM FOR AC&DC ESS BUS. |
| | Applicable to: ALL | | | |
| | P10267 | | 20 AUG 10 | NAVIGATION - RADIO MAGNETIC INFORMATION SWITCHING AND INDICATING : RE-INSTALL THALES DDRMI VOR/DME INDICATORS (ANTI-MOD 33503) |
| | Applicable to: ALL | | | |
| | P10321 | 22-1289 01 | 07 APR 11 | AUTO-FLIGHT - GENERAL - REMOVE AFM LIMITATION ON NON PRECISION APPROACHES WITH ONE ENGINE OUT |
| | Applicable to: ALL | | | |
| | P10383 | 31-1334 04 31-1414 03 | 20 AUG 10 | INDICATING/RECORDING SYSTEMS FLIGHT WARNING COMPUTER (FWC) INSTALL FWC STANDARD H2-F5 |
| | Applicable to: ALL | | | |
| | P10439 | 22-1248 01 | 20 AUG 10 | AUTO-FLIGHT FMGC INSTALL FMGC HNWL STD P1C12 ON CFM A/C |
| | Applicable to: ALL | | | |
| | P10443 | 27-1182 04 | 07 APR 11 | FLIGHT CONTROL - ELAC SYSTEM - INTRODUCE ELAC "L93" SOFTWARE STANDARD |
| | Applicable to: ALL | | | |
| | P10493 | | 07 APR 11 | FLIGHT CONTROL - ELAC - ACTIVATE HIGH ALTITUDE UPSETS VMO/MMO OVERSHOOT PROTECTION FUNCTION ON ELAC |
| | Applicable to: ALL | | | |
| | P10686 | 22-1266 03 | 07 APR 11 | AUTO-FLIGHT - FMGC INSTALL HONEYWELL PERFORMANCE DATABASE RELEASE 1A (PS4087592-901) |
| | Applicable to: ALL | | | |
| | P10762 | 22-1269 05 | 20 AUG 10 | AUTO FLIGHT - FMGC INSTALL FMGC HWL H2C12 (RELEASE 1A) ON CFM A/C |
| | Applicable to: ALL | | | |
| | P11325 | 73-1095 02 | 18 MAR 15 | ENGINE FUEL AND CONTROL - FADEC SYSTEM INTRODUCE ECU SOFTWARE STANDARD "5BR" ON CFM56-5B ENGINES |
| | Applicable to: ALL | | | |

Continued on the following page

Continued from the previous page

| M ⁽¹⁾ | MODIFICATION | Linked SB | Incorp. Date | Title |
|------------------|---------------------------|------------|--------------|---|
| | P11473 | 22-1315 05 | 22 MAR 16 | AUTO FLIGHT - FLIGHT MANAGEMENT SYSTEM (FMS) ACTIVE BARO RADIO SETTING FUNCTION |
| | Applicable to: ALL | | | |
| | P11856 | 22-1315 05 | 07 APR 11 | AUTO - FLIGHT FMGC: ACTIVATE NO AP DISCONNECTION BELOW MDA/MDH UNTIL MISSED APPROACH POINT |
| | Applicable to: ALL | | | |
| | P1237 | | 20 AUG 10 | INDICATING RECORDING SYSTEM-TOGGLE SWITCHES RELOCATED IN 25VU ON OVERHEAD PANEL |
| | Applicable to: ALL | | | |
| | P1302 | | 20 AUG 10 | LANDING GEAR-POST EIS STANDARD 4 OF BSCU EQUIPMENT |
| | Applicable to: ALL | | | |
| | P1312 | | 07 APR 11 | LIGHTS-COCKPIT-INTEGRALLY LIGHTED PLACARD 25VU,ANTI ICE PART MODIFIED |
| | Applicable to: ALL | | | |
| | P1390 | | 20 AUG 10 | ELECTRICAL GENERATION-BCL'S CHANGE |
| | Applicable to: ALL | | | |
| | P1450 | | 20 AUG 10 | NAVIGATION - ATC MODE "S" - ACTIVATION OF SELECTIVE INTERROGATION FUNCTION |
| | Applicable to: ALL | | | |
| | P1485 | | 20 AUG 10 | ELECTRICAL POWER-"BAT OFF"INDICATOR LIGHT POWER SOURCE MODIFIED |
| | Applicable to: ALL | | | |
| | P1631 | | 20 AUG 10 | NAVIGATION - MODIFY GPWC WARNINGS |
| | Applicable to: ALL | | | |
| | P1669 | | 20 AUG 10 | AIR CONDITIONING-AVIONICS VENTILATION ADD A NON RETURN VALVE AT AIR INLET |
| | Applicable to: ALL | | | |
| | P1752 | | 20 AUG 10 | HYDRAULICS-MODIFICATION OF ELECTRICAL ROUTING OF GREEN LEAKAGE MEASUREMENT ELECTROVALVE CONTROL |
| | Applicable to: ALL | | | |
| | P1850 | | 20 AUG 10 | FLIGHT CONTROLS-ELAC SYSTEM-EFCS ELAC -SOFTWARE L62 |
| | Applicable to: ALL | | | |
| | P1873 | | 20 AUG 10 | AIR CONDITIONING-ESSENTIAL DC SUPPLY FOR FORWARD CARGO COMPARTMENT SHUT-OFF VALVES |
| | Applicable to: ALL | | | |

Continued on the following page

**PRELIMINARY PAGES
LIST OF MODIFICATIONS**

A318/A319/A320/A321
FLIGHT CREW
OPERATING MANUAL

Continued from the previous page

| M⁽¹⁾ | MODIFICATION | Linked SB | Incorp. Date | Title |
|------------------------|---------------------------|------------------|---------------------|--|
| | P1883 | | 20 AUG 10 | FLIGHT CONTROLS-FCDC L 40 |
| | Applicable to: ALL | | | |
| | P1906 | | 20 AUG 10 | ENGINES FUEL AND CONTROL-EIU FOR CFMI POWERPLANT (SOFTWARE VERSION 11) |
| | Applicable to: ALL | | | |
| | P1970 | 23-1365 15 | 20 AUG 10 | COMMUNICATIONS-INSTALL HF1 IN EMERGENCY CONFIG. (ETOPS) |
| | Applicable to: ALL | | | |
| | P2040 | | 20 AUG 10 | OXYGENE-COCKPIT-MODIFY LP VALVE |
| | Applicable to: ALL | | | |
| | P2196 | | 20 AUG 10 | BATCH OF MINOR IMPROVEMENTS OF SERIES A/C DESIGN (AS ZONE) FROM A/C N 268 |
| | Applicable to: ALL | | | |
| | P2205 | | 20 AUG 10 | FIRE PROTECTION - REPLACE ENGINE/APU FIRE PANEL |
| | Applicable to: ALL | | | |
| | P2218 | | 20 AUG 10 | NAVIGATION - TCAS II COMPLETE PROVISIONS |
| | Applicable to: ALL | | | |
| | P2223 | | 20 AUG 10 | NAVIGATION - INSTALLATION OF GPWC MARK V WITH INTERFACE WITH CFDS |
| | Applicable to: ALL | | | |
| | P2294 | | 20 AUG 10 | ENGINE FUEL AND CONTROL - CFM 56 POWERPLANT EIU VERSION 12 |
| | Applicable to: ALL | | | |
| | P2316 | | 20 AUG 10 | AUTOFLIGHT - ACTIVATE WINDSHEAR FUNCTION |
| | Applicable to: ALL | | | |
| | P2493 | | 20 AUG 10 | COCKPIT - INSTALL A340 TYPE PILOT SEATS |
| | Applicable to: ALL | | | |
| | P2546 | | 20 AUG 10 | INDICATING/RECORDING SYSTEMS - INSTRUMENTS - DEFINE SDAC STANDARD FOR A321 COF A |
| | Applicable to: ALL | | | |
| | P2547 | | 07 APR 11 | INDICATING/RECORDING SYSTEMS - INSTRUMENTS - DEFINE DMC STANDARD FOR A321 COF A |
| | Applicable to: ALL | | | |
| | P2588 | | 20 AUG 10 | OXYGEN - COCKPIT - REPLACE BASIC AIR LIQUIDE PBE BY DRAEGER |
| | Applicable to: ALL | | | |
| | P2590 | | 20 AUG 10 | NAVIGATION - INSTALL A TCAS II COLLISION AVOIDANCE SYSTEM |
| | Applicable to: ALL | | | |

Continued on the following page

Continued from the previous page

| M⁽¹⁾ | MODIFICATION | Linked SB | Incorp. Date | Title |
|------------------------|---------------------------|------------------|---------------------|--|
| | P2879 | | 20 AUG 10 | INDICATING RECORDING SYSTEM - SDAC - DEFINE A PIN PROGRAM FOR FWD C.C VENTILATION |
| | Applicable to: ALL | | | |
| | P2960 | | 20 AUG 10 | CERTIFICATION DOCUMENTS - GENERAL - CERTIFICATION FOR TAKING OFF WITH 15 KNOT TAILWING |
| | Applicable to: ALL | | | |
| | P2963 | | 20 AUG 10 | AIR CONDITIONING - IMPROVE CABIN PRESSURIZATION CONTROL ON 25VU - |
| | Applicable to: ALL | | | |
| | P3004 | | 20 AUG 10 | LIGHTS-COCKPIT LIGHTING-IMPROVE COCKPIT LIGHTING |
| | Applicable to: ALL | | | |
| | P3011 | | 20 AUG 10 | FMS - FMS CROSS LOAD |
| | Applicable to: ALL | | | |
| | P3044 | | 20 AUG 10 | NAVIGATION -ADAPT SHELVES FOR INSTALLATION OF 4MCUADIRS - |
| | Applicable to: ALL | | | |
| | P3102 | | 20 AUG 10 | AUTO FLIGHT - FCU-CPIP1 STANDARD |
| | Applicable to: ALL | | | |
| | P3105 | | 20 AUG 10 | ENGINE FUEL AND CONTROL - CFM 56 - EIU VERSION 13 |
| | Applicable to: ALL | | | |
| | P3197 | | 20 AUG 10 | GENERAL - OPERATION FROM HIGH ALTITUDE AIRPORTS (CFM ENGINES) (PRESSURE ALTITUDE LIMIT 9200 FT) |
| | Applicable to: ALL | | | |
| | P3202 | | 20 AUG 10 | AUTOFLIGHT - FCU - CPIP 2 STANDARD M10 |
| | Applicable to: ALL | | | |
| | P3204 | | 20 AUG 10 | AUTO FLIGHT - FMGC - A320/A321 STANDARD WITH SOFTWARE OPTIONS + 400 KILOWORDS DATA BASE OPTION + ACARS HARDWARE PROVISION (B1 CFM VERSION) |
| | Applicable to: ALL | | | |
| | P3365 | | 20 AUG 10 | ICE PROTECTION - ICING INDICATOR ILLUMINATION |
| | Applicable to: ALL | | | |
| | P3379 | | 20 AUG 10 | INDICATING/RECORDING SYSTEMS - GENERAL - DEFINE PIN PROGRAMMING FOR STD VERSIONS |
| | Applicable to: ALL | | | |

Continued on the following page

Continued from the previous page

| M⁽¹⁾ | MODIFICATION | Linked SB | Incorp. Date | Title |
|------------------------|---------------------------|------------------|---------------------|--|
| | P3420 | | 22 MAR 16 | A320/321 ENERGY MANAGEMENT FUNCTIONS - ACTIVATION BY PIN PROGRAMMING FOR IAE AND CFM ENGINES |
| | Applicable to: ALL | | | |
| | P3510 | | 20 AUG 10 | NAVIGATION - ADIRS - IMPROVED STANDARD OF A320 ADIRU |
| | Applicable to: ALL | | | |
| | P3511 | | 20 AUG 10 | AUTO FLIGHT - FLIGHT AUGMENTATION - AFS COMPUTER A320/A321 FAC CFM/IAE |
| | Applicable to: ALL | | | |
| | P3524 | | 20 AUG 10 | ELECTRICAL GENERATION - APU GENERATOR NEW STANDARD |
| | Applicable to: ALL | | | |
| | P3588 | | 20 AUG 10 | LANDING GEAR - A320/A321 TWIN WHEELS BSCU STANDARD 7 (70B VERSION) |
| | Applicable to: ALL | | | |
| | P3594 | | 20 AUG 10 | INDICATING/RECORDING SYSTEMS - ELECTRICAL CLOCK - INSTALLATION OF A CLOCK SMITHS TYPE 2610 |
| | Applicable to: ALL | | | |
| | P3660 | | 20 AUG 10 | FLIGHT CONTROLS - EFCS EQUIPMENT - MODIFY SEC STANDARD FOR A320 AND A321 |
| | Applicable to: ALL | | | |
| | P3686 | | 20 AUG 10 | AUTO FLIGHT: FLIGHT AUGMENTATION COMPUTER INTRODUCE FAC POST CDN ON A320/321. |
| | Applicable to: ALL | | | |
| | P3694 | | 20 OCT 11 | AUTO FLIGHT-FMGC-A320/321-FG STANDARD FOR A321 CFM CAT III |
| | Applicable to: ALL | | | |
| | P3756 | | 20 AUG 10 | AUTO FLIGHT - GENERAL - EXTEND CAT III B AUTOMATICLANDING CAPABILITY (FOR CFM ENGINES) |
| | Applicable to: ALL | | | |
| | P3790 | | 20 AUG 10 | NAVIGATION-AIRS-IMPROVED STANDARD OF HONEYWELL 4 MCU ADIRU |
| | Applicable to: ALL | | | |
| | P3830 | | 20 AUG 10 | FLIGHT CONTROLS-PARTIAL LIFT DUMPING FUNCTION ACTIVATION |
| | Applicable to: ALL | | | |
| | P3878 | | 20 AUG 10 | FLIGHT CONTROL-ELAC SYSTEM-INSTALL ELAC 69J |
| | Applicable to: ALL | | | |

Continued on the following page

Continued from the previous page

| M⁽¹⁾ | MODIFICATION | Linked SB | Incorp. Date | Title |
|------------------------|---------------------------|------------------|---------------------|---|
| | P3955 | | 07 APR 11 | NACELLES/PYLONS-IAE/CFM-ADAPT PYLON PRIMARY STRUCTURE FOR A321 GROWTH VERSION |
| | Applicable to: ALL | | | |
| | P3957 | | 06 JUL 16 | ATA 2900 HYDRAULIC POWER-GENERAL INSTALL AN HYDRAULIC SHUT-OFF VALVE ON THE CFM THRUST REVERSER SYSTEM |
| | Applicable to: ALL | | | |
| | P3964 | | 20 AUG 10 | NAVIGATION-WEATHER RADAR SYSTEM-NEW SEXTANT ATC/TCAS CONTROL PANEL -SFE WITH FULL TIME AND ABOVE BELOW FUNCTIONS |
| | Applicable to: ALL | | | |
| | P4023 | 35-1025 07 | 20 AUG 10 | GENERAL - HIGH ALTITUDE CERTIFICATION UP TO 14.500 FT |
| | Applicable to: ALL | | | |
| | P4054 | | 20 AUG 10 | AUTOFLIGHT-FCU-INSTALL M11 STANDARD |
| | Applicable to: ALL | | | |
| | P4087 | | 20 AUG 10 | NAVIGATION-ADIRS-INSTALL HONEYWELL ADIRS PROVIDING THE GPS PRIMARY NAVIGATION CAPABILITY |
| | Applicable to: ALL | | | |
| | P4089 | | 20 AUG 10 | AUTO-FLIGHT - FMGC - REDUCE VAPP FOR A320 CFM/IAE |
| | Applicable to: ALL | | | |
| | P4121 | | 20 AUG 10 | EXHAUST - THRUST REVERSER CONTROL AND INDICATING -ACTIVATE ADDITIONAL THRUST REVERSER LOCK CONTROL |
| | Applicable to: ALL | | | |
| | P4151 | | 20 AUG 10 | INDICATING/RECORDING SYSTEMS - UP AND DOWN DATA LOADING SYSTEM - INSTALL A "PORTABLE DATA LOADER" CONNECTOR AND DISK STOWAGE. |
| | Applicable to: ALL | | | |
| | P4155 | | 20 AUG 10 | AUTOFLIGHT - FLIGHT MANAGEMENT AND GUIDANCE COMPUTER - ACTIVATION OF ACARS AND PRINTER INTERFACES IN F.M.S (CFM ENGINES) |
| | Applicable to: ALL | | | |
| | P4170 | | 20 AUG 10 | FLIGHT CONTROLS - FCDC - PROVIDE A VISUAL INDICATION FOR SIMULTANEOUS SIDE STICK ACTION |
| | Applicable to: ALL | | | |

Continued on the following page

Continued from the previous page

| M ⁽¹⁾ | MODIFICATION | Linked SB | Incorp. Date | Title |
|------------------|---------------------------|------------|--------------|---|
| | P4191 | | 20 AUG 10 | NAVIGATION AND COMMUNICATIONS REPLACE BFE EQUIPMENT BY SFE EQUIPMENT |
| | Applicable to: ALL | | | |
| | P4205 | | 20 AUG 10 | AUTOFLIGHT - FMGC - ACTIVATE PRINTER INTERFACE IN FMS (CFM AND IAE ENGINES) |
| | Applicable to: ALL | | | |
| | P4230 | | 20 AUG 10 | POWER PLANT-GENERAL INTRODUCTION OF CFM56-5B/P |
| | Applicable to: ALL | | | |
| | P4234 | | 20 AUG 10 | ICE AND RAIN PROTECTION-WINDSHIELD RAIN PROTECTION DESACTIVATION OF RAIN REPELLENT SYSTEM. |
| | Applicable to: ALL | | | |
| | P4281 | | 20 AUG 10 | ENGINE FUEL AND CONTROL-CONTROLLING INTRODUCE OF A NEW ECU SOFTWARE STANDARD 5BE-1 FOR CFM56-5B SAC ENGINES |
| | Applicable to: ALL | | | |
| | P4287 | 31-1264 04 | 20 AUG 10 | INDICATING-RECORDING SYSTEM FWC DEFINE OEB REMINDER NEW FUNCTION IN FWC |
| | Applicable to: ALL | | | |
| | P4319 | | 20 AUG 10 | AUTO FLIGHT/FCU DEFINE FD ENGAGEMENT IN CROSSED BARS AT GO AROUND |
| | Applicable to: ALL | | | |
| | P4320 | | 20 AUG 10 | AUTO FLIGHT - ACTIVATE GLOBAL SPEED PROTECTION AND FD DISENGAGEMENT UPON SPEED CONDITIONS |
| | Applicable to: ALL | | | |
| | P4378 | 00-1054 19 | 20 AUG 10 | CERTIFICATION - GENERAL - CERTIFICATION FOR HIGH ALTITUDE AIRPORT OPERATION |
| | Applicable to: ALL | | | |
| | P4395 | | 20 AUG 10 | INDICATING/RECORDING SYSTEMS.EIS.UNITS OF UNITS OF INDICATION "RUNWAY LENGHTS"IN FEET. |
| | Applicable to: ALL | | | |
| | P4419 | | 25 NOV 11 | NAVIGATION - ADIRS - INSTALL HONEYWELL ADIRU 4 MCU STANDARD WITH OPTIMIZED HARDWARE P/N "AD09" |
| | Applicable to: ALL | | | |
| | P4425 | | 25 NOV 11 | NAVIGATION-ADIRS-INSTALL HONEYWELL ADIRU 4 MCU STANDARD, CAPABLE OF A319 IAE AIRCRAFT |
| | Applicable to: ALL | | | |

Continued on the following page

Continued from the previous page

| M⁽¹⁾ | MODIFICATION | Linked SB | Incorp. Date | Title |
|------------------------|---------------------------|------------------|---------------------|---|
| | P4495 | | 20 AUG 10 | INDICATING/RECORDING SYSTEMS- DISPLAY MANAGEMENT COMPUTER (DMC) DEFINE DMC V32 STANDARD |
| | Applicable to: ALL | | | |
| | P4497 | | 20 AUG 10 | DOORS-EMERGENCY ESCAPE SLIDE RELEASE AND OVERPRESSURE WARNING SYSTEMS-MODIFY CONTROL LOGIC OF THE OVERPRESSURE WARNING SYSTEM |
| | Applicable to: ALL | | | |
| | P4502 | | 20 AUG 10 | INFORMATION SYSTEMS - ATIMS - INSTALL ATSU COMPUTER FOR PRE-FANS CONFIGURATION |
| | Applicable to: ALL | | | |
| | P4528 | | 20 AUG 10 | ENGINE FUEL AND CONTROL -CONTROLLING- INTRODUCE AN ECU SOFTWARE STD 5BH FOR CFM56-5B SAC ENGINES. |
| | Applicable to: ALL | | | |
| | P4539 | | 20 AUG 10 | AUTO FLIGHT-GENERAL/FLIGHT CONTROL UNIT- DEFINE AND INSTALL SEXTANT MODULAR FCU |
| | Applicable to: ALL | | | |
| | P4576 | | 20 AUG 10 | LANDING GEAR-GENERAL WHEELS AND BRAKES EQUIPMENT COST REDUCTION ELECTRICAL ALTERNATE BRAKING |
| | Applicable to: ALL | | | |
| | P4647 | | 20 AUG 10 | NAVIGATION - WEATHER RADAR SYSTEM - COLLINS DUAL PWS ACTIVATOR |
| | Applicable to: ALL | | | |
| | P4706 | | 22 MAR 16 | NAVIGATION - ADF - INSTALLATION OF 1 ADF QUANTUM LINE P/N 066-50014-0202 |
| | Applicable to: ALL | | | |
| | P4709 | 00-1043 56 | 20 AUG 10 | LANDING WITH A 15 KNOT TAILWIND |
| | Applicable to: ALL | | | |
| | P4770 | | 20 AUG 10 | NAVIGATION - WEATHER RADAR SYSTEM. INSTALL FULL PROVISION FOR THE SECOND TRANSCEIVER. |
| | Applicable to: ALL | | | |
| | P4773 | | 20 AUG 10 | NAVIGATION - INSTALL DUAL COLLINS ADF 700 - P/N 622-5222-020 |
| | Applicable to: ALL | | | |
| | P4786 | | 07 APR 11 | COCKPIT PROTECTIVE BREATHING EQUIPMENT (PBE)-SCOTT AVIATION |
| | Applicable to: ALL | | | |

Continued on the following page

Continued from the previous page

| M⁽¹⁾ | MODIFICATION | Linked SB | Incorp. Date | Title |
|------------------------|---------------------------|------------------|---------------------|---|
| | P4789 | | 20 AUG 10 | NAVIGATION-MMR-INSTALLATION OF SEXTANT MULTICI-MODE RECEIVERS PROVIDING ILS (FM IMMUNE) AND GPS PRIMARY FUNCTION |
| | Applicable to: ALL | | | |
| | P4801 | | 20 AUG 10 | ELECTRICAL POWER - GENERATION SYSTEM - DEFINE AND INSTALL ON A320 FAMILY NEW ELECTRICAL GENERATION CONCEPT (WIRING/EQUIPMENT) |
| | Applicable to: ALL | | | |
| | P4808 | | 20 AUG 10 | LANDING GEAR - GENERAL - WHEELS AND BRAKES - EQUIPMENT COST REDUCTION BSCU REDESIGN |
| | Applicable to: ALL | | | |
| | P4859 | | 22 MAR 16 | NAVIGATION - ADF - INSTALL AN ADF 900 RECEIVER P/N 822-0299-020 |
| | Applicable to: ALL | | | |
| | P4867 | | 22 MAR 17 | NAVIGATION - EGPWS - INSTL. NEW SPECIFICATION INSTALLATION OF EGPWC (NEW SPECIFICATION) |
| | Applicable to: ALL | | | |
| | P4885 | | 20 AUG 10 | NAVIGATION - EGPWS - ACTIVATION OF ENHANCED FUNCTIONS OF THE EGPWS |
| | Applicable to: ALL | | | |
| | P4916 | | 20 AUG 10 | FLIGHT CONTROL - GENERAL - ELAC-SYSTEM - INSTALL ELAC COMPATIBLE A320/321/319 (EM2 PROGRAM) |
| | Applicable to: ALL | | | |
| | P4954 | | 20 AUG 10 | AUTO FLIGHT - FMGC - DEFINE AND INSTALL FMGC B546CAM0102 FOR A319 AUTOLAND CFM ENGINES (CAPABLE OF GPS/ACARS FUNCTION) |
| | Applicable to: ALL | | | |
| | P4977 | 31-1264 04 | 20 AUG 10 | INDICATING/RECORDING SYSTEMS - FWC - PROVIDE NEW SYNTHETIC VOICE "DUAL INPUT" |
| | Applicable to: ALL | | | |
| | P4983 | | 20 AUG 10 | AUTO FLIGHT - FLIGHT AUGMENTATION - DEFINE FAC STANDARD B0513 |
| | Applicable to: ALL | | | |
| | P5020 | | 20 AUG 10 | NAVIGATION - ATC - INSTALL GABLES ATC/TCAS CONTROL PANEL P/N G6990-40 |
| | Applicable to: ALL | | | |
| | P5071 | | 20 AUG 10 | ICE AND RAIN PROTECTION-WINDSHIELD RAIN PROTECTIONREACTIVATE RAIN REPELLENT |

Continued on the following page

Continued from the previous page

| M⁽¹⁾ | MODIFICATION | Linked SB | Incorp. Date | Title |
|------------------------|---------------------------|------------------|---------------------|---|
| | | | | SYSTEM WITH FLUID COMPATIBLE WITH OZONE PROTECTION RULES |
| | Applicable to: ALL | | | |
| | P5138 | | 20 AUG 10 | FLIGHT CONTROLS-GENERAL-ELAC SYSTEM- INSTALL ELAC STANDARD L80 |
| | Applicable to: ALL | | | |
| | P5168 | | 20 AUG 10 | NAVIGATION-MMR-INSTALLATION OF COLLINS MULTI-MODE RECEIVERS PROVIDING ILS (FM IMMUNE) AND GPS PRIMARY FUNCTION |
| | Applicable to: ALL | | | |
| | P5224 | | 20 AUG 10 | NAVIGATION - EGPWS - INTRODUCE OPTIONAL AURAL WARNINGS FOR EGPWS |
| | Applicable to: ALL | | | |
| | P5228 | 31-1118 20 | 07 APR 11 | INDICATING/RECORDING SYSTEM-FWC-ACTIVATE THE HI ALT SET" RIGH MEMO FOR HIGH ALTITUDE AIRPORT OPERATION |
| | Applicable to: ALL | | | |
| | P5239 | | 20 AUG 10 | NAVIGATION-ATC MODE "S"-INSTALL ATC/TCAS CONTROL UNIT P/N C12240B02 |
| | Applicable to: ALL | | | |
| | P5241 | | 20 AUG 10 | NAVIGATION-WEATHER RADAR SYSTEMS-INSTALL COLLINS SINGLE WITH PROVISION FOR THE SECOND SYSTEM |
| | Applicable to: ALL | | | |
| | P5253 | | 20 AUG 10 | NAVIGATION ADIRS REMOVE ADIRS CDU |
| | Applicable to: ALL | | | |
| | P5314 | | 20 AUG 10 | AUTO FLIGHT - GENERAL - MULTIPURPOSE CONTROL AND DISPLAY UNIT (MCDU) - INSTALL MCDU HONEYWELL 2ND GENERATION P/N : 4077880-980 |
| | Applicable to: ALL | | | |
| | P5429 | | 20 AUG 10 | ENGINE FUEL AND CONTROL - GENERAL FADEC SYSTEM A320/CFM56-5B - INTRODUCE ECU SOFTWARE STANDARD 5BI |
| | Applicable to: ALL | | | |
| | P5451 | | 20 AUG 10 | ELECTRICAL POWER - GENERAL AC & DC MAIN DISTRIBUTION - INSTALL A/C AND DC SHEDDABLE BUSBARS |
| | Applicable to: ALL | | | |
| | P5459 | | 20 AUG 10 | POWER PLANT - GENERAL - ADD RELAY LOGIC FOR CONTROL PACK CLOSURE AT ENGINE START |
| | Applicable to: ALL | | | |

Continued on the following page

Continued from the previous page

| M ⁽¹⁾ | MODIFICATION | Linked SB | Incorp. Date | Title |
|---------------------------|--------------|------------|--------------|---|
| | P5465 | | 20 AUG 10 | INDICATING/RECORDING SYSTEMS - CLOCKS - INSTALL AIR PRECISION CLOCK P/N APE5100 CAPABLE OF GPS TIME |
| Applicable to: ALL | | | | |
| | P5518 | 32-1336 01 | 20 AUG 10 | LANDING GEAR - GENERAL - NORMAL BRAKING - INTRODUCE STD 8 BSCU TWIN VERSION |
| Applicable to: ALL | | | | |
| | P5567 | | 20 AUG 10 | INDICATING/RECORDING SYSTEM - DMC - DEFINE DMC V40 STANDARD |
| Applicable to: ALL | | | | |
| | P5583 | | 20 AUG 10 | NAVIGATION - ADIRS - REDUCED VERTICAL SEPARATION MINIMUM (RVSM) USING ADR 1 AND ADR 2 ONLY (A319/A320/A321 APPLICABLE) |
| Applicable to: ALL | | | | |
| | P5638 | | 20 AUG 10 | NAVIGATION - STANDBY DATA : ALTITUDE AND HEADING -INSTALL ISIS (INTEGRATED STANDBY INSTRUMENT SYSTEM) - SERIAL SOLUTION - |
| Applicable to: ALL | | | | |
| | P5669 | | 20 AUG 10 | NAVIGATION - TCAS - INSTALL ALLIED SIGNAL TCAS COMPUTER P/N 066-50000-2220 (WITH CHANGE 7.0) (BFE) |
| Applicable to: ALL | | | | |
| | P5706 | 31-1257 01 | 20 AUG 10 | INDICATING/RECORDING SYSTEMS- FLIGHT WARNING COMPUTER (FWC) INSTALL FWC STD H2/E3 |
| Applicable to: ALL | | | | |
| | P5768 | | 20 AUG 10 | ELECTRICAL POWER - AC EMERGENCY GENERATION - ACTIVATE ON A320 SAME ELECTRICAL EMERG. CONFIGURATION THAN A321 |
| Applicable to: ALL | | | | |
| | P5895 | | 20 AUG 10 | NAVIGATION-GPWS-INSTALL EGPWS P/N-206-206 & INHIBIT AUTOMATIC DEACTIVATION OF ENHANCED FUNCTIONS. |
| Applicable to: ALL | | | | |
| | P6030 | | 05 SEP 17 | ELECTRICAL POWER - AC GENERATION - INSTALL ELECTRICAL OUTLETS IN COCKPIT |
| Applicable to: ALL | | | | |
| | P6044 | | 20 AUG 10 | ICE AND RAIN PROTECTION - GENERAL - WINDSHIELD RAIN PROTECTION INSTALL IMPROVED GAGE ASSY P/N 4020W35-2 |
| Applicable to: ALL | | | | |

Continued on the following page

Continued from the previous page

| M⁽¹⁾ | MODIFICATION | Linked SB | Incorp. Date | Title |
|---------------------------|---------------------|------------------|---------------------|---|
| | P6125 | | 25 NOV 11 | NAVIGATION - ADIRU - INSTALL HNWL ADIRU 4 MCU AD11 (NEW HARD) WITH 4 TRIMS OF ANEMO CORRECTION LAWS POSSIBILITIES AND MAGVAR TABLES UPDATED |
| Applicable to: ALL | | | | |
| | P6142 | | 20 AUG 10 | NAVIGATION -STANDBY BY DATA-ATTITUDE AND HEADING-COMPLETE PROVISIONS FOR ISIS ELECTRICAL SUPPLY |
| Applicable to: ALL | | | | |
| | P6146 | | 20 AUG 10 | INDICATING/RECORDING SYSTEM - FWC - INTRODUCE "F/CTL FLAP LVR NOT ZERO" RED WARNING |
| Applicable to: ALL | | | | |
| | P6201 | | 20 AUG 10 | GENERAL-FLIGHT ENVIRONMENTAL ENVELOPE- EXTENSION TO 12100 M |
| Applicable to: ALL | | | | |
| | P6251 | | 20 AUG 10 | ICE AND RAIN PROTECTION - GENERAL - WINDSHIELD RAIN PROTECTION - INSTALL NEW GAGE ASSYWITHOUT INPUT VALVE FUNCTION P/N 4020W35-3 |
| Applicable to: ALL | | | | |
| | P6375 | | 20 AUG 10 | LANDING GEAR-PARKING/ULTIMATE EMERGENCY BRAKING -INSTALL A PRESSURE SWITCH (PARKING BRAKE SYSTEM IMPROVEMENT |
| Applicable to: ALL | | | | |
| | P6544 | | 20 AUG 10 | INDICATING RECORDING SYSTEM - FWC ACTIVATE SPECIFIC FWC PROCEDURE |
| Applicable to: ALL | | | | |
| | P6578 | | 20 AUG 10 | INDICATING/RECORDING SYSTEMS - ELECTRONIC INSTRUMENT SYSTEM INSTALL DMC, DU AND DISKETTES FOR EIS2 |
| Applicable to: ALL | | | | |
| | P6588 | | 20 AUG 10 | INFORMATION SYSTEM - ATIMS IMPROVE ATSU AIRCRAFT INTERFACE SOFTWARE TO UPDATE SERVICE PROVIDERS LIST AND MANAGEMEN |
| Applicable to: ALL | | | | |
| | P6589 | | 20 AUG 10 | INDICATING/RECORDING SYSTEMS - CFDIU INTRODUCE CFDIU STANDARD 9B |
| Applicable to: ALL | | | | |

Continued on the following page

Continued from the previous page

| M⁽¹⁾ | MODIFICATION | Linked SB | Incorp. Date | Title |
|---------------------------|---------------------|--|---------------------|--|
| | P6630 | 00-1058 97 | 20 AUG 10 | CERTIFICATION DOCUMENTS - GENERAL - CERTIFY AIRCRAFT FOR OPERATION ON RUNWAYS LESS THAN 45 M WIDTH |
| Applicable to: ALL | | | | |
| | P6687 | | 20 AUG 10 | COMMUNICATION - RADIO MANAGMENT INTRODUCE NEW RMP STANDARD 2 P/N C12848AB02 |
| Applicable to: ALL | | | | |
| | P6688 | | 07 APR 11 | COMMUNICATIONS - RADIO MANAGEMENT INSTALL A THIRD RADIO MANAGEMENT PANEL |
| Applicable to: ALL | | | | |
| | P6703 | 22-1079 08 22-1102 02 22-1226 04 | 20 AUG 10 | AUTO FLIGHT - FLIGHT AUGMENTATION COMPUTER INSTALL NEW FAC SOFTWARE STANDARD P/N B397BAM0515 |
| Applicable to: ALL | | | | |
| | P6766 | | 26 JAN 16 | NAVIGATION - ILS (MMR) - INSTALL HONEYWELL MMR PROVIDING ILS (FM IMMUNE) AND GPS PRIMARY FUNCTIONS (HYBRID ARCHITECTURE) |
| Applicable to: ALL | | | | |
| | P6777 | | 07 APR 11 | INFORMATION SYSTEM - ATIMS UPGRADE ATSU HARDWARE FOR NEW ARINC 429 I/O BOARD |
| Applicable to: ALL | | | | |
| | P6801 | 31-1257 01 | 20 AUG 10 | INDICATING RECORDING SYSTEM - FWC INSTALL FWC STANDARD H2E4 |
| Applicable to: ALL | | | | |
| | P6832 | | 20 AUG 10 | INFORMATION SYSTEMS - ATIMS - DEFINE AND INSTALL NEW SOFTWARE ATSU A/C INTERFACE UPGRADED |
| Applicable to: ALL | | | | |
| | P6901 | 27-1160 01 | 20 AUG 10 | FLIGHT CONTROLS - ELAC SYSTEM - INTRODUCE ELAC SOFTWARE "L90" CAPABLE OF A318 |
| Applicable to: ALL | | | | |
| | P6911 | | 20 AUG 10 | INDICATING/RECORDING SYSTEM : FROM FWC-F1 PIN-PROGRAMMING FOR IMPROVING THE MONITORING ABOUT THE NORMAL BRAKING SYSTEM |
| Applicable to: ALL | | | | |
| | P6954 | 22-1102 02 22-1226 04 | 20 AUG 10 | AUTO FLIGHT - FLIGHT AUGMENTATION COMPUTER (FAC SYSTEM) - INTRODUCE FAC SOFTWARE "BAM0516" CAPABLE OF A318 |
| Applicable to: ALL | | | | |

Continued on the following page

Continued from the previous page

| M ⁽¹⁾ | MODIFICATION | Linked SB | Incorp. Date | Title |
|------------------|---------------------------|------------|--------------|--|
| | P6985 | | 20 AUG 10 | NAVIGATION - ADIRS - INSTALL HONEYWELL ADIRU 4MCU CAPABLE OF A318 A/C |
| | Applicable to: ALL | | | |
| | P6987 | | 20 AUG 10 | AUTO FLIGHT - FMGC INSTALL FMGC P/N B546CAM0103 (CFM GPS/ACARS) |
| | Applicable to: ALL | | | |
| | P7005 | 32-1336 01 | 20 AUG 10 | LANDING GEAR - NORMAL BRAKING - INTRODUCE STD 9 BSCU (TWIN VERSION) |
| | Applicable to: ALL | | | |
| | P7092 | | 20 AUG 10 | INDICATING/RECORDING SYSTEM - EIS - ACTIVATE FUEL FLOW/DELTA ISA FUNCTION BY PIN PROGRAMMING ON DMC |
| | Applicable to: ALL | | | |
| | P7125 | 31-1257 01 | 20 AUG 10 | INDICATING/RECORDING SYSTEMS - FWC - INSTALL FWC STANDARD H2 F1 ON A318 PW |
| | Applicable to: ALL | | | |
| | P7148 | | 20 AUG 10 | COMMUNICATIONS - HF SYSTEM - ACTIVATE DATA LINK FUNCTION FOR HFDR 1 |
| | Applicable to: ALL | | | |
| | P7175 | | 20 AUG 10 | ELECTRICAL POWER - GENERAL - INSTALL A COMMERCIAL SHEDDING PUSH-BUTTON SWITCH IN COCKPIT |
| | Applicable to: ALL | | | |
| | P7185 | | 19 JUN 17 | NAVIGATION - EGPWS INSTALL ENHANCED GPWS P/N 965-1676-001 |
| | Applicable to: ALL | | | |
| | P7186 | | 20 AUG 10 | NAVIGATION - EGPWS ACTIVATE PEAKS MODE OF EGPWS IN CONJUNCTION WITH THE TERRAIN DISPLAY |
| | Applicable to: ALL | | | |
| | P7187 | | 20 AUG 10 | NAVIGATION - EGPWS ACTIVATE GEOMETRIC ALTITUDE FUNCTION IN THE EGPWS |
| | Applicable to: ALL | | | |
| | P7188 | | 20 AUG 10 | NAVIGATION - EGPWS ACTIVATE OBSTACLE OPTION ON THE EGPWS |
| | Applicable to: ALL | | | |
| | P7218 | | 22 MAR 16 | AUTOFLIGHT - FLIGHT MANAGEMENT AND GUIDANCE COMPUTER (FMGC) DEVELOP FMS 2ND GENERATION HONEYWELL STEP1 |
| | Applicable to: ALL | | | |

Continued on the following page

Continued from the previous page

| M⁽¹⁾ | MODIFICATION | Linked SB | Incorp. Date | Title |
|---------------------------|---------------------|------------------|---------------------|--|
| | P7247 | | 20 AUG 10 | FLIGHT CONTROLS - ELAC SYSTEM - INSTALL ELAC STANDARD L81 |
| Applicable to: ALL | | | | |
| | P7268 | | 20 AUG 10 | NAVIGATION - ADIRU RESTORE RVSM 3 CIRCUITS CAPABILITIES - SERIAL SOLUTION |
| Applicable to: ALL | | | | |
| | P7278 | | 20 AUG 10 | INDICATING RECORDING SYSTEM - EIS2 INSTALL EIS2 SOFTWARE CAPABLE OF A318 A/C |
| Applicable to: ALL | | | | |
| | P7300 | | 05 SEP 17 | ELECTRICAL POWER - AC GENERATION - INSTALL ELECTRICAL OUTLETS IN COCKPIT 4MM AND 4.8MM DIA. PLUGS |
| Applicable to: ALL | | | | |
| | P7397 | | 01 DEC 15 | NAVIGATION - ADIRS INSTALL HONEYWELL ADIRU 4MCU CAPABLE OF A318 |
| Applicable to: ALL | | | | |
| | P7407 | | 07 APR 11 | COMMUNICATION - RADIO MANAGEMENT INSTALL RMP STANDARD 3 WITH MLS AND GLS FUNCTION CAPABILITY |
| Applicable to: ALL | | | | |
| | P7425 | | 06 JUL 16 | NAVIGATION - ATC - INSTALL HONEYWELL ATC TRA67A INCORPORATING EUROPEAN MODE S REGULATIONS |
| Applicable to: ALL | | | | |
| | P7455 | | 20 AUG 10 | ELECTRICAL POWER - GENERAL IN FLIGHT ENTERTAINMENT (IFE) POWER SUPPLY ON SHEDDABLE BUSBARS CONTROLLED BY "GALY & CAB" SW |
| Applicable to: ALL | | | | |
| | P7519 | | 20 AUG 10 | AUTOFLIGHT - FMGC - INSTALL FMGC CFM C13042AA01 (EQUIPPED WITH FMS2 HONEYWELL) |
| Applicable to: ALL | | | | |
| | P7635 | 27-1160 01 | 20 AUG 10 | FLIGHT CONTROLS - ELAC SYSTEM INTRODUCE ELAC SOFTWARE L82 |
| Applicable to: ALL | | | | |
| | P7721 | 32-1247 02 | 20 AUG 10 | LANDING GEAR - WHEELS AND BRAKES REMOVE THE TEMPORARY REVISIONS 5.02.00/23 AND 5.03.00/23 ON FLIGHT MANAL |
| Applicable to: ALL | | | | |

Continued on the following page

Continued from the previous page

| M⁽¹⁾ | MODIFICATION | Linked SB | Incorp. Date | Title |
|------------------------|---------------------------|------------------|---------------------|---|
| | P7790 | | 20 AUG 10 | AUTO FLIGHT FLIGHT MANAGEMENT AND GUIDANCE SYSTEM ACTIVATE FMA ENHANCEMENT FUNCTION |
| | Applicable to: ALL | | | |
| | P7919 | | 20 AUG 10 | ENGINE FUEL AND CONTROL - FADEC SYSTEM - INTRODUCE NEW FADEC SOFTWARE "5BK" ON SAC CFM56-5B ENGINES |
| | Applicable to: ALL | | | |
| | P7929 | | 20 AUG 10 | NAVIGATION - WEATHER RADAR SYSTEM INSTALL COLLINS DUAL CONTROL PANEL TO ACTIVATE MULTISCAN FUNCTION |
| | Applicable to: ALL | | | |
| | P8069 | 73-1080 01 | 20 AUG 10 | ENGINE FUEL AND CONTROL - FADEC SYSTEM INTRODUCE NEW ECU SOFTWARE STANDARD "5BL" FOR CFM56-5B ENGINES CAPABLE OF A318 CFM A/C |
| | Applicable to: ALL | | | |
| | P8076 | | 20 AUG 10 | LANDING GEAR NORMAL BRAKING INSTALL BSCU STD L4.5 |
| | Applicable to: ALL | | | |
| | P8175 | | 20 AUG 10 | INDICATING/RECORDING SYSTEMS - SDAC - ACTIVATE IAS DISCREPANCY MONITORING BY PIN PROGRAMMING |
| | Applicable to: ALL | | | |
| | P8176 | | 07 APR 11 | INDICATING/RECORDING SYSTEMS - SDAC - ACTIVATE DUAL PITOT MONITORING BY PIN PROGRAMMING |
| | Applicable to: ALL | | | |
| | P8194 | | 20 AUG 10 | NAVIGATION - ADIRS ACTIVATE ALIGNMENT IMPROVEMENT FUNCTION ON ADIRU |
| | Applicable to: ALL | | | |
| | P8232 | 31-1266 02 | 20 AUG 10 | INDICATING/RECORDING SYSTEMS - FWC - INTRODUCE IAS DISCREPANCY AND DUAL PITOT MONITORING ON FWC H2F1 |
| | Applicable to: ALL | | | |
| | P8241 | | 07 APR 11 | PLACARDS AND MARKINGS - CABIN - CONFIGURATE THE CABIN FOR NON SMOKING FLIGHT |
| | Applicable to: ALL | | | |

Continued on the following page

Continued from the previous page

| M⁽¹⁾ | MODIFICATION | Linked SB | Incorp. Date | Title |
|---------------------------|---------------------|--------------------------|---------------------|--|
| | P8243 | | 20 AUG 10 | CERTIFICATION DOCUMENTS / EXTEND OPERATING FLIGHT ENVELOPE TO MINUS 2000FT PRESSURE ALTITUDE |
| Applicable to: ALL | | | | |
| | P8256 | 22-1102 02 22-1226 04 | 20 AUG 10 | AUTO FLIGHT FLIGHT AUGMENTATION COMPUTER INSTALL FAC STANDARD BAM0617 FOR A318 EIS |
| Applicable to: ALL | | | | |
| | P8274 | 31-1257 01 | 20 AUG 10 | INDICATING RECORDING SYSTEM FWC INSTALL FWC STANDARD H2F2 |
| Applicable to: ALL | | | | |
| | P8303 | | 20 AUG 10 | NAVIGATION DDRMI REMOVE DDRMI VOR/ADF/DME INDICATORS |
| Applicable to: ALL | | | | |
| | P8440 | 32-1291 01 | 20 AUG 10 | LANDING GEAR - WHEELS AND BRAKES INTRODUCE GOODRICH DURACARB CARBON BRAKES WITH ANTI - OXYDAN "M1" |
| Applicable to: ALL | | | | |
| | P8564 | | 20 AUG 10 | INDICATING/RECORDING SYSTEM EIS ACTIVATE ENGINE AVAIL DISPLAY |
| Applicable to: ALL | | | | |
| | P8626 | | 20 AUG 10 | NAVIGATION - STANDBY DATA (ISIS) - INSTALL ISIS STANDARD VA01 WITH CORRECTION OF "OUT OF ORDER" MESSAGE & "NEW IMU STANDARD" |
| Applicable to: ALL | | | | |
| | P8671 | | 20 AUG 10 | INDICATING RECORDING SYSTEM EIS INSTALL DMC SOFTWARE EIS2 S4-2 TO CORRECT TEMPORARY LOSS OF ALL EIS2 IMAGES |
| Applicable to: ALL | | | | |
| | P8708 | 22-1168 01 | 20 AUG 10 | AUTOFLIGHT - FMGC INSTALL FMS2 HONEYWELL P1C11 ON A/C FITTED WITH CFMI PPS |
| Applicable to: ALL | | | | |
| | P8710 | | 20 AUG 10 | NAVIGATION - WEATHER RADAR SYSTEM - INSTALL COLLINS TRANSCIEVER FULLY COMPLIANT WITH MULTISCAN FUNCTION |
| Applicable to: ALL | | | | |
| | P8751 | | 20 AUG 10 | NAVIGATION - EGPWS - INSTALL AN EGPWC CAPABLE OF PEAKS/OBSTACLE FUNCTIONS WITH EIS1 & OF USING GPS LATERAL POSITION |
| Applicable to: ALL | | | | |

Continued on the following page

Continued from the previous page

| M⁽¹⁾ | MODIFICATION | Linked SB | Incorp. Date | Title |
|------------------------|---------------------------|--------------------------|---------------------|--|
| | P8799 | | 20 AUG 10 | NAVIGATION - EGPWS - INSTALL AN EGPWC CAPABLE OF PEAKS/OBSTACLE FUNCTIONS WITH EIS1 & OF USING GPS LATERAL POSITION |
| | Applicable to: ALL | | | |
| | P8850 | | 20 AUG 10 | PNEUMATIC - ENGINE BLEED AIR SUPPLY - INTRODUCE BMC STD 9 CAPABLE OF A318 PW |
| | Applicable to: ALL | | | |
| | P8863 | | 20 AUG 10 | INDICATING/RECORDING SYSTEM FWC ACQUISITION INTERFACE CONNECT FWC TO RPWS TO PREVENT DOOR OPENING WITH RESIDUAL CABIN PRESSURE |
| | Applicable to: ALL | | | |
| | P8866 | | 20 AUG 10 | LANDING GEAR NORMAL BRAKING INSTALL BSCU STD L4.8 (EM2) |
| | Applicable to: ALL | | | |
| | P9038 | | 20 AUG 10 | AUTO FLIGHT MCDU INSTALL LCD MCDU HONEYWELL |
| | Applicable to: ALL | | | |
| | P9107 | 31-1267 03 31-1300 02 | 20 AUG 10 | INDICATING/RECORDING SYSTEM FLIGHT WARNING COMPUTER - FWC - INSTALL FWC STANDARD H2 F3 |
| | Applicable to: ALL | | | |
| | P9196 | | 07 APR 11 | NAVIGATION - STANDBY DATA (ISIS) INSTALL ISIS STD WB01 WITH CORRECTION OF "OUT OF ORDER" MESSAGE |
| | Applicable to: ALL | | | |
| | P9207 | | 20 AUG 10 | NAVIGATION - ATC / MODE S - CERTIFY EHS FUNCTION |
| | Applicable to: ALL | | | |
| | P9225 | | 20 AUG 10 | INDICATING / RECORDING SYSTEM : ELECTRONIC INSTRUMENT SYSTEM (EIS) - INSTALL DISPLAY MANAGEMENT COMPUTER SOFTWARE EIS2 S6-1 |
| | Applicable to: ALL | | | |
| | P9333 | | 01 DEC 15 | NAVIGATION - AIR DATA/INERTIAL REFERENCE SYSTEM - INSTALL HONEYWELL ADIRU P/N HG2030-AE23 |
| | Applicable to: ALL | | | |
| | P9508 | | 20 AUG 10 | INDICATING/RECORDING SYSTEMS - SDAC - ACQUISITION/INTERFACE CONFIGURATION CABIN FOR NO PED FLIGHTS |
| | Applicable to: ALL | | | |

Continued on the following page

**PRELIMINARY PAGES
LIST OF MODIFICATIONS**

A318/A319/A320/A321
FLIGHT CREW
OPERATING MANUAL

Continued from the previous page

| M⁽¹⁾ | MODIFICATION | Linked SB | Incorp. Date | Title |
|---------------------------|---------------------|------------------|---------------------|--|
| | P9522 | | 20 AUG 10 | AUTO FLIGHT - MCDU ACTIVATE BACK UP NAV FUNCTION |
| Applicable to: ALL | | | | |
| | P9552 | 73-1086 00 | 20 AUG 10 | ENGINE FUEL AND CONTROL - FADEC SYSTEM INSTALL "5BM" STANDARD ECU SOFTWARE FOR CFM 56-5B ENGINES |
| Applicable to: ALL | | | | |
| | P9594 | | 07 APR 11 | PNEUMATIC LEAK DETECTION ACTIVATE PYLON LEAK DETECTION MONITORING |
| Applicable to: ALL | | | | |
| | P9655 | | 07 APR 11 | LANDING GEAR NORMAL BRAKING INSTALL BSCU SOFTWARE STD "L4.9" (EM2) |
| Applicable to: ALL | | | | |
| | P9824 | | 20 AUG 10 | INDICATING / RECORDING SYSTEMS NSTALL DISPLAY MANAGEMENT COMPUTER SOFTWARE EIS2 S7 ELECTRONIC INSTRUMENT SYSTEM |
| Applicable to: ALL | | | | |
| | P9873 | | 20 AUG 10 | POWER PLANT - GENERAL INTRODUCE CFM56-5Bx/3 ENGINE (SAC) "TECH INSERTION PROGRAM" |
| Applicable to: ALL | | | | |
| | P9894 | | 07 APR 11 | AUTO FLIGHT - FLIGHT AUGMENTATION COMPUTER - INTRODUCE TAIL STRIKE INDICATION ON PFD FOR A320 & A321 A/C |
| Applicable to: ALL | | | | |
| | P9895 | | 20 AUG 10 | AUTO FLIGHT - FLIGHT AUGMENTATION COMPUTER - INTRODUCE TAIL STRIKE "PITCH-PITCH" CALL-OUT FOR A320 & A321 AIRCRAFT |
| Applicable to: ALL | | | | |
| | P9902 | | 07 APR 11 | NAVIGATION - WEATHER RADAR SYSTEM - INSTALL COLLINS WXR MULTISCAN WRT -2100 P/N 822-1710-213 |
| Applicable to: ALL | | | | |
| | P9920 | | 07 APR 11 | GENERAL - TECHNICAL DOCUMENTATION EXTENSION OF FLEX TEMPERATURE - UPDATE FM & FCOM DOCUMENTATION |
| Applicable to: ALL | | | | |
| | 22-1375 00 | | 12 APR 17 | AUTO FLIGHT - FLIGHT AUGMENTATION COMPUTER (FAC) - INTRODUCE FAC SOFTWARE STANDARD BAM0621 (ROPS FUNCTION). |
| Applicable to: ALL | | | | |

Continued on the following page

Continued from the previous page

| M⁽¹⁾ | MODIFICATION | Linked SB | Incorp. Date | Title |
|------------------------|---------------------------|------------------|---------------------|---|
| | 22-1480 03 | | 12 APR 17 | AUTO FLIGHT-FLIGHT AUGMENTATION (FAC) DEFINE STOP RUDDER INPUT WARNING FUNCTION ON AIRCRAFT |
| | Applicable to: ALL | | | |
| | 22-1553 00 | | 12 APR 17 | AUTO FLIGHT - FLIGHT AUGMENTATION COMPUTER (FAC) - INTRODUCE FAC B624 (ROPS AND SHARKLET) |
| | Applicable to: ALL | | | |
| | 27-1230 01 | | 31 JUL 14 | FLIGHT CONTROLS - SPOILER AND ELEVATOR COMPUTER (SEC) - INSTALL SEC 123 HARDWARE B |
| | Applicable to: ALL | | | |
| | 27-1238 00 | | 06 JUL 16 | FLIGHT CONTROLS - ELAC - INSTALL L97 STANDARD ON ELAC B WITHOUT DATALOADING CAPABILITY |
| | Applicable to: ALL | | | |
| | 31-1373 00 | | 31 JUL 14 | INDICATING/RECORDING SYSTEMS - FLIGHT WARNING COMPUTER (FWC) - INSTALL FWC STANDARD H2-F6 |
| | Applicable to: ALL | | | |
| | 34-1412 06 | | 22 MAR 17 | NAVIGATION - EGPWS - INSTALL EGPWC PN 965-1676-003. |
| | Applicable to: ALL | | | |
| | 34-1506 34 | | 22 MAR 17 | NAVIGATION - TCAS - INSTALL A NEW HONEYWELL TCAS TPA-100B |
| | Applicable to: ALL | | | |

(1) Evolution code : N=New, R=Revised, E=Effectivity



A318/A319/A320/A321
FLIGHT CREW
OPERATING MANUAL

PRELIMINARY PAGES
LIST OF MODIFICATIONS

Intentionally left blank

GENERAL INFORMATION

Intentionally left blank



A318/A319/A320/A321
FLIGHT CREW
OPERATING MANUAL

GENERAL INFORMATION

PRELIMINARY PAGES

TABLE OF CONTENTS

| | |
|---|---|
| Aircraft Configuration Summary..... | A |
| If Installed Table..... | B |
| Main FCOM Changes..... | C |
| FCOM Purpose..... | D |
| List of Effective Sections/Subsections (LESS) - Paper ONLY..... | E |
| List of Effective Operations Engineering Bulletins (LEOEB)..... | F |
| List of Effective Documentary Units (LEDU) - Paper Only..... | G |
| List of Effective Temporary Documentary Units (LETDU) - Paper Only..... | H |
| Aircraft Allocation Table (AAT) - Paper Only..... | I |
| List of Modifications (LOM) - Paper Only..... | J |
| FCOM Use and Organization..... | K |
| FCOM Format and Style Information - Paper only..... | L |
| FCOM Revisions..... | M |
| Abbreviations..... | N |



A318/A319/A320/A321
FLIGHT CREW
OPERATING MANUAL

GENERAL INFORMATION

PRELIMINARY PAGES

TABLE OF CONTENTS

Intentionally left blank



A318/A319/A320/A321
FLIGHT CREW
OPERATING MANUAL

GENERAL INFORMATION

AIRCRAFT CONFIGURATION SUMMARY

Applicable to: ALL

Ident.: GEN-ACS-00016449.0001001 / 26 JUN 15

For awareness and for the specified aircraft, the following table provides the flight crew with a list of optional aircraft systems and functions related to flight and aircraft operations.

Ident.: GEN-ACS-00018963.0001001 / 04 MAR 16

| Item | System | Installed |
|------|--------|-----------|
|------|--------|-----------|

Ident.: GEN-ACS-00015613.0001001 / 23 JUN 15

| | | |
|-----------|------|----|
| ADS-B OUT | SURV | No |
|-----------|------|----|

Ident.: GEN-ACS-00016448.0001001 / 23 JUN 15

| | | |
|--------------------------------------|----------|----|
| AP Automatic Disconnection at Minima | AUTO FLT | No |
|--------------------------------------|----------|----|

Ident.: GEN-ACS-00015927.0001001 / 26 JUN 15

| | | |
|-------------|----------|----|
| AP /FD TCAS | AUTO FLT | No |
|-------------|----------|----|

Ident.: GEN-ACS-00015892.0002001 / 19 FEB 16

| | | |
|-----------------------------|----------|-----|
| Automatic FD Bar Engagement | AUTO FLT | Yes |
|-----------------------------|----------|-----|

Ident.: GEN-ACS-00016009.0002001 / 23 JUN 15

| | | |
|--|----------|-----|
| Backup Navigation Function of the MCDU | AUTO FLT | Yes |
|--|----------|-----|

Ident.: GEN-ACS-00016014.0001001 / 23 JUN 15

| | | |
|------|-----|----|
| BUSS | NAV | No |
|------|-----|----|

Ident.: GEN-ACS-00016010.0001001 / 23 JUN 15

| | | |
|-------|----------|----|
| CPDLC | DATALINK | No |
|-------|----------|----|

Ident.: GEN-ACS-00015917.0001001 / 23 JUN 15

| | | |
|-----------------|-----|----|
| Derated Takeoff | ENG | No |
|-----------------|-----|----|

Ident.: GEN-ACS-00019728.0002001 / 06 JUN 16

| | | |
|------------------------------------|----------|----|
| Descent Profile Optimization (DPO) | AUTO FLT | No |
|------------------------------------|----------|----|

Ident.: GEN-ACS-00015912.0001001 / 23 JUN 15

| | | |
|-------------------------|----------|----|
| FLS Function in the FMS | AUTO FLT | No |
|-------------------------|----------|----|

Ident.: GEN-ACS-00015913.0005001 / 23 JUN 15

| | | |
|------------------|----------|-----|
| FMS 2 Release 1A | AUTO FLT | Yes |
|------------------|----------|-----|

Ident.: GEN-ACS-00015899.0001001 / 23 JUN 15

| | | |
|-----|----------|----|
| GLS | AUTO FLT | No |
|-----|----------|----|

A318/A319/A320/A321
FLIGHT CREW
OPERATING MANUAL

Ident.: GEN-ACS-00015924.0002001 / 23 JUN 15

| | | |
|-----|-----|-----|
| GPS | NAV | Yes |
|-----|-----|-----|

Ident.: GEN-ACS-00016553.0002001 / 23 JUN 15

| | | |
|----------------------|-----|-----|
| GPS PRIMARY Function | NAV | Yes |
|----------------------|-----|-----|

Ident.: GEN-ACS-00015926.0001001 / 23 JUN 15

| | | |
|--|-----|----|
| Metric Altitude Indications on the PFD | EIS | No |
|--|-----|----|

Ident.: GEN-ACS-00015900.0001001 / 23 JUN 15

| | | |
|-----|----------|----|
| MLS | AUTO FLT | No |
|-----|----------|----|

Ident.: GEN-ACS-00015923.0001001 / 19 FEB 16

| | | |
|---|----------|----|
| NAV Mode automatically Engaged (Armed) in Go-Around | AUTO FLT | No |
|---|----------|----|

Ident.: GEN-ACS-00016013.0002001 / 23 JUN 15

| | | |
|-----|------|-----|
| PWS | SURV | Yes |
|-----|------|-----|

Ident.: GEN-ACS-00015920.0001001 / 23 JUN 15

| | | |
|------------------|-----|----|
| QFE BARO Setting | NAV | No |
|------------------|-----|----|

Ident.: GEN-ACS-00019573.0001001 / 10 MAY 16

| | | |
|------|------|----|
| RAAS | SURV | No |
|------|------|----|

Ident.: GEN-ACS-00015897.0001001 / 23 JUN 15

| | | |
|--------|----------|----|
| RNP AR | AUTO FLT | No |
|--------|----------|----|

Ident.: GEN-ACS-00016008.0001001 / 23 JUN 15

| | | |
|------------|------|----|
| ROW / ROPS | SURV | No |
|------------|------|----|

Ident.: GEN-ACS-00016015.0001001 / 22 MAR 17

| | | |
|----------------|-----|----|
| Soft Go-Around | ENG | No |
|----------------|-----|----|

IF INSTALLED TABLE

Applicable to: ALL

Ident.: GEN-IFIT-00016590.0001001 / 23 JUN 15

The "If Installed Table" provides a list of optional systems and functions of the aircraft. For most of the optional systems or functions associated with the "if installed"  symbol in the FCOM, the table indicates if the optional systems or functions are installed, or not installed.

Note: Highly customized options such as cabin installations are not covered in the following table.

Ident.: GEN-IFIT-00018965.0001001 / 22 MAR 16

| Item | System | Installed |
|------|--------|-----------|
|------|--------|-----------|

| | |
|---|----------------------------|
|  A318/A319/A320/A321 FLIGHT CREW OPERATING MANUAL | GENERAL INFORMATION |
|---|----------------------------|

Ident.: GEN-IFIT-00015896.0002001 / 17 MAR 17

L13

| | | |
|--|-----------|-----|
| 4th Occupant Folding Seat 4th Occupant Fourth Occupant | EQUIPMENT | Yes |
|--|-----------|-----|

Ident.: GEN-IFIT-00016012.0002001 / 21 MAR 16

L13

| | | |
|-------------------------|-----|-----|
| 4th Oxygen Mask Four | OXY | Yes |
|-------------------------|-----|-----|

Ident.: GEN-IFIT-00018779.0002001 / 21 MAR 16

| | | |
|----------------------------|------|-----|
| AC ESS FEED Auto Switching | ELEC | Yes |
|----------------------------|------|-----|

Ident.: GEN-IFIT-00016516.0001001 / 21 MAR 17

L13

| | | |
|---|------|----|
| ACT 1 ACT 2 ACTs ACT 1 ACT 2 ACT 1 OR 2 ACT PUMP ACT PUMP LO PR ACT XFR FAULT ACT1 ACT2 ACTs Additional center tank | FUEL | No |
|---|------|----|

Ident.: GEN-IFIT-00020299.0002001 / 13 SEP 16

L13

| | | |
|------------------------|-----|----|
| 1 ADF ADF 1 ADF1 | NAV | No |
|------------------------|-----|----|

Ident.: GEN-IFIT-00020300.0002001 / 13 SEP 16

L13

| | | |
|---|-----|-----|
| 2 ADF s 2 ADF ADF 1 ADF 1 ADF 2 ADF 2 ADF s | NAV | Yes |
|---|-----|-----|



GENERAL INFORMATION

A318/A319/A320/A321
FLIGHT CREW
OPERATING MANUAL

Ident.: GEN-IFIT-00016641.0001001 / 23 JUN 15

| | | |
|-----------|------|----|
| ADS-B OUT | SURV | No |
|-----------|------|----|

Ident.: GEN-IFIT-00015891.0001001 / 21 MAR 16

| | | |
|--|------|----|
| L13 AFT Cargo Heating AFT CRG HOT AIR temperature selector HOT AIR pb AFT CRG HEAT AFT CARGO HEAT AFT CARGO DUCT OVHT AFT Cargo heat controller Cargo Heat Cargo Temperature Regulation CRG HEAT Forward (aft) cargo heat controller HOT AIR | COND | No |
|--|------|----|

Ident.: GEN-IFIT-00015901.0002001 / 21 MAR 16

| | | |
|---|------|-----|
| L13 AFT Cargo Smoke Detector SMOKE AFT CARGO SMOKE SMOKE AFT CRG DET FAULT AFT CRG DET AFT CARGO SMOKE AFT CRG DET FAULT | FIRE | Yes |
|---|------|-----|

Ident.: GEN-IFIT-00015931.0001001 / 21 MAR 16

| | | |
|--|------|----|
| L13 AFT Cargo Ventilation Cargo Ventilation AFT ISOL VALVE AFT CRG VENT AFT CRG VENT FAULT AFT Cargo isol valves FWD (AFT) CARGO DUCT OVHT FWD (AFT) CRG HEAT FWD (AFT) CRG HEAT FAULT FWD (AFT) CRG ISOL VALVE FWD (AFT) CRG VENT FAULT FWD (AFT) CRG VENT Forward (aft) cargo isolation valves isolation valves | VENT | No |
|--|------|----|

Ident.: GEN-IFIT-00016522.0001001 / 23 JUN 15

| | | |
|--------------------|-------|----|
| Aileron Anti Droop | F/CTL | No |
|--------------------|-------|----|

A318/A319/A320/A321
FLIGHT CREW
OPERATING MANUAL

Ident.: GEN-IFIT-00015919.0002001 / 21 MAR 16

L13

| | | |
|--|------|-----|
| Air Conditioning System Controller (ACSC) ACSC ACSC 1 ACSC 2 Air Conditioning System Controllers | COND | Yes |
|--|------|-----|

Ident.: GEN-IFIT-00016523.0001001 / 23 JUN 15

| | | |
|--------------|----------|----|
| AP / FD TCAS | AUTO FLT | No |
|--------------|----------|----|

Ident.: GEN-IFIT-00016640.0001001 / 21 MAR 16

L13

| | | |
|-------------------|------|----|
| ATSAW ADS-B IN | SURV | No |
|-------------------|------|----|

Ident.: GEN-IFIT-00016524.0002001 / 23 JUN 15

| | | |
|-----------------------------|----------|-----|
| Automatic FD Bar Engagement | AUTO FLT | Yes |
|-----------------------------|----------|-----|

Ident.: GEN-IFIT-00018780.0002001 / 21 MAR 16

L13

| | | |
|--|-----|-----|
| Avail Indication During Engine Start AVAIL Indication | ENG | Yes |
|--|-----|-----|

Ident.: GEN-IFIT-00016681.0002001 / 21 MAR 16

L13

| | | |
|---|----------|-----|
| Backup Navigation Function of the MCDU BACK UP NAV | AUTO FLT | Yes |
|---|----------|-----|

Ident.: GEN-IFIT-00016525.0002001 / 21 MAR 16

L13

| | | |
|--|-----|-----|
| BARO /RADIO Instead of MDA / MDH / DH BARO BARO /RADIO | NAV | Yes |
|--|-----|-----|

Ident.: GEN-IFIT-00016526.0001001 / 21 MAR 16

L13

| | | |
|--|-------|----|
| Brake Fans Brake cooling fans BRK FAN Brake Fan Brake fans 1, 2, 3 and 4 Brake fans 5, 6, 7 and 8 | BRAKE | No |
|--|-------|----|

A318/A319/A320/A321
FLIGHT CREW
OPERATING MANUAL

Ident.: GEN-IFIT-00015875.0002001 / 21 MAR 16

L13

| | | |
|---|-------|-----|
| Bulk Cargo Door Bulk Cargo Compartment Door Bulk Door | DOORS | Yes |
|---|-------|-----|

Ident.: GEN-IFIT-00018781.0001001 / 21 MAR 16

L13

| | | |
|---|-----|----|
| BUSS Backup Speed/Altitude Scale Backup Speed Scale | NAV | No |
|---|-----|----|

Ident.: GEN-IFIT-00021488.0002001 / 17 MAR 17

L13

| | | |
|--|------|-----|
| Cargo ventilation system Cargo isolation valves Extraction fan | VENT | Yes |
|--|------|-----|

Ident.: GEN-IFIT-00016535.0001001 / 22 MAR 17

L13

| | | |
|---|------|----|
| Center Fuel Tank Transfer Valves Center Tank Transfer Valves L CTR TK XFR valve CTR TK XFR valve R | FUEL | No |
|---|------|----|

Ident.: GEN-IFIT-00021220.0001001 / 22 MAR 17

L13

| | | |
|--|------|-----|
| Center Fuel Tank Pumps CTR TK PUMP 1 CTR TK PUMP 2 | FUEL | Yes |
|--|------|-----|

Ident.: GEN-IFIT-00015930.0002001 / 21 MAR 16

L13

| | | |
|---|-----|-----|
| Chemical Oxygen System 22 min Chemical Oxygen System 22 min | OXY | Yes |
|---|-----|-----|

Ident.: GEN-IFIT-00016625.0002001 / 17 MAR 17

L13

| | | |
|---|-------|-----|
| CIDS-SDF CIDS 1 SMOKE DETECT Smoke Detection Function (SDF) | SMOKE | Yes |
|---|-------|-----|

Ident.: GEN-IFIT-00015929.0002001 / 17 MAR 17

L13

| | | |
|-----------------------------------|-----------|-----|
| Cockpit Door Deadbolt Deadbolt | EQUIPMENT | Yes |
|-----------------------------------|-----------|-----|

A318/A319/A320/A321
FLIGHT CREW
OPERATING MANUAL

Ident.: GEN-IFIT-00018782.0002001 / 21 MAR 16

| | | |
|---------------------------|------|-----|
| Cockpit Door Escape Panel | DOOR | Yes |
|---------------------------|------|-----|

Ident.: GEN-IFIT-00016690.0001001 / 21 MAR 16

L13

| | | |
|---|-----|----|
| Cockpit Fixed Second Oxygen Bottle Two | OXY | No |
|---|-----|----|

Ident.: GEN-IFIT-00016612.0001001 / 23 JUN 15

| | | |
|---------------------|------|----|
| Cockpit Foot Heater | COND | No |
|---------------------|------|----|

Ident.: GEN-IFIT-00016639.0001001 / 17 MAR 17

L13

| | | |
|--|-----------|----|
| Cockpit Foot Warmer Foot Warmer System Foot Warmer ON/OFF Control Switch | EQUIPMENT | No |
|--|-----------|----|

Ident.: GEN-IFIT-00021875.0002001 / 25 JUL 17

L13

| | | |
|--------------------------------------|-----------|-----|
| Cockpit Power Outlet Power Outlet | EQUIPMENT | Yes |
|--------------------------------------|-----------|-----|

Ident.: GEN-IFIT-00016614.0002001 / 21 MAR 16

L13

| | | |
|-----------------------------|------|-----|
| COMMERCIAL pb COMMERCIAL | ELEC | Yes |
|-----------------------------|------|-----|

Ident.: GEN-IFIT-00016615.0001001 / 23 JUN 15

| | | |
|-----------------------|-----|----|
| CVR Datalink Function | COM | No |
|-----------------------|-----|----|

Ident.: GEN-IFIT-00016626.0001001 / 23 JUN 15

| | | |
|--------------|-----|----|
| CVR ERASE pb | COM | No |
|--------------|-----|----|

Ident.: GEN-IFIT-00016647.0001001 / 21 MAR 17

L13

| | | |
|---|------|----|
| DC BUS Entertainment TR Entertainment DC BUS Ent DC BUS Entertainment TR Ent TR Ent. | ELEC | No |
|---|------|----|

Ident.: GEN-IFIT-00016527.0002001 / 21 MAR 16

L13

| | | |
|--|-----|-----|
| DDRMI Digital Distance and Radio Magnetic Indicator | NAV | Yes |
|--|-----|-----|

A318/A319/A320/A321
FLIGHT CREW
OPERATING MANUAL

Ident.: GEN-IFIT-00016528.0001001 / 21 MAR 16

L13

| | | |
|---------------------------|-----|----|
| Derated Takeoff DERATE | ENG | No |
|---------------------------|-----|----|

Ident.: GEN-IFIT-00019730.0002001 / 06 JUN 16

L13

| | | |
|-------------------------------------|----------|----|
| Descent Profile Optimization DPO | AUTO FLT | No |
|-------------------------------------|----------|----|

Ident.: GEN-IFIT-00016580.0002001 / 21 MAR 16

L13

| | | |
|-----------------------------------|-----|-----|
| Display of Delta ISA Delta ISA | EIS | Yes |
|-----------------------------------|-----|-----|

Ident.: GEN-IFIT-00016529.0001001 / 23 JUN 15

| | | |
|---------------------------|-----|----|
| Dual Ice Detection System | ICE | No |
|---------------------------|-----|----|

Ident.: GEN-IFIT-00016574.0002001 / 23 JUN 15

| | | |
|------------------------|--------|-----|
| Dual Navigation Lights | LIGHTS | Yes |
|------------------------|--------|-----|

Ident.: GEN-IFIT-00016628.0002001 / 17 MAR 17

L13

| | | |
|-------|------|-----|
| EGPWS | SURV | Yes |
|-------|------|-----|

Ident.: GEN-IFIT-00016530.0002001 / 23 JUN 15

| | | |
|------------------------------|-----|-----|
| Electrical Alternate Braking | L/G | Yes |
|------------------------------|-----|-----|

Ident.: GEN-IFIT-00016575.0002001 / 23 JUN 15

| | | |
|--------|-----|-----|
| ELT sw | COM | Yes |
|--------|-----|-----|

Ident.: GEN-IFIT-00020758.0002001 / 18 MAY 17

L13

| | | |
|--|-----|-----|
| EVAC Panel COMMAND PB (guarded) COMMAND PB Evacuation (EVAC) signalling EVAC HORN HORN SHUT OFF PB CAPT and PURS/CAPT SW | COM | Yes |
|--|-----|-----|

Ident.: GEN-IFIT-00021713.0001001 / 03 AUG 17

| | | |
|----------|----------|-----|
| Expedite | AUTO FLT | Yes |
|----------|----------|-----|

Ident.: GEN-IFIT-00015918.0002001 / 23 JUN 15

| | | |
|-----------------------|-----|-----|
| Extended FLEX Takeoff | ENG | Yes |
|-----------------------|-----|-----|



A318/A319/A320/A321
FLIGHT CREW
OPERATING MANUAL

GENERAL INFORMATION

Ident.: GEN-IFIT-00016531.0002001 / 21 MAR 16

L13

| | | |
|--|-----|-----|
| External Ice Detector Light ICE IND | ICE | Yes |
|--|-----|-----|

Ident.: GEN-IFIT-00021527.0001001 / 17 MAR 17

| | | |
|-------------------------------|------|----|
| FANS A+ DCDU ATC MSG pb | FANS | No |
|-------------------------------|------|----|

Ident.: GEN-IFIT-00021529.0001001 / 17 MAR 17

| | | |
|------------------------------|------|----|
| FANS B DCDU ATC MSG pb | FANS | No |
|------------------------------|------|----|

Ident.: GEN-IFIT-00021530.0001001 / 17 MAR 17

| | | |
|-------------------------------|------|----|
| FANS B+ DCDU ATC MSG pb | FANS | No |
|-------------------------------|------|----|

Ident.: GEN-IFIT-00015909.0001001 / 21 MAR 16

L13

| | | |
|--|------|----|
| Fan Speed Controller (FSC) Two Operating Speeds | VENT | No |
|--|------|----|

Ident.: GEN-IFIT-00016629.0003001 / 21 MAR 16

L13

| | | |
|---|------|-----|
| Fire Extinguishing in the AFT Cargo SMOKE FWD (AFT) CRG BTL 1(2) FAULT Forward (aft) cargo fire extinguishing | FIRE | Yes |
|---|------|-----|

Ident.: GEN-IFIT-00016630.0005001 / 21 MAR 16

L13

| | | |
|---|------|-----|
| Fire Extinguishing in the FWD Cargo SMOKE FWD (AFT) CRG BTL 1(2) FAULT Forward (aft) cargo fire extinguishing | FIRE | Yes |
|---|------|-----|

A318/A319/A320/A321
FLIGHT CREW
OPERATING MANUAL

Ident.: GEN-IFIT-00015898.0001001 / 21 MAR 17

L13

| | | |
|---|----------|----|
| FLS F-G/S F-G/S BASED ON ISA F-G/S-F-LOC F-G/S-LOC F-LOC F-LOC*/F-LOC FLS 1 FLS 2 FLS function NO FLS FOR THIS APPR | AUTO FLT | No |
|---|----------|----|

Ident.: GEN-IFIT-00016579.0002001 / 23 JUN 15

| | | |
|---------------|----------|-----|
| FMS Crossload | AUTO FLT | Yes |
|---------------|----------|-----|

Ident.: GEN-IFIT-00016589.0004001 / 23 JUN 15

| | | |
|-------------------------------|----------|-----|
| HONEYWELL FMS 2 Release 1A H2 | AUTO FLT | Yes |
|-------------------------------|----------|-----|

Ident.: GEN-IFIT-00015617.0001001 / 23 JUN 15

| | | |
|------|------|----|
| FTIS | FUEL | No |
|------|------|----|

Ident.: GEN-IFIT-00016532.0001001 / 23 JUN 15

| | | |
|---------------------|------|----|
| Fuel Leak Detection | FUEL | No |
|---------------------|------|----|

Ident.: GEN-IFIT-00016533.0001001 / 23 JUN 15

| | | |
|--------------------------|------|----|
| Fuel Tank Overflow Alert | FUEL | No |
|--------------------------|------|----|

Ident.: GEN-IFIT-00015893.0001001 / 21 MAR 16

L13

| | | |
|---|------|----|
| FWD Cargo Heating Temperature Selector FWD (AFT) CARGO DUCT OVHT FWD (AFT) CRG HEAT FWD (AFT) CRG HEAT FAULT FWD CRG HEAT Cargo Heat Cargo Temperature Regulation CRG HEAT Forward (aft) cargo heat controller HOT AIR Fwd cargo heat controller | COND | No |
|---|------|----|

A318/A319/A320/A321
FLIGHT CREW
OPERATING MANUAL

Ident.: GEN-IFIT-00015925.0002001 / 21 MAR 16

L13

| | | |
|--|------|-----|
| FWD Cargo Smoke Detector SMOKE FWD CARGO SMOKE FWD CARGO SMOKE SMOKE FWD CRG DET FAULT FWD CRG DET | FIRE | Yes |
|--|------|-----|

Ident.: GEN-IFIT-00015932.0002001 / 21 MAR 16

L13

| | | |
|---|------|-----|
| FWD Cargo Ventilation FWD Cargo Outlet Isolation Valve Cargo Ventilation FWD ISOL Valve FWD CRG VENT FWD CARGO ISOL VALVE Forward (aft) cargo isolation valves Fwd cargo isol valves | VENT | Yes |
|---|------|-----|

Ident.: GEN-IFIT-00016617.0001001 / 21 MAR 16

L13

| | | |
|---|------|----|
| Galley Bus Automatic Shedding Galley Load Automatic Shedding | ELEC | No |
|---|------|----|

Ident.: GEN-IFIT-00016618.0002001 / 21 MAR 16

L13

| | | |
|--|------|-----|
| GAPCU Ground and Auxiliary Power Control Unit | ELEC | Yes |
|--|------|-----|

Ident.: GEN-IFIT-00019705.0001001 / 13 MAY 16

L13

| | | |
|---|-----|----|
| Gaseous Oxygen Generators in lavatories Gaseous Generators | OXY | No |
|---|-----|----|

Ident.: GEN-IFIT-00016534.0001001 / 21 MAR 16

L13

| | | |
|-------------------------------------|----------|----|
| GLS GLS Autoland GLS1 GLS2 | AUTO FLT | No |
|-------------------------------------|----------|----|

A318/A319/A320/A321
FLIGHT CREW
OPERATING MANUAL

Ident.: GEN-IFIT-00016649.0002001 / 21 MAR 16

| | | |
|---|-----|-----|
| L13 | | |
| GPS FM / GPS POS DISAGREE GPS 1(2) FAULT GPS 1 GPS 2 GPS 1+2 | NAV | Yes |

Ident.: GEN-IFIT-00016650.0002001 / 21 MAR 16

| | | |
|-------------------------------------|-----|-----|
| L13 | | |
| GPS PRIMARY Function GPS PRIMARY | NAV | Yes |

Ident.: GEN-IFIT-00020297.0001001 / 17 MAR 17

| | | |
|-------------|-----|----|
| GSM Onboard | COM | No |
|-------------|-----|----|

Ident.: GEN-IFIT-00015911.0002001 / 21 MAR 17

| | | |
|---|-----|-----|
| L13 | | |
| HF Datalink HF 1(2) DATA FAULT HF DATA LINK | COM | Yes |

Ident.: GEN-IFIT-00020132.0002001 / 22 MAR 17

| | | |
|---------------------------------|-----|-----|
| L13 | | |
| HF System HF HF 1 HF 2 | COM | Yes |

Ident.: GEN-IFIT-00016644.0002001 / 21 MAR 16

| | | |
|---|-----|-----|
| L13 | | |
| HI ALT pb Operation on High Altitude Airfields HI ALT LANDING pb-sw HI ALT LANDING pb-sw | OXY | Yes |

Ident.: GEN-IFIT-00018783.0001001 / 21 MAR 16

| | | |
|-----|------|----|
| HUD | SURV | No |
|-----|------|----|

Ident.: GEN-IFIT-00016651.0002001 / 23 JUN 15

| | | |
|-------------------------------------|-----|-----|
| IRS Alignment Based on GPS Position | NAV | Yes |
|-------------------------------------|-----|-----|

Ident.: GEN-IFIT-00015618.0002001 / 23 JUN 15

| | | |
|------|-----|-----|
| ISIS | NAV | Yes |
|------|-----|-----|

A318/A319/A320/A321
FLIGHT CREW
OPERATING MANUAL

Ident.: GEN-IFIT-00020693.0001001 / 17 MAR 17

L13

| | | |
|---|------|----|
| ITP ATSA ITP ITP TRAFFIC LIST page IN TRAIL PROCEDURE IN TRAIL PROCEDURE page | SURV | No |
|---|------|----|

Ident.: GEN-IFIT-00016594.0002001 / 23 JUN 15

| | | |
|-----|-------|----|
| LAF | F/CTL | No |
|-----|-------|----|

Ident.: GEN-IFIT-00016596.0001001 / 21 MAR 16

L13

| | | |
|---|-----|----|
| LAT DEV SCALE pb L/DEV deviation scale | NAV | No |
|---|-----|----|

Ident.: GEN-IFIT-00016600.0001001 / 23 JUN 15

| | | |
|---------|----------|----|
| LOC B/C | AUTO FLT | No |
|---------|----------|----|

Ident.: GEN-IFIT-00016602.0002001 / 21 MAR 16

L13

| | | |
|-----------------------------------|--------|-----|
| Logo Light LOGO Logo Lights | LIGHTS | Yes |
|-----------------------------------|--------|-----|

Ident.: GEN-IFIT-00020306.0001001 / 17 MAR 17

| | | |
|----------------------------|------|-----|
| Man-made Obstacle Function | SURV | Yes |
|----------------------------|------|-----|

Ident.: GEN-IFIT-00016604.0002001 / 23 JUN 15

| | | |
|----------------------|-------|-----|
| Manual Flush Control | WATER | Yes |
|----------------------|-------|-----|

Ident.: GEN-IFIT-00016605.0002001 / 21 MAR 16

| | | |
|-----------------------|-------|-----|
| Manual Shutoff Valves | WATER | Yes |
|-----------------------|-------|-----|

Ident.: GEN-IFIT-00016688.0001001 / 23 JUN 15

| | | |
|--|-----|----|
| Metric Altitude Indications on the PFD | EIS | No |
|--|-----|----|

Ident.: GEN-IFIT-00016536.0001001 / 21 MAR 16

L13

| | | |
|---------------------|----------|----|
| MLS MLS1 MLS2 | AUTO FLT | No |
|---------------------|----------|----|

Ident.: GEN-IFIT-00016603.0001001 / 23 JUN 15

| | | |
|---|----------|----|
| NAV Mode automatically Engaged (Armed) in Go-Around | AUTO FLT | No |
|---|----------|----|

A318/A319/A320/A321
FLIGHT CREW
OPERATING MANUAL

Ident.: GEN-IFIT-00016645.0002001 / 23 JUN 15

| | | |
|--------------|-----|-----|
| OEB Reminder | EIS | Yes |
|--------------|-----|-----|

Ident.: GEN-IFIT-00021528.0001001 / 17 MAR 17

| | | |
|--|------|----|
| Optional Applications: DCL OCL D-ATIS | FANS | No |
|--|------|----|

Ident.: GEN-IFIT-00016597.0003001 / 21 MAR 16

| | | |
|---|-------|-----|
| L13 2 Pairs of Overwing Emergency Exit Overwing Escape Route FWD EMER EXIT | DOORS | Yes |
|---|-------|-----|

Ident.: GEN-IFIT-00016538.0001001 / 21 MAR 16

| | | |
|---|-------|----|
| L13 Parking Brake Monitoring PARK BRK FAULT | BRAKE | No |
|---|-------|----|

Ident.: GEN-IFIT-00021553.0002001 / 17 MAR 17

| | | |
|-----------------|------|-----|
| Predictive GPWS | SURV | Yes |
|-----------------|------|-----|

Ident.: GEN-IFIT-00016608.0002001 / 22 MAR 16

| | | |
|---|----------|-----|
| L13 Printer Function in FMS PRINT FUNCTION PRINTER NOT AVAILABLE | AUTO FLT | Yes |
|---|----------|-----|

Ident.: GEN-IFIT-00016609.0002001 / 21 MAR 16

| | | |
|-------------------|----------|-----|
| Push to Level Off | AUTO FLT | Yes |
|-------------------|----------|-----|

Ident.: GEN-IFIT-00016648.0002001 / 17 MAR 17

| | | |
|--|------|-----|
| L13 PWS Windshear DET WINDSHEAR DETECTION PRED W/S DET FAULT W/S AHEAD WINDSHEAR AHEAD Windshear PRED W/S DET predictive windshear system PWS SCAN | SURV | Yes |
|--|------|-----|

Ident.: GEN-IFIT-00016695.0001001 / 23 JUN 15

| | | |
|-----|-----------|----|
| QAR | RECORDING | No |
|-----|-----------|----|

Ident.: GEN-IFIT-00016643.0001001 / 21 MAR 16

L13

| | | |
|--------------------------------|-----|----|
| QFE BARO Setting QFE OPTION | NAV | No |
|--------------------------------|-----|----|

Ident.: GEN-IFIT-00016610.0001001 / 23 JUN 15

| | | |
|------|------|----|
| RAAS | SURV | No |
|------|------|----|

Ident.: GEN-IFIT-00016539.0003001 / 21 MAR 16

L13

| | | |
|--|------|-----|
| Rain Repellent System Rain Repellent RAIN RPLNT pb RAIN RPLNT | RAIN | Yes |
|--|------|-----|

Ident.: GEN-IFIT-00016737.0001001 / 23 JUN 15

| | | |
|-------------------|-----|----|
| RMP Load Function | COM | No |
|-------------------|-----|----|

Ident.: GEN-IFIT-00016581.0001001 / 23 JUN 15

| | | |
|--------|-----|----|
| RNP pb | NAV | No |
|--------|-----|----|

Ident.: GEN-IFIT-00016582.0001001 / 21 MAR 16

L13

| | | |
|------------------------|------|----|
| ROW / ROPS ROW /ROP | SURV | No |
|------------------------|------|----|

Ident.: GEN-IFIT-00016583.0002001 / 23 JUN 15

| | | |
|------|--------|-----|
| RPCU | CAB PR | Yes |
|------|--------|-----|

Ident.: GEN-IFIT-00016642.0001001 / 22 MAR 17

L13

| | | |
|---|-----|----|
| SATCOM SATCOM DATA FAULT SATCOM FAULT Satellite Communications (SATCOM) SATCOM System | COM | No |
|---|-----|----|

Ident.: GEN-IFIT-00016646.0001001 / 17 MAR 17

L13

| | | |
|---|-------|----|
| SDCU Smoke Detection Control Unit SDCU | SMOKE | No |
|---|-------|----|

Ident.: GEN-IFIT-00016584.0001001 / 23 JUN 15

| | | |
|----------------------------------|------|----|
| Second Fire Extinguishing Bottle | FIRE | No |
|----------------------------------|------|----|

A318/A319/A320/A321
FLIGHT CREW
OPERATING MANUAL

Ident.: GEN-IFIT-00018784.0001001 / 22 MAR 17

L13

| | | |
|---|-----|----|
| Soft Go-Around SOFT GA Go-Around soft | ENG | No |
|---|-----|----|

Ident.: GEN-IFIT-00018785.0001001 / 21 MAR 16

L13

| | | |
|---|-----|----|
| Steep Approach Capability STEEP APPR | NAV | No |
|---|-----|----|

Ident.: GEN-IFIT-00016586.0001001 / 23 JUN 15

| | | |
|-------|------|----|
| T2CAS | SURV | No |
|-------|------|----|

Ident.: GEN-IFIT-00016587.0001001 / 23 JUN 15

| | | |
|-------|------|----|
| T3CAS | SURV | No |
|-------|------|----|

Ident.: GEN-IFIT-00016588.0002001 / 21 MAR 17

L13

| | | |
|---|-----|-----|
| Tail Strike Pitch Limit Indicator Tailstrike Pitch Limit Indicator | EIS | Yes |
|---|-----|-----|

Ident.: GEN-IFIT-00018786.0002001 / 21 MAR 16

| | | |
|---------------------------|------|-----|
| Temperature Control Panel | COND | Yes |
|---------------------------|------|-----|

Ident.: GEN-IFIT-00016541.0001001 / 23 JUN 15

| | | |
|-------------|-----|----|
| Thrust Bump | ENG | No |
|-------------|-----|----|

Ident.: GEN-IFIT-00016011.0001001 / 21 MAR 16

L13

| | | |
|--------------------|-------|----|
| TPIS TYRE LO PR | WHEEL | No |
|--------------------|-------|----|

Ident.: GEN-IFIT-00017055.0001001 / 17 MAR 17

| | | |
|---|------|----|
| HZD switch ON Weather Hazard Prediction Function WX+T+H WX+T+HZD | SURV | No |
|---|------|----|

Ident.: GEN-IFIT-00020783.0001001 / 20 DEC 16

| | | |
|---------------------------------|-----|----|
| Weight and Balance System (WBS) | EIS | No |
|---------------------------------|-----|----|

Ident.: GEN-IFIT-00016543.0001001 / 21 MAR 16

L13

| | | |
|---|------|----|
| Wiper Intermittent Position Intermittent Sweep Function Intermittent Sweeping | RAIN | No |
|---|------|----|

| | |
|---|----------------------------|
|  A318/A319/A320/A321 FLIGHT CREW OPERATING MANUAL | GENERAL INFORMATION |
|---|----------------------------|

| |
|--------------------------|
| MAIN FCOM CHANGES |
|--------------------------|

Ident.: GEN-00012867.0001001 / 03 AUG 17

Applicable to: ALL

The purpose of the Main FCOM Changes is to provide operators with general information about the most significant changes that are introduced in the current revision of the manual.

The main FCOM changes are available on the Airbus World portal, under the path: Content Library / Flight Operations / Manuals / Main FCOM - FCTM - MMEL Changes.

In addition, every revised Documentary Unit (DU) has a revision highlight (HL) that:

- Indicates the change(s) made to the DU
- Can be found in the associated “Preliminary Pages – Summary of Highlights” subchapter.

In addition to the Main FCOM Changes, the Modification Operational Impact (MOI) documents available on the Airbus World portal provide the operational impact linked to a MOD number.

| |
|---------------------|
| FCOM PURPOSE |
|---------------------|

Ident.: GEN-00012627.0001001 / 17 MAR 17

Applicable to: ALL

FCOM PURPOSE

The Flight Crew Operating Manual (FCOM) is a support documentation for flight crew.

The purpose of the FCOM is to:

- Provide all necessary operating limitations, procedures, performance and system information the flight crew needs to safely and efficiently operate A320 family aircraft during normal, abnormal, and emergency situations
- Serve directly as Flight Crew Operating Manual, or as a basis for Operators to develop their own customized Airline Operations Manual, in accordance with applicable requirements
- Serve as a comprehensive reference guide during initial and refresher flight crew training.

Note: This manual is not designed:

- To teach basic piloting skills
- To provide basic piloting techniques applicable to jet aircraft, or information, that are considered as basic airmanship for trained flight crews who are familiar with that type of aircraft and its general handling characteristics.

The Flight Crew Operating Manual (FCOM) complements the Airplane Flight Manual (AFM).

If the FCOM data differs from the AFM data, the AFM remains the reference.

As a supplement to the FCOM , the FCTM may provide additional information that the flight crew should read in conjunction with the FCOM. For more information, *Refer to FCTM/GI FCTM Purpose.*

For any questions or comments related to this manual, the Operator's Flight Operations Management can contact the Airbus Flight Operations Support & Training Standards department.

FCOM CONTENTS

The FCOM has five sections:

- Aircraft Systems : This section is divided into ATA chapters for each aircraft system. This section includes a specific description of each system and its associated cockpit interfaces.
- Procedures : This section contains the following chapters:
 - Normal Procedures that include the SOP , the SRP, and the Supplementary Procedures
 - Abnormal and Emergency Procedures
 - Special Operations.
- Limitations : This section provides the aircraft and system limitations that the flight crew must know or refer to in operations.
- Operations Engineering Bulletins (OEB)
- Performance : This section includes the aircraft performance for each flight phase.

DOCUMENTARY UNITS

The FCOM is made of Documentary Units (DU). The DU is the smallest part of information with a technical content.

The DUs are listed on a separate "List of Effective Documentary Units" (LEDU). *Refer to the General section.*

- Note:
1. *DUs can be grouped into Group of DU (GDU)*
 2. *Temporary information may be provided via Temporary DU (TDU).*

IDENTIFICATION STRIP

Below the title of the DU, the identification strip provides:

- The list of MSN the DU is applicable to
- For TDU , the reference to the DU impacted by the TDU.

LIST OF EFFECTIVE SECTIONS/SUBSECTIONS (LESS) - PAPER ONLY

Ident.: GEN-00013786.0001001 / 23 JUN 15

Applicable to: **ALL**

The List of Effective Sections/Subsections (LESS) summarizes all the sections and subsections contained in the FCOM . For each revision, a new LESS is issued when at least one DU of the section/subsection is changed.

The LESS consists of:

- The "M" field that may provide the following evolution code:
 - The "N" letter indicates a new section introduced by the revision
 - The "R" letter indicates a section in which the content has been revised
 - The "E" letter indicates an aircraft validity change within the section
 - The "M" letter indicates a section that have move within the FCOM
- The "Localization" field that allows localizing the section within the manual with the product structure
- The "Subsection title" field
- The "Rev. Date" field that indicated the date at which the section was changed.

LIST OF EFFECTIVE OPERATIONS ENGINEERING BULLETINS (LEOEB)

Ident.: GEN-00013787.0001001 / 17 MAR 17

Applicable to: ALL

Refer to OEB-GEN OEB Content and Management

LIST OF EFFECTIVE DOCUMENTARY UNITS (LEDU) - PAPER ONLY

Ident.: GEN-00013789.0001001 / 23 MAR 11

Applicable to: ALL

For each revision, a new List of Effective Documentary Units (LEDU) is issued at the section level. The LEDU provides information about the DU localization, applicability, identification and issue date.

The LEDU consists of:

- The "M" field that may provide the following Evolution Code:
 - The "N" letter indicates a new DU introduced by the revision
 - The "R" letter indicates a revised DU: The content of the DU is updated by the revision. A vertical line in the margin of the DU locates the modified part
 - The "E" letter indicates an aircraft validity change for the DU: The list of MSNs for which the DU is effective has been changed compared to the previous LEDU, by addition or deletion of one or several MSN
- The "Localization" field that allows localizing the DU in the manual with the product structure of the manual
- The "T" field (Temporary Information) that contains a cross if the associated DU is a TDU
- The "DU title" that provides the title of the DU
- The "DU identification" that identifies the DU with its own unique identification number or the GDU with its own unique code.
- The "DU date" that indicates when the DU has been released

A318/A319/A320/A321
FLIGHT CREW
OPERATING MANUAL

- The DU criteria which lists the technical or operational criteria for which the DU and solution is applicable to.
- The “Applicable to” which provides the list of aircraft this DU and solution is applicable to
- The “Impacted by TDU” which is the identification of the TDU superseding the DU

LIST OF EFFECTIVE TEMPORARY DOCUMENTARY UNITS (LETDU) - PAPER ONLY

Ident.: GEN-00013803.0001001 / 23 JUN 15

Applicable to: **ALL**

The List of Effective Temporary Documentary Units (LETDU) provides a summary of the Temporary DU impacting the section.

The LETDU consists of:

- The "M" field that may provide the following Evolution Code:
 - The "N" letter indicates a new TDU introduced by the revision
 - The "R" letter indicates a revised TDU: The content of the TDU is updated by the revision. A vertical line in the margin of the TDU locates the modified part
 - The "E" letter indicates an aircraft validity change for the TDU: The list of MSNs the TDU is applicable to has been changed compared to the previous LETDU, by addition or deletion of one or several MSN
- The “Localization” field that allows localizing the TDU in the manual with the product structure of the manual
- The “TDU Title” that provides the title of the TDU
- The “TDU identification” that identifies the TDU with its identification number with its own unique code
- The “TDU date” that indicates when the TDU has been released
- The TDU criteria which lists the technical or operational criteria, the it is applicable to
- The “Applicable to” which provides the list of aircraft this TDU is applicable to
- The “Impacted DU” which is the Identification of DU superseded by the TDU
- The “Reason for issue” of the TDU

Note: 1. TDU is displayed on a yellow background
2. within the QRH the TDU replaces the impacted DU

AIRCRAFT ALLOCATION TABLE (AAT) - PAPER ONLY

Ident.: GEN-00013804.0001001 / 23 JUN 15

Applicable to: **ALL**

The Aircraft Allocation Table (AAT) provides a view of the fleet covered in the FCOM . For each aircraft, the AAT provides its MSN, its registration number and the model.

| | |
|---|----------------------------|
|  A318/A319/A320/A321 FLIGHT CREW OPERATING MANUAL | GENERAL INFORMATION |
|---|----------------------------|

LIST OF MODIFICATIONS (LOM) - PAPER ONLY

Ident.: GEN-00013805.0001001 / 23 JUN 15
Applicable to: ALL

The List of Modifications (LOM) lists the criteria (Modification Proposal (MP) or Service Bulletins (SB)) which the installation on the aircraft affects the FCOM.

Note: Each MP has one or more associated MODs. The MP/MOD correlation is available in AirN@v / Engineering.

The LOM also indicates:

- The title of the criteria
- The date of incorporation of the criteria in the FCOM
- The list of aircraft that have the criteria
- The "M" field that may indicate the following evolution code
 - The "E" letter indicates an aircraft validity change of the criteria. The list of aircraft to which the criteria applies has changed compared to the previous FCOM revision, by addition or deletion of one or several aircraft.
 - The "N" letter indicates new criteria added by this FCOM revision
 - The "R" letter indicates a change in the criteria title or associated SB

FCOM USE AND ORGANIZATION

Ident.: GEN-00012688.0001001 / 21 MAR 16
Applicable to: ALL

DEFINITIONS OF WARNINGS, CAUTIONS AND NOTES

The following are the official definitions of warnings, cautions and notes taken directly from the JAR25/CS-25 and applicable to Airbus flight operation documentation:

- | | |
|----------------|---|
| WARNING | An operating procedure, technique, etc. that may result in personal injury or loss of life if not followed. |
| CAUTION | An operating procedure, technique, etc. that may result in damage to equipment if not followed. |
| NOTE | An operating procedure, technique, etc. considered essential to emphasize. Information contained in notes may also be safety related. |

INFORMATION TYPE AND LAYERS

The FCOM has technical information that may be used for:

- Flight crew operations in flight, or on ground
- Airlines operations on ground
- Training.

To take the above-noted objectives into account, the FCOM is organized in three layers as follows:

- Layer 1: "Need to know"
 Layer 1 presents information that is necessary in the cockpit.
- Layer 2: "Nice to know"
 Layer 2 presents information that is used as a reference, in order to fully understand the logic of the aircraft and pilot interfaces.
- Layer 3: Detailed information
 Layer 3 provides more detailed explanations, that are not necessarily needed in flight.

Note: For paper only, the following examples show the visual characteristics of each kind of layer

| | |
|----------------|--|
| EXAMPLE | - Text in layer 1 Layer 1 is the default layer. No symbology when not following layer 2 or layer 3 information. |
|----------------|--|

| | | |
|-----------|----------------|-------------------|
| L2 | EXAMPLE | - Text in layer 2 |
|-----------|----------------|-------------------|

| | | |
|-----------|----------------|-------------------|
| L3 | EXAMPLE | - Text in layer 3 |
|-----------|----------------|-------------------|

| | | |
|-----------|----------------|---|
| L1 | EXAMPLE | - Text in layer 1 (as this text follows a text in layer 2 or 3, symbology "L1") |
|-----------|----------------|---|

OPTIONAL EQUIPMENT

The legend  (if installed) indicates that a paragraph or an illustration is applicable only if the related optional equipment is installed.

FCOM FORMAT AND STYLE INFORMATION - PAPER ONLY

Ident.: GEN-00013793.0001001 / 21 MAR 16

Applicable to: ALL

TABLE OF CONTENTS

Each TOC entry has an alphabetical index that identifies this TOC entry within its subsection. The manual user can easily find a TOC entry content within the manual thanks to this alphabetical

index and the subsection identification. Both are indicated in the TOC and both cross-refer to the paper page footer (see the TOC indexing part below).

| | | | |
|--|--|---|--|
| <ul style="list-style-type: none"> [-] DSC-35 Oxygen <ul style="list-style-type: none"> [-] Preliminary Pages <ul style="list-style-type: none"> Table of Contents Summary of Highlights [-] DSC-35-10 General <ul style="list-style-type: none"> Description [-] DSC-35-20 Fixed Oxygen System for Cockpit <ul style="list-style-type: none"> [-] DSC-35-20-10 Description <ul style="list-style-type: none"> General Operation Schematic Mask Setting Mask Stowage [-] DSC-35-20-20 Controls and Indicators <ul style="list-style-type: none"> Overhead Panel Stowage Box Crew Oxygen Mask Pressure Regulator DOOR/OXY ECAM Page [-] DSC-35-20-30 Electrical Supply [-] DSC-35-30 Fixed Oxygen System for Cabin [-] DSC-35-40 Portable Oxygen System | <table border="1" style="width: 100%; border-collapse: collapse;"> <tr> <td style="text-align: center; width: 150px;"> A318/A319/A320/A321 <small>FLIGHT CREW OPERATING MANUAL</small> </td> <td style="text-align: center;"> AIRCRAFT SYSTEMS OXYGEN <small>PRELIMINARY PAGES - TABLE OF CONTENTS</small> </td> </tr> </table> <p>DSC-35-10 General Description A</p> <p>DSC-35-20 Fixed Oxygen System for Cockpit</p> <p>DSC-35-20-10 Description</p> <p>General A</p> <p>Operational B</p> <p>Schematic C</p> <p>Mask Setting D</p> <p>Mask Stowage E</p> <p>DSC-35-20-20 Controls and Indicators</p> <p>Overhead Panel A</p> <p>Stowage Box B</p> <p>Crew Oxygen Mask C</p> <p>Pressure Regulator D</p> <p>DOOR/OXY ECAM Page E</p> <p>DSC-35-20-30 Electrical Supply</p> <p>Bus Equipment List A</p> | A318/A319/A320/A321 <small>FLIGHT CREW OPERATING MANUAL</small> | AIRCRAFT SYSTEMS OXYGEN <small>PRELIMINARY PAGES - TABLE OF CONTENTS</small> |
| A318/A319/A320/A321 <small>FLIGHT CREW OPERATING MANUAL</small> | AIRCRAFT SYSTEMS OXYGEN <small>PRELIMINARY PAGES - TABLE OF CONTENTS</small> | | |

HEADER AND FOOTER

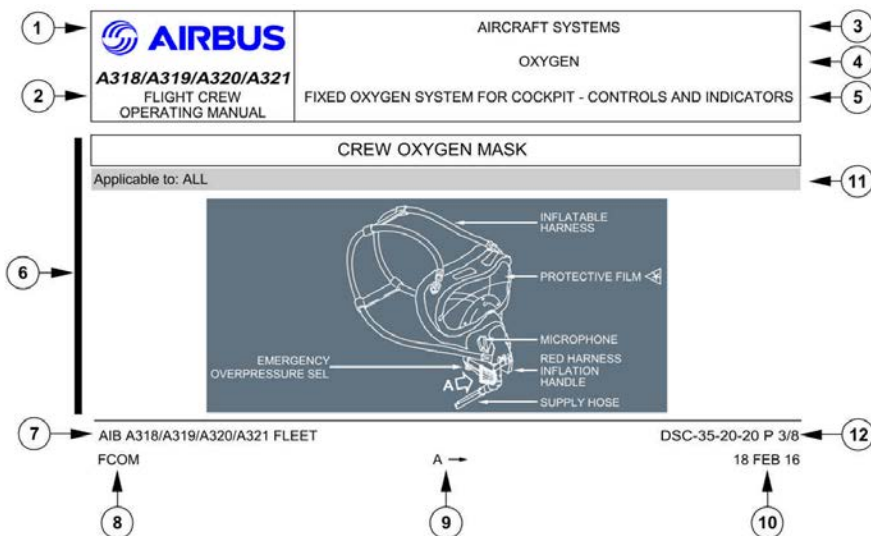

1. Airline logo
2. Aircraft types and manual
3. Level 2 chapter (PSL level 2 : GEN, DSC, PRO, LIM, OEB, PER)
4. Level 3 chapter
5. Level 4 chapter
6. Revision mark
7. Key product (document identification and aircraft designation)
8. Key product (manual code)
9. Page index
10. Last evolution date
11. Identification strip (list of impacted aircraft)
12. PSL path

REVISION MARK

In the paper format, a vertical bar in the margin of the DU identifies the modified part. Each vertical bar has a numerical index that refers to the associated reason of the change in the Summary of Highlight.

This Summary of Highlight lists all the changes and associated reasons of the change (if necessary) that the revision has introduced.

TOC INDEXING

In the paper page footer, the TOC indexing is of the following type:

- A : The paper page contains the whole "A" TOC entry content
- A to B : The paper page contains the whole "A" and "B" TOC entries contents
- A → : The "A" TOC entry content starts on this paper page and continues on the following paper page
- ← A : The "A" TOC entry content starts on a previous paper page and finishes on this paper page
- ← A → : The "A" TOC entry content starts on a previous paper page and continues on the following paper page
- A to C→ : The paper page contains the whole "A" and "B" TOC entries contents but the "C" TOC entry content starts on this paper page and continues on the following paper page

| | |
|---|----------------------------|
|  A318/A319/A320/A321 FLIGHT CREW OPERATING MANUAL | GENERAL INFORMATION |
|---|----------------------------|

- ← A to C : The paper page contains the whole "B" and "C" TOC entries contents but the "A" TOC entry content starts on a previous paper page and finishes on this paper page
- ← A to C → : The paper page contains the whole "B" TOC entry content but the "A" TOC entry content starts on a previous paper page and finishes on this paper page and the "C" TOC entry content starts on this paper page and continues on the following paper page

- Note:*
1. The indexes follow the alphabetical order: A, B, C, ..., Z, AA, AB, AC, ..., AZ, BA, BB, BC, ...
 2. For each subsection, the index starts again from A.
 3. When a TOC entry content continues on the following paper page, the text "Continued on the following page" is also indicated.

| |
|-----------------------|
| FCOM REVISIONS |
|-----------------------|

Ident.: GEN-00012634.0001001 / 24 OCT 14
 Applicable to: ALL

FCOM REVISION

FCOM revisions are issued to add, update, or revise information. The Operator determines the revision periodicity.
 When necessary, a revision may be issued in between the defined periodicity (e.g. need for urgent update).
 A vertical bar appears to the left of all revised parts of the manual.

TEMPORARY INFORMATION

Some FCOM sections may need a temporary update (e.g. to explain a system behavior that will be modified by a future standard). In such cases, the applicable FCOM section is updated with a Temporary Documentary Unit (TDU).
 Information contained in the TDU is highlighted in the manual and the initial content of the FCOM remains available for consultation and comparison and is highlighted (identification strip) as being impacted by the TDU.
 A List of Effective Documentary Units (LEDU) is provided in the FCOM

OPERATIONS ENGINEERING BULLETINS

Operations Engineering Bulletins (OEB) are issued, when it is necessary, to rapidly transmit technical and procedural information.
 The OEB chapter provides a list of all applicable OEBs.

ABBREVIATIONS

Ident.: GEN-00012598.0001001 / 05 SEP 17

Applicable to: **ALL**

A

| Abbreviation | Term |
|--------------|---|
| A>B | A is greater than B |
| A≥B | A is greater than or equal to B |
| A<B | A is less than B |
| A≤B | A is less than or equal to B |
| A/BRK | Autobrake |
| A/C | Aircraft |
| A/P | Autopilot |
| AP | Autopilot |
| A/S | Airspeed |
| A/SKID | Anti-skid |
| A/THR | Auto Thrust |
| AA | Airworthiness Authorities |
| AAL | Above Aerodrome Level |
| AAT | Aircraft Allocation Table |
| AB | Abort |
| ABCU | Alternate Braking Control Unit |
| ABN | Abnormal |
| ABV | Above |
| AC | Alternating Current |
| ACARS | ARINC Communication Addressing and Reporting System |
| ACAS | Airborne Collision Avoidance System |
| ACCEL | Acceleration |
| ACC | Active Clearance Control |
| ACCU | Accumulator |
| ACP | Audio Control Panel |
| ACS | Aircraft Configuration Summary |
| ACSC | Air Conditioning System Controller |
| ACT | Additional Center Tank |
| ADC | Air Data Computer |
| ADF | Automatic Direction Finder |
| ADIRS | Air Data Inertial Reference System |
| ADIRU | Air Data Inertial Reference Unit |
| ADM | Air Data Module |
| ADR | Air Data Reference |
| ADS-B | Automatic Dependent Surveillance - Broadcast |
| ADS-C | Automatic Dependent Surveillance - Contract |

Continued on the following page

Continued from the previous page

| Abbreviation | Term |
|---------------------|---|
| ADV | Advisory |
| AEVC | Avionic Equipment Ventilation Controller |
| AFM | Airplane Flight Manual |
| AFS | Auto Flight System |
| AGL | Above Ground Level |
| AIDS | Aircraft Integrated Data System |
| AIL | Aileron |
| AIME | Autonomous Integrity Monitoring Extrapolation |
| AIP | Attendant Indication Panel |
| AIU | Audio Interface Unit |
| ALT | Altitude |
| ALTN | Alternate |
| AMC | Acceptable Means of Compliance |
| AMI | Airline Modifiable Information |
| AMU | Audio Management Unit |
| ANT | Antenna |
| AOA | Angle of Attack |
| AOC | Airline Operational Control |
| APP | Approach |
| APPR | Approach |
| APPU | Assymetry Position Pick-off Unit |
| APU | Auxiliary Power Unit |
| AR | Authorization Required |
| ARINC | Aeronautical Radio Incorporated |
| ARN | Aircraft Registration Number |
| ARP | Aerospace Recommended Practice |
| ARPT | Airport |
| ASAP | As Soon As Possible |
| ASD | Accelerate Stop Distance |
| ASI | Air Speed Indicator |
| ASP | Audio Selector Panel |
| ATC | Air Traffic Control |
| ATM | Air Traffic Management |
| ATN | Aeronautical Telecommunications Network |
| ATE | Automatic Test Equipment |
| ATIS | Automatic Terminal Information System |
| ATS | Auto Thrust System |
| ATSAW | Airborne Traffic Situational Awareness |
| ATSU | Air Traffic Service Unit |
| ATT | Attitude |

Continued on the following page

Continued from the previous page

| Abbreviation | Term |
|--------------|-----------|
| AUTO | Automatic |
| AVNCS | Avionics |
| AWY | Airway |

B

| Abbreviation | Term |
|--------------|-------------------------------|
| B/C | Back Course |
| BARO | Barometric |
| BAT | Battery |
| BCL | Battery Charge Limiter |
| BCDS | Bite Centralized Data System |
| BCU | Backup Control Unit |
| BDDV | Brake Dual Distribution Valve |
| BITE | Built-In Test Equipment |
| BIU | BITE Interface Unit |
| BFE | Buyer Furnished Equipment |
| BFO | Beat Frequency Oscillator |
| BMC | Bleed Monitoring Computer |
| BNR | Binary |
| BRG | Bearing |
| BRK | Brake |
| BRT | Bright |
| BSCU | Braking Steering Control Unit |
| BTC | Bus Tie Contactor |
| BTL | Bottle |
| BTS | Bleed Temperature Sensor |
| BUS | Busbar |
| BUSS | Back Up Speed Scale |

C

| Abbreviation | Term |
|--------------|-----------------------------------|
| C/B | Circuit Breaker |
| CB | Circuit Breaker |
| C/L | Checklist |
| CL | Checklist |
| CAB | Cabin |
| CAPT | Captain, Capture |
| CAS | Calibrated Airspeed |
| CAT | Category |
| CBMS | Circuit Breaker Monitoring System |

Continued on the following page

Continued from the previous page

| Abbreviation | Term |
|---------------------|---|
| CCD | Cursor Control Device |
| CDL | Configuration Deviation List |
| CDLS | Cockpit Door Locking System |
| CDSS | Cockpit Door Surveillance System |
| CDU | Control Display Unit |
| CF | Cost of Fuel |
| CFDIU | Centralized Fault Display Interface Unit |
| CFDS | Centralized Fault Display System |
| CFP | Computerized Flight Plan |
| CG | Center of Gravity |
| CHAN | Channel |
| CHG | Change |
| CHK | Check |
| CI | Cost Index |
| CIDS | Cabin Intercommunication Data System |
| CIDS-SDF | Cabin Intercommunication Data System - Smoke Detection Function |
| CKPT | Cockpit |
| CIS | Commonwealth of Independent States |
| CLB | Climb |
| CLR | Clear |
| CLSD | Closed |
| CM1(2) | Crewmember 1 (left seat) or 2 (right seat) |
| CM1 | Crewmember 1 (left seat) |
| CM2 | Crewmember 2 (right seat) |
| CMPTR | Computer |
| CMS | Constant Mach Segment |
| CMS | Centralized Maintenance System |
| CNSU | Cabin Network Server Unit |
| CO | Company |
| CO RTE | Company Route |
| COND | Conditioning |
| CONF | Configuration |
| CONT | Continuous |
| CPC | Cabin Pressure Controller |
| CPCU | Cabin Pressure Controller Unit |
| CPDLC | Controller-Pilot Data Link Communication |
| CRC | Continuous Repetitive Chime |
| CRG | Cargo |
| CRS | Course |
| CRT | Cathode Ray Tube |

Continued on the following page

Continued from the previous page

| Abbreviation | Term |
|--------------|--------------------------------|
| CRZ | Cruise |
| CSAS | Conditioned Service Air System |
| CSCU | Cargo Smoke Control Unit |
| CSD | Constant Speed Drive |
| CSM/G | Constant Speed Motor/Generator |
| CSTR | Constraint |
| CT | Cost of Time |
| CTL | Control |
| CTL PNL | Control Panel |
| CTR | Center |
| CVR | Cockpit Voice Recorder |

D

| Abbreviation | Term |
|--------------|---|
| DA | Drift Angle |
| DAC | Digital to Analog Converter |
| DAC | Double Annular Combustor |
| DAR | Digital AIDS Recorder |
| DC | Direct Current |
| DCDU | Datalink Control and Display Unit |
| DCL | Digital Cabin Logbook |
| DDRMI | Digital Distance and Radio Magnetic Indicator |
| DECEL | Deceleration |
| DES | Descent |
| DEST | Destination |
| DET | Detection, Detector |
| DEV | Deviation |
| DFA | Delayed Flap Approach |
| DFDR | Digital Flight Data Recorder |
| DH | Decision Height |
| DIR | Direction |
| DIR TO | Direct To |
| DISC | Disconnect |
| DISCH | Discharge |
| DIST | Distance |
| DITS | Digital Information Transfer System |
| DIV | Diverter |
| DMC | Display Management Computer |
| DME | Distance Measuring Equipment |
| DMU | Data Management Unit (Aids) |

Continued on the following page

Continued from the previous page

| Abbreviation | Term |
|--------------|------------------------------|
| DN | Down |
| DPO | Descent Profile Optimization |
| DSDL | Dedicated Serial Data Link |
| DTG | Distance To Go |
| DTO | Derated Takeoff |
| DU | Display Unit |
| DU | Documentary Unit |

E

| Abbreviation | Term |
|--------------|--|
| EWD | Engine/Warning Display |
| ECAM | Electronic Centralized Aircraft Monitoring |
| ECAS | Emergency Cockpit Alerting System |
| ECB | Electronic Control Box (APU) |
| ECM | Engine Condition Monitoring |
| ECON | Economic |
| ECP | ECAM Control Panel |
| ECS | Environmental Control System |
| ECU | Engine Control Unit |
| EDP | Engine-Driven Pump |
| EEC | Electronic Engine Computer |
| EFB | Electronic Flight Bag |
| EFCS | Electronic Flight Control System |
| EFIS | Electronic Flight Instruments System |
| EFF | Electronic Flight Folder |
| EFOB | Estimated Fuel On Board |
| EGPWS | Enhanced Ground Proximity Warning System |
| EGT | Exhaust Gas Temperature |
| EIS | Electronic Instruments System |
| EIU | Engine Interface Unit |
| ELAC | Elevator Aileron Computer |
| ELEC | Electrics |
| ELT | Emergency Locator Transmitter |
| ELEV | Elevator |
| ELV | Elevation |
| EMER | Emergency |
| EMER GEN | Emergency Generator |
| ENG | Engine |
| EO | Engine-Out |
| EOSID | Engine-Out Standard Instrument Departure |

Continued on the following page

Continued from the previous page

| Abbreviation | Term |
|--------------|---|
| EPE | Estimated Position Error (equal to EPU) |
| EPR | Engine Pressure Ratio |
| EPU | Emergency Power Unit |
| EPU | Estimated Position Uncertainty (equal to EPE) |
| EQPT | Equipment |
| EROPS | Extended Range Operation |
| ESS | Essential |
| EST | Estimated |
| ETA | Estimated Time of Arrival |
| ETE | Estimated Time Enroute |
| ETOPS | Extended Twin Operations |
| ETP | Equal Time Point |
| EVMU | Engine Vibration Monitoring Unit |
| EWD | Engine/Warning Display |
| EXP | Expedite |
| EXT PWR | External Power |
| EXTN | Extension |

F

| Abbreviation | Term |
|--------------|--|
| F | Fuel |
| FAA | Federal Aviation Administration |
| FAP | Forward Attendant Panel |
| F/C | Flight Crew |
| F/O | First Officer |
| FO | First Officer |
| FAC | Flight Augmentation Computer |
| FADEC | Full Authority Digital Engine Control System |
| FAF | Final Approach Fix |
| FANS | Future Air Navigation System |
| FAP | Forward Attendant Panel |
| FAR | Federal Aviation Regulations |
| FAV | Fan Air Valve |
| FCDC | Flight Control Data Concentrator |
| FCMS | Fuel Control and Monitoring System |
| FCOM | Flight Crew Operating Manual |
| FCTM | Flight Crew Techniques Manual |
| FCU | Flight Control Unit |
| FD | Flight Director |
| FDGJ | Fan Drive Gear System |

Continued on the following page

Continued from the previous page

| Abbreviation | Term |
|---------------------|---|
| FDIMU | Flight Data Interface and Management Unit |
| FDIU | Flight Data Interface Unit |
| FDU | Fire Detection Unit |
| FEP | Final End Point |
| FF | Fuel Flow |
| FG | Flight Guidance |
| FGC | Flight Guidance Computer |
| F-G/S | FLS Glide Slope |
| FIDS | Fault Isolation and Detection System |
| FL | Flight Level |
| FLEX | Flexible |
| FLHV | Fuel Lower Heating Value |
| F-LOC | FLS Localizer |
| FLP | Flap |
| FLS | FMS Landing System |
| FLSCU | Fuel Level Sensing Control Unit |
| FLT | Flight |
| F/CTL | Flight Control |
| FLT CTL | Flight Control |
| FLXTO | Flexible Takeoff |
| FM | Flight Management |
| FMA | Flight Mode Annunciator |
| FMGC | Flight Management and Guidance Computer |
| FMGS | Flight Management and Guidance System |
| FMS | Flight Management System |
| FMV | Fuel Metering Valve |
| FNL | Final |
| FOB | Fuel On Board |
| FOHE | Fuel Oil Heat Exchanger |
| FOM | Figure Of Merit |
| FPA | Flight Path Angle |
| F-PLN | Flight Plan |
| FPD | Flight Path Director |
| FPPU | Feedback Position Pick-off Unit |
| FPV | Flight Path Vector |
| FQ | Fuel Quantity |
| FQI | Fuel Quantity Indication |
| FQIC | Fuel Quantity Indication Computer |
| FQU | Fuel Quantity Unit |
| FREQ | Frequency |

Continued on the following page

Continued from the previous page

| Abbreviation | Term |
|--------------|---------------------------|
| FRT | Front |
| FRV | Fuel Return Valve |
| FTIS | Fuel Tank Inerting System |
| FU | Fuel Used |
| FWC | Flight Warning Computer |
| FWD | Forward |
| FWS | Flight Warning System |

G

| Abbreviation | Term |
|--------------|--|
| G/S | Glideslope |
| GA | Go-Around |
| GAPCU | Ground and Auxiliary Power Control Unit |
| GBAS | Ground Based Augmentation System |
| GCU | Generator Control Unit |
| GDU | Group of Documentary Unit |
| GEN | Generator |
| GES | Ground Earth Station |
| GLC | Generator Line Contactor |
| GLS | GBAS Landing System |
| GLS | GNSS Landing System |
| GMT | Greenwich Mean Time |
| GND | Ground |
| GND TEMP | Ground Temperature |
| GNSS | Global Navigation Satellite System |
| GPCU | Ground Power Control Unit |
| GPIRS | Global Positioning and Inertial Reference System |
| GPS | Global Positioning System |
| GPWS | Ground Proximity Warning System |
| GRND | Ground |
| GRP | Geographic Reference Point |
| GRVTY | Gravity |
| GS | Ground Speed |
| GSM | Global System for Mobile Communication |
| GW | Gross Weight |

H

| Abbreviation | Term |
|--------------|------------------------|
| HC | Harness Connector |
| HCU | Hydraulic Control Unit |

Continued on the following page

Continued from the previous page

| Abbreviation | Term |
|--------------|---|
| HDG | Heading |
| HDG/S | Heading Selected |
| HDL | Handle |
| HF | High Frequency |
| HI | High |
| HLD | Hold |
| HM | Holding Pattern with a Manual Termination |
| HMU | Hydrau-Mechanical Unit |
| HMS | Heat Management System |
| HP | High Pressure |
| HPA | Hectopascal |
| HPC | High Pressure Compressor |
| HPSOV | High Pressure Shut-off Valve |
| HPT | High Pressure Turbine |
| HPV | High Pressure Valve |
| HUD | Head Up Display |
| HUDC | Head Up Display Computer |
| HYD | Hydraulic |

!

| Abbreviation | Term |
|--------------|--|
| I/O | Inputs/Outputs |
| I/P | Input or Intercept Profile |
| IAF | Initial Approach Fix |
| IAS | Indicated Airspeed |
| IATA | International Air Transport Association |
| ICAO | International Air Transport Organization |
| IDENT | Identification |
| IDG | Integrated Drive Generator |
| IFE | In Flight Entertainment |
| IFPC | Integrated Fuel Pump and Control |
| IFR | Instrument Flight Rules |
| IGGS | Inert Gas Generation System |
| IGN | Ignition |
| INHIB | Inhibited |
| ILS | Instrument Landing System |
| IM | Inner Marker |
| IMC | Instrument Meteorological Conditions |
| IMM | Immediate |
| INB | Inbound |

Continued on the following page

Continued from the previous page

| Abbreviation | Term |
|--------------|--|
| INBO | Inboard |
| INCREM | Increment |
| IND | Indicator |
| INIT | Initialization |
| INOP | Inoperative |
| INR | Inner |
| INST | Instrument |
| INTCPT | Intercept |
| INV | Inverter |
| IP | Intermediate Pressure |
| IPC | Intermediate Pressure Check valve |
| IPPU | Instrumentation Position Pick-off Unit |
| IR | Inertial Reference |
| IRS | Inertial Reference System |
| ISA | International Standard Atmosphere |
| ISDU | Initial System Display Unit |
| ISIS | Integrated Standby Instrument System |
| ISOL | Isolation |
| ISPSS | In Seat Power Supply System |
| ITP | In-Trail Procedure |

J

| Abbreviation | Term |
|--------------|-----------------------------|
| JAA | Joint Aviation Authorities |
| JAR | Joint Aviation Requirements |

K

| Abbreviation | Term |
|--------------|------|
|--------------|------|

L

| Abbreviation | Term |
|--------------|----------------------------|
| L/G | Landing Gear |
| LAF | Load Alleviation Function |
| LAT | Lateral |
| LAT | Latitude |
| LAT REV | Lateral Revision |
| LAV | Lavatory |
| LCD | Liquid Crystal Display |
| LCN | Load Classification Number |

Continued on the following page

Continued from the previous page

| Abbreviation | Term |
|---------------------|--|
| LDA | Landing Distance Available |
| | Localizer Directional Aid |
| L DEV | Lateral Deviation |
| LDG | Landing |
| LDS | Laptop Docking Station |
| LED | Light Emitting Diode |
| LEDU | List of Effective Documentary Units |
| LEOEB | List of Effective Operations Engineering Bulletins |
| LESS | List of Effective Section/Subsections |
| LF | Low Frequency |
| LGCIU | Landing Gear Control Interface Unit |
| LGPIU | Landing Gear Position Indicator Unit |
| LH | Left-Hand |
| LIM | Limitation |
| LIS | Localizer Inertial Smoothing |
| LK | Lock |
| LL | Latitude/Longitude |
| LLS | Left-Line Select key |
| LO | Low |
| LOC | Localizer |
| LONG | Longitude |
| LP | Low Pressure |
| LPC | Low Pressure Compressor |
| LPT | Low Pressure Turbine |
| LRRA | Low Range Radio Altimeter |
| LRU | Line Replaceable Unit |
| LS | Loudspeaker |
| LSK | Line Select Key |
| LT | Light |
| LTS | Load and Trim Sheet |
| LVL | Level |
| LVL/CH | Level Change |
| LVR | Lever |
| LW | Landing Weight |

M

| Abbreviation | Term |
|---------------------|-----------------------------------|
| MABH | Minimum Approach Break-off Height |
| MAC | Mean Aerodynamic Chord |
| MAG | Magnetic |

Continued on the following page

Continued from the previous page

| Abbreviation | Term |
|---------------------|--|
| MAG DEC | Magnetic Declination |
| MAG VAR | Magnetic Variation |
| MAINT | Maintenance |
| MAN | Manual |
| MAP | Missed Approach Point |
| MAX | Maximum |
| MAX CLB | Maximum Climb |
| MAX DES | Maximum Descent |
| MAX END | Maximum Endurance |
| MC | Master Caution |
| MCDU | Multipurpose Control and Display Unit |
| MCT | Maximum Continuous Thrust |
| MCU | Modular Concept Unit |
| MDA | Minimum Descent Altitude |
| MDDU | Multifunction Disk Drive Unit |
| MDH | Minimum Descent Height |
| MECH | Mechanic |
| MEA | Minimum En Route Altitude |
| MED | Medium |
| MEL | Minimum Equipment List |
| MFA | Memorized Fault Annunciator |
| MGB | Main Gearbox |
| MIN | Minimum |
| MKR | Marker |
| MLA | Maneuver Load Alleviation |
| MLG | Main Landing Gear |
| MLS | Microwave Landing System |
| MLW | Maximum Landing Weight |
| MM | Middle Marker |
| MMEL | Master Minimum Equipment List |
| MMO | Maximum Operating Mach |
| MMR | Multi Mode Receiver |
| MN | Mach number |
| MORA | Minimum Off Route Altitude |
| MP | Modification Proposal |
| MRIU | Maintenance and Recording Interface Unit |
| MSA | Minimum Safe Altitude |
| MSG | Message |
| MSL | Mean Sea Level |
| MSU | Mode Selector Unit |

Continued on the following page

Continued from the previous page

| Abbreviation | Term |
|--------------|---------------------------|
| MTBF | Mean Time Between Failure |
| MTC | Modulated Turbine Cooling |
| MTOW | Maximum Takeoff Weight |
| MZFW | Maximum Zero Fuel Weight |

N

| Abbreviation | Term |
|--------------|---|
| N/A | Not Applicable |
| NA | Not Applicable |
| N1 | Low Pressure Rotor Speed (in %) |
| N2 | High Pressure Rotor Speed (in %) |
| NACA | National Advisory Committee for Aeronautics |
| NAI | Engine Nacelle Anti-Ice |
| NAV | Navigation |
| NAVAID | Navigation Aid |
| NCD | Non Computed Data |
| ND | Navigation Display |
| NDB | Non Directional Beacon |
| NLG | Nose Landing Gear |
| NORM | Normal |
| NPA | Non Precision Approach |
| NW | Nosewheel |
| NWS | Nosewheel Steering |

O

| Abbreviation | Term |
|--------------|------------------------------------|
| O/P | Output |
| OANS | On-board Airport Navigation System |
| OAT | Outside Air Temperature |
| OBRM | On Board Replaceable Module |
| OEB | Operations Engineering Bulletin |
| OFF/R | Off Reset |
| OFST | Offset |
| OIS | Onboard Information System |
| OIT | Onboard Information Terminal |
| OLB | OPS Library Browser |
| OM | Outer Marker |
| OP | Open |
| OPP | Opposite |
| OPS | Operations |

Continued on the following page

Continued from the previous page

| Abbreviation | Term |
|--------------|-----------|
| OPT | Optimum |
| OUTB | Outbound |
| OUTR | Outer |
| OVBD | Overboard |
| OVHD | Overhead |
| OVHT | Overheat |
| OVRD | Override |
| OVSPD | Overspeed |
| OXY | Oxygen |

P

| Abbreviation | Term |
|--------------|--|
| P/N | Part Number |
| PN | Part Number |
| PA | Passenger Address |
| P-ALT | Profile Altitude |
| PAX | Passenger |
| PAR | Precision Approach Radar |
| PBCS | Performance-Based Communication and Surveillance |
| PBE | Portable Breathing Equipment |
| PBN | Performance Based Navigation |
| P-CLB | Profile Climb |
| PCU | Power Control Unit |
| P-DES | Profile Descent |
| PDB | Performance Data Base |
| PDU | Pilot Display Unit |
| PED | Portable Electronic Device |
| PERF | Performance |
| PES | Passenger Entertainment System |
| PF | Pilot Flying |
| PFC | Porous Friction Course |
| PFD | Primary Flight Display |
| PHC | Probes Heat Computer |
| P-MACH | Profile Mach |
| PM | Pilot Monitoring |
| PNL | Panel |
| POB | Pressure Off Brake |
| POS | Position |
| PPOS | Present Position |
| PPU | Position Pick-off Unit |

Continued on the following page

Continued from the previous page

| Abbreviation | Term |
|--------------|---------------------------------|
| PR | Pressure |
| PRED | Prediction |
| PRESS | Pressure, Pressurization |
| PROC | Procedure |
| PROC T | Procedure Turn |
| PROF | Profile |
| PROG | Progress |
| PROTEC | Protection |
| P-SPEED | Profile Speed |
| PSL | Product Structure Level |
| PSU | Passenger Service Unit |
| PT | Point |
| PTR | Printer |
| PTT | Push To Talk |
| PTU | Power Transfer Unit (Hydraulic) |
| PVI | Paravisual Indicator |
| PWR | Power |
| PWS | Predictive Windshear System |

Q

| Abbreviation | Term |
|--------------|---|
| QAR | Quick Access Recorder |
| QFE | Field Elevation Atmosphere Pressure |
| QFU | Runway Heading |
| QNE | Sea Level Standard Atmosphere Pressure (1013 hPa) |
| QNH | Sea Level Atmosphere Pressure |
| QRH | Quick Reference Handbook |
| QT | Quart (US) |
| QTY | Quantity |

R

| Abbreviation | Term |
|--------------|--|
| R/I | Radio/Inertial |
| RA | Radio Altimeter, Resolution Advisory |
| RAAS | Runway Awareness and Advisory System |
| RACC | Rotor Active Clearance Control |
| RAD | Radio |
| RAIM | Receiver Autonomous Integrity Monitoring |
| RAT | Ram Air Turbine |
| RATC | Remote ATC Box |

Continued on the following page

Continued from the previous page

| Abbreviation | Term |
|--------------|-------------------------------------|
| RCDR | Recorder |
| RCL | Recall |
| RCP | Required Communication Performance |
| RCVR | Receiver |
| REAC | Reactive |
| REC | Recommended |
| RED | Reduction |
| REG | Regulation |
| REL | Release |
| REV | Reverse |
| RH | Right-Hand |
| RLD | Required Landing Distance |
| RLSK | Right Line Select Key |
| RMI | Radio Magnetic Indicator |
| RMP | Radio Management Panel |
| RNAV | Area Navigation |
| RNG | Range |
| RNP | Required Navigation Performance |
| ROP | Runway Overrun Protection |
| ROPS | Runway Overrun Prevention System |
| ROW | Runway Overrun Warning |
| RPCU | Residual Pressure Control Unit |
| RPM | Revolution Per Minute |
| RPTG | Repeating |
| RQRD | Required |
| RSP | Required Surveillance Performance |
| RSV | Reserves |
| RSVR | Reservoir |
| RTA | Required Time of Arrival |
| RTE | Route |
| RTL | Rudder Travel Limit |
| RTO | Rejected Takeoff |
| RTOW | Regulatory Takeoff Weight |
| RUD | Rudder |
| RVSM | Reduced Vertical Separation Minimum |
| RWY | Runway |

S

| Abbreviation | Term |
|---------------------|---|
| S | South |
| S/C | Step Climb |
| S/D | Step Descent |
| S/D | Shut Down |
| S/F | Slats/Flaps |
| S/N | Serial Number |
| SN | Serial Number |
| SAAAR | Special Aircrew and Aircraft Authorization Required |
| SAC | Single Annular Chamber |
| SAT | Static Air Temperature |
| SATCOM | Satellite Communication |
| SC | Single Chime |
| SCP | Software Control Panel |
| SD | System Display |
| SDAC | System Data Acquisition Concentrator |
| SDCU | Smoke Detection Control Unit |
| SDF | Smoke Detection Function, Simplified Directional Facility |
| SEC | Spoiler Elevator Computer |
| SEL | Selector |
| SFCC | Slat/Flap Control Computer |
| SFE | Seller-Furnished Equipment |
| SID | Standard Instrument Departure |
| SIM | Simulation |
| SLT | Slat |
| SOP | Standard Operating Procedure |
| SPD | Speed |
| SPD LIM | Speed Limit |
| SPLR | Spoiler |
| SRS | Speed Reference System |
| STAR | Standard Terminal Arrival Route |
| STAT | Static |
| STAT INV | Static Inverter |
| STBY | Standby |
| STD | Standard |
| STEER | Steering |
| STRG | Steering |
| STS | Status |
| SWTG | Switching |
| SYNC | Synchronize |
| SYS | System |

T

| Abbreviation | Term |
|--------------|--|
| T.O | Takeoff |
| T/O | Takeoff |
| TO | Takeoff |
| T/C | Top of Climb |
| T/D | Top of Descent |
| TA | Traffic Advisory |
| TAC | Taxiing Aid Camera |
| TACAN | Tactical Air Navigation |
| TACT | Tactical |
| TAS | True Air Speed |
| TAT | Total Air Temperature |
| TAU | Time to intercept |
| TAWS | Terrain Awareness and Warning System |
| TBC | To Be Confirmed |
| TBD | To Be Determined |
| T2CAS | Traffic and Terrain Collision Avoidance System |
| T3CAS | Traffic and Terrain Collision Avoidance System |
| TCA | Turbine Cooling Air |
| TCAS | Traffic Alert and Collision Avoidance System |
| TCC | Turbine Case Cooling |
| TCM | Thrust Control Malfunction |
| TDU | Temporary Documentary Unit |
| TEMP | Temperature |
| TFTS | Terrestrial Flight Telephon System |
| TGT | Target |
| THR | Thrust |
| THS | Trimable Horizontal Stabilizer |
| TK | Tank |
| TK | Track angle |
| TKE | Track Angle Error |
| TLA | Throttle Lever Angle |
| TLU | Travel Limitation Unit |
| TMR | Timer |
| TOC | Table of Contents |
| TOD | Takeoff Distance |
| TOGA | Takeoff - Go-Around |
| TOGW | Takeoff Gross Weight |
| TOR | Takeoff Run |
| TOW | Takeoff Weight |

Continued on the following page

Continued from the previous page

| Abbreviation | Term |
|--------------|-----------------------------------|
| T-P | Turn Point |
| TPIS | Tire Pressure Indicating System |
| TR | Transformer Rectifier |
| T-R | Transmitter-Receiver |
| TRANS | Transition |
| TRK | Track |
| TROPO | Tropopause |
| TRU | Transformer Rectifier Unit |
| TRV | Travel |
| TSM | Trouble Shooting Manual |
| TTG | Time to Go |
| TVMC | Minimum Control Speed Temperature |
| TWY | Taxiway |

U

| Abbreviation | Term |
|--------------|----------------------------|
| UFD | Unit Fault Data |
| ULB | Underwater Locator Beacon |
| UNLK | Unlock |
| UP | Up, Upper |
| USB | Universal Serial Bus |
| UTC | Universal Coordinated Time |

V

| Abbreviation | Term |
|--------------|---|
| V/S | Vertical Speed |
| V1 | Decision Speed |
| V2 | Takeoff Safety Speed |
| VAPP | Approach Speed |
| VBV | Variable Bypass Valve |
| VC | Calibrated airspeed |
| VDEV | Vertical Deviation |
| VEL | Velocity |
| VERT | Vertical |
| VERT REV | Vertical Revisor |
| VFE | Maximum Speed for each Flap configuration |
| VFEN | VFE Next |
| VFTO | Final Takeoff Speed |
| VHF | Very High Frequency |
| VHV | Very High Voltage |

Continued on the following page

Continued from the previous page

| Abbreviation | Term |
|--------------|-------------------------------------|
| VIB | Vibration |
| VIP | Vertical Intersection Point |
| VLE | Maximum Landing Gear Extended Speed |
| VLS | Lowest Selectable Speed |
| VLV | Valve |
| VM | Maneuvering Speed |
| VMAX | Maximum Allowable Speed |
| VMC | Visual Meteorological Conditions |
| VMCA | Minimum Control Speed in the Air |
| VMCG | Minimum Control Speed on Ground |
| VMCL | Minimum Control Speed at Landing |
| VMIN | Minimum Operating Speed |
| VMO | Maximum Operating Speed |
| VMU | Minimum Unstick Speed |
| VOR | VHF Omnidirectional Range |
| VOR-D | VOR-DME |
| VR | Rotation Speed |
| VREF | Landing Reference Speed |
| VSC | Vacuum System Controller |
| VSI | Vertical Speed Indicator |
| VSV | Variable Stator Vane |
| VU | Visual Unit |

W

| Abbreviation | Term |
|--------------|-----------------------------|
| W/S | Wind Shear |
| WAI | Wing Anti-Ice |
| WARN | Warning |
| WBm | Weight and Balance Manual |
| WBS | Weight and Balance System |
| WBS | Weight and Balance System |
| WD | Warning Display |
| WGD | Windshield Guidance Display |
| WHC | Window Heat Computer |
| WNDW | Window |
| WPT | Waypoint |
| WSHLD | Windshield |
| WT | Weight |
| WTB | Wing Tip Brake |
| WXR | Weather Radar |

A318/A319/A320/A321
FLIGHT CREW
OPERATING MANUAL

X

| Abbreviation | Term |
|--------------|------------------|
| XBLD | Crossbleed |
| XCVR | Transceiver |
| XFR | Transfer |
| XMTR | Transmitter |
| XPDR | Transponder |
| XTK | Crosstrack Error |

Y

| Abbreviation | Term |
|--------------|------|
|--------------|------|

Z

| Abbreviation | Term |
|--------------|--|
| ZFCG | Zero Fuel Center of Gravity |
| ZFW | Zero Fuel Weight |
| ZFWCG | Zero Fuel Weight Center of Gravity field |
| Zp | Pressure Altitude |

A318/A319/A320/A321
FLIGHT CREW
OPERATING MANUAL

Intentionally left blank

AIRCRAFT SYSTEMS

Intentionally left blank

DSC-20 Aircraft General

DSC-21 Air Conditioning / Pressurization / Ventilation

DSC-22_10 Auto Flight - General

DSC-22_20 Auto Flight - Flight Management

DSC-22_30 Auto Flight - Flight Guidance

DSC-22_40 Auto Flight - Flight Augmentation

DSC-22_45 Auto Flight - AOC Functions

DSC-22_46 Auto Flight - Print Interface

DSC-23 Communications

DSC-24 Electrical

DSC-25 Equipment

DSC-26 Fire Protection

DSC-27 Flight Controls

DSC-28 Fuel

DSC-29 Hydraulic

DSC-30 Ice and Rain Protection

DSC-31 Indicating/Recording Systems

DSC-32 Landing Gear

DSC-33 Lights

DSC-34-NAV Navigation

Continued on the following page

Continued from the previous page

DSC-34-SURV Surveillance

DSC-35 Oxygen

DSC-36 Pneumatic

DSC-38 Water / Waste

DSC-45 Maintenance System

DSC-46 Information Systems

DSC-49 APU

DSC-52 Doors

DSC-56 Cockpit Windows

DSC-70 Engines



A318/A319/A320/A321
FLIGHT CREW
OPERATING MANUAL

AIRCRAFT SYSTEMS

PRELIMINARY PAGES

LIST OF EFFECTIVE TEMPORARY DOCUMENTARY UNITS

| M | Localization | DU Title | DU identification | DU date |
|---|--------------|----------|-------------------|---------|
|---|--------------|----------|-------------------|---------|

No Temporary Documentary Unit



A318/A319/A320/A321
FLIGHT CREW
OPERATING MANUAL

AIRCRAFT SYSTEMS

PRELIMINARY PAGES

LIST OF EFFECTIVE TEMPORARY DOCUMENTARY UNITS

Intentionally left blank

AIRCRAFT SYSTEMS

AIRCRAFT GENERAL

Intentionally left blank

DSC-20-10 Overview

| | |
|--------------|---|
| General..... | A |
| Engines..... | B |
| Cockpit..... | C |
| Cabin..... | D |
| Cargo..... | E |

DSC-20-20 Description

| | |
|--|---|
| General Arrangement..... | A |
| Principal Dimensions..... | B |
| Unpressurized Compartments..... | C |
| Antenna Locations..... | D |
| Ground Service Connections and Panels..... | E |



DSC-20-30 Ground Handling

| | |
|---------------------------------|---|
| Taxiing..... | A |
| 180 degrees Turn on Runway..... | B |

DSC-20-40 Ground Clearance Diagram

| | |
|-------------------------------|---|
| Ground Clearance Diagram..... | A |
|-------------------------------|---|

DSC-20-50 Landing Geometry

| | |
|---|---|
| ILS/GLS  /MLS  Final Approach and Landing Geometry..... | A |
| Minimum Visual Ground Segments (Flare Phase)..... | B |

DSC-20-60 Visual Ground Geometry

| | |
|-----------------------------|---|
| Visual Ground Geometry..... | A |
|-----------------------------|---|



A318/A319/A320/A321
FLIGHT CREW
OPERATING MANUAL

AIRCRAFT SYSTEMS

AIRCRAFT GENERAL

PRELIMINARY PAGES - TABLE OF CONTENTS

Intentionally left blank



A318/A319/A320/A321
FLIGHT CREW
OPERATING MANUAL

AIRCRAFT SYSTEMS

AIRCRAFT GENERAL

OVERVIEW

GENERAL

Ident.: DSC-20-10-00000284.0001001 / 22 MAR 16

Applicable to: ALL

The A320 is a subsonic, medium-range, civil transport aircraft.

ENGINES

Ident.: DSC-20-10-00000285.0001001 / 13 DEC 10

Applicable to: ALL

The aircraft has two high bypass turbofan engines mounted under the wings.

COCKPIT

Ident.: DSC-20-10-00000286.0002001 / 13 DEC 10

Applicable to: ALL

The cockpit is designed for a two-member crew. It also has a place for 2 observers.

CABIN

Ident.: DSC-20-10-00000287.0007001 / 05 FEB 15

Applicable to: ALL

The passenger seating layout may vary, depending on operating requirements.

CARGO

Ident.: DSC-20-10-00000289.0001001 / 13 DEC 10

Applicable to: ALL

Two cargo compartments are under the cabin floor.



A318/A319/A320/A321
FLIGHT CREW
OPERATING MANUAL

AIRCRAFT SYSTEMS

AIRCRAFT GENERAL

OVERVIEW

Intentionally left blank



A318/A319/A320/A321
FLIGHT CREW
OPERATING MANUAL

AIRCRAFT SYSTEMS

AIRCRAFT GENERAL

DESCRIPTION

GENERAL ARRANGEMENT

Ident.: DSC-20-20-00000290.0001001 / 21 MAR 16

Applicable to: ALL

This subchapter gives the principal aircraft dimensions, location of unpressurized areas, antennas, ground service connections, and ground maneuvering characteristics.

PRINCIPAL DIMENSIONS

Ident.: DSC-20-20-00000291.0001001 / 22 MAY 12

Applicable to: **ALL**

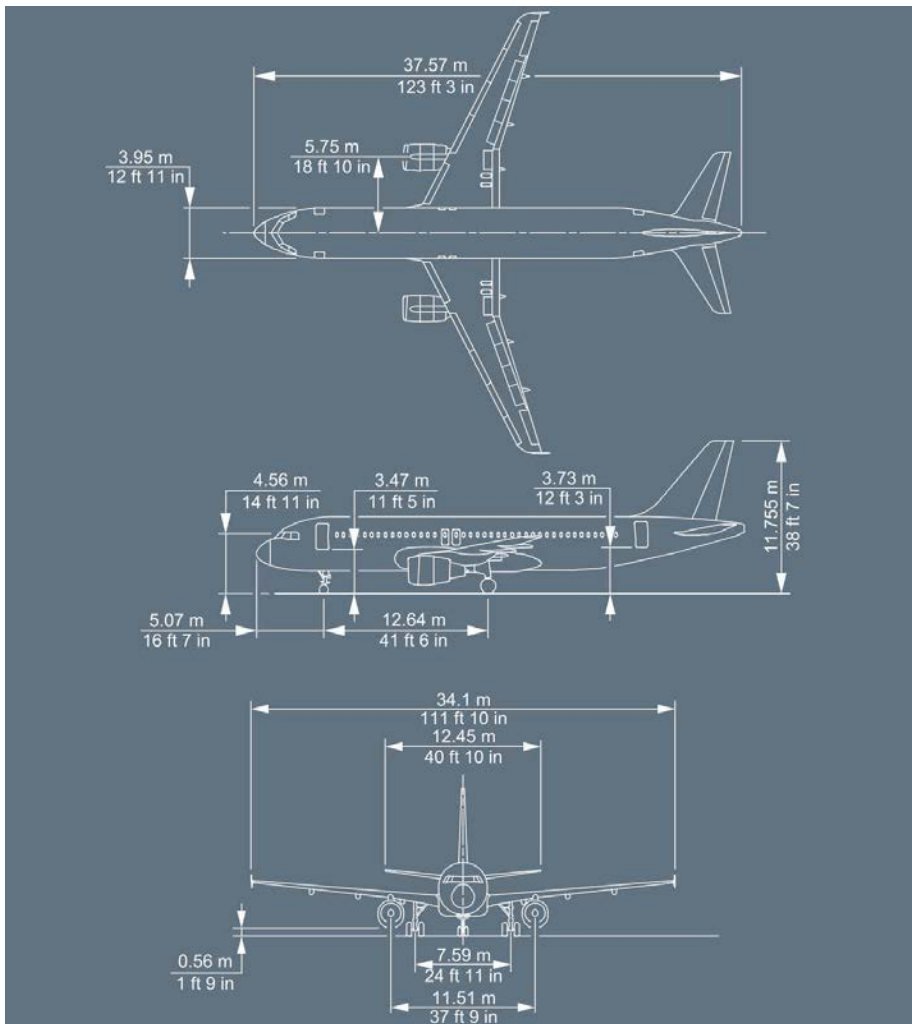

UNPRESSURIZED COMPARTMENTS

Ident.: DSC-20-20-00000292.0001001 / 21 MAR 16

Applicable to: ALL

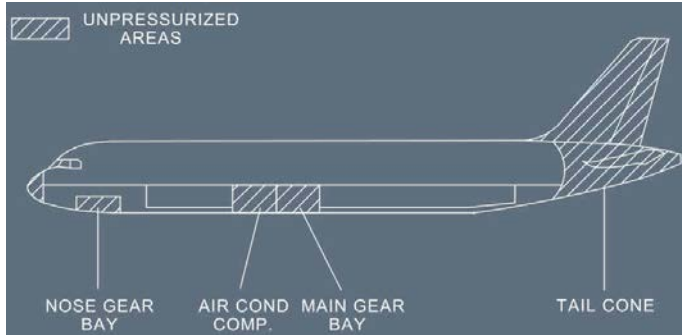

ANTENNA LOCATIONS

Ident.: DSC-20-20-00000293.0001001 / 28 JUL 14

Applicable to: ALL

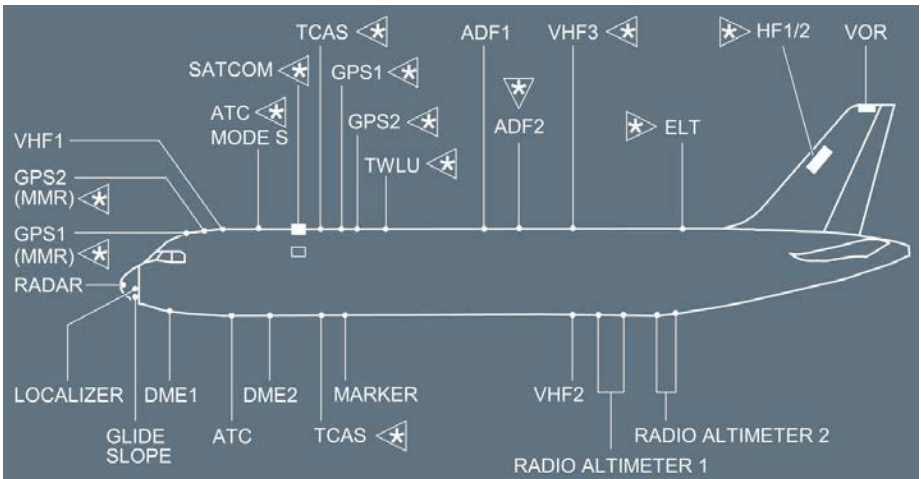

GROUND SERVICE CONNECTIONS AND PANELS

Ident.: DSC-20-20-00000295.0001001 / 09 OCT 12

Applicable to: ALL

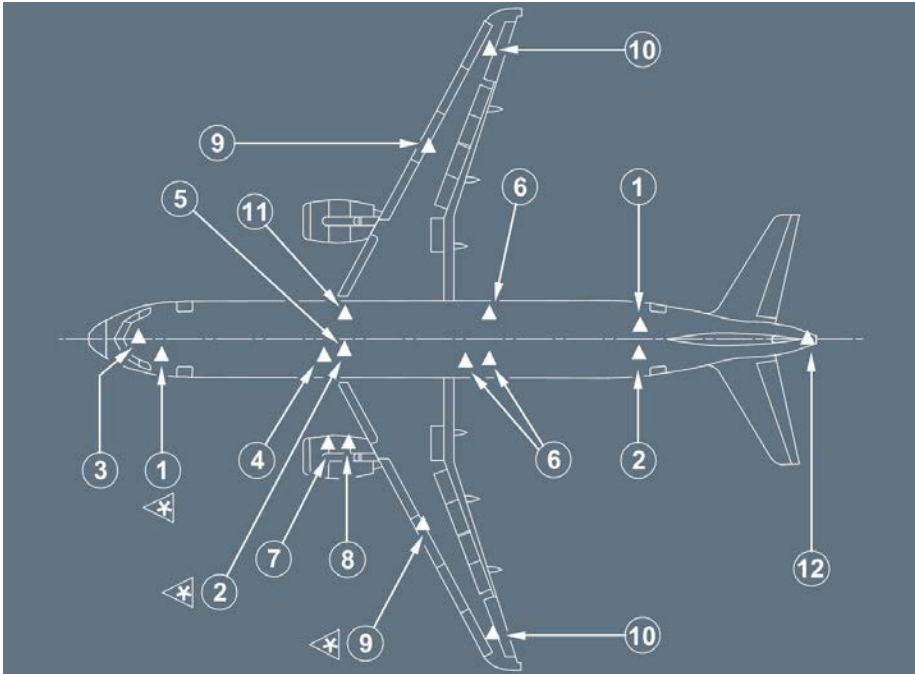

- (1) Toilet servicing
- (2) Water filling and/or draining
- (3) Electrical ground power receptacle
- (4) LP ground air supply connector
- (5) HP ground air supply connector
- (6) Hydraulic
- (7) IDG oil filling
- (8) Engine oil filling
- (9) Refueling/defueling

- (10) Gravity filling panels
- (11) Refueling/defueling panel
- (12) APU oil filling



A318/A319/A320/A321
FLIGHT CREW
OPERATING MANUAL

AIRCRAFT SYSTEMS

AIRCRAFT GENERAL

DESCRIPTION

Intentionally left blank

TAXIING

Ident.: DSC-20-30-00000294.0002001 / 01 JUN 17

Applicable to: ALL

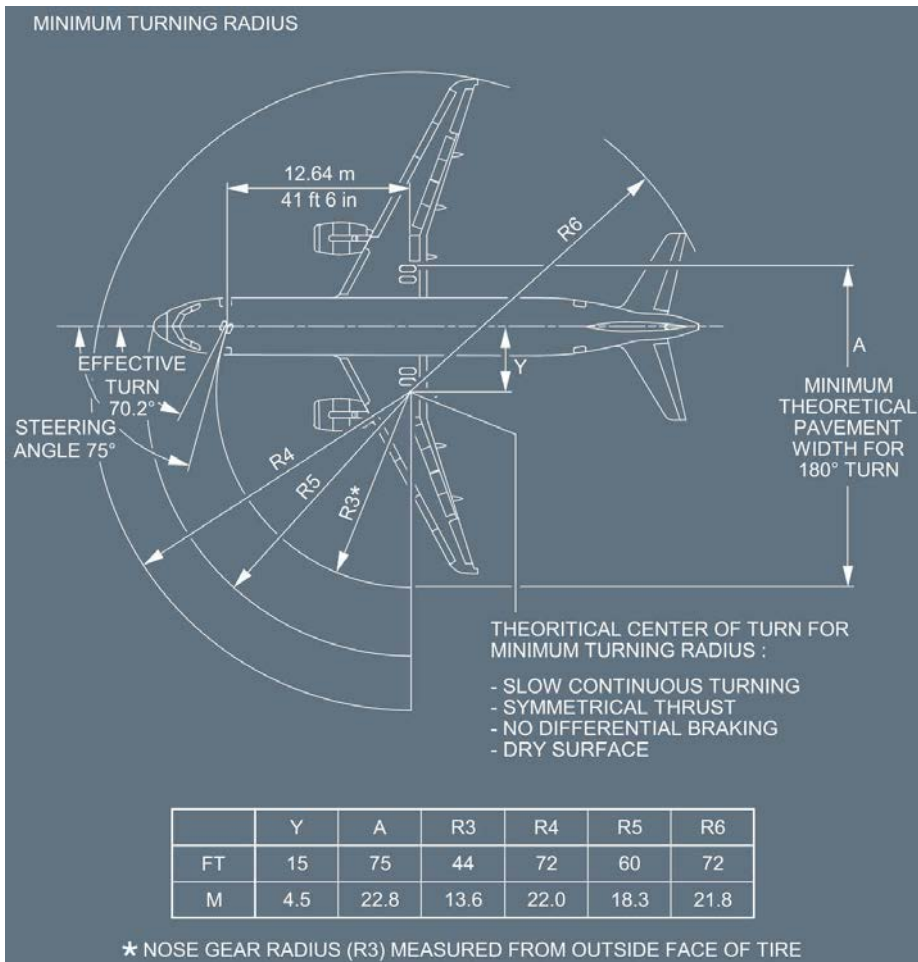

180 DEGREES TURN ON RUNWAY

Ident.: DSC-20-30-00021674.0001001 / 06 JUN 17

Applicable to: **ALL**

With the recommended 180 ° turn technique, on dry runway, the approximate turn width is 24 m (79 ft) without margin.

Note: The flight crew should consider additional margin when the runway is wet or contaminated.

For more information about the 180 ° Turn Technique, Refer to *FCTM/PR-NP-SOP-100 180 degrees Turn on Runway*.

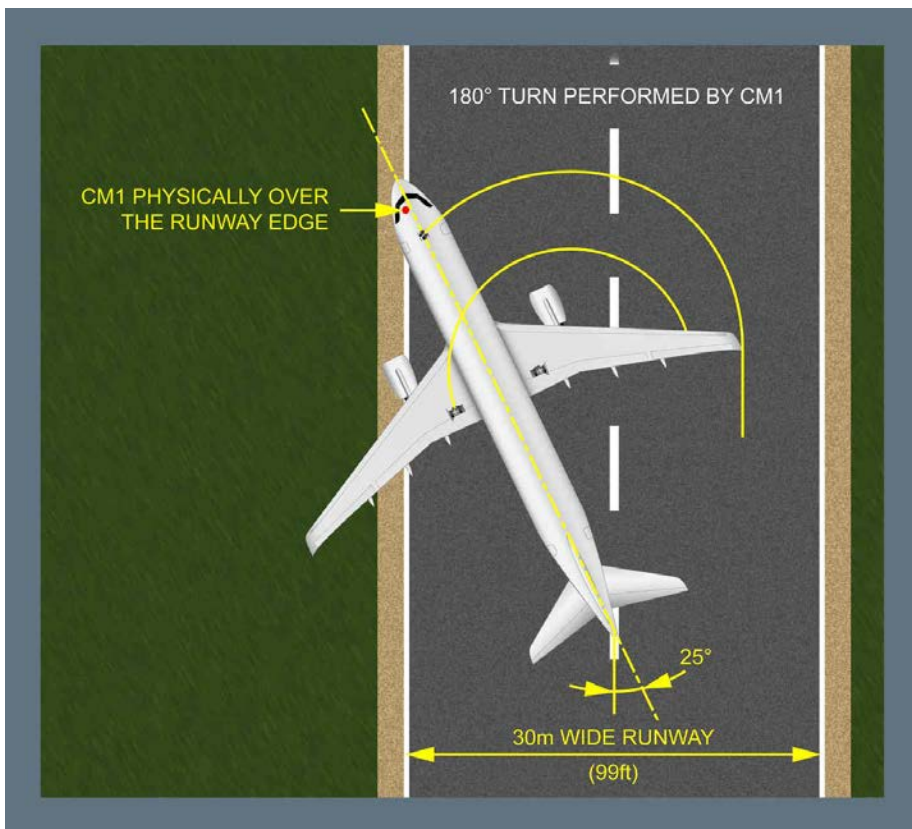

GROUND CLEARANCE DIAGRAM

Ident.: DSC-20-40-00018435.0001001 / 19 JAN 16

Applicable to: ALL

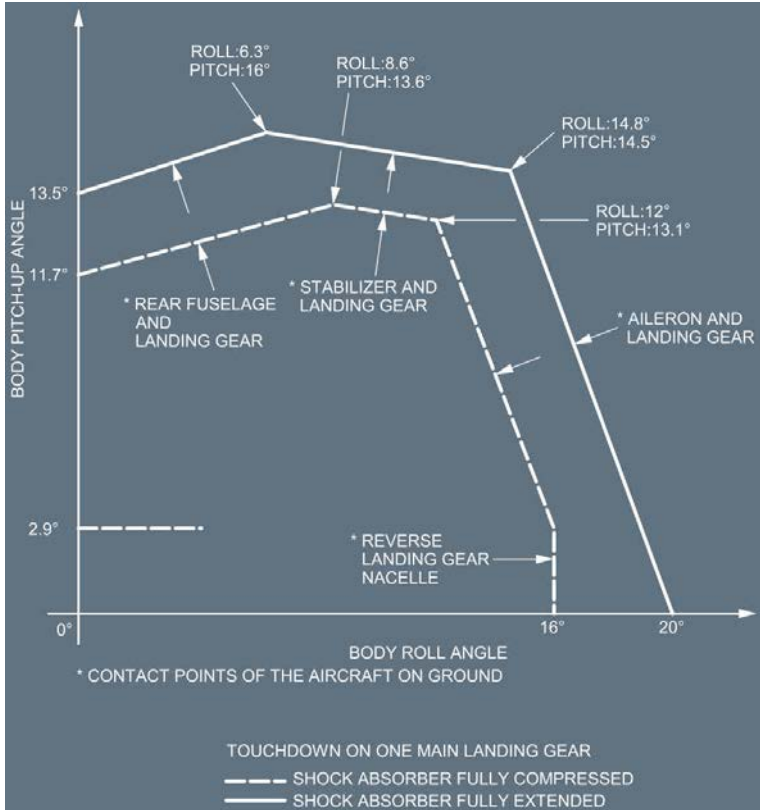



A318/A319/A320/A321
FLIGHT CREW
OPERATING MANUAL

AIRCRAFT SYSTEMS

AIRCRAFT GENERAL

GROUND CLEARANCE DIAGRAM

Intentionally left blank

ILS/GLS ◀ /MLS ◀ FINAL APPROACH AND LANDING GEOMETRY

Ident.: DSC-20-50-00019878.0001001 / 22 FEB 17

Applicable to: ALL

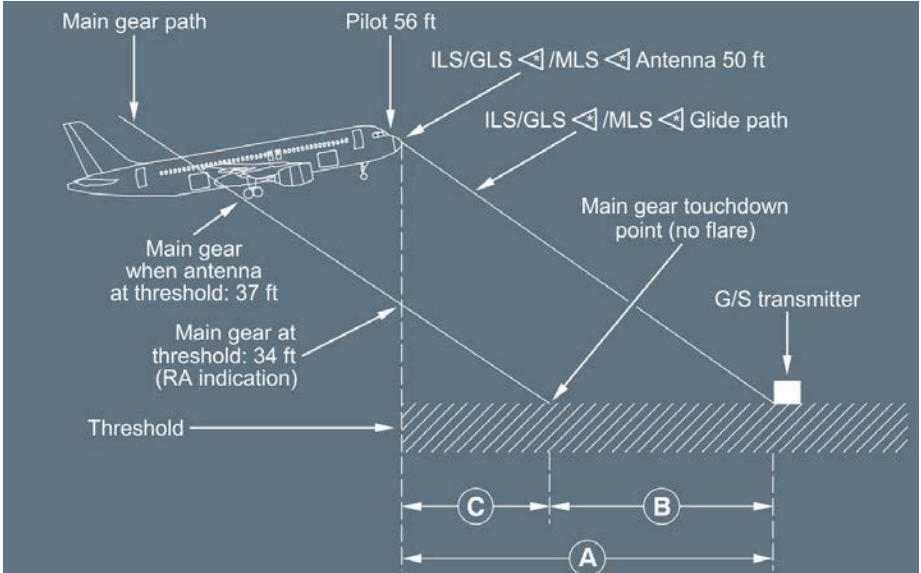

| CONDITIONS : | GLIDE PATH (°) | A | B | TOUCHDOWN POINT C |
|-------------------------------------|----------------|------------------|-----------------|-------------------|
| - FLAPS FULL | | | | |
| - ILS ANTENNA AT 50 ft AT THRESHOLD | 2°5 | 348 m 1145 ft | 112 m 366 ft | 236 m 779 ft |
| - NO FLARE - PITCH ANGLE : 4° | 3° | 291 m 954 ft | 93 m 306 ft | 198 m 648 ft |

MINIMUM VISUAL GROUND SEGMENTS (FLARE PHASE)

Ident.: DSC-20-50-00019879.0001001 / 22 FEB 17

Applicable to: ALL

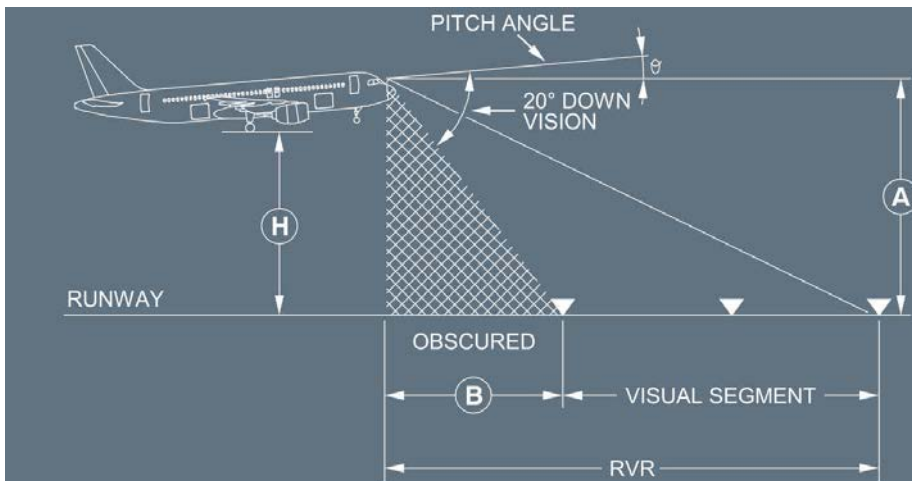

| | CAT III | | CAT II |
|----------------------|-----------------------------------|-----------------------------------|------------------------------------|
| H | 15 ft ($\theta = 5.4^\circ$) | 50 ft ($\theta = 4.7^\circ$) | 100 ft ($\theta = 4.7^\circ$) |
| VISUAL SEGMENT | 60 m (197 ft) | | 120 m (394 ft) |
| A | 36 ft | 71 ft | 121 ft |
| OBSCURED B | 43 m (140 ft) | 79 m (259 ft) | 134 m (442 ft) |
| MINIMUM RVR | 103 m (337 ft) | 139 m (456 ft) | 254 m (836 ft) |

Note: This drawing illustrates that, for a CAT III landing (60 m minimum visual segment), the minimum Runway Visual Range (RVR) is 103 m at 15 ft.

VISUAL GROUND GEOMETRY

Ident.: DSC-20-60-00010294.0001001 / 22 MAY 12

Applicable to: ALL

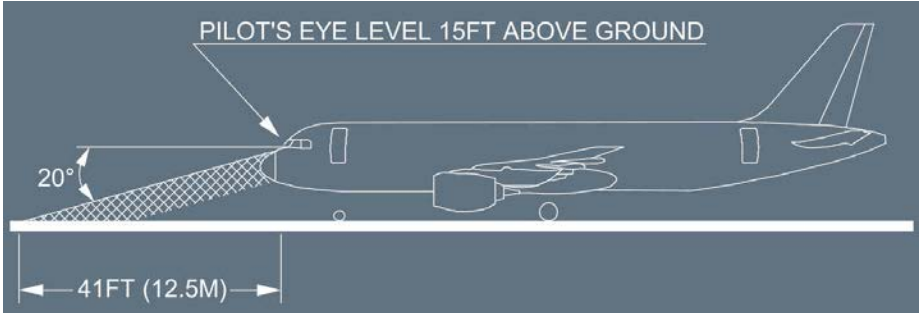



A318/A319/A320/A321
FLIGHT CREW
OPERATING MANUAL

AIRCRAFT SYSTEMS

AIRCRAFT GENERAL

VISUAL GROUND GEOMETRY

Intentionally left blank

AIRCRAFT SYSTEMS

AIR CONDITIONING / PRESSURIZATION /
VENTILATION

Intentionally left blank

DSC-21-10 Air Conditioning

DSC-21-10-10 General

| | |
|-------------------|---|
| General..... | A |
| Architecture..... | B |

DSC-21-10-20 Main Components

| | |
|--|---|
| Air Conditioning Pack..... | A |
| Pack Schematic (Simplified)..... | B |
| Pack Flow Control Valve..... | C |
| Emergency Ram Air..... | D |
| Mixer Unit..... | E |
| Hot-Air Pressure-Regulating Valve..... | F |
| Trim Air Valves..... | G |

DSC-21-10-30 Temperature and Flow Regulation

| | |
|--|---|
| General..... | A |
| Temperature Regulation..... | B |
| Air Conditioning System Controllers..... | C |

DSC-21-10-40 System Operation under Failure Condition

| | |
|---|---|
| General..... | A |
| Air Conditioning System Controllers  | B |
| Air Cycle Machine Failure..... | C |
| Hot Air Pressure Regulating Valve Failure..... | D |
| Trim Air Valve Failure..... | E |

DSC-21-10-50 Controls and Indicators

| | |
|---------------------------------|---|
| Controls on Overhead Panel..... | A |
| ECAM BLEED Page..... | B |
| ECAM COND Page..... | C |
| ECAM CAB PRESS Page..... | D |
| ECAM Cruise Page..... | E |
| Memo Display..... | F |

DSC-21-20 Pressurization

DSC-21-20-10 General

| | |
|--------------------------|---|
| General..... | A |
| Automatic Operation..... | B |
| Manual Operation..... | C |
| SCHEMATICS..... | D |

Continued on the following page

Continued from the previous page

DSC-21-20-20 Main Components

| | |
|---|---|
| Cabin Pressure Controllers..... | A |
| Outflow Valve..... | B |
| Safety Valves..... | C |
| Residual Pressure Control Unit (RPCU )..... | D |

DSC-21-20-30 System Operation

| | |
|--------------------------------------|---|
| Automatic Pressure Control Mode..... | A |
| Pressurization Flight Profile..... | B |
| Manual Pressure Control Mode..... | C |
| Ditching..... | D |

DSC-21-20-40 Controls and Indicators

| | |
|--------------------------|---|
| Overhead Panel..... | A |
| ECAM CAB PRESS Page..... | B |
| ECAM Cruise Page..... | C |
| ECAM DOOR/OXY Page..... | D |
| Memo Display..... | E |

DSC-21-30 Ventilation

DSC-21-30-10 General

| | |
|--------------|---|
| General..... | A |
|--------------|---|

DSC-21-30-20 Avionics Ventilation

| | |
|--|---|
| General..... | A |
| Main Components..... | B |
| Normal Operation, Open-Circuit Configuration..... | C |
| Normal Operation, Close-Circuit Configuration..... | D |
| Normal Operation, Intermediate Configuration..... | E |
| Abnormal Operation..... | F |

DSC-21-30-40 Battery Ventilation

| | |
|--------------------------|---|
| Battery Ventilation..... | A |
|--------------------------|---|

DSC-21-30-50 Lavatory and Galley Ventilation

| | |
|--------------------------|---|
| Lavatory and Galley..... | A |
|--------------------------|---|

DSC-21-30-60 Controls and Indicators

| | |
|--------------------------|---|
| Overhead Panel..... | A |
| ECAM CAB PRESS Page..... | B |

Continued on the following page



Continued from the previous page

DSC-21-40 Cargo

DSC-21-40-10 General

| | |
|----------------|---|
| General..... | A |
| Schematic..... | B |

DSC-21-40-20 System Operation

| | |
|---|---|
| FWD Cargo Ventilation  | A |
| AFT Cargo Ventilation  | B |
| AFT Cargo Heating  | C |
| FWD Cargo Heating  | D |

DSC-21-40-30 Controls and Indicators

| | |
|---------------------|---|
| Overhead Panel..... | A |
|---------------------|---|

DSC-21-40-35 ECAM Cond Page

| | |
|---------------------|---|
| ECAM COND Page..... | A |
|---------------------|---|



A318/A319/A320/A321
FLIGHT CREW
OPERATING MANUAL

AIRCRAFT SYSTEMS

AIR CONDITIONING / PRESSURIZATION / VENTILATION

PRELIMINARY PAGES - TABLE OF CONTENTS

Intentionally left blank

GENERAL

Ident.: DSC-21-10-10-00017767.0001001 / 21 MAR 16

Applicable to: ALL

The air conditioning system is fully automatic.

It provides continuous air renewal and maintains a constant, selected temperature in the following three zones : COCKPIT, FWD CABIN, AFT CABIN. These three zones are independently controlled.

Air is supplied by the pneumatic system, via:

- Two pack flow control valves,
- Two packs,
- The mixing unit, which mixes the air that comes from the cabin and the packs.

Air is then distributed to the cockpit and the cabin.

In an emergency, a ram air inlet can provide ambient air to the mixing unit.

The temperature in the flight deck and in the cabin can be selected from the cockpit's AIR COND panel. Temperature regulation of the temperature is ensured by a zone controller and two pack controllers, or two Air Conditioning System Controller (ACSC) .

Temperature regulation is optimized via the hot air pressure regulating valve, and the trim air valves that add hot air, tapped upstream of the packs, to the air coming from the mixing unit.

A temperature control panel  is also available on the Forward Attendant Panel (FAP). During cruise, the cabin crew can modify each cabin zone temperature that is selected from the cockpit, with a limited authority of ± 2.5 °C. (± 4.5 °F).

Low-pressure air is supplied to the mixing unit by a ground connection.

ARCHITECTURE

Ident.: DSC-21-10-10-00000297.0003001 / 22 MAY 12

Applicable to: **ALL**

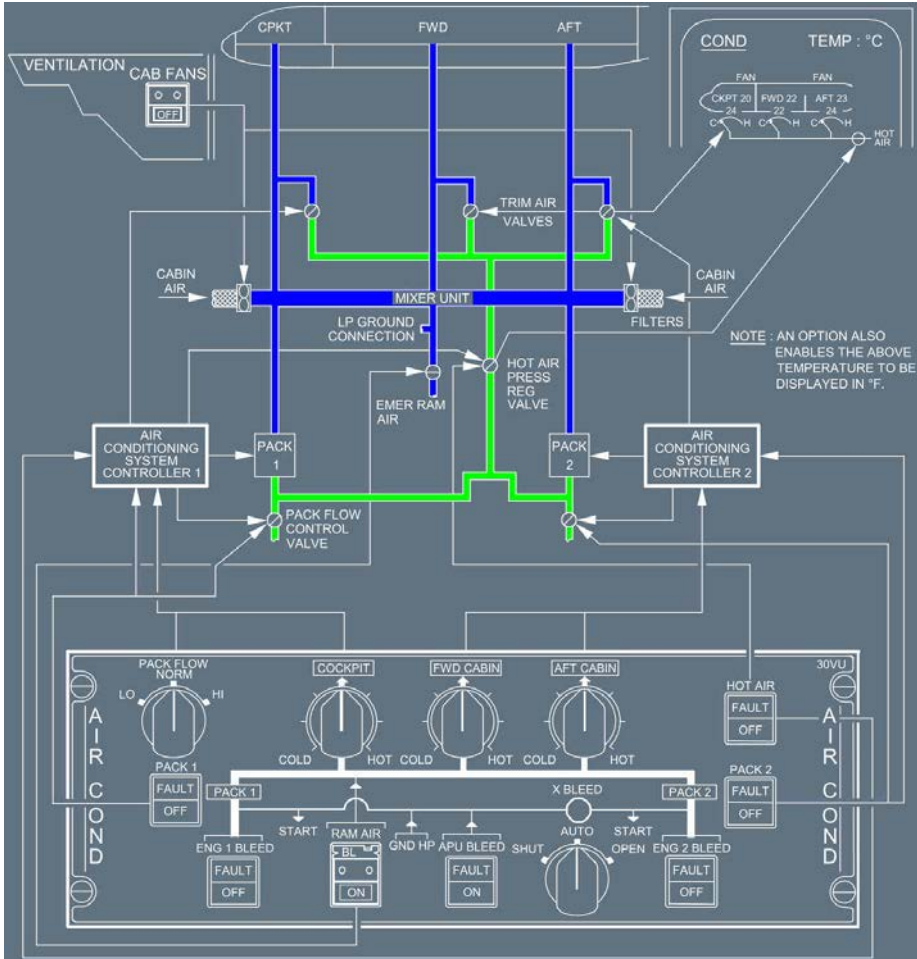

AIR CONDITIONING PACK

Ident.: DSC-21-10-20-00017768.0001001 / 21 MAR 16

Applicable to: ALL

The two packs operate automatically and independently of each other. Pack operation is controlled by signals coming from the pack controller or the Air Conditioning System Controller (ACSC) . Warm pre-conditioned bleed air enters the cooling path via the pack flow control valve, and is ducted to the primary heat exchanger.

Then, the cooled bleed air enters the compressor section of the air-cycle machine and is compressed to a higher pressure and temperature.

It is cooled again in the main heat exchanger and enters the turbine section, where it expands and, in expanding, generates power to drive the compressor and cooling air fan.

The removal of energy during this process reduces air temperature, resulting in very low air temperature at turbine discharge.

 A water separator system dries the air before it enters the turbine section.

PACK SCHEMATIC (SIMPLIFIED)

Ident.: DSC-21-10-20-00000299.0008001 / 22 MAY 12

Applicable to: ALL

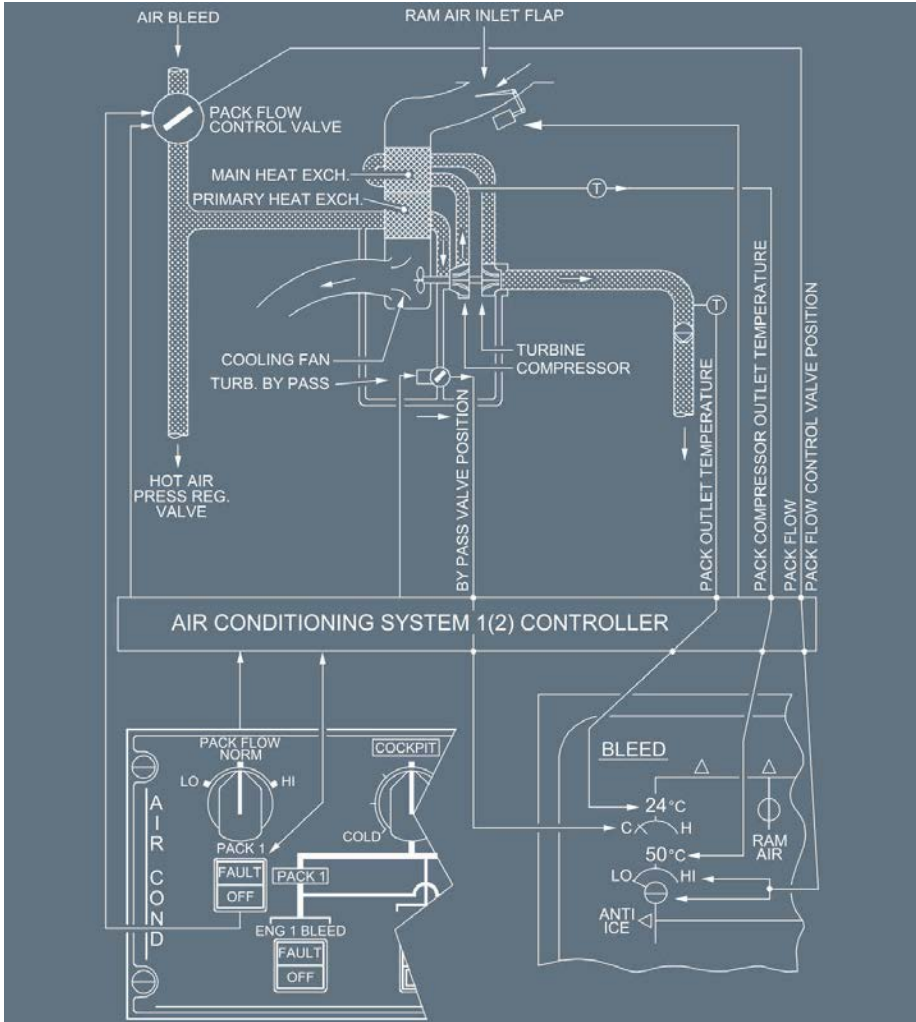

PACK FLOW CONTROL VALVE

Ident.: DSC-21-10-20-00017769.0001001 / 21 MAR 16

Applicable to: ALL

This valve is pneumatically-operated and electrically-controlled. It regulates the air flow in accordance with signals received from the pack controllers or the ACSC  .

In the absence of air pressure, a spring keeps the valve closed.

The valve closes automatically in case of pack overheat, engine start, or operation of the fire or ditching pushbutton. The valve is controlled from the AIR COND panel.

EMERGENCY RAM AIR

Ident.: DSC-21-10-20-00000301.0001001 / 20 DEC 16

Applicable to: ALL

An emergency ram air inlet ventilates the cockpit and cabin to remove smoke, or if both packs fail. The emergency ram air inlet valve is controlled by the RAM AIR pushbutton on the AIR COND panel. This pushbutton opens the ram air valve, provided that ditching is not selected.

When the RAM AIR pushbutton is ON : The outflow valve opens about 50 %, provided that it is under automatic control and ΔP is less than 1 PSI. The outflow valve does not automatically open if it is under manual control, even if ΔP is less than 1 PSI. If ΔP is greater than 1 PSI, the check valve located downstream the ram air door will not open, even if the ram air door has been selected open. No airflow will then be supplied.

MIXER UNIT

Ident.: DSC-21-10-20-00000302.0001001 / 21 MAR 16

Applicable to: ALL

This unit mixes cold fresh air from the packs with the cabin air being recirculated through recirculation fans. The mixer unit is also connected to the emergency ram air inlet and the low pressure ground inlets.

HOT-AIR PRESSURE-REGULATING VALVE

Ident.: DSC-21-10-20-00000303.0003001 / 15 FEB 11

Applicable to: ALL

In the absence of air, a spring keeps the valve closed. This pneumatically-operated and electrically-controlled valve regulates hot air pressure, which is tapped upstream of the packs. The air conditioning system controller 1 regulates this valve. This valve closes upon pressing the HOT AIR pushbutton on the AIR COND panel, or when both lanes of one air conditioning system controller fail.

The valve closes automatically, if:

- The duct overheats, or
- The cockpit trim air valve fails, or
- Both cabin trim air valves fail.



The hot-air pressure-regulating valve remains operative, even if either the forward or aft cabin trim air valve fails.

TRIM AIR VALVES

Ident.: DSC-21-10-20-00017771.0001001 / 21 MAR 16

Applicable to: ALL

These valves are electrically-controlled by the zone controller or the ACSC . A trim air valve, associated with each zone, adjusts the temperature by adding hot air.

The cockpit trim air valve is controlled by the ACSC 1 , and the cabin trim air valves are controlled by the ACSC 2 .

AIRCRAFT SYSTEMS

AIR CONDITIONING / PRESSURIZATION / VENTILATION

AIR CONDITIONING - TEMPERATURE AND FLOW REGULATION

GENERAL

Ident.: DSC-21-10-30-00017772.0001001 / 21 MAR 16

Applicable to: ALL



Temperature regulation is automatic and controlled by one zone controller and two pack controllers, or the ACSC .

TEMPERATURE REGULATION



Ident.: DSC-21-10-30-00017773.0001001 / 21 MAR 16

Applicable to: ALL

Temperature regulation is achieved by the zone controller or the ACSC .

The zone controller regulates the temperature of the two cabin zones and the cockpit. The ACSC 2  regulates the temperature of the two cabin zones, and the ACSC 1  regulates the cockpit temperature.

BASIC TEMPERATURE REGULATION

The flight crew uses the temperature selectors on the air conditioning panel to select the reference temperatures. The zone controller or the ACSC  computes a temperature demand from the selected temperature and the actual temperature. The reference temperatures are then fine tuned for each cabin zone through the temperature control panel  installed on the FAP.

The actual temperature is measured by sensors:

- In the cockpit, for the cockpit zone;
- In the lavatory extraction circuit and galley ventilation system, for the cabin.

A signal corresponding to the lowest demanded zone temperature goes to the pack controller or the ACSC , which then make both packs supply the required outlet temperature.

OPTIMIZED TEMPERATURE REGULATION

The zone controller or the ACSC  optimizes temperature by acting on the trim air valves. The temperature selection range is from 18 °C (64 °F) to 30 °C (86 °F).

AIR CONDITIONING SYSTEM CONTROLLERS

Ident.: DSC-21-10-30-00017775.0001001 / 20 DEC 16

Applicable to: ALL

Each air conditioning system controller regulates the temperature of its associated pack, by modulating the bypass valve and the ram air inlet flap.

The ram air inlet flap closes during takeoff and landing to avoid the ingestion of foreign matter.

Note: During takeoff, the ram air inlet flap closes when takeoff power is set, and the main landing gear struts are compressed.

During landing, it closes as soon as the main landing gear struts are compressed, as long as speed is at or above 70 kt.

It opens 20 s after the speed drops below 70 kt.

The air conditioning system controllers also regulate flow by modulating the associated pack flow control valve.

PACK FLOW CONTROL

The flight crew can use the PACK FLOW selector to adjust the pack flow for the number of passengers and for external conditions.

Whatever the crew selects, the system delivers higher flow for any of the following circumstances:

- In single-pack operation,
- When the APU is supplying bleed air.

The system delivers normal flow if the flight crew selects LO flow and the temperature demand cannot be satisfied.

ENGINE PRESSURE DEMAND

When the cooling demand in one zone cannot be satisfied, if the bleed pressure is too low, the air conditioning system controller sends a pressure demand signal to both Engine Interface Units (EIU) to increase the minimum idle and to raise the bleed pressure.

APU FLOW DEMAND

When the APU bleed valve is open, the air conditioning system controller signals the APU 's Electronic Control Box (ECB) to increase the APU flow output when any zone temperature demand cannot be satisfied.

| | |
|---|---|
|  <p>A318/A319/A320/A321 FLIGHT CREW OPERATING MANUAL</p> | <p style="text-align: center;">AIRCRAFT SYSTEMS</p> <p style="text-align: center;">AIR CONDITIONING / PRESSURIZATION / VENTILATION</p> <p>AIR CONDITIONING - SYSTEM OPERATION UNDER FAILURE CONDITION</p> |
|---|---|

GENERAL

Ident.: DSC-21-10-40-00000309.0002001 / 21 MAR 16

Applicable to: ALL

Each controller is comprised of two lanes. One lane controls the system, the other takes over full control, in case of an active lane failure.

AIR CONDITIONING SYSTEM CONTROLLERS ⚠

Ident.: DSC-21-10-40-00018747.0001001 / 21 MAR 16

Applicable to: ALL

ONE LANE FAILURE

No effect, as the second lane takes over.

BOTH LANES FAILURE

The related pack is lost, and the hot air pressure-regulating valve and associated trim air valves close.

AIR CYCLE MACHINE FAILURE

Ident.: DSC-21-10-40-00000312.0003001 / 21 MAR 16

Applicable to: ALL

If the Air Cycle Machine (ACM) fails (compressor/turbine seizure), the affected pack may be operated in heat exchanger cooling mode.

Warm pre-conditioned bleed air enters the cooling path via the pack valve and goes to the primary heat exchanger. Then, the main part of the cooled air goes directly downstream of ACM turbine through the bypass valve, and the rest goes through the failed ACM.

The ACM seizure reduces the pack flow.

As for normal pack operation :

- The air conditioning system controller regulates temperature by modulating the bypass valve and the ram air inlet flap.
- The air conditioning system controller regulates the hot air flow through the trim air valves to optimize cockpit/cabin temperature regulation. Hot air flow is lower than in normal pack operation, because pack flow is reduced.

HOT AIR PRESSURE REGULATING VALVE FAILURE

Ident.: DSC-21-10-40-00000313.0001001 / 21 MAR 16

Applicable to: ALL

Failed open : No effect.

Failed closed : Optimized regulation is lost. Trim air valves are driven to the fully closed position. Pack 1 controls the cockpit temperature to the selected value and pack 2 controls the cabin temperature (FWD and AFT) to the mean value of the selected temperatures.

TRIM AIR VALVE FAILURE

Ident.: DSC-21-10-40-00000314.0001001 / 21 MAR 16

Applicable to: **ALL**

Optimized temperature regulation of the corresponding zone is lost.

CONTROLS ON OVERHEAD PANEL

Ident.: DSC-21-10-50-00000315.0002001 / 20 DEC 16

Applicable to: ALL

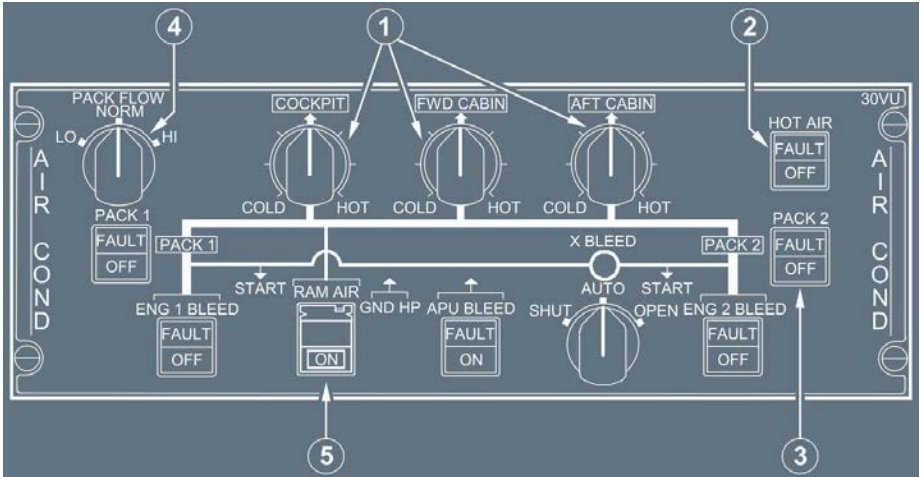

(1) Zone temperature selector

- 12 o'clock position: 24 °C (76 °F)
- COLD position: 18 °C (64 °F)
- HOT position: 30 °C (86 °F).

(2) HOT AIR pb

ON : The valve regulates hot air pressure.

OFF : The valve closes, and the trim air valves close.

The FAULT circuit is reset.

FAULT : The FAULT light comes on amber, along with an associated ECAM caution, when duct overheat is detected. The fault circuit detects an overheat when the duct temperature reaches 88 °C (190 °F) once.

The valve and trim air valves close automatically.

The FAULT light goes off when the temperature drops below 70 °C (158 °F), and the flight crew selects OFF.

(3) PACK pb-sw

ON : The pack flow control valve is automatically-controlled.

It opens, except in the following cases:

- Upstream pressure below minimum
- Compressor outlet overheat
- Engine start sequence:
 1. If the crossbleed valve is closed, the valve located on the starting engine side immediately closes, when the MODE selector is set to IGN (or CRK)
 2. It remains closed on the starting engine side (provided the crossbleed valve is closed) when:
 - The MASTER sw is set to ON (or MAN START pb is set to ON)
 - The start valve is open
 - $N_2 < 50 \%$.

Note: If the crossbleed valve is open at engine start, both pack flow control valves close.

3. On ground, reopening of the valves is delayed for 30 s to avoid a supplementary pack closure cycle during second engine start.

- FIRE pb, of the engine on the related side, is pressed
- Ditching is selected.

OFF : The pack flow control valve closes.

FAULT It : Comes on amber, and a caution appears on the ECAM, if the pack flow control valve position disagrees with the selected position, or in the case of compressor outlet overheat or pack outlet overheat.

(4) PACK FLOW selector

- Permits the selection of pack valve flow, according to the number of passengers and ambient conditions (smoke removal, hot or wet conditions)
 LO (80 %) – NORM (100 %) – HI (120 %)
- Manual selection is irrelevant in single pack operation, or with APU bleed supply. In these cases, HI is automatically selected
- If LO is selected, the pack flow can be automatically selected up to 100 % when the cooling demand cannot be satisfied.

(5) RAM AIR pb (guarded)

ON : The ON light comes on white.

If the DITCHING pb, on the CABIN PRESS panel, is in normal position:

- The emergency ram air inlet opens
- If $\Delta p \geq 1$ PSI: The outflow valve control remains normal. No emergency ram air flows in
- If $\Delta p < 1$ PSI: The outflow valve opens to about 50 % when under automatic control. It does not automatically open when it is under manual control. Emergency ram airflow is directly supplied to the mixer unit.

OFF: The emergency ram air inlet closes.

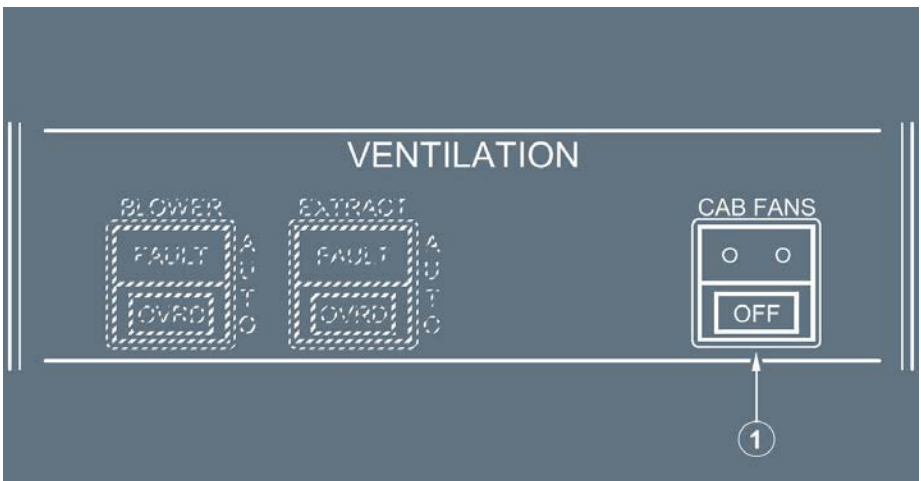

(1) CAB FAN pb

ON : The two cabin fans are on.

OFF: The two cabin fans are off.

ECAM BLEED PAGE

Ident.: DSC-21-10-50-00000316.0003001 / 21 MAR 16

Applicable to: ALL

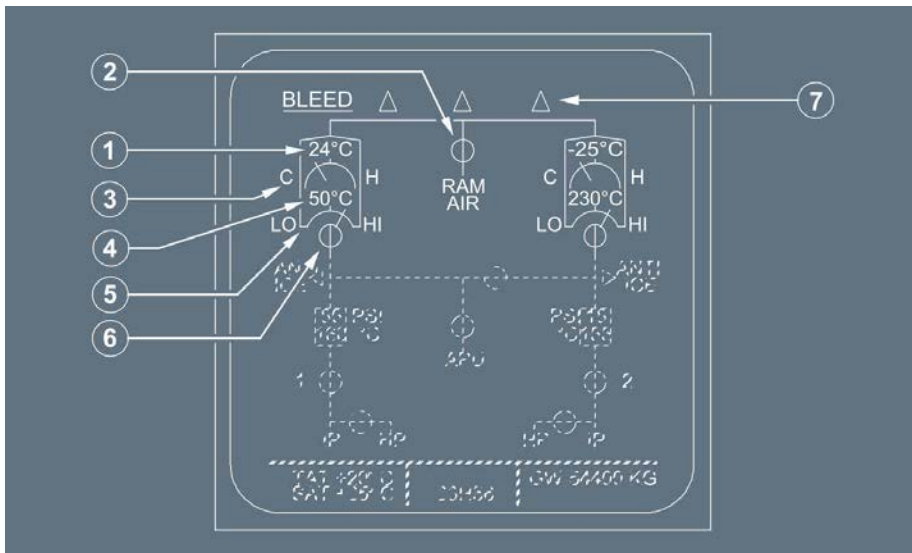

- (1) Pack outlet temperature
 It appears in green. It becomes amber, if the temperature is higher than 90 °C.
- (2) PACK RAM AIR inlet
 Crossline: The flap is normally closed.
 – Green
 In transit : The flap is partially open
 – Amber
 Inline – : The flap is fully open on ground.
 Amber
 Inline – : The flap is fully open in flight.
 Green
- (3) Pack turbine bypass valve position
 Indication is green.
 C = Cold – Valve closed
 H = Hot – Valve open.

- (4) Pack compressor outlet temperature
It appears in green. It becomes amber, if the temperature is higher than 260 °C.
- (5) Pack flow
It appears in green. It becomes amber, if the pack flow control valve is closed.
Note: The pack flow indication can be up to 30 % below the actual flow rate.
- (6) Pack flow control valve
 - Inline - Green : Open.
 - Inline - Amber : Open, and disagrees with the control position.
 - Crossline - Green : Fully closed.
 - Crossline - Amber : Fully closed, and disagrees with the control position.
- (7) User Indication
It appears in green. It becomes amber, in flight, when RAM AIR flap is not fully open, and both pack flow control valves are closed .

ECAM COND PAGE

Ident.: DSC-21-10-50-00000317.0004001 / 09 OCT 12

Applicable to: ALL

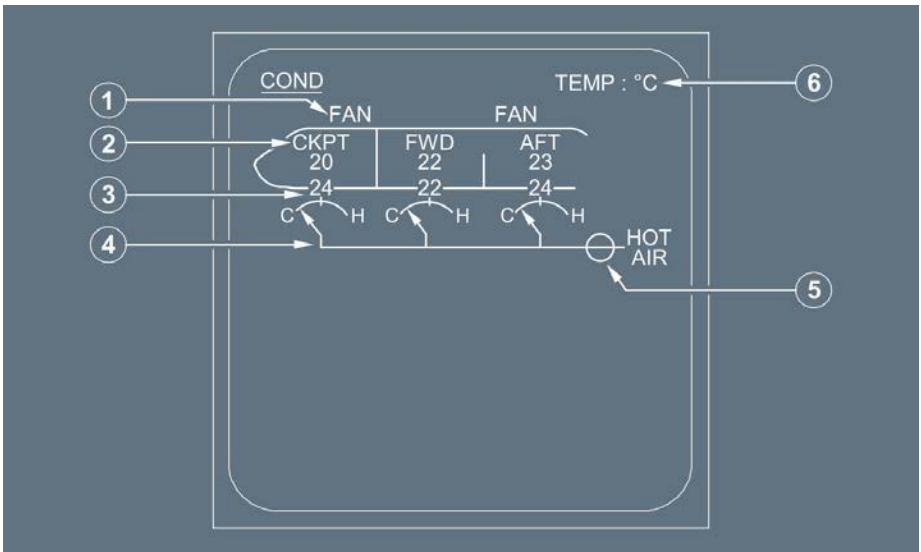

- (1) Cabin FAN fault indication
It appears in amber, if the recirculation fan is detected as faulty.
- (2) Zone temperature
It is in green.
- (3) Zone duct temperature
It appears in green, and becomes amber at 80 °C (176 °F).
- (4) Zone trim air valve position
The arrow is green. It is replaced by amber crosses ("XX") if the valve fails.
C = Cold valve fully closed.
H = Hot valve fully open.
- (5) Hot air pressure regulating valve
In line - Green : Valve is normally open.
In line - Amber : Valve is abnormally open (disagrees with control position).
Crossline - Green : Valve is normally fully closed.
Crossline - Amber : Valve is closed and pushbutton OFF, or valve position disagrees with control position.
- (6) TEMP
Unit of measure (°C or °F) is indicated in cyan.

ECAM CAB PRESS PAGE

Ident.: DSC-21-10-50-00000318.0001001 / 09 OCT 12

Applicable to: ALL

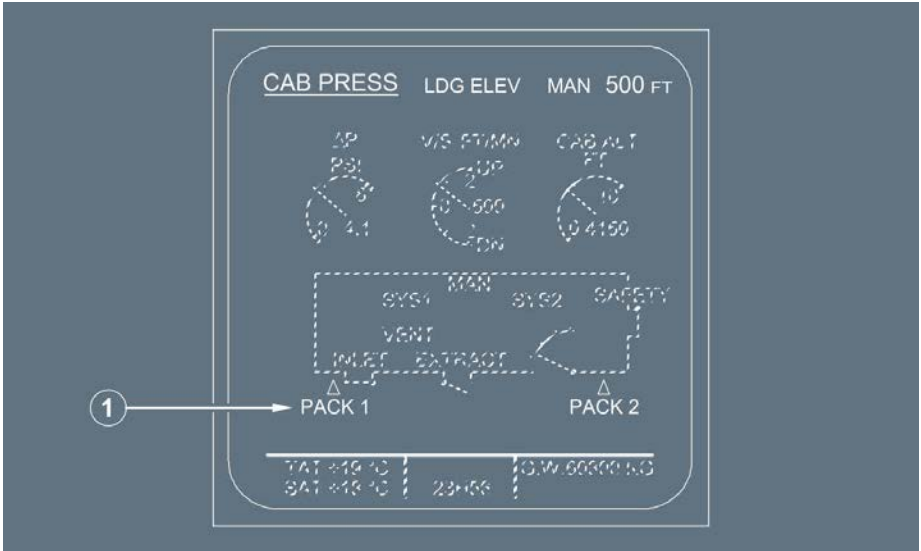

(1) PACK indication

Triangle normally green, PACK 1(2) indication normally white. Both become amber when pack flow control valve is closed with associated engine running.

AIRCRAFT SYSTEMS

AIR CONDITIONING / PRESSURIZATION / VENTILATION

AIR CONDITIONING - CONTROLS AND INDICATORS

ECAM CRUISE PAGE

Ident.: DSC-21-10-50-00000319.0002001 / 09 OCT 12

Applicable to: ALL

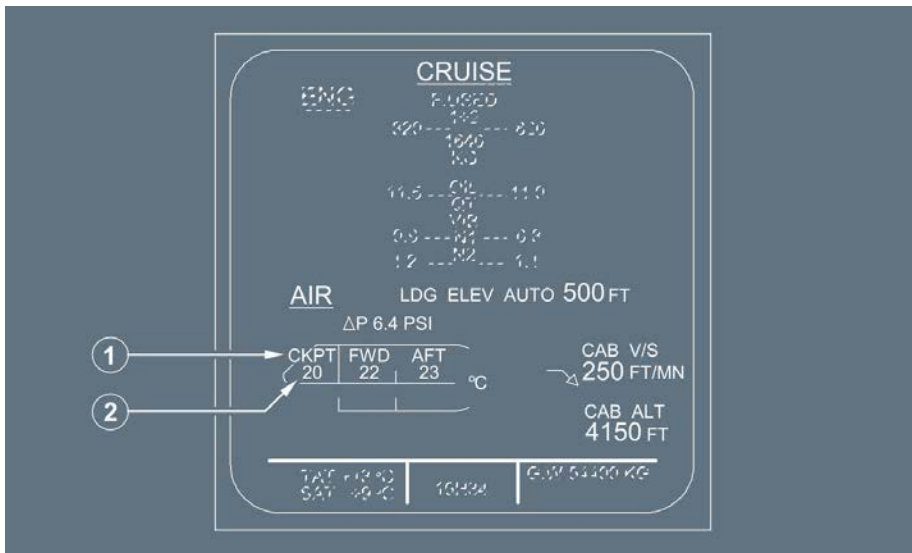

- (1) Zone indication
 This field also displays the temperature scale in use (°C or °F).
- (2) Zone temperature

MEMO DISPLAY

Ident.: DSC-21-10-50-00016760.0001001 / 21 MAR 16

Applicable to: ALL

RAM AIR ON : This memo appears in green, if the RAM AIR pb-sw is ON.

| | |
|---|--|
|  <p>A318/A319/A320/A321 FLIGHT CREW OPERATING MANUAL</p> | <p>AIRCRAFT SYSTEMS</p> <p>AIR CONDITIONING / PRESSURIZATION / VENTILATION</p> <p>PRESSURIZATION - GENERAL</p> |
|---|--|

GENERAL

Ident.: DSC-21-20-10-00017903.0001001 / 21 MAR 16
Applicable to: ALL

The cabin pressurization system has four general functions:

- Ground function : Fully opens the outflow valve on ground
- Prepressurization : During takeoff, increases cabin pressure to avoid a surge in cabin pressure during rotation
- Pressurization in flight : Adjusts cabin altitude, and rate of change to provide passengers with a comfortable flight
- Depressurization : After touchdown, gradually releases residual cabin overpressure before the ground function fully opens the outflow valve.

The system consists of:

- Two Cabin Pressure Controllers (CPC)
- One Residual Pressure Control Unit (RPCU ())
- One outflow valve, with an actuator that incorporates three motors (two for automatic operation, one for manual operation)
- One control panel
- Two safety valves.

Any one of the three independent electric motors may power the outflow valve.

Normally, one of the two cabin pressure controllers operates the outflow valve by means of its associated automatic motor.

In case of ditching, an override switch on the control panel allows the flight crew to close the outflow valve and all valves below the flotation line.

The flight crew can set the system to operate automatically, semi-automatically, or manually.

In normal operation, cabin pressurization is fully automatic.

AUTOMATIC OPERATION

Ident.: DSC-21-20-10-00000323.0001001 / 21 MAR 16
Applicable to: ALL

The flight crew monitors the operation of the system, but does nothing to control it. Air pressure in the cabin follows external schedules that the system receives as signals from the Flight Management and Guidance System (FMGS).

When FMGS data is not available for automatic pressurization, the crew only needs to select the landing field elevation.

The pressurization system then uses the manually-selected landing field elevation for internal schedules.



A318/A319/A320/A321
FLIGHT CREW
OPERATING MANUAL

AIRCRAFT SYSTEMS
AIR CONDITIONING / PRESSURIZATION / VENTILATION
PRESSURIZATION - GENERAL

MANUAL OPERATION

Ident.: DSC-21-20-10-00000324.0001001 / 21 MAR 16

Applicable to: **ALL**

In manual mode, the flight crew controls the cabin altitude via the manual motor of the outflow valves, by operating controls on the pressurization control panel.



A318/A319/A320/A321
FLIGHT CREW
OPERATING MANUAL

AIRCRAFT SYSTEMS

AIR CONDITIONING / PRESSURIZATION / VENTILATION

PRESSURIZATION - GENERAL

SCHEMATICS

Ident.: DSC-21-20-10-00000325.0002001 / 21 MAR 16

Applicable to: ALL

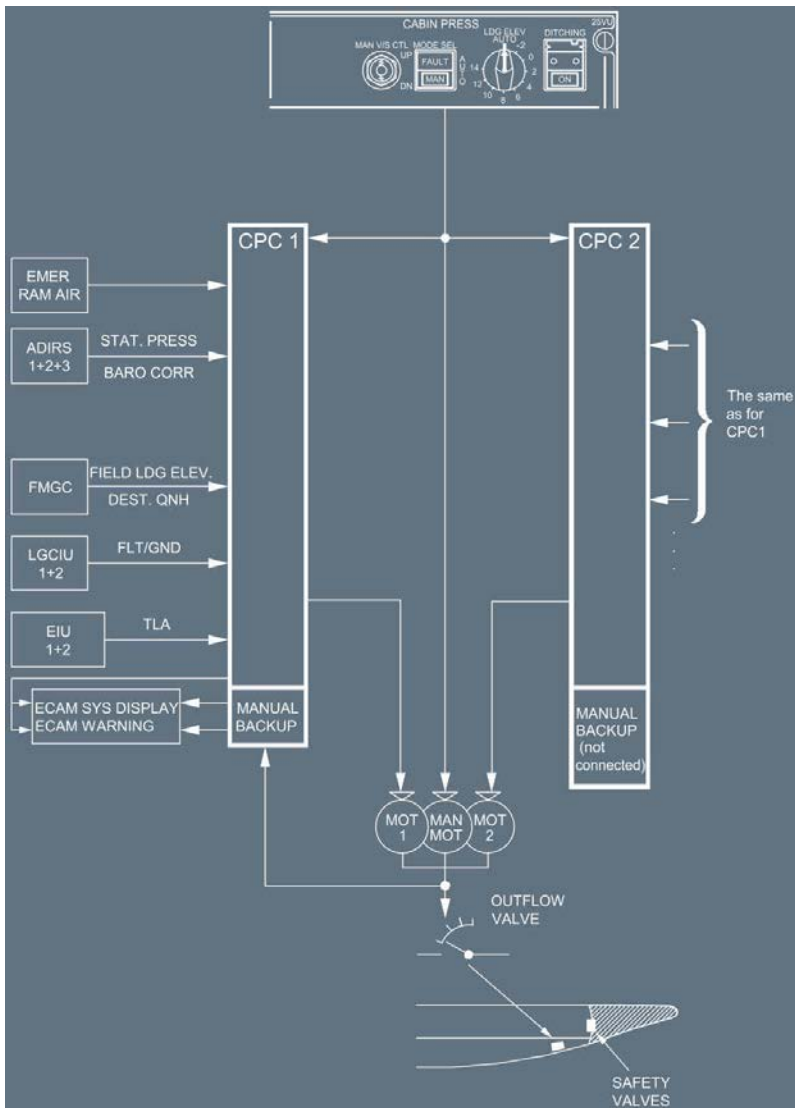

CABIN PRESSURE CONTROLLERS

Ident.: DSC-21-20-20-00000326.0001001 / 21 MAR 16

Applicable to: ALL

Two identical, independent, digital controllers automatically control the system, by maintaining the proper cabin pressure. They receive signals from the Air Data Inertial Reference System (ADIRS), the Flight Management and Guidance Computer (FMGC), the Engine Interface Unit (EIU), and the Landing Gear Control Interface Unit (LGCIU).

When the system is in automatic or semi-automatic mode, one controller is active, the other is on standby.

The controllers also generate signals for the Electronic Centralized Aircraft Monitoring (ECAM). For operation in manual mode, each controller has a backup section, which is powered by an independent power supply in the controller N°1 position. This section also has a pressure sensor that generates the cabin altitude and pressure signal for the ECAM, when MAN mode is selected. The controllers communicate with each other via a cross-channel link.

OUTFLOW VALVE

Ident.: DSC-21-20-20-00000327.0001001 / 21 MAR 16

Applicable to: ALL

The outflow valve is on the right-hand side of fuselage, behind the aft cargo compartment and below the flotation line.

The outflow valve assembly consists of a flush, skin-mounted, rectangular frame, carrying inward and outward opening flaps linked to the actuator. The actuator contains the drives of the two automatic motors and the manual motor. Either of two automatic motors operates the valve in automatic mode, and the manual motor operates it in manual mode.

In automatic mode, the operating controller signals the position of the valve to the ECAM.

In manual mode, the backup section of the N° 1 controller signals the position of the valve to the ECAM.

Note: *When the RAM AIR pushbutton is ON, and Δp is below 1 PSI, the system drives the outflow valve about 50 % open if it is under automatic control. If the system is under manual control, the outflow valve does not automatically open, even if Δp is below 1 PSI.*

SAFETY VALVES

Ident.: DSC-21-20-20-00000328.0001001 / 21 MAR 16

Applicable to: ALL

Two independent pneumatic safety valves prevent cabin pressure from going too high (8.6 PSI above ambient) or too low (1 PSI below ambient).

They are located on the rear pressure bulkhead, above the flotation line.

RESIDUAL PRESSURE CONTROL UNIT (RPCU )

Ident.: DSC-21-20-20-00017788.0001001 / 21 MAR 16

Applicable to: ALL

The RPCU automatically depressurizes the aircraft in case of abnormal residual pressure on ground. It automatically opens the outflow valve, when:

- The outflow valve is not fully open, and
- Both CPCs are failed, or manual mode is selected, and
- The aircraft is on ground, and
- All engines are shutdown, or all ADIRS indicate an airspeed below 100 kt.

AUTOMATIC PRESSURE CONTROL MODE

Ident.: DSC-21-20-30-00000329.0001001 / 14 NOV 11

Applicable to: ALL

GENERAL

- Two identical, independent, automatic systems (each consisting of a controller and its associated motors) control cabin pressure.
Either system controls the single outflow valve.
Only one controller operates at a time.

An automatic transfer occurs:
 - 70 s after each landing.
 - If the operating system fails.
- The controller automatically controls the cabin pressure. It limits the cabin pressure to 8 000 ft maximum and optimizes it during climb and descent phases.
- The controller normally uses the landing elevation and the QNH from the FMGC , and the pressure altitude from ADIRS.
If FMGC data are not available, the controller uses the captain BARO Reference from the ADIRS and the LDG ELEV selection.
- Pressurization is assumed through the following modes:

GROUND (GN)

Before takeoff, and 55 s after landing, the outflow valve fully opens to ensure that there is no residual cabin pressure. At touchdown, any remaining cabin pressure is released at a cabin vertical speed of 500 ft/min.

TAKEOFF (TO)

To avoid a pressure surge at rotation, the controller pre-pressurizes the aircraft at a rate of 400 ft/min, until the ΔP reaches 0.1 PSI. At liftoff, the controller initiates the climb phase.

CLIMB (CL)

During climb, the cabin altitude varies according to a fixed pre-programmed law that takes into account the aircraft's actual rate of climb.

CRUISE (CR)

During cruise, the controller maintains cabin altitude at the level-off value, or at the landing field elevation, whichever is higher.

DESCENT (DE)

During descent, the controller maintains a cabin rate of descent, such that the cabin pressure is equal to the landing field pressure +0.1 PSI, shortly before landing.
The maximum descent rate is 750 ft/min.

ABORT (AB)

If the aircraft does not climb after takeoff, the abort mode prevents the cabin altitude from climbing.
Cabin pressure is set back to the takeoff altitude +0.1 PSI.

PRESSURIZATION FLIGHT PROFILE

Ident.: DSC-21-20-30-00000331.0001001 / 08 SEP 15

Applicable to: ALL

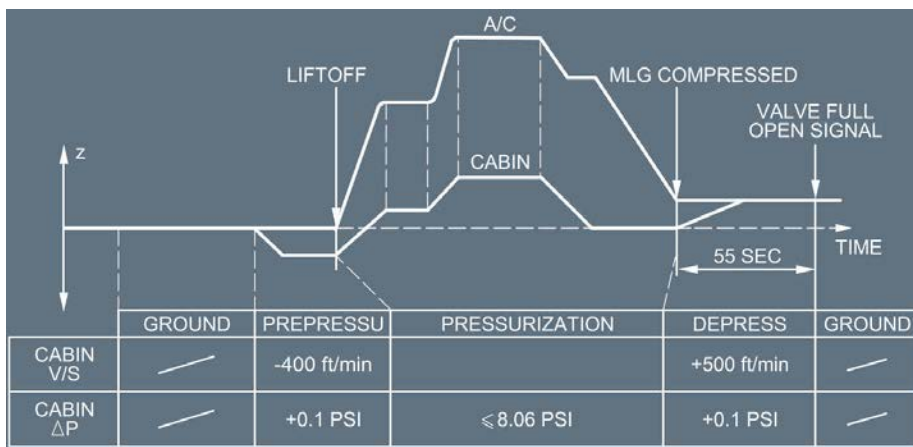

MANUAL PRESSURE CONTROL MODE

Ident.: DSC-21-20-30-00000332.0001001 / 21 MAR 16

Applicable to: ALL

If both automatic systems fail, the flight crew may use the CABIN PRESS control panel to take over manual control of cabin pressurization.

- Release the MODE SEL pushbutton to select MAN, and
- Push the MAN V/S CTL switch UP or DN to increase or decrease cabin altitude.

The first of these actions cuts off power to the AUTO motors, and enables the MAN motor to control the outflow valve.

- Note:
1. Due to the slow operation of the outflow valves in manual mode, and the limited resolution of the outflow valves' position on the ECAM , the visual ECAM indication of a change in the outflow valves' position can take up to 5 s.
 2. As the pressurization system is manually-controlled, the outflow valve does not open automatically at touchdown.

DITCHING

Ident.: DSC-21-20-30-00017789.0001001 / 21 MAR 16

Applicable to: ALL

To prepare for ditching, the flight crew must press the DITCHING pb on the CABIN PRESS control panel to close the outflow valve, the emergency ram air inlet, the avionics ventilation inlet and extract valves, the pack flow control valves, and the FWD cargo outlet isolation valve .



A318/A319/A320/A321
FLIGHT CREW
OPERATING MANUAL

AIRCRAFT SYSTEMS

AIR CONDITIONING / PRESSURIZATION / VENTILATION

PRESSURIZATION - SYSTEM OPERATION

Intentionally left blank

OVERHEAD PANEL

Ident.: DSC-21-20-40-00000334.0004001 / 07 MAY 13

Applicable to: ALL



(1) LDG ELEV knob

AUTO : The pressurization system uses the FMGS data to construct an optimized pressure schedule.
To exit the AUTO position, pull out and turn the selector.

Other positions : The pressurization schedule does not use the landing elevation from the FMGS, but instead uses the landing elevation selected with this knob (from -2 000 to +14 000 ft) as its reference.

Note: The LDG ELEV knob scale is only given as an indication; refer to the ECAM information for accurate adjustment.

(2) MODE SEL pb

AUTO : Automatic mode is operating. One of the two systems controls the outflow valve.

MAN : This legend appears in white, and FAULT does not come on. The flight crew then uses the MAN V/S CTL selector to control the outflow valve.

Note: Switching the MODE SEL pb to MAN, for at least 10 s, then returning it to AUTO will select the other system.

FAULT It : This legend appears in amber and the ECAM caution light comes on only when both automatic systems are faulty.

Note: *The pilot may notice a variation in the CAB ALT indication on the ECAM PRESS page, when the system switches from the cabin pressure control AUTO mode to MAN mode, due to the reduced resolution of the backup pressure sensor.*

(3) MAN V/S CTL selector

The switch is springloaded to neutral and controls the outflow valve position through operation of the MAN motor, when the MODE SEL pb is in the MAN position.

UP : The valve moves towards the open position.

DN : The valve moves towards the closed position.

Note: *To target precise cabin vertical speed rate, only short inputs should be applied on the selector.*

(4) DITCHING pb (guarded)

Normal : The system functions normally.

ON : The operating system sends a “close” signal to the outflow valve, emergency ram air inlet, avionics ventilation inlet and extract valves, pack flow control valves, and forward cargo isolation outlet valve.
The cargo extract fans stop automatically.

Note: *The outflow valve will not close automatically, if it is under manual control.*

CAUTION

On ground, If the ditching pushbutton is set to ON, with the low pressure ground cart connected and all doors closed, a differential pressure will build up.

ECAM CAB PRESS PAGE

Ident.: DSC-21-20-40-00000335.0002001 / 21 MAR 16

Applicable to: ALL

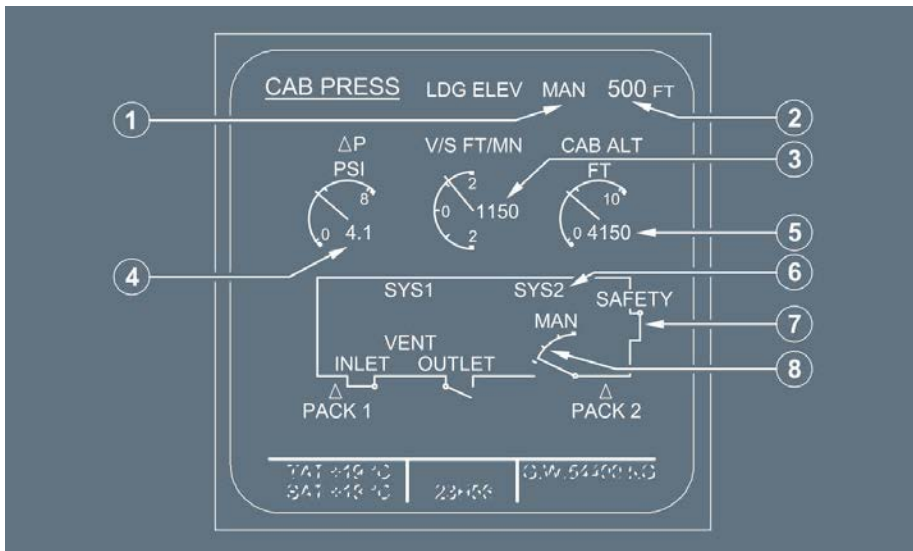

(1) LDG ELEV AUTO/MAN

- LDG ELEV AUTO: appears in green when the LDG ELEV selector is in AUTO.
- LDG ELEV MAN: appears in green when the LDG ELEV selector is not in AUTO.

Neither appears when the indications from SDAC are not valid.

(2) Landing elevation

The landing elevation selected either automatically by the FMGS or manually by the pilot appears in green (but not when the MODE SEL pushbutton switch is in MAN).

(3) V/S FT/MIN (cabin vertical speed)

The analog and digital presentations appear in green when V/S is in the normal range. The digital presentation pulses when V/S > 1 750 ft/min (resets at 1 650 ft/min).

(4) ΔP PSI (cabin differential pressure)

The analog and digital presentations appear in green when ΔP is in the normal range. They appear in amber when $\Delta P \leq -0.4$ PSI or ≥ 8.5 PSI.

The digital presentation pulses if $\Delta p > 1.5$ PSI (resets at 1 PSI) during flight phase 7. (Refer to DSC-31-15 Flight Phases).

AIRCRAFT SYSTEMS

AIR CONDITIONING / PRESSURIZATION / VENTILATION

PRESSURIZATION - CONTROLS AND INDICATORS

(5) CAB ALT FT (cabin altitude)

The analog and digital presentations appear in green, in normal range.

They appear in red if the cabin altitude goes above 9 550 ft.

The digital presentation pulses if the cabin altitude is at or above 8 800 ft (resets at 8 600 ft).

(6) Active system indication (SYS 1 or SYS 2 or MAN)

SYS 1 or SYS 2 appears in green when active and in amber when faulty. When either system is inactive, its title does not appear.

MAN appears in green when the MODE SEL switch is in MAN.

(7) Safety valve position

SAFETY appears in white and the diagram in green when both safety valves are fully closed.

SAFETY and the diagram appear in amber when either valve is not closed.

Note: The safety valve opens when the cabin differential pressure is between 8.2 and 8.9 PSI. The range is due to the reduced accuracy of ΔP measurements (in MAN mode), combined with the decrease in cabin differential pressure that occurs immediately after the safety valves open.

(8) Outflow valve position

The diagram is green when the valve is operating normally.

The diagram becomes amber when the valve opens more than 95 % during flight.

ECAM CRUISE PAGE

Ident.: DSC-21-20-40-00000336.0002001 / 09 OCT 12

Applicable to: ALL

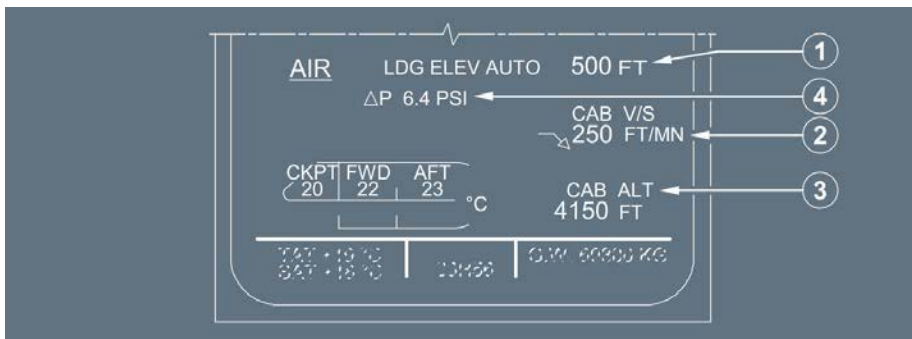

(1) LDG ELEV AUTO/MAN

Identical to the CAB PRESS page

- (2) CAB V/S FT/MIN (cabin vertical speed)

Green, in normal range.

Pulses, when the V/S > 1 750 ft/min (resets at 1 650 ft/min).

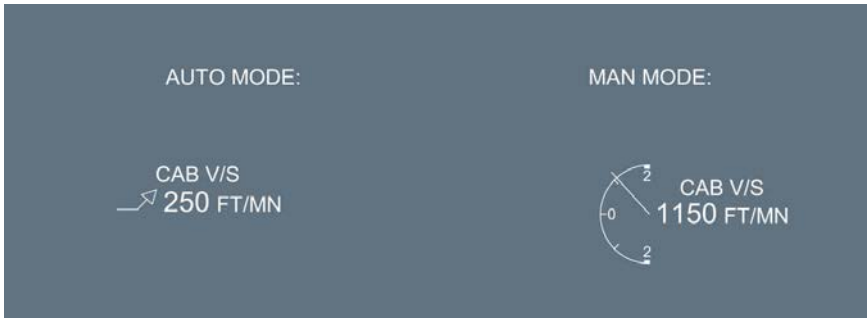

- (3) CAB ALT FT (cabin altitude)

Green, in normal range.

Red, for excessive cabin altitude : $\geq 9\ 550$ ft.

Pulses for cabin altitude at, or above, 8 800 ft (resets at 8 600 ft).

- (4) Δ P indication

It is normally green. Pulses green when CAB Δ P ≥ 1.5 PSI before landing.

It becomes amber, when out of normal range Δ p ≤ -0.4 PSI or ≥ 8.5 PSI.

ECAM DOOR/OXY PAGE

Ident.: DSC-21-20-40-00000337.0003001 / 21 MAR 16

Applicable to: ALL

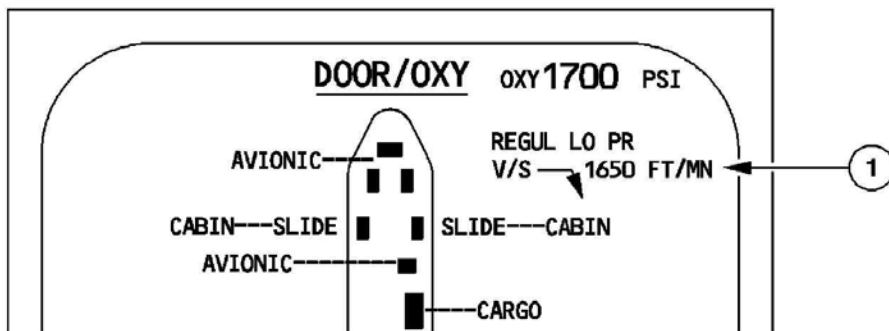

(1) V/S (cabin vertical speed)

This number only appears during flight phases 5, 6 and 7. (Refer to DSC-31-15 Flight Phases for flight phase definitions).

- It is normally green.
- It pulses, when the V/S is greater than 1 750 ft/min and stops pulsing, when less than 1 650 ft/min.
- It becomes amber, when the V/S is greater than 2 000 ft/min, or less than -2 000 ft/min.

MEMO DISPLAY

Ident.: DSC-21-20-40-00016761.0001001 / 21 MAR 16

Applicable to: ALL

MAN LDG ELEV : This memo appears in green, if the LDG ELEV knob is not in the AUTO position.

GENERAL

Ident.: DSC-21-30-10-00017790.0001001 / 21 MAR 16

Applicable to: ALL

The ventilation system includes ventilation for:

- The avionics, controlled by the Avionics Equipment Ventilation Controller (AEVC),
- The batteries,
- The lavatories and galleys.

Note: For more information about cargo ventilation  , Refer to DSC-21-40-10 General.



A318/A319/A320/A321
FLIGHT CREW
OPERATING MANUAL

AIRCRAFT SYSTEMS

AIR CONDITIONING / PRESSURIZATION / VENTILATION

VENTILATION - GENERAL

Intentionally left blank

| | |
|---|--|
|  <p>A318/A319/A320/A321 FLIGHT CREW OPERATING MANUAL</p> | <p>AIRCRAFT SYSTEMS</p> <p>AIR CONDITIONING / PRESSURIZATION / VENTILATION</p> <p>VENTILATION - AVIONICS VENTILATION</p> |
|---|--|

GENERAL

Ident.: DSC-21-30-20-00000341.0001001 / 24 FEB 11
Applicable to: ALL

The avionics ventilation system is fully automatic. It cools the electrical and electronic components in the avionics compartment and on the flight deck, including the instrument and circuit breaker panels. It uses two electric fans to force the circulation of cooling air. Whatever the configuration of the avionics ventilation system is, a part of the avionics ventilation air is sucked from the cockpit through the different cockpit panels.

MAIN COMPONENTS

Ident.: DSC-21-30-20-00017791.0001001 / 21 MAR 16
Applicable to: ALL

FANS

Two electric fans continuously circulate air around the avionics equipment, when the aircraft is electrically supplied. The Fan Speed Controller (FSC)  controls the avionics ventilation fan speed as a function of temperature::

1. High speed when the ventilation air temperature is above +40 °C (104 °F)
2. Low speed when the ventilation air temperature is below +35 °C (95 °F)

SKIN AIR INLET AND OUTLET VALVES

These valves admit air from outside the aircraft and evacuate hot air from the avionics equipment.

SKIN EXCHANGE INLET AND OUTLET BYPASS VALVES

These valves enable air to circulate between the avionics bay and the space under the cargo compartment floor.

AIR CONDITIONING INLET VALVE

This valve opens to enable the air conditioning circuit to supply fresh air to the avionics bay.

SKIN EXCHANGE ISOLATION VALVE

This valve connects or isolates the skin heat exchanger.

AVIONICS EQUIPMENT VENTILATION CONTROLLER (AEVC)

The AEVC controls the operation of all fans and valves in the avionics ventilation system.

NORMAL OPERATION, OPEN-CIRCUIT CONFIGURATION

Ident.: DSC-21-30-20-00000343.0001001 / 16 APR 14

Applicable to: ALL

GROUND OPERATIONS

The open-circuit configuration operates when skin temperature is above the on-ground threshold.

On-ground threshold = +12 °C (53 °F), temperature increasing, or
 +9 °C (48 °F), temperature decreasing.

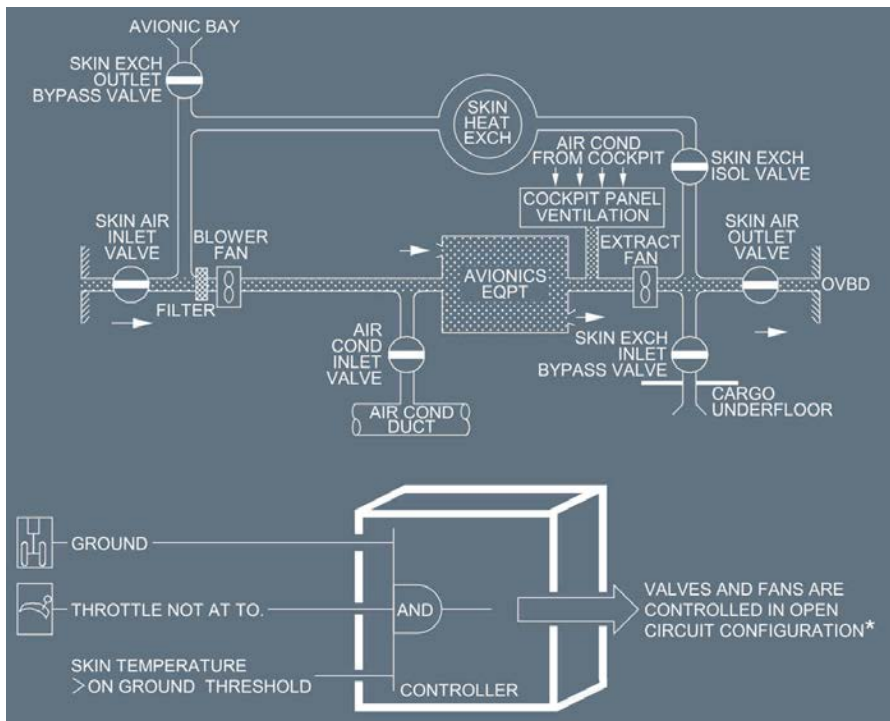

(*)

Note: In some cases, the opening of the skin air valves can be delayed even if the skin temperature is above the on-ground thresholds: This is to avoid condensation phenomenon when the temperature inside the avionics compartment is too cold.

NORMAL OPERATION, CLOSE-CIRCUIT CONFIGURATION

Ident.: DSC-21-30-20-00000345.0001001 / 09 OCT 12

Applicable to: ALL

FLIGHT OPERATIONS

The close-circuit configuration operates when skin temperature is beneath the in-flight threshold.

In flight threshold = +35 °C (95 °F), temperature increasing, or
+32 °C (90 °F), temperature decreasing.

GROUND OPERATIONS

The close-circuit configuration operates when skin temperature is beneath the on-ground threshold.

On ground threshold = +12 °C (53 °F), temperature increasing, or
+9 °C (48 °F), temperature decreasing.

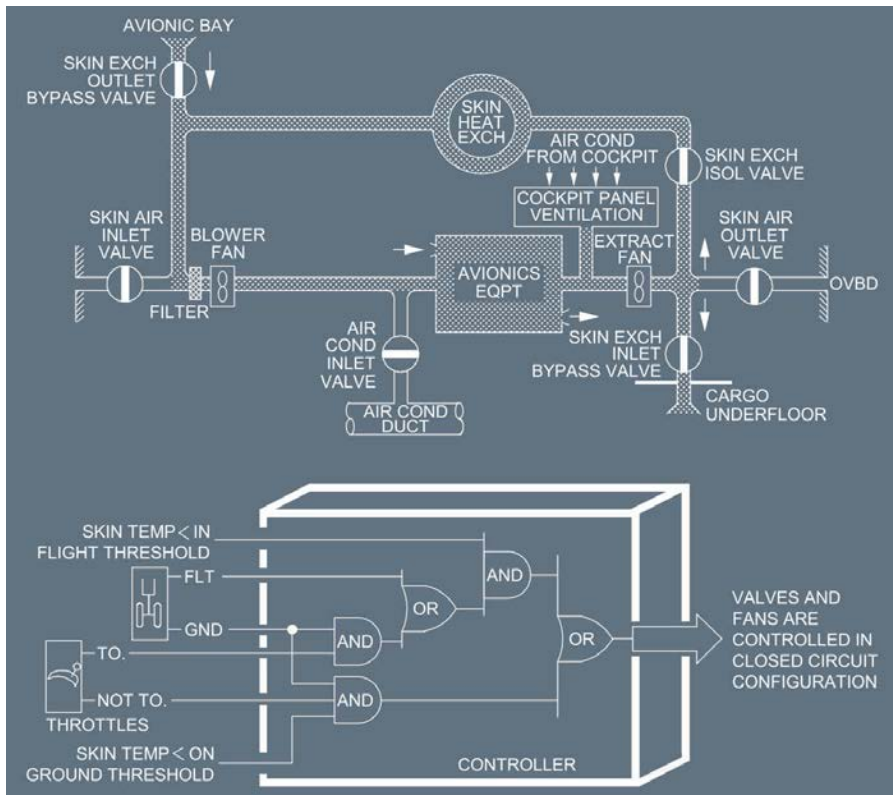

NORMAL OPERATION, INTERMEDIATE CONFIGURATION

Ident.: DSC-21-30-20-00000344.0001001 / 09 OCT 12

Applicable to: ALL

FLIGHT OPERATIONS

The intermediate configuration operates when skin temperature is above the in-flight threshold.

In flight threshold = +35 °C (95 °F), temperature increasing, or
+32 °C (90 °F), temperature decreasing.

Note: The measuring range of the skin temperature sensed is between -50 °C and 80 °C. Outside of this range, the AEVC sets the avionics ventilation configuration to the intermediate configuration (partially open) until the temperature is within the operation range again.

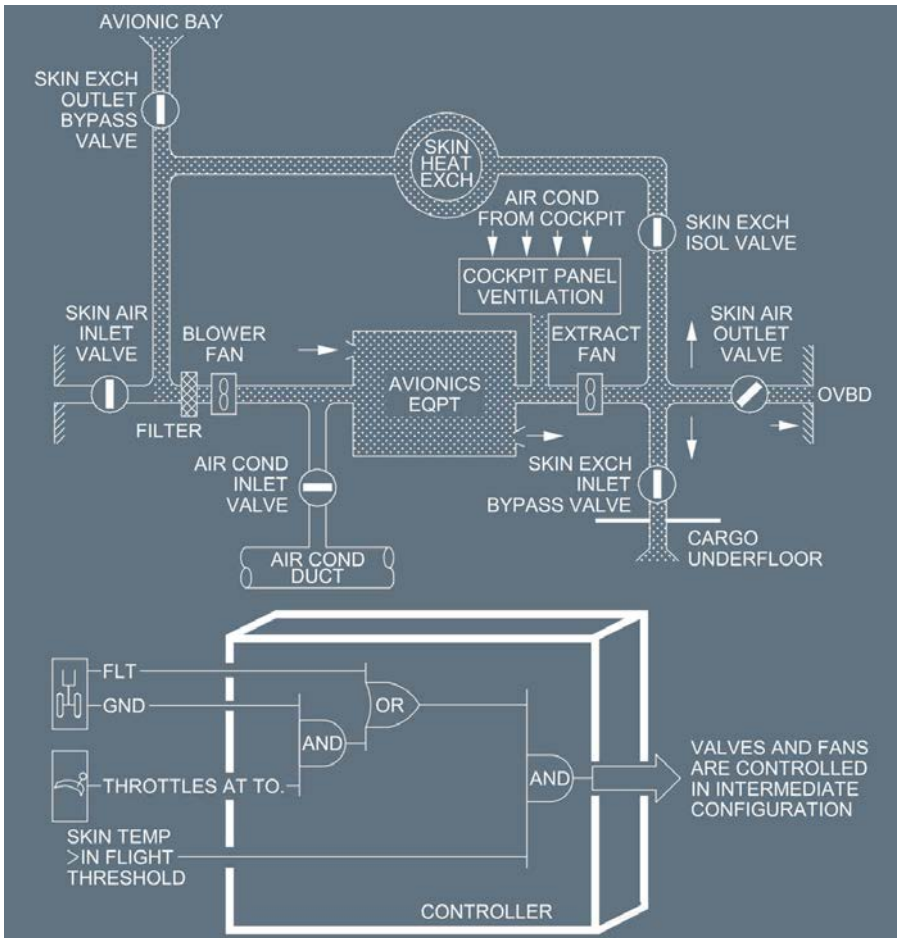

ABNORMAL OPERATION

Applicable to: ALL

Ident.: DSC-21-30-20-A-00000346.0001001 / 20 JAN 15

BLOWER FAULT OR EXTRACT FAULT ALERT

When the BLOWER or the EXTRACT pushbutton switch is set at the OVRD (override) position, the system is in closed-circuit configuration and adds air from the air conditioning system to the ventilation air.

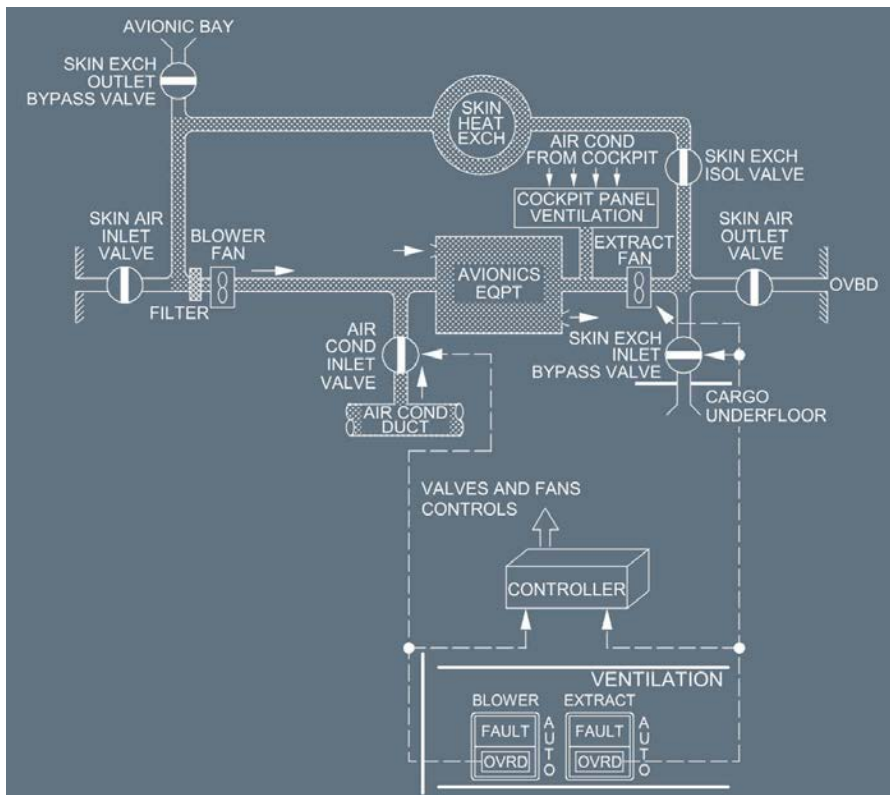

When the BLOWER pushbutton switch is set at OVRD, the blower fan is stopped and the extract fan continues to run.

When the EXTRACT pushbutton switch is set at OVRD, the extract fan is controlled directly from the pushbutton. Both fans continue to run.

Ident.: DSC-21-30-20-A-00000347.0001001 / 09 OCT 12

SMOKE CONFIGURATION

When the smoke detector detects smoke in the avionics ventilation air the BLOWER and the EXTRACT FAULT lights come on.

When both the BLOWER and the EXTRACT pushbuttons are set to the OVRD position, the air conditioning system supplies cooling air, which is then exhausted overboard. The blower fan stops.

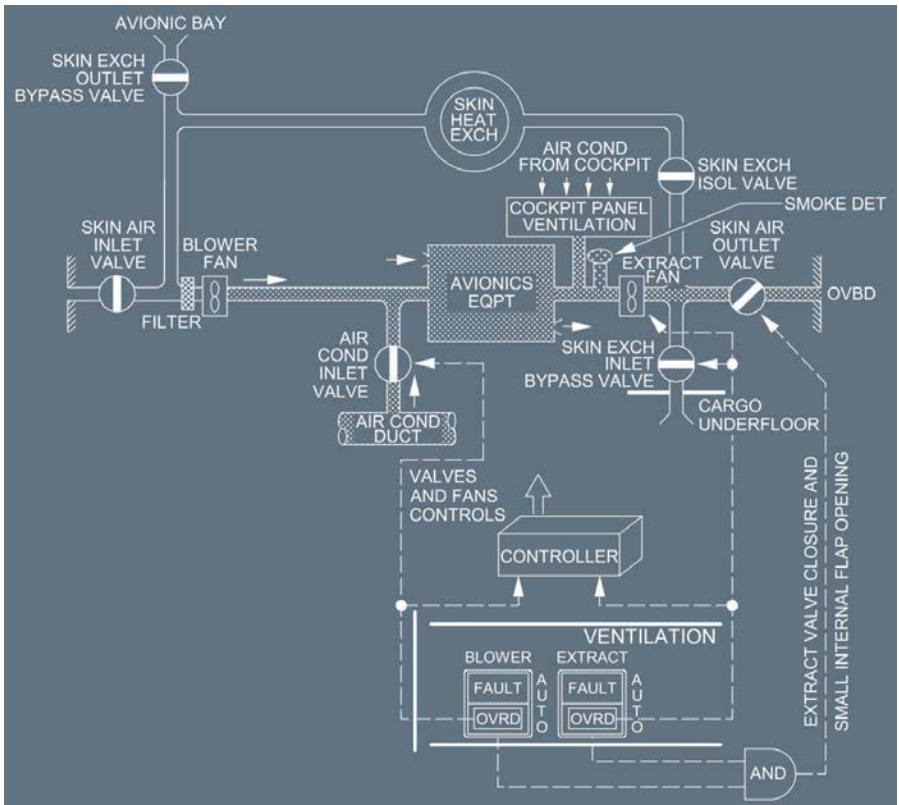

Ident.: DSC-21-30-20-A-00000348.0001001 / 21 MAR 16

CONTROLLER FAILURE

The system goes to the same configuration as above, except that the skin exchange isolation valve stays open.

The inlet valve and the skin exchange inlet bypass valve remain in the position they were in before the failure occurred.

The extract fan keeps running.



A318/A319/A320/A321
FLIGHT CREW
OPERATING MANUAL

AIRCRAFT SYSTEMS

AIR CONDITIONING / PRESSURIZATION / VENTILATION

VENTILATION - BATTERY VENTILATION

BATTERY VENTILATION

Ident.: DSC-21-30-40-00000350.0001001 / 21 MAR 16

Applicable to: ALL

A venturi in the skin of the aircraft draws air from the space around the batteries and vents it overboard. The resulting airflow ventilates the batteries.



A318/A319/A320/A321
FLIGHT CREW
OPERATING MANUAL

AIRCRAFT SYSTEMS

AIR CONDITIONING / PRESSURIZATION / VENTILATION

VENTILATION - BATTERY VENTILATION

Intentionally left blank

LAVATORY AND GALLEY

Ident.: DSC-21-30-50-00000351.0001001 / 09 OCT 12

Applicable to: ALL

An extraction fan draws ambient cabin air through the lavatories and galleys and exhausts it near the outflow valve.

The extraction fan runs continually when electric power is available.

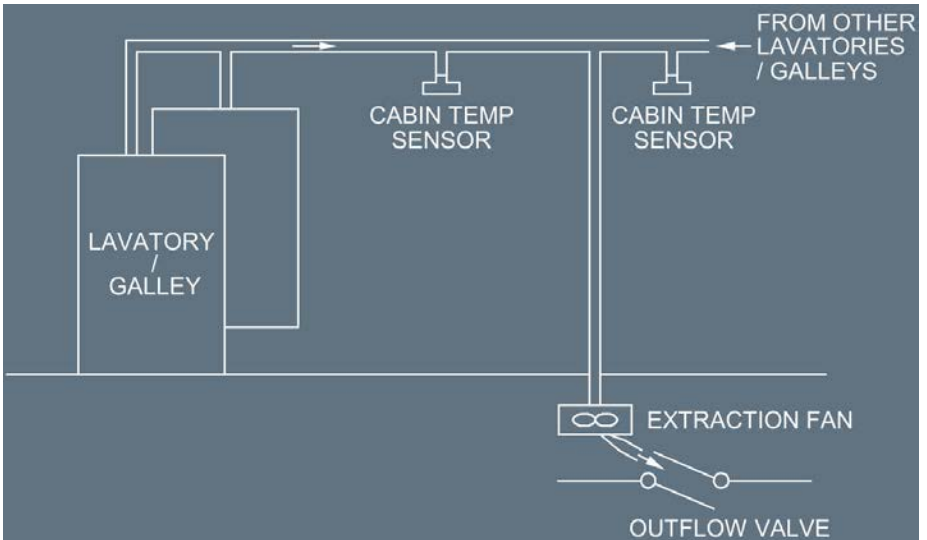



A318/A319/A320/A321
FLIGHT CREW
OPERATING MANUAL

AIRCRAFT SYSTEMS

AIR CONDITIONING / PRESSURIZATION / VENTILATION

VENTILATION - LAVATORY AND GALLEY VENTILATION

Intentionally left blank

OVERHEAD PANEL

Ident.: DSC-21-30-60-00000352.0001001 / 24 FEB 11

Applicable to: ALL

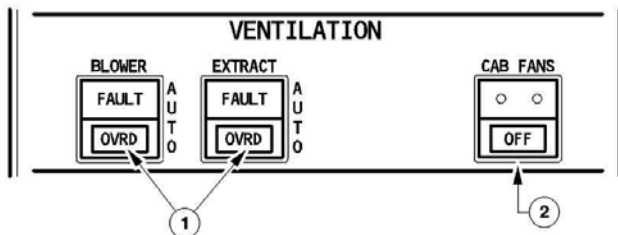

(1) BLOWER pb-sw and EXTRACT pb-sw

AUTO: : When both pushbutton switches are on AUTO:

- On the ground before the application of TO power, the ventilation system is in open circuit configuration (closed configuration when the skin temperature is below the ground threshold).
- On the ground after the application of TO power, and in flight, the ventilation system is in closed circuit configuration.

OVRD: : When either pushbutton switch is on OVRD:

- The system goes to closed circuit configuration.
- Air from the air conditioning system is added to ventilation air. (The blower fan stops if the BLOWER pushbutton switch is in the OVRD position).

When both pushbutton switches are on OVRD:

- Air flows from the air conditioning system and then overboard.
- The extract fan continues to run.

FAULT : Lights up amber (and ECAM activates)

- It:
- in the blower switch, if :
 - blowing pressure is low (See *)
 - duct overheats (See *)
 - computer power supply fails
 - smoke warning is activated
 - in the extract switch, if :
 - extract pressure is low (See *)
 - computer power supply fails
 - smoke warning is activated.

* If the warning occurs on the ground when the engines are stopped, the external horn sounds.

(2) *Refer to DSC-21-10-50 Controls on Overhead Panel*

ECAM CAB PRESS PAGE

Ident.: DSC-21-30-60-00000353.0003001 / 03 APR 13

Applicable to: ALL

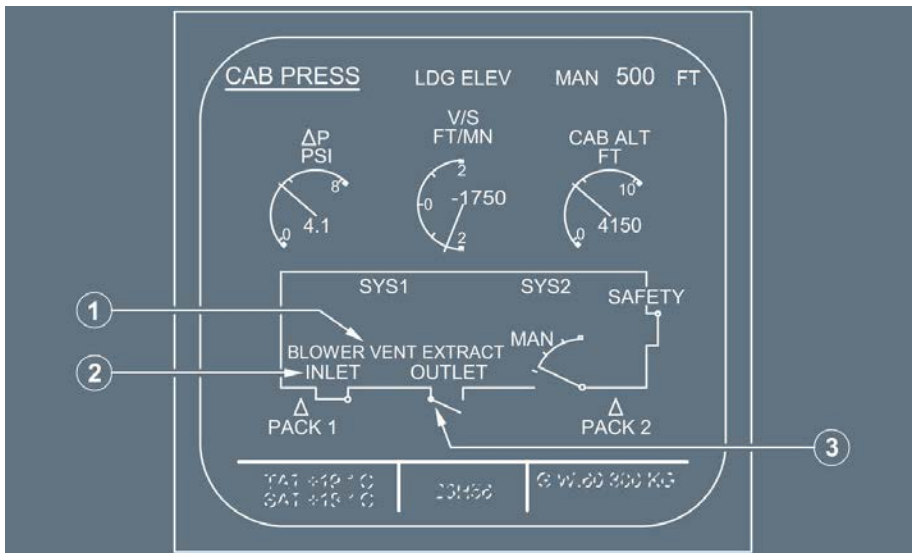

(1) BLOWER, VENT and EXTRACT Indications

VENT message normally appears in white. It becomes amber, if there is a BLOWER FAULT, EXTRACT FAULT, or AVNCS SYS FAULT.

BLOWER message appears in amber if there is a BLOWER FAULT.

EXTRACT message appears in amber if there is an EXTRACT FAULT.

(2) INLET and OUTLET Indications

Normally white. The corresponding indication becomes amber, when the inlet valve or the outlet valve is failed.

(3) INLET and OUTLET Valve Diagrams



This indicates that the valve is fully closed.
It is normally green, but is amber if there is a disagreement.



This indicates that the valve is fully open.
It is normally green, but is amber if there is a disagreement.

NOTE: Because of the accuracy of the temperature sensors, on the ground the closed or open indication may become amber when the temperature is close to the valve opening or closing threshold.



This indicates that the inlet valve is in transit (inlet valve only).
It is amber.



This indicates that the outlet valve is partially open (the outlet valve is closed but a small internal flap is open).



If the valve position is not available or the received status for the valve is inconsistent, XX appears in amber.



A318/A319/A320/A321
FLIGHT CREW
OPERATING MANUAL

AIRCRAFT SYSTEMS

AIR CONDITIONING / PRESSURIZATION / VENTILATION

VENTILATION - CONTROLS AND INDICATORS

Intentionally left blank

GENERAL

Ident.: DSC-21-40-10-00017795.0001001 / 21 MAR 16

Applicable to: ALL

CARGO VENTILATION 

An extraction fan draws air from forward cargo compartment or aft cargo compartment, and exhausts it overboard. Air from the cabin replaces the exhausted air, thus ventilating the cargo compartments.

CARGO TEMPERATURE REGULATION 

The system can mix hot bleed air with the air coming from the cabin, therefore giving the flight crew control of the temperature in the forward or aft cargo compartment.

SCHEMATIC

Ident.: DSC-21-40-10-00000357.0001001 / 22 MAY 12

Applicable to: ALL

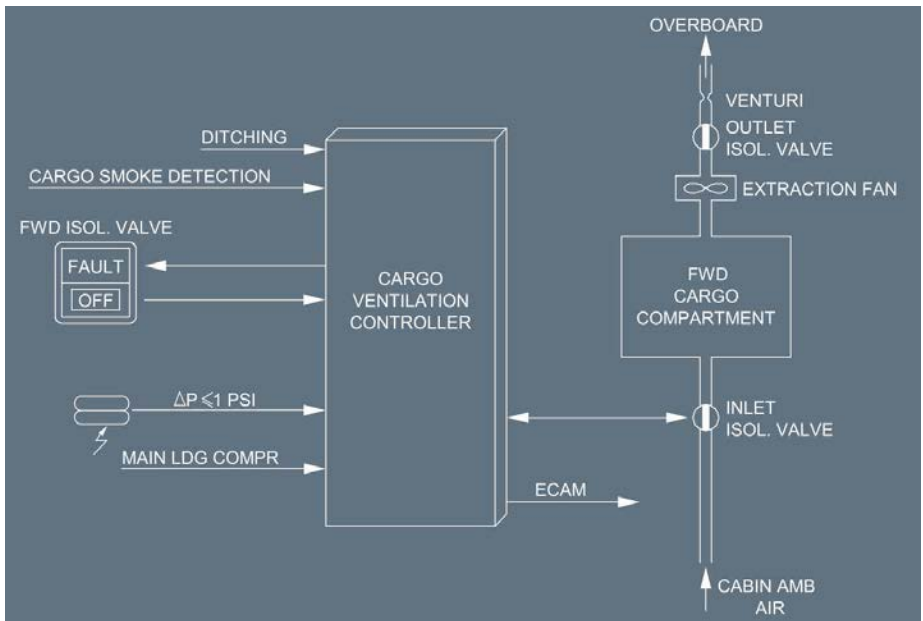



A318/A319/A320/A321
FLIGHT CREW
OPERATING MANUAL

AIRCRAFT SYSTEMS

AIR CONDITIONING / PRESSURIZATION / VENTILATION

CARGO - GENERAL

Intentionally left blank

FWD CARGO VENTILATION 

Ident.: DSC-21-40-20-00017796.0001001 / 21 MAR 16

Applicable to: ALL

Air from the cabin goes via the inlet isolation valve to the forward cargo compartment, driven either by an extraction fan or by differential pressure in flight. A skin-mounted venturi discharges the air overboard via the outlet isolation valve. The cargo ventilation controller controls the operation of the inlet and outlet isolation valves and the extraction fan.

The ventilation system operates in two modes:

- On the ground or when $\Delta P \leq 1$ PSI in flight, the controller opens the isolation valves, then starts the extraction fan
- In flight when $\Delta P > 1$ PSI, the controller stops the fan, and differential pressure maintains the ventilation.

The controller closes the isolation valves and stops the extraction fan when:

- The flight crew sets the FWD ISOL VALVE pb-sw to OFF, or
- The forward cargo smoke detection unit detects smoke.

The outlet valve closes and the extraction fan stops when the flight crew sets the DITCHING pb-sw to ON.

AFT CARGO VENTILATION 

Ident.: DSC-21-40-20-00017797.0001001 / 21 MAR 16

Applicable to: ALL

Air from the cabin goes via the inlet isolation valve to the aft cargo compartment, driven by an extraction fan. Air is controlled by the outlet isolation valve and then goes outboard through the outflow valve.

The cargo ventilation controller controls the operation of the inlet and outlet isolation valves and the extraction fan.

When the isolation valves are fully open, the extraction fan operates continuously when the aircraft is on the ground and during flight.

The controller closes the isolation valves and stops the extraction fan when:

- The flight crew sets the AFT ISOL VALVE pb-sw to OFF, or
- The aft cargo smoke detection unit detects smoke.

AFT CARGO HEATING 

Ident.: DSC-21-40-20-00017798.0001001 / 21 MAR 16

Applicable to: **ALL**

The ventilation system for the aft cargo compartment uses hot engine bleed air (upstream of the packs), mixing it with the ambient cabin air that flows through the cargo compartment.

The cargo regulating valve regulates the pressure of this hot air supply, and the trim air valve, which is modulated electrically by the controller, controls the flow.

The cargo pressure regulating valve is pneumatically operated and electrically controlled from the HOT AIR pb on the CARGO HEAT panel.

The hot air is controlled by the cargo trim air valve which is modulated electrically by the controller.

The hot air is then mixed with air from the cabin and supplied to the cargo compartment through the ventilation inlet isolation valve.

According to the temperature selector demand, the controller regulates the amount of hot air added by the trim air valve, until the desired temperature is reached.

If the inlet temperature exceeds 70 °C, the controller closes the trim air valve.

If the inlet temperature exceeds 88 °C, the controller interprets this as a duct overheat and closes the pressure regulating valve. This valve then remains closed until the flight crew resets the system by pressing the HOT AIR pb — which it cannot do until the temperature drops below 70 °C.

FWD CARGO HEATING 

Ident.: DSC-21-40-20-00017799.0001001 / 21 MAR 16

Applicable to: **ALL**

The ventilation system for the forward cargo compartment uses hot engine bleed air, which is also used for cockpit and cabin temperature control, mixing it with the ambient cabin air that flows through the cargo compartment.

The cockpit and cabin hot air pressure regulating valve regulates the pressure of this hot air supply, and the cargo trim air valve, which is modulated electrically by the controller, controls the flow.

The hot air mixes with air from the cabin as it supplied to the cargo compartment through the ventilation inlet isolation valve.

The controller regulates the amount of hot air added by the trim air valve to get the desired temperature, per the temperature selector.

If the inlet temperature exceeds 70 °C, the controller closes the trim air valve. If the inlet temperature reaches 88 °C, the controller interprets this as a duct overhead and closes the pressure regulating valve. This valve then remains closed until the flight crew resets the system by pressing the HOT AIR pb - which it cannot do until the temperature drops below 70 °C.

OVERHEAD PANEL

Ident.: DSC-21-40-30-00017800.0001001 / 20 MAR 17

Applicable to: ALL

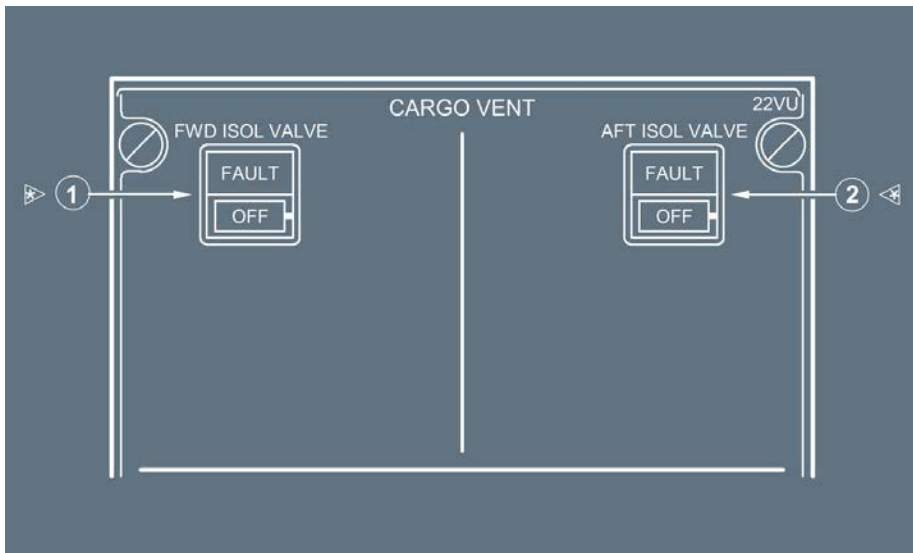

(1) **FWD ISOL VALVE pb-sw** 

The switch controls the forward isolation valves and the extraction fan.

Auto : The inlet and outlet isolation valves open, extraction fan runs if there is no smoke detected in the fwd cargo bay.

OFF : The inlet and outlet isolation valves and the trim air valve close, the extraction fan stops.

FAULT It : The light, associated with the ECAM caution, comes on amber when either inlet or outlet valve is not in the selected position.

(2) **AFT ISOL VALVE pb-sw** 

The switch controls the isolation valves and the extraction fan.

Auto : The inlet and outlet isolation valves open, extraction fan runs if there is no smoke detected in the aft cargo bay.

OFF : The inlet and outlet isolation valves and the trim air valve close, the extraction fan stops.

AIRCRAFT SYSTEMS

AIR CONDITIONING / PRESSURIZATION / VENTILATION

CARGO - CONTROLS AND INDICATORS

FAULT It : The light, associated with the ECAM caution, comes on amber when either inlet or outlet valve is not in the selected position.

ECAM COND PAGE

Ident.: DSC-21-40-35-00006005.0009001 / 22 MAY 12

Applicable to: ALL

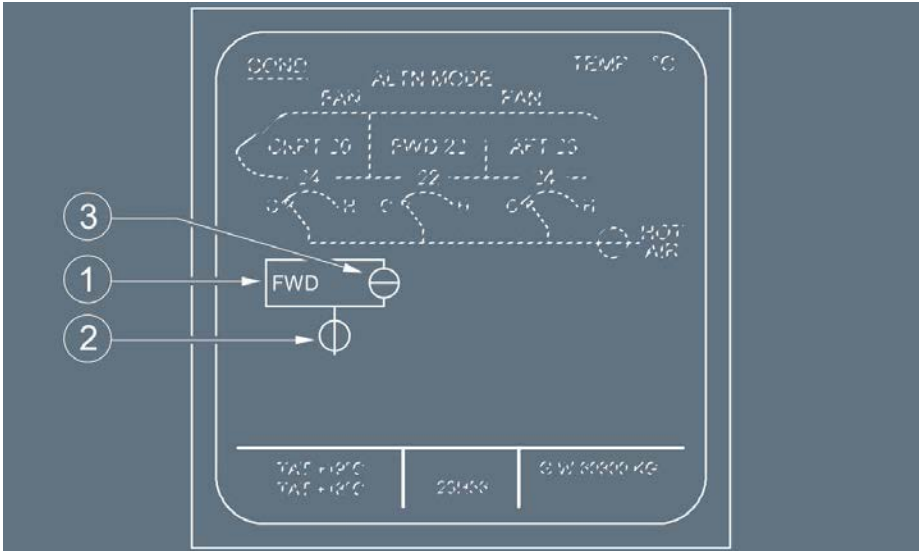

- (1) Zone indication
It is white.
- (2) Inlet isolation valve
In line – Green : Valve is open.
Crossline – Amber : Valve is closed.
- (3) Outlet isolation valve
Crossline – Green : Valve is open.
In line – Amber : Valve is closed.

Intentionally left blank

AIRCRAFT SYSTEMS

AUTO FLIGHT - GENERAL

Intentionally left blank

DSC-22_10-10 Description

| | |
|---|---|
| FMGC Standard..... | A |
| Preamble..... | B |
| Description..... | C |
| General Philosophy..... | D |
| Flight Management Guidance Computer (FMGC)..... | E |
| Multipurpose Control and Display Unit (MCDU)..... | F |
| Flight Control Unit (FCU)..... | G |
| Flight Augmentation Computer (FAC)..... | H |
| Other Flight Crew Interfaces..... | I |
| Flight Crew Interface with FMGC..... | J |

DSC-22_10-20 System Interface Diagram

| | |
|-------------------------------|---|
| System Interface Diagram..... | A |
|-------------------------------|---|

DSC-22_10-30 FMGS Modes of Operation

| | |
|------------------------------|---|
| General..... | A |
| Dual Mode..... | B |
| Independent Mode..... | C |
| Single Mode..... | D |
| Back Up Navigation Mode..... | E |

DSC-22_10-40 Pilot Interface

DSC-22_10-40-05 Management of the Displays

| | |
|--------------|---|
| General..... | A |
|--------------|---|

DSC-22_10-40-10 MCDU

| | |
|-----------|---|
| MCDU..... | A |
|-----------|---|

DSC-22_10-40-20 FCU

| | |
|------------------------------|---|
| FCU..... | A |
| FCU Philosophy..... | B |
| Speed/Mach Control Area..... | C |
| Lateral Control Area..... | D |
| AP-A/THR Control Area..... | E |
| Vertical Control Area..... | F |

DSC-22_10-40-30 Thrust Levers

| | |
|--------------------|---|
| Thrust Levers..... | A |
|--------------------|---|

Continued on the following page

Continued from the previous page

DSC-22_10-40-40 Primary Flight Display

 PFD..... A

 Climb Phase..... B

 Approach Phase..... C

DSC-22_10-40-50 Navigation Display

 ND..... A

 Arc Mode..... B

 Plan Mode..... C

 Rose Modes..... D

 Flight Plan Display Colors..... E

DSC-22_10-50 Speeds Definition

DSC-22_10-50-10 General

 General..... A

DSC-22_10-50-20 Characteristic Speeds

 Characteristic Speeds..... A

DSC-22_10-50-30 Limit Speeds

 Limit Speeds..... A

DSC-22_10-50-40 Protection Speeds

 Protection Speeds..... A

DSC-22_10-50-50 Other Speeds

 Other Speeds..... A

| | |
|---|--|
|  <p>A318/A319/A320/A321 FLIGHT CREW OPERATING MANUAL</p> | <p style="text-align: center;">AIRCRAFT SYSTEMS AUTO FLIGHT - GENERAL</p> <p style="text-align: center;">DESCRIPTION</p> |
|---|--|

FMGC STANDARD

Ident.: DSC-22_10-10-00014871.0005001 / 24 JUL 13
Applicable to: ALL

The aircraft is equipped with FMS 2 HONEYWELL Release 1A H2 and FG C12.

PREAMBLE

Ident.: DSC-22_10-10-00010067.0001001 / 17 AUG 10
Applicable to: ALL

This section gives a general description of the Auto Flight System and its functions:

- Architecture
- Function description
- Basic principle of systems:
 - Reversion
 - Protection
 - Managed and selected guidance modes.
- Mode information
- Display characteristics
- Operational principles
- Flight crew interface (MCDU pages)
- Degraded modes of operations.

DESCRIPTION

Ident.: DSC-22_10-10-00010068.0001001 / 17 AUG 10
Applicable to: ALL

The Flight Management Guidance System (FMGS) contains the following units:

- Two Flight Management Guidance Computers (FMGC)
- Two Multipurpose Control and Display Units (MCDU) (third MCDU optional)
- One Flight Control Unit (FCU)
- Two Flight Augmentation Computers (FAC).

GENERAL PHILOSOPHY

Ident.: DSC-22_10-10-00010069.0001001 / 17 AUG 10
Applicable to: ALL

The Flight Management and Guidance System (FMGS) provides predictions of flight time, mileage, speed, economy profiles and altitude.
 It reduces cockpit workload, improves efficiency, and eliminates many routine operations generally performed by the flight crew.

The Flight Management Guidance System (FMGS) operates as follows:

- During cockpit preparation the flight crew uses the Multipurpose Control and Display Unit (MCDU) to insert a preplanned route from origin to destination. This route includes SID , EN ROUTE, WAYPOINTS, STAR , APPROACH, MISSED APPR , and ALTN route as available from the navigation database.
- Subsequently the system defines a vertical profile and a speed profile, taking into account ATC requirements and performance criteria.

Either FMGC performs all operations, if one FMGC fails.

The FMGS computes the aircraft position continually, using stored aircraft performance data and navigation data. Therefore it can steer the aircraft along a preplanned route and vertical and speed profiles. This type of guidance is said to be “managed”.

If the flight crew wants to modify any flight parameter (SPD , V/S , HDG , etc.) temporarily, they may do so by using the various Flight Control Unit (FCU) selectors. The FMGS then guides the aircraft to the target value of this parameter that they have selected. This type of guidance is said to be “selected”.

The two available types of guidance, then, are:

- Managed guidance guides the aircraft along the preplanned route and the vertical and speed/Mach profile. (The FMGS computes the target values of the various flight parameters).
- Selected guidance guides the aircraft to the target values of the various flight parameters the flight crew selects by using the FCU selectors.

Selected guidance always has priority over managed guidance.

FLIGHT MANAGEMENT GUIDANCE COMPUTER (FMGC)

Ident.: DSC-22_10-10-00010073.0002001 / 17 AUG 10

Applicable to: **ALL**

Each FMGC is divided into two main parts:

- The Flight Management (FM) part controls the following functions:
 - Navigation and management of navigation radios
 - Management of flight planning
 - Prediction and optimization of performance
 - Display management.
- The Flight Guidance (FG) part performs the following functions:
 - Autopilot (AP) command
 - Flight Director (FD) command
 - Autothrust (A/THR) command.

Each FMGC has its own set of databases. The individual databases can be independently loaded into their respective FMGC , or independently copied from one FMGC to the other.

| | |
|---|--|
|  <p>A318/A319/A320/A321 FLIGHT CREW OPERATING MANUAL</p> | <p align="center">AIRCRAFT SYSTEMS AUTO FLIGHT - GENERAL</p> <p align="center">DESCRIPTION</p> |
|---|--|

Each FMGC contains these main databases:

1. The Navigation database (2.8 Mbytes) contains standard navigation data: Navaids, waypoints, airways, enroute information, holding patterns, airports, runways, procedures (SID s, STARs, etc.), company routes, alternates.
The airline updates this part every 28 days, and is responsible for defining, acquiring, updating, loading, and using this data. The updating operation takes 20 min to complete or 5 min if cross loaded from the opposite FMGC.
2. The Airline Modifiable Information (AMI), also described as the FM Airline Configuration file, contains:
 - Airline policy values: THR RED altitude, ACC altitude, EO ACC altitude, PERF factor, IDLE factor.
 - Fuel policy values: Fuel for taxi, % of route reserve, maximum and minimum values of route reserve, etc.
 - AOC functions customization.
3. The Aircraft Performance database includes the Engine model, Aerodynamical model, and Performance model. The airline cannot modify this database.
4. The Magnetic Variation database.
5. Each FMGC contains elements stored by the flight crew that enable them to create 20 waypoints, 10 runways, 20 nav aids, and 5 routes.

| |
|---|
| MULTIPURPOSE CONTROL AND DISPLAY UNIT (MCDU) |
|---|

Ident.: DSC-22_10-10-00010074.0002001 / 17 AUG 10

Applicable to: ALL

Two MCDU s are installed on the pedestal for flight crew loading and display of data. The use of the MCDU allows the flight crew to interface with the FMGC by selection of a flight plan for lateral and vertical trajectories and speed profiles. The flight crew may also modify selected navigation or performance data and specific functions of Flight Management (revised flight plan, engine-out, secondary flight plan, etc.). Additional data from peripherals (Centralized Fault Display System (CFDS), ARINC Communication Addressing and Reporting System (ACARS), Air Traffic Service Unit (ATSU)...) can also be displayed. Data that is entered into the MCDU that is illogical or beyond the aircraft capabilities will either be disregarded or will generate an advisory message. The MCDU s allow the activation of the back-up navigation in the case of a dual FM Failure.

| |
|----------------------------------|
| FLIGHT CONTROL UNIT (FCU) |
|----------------------------------|

Ident.: DSC-22_10-10-00010075.0001001 / 17 AUG 10

Applicable to: ALL

The FCU located on the glareshield, is the short-term interface between the flight crew and the FMGC . It is used to select any flight parameters or modify those selected in the MCDU. The

autopilots and autothrust functions may be engaged or disengaged. Different guidance modes can be selected to change various targets (speed, heading, track, altitude, flight path angle, vertical speed).

FLIGHT AUGMENTATION COMPUTER (FAC)

Ident.: DSC-22_10-10-00010076.0001001 / 17 AUG 10

Applicable to: ALL

The FAC controls rudder, rudder trim and yaw damper inputs. It computes data for the flight envelope and speed functions. The FAC also provides warning for low-energy and windshear detection if these functions are installed.

OTHER FLIGHT CREW INTERFACES

Applicable to: ALL

Ident.: DSC-22_10-10-A-00010077.0001001 / 23 JUN 15

THRUST LEVERS

The thrust levers are the main interface between the Flight Management Guidance Computer (FMGC), the Full Authority Digital Engine Control System (FADEC), and the flight crew.

The thrust levers:

- Arm the autothrust at takeoff, when FLX or TOGA is selected
- Limit the maximum thrust by their position when autothrust is active
- Disconnect the autothrust system when the flight crew sets them to IDLE
- Command the thrust manually when autothrust is not active
- Engage the common modes (takeoff or go-around) when TOGA (or FLX for takeoff) is set
- Set the autothrust to the active mode when they are between IDLE and CL detent (MCT in engine out).

Ident.: DSC-22_10-10-A-00010078.0001001 / 17 AUG 10

ELECTRONIC FLIGHT INSTRUMENTS (EFIS)

Two Primary Flight Displays (PFD) and Navigation Displays (ND) provide the flight crew with full-time flight guidance, navigation and system advisory information for all flight phases. An EFIS control panel is located at each end of the glareshield and is used to control both Primary and Navigation Displays. This panel includes controls to select various modes within the PFD. A selector allows the barometric altimeter setting to be displayed on the PFD. Various distance ranges can be selected on the ND, and two switches allow either the left or right VOR /ADF bearing pointers to be displayed on the ND.

Ident.: DSC-22_10-10-A-00010079.0001001 / 17 AUG 10

PRIMARY FLIGHT DISPLAYS

The PFDs combine several conventional flight instrument indications on one color display panel, for centralized reference of flight data.

This centralized color display includes:

- Flight Director attitude guidance targets
- Armed and engaged modes
- Navigation and instrument approach information
- Altimeter setting
- Barometric altitude
- System messages.

Ident.: DSC-22_10-10-A-00010080.0002001 / 17 AUG 10

NAVIGATION DISPLAYS

Five different color navigation compass displays can be selected:

- ARC (map mode)
- ROSE NAV (map mode)
- ROSE VOR
- ROSE LS
- PLAN.

Information displayed on these modes uses the aircraft's position as a reference point for the flight plan navigation data (lateral and vertical information).

FLIGHT CREW INTERFACE WITH FMGC

Ident.: DSC-22_10-10-00010082.0002001 / 14 MAY 12

Applicable to: ALL

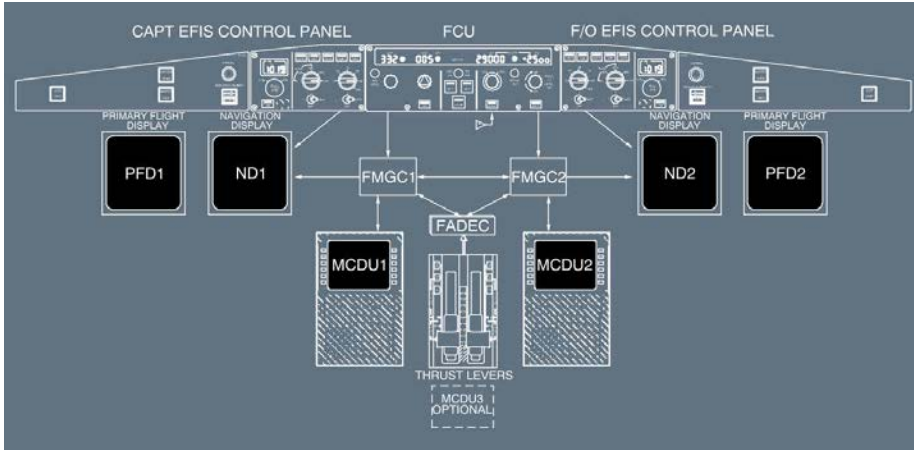

SYSTEM INTERFACE DIAGRAM

Ident.: DSC-22_10-20-00010084.0001001 / 01 OCT 12

Applicable to: ALL

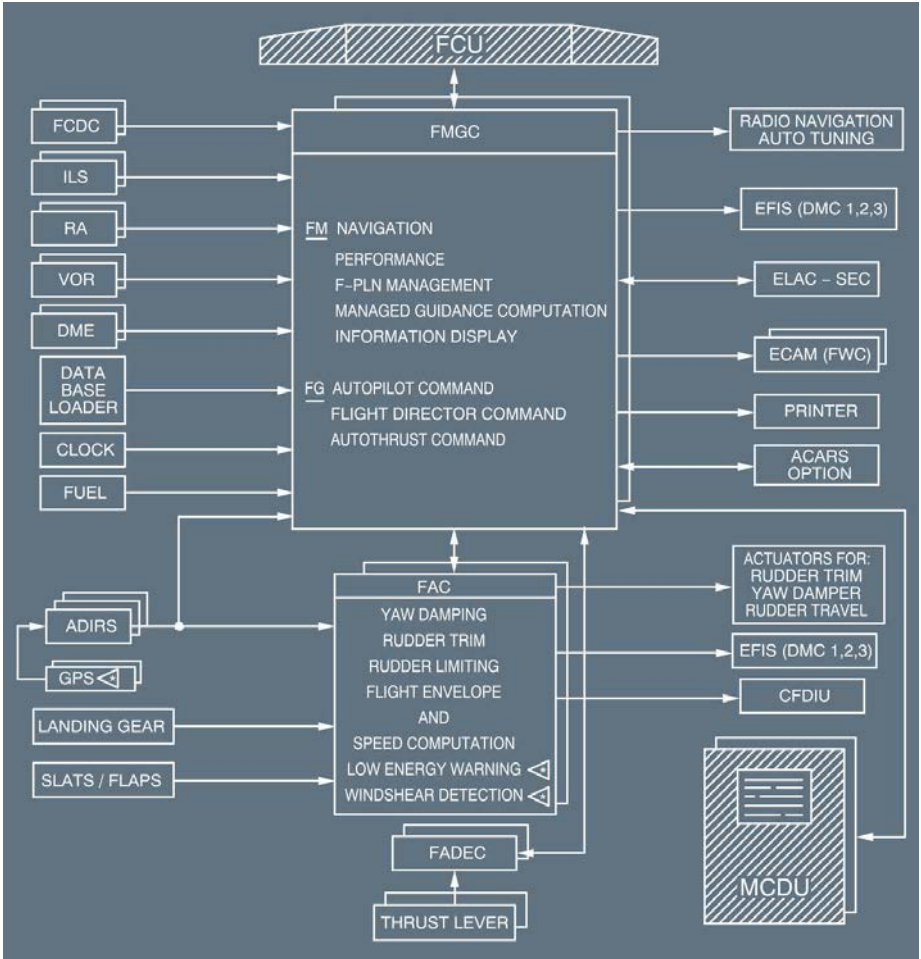



A318/A319/A320/A321
FLIGHT CREW
OPERATING MANUAL

AIRCRAFT SYSTEMS
AUTO FLIGHT - GENERAL
SYSTEM INTERFACE DIAGRAM

Intentionally left blank

GENERAL

Ident.: DSC-22_10-30-00010085.0002001 / 17 AUG 10

Applicable to: ALL

The FMGS has four modes of operation:

- Dual mode (the normal mode)
- Independent mode. Each FMGC being controlled by its associated MCDU
- Single mode (using one FMGC only)
- Back-up navigation mode.

DUAL MODE

Ident.: DSC-22_10-30-00010086.0001001 / 01 OCT 12

Applicable to: ALL

This is the normal mode. The two FMGCs are synchronized: each performs its own computations and exchanges data with the other through a crosstalk bus.

One FMGC is the master, the other the slave, so that some data in the slave FMGC comes from the master.

All data inserted into any MCDU is transferred to both FMGCs and to all peripherals.

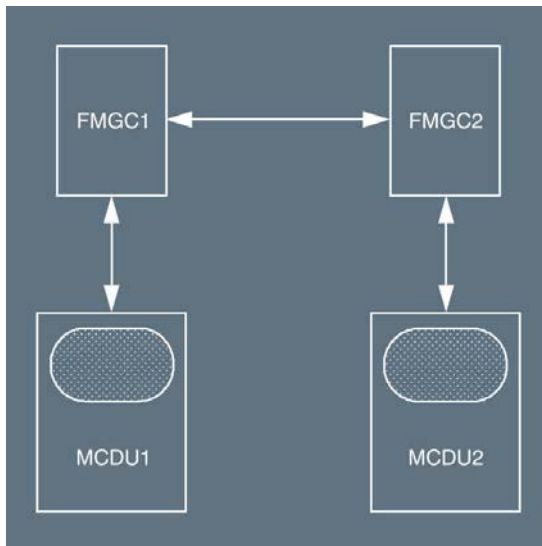

MASTER FMGC LOGIC

- If one autopilot (AP) is engaged, the related FMGC is master:
 - It uses the onside FD for guidance
 - It controls the A/THR
 - It controls the FMA 1 and 2.
- If two AP s are engaged, FMGC1 is master.
- If no AP is engaged, and
 - The FD1 pb is on, then FMGC1 is master
 - The FD1 pb is off, and FD2 pb on then FMGC2 is master.
- If no AP /FD is engaged, A/THR is controlled by FMGC1.

INDEPENDENT MODE

Ident.: DSC-22_10-30-00010087.0001001 / 01 OCT 12

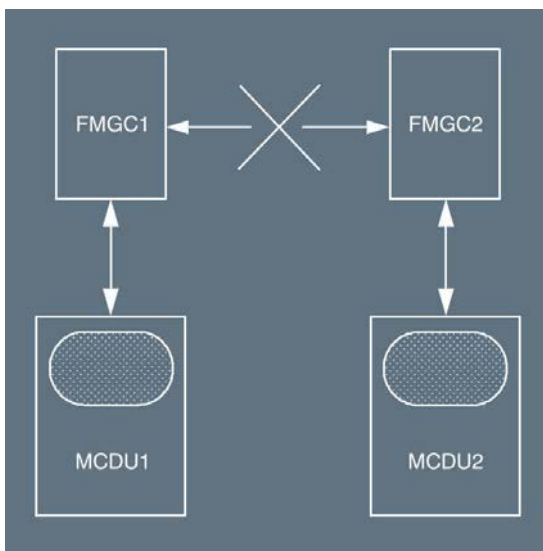

Applicable to: ALL



The system automatically selects this degraded mode under specific abnormal conditions (e.g. different database validity on both FMGCs).

Both FMGCs work independently and are linked only to peripherals on their own sides of the flight deck (“onside” peripherals).

When this occurs, the “INDEPENDENT OPERATION” message is displayed on both MCDU scratchpads.

Each MCDU transmits data it receives from its onside FMGC . It affects only the onside EFIS (Electronic Flight Instrument System) and RMP (Radio Management Panel).
On the POS MONITOR page (and GPS MONITOR page ), FMGS position (and GPS position ) from the opposite FMGC is not displayed.
On the RAD NAV page (and PROG page, if the FMGS GPS is not installed), nav aids tuned on the opposite MCDU are not displayed. Corresponding fields are blank.

PROCEDURES ON GROUND

- **If each FMGC is loaded with a different database**, the FMGS will only operate in independent mode.

CHECK the database number and validity.

CROSSLOAD  the database to restore the dual operation.

Crossload function is available on ground only (in preflight or done phase), when an independent operation is detected.

PROCEDURES IN FLIGHT

DO NOT SWITCH the navigation databases.

MAKE the same entries on both MCDU s to have both AP /FDs similar orders.

Both FG s being valid, 2 AP s may be engaged for CAT II or CAT III operations.

- **In the event of a go-around and when the second AP is disconnected:**

ENSURE that the FMGC in command has correct flight plan orders and an updated nav database.

Airbus does not recommend pulling one FMGC circuit breaker to force the system to operate in SINGLE mode.

SINGLE MODE

Ident.: DSC-22_10-30-00010088.0004001 / 01 OCT 12

Applicable to: ALL

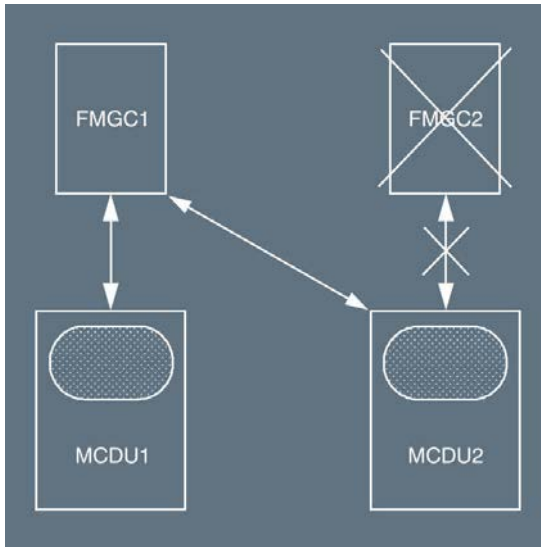

The system automatically selects this degraded mode when one FMGC fails. When this occurs, the failed FMGC displays "OPP FMGC IN PROCESS" in white on the MCDU scratchpad.

On the ND usually associated with the failed FM:

- If the ND s are not both in the same mode or range, the associated ND displays "MAP NOT AVAIL" and "SET OFFSIDE RNG/MODE".
- If the ND s are in the same mode and range, the associated ND displays the "OFFSIDE FM CONTROL" amber message.

Both POS MONITOR pages display the same position (operative FMGC position).

Both FD s are driven by the same FMGC . Any entry on either MCDU is sent to the operative FMGC.

PROCEDURES

● **If a transient failure triggers a single mode of operation:**

DO NOT USE the MCDU(s) until the PLEASE WAIT message is suppressed.

SET both NDs on the same range and mode to display the same information from the operative FMGC.

When convenient, RESET the failed FMGC. (*Refer to DSC-22_20-90-10 Manual FMGC Reset - General*).

BACK UP NAVIGATION MODE

Ident.: DSC-22_10-30-00010089.0001001 / 01 OCT 12

Applicable to: ALL

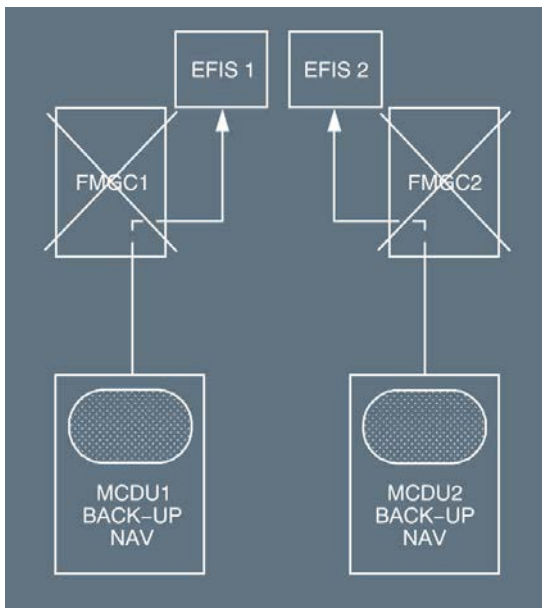

The flight crew selects on the MCDU MENU page this degraded mode when both FMGCs fail. They recover the navigation function through the MCDU and IRS /GPS \llcorner . The MCDU continuously memorizes the active flight plan in its memory.

If both FMGCs fail, the back up navigation provides the following functions:

- Flight Planning
- Aircraft position using inside IRS , IRS 3, or GPIRS position (if GPS \llcorner)
- F-PLN display on ND
- No AP /FD NAV mode
- Limited lateral revision
- F-PLN automatic sequencing.



A318/A319/A320/A321
FLIGHT CREW
OPERATING MANUAL

AIRCRAFT SYSTEMS
AUTO FLIGHT - GENERAL
FMGS MODES OF OPERATION

Intentionally left blank



A318/A319/A320/A321
FLIGHT CREW
OPERATING MANUAL

AIRCRAFT SYSTEMS
AUTO FLIGHT - GENERAL

PILOT INTERFACE - MANAGEMENT OF THE DISPLAYS

GENERAL

Ident.: DSC-22_10-40-05-00010083.0001001 / 17 AUG 10

Applicable to: ALL

The flight management system displays navigation, performance and guidance information on the:

- Multipurpose Control and Display Unit (MCDU)
- Navigation Display (ND) of the Electronic Flight Instrument System (EFIS)
- Primary Flight Display (PFD) of the EFIS.



A318/A319/A320/A321
FLIGHT CREW
OPERATING MANUAL

AIRCRAFT SYSTEMS
AUTO FLIGHT - GENERAL

PILOT INTERFACE - MANAGEMENT OF THE DISPLAYS

Intentionally left blank

MCDU

Applicable to: ALL

Ident.: DSC-22_10-40-10-A-00010090.0003001 / 14 MAY 12

MCDU INTERFACE

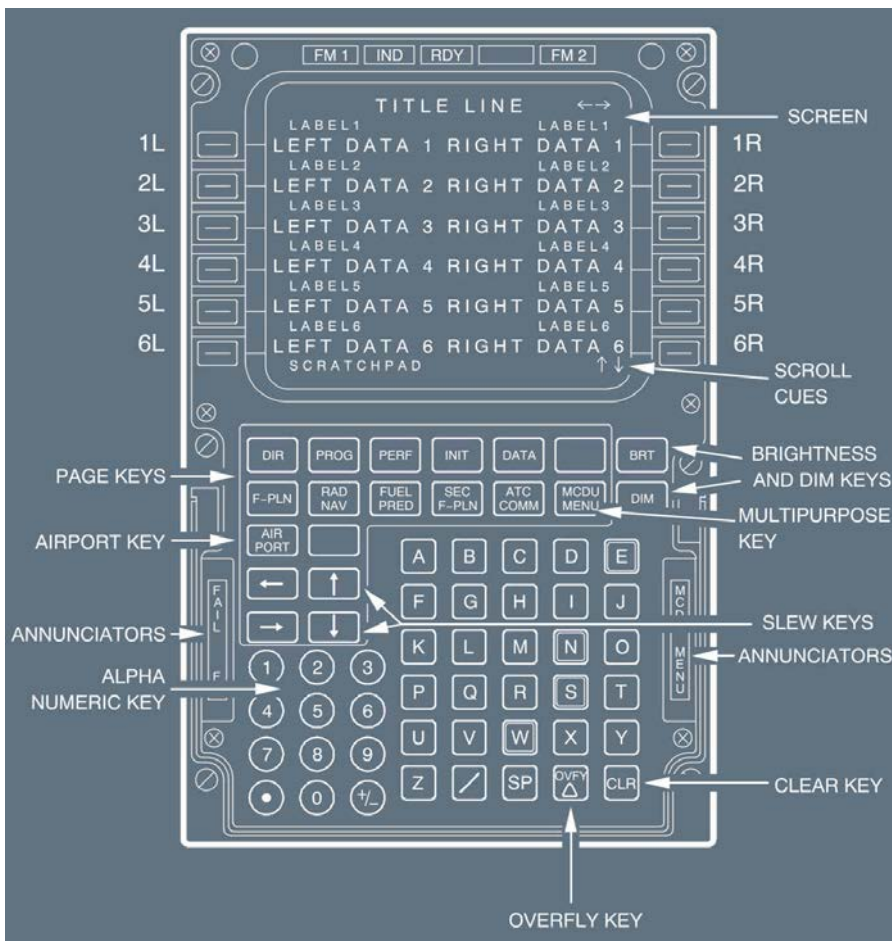

Ident.: DSC-22_10-40-10-A-00010091.0002001 / 13 DEC 12

GENERAL

The Multipurpose Control and Display Unit (MCDU) has a Liquid Crystal Display (LCD) with 14 lines of 24 characters each, including:

- A title line that gives the name of the current page in large letters
- Six label lines, each of which names the data displayed just below it (on the data field line)
- Six data field lines that display computed data or data inserted by the flight crew
- The scratchpad line that displays:
 - Specific messages
 - Information the flight crew has entered by means of the number and letter keys and which can then be moved to one of the data fields.

Ident.: DSC-22_10-40-10-A-00010092.0001001 / 17 AUG 10

LINE SELECT KEYS

There is a column of Line Select Keys (LSKs) on each side of the screen.

The flight crew uses these keys to:

- Move a parameter they have entered in the scratchpad to the appropriate line on the main screen
- Call up a specific function page indicated by a prompt displayed on the adjacent line
- Call up lateral or vertical revision pages from the flight plan page.

| | |
|---|--|
|  <p>A318/A319/A320/A321 FLIGHT CREW OPERATING MANUAL</p> | <p>AIRCRAFT SYSTEMS</p> <p>AUTO FLIGHT - GENERAL</p> <p>PILOT INTERFACE - MCDU</p> |
|---|--|

Ident.: DSC-22_10-40-10-A-00010093.0002001 / 17 AUG 10

KEYBOARD

The keyboard includes:

- Function and Page keys Call up functions and pages the flight crew uses for flight management functions and computations.
- ↑ ↓ (or SLEW) keys Move a page up or down to display portions that are off the screen.
- ← → keys Moves to the next page of a multi-page element. An arrow in the top right corner indicates that another page is available.
- AIRPORT key Calls up the flight plan page that contains the next airport along the current flight plan. Successive pushes on the key show the alternate airport, the origin airport (before takeoff), and the next airport again.
- Number and letter keys allow the flight crew to insert data in the scratchpad so that they can use a line select key to enter it in the main display.
- Three keys have special functions:
 - CLR (clear) key Erases material (messages or inserted data) from the scratchpad or from certain areas of displayed pages.
 - OVFY (overfly) key Allows the aircraft to overfly a selected waypoint.
 - SP (space) key Allows to insert a space in specific message.

Ident.: DSC-22_10-40-10-A-00010094.0002001 / 17 AUG 10

ANNUNCIATORS (ON THE SIDE OF THE KEYBOARD)

- FAIL (amber) Indicates that the Multipurpose Control and Display Unit (MCDU) has failed.
- MCDU MENU (white) Indicates that the flight crew should call up a peripheral linked to the MCDU (such as ACARS , ATSU or CFDS).
- FM (white) Comes on while the flight crew is using the MCDU to display peripherals. This light tells the flight crew that the FMGC has an important message to deliver. The flight crew accesses the message by pressing the MCDU MENU key and the line select key adjacent to the FMGC prompt.

Ident.: DSC-22_10-40-10-A-00010757.0002001 / 17 AUG 10

ANNUNCIATORS (ON THE TOP OF THE KEYBOARD)

- FM 1 and FM 2 (amber) The onside FM is failed
- IND (amber) The onside FM detects an independent mode of operation while both FM are healthy.
- RDY (green) MCDU has passed its power up test after it was turned off using its DIM key.

Ident.: DSC-22_10-40-10-A-00010750.0001001 / 17 AUG 10

BRT AND DIM KEYS

Control the light intensity of the entire MCDU . MCDU power up is performed with the BRT key and MCDU shut down is performed with the DIM key.

Ident.: DSC-22_10-40-10-A-00010097.0001001 / 17 AUG 10

DATA ENTRY

The flight crew enters data by typing it into the scratchpad on the MCDU . Next, pressing the line select key (LSK) will load the data from the scratchpad into the desired field. An error message displays if the data is out of range or not formatted correctly. To correct data, the flight crew may clear the message with the clear (CLR) key and then retype the message into the scratchpad. Pressing the CLR key when the scratchpad is empty displays "CLR". To clear data from a field, select CLR from the scratchpad to the data field to be cleared.

Ident.: DSC-22_10-40-10-A-00010098.0001001 / 17 AUG 10

MCDU ENTRY FORMAT

The flight crew enters information into the MCDU at the bottom line of the scratchpad. When data has lead zeros, they may be omitted if desired. For example a three-digit wind direction of 060 may be typed as 60. The display will still show 060. To enter an altitude below 1 000 ft, the lead zero must be added as 0400 for 400 ft. This differentiates the altitude from a flight level. To enter a double data entry such a speed/altitude, the separating slash must be used. If entering only the first part of a double entry, omit the slash. To enter only the second part of a double entry, a leading slash must be used i.e. /0400.

Ident.: DSC-22_10-40-10-A-00010099.0001001 / 17 AUG 10

MESSAGES

The scratchpad displays various messages for flight crew information. These messages are prioritized by importance to the flight crew as either amber or white.

Amber messages are:

- Navigation messages
- Data entry messages
- EFIS repeat messages.

Amber messages are categorized into two types:

- Type 1 message that is a direct result of a flight crew action. Type 1 messages are displayed immediately in the scratchpad ahead of other messages.
- Type 2 messages inform the flight crew of a given situation or request a specific action. Stored in "last in", "first out" message queue that holds maximum of 5 messages.
Type 2 messages are displayed in the scratchpad only if there are no Type 1 messages or other data and will remain until all the messages have been viewed and cleared with the CLR key.

White messages are advisory only.

Ident.: DSC-22_10-40-10-A-00010101.0001001 / 17 AUG 10

CHARACTERS

Small and large fonts are displayed according to the following rules:

- The title line and the scratchpad are displayed in large font
- Datafields are usually displayed in large font
- Label lines are displayed in small font
- Flight crew entries and modifiable data are displayed in large font
- Defaulted/computed and non modifiable data are displayed in small font.

Ident.: DSC-22_10-40-10-A-00010102.0001001 / 17 AUG 10

COLORS

| DATA | MCDU COLOR |
|--|------------------------------|
| TITLES, COMMENTS, <, >, ↑ ↓, ← →, DASHES, MINOR MESSAGES | WHITE |
| - MODIFIABLE DATA - SELECTABLE DATA - BRACKETS | BLUE |
| - NON MODIFIABLE DATA - ACTIVE DATA | GREEN |
| - MANDATORY DATA (BOXES) - FLIGHT CREW ACTION REQUIRED - IMPORTANT MESSAGES - MISSED CONSTRAINT | AMBER |
| - CONSTRAINTS - MAX ALTITUDE | MAGENTA |
| PRIMARY F-PLN | GREEN WAYPOINTS, WHITE LEGS |
| TEMPORARY F-PLN | YELLOW WAYPOINTS, WHITE LEGS |

Continued on the following page



A318/A319/A320/A321
FLIGHT CREW
OPERATING MANUAL

AIRCRAFT SYSTEMS
AUTO FLIGHT - GENERAL
PILOT INTERFACE - MCDU

Continued from the previous page

| DATA | MCDU COLOR |
|-------------------------------|---|
| SECONDARY F-PLN | WHITE WAYPOINTS AND LEGS |
| MISSED APPROACH (not active) | BLUE WAYPOINTS, WHITE LEGS |
| ALTERNATE F-PLN (not active) | BLUE WAYPOINTS, WHITE LEGS |
| OFFSET | GREEN WAYPOINTS, WHITE LEGS, OFST DISPLAYED IN THE TITLE OF THE F-PLN PAGE |
| TUNED NAVAID | BLUE |
| "TO" WAYPOINT AND DESTINATION | WHITE |

Ident.: DSC-22_10-40-10-A-00010103.0001001 / 14 MAY 12

SCREEN PROMPTS

Screen 1: INIT

Annotations for Screen 1:

- ☐☐☐: Data entry is mandatory to allow the FMGC to perform all its functions.
- ↑↓: When these arrows are beside a label line, it is possible to increase or decrease the value displayed below by pressing [↑] or [↓] keys on the keyboard.
- Label line
- Dataline or data field
- Upper right corner of screen indicates that next page is available by depressing next page key.
- : This data will be computed by the FMGC if it has enough information, or provided out of the database or inserted by the crew.

Screen 2: FROM TMPY

Annotations for Screen 2:

- ← →: A turn (left ← or right →) is specified on the leg which started at the waypoints adjacent to the arrow.
- Δ: Displayed beside a fixed waypoint on the F-PLN page to indicate that the A/C will overfly the fixed point
- ← →: Indicate that pressing the adjacent LS key will activate the prompt or select some data.
- *: Indicates that a constraint has been inserted. Displayed only if predictions available.
- *: Indicates that pressing the adjacent LS key will change parameters affecting the active situation.
- ↑↓: Scrolling is available by pressing ↑ or ↓ key on the keyboard. The page is not large enough to display the whole information.

Screen 3: LAT REV FRZ

Annotations for Screen 3:

- < or >: Means that another page may be accessed by pressing the adjacent key.
- []: A data insertion is possible.
- +,-: When an altitude constraint has been entered at the waypoint, the constraint value is displayed on the VERT REV page. A plus (+) is displayed for at or above altitude constraint and a minus (-) for at or below altitude constraint.

Ident.: DSC-22_10-40-10-A-00010104.0002001 / 23 JUN 15

MCDU FUNCTION KEYS

The function keys on the Multipurpose Control and Display Units allow the flight crew to call up MCDU pages quickly.

The following is a summary of the purpose of each key:

| | |
|---------|--|
| DIR | <p>Calls up the DIR TO page, and enables the flight crew to proceed directly from the present position to any waypoint, entered manually or selected in the active flight plan.</p> |
| PROG | <p>Calls up the progress page corresponding to the phase of the active flight plan that is in progress.</p> <p>This page displays navigation information and active data such as the optimum and maximum recommended cruise flight levels. It enables the flight crew to update the FMGS position and to obtain a bearing and distance to any location.</p> |
| PERF | <p>Calls up the performance pages, that display the optimum speed or Mach number for each phase. The flight crew can amend these pages. The first page to be displayed is the one corresponding to the current flight phase (except for preflight and done phases).</p> <p>The flight crew can then use the appropriate 6L or 6R LSK to call up pages corresponding to future flight phases.</p> |
| INIT | <p>Calls up the flight plan initialization A page, which also gives the flight crew access to the B page. The flight crew uses the INIT pages to initialize Flight Management for the flight.</p> <p>The flight crew uses the INIT A page primarily to insert his flight plan and to align the inertial reference system.</p> <p>The flight crew uses the INIT B page to insert aircraft weight, fuel on board, CG and various fuel requirements. The FMGS uses this data to compute predictions and fuel planning parameters.</p> <p>The flight crew has access to the INIT A page only in the preflight phase. INIT B page (not accessible after engine start) is called up by pressing the "NEXT PAGE" key.</p> |
| DATA | <p>Calls up the data index page. This gives the flight crew access to various reference pages that show aircraft position, aircraft status, runways, waypoints, navaids, routes, and data stored by the flight crew.</p> |
| F-PLN | <p>Calls up the flight plan A and B pages, which contain a leg-by-leg description of the active primary flight plan.</p> <p>The flight crew can use the slewing keys to review the entire active flight plan. They can make all lateral and vertical revisions to the flight plan through these pages, using the left LSKs for lateral revision and the right keys for vertical revision.</p> |
| RAD NAV | <p>Calls up the radio navigation page. This page displays the Radio Navaids tuned automatically or manually through the FMGC.</p> |

| | |
|---|--|
|  <p>A318/A319/A320/A321 FLIGHT CREW OPERATING MANUAL</p> | <p>AIRCRAFT SYSTEMS</p> <p>AUTO FLIGHT - GENERAL</p> <p>PILOT INTERFACE - MCDU</p> |
|---|--|

| | |
|-----------|---|
| FUEL PRED | Calls up the fuel prediction page. Once the engines are started, this page displays the fuel predicted to be remaining at the destination and the alternate, as well as fuel management data. |
| SEC F-PLN | Calls up the index page for the secondary flight plan. The flight crew can use this page to call up the secondary flight plan and all the functions related to it (copying, deleting, reviewing, activating, and the INIT and PERF pages). |
| ATC COMM | Calls up the ATC applications (not activated). |
| MCDU MENU | Calls up the MCDU MENU page, which displays the subsystems currently addressed via the MCDU. The key next to the name of a subsystem enables the flight crew to select that subsystem. When the MCDU MENU annunciator lights up, the flight crew should press the MCDU MENU key. The menu will have [REQ] displayed next to the name of the subsystem that requires attention. |

Ident.: DSC-22_10-40-10-A-00010107.0005001 / 01 OCT 12

MCDU DISPLAY

The MCDUs display:

- Position and accuracy information
- Tuned nav aids
- Lateral and vertical flight plans (waypoints, pseudo waypoints, constraints)
- Predictions (SPD, TIME, ALT, WIND)
- Fuel predictions and fuel management information (estimated fuel on board, extra fuel)
- Performance data.

F-PLN A page

| | | |
|------|-----------------------|------|
| | FROM AF5612 → | |
| [1L] | TOP9A TIME SPD/ALT | [1R] |
| | LSGG23 0000 148/ 1365 | |
| [2L] | TOP9A BRG228° 6NM | [2R] |
| | PAS 0003 210/*5500 | |
| [3L] | HOLD L TRK228° 12 | [3R] |
| | 7000 0006 °/ 7000 | |
| [4L] | [SPD] 0 | [4R] |
| | [LIM] 0006 210/ 7000 | |
| [5L] | TOP9A 5 | [5R] |
| | D136E 0007 *230* FL90 | |
| [6L] | DEST TIME DIST EFOB | [6R] |
| | LGAT33R 0220 990 8.4 | |
| | ↑↓ | |

RADIO NAV PAGE

| | | |
|--------------|-------------|------|
| RADIO NAV | | |
| VOR1/FREQ | FREQ/VOR2 | |
| STU/113.10 | 112.5 / TGO | [1R] |
| CRS | CRS | [2R] |
| [] | [] | |
| ILS/FREQ | | |
| ISW / 109.90 | | [3R] |
| CRS SLOPE | | |
| 227 -3.0 | | [4R] |
| ADF1/FREQ | FREQ/ADF2 | |
| TOE/415.00 | [] [] | [5R] |
| [] | [] | [6R] |
| ← ADF1 BFO | | |

FCU

Ident.: DSC-22_10-40-20-00010112.0003001 / 03 AUG 17

Applicable to: ALL

The Flight Control Unit (FCU) is located on the glareshield and is constituted of three control panels: One for the automatic flight controls and two for the Electronic Flight Instrument System (EFIS). The FCU has two channels, each of which can independently command the central control panel. If one channel fails, the other channel can control all the functions.

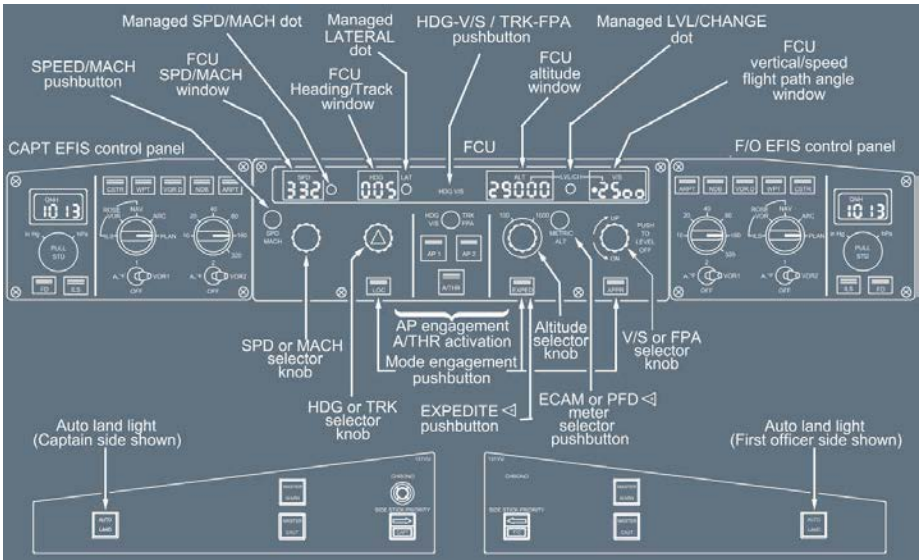

FCU PHILOSOPHY

Ident.: DSC-22_10-40-20-00010113.0002001 / 14 MAY 12

Applicable to: ALL

The flight crew can use two types of guidance to control the aircraft in auto flight. One type is managed by the Flight Management Guidance System (FMGS). The other uses target quantities which are manually entered by the flight crew.

When the aircraft uses target quantities from the FMGS (managed guidance), the FCU windows display dashes and the white dots next to those windows light up. When the aircraft uses target quantities, entered by the flight crew (selected guidance), the windows display the selected numbers and the white dots do not light up.

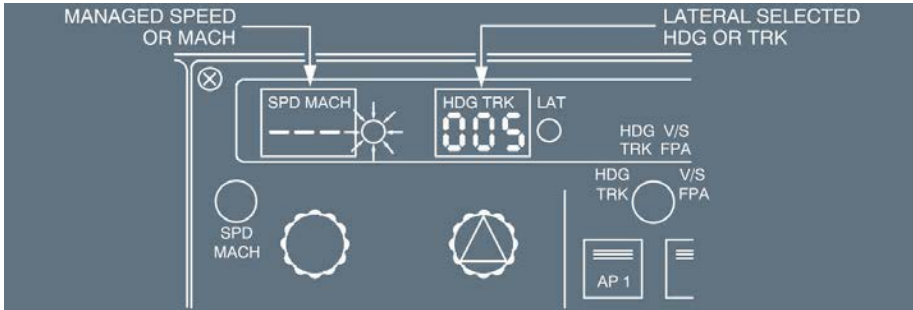

Note: The altitude window always displays an altitude selected by the flight crew (never dashes).

The FCU has four knobs:

- SPD-MACH
- HDG -TRK
- ALT
- V/S -FPA.

The knobs can be rotated, pushed in, and pulled out:

- In order to arm or engage managed guidance for a given mode, the flight crew pushes in the associated knob. If, for example, they push in the HDG knob, they engage or arms the NAV mode.
- In order to engage a selected guidance mode, the flight crew turns the knob to set the desired value, then pulls the knob out to engage the mode with a target value equal to the selected value.

Note: In managed guidance (lateral, vertical guidance or managed speed), the corresponding window is dashed. Turning a knob without pulling it, displays a value that is the sum of the current target and the turn action value. The display remains 45 s on the HDG /TRK and V/S windows and 10 s on the SPD/MACH window before the dashes reappear. This rule does not apply to the ALT knob/window.

SPEED/MACH CONTROL AREA

Ident.: DSC-22_10-40-20-00010114.0002001 / 14 MAY 12

Applicable to: ALL

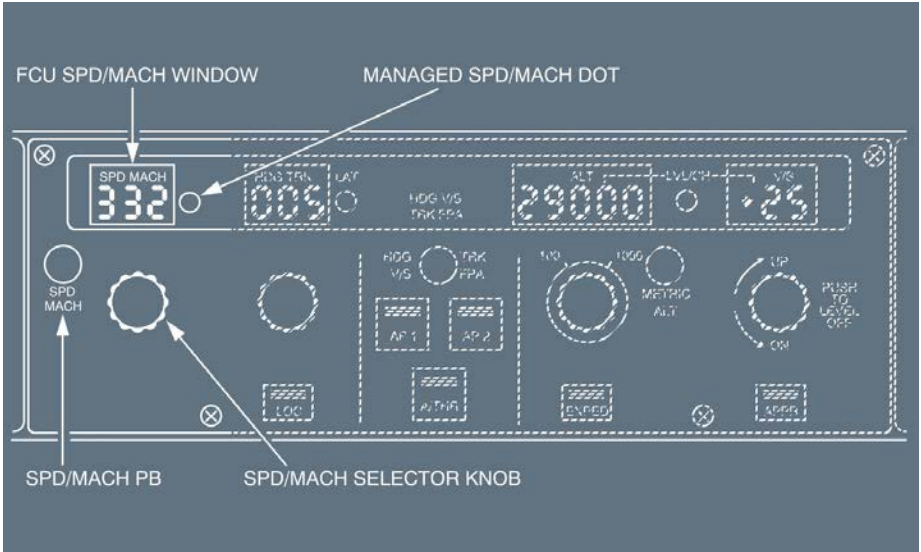

SPD/MACH knob

Display range: between 100 and 399 kt for speed, between 0.10 and 0.99 for Mach number.
 One rotation of the knob corresponds to approximately 32 kt or M 0.32.

SPD/MACH pb

Pushing this pushbutton changes the SPD target to the corresponding MACH target and vice versa.

LATERAL CONTROL AREA

Ident.: DSC-22_10-40-20-00010115.0007001 / 14 MAY 12

Applicable to: ALL

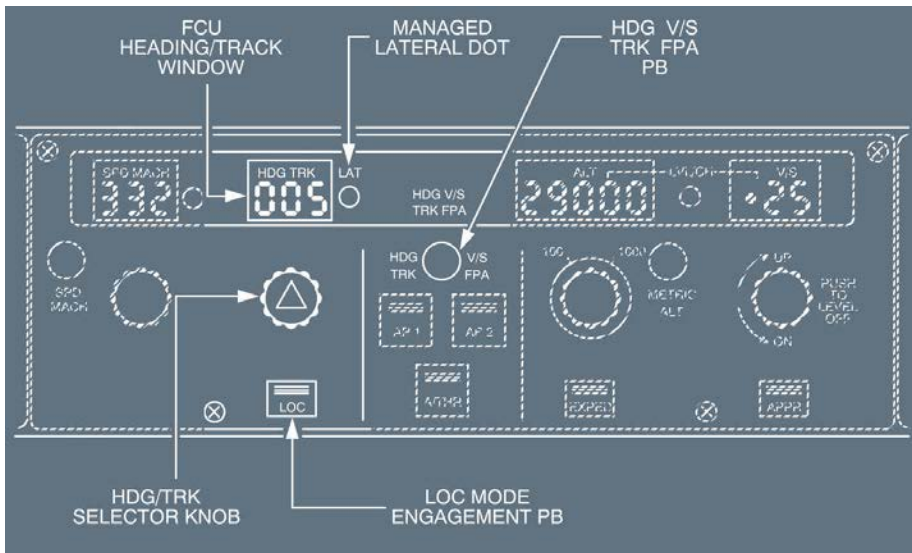

HDG/TRK knob

Display range: between 0 ° and 359 °.
 One rotation of the knob corresponds to 32 ° (1 ° per click).

LOC pb

Pushing this pushbutton arms, engages, or disengages the LOC mode.

HDG V/S – TRK FPA pb

The flight crew uses this pushbutton to select HDG (associated with V/S) or TRK (associated with FPA). Pushing it:

- Displays the Flight Path Vector (FPV) on the Primary Flight Display (PFD) or deletes it.
- On the PFD, changes the FD crossbar display (with the aircraft attitude as its reference) to the aircraft Flight Path Director (with the flight path vector as its reference) and vice versa.
- Changes heading reference into track reference in the HDG /TRK window and vice versa.
- Changes vertical speed reference target into flight path angle reference target in the V/S -FPA window and vice versa.

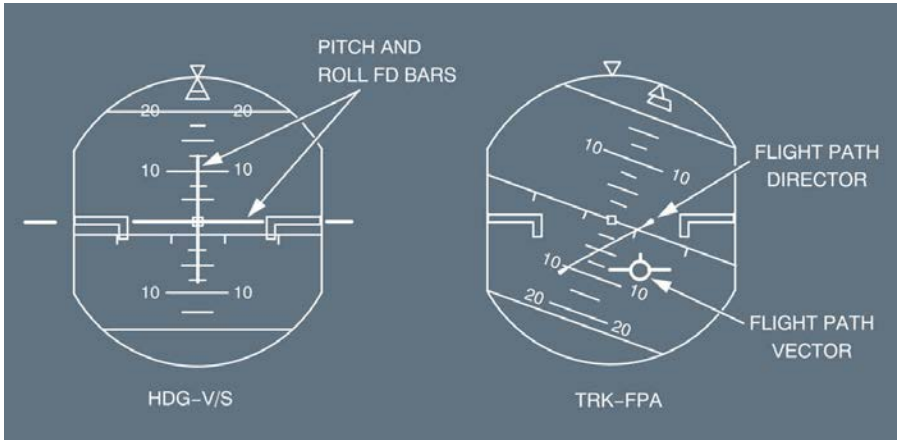

AP-A/THR CONTROL AREA

Ident.: DSC-22_10-40-20-00010116.0001001 / 14 MAY 12

Applicable to: ALL

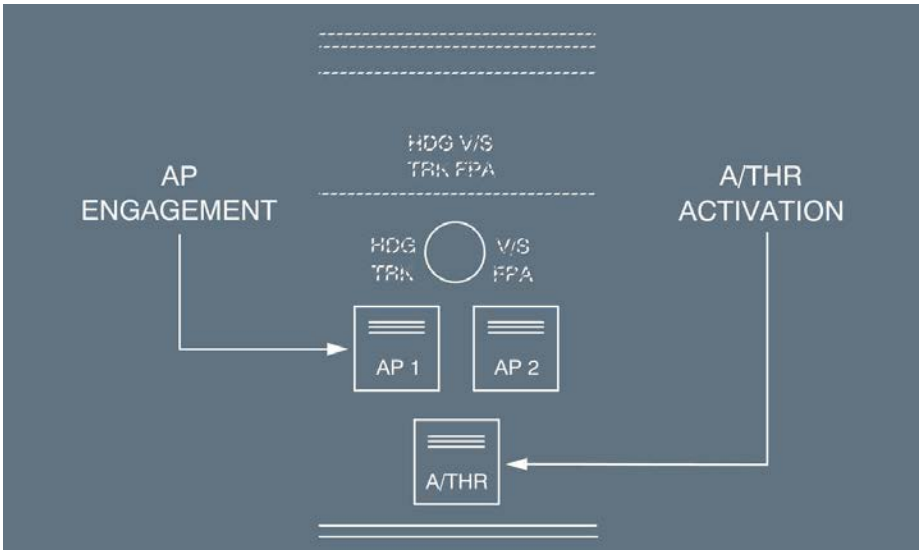

AP1 pb AND AP2 pb

The flight crew uses these pushbuttons to engage or disengage the autopilots. The buttons illuminate green when the autopilot is engaged.

A/THR pb

The flight crew uses this pushbutton to arm, activate, or disconnect the autothrust (A/THR). This button illuminates green if the A/THR is armed or active.

VERTICAL CONTROL AREA

Ident.: DSC-22_10-40-20-00010117.0006001 / 22 MAY 12
Applicable to: ALL

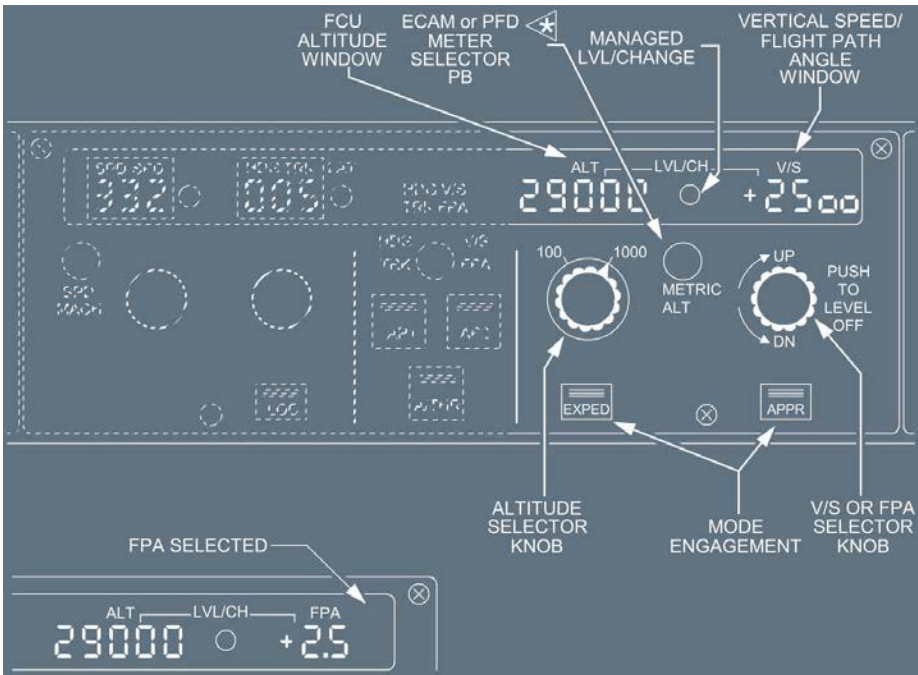

The FCU altitude window always displays a target value selected by the flight crew. It never displays dashes.

| | |
|---|--|
|  <p>A318/A319/A320/A321 FLIGHT CREW OPERATING MANUAL</p> | <p>AIRCRAFT SYSTEMS AUTO FLIGHT - GENERAL PILOT INTERFACE - FCU</p> |
|---|--|

Altitude knob (INNER AND OUTER)

Display range: 100 to 49 000 ft

- The outer knob has two positions: 100 and 1000
- The inner knob sets the altitude in the FCU window in increments of 100 or 1 000 ft, depending upon the position of the outer knob.

EXPED pb

This pushbutton is used to engage the expedite mode. *Refer to DSC-22_30-70-90 General.*

METRIC ALT pb

This pushbutton is used to display the FCU altitude target in meters on the ECAM , or the current altitude and FCU /FM altitude target in meters on the PFD  .

V/S or FPA knob

Range (V/S) : -6 000 to +6 000 ft/min

2 clicks = 100 ft/min

If the flight crew turns the knob slowly, each click equals 100 ft/min.

Range (FPA) : -9.9 ° to +9.9 °

1 click = 0.1 °

The flight crew turns this knob to set the value of the vertical speed (V/S) or flight path angle (FPA) to be displayed in the V/S or FPA window (They choose which, V/S or FPA, is to be displayed by pushing the HDG V/S - TRK FPA pb).

One rotation of the knob corresponds to 32 clicks. One complete rotation sets:

FPA = 3.2 °

V/S = 1 600 ft/min

When the flight crew pushes in the V/S or FPA knob, the system commands an immediate level-off by engaging the V/S or FPA mode with a target of zero. The flight mode annunciator (FMA) then displays "V/S = 0" in green when V/S or FPA is nulled. If the flight crew now turns the knob to put in a new setting for V/S or FPA, the aircraft changes flight path accordingly.

APPR pb

This pushbutton arms, disarms, engages, or disengages the approach modes:

- LOC and G/S modes, if an ILS approach is selected in the active F-PLN.
- APP NAV -FINAL modes, if a non precision approach is selected in the active F-PLN.



A318/A319/A320/A321
FLIGHT CREW
OPERATING MANUAL

AIRCRAFT SYSTEMS
AUTO FLIGHT - GENERAL
PILOT INTERFACE - FCU

Intentionally left blank

THRUST LEVERS

Ident.: DSC-22_10-40-30-00010119.0001001 / 14 MAY 12

Applicable to: ALL

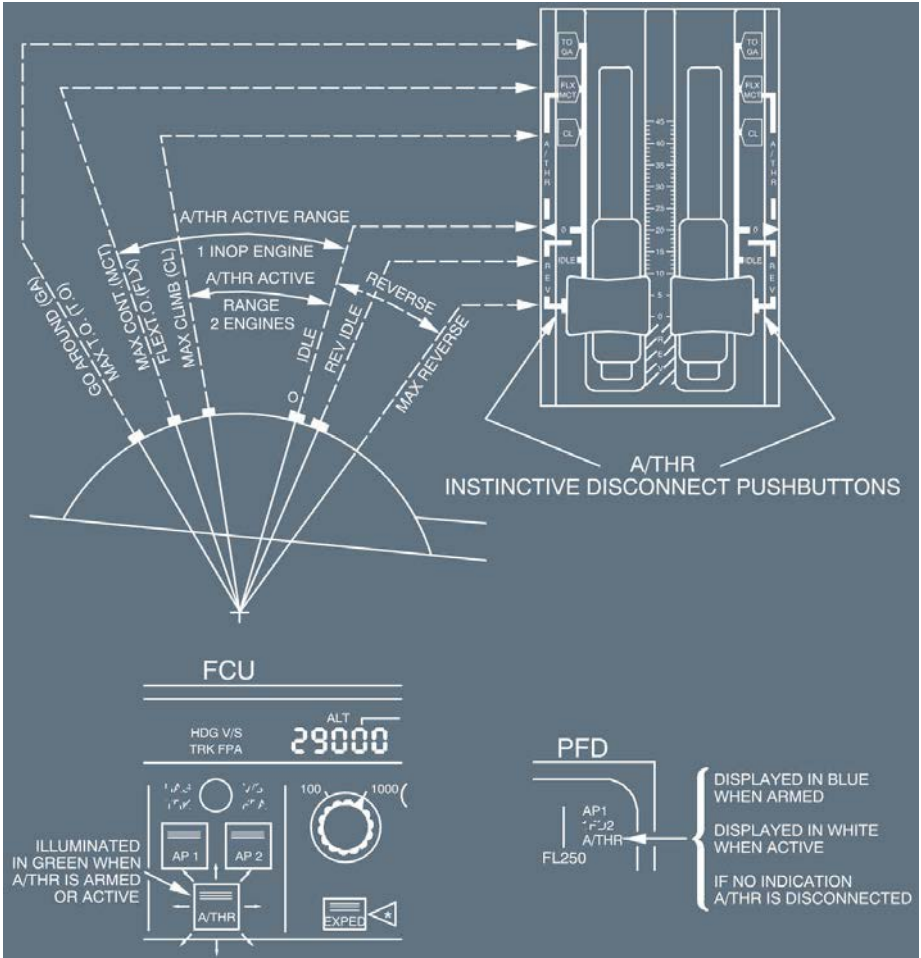



A318/A319/A320/A321
FLIGHT CREW
OPERATING MANUAL

AIRCRAFT SYSTEMS

AUTO FLIGHT - GENERAL

PILOT INTERFACE - THRUST LEVERS

Intentionally left blank

PFD

Ident.: DSC-22_10-40-40-00010677.0001001 / 17 AUG 10

Applicable to: ALL

The Flight Management and Guidance System generates the following information to the EFIS Primary Flight Display:

- Armed and engaged modes on the Flight Mode Annunciator (FMA)
- FMGS guidance targets (SPD , ALT , HDG)
- Vertical deviation from descent profile
- Messages
- Navigation information.

CLIMB PHASE

Ident.: DSC-22_10-40-40-00010121.0002001 / 14 MAY 12

Applicable to: ALL

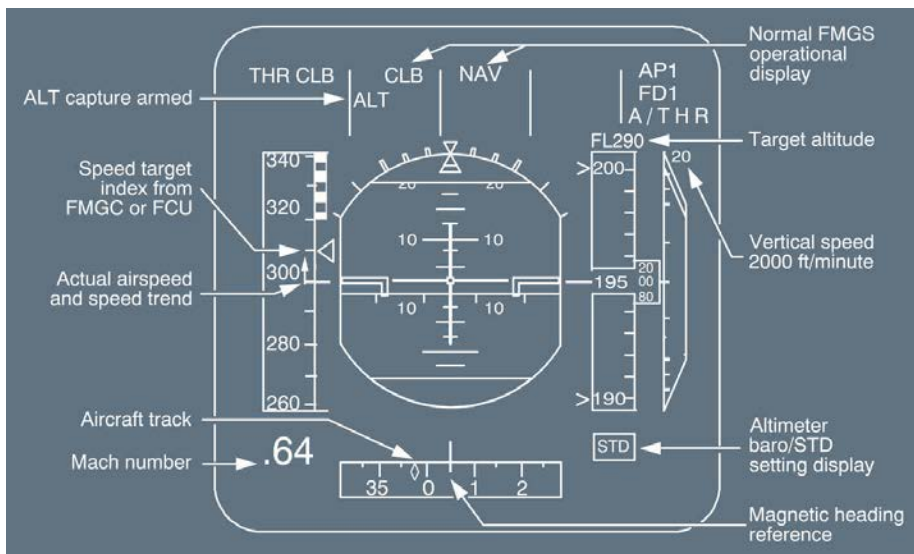

APPROACH PHASE

Ident.: DSC-22_10-40-40-00010122.0013001 / 14 MAY 12

Applicable to: ALL

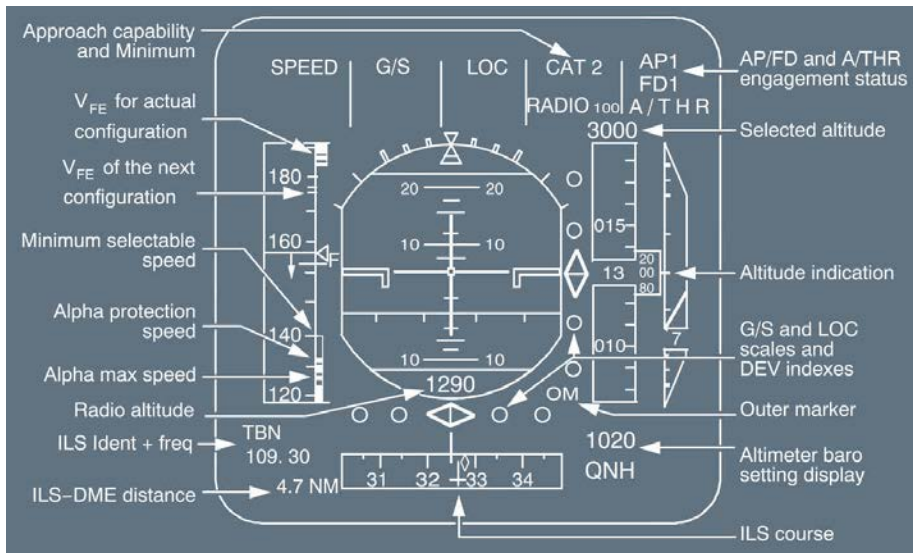

ND

Ident.: DSC-22_10-40-50-00010123.0001001 / 17 AUG 10

Applicable to: ALL

The FMGS generates the following information, displayed on the EFIS Navigation Displays:

- Flight plan (active secondary, temporary, dashed)
- Aircraft position and lateral deviation from the flight plan
- Pseudo-waypoints along the flight plan
- Raw data from tuned Nav aids and type of selected approach
- Various display options (waypoints, Nav aids, NDBs, airports, constraints)
- Wind information and various messages.

ARC MODE

Ident.: DSC-22_10-40-50-00010124.0001001 / 14 MAY 12

Applicable to: ALL

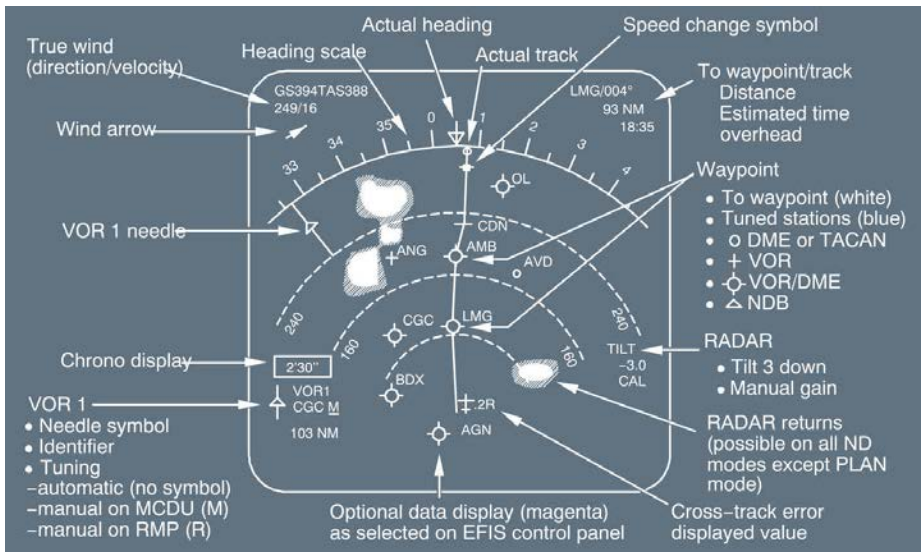

PLAN MODE

Ident.: DSC-22_10-40-50-00010125.0001001 / 01 OCT 12

Applicable to: ALL

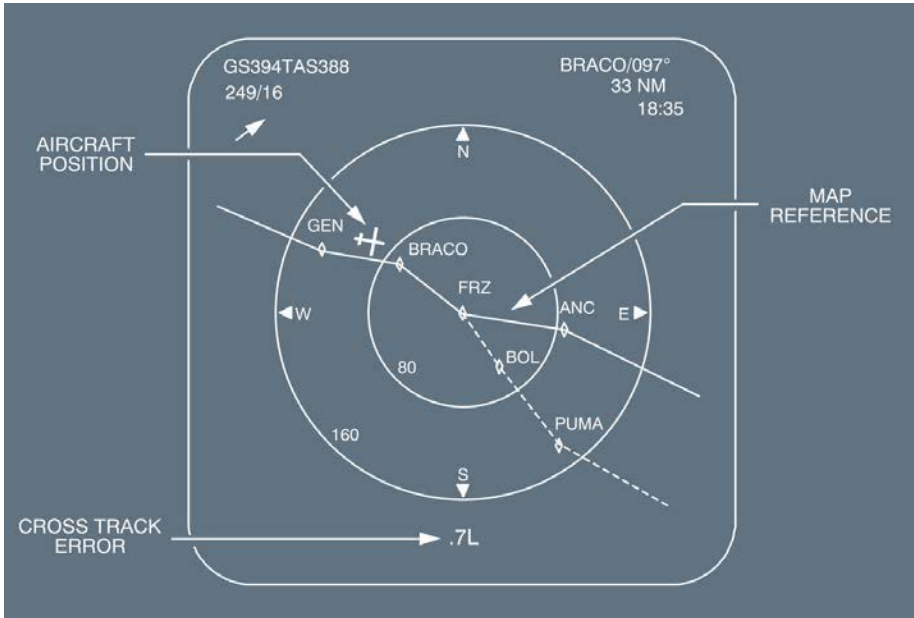

ROSE MODES

Ident.: DSC-22_10-40-50-00010126.0022001 / 09 MAR 15

Applicable to: ALL

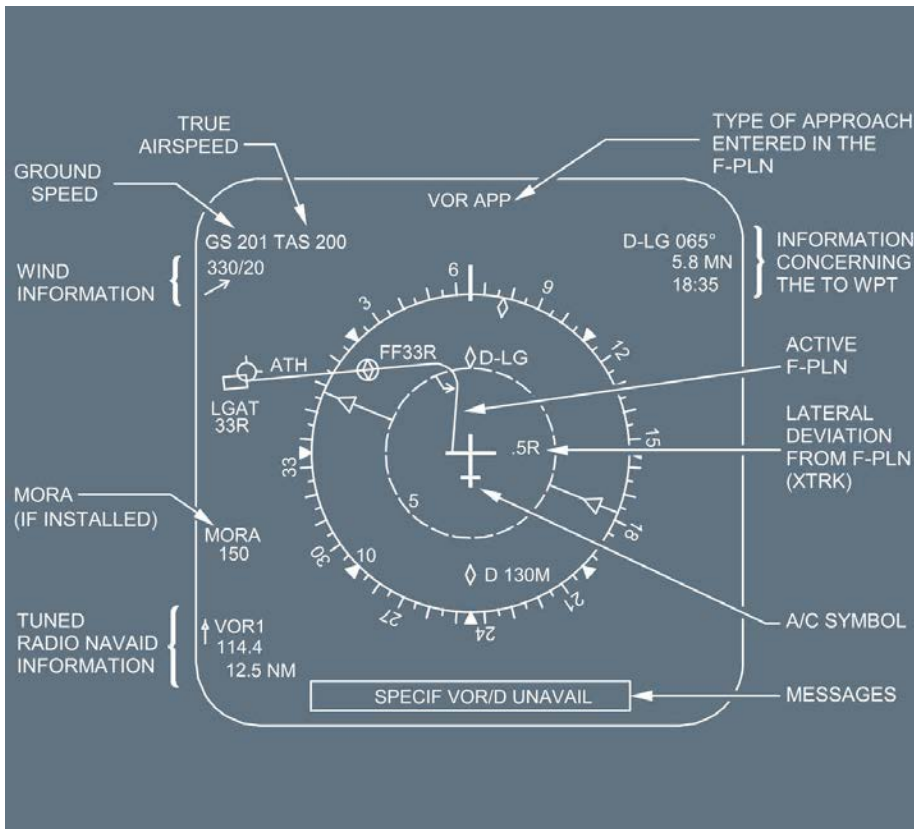



AEROLINEAS GALAPAGOS S.A.

A318/A319/A320/A321
FLIGHT CREW
OPERATING MANUAL

AIRCRAFT SYSTEMS

AUTO FLIGHT - GENERAL

PILOT INTERFACE - NAVIGATION DISPLAY

FLIGHT PLAN DISPLAY COLORS

Ident.: DSC-22_10-40-50-00010127.0002001 / 17 AUG 10

Applicable to: ALL

| F-PLN | Color |
|-------------------------------|---|
| Primary Flight Plan | - Managed mode: Steady green - Selected mode: Dashed green |
| Track line | Steady green |
| Alternate flight plan | Dashed blue |
| Missed approach | Steady blue |
| Offset flight plan | Steady green (Original flight plan: Dashed green) |
| Temporary flight plan | Dashed yellow |
| Engine-out SID (not inserted) | Steady yellow |
| Secondary flight plan | Steady dimmed white |
| Abeam/Radial | Dashed blue |



A318/A319/A320/A321
FLIGHT CREW
OPERATING MANUAL

AIRCRAFT SYSTEMS
AUTO FLIGHT - GENERAL
SPEEDS DEFINITION - GENERAL

GENERAL

Ident.: DSC-22_10-50-10-00020369.0001001 / 17 MAR 17

Applicable to: ALL

This chapter shows the speed symbols and definitions.
The source of the computation is also given, when applicable.



A318/A319/A320/A321
FLIGHT CREW
OPERATING MANUAL

AIRCRAFT SYSTEMS
AUTO FLIGHT - GENERAL
SPEEDS DEFINITION - GENERAL

Intentionally left blank

CHARACTERISTIC SPEEDS

Ident.: DSC-22_10-50-20-00020370.0002001 / 17 MAR 17

Applicable to: ALL

The characteristic speeds displayed on the PFD are computed by the Flight Augmentation Computer (FAC), according to aerodynamic data.

VLS (of normal landing configuration: CONF 3 or FULL), F, S and Green Dot speeds are also displayed on the MCDU TAKEOFF and/or APPR pages.

The speeds displayed by the MCDU are computed by the FMS, based on the aircraft gross weight (which is computed according to the entered ZFW and the FOB), or the predicted gross weight (for approach or go-around).

VS : Stalling speed.
Not displayed.

For a conventional aircraft, the reference stall speed, VSmin, is based on a load factor that is less than 1 g. This gives a stall speed that is lower than the stall speed at 1 g. All operating speeds are expressed as functions of this speed (for example, VREF = 1.3 VSmin).

Because aircraft of the A320 family have a low-speed protection feature (alpha limit) that the flight crew cannot override, Airworthiness Authorities have reconsidered the definition of stall speed for these aircraft.

All the operating speeds must be referenced to a speed that can be demonstrated by flight tests. This speed is designated VS1g.

Airworthiness Authorities have agreed that a factor of 0.94 represents the relationship between VS1g for aircraft of the A320 family and VSmin for conventional aircraft types. As a result, Authorities allow aircraft of the A320 family to use the following factors :

$$V2 = 1.2 \times 0.94 \text{ VS1g} = 1.13 \text{ VS1g}$$
$$VREF = 1.3 \times 0.94 \text{ VS1g} = 1.23 \text{ VS1g}$$

These speeds are identical to those that the conventional 94 % rule would have defined for these aircraft. The A318, A319, A320 and A321 have exactly the same maneuver margin that a conventional aircraft would have at its reference speeds.

The FCOM uses VS for VS1g.

VLS : Lowest Selectable Speed.

Represented by the top of an amber strip along the airspeed scale on the PFD.

Computed by the FAC, based on aerodynamic data, and corresponds to 1.13 VS during takeoff, or following a touch and go.

Becomes 1.23 VS, after retraction of one step of flaps.

Becomes 1.28 VS, when in clean configuration.

Note: If in CONF 0 VLS were 1.23 VS (instead of 1.28 VS), the alpha protection strip would hit the VLS strip on the PFD.

Above 20 000 ft, VLS is corrected for Mach effect to maintain a buffet margin of 0.2 g.

In addition, VLS increases when the speedbrakes are extended.

F : Minimum speed at which the flaps may be retracted at takeoff.

In approach, used as a target speed when the aircraft is in CONF 2 or CONF 3.

Represented by "F" on the PFD speed scale. Equal to about 1.18 VS to 1.22 VS of CONF 1 + F.

S : Minimum speed at which the slats may be retracted at takeoff.

In approach, used as a target speed when the aircraft is in CONF 1.

Represented by "S" on the PFD airspeed scale.

Equal to about 1.22 VS to 1.25 VS of clean configuration.

O : Green dot speed.

Engine-out operating speed in clean configuration.

(Best lift-to-drag ratio speed).

Also corresponds to the final takeoff speed.

Represented by a green dot on the PFD scale.

Below 20 000 ft equal to 2 × weight (tons) +85

Above 20 000 ft, add 1 kt per 1 000 ft

LIMIT SPEEDS

Ident.: DSC-22_10-50-30-00020383.0001001 / 17 MAR 17

Applicable to: ALL

- VA : Maximum design maneuvering speed. This corresponds to the maximum structural speed permitted for full control deflection, if alternate or direct law is active.
- VMCG : Minimum speed, on the ground during takeoff, at which the aircraft can be controlled by only using the primary flight controls, after a sudden failure of the critical engine, the other engine remaining at takeoff thrust.
- VMCA : Minimum control speed in flight at which the aircraft can be controlled with a maximum bank of 5 °, if one engine fails, the other engine remaining at takeoff thrust (takeoff flap setting, gear retracted).
- VMCL : Minimum control speed in flight, at which the aircraft can be controlled with a maximum bank of 5 °, if one engine fails, the other engine remaining at takeoff thrust (approach flap setting).
- VFE : Maximum speed for each flap configuration.
- VLE : Maximum speed with landing gear extended.
- VLO : Maximum speed for landing gear operation.
- VMO : Maximum speed.
- VFE NEXT : Maximum speed for the next (further extended) flap lever position.



A318/A319/A320/A321
FLIGHT CREW
OPERATING MANUAL

AIRCRAFT SYSTEMS

AUTO FLIGHT - GENERAL

SPEEDS DEFINITION - LIMIT SPEEDS

Intentionally left blank

PROTECTION SPEEDS

Ident.: DSC-22_10-50-40-00020382.0001001 / 17 MAR 17

Applicable to: ALL

V_{α} PROT, V_{α} MAX and VSW are computed by the FAC , based on aerodynamic data. They are only used for display on the PFD , and not for flight control protection (the activation of the protections is computed by the ELAC).

V_{α} PROT : Angle of attack protection speed.

Corresponds to the angle of attack at which the angle of attack protection becomes active.

Represented by the top of a black and amber strip along the PFD speed scale, in normal law.

V_{α} MAX : Maximum angle of attack speed.

Corresponds to the maximum angle of attack that may be reached in pitch normal law.

Represented by the top of a red strip along the PFD speed scale, in normal law.

VSW : Stall warning speed.

Represented by a red and black strip along the speed scale when the flight control normal law is inoperative.

VMAX : Represented by the bottom of a red and black strip along the speed scale.

Determined by the FAC according to the aircraft configuration.

Is equal to VMO (or speed corresponding to MMO), VLE or VFE.



A318/A319/A320/A321
FLIGHT CREW
OPERATING MANUAL

AIRCRAFT SYSTEMS

AUTO FLIGHT - GENERAL

SPEEDS DEFINITION - PROTECTION SPEEDS

Intentionally left blank

OTHER SPEEDS

Ident.: DSC-22_10-50-50-00020384.0004001 / 17 MAR 17

Applicable to: ALL

- V1 : The highest speed, during takeoff, at which the flight crew has a choice between continuing the takeoff or stopping the aircraft.
Represented by “1” on the airspeed scale (or the V1 value when it is off the airspeed scale).
Inserted manually through the MCDU by the flight crew.
Displayed on the MCDU TAKEOFF page.
- VR : The speed at which the pilot rotates in order to reach V2 at an altitude of 35 ft at the latest after an engine failure.
Inserted manually through the MCDU by the flight crew.
Displayed on the MCDU TAKEOFF page.
- V2 : Takeoff safety speed that the aircraft attains at the latest at an altitude of 35 ft with one engine failed, and maintains during the second segment of the takeoff.
Represented by the SPEED SELECT symbol on the speed scale.
Minimum value equal to 1.13 VS for the corresponding configuration.
Inserted manually through the MCDU by the flight crew.
Displayed on the MCDU TAKEOFF page.
- VREF : Reference speed used for normal final approach.
Equal to $1.23 \times VS$ of CONF FULL.
Displayed on the MCDU APPR page, if landing is planned in CONF FULL (VLS CONF FULL).
- VAPP : Final approach speed.
Displayed on MCDU APPR page.
Calculated by the FMGCs.
Represents : $VAPP = VLS + \text{wind correction}$
The wind correction is limited to a minimum of 5 kt and a maximum of 15 kt.

The flight crew may modify VAPP through the MCDU.
- During autoland or when A/THR is on or in case of ice accretion or gusty crosswind greater than 20 kt, VAPP must not be lower than $VLS + 5$ kt.

SPEED TARGET : Represented by a magenta triangle.
Calculated by the FMGCs
Gives efficient speed guidance in approach during various windy conditions.
Represents :
 $SPEED\ TARGET = GS\ mini + actual\ headwind\ (measured\ by\ ADIRS)$
 $GS\ mini = VAPP - TOWER\ WIND\ (headwind\ component\ along\ runway\ axis\ calculated\ by\ FMGC\ from\ tower\ wind\ entered\ on\ MCDU).$

AIRCRAFT SYSTEMS

AUTO FLIGHT - FLIGHT MANAGEMENT

Intentionally left blank

DSC-22_20-10 General

General.....A

DSC-22_20-20 Navigation

DSC-22_20-20-05 General

Navigation.....A

DSC-22_20-20-10 Position Computation

General.....A
 MIX IRS Position.....B
 GPS Position.....C
 Radio Position.....D
 FM Position.....E
 Position Monitor.....F
 Takeoff Update.....G
 Navigation Modes.....H

DSC-22_20-20-20 Evaluation of Position Accuracy

General.....A
 Estimated Position Uncertainty.....B
 FM/GPS Position Disagreement.....C
 Predictive GPS Page.....D

DSC-22_20-20-30 Radio Navigation Tuning

General.....A
 Architecture.....B
 VOR.....C
 DME.....D
 ADF.....E
 ILS.....F
 Selection of Nav aids on MCDU Pages.....G
 Manual Tuning.....H
 Nav aid Identification.....I

DSC-22_20-20-40 Alignment of Inertial Reference System

Alignment of Inertial Reference System.....A

DSC-22_20-20-50 Navigation Database

General.....A
 Operations with an Outdated Navigation Database.....B

Continued on the following page

Continued from the previous page

DSC-22_20-30 Flight Planning

DSC-22_20-30-05 General

Flight Planning..... A

DSC-22_20-30-10 Lateral Functions

DSC-22_20-30-10-05 General

General..... A
 Manual Legs..... B
 Flight Plan Construction..... C
 Flight Plan Capacity..... D
 Lateral Revisions..... E

DSC-22_20-30-10-15 FMS2 HONEYWELL

General..... A
 Temporary F-PLN (TMPY)..... B
 Inserting an Airway with "Via"..... C
 Inserting a Waypoint..... D
 Fix Info..... E
 Inserting a New Destination..... F
 Holding Pattern..... G
 Offset..... H
 Alternate Function..... I
 Enable ALTN..... J
 DIR Key (Direct-to-Function)..... K
 OVFY (Overfly) Key..... L
 "Update at"..... M

DSC-22_20-30-20 Vertical Functions

DSC-22_20-30-20-05 General

General..... A
 Vertical Flight Planning..... B
 Flight Phases..... C
 Vertical Revision..... D
 Vertical Constraints (Speed, Altitude, Time)..... E

DSC-22_20-30-20-25 FMS2 Honeywell

General..... A
 Required Time of Arrival (RTA)..... B
 Wind - Temperature - QNH..... C
 Constant Mach Segment..... D

Continued on the following page

Continued from the previous page

DSC-22_20-40 Performance

DSC-22_20-40-10 Optimization

| | |
|-------------------|---|
| General..... | A |
| Optimization..... | B |

DSC-22_20-40-20 Cost Index

| | |
|----------------------|---|
| Cost Index (CI)..... | A |
|----------------------|---|

DSC-22_20-40-30 Predictions

| | |
|--|---|
| General..... | A |
| Predictions for the Primary Flight Plan..... | B |
| Computation of Predictions..... | C |
| Predictions Displayed on the Navigation Display..... | D |
| Predictions Displayed on the MCDU..... | E |
| Type of Predictions..... | F |
| Examples of MCDU Predictions..... | G |
| Constraint Symbols (Star)..... | H |
| Vertical Deviation..... | I |
| Operation Rules Concerning Predictions..... | J |
| Other Computations..... | K |
| Return-to-Trajectory Assumptions..... | L |
| Energy Circle..... | M |
| Introduction to PERF and IDLE Factors..... | N |
| PERF Factor..... | O |
| IDLE Factor..... | P |
| Procedure to Modify the PERF and IDLE Factors..... | Q |

DSC-22_20-50 Controls and Indicators

DSC-22_20-50-10 MCDU - Page Description

DSC-22_20-50-10-25 FMS2 Honeywell

| | |
|-----------------------------|---|
| General..... | A |
| MCDU MENU Page..... | B |
| INIT A Page..... | C |
| Route Selection Page..... | D |
| IRS INIT Page..... | E |
| WIND Pages..... | F |
| INIT B Page..... | G |
| Fuel Prediction Page..... | H |
| Flight Plan Pages..... | I |
| Lateral Revision Pages..... | J |

Continued on the following page

Continued from the previous page

| | |
|--|----|
| Fix Info Page..... | K |
| Offset Page..... | L |
| Airways Page..... | M |
| Departure Pages..... | N |
| Hold Pages..... | O |
| Direct TO Page..... | P |
| ARRIVAL Pages..... | Q |
| Alternate Page..... | R |
| Route Selection Page for Alternate..... | S |
| VERTICAL REVISION Pages..... | T |
| Step ALTS Page..... | U |
| RTA Page..... | V |
| Data Index Pages..... | W |
| Waypoint/Stored Waypoint/New Waypoint Pages..... | X |
| NAVAID/Stored NAVAID/New NAVAID Pages..... | Y |
| Runways/Stored Runways/New Runway Pages..... | Z |
| Route/Stored Route/New Route Pages..... | AA |
| Aircraft Status Page..... | AB |
| P/N XLOAD Page..... | AC |
| P/N Status Pages..... | AD |
| Duplicate Names Page..... | AE |
| Position Monitor Page..... | AF |
| Position Monitor and Position Frozen Page..... | AG |
| Selected NAVAIDS Page..... | AH |
| IRS Monitor Page..... | AI |
| GPS Monitor Page..... | AJ |
| Closest Airports Pages..... | AK |
| Equi-Time Point Page..... | AL |
| Print Function Pages..... | AM |
| ACARS Function Page..... | AN |
| ACARS Function Page 1..... | AO |
| Uplink TO Data REQ Pages..... | AP |
| Uplink MAX TO Data Pages..... | AQ |
| Uplink FLX TO Data Pages..... | AR |
| ACARS Function Page 2..... | AS |
| PERF Page..... | AT |
| PERF Takeoff Page..... | AU |
| PERF Climb Page..... | AV |
| PERF Cruise Page..... | AW |
| PERF Descent Page..... | AX |

Continued on the following page

Continued from the previous page

| | |
|---|----|
| PERF APPR Page..... | AY |
| PERF Go Around Page..... | AZ |
| PROG Pages..... | BA |
| Predictive GPS Pages..... | BB |
| Report Page..... | BC |
| Radio NAV Page..... | BD |
| Secondary Pages..... | BE |
| Back Up NAV Pages..... | BF |
| | |
| DSC-22_20-50-20 MCDU - Messages | |
| DSC-22_20-50-20-35 FMS2 Honeywell | |
| MCDU Message List..... | A |
| DSC-22_20-50-30 MCDU - Data Format List | |
| MCDU Data Format List..... | A |
| | |
| DSC-22_20-60 Other Functions | |
| DSC-22_20-60-10 Effect of Baro Reference Setting | |
| GENERAL..... | A |
| MCDU Altitude Predictions..... | B |
| Target Altitude on PFD..... | C |
| Procedures..... | D |
| DSC-22_20-60-20 Clear Key (Clearing Function) | |
| Clearing the Scratchpad of Data or Messages..... | A |
| Clearing Data Fields..... | B |
| DSC-22_20-60-30 How to Execute a Diversion | |
| General..... | A |
| En Route Diversion with Several Airports Available..... | B |
| En Route Diversion over Oceanic or Desertic Area..... | C |
| Diversion Preparation on the Secondary Flight Plan..... | D |
| Miscellaneous..... | E |
| Execution of the Diversion..... | F |
| Diversion to the Alternate Airport..... | G |
| DSC-22_20-60-40 Engine Out | |
| General..... | A |
| Flight Management Part..... | B |
| Flight Guidance Part..... | C |
| Autothrust..... | D |
| Engine-Out Conditions..... | E |

Continued on the following page

Continued from the previous page

| | |
|--|---|
| Engine-Out SID..... | F |
| Engine-Out in CLB Phase (above acceleration altitude)..... | G |
| Engine-Out in Cruise Phase..... | H |
| Engine-Out in Descent Phase..... | I |
| Engine-Out In Approach Phase..... | J |
| Engine-Out in Go-Around Phase..... | K |
| DSC-22_20-60-50 Secondary Flight Plan | |
| Secondary Flight Plan..... | A |
| DSC-22_20-60-60 Pilots/Stored Route Function | |
| Stored Route Function..... | A |
| DSC-22_20-60-70 Report Page | |
| General..... | A |
| Report Page Access..... | B |
| DSC-22_20-60-80 Closest Airports | |
| Closest Airports..... | A |
| DSC-22_20-60-90 Time Marker | |
| General..... | A |
| How to Insert a Time Marker..... | B |
| DSC-22_20-60-100 Step ALTS | |
| Step Climb/Step Descent..... | A |
| DSC-22_20-60-110 Required Time of Arrival (RTA) | |
| General..... | A |
| Estimated Takeoff Time (ETT)..... | B |
| DSC-22_20-60-120 Equitime Point | |
| Equitime Point..... | A |
| Equitime Point Entry..... | B |
| DSC-22_20-60-130 MCDU Back Up Navigation | |
| General..... | A |
| Back Up NAV Selection..... | B |
| Back Up NAV Operation..... | C |
| DSC-22_20-60-150 Descent Profile Optimization (if installed) | |
| Descent Profile Optimization  | A |

Continued on the following page

Continued from the previous page

DSC-22_20-70 AOC Functions

| | |
|---|---|
| Flight Plan Initialization Through ACARS..... | A |
| Takeoff Data..... | B |
| Wind Data..... | C |

DSC-22_20-80 Print Functions

| | |
|--------------------------------------|---|
| Print Function..... | A |
| Print Function Access..... | B |
| On Ground Before Engine Start..... | C |
| Example (FM Preflight Report)..... | D |
| In Flight..... | E |
| Example (FM Inflight Report)..... | F |
| Reaching the Gate After Landing..... | G |
| Example (FM Postflight Report)..... | H |

DSC-22_20-90 Abnormal Operations

DSC-22_20-90-10 FMGC Reset

| | |
|---|---|
| Automatic FMGC Reset and Resynchronization..... | A |
| Manual FMGC Reset..... | B |

DSC-22_20-90-20 "CHECK GW" or "CHECK WEIGHT" Message

| | |
|-----------------------------|---|
| "CHECK WEIGHT" Message..... | A |
|-----------------------------|---|

DSC-22_20-100 Temporary Abnormal Behaviors

DSC-22_20-100-20 FMS2 HONEYWELL Temporary Abnormal Behaviors

| | |
|--|---|
| Misalignment Of FMS F-PLN Legs For ILS Approaches..... | A |
| Incorrect Management Of ETA Entry On Predictive GPS Page..... | B |
| Flight Number Erased Upon AOC Flight Plan Uplink..... | C |
| Loss Of FMS Position Further To IRS Loss..... | D |
| Erroneous Fuel Prediction In The Case Of Descent With Two Altitude Constraints..... | E |
| Unexpected Switch Of Speed Target When RTA Is Used..... | F |
| Undue AP Disconnection or Reversion to V/S during Climb and Descent..... | G |
| VOR/DME and VOR/TACAN Not Automatically Tuned..... | H |
| Optimum Target Speeds not Updated following the Automatic Deletion of a Step Climb..... | I |
| Erroneous Lateral Guidance in NAV Mode with LOC Mode Armed during Approach..... | J |
| Undue Reduction of the Speed Target in case of DIR TO/ABEAM while Flying a Constant Mach Segment..... | K |
| Loss of Fuel and Time Predictions During Takeoff Data Insertion..... | L |
| Erroneous Trajectory during Procedures with a Turn Direction on a Leg with an Altitude Termination..... | M |
| Erroneous Vertical Profile during LOC B/C Approaches with a MAP Located Before the Runway Threshold..... | N |

Continued on the following page



AEROLINEAS GALAPAGOS S.A.

A318/A319/A320/A321
FLIGHT CREW
OPERATING MANUAL

AIRCRAFT SYSTEMS

AUTO FLIGHT - FLIGHT MANAGEMENT

PRELIMINARY PAGES - TABLE OF CONTENTS

Continued from the previous page

DSC-22_20-100-40 All FMS Temporary Abnormal Behaviors

| | |
|-------------------------------------|---|
| Erroneous Predictions..... | A |
| Spurious Engine Out Indication..... | B |

GENERAL

Ident.: DSC-22_20-10-00010128.0001001 / 17 AUG 10

Applicable to: ALL

The flight management and guidance system (FMGS) performs navigation functions and lateral and vertical flight planning functions. It also computes performance parameters and guides the aircraft along a preplanned route.

The Flight Management (FM) part controls the following functions:

- Navigation
- Management of flight planning
- Prediction and optimization of performance
- Management of navigation radios
- Management of displays



A318/A319/A320/A321
FLIGHT CREW
OPERATING MANUAL

AIRCRAFT SYSTEMS
AUTO FLIGHT - FLIGHT MANAGEMENT

GENERAL

Intentionally left blank



A318/A319/A320/A321
FLIGHT CREW
OPERATING MANUAL

AIRCRAFT SYSTEMS
AUTO FLIGHT - FLIGHT MANAGEMENT
NAVIGATION - GENERAL

NAVIGATION

Ident.: DSC-22_20-20-05-00010129.0001001 / 17 AUG 10

Applicable to: ALL

Essential navigation functions are:

- Computation of position
- Evaluation of position accuracy
- Radio navigation tuning
- Alignment of Inertial Reference System.



A318/A319/A320/A321
FLIGHT CREW
OPERATING MANUAL

AIRCRAFT SYSTEMS
AUTO FLIGHT - FLIGHT MANAGEMENT

NAVIGATION - GENERAL

Intentionally left blank

| | |
|---|--|
|  <p>A318/A319/A320/A321 FLIGHT CREW OPERATING MANUAL</p> | <p align="center">AIRCRAFT SYSTEMS</p> <p align="center">AUTO FLIGHT - FLIGHT MANAGEMENT</p> <p align="center">NAVIGATION - POSITION COMPUTATION</p> |
|---|--|

GENERAL

Ident.: DSC-22_20-20-10-00010130.0002001 / 16 MAR 11

Applicable to: ALL

Each FMGC computes its own aircraft position (called the "FM position") from a MIX IRS position and a computed radio position, or a GPS position.

The FMGS selects the most accurate position, considering the estimated accuracy and integrity of each positioning equipment.

GPS /INERTIAL is the basic navigation mode, provided GPS data is valid and successfully tested. Otherwise, nav aids plus inertial or inertial only are used. (*Refer to DSC-22_20-20-10 Navigation Modes*).

MIX IRS POSITION

Ident.: DSC-22_20-20-10-00010131.0002001 / 01 OCT 12

Applicable to: ALL

Each FMGC receives a position from each of the three IRS s, and computes a mean-weighted average called the "MIX IRS" position:

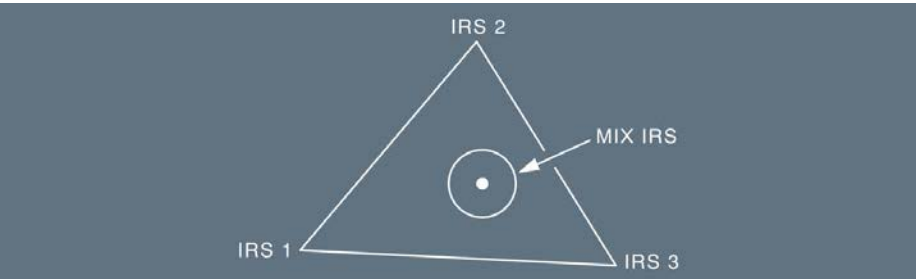

- If one of the IRS s drifts abnormally, the MIX IRS position uses an algorithm that decreases the influence of the drifting IRS within the MIX IRS position.

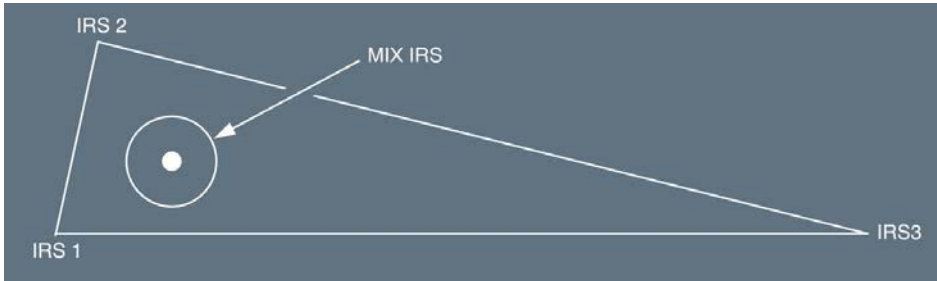

- If one of the IRS s fails, each FMGC uses only one IRS (onside IRS or IRS 3). Each IRS position and inertial speed are continuously tested. If the test fails, the corresponding IRS is rejected.
- When the "CHECK IRS (1, 2 or 3)/FM POSITION" message appears on the MCDU.

GPS POSITION

Ident.: DSC-22_20-20-10-00010132.0002001 / 23 JUN 15

Applicable to: **ALL**

Each IRS computes a mixed IRS /GPS position called the GPIRS position. For this, each IRS can independently select their GPS source in order to maximize the availability of GPS data. Of the three GPIRS positions that each FMGC receives, the FMS selects one GPIRS position based on a figure of merit and priority.

The FMS uses the following hierarchy to perform the selection:

- Onside GPIRS position
- GPIRS 3
- Opposite GPIRS position.

If the GPIRS data does not comply with an integrity criterion that is based on a Horizontal Integrity Limit (HIL) and on the automatic detection of failed satellites, the FMS rejects the GPS mode and uses the radio position update.

The flight crew can deselect/select the GPS position on the SELECTED NAVAIDS page, if necessary.

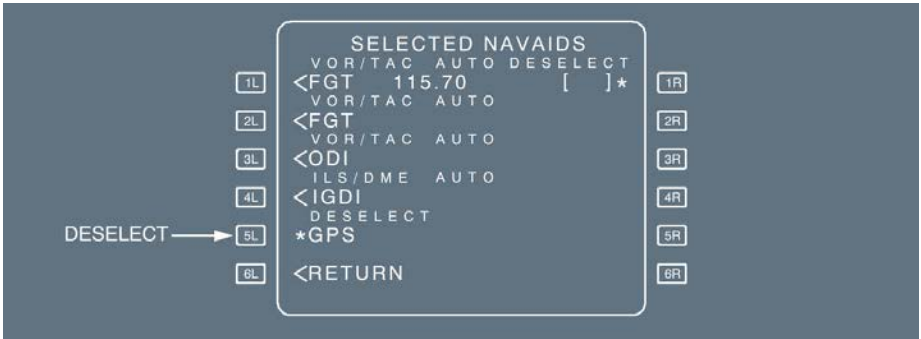

Information about the GPS position is displayed on the GPS MONITOR page.

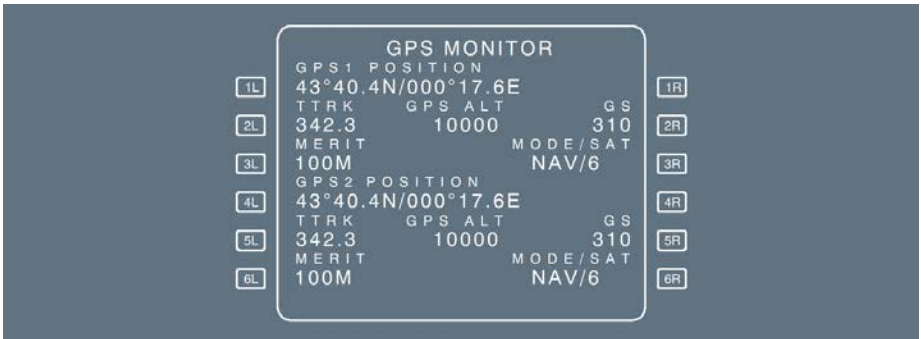

Note: In nominal case, ADIRU 1 selects GPS 1 and ADIRU 2 selects GPS 2. The GPS selection by ADIRU 3 depends on the position of the ATT HDG selector switch. If one of the GPS source is rejected by the ADIRU s, all ADIRU s will select the same GPS source. As a result, the data of the GPS that is not selected is dashed on the GPS MONITOR page. The “GPS PRIMARY LOST” message may not be displayed.

RADIO POSITION

Ident.: DSC-22_20-20-10-00010669.0020001 / 01 OCT 12

Applicable to: ALL

Each FMGC uses outside navaids to compute its own radio position. These navaids are displayed on the SELECTED NAVAIDS page.

The available navaids are:

- DME /DME
- VOR /DME

- LOC
- DME /DME -LOC
- VOR /DME -LOC.

It uses LOC to update the lateral position, using LOC beam during ILS approach.

LOC is also used for quick update, when in GPS /IRS mode.

If one or more nav aids fail, each FMGC can use offside nav aids to compute the VOR /DME , or the DME /DME radio position.

The radio nav aid selection is displayed on the DATA “SELECTED NAV AIDS” page.

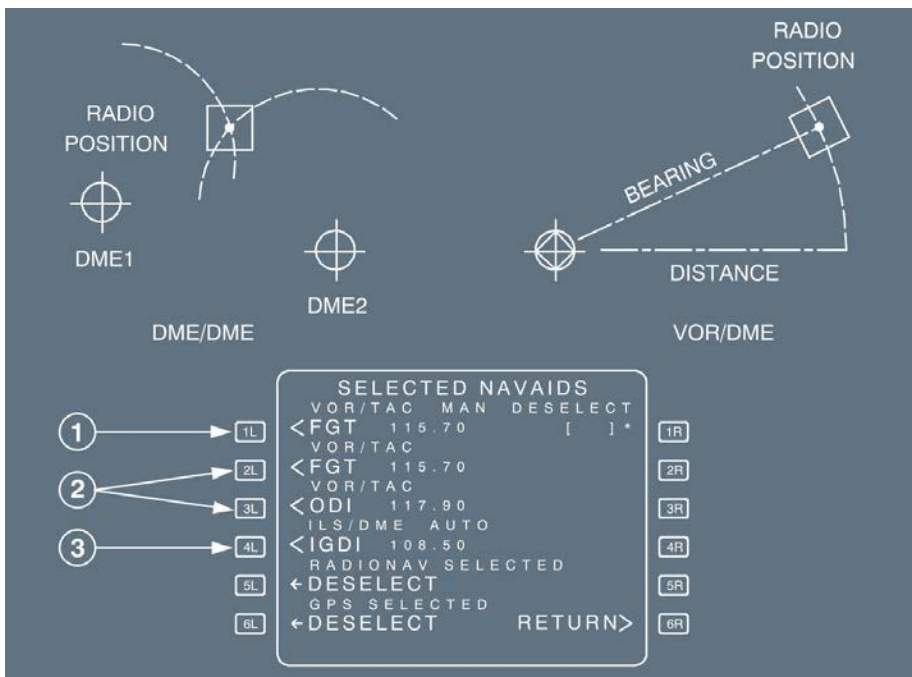

- (1) VOR /DME selection (auto or manual) for display (onside VOR).
- (2) DME s automatic selection for DME /DME onside radio position.
- (3) ILS selection (auto or manual) for LOC update computation.

| | |
|---|---|
|  <p>A318/A319/A320/A321 FLIGHT CREW OPERATING MANUAL</p> | <p style="text-align: center;">AIRCRAFT SYSTEMS</p> <p style="text-align: center;">AUTO FLIGHT - FLIGHT MANAGEMENT</p> <p style="text-align: center;">NAVIGATION - POSITION COMPUTATION</p> |
|---|---|

FM POSITION

Ident.: DSC-22_20-20-10-00010135.0017001 / 17 AUG 10
Applicable to: ALL

- At flight initialization, each FMGC displays an FM position that is a MIX IRS /GPS position (GPIRS):
- At takeoff, when the FM position is updated to the runway threshold position as stored in the database, possibly corrected by the takeoff shift entered on PERF TO page.
 - In flight, the FM position approaches the radio position or the GPS position at a rate depending upon the aircraft altitude.

Note: The FM position update at takeoff is inhibited when GPS PRIMARY is active.

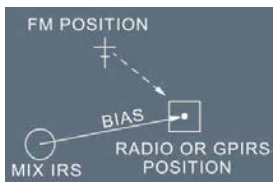

BIAS

Each FMGC computes a vector from its MIX IRS position to the radio position or GPIRS position. This vector is called the “bias”.

Each FMGC updates its bias continuously as long as a radio position or a GPIRS position is available.

If an FMGC loses its radio/GPIRS position, it memorizes the bias and uses it to compute the FM position, which equals the MIX IRS position plus the bias. Until the radio or the GPIRS position is restored, the bias does not change.

The flight crew can update the FM position manually. This also updates the bias.

POSITION MONITOR

Ident.: DSC-22_20-20-10-00010136.0016001 / 07 MAY 13
Applicable to: ALL

The flight crew may check the position computation using the GPS MONITOR or POSITION MONITOR page.

GPS MONITOR

| | | | |
|---------------|------------------------|--|----|
| GPS1 POSITION | | | |
| 1L | 43°40.4N/000°17.6E | | 1R |
| | TTRK UTC GS | | |
| 2L | 342.3 10:37:42 310 | | 2R |
| | MERIT GPS ALT MODE/SAT | | |
| 3L | 100M 10000 NAV/6 | | 3R |
| GPS2 POSITION | | | |
| 4L | 43°40.4N/000°17.6E | | 4R |
| | TTRK UTC GS | | |
| 5L | 342.3 10:37:42 310 | | 5R |
| | MERIT GPS ALT MODE/SAT | | |
| 6L | 100M 10000 NAV/6 | | 6R |

POSITION MONITOR

| | | | |
|----|--------------------------|----------|----|
| 1L | FMS 1 4340.4N/00017.6E | | 1R |
| | 3IRS/GPS | | |
| 2L | FMS 2 4340.4N/00017.6E | | 2R |
| | 3IRS/GPS | | |
| 3L | GPIRS 4340.4N/00017.6E | | 3R |
| 4L | MIX IRS 4340.4N/00017.6E | | 4R |
| | IRS1 IRS2 IRS3 | | |
| 5L | NAV 0.4 NAV 0.2 NAV 0.4 | | 5R |
| | SEL | | |
| 6L | <FREEZE | NAVAIDS> | 6R |

1L FM POSITION (FMGC1)

2L FM POSITION (FMGC2)

3L GPIRS OR RADIO POSITION (ON SIDE FMGC) WHICHEVER IS USED FOR POSITION UPDATING

4L MIX IRS POSITION (ON SIDE FMGC)

TAKEOFF UPDATE

Ident.: DSC-22_20-20-10-00010137.0017001 / 04 AUG 16

Applicable to: ALL

A takeoff update requires that the takeoff runway be part of the flight plan. This provides the most accurate position update.

If the takeoff run starts at an intersection, enter a takeoff shift on the PERF TO page to refine the takeoff update.

An accurate takeoff update ensures a precise aircraft position during departure.

TAKE OFF

| | | | | |
|----|-----------|----------|-------------|----|
| 1L | V1 | FLP RETR | RWY | 1R |
| 2L | 130 | F=138 | 15R | 2R |
| 3L | VR | SLT RETR | TO SHIFT | 3R |
| 4L | 131 | S=179 | CM 900 | 4R |
| 5L | V2 | CLEAN | FLAPS/THS | 5R |
| 6L | 131 | O=202 | []/[] | 6R |
| | TRANS | ALT | FLX TO TEMP | |
| | 4800 | | 45° | |
| | THR | RED/ACC | ENG OUT ACC | |
| | 3000/4365 | | | |
| | | | NEXT PHASE> | |

PERF TO PAGE

If the takeoff is not initiated from runway threshold, to shift should be inserted to update the position.

FROM

| | | | |
|----|---------|----------------|----|
| 1L | FROM | AF5612 → | 1R |
| 2L | LFB015R | 0000 148/1490 | 2R |
| 3L | H146 | BRG145 3NM | 3R |
| 4L | TOU/08 | --- | 4R |
| 5L | 6034 | TRK034 14 | 5R |
| 6L | D0730 | --- | 6R |
| | HUM20 | 21 | |
| | CRESP | --- | |
| | MUPA2D | 24 | |
| | DO432 | --- | |
| | DEST | TIME DIST EFOB | |
| | EDHI | 0148 759 | |
| | | ↑ ↓ | |

Takeoff runway in the flight plan.

F-PLN A PAGE (WITHOUT PREDICTIONS)

NAVIGATION MODES

Ident.: DSC-22_20-20-10-00010138.0001001 / 19 JUL 11

Applicable to: ALL

The FMGS updates the FM position via the use of radio navaids or GPS , if available. It can use four different FM navigation modes to make this update.

The decreasing order of priority is:

- IRS -GPS
- IRS -DME /DME
- IRS -VOR /DME
- IRS only.

During ILS approaches, the system performs a temporary lateral update, via one of the following modes:

- IRS -GPS /LOC
- IRS -DME /DME -LOC



A318/A319/A320/A321
FLIGHT CREW
OPERATING MANUAL

AIRCRAFT SYSTEMS

AUTO FLIGHT - FLIGHT MANAGEMENT

NAVIGATION - POSITION COMPUTATION

- IRS -VOR /DME -LOC
- IRS -LOC.

| | |
|---|---|
|  A318/A319/A320/A321 FLIGHT CREW OPERATING MANUAL | AIRCRAFT SYSTEMS AUTO FLIGHT - FLIGHT MANAGEMENT NAVIGATION - EVALUATION OF POSITION ACCURACY |
|---|---|

GENERAL

Ident.: DSC-22_20-20-20-00010448.0023001 / 27 MAY 13

Applicable to: ALL

The FMGS continuously computes an Estimated Position Uncertainty (EPU). It is an estimate of how much the FM position diverged, and it is a function of the navigation mode that the system uses.

| CURRENT NAV MODE | EPU (RATE or THRESHOLD) | REMARK |
|------------------|--|--|
| IRS /GPS | $\sqrt{(FOM^2 + 100^2)}$ (in meters). | FOM = Figure of Merit of GPS. If above 0.28 NM, the FMS rejects the GPS position. |
| IRS /DME /DME | Moves toward 0.28 NM. | EPU decreases from initial value to 0.28 NM. |
| IRS /VOR /DME | 0.1 NM + 0.05 X DME DIST. Minimum : 0.28 NM. | Dependent on the distance between the aircraft and the VOR /DME. |
| IRS ONLY | +8 nm/h for the first 30 min. 0 nm/h for the following 60 min. +4 nm/h for the following 30 min. 0 nm/h for the following 60 min. +2 nm/h after. | EPU increases continuously. |

Note: After an IRS alignment or at takeoff, the EPU is set to 0.2 NM.

ESTIMATED POSITION UNCERTAINTY

Ident.: DSC-22_20-20-20-00010499.0076001 / 01 OCT 12

Applicable to: ALL

The FMS displays the EPU to the flight crew and compares it with the Required Navigation Performance (RNP):

- If the EPU does not exceed the RNP, accuracy is HIGH
- If the EPU exceeds the RNP, accuracy is LOW.

The RNP is displayed in the REQUIRED field of the PROG page. The displayed RNP is (in a decreasing order of priority):

- The value that the flight crew entered
- The navigation database procedure value
- The system's default value.

When a flight crew enters an RNP that is higher than the published value, one of the following messages is displayed : "PROCEDURE RNP IS XX.XX", or "AREA RNP IS XX.XX". When this occurs, the flight crew should verify the RNP value that was manually entered in the REQUIRED field of the PROG page, and clear or modify it if necessary.

The "AREA RNP IS XX.XX" message is also displayed at the change of flight area if the new RNP (default value) is smaller than the displayed RNP (manually entered).

DEFAULT AREA RNP VALUES

| | |
|----------|----------------------------------|
| EN ROUTE | 2.0 NM |
| TERMINAL | 1.0 NM |
| APPROACH | GPS 0.3 NM OTHER CASES 0.5 NM |

When one FMGC changes the NAV accuracy from LOW to HIGH (or HIGH to LOW), the MCDU and the ND display the "NAV ACCUR UPGRAD" (or DOWNGRAD) message.

These messages are inhibited when the navigation mode is IRS /GPS.

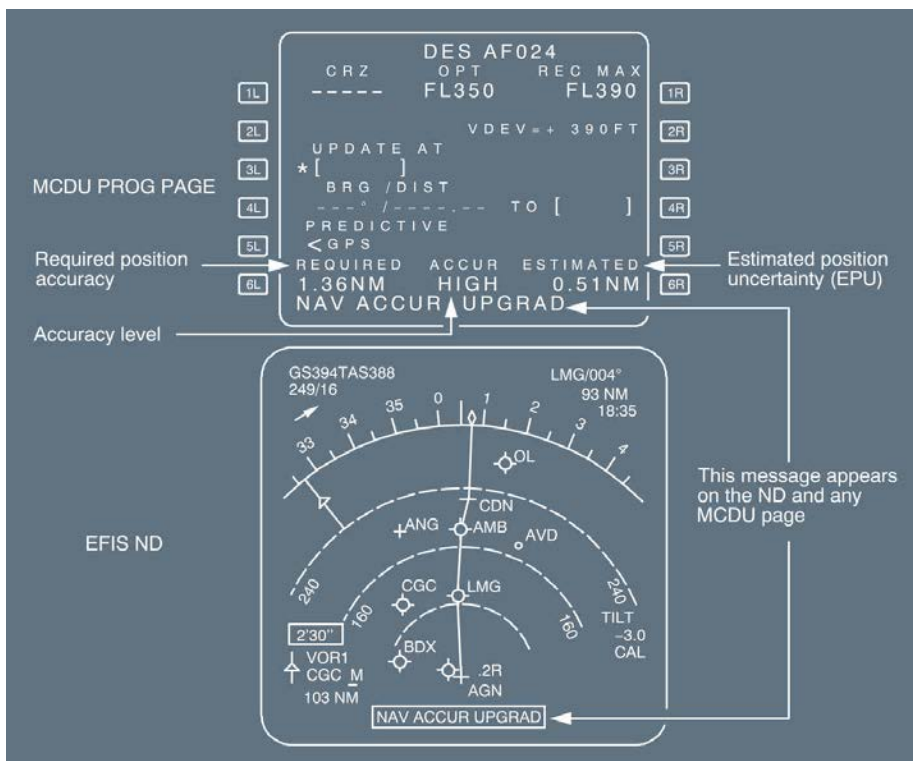

The diagram illustrates the MCDU PROG PAGE and EFIS ND displays. The MCDU PROG PAGE shows flight data for DES AF024, including CRZ, OPT, REC, and MAX altitudes, and VDEV. It also displays predictive accuracy information: REQUIRED ACCUR (1.36NM), ESTIMATED ACCUR (HIGH 0.51NM), and a NAV ACCUR UPGRAD message. The EFIS ND shows a navigation display with various waypoints (VOR1, CGC, BDX, LMG, .2R, AGN, CDN, AMB, AVD, ANG, OL) and a NAV ACCUR UPGRAD message at the bottom. Annotations indicate that the message appears on the ND and any MCDU page.

When in IRS /GPS mode, the GPS PRIMARY status combines two different criteria:

- The accuracy criterion previously described (HIGH/LOW accuracy)
- An integrity criterion: This is the capability to detect a failure and provide appropriate warning of it. This criterion indicates the confidence that the flight crew can have in the FMS position.

If the GPS PRIMARY status complies with both criteria, "GPS PRIMARY" is displayed on the MCDU (PROG page, [5R] field and scratchpad) and temporarily on the ND.

If the GPS PRIMARY status no longer complies with one of these criteria (Navigation downgraded or integrity lost), the GPS PRIMARY status is lost and the MCDU and the ND display the "GPS PRIMARY LOST" message. It is possible to clear the scratchpad message on the MCDU , but not on the ND.

CAUTION

"HIGH" or "LOW" on the PROG page indicates the FM position accuracy, based on estimated uncertainty. When GPS PRIMARY mode is lost, the flight crew must periodically check this position accuracy. In GPS PRIMARY mode, the position accuracy is always at HIGH.

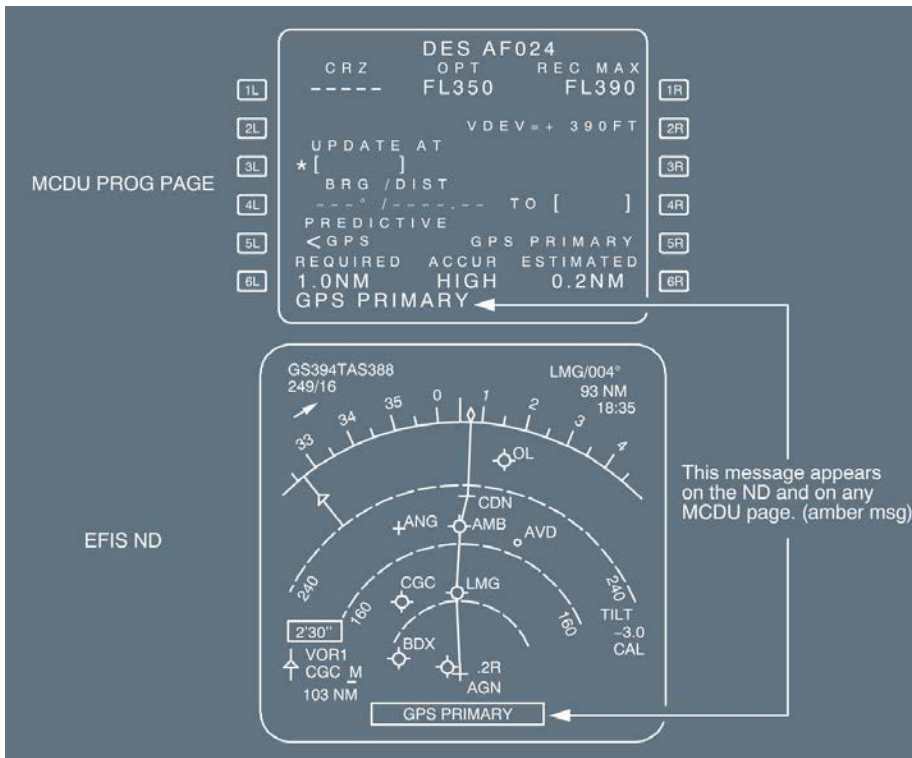

When the GPS is manually deselected, the "GPS IS DESELECTED" message is displayed on the MCDU , 80 NM before the T/D or at approach phase transition.

FM/GPS POSITION DISAGREEMENT

Ident.: DSC-22_20-20-00010500.0011001 / 17 AUG 10

Applicable to: ALL

When the GPS PRIMARY function is active, and either of the FM positions deviate from the GPS positions 1 or 2 by more than:

- A longitude threshold that depends on the latitude:
 - 0.5' for latitudes below 55°
 - 0.9' for latitudes at or above 55°, and below 70°.
- A latitude threshold of 0.5', regardless of the latitude,

then, the lower ECAM displays the NAV FM /GPS POS DISAGREE amber caution. The master caution light comes on and the single chime sounds.

This amber caution is inhibited during the takeoff phase.

Above 70° of latitude, a longitude difference does not trigger the alarm.

PREDICTIVE GPS PAGE

Ident.: DSC-22_20-20-00010501.0001001 / 16 MAR 11

Applicable to: ALL

The predictive GPS page is only operative with the Honeywell ADIRS equipment. All fields are blank with Litton ADIRS equipment.

The predictive GPS function predicts the availability of the GPS within ± 15 min of ETA at destination, or at any waypoint entered by the flight crew.

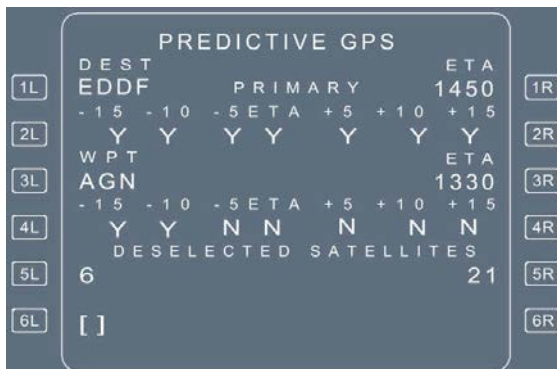

Predictions are displayed on the predictive GPS page at time intervals of 5 min (+15 and -15 min of ETA).

To access this page, press the 5L key of the PROG page. This page also enables the deselection of up to 4 satellites at a time.



A318/A319/A320/A321
FLIGHT CREW
OPERATING MANUAL

AIRCRAFT SYSTEMS

AUTO FLIGHT - FLIGHT MANAGEMENT

NAVIGATION - EVALUATION OF POSITION ACCURACY

Intentionally left blank

GENERAL

Ident.: DSC-22_20-20-30-00010478.0001001 / 17 AUG 10

Applicable to: ALL

Radio nav aids are tuned for two different purposes: Display and computation.

It is possible to perform tuning for display in three different ways:

- Automatic tuning via FMGC software
- Manual tuning via the MCDU RAD NAV page
- Manual tuning via the Radio Management Panel (RMP) if both FMGC s or both MCDUs fail.

The FMGS automatically tunes the radio nav aids for computation of the radio position.







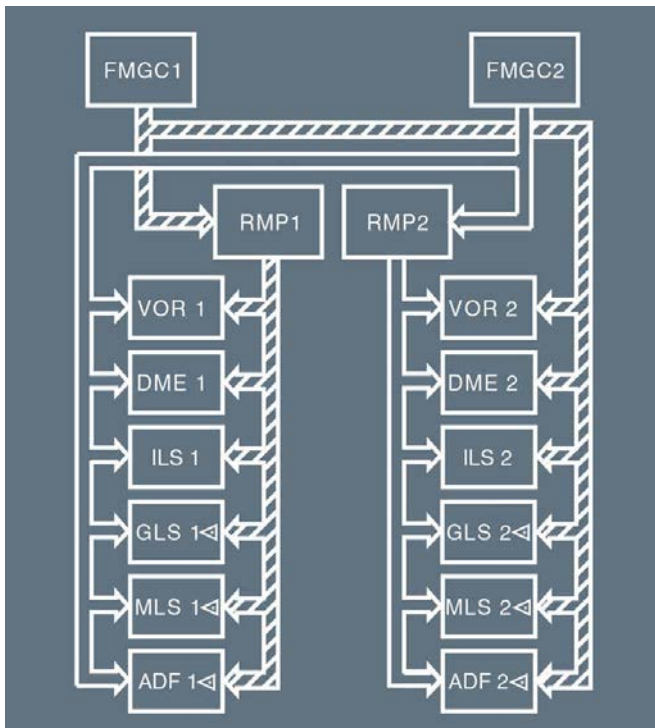

Note: The manual selection of a VOR or VOR /DME may prevent the FMGS from automatically tuning a VOR /DME to compute position. In this case, the related MCDU displays "TUNE BBB FFF.FF" (BBB = ident, FFF.FF = frequency).

ARCHITECTURE

Ident.: DSC-22_20-20-30-00010479.0001001 / 31 AUG 17

Applicable to: ALL



- In dual mode and independent mode, each FMGC simultaneously tunes the nav aids on its own side (one VOR , one DME , one ILS , one GLS  , one MLS  and one ADF ). In these modes, the flight crew can also manually tune the VOR (and associated DME) , ILS, GLS  , MLS  and ADF  .
- In single mode, the valid FMGC tunes nav aids on both sides. The flight crew can also use the RAD NAV page to manually tune both VOR s, both ADFs  , and the ILS / GLS  / MLS  .

Manual tuning has priority over automatic tuning.

Note: If one receiver fails, both FMGCs use the operative radio receiver to compute the position of the aircraft.

VOR

Ident.: DSC-22_20-20-30-00010480.0001001 / 17 AUG 10

Applicable to: ALL

Each FMGC may tune only one VOR (manually or automatically).

Automatic tuning complies with the following priorities for tuning the VOR:

1. The specified navaid for the approach
2. The navaid that the flight crew should use to compute the current radio position
3. For display purposes:
 - A navaid specified for the active flight leg
 - The "TO" waypoint (TO WPT), if it is a navaid
 - The "FROM" waypoint (FROM WPT), if it is a navaid
 - A waypoint farther along the flight path, if it is a navaid
 - The navaid closest to the current position of the aircraft.

The scratchpad displays "SPECIFIC VOR-D UNAVAIL", if the VOR or the VOR /DME that the flight crew requires for tuning is deselected.

DME

Ident.: DSC-22_20-20-30-00010481.0002001 / 17 AUG 10

Applicable to: ALL

Each FMGC automatically uses its four DME frequencies as follows:

- One DME frequency for display. It is possible to tune it manually or automatically. This DME frequency is also used for VOR /DME position computation.
- Two DME frequencies in DME /DME mode for calculating the radio position of the aircraft. The FMGC automatically tunes these as a function of their best accuracy. The flight crew does not receive any indication that this process is happening.
- One DME frequency is connected to the ILS /DME.

ADF

Ident.: DSC-22_20-20-30-00010482.0001001 / 17 AUG 10

Applicable to: ALL

The FMGC automatically tunes one ADF, when the flight plan specifies a Non Directional Beacon (NDB) approach and a fix in the approach is the "TO" waypoint.

The scratchpad displays "SPECIFIC NDB UNAVAIL", if the NDB that the flight crew requires for autotuning is deselected.

ILS

Ident.: DSC-22_20-20-30-00010483.0001001 / 17 AUG 10

Applicable to: ALL

Each FMGC automatically tunes one ILS frequency:

- In the PREFLIGHT or TAKEOFF phase, when the takeoff runway has an associated ILS.
- In the CLIMB, CRUISE, DESCENT, APPROACH, or GO-AROUND phase, when the type of approach in the flight plan is ILS.

The scratchpad displays "RWY /ILS MISMATCH" when the flight crew manually tunes the ILS and the entered frequency does not agree with the ILS or the LOC IDENT /FREQ that the flight crew requests for automatic tuning. The FMGS logic does not enable the flight crew to modify the course of an ILS when its frequency is identical to the ILS selected in the F-PLN.

SELECTION OF NAVAIDS ON MCDU PAGES

Ident.: DSC-22_20-20-30-00010485.0032001 / 31 AUG 17

Applicable to: ALL

The MCDU displays the navaids tuned by the FMGC on two pages:

- RADIO NAV Page
- SELECTED NAVAIDS Page.

RADIO NAV PAGE

This page shows which navaids have been tuned automatically or manually for display purposes.



SELECTED NAVAIDS PAGE

This page lists the navaids tuned by the onside FMGC. No navaids can be modified on this page. The flight crew may deselect navaids and or GPS  for the whole flight.

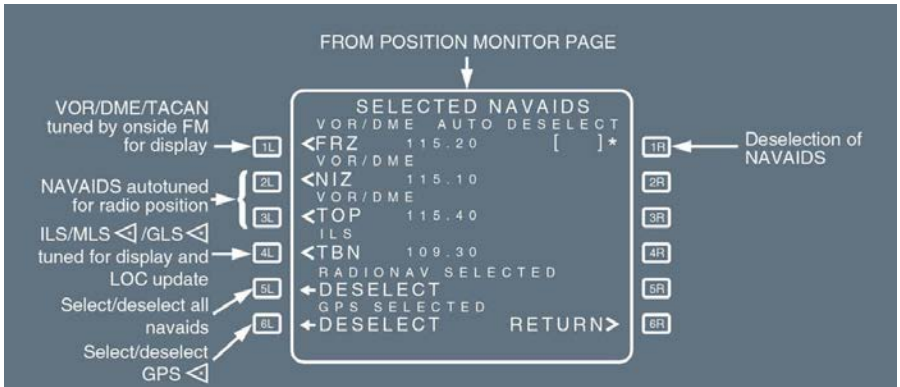

MANUAL TUNING

Ident.: DSC-22_20-20-30-00010486.0002001 / 01 MAR 17

Applicable to: ALL

INSERT the identifier on the RADIO NAV page.

Preferably use the identifier.



Note: The RAD NAV page may differ according to option installed (ADF 1, ADF2, xLS).

- If the MCDU displays “NOT IN DATA BASE”:

INSERT the frequency.

DISREGARD the ident that appears in small font on the MCDU.

When a frequency is entered in the VOR field, the FMGC automatically associates to the tuned frequency the closest navaid identifier with the same frequency, and displays it on the RAD NAV page. This identifier may not correspond to the tuned navaid.



If the closest navaid, found in the database, is of a different type (e.g. VOR instead of VOR /DME), the flight crew will obtain a partial tuning (e.g. VOR indication instead of VOR /DME indication).
ENTER the course.

If the flight crew intends to manually tune an ILS that is not in the Navigation Database or to manually tune an ILS by its frequency (ident not entered), and if they do not enter the course, the flight crew will not be able to arm approach modes.



NAVAID IDENTIFICATION

Ident.: DSC-22_20-20-30-00010487.0001001 / 31 AUG 17

Applicable to: ALL

CHECK the xLS (ILS or GLS  or MLS ) identifier decoded on the PFD, and the VOR or ADF  on the ND.

When the navaid identifier is decoded in agreement with that published, no audio check is necessary. When the decoding is different from the published one, check the audio. Due to morse coding inaccuracy, wrong decoding may sometimes occur.

For GLS , the audio signal may be inaudible. However, the GLS  identifier displayed on ND and PFD is raw data. Consequently, for GLS , no audio check is necessary.

Note: *When a DME or a TACAN only is selected using either its identifier or its frequency, the NDs do not display the decoded indication.*

ALIGNMENT OF INERTIAL REFERENCE SYSTEM

Ident.: DSC-22_20-20-40-00010143.0013001 / 01 OCT 12

Applicable to: ALL

The FMGS uses the reference point coordinates of the departure airport to align the IRS. It calls these up from the database automatically after the flight crew has entered a company route or an origin-destination city pair and pressed the ALIGN IRS key on the MCDU. The flight crew can adjust these coordinates manually to the gate position. A normal alignment takes 10 min, a fast alignment 30 s.

Fast alignment is used to refine a position when time is limited.



Note: If the "IRS IN ALIGN" memo flashes on the E/WD during the alignment process, it indicates one of the following:

- It has detected excessive motion. (It automatically restarts the alignment)
- It has detected a disagreement between the position the MCDU has sent to the IRS, and the last memorized IRS position. The flight crew must enter new coordinates in the MCDU, and realign the IRS
- It has detected a disagreement between the latitude the MCDU has sent to the IRS, and the latitude the IRS has computed during the alignment
- The IRS has not received a position from the MCDU.



A318/A319/A320/A321
FLIGHT CREW
OPERATING MANUAL

AIRCRAFT SYSTEMS

AUTO FLIGHT - FLIGHT MANAGEMENT

NAVIGATION - ALIGNMENT OF INERTIAL REFERENCE SYSTEM

Intentionally left blank

| | |
|---|---|
|  A318/A319/A320/A321 FLIGHT CREW OPERATING MANUAL | AIRCRAFT SYSTEMS AUTO FLIGHT - FLIGHT MANAGEMENT NAVIGATION - NAVIGATION DATABASE |
|---|---|

| |
|----------------|
| GENERAL |
|----------------|

Ident.: DSC-22_20-20-50-00010410.0001001 / 09 MAR 15

Applicable to: ALL

Overall navigation performance is mainly based on two elements:

- The accuracy of the aircraft position calculation
- The validity of the flight path definition, as extracted from the navigation database.

The level of validation depends on the type of operations. For example, JAA TGL 10 requires that, for Precision RNAV in terminal area, providers and operators implement a quality assurance program for the navigation database, which may include a navigation database validation process. The highest level of validation is required for RNAV approach, with lateral and vertical navigation.

The navigation databases are revised every 28 days (AIRAC cycle). Flights should be conducted with a navigation database that is within its cycle. This should be checked on the AIRCRAFT STATUS MCDU page.

| |
|--|
| OPERATIONS WITH AN OUTDATED NAVIGATION DATABASE |
|--|

Ident.: DSC-22_20-20-50-00010411.0001001 / 13 DEC 12

Applicable to: ALL

Airbus recommends flying with an updated navigation database. However, in exceptional circumstances, and for a limited period of time, an aircraft can continue to operate beyond the end date of the database cycle, provided it is approved by the national authorities.

The following precautions need to be considered:

- Prior to flight, identify recent changes on the intended route, with the navigation charts and manuals. Some “strategic” new waypoints, not in the navigation database, may be worth entering as DEFINED WAYPOINT on MCDU.

***Note:** Flying with an outdated database, in an airspace that was recently restructured with numerous new waypoints, should be avoided.*

- Check SID , STAR, and approach procedures of departure, destination and required alternates for recent changes.

Do not attempt to modify or manually construct terminal instrument procedures or approaches.

- Fly terminal instrument procedures and approaches with managed guidance, that are in the navigation database and that have been checked for accuracy. Otherwise, fly the procedure, or the approach, in selected guidance with conventional radio navaid raw data.



A318/A319/A320/A321
FLIGHT CREW
OPERATING MANUAL

AIRCRAFT SYSTEMS

AUTO FLIGHT - FLIGHT MANAGEMENT

NAVIGATION - NAVIGATION DATABASE

Intentionally left blank

FLIGHT PLANNING

Ident.: DSC-22_20-30-05-00010492.0002001 / 17 AUG 10

Applicable to: ALL

The flight crew uses the MCDU to insert flight plans into the FMGS:

- A lateral flight plan that defines the intended horizontal flight path
- A vertical flight plan that defines the intended speed and altitude profile for the aircraft to follow while flying the lateral flight plan.

Note: The flight planning function is available for both the primary and secondary flight plans.

The FMGS can contain two different flight plans:

- The ACTIVE flight plan, which is the basis for:
 - Lateral and vertical guidance
 - MCDU and ND display
 - Radio navigation autotuning
 - Performance predictions
 - Fuel planning.
- The SECONDARY flight plan which the flight crew may use:
 - When an alternate takeoff runway is probable
 - To plan a diversion
 - To prepare the next flight
 - To compare predictions or evaluations.

Each flight plan is composed of the same elements:

- The primary flight plan, from origin to destination and missed approach
- The alternate flight plan, from destination to alternate destination.

The flight crew enters the flight plan in either of two ways:

- Automatically by selecting a company route. Such a selection will call all the elements of the route out of the database.
- Manually by selecting an ORIGIN/DEST pair, and then selecting all successive waypoints, procedures, and vertical constraints on the MCDU.

The flight crew may then modify the flight plan on the ground or in flight, by making lateral and vertical revisions.



A318/A319/A320/A321
FLIGHT CREW
OPERATING MANUAL

AIRCRAFT SYSTEMS
AUTO FLIGHT - FLIGHT MANAGEMENT

FLIGHT PLANNING - GENERAL

Intentionally left blank

General

GENERAL

Ident.: DSC-22_20-30-10-05-00011075.0002001 / 23 JUN 15

Applicable to: ALL

To insert the lateral flight plan, the flight crew can use either a company route number or an ICAO four-letter city pair.

The lateral flight plan includes the following elements:

- Departure
 - Takeoff runway
 - SID
 - En route transition.
- En route
 - En route waypoints and airways.
- Arrival
 - En route transition
 - STARs/VIAs
 - Landing runway with selected approach
 - Missed approach.
- Alternate flight plan.

These elements are defined by waypoints and legs between the waypoints.

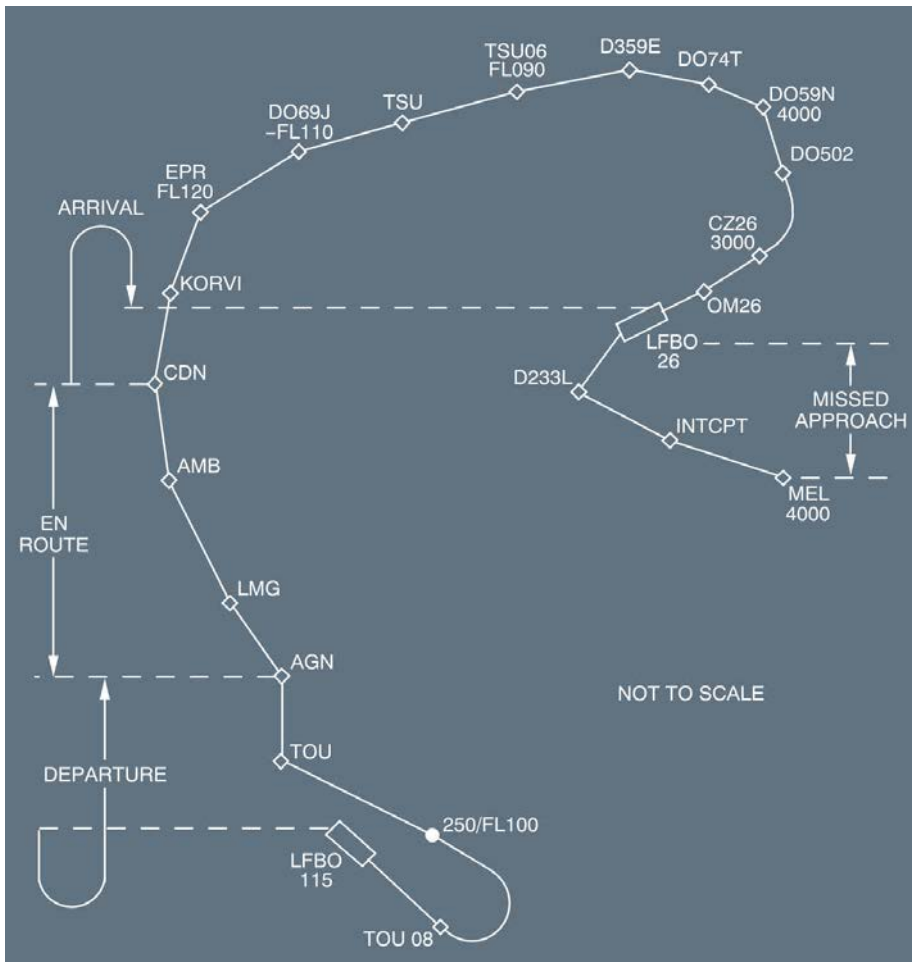

The FMGC automatically strings the legs in sequence.

The flight plan has a discontinuity if any two waypoints do not have a leg defined between them.

The computer assumes that the aircraft will fly a direct leg between the two waypoints that define the discontinuity.

- Note:*
1. When the aircraft overflies a flight plan discontinuity, the NAV mode automatically reverts to the HDG (TRK) mode.
 2. In HDG /TRK mode, a waypoint is sequenced when it passes behind the aircraft, and the aircraft is less than 7 NM from it, and also when the difference between the track of the aircraft and the track of the leg is less than 90 °.
 If the aircraft is flying a discontinuity towards a waypoint, this waypoint is sequenced when the aircraft is less than 5 NM from it.
 The same conditions apply in NAV mode, except that no distance to the waypoint is taken into account.

The FMGS automatically strings additional types of legs, when departure or arrival procedures (SID - STAR - TRANS) are defined.

Those strings correspond to specific patterns that are heading or track referenced and are defined in the database, such as:

- DME arc leg
- Holding pattern to a fix, or reverse turn
- Course-to-fix leg
- Radius-to-fix leg
- Heading leg
- MANUAL leg.

The flight crew cannot create these types of legs: They are part of the stored departure/arrival procedures they have selected.

The flight crew can only create direct legs between manually defined geographic points (navaids, airports, waypoints).

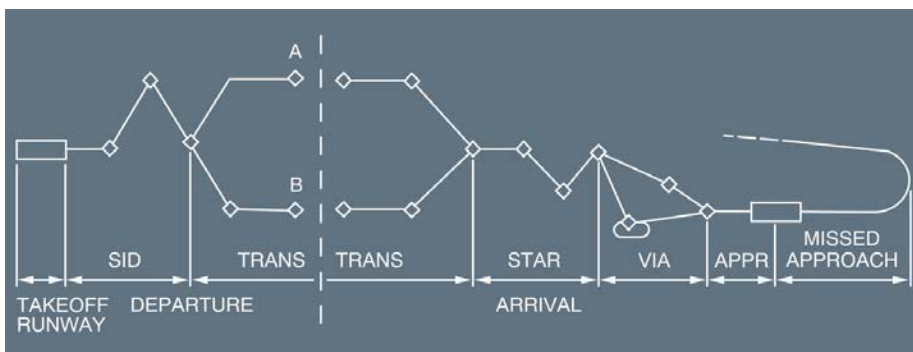

Note: The departure and arrival procedures are defined in the database to minimize the amount of memory required.

They are divided, as follows:

- DEPARTURE = SID + EN ROUTE TRANSITION
- ARRIVAL = APPR VIA + STAR + EN ROUTE TRANSITION

The SID is the central common part of the departure procedure, as the STAR is of the arrival procedure. Enroute transitions (TRANS) are the various possible trajectories defined between the last SID point and the first enroute waypoints, and between the last enroute waypoint and the first fix of the STAR. "APPR VIAs" are the possible trajectories, defined between the last STAR point and the first point of the approach.

MANUAL LEGS

Ident.: DSC-22_20-30-10-05-00010629.0001001 / 17 AUG 10

Applicable to: ALL

A MANUAL leg stays on a constant TRK or HDG and has no termination point. The flight crew cannot insert it into a flight plan manually: it is part of a given procedure such as a SID or a STAR. When the aircraft is flying a MANUAL leg, the NAV mode remains engaged and predictions assume that the aircraft will fly a direct leg from its present position to the next waypoint (DIR TO). When the aircraft is cleared to fly to the next waypoint of the flight plan, the flight crew performs a DIR TO.

- Note:
1. In NAV mode, a MANUAL leg is sequenced only by performing a DIR TO.
 2. The use of the descent mode (DES) on a MANUAL leg is not recommended.



FLIGHT PLAN CONSTRUCTION

Ident.: DSC-22_20-30-10-05-00011076.0032001 / 01 OCT 12

Applicable to: ALL

There are three ways of defining the route:

1. A company route, that is in the database, and is known by the flight crew.

The flight crew enters the name of the CO RTE into the [1L] field of the INIT A page. This action enters all the elements of the flight plan. The database usually includes an alternate route associated with the destination.

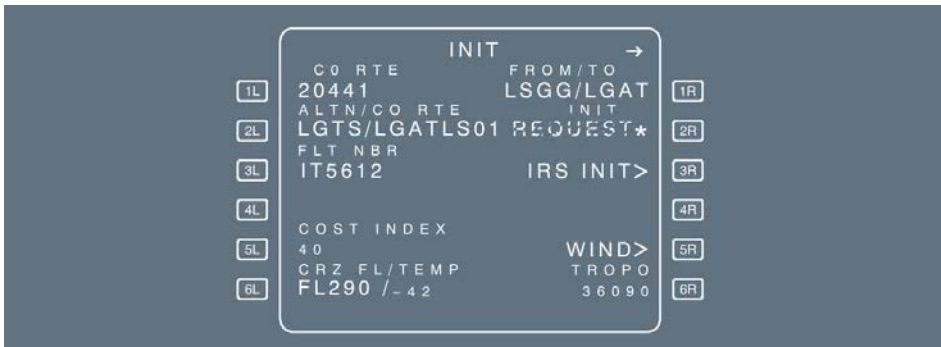

2. A company route, that is in the database, but the flight crew does not know it is there.

The flight crew enters a city pair in the [1R] field. The ROUTE SELECTION page automatically appears and enables the flight crew to review all stored routes between the two cities before selecting one of them.

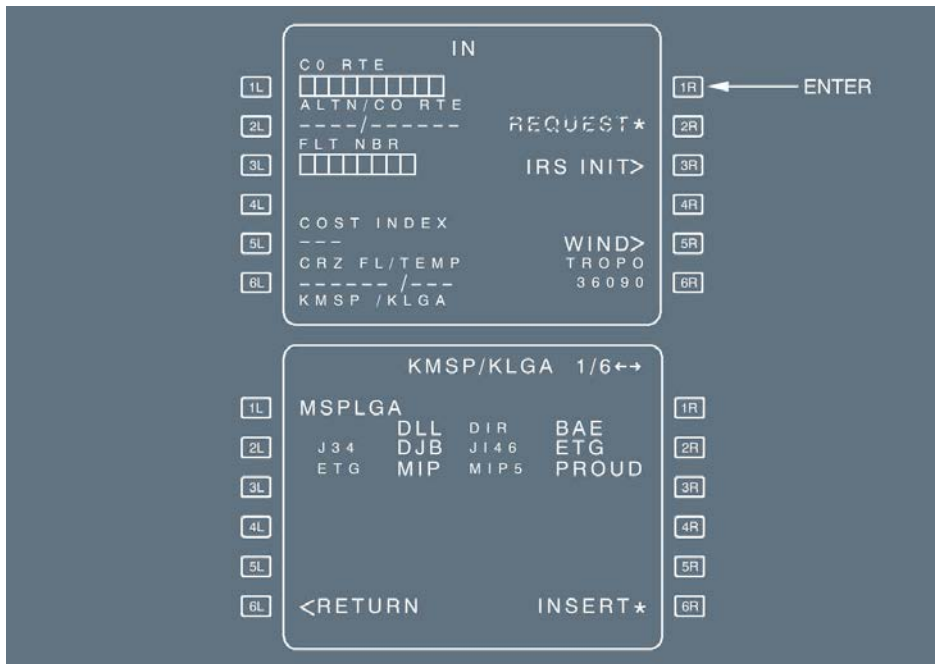

3. There is no company route between the two cities.

The flight crew enters the city pair in the [1R] field. The ROUTE SELECTION page appears and displays “NONE”.

The flight crew has to manually construct the entire flight plan.

For procedure, *Refer to PRO-NOR-SRP-01-10 Flight Plan Initialization - General.*

FLIGHT PLAN CAPACITY

Ident.: DSC-22_20-30-10-05-00010631.0002001 / 17 AUG 10

Applicable to: ALL

In terms of flight plan capacity, the FMS takes into account 3 flight plans:

- The active flight plan
- The secondary flight plan
- The temporary flight plan.

Each flight plan can contain up to 200 legs. If a flight plan contains 200 legs, and if the flight crew attempts to perform a lateral revision that increases the number of legs of this flight plan, the FMS rejects the revision and the MCDU displays the “F-PLN FULL” message. For the active and



A318/A319/A320/A321
FLIGHT CREW
OPERATING MANUAL

AIRCRAFT SYSTEMS

AUTO FLIGHT - FLIGHT MANAGEMENT

FLIGHT PLANNING - LATERAL FUNCTIONS

secondary flight plans, the primary parts must contain less than 135 legs, and the alternate parts must contain less than 65 legs.

LATERAL REVISIONS

Ident.: DSC-22_20-30-10-05-00010632.0002001 / 07 APR 17

Applicable to: **ALL**

The flight crew can revise the lateral flight plan following two types of revisions:

1. Lateral revisions that have an immediate effect on the active flight plan:
 - The flight crew inserts a new waypoint directly on the F-PLN page, deletes, or changes a waypoint from it:

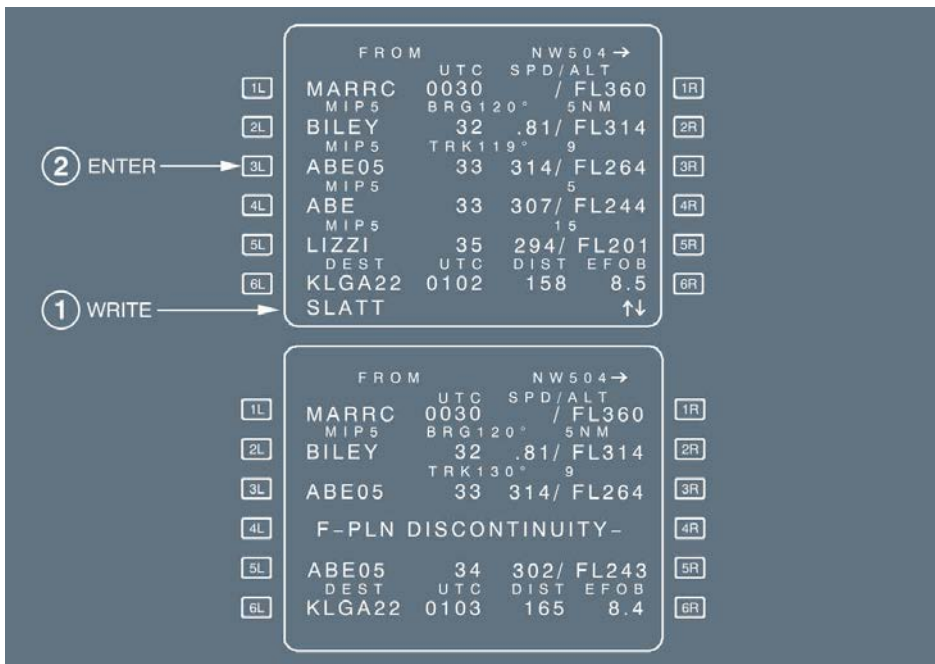

When the flight crew enters a new waypoint, which does not exist in the flight plan, the following waypoint moves down the flight plan, with a discontinuity shown after the new waypoint.

- The flight crew adds a direct leg (DIR TO) from his present position to a selected waypoint: The flight crew can change the "TO" waypoint of the active leg. The DIR TO function gives access to DIR TO , DIR TO ABEAM, or DIR TO/INTERCEPT. The active leg then goes from the present position (T/P) to the waypoint selected or inserted as the new "TO" waypoint.

1 SELECT →

| DIR TO | FBS1 | |
|---------------|----------------|----|
| * [] | | |
| 1L LMG 0708 | .79 / FL350 | 1R |
| 2L (T/D) 0718 | 7.9 NM / FL350 | 2R |
| 3L | TRK 004° 18 | 3R |
| 4L AMB 0721 | 273 / FL301 | 4R |
| 5L VILRO 0723 | " / FL253 | 5R |
| 6L (LIM) 0730 | *250 / FL100 | 6R |
| | ↑↓ | |

2 SELECT →

| DIR TO | FBS1 | |
|---------------|-------------------------|----|
| *AMB | 184° * | 1R |
| WITH | RADIAL IN | |
| *ABEAM PTS | []° | 2R |
| 3L LMG 0709 | .79 / FL350 | 3R |
| 4L (T/D) 0719 | 7.9 NM / FL350 | 4R |
| 5L AMB 0722 | TRK 004° 18 273 / FL301 | 5R |
| 6L VILRO 0724 | " / FL253 | 6R |
| | ↑↓ | |

| FROM UTC | FBS1 | |
|----------------|-----------------------------|----|
| T-P | SPD / ALT | 1R |
| 2L (T/D) 0722 | .80 / FL350 | 2R |
| 3L AMB 0724 | BRG 004° 8.7 NM 283 / FL301 | 3R |
| 4L VILRO 0727 | " / FL253 | 4R |
| 5L (LIM) 0734 | 16 250 / FL100 | 5R |
| 6L LFP007 0745 | 47 207 16.5 | 6R |
| | DEST UTC DIST EFOB | |
| | ↑↓ | |

2. Lateral revisions that lead to a temporary flight plan (TMPY) before they take effect:

The flight crew creates a temporary flight plan, then inserts it as a revision to the active flight plan. The flight crew does this when selecting, deleting, or modifying several waypoints of an airway or procedure at once (SID, STAR, HOLD, TAKEOFF or LANDING RWY). This modification is made on specific "LAT REV" pages from the flight plan page.

Possible revisions are:

- Insert or modify the departure procedure
- Insert or modify the arrival procedure
- Insert a waypoint
- Change the destination
- Insert an airway
- Insert an offset
- Insert a holding pattern
- Select or enable an alternate flight plan
- Fix information.

The purpose of the temporary flight plan is to allow the flight crew to check a revision on the MCDU and on the ND before inserting the changes into the active flight plan. It is a copy of the active flight plan that has been changed according to the flight crew revision. While it is displayed, the aircraft will continue to follow the original active flight plan.

No predictions are computed or displayed on the pages of the temporary flight plan.

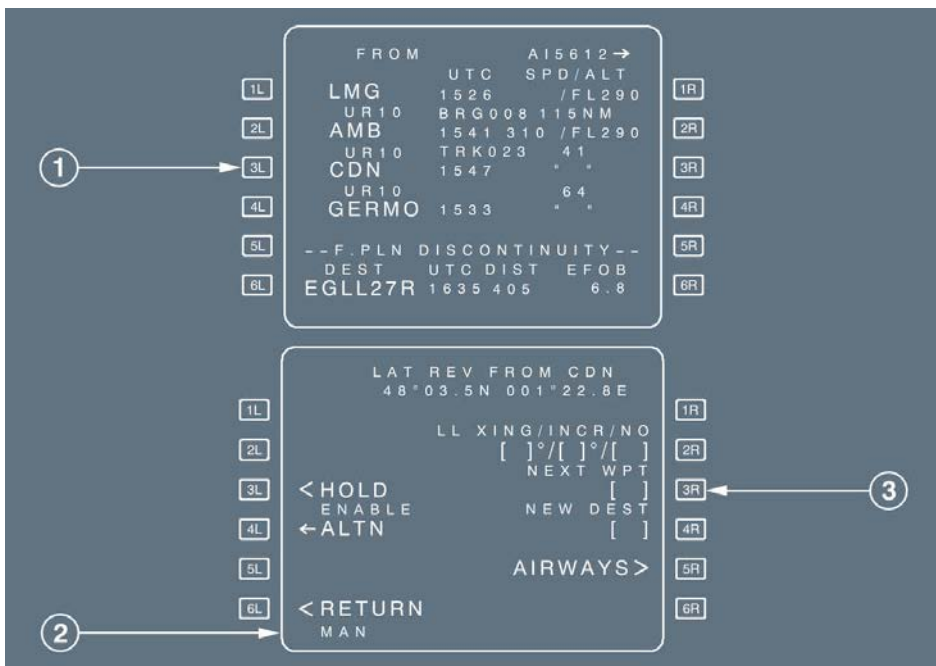

1L

2L

3L

4L

5L

6L

FROM AI5612 →

| | UTC | SPD/ALT | |
|-------|----------|---------|--|
| LMG | 1526 | /FL290 | |
| UR10 | BRG008 | 115NM | |
| AMB | 1541 310 | /FL290 | |
| UR10 | TRK023 | 41 | |
| CDN | 1547 | * * | |
| UR10 | | 64 | |
| GERMO | 1533 | * * | |

-- F. PLN DISCONTINUITY --

| DEST | UTC | DIST | EFOB |
|---------|------|------|------|
| EGLL27R | 1635 | 405 | 6.8 |

1R

2R

3R

4R

5R

6R

2L

3L

4L

5L

6L

LAT REV FROM CDN

48°03.5N 001°22.8E

LL XING/INCR/NO

[]°/[]°/[]

NEXT WPT []

NEW DEST []

AIRWAYS >

< RETURN

MAN

1R

2R

3R

4R

5R

6R

GLG A318/A319/A320/A321 For A/C: HC-CSF
 FCOM

← E →

DSC-22_20-30-10-05 P 10/12
 12 APR 17

A temporary flight plan is displayed for a check and/or new modification. Inserting the temporary revision will modify the active flight plan.

The diagram illustrates the process of inserting a temporary flight plan into the active flight plan. It shows two stages of the flight management display.

Top Stage (Temporary Flight Plan):

- FROM: TMPY AI5612 →
- UTC SPD/ALT
- LMG 1526 /FL290
- UR10 BRG008 115NM
- AMB ----- /-----
- UR10 TRK023 41
- CDN ----- /-----
- UB19 ----- 55
- MAN ----- /-----
- UB19 ----- 20
- PON ----- /-----
- ← ERASE INSERT * ↑↓

Bottom Stage (Active Flight Plan):

- FROM AI5612 →
- UTC SPD/ALT
- LMG 1526 /FL290
- UR10 BRG008 115NM
- AMB 1541 310/FL290
- UR10 TRK023 41
- CDN 1547 " / " 41
- UB19 ----- 55
- MAN 1553 " / "
- UB19 ----- 20
- PON 1558 " / "
- DEST UTC DIST EFOB
- EGLL27R 1638 405 6.7

A line with an arrow points from the 'INSERT *' option in the top stage to the 'FROM' field in the bottom stage, indicating the insertion of the temporary plan into the active plan.



A318/A319/A320/A321
FLIGHT CREW
OPERATING MANUAL

AIRCRAFT SYSTEMS

AUTO FLIGHT - FLIGHT MANAGEMENT

FLIGHT PLANNING - LATERAL FUNCTIONS

Intentionally left blank

FMS2 HONEYWELL

GENERAL

Ident.: DSC-22_20-30-10-15-00005067.0001001 / 09 FEB 11

Applicable to: ALL

The lateral revision function allows the pilot to create or modify the following parts of the flight plan:

- Airway
- Waypoint
- New destination
- Holding pattern
- Offset
- Alternate
- Fix information

Each time the pilot activates one of the above-listed revisions, he accesses a temporary flight plan that enables the modification to be checked before inserting it in the active flight plan. The crew selects these functions by pressing the left keys on F-PLN A or B.

- Direct to and overfly functions are accessed via the MCDU keys. No temporary flight plan is created with these functions.
- "Update at" capability is a specific function that manually updates the FM position. It does not use a temporary flight plan, but the pilot must confirm its insertion before it is activated.

TEMPORARY F-PLN (TMPY)

Ident.: DSC-22_20-30-10-15-00000460.0001001 / 01 OCT 12

Applicable to: ALL

When a pilot makes a lateral revision to the F-PLN, the FMGS creates a temporary flight plan. This is a copy of the active F-PLN, but is corrected by the lateral revision in progress.

The aircraft continues to follow the active F-PLN, until the temporary revision is inserted.

The revision appears in yellow font on both MCDU s and NDs.

- Lateral and vertical revisions cannot be made to a temporary F-PLN.
- Only one temporary F-PLN may be accessed at a time.
- The "DIRECT TO" function, when used, erases a temporary F-PLN.
- When a DIR TO is in process, a temporary revision cannot be displayed on the other MCDU.
- A TMPY F-PLN changes the title of the flight plan pages. (TMPY appears in all titles).
- No predictions are computed for a temporary flight plan (dashes are displayed).



Temporary data is displayed in yellow (ND and MCDU). Once inserted, it becomes active and is displayed in green.

INSERTING AN AIRWAY WITH "VIA"

Applicable to: **ALL**

Ident.: DSC-22_20-30-10-15-E-00012828.0001001 / 14 MAY 12

GENERAL

In the active flight plan, the pilot can insert up to 5 successive airway segments, going from a revised waypoint or ending at a given waypoint of the flight plan.

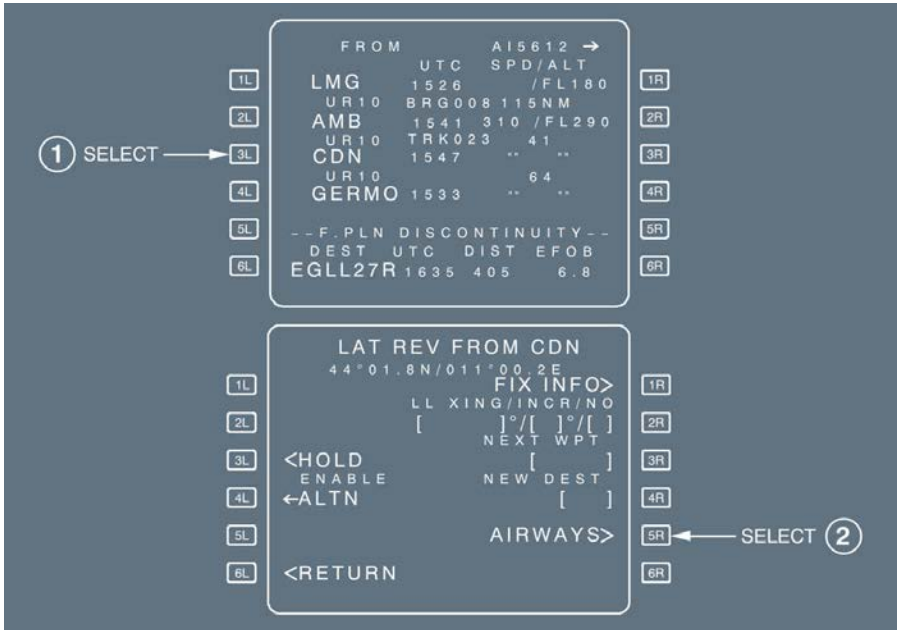

SELECT the revised waypoint (here CDN).
 PRESS [5R] to select the airways function.

Ident.: DSC-22_20-30-10-15-E-00012829.0001001 / 14 MAY 12

THE PILOT WISHES TO INSERT SUCCESSIVE AIRWAY SEGMENTS FROM A WAYPOINT

e.g. from CDN - Airways UB19 – Airways UB25 – Ending point AAA.

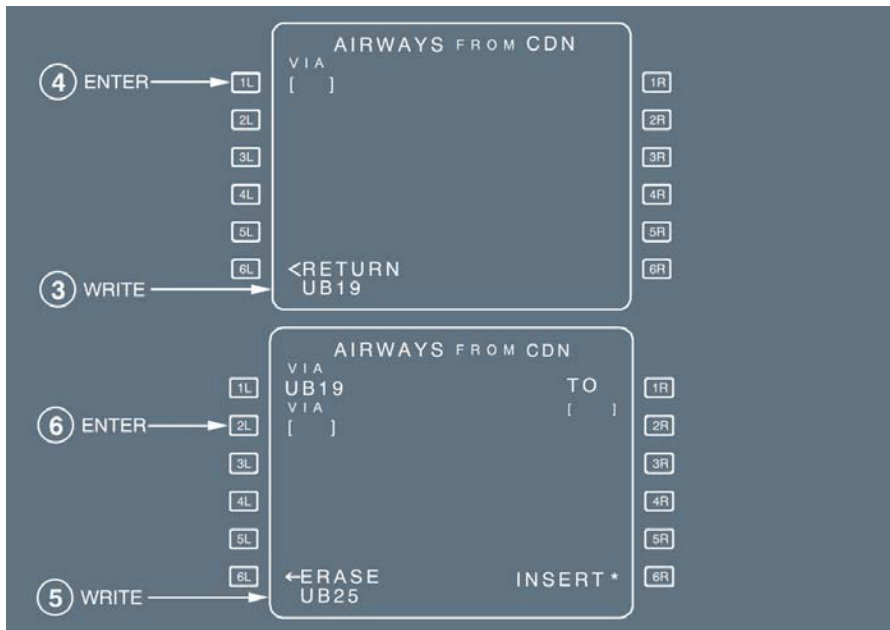

WRITE the first airway in the scratchpad (here UB19).

PRESS [1L] to insert it into the VIA field.

WRITE the second airway in the scratchpad (here UB25).

PRESS [2L] to insert it into the VIA field.

The system automatically determines the first downpath intersection point between the 2 airways.

- If the airways have a common waypoint, the system selects it as the ending point of the first VIA.
- If they have no common waypoint, but have a single intersection, the system creates this intersection as an FM -computed point and displays X followed by the airway IDENT (here XUB25).
- If they have no common waypoint or intersection, the system displays NO INTERSECTION FOUND in the scratchpad.

Once the pilot has entered the required airways (up to 5), he must enter the ending point of the last selected airways:

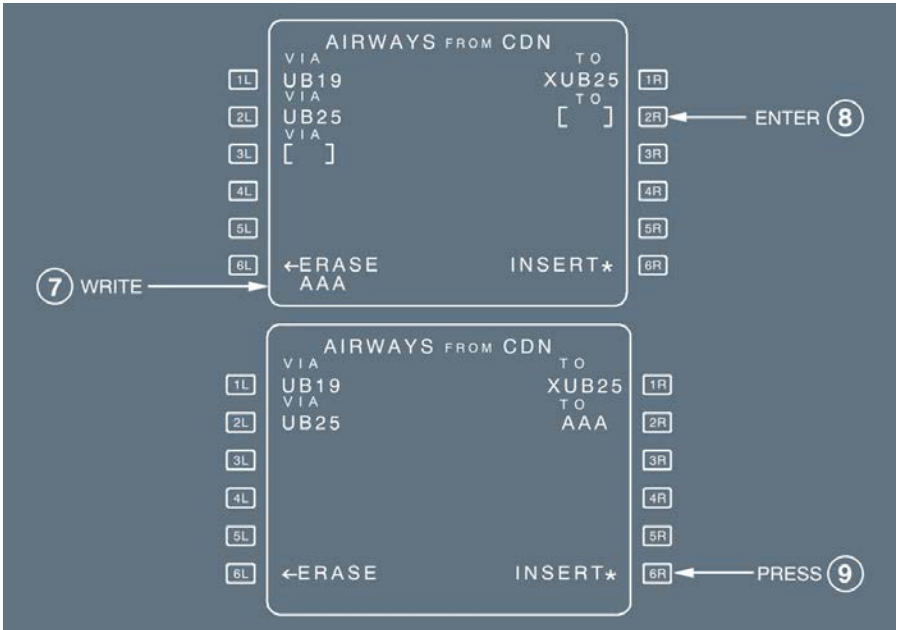

WRITE the ending waypoint in the scratchpad (here AAA).

PRESS [2R] to insert the ending waypoint into the TO field.

Note: If two waypoints with the same IDENT belong to the same airway, the DUPLICATE NAMES page will not be called up, and the system selects the first one in the database.

Ident.: DSC-22_20-30-10-15-E-00012830.0001001 / 01 OCT 12

THE PILOT WISHES TO INSERT ONE AIRWAY SEGMENT TO AN ENDING WAYPOINT

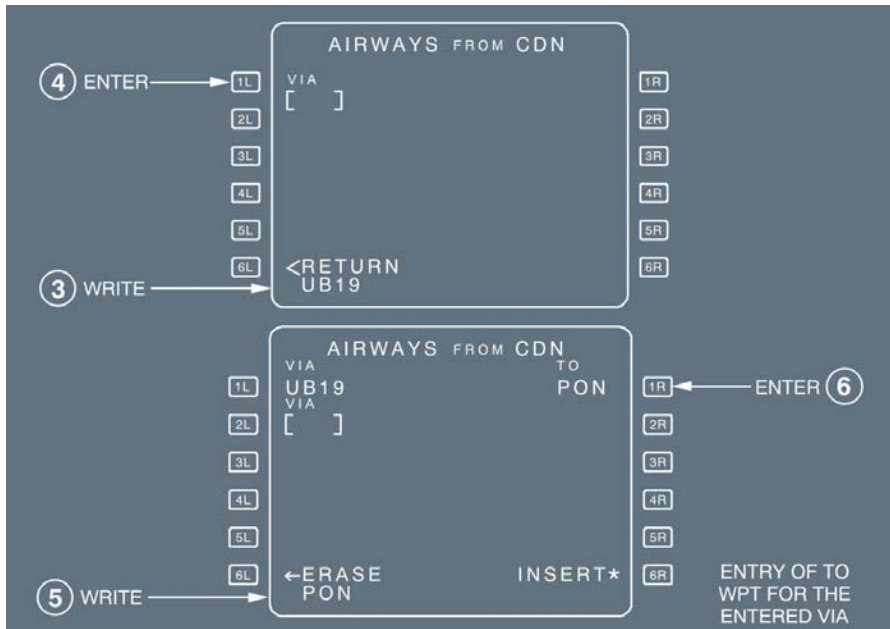

WRITE the airway IDENT in the scratchpad (here UB19).
 PRESS [1L] to insert it into the VIA field.
 WRITE the ending waypoint in the scratchpad (here PON).
 PRESS [1R] to insert it into the TO field.

- Note:*
- If the revise waypoint, or the ending waypoint, does not belong to the entered airway, the system displays AWY /WPT MISMATCH in the scratchpad.
 - If two waypoints with the same IDENT belong to the same airway, the DUPLICATE NAMES page will not be called up and the system selects the first one in the database.

Ident.: DSC-22_20-30-10-15-E-00012831.0001001 / 09 FEB 11

FLIGHT PLAN INSERTION

The flight crew either inserts the flight plan directly from the AIRWAYS page, or from the TMPY F-PLN page. In both cases:
 PRESS [6R] to insert the temporary flight plan. Clear flight plan discontinuity, as needed.

| | |
|---|---|
|  <p>A318/A319/A320/A321 FLIGHT CREW OPERATING MANUAL</p> | <p style="text-align: center;">AIRCRAFT SYSTEMS</p> <p style="text-align: center;">AUTO FLIGHT - FLIGHT MANAGEMENT</p> <p style="text-align: center;">FLIGHT PLANNING - LATERAL FUNCTIONS</p> |
|---|---|

INSERTING A WAYPOINT

Applicable to: ALL

Ident.: DSC-22_20-30-10-15-F-00012832.0001001 / 09 FEB 11

GENERAL

Waypoints can be inserted in two ways:

- Directly into the flight plan. All modifications go directly into the active flight plan. No temporary flight plan is created.
- By means of a lateral revision at the “NEXT WAYPOINT”, a process that creates a temporary flight plan.

The second method enables the temporary flight plan to be checked before it is inserted.

Ident.: DSC-22_20-30-10-15-F-00012833.0001001 / 09 FEB 11

WAYPOINT IDENTIFICATION

The pilot can identify a waypoint by:

- Its identifier (if it is in the navigation database).
- A Latitude/Longitude (LL).
- A Place/Bearing/Distance (PBD). The waypoint is defined by its bearing and distance from a place.
- A Place-Bearing/Place-Bearing (PBX). The waypoint is defined by the interception of 2 radials from 2 places.
- A Place/Distance (PD). The waypoint is defined by a distance from a place, along the F-PLN.

Note: If a slash or a dash is not entered properly, the MCDU displays a “FORMAT ERROR” message.

When the Flight Management Guidance System receives a waypoint that is not in the database, it identifies it as LLxx or PBD xx or PBX xx or PD xx (xx is a two-digit number between 01 and 20) and stores it in the stored waypoints file of the database.

Note: When NAV mode is engaged, the crew cannot modify the “TO” waypoint (active leg) using the waypoint insertion function. If the crew wants to modify it, the DIR TO function will be used.

Ident.: DSC-22_20-30-10-15-F-00012834.0001001 / 14 MAY 12

WAYPOINT INSERTED DIRECTLY IN THE FLIGHT PLAN

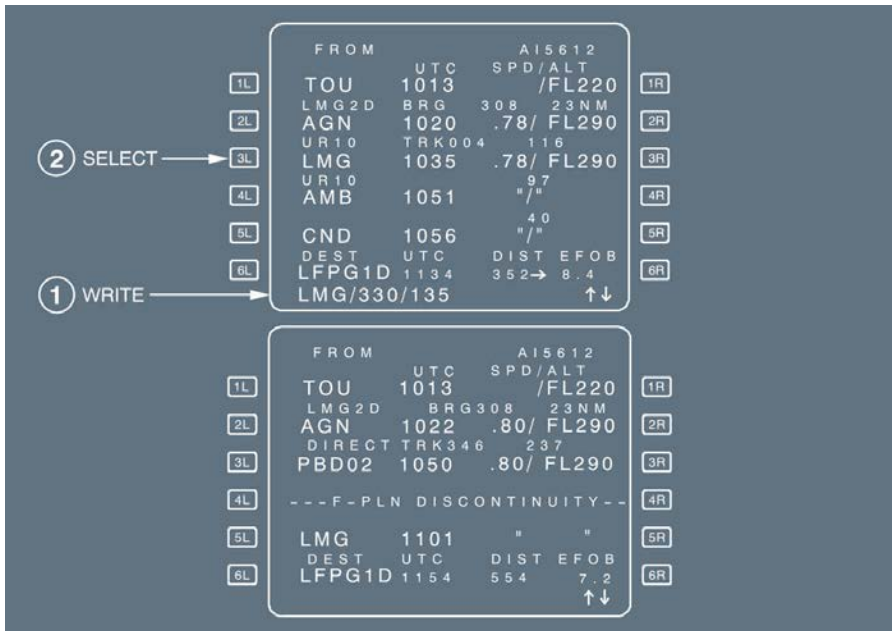

Stage 1: Initial Flight Plan

| 1L | 2L | 3L | 4L | 5L | 6L | 1R | 2R | 3R | 4R | 5R | 6R |
|----|----|-------------|------|-----|----|---------|-------|----|----|----|----|
| | | FROM | | | | A15612 | | | | | |
| | | TOU | UTC | | | SPD/ALT | | | | | |
| | | LMG2D | BRG | | | /FL | 220 | | | | |
| | | AGN | 1020 | | | .78/ | FL290 | | | | |
| | | UR10 | TRK | 004 | | 116 | | | | | |
| | | LMG | 1035 | | | .78/ | FL290 | | | | |
| | | UR10 | | | | " / " | 97 | | | | |
| | | AMB | 1051 | | | " / " | 40 | | | | |
| | | CND | 1056 | | | " / " | | | | | |
| | | DEST | UTC | | | DIST | EFOB | | | | |
| | | LFPG1D | 1134 | | | 352 | 8.4 | | | | |
| | | LMG/330/135 | | | | | | | | | |

Stage 2: Updated Flight Plan

| 1L | 2L | 3L | 4L | 5L | 6L | 1R | 2R | 3R | 4R | 5R | 6R |
|----|----|---------------------------|------|-----|----|---------|-------|----|----|----|----|
| | | FROM | | | | A15612 | | | | | |
| | | TOU | 1013 | | | SPD/ALT | | | | | |
| | | LMG2D | BRG | 308 | | 23NM | | | | | |
| | | AGN | 1022 | | | .80/ | FL290 | | | | |
| | | DIRECT | TRK | 346 | | 237 | | | | | |
| | | PBD02 | 1050 | | | .80/ | FL290 | | | | |
| | | ---F-PLN DISCONTINUITY--- | | | | | | | | | |
| | | LMG | 1101 | | | " | " | | | | |
| | | DEST | UTC | | | DIST | EFOB | | | | |
| | | LFPG1D | 1154 | | | 554 | 7.2 | | | | |



WRITE the waypoint identifier or LAT /LONG, Place/Bearing/Distance or Place-Bearing/Place-Bearing into the scratchpad. (Example: Place: LMG, Bearing: 330 °, Distance: 135 NM).

PRESS the appropriate key to enter the waypoint into the flight plan. The rule is that the new waypoint appears next to the pressed key, and the previous waypoint moves down the flight plan path.

This operation creates a discontinuity between the new waypoint and the previous one. The new flight plan will have to be cleared of the discontinuity and some waypoints erased.

Ident.: DSC-22_20-30-10-15-F-00012835.0001001 / 01 OCT 12

ALONG TRACK WAYPOINT INSERTION

On the F-PLN or STEP ALTS page, the pilot can enter an along track waypoint, defined as a place/distance waypoint.

The diagram illustrates the process of inserting an along track waypoint into a flight plan. It shows two screenshots of the cockpit display with numbered callouts and arrows indicating the sequence of actions.

Top Screenshot: Shows the flight plan with waypoints: TOU, LMG2D, AGN, LMG, AMB, and CND. A callout '1 WRITE' points to the 'AMB' entry in the scratchpad, which contains 'AMB/-040'. A callout '2 SELECT' points to the '4L' key on the left side of the display.

| FROM | UTC | SPD/ALT | A1101 |
|----------|---------|------------|-------|
| TOU | 1013 | /FL220 | |
| LMG2D | BRG 308 | 23NM | |
| AGN | 1020 | .78/ FL290 | |
| UR10 | TRK004 | 116 | |
| LMG | 1035 | .78/ FL290 | |
| UR10 | | 97 | |
| AMB | 1051 | "/" | |
| UR10 | TRK015 | 40 | |
| CND | 1056 | "/" | |
| DEST | UTC | DIST | EFOB |
| LFPG1D | 1134 | 352 | 8.4 |
| AMB/-040 | | | ↑↓ |

Bottom Screenshot: Shows the flight plan after the insertion. The 'AMB' waypoint has been moved to the 4L position and is now 'PD01 1045 "/>

| FROM | UTC | SPD/ALT | A1101 |
|--------|---------|------------|-------|
| TOU | 1013 | /FL220 | |
| LMG2D | BRG 308 | 23NM | |
| AGN | 1022 | .80/ FL290 | |
| UR10 | TRK004 | 116 | |
| LMG | 1035 | .78/ FL290 | |
| UR10 | | 57 | |
| 4L | PD01 | 1045 | "/" |
| UR10 | | 40 | |
| AMB | 1051 | "/" | |
| DEST | UTC | DIST | EFOB |
| LFPG1D | 1154 | 554 | 7.2 |
| | | | ↑↓ |



WRITE the waypoint identifier and distance from this place.

According to the sign of the distance, the crew may define an along track waypoint before or after the revised place. (Example: AMB/-040).

PRESS the appropriate key adjacent to the place identifier. The system automatically positions the waypoint in the flight plan.

This operation does not create any discontinuity.

The system does not accept an along track waypoint entered at the FROM waypoint.

Ident.: DSC-22_20-30-10-15-F-00012836.0001001 / 01 OCT 12

WAYPOINT INSERTED THROUGH THE USE OF "NEXT WAYPOINT"

The screenshot displays the flight management system interface with two main data windows and a set of control buttons (1L-6L and 1R-6R).

Top Window (Waypoint List):

| FROM | UTC | IT5612 | SPD/ALT |
|--------|--------|--------|-----------|
| AGN | 1013 | | /FL220 |
| LMG2D | BRG004 | | 93NM |
| LMG | 1025 | | .78/FL290 |
| UR10 | TRK006 | | 97 |
| AMB | 1030 | | "/" |
| UR10 | | | 40 |
| CDN | 1043 | | "/" |
| DIRECT | | | 60 |
| EVX | 1051 | | "/" |
| DEST | UTC | DIST | EFOB |
| LFPG1D | 1134 | 352 | 8.4 |

Bottom Window (Waypoint Details):

LAT REV FROM LMG
 45°49.0N/001°01.8E

FIX INFO>

LL XING/INCR/NO
 []/[]/[]

NEXT WPT []

NEW DEST []

AIRWAYS>

<HOLD ENABLE
 <ALTN

<RETURN ANG

Annotations:

- 1 SELECT:** Arrow pointing to the 2L button.
- 2 WRITE:** Arrow pointing to the 6L button.
- 3 ENTER:** Arrow pointing to the 3R button.

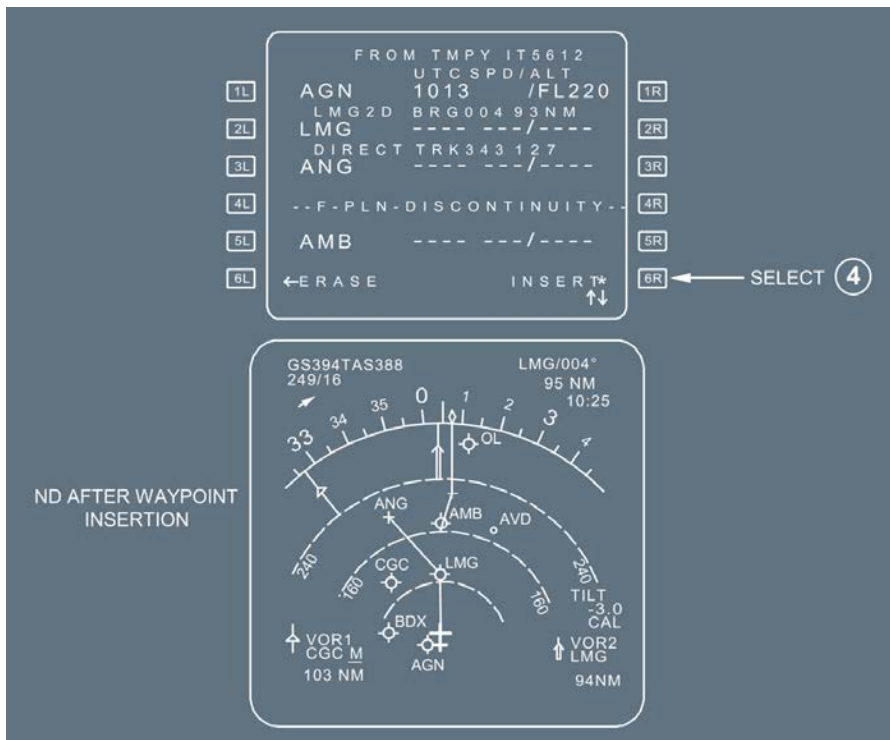

- SELECT the lateral revision (LAT REV) function at an appropriate waypoint.
- WRITE the waypoint identifier, or LAT /LONG, or Place/Bearing/Distance, or Place-Bearing / Place-Bearing into the scratchpad.
- ENTER it in the brackets under NEXT WPT (next waypoint).
- INSERT the temporary flight plan by pressing the [6R] key.
- CLEAR the F-PLN discontinuity, as appropriate.

Ident.: DSC-22_20-30-10-15-F-00012837.0001001 / 14 MAY 12

LATITUDE/LONGITUDE CROSSING WAYPOINT INSERTION

This function allows the insertion of one or several points along the flight-plan beyond the revised waypoint, at fixed latitude or longitude intervals (INCR) from a specified latitude or longitude. These waypoints are not considered as part of the pilot-defined elements. The system deletes them when sequenced.

LAT REV AT A WPT

LAT REV FROM LMG
45°49.0N/001°01.6E

LL XING/INCR/NO
[]*[]*/[]

NEXT WPT
[]

NEW DEST
[]

AIRWAYS>

<RETURN
N46/1/3

1 WRITE →

ENTER 2 ←

| FROM | UTC | SPD/ALT | FBS1 → |
|--------|------|------------|--------|
| T-P | 1038 | .70/ FL350 | |
| LMG | 1211 | 250/ 2000 | |
| N46 | 1213 | " / " | 11 |
| N47 | 1227 | " / " | 60 |
| N48 | 1241 | " / " | 61 |
| DEST | UTC | DIST | EFOB |
| LFP007 | 1300 | 206 | 12.7 |

INSERT 3 ←



WRITE the latitude (NXX, XXN, SXX or XXS), the required increment in degrees between the successive waypoints, and the number of required waypoints.

(Example: The pilot wants to obtain 3 points, every degree from latitude N46: He enters N46/1/3).

PRESS [2R] to insert it into the LL XING/INCR/NO field.

PRESS [6R] to insert the new waypoints in the flight plan without discontinuity.

The system does not store these waypoints in the database.

FIX INFO

Applicable to: ALL

Ident.: DSC-22_20-30-10-15-G-00012838.0008001 / 09 FEB 11

GENERAL

When using the FIX INFO function, the flight crew defines waypoint intersections of the flight plan with radials, circle or abeam associated to a fix.

When the flight crew inserts the intersection points, the system automatically identifies these points, but does not store them in the navigation database.

Ident.: DSC-22_20-30-10-15-G-00012839.0008001 / 01 OCT 12

INSERTING A RADIAL INTERCEPT WAYPOINT

The flight crew accesses the radial intercept function from the lateral revision page at the origin or “from” waypoint.

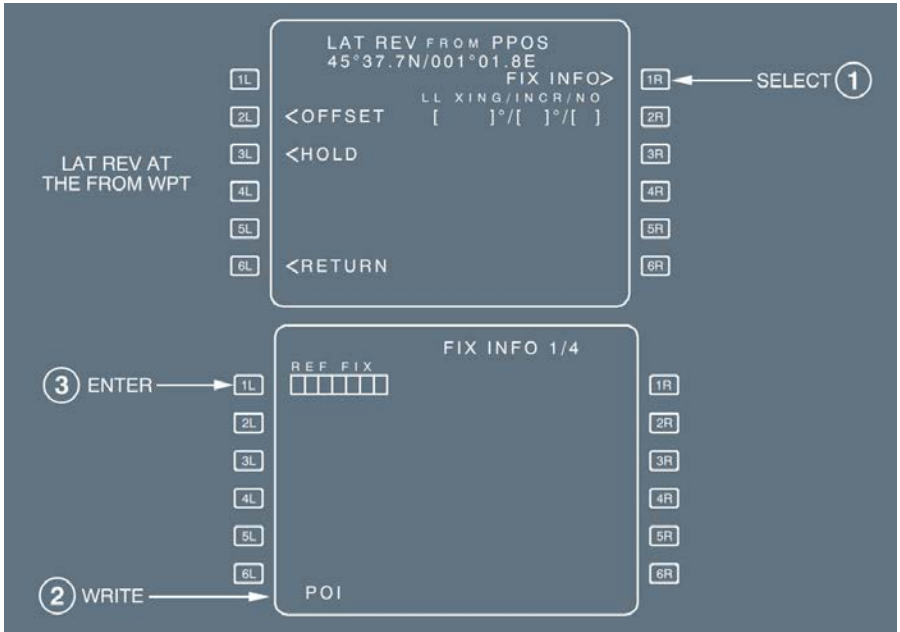

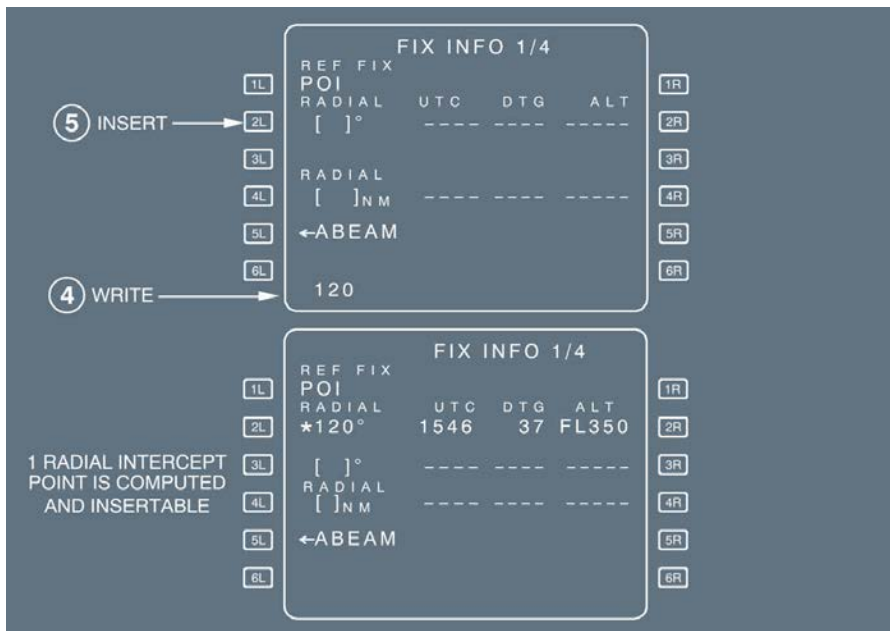

WRITE the reference fix identifier into the scratchpad (here POI), and ENTER it [1L].

It may be any database or pilot-defined fix.

WRITE the radial into the scratchpad (here 120 °) and ENTER it [2L].

The defined radial appears as a blue dashed line on the ND.

If the radial line intersects the active flight plan, the system computes the time, distance to go, and the altitude at the intersection point.

Up to two radials can be entered.

SELECT the required radial to insert the associated waypoint into the flight plan (if needed):

The system automatically assigns its IDENT as the three first characters of the reference fix IDENT , followed by the radial. (Example: ABC 140). The blue dashed line disappears from the ND.

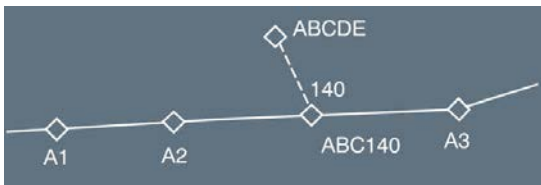

Ident.: DSC-22_20-30-10-15-G-00012840.0001001 / 01 OCT 12

INSERTING A CIRCLE INTERCEPT WAYPOINT

The screenshot shows the 'FIX INFO 1/4' page in two states. In the first state, the 'POI' field is empty and the 'RADIUS' field is set to 20. A '2 INSERT' arrow points to the '4L' field. In the second state, the 'POI' field contains '20' and the 'RADIUS' field is set to '*20NM'. A '1 WRITE' arrow points to the '4L' field. The right side of the page contains explanatory text: 'FIX INFO PAGE FOLLOWING REF FIX ENTRY' and 'A CIRCLE INTCPPT POINT IS COMPUTED AND INSERTABLE'.

WRITE the reference fix identifier into the scratchpad (here POI), and ENTER it [1L].

WRITE the circle radius in the scratchpad (here 20 NM), and ENTER it [4L]:

The defined circle appears as a blue dashed circle on the ND. If the circle intersects the active flight plan, the system computes the time, along path distance to go and altitude at the first intersection point from the current aircraft position.

SELECT the required radius to insert the associated waypoint into the flight plan (if needed).
 The system automatically assigns its IDENT as a D, followed by the radius, and followed by the three first characters of the reference fix IDENT (example D020 POI). The blue dashed circle disappears from the ND.

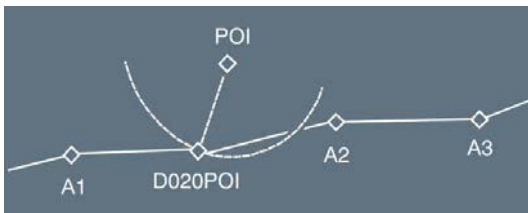

Ident.: DSC-22_20-30-10-15-G-00012841.0008001 / 01 OCT 12

INSERTING AN ABEAM INTERCEPT WAYPOINT

SELECT →

FIX INFO 1/4 →

| | | | | | |
|---------|---------|--------|-----|-----|-----|
| REF FIX | POI | RADIAL | UTC | DTG | ALT |
| [1L] | [] | []° | --- | --- | --- |
| [2L] | [] | [] | --- | --- | --- |
| [3L] | RADIUS | [] NM | --- | --- | --- |
| [4L] | [] | [] | --- | --- | --- |
| [5L] | ← ABEAM | | | | |
| [6L] | | | | | |

[1R]

[2R]

[3R]

[4R]

[5R]

[6R]

FIX INFO PAGE
FOLLOWING REF
FIX ENTRY

SELECT →

FIX INFO 1/4

| | | | | | |
|---------|--------|--------|---------|-------|-----|
| REF FIX | POI | RADIAL | UTC | DTG | ALT |
| [1L] | [] | []° | --- | --- | --- |
| [2L] | [] | [] | --- | --- | --- |
| [3L] | RADIUS | [] NM | --- | --- | --- |
| [4L] | [] | [] | --- | --- | --- |
| [5L] | ABEAM | *0.94° | 1505 52 | FL350 | |
| [6L] | | | | | |

[1R]

[2R]

[3R]

[4R]

[5R]

[6R]

ABEAM INTCPT
POINT IS COMPUTED
AND INSERTABLE

WRITE the reference fix identifier into the scratchpad (here POI), and ENTER it [1L]

SELECT the ABEAM prompt [5L]:

A blue dashed line from the reference fix and perpendicular to the flight plan appears on the ND. The system computes the radial, time, distance to go, altitude and predictions related to the waypoint abeam the reference fix.

SELECT [5L] to insert the abeam intercept waypoint into the flight plan (if needed):

The system automatically assigns its identifier as AB, followed by the first five characters of the reference fix identifier (Example ABXYZ). The blue dashed line disappears from the ND.

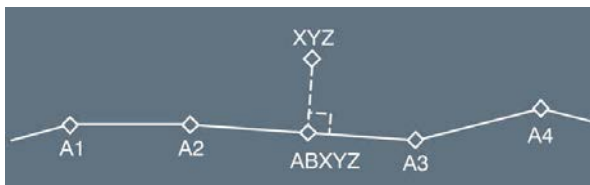

INSERTING A NEW DESTINATION

Ident.: DSC-22_20-30-10-15-00000471.0001001 / 14 MAY 12

Applicable to: ALL

The pilot may define a new destination and insert it via the lateral revision page. The pilot may then call up the new destination from any waypoint along the flight plan, except the FROM waypoint, the destination, and the missed-approach waypoint. When the new destination has been inserted, a flight plan discontinuity appears between the revision waypoint and the new destination. All waypoints beyond the revision waypoint (including the previous destination and associated missed approach) are deleted.

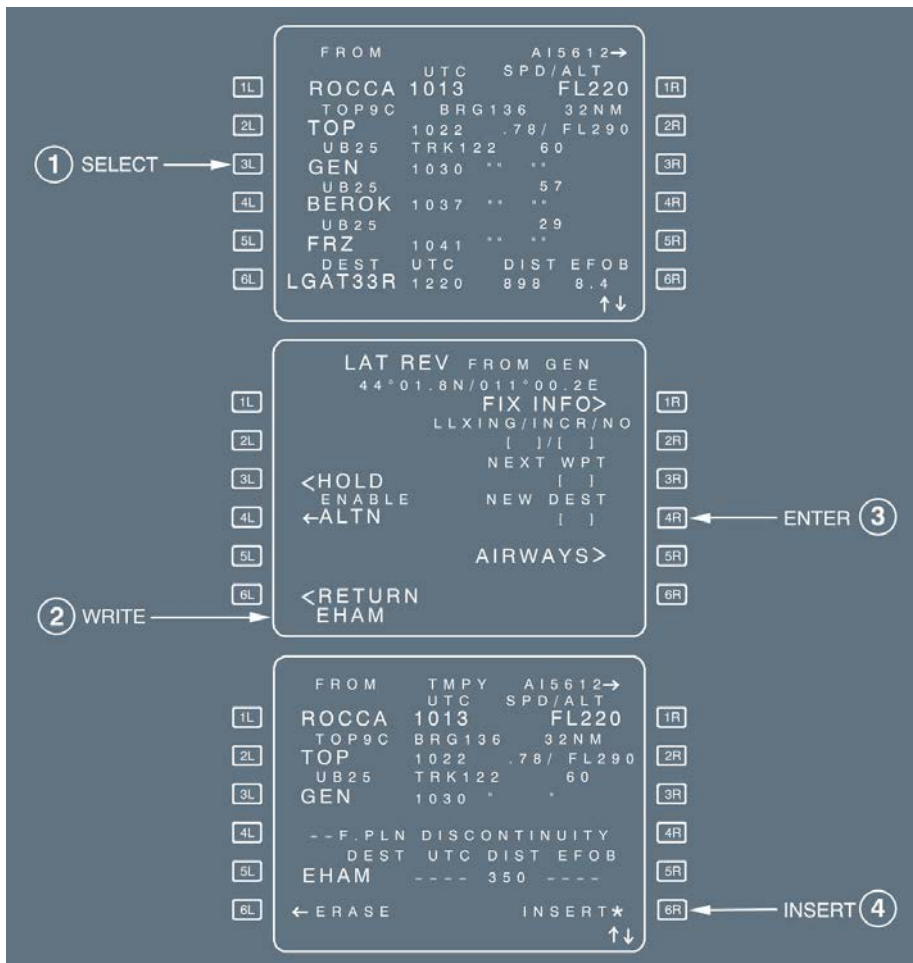

The diagram illustrates the flight management system interface with three screens and numbered callouts for operations:

- Screen 1 (Top):** Shows flight plan data for route ROCCA to LGAT33R. Callout 1 (SELECT) points to the 3L key.
- Screen 2 (Middle):** Shows the 'LAT REV FROM GEN' screen with options like '<HOLD', '<ENABLE', '<ALTN', and '<RETURN EHAM'. Callout 2 (WRITE) points to the 3L key, and callout 3 (ENTER) points to the 4R key.
- Screen 3 (Bottom):** Shows flight plan data for route ROCCA to EHAM. Callout 4 (INSERT) points to the 6R key.

SELECT the lateral revision function at an appropriate waypoint.

WRITE the new destination in the scratchpad.

Enter it in the brackets under "NEW DEST".

INSERT the temporary flight plan ([6R] key), and complete the flight plan to the new destination.

HOLDING PATTERN

Applicable to: ALL

Ident.: DSC-22_20-30-10-15-A-00007222.0001001 / 09 FEB 11

GENERAL

This section describes holding patterns, associated guidance and flight crew procedures.

The Flight Management and Guidance Computer (FMGC) has three types of holding patterns that the pilot can use in a flight plan.

Ident.: DSC-22_20-30-10-15-A-00007163.0001001 / 01 OCT 12

HOLD TO FIX (HF)

The holding pattern is always part of an arrival or departure procedure. The aircraft flies it once and then automatically exits the holding pattern at the fix. The predicted speed in the holding pattern is the lowest of the ICAO speed limit, max endurance speed, or any speed constraint. Guidance to the fix in the holding pattern is similar to that on any leg of a flight plan. The HF patterns are part of the navigation database and cannot be created by the crew.

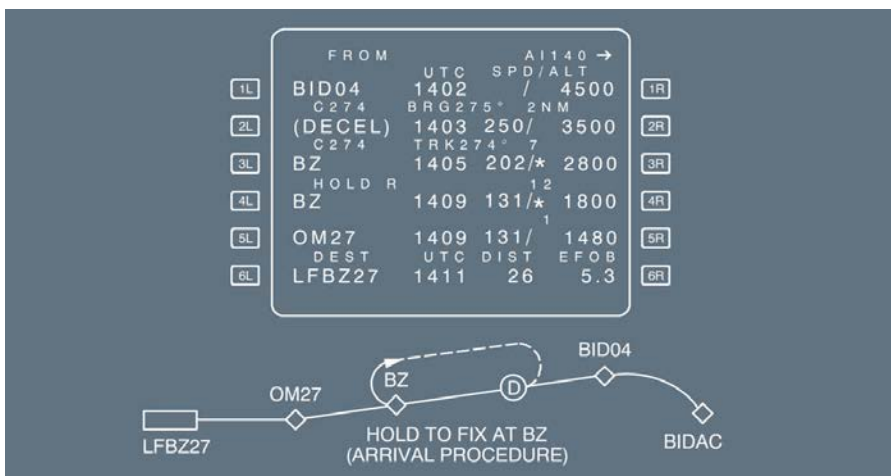

Ident.: DSC-22_20-30-10-15-A-00007182.0001001 / 01 OCT 12

HOLD TO ALTITUDE (HA)

The aircraft flies the hold until it reaches the specified altitude. Then, it automatically exits the hold at the fix.

The predicted speed for the holding pattern is the lowest of the ICAO speed limits, the max endurance speed, or any speed constraint.

The size of the holding pattern is a function of the predicted speed.

Guidance in a hold to altitude (HA) is similar to that for any leg of a flight plan.

The HAs are in the navigation database, as part of the arrival or departure procedures, and cannot be created by the crew.

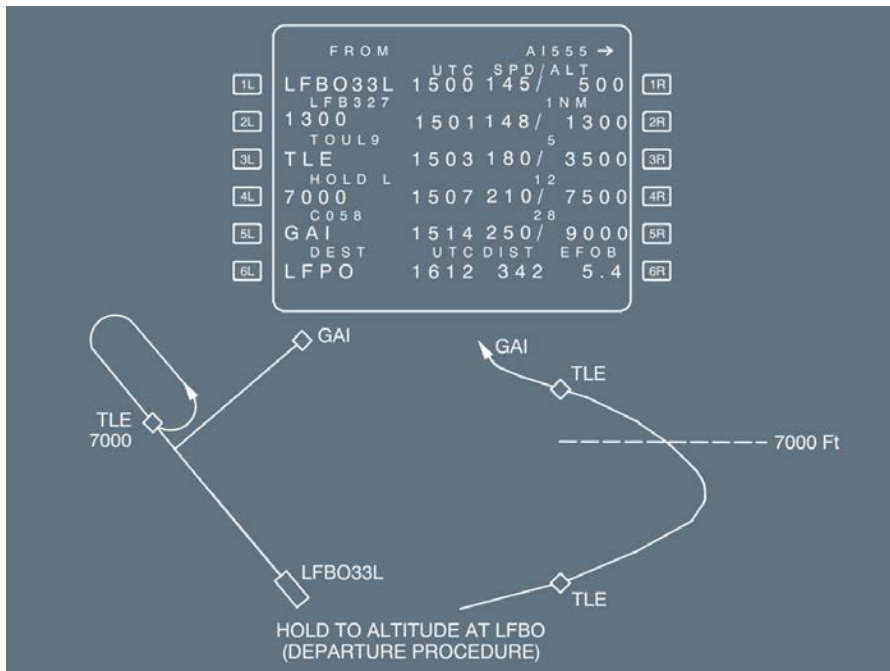

Ident.: DSC-22_20-30-10-15-A-00007206.0013001 / 01 OCT 12

HOLD WITH MANUAL TERMINATION (HM)

This type of holding pattern may be part of an arrival procedure, or the pilot may enter it at the present position or at any flight plan waypoint.

The pilot will use this type of holding pattern to comply with a defined procedure or a clearance limit, or to meet an operational need (such as losing altitude, holding for weather improvement, or absorbing an ATC delay).

This type of holding pattern is exited according to the pilot's decision, not automatically.

There are 3 types of HM.

All are modifiable.

DATABASE HOLD

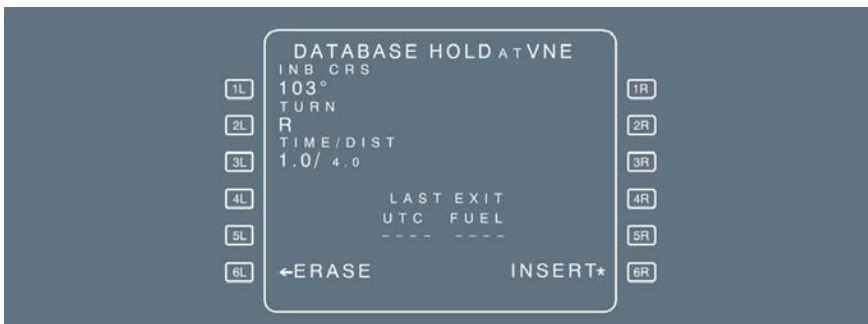

If the holding pattern is part of the database, it is named DATABASE HOLD and all its associated data (inbound course, turn direction, time/distance) are defined in the database. The flight crew can modify this data.

COMPUTED HOLD AT...



If the holding pattern is not in the database, the FMGC designs a holding pattern and proposes it to the pilot. The associated data consists of default values that the pilot can modify.

HOLD AT...



If the pilot inserts into the active flight plan a holding pattern that is manually-corrected from a hold defined by the FMGS, the screen displays a “HOLD AT...” page. The 2R field displays REVERT TO DATABASE or REVERT TO COMPUTED to restore the database data, if necessary.

PREDICTIONS AND GUIDANCE ASSOCIATED WITH A HM HOLDING PATTERN (HOLD WITH MANUAL TERMINATION)

Before deceleration

If an altitude constraint is defined at the hold entry fix, then the FMS duplicates this constraint on the hold exit.

However, different constraints may be inserted at entry and exit fixes.

Although the hold is inserted into the flight plan, the FMGS does not take it into account for predictions until the aircraft enters the hold.

However, if the hold is not deleted by the crew, the FMGS schedules a deceleration point and displays it on the ND.

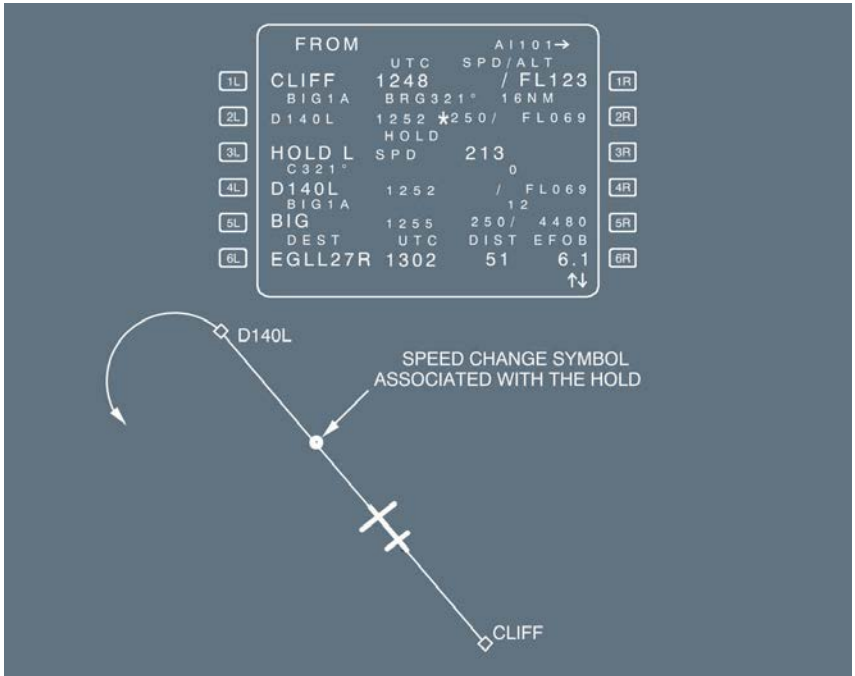

The FMGS predicts the estimated time and amount of fuel remaining at which the aircraft must exit holding, so as to comply with the fuel policy specified on the fuel prediction page. When the aircraft enters the holding pattern, the FMGS revises all predictions and assumes the aircraft will fly one turn of the holding pattern. All predictions are revised for one more holding circuit at holding fix overfly.

Upon reaching the speed change pseudo waypoint

The FMGS either causes the aircraft to decelerate to the hold speed (if managed speed is active and NAV mode engaged), or displays “SET HOLD SPD” (set hold speed) on the MCDU and primary flight display, if the flight crew had selected a speed target.

The default hold speed is the lowest of the:

- Maximum endurance speed
- ICAO limit holding speed
- Speed constraint (if any).

When no specific speed limit applies, the default hold speed is approximately equal to:

- Green Dot speed on the A318, A319, A320 (CFM) and A321
- Green Dot + 20 kt for altitude lower than 20 000 ft, on the A320 (IAE).
- Green Dot + 5 kt for altitude bigger than 20 000 ft, on the A320 (IAE).

The flight plan predictions for time and fuel do not yet consider that the hold will be flown, however, the navigation display shows the hold entry and holding pattern trajectory.

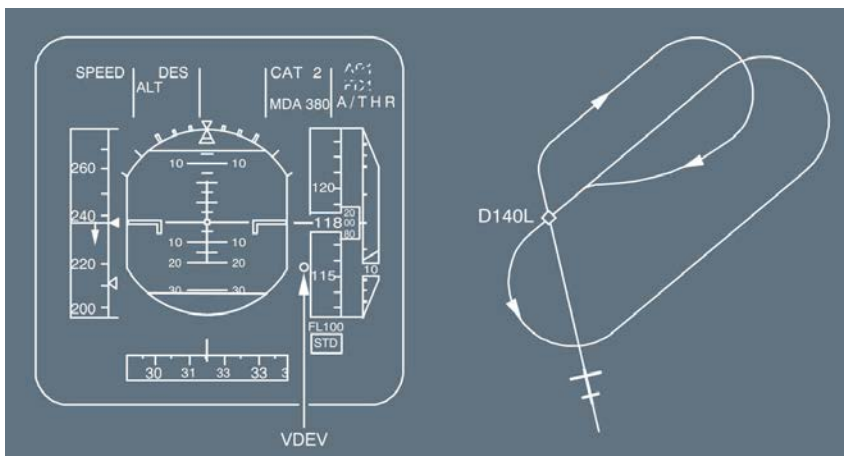

Deceleration receives priority, so that when the aircraft is in descent with the descent mode engaged, it will deviate above the descent path to decelerate. (VDEV becomes positive on the progress page).

The flight plan page displays an immediate exit prompt.

If the flight crew presses the key next to “IMM EXIT” before arriving at the holding fix, the aircraft will not enter the holding pattern, but will resume its phase-related managed-speed profile.



After reaching the hold entry fix

The aircraft enters the hold. The MCDU HOLD page displays the associated holding data:

- The inbound course (INB CRS)
- The TURN direction (L or R)
- The TIME/DIST
- The LAST EXIT time and the associated fuel to reach the alternate airport with no extra fuel.

The FMS assumes that the aircraft will fly one turn of the holding pattern, and revises the predictions accordingly.

When the holding pattern is defined by a leg time (and not a leg distance), the system revises the size of the hold as a function of the target speed.

- If managed speed is active, the system uses the predicted holding speed to calculate the size of the holding pattern.
- If the selected speed is active, the system uses the target speed selected by the flight crew at the entry fix sequencing to calculate the size of the holding pattern.
- The VDEV displayed on the primary flight display and the PROG page when the aircraft is flying in the HM (hold pattern with manual termination) is the difference between the aircraft's current altitude and the altitude at which it should be when it reaches the hold exit fix in order to be correctly positioned on the descent path.

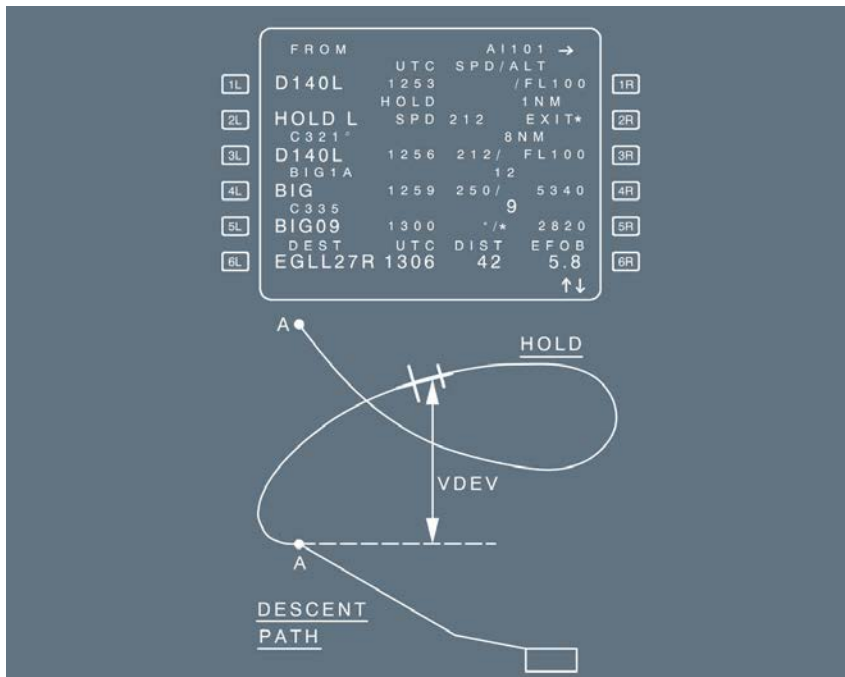

With IMM EXIT pressed (aircraft in the holding pattern)

The predictions and guidance assume that the aircraft is immediately returning to the hold fix. Sequencing the hold fix, the aircraft exits the holding pattern and resumes its navigation. The flight plan page displays “RESUME HOLD*” instead of “IMM EXIT*”.

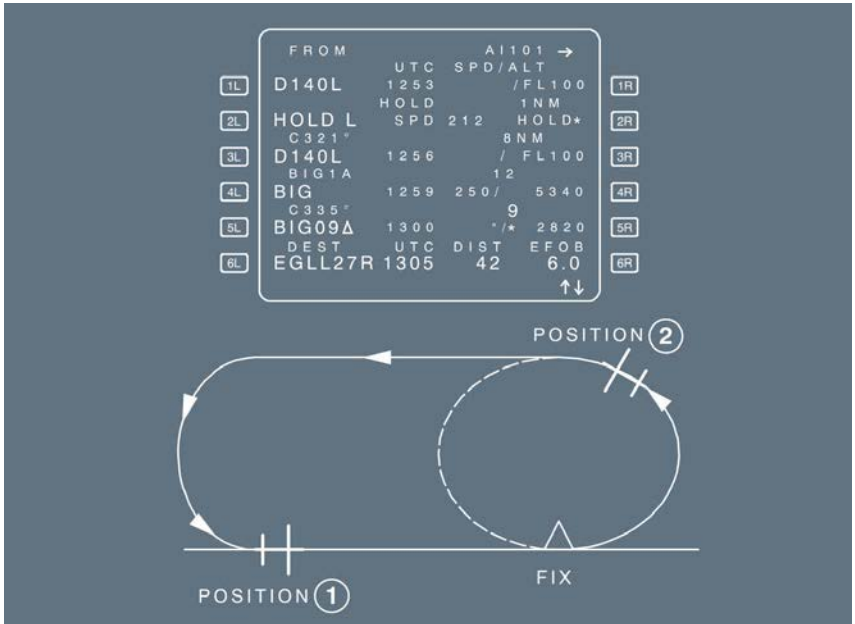

HOLD EXIT PROCEDURE

Position (1) If “IMM EXIT” pressed, the aircraft will exit at the next fix overfly.

Position (2) If “IMM EXIT” pressed, the aircraft will make an immediate turn to the fix where the hold will be exited.

- **If managed speed is active:**

The computer sets the target speed to the applicable speed of the current phase (for example, speed constraint, ECON speed, or speed limit).

The computer then bases its predictions on the assumption that the flight will continue on the descent path, if the aircraft is in descent.

● **If DES mode is engaged:**

The following applies:

- The holding pattern is never included in the descent path computation.
- The flight crew cannot enter altitude and speed constraints at the hold exit fix. (This is only allowed at the hold entry fix).
- The vertical guidance in the HM , during the descent phase, calls for a constant -1 000 ft/min. But the computer considers altitude constraints that will take effect farther down the flight path as it calculates vertical guidance and predictions. The system will not allow the aircraft to descend below the next altitude constraint, neither the FCU selected altitude. If the aircraft reaches the next altitude constraint, it will level off and the altitude constraint mode will engage.

With RESUME HOLD pressed

If the flight crew presses the key next to “RESUME HOLD”, the aircraft remains in the holding pattern, and “IMM EXIT” is displayed again.

After that, each time the aircraft flies over the holding fix, the system updates the predictions for one more holding circuit.

HOLDING PATTERN ENTRIES

The FMGS offers three types of entry into holding patterns:

1. Direct entry
2. Teardrop entry
3. Parallel entry

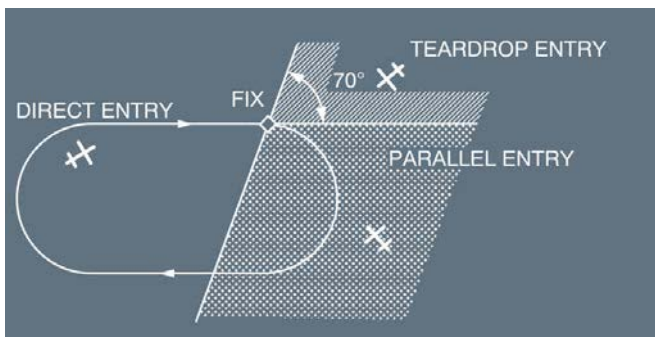

1. The direct entry

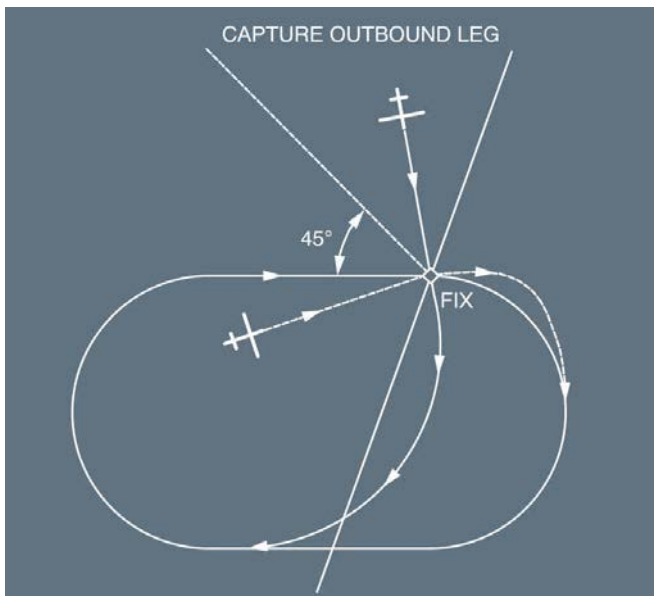

2. The teardrop entry

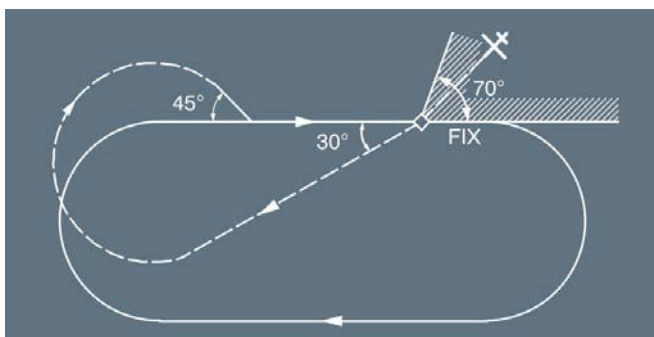

3. The parallel entry

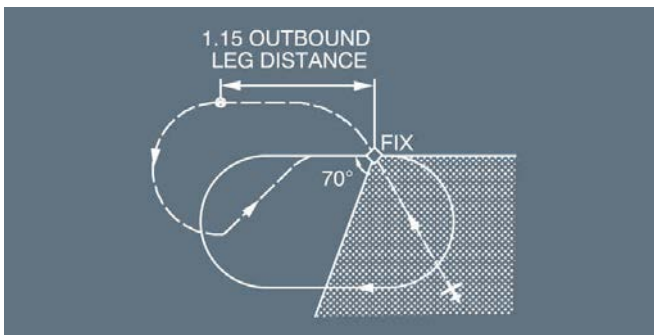

Note: If the leg the aircraft is flying toward the holding fix is on a “limit” between a teardrop entry and a parallel entry, the FMGC may compute and display either of the two entries. The pilot should keep this in mind and should not assume that the FMGC is malfunctioning.

If the flight plan leg toward the hold entry fix is on a course that is the reciprocal of the inbound course of the holding pattern, the aircraft will fly a parallel entry.

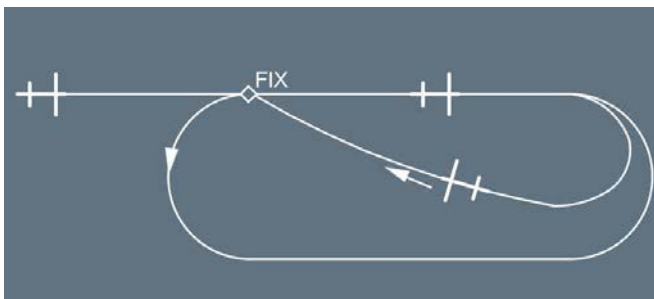

Ident.: DSC-22_20-30-10-15-A-00007220.0001001 / 09 FEB 11

PROCEDURE TO INSERT A HOLD (HOLD WITH MANUAL TERMINATION)

The HOLD prompt allows the flight crew to enter a hold with manual termination (HM), at the revised waypoint or at the present position.

The flight crew accesses the HOLD page from a lateral revision at the present position (PPOS) or at a waypoint.

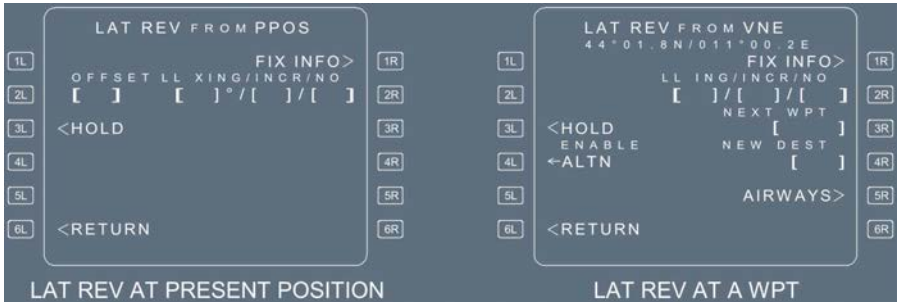

SELECT lateral revision at present position (PPOS), or an applicable waypoint.
 PRESS the HOLD prompt [3L].

*A TMPY F-PLN is created and if applicable, the database hold is proposed.
 If no database hold is available, the computed hold is proposed.*

CHECK and (if necessary) MODIFY the HOLD data.
 CHECK the temporary flight plan and INSERT it, if appropriate.

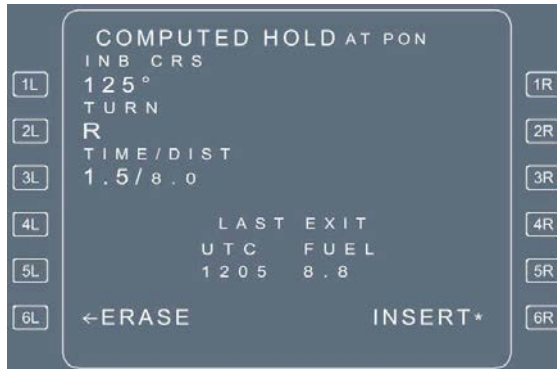

Ident.: DSC-22_20-30-10-15-A-00007219.0001001 / 09 FEB 11

PROCEDURE TO DELETE A HOLD (HOLD WITH MANUAL TERMINATION)

CLEAR the HOLD directly in the flight plan, as can be done for a normal waypoint.

OFFSET

Applicable to: ALL

Ident.: DSC-22_20-30-10-15-B-00007230.0009001 / 14 MAY 12

GENERAL

Offset allows the flight crew to define an offset of the active flight plan. The offset can be immediate or deferred to start on a downstream leg. The offset will end by default or at a pre-planned end waypoint. Additionally, the flight crew can specify the intercept angle used for the transitions to and from the offset path.

In most cases, the pilot will use it enroute because of an ATC clearance, or to avoid bad weather expected along the flight plan route.

This page is accessed from LAT REV page at the FROM waypoint or at any waypoint downpath the flight plan, except the destination airport.

After inserting the offset in the flight plan, the flight plan page shows OFST in its title, left or right arrows are displayed on every label line between the start and end waypoints of the offset, and the navigation display shows the offset flight plan with a solid green line and the original flight plan with a dashed green line.

The offset is cleared:

- Automatically (holding pattern, approach), or
- Manually with the clear (CLR) key, or by entering "o" in the offset value field [1L] or by using the delete prompt in the OFFSET page.

Note: If the pilot enters an OFFSET when the aircraft is too close to the TO waypoint, the FMGS may refuse to accept it, in which case the MCDU displays the "ENTRY OUT OF RANGE" message.

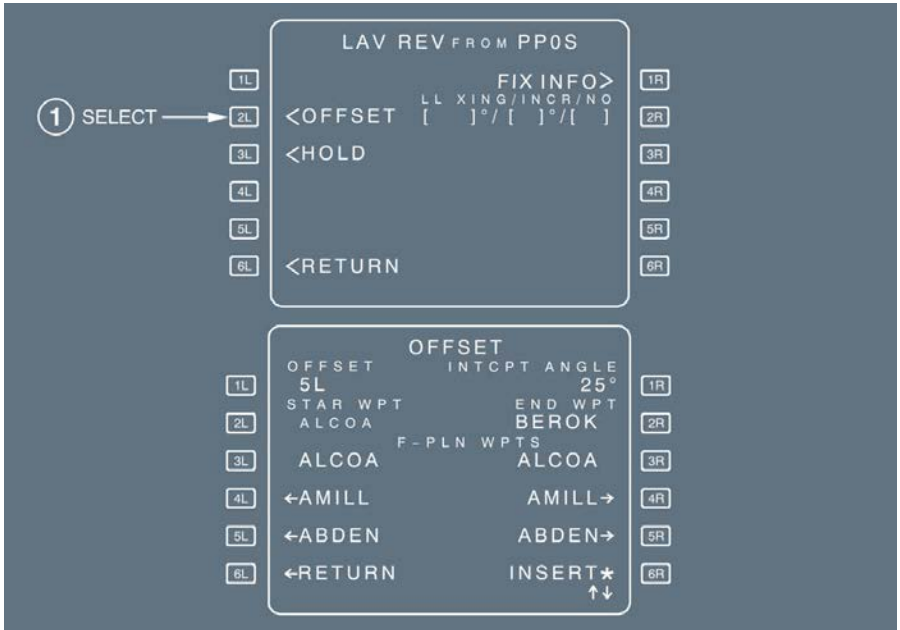

Ident.: DSC-22_20-30-10-15-B-00007207.0010001 / 01 OCT 12

INSERTING AN OFFSET

SELECT LAT REV page at a waypoint.

SELECT OFFSET function by pressing [2L].

WRITE the required offset value and direction (for example, L5 or 5L), and enter it into [1L] field.

CHECK or INSERT the START WPT from the list in [3L] - [5L] fields or manually enter it.

CHECK or ENTER the INTCP ANGLE in [1R] field.

CHECK OR INSERT the END WPT from the list in [3R] - [5R] fields or manually enter it.

PRESS INSERT in [6R] field to activate the OFFSET.

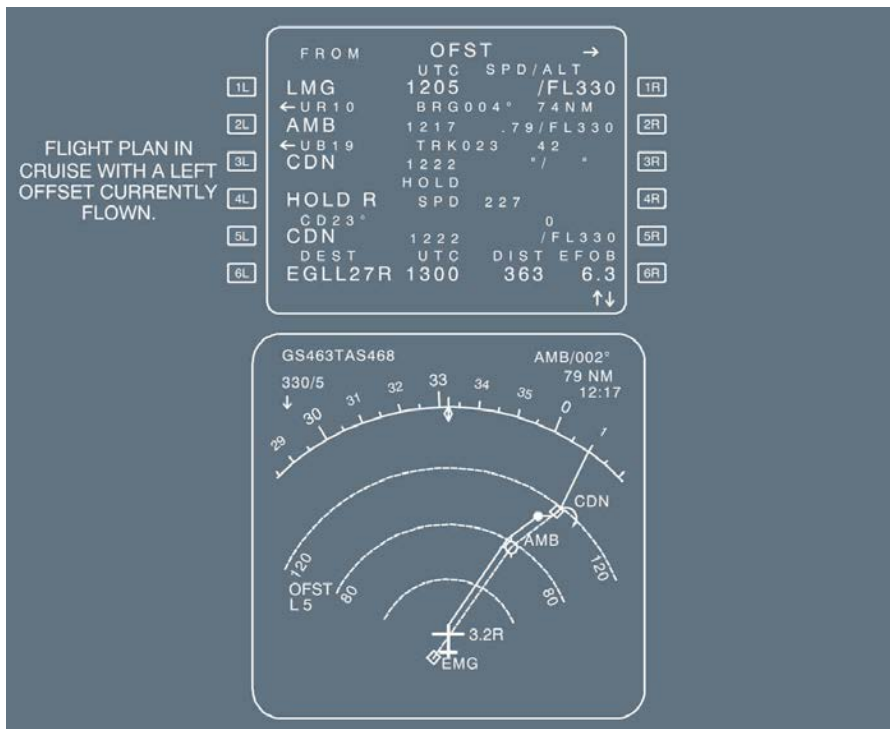

Ident.: DSC-22_20-30-10-15-B-00007218.0009001 / 14 MAY 12

MANUAL CANCELLATION OF AN OFFSET

There are two standard methods for cancelling an offset:

1. SELECT DIR TO a waypoint (the next waypoint, for example).
2. SELECT a Lateral Revision (LAT REV) at FROM WPT.

CLEAR the OFFSET field or enter "0" in the OFFSET value field [1L], and press INSERT* in [6R] to activate the temporary flight plan (cancelling OFFSET), or PRESS the OFFSET DELETE prompt [6R] to activate the temporary flight plan (cancelling OFFSET).

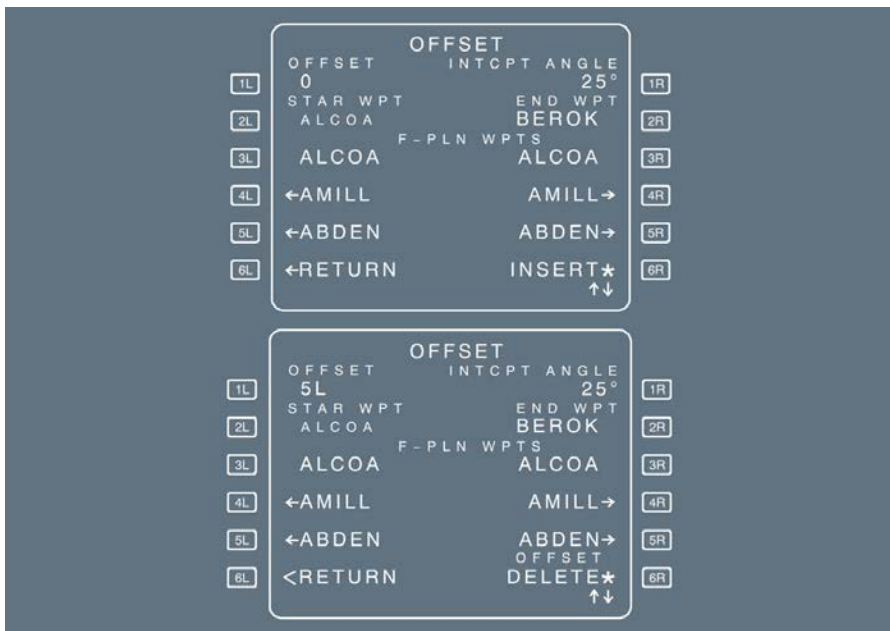

ALTERNATE FUNCTION

Applicable to: ALL

Ident.: DSC-22_20-30-10-15-C-00007240.0001001 / 09 FEB 11

GENERAL

- The ALTERNATE FUNCTION performs two actions:
- It reviews and defines alternate airports and inserts them into the flight plan.
 - It allows a diversion to be activated through the ENABLE ALTN command.

Ident.: DSC-22_20-30-10-15-C-00007217.0009001 / 23 JUN 15

REVIEW AND SELECTION OF ALTERNATE AIRPORT

Several alternate airfields may be stored in the database and assigned to a destination. When the pilot selects a company route (CO RTE) (or a city pair), the computer strings the preferred alternate into the active flight plan.

The pilot may review the alternate airports on the ALTN page and, if the one selected is not suitable because of weather or fuel considerations, another alternate may be strung into the active flight plan.

The pilot may define an additional alternate airport into the list, if necessary.

The ALTERNATE page shows the track and distance (airway or direct) between destination and alternate, as well as fuel management data (EXTRA fuel, assuming the associated airfield is the alternate airport). This data will help the pilot change the preferred alternate, if necessary.

Access the ALTERNATE page through the ALTN prompt on the LAT REV page at destination.

Alternate airfields are attached to the destination.

ENTERING NEW ALTERNATE INTO THE F-PLN

If the preferred alternate is unsuitable, proceed as follows:

SELECT F-PLN key on MCDU.

SELECT LAT REV at destination.

SELECT ALTN [5L].

SELECT an AIRFIELD IDENTIFIER.

INSERT the temporary flight plan.

*Note: If weather and destination airfield conditions permit, you may select "NO ALTN".
Fuel predictions will be computed without alternate fuel.*

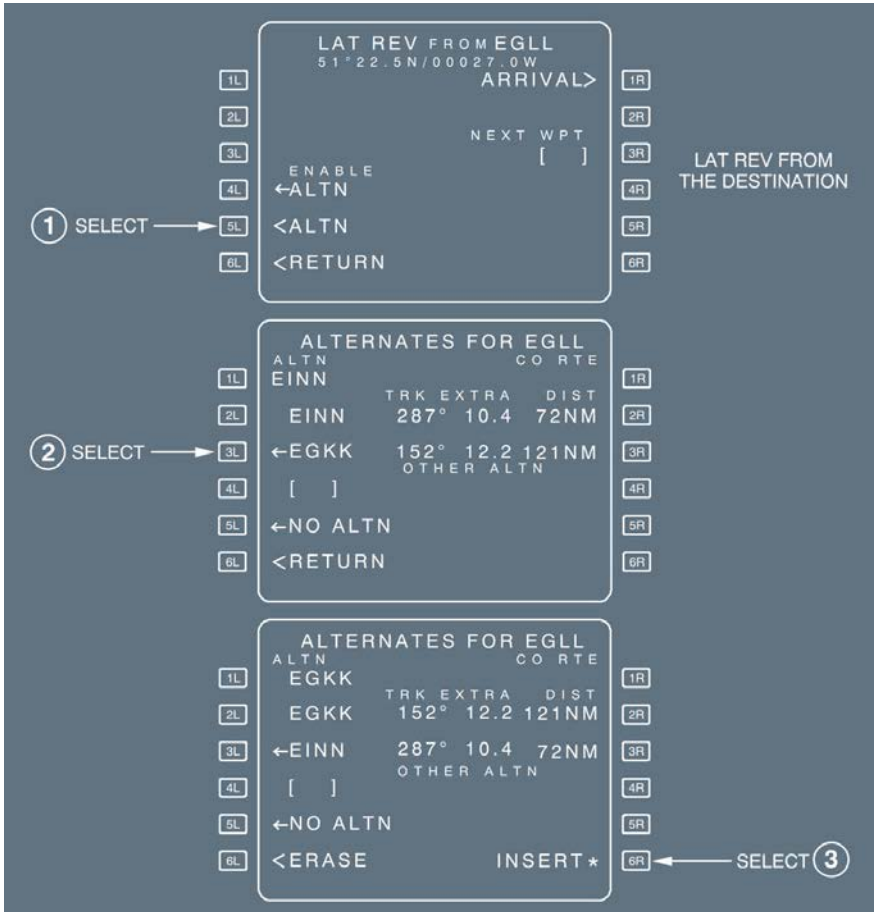

SELECTION OF ANOTHER ALTERNATE

Fuel management information for flight to another alternate airfield may be obtained by selecting the OTHER ALTN field.

SELECT LAT REV at DESTINATION.

SELECT ALTN [5L].

ENTER the airfield identifier in the brackets.

- If the airfield is not in the database, the **NEW RUNWAY** page automatically appears.
- If the airfield is in the database and there is a company route (CO RTE) to it, the **ROUTE SELECTION** page automatically appears.

SELECT the route, as appropriate, or RETURN to the ALTN page.

ENTER the distance in the brackets (if required). XTRA fuel and track (TRK) will appear.

SELECT the other alternate (OTHER ALTN) as a primary alternate if convenient. (EXTRA fuel and DIST revert to AIRWAY distance).

INSERT it, if you want to have it as a primary alternate.

- Note:
- The pilot can always overwrite the "OTHER ALTN ". The new "OTHER ALTN" then replaces the previous one, which is lost.
 - The pilot can select OTHER ALTN as a primary alternate (active flight plan), to replace any alternate on the initial list.
 - If the pilot selects the other alternate as a primary alternate, and overwrites the OTHER ALTN field by entering a new airport, the first one will remain a primary alternate and the system will memorize a second OTHER ALTN.

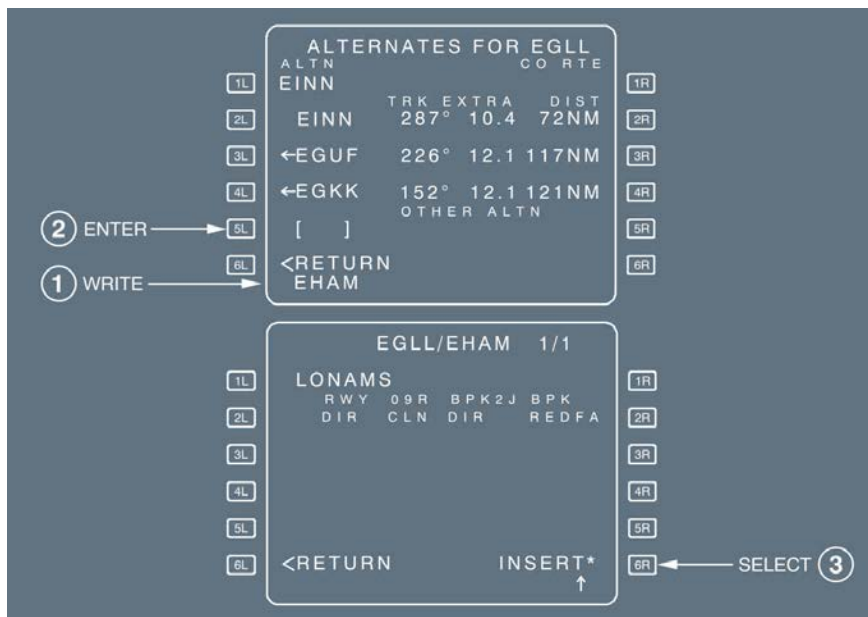

ALTERNATES FOR EGLL
 ALTN CO RTE

| ALTN | TRK | EXTRA | DIST |
|------------|--------------------|-------|-------|
| EINN | 287° | 10.8 | 72NM |
| ←EINN | 287° | 10.8 | 72NM |
| ←EGUF | 226° | 12.1 | 117NM |
| ←EGKK | 152° | 12.1 | 121NM |
| OTHER ALTN | EHAM 0.73° 6.5 250 | | |
| ←RETURN | INSERT* | | ↑ |
| 250 | | | |

ALTERNATES FOR EGLL
 ALTN CO RTE

| ALTN | TRK | EXTRA | DIST |
|------------|---------------------|-------|-------|
| EHAM | 287° | 0.8 | 322NM |
| ←EINN | 287° | 0.8 | 322NM |
| ←EGUF | 226° | 2.1 | 17NM |
| ←EGKK | 152° | 2.1 | 21NM |
| OTHER ALTN | EHAM 073° 8.9 214NM | | |
| ←ERASE | INSERT* | | ↑ |

The pilot may enter a distance in the OTHER ALTN field. The system will compute the extra fuel and the track for this distance.

PREDICTED DATA FOR ALTERNATE

Data predictions are based on:

- Aircraft weight being equal to landing weight at primary destination.
- Flight at FL 100 if the alternate F-PLN length is less than 100 NM , at FL 220 if the alternate F-PLN length is comprised between 100 and 200 NM , or else at FL 310.
- Cost index 0.
- Constant wind (as entered in the alternate field of the DES WIND page).
- Constant delta ISA (equal to delta ISA at primary destination).
- The along flight path distance from the destination to the alternate airport. If the flight crew enters an ALTN fuel value, this value is the one taken into account.

ENABLE ALTN

Ident.: DSC-22_20-30-10-15-00000467.0009001 / 01 OCT 12

Applicable to: ALL

This enables the pilot to initiate a diversion by entering the alternate flight plan just after the revision waypoint (with a discontinuity).

The pilot may have to adjust the resulting flight plan (use “direct to”, or add or suppress waypoints), depending on the circumstances.

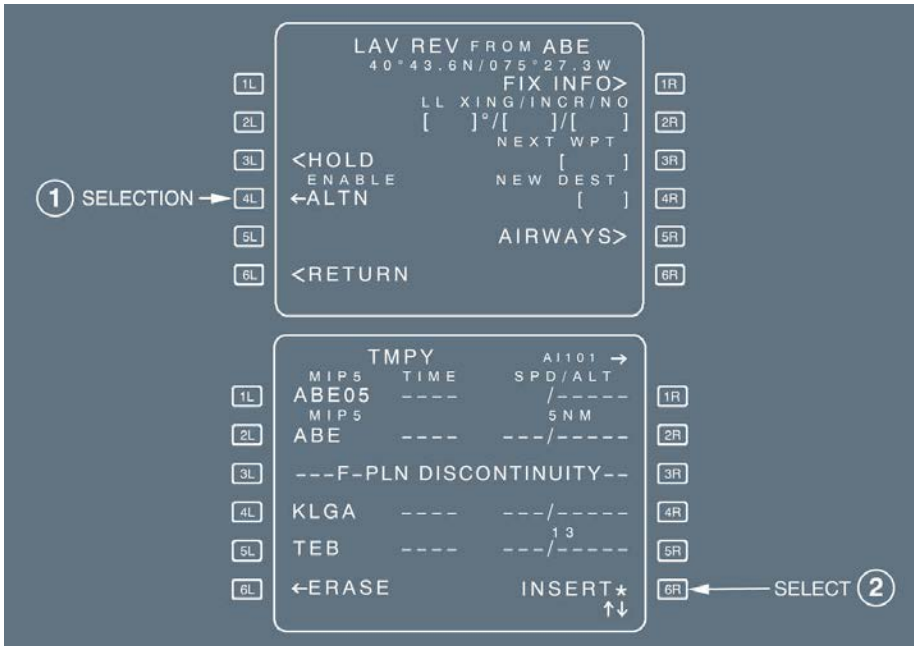

TO ACTIVATE THE PRIMARY ALTN:

SELECT a LAT REV at the “TO” waypoint (or at another suitable waypoint).

PRESS the ENABLE ALTN key.

INSERT the temporary flight plan.

ENTER an appropriate waypoint in DIRECT TO and adjust the flight plan.

ADJUST the cost index on the PERF page and the defaulted cruise flight level (CRZ FL) on the PROG page, as required.

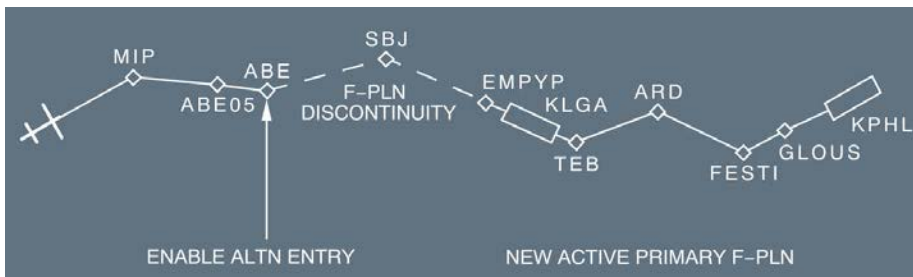

When ENABLE ALT is pressed at ABE, a flight plan discontinuity is created from ABE down to destination and the alternate route is linked to the active flight plan.

DIR KEY (DIRECT-TO-FUNCTION)

Applicable to: ALL

Ident.: DSC-22_20-30-10-15-D-00007243.0001001 / 09 FEB 11

GENERAL

The pilot uses the “Direct To” function to define a direct leg from the present position to any waypoint on the active flight plan or to any waypoint.

The designated waypoint may be entered by its identifier (if it is stored in the database) or by a latitude/longitude, place/bearing/distance, or a place-bearing/place-bearing.

Note: If the autopilot or flight director is in the heading/track or localizer mode, the “DIR TO” function engages the NAV mode.

Three functions are available through the DIR TO key:

- The DIR TO defines a direct leg from the present position to a specified waypoint. NAV mode engages simultaneously to the DIR TO selection. When the pilot uses DIR TO , the present position (PPOS) becomes the “FROM” waypoint and the active flight plan shows it as the T-P (turn point).
- The DIR TO /ABEAM function, defines the abeam waypoints along the direct leg. These waypoints are the projection on the direct leg of the initial F-PLN waypoints located between the aircraft position and the specified waypoint. NAV mode engages simultaneously to the DIR TO/ABEAM selection.
- The DIR TO /INTCPT function allows the definition of a specified RADIAL INBOUND or OUTBOUND at an inserted waypoint. The current aircraft track is used to compute the INTCPT point with the specified radial. NAV mode is armed simultaneously to the DIR TO /INTCPT selection.

The ND displays the DIR TO leg as a temporary flight plan leg between current aircraft position and specified waypoint. In case of a DIR TO /INTCPT, the leg is not displayed when the angle between the current aircraft track and the intercept radial exceeds 160 °.

Ident.: DSC-22_20-30-10-15-D-00007216.0001001 / 14 MAY 12

PROCEDURE FOR DIR TO WAYPOINT

CASE 1. THE “TO” WAYPOINT IS IN THE FLIGHT PLAN

Example : DIR TO FRZ

PRESS the DIR key on the MCDU.

PRESS the line select key next to “FRZ”.

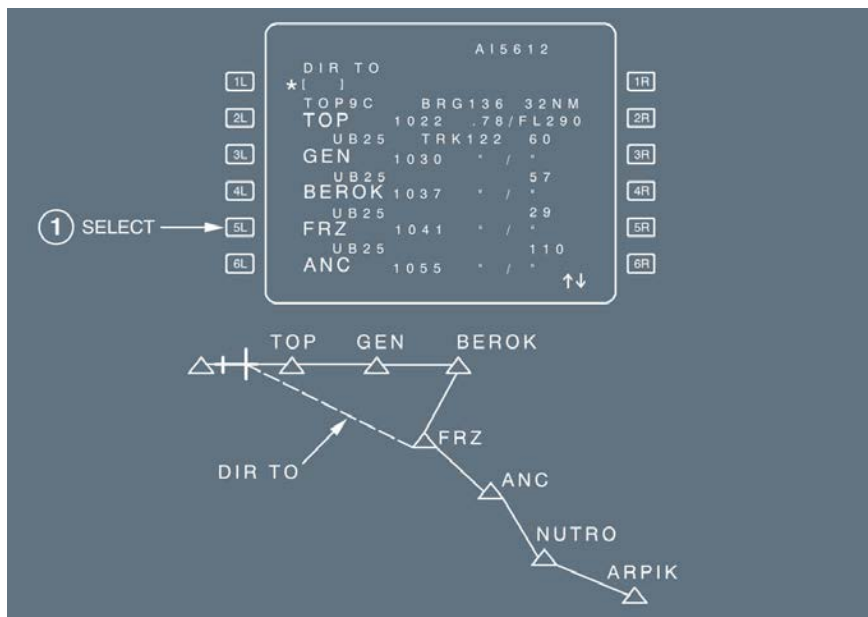

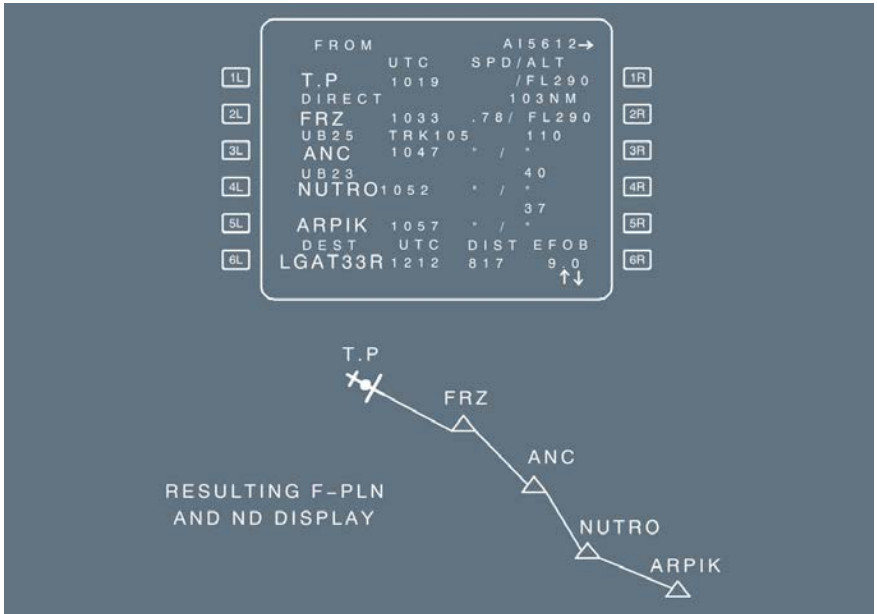

CASE 2. THE “TO” WAYPOINT DOES NOT BELONG TO THE FLIGHT PLAN

Example : Direct to ABC (ABC being an ident, LL or PBD or PBX (Place/Bearing-Place/Bearing)

PRESS the DIR key.

WRITE the waypoint identifier (e.g. ABC) into the scratchpad.

PRESS [1 L] to enter “ABC” in the “DIR TO” field.

DIR TO AI5612

| | | | | |
|------|-------|------|-----------|------|
| *[] | TOP | 9C | BRG136 | 32NM |
| [2L] | TOP | 1022 | .78/FL290 | |
| [3L] | GEN | 1030 | * / * | |
| [4L] | BEROK | 1037 | * / * | |
| [5L] | FRZ | 1041 | * / * | |
| [6L] | ANC | 1055 | * / * | |
| | ABC | | | |

BEFORE THE DIR TO

Diagram: + --- TOP --- GEN --- BEROK --- FRZ

FROM AI5612→

| | | | | | |
|------|---------|--------|-----------|---------|------|
| [1L] | T.P | 1019 | UTC | SPD/ALT | [1R] |
| [2L] | DIRECT | BRG157 | 54NM | | [2R] |
| [3L] | ABC | 1026 | .78/FL290 | | [3R] |
| [4L] | TOP | 1034 | * / * | | [4R] |
| [5L] | GEN | 1042 | * / * | | [5R] |
| [6L] | DEST | UTC | DIST | EFOB | [6R] |
| | LGAT33R | 1221 | 898 | 8.4 | |

- F.PLN DISCONTINUITY -

AFTER THE DIR TO

Diagram: T.P --- ABC --- TOP --- GEN --- BEROK --- FRZ

F.PLN DISCONTINUITY

Clear the discontinuity and the waypoints that are not included in the new flight plan.

PARTICULAR CASES FOR USE OF DIR TO

- If the pilot is flying a manual leg (part of a SID or STAR), the flight plan page displays “F-PLN DISCONTINUITY”, preceded by “MANUAL” (see below).
 These legs are specific heading or track legs flown with no defined end waypoint.

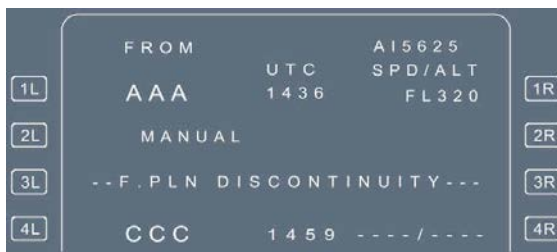

- When the pilot encounters a flight plan discontinuity, or if a major reset occurs, the flight plan page displays “PPOS - F-PLAN DISCONTINUITY”, and the pilot loses managed guidance in both the lateral and vertical plans.
 The autopilot or flight director reverts to the basic HDG V/S (or TRK FPA) modes. Predictions remain available and are based on the assumption that the aircraft will fly a direct leg from its present position to the next waypoint.



- **In both of these cases, the only way to get back to a standard flight plan is to perform a “DIR TO ” to a designated waypoint.**
- Following a DIR TO , the message “MAP PARTLY DISPLAYED” may appear on the NDs, if the new flight plan includes a very long leg (*Refer to DSC-31-45 Flags and Messages Displayed on ND*). When this message comes up, enter an intermediate waypoint to shorten the leg.

Note: During cruise, the DIR TO function is not available as long as uplink wind data, received through ACARS , is not inserted or cancelled on the CRUISE WIND page.

Ident.: DSC-22_20-30-10-15-D-00007208.0009001 / 22 OCT 13

PROCEDURE FOR DIR TO/ABEAM

Example : DIR TO/ABEAM BEROK

PRESS the DIR on the MCDU.

WRITE the waypoint identifier into the scratchpad (Example : BEROK).

PRESS [1 L] to enter the waypoint in the DIR TO field.

SELECT the ABEAM PTS function.

The display reverts to F-PLN A page.

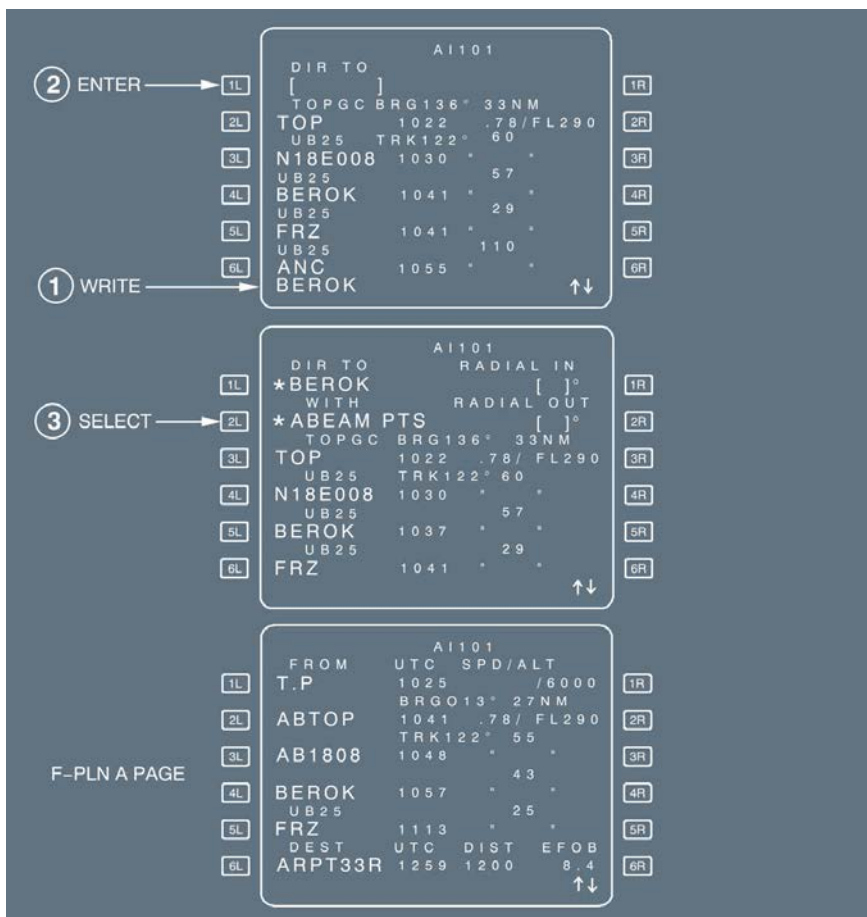

1 WRITE → [6L] BEROK

| DIR TO | | AI101 | |
|--------|---------|---------|-----------|
| [1L] | TOPGC | BRG136° | 33NM |
| [2L] | TOP | 1022 | .78/FL290 |
| [3L] | UB25 | TRK122° | 60 |
| [4L] | N18E008 | 1030 | " " |
| [5L] | UB25 | | 57 |
| [6L] | BEROK | 1041 | " " |
| | UB25 | | 29 |
| | FRZ | 1041 | " " |
| | UB25 | | 110 |
| | ANC | 1055 | " " |
| | BEROK | | |

2 ENTER → [1L]

| DIR TO | | AI101 | |
|--------|------------|------------|-----------|
| [1L] | *BEROK | | |
| [2L] | WITH | RADIAL IN | []° |
| [3L] | *ABEAM PTS | RADIAL OUT | []° |
| [4L] | TOPGC | BRG136° | 33NM |
| [5L] | TOP | 1022 | .78/FL290 |
| [6L] | UB25 | TRK122° | 60 |
| | N18E008 | 1030 | " " |
| | UB25 | | 57 |
| | BEROK | 1037 | " " |
| | UB25 | | 29 |
| | FRZ | 1041 | " " |

3 SELECT → [2L]

| FROM | | AI101 | |
|------|---------|---------|-----------|
| [1L] | T.P | UTC | SPD/ALT |
| [2L] | ABTOP | 1025 | /6000 |
| [3L] | AB1808 | BRG013° | 27NM |
| [4L] | BEROK | 1041 | .78/FL290 |
| [5L] | UB25 | TRK122° | 55 |
| [6L] | FRZ | 1048 | " " |
| | | | 43 |
| | BEROK | 1057 | " " |
| | UB25 | | 25 |
| | FRZ | 1113 | " " |
| | DEST | UTC | DIST |
| | ARPT33R | 1259 | 1200 |
| | | | EFOB |
| | | | 8.4 |

F-PLN A PAGE

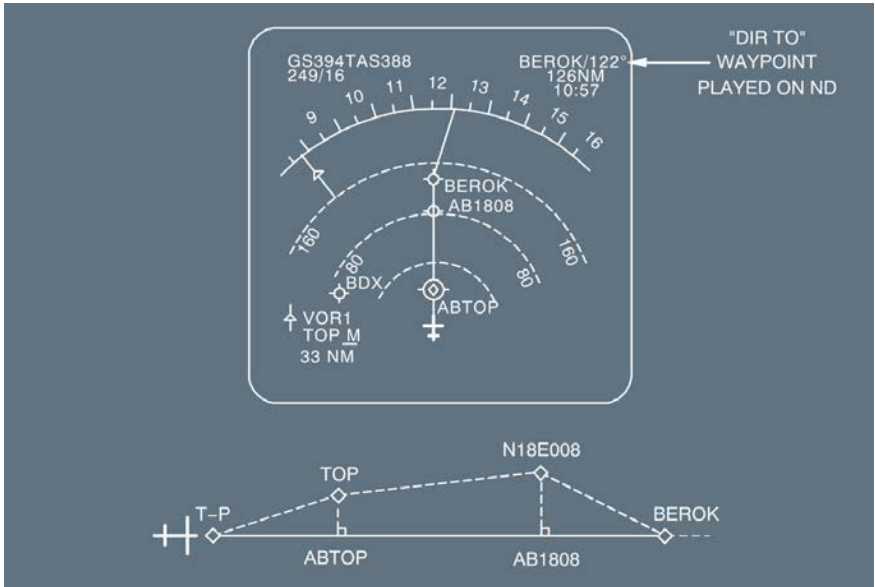

- Note:**
1. If, between two waypoints projected on the direct leg, there was a discontinuity in the original flight plan, this discontinuity disappears between the corresponding abeam points on the direct leg.
 2. . Abeam waypoints computed from latitude/longitude-type waypoints are renamed by the system as "AB XXXXX", where "xxxxx" is an abbreviation in 5 characters, of the latitude and longitude of the initial waypoints.

Ident.: DSC-22_20-30-10-15-D-00007221.0001001 / 14 MAY 12

PROCEDURE FOR DIR TO/INTERCEPT

PRESS the DIR key.

WRITE the waypoint identifier into the scratchpad.

PRESS [1L] to enter the waypoint in the DIR TO field.

In the [1R] and [2R] fields, the MCDU displays the functions radial inbound and radial outbound from the waypoint.

If the waypoint belongs to the flight plan, the system displays the flight plan track as the default inbound radial. The crew can modify it.

WRITE the required in or out radial into the scratchpad.

PRESS [1R] or [2R] to enter the radial in the required field.

The ND displays the entered radial as an amber dotted line : The pilot can still modify it.

PRESS [1R] or [2R] to confirm the DIR TO/INTERCEPT selection.

The display reverts to the F-PLN A page, the system arms the NAV mode, and engages the HDG mode. The FROM waypoint is the aircraft position at the time of the DIR TO /INTERCEPT selection. The MCDU indicates it as INBND or OUTBND.

- Note:**
1. If the waypoint does not belong to the flight plan, the system strings the DIR TO/INTERCEPT leg to this waypoint, and inserts a discontinuity following the waypoint.
 2. A DIR TO/INTERCEPT cancels any active offset.
 3. If the current AP /FD lateral mode is HDG or TRK , NAV becomes armed. If the NAV mode was engaged, NAV becomes armed. FCU HDG or TRK must be used to guide the aircraft.
The ND displays an intercept point, if the intercept angle is less than 120 °. The system constantly updates it to reflect the current aircraft track and position with respect to the intercept radial. The NAV mode engages when reaching the intercept point.

EXAMPLE: RADIAL INBND

DIR TO AMB - RADIAL 200 ° INBOUND

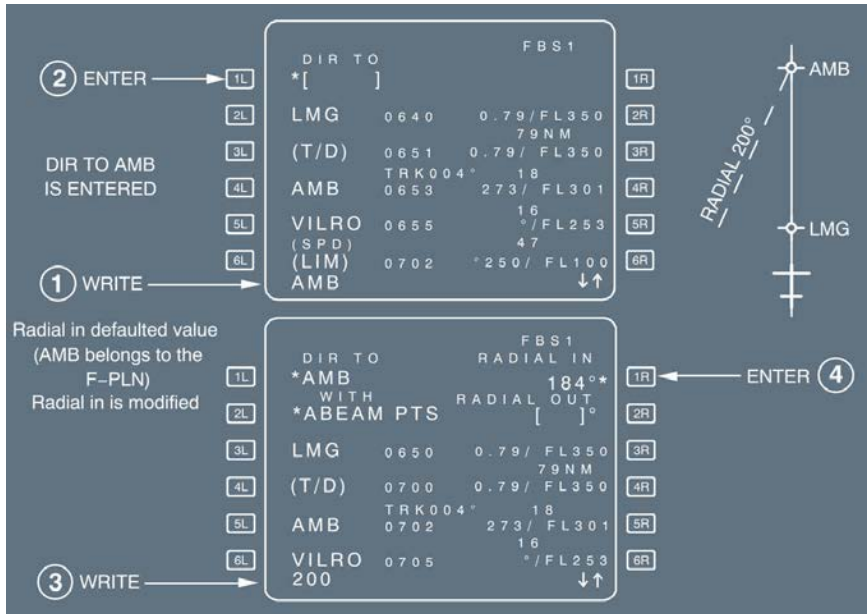

Step 1: DIR TO AMB IS ENTERED

| | | | | | | | |
|------|--------|-------|--------------|------|--|------|--|
| [1L] | DIR TO | FBS1 | | | | | |
| [2L] | LMG | 0640 | 0.79 / FL350 | [1R] | | [2R] | |
| [3L] | (T/D) | 0651 | 0.79 / FL350 | [3R] | | [3R] | |
| [4L] | AMB | 0653 | 273 / FL301 | [4R] | | [4R] | |
| [5L] | VILRO | 0655 | 16 | [5R] | | [5R] | |
| [6L] | (SPD) | (LIM) | 47 | [6R] | | [6R] | |
| | AMB | 0702 | *250 / FL100 | | | | |

Step 2: Radial in defaulted value (AMB belongs to the F-PLN)

| | | | | | | | |
|------|------------|-----------|--------------|------|--|------|--|
| [1L] | DIR TO | RADIAL IN | 184.0* | | | | |
| [2L] | *AMB | WITH | RADIAL OUT | [1R] | | [2R] | |
| [3L] | *ABEAM PTS | []° | | [3R] | | [3R] | |
| [4L] | LMG | 0650 | 0.79 / FL350 | [4R] | | [4R] | |
| [5L] | (T/D) | 0700 | 0.79 / FL350 | [5R] | | [5R] | |
| [6L] | AMB | 0702 | 273 / FL301 | [6R] | | [6R] | |
| | VILRO | 0705 | 16 | | | | |
| | 200 | | * / FL253 | | | | |

Step 3: Radial in is modified

| | | | | | | | |
|------|------------|-----------|--------------|------|--|------|--|
| [1L] | DIR TO | RADIAL IN | 184.0* | | | | |
| [2L] | *AMB | WITH | RADIAL OUT | [1R] | | [2R] | |
| [3L] | *ABEAM PTS | []° | | [3R] | | [3R] | |
| [4L] | LMG | 0650 | 0.79 / FL350 | [4R] | | [4R] | |
| [5L] | (T/D) | 0700 | 0.79 / FL350 | [5R] | | [5R] | |
| [6L] | AMB | 0702 | 273 / FL301 | [6R] | | [6R] | |
| | VILRO | 0705 | 16 | | | | |
| | 200 | | * / FL253 | | | | |

Step 4: Final display

| | | | | | | | |
|------|------------|-----------|--------------|------|--|------|--|
| [1L] | DIR TO | RADIAL IN | 184.0* | | | | |
| [2L] | *AMB | WITH | RADIAL OUT | [1R] | | [2R] | |
| [3L] | *ABEAM PTS | []° | | [3R] | | [3R] | |
| [4L] | LMG | 0650 | 0.79 / FL350 | [4R] | | [4R] | |
| [5L] | (T/D) | 0700 | 0.79 / FL350 | [5R] | | [5R] | |
| [6L] | AMB | 0702 | 273 / FL301 | [6R] | | [6R] | |
| | VILRO | 0705 | 16 | | | | |
| | 200 | | * / FL253 | | | | |

Diagram: A vertical line represents the flight path. Waypoint AMB is at the top, and LMG is below it. A dashed line labeled 'RADIAL 200°' originates from AMB and points towards LMG, indicating the intercept radial.

DIR TO **FBS1**
RADIAL IN
 AMB 200°
 WITH RADIAL OUT
 *ABEAM PTS []°

| | | | | |
|----|-------|------|--------------|----|
| 1L | LMG | 0650 | 0.79 / FL350 | 3R |
| 2L | (T/D) | 0700 | 0.79 FL350 | 4R |
| 3L | TRK | 004° | 18 | 5R |
| 4L | AMB | 0702 | 273 / FL301 | 6R |
| 5L | VILRO | 0705 | * / FL253 | |
| 6L | | | ↓↑ | |

1R ← CONFIRM **5**

2R

3R

4R

5R

6R

New radial is confirmed

FROM **FBS1 →**

| | | | | |
|----|-------------|------|--------------|------|
| 1L | IN-BND | 0650 | 0.79 / FL350 | 1R |
| 2L | (T/D) | 0703 | 0.80 / FL350 | 2R |
| 3L | TRK | 004° | 17 | 3R |
| 4L | AMB | 0706 | 283 / FL301 | 4R |
| 5L | VILRO (SPD) | 0708 | * / FL350 | 5R |
| 6L | (LIM) | 0715 | *250 / FL100 | 6R |
| | DEST | UTC | DIST | EFOB |
| | LFP007 | 0727 | 207 | 16.5 |
| | | | ↓↑ | |

F-PLN
A PAGE

INTCPT

AMB

LMG

RADIAL 200°

EXAMPLE: RADIAL OUTBND

DIR TO AMB - RADIAL 200° OUTBOUND

2 ENTER → [1L]

DIR TO AMB
is entered

[2L]

[3L]

[4L]

[5L]

[6L]

1 WRITE →

| DIR TO | FBS1 | |
|--------|-------------|--------------------|
| *[] | | |
| LMG | 0 7 0 4 | 0 . 7 9 / FL 3 5 0 |
| (T/D) | 0 7 1 5 | 0 . 7 9 / FL 3 5 0 |
| | TRK 0 0 4 ° | 1 8 |
| AMB | 0 7 1 7 | 2 7 3 / FL 3 0 1 |
| | | 1 6 |
| VILRO | 0 7 1 9 | ° / FL 2 5 3 |
| (SPD) | | 4 7 |
| (LIM) | 0 7 2 7 | ° 2 5 0 / FL 1 0 0 |
| AMB | | ↓ ↑ |



Radial in defaulted value
(AMB belongs to the
F-PLN)

Radial out is entered

3 WRITE →

| DIR TO | FBS1 | |
|------------|-------------|--------------------|
| *AMB | | RADIAL IN |
| WITH | | 1 8 4 ° * |
| *ABEAM PTS | | RADIAL OUT |
| | | [] ° |
| LMG | 0 7 0 5 | 0 . 7 9 / FL 3 5 0 |
| (T/D) | 0 7 1 5 | 0 . 7 9 / FL 3 5 0 |
| | TRK 0 0 4 ° | 1 8 |
| AMB | 0 7 1 7 | 2 7 3 / FL 3 0 1 |
| | | 1 6 |
| VILRO | 0 7 2 0 | ° / FL 2 5 3 |
| 200 | | ↓ ↑ |

← ENTER **4**

The screenshot shows two data pages from the FMS. The top page displays radial out information for waypoints *AMB and *ABEAM PTS. The bottom page shows flight plan discontinuity information, indicating that the current page is a page out of the BND (Bypass) page.

Top Page Data:

| DIR TO | FBS1 | RADIAL IN | []° |
|------------|---------|--------------|-------|
| *AMB | | | |
| WITH | | | |
| *ABEAM PTS | | RADIAL OUT | 200°* |
| LMG | 0705 | 0.79 / FL350 | |
| (T/D) | 0715 | 0.79 FL350 | |
| | | | 79 NM |
| AMB | TRK004* | 18 | |
| | 0707 | 273 / FL301 | |
| | | | 16 |
| VILRO | 0720 | * / FL253 | |

Bottom Page Data:

| FROM | UTC | SPD/ALT | FBS1 → |
|---------------------------|------|-------------|--------|
| OUT-BND | 0705 | .79 / FL350 | |
| | | | |
| | | | |
| MANUAL | 0719 | .80 / FL350 | |
| | | | |
| | | | |
| ---F-PLN DISCONTINUITY--- | | | |
| (T/D) | 0721 | .80 / FL350 | |
| | | | |
| | | | |
| VILRO | 0725 | 283 / FL253 | |
| DEST | UTC | DIST | EFOB |
| LFP007 | 0744 | 241 | 15.8 |

Annotations:

- Left side: 1L-6L buttons.
- Right side: 1R-6R buttons.
- Text: "RADIAL OUT IS CONFIRMED" (left), "CONFIRM 5" (right).
- Diagram: Shows a flight path with waypoints INTCP, LMG, and AMB. A dashed line indicates a radial out of 200 degrees from AMB.
- Text: "F-PLN a page out-BND becomes the from WPT and followed by the manual termination" (left).

OVFY (OVERFLY) KEY

Ident.: DSC-22_20-30-10-15-00000469.0001001 / 01 OCT 12

Applicable to: ALL

The overfly key programs the Flight Management Guidance Computer to fly over a specific waypoint or NAVAID. To use it:

PRESS the "OVFY" key.

A "Δ" appears in the scratchpad.

INSERT it by pressing the key adjacent to the waypoint to be overflown. [3L] in this example.

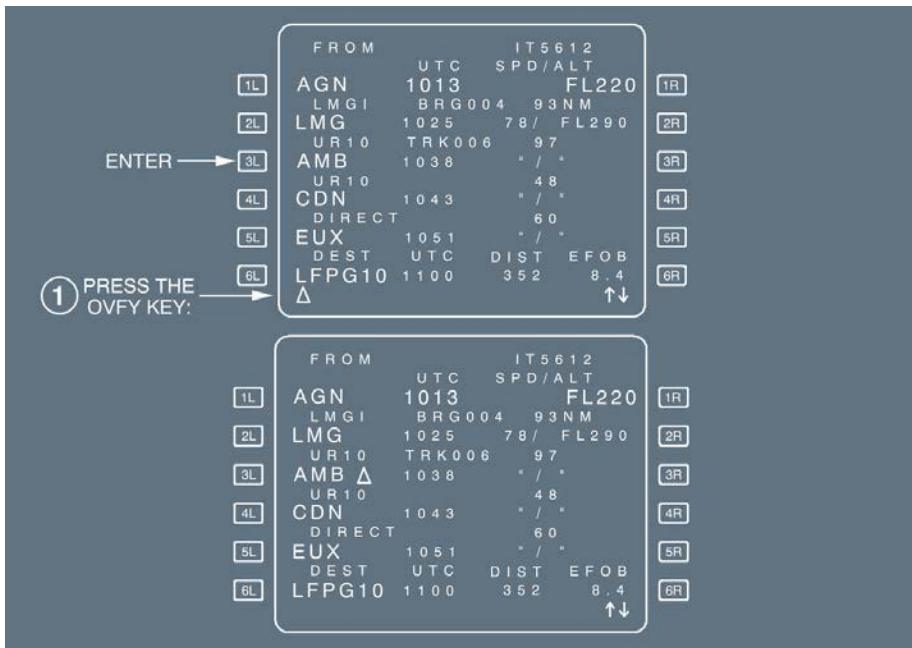

FROM IT5612
 UTC SPD/ALT
 1L AGN 1013 FL220 1R
 LMG1 BRG004 93NM
 2L LMG 1025 78/ FL290 2R
 UR10 TRK006 97 3R
 3L AMB 1038 " / " 4R
 UR10 " / " 48 5R
 4L CDN 1043 " / " 60 6R
 DIRECT " / " 60
 5L EUX 1051 " / " 5R
 DEST UTC DIST EFOB
 6L LFPG10 1100 352 8.4 6R
 Δ ↑↓

1 PRESS THE OVFY KEY:

FROM IT5612
 UTC SPD/ALT
 1L AGN 1013 FL220 1R
 LMG1 BRG004 93NM
 2L LMG 1025 78/ FL290 2R
 3L AMB Δ 1038 " / " 3R
 UR10 " / " 48 4R
 4L CDN 1043 " / " 60 5R
 DIRECT " / " 60
 5L EUX 1051 " / " 5R
 DEST UTC DIST EFOB
 6L LFPG10 1100 352 8.4 6R
 ↑↓

The pilot cannot cancel the overfly program. If you do not want to fly over the point you have entered, use DIR TO (direct to) the next waypoint or engage the heading mode, whichever is more suitable.

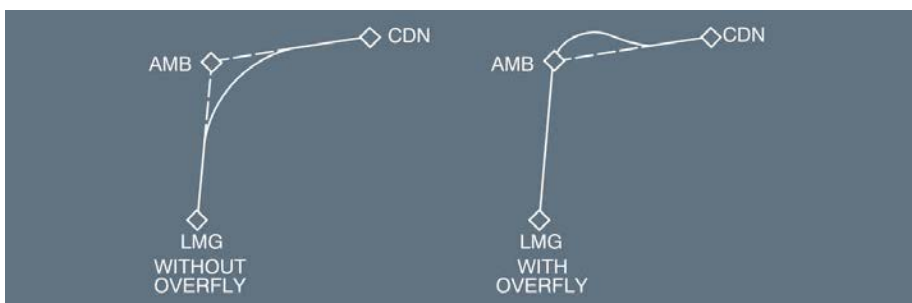

The overfly function allows you to fly over a specific waypoint, and return the aircraft to the great circle track.

"UPDATE AT"

Ident.: DSC-22_20-30-10-15-00000470.0001001 / 01 OCT 12

Applicable to: ALL

To manually change the position computed by the FMGC (FM position and bias), the pilot uses "UPDATE AT" on the progress page.

Use this facility with extreme caution: It is apt to be inaccurate, because it relies on the pilot's estimation of when a designated position has been reached.

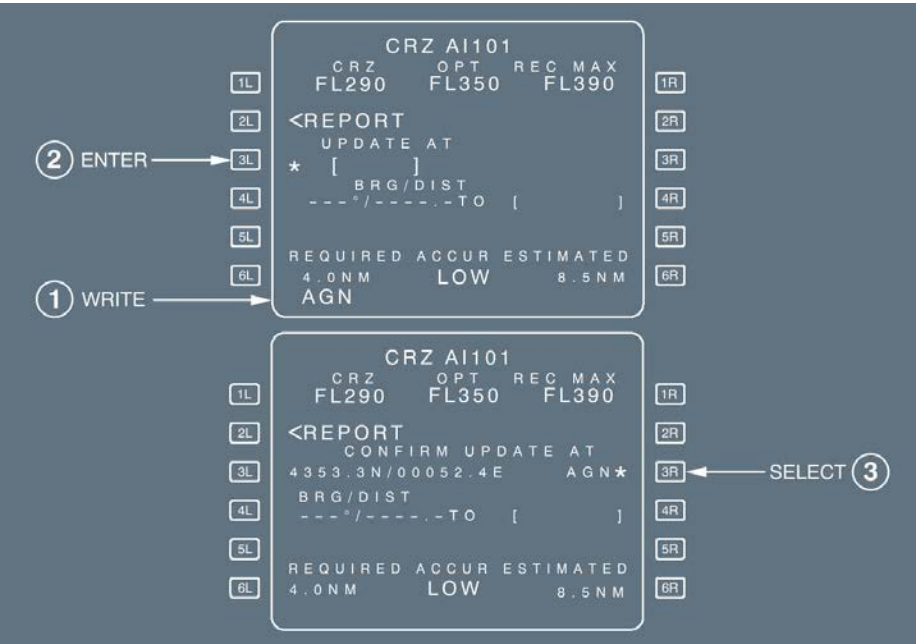

WRITE the ident for the NAVAID (or waypoint or airport), or the coordinates, or the PBD or PBX (Place/Bearing-Place/Bearing) at which the update is intended.
 PRESS [3L] to enter the ident in the "UPDATE AT" field. The coordinates of the point, along with its identifier (or "ENTRY", if the identifier is not in the database), appear in that field.
 PRESS [3R] to activate the update, when you estimate that you are at the position.

Note: The system reinitializes the Estimated Position Error computation when a position update is performed. This may lead to the appearance of a "NAV ACCUR DOWNGRAD" or "NAV ACCUR UPGRAD" message.

If the "UPDATE AT" does not properly take effect, it corrupts the FM position.

- In an area with good radio NAVAID coverage:
 - If the update error is small, subsequent radio position updating will correct the FM position.
 - If the update error is large, the system will reject any radio updating because its internal "reasonableness test" will reject the various NAVAID s. Thus, the FM position will only be the MIX IRS position corrected by the position bias, determined at the time of the update, and the error will be maintained.
- In an area without proper NAVAID coverage, radio position updating will not be available and the FM position, if incorrect, will remain incorrect until a new manual update is performed.
- Therefore, the pilot should only use "UPDATE AT" in case of a major position problem, such as:
 - On the ground, no flight plan appears on the navigation display and ARC/ROSE NAV mode is selected.
 - A "CHECK IRS /FM POSITION" message appears on the MCDU.
 - A "FM /IR POSITION DISAGREE" message appears on the ECAM.

When GPS PRIMARY is operative, the FM position will always converge towards the GPS position at a rate depending on the aircraft altitude. Therefore, when GPS PRIMARY is operative, an inaccurate "update at" will have a temporary effect on the FM position.

General

GENERAL

Ident.: DSC-22_20-30-20-05-00010939.0001001 / 01 OCT 12

Applicable to: ALL

The vertical flight plan is divided into the following flight phases:

Preflight - Takeoff - Climb - Cruise - Descent - Approach - Go-Around - Done.

All but "Preflight" and "Done" phases are associated with speed and altitude profiles.

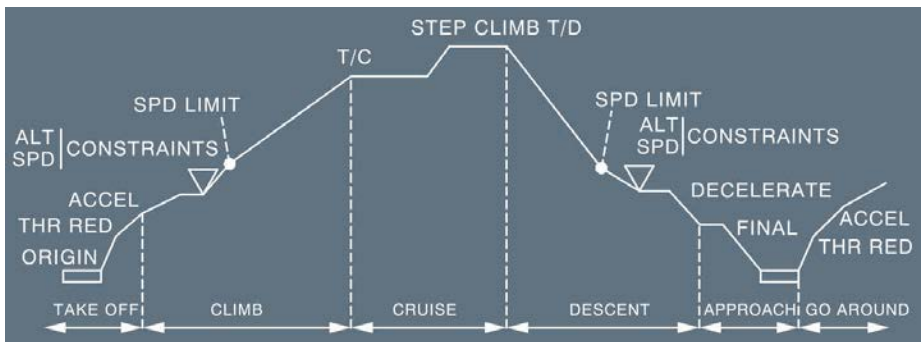

Each phase has an assigned profile of target speeds. For each phase the FMGS computes an optimum (ECON) speed as a function of the strategic parameters (CI, CRZ FL, ZFW, ZFWCG, block FUEL) and performance criteria.

ECON speed is the basis of the managed speed profile.

The ECON speed can be modified by:

- Presetting a speed or Mach number on the MCDU (PERF page) for the next phase
- Selecting on the FCU a speed or a Mach number for the active phase
- Inserting speed constraints or speed limits on the MCDU vertical revision (VERT REV) page.

The vertical flight plan includes vertical constraints (altitude, speed, time) that may be stored in the data base or entered manually by the flight crew through vertical revision pages.

The flight crew may also define step climbs or step descents for cruise purposes. If the flight crew plans to climb to a higher flight level or descend to a lower level, they can use a vertical revision at any waypoint to insert the new level.

When all the vertical data has been defined, the FMGC computes the vertical profile and the managed speed/Mach profile from takeoff to landing.



A318/A319/A320/A321
FLIGHT CREW
OPERATING MANUAL

AIRCRAFT SYSTEMS

AUTO FLIGHT - FLIGHT MANAGEMENT

FLIGHT PLANNING - VERTICAL FUNCTIONS

VERTICAL FLIGHT PLANNING

Ident.: DSC-22_20-30-20-05-00011065.0002001 / 17 AUG 10

Applicable to: ALL

DATA ENTRY

The vertical flight plan provides the FMGS with all the data required to calculate performance and predictions. This data is either entered by the flight crew or calculated by the FMS.

There are three categories of data:

- Strategic data, that applies to the overall flight profile:
 - Cost Index (CI)
 - Cruise Flight Level (CRZ FL) and STEP ALTS if any
 - Zero-Fuel Weight (ZFW)
 - Zero-Fuel Weight Center of Gravity (ZFWCG)
 - Block Fuel.
- Weather data:
 - Winds (for climb, cruise, descent, approach)
 - Sea level atmospheric pressure (QNH) at destination
 - Surface temperature (TEMP) at destination
 - Temperature in cruise phase
 - The Tropopause altitude (TROPO).
- Tactical data for the flight phases:
 - Phase switching conditions:
 - Setting of the thrust levers to TOGA or FLEX positions
 - Reaching acceleration altitude (ACCEL ALT)
 - Entering cruise (T/C)
 - Initiation of descent (T/D)
 - Passing a deceleration pseudo waypoint (DECEL PSEUDO WPT)
 - Touchdown.
 - Speed profile:
 - V2
 - Economy climb speed or Mach (ECON CLB SPD/MACH)
 - Preselected speed or Mach (SPD/MACH PRESELECTION)
 - Economy cruise Mach (ECON CRZ MACH)
 - Constant Mach
 - Economy descent Mach or speed (ECON DES MACH/SPD)
 - Approach speed (VAPP).
 - Vertical limitations:
 - Speed limits (SPD LIMIT)
 - Speed and altitude constraints (SPD AND ALT CSTR)
 - Time constraints or Required Time of Arrival (RTA).

In addition to the data entered by the flight crew, the FMS uses some real flight data parameters (CRZ SAT, actual wind) to improve the accuracy of the computed predictions.

FLIGHT PHASES

Ident.: DSC-22_20-30-20-05-00011024.0007001 / 22 MAR 16

Applicable to: ALL

The vertical flight plan is divided into flight phases. For each phase, the FMGS computes the optimum speed or Mach Profile. These flight phases are:

Preflight - Takeoff - Climb - Cruise - Descent - Approach - Go-Around - Done.

| FLIGHT PHASES | OPTIMUM SPEED PROFILE | SWITCHING CONDITIONS TO NEXT PHASE |
|---------------|---|---|
| PREFLIGHT | / | SRS takeoff mode engaged and N1 > 85 %(EPR ≥ 1.25) or Ground Speed >90 kt |
| TAKEOFF | V2 (V2 + 10) | At acceleration altitude or by engagement of another vertical mode. |
| CLIMB | ECON CLB SPD / MACH | Reaching cruise FL |
| CRUISE | ECON CRZ MACH | No step descent, and distance to destination < 200 NM, or all engines operative and selected altitude below Max [FL 200, highest DES ALT CSTR] |
| DESCENT | ECON DES MACH / SPD | <ul style="list-style-type: none"> - Overflying (DECEL) pseudo waypoint with NAV (or LOC */LOC) mode engaged and altitude <9 500 ft AGL - Manual activation of the approach phase. |
| APPROACH | VAPP (GS Min) | <ol style="list-style-type: none"> 1. To Go-Around: When thrust levers at TOGA detent, or 2. To Done: 30 s after landing, or 3. To Climb: When inserting a new CRZ FL. |
| GO-AROUND | VAPP or current SPD, whichever is greater. Green Dot at ACC ALT | <ol style="list-style-type: none"> 1. To Approach: Manual activation of the approach phase, or 2. To Climb: Above acceleration altitude, modification of the destination airport by: <ul style="list-style-type: none"> - Selection of the ALTN, or - Insertion of a NEW DEST, or - Insertion of a SEC F-PLN with a destination airport different from the destination airport of the active F-PLN. |
| DONE | / | To Preflight: When INIT or PERF key depressed. |

Note: During the preflight phase, the flight crew inserts the flight plan, which includes all data needed for the flight.

During the Done phase, the FMGC erases the data entered for the flight. If the descent or the approach phase is inadvertently activated (manual approach phase activation, for example), the flight crew may reselect a CRZ FL on the PROG page to reactivate the CRZ phase.

VERTICAL REVISION

Ident.: DSC-22_20-30-20-05-00011025.0002001 / 17 AUG 10

Applicable to: ALL

- The flight crew uses vertical revisions to enter or modify:
- The speed limit in the climb and descent phases
 - An altitude or speed constraint at the revised waypoint
 - A step climb or a step descent
 - New wind data
 - A time constraint.

The vertical revision page is accessed by pressing a right hand select key of the flight plan page.



VERTICAL CONSTRAINTS (SPEED, ALTITUDE, TIME)

Ident.: DSC-22_20-30-20-05-00012689.0005001 / 18 FEB 15

Applicable to: ALL

The flight crew enters speed, altitude and time constraint, either to comply with ATC requests and specified procedures, or at the discretion of the flight crew, in response to operational variables.

SPEED LIMIT

A speed limit is associated with altitude as a maximum speed below a specified altitude (only one in climb and one in descent).

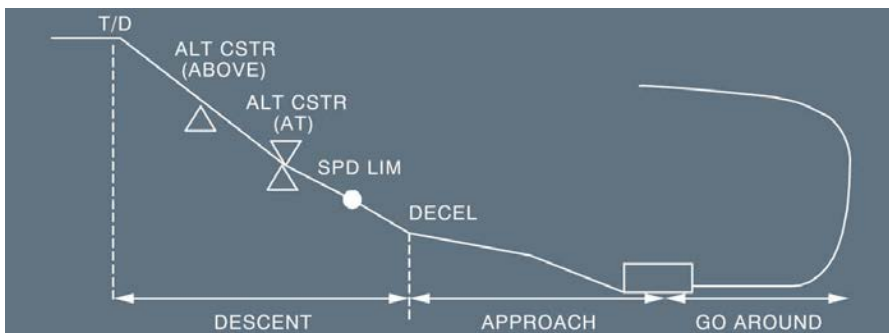
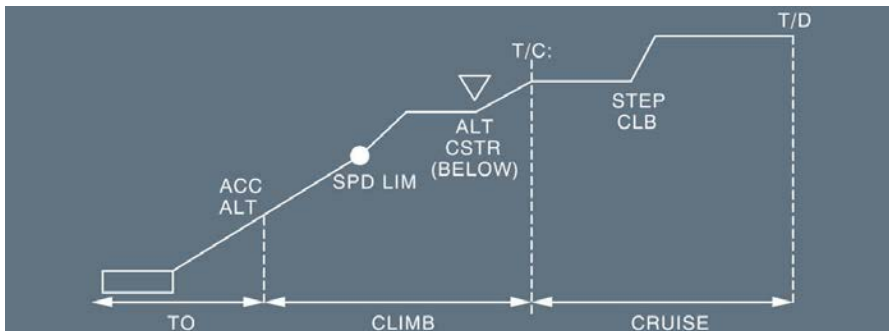

ALTITUDE CONSTRAINT

Altitude constraints may be attached to specific waypoints in the climb, descent, or approach phases.

To meet the altitude constraint, the aircraft must fly over the waypoint at an altitude equal, above or below the altitude constraint as specified by the flight crew or the database.

Note: The database may contain an altitude constraint window (two altitudes between which the aircraft must fly passing over a given waypoint), but the flight crew cannot enter such a constraint manually.

An altitude constraint is considered as missed if the system predicts more than 250 ft of difference between the constraint value and the predicted aircraft altitude.

Altitude constraints are observed in CLB or DES or APP NAV-FINAL modes.

The FMS automatically deletes from the F-PLN:

- The altitude constraints ("AT", "AT OR ABOVE", or "AT OR BELOW") with values greater than the CRZ FL
- The altitude constraint windows with the upper constraint greater than the CRZ FL.

The MCDU and the ND no longer display the deleted altitude constraints. These altitude constraints are no longer used for the computation of the FMS climb and descent profile. In that case, the scratchpad of the MCDU displays the "CSTR DEL ABOVE CRZ FL" message. The FMS does not delete the altitude constraints at the CRZ FL. The FMS computes the T/D, in order to respect these altitude constraints. However these altitude constraints are not used for guidance. If the flight crew initiates the descent before reaching the T/D, the aircraft descends below the altitude constraints, and the altitude constraints are missed (amber on the MCDU and on the ND).

SPEED CONSTRAINT

Speed constraints may be attached to specific waypoints in the climb, descent or approach phases. To meet the speed constraint, the aircraft must fly over the waypoint with a speed equal or less than the speed constraint.

A speed constraint is considered as missed if the system predicts an aircraft speed 10 kt greater than the speed constraint.

Speed constraints are observed when NAV mode is engaged and speed target is managed. Otherwise speed constraints are disregarded.

TIME CONSTRAINT

Time constraint may be attached to any waypoint except the "from" waypoint.

Note: No constraint can be associated with go-around waypoints.



A318/A319/A320/A321
FLIGHT CREW
OPERATING MANUAL

AIRCRAFT SYSTEMS

AUTO FLIGHT - FLIGHT MANAGEMENT

FLIGHT PLANNING - VERTICAL FUNCTIONS

Intentionally left blank

FMS2 Honeywell

GENERAL

Ident.: DSC-22_20-30-20-25-00009323.0008001 / 14 MAY 12

Applicable to: ALL

The vertical revision function allows the pilot to modify the following parts of the flight plan:

- Speed limit
- Speed and altitude constraints
- Time constraints
- Wind
- Step climb or step descent
- Constant Mach Segment

The pilot selects these functions by pressing the right key on flight plan A or B.

FROM AI504 →

| | EF OB | WIND | |
|--------|----------|----------|-------|
| ADALE | 15.3 | 246°/076 | |
| J34 | BRG 104° | 28 NM | |
| 01CRL | 15.1 | " ° / " | |
| J34 | TRK 120° | 17 | |
| HASTE | 14.9 | " ° / " | |
| J34 | | 3.2 | |
| ALPHE | 14.6 | 240°/092 | |
| J34 | | 5.2 | |
| CRL | 14.1 | " ° / " | |
| DEST | UTC | DIST | EF OB |
| KLGA22 | 0058 | 636 | 9.3 |
| | | | ↑↓ |

VERT REV AT ALPHE
EF OB = 14.6 EXTRA = 0.3

| | |
|----------------|------------|
| CLB SPD LIM | RTA > |
| 250/10000 | |
| SPD CSTR | ALT CSTR |
| *[] | []* |
| MACH/START WPT | |
| *[]/ALPHE | |
| <WIND | STEP ALTS> |
| <RETURN | |

SELECT

*Note: This vertical functions section only describes the following three functions: Wind and time constraints, and Constant Mach Segment.
For other vertical revision functions: Refer to the Systems Related Procedures section.*

REQUIRED TIME OF ARRIVAL (RTA)

Applicable to: ALL

Ident.: DSC-22_20-30-20-25-A-00009324.0001001 / 24 JAN 11

GENERAL

A Required Time of Arrival (RTA) is a time requirement to be met over a specified waypoint of the lateral flight plan, including destination but excluding the origin and FROM waypoints. When the predictions are available, the time constraint value is replaced by the predicted time at the related waypoint, highlighted by a star (*):

- If the RTA is predicted as matched, the star (*) is in magenta.
- If the RTA is predicted as missed, the star (*) is in amber.

No specific symbol is provided on the ND.

A time constraint is cleared in the same way as any other constraints. If a time constraint is automatically deleted. The MCDU displays an "RTA DELETED" message.

Ident.: DSC-22_20-30-20-25-A-00000489.0008001 / 14 MAY 12

ENTERING A REQUIRED TIME OF ARRIVAL

SELECT the F-PLN key on the MCDU.

SELECT a VERT REV at the revised waypoint.

SELECT the RTA prompt (2R).

CHECK, ENTER or MODIFY the identifier of the waypoint at which the time constraint is to be defined in the [1L] field.

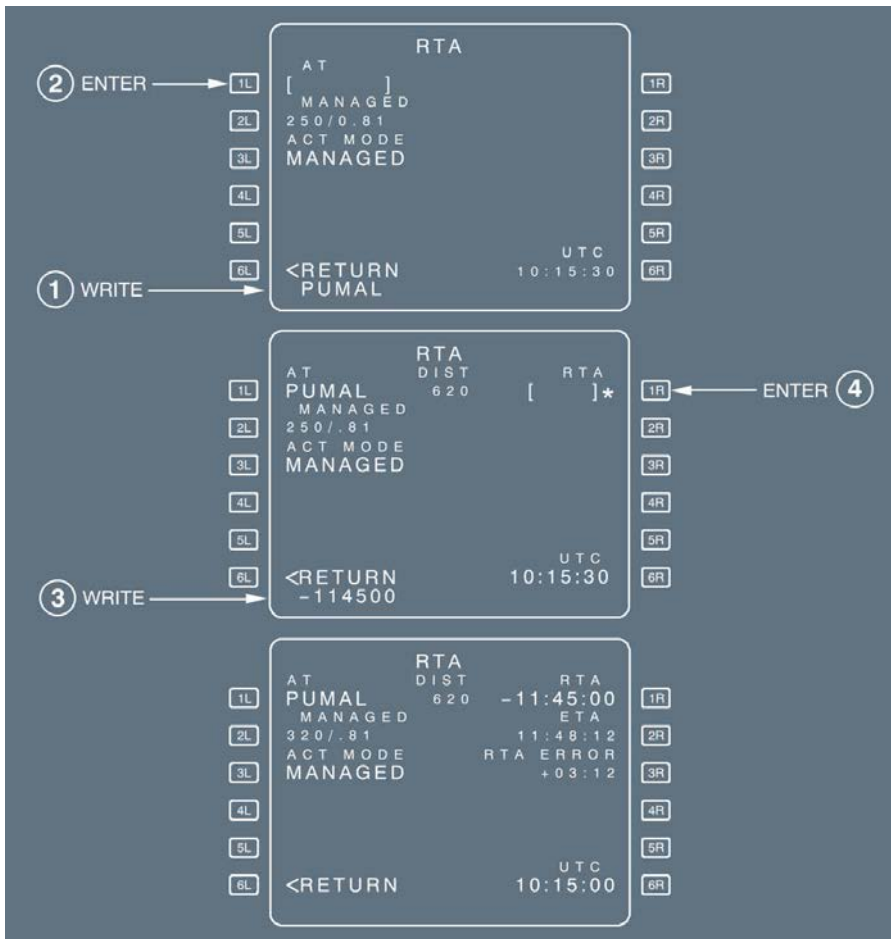

WRITE the required time of arrival.

The format is +/- HHMMSS (entry of seconds is not mandatory).

ENTER it in the 1R field.

CHECK the 2R and 3R fields to determine whether the entered constraint can be met.

WIND - TEMPERATURE - QNH

Applicable to: ALL

Ident.: DSC-22_20-30-20-25-B-00000490.0001001 / 24 JAN 11

GENERAL

In order to receive the best predictions, the pilot must enter wind and temperature values for the different phases and for the various waypoints of the cruise phase.

The system uses the temperature value at a given altitude, associated with the tropopause entered on the INIT A page, to optimize the temperature profile.

Ident.: DSC-22_20-30-20-25-B-00009327.0001001 / 24 JAN 11

ENTERING THE TRIP WIND AND TEMPERATURE DURING F-PLN INITIALIZATION

The trip wind is a mean wind component for the entire flight from origin to destination. The pilot can enter it on the INIT B page prior to engine start. It is usually defined by the airline's flight operations on the computerized flight plan.

The FMGS does not consider the trip wind for alternate predictions.

The trip wind is used as long as no winds are entered in the CLB , CRZ , and DES WIND pages. When the pilot enters a CLB , CRZ or DES WIND, the FMGS disregards the trip wind.

PRESS the INIT key.

INSERT the temperature at cruise FL.

On the INIT B page, INSERT the TRIP WIND.

The trip wind is defined as a headwind component (HDXX, XXHD or -XX), or as a tailwind (TLXX, XXTL or +XX).

The FMGS uses the trip wind to compute preliminary performance, time and fuel predictions.

CHECK the predictions on the F-PLN B page.

Ident.: DSC-22_20-30-20-25-B-00009328.0008001 / 01 OCT 12

ENTERING THE WIND AND TEMPERATURE DURING F-PLN INITIALIZATION

When completing the INIT A page, and once the wind and cruise FL temperature forecasts are available, the pilot may enter them, if significantly different, by pressing the wind prompt.

The pilot will access the different wind pages by using the NEXT PHASE and PREV PHASE prompts. He will slew the CRZ WIND page to access the various cruise wind waypoints.

The pilot will enter wind data as follows:

- For climb phase: By inserting either the HISTORY WIND data (as recorded during the last descent), or by inserting winds (at up to 5 altitudes) on the CLIMB WIND page.
- For cruise phase: By inserting winds (at up to 4 FL) at various CRZ waypoints on the CRZ WIND pages. The 4 levels are the same for all the cruise waypoints. The pilot may enter the temperature of each waypoint and at destination on this page.
- For descent phase: By inserting winds (at up to 5 FL /altitudes) on the DES WIND page.
- For the ALTN F-PLN , an average wind may be entered on the DES WIND page for alternate cruise flight level.

Note: Wind can be automatically received (and inserted) through the ACARS system (Refer to DSC-22_20-70 Wind Data - Request for Wind Data).

Once a CLIMB, CRZ, or DESCENT WIND is entered, the system ignores the TRIP WIND.

Once temperature and winds are inserted, the FMGS computes the ISA profile, and the F-PLN B page displays the forecast wind profile (by linear interpolation and propagation).

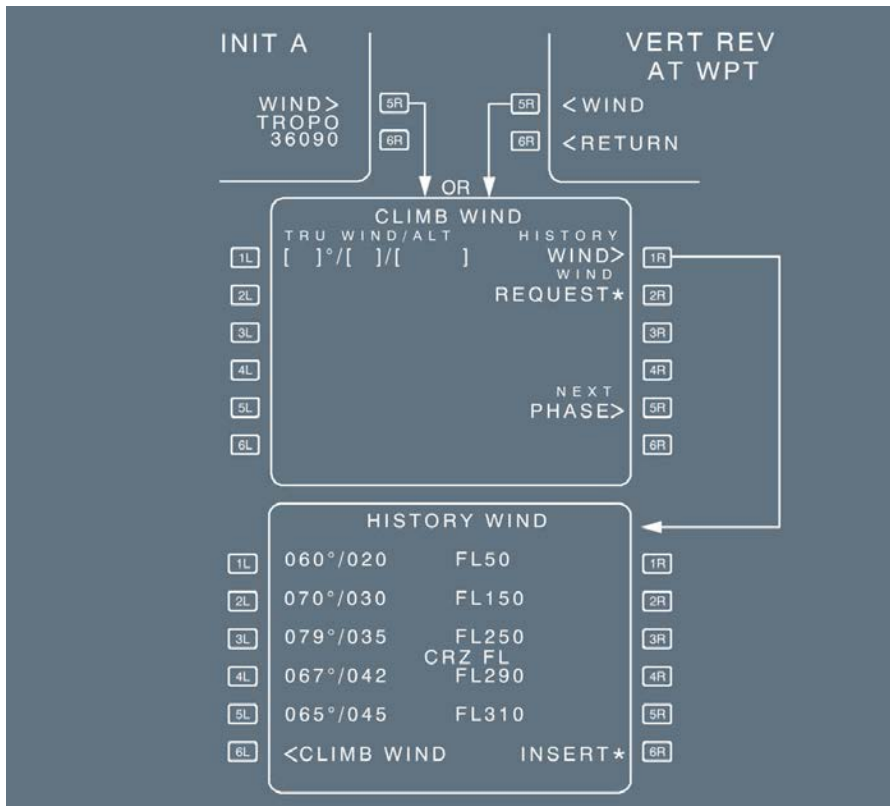

WIND ENTRY RULES

When a wind entry is performed from an empty field, direction/velocity/altitude (or flight level) must be entered simultaneously. One entry in each bracket.

Overwriting a wind cancels the previous one.

Entered wind data can be cleared: The field reverts to brackets.

Propagated wind cannot be cleared.

Entering a new altitude, over an existing altitude, replaces that existing altitude at all cruise waypoints. Any winds entered at the overwritten altitude are lost at all cruise waypoints.

ENTERING THE HISTORY WIND (F-PLN INITIALIZATION)

The pilot may insert the history wind, but cannot modify this page.

If convenient, PRESS the (6R) prompt to insert. After insertion, the [6R] prompt is suppressed, but the page still displays the wind values for information.

ENTERING THE CLIMB WIND (F-PLN INITIALIZATION)

If history winds are not convenient:

SELECT CLIMB WIND page from INIT A page or VERT REV page.

WRITE new winds into the scratchpad and ENTER.



Winds entered on the CLIMB, CRZ, and DESCENT WIND pages are always true north referenced.

Tower wind, entered on PERF APPR page is magnetic-referenced.

The pilot can enter “GRND” in the altitude field for wind at destination.

CLIMB WIND cannot be modified when the climb phase is active.

At climb phase transition, wind data switches from blue to green, and any attempted modification will trigger the “NOT ALLOWED” message.

The system extrapolates the highest wind entry to all higher levels.

The system interpolates winds between 2 entered levels.

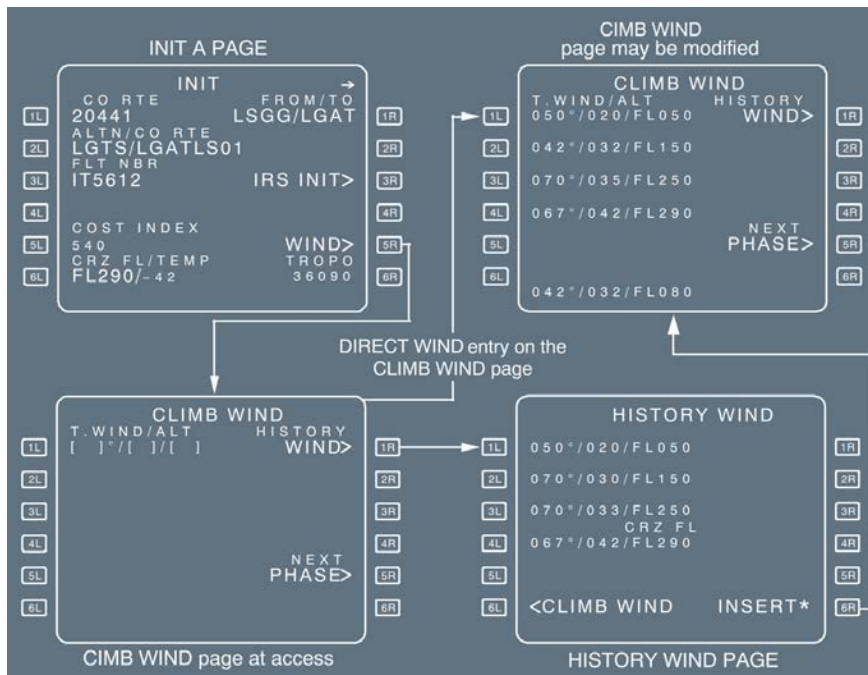

Ident.: DSC-22_20-30-20-25-B-00009329.0001001 / 14 MAY 12

ENTERING THE CRUISE WINDS AND TEMPERATURES

At flight plan initialization, the CRZ WIND page displays all cruise waypoints with empty brackets. In flight, only downpath waypoints are displayed.

SELECT VERT REV at WPT.

PRESS the WIND prompt.

SELECT NEXT PHASE.

SLEW until relevant waypoint is displayed.

WRITE and ENTER the new temperature into the scratchpad.

WRITE and ENTER the new wind data into the scratchpad.

WIND and temperature may be entered through the ACARS pages. (Refer to DSC-22_20-70 Wind Data - Procedure to Insert Wind Data).

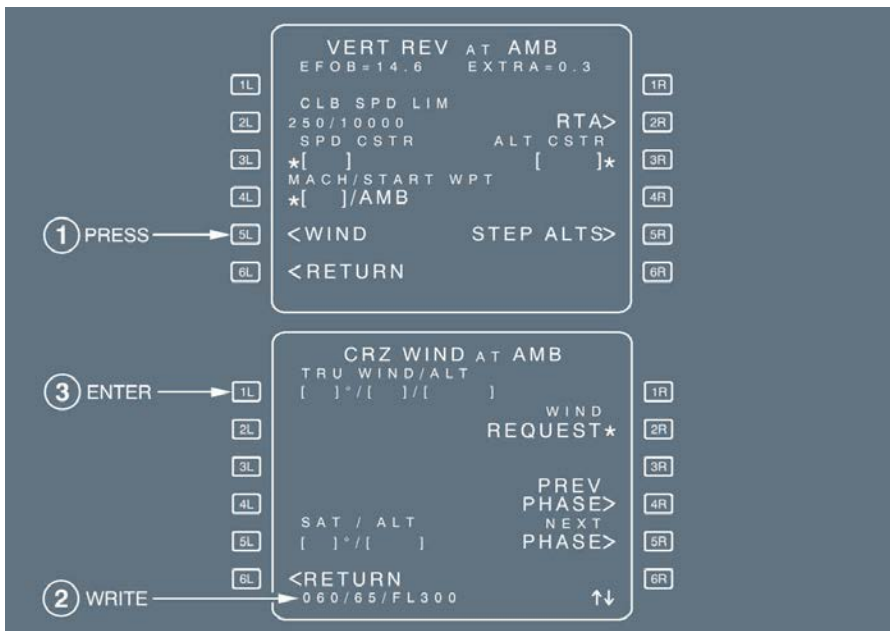

The crew will modify the entered winds and temperatures in flight, if a significant difference is expected (greater than 30 kt or 30 ° for the wind data and greater than 5 °C for the temperature). The system propagates the pilot's (or ACARS) wind and temperature entries downpath, until a waypoint for which a different temperature or wind has been entered (for the same flight level), or until the last cruise waypoint.

The forecast winds at a waypoint are determined as follows:

- If the predicted altitude at the waypoint matches an altitude defined in the CRZ WIND page, the forecast wind, is the corresponding entered or propagated wind, displayed at that waypoint on the CRZ WIND page.
- If the predicted altitude lies between two altitudes entered on the CRZ WIND page, the wind direction and velocity are linearly interpolated.
- If the predicted altitude is above or below the set of cruise altitudes, the forecast wind is a constant value extrapolated from the entered or propagated wind at the highest (or lowest) altitude displayed on the CRZ WIND page for that point.

Once in flight, the FMGS considers the actual measured wind up to 200 NM ahead of the aircraft to permanently update the wind profile. This updated wind profile is used to compute the predictions and the performance data, but is not displayed to the crew.

The CRZ WIND pages display the propagated values in small blue font, and the pilot (or ACARS) entries in large blue font.

Note: The CRZ WIND page displays ACARS or crew-entered or propagated data. It never displays computed data (F-PLN B page only).

Example:

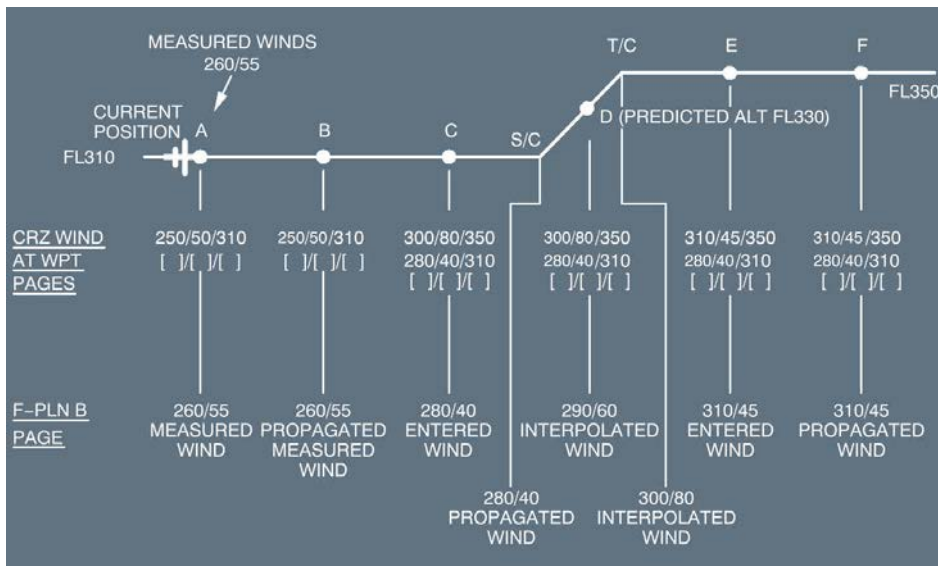

Ident.: DSC-22_20-30-20-25-B-00009330.0001001 / 24 JAN 11

EFFECT OF WIND ENTRIES ON OPTIMUM FLIGHT LEVEL

The OPT FL computation considers the wind entries made at different altitudes (normally at the different CRZ FL).

When flying the subsequent CRZ FL, the OPT FL proposed by the PROG page may be affected by the wind entries made at the previous CRZ FL; these winds are automatically propagated and may be significantly different from the actual winds.

We recommend the following procedure: If the propagated winds at the lower altitudes are significantly different from the actual winds, enter the wind at these altitudes, or if not available, the wind measured at the current CRZ FL.

Ident.: DSC-22_20-30-20-25-B-00009331.0016001 / 14 MAY 12

ENTERING THE DESCENT WINDS

The pilot will enter as many as one wind at 5 different FL or altitudes. This wind data will be used for descent profile and prediction computation.

From the vertical revision page, or from the CRZ WIND page:

PRESS the WIND prompt.

SELECT the DESCENT WIND page.

ENTER up to 5 different “wind/altitude”.

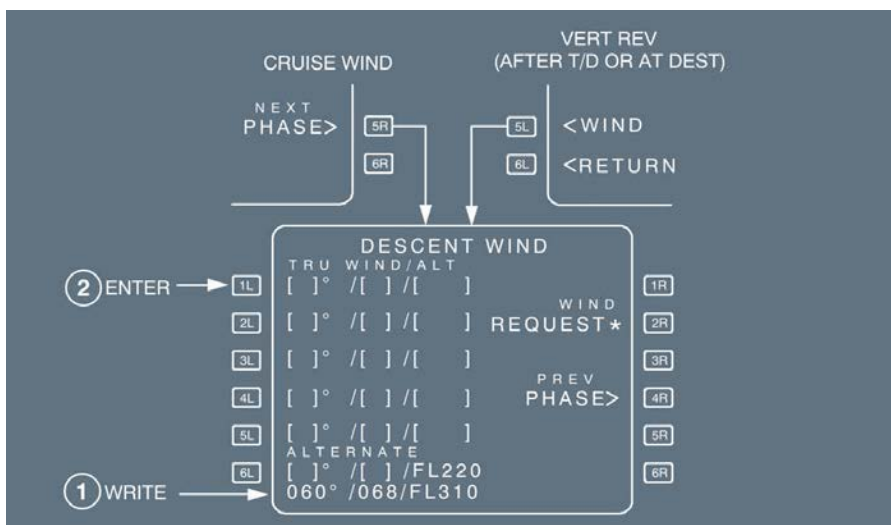

A wind is written as true direction/velocity/flight level or altitude in feet.

If the crew enters “GRND” in the altitude field, the system uses the associated wind as wind at destination.

The descent profile is corrected, as well as the tower wind entered in the PERF APPR page.

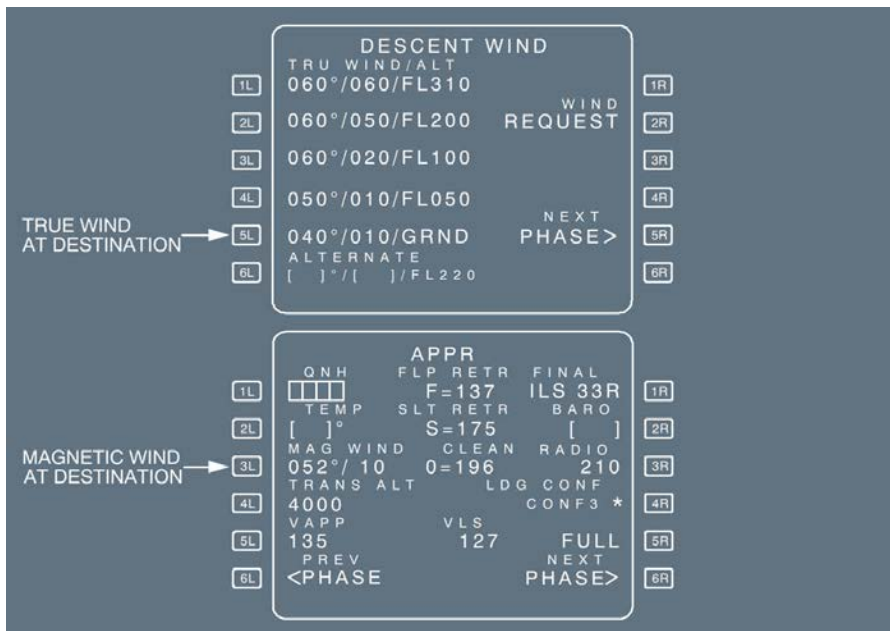

When the winds have been entered, the F-PLN B page displays the forecasted wind profile at all descent waypoints, using values it has interpolated from manual entries. Descent winds are not modifiable when the descent, approach, or go-around phase is active. At descent phase transition, wind data switches from blue to green, and any attempted modification will trigger the “NOT ALLOWED” message.

Ident.: DSC-22_20-30-20-25-B-00009332.0001001 / 24 JAN 11

ENTERING THE ALTERNATE WIND

Alternate wind is entered on the DESCENT WIND page.

The alternate cruise (ALTN CRZ) level defaults to:

- FL 220 if the length of the ALTN F-PLN is less than 200 NM.
- FL 310 if the length of the ALTN F-PLN is greater than 200 NM.

If an alternate wind is not defined, the predictions are computed with a wind defaulted to zero. Alternate wind can be modified at any time.

The alternate wind profile is as follows:

- ALTN CLB wind : Mean wind between ALTN CRZ wind (as entered on the DESCENT WIND page), and the wind at primary DEST (as entered on the PERF APPR page).
- ALTN CRZ wind : If no ALTN WIND has been entered on the DESCENT WIND page, the WIND at primary DEST (as entered on the PERF APPR page) is considered.
In case no entry is made, zero wind is assumed.
- ALTN DES wind : Mean wind between ALTN CRZ WIND and wind at FL 100.
Wind at FL 100 = Interpolation between wind at ALTN CRZ FL and zero at ALTN DEST.

Ident.: DSC-22_20-30-20-25-B-00009333.0016001 / 14 MAY 12

ENTERING THE APPROACH WIND TEMPERATURE AND QNH

The wind at destination is entered in the 3L field of the PERF APPR page. It is copied in true reference into the DESCENT WIND page at ground level (GRND), and F-PLN B page at destination. A ground entry on the DESCENT WIND page is, in the same way, automatically copied to F-PLN B page and the PERF APPR page. This wind is modifiable in descent, approach, and go-around phases.



- SELECT the PERF key on the MCDU.
- PRESS NEXT PHASE (6R).
- WRITE QNH and temperature, and enter them.
- WRITE the surface wind in the scratchpad, and enter it.

Note: At each wind entry, the descent profile is recomputed. Therefore, it is recommended to enter all winds, temperature, and QNH at the same time in order to minimize recomputation time.

CONSTANT MACH SEGMENT

Applicable to: ALL

Ident.: DSC-22_20-30-20-25-C-00009334.0001001 / 14 MAY 12

GENERAL

The pilot can enter the start and end points of a constant Mach segment, and its associated Mach number, from the VERT REV page.

Only one constant Mach segment may be defined in the active flight plan, and only one in the secondary flight plan. No constant Mach segment can be defined in the alternate flight plan.

Ident.: DSC-22_20-30-20-25-C-00000491.0008001 / 01 OCT 12

ENTERING A CONSTANT MACH SEGMENT

SELECT the F-PLN key on the MCDU.

SELECT VERT REV at a waypoint.

(Except the destination and alternate flight plan waypoint).

WRITE the Mach/start waypoint pair.

It is possible to enter only the Mach or the waypoint. But, for the first entry, a Mach entry is mandatory.

The waypoint must be located in front of the aircraft and must be part of the cruise.

ENTER it in the 4L field

The END WPT prompt appears in the 4R field.

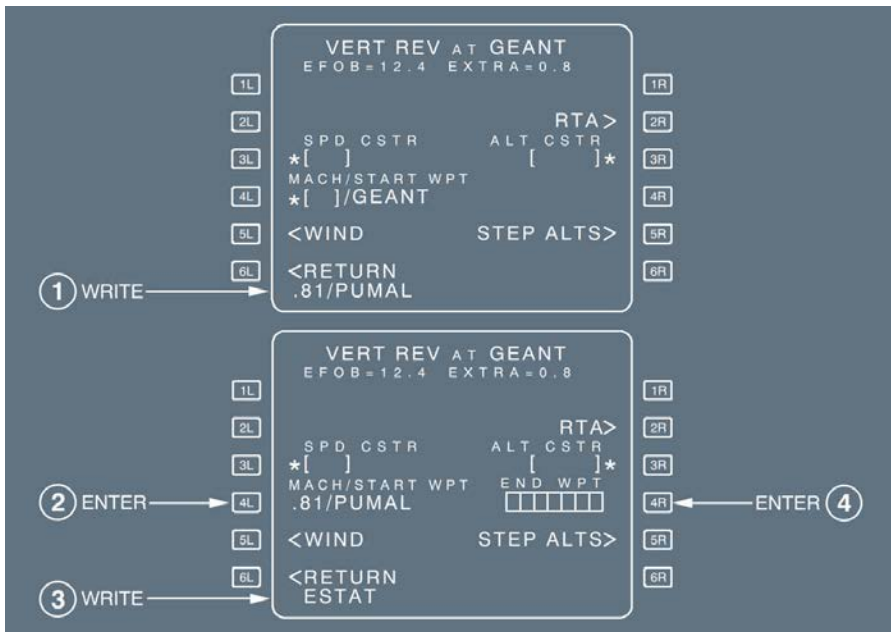

WRITE the end waypoint.

The end waypoint must be part of the cruise.

ENTER it in the 4R field.



A318/A319/A320/A321
FLIGHT CREW
OPERATING MANUAL

AIRCRAFT SYSTEMS

AUTO FLIGHT - FLIGHT MANAGEMENT

FLIGHT PLANNING - VERTICAL FUNCTIONS

Intentionally left blank

| | |
|---|---|
|  A318/A319/A320/A321 FLIGHT CREW OPERATING MANUAL | AIRCRAFT SYSTEMS AUTO FLIGHT - FLIGHT MANAGEMENT PERFORMANCE - OPTIMIZATION |
|---|---|

GENERAL

Ident.: DSC-22_20-40-10-00011077.0001001 / 17 AUG 10

Applicable to: ALL

The performance function:

- Optimizes a flight plan
- Computes predictions.

OPTIMIZATION

Ident.: DSC-22_20-40-10-00011084.0029001 / 23 JUN 15

Applicable to: ALL

The FMGC minimizes cost by optimizing the following items:

- Takeoff, approach, and go-around speeds (F , S , Green Dot, VAPP)
- Target speed for CLB , CRZ and DES phases (ECON SPD/MACH)
- Flight Level (for flight crew's information)
- Descent profile from CRZ FL down to the destination airport.

These items depend on the data the flight crew inserts during lateral and vertical flight planning and revision procedures.

Most are displayed on the PERF pages associated with the appropriate flight phases.

WIND PROFILE

To obtain the best predictions, the flight crew must enter the wind for the various flight phases and specifically for waypoints in cruise.

■ **ON GROUND:**

During flight planning initialization, enter the winds for the climb and cruise phases using the HISTORY WIND and WIND pages. Enter, manually or with ACARS , different wind values in the climb and cruise phases. The system will compute a wind for all waypoints of the F-PLN using linear interpolation between manual/ACARS entries.

The wind profile will be displayed on the F-PLN B page, and is called forecast wind profile. Flight crew or ACARS entries are displayed in large font, and system-computed winds in small font.

■ **IN FLIGHT:**

The system updates the predictions and the current ECON speed, using the measured wind at the present position. It combines actual wind and forecast winds to compute the wind ahead of the aircraft, but this is totally transparent to the flight crew.

During cruise, the flight crew will enter the descent winds and the approach wind. The system will update the final predictions, compute the optimum descent profile and compute the optimum speed in descent and approach.

The forecast wind profile will be used to compute fuel and time predictions, as well as ECON speed/Mach targets.

OPTIMUM TAKEOFF, APPROACH AND GO-AROUND SPEEDS

The FMGC computes takeoff speeds (F , S, Green Dot) during the preflight and takeoff phases, using the performance model in the database and the takeoff weight.

The flight crew has to insert V1 , VR , and V2 in the PERF TO page manually.

The FMGC uses the performance model and either the predicted landing weight or the current gross weight at transition to the approach phase to compute approach speeds (VLS , VAPP , F , S, Green Dot).

On the PERF APPR page, the selected LDG CONF determines the applicable VLS and VAPP , the latter being updated by the WIND correction that the flight crew enters on the same page. The FMGC uses the performance model and gross weight to compute go-around speeds (F , S, Green Dot).



OPTIMUM TARGET SPEED FOR CLIMB, CRUISE AND DESCENT (ECON SPD/MACH)

The FMGS computes the optimum target speed (ECON SPD/MACH) as a function of:

- Cost index (CI)
- Cruise flight level (CRZ FL)
- Gross weight (GW)
- Wind and temperature models
- Performance factor.

The computer processes the ECON SPDs for the climb and descent phases before the initiation of the flight phase, and freezes the values once the flight phase becomes active.

When there is no time or speed constraint/limit, ECON SPEED is the optimum speed for the selected cost index. It refers to fuel and time cost and not directly to fuel saving.

The FM calculates ECON CLB , ECON DES and the associated top of climb and top of descent as a function of cost index, cruise FL, and meteo data.

The computer continually updates ECON CRUISE MACH (SPD), taking into account current weather conditions and modifications to the flight plan.

*Note: If the cruise FL is below FL 250, ECON CRUISE SPEED is computed.
 If the cruise FL is above FL 250, ECON CRUISE MACH is computed.*

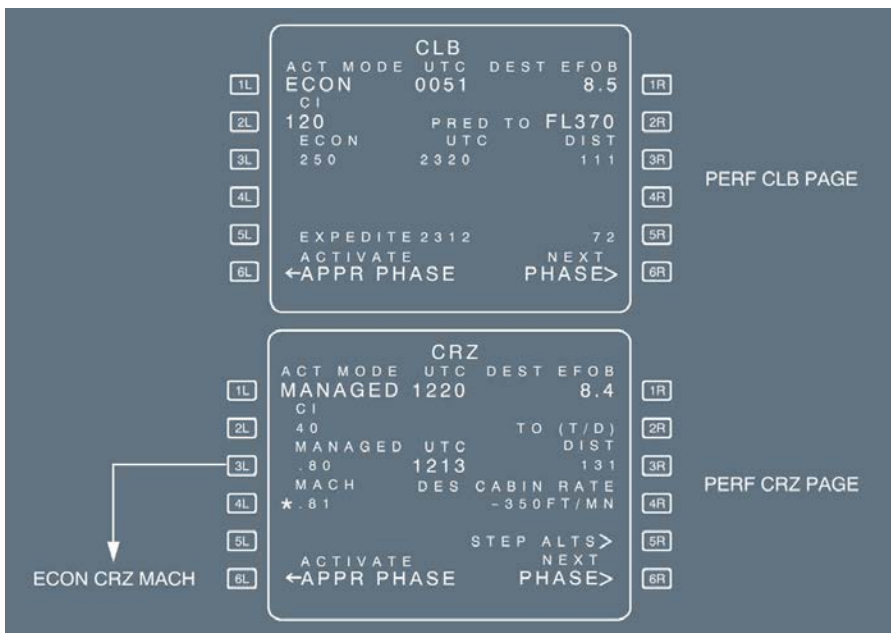

PRESET TARGET SPEED FOR CLB PHASE

The flight crew can preselect the climb speed before the CLB phase begins, by inserting a speed in the PRESEL field:

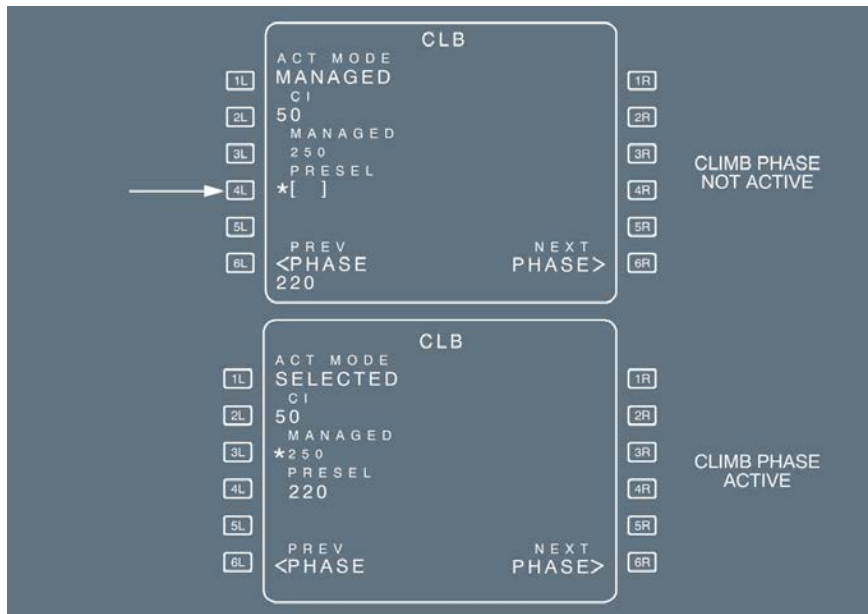

The active mode field changes from MANAGED to SELECTED, and the FM will use the entered speed for climb predictions computation.

The flight crew can revert to managed mode by pressing the 3L key.

PRESET TARGET SPEED/MACH FOR DES PHASE

The flight crew can change the speed and/or Mach displayed in the MANAGED field by inserting a speed and/or Mach in the MANAGED field.

Although the entered speed is chosen by the flight crew, the FMGS uses it to compute the descent flight path and top of descent. It is therefore part of the managed descent profile.

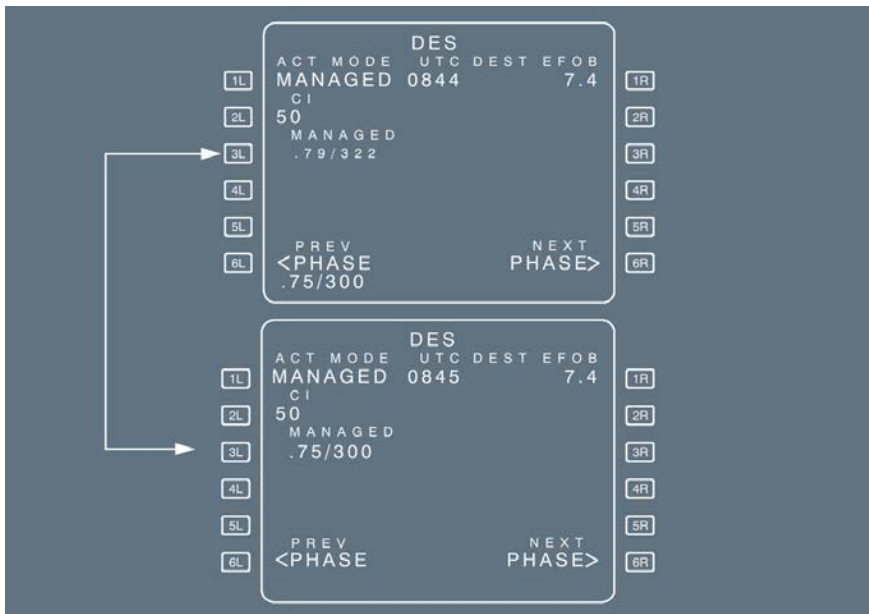

The flight crew can revert to the optimum speed/Mach by clearing the 3L field.

OPTIMUM FLIGHT LEVEL

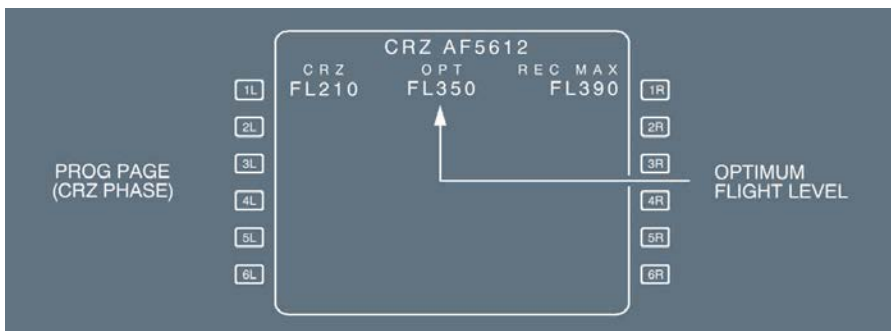

The optimum flight level (OPT FL) indicates the most economic flight level for a given cost index, weight, weather data. It is continuously updated in flight. It requires a 5 min minimum cruise time, at a minimum cruise flight level of FL 100.

The OPT FL is a compromise between fuel and time saving. As a result, the flight crew may observe jumps in OPT FL due to GW, ISA, or wind changes. The computation of the OPT FL considers the wind entries made at the different altitudes (normally at the different CRZ FL). When flying the subsequent CRZ FL, the OPT FL proposed by the PROG page may be affected by the wind entries made at the previous CRZ FL; these winds are automatically propagated and may be significantly different from the actual winds.

Note: For simplification purposes, the FCOM /QRH gives the OPT FL at a given Mach number. It does not consider the cost index, therefore the FMGS and the FCOM /QRH values are different.

FM displays OPT FL on the PROG page. The PROG page displays dashes for this quantity when the system detects an engine-out condition.

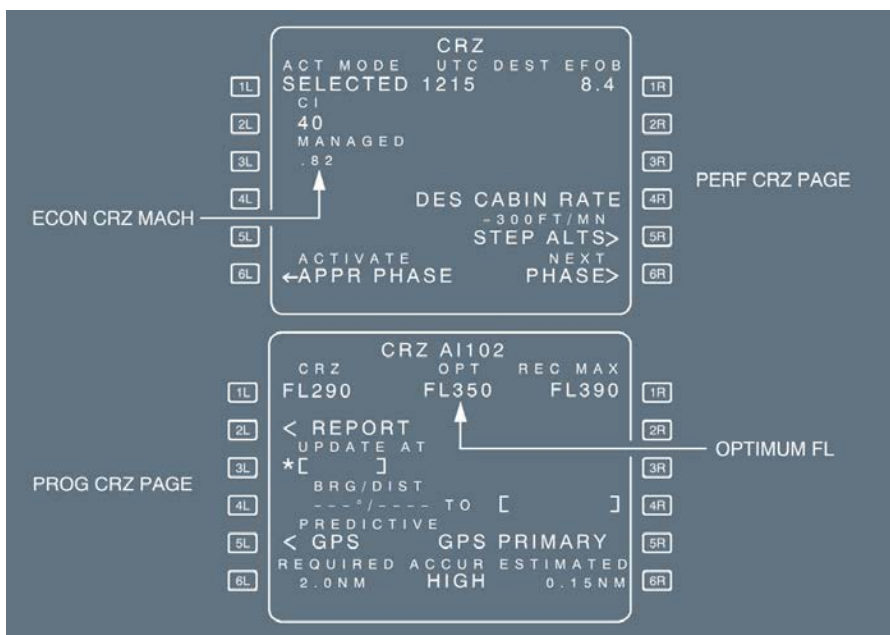

OPTIMUM DESCENT PATH

The vertical flight path is computed to minimize fuel consumption, while satisfying the various altitude constraints of the F-PLN and the descent speed profile, in order to reach VAPP at 1 000 ft.

The computer calculates the descent profile before the descent phase is initiated, taking into account:

- All lateral and vertical flight plan data
- The descent and approach winds, as inserted into the DESCENT WIND page and PERF APPR page, and the required maximum cabin rate of descent.

During descent, the descent profile is updated only if the flight plan is modified, or if data for the APPR phase (WIND, VAPP , or LDG CONF) are changed.



A318/A319/A320/A321
FLIGHT CREW
OPERATING MANUAL

AIRCRAFT SYSTEMS
AUTO FLIGHT - FLIGHT MANAGEMENT
PERFORMANCE - OPTIMIZATION

Intentionally left blank

COST INDEX (CI)

Ident.: DSC-22_20-40-20-00011041.0001001 / 17 AUG 10

Applicable to: ALL

The cost index is a fundamental input for the ECON SPEED or ECON MACH computation. ECON SPEED and ECON MACH reduce the total flight cost in terms of flight time and fuel consumption (and not only in terms of fuel saving).

CI is the ratio of flight time cost (CT) to fuel cost (CF).

$CI = CT / CF$ (kg/min or 100 lb/h).

CI = 0 corresponds to minimum fuel consumption (Max Range).

CI = 999 corresponds to minimum time.

CI = Long Range Cruise (Refer to PRO-NOR-SRP-01-50 Preparation for Descent and Approach - Cost Index for Long-Range Cruise).

Note: The airline's operations department usually defines the cost index, to optimize each company route. The flight crew does not ordinarily modify the cost index during a flight.



A318/A319/A320/A321
FLIGHT CREW
OPERATING MANUAL

AIRCRAFT SYSTEMS
AUTO FLIGHT - FLIGHT MANAGEMENT

PERFORMANCE - COST INDEX

Intentionally left blank

| | |
|---|---|
|  <p>A318/A319/A320/A321 FLIGHT CREW OPERATING MANUAL</p> | <p>AIRCRAFT SYSTEMS</p> <p>AUTO FLIGHT - FLIGHT MANAGEMENT</p> <p>PERFORMANCE - PREDICTIONS</p> |
|---|---|

GENERAL

Ident.: DSC-22_20-40-30-00011080.0002001 / 17 AUG 10
Applicable to: ALL

The FMGC computes predictions for the primary and secondary flight plans and displays them on the Multipurpose Control and Display Units (MCDU s), and on the navigation display (ND) of the Electronic Flight Instrument System (EFIS).

The computations use the current state of the aircraft (GW , CG, position, altitude, speed, engaged mode of the autopilot or flight director, time, wind, temperature) for the active flight plan.

The computations use data entered by the flight crew for the secondary flight plan when it is not a copy of the active flight plan. When the secondary flight plan is a copy of the active flight plan, it uses the same data.

PREDICTIONS FOR THE PRIMARY FLIGHT PLAN

Ident.: DSC-22_20-40-30-00011085.0001001 / 17 AUG 10
Applicable to: ALL

The predictions displayed on the MCDU assume that the FMGS will guide the aircraft along the replanned lateral and vertical flight plans.

The predictions displayed on the ND assume that the aircraft will continue to operate in the modes (selected or managed) that are currently active.

As long as the aircraft is flying the flight plan under managed guidance, the predictions on the MCDU will match those on the ND.

If the flight crew does not fly the flight plan, the MCDU predictions assume that:

- The flight crew will fly back towards the flight-planned route
- The flight crew will immediately resume flying the FMGC managed modes.

If the flight crew does not fly the managed speed profile, the MCDU predictions assume that they will maintain the selected speed until they reach:

- In the climb or descent phase, the next speed limit or speed constraint if any, or next phase
- In cruise, the top of descent.

Then, the predictions assume that the flight crew will revert to managed speed.

COMPUTATION OF PREDICTIONS

Ident.: DSC-22_20-40-30-00011086.0001001 / 17 AUG 10
Applicable to: ALL

The system calculates various predictions for the active flight plan and updates them continually during flight as functions of:

- Revisions to the lateral and vertical flight plans
- Cost index

- Current winds and temperature
- Present position versus lateral and vertical flight plans
- Current guidance modes
- Speed control (managed/selected).

The MCDU and the ND show these predictions, each of which is based on specific assumptions.





Note: During computation, prediction fields on the MCDU pages display dashes.

PREDICTIONS DISPLAYED ON THE NAVIGATION DISPLAY

Ident.: DSC-22_20-40-30-00011090.0002001 / 17 AUG 10

Applicable to: ALL





These predictions consist of symbols positioned along the lateral flight plan (NAV mode engaged) or the track line (NAV mode not engaged). These symbols (named as pseudo waypoints) and their meanings are:

| Pseudo waypoint | Definition |
|---|---|
|  | Level symbol at the position (top of climb or level-off) where the aircraft will reach: <ul style="list-style-type: none"> - The FCU selected altitude (blue) or - The constrained altitude, if it is more restrictive than the FCU altitude and if appropriate modes are engaged (magenta). |
|  | Top of descent or continue descent symbol: <ul style="list-style-type: none"> - Top of descent (always white) - Continue descent symbol (white if DES is not armed, blue if it is). |
|  | Start of CLIMB symbol: <ul style="list-style-type: none"> - White if CLB is not armed - Blue if CLB is armed. |
|  | Intercept point symbol: The point where the aircraft is predicted to intercept the descent path, if there is any vertical deviation when the aircraft is in DES mode (white if DES is not engaged, blue if it is). |
| • | Speed change symbol: The point at which the aircraft will initiate an automatic ACCEL or DECEL from current speed to a new computed speed if it encounters a SPD LIM , SPD CSTR , or HOLDING SPD (magenta). |
|  | Decelerate point symbol: <ul style="list-style-type: none"> - Indicates the point at which the aircraft is predicted to decelerate for approach (and thus switch to the approach phase) - Magenta, if in managed speed and NAV or approach mode is engaged - White, if in selected speed or HDG /TRK mode - Automatic deceleration only occurs when displayed in magenta. |

Continued on the following page

| | |
|---|---|
|  <p>A318/A319/A320/A321 FLIGHT CREW OPERATING MANUAL</p> | <p>AIRCRAFT SYSTEMS</p> <p>AUTO FLIGHT - FLIGHT MANAGEMENT</p> <p>PERFORMANCE - PREDICTIONS</p> |
|---|---|

Continued from the previous page

| Pseudo waypoint | Definition |
|--|--|
|  | ALT CSTR symbol set around the constrained waypoint: <ul style="list-style-type: none"> - Magenta, when the ALT CSTR is predicted to be met - Amber, when the ALT CSTR is predicted to be missed - White, when the ALT CSTR is not taken into account by the FMGS , and the NAV mode is engaged. |
|  (10 45)  (ETP) | Time marker and equitime point symbols appear in green to indicate where the aircraft reaches the time marker or equitime point. |
|  | Energy circle symbol (green arc) centered on the aircraft position and oriented to the current track line. Represents the Required Distance to Land. Only displayed if the lateral guidance mode is heading or track, and the current FMS flight phase is in cruise, descent or approach, and the aircraft is within 180 NM of the destination. |
| Crosstrack error XX.XR or XX.XL (X is a number) | The crosstrack error displays the lateral deviation between the aircraft position and the track of the F-PLN active leg. The value is limited to 99.9 NM left or right. |
| INTCPT | Intercept waypoint is displayed on the ND at the point at which the present track intercepts the F-PLN. |

The predicted time of arrival at the TO WPT is located in the upper right-hand corner of the ND . It assumes direct distance from the aircraft position to the TO WPT and assumes current ground speed will be constant.

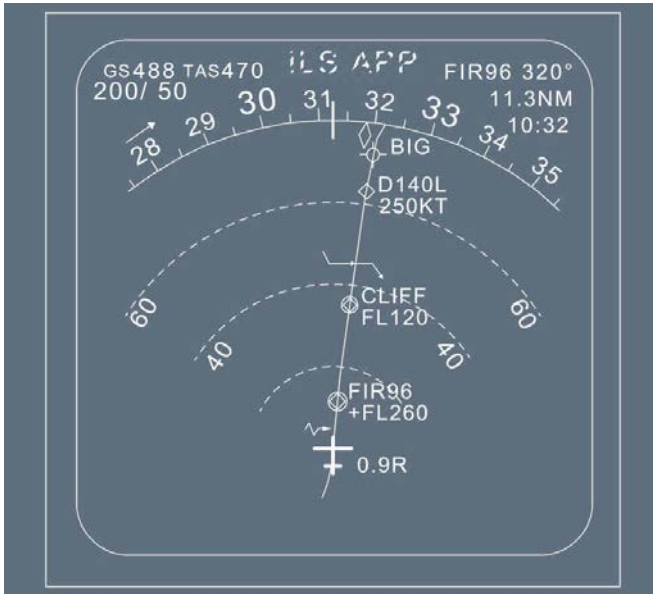

As a general rule, the ND indicates what the aircraft will fly, with the current active FG modes.

For example:

- The continuous green line on the ND represents the track the aircraft is currently flying:
 - If HDG /TRK is engaged, the track line is green and the flight plan is dashed
 - If NAV mode is engaged, the green line is the flight plan.
- If the speed target is manually selected, the speed-change symbol is no longer displayed because it will not be taken into account.
- When the aircraft is not following the vertical flight plan (OP CLB , OP DES , V/S) but the NAV mode is engaged, the system disregards any altitude constraints and puts white circles around the waypoints that have these constraints and positions level symbols accordingly.
- Pseudo waypoints are adjusted each time predictions are updated.

PREDICTIONS DISPLAYED ON THE MCDU

Ident.: DSC-22_20-40-30-00011093.0001001 / 14 MAY 12

Applicable to: ALL

The predictions displayed on the MCDU assume that AP (or FD order) is controlling the aircraft and flying it along the preplanned lateral and vertical flight plan.

Therefore:

- If the aircraft is guided along the flight plan (managed guidance), the MCDU predictions correspond exactly to what the aircraft is doing
- If the aircraft is not guided along the flight plan (selected guidance), the MCDU predictions assume that it will return immediately to the flight plan, intercepting at a predetermined angle, and will then proceed under managed guidance
- If the aircraft does not fly the managed speed profile (ECON , SPD CSTR ...), the MCDU predictions assume that it will remain at the present selected speed/Mach until it reaches the next SPD CSTR or SPD LIM or enters the next flight phase.

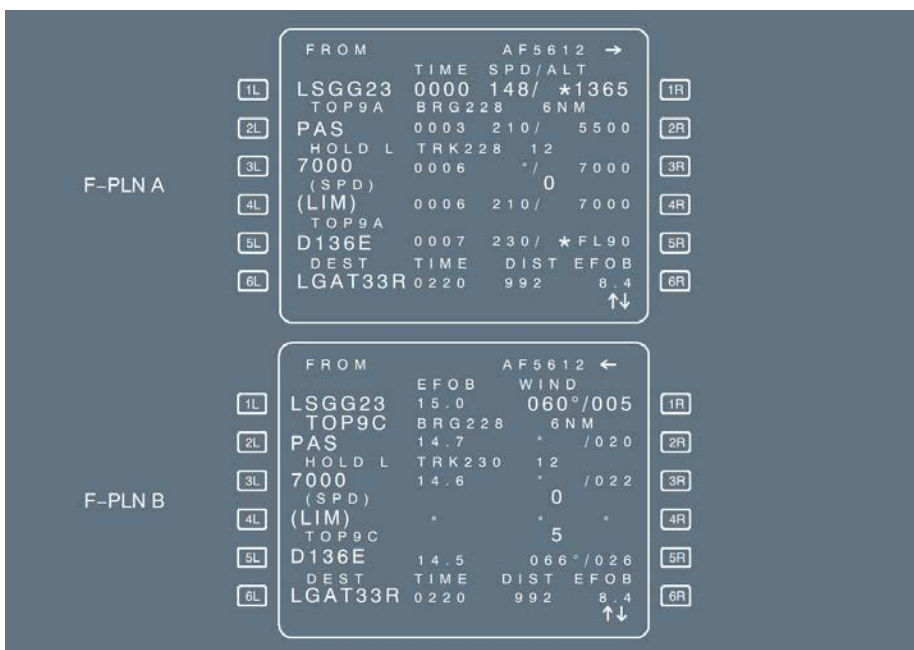

The image shows two MCDU performance prediction screens. The top screen, labeled 'F-PLN A', displays data for a primary flight plan. The bottom screen, labeled 'F-PLN B', displays data for a secondary flight plan. Both screens show a table of performance data for various flight phases, including LSGG23, PAS, 7000, D136E, and LGAT33R. The data includes parameters like time, speed, altitude, and distance to go.

| FROM | TIME | SPD | ALT |
|---------|--------|------|-------|
| LSGG23 | 0000 | 148 | *1365 |
| TOP9A | BRG228 | 6NM | |
| PAS | 0003 | 210 | 5500 |
| HOLD L | TRK228 | 12 | |
| 7000 | 0006 | * | 7000 |
| (SPD) | | 0 | |
| (LIM) | 0006 | 210 | 7000 |
| TOP9A | | | |
| D136E | 0007 | 230 | *FL90 |
| DEST | TIME | DIST | EFOB |
| LGAT33R | 0220 | 992 | 8.4 |

| FROM | EFOB | WIND | |
|---------|--------|----------|------|
| LSGG23 | 15.0 | 060°/005 | |
| TOP9C | BRG228 | 6NM | |
| PAS | 14.7 | * /020 | |
| HOLD L | TRK230 | 12 | |
| 7000 | 14.6 | * /022 | |
| (SPD) | | 0 | |
| (LIM) | * | * | |
| TOP9C | | 5 | |
| D136E | 14.5 | 066°/026 | |
| DEST | TIME | DIST | EFOB |
| LGAT33R | 0220 | 992 | 8.4 |

Note: For secondary flight plan predictions, Refer to DSC-22_20-60-50 Secondary Flight Plan.

TYPE OF PREDICTIONS

Ident.: DSC-22_20-40-30-00011113.0002001 / 18 MAR 11

Applicable to: ALL

| | MCDU PAGE |
|---|-------------------------------|
| Pseudo waypoints: T/C , T/D , S/C , S/D , I/P , SPD LIM , DECEL | F-PLN A and B |
| TIME/SPD /ALT at each WPT and pseudo-WPT | F-PLN A |
| ETA /DIST TO DEST along F-PLN /EFOB at destination | F-PLN A and B |
| EFOB /T-WIND at each WPT and pseudo-WPT | F-PLN B |
| Constraint symbol * at each constrained WPT (TIME/SPD /ALT) | F-PLN A and B |
| Altitude error in case of missed ALT constraint | VERT REV |
| EFOB /EXTRA FUEL at each WPT | VERT REV |
| TIME/EFOB at destination | FUEL PRED /PERF CLB /CRZ /DES |
| TIME/DIST to a selected altitude | PERF CLB or DES |
| Fuel prediction prior engine start | INIT B |
| REC MAX FL | PROG |
| TIME/EFOB at Alternate | FUEL PRED |
| XTRA FUEL for various Alternates | ALTN |
| VDEV vertical deviation from vertical flight path | PROG |

EXAMPLES OF MCDU PREDICTIONS

Ident.: DSC-22_20-40-30-00011120.0001001 / 14 MAY 12

Applicable to: ALL

The following MCDU pages display some of the prediction types.

- Pseudo-waypoints:
Top of Climb (T/C) , Top-of-Descent (T/D) , Start of Climb (S/C) or Start of Descent (S/D) for Step Climb/Descent, Speed Limit (SPD LIM) , deceleration to approach phase (DECEL)
- Time, speed, and altitude predictions:
TIME/SPD /ALT for all waypoints and pseudo-waypoints.

| | | FBS001 → | | | |
|----|-----------|----------|-------------|------|----|
| | | UTC | SPD/ALT | | |
| 1L | TOU | 1254 | 250 / 4240 | 1R | |
| | (SPD) | | 8 NM | | |
| 2L | (LIM) | 1256 | 250 / FL100 | 2R | |
| | LMG3B | TRK337° | 2 | | |
| 3L | OSKAM | 1257 | 315 / FL118 | 3R | |
| | LMG3B | | 33 | | |
| 4L | (T/C) | 1302 | .79 / FL310 | 4R | |
| | LMG3B | | 86 | | |
| 5L | LMG | 1313 | " / " | 5R | |
| | DEST | UTC | DIST | EFOB | |
| 6L | LFP007 | 1343 | 325 | 7.8 | 6R |
| | NAV ACCUR | UPGRAD | ↓↑ | | |

| | | FROM | | | |
|----|--------|---------|-------------|------|----|
| | | UTC | SPD/ALT | | |
| 1L | OSKAM | 1300 | 270 / FL107 | 1R | |
| | LMG3B | BRG359° | 33 NM | | |
| 2L | (T/C) | 1322 | .79 / FL310 | 2R | |
| | LMG3B | TRK358° | 85 | | |
| 3L | LMG | 1333 | " / " | 3R | |
| | | | 0 | | |
| 4L | (S/C) | 1333 | .79 / FL310 | 4R | |
| | | | 5 | | |
| 5L | (T/C) | 1333 | .79 / FL320 | 5R | |
| | DEST | UTC | DIST | EFOB | |
| 6L | LFP007 | 1451 | 450 | 6.3 | 6R |
| | | | ↓↑ | | |

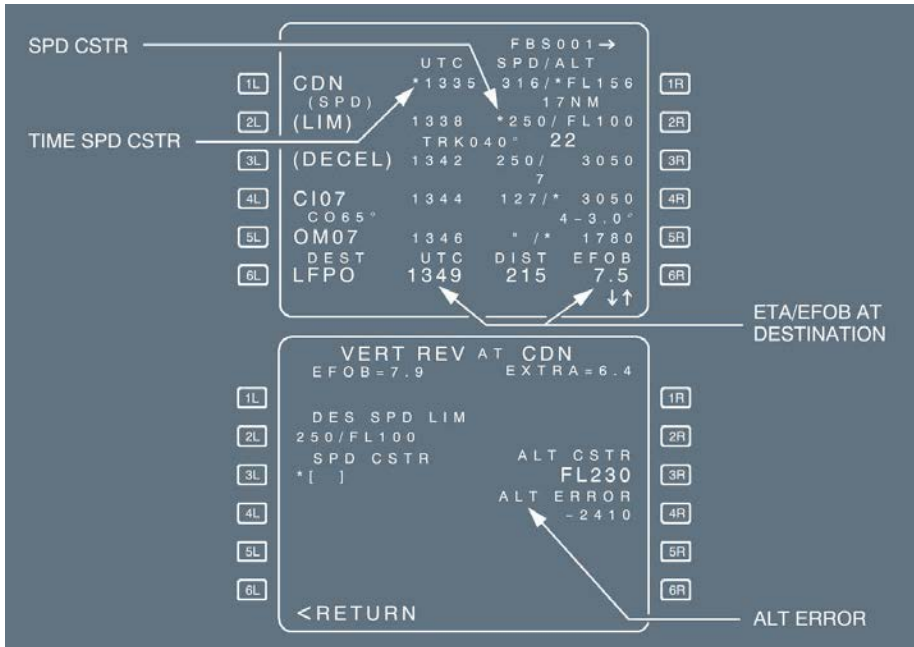

CONSTRAINT SYMBOLS (STAR)

Ident.: DSC-22_20-40-30-00011150.0001001 / 14 MAY 12

Applicable to: ALL

When a time speed or an altitude constraint is part of the vertical flight plan, it appears on the F-PLN A page only at the time of insertion, or when predictions are not yet available.

Once available, the time speed and altitude predictions are displayed for all F-PLN waypoints: when a speed or an altitude constraint is at a waypoint, a star symbol appears adjacent to the speed or altitude prediction. If the star is magenta, the constraint is predicted to be matched. If the star is amber, the constraint is predicted to be missed.

F-PLN A PAGE
DURING PREDICTION
COMPUTATION

| | | |
|------|--------|----------------|
| | | NW504 → |
| [1L] | EMPYR | UTC SPD/ALT |
| [2L] | NANCI | --- |
| [3L] | NYACK | 5 NM |
| [4L] | HAARD | --- / 6000 |
| [5L] | YOMAN | TRK 021° 38 NM |
| [6L] | DEST | --- 210 / 6000 |
| | KLGA22 | 18 NM |
| | | --- / +3000 |
| | | UTC DIST EFOB |
| | | --- 208 --- |
| | | ↑ ↓ |

[1R]
[2R]
[3R]
[4R]
[5R]
[6R]

F-PLN A PAGE
ONCE PREDICTIONS
AVAILABLE

| | | |
|------|---------|------------------|
| | | NW504 → |
| [1L] | EMPYR | 0528 250 / 7400 |
| [2L] | NANCI | 530 * / *6000 |
| [3L] | NYACK | TRK 021° 38 |
| [4L] | (DECEL) | 538 *210 / *6000 |
| [5L] | HAARD | 14 |
| [6L] | DEST | 4 |
| | KLGA22 | 542 200 / *3300 |
| | | UTC DIST EFOB |
| | | 0549 208 8.9 |
| | | ↑ ↓ |

[1R]
[2R]
[3R]
[4R]
[5R]
[6R]

Note: If an altitude constraint is predicted as missed, the system tells you what will be the error at the specific waypoint.

VERTICAL DEVIATION

Ident.: DSC-22_20-40-30-00011139.0001001 / 29 SEP 15

Applicable to: ALL

During descent, the system indicates to the flight crew the vertical deviation from the computed descent profile (PFD and MCDU) and predicts where the flight crew can rejoin it. VDEV on the PFD and PROG page, predictions on the MCDU F-PLN page, symbols on the ND, enable assessment to the vertical position versus the computed flight profile.

OPERATION RULES CONCERNING PREDICTIONS

Ident.: DSC-22_20-40-30-00011140.0001001 / 17 AUG 10

Applicable to: ALL

The flight crew must properly update the flight plan data during the flight, in order to obtain accurate and meaningful predictions.

The flight crew should rely on the ND for short-term predictions. It indicates what the aircraft will do under the currently engaged modes (selected or managed).

The flight crew should rely on the MCDU for long-term predictions, when managed guidance is active or about to be reengaged.

OTHER COMPUTATIONS

Applicable to: ALL

Ident.: DSC-22_20-40-30-A-00011141.0002001 / 17 AUG 10

ENGINE-OUT CASE

The FMGS computes an engine-out target speed for each flight phase. It computes an engine-out maximum altitude at long-range cruise speed, and displays it on the PROG page.

The new speed target becomes Green Dot in climb, and EO CRZ SPD in cruise.

The system computes the flight plan predictions down to the primary destination. If the aircraft is above EO MAX ALT, the predictions are computed, assuming that a drift down descent will immediately be performed to reach EO MAX ALT.

Ident.: DSC-22_20-40-30-A-00011142.0001001 / 17 AUG 10

RECOMMENDED MAXIMUM ALTITUDE (REC MAX)

The recommended maximum altitude is the lowest of the maximum altitude that:

- The aircraft can reach with a 0.3 g buffet margin
- The aircraft can fly in level flight at MAX CRZ rating
- The aircraft can maintain a V/S of 300 ft/min at MAX CLB thrust
- The aircraft can fly at a speed higher than Green Dot and lower than VMO /MMO
- The aircraft is certified at.

The REC MAX altitude is displayed on the PROG page.

Anti-ice is not taken into account for this computation. Refer to QRH graphs if icing conditions are expected.

A maximum altitude using a 0.2 g buffet margin is also computed. It is not displayed, but the system uses it to limit CRZ ALT entry.

Ident.: DSC-22_20-40-30-A-00011250.0001001 / 17 AUG 10

PREDICTIONS FOR ALTERNATES

Predictions for alternates are displayed on the ALTERNATES page.

| ALTERNATES FOR LGAT | | | | | |
|---------------------|-------|-------|------|--|----|
| ALTN | CORTE | | | | |
| 1L LGTS | | 1907 | | | 1R |
| 1987 | TRK | EXTRA | DIST | | 2R |
| 2L LGTS | 325° | 0.9 | 161 | | 2R |
| 2AB3 | | | | | |
| 3L ←LGRP | 113° | 0.7 | 230 | | 3R |
| 7113 | | | | | |
| 4L ←LGKR | 298° | 0.8 | 197 | | 4R |
| 2828 | | | | | |
| 5L ←LGTR | 305° | 0.5 | 257 | | 5R |
| | | | | | |
| 6L <RETURN | | | | | 6R |

They are based on:

- A default cruise FL equal to 220, if the airway distance is less than 200 NM. Otherwise, it is FL 310
- Simplified wind/temperature models, based on flight crew entries:
 - ALT CRZ wind, as entered on the FUEL PRED page
 - CRZ temperature interpolated from the temperature model for the primary flight plan.
- Airway distance, or direct distance, as provided by the database (manual entry, if not in the database)
- Cost index = 0 (minimum fuel)
- Initial aircraft weight equal to landing weight at primary destination.

Note:

1. No step can be inserted in an alternate flight plan
2. No predictions are displayed for the selected alternate on flight plan pages. However, the flight crew can read ALTN trip fuel and time on the INIT B page before engine start, and estimated time and estimated fuel on board at alternate on the FUEL PRED page after engine start.

RETURN-TO-TRAJECTORY ASSUMPTIONS

Ident.: DSC-22_20-40-30-00011148.0001001 / 19 DEC 12

Applicable to: ALL

If the aircraft is not on the lateral flight plan, predictions assume an immediate return to the active lateral leg with a 45° convergence angle, or that it will fly directly to the "TO" waypoint, when the required convergence angle is greater than 45°.

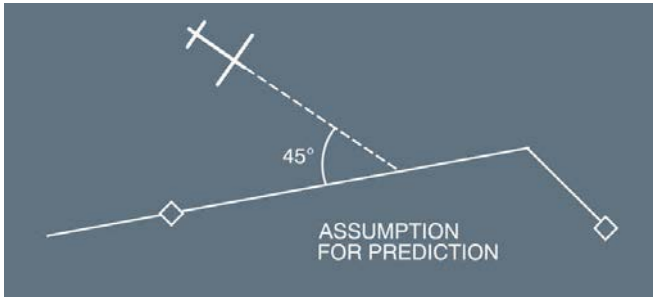

ENERGY CIRCLE

Ident.: DSC-22_20-40-30-00011144.0001001 / 17 AUG 10

Applicable to: ALL

The energy circle is a green arc, centered on the aircraft's position and oriented towards the current track line. It is displayed on the ND s during descent, when HDG or TRK mode is selected. It represents the required distance to land from the aircraft's position down to airport elevation at VAPP speed, considering all speed constraints on the vertical profile.

INTRODUCTION TO PERF AND IDLE FACTORS

Ident.: DSC-22_20-40-30-00014856.0001001 / 31 JAN 13

Applicable to: ALL

The FMGS contains a performance database to compute the predictions and the performance data. This performance database has a model of several aircraft configurations (aircraft type/engine model) to tune the performance and the FMGS predictions. For some aircraft configurations, the model can differ from the real aircraft performance. In these cases, the FMGS has to correct the computation of the performance and the predictions. This is the aim of PERF and IDLE factors. With time, the real aircraft drag and engine performance can deviate from the nominal model. The airline Flight Operations should periodically revise the value of these factors to adapt FMGS predictions to actual aircraft performance.

Note: *The IDLE factor is not available on aircraft with FMS1 Honeywell Legacy.*

PERF FACTOR

Applicable to: ALL

Ident.: DSC-22_20-40-30-B-00011145.0001001 / 30 JAN 13

GENERAL

The FMGS uses the PERF factor to correct the predicted fuel flow that is used for the computation of the fuel predictions.

The PERF factor modifies the predicted fuel flow, according to the following formula:

$$FF_{pred} = FF_{model} \times \left(1 + \frac{PERF\ FACTOR}{100} \right)$$

FF pred is the FF used for prediction.

FF model is the FF from the aero-engine model.

This correction is applied throughout the entire flight, and modifies the performance predictions and the ECON speed or Mach.

For example: Entering a PERF factor of +1.5 means that Flight Operations have evaluated the aircraft fuel deviation as 1.5 %, compared to the basic performance model (0.0).

Ident.: DSC-22_20-40-30-B-00011147.0002001 / 06 SEP 16

PERF FACTOR VALUES

The PERF factors to be used on FMS2, depending on engine type, are:

- For CFM 56-5B engines only:
Depending on the engine type: CFM 56–5B SAC (Single Annular Chamber) or DAC (Double Annular Chambers), or non/P (without the new LP and HP blade compressor), a positive performance factor has to be entered on the MCDU STATUS page to increase the FMGS' predicted fuel consumption and match the actual fuel burnt.

| | | NON/P | | /P or /3 | |
|-----------------|------------------|-------|-----|----------|-----|
| | | SAC | DAC | SAC | DAC |
| A321-111 | CFM56-5B1 | 2 | 2 | 0 | 1 |
| A321-112 | CFM56-5B2 | 2 | 2 | 0 | 1 |
| A321-211 | CFM56-5B3 | 2 | 2 | 0 | 1 |
| A321-212 | CFM56-5B1 | 2 | 2 | 0 | 1 |
| A321-213 | CFM56-5B2 | 2 | 2 | 0 | 1 |
| A321-214 | CFM56-5B4 | - | - | 1 | - |
| A320-214 | CFM56-5B4 | 3 | 3 | 0 | 1 |
| A320-215 | CFM56-5B5 | - | - | 0 | - |
| A320-216 | CFM56-5B6 | - | - | 0 | - |
| A319-111 | CFM56-5B5 | 4.5 | 4.5 | 0 | 1 |
| A319-112 | CFM56-5B6 | 4.5 | 4.5 | 0 | 1 |
| A319-115 | CFM56-5B7 | 4.5 | 4.5 | 0 | 1 |
| A318-111 | CFM56-5B8 | - | - | 0 | - |
| A318-112 | CFM56-5B9 | - | - | 0 | - |

- For other engines:
 - A318 “PW”: 0.0 %
 - A319/A320 “CFM” Family fitted with CFM 56-5A engines: 0.0 %
 - A319/A320/A321 “IAE” Family: 0.0 %
 - A320 “PW” Family: 0.0 %
 - A320 “CFM LEAP” Family: 0.0 %

All these numbers assume that:

- The aircraft is brand-new
- Anti-ice is OFF
- The air conditioning is on NORMAL for “IAE” engines and on LOW for “CFM” engines
- The conservative Fuel Lower Heating Value (FLHV) is 18400 btu/lb.

When an aircraft ages, fuel consumption degradation will be measured to determine the so-called “monitored fuel factor”. This factor corresponds to the deviation of the aircraft’s actual fuel consumption from the nominal model. Generally, the FLHV that is used during fuel factor monitoring is higher than the FMS value.

In order not to penalize FMS predictions, it is necessary to correct the “monitored fuel factor”. For example, add -1 % to the “monitored fuel factor”, when an FLHV of 18590 btu/lb is used. Once this factor is established by the airline, it should be arithmetically added to the above-noted performance factor.

- Note:**
1. At delivery, **ENTER** the **PERF** factor (given in the table above) directly in the **MCDU** (no correction factor is needed).
 2. When replacing an **FMS 1 Legacy** by an **FMS 2**, on any given aircraft model, the performance model that is stored in the **FMS 2** may be different from the one that was previously stored in the **FMS1 Legacy**.
As a result, **DISREGARD** the **PERF** factor previously entered in the **MCDU**.
ADD the “monitored fuel factor” (when available) to the **PERF** factor (given above), and **ENTER** the resulting factor in the **MCDU**.

IDLE FACTOR

Applicable to: **ALL**

Ident.: DSC-22_20-40-30-D-00014861.0001001 / 29 SEP 15

GENERAL

The FMGS uses the **IDLE** factor to adjust the computation of the vertical profile during the descent phase (**IDLE** segment).

The FMGS computes the vertical profile and the predictions from the Top of Descent (**T/D**) to the first altitude constraint with the following assumptions:

- The aircraft has a given thrust
- The aircraft has a given speed (within the speed target range).

The **IDLE** Factor adjusts the value of the given thrust by an addition of a delta (**DELTA**) thrust to **IDLE** thrust. With this additional thrust, the **IDLE** Factor gives flexibility to maintain the aircraft on the computed vertical profile in case of external perturbations such as windy conditions (previously entered by the flight crew in **WIND** pages).

Depending on the **IDLE** factor value, the FMGS modifies the position of the **T/D** and computes a vertical profile in function of the given thrust (**IDLE** + **DELTA**).

Therefore, the **IDLE** factor has a direct impact on:

- The computation of vertical profile
- The capability of the aircraft to maintain the vertical profile.

IMPACT ON VERTICAL PROFILE

- If the IDLE factor is positive, the vertical profile is less steep than with IDLE factor 0. The descent phase starts earlier.
- If the IDLE factor is negative, the descent path is steeper than with IDLE factor 0. The descent phase starts later.

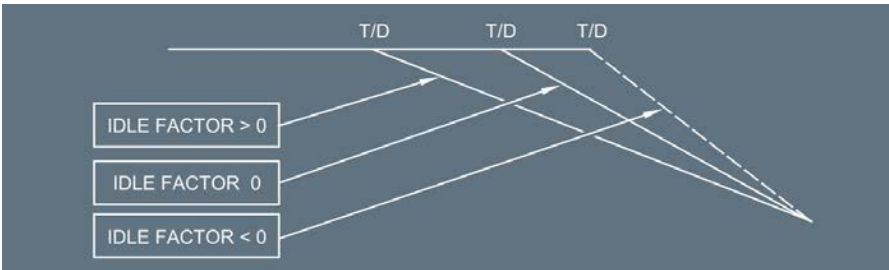

The following graph provides an example (average values) of the IDLE factor's effect on descent length:

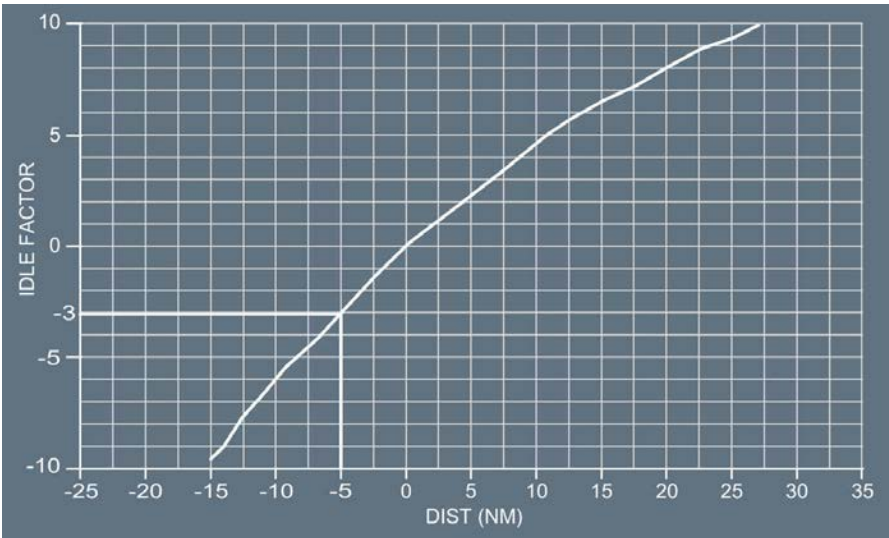

Example: An IDLE factor of -3 decreases the computed descent length by 5 NM.

Ident.: DSC-22_20-40-30-D-00014863.0001001 / 30 JAN 13

IMPACT ON GUIDANCE

In DES mode, the FMGS maintains the aircraft on the vertical profile and keeps the IAS within the speed target range.

If the aircraft deviates above the profile, the IAS will increase to return to the vertical profile.

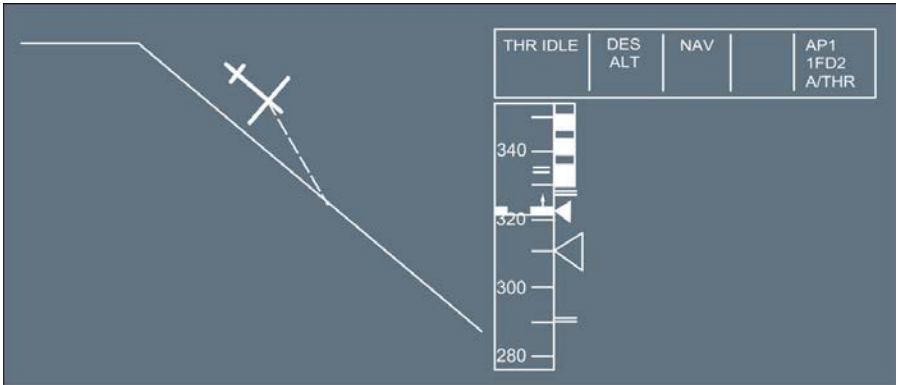

When the aircraft returns to the descent profile, the IAS will decrease to the target speed.

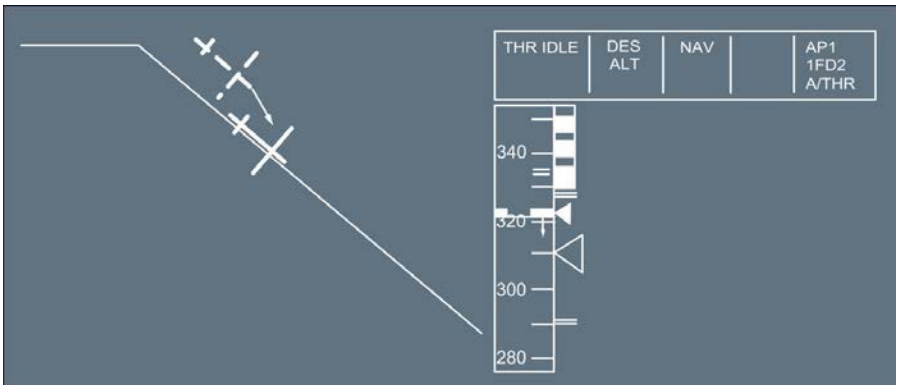

Ident.: DSC-22_20-40-30-D-00014864.0001001 / 30 JAN 13

IDLE FACTOR AT DELIVERY

The IDLE factor to be used at delivery is 0 %.

PROCEDURE TO MODIFY THE PERF AND IDLE FACTORS

Ident.: DSC-22_20-40-30-00014857.0001001 / 30 JAN 13

Applicable to: ALL

PROCEDURE TO MODIFY THE PERF AND IDLE FACTORS (ON GROUND ONLY)

- PRESS the MCDU DATA key and then the A/C STATUS prompt in order to access the A/C STATUS page
- For aircraft with FMS2 Honeywell or Thales:
 - ENTER the change code in the CHG CODE field.
The default value for this code is "ARM" but it is possible to modify it on airline request. The applicable code is then coded in the Airline Modifiable Information (AMI).
When a valid change code is entered, the IDLE and PERF factors are displayed in blue.
 - ENTER the new IDLE and PERF factors in the MCDU scratchpad separated by a "/".
For example: "-2/+1"
 - PRESS the corresponding key to insert the new IDLE and PERF factors.
The new IDLE and PERF factors are displayed in large blue font.

Note: Only authorized personnel should take the responsibility to update the IDLE and PERF factor values.

- For aircraft with FMS1 Honeywell Legacy:
 - ENTER the new PERF factor in the MCDU scratchpad.
 - PRESS the corresponding key to insert the new PERF factor.
The new PERF factor is displayed in large blue font.

*Note: 1. Only authorized personnel should take the responsibility to update the PERF factor value.
2. The IDLE Factor is not available on aircraft with FMS1 Honeywell Legacy.*

FMS2 Honeywell

GENERAL

Ident.: DSC-22_20-50-10-25-00000556.0001001 / 01 OCT 12

Applicable to: ALL

The Flight Management and Guidance System (FMGS) displays information on various “pages”. When a page cannot display all of the assigned information, it cues the pilot to call up additional information. There are three types of pages, and each type has its particular way of cuing the pilot to call up additional information.

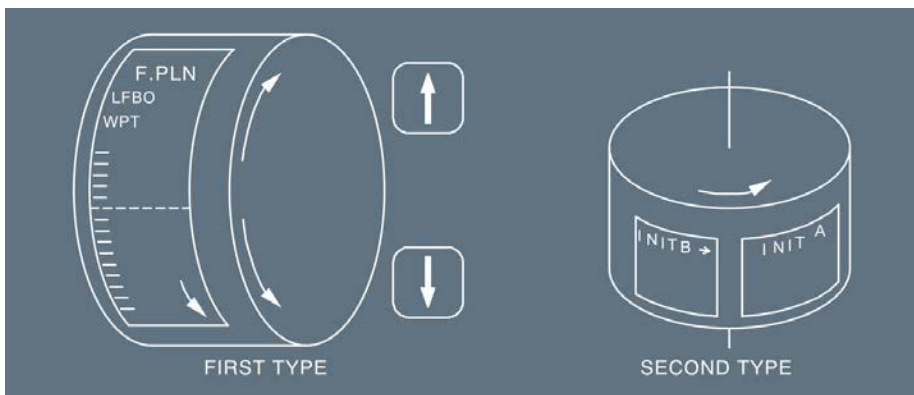

FIRST TYPE

When this page cannot simultaneously display all the information on the screen (more information than the six pairs of lines can hold), the pilot can scroll the page up or down.

In this case, the screen displays a $\uparrow \downarrow$ symbol in the bottom righthand corner (F-PLN pages, secondary F-PLN page, departure/arrival pages,...).

SECOND TYPE

When the information is on successive pages, the pilot presses the “NEXT PAGE” key to sequentially call up these pages.

In this case, an arrow is displayed in the top righthand corner of the screen (INIT pages).

THIRD TYPE

When different types of information are on successive pages, the pilot calls up these pages by pressing the key adjacent to the prompts $>$, $<$ or $*$.

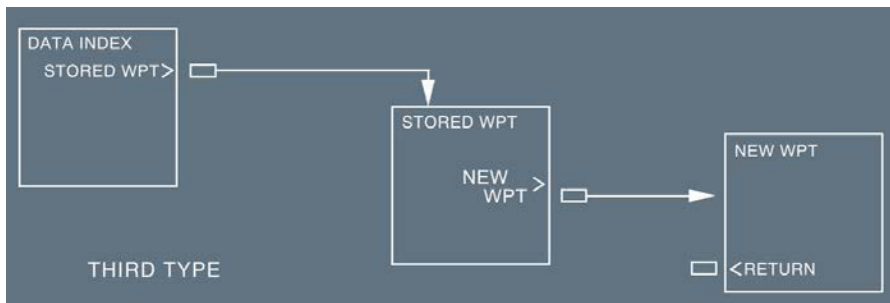

MCDU MENU PAGE

Ident.: DSC-22_20-50-10-25-00000557.0010001 / 14 MAY 12

Applicable to: **ALL**

This page lists the various systems which the pilot can access via the MCDU.

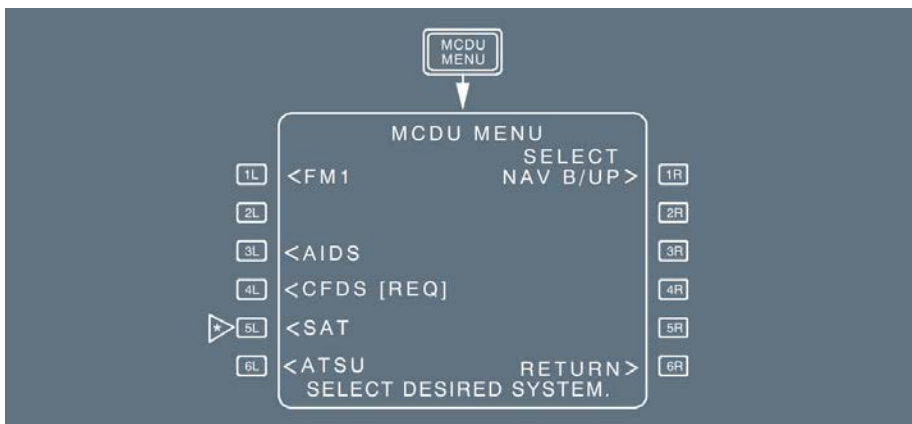

The flight crew selects a system by pressing the key adjacent to the name of that system.

The name of the selected system is displayed in green, all others in white.

If the MCDU cannot establish communication with the selected system, it displays “OUT”.

When a system calls for the flight crew attention, the MCDU displays “REQ” next to the system’s name, and the “MCDU MENU” annunciator lights up.

When the flight crew presses the key next to the name of the system requiring attention, the “MCDU MENU” annunciator light goes out.

SELECT Pressing the [1R] key selects the NAV B/UP function and DESELECT

NAV B/UP NAV B/UP appears in the [1R] field.

If the NAV B/UP is inoperative, the field is blank.

RETURN This field is displayed when a function is active

When the MCDU communicated with a system other than the FMGC , the flight crew should use the MCDU MENU page to revert to the FMGC system.

INIT A PAGE

Ident.: DSC-22_20-50-10-25-00000558.0009001 / 14 MAY 12

Applicable to: ALL

The flight crew uses the INIT A page to initialize the flight plan and align the inertial reference system.

- The flight crew accesses to this page by pressing the INIT key on the MCDU . The INIT A page can be accessed on ground or in flight.
- The flight crew may also call up this page by:
 - Pressing the “NEXT PAGE” key on the MCDU console, while on the INIT B page, or
 - Pressing the key next to “RETURN” or “INSERT” on the route selection page, or
 - Pressing the key next to “INSERT” on the wind page.
- When in the done phase, the pilot may press the INIT key to switch to the next preflight phase.

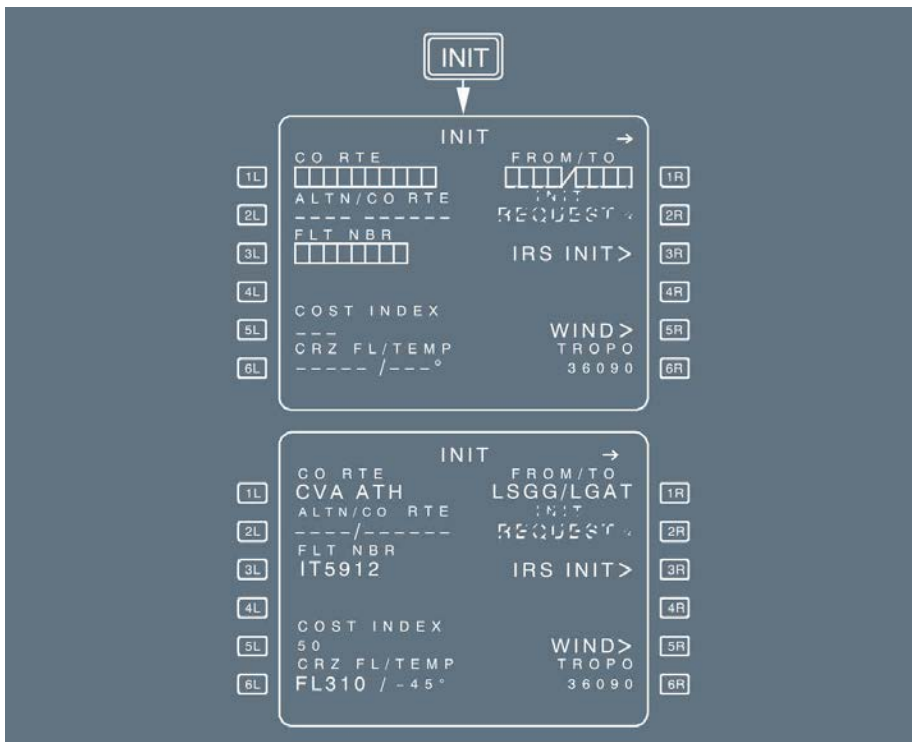

[1L] CO RTE

If the flight crew enters a company route number, the screen displays all data associated with that route (8 or 10 characters, depending on the pin program).

Inserting the CO RTE into the RTE selection page also enters the CO RTE number in this field.

[2L] ALTN/CO RTE
 (blue)

This field is dashed, until a primary destination is entered in the 1R field. If a preferred alternate is associated with the primary destination, it is displayed in this field with the company route identification. The crew may manually enter an alternate and company route.

If preferred alternate is not associated with the primary destination, NONE is displayed in this field.

When the alternate route and the primary destination do not match, the MCDU scratchpad displays “DEST /ALTN MISMATCH”.

If the primary destination is changed, this field is modified accordingly.

| | |
|---|---|
|  <p>A318/A319/A320/A321 FLIGHT CREW OPERATING MANUAL</p> | <p style="text-align: center;">AIRCRAFT SYSTEMS</p> <p style="text-align: center;">AUTO FLIGHT - FLIGHT MANAGEMENT</p> <p style="text-align: center;">CONTROLS AND INDICATORS - MCDU - PAGE DESCRIPTION</p> |
|---|---|

- [3L] FLIGHT NUMBER The flight number automatically appears in this field, if it is stored with the company route. The flight crew may modify it, or enter a new number here.
- [5L] COST INDEX This is usually stored in the database along with the company route. The flight crew may modify it, or enter a new value here. It defaults to the last entered value, if a value is not stored in the database.
- [6L] CRZ FL/TEMP (cruise flight level and temperature) The cruise flight level is usually stored in the database along with the company route. If not, it has to be entered manually. If no cruise flight level is entered, the system will not furnish predictions, while the aircraft is on the ground. The flight crew has to enter the temperature at cruise flight level in order to refine the predictions. Otherwise, these are computed for ISA conditions. (If no sign is entered, the system uses a plus).
- [1R] FROM/TO This field allows the pilot to enter a city pair (ICAO codes for city of origin and destination). This entry automatically deletes any previously entered company route and calls up the route selection page. If one airfield of the pair is not in the database, the display changes to the NEW RWY page.
- [2R] INIT REQUEST This prompt is displayed if the pilot did not enter an active flight plan or entered a flight number or a company route that is not in the aircraft database. Selecting this prompt sends the ground a request for active flight plan initialization (downlink message). When the star is not displayed, a downlink message cannot be sent. The uplink flight plan is automatically inserted in the active flight plan, prior to engine start, provided an active flight plan does not exist. After engine start, the uplink flight plan is sent to the secondary flight plan and manually inserted or rejected. (*Refer to DSC-22_20-70 Flight Plan Initialization Through ACARS*).
- [3R] IRS INIT The flight crew presses this key to access the IRS INIT page.
- [5R] WIND The pilot presses this key in order to gain access to the climb wind page, unless a temporary flight plan exists. In this case, the scratchpad displays TEMPORARY F-PLN EXISTS.
- [6R] TROPO The default tropopause altitude is 36 090 ft. The pilot can use this field to modify it (60 000 ft maximum).

ROUTE SELECTION PAGE

Ident.: DSC-22_20-50-10-25-00000559.0001001 / 17 MAR 11

Applicable to: ALL

This page displays all the company routes, stored in the database, that are associated with the inserted city pair. They can be called up manually, or displayed automatically.

- Manually : The pilot presses the FROM/TO or ALTN key on the INIT A page when a city pair is displayed.
- Automatically : The system displays it, when the pilot enters a city pair, or defines an alternate on the INIT A page of the active or secondary flight plan.



TITLE Identifies the city pair inserted on the INIT A page.
 (The numbers in the upper righthand corner are the total number of company routes from this city pair stored in the database).

[1 L] This field shows the name of the company route. NONE appears, if there is no company route for this city pair.

Line 2 to Line 5 These fields display the various elements of the company route: Waypoints in large green font, and airways in small white font.

[6 L] RETURN The pilot presses this key to return to the INIT A page.

[6 R] INSERT The pilot presses this key to insert the displayed company route in the flight plan, and return to the INIT A page.

Note: The pilot can slew the display to show the rest of the route, if one page does not show it all, or to display other company routes for this city pair.

IRS INIT PAGE

Ident.: DSC-22_20-50-10-25-00013511.0051001 / 14 MAY 12
Applicable to: ALL

The flight crew uses the IRS INIT page to align the inertial reference system. The crew accesses this page, by pressing the IRS INIT key on the INIT A page.



- Line 1
LAT-REFERENCE-LONG

This line provides the latitude and longitude of the FM reference position. This reference is extracted from the navigation database. The flight crew can modify this reference. Only when the FM reference position matches the origin airport position, the airport identifier is displayed in green. Otherwise, there are dashes at the place of the airport identifier. Latitude and longitude of the FM reference position are displayed in blue. The flight crew can modify the latitude and longitude values using the scroll keys.
- Line 2 LAT-GPS
POSITION-LONG

This line displays the GPS position latitude and longitude.
- Line 3 to 5

These lines display the IRS 1-2-3 alignment state, source and latitude/longitude.
 The alignment status can be ALIGNING ON XXX, or ALIGNED ON XXX or IN ATT . XXX is the alignment source and can be GPS or CDU or REF. It is displayed in white font.
 The latitude and longitude values are displayed in green.
- [6L] RETURN

This prompt enables the flight crew to return to the INIT A page.

[6R]

If a reference is available, field displays ALIGN ON REF → in blue which is replaced by CONFIRM ALIGN* in amber when 6R prompt is pressed. Pressing again the 6R prompt enables the transmission of the FM reference position displayed in line 1.

WIND PAGES

Ident.: DSC-22_20-50-10-25-00000560.0009001 / 17 MAR 11

Applicable to: ALL

Winds in climb, cruise, descent and approach are necessary to provide the pilot with reliable predictions and performance. Wind pages enable the pilot to enter and/or review the winds propagated by the FMGS or sent by ACARS for the various flight phases.

Note: On WIND pages, wind direction is always true-referenced.

CLIMB WIND PAGE

This page enables the pilot to enter and/or review predicted wind vectors (direction and velocity) at up to 5 different levels.

THE CLIMB WIND PAGE IS ACCESSED FROM:

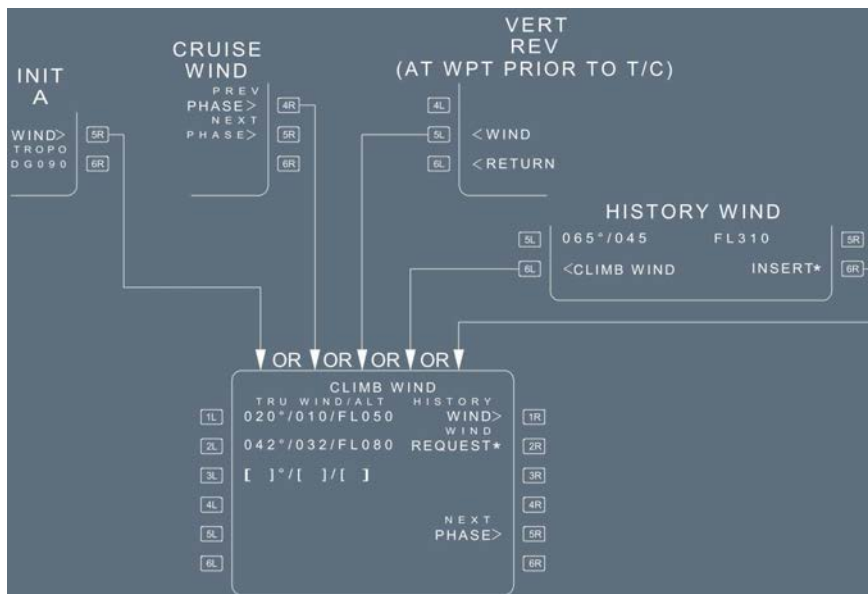

TITLE

CLIMB WIND in large white font.

[1L] to [5L] TRU
WIND/ALT

This field displays the winds, entered at various climb altitudes : In blue before climb phase activation, and in green after climb phase activation.

This field may also display history winds or uplink winds. Large blue brackets are displayed before any wind entry. Pilot-entered and uplinked winds are displayed in large font. History wind data is displayed in small font.

Upon sequencing the top of climb, the climb winds are deleted.

Note: Climb winds are not deleted, when the origin airport is changed.

[1R] HISTORY WIND

Displayed in preflight phase only. This key calls up the history wind page. This page is not modifiable (small green font), but can be inserted into the CLIMB WIND page by using the 6R key and modified accordingly.

[2R] WIND REQUEST

Pressing this key sends a request for ACARS winds. (*Refer to DSC-22_20-70 Wind Data - Request for Wind Data*).

[5R] NEXT PHASE

Pressing this key calls up the CRUISE WIND page, or the DESCENT WIND page, if no cruise waypoint exists.

HISTORY WIND PAGE



[6L] CLIMB WIND

This key reverts the display to the CLIMB WIND page.

[6R] INSERT

This key inserts the history wind values into the CLIMB WIND page.

CRZ WIND PAGE

This page displays the wind direction and velocity for each cruise waypoint.

The cruise wind page enables the definition of a temperature at a given altitude, and is accessed as follows:

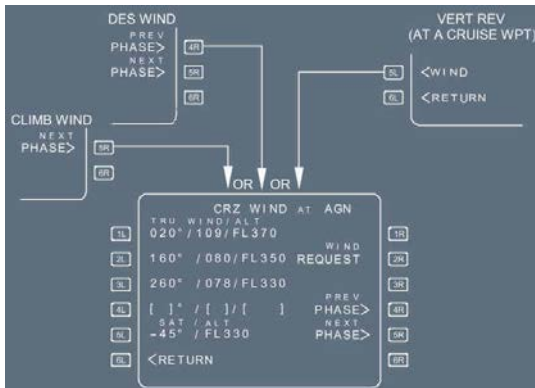

- | | |
|-------------------------------|--|
| TITLE | CRZ WIND AT in large white font. |
| [1L] to [4L] TRU WIND/ALT | These fields display the entered wind at various altitudes in blue. The entered winds are propagated at the same altitude to the downpath cruise waypoints, if no other winds are entered. The propagated wind direction and velocity are displayed in small fonts. Both uplinked winds and pilot-entered winds are displayed in large blue font. Wind data is modifiable during cruise. |
| [5L] SAT/ALT | This field allows the pilot to enter a temperature at a given flight level, or to display a propagated value. The crew must enter both temperature and altitude at the first entry. They can then independently modify the temperature, or the altitude. |
| [2R] WIND REQUEST | Pressing this key sends a request for ACARS winds. (<i>Refer to DSC-22_20-70 Wind Data - Request for Wind Data</i>) |
| [4R] PREV PHASE | This prompt is displayed in Preflight, Takeoff, Climb and Done phases. Pressing this prompt calls up the CLIMB WIND page. |
| [5R] NEXT PHASE | Pressing this prompt calls up the DES WIND page. Any new entry performed on the CRZ WIND page is immediately inserted into the corresponding flight plan. Predictions are dashed on the F-PLN pages during the recomputation time. CRZ WIND page automatically reverts to F-PLN page, if a temporary flight plan is created or the secondary flight plan is activated. |

DESCENT WIND PAGE

This page enables the pilot to define and display the winds used for computing the descent profile.

The pilot calls it up by selecting NEXT PHASE on the CRUISE WIND page, or the WIND prompt on the VERT REV page.



[1L] to [5L]

This displays inserted winds or uplinked winds, in large blue fonts, prior to activating the descent phase (modifiable values), and in green after descent phase activation (not modifiable values).

An entry of “GRND” in the “ALT” field is seen as the wind at ground level. This wind is copied on the PERF APPR page (and corrected for the magnetic variation).

A clear action on one key reverts the line to blue brackets.

[6L] ALTERNATE

This field is only displayed when an alternate is defined.

The pilot-entered value or uplinked value is displayed in large blue font. It is always modifiable by the pilot.

[2R] WIND REQUEST*

Pressing this key sends a request for ACARS winds. (*Refer to DSC-22_20-70 Wind Data - Request for Wind Data*).

[4R] PREV PHASE

Pressing this key calls up the CRUISE WIND page. The field is erased after the top of descent has sequenced.

Note: Descent winds and alternate wind are deleted, if the destination airport is changed.

INIT B PAGE

Ident.: DSC-22_20-50-10-25-00000561.0009001 / 14 MAY 12

Applicable to: ALL

The pilot uses this page to initialize the gross weight and center of gravity, before starting the engines.

The pilot can call it up from the INIT A page during preflight phase prior to engine start, by pressing the NEXT PAGE key on the MCDU console, as long as engines have not been started.

This page automatically reverts to the FUEL PRED page after the first engine is started. The FMGC will stop using the pilot-entered block fuel and will compute its predictions based on the FOB indicated by the FQI computer (or the FAC as a back up) from that moment on.

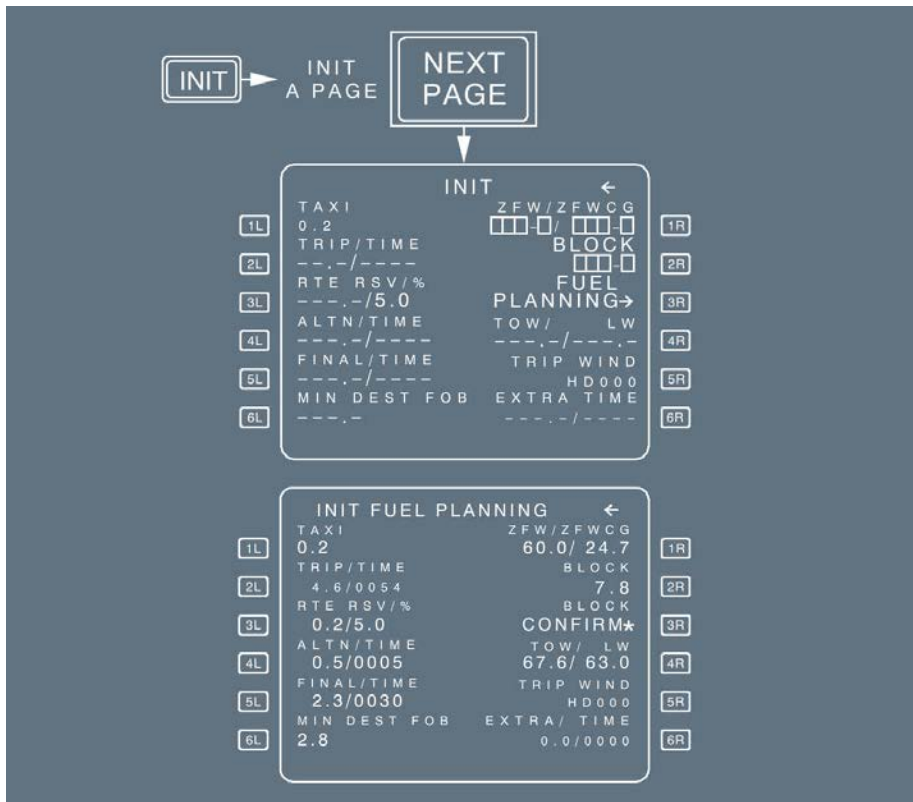

- [1L] TAXI This is the taxi fuel, which defaults to a preset value, (usually 200 kg or 400 lb in the AMI file). The crew can change the value through this field.
- [2L] TRIP/TIME (green) This field displays trip fuel and time when predictions become available. The pilot cannot modify this data.
- [3L] RTE RSV/% (blue) This field displays the contingency fuel for the route and the corresponding percentage of trip fuel. It may be equal to 0.0, if such is the policy of the operator. The flight crew can either enter a fuel quantity, or a percentage.

- [4L] ALTN/TIME (blue/green) Displays alternate trip fuel and time, assuming that the Cost Index = 0 and that the aircraft flies at the default cruise flight level. (*Refer to DSC-22_20-30-10-15 Alternate Function - Review and Selection of Alternate Airport*). The flight crew can modify the alternate fuel as required. In this case, alternate time will be dashed.
- [5L] FINAL/TIME (blue) Displays the final reserve fuel and time calculated at the alternate airport (or destination airport, if selected in the “airline fuel policy” section of the AMI). Before any crew entry, the FINAL field is dashed and FINAL TIME field is defaulted to the value specified in the AMI file (typically 30 min). The flight crew may enter a final fuel or time, and the system will compute associated holding time/fuel available. The system assumes a holding pattern at 1 500 ft AGL , with the aircraft in CONF 1 at maximum endurance speed (racetrack pattern, altitude and selected airport can be modified through the “airline fuel policy” section of the AMI).
- [6L] MIN DEST FOB (blue) Displays the expected minimum fuel at destination. It is equal by default to the ALTN + FINAL fuel. This field can be modified directly by the flight crew, and is also impacted by the modification of ALTN and/or FINAL fuel.
- Note: If pilot entry of MIN DEST FOB is lower than ALTN + FINAL fuel, the message “CHECK MIN DEST FOB” is triggered on the MCDU.*
- [1R] ZFW/ZFWCG (blue) Displays the Zero Fuel Weight (ZFW) and Zero Fuel Weight CG (ZFWCG). The flight crew must enter the ZFW /ZFWCG values (as appropriate) to obtain a speed profile and predictions.
- Note: If the flight crew enters a ZFW value that exceeds the acceptable range (as defined in the OPC or in the performance database), the “ENTRY OUT OF RANGE” message appears and the value is rejected.*
- [2R] BLOCK The block fuel in this field is a mandatory entry. When the flight crew enters a block fuel, the page title changes to INIT FUEL PREDICTION.

- [3R] FUEL PLANNING (amber) Initiates an FMGC block fuel computation using current hypothesis and extra = 0. When the pilot selects this function, FUEL PLANNING becomes green, and the BLOCK field is dashed during FMGC computation. The title of the page changes to INIT FUEL PLANNING, and BLOCK CONFIRM* replaces the FUEL PLANNING prompt, when the block fuel is computed by the FMGC. If the pilot modifies the parameters used to compute prediction before confirmation, the computation automatically restarts and FUEL PLANNING is displayed in green.
- [4R] TOW/LW (green) Displays the computed Takeoff Weight (TOW) and Landing Weight (LW) at the primary destination. This cannot be modified.
- [5R] TRIP WIND (blue) This field allows the entry of a mean wind component for the trip from the origin to the destination. Upon entry of a CO RTE or FROM/TO pair, this field defaults to HD 000 in small font.
An entry preceded by -, H, HD is considered to be headwind, +, T, TL to be tailwind. The entered speed is displayed in large blue font.
When the flight crew inserts a wind on the CLIMB, CRUISE or DESCENT WIND page, or on the PERF APP page, the system no longer considers the trip wind, and the corresponding field is dashed.
- [6R] EXTRA/TIME (green) Displays the amount of extra fuel, and the resulting time available for holding over the primary destination.
EXTRA FUEL = BLOCK – (TAXI + TRIP + RSV + MIN DEST FOB).
The field displays its information in small font, and it cannot be modified by the flight crew.

FUEL PREDICTION PAGE

Ident.: DSC-22_20-50-10-25-00000562.0009001 / 14 MAY 12

Applicable to: ALL

The pilot presses the FUEL PRED key on the MCDU console to display fuel prediction information at destination and alternate, as well as fuel management data after the engines are started.

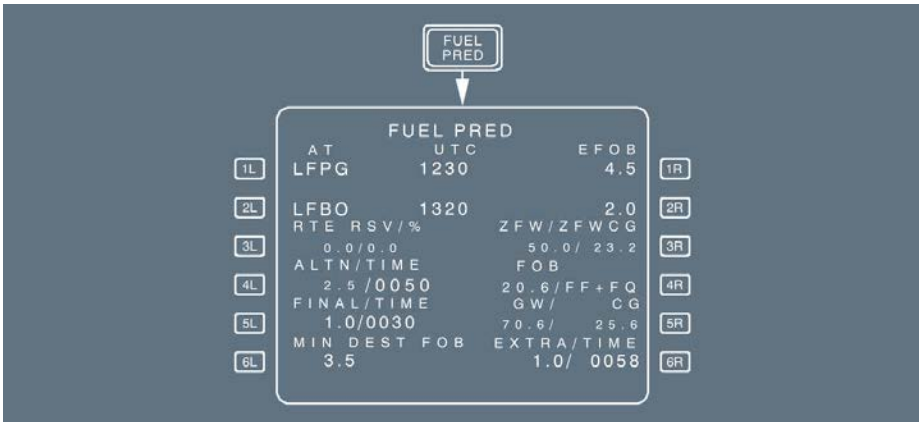

- [1L] - [1R]
 AT-UTC/TIME-EFOB
 (green)
 Display time and fuel predictions to the primary destination. TIME is displayed before takeoff. UTC predictions are displayed after takeoff. If the flight crew has entered an Estimated Takeoff Time (ETT), the UTC is displayed. The EFOB at destination will turn to amber, if it becomes less than the MIN DEST FOB value.
- [2L] - [2R]
 AT-UTC/TIME-EFOB
 (green)
 These lines display time and fuel predictions to the alternate airport. (*Refer to DSC-22_20-30-10-15 Alternate Function - General*).
- [3L] RTE RSV% (blue)
 Before departure, this field displays the route reserve fuel and the corresponding percentage of trip fuel. It may be equal to 0.0, if such is the policy of the operator. The crew can either enter a fuel quantity or a percentage. After takeoff, it becomes green 0.0/0.0, and the corresponding fuel is added to the EXTRA fuel.
- [4L] ALTN/TIME
 (blue/green)
 Displays alternate trip fuel and time, assuming that the Cost Index = 0 and that the aircraft flies at the default cruise flight level. (*Refer to DSC-22_20-30-10-15 Alternate Function - Review and Selection of Alternate Airport*).
 The flight crew can modify the alternate fuel as required. In this case, alternate time will be dashed.

- | | |
|-------------------------------|--|
| [5L] FINAL/TIME (blue) | <p>Displays the final reserve fuel and time calculated at the alternate airport (or destination airport, if selected in the “airline fuel policy” section of the AMI). The flight crew may enter a final fuel or time, and the system will compute associated holding time/fuel available.</p> <p>The system assumes a holding pattern at 1 500 ft AGL , with the aircraft in CONF 1 at maximum endurance speed (racetrack pattern, altitude and selected airport can be modified through the “airline fuel policy” section of the AMI).</p> |
| [6L] MIN DEST FOB (blue) | <p>Displays the expected Minimum Fuel at Destination. It is equal to the FINAL + ALTN fuel. The field can be modified directly by the flight crew, and is also impacted by the modification of the ALTN and/or the FINAL fuel.</p> |
| [3R] ZFW/ZFWCG (blue) | <p>Displays the Zero Fuel Weight (ZFW) and Zero Fuel Weight Center of Gravity (ZFWCG) values, as entered before engine start on the INIT B page. The flight crew can re-enter or modify these values after engine start on the FUEL PRED page. If at engine start, no ZFW or ZFWCG values have been entered, amber boxes are displayed in the corresponding field. The flight crew must enter the ZFW /ZFWCG values to obtain a speed profile and predictions.</p> |
| [4R] FOB (blue) | <p>Displays the Fuel On Board (FOB) calculated by the FMGS and the following fuel sensors:</p> <ul style="list-style-type: none"> - Fuel flow and fuel quantity sensors (/FF+FQ) - Fuel flow sensors only (/FF). - Fuel quantity sensors only (/FQ). <p>The flight crew can modify the FOB value in flight, or modify the sensors used by entering “/FF ”, “/FQ” or “/FF+FQ”, as required.</p> |
| [5R] GW/CG (green) | <p>The FMS continuously updates the GrossWeight (GW) and Center of Gravity (CG) during the flight. The field displays dashes, as long as the system is not calculating the Fuel On Board, or the ZFW has not been entered by the flight crew.</p> <p>The field cannot be modified.</p> |
| [6R] EXTRA/TIME (green) | <p>Displays the amount of extra fuel, and the resulting time available for holding over the primary destination.</p> <p>EXTRA FUEL = FOB – (TAXI + TRIP + RSV + MIN DEST FOB).</p> <p>This field displays its information in small green font, and it cannot be modified by the flight crew.</p> |

Note: All fields are dashed before engines are started.

FLIGHT PLAN PAGES

Ident.: DSC-22_20-50-10-25-00000563.0009001 / 23 JUN 15

Applicable to: ALL

These pages display all waypoints of the active and alternate flight plans, along with associated predictions.

The pilot can make all revisions to the lateral and vertical flight plans from these pages:

He presses the left key to revise the lateral flight plan, and the right key to revise the vertical flight plan.

He presses the F-PLN key on the MCDU console to access the page A of the active flight plan.

FLIGHT PLAN A PAGE

Page A displays time, speed, and altitude predictions for each waypoint of the active flight plan.

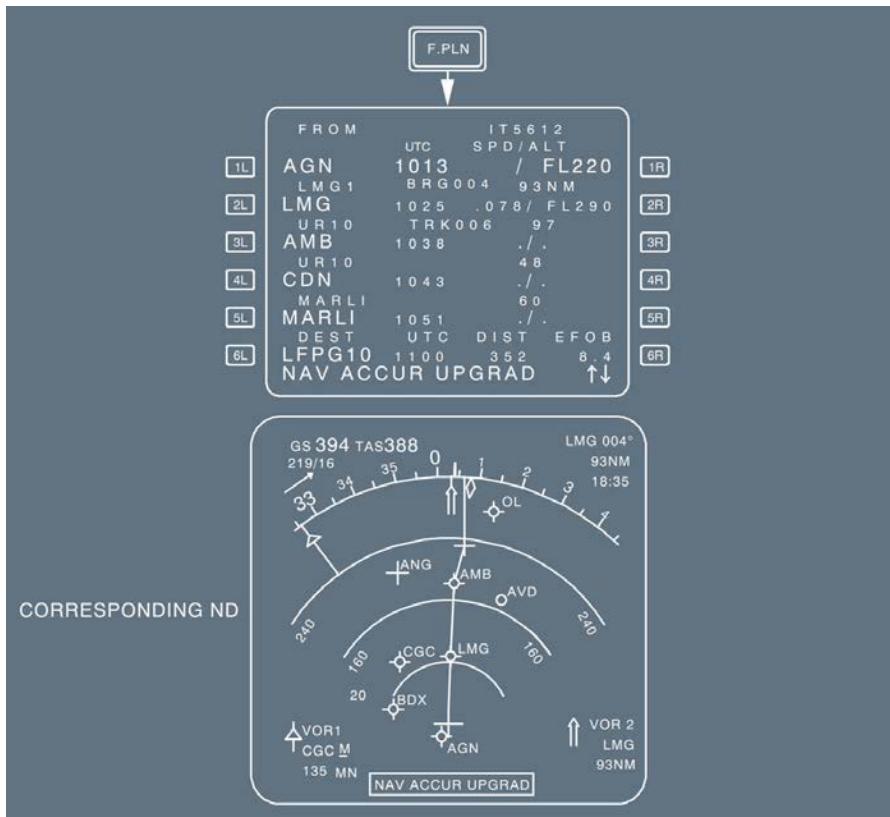

TITLE

FLIGHT NUMBER (blank, if no flight number has been entered).
 This line may display: TMPY in yellow if a temporary flight plan exists;
 OFST in white, if a lateral offset is flown; or, OFST in yellow, if a lateral
 offset revision is pending.

Line 1 to Line 5 WPT,
 UTC, SPD, ALT

These lines display consecutive waypoints along with associated
 predictions of time, speed or Mach and altitude for each.
 TIME is displayed before takeoff, and UTC after takeoff. After the pilot
 enters an estimated takeoff time (ETT), UTC is displayed.
 The time and flight level display at the FROM waypoint (first line of
 the flight plan) are values that the system memorized at waypoint
 sequencing.

[1R] SPD/ALT

The field dedicated to SPEED or MACH is blank at the FROM waypoint, except at the departure airport. (V1 associated with runway elevation, is displayed).

Note: When the HOLD marker is slewed, the HOLD SPD Label will overwrite the TIME/UTC title.

Line 6, DEST UTC/TIME
 DIST, EFOB

DIST is the distance to destination along the displayed flight plan. EFOB is the estimated fuel on board at destination. The EFOB at destination will turn to amber, if it becomes less than the MIN DEST FOB value. The sixth line is permanent and is displayed in white font once predictions are available, except when a TMPY F-PLN is displayed or in some cases when an ALT CSTR is entered (“*CLB or DES*” prompt appears).

Note: The predicted altitude at a waypoint is related to the QNH below the transition altitude, and is given as a flight level above the transition altitude.

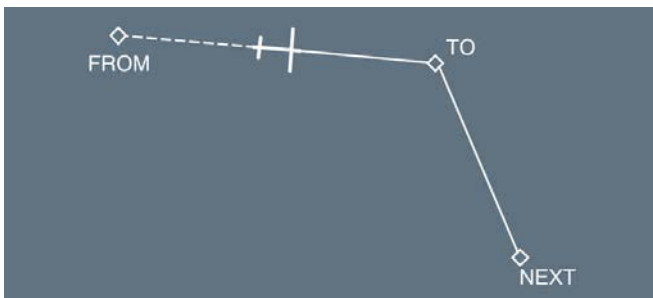

The generic flight plan page displays the FROM waypoint (last waypoint to be overflown) on the first line, and the TO waypoint (in white) on the second line. The FROM/TO flight plan leg is called the active leg.

The flight crew can use the scroll keys to review all flight plan legs down to the last point of the alternate flight plan. The AIRPORT key serves as a fast slew key. The pilot can press it to call up the next airport (DEST , ALTN, ORIGIN) to be displayed on the flight plan page.

In order to return to the beginning of the flight plan page, the pilot presses the F-PLN key on the MCDU console.

The display shows the name of the leg between two waypoints, and the distance between them on a line between the lines that identify them. During an approach, this in-between line also defines the angle of the final descent path. For example, “2-3 °” indicates that the leg is two nautical miles long, and the flight path angle is -3 °.

The display shows the bearing between FROM and TO waypoints as the bearing from the aircraft position to the TO waypoint. It shows track (TRK) between the waypoints shown in lines 2 and 3.

This is the outbound track of the next leg.

If the database contains a published missed approach procedure, or if someone has inserted one manually, the display shows it in blue after the destination runway identification. It turns green when the go-around phase becomes active.

After the last waypoint of the missed approach, the display shows the alternate flight plan in NAV mode.

When NAV mode is engaged, the flight crew can only clear or modify the TO waypoint by using the DIR key on the MCDU console.

PREDICTIONS

The system calculates and displays predictions for all waypoints.

It uses the current wind to compute TO waypoint predictions, and uses predicted winds to compute all others.

CONSTRAINTS

The database may define an altitude and speed constraint for each waypoint of the climb, descent, and approach phases, or the pilot may manually insert such constraints (except at origin, destination, FROM, and pseudo-waypoints).

The constraints are displayed in magenta, as long as predictions are not completed.

Once predictions are available, constraints are replaced by speed and altitude predictions, preceded by stars. If the star is in magenta, the system predicts that the aircraft will match the constraint (altitude within 250 ft, speed not more than 10 kt above the constraints). If the star is in amber, the system predicts that the aircraft will miss the constraint and the MCDU displays: "SPD ERROR AT WPT".

Note: SPD and ALT CSTR may either be entered on the VERT REV page or directly on the F-PLN A page, whereas TIME CSTR may only be entered from the RTA page.

PSEUDO-WAYPOINTS

Pseudo-waypoints are geographical positions corresponding to an event in the vertical flight plan: T/C (top of climb), T/D (top of descent), SPD /LIM (speed limit), DECEL (deceleration for approach), etc. The display shows them as waypoints in parentheses.

APPROACH DISPLAY

The flight crew cannot enter an altitude constraint at destination or Missed Approach Point (MAP).

ILS APPROACH

| | | | | | | |
|----|---------|--------------|------|--------|----|----------------|
| 1L | 01508 | AI101 | ← | 2500 | 1R | |
| 2L | C330° | TIME SPD/ALT | | 4 NM | 2R | GLIDESLOPE |
| | BRAVO | --- | --- | 2500 | 3R | CROSSING |
| 3L | C330° | TRK330° | | 8-0.0° | 4R | ALTITUDE |
| 4L | 0M33R | --- | --- | 1260 | 5R | |
| | C330° | --- | --- | 4-2.8° | 6R | DEST ELEVATION |
| 5L | LGAT33R | --- | --- | 90 | | (+50FT IF |
| | H330° | --- | --- | 2 | | PREDICTIONS |
| 6L | 600 | --- | --- | --- | | NOT AVAILABLE) |
| | DEST | TIME | DIST | EFOB | | |
| | LGAT33R | 0220 | 990 | 8.4 | | |
| | | | | ↑↓ | | |

OUTER MARKER → 3L

DESTINATION → 5L

FLIGHT PLAN B PAGE

This page displays fuel predictions and forecast winds at each waypoint.

The pilot calls it up by pressing the NEXT PAGE key when the FLIGHT PLAN A page is displayed.

F-PLN → F-PLN A PAGE

NEXT PAGE

| | | | | | | |
|----|---------|---------|----------|------|----|--|
| 1L | FROM | AI101 | ← | | 1R | |
| 2L | TOP9C | EFOB | T.WIND | | 2R | |
| | LSGG23 | 15.0 | 060°/005 | | 3R | |
| 3L | TOP9C | BRG220° | 6 NM | | 4R | |
| 4L | PAS | 14.7 | " /020 | | 5R | |
| | HOLD L | TRK230° | 12 | | 6R | |
| 5L | 7000 | 14.5 | " /022 | | | |
| | (SPD) | " | 0 | | | |
| 6L | (LIM) | " | " | | | |
| | TOP9C | " | 5 | | | |
| | D136E | 14.5 | 066°/025 | | | |
| | DEST | TIME | DIST | EFOB | | |
| | LGAT33R | 0220 | 990 | 8.4 | | |
| | | | | ↑↓ | | |

TITLE

FLIGHT NUMBER (blank if no flight number has been entered).

Line 1 to Line 5
WPT-EFOB-WIND

These lines display consecutive waypoints and associated fuel predictions, and the forecast wind profile.
The direction of forecast winds is relative to true north.
Forecast winds include winds entered by the pilot (large font) and the propagated winds at intermediate waypoints (small font).
If the flight crew uses a trip wind, it will be displayed for each waypoint.
If no other wind entry is made after takeoff, the FROM waypoint will display the actually recorded wind, and the waypoints downpath will still display the trip wind.

Line 6
DEST-UTC/DIST-EFOB

Identical to F-PLN A page.

LATERAL REVISION PAGES

Ident.: DSC-22_20-50-10-25-00000564.0009001 / 01 OCT 12

Applicable to: **ALL**

These pages give the pilot a list of the lateral flight plan revisions, which can be used to change the flight plan beyond a selected waypoint.

The pilot calls up these pages from the flight plan pages (A or B) by pressing the left key adjacent to the selected waypoint.

Different lateral flight plan revisions are available for different waypoints.

LAT REV AT THE ORIGIN

LAT REV FROM LSGG
 45°12.0N/007°27.2E

1L <DEPARTURE FIX INFO> 1R
 2L <OFFSET LL XING/INCR/NO 2R
 3L []/[]/[]/[] 3R
 4L ENABLE NEXT WPT 4R
 5L <ALTN NEW DEST 5R
 6L <RETURN 6R

LAT REV AT THE DESTINATION

LAT REV FROM LGAT
 37°53.8N/023°43.7E

1L <ARRIVAL> 1R
 2L NEXT WPT 2R
 3L []/[]/[]/[] 3R
 4L ENABLE <ALTN 4R
 5L <ALTN 5R
 6L <RETURN 6R

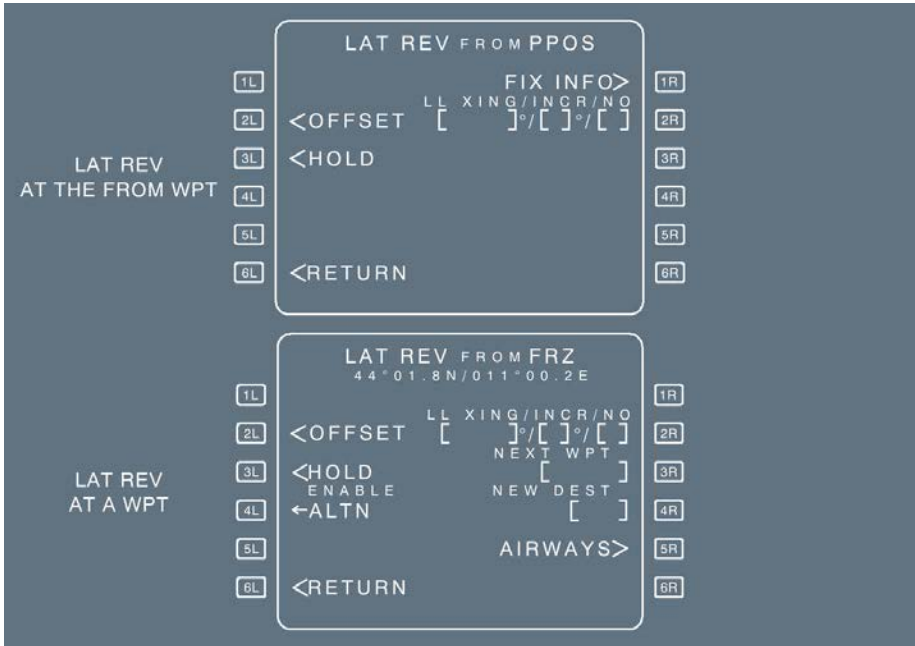

| | |
|--------------------|---|
| TITLE | The ident of the waypoint or airport selected for revision, along with its latitude and longitude. If the selected waypoint is the FROM waypoint, the title omits the aircraft latitude and longitude, and displays the “PPOS” (present position) instead. |
| [1L] DEPARTURE | This prompt gives the pilot access to the departure pages, where he can select and insert runways, SID s, and TRANSs. |
| [2L] OFFSET | This prompt gives the flight crew access to the OFFSET page. |
| [3L] HOLD | This prompt gives access to the hold pages. |
| [4L] ENABLE ALTN | This prompt allows the pilot to switch to the alternate flight plan at the selected revision waypoint, and use it as a new active flight plan. The system never displays this prompt at the FROM waypoint. |
| [5L] ALTN | This prompt gives access to the alternate airport page. The system displays it only at the destination. |
| [6L] RETURN | This prompt returns the display to the flight plan page. |
| [1R] ARRIVAL | This prompt calls up the arrival pages, where RWY , APPR, STAR TRANS and VIA can be selected and inserted. |

- [1R] FIX INFO FIX INFO is only displayed on the lateral revision page at the origin or FROM waypoint. It gives access to the FIX INFO page.
- [2R] LLLXING/INCR/NO This prompt allows the pilot to create the latitude/longitude crossing point. The increment (INCR) ranges from 1 to 20 °, and the number of crossing points from 1 to 99. This prompt is not displayed for waypoints belonging to the descent procedure.
- [3R] NEXT WPT The pilot uses this prompt to enter the next waypoint. If this waypoint is a latitude/longitude, or is neither in the database nor in the pilot-defined elements, the display reverts to the NEW WAYPOINT PAGE.
- [4R] NEW DEST The pilot uses this prompt to enter a new destination.
- [5R] AIRWAYS The pilot uses this prompt to access the AIRWAYS page.
- [6R] INSERT This prompt is displayed when the pilot has created a temporary flight plan. It can be used to activate the temporary flight plan.

TEMPORARY REVISION

When the pilot selects a lateral revision, the system creates a “Temporary F-PLN ” and displays it in yellow on the MCDU , and as a dashed yellow line on the ND, enabling the pilot to review the data before inserting it. As long as the temporary flight plan is not inserted, the previous flight plan remains active and the system guides the aircraft along it.

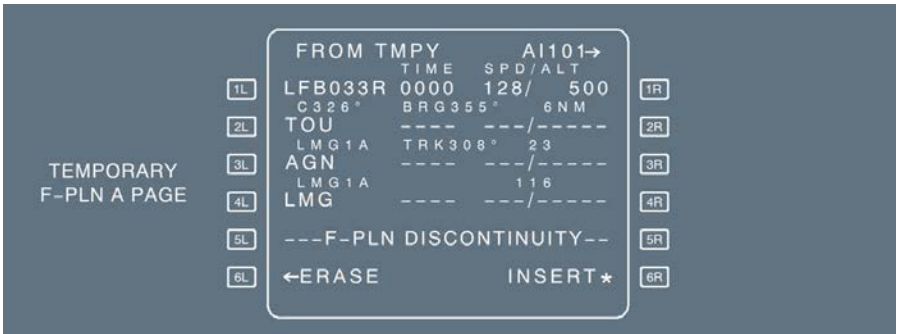

FIX INFO PAGE

Ident.: DSC-22_20-50-10-25-00000565.0009001 / 14 MAY 12
Applicable to: ALL

This page provides access to the RADIAL, CIRCLE, and ABEAM intercept functions. The reference may be a given database fix or a pilot-defined element. If the radial, circle or abeam intercepts the active flight plan, the intersection point can be converted to a waypoint and inserted into the flight plan.

The FIX INFO page may be accessed from the LAT REV page at the origin airport, or at FROM.

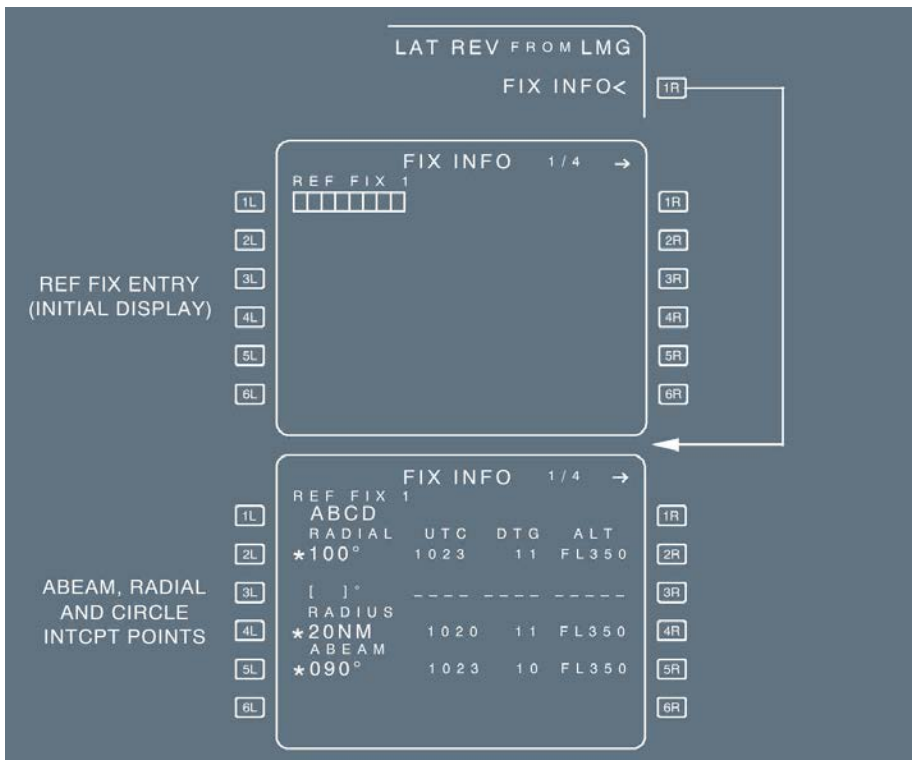

[1L] REF FIX (blue) Allows entries of the REF FIX. This reference may be any database element (navaid, waypoint, NDB, airport, runway) or a pilot-defined element. Prior to entry, amber boxes are displayed.

[2L] - [2R] RADIAL Enables entry of a radial from the REF FIX.
 (blue) and [3L] - [3R] (blue) If the radial line intersects the active flight plan, the FMGS will compute the time, the along path DTG (Distance To Go), and the altitude at the intersection point (small green font). A large blue star is then displayed to insert the intersection waypoint into the flight plan. This waypoint is not part of the pilot-stored elements. Format of the created waypoint is:

| | | |
|--------|-------|-----------------------------------|
| XXXNNN | XXX = | First 3 letters of REF FIX ident. |
| | NNN = | Value of the radial |

[4L] - [4R] RADIUS
 (blue)

This function enables the flight crew to enter a radius that defines a circle around the REF FIX.
 When the circle intercepts the current flight path, the FMGS will compute the time, the along path distance and the altitude at the first intersection point, from the current aircraft position (small green front).
 A large blue star is then displayed to insert the intersection waypoint into the flight plan. This waypoint is not part of the pilot stored element.

The waypoint is automatically labelled:

“DNNNXXX” NNN = Value of the radius
 XXX = First 3 letters of the REF FIX ident.

[5L] - [5R] ABEAM

This function enables the pilot to create waypoints on a flight plan (primary or secondary) that are abeam a reference fix.
 Once computed, the page displays the radial number in large green font. Time, distance and altitude predictions are displayed in small green font. Selecting the key adjacent to the star creates the waypoint and inserts it into the flight plan.
 The waypoint is identified by AB + the REF FIX ident e.g. AB TLS.
 Abeam waypoints are not stored in the pilot-stored waypoint database.

Note: Four FIX INFO pages, providing the capability to define four different REF FIX elements, are available.

OFFSET PAGE

Ident.: DSC-22_20-50-10-25-00013512.0019001 / 14 MAY 12

Applicable to: ALL

This page allows the flight crew to insert a replanned offset into the flight plan by entering:

- A start waypoint
- An end waypoint
- An offset distance to the left or to the right
- The intercept angle value.

The flight crew calls up this page from the LATERAL REVISION page, by pressing [2L] key.

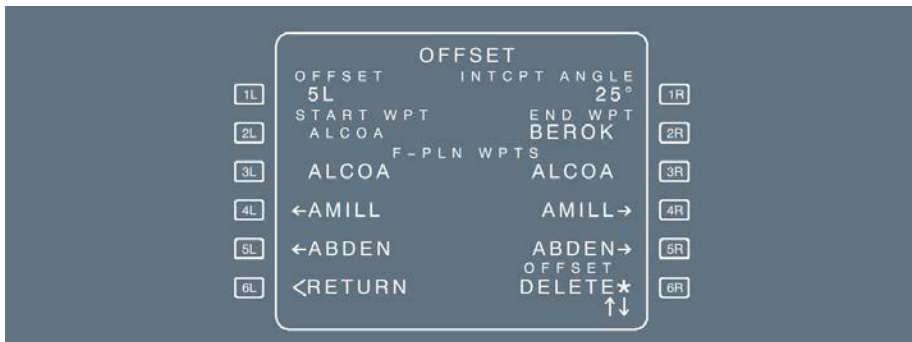

TITLE OFFSET in white large font. If a temporary flight plan exists, it is displayed in yellow large font.

[1L] OFFSET This field displays the lateral offset distance, left or right, in the flight plan. The offset may be between 1 and 50 NM. Blue brackets are displayed until an offset is inserted. When the flight crew enters an offset, or modifies another element in the OFFSET page, the OFFSET field becomes yellow. One time the temporary flight plan is inserted, the field becomes blue. The flight crew can delete an inserted offset either by pressing the CLR key, by entering a zero for the amount of the offset, or by pressing OFFSET DELETE in 6L field.

[2L] START WPT The START WPT ident for the offset is displayed in yellow if a temporary flight plan exists, in blue if already inserted, or in green when the field is not modifiable.

The default START WPT shall be the waypoint where the lateral revision is performed, the first waypoint offsettable, or PPOS if the offset is currently flown.

This waypoint can also be selected from the list of waypoints in the fields 3L to 5L, or can be manually entered by the flight crew.

[3L] to [5L] Display the start waypoints available for selection. Two scrolling list are available. The active start waypoint is displayed in green in the list. Other waypoints are displayed in blue. The currently selected start waypoint does not have selection arrow associated.

[6L] RETURN ERASE RETURN: The flight crew presses this key to return to the last displayed LAT REV page.
 ERASE: It is displayed when a temporary flight plan has been created, and it enables the flight crew to erase the temporary flight plan.

| | |
|---|---|
|  <p>A318/A319/A320/A321 FLIGHT CREW OPERATING MANUAL</p> | <p>AIRCRAFT SYSTEMS</p> <p>AUTO FLIGHT - FLIGHT MANAGEMENT</p> <p>CONTROLS AND INDICATORS - MCDU - PAGE DESCRIPTION</p> |
|---|---|

- [1R] INTCP T ANGLE This field displays the intercept angle. The angle may be between 10 ° and 50 °. The intercept angle in the AMI is the default value, and is shown in blue. When the flight crew enters an intercept angle, or modifies another element in the OFFSET page, the field becomes yellow. One time the temporary flight plan is inserted, the field becomes blue.
- [2R] END WPT The END WPT ident for the offset is displayed in yellow if a temporary flight plan exists, or in blue if already inserted. The default END WPT shall be the waypoint terminating the last consecutive offsettable leg from default or currently selected START WPT. This waypoint can also be selected from the list of waypoints in the fields 3R to 5R, or can be manually entered by the flight crew.
- [3R] to [5R] Display the end waypoints available for selection. Two scrolling lists are available. The active end waypoint is displayed in green in the lists. Other waypoints are displayed in blue. The currently selected end waypoint does not have selection arrow associated.
- [6R] INSERT OFFSET INSERT: This field allows the flight crew to activate the temporary flight plan and reverts the display to the active flight plan. This field is displayed when the offset segment is completely defined on OFFSET page.
DELETE: This prompt enables the flight crew to create a temporary flight plan where the predefined offset is canceled. This field is displayed when an offset exists in the active flight plan.

Note: If the waypoint lists in lines 3 to 5 do not fit in one page, the flight crew can scroll in an open loop, two lines by two lines. To keep the initial order of the list, two markers appear:

- - START OF LIST - : This marker is displayed at the beginning of the list
- - END OF LIST - : This marker is displayed at the end of the list.

| |
|---------------------|
| AIRWAYS PAGE |
|---------------------|

Ident.: DSC-22_20-50-10-25-00000566.0009001 / 14 MAY 12

Applicable to: ALL

This page allows the pilot to select up to five airways for stringing into the flight plan, after the revise waypoint.

The pilot calls up this page by pressing the lateral revision page [5R] key.

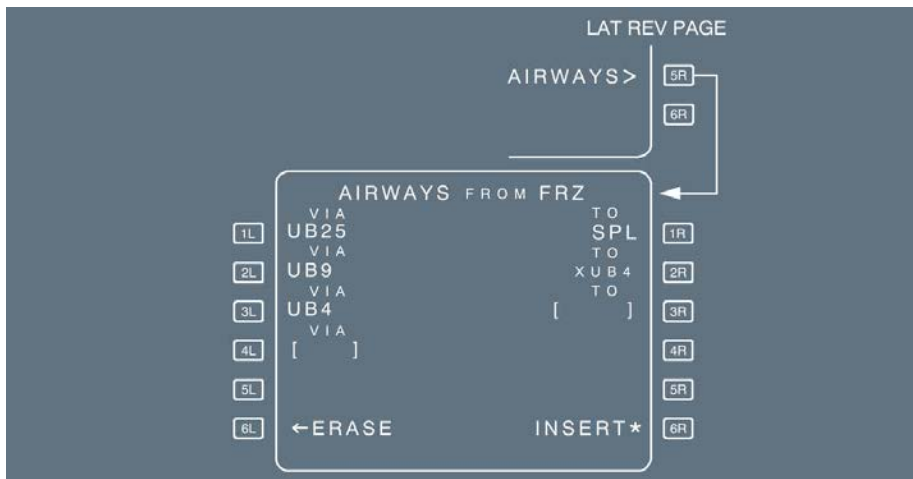

| | |
|------------------------|---|
| TITLE | Revise point ident (large green font) |
| [1L] to [5L] VIA | This field displays the airways entered by the pilot. |
| [6L] ERASE or RETURN | The flight crew presses this key to return to the lateral revision page. This field displays ERASE when a temporary flight plan is created. It enables the temporary flight plan to be erased. |
| [1R] to [5R] TO | Displays the end points of the corresponding airways entered on the [1L] to [5L] entries. The ending point is displayed in large blue font, if manually-entered, in blue small font if FMGC-computed. |
| [6R] INSERT (amber) | Allows the entered VIA/TO segments to be inserted into the flight plan. The display reverts to the F-PLN page. |

- Note:**
1. If the entered airway contains at least one fixed radius transition waypoint as defined in the navigation database, and the TO waypoint is defined and, the fixed radius transition waypoint is in the flight plan, then, "FIXED TURN RADIUS AWAY" is displayed between the VIA and TO fields.
 2. If the condition for display "FIXED TURN RADIUS AWAY" is satisfied for two consecutive airways lines, the second line displays (") instead of the whole message.



A318/A319/A320/A321
FLIGHT CREW
OPERATING MANUAL

AIRCRAFT SYSTEMS

AUTO FLIGHT - FLIGHT MANAGEMENT

CONTROLS AND INDICATORS - MCDU - PAGE DESCRIPTION

DEPARTURE PAGES

Ident.: DSC-22_20-50-10-25-00000567.0001001 / 17 MAR 11

Applicable to: ALL

These pages allow the pilot to review departure procedures (RWY , SID , TRANS) and enter them into the active flight plan.

When the display shows the lateral revision page for the origin, the pilot calls them up by pressing the 1L key.

Three pages are available: RWY , and SID S and TRANS (if any).

The pilot sequentially calls up each page by selecting a data item (such as RWY), or by pressing the NEXT PAGE key on the MCDU console.

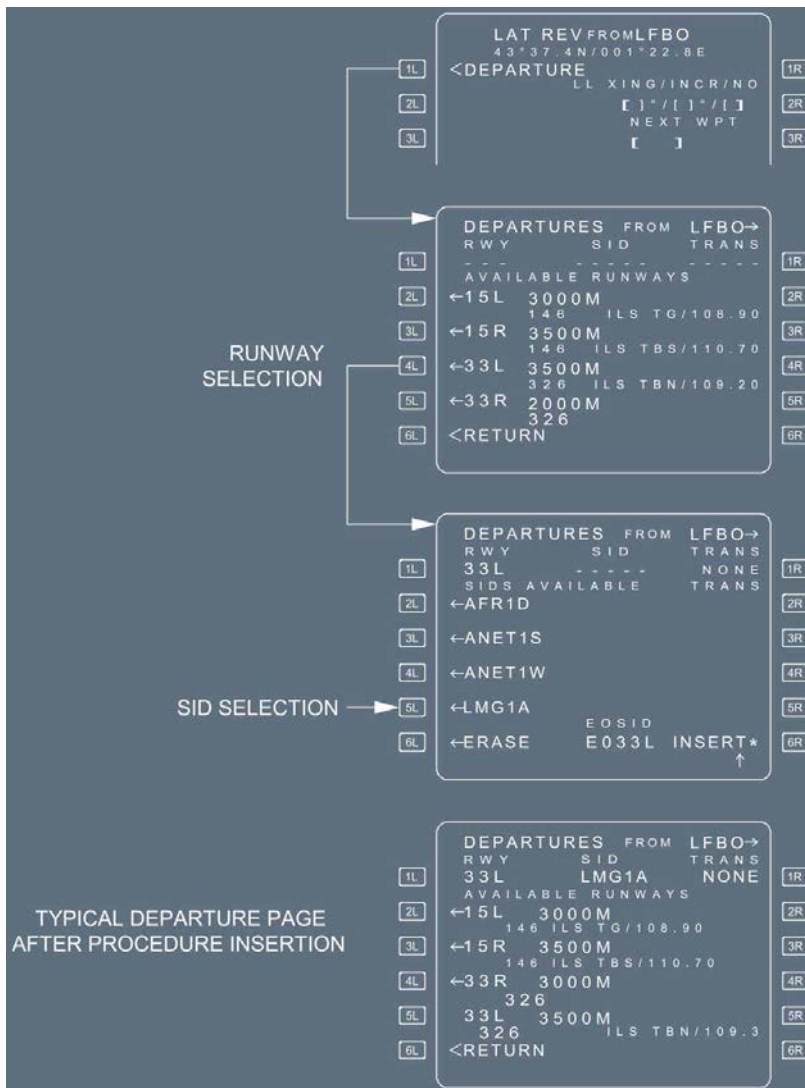

Line 1 RWY, SID
 TRANS

This line displays the RWY, SID, and TRANS in green after they have been inserted into the active flight plan, or in yellow if selected but not yet inserted. If nothing has been selected or inserted, the line displays dashes.

| | |
|------------------------------|---|
| [2L] to [5L] RWY/SIDs | <p>These fields display selectable and selected RWY s or SID s (including EOSID and NO SID option). The pilot can slew each list. Selectable RWY s and SIDs are displayed in blue with an arrow.</p> <p>Once a RWY or SID is selected, the arrow disappears.</p> <p>A RWY or SID, already inserted in the flight plan, is displayed in green.</p> <p>The display shows the length, heading, and, if available, the ILS ident and frequency for each runway.</p> |
| [6L] ERASE or RETURN | <p>The pilot presses this key to erase a selected data item and revert to the previous selection.</p> <p>If the pilot erases the page, the display reverts to the active flight plan page.</p> <p>The display shows RETURN instead of ERASE, when the pilot has not created a temporary flight plan.</p> |
| [2R] to [5R] TRANS | <p>This field displays the selectable and selected enroute transitions in blue and green respectively. They are blank, if there are no transitions.</p> |
| [6R] INSERT or BLANK | <p>The pilot uses this key to insert a temporary procedure into the flight plan. The page reverts to the active flight plan page, when the insertion is completed.</p> <p>It is associated with RETURN (6L).</p> |
| [6M] EOSID | <p>Once a runway is inserted into the flight plan, this field displays any ENG OUT SID for that runway. If there is none, it displays NONE.</p> |

HOLD PAGES

Ident.: DSC-22_20-50-10-25-00000568.0001001 / 01 OCT 12

Applicable to: ALL

These pages allow the pilot to review and modify the holding pattern parameters at the selected revise waypoint.

The flight crew calls up these pages by pressing the HOLD key on the LAT REV page for the waypoint. The flight crew can insert database hold, holds computed by the FMS or holds that they manually define.



At first access, the HOLD page appears as follow:

DATABASE HOLD

If a hold is defined in the navigation database for the revised waypoint, and can be inserted, the parameters in [1L], [2L] and [3L] appear in yellow.



COMPUTED HOLD

If a default hold is computed by the FMS and can be inserted, the parameters in [1L], [2L] and [3L] appear in yellow.



A computed hold has the following default parameters:

- | | |
|------------------|--|
| [1L] INB CRS | Inbound track of the F-PLN leg leading to the revised waypoint |
| [2L] TURN | Direction right (R) to turn in the hold |
| [3L] TIME/DIST | TIME on outbound leg is 1.5 min above 14 000 ft, 1 min below 14 000 ft. |
| [2R] | This field shows "REVERT TO COMPUTED" when the flight crew has modified the holding pattern. |

HOLD MODIFIED BY FLIGHT CREW

If the flight plan contains a holding pattern that was defined by the pilot from an existing database or computed hold, the parameters in [1L], [2L] and [3L] appear in blue.

If the pilot has modified holding pattern data from the database, the field next to [2R] displays "REVERT TO DATABASE" or "REVERT TO COMPUTED" to enable the pilot to revert to default parameters.

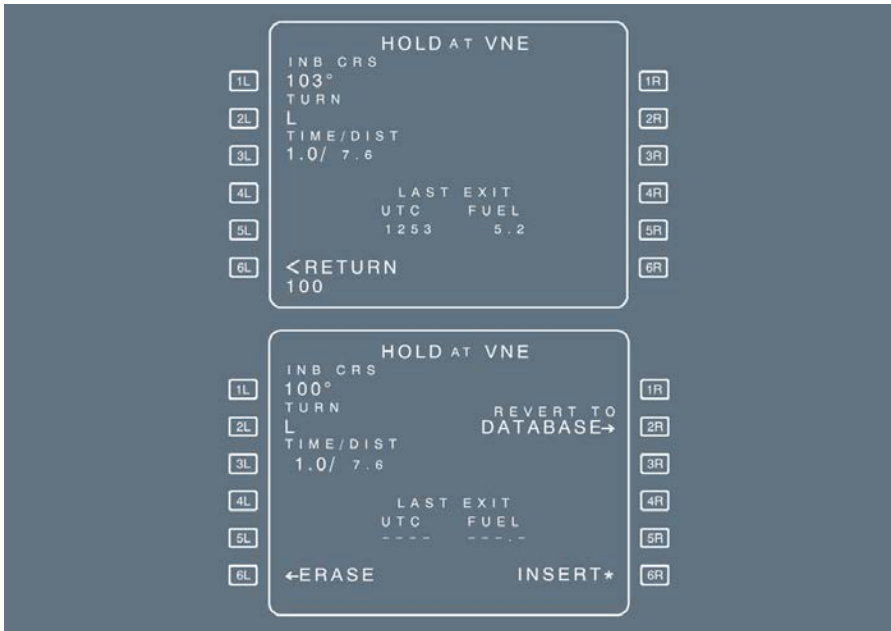

EXAMPLE | The pilot modifies the inbound course.

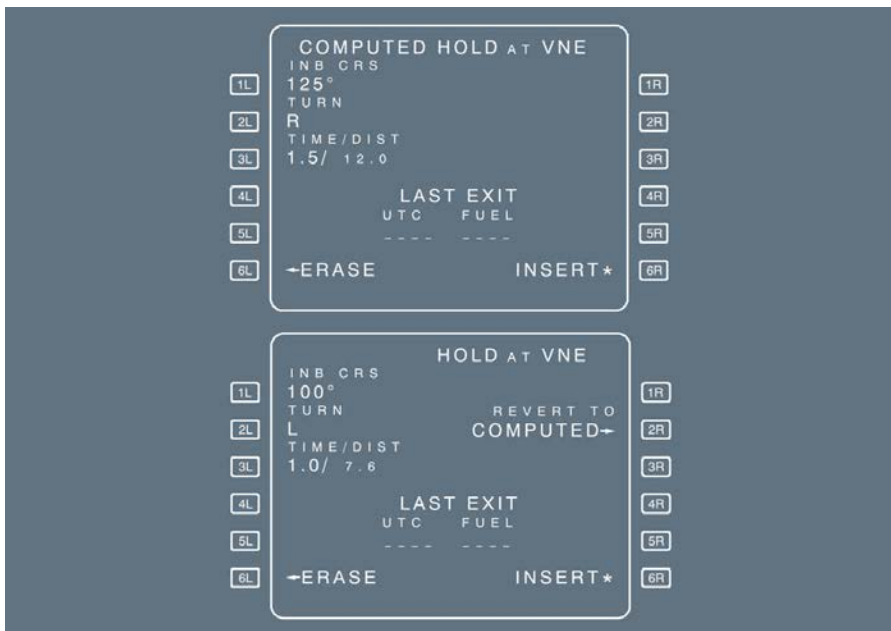

- [1L] INB CRS This field displays the inbound course of the holding pattern. The data may be manually or automatically modified.
- [2L] TURN This field shows the direction to turn in the hold (L or R). The data may be modified.
- [3L] TIME/DIST This field shows the time and distance for the outbound leg. The data may be modified, but time and distance cannot be entered simultaneously. Time and distance are dependent values that the system calculates from the predicted true airspeed, which in turn depends upon the holding speed (speed for maximum endurance, ICAO speed limit, or constraint speed, whichever is lower).
- [6L] ERASE or RETURN The pilot presses this key when the field shows “ERASE”, to erase the holding pattern.
 The pilot presses this key when the field shows “RETURN”, to return to the LAT REV page, if the hold is already inserted in the flight plan.
- [2R] REVERT TO... The pilot presses this key to delete manual modifications to the database hold (or computed hold), and to revert to the database (or computed) holding data.

- [6R] INSERT The pilot presses this key to insert the hold into the active flight plan.
- LAST EXIT UTC FUEL This field displays the time at which the aircraft must leave the holding pattern in order to meet fuel policy criteria (extra fuel = 0). The system also displays the estimated fuel on board at that time. Always displayed in thousand of kilograms or pounds.

DIRECT TO PAGE

Ident.: DSC-22_20-50-10-25-00000569.0001001 / 23 JUN 15

Applicable to: ALL

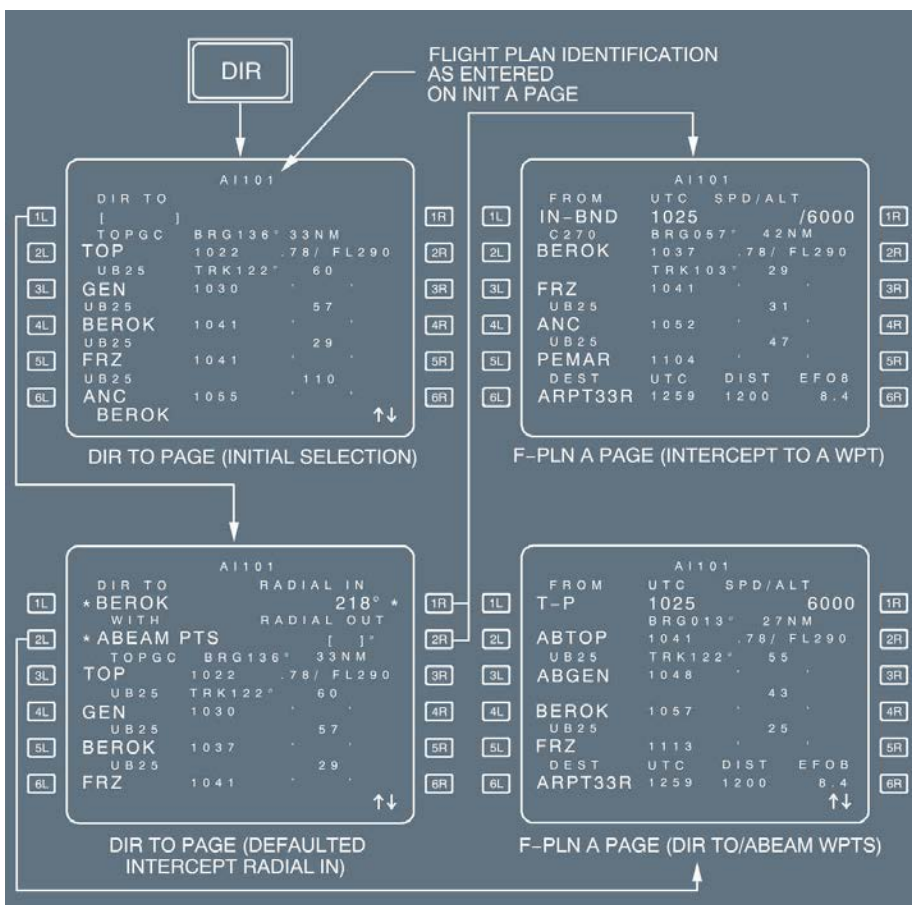

Pressing the “DIR” key under the MCDU screen brings up the DIR TO page. On this page, the [1L] key is the DIR TO key. The pilot presses it to modify the flight plan by creating a direct leg from the aircraft's present position to any selected waypoint. When in NAV mode, the pilot must use this key to modify the active leg or the TO waypoint. The pilot cannot call up this page when the aircraft's present position is not valid.

- [1L] DIR TO Pressing this key selects the DIRECT TO or INTERCEPT waypoint. The pilot can identify the waypoint to be inserted by using its identifier, its latitude and longitude, place/bearing/distance, or place-bearing/place-bearing.

Note: If the entered DIR TO is a latitude/longitude, the NEW WAYPOINT page is automatically called up.

 If the pilot does not select the RADIAL IN (1R) or RADIAL OUT (2R) or ABEAM PTS (2L), the DIR TO function routes the aircraft from the present position to the waypoint inserted in the DIR TO field.
- Line 3 to Line 6 These lines display the active flight plan with time/speed/distance predictions. The display may be slewed ↑ ↓ .
 Pressing any key activates the DIRECT TO function from the present position to the waypoint adjacent to that key.
- [2L] ABEAM PTS The flight crew presses this key to activate the DIR TO /ABEAM function which projects the flight plan waypoints perpendicular on the DIR TO leg;

EXAMPLE: DIR TO BEROK - ABEAM.

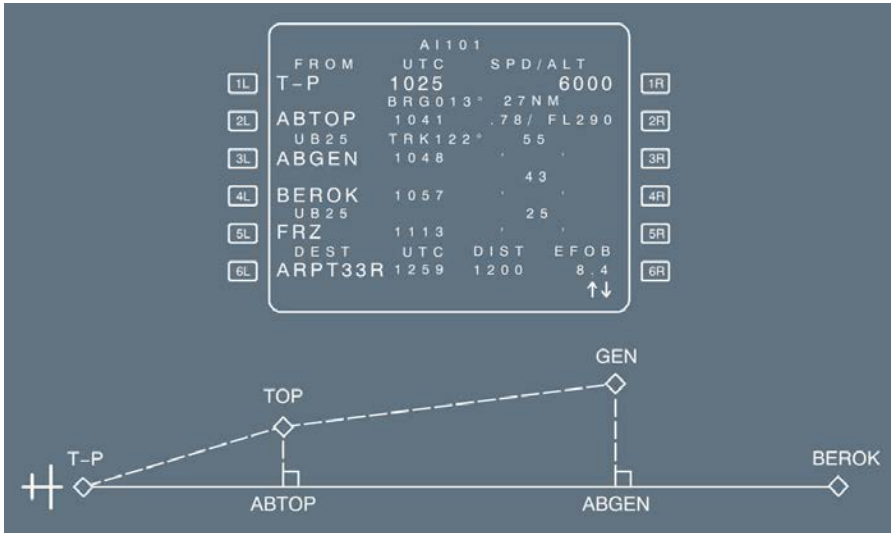

[1R] RADIAL IN and
 [2R] RADIAL OUT

The pilot fills in these fields to define a radial, associated to the waypoint defined in 1L. These keys respectively activate the DIR TO /INTERCEPT TO and DIR TO/INTERCEPT FROM functions. The pilot enters the radial in, or radial out, as : XXX, XXX being the radial. The aircraft intercepts from its current position and tracks the selected waypoint and radial to (or from) this waypoint.

EXAMPLE: RADIAL INBND - DIR TO BEROK - RADIAL 270 ° INBOUND

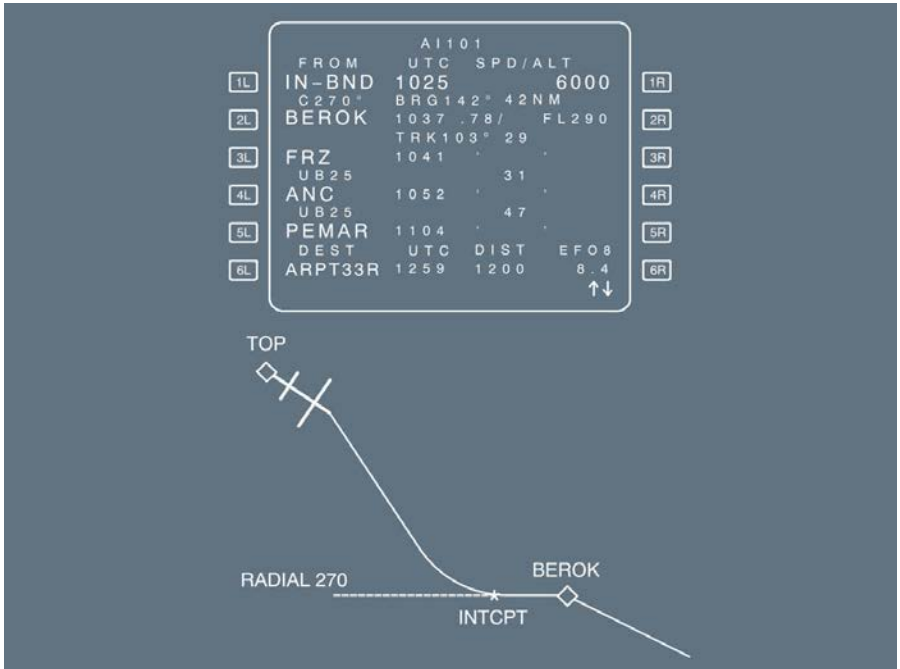

If the DIR TO /INTCPT WPT entry is to a waypoint already in the flight plan, a default RADIAL IN is displayed in small font. However, no radial is displayed on the ND for this default radial. No default radial is provided for the RADIAL OUT field.

Selecting the INTCPT TO (RADIAL IN [1R]) function:

- Activates the intercept radial INTO the WPT.
- Sets the course = radial IN + 180 °.
- Reverts the display to the F-PLN A page.

Selecting the INTCPT FROM (RADIAL OUT [2R]) function:

- Activates the intercept radial FROM the WPT.
- Sets the course = radial OUT.
- Reverts the display to F-PLN A page.

For details, DSC_22_20_30 Flight Planning.

Note: It is not recommended to use the DIR TO function when the aircraft is on the ground. The use of the DIR TO function when the aircraft is on the ground may result in the loss of all departure data, that includes both of the following:

- The takeoff speeds
- The derated level, or the flexible temperature.

ARRIVAL PAGES

Ident.: DSC-22_20-50-10-25-00000570.0009001 / 14 MAY 12

Applicable to: ALL

These pages enable the pilot to review arrival procedures (approaches, VIAs, STAR s, TRANS) and enter them into the active flight plan.

The pilot calls them up from the LAT REV page for the destination by the pressing the 1R key.

Three pages, APPR , STAR , and VIA, are available, along with a fourth, TRANS, if there are any transitions.

The pilot calls up each page sequentially, either by selecting a data item (such as APPR), or by pressing the NEXT PAGE key on the MCDU console.

Line [1L] - [1R] [2R] This line displays the APPR , VIA, STAR , and TRANS in green, if they have been inserted in the flight plan, and in yellow, as a temporary flight plan, if they have been selected but not yet inserted.

It displays dashes or NONE, if nothing has been selected or inserted.

[2L] APPR VIAS The pilot presses this key to call up transitions from the last point of the STAR to the first point of the approach.

[3L] to [5L] These fields list selectable and selected APPR s, STAR s, and VIAs. The flight crew can slew the pages, when necessary. Selectable APPR s, STARs, and VIAs are displayed in blue with an arrow. Once the pilot has selected an APPR , STAR , or VIA, the arrow disappears. After the APPR , STAR, or VIA is inserted into the flight plan, it is displayed in green.

For each approach, the display shows runway length, heading, and the frequency and identifier of the ILS when ILS is available.

In case there are multiple approaches for the same runway, the approach is identified with the runway plus the multiple indicator (i.e. ILS 33L-S).

[6L] ERASE or RETURN The pilot presses this key to erase selected data and to revert to the previous selection. The page reverts to the LAT REV page.

The field displays "RETURN", instead of ERASE, when the flight crew has not created a temporary flight plan.

[3R] TRANS to [5R] These fields display selectable and selected enroute transitions (if any). They are blue when selected, and become green when inserted into the active flight plan.

[6R] INSERT The pilot presses this key to insert the temporary procedure into the active flight plan. The page reverts to the active flight plan page when this occurs.

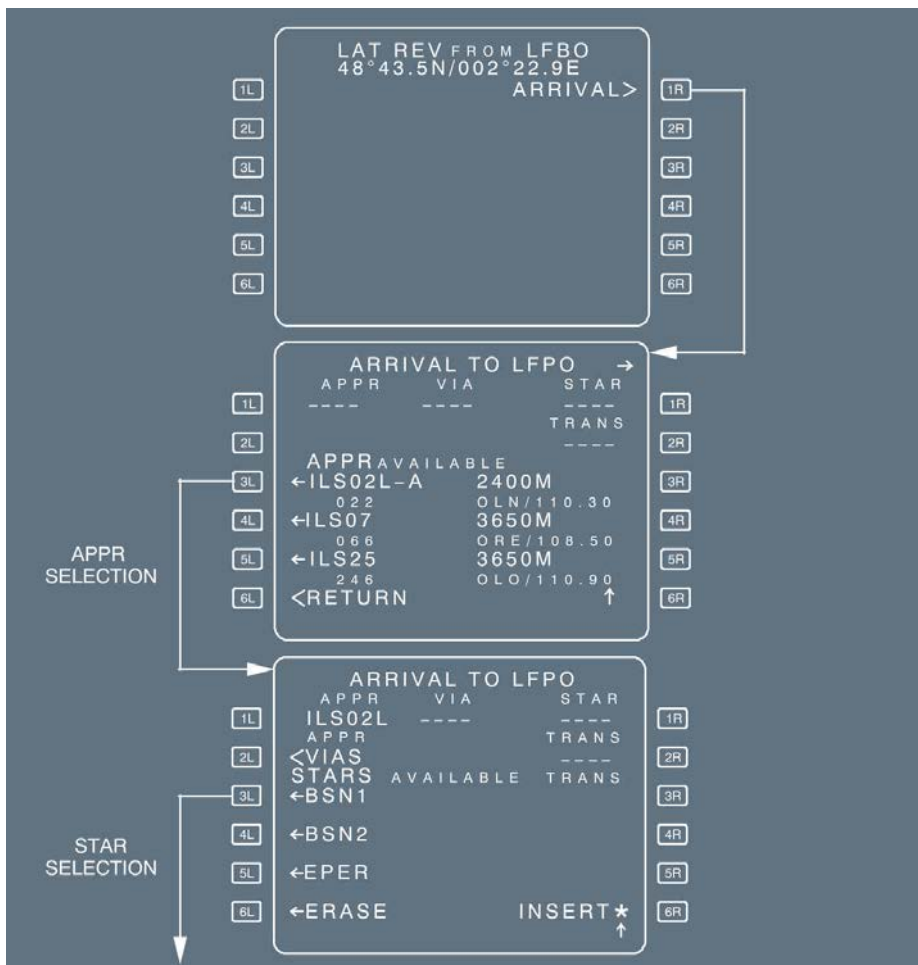

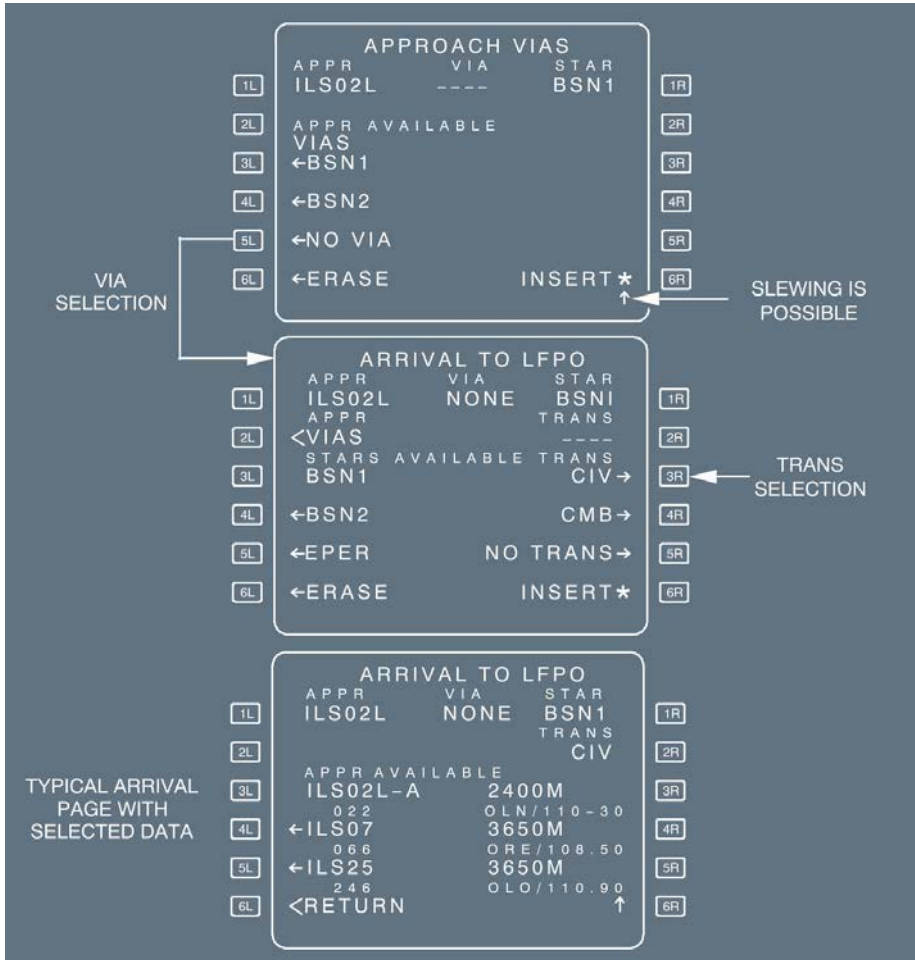

ALTERNATE PAGE

Ident.: DSC-22_20-50-10-25-00000571.0001001 / 17 MAR 11

Applicable to: ALL

This page enables the pilot to review, in the NAV database, the alternate airports that are paired with the destination, and define additional alternates, if needed. (Alternate airports are linked to the

destination). The pilot calls up this page with the ALTN prompt, from the lateral revision page for the destination.



TITLE

The destination airport is displayed large green font.

[1L] ALTN

This field displays the selected alternate: In green, if it is active; in yellow, if it is temporary. "NONE" is displayed, if NO ALTN option is selected, or if the destination has no alternate.

Line 2 to line 5

These lines display the identifications of alternates (up to 6), the extra fuel weight remaining after landing at the alternates, and the great-circle track and distances to them from the destination.

If the database contains a company route between the destination and the alternate, the distance shown is an airway distance, not a great-circle distance.

When the database defines a preferred alternate, it is displayed on Line 2 (if no scrolling has been performed).

- [4L] OTHER ALTN The pilot can enter an airport identifier in the brackets (Line 3). If that airport is not stored in the database , the NEW RUNWAY page appears for the pilot to use in defining it.
 If it is stored in the database, the ROUTE SELECTION page appears, and the pilot can use it to select the best route.
 The pilot may enter a distance in the DIST field of the OTHER ALTN prompt, in order to get preliminary fuel predictions. However, once he has selected the alternate airfield as a temporary alternate and then inserted it, the ALTN distance reverts either to the airway distance, if he has selected a company route, or otherwise to the direct distance to the alternate.
 The pilot can use OTHER ALTN to overwrite and replace the previous OTHER ALTN.

- NO ALTN The pilot uses this key to select the NO ALTN option.

- [6L] RETURN or
 ERASE The pilot presses this key to make the display revert to the LAT REV page.
 Pressing this key erases the temporary selection.

- [1R] CO RTE Pressing this key displays the active company route between the destination and the selected alternate.

- [6R] INSERT Pressing this key activates the temporary selection.

ROUTE SELECTION PAGE FOR ALTERNATE

Ident.: DSC-22_20-50-10-25-00000572.0001001 / 17 MAR 11

Applicable to: ALL

This page enables the pilot to review the company route between the destination and the alternate, and to select a different route, if that seems appropriate.
 This page comes up automatically, when the flight crew enters an ident in the OTHER ALTN field.
 See the “Route Selection” page *Refer to DSC-22_20-50-10-25 Route Selection Page* for a description of this page.



[6R] SELECT

Pressing this key reverts the display to the alternate page. (The distance between the destination and the alternate is then the airway distance).

VERTICAL REVISION PAGES

Ident.: DSC-22_20-50-10-25-00000573.0009001 / 14 MAY 12

Applicable to: ALL

These pages contain the menu of available vertical flight plan revisions that can be applied at a selected waypoint.

The pilot calls up these pages from the flight plan A or B pages by pressing the right hand key next to the selected revised waypoint.

The pilot may make several different vertical revisions (although some may not be available at all waypoints): Speed limit, speed constraint, altitude constraint, time constraint, wind page and STEP ALTS page.

AIRCRAFT SYSTEMS
AUTO FLIGHT - FLIGHT MANAGEMENT

CONTROLS AND INDICATORS - MCDU - PAGE DESCRIPTION

A318/A319/A320/A321
FLIGHT CREW
OPERATING MANUAL

| | | | | |
|--|----|--|--------------------|----|
| <p>VERT REV AT ORIGIN</p> | 1L | <p>VERT REV AT LFBO15R EFOB=13.2 EXTRA=2.3</p> | | 1R |
| | 2L | CLB SPD LIM 250/FL100 | RTA> | 2R |
| | 3L | | | 3R |
| | 4L | | | 4R |
| | 5L | <WIND | STEP ALTS> | 5R |
| | 6L | <RETURN | | 6R |
| <p>VERT REV at cruise WPT</p> | 1L | <p>VERT REV AT MIP EFOB=12.4 EXTRA=0.8</p> | | 1R |
| | 2L | | RTA> | 2R |
| | 3L | SPD CSTR ALT CSTR *[] []* | | 3R |
| | 4L | MACH/START WPT *[]/MIP | | 4R |
| | 5L | <WIND | STEP ALTS> | 5R |
| | 6L | <RETURN | | 6R |
| <p>VERT REV at WPT in climb (ALT CSTR entered and predicted missed)</p> | 1L | <p>VERT REV AT SBJ EFOB=14.5 EXTRA=0.8</p> | | 1R |
| | 2L | CLB SPD LIM 210/ 7000 | RTA> | 2R |
| | 3L | SPD CSTR ALT CSTR [] 5000 | | 3R |
| | 4L | | ALT ERROR - 500 | 4R |
| | 5L | <WIND | STEP ALTS> | 5R |
| | 6L | <RETURN | | 6R |

| | | | | | | | | | | | | | | | | | | | | | | | | | | | | | | | |
|---|--|----|-------------------|----|--|---------------------|--|----|-------------|----|--|-------------------|--|----|--------------|----|--|------------------------|--|----|---------------------|----|----|------------------|----|----|------------------|----|----|---------|----|
| VERT REV AT DEST | <table border="0"> <tr> <td style="border: 1px solid gray; width: 20px; text-align: center;">1L</td> <td style="text-align: center;">VERT REV AT KLGA</td> <td style="border: 1px solid gray; width: 20px; text-align: center;">1R</td> </tr> <tr> <td></td> <td style="font-size: small;">EFOB=8.4 EXTRA=0.8</td> <td></td> </tr> <tr> <td style="border: 1px solid gray; text-align: center;">2L</td> <td style="text-align: center;">CLB SPD LIM</td> <td style="border: 1px solid gray; text-align: center;">2R</td> </tr> <tr> <td></td> <td style="font-size: small;">250/10000</td> <td></td> </tr> <tr> <td style="border: 1px solid gray; text-align: center;">3L</td> <td style="text-align: right;">RTA></td> <td style="border: 1px solid gray; text-align: center;">3R</td> </tr> <tr> <td></td> <td style="font-size: small;">G/S INTCP 2000</td> <td></td> </tr> <tr> <td style="border: 1px solid gray; text-align: center;">4L</td> <td style="text-align: center;">QNH</td> <td style="border: 1px solid gray; text-align: center;">4R</td> </tr> <tr> <td></td> <td style="font-size: small;">□□□□</td> <td></td> </tr> <tr> <td style="border: 1px solid gray; text-align: center;">5L</td> <td style="text-align: center;"><WIND STEP ALTS></td> <td style="border: 1px solid gray; text-align: center;">5R</td> </tr> <tr> <td style="border: 1px solid gray; text-align: center;">6L</td> <td style="text-align: center;"><RETURN</td> <td style="border: 1px solid gray; text-align: center;">6R</td> </tr> </table> | 1L | VERT REV AT KLGA | 1R | | EFOB=8.4 EXTRA=0.8 | | 2L | CLB SPD LIM | 2R | | 250/10000 | | 3L | RTA> | 3R | | G/S INTCP 2000 | | 4L | QNH | 4R | | □□□□ | | 5L | <WIND STEP ALTS> | 5R | 6L | <RETURN | 6R |
| 1L | VERT REV AT KLGA | 1R | | | | | | | | | | | | | | | | | | | | | | | | | | | | | |
| | EFOB=8.4 EXTRA=0.8 | | | | | | | | | | | | | | | | | | | | | | | | | | | | | | |
| 2L | CLB SPD LIM | 2R | | | | | | | | | | | | | | | | | | | | | | | | | | | | | |
| | 250/10000 | | | | | | | | | | | | | | | | | | | | | | | | | | | | | | |
| 3L | RTA> | 3R | | | | | | | | | | | | | | | | | | | | | | | | | | | | | |
| | G/S INTCP 2000 | | | | | | | | | | | | | | | | | | | | | | | | | | | | | | |
| 4L | QNH | 4R | | | | | | | | | | | | | | | | | | | | | | | | | | | | | |
| | □□□□ | | | | | | | | | | | | | | | | | | | | | | | | | | | | | | |
| 5L | <WIND STEP ALTS> | 5R | | | | | | | | | | | | | | | | | | | | | | | | | | | | | |
| 6L | <RETURN | 6R | | | | | | | | | | | | | | | | | | | | | | | | | | | | | |
| VERT REV AT WPT (Predictions not available) | <table border="0"> <tr> <td style="border: 1px solid gray; width: 20px; text-align: center;">1L</td> <td style="text-align: center;">VERT REV AT CXR</td> <td style="border: 1px solid gray; width: 20px; text-align: center;">1R</td> </tr> <tr> <td></td> <td style="font-size: small;">EFOB---- EXTRA----</td> <td></td> </tr> <tr> <td style="border: 1px solid gray; text-align: center;">2L</td> <td style="text-align: right;">RTA></td> <td style="border: 1px solid gray; text-align: center;">2R</td> </tr> <tr> <td></td> <td style="font-size: small;">SPD CSTR ALT CSTR</td> <td></td> </tr> <tr> <td style="border: 1px solid gray; text-align: center;">3L</td> <td style="font-size: small;">* [] -FL310</td> <td style="border: 1px solid gray; text-align: center;">3R</td> </tr> <tr> <td></td> <td style="font-size: small;">MACH/START WPT</td> <td></td> </tr> <tr> <td style="border: 1px solid gray; text-align: center;">4L</td> <td style="font-size: small;">* [] /CXR</td> <td style="border: 1px solid gray; text-align: center;">4R</td> </tr> <tr> <td style="border: 1px solid gray; text-align: center;">5L</td> <td style="text-align: center;"><WIND STEP ALTS></td> <td style="border: 1px solid gray; text-align: center;">5R</td> </tr> <tr> <td style="border: 1px solid gray; text-align: center;">6L</td> <td style="text-align: center;">*CLB OR DES*</td> <td style="border: 1px solid gray; text-align: center;">6R</td> </tr> </table> | 1L | VERT REV AT CXR | 1R | | EFOB---- EXTRA---- | | 2L | RTA> | 2R | | SPD CSTR ALT CSTR | | 3L | * [] -FL310 | 3R | | MACH/START WPT | | 4L | * [] /CXR | 4R | 5L | <WIND STEP ALTS> | 5R | 6L | *CLB OR DES* | 6R | | | |
| 1L | VERT REV AT CXR | 1R | | | | | | | | | | | | | | | | | | | | | | | | | | | | | |
| | EFOB---- EXTRA---- | | | | | | | | | | | | | | | | | | | | | | | | | | | | | | |
| 2L | RTA> | 2R | | | | | | | | | | | | | | | | | | | | | | | | | | | | | |
| | SPD CSTR ALT CSTR | | | | | | | | | | | | | | | | | | | | | | | | | | | | | | |
| 3L | * [] -FL310 | 3R | | | | | | | | | | | | | | | | | | | | | | | | | | | | | |
| | MACH/START WPT | | | | | | | | | | | | | | | | | | | | | | | | | | | | | | |
| 4L | * [] /CXR | 4R | | | | | | | | | | | | | | | | | | | | | | | | | | | | | |
| 5L | <WIND STEP ALTS> | 5R | | | | | | | | | | | | | | | | | | | | | | | | | | | | | |
| 6L | *CLB OR DES* | 6R | | | | | | | | | | | | | | | | | | | | | | | | | | | | | |
| VERT REV with constant MACH segment defined between N47E005 and N47W009 (both waypoints are in CRZ phase) | <table border="0"> <tr> <td style="border: 1px solid gray; width: 20px; text-align: center;">1L</td> <td style="text-align: center;">VERT REV AT PEMAR</td> <td style="border: 1px solid gray; width: 20px; text-align: center;">1R</td> </tr> <tr> <td></td> <td style="font-size: small;">EFOB=12.4 EXTRA=0.8</td> <td></td> </tr> <tr> <td style="border: 1px solid gray; text-align: center;">2L</td> <td style="text-align: right;">RTA></td> <td style="border: 1px solid gray; text-align: center;">2R</td> </tr> <tr> <td></td> <td style="font-size: small;">SPD CSTR ALT CSTR</td> <td></td> </tr> <tr> <td style="border: 1px solid gray; text-align: center;">3L</td> <td style="font-size: small;">* [] []*</td> <td style="border: 1px solid gray; text-align: center;">3R</td> </tr> <tr> <td></td> <td style="font-size: small;">MACH/START WPT END WPT</td> <td></td> </tr> <tr> <td style="border: 1px solid gray; text-align: center;">4L</td> <td style="font-size: small;">.81/N47E005 N47W009</td> <td style="border: 1px solid gray; text-align: center;">4R</td> </tr> <tr> <td style="border: 1px solid gray; text-align: center;">5L</td> <td style="text-align: center;"><WIND STEP ALTS></td> <td style="border: 1px solid gray; text-align: center;">5R</td> </tr> <tr> <td style="border: 1px solid gray; text-align: center;">6L</td> <td style="text-align: center;"><RETURN</td> <td style="border: 1px solid gray; text-align: center;">6R</td> </tr> </table> | 1L | VERT REV AT PEMAR | 1R | | EFOB=12.4 EXTRA=0.8 | | 2L | RTA> | 2R | | SPD CSTR ALT CSTR | | 3L | * [] []* | 3R | | MACH/START WPT END WPT | | 4L | .81/N47E005 N47W009 | 4R | 5L | <WIND STEP ALTS> | 5R | 6L | <RETURN | 6R | | | |
| 1L | VERT REV AT PEMAR | 1R | | | | | | | | | | | | | | | | | | | | | | | | | | | | | |
| | EFOB=12.4 EXTRA=0.8 | | | | | | | | | | | | | | | | | | | | | | | | | | | | | | |
| 2L | RTA> | 2R | | | | | | | | | | | | | | | | | | | | | | | | | | | | | |
| | SPD CSTR ALT CSTR | | | | | | | | | | | | | | | | | | | | | | | | | | | | | | |
| 3L | * [] []* | 3R | | | | | | | | | | | | | | | | | | | | | | | | | | | | | |
| | MACH/START WPT END WPT | | | | | | | | | | | | | | | | | | | | | | | | | | | | | | |
| 4L | .81/N47E005 N47W009 | 4R | | | | | | | | | | | | | | | | | | | | | | | | | | | | | |
| 5L | <WIND STEP ALTS> | 5R | | | | | | | | | | | | | | | | | | | | | | | | | | | | | |
| 6L | <RETURN | 6R | | | | | | | | | | | | | | | | | | | | | | | | | | | | | |

TITLE (white)

“VERT REV AT [location]”

The second line shows remaining fuel and extra fuel at the waypoint being revised.

[1L] “TOO STEEP PATH BEYOND” (amber)

This message is displayed, if the waypoint is part of a leg with too steep a descent path.

| | |
|----------------------------------|---|
| [2L] CLB/DES SPD LIM (magenta) | This field displays the speed limit applicable to the climb or descent phase. It displays it in large font when data has been inserted manually, and in small font when data comes from the database. |
| [3L] SPD CSTR (magenta) | This field displays any speed constraint assigned to the revised waypoint. It is in large font when inserted manually, and in small font when it comes from the database. It is not displayed at the origin airport, at a FROM waypoint, a speed limit pseudo waypoint, or the destination airport. |
| [4L] QNH | This field only functions when the revised waypoint is the primary destination. It allows the pilot to enter the atmospheric pressure at sea level. This field is identical to the QNH field of the PERF APPR page. |
| [4L] MACH/START WPT (blue) | This prompt allows the pilot to enter or modify the start point of a constant Mach segment, and its associated Mach. It is not displayed at primary destination and alternate flight plan waypoints. (<i>Refer to DSC-22_20-30-20-25 Constant Mach Segment - Entering a Constant Mach Segment</i>). |
| [5L] WIND (blue) | The pilot presses this key to access the wind pages. The first wind displayed page, corresponds to the selected waypoint (e.g. climb page), if the selected waypoint is a climb phase waypoint. A CLR action reverts it to brackets. |
| [6L] RETURN or CLB | The pilot presses this key to return to the last displayed flight plan page. When displayed, pressing this key assigns the constraint to CLB phase and inserts it into the vertical flight plan. The page reverts to the flight plan page. |
| [2R] RTA prompt | This prompt gives access to the RTA page. It is not displayed when the VERT REV page is accessed from the alternate F-PLN. |
| [3R] ALT CSTR (magenta) | This field displays the altitude constraint assigned to this revised waypoint. It uses large font when the constraint is manually-entered, and small font when it is from the database. A CLR action reverts it to brackets. The constraint may be: <ul style="list-style-type: none"> - "At", entered as XXXXX (Example: FL 180). - "At or above", entered as + XXXXX or XXXXX + (Example: FL +310). - "At or below", entered as - XXXXX or XXXXX - (Example: -5 000). - A "window" constraint. The altitude window consists of two altitudes between which the aircraft should fly. The crew cannot manually enter a "window" constraint. |

| | |
|---|---|
|  <p>A318/A319/A320/A321 FLIGHT CREW OPERATING MANUAL</p> | <p>AIRCRAFT SYSTEMS</p> <p>AUTO FLIGHT - FLIGHT MANAGEMENT</p> <p>CONTROLS AND INDICATORS - MCDU - PAGE DESCRIPTION</p> |
|---|---|

- G/S INTCP (green) This field displays the glide intercept altitude for an ILS approach on the vertical revision page at destination.
- [4R] ALT ERROR (green) When the aircraft misses a predicted altitude constraint, this field displays the difference between the altitude constraint and the predicted altitude. If, for example, “-500” appears in this field in green, the aircraft will reach the waypoint at an altitude 500 ft below the constraint altitude. This only applies to waypoints in the climb and descent phases.
- [4R] END WPT (blue) This prompt allows the pilot to enter or modify the endpoint of a constant Mach segment. It is displayed when a pair Mach/start exists in 4L field. This prompt is not displayed on the destination VERT REV page. (*Refer to DSC-22_20-30-20-25 Constant Mach Segment - Entering a Constant Mach Segment*).
- [5R] STEP ALTS (white) This legend appears for any waypoint, once a cruise altitude has been entered. It is not available in engine-out, descent, approach, and go-around phases. This gives the pilot access to the STEP ALTS page.
- [6R] DES When this field displays “DES”, pressing this key assigns the constraints to the descent phase and inserts them into the vertical flight plan. The page reverts to the F-PLN page. (See note below).

Note: *Altitude and speed constraints may apply to the climb, descent, or approach phase, but never to the cruise phase. Fields 6L/6R display “CLB /DES” when the revised waypoint is a cruise phase waypoint and the FMGS needs to know if the new constraint is to be applied in climb or descent phase. The FMGS will modify the cruise phase accordingly. These 2 prompts also display “CLB /DES” when the predictions are not computed. (Top of climb and top of descent not yet defined).*

| |
|-----------------------|
| STEP ALTS PAGE |
|-----------------------|

Ident.: DSC-22_20-50-10-25-00000574.0009001 / 14 MAY 12

Applicable to: ALL

This page allows the pilot to insert up to four geographic step points and one optimal step point into the flight plan. This page also displays the fuel/time savings associated with the optional step. The flight crew calls it up either from the vertical revision page.

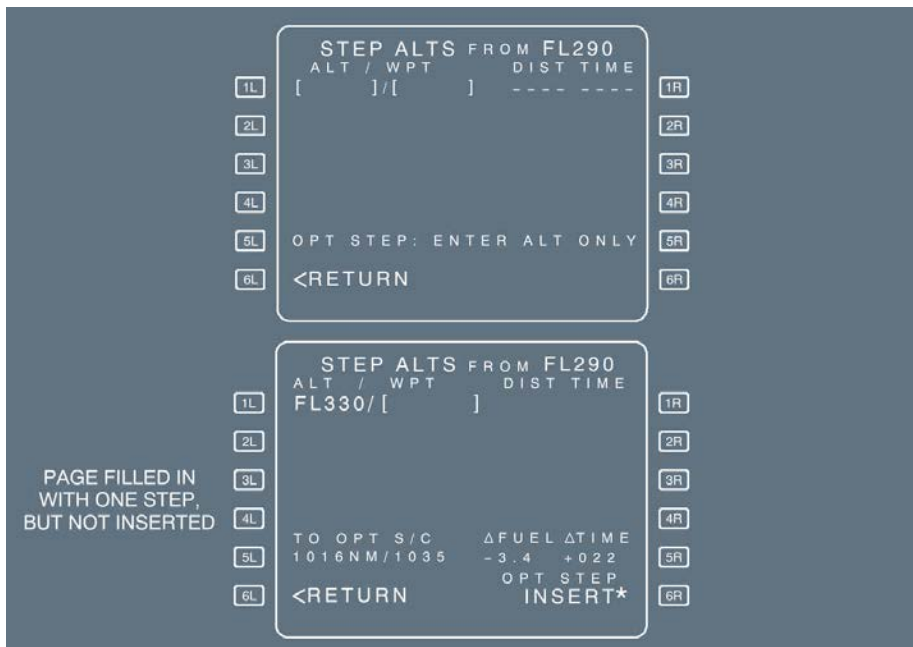

TITLE [1L] - [1R] [4L] - STEP ALTS in white followed by the current cruise altitude in green. [4R]

ALT/WPT {blue} : The waypoint identifier, as well as the altitude to step, can be entered in this field. Both are displayed in large font. The waypoint may either be an active (or secondary) flight plan waypoint, or an inserted optimal point (OPT). When an entry is made, a temporary F-PLN is created.

DIST / TIME (UTC)
 (small green font)

Displays the distance to go, and time from the present aircraft position along the flight plan to the step point.

Note: The following messages may be displayed in the DIST/TIME field:

- ABOVE MAX , if the step altitude exceeds the MAX altitude.
- "IGNORED", if the step start or end point is less than 50 NM from the top of descent or if the step climb is located prior to the top of climb or after the top of descent.
- "STEP AHEAD", when the aircraft is within 20 NM of the start step point.
- "NO OPTIMAL" if a non inserted optimal step falls in a discontinuity due to a flight plan change, or when no new optimal exists after an UPDATE or when no optimal step point exists for the entered altitude.

Note: If no optimal step point exists for the altitude displayed in [1L], the "NO OPTIMAL" message is displayed in the FUEL/TIME field. This message is also displayed, if the optimal step falls into a discontinuity.

[5L] OPT STEP:
 ENTER ONLY ALT
 (white) TO OPT S/C
 (green small front)

This field displays the distance and time to an uninserted optimal step point, if one exists. It is displayed to guide the flight crew for the entry format of an optional step.

Note: On any flight plan change, an inserted optimal step remains in the flight plan at a fixed distance to destination.

[6L] RETURN
 [5R] SAVINGS

The flight crew presses this key to return to the previous page.

This field displays the fuel and time savings prior to the insertion of the optimal step point.

Fuel savings are displayed in thousand of kilograms (or pounds) (maxi 99.9).

The value is preceded by:

"-" in case of fuel saving,

"+" in case of additional fuel cost.

Time savings are displayed in hours and minutes. The value is preceded by

"-" in case of time saving,

"+" in case of additional time cost.

[6R] INSERT* (amber) This field displays INSERT*, when an optimal step point exists but is not yet inserted. When INSERT is selected:

- The optimal step point is inserted into the flight plan.
- OPT is displayed in line 1L.
- Optimal step distance and time are deleted in line 5L.
- The UPDATE* blue prompt replaces the INSERT* prompt.

UPDATE* This prompt enables the computation of another optimal step point. The UPDATE* prompt is then replaced by the INSERT* prompt.

RTA PAGE

Ident.: DSC-22_20-50-10-25-00000575.0009001 / 14 MAY 12

Applicable to: ALL

The Required Time of Arrival (RTA) page allows the entry and display of a waypoint identifier, with associated time constraints. The page also displays the entered or computed Estimated Takeoff Time (ETT), as well as the following data:

- Predicted ETA at the time-constrained waypoint;
- Performance adjusted SPD target;
- Time error;
- Distance to time constrained waypoint;
- Active speed mode;

The flight crew calls up this page with the RTA prompt from the vertical revision page.



TITLE RTA (large white font)

| | |
|----------------|--|
| line 1 | <p>This line displays:</p> <ul style="list-style-type: none"> - AT WPT , DIST and RTA when a time constraint can be defined. The identifier of the revised waypoint or the first following waypoint at which the time constraint can be defined, is displayed by default in large blue font - AT WPT , DIST and RTA when a time constraint has already been defined. The associated constrained waypoint identifier is displayed by default in large blue font - AT WPT and white dashes when no time constraint can be defined - AT WPT and blue brackets if a time constraint can only be introduced before the waypoint at which the VERT REV has been initiated. <p>Only when the waypoint identifier has been defined (by the flight crew or by default), blue brackets and a blue star are displayed in [1R] field.</p> <p>The flight crew enters the time constraint as "HHMMSS", preceded by:</p> <ul style="list-style-type: none"> - for at or before; + for at or after; no sign for at. |
| [2L] MANAGED | <p>This field displays the FMGS -computed ECON speed/Mach (<i>Refer to DSC-22_20-40-10 Optimization</i>)</p> |
| [3L] ACT MODE | <p>This field displays the active speed mode : MANAGED or SELECTED/NNN (NNN is the selected target speed). The pilot cannot modify it through this field.</p> |
| [6L] RETURN | <p>The pilot presses this key to revert the display to the VERT REV page.</p> |
| [2R] ETA | <p>When a required time at arrival has been defined, the 2R field displays the estimated time of arrival as "HHMMSS".</p> |
| [3R] RTA ERROR | <p>This field is blank when the RTA is predicted as made. If the RTA is predicted as missed, "RTA ERROR" is displayed in small white font, and the time error between ETA and RTA is displayed in small amber font.</p> |
| [6R] ETT | <p>The Estimated Takeoff Time (ETT) field is available in the preflight phase. If no ETT is available, the 6R field displays blue brackets and a blue star. Once available, the ETT is displayed in magenta.</p> |
| UTC | <p>Universal time is displayed in green for takeoff, climb, cruise, descent and approach phases.</p> |

DATA INDEX PAGES

Ident.: DSC-22_20-50-10-25-00000576.0001001 / 17 MAR 11

Applicable to: ALL

There are two INDEX pages:

The DATA INDEX 1/2 page gives access to various pages devoted to navigation.

The DATA INDEX 2/2 page lists the navigation data, entered in the FMGS.

The pilot enters those items labeled “stored” and can modify them. The pilot can call up the others, but cannot modify them.

The pilot calls up these pages by pressing the DATA key on the MCDU console:

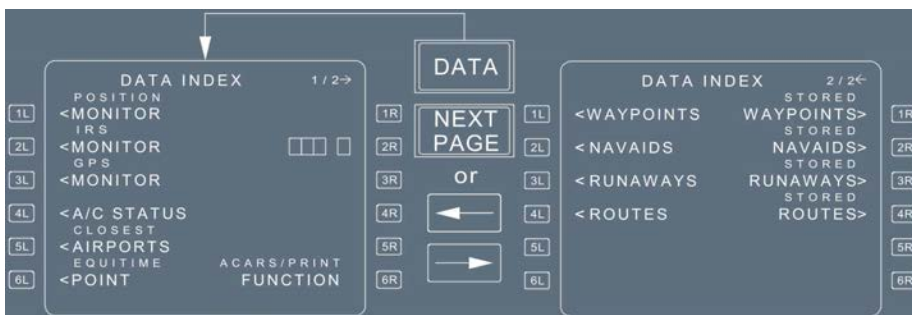

DATA INDEX 1/2 PAGE

- | | |
|--|---|
| [1L] POSITION MONITOR - [2L] IRS MONITOR | When the flight crew presses these keys, the display shows all essential navigation data. |
| [3L] GPS MONITOR | This key calls up the GPS MONITOR page. |
| [4L] A/C STATUS | This key calls up the aircraft status page. |
| [5L] CLOSEST AIRPORTS. | This key calls up the closest airports page. |
| [6L] EQUITIME POINT | This key calls up the equitime point page. |
| [6R] ACARS/PRINT | This key calls up the PRINT function pages and the ACARS function pages. |

DATA INDEX 2/2 PAGE

[1L] WAYPOINTS

[2L] NAVAIDS

[3L] RUNWAYS

[4L] ROUTES

[1R] STORED WAYPOINTS

[2R] STORED NAVAIDS

[3R] STORED RUNWAYS

[4R] STORED ROUTES

These keys call up descriptions of waypoints, NAVAIDs, runways, and routes stored in the database, so that they can be reviewed.

These keys call up waypoints, NAVAIDs, runways, and routes that the pilot has stored, enabling the pilot to review and store them in, or delete them from, the database.

The airline can choose to automatically have all pilot-stored data erased in the done phase.

WAYPOINT/STORED WAYPOINT/NEW WAYPOINT PAGES

Ident.: DSC-22_20-50-10-25-00000577.0001001 / 01 OCT 12

Applicable to: **ALL**

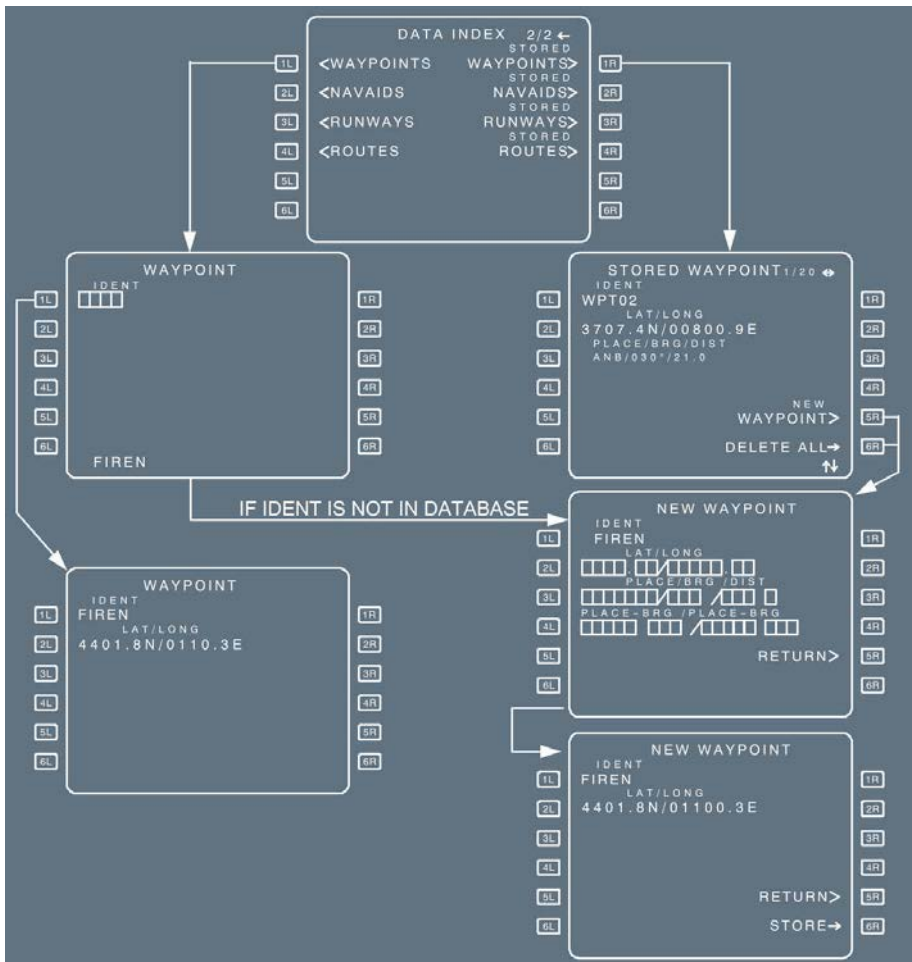

WAYPOINT PAGE

- The pilot can call up this page by pressing the 1L key on the DATA INDEX page. The display then shows waypoint information associated with the identifier the flight crew inserts it in the [1L] field.
- With this page it is possible to call any waypoint not stored in the stored waypoint list, if they belong to the active, temporary, or secondary flight plan.

STORED WAYPOINT PAGE

The pilot calls up this page by pressing the 1R key on the DATA INDEX page. This page displays waypoints, defined and stored by the pilot. It lists each stored waypoint, along with a number that shows the relative order in which it was inserted in the database. This number is displayed in the upper righthand corner of the page. For example, "1/20" indicates that the waypoint was the first of 20 stored.

Note: Latitude/Longitude crossing points and Abeam/Radial Intercept points are never included in the stored waypoint list.

- | | |
|------------------------|---|
| [1L] IDENT | To delete a waypoint, the pilot clears the 1L ident display. |
| [2L] LAT/LONG | Latitude and longitude of the waypoint are displayed in this field. |
| [3L] | This field either displays PLACE/BRG /DIST or PLACE-BRG/ PLACE-BRG or PLACE/DIST, depending on how the waypoint was defined. |
| [5R] NEW WAYPOINT | The pilot presses this key to call up the NEW WAYPOINT page. |
| [6R] DELETE ALL | The pilot presses this key and the label changes to amber CONFIRM DELETE ALL. Pressing this key a second time deletes all the waypoints, stored by the flight crew, except those currently used in the active or secondary flight plan. ("F-PLN ELEMENT RETAINED" appears on the MCDU). |

NEW WAYPOINT PAGE

- The pilot calls up this page by pressing the 5R key on the STORED WAYPOINT page.
- The pilot can use this page to define and store up to 20 waypoints. Entering an additional waypoint deletes the first one.
The pilot defines a waypoint by entering its ident in the data field next to 1L, then by entering its position in the amber boxes.
The STORE prompt appears next to 6R when the boxes are filled in, and the pilot presses the key to store the waypoint in the database.
If the pilot enters the waypoint's position as place/bearing/distance, or place-bearing/place-bearing, the FMGC computes its latitude and longitude.

NAVAID/STORED NAVAID/NEW NAVAID PAGES

Ident.: DSC-22_20-50-10-25-00000578.0001001 / 01 OCT 12

Applicable to: ALL

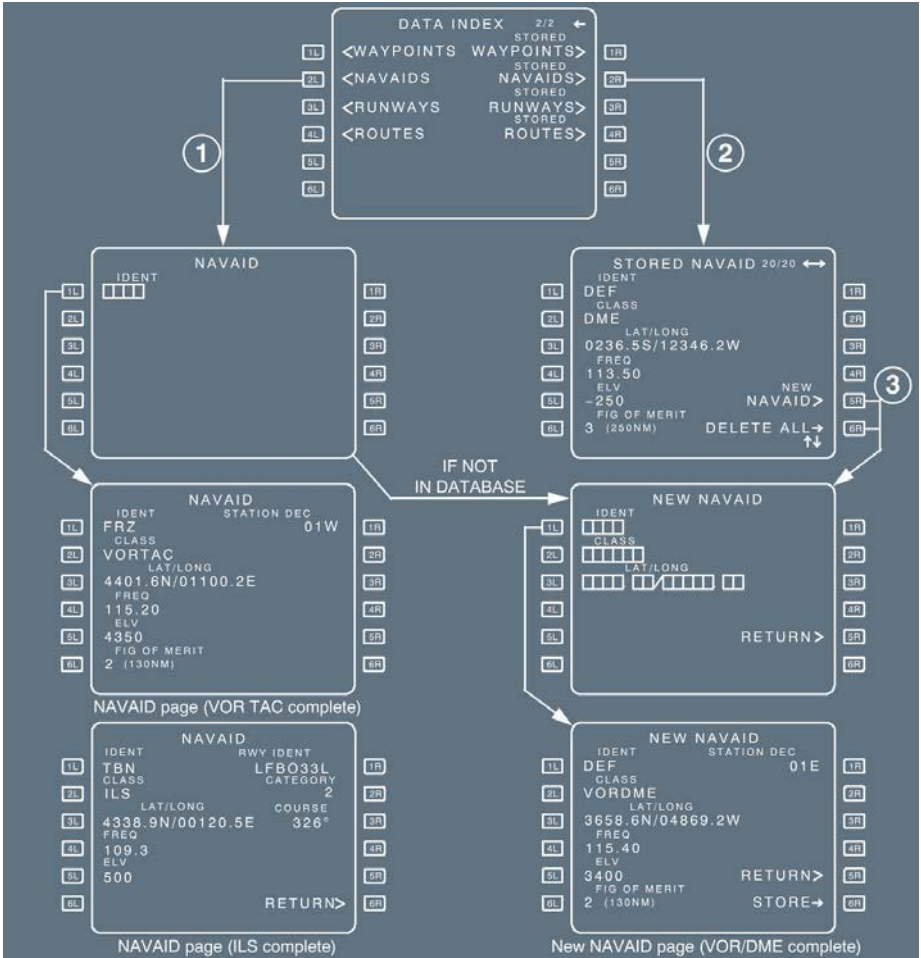

NAVAID PAGE

The pilot calls up this page by pressing the 2L key on the DATA INDEX page 2.

This page displays NAVAID information associated with the identifier the pilot inserts in the [1L] field.

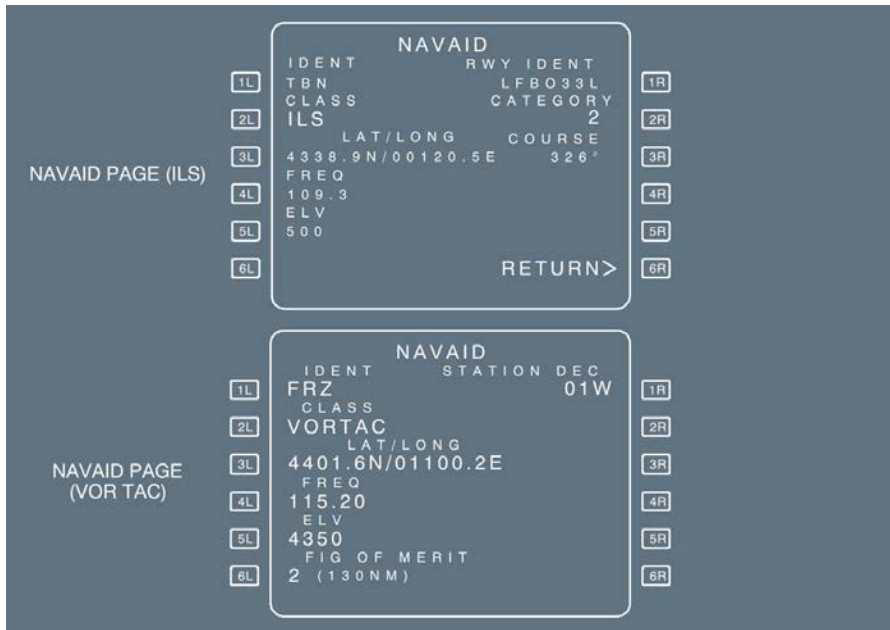

- [2L] CLASS This field identifies the NAVAID as VOR , DME , VOR DME , VORTAC, NDB , LOC , ILS , MLS , ILS /DME , MLS /DME , ILS /TAC or TACAN. It displays NON COLLOCATED, if the NAVAID is uncollocated.
- [4L] FREQ or CHAN CHAN is displayed, if the class of NAVAID is an MLS or an MLS DME.
- [5L] ELV This field gives the NAVAID elevation in feet above sea level. It is not displayed for VOR or NDB.
- [6L] FIG OF MERIT This field shows how far out the FMGS can autotune a VOR , VOR /DME , VORTAC, or DME for display or for computing position.
 - 0 : up to 40 NM
 - 1 : up to 70 NM
 - 2 : up to 130 NM
 - 3 : up to 250 NM

| | |
|---|---|
|  <p>A318/A319/A320/A321 FLIGHT CREW OPERATING MANUAL</p> | <p>AIRCRAFT SYSTEMS</p> <p>AUTO FLIGHT - FLIGHT MANAGEMENT</p> <p>CONTROLS AND INDICATORS - MCDU - PAGE DESCRIPTION</p> |
|---|---|

- [1R] STATION DEC or RWY IDENT This is the magnetic declination in the NAVAID area (used only for VOR , VOR /DME, and VORTAC).
The field displays RWY IDENT , if the NAVAID is a LOC , ILS , MLS , ILS /DME , MLS /DME or ILS/TAC.
- [2R] CATEGORY This field shows the NAVAID 's category, if it is an ILS , ILS /DME , MLS , MLS /DME or ILS /TAC. A LOC DME has a category = 0.
- [3R] COURSE This is the localizer course, if the NAVAID is an ILS or a LOC.
- [6R] RETURN This prompt is displayed, if the page has been accessed from the SELECTED NAVAID page. The pilot presses this key to return to the SELECTED NAVAID page.

STORED NAVAID PAGE

The pilot calls up this page by pressing the 2R key on the DATA INDEX page. This page is used to display or delete defined and stored NAVAIDs.

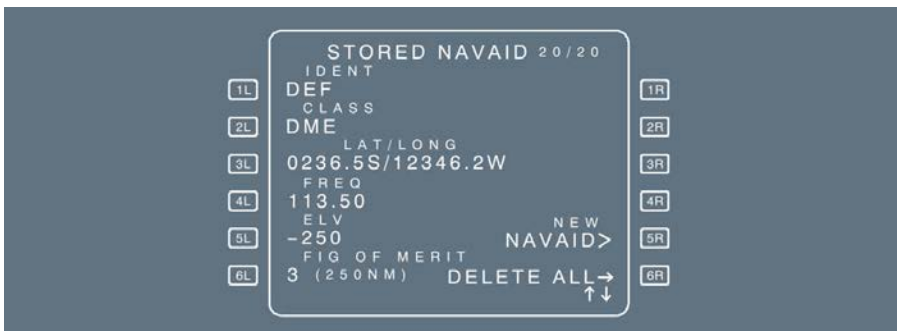

A number in the upper righthand corner of the screen shows the relative order in which the NAVAIDs were stored. (For example, 3/7 means the third out of the seven stored).

Slew keys give the pilot access to the different stored NAVAIDs.

- [1L] IDENT The pilot deletes a stored NAVAID by entering its ident in this field, then by pressing the CLR key at the bottom of the MCDU control panel.
- [6R] DELETE ALL and CONFIRM The pilot presses this key to erase all the stored NAVAID s, except those currently used in the active or secondary flight plan. (The MCDU displays "F-PLN ELEMENT RETAINED.").

NEW NAVAID PAGE

The pilot calls up this page by pressing the 5R key on the STORED NAVAID page.

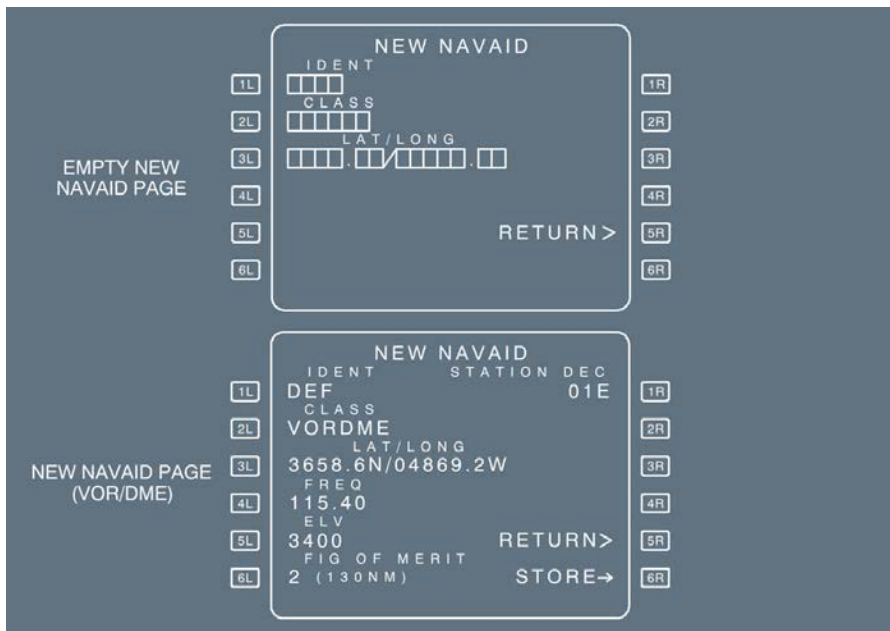

It can be used to define and store up to 20 NAVAID s. Entering an additional waypoint deletes the first one. The NAVAID elements must be entered in two steps:

1. Enter the data in the lines of amber boxes.
2. Enter frequency, elevation, figure of merit, and station declination or ILS category and course, if applicable.

Note: *The pilot cannot create an ILS /DME or an uncollocated NAVAID. If the runway associated with the ILS has been entered through the new runway page, the course, IDENT , and runway IDENT are already displayed on the new NAVAID page when it comes up (copied from the new runway page). For details, see the new runway page info below.*

- [1R] STATION DEC The pilot must enter the magnetic declination, if the prompt is displayed. This prompt is displayed only for VOR , VORTAC or VOR /DME.
- [3R] COURSE If the NAVAID is an ILS , LOC, enter the course.
- [6R] STORE This prompt appears when all the amber boxes are filled in. The pilot presses the key to store the NAVAID.

A stored NAVAID is never used for position computation.

RUNWAYS/STORED RUNWAYS/NEW RUNWAY PAGES

Ident.: DSC-22_20-50-10-25-00000579.0001001 / 17 MAR 11

Applicable to: ALL

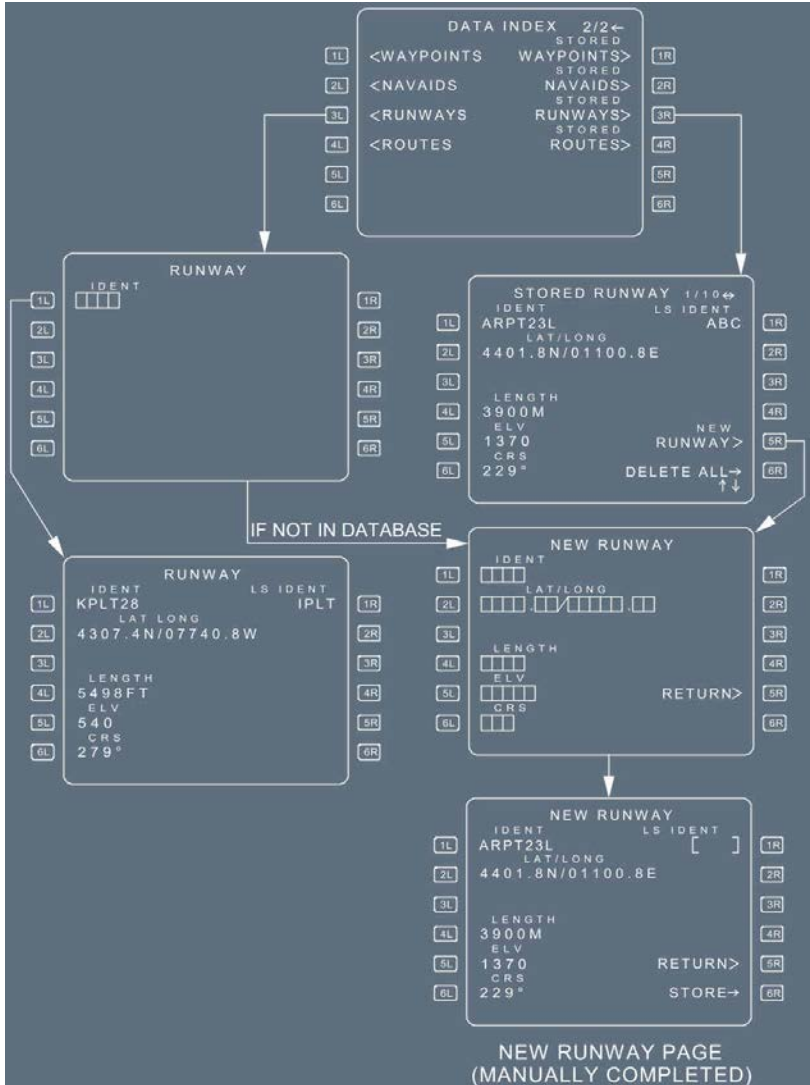

RUNWAY PAGE

This page displays the following information:

- [1L] IDENT The runway IDENT, which comprises the airport identification and the runway direction, uses six or seven digits (Example: CYYZ 24L and LFRJ 08).
- [2L] LAT/LONG The latitude and longitude of the runway threshold.
- [4L] LENGTH The runway length in meters (M) or feet (ft), in five digits (9 999 ft).
- [5L] ELV The elevation of the threshold in feet above sea level.
- [6L] CRS The runway course (degrees magnetic).
- [1R] LS IDENT The LOC or ILS identifier.

STORED RUNWAY PAGE

The pilot uses this page to display or delete the defined and stored runways. The stored runways are listed and numbered in the order in which they were inserted. The number is displayed in the upper righthand corner of the page. (For example, 2/4 means the runway is the second of the four stored runways).

The pilot can delete any stored runway from the database by displaying its IDENT in the 1L field, then by pressing the CLR key on the MCDU control panel.

- [6R] DELETE ALL The pilot presses this key to erase all the stored runways, except those and CONFIRM used in the active or secondary flight plan. (The MCDU displays "F-PLN DELETE ALL ELEMENT RETAINED").
- [1L] to [6L] These fields are similar to the RUNWAY page fields.

NEW RUNWAY PAGE

The pilot can use this page to define and store up to 10 runways.

- **When the pilot enters an ILS /LOC IDENT in the [1R] field the new NAVAID page comes up. When the pilot has entered and stored the necessary data in the new NAVAID page, the new runway page reappears.**

The new runway page and the new NAVAID page (ILS /LOC) are not independent:

- **When the flight crew first defines the ILS /LOC (on the new NAVAID page) the new runway page, when called up, already displays the RWY course, RWY IDENT , and ILS IDENT (copied from the new NAVAID page).**
- **When the flight crew first defines the runway (on the new runway page) the new NAVAID page, when called up, already displays the ILS course, ILS IDENT , and runway IDENT.**

The pilot must enter the two runway directions on two different new runway pages (Example: LFRJ 08 and LFRJ 26) to allow the flight plan to select either one.

Note: When 10 runways are stored, entering a new stored runway deletes the first one of the list (1/10).

- [1L] to [6L] Enter information about the new runway.
- [1R] LS IDENT Enter the ILS /LOC IDENT . The NEW NAVAID page comes up.
- [5R] RETURN The pilot presses this key to return to the NEW NAVAID page.
- [6R] STORE This prompt only appears when all the amber boxes have been filled in.

Note: The NEW RUNWAY may be used for departure or destination, but no SID or STAR can be associated or stored with this runway. Therefore, the pilot will use it as an "independent" airport.
A new runway is identified by the 4-letter ICAO airport identifier, although all six or seven digits must be entered.

ROUTE/STORED ROUTE/NEW ROUTE PAGES

Ident.: DSC-22_20-50-10-25-00000580.0001001 / 01 OCT 12

Applicable to: ALL

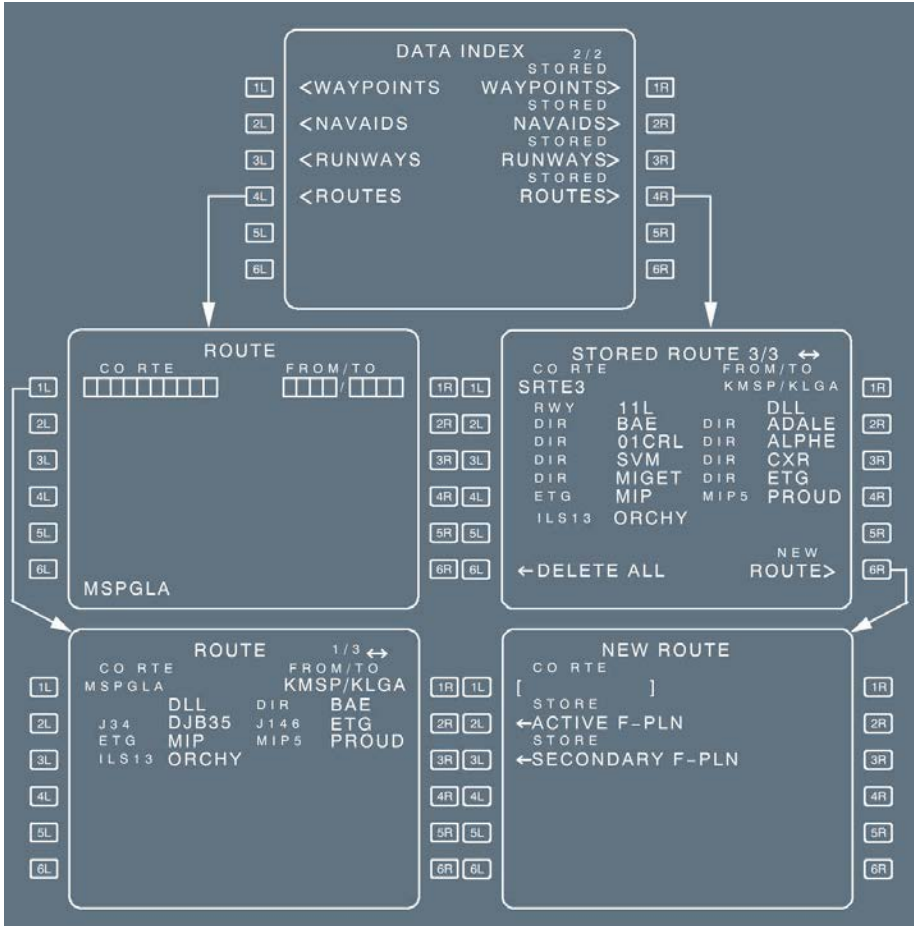

ROUTE PAGES

(Not-modifiable)

[1L] CO RTE

Any company route IDENT, entered in this field, causes all the elements of the route to be displayed.

Line 2 to Line 6 These lines display the various route elements, including waypoints and airways.

[1R] FROM/TO This field is automatically filled in, when the pilot enters the IDENT for a company route. When the pilot manually enters a city pair, the MCDU displays “NOT IN DATA BASE” if the city pair is not in the navigation database. If the city pair is in the database, the CO RTE field displays the first route stored (small blue font). If more than one route is stored, the pilot can slew to see the different routes.

STORED ROUTE PAGE



This page displays up to 5 routes, stored by the pilot. The stored routes are listed and numbered in the order of insertion. The number is displayed in the upper right-hand corner of the page.

[1L] CO RTE This field identifies the stored route. Clearing this field deletes the stored route.

Line 2 to Line 5 The fields in these lines are identical to the corresponding fields in the route page.

[6L] DELETE ALL Pressing this key changes the label to amber CONFIRM DELETE ALL. Pressing this key a second time deletes all previously-stored routes.

[1R] FROM/TO This identifies the city pair of the stored route.

[6R] NEW ROUTE Pressing this key calls up the new route page.

NEW ROUTE PAGE

The pilot calls up this page by pressing the NEW ROUTE key on the stored route page. It can be used to store up to five new routes that have already been defined in the active or secondary flight plan.

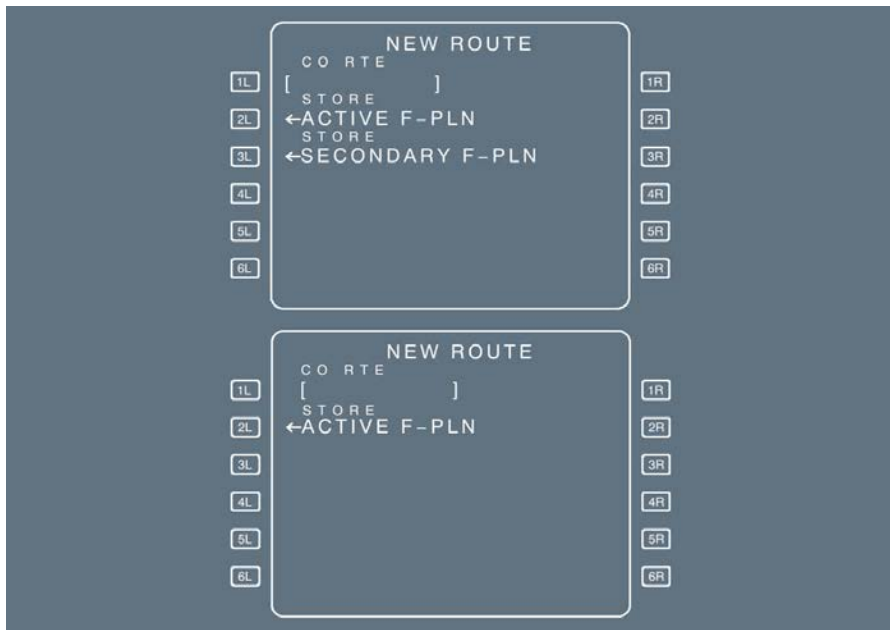

- [1L] CO RTE This field enables the pilot to enter a new company route IDENT . If that IDENT has already been assigned, the entry is rejected.

- [2L] STORE ACTIVE F-PLN (blue) Pressing this key stores parameters of the active flight plan as new route. The display shows this prompt when the system contains a FROM/TO, but only during preflight.

- [3L] STORE SECONDARY F-PLN (blue) Pressing this key stores parameters of the secondary flight plan as new route. The display shows this prompt when the system contains a FROM/TO and the secondary flight plan has not yet been sequenced.

- Note:
- If it has not already been named, a stored route is automatically named when stored: SRTE 1 to SRTE 5.
 - When 5 routes are already stored, the pilot cannot insert a new stored route. The “STORED ROUTE FULL” message is displayed, and the pilot must manually delete a route in order to store a new one.
 - Several flight plan elements are not retained when the route is stored:
 - Pilot-entered holds
 - Offset
 - Pilot-entered constraints
 - Modifications to terminal procedures
 - Pseudo-waypoints
 - Step at optimum.
 - Pilot-entered constant Mach segment.
 The MCDU then displays “REVISIONS NOT STORED”.

| |
|-----------------------------|
| AIRCRAFT STATUS PAGE |
|-----------------------------|

Ident.: DSC-22_20-50-10-25-00000581.0001001 / 28 APR 14
 Applicable to: ALL

The system automatically displays this page at power up, but the pilot may also call it up by pressing the DATA key on the MCDU console.



TITLE **AIRCRAFT TYPE**

[1L] ENGINE TYPE The system uses this to calculate predictions.

Note: When the same performance database is used for various aircraft configurations, the aircraft type displayed may differ from the actual aircraft.

- [2L] ACTIVE DATABASE The validity period and part number are displayed in large font.
- [3L] SECOND DATABASE The validity period is displayed in small font. The pilot can press the 3L key to switch to the second database as the active database.

CAUTION Cycling the database erases the primary and secondary flight plans, as well as the stored data. The flight crew must never do this in flight.

- [5L] CHG CODE This field allows the entry of a code to change the IDLE and/or PERF factor, displayed in 6L. It is displayed in the PREFLIGHT and DONE phases. The label is displayed in small white font. The brackets, or the entered value, is displayed in large blue font.

- [6L] IDLE/PERF It is only possible to modify these factors when the aircraft is on ground. If no value was entered, the FMS displays default values coded in the Airline Modifiable Information (AMI) file. Default values are displayed in small font, although manually entered values are displayed in large font.

When it is necessary to modify the IDLE or the PERF factor:

- ENTER the change code in the CHG CODE field [5L].
 The default value for this code is "ARM" but it is possible to modify it on airline request (the applicable code is then coded in the Airline Modifiable Information (AMI) file).
 When a valid change code is entered, the IDLE and PERF factors are displayed in blue.
- ENTER the new IDLE and/or PERF factor(s) in the scratchpad.
- PRESS the [6L] key to insert the new IDLE and/or PERF factor(s).
 The new IDLE and/or PERF factor(s) is (are) displayed in large blue font.

- [4R] STORED This field displays pilot-stored data in a large green font. The field is blank, if no data is stored. (The airline can choose to have this data automatically erased at the done phase).
- [5R] DELETE ALL Pressing this key changes the label to amber CONFIRM DELETE ALL. Pressing this key a second time deletes all pilot-stored data, except data that is part of the active and secondary flight plans.
- [6R] STATUS/XLOAD This prompt gives access to the P/N STATUS and P/N XLOAD pages.

P/N XLOAD PAGE

Ident.: DSC-22_20-50-10-25-00000582.0001001 / 17 MAR 11

Applicable to: ALL

This page allows the crossloading of all databases or configuration files part numbers which are different between both sides. Crossloading from this page avoids reviewing each individual P/N STATUS page.



- | | |
|----------------|---|
| TITLE | P/N XLOAD |
| [1L] | FMS 1 UPDATE: FMS 1 can be loaded on the right side MCDU. FMS 2 UPDATE: FMS 2 can be loaded on the left side MCDU |
| [4L] | START XLOAD: This blue prompt is displayed, only if the system detects a difference between both sides' part numbers. FMS 1/FMS 2 IDENTICAL: Displayed in green, when there is no difference between both sides' part numbers. |
| Line 5 | FM 1 TO FM 2 or FM 2 TO FM 1: Indicates the crossloading direction. This line is not displayed when there is no difference between both side part numbers. |
| [5L] | A/C STATUS: This white prompt is displayed, when there is no crossloading in process. It gives access to the A/C STATUS page. MM: SS MIN REMAINING: Indicates the time remaining for crossload completion, when a crossload is in process. |
| [6L] PREV PAGE | The pilot presses this key to return to the A/C STATUS page. |
| [6R] NEXT PAGE | Pressing this key calls up the next P/N XLOAD page. |

P/N STATUS PAGES

Ident.: DSC-22_20-50-10-25-00000583.0001001 / 01 OCT 12

Applicable to: **ALL**

These pages allow reviewing and crossloading the following databases and configuration files between both FMS:

- Page 2 FMS SOFTWARE part numbers
- Page 3 NAV DATA BASE part numbers
- Page 4 FM AIRLINE CONFIG part numbers
- Page 5 FM OPTIONS CONFIG part numbers
- Page 6 PERF DATA BASE part numbers
- Page 7 FLIGHT TEST DATA BASE

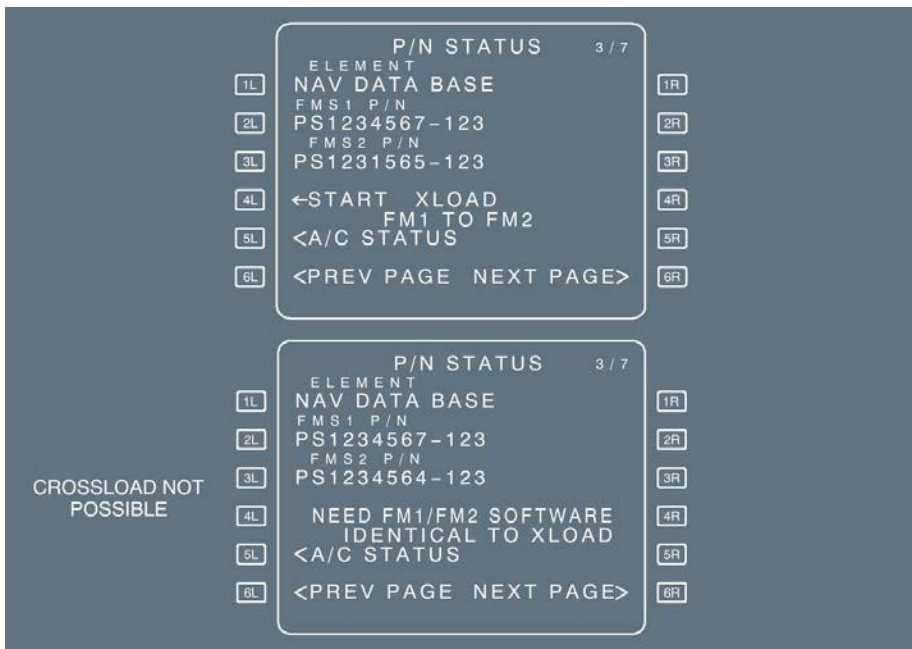

P/N STATUS 3 / 7

ELEMENT

NAV DATA BASE

FMS 1 P/N

PS1234567-123

FMS 2 P/N

PS1231565-123

←START XLOAD

FM1 TO FM2

<A/C STATUS

<PREV PAGE NEXT PAGE>

CROSSLOAD NOT POSSIBLE

P/N STATUS 3 / 7

ELEMENT

NAV DATA BASE

FMS 1 P/N

PS1234567-123

FMS 2 P/N

PS1234564-123

NEED FM1/FM2 SOFTWARE IDENTICAL TO XLOAD

<A/C STATUS

<PREV PAGE NEXT PAGE>

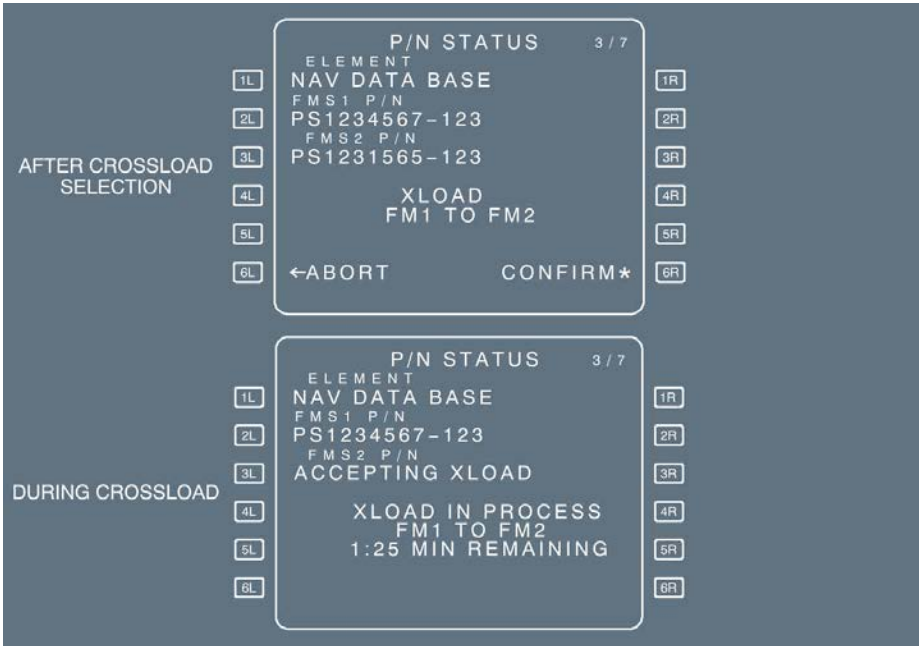

TITLE

P/N STATUS

Line 1 ELEMENT

Indicates the name of the database or configuration file that can be crossloaded:

- FMS SOFTWARE on Page 2
- NAV DATA BASE on Page 3
- FM AIRLINE CONFIG on Page 4
- FM OPTIONS CONFIG on Page 5
- PERF DATA BASE on Page 6
- FLIGHT TEST DATABASE on Page 7.

Line 2 FMS1 P/N Line 3 FMS2 P/N

These fields display the part numbers of the database or configuration file (stated on line 1), that are installed on the FMS 1 and 2.

Identical part numbers are displayed in green, different ones in amber. During crossload, the updated part number is replaced by the amber “ACCEPTING XLOAD” message.

| | |
|----------------------------|--|
| Line 4 | <p>This line is empty when the active flight phase is not Preflight or Done.</p> <p>XLOAD FMx TO FMy or START XLOAD FMx TO FMy: This blue prompt is displayed when the database or configuration file (stated on line 1) can be crossloaded.</p> <p>XLOAD ARMED: Displayed in blue on the receiving FM when the crossload has been requested, but not yet confirmed.</p> <p>XLOAD IN PROCESS: Displayed in white when the crossload is ongoing.</p> <p>XLOAD NOT SUPPORTED: Crossloading is unavailable for this element.</p> <p>NO P/N TO XLOAD: The element is missing.</p> <p>NEED FG 1/FG 2 IDENTICAL TO XLOAD: The receiving side's FG software is incompatible with the FG software to be crossloaded.</p> <p>NEED FM 1/FM 2 SOFTWARE IDENTICAL TO XLOAD: The crossloaded element is incompatible with the receiving side's FM software.</p> |
| [5L] A/C STATUS | <p>This prompt is available, when no crossload is in process. This gives the pilot access to the aircraft status page.</p> <p>MM: SS MIN REMAINING: Displays the time remaining to complete the crossload, when a crossload is in process.</p> |
| [6L] PREV PAGE ABORT | <p>This key calls up the previous P/N STATUS page.</p> <p>This amber prompt is displayed when a crossload is in process. The pilot uses it to stop the crossload.</p> |
| [6R] NEXT PAGE CONFIRM* | <p>This key calls up the next P/N STATUS page.</p> <p>This amber prompt is displayed when a crossload has been armed. The pilot presses it to start the crossload.</p> |

DUPLICATE NAMES PAGE

Ident.: DSC-22_20-50-10-25-00000584.0001001 / 01 OCT 12

Applicable to: **ALL**

This page, which automatically appears, allows the pilot to select a specific waypoint, airport, or NAVAID when the database holds more than one under the same identifier.

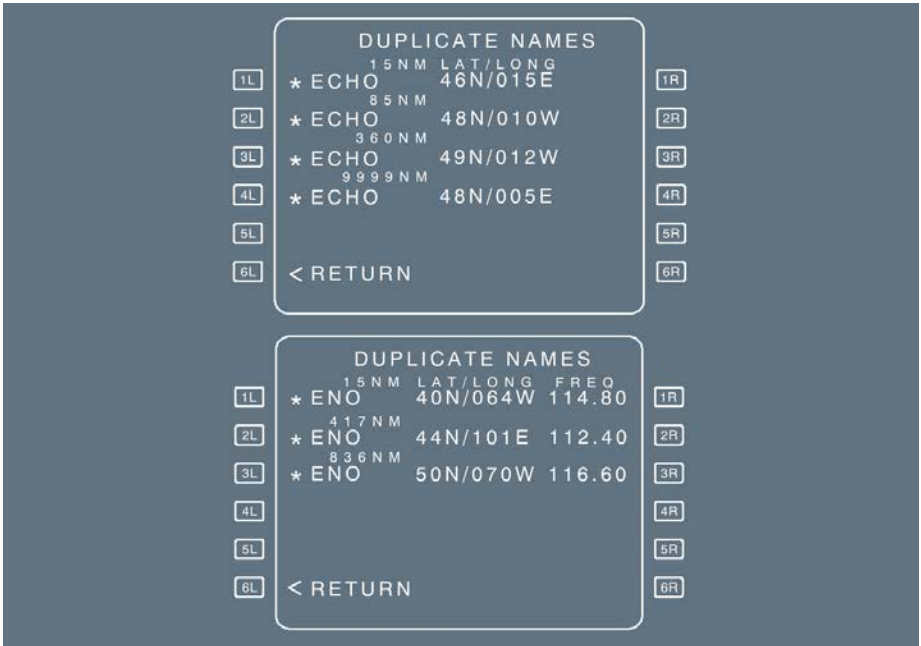

The pilot presses the key adjacent to a waypoint, NAVAID, or airport to select it as the one to be entered. When the pilot has finished, the page automatically reverts to the previously displayed page.

DISTANCE

The direct distance to the aircraft is displayed in green above each name. If this distance is greater than 9 999 NM, 9 999 NM is displayed.

LAT /LONG COLUMN

This column lists the rounded off latitudes and longitudes of the different points, using the same identifier.

FREQ/CHAN COLUMN

This column lists the NAVAID s frequencies, if any. It displays CHAN for a MLS.

- Note:
- The *DUPLICATE NAMES* page is not displayed when 2 waypoints with the same *IDENT* belong to the same airway. The system selects the first waypoint found in the database.
 - The waypoints or *NAVAIDs* are ranked by their distance from the aircraft position.
 - When a waypoint is named using ICAO phonetic alpha characters, a minus sign and the ICAO code of the country where the waypoint is located, are displayed. e.g. Alpha in France becomes A-LF; Bravo in England becomes B-EG.

POSITION MONITOR PAGE

Ident.: DSC-22_20-50-10-25-00000585.0001001 / 17 MAR 11

Applicable to: ALL

This page displays all the different positions that the FMGC has computed with the various available methods of navigation. It also shows which method obtained each position. (The positions should be almost identical).

The pilot calls up this page by pressing the 1L key on the data index page.

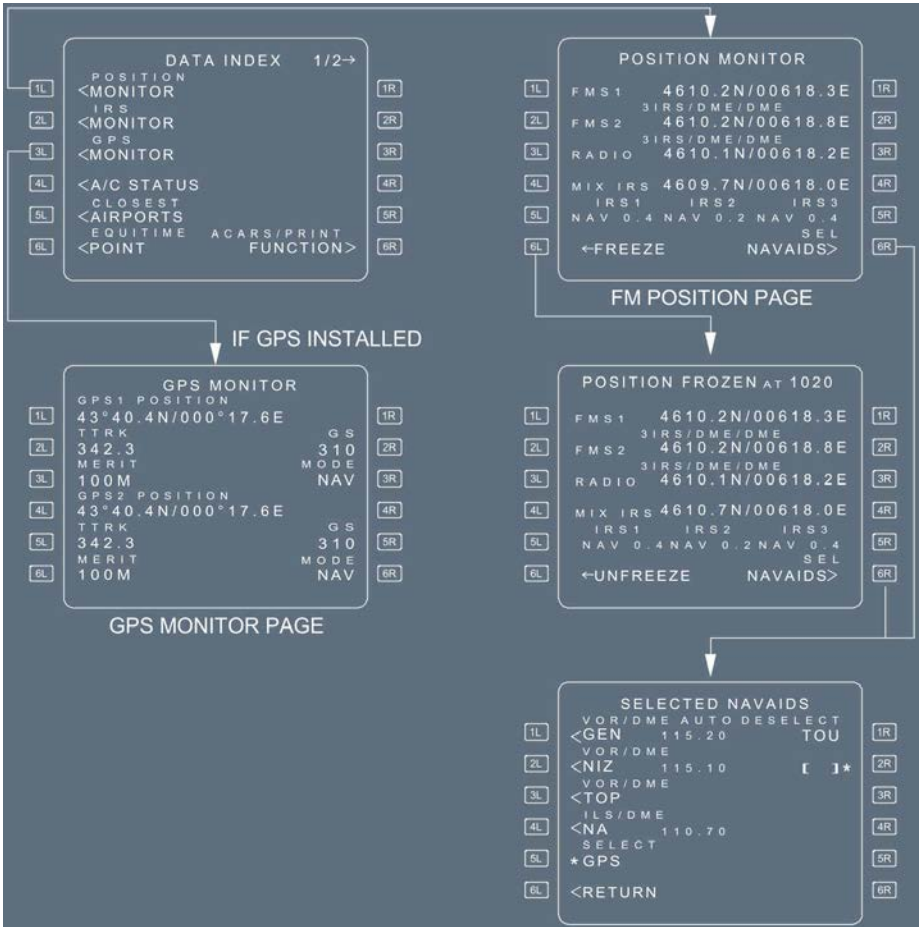

POSITION MONITOR AND POSITION FROZEN PAGE

Ident.: DSC-22_20-50-10-25-00009133.0001001 / 29 MAR 12

Applicable to: ALL

Line 1 FMGC 1

This line shows the latitude and longitude, as calculated by the FMGC 1, and the navigation method used by the FMGC for that calculation (Example: "3 IRS /DME /DME").



- Line 2 FMGC 2 This line shows the latitude and longitude, as calculated by the FMGC 2, and the navigation method used.
- Line 3 RADIO or GPS or GPIRS This line shows the latitude and longitude, calculated by the onside FMGC from selected radio NAVAID s (Example: DME /DME , VOR /DME , or LOC) or from GPS or GPIRS.
- Line 4 MIX IRS This line shows the latitude and longitude of the weighted mean inertial reference system (IRS) calculated by the onside FMGC from the available IRSs.
- Line 5 IRS 1,2,3 This line shows the deviation in nautical miles of each IRS position from the onside FMGC position. It also displays the IRS mode, which can be INVAL, ALIGN, NAV or ATT.
- Note: INVAL is displayed when an ADIRS has failed, or the IRS position is not refreshed.*
- [6L] FREEZE/UNFREEZE The pilot presses this key to freeze (or unfreeze) all the data displayed on the page. When the data is frozen, the title of the page specifies the time at which it was frozen.
- [6R] SEL NAVAIDS The pilot presses this key to access the selected NAVAIDs page.

SELECTED NAVAIDS PAGE

Ident.: DSC-22_20-50-10-25-00000586.0014001 / 03 APR 13

Applicable to: ALL

MODIFIABLE ONLY FOR DESELECTION

- Line 1 This field displays the NAVAID tuned for display purposes, and the tuning mode (AUTO, MAN , or RMP).
- Line 2 and 3 These fields display the NAVAID s, if any, tuned for the calculation of radio position by the FMGC.
- [4L] This field displays the tuned ILS, GLS , MLS , if any.
- [5L] DESELECT/SELECT RADIONAV The flight crew presses this key to manually select or deselect the NAVAIDs.
- If the flight crew selects (deselects) the NAVAID s for position calculation, "RADIONAV SELECTED" ("RADIONAV DESELECTED") is displayed in the label line in blue small font and "DESELECT" ("SELECT") is displayed in white large font. By default NAVAIDs are selected.
- The deselection of the RADIONAV inhibits use of radio position (either DME /DME or VOR /DME) for position calculation.

| | |
|---|--|
| <p>[6L] DESELECT/SELECT GPS</p> | <p>The crew presses this key to manually select or deselect the GPS for position computation. Upon transition to the DONE phase, the prompt returns to DESELECT status.</p> <p>If the pilot deselects the GPS , “GPS IS DESELECTED” is displayed when the aircraft is less than 80 NM from the top of descent, or in approach phase.</p> |
| <p>[1R] DESELECT to [4R]</p> | <p>The pilot deselects a NAVAID by entering its identifier in one of these six fields. Once deselected in this way, the NAVAID can no longer be tuned manually through the entry of its IDENT, nor can it be autotuned for display or determination of the position for the rest of the flight.</p> <p>The deselection is cleared:</p> <ul style="list-style-type: none"> - Manually, by a CLR action into this field, or - Automatically upon transition to the done or preflight phase, or upon activation of the second database. <p>The pilot may deselect as many as four stations.</p> |
| <p>[6R] RETURN</p> | <p>The pilot presses this key to return to the POSITION MONITOR page.</p> |

IRS MONITOR PAGE

Ident.: DSC-22_20-50-10-25-00000587.0010001 / 01 OCT 12

Applicable to: ALL

This page displays the IRS data. The crew calls up this page by pressing the IRS monitor prompt of the DATA INDEX page.

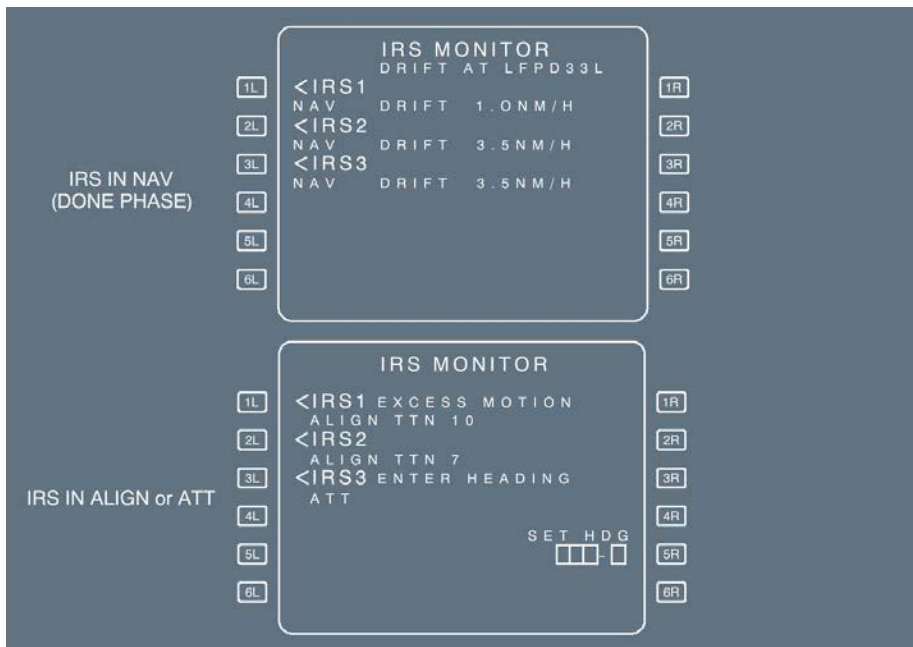

TITLE DRIFT AT XXXX Displays "DRIFT AT" runway identifier, if at least one IRS average drift is displayed. (amber)

[1L] to [3L] IRS 1(2) (3) These prompts allow access to the associated IRS pages. Each label line displays the mode (NAV , ALIGN, ATT or INVAL), the average drift (upon transition to DONE phase), and the Time To NAV (if IRS in align) for each IRS. (white)

[1R] to [3R]

Displays the status message of the associated IRS in small green font.

List of available messages:

IR FAULT
CHECK C/B
DELAYED MAINT
CDU FAULT
ENTER PPOS
ENTER HEADING
SELECT ATT
REENTER PPOS
EXCESS MOTION
SYS BELOW -15 °
SWITCH ADR

[5R] SET HDG (white) This field is displayed, if at least one IRS is in ATT mode.

This function allows initialization of a heading for IRS in ATT mode:

- If a heading has been entered in this field, or on the ADIRS panel, the value is displayed in blue.
- If not, amber boxes are displayed.

IRS 1 (2)(3) PAGE

This page displays the IRS parameters and GPS /IRS hybrid parameters. The pilot calls up this page by pressing either the 1L key from the IRS MONITOR page, or the NEXT IRS prompt on another IRS page (closed loop).

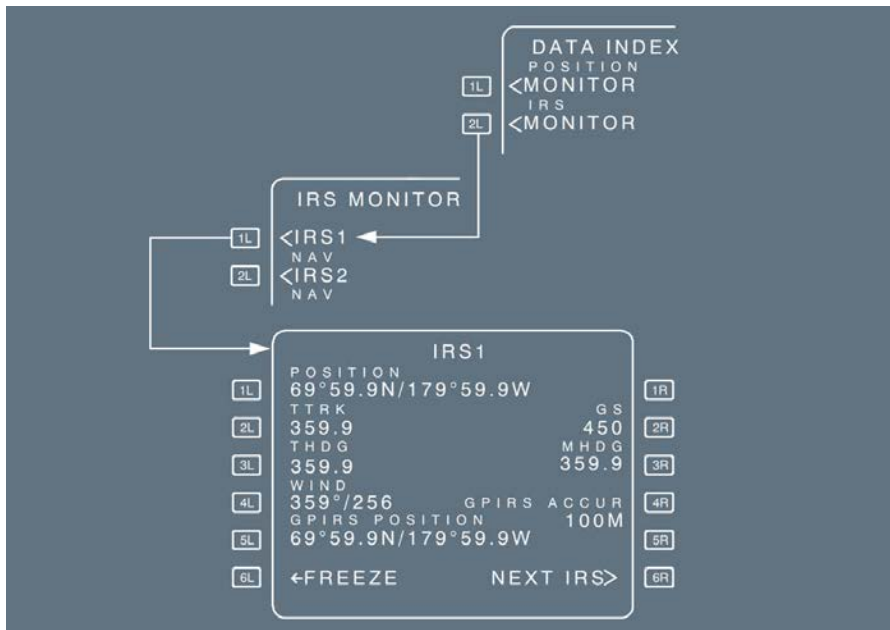

- TITLE** Displays the selected IRS in large white font.
When data is frozen, IRS is replaced by "IRS FROZEN AT", followed by the time at which the pilot has frozen the display.
- [1L] POSITION Displays the latitude/longitude given by the selected IRS.
- [2L] TTRK True track
- [3L] THDG True heading
- [4L] WIND True wind direction/velocity
- [5L] GPIRS GPS /IRS hybrid position of the IRS
- [6L] FREEZE/UNFREEZE Allows the crew to freeze or unfreeze all data displayed on all three IRS pages. When the data is frozen, the title of the page specifies the time at which it was frozen. It is automatically unfrozen when exiting the page.
- [2R] GS Ground speed
- [3R] MHDG Magnetic heading
- [4R] GPIRS ACCUR GPS /IRS Figure of Merit (meters or feet)

[6R] NEXT IRS This prompt enables another IRS page (closed loop IRS 1 → 2 → 3 → 1) to be displayed.

| |
|-------------------------|
| GPS MONITOR PAGE |
|-------------------------|

Ident.: DSC-22_20-50-10-25-00000588.0001001 / 17 MAR 11
Applicable to: ALL

This page displays the GPS data. The pilot calls up this page by pressing the GPS MONITOR prompt of the DATA INDEX page.

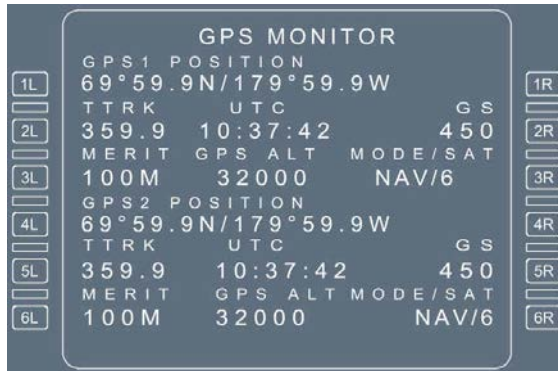

- Line 1 and 4 GPS 1,2 POSITION
- [2L] and [5L] TTRK GPS 1, 2 true track
- [3L] and [6L] MERIT GPS 1, 2 figure of merit (meters or feet)
- [2R] and [5R] GS GPS 1, 2 ground speed
- [3R] and [6R] GPS 1, 2 mode (INIT , ACQ, NAV, TEST, FAULT, AIDED or ALTAID) and
MODE/SAT Number of satellites tracked.
- INIT : System initialization
- ACQ : Satellite acquisition
- NAV : Normal mode
- TEST : System test
- FAULT : Invalid system
- ALTAID/AIDED : Degraded modes. GPS uses aircraft inputs for computation purposes.

- [2] and [5] UTC : GPS 1, 2 UTC
- [3] and [6] GPS : GPS altitude is displayed for information purposes. It is not used by the ALT FMGS.

CLOSEST AIRPORTS PAGES

Ident.: DSC-22_20-50-10-25-00000589.0001001 / 17 MAR 11

Applicable to: ALL

The system automatically selects the closest 4 airports from the current aircraft position, and displays them on these pages. A fifth one can be selected by the pilot.

Page 1 displays the bearing, distance, and time to go to each airport; page 2 displays the EFOB and allows the crew to enter an effective wind to be flown to each airport.

The flight crew accesses the CLOSEST AIRPORTS page 1 by pressing the 5L key from the DATA INDEX A page. They access the CLOSEST AIRPORTS page 2 by pressing the EFOB/WIND prompt (6R key) on page 1.

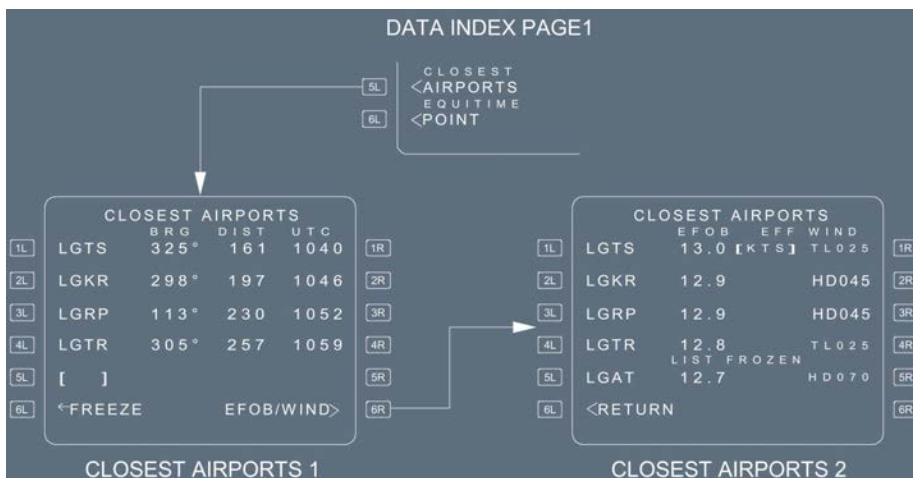

[1L] - [1R] to [4L] - [4R] The closest four airports are extracted from the database, and ranked by distance from the aircraft position.

BRG Displays the current bearing from the aircraft's position to the airport.

DIST Displays the current great-circle distance from the aircraft's position to the airport.

TIME or UTC Displays the predicted time to the airport, computed using the current wind or a wind vector entered on page 2, and the speed according to the current mode (managed or selected).

The time is only computed in cruise phase.

- [5L] The crew may enter a fifth airport here, using the 4-letter code. The entry may be modified at any time, even when "LIST FROZEN" is displayed. If the pilot enters an airport that is not in the database, then "NOT IN DATABASE" appears in the scratchpad.
- [1L] - [1R] EFOB to [5L] Displays the EFOB at each airport. EFOB is only computed in cruise phase.
 - [5R] EFF WIND Used to enter an anticipated headwind or tailwind along the bearing to the airport. If the entry is preceded by +, T, or TL, a tailwind is assumed. If the entry is preceded by -, H, or HD, a headwind is assumed. Before pilot entry, a default value may be displayed, based on the current wind. The effective wind is used to compute the EFOB and time to the airport.
- [6L] This prompt enables the pilot to freeze and unfreeze the list of four airports.
 FREEZE/UNFREEZE The list is automatically frozen when accessing page 2. It will remain frozen upon returning to page 1. The "LIST FROZEN" message is always displayed on page 2.
- RETURN Returns to page 1.
- [6R] EFOB/WIND Gives access to page 2. Pressing this prompt automatically freezes the list of the four closest airports.

Note:

- If the aircraft position becomes invalid, all fields are dashed, FREEZE/UNFREEZE and EFOB /WIND prompts are removed, LIST FROZEN is displayed, and the A/C POSITION INVALID message is displayed in the scratchpad. Page 2 cannot be accessed.
- Predictions (EFOB, TIME) displayed on the page assume:
 - ECON CRZ speed (managed) or current selected speed (selected)
 - CI (for managed speed only) and CRZ FL from primary F-PLN are kept
 - constant wind value
 - In case of engine out, the aircraft altitude is the minimum of (CRZ FL , EO MAX ALT)
 - Downpath steps are not considered
 - Descent fuel burn is a conservative value which only depends on the difference between current CRZ ALT and destination altitude.

EQUI-TIME POINT PAGE

Ident.: DSC-22_20-50-10-25-00000590.0001001 / 18 DEC 12
 Applicable to: ALL

The pilot uses this page to require an equitime point computation between two different points (airport, NAVAID , runway, NDB or waypoint). This pseudo-waypoint (ETP) is displayed on the navigation display along the F-PLN. The EQUI-TIME POINT page is accessed by pressing the 6L key from the DATA INDEX page:

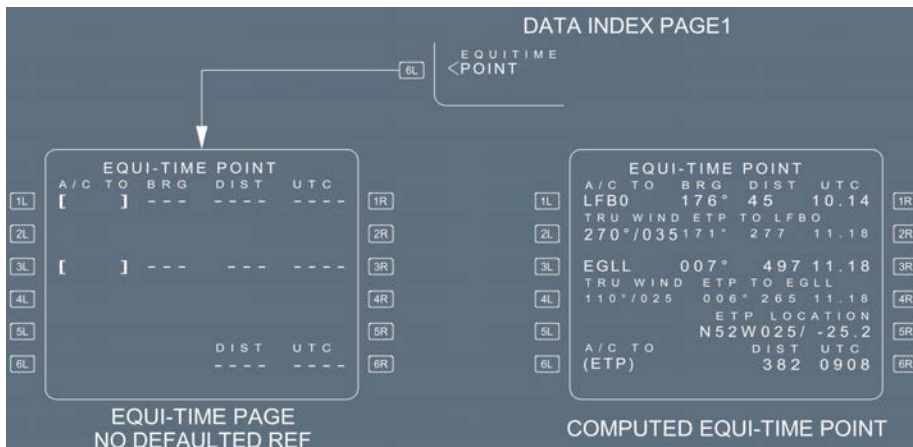

- [1L] A/C TO and (blue) [3L] Displays reference waypoint 1.
Displays reference waypoint 2.

Note: Origin and destination airports are used by default for respective reference points 1 and 2, until a pilot entry is made.

- [1R] BRG/DIST/UTC and [3R] (green) Displays the bearing, distance, time, from the aircraft's current position to the reference waypoint 1.
Displays the bearing, distance, time, from the current position of the aircraft to the reference waypoint 2.

- BRG : Displays the current great-circle bearing from the position of the aircraft to the reference waypoint.
DIST : Displays the current great-circle distance from the position of the aircraft to the reference waypoint.
UTC : Displays the predicted time of arrival at the reference waypoint (computed using the current wind or a wind vector, entered by the crew).
The time is only computed in cruise phase. In other phases, it is dashed.

- [2L] and [4L] TRU WIND (blue) The pilot may enter the wind (direction/velocity) at the reference waypoint and the CRZ FL:
This wind is used to compute the time from the aircraft's position to the reference waypoint, and to locate the equitime point.
If no entry is made, the wind/velocity field will read zero.

| | |
|---|---|
| [2R] and [4R] EPT TO XXX (green) | This field displays the bearing distance and the time from the equitime point position (ETP) to the reference waypoint. |
| [5R] ETP LOCATION | This field displays the ident of the next waypoint following the equitime point. It provides the distance along the flight plan from the equitime point to the indicated waypoint. |
| [6L] - [6R] A/C TO (ETP) DIST/UTC (green) | This field displays the distance and time from the aircraft's current position to the equitime point along the flight plan. If at least one reference waypoint exists, but no equitime point exists, the field is blank and NO ETP is displayed in 6L. |

*Note: The assumptions for the equitime point computation include the cost index, speed managed (with SPD LIM), and winds.
In case of engine-out, the EO LRC speed is considered.*

PRINT FUNCTION PAGES

Ident.: DSC-22_20-50-10-25-00000591.0001001 / 01 OCT 12

Applicable to: ALL

The PRINT FUNCTION pages enable the crew to print the data relative to the current flight.

This data comes from 2 different sources:

- ACARS uplink messages, and
- Active data from the current flight.

The pilot may access these pages from the "DATA INDEX" page 1/2 by pressing the [6R] ACARS/PRINT FUNCTION key.

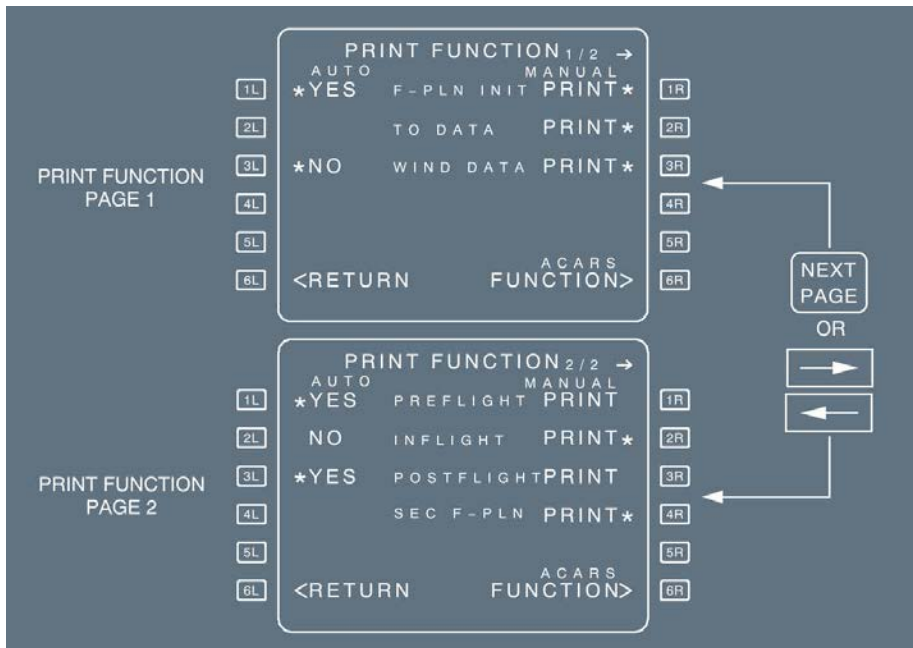

PRINT FUNCTION PAGE 1/2

This page displays the status of the automatic printing capabilities, for the uplink messages (left column), and the status of the manual printing capabilities of the current active data (right column).

LEFT COLUMN

- AUTO
- * YES (blue)
 - Line 1: Uplink messages related to flight plan INIT data are automatically printed when received.
 - Line 2: Uplink messages related to takeoff data are automatically printed when received.
 - Line 3: Uplink messages related to wind data are automatically printed when received.
- * NO (blue)

When "NO", preceded by a star, is displayed in front of a line, automatic printing is deselected. The pilot can reactivate it by pressing the left key of the line.
- NO (without a star)

Automatic printing is internally deactivated for the data of the line. The pilot cannot reactivate it manually.
- Blank

The ACARS function is not available for this line. Uplink messages can neither be received nor automatically printed.

RIGHT COLUMN

MANUAL Displays the status of the manual printing capability of the active data (and not of the ACARS uplink data).

PRINT * (amber) Pressing the right keys prints the following active data:
 Line 1: Active flight plan INIT data
 Line 2: Active takeoff data
 Line 3: Active wind data

If the star is not displayed, printing is not possible.
 When the key is pressed, the star is removed until the data is printed.

[6L] RETURN Pressing this key reverts the display to the DATA INDEX page.
 [6R] ACARS FUNCTION Pressing this key reverts the display to the ACARS FUNCTION page.

PRINT FUNCTION PAGE 2/2

This page describes the printing capabilities of the reports displayed on lines 1 to 4.

LEFT COLUMN

AUTO (white) Line 1: The PREFLIGHT report is automatically printed at engine start.
*** YES (blue)** Line 2: The INFLIGHT report is automatically printed at takeoff.
 Line 3: The POSTFLIGHT report is automatically printed at engine shutdown.

*** NO (blue)** The report, displayed on the line, is not printed automatically. The pilot can reactivate the function by pressing the left key of the line.

NO (without a star) Automatic printing is internally deactivated for the report. The pilot cannot reactivate it.

RIGHT COLUMN

MANUAL Pressing a right key prints the report displayed on the line.
PRINT * If the star is not displayed, printing is not possible.
 When the key is pressed, the star is removed until the report is printed.
 For the PREFLIGHT, INFLIGHT and POSTFLIGHT reports, only one type of report is available for printing at any given time, depending on the current flight phase.
 For the SEC F-PLN report, the print selection start is only displayed if a secondary flight plan exists.

ACARS FUNCTION PAGE

Ident.: DSC-22_20-50-10-25-00000592.0001001 / 01 OCT 12

Applicable to: ALL

The ACARS FUNCTION pages display the functions enabling the crew to send manual requests or reports to the ground.

All functions, displayed on pages 1 and 2, may be inhibited through a pin program.
 The ACARS /PRINT FUNCTION prompt is displayed on the DATA INDEX page 1/2. Pressing this key displays the PRINT FUNCTION page from which the ACARS FUNCTION page can be accessed.

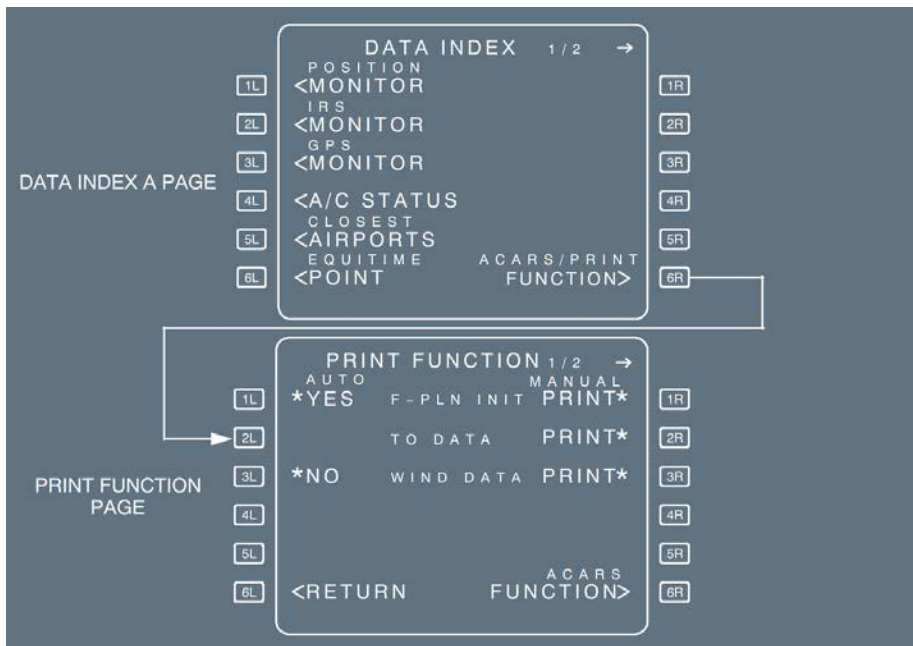

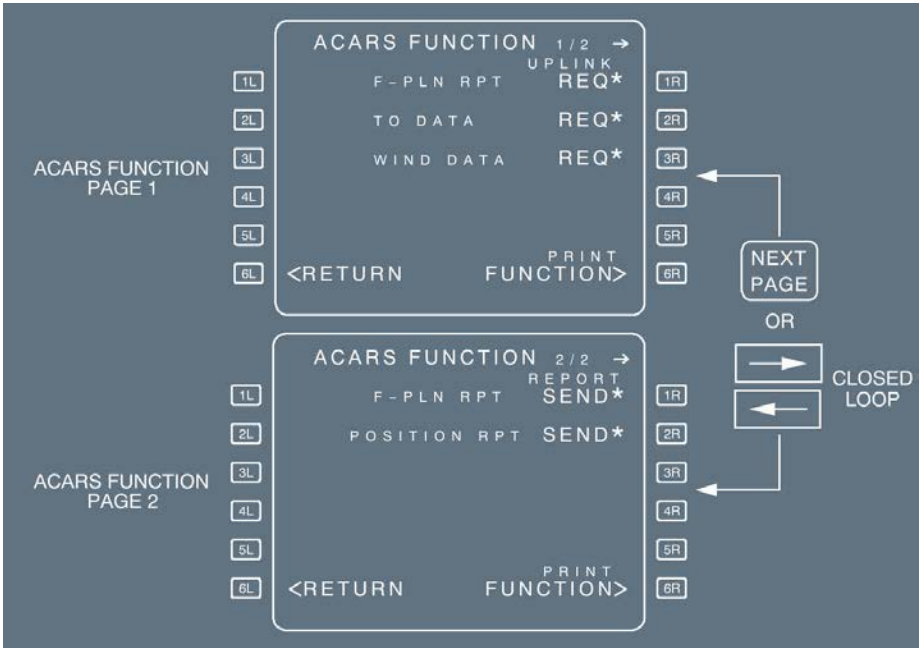

ACARS FUNCTION PAGE 1

Ident.: DSC-22_20-50-10-25-00000593.0001001 / 17 MAR 11

Applicable to: ALL

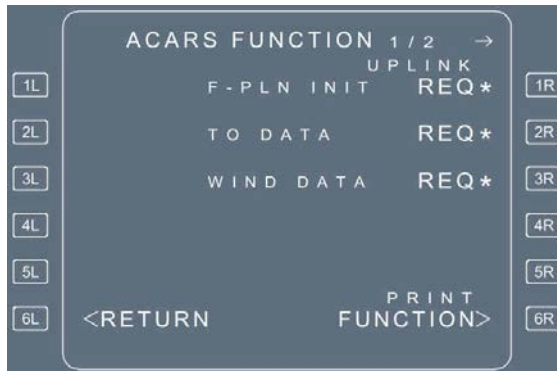

TITLE

ACARS FUNCTION 1/2 in white

- Line 1 F-PLN INIT REQ* Pressing this key sends a request for flight plan to the ground (downlink message)
The INIT REQUEST prompt of the INIT A page provides the same function.
- Line 2 TO DATA REQ* Pressing this key sends a request for takeoff data.
Displayed in the DONE and PREFLIGHT phases.
The TO DATA REQUEST prompt of the UPLINK TO DATA REQ page provides the same function.
- Line 3 WIND DATA REQ* Pressing this key sends a request for wind data.
The WIND REQUEST prompt of the CLIMB, CRUISE, and DESCENT WIND pages provides the same function.

*Note: If "REQ" is not followed by a star, the request cannot be sent (downlink message).
When a function (line 1 or 2 or 3) is deactivated internally, the corresponding line is blank.*

- [6L] RETURN The pilot presses this key to make the display revert to the DATA INDEX page.
- [6R] PRINT FUNCTION The pilot presses this key to access the PRINT FUNCTION page. (*Refer to DSC-22_20-50-10-25 Print Function Pages*).

UPLINK TO DATA REQ PAGES

Ident.: DSC-22_20-50-10-25-00000594.0009001 / 14 MAY 12

Applicable to: **ALL**

This page allows the flight crew to send a request for takeoff data for up to 2 runways. There is one page for each runway. The page is accessed from the PERF TAKEOFF page, or from the UPLINK XXX (MAX or DRT or FLX) TO DATA page, by pressing the UPLINK TO DATA prompt.

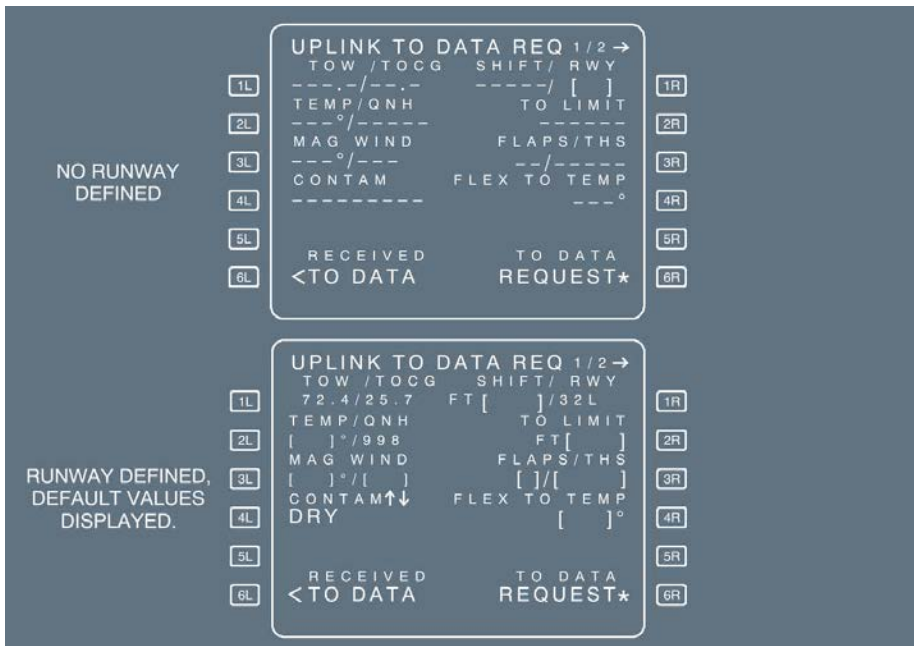

TITLE

White.

[1L] TOW/TOCG
(green)

This field is dashed, until a runway is defined in the [1R] field. The TOW /TOCG is defaulted to the values of the INIT B and FUEL PRED pages. If not available, dashes are displayed. It cannot be modified by the pilot.

[2L] TEMP/QNH or
QFE (green/blue)

This field is dashed, until a runway is defined in the [1R] field. It displays the temperature at origin and baro setting. TEMP = If the temperature is not defined, blue brackets are displayed, and the flight crew can modify this field according to the weather information. BARO = Defaulted to FCU selection and can be modified by the pilot.

[3L] MAG WIND (blue)

This field is dashed, until a runway is defined in the [1R] field. It displays the wind at the origin. If the wind is not defined, blue brackets are displayed. The pilot can modify this field.

- [4L] **CONTAM** (blue) This field is dashed, until a runway is defined in the [1R] field. The display is defaulted to DRY.
 The scroll keys allow the crew to modify the runway contamination.
 DRY, WET, 1/4 WATER, 1/2 WATER, 1/4 SLUSH, 1/2 SLUSH, COMP SNOW.
- [6L] **RECEIVED TO DATA** This field calls up the UPLINK MAX (or FLX or DRT) TO DATA page that displays the data received by AOC.



- [1R] **SHIFT/RWY** (blue) This field is dashed, until a runway is defined in the F-PLN . If a runway is defined in the F-PLN, it is automatically filled in as:
 SHIFT = Value from the PERF TO page, or blue brackets [], if no value is defined.
 RWY = F-PLN departure runway. The pilot can modify this field.
- [2R] **TO LIMIT** (blue) It is dashed, until a runway is defined in the [1R] field. It displays blue brackets [], when a runway is defined. The pilot may enter a length, considering runway obstacles.
- [3R] **FLAPS/THS** (blue) This field is dashed, until a runway is defined in the [1R] field; it is then defaulted to values from the PERF TO page. Blue brackets are displayed, if the PERF TO page does not have any defined values.
- [4R] **FLEX TO TEMP** (blue) This field is dashed, until a runway is defined in the [1R] field; it is then defaulted to values from the PERF TO page. Blue brackets are displayed, if the PERF TO page does not have any defined values. The pilot can modify this field and enter a FLEX TO temperature (FXX).
- [6R] **TO DATA REQUEST*** (amber) Pressing the key sends the takeoff data request message to the ground. The asterisk disappears when the request is sent. It reappears when the data is available.

Page 2/2 is a page used for requesting a second runway data.

Note: If the UPLINK TO DATA REQ Page 2 is accessed (Page 1 being filled), the fields of this page are filled with default values after entry of a runway in [1R]. QNH or QFE and wind are common with Page 1.

UPLINK MAX TO DATA PAGES

Ident.: DSC-22_20-50-10-25-00000595.0010001 / 01 OCT 12

Applicable to: ALL

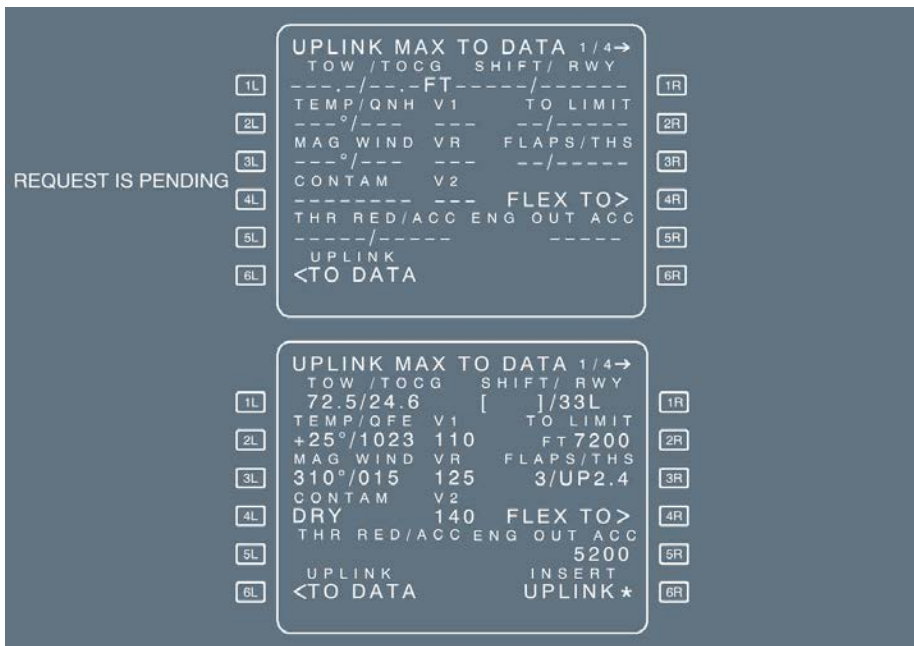

This page is accessed from the UPLINK TO DATA REQ page by pressing the RECEIVED TO DATA key.

There is a set of 2 pages (MAX TO DATA and FLEX TO DATA) for each of the 4 uplinked runway data. Uplinked data is displayed in green. (It cannot be modified by the flight crew).

- [1L] TOW/TOCG Uplinked reference Takeoff Gross Weight and Takeoff Center of Gravity.
- [2L] TEMP/QNH (or QFE) Uplinked assumed temperature and BARO setting.
- [3L] MAG WIND Uplinked takeoff runway wind.
- [4L] CONTAM Uplinked takeoff runway contamination.

- [5L] THR RED/ACC Uplinked Thrust Reduction and Acceleration altitudes.
 - [6L] UPLINK TO DATA Pressing the key calls up the UPLINK TO DATA REQ page.
 - V1, VR, V2 Uplinked takeoff speeds.
 - [1R] SHIFT/RWY Uplinked TO runway IDENT, runway intersection and position shift.
 - [2R] TO LIMIT Uplinked runway length remaining.
 - [3R] FLAPS/THS Uplinked FLAPS/SLATS CONF and TRIM position.
 - [4R] FLEX TO Pressing this key calls up the UPLINK FLEX TO DATA pages.
 - [5R] ENG OUT ACC Uplinked engine-out acceleration altitude.
 - [6R] INSERT UPLINK* Uplinked takeoff data is available for insertion.
- Selecting this prompt inserts the following data on the PERF TO page:
- V1 , VR , V2
 - THR RED/ACC, ENG OUT ACC altitudes
 - FLAPS/THS
 - SHIFT
 - FLEX
- The display reverts to the PERF TO page, the asterisk disappears.
- This field is not displayed, if the runway does not match the active runway. If the runway matches the active runway but the uplinked TOW differs from the current TOW (the uplinked TOW is 3 t greater or 1 t lower than the TOW estimated by the FMS):
- The asterisk disappears and the insertion is not possible
 - The TOW value is displayed in amber in [1L] field.

Note: All previously-received data is replaced by the new uplinked data.

UPLINK FLX TO DATA PAGES

Ident.: DSC-22_20-50-10-25-00000596.0001001 / 23 JUN 15

Applicable to: ALL

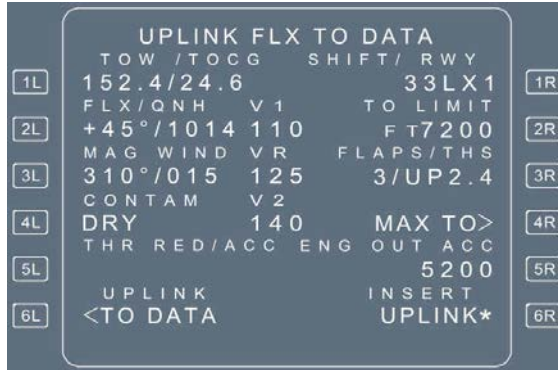

TITLE

UPLINK FLX TO DATA.

[2L]

FLX/QNH (or QFE)

When the UPLINK FLEX TO DATA page is selected, it displays uplink assumed Flex Temperature and BARO setting (QNH or QFE).

[4R] MAX TO

Pressing this key calls up the MAX TO DATA page.

For all other fields, *Refer to DSC-22_20-50-10-25 Uplink MAX TO Data Pages*

ACARS FUNCTION PAGE 2

Ident.: DSC-22_20-50-10-25-00000597.0001001 / 17 MAR 11

Applicable to: ALL

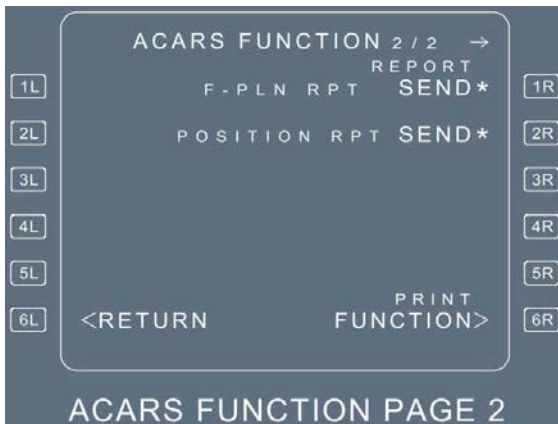

Line 1 F-PLN RPT Pressing this key sends the flight plan report to the ground.
 SEND

Line 2 POSITION RPT Pressing this key sends a Position Report to the ground.
 SEND

Note: - No report can be sent, if "SEND" is not followed by a star
 - When a function (line 1 or 2) is deactivated through the navigation database policy file, the corresponding line is blank.

[6L] RETURN The pilot presses this key to revert to the DATA INDEX page.

[6R] PRINT FUNCTION The pilot presses this key to access the PRINT FUNCTION page.

PERF PAGE

Ident.: DSC-22_20-50-10-25-00000598.0001001 / 17 MAR 11

Applicable to: ALL

The flight plan is divided into the following phases:
 PREFLIGHT, TAKEOFF, CLIMB, CRUISE, DESCENT, APPROACH, GO-AROUND, DONE.
 Each phase, except for the preflight and done phases, has a performance (PERF) page. The PERF pages display performance data, speeds related to the various phases, and predictions.
 Pressing the PERF key on the MCDU console calls up the performance page for the current active phase. Performance pages, relating to phases already flown, are not available.
 In the preflight and done phases, pressing the PERF brings up the takeoff performance page.

Pressing the PERF key in the done phase makes the phase transition to the preflight phase.

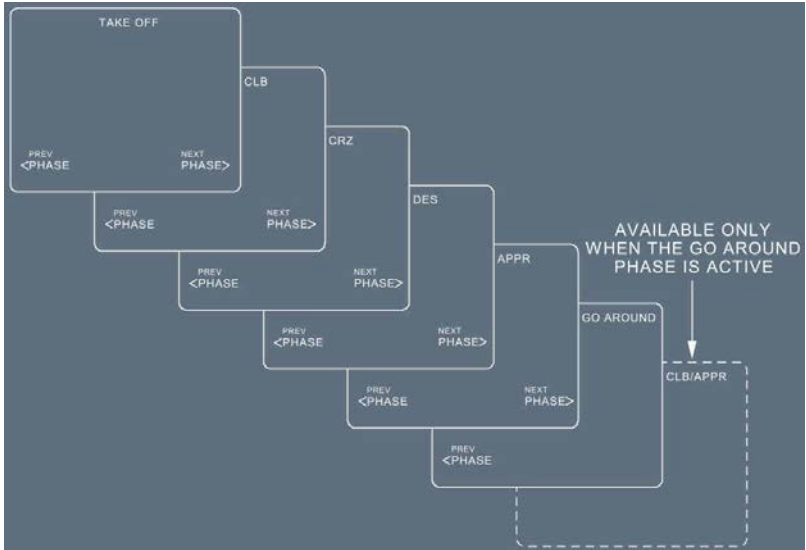

The FMGS flight phases are not related to the FWC flight phases.

Line 6 Fields may display two different prompts, depending upon whether the phase is active or not.

- [6L] PREV PHASE To review the performance page for the previous phase. The prompt is unavailable on the takeoff performance page. It is also unavailable for phases already flown.
- [6L] ACTIVATE APPR PHASE To activate, then confirm, the APPR phase. Available only on the page corresponding to the active phase.
- [6R] NEXT PHASE To review the performance page for the next phase.

Note: Engine-out condition

- When the FMGS detects an engine-out condition, the system automatically calls up the performance page for the current flight phase (except when this occurs before the diversion point during takeoff or no EOSID exists in the flight plan) and displays "EO CLR **" in the [1R] field and EO LRC (engine-out long range cruise) in the [2L] field. On the CLB, CRZ and DES (when the descent phase is not active) PERF pages, the pilot can enter a cost index value and overwrite to "EO LRC". Clearing the cost index reverts to EO LRC.
 If the pilot presses the [1R] key, the system reverts to the normal processing (with no engine failed) and suppresses the EO information. (Refer to DSC-22_20-30-10-15 General).
- If the engine-out condition is detected before the diversion point at takeoff, a temporary flight plan is created.

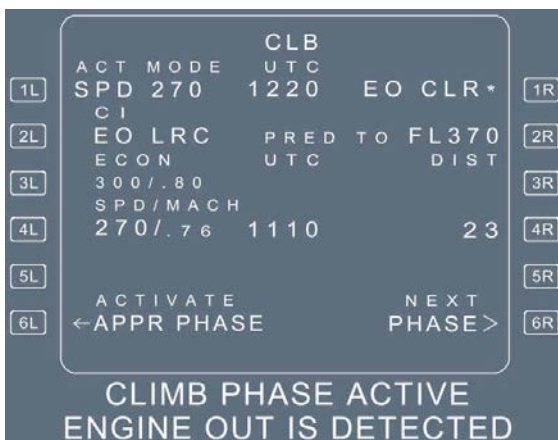

PERF TAKEOFF PAGE

Ident.: DSC-22_20-50-10-25-00000599.0010001 / 08 JUL 15

Applicable to: ALL

During the preflight phase, the pilot presses the PERF key to call up the takeoff performance page.

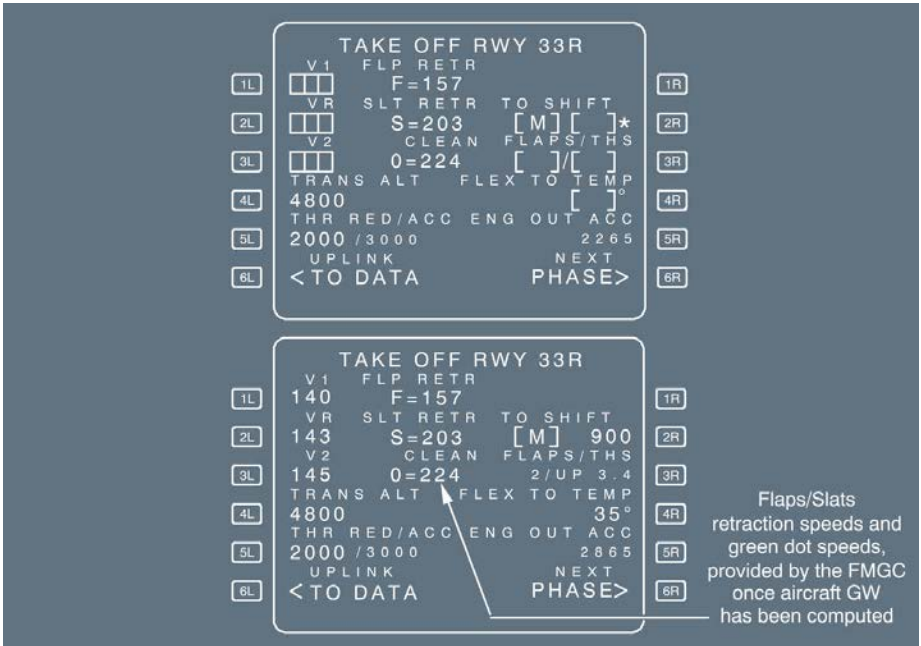

TITLE

TAKE OFF RWY is in large green font when the takeoff phase is active, and in large white font when it is inactive. The active flight plan selected runway is displayed in large green font.

Note: If the takeoff shift, or the flaps/THS, or the runway is changed after V1, VR or V2 insertion, but the origin airport remains the same, the MCDU "CHECK TAKE OFF DATA" message appears. All takeoff parameters are retained except in case of runway change. In case of runway change, the parameters are invalidated, but still displayed adjacent to each field. The "CONFIRM TO DATA" prompt in [6R] allows reverting to the previous values.

[1L] V1 [2L] VR [3L] V2 The boxes remain amber, as long as the pilot does not make entries in them. The pilot can modify any entry, as long as the takeoff phase is not active.

- Note:
1. If the flight crew does not enter V2, the SRS mode will be unavailable at takeoff.
 2. The MCDU "V1 /VR /V2 DISAGREE" amber message appears if the inserted V1, VR, V2 speeds do not satisfy the condition: $V1 \leq VR \leq V2$.
 3. The MCDU "TO SPEED TOO LOW" amber message appears if the inserted V1, VR, V2 speeds do not satisfy the existing regulatory conditions regarding VMCG /VMCA and VS1G speeds.

[4L] TRANS ALT This field displays the navigation database default altitude (if defined) once the origin airport is entered. The pilot can modify it.
(transion altitude)

[5L] THR RED (thrust This is the altitude at which the pilot should reduce the thrust from TOGA /FLX to MAX CLIMB (CL detent) with all engines operative ("CLB" or "LVR CLB" flashing on the FMA).
reduction altitude)

- The thrust reduction altitude defaults to 1 500 ft above the runway elevation, or to the altitude set by the airline
- The pilot can modify this altitude: The minimum is 400 ft above the runway elevation.

ACC (Acceleration This is the altitude at which the climb phase is triggered.
altitude)

- The target speed jumps to the initial climb speed
- The default value is 1 500 ft above runway elevation
- The flight crew can modify the value. The minimum value is 400 ft above runway elevation, and it can be higher than, or equal to, or lower than THR RED.

- Note:
- A clearing action reverts both values to the defaulted ones
 - When the flight crew selects an altitude on the FCU that is below THR RED, it brings THR RED and ACC down to this altitude. (The 400 ft minimum still applies).

[6L] UPLINK TO DATA This key calls up the UPLINK TO DATA REQ page.
It is only displayed in the preflight and done phases.

[1R] EO CLR EO CLR is displayed when an engine-out is detected and when active flight phase is takeoff.

| | |
|------------------------------------|--|
| [2R] TO SHIFT | The takeoff shift is the distance in meters or feet between the beginning of the runway and the aircraft's takeoff position. When taking off from an intersection, the flight crew should insert this value to ensure a correct update of the FM position. The takeoff shift value must be positive, and cannot be greater than the runway length. |
| [3R] FLAPS/THS | This is a flight crew entry for the positions of the flaps and the trimmable horizontal stabilizer (THS) at takeoff. The flight crew can modify it until takeoff, by entering "UP X.X" or "X.X UP", or "DN X.X" or "X.X DN" for the THS. |
| [4R] FLX TO TEMP | The flight crew inserts the FLX TO temperature for FLX takeoff setting purposes. The flight crew can only enter it during preflight. The system sends it to the FADEC and displays the entered data on the upper ECAM display. The TEMP value is always entered in degrees Celsius. |
| [5R] ENG OUT ACC | This field displays the engine-out acceleration altitude, as defined in the database, or is manually entered by the flight crew. This is for display only, as a reminder. It cannot be cleared. The above ACC altitude rules of [5L] apply to this field. |
| [6R] NEXT PAGE or CONFIRM TO DATA* | This key calls up the climb performance page, or allows the flight crew to revert to the previously-entered T.O. parameters, in case of runway change with the same origin airport. |

PERF CLIMB PAGE

Ident.: DSC-22_20-50-10-25-00000600.0001001 / 14 MAY 12

Applicable to: ALL

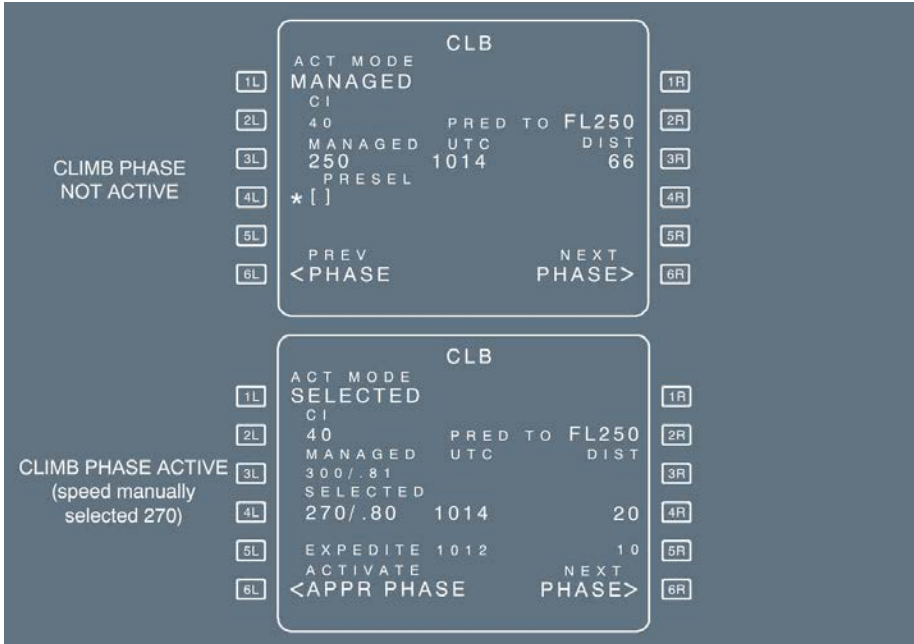

- TITLE** CLB is displayed in large white fonts when the climb phase is inactive, and in large green fonts if it is active.
- [1L] ACT MODE** This field displays the preselected or active speed mode: **SELECTED** or **MANAGED**.
 The pilot cannot modify it from this field.
- [2L] CI (Cost Index)** This field displays the cost index, as initialized on the INIT A or defaulted from the database, or inserted in this field by the pilot. EO LRC automatically replaces the cost index value in case of engine-out.
- [3L] MANAGED** This field displays the FMGS computed ECON speed/Mach (*Refer to DSC-22_20-40-10 Optimization*).
 Before **CLIMB** phase is active, if the preselected speed mode is **SELECTED**, a star is displayed next to the **MANAGED** speed. Pressing the 3L key in this case preselects **MANAGED** speed, and 4L reverts to brackets.

| | |
|-------------------------------------|--|
| <p>[4L] PRESEL or SELECTED</p> | <p><u>If the climb phase is not active:</u> This field displays PRESEL as long as the climb phase is not active. The pilot can enter a preselected speed only.</p> <p><u>If the climb phase is active:</u> The title of this field becomes SELECTED. This field displays the selected (or preselected) SPD or MACH target. The pilot cannot modify it directly in this field, but can adjust it with the SPD /MACH selection knob on the FCU. If the pilot pushes in the FCU SPD /MACH selection knob to revert to managed speed, the system selects (or reselects) ECON SPD/MACH and [4L] is blank.</p> |
| <p>[5L] Blank or EXPEDITE</p> | <p>This field is blank as long as the aircraft is in preflight. This field displays this legend when the takeoff or climb phase is active. The flight crew cannot engage EXPEDITE from this field. It indicates the time and distance required to reach the altitude displayed in the 2R field, in case of climb at green dot.</p> |
| <p>[6L] PREV PHASE</p> | <p>This field displays this legend if climb phase is not active. The pilot presses this key to call up the takeoff page.</p> |
| <p>[6L] ACTIVATE APPR PHASE</p> | <p>The field displays this legend if the climb phase is active. Pressing this key once displays “CONFIRM APPR PHASE*”. Pressing it again activates the approach phase.</p> |
| <p>[1R] EO CLR</p> | <p>The system displays the EO CLR prompt in case of engine out in climb.</p> |
| <p>[2R] PRED TO...</p> | <p>This field displays the target altitude for the predictions shown in 3R, 4R, or 5L. It defaults to FCU altitude, but the pilot can modify it to any altitude below CRZ FL.</p> |
| <p>[3R] [4R] [5R]</p> | <p>These fields show time and distance predictions for the target altitude selected in [2R], computed for the current vertical mode and speed mode (MANAGED, SELECTED). These fields are displayed only while the takeoff, or climb phase is active.</p> |
| <p>[6R] NEXT PHASE</p> | <p>The flight crew presses this key to call up the PERF CRZ page.</p> |

PERF CRUISE PAGE

Ident.: DSC-22_20-50-10-25-00000601.0009001 / 30 MAR 15

Applicable to: ALL

| | | | | | | |
|-------------------------|----|---|--|--|--|----|
| CRZ PHASE NOT ACTIVE | 1L | <p>CRZ ACT MODE UTC DEST EFOB MANAGED 1220 8.4</p> | | | | 1R |
| | 2L | <p>CI 540</p> | | | | 2R |
| | 3L | <p>MANAGED .80</p> | | | | 3R |
| | 4L | <p>PRESEL DES CABIN RATE * [] -350 FT/MN</p> | | | | 4R |
| | 5L | <p>STEP ALTS> NEXT</p> | | | | 5R |
| | 6L | <p>PREV <PHASE PHASE></p> | | | | 6R |
| CRZ PHASE ACTIVE | 1L | <p>CRZ ACT MODE UTC DEST EFOB SELECTED 1114 8.4</p> | | | | 1R |
| | 2L | <p>CI 540</p> | | | | 2R |
| | 3L | <p>MANAGED .80</p> | | | | 3R |
| | 4L | <p>DES CABIN RATE -350 FT/MN</p> | | | | 4R |
| | 5L | <p>STEP ALTS> NEXT</p> | | | | 5R |
| | 6L | <p>ACTIVATE ←APPR PHASE PHASE></p> | | | | 6R |

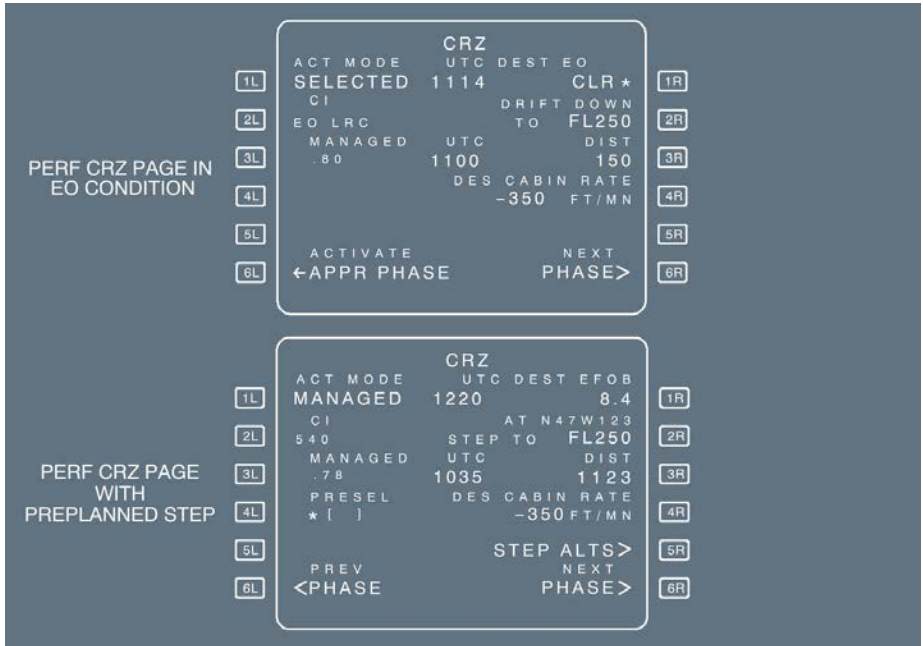

- TITLE** CRZ in white large font, when cruise phase is not active, in green large font, when it is.
- [1L] ACT MODE This field shows the preselected or active speed mode: SELECTED or MANAGED.
 The pilot cannot modify it through this field.
- [2L] CI This field shows the cost index as initialized on the INIT A page or defaulted from the database, or as inserted in this field by the crew.
 EO LRC replaces automatically the cost index value in case of engine out.
- [3L] MANAGED This field displays the FMGS computed ECON speed/Mach (*Refer to DSC-22_20-40-10 Optimization*).
 Before CRUISE phase is active, if the preselected speed mode is SELECTED, a star is displayed next to the MANAGED speed. Pressing the 3L key in this case preselects MANAGED speed, and 4L reverts to brackets.

AIRCRAFT SYSTEMS

AUTO FLIGHT - FLIGHT MANAGEMENT

CONTROLS AND INDICATORS - MCDU - PAGE DESCRIPTION

| | |
|--|--|
| [4L] PRESEL | <p><u>If cruise phase is not active:</u> The pilot can enter a preselected speed or Mach number.</p> <p><u>If cruise phase is active:</u> This field is blank.</p> <p><u>Note:</u> <i>If the flight crew enters a value in the PRESEL field during the cruise altitude capture (ALT CRZ*), the FCU selected speed may revert to M 0.01.</i></p> |
| [6L] PREV PHASE or | The pilot can press this key to call up the climb page, if the cruise phase is not yet active. |
| [6L] ACTIVATE APPR PHASE | <p>This field displays this legend if the cruise phase is active. The flight crew presses the key once to change the legend to “CONFIRM APPR PHASE”. A second press activates the approach phase.</p> <p><u>Note:</u> <i>If the pilot activates the approach phase inadvertently, it can reselect the cruise flight level into the progress page to reactivate the cruise phase.</i></p> |
| [1R] TIME/UTC DES EFOB | <p>Before takeoff this field displays the flight time to destination and the predicted remaining fuel on board. If the crew enters an estimated takeoff time, the field displays automatically the predicted arrival time (UTC) at destination. After takeoff it displays the predicted arrival time at destination (UTC) and the remaining fuel on board (DEST EFOB) at destination, in green font. The DEST EFOB field will turn to amber, if the EFOB at destination becomes less than the MIN DEST FOB value displayed on the FUEL PRED page. EO CLR is displayed when an engine-out is detected.</p> |
| [2R] STEP TO FL XX, DRIFT DOWN TO FL XX, or TO T/D | The field, in combination with 3R, displays the predictions for the step point and the step altitude, the drift down altitude, or the Top of Descent. |
| [3R] TIME/UTC and DIST | This field displays the time and distance to go to the various points identified in 2R. |
| [4R] DES CABIN RATE | <p>This field displays MAX [computed DES cabin rate, maximum descent cabin rate]. The pilot may modify the value: the FM recomputes then the top of descent in order to match this value. If the FM cannot match the pilot entry, the FM computed value overwrites the pilot entry.</p> <p>A clear action reverts to the default value (-350 ft/min). DES CAB RATE being a negative value, 'minus" is not a necessary entry.</p> |
| [5R] STEP ALTS | This key calls up the STEP ALTS page (vertical revision <i>Refer to DSC-22_20-50-10-25 VERTICAL REVISION Pages</i>). |

[6R] NEXT PHASE This key calls up the DES page.

PERF DESCENT PAGE

Ident.: DSC-22_20-50-10-25-00000602.0011001 / 23 JUN 15

Applicable to: ALL

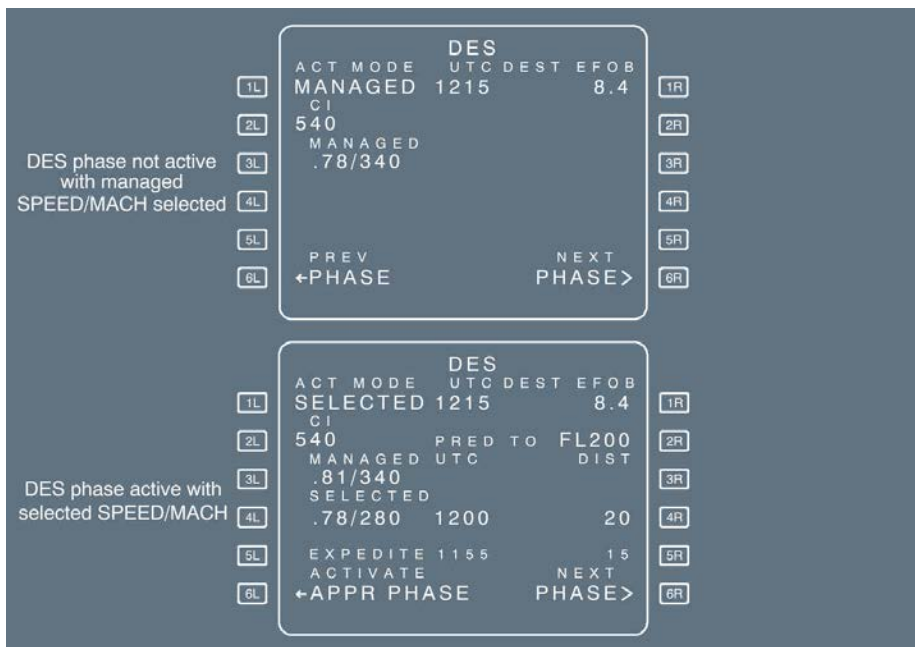

TITLE DES is in large white font if the descent phase is not active; it is in large green font, if it is.

[1L] ACT MODE This field displays the preselected or active speed mode (MANAGED or SELECTED). The flight crew cannot modify it through this field.

[2L] CI This field displays the cost index, as initialized on the INIT A page or defaulted from the database, or inserted in this field by the flight crew. The flight crew cannot modify it when the descent phase is active.

[3L] MANAGED

If the descent phase is not active:

Before the flight crew makes any entry. This field displays MANAGED in white, with the associated ECON descent Mach or speed in blue. The crew may overwrite the ECON descent Mach or speed by entering a Mach number or a speed in this field. The system uses the pilot entry to compute the descent profile. The descent may be flown in managed using this new pilot entry.

The entry is modifiable. It can be cleared to revert to ECON speed/Mach.

If the descent phase is active:

The flight crew cannot make an entry in this field.

The field displays the ECON speed/Mach or the speed/Mach value previously entered by the pilot.

[4L] blank or
 SELECTED

If the descent phase is not active, or the descent phase is active but the active speed mode is MANAGED:

This field is blank.

If the descent phase is active and the active speed mode is SELECTED:

The field displays the speed or Mach target manually selected by the pilot. "SELECTED" is displayed in the [1L] field.

To modify the field value, the pilot will use the SPD /MACH selector knob of the FCU . [4L] field and FCU window will display the same value.

Pushing in the FCU speed selector knob activates the managed SPD/MACH target displayed in the [3L] field.

[5L] Blank or
 EXPEDITE

If the descent phase is not active this field is blank.

Displays this legend if the descent phase is active.

It indicates the time and distance required to reach the altitude displayed in the 2R field at MMO /VMO speed. The pilot cannot select the EXPEDITE mode through this field.

[6L] PREV PHASE
 or ACTIVATE APPR
 PHASE

This key calls up the cruise phase page if the descent phase is not yet active.

Displayed if the descent phase is active. First press causes "CONFIRM APPR PHASE" to be displayed. Second press activates the approach phase.

- [1R] TIME/UTC DEST Before takeoff, this field displays the flight time to destination and the predicted remaining fuel on board. If the crew enters an estimated takeoff time, the field displays automatically the predicted arrival time (UTC). After takeoff, it displays the predicted arrival time at destination (UTC) and the remaining fuel on board (DEST EFOB) at destination in green font. The DEST EFOB field will turn to amber, if the EFOB at destination becomes less than the MIN DEST FOB value displayed on the FUEL PRED page. EO CLR is displayed when an engine-out is detected.
- [2R] PRED TO... This field displays the target altitude for the predictions in [3R] [4R], or [5R]. The display defaults to the altitude selected on the FCU. The flight crew can modify it to any altitude lower than present altitude.
- [3R] [4R] [5R] These fields display time and distance predictions down to the target altitude selected in [2R], computed for the current vertical mode (DES or OP DES) and the indicated speed mode (MANAGED, SELECTED).
- [6R] NEXT PHASE The pilot presses this key to call up the PERF APPR page.

PERF APPR PAGE

Ident.: DSC-22_20-50-10-25-00016132.0010001 / 24 FEB 15

Applicable to: ALL

PERF APPR Page

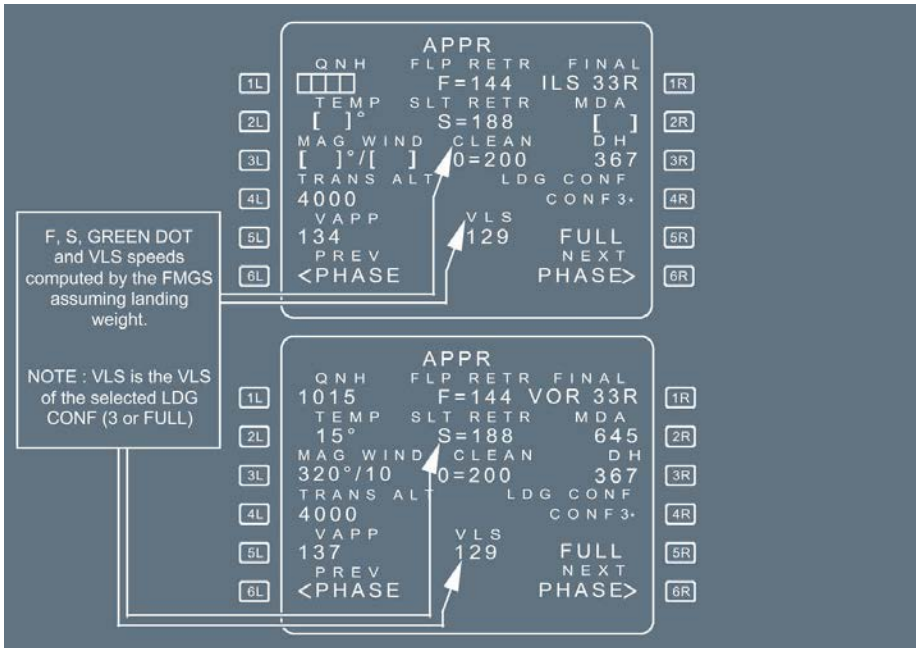

The diagram illustrates the PERF APPR MCDU page with two views of the display. Each view is flanked by six row select buttons (1L-6L on the left, 1R-6R on the right).

Top View:

- 1L: [] [] [] []
- 2L: [] °
- 3L: [] °/[] []
- 4L: 4000
- 5L: 134
- 6L: <PHASE

Display Content (Top View):

APPR

QNH FLP RETR FINAL
F=144 ILS 33R

TEMP SLT RETR MDA
S=188 []

MAG WIND CLEAN DH
0=200 367

TRANS ALT LDG CONF
4000

VAPP VLS FULL
134 129 NEXT

PREV PHASE >

Bottom View:

- 1L: 1015
- 2L: 15 °
- 3L: 320°/10
- 4L: 4000
- 5L: 137
- 6L: <PHASE

Display Content (Bottom View):

APPR

QNH FLP RETR FINAL
F=144 VOR 33R

TEMP SLT RETR MDA
S=188 645

MAG WIND CLEAN DH
0=200 367

TRANS ALT LDG CONF
4000

VAPP VLS FULL
137 129 NEXT

PREV PHASE >

Callouts:

- A box on the left explains: "F, S, GREEN DOT and VLS speeds computed by the FMGS assuming landing weight."
- A note below states: "NOTE : VLS is the VLS of the selected LDG CONF (3 or FULL)"
- Arrows point from the VLS callouts to the VLS values (129) on the display.

PERF APPR Page (with BARO/RADIO  option)

State 1: APPR (White)

| | | | | | |
|----|-----------|---------|--------|-------|----|
| 1L | QNH | FLP | RETR | FINAL | 1R |
| | [] | F=144 | ILS | 33R | |
| 2L | TEMP | SLT | RETR | BARO | 2R |
| | []° | S=188 | [] | | |
| 3L | MAG WIND | CLEAN | RADIO | 3R | |
| | []°/[] | 0=200 | 367 | | |
| 4L | TRANS ALT | LDG | CONF | 4R | |
| | 4000 | CONF 3· | | | |
| 5L | V APP | VLS | FULL | 5R | |
| | 134 | 129 | NEXT | | |
| 6L | PREV | <PHASE | PHASE> | 6R | |





State 2: APPR (Green)

| | | | | | |
|----|-----------|---------|--------|-------|----|
| 1L | QNH | FLP | RETR | FINAL | 1R |
| | 1015 | F=144 | VOR | 33R | |
| 2L | TEMP | SLT | RETR | BARO | 2R |
| | 15° | S=188 | 645 | | |
| 3L | MAG WIND | CLEAN | RADIO | 3R | |
| | 320°/10 | 0=200 | 367 | | |
| 4L | TRANS ALT | LDG | CONF | 4R | |
| | 4000 | CONF 3· | | | |
| 5L | V APP | VLS | FULL | 5R | |
| | 137 | 129 | NEXT | | |
| 6L | PREV | <PHASE | PHASE> | 6R | |

Callout Box:
 F, S, GREEN DOT and VLS speeds computed by the FMGS assuming landing weight.
 NOTE : VLS is the VLS of the selected LDG CONF (3 or FULL)

APPR is in large white font, if the approach phase is not active; it is in large green font, if it is.

| | |
|----------------|--|
| [1L] QNH | <p>This field displays brackets, when the aircraft is more than 180 NM from the destination. Inside 180 NM, a mandatory amber box appears. The flight crew must enter the QNH in hPa or in inches of mercury.</p> <ul style="list-style-type: none"> - For hPa, enter three or four digits - For inches of mercury: <ul style="list-style-type: none"> • Enter two digits, or • Enter two digits followed by a decimal point and two additional digits. <p>The system interprets:</p> <ul style="list-style-type: none"> - 1 003 as 1 003 hPa; - 29 as 29.00 in. - 29.92 as 29.92 in. <p><i>Note:</i> An erroneous entry of an OAT in QNH field, for example 22 °C, or a higher value, is accepted by the system.</p> <p>The flight crew can modify this entry at any time. The Cabin Pressure Controller (CPC) uses the QNH to compute the cabin repressurization segment. Therefore, an erroneous QNH entry may result in a cabin pressurization that is not appropriate.</p> |
| [2L] TEMP | <p>This field displays the temperature at destination. The field displays brackets until the pilot enters the temperature. The pilot can modify this figure. The system uses this temperature to refine its computation of the descent profile (ISA model).</p> |
| [3L] MAG WIND | <p>The flight crew enters the magnetic wind in knots at the destination in this field. The system transmits any entry made in this field to the vertical revision and flight plan B pages (which display wind direction as true, not magnetic).</p> |
| [4L] TRANS ALT | <p>This field displays the transition altitude taken from the data base (small font) or entered by the flight crew (large font). The flight crew can modify it at any time.</p> |
| [5L] VAPP | <p>The FMGC computes this approach speed, using the formula: $VAPP = VLS + 1/3$ of the headwind components (limited to $VLS + 5$ as a minimum and $VLS + 15$ as a maximum). The flight crew can modify VAPP . A clear action reverts VAPP to the computed value.</p> <p><i>Note:</i> $VLS = 1.23 VS1G$ of the selected landing configuration (full or 3).</p> |
| [6L] PREV PAGE | <p>This field displays this legend if the approach phase is not active. Pressing this key calls up the descent performance page.</p> |

- [1R] FINAL This field displays the approach specified in the flight plan. The flight crew cannot modify it through this field.
- [2R] MDA/MDH or BARO  This field displays:
- The Minimum Descent Altitude with associated brackets, or
 - The Minimum Descent Height with associated brackets, if:
 - The QFE pin program is activated, or
 - The FCU setting is QFE, on aircraft equipped with the BARO  option.
- The flight crew inserts the value, which it can modify at any time. If the flight crew makes an entry in [3R] or changes the approach, it clears this figure.
- [3R] DH or RADIO  If the flight plan includes an ILS approach, this field displays "DH " or "RADIO"  and empty brackets. The flight crew inserts the decision height. The system will accept an entry of "NO", "NODH" or "NO DH". If the flight crew inserts an MDA or an MDH (or a BARO  value) in FIELD [2R], this erases the decision height, and this field reverts to brackets. The DH or RADIO range is 0 to 700 ft.
- [4R] LDG CONF CONF 3 The flight crew can select configuration 3 by pressing the 4R key. This moves the * down to the [5R] field, which is displaying "FULL"?.
- [5R] FULL The flight crew can use this key to select configuration FULL when necessary configuration FULL is the default landing configuration.
- [6R] NEXT PHASE Pressing this key calls up the go-around performance page.

PERF GO AROUND PAGE

Ident.: DSC-22_20-50-10-25-00000604.0002001 / 01 OCT 12

Applicable to: ALL

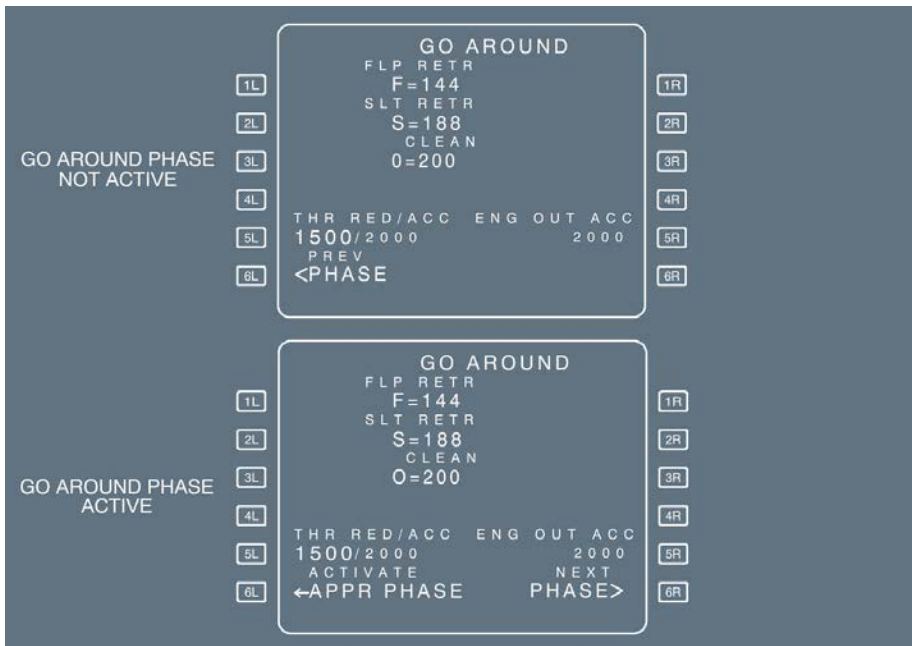

TITLE

GO AROUND is in large white font, if the go-around phase is not active; it is in large green font, if it is.

[5L] THR RED ACC This field displays the thrust reduction altitude and the acceleration altitude.

Thrust reduction altitude:

- Altitude at which thrust must be reduced from takeoff/go-around thrust to maximum climb thrust
- “CLB ” or “LVR CLB” flashing on flight mode annunciator
- Defaults to 1 500 ft above destination runway elevation, or to the altitude set by the airline
- Can be modified by the crew (minimum 400 ft above destination runway elevation).

Acceleration altitude:

- Altitude at which target speed jumps to green-dot speed (see the note below)
- Defaults to 1 500 ft above destination runway elevation, or to the altitude set by the airline.
- Can be modified by the crew, but is always equal to (or higher than) the thrust reduction altitude.

[6L] PREV PHASE or This field displays this legend if the go-around phase is not active. Pressing the key calls up the PERF APPR page.

ACTIVATE APPR This field displays this legend if the go-around phase is active. Pressing it once makes “CONFIRM APPR” appear. A second press activates the approach phase.

[5R] ENG OUT ACC This display has the same characteristics as the display beside the 5R key on the takeoff page. It is for display only, and the pilot can modify it.

[6R] NEXT PHASE Pressing this key calls up the PERF APPR page.

[1R] Blank or EO CLR* This field is normally blank. EO CLR* is displayed when GO AROUND is the active phase and an engine-out condition is detected.

Note: When the go-around phase is active, if the pilot enables ALTN or if the pilot inserts a new destination in the active flight plan and a new cruise flight level on the progress page, the go-around phase shifts automatically into the climb phase. (The target speed jumps from green dot speed to initial climb speed).

PROG PAGES

Ident.: DSC-22_20-50-10-25-00000605.0051001 / 22 MAR 17

Applicable to: ALL

The progress page is a multifunction page that enables the pilot to:

- Select a new cruise flight level
- Crosscheck the navigation accuracy of the Flight Management (FM) system and validate it
- Update the FM position
- Monitor the descent.

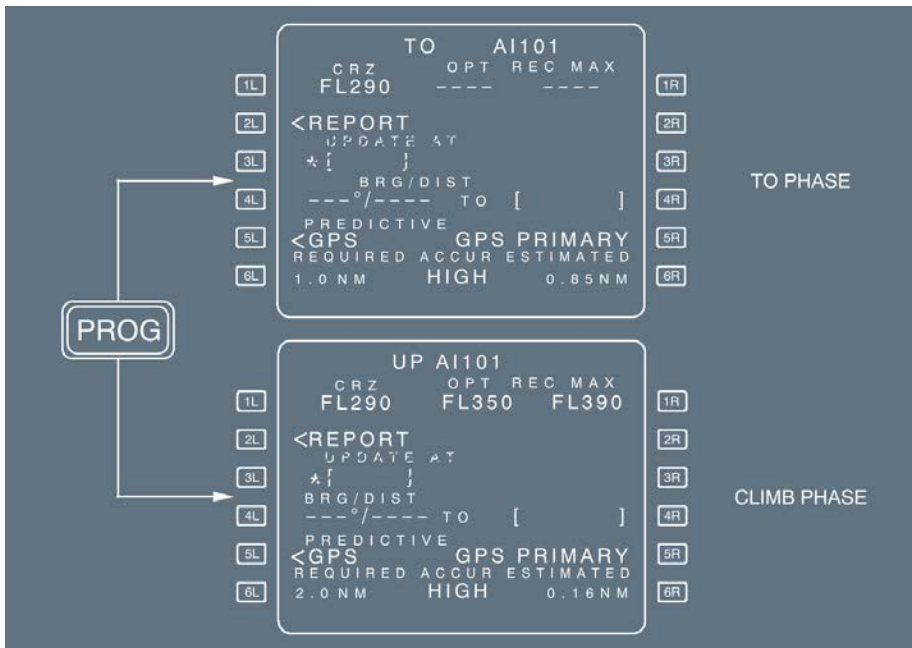

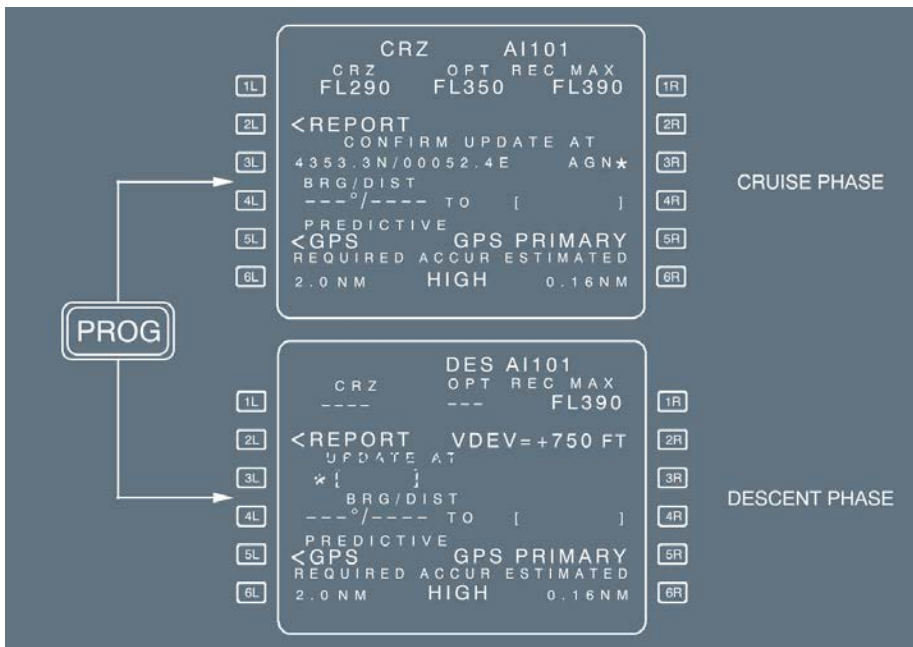

- TITLE** Different for each flight phase (see above). The vertical phase is in large green font. The flight number is in large white font. EO is large amber font, if the engine-out condition is detected.
- Line 1 CRZ (blue)** This line displays the cruise flight level, inserted on the INIT A page or directly in this field in blue. If the flight crew uses the FCU to select an altitude that is higher than the one displayed in this field, the system changes the number displayed to agree. In this line, the flight crew cannot insert a flight level that is lower than the FCU-selected altitude. This field shows dashes when the descent or approach phase is active.
- OPT** This field displays the optimum flight level (in green), that is computed based on the current gross weight, cost index, temperature and wind. This flight level requires a 5 min minimum cruise at a minimum cruise flight level of FL 100. It displays dashes if an engine-out is detected.

REC MAX

This field displays the recommended maximum altitude (in magenta), that is computed based on the current gross weight and temperature, and assuming that the anti-ice is off (if icing conditions are expected, Refer to QRH/PER-M Optimum & Maximum Altitudes (Paper Only) or the performance application of FlySmart with Airbus). It provides the aircraft with a 0.3 g buffet margin, a minimum rate of climb at MAX CL thrust, and level flight at MAX CRZ thrust. This field is limited to FL 398.
 If one engine is out, this field displays the recommended maximum engine-out altitude, that is computed based on the long-range cruise speed and assuming that anti-ice is off.

[2L] REPORT

This key calls up the REPORT PAGE.

[2R] VDEV

This field is displayed during the descent and approach phases, when NAV mode is engaged, or in HDG mode, provided that the crosstrack error (XTK) is less than 5 NM. It displays the vertical deviation between the aircraft's current altitude and the FMS-computed vertical profile.



Line 3 POSITION
 UPDATE AT 

The flight crew can update the FMS position via this field by entering either the IDENT of a waypoint, a NAVAID, an airport, a latitude and longitude (LL), a place/bearing/distance, or a place-bearing/place-bearing (PBX). When the flight crew has entered this data, this field changes its format to: "CONFIRM UPDATE AT", followed by the latitude/longitude and IDENT of the inserted position with an asterisk.

The flight crew presses the right-hand key adjacent to the asterisk to confirm the update, when the aircraft overflies the inserted position.

Note: If no IDENT has been inserted, the field displays "ENTRY" instead of an IDENT.

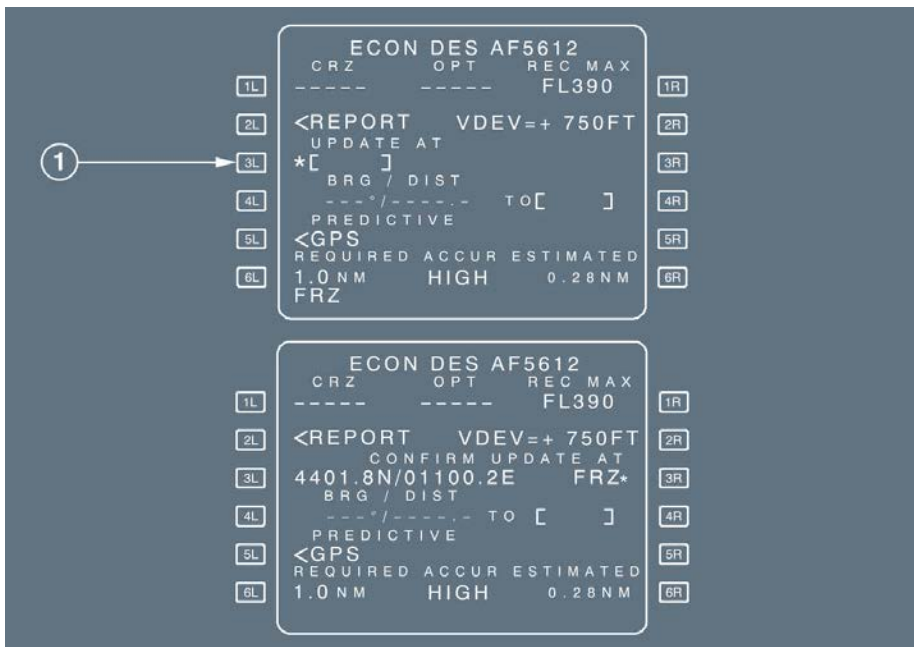

Line 4 BRG/DIST

On this line, the pilot can enter an airport, a waypoint, a NAVAID , or a runway. The pilot may enter each as an IDENT , a latitude/longitude (LL), a place/bearing/distance (PBD), or a place-bearing/place-bearing (PBX). The field then shows the FMGC -computed bearing and distance from this site to the aircraft's present position. The last distance digit is in 1/10 of a NM. If it does not have an IDENT, the point is called "ENTRY".

Example:

BRG /DIST

340 °/95.4 to ENTRY

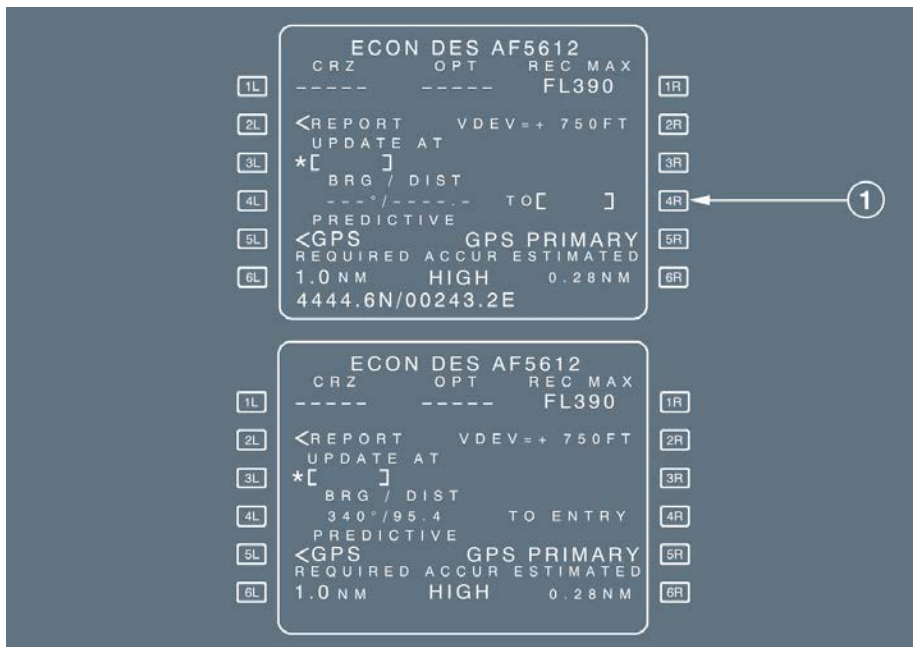

[5L] PREDICTIVE GPS This prompt gives access to the PREDICTIVE GPS page.

[5R] GPS PRIMARY This prompt is displayed, when the FMS navigation mode is GPS PRIMARY. When GPS PRIMARY is not available, or navigation mode is not GPS /IRS, this field is blank.

The scratchpad displays the relevant “GPS PRIMARY” message when this prompt appears; and “GPS PRIMARY LOST”, when the field turns to blank.

[6L] REQUIRED This field displays the default value for the required navigation accuracy level. The pilot can modify it. Provided no pilot entry has been made, the default value changes according to the actual flight area (En route, terminal, approach).

ACCUR HIGH/LOW This field shows the flight management system’s estimate of the navigational accuracy. “HIGH” indicates that the FMS estimates that the navigational accuracy matches the accuracy criteria of the area currently flown. “LOW” indicates that the criteria are not matched.

[6R] ESTIMATED This field displays the current estimated navigation accuracy value (EPE) as computed by the FMS.

PREDICTIVE GPS PAGES

Ident.: DSC-22_20-50-10-25-00009139.0001001 / 31 AUG 17

Applicable to: ALL

- Note:
1. This page is only operative with Honeywell ADIRS.
 2. This page cannot be used as a substitute to determine pre-flight planning RAIM availability when required by operational regulations. Refer to PRO-NOR-SOP-02 GPS PRIMARY Availability (If Installed).

The pilot accesses this page by pressing the PREDICTIVE GPS prompt of the PROG page. This page displays information relative to theoretical predictive availability of GPS PRIMARY at destination, and at any waypoint selected by the crew.

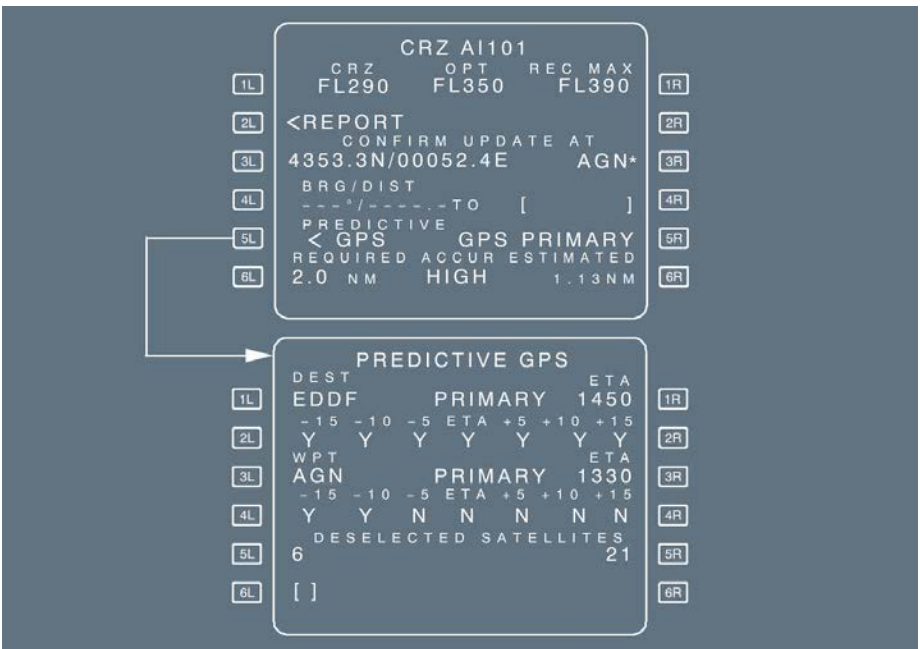

[1L] DEST

Destination, airport as currently selected in active flight plan. It is not modifiable. This field displays dashes, when no destination airport exists.

[1R] ETA

This field is defaulted to the Estimated Arrival Time, as computed by the FMS (small blue font). The pilot may enter a value in this field (large blue font). Amber boxes are displayed, when no prediction exists, or the crew entry has been cleared.

| | |
|--|---|
| Line 2 PRIMARY Y/N | <p>Predicted primary status at destination airport, at the following times: Estimated time of arrival $\pm 5, 10, 15$ min. Availability of GPS PRIMARY at the corresponding time is indicated by Y, when PRIMARY is predicted to be available; and, by N, when GPS PRIMARY is predicted not to be available. These fields are blanked when the destination [1L] field, or the time [1R] field is not defined.</p> |
| [3L] WPT | <p>The pilot may enter a reference waypoint in this field. Blue brackets are displayed, when no entry has been made.</p> |
| [3R] ETA | <p>When a reference waypoint has been entered in the [3L] field, amber boxes are displayed. The crew is requested to enter a reference time in this field.</p> |
| Line 4 PRIMARY Y/N | <p>Information equivalent to [2L] / [2R] is displayed for any pilot-selected waypoint. The corresponding time of arrival is also displayed.</p> |
| Line 5 DESELECTED SATELLITES and Line 6 SATELLITES | <p>Enables the pilot to deselect up to four satellites by inserting the corresponding satellite number ; the number is then displayed in large blue font. When deactivated, the satellites are not considered for predictive GPS availability at destination, or at the selected waypoint. The deselection is cancelled when the entry is cleared (blue brackets are displayed), or the field is overwritten by a different satellite number.</p> |

REPORT PAGE

Ident.: DSC-22_20-50-10-25-00000606.0009001 / 14 MAY 12

Applicable to: ALL

The pilot calls this page by pressing the [2L] key on the PROG page:

The diagram illustrates the MCDU REPORT page in two states: PREFLIGHT PHASE and IN FLIGHT. The page is divided into six rows, each with a label on the left (1L-6L) and right (1R-6R). A white arrow points from the PREFLIGHT PHASE state to the IN FLIGHT state.

REPORT PAGE IN PREFLIGHT PHASE

| | | |
|----|----------------|----|
| 1L | <REPORT | 1R |
| 2L | UPDATE AT | 2R |
| 3L | *f | 3R |
| 4L | BRG/DIST | 4R |
| 5L | ---*/--- TO | 5R |
| 6L | PREDICTIVE | 6R |
| | <GPS | |
| | REQUIRED ACCUR | |
| | 0.36NM HIGH | |

REPORT PAGE IN FLIGHT

| | | |
|----|--------------|----|
| 1L | REPORT AI101 | 1R |
| 2L | OVHD | 2R |
| 3L | TO | 3R |
| 4L | AGN | 4R |
| 5L | NEXT | 5R |
| 6L | AUCH | 6R |
| | SAT | |
| | T.WIND | |
| | FOB | |
| | --- | |
| | DEST | |
| | UTC | |
| | DIST | |
| | EFOB | |
| | LFBZ | |
| | 1110 | |
| | 396 | |
| | 2.0 | |

REPORT PAGE IN FLIGHT

| | | |
|----|--------------|----|
| 1L | REPORT AI101 | 1R |
| 2L | OVHD | 2R |
| 3L | LMG | 3R |
| 4L | TO | 4R |
| 5L | AGN | 5R |
| 6L | NEXT | 6R |
| | AUCH | |
| | SAT | |
| | T.WIND | |
| | FOB | |
| | -42° | |
| | 145°/063 | |
| | 18.0 | |
| | T/D | |
| | UTC | |
| | DIST | |
| | AT FL380 | |
| | 1055 | |
| | 302 | |
| | SEND* | |
| | DEST | |
| | UTC | |
| | DIST | |
| | EFOB | |
| | LFBZ | |
| | 1110 | |
| | 396 | |
| | 2.0 | |

This page displays information related to the FROM, TO, NEXT and DEST waypoints, as well as the current wind, temperature, distance and time to the next cruise profile change.

TITLE (White) Displays the flight number. This line displays EO in amber, in case an engine-out is detected.

[1L] OVHD (green) Displays the last sequenced waypoint. This field never displays the pseudo-waypoints and the F-PLN markers (T-P, PPOS, IN-BND, OUT-BND).

- [1R] UTC/TIME ALT (green) This field displays the time and altitude recorded at the time of sequence.
- [2L]-[2R] TO (green) This field displays the active waypoint, predicted time of arrival and predicted altitude at this waypoint.
Note: Time and altitude values are identical to those values on the F-PLN pages.
- [3L]-[3R] NEXT (green) Same information for the next waypoint.
- [4L] [4R] SAT/T.WIND/FOB (green) This field displays the static air temperature, the wind direction and velocity, and the FOB recorded at waypoint sequencing.
- [5L] T/D/UTC/DIST (green) This field displays the estimated time, and the distance to go to the next change of the cruise profile (T/D , S/C , S/D). These data are only displayed when the cruise phase is active.
- [5R] SEND* (blue) The crew uses this prompt to downlink a position report. This field may be blank, depending on airline policy.
- Line 6 This field displays the estimated time of arrival, the distance along the F-PLN DEST/UTC/DIST/EFOB , and the estimated fuel on board (DEST EFOB) at destination. The DEST EFOB field will turn to amber, if the EFOB at destination becomes less than the MIN DEST FOB value displayed on the FUEL PRED page.. This display is identical to the information on the F-PLN pages.

Note: No data can be inserted or modified on the REPORT page.

RADIO NAV PAGE

Ident.: DSC-22_20-50-10-25-00000607.0009001 / 06 APR 16

Applicable to: **ALL**

This page enables the pilot to select or verify the radio NAVAIDs, tuned for display purposes only. These NAVAID s include: VOR , VOR /DME , TAC , VORTAC, ILS , and ADF.

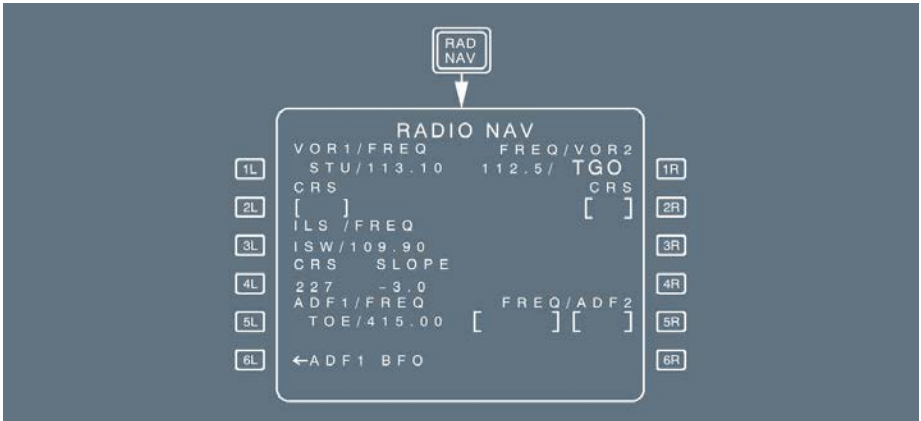

Line 1 VOR1/FREQ
 FREQ/VOR2

This line displays the identifiers and frequencies of VORs 1 and 2, whether they are automatically or manually tuned.

To manually tune a VOR , the pilot inserts the IDENT or frequency. If the IDENT is not in the database, the new NAVAID page comes up. A “clear” action reverts the selection to the autotuned NAVAID.

Line 2 CRS

This line displays courses for the NAVAIDs in Line 1.

The pilot can manually enter the courses through these fields.

[3L] LS/FREQ

This field displays the IDENT of an ILS and its frequency (for ILS). It is autotuned, if the ILS is associated to the departure runway, or if the flight plan contains an ILS approach. The flight crew may also enter an ILS manually. When the manually entered ILS differs from the ILS that the FMS would autotune, “RWY-LS MISMATCH” appears.

[4L] CRS SLOPE CRS : This field displays the course associated with the LS displayed in Line 3. It comes up automatically if an LS is autotuned, or if an LS has been manually tuned via its IDENT. Otherwise, the course must be entered manually. The course may be backbeam (Bxxx) or frontbeam (Fxxx)..
 SLOPE: This field displays the slope associated with the LS displayed in Line 3. It comes up automatically if an LS is autotuned for approach, or if an LS has been manually tuned via its IDENT.

- Note:
1. The slope does not apply to LOC only, LDA, SDF or Backbeam approaches.
 2. If the flight crew intends to manually tune an ILS that is not in the navigation database or to manually tune an ILS by its frequency (ident not entered), and if they do not enter the course, the flight crew will not be able to arm approach modes.

Line 5 ADF1/FREQ This line displays the identifiers and frequencies of ADFs 1 and 2.
 FREQ/ADF2 The pilot can use the IDENT or the frequency to manually tune the ADF.

Line 6 ADF1/BFO When an ADF is selected, these fields display an ADF /BFO prompt. The
 BFO/ADF2 flight crew presses the key once to erase the arrow and put the ADF in BFO mode. A clear action brings the arrow back and cancels BFO.

- Note:
- The autotune function only works for NAVAIDs stored in the database.
 - When tuning manually, the operator should use the IDENT , rather than the frequency, unless the NAVAID is not in the database.
 - Manually-tuned frequencies are displayed in large font.

SECONDARY PAGES

Ident.: DSC-22_20-50-10-25-00000608.0009001 / 13 FEB 13

Applicable to: ALL

The SEC F-PLN key on the MCDU console allows the flight crew to call up the secondary index page and the secondary flight plan page. The secondary flight plan is generally for a diversion, for predictable runway changes for takeoff or landing, or for training.

There are two types of secondary index pages. The type selected depends on the presence of a secondary flight plan.

SECONDARY INDEX PAGE

A SECONDARY FLIGHT PLAN IS ALREADY DEFINED

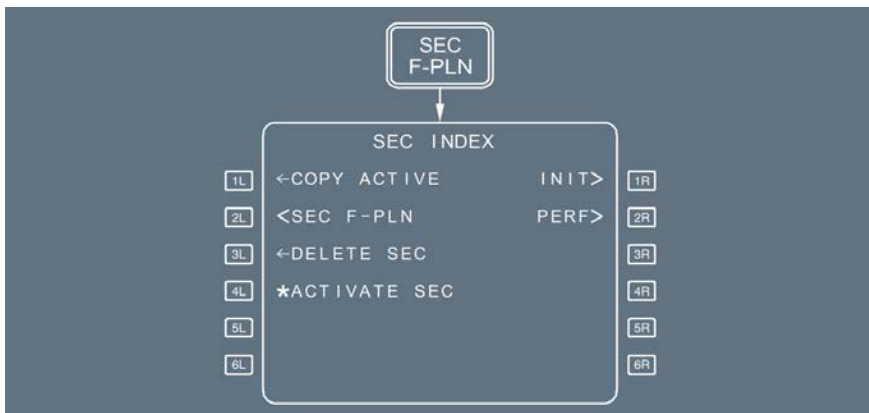

[1L] COPY ACTIVE (blue) The flight crew presses this key to copy the active flight plan into the secondary flight plan and delete the previous secondary plan.

[2L] SEC F-PLN (white) The flight crew presses this key to call up the secondary flight plan pages.

[3L] DELETE SEC (blue) The flight crew presses this key to delete the current secondary flight plan.

[4L] ACTIVATE SEC (amber) The flight crew presses this key to activate the secondary flight plan as the active flight plan.

Note: "ACTIVATE SEC" routinely appears if the HDG/TRK mode is active. If the NAV mode is active, "ACTIVATE SEC" appears only if the active and secondary flight plans have a common active leg.

[1R] INIT (white) The flight crew presses this key to call up the SEC INIT A page.

[2R] PERF (white) The flight crew presses this key to call up the performance pages for the secondary flight plan.

A SECONDARY FLIGHT PLAN IS NOT DEFINED



- [1L] COPY ACTIVE (blue) The pilot presses this key to copy the primary active flight plan into the secondary flight plan.
- [2L] SEC F-PLN (white) The pilot presses this key to call up the secondary flight plan pages.
- [1R] INIT (white) The pilot presses this key to call up the secondary INIT page. It is similar to the active INIT page, but blue brackets replace all the amber boxes.

SECONDARY FLIGHT PLAN PAGES

The secondary flight plan pages A and B are identical to those of the active flight plan, but are automatically sequenced, only when the secondary is copied from the primary and their active legs are identical.

The active and secondary flight plans pages differ from each other as follows:

SECONDARY LATERAL REVISION PAGES:

- ERASE and INSERT are not displayed.
- FIX INFO is not available.
- A lateral revision of the secondary flight plan does not create a temporary flight plan: All revisions are directly applied to the secondary flight plan.

SECONDARY VERTICAL REVISION PAGES:

A vertical revision on the secondary flight plan does not create a temporary flight plan.

SECONDARY INIT A AND B PAGES:

- They use blue brackets, instead of amber boxes.
- They have no align prompt.
- They do not provide for slewing or entering data in the 4L-4R fields (airport reference).

SECONDARY STEP ALTITUDE PAGES:

These pages operate as the primary STEP ALTS page, except that optimal step, savings are not available.

SECONDARY WIND PAGES:

They have no history wind page.

SECONDARY PERFORMANCE PAGES:

- All boxes are replaced by blue brackets.
- They have no engine-out mode, no engine-out long range cruise cost index.
- They have no expedite predictions.
- They have no ACTIVATE/CONFIRM APPROACH PHASE prompt.
- They have no PRED TO ALTN predictions on the PERF CLB and PERF DES pages.
- They have no engine-out drift down, no top of descent, no cabin descent rate information on the PERF CRZ page.

The secondary flight plan has no FUEL PRED page.

SECONDARY INIT A PAGE IS ALSO USED TO REQUEST OR DISPLAY AN UPLINK INIT MESSAGE RECEIVED AFTER ENGINE START.

This uplink INIT message can be cleared or inserted as SECONDARY INIT data.

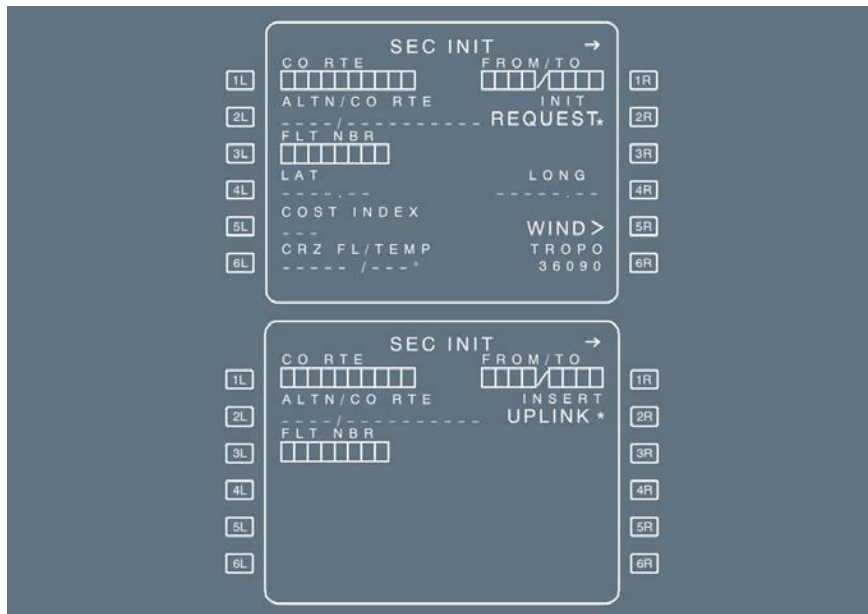

[2R] INIT REQUEST* Enable to request init data from the ground or,

[2R] INSERT UPLINK* A downlink message has been received following a request.

The message can be cleared or entered in the SEC INIT page.



BACK UP NAV PAGES

Ident.: DSC-22_20-50-10-25-00013508.0019001 / 29 JAN 13

Applicable to: ALL

The MCDU features a back up navigation function which provides simplified point-to-point GPIRS and IRS based navigation in case of a dual FM failure.

The backup Navigation mode allows limited lateral flight planning within the MCDU , that can be used to drive the Navigation Display and provides relative path position information and auto-sequencing of the Backup Navigation flight plan. The Backup Navigation flight plan reflects, as much as possible, the active primary FM flight plan upon its initial activation.

During FM normal operation, the F-PLN is continuously downloaded in the MCDU memory: the BACK UP NAV function links the MCDU of the failed FM to its onside IRS . All navigation data related to the MCDU F-PLN are displayed on the associated ND.

BACK UP NAV function is activated on the MCDU MENU page by pressing the NAV B/UP prompt. The MCDU back-up F-PLN may accept a maximum of 165 legs, including information such as waypoint position/identification, leg type, discontinuity, overfly and turn direction information (radial, pattern, heading leg... cannot be part of the MCDU F-PLN). No secondary or temporary F-PLN exists.

BACK UP NAV pages display the data related to the BACK UP NAV function. There are six pages available while BACK UP NAV is active:

- B/UP F-PLN
- B/UP F-PLN for DIRECT TO
- B/UP PROG
- B/UP IRS for onside IRS (1+2)
- B/UP IRS 3
- B/UP GPS (if the GPS is installed)

B/UP F-PLN PAGE

The B/UP F-PLN page displays the MCDU F-PLN data. The pilot calls up this page by pressing the F-PLN key while B/UP NAV is active.

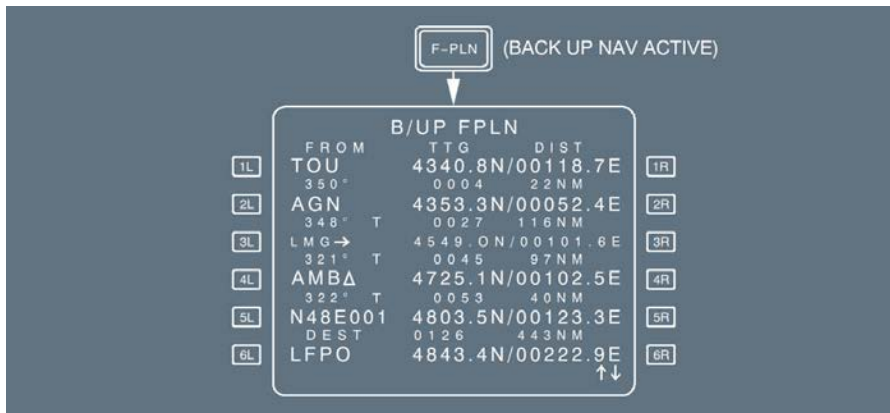

TITLE line 1 to line 5

B/UP F-PLN is displayed in a white large font

Display consecutive waypoints with their associated latitude/longitude. If a waypoint is to be overflowed, an overfly symbol (Δ) is displayed after the identifier.

If a turn is specified into the next leg, a large font arrow is displayed after the identifier.

Label lines contain the bearing, time to go and distance to the next waypoint displayed in small font.

white bearing

green time to go and distance

BRG Between FROM and TO waypoints: True or Mag depending on the TRUE pb-sw  position. T is displayed when the bearing is true referenced.

Between other waypoints: out bound true track of the great circle joining the 2 related waypoints, independant of TRUE pb-sw .

TTG HHMM limited to 9 959. Time between the 2 related waypoints.

DIST NM limited to 9 999.

line 6 DEST

DEST airport identifier and associated latitude/longitude.
 DIST to destination is computed as the direct distance from the aircraft to the active waypoint plus the along flight plan distances.
 time to go to destination is computed as distance to destination divided by ground speed.
 TTG and DEST are dashed if aircraft position is unavailable.

B/UP F-PLN (DIR TO)PAGE

The pilot calls up this page using the DIR key on MCDU while BACK UP NAV is active and aircraft position is valid.

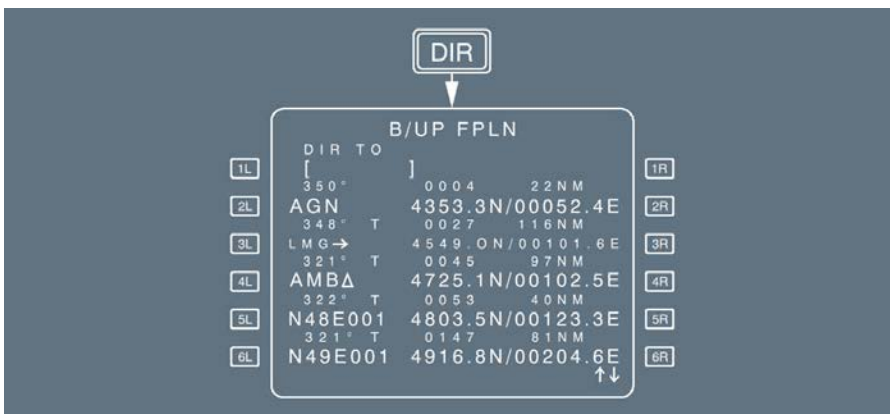

TITLE [1L] DIR TO

B/UP F-PLN is displayed in a white large font
 Allows DIRECT TO selection to the desired waypoint.
 This waypoint can be selected from the F-PLN or manually entered through the scratchpad (IDENT /LAT /LONG or LAT /LONG)

line 2 to line 6

Display consecutive waypoints of the F-PLN.
 Same as the B/UP F-PLN page.
 The TO WAYPOINT is displayed in [2L].
 Vertical slewing function is available.

After a DIR TO selection, the B/UP F-PLN page is modified as following:

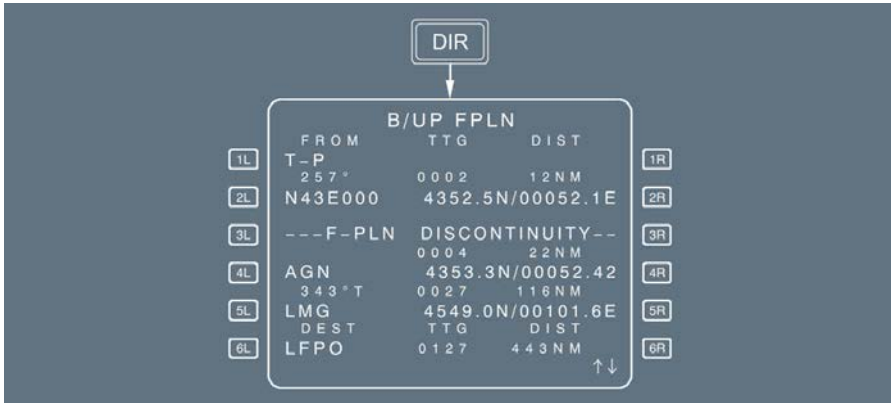

B/UP PROG PAGE

It displays flight parameters relative to the F-PLN or a selected waypoint. The flight crew calls up this page by pressing the PROG key on MCDU when BACK UP NAV is active.

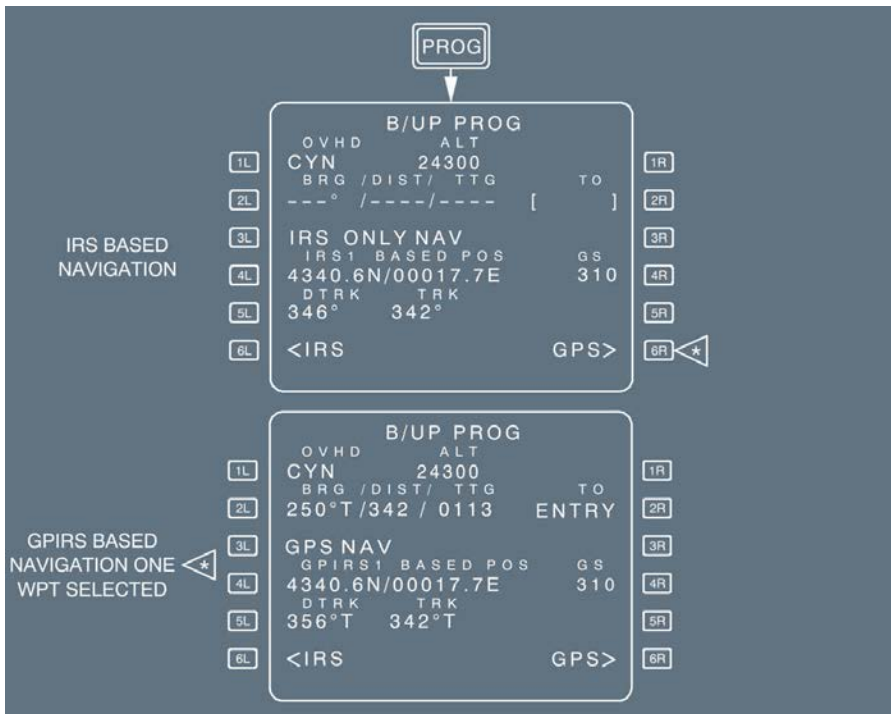

TITLE line 1 OVHD/ALT B/UP PROG is displayed in a white large font.

Displays the identifier of the last sequenced waypoint and the altitude at the time of the sequence.

AIRCRAFT SYSTEMS
AUTO FLIGHT - FLIGHT MANAGEMENT



CONTROLS AND INDICATORS - MCDU - PAGE DESCRIPTION

line 2 BRG/DIST/TTG/TO Allows the flight crew to enter an existing MCDU F-PLN waypoint identifier or LAT /LONG or IDENT /LAT /LONG. MCDU then computes bearing, distance and time to go to that waypoint from the present position. The pilot may modify or clear this entry (2R field).

- BRG True or magnetic outbound track of the great circle joining aircraft present position to the entered waypoint: dependent on the TRUE pb-sw  position.
- DIST limited to 9 999.
- TTG HHMM limited to 9 959. time to go to the entered position computed assuming current ground speed.

These fields are displayed in a green small font. They are dashed if present position is unavailable.

[3L] Means of navigation used by the Back-Up Navigation. If GPS is fitted and is the navigation source, "GPS NAV " is displayed, otherwise "IRS ONLY NAV" is displayed. If the GPS is not installed, this field is blank.

[4L] IRS 1 (2 or 3) Current aircraft position provided by the selected IRS GPIRS
 BASED POS GPIRS 1 (2 IRS 1 (or 3 if IRS 1 failed) on MCDU 1
 or 3) (green) IRS 2 (or 3 if IRS 2 failed) on MCDU 2
 GPIRS 1 (or GPIRS 3) or MCDU 1 
 GPIRS 2 (or GPIRS 3) or MCDU 2 

[4R] GS (green) Current ground speed from the selected IRS or GPS .

[5L] DTRK/TRK (green) Desired track of the MCDU F-PLN active leg and current aircraft track from the selected IRS /GPS (True or Mag). These tracks are true or magnetic depending on TRUE pb-sw  position.

[6L] IRS 1 (2) Gives access to onside B/UP IRS (1 or 2) page

[6R] GPS Gives access to B/UP GPS page. This prompt only appears when the GPS is installed.

B/UP IRS 1 OR 2 OR 3 PAGE

Display IRS 1, 2, 3 navigation data. The pilot calls up this page from B/UP PROG page, by pressing the corresponding prompt.

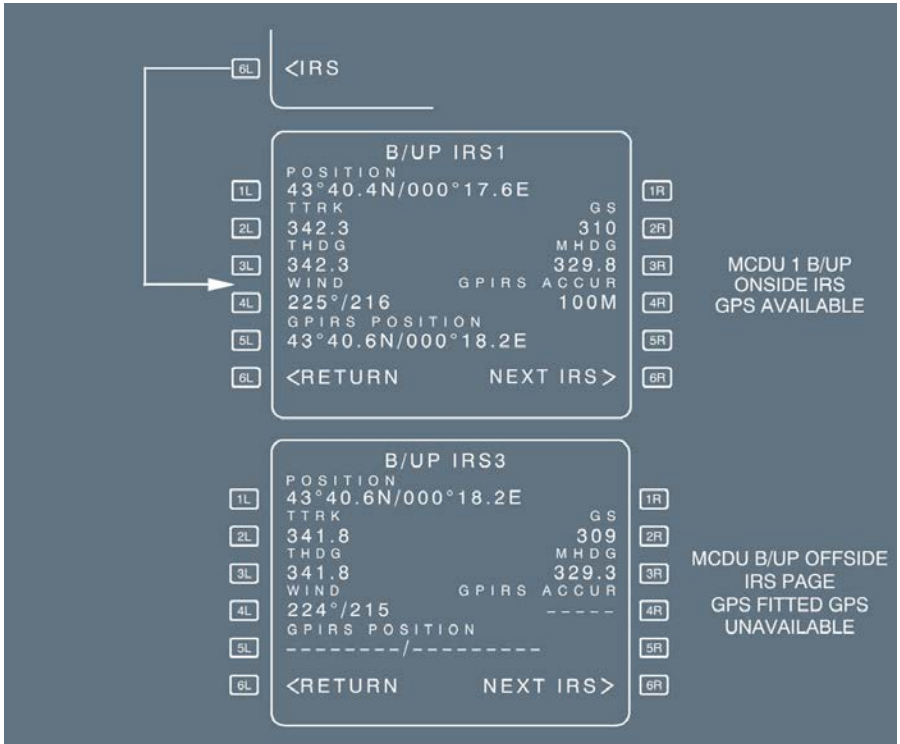

| | |
|---------------------|---|
| TITLE | B/UP IRS 1, 2, 3 displayed in a white large font. |
| [1L] POSITION | Current aircraft position from selected IRS |
| [2L] T TRK | True track |
| [2R] GS | Ground speed |
| [3L] T HDG | True heading |
| [3R] M HDG | Magnetic heading |
| [4L] WIND | Wind direction and velocity Wind direction is always true referenced. |
| [4R] GPIRS ACCUR | GPS accuracy in meters as in the IRS page. |
| [5R] GPIRS POSITION | If GPS is installed, the GPS IRS position is provided as in the IRS page. |
| [6L] RETURN | Gives access to B/UP PROG page |

[6R] NEXT IRS Gives access to the next IRS page.
 (Closed loop 1 → 2 → 3 → 1)

This page is not modifiable by the crew.

Note: The fields [4R] and [5L] are blanked when the GPS is not installed.

B/UP GPS 

Display GPS navigation data.

The flight crew calls up this page from B/UP PROG page, by pressing the corresponding prompt.

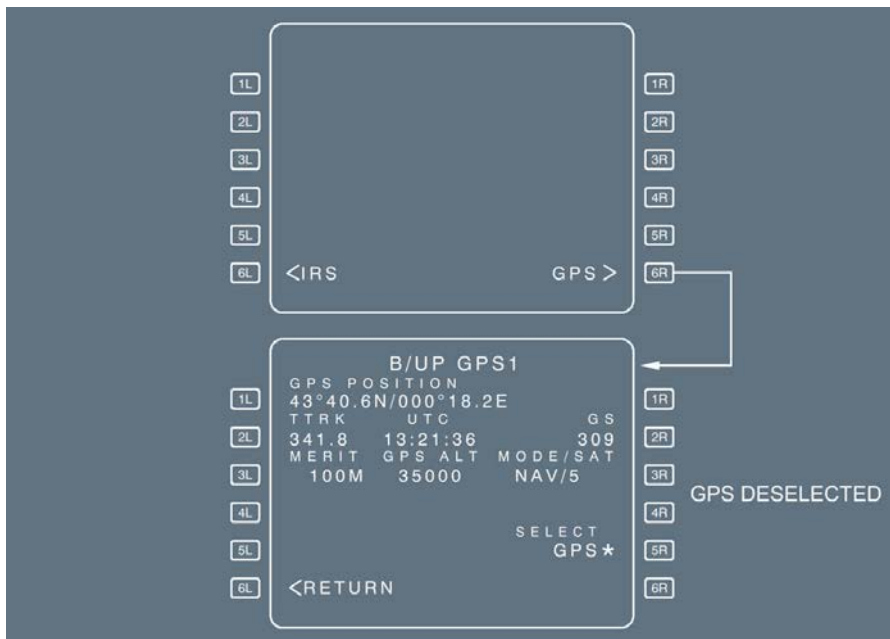

TITLE B/UP GPS 1, 2 displayed in a white large font.

[1L] GPS POSITION

Line 2: TTRK GPIRS position (latitude/longitude)
 UTC: Time
 GS: Ground Speed

Line 3: MERIT: GPS figure of merit
 GPS ALT : GPS altitude
 MODE/SAT: Navigation mode and number of tracked satellites. These values are displayed as in the FM GPS page.

[5R]

DESELECT/SELECT GPS : The flight crew may select and deselect the GPS for navigation Backup function. The default configuration is GPS selected.



A318/A319/A320/A321
FLIGHT CREW
OPERATING MANUAL

AIRCRAFT SYSTEMS

AUTO FLIGHT - FLIGHT MANAGEMENT

CONTROLS AND INDICATORS - MCDU - PAGE DESCRIPTION

Intentionally left blank



A318/A319/A320/A321
FLIGHT CREW
OPERATING MANUAL

AIRCRAFT SYSTEMS

AUTO FLIGHT - FLIGHT MANAGEMENT

CONTROLS AND INDICATORS - MCDU - MESSAGES

FMS2 Honeywell

MCDU MESSAGE LIST

Ident.: DSC-22_20-50-20-35-00000918.0020001 / 03 NOV 14

Applicable to: ALL

Messages displayed on the MCDU are of two types and displayed in two colors.

Type I : A direct result of a pilot action;

Type II : Information about a situation, or a call for pilot action;

Type II messages are stored in a first-in/first-out message queue (5 messages max)

They are suppressed, if correct data is entered or when they no longer apply

The flight crew can clear all messages by pressing the CLEAR key on the MCDU console.

Amber (A) : Important

White (W) : Less important

| MESSAGE | TYPE/COLOR | CONDITIONS |
|--------------------------------|------------|--|
| A/C POSITION INVALID | II/A | The aircraft position has become invalid. If the message has been cleared and the flight crew attempts to call up the HOLD at PPOS or DIR TO page while the aircraft position is still invalid, then the message is displayed again. |
| ACT RTE UPLINK (ACARS msg) | II/W | A flight plan is stored in the active flight plan. |
| ALIGN IRS | II/A | Appears when the IRS are ready for alignment, but the INIT A page is not displayed on either side of the flight deck. The ALIGN IRS message requires that one of the flight crew call up the IRS INIT page, to align the IRS. |
| AREA RNP IS XX-XX | II/A | Displayed when the RNP value, manually-entered on the PROG page, is larger than the default RNP value associated to the current flight area and when there is no RNP value defined in the navigation database for the active leg or route. |
| AWY /WPT MISMATCH | I/W | The pilot entered VIA on the AIRWAYS page does not contain the revised point. If you enter a second airway IDENT, it must contain the first airway ending point. |
| BLOCK IGNORES RTA | II/W | A time constraint existing at initiation of flight planning, or an entry of a time constraint made after initiation of flight planning, are ignored by the fuel planning function. |
| CABIN RATE EXCEEDED | II/W | This message appears when the aircraft gets within 200 NM of the destination and the computed rate of descent makes it impossible for the cabin to be repressurized at the maximum rate. |
| CHECK ALTN WIND (ACARS msg) | II/W | The uplinked alternate cruise flight level differs from the defaulted alternate cruise flight level. |

Continued on the following page

AIRCRAFT SYSTEMS
AUTO FLIGHT - FLIGHT MANAGEMENT

CONTROLS AND INDICATORS - MCDU - MESSAGES

Continued from the previous page

| MESSAGE | TYPE/COLOR | CONDITIONS |
|---|------------|--|
| CHECK APPR SELECTION *EFIS PFD (FMA) | II/W | Displayed when a NON ILS approach is part of the F-PLN and an ILS is manually tuned on RAD NAV page. This message reminds the flight crew that available guidance modes for the approach are APP NAV/FINAL. Displayed when in cruise at less than 100 NM from the top of descent or in descent or approach phase. |
| CHECK CO RTE (ACARS msg) | II/W | The uplinked company route identifier differs from the one specified in the request. |
| CHECK DATA BASE CYCLE | II/W | The current date does not match the effective date of the active database, and someone attempts to enter a FROM/TO or CO RTE. |
| CHECK IRS 1(2)(3)/FM POSITION | II/A | Each IRS position is compared to the FM position. The difference is greater than a threshold function of time. |
| CHECK IRS /AIRPORT POS | I/A | The distance between ADIRS alignment position and the NAV Database Airport Reference Point is at least 5 NM |
| CHECK DEST DATA (ACARS msg) | II/A | The aircraft is at 180 NM from destination and the destination QNH , TEMP or WIND displayed on the PERF APPR page received by ACARS uplink has to be checked. If a modification of these parameters is performed creating a conflict with previous data, the message is triggered again. |
| CHECK FLT NBR (ACARS msg) | II/A | The uplinked flight number differs from the flight number specified in the request. |
| CHECK MIN DEST FOB | II/W | This message appears when the flight crew has manually entered the MIN DEST FOB value, and MIN DEST FOB < ALTN + FINAL, being FINAL an ALTN valid data. |
| CHECK NORTH REF * EFIS ND | II/A | The MAG/TRUE sw does not correspond to the airport MAG /TRUE bearing reference (as stored in the FMGS navigation database), either at the departure airport (during preflight), or at the destination airport (when entering the ARRIVAL area). |
| CHECK QFE | II/A | This appears at the transition from QNH to QFE reference, when the QFE altitude differs by more than 100 ft from the predicted altitude, with the QNH set on the MCDU by means of the airport elevation in the NAV database. |
| CHECK TAKEOFF DATA | II/A | Following a flight crew entry or modification of one of the take-off parameters, there may be an inconsistency between the take-off runway or the TO shift and V1 , VR , V2 , FLEX TO temperature or derated level. The flight crew activated the secondary F-PLN in PREFLIGHT or DONE phase. |
| CHECK WEIGHT | II/A | The gross weights (GW) computed by the flight management computer (FMC) and the flight augmentation computer (FAC) disagree by more than 7 t (7.7 US tons). |

Continued on the following page

Continued from the previous page

| MESSAGE | TYPE/COLOR | CONDITIONS |
|--|------------|--|
| CLK IS TAKEOFF TIME | II/W | This appears when the flight crew has entered an Estimated Takeoff Time (ETT), and the actual time is equal to ETT. |
| CLOCK/GPS TIME DIFF XX | II/A | Aircraft clock time and GPS time differ by more than XX minutes. |
| CROSSLOAD ABORTED | II/W | Message displayed on the transmitting MCDU, indicating an error in the transmission process. |
| CROSSLOAD COMPLETE | II/W | The database crossload from one FMGC to the other was successfully completed. |
| CRZ FL ABOVE MAX FL | II/W | This appears when the flight crew enters a cruise altitude that is above the computed maximum altitude. |
| CSTR DEL ABOVE CRZ FL | II/W | This appears when a flight plan altitude constraint has been deleted because the flight crew has inserted a cruise flight level, or step-down altitude that is at or below the flight plan constraint. |
| CSTR DEL UP TO WPT 01 | II/W | This appears when constraints get deleted because the aircraft transitions to a go-around flight phase, before the FMGS sequences the flight plan destination. |
| DECELERATE or T/D REACHED (Also displayed on PFD) | II/W | One of these messages appears when the aircraft has reached the T/D in managed speed and it has not yet begun the descent. |
| DELETING OFFSET | II/W | This appears when the system is deleting an offset automatically, which it does under certain specific conditions, such as: <ul style="list-style-type: none"> - Change of active leg due to lateral revision. - Termination of next leg at destination runway and the current distance to go is less than or equal to the distance required to reach the path, or the next leg is not a CF, FM or TF leg. |
| DEST /ALTN MISMATCH | I/W | The pilot attempts to enter an alternate CO RTE (which starts at an origin that is not the primary flight plan destination). |
| DEST EFOB BELOW MIN | II/A | The EFOB at destination calculated by the FMS is less than the MIN DEST FOB value specified on the FUEL PRED page, for more than 2 min. The message is triggered in flight, except during Takeoff and Climb phases. |
| DIR TO IN PROCESS | I/W | The flight crew calls up the vertical or lateral revision page on one MCDU while the direct to page is displayed on the other MCDU. |
| ENTER DEST DATA | II/A | The flight crew has not entered wind, QNH, or temperature for the destination, and the aircraft is 180 NM out. |
| ENTRY OUT OF RANGE | I/W | The flight crew attempts to enter data that is out of the range specified for the selected field. |
| FLT NBR UPLINK (ACARS msg) | II/W | A flight number has been added to the uplink flight plan without previous request. |
| F-PLN ELEMENT RETAINED | I/W | The flight crew attempts to delete stored NAVAIDs, waypoints or runways that are contained in any flight plan or that are being tuned. |

Continued on the following page

AIRCRAFT SYSTEMS
AUTO FLIGHT - FLIGHT MANAGEMENT

CONTROLS AND INDICATORS - MCDU - MESSAGES

Continued from the previous page

| MESSAGE | TYPE/COLOR | CONDITIONS |
|--|------------|---|
| F-PLN FULL | II/W | There is not enough memory in the flight plan allotment for the computer to accept more flight plan data. |
| FMS 1/FMS 2 A/C STS DIFF | II/W | This message always precedes a transition to independent mode, and appears at power-up if the system detects a difference in one of the following: - NAV database serial number - Performance database - FM operational program - Aircraft and airline program pins |
| FMS 1/FMS 2 GW DIFF | II/W | Onside and offside aircraft weight differ by 2 t or more. |
| FMS 1/FMS 2 PGM PIN DIFF | II/W | Onside and offside program pins are different. |
| FMS 1/FMS 2 POS DIFF | II/A | Onside and offside positions differ by 0.5 NM or more (5 NM when GPS is not installed). |
| FMS 1/FMS 2 SPD TGT DIFF | II/W | Onside and offside target speeds displayed on the PFD differ by 5 kt or more. |
| FORMAT ERROR | I/W | A data entry does not meet the specified entry format for a given field. |
| GPS PRIMARY LOST (also displayed on ND) | II/A | Displayed when GPS PRIMARY mode is lost. |
| GPS PRIMARY | II/W | Displayed when the FMS is transitioning to GPS PRIMARY |
| GPS IS DESELECTED | II/A | This message appears when GPS has been manually deselected and the aircraft is 80 NM before the top of descent or in approach phase. |
| INDEPENDENT OPERATION | II/A | The FMGCs operate independently of each other. |
| INITIALIZE WEIGHT/CG | II/A | The zero-fuel weight or block fuel (FOB) is undefined after engine start. |
| INVALID FLT NBR UPLINK (ACARS msg) | II/W | The uplink message contains a valid flight plan but no flight number. |
| INVALID PERF UPLINK (ACARS msg) | II/W | Performance uplink message has been rejected. |
| INVALID RTE UPLINK (ACARS msg) | II/W | An error was detected into the uplink message and it is rejected. |
| INVALID TAKEOFF UPLINK (ACARS msg) | II/W | The current uplink takeoff data message is rejected. |
| INVALID WIND UPLINK (ACARS msg) | II/W | The current uplink wind message is rejected. |
| LAT DISCONT AHEAD | II/A | The next leg is a discontinuity and the aircraft is 30 s from flying the leg. |
| LIST OF 10 IN USE | I/W | The flight crew has tried to enter more than ten stored runways into the database, and all of the first ten are included in a flight plan or a pilot-stored route. |

Continued on the following page

Continued from the previous page

| MESSAGE | TYPE/COLOR | CONDITIONS |
|--|------------|--|
| LIST OF 20 IN USE | I/W | The flight crew has tried to create a PBD, LAT /LONG , or PBX, or store a pilot-defined waypoint or NAVAID when 20 are already in use (in a flight plan or pilot-stored routes). |
| MACH SEGMENT DELETED | II/W | A constant Mach segment of the active flight plan has been automatically deleted. This occurs when the secondary flight plan or the alternate is activated, or engine out is detected or when the flight phase changes from CRZ to another one. |
| MCDU OVERHEATED | II/A | This message is displayed for 15 s in case of MCDU overheating. |
| MORE DRAG (EFIS PFD) | II/W | DES mode is engaged, idle is selected and the aircraft must decelerate in order to recover the path, or to respect an altitude constraint, a speed limit or a speed constraint. |
| NAV ACCUR DOWNGRAD (also displayed on ND) | II/A | NAV accuracy has been downgraded from HIGH to LOW. (See FMGS principles for an explanation). |
| NAV ACCUR UPGRAD (*EFIS ND) | II/W | NAV accuracy has been upgraded from LOW to HIGH. |
| NEW ACC ALT-HHHH | II/W | The acceleration altitude has been changed. |
| NEW CRZ ALT-HHHHH | II/W | The cruise altitude has been changed. |
| NEW THR RED ALT-HHHH | II/W | The thrust reduction altitude has been changed. |
| NO ANSWER TO REQUEST (ACARS msg) | I/W | A crew request, was previously sent to the ground and no answer has been received for 4 min. |
| NO INTERSECTION FOUND | I/W | The system could not find any common waypoint nor intersection point through the airway. |
| NON UNIQUE ROUTE IDENT | I/W | The flight crew has tried to enter on the new route page a company route IDENT that is identical to an existing company route IDENT (pilot-defined or in the database). |
| NOT ALLOWED | I/W | Data entry is not allowed in the selected field, or a selection action is not allowed. |
| NOT ALLOWED IN NAV | I/W | An attempt to modify the TO waypoint is made while in NAV mode. |
| NO NAV INTERCEPT | II/A | It is triggered, when NAV mode is armed and, no INTERCEPT waypoint exists before the TO waypoint. |
| NOT IN DATA BASE | I/W | The pilot is trying to enter or call up a company route IDENT , a FROM/TO pair, a place defined by place-bearing-distance (PBD) or place-bearing/place-bearing (PBX) or an airport NAVAID , waypoint runway, or NAVAID frequency (including pilot-defined elements) that is not in the current database. |
| NOT XMITTED TO ACARS (ACARS msg) | II/W | A pilot request or a crew report was sent but the communication was not established or not acknowledged. |
| ONLY SPD ENTRY ALLOWED | I/W | The pilot is trying to enter a Mach number for a preselected speed value on the CLIMB page. |

Continued on the following page

AIRCRAFT SYSTEMS
AUTO FLIGHT - FLIGHT MANAGEMENT

CONTROLS AND INDICATORS - MCDU - MESSAGES

Continued from the previous page

| MESSAGE | TYPE/COLOR | CONDITIONS |
|--------------------------------------|------------|---|
| OPP FMGC IN PROCESS | II/W | The offside FMGC is unhealthy, and the FM system mode is SINGLE. The message indicates that the MCDU on which the message is displayed is being driven by the FMGC on the other side. |
| PAGE UPDATE IN PROCESS | I/W | The pilot presses a key on the flight plan page while predictions are being updated. |
| PERF DATA UPLINK (ACARS msg) | II/W | Performance data are received from ground. |
| PLACE/D IN TRANSITION | I/W | If a place/distance waypoint is defined within a pre-planned "fixed turn radius" transition, the entry is rejected and the "PLACE/D IN TRANSITION" scratchpad message is displayed. |
| PLEASE WAIT | I/W | Resynchronization between both FMGCs is in progress. |
| PROCEDURE RNP IS XX.XX | II/A | Displayed when the RNP value, manually-entered on the PROG page, is larger than the RNP value defined in the navigation database for the active leg or route. |
| PRINTER NOT AVAILABLE (ACARS msg) | II/W | A printer communication error has been detected while printing a report. The printing is terminated. |
| RADIONAV IS DESELECTED | II/A | Radio nav aids have been manually deselected and the aircraft is 80 NM before the top of descent or in approach phase. |
| REF/GPS POS DIFF | I/A | This message is displayed when there is a discrepancy between the reference position entered by the pilot and the GPS position. |
| REF/LAST IRS POS DIFF | I/A | This message is displayed when there is a discrepancy between the reference position entered by the pilot and the last stored IRS position. |
| REVISIONS NOT STORED | II/W | This message, displayed when a pilot-defined route or company route (active or secondary flight plan) is stored, indicates that the following elements are not retained: <ul style="list-style-type: none"> - Pilot-entered holds - Offsets - Modifications to terminal area procedures - Pilot-entered constraints - Pseudo waypoints - Step at optimum. |

Continued on the following page

Continued from the previous page

| MESSAGE | TYPE/COLOR | CONDITIONS |
|--|------------|--|
| RTA DELETED | I/W | A time constraint is automatically deleted: <ul style="list-style-type: none"> - In case of engine-out - When entering the holding pattern - In case of go-around - At phase transition from descent or approach to climb or cruise - When a time constraint is inserted in the same flight plan at a different waypoint - When the alternate flight plan is activated - When a DIR TO/ABEAM is performed, only if the time constrained waypoint is projected as an ABEAM waypoint - The time constrained waypoint is cleared or sequenced (regardless of active lateral mode) - Valid clock data is lost - The time constraint belongs to the active flight plan and the secondary flight plan is activated - The time constraint belongs to the secondary flight plan and COPY ACTIVE is performed. |
| RTA EXISTS | I/W | Displayed if the pilot tries to clear an estimated takeoff time defined by the system. |
| RTE DATALINK IN PROG (ACARS msg) | I/W | A flight plan modification is performed after a F-PLN INIT request has been sent. This message is displayed until the uplink is entirely received. |
| RWY/LS MISMATCH | I/A | <ul style="list-style-type: none"> - During climb, cruise, (ILS or MLS) descent approach, or go-around, the LS frequency entered on the RAD NAV page does not match the LS associated with the destination runway. - During preflight or takeoff, the LS frequency entered on the RAD NAV page does not match the LS associated with the takeoff runway. |
| SEC RTE UPLINK (ACARS msg) | I/W | A flight plan is stored in the secondary flight plan. |
| SELECT DESIRED SYSTEM | I/W | The MCDU displays its MENU page. |
| SELECT TRUE (also displayed on the ND) | I/A | The MAG/TRUE sw is set to MAG , while the IRS send true HDG /TRK. |
| SENSOR IS INVALID | I/W | <ul style="list-style-type: none"> - The pilot has selected FF or FQ, or FF + FQ, or FQ + FF on the FUEL PRED page and the sole sensor or both of the selected sensors are invalid, or - The flight crew has entered fuel on board only, and the FF sensor is invalid. |

Continued on the following page

Continued from the previous page

| MESSAGE | TYPE/COLOR | CONDITIONS |
|---|-------------|---|
| SET GREEN DOT SPEED (*SET GREEN DOT* displayed on PFD) | II/W (W) | This message appears when the following conditions are all met: - Engine-out condition - Aircraft in selected speed mode - FCU -selected speed equal to or greater than green-dot speed +10 kt, and ALT * or ALT not active, or FCU-selected speed equal to or less than green-dot speed -10 kt. |
| SET HOLD SPEED (also displayed on PFD) | II/W (W) | This instruction appears when the aircraft is in selected speed, the pilot has inserted a hold in the flight plan, the aircraft is 30 s or less from the point where it must start decelerating towards hold speed, and the selected speed differs from the hold speed by more than 5 kt. |
| SET MANAGED SPEED or CHECK SPEED MODE (Also displayed on PFD) | II/W (W) | The target speed is selected for the current phase, but there is no preselected speed for the next flight phase. When this is so, one of these messages is displayed at transitions from climb to cruise, and from climb or cruise to descent. The message is always displayed at the transition to descent from climb or cruise if selected speed is active. It is not displayed if managed speed is active. |
| SETTING SPD/RTA | II/W | Displayed when the system recomputes its managed speed target to satisfy the RTA constraints. |
| SPECIF NDB UNAVAIL | II/A | The NDB to be autotuned (specified for a NDB approach) is not available. |
| SPECIF VOR-D UNAVAIL (also displayed on ND) | II/A | - The VOR , VOR -DME , or VORTAC to be autotuned (specified for an RNAV or VOR approach) has previously been deselected by the flight crew, or - The bearing, the frequency, or the IDENT of the VOR (or VORDME or VORTAC) to be autotuned is invalid. |
| SPD ERROR AT WPT 01 | II/W | In lateral managed flight, the system predicts that the aircraft will miss a speed constraint by more than 10 kt. When the prediction changes to bring the miss within 5 kt, the message is cleared. |
| SPD LIM EXCEEDED | II/A | The aircraft is more that 150 ft below the speed limit altitude and more than 10 kt over green dot or the speed limit (which ever is smaller). |
| STEP ABOVE MAX FL | II/W | The pilot has entered a step altitude that is above the predicted maximum altitude. |
| STEP AHEAD | II/W | Indicates that the aircraft is within 20 NM of the active step point. |
| STEP DELETED | II/W | A step has been automatically deleted. |
| STORED ROUTES FULL | I/W | The system already contains five pilot-defined routes. (Only five are allowed.) |
| TAKEOFF DATA UPLINK (ACARS msg) | II/W | A takeoff data message is received. |

Continued on the following page

Continued from the previous page

| MESSAGE | TYPE/COLOR | CONDITIONS |
|--------------------------------------|------------|--|
| TEMPORARY F-PLN EXISTS | I/W | The flight crew has selected any key (except ERASE or INSERT) or attempted a flight planning operation on the secondary flight plan while the system is displaying a temporary flight plan. |
| TIME ERROR AT WPT 01 | II/W | While the aircraft is in lateral managed flight the FMGC predicts that it will miss a time constraint (<i>Refer to DSC-22_20-30-20-25 Required Time of Arrival (RTA) - Entering a Required Time of Arrival</i>). |
| TIME MARKER LIST FULL | I/W | The system already contains four time markers. (Only four are allowed). |
| TIME TO EXIT | II/A | The aircraft must leave holding immediately to satisfy fuel reserve requirements. (Extra fuel is zero). |
| TO SPEED TOO LOW | II/A | This message appears if the inserted V1 , VR , V2 speeds do not satisfy the existing regulatory conditions regarding VMC and VS1G speeds. |
| TOO STEEP PATH AHEAD | II/A | The system displays this message in cruise phase if the aircraft is within 150 NM of its destination or in descent or approach phase and in NAV mode and the descent profile contains a segment that is too steep. |
| TUNE BBB FFF.FF | II/A | The system cannot autotune the VOR for approach or position because of a manual VOR selection. |
| TURN AREA EXCEEDANCE | II/A | This message is displayed 1.5 min before entry of the PI leg, when in NAV mode, if the PI lateral path exceed the protection envelope defined in the Navigation database. |
| UNKNOWN PROGRAM PIN | II/W | The system has been unable to initialize because of an incompatible or undefined aircraft pin program combination (A/C type, engine type, VMO/MMO parity) in the FMGC software. |
| UPLINK INSERT IN PROG (ACARS msg) | II/W | Displayed when an uplink message is currently inserted in the FMGS. |
| USING COST INDEX-NNN | I/W | This message is displayed when the system contains a flight plan, and the flight crew tries to enter a zero fuel weight or a gross weight into it before defining a Cost Index (CI). (In this case, the FMS defaults to the Cost Index from the last flight). It is also displayed when the flight crew inserts the ALTN F-PLN (in this case, the FMS defaults the cost index to 0). |
| V1 /VR /V2 DISAGREE | II/A | This message is displayed when the entered V1 , VR and V2 speeds do not satisfy the condition $V1 \leq VR \leq V2$. |
| WAIT FOR SYSTEM RESPONSE | I/W | During the time between a subsystem selection and the display of the subsystem page, the MCDU MENU page remains displayed with this message. |
| WIND DATA UPLINK (ACARS msg) | II/W | Uplink wind message has been received. |
| WIND UPLINK EXISTS (ACARS msg) | I/W | A flight plan modification (active or secondary) is attempted when uplink winds are not inserted yet. |

Continued on the following page



A318/A319/A320/A321
FLIGHT CREW
OPERATING MANUAL

AIRCRAFT SYSTEMS
AUTO FLIGHT - FLIGHT MANAGEMENT

CONTROLS AND INDICATORS - MCDU - MESSAGES

Continued from the previous page

| MESSAGE | TYPE/COLOR | CONDITIONS |
|------------------------------------|------------|---|
| WIND UPLINK PENDING (ACARS msg) | I/A | A temporary flight plan exists or a DIR TO page is displayed and a wind uplink is received and stored. |
| XXXX IS DESELECTED | I/W | The flight crew attempts to enter a deselected NAVAID , via the SELECTED NAVAID page, that has already been deselected. |

MCDU DATA FORMAT LIST

Ident.: DSC-22_20-50-30-00000920.0051001 / 21 MAR 16

Applicable to: ALL

The following chart lists all the data the pilot may enter on the MCDU.

It also shows the acceptable format for the various data items, the acceptable range, the units of entry, and the MCDU pages on which the data can be entered.

The following codes are used to indicate various data formats:

- A : letters
- N : numbers
- X : letters and numbers

| DATA NAME | FORMAT | RANGE (X is input) | UNITS | DISPLAY PAGE |
|----------------------|---|---|------------------------------------|--|
| ACCEL ALT | See ALT | | ft (MSL) | TAKEOFF (ACT/SEC ⁽²⁾) GO AROUND (ACT/SEC ⁽²⁾) |
| ALT | NNNN or NNNNN (leading zeros must be included) | Max ALT = 39 000 Entry is rounded to the nearest 10 ft | ft (MSL) | PERF CLB PERF DES |
| ALT CSTR | See ALT | See ALT | ft (MSL) | VERT REV F-PLN A SEC F-PLN A |
| AIRWAYS (VIA) | XXXX | If not in data base "NOT IN DATA BASE" is displayed | N/A | LAT REV AIRWAYS <A> |
| ARPT | AAAA 1 character minimum. 4 maximum. | If AAAA is not in the database airport file, the New Runway page is displayed | | INIT A (ACT/SEC ⁽²⁾) LAT REV ALTN F-PLN A-B (ACT/SEC ⁽²⁾) WAYPOINT DIR TO |
| BARO | Same as ALT | Ldg elevation to Idg elevation + 5000 | ft (MSL) | PERF APPR (ACT/SEC ⁽²⁾) |
| BLOCK FUEL | NN.N leading zeros may be omitted. | 0-80/0-175.2 | Thousands of Kg or thousands of Lb | INIT B (ACT/SEC ⁽²⁾) |
| CABIN RATE | - NNN (- may be omitted) | 100 - 999 | ft/min | DES FORECAST or CRUISE PERF PAGE <A> |
| CG | NN.N | 8.0 - 45.0 | % MAC | INIT B. (ACT/SEC ⁽²⁾) FUEL PRED |
| CHANNEL <A> | NNN | 500 - 699 | | NEW NAV AID RAD NAV |





Continued on the following page

AIRCRAFT SYSTEMS
AUTO FLIGHT - FLIGHT MANAGEMENT

A318/A319/A320/A321
FLIGHT CREW
OPERATING MANUAL

CONTROLS AND INDICATORS - MCDU - DATA FORMAT LIST

Continued from the previous page

| DATA NAME | FORMAT | RANGE (X is input) | UNITS | DISPLAY PAGE |
|---|---|--|------------------------|--|
| CLASS (NAVAID) | AAAAAA (refer to RANGE for exact inputs allowed) | VOR DME VORDME VORTAC LOC , ILS NDB ILSDME MLS  TACAN  | N/A | NEW NAVAIID |
| CO RTE | XXXXXXX 7 or 10 characters (pin program) | If not in the NAVdatabase, a message will be displayed | N/A | INIT A ROUTE SELECTION NEW ROUTE ALTERNATE |
| COST INDEX | NNN may be entered as 1-3 digits; leading zeros may be omitted | 0 to 999 | Kg/Min or 100 lb/Hr | INIT A (ACT/SEC ⁽²⁾) PERF CLB (ACT/SEC ⁽²⁾) PERF CRZ (ACT/SEC ⁽²⁾) PERF DES (ALT/SEC ⁽²⁾) |
| CRS | See INB CRS | See INB CRS | degrees | RADIO NAV NEW NAVAIID NEW RUNWAY |
| CRZ FL | Must be entered as FLIGHT LEVEL | Maximum FL (See FLIGHT LEVEL) | Hundred of ft | INIT A (ACT/SEC ⁽²⁾) PROG |
| CRZ TEMP | See TEMP | | See TEMP | INIT A (ACT/SEC ⁽²⁾) FUEL PREDICTION |
| CRZ WIND | See WIND DIR/MAG | See WIND DIR/MAG | See WIND DIR/MAG | INIT A (ACT/SEC ⁽²⁾) FUEL PREDICTION |
| DIST | NN.N leading and trailing 0's may be omitted. | 0 - 99.9 or 0 - 999 (or 9999 ) | NM NM | HOLD ALTN |
| DRT TO  | "D"NN | Eight possible values | | PERF TAKEOFF |
| EFF WIND  | ± NNN " +" may be entered as "T" or "TL" " - " may be entered as "H" or "HD" Leading zeros may be omitted If no sign is input, "+" is taken | 0 - 500 | kts | CLOSEST AIRPORT EQUI-TIME INIT A SEC INT A |

Continued on the following page

Continued from the previous page

| DATA NAME | FORMAT | RANGE (X is input) | UNITS | DISPLAY PAGE |
|---|---|--|--|---|
| ELV | ± NNNN if no sign, + assumed Leading 0's may be omitted | Entry displayed to nearest 10 ft -400 to 20 470 ft (RWY) (or - 1000 to 20 470 ft \triangleleft) -2 000 to 20 470 (NAVAID) | ft (MSL) | NEW RUNWAY NEW NAVAID |
| ETT/RTA \triangleleft | HH:MM:SS | 00:00:00 to 23:59:59 | Hour HH Min MM Sec SS | RTA |
| FF/FQ Sensors | One or both may be entered, Both - /FF + FQ or - / FQ + FF Fuel flow - /FF Fuel Quantity - / FQ | | N/A | FUEL PREDICTION |
| FIG OF MERIT | N | 0 - 3 | N/A | NEW NAVAID |
| FINAL/TIME | Only one may be entered at a time. NN.N or (NNN.N \triangleleft) for FINAL NNNN for TIME | FINAL 0 - 10.0 (or 0 - 100 \triangleleft) or 0 - 22.0 0 - 90 TIME | Thousand of kg or Thousand of lb minutes | FUEL PRED INIT B |
| FLAPS | | 0, 1, 2, or 3 | | TAKEOFF |
| FLEX TO TEMP | 1. If Derated TO option not implemented: same as TEMP 2. If Derated TO option is implemented: F NN | | NN in degrees centigrade | TAKEOFF |
| FLIGHT LEVEL | FLNNN or NNN Leading zeros on NNN may be omitted | Max FL = 390 (or Max FL = 410 \triangleleft) | Hundreds of ft (MSL) | F-PLN A-B, PROG VERT REV INIT A (ACT, SEC ⁽²⁾) PERF CLB PERF DES STEP PRED STEP ALTS \triangleleft |

Continued on the following page

AIRCRAFT SYSTEMS
AUTO FLIGHT - FLIGHT MANAGEMENT

CONTROLS AND INDICATORS - MCDU - DATA FORMAT LIST

Continued from the previous page

| DATA NAME | FORMAT | RANGE (X is input) | UNITS | DISPLAY PAGE |
|---|---|--|--|--|
| FLIGHT NUMBER | XXXXXXXX The 8 alphanumeric are not mandatory | N/A | N/A | INIT A F-PLN A-B |
| FOB | NN.N (leading zeros may be omitted) | See BLOCK | Thousands of kg or Thousands of Lb | FUEL PREDICTION |
| FREQ | NNN.NN ILS /VOR NNN.N NDB | 108.00 - 117.95 190.0 - 1 750.0 | MHz KHz | PROG. NEW NAVAID RADIO NAV |
| FROM/TO | AAAA /AAAA | AAAA must be in data base or message will be displayed | N/A | INIT A (ACT/SEC ⁽²⁾) |
| GW | NN.N Leading and trailing zeros may be omitted | 35 - 99.9 or 77.2 - 218 | Thousands of kg or Thousands of Lb | FUEL PREDICTION |
| IDLE FACTOR  | ± N.N Leading and trailing zeros may be omitted | -9.9, +9.9 | % | A/C STATUS |
| INB CRS | NNN Leading zeros may be omitted. An entry of 360 is displayed as 0. | 000 - 359 | Degrees | HOLD |
| LAT | DDMM.MB or BDDMM.M DD - degrees, MM.M - minutes, B - direction. Leading zeros may be omitted but the direction (B) is necessary. Latitude is displayed as DDMM.MB | B: N or S 0 ≤ DD ≤ 90 0 ≤ MM.M ≤ 59.9 | Degree minutes tenths of minutes | INIT A (ACT/SEC ⁽²⁾) |
| LAT /LONG | LAT /LONG See LAT and See LONG except both must be entered with "/" in between | See LAT and See LONG | See LAT and See LONG | F-PLN A-B (ACT/SEC ⁽²⁾) PROG NEW WAYPOINT NEW NAVAID DIR TO LAT REV NEW RUNWAY |

Continued on the following page

Continued from the previous page







| DATA NAME | FORMAT | RANGE (X is input) | UNITS | DISPLAY PAGE |
|--------------------|---|---|-------------------------------------|---|
| LENGTH | NNNN Leading zeros may be omitted | 1 000 - 8 000 m 3 282 - 9 999 ft | Meters or feet | NEW RUNWAY |
| LONG | DDDDMM.MB or BDDDDMM.M DDD - degrees MM.M - minutes B - direction. Leading zeros may be omitted but the direction (B) is necessary | B: E or W 0 ≤ DDD ≤ 180 0 ≤ MM.M ≤ 59 | Degree minutes tenths of minutes | INIT A |
| MACH | .NN The decimal point is necessary. Trailing zeros are not necessary | MAX = 0.82 MIN = 0.15 | Mach Number | F-PLN A (ACT/SEC ⁽²⁾) PERF CLB PERF CRZ PERF DES |
| MACH/SPD | MACH and SPD must be entered with "/" between (See MACH and See SPD formats) | See MACH and See SPD | See MACH and See SPD | PERF DES (ACT/SEC ⁽²⁾) |
| NAVAID | XXXX | Any alphanumeric | N/A | PROG NEW NAVAID NAVAID F-PLN A-B (ACT/SEC ⁽²⁾) LAT REV DIR TO RADIO NAV SELECTED NAVAIDS |
| OFST | NNB or BNN NN offset distance B direction | B: L or R 1 < NN < 50 | NM | LAT REV |
| PERF FACTOR | NN.N leading or trailing zeros may be omitted (± N.N) | -10.0 to +10.0 (or -9.9 - +9.9 ) | N/A | A/C STATUS |

Continued on the following page

AIRCRAFT SYSTEMS
AUTO FLIGHT - FLIGHT MANAGEMENT







CONTROLS AND INDICATORS - MCDU - DATA FORMAT LIST

Continued from the previous page

| DATA NAME | FORMAT | RANGE (X is input) | UNITS | DISPLAY PAGE |
|---|---|--|---------------------|--|
| PLACE/BRG /DIST | PLACE can be any data base ARPT , NAVAID or WAYPOINT - BRG must be a 3 digit entry without decimal digit. An entry of BRG = 360 is displayed as 0. | PLACE - If not in data base, a message "NOT IN DATA BASE" is displayed BRG - 000 - 360 | N/A degrees | LAT REV (ACT/SEC ⁽²⁾) NEW WAYPOINT PROG DIR TO F-PLNA-B (ACT/SEC ⁽²⁾) STEP ALTS  |
| | DIST is NNN.N where leading zeros may be omitted ; all 3 parameters must be entered with "/" between | DIST - 0 - 999.9 | NM | |
| PLACE-BRG / PLACE-BRG | See PLACE/BRG/ DIST A couple PLACE-BRG is entered with a dash in the middle. 2 couples have to be entered with "/" between | See PLACE/BRG/DIST | See PLACE/BRG/DIST | See PLACE/BRG/DIST |
| PLACE/DIST  | PLACE: See PLACE/ BRG/DIST DIST: See PLACE/ BRG/DIST | PLACE: See PLACE/ BRG/DIST DIST: 0 - 999.9 | N/A NM | F-PLN A and B SEC F-PLN A and B LAT REV NEW WAYPOINT DIR TO STEP ALTS |
| QNH | NNNN (leading zero may be omitted). | 950 - 1 050 (or 745 - 1050 ) | Hecto-Pascals (hPa) | PERF APPR (ACT/SEC ⁽²⁾) |
| | NN.NN (leading and trailing zeros may be omitted). | 28.06 - 31.01 (or 22.00 - 31.00 ) | In.Hg | |
| RADIAL  | NNN(T) 3 digits entry | 000 - 360 | Degrees | FIX INFO 1 to 4 |
| RADIAL IN  | NNN(T) 3 digits entry | 000 - 360 | Degrees | DIR TO |
| RADIAL OUT  | NNN(T) 3 digits entry | 000 - 360 | Degrees | DIR TO FIX INFO 1 to 4 |

Continued on the following page

Continued from the previous page

| DATA NAME | FORMAT | RANGE (X is input) | UNITS | DISPLAY PAGE |
|---|---|---|------------------------------------|--|
| RADIO | NNN | 0-700 No is accepted if an ILS / GLS  ; APPR is selected | ft | PERF APPR (ACT/SEC ⁽²⁾) |
| RADIUS  | DNNN 3 digits entry D is the identifiant of the circle radius | 000 - 256 | NM | FIX INFO 1 to 4 |
| REF FIX  | See waypoint | | | FIX INFO 1 to 4 |
| RTE RSV | may be entered as fuel or percentage of trip fuel | Fuel 0 - 10.0 0 - 21.7 % : 0 - 15.0 | thousands of kg thousands of lb | INIT B (ACT/SEC ⁽²⁾) FUEL PRED |
| RWY | AAAAANND Where AAAA is See ARPT. NN is runway number (2 digits) must be entered D is L or R to be included only when there is more than one runway with the same number at ARPT. | | | RUNWAY NEW RUNWAY F-PLN A-B |
| SAT /ALT  | TEMP /ALT | See TEMP and See ALT | N/A | CRUISE WIND |
| SET HDG  | NNN/N (leading and trailing zeros may be omitted) will always be displayed as NNN/N | 000.0 - 360.0 | Degrees | IRS MONITOR |
| SLOPE  | NN.N | 00.0 - 90.0 | Degrees | NEW NAVAID |
| SPD | NNN (leading zero may be omitted) | MAX = 350 kt MIN = 90 kt | kt (CAS) | SEC F-PLN A PERF CLB PERF CRZ (ACT, SEC ⁽²⁾) PERF DES |
| SPD CSTR | See SPD | See SPD | kt (CAS) | F-PLN A (ACT/SEC ⁽²⁾) VERT REV (ACT/SEC ⁽²⁾) |



Continued on the following page

AIRCRAFT SYSTEMS
AUTO FLIGHT - FLIGHT MANAGEMENT

A318/A319/A320/A321
FLIGHT CREW
OPERATING MANUAL

CONTROLS AND INDICATORS - MCDU - DATA FORMAT LIST

Continued from the previous page

| DATA NAME | FORMAT | RANGE (X is input) | UNITS | DISPLAY PAGE |
|---|---|---|--------------------------------|--|
| SPD LIM | SSS/NNNNN SSS is a speed NNNNN is an ALT or FLIGHT LEVEL (See ALT and See FLIGHT LEVEL) | SSS: See SPD | kt/ft (MSL) | VERT REV (ACT/SEC ⁽²⁾) |
| SPD/MACH | See MACH/SPD | See MACH and See SPD | See MACH and See SPD | PERF DES (ACT/SEC ⁽²⁾) |
| STATION DEC | NND Where NN is the declination and D is the direction. Leading zeros may be omitted. D is not required for an entry of zero declination. | NN: 01 - 99 D: E or W | Degrees | NEW NAVAID |
| STEP ALT  | SNNN or NNNS (where NNN is in Flight Level) or SNNNNN or NNNNNS (where NNNNN is in ALT) Leading zeros may be omitted | See FLIGHT LEVEL or See ALT | See FLIGHT LEVEL or See ALT | F-PLN A |
| TAXI | N.N Leading or trailing zeros may be omitted | 0 - 9.9 | Thousands of kg | INIT B (ACT/SEC ⁽²⁾) |
| TEMP | ± NN If no sign, + assumed | ± 99 | Degrees celsius | INIT A (ACT/SEC ⁽²⁾) FUEL PRED PERF APPR |
| THR RED ALT | See ALT | 400 ft AGL mini | ft (MSL) | PERF TAKE OFF |
| THS | AAN.N or N.NAA where AA is UP or DN | max UP 7.0 max DN 5.0 increment 0.1 | degrees | PERF TAKEOFF |
| TRANS ALT | See ALT | | | PERF GO AROUND |
| TIME | N.N | 0 - 9.9 | Minutes | HOLD |
| TIME MARK.  | HHMM | HH: 0 - 23 MM: 0 - 59 | Hours Minutes | F-PLN A and B |
| T.O SHIFT | NNNN | 1-Length of origin runway | m or ft | PERF TAKEOFF |







Continued on the following page

AIRCRAFT SYSTEMS

AUTO FLIGHT - FLIGHT MANAGEMENT

CONTROLS AND INDICATORS - MCDU - DATA FORMAT LIST

Continued from the previous page

| DATA NAME | FORMAT | RANGE (X is input) | UNITS | DISPLAY PAGE |
|------------------|---|---|---------------------------|---|
| TRIP WIND | See EFF WIND | | kts | INIT A SET INIT A |
| TROPO | See ALT | See ALT (or 60 000 ) | ft | INIT A FUEL PREDICTION SEC FUEL PREDICTION |
| UTC CSTR | HH MM Where HH are hours and MM are minutes. Leading zeros may be omitted 1 or 2 digit entry is interpreted as minutes | HH: 0 - 23 MM: 0 - 59 | Hours and minutes | VERT REV |
| V1 | See SPD | | kt (CAS) | PERF TAKEOFF (ACT/SEC ⁽²⁾) |
| V2 | See SPD | | kt (CAS) | PERF TAKEOFF (ACT/SEC ⁽²⁾) |
| VR | See SPD | | kt (CAS) | PERF TAKEOFF (ACT/SEC ⁽²⁾) |
| WIND | See WIND DIR/ VELOCITY | See WIND DIR/ VELOCITY | See WIND DIR/ VELOCITY | F-PLN B (ACT/SEC ⁽²⁾) FUEL PREDICTION |
| WAYPOINT | XXXXX - may be from . 1-5 (1-7 )) characters for waypoint. Acceptable as waypoint IDENT: ARPT NAVAID WAYPOINT LAT /LONG, PLACE BRG / PLACE BRG and PLACE/BRG / DIST PLACE/DIST  may be entered to define a waypoint | | | WAYPOINT NEW WAYPOINT F-PLN A and B (ACT/SEC ⁽²⁾) LAT REV PROG DIR TO FIX INFO  1 AND 2 EQUI-TIME POINT  STEP ALTS  PREDICTIVE GPS  |

Continued on the following page

AIRCRAFT SYSTEMS
AUTO FLIGHT - FLIGHT MANAGEMENT

CONTROLS AND INDICATORS - MCDU - DATA FORMAT LIST

Continued from the previous page

| DATA NAME | FORMAT | RANGE (X is input) | UNITS | DISPLAY PAGE |
|---|--|---|--|--|
| WIND DIR /WIND MAG | NNN/NNN Both must be entered ; leading zeros may be omitted. An entry of WIND DIR = 360 is displayed as 0. | WIND DIRECTION 0 - 360 | Degrees | INIT A PERF APPR (ACT/SEC ⁽²⁾) STEP PRED |
| | | WIND MAG 0 - 200 (or 0 - 500 \leq) | Kt | WIND F-PLN B VERT REV |
| WIND DIRECTION/ MAG /ALT | NNN/NNN/FL NNN or NNN/NNN/NN NNN | Direction and Velocity as above Minimum ALT 1 000 | FL in hundred of ft, ALT in ft | DES FORECAST WIND PAGES \leq |
| ZFW | NN.N OR NNN.N Leading and trailing zeros may be omitted | MIN ZFW See – Max ZFW See | Thousands of kg or thousands of Lb | INIT B (ACT/SEC ⁽²⁾) |

⁽¹⁾ As defined in the Performance Data Base.

⁽²⁾ ACT/SEC = Active or Secondary

GENERAL

Ident.: DSC-22_20-60-10-00000921.0001001 / 10 DEC 09

Applicable to: ALL

The baro reference selector of the EIS (Electronic Instrument System) allows the pilot to use the standard barometric reference (STD), sea level atmospheric pressure (QNH), or atmospheric pressure at airfield elevation (QFE option) for the barometer setting.

The selected value is displayed in the baro reference display window of the EFIS control panel and on the Primary Flight Display (PFD) below the altitude scale.

The barometer setting is used as a reference for the altimeter of the PFD and for the PFD target altitude. In flight, it affects the predicted altitudes on the MCDU and the descent path computation.

MCDU ALTITUDE PREDICTIONS

Applicable to: ALL

Ident.: DSC-22_20-60-10-A-00000922.0001001 / 10 DEC 09

GENERAL

The FMGS predicts at each waypoint of the flight plan an altitude that is a function of all data in the lateral and vertical flight plans.

Ident.: DSC-22_20-60-10-A-00000927.0001001 / 10 DEC 09

ON THE GROUND

The altitude predicted at each waypoint is displayed as altitude in feet above mean sea level (AMSL) when it is below the transition altitude and as flight level when it is above the transition altitude. The altitude constraints are also displayed, and they follow the same rule (feet or flight level).

The predicted altitude is equal to the airport elevation plus the height you must attain in order to reach the waypoint in the applicable mode (climb or descent).



Ident.: DSC-22_20-60-10-A-00000924.0001001 / 16 FEB 11

IN FLIGHT

The predicted altitude is equal to the aircraft altitude (as a function of the barometer setting), plus or minus the height you must attain to reach the waypoint in the applicable mode (climb or descent).

- In climb:

Altitude predictions and constraints are displayed as altitude in feet above mean sea level (AMSL) at, or below, the transition altitude, and as the flight level above it.

For example : If the transition altitude is 5 000 ft and you insert an altitude constraint as 8 000 ft, the MCDU F-PLN A page displays it as FL 80

- In descent:

If “STD ” is selected on the EIS control panel, altitude predictions and constraints above the transition level are displayed as flight levels, and those below the transition level are displayed as altitude AMSL.

If sea level standard pressure (QNH), or field elevation pressure (QFE option), is selected on the EIS control panel, altitude predictions and constraints are displayed as altitudes AMSL, regardless of the transition altitude.

For example: If the transition level is FL 50 and you insert an altitude constraint of 8 000 ft into the MCDU , the MCDU F-PLN S A page will display it as FL 80, if “STD ” is selected, and as 8 000 ft, if “QNH ” (or “QFE ” option) F-PLN A page is selected.

TARGET ALTITUDE ON PFD

Ident.: DSC-22_20-60-10-00000925.0001001 / 01 OCT 12

Applicable to: ALL

The PFD target altitude may either be:

- The altitude selected on the FCU, or
- A flight management altitude constraint, if the climb mode or descent mode is engaged and the system predicts a level-off at a constraint that comes before reaching the FCU altitude.

The PFD target altitude depends on the barometer setting:

- If “STD” is selected, the target is a flight level
- If “QNH ” or “QFE” is selected, the target is an altitude or height.

The aircraft will level off accordingly.

- Note:
- If the pilot changes the barometer setting during ALT * or ALT CST*, the aircraft may overshoot the target altitude, because the current value has been changed. However, the ALT * and ALT CST* modes allow the aircraft to regain the FCU altitude. As a general rule, avoid changing the barometer setting when in ALT * or ALT CST*
 - In aircraft equipped to use field elevation pressure (QFE option), switching from STD to QFE (or vice versa) in ALT CST* green changes the target value and may revert the vertical mode into V/S mode.

NOTE FOR AIRCRAFT WITH QFE (FIELD ELEVATION PRESSURE) PIN PROGRAM

If you select "QFE" on the EFIS control panel:

- The MCDU predictions follow the basic rules (altitudes are AMSL below the transition level, flight levels above it)
- The altitude constraints on the MCDU follow the basic rules
- The target altitude on the PFD is QFE related:
 - If the target altitude has been selected by the FCU, the aircraft will level off there.
 - If the target altitude is an altitude constraint, the PFD automatically shows that constraint as corrected by the airport elevation.

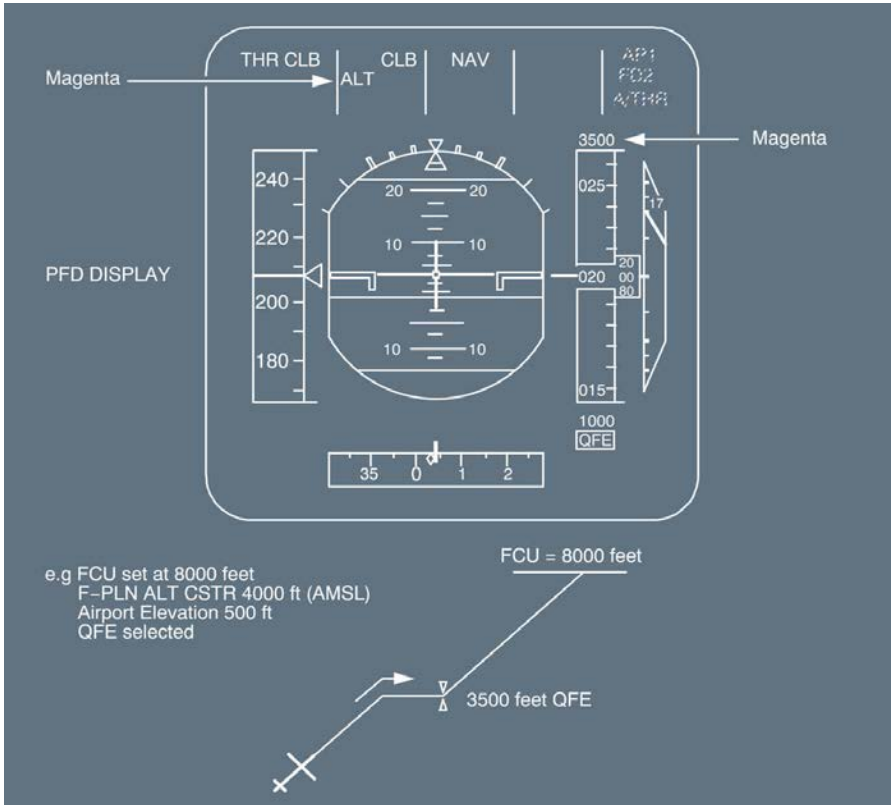

PROCEDURES

Ident.: DSC-22_20-60-10-00000928.0001001 / 16 FEB 11

Applicable to: **ALL**

- a. The altitude constraints in departure and arrival procedures should be defined in the navigation database or by the pilot on the MCDU:
 - in terms of altitude AMSL below the transition altitude
 - in terms of flight level above the transition altitude

If a departure procedure defines an altitude constraint as an AMSL altitude above the transition altitude, you must convert it to STD, because the system and guidance will treat it as a flight level whenever you select the standard barometer setting.

- b. In climb you should switch from QNH (or QFE) to STD on both EFIS control panels simultaneously when you reach the transition altitude.
All MCDU altitude predictions and altitude constraints and all PFD altitude targets will be displayed as flight levels.
- c. In descent, when ATC clears you to an altitude below the transition altitude, you can select QNH (or QFE) on both EFIS control panels simultaneously.
All MCDU altitude predictions and constraints and PFD targets are now altitude AMSL.



A318/A319/A320/A321
FLIGHT CREW
OPERATING MANUAL

AIRCRAFT SYSTEMS

AUTO FLIGHT - FLIGHT MANAGEMENT

OTHER FUNCTIONS - EFFECT OF BARO REFERENCE SETTING

Intentionally left blank

CLEARING THE SCRATCHPAD OF DATA OR MESSAGES

Ident.: DSC-22_20-60-20-00000929.0001001 / 16 FEB 11

Applicable to: ALL

Press the “CLR” key with a single brief touch to erase the last alphanumeric character inserted in the scratchpad.

Press the key for more than three seconds to erase all the data inserted in the scratchpad. If the scratchpad is empty, it displays “CLR”.

CLEARING DATA FIELDS

Ident.: DSC-22_20-60-20-00000930.0001001 / 16 FEB 11

Applicable to: ALL

Clear a data field by pressing the “CLR” key, the scratchpad displays CLR, then select the prompt for the field you want to clear (3L for example).

- You cannot clear all data fields:
 - If the field contains data that has a default value or a value computed by the FMGC, the data reverts to this value.
 - Any attempt to clear the defaulted value has no effect.
- Clearing a constraint on the F-PLN page deletes both the speed constraint and the altitude constraint associated with the waypoint
- If you clear a data field that is a waypoint in the flight plan (primary or secondary), you delete this waypoint from the flight plan and create a discontinuity. The discontinuity can also be cleared in a similar way.

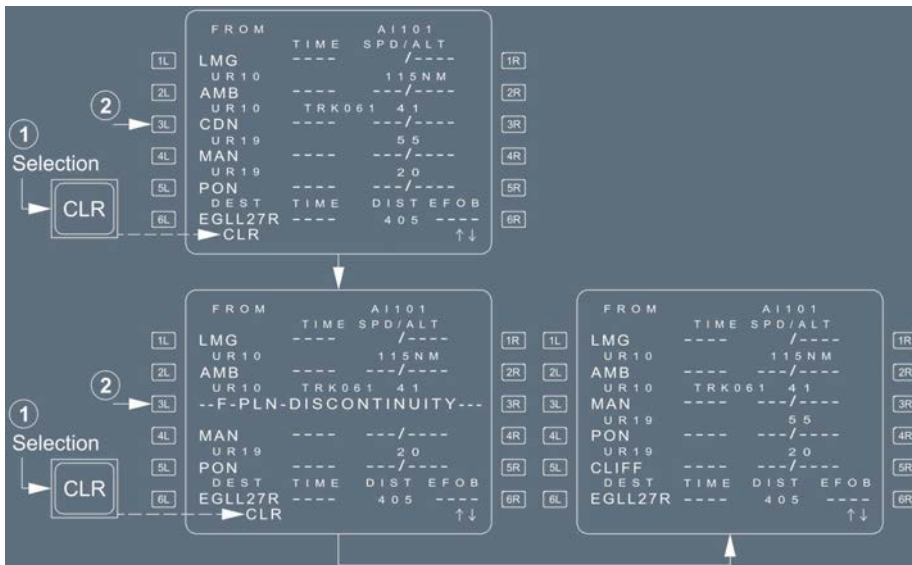

GENERAL

Ident.: DSC-22_20-60-30-0000932.0002001 / 16 FEB 11

Applicable to: ALL

Various features are provided to the crew in order to execute a diversion:

- The EQUITIME POINT
- The CLOSEST AIRPORTS pages
- The SECONDARY F-PLN
- The ENABLE ALTN function
- The NEW DEST revision

EN ROUTE DIVERSION WITH SEVERAL AIRPORTS AVAILABLE

Ident.: DSC-22_20-60-30-00009508.0002001 / 16 FEB 11

Applicable to: ALL

SELECT the CLOSEST AIRPORTS page.



SELECT the EFOB/WIND prompt.

INSERT the effective wind at selected airport.

CHECK the predictions and CHOOSE the adequate diversion airport.

PREPARE the diversion flight plan on the SEC F-PLN.

Note: Fuel/time predictions on the CLOSEST AIRPORTS page assume managed speed profile.

EN ROUTE DIVERSION OVER OCEANIC OR DESERTIC AREA

Ident.: DSC-22_20-60-30-00009528.0001001 / 16 FEB 11

Applicable to: ALL

The diversion airports are usually determined before departure or using the CLOSEST AIRPORTS data.

SELECT the EQUI-TIME POINT page.



- ENTER the airport identns in 1L and 3L fields.
- ENTER the associated winds in 2L and 4L fields.
- CHECK the ETP position and time.
- ENTER a predicted time at ETP as time marker.
- PREPARE a diversion flight plan on the secondary flight plan.

DIVERSION PREPARATION ON THE SECONDARY FLIGHT PLAN

Ident.: DSC-22_20-60-30-00009530.0002001 / 16 FEB 11

Applicable to: ALL

The following procedure shall be applied for all diversion cases, once the diversion airport has been selected, as well as the “most probable diversion point of the F-PLN”:

- PRESS the SEC F-PLN key
- PRESS the COPY ACTIVE prompt
- SELECT a lateral revision at diversion waypoint
- ENTER the ident of the diversion airport in the NEW DEST field.

Then finalize the flight plan between the diversion point and the diversion airport. When the diversion airport is no longer applicable or ETP is sequenced, repeat the same procedure for the next diversion airport.

| | |
|---|---|
|  A318/A319/A320/A321 FLIGHT CREW OPERATING MANUAL | AIRCRAFT SYSTEMS AUTO FLIGHT - FLIGHT MANAGEMENT OTHER FUNCTIONS - HOW TO EXECUTE A DIVERSION |
|---|---|

MISCELLANEOUS

Ident.: DSC-22_20-60-30-00009531.0002001 / 16 FEB 11

Applicable to: ALL

In some cases, the diversion airport may be simply chosen using the airports displayed on ND when AIRPORT is selected on the EIS control panel.

During oceanic or desertic area flights, the flight crew may use the PROG page, as follows:

ENTER the ident of the diversion airport in the 4R field of MCDU 1

ENTER the next diversion airport in the 4R field of MCDU 2

Then, the FMS continuously calculated the BRG /DIST to the selected diversion airports.

UPDATE the PROG pages when sequencing the ETP.

EXECUTION OF THE DIVERSION

Ident.: DSC-22_20-60-30-00009532.0001001 / 16 FEB 11

Applicable to: ALL

When the crew decides to divert:

PRESS the SEC F-PLN key.

SELECT the ACTIVATE SEC prompt.

SELECT DIR TO required point.



DIVERSION TO THE ALTERNATE AIRPORT

Ident.: DSC-22_20-60-30-00009537.0001001 / 16 FEB 11

Applicable to: ALL

The primary F-PLN includes an alternate flight plan from destination to the preferred alternate airport. All fuel prediction and management (EXTRA fuel) take the alternate flight plan into consideration. If the crew decides to divert at the end of the cruise, or beyond the last ETP, or in the descent or go-around phases, this will most probably be to the alternate airport.

When the crew decides to divert:

SELECT a lateral revision at suitable waypoint
SELECT ENABLE ALTN prompt
CHECK the temporary flight plan and INSERT
SELECT DIR TO required waypoint

Note:

- *In most cases, the LAT REV shall be selected at the TO WPT . This will facilitate the subsequent selection of the DIR TO waypoint.*
- *The ALTN flight plan shall be finalized, whenever the landing runway is known by the crew (before approach briefing).*
In most cases, this will ensure that the most probable flight plan is displayed on the MCDU once ENABLE ALTN is selected.

GENERAL

Ident.: DSC-22_20-60-40-00000937.0001001 / 16 FEB 11

Applicable to: ALL

When the FMGS detects an engine-out condition, the following occurs:

FLIGHT MANAGEMENT PART

Ident.: DSC-22_20-60-40-00000938.0026001 / 16 MAR 11

Applicable to: ALL

- The managed target speeds is immediately set to a value that depends upon the flight phase
- All preselected speeds entered in the MCDU are deleted
- Step climb (or step descent), if entered, is deleted
- The time constraint is deleted
- The PROG page shows the engine-out maximum recommended (EO MAX REC) altitude
- The system automatically calls up the current performance page, which has the EO CLR (engine-out clear) prompt displayed in the 1R field (except during takeoff, before the diversion point is reached).

If the crew presses the EO CLR , the 2 engine predictions and performance will be restored. Reverting back to one engine-out performance is not possible, unless the system detects a new EO condition. Therefore, the pilot should not press the EO CLR key, if an actual engine-out is detected

FLIGHT GUIDANCE PART

Ident.: DSC-22_20-60-40-00000939.0002001 / 04 JUL 17

Applicable to: **ALL**

- All selected modes remain available (the “HDG/TRK”, “V/S”, and “OPEN” modes, for example)
- In the speed reference system (SRS) mode, the takeoff speed target is V_2 , or the current speed if it is higher but no more than $V_2 +15$. The magenta triangle indicates V_2 in all cases. The GO Around speed target is V_{APP} , or the current speed if higher, limited to $VLS +15$ kt
- The system limits autopilot (AP) and flight director (FD) bank angles during takeoff and approach phases as follows:
 - 15° when the aircraft speed is below the maneuvering speeds (F, S, or Green Dot speed) -10 kt , and then
 - In selected lateral guidance:
 - Linear increase to 25° up to maneuvering speeds (F, S, or Green Dot speed) -3 kt
 - 25° above maneuvering speeds (F, S, or Green Dot speed) -3 kt .
 - In managed lateral guidance:
 - Linear increase to 30° up to maneuvering speeds (F, S, or Green Dot speed) -3 kt
 - 30° above maneuvering speeds (F, S, or Green Dot speed) -3 kt .

Note: *The engine-out bank angle limits apply, when the FG part of the FMGS has detected an engine-out. It cannot be cleared by the crew through the MCDU EO CLEAR prompt.*

AUTOTHRUST

Ident.: DSC-22_20-60-40-00000940.0001001 / 16 FEB 11

Applicable to: **ALL**

The system extends the active range of the active engine from idle to maximum continuous thrust (MCT instead of CL thrust).

The Flight Mode Annunciator requests maximum continuous thrust on the live engine at a time that depends on when the engine-out occurs.

ENGINE-OUT CONDITIONS

Ident.: DSC-22_20-60-40-00000941.0001001 / 16 FEB 11

Applicable to: **ALL**

The FMGS considers the aircraft to be in an engine-out condition, when one of the following conditions is present and the aircraft has commenced takeoff or is in flight:

- One engine master switch off, or
- N_2 below idle, or

- One thrust lever angle is below 5 ° with the other above 22 °, or
- The FADEC shows an engine fault.

ENGINE-OUT SID

Applicable to: ALL

Ident.: DSC-22_20-60-40-A-00000942.0001001 / 14 MAY 12

GENERAL

An engine-out standard instrument departure (EOSID), when defined in the database, is always for a specific runway. It is indicated on the bottom line of the SID page for that runway, and you can select it manually.

The pilot can review the SID either by selecting the PLAN mode on the navigation display (solid yellow line), or by selecting it on the SID page. In the latter case, the navigation display shows the SID as a temporary flight plan.

The last point, if any, that is common to both the SID and engine-out SID is called the diversion point (DP).

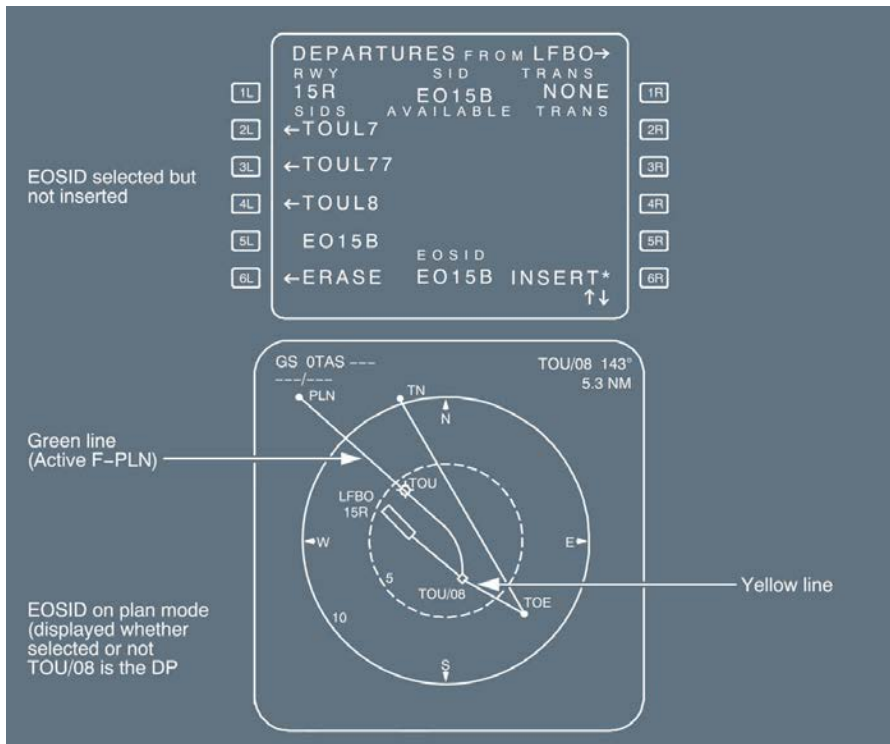

Ident.: DSC-22_20-60-40-A-00000943.0001001 / 14 MAY 12

WHEN AN ENGINE-OUT CONDITION OCCURS BEFORE THE DIVERSION POINT

The MCDU automatically shows the engine-out SID as a temporary flight plan on the F-PLN page and on the ND. The EOSID can be inserted or erased.

Note: The EOSID Diversion Point is the waypoint at which the EOSID diverges from the active SID.

If there is no common leg between the SID and the EOSID in the navigation database, the diversion point is by default the runway threshold. Therefore the SID and EOSID common leg(s) before the flight paths separation must be the same type and nature.

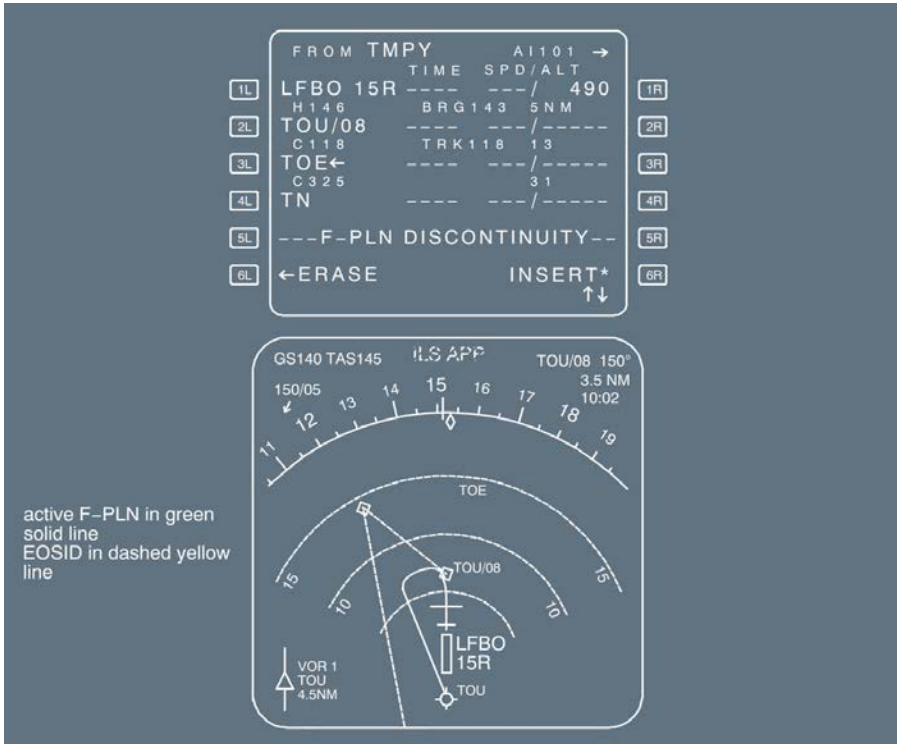

Ident.: DSC-22_20-60-40-A-00000944.0001001 / 14 MAY 12

WHEN AN ENGINE-OUT CONDITION OCCURS AFTER THE DIVERSION POINT

REMAIN on the SID path

Note: The navigation display shows the engine-out SID as a yellow line for your information. Directing the aircraft to the EOSID should not be performed unless it allows obstacle clearance and the flight crew considers it is the best strategy for a particular case.

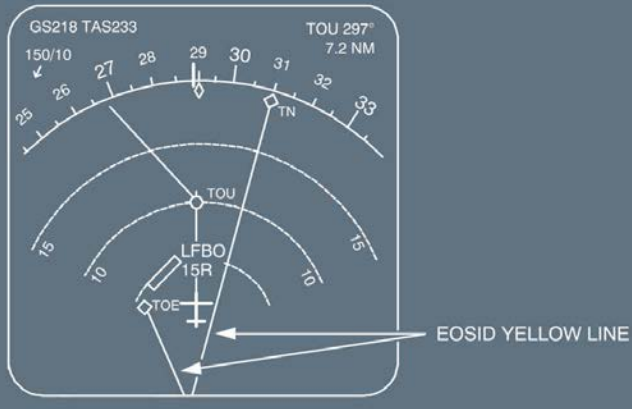
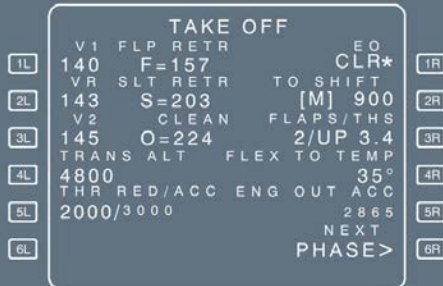

Ident.: DSC-22_20-60-40-A-00000945.0002001 / 14 MAY 12

BELOW THRUST-REDUCTION (THR RED) ALTITUDE

- The managed target speed changes to V2
- The PROG page displays the engine-out maximum recommended altitude

- The PERF TO page comes up on the display automatically with the “EO CLR” prompt in the 1R field
- The MCDU and the navigation display show the engine-out SID as a temporary flight plan, or the navigation display shows it for information only, depending upon the diversion point location.



PROCEDURE

● **When the aircraft reaches the engine-out acceleration altitude**

PUSH in the V/S knob to level off.

CLEAN up your configuration as the speed increases toward target speed.

When the aircraft is clean and has reached Green Dot speed, “LVR MCT” flashes on the FMA,

PULL out the altitude selector knob to resume the climb.

The OP CLB. mode engages.

MOVE the thrust lever for the live engine to “MCT” detent.

Ident.: DSC-22_20-60-40-A-00000946.0006001 / 16 FEB 11

ABOVE THRUST REDUCTION (THR RED) ALTITUDE

- The managed target speed changes to V2
- “LVR MCT” flashes amber on the flight mode annunciator
- The PROG page displays the engine-out maximum recommended altitude
- The PERF TO page displays the “EO CLR” prompt in the 1R field
- The navigation display shows the EO SID.

PROCEDURE

MOVE the thrust lever of the active engine to the MCT detent.

● **When the aircraft reaches the engine-out acceleration altitude:**

PUSH the V/S knob, in order to level off.

CLEAN UP configuration as the speed increases.

● **When the aircraft reaches Green Dot speed:**

PULL the ALT knob to resume the climb.

Note: If necessary, move the thrust lever of the active engine to the TOGA detent. The Flight Mode Annunciator will display "LVR MCT", flashing in white, when the aircraft reaches Green Dot speed.

ENGINE-OUT IN CLB PHASE (ABOVE ACCELERATION ALTITUDE)

Applicable to: ALL

Ident.: DSC-22_20-60-40-B-00000947.0003001 / 16 FEB 11

ENGINE-OUT OCCURS WHILE AIRCRAFT IS ACTUALLY CLIMBING

- The managed target speed changes to Green Dot speed
- "LVR MCT" flashes white on the Flight Mode Annunciator
- The climb mode reverts to open climb (OP CLB) and the aircraft slowly decelerates down to Green Dot speed
- The MCDU shows the PERF CLB page with an "EO CLR*" (clear engine-out) prompt
- The PROG page shows the engine-out maximum recommended altitude (EO MAX REC ALT).

PROCEDURE

MOVE the thrust lever of the active engine to the MCT detent.

SET the altitude on the Flight Control Unit to an altitude below the engine-out maximum recovery altitude, as cleared by ATC.

INITIATE a diversion, when cleared to do so.

Ident.: DSC-22_20-60-40-B-00000948.0001001 / 16 FEB 11

ENGINE-OUT OCCURS WHILE THE AIRCRAFT IS FLYING IN ALT MODE AT AN ALTITUDE SET ON THE FLIGHT CONTROL UNIT

- The target speed is set to engine-out cruise speed (EO CRZ SPD), computed at the altitude set on the Flight Control Unit, but limited by the limit speed (SPD LIM), if there is one.

Other consequences and procedures are similar to previous engine out climb.

ENGINE-OUT IN CRUISE PHASE

Ident.: DSC-22_20-60-40-00000949.0001001 / 21 MAR 17

Applicable to: ALL

- The system sets the managed target speed to the higher of engine-out cruise Mach number or speed, or current speed.
- “LVR MCT” (or MCT) flashes on the Flight Mode Annunciator.
- The PERF CRZ page appears with the “EO CLR*” (clear engine-out) prompt.
- The PROG page displays the engine-out maximum recommended altitude (EO MAX REC ALT).

PROCEDURE

Perform engine out abnormal procedure.

Refer to *PER-OEI-GEN INTRODUCTION* “SINGLE ENGINE OPERATIONS”

- For standard strategy, Refer to *FCTM/PR-AEP-ENG Engine Failure During Cruise*
- For obstacle strategy, Refer to *FCTM/PR-AEP-ENG Engine Failure During Cruise*
- For fixed strategy, Refer to *FCTM/PR-AEP-ENG Engine Failure During Cruise*

Initiate a diversion if necessary.

Note: The engine-out descent strategy requires disconnection of the autothrust, and descent in OPEN DES mode.

Disconnecting the autothrust prevents an automatic setting of THR IDLE; therefore, the autopilot will fly the target speed in OP DES mode, with a thrust manually selected by the crew.

When reaching the FCU-selected altitude, or whenever normal descent is resumed to a lower altitude, reengage the autothrust.

ENGINE-OUT IN DESCENT PHASE

Ident.: DSC-22_20-60-40-00000951.0001001 / 16 FEB 11

Applicable to: ALL

- The managed target speed remains unchanged (ECON DES Mach number or speed, with any speed limitations).
- “LVR MCT” (or MCT) flashes on the Flight Mode Annunciator.
- The PERF DES page appears, showing the “EO CLR*” prompt.
- The PROG page displays the engine-out maximum recommended altitude (EO MAX REC ALT).
- The descent mode (if engaged) reverts to V/S, if the aircraft is above the EO REC MAX. If not, the descent mode is maintained.

PROCEDURE

MOVE the thrust lever for the live engine to the MCT detent.
If necessary, SELECT a suitable flight mode for descent.
DISCONNECT the autothrust and ADJUST thrust if necessary.

ENGINE-OUT IN APPROACH PHASE

Ident.: DSC-22_20-60-40-00000952.0001001 / 04 JUL 17

Applicable to: **ALL**

- The aircraft maintains approach speed (VAPP).
- "LVR MCT" (or MCT) flashes on the Flight Mode Annunciator.
- The PERF APPR page appears, showing the "EO CLR" prompt.
- The progress page displays the engine-out maximum recommended altitude (EO MAX REC ALT).

PROCEDURE

MOVE the thrust lever for the live engine to the MCT detent.

CAUTION

Below maneuvering speed (F, S, Green Dot) – 10 kt, the autopilot or flight director (AP/FD) cannot order a bank angle greater than 15 °.

Above maneuvering speed – 10 kt, this limit linearly increases until it reaches:

- In selected lateral guidance: 25 ° at maneuvering speed – 3 kt. The limit is then 25 ° for all speeds above maneuvering speed – 3 kt.
- In managed lateral guidance: 30 ° at maneuvering speed – 3 kt. The limit is then 30 ° for all speeds above maneuvering speed – 3 kt.

ENGINE-OUT IN GO-AROUND PHASE

Ident.: DSC-22_20-60-40-00000953.0002001 / 16 FEB 11

Applicable to: **ALL**

The results and procedures for takeoff phase apply, except that the displays do not show the engine-out SID.

SECONDARY FLIGHT PLAN

Ident.: DSC-22_20-60-50-00000954.0011001 / 14 MAY 12

Applicable to: ALL

The secondary flight plan (SEC F-PLN) is an alternative flight plan which can be activated when required.

It may include all the vertical elements except history wind data.

The flight crew can:

- Create a secondary flight independently from the active flight plan (a secondary flight plan can be created while a temporary flight plan exists).
- Copy it from the active flight plan.
- Delete it completely.

- Activate it, when the “ACTIVATE SEC” prompt is displayed: The secondary flight plan becomes the active flight plan.

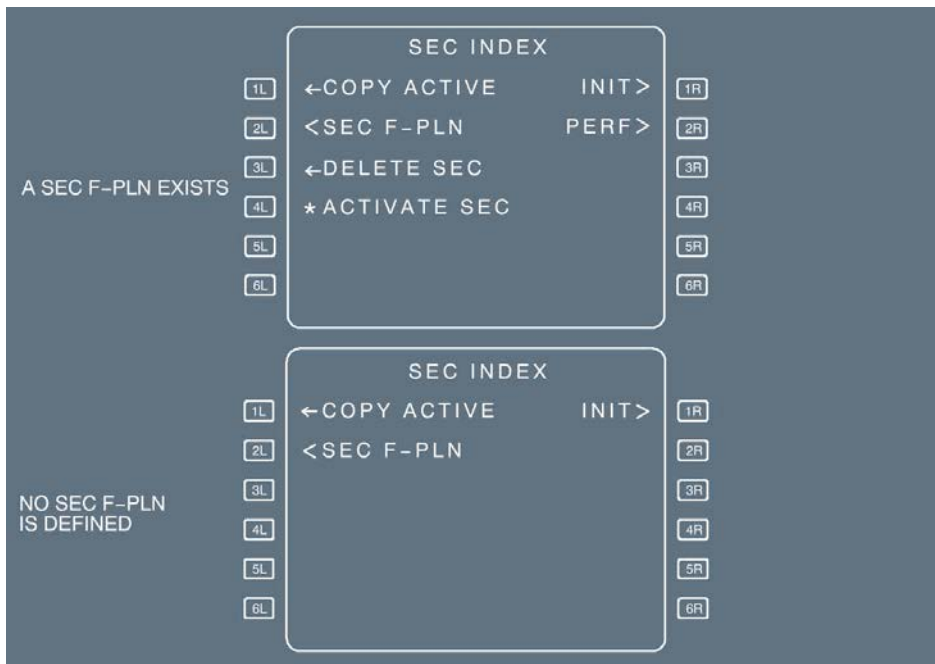

- The screen displays the “ACTIVATE SEC” prompt in flight if:
 - HDG (or TRK) mode is engaged, or
 - NAV mode is engaged, and the active leg of the primary and secondary flight plans is the same.
 The FMS sequences the secondary flight plan the same way as the active flight plan, when it is a copy of the active flight plan.

The navigation display shows the secondary flight plan in white. In PLAN mode, the crew can use the slew keys to review the secondary flight plan (as for the primary flight plan).

PREDICTIONS

The FMGS computes predictions using the same performance methods and performance factor it uses for the active flight plan. However, it predicts pseudo waypoints only for the MCDU not for the Navigation Display (ND).

- **When the flight crew initializes the secondary flight plan with the SEC INIT function:**
The FMGS computes the secondary flight plan predictions as if the aircraft were on ground before engine start. The FMGS computes these predictions one time and does not update them to indicate the progress of the flight (aircraft position, fuel consumption, etc.).
- **When the flight crew initializes the secondary flight plan with the COPY ACTIVE function:**
The FMGS computes the secondary flight plan predictions as for the active flight plan. However:
 - The FMGS stops the update of the predictions if the first leg of the active flight plan is no longer the same as the active leg (i.e. if both flight plans diverge). The flight phase is the same as the flight phase at the time of the divergence.

Note: This does not apply to the preflight phase, when the FMGS computes the predictions if the departure airports are the same, even if the takeoff runways are different.
- **The flight crew may use the secondary flight plan in the following cases:**
 - At takeoff when an alternate takeoff runway is probable
 - On ground to initialize the FMGS again if the flight that the flight crew initially prepared is replaced by another flight (*Refer to PRO-NOR-SRP-01-05 Introduction*)
 - In flight to prepare a diversion
 - In flight when an alternate landing runway is probable
 - To prepare the next flight.



A318/A319/A320/A321
FLIGHT CREW
OPERATING MANUAL

AIRCRAFT SYSTEMS

AUTO FLIGHT - FLIGHT MANAGEMENT

OTHER FUNCTIONS - SECONDARY FLIGHT PLAN

Intentionally left blank

STORED ROUTE FUNCTION

Ident.: DSC-22_20-60-60-00000955.0002001 / 01 OCT 12

Applicable to: ALL

The stored route function allows the pilot to store or review as many as five different routes defined in an active or secondary flight plan.

This also allows the pilot to store a company route that is not yet in the database, but is expected to be flown several times (a charter route, for example).

Access the STORED ROUTES page from the DATA INDEX page.

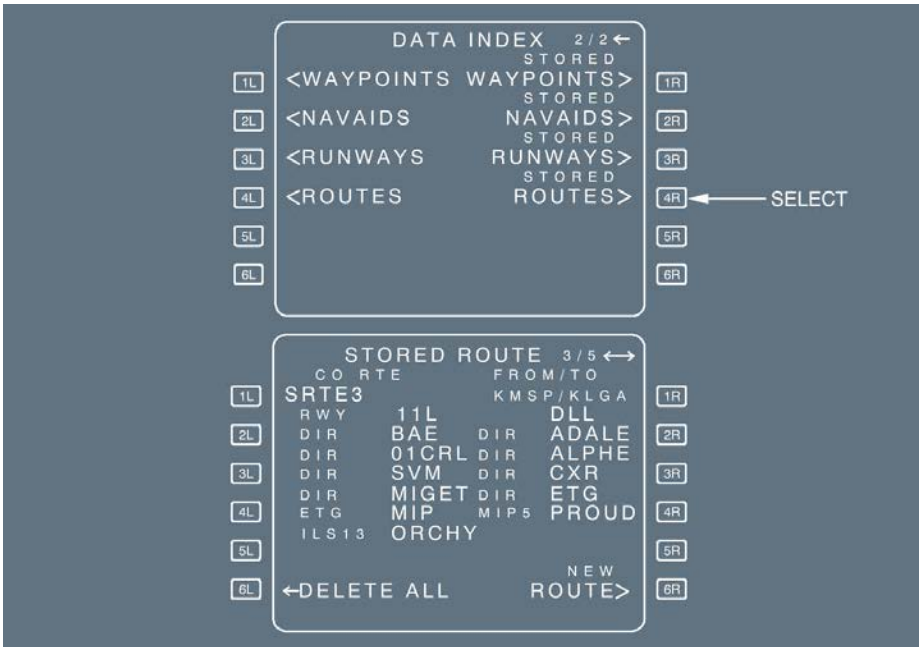

A stored route can be reviewed by using the slew key.

In order to store a new route, first define the route through the active flight plan (on the ground only) or the secondary flight plan (on the ground or in flight) then proceed as described below.

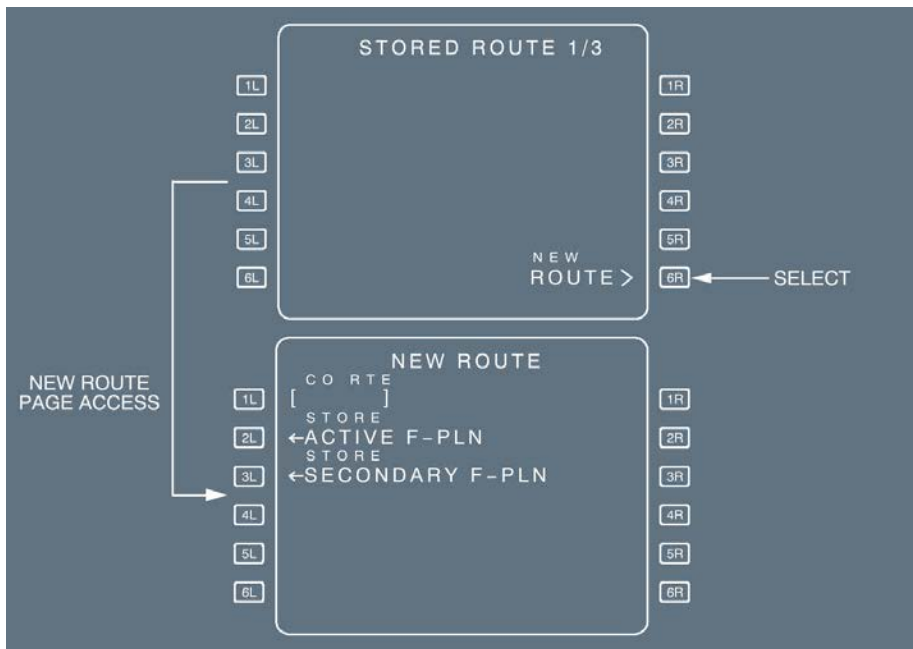

HOW TO STORE THE ACTIVE FLIGHT PLAN (DURING PREFLIGHT ONLY)

- SELECT the DATA key on MCDU
- PRESS the "STORED ROUTES" key
- PRESS the "NEW ROUTE" key
- ENTER the name of the company route (optional).
- PRESS the "STORE ACTIVE F-PLN" key

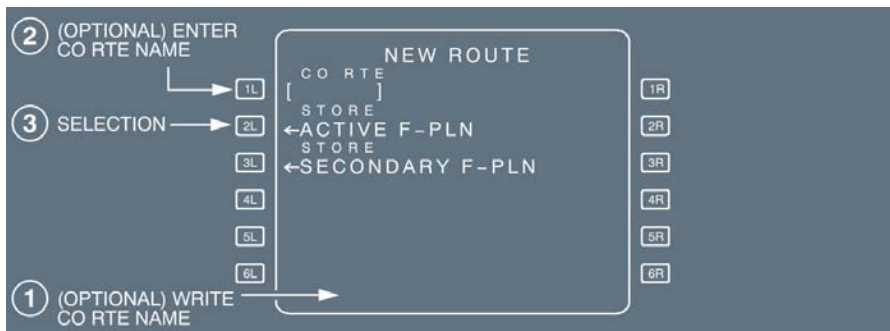

HOW TO STORE THE SECONDARY FLIGHT PLAN

SELECT the DATA key on MCDU
PRESS the "STORED ROUTES" key
PRESS the "NEW ROUTE" key
ENTER the company route name (optional)
PRESS the "STORE SECONDARY F-PLN" key

- Note:
- 1. In either case, you may only store a company route if the active or secondary flight plan is complete from origin to destination.*
 - 2. If you do not enter a name, the FMGS automatically names the stored route as "SRTE 1 (or 2 ...)" when it is stored.*
 - 3. The system does not retain several elements of the flight plans, when they are stored:*
 - Pilot-entered holds
 - Offsets
 - Pilot-entered constraints
 - Modifications to a terminal procedure
 - Pseudo waypoints*When this happens, it displays "REVISIONS NOT STORED".*
 - 4. If five routes are already stored the system will reject a new entry and display "STORED ROUTES FULL" on the MCDU . Delete one stored route by clearing the CO RTE name before inserting a new one.*



A318/A319/A320/A321
FLIGHT CREW
OPERATING MANUAL

AIRCRAFT SYSTEMS

AUTO FLIGHT - FLIGHT MANAGEMENT

OTHER FUNCTIONS - PILOTS/STORED ROUTE FUNCTION

Intentionally left blank



A318/A319/A320/A321
FLIGHT CREW
OPERATING MANUAL

AIRCRAFT SYSTEMS
AUTO FLIGHT - FLIGHT MANAGEMENT
OTHER FUNCTIONS - REPORT PAGE

GENERAL

Ident.: DSC-22_20-60-70-00006017.0001001 / 16 FEB 11

Applicable to: ALL

The REPORT page allows the crew to achieve the position reporting.

REPORT PAGE ACCESS

Ident.: DSC-22_20-60-70-00009524.0008001 / 29 SEP 15

Applicable to: ALL

The report page is accessed from the PROG PAGE.

1L

2L

3L

4L

5L

6L

```

<REPORT
UPDATE AT
*| |
BRG/DIST
--°/---
PREDICTIVE
<GPS
REQUIRED
2.0 NM
          
```

1R

2R

3R

4R

5R

6R

1L

2L

3L

4L

5L

6L

```

REPORT AI101
OVHD      UTC  ALT
---      -
TO
AGN              1028  5000
NEXT
AUCHE           1036  FL145
SAT          T.WIND  FOB
--°         ---°/---

DEST      UTC  DIST  EFOB
LFBZ     1110  396   8.2
          
```

1R

2R

3R

4R

5R

6R

REPORT PAGE IN
PREFLIGHT PHASE

1L

2L

3L

4L

5L

6L

```

REPORT AI101
OVHD      UTC  ALT
---      -
LMG              1013  38000
TO
AGN              1028  FL380
NEXT
AUCHE           1036  FL380
SAT          T.WIND  FOB
-42°        145°/063   10.0
T/D          UTC  DIST
AT FL380    1055  302  SEND*
DEST      UTC  DIST  EFOB
LFBZ     1110  396   8.2
          
```

1R

2R

3R

4R

5R

6R

REPORT PAGE
IN FLIGHT

Note: In case a DIR TO with ABEAM WPT s is achieved, or in case a FIX INFO with ABEAM or RADIAL/CIRCLE intersection is inserted in the F-PLN , the TO WPT (provided on the REPORT page) will be the ABEAM WPT or the RADIAL/CIRCLE intersect waypoint, if any, as on the F-PLN page.

CLOSEST AIRPORTS

Ident.: DSC-22_20-60-80-00006018.0001001 / 07 APR 11

Applicable to: ALL

The CLOSEST AIRPORTS page displays the four closest airports, from the position of the aircraft, found in the navigation database (*Refer to DSC-22_20-50-10-25 Closest Airports Pages* for the page description), and the 5th airport, as selected by the crew.

For each airport, the FM computes:

- The BRG /DIST /ESTIMATED UTC from the position of the aircraft to the corresponding airport.
- The EFOB at the airport, assuming an EFFECTIVE WIND (defaulted or entered by the pilot).

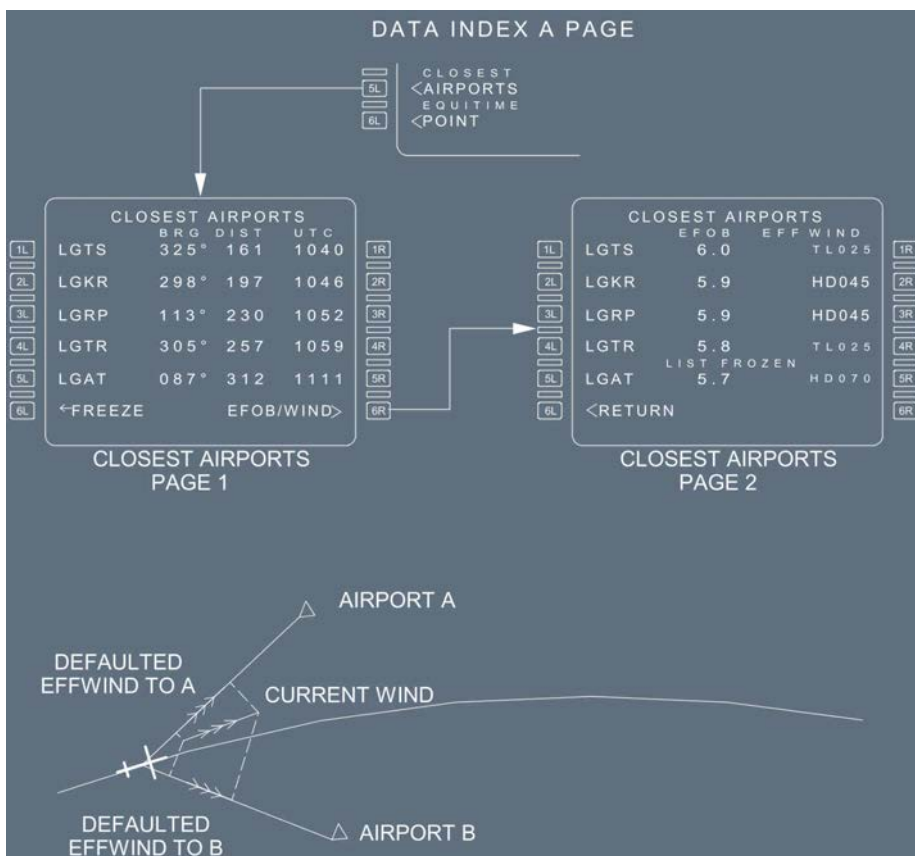

Note: When the **CLOSEST AIRPORTS** page 2 is selected, the list of airports is automatically frozen, as indicated on the page.

The FUEL/TIME predictions to the closest airports use simplified assumptions:

- Managed speed profile in cruise, with the effective wind from the **CLOSEST AIRPORTS** page 2. In case of EO, Engine Out condition is considered.
- Continuous descent from CRZ FL down to the airport elevation.

Note: In case **SELECTED SPD** is used, the **CLOSEST AIRPORTS** page still provides good use to choose the applicable closest airport for diversion purposes. However, when **SELECTED SPD** is significantly different from **MANAGED SPD**, the predictions in terms of time and fuel must be disregarded since they are misleading.
The predictions may then be checked on the **SEC F-PLN**.

GENERAL

Ident.: DSC-22_20-60-90-00006019.0001001 / 16 FEB 11

Applicable to: ALL

The crew can enter a time marker in the F-PLN A or B page. Once entered, the FMGS displays a pseudo waypoint along the flight plan on the MCDU and on the Navigation Display. This pseudo waypoint shows the predicted location of the aircraft at the entered time.

HOW TO INSERT A TIME MARKER

Ident.: DSC-22_20-60-90-00009522.0001001 / 01 OCT 12

Applicable to: ALL

WRITE the time marker in the scratchpad. The entry format is HHMM.
 SELECT any left key of the F-PLN A or B page, to insert the time marker in the active flight plan.
The time marker is inserted in the flight plan according to time criteria, irrespective of the key chosen for entry.

| | | FROM | AI101 → | | |
|-----------------------|----|---------|---------|------|--------------|
| | 1L | AGN | 1149 | UTC | SPD/ALT |
| | | | | | /*FL120 |
| | | | | | BRG006° 24NM |
| 2 ENTER → | 2L | LACOU | 1152 | 280/ | *FL205 |
| | | | | | TRK005 49 |
| | 3L | (T/C) | 1159 | .78/ | FL330 |
| | | | | | 43 |
| | 4L | LMG | 1205 | */ | * |
| | | | | | 96 |
| | 5L | AMB | 1217 | */ | * |
| | | | | | 96 |
| 1 WRITE TIME MARKER → | 6L | EGLL27R | 1300 | DIST | EFOB |
| | | | | | 6.3 |
| | | | | | ↑↓ |

| | | FROM | AI101 → | | |
|-----------------|----|---------|---------|------|--------------|
| | 1L | AGN | 1149 | UTC | SPD/ALT |
| | | | | | /*FL120 |
| | | | | | BRG006° 24NM |
| | 2L | LACOU | 1152 | 280/ | *FL205 |
| | | | | | TRK005 49 |
| | 3L | (T/C) | 1159 | .78/ | FL330 |
| | | | | | 43 |
| | 4L | LMG | 1205 | */ | * |
| | | | | | 96 |
| | 5L | (UTC) | 1210 | */ | * |
| | | | | | 96 |
| TIME MARKER → | 6L | EGLL27R | 1300 | DIST | EFOB |
| PSEUDO-WAYPOINT | | | | | 6.3 |
| | | | | | ↑↓ |

Prediction are recomputed. Time marker pseudo-waypoint is inserted along the active F-PLN (MCDU and ND)

Up to four time markers may exist at a time. An attempt to enter a fifth time marker will cause the "TIME MARKER LIST FULL" message to appear on the scratchpad.

The FMGS updates the time marker position with the predictions.

When the current clock time equals or exceeds the time marker entry, the FMGS sequences the time marker (even in preflight).

STEP CLIMB/STEP DESCENT

Ident.: DSC-22_20-60-100-00006020.0012001 / 12 APR 17

Applicable to: ALL

The STEP ALTS function enables to define the successive cruise Flight Levels. The optimum position to initiate a climb, from the initial (or current) cruise Flight Level to the next one, can also be determined.

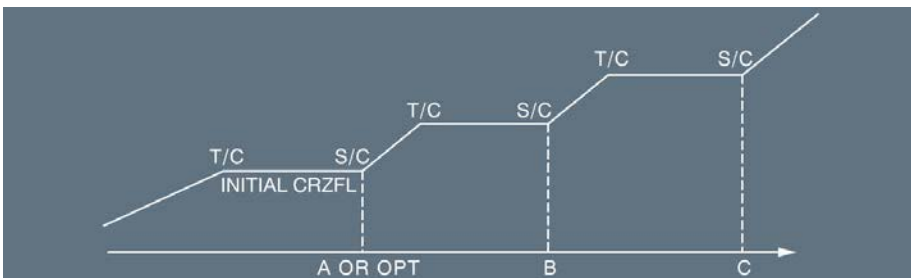

PRINCIPLE

GEOGRAPHIC STEPS

Up to four geographic steps may be defined on the STEP ALTS page. These steps are initiated at the geographical position, along the F-PLN.

Rules

- The minimum step size is 1 000 ft.
- A Step Climb (S/C) cannot follow a Step Descent (S/D).
- A STEP is automatically cleared, if:
 - The S/C (S/D) is sequenced without any level change done by the crew.
 - The crew achieves a LAT REV , which deletes the associated waypoint from the F-PLN
 - By EO condition.
- A STEP is manually cleared:
 - On the STEP ALTS page, by CLEARING the corresponding field.
 - On the F-PLN page, by CLEARING the (S/C) or (S/D) pseudo-waypoints.
- A STEP entry is IGNORED, if the remaining CRZ distance is less than about 50 NM.
- Once the steps are inserted in the F-PLN, they are displayed:
 - On the MCDU , as (S/C) , (S/D) , (T/C) , (T/D) pseudo waypoints.
 - On the ND, by associated white symbols.

OPTIMUM STEP

When geographic steps are inserted, or an altitude is entered, the FM proposes an OPTIMUM STEP start of climb position for the first step climb altitude ahead. Predicted FUEL and TIME savings are displayed when calculated to be greater than 100 kg or 1 min respectively. If no savings are found, no optimum step is proposed.

The OPT STEP is not automatically inserted. The crew must insert it, if appropriate. Once inserted, the OPT STEP point (OPT) becomes a fixed geographical point.

If some F-PLN parameters are subsequently changed (e.g. winds, new waypoints), an update of the optimum position relative to the previous one may be proposed. If savings exist, this new optimum may be inserted to replace the previous optimum step point.

Once an OPT STEP is inserted in the F-PLN, and the crew achieves a lateral F-PLN revision, the FM keeps the (OPT) along the new F-PLN, at the same distance from the aircraft's position, as previously determined.

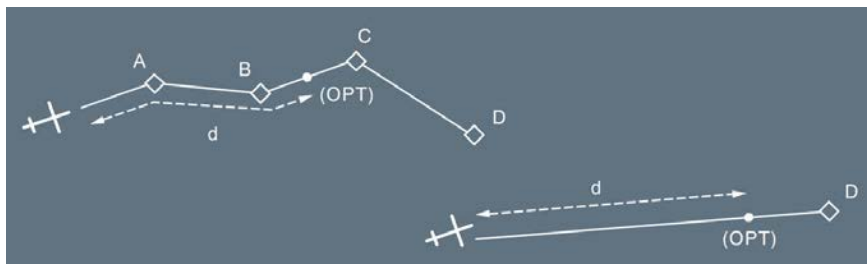

Rules

- The OPT STEP is only computed by the FM, if data required for the prediction computation are inserted : F-PLN, CRZ FL, CI, GW, CG at least.
- The search of the OPT STEP begins 20 NM beyond (T/C) before Cruise, or ahead of the aircraft's position.
- The search of the OPT STEP ends 20 NM before the next STEP POINT, or 300 NM before the (T/D).
- Only one OPT STEP is computed at a time.

Guidance

When reaching the step point, the steps must be initiated by the crew by selecting the new CRZ FL, and pressing the FCU ALT selector knob. If sequenced without any crew action, the step is automatically deleted.

If the crew initiates the step:

- The CRZ FL is automatically reassigned to its new value.
- The guidance is THR CLB /CLB for a step climb.
 THR IDLE/DES with V/S = -1 000 ft/min for a step descent.

STEP ENTRY

The STEP ALTS page is either accessed from : - The VERT REV page, or
 the - PERF CRZ page.

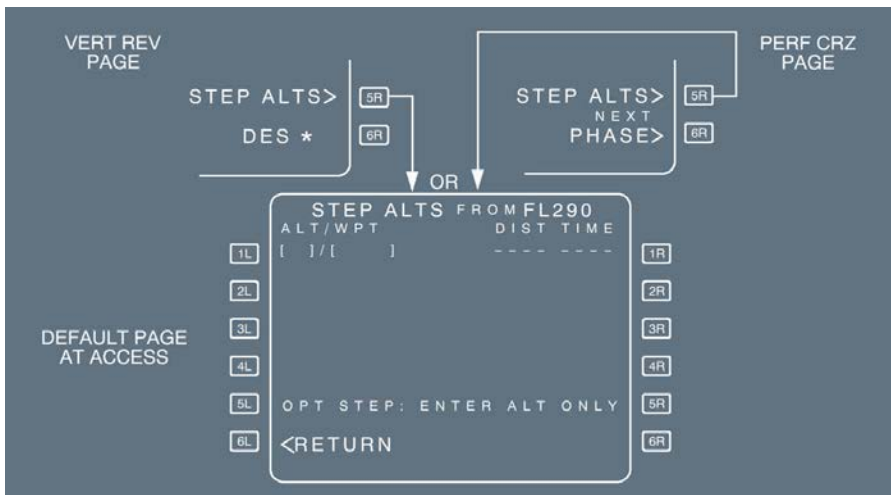

FOR GEOGRAPHIC STEP:

- PRESS the F-PLN or PERF key.
- SELECT vertical revision at a cruise waypoint.
- SELECT the STEP ALTS prompt.

WRITE the ALT /WPT in the scratchpad, and ENTER it in [1L] to [4L].

- Note:
- The position may be a waypoint ident, PBD, PD.
 - The pilot may enter FL 350/LMG/-20. The FM will compute the geographic step 20 NM before LMG to FL 350.
 - To modify an inserted STEP:
 - To modify the CRZ FL only, enter it in the left key, as "FLXXX".
 - To modify the position only, enter it in the left key, as "/XXX".
 - To modify both, modify the position first, and then the CRZ FL (it is not possible to modify both in a single entry).

CHECK the PREDICTIONS.

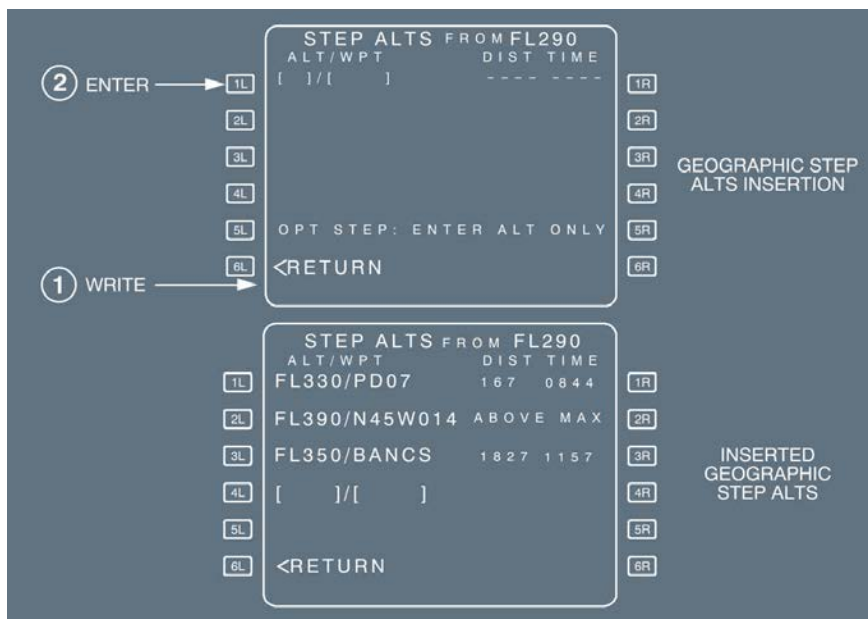

FOR OPTIMAL STEP

Once all geographical steps are inserted, and the predictions are available, the STEP ALTS page displays the FUEL/TIME savings for the first step climb. If no significant savings are predicted, the NO OPTIMAL message is displayed.

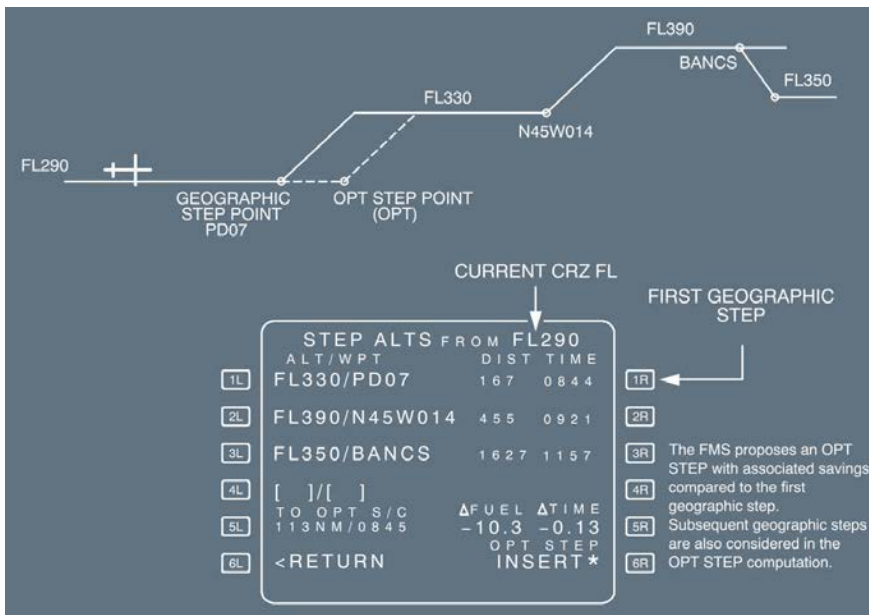

To INSERT the proposed OPT STEP displayed in [5L]:
SELECT the INSERT* prompt in [6R].



The computed (OPT) step replaces the initially inserted step position, and is then considered at a fixed geographic position. Savings are no longer displayed, and the UPDATE* prompt replaces the INSERT* prompt. This prompt allows the crew to update the (OPT) step position, considering possible F-PLN or inserted wind changes.

If pressed, a new OPT point is proposed, with the associated SAVINGS and INSERT prompt, or NO OPTIMAL.

UPDATE prompt has been pressed, the new OPT STEP point gives additional savings:



THERE ARE ONLY 2 CRZ FL S IN THE F-PLN:

The pilot may obtain the OPT position of the STEP point, as follows:

INSERT the initial cruise FL on the INIT A page.

ENSURE that the ZFW , ZFWCG and BLOCK fuel are inserted on the INIT B page.

WRITE the new CRZ FL in the STEP ALTS page, in the [1L] field.

Distance and time to optimum point and fuel/time saving are displayed.

CHECK the fuel and time savings and prediction on the [5R] field.

Savings are computed by comparing the entered step altitude, and the origin altitude of the step.

INSERT, if suitable.

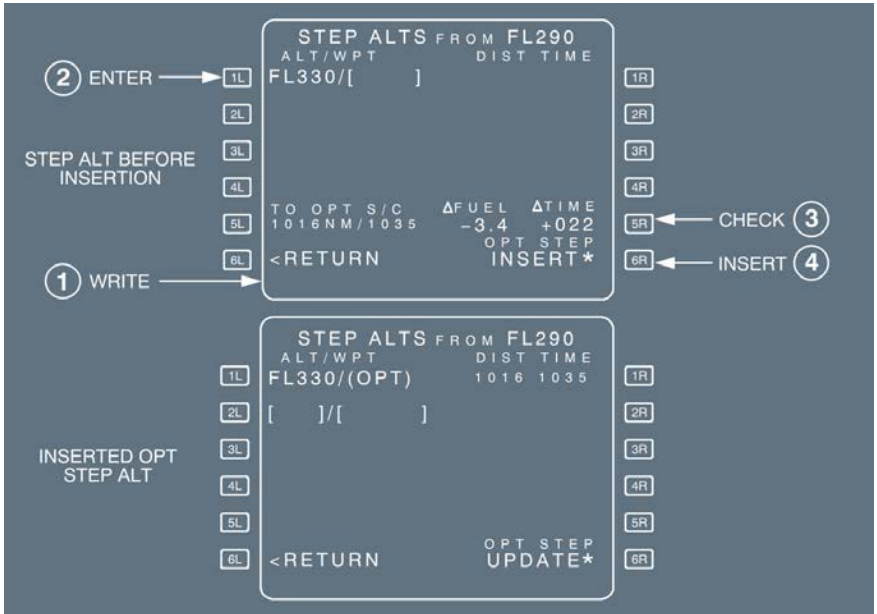

Note: No OPT STEP is available in the SEC F-PLN.

MESSAGES

Messages may be displayed in the DIST/TIME field:

- “ABOVE MAX”, if the inserted step altitude exceeds the REC MAX ALT. The “STEP ABOVE MAX FL” scratchpad message is associated to the “ABOVE MAX” message.
- “IGNORED”

This message is displayed in the following cases:

- Step climb is located prior to the top of climb, or after the top of descent.
- Step end is at less than 50 NM from the top of descent. An optimum step point, < 200 NM from top of descent, cannot be inserted

- “STEP AHEAD”, when the distance to the step point is less than 20 NM . A “STEP AHEAD” scratchpad message is also displayed.
The following message may be displayed in the scratchpad:
- “NOT ALLOWED”, if:
 - Four steps already exist in the F-PLN, and an additionnal entry is attempted.
 - Any attempt to enter a step at the FROM waypoint, or at a pseudo waypoint is done.
 - Two consecutive steps are entered at the same waypoint (e.g. step climb after step descent).

GENERAL

Ident.: DSC-22_20-60-110-00006021.0001001 / 01 OCT 12

Applicable to: ALL

A time constraint (RTA) may be assigned at any waypoint of the F-PLN, downpath of the origin and the FROM waypoint. It can be an "AT", "AT OR BEFORE", or "AT OR AFTER" constraint.

The FMS computes a new managed speed profile from the aircraft position to the constrained waypoint, in order to match the 30 s difference (ΔT) between the time predicted at the constrained waypoint and the RTA. This modified managed speed profile can be checked using the speed prediction, displayed for each waypoint of the F-PLN page.

The RTA function uses a speed range between Green Dot speed and VMO - 10 (or MMO - 0.02). When the constrained waypoint is sequenced, the ECON SPD/MACH is resumed unless the constrained waypoint is located in a descent segment.

Note: The FM does not compute a new managed speed profile when a RTA is entered in the descent profile while the aircraft is in cruise within 40 NM from the top of descent.

The time constraint is inserted on the RTA page. A time constraint may be inserted at any waypoint of the primary or secondary flight plan.

If an engine-out condition is detected, the time constraint is automatically deleted and RTA DELETED message on scratchpad.

If the aircraft enters a holding pattern, the downpath time constraint is deleted.

Once inserted in the F-PLN, the RTA is displayed in magenta on the F-PLN page, as long as no predictions are available.

Once the predictions are available, the time constraint is replaced by the new predicted time at the associated waypoint, and highlighted by a star: (*)

- The (*) is magenta, if the time constraint is matched with the 30 s criteria.
- The (*) is amber, if the time constraint is missed.

Time constraint matching criteria:

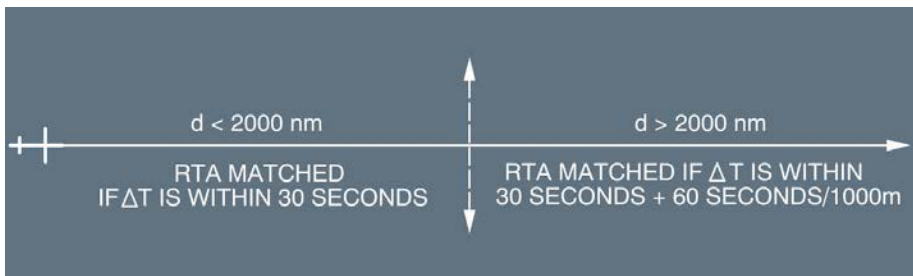

Note: ΔT is the time difference between the time predicted at the constrained waypoint and the RTA.

TIME CSTR ENTRY

PRESS the F-PLN key.

SELECT vertical revision at the revised waypoint.

SELECT the RTA key.

ENTER a waypoint at which a time constraint is to be defined.

WRITE the time constraint (+/-HHMMSS) into the scratchpad and ENTER

The display automatically reverts to the F-PLN A page.



- Note:
- The TIME CSTR can be directly cleared on the F-PLN A page, using the CLR key.
 - The time constraint is automatically deleted in the following cases:
 - Engine out, or
 - When entering a holding pattern, or
 - In case of Go-Around, or
 - A time constraint is entered at another waypoint, while another time constraint already exists.

A scratchpad "RTA DELETED" message is displayed.

ESTIMATED TAKEOFF TIME (ETT)

Ident.: DSC-22_20-60-110-00009523.0001001 / 23 JUN 15

Applicable to: ALL

The Estimated Takeoff Time (ETT) may be entered by the pilot during the preflight phase at the origin airport. This time is used as the initialization time for predictions.

The entry is accepted in the preflight phase, if the ETT is greater than the clock time.

PROCEDURE

PRESS the F-PLN key

SELECT a vertical revision at origin

SELECT the RTA page

WRITE the ETT into the scratchpad, and ENTER in the ETT field.

The display automatically reverts to the F-PLN A page.

- Note:
- If the current time exceeds the ETT entry, the *CLK IS TAKE OFF TIME* message is displayed ; the ETT is replaced by the clock time.
 - At takeoff, the takeoff time is automatically updated using the actual clock time.
 - An ETT entry is automatically deleted, if the origin airport is modified, or if the clock is inoperative.
 - If a time constraint is entered at a waypoint in the F-PLN , the takeoff time required to match the constraint is automatically computed by the FM. This result is displayed in magenta as ETT at the origin.

USE OF TIME/ETT CONSTRAINT

- During preflight : - If an ETT has been entered, time predictions are based on the entered value (or clock time, if greater).
- If both an ETT and a time constraint have been entered, time predictions are based on the entered ETT value (or clock time, if greater). The managed speed profile is computed to match the time constraint, as closely as possible, using a pseudo cost index value. (Not displayed).
 - If only a time constraint has been entered:
 - Optimum speeds are computed to determine the ETT, so as to satisfy the time constraint.
 - If necessary, flight time (based on optimum speeds) plus clock time (current) is greater than the time constraint ; optimum speeds are modified to match the time constraint as closely as possible.
- After Takeoff : The predictions are based on the current time.
Speeds are adjusted to satisfy the time constraint.



A318/A319/A320/A321
FLIGHT CREW
OPERATING MANUAL

AIRCRAFT SYSTEMS

AUTO FLIGHT - FLIGHT MANAGEMENT

OTHER FUNCTIONS - REQUIRED TIME OF ARRIVAL (RTA)

Intentionally left blank

| | |
|---|--|
|  <p>A318/A319/A320/A321 FLIGHT CREW OPERATING MANUAL</p> | <p style="text-align: center;">AIRCRAFT SYSTEMS</p> <p style="text-align: center;">AUTO FLIGHT - FLIGHT MANAGEMENT</p> <p style="text-align: center;">OTHER FUNCTIONS - EQUITIME POINT</p> |
|---|--|

EQUITIME POINT

Ident.: DSC-22_20-60-120-00006015.0001001 / 16 MAR 11

Applicable to: ALL

The equitime point page displays the ETP , computed along the F-PLN route between two referenced positions (airports, waypoints or nav aids), defined by the pilot (*Refer to DSC-22_20-50-10-25 Equi - Time Point Page* for the page description).

When first accessing the page, the FMS proposes origin and destination airfields, as defaulted positions.

The pilot may overwrite these two positions and insert the wind in their vicinity at the applicable CRZ FL.

The FMS then computes the resulting ETP , using the managed or selected speed, and blending the forecasted winds along the F-PLN route with the inserted winds.

The FMS provides:

- TIME and DIST from the aircraft position (or origin on ground) to the ETP
- The BRG /DIST from the ETP to the defined positions
- TIME overhead each position, assuming the aircraft flies from the present position to the defined position via the ETP
- (ETP) pseudo waypoint is displayed on the ND along the F-PLN
- ETP location in relation to the subsequent waypoint.

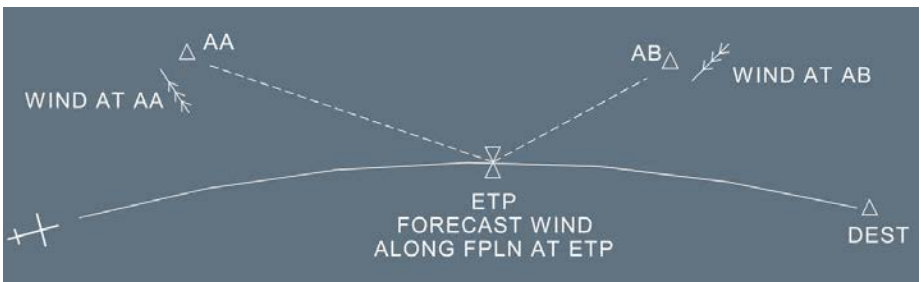

EQUITIME POINT ENTRY

Ident.: DSC-22_20-60-120-00009536.0001001 / 01 OCT 12

Applicable to: ALL

PRESS the DATA key.

SELECT the EQUI-TIME POINT prompt.

The EQUI-TIME POINT page is displayed. The origin and destination airports are used by default.

ENTER the REF POINT 1 in the [1L] field.

ENTER the associated wind in the [2L] field.

The wind to be inserted is the wind in the vicinity of the reference point at the CRZ FL.

ENTER the REF POINT 2 in the [3L] field.

ENTER the associated wind in the [4L] field.

The system displays the ETP location with regards to the next waypoint of the active flight plan following the ETP in the [5R] field, and the A/C TO (ETP) predictions in the [6R] field.

EQUI-TIME PAGE
AT ACCESS
(DEFAULTED)

| EQUI-TIME POINT | | | |
|---|-------------|------|------|
| A/C TO | BRG | DIST | UTC |
| [1L] LFBO | 176° | 249 | 1139 |
| [2L] TRU WIND | ETP TO LF80 | | [1R] |
| [2L] 110°/025 | 171° | 265 | 1147 |
| [3L] EGLL | 007° | 293 | 1147 |
| [4L] TRU WIND | ETP TO EGLL | | [3R] |
| [4L] 185°/045 | 006° | 281 | 1147 |
| [5L] colspan="4" style="text-align: center;">ETP LOCATION | | | |
| [5L] colspan="4" style="text-align: center;">N52W025/ -25.2 | | | |
| [6L] A/C TO | DIST | | UTC |
| [6L] (ETP) | 281 | | 1112 |
| [6R] | [6R] | [6R] | [6R] |

| EQUI-TIME POINT | | | |
|---|-----------|------|------|
| A/C TO | BRG | DIST | UTC |
| [1L] AA | 029° | 788 | 0945 |
| [2L] TRU WIND | ETP TO AA | | [1R] |
| [2L] 075°/020 | 003° | 563 | 1015 |
| [3L] AB | 075° | 1001 | 1012 |
| [4L] TRU WIND | ETP TO AB | | [3R] |
| [4L] 270°/030 | 077° | 627 | 1015 |
| [5L] colspan="4" style="text-align: center;">ETP LOCATION | | | |
| [5L] colspan="4" style="text-align: center;">N52W025/ -25.2 | | | |
| [6L] A/C TO | DIST | | UTC |
| [6L] (ETP) | 371 | | 0953 |
| [6R] | [6R] | [6R] | [6R] |

- Note:
- The ETP pseudo-waypoint is not displayed on the MCDU F-PLN page. In order to easily locate it, or when closing the applicable ETP, the TIME MARKER may be used; this allows the crew to visualize it in advance on the F-PLN page or, to prepare the next applicable ETP on the Equi-time Point page
 - The ETP is computed using speed according to the current mode (managed or selected).

| | |
|---|--|
|  A318/A319/A320/A321 FLIGHT CREW OPERATING MANUAL | AIRCRAFT SYSTEMS AUTO FLIGHT - FLIGHT MANAGEMENT OTHER FUNCTIONS - MCDU BACK UP NAVIGATION |
|---|--|

GENERAL

Ident.: DSC-22_20-60-130-00012906.0011001 / 24 FEB 14

Applicable to: ALL

The MCDU NAV B/UP allows to link a MCDU to its associated IRS in order to allow the flight crew to monitor the navigation and to be provided with some basic flight planning functions in case of FM 1 + 2 failure.

CAUTION The MCDU NAV B/UP is to be used only in case of FM 1 + 2 failure. It can be selected temporarily in case of FM1 or 2 only failure, in order to ensure that the function is available on the failed side.
 When in MCDU NAV B/UP on both sides, one FG at least must be available to engage AP and A/THR.

The MCDU NAV B/UP function provides:

- Aircraft position using outside IRS or IRS 3
- Aircraft position using GPIRS  position
- F-PLN as memorized in the MCDU
- F-PLN display on ND
- F-PLN automatic sequencing
- Limited lateral revisions
- Mag (True) bearing depending on the pilot selection, from aircraft position to the TO WPT and associated distance
- True track between waypoints
- Time estimates computed with current GS from outside IRS
- Total time and distance to destination

The following features are not provided:

- No DATA BASE available:
 - No autotuning, NAVAID S must be selected on RMP
 - No radio position
 - No EFIS CTL PANEL options
 - No LDG ELEV (must be manually selected on overhead panel).
- No performance data:
 - No CLB /DES /APP NAV/FINAL modes
 - No SPEED MANAGED
 - No automatic SPD/MACH change over.
- Most of predictions are lost:
 - No EFOB
 - No XTRA
 - No ETA at DEST.
- No multiple lateral F-PLN

- No AP/FD managed modes
- No crosstalk between MCDU s: F-PLN revisions have to be achieved on both MCDUs.

BACK UP NAV SELECTION

Applicable to: **ALL**

Ident.: DSC-22_20-60-130-A-00012907.0011001 / 16 FEB 11

FM F-PLN DOWNLOAD IN MCDU

While BACK UP NAV is not active, the FM downloads permanently a condensed form of the F-PLN in the MCDU.

Downloaded information include:

- Waypoint position
- Waypoint identifier
- Leg type
- Discontinuity
- Overfly
- Turn direction.

Heading legs, course to fix legs, ..., computed INTCPT positions, pseudo waypoints, ..., cannot be downloaded.

They are replaced by discontinuities.

Maximum of 150 waypoints are downloaded.

Ident.: DSC-22_20-60-130-A-00012908.0011001 / 14 MAY 12

EXAMPLE OF DOWNLOADED F-PLN

| | | | | | |
|-------------------------|---------|---------|--------------|-------------|------|
| F-PLN before FM failure | [1L] | FROM | A1101 → | | [1R] |
| | | BIGAR | UTC | SPD/ALT | |
| | [2L] | BIG | 117 | / 4888 | [2R] |
| | | C335° | | 9NM | |
| | [3L] | BIG09Δ | 116 | 250 / *2700 | [3R] |
| | | TRK275° | | 1 | |
| | (DECEL) | 117 | / 2500 | | |
| [4L] | C275° | | 6 | [4R] | |
| | AMB | 118 | 160 / *2500 | | |
| [5L] | C275° | | 4 3.0° | [5R] | |
| | OM27R | 120 | *136 / *1310 | | |
| [6L] | DEST | TIME | DIST | EFOB | [6R] |
| | EGLL27R | 121 | 518 | 36.9 | |
| | | | | ↑↓ | |

| | | | | | |
|---|---------|-------------------------|------------------|------|------|
| Download B/UP F-PLN -CF legs are preceded by a discontinuity -PSEUDO WPT are not downloaded | [1L] | B/UP FPLN | | | [1R] |
| | | FROM | TTG | DIST | |
| | [2L] | BIG | 5119.8N/00002.2E | | [2R] |
| | | --F-PLN DISCONTINUITY-- | | | |
| | [3L] | BIG09Δ | 5127.0N/00004.6W | | [3R] |
| | | --F-PLN DISCONTINUITY-- | | | |
| [4L] | AMB | 5128.6N/00014.1W | | [4R] | |
| [5L] | DEST | TTG | DIST | [5R] | |
| | EGLL27R | --- | 518NM | [6R] | |
| | | | | ↑↓ | |

In that procedure, all the legs are coded as CF (Course to Fix) legs. This explains all the discontinuities resulting in the B/UP F-PLN.

These discontinuities may be cleared.

When the second FM fails

REENGAGE and SELECT the required AP and A/THR modes (if disconnected).

SELECT the NAV B/UP prompt on both MCDU.

SELECT NAV on both RMP

Tune the required nav aids

MCDU MENU
SELECT
NAV B/UP>

| | | |
|----|-------------------|----|
| 1L | <FM1 | 1R |
| 2L | <ACARS | 2R |
| 3L | <ACMS | 3R |
| 4L | <CMS | 4R |
| 5L | | 5R |
| 6L | RETURN> | 6R |

B/UP FPLN

| | FROM | TTG | DIST | |
|----|----------------|-------------------------|-----------|----|
| 1L | TOU | 4340.8N/00118.7E | | 1R |
| | 3 5 0 ° | 0 0 0 4 | 2 2 N M | |
| 2L | AGN | 4353.3N/00052.4E | | 2R |
| | 3 4 8 ° | 0 0 4 5 | 1 1 6 N M | |
| 3L | LMG | 4549.ON/00101.6E | | 3R |
| | 3 2 1 ° T | 0 0 4 5 | 9 7 N M | |
| 4L | AMBA | 4725.1N/00102.5E | | 4R |
| | 3 2 2 ° T | 0 0 5 3 | 4 0 N M | |
| 5L | N48E001 | 4803.5N/00123.3E | | 5R |
| | D E S T | 0 1 2 6 | 4 4 3 N M | |
| 6L | LFPO | 4843.4N/00222.9E | | 6R |
| | | ↑ ↓ | | |

B/UP F-PLN PAGE

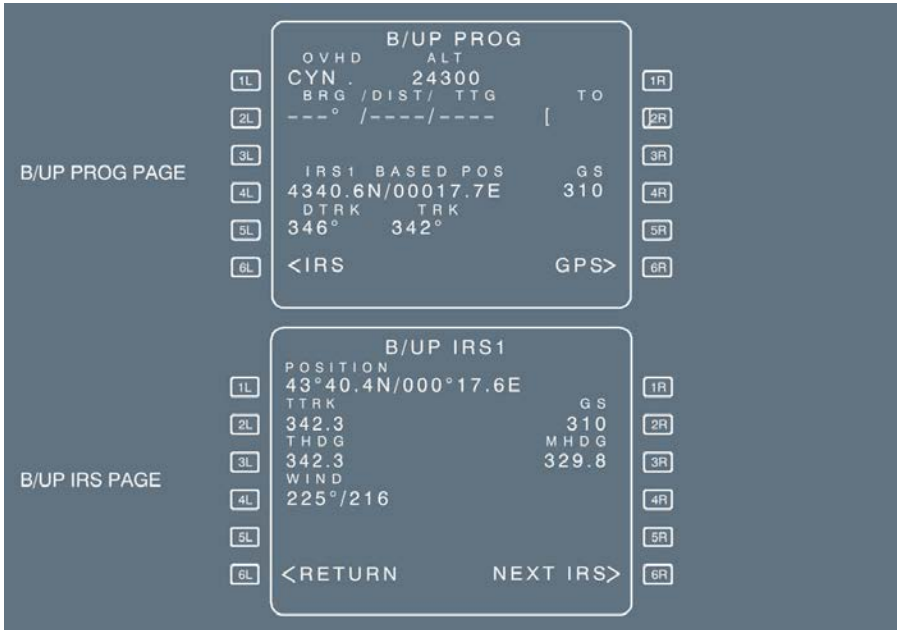

- Only MCDU MENU
 - F-PLN key
 - PROG key
 - DIR key
- B/UP F-PLN page
 - B/UP PROG page
 - B/UP IRS 1, 2, 3 pages are available when BACK UP NAV is selected.
- B/U GPS (if GPS is installed).

BACK UP NAV OPERATION

Applicable to: ALL

Ident.: DSC-22_20-60-130-B-00012909.0011001 / 16 FEB 11

AP AND A/THR

One FG at least must be available to allow the engagement of AP /FD and A/THR . All FM managed modes are lost as well as managed speed.

As a consequence:

- LAT F-PLN is flown in HDG /TRK modes
- VERT F-PLN is flown in OPEN/V/S /FPA modes
- SPD TARGET is manually SELECTED on the FCU
- SPD /MACH crossover is manually SELECTED on the FCU.

It is recommended to use the TRK /FPA modes:

SELECT the required TRK on FCU at waypoint sequencing (as no AP /FD coupling exists in NAV B/UP). F-PLN sequencing is automatic.

MONITOR the track of the next leg prior reaching the TO waypoint (track between TO and next waypoints is true track).

ADJUST the track to follow the F-PLN with X-TRK = 0

USE OP DES or FPA to descend as suitable.

FPA allows easy altitudes predictions:

$$DNM = \Delta(\text{FL}) / \text{FPA}^\circ$$

Ident.: DSC-22_20-60-130-B-00012910.0011001 / 16 FEB 11

NAVIGATION MONITORING

The navigation accuracy check must be achieved periodically using the same principle as with FM navigation:

COMPARE computed data with raw data

SELECT ON RMP the applicable navaid

PRESS the [PROG] key



B/UP PROG page is displayed

WRITE in the scratchpad then ENTER the navaid LAT /LONG

SELECT associated navaid needle on the EFIS control panel.

COMPARE computed BRG /DIST with RAW DATA on ND

- *If the crosscheck is POSITIVE the ND may be used in ROSE NAV /MAP modes with raw data*
- *If the crosscheck is NEGATIVE the ND must be used in ROSE VOR /ROSE ILS modes.*

Note: B/UP IRS  and B/UP GPS  pages may also be used to check the position.

Ident.: DSC-22_20-60-130-B-00012911.0011001 / 16 FEB 11

FLIGHT PLANNING

The following revisions may be achieved:

- WPT insertion/deletion
- OVERFLY insertion/deletion

- DIR TO a waypoint
- CLR waypoints/discontinuities.

Waypoint identifiers are either published waypoint identifiers if present in the MCDU active F-PLN , or coded LAT /LONG identifiers resulting from flight crew entries.

All flight planning functions are directly applied on active F-PLN without LAT REV page.

Ident.: DSC-22_20-60-130-B-00012912.0011001 / 23 JUN 15

WAYPOINT INSERTION

Waypoint insertion into the F-PLN is performed via the B/UP F-PLN page by selecting the line key adjacent to the desired point of insertion, whenever a pre-existing waypoint identifier or valid IDENT /LAT /LONG or LAT /LONG entry is displayed in the scratchpad.

Any waypoint entry which causes the number of legs in the route to exceed the maximum allowed results in the “F-PLN FULL” message.

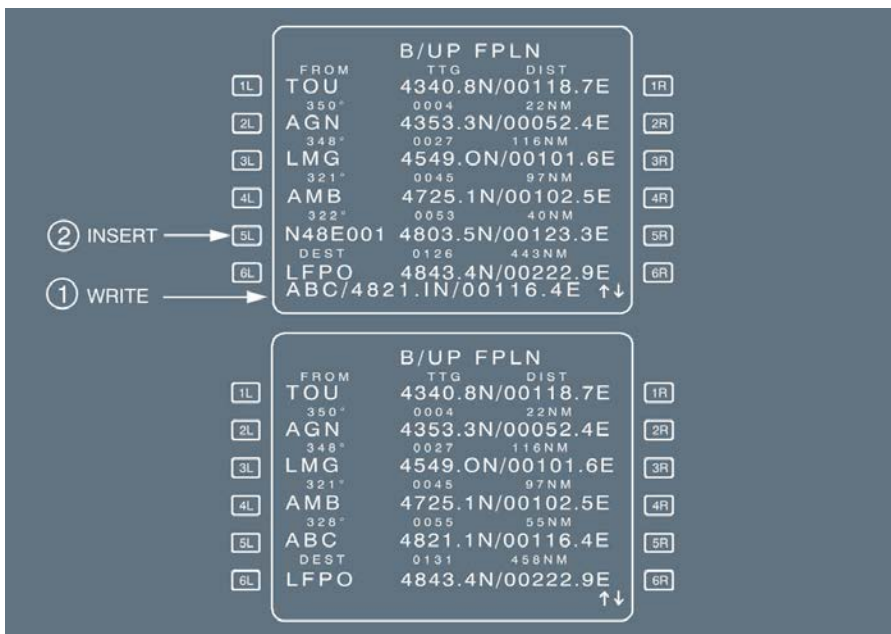

- Note:
- If the inserted waypoint is entered only with LAT /LONG, its identifier would be : N48E001
 - If the flight crew writes a waypoint IDENT /LAT /LONG with an IDENT already used in the F-PLN, a message “NOT ALLOWED” is displayed.

Ident.: DSC-22_20-60-130-B-00012913.0011001 / 16 FEB 11

WAYPOINT DELETION

Waypoint and discontinuity may be deleted from the B/UP F-PLN page by using the CLR key.

Ident.: DSC-22_20-60-130-B-00012914.0011001 / 16 FEB 11

OVERFLY INSERTION/DELETION

Same as for the FM F-PLN.

Ident.: DSC-22_20-60-130-B-00012915.0011001 / 23 JUN 15

DIRECT TO A WAYPOINT

The DIR TO function operates as for the normal F-PLN, except that RADIAL INTERCEPT and ABEAM functions are not available.

PRESS the DIR key.

WRITE LAT /LONG (or IDENT /LAT /LONG) on the scratchpad then INSERT in [1L].

SELECT the correct track on the FCU in order for the aircraft to turn toward the new TO waypoint.

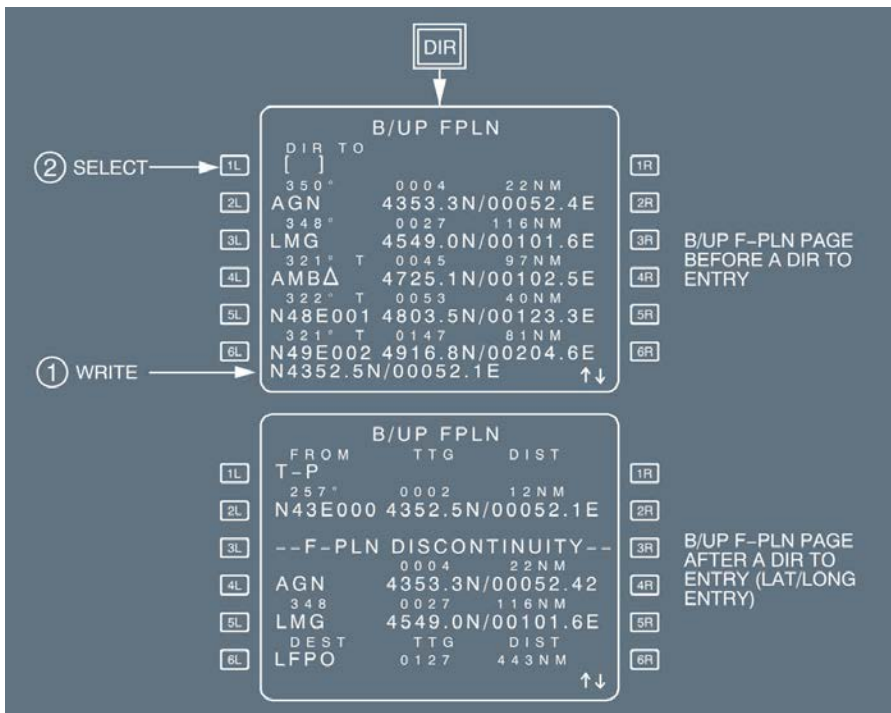

In this example, the entered DIR TO waypoint is a LAT /LONG waypoint.

Due to the fact that this new waypoint is not identical to any waypoint in the F-PLN, a direct leg to that waypoint is created and followed by a discontinuity.

When the DIR TO function is completed, the B/UP F-PLN page is displayed with the DIR TO waypoint as the TO waypoint and the T-P waypoint as the FROM waypoint.

If a DIR TO function is achieved for a waypoint that belongs to the B/UP F-PLN , no F-PLN discontinuity is created.

Note: - In case of a DIR TO waypoint associated with an OVERFLY condition, the OVERFLY is kept.

Ident.: DSC-22_20-60-130-B-00012916.0011001 / 14 MAY 12

CLR WAYPOINT/DISCONTINUITY

CLR as for normal operation.

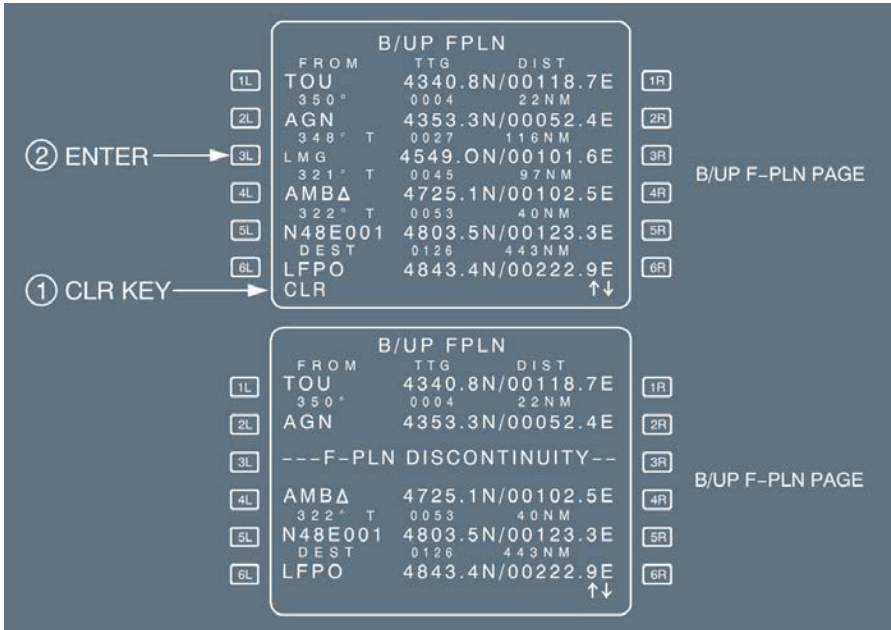

B/UP FPLN

| FROM | TTG | DIST |
|---------|------------------|--------|
| TOU | 4340.8N/00118.7E | |
| 350° | 0004 | 2.2NM |
| AGN | 4353.3N/00052.4E | |
| 348° T | 0027 | 1.16NM |
| LMG | 4549.0N/00101.6E | |
| 321° T | 0045 | 0.97NM |
| AMBA | 4725.1N/00102.5E | |
| 322° T | 0053 | 0.40NM |
| N48E001 | 4803.5N/00123.3E | |
| DEST | 0126 | 4.43NM |
| LFPO | 4843.4N/00222.9E | |
| CLR | | ↑↓ |

B/UP F-PLN PAGE

B/UP FPLN

| FROM | TTG | DIST |
|-----------------------------|------------------|--------|
| TOU | 4340.8N/00118.7E | |
| 350° | 0004 | 2.2NM |
| AGN | 4353.3N/00052.4E | |
| --- F-PLN DISCONTINUITY --- | | |
| AMBA | 4725.1N/00102.5E | |
| 322° T | 0053 | 0.40NM |
| N48E001 | 4803.5N/00123.3E | |
| DEST | 0126 | 4.43NM |
| LFPO | 4843.4N/00222.9E | |
| | | ↑↓ |

B/UP F-PLN PAGE

Ident.: DSC-22_20-60-130-B-00012917.0011001 / 23 DEC 14

APPROACHES

- ND display selection rule
As per normal operation, it depends upon the result of NAV ACCY CROSS CHECK.
Furthermore it depends also whether the F-PLN is complete, including the approach.

| F-PLN | NAV ACCY CHECK | ND | |
|------------------------------------|----------------------|--|--|
| | | PF | PM |
| Complete with appropriate approach | Positive | ARC or ROSE NAV Ref navaid Raw data | |
| | Negative | ROSE VOR /ILS | ARC or ROSE NAV or ROSE VOR /ILS Ref Navaid Raw Data |
| Incomplete | Positive or Negative | ROSE VOR /ILS | |

Ident.: DSC-22_20-60-130-B-00012918.0011001 / 16 FEB 11

END OF DESCENT

ADJUST manually the landing elevation on the overhead panel.

SET the MDA on the standby altimeter.

Ident.: DSC-22_20-60-130-B-00012919.0011001 / 23 JUN 15

NON ILS APPROACHES

SELECT on RMP the approach reference nav aids.

The autopilot and flight director available modes are TRK -FPA and HDG/VS

The autothrust available speed target is selected speed.

Ident.: DSC-22_20-60-130-B-00012920.0011001 / 16 FEB 11

ILS APPROACHES

Only CAT 1 approaches may be flown since the DH indication is not available.

CHECK the ILS frequency and course on the RMP.

PUSH the LS pb on the EIS control panel.

The autopilot and flight director available modes are APP (LOC – G/S – LAND)

The autothrottle available speed target is selected speed

CHECK VAPP in the QRH.



A318/A319/A320/A321
FLIGHT CREW
OPERATING MANUAL

AIRCRAFT SYSTEMS

AUTO FLIGHT - FLIGHT MANAGEMENT

OTHER FUNCTIONS - MCDU BACK UP NAVIGATION

Intentionally left blank

DESCENT PROFILE OPTIMIZATION ◀

Ident.: DSC-22_20-60-150-00019723.0001001 / 07 JUN 16

Applicable to: ALL

During the idle segment in descent, margins are added to the idle thrust to have more flexibility to maintain the aircraft on the computed descent profile in case of external perturbations such as important wind change.

The Descent Profile Optimization (DPO ◀) optimizes the computed vertical profile. It decreases the idle thrust margins in descent and the speed margins in approach to reduce fuel burn in descent phase.

With DPO ◀, the computed vertical profile is steeper. The T/D is reached later. Before the final approach, the deceleration level-off is shorter.

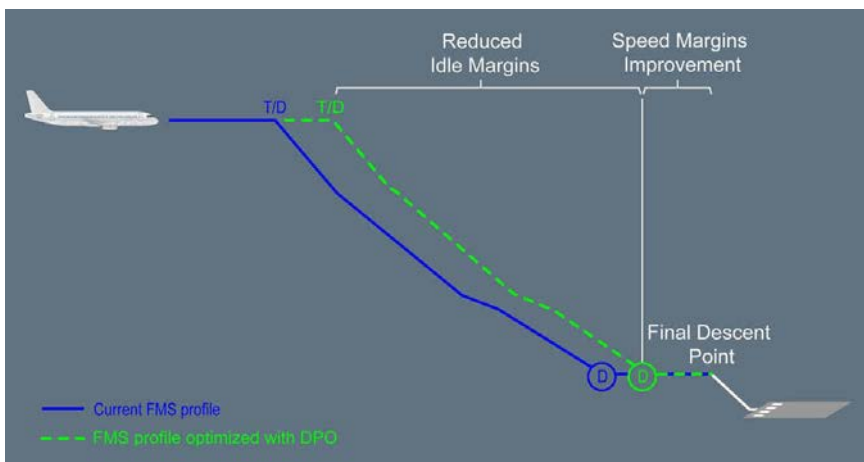

With DPO ◀, along the idle segment, without altitude constraint, the descent profile computed by the FMS is the same as the one flown in OPEN DES mode. Therefore, reverting in OPEN DES mode during the descent does not change the descent rate.

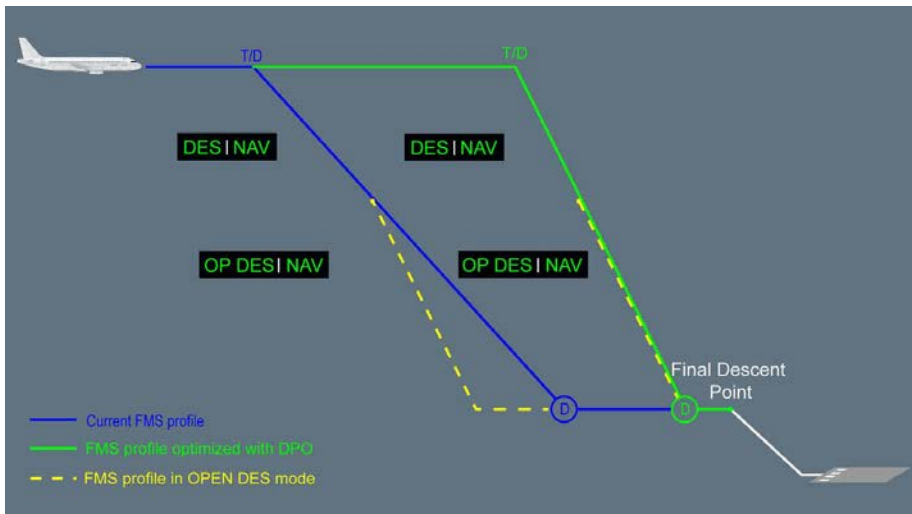

With DPO , the FMGS has less flexibility to maintain the aircraft on the computed vertical profile in case of difference between wind entry and effective wind. Therefore, the accurate winds have to be entered in the FMGS before descent.

During descent, the VDEV should be closely monitored. If the aircraft goes above the flight descent profile, the flight crew may have to extend speed brakes to go back on the computed descent profile. If ENG ANTI ICE or ENG ANTI ICE + WING ANTI ICE are used during descent (inducing an increased idle thrust), the flight crew may have to extend speed brakes to stay on the computed descent profile.

FLIGHT PLAN INITIALIZATION THROUGH ACARS

Ident.: DSC-22_20-70-00000956.0007001 / 01 OCT 12

Applicable to: ALL

REQUEST FOR ACTIVE FLIGHT PLAN INITIALIZATION BEFORE ENGINE START

Before engine start, the crew may request a route for the active flight plan. When the route is received, "AOC ACT F-PLN UPLINK" message is displayed on the MCDU indicating that the flight plan has been received and automatically inserted.

After engine start, it is not possible to initialize directly the active flight plan since the received flight plan is automatically routed into the secondary, and the MDCU displays "AOC SEC F-PLN UPLINK".

PROCEDURE

PRESS the INIT REQUEST * prompt.

The star () disappears, all data fields are dashed except:*

- CO RTE , FLT NBR if previously displayed and
- Ddefault values.

The star is not displayed when the FMGS cannot communicate with the ACARS. No request can be sent.

When an active flight plan exists, INIT REQUEST prompt is removed from the active INIT page and no request can be sent for the active flight plan. If a flight plan is entered manually after the request, the uplink message is routed to the secondary.

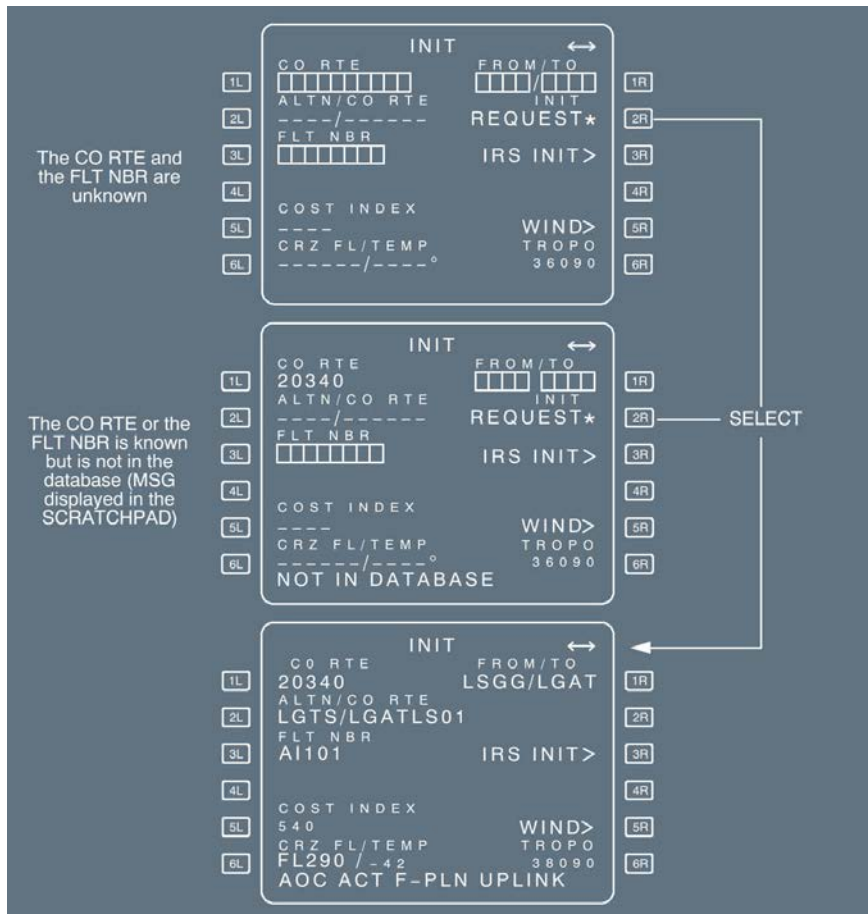

REQUEST FOR SECONDARY FLIGHT PLAN

A request for a secondary flight plan can be initiated anytime. Any flight plan received after engine start is automatically routed into the secondary flight plan.

When the flight plan is received, a message “AOC SEC F-PLN UPLINK” is displayed on the MCDU scratchpad.

Before engine start, and if the SEC F-PLN is empty, any uplinked flight plan is automatically inserted into the secondary flight plan, and no flight crew action is required.

After engine start, or if the SEC F-PLN is not empty, the flight crew must manually insert the uplinked flight plan via INSERT UPLINK prompt.

PROCEDURE TO INSERT OR REJECT A SECONDARY FLIGHT PLAN

When the uplink message is received, the INIT REQUEST prompt of the INIT A page is replaced by INSERT UPLINK (2R field). Pressing the 2R key will insert the flight plan into the secondary. Clearing the prompt will reject it.

If a temporary flight plan or a DIR TO is in progress, the uplink insertion is not accepted until the temporary flight plan or the DIR TO is completed.

1L

2L

3L

4L

5L

6L

SEC INIT →

| | |
|----------------------|----------|
| CO RTE | FROM/TO |
| □□□□□□ | □□□□ |
| ALTN/CO RTE | INIT |
| -----/----- | REQUEST* |
| FLT NBR | |
| □□□□□□ | |
| LAT | LONG |
| ----- | ----- |
| COST INDEX | |
| --- | WIND> |
| CRZ FL/TEMP | TROPO |
| -----/-----° | 36090 |
| AOC SEC F-PLN UPLINK | |

1R

2R ← PRESS ①

3R

4R

5R

6R

1L

2L

3L

4L

5L

6L

SEC INIT →

| | |
|-----------------------|-----------|
| CO RTE | FROM/TO |
| □□□□□□ | □□□□/□□□□ |
| ALTN/CO RTE | INSERT |
| -----/----- | UPLINK* |
| FLT NBR | |
| □□□□□□ | |
| LAT | LONG |
| ----- | ----- |
| COST INDEX | |
| --- | WIND> |
| CRZ FL/TEMP | TROPO |
| -----/-----° | 36090 |
| UPLINK INSERT IN PROG | |

1R

2R ← PRESS ②

3R

4R

5R

6R

1L

2L

3L

4L

5L

6L

SEC INIT →

| | |
|-------------|-----------|
| CO RTE | FROM/TO |
| 20441 | LSGG/LGAT |
| ALTN/CO RTE | INIT |
| LGTS | REQUEST* |
| FLT NBR | |
| A1101 | |
| LAT | LONG |
| 4512.ON | 00727.2E |
| COST INDEX | |
| 540 | WIND> |
| CRZ FL/TEMP | TROPO |
| FL290/-42° | 36090 |

1R

2R

3R

4R

5R

6R

TAKEOFF DATA

Applicable to: ALL

Ident.: DSC-22_20-70-A-00000957.0001001 / 15 FEB 11

GENERAL

The takeoff data may be requested in preflight or done phase for the active flight plan only. It is always associated with the active flight plan message.

Ident.: DSC-22_20-70-A-00000959.0001001 / 23 JUN 15

PROCEDURE TO INSERT UPLINK TAKEOFF DATA

PRESS the 6L key "RECEIVED TO DATA" when the message TAKEOFF DATA UPLINK is displayed.

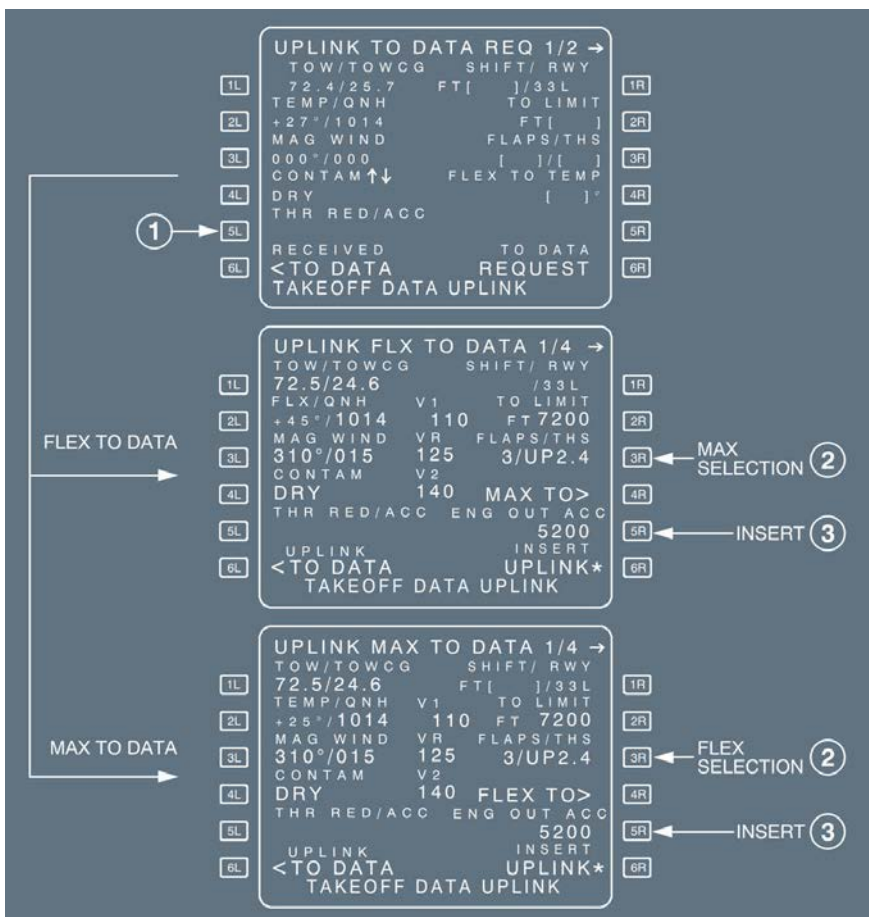

This displays the uplink data on 2 different pages: **UPLINK MAX TO DATA**
UPLINK FLX TO DATA

SELECT the data corresponding to the thrust to be used (MAX or FLEX) by pressing [4R].
 SELECT the active runway data by slewing the pages (1/4... 4/4).

PRESS the [6R] key “INSERT UPLINK”.

UPLINK MAX TO DATA and UPLINK FLX TO DATA pages are not modifiable.

- **If the takeoff data displayed on this page are not relevant to the active runway entered in the flight plan** , the INSERT UPLINK prompt is not displayed.
- **When the takeoff data have been inserted** , the PERF TO page is amended of the new data.

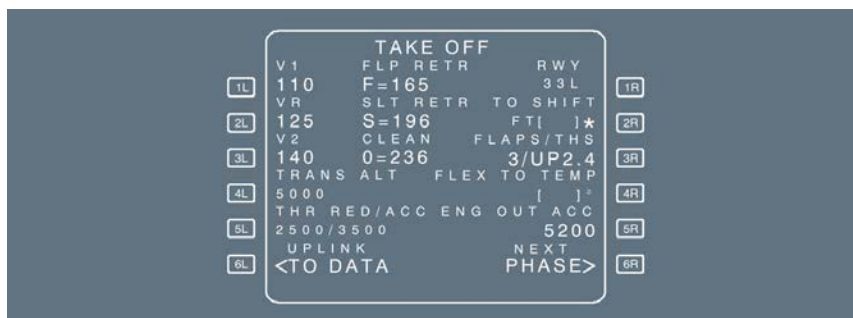

WIND DATA

Applicable to: ALL

Ident.: DSC-22_20-70-B-00000961.0001001 / 01 OCT 12

REQUEST FOR WIND DATA

To send a wind request, press the “WIND REQUEST” selection key of any wind pages. This request is automatically sent to the ground for one or more flight phases and for the selected flight plan (primary or secondary). The content of the wind request message is not dependent on the selected wind page (CLIMB, CRUISE or DESCENT) but on the flight phase in progress.

- For active flight plan or secondary flight plan that is a “COPY ACTIVE”, a wind request sent by the crew:
 - during preflight or takeoff phase, initiates a demand for climb, cruise, descent and alternate winds.
 - during climb and cruise phase, initiates a demand for cruise, descent and alternate winds.
 - during descent/approach and go around, no wind request is possible.
- For secondary flight plan that is not a “COPY ACTIVE” there is no restriction linked to flight phase.

Before engine start, and if data has not been entered in any WIND page for the flight plan, the uplinked wind data is automatically inserted into the flight plan, and no flight crew action is required.

If the uplinked wind message is received after engine start, or if data has been entered in any WIND page of the flight plan, the flight crew must manually insert the uplinked wind data via the INSERT UPLINK prompt.

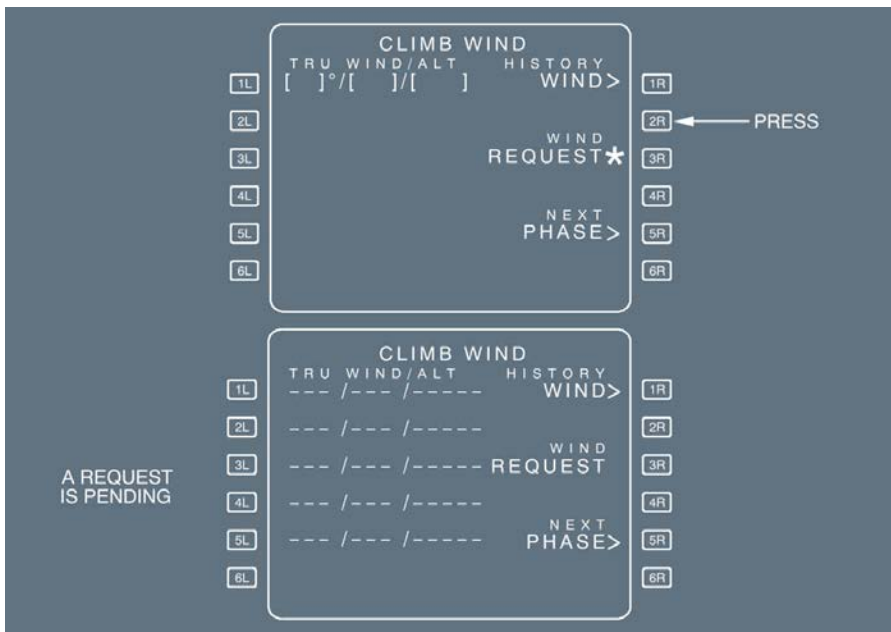

When the amber star following the “WIND REQUEST” is not displayed, the FM is not able to communicate with the ACARS and the pilot cannot send any request.

Ident.: DSC-22_20-70-B-00000962.0020001 / 14 MAY 12

PROCEDURE TO INSERT WIND DATA

When the uplink message is received, the 2R field is modified, the amber “WIND REQUEST” is replaced by the blue “INSERT UPLINK*”. This prompt, when pressed, enables the flight crew to insert the uplink wind data, phase by phase.

To access, review, insert or delete the uplink wind data of other phases, the crew uses “NEXT PHASE” or “PREV PHASE” key.

If the crew is not satisfied with the uplink winds, the flight crew will delete the winds, phase by phase clearing the "INSERT UPLINK" prompt. This will delete all the uplinked winds of the selected flight phase.

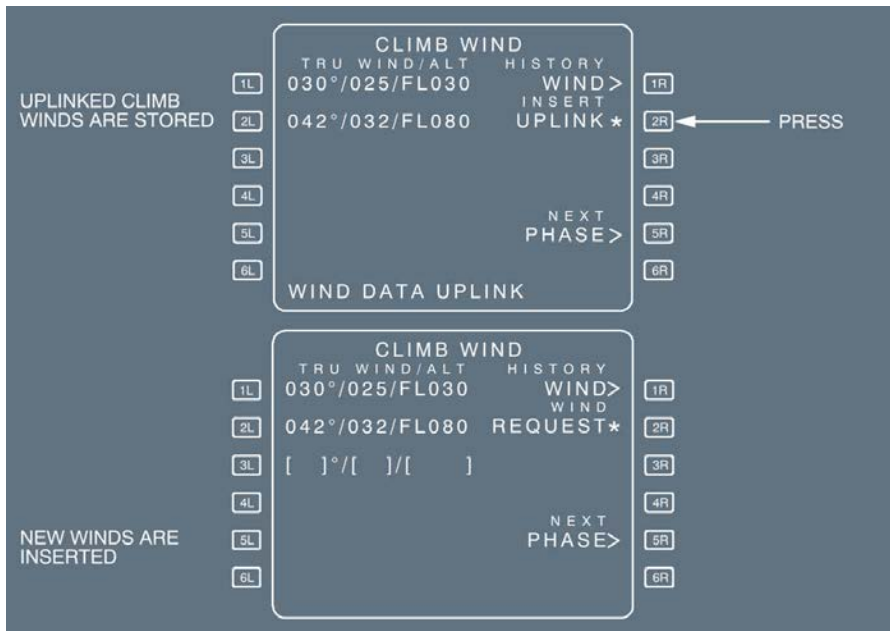

CLIMB WIND PAGE

When a request is pending, the history WIND page cannot be accessed.

When the climb phase is active, the crew cannot request neither modify the climb winds of the active flight plan or secondary flight plan if it is a copy active.

CRUISE WIND PAGE

CRUISE WIND
TRU WIND/WPT CRZ FL
---°/---/TOP FL330
WIND
---°/---/KEBT REQUEST
---°/---/BTIE
STEP FL370 PREV PHASE>
---°/---/COVT NEXT PHASE>
---°/---/KUABE
---°/---/CAT ↑↓

CRUISE WIND PAGE REQUEST IS PENDING

CRUISE WIND
TRU WIND/WPT CRZ FL
260°/109/TOP FL330
INSERT
258°/080/KEBT UPLINK*
265°/096/BTIE
STEP FL370 PREV PHASE>
240°/060/COVT NEXT PHASE>
245°/085/KUABE
250°/105/CAT WIND DATA UPLINK ↑↓

UPLINKED DATA PRIOR TO INSERTION

A wind request sent during cruise phase will apply for downpath waypoints of the cruise, descent, approach and alternate phases.

- If the uplink message contains more data and waypoints than the flight plan, the winds at extra waypoints are not considered and automatically discarded. This is transparent to the pilot
- Clearing the INSERT UPLINK* prompt deletes all uplink wind data of the cruise phase. Cruise page reverts to the previous data.

Note: During cruise, whenever uplink wind data is received and not inserted or cancelled on the CRUISE WIND page, access to the DIR TO function is not possible. The “WIND UPLINK EXISTS” message is displayed on the MCDU scratchpad. Insert or cancel the uplinked wind message first and then access the DIR TO function.

DESCENT WIND PAGE

The procedures to insert, review or delete descent winds during preflight, climb or cruise phase are described in the above wind general procedure.

DESCENT WIND PAGE
REQUEST IS PENDING

DESCENT WIND

TRU WIND/ALT

| | | |
|----|-----------|-----------------|
| 1L | --°/--/-- | |
| 2L | --°/--/-- | WIND REQUEST |
| 3L | --°/--/-- | |
| 4L | --°/--/-- | PREV PHASE> |
| 5L | --°/--/-- | |
| 6L | --°/--/-- | ALTERNATE |

1R

2R

3R

4R

5R

6R

UPLINKED DATA
PRIOR TO INSERTION

DESCENT WIND

TRU WIND/ALT

| | | |
|----|-----------------------------|-------------------|
| 1L | 060°/060/FL310 | |
| 2L | 060°/050/FL200 | INSERT UPLINK★ |
| 3L | 060°/020/FL100 | |
| 4L | 050°/010/FL050 | PREV PHASE> |
| 5L | ALTERNATE 065°/050/FL250 | |
| 6L | | ALTN CRZ FL220 |

WIND DATA UPLINK

1R

2R

3R

4R

5R

6R



If the alternate wind is not available, dashes are displayed in the field.

In descent, approach or go around phases, the pilot cannot request or modify the descent winds of the active flight plan or secondary flight plan if it is a "COPY ACTIVE".

PRINT FUNCTION

Ident.: DSC-22_20-80-00000964.0009001 / 18 MAR 11



Applicable to: ALL

The PRINT function allows various reports to be printed either automatically (when linked to ACARS  or ATSU ) or manually.

The manual PRINT function allows printing of FM-generated flight reports and additional data:

| | |
|------------|---------------------|
| F-PLN | INITialization data |
| T.O. | Data |
| WIND | Data |
| PREFLIGHT | REPORT |
| IN FLIGHT | REPORT |
| POSTFLIGHT | REPORT |

A detailed description of the PRINT FUNCTION pages is provided in *Refer to DSC-22_20-50-10-25 Print Function Pages.*

The print function is available if ACARS  or ATSU  are available or not.

The various flight reports contain most of the prediction information required by the flight crew to monitor the progress of the flight. The resulting documents can therefore be used as realistic master documents, based on the latest data provided by the flight crew to the computer, in terms of ATC clearances and weather information.

PRINT FUNCTION ACCESS

Ident.: DSC-22_20-80-00000965.0004001 / 01 OCT 12

Applicable to: ALL

The PRINT FUNCTION page is accessed:

- From the DATA INDEX A PAGE, or
- From the AOC FUNCTION page (if ACARS ).

AIRCRAFT SYSTEMS

AUTO FLIGHT - FLIGHT MANAGEMENT

PRINT FUNCTIONS

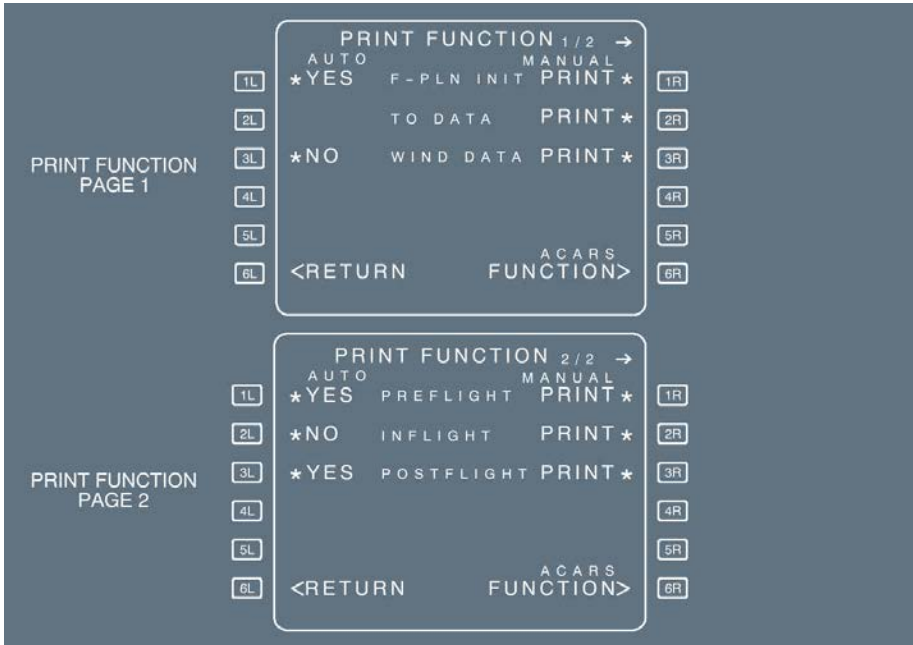

Note: For an automatic printing, "time" is the time of the reception of the message. For a manual printing, "time" is the time of the print request.

ON GROUND BEFORE ENGINE START

Ident.: DSC-22_20-80-00000966.0001001 / 23 JUN 15

Applicable to: ALL

When the overall F-PLN data (lateral, vertical including winds, steps, constraints) and the ZFW and ZFWCG values have been inserted:

SELECT the FUEL PLANNING prompt [3R],

- **If the computed BLOCK fuel does not correspond to the actual block fuel required for the flight:**

ENTER the actual block required for the flight in the [2R] field,

PRINT the PREFLIGHT report.

The flight crew may then use the PREFLIGHT report to monitor the progress of the flight.

Note: Before printing the PREFLIGHT report, the flight crew must check that the F-PLN is complete (all F-PLN discontinuities must be cleared) and that all the F-PLN elements (including winds, steps, constraints, alternate airport) have been inserted, in order to obtain an accurate PREFLIGHT report.



AIRCRAFT SYSTEMS
AUTO FLIGHT - FLIGHT MANAGEMENT

A318/A319/A320/A321
FLIGHT CREW
OPERATING MANUAL

PRINT FUNCTIONS

EXAMPLE (FM PREFLIGHT REPORT)

Ident.: DSC-22_20-80-00000967.0001001 / 18 MAR 11

Applicable to: ALL

FM PREFLIGHT REPORT

DATE : 24 OCT 06
TIME : 07 : 24

| | | | |
|--------------------------|-------------|------------|-----------------|
| A/C TYPE | : A320-200 | DATABASE | : AB49402001 |
| ENG TYPE | : CFM56-5B4 | CYCLE | : 29 SEP-26 OCT |
| FLT NUMBER | : AIB 105 | FROM/TO | : EINN/LFBO |
| CO RTE | : | ALTN | : LFBP |
| ALTN CO RTE | : | | |
| PERF FACTOR | : +1.5 | COST INDEX | : 100 |
| IDLE FACTOR | : +0.0 | | |
| CRUISE FL/STEP START WPT | | | |
| CRZ FL 1 | : FL410 | | |
| FLIGHT PLAN DATA | | | |

| | | | |
|-----------|---------|-------|---------|
| DEST-LFBO | DIST | TIME | CRZ FL |
| : 714 | | 01:32 | FL410 |
| ALTN-LFBP | : 80 | 01:52 | FL220 |
| DEP RWY | : 24 | | ARV PRC |
| DEP PRC | : | | : |
| | | | APR PRC |
| | | | : |
| | | | ARV RWY |
| | | | : |

| WPT | TIME | SPD/ALT | FOB | T. WIND | TAS | SAT | CRS | DIST |
|------------------|-------|-----------|------|---------|-----|-----|-----|------|
| PREDICTED VALUES | | | | | | | | |
| EINN24 | 00:00 | 133/-95 | 13.6 | TL/040 | - | +11 | 183 | 0 |
| 1520 | 00:00 | 159/1574 | 13.2 | TL/040 | 163 | +12 | 240 | 2 |
| SHA | 00:02 | 190/FL70 | 13.0 | TL/040 | 211 | +01 | 059 | 3 |
| CRK | 00:10 | 295/FL300 | 11.4 | TL/040 | 459 | -44 | 173 | 55 |
| TIVLI | 00:16 | 82/FL400 | 11.2 | TL/040 | 467 | -57 | 140 | 50 |
| LND | 00:27 | 84/FL410 | 11.0 | TL/040 | 482 | -57 | 140 | 99 |
| NAKID | 00:33 | 84/FL410 | 10.9 | TL/040 | 482 | -57 | 130 | 46 |
| LIZAD | 00:34 | 84/FL410 | 9.2 | TL/040 | 482 | -57 | 129 | 14 |
| BALOT | 00:38 | 84/FL410 | 8.7 | TL/040 | 482 | -57 | 130 | 37 |
| BERAT | 00:41 | 84/FL410 | 8.2 | TL/040 | 482 | -57 | 129 | 23 |
| DIN | 00:46 | 84/FL410 | 7.6 | TL/040 | 482 | -57 | 128 | 47 |
| NTS | 00:56 | 84/FL410 | 7.3 | TL/040 | 482 | -57 | 173 | 88 |
| MINEL | 01:02 | 84/FL410 | 7.1 | TL/040 | 482 | -57 | 153 | 46 |
| VENAR | 01:05 | 84/FL410 | 6.6 | TL/040 | 482 | -57 | 152 | 25 |
| CGC | 01:08 | 84/FL410 | 6.1 | TL/040 | 482 | -57 | 153 | 34 |
| VELIN | 01:14 | 320/FL280 | 5.9 | TL/040 | 482 | -41 | 158 | 45 |
| AGN | 01:25 | 250/FL60 | 5.2 | TL/040 | 274 | +02 | 157 | 72 |
| LFBO | 01:32 | 128/550 | 5.2 | TL/040 | 129 | +14 | 001 | 27 |

FUEL PREDICTIONS

| | | | |
|---------------|------|-------|----------|
| TAXI : | 0.2 | ZFWCG | : 25.0 % |
| TRIP (DEST) : | 8.4 | ZFW | : 51.2 |
| RSV : | 1.3 | TOW | : 66.5 |
| ALTN : | 0.6 | LW | : 55.9 |
| FINAL : | 1.8 | CG | : --- |
| EXTRA : | 0.8 | | |
| BLOCK : | 15.5 | | |

MISC PERF DATA

| | |
|--------------|-------|
| TROPOPAUSE : | 36090 |
| CLB TRANS : | 5000 |
| CRZ TEMP : | -60 |

IN FLIGHT

Ident.: DSC-22_20-80-0000968.0007001 / 18 MAR 11

Applicable to: ALL

Once the aircraft has reached the CRZ FL once, all the latest ATC clearances have been inserted in the FM, when all the WINDS/STEPS have been properly updated:

ACCESS the PRINT FUNCTION page

PRINT the INFLIGHT REPORT

The inflight report provides the list of all the overflow F-PLN waypoints (HISTORY VALUES) with their associated data (Time, ALT, Fuel, ...), and the predictions to all the downpath waypoints (PREDICTED VALUES).

This new document replaces the PREFLIGHT report, since it carries all the latest expected F-PLN changes. It is the new applicable master document used to monitor the progress of the flight. The inflight report will be printed after each important F-PLN modification.

Note: *If the selected Fuel Unit option is pounds, the HISTORY FOB values may be incorrectly printed in tons on the INFLIGHT REPORT. The CURRENT and PREDICTED FOB values, however, are correctly printed in pounds.*



AIRCRAFT SYSTEMS
AUTO FLIGHT - FLIGHT MANAGEMENT

A318/A319/A320/A321
FLIGHT CREW
OPERATING MANUAL

PRINT FUNCTIONS

EXAMPLE (FM INFLIGHT REPORT)

Ident.: DSC-22_20-80-00000969.0001001 / 18 MAR 11

Applicable to: ALL

FM INFLIGHT REPORT

DATE : 24 OCT 06

TIME : 09 : 24

| | | | |
|--------------------------|-------------|------------|-----------------|
| A/C TYPE | : A320-200 | DATABASE | : AB49402001 |
| ENG TYPE | : CFM56-5B4 | CYCLE | : 29 SEP-26 OCT |
| FLT NUMBER | : AIB 105 | FROM/TO | : LFBO/EINN |
| CO RTE | : | ALTN | : EIDW |
| ALTN CO RTE | : | | |
| PERF FACTOR | : +1.5 | COST INDEX | : 90 |
| IDLE FACTOR | : +0.0 | | |
| CRUISE FL/STEP START WPT | | | |
| CRZ FL 1 | : FL390 | | |

FLIGHT PLAN DATA

| | | | | | | | |
|-----------|---------|-------|---------|---------|--|--|--|
| | DIST | TIME | CRZ FL | | | | |
| DEST-EINN | : 730 | 10:24 | FL390 | | | | |
| ALTN-EIDW | : 106 | 10:50 | FL220 | | | | |
| DEP RWY | : 14R | | ARV PRC | : | | | |
| DEP PRC | : LMG3A | | APR PRC | : | | | |
| | | | ARV RWY | : | | | |

| WPT | TIME | SPD/ALT | FOB | T. WIND | TAS | SAT | CRS | DIST |
|----------------|-------|---------|------|---------|-----|-----|-----|------|
| HISTORY VALUES | | | | | | | | |
| LFBO14R | 08:29 | 126/536 | 13.6 | HD/070 | - | +12 | 142 | 0 |
| 1000 | 08:30 | 141/982 | 13.2 | 056/003 | 141 | +10 | 143 | 2 |

CURRENT POSITION : N43-37.9/E001-22.0

| | | | | | | | | |
|--|-------|---------|------|--------|-----|-----|-----|----|
| | 08:32 | 252FL63 | 13.6 | HD/070 | 297 | -11 | 350 | 10 |
|--|-------|---------|------|--------|-----|-----|-----|----|

PREDICTED VALUES

| | | | | | | | | |
|-------|-------|-----------|------|--------|-----|-----|-----|-----|
| OSKAM | 08:34 | 320/FL130 | 10.4 | HD/070 | 387 | -11 | 350 | 14 |
| LMG | 08:52 | .84/FL390 | 10.2 | HD/070 | 482 | -57 | 359 | 119 |
| VERAC | 08:59 | .84/FL390 | 10.0 | HD/070 | 482 | -57 | 310 | 48 |
| MAIXE | 09:01 | .84/FL390 | 9.9 | HD/070 | 482 | -57 | 310 | 18 |
| NTS | 09:11 | .84/FL390 | 8.2 | HD/070 | 482 | -57 | 310 | 70 |
| DIN | 09:24 | .84/FL390 | 7.7 | HD/070 | 482 | -57 | 352 | 88 |
| BERAT | 09:31 | .84/FL390 | 7.2 | HD/070 | 482 | -57 | 309 | 47 |
| BALOT | 09:34 | .84/FL390 | 6.6 | HD/070 | 482 | -57 | 309 | 23 |
| LIZAD | 09:40 | .84/FL390 | 6.3 | HD/070 | 482 | -57 | 310 | 37 |
| NAKID | 09:42 | .84/FL390 | 6.1 | HD/070 | 482 | -57 | 309 | 14 |
| LND | 09:48 | .84/FL390 | 5.6 | HD/070 | 482 | -57 | 309 | 46 |
| TIVLI | 10:03 | .84/FL390 | 5.1 | HD/070 | 482 | -57 | 322 | 99 |
| CRK | 10:10 | 320/FL170 | 4.9 | HD/070 | 407 | -19 | 319 | 50 |
| SHA | 10:23 | 128/900 | 4.2 | HD/070 | 130 | +13 | 353 | 55 |
| EINN | 10:24 | 128/100 | 4.2 | HD/070 | 128 | +15 | 001 | 2 |

FUEL INFORMATION AT 08:32

| WEIGHT | CG | FOB | RSV/RSW% | FINAL | EXTRA |
|--------|-------|------|----------|-------|-------|
| 65.0 | 37.3% | 13.6 | 0.4/5.0% | 3.1 | 2.8 |

Note: In case of a major failure such as an engine out, a new print will be done when time permits.

REACHING THE GATE AFTER LANDING

Ident.: DSC-22_20-80-00000970.0007001 / 18 MAR 11

Applicable to: ALL

The POSTFLIGHT REPORT gives a complete list of all the overflown waypoints during the flight (HISTORY VALUES).

Furthermore it provides:

- FUEL/TIME summary
- IRS Drift and G/S

When at the gate, after engine shutdown:

- ACCESS the PRINT FUNCTION page
- PRINT the POSTFLIGHT REPORT

Note: If the selected Fuel Unit option is pounds, the HISTORY FOB values may be incorrectly printed in tons on the POSTFLIGHT REPORT.



AIRCRAFT SYSTEMS
AUTO FLIGHT - FLIGHT MANAGEMENT

A318/A319/A320/A321
FLIGHT CREW
OPERATING MANUAL

PRINT FUNCTIONS

EXAMPLE (FM POSTFLIGHT REPORT)

Ident.: DSC-22_20-80-00000971.0001001 / 18 MAR 11

Applicable to: ALL

FM POSTFLIGHT REPORT

DATE : 24 OCT 06

TIME : 12 : 05

| | | | |
|------------------|-------------|------------|-----------------|
| A/C TYPE | : A320-200 | DATABASE | : AB49402001 |
| ENG TYPE | : CFM56-5B4 | CYCLE | : 29 SEP-26 OCT |
| FLT NUMBER | : AIB 105 | FROM/TO | : EINN/LFBO |
| CO RTE | : | ALTN | : LFBP |
| ALTN CO RTE | : | | |
| PERF FACTOR | : +1.5 | COST INDEX | : 90 |
| IDLE FACTOR | : +0.0 | | |
| FLIGHT PLAN DATA | | | |

| | | | | | | | |
|-----------|---------|-------|---------|----------|--|--|--|
| DEST-LFBO | DIST | TIME | CRZ FL | | | | |
| ALTN/ | : — | 11:52 | FL— | | | | |
| DEP RWY | : — | —:— | FL— | | | | |
| DEP PRC | : 06 | | ARV PRC | : AGN2T | | | |
| | : | | APR PRC | : VOR32L | | | |
| | | | ARV RWY | : 32L | | | |

| WPT | TIME | SPD/ALT | FOB | T. WIND | TAS | SAT | CRS | DIST |
|----------------|-------|------------|------|---------|-----|-----|-----|------|
| HISTORY VALUES | | | | | | | | |
| EINN06 | 10:17 | 134/44 | 17.0 | 043/005 | - | +11 | 053 | 0 |
| 1550 | 10:18 | 163/1536 | 16.9 | 235/019 | 165 | +08 | 050 | 2 |
| SHA | 10:18 | 161/1691 | 16.9 | 236/019 | 163 | +08 | 049 | 0 |
| ABCRK | 10:27 | 305/FL280 | 15.1 | 295/049 | 459 | -41 | 149 | 53 |
| TIVLI | 10:33 | .80/FL330 | 14.8 | 298/057 | 448 | -64 | 143 | 46 |
| LND | 10:44 | .84/FL330 | 14.1 | 320/034 | 477 | -61 | 129 | 111 |
| ABLIZAD | 10:51 | .84/FL330 | 13.6 | 326/034 | 474 | -61 | 141 | 47 |
| ABBERAT | 10:58 | .84/FL330 | 12.4 | 313/029 | 480 | -59 | 141 | 21 |
| ABOIN | 11:03 | .84/FL330 | 12.2 | 326/030 | 479 | -60 | 142 | 44 |
| ABNTS | 11:13 | .84/FL330 | 12.0 | 330/034 | 481 | -60 | 142 | 126 |
| ABVENAR | 11:21 | .84/FL330 | 10.2 | 335/028 | 479 | -60 | 143 | 24 |
| CGC | 11:25 | .84/FL330 | 9.7 | 339/031 | 476 | -61 | 150 | 33 |
| VELIN | 11:31 | .84/FL330 | 9.2 | 352/028 | 476 | -60 | 154 | 45 |
| AGN | 11:40 | 312/FL220 | 8.6 | 050/024 | 429 | -26 | 149 | 72 |
| SOTAK | 11:40 | 321/FL190 | 8.3 | 052/025 | 425 | -20 | 141 | 5 |
| D191K | 11:44 | 253/FL90 | 8.1 | 347/015 | 288 | +00 | 137 | 24 |
| D165R | 11:46 | 253/4360 | 7.6 | 309/014 | 265 | +04 | 103 | 11 |
| CD32L | 11:49 | 175/2967 | 6.9 | 293/009 | 180 | +05 | 322 | 5 |
| FD32L | 11:50 | 253/FL1609 | 6.2 | 308/007 | 132 | +08 | 323 | 4 |
| LFB032L | 11:52 | 132/674 | 6.2 | 326/006 | 131 | +11 | 321 | 3 |

FUEL AND TIME SUMMARY

| | |
|---------------|------------------|
| START UP | SHUT DOWN |
| FUEL : 17.0 | FUEL : 4.2 |
| WEIGHT : 75.8 | WEIGHT : 65.0 |
| TIME : 10.09 | TIME : 12:01 |
| TO TIME : —:— | LDG TIME : 11:52 |

IRS DATA AT : LFB032L

| | | | |
|------------------|-------------|-----------|-----------|
| AVERAGE DRIFT | IRS 1 | IRS 2 | IRS 3 |
| RESIDUAL GND SPD | - 00.3 NM/H | 00.4 NM/H | 00.3 NM/H |
| | - 01.0 KTS | 03.0 KTS | 1.0 KTS |

AUTOMATIC FMGC RESET AND RESYNCHRONIZATION

Applicable to: ALL

Ident.: DSC-22_20-90-10-A-00012661.0001001 / 07 MAR 13

FM RESET

When the FM software cannot work properly or receives instructions to perform impossible operations, it automatically resets itself. A resynchronization with the other FM always follows. When the reset is a minor one, the system will recover by itself. One single reset lasts 2 to 3 s maximum followed by 25 s of resynchronization.

When the reset is a major one:

- Resets recur at short intervals (several in 2 or 3 min)
- The memories are cleared, leading to the loss of F-PLN , GW , CI , CRZ FL , MCDU -entered speeds and NAVAIDs and to database switching.

Note: If three dual FM resets occur in 2 min, pilot-entered data is lost. If a dual reset is identified, it is recommended that the flight crew does not perform again the last MCDU actions for 1 min (in order to avoid a potential second dual reset, leading to the loss of pilot-entered data).

Ident.: DSC-22_20-90-10-A-00012662.0001001 / 10 JAN 11

FM RESYNCHRONIZATION

An FM resynchronization automatically occurs after an FM reset but it may occur independently each time self comparisons between FM 1 and FM2 reveal discrepancies.

One single resynchronization lasts approximately 25 s.

If 5 several resynchronizations occur within 5 min, independent mode commences.

Ident.: DSC-22_20-90-10-A-00012663.0001001 / 29 SEP 15

FMGC STATUS DURING A RESET/RESYNCHRONIZATION

While a RESET/RESYNCH occurs:

- The ND shows "MAP NOT AVAIL"
- The MCDU reverts to the A/C STATUS page, with "PLEASE WAIT" displayed in the scratchpad
- Autotuning of Nav aids (VOR , DME , ADF) are lost on the failed side
- AP and managed modes may be transiently lost (reversion to HDG /V/S or TRK/FPA)
- If the pilot presses a key while the scratchpad is showing "PLEASE WAIT", there is no change at MCDU level. This is normal, and the crew should not respond by pulling the MCDU circuit breaker.



Ident.: DSC-22_20-90-10-A-00012664.0002001 / 10 JAN 11

SINGLE RESET OR DUAL RESET WITH AUTORECOVERY

If the RESET/RESYNCH succeeds, all functions are recovered.

Note: When an FMGC is recovered, its FD if previously engaged, is also recovered and its status is displayed on the FMA.

PROCEDURE

RESELECT the convenient MCDU page.
 REENGAGE managed modes and the AP.

WAIT 1 min after the "PLEASE-WAIT" message has disappeared, before engaging the AP /FD of the failed FMGC.

If both "MAP NOT AVAIL" and "SET OFFSIDE RNG/MODE" remain displayed on one ND , or if "OFFSIDE FM CONTROL" remains displayed, temporarily SELECT a different mode or range on the corresponding EIS control panel.

Ident.: DSC-22_20-90-10-A-00012665.0002001 / 16 NOV 11

SINGLE LATCH

If five successive resets occur, the failing FMGC will latch, and single mode operation will start.

While failed, the following occurs:

- On the ND usually associated with the failed FMGC:
 If the ND s are not both in the same mode or range, the associated ND displays "MAP NOT AVAIL" and "SET OFFSIDE RNG/MODE". If the ND s are in the same mode and range, the associated ND displays the "OFFSIDE FM CONTROL" amber message
- The MCDU reverts to the MENU PAGE and shows an "FMGC TIME OUT" prompt

- If the AP and FD were previously engaged on the failed side, the AP and FD disengage and the right-hand column of the FMA shows that the operating FD is offside. The ECAM displays the “AP OFF” warning, and the master warning light and audio remind the pilot of the AP disengagement.
- All functions are restored on the operative side.

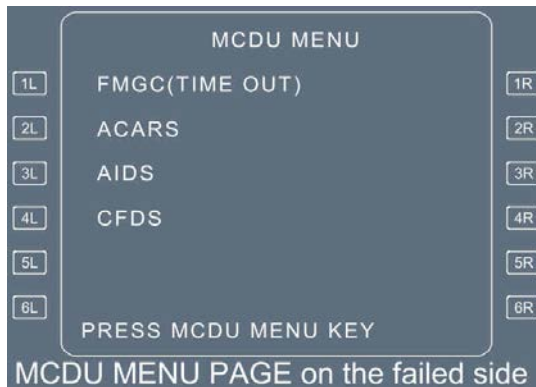

PROCEDURE

Select the same range and mode on both ND s to give the failed ND side something to display. Select any function key on the affected FMGC MCDU. (The page will display “OPP FMGC IN PROGRESS”).

Both MCDU s are now driven by the other FMGC , and only one AP /FD is available. The system works in SINGLE Mode.

Perform a manual reset of the failed FMGC, when convenient.

Ident.: DSC-22_20-90-10-A-00012666.0012001 / 10 JAN 11

DUAL RESET WITH LOSS OF DATA AND AUTORECOVERY

Three successive dual resets without result erases all pilot-entered data (F-PLN , GW , CRZ FL , Cl...).

When FMGS recovery is obtained:

- Database cycle may have switched
- The FM position bias is lost. The FM position returns to the MIX IRS position
- Autotuning the VOR /DME is restored, based on the aircraft’s IRS position
- FMGS tuning of the ILS and ADF is not possible
- Lateral and vertical managed mode cannot reengage

- The “CAB PR LDG ELEV FAULT” ECAM message is displayed
- A map display may be lost on one ND.

PROCEDURE

When the system has recovered:

SELECT the initial database.

SELECT DIR TO the required downpath waypoint.

SELECT LAT REV at the downpath waypoint, and redefine the DESTINATION.

SELECT the FUEL PRED page, and enter GW.

SELECT the PROG page, and enter CRZ FL.

SELECT the PERF page, and enter CI.

CHECK or reengage (as appropriate) the relevant speed/Mach target and vertical mode.

Redefine the flight plan for the remainder of the flight, as the opportunity presents itself.

If both “MAP NOT AVAIL” and “SET OFFSIDE RNG/MODE” remain displayed on one ND , or if “OFFSIDE FM CONTROL” remains displayed, temporarily SELECT a different mode or range on the corresponding EFIS control panel.

PERFORM a NAV accuracy check, when possible.

A manual FM position update should be considered, if MIX IRS and actual positions differ by more than 20 NM.

Ident.: DSC-22_20-90-10-A-00012668.0013001 / 17 MAR 17

DUAL LATCH

- Both FMGC s are inoperative. FM and FG capability are lost
- Both ND s display “MAP NOT AVAILABLE”. NAVAID tuning is not performed
- AP /FD , A/THR are lost
- FMGC (TIME OUT) subsystem page is displayed on both MCDUs
- The following messages are displayed on the ECAM:
 - “CAB PR LDG ELEV FAULT”
 - “AUTO FLT AP OFF”, if AP was engaged
 - “AUTO FLT A/THR OFF”, if A/THR was engaged.

PROCEDURE

FLY raw data.

TUNE necessary NAVAID s using the RMPs.

PERFORM a manual reset of both FMGCs.

- **If successful, refer to dual reset with loss of data and auto recovery:**

Note: A recovery will result in the loss of all pilot-entered data.

■ **If unsuccessful:**

FLY raw data.

Select the NAV B/UP prompt on both MCDU DATA pages.

(Refer to DSC-22_20-60-130 General HOW TO USE, concerning navigation backup operation).

SET the landing elevation of the destination on the overhead panel.

Note for all FMGC automatic resets

- A single or double FM auto-reset does not affect an ILS approach below 700 ft AGL . ILS frequency is locked and AP /FDs remain engaged
- Above 700 ft , the loss of ILS tuning due to a dual reset will cause a loss of LOC and G/S , and the disengagement of AP s and FDs
- During a non ILS approach, if the master FMGC fails, AP /FD and managed modes are lost and FDs engage in basic modes.

MANUAL FMGC RESET

Applicable to: **ALL**

Ident.: DSC-22_20-90-10-B-00012669.0001001 / 10 JAN 11

On rare occasions, the FMGC may require manual resetting.
If this occurs in flight, reset one FMGC at a time.

Ident.: DSC-22_20-90-10-B-00020857.0001001 / 17 MAR 17

Refer to System Reset Table - AUTO FLT
for the manual reset procedure of the FMGC.

Ident.: DSC-22_20-90-10-B-00012671.0001001 / 17 MAR 17

MANUAL RESET OF BOTH FMGC

When the aircraft is on ground with the engines stopped, the flight crew may attempt a double and simultaneous CB reset when a single CB reset has failed.



A318/A319/A320/A321
FLIGHT CREW
OPERATING MANUAL

AIRCRAFT SYSTEMS

AUTO FLIGHT - FLIGHT MANAGEMENT

ABNORMAL OPERATIONS - FMGC RESET

Intentionally left blank

| | |
|---|--|
|  <p>A318/A319/A320/A321 FLIGHT CREW OPERATING MANUAL</p> | <p style="text-align: center;">AIRCRAFT SYSTEMS</p> <p style="text-align: center;">AUTO FLIGHT - FLIGHT MANAGEMENT</p> <p style="text-align: center;">ABNORMAL OPERATIONS - "CHECK GW" OR "CHECK WEIGHT" MESSAGE</p> |
|---|--|

"CHECK WEIGHT" MESSAGE

Ident.: DSC-22_20-90-20-00012677.0001001 / 17 MAR 17

Applicable to: ALL

DESCRIPTION

The "CHECK WEIGHT" message appears on the MCDU when the Gross Weight (GW) computed by the FMGC and the GW computed by the FAC disagree by more than 7 t (16 055 lb).

PROCEDURE

When this message appears:

FMS FOB CHECK
CALL UP the MCDU FUEL PRED page and compare the FOB to the FOB from the Computerized F-PLN. Correct it if necessary.

FMS ZFW value..... CHECK
CALL UP the MCDU FUEL PRED page and compare the ZFW to the ZFW on the loadsheet.

● **If the FMS ZFW on the MCDU is not correct:**

FMS ZFW CORRECT/RE-INSERT
The entry of a correct ZFW will clear the MCDU message.

● **If the FMS ZFW on the MCDU is correct:**

VLS , F , S , GREEN DOT (PFD)..... DISREGARD
If the FMS GW is correct, the characteristic speeds computed by the FAC (displayed on PFD) may not be correct.

QRH OPERATING SPEEDS..... USE
Refer to QRH/OPS Operating Speeds



A318/A319/A320/A321
FLIGHT CREW
OPERATING MANUAL

AIRCRAFT SYSTEMS

AUTO FLIGHT - FLIGHT MANAGEMENT

ABNORMAL OPERATIONS - "CHECK
GW" OR "CHECK WEIGHT" MESSAGE

Intentionally left blank

MISALIGNMENT OF FMS F-PLN LEGS FOR ILS APPROACHES

Ident.: DSC-22_20-100-20-00013650.0001001 / 23 JUN 15

Applicable to: ALL

For the F-PLN legs belonging to an ILS approach, the FMS incorrectly uses its own Magnetic Variation table instead of the Magnetic Variation of the ILS associated to the approach (coded in the Navigation Data Base). This misbehaviour occurs when the Navaid used for the ILS approach is a DME.

In some cases, it may happen that magnetic variation of the airport differs by a few degrees from the ILS navaid. Thus, the FMS F-PLN does not match with the actual beam of the ILS beam.

When the ILS approach is coded with successive legs, these legs may also appear as not matching with intermediate approach waypoint.

For all approaches affected by this behaviour, the FMS will display an incorrect trajectory on ND for the LS approach. The guidance would also be wrong if the approach legs are flown in NAV instead of LOC mode.

INCORRECT MANAGEMENT OF ETA ENTRY ON PREDICTIVE GPS PAGE

Ident.: DSC-22_20-100-20-00013652.0001001 / 22 MAY 12

Applicable to: ALL

During pre-flight, when a destination airport exists but the FMS does not compute predictions, amber boxes are displayed in the MCDU field ETA of the predicitive GPS page. When the flight crew manually enters an ETA, the value should be displayed in large cyan font.

With the current H2 standard, the FMS does not take into account the manual entry of an ETA (field 1R) for the destination (DEST, field 1L).

The FMS validates the manual entry only when an ETA is already computed by the FMS , when predictions are available (necessary conditions to have some predictions are : entry of a GW , CRZ FL , Cl and F-PLN).

This anomaly does not impact the ETA of the WPT field (3L and 3R). An ETA can be entered in the field 3L even if no predictions are computed.

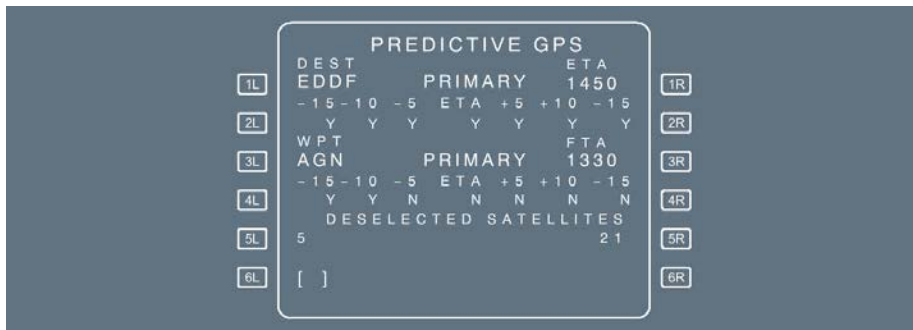

FLIGHT NUMBER ERASED UPON AOC FLIGHT PLAN UPLINK

Ident.: DSC-22_20-100-20-00013653.0001001 / 16 MAR 11

Applicable to: **ALL**

When a Flight Plan (F-PLN) uplink is performed, if the uplinked F-PLN is inserted as the active F-PLN but does not contain a Flight Number, the previously entered Flight Number is erased. In such a case, the flight crew needs to re-enter the correct Flight Number on the INIT A page.

LOSS OF FMS POSITION FURTHER TO IRS LOSS

Ident.: DSC-22_20-100-20-00013654.0001001 / 23 JUN 15

Applicable to: **ALL**

The loss or the failure of an Inertial Reference System (IRS) could result in the loss of the FMS position with the following cockpit effects :

- MAP NOT AVAIL GPS , PRIMARY LOST displayed on ND
- The DIR TO page is unavailable on both MCDU
- During approach, transient ATHR thrust variations at autopilot disconnection (Only applicable in case of IR 1 FAULT).

Technical explanation :

The FMS needs valid data from the IRS in order to compute a position.

The FMS checks the IRS data with a specific parameter coming from the Flight Guidance (FG) part of the FMGC . When an IRS is lost or off (dispatched inoperative), the inside FG erroneously indicates to the FMS that the IRS DATA is still valid.

As a result, the FMS position is lost on the same side than the IRS inoperative (IRS 1 for FMS 1 and IRS for FMS2). The manual switching on IRS 3 (ATT HDG on CAPT 3 or F/O 3) does not enable to recover the data.

PROCEDURE:

In case of an IR x FAULT ECAM warning in flight with the above mentioned cockpit effects, apply the following procedure :

De-activate (do not perform a reset) the FMS on the same side than the IRS inoperative :

- For IR 1 FAULT : pull FMGC 1 CB B2 (VU 49)
- For IR 2 FAULT : pull FMGC 2 CB M17 (VU 121)

**ERRONEOUS FUEL PREDICTION IN THE CASE OF
DESCENT WITH TWO ALTITUDE CONSTRAINTS**

Ident.: DSC-22_20-100-20-00013655.0001001 / 16 MAR 11

Applicable to: ALL

DESCRIPTION:

If the flight plan has two altitude constraints for the descent, the flight crew may notice erroneous FMS fuel predictions.

EXPLANATION

If the flight plan has two altitude constraints for the descent, the FMS may define a geometric segment between both altitude constraints. If there is a deceleration required within the geometric segment, the FMS may consider that the geometric segment is too steep to fly without speedbrakes. In this case, the FMS tags the entire geometric segment as a speedbrake segment : The FMS assumes that during the entire segment half of the speedbrakes are extended, even for the parts where no deceleration is planned. As a consequence, the FMS will predict an increased thrust for the entire geometric segment. This may lead to erroneous fuel predictions. (a long geometric segment (e.g. above 100 NM) may lead to an error of 1.5 t for the fuel prediction at destination).

Note: When flying the geometric segment, the predictions become better as the aircraft approaches the end of the geometric segment, and turn back to normal when the aircraft has sequenced the second altitude constraint.

PROCEDURE:

If the flight crew suspects this behavior in preflight, or during the flight, they can delete and enter again one altitude constraint in descent and compare the fuel predictions of the flight plan with and without the geometric segment. This allows the flight crew to evaluate the impact of the geometric segment on the fuel predictions.

It is not recommended to permanently delete altitude constraints that are stored in the navigation database.

UNEXPECTED SWITCH OF SPEED TARGET WHEN RTA IS USED

Ident.: DSC-22_20-100-20-00013659.0001001 / 16 NOV 11

Applicable to: ALL

An anomaly could be experienced when the RTA (Requested Time of Arrival) function is used. The MCDU and the PFD could suddenly display an erroneous speed target at the transition altitude when a RTA is entered and if the flight crew performs an action (Vapp entry or altitude constraint modification) that causes a F-PLN profile recomputation.

This scenario could also occur if the flight crew has inserted a RTA and then deleted this RTA (the FMS may erroneously retain the RTA target).

Some cases could happen while the aircraft is in descent (DES mode) in managed speed. This speed target change is significant at high altitude if the RTA speed target is lower than the speed target used before the beginning of the descent.

PROCEDURE

If an erroneous speed target is displayed at high altitude, the flight crew can manually select a speed to continue the descent.

UNDUE AP DISCONNECTION OR REVERSION TO V/S DURING CLIMB AND DESCENT

Ident.: DSC-22_20-100-20-00014436.0017001 / 23 JUN 15

Applicable to: ALL

An AP disconnection or a reversion to the V/S mode may occur when the aircraft reaches an altitude constraint in the CLB or DES mode. The following are two situations in which this behavior may occur.

Situation 1: The aircraft is above the vertical profile.

When the aircraft is not on the vertical profile, the FMS makes assumptions in order to compute the FMS predictions. For example, if the aircraft flies in selected speed, the FMS considers an immediate return to managed speed.

These assumptions can result in FMS predictions that are not consistent with the real trajectory of the aircraft. Therefore, the FMS may not anticipate the need to level off, when the FCU selected altitude is above the altitude constraint in climb or below the altitude constraint in descent.

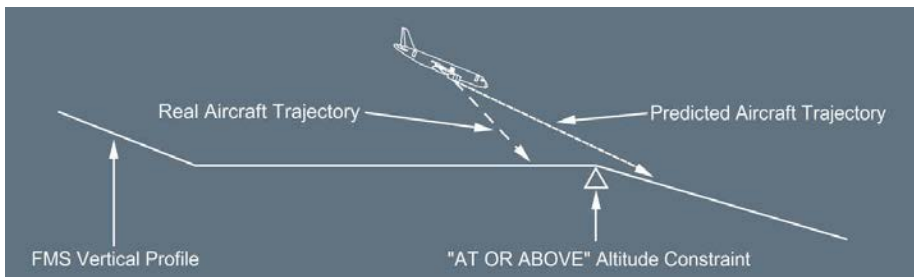

However, the FMS requests the ALT CST* mode, when the aircraft reaches the altitude constraint, in order to level off and comply with the altitude constraint.

Due to problem of communication between the FMS and the FG , the FMGC may unduly revert to the V/S mode. The FWC triggers a triple-click aural warning  , and the aircraft goes beyond the altitude constraint.

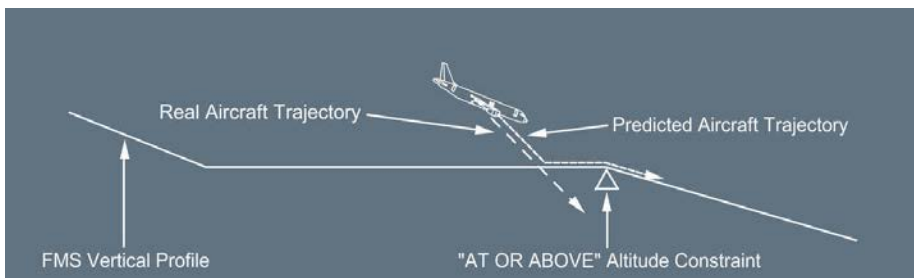

Situation 2: The aircraft levels off at an altitude constraint in descent.

When the aircraft reaches an altitude constraint with the DES mode engaged and the FCU selected altitude below the altitude constraint, the FG engages the ALT CST * mode. The FG also arms the DES mode, in order to resume the descent beyond the waypoint with the altitude constraint.

In very rare cases, the FMS does not see that the FG arms the DES mode:

- If the FINAL APP mode is armed, the FMGC may unduly:
 - Disconnect the AP, or
 - Disconnect the AP and revert to the V/S mode, or
 - Revert to the V/S mode.
- If the FINAL APP mode is not armed, the FMGC may unduly revert to the V/S mode.

In both of the above-mentioned cases, the FWC triggers a triple-click aural warning  , and the aircraft goes beyond the altitude constraint.

If the AP disconnects, the FWC triggers a cavalry-charge aural warning.

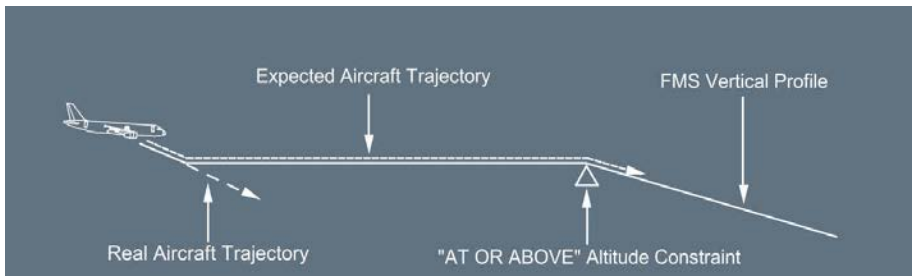

OPERATIONAL RECOMMENDATIONS

Understand your FMA at all times.

- **If the AP disconnects, or if the FMGC reverts to the V/S mode:**

Adjust the vertical speed or level off in order to comply with the altitude constraint.

VOR/DME AND VOR/TACAN NOT AUTOMATICALLY TUNED

Ident.: DSC-22_20-100-20-00014440.0001001 / 04 MAY 12

Applicable to: ALL

In case there is no NAVAID in the flight plan, nor any recommended NAVAID coded in the inserted procedure, the FMS may not automatically tune the expected Terminal or Low Altitude VOR /DME or VOR /TACAN.

The FMS may not automatically tune the expected NAVAID , if the aircraft is above 12 000 ft for a Terminal VOR /DME or VOR /TACAN , and above 18 000 ft for a Low Altitude NAVAID.

As a consequence, the ND and the MCDU RAD NAV page may not display the NAVAID information.

OPERATIONAL RECOMMENDATIONS

If the flight crew encounters the misbehavior during the flight, the flight crew can manually tune the expected VOR /DME or VOR /TACAN to recover the display on the ND.

As a manual tuning overrides any automatic tuning, the flight crew must clear the manual tuning, when the NAVAID is no longer required, in order to revert to the automatic NAVAID tuning.

**OPTIMUM TARGET SPEEDS NOT UPDATED FOLLOWING
 THE AUTOMATIC DELETION OF A STEP CLIMB**

Ident.: DSC-22_20-100-20-00014756.0001001 / 18 DEC 12

Applicable to: ALL

During the FMS climb phase, if the flight crew selects an altitude on the FCU that is above the Cruise Flight Level (CRZ FL) displayed on the PROG page, the altitude selected on the FCU becomes the new CRZ FL.

If this new CRZ FL is at or above the altitude of a Step Climb of the flight plan, the FMS automatically deletes the Step Climb. The FMS displays the "STEP DELETED" message.

As the optimum target speeds (ECON CLIMB speed/Mach and ECON CRUISE speed/Mach) depend on the CRZ FL, the FMS should immediately update the ECON CLIMB speed/Mach and the ECON CRUISE speed/Mach.

Due to a FMS misbehavior, the FMS may not correctly manage the automatic deletion of the Step Climb when the CRZ FL is automatically set to the altitude selected on the FCU. The FMS may not update the ECON CLIMB speed/Mach and the ECON CRUISE speed/Mach accordingly.

If the ECON CRUISE speed/Mach was not correctly updated, the FMS updates the ECON CRUISE speed/Mach when the aircraft reaches the new CRZ FL. However the FMS updates the ECON CRUISE speed/Mach with a rate of 0.01 Mach/min, in order to avoid a sudden increase of the speed target. Therefore the aircraft may take several minutes to reach the new ECON CRUISE speed/Mach.

OPERATIONAL RECOMMENDATIONS

If the flight crew suspects this misbehavior during the flight:

REENTER the Cruise Flight Level (CRZ FL) on the PROG page, or the Cost Index (CI) on the PERF page, in order to activate an immediate update of the optimum target speeds (ECON CLIMB speed/Mach and ECON CRUISE speed/Mach).

**ERRONEOUS LATERAL GUIDANCE IN NAV MODE
 WITH LOC MODE ARMED DURING APPROACH**

Ident.: DSC-22_20-100-20-00015035.0001001 / 03 DEC 13

Applicable to: ALL

During approach, the FMS may guide the aircraft along a specific track instead of along the F-PLN with NAV mode green on the FMA, because of the LOC Convergence function (*Refer to DSC-22_30-80-30-10 Precision Approach Modes - APPR Mode*).

The logics of the LOC Convergence function is as follows:

- **If NAV mode is engaged, and LOC mode is armed,**
 and
The aircraft is within 20 NM of the destination runway,
 and
The difference between the aircraft track and the QFU is less than 20 °.

The aircraft is guided with a converging track of 20 ° from the LOC axis.

The NAV mode remains engaged. However the aircraft no longer follows the F-PLN, but converges towards the LOC axis.

AIRCRAFT SYSTEMS

AUTO FLIGHT - FLIGHT MANAGEMENT

TEMPORARY ABNORMAL BEHAVIORS - FMS2
HONEYWELL TEMPORARY ABNORMAL BEHAVIORS

- **If the difference between the aircraft track and the QFU becomes more than 20 ° when the LOC Convergence function is active:**

The FMS deactivates the LOC Convergence function, and the aircraft follows back the F-PLN. It may lead to slight oscillations, since the FMS may successively activate and deactivate the LOC Convergence function.

OPERATIONAL RECOMMENDATIONS

- **If the flight crew considers that the LOC Convergence function may affect the guidance along the F-PLN trajectory in NAV mode:**

On the intercept trajectory for the LOC axis, the flight crew should push the APPR pb (or the LOC pb-sw) when appropriate.

- **If the flight crew detects that the aircraft does not follow the intended trajectory:**

The flight crew should revert to HDG/TRK mode, and intercept the LOC axis with the HDG/TRK mode engaged and the LOC mode armed.

UNDUE REDUCTION OF THE SPEED TARGET IN CASE OF DIR TO/ABEAM WHILE FLYING A CONSTANT MACH SEGMENT

Ident.: DSC-22_20-100-20-00015532.0003001 / 18 MAR 14

Applicable to: ALL

The FMS may erroneously command a Mach target of 0, when the following conditions are met:

- The aircraft is flying a Constant Mach Segment (CMS), and
- The TO waypoint is the end of the CMS, and
- The aircraft is close to the TO waypoint, i.e. about 1 NM, and
- The flight crew performs a DIR TO/ABEAM to a waypoint that is not part of the CMS.

In that case, the FMS does not create the abeam of the TO waypoint (end of the CMS), since it is too close from the aircraft.

In addition, the FMS erroneously keeps the CMS until the abeam of the next waypoint, and defines 0 as Mach target on the CMS. The FMS correctly computes the speed target once the abeam of the next waypoint is sequenced.

OPERATIONAL RECOMMENDATIONS

The flight crew should manually clear the CMS on the MCDU VERT REV page.

LOSS OF FUEL AND TIME PREDICTIONS DURING TAKEOFF DATA INSERTION

Ident.: DSC-22_20-100-20-00015602.0001001 / 05 AUG 14

Applicable to: ALL

The flight crew may lose fuel and time prediction when the altitude of the first constraint is less than 50 ft below either the THR RED ALT or the ACC ALT, the update of fuel and time computation predictions may last a long time. The flight crew may think that the predictions are lost (the DEST EFOB and TRIP FUEL are also dashed on the FUEL PRED page).

The flight crew may encounter the situation described above, if one of the following occurs:

- The first altitude constraint of the SID is less than 50 ft below either the THR RED ALT or the ACC ALT.
- The flight crew inserts a THR RED ALT or an ACC ALT less than 50 ft above the first altitude constraint of the F-PLN.
- The flight crew modifies the F-PLN to insert an AT or an AT OR BELOW altitude constraint less than 50 ft below the THR RED ALT or the ACC ALT.

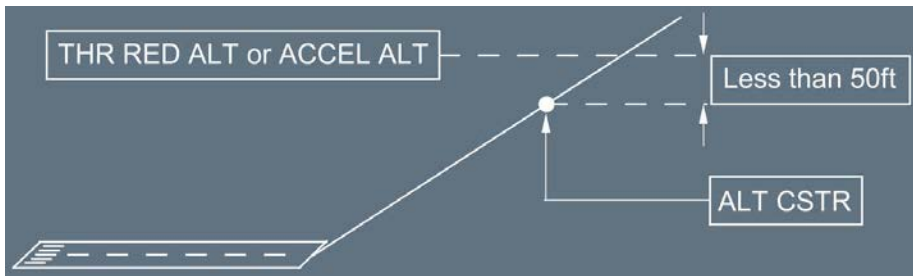

OPERATIONAL RECOMMENDATION:

The flight crew can recover the fuel and time predictions if the flight crew sets the THR RED ALT or ACC ALT value on the PERF TAKEOFF page to the same value as the first altitude constraint of the F-PLN.

ERRONEOUS TRAJECTORY DURING PROCEDURES WITH A TURN DIRECTION ON A LEG WITH AN ALTITUDE TERMINATION

Ident.: DSC-22_20-100-20-00015748.0001001 / 09 SEP 14

Applicable to: ALL

In some very specific operational conditions that depend on the coding in the Navigation Database of the procedure, and on various performance conditions (aircraft weight, flaps, thrust setting, temperature, wind...), the FMS may compute an erroneous trajectory on some Standard Instrument Departures (SID), and on some Missed Approach procedures.

The SIDs and the Missed Approach procedures that may be affected are coded in the Navigation Database with a leg that has a turn direction and an altitude termination. The leg can be one of the following:

- A Course-to-an-Altitude (CA) leg that defines a course to follow to an altitude
- A Fix-to-an-Altitude (FA) leg that defines a track to follow from a waypoint to an altitude
- A Heading-to-an-Altitude (VA) leg that defines a heading to follow to an altitude
- A Holding-to-an-Altitude (HA) leg that defines a holding pattern to an altitude

The turn direction (left or right) that is coded on a leg indicates that the aircraft has to execute a turn in the specified direction to intercept the leg.

In some very specific operational conditions (aircraft weight, wind...), the FMS may predict that the aircraft will reach the altitude that terminates the leg, before the initiation of the leg. In that case, the FMS ignores the leg, and the associated turn direction.

The FMS computes a new trajectory to directly join the next leg. The trajectory may not be consistent with the published trajectory.

Example:

- Leg 1: a Course-to-Fix (CF) leg that defines a track (360 °) to a waypoint (WPT1)
- Leg 2: a Course-to-an-Altitude (CA) leg that defines a track (130 °) to intercept an altitude (3 000 ft). The leg is coded in the Navigation Database with a turn direction (left). The end of the leg depends on the aircraft performance. The turn direction is indicated by an arrow on the line of leg 1 on the MCDU
- Leg 3: a CF leg that defines a track (120 °) to a waypoint (WPT2)

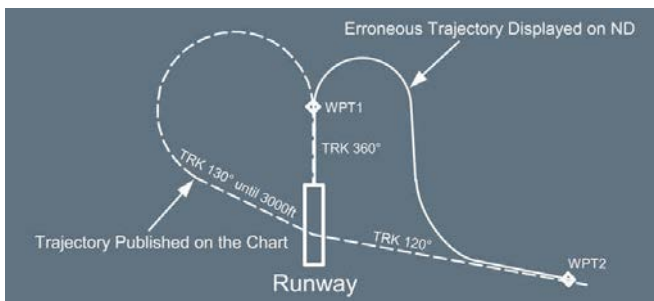

Depending on the aircraft performance, the FMS may predict that the aircraft will reach 3 000 ft before WPT1. In that case, the FMS ignores the leg 2 (CA leg) because the aircraft is already above the altitude that ends leg 2, before the beginning of leg 2. The FMS also ignores the turn direction that is coded on the leg.

| | |
|---|---|
|  <p>A318/A319/A320/A321 FLIGHT CREW OPERATING MANUAL</p> | <p align="center">AIRCRAFT SYSTEMS</p> <p align="center">AUTO FLIGHT - FLIGHT MANAGEMENT</p> <p align="center">TEMPORARY ABNORMAL BEHAVIORS - FMS2 HONEYWELL TEMPORARY ABNORMAL BEHAVIORS</p> |
|---|---|

As a result, the FMS computes again the trajectory from the end of leg 1, directly to leg 3. As shown on the above illustration, this trajectory includes a right turn, instead of a left turn, because it induces the shortest course change to intercept leg 3 (CF leg).

If the NAV mode is engaged, the aircraft follows this erroneous trajectory.

OPERATIONAL RECOMMENDATIONS

The flight crew should pay particular attention to the check of the flight plan during the Cockpit Preparation, and during the Descent Preparation.

| | |
|----------------|--|
| CAUTION | Even if the flight plan is correct during the Cockpit Preparation or during the Descent Preparation, the FMS may compute and display an erroneous trajectory when the FMS updates its predictions after takeoff or after go-around initiation. |
|----------------|--|

If the flight crew detects that the lateral flight plan does not agree with the published trajectory, the flight crew should revert to the HDG /TRK mode, and monitor NAVAID raw data as appropriate. The flight crew should reengage the NAV mode when the lateral flight plan is consistent with the published trajectory.

| |
|---|
| <p>ERRONEOUS VERTICAL PROFILE DURING LOC B/C APPROACHES WITH A MAP LOCATED BEFORE THE RUNWAY THRESHOLD</p> |
|---|

Ident.: DSC-22_20-100-20-00019782.0001001 / 25 JUL 16

Applicable to: ALL

DESCRIPTION

When the flight crew selects a LOC Back Course (LOC B/C) approach in the arrival page of the MCDU , if the Missed Approach Point (MAP) is located before the runway threshold, the FMS builds the final approach vertical flight path assuming that there is an altitude constraint at the MAP , equal to the runway (RWY) threshold elevation plus 50 ft, disregarding the actual coded MAP altitude.

As a result, the FMS computes an erroneous vertical flight path for the final approach, an erroneous crossing altitude at the MAP , and displays an erroneous vertical deviation indication (V/DEV symbol on the PFD and V/DEV value on MCDU PROG page), when flying the approach.

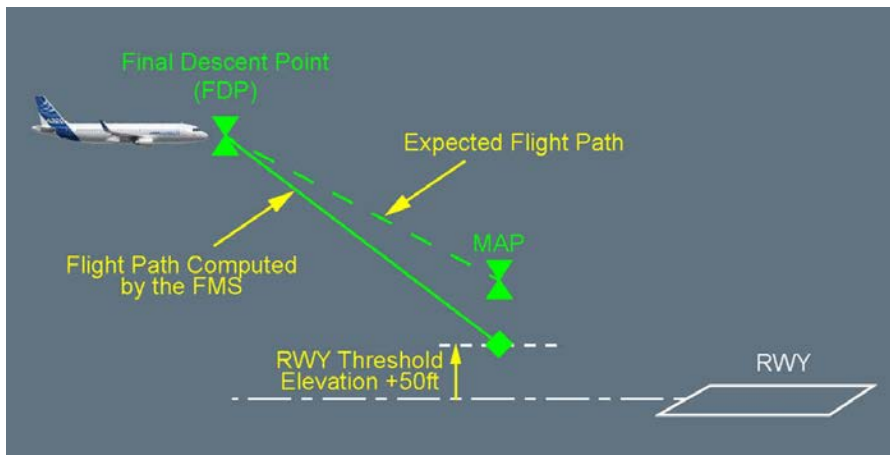

Therefore, the flight crew must fly the LOC B/C approaches in selected vertical guidance mode (FPA or V/S mode), and they must disregard the V/DEV displayed on the PFD and MCDU PROG page.

PROCEDURE

For LOC B/C approaches, check the position of the MAP on the approach chart:

■ **If the MAP is located at the runway threshold:**

V/DEV symbol can be used to assist the flight crew in flying the vertical flight path in selected mode. Crosscheck the final descent with the published chart using altitude versus distance, as per Standard Operating Procedures (SOPs).

■ **If the MAP is located before the runway threshold:**

DISREGARD the V/DEV symbol, and crosscheck the final descent using the altitude versus the distance to the MAP.

ERRONEOUS PREDICTIONS

Ident.: DSC-22_20-100-40-00012672.0001001 / 17 MAR 17

Applicable to: ALL

The FMGS may display temporary erroneous predictions that can affect such data as ECON speed/Mach, optimum flight level, fuel or time predictions.

PROCEDURE

If erroneous predictions are observed:

ON GROUND, OR IN FLIGHT

Check the cruise temperature (sign and value), the gross weight, and the cruise flight level.
REENTER the same cost index to restart a computation (In descent or approach, a cost index change does not restart a computation), or
MAKE a COPY ACTIVE, then activate the secondary, or
MAKE a DIR TO the "TO" waypoint.

SPURIOUS ENGINE OUT INDICATION

Ident.: DSC-22_20-100-40-00012673.0001001 / 17 MAR 17

Applicable to: ALL

PROCEDURE

If a spurious engine-out is detected:

PRESS the EO CLR prompt of the MCDU PERF page
RE-ENGAGE previous vertical mode
RE-ENTER preselected speeds (if any). No other consequences are to be expected.



A318/A319/A320/A321
FLIGHT CREW
OPERATING MANUAL

AIRCRAFT SYSTEMS

AUTO FLIGHT - FLIGHT MANAGEMENT

TEMPORARY ABNORMAL BEHAVIORS - ALL
FMS TEMPORARY ABNORMAL BEHAVIORS

Intentionally left blank

AIRCRAFT SYSTEMS

AUTO FLIGHT - FLIGHT GUIDANCE

Intentionally left blank

DSC-22_30-10 General

| | |
|--|---|
| General..... | A |
| Mode Reversions..... | B |
| Guidance Modes..... | C |
| Mode Selection..... | D |
| Lateral Modes..... | E |
| Vertical Modes..... | F |
| Interaction between AP/FD and A/THR Modes..... | G |

DSC-22_30-20 Flight Director

| | |
|---|---|
| General..... | A |
| Flight Director (FD) Engagement..... | B |
| Flight Director (FD) Disengagement..... | C |
| Automatic FD Removal..... | D |
| FD Warnings..... | E |

DSC-22_30-30 Autopilot (AP)

| | |
|-----------------------|---|
| General..... | A |
| AP Engagement..... | B |
| AP Disengagement..... | C |
| AP Warnings..... | D |
| Autoland Warning..... | E |

DSC-22_30-40 Speed/Mach Control

| | |
|--|---|
| General..... | A |
| Managed Speed/Mach Target..... | B |
| Selected Speed/Mach Target..... | C |
| Auto SPD..... | D |
| Speed/Mach Switching..... | E |
| Managed Speed Target Memorization..... | F |
| Speed/Mach FCU Window Synchronization..... | G |

DSC-22_30-50 AP/FD Modes General

| | |
|--------------------------|---|
| AP/FD Modes General..... | A |
|--------------------------|---|

DSC-22_30-60 AP/FD Lateral Modes

| | |
|--|---|
| Heading or Track: HDG - TRK..... | A |
| HDG/TRK Preset..... | B |
| Navigation (NAV)..... | C |
| Localizer Mode through the LOC Pushbutton..... | D |

Continued on the following page

Continued from the previous page

DSC-22_30-70 AP/FD Vertical Modes

DSC-22_30-70-10 Principles

| | |
|-----------------|---|
| General..... | A |
| Principles..... | B |

DSC-22_30-70-20 Climb Mode

| | |
|-------------------------------|---|
| General..... | A |
| Arming Conditions..... | B |
| Disarming Conditions..... | C |
| Engagement Conditions..... | D |
| Disengagement Conditions..... | E |
| Guidance..... | F |

DSC-22_30-70-30 Open Climb Mode

| | |
|-------------------------------|---|
| General..... | A |
| Engagement Conditions..... | B |
| Disengagement Conditions..... | C |
| Guidance..... | D |

DSC-22_30-70-50 Descent Mode

| | |
|-------------------------------|---|
| General..... | A |
| Arming Conditions..... | B |
| Disarming Conditions..... | C |
| Engagement Conditions..... | D |
| Disengagement Conditions..... | E |
| Repressurization Segment..... | F |
| Descent Speed Profile..... | G |
| Guidance in DES Mode..... | H |
| DES Mode Profile..... | I |

DSC-22_30-70-60 Open Descent Mode

| | |
|-------------------------------|---|
| General..... | A |
| Engagement Conditions..... | B |
| Disengagement Conditions..... | C |
| Guidance..... | D |

DSC-22_30-70-65 Altitude Acquire Mode

| | |
|-------------------------------|---|
| General..... | A |
| Engagement Conditions..... | B |
| Disengagement Conditions..... | C |
| Guidance..... | D |

Continued on the following page

Continued from the previous page

DSC-22_30-70-70 Altitude Hold Mode

| | |
|----------------------------------|---|
| General..... | A |
| Arming Conditions..... | B |
| Engagement Conditions..... | C |
| Disengagement Conditions..... | D |
| Guidance..... | E |
| Soft Altitude Mode (Cruise)..... | F |

DSC-22_30-70-80 Vertical Speed Mode - Flight Path Angle Mode (V/S - FPA)

| | |
|-------------------------------|---|
| General..... | A |
| Engagement Conditions..... | B |
| Disengagement Conditions..... | C |
| Guidance..... | D |

DSC-22_30-70-90 Expedite

| | |
|-------------------------------|---|
| General..... | A |
| Engagement Conditions..... | B |
| Disengagement Conditions..... | C |
| Guidance..... | D |

DSC-22_30-75 Mode Reversions

| | |
|---|---|
| General..... | A |
| Interaction between Lateral Modes, Vertical Modes, and Managed Speed Profile..... | B |
| Mode Reversion due to FCU Altitude Change..... | C |
| Reversion with Global Speed Protection..... | D |
| Mode Reversions (Summary)..... | E |

DSC-22_30-80 AP/FD Common Modes

DSC-22_30-80-10 General

| | |
|--------------|---|
| General..... | A |
|--------------|---|

DSC-22_30-80-20 Takeoff

| | |
|-----------------------------------|---|
| General..... | A |
| SRS (Speed Reference System)..... | B |
| Runway (RWY)..... | C |

DSC-22_30-80-30 Approach

DSC-22_30-80-30-05 General

| | |
|--------------|---|
| General..... | A |
|--------------|---|

Continued on the following page

Continued from the previous page

DSC-22_30-80-30-10 Precision Approach

| | |
|-------------------------------|---|
| Precision Approach Modes..... | A |
| Speed Control..... | B |
| Typical ILS Approach..... | C |
| Autoland Warning Light..... | D |
| Landing Capabilities..... | E |

DSC-22_30-80-30-20 Non Precision Approach

| | |
|-------------------------------|---|
| General..... | A |
| Selection..... | B |
| Arming Conditions..... | C |
| Disarming Conditions..... | D |
| Engagement Conditions..... | E |
| Disengagement Conditions..... | F |
| Guidance..... | G |

DSC-22_30-80-40 Go Around (GA)

| | |
|-------------------------------|---|
| General..... | A |
| Engagement Conditions..... | B |
| Disengagement Conditions..... | C |
| Guidance..... | D |

DSC-22_30-90 Autothrust

| | |
|-----------------------------------|---|
| General..... | A |
| Thrust Levers..... | B |
| A/THR Arming Conditions..... | C |
| A/THR Activation..... | D |
| A/THR Disconnection..... | E |
| Thrust Lock Function..... | F |
| A/THR Disconnection Caution..... | G |
| A/THR Modes..... | H |
| SPEED Mode in Approach Phase..... | I |

Continued on the following page

Continued from the previous page

DSC-22_30-100 Flight Mode Annunciator (FMA)

| | |
|---|---|
| Flight Mode Annunciator (FMA)..... | A |
| Autothrust Annunciations (FMA Column 1)..... | B |
| AP/FD Vertical Modes (FMA Column 2)..... | C |
| AP/FD Lateral Modes (FMA Column 3)..... | D |
| AP/FD Common Modes (FMA Columns 2 and 3) | E |
| Approach Capabilities (FMA Column 4)..... | F |
| AP/FD - A/THR Engagement Status (FMA Column 5)..... | G |
| Special Messages (FMA Columns 2 and 3)..... | H |

DSC-22_30-110 Temporary Abnormal Behaviors

| | |
|--|---|
| CAT 3 Dual Inoperative..... | A |
| Left Turn Not Expected while in HDG or TRK Mode..... | B |



A318/A319/A320/A321
FLIGHT CREW
OPERATING MANUAL

AIRCRAFT SYSTEMS

AUTO FLIGHT - FLIGHT GUIDANCE

PRELIMINARY PAGES - TABLE OF CONTENTS

Intentionally left blank

GENERAL

Ident.: DSC-22_30-10-00011031.0001001 / 17 AUG 10

Applicable to: ALL

The Flight Guidance (FG) part of the FMGS controls:

- The Flight Director (FD)
- The Autopilot (AP)
- The Autothrust (A/THR).

MODE REVERSIONS

Ident.: DSC-22_30-10-00011032.0001001 / 17 AUG 10

Applicable to: ALL

There are several types of mode reversions. Each one observes a specific logic that is described in the "Mode Reversions" section. (*Refer to DSC-22_30-75 General*).

GUIDANCE MODES

Ident.: DSC-22_30-10-00011033.0002001 / 23 JUN 15

Applicable to: ALL

Two types of autopilot and flight director modes are available to guide the aircraft:

- Managed modes: When the aircraft is using managed targets, the Flight Management and Guidance System (FMGS) guides it along lateral and vertical flight paths and speed profiles computed by the Flight Management function (FM) from data in the MCDU . FM manages the guidance targets.
- Selected modes: When the flight crew is using selected targets, the FMGS guides the aircraft along lateral and vertical flight paths and speed profiles to meet targets that the flight crew has selected manually on the FCU. The flight crew selects the guidance targets.

| GUIDANCE | MANAGED modes | SELECTED modes |
|-----------------|---|--|
| LATERAL | NAV, APP NAV LOC *, LOC RWY RWY TRK GA TRK ROLL OUT | HDG -TRK |
| VERTICAL | SRS (TO and GA) CLB , DES ALT CST, ALT CST* ALT CRZ G/S *, G/S FINAL, FINAL APP FLARE | OP CLB , OP DES V/S , FPA ALT *, ALT EXPEDITE  |
| SPEED | FMGC REFERENCE (ECON , Auto SPD , SPD LIM) EXPEDITE | FCU REFERENCE |

MODE SELECTION

Ident.: DSC-22_30-10-00011034.0001001 / 23 JUN 15

Applicable to: ALL

MANAGED MODES

- At takeoff, the managed modes engage automatically when the flight crew sets the thrust levers at the TO or FLX detent.
- During flight, the flight crew can arm or engage the managed modes (if the aircraft meets engagement conditions) by pushing in the appropriate knobs on the Flight Control Unit (FCU).
- The flight crew pushes the DIR TO key on the MCDU to insert a DIR TO leg. It engages or maintains the NAV mode.
- The flight crew pushes the APPR pb on the FCU to arm or engage the localizer and glide slope or “APP NAV-FINAL”, depending upon the approach type insert in the flight plan.
- The LOC pb arms or engages only the localizer mode.

SELECTED MODES

The flight crew can engage the selected modes by pulling out the appropriate FCU selection knobs.

LATERAL MODES

Ident.: DSC-22_30-10-00011035.0003001 / 23 JUN 15

Applicable to: ALL

| MODE | TYPE | GUIDANCE | REMARK |
|-----------------|----------|---|---|
| RWY | MANAGED | Mode used at takeoff to guide the aircraft along the runway centerline, using LOC. | Triggered by the thrust levers at FLX or TOGA position. |
| RWY TRK | MANAGED | Mode used to guide the aircraft along the track the aircraft was following at mode engagement. | |
| NAV | MANAGED | Mode used to guide the aircraft along the lateral F-PLN. Available above 30 ft after takeoff. | Automatically armed at takeoff, unless HDG /TRK is preset. In that case, RWY TRK engages after takeoff. |
| HDG -TRK | SELECTED | Mode used to guide the aircraft on a heading or a track selected by the flight crew. The target value is displayed in the FCU window. | <i>Note:</i> HDG /TRK is called "basic mode" because it is a backup mode for certain situations: <ul style="list-style-type: none"> - F-PLN discontinuity entry - AP engagement with no FD - Loss of F-PLN - MCDU NAV BACK UP. |

Continued on the following page

Continued from the previous page

| MODE | TYPE | GUIDANCE | REMARK |
|---|---------|--|---|
| LOC* LOC APP NAV | MANAGED | Mode used to guide the aircraft on the lateral approach path (LOC or F-PLN approach path). | Selected by pressing APPR pb on the FCU ; the mode that engages depends upon the selected approach in the F-PLN. <i>Note: For LOC only approach, do not select the FCU's APPR pb, but rather the LOC pb.</i> |
| LAND | MANAGED | Common mode engaged below 400 ft RA during an automatic ILS approach. | Engaged only if LOC mode and G/S mode are already engaged. |
| GA TRK | MANAGED | Mode used to guide the aircraft along the track the aircraft was following at mode engagement. | Triggered by the thrust levers at TOGA with Slats/Flaps in at least CONF 1. |
| ROLL OUT | MANAGED | Mode used to guide the aircraft on the runway, following an automatic landing. | FD rollout symbol is displayed on the PFD at touchdown. |

VERTICAL MODES

Ident.: DSC-22_30-10-00011036.0002001 / 23 JUN 15

Applicable to: ALL

| MODE | TYPE | GUIDANCE | REMARK |
|---|----------|---|--|
| SRS | MANAGED | Mode used at takeoff or go-around to maintain SRS speed (V2 , V2+10, VAPP...). | Triggered by the thrust levers at FLX or TOGA position. Disengages automatically at ACC ALT or when another VERT mode is engaged. |
| CLB | MANAGED | Mode used to climb towards FCU selected altitude along VERT F-PLN taking into account ALT CSTR . Available only if NAV mode engaged. The A/THR is in thrust mode (CLB). | The speed target may be either selected or managed. If managed, SPD CSTR , SPD LIM and HOLD SPD are taken into account. ALT mode is always armed ; displayed in magenta if the next level off is predicted at an ALT CSTR , and in blue if the next level off is predicted at the FCU selected altitude. |
| DES | MANAGED | Mode used to descend towards FCU selected altitude along the computed descent path taking into account ALT CSTR . Available only if NAV mode engaged. The A/THR may be in THRUST or SPD mode. | |
| OP CLB OP DES | SELECTED | Mode used to climb/descent directly to the FCU selected altitude. These modes disregard all ALT CSTR . The A/THR is in THRUST mode (CLB/DLE). | The speed target may be either selected or managed. ALT mode is systematically armed and blue. Altitude target is blue on PFD. |
| EXPEDITE  | SELECTED | Mode used to increase the vertical speed by selecting green dot in climb or 0.80/340 kt in descent. | Used to expedite a climb or descent towards a specific level. |
| ALT CST* ALT CST | MANAGED | Mode automatically engaged when reaching an ALT CSTR before the FCU selected altitude. | CLB /DES mode are systematically armed (blue). |
| ALT* ALT ALT CRZ | SELECTED | Mode used to maintain a level flight at the FCU selected altitude. | Soft ALT mode engages when FCU selected altitude = CRZ FL. Soft ALT is part of the managed guidance. |

Continued on the following page

Continued from the previous page

| MODE | TYPE | GUIDANCE | REMARK |
|----------------------|----------|---|--|
| V/S -FPA | SELECTED | Mode used to guide the aircraft along a vertical speed or a selected flight path angle. | Altitude target is blue on PFD . V/S -FPA is a basic mode. (Refer to DSC-22_30-10 Lateral Modes). |
| G/S* G/S FINAL | MANAGED | Mode used to guide the aircraft along the final approach path (G/S or non ILS) | Selected by depressing the APPR pb on the FCU . The mode engaged depends upon the selected approach in the F-PLN . Linked to APPR common mode (APPR pb). |
| FLARE | MANAGED | Common mode which provides the alignment to the runway center line on the yaw axis and the flare on the pitch axis. | Engages below 50 ft RA as a function of the current vertical speed. |

INTERACTION BETWEEN AP/FD AND A/THR MODES

Ident.: DSC-22_30-10-00011037.0002001 / 23 JUN 15

Applicable to: **ALL**

The AP and FD pitch modes can control a target SPD /MACH or a vertical trajectory, and the A/THR mode can control a fixed thrust or a target SPD /MACH. However, the AP /FD and the A/THR cannot both control a target SPD/MACH simultaneously.

Therefore the AP /FD pitch modes and A/THR mode are coordinated as follows:

- If an AP /FD pitch mode controls a vertical trajectory, the A/THR mode controls the target SPD/MACH.
- If an AP /FD pitch mode controls a target SPD or MACH, the A/THR mode controls the thrust.
- If no AP /FD pitch mode is engaged, the A/THR mode reverts to controlling the SPD/MACH mode.

In other words, the selection of an AP /FD pitch mode determines which mode the A/THR controls.

| AP /FD pitch modes | A/THR modes |
|--|-----------------|
| V/S - FPA DES (geometric path) ALT *, ALT ALT CRZ *, ALT CRZ ALT CST*, ALT CST G/S *, G/S FINAL, FINAL APP | SPEED/MACH MODE |
| AP /FD OFF | |

Continued on the following page



A318/A319/A320/A321
FLIGHT CREW
OPERATING MANUAL

AIRCRAFT SYSTEMS
AUTO FLIGHT - FLIGHT GUIDANCE

GENERAL

Continued from the previous page

| AP /FD pitch modes | A/THR modes |
|--|----------------------|
| CLB /DES (idle path) OP CLB /OP DES EXP CLB/EXP DES  SRS | THR (CLB, IDLE) MODE |
| FLARE | RETARD (IDLE) |



A318/A319/A320/A321
FLIGHT CREW
OPERATING MANUAL

AIRCRAFT SYSTEMS
AUTO FLIGHT - FLIGHT GUIDANCE

GENERAL

Intentionally left blank

GENERAL

Ident.: DSC-22_30-20-00012468.0001001 / 14 MAY 12

Applicable to: ALL

The Flight Director (FD) displays guidance commands from the Flight Management and Guidance Computer (FMGC) on the Primary Flight Display (PFD).

The flight crew may manually fly the aircraft, following FMGC guidance commands, or crosscheck the FMGC orders when the autopilot is engaged.

In normal operations, FD 1 displays FMGC 1 orders on the PFD 1 and FD 2 displays FMGC 2 orders on the PFD2.

The FD s use their respective outside FMGCs.

On the PFD:

1. The FD pitch and roll crossbars show pitch and roll demands.
2. Below 30 ft during landing and takeoff, when a localizer is available, the vertical bar is replaced by a yaw bar that gives lateral orders.
3. The Flight Path Director (FPD) symbol relates to the Flight Path Vector (FPV).

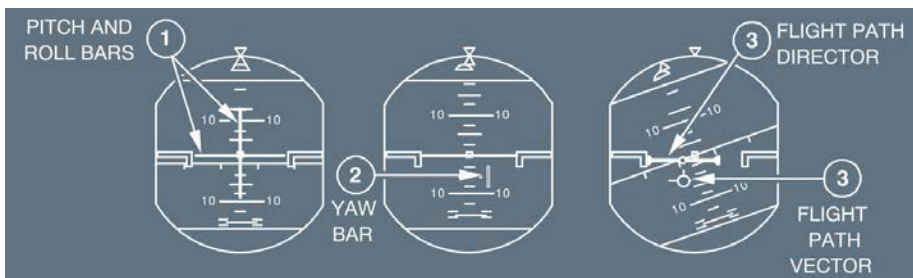

The HDG V/S – TRK FPA pb on the FCU enables the flight crew to select either type of reference and display.

The FD pb on the Electronic Flight Instrument System (EFIS) control panel allows the FD bars to be displayed or removed.

FD BARS (HDG V/S SELECTED ON THE FCU)

- The pitch bar is displayed if a vertical mode is engaged. It gives pitch orders for the vertical guidance
- The roll bar is displayed if a lateral mode is engaged. It gives roll orders for lateral guidance.

FLIGHT PATH DIRECTOR (TRK FPA SELECTED ON THE FCU)

The display is an alternate way of transmitting flight director commands.

- The Flight Path Vector (FPV) symbol illustrates the track and flight path angle actually being flown
- The Flight Path Director (FPD) symbol shows the flight crew how to intercept the required vertical and lateral flight trajectory. When the flight crew superimposes the FPV and the FPD symbols, the aircraft is flying the required trajectory.

YAW BAR

The yaw bar is displayed in RWY mode on takeoff and in FLARE and ROLL OUT modes at landing.

FLIGHT DIRECTOR (FD) ENGAGEMENT

Ident.: DSC-22_30-20-00012469.0008001 / 01 OCT 12

Applicable to: **ALL**

The FD s are engaged automatically when the FMGC powers up.

GROUND ENGAGEMENT

- The "1FD 2" symbol appears on both PFDs
- No FD bars appear on the PFD s. (The PFD displays FD orders when a mode is active on the corresponding axis)
- The FCU windows display dashes.

MANUAL FLIGHT ENGAGEMENT

The two FD s engage in the HDG V/S or TRK FPA modes (basic modes).

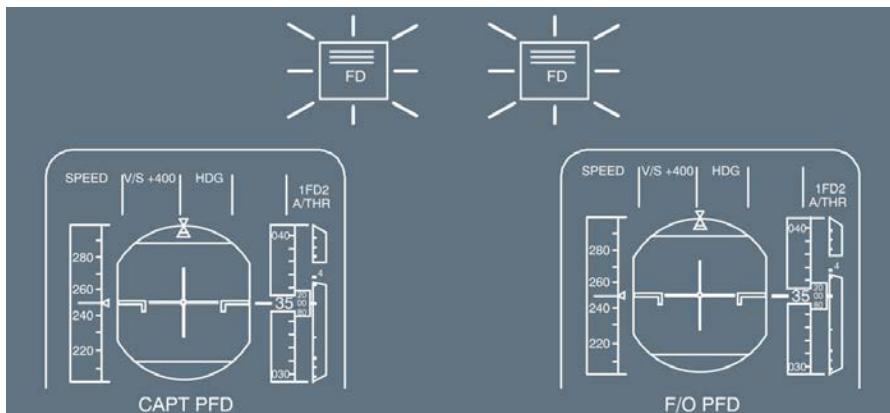

AUTOMATIC FLIGHT ENGAGEMENT

FD bars are automatically restored in SRS /GA TRK modes at go-around engagement. If FPV /FPD was previously selected, it reverts to FD bars.

FLIGHT DIRECTOR (FD) DISENGAGEMENT

Ident.: DSC-22_30-20-00012470.0006001 / 19 DEC 12

Applicable to: ALL

The flight crew may disengage one or two FD s manually, or FDs may disengage automatically if there is a failure.

MANUAL DISENGAGEMENT

One FD OFF:

- The FD bars no longer appear on the associated PFD.
- The corresponding FD is disengaged.

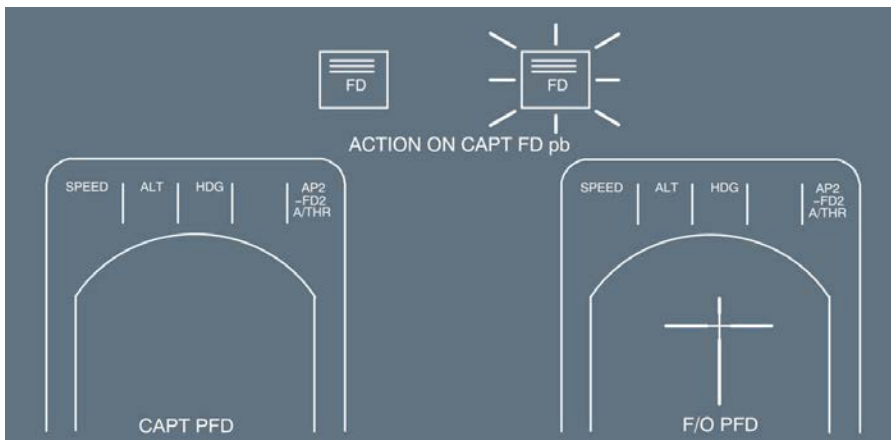

Both FDs OFF:

- The FD bars disappear from both PFDs.
- If no AP was engaged, lateral and vertical modes disengage. The A/THR, if active, automatically reverts to (or remains in) SPEED/MACH mode.
- If one AP was engaged when FD s are switched OFF, this AP remains engaged in the active modes but the FDs are no longer displayed.

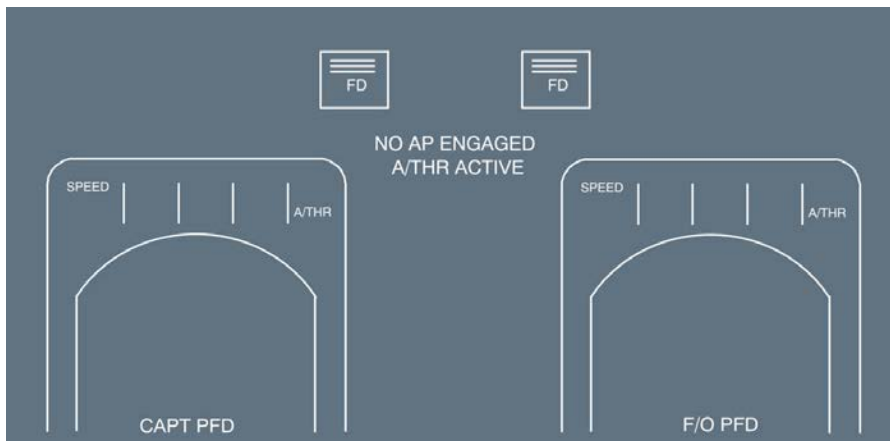

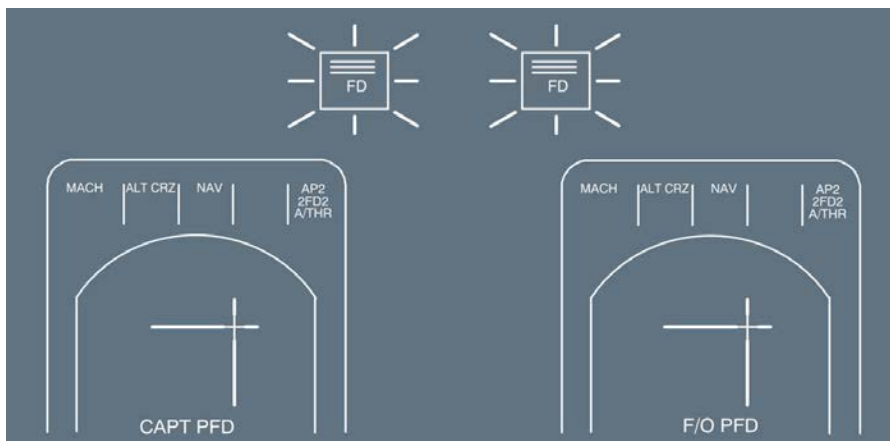

AUTOMATIC DISENGAGEMENT

If one FD fails or one FMGC is not valid, both PFD s display the remaining FD.



AUTOMATIC DISENGAGEMENT DUE TO SPEED PROTECTION

When AP s are not engaged and the flight crew does not follow the FD bars to maintain the commanded trajectory in climb with CLB or OP CLB (or EXP CLB ) engaged or in descent with DES or OP DES (or EXP DES ) engaged, the FDs will disengage at the activation of the automatic speed mode protection.

| | |
|---|--|
|  A318/A319/A320/A321 FLIGHT CREW OPERATING MANUAL | AIRCRAFT SYSTEMS AUTO FLIGHT - FLIGHT GUIDANCE FLIGHT DIRECTOR |
|---|--|

Refer to DSC-22_30-75 Reversion with Global Speed Protection - Automatic Speed Mode Protection in Climb.

| |
|-----------------------------|
| AUTOMATIC FD REMOVAL |
|-----------------------------|

Ident.: DSC-22_30-20-00012472.0001001 / 28 JAN 14

Applicable to: ALL

- The FD pitch bar is removed when no vertical mode is engaged or when ROLL OUT mode is engaged.
- The FD roll bar is removed when no lateral mode is engaged or when the RWY or ROLL OUT mode is engaged.
- Both FDs are removed when the aircraft pitch exceeds 25 ° up or 13 ° down, or bank angle exceeds 45 °.

| |
|--------------------|
| FD WARNINGS |
|--------------------|

Ident.: DSC-22_30-20-00012473.0001001 / 16 MAR 11

Applicable to: ALL

| FD bar WARNINGS | CONDITIONS |
|--|---|
| Pitch FD bar (or FPV) flashes 10 s and then remains steady | <ul style="list-style-type: none"> - If the ALT * mode is lost further to FCU altitude reference change of more than 250 ft. - When in APPR mode (G/S *, G/S , LAND, FINAL), FD reverts to V/S mode (flight crew action or loss of vertical approach mode). - One AP or one FD is engaged while both AP /FD were previously OFF. |
| Pitch FD bar (or FPV) flashes permanently | Transmission of the GLIDE data is interrupted when in G/S , G/S * or LAND modes above 100 ft RA. |
| Roll FD bar (or FPV) flashes 10 s and then remains steady | <ul style="list-style-type: none"> - When in APPR mode (LOC *, LOC , LAND, APP NAV), FD reverts to HDG mode (flight crew action or loss of lateral approach mode). - One AP or one FD is engaged while both AP /FD were previously OFF. |
| Roll FD bar (or FPV) flashes permanently | Transmission of the LOC data is interrupted when in LOC , LOC * or LAND modes above 15 ft RA. |



A318/A319/A320/A321
FLIGHT CREW
OPERATING MANUAL

AIRCRAFT SYSTEMS
AUTO FLIGHT - FLIGHT GUIDANCE

FLIGHT DIRECTOR

Intentionally left blank

| | |
|---|--|
|  <p>A318/A319/A320/A321 FLIGHT CREW OPERATING MANUAL</p> | <p style="text-align: center;">AIRCRAFT SYSTEMS AUTO FLIGHT - FLIGHT GUIDANCE AUTOPILOT (AP)</p> |
|---|--|

GENERAL

Ident.: DSC-22_30-30-00011816.0001001 / 17 AUG 10
Applicable to: ALL

The AP:

- Stabilizes the aircraft around its center of gravity
- Acquires and tracks a flight path
- Flies the aircraft to an automatic landing or go-around.

The AP commands the:

- Position of the flight control surfaces for pitch, roll and yaw
- Nose wheel position.

AP ENGAGEMENT

Ident.: DSC-22_30-30-00011817.0014001 / 16 MAR 11
Applicable to: ALL

The flight crew can engage AP 1 or AP 2 by pressing the corresponding pushbutton on the FCU if the aircraft has been airborne for at least 5 s.

When one AP is engaged, the corresponding FCU pushbutton comes on and AP 1 (or 2) is displayed on the FMAs.

In BACK-UP NAV , AP can be engaged in selected modes if the FG part is available.

- One AP can be engaged on ground if the engines are not running. It disengages when one engine is started.
- Two AP s may be engaged at a time (AP 1 active, AP2 in standby), when the localizer/glide-slope or roll out or go-around mode is armed or engaged.
Only one AP can be engaged at a time in all other cases.
- If one AP pb is set to ON with both FD s OFF, the AP engages in HDG V/S or TRK FPA mode, depending upon which mode the flight crew has selected on the FCU.
- If one AP pb is set to ON with at least one FD already ON, the AP engages in the current active FD modes.
- At takeoff, the AP cannot be engaged below 100 ft.

AP engagement increases the break out force on the sidestick controllers and on the rudder pedals.

AP engagement is indicated by the lighting of the corresponding FCU pushbutton and by the appearance of AP 1 (or 2) on the PFD 's FMA.

AP DISENGAGEMENT

Ident.: DSC-22_30-30-00011818.0008001 / 04 NOV 13

Applicable to: ALL

AP1 or 2 disengages when:

- The flight crew presses the takeover pb on the sidestick, or
- The flight crew presses the corresponding AP pb on the FCU, or
- The flight crew pushes on the sidestick harder than a defined threshold, or moves on the rudder pedals beyond a defined threshold, or
- The flight crew moves the pitch trim wheel beyond a defined threshold, or
- The other AP is engaged, except when localizer/glideslope modes are armed or engaged, or when the rollout or go-around mode is engaged, or
- Both thrust levers are set above the MCT detent and the aircraft is on ground, or
- In a non-precision approach, the aircraft reaches the Missed Approach Point (MAP) with FINAL APP mode engaged, or
- One of the engagement conditions is lost.

In addition, in normal law with all protections available, the AP will disengage when:

- High speed protection activates, or
- Angle-of-attack protection activates:
 - From the liftoff to 100 ft RA during the landing, when α prot +1 ° is reached, or
 - Below 100 ft RA during the landing, when α MAX is reached, or
- Pitch attitude exceeds 25 ° up, or 13 ° down, or bank angle exceeds 45 °, or
- A rudder pedal deflection is more than 10 ° out of trim.

The standard manner for the flight crew to disengage the AP is to press the takeover pb on the sidestick.

When the AP is OFF, the associated pushbutton on the FCU goes off, and AP 1 (or AP 2) disappears from the FMA.

AP WARNINGS

Ident.: DSC-22_30-30-00011819.0001001 / 17 AUG 10

Applicable to: ALL

When the AP is disengaged, the system warns the flight crew:

- If the flight crew disengages it with the takeover pb on the sidestick, the warnings are temporary
- If the disengagement results from a failure, from the flight crew pushing the pushbutton on the FCU, or from a force on the sidestick, the visual and audio warnings are continual.

| | |
|---|---|
|  A318/A319/A320/A321 FLIGHT CREW OPERATING MANUAL | AIRCRAFT SYSTEMS AUTO FLIGHT - FLIGHT GUIDANCE AUTOPILOT (AP) |
|---|---|

| | | AP DISENGAGEMENT | |
|----------------------------|-------------------------------------|---|--|
| | | TAKEOVER pb on SIDESTICK | BY OTHER MEANS |
| CONSEQUENCE | MASTER WARNING light | Flashing red during 3 s maximum | Flashing red |
| | ECAM | AP OFF red message 9 s maximum | <u>AUTO FLT</u> AP OFF red warning |
| | AUDIO | Cavalry charge 0.5 s minimum 1.5 s maximum | Continuous cavalry charge 1.5 s minimum |
| | CLR pb on ECAM CONTROL PANEL | Extinguished | Illuminated |
| ACTION | MASTER WARNING light | <ul style="list-style-type: none"> - Extinguishes Master Warning light - Erases ECAM warning - Stops audio if pressed within 1.5 s | <ul style="list-style-type: none"> - Extinguishes Master Warning light - Stops audio after 1.5 s |
| | CLR pb on ECAM CONTROL PANEL | No effect | <ul style="list-style-type: none"> - Extinguishes CLR pb - Erases ECAM message - Calls status |
| | TAKEOVER pb | <ul style="list-style-type: none"> - Extinguishes Master Warning light - Erases ECAM warning - Stops audio if pressed within 1.5 s | <ul style="list-style-type: none"> - Extinguishes Master Warning light - Stops audio after 1.5 s |
| ECAM STATUS MESSAGE | | NO | YES |

| |
|-------------------------|
| AUTOLAND WARNING |
|-------------------------|

Ident.: DSC-22_30-30-00011820.0001001 / 09 APR 15

Applicable to: ALL

Below 200 ft RA, an Autoland red light flashes in case of failures that require the interruption of an automatic landing.

Refer to DSC-22_30-80-30-10 Autoland Warning Light for the detailed conditions triggering the Autoland warning.



A318/A319/A320/A321
FLIGHT CREW
OPERATING MANUAL

AIRCRAFT SYSTEMS
AUTO FLIGHT - FLIGHT GUIDANCE

AUTOPILOT (AP)

Intentionally left blank

| | |
|---|---|
|  A318/A319/A320/A321 FLIGHT CREW OPERATING MANUAL | AIRCRAFT SYSTEMS AUTO FLIGHT - FLIGHT GUIDANCE SPEED/MACH CONTROL |
|---|---|

| |
|----------------|
| GENERAL |
|----------------|

Ident.: DSC-22_30-40-00011893.0001001 / 17 AUG 10

Applicable to: ALL

In flight, either the AP /FD pitch control, or autothrust may acquire and hold a target speed or Mach number, depending on the engaged modes.

Speed control is:

- Managed when the target comes from the FMGS
- Selected when the target comes from the SPD /MACH FCU window.

| |
|----------------------------------|
| MANAGED SPEED/MACH TARGET |
|----------------------------------|

Ident.: DSC-22_30-40-00011894.0001001 / 01 DEC 14

Applicable to: ALL

When the speed target is managed, the SPD /MACH window of the FCU shows dashes, and the corresponding dot is lighted. The PFD speed scale shows the speed target in magenta.

ENGAGEMENT CONDITIONS

The SPD target is managed, whenever AP or FD is engaged, and one of the following occurs:

- The flight crew pushes in the SPD/MACH knob
- EXPEDITE mode  is engaged
- V2 is inserted in the MCDU
- The speed reference system (SRS) is engaged (takeoff or go-around mode).

Note: At takeoff, SRS will not engage if V2 is not available.

DISENGAGEMENT CONDITIONS

Managed speed disengages any time the flight crew selects a speed target on the FCU, or if the speed was preselected.

SPEED PROFILE

The form of the managed SPD profile depends on the lateral NAV mode.

- **If NAV mode is engaged, the SPD profile takes into account all the constraints linked to the flight plan.**

The SPD profile is:

- V2 - SPD LIM - SPD CSTR (if applicable) - ECON CLB SPD /MACH - ECON CRZ MACH
- ECON or preset DES MACH/SPD -SPD LIM - SPD CSTR (if applicable) - HOLD SPD (if applicable) - VAPP.

- **If NAV mode is not engaged, the SPD/MACH constraints are not considered.**

The SPD profile is:

V2 - SPD LIM - ECON CLB SPD /MACH - ECON CRZ MACH - ECON or preset DES
MACH/SPD - SPD LIM - VAPP.

- Note:
1. When both AP /FD s are OFF, A/THR reverts to selected SPEED mode, except when the approach phase is activated on MCDU where both managed and selected SPD are available.
 2. When expedite mode is engaged, the system disregards SPD LIM and SPD CSTR no matter what lateral mode is engaged.
 3. The managed speed/Mach target may be set below maneuvering speed but as long as the speed target is managed, the FMGS limits the aircraft to the maneuvering speed of the current slats/flaps configuration (VAPP , F , S, Green Dot).
 4. If the managed speed/Mach target is set above VMAX (VFE , VMO , MMO), the FMGS automatically limits the speed to VMAX.
 5. If a SPD/MACH constraint has already been taken into account, it remains applied (until a more restrictive constraint applies).

MINI GROUND SPEED

In approach phase, the managed speed target is the Mini Ground Speed target computed by the Flight Guidance (FG) part of the FMGS. *Refer to DSC-22_30-90 General* for details.

SELECTED SPEED/MACH TARGET

Ident.: DSC-22_30-40-00011895.0002001 / 17 AUG 10

Applicable to: ALL

To use a selected speed/Mach target, the flight crew uses the knob on the FCU to set the target speed, which is then displayed in the FCU window. It is also displayed in blue on the PFD speed scale.

Note: *The selected speed/Mach target may be set beyond VLS or VMAX , but when autothrust is active, the guidance limits the speed to VLS or VMAX.*

Selected speed has priority over managed speed. The only automatic change-over from selected to managed speed target may occur at go-around mode engagement.

In flight, if the situation calls for managed speed, both the PFD and the MCDU display a message proposing a manual change to managed speed (for example, SET MANAGED SPEED, SET HOLD SPEED, or SET GREEN DOT SPEED).

ENGAGEMENT CONDITIONS

The aircraft has a selected speed target under any one of the following conditions:

- The flight crew pulls out the SPD/MACH knob (5 s after lift-off)
- Both AP /FD s are OFF (except in APPR phase)
- The FM speed target is lost (except in SRS , G/S, LAND, and GO AROUND modes)

- The MCDU has a preselected speed for the next phase, and the aircraft transitions into that phase
- The FMGC is powered up in flight.

DISENGAGEMENT CONDITIONS

The selected speed target disengages:

- When the managed SPD engages
- When the aircraft is on ground at engine start.

Note: With engines running, the flight crew can select a speed on the FCU only after takeoff.

AUTO SPD

Ident.: DSC-22_30-40-00011896.0001001 / 17 AUG 10

Applicable to: ALL

The flight crew may insert the AUTO SPD (speed or Mach) on the PERF DES page to replace the ECON DES SPD.

In this case, the managed speed profile takes into account the selected value. The top of descent and the descent path are computed on AUTO SPD assumption.

SPEED/MACH SWITCHING

Ident.: DSC-22_30-40-00011897.0001001 / 16 MAR 11

Applicable to: ALL

In managed speed, at the crossover altitude, the FMGC automatically changes the managed speed target to the corresponding MACH target. The FCU displays the Mach number corresponding to the speed at the switching altitude.

SPEED/MACH CROSS OVER TABLE.

| ALTITUDE | | | | | | | |
|----------|------|------|------|------|------|------|------|
| 30500 | 280 | | | | | | |
| 29500 | | 290 | | | | | |
| 28500 | 295 | | 300 | | | | |
| 27500 | | 305 | | 310 | | | |
| 26500 | 300 | | 315 | | 325 | | |
| 25500 | | 310 | | 325 | | 330 | |
| 24500 | | | 320 | | 335 | | 350 |
| MACH | 0.76 | 0.77 | 0.78 | 0.79 | 0.80 | 0.81 | 0.82 |

Note: When the speed is selected, the flight crew has to perform the switching manually by pressing the SPD/MACH pb on the FCU . The FCU then displays the aircraft Mach number.

When the target speed is managed, the FMGC commands the switchover automatically as a function of the ECON MACH value.

MANAGED SPEED TARGET MEMORIZATION

Ident.: DSC-22_30-40-00011898.0001001 / 13 JAN 14

Applicable to: **ALL**

A dual FM failure has different consequences when it occurs in different phases of the flight.

The system handles target speed and SPD mode as follows:

- During approach with LOC and G/S engaged and radio height < 700 ft, the target speed is set to VAPP as previously memorized, and managed SPD target is maintained.
- At go-around, the target speed becomes the memorized go-around speed, which is the higher of VAPP or the speed when go-around was initiated. Managed SPD target is maintained.
- In all other cases, managed target speed reverts to selected, the value being the speed at the moment of the failure.

SPEED/MACH FCU WINDOW SYNCHRONIZATION

Ident.: DSC-22_30-40-00011899.0001001 / 17 AUG 10

Applicable to: **ALL**

When the target SPD is managed, the SPD /MACH display of the FCU shows dashes.

However, the window displays the target SPD or MACH in the following situations:

- The flight crew turns the SPD/MACH knob.
If the flight crew does not pull the knob within 10 s after turning it, the selection reverts to dashes.
- The flight crew manually engages a selected SPD target.
- If the flight crew has manually preselected a speed or Mach number for the next phase on the MCDU PERF page, that preselected SPD /MACH engages when the aircraft enters that phase and the FCU window then displays as the target the preselected speed or Mach.
- If the FMGS is powered up in flight, the synchronized speed/Mach value is the current aircraft speed or Mach number.
- If no V2 is entered at takeoff, the V/S mode engages 5 s after lift-off (no speed reference system).
The FCU speed target is the speed at V/S mode engagement. (A/THR becomes active when the thrust levers are set in the active range).

AP/FD MODES GENERAL

Ident.: DSC-22_30-50-00011767.0007001 / 23 JUN 15



Applicable to: ALL

The FMGS has guidance parameters for both AP /FD lateral and vertical modes.

The AP /FD lateral modes are:

| | |
|--------------|--|
| RWY, RWY TRK | Runway, Runway track mode |
| NAV | Nav mode |
| HDG, TRK | Heading, track mode. Also called basic modes |
| APP NAV | Approach Nav mode |
| LOC*, LOC | Loc capture, Loc track mode |
| LAND | Land mode. Managed submode that includes LOC and G/S modes below 400 ft RA |
| FINAL APP | Final approach mode. Managed submode that includes APP NAV and FINAL modes during non precision approach |
| ROLL OUT | Roll out mode (Autoland) |
| GA TRK | Go-around track mode |

The AP /FD vertical modes are:

| | |
|--|--|
| SRS | SRS mode used for takeoff and go-around |
| CLB | Climb mode |
| DES | Descent mode |
| OP CLB | Open Climb mode |
| OP DES | Open Descent mode |
| EXP CLB  | Expedite mode in climb |
| EXP DES  | Expedite mode in descent |
| V/S or FPA | Vertical Speed mode or Flight Path Angle mode. Also called basic modes |
| ALT* | Altitude capture |
| ALT | Altitude Hold mode |
| ALT CST* | Altitude constraint capture |
| ALT CST | Altitude constraint hold mode |
| ALT CRZ | Altitude hold of the cruise flight level |
| G/S* | Glide slope capture |
| G/S | Glide slope mode |
| FINAL | Final mode (Non precision approach) |
| FLARE | Flare mode (Autoland) |



A318/A319/A320/A321
FLIGHT CREW
OPERATING MANUAL

AIRCRAFT SYSTEMS
AUTO FLIGHT - FLIGHT GUIDANCE

AP/FD MODES GENERAL

Intentionally left blank

| | |
|---|--|
|  <p>A318/A319/A320/A321 FLIGHT CREW OPERATING MANUAL</p> | <p align="center">AIRCRAFT SYSTEMS</p> <p align="center">AUTO FLIGHT - FLIGHT GUIDANCE</p> <p align="center">AP/FD LATERAL MODES</p> |
|---|--|

HEADING OR TRACK: HDG - TRK

Ident.: DSC-22_30-60-00012328.0001001 / 17 AUG 10

Applicable to: ALL

These modes guide the aircraft laterally along a heading or track selected by the flight crew. The HDG /TRK window of the FCU displays the target heading or track. The flight crew uses the HDG V/S -TRK FPA pb to select heading or track.

ENGAGEMENT CONDITIONS

HDG or TRK is engaged when one of the following conditions is met:

- The flight crew pulls out the HDG/TRK knob (not sooner than 5 s after lift-off)
- NAV is disengaged, either by the loss of the lateral flight plan or by the flight crew entering a flight plan discontinuity
- FINAL mode (armed or engaged) is lost when the aircraft is in APP NAV mode
- LOC or LOC* mode is lost
- The flight crew engages the AP /FD with no other mode already engaged (basic mode of AP /FD engagement)
- LOC mode is armed when APP NAV FINAL were previously engaged.

DISENGAGEMENT CONDITIONS

The engagement of any other lateral mode disengages HDG or TRK.

SYNCHRONIZING THE HDG /TRK WINDOW OF THE FCU

The lateral window of the FCU displays a heading or a track value when:

- The HDG /TRK mode is engaged. The displayed value is the current HDG /TRK or the manually selected value of the target
- The flight crew turns the HDG/TRK knob. The value in the window first synchronizes with the current HDG /TRK , then displays the manual selection. It remains displayed for 10 s or 45 s depending upon FCU standard, then vanishes if the flight crew does not pull the knob (except in HDG preset)
- A HDG /TRK is preset (*Refer to DSC-22_30-60 HDG/TRK Preset*)
- AP /FD is lost. The value becomes that of the aircraft current heading or track.

Note: If HDG is switched to TRK (or vice versa), the value displayed in the window switches from heading to track (or vice versa).

HDG/TRK PRESET

Ident.: DSC-22_30-60-00012329.0001001 / 17 AUG 10

Applicable to: ALL

The system has a HDG /TRK preset function for takeoff and go-around.

If the flight crew chooses not to fly the flight plan after takeoff or go-around, they may preset a HDG or a TRK on the FCU by turning the HDG/TRK knob. The value they set remains displayed in the FCU HDG /TRK window until they pull the knob.

OPERATION AT TAKEOFF

HDG /TRK preset is available before takeoff and up to 30 ft RA . Turning the HDG/TRK knob before 30 ft sets the desired HDG /TRK. As a consequence:

- NAV is disarmed
- At 30 ft, RWY TRK is annunciated until the HDG/TRK knob is pulled.

OPERATION AT GO-AROUND

Whenever the LOC *, LOC , LAND, FINAL APP, or GA modes are engaged, the HDG preset is available. If the flight crew rotates the HDG/TRK knob to set the value, it will remain displayed in the window. Pull out the HDG/TRK knob to activate the mode and turn the aircraft to the preset value.

CANCELLATION

The flight crew can cancel a preset HDG /TRK by:

- Engaging the NAV mode using the DIR TO
- Pushing in the HDG/TRK knob (arming NAV mode)
- Disengaging AP /FD.

NAVIGATION (NAV)

Ident.: DSC-22_30-60-00012330.0002001 / 23 JUN 15

Applicable to: **ALL**

NAV mode is a managed mode that steers the aircraft laterally along the flight plan defined in the FMGS . It is designed to have a zero cross-track error. The flight crew can arm or engage the NAV mode if the MCDU contains a lateral flight plan.

ARMING CONDITIONS

Satisfying one of the following conditions arms NAV:

- The aircraft is on ground with no HDG /TRK preset and no other lateral mode except runway mode
- The flight crew pushes in the HDG/TRK knob, unless the LOC mode is engaged
- The flight crew presses the APPR pb, if a non-ILS approach is selected.

DISARMING CONDITIONS

NAV mode disarms if one of the following occurs:

- The flight crew pulls out the HDG/TRK knob
- The flight crew selects a preset HDG /TRK (TO or GA)

- The flight crew arms the LOC mode by pressing the LOC pb
- The flight crew selects GA mode
- LAND mode has engaged
- The flight crew presses the APPR pb, if an XLS approach is selected.

ENGAGEMENT CONDITIONS

NAV mode engages:

- Automatically at 30 ft RA after takeoff (if armed on the ground)
- When the flight crew orders "DIR TO " (except below 700 ft RA in LOC mode)
- When the flight crew pushes in the HDG/TRK knob when the aircraft is close to (within ~1 NM of) the active flight plan leg
- Automatically in flight when NAV is armed and the aircraft reaches the capture zone for the active flight plan leg.

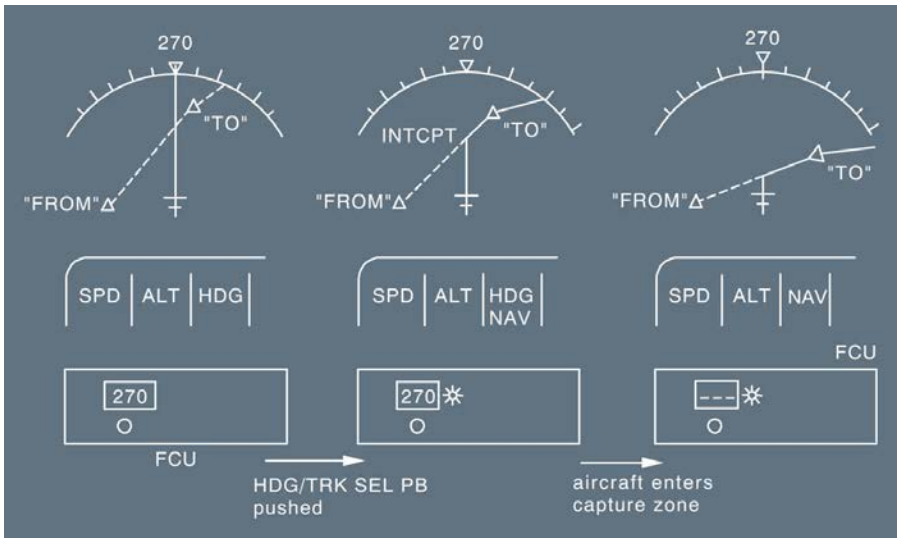

CAUTION When NAV is armed, it will automatically engage if:

- The aircraft track line intercepts the flight plan before the TO waypoint, and
- The intercept waypoint (INTCP) is displayed on the ND, and
- The aircraft reaches the active flight plan leg.

Note: The TO waypoint is displayed in white on ND s and MCDUs.

DISENGAGEMENT CONDITIONS

The NAV mode disengages when:

- Any other lateral mode is engaged
- The flight plan is lost or the aircraft enters a flight plan discontinuity.

INTERACTIONS WITH VERTICAL MODES

When NAV mode is engaged, the vertical managed modes CLB or DES or FINAL take into account altitude and speed constraints linked to waypoints on the lateral flight plan. If NAV mode is disengaged, the vertical managed modes are not available and all downpath altitude and speed constraints are ignored.

LOCALIZER MODE THROUGH THE LOC PUSHBUTTON

Ident.: DSC-22_30-60-00012331.0001001 / 17 AUG 10

Applicable to: **ALL**

This mode captures and tracks a localizer beam independently of the glide path beam. Flight crew use it to fly localizer-only approaches or to initiate an ILS approach when intercepting the glide slope from above.

ARMING CONDITIONS

The flight crew arms the LOC mode by pressing the LOC pb, provided that:

- An ILS is tuned (frequency and runway course)
- The aircraft is above 400 ft RA
- TO or GA mode is not engaged.

DISARMING CONDITIONS

LOC mode is disarmed by:

- Pressing the LOC pb when LOC is armed
- Arming the NAV mode
- Engaging the GA mode.

Note: Engaging NAV mode by selecting DIR TO does not disarm the LOC mode.

ENGAGEMENT CONDITIONS

The LOC mode engages automatically when capture conditions are met.

DISENGAGEMENT CONDITIONS

The LOC mode disengages:

- When another lateral mode is engaged
- When the flight crew presses the LOC pb again (engaging the HDG /TRK mode on the current HDG /TRK).



A318/A319/A320/A321
FLIGHT CREW
OPERATING MANUAL

AIRCRAFT SYSTEMS
AUTO FLIGHT - FLIGHT GUIDANCE

AP/FD LATERAL MODES

Intentionally left blank

GENERAL

Ident.: DSC-22_30-70-10-00010507.0001001 / 17 AUG 10

Applicable to: ALL

Vertical modes guide the aircraft in the vertical plan.

PRINCIPLES

Ident.: DSC-22_30-70-10-00010508.0001001 / 17 AUG 10

Applicable to: ALL

To leave an FCU selected altitude for another target altitude, the flight crew must turn the Altitude (ALT) knob in order to display the new target altitude and either:

- Pull out the ALT knob to engage the OPEN CLB /DES mode, or
- Push in the ALT knob to engage the CLB /DES mode, or
- Select a target vertical speed (V/S) and pull out the V/S or FPA knob to engage V/S mode, or
- Select EXPEDITE  .

This arms ALT mode.



A318/A319/A320/A321
FLIGHT CREW
OPERATING MANUAL

AIRCRAFT SYSTEMS

AUTO FLIGHT - FLIGHT GUIDANCE

AP/FD VERTICAL MODES - PRINCIPLES

Intentionally left blank

GENERAL

Ident.: DSC-22_30-70-20-00010509.0001001 / 01 OCT 12

Applicable to: ALL

CLB mode guides the aircraft in a managed climb, at either a managed or a selected target speed, to an FCU selected altitude, taking into account altitude constraints at waypoints.

The system also considers speed constraints if the target speed is managed. The vertical flight path may include several segments:



The flight crew can arm the CLB mode during the takeoff, go-around, climb, and cruise phases and engage it during the climb and cruise phases.

ARMING CONDITIONS

Ident.: DSC-22_30-70-20-00010510.0001001 / 17 AUG 10

Applicable to: ALL

The CLB mode is armed:

- On ground or when SRS mode is engaged (TO or GA) if the following conditions are met:
 - No other vertical mode is engaged
 - The ACCEL ALT (defined on the PERF TO or GA MCDU pages) is below the FCU selected altitude and the lowest altitude constraint.
- In flight, when the climb or go-around phase is active, and the following conditions are met:
 - The lateral NAV mode is engaged
 - The FCU selected altitude is above the aircraft's present altitude and the aircraft captures or flies an altitude constraint.

DISARMING CONDITIONS

Ident.: DSC-22_30-70-20-00010511.0002001 / 23 JUN 15

Applicable to: ALL

The CLB mode is disarmed, if one of the following conditions is met:

- Another vertical mode is engaged
- The FCU selected altitude is lower than the present aircraft level
- The FCU selected altitude is set at the altitude constraint while ALT CST* or ALT CST mode is engaged
- The aircraft transitions to DES or APPR phase
- Arming requirements are no longer met
- Vertical flight path validity is lost, or NAV mode is lost while ALT CST* or ALT CST mode is engaged.

ENGAGEMENT CONDITIONS

Ident.: DSC-22_30-70-20-00010512.0001001 / 17 AUG 10

Applicable to: ALL

The CLB mode can be engaged, if the following conditions are all met:

- The aircraft has been in flight for more than 5 s
- The selected FCU level is above the present aircraft level
- The descent, approach, or go-around phase is not active
- NAV mode is engaged
- Glideslope (G/S) mode is not engaged.

CLB mode automatically engages when the aircraft reaches ACC ALT , or sequences a waypoint with an altitude constraint while the CLB mode is armed.

CLB mode manually engages when the flight crew pushes in the ALT knob, with the CLB mode not armed and the current altitude is not an effective altitude constraint of the flight plan.

Note: When CLB mode is engaged:

- The V/S (FPA) window of the FCU shows dashes
- The managed LVL/CH dot on the FCU lights up
- The Flight Mode Annunciator displays "CLB" in Column 2.

DISENGAGEMENT CONDITIONS

Ident.: DSC-22_30-70-20-00010513.0002001 / 17 AUG 10

Applicable to: ALL

The CLB mode disengages, if one of the following conditions is met:

- NAV mode is lost or disengaged (OP CLB engages). In this case, the reversion to OP CLB is accompanied by a triple click aural warning
- Another vertical mode engages
- The flight crew selects an altitude on the FCU that is lower than the present aircraft altitude. V/S (FPA) engages on the current V/S (FPA).

GUIDANCE

Ident.: DSC-22_30-70-20-00010514.0002001 / 01 OCT 12

Applicable to: ALL

Climb mode gives the aircraft managed vertical guidance to the FCU selected altitude. It meets altitude constraints at waypoints either with managed speed incorporating speed constraints or with selected speed as target speed. The AP /FD pitch controls the speed or Mach number target and the A/THR is in thrust mode (CLB) corresponding to maximum climb thrust. The flight path may include several segments.

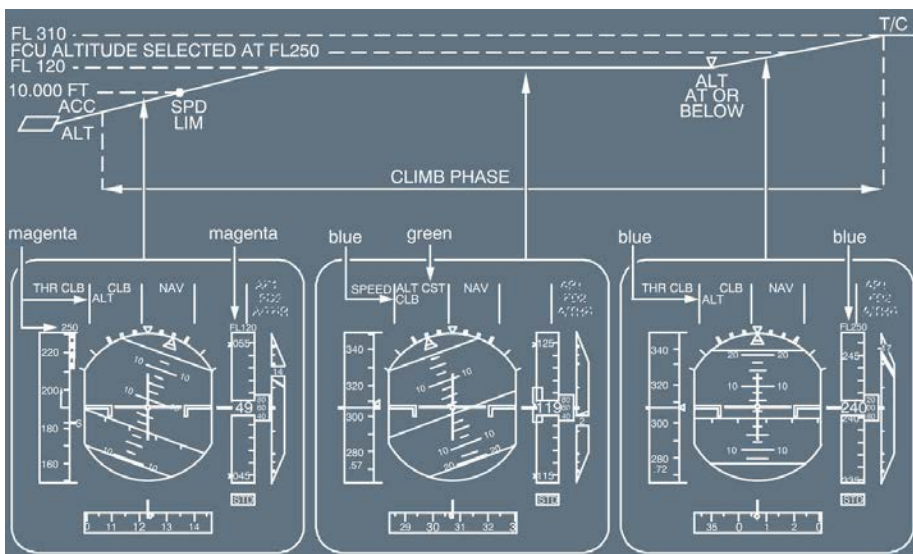

- When CLB mode is engaged, the system arms ALT and displays the applicable target altitude on the ALT scale.
 - If the next predicted level-off is an ALT CSTR , ALT is magenta on the FMA and the ALT CSTR is displayed in magenta on the altitude scale
 - If the next predicted level-off is the FCU altitude, ALT is blue on the FMA and the FCU selected altitude is displayed in blue on the altitude scale.

Note: The system takes into account all constraints defined by the database or manually entered by the flight crew. Nevertheless this mode has the following particularity: When the aircraft is in CLB mode and the system predicts that it will miss an altitude constraint, it will not modify the target speed in an attempt to meet it. In this case, the flight crew may select an appropriate speed in order to meet the ALT CSTR.

- The guidance does not modify the target speed in order to satisfy an altitude constraint. Therefore the constraint may not be met and may be predicted as missed
- When the aircraft levels off at the ALT CSTR , CLB mode arms automatically, then engages when the aircraft passes the constrained waypoint (if the FCU altitude is above the constraint altitude).

| | |
|---|--|
|  <p>A318/A319/A320/A321 FLIGHT CREW OPERATING MANUAL</p> | <p style="text-align: center;">AIRCRAFT SYSTEMS</p> <p style="text-align: center;">AUTO FLIGHT - FLIGHT GUIDANCE</p> <p style="text-align: center;">AP/FD VERTICAL MODES - OPEN CLIMB MODE</p> |
|---|--|

GENERAL

Ident.: DSC-22_30-70-30-00010515.0001001 / 17 AUG 10
Applicable to: ALL

The OPEN CLB mode is a selected mode. It uses the AP /FD pitch mode to maintain a SPD/MACH (selected or managed) while the autothrust (if active) maintains maximum climb thrust.

ENGAGEMENT CONDITIONS

Ident.: DSC-22_30-70-30-00010516.0002001 / 16 MAR 11
Applicable to: ALL

The OPEN CLB mode can only be engaged, if all of the following conditions are met:

- The aircraft is in flight for more than 5 s
- The LAND mode is not engaged
- The FCU selected altitude is higher than the aircraft's present altitude.

The OPEN CLB mode is engaged, if one of the following conditions occurs:

- The flight crew pulls out the ALT knob
- The flight crew pulls out the SPD/MACH knob, when TOGA mode or EXPED CLB  is engaged
- Acceleration altitude is reached, with CLB armed, and NAV mode not engaged
- Guidance reverts to ensure speed protection
- NAV mode is lost (or disengaged), when previously in CLB mode. Reversion to OPEN CLB is accompanied by a triple click aural warning (*Refer to DSC-22_30-75 General*).

Note: When OPEN CLB is engaged:

- The FMA displays "OP CLB"
- The managed LVL/CH dot on the FCU goes out.

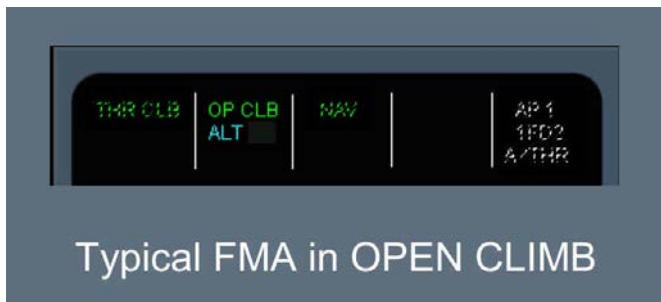

DISENGAGEMENT CONDITIONS

Ident.: DSC-22_30-70-30-00010517.0001001 / 17 AUG 10

Applicable to: **ALL**

The OPEN CLB mode is disengaged by one of the following conditions:

- Engagement of any other vertical mode
- Reversion to V/S mode (*Refer to DSC-22_30-75 General*)
- Selection of a lower altitude than the current aircraft altitude. V/S (FPA) engages on the current V/S (FPA).

GUIDANCE

Ident.: DSC-22_30-70-30-00010518.0001001 / 01 OCT 12

Applicable to: **ALL**

When OPEN CLB is engaged, the target speed/Mach is maintained by adjusting the pitch with the elevator, whereas thrust is maintained either by the A/THR, or manually by the flight crew. Speed target may either be selected or managed.

The OPEN CLB mode disregards all altitude constraints up to the FCU selected altitude.

OPEN CLB MODES, MANAGED SPEED

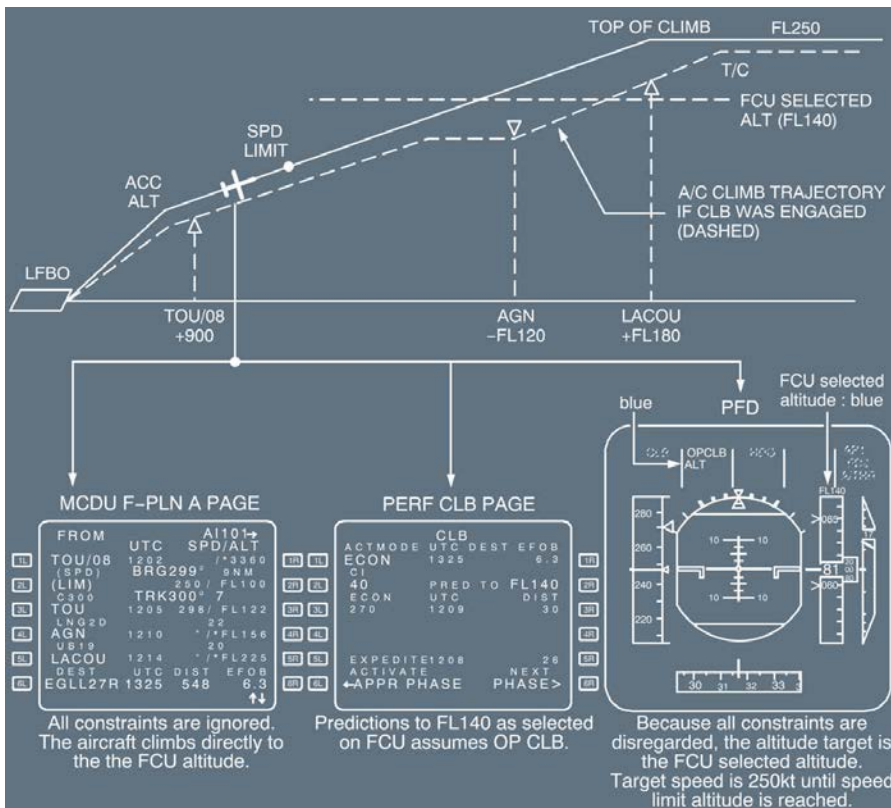

Note: If the change is less than 1 200 ft in OPEN CLB mode, the aircraft responds with a rate of climb of 1 000 ft/min.



A318/A319/A320/A321
FLIGHT CREW
OPERATING MANUAL

AIRCRAFT SYSTEMS

AUTO FLIGHT - FLIGHT GUIDANCE

AP/FD VERTICAL MODES - OPEN CLIMB MODE

Intentionally left blank

GENERAL

Ident.: DSC-22_30-70-50-00010521.0001001 / 17 AUG 10

Applicable to: ALL

The DES mode guides the aircraft along the descent path computed by the FMGS . The system computes this flight path backwards from the deceleration point up to the top of descent (T/D), with respect to the speed and altitude constraints at the deceleration point, the guidance begins the deceleration to VAPP, to be reached at 1 000 ft above touchdown on the final descent path. Internally, the computer divides the descent path into various segments, depending on the relative positions of the constraints. It starts at top of descent (T/D) by setting up an “idle” segment that takes the aircraft down to the first constraint, and follows this with “geometric” segments between constraints.

The descent profile takes into account wind data and data from the lateral and vertical flight plans, and it is based upon the managed descent speed profile. It does not take holding patterns into consideration.

The descent profile has several segments:

- A repressurization segment. When necessary, this produces a repressurization rate for the cabin during descent. It is a function of the destination airport altitude and the selected cabin rate (defaulted to -350 ft/min but this can be modified)
- Idle path segment. The AP /FD controls the speed and the autothrust stays at idle thrust. The guidance computes this profile from the top of descent or the end of the repressurization segment to the first vertical constraint that cannot be flown at idle thrust
- Geometric path segments. The AP /FD controls the vertical path, and autothrust controls the speed. These segments take the aircraft from the first constraint to the deceleration point.

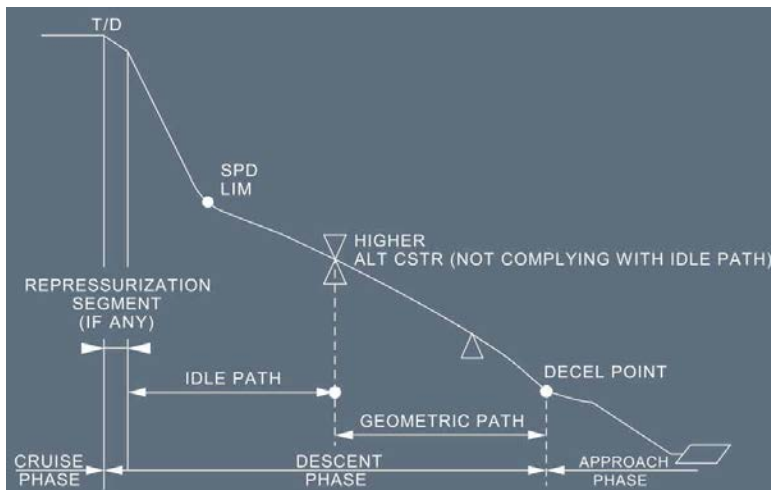

The descent mode is a managed mode that may be engaged during cruise. It can be armed or engaged in descent and approach phases (except if the FCU selected altitude is higher than the present aircraft altitude).

ARMING CONDITIONS

Ident.: DSC-22_30-70-50-00010522.0001001 / 17 AUG 10

Applicable to: ALL

The DES mode is armed when an ALT CSTR is captured and all the following conditions are met:

- FCU selected altitude is lower than present altitude
- NAV , LOC * or LOC mode is engaged
- Takeoff or go-around phase is not active
- Flight profile is available.

DISARMING CONDITIONS

Ident.: DSC-22_30-70-50-00010523.0002001 / 23 JUN 15

Applicable to: ALL

The DES mode is disarmed if one of the following conditions is met:

- Engagement of another vertical mode
- FCU selected altitude is set above the aircraft current altitude
- Loss of NAV , LOC * , or LOC mode
- Switching to the go-around phase

- Loss of vertical flight path validity
- Setting the FCU selected altitude at an altitude constraint while ALT CST* was engaged. (ALT * engages and DES mode disarms).

ENGAGEMENT CONDITIONS

Ident.: DSC-22_30-70-50-00010524.0002001 / 23 JUN 15

Applicable to: ALL

The DES mode can be engaged, when the following conditions are met:

- The FCU selected altitude is lower than present altitude
- NAV , LOC * , or LOC mode is engaged
- Takeoff, climb, or go-around phase is not active
- Vertical flight path is valid
- TO , G/S , LAND, FINAL or GA mode is not engaged, and:
 - The aircraft sequences a waypoint with an ALT CSTR , and DES mode is armed. The DES mode engages automatically, or
 - The flight crew presses the ALT knob, while ALT CST* or ALT CST is not engaged, or
 - The flight crew presses the ALT knob, while ALT * or ALT is engaged, but the current altitude is not an effective altitude constraint of the F-PLN.

Note: When DES mode is engaged:

- The V/S - FPA window of the FCU shows dashes
- The managed LVL/CH dot on the FCU lights up.

DISENGAGEMENT CONDITIONS

Ident.: DSC-22_30-70-50-00010525.0002001 / 17 AUG 10

Applicable to: ALL

The DES mode is disengaged, if one of the following conditions is met:

- The NAV mode is lost or disengaged and the V/S or FPA mode engages. A triple click aural warning will sound
- Another vertical mode engages
- The flight crew selects an altitude on the FCU that is higher than the aircraft present altitude and the V/S (FPA) engages on current V/S (FPA). Same triple click logic, as for the OP DES case
- NAV mode is lost due to a discontinuity in the descent profile. AP /FD reverts to basic mode, and a triple click aural warning sounds. The vertical mode is boxed in white for 10 s.

Refer to DSC-22_30-75 General.

REPRESSURIZATION SEGMENT

Ident.: DSC-22_30-70-50-00010559.0002001 / 14 MAY 12

Applicable to: ALL

The top of descent (T/D) may be updated if the flight crew modifies the cabin rate of descent (default rate is -350 ft/min).

If the flight crew enters a lower cabin rate, the system computes a repressurization segment that takes into account the additional time needed for repressurization.



DESCENT SPEED PROFILE

Ident.: DSC-22_30-70-50-00012563.0002001 / 14 MAY 12

Applicable to: ALL

The descent speed profile is usually the ECON SPD profile, amended by any speed constraints and speed limit contained in the flight plan.

Before the descent phase is active, if flight crew does not intend to fly the ECON speed/Mach profile, a different speed or Mach can be entered to amend the speed profile.

It is obtained by entering a Mach number and/or a speed in the MANAGED field of the PERF DES MCDU page (3L key).



If the flight crew reverts to the **SELECTED** speed/MACH mode during descent, the profile is not modified and the aircraft flies the same profile at the FCU selected speed/MACH value.

Basic managed SPD /MACH profile in DES mode is:

- ECON MACH, or **SELECTED** Mach
- ECON SPD, or **SELECTED** Speed
- SPD CSTR (if any)
- SPD LIMIT
- Green Dot/S /F /VAPP
- VAPP TARGET.

GUIDANCE IN DES MODE

Applicable to: ALL

Ident.: DSC-22_30-70-50-A-00010575.0001001 / 17 AUG 10

DESCENT INITIATION

The aircraft will not start its descent automatically when reaching the top of descent (T/D). In order to initiate the descent, the flight crew sets the clearance altitude by turning the ALT knob then pushes the ALT knob.

The aircraft will descend immediately:

- If the top of descent is not reached, the aircraft descends at a constant V/S converging on the descent path
- If the aircraft is at or beyond the T/D, it descends at idle thrust.

Ident.: DSC-22_30-70-50-A-00010563.0005001 / 01 OCT 12

DURING THE DESCENT

The flight crew will see a vertical deviation symbol (VDEV) along the ALT scale on the PFD and a VDEV value on the PROG page, so that the aircraft's vertical position can be monitored versus the calculated descent profile.

The aircraft may deviate from the DES profile while DES mode is engaged if:

- Unexpected wind conditions are encountered
- Anti-icing is turned on
- The lateral flight plan is changed.

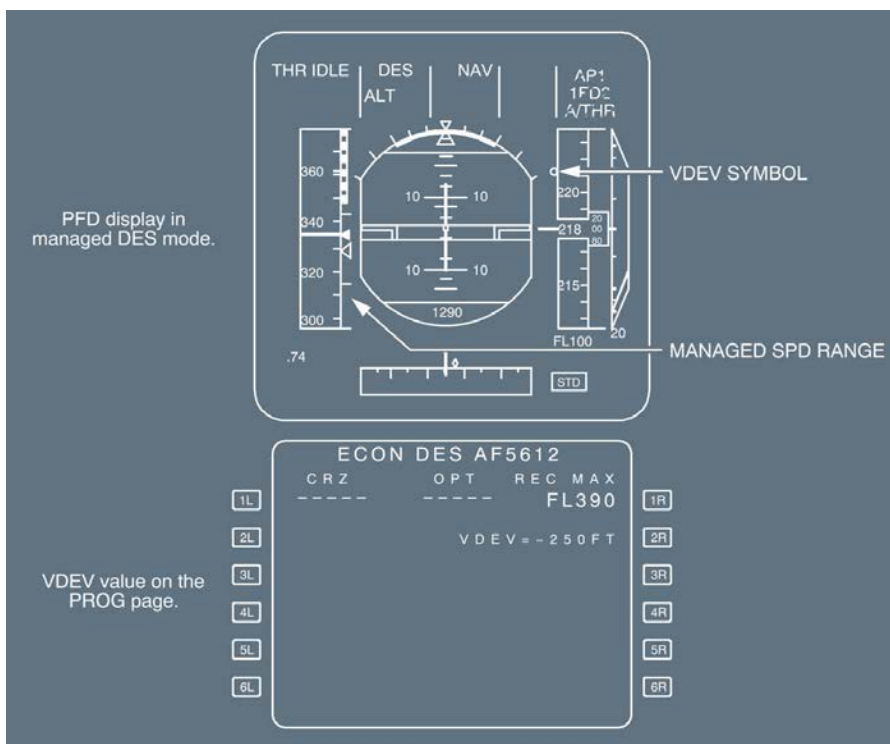

When the speed is managed, a target speed range displayed on the PFD defines acceptable speed variations around the nominal descent speed target.

Ident.: DSC-22_30-70-50-A-00010565.0001001 / 19 DEC 12

FMA DISPLAY

When DES mode is engaged, the system arms ALT and displays the applicable target altitude on the PFD altitude scale.

- If the next predicted level-off is an altitude constraint, ALT is magenta on the FMA second line and the PFD displays the altitude constraint magenta above the altitude scale.

When the aircraft flies at the altitude constraint (ALT CSTR), the system arms DES blue.

When the aircraft meets the constraint, DES engages again automatically.

- If the next predicted level-off is the FCU altitude, ALT is blue on the FMA and the PFD displays the FCU selected altitude in blue.



DES MODE PROFILE

Applicable to: ALL

Ident.: DSC-22_30-70-50-B-00010567.0005001 / 01 OCT 12

GENERAL

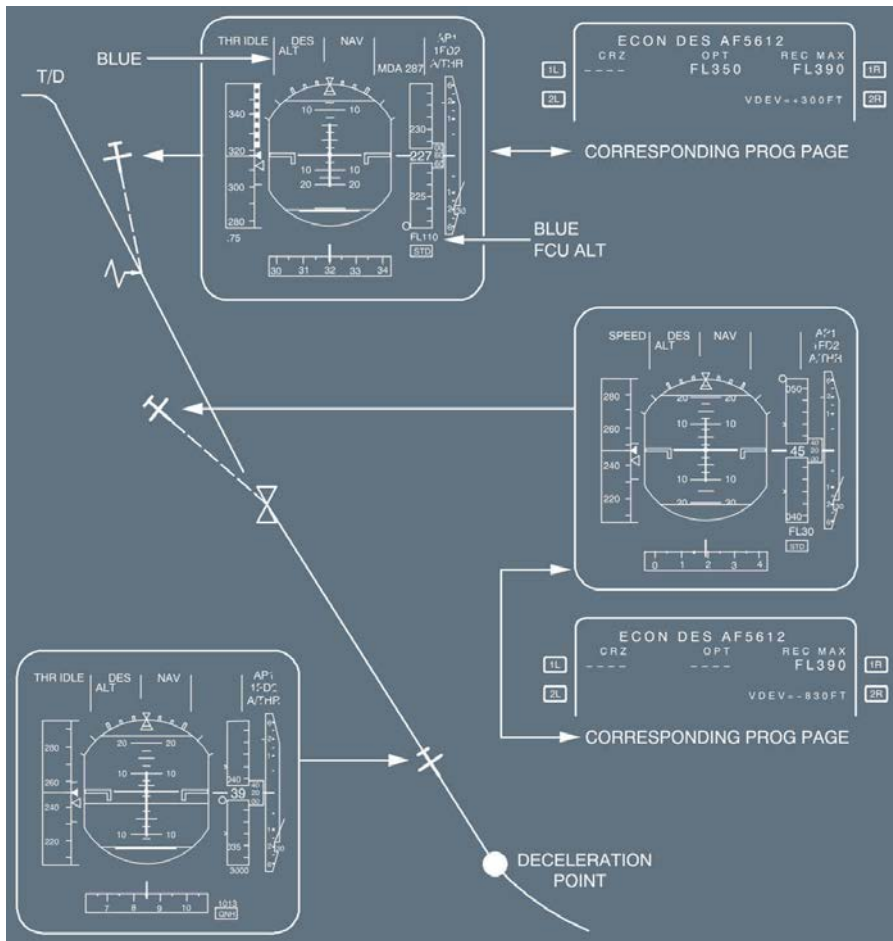

Ident.: DSC-22_30-70-50-B-00010568.0005001 / 17 AUG 10

INTERCEPT POINT

Associated with the VDEV displayed on PF_D, the ND shows an intercept point (I/P) on the flight plan. It indicates the position where the system predicts that the aircraft will intercept the descent profile.

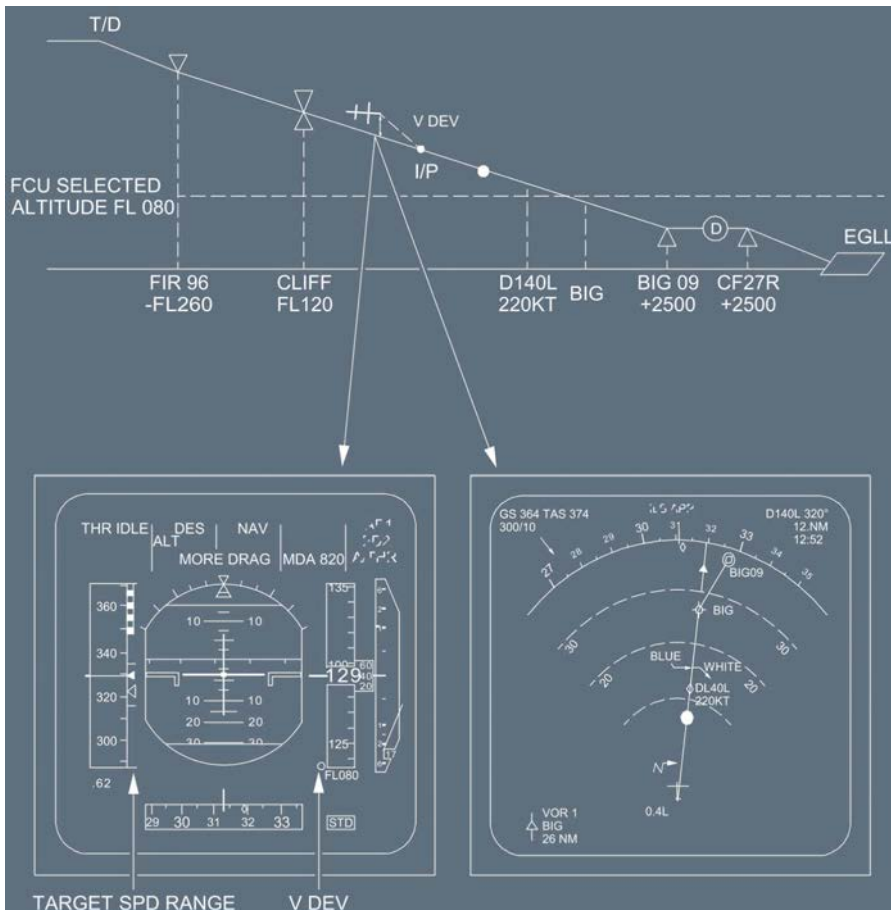

AIRCRAFT ABOVE THE DESCENT PROFILE

If the aircraft is above the descent profile, the speed will increase toward the upper limit of the managed speed range. If the speed reaches the upper limit, the aircraft will maintain the speed but will deviate from the profile (autothrust at idle).

The navigation display presents a pseudo waypoint  (intercept point) along the flight plan that assumes the aircraft will return to the profile using:

- Idle thrust
- 1/2 speedbrake extension
- ECON speed plus a margin (until intercepting the profile).

If necessary, the message “AIRBRAKES” (old FMGC standard) or “MORE DRAG” comes up on the PFD and the MCDU, and remains there as long as more drag (speedbrakes) is still required. The flight crew should respond to this message by deploying half speedbrakes.

Whenever the intercept point is predicted to be close to a constrained waypoint, the PFD and MCDU display an “AIRBRAKES” or “MORE DRAG” message depending upon the FMGS standard.

Note: With DES mode engaged, the speedbrakes extension will not necessarily increase the descent rate. It increases only if the aircraft is above path.

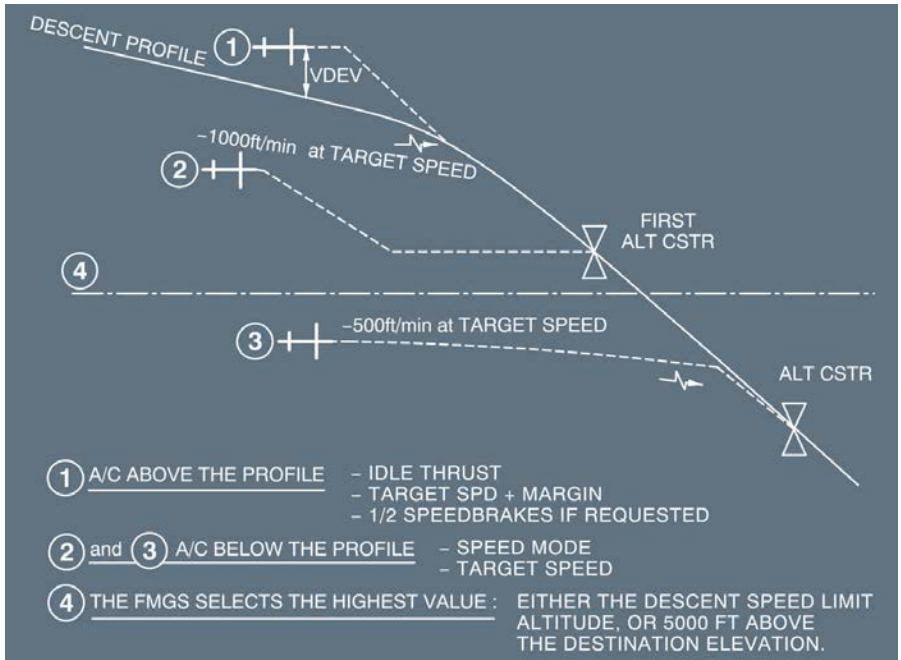

Ident.: DSC-22_30-70-50-B-00010570.0002001 / 17 AUG 10

AIRCRAFT BELOW THE DESCENT PROFILE

If the aircraft is below the descent profile, its speed will be maintained at target speed until it reaches the descent profile. The lower margin becomes effective when the aircraft is on the descent profile but has to loose speed in order to stay on it.

The intercept point on the navigation display is based on the following assumptions:

- **If the aircraft is flying at an altitude that is higher than both the descent speed limit altitude and the destination elevation +5 000 ft:**
 The FMGS maintains the V/S at -1 000 ft/min and the target speed, until the aircraft reaches the altitude constraint, or intercepts the descent profile.
- **If the aircraft is flying at an altitude that is lower than either the descent speed limit altitude, or the destination elevation +5 000 ft:**
 The FMGS maintains the V/S at -500 ft/min and the target speed, until the aircraft reaches the altitude constraint or intercepts the descent profile.

Ident.: DSC-22_30-70-50-B-00010572.0001001 / 17 AUG 10

LEVELING OFF AT A CONSTRAINT

If the aircraft levels off at an ALT CSTR , the DES mode arms and remains armed until the aircraft passes the constraint, then reengages (if the FCU altitude is set below the altitude of the constraint).

If the FCU selected altitude is that of a constraint, the flight crew may continue the descent below that altitude by turning the ALT knob and pushing it in. This arms the DES mode, which reengages when the aircraft passes the constraint waypoint.

Ident.: DSC-22_30-70-50-B-00010573.0002001 / 17 AUG 10

GUIDANCE IN A HOLD

Just before the aircraft enters a holding pattern, the speed target becomes the holding speed. In the holding pattern, the DES mode commands $V/S = -1\ 000\ \text{ft/min}$ while A/THR maintains the holding speed. The aircraft will level off at the next altitude constraint if it is reached during the hold.

The current vertical deviation VDEV is based on the altitude at which the aircraft is supposed to cross the exit fix in order to be properly positioned on the descent profile.

Until the flight crew exits the hold, the FMGS in DES mode will maintain $V/S = -1\ 000\ \text{ft/min}$ considering downpath vertical constraint. This means that the aircraft will not descent below the next altitude constraint, neither the FCU selected altitude. If the aircraft reaches the next altitude constraint it will level off and ALT CST mode will engage.

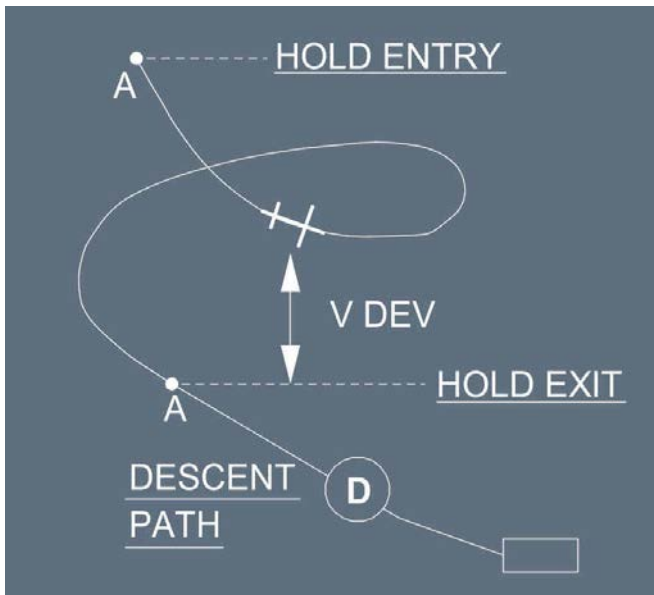

Ident.: DSC-22_30-70-50-B-00010574.0001001 / 01 OCT 12

TOO STEEP PATH

A descent segment is called “too steep path” when FM predicts that the descent segment between two constraint waypoints is impossible to fly at the planned descent speed with half speedbrakes extended.

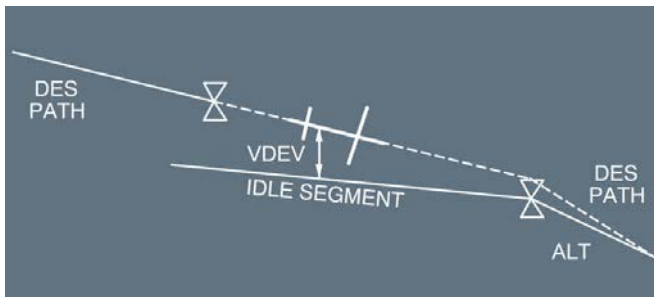

When this occurs, the MCDU displays no predictions between the upper and the lower points of the too steep path. Relevant message “TOO STEEP PATH” is displayed on MCDU.



When the aircraft reaches the beginning of the too steep path segment, the FM recomputes the VDEV using an idle segment from the end of the too steep path segment.

GENERAL

Ident.: DSC-22_30-70-60-00010576.0001001 / 17 AUG 10

Applicable to: ALL

The OPEN DES mode is a selected mode. It maintains a SPD /MACH (selected or managed) with the AP /FD pitch mode while autothrust (if active) maintains IDLE thrust.
It is not to be used for final approach.

ENGAGEMENT CONDITIONS

Ident.: DSC-22_30-70-60-00010577.0002001 / 17 AUG 10

Applicable to: ALL

The OPEN DES mode can be engaged only if the following conditions are met:

- The aircraft has been in flight for more than 5 s
- LAND mode is not engaged
- The FCU selected altitude is lower than present altitude.

The OPEN DES mode is engaged by one of the following:

- Pulling out the ALT knob
- Selecting a manual speed when EXP mode  is engaged.

Note: When OP DES is engaged:

- The FMA displays "OP DES"
- The managed LVL/CH dot on the FCU goes out
- The system arms the ALT mode.

DISENGAGEMENT CONDITIONS

Ident.: DSC-22_30-70-60-00010578.0003001 / 17 AUG 10

Applicable to: ALL

The OPEN DES mode is disengaged by one of the following conditions:

- Manual engagement of another vertical mode
- Selection of an altitude higher than present altitude. V/S (FPA) engages on current V/S (FPA).
The vertical mode is boxed white. If within 5 s after the reversion to V/S , the flight crew does not confirm the altitude target change by another expected action, a triple click aural warning sounds, and the V/S (FPA) is boxed white and flashes for 10 s.

GUIDANCE

Ident.: DSC-22_30-70-60-00010579.0002001 / 16 MAR 11

Applicable to: **ALL**

When OPEN DES is engaged, pitch control maintains the target speed/Mach number, and autothrust maintains idle thrust (or the flight crew maintains it manually). The speed target may be either selected or managed.

The OPEN DES mode disregards all altitude constraints.



GENERAL

Ident.: DSC-22_30-70-65-00010580.0002001 / 07 APR 17

Applicable to: ALL

ALT * mode guides the aircraft to acquire the FCU selected altitude.

ALT CST* guides the aircraft to acquire an altitude constraint provided by Flight Management. Once the aircraft has reached the altitude, the altitude mode (ALT or ALT CST) engages.

ENGAGEMENT CONDITIONS

Ident.: DSC-22_30-70-65-00010581.0002001 / 23 JUN 15

Applicable to: ALL

The mode engages when the aircraft reaches the altitude capture zone, defined by the aircraft vertical speed (among other parameters).

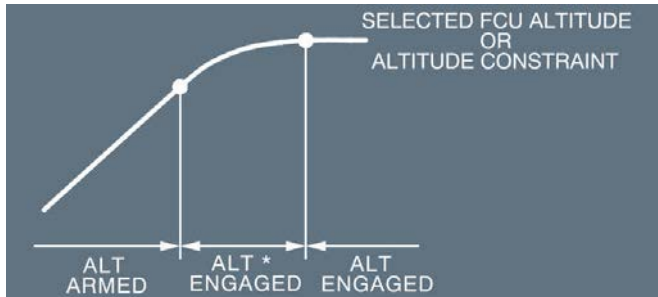

Note: ALT * and ALT CST* cannot be engaged below 400 ft, if either the takeoff or the go-around mode is engaged.

DISENGAGEMENT CONDITIONS

Ident.: DSC-22_30-70-65-00010582.0008001 / 19 DEC 12

Applicable to: **ALL**

The mode is disengaged by one of the following conditions:

- Engagement of V/S mode on current vertical speed by turning the FCU ALT knob by more than 250 ft.

If within 5 s after reversion to V/S (FPA) the flight crew does not confirm the altitude target change by:

- Pulling the ALT knob, or
- Setting a new V/S (FPA) target, or
- Pushing the V/S or FPA knob on the FCU,

then, a triple click aural warning sounds, and the V/S (FPA) is boxed white for additional 10 s.

- Engagement of another vertical mode provided the FCU altitude has been changed by more than 250 ft.



GUIDANCE

Ident.: DSC-22_30-70-65-00010583.0006001 / 07 APR 17

Applicable to: **ALL**

The ALT* and ALT CST* mode have internal V/S guidance that is a direct function of the difference between present altitude and the altitude target.

The system switches automatically to ALT (altitude hold) when the altitude deviation becomes less than 20 ft.

ALT* and ALT CST* modes have internal protections that decreases the vertical speed when VLS or VMAX is reached (VLS or VMAX becomes the priority target).

- Note:
- *If the baro setting is changed during ALT * mode, this may lead to an FCU target overshoot due to the change of the current value of the altitude. However ALT * mode will allow the FCU altitude to be regained.*
 - *For aircraft equipped with QFE option, a switching from STD to QFE (or vice versa) in ALT CST* mode, will change the target value and a reversion to V/S may occur if the target value is modified of 250 ft or more.*



A318/A319/A320/A321
FLIGHT CREW
OPERATING MANUAL

AIRCRAFT SYSTEMS

AUTO FLIGHT - FLIGHT GUIDANCE

AP/FD VERTICAL MODES - ALTITUDE ACQUIRE MODE

Intentionally left blank

GENERAL

Ident.: DSC-22_30-70-70-00010584.0001001 / 17 AUG 10

Applicable to: ALL

The ALT mode maintains a target altitude. This target altitude is either the FCU selected altitude or an altitude constraint delivered by Flight Management.

ARMING CONDITIONS

Ident.: DSC-22_30-70-70-00010585.0001001 / 17 AUG 10

Applicable to: ALL

The ALT mode arms automatically whenever the aircraft climbs or descends toward the target altitude.

Note: *The ALT mode arms only if the difference between the current altitude and the FCU selected altitude is at least 250 ft.*

When ALT is armed, the FMA displays the ALT message on its second line:

- Blue when the target altitude is the FCU selected altitude
- Magenta if the target altitude is an altitude constraint.

ENGAGEMENT CONDITIONS

Ident.: DSC-22_30-70-70-00010586.0002001 / 17 AUG 10

Applicable to: ALL

The ALT mode is engaged automatically when the difference between present altitude and the target altitude becomes less than 20 ft with ALT* engaged.

Note: *The ALT mode is displayed on the FMA when the V/S knob is pushed in or is pulled out with V/S -FPA target set to zero but V/S mode is still active. In other words, if V/S knob is dialled up or down, the aircraft will climb or descend without any pulling action.*

DISENGAGEMENT CONDITIONS

Ident.: DSC-22_30-70-70-00010587.0001001 / 17 AUG 10

Applicable to: ALL

The ALT mode disengages when any other vertical mode engages.

GUIDANCE

Ident.: DSC-22_30-70-70-00010588.0002001 / 23 JUN 15

Applicable to: ALL

- The altitude that ALT mode holds is the altitude it memorized when engaged. It is not affected by a change of reference in the ALT window or by a change in the barometric correction.
- When ALT is engaged, the FMA displays ALT in green (FCU altitude hold) or ALT CST in green if it is an altitude constraint.



- If the AP is engaged while FD is already engaged in ALT mode at the FCU selected altitude, the autopilot:
 - Acquires and holds the FCU altitude if present altitude is within 250 ft of it, or
 - Commands a level-off if present altitude is more than 250 ft from the FCU altitude.

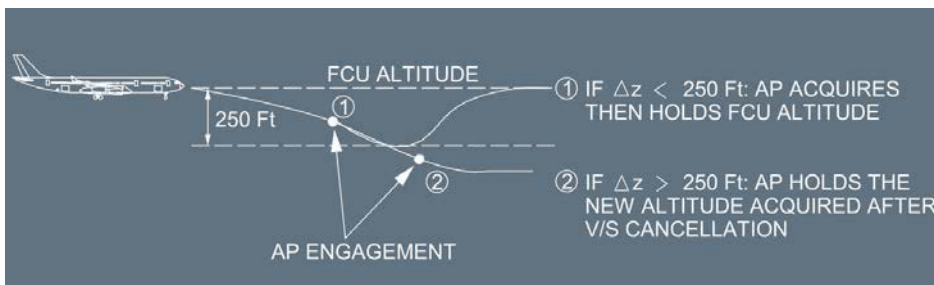

SOFT ALTITUDE MODE (CRUISE)

Ident.: DSC-22_30-70-70-00010589.0002001 / 19 DEC 12

Applicable to: ALL

The soft altitude mode engages when the aircraft reaches the FCU altitude set as the cruise flight level (entered in the F-PLN or on PROG page).
 The soft altitude mode corrects minor deviations from the Mach target by allowing a ± 50 ft variation from the CRZ FL. This feature improves fuel efficiency and passenger comfort and minimizes the changes in thrust.

MACH

ALT CRZ

HDG

AP1
1FD2
A/THR

FMA in SOFT ALT HOLD MODE



A318/A319/A320/A321
FLIGHT CREW
OPERATING MANUAL

AIRCRAFT SYSTEMS

AUTO FLIGHT - FLIGHT GUIDANCE

AP/FD VERTICAL MODES - ALTITUDE HOLD MODE

Intentionally left blank

GENERAL

Ident.: DSC-22_30-70-80-00010611.0004001 / 19 DEC 12

Applicable to: ALL

The V/S - FPA mode is a selected mode. It acquires and holds the vertical speed or the flight path angle displayed in the V/S - FPA window of the FCU.

The HDG V/S -TRK FPA pb on the FCU allows the flight crew to select either type of reference to be used for guidance and for display on the PFD.

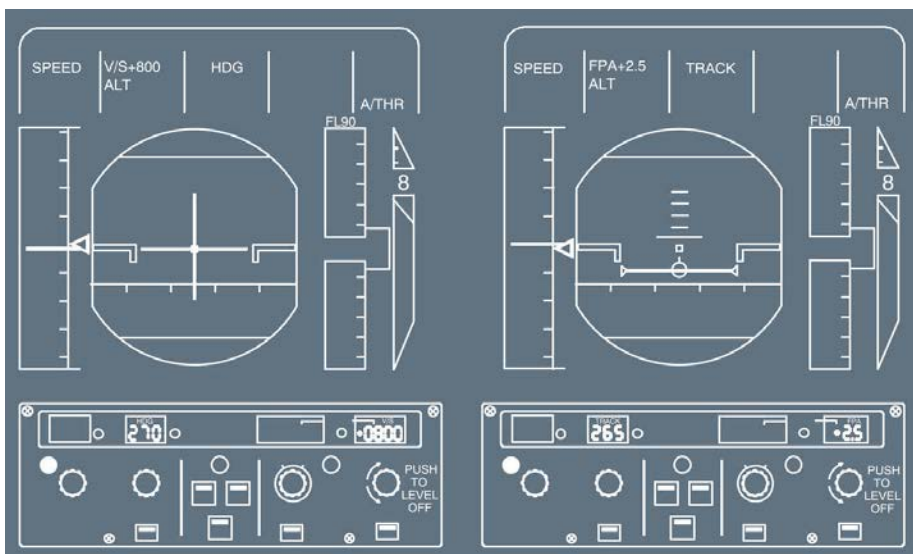

ENGAGEMENT CONDITIONS

Ident.: DSC-22_30-70-80-00010612.0003001 / 17 AUG 10

Applicable to: ALL

The flight crew can engage the mode manually as follows:

- Pull out the V/S or FPA knob (at least 5 s after lift-off) or push it in for an immediate level off (V/S=0)
- Engage the AP and/or FD if AP and FD are not engaged (basic mode of AP /FD engagement)
- Select a different altitude (more than 250 ft from present altitude) when in ALT* mode
- Select a higher altitude than present altitude when in DES , OP DES modes or EXP DES mode
- Select a lower altitude than present altitude when in CLB , OP CLB modes or EXP CLB mode.

AIRCRAFT SYSTEMS

AUTO FLIGHT - FLIGHT GUIDANCE

AP/FD VERTICAL MODES - VERTICAL SPEED
MODE - FLIGHT PATH ANGLE MODE (V/S - FPA)

The mode engages automatically:

- 5 s after lift-off, if no other vertical mode is engaged
- Upon loss of G/S * or G/S mode
- Upon loss of FINAL mode
- Upon loss of LOC * or LOC mode
- Upon loss of NAV mode when DES mode is engaged
- Upon loss of vertical flight path in DES mode.

DISENGAGEMENT CONDITIONS

Ident.: DSC-22_30-70-80-00010592.0002001 / 17 AUG 10

Applicable to: ALL

The flight crew can disengage the V/S mode manually by:

- Pulling or pushing the Altitude knob, or
- Pushing the EXPED pb , or
- Initiating a go-around.

It disengages automatically:

- When the aircraft reaches the FCU altitude, or
- Upon G/S* engagement.

GUIDANCE

Ident.: DSC-22_30-70-80-00010593.0009001 / 04 JUL 17

Applicable to: ALL

The FMGC pitch mode guides the aircraft to the target V/S or FPA . The corresponding A/THR mode is SPEED or MACH. The FMA displays V/S (FPA).

The V/S (FPA) guidance has priority over the speed guidance. If the selected target V/S or FPA is too high (relative to the current thrust condition and speed), the FMGC will steer the aircraft to the target V/S or FPA, but the aircraft will also accelerate or decelerate.

When the speed reaches its authorized limit, V/S or FPA automatically decreases to maintain the minimum (or maximum) speed limit.

Note: If the flight crew sets V/S = 0 or pushes the V/S or FPA knob to level off, it automatically sets V/S or FPA target to zero and the aircraft levels off and maintains its altitude.

Note: If AP is engaged while a V/S is selected with only FD ON, the V/S will synchronise on the current aircraft V/S.

GENERAL

Ident.: DSC-22_30-70-90-00010223.0001001 / 17 AUG 10

Applicable to: ALL

Expedite mode is an OPEN mode used in climb or descent to reach the desired altitude with the maximum vertical gradient.

ENGAGEMENT CONDITIONS

Ident.: DSC-22_30-70-90-00010594.0001001 / 17 AUG 10

Applicable to: ALL

The flight crew can engage EXPEDITE if:

- The aircraft has been in flight for more than 5 s
- Managed speed is available.

The flight crew engages EXPEDITE manually by pushing the EXPED pb on the FCU:

- If the FCU selected altitude is higher than present altitude, EXP CLB mode engages
- If the FCU selected altitude is lower than present altitude, EXP DES mode engages.

DISENGAGEMENT CONDITIONS

Ident.: DSC-22_30-70-90-00010595.0003001 / 17 AUG 10

Applicable to: ALL

The flight crew can disengage EXPEDITE manually by:

- Pulling out the V/S or FPA knob to engage the V/S or FPA mode
- Pulling out the ALT knob to engage OP CLB or OP DES
- Pulling out the SPD/MACH knob to activate the selected speed target and engage OP CLB or OP DES. A white box appears around the longitudinal mode and flashes for 10 s. A triple click sounds
- Pushing in the ALT knob to engage the CLB or DES mode, provided that the engagement conditions are met
- Selecting a higher altitude than present altitude when in EXP DES. If this action is not followed by another expected flight crew action within 5 s, a triple click sounds. A steady white box appears around the longitudinal mode, then flashes for 10 s after the triple click

AIRCRAFT SYSTEMS

AUTO FLIGHT - FLIGHT GUIDANCE

AP/FD VERTICAL MODES - EXPEDITE

- Selecting a lower altitude than present altitude when in EXP CLB. If this action is not followed by another expected flight crew action within 5 s, a triple click sounds. A steady white box appears around the longitudinal mode, then flashes for 10 s after the triple click
- Activating a reversion to V/S to protect the aircraft from exceeding VLS or VMAX. A white box appears around the longitudinal mode and flashes for 10 s. A triple click sounds.

Note: In FD mode only, if the flight crew does not follow the FD orders, a reversion to V/S occurs when reaching VMAX + 4 in EXP CLB or VLS - 2 in EXP DES (VLS - 17 with speedbrakes). Refer to DSC-22_30-75 General.

EXPEDITE disengages automatically with ALT* engagement.

GUIDANCE

Ident.: DSC-22_30-70-90-00010610.0002001 / 19 DEC 12

Applicable to: **ALL**

When the aircraft is in EXP CLB , the target speed is Green Dot, which is maintained with pitch control. Autothrust, if active, sets the thrust at CLB THRUST automatically.

When the aircraft is in EXP DES, the target speed is 340 kt or M 0.8 which is maintained with pitch control. Autothrust, if active, sets the thrust at IDLE automatically.

When EXPEDITE is engaged, the system disregards SPD CSTR , ALT CSTR , and SPD LIM.

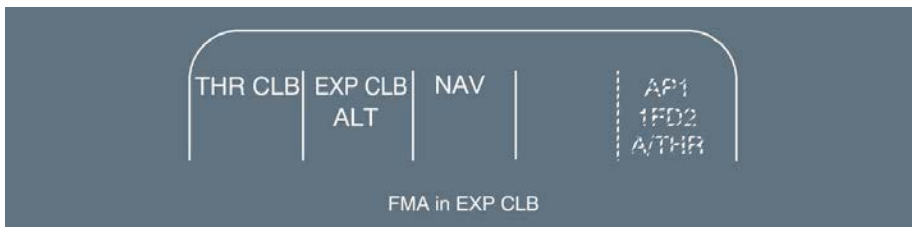

GENERAL

Ident.: DSC-22_30-75-00010633.0001001 / 17 MAR 17

Applicable to: ALL

Mode reversion are automatic mode changes that unexpectedly occur, but are designed to ensure coherent AP, FD and A/THR operations, in conjunction with flight crew input (or when entering a F-PLN discontinuity).

Due to the unexpected nature of their occurrence, the FMA should be closely monitored for mode reversion.

**INTERACTION BETWEEN LATERAL MODES,
VERTICAL MODES, AND MANAGED SPEED PROFILE**

Ident.: DSC-22_30-75-00012054.0006001 / 17 MAR 17

Applicable to: ALL

● **When NAV mode is engaged:**

The FMGS guides the aircraft along the flight plan and considers the constraints attached to the F-PLN waypoints. As a result:

- Managed CLB and DES modes are available
- The managed speed profile includes: V2 - SPD CSTR (if applicable) - SPD LIM - ECON CLB - SPD /MACH - ECON CRZ - MACH - ECON DES (MANAGED SPD) - SPD /MACH - SPD CSTR - SPD LIM - HOLD SPD - VAPP /GS MIN.

It is valid for all vertical modes, except EXPEDITE .

● **When NAV mode is not engaged:**

The FMGS considers that the flight plan is not followed, and ignores all speed and altitude constraints linked to the F-PLN waypoints. As a result:

- The managed vertical CLB and DES modes are not available
- The managed SPD profile disregards the speed constraints and includes: V2 - SPD LIM - ECON CLB - ECON CRZ - ECON DES (MANAGED SPD) - SPD LIM - VAPP /GS MIN target.

As a consequence, when NAV mode disengages (manual or automatic):

- CLB mode, when engaged, reverts to OPEN CLB. The lateral mode is boxed white for 10 s. The vertical mode is boxed white.

If within 5 s, the disengagement of the NAV mode is not confirmed by one of the following flight crew actions:

- FCU altitude change
- Level-off
- Selection of the V/S mode

then, a triple click aural warning sounds. In addition, a white box flashes around the vertical mode for additional 10 s.

- DES mode, when engaged, reverts to V/S mode on current value.

If within 5 s, the disengagement of the NAV mode is not confirmed by one of the following flight crew actions:

- FCU altitude change
- Level-off
- Selection of the V/S mode

then, a triple click aural warning sounds. In addition, a white box flashes around the vertical mode for additional 10 s.

This reversion to V/S (FPA) mode on the current V/S target does not modify the pitch behavior of the aircraft. It is the flight crew's responsibility to adapt pitch, if necessary.

- Speed and altitude constraints are disregarded (but speed limit is retained).

MODE REVERSION DUE TO FCU ALTITUDE CHANGE

Ident.: DSC-22_30-75-00012053.0006001 / 01 OCT 12

Applicable to: **ALL**

When an OPEN mode is engaged, the aircraft climbs or descends towards the altitude set on the FCU . If the flight crew sets the FCU altitude to a target not compatible with the active open mode, a mode reversion occurs and V/S (or FPA) engages on current V/S (or FPA).

This reversion applies to CLB , OP CLB , DES , OP DES, EXP DES  , EXP CLB  .

Example: Reversion from OP CLB to V/S:

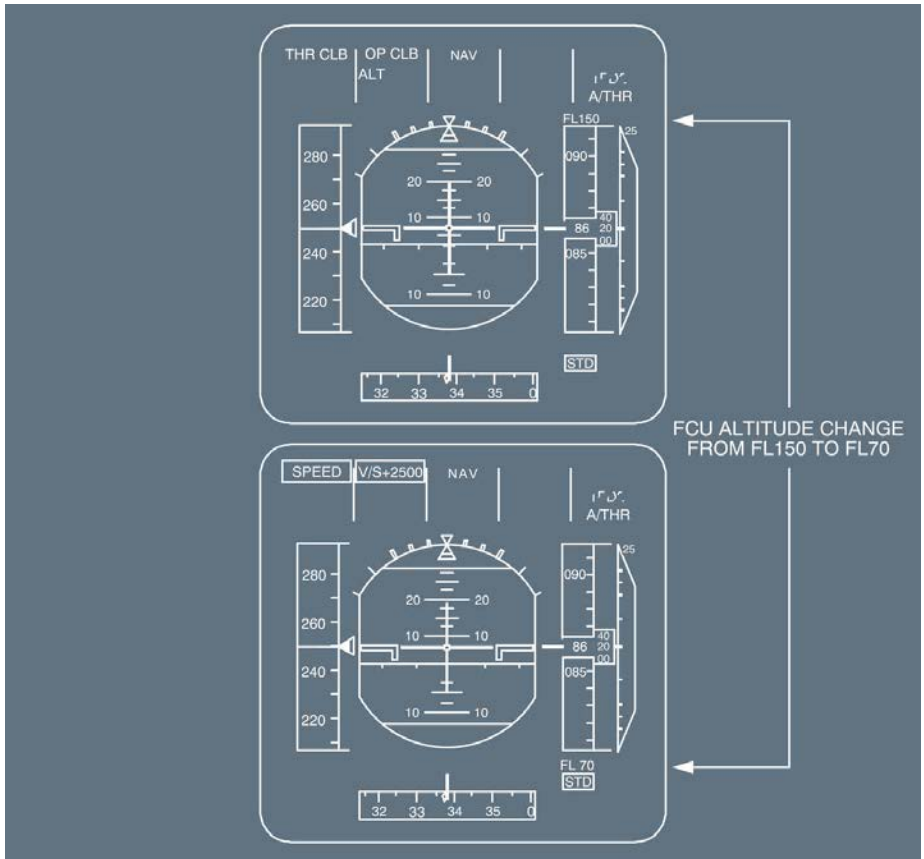

With ALT * engaged, the target altitude is changed by any value greater than 250 ft, V/S (or FPA) engages on currents V/S (or FPA). Refer to DSC-22_30-75 Mode Reversions (Summary).

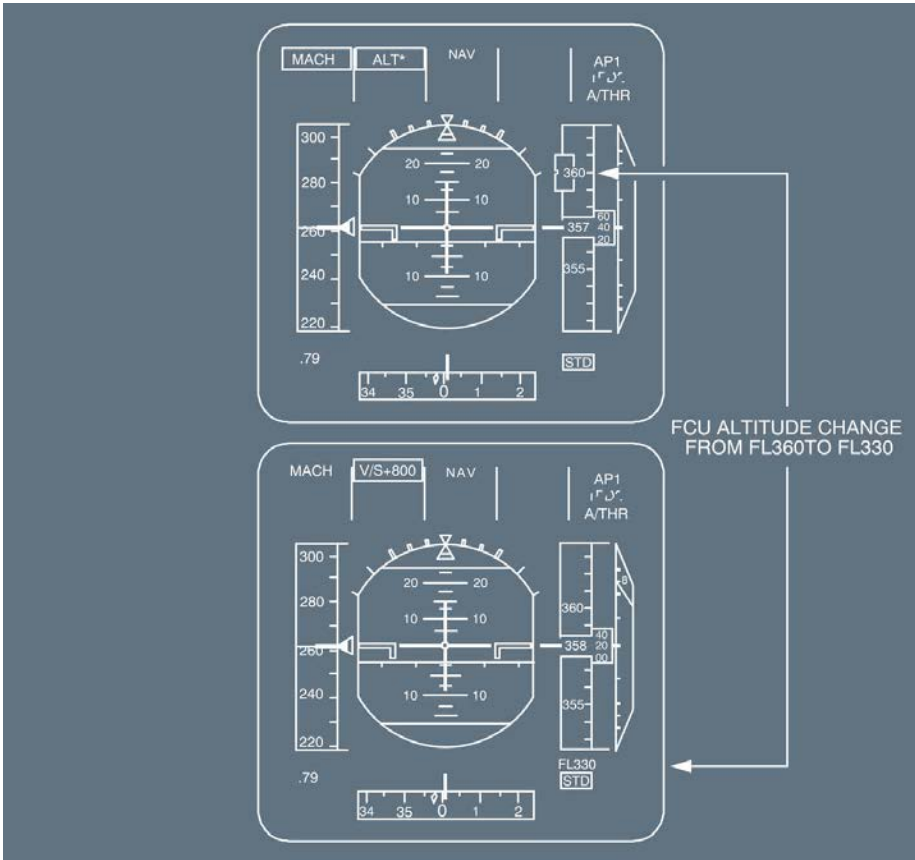

If within 5 s after the reversion to V/S (FPA), the flight crew does not confirm the altitude target change by:

- Pulling the ALT knob, or
- Setting a new V/S (or FPA) target, or
- Pushing the V/S or FPA knob on the FCU,

then, a triple click sounds, and the V/S (FPA) is boxed white for additional 10 s.

REVERSION WITH GLOBAL SPEED PROTECTION

Applicable to: ALL

Ident.: DSC-22_30-75-A-00012055.0010001 / 19 DEC 12

AUTOMATIC SPEED MODE PROTECTION IN CLIMB

FD s are engaged in an OPEN mode in climb with AP not engaged.

If FD s are engaged in CLIMB or OPEN CLIMB mode or EXP CLB and the flight crew does not follow the FD bars to maintain the commanded climb (pitch too low and autothrust in maximum climb thrust), the aircraft accelerates.

Both FD s disengage when VMAX +4 is reached (VMAX being VMO , VLE or VFE). If the A/THR is active, it reverts to SPEED mode and reduces the thrust to recover the speed target.

A triple click aural warning sounds.

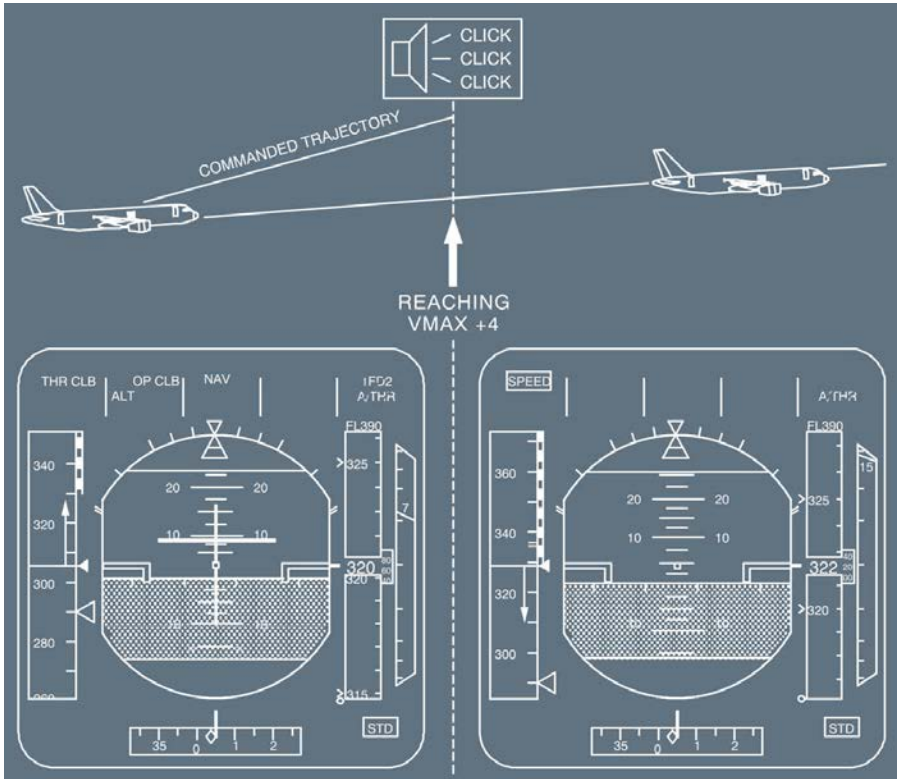

Ident.: DSC-22_30-75-A-00012056.0010001 / 01 OCT 12

AUTOMATIC SPEED PROTECTION IN V/S (OR FPA) MODE IN CLIMB

When climbing with V/S mode engaged: If the selected V/S value is excessive (with regards to thrust and speed), the FMGS maintains the V/S target, but the airspeed decreases. When reaching VLS (or VLS -5, if the speed target is VLS), the AP temporarily abandons the V/S target, and automatically decreases the vertical speed to maintain VLS . The same applies if FPA mode is used with an excessive FPA target.

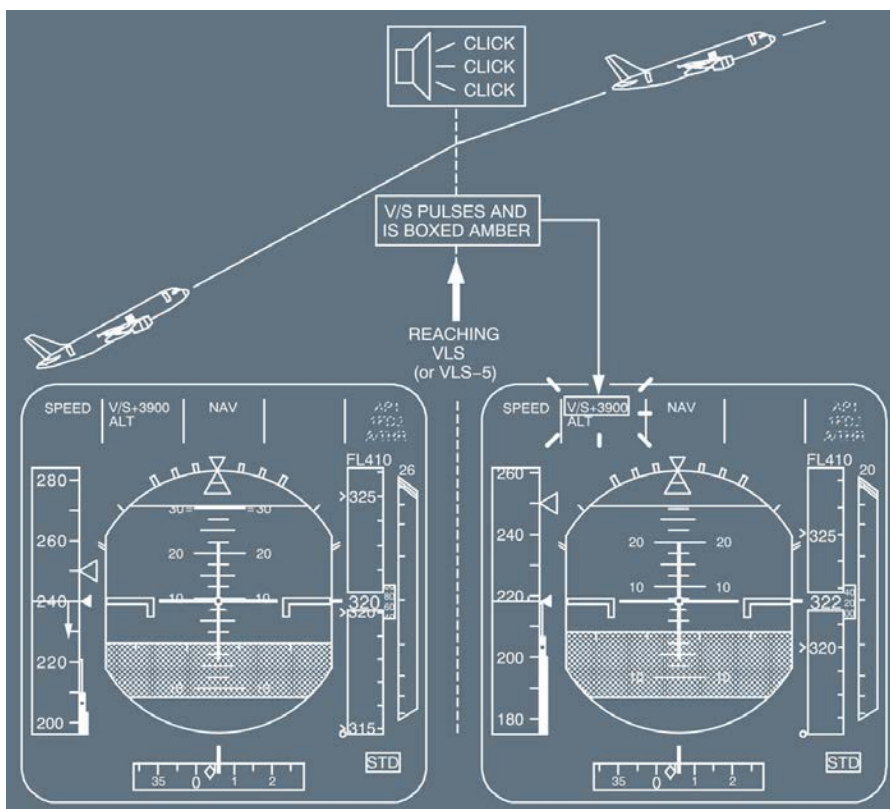

V/S mode remains engaged.

On the FMA , the V/S target is boxed with a flashing amber rectangle, and the V/S value pulses. Besides, an aural triple click is generated.

Note: When flying with FD bars only (AP OFF), the FMGS adjusts the pitch bar so that VLS is maintained. However, no triple click is generated and the V/S target display on the FMA remains unchanged.

Ident.: DSC-22_30-75-A-00012057.0010001 / 01 OCT 12

AUTOMATIC SPEED MODE PROTECTION IN DESCENT

FD s are engaged in an OPEN mode in descent with the AP not engaged.

If the FD s are engaged in DES , or OP DES mode, or EXP DES  and, if the flight crew does not follow the FD bars to maintain the commanded pitch, the aircraft decelerates (insufficient descent rate and idle thrust).

If the airspeed reaches VLS -2, both FD s disengage. (If speedbrakes are extended, the FD s disengage between VLS -2 and VLS-19, depending on the position of the speedbrakes).

The A/THR , if active, reverts to SPEED mode upon FDs disengagement, and increases thrust to recover the speed target.

A triple-click aural warning sounds.

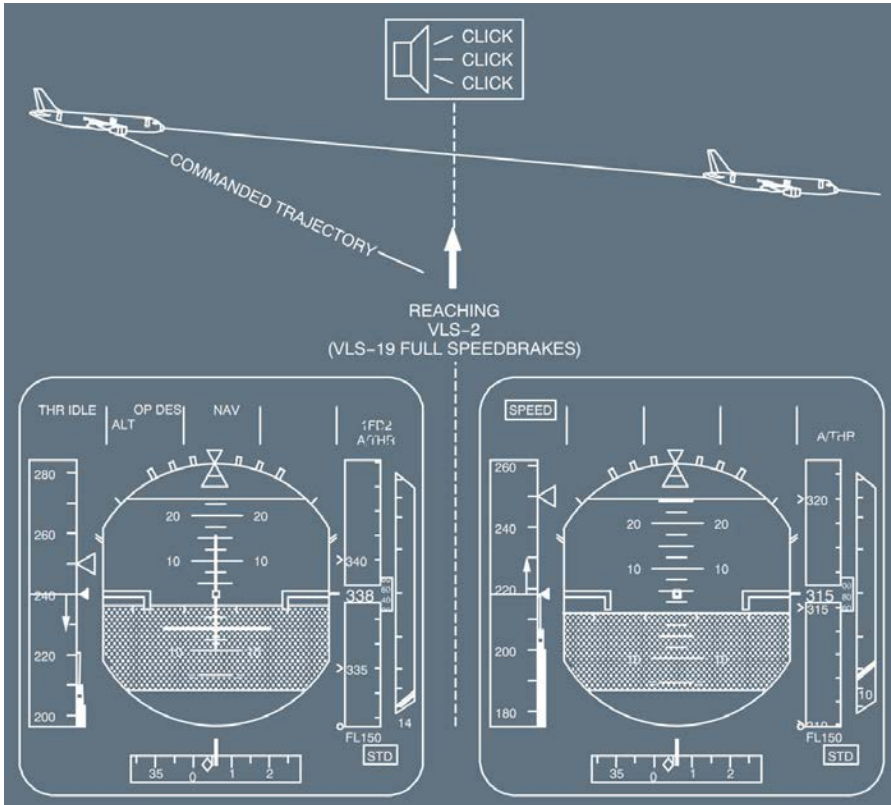

Ident.: DSC-22_30-75-A-00012058.0010001 / 01 OCT 12

AUTOMATIC SPEED PROTECTION IN VS (OR FPA) MODE IN DESCENT

When descending with V/S mode engaged: If the selected V/S value is excessive (with regards to thrust and speed), the FMGS maintains the V/S target, but the airspeed increases. When reaching VMAX (VMO or VLE in clean, or VFE +4 kt), the AP temporarily abandons the V/S target, and automatically decreases the vertical speed to maintain VMAX.

The same applies if FPA mode is used with an excessive FPA target.

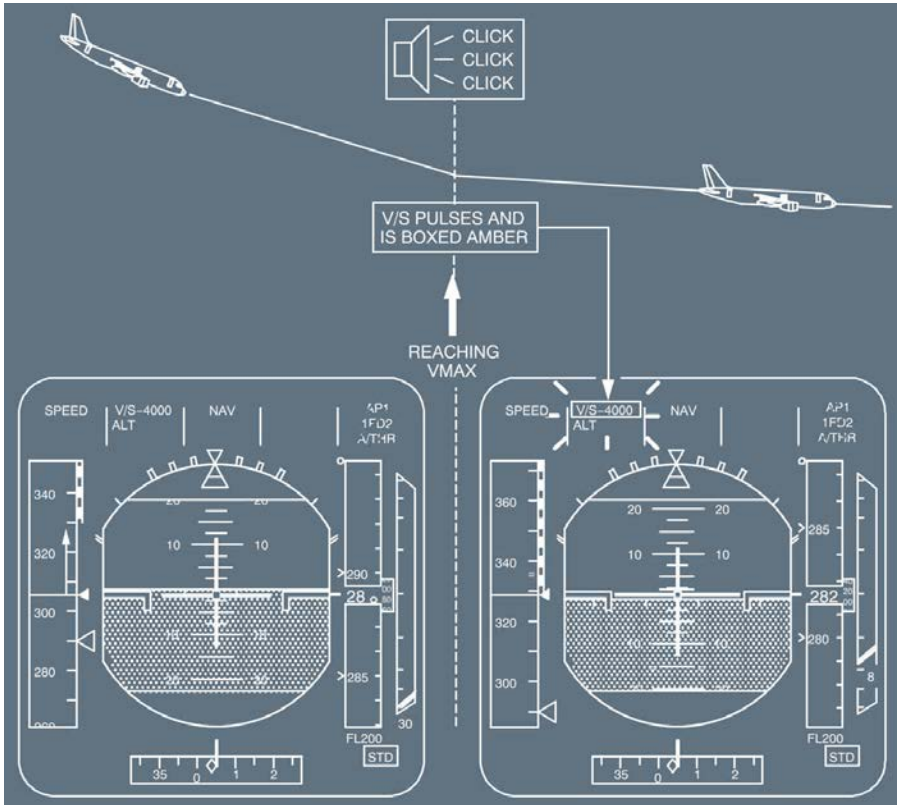

V/S mode remains engaged.

On the FMA , the V/S target is boxed with a flashing amber rectangle, and the V/S values pulses. Besides, an aural triple click is generated.

Note: When flying with FD bars only (AP OFF), the FMGS adjusts the pitch bar so that VMAX is maintained. However, no triple click is generated and the V/S target display on the FMA remains unchanged.



MODE REVERSIONS (SUMMARY)

Ident.: DSC-22_30-75-00012052.0005001 / 23 JUN 15

Applicable to: ALL

There are only 2 types of vertical mode reversions on aircraft equipped with global speed protection.



REVERSION DUE TO A CHANGE OF THE FCU SELECTED ALTITUDE

| Vertical Mode Engaged | FCU Altitude Selection Change | Vertical Mode Switches to |
|---|-------------------------------|---------------------------|
| CLB - OP CLB EXP CLB  | Below aircraft altitude | V/S on current V/S |
| DES - OP DES EXP DES  | Above aircraft altitude | |
| ALT* ACTIVE | Any change | |

REVERSION DUE TO THE LOSS OF NAV MODE (MANUAL OR AUTOMATIC)

| CONDITIONS | EVENT | CONSEQUENCE |
|-------------|------------------|----------------|
| CLB engaged | Loss of NAV mode | OP CLB engages |
| DES engaged | | V/S engages |

SPEED PROTECTION WHEN FD ORDERS ARE NOT FOLLOWED BY THE FLIGHT CREW (AP NOT ENGAGED)

| CONDITIONS | EVENT | CONSEQUENCE |
|---|--|--|
| <ul style="list-style-type: none"> - FD engaged only (no AP), and - OP DES or EXP DES  or DES engaged - A/THR active (IDLE thrust) | IAS = VLS-2 (if speedbrakes are extended between VLS -2 and VLS-19) | FD bars disappear. If A/THR active, automatic engagement of SPEED mode on the A/THR. Thrust increases to recover the speed target. |
| <ul style="list-style-type: none"> - FD engaged only (no AP), and - OP CLB or EXP CLB  or CLB engaged - A/THR active (CLIMB thrust) | IAS = VMAX+4 VMAX = VFE or VLE or VMO /MMO | FD bars disappear. If A/THR active, automatic engagement of SPEED mode on the A/THR. Thrust decreases to recover the speed target. |

SPEED PROTECTION DUE TO EXCESSIVE V/S

| CONDITIONS | EVENT | CONSEQUENCE |
|--|--|---|
| Excessive V/S or FPA selected in climb | IAS = VLS (or VLS -5, if target = VLS) | The selected V/S (or FPA) target is temporarily abandoned to maintain VLS in climb or VMAX in descent. |
| <ul style="list-style-type: none"> - Excessive V/S or FPA selected in descent, and - Clean configuration | IAS = VMAX | |
| <ul style="list-style-type: none"> - Excessive V/S or FPA < 0 selected in descent, and - Configuration other than clean | IAS = VMAX | |

ENHANCED MODE REVERSION ALERTNESS

The following sequences, or mode reversions, are highlighted by a triple click:

- V/S selection in ALT*
- SPD selection in SRS
- CLB (or EXP CLB ) to OP CLB, upon lateral flight crew action while climbing toward a constraint
- ALT * to V/S , upon ALT target change
- FD disengagement in OPEN modes
- Alerting FMA display when V/S -(FPA) target is not held
- CLB to OP CLB reversion, upon profile loss
- Automatic FD re-engagement in basic mode
- DES to V/S upon flight plan loss
- FINAL DES to V/S , upon NAV loss
- Reversion to V/S when selected ALT crosses the current altitude
- NAV to HDG , upon NAV loss.



A318/A319/A320/A321
FLIGHT CREW
OPERATING MANUAL

AIRCRAFT SYSTEMS
AUTO FLIGHT - FLIGHT GUIDANCE

MODE REVERSIONS

Intentionally left blank

GENERAL

Ident.: DSC-22_30-80-10-00011875.0001001 / 17 AUG 10

Applicable to: ALL

These modes are called “common” because they are related to both the lateral and the vertical axes.

The AP /FD common modes are:

- On takeoff: Runway/Runway track associated to SRS vertical modes
- In approach: ILS approach (LAND) or non-ILS approach (APP NAV FINAL)
- In go around: Go around track associated to SRS vertical modes.

These modes are engaged simultaneously on both axes.

| COMMON MODES | | VERTICAL | LATERAL |
|-------------------|---------------------|-------------|----------------|
| TAKEOFF | | SRS | RWY RWY TRK |
| APPROACH MODES | ILS APPROACH | G/S* G/S | LOC* LOC |
| | NON-ILS APPROACH | FINAL | APP NAV |
| GO AROUND (GA) | | SRS | GA TRK |



A318/A319/A320/A321
FLIGHT CREW
OPERATING MANUAL

AIRCRAFT SYSTEMS

AUTO FLIGHT - FLIGHT GUIDANCE

AP/FD COMMON MODES - GENERAL

Intentionally left blank



A318/A319/A320/A321
FLIGHT CREW
OPERATING MANUAL

AIRCRAFT SYSTEMS

AUTO FLIGHT - FLIGHT GUIDANCE

AP/FD COMMON MODES - TAKEOFF

GENERAL

Ident.: DSC-22_30-80-20-00012253.0001001 / 17 AUG 10

Applicable to: ALL

Takeoff mode combines the SRS (Speed Reference System) vertical mode with the RWY lateral mode. Both are simultaneously engaged, but may be disengaged separately.

Takeoff mode is available:

- During the takeoff run and initial climb for FD bars guidance
- 5 s after lift-off for AP use.

SRS (SPEED REFERENCE SYSTEM)

Applicable to: ALL

Ident.: DSC-22_30-80-20-A-00012260.0001001 / 17 AUG 10

GENERAL

The SRS mode controls pitch to steer the aircraft along a path in the vertical plan at a speed defined by the SRS guidance law.

Ident.: DSC-22_30-80-20-A-00012256.0001001 / 23 JUN 15

ENGAGEMENT CONDITIONS

The SRS mode engages automatically when the thrust levers are set to the TOGA or FLX/MCT detent, providing:

- V2 has been inserted in the MCDU PERF TAKEOFF page
- The slats are extended
- The aircraft has been on ground for at least 30 s.

Ident.: DSC-22_30-80-20-A-00012258.0002001 / 23 JUN 15

DISENGAGEMENT CONDITIONS

The SRS mode disengages:

- Automatically, at the acceleration altitude (ACC ALT), or if ALT* or ALT CST* mode engages (above 400 ft RA)
- If the flight crew engages another vertical mode
- If the flight crew selects a speed while in SRS mode: SRS reverts to OP CLB mode, and a triple-click aural warning is heard.

Note: In Engine Out conditions, the SRS mode does not automatically disengage at EO ACC ALT. Refer to DSC-22_20-60-40 General.

Ident.: DSC-22_30-80-20-A-00012259.0011001 / 16 MAR 11

GUIDANCE

In SRS mode, the aircraft maintains a speed target equal to V2 +10 kt in normal engine configuration. When the FMGS detects an engine failure, the speed target becomes the highest of V2 or current speed, limited by V2+ 15 kt.

The SRS guidance law also includes:

- Attitude protection to reduce aircraft nose-up effect during takeoff (18 ° or 22.5 ° maximum in case of windshear)
- Flight path angle protection that ensures a minimum vertical speed of 120 ft/min
- A speed protection limiting the target speed to V2+15 kt.

Note: If during takeoff the flight crew inadvertently sets an altitude on the FCU below the current altitude, the aircraft will remain in SRS mode until the flight crew takes some other action.

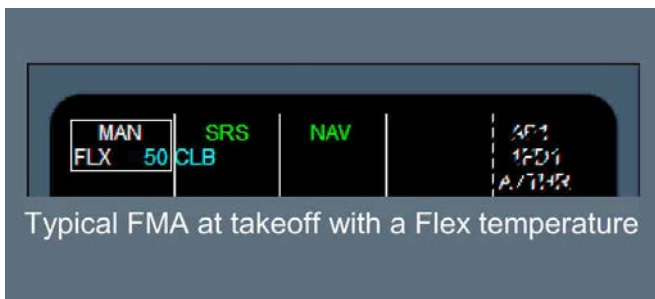

RUNWAY (RWY)

Applicable to: **ALL**

Ident.: DSC-22_30-80-20-B-00012255.0001001 / 17 AUG 10

GENERAL

The RUNWAY mode has two submodes:

- RWY mode, which gives lateral guidance orders during takeoff roll and initial climb out (up to 30 ft RA) if a LOC signal is available
- RWY TRK mode, which gives lateral guidance on the track the aircraft was flying at mode engagement (at 30 ft RA).

Ident.: DSC-22_30-80-20-B-00012323.0001001 / 17 AUG 10

ENGAGEMENT CONDITIONS

The RWY engagement conditions are:

- The conditions required for SRS mode engagement:
 - V2 is inserted in the MCDU PERF TAKEOFF page
 - Slats are extended
 - The aircraft has been on ground for at least 30 s.
- The aircraft is receiving a LOC signal and LOC deviation is less than 1/2 dot
- The aircraft heading is within 20 ° of the ILS related course
- The ILS course is identical to the runway heading of the origin airport as selected for the active flight plan, if any.

The RWY TRK mode engages automatically at 30 ft (RA) if NAV mode does not engage (NAV not armed prior to takeoff).

Ident.: DSC-22_30-80-20-B-00012324.0001001 / 17 AUG 10

DISENGAGEMENT CONDITIONS

RWY mode disengages if:

- The LOC signal is lost below 30 ft RA or the aircraft heading and the runway heading differ by more than 20 °.
- Another lateral mode is engaged.

Note: If the takeoff runway has no ILS , RWY mode is not available and the PFD does not display the yaw bar nor "RWY " on FMA.

Ident.: DSC-22_30-80-20-B-00012325.0002001 / 16 MAR 11

GUIDANCE

The RWY mode uses the LOC signal to guide the aircraft on the runway centerline while the aircraft is on the ground. The PFD displays the FD yaw bar and the FMA displays "RWY". The RWY TRK mode guides the aircraft on the track the aircraft was flying at mode engagement. The FD displays the conventional guidance bar and the FMA displays "RWY TRK".



Typical FMA with RWY mode engaged.



General

GENERAL

Ident.: DSC-22_30-80-30-05-00012378.0008001 / 01 OCT 12

Applicable to: ALL

The aircraft can fly different types of approaches:

- Precision approaches: ILS, MLS 
- Non-precision approaches: VOR /DME , VOR , NDB (if ADF ), RNAV
- Non-precision approaches using a Localizer only: LOC.

The flight crew uses an ARRIVAL lateral revision to insert these approaches into the flight plan:

- For precision approaches, the flight crew uses the APPR pb on the FCU to arm or engage the LOC and G/S guidance modes
- For non-precision approaches, the flight crew uses the APPR pb on the FCU to arm or engage the APP NAV and FINAL guidance modes, except for LOC approaches, where the flight crew only uses the LOC pb to arm or engage the LOC mode.

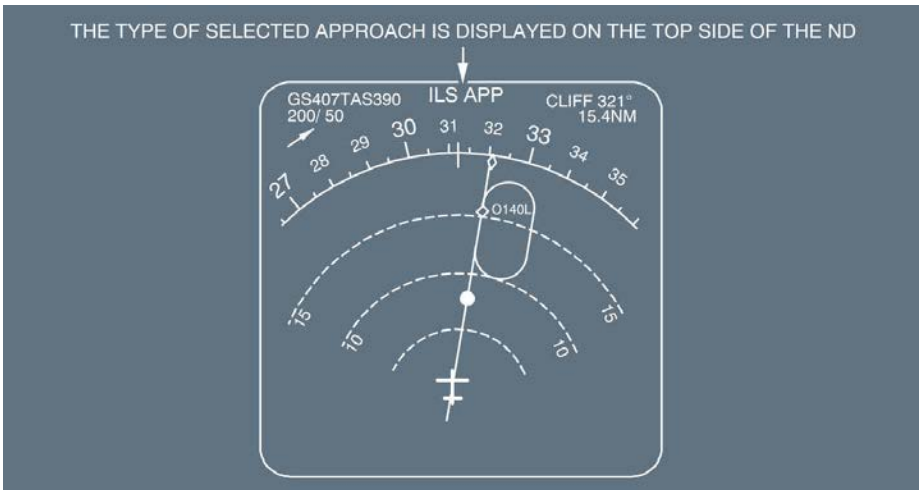



A318/A319/A320/A321
FLIGHT CREW
OPERATING MANUAL

AIRCRAFT SYSTEMS

AUTO FLIGHT - FLIGHT GUIDANCE

AP/FD COMMON MODES - APPROACH

Intentionally left blank

Precision Approach

PRECISION APPROACH MODES

Applicable to: ALL

Ident.: DSC-22_30-80-30-10-A-00012379.0003001 / 01 OCT 12

GENERAL

The ILS approach mode includes the following modes:

| VERTICAL MODE | LATERAL MODE |
|--|----------------|
| G/S* (capture) | LOC* (capture) |
| G/S (track) | LOC (track) |
| COMMON MODES: LAND - FLARE - ROLL OUT | |

The sequencing of these modes is automatic once the flight crew has pushed the APPR pb and the conditions for engagement are met.

SELECTION

The ILS approach is selected when the APPR pb of the FCU is pressed and:

- An ILS approach or a runway only or no approach is inserted in the Flight Management flight plan (ARRIVAL page), and an ILS frequency is set in on the MCDU, or
- Both radio management panels are set to NAV and each one has the ILS frequency and course set in.

CHECK APPROACH SELECTION MESSAGE

If the flight crew inserts a non-ILS approach into the flight plan, and then uses the RAD NAV page to tune an ILS manually, the MCDU displays “CHECK APPR SELECTION”. This message is a reminder that the available APPR guidance modes are APP NAV and FINAL.

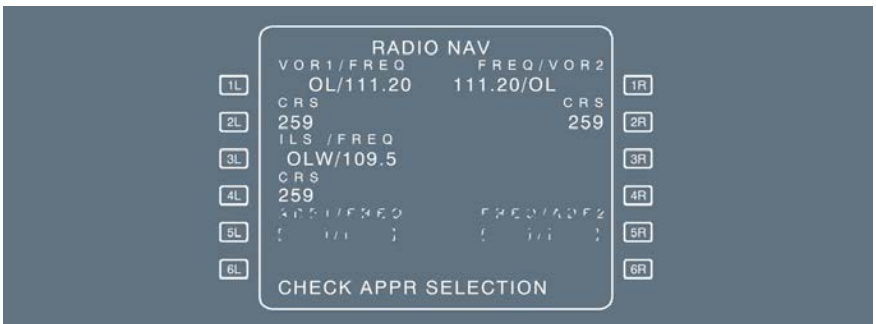

APPR MODE

ARMING CONDITIONS OF LOC AND G/S MODES

The flight crew arms the ILS APPR mode (LOC and G/S in blue on the FMA) by pushing the APPR pb on the FCU, provided that:

- An ILS approach is selected
- The aircraft is above 400 ft RA
- The ILS and RA are available
- Go-around or takeoff or final mode is not engaged
- ILS frequency and course are identically set on both receivers.

LOC and G/S blue are displayed on the FMA. Both modes will automatically engage when conditions are met.

Second autopilot may be engaged.

Current landing capability is displayed on the FMA.

DISARMING CONDITIONS OF LOC AND G/S MODES

ILS APPR mode is disarmed, if the aircraft is above 400 ft and:

- When the flight crew presses the APPR pb, both the LOC and the G/S modes disarm.
 The HDG /TRK mode engages if the LOC mode was engaged, and the V/S (FPA) mode engages if the G/S mode was engaged
- When the flight crew presses the LOC pb, only the G/S mode disarms.
 The V/S (FPA) mode engages, if the G/S mode was engaged
- When the flight crew pulls the HDG/TRK knob
- When the flight crew engages the go-around mode.

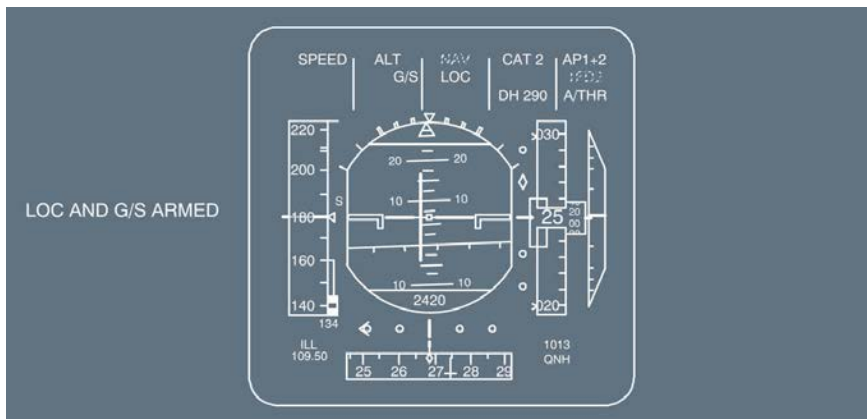

ENGAGEMENT CONDITIONS OF LOC AND G/S MODES

When ILS capture conditions are fulfilled:

- LOC* mode engages, and
- G/S * mode engages. No radio altimeter validity is required with this FMGC standard for G/S engagement. The FMA displays “LOC*”, or “G/S*”, or both, in green.

Nevertheless, the G/S* mode cannot engage, if:

- LOC* mode is not engaged, or
- The aircraft is above the glide path and its trajectory does not cross the ILS G/S beam.

When the aircraft is established on the LOC axis, the LOC mode engages.

When the aircraft is established on the G/S axis, the G/S mode engages.

The FMA displays “LOC” and “G/S” in green. The AP /FD guides the aircraft along the G/S down to 30 ft, and along the LOC during the flare and rollout.

*Note: G/S * or G/S modes may be engaged above the operating range of the radio altimeters (8 000 ft for TRT, and 5 000 ft for Collins and Honeywell radio altimeters). The landing capability displayed on the FMA will reflect the lack of RA validity (CAT 1) until the radio altimeters become active.*

But, if the radio altimeters fail, or if the FMGS receives no radio altimeter data, LOC, G/S, and AP /FD s will disengage and FDs will re-engage on basic modes.

DISENGAGEMENT CONDITIONS OF LOC AND G/S MODES

If the aircraft is above 400 ft, the ILS APPR mode disengages when the flight crew:

- Presses the APPR pb, HDG V/S or TRK FPA engages
- Presses the LOC pb, the LOC mode remains engaged. The system reverts to V/S (FPA), if G/S was engaged
- Pulls out the HDG/TRK knob, HDG V/S or TRK FPA engages
- Engages the go-around mode
- When the LOC or G/S signal has been lost for 7 s or more above 200 ft RA. AP /FD s disengage and FD s reengage in basic modes (HDG V/S or TRK FPA).

DISENGAGEMENT CONDITIONS OF G/S ONLY

- The flight crew pulls out the V/S or FPA knob. LOC mode remains engaged, but G/S mode disengages and V/S or FPA engages.
- The flight crew pushes or pulls the ALT knob. LOC mode remains engaged, and the mode selected by the flight crew engages, as a function of the FCU selected altitude.

LOC CONVERGENCE FUNCTION

The aim of the LOC Convergence function is to help the aircraft intercept and capture the LOC axis.

The aircraft is guided with a converging track of 20° from the LOC axis, when all the following conditions are met:

- NAV mode is engaged, and LOC mode is armed
- The aircraft is within 20 NM of the destination runway
- The difference between the aircraft track and the QFU is less than 20° .

ENHANCED LOC CAPTURE FUNCTION

The Enhanced LOC Capture function enhances the performance of the LOC capture and helps the aircraft to capture the LOC beam without overshoot.

Pre-Capture of the LOC Beam

The pre-capture of the LOC beam aims to begin the LOC beam capture sooner.

LOC * mode may engage when LOC mode is armed and when the aircraft reaches the LOC pre-capture zone. The LOC pre-capture zone is a geographical zone around LOC beam where it is possible to guide the aircraft toward the LOC beam, with the help of FMS position data. To ensure the capture of the LOC beam, the aircraft is guided with a 15° convergence angle with respect to runway QFU.

The LOC* mode engagement in the pre-capture zone is possible, when :

- The LOC deviation is more than 2.3 dots
- The FMS is in GPS PRIMARY
- The difference between the track and the QFU is between 25° and 115°
- The guidance roll order is such that LOC * will capture the LOC beam without overshoot.

When the LOC deviation becomes lower than 2.3 dots, LOC * mode no longer uses the FMS position data for guidance, but the actual LOC beam deviation to complete the capture of the axis.

Capture of the LOC Beam

Current conditions of LOC beam capture in the capture zone remain the same. This means that if approach conditions of the aircraft (interception angle, speed) do not need activation of the capture assistance, the LOC beam capture will occur as usual based on LOC deviation, aircraft track and guidance roll order conditions.

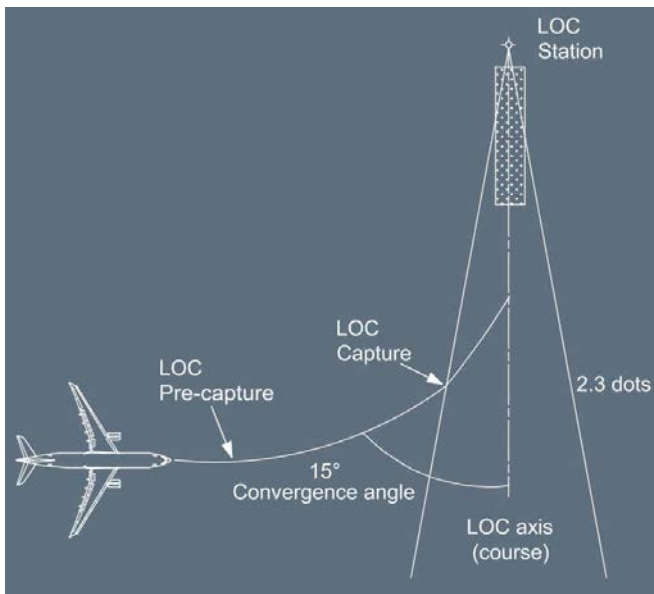

Note: On the PFD and on the ND, the flight crew will observe movement of the LOC deviation toward the center of the scale, only when the LOC deviation is less than 2 dots. This occurs when the aircraft is in the capture zone.

When the ILS frequency or the ILS ident entered on the RAD NAV page differs from the ILS of the destination runway entered in the Flight Plan :

- The aircraft loses the LOC capture assistance function
- The "RWY/LS MISMATCH" message is displayed on the scratchpad
- The flight crew should select HDG mode to perform the LOC capture.

Note: There is no glideslope capture assistance. The flight crew shall ensure that the aircraft flight path intercepts the G/S beam.

Ident.: DSC-22_30-80-30-10-A-00012381.0002001 / 17 AUG 10

LAND MODE

ENGAGEMENT CONDITIONS

LAND mode automatically engages when the LOC and G/S modes are engaged, and the aircraft is below 400 ft RA . The FMA displays "LAND", indicating that LOC and G/S are locked. No action on the FCU will disengage LAND mode. FLARE and ROLL OUT modes will successively engage.

DISENGAGEMENT CONDITIONS

LAND mode disengages:

- Upon engagement of the go-around mode
- If the flight crew presses the APPR pb, when the aircraft has been on ground for at least 10 s with the autopilot disconnected
- When both AP /FDs are disengaged.

Note: When LAND is not displayed on the FMA , at/or slightly below 400 ft, the landing capability degrades to CAT 1 and the triple click is generated. No autoland is authorized with CAT 1 displayed on the FMA.

Ident.: DSC-22_30-80-30-10-A-00012382.0001001 / 17 AUG 10

FLARE MODE

Once the aircraft reaches approximately 40 ft RA (the precise value is a function of V/S):

- The FLARE mode engages
- The FMA displays “FLARE” in green.

At 30 ft RA , the AP /FD aligns the yaw axis with the runway centerline and the aircraft flares on the pitch axis. If the autothrust is active, thrust is automatically reduced to IDLE (*Refer to DSC-22_30-90 A/THR Modes - RETARD Mode*).

When both AP /FDs are disengaged, FLARE mode disengages.

After main landing gear touchdown, the autopilot (if engaged) sends a nose down order.

ALIGN SUB-MODE

ALIGN is a sub-mode of LAND mode that lines up the aircraft’s axis with the ILS course. It is not displayed to the flight crew.

Ident.: DSC-22_30-80-30-10-A-00012383.0001001 / 17 AUG 10

ROLL OUT MODE

At touchdown, the ROLL OUT mode engages and guides the aircraft along the runway centerline. The FMA displays “ROLL OUT” in green, and the PFD displays the yaw bar and no FD bars.

SPEED CONTROL

Ident.: DSC-22_30-80-30-10-00012384.0001001 / 17 AUG 10

Applicable to: ALL

The autothrust, when active, controls speed. The approach speed target (VAPP) is either managed by the FMGS or selected by the flight crew:

- When managed, the speed target is computed by the FMGS and may be modified by the flight crew through the MCDU . At 700 ft RA , the current speed target value is memorized by the autothrust, to ensure stabilized speed guidance, even if Flight Management fails. Below 700 ft, any new VAPP or WIND entry in the MCDU has no effect on the speed target.
- When selected, the autothrust always targets the speed selected on the FCU.

TYPICAL ILS APPROACH

Ident.: DSC-22_30-80-30-10-00012385.0001001 / 16 MAR 11

Applicable to: ALL

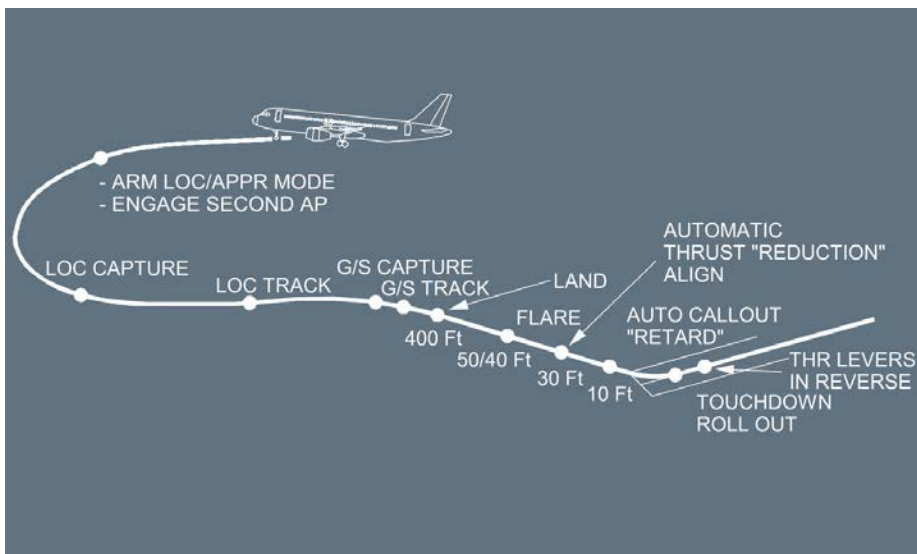



A318/A319/A320/A321
FLIGHT CREW
OPERATING MANUAL

AIRCRAFT SYSTEMS

AUTO FLIGHT - FLIGHT GUIDANCE

AP/FD COMMON MODES - APPROACH

AUTOLAND WARNING LIGHT

Ident.: DSC-22_30-80-30-10-00012386.0001001 / 03 JUN 14

Applicable to: ALL

The following situations, when occurring below 200 ft RA with the aircraft in LAND mode, trigger the flashing Autoland red warning:

- Both AP s OFF below 200 ft RA.
- Excessive deviation in LOC (1/4 dot above 15 ft RA) or GLIDE (1 dot above 100 ft RA). In addition, LOC and GLIDE scales flash on the PFD.
- Loss of LOC signal above 15 ft, or loss of GLIDE signal above 100 ft. The FD bars flash on the PFD. The LAND mode remains engaged.
- The difference between both radio altimeter indications is greater than 15 ft.

LANDING CAPABILITIES

Ident.: DSC-22_30-80-30-10-00012387.0001001 / 17 AUG 10

Applicable to: ALL

Each FMGC computes its own automatic landing capability.

The FMA displays “CAT 1”, “CAT 2”, “CAT 3 SINGLE” or “CAT 3 DUAL” messages as soon as the APPR pb is pushed in to arm ILS approach modes.

Refer to PRO-NOR-SRP-01-70 Initial Approach.

Non Precision Approach

GENERAL

Ident.: DSC-22_30-80-30-20-00012388.0090001 / 01 OCT 12

Applicable to: ALL

This mode guides the aircraft laterally and vertically down to the minimum along the final descent profile computed by the FMGS.

This mode is used to fly a non-ILS approach (VOR , VOR /DME , NDB (if ADF ), RNAV...) as inserted into the flight plan.

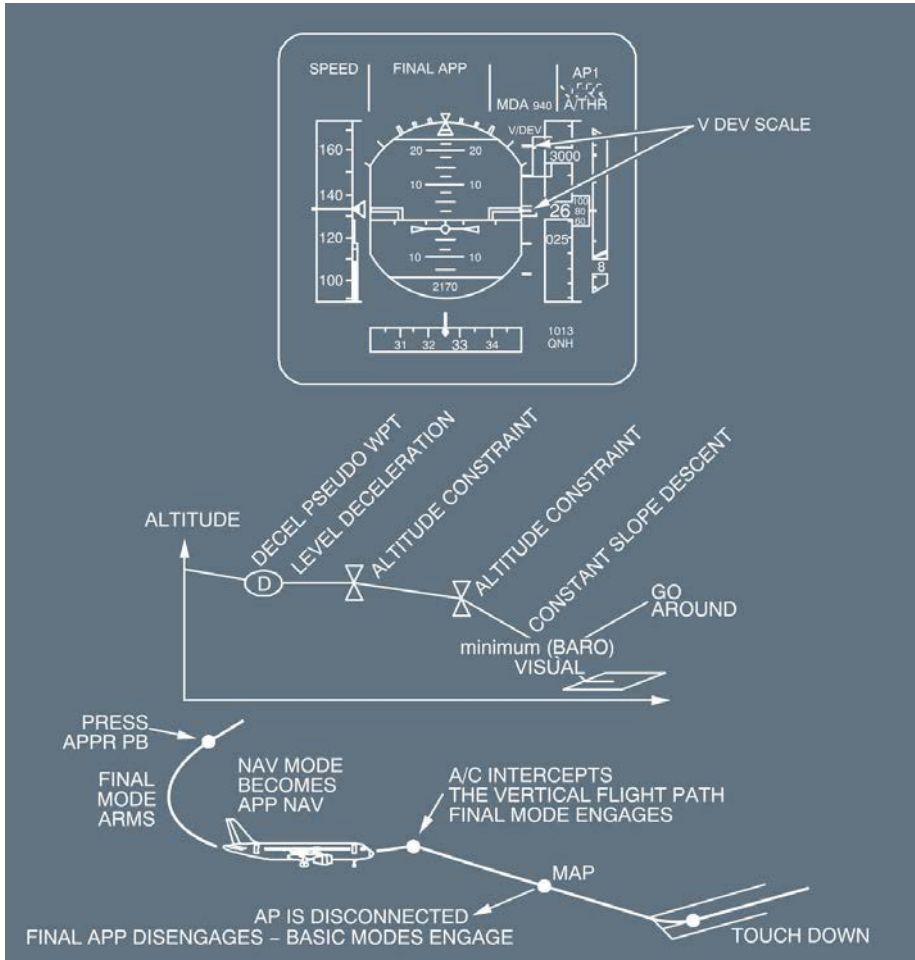

The non-ILS approach includes the following managed modes:

- APP NAV mode for lateral guidance
- FINAL mode for vertical guidance.



A318/A319/A320/A321
FLIGHT CREW
OPERATING MANUAL

AIRCRAFT SYSTEMS

AUTO FLIGHT - FLIGHT GUIDANCE

AP/FD COMMON MODES - APPROACH

SELECTION

Ident.: DSC-22_30-80-30-20-00012389.0001001 / 17 AUG 10

Applicable to: ALL

A non-ILS approach (VOR , VOR /DME , NDB (if ADF ), RNAV) is selected if the active flight plan calls for it (and it has been inserted in that flight plan).

ARMING CONDITIONS

Ident.: DSC-22_30-80-30-20-00012390.0001001 / 17 AUG 10

Applicable to: ALL

The flight crew arms the APP NAV and FINAL modes by pressing the APPR pb on the FCU, if all of the following conditions are met:

- The aircraft is above 400 ft AGL
- The flight plan is valid (lateral and vertical profile)
- The active flight plan has selected a non-ILS approach
- GA mode is not engaged.

The FMA displays “FINAL” and “APP NAV” in blue.

If NAV mode was already engaged, APP NAV engages immediately.

DISARMING CONDITIONS

Ident.: DSC-22_30-80-30-20-00012391.0001001 / 17 AUG 10

Applicable to: ALL

FINAL and APP NAV modes are disarmed if the flight crew:

- Presses the APPR pb, or
- Presses the LOC pb arming the LOC mode, or
- Engages the GO AROUND mode.

ENGAGEMENT CONDITIONS

Ident.: DSC-22_30-80-30-20-00012392.0003001 / 08 AUG 17

Applicable to: ALL

APP NAV and NAV modes engage under the same conditions:

If NAV mode was engaged, APP NAV engages immediately. If HDG /TRK is engaged, APP NAV engages when the intercept conditions are met (aircraft track line must intercept the flight plan active leg).

APP NAV will not engage if the "TO" waypoint is not displayed in white on the ND and MCDU.

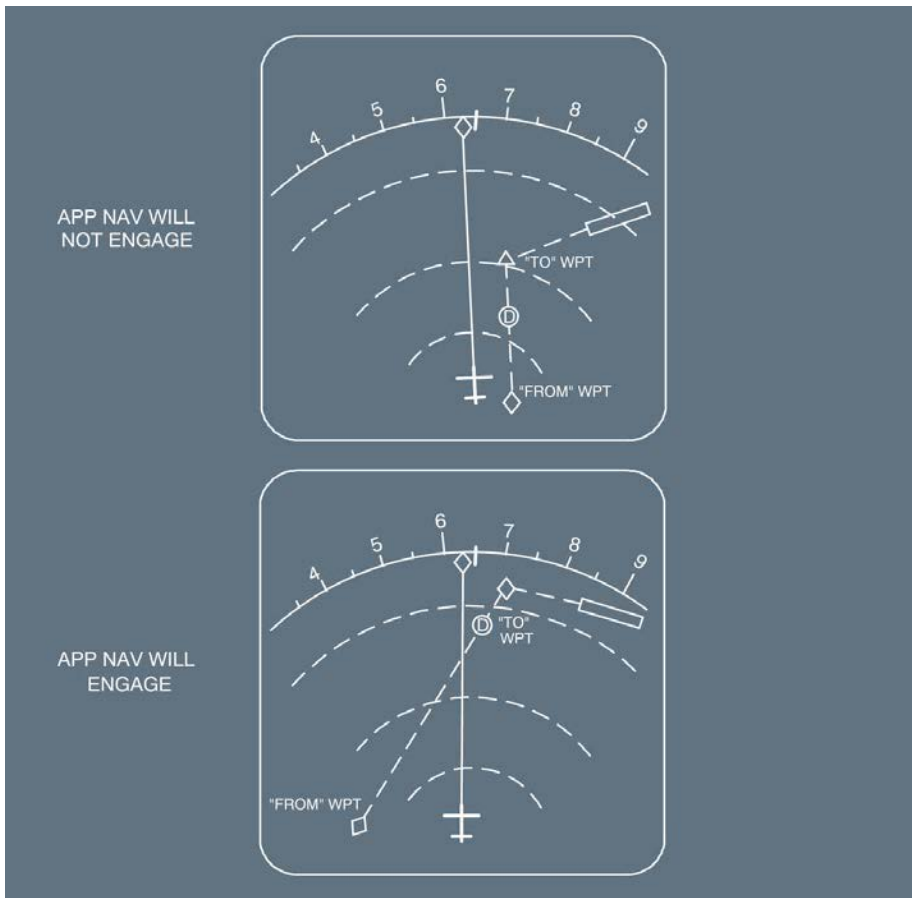

FINAL APP is a lateral and vertical managed guidance approach mode that aims guiding aircraft from FDP down to MAP along a defined FPA. It is thus recommended to arm this mode when the TO waypoint is the FDP.

FINAL APP mode engages when:

- NAV or APP NAV is engaged,
- FINAL is armed (by pressing APPR on the FCU),
- Predictions are available in FMS,

- APPROACH phase is active,

Note: APPROACH phase may have to be manually activated on MCDU PERF page if the approach starts at high altitude above aerodrome level (i.e. RNAV (RNP) approaches).

- The aircraft is within the capture area of the FMS profile:
 - Laterally: ± 1.5 NM from the Final Descent Point.
 - Vertically: +150 ft above the Final Descent Point.
- The aircraft intercepts a descending leg of the vertical flight path.

Note: if APPR pb is pressed earlier, FINAL APP mode may engage. As a consequence, resulting speed and altitude management in FINAL APP may be inappropriate before FDP.

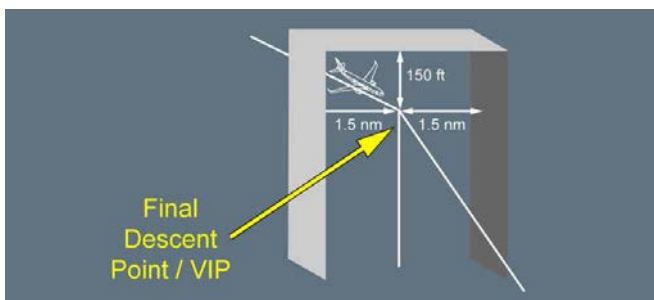

A blue arrow is displayed on ND s to indicate where the FINAL APP engagement conditions are met and where the final descent will begin automatically.

If the same arrow is displayed in white, at least one engagement condition is not fulfilled, FINAL APP will not engage and the aircraft will not descend automatically.

Definition of the Final Descent Point (also called Vertical Intersection Point "VIP" for RNAV (RNP) approaches)

The Final Descent Point is the waypoint from which starts the FMS segment with coded FPA . For RNAV (RNP) approaches, this point may be indicated on the chart as "VIP".

This point is defined in the Navigation Database by:

- A constant vertical flight path beyond this point,
- A coded altitude constraint that may be "at" or "at or above" (e.g. +3 000 ft). This constraint is displayed on ND (in magenta), next to the corresponding waypoint, when the CSTR key is selected on the EFIS Control Panel. It is also shown on the F-PLN page at this WPT.

AIRCRAFT SYSTEMS

AUTO FLIGHT - FLIGHT GUIDANCE

AP/FD COMMON MODES - APPROACH

Note: The Final Approach Fix (FAF) is the position from where the obstacle clearance is defined relative to an Obstacle Clearance Surface (OCS). Obstacle clearance is only ensured if the aircraft is flying on the defined vertical flight path. Before the FAF, minimum altitudes are published with fixed Minimum Obstacle Clearance (MOC). The Final Descent Point is the point in the procedure at or before the FAF from which a constant vertical flight path is defined.

DISENGAGEMENT CONDITIONS

Ident.: DSC-22_30-80-30-20-00012393.0037001 / 17 MAR 15

Applicable to: ALL

The FINAL and APP NAV modes disengage:

- If the flight crew pushes the APPR pb (HDG -V/S or TRK -FPA modes engage)
- If the flight crew pushes the LOC pb (LOC mode arms if an ILS is selected and HDG -V/S or TRK -FPA modes engage)
- If the flight crew pulls out the HDG/TRK knob, the FMGS reverts to HDG -V/S or TRK -FPA basic modes
- Automatically at missed Approach Point .
- When the GO AROUND mode engages.

Note: If the flight crew engages V/S or FPA mode, only FINAL mode disengages. NAV mode remains engaged.

GUIDANCE

Ident.: DSC-22_30-80-30-20-00012394.0021001 / 18 MAR 11

Applicable to: ALL

The FINAL mode guides the aircraft on the vertical profile down to the minimum.

The FINAL mode does the following:

- Displays a vertical deviation scale (± 200 ft) on the PFD and a VDEV symbol showing deviation from descent path
- Anticipates leaving the altitude selected by the FCU when the aircraft reaches the Continue Descent symbol (blue arrow on the ND)
- Gives precise vertical guidance on the descent and final path with an internal vertical speed limitation to avoid excessive V/S.

If the autopilot is engaged while you are using the APP NAV/ FINAL modes, it disengages automatically at the Missed Approach Point (MAP).

FD modes revert to HDG -V/S or TRK -FPA basic modes.

GENERAL

Ident.: DSC-22_30-80-40-00012050.0001001 / 17 AUG 10

Applicable to: ALL

Go-around mode combines the Speed Reference System (SRS) vertical mode with the GA TRK lateral mode.

ENGAGEMENT CONDITIONS

Ident.: DSC-22_30-80-40-00012210.0002001 / 17 AUG 10

Applicable to: ALL

Setting at least one thrust lever to the TOGA detent engages both SRS /GA TRK modes, if:

- The flaps lever is at least in position 1, and
- The aircraft is in flight, or
- The aircraft has been on ground for less than 30 s (AP disengages and can be re-engaged 5 s after lift-off).

FD bars are automatically restored in SRS /GA TRK modes. If FPV /FPD was previously selected, it reverts to FD bars.

The FMA displays “SRS ” and “GA TRK” in green.

DISENGAGEMENT CONDITIONS

Ident.: DSC-22_30-80-40-00012220.0028001 / 17 AUG 10

Applicable to: ALL

The SRS mode disengages:

- Automatically, at the Go-around acceleration altitude (GA ACC ALT), or if ALT * mode engages (above 400 ft RA)
- If the flight crew engages another vertical mode
- If the flight crew selects a speed while in SRS mode: SRS reverts to OP CLB mode and a triple-click aural warning is heard.

Note: *In Engine Out conditions, the SRS mode does not automatically disengage at EO ACC ALT. Refer to DSC-22_20-60-40 General.*

GA TRK disengages when the flight crew engages another lateral mode, above 100 ft RA.

Note: *In dual AP configuration, disengagement of the Go-around mode on either axis causes AP2 to disconnect.*

GUIDANCE

Ident.: DSC-22_30-80-40-00012213.0009001 / 16 MAR 11

Applicable to: **ALL**

The SRS law maintains the current speed at Go-around engagement, or VAPP, whichever is higher. Nevertheless, the SRS speed target is limited to VLS +25 kt, in a two-engine configuration, and VLS +15 kt, in an engine-out configuration. When the SRS mode disengages, the target speed becomes the smaller of green dot speed or speed constraints.

GA TRK mode guides the aircraft along the current track at Go-around initiation.

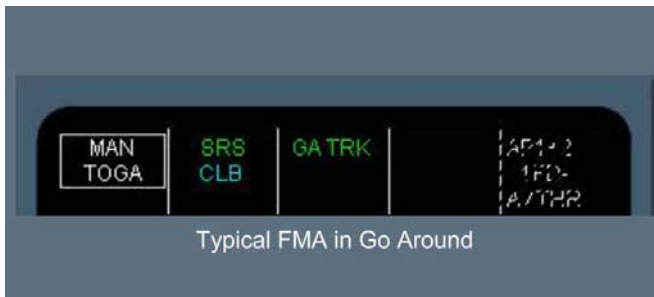

GENERAL

Ident.: DSC-22_30-90-00011930.0001001 / 17 MAR 17

Applicable to: ALL

The autothrust (A/THR) is a function of the FMGS , it includes two independent A/THR commands, one per FMGC . Each one is able to control the thrust of both engines simultaneously through two Engine Interface Units and two Electronic Engine Controls (IAE engines) or two Engine Control Units (CFM engines). Only one FMGC controls the active A/THR , it is called the master FMGC.

Thrust is controlled:

- Automatically when the A/THR is active
- Manually by the flight crew.

The autothrust is active when the A/THR pb of the FCU is lighted green and A/THR is displayed white in the FMA 5th column.

The position of the thrust levers determines whether A/THR is armed, active, or disconnected.

The autothrust system, when active:

- Maintains a specific thrust in THRUST mode
- Controls the aircraft speed or Mach in SPEED/MACH mode
- Uses ALPHA FLOOR mode to set maximum thrust when the aircraft angle of attack exceeds a specific threshold.

The autothrust system can operate independently or with the AP /FD:

- When performing alone, A/THR always controls the speed
- If the autothrust system is working with the AP /FD , the A/THR mode and AP /FD pitch modes are linked together. *Refer to DSC-22_30-10 Interaction between AP/FD and A/THR Modes.*

When autothrust is active, the FMGS commands the thrust according to the vertical mode logic, but uses a thrust not greater than the thrust commanded by the position of the thrust lever. For example, when the thrust levers are set at the CL (climb) detent, FG can command thrust between idle and max climb.

The autothrust system, when armed, automatically activates if the thrust levers are moved into the active range sector. Outside of this range, thrust levers control thrust directly.

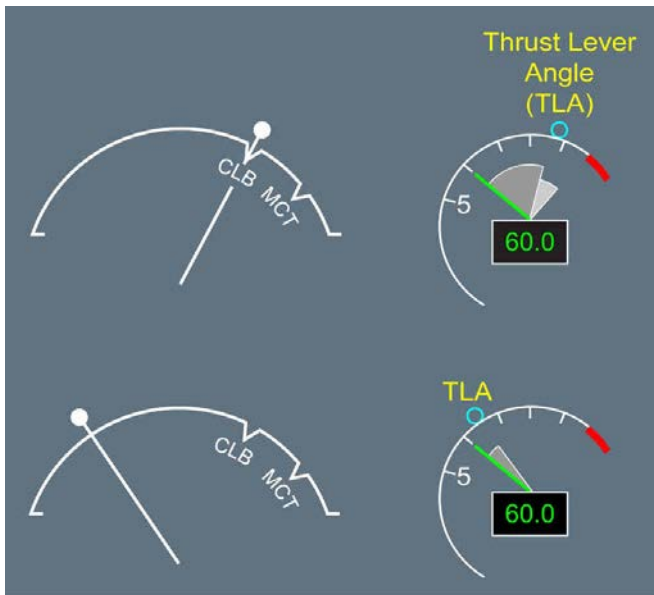

THRUST LEVERS

Ident.: DSC-22_30-90-00011957.0001001 / 23 JUN 15

Applicable to: ALL

The flight crew uses the thrust levers to do the following:

- Manually select engine thrust
- Arm and activate autothrust (A/THR)
- Engage reverse thrust
- Engage the takeoff and go-around modes.

When autothrust is disconnected, the thrust levers control thrust directly: each lever position corresponds to a given thrust.

Five detents divide each of the thrust lever sectors into four segments. The detents are:

- | | | |
|---------|---|---|
| TO GA | : | Max takeoff thrust |
| FLX MCT | : | Max continuous thrust (or FLX at takeoff) |
| CL | : | Maximum climb thrust |
| IDLE | : | Idle thrust for both forward and reverse thrust |
| MAX REV | : | Maximum reverse thrust |

When the thrust levers are at the IDLE position, the flight crew can pull them up to clear the IDLE stop and select reverse thrust. (There is no reverse detent as such).

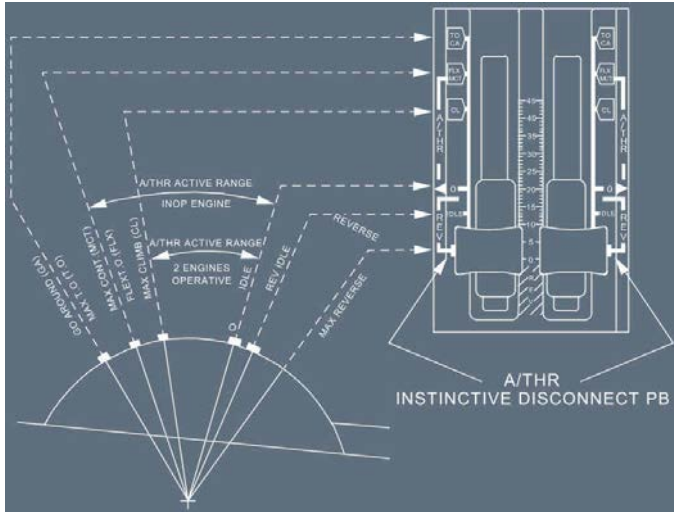

A/THR ARMING CONDITIONS

Ident.: DSC-22_30-90-00011958.0001001 / 23 JUN 15

Applicable to: ALL

Arming conditions of the A/THR are numerous. The following is a list of the most important ones:

- One FMGC operative
- One FAC operative
- Two ADIRS operative
- Two FADECs operative
- One channel of the FCU operative
- One LGCIU operative
- A/THR is not manually disabled (instinctive disconnect pb has not been pressed for more than 15 s).

The flight crew arms A/THR:

- On ground
 - By pushing the A/THR pb on the FCU when the engines are not running, or
 - By setting the thrust levers at the FLX or TOGA detent when the engines are running.
- In flight
 - By pushing the A/THR pb on the FCU while the thrust levers are out of the active range, or
 - While A/THR is active (“A/THR ” white on the FMA), by setting all thrust levers beyond the CL detent or at least one lever above the MCT detent, or
 - By engaging the go around mode.

When the A/THR is armed:

- The FCU's A/THR pb light comes on
- “A/THR ” is displayed in blue on the FMA.



Note: At takeoff, if the thrust levers are set back to idle, the A/THR disengages and cannot be rearmed until the aircraft becomes airborne.

A/THR ACTIVATION

Applicable to: ALL

Ident.: DSC-22_30-90-A-00011959.0001001 / 14 MAY 12

GENERAL

The A/THR is active when it controls thrust or speed. The position of the thrust lever determines the maximum thrust that the A/THR system can command (except in α -floor condition).

The A/THR being armed, is activated:

- When the flight crew sets both thrust levers between the CL and IDLE detents (two engines operative), or
- When the flight crew sets one thrust lever between the MCT and IDLE detents (one engine inoperative).

The A/THR being disconnected, is activated when the flight crew pushes the A/THR pb on the FCU while the thrust levers are within the active range, including IDLE position.

Note: When the flight crew sets both thrust levers to IDLE position, the A/THR disconnects but, if the flight crew pushes the A/THR pb of the FCU, they will simultaneously arm and activate the autothrust. Due to the thrust levers position, IDLE thrust will be maintained.

When ALPHA FLOOR is activated, regardless of the initial status of A/THR and the position of the thrust levers, the A/THR activates.

When A/THR is active:

- The A/THR pb on the FCU lights up
- The FMA displays A/THR mode in green in the first column and "A/THR" in white in the fifth column.



ident.: DSC-22_30-90-A-00011960.0002001 / 16 MAR 11

EFFECTS OF THRUST LEVER MOVEMENT DURING A/THR ACTIVATION

While A/THR is active:

- When both thrust levers are set above the CL detent (both engines operative) or one thrust lever is set above MCT (one engine operative), the A/THR reverts from active to armed. "A/THR" turns to blue on the FMA and the thrust levers control thrust directly.

The FMA displays "MAN THR" in white in its first column.

The thrust levers provide the flight crew with an immediate increase of thrust when both thrust levers are pushed above the CL detent (two engines) or the active thrust lever above the MCT detent (one engine operative).

- When both thrust levers are set below the CL detent (both engines operative) or one thrust lever is set below MCT (one engine operative), a repeating warning (amber caution, single chime, "A/THR LIMITED" ECAM message) is activated every 5 s until the flight crew moves the lever back into the detent. "LVR CLB" (both engines operative) or "LVR MCT" (one engine operative) flashes white in the first column of the FMA.

This device reminds the flight crew that the normal operating position of the thrust levers, when A/THR active, is the CL detent (two engines) or the MCT detent (one engine operative).

- When one thrust lever is in the CL detent and the other one out of detent, the "LVR ASYM" amber message comes up until both levers are set in the CL detent (only with both engines operative).

A/THR DISCONNECTION

Applicable to: ALL

ident.: DSC-22_30-90-B-00011961.0001001 / 17 AUG 10

GENERAL

When the A/THR is disconnected, it is neither armed nor active.

The A/THR can be disconnected in two ways:

- Standard disconnection:
 - The flight crew pushes the instinctive disconnect pb on the thrust levers, or
 - The flight crew sets both thrust levers to IDLE detent.
- Non-standard disconnection:
 - The flight crew pushes the A/THR pb on the FCU while A/THR is active/armed, or
 - The system loses one of the arming conditions.

CAUTION

If the flight crew pushes and holds one instinctive disconnect pb for more than 15 s, the A/THR system is disconnected for the remainder of the flight. All A/THR functions including ALPHA FLOOR are lost, and they can be recovered only at the next FMGC power-up (on ground).

THRUST LOCK FUNCTION

Ident.: DSC-22_30-90-00011963.0002001 / 17 AUG 10

Applicable to: ALL

The Thrust Lock function is activated when the thrust levers are in the CL detent (or the MCT detent with one engine out), and:

- The flight crew pushes the A/THR pb on the FCU, or
- The A/THR disconnects due to a failure.

The thrust is locked at its level prior to disconnection. Moving the thrust levers out of CL or MCT suppresses the thrust lock and gives the flight crew manual control with the thrust levers.

When the Thrust Lock function is active:

- "THR LK" flashes amber on the FMA
- ECAM "ENG THRUST LOCKED" flashes every 5 s
- ECAM displays "THR LEVERS.....MOVE"
- A single chime sounds and the Master Caution light flashes every 5 s.

All warnings cease when the flight crew moves the thrust levers out of the detent.

A/THR DISCONNECTION CAUTION

Ident.: DSC-22_30-90-00011964.0002001 / 17 AUG 10

Applicable to: ALL

| | | A/THR DISCONNECTION | |
|---------------------|------------------------------|--|---|
| | | BY INSTINCTIVE DISCONNECT pb OR SETTING TWO LEVERS TO IDLE (if above 50 ft RA) | BY OTHER MEANS |
| CONSEQUENCE | MASTER CAUTION light | Illuminated 3 s maximum | Illuminated |
| | ECAM MESSAGE | A/THR OFF amber message 9 s maximum | Flashing ENG THRUST LOCKED amber caution, AUTO FLT A/THR OFF amber caution, blue "THR LEVERS....MOVE" |
| | AUDIO | Single chime | Single chime |
| | CLR pb on ECAM CONTROL PANEL | Extinguished | Illuminated |
| ACTION | MASTER CAUTION light | - Extinguishes MASTER CAUTION light - Erases ECAM message | Extinguishes MASTER CAUTION light |
| | CLR pb on ECAM CONTROL PANEL | No effect | - Extinguishes MASTER CAUTION light and CLR pb - Erases ECAM message - Calls status |
| | INSTINCTIVE DISCONNECT pb | - Extinguishes MASTER CAUTION light - Erases ECAM message | Extinguishes MASTER CAUTION light |
| ECAM STATUS MESSAGE | | NO | YES |

The standard disconnection triggers temporary ECAM message and caution light. Single chime sounds.

The non standard disconnection triggers caution light and ECAM message removed only by a flight crew action. Single chime sounds.

| | |
|---|---|
|  A318/A319/A320/A321 FLIGHT CREW OPERATING MANUAL | AIRCRAFT SYSTEMS AUTO FLIGHT - FLIGHT GUIDANCE AUTOTHURST |
|---|---|

A/THR MODES

Applicable to: ALL



Ident.: DSC-22_30-90-C-00011965.0002001 / 23 JUN 15

GENERAL

Except in takeoff and go-around situations, normal operation of the A/THR system requires the thrust levers to be:

- In the CL detent for the two-engine configuration. If they are not set in the CL detent, “LVR CLB ” flashes white on the FMA.
- In MCT detent when in the one-engine-out configuration. If the appropriate lever is not set in the MCT detent, “LVR MCT ” flashes white on the FMA.

The A/THR modes are selected automatically in conjunction with the AP /FD modes (except for ALPHA FLOOR):

| | |
|--------------------------|---|
| A/THR in THRUST mode | AP /FD pitch mode maintains the speed: OP CLB - OP DES - CLB - EXP CLB  - EXP DES  - SRS - FLARE and DES (IDLE path) |
| A/THR in SPEED/MACH mode | If neither AP nor FD is engaged If AP /FD controls a vertical path: V/S - FPA - ALT * - ALT CST* - ALT - ALT CRZ - G/S * - G/S - FINAL and DES (geometric path) |
| A/THR in RETARD mode | AP /FD engaged in LAND mode during an automatic landing |

Ident.: DSC-22_30-90-C-00011966.0002001 / 23 JUN 15

THRUST MODE

In THRUST mode, autothrust commands a specific thrust level in conjunction with the AP /FD pitch mode. This thrust level is limited by thrust lever position.

| FMA Display | Meaning |
|-------------|---|
| THR MCT | Single engine thrust in climb. The live engine is at maximum continuous thrust (thrust lever in MCT detent) |
| THR CLB | Climb thrust in two engine configuration (at least one thrust lever in the CL detent, the other one below CL) |
| THR LVR | Undetermined thrust (neither CLB nor MCT thrust) |
| THR IDLE | Minimum thrust (both engines at IDLE thrust) |

Note: When the A/THR is armed for takeoff or go-around, the FMA displays “MAN TOGA ” (or “MAN FLX”) in white to remind the flight crew that the thrust levers have been positioned properly.

Ident.: DSC-22_30-90-C-00011967.0001001 / 27 JAN 12

RETARD MODE

The RETARD mode is only available during automatic landing (AP engaged in LAND mode). At approximately 40 ft RA , the RETARD mode engages and remains engaged after touchdown. The A/THR commands IDLE thrust during the flare, and the FMA and engine warning display “IDLE”. If the autopilot is disengaged during the flare before touchdown, the SPEED mode replaces the RETARD mode, and the flight crew has to manually reduce thrust.

Note: In an automatic landing, the system generates a “RETARD” callout at 10 ft RA , which prompts the flight crew to move the thrust levers to IDLE in order to confirm thrust reduction. In manual landing conditions, the system generates this callout at 20 ft RA , as a reminder.

Ident.: DSC-22_30-90-C-00011968.0002001 / 17 AUG 10

ALPHA FLOOR

ALPHA FLOOR is a protection that commands TOGA thrust, regardless of the thrust levers' positions. This protection is available from lift-off to 100 ft RA on approach.

ALPHA FLOOR calls up the following indications:

- “A FLOOR” in green, surrounded by a flashing amber box on the FMA, and in amber on the engine warning display, (as long as α -floor conditions are met)
- “TOGA LK” in green, surrounded by a flashing amber box on the FMA , when the aircraft leaves the α -floor conditions. TOGA thrust is frozen.

To cancel ALPHA FLOOR or TOGA LK thrust, the flight crew must disconnect the autothrust.

Ident.: DSC-22_30-90-C-00011969.0001001 / 17 AUG 10

SPEED/MACH MODE

In SPEED/MACH mode, the A/THR adjusts the thrust in order to acquire and hold a speed or Mach target.

The speed or Mach target may be:

- Selected on the FCU by the flight crew
- Managed by the FMGC.

When in SPEED/MACH mode, the A/THR does not allow speed excursions beyond the following limits, regardless of the target speed or Mach number:

- For a selected speed target, the limits are VLS and VMAX (VMO -MMO , VFE -VLE, whichever applies)
- For a managed speed target, the limits are maneuvering speed (Green Dot, S , F , whichever applies) and maximum speed (340/0.80-VFE -VLE, whichever applies).

| | |
|---|---|
|  <p>A318/A319/A320/A321 FLIGHT CREW OPERATING MANUAL</p> | <p style="text-align: center;">AIRCRAFT SYSTEMS AUTO FLIGHT - FLIGHT GUIDANCE</p> <p style="text-align: center;">AUTOTHURST</p> |
|---|---|

The changeover from SPEED to MACH mode is either automatic, performed by the FMGC, or manual, with the flight crew pushing the SPD/MACH pb.
The FMA displays "SPEED" or "MACH".

APPROACH AUTOTHURST:

Below 3 200 ft RA , with at least CONF 1, the A/THR logic is modified to be more responsive to speed variation. This is referred to as approach autothrust.

SPEED MODE IN APPROACH PHASE

Applicable to: ALL

Ident.: DSC-22_30-90-D-00011970.0001001 / 17 AUG 10

GENERAL

When the aircraft flies an approach in managed speed, the speed target displayed on the PFD in magenta is variable during the approach.

This managed speed target is computed in the FMGS using the "ground speed mini function".

Ident.: DSC-22_30-90-D-00011971.0002001 / 17 MAR 17

GROUND SPEED MINI FUNCTION PRINCIPLE

The purpose of the "ground speed mini function" is to take advantage of the aircraft inertia when the wind conditions vary during the approach. It does so by providing the flight crew with an adequate indicated speed target. When the aircraft flies this indicated speed target, the energy of the aircraft is maintained above a minimum level ensuring standard aerodynamic margins versus stall.

If the A/THR is active in SPEED mode, it will automatically follow the IAS target, ensuring an efficient thrust management during the approach.

The minimum energy level is the energy level the aircraft will have at touch down if it lands at VAPP speed with the tower reported wind as inserted in the PERF APPR page.

The minimum energy level is represented by the Ground Speed the aircraft will have at touch down. This Ground Speed is called "GROUND SPD MINI".

During the approach, the FMGS continuously computes the speed target using the wind experienced by the aircraft in order to keep the ground speed at or above the "Ground Speed Mini".

The ground speed mini enables an efficient management of the thrust in gusts or longitudinal shears. Thrust varies in the right sense, but in a smaller range ($\pm 15\%$ N1) in gusty situations, which explains why it is recommended in such situations.

It provides additional but rational safety margins in shears.

It allows pilots "to understand what is going on" in perturbed approaches by monitoring the target speed magenta bugs: when target goes up = head wind gust.

The speed target is displayed on the PFD speed scale in magenta when approach phase and managed speed are active. It is independent of the AP /FD and/or A/THR engagements. Wind is a key factor in the "ground speed mini function".

Ident.: DSC-22_30-90-D-00011972.0001001 / 17 AUG 10

TWR WIND

It is the MAG WIND entered in the PERF APPR page. It is the average wind as provided by the ATIS or the tower. Gusts must not be inserted, they are included in the ground speed mini computation.

Ident.: DSC-22_30-90-D-00011973.0001001 / 17 AUG 10

TWR HEADWIND COMPONENT

The TWR HEADWIND COMPONENT is the component of the MAG WIND projected on the runway axis (landing runway entered in the flight plan). It is used to compute VAPP and GS mini.

Ident.: DSC-22_30-90-D-00011974.0001001 / 17 AUG 10

CURRENT HEADWIND COMPONENT

The actual wind measured by ADIRS is projected on the aircraft axis to define the CURRENT HEADWIND COMPONENT (instantaneous headwind).

The CURRENT HEADWIND COMPONENT is used to compute the variable speed target during final (IAS target).

Ident.: DSC-22_30-90-D-00011975.0002001 / 17 AUG 10

VAPP COMPUTATION

VAPP , automatically displayed on the MCDU PERF APPR page, is computed as follows:

- $VAPP = VLS + 1/3$ of the TWR HEADWIND COMPONENT, or
- $VAPP = VLS + 5$ kt, whichever is the highest.

"1/3 of the TWR HEADWIND COMPONENT" has two limits:

- 0 kt as the minimum value (no wind or tailwind)
- +15 kt as the maximum value.

The flight crew can manually modify the VAPP and TWR wind values on the PERF APPR page.

Ident.: DSC-22_30-90-D-00011976.0002001 / 01 OCT 12

SPEED TARGET COMPUTATION

The FMGS continuously computes a speed target (IAS target) that is the MCDU VAPP value plus an additional variable gust.



The gust is the instantaneous difference between the CURRENT HEADWIND COMPONENT and the TWR HEADWIND COMPONENT. It is always positive (or equal to zero for no wind or tailwind).

The IAS target is displayed on the PFD as a magenta triangle moving with the gust variation.

The IAS targets have 2 limits:

- VAPP, as the minimum value
- VFE -5 kt in CONF FULL, or VFE of the next configuration in CONF 1, 2 or 3 as the maximum value.

Ident.: DSC-22_30-90-D-00011977.0001001 / 17 MAR 17

GROUND SPEED MINI (GS MINI) COMPUTATION

Ground speed mini concept has been defined to prevent the aircraft energy from dropping below a minimum level during final approach. The GS mini value is not displayed to the flight crew.

This minimum energy level is the energy the aircraft will have at landing with the expected tower wind; it is materialized by the ground speed of the aircraft at that time which is called GS mini:

$$\text{GS mini} = \text{VAPP} - \text{Tower head wind component}$$

In order to achieve that goal, the aircraft ground speed should never drop below GS mini in the approach, while the winds are changing. Thus the aircraft IAS must vary while flying down, in order to cope with the gusts or wind changes. In order to make this possible for the pilot or for the A/THR, the FMGS continuously computes an IAS target speed, which ensures that the aircraft ground speed is at least equal to GS mini; the FMGS uses the instantaneous wind component experienced by the aircraft:

$$\text{IAS Target Speed} = \text{GS mini} + \text{Current headwind component}$$

This target speed is limited by VAPP in case of tailwind or if instantaneous wind is lower than the tower wind.

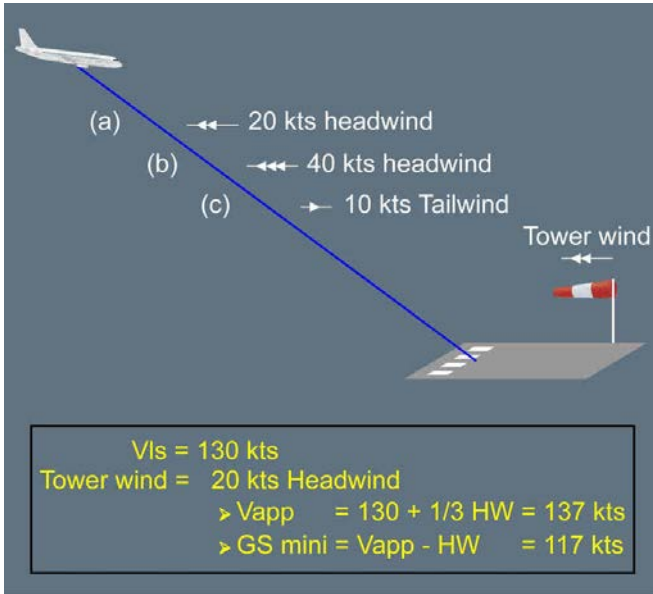

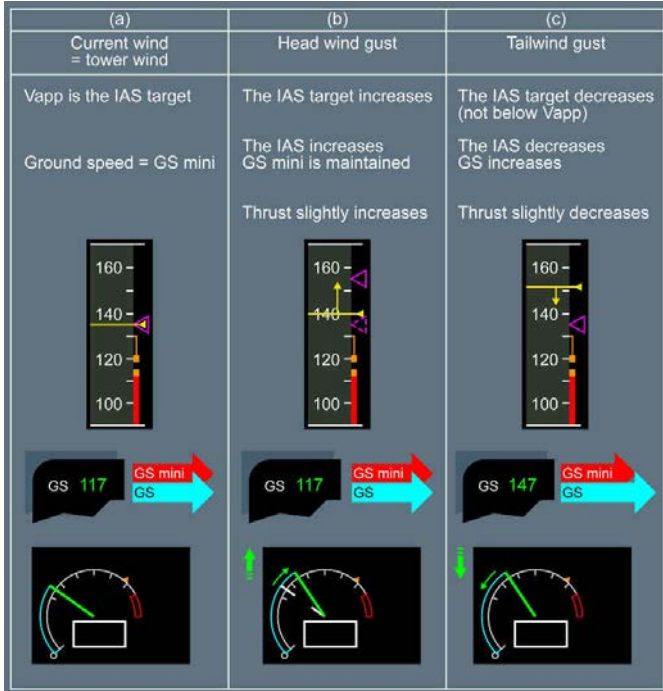



A318/A319/A320/A321
FLIGHT CREW
OPERATING MANUAL

AIRCRAFT SYSTEMS
AUTO FLIGHT - FLIGHT GUIDANCE

AUTOTHURST

Intentionally left blank

FLIGHT MODE ANNUNCIATOR (FMA)

Applicable to: ALL

Ident.: DSC-22_30-100-A-00012356.0012001 / 19 DEC 12

GENERAL

The Flight Mode Annunciator (FMA) which is just above the PFDs, shows the status of the A/THR, the AP/FD vertical and lateral modes, the approach capabilities, and the AP/FD -A/THR engagement status.

A white box is displayed for 10 s around each new annunciation. The white box display time may be increased to 15 s in some mode reversion cases associated with an aural triple click.

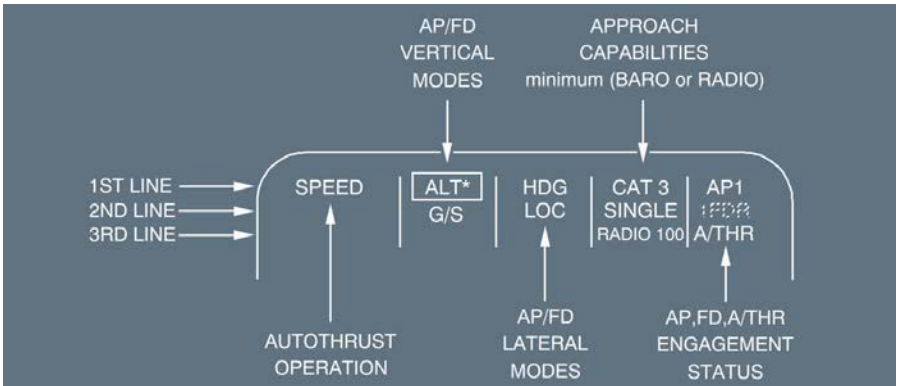

Ident.: DSC-22_30-100-A-00012357.0002001 / 17 AUG 10

THE THREE LEFT COLUMNS

The first line shows the engaged modes in green.

The second line shows the armed modes in blue or magenta.

Magenta indicates that the modes are armed or engaged because of a constraint.

The third line displays special messages:

- Messages related to flight controls have first priority:
 - “MAN PITCH TRIM ONLY” in red, flashing for 9 s, then steady
 - “USE MAN PITCH TRIM” in amber, pulsing for 9 s, then steady.
- Messages related to the FMGS have second priority.

Ident.: DSC-22_30-100-A-00012358.0014001 / 16 MAR 11

THE FOURTH COLUMN

Displays approach capabilities in white.

Displays minimum in blue.

Note: The BARO or RADIO value on the FMA is not rounded off. The exact value appears on the FMA, and is the same value as the one inserted in the MCDU PERF APPR page.

Ident.: DSC-22_30-100-A-00012359.0001001 / 17 AUG 10

THE FIFTH COLUMN

Displays the engagement status of AP, FD, and A/THR in white.

Displays a box around FD for 10 s in case of automatic FMGC switching.

Displays A/THR in blue when autothrust is armed but not active.

Note: The FMGS synchronizes A/THR mode, AP/FD modes and approach capability to provide identical information on both PFDs.

AUTOTHURST ANNUNCIATIONS (FMA COLUMN 1)

Applicable to: ALL

Ident.: DSC-22_30-100-B-00012360.0002001 / 23 JUN 15

FIRST LINE

| DISPLAY | COLOR | MEANING |
|---------------|------------------------------------|---|
| MAN TOGA | White White box | A/THR is armed, at least one thrust lever is in TOGA detent. |
| MAN FLX XX | White White box Blue numbers | A/THR is armed, at least one thrust lever is in MCT/FLX detent with FLXTO temp set at XX°. The other thrust lever is at or below the MCT/FLX detent. |
| MAN MCT | White White box | A/THR is armed, at least one thrust lever is in the MCT/FLX detent, the other is at, or below this detent. |
| MAN THR | White Amber box | A/THR is armed, and the most advanced thrust lever is above CL detent (two engines operative), or one above MCT/FLX (engine-out) and not in a detent. |
| THR MCT | Green | A/THR is active in thrust mode and the most advanced thrust lever is in the MCT/FLX detent (engine-out). |
| THR CLB | Green | A/THR is active in thrust mode and the most advanced thrust lever is in the CL detent. |
| THR IDLE | Green | A/THR is active in thrust mode and commands idle thrust. |
| THR LVR | Green | A/THR is active in thrust mode with both thrust levers below CL detent, or the live thrust lever (one engine) below MCT. |
| SPEED or MACH | Green | A/THR is active in SPEED or MACH mode. |
| A. FLOOR | Green Amber box | A/THR is active and commands TOGA thrust while α FLOOR conditions are met. |
| TOGA LK | Green Amber box | A/THR is active and TOGA thrust is locked (α FLOOR conditions are no longer met). |

| | |
|---|--|
|  A318/A319/A320/A321 FLIGHT CREW OPERATING MANUAL | AIRCRAFT SYSTEMS AUTO FLIGHT - FLIGHT GUIDANCE FLIGHT MODE ANNUNCIATOR (FMA) |
|---|--|

Ident.: DSC-22_30-100-B-00012361.0002001 / 17 AUG 10

SECOND LINE

Not used with this standard.

Ident.: DSC-22_30-100-B-00012362.0002001 / 16 NOV 15

THIRD LINE

| DISPLAY | COLOR | MEANING |
|-----------------------|-------|--|
| LVR CLB (flashing) | White | Request to set the thrust levers in CL detent in the case not in position while the aircraft is above the altitude of thrust reduction with both engines running. |
| LVR MCT (flashing) | White | Request to set the live thrust lever in MCT/FLX detent in the case not in position after an engine failure (with speed above green dot). |
| LVR ASYM | Amber | (Two engines only). One thrust lever in CL or MCT/FLX detent and the other one is not in this detent. |
| THR LK (flashing) | Amber | After A/THR disconnection (action of the flight crew on FCU or failure) resulting in thrust being frozen. Both thrust levers being in CL detent or one in MCT/FLX (engine out) detent. |

Note: The amber caution light flashes and a single chime sounds every 5 s, as long as the flight crew takes no appropriate action in the following cases:

- THR LK
- LVR CLB (if the thrust levers are below the CLB detent)
- LVR MCT (if the thrust levers are below the FLX/MCT detent).

AP/FD VERTICAL MODES (FMA COLUMN 2)

Applicable to: ALL

Ident.: DSC-22_30-100-C-00012363.0006001 / 23 JUN 15

FIRST LINE

| DISPLAY | COLOR | MEANING |
|------------------------|-------|---|
| SRS | Green | Takeoff or go-around mode is engaged. |
| CLB | Green | Climb mode is engaged. The FMGS target altitude is higher than the actual altitude. ALT CSTR are taken into account. |
| OP CLB | Green | Open Climb mode is engaged. The FCU selected altitude is higher than the actual altitude. ALT CSTR are disregarded. |
| EXP CLB | Green | Expedite Climb is engaged. The selected altitude is higher than the actual altitude. Green dot speed is maintained, ALT CSTR are disregarded. |
| ALT* or ALT CST* | Green | ALT CAPTURE is engaged: - ALT * green in case of FCU selected altitude capture - ALT CST* green in case of ALT CSTR capture (vertical profile). |

Continued on the following page

AIRCRAFT SYSTEMS

AUTO FLIGHT - FLIGHT GUIDANCE

FLIGHT MODE ANNUNCIATOR (FMA)

Continued from the previous page

| DISPLAY | COLOR | MEANING |
|----------------------|----------------------------|--|
| ALT or ALT CST | Green | ALTITUDE HOLD mode is engaged: - ALT is green when the FCU selected altitude is held - ALT CST is green when an ALT CSTR is held (vertical profile). |
| ALT CRZ | Green | ALT mode is engaged and CRZ FL is held. |
| DES | Green | Descent mode is engaged. The FMGS target altitude is lower than the actual altitude. ALT CSTR are taken into account. |
| OP DES | Green | Open Descent mode is engaged. The FCU selected altitude is lower than the actual altitude. ALT CSTR are disregarded. |
| EXP DES | Green | Expedite Descent is engaged, the selected altitude is lower than the actual altitude. M 0.80 or 340 kt is maintained. ALT CSTR are disregarded. |
| G/S* | Green | Glide Slope capture mode is engaged. |
| G/S | Green | Glide Slope mode is engaged. |
| V/S±XXXX | Green + blue numbers | Vertical speed mode is engaged to acquire and hold the V/S selected on the FCU . ALT CSTR are disregarded. If the aircraft reaches VLS or VMAX and cannot maintain the target, the indication is boxed amber and flashes, and the target pulses. |
| FPA±XX | Green + blue numbers | Flight Path Angle mode is engaged to acquire and hold the FPA selected on the FCU . ALT CSTR are disregarded. If the aircraft reaches VLS or VMAX and cannot maintain the target, the indication is boxed amber and flashes, and the target pulses. |

Ident.: DSC-22_30-100-C-00012364.0002001 / 23 JUN 15

SECOND LINE

| DISPLAY | COLOR | MEANING |
|-----------|-----------------------|---|
| CLB | Blue | Climb mode is armed. |
| ALT | Blue or Magenta | Altitude mode is armed: - Blue when the target altitude is the FCU selected altitude - Magenta when the target altitude is an ALT CSTR. |
| DES | Blue | Descent mode is armed before the descent phase. |
| G/S | Blue | Glide Slope mode is armed. |
| FINAL | Blue | Final descent mode is armed. |
| ALT G/S | Blue/Blue | ALT and G/S modes are armed. |
| ALT G/S | Magenta/ Blue | ALT CST and G/S modes are armed. |
| ALT FINAL | Blue/Blue | ALT and FINAL modes are armed. |
| ALT FINAL | Magenta/ Blue | ALT CST and FINAL modes are armed. |
| DES G/S | Blue/Blue | DES and G/S modes are armed. |
| DES FINAL | Blue/Blue | DES and FINAL modes are armed. |

| | |
|---|--|
|  A318/A319/A320/A321 FLIGHT CREW OPERATING MANUAL | AIRCRAFT SYSTEMS AUTO FLIGHT - FLIGHT GUIDANCE FLIGHT MODE ANNUNCIATOR (FMA) |
|---|--|

Ident.: DSC-22_30-100-C-00012365.0001001 / 17 AUG 10

THIRD LINE

| DISPLAY | COLOR | MEANING |
|---------------|-------|---|
| SPEED SEL:XXX | Blue | Indicates a preset speed associated with the cruise or climb phase. |
| MACH SEL:XX | Blue | Indicates a preset Mach associated with the cruise or climb phase. |

Note: These two messages use both the first and second columns (third line).

AP/FD LATERAL MODES (FMA COLUMN 3)

Applicable to: ALL

Ident.: DSC-22_30-100-D-00012366.0002001 / 16 MAR 11

FIRST LINE

| DISPLAY | COLOR | MEANING |
|---------|-------|---|
| RWY | Green | RWY mode is engaged. |
| RWY TRK | Green | RWY mode is engaged once airborne at or above 30 ft RA. |
| HDG | Green | HEADING mode is engaged. |
| TRK | Green | TRACK mode is engaged. |
| NAV | Green | NAV mode is engaged to guide the aircraft along the FM lateral F-PLN. |
| LOC* | Green | LOC capture mode is engaged. |
| LOC | Green | LOC track mode is engaged. |
| APP NAV | Green | NAV mode is engaged during a non-ILS approach. |
| GA TRK | Green | GO-AROUND TRACK mode is engaged. |

Ident.: DSC-22_30-100-D-00012367.0001001 / 17 AUG 10

SECOND LINE

| DISPLAY | COLOR | MEANING |
|---------|-------|---|
| NAV | Blue | NAV mode is armed. |
| LOC | Blue | LOC mode is armed. |
| APP NAV | Blue | NAV mode is armed for a non-ILS approach. |

AP/FD COMMON MODES (FMA COLUMNS 2 AND 3)

Ident.: DSC-22_30-100-00012368.0002001 / 17 AUG 10

Applicable to: ALL

| DISPLAY | COLOR | MEANING |
|---------|-------|---------------------------------------|
| LAND | Green | Land mode is engaged below 400 ft RA. |
| FLARE | Green | Flare mode is engaged. |

Continued on the following page



A318/A319/A320/A321
FLIGHT CREW
OPERATING MANUAL

AIRCRAFT SYSTEMS
AUTO FLIGHT - FLIGHT GUIDANCE
FLIGHT MODE ANNUNCIATOR (FMA)

Continued from the previous page

| DISPLAY | COLOR | MEANING |
|-----------|-------|--|
| ROLL OUT | Green | Roll out mode is engaged. |
| FINAL APP | Green | APP NAV and Final modes are engaged during a non-ILS approach. |

APPROACH CAPABILITIES (FMA COLUMN 4)

Applicable to: ALL

Ident.: DSC-22_30-100-E-00012369.0002001 / 17 AUG 10

FIRST LINE

| DISPLAY | COLOR | MEANING |
|---------|-------|-----------------------------|
| CAT 1 | White | CAT 1 capability available. |
| CAT 2 | White | CAT 2 capability available. |
| CAT 3 | White | CAT 3 capability available. |

Ident.: DSC-22_30-100-E-00012370.0002001 / 17 AUG 10

SECOND LINE

| DISPLAY | COLOR | MEANING |
|---------|-------|--|
| SINGLE | White | CAT 3 capability available, with FAIL PASSIVE condition. |
| DUAL | White | CAT 3 capability available, with FAIL OPERATIONAL condition. |

Ident.: DSC-22_30-100-E-00012371.0009001 / 16 MAR 11

THIRD LINE

| DISPLAY | COLOR | MEANING |
|-----------------|---------------|--|
| BARO XXXX | White Blue | Minimum Descent Altitude or Minimum Descent Height as inserted by the flight crew on the MCDU PERF APPR page. |
| RADIO XXX/NO DH | White Blue | Decision Height as inserted by the flight crew on the MCDU PERF APPR page. NO DH : when NO inserted on the MCDU PERF APPR page. |

AP/FD - A/THR ENGAGEMENT STATUS (FMA COLUMN 5)

Applicable to: ALL

Ident.: DSC-22_30-100-F-00012372.0001001 / 17 AUG 10

FIRST LINE

| DISPLAY | COLOR | MEANING |
|---------|-------|--------------------------------|
| AP1 + 2 | White | Autopilot 1 and 2 are engaged. |
| AP1 | White | Autopilot 1 is engaged. |
| AP2 | White | Autopilot 2 is engaged. |

Ident.: DSC-22_30-100-F-00012373.0002001 / 17 AUG 10

SECOND LINE

| DISPLAY | COLOR | MEANING |
|---------|-------|--|
| X FD Y | White | X and Y give the FD engagement status on PFD 1 and PFD2. X and Y can be 1, 2, or -: - -: No FD is engaged on the corresponding PFD - 1: FD 1 is engaged on the corresponding PFD - 2: FD 2 is engaged on the corresponding PFD. The normal status (FD 1 and 2 engaged) is 1 FD 2. |

Ident.: DSC-22_30-100-F-00012374.0001001 / 17 AUG 10

THIRD LINE

| DISPLAY | COLOR | MEANING |
|---------|-------|------------------|
| A/THR | White | A/THR is active. |
| A/THR | Blue | A/THR is armed. |



SPECIAL MESSAGES (FMA COLUMNS 2 AND 3)

Ident.: DSC-22_30-100-00012539.0017001 / 05 NOV 15

Applicable to: ALL

The third line displays three types of messages:

- It gives first priority to Flight Control messages
- It gives second priority to vertical Flight Management messages
- It gives last priority to EFIS reconfiguration messages.

| DISPLAY | COLOR | MEANING |
|--|-------|---|
| MAN PITCH TRIM ONLY | Red | Displayed in case of loss of L+R elevators. |
| USE MAN PITCH TRIM | Amber | F/CTL are in direct law. |
| CHECK APPR SELECTION | White | The aircraft is in cruise at less than 100 NM from the Top of Descent or in descent or in approach and: - A non-ILS /non-GLS  approach has been selected - An ILS frequency/GLS  channel is tuned on the MCDU RAD NAV page. |
| SET MANAGED SPEED or CHECK SPEED MODE (Also displayed on PFD) | White | The SPEED target is selected but a preselected SPEED does not exist for the next flight phase. |

Continued on the following page

Continued from the previous page

| DISPLAY | COLOR | MEANING |
|--|-------|--|
| SET GREEN DOT SPEED | White | The aircraft is in Engine Out mode and the SPEED target is selected. This message is displayed if the FCU selected speed is: <ul style="list-style-type: none"> ≤ Green Dot -10 kt, or ≥ Green Dot +10 kt, except in ALT * and ALT mode. |
| SET HOLD SPEED | White | The aircraft is in selected SPEED control, a Holding pattern is inserted in the F-PLN and the aircraft is 30 s before the deceleration point to the precomputed HOLD SPEED. |
| DECELERATE or T/D REACHED (Also displayed on PFD) | White | This message is displayed if the thrust is not reduced when passing the top of descent and the aircraft is above the descent profile. |
| MORE DRAG | White | DES mode is engaged, idle is selected, and either: <ul style="list-style-type: none"> - The aircraft is above the vertical profile and the predicted intercept point of the theoretical profile is at less than 2 NM from the next ALT CSTR, or - In auto speed control and the aircraft enters a speedbrake decelerating segment. |

CAT 3 DUAL INOPERATIVE

Ident.: DSC-22_30-110-00012674.0001001 / 28 JUN 17

Applicable to: ALL

"CAT 3 DUAL" INOP SYS is triggered in particular if one ADR or IR is rejected by FAC or FMGC. If "CAT 3 DUAL" is displayed in INOP SYS without any other failure being detected:

CHANGE the AP in command. It may allow the CAT 3 DUAL function to be recovered.

If unsuccessful:

SET FAC 1 pb to OFF, and back to ON

WAIT for FAC 1 fault ECAM warning to disappear, and

APPLY the same sequence for FAC 2.

Note: 1. Do not reset the FACs with the C/Bs.
2. If the CAT 3 DUAL INOP SYS is associated to another ECAM message (in particular ADR FAULT or IR FAULT...), it means that the root cause is not an ADR or IR rejection by FAC or FMGC. And consequently the AP switch or FAC reset will not clear the CAT 3 DUAL inop.

LEFT TURN NOT EXPECTED WHILE IN HDG OR TRK MODE

Ident.: DSC-22_30-110-00015029.0001001 / 08 AUG 13

Applicable to: ALL

The AP /FD may erroneously order a left turn if the following conditions are fulfilled:

- The aircraft is in a right turn in HDG or TRK mode
- Within 180 ms, the difference between the target selected on the FCU and the current aircraft heading/track, initially above 85 °:
 1. First goes below 85 °
 2. Then goes above 95 °.

The flight crew may encounter this misbehavior in two different situations:

- The flight crew requests a right turn, then rapidly reduces and increases again the target selected on the FCU
- The flight crew increases the target selected on the FCU according to the above conditions, while the aircraft is already in a right turn.

The misbehavior may affect either one AP /FD or both AP /FD.

OPERATIONAL RECOMMENDATIONS:

The flight crew must immediately take appropriate actions:

- The flight crew must disconnect the AP and the FD, and manually turn.
- When established on the intended trajectory, the flight crew can reengage the FD first, and then the AP.

AIRCRAFT SYSTEMS

AUTO FLIGHT - FLIGHT AUGMENTATION

Intentionally left blank

DSC-22_40-10 General

GENERAL..... A

DSC-22_40-20 Yaw Functions

YAW DAMPING..... A
RUDDER TRIM..... B
RUDDER TRAVEL LIMITATION..... C

DSC-22_40-30 Flight Envelope Function

GENERAL..... A
PFD Speed Scale Management..... B
Alpha-Floor Protection..... C
Low - Energy Aural Alert..... D

DSC-22_40-40 Windshear Detection Function

Windshear Detection Function..... A
WINDSHEAR DETECTION PRINCIPLES..... B
GUIDANCE..... C

DSC-22_40-50 Controls and Indicators

FAC ENGAGEMENT..... A
RUDDER TRIM OPERATION..... B



A318/A319/A320/A321
FLIGHT CREW
OPERATING MANUAL

AIRCRAFT SYSTEMS

AUTO FLIGHT - FLIGHT AUGMENTATION

PRELIMINARY PAGES - TABLE OF CONTENTS

Intentionally left blank



| | |
|---|---|
|  <p>A318/A319/A320/A321 FLIGHT CREW OPERATING MANUAL</p> | <p>AIRCRAFT SYSTEMS</p> <p>AUTO FLIGHT - FLIGHT AUGMENTATION</p> <p>GENERAL</p> |
|---|---|

GENERAL

Ident.: DSC-22_40-10-00000840.0001001 / 24 FEB 15

Applicable to: ALL

The aircraft has two flight augmentation computers (FACs) that perform four main functions:

- Yaw function
 - Yaw damping and turn coordination
 - Rudder trim
 - Rudder travel limitation
- Flight envelope function
 - PFD speed scale management
 - Minimum/maximum speed computation
 - Maneuvering speed computation
 - Alpha-floor protection
- Low-Energy Aural Alert function 
- Windshear detection function 

In performing these functions the FAC uses independent channels :

- Yaw damper
- Rudder trim
- Rudder travel limit
- Flight envelope

Each FAC interfaces with the elevator aileron computers (ELAC s) when the AP s are disengaged, or with the FMGS when at least one AP is engaged.

Both FACs engage automatically at power-up.

The pilot can disengage or reset each FAC (in case of failure) by means of a pushbutton on the flight control overhead panel.

When a FAC is disengaged (FAC pushbutton set off) but still valid, the flight envelope function of the FAC remains active.

If both FAC s are valid, FAC 1 controls the yaw damper, turn coordination, rudder trim, and rudder travel limit, and FAC2 is in standby.

FAC 1 keeps the aircraft within the flight envelope through FD 1 ; FAC 2 performs this function through FD2.

If a failure is detected on any channel of FAC 1, FAC2 takes over the corresponding channel.



A318/A319/A320/A321
FLIGHT CREW
OPERATING MANUAL

AIRCRAFT SYSTEMS
AUTO FLIGHT - FLIGHT AUGMENTATION

GENERAL

Intentionally left blank

YAW DAMPING

Ident.: DSC-22_40-20-00000851.0001001 / 18 MAR 11

Applicable to: ALL

Yaw damping stabilizes the aircraft in yaw and coordinates its turns.

In automatic flight (AP engaged) during takeoff and go around, it assists rudder application after an engine failure (short-term yaw compensation).

Note: When the AP is engaged, the FMGS sends orders to the FAC to give :

- Yaw damping during approach
- Yaw control for runway alignment in ROLL OUT mode

RUDDER TRIM

Ident.: DSC-22_40-20-00000855.0001001 / 09 DEC 09

Applicable to: ALL

The rudder trim function :

- Executes trim orders, entered by the pilot by using the manual trim knob.
- When AP is engaged
 - executes trim orders from the FMGS.
 - Assists the system in recovering from engine failure (long-term yaw compensation) in all flight guidance modes.
 - If the pilot pushes the rudder more than 10 ° out of trim, it disengages the AP.

Note: When the AP is engaged, the rudder trim knob is inoperative : the master FMGC sends rudder trim orders to the FAC.

RUDDER TRAVEL LIMITATION

Ident.: DSC-22_40-20-00000857.0001001 / 01 OCT 12

Applicable to: ALL

This function limits rudder deflection is based on speed in order to avoid high structural loads. It is governed by the following law :

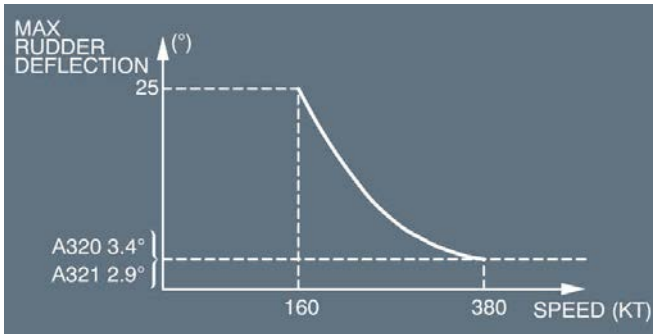

If both FACs lose the rudder travel limitation function, the value of the rudder deflection limit is locked at the time of the second failure.

When the slats are extended, the FACs automatically set the rudder deflection limit at the low-speed setting (maximum authorized deflection).

GENERAL

Ident.: DSC-22_40-30-00000859.0001001 / 09 DEC 09

Applicable to: ALL

As long as one Flight Augmentation Computer (FAC) is valid, it governs the flight envelope function, the rudder position display, and the rudder trim indication regardless of what the flight crew does with the FAC pushbutton.

PFD SPEED SCALE MANAGEMENT

Ident.: DSC-22_40-30-00000860.0001001 / 21 MAR 17

Applicable to: ALL

The FAC controls the speed scale on the PFD (*Refer to DSC-31-40 Attitude Data*).
When both FAC s are operative, FAC 1 supplies data to PFD 1 and FAC 2 supplies it to PFD2.

The FAC computes:

- The minimum and maximum speeds:
 - VSW (stall warning)
 - VLS
 - VFE and VFE for the next configuration
 - VLE
 - VMO /MMO
- The maneuvering speeds:
 - Green Dot Speed
 - S speed
 - F speed

The FAC also computes the speed trend and displays it as an arrow on the PFD speed scale.
The PFD displays these various speeds as appropriate, and they also go to the FMGC to be used as limits for various guidance modes.

Note: The principle of the speed computation is as follows:

- First, the FAC computes VS1G (stall speed). From VS1G it computes the Gross Weight (GW) which is also sent to the Elevator Aileron computers:
 - When the aircraft is below 14 500 ft and 250 kt, it computes this from current angle of attack, speed/Mach, altitude, thrust, and CG.
 - When the aircraft is above 14 500 ft or 250 kt, it computes this out of the GW, which it has memorized and updated with a fuel consumption model set in the FAC.
- Finally the FAC computes the various minimum and maneuvering speeds, $V_{\alpha prot}$ and V_{sw} .
- The accuracies of the various minimum and maximum speeds are functions of the accuracy with which the FAC computes aircraft gross weight. Normal accuracy for VLS in CONFIG FULL is about ± 3 kt.

ALPHA-FLOOR PROTECTION

Ident.: DSC-22_40-30-00006198.0015001 / 17 MAR 17

Applicable to: ALL

Alpha-floor protection automatically sets the thrust at TOGA thrust, when the aircraft reaches a very high angle of attack.

The Flight Augmentation Computer (FAC) generates the signal that triggers the alpha-floor mode. This, in turn, sets TOGA thrust on the engines, regardless of the thrust lever positions (*Refer to DSC-22_30-90 A/THR Modes - General*).

The FAC sends this signal when:

- The angle of attack is above a predetermined threshold, that is a function of the configuration.
- In CONF 3 and CONF FULL, this threshold decreases as a function of the aircraft deceleration rate (down to -3°).

Alpha-floor is available from lift-off until the aircraft reaches 100 ft RA in approach.

Note: The α floor is activated through the A/THR system, when:

- α is greater than α_{floor} (9.5° in configuration 0; 15° in configuration 1, 2; 14° in configuration 3; 13° in configuration FULL), or
- Sidestick deflection is greater than 14° nose up, with either the pitch attitude or the angle-of-attack protection active.

The α floor function is available from lift-off to 100 ft RA before landing.

Alpha-floor is inhibited above M 0.6.

- Note:
- *Alpha-floor is lost, when one of the following combinations of failures occurs:
SFCC 1 and FAC2, or
SFCC 2 and FAC1, or
Both FCU channels, or
1 EIU, or
Both FMGCs.*
 - *Alpha-floor is lost under alternate or direct flight control law.*
 - *Alpha-floor is lost in engine-out, when slats/flaps are extended.*

LOW - ENERGY AURAL ALERT

Ident.: DSC-22_40-30-00006197.0001001 / 24 FEB 15

Applicable to: ALL

An aural low-energy “SPEED SPEED SPEED” alert, repeated every 5 s, warns the pilot that the aircraft’s energy level is going below a threshold under which he has to increase thrust, in order to regain a positive flight path angle through pitch control.

It is available in Configuration 2, 3, and FULL. The FAC computes the energy level with the following inputs:

- Aircraft configuration
- Horizontal deceleration rate
- Flight path angle.

The aural alert is inhibited when:

- TOGA is selected, or
- Below 100 ft RA, or
- Above 2 000 ft RA, or
- Alpha-floor, or the ground proximity warning system alert is triggered, or
- In alternate or direct law, or
- If both radio altimeters fail.

During deceleration, the low-energy aural alert is triggered before alpha floor (unless alpha floor is triggered by stick deflection). The amount of time between the two alerts depends on the deceleration rate.



A318/A319/A320/A321
FLIGHT CREW
OPERATING MANUAL

AIRCRAFT SYSTEMS
AUTO FLIGHT - FLIGHT AUGMENTATION

FLIGHT ENVELOPE FUNCTION

Intentionally left blank

WINDSHEAR DETECTION FUNCTION

Ident.: DSC-22_40-40-00006194.0001001 / 07 JUL 11

Applicable to: ALL

The windshear detection function is provided by the Flight Augmentation Computer (FAC) in takeoff and approach phase in the following conditions:

- At takeoff, 3 s after liftoff, up to 1 300 ft RA
- At landing, from 1 300 ft RA to 50 ft RA
- With at least CONF 1 selected.

The warning consists of:

- A visual "WINDSHEAR" red message displayed on both PFDs for a minimum of 15 s.
- An aural synthetic voice announcing "WINDSHEAR" three times.

WINDSHEAR DETECTION PRINCIPLES

Ident.: DSC-22_40-40-00006195.0001001 / 23 JUN 15

Applicable to: ALL

The FACs generate the windshear warning whenever the predicted energy level for the aircraft falls below a predetermined threshold.

In computing this energy level prediction, the FAC s use data from different sources. From ADIRS comes data such as vertical speed, air and ground speeds and slope ; from other sources come such derived parameters as total slope, longitudinal wind gradient, and vertical wind.

The FACs express this energy level as an angle of attack and compare it with an angle-of-attack threshold above which windshear conditions are most likely and pilot action is required.

GUIDANCE

Ident.: DSC-22_40-40-00006196.0001001 / 09 DEC 09

Applicable to: ALL

In windshear conditions, flight guidance acts on specially adapted FD pitch orders received from the speed reference system (SRS). The pilot must set go around thrust immediately (which also triggers the FD SRS mode), and follow the pitch order to execute the optimum escape maneuver.



A318/A319/A320/A321
FLIGHT CREW
OPERATING MANUAL

AIRCRAFT SYSTEMS
AUTO FLIGHT - FLIGHT AUGMENTATION

WINDSHEAR DETECTION FUNCTION

Intentionally left blank



A318/A319/A320/A321
FLIGHT CREW
OPERATING MANUAL

AIRCRAFT SYSTEMS
AUTO FLIGHT - FLIGHT AUGMENTATION

CONTROLS AND INDICATORS

FAC ENGAGEMENT

Ident.: DSC-22_40-50-00000861.0001001 / 09 DEC 09

Applicable to: ALL

Refer to DSC-27-10-20 Yaw Control - General

RUDDER TRIM OPERATION

Ident.: DSC-22_40-50-00000862.0001001 / 09 DEC 09

Applicable to: ALL

Refer to DSC-27-10-20 Yaw Control - General



A318/A319/A320/A321
FLIGHT CREW
OPERATING MANUAL

AIRCRAFT SYSTEMS
AUTO FLIGHT - FLIGHT AUGMENTATION

CONTROLS AND INDICATORS

Intentionally left blank

AIRCRAFT SYSTEMS

AUTO FLIGHT - AOC FUNCTIONS

Intentionally left blank



A318/A319/A320/A321
FLIGHT CREW
OPERATING MANUAL

AIRCRAFT SYSTEMS
AUTO FLIGHT - AOC FUNCTIONS

PRELIMINARY PAGES - TABLE OF CONTENTS

| | |
|--|---|
| General..... | A |
| Flight Plan Initialization Function..... | B |
| Takeoff Data Function..... | C |
| Wind Data Function..... | D |
| Flight Reports..... | E |



A318/A319/A320/A321
FLIGHT CREW
OPERATING MANUAL

AIRCRAFT SYSTEMS

AUTO FLIGHT - AOC FUNCTIONS

PRELIMINARY PAGES - TABLE OF CONTENTS

Intentionally left blank

| | |
|---|---|
|  A318/A319/A320/A321 FLIGHT CREW OPERATING MANUAL | AIRCRAFT SYSTEMS AUTO FLIGHT - AOC FUNCTIONS |
|---|---|

GENERAL

Ident.: DSC-22_45-00000864.0001001 / 18 MAR 11
Applicable to: ALL

The FMS AOC function gives an interface between a ground station and one onboard FMGC , allowing data transmission between these two computers via the ACARS Management Unit or the ATSU.

- Two different sets of message can be exchanged:
- UPLINK messages from the ground station. They consist in reception of data requested or directly sent to the crew.
 - DOWNLINK messages from the FMGC (master). They consist in reports or requests sent to the ground station.

The FMGS /ACARS or FMGS /ATSU interface enables the following AOC capabilities.

- F-PLN initialization (flight plan and performance data)
- Takeoff data
- Wind data
- Flight reports
- Broadcast data

Crews can send message using ACARS FUNCTION pages or relevant MCDU pages. Only one FMGC talks to the ground station. This FMGC is called FMGC “master”.

GENERAL SCRATCHPAD MESSAGES

- NOT XMITTED TO ACARS: A crew request or report was sent to the ground but the communication was not established or not acknowledged.
- NO ANSWER TO REQUEST : A crew request was previously sent to the ground and no answer (uplink message) was received within 4 min.

FLIGHT PLAN INITIALIZATION FUNCTION

Ident.: DSC-22_45-00000865.0001001 / 18 MAR 11
Applicable to: ALL

This function enables lateral and vertical flight plan data as well as initialization data to be exchanged between the aircraft and a ground station. The aircraft may send flight plan requests for active and secondary flight plan. (downlink messages). The ground station may send flight plan and initialization data (uplink messages) either under aircraft request or automatically without any request. Each uplink message concerns either the active or secondary flight plan but never both flight plans at the same time. The data sent to the aircraft are checked for flight plan consistency. A MCDU message comes up when an uplink message is received. “ACT (or SEC) RTE UPLINK”.

If an error prevents the decoding process of the message, “INVALID RTE UPLINK” is displayed on MCDUs.

An uplink message can be routed to the active flight plan if no engine is started and no active flight plan exists. Otherwise, it is routed to the secondary. The crew will insert it into the secondary flight plan or will reject it using the CLR key.

Note: The flight plan may also be initialized using the ACARS FUNCTION page selected from DATA INDEX page.

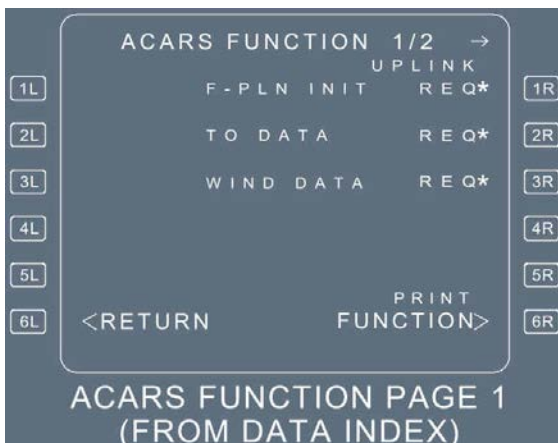

PERFORMANCE DATA

On ground and before engine start, the ground station may also send performance data to the aircraft.

Performance data are always associated with the uplink flight plan. It is either automatically inserted with the active flight plan data, or stored in the secondary with the corresponding flight plan.

This message contains part or all of the following data:

ZFW, ZFWCG, taxi fuel, block fuel, cruise flight level, tropopause altitude, cruise temperature, transition altitude, cost index, performance factor.

Note: After engine start an uplink performance data message is rejected automatically without any scratchpad message.

SCRATCHPAD MESSAGES RELATED TO FLIGHT PLAN AND PERFORMANCE

INVALID RTE UPLINK An error is detected, the uplink message is rejected.

ACT or SEC RTE UPLINK A F-PLN is stored in the active or secondary flight plan.

| | |
|------------------------|---|
| FLT NUMBER UPLINK | FLT NBR has been initialized within a F-PLN message without previous request. |
| CHECK FLT NUMBER | The uplinked FLT NBR differs from the one specified in the request. |
| CHECK CO RTE | The uplinked CO RTE ident differs from the one specified in the request. |
| INVALID FLT NBR UPLINK | The uplink contains a valid F-PLN but the FLT NBR is invalid. |
| PERF DATA UPLINK | Performance data is received |
| INVALID PERF UPLINK | Performance uplink message has been rejected |
| RTE DATALINK IN PROG | A flight plan modification is performed after a F-PLN INIT request has been sent; this message is displayed until the uplink is received. |
| UPLINK INSERT IN PROG | This message is displayed during insertion of a Flight Plan. |

TAKEOFF DATA FUNCTION

Ident.: DSC-22_45-00000866.0001001 / 18 MAR 11

Applicable to: ALL

The takeoff data function is available for the active flight plan only. It is used to request to the ground station, information data for up to 2 runways and to receive this data for up to 4 runways. The crew sends a request indicating the departure airport, runway idents, CG , GW and weather conditions (such as BARO setting wind, temperature...). In response he receives the takeoff speeds for up to 4 runways but only one set of data may be inserted in the active flight plan for the selected active runway.

Takeoff speeds are computed for max and flex takeoff.

The takeoff data function has required the modification of the standard PERF TAKEOFF page and the addition of 2 news pages:

- UPLINK TO DAT REQ page that enables the crew to specify a request to the ground.
- UPLINK XXX TO DATA page (XXX for MAX or FLEX)

These 2 pages are accessed from the PERF TAKEOFF page in PREFLIGHT and DONE phase only.

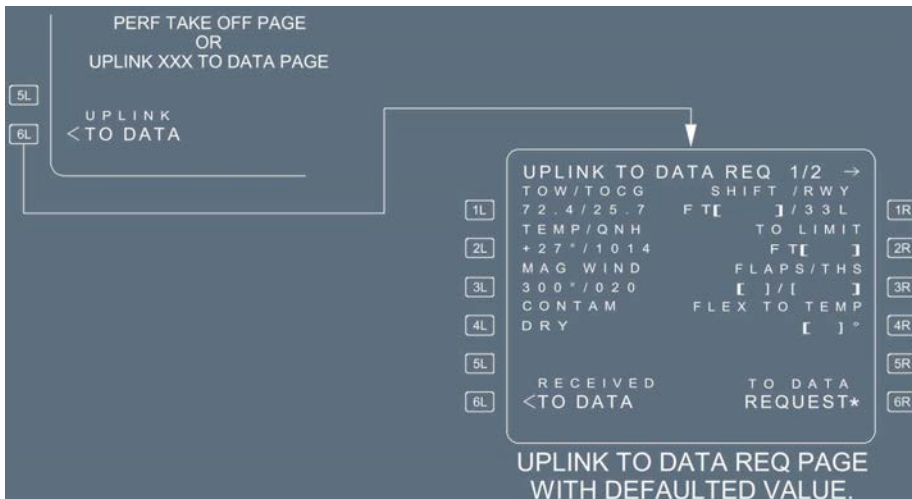

SCRATCHPAD MESSAGES RELATED TO TAKEOFF DATA

- TAKEOFF DATA UPLINK : Takeoff data uplink message is received
- INVALID TAKEOFF : The UPLINK message is rejected
- UPLINK

WIND DATA FUNCTION

Ident.: DSC-22_45-00000867.0001001 / 18 MAR 11

Applicable to: ALL

This function enables the crew to request and to receive forecasted winds associated to the active or secondary flight plan.

The uplink message (ground station to aircraft) may be received upon crew request or automatically without crew request.

The request is initiated from WIND pages or from ACARS FUNCTION page (*Refer to DSC-22_20-70 Wind Data - Request for Wind Data*).

The uplink wind data when received are directly displayed on the wind pages but not inserted in the flight plan, one set for each flight phase: CLIMB, CRUISE, DESCENT. The alternate wind at alternate cruise flight level is displayed on DESCENT page.

- Winds are associated to altitude for climb and descent phases
- Winds are associated to waypoint for cruise phase and step level. One wind per waypoint.
 - On ground and without entered winds, an uplink message is directly inserted in the flight plan.
 - In flight, winds are temporary stored until the crew inserts it phase per phase. Phase of flight is indicated in the WIND title page.
 - Clearing the INSERT UPLINK* prompt using the CLR key deletes the uplink wind data for the selected phase.

When uplink winds are deleted, the wind page reverts to the previous status.

The flight plan B page is modified of the uplink wind only after it is inserted by the crew. AOC uplink winds are then considered as crew manual entries (large font).

SCRATCHPAD MESSAGES RELATED TO WIND DATA

| | |
|---------------------|---|
| INVALID WIND UPLINK | An error is detected, the uplink is rejected. |
| WIND DATA UPLINK | Uplinked winds are received. |
| WIND UPLINK PENDING | A temporary flight plan exists or a DIR TO page is displayed when a wind uplink is received. The message is stored. |
| WIND UPLINK EXISTS | A F-PLN modification (active or secondary) is attempted when uplink winds are not inserted. This message disappears automatically when the wind uplink is inserted or deleted. |
| CHECK DEST DATA | The aircraft is at 180 NM from destination, and the destination QNH , TEMP or WIND displayed on the PERF APPR page was received by AOC uplink or, if following insertion of a descent wind uplink, a conflict concerning the above parameters exists. |
| CHECK ALTN WIND | The uplinked alternate cruise flight level differs from the default alternate cruise flight level. |

FLIGHT REPORTS

Ident.: DSC-22_45-00000868.0001001 / 01 OCT 12

Applicable to: ALL

Flight reports provide real time information to the ground concerning the aircraft current situation and position.

Several types of flight reports are available:

- The Position report : provides current aircraft position
- the Progress report : provides data relative to the destination

- The Flight-Plan report : provides the active route
- the Performance Data report : provides performance data currently used by FMS.

These reports may be manually initiated via a dedicated prompt or automatically sent in response to a ground request or upon specific conditions.

POSITION REPORT

This report is sent:

- manually via a MCDU prompt or
- following a ground request or
- automatically upon sequencing a designated reporting fix (designated by the ground in a uplink message).

The manual POSITION REPORT downlink prompt is displayed on the PROG page. (SEND POS prompt).

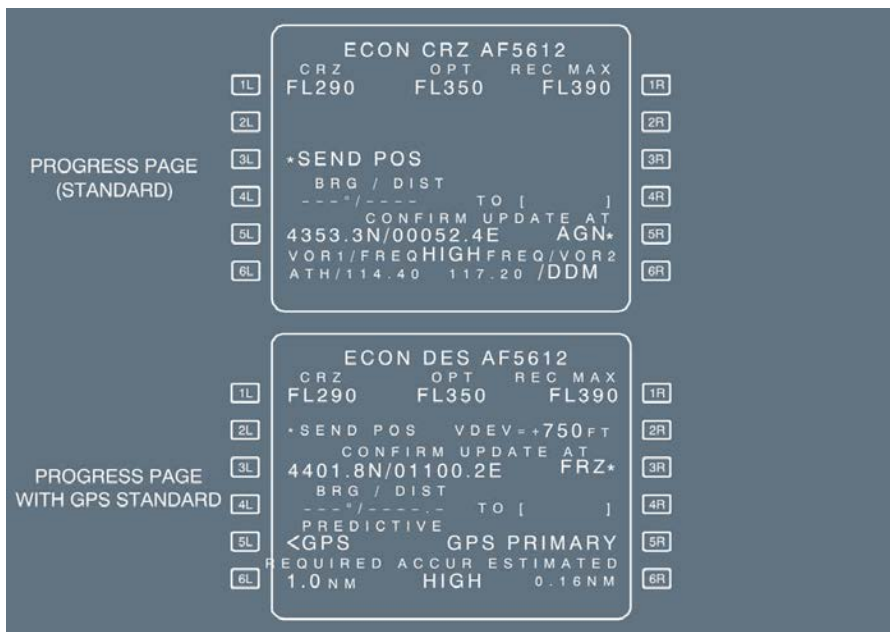

PROGRESS PAGE (STANDARD)

```

ECON CRZ AF5612
CRZ      OPT      REC MAX
FL290    FL350    FL390

+SEND POS
BRG / DIST      TO [    ]
---*/-----
CONFIRM UPDATE AT
4353.3N/00052.4E  AGN*
VOR1/FREQHIGHFREQ/VOR2
ATH/114.40  117.20 /DDM
    
```

PROGRESS PAGE WITH GPS STANDARD

```

ECON DES AF5612
CRZ      OPT      REC MAX
FL290    FL350    FL390

+SEND POS  VDEV=+750FT
CONFIRM UPDATE AT
4401.8N/01100.2E  FRZ*
BRG / DIST      TO [    ]
---*/-----
PREDICTIVE
<GPS      GPS PRIMARY
REQUIRED ACCUR ESTIMATED
1.0 NM    HIGH    0.16 NM
    
```

Note: Position report are initiated from active flight plan only.

POSITION REPORT CONTENT

- Aircraft position
- Overfly reporting waypoint
- Time of report (UTC)
- Aircraft altitude
- Next reporting waypoint
- ETA at next reporting waypoint
- Reporting waypoint following next report
- SAT
- Current wind
- Remaining fuel

PROGRESS REPORT

A progress report contains data relative to the aircraft arrival time and EFOB at destination for the active F-PLN.

This downlink message is automatically sent following:

- a ground request or
- a change of destination or
- a change of runway or
- a specific event. The possible events that can be selected in the navigation database policy file are :
 - X minutes to Top of Descent
 - Z minutes to Destination
 - ETA changes more than W minutes from the previous report.X, Z and W are minutes of time set in the navigation database policy file.

The progress report cannot be manually sent by the crew via a dedicated MCDU prompt.

PROGRESS REPORT CONTENT

- Flight Number
- Arrival Airport Ident
- Destination Runway Ident
- Predicted remaining fuel
- ETA at destination
- Reason for report (specific event, ground request...).

FLIGHT PLAN REPORT

The F-PLN report broadcasts flight plan data to the ground. Only data from the active flight plan can be sent.

This downlink message is sent to the ground:

- automatically following a ground request
- manually by the crew using a prompt displayed on the ACARS FUNCTION page (DSC-22_20 Auto Flight - Flight Management/50 Controls and Indicators/10 MCDU - Page Description/25 FMS2 Honeywell/ACARS Function Page). This prompt may be invalidated through the navigation database policy file.

The Flight Plan report can be downlinked either while on ground or in flight during any flight phase.

FLIGHT PLAN REPORT CONTENT

The report contains the active and alternate flight plan.

PERFORMANCE DATA REPORT

The Performance Data report is a downlink message that allows the transmission of performance data (CG , FUEL, CG ...) relative to the active F-PLN.

This message is automatically sent following a ground request. Manual sending is not possible.

PERFORMANCE DATA REPORT CONTENT

Sends to the ground:

- Current GW
- Cruise Altitude
- Current CG
- Fuel on Board
- Block Fuel
- Reserve Fuel
- Cost Index
- Top of Climb Temperature
- Climb Transition Altitude
- Tropopause Altitude
- Taxi Fuel
- ZFW
- ZFWCG

AIRCRAFT SYSTEMS

AUTO FLIGHT - PRINT INTERFACE

Intentionally left blank



A318/A319/A320/A321
FLIGHT CREW
OPERATING MANUAL

AIRCRAFT SYSTEMS
AUTO FLIGHT - PRINT INTERFACE

PRELIMINARY PAGES - TABLE OF CONTENTS

Print Function.....A
AOC/Printer Programming OptionsB



A318/A319/A320/A321
FLIGHT CREW
OPERATING MANUAL

AIRCRAFT SYSTEMS

AUTO FLIGHT - PRINT INTERFACE

PRELIMINARY PAGES - TABLE OF CONTENTS

Intentionally left blank

PRINT FUNCTION

Ident.: DSC-22_46-00000869.0003001 / 01 APR 11

Applicable to: ALL

The print function enables several types of data and report to be printed :

- Flight plan initialization data
- Takeoff data
- Wind data
- Preflight report
- In flight report
- Post flight report

The 3 first reports may differ when automatically or manually printed for the following reason :
 The automatic process prints the uplink message although the manual process prints the current active data as displayed on the relevant MCDU pages.

The last 3 reports being processed from the same sources are identical in automatic or manual printing.

Note: *ACARS is not necessary linked to printing process. The printing function may be activated within the FMGS and selected independently from the ACARS.*

- One or several print functions may be deactivated *Refer to DSC-22_20-50-10-25 Print Function Pages.*
- If an ACARS function is not active, (not selected in the nav database policy file) the printing process is invalidated for this specific ACARS function.

AOC/PRINTER PROGRAMMING OPTIONS 

Ident.: DSC-22_46-00000870.0002001 / 11 FEB 11

Applicable to: ALL

Option programming for the AOC /PRINTER functions is obtained through the Navigation Data Base policy file or the Airline Modifiable Information (AMI) file.

The list summarizes the possible options:

| | |
|----------------------------------|--|
| Data Link (ACARS or AOC) Inhibit | Disables AOC function |
| F-PLN Data Request Inhibit | Disables uplink and downlink requests of F-PLN initialization data |
| Performance Data Request Inhibit | Disables uplink and downlink requests of Performance Initialization data |
| Takeoff Data Request Inhibit | Disables uplink and downlink request of Takeoff Initialization data |
| Wind Data Request Inhibit | Disables uplink and downlink request of predicted wind data |

| | |
|------------------------------------|---|
| Flight Number Enable | Flight Number is included within the F-PLN Request or Progress Report downlinks |
| Position Report Inhibit | Disables a manual Position Report downlink |
| Progress Report Triggers | Defines the triggers for the automatic downlink of the Progress Report |
| F-PLN Report Inhibit | Disables the manual downlink of the F-PLN Report |
| Auto Print of ACARS or AOC uplinks | Selects/Deselects the automatic printing of the F-PLN , INIT , TO and wind data uplinks. If Autoprint is selected, the crew can deselect it manually. If auto printing is deselected, the crew cannot manually reselect it. |
| Auto Print of Flight Reports | Selects/Deselects the automatic printing of the Preflight, Inflight, Postflight reports. If selected, the crew can deselect it manually. If autoprint is deselected, the crew cannot manually preselected it. |

AIRCRAFT SYSTEMS

COMMUNICATIONS

Intentionally left blank

DSC-23-10 General

DSC-23-10-10 Introduction

Introduction.....A

DSC-23-10-20 Radio Tuning

Description.....A

Radio Management Panel.....B

DSC-23-10-30 Intercommunication Systems

Audio Management System.....A

Cabin Intercommunication Data System.....B

DSC-23-10-40 Cockpit Voice Recorder

Description.....A

Controls and Indicators.....B

DSC-23-10-50 Controls

Audio Control Panel.....A

Side Stick Radio Selector.....B

Loudspeaker Volume Knob.....C

Audio Switching.....D

DSC-23-20 Internal Communication

DSC-23-20-10 Flight Crew Interphone System

Flight Crew Interphone System.....A

DSC-23-20-20 Cabin Interphone System

Introduction.....A

Cabin Call System.....B

DSC-23-20-30 Service Interphone System

Introduction.....A

Ground Mechanic Call System.....B

DSC-23-20-40 Passenger Address

Description.....A

Controls and Indicators.....B

Continued on the following page

Continued from the previous page

DSC-23-30 External Communication

DSC-23-30-10 Radio Communication

| | |
|---------------------------------|---|
| Description..... | A |
| VHF..... | B |
| HF..... | C |
| SELCAL (Selective calling)..... | D |

DSC-23-40 Emergency Communication



DSC-23-40-10 Emergency Evacuation

| | |
|------------------------------|---|
| Controls and Indicators..... | A |
| Purser Station..... | B |

DSC-23-40-30 Emergency Locator Transmitter

| | |
|------------------------------|---|
| Controls and Indicators..... | A |
|------------------------------|---|

DSC-23-50 Memo Display

| | |
|--|---|
| ACARS  | A |
| ATSU  | B |
| AUDIO 3 XFRD..... | C |
| SATCOM  | D |

INTRODUCTION

Ident.: DSC-23-10-10-00018503.0001001 / 17 MAR 17

Applicable to: ALL

The communications system comprises the following subsystems :

- VHF/HF transceivers
- Radio tuning systems (Radio Management Panels).
- Audio integrating system (Audio Management Unit, Audio Control Panels).

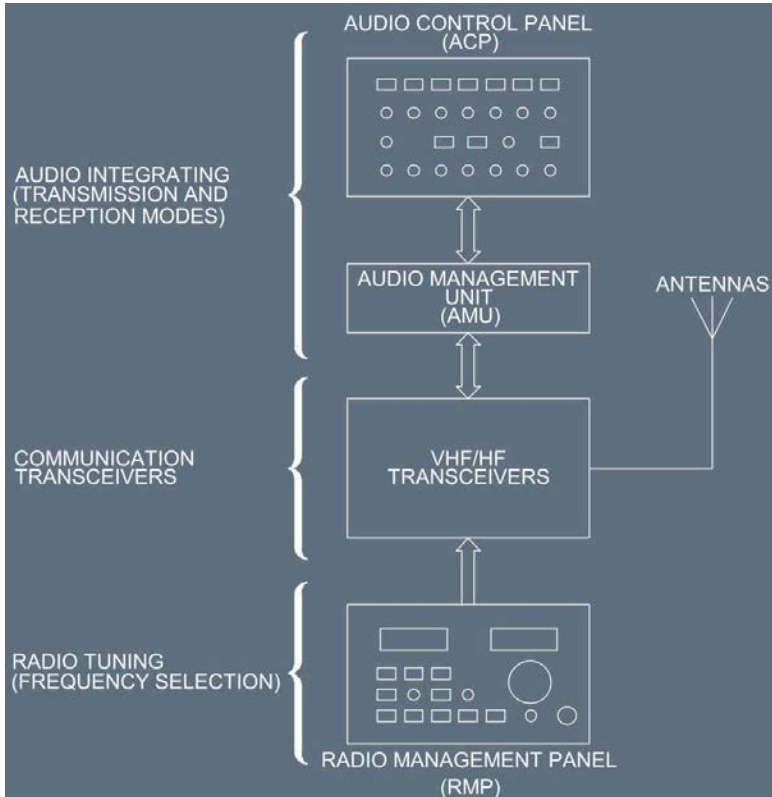



A318/A319/A320/A321
FLIGHT CREW
OPERATING MANUAL

AIRCRAFT SYSTEMS

COMMUNICATIONS

GENERAL - INTRODUCTION

Intentionally left blank

DESCRIPTION

Ident.: DSC-23-10-20-00018494.0001001 / 17 MAR 17

Applicable to: ALL

Identical Radio Management Panels (RMPs):

- Give the flight crew control of all VHF radio communication systems (HF systems ☞).
- Provide backup to the FMGCs for controlling radio navigation systems (*Refer to DSC-34-NAV-30-10 General*).

The two RMPs are on the center pedestal (and the third ☞ is on the overhead panel).

Each RMP can control any VHF (HF ☞) transceiver. RMP 1 and RMP 2 are connected directly to all VHF (HF ☞) transceivers, (whereas RMP3 ☞ is connected to them via RMP 1 and RMP 2). RMP s are connected together so that each RMP is updated to the selections made on the other RMPs.

Only RMP1 functions in EMER ELEC CONFIG.

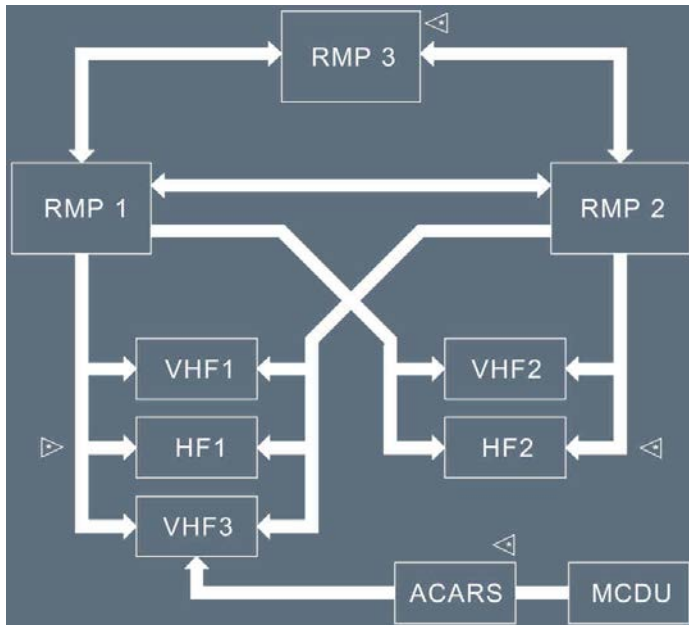

If one RMP fails, the remaining one controls all the VHF (HF ☞) transceivers.

RADIO MANAGEMENT PANEL

Ident.: DSC-23-10-20-00018495.0002001 / 17 MAR 17

Applicable to: ALL



(1) Frequency displays

The ACTIVE display window shows the active frequency of the selected radio, which is identified by a green light on the selection key.

The STBY /CRS (standby/course) display window shows a standby frequency that the pilot can activate by pressing the transfer key or change by rotating the tuning knobs. (For a description of the CRS function *Refer to DSC-34-NAV-30-30 Radio Management Panel (RMP)*).

(2) Transfer key



Pressing this key moves the active frequency to the standby window and the standby frequency to the active window.

This tunes the selected receiver to the new active frequency.

(3) Radio com selection keys

When the pilot presses one of these keys:

- The ACTIVE window displays the frequency set on that radio.
- The STBY /CRS window displays the selected standby frequency or course.
- The selected key displays a green monitor light.

- (4) Frequency selector knobs
The pilot uses these concentric knobs to select the STBY frequency or CRS.
The outer knob controls whole numbers; the inner knob controls decimal fractions.
- (5) AM pb-sw
If the aircraft has HF radios and the flight crew has selected an HF transceiver, this switch selects the AM mode. (The default mode is the SSB, or single side-band, mode).
This key displays a green monitor light when the AM mode is active.
- (6) SEL indicator
The SEL indicator on both RMP s comes on amber when a transceiver normally associated with one RMP is tuned by another:
- VHF 1 tuned by RMP 2 or RMP 3,
 - VHF 2 tuned by RMP 1 or RMP 3.
 - VHF 3, HF 1, HF 2 () tuned by RMP 1 or RMP 2.
- (7) NAV pb sw (with transparent switchguard)
The pilot presses this key to be able to select navigation receivers and courses through the RMP. It does not affect the selection of communication radios and their frequencies. (*Refer to DSC-34-NAV-30-30 Radio Management Panel (RMP), for additional information*).
- (8) Radio navigation selection keys
The pilot presses one of these keys to select a navigation radio to control through this RMP.
This turns on the green monitor light in the key.
Refer to DSC-34-NAV-30-30 Radio Management Panel (RMP), for additional information.
- (9) ON/OFF sw
This switch controls the power supply to the RMP.
Note: *RMP 3 is able to control VHF and HF transceivers through RMP 1 and RMP 2 even when they are OFF.*
- (10) LOAD FUNCTION 
When the ATC sends (CONTACT or MONITOR) CPDLC messages to the flight crew, a white light above the LOAD key comes on to indicate that the sent frequency is available to be loaded.
Press on this LOAD key before closing the CONTACT/MONITOR messages to load this VHF frequency to the STBY /CRS window.

*Note: When a frequency from the ATC services (sent label via datalink) has been received, the ATSU validates the frequency and simultaneously sends the information to all the RMP in order to activate the LOAD function.
When the LOAD function is activated, the flight crew can repeatedly load the frequency on each RMP as often as necessary; except if DATA is present on standby window.*

AUDIO MANAGEMENT SYSTEM



Ident.: DSC-23-10-30-00018496.0002001 / 17 MAR 17

Applicable to: ALL

The audio management system allows the flight crew to use :

- All the radio communication and radio navigation facilities installed on the aircraft in transmission and reception mode.
- The interphone systems.
- The call systems.
- The passenger address system.

The audio management system includes :

- An audio management unit (AMU).
- Three audio control panels (ACPs) (fourth and fifth optional).
- Sockets at each station:
 - Headset jack and boomset connector (hand microphone connector ) for pilot, copilot, and third occupant.
 - Headset jack for fourth occupant.
- One interphone jack at the ground power receptacle.
- Boomsets for the pilot, copilot, and third occupant, and three hand microphones (fourth ).
- Three cockpit oxygen mask microphones.
- One radio press-to-talk switch on each sidestick.
- One SELCAL code selection panel (avionics compartment).
- Two cockpit loudspeakers with separate volume controls.
- If installed, a jack panel in the electronic compartment that groups the headset jack, service interphone jack, hand mike connector, and boomset.
- An audio switching facility.

If audio channel 1 or 2 fails due to a failure either in an ACP or the corresponding AMU, the crew can use the AUDIO SWITCHING selector to select the third audio channel.

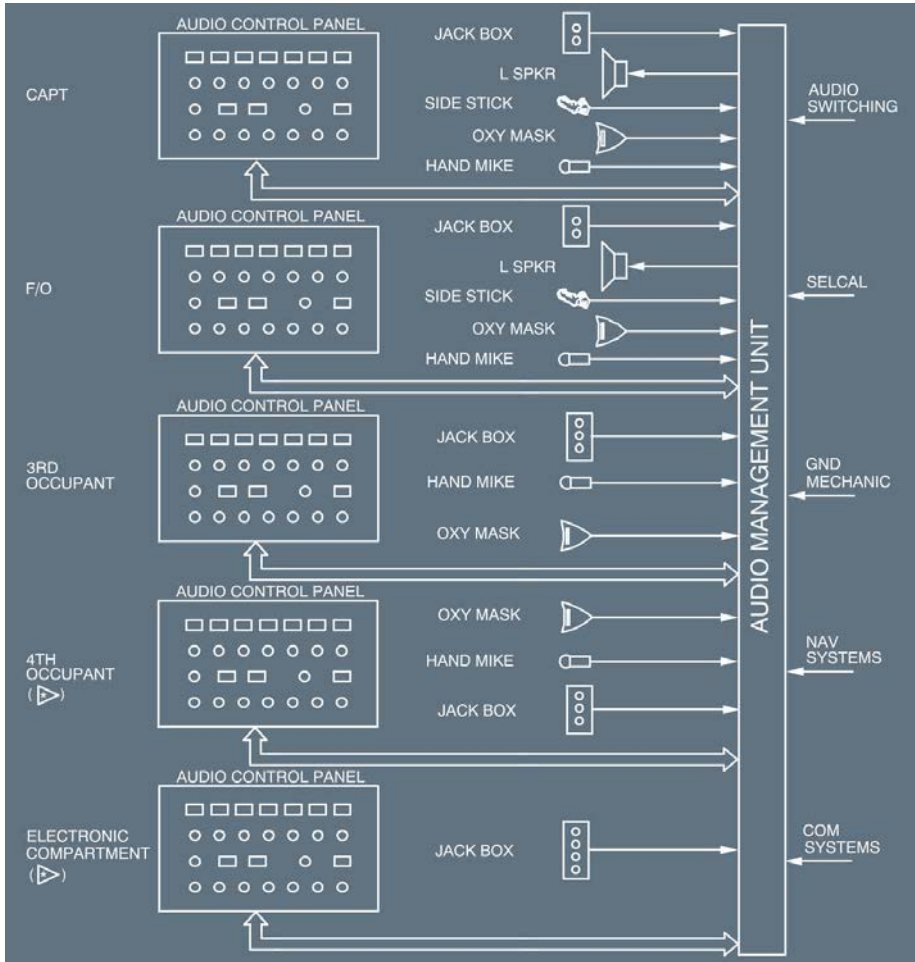

LOCATION OF COMPONENTS (PILOT'S STATION)

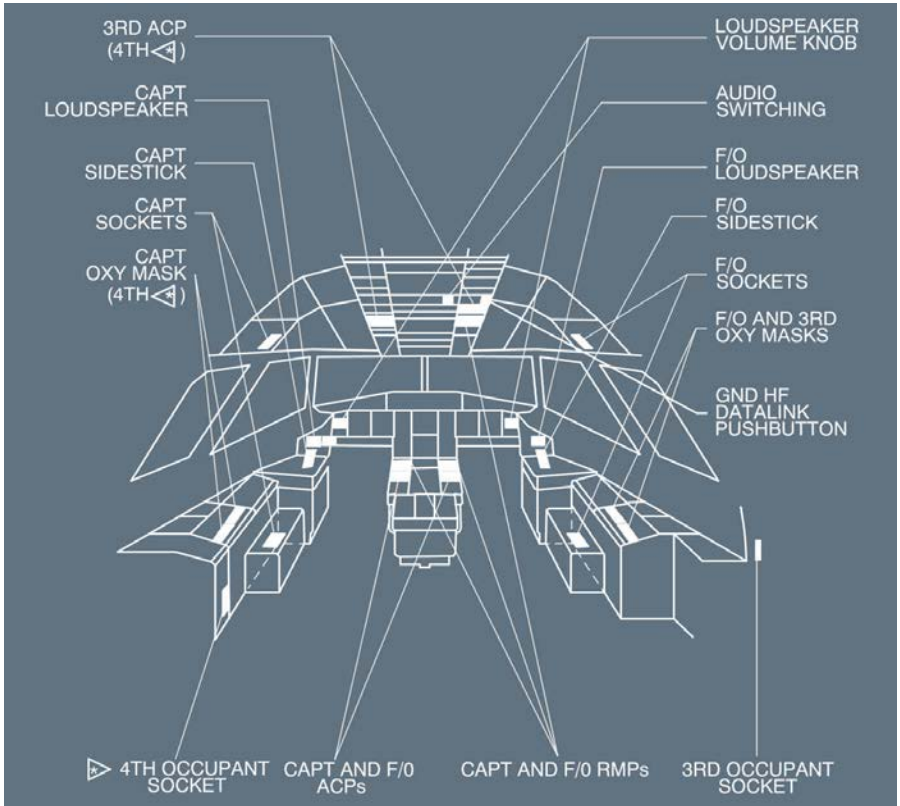

CABIN INTERCOMMUNICATION DATA SYSTEM

Ident.: DSC-23-10-30-00018497.0002001 / 17 MAR 17

Applicable to: ALL

The Cabin Intercommunication Data System (CIDS) transmits, controls, and processes signals for the following cabin systems :

- Cabin and service interphone
- Passenger address
- Passenger lighted signs
- Reading lights (LED technology)
- General cabin illumination

- Emergency evacuation signalling
- Lavatory smoke detectors and indicators
- Passenger entertainment music and video
- Escape slide bottle pressure monitoring
- Vacuum system control function
- Cargo and lavatory smoke detection function

The CIDS has the following main components :

- Two CIDS directors connected in parallel ; one active, and the other on standby.
 - Flight Attendant Panel (FAP) to monitor and control the cabin systems.
 - Attendant Indication Panels (AIP), After Attendant Panels (AAP) and Area Call Panels (ACP)
 - Decoder/Encoder Units (DEUs) linked to the two directors.
- Type A units (for passengers) installed along the cabin.
 The loudspeakers, lighted signs, call buttons, call lights and general illumination ballast units are divided into small groups, each connected to a type A DEU.
 - Type B units (for attendants) installed near the exit doors. The Area Call panels, smoke detectors, attendant handsets, slide and door pressure sensors, and attendant indicator panels, are connected to type B DEUs.

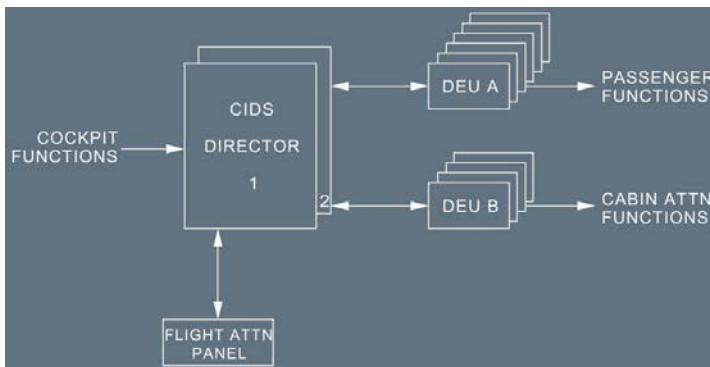

| | |
|---|--|
|  <p>A318/A319/A320/A321 FLIGHT CREW OPERATING MANUAL</p> | <p align="center">AIRCRAFT SYSTEMS COMMUNICATIONS</p> <p align="center">GENERAL - COCKPIT VOICE RECORDER</p> |
|---|--|

| |
|--------------------|
| DESCRIPTION |
|--------------------|

Ident.: DSC-23-10-40-00018569.0002001 / 17 MAR 17

Applicable to: ALL

The cockpit voice recorder (CVR) records :

- direct conversations between crew members in the cockpit
- all aural warnings sounded in the cockpit
- audio communications received and transmitted
- intercommunications conversations between crew members
- announcements transmitted over the passenger address system, if PA reception is selected on at least one audio control panel.

Only the last 2 h of recording are retained.

The CVR system consists of :

- a remote microphone behind the overhead panel
- a "hot mike" function, which records the crew members voice directly from their microphone, even if the push to talk switch is not activated.
- a crashproof four-track recorder, equipped with an underwater locating beacon, in the aft section of the aircraft
- a control panel on the overhead panel.

It is energized automatically :

- on the ground during the first 5 min after the aircraft electrical network is energized
- on the ground with one engine running
- in flight

On the ground, it is stopped automatically 5 min after the last engine shutdown provided the CVR jack is not used.

On the ground, the crew can energize the CVR manually by pressing the GND CTL pushbutton.

CONTROLS AND INDICATORS

Ident.: DSC-23-10-40-00018570.0001001 / 17 MAR 17

Applicable to: ALL

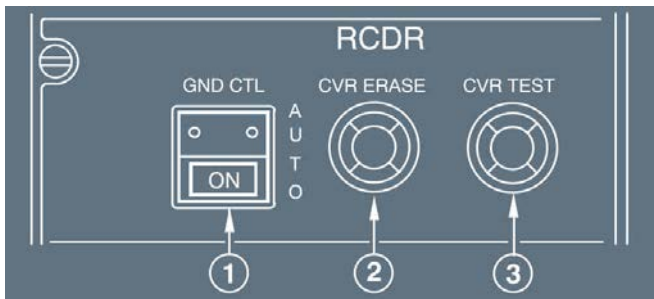

(1) GND CTL switch (spring-loaded)

ON : The CVR , DFDR , and QAR  are on.
 The ON light comes on blue.

AUTO: The CVR , DFDR , and QAR  are on, according to the logic. (*Refer to DSC-23-10-40 Description*).

(2) CVR ERASE pb 

Pressed for 2 s : This completely erases the tape, if :

- The aircraft is on the ground, and
- The parking brake is on.

(3) CVR TEST pushbutton

Pressed and held : This activates the test, if the CVR is on (the GND CTL pushbutton pressed, or during the first 5 min after energization of the aircraft electrical network), and the parking brake is on.

Refer to PRO-NOR-SOP-06 Overhead Panel - RCDR for additional information.

AUDIO CONTROL PANEL

Ident.: DSC-23-10-50-00018498.0002001 / 17 MAR 17

Applicable to: ALL

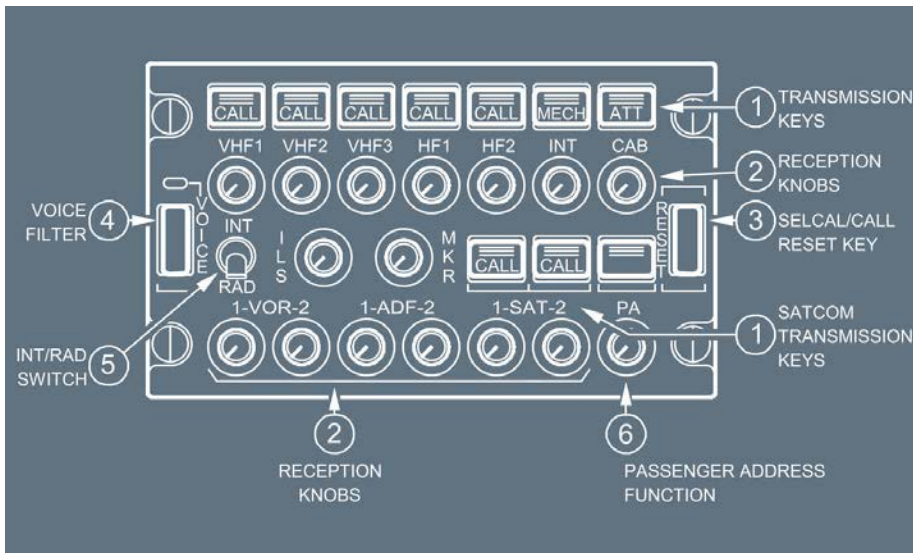

(1) Transmission keys

- Pressed : The associated channel is selected for transmission. The three green lines come on. The pilot deselects the channel by pressing the pushbutton again, or selecting another channel.
- CALL : The legend flashes amber (and buzzer sounds) when the SELCAL system detects a call.
- MECH : The legend flashes amber (and buzzer sounds) for a call from the nose gear bay. The MECH light goes off after 60 s, if it is not reset.
- ATT : The legend flashes amber (and buzzer sounds) for a call from a cabin crew member. The ATT light goes off after 60 s, if it is not reset.
- SAT CALL It : The legend flashes amber when the SATCOM system detects a call.  The three green lines flash during the establishment of air to ground calls, or when SATCOM calls are on hold. After call establishment, the three green lines remain steady.

(2) Reception knobs

- Pressing and releasing the knob (knob out) selects the associated audio reception channel and the integral white light comes on
- Rotating the knob adjusts the volume
- The INTEG LT knob or ANN LT knob controls the brightness
- Pressing the knob (knob stays in) disconnects the associated audio reception channel.

Note: To receive DME audio navigation signals that are associated with an ILS or MLS or GLS station: the flight crew must select the ILS pb (or LS pb) on the FCU . On some aircraft, the VOR reception channel must also be active on the ACP.

(3) SELCAL/CALL RESET key

Pressing this key extinguishes CALL, MECH , and ATT lights.

(4) ON VOICE key

This key allows the flight crew to inhibit the audio navigation signals (VOR , ADF)
Pressing this key filters out IDENT signals and turns on the green ON light.

(5) INT/RAD switch

This switch operates as a press-to-talk switch for boom mike or oxygen mask mike.

INT : Boom and mask mikes transmit on interphone regardless of which transmission key is selected. For reception on interphone, the crew member must have INT selected (INT reception knob out).

Neutral : Reception is normal. Boom and mask mikes do not transmit.

RAD (press and hold) : Boom and mask mikes transmit on the radio selected on the audio control panel.

(6) Passenger address (PA) function

(Refer to DSC-23-20-40 Description).

SIDE STICK RADIO SELECTOR

Ident.: DSC-23-10-50-00018499.0001001 / 17 MAR 17

Applicable to: ALL

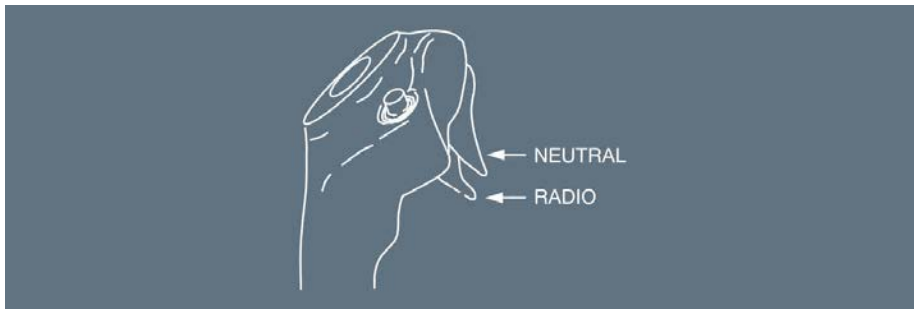

This selector has the same function as the INT/RAD switch on the ACP.

NEUTRAL (spring-loaded) : Boom and mask mikes are dead.
Reception is normal.

RADIO (squeezed) : Boom and mask mikes transmit through the equipment selected by the transmission key on the ACP.

Note: If **RADIO** is selected on the side stick when the INT/RAD switch is on INT, the radio function has priority over the interphone function.

LOUDSPEAKER VOLUME KNOB

Ident.: DSC-23-10-50-00018500.0001001 / 17 MAR 17

Applicable to: ALL

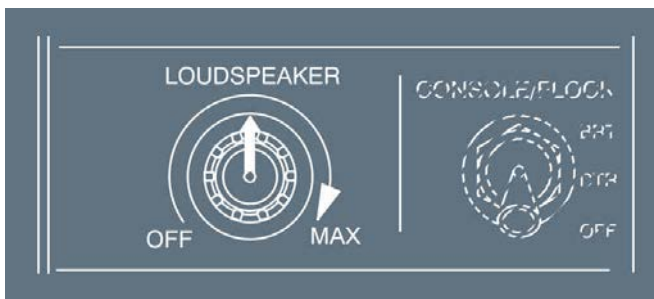

This knob adjusts the volume of the loudspeaker for radio communication.

- OFF : Loudspeaker does not respond to signals from the aircraft's radio equipment.
- Clockwise rotation : Loudspeaker broadcasts signals from the aircraft's radio equipment at increasing volume.

Note: This knob does not control the loudness of aural alert and voice messages. In the case of acoustic feedback (i.e. Larsen effect) from the cockpit loudspeaker, the flight crew should reduce the volume of the cockpit loudspeaker. However, the flight crew should ensure that the volume of the cockpit loudspeaker is sufficient to hear radio communication.

AUDIO SWITCHING

Ident.: DSC-23-10-50-00018501.0001001 / 17 MAR 17

Applicable to: ALL

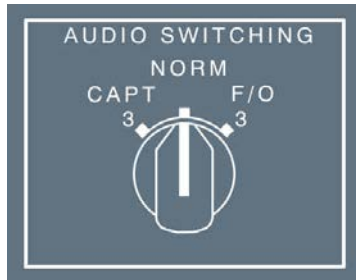

The crew can switch to the third ACP if ACP 1 or ACP2 fails.

When the crew does this, it takes away the third occupant's access to the acoustic equipment.

AUDIO 3 XFRD appears in green on the ECAM MEMO display.

NORM : Each crew member uses his dedicated communication equipment.

CAPT 3: The pilot uses his acoustic equipment and the third occupant's ACP.

F/O 3 : The copilot uses his acoustic equipment and the third occupant's ACP.

FLIGHT CREW INTERPHONE SYSTEM

Ident.: DSC-23-20-10-00019716.0001001 / 17 MAR 17

Applicable to: ALL

This system allows the flight crew members to communicate among themselves and, through a jack on the external power panel, with the ground mechanic.

EXTERNAL POWER PANEL (FORWARD OF THE NOSE L/G BAY)

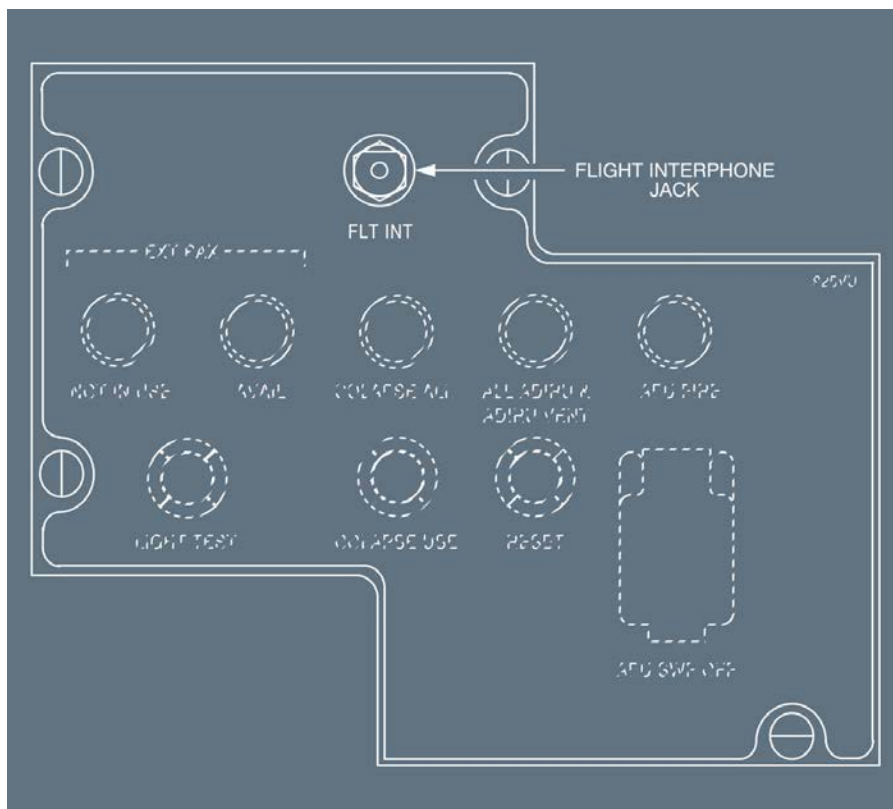



A318/A319/A320/A321
FLIGHT CREW
OPERATING MANUAL

AIRCRAFT SYSTEMS
COMMUNICATIONS

INTERNAL COMMUNICATION - FLIGHT CREW INTERPHONE SYSTEM

Intentionally left blank

INTRODUCTION

Ident.: DSC-23-20-20-00018481.0001001 / 20 JUL 17

Applicable to: ALL

The system allows the flight crew to communicate with the flight attendants, and the flight attendants to communicate among themselves.

Note: Cabin interphone monitoring may be deactivated in flight depending on CIDS customization.

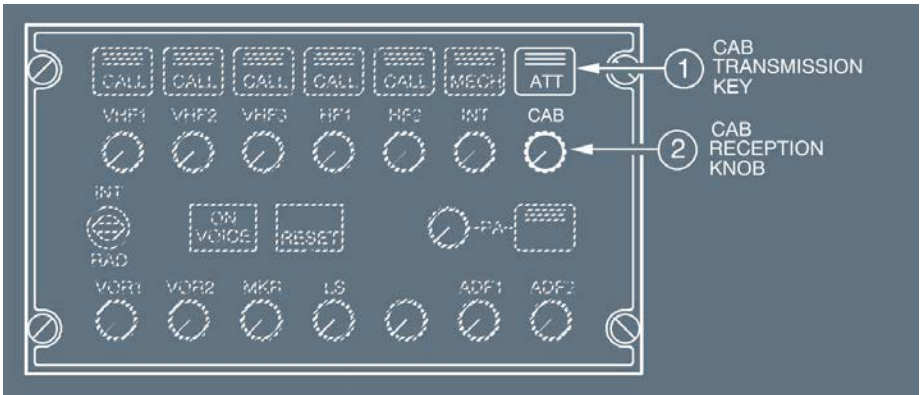

(1) CAB transmission key

Pressed: Three green lines come on.
Boom, mask, and hand mikes may be used for cabin interphone.

(2) CAB reception knob

Pressed and released (knob out): The integral white light comes on.
The station receives audio signals from the cabin.
Rotating the knob adjusts the volume.

Pressed (knob in): The white light goes out.
The cabin interphone is disconnected.

CABIN CALL SYSTEM

Applicable to: ALL

Ident.: DSC-23-20-20-10-00018482.0001001 / 02 NOV 16

CALLS FROM THE COCKPIT

The pushbuttons described here below are installed on the CALLS panel located on the overhead panel.

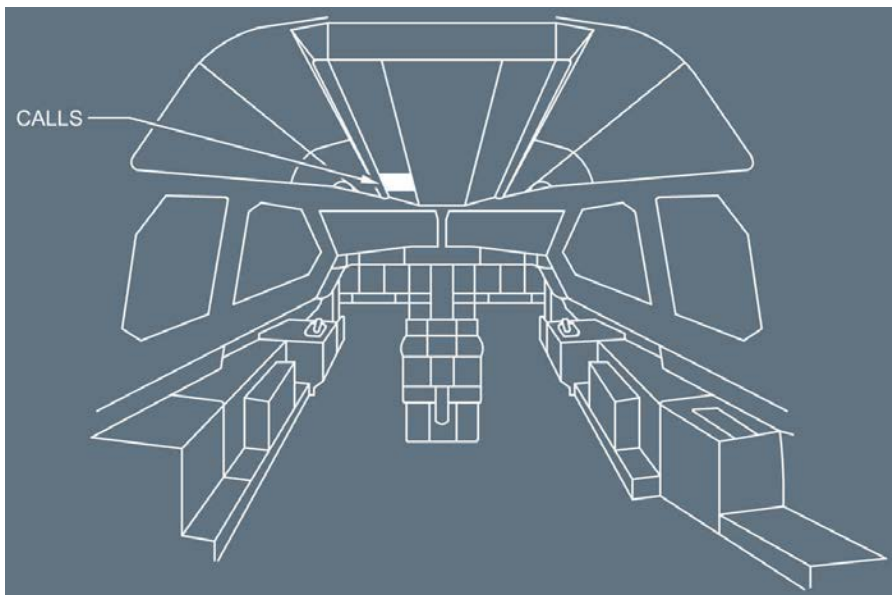

PURS  /FWD/MID  /EXIT  /AFT PUSHBUTTON

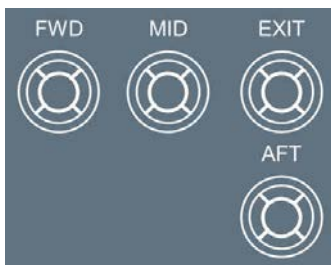

When pressed, the following aural and visual alerts will trigger in the cabin:

- Two lights come on in pink on the related area of the CALLS panel, as applicable.
- On the Attendant Indication Panel (AIP), the “CAPTAIN CALL” message appears and a light comes on in green.
- A high-low chime sounds in the related section of the cabin, as applicable.

ALL pb 



When pressed, all the stations simultaneously respond, as indicated above.

EMER pb-sw (GUARDED)



When pressed, the following aural and visual alerts will trigger in the cabin:

- Two pink lights flash on all area call panels.
- The “EMERGENCY CALL” message appears on all AIPs.
- A high-low chime sounds three times, on all of the loudspeakers.

Depending on aircraft configuration, on the cockpit CALLS panel, the white ON light and the amber CALL light come on.

The following aural and visual alerts will trigger in the cockpit, when an emergency call is made from the cabin to the cockpit:

- On the EMER pb-sw: The amber CALL light flashes.
- The ATT lights will flash on all Audio Control Panels (ACPs).
- Three buzzers will sound consecutively (for approx. three seconds each).

The cabin call system will reset, when the cabin crewmember hangs up the handset.

TT light 



When the TT pb on the FWD or AFT Attendant Panel is pressed, the TT light on the cockpit CALLS panel comes ON and a buzzer sounds three times in the cockpit.

ATTND ADV pb 



When pressed, in the case of an imminent takeoff or landing, the ON light comes on in blue, in addition to a green light on the area call panel in the cabin.

Ident.: DSC-23-20-20-10-00018483.0003001 / 17 MAR 17

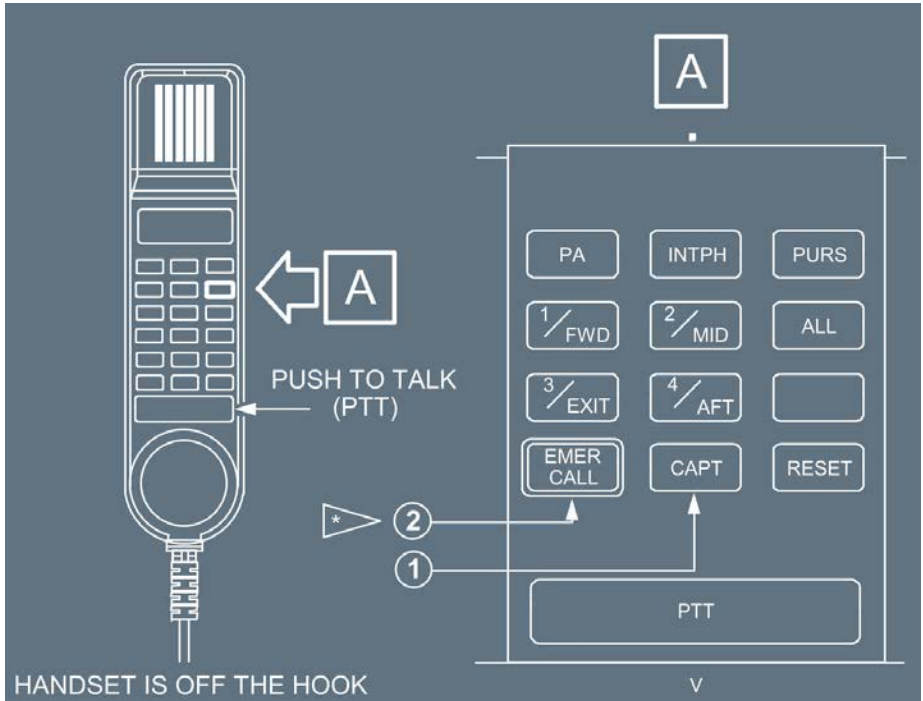

(1) CAPT key

When pressed, the following aural and visual alerts will trigger in the cockpit:

- The ATT lights will flash on all Audio Control Panels (ACPs).
- A buzzer (inhibited during takeoff and landing) will sound.

In the cabin, the “CAPTAIN” message will appear on the Attendant Indication Panel (AIP) for which the CAPT key was pressed.

(2) EMER CALL key 

When pressed, the following aural and visual alerts will trigger in the cockpit:

- On the EMER pb-sw: the ON light flashes in white, and the CALL light flashes in amber.
- The ATT lights will flash on all ACPs.
- Three buzzers (inhibited during takeoff and landing) will sound consecutively.

In the cabin, the “EMERGENCY CALL” message will appear on all AIPs or on the AIP of the originating station based on its customization.

INTRODUCTION

Ident.: DSC-23-20-30-00018485.0001001 / 20 JUL 17

Applicable to: ALL

The system allows for communication between :

- The flight crew and the service interphone jacks.
- The flight attendant stations and the service interphone jacks.
- The different service interphone jacks.

The Service Interphone system has :

- Seven interphone jacks.
- An OVRD switch located on the overhead panel.

The audio lines from the interphone jacks are connected to both CIDS directors.

LOCATION OF INTERPHONE JACKS

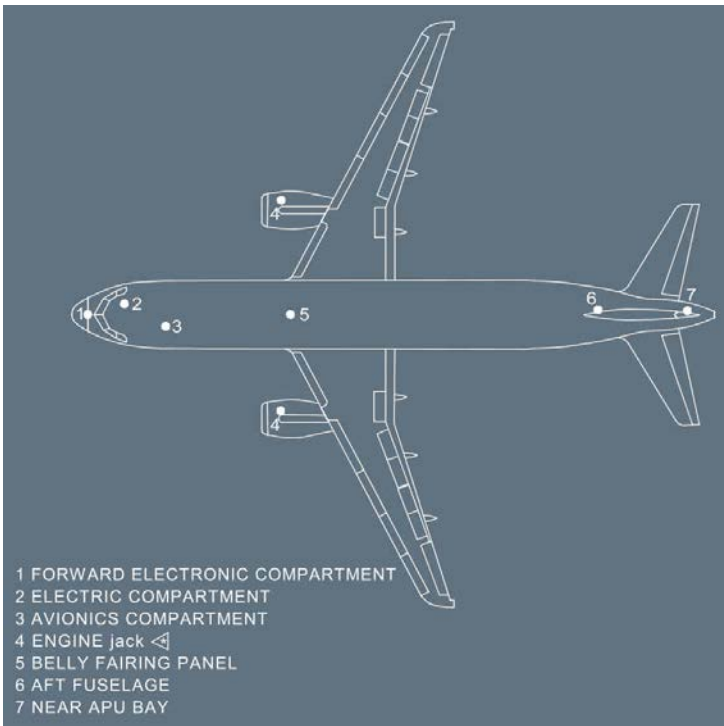

CONTROLS AND INDICATORS AT OVERHEAD PANEL

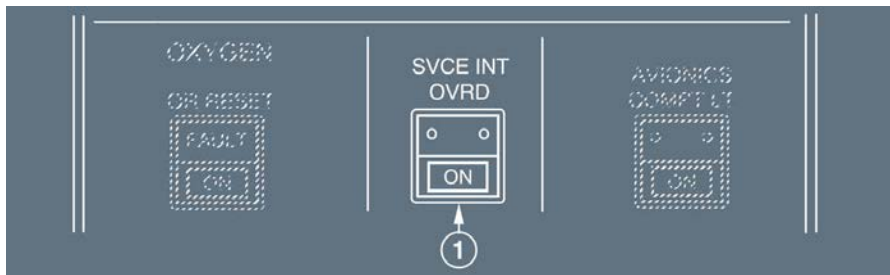

(1) SVCE INT OVRD pushbutton switch

- Auto : Ground personnel can communicate with the flight crew by means of the service interphone jacks 10 s after the aircraft has landed. The landing gear must be compressed.
- ON : Communication is possible when the landing gear is not compressed. The ON light is white.

GROUND MECHANIC CALL SYSTEM

Applicable to: ALL

Ident.: DSC-23-20-30-10-00018486.0001001 / 17 MAR 17

CONTROLS AND INDICATORS ON OVERHEAD PANEL

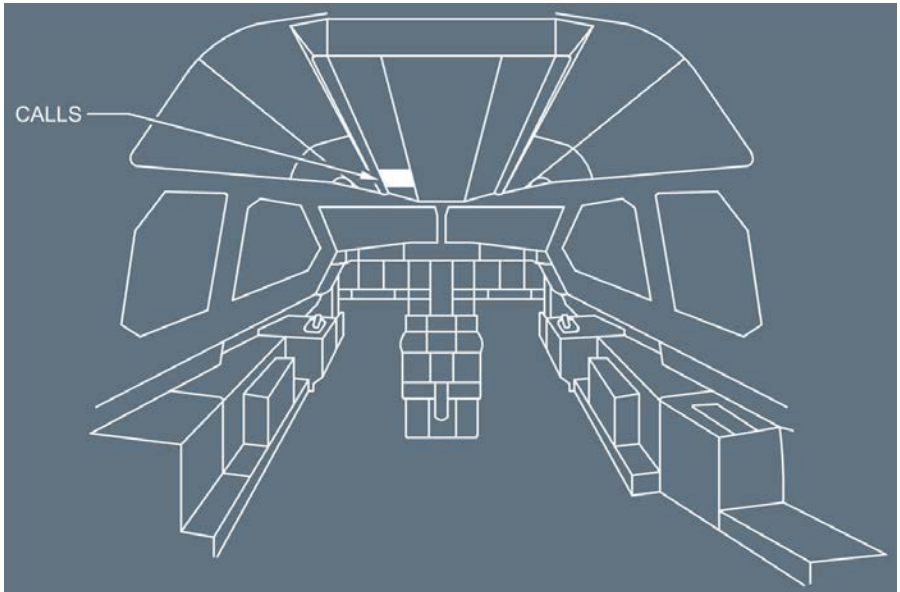

MECH pb

- Pressed (and held) : COCKPIT CALL lights up blue on the external power panel in the nose L/G bay.
An external horn sounds.
- Released : COCKPIT CALL remains lighted.
The ground mechanic can extinguish it by pressing the RESET button on the external power panel. The external horn stops sounding.

Ident.: DSC-23-20-30-10-00018487.0001001 / 17 MAR 17

CONTROLS AND INDICATORS ON THE EXTERNAL POWER PANEL

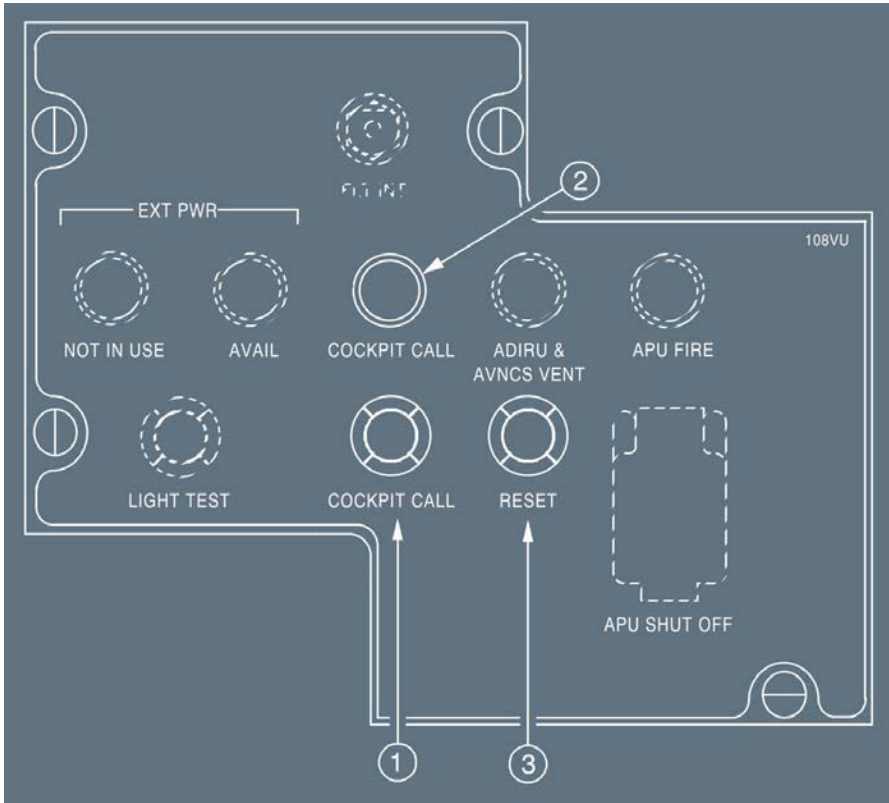

(1) COCKPIT CALL pushbutton

Pressed : This calls the cockpit.

The MECH lights flash amber on the ACPs and a buzzer sounds.

Released : The MECH lights go out after 60 s if they are not reset on the ACPs.

The buzzer stops.

(2) COCKPIT CALL light

The blue light appears when cockpit calls the ground mechanic. An external horn also sounds.

(3) RESET pushbutton

Pressed The COCKPIT CALL light goes out.



A318/A319/A320/A321
FLIGHT CREW
OPERATING MANUAL

AIRCRAFT SYSTEMS
COMMUNICATIONS

INTERNAL COMMUNICATION - SERVICE INTERPHONE SYSTEM

Intentionally left blank

DESCRIPTION

Ident.: DSC-23-20-40-00018685.0001001 / 17 MAR 17

Applicable to: ALL

The passenger address allows all crew members to make announcements to passengers in the cabin through loudspeakers. It can be operated from the cockpit (with ACP or handset) or from the cabin (attendant stations).

CONTROLS AND INDICATORS

Ident.: DSC-23-20-40-00018686.0001001 / 20 JUL 17

Applicable to: ALL

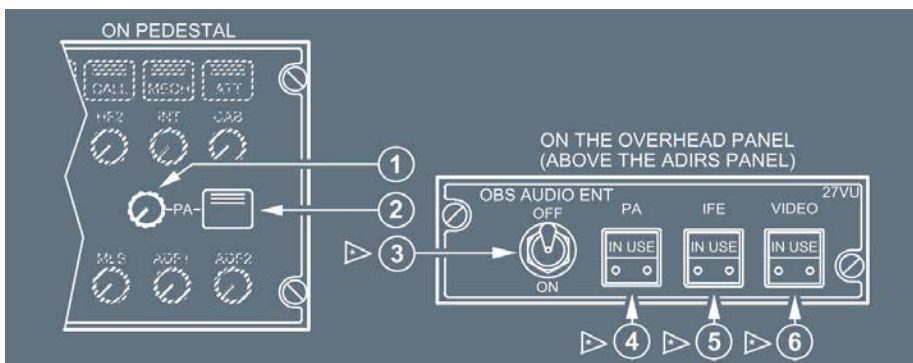

(1) PA reception knob

Pressed and released : The message goes to the loudspeakers, and the integral white light comes on.

The flight crew can turn the knob to adjust the volume.



Pressed (knob in) : The PA reception to the loudspeakers is disconnected. The white light goes out.

(2) PA transmission key

Pressed and held : The flight crew may use a boom, mask, or hand mike to make an announcement.

Three green lines come on.

Note: The flight crew may use a cockpit handset to make PA announcements without action on the ACPs.

- (3) OBS AUDIO ENT sw 
 - ON : Announcement from the cockpit can be heard through channel 9 of Passenger Entertainment System (PES).
 - OFF : Normal functioning of PES is restored.
- (4) PAIN USE light 

The light comes on when the PA is activated from the cockpit or from the cabin (cabin attendant or prerecorded announcement).
- (5) IFEIN USE light 

The light comes on when the IFE system is in use.
- (6) VIDEO IN USE light 

The light comes on when the video system is in use.

The flight crew can also use the cockpit handset, located at the bottom of the pedestal, for PA announcements.



Note: Due to numerous customizations of the handset and keypad, their functions are not described in detail.

| | |
|---|--|
|  <p>A318/A319/A320/A321 FLIGHT CREW OPERATING MANUAL</p> | <p style="text-align: center;">AIRCRAFT SYSTEMS COMMUNICATIONS</p> <p style="text-align: center;">EXTERNAL COMMUNICATION - RADIO COMMUNICATION</p> |
|---|--|

| |
|--------------------|
| DESCRIPTION |
|--------------------|

Ident.: DSC-23-30-10-00018475.0001001 / 17 MAR 17
Applicable to: ALL

Either of the two Radio Management Panels (RMPs) (third RMP ) can be used to tune each transceiver.

To transmit, the flight crew uses the Audio Control Panel (ACP) to select a VHF or HF system. The ACP works through the Audio Management Unit (AMU). Each system is connected to the RMP s, for frequency selection, and to the AMU for connection to the audio integrating and SELCAL (selective calling) systems.

| |
|------------|
| VHF |
|------------|

Ident.: DSC-23-30-10-00018472.0001001 / 27 APR 17
Applicable to: ALL

Two identical VHF communication systems (third VHF system ) are installed. Each system has a transceiver in the avionics compartment, and an antenna on the fuselage. Only VHF1 functions in EMER ELEC CONFIG. Its range is from 118.0 to 136.975 MHz.

| |
|-----------|
| HF |
|-----------|

Ident.: DSC-23-30-10-00018473.0003001 / 04 JUL 17
Applicable to: ALL

Two identical HF communication systems are optional. Each has a transceiver in the avionics compartment, and a common tuner and antenna in the vertical stabilizer. Its range is from 2.8 to 24 MHz.

The HF DATA transmission is inhibited on ground. A GND HF DATALINK pb, located on the overhead panel, may override the inhibition. HF must not be used during refueling.

The HF VOICE MODE is not inhibited on ground. The use of HF on ground must be limited to operational needs. It is important to check that nobody stays in the direct vicinity of the antennas if the HF is use on ground.

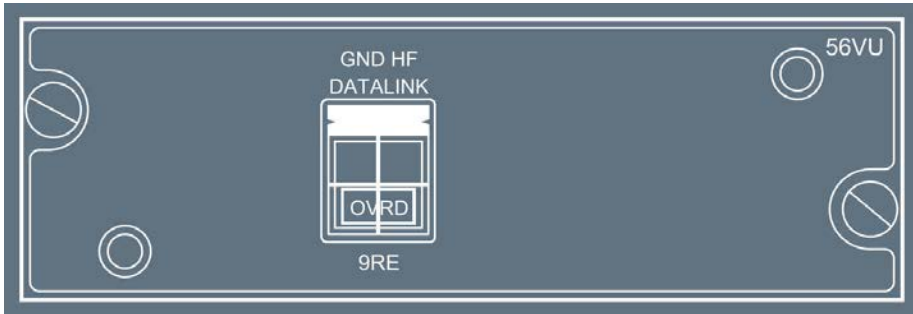

SELCAL (SELECTIVE CALLING)

Ident.: DSC-23-30-10-00018476.0001001 / 17 MAR 17

Applicable to: **ALL**

Upon receiving a call code corresponding to that of the aircraft, the SELCAL system aurally and visually advises the flight crew that a ground station is calling the aircraft.
The aural warning is inhibited during takeoff and landing.

CONTROLS AND INDICATORS

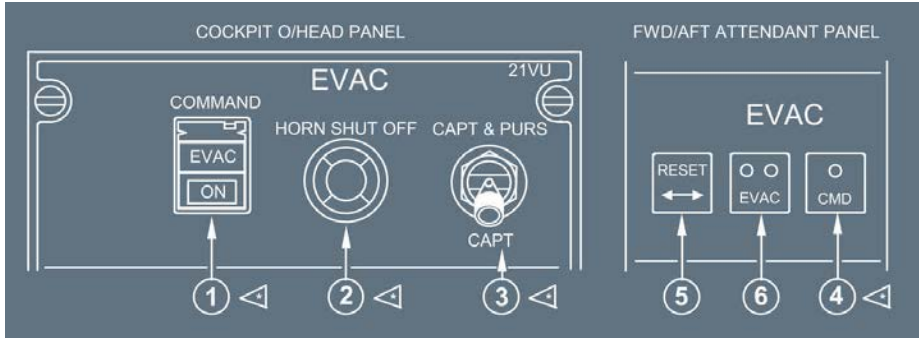

Ident.: DSC-23-40-10-00018468.0001001 / 18 MAY 17

Applicable to: ALL



- (1) COMMAND pb (guarded) 
 - ON : In the cockpit : - EVAC light flashes red.
 - Depending on aircraft configuration, horn sounds.
 - In the cabin : - EVAC lights flash at FWD and AFT attendant panels.
 - Evacuation tone sounds.

OFF : The alert is stopped.
The EVAC light flashes red when the alert is activated.
- (2) HORN SHUT OFF pb 

Pressing this button silences the cockpit horn.
- (3) CAPT and PURS/CAPT sw 
 - CAPT and PURS : The alert may either be activated from the cockpit or the cabin.
 - CAPT : The alert may only be activated from the cockpit.
 - If one of the cabin CMD pb is pressed, only the cockpit horn sounds for 3 s.
- (4) CMD pb 

Pressing this button activates the alert, if the cockpit switch is at the CAPT & PURS position.
Pressing it again stops the alert.
- (5) RESET pb

Pressing this button silences the EVAC tone.

(6) EVAC light

This light flashes when the alert is activated.

PURSER STATION

Ident.: DSC-23-40-10-00018469.0001001 / 17 MAR 17

Applicable to: **ALL**

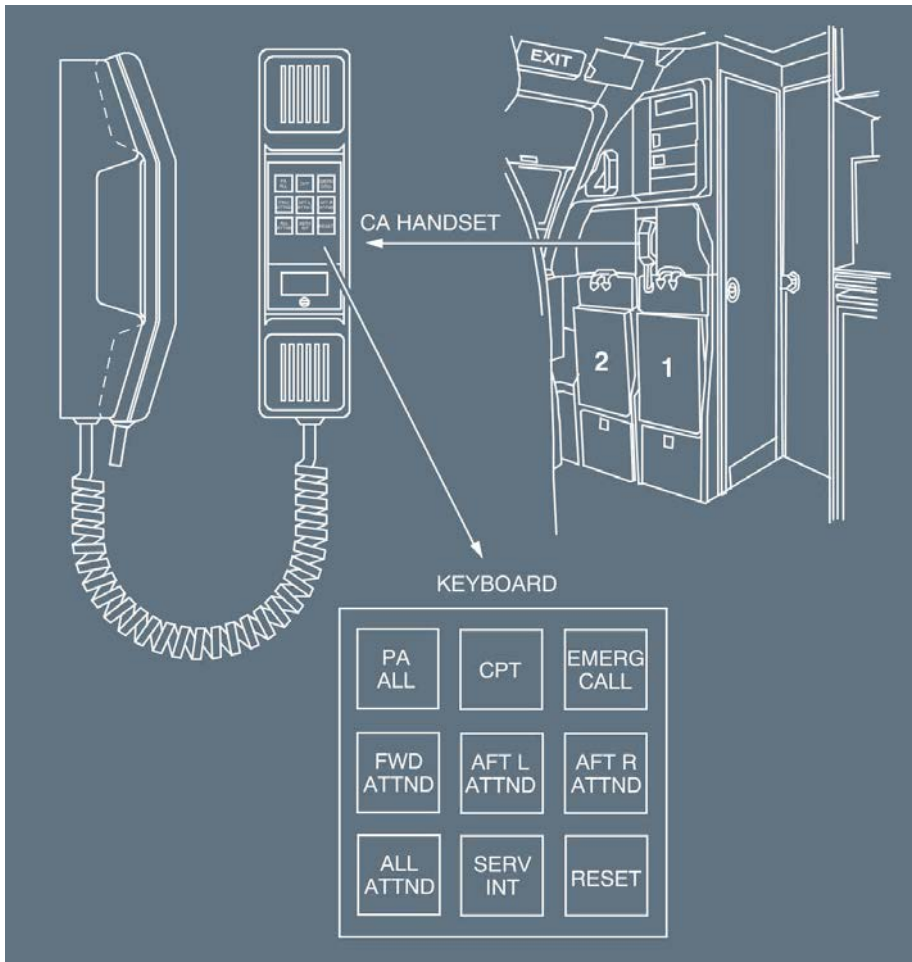

CONTROLS AND INDICATORS

Ident.: DSC-23-40-30-00018516.0002001 / 17 MAR 17

Applicable to: ALL

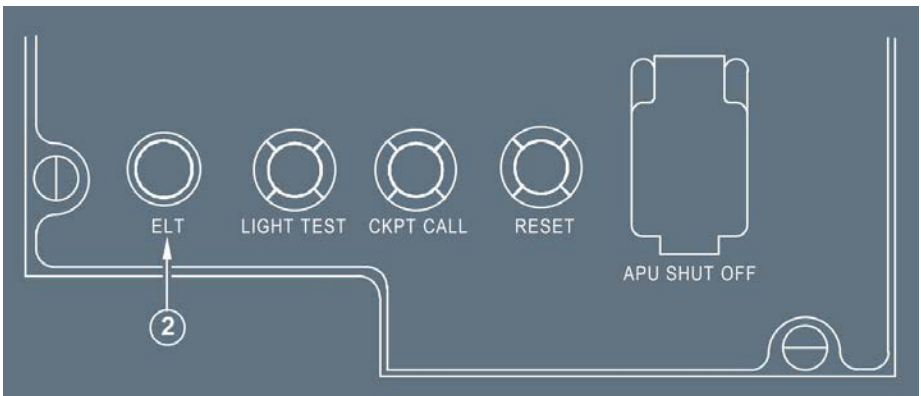

(1) ELT selector

- ON : The Emergency Locator Transmitter (ELT) transmits an emergency signal.
- ARMED : In case of impact, the ELT transmits an emergency signal (on 121.5, 243 and 406 MHz).
- TEST/RESET : Starts the ELT autotest.

Note: If the ELT is unduly triggered in ARMED mode (by an external impact, hard landing, etc.), select the TEST/RESET position to reset the ELT and stop signal transmission.

(2) ON light and ELT light

These lights come on amber either when the emergency signal is transmitted, or during ELT autotest.

| | |
|---|---|
|  <p>A318/A319/A320/A321 FLIGHT CREW OPERATING MANUAL</p> | <p>AIRCRAFT SYSTEMS</p> <p>COMMUNICATIONS</p> <p>MEMO DISPLAY</p> |
|---|---|

ACARS 

Ident.: DSC-23-50-00018505.0001001 / 31 AUG 17
Applicable to: ALL

- ACARS CALL** : This memo appears in green when ACARS has received a message from the ground requesting a voice communication on VHF. This message is pulsing green during 60 s then steady.
- VHF 3 VOICE** : This memo appears in green when VHF 3 is operating in voice mode and ACARS communication is interrupted.
- ACARS MSG** : This memo appears in green when ACARS has received a message from the ground. This message is pulsing green during 60 s then steady.
- ACARS STBY** : This memo appears in green when ACARS communications between the aircraft and the ground are lost, or when a failure occurs at ATSU initialization to indicate to the crew to enter some initialization parameters.

ATSU 

Ident.: DSC-23-50-00018506.0001001 / 31 AUG 17
Applicable to: ALL

- VHF 3 VOICE** : This memo appears in green, if VHF 3 is operating in voice mode and ACARS communication is interrupted.
- HF VOICE** : This memo appears in green, if both HF s  are operating in voice mode. This message flashes for 10 s and then steady.

AUDIO 3 XFRD

Ident.: DSC-23-50-00018507.0001001 / 17 MAR 17
Applicable to: ALL

- AUDIO 3 XFRD** : This memo appears in green, if the AUDIO SWITCHING selector is not on NORM.

SATCOM 

Ident.: DSC-23-50-00018508.0001001 / 31 AUG 17
Applicable to: ALL

- SATCOM ALERT** : This memo appears in green when a message with priority level below 4 is received from the ground.



A318/A319/A320/A321
FLIGHT CREW
OPERATING MANUAL

AIRCRAFT SYSTEMS

COMMUNICATIONS

MEMO DISPLAY

Intentionally left blank

AIRCRAFT SYSTEMS

ELECTRICAL

Intentionally left blank

DSC-24-10 Description

DSC-24-10-10 General

General.....A

DSC-24-10-20 Generation of Electrical Power

AC Generators.....A

DC Generation.....B

Circuit Breakers (C/Bs).....C

DSC-24-10-30 Operations

DSC-24-10-30-10 General

General.....A

DSC-24-10-30-20 Normal Configuration

In Flight.....A

On Ground.....B

DSC-24-10-30-30 Abnormal Configurations

Failure of One Engine Generator.....A

Failure of AC BUS 1.....B

Failure of One TR.....C

Failure of TR 1 and TR 2.....D

Emergency Generation after Loss of All Main Generators.....E

EMER GEN Running.....F

EMER GEN Running (Cont'd).....G

Flight with Batteries Only.....H

On Ground, Batteries Only (Speed < 50 kt).....I

Smoke Configuration.....J

DSC-24-10-30-40 Distribution Table

Distribution Table.....A

DSC-24-20 Controls and Indicators

Overhead Panel.....A

Overhead Panel (Cont'd).....B

External Power Panel.....C

Forward Cabin.....D

ECAM ELEC Page.....E

Memo Display.....F



A318/A319/A320/A321
FLIGHT CREW
OPERATING MANUAL

AIRCRAFT SYSTEMS

ELECTRICAL

PRELIMINARY PAGES - TABLE OF CONTENTS

Intentionally left blank



A318/A319/A320/A321
FLIGHT CREW
OPERATING MANUAL

AIRCRAFT SYSTEMS

ELECTRICAL

DESCRIPTION - GENERAL

GENERAL

Ident.: DSC-24-10-10-00017750.0001001 / 21 MAR 16

Applicable to: ALL

The electrical power system consists of a three-phase 115/200 V 400 Hz constant-frequency AC system and a 28 V DC system. Electrical transients are acceptable for equipment. Commercial supply has secondary priority.

In normal configuration, the electrical power system provides AC power. The electrical power system is constituted of 2 engine generators and 1 APU generator. Each generator can provide AC power to all electrical bus bars. A part of this AC power is converted into DC power for certain applications.

In the event that normal AC power is not available, an emergency generator can provide AC power. In the event that all AC power is not available, the electrical power system can invert DC power from the batteries into AC power.

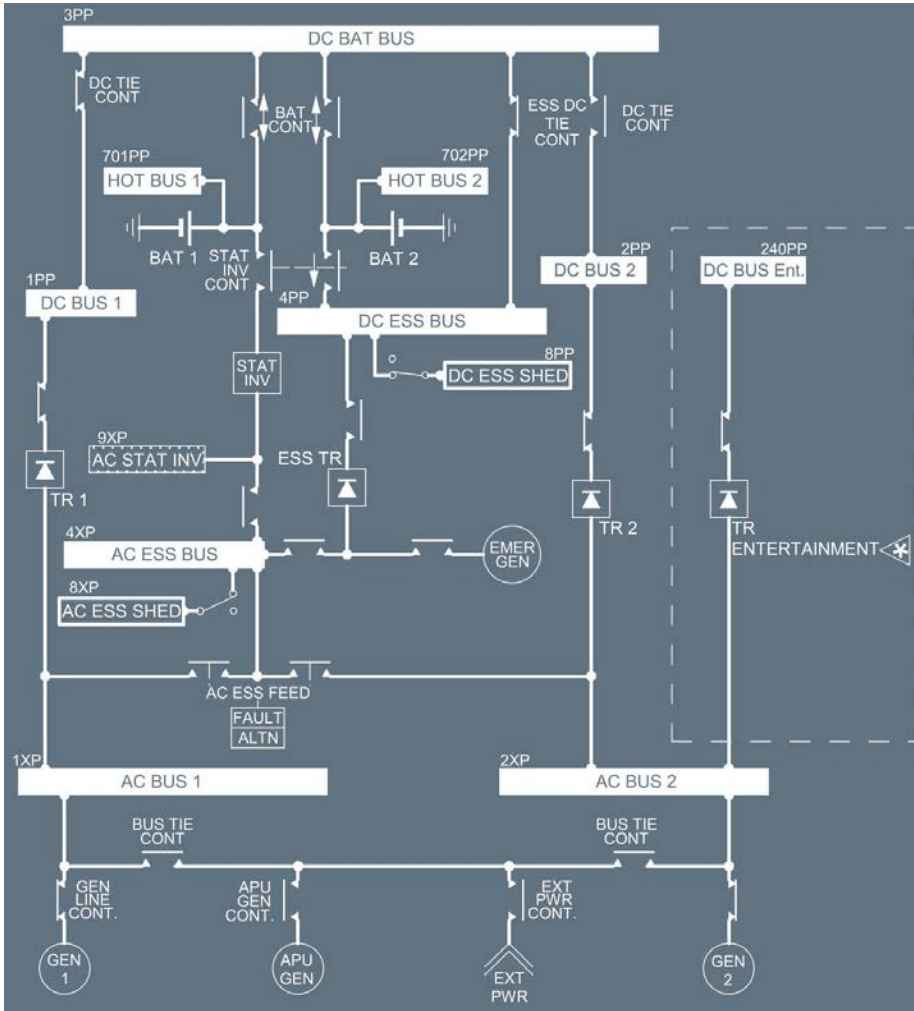

| | |
|---|--|
|  <p>A318/A319/A320/A321 FLIGHT CREW OPERATING MANUAL</p> | <p style="text-align: center;">AIRCRAFT SYSTEMS ELECTRICAL</p> <p style="text-align: center;">DESCRIPTION - GENERATION OF ELECTRICAL POWER</p> |
|---|--|

AC GENERATORS

Ident.: DSC-24-10-20-00017751.0001001 / 21 MAR 16

Applicable to: ALL

ENGINE – DRIVEN GENERATORS

Two AC generators (GEN 1, GEN 2), one driven by each main engine through an integrated drive, supply aircraft electrical power. Each generator can supply up to 90 KVA of three phase 115/200 V 400 Hz power.

Two Generators Control Units (GCU) control the output of their respective generator. The main functions of each GCU are :

- Control the frequency and voltage of the generator output.
- Protect the network by controlling the associated generator line contactor.

APU GENERATOR AND EXTERNAL POWER

A third generator (APU GEN), driven directly by the APU and producing the same output as each main engine generator, can replace either or both main engine generators at any time. A ground power connector near the nosewheel allows ground power to be supplied to all busbars.

A Ground Power Control Unit (GPCU) :

- Protects the network by controlling the external power contactor, or

A Ground and Auxiliary Power Control Unit (GAPCU)  :

- Regulates, via the APU Electronic Control Box, the frequency and voltage of the APU generator.
- Protects the network by controlling the external power contactor and the APU generator line contactor.

EMERGENCY GENERATOR

The blue hydraulic circuit drives an emergency generator that automatically supplies emergency AC power to the aircraft electrical system, if all main generators fail. This generator supplies 5 KVA of three-phase 115 and 200 V 400 Hz power.

A Generator Control Unit (GCU) :

- Keeps the emergency generator at a constant speed,
- Controls the generator's output voltage,
- Protects the network by the controlling the emergency generator line contactor, and
- Controls the emergency generator start-up.

STATIC INVERTER

A static inverter transforms DC power from Battery 1 into one KVA of single-phase 115 V 400 Hz AC power, which is then supplied to part of the AC essential bus. When the aircraft speed is above

AIRCRAFT SYSTEMS

ELECTRICAL

DESCRIPTION - GENERATION OF ELECTRICAL POWER

50 kt, the inverter is automatically activated, if only the batteries are supplying electrical power to the aircraft, regardless of the BAT 1 and BAT 2 pushbutton positions.

When the aircraft speed is below 50 kt, the inverter is activated, if only the batteries are supplying electrical power to the aircraft, and both BAT 1 and BAT 2 pushbuttons are on.

DC GENERATION

Ident.: DSC-24-10-20-00017752.0001001 / 21 MAR 16

Applicable to: ALL

TRANSFORMER RECTIFIERS (TRS)

Two main transformer rectifiers, TR 1 and TR 2, supply the aircraft's electrical system, with up to 200 A of DC current.

A third (identical) Transformer Rectifier, the ESS TR, can power the essential DC circuit from the emergency generator, if the engine and APU generators all fail, or if TR 1 or TR 2 fails.

Each TR controls its contactor by internal logic.

A fourth Transformer Rectifier (TR Entertainment ) powers the DC Entertainment bus bar dedicated to the In-Flight Entertainment system (IFE) in order to take into account IFE needs.

BATTERIES

Two main batteries, each with a normal capacity of 23 Ah, are permanently connected to the two hot buses.

Each battery has an associated Battery Charge Limiter (BCL).

The BCL monitors battery charging and controls its battery contactor.

CIRCUIT BREAKERS (C/BS)

Ident.: DSC-24-10-20-00000874.0002001 / 15 FEB 11

Applicable to: ALL

The aircraft has two types of C/Bs:

- Monitored (green): When out for more than 1 min, the C/B TRIPPED warning is triggered on the ECAM.
- Non-monitored (black).

The Wing Tip Brake (WTB) C/Bs have red caps on them to prevent them from being reset.

The C/B TRIPPED warning on the ECAM indicates the location of the affected C/B. The following panels are monitored: OVHD PNL, L(R) ELEC BAY, REAR PNL J-M or N-R or S-V or W-Z.

- Note: *The flight crew can clear the ECAM C/B TRIPPED caution by pressing:*
- *The EMER CANC pb: When pressed, this pushbutton clears and inhibits the ECAM C/B TRIPPED caution for the remainder of the flight, or*
 - *The CLR pb: When pressed, this pushbutton only clears the ECAM C/B TRIPPED caution. If the C/B remains pulled, any additional tripped circuit breakers on the same panel will not be detected, and the ECAM will not trigger the caution. However, if the C/B is pushed, any additional tripped circuit breakers will be detected, and the ECAM will trigger the caution again.*



A318/A319/A320/A321
FLIGHT CREW
OPERATING MANUAL

AIRCRAFT SYSTEMS

ELECTRICAL

DESCRIPTION - GENERATION OF ELECTRICAL POWER

Intentionally left blank

General

GENERAL

Ident.: DSC-24-10-30-10-00017759.0001001 / 21 MAR 16

Applicable to: ALL

GEN 1 and 2 when operating have priority over the APU generator and over external power.
External power has priority over the APU generator when the EXT PWR pb switch is ON.
The APU generator or external power can supply the entire network.
One engine generator can supply the entire network, except the DC BUS Entertainment.
The generators cannot be connected in parallel.

Note: *Two generators are needed to supply the DC BUS Entertainment  , except on ground, where the APU generator (if not overloaded) or the external power is sufficient.*



A318/A319/A320/A321
FLIGHT CREW
OPERATING MANUAL

AIRCRAFT SYSTEMS

ELECTRICAL

DESCRIPTION - OPERATIONS

Intentionally left blank

Normal Configuration

IN FLIGHT

Ident.: DSC-24-10-30-20-00000876.0002001 / 09 OCT 12

Applicable to: ALL

Each engine-driven generator supplies its associated AC BUS (1 and 2) via its generator line contactor (GLC 1 and GLC 2).

AC BUS 1 normally supplies the AC ESS BUS via a contactor.

TR 1 normally supplies DC BUS 1, DC BAT BUS, and DC ESS BUS.

TR 2 normally supplies DC BUS 2.

The two batteries are connected to the DC BAT BUS, if they need charging. When they are fully charged, the battery charge limiter disconnects them.

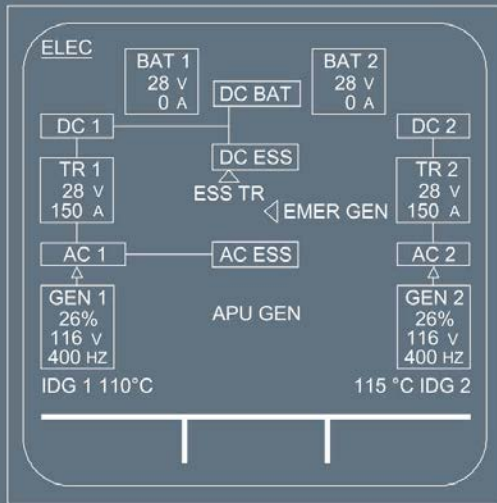

ON GROUND

Ident.: DSC-24-10-30-20-00000877.0002001 / 22 MAY 12

Applicable to: ALL

Either the APU generator, or external power, may supply the complete system.

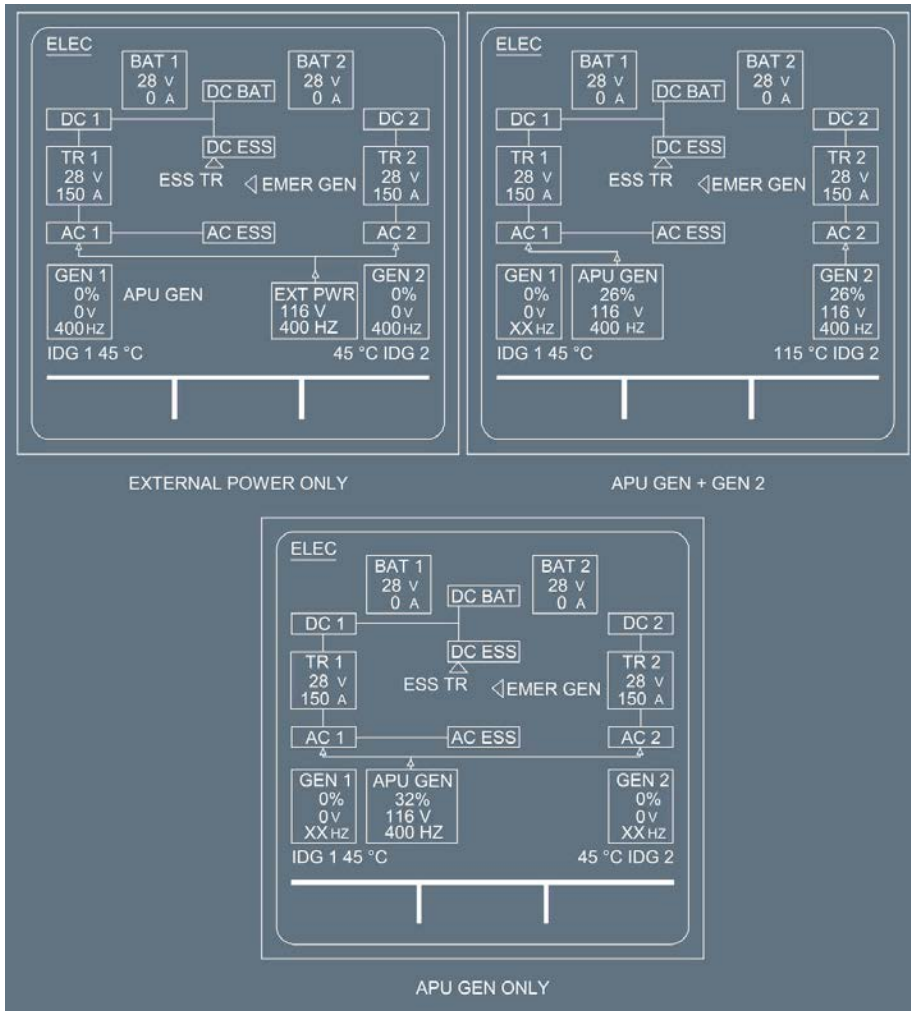

On ground, when only ground services are required, external power can supply the AC and DC GND /FLT BUSES directly without supplying the entire aircraft network.

Personnel select this configuration with the MAINT BUS switch in the forward entrance area.

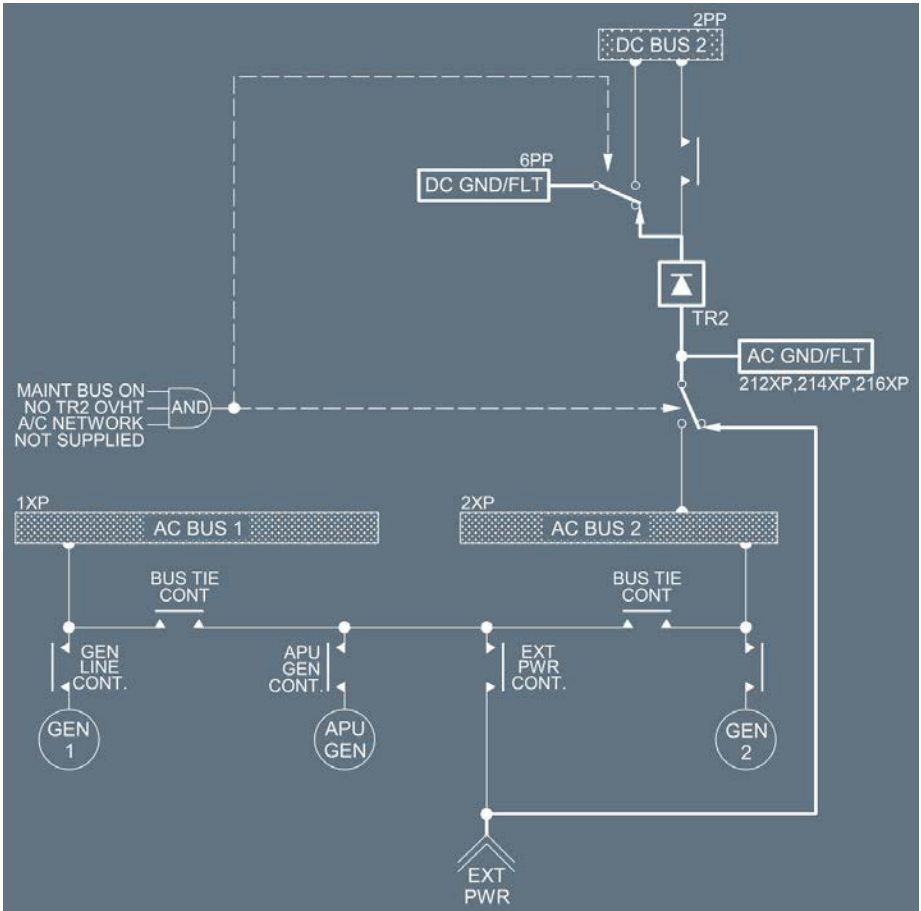



A318/A319/A320/A321
FLIGHT CREW
OPERATING MANUAL

AIRCRAFT SYSTEMS

ELECTRICAL

DESCRIPTION - OPERATIONS

Intentionally left blank

Abnormal Configurations

FAILURE OF ONE ENGINE GENERATOR

Ident.: DSC-24-10-30-00017760.0002001 / 21 MAR 16

Applicable to: ALL

The system automatically replaces the failed generator, with the :

- APU GEN, if available, or
- Other engine generator.

Part of the galley load and the DC BUS Ent  are automatically shed.

Note: The Galley Load Automatic Shedding  allows all the galley load to be automatically shed.

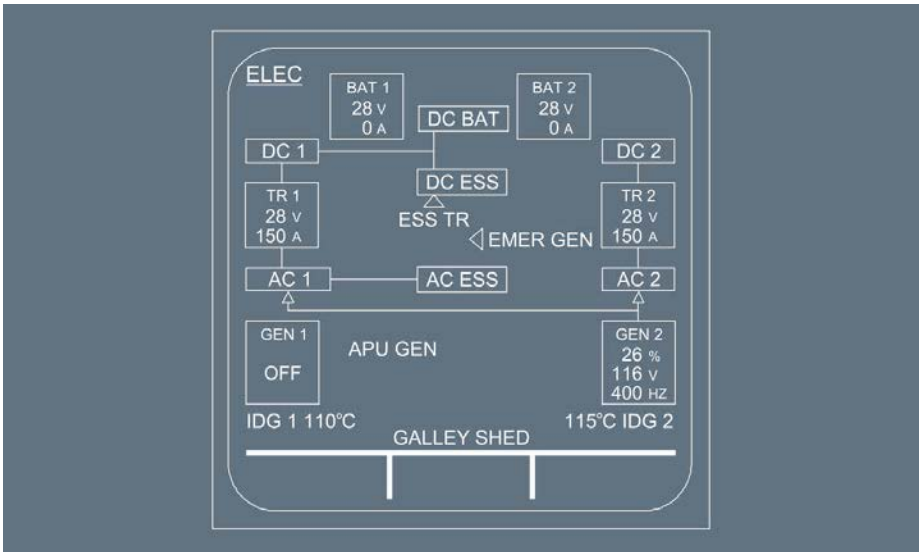

FAILURE OF AC BUS 1

Ident.: DSC-24-10-30-00017761.0002001 / 21 MAR 16

Applicable to: ALL

- AC BUS 2 can supply AC ESS BUS, and ESS TR can supply DC ESS BUS, both via the AC ESS FEED pb. This is done automatically with the AC ESS FEED Auto Switching .
- DC BUS 2 supplies DC BUS 1 and DC BAT BUS automatically after 5 s.

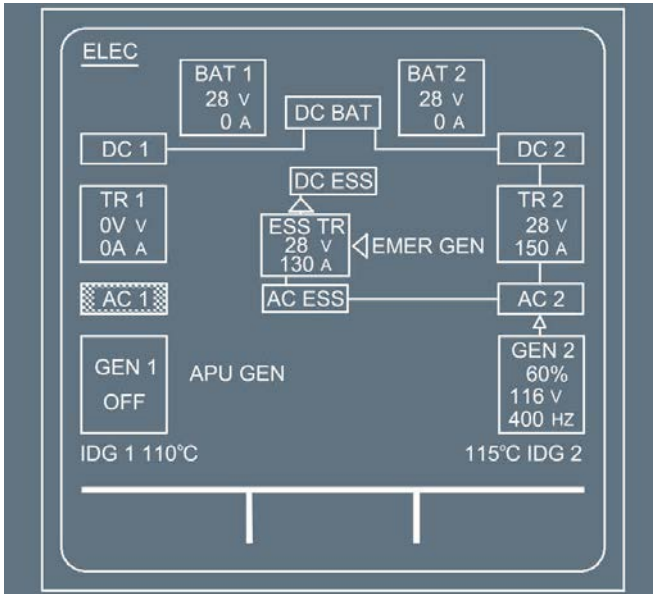

FAILURE OF ONE TR

Ident.: DSC-24-10-30-30-00000880.0002001 / 21 MAR 16

Applicable to: ALL

The contactor of each TR opens automatically, in case of :

- Overheat
- Minimum current

The other TR automatically replaces the faulty one.

The ESS TR supplies the DC ESS BUS.

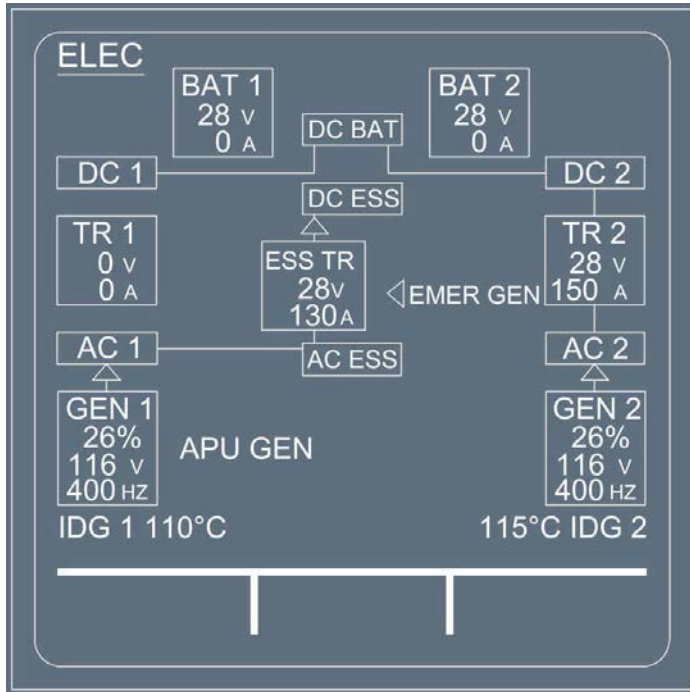

FAILURE OF TR 1 AND TR 2

Ident.: DSC-24-10-30-30-00000881.0002001 / 09 OCT 12

Applicable to: ALL

If TR 1 and TR 2 are lost, DC BUS 1, DC BUS 2, and DC BAT BUS are lost. The DC ESS BUS is supplied by the ESS TR.

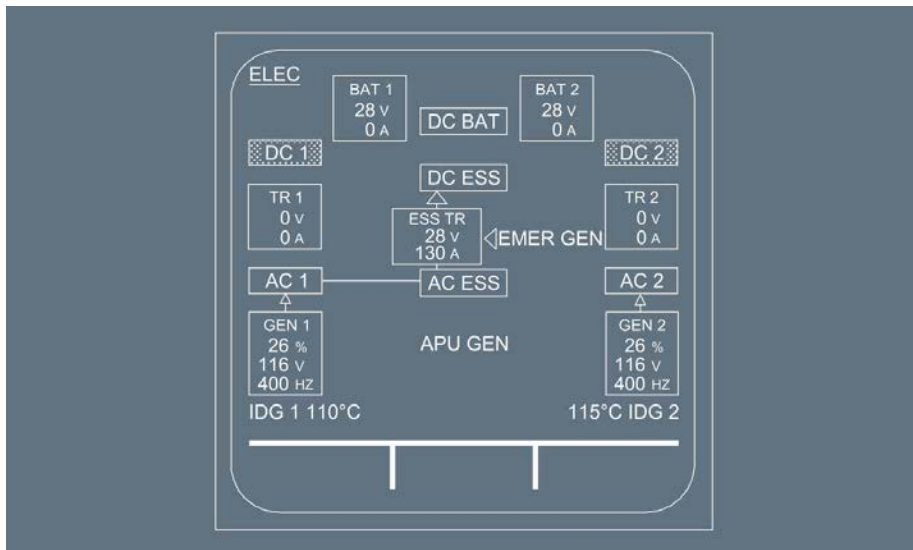

EMERGENCY GENERATION AFTER LOSS OF ALL MAIN GENERATORS

Ident.: DSC-24-10-30-30-00000882.0002001 / 21 MAR 16

Applicable to: ALL

If both AC BUS 1 and AC BUS 2 are lost and the aircraft speed is above 100 kt, the Ram Air Turbine (RAT) extends automatically. This powers the blue hydraulic system, which drives the emergency generator by means of a hydraulic motor. This generator supplies the AC ESS BUS, and the DC ESS BUS via the ESS TR.

If the RAT stalls, or if the aircraft is on the ground with a speed below 100 kt, the emergency generator has nothing to drive it. The emergency generation network automatically transfers to the batteries and static inverter, and the system automatically sheds the AC SHED ESS and DC SHED ESS buses.

When the aircraft is on ground :

- Below 100 kt, DC BAT BUS is automatically connected to the batteries.
- Below 50 kt, AC ESS BUS is automatically shed, leading to the loss of all display units.

- Note:**
1. During RAT extension and emergency generator coupling (about 8 s), the batteries power the emergency generation network.
 2. On ground, if only the batteries are powering the emergency generation network, APU start is only available when the speed is below 100 kt.

EMER GEN RUNNING

Ident.: DSC-24-10-30-30-00000883.0002001 / 17 MAR 11

Applicable to: ALL

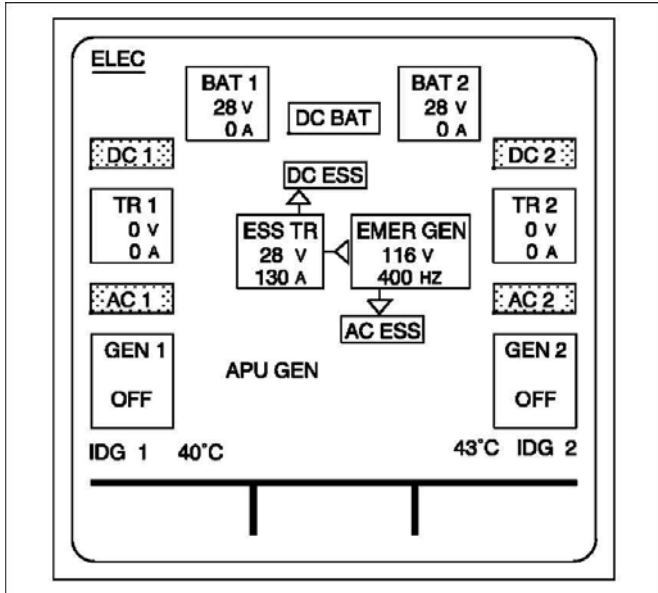

EMER GEN RUNNING (CONT'D)

Ident.: DSC-24-10-30-30-00000884.0002001 / 21 MAR 16

Applicable to: ALL

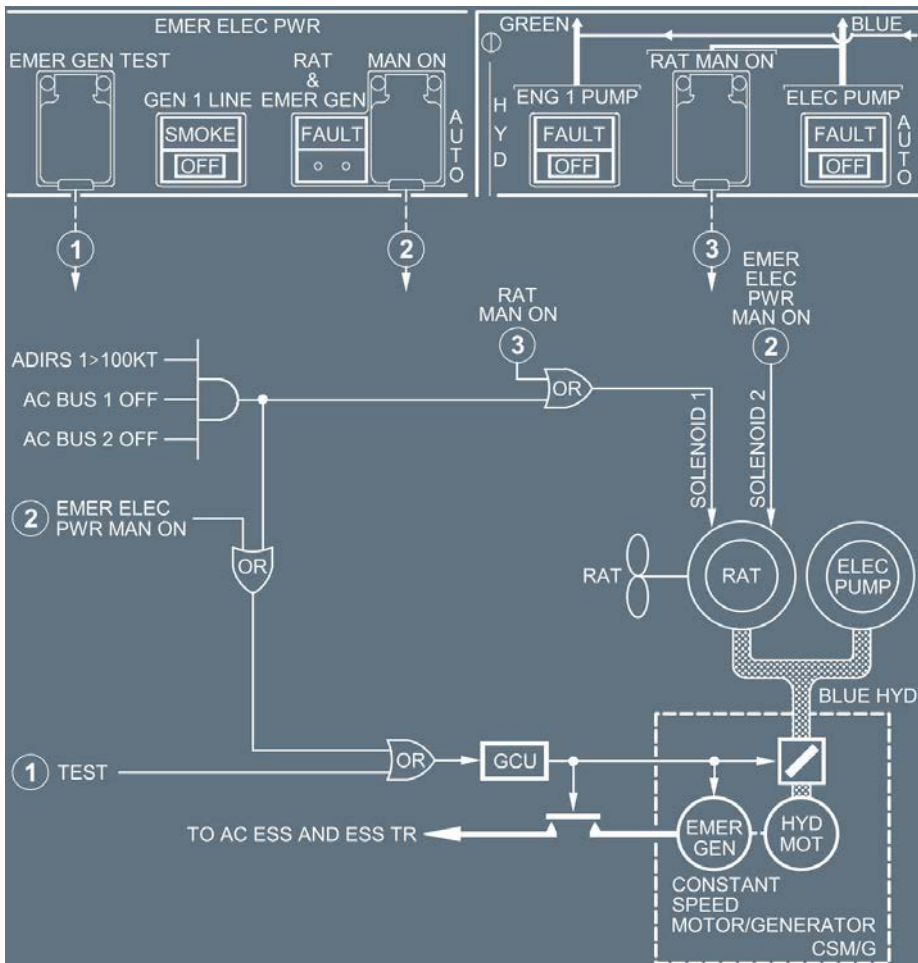

FLIGHT WITH BATTERIES ONLY

Ident.: DSC-24-10-30-00017762.0001001 / 21 MAR 16

Applicable to: ALL

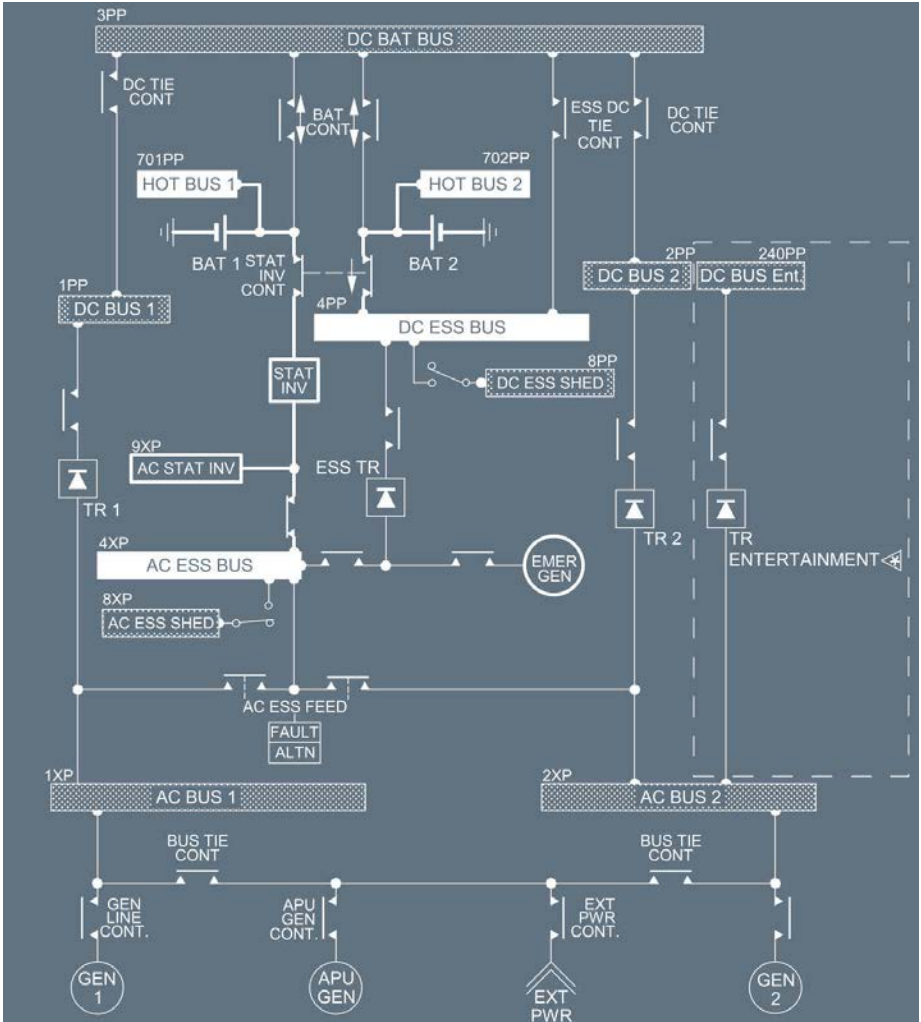

ON GROUND, BATTERIES ONLY (SPEED < 50 KT)

Ident.: DSC-24-10-30-30-00017763.0001001 / 21 MAR 16

Applicable to: ALL

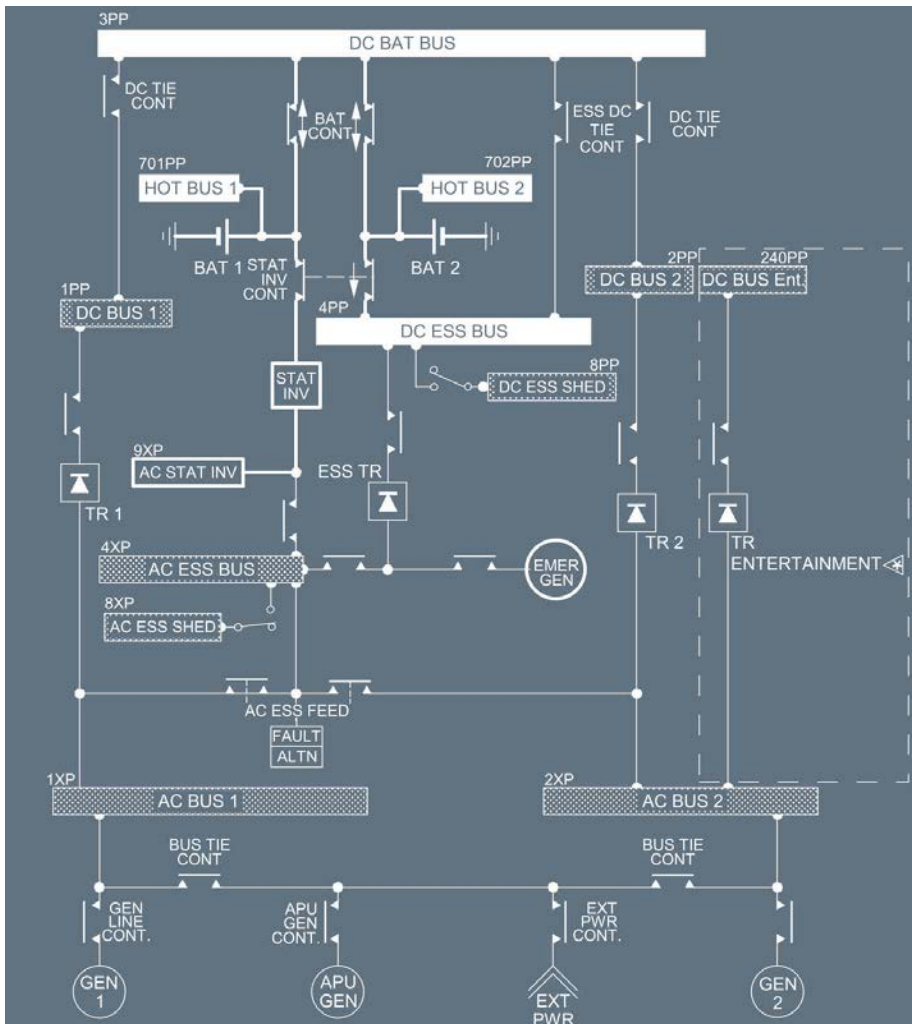

SMOKE CONFIGURATION

Ident.: DSC-24-10-30-30-00017764.0002001 / 21 MAR 16

Applicable to: ALL

In this configuration the main busbars are shed. The electrical distribution is the same as it is in the emergency electrical configuration (loss of main generators), except the fact that in smoke configuration the fuel pumps are connected upstream of the GEN 1 line connector. The procedure sheds approximately 75 % of electrical equipment. All equipment that remains powered is supplied via the circuit breakers on the overhead panel (except for equipment supplied by hot buses).

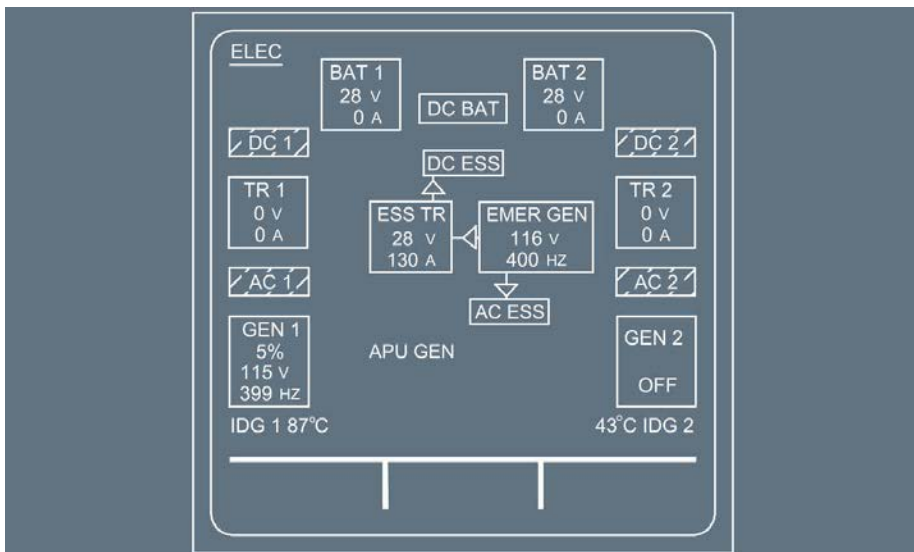

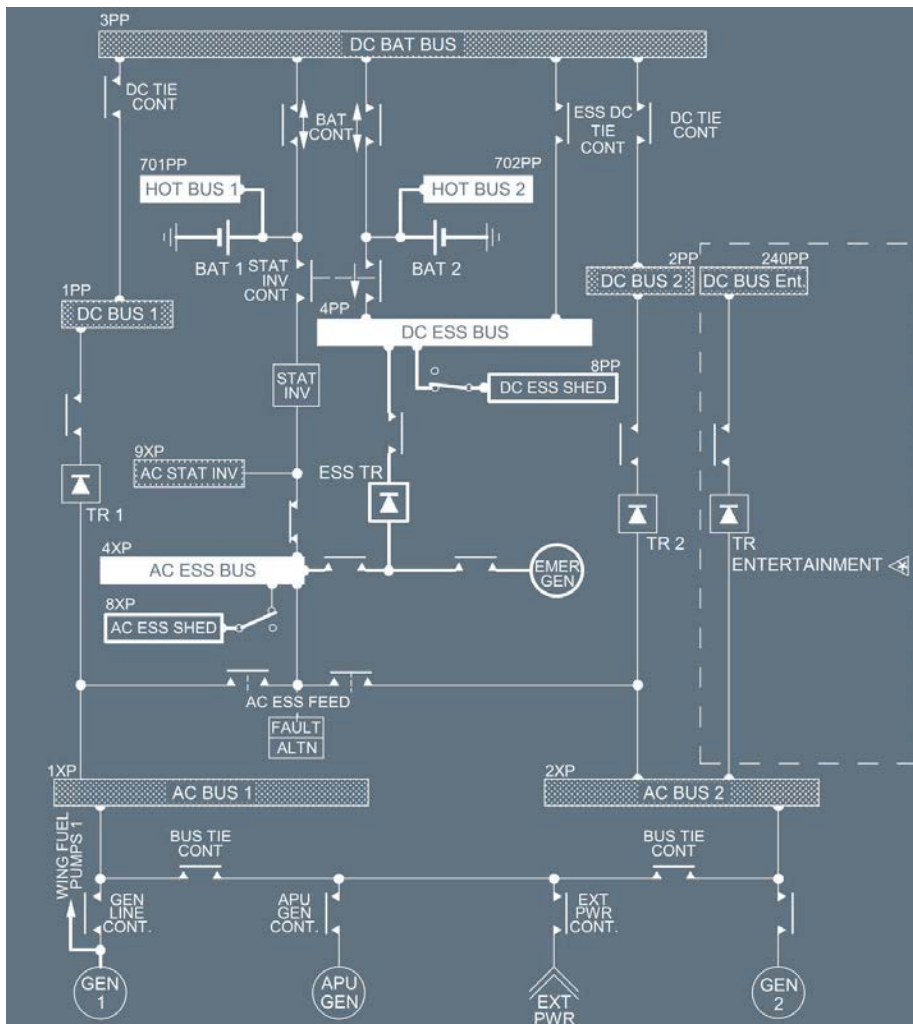

Note: ECAM ELEC page is identical to that for emergency generator running.

Distribution Table

DISTRIBUTION TABLE

Ident.: DSC-24-10-30-40-00017765.0002001 / 21 MAR 16

Applicable to: ALL

| | AC BUS 1 | AC BUS 2 | AC ESS BUS | AC SHED ESS | AC STAT INV | TR 1 | TR 2 | ESS TR | TR Ent. ⚠ (1) | DC BUS 1 | DC BUS 2 | DC BUS Ent. (1) | DC BAT BUS | DC ESS BUS | DC SHED ESS | HOT BUS 1 | HOT BUS 2 |
|---|----------------|----------------|-----------------------|-------------------|-----------------------|----------|----------|-------------|------------------------|------------------|------------------|--------------------------|------------------|--------------------------|--------------------------|-----------------|-----------------|
| NORM CONF | GEN 1 | GEN 2 | GEN 1 | GEN 1 | - | GEN 1 | GEN 2 | - | GEN 2 | TR 1 GEN 1 | TR 2 GEN 2 | REN GEN 2 | TR 1 GEN 1 | TR 1 GEN 1 | TR 1 GEN 1 | BAT 1 | BAT 2 |
| ONE GEN INOP AVAIL-X- (1, 2 or APU) | GEN X | GEN X | GEN X | GEN X | - | GEN X | GEN X | - | GEN X | TR 1 GEN X | TR 2 GEN X | REN GEN X | TR 1 GEN X | TR 1 GEN X | TR 1 GEN X | BAT 1 | BAT 2 |
| EMER CONF • BEFORE EMER GEN AVAILABILITY (about 8 s) | - | - | ST INV BAT 1 | - | ST INV BAT 1 | - | - | - | - | - | - | - | - | BAT 2 | - | BAT 1 | BAT 2 |
| • EMER GEN RUNNING | - | - | EMER GEN | EMER GEN | - | - | - | EMER GEN | - | - | - | - | - | ESS TR EMER GEN | ESS TR EMER GEN | BAT 1 | BAT 2 |
| TR 1 FAULT | GEN 1 | GEN 2 | GEN 1 | GEN 1 | - | - | GEN 2 | GEN 1 | - | TR 2 GEN 2 | TR 2 GEN 2 | - | TR 2 GEN 2 | ESS TR GEN 1 | ESS TR GEN 1 | BAT 1 | BAT 2 |
| TR 2 FAULT | GEN 1 | GEN 2 | GEN 1 | GEN 1 | - | GEN 1 | - | GEN 1 | - | TR 1 GEN 1 | TR 1 GEN 1 | - | TR 1 GEN 1 | ESS TR GEN 1 | ESS TR GEN 1 | BAT 1 | BAT 2 |
| TR 1 + 2 FAULT | GEN 1 | GEN 2 | GEN 1 | GEN 1 | - | - | - | GEN 1 | - | - | - | - | - | ESS TR -GEN 1 | ESS TR -GEN 1 | BAT 1 | BAT 2 |

(1) Two generators are needed to supply the DC BUS Entertainment ⚠, except on ground, where the APU generator (if not overloaded) or the external power is sufficient.

AIRCRAFT SYSTEMS

ELECTRICAL

DESCRIPTION - OPERATIONS

A318/A319/A320/A321

FLIGHT CREW
OPERATING MANUAL

| ON GROUND BAT. ONLY | AC BUS 1 | AC BUS 2 | AC ESS BUS | AC SHED ESS | AC STAT INV | TR 1 | TR 2 | ESS TR | TR Ent. | DC BUS 1 | DC BUS 2 | DC BUS Ent. | DC BAT BUS | DC ESS BUS | DC SHED ESS | HOT BUS 1 | HOT BUS 2 |
|--|----------------|----------------|-----------------------|-------------------|-----------------------|------|------|-------------|------------|----------------|----------------|-------------------|------------------|--------------------------|--------------------------|-----------------|-----------------|
| Speed >100 kt | - | - | EMER GEN | EMER GEN | - | - | - | EMER GEN | - | - | - | - | - | ESS TR EMER GEN | ESS TR EMER GEN | BAT 1 | BAT 2 |
| Rat stall or 50 kt ≤ speed ≤ 100 kt | - | - | ST INV BAT 1 | - | ST INV BAT 1 | - | - | - | - | - | - | - | BAT 1-2 | BAT 2 | - | BAT 1 | BAT 2 |
| Speed < 50 kt | - | - | - | - | ST INV BAT 1 | - | - | - | - | - | - | - | BAT 1-2 | BAT 2 | - | BAT 1 | BAT 2 |

OVERHEAD PANEL

Ident.: DSC-24-20-00017766.0004001 / 21 MAR 16

Applicable to: ALL

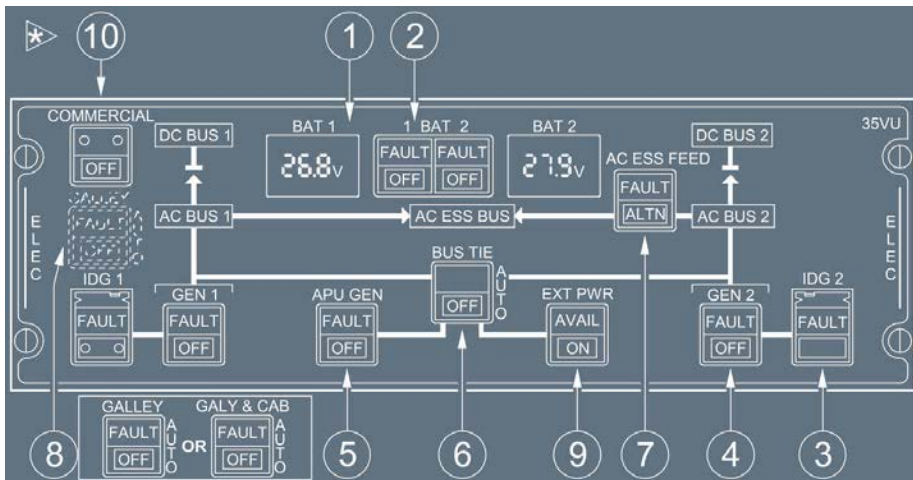

- (1) BAT 1(2) ind.
Shows battery voltage in white.
- (2) BAT 1(2) pb-sw
Controls the operation of the corresponding battery charge limiter.

- Auto** : The battery charge limiter controls automatically the connection and the disconnection of the corresponding battery to the DC BAT BUS (3 PP) by closing and opening of the battery line contactor.
- The batteries are connected to the DC BAT BUS in the following cases:
 - APU starting (MASTER SW pb-sw at ON and N < 95 %).

Note: The connection is limited to 3 min when the emergency generator is running.

 - Battery voltage below 26.5 V (battery charge). The charging cycle ends when battery charge current goes below 4 A.
 - On ground, immediately
 - In flight, after a time delay of 30 min.
 - Loss of AC BUS 1 and 2 when below 100 kt (EMER GEN not supplying).
- If AC BUS 1 and 2 are not energized and the EMER GEN is not supplying:
- Battery 1 supplies the AC STAT INV BUS, and, if speed is greater than 50 kt, the AC ESS BUS.
 - Battery 2 supplies the DC ESS BUS.
- Note:* In normal configuration the batteries are disconnected most of the time.
- Note:* A battery automatic cut-off logic prevents the batteries from discharging completely when the aircraft is on the ground (parking).
- Automatic battery contactors open when:*
- The aircraft is on the ground
 - The BAT pb switches are at AUTO
 - The main power supply (EXT PWR + GEN) is cut off
 - Battery voltage is low.
- The flight crew can reset the contactors by switching the BAT pb-sw to OFF then to AUTO.*

OFF : The battery charge limiter is not operating: the battery line contactor is open. OFF comes on white if the DC BAT BUS is supplied. Hot buses remain supplied.

FAULT light : Comes on amber, accompanied by an ECAM caution, when the charging current for the corresponding battery is outside limits. In this case the battery contactor opens.

| | |
|---|--|
|  <p>A318/A319/A320/A321 FLIGHT CREW OPERATING MANUAL</p> | <p>AIRCRAFT SYSTEMS</p> <p>ELECTRICAL</p> <p>CONTROLS AND INDICATORS</p> |
|---|--|

(3) IDG 1(2) (Integrated Drive Generator) pb-sw (guarded)

| | |
|----------------|--|
| CAUTION | <ol style="list-style-type: none"> 1. Maintaining the IDG pb-sw during more than 3 s may damage the IDG disconnection mechanism. 2. Disconnect the IDG only when the engine is running or windmilling. If not, the IDG will be damaged when starting the engine. |
|----------------|--|

The IDG switches are normally springloaded out.

Pressing this switch disconnects the IDG from its driveshaft: only maintenance personnel can reconnect it.

FAULT : Lights up amber, and ECAM caution comes on, if:

- light**
- IDG oil outlet overheats (above 185 °C), or
 - IDG oil pressure is low (inhibited at low engine speed: N2 below 14 %).
- It extinguishes when the IDG is disconnected.

(4) GEN 1 (2) pb-sw

ON : The generator field is energized and the line contactor closes if electrical parameters are normal.

OFF : The generator field is de-energized and the line contactors opens. The fault circuit is reset.

FAULT light : Lights up amber, and an ECAM caution comes on, if:

- The associated generator control unit (GCU) trips it.

Note: If a differential fault trips the protection, reset action has no effect after two attempts.

- Opening of the line contactor (except if the GEN pb-sw is selected OFF).

(5) APU GEN pb-sw

ON : The APU generator field is energized and the line contactor closes if parameters are normal and the EXT PWR line contactor is open. The bus tie contactor 1(2) closes automatically if GEN 1(2) is not operating.

OFF : The generator field is de-energized and the line contactor opens. The fault circuit is reset.

FAULT : Same as GEN 1 or 2 **FAULT**

light The APU GEN **FAULT** light is inhibited when APU speed is too low or if the APU GEN line contactor opens after EXT PWR or ENG GEN takes over.

(6) BUS TIE pb

- AUTO** : The bus tie contactors (BTC s) automatically open or close to maintain power supply to both AC BUS 1 and 2.
- One contactor is closed, when:
 - One engine generator supplies the associated AC BUS, and
 - The APU generator, or external power supplies the other side.
 - Both contactors are closed during single-engine operation, or operation on the APU generator, or external power supply.
- OFF** : Both bus tie contactors open.

(7) AC ESS FEED pb



- NORMAL** : The AC ESS BUS is supplied by AC BUS 1.
- ALTN** : The AC ESS BUS is supplied by AC BUS 2. The light comes on when manually selected.



Note: With the AC ESS FEED Auto Switching  , AC BUS 2 will automatically supply AC ESS BUS when AC BUS 1 is lost.

- FAULT light** : The amber light, and ECAM caution come on, when the AC ESS BUS is not electrically-supplied.

Note: In case of a total loss of the main generators, the AC ESS BUS is automatically supplied by the emergency generator, or by the static inverter, if the emergency generator is not available.



(8) GALLEY pb or GALY & CAB pb

- AUTO** : Main galley, secondary galley, in-seat power supply  and IFE  system (prerecorded announcement, telephone system, video/airshow, music...), are supplied.

The main galley, the in-seat power supply  and the IFE  systems are automatically shed:

- In flight: When only one generator is operating.
- On ground: When only one engine generator is operating. (All galleys are available when the APU GEN or EXT PWR is supplying power.)

Note: With the Galley Load Automatic Shedding  the secondary galley is also automatically shed.

- OFF : The main galley, secondary galley, in-seat power supply  and IFE  system (prerecorded announcement, telephone system, video/airshow, music) are not supplied.
 The electrical supply of the heating floor panels is shed.
- FAULT light : The amber light, and ECAM caution come on, when the load on any generator is more than 100 % of rated output.

(9) EXT PWR pb

- AVAIL light comes on green, if:
- External power is plugged in, and
 - External power parameters are normal.

When pressed:

- If the AVAIL light was on:
 - The external power line contactor closes
 - The AVAIL light goes off
 - The ON light comes on blue.
- If the ON light was on:
 - The external power line contactor opens
 - The ON light goes off
 - The AVAIL light comes on.

- Note:
1. External power has priority over the APU generator. The engine generators have priority over external power.
 2. The ON light stays on, even when the engine generators supply the aircraft.

(10) COMMERCIAL pb 

- ON : All aircraft commercial electrical loads are supplied:
- Cabin and cargo lights
 - Water and toilet system
 - Drain mast ice protection
 - Galley
 - Passenger's entertainment
 - Semi-automatic cargo loading 
- OFF : Switches off all aircraft commercial electrical loads.

OVERHEAD PANEL (CONT'D)

Ident.: DSC-24-20-00017778.0002001 / 21 MAR 17

Applicable to: ALL

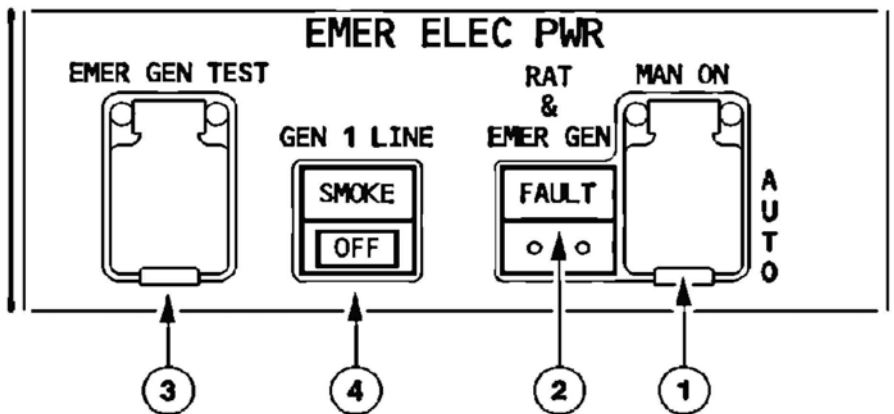

(1) MAN ON pb (guarded)

AUTO : When the following conditions are met:

- AC BUS 1 is not electrically supplied, and
- AC BUS 2 is not electrically supplied, and
- Aircraft speed is greater than 100 kt.

- The RAT extends, and
- The blue hydraulic system drives the emergency generator.

As soon as the emergency generator electrical parameters are within tolerance the emergency generator is connected to the aircraft network.

Pressed : This selects manual RAT extension.

Emergency generator coupling occurs 3 s after the RAT supplies the emergency generator.

(2) FAULT light

This light comes on red if the emergency generator is not supplying power when AC BUS 1 and AC BUS 2 are not powered.

(3) EMER GEN TEST pb (guarded)

Pressed and held:

- If AC NORMAL BUSES are supplied:

- The EMER GEN is driven hydraulically if the blue electric pump is running.
The AC ESS BUS and the DC ESS BUS are connected to the emergency generator.
(The DC ESS SHED and AC ESS SHED buses are not powered.)
- ECAM displays the ELEC page automatically (only on the ground).

- If only the batteries supply the aircraft:

- The static inverter powers the AC ESS BUS.

(4) GEN 1 LINE pb-sw

OFF : GEN 1 line contactor opens.

The AC BUS 1 channel is supplied from GEN 2 through bus tie contactors. This is used for smoked drill.

SMOKE : *Refer to DSC-26-30-20 GEN 1 LINE pb-sw.*
light

EXTERNAL POWER PANEL

Ident.: DSC-24-20-00000891.0001001 / 21 MAR 16

Applicable to: ALL

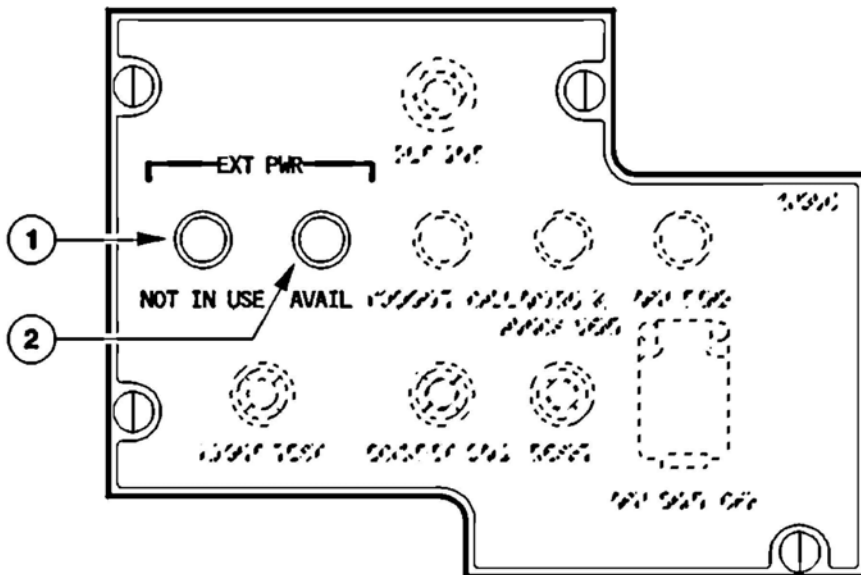

- (1) EXT PWR NOT IN USE
 This white light comes on to inform ground personnel that the ground power unit is not supplying the aircraft network and can be removed.
- (2) EXT PWR AVAIL
 This amber light comes on to indicate that external power is available and the voltage is correct.

FORWARD CABIN

Ident.: DSC-24-20-00000892.0001001 / 22 MAY 12

Applicable to: ALL

MAINT BUS SW:

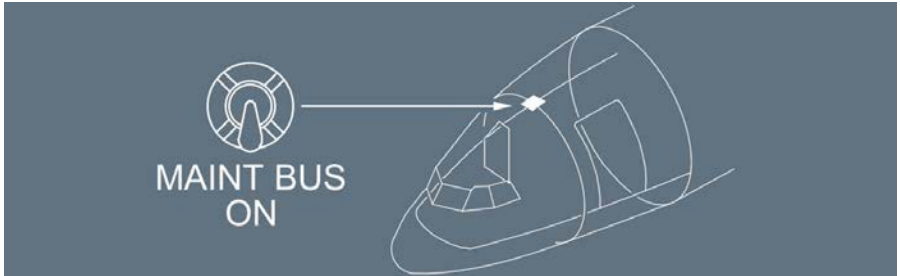

This switch allows personnel to energize electrical circuits for ground servicing without energizing the entire aircraft electrical system.

ON : The switch latches magnetically if external power is connected and normal (AVAIL light on).

The AC and DC GND /FLT buses have power and the following loads can be energized:

- passenger compartment lighting
- galley lighting
- entrance area lights
- lavatory lighting and service
- vacuum cleaner sockets
- flight compartment service outlets
- hydraulic pump (yellow system)
- flight compartment flood lighting
- fuel quantity indications
- refueling
- cargo hold lighting
- main and nose landing gear compartment lighting
- belly fairing panel service outlets
- ground call
- equipment compartment lights and service outlets
- navigation lights.

The switch trips when the external source is removed.

OFF : The AC and DC GND /FLT buses are connected to AC BUS 2 and DC BUS 2.

ECAM ELEC PAGE

Ident.: DSC-24-20-00017780.0002001 / 21 MAR 16

Applicable to: **ALL**

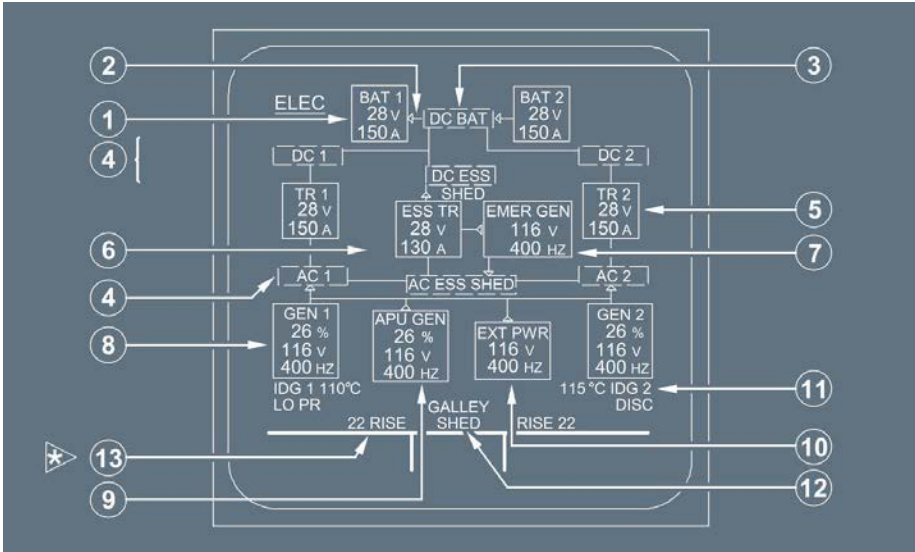

(1) Battery indications

- BAT pb-sw at OFF:
Legend is in white.



- BAT pb-sw at Auto:

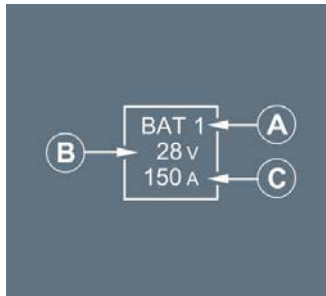

(A)

Legend is normally white, but becomes amber:

- when voltage and current indications change to amber, or
- in case of a BAT FAULT alert.

(B) Battery voltage is normally green, but becomes amber if $V > 31\text{ V}$ or $V < 25\text{ V}$.

(C) Battery current is normally green, but becomes amber if discharge current $> 5\text{ A}$.

(2) Battery charge/discharge indication

 BATTERY CONTACTOR CLOSED. BATTERY CHARGING CURRENT > 1A (GREEN)
 BATTERY CONTACTOR CLOSED. BATTERY DISCHARGE CURRENT > 1A (AMBER)
 BATTERY CONTACTOR CLOSED. CURRENT < 1A (GREEN)
 BATTERY CONTACTOR OPEN.

(3) DC BAT indication

It is normally in green. It becomes amber, if DC BAT voltage ≤ 25 V.

(4) Bus bar indication

The bus bar indication is normally green. It becomes amber when the corresponding bus bar is not powered.

SHED appears in amber, when AC or DC SHED ESS BUS is shed.

(5) TR 1 (2) indication

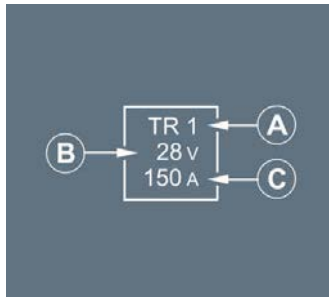

(A) Normally white, this legend becomes amber when legends B and C do.

(B) The TR voltage is normally in green. It becomes amber, if $V > 31$ V, or $V < 25$ V.

(C) The TR current is normally in green. It becomes amber, when the TR current ≤ 5 A.

(6) ESS TR indication



This legend follows the logic of the above-noted TR 1 (2) legend.
The voltage and current are not displayed, when the essential TR contactor is open.

(7) EMER GEN indication

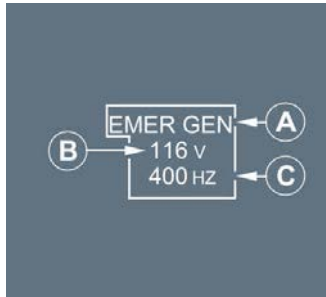

(A) This legend is normally in white. It becomes amber when either the voltage or frequency legend becomes amber.

(B)

This legend is normally in green. It becomes amber, if:

- $V > 120 \text{ V}$ or
- $V < 110 \text{ V}$.

(C)

This legend is normally in green. It becomes amber, if:

- $F > 410 \text{ Hz}$ or
- $F < 390 \text{ Hz}$.

Voltage and frequency indications are not displayed, when the EMER GEN line contactor is open.

(8) GEN 1(2) indications

- GEN pb-sw is OFF:

GEN is amber.

OFF indication is white

1 or 2 indication is white if the associated engine is running, amber if it is not.

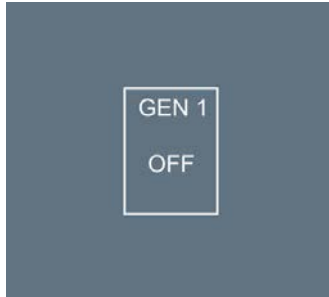

- GEN pb-sw is ON.

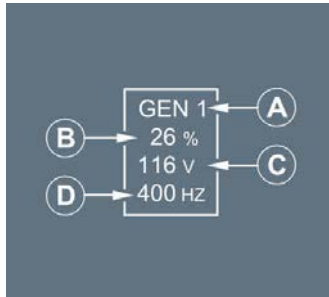

- (A) GEN 1 or GEN 2, normally white, becomes amber if any of the following legends become amber.
- (B) The load legend, normally green, becomes amber if load > 100 %.
- (C) The voltage legend, normally green, becomes amber if $V > 120 V$ or $V < 110 V$.
- (D) The frequency legend, normally green, becomes amber if $F > 410 Hz$ or $F < 390 Hz$.

(9) APU GEN indications

- When the APU MASTER sw is OFF this legend is white regardless of the position of the APU GEN pb-sw.

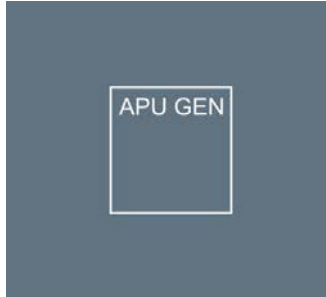

- When the APU MASTER sw is ON, and the APU GEN pb-sw is OFF:
The APU GEN legend is amber.
The OFF legend is white.

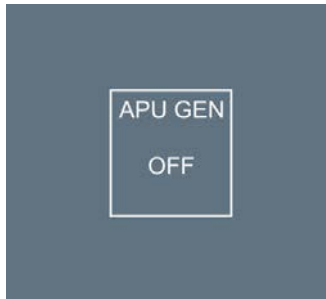

- When the APU MASTER sw is ON and the APU GEN pb-sw is ON:
The indications are the same as for GEN 1 (2).

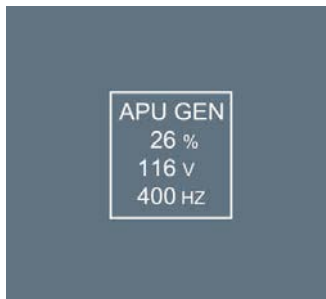

(10) EXT PWR indications

- External power is not available.

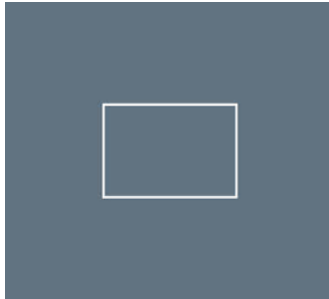

- When external power is available:

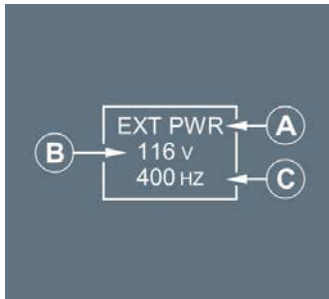

- (A) This legend is normally white, but becomes amber, if either of the following legends turns amber.
- (B) This legend is normally green, but becomes amber, if $V > 120 V$ or if $V < 110 V$.
- (C) This legend is normally green, but becomes amber, if $F > 410 Hz$ or if $F < 390 Hz$.

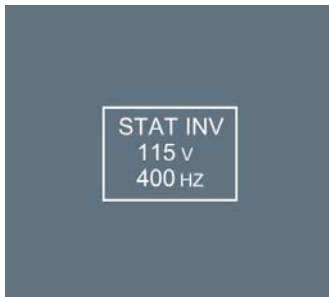

- This legend appears during the static inverter test, and when pressing the ELEC pb on the ECAM control panel while ESS BUSES are supplied by the batteries. It is normally green, but becomes amber, if:
 - V < 110 V or V > 120 V.
 - F < 390 Hz or F > 410 Hz.

(11) IDG indications

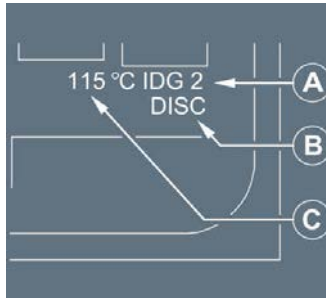

(A) IDG1 (2) legend

The IDG legend is normally white, but becomes amber, if:

- Oil outlet temperature > 185 °C.
- Oil pressure gets too low.
- IDG becomes disconnected.

The 1 or 2 is white if the corresponding engine is running, amber if it is not and the FADEC is powered.

(B) DISC/LO PR indication

The DISC legend appears in amber, when the IDG is disconnected.

LO PR appears in amber, when IDG low pressure is detected and the associated engine is running.

(C) Oil outlet temperature

This legend is normally in green, but appears amber, if T > 185 °C.

It flashes, if 147 °C < T < 185 °C (advisory).

(12) GALLEY SHED indication

This legend appears in white when:

- The GALLEY pb-sw is OFF, or
- The main galleys are shed, meaning:
 - In flight, only one generator is operating.
 - On ground, the aircraft is being supplied by one engine generator only.

The legend is not displayed, when the aircraft is in its normal configuration.

(13) RISE indication 

This number, displayed in green, is the difference between the temperature at the IDG inlet and that at the IDG outlet.

MEMO DISPLAY

Ident.: DSC-24-20-00016808.0001001 / 21 MAR 16

Applicable to: **ALL**

EMER GEN : This memo appears in green, when the emergency generator is running.

AIRCRAFT SYSTEMS

EQUIPMENT

Intentionally left blank

DSC-25-10 Flight Deck



DSC-25-10-10 General

General.....A
 Principles For Pushbuttons With Integrated Indications.....B
 General Arrangement.....C

DSC-25-10-20 Cockpit Plan

General.....A
 Right Rear Corner.....B
 Left Rear Corner.....C

DSC-25-10-30 Seats

Pilot Seats.....A
 Pilot Seat Mechanical Adjustment.....B
 Pilot Seat Electrical Adjustment C
 Head Rest Adjustment D
 Armrest Adjustment.....E
 Observer Seat.....F
 Observer Seat Adjustment.....G
 Armrest.....H

DSC-25-10-40 Main Instrument Panels

Main Instrument Panel - Captain Side.....A
 Main Instrument Panel - First Officer Side.....B

DSC-25-10-50 Pedestal

Pedestal.....A

DSC-25-10-60 Overhead Panel

Overhead Panel.....A

DSC-25-10-70 C/B Panels

C/B Panels.....A

DSC-25-10-80 Foot Warmer (If Installed)

General.....A
 Controls.....B

DSC-25-20 Emergency Equipment

Flashlights A



A318/A319/A320/A321
FLIGHT CREW
OPERATING MANUAL

AIRCRAFT SYSTEMS

EQUIPMENT

PRELIMINARY PAGES - TABLE OF CONTENTS

Intentionally left blank

GENERAL

Ident.: DSC-25-10-10-00020853.0001001 / 17 MAR 17

Applicable to: ALL

The aircraft and system controls, required for piloting the aircraft, are arranged in such a way that the crew faces forward and all crewmembers can monitor instruments and systems.

The designers concentrated system controls on the overhead panel by making extensive use of pushbuttons, directly installed in the system synoptic.

Note: This chapter describes the panels and equipment of the basic aircraft configuration, and may not correspond to the customized configuration of a specific aircraft. For more information on the installed equipment or panels, refer to the relevant chapter's system description.

PRINCIPLES FOR PUSHBUTTONS WITH INTEGRATED INDICATIONS

Ident.: DSC-25-10-10-00000983.0001001 / 21 MAR 16

Applicable to: ALL

Whenever possible, pushbuttons used for corrective actions, have integrated status and failure indications.

The pushbutton positions, and their illuminated indications, follow the "lights out" principle.

- While corresponding to particular aircraft configurations, indications also have the following color codes :

- Warnings
 RED : A failure requiring immediate action.
- Cautions
 AMBER : A failure, of which the flight crew should be aware, but does not call for immediate action.
- Indications
 GREEN : For normal system operation.
 BLUE : For normal operation of a system used temporarily
 WHITE : - For an abnormal pushbutton position.
 - For a test result or maintenance information.

When the aircraft is in a normal configuration, only green lights can be permanently lit, whereas blue lights can be intermittently.

- Pushbutton positions :

| POSITION | BASIC FUNCTION |
|-----------------|-----------------------|
| Pressed In | ON, AUTO, OVRD, OPEN |
| Released Out | OFF, MAN , ALTN, SHUT |

- Note:*
1. Certain pushbutton lights have two dots, indicating that the corresponding part of the pushbutton is not used.
 2. Certain pushbuttons do not remain pressed in. These are referred to as "Momentary Action" pushbuttons.



A318/A319/A320/A321
FLIGHT CREW
OPERATING MANUAL

AIRCRAFT SYSTEMS

EQUIPMENT

FLIGHT DECK - GENERAL

GENERAL ARRANGEMENT

Ident.: DSC-25-10-10-00018419.0001001 / 17 MAR 17

Applicable to: ALL

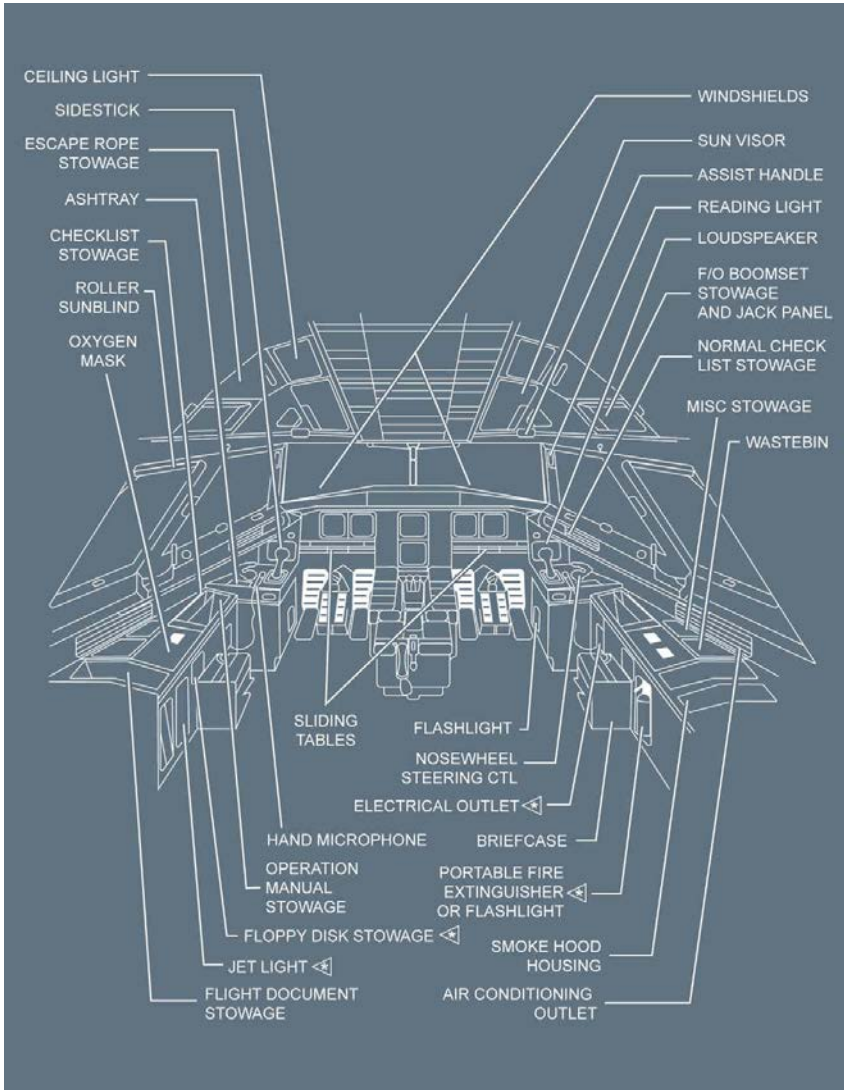

GENERAL

Ident.: DSC-25-10-20-00017002.0001001 / 17 MAR 17

Applicable to: ALL

The cockpit can accommodate two crewmembers, plus a third and fourth occupant  .
 The two pilot seats are mounted on columns.
 The third and fourth occupant seats are folding seats.

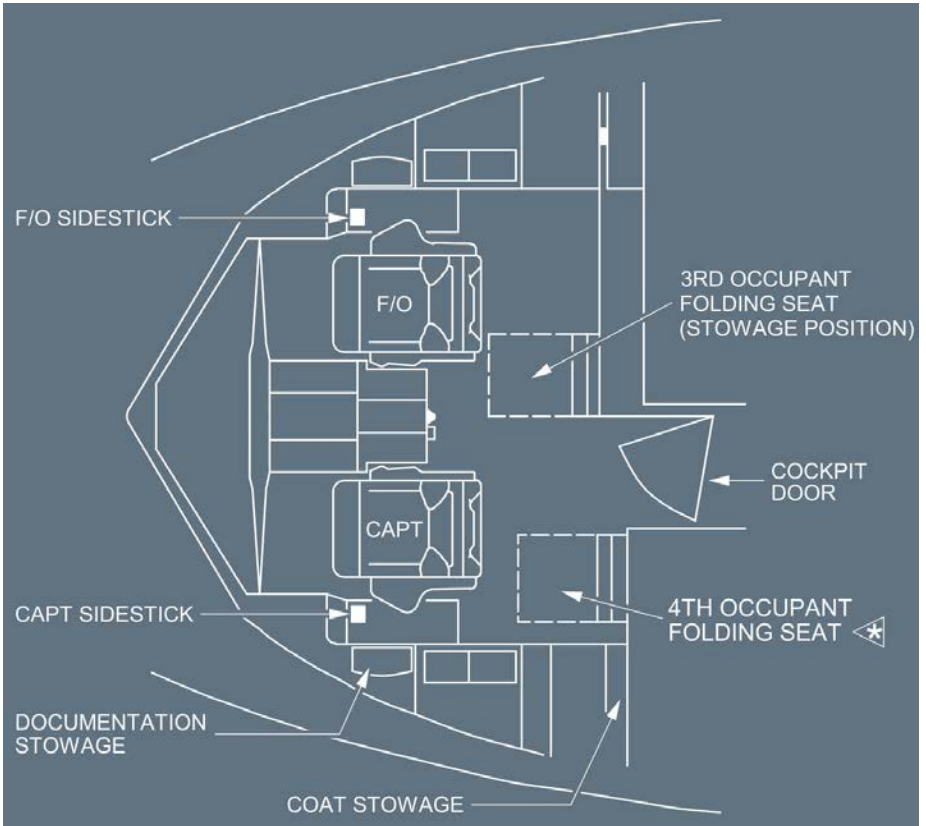

RIGHT REAR CORNER

Ident.: DSC-25-10-20-00000986.0001001 / 06 DEC 16

Applicable to: ALL

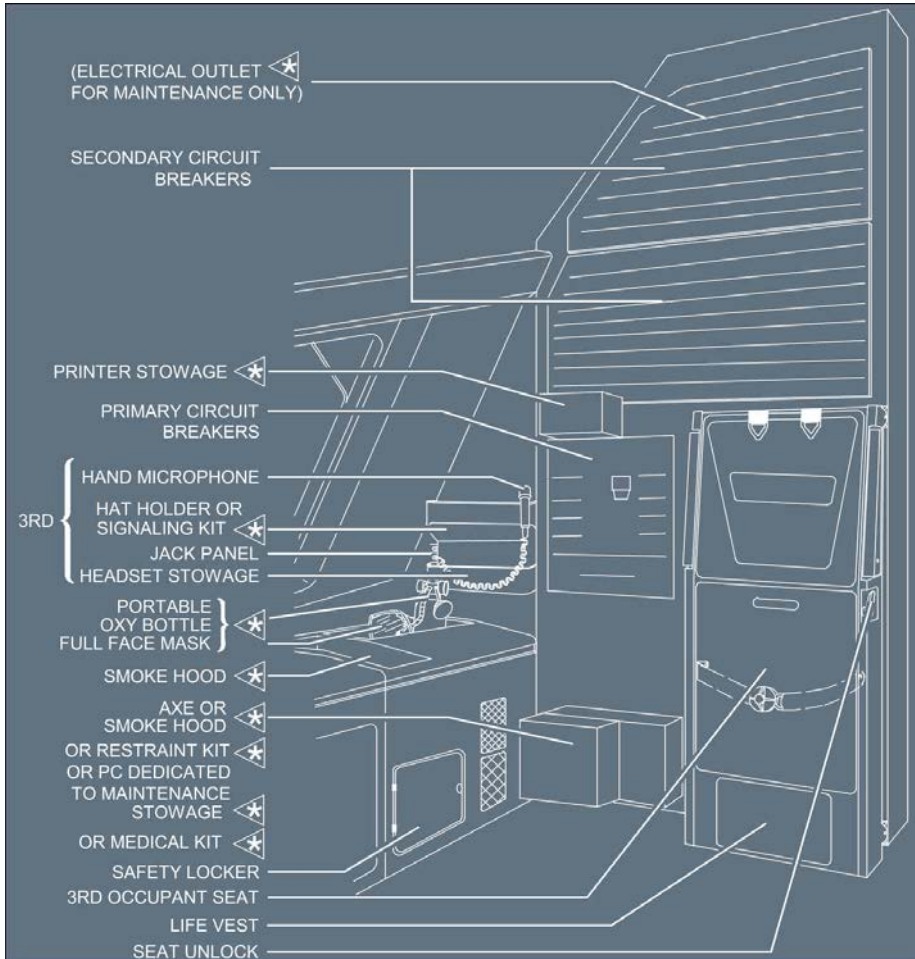

LEFT REAR CORNER

Ident.: DSC-25-10-20-00018428.0001001 / 17 MAR 17

Applicable to: ALL

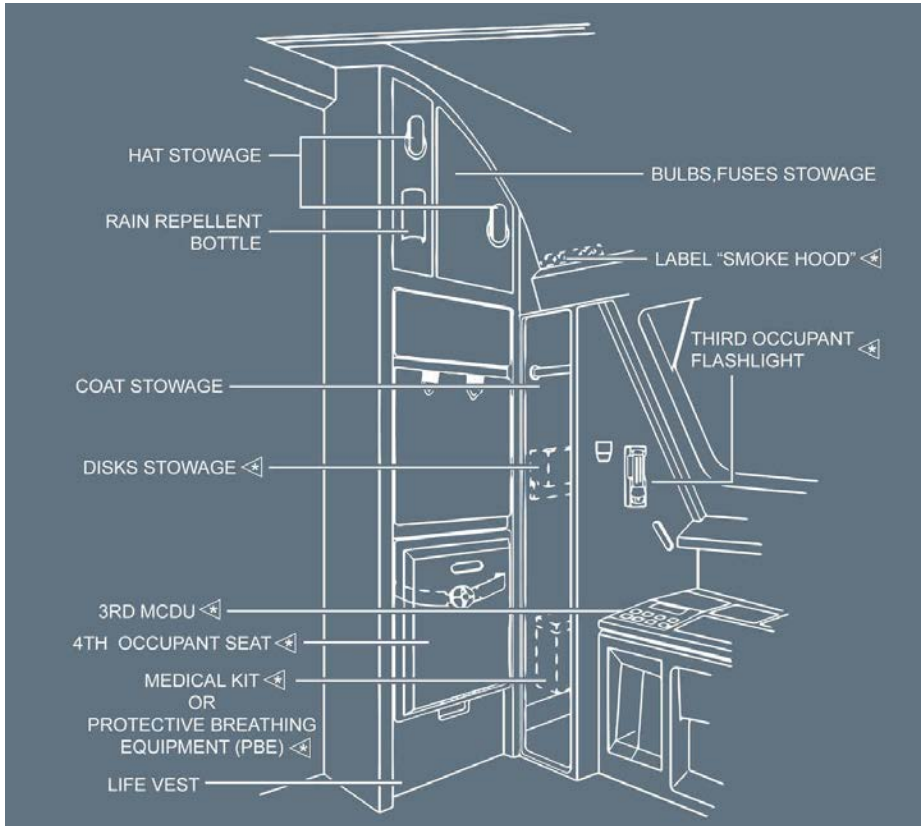



A318/A319/A320/A321
FLIGHT CREW
OPERATING MANUAL

AIRCRAFT SYSTEMS

EQUIPMENT

FLIGHT DECK - COCKPIT PLAN

Intentionally left blank



A318/A319/A320/A321
FLIGHT CREW
OPERATING MANUAL

AIRCRAFT SYSTEMS

EQUIPMENT

FLIGHT DECK - SEATS

PILOT SEATS

Ident.: DSC-25-10-30-00018429.0002001 / 17 MAR 17

Applicable to: ALL

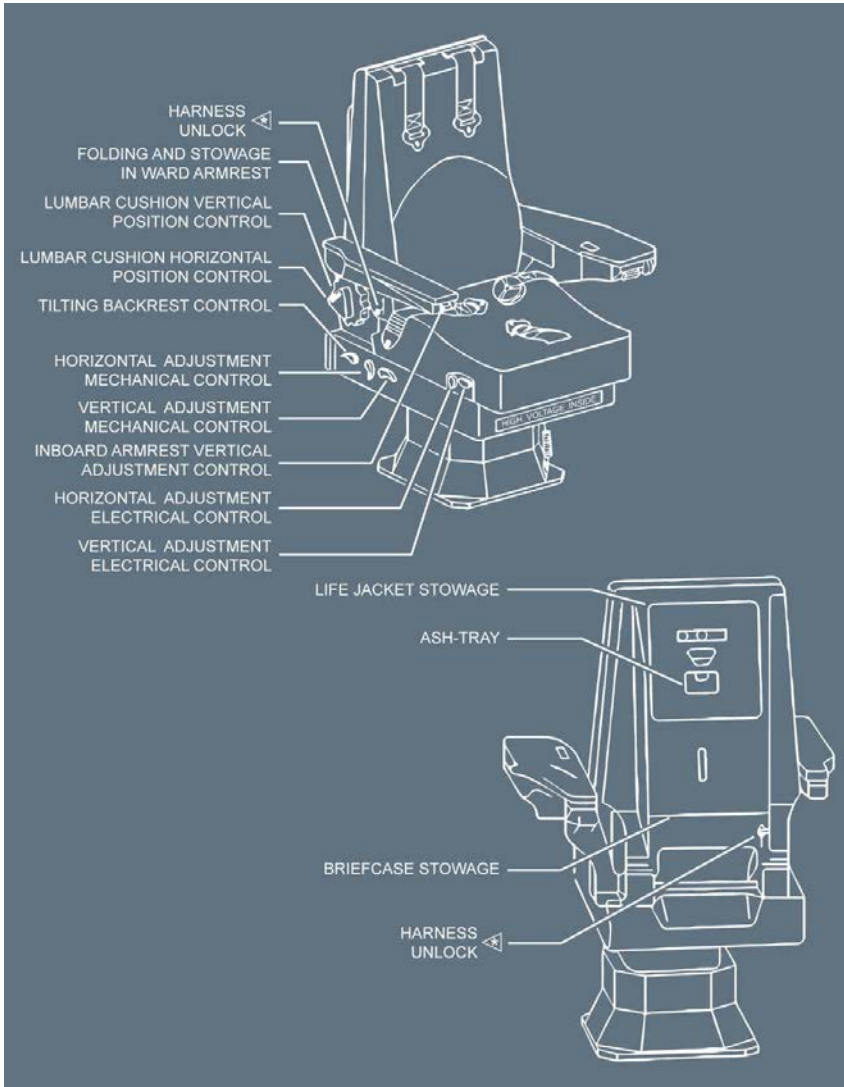

| | |
|---|--|
|  <p>A318/A319/A320/A321 FLIGHT CREW OPERATING MANUAL</p> | <p align="center">AIRCRAFT SYSTEMS EQUIPMENT FLIGHT DECK - SEATS</p> |
|---|--|

PILOT SEAT MECHANICAL ADJUSTMENT

Ident.: DSC-25-10-30-00000989.0001001 / 22 MAR 17
Applicable to: ALL

To adjust a seat mechanically, the occupant must lift the appropriate control handle. This unlocks the seat so that it may be moved. Releasing the control handle returns it to springloaded locked position. On electrically-powered seats, the mechanical adjustment is a backup: The seat should be adjusted electrically.

PILOT SEAT ELECTRICAL ADJUSTMENT 

Ident.: DSC-25-10-30-00018405.0001001 / 17 MAR 17
Applicable to: ALL

To adjust a seat electrically, the occupant must press the appropriate control switch in the desired direction, and release it when the seat reaches the desired position. The switch then returns to the springloaded neutral position.

To adjust the vertical position of the lumbar cushion, the occupant must:

- Pull the control out to the unlocked position
- Turn the control to adjust the position of the cushion
- Push the control into the locked position.

HEAD REST ADJUSTMENT 

Ident.: DSC-25-10-30-00018406.0001001 / 17 MAR 17
Applicable to: ALL

To adjust the headrest in inclination, the occupant presses the inclination control button, and releases it to lock the position.
 To control the height of the headrest, the occupant must push it horizontally, adjust the height, and release it to lock the position.

ARMREST ADJUSTMENT

Ident.: DSC-25-10-30-00000993.0001001 / 21 MAR 17
Applicable to: ALL

To adjust the inboard armrest, the occupant must turn the knurled knob, located on the bottom surface of the armrest.

OBSERVER SEAT

Ident.: DSC-25-10-30-00018430.0001001 / 17 MAR 17

Applicable to: ALL

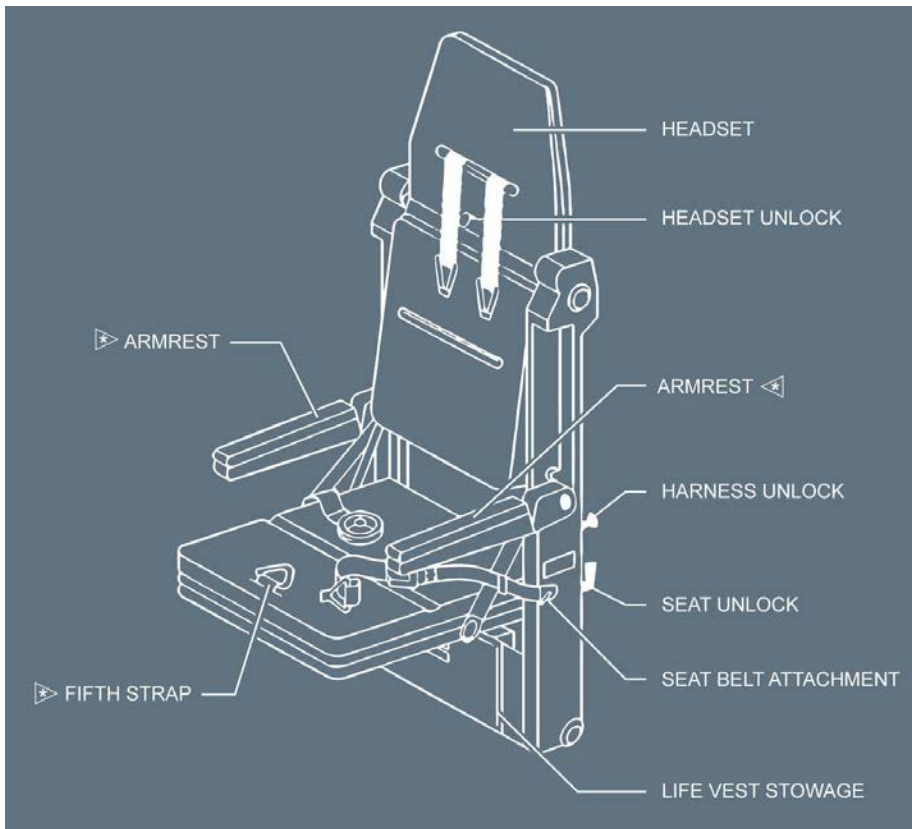



A318/A319/A320/A321
FLIGHT CREW
OPERATING MANUAL

AIRCRAFT SYSTEMS

EQUIPMENT

FLIGHT DECK - SEATS

OBSERVER SEAT ADJUSTMENT

Ident.: DSC-25-10-30-00000995.0001001 / 21 MAR 17

Applicable to: ALL

This seat has three positions :

- Normal : Centered on aircraft axis.
- Intermediate : Clear of the cockpit entrance.
- Stowed : Seat vertical and headrest folded back. The seat is usable in this position, and does not impede access to the documents and equipment on the right side of the cockpit.

ARMREST

Ident.: DSC-25-10-30-00018431.0001001 / 17 MAR 17

Applicable to: **ALL**

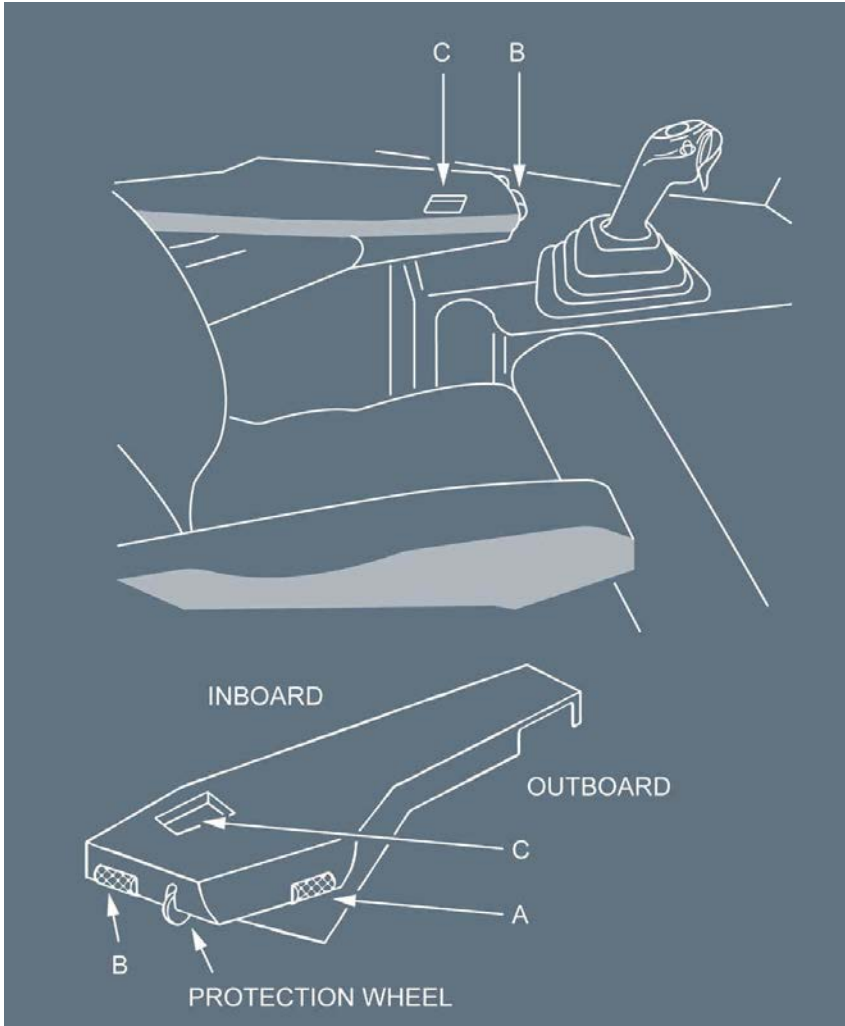

The position of the armrest is adjustable as follows:

- A. Height adjustment
- B. Pitch adjustment

The armrest also has a memory display (C) that shows pitch and height.



A318/A319/A320/A321
FLIGHT CREW
OPERATING MANUAL

AIRCRAFT SYSTEMS
EQUIPMENT

FLIGHT DECK - SEATS

Intentionally left blank

MAIN INSTRUMENT PANEL - CAPTAIN SIDE

Ident.: DSC-25-10-40-00020851.0001001 / 21 MAR 17

Applicable to: ALL

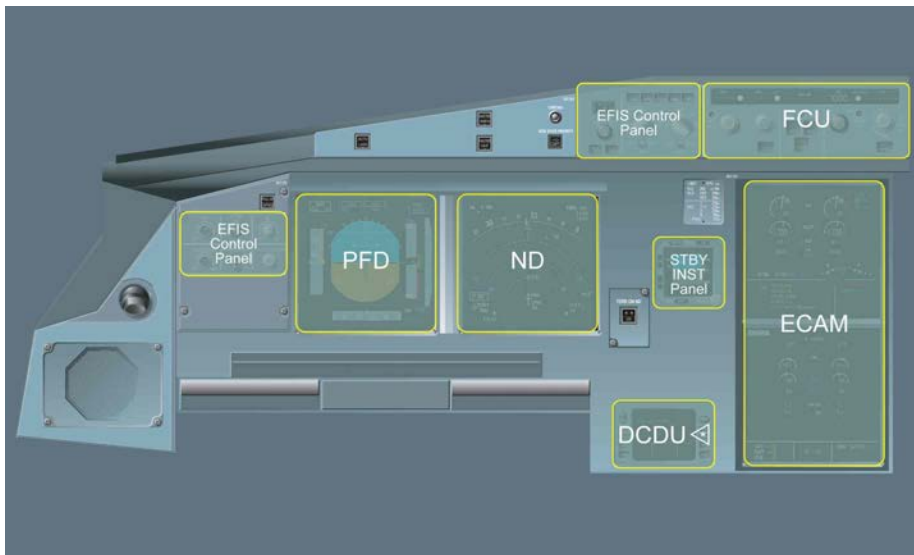

MAIN INSTRUMENT PANEL - FIRST OFFICER SIDE

Ident.: DSC-25-10-40-00020852.0001001 / 21 MAR 17

Applicable to: ALL

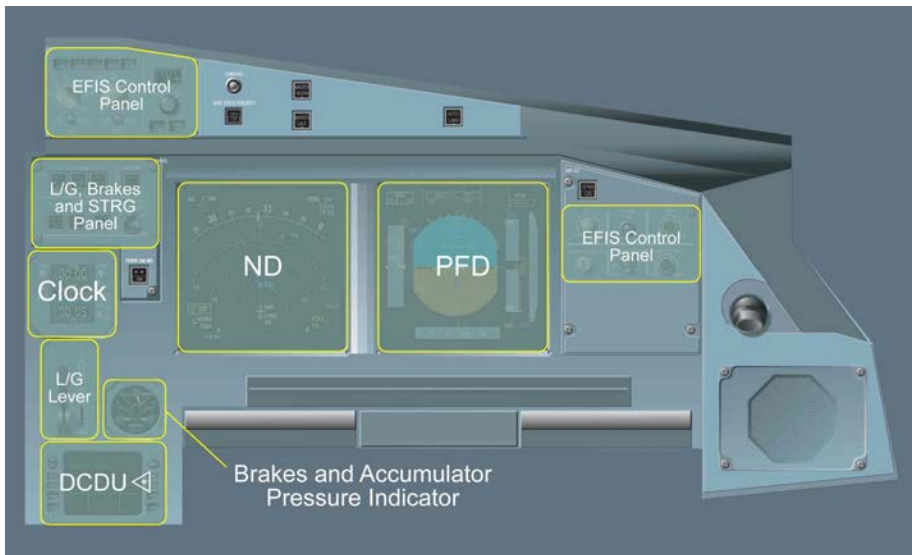

PEDESTAL

Ident.: DSC-25-10-50-00020854.0001001 / 17 MAR 17

Applicable to: ALL

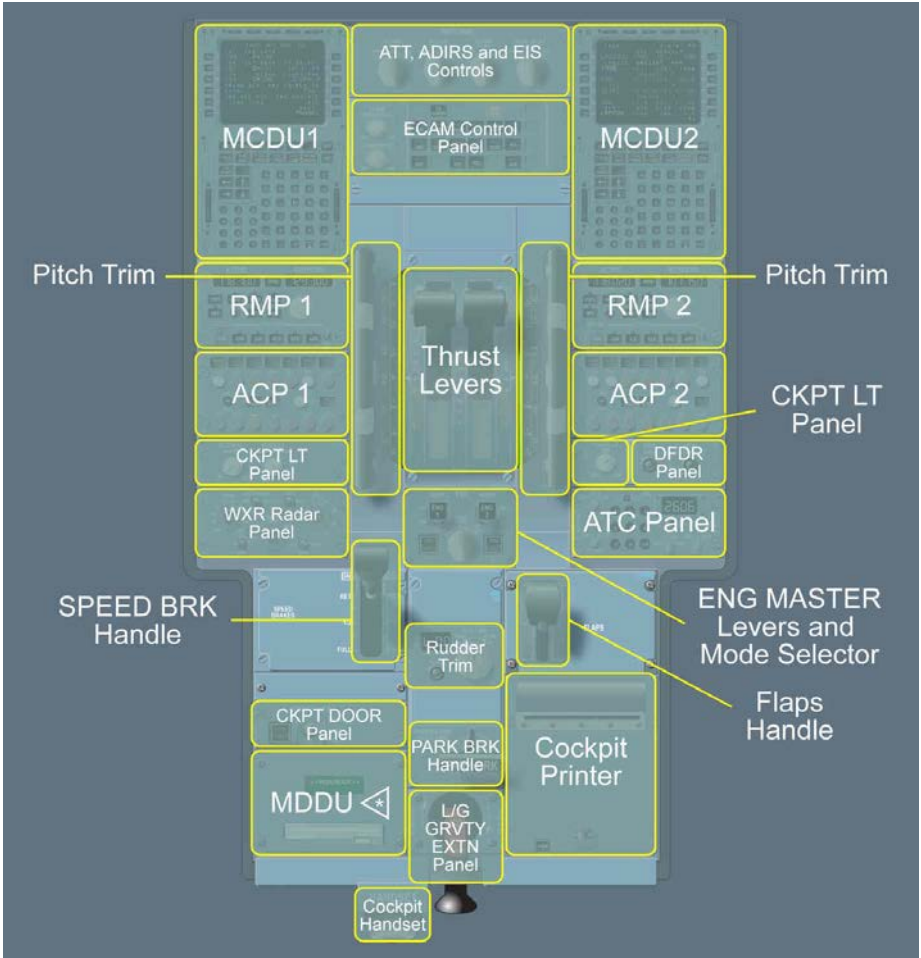



A318/A319/A320/A321
FLIGHT CREW
OPERATING MANUAL

AIRCRAFT SYSTEMS
EQUIPMENT

FLIGHT DECK - PEDESTAL

Intentionally left blank

OVERHEAD PANEL

Ident.: DSC-25-10-60-00020855.0001001 / 17 MAR 17

Applicable to: ALL

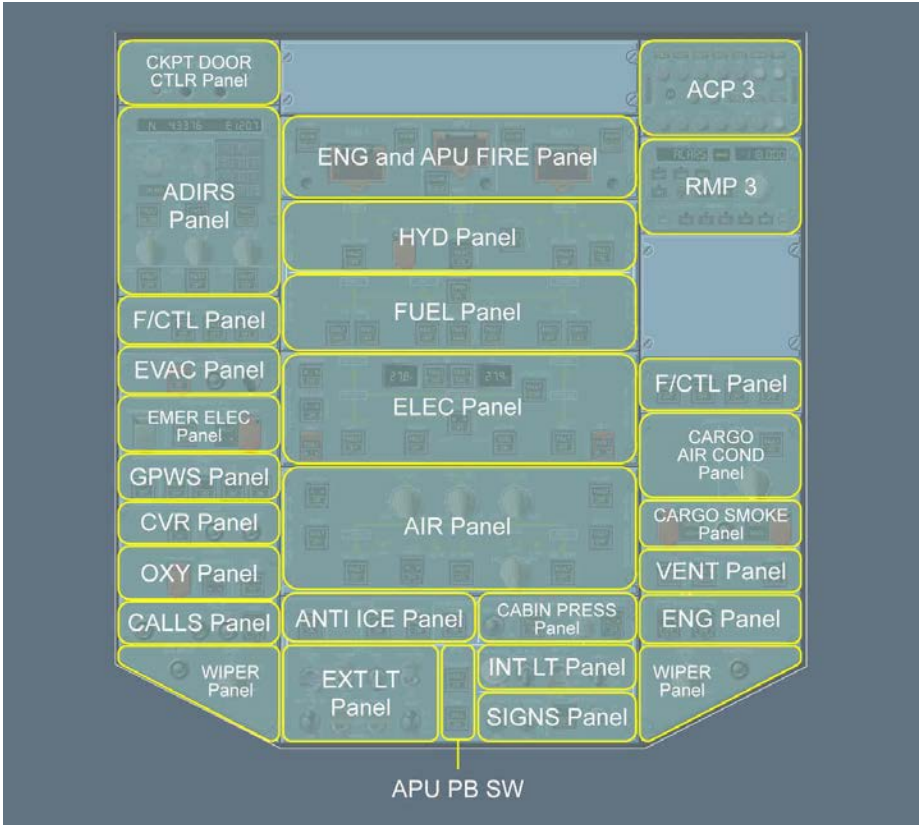



C/B PANELS

Ident.: DSC-25-10-70-00018436.0001001 / 17 MAR 17

Applicable to: ALL

OVERHEAD PANEL

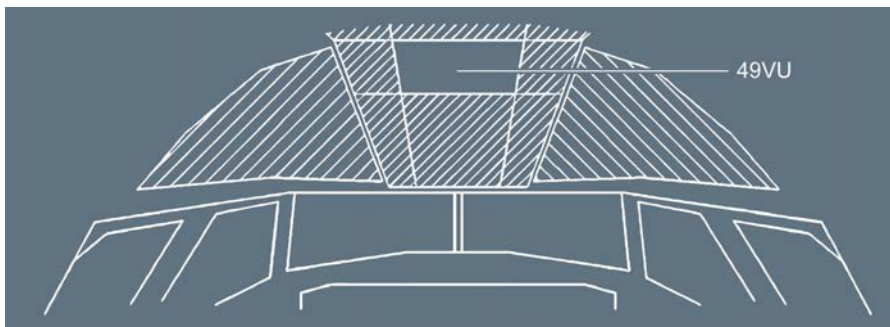

RIGHT REAR PANEL

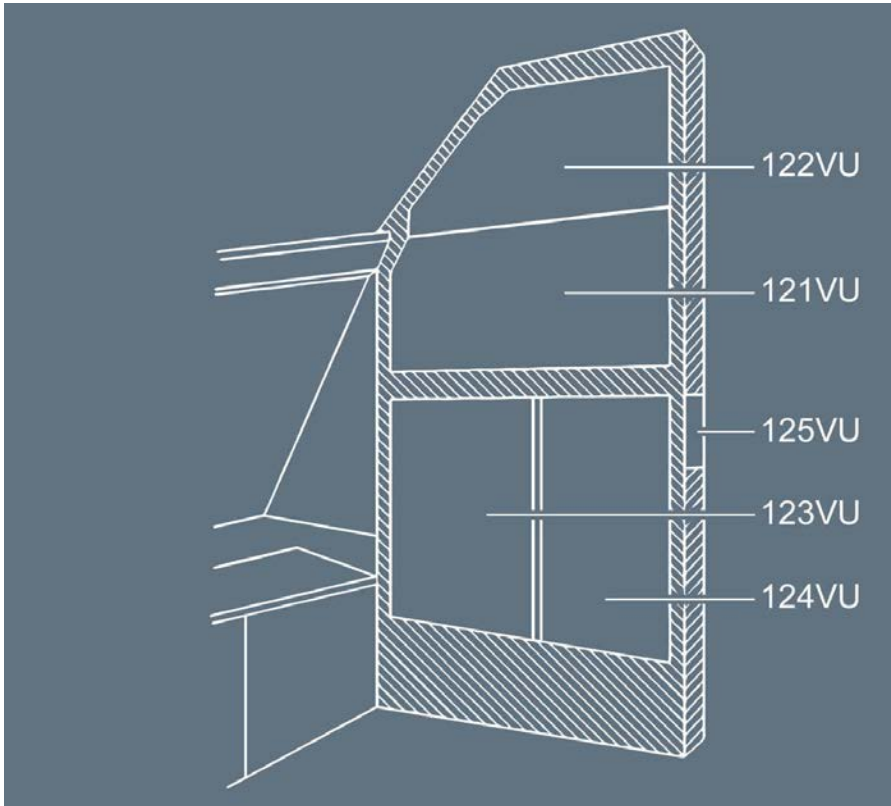

| | |
|---|---|
|  <p>A318/A319/A320/A321 FLIGHT CREW OPERATING MANUAL</p> | <p style="text-align: center;">AIRCRAFT SYSTEMS EQUIPMENT</p> <p style="text-align: center;">FLIGHT DECK - FOOT WARMER (IF INSTALLED)</p> |
|---|---|

GENERAL

Ident.: DSC-25-10-80-00017009.0001001 / 17 MAR 17
Applicable to: ALL

The foot warmer system  has a heating panel attached to each pedal. The temperature of the panels is about 20 °C (68 °F).

CONTROLS

Ident.: DSC-25-10-80-00017008.0001001 / 17 MAR 17
Applicable to: ALL

The Foot Warmer ON/OFF control switch  is located on the main instrument panel, on the captain's and first officer's side.



FOOT WARMER sw

Operation of the associated heating panel on captain's pedals or first officer's pedals.



A318/A319/A320/A321
FLIGHT CREW
OPERATING MANUAL

AIRCRAFT SYSTEMS

EQUIPMENT

FLIGHT DECK - FOOT WARMER (IF INSTALLED)

Intentionally left blank

FLASHLIGHTS 

Ident.: DSC-25-20-00018439.0001001 / 17 MAR 17

Applicable to: ALL

Emergency flashlights are installed in a bracket at each lateral console.
Each flashlight comes on automatically when it is removed from its bracket.
A push-to-test button and its associated red/green LED indicate the battery status.

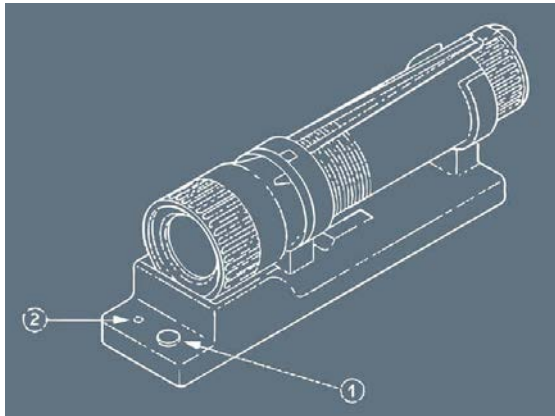

(1) Push-to-Test Button

Pressing this button indicates the battery status.

(2) Charge Indicator (LED)

When the Push-to-Test button is pressed:

- If the LED comes on in green (flashes green one time), the flashlight battery is charged
- If the LED comes on in red (flashes red one time), the battery is low, and should be changed
- If the LED does not come on, the flashlight system has a failure and must be repaired.



A318/A319/A320/A321
FLIGHT CREW
OPERATING MANUAL

AIRCRAFT SYSTEMS

EQUIPMENT

EMERGENCY EQUIPMENT

Intentionally left blank

AIRCRAFT SYSTEMS

FIRE PROTECTION

Intentionally left blank

DSC-26-10 General

Description..... A

DSC-26-20 Engines and APU

DSC-26-20-10 System Description

Fire Detection..... A

Extinguishing..... B

Fire Detection and Detection Fault Logic..... C

DSC-26-20-20 Controls and Indicators

FIRE Panel..... A

ENG MASTER Panel..... B

EXTERNAL POWER Panel..... C

MAINTENANCE Panel..... D

DSC-26-30 Avionics Bay

DSC-26-30-10 System Description

Smoke Detection..... A

DSC-26-30-20 Controls and Indicators

EMER ELEC PWR Panel..... A

VENTILATION Panel..... B

DSC-26-40 Lavatory

DSC-26-40-10 System Description

Smoke Detection..... A

Wastebin Fire Extinguishing..... B

DSC-26-50 Cargo Compartments

DSC-26-50-10 System Description

Smoke Detection..... A

Fire Extinguishing..... B

DSC-26-50-20 Controls and Indicators

CARGO SMOKE Panel..... A



A318/A319/A320/A321
FLIGHT CREW
OPERATING MANUAL

AIRCRAFT SYSTEMS

FIRE PROTECTION

PRELIMINARY PAGES - TABLE OF CONTENTS

Intentionally left blank



A318/A319/A320/A321
FLIGHT CREW
OPERATING MANUAL

AIRCRAFT SYSTEMS

FIRE PROTECTION

GENERAL

DESCRIPTION

Ident.: DSC-26-10-00021387.0006001 / 17 MAR 17

Applicable to: ALL

The fire and smoke protection system includes:

- Fire and overheat detection for the engines and APU
- Smoke detection for the cargo compartments, the lavatories, and the avionics bay
- Fire extinguishing for the cargo compartments, the engines, the APU, and the lavatories.

In addition, the aircraft includes portable fire extinguishers in the cockpit and in the cabin areas.



A318/A319/A320/A321
FLIGHT CREW
OPERATING MANUAL

AIRCRAFT SYSTEMS

FIRE PROTECTION

GENERAL

Intentionally left blank

FIRE DETECTION

Ident.: DSC-26-20-10-00021393.0001001 / 17 MAR 17

Applicable to: ALL

The engines and the APU each have a fire and overheat detection system consisting of:

- Two identical detection loops (A and B) mounted in parallel
- A Fire Detection Unit (FDU).

The fire detection loops consist of:

- Three or four (as installed) engine fire sensing elements, in the pylon nacelle, in the engine core, and in the engine fan section
- One fire sensing element in the APU compartment.

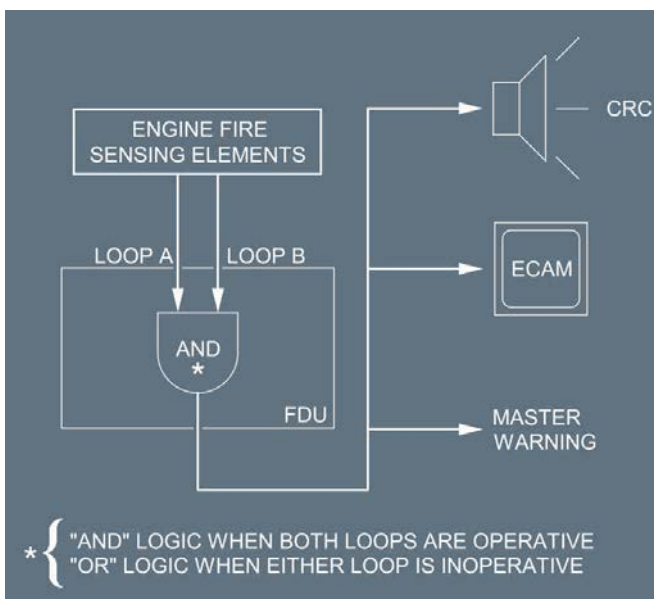

When a sensing element is subjected to heat, it sends a signal to the FDU. As soon as loops A and B detect temperature above a preset level, the fire warning system is triggered.

A fault in one loop (break or loss of electrical supply) does not affect the warning system and the unaffected loop still protects the aircraft.

EXTINGUISHING

Ident.: DSC-26-20-10-00021395.0001001 / 04 JUL 17

Applicable to: **ALL**

ENGINES

Each engine has two fire extinguisher bottles, with electrically-operated squibs to discharge their agents. Each squib has a dual electric supply. The flight crew controls the discharge of the fire extinguisher bottles from the FIRE panel in the cockpit.

APU

The APU has one fire extinguisher bottle, with two electrically-operated squibs to discharge its agent. The flight crew controls the discharge of the fire extinguisher bottle from the FIRE panel in the cockpit. When an APU fire is detected on the ground, the APU automatically shuts down, and the extinguisher bottle discharges automatically.

FIRE DETECTION AND DETECTION FAULT LOGIC

Ident.: DSC-26-20-10-00021394.0001001 / 17 MAR 17

Applicable to: **ALL**

Fire detection units process all the warnings and cautions originating in the sensing elements.

- A fire warning appears, if:
 - Both loops A and B send a fire signal, or
 - One loop sends a fire signal and the other one is failed, or
 - Breaks occur in both loops within 5 s of each other (flame effect), or
 - A test is performed on the FIRE panel
- A loop-fault caution appears, if:
 - One loop is failed, or
 - Both loops are failed, or
 - The FDU fails.

FIRE PANEL

Applicable to: ALL

Ident.: DSC-26-20-20-10-00021396.0002001 / 17 MAR 17

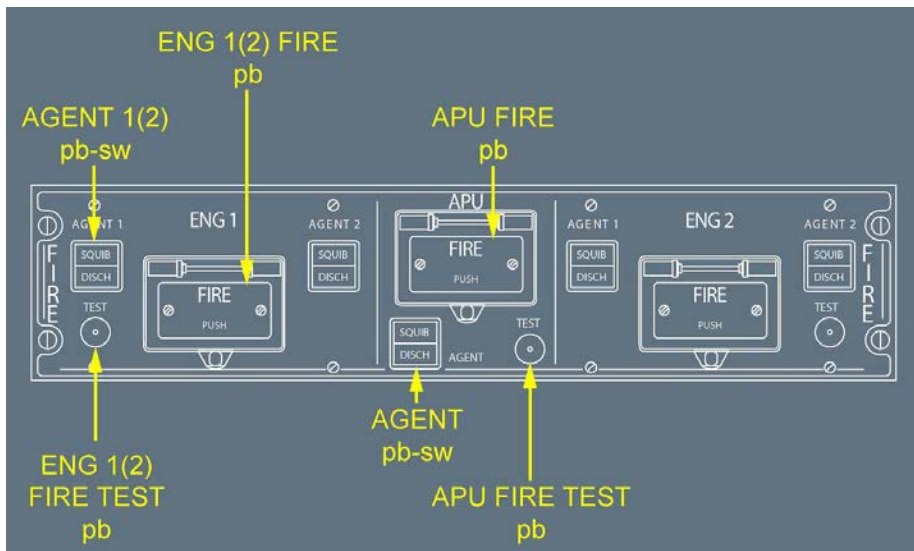

Ident.: DSC-26-20-20-10-00021415.0001001 / 17 MAR 17

ENG 1(2) FIRE PB

The pushbutton normal position is in, and guarded. When the flight crew pushes it, the pushbutton is released and sends an electrical signal that performs the following for the corresponding engine:

- Silences the aural fire warning
- Arms the fire extinguisher squibs
- Closes the low-pressure fuel valve
- Closes the hydraulic fire shut off valve
- Closes the engine bleed valve
- Closes the pack flow control valve
- Cuts off the FADEC power supply
- Deactivates the IDG.

The red lights come on, regardless of the pushbutton position, whenever the fire warning for the corresponding engine is activated.

Ident.: DSC-26-20-20-10-00021420.0001001 / 17 MAR 17

AGENT 1(2) PB-SW

Both AGENT pushbutton-switches of an affected engine become active when the flight crew releases the ENG 1(2) FIRE pb.

A brief push on the pushbutton-switch discharges the corresponding fire agent.

- “SQUIB” comes on white when the flight crew releases the ENG 1(2) FIRE pb to help the flight crew identify the AGENT pb-sw to be activated.
- “DISCH” comes on amber when the corresponding fire extinguisher bottle has lost pressure.

Ident.: DSC-26-20-20-10-00021421.0001001 / 17 MAR 17

ENG 1(2) FIRE TEST PB

This pushbutton tests the operation of the fire detection and extinguishing system for ENG 1(2).

When pressed:

- A continuous repetitive chime (CRC) sounds
- The MASTER WARNING lights flash
- ENG FIRE warning appears on ECAM.
- On the FIRE panel:
 - The ENG 1(2) FIRE pb lights up red
 - The SQUIB lights come on white if discharge supplies are available
 - The DISCH lights come on amber.
- On the ENG MASTER panel (pedestal):
 - The FIRE lights come on red.

Ident.: DSC-26-20-20-10-00021423.0001001 / 17 MAR 17

APU FIRE PB

The pushbutton normal position is in, and guarded. When the flight crew pushes it, the pushbutton is released and sends an electrical signal that performs the following for the APU:

- Shuts down the APU
- Silences the aural warning
- Arms the squib on the APU fire extinguisher
- Closes the low-pressure fuel valve
- Shuts off the APU fuel pump
- Closes the APU bleed valve and X bleed valve and deactivates the APU generator.

The red lights come on, regardless of the pushbutton position, whenever an APU fire warning is activated.

Ident.: DSC-26-20-20-10-00021424.0001001 / 17 MAR 17

AGENT PB-SW

The APU AGENT pb-sw becomes active when the flight crew releases the APU FIRE pb. A brief push on the pushbutton-switch discharges the corresponding fire agent.

- “SQUIB” comes on white when the pilot releases the APU FIRE pb.
- “DISCH” comes on amber when the fire extinguisher bottle has lost pressure.

Note: A red disk, which is outside at the rear of the fuselage, signals that the agent is not discharged overboard due to bottle overpressure.

Ident.: DSC-26-20-20-10-00021425.0001001 / 17 MAR 17

APU FIRE TEST PB

This pushbutton tests the operation of the APU fire detection and extinguishing system.

When pressed:

- A continuous repetitive chime (CRC) sounds
- The MASTER WARNING lights flash
- APU FIRE warning appears on ECAM.
- On the FIRE panel:
 - The APU FIRE pb lights up red
 - The SQUIB light comes on white if discharge supplies are available
 - The DISCH light comes on amber.

Note: The automatic shutdown of the APU on the ground does not occur when the flight crew performs this test.

ENG MASTER PANEL

Applicable to: ALL

Ident.: DSC-26-20-20-00021427.0001001 / 17 MAR 17

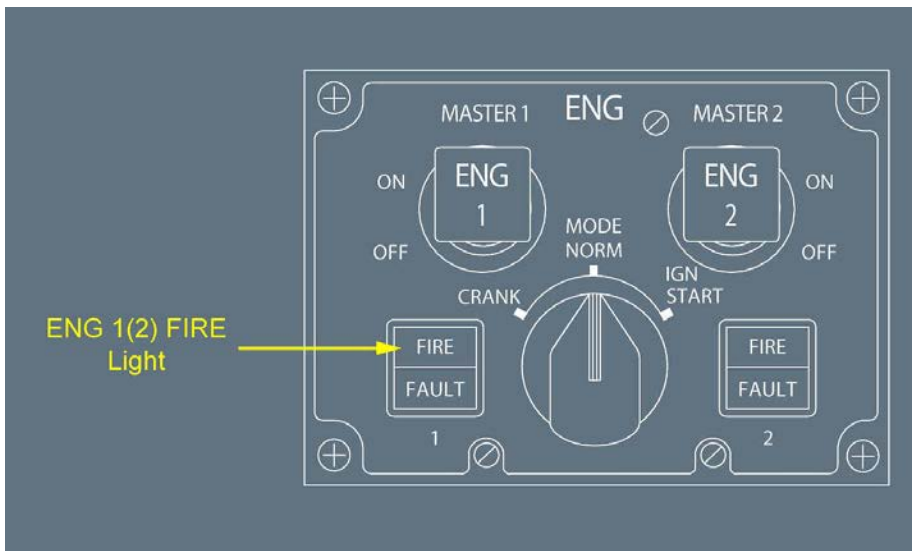

Ident.: DSC-26-20-20-00021428.0001001 / 17 MAR 17

ENG 1(2) FIRE LIGHT

This light identifies the engine to be shutdown in the case of fire.
The light comes on red when an engine fire warning is triggered.

EXTERNAL POWER PANEL

Applicable to: ALL

Ident.: DSC-26-20-20-30-00021429.0001001 / 17 MAR 17

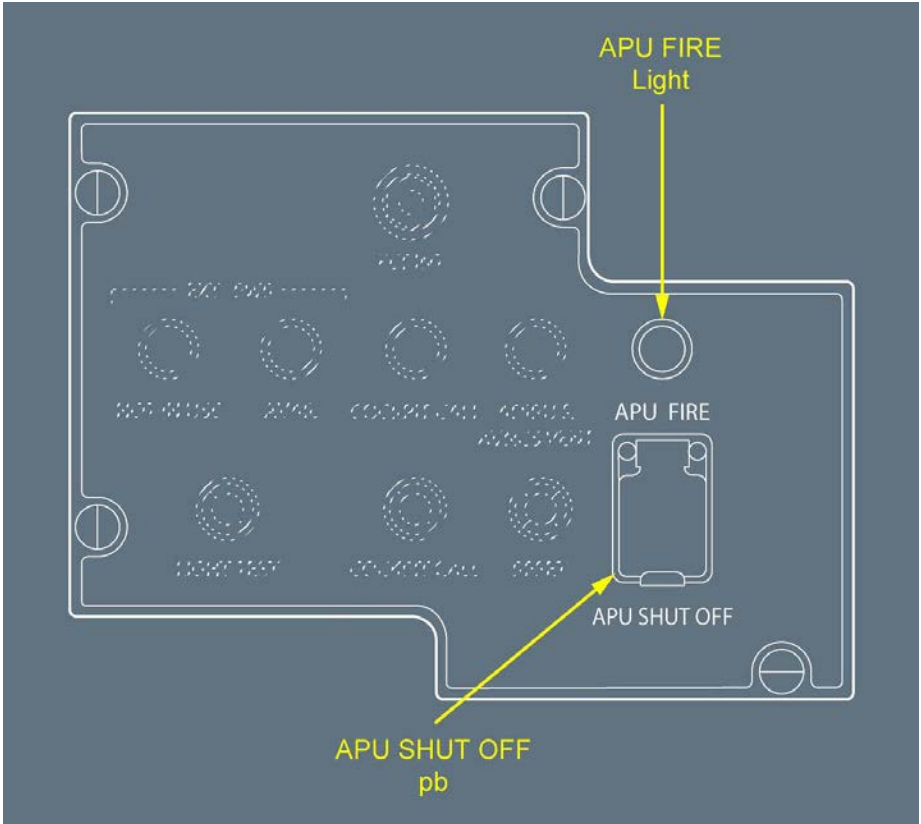

Ident.: DSC-26-20-20-30-00021430.0001001 / 17 MAR 17

APU FIRE LIGHT

The red APU FIRE light comes on and an external warning horn sounds when the system detects an APU fire.

The APU fire extinguisher discharges automatically 3 s after the appearance of the fire warning.

The light goes out when the fire has been extinguished.

Ident.: DSC-26-20-20-30-00021431.0001001 / 17 MAR 17

APU SHUT OFF PB

This pushbutton is used for manual APU emergency shutdown, if an emergency situation is detected on ground by the ground crew. When this pushbutton is pressed, the APU low pressure fuel shutoff valve closes, and the ECB receives a signal that starts the shutdown sequence. The shutdown sequence is the same as the APU automatic shutdown sequence, except that there is no cool down cycle. Pressing this pushbutton also silences the external warning horn.

MAINTENANCE PANEL

Applicable to: **ALL**

Ident.: DSC-26-20-20-40-00021432.0001001 / 17 MAR 17

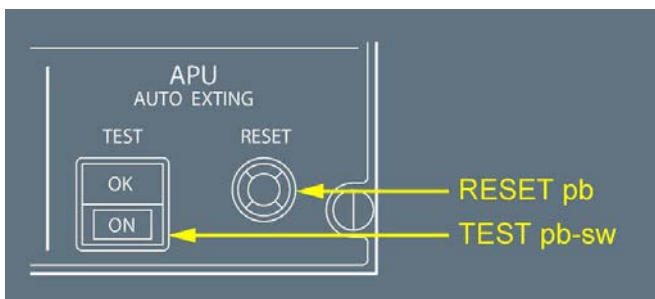

Ident.: DSC-26-20-20-40-00021435.0001001 / 17 MAR 17

TEST PB-SW

When pressed, tests the following APU circuits:

- Fire warning
- Auto extinguishing
- Shutdown.

During the test sequence, the APU MASTER sw must be ON.

If all circuits are operating correctly, the OK light comes on.

Note: If the APU was running, it shuts down.

Ident.: DSC-26-20-20-40-00021436.0001001 / 17 MAR 17

RESET PB

When pressed, resets the test circuit.

SMOKE DETECTION

Ident.: DSC-26-30-10-00021401.0001001 / 17 MAR 17

Applicable to: ALL

The air extraction duct of the avionics ventilation system has one smoke detector.

When smoke is detected for more than 5 s:

- The Single Chime (SC) sounds
- The MASTER CAUTION lights flash
- The ECAM **AVIONICS SMOKE** alert triggers
- On the EMER ELEC PWR panel, the SMOKE light of the GEN 1 LINE pb-sw comes on
- On the VENTILATION panel, the FAULT lights of the BLOWER pb-sw and the EXTRACT pb-sw come on.

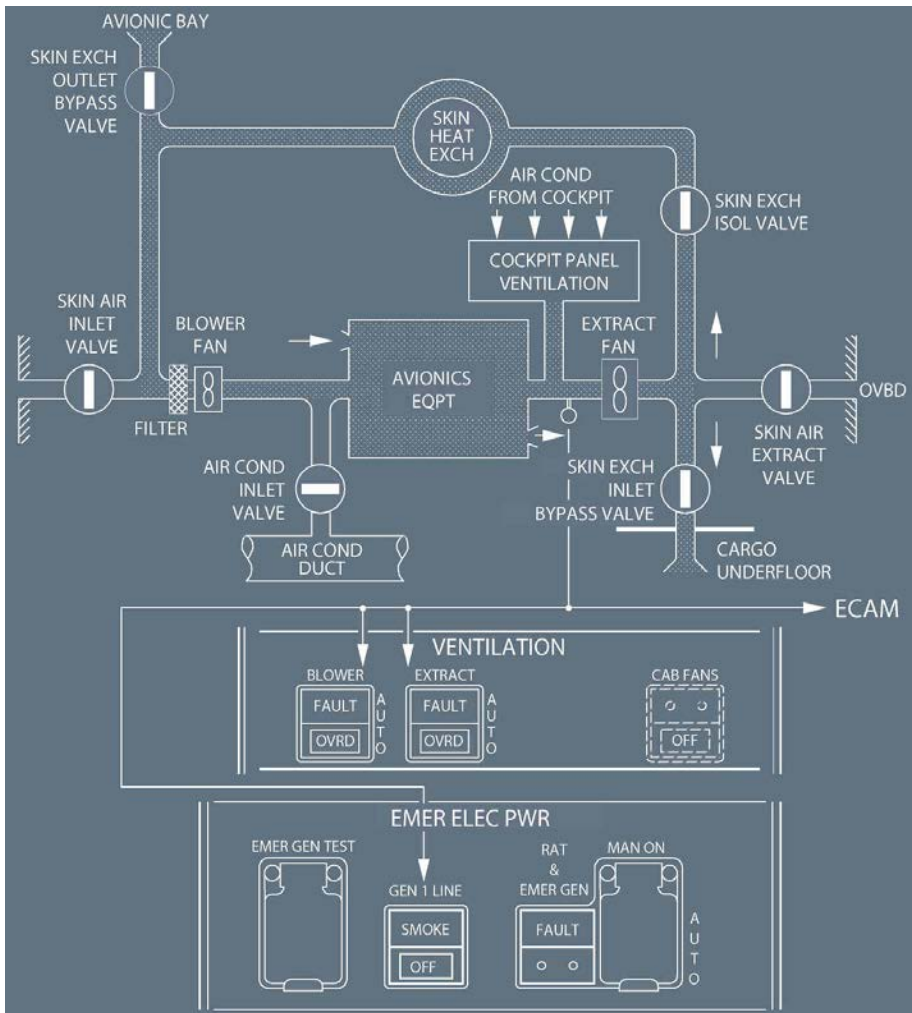

EMER ELEC PWR PANEL

Applicable to: ALL

Ident.: DSC-26-30-20-A-00021439.0001001 / 17 MAR 17

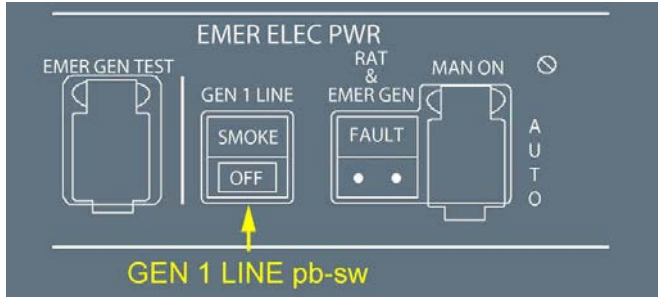

Ident.: DSC-26-30-20-A-00021440.0001001 / 17 MAR 17

GEN 1 LINE PB-SW

SMOKE light on : The amber light comes on when smoke is detected in the avionics ventilation duct.

VENTILATION PANEL

Applicable to: ALL

Ident.: DSC-26-30-20-B-00021402.0001001 / 17 MAR 17

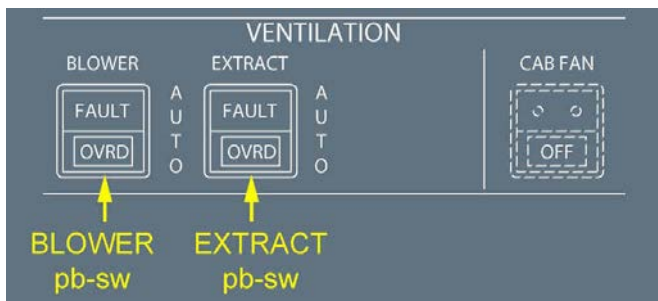

Ident.: DSC-26-30-20-B-00021437.0001001 / 17 MAR 17

BLOWER PB-SW

FAULT light on : The amber light comes on when smoke is detected in the avionics ventilation duct.

Ident.: DSC-26-30-20-B-00021438.0001001 / 17 MAR 17

EXTRACT PB-SW

FAULT light on : The amber light comes on when smoke is detected in the avionics ventilation duct.

SMOKE DETECTION

Ident.: DSC-26-40-10-00021441.0001001 / 17 MAR 17

Applicable to: ALL

The lavatory smoke detection system consists of:

- One smoke detector, in the air extraction duct of the lavatory
- A double channel Smoke Detection Control Unit (SDCU) or a Cabin Intercommunication Data Systems (CIDS) with a Smoke Detection Function (SDF) that triggers the applicable alerts (cockpit and cabin).

In the case of smoke in a lavatory, the detector sends a signal to the SDCU or CIDS, which transmits it to the Flight Warning Computer (FWC) for warning in the cockpit and in the cabin.

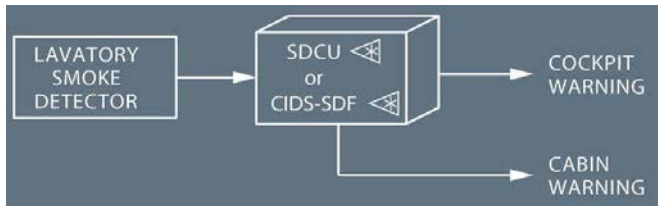

WASTEBIN FIRE EXTINGUISHING

Ident.: DSC-26-40-10-00001034.0001001 / 21 MAR 16

Applicable to: ALL

Each lavatory wastebin has an automatic fire extinguishing system.



A318/A319/A320/A321
FLIGHT CREW
OPERATING MANUAL

AIRCRAFT SYSTEMS

FIRE PROTECTION

LAVATORY - SYSTEM DESCRIPTION

Intentionally left blank

SMOKE DETECTION

Ident.: DSC-26-50-10-00021442.0003001 / 17 MAR 17

Applicable to: ALL

The forward and aft cargo compartments smoke detection system consists of:

- Two smoke detectors that are in the forward cargo compartment ceiling panel cavities. Each detector is linked to one of the two detection loops (dual loop principle).
- Four smoke detectors that are in the aft cargo compartment ceiling panel cavities. Each detector is linked to one of the two detection loops (dual loop principle).
- A Smoke Detection Control Unit (SDCU) with two identical channels, or a Cabin Intercommunication Data Systems (CIDS) with a Smoke Detection Function (SDF), that receives signals from the smoke detectors, and transmits it to the ECAM.

Smoke in one cavity activates the cargo smoke warning if:

- Both smoke detectors detect smoke, or
- One smoke detector detects smoke and the other is inoperative.

Cargo isolation valves close automatically, and the extraction fan stops when the cargo smoke warning is activated.

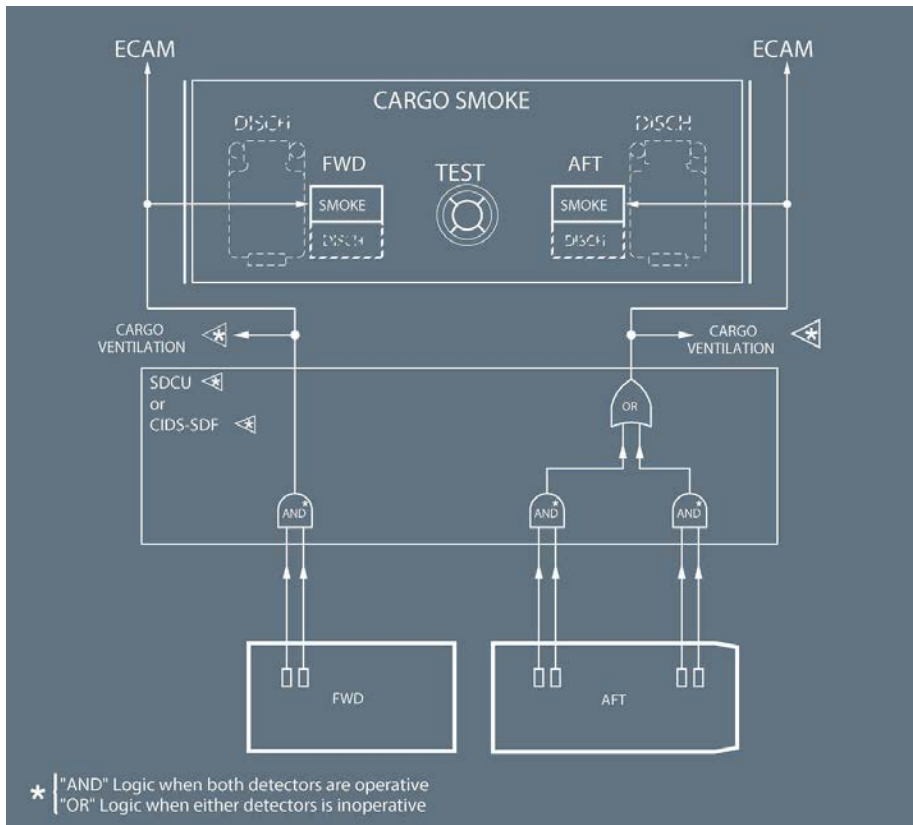

FIRE EXTINGUISHING

Ident.: DSC-26-50-10-00021443.0005001 / 17 MAR 17

Applicable to: ALL

A fire extinguishing system protects the forward and aft cargo compartments.

One fire bottle with two discharge heads, one for each compartment, supplies three nozzles:

- One nozzle in the forward cargo compartment
- Two nozzles in the aft cargo compartment.

When the flight crew presses the FWD(AFT) DISCH pb, the action ignites the corresponding squib on the fire bottle, which then discharges the extinguisher agent into that cargo compartment.

When the bottle is empty, the DISCH light comes on amber.

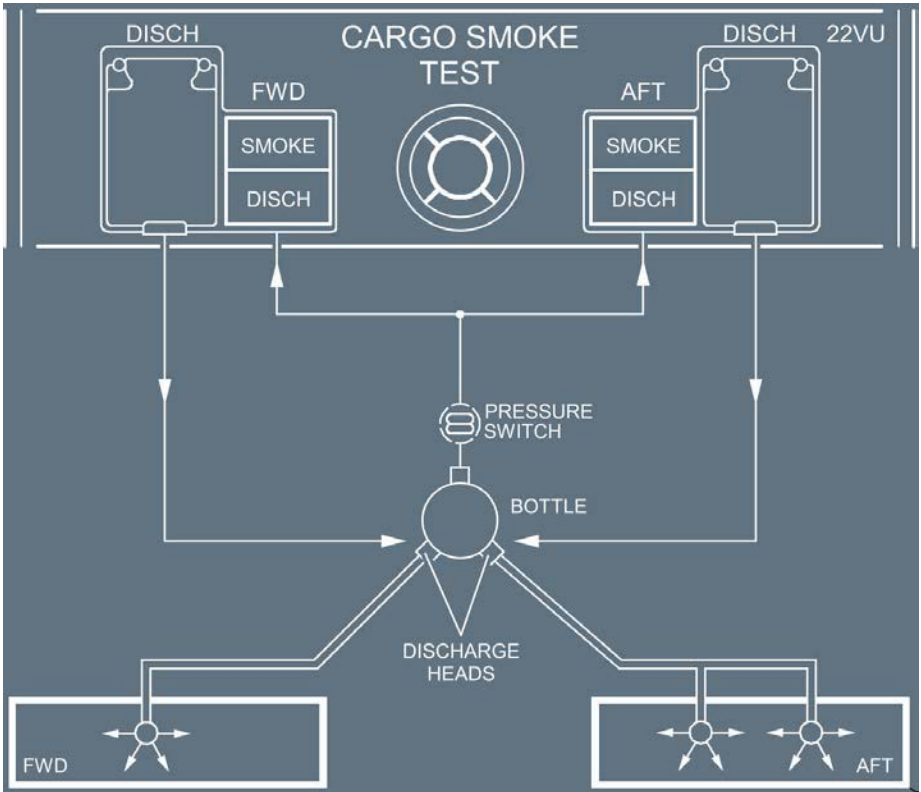



A318/A319/A320/A321
FLIGHT CREW
OPERATING MANUAL

AIRCRAFT SYSTEMS

FIRE PROTECTION

CARGO COMPARTMENTS - SYSTEM DESCRIPTION

Intentionally left blank

CARGO SMOKE PANEL

Applicable to: ALL

Ident.: DSC-26-50-20-10-00021446.0005001 / 17 MAR 17

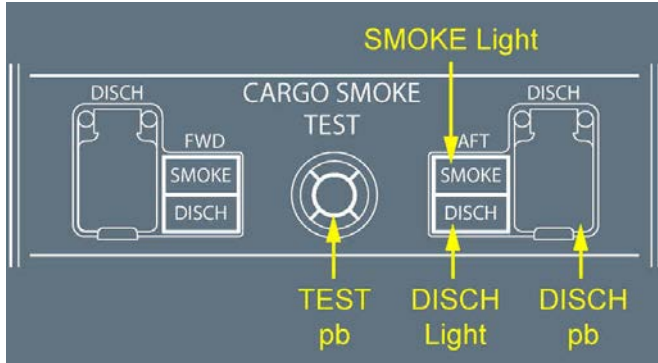

Ident.: DSC-26-50-20-10-00021450.0001001 / 17 MAR 17

SMOKE LIGHT

This red light, and the associated ECAM warning, come on when the system detects smoke in the indicated cargo compartment. This light comes on, if:

- Both channels detect smoke, or
- One channel detects smoke and the other channel is faulty.

Ident.: DSC-26-50-20-10-00021451.0002001 / 17 MAR 17

TEST PB

Tests the operation of the cargo smoke detection system.

When pressed for at least 3 s, and until released:

- Tests the smoke detectors in sequence
- Turns on the red SMOKE lights twice, and displays the ECAM warning
- Closes the isolation valves of the cargo ventilation system
- The DISCH lights come on in amber.

Ident.: DSC-26-50-20-10-00021452.0001001 / 17 MAR 17

DISCH LIGHT

Within 60 s after pressing the discharge pushbutton, the amber DISCH light comes on when the associated bottle is fully discharged.

Ident.: DSC-26-50-20-10-00021454.0001001 / 17 MAR 17

DISCH PB

The DISCH pb ignites the squib, thereby discharging the extinguishing agent in the affected cargo compartment.

AIRCRAFT SYSTEMS

FLIGHT CONTROLS

Intentionally left blank

DSC-27-10 General

DSC-27-10-10 General

| | |
|-----------------------|---|
| General..... | A |
| Basic Principle..... | B |
| Control Surfaces..... | C |
| Cockpit Controls..... | D |
| Computers..... | E |

DSC-27-10-20 Architecture

| | |
|---------------------------------------|---|
| General Architecture..... | A |
| Pitch Control..... | B |
| Roll Control..... | C |
| Speed Brakes and Ground Spoilers..... | D |
| Yaw Control..... | E |

DSC-27-20 Flight Control System

DSC-27-20-10 Normal Law

DSC-27-20-10-10 General

| | |
|--------------|---|
| General..... | A |
|--------------|---|

DSC-27-20-10-20 Pitch Control

| | |
|------------------|---|
| Ground Mode..... | A |
| Flight Mode..... | B |
| Flare Mode..... | C |
| Protections..... | D |

DSC-27-20-10-30 Lateral Control

| | |
|----------------------------|---|
| Normal Law..... | A |
| Bank Angle Protection..... | B |

DSC-27-20-10-50 Sideslip Target

| | |
|----------------------|---|
| Sideslip Target..... | A |
|----------------------|---|

DSC-27-20-10-70 Aircraft Trimming

| | |
|------------------------|---|
| AIRCRAFT TRIMMING..... | A |
|------------------------|---|

Continued on the following page

Continued from the previous page

DSC-27-20-20 Reconfiguration Control Laws

| | |
|---|---|
| General..... | A |
| Flight Controls Law Reconfiguration..... | B |
| Alternate Law..... | C |
| Alternate Law Without Reduced Protection..... | D |
| Direct Law..... | E |
| Abnormal Attitude Laws..... | F |
| Mechanical Back-Up..... | G |

DSC-27-20-30 Controls and Indicators

| | |
|------------------------------------|---|
| Pedestal..... | A |
| Lateral Consoles..... | B |
| Glareshield..... | C |
| Overhead Panel..... | D |
| Side Stick Indications On PFD..... | E |
| ECAM F/CTL Page..... | F |
| ECAM Wheel Page..... | G |
| Memo Display..... | H |

DSC-27-30 Flaps and Slats

DSC-27-30-10 Description

| | |
|--|---|
| General..... | A |
| Main Components..... | B |
| Architecture..... | C |
| Configurations..... | D |
| Alpha/Speed Lock Function (Slats)..... | E |

DSC-27-30-20 Controls and Indicators

| | |
|-------------------------|---|
| Pedestal..... | A |
| ECAM Upper Display..... | B |

GENERAL

Ident.: DSC-27-10-10-00001043.0001001 / 21 MAR 16

Applicable to: ALL

The fly-by-wire system was designed and certified to render the new generation of aircraft even more safe, cost effective, and pleasant to fly.

BASIC PRINCIPLE

Ident.: DSC-27-10-10-00001044.0001001 / 21 MAR 16

Applicable to: ALL

Flight control surfaces are all :

- Electrically-controlled, and
- Hydraulically-activated.

The stabilizer and rudder can also be mechanically-controlled.

Pilots use sidesticks to fly the aircraft in pitch and roll (and in yaw, indirectly, through turn coordination).

Computers interpret pilot input and move the flight control surfaces, as necessary, to follow their orders.

However, when in normal law, regardless of the pilot's input, the computers will prevent excessive maneuvers and exceedance of the safe envelope in pitch and roll axis.

However, as on conventional aircraft, the rudder has no such protection.

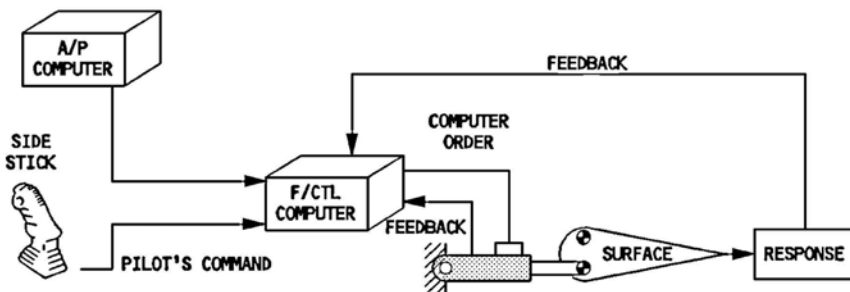

CONTROL SURFACES

Ident.: DSC-27-10-10-00001045.0001001 / 21 MAR 16

Applicable to: ALL

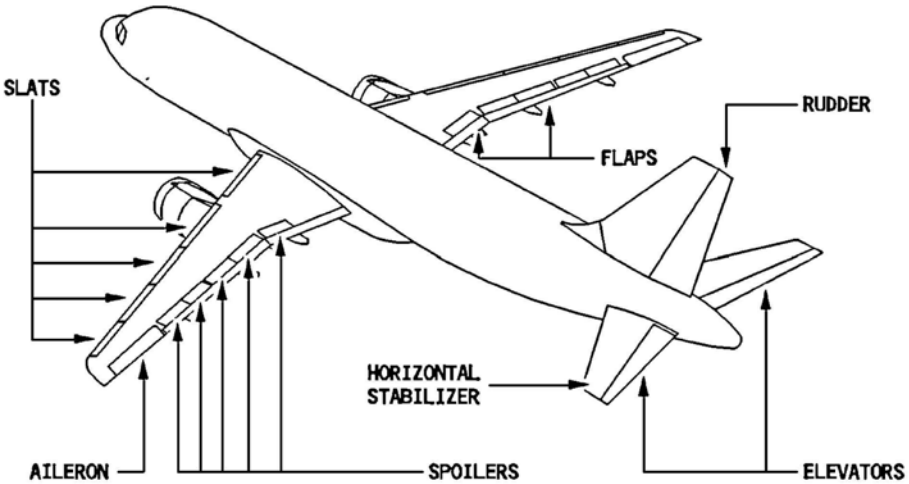

The flight controls are electrically or mechanically controlled as follows :

PITCH AXIS

- Elevator = Electrical
- Stabilizer = Electrical for normal or alternate control. Mechanical for manual trim control

ROLL AXIS

- Ailerons = Electrical
- Spoilers = Electrical

YAW AXIS

- Rudder = Mechanical, however control for yaw damping, turn coordination and trim is electrical.

SPEED BRAKES

- Speed brakes = Electrical

Note: All surfaces are hydraulically actuated.

COCKPIT CONTROLS

Ident.: DSC-27-10-10-00001046.0001001 / 21 MAR 16

Applicable to: ALL

- Each pilot has a sidestick controller with which to exercise manual control of pitch and roll. These are on their respective lateral consoles.
The two sidestick controllers are not coupled mechanically, and they send separate sets of signals to the flight control computers.
- Two pairs of pedals, which are rigidly interconnected, give the pilot mechanical control of the rudder.
- The pilots control speed brakes with a lever on the center pedestal.
- The pilots use mechanically interconnected handwheels on each side of the center pedestal to control the trimmable horizontal stabilizer.
- The pilots use a single switch on the center pedestal to set the rudder trim.
- There is no manual switch for trimming the ailerons.

COMPUTERS

Ident.: DSC-27-10-10-00001047.0001001 / 21 MAR 16

Applicable to: ALL

Seven flight control computers process pilot and autopilot inputs according to normal, alternate, or direct flight control laws.

The computers are :

2 ELAC s

(Elevator Aileron Computer)

For : Normal elevator and stabilizer control.
Aileron control.

3 SEC s

(Spoilers Elevator Computer)

For : Spoilers control.
Standby elevator and stabilizer control.

2 FAC s

(Flight Augmentation Computer)

For : Electrical rudder control.

IN ADDITION 2 FCDC

Flight Control Data Concentrators (FCDC) acquire data from the ELAC s and SEC s and send it to the electronic instrument system (EIS) and the centralized fault display system (CFDS).

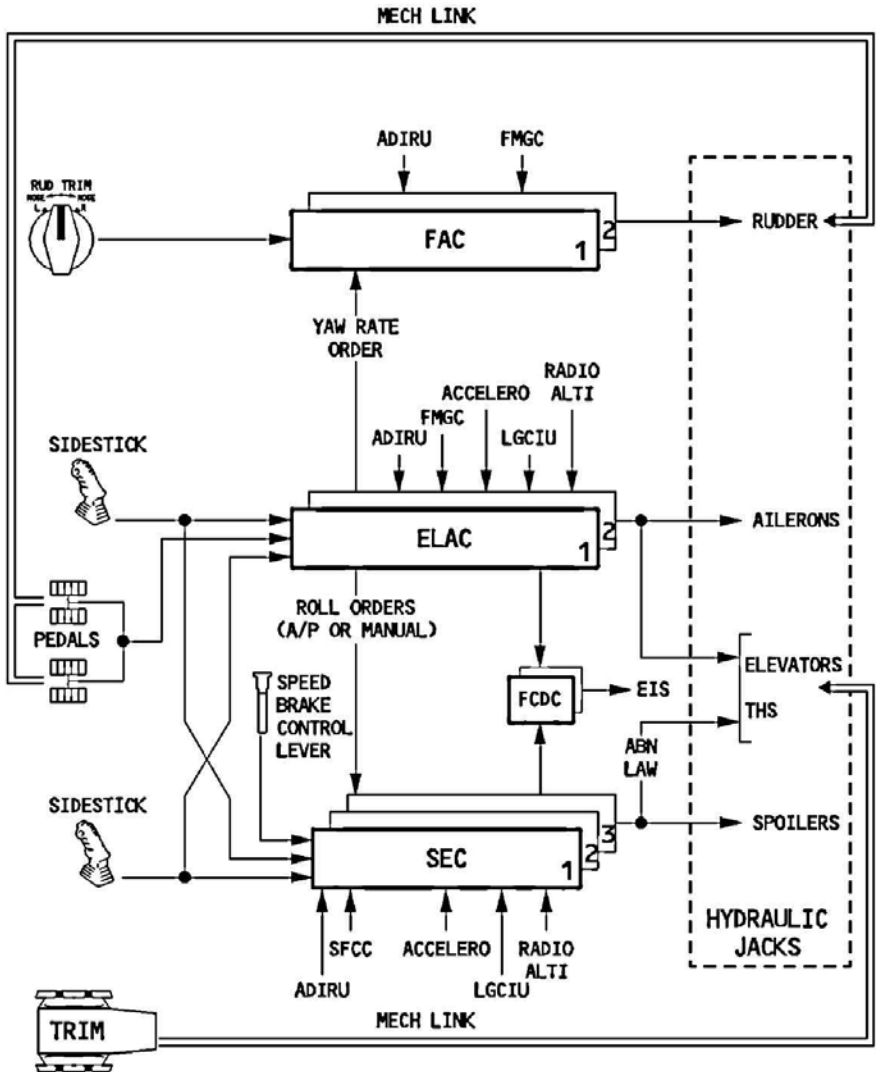



A318/A319/A320/A321
FLIGHT CREW
OPERATING MANUAL

AIRCRAFT SYSTEMS

FLIGHT CONTROLS

GENERAL - GENERAL

Intentionally left blank

GENERAL ARCHITECTURE

Ident.: DSC-27-10-20-00001048.0002001 / 13 JAN 14

Applicable to: ALL

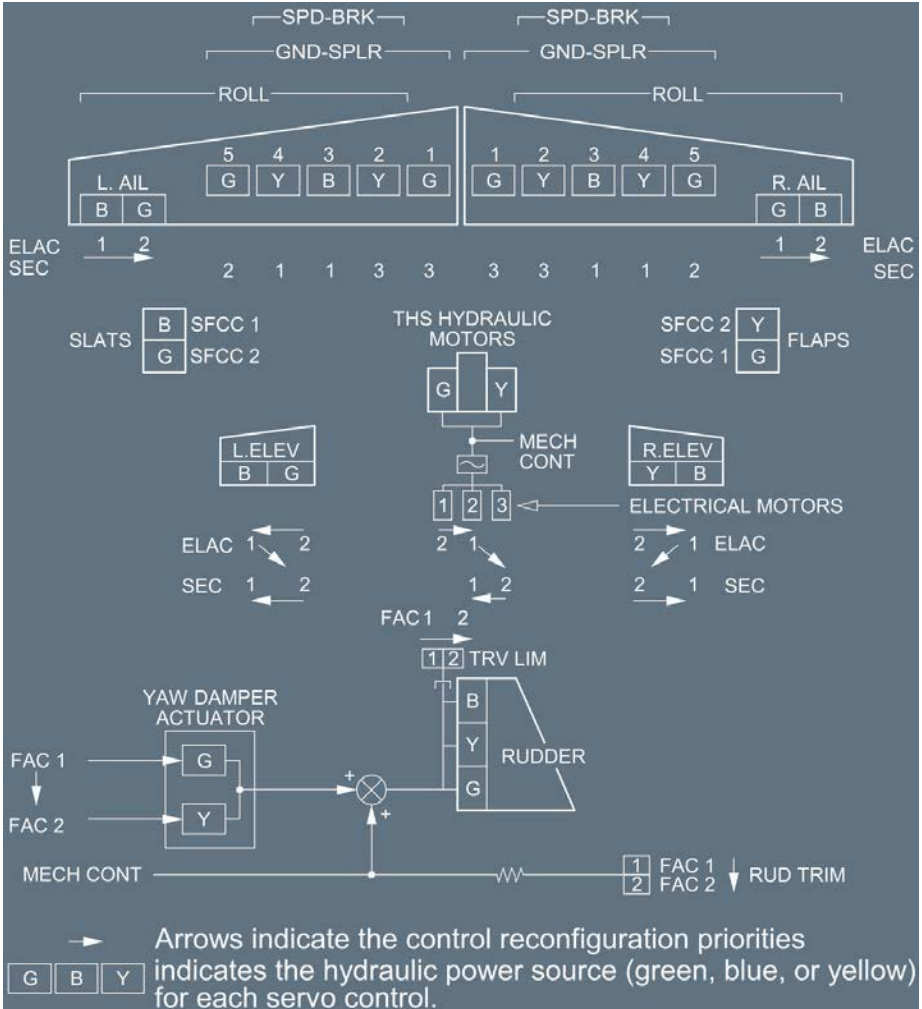

PITCH CONTROL

Applicable to: ALL

Ident.: DSC-27-10-20-A-00001049.0001001 / 21 MAR 16

GENERAL

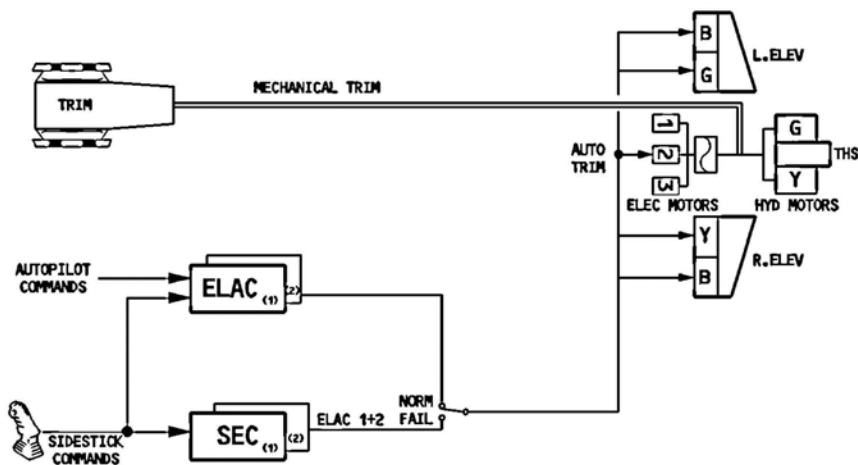

Two elevators and the Trimmable Horizontal Stabilizer (THS) control the aircraft in pitch. The maximum elevator deflection is 30 ° nose up, and 17 ° nose down. The maximum THS deflection is 13.5 ° nose up, and 4 ° nose down.

Ident.: DSC-27-10-20-A-00001050.0001001 / 21 MAR 16

ELECTRICAL CONTROL

- In normal operations, ELAC2 controls the elevators and the horizontal stabilizer, and the green and yellow hydraulic jacks drive the left and right elevator surfaces respectively. The THS is driven by N° 1 of three electric motors.
- If a failure occurs in ELAC 2, or in the associated hydraulic systems, or with the hydraulic jacks, the system shifts pitch control to ELAC 1. ELAC 1 then controls the elevators via the blue hydraulic jacks and controls the THS via the N° 2 electric motor.
- If neither ELAC 1 nor ELAC 2 is available, the system shifts pitch control either to SEC 1 or to SEC 2, (depending on the status of the associated circuits), and to THS motor N° 2 or N° 3.

In case of failure, the actuators are reconfigured, *Refer to DSC-27-10-20 Pitch Control - Schematic.*

Ident.: DSC-27-10-20-A-00001051.0001001 / 21 MAR 16

MECHANICAL CONTROL

Mechanical control of the THS is available from the pitch trim wheel at any time, if either the green or yellow hydraulic system is functioning.

Mechanical control from the pitch trim wheel has priority over electrical control.

Ident.: DSC-27-10-20-A-00001053.0002001 / 21 MAR 16

ACTUATION

ELEVATORS

- Two electrically-controlled hydraulic servojacks drive each elevator.

Each servojack has three control modes :

- Active : The jack position is electrically-controlled.
- Damping : The jack follows surface movement.
- Centering : The jack is hydraulically retained in the neutral position.

- In normal operation :

- One jack is in active mode.
- The other jack is in damping mode.
- Some maneuvers cause the second jack to become active.

- If the active servojack fails, the damped one becomes active, and the failed jack is automatically switched to damping mode.
- If neither jack is being controlled electrically, both are automatically switched to the centering mode.
- If neither jack is being controlled hydraulically, both are automatically switched to damping mode.
- If one elevator fails, the deflection of the remaining elevator is limited in order to avoid putting excessive asymmetric loads on the horizontal tailplane or rear fuselage.

STABILIZER

- A screwjack driven by two hydraulic motors drives the stabilizer.
- The two hydraulic motors are controlled by :
 - One of three electric motors, or
 - The mechanical trim wheel.

Ident.: DSC-27-10-20-A-00001054.0001001 / 09 OCT 12

SCHEMATIC

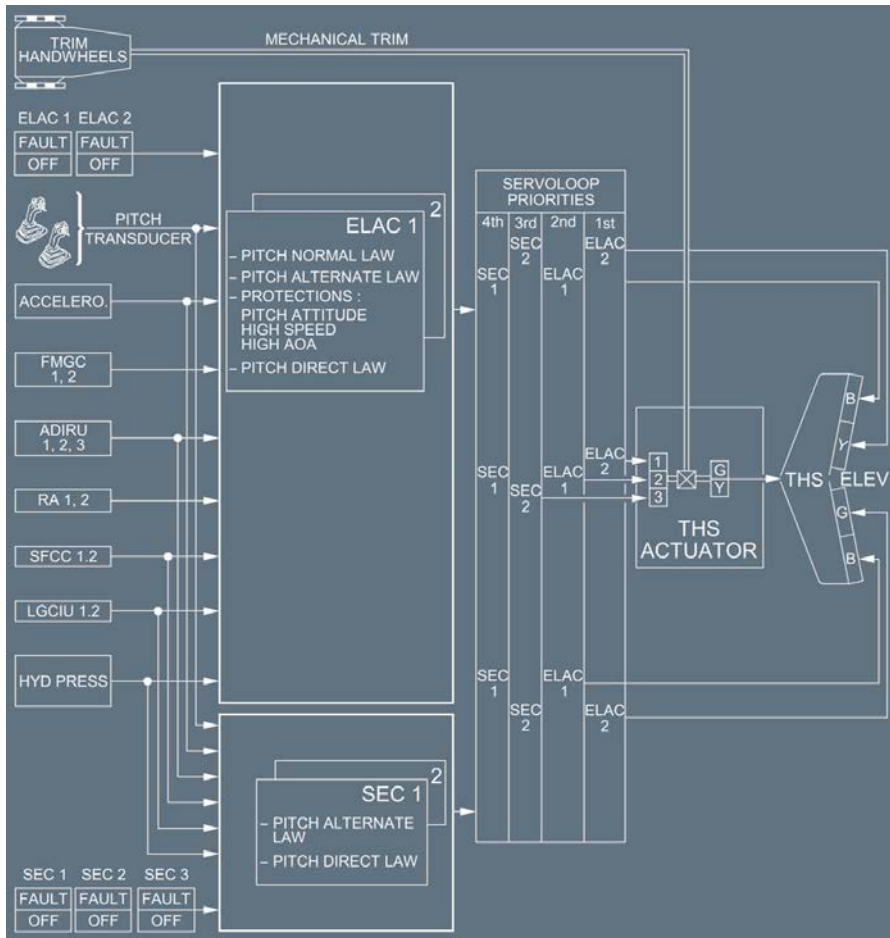

ROLL CONTROL

Applicable to: ALL

Ident.: DSC-27-10-20-B-00001055.0003001 / 09 OCT 12

GENERAL

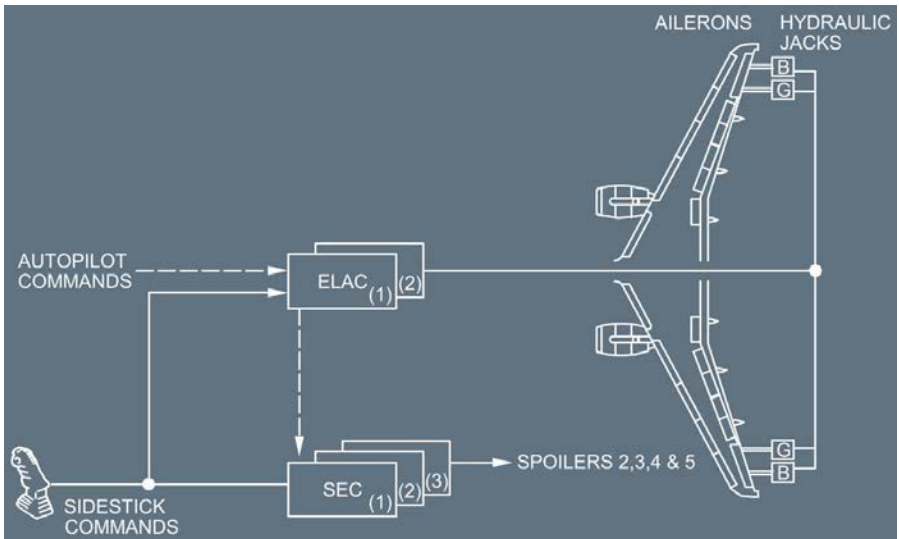

One aileron and four spoilers on each wing control the aircraft about the roll axis.

The maximum deflection of the ailerons is 25 °.

The ailerons extend 5 ° down when the flaps are extended (aileron droop).

The maximum deflection of the spoilers is 35 °.

Ident.: DSC-27-10-20-B-00001056.0001001 / 21 MAR 16

ELECTRIC CONTROL

- The ELAC 1 normally controls the ailerons.
If ELAC 1 fails, the system automatically transfers aileron control to ELAC2.
If both ELACs fail, the ailerons revert to the damping mode.
- SEC 3 controls the N° 2 spoilers, SEC 1 the N° 3 and 4 spoilers, and SEC2 the N° 5 spoilers.
If a SEC fails, the spoilers it controls are automatically retracted.

Ident.: DSC-27-10-20-B-00001057.0001001 / 21 MAR 16

ACTUATION

AILERONS

Each aileron has two electrically controlled hydraulic servo jacks.
One of these servo jacks per aileron operates at a time.

Each servo jack has two control modes :

- Active : Jack position is controlled electrically
- Damping : Jack follows surface movement.

The system automatically selects damping mode, if both ELACs fail or in the event of blue and green hydraulic low pressure.

SPOILERS

A servo jack positions each spoiler. Each servo jack receives hydraulic power from either the green, yellow, or blue hydraulic system, controlled by the SEC1, 2 or 3 (*Refer to DSC-27-10-20 General Architecture diagram*).

The system automatically retracts the spoilers to their zero position, if it detects a fault or loses electrical control.

If the system loses hydraulic pressure, the spoiler retains the deflection it had at the time of the loss, or a lesser deflection if aerodynamic forces push it down.

When a spoiler surface on one wing fails, the symmetric one on the other wing is inhibited.

SPEED BRAKES AND GROUND SPOILERS

Applicable to: ALL

Ident.: DSC-27-10-20-C-00001058.0011001 / 26 MAY 14

SPEED BRAKE CONTROL

The pilot controls the speedbrakes with the speed brake lever.
The speedbrakes are actually spoilers 2, 3 and 4.

Speedbrake extension is inhibited, if:

- SEC 1 and SEC 3 both have faults, or
- An elevator (L or R) has a fault, or
- Angle-of-attack protection is active, or
- Flaps are in configuration FULL, or
- Thrust levers above MCT position, or
- Alpha Floor activation.

If an inhibition occurs when the speedbrakes are extended, they retract automatically and stay retracted until the inhibition condition disappears and the pilots reset the lever. (The speedbrakes can be extended again 10 s or more after the lever is reset).

When a speedbrake surface on one wing fails, the symmetric one on the other wing is inhibited.

Note:

1. For maintenance purposes, the speedbrake lever will extend the N° 1 surfaces when the aircraft is stopped on ground, whatever the slat/flap configuration.
2. When the aircraft is flying faster than 315 kt or M 0.75 with the autopilot engaged, the speedbrake retraction rate is reduced (Retraction from FULL to in takes about 25 s).

L3 The maximum speedbrake deflection in manual flight is:

- 40 ° for spoilers 3 and 4
- 20 ° for spoiler 2.

The maximum speedbrake deflection with the autopilot engaged is:

- 25 ° for spoilers 3 and 4
- 12.5 ° for spoiler 2.

The maximum speedbrake deflection achievable with the autopilot engaged is obtained by setting the speedbrake lever to the half way position. On setting the position of the speedbrake lever from half to full, no increase in speedbrake deflection will be achieved.

For these surfaces (which perform both roll and speedbrake functions) the roll function has priority. When the sum of a roll order and a simultaneous speedbrake order on one surface is greater than the maximum deflection available in flight, the same surface on the other wing is retracted until the difference between the two surfaces is equal to the roll order.

Ident.: DSC-27-10-20-C-00017787.0002001 / 28 APR 16

GROUND SPOILER CONTROL

The ground spoiler function involves all spoilers (full extension) and ailerons (Aileron Anti Droop ).

When a ground spoiler surface on one wing fails, the symmetric ground spoiler surface on the other wing is inhibited.

ARMING

The pilot arms the ground spoilers by pulling the speedbrake control lever up into the armed position.

FULL EXTENSION – REJECTED TAKEOFF PHASE

- If the ground spoilers are armed and the speed exceeds 72 kt, the ground spoilers will automatically extend as soon as both thrust levers are reset to idle.
- If the ground spoilers are not armed and the speed exceeds 72 kt, the ground spoilers will automatically extend as soon as reverse is selected on one engine (the other thrust lever remains at idle).

FULL EXTENSION - LANDING PHASE

The ground spoilers will automatically extend when the following conditions are met:

- Speed brake lever not in the retracted position or ground spoilers armed and:
 - Both main landing gears on ground,
 - Both thrust levers at or below Idle position, or Reverse selected on at least one engine (and the other thrust lever below MCT position).
- Speed brake lever in the retracted position but ground spoilers not armed and:
 - Both main landing gears on ground,
 - Reverse selected on at least one engine (and the other thrust lever below MCT position).

The ailerons are fully-extended (Aileron Anti Droop ), provided one aileron servocontrol is available on each side, when:

- The ground spoilers are fully extended
- Flaps are not in clean CONF
- Pitch attitude is lower than 2.5 °
- Flying manually
- In normal law only.

PARTIAL EXTENSION

In order to accelerate the full spoiler extension, the Phased Lift Dumping (PLD) function allows the ground spoilers to deploy with a reduced deflection when the following conditions are met:

- Speed brake lever not in the retracted position or ground spoilers armed and:
 - One main landing gear on ground,
 - Both thrust levers at or below Idle position.
- Speed brake lever in the retracted position but ground spoilers not armed and:
 - One main landing gear on ground,
 - Reverse selected on at least one engine (and the other thrust lever below MCT position).

In order to reduce the bounce severity at landing in the case of an inappropriate thrust lever handling during flare, ground spoilers are also partially deployed when the following conditions are met:

- Ground spoilers armed,
- Both main landing gears on ground,
- Both thrust levers at or below the Climb position.

RETRACTION

The ground spoilers retract:

- After landing,
- After a rejected takeoff, when the ground spoilers are disarmed.
- During a touch and go, when at least one thrust lever is advanced above 20 °.

Ident.: DSC-27-10-20-C-00001060.0002001 / 22 MAY 12

ROLL CONTROL - SCHEMATIC

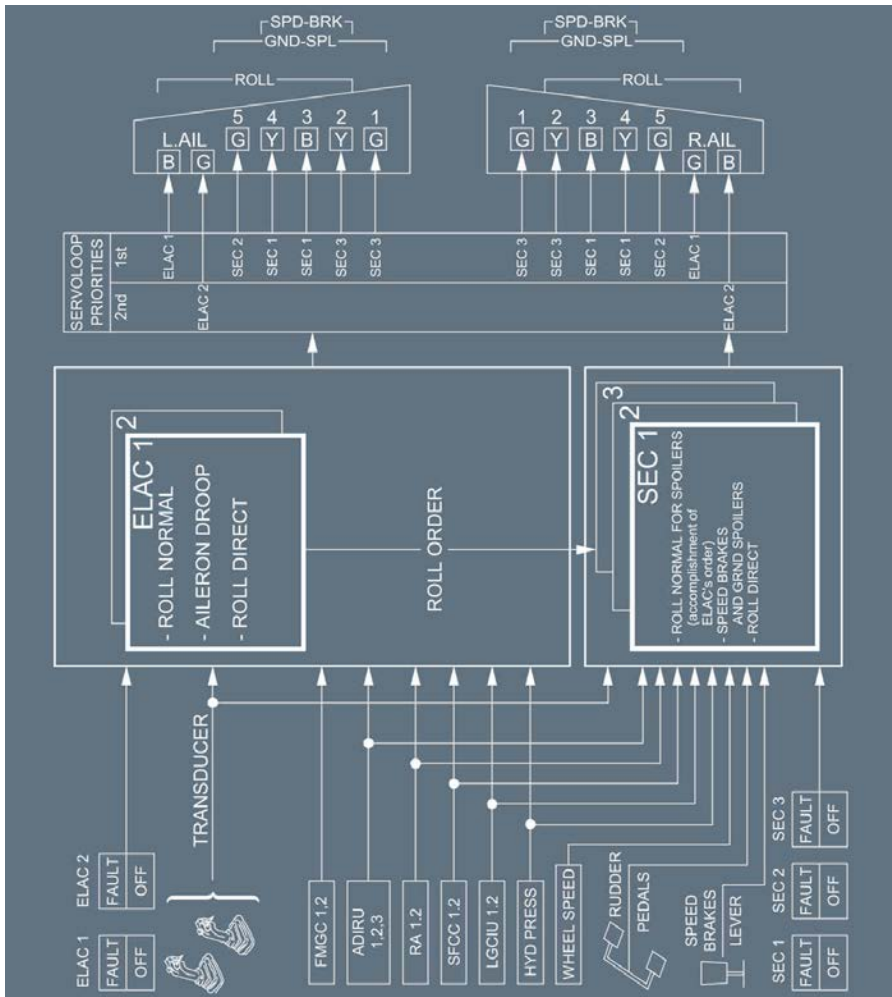

YAW CONTROL

Applicable to: ALL

Ident.: DSC-27-10-20-D-00001061.0001001 / 09 OCT 12

GENERAL

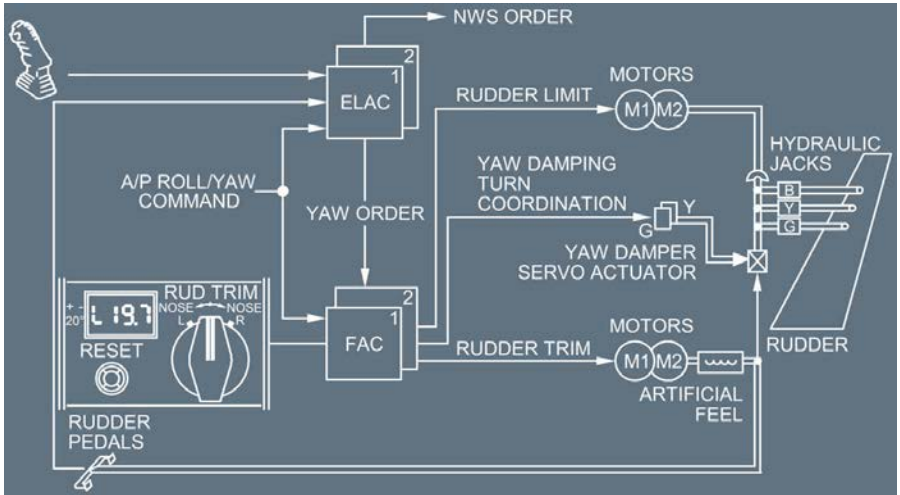

One rudder surface controls yaw.

Ident.: DSC-27-10-20-D-00001062.0001001 / 21 MAR 16

ELECTRICAL RUDDER CONTROL

The yaw damping and turn coordination functions are automatic.

The ELAC s compute yaw orders for coordinating turns and damping yaw oscillations, and transmit them to the FACs.

Ident.: DSC-27-10-20-D-00001063.0001001 / 21 MAR 16

MECHANICAL RUDDER CONTROL

The pilots can use conventional rudder pedals to control the rudder.

Ident.: DSC-27-10-20-D-00001064.0001001 / 21 MAR 16

RUDDER ACTUATION

Three independent hydraulic servojacks, operating in parallel, actuate the rudder. In automatic operation (yaw damping, turn coordination) a green servo actuator drives all three servojacks. A yellow servo actuator remains synchronized and takes over if there is a failure.

There is no feedback to the rudder pedals from the yaw damping and turn coordination functions.

Ident.: DSC-27-10-20-D-00001065.0003001 / 21 MAR 16

RUDDER TRAVEL LIMIT

The maximum rudder travel deflection gradually reduces as the speed increases, to avoid structural loads:

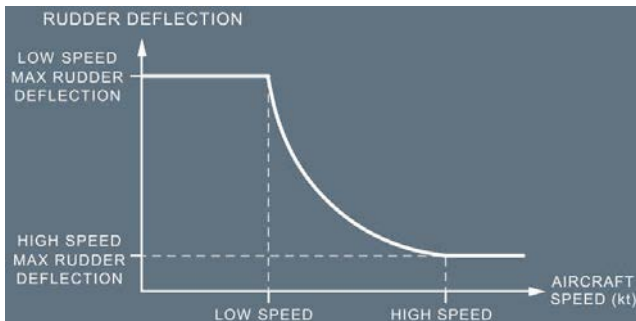

In the case of a failure that causes loss of the Rudder Travel limit system, the rudder deflection limit stops at the last value reached. At slats extension, full rudder travel authority is recovered. In all cases, the available rudder deflection provides sufficient yaw control within the entire flight envelope. This includes the case of maximum asymmetric thrust.

Ident.: DSC-27-10-20-D-00015506.0001001 / 21 MAR 16

RELATIONSHIP BETWEEN SIDESLIP/RUDDER DEFLECTION/RUDDER PEDAL TRAVEL

Regardless of the aircraft speed, therefore the maximum rudder deflection, full rudder pedal travel remains available. However, except at low speed, maximum rudder deflection is achieved before reaching maximum rudder pedal travel.

Ident.: DSC-27-10-20-D-00001066.0002001 / 21 MAR 16

RUDDER TRIM

The two electric motors that position the artificial feel unit also trim the rudder. In normal operation, motor N° 1 (controlled by FAC 1), powers the trim, and FAC2 with motor N° 2 remains synchronized as a backup.

In manual flight, the pilot can apply rudder trim via the rotary RUD TRIM switch on the pedestal. The pilot can use a button on the RUD TRIM panel to reset the rudder trim to zero.

Note: With the autopilot engaged, the FMGC computes the rudder trim orders. The rudder trim rotary switch and the rudder trim reset pushbutton are not active.

Ident.: DSC-27-10-20-D-00001067.0001001 / 21 MAR 16

SCHEMATIC

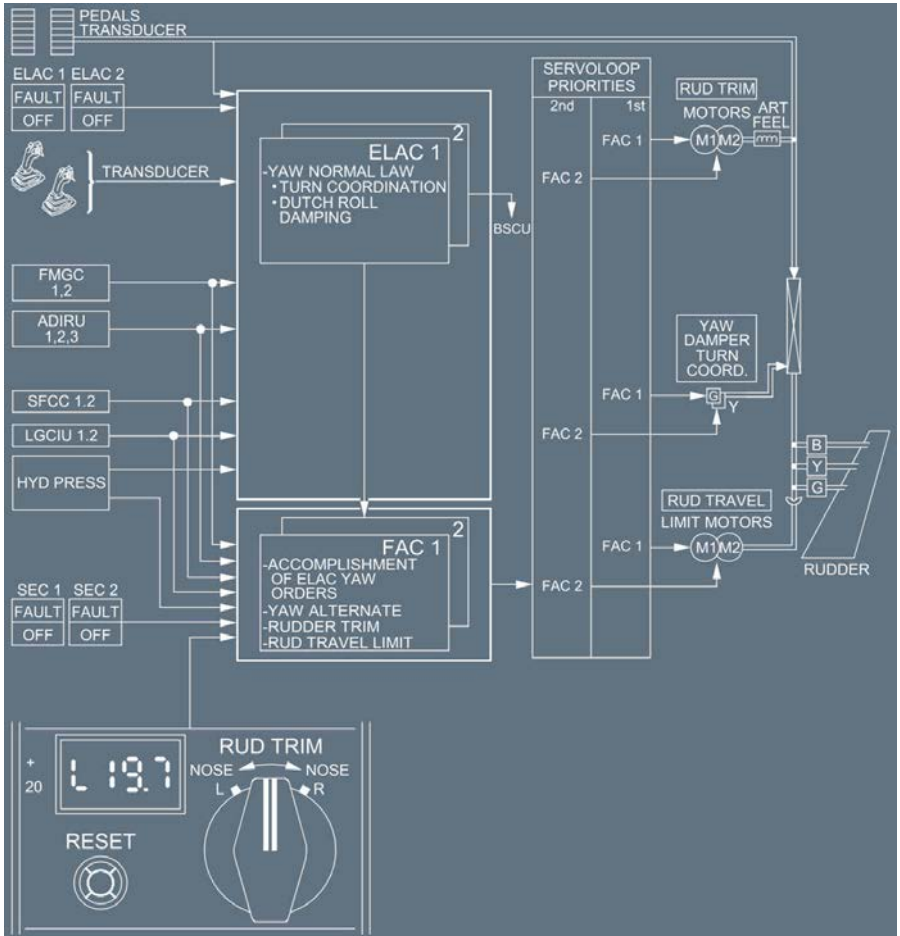



A318/A319/A320/A321
FLIGHT CREW
OPERATING MANUAL

AIRCRAFT SYSTEMS

FLIGHT CONTROLS

GENERAL - ARCHITECTURE

Intentionally left blank

General

GENERAL

Ident.: DSC-27-20-10-10-00001068.0001001 / 17 MAR 17

Applicable to: ALL

Flight control normal law covers:

- three-axis control
- flight envelope protection
- alleviation of maneuver loads

| NORMAL LAW protection | Pitch Control | | | NORMAL LAW Protection | Lateral Control | |
|-----------------------|---------------|-------------|------------|-----------------------|-----------------|-------------|
| | Ground Mode | Flight Mode | Flare Mode | | Ground Mode | Flight Mode |
| Pitch Attitude | | × | | Bank Angle | | × |
| Load Factor | | × | | | | |
| High Speed | | × | | | | |
| High Angle Of Attack | | × | × | | | |

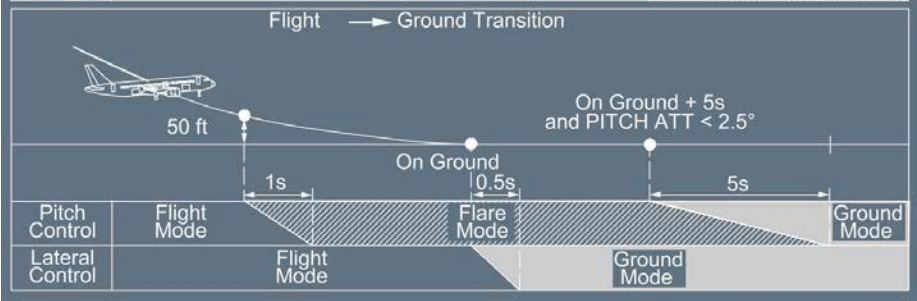
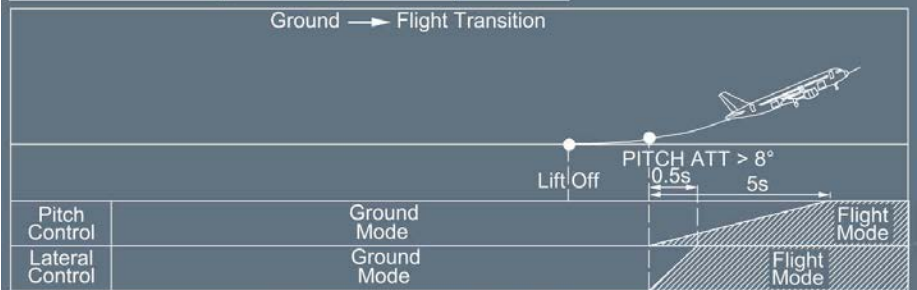

One of the PF's primary tasks is to maintain the aircraft within the limits of the normal flight envelope. However, some circumstances, due to extreme situations or aircraft mishandling, may provoke the violation of these limits.

Despite system protections, the PF must not exceed deliberately the normal flight envelope. In addition, these protections are not designed to be structural limit protections (e.g. opposite rudder pedal inputs). Rather, they are designed to assist the PF in emergency and stressful situations, where only instinctive and rapid reactions will be effective.

Protections are intended to:

- Provide full authority to the PF to consistently achieve the best possible aircraft performance in extreme conditions
- Reduce the risks of overcontrolling, or overstressing the aircraft
- Provide PF with an instinctive and immediate procedure to ensure that the PF achieves the best possible result.

Pitch Control

GROUND MODE

Ident.: DSC-27-20-10-20-00001069.0001001 / 20 SEP 13

Applicable to: ALL

Ground mode is a direct relationship between sidestick deflection and elevator deflection, without auto trim.

It automatically sets the trimmable horizontal stabilizer (THS) at 0 ° (inside the green band).

A setting that the pilot enters manually to adjust for CG has priority for takeoff.

When the aircraft reaches 75 kt during the takeoff roll, the system reduces the maximum up elevator deflection from 30 ° to 20 °.

FLIGHT MODE

Ident.: DSC-27-20-10-20-00001070.0003001 / 17 MAR 17

Applicable to: ALL

The normal-law flight mode is a load-factor-demand mode with automatic trim and protection throughout the flight envelope.

Following normal law, the sidestick controllers set the elevator and THS to maintain load factor proportional to stick deflection and independent of speed.

With the sidestick at neutral, wings level, the system maintains 1 g in pitch (corrected for pitch attitude), and there is no need for the pilot to trim by changing speed or configuration. Therefore pilots only need to perform minor corrections on the sidestick, if the aircraft deviates from its intended flight path. If the pilot senses an overcontrol, the sidestick should be released.

Pitch trim is automatic both in manual mode and when the autopilot is engaged. In normal turns (up to 33 ° of bank) the pilot does not have to make any pitch corrections once the turn is established.

The flight mode is active from takeoff to landing, and follows the logic shown schematically (*Refer to DSC-27-20-10-10 General*).

Airbus Pitch Characteristic

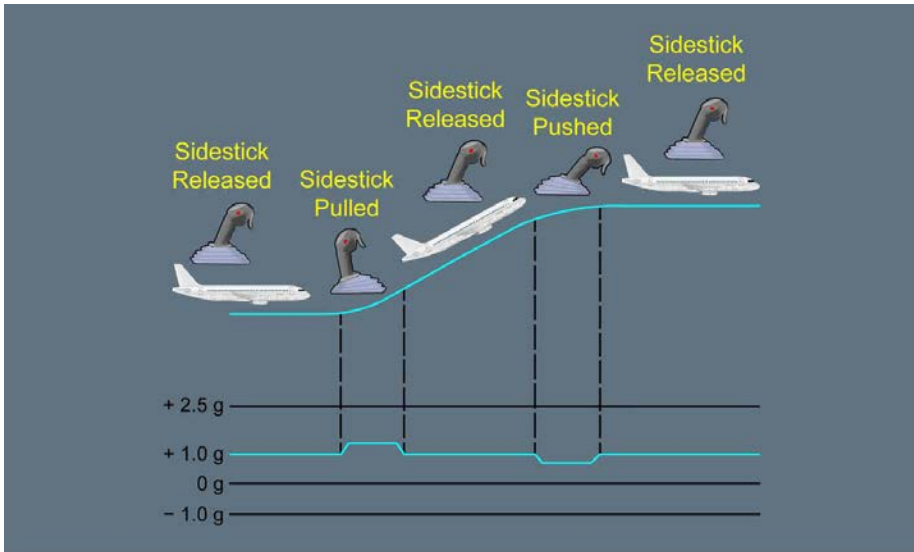

Automatic pitch trim freezes in the following situations:

- The pilot enters a manual trim order.
- The radio height is below 50 ft (100 ft with autopilot engaged).
- The load factor goes below 0.5 g.

When angle-of-attack protection is active, the THS setting is limited between the setting at the aircraft's entry into this protection and 3.5 ° nose down. (Neither the pilot nor the system can apply additional nose-up trim).

Similarly, when the load factor is higher than 1.25 g or when the aircraft exceeds 33 ° of bank, the THS setting is limited to values between the actual setting and 3.5 ° nose down.

When High Speed or High Mach Protection is active, the THS Setting is limited between the setting at the aircraft's entry into this protection and 11 ° nose-up.

CONTROL WITH AUTOPILOT ENGAGED

- The ELAC s and SECs limit what the autopilot can order.
- The pilot has to overcome a restraining force in order to move the sidestick when the autopilot is engaged. If he overcomes this force, he disconnects the autopilot.

- The pilot can also disconnect the autopilot by pushing on the rudder pedals (10 ° out of trim), or by moving the pitch trim wheel beyond a certain threshold.
- All protections of normal laws remain effective except pitch attitude protection.

FLARE MODE

Ident.: DSC-27-20-10-20-00001071.0001001 / 21 MAR 16

Applicable to: ALL

When the aircraft passes 50 ft RA, the THS is frozen and the normal flight mode changes to flare mode as the aircraft descends to land. Flare mode is essentially a direct stick-to-elevator relationship (with some damping provided by the load factor and the pitch rate feedbacks).

The system memorizes the aircraft's attitude at 50 ft, and it becomes the initial reference for pitch attitude control.

As the aircraft descends through 30 ft, the system begins to reduce the pitch attitude to -2 °nose down over a period of 8 s. Consequently, to flare the aircraft, a gentle nose-up action by the pilot is required.

PROTECTIONS

Applicable to: ALL

Ident.: DSC-27-20-10-20-A-00001072.0001001 / 21 MAR 16

GENERAL

The normal law protects the aircraft throughout the flight envelope, as follows :

- load factor limitation
- pitch attitude protection
- high-angle-of-attack (AOA) protection
- high-speed protection.

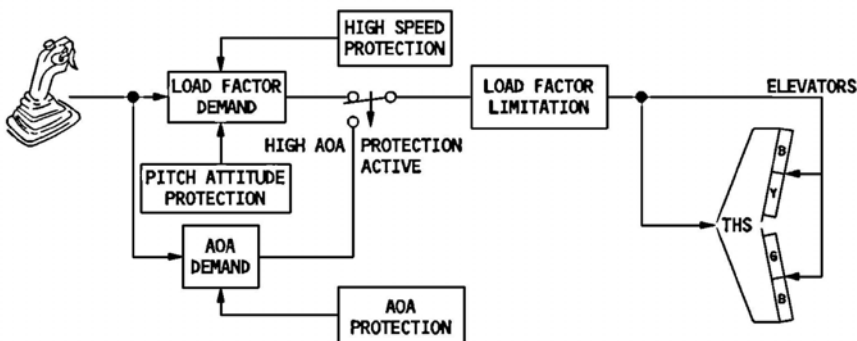

LOAD FACTOR PROTECTION

High load factors can be encountered during evasive maneuvers due to potential collisions, or CFIT ...

Pulling "g" is efficient, if the resulting maneuver is really flown with this "g" number. If the aircraft is not able to fly this trajectory, or to perform this maneuver, pulling "g" will be detrimental.

The load factor is automatically limited to:

- +2.5 g to -1 g for clean configuration.
- +2 g to 0 for other configurations.

Airbus LOAD FACTOR PROTECTION AND SAFETY

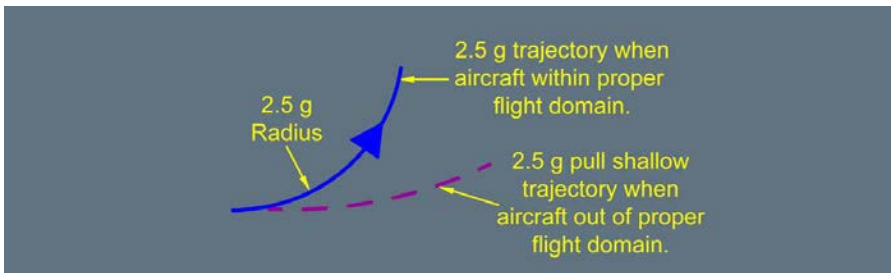

On most commercial aircraft, the potential for an efficient 2.5 g maneuver is very remote. Furthermore, as G Load information is not continuously provided in the cockpit, airline pilots are not used to controlling this parameter. This is further evidenced by inflight experience, which reveals that: In emergency situations, initial PF reaction on a yoke or sidestick is hesitant, then aggressive.

With load factor protection, the PF may immediately and instinctively pull the sidestick full aft: The aircraft will initially fly a 2.5 g maneuver without losing time. Then, if the PF still needs to maintain the sidestick full aft stick, because the danger still exists, then the high AOA protection will take over. Load factor protection enhances this high AOA protection.

Load factor protection enables immediate PF reaction, without any risk of overstressing the aircraft.

Flight experience has also revealed that an immediate 2.5 g reaction provides larger obstacle clearance, than a hesitant and delayed high G Load maneuver (two-second delay).

Ident.: DSC-27-20-10-20-A-00001074.0001001 / 17 MAR 17

PITCH ATTITUDE PROTECTION

Excessive pitch attitudes, caused by upsets or inappropriate maneuvers, lead to hazardous situations:

- Too high a nose-up ► Very rapid energy loss
- Too low a nose-down ► Very rapid energy gain

Furthermore, there is no emergency situation that requires flying at excessive attitudes. For these reasons, pitch attitude protection limits pitch attitude:

- 30 ° nose up in conf 0 to 3 (progressively reduced to 25 ° at low speed).
- 25 ° nose up in conf FULL (progressively reduced to 20 ° at low speed).
- 15 ° nose down (indicated by green symbols “=” on the PFD’s pitch scale).

The flight director bars disappear from the PFD when the pitch attitude exceeds 25 ° up or 13 ° down. They return to the display when the pitch angle returns to the region between 22 ° up and 10 ° down.

Pitch attitude protection enhances high speed protection, high load factor protection, and high AOA protection.

Ident.: DSC-27-20-10-20-A-00001075.0002001 / 17 MAR 17

HIGH ANGLE-OF-ATTACK PROTECTION

In the normal law, the aircraft is protected against stall, in dynamic maneuvers or gusts. When the current angle-of-attack becomes greater than α_{PROT} , the high angle-of-attack (AOA) protection activates.

Without pilot input, the F/CTL computers will maintain the AOA equal to α_{PROT} . The AOA can be further increased by the pilot input, up to a maximum value equal to α_{MAX} . When the High AOA protection is activated, the normal law demand is modified and the side stick input is an angle-of-attack demand, instead of a load factor demand.

The PF must not deliberately fly the aircraft in the High AOA, except for brief periods, when maximum maneuvering speed is required.

Airbus AOA Protection

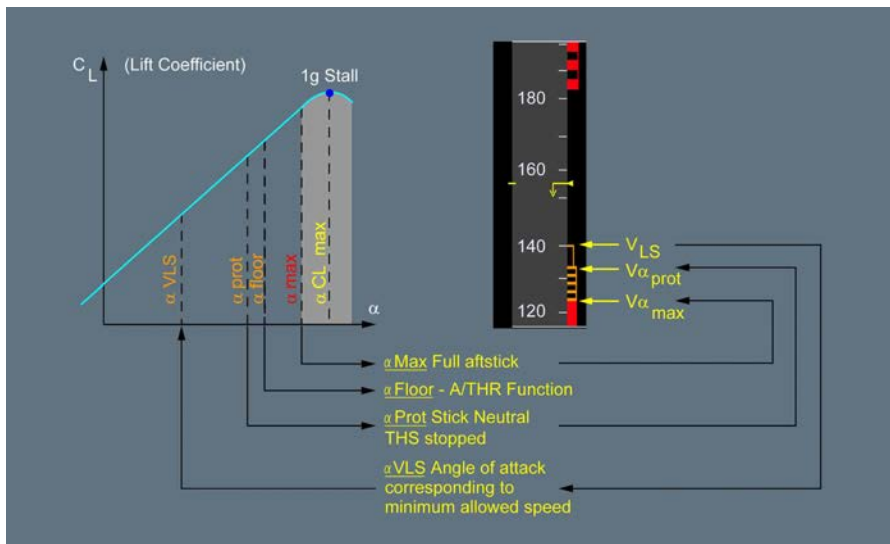

V_{α} PROT , V_{α} floor, V_{α} MAX are mainly computed based on the AOA, and therefore they vary with configuration, weight and load factor.

Refer to DSC-22_10-50-20 Characteristic Speeds for more information.

The angle-of-attack will not exceed α_{MAX} , even if the pilot gently pulls the sidestick all the way back. The pilot can hold full back stick, if it is needed, and the aircraft stabilizes at an angle-of-attack close to but less than the 1 g stall. When flying at α_{MAX} , the PF can make gentle turns, if necessary. If the pilot releases the sidestick, the angle-of-attack returns to α_{PROT} and stays there. As the aircraft enters protection at the amber and black strip (α_{PROT}), the system inhibits further nose-up trim beyond the point already reached. The nose-down trim remains available, if the pilot pushes the stick forward.

Note: At takeoff, the α_{PROT} is equal to the α_{MAX} for 5 s.

This High AOA protection has priority over all other protections.

The aircraft can also enter α_{PROT} at a high flight level, where it protects the aircraft from the buffet boundary. As at a low speed or low flight level, if the sidestick is merely released to neutral, the aircraft maintains the alpha for α_{PROT} . This value of alpha is not the same as the value used at the low speed. Alpha for α_{PROT} is reduced as a function of Mach, so that a typical cruise value is about 3.5 ° for the A318 and A321 aircraft, or 4.5 ° for the A319 and A320 aircraft. Therefore, the aircraft may climb with the sidestick free, when leaving a turn after entering α_{PROT} .

If the pilot flies into α PROT, he should leave it as soon as other considerations allow, by easing forward on the sidestick to reduce alpha below the value of α PROT, while simultaneously adding power (if the α floor has not yet been activated, or cancelled).

To deactivate the angle of attack protection, the pilot must push the sidestick:

- Greater than 8° forward, or,
- Greater than 0.5° for at least 0.5 s when $\alpha < \alpha$ MAX.

In addition, below 200 ft, the angle of attack protection is also deactivated, when:

- Sidestick deflection is less than half nose-up, and
- Actual α is less than α PROT – 2° .

Between the α PROT and α MAX, α floor protection may automatically set the go-around thrust. The α floor will usually be triggered just after entering α PROT, and the go-around thrust will automatically be applied. Therefore, if the sidestick is held aft, either inadvertently or deliberately, the aircraft will start to climb at a relatively constant low airspeed. To recover a normal flight condition, the α PROT should be exited by easing forward on the sidestick, as described above, and the α floor should be cancelled by using the disconnect pushbutton on either thrust lever as soon as a safe speed is regained. *Refer to DSC-22_40-30 Alpha-Floor Protection* for more information.

GPWS / WINDSHEAR CASE:

In the case of application of GPWS or windshear procedures, aircraft protections provide maximum lift / maximum thrust / minimum drag. Therefore, CFIT escape manoeuvres will be much more efficient.

Protected A/C Versus Non-protected A/C Go-around Trajectory

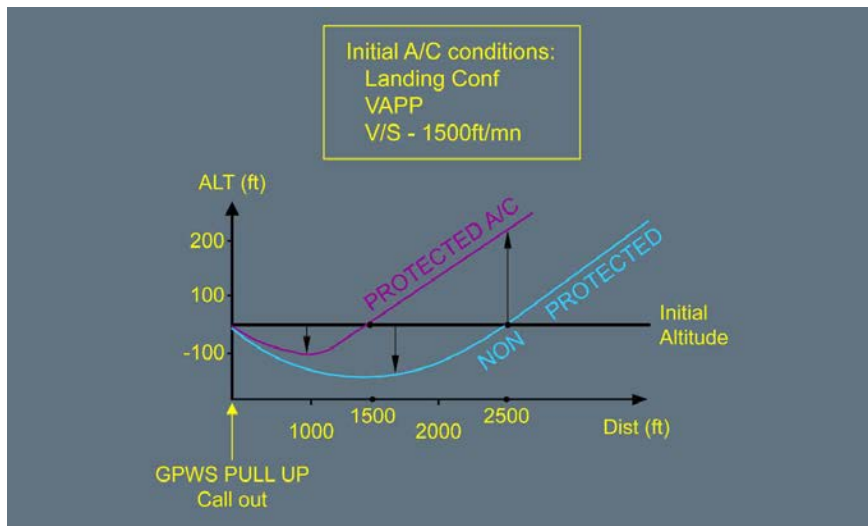

The above-illustrated are typical trajectories flown by protected or not protected aircraft, when the PF applies the escape procedure after an aural “ GPWS PULL UP” alert.

The graph demonstrates the efficiency of the protection, to ensure a duck-under that is 50 % lower, a bucket-distance that is 50 % shorter, a safety margin that more than doubles (due to a quicker reaction time), and a significant altitude gain (± 250 ft). These characteristics are common to all protected aircraft, because the escape procedure is easy to achieve, and enables the PF to fly the aircraft at a constant AOA , close to the max AOA . It is much more difficult to fly the stick shaker AOA on an aircraft that is not protected.

Ident.: DSC-27-20-10-20-A-00001076.0002001 / 17 MAR 17

HIGH SPEED PROTECTION

The aircraft automatically recovers, following a high speed upset. Depending on the flight conditions (high acceleration, low pitch attitude), High Speed Protection is activated at/or above VMO /MMO.

When it is activated, the THS setting is limited between the setting at the aircraft’s entry into this protection and 11 ° nose-up. Positive spiral static stability is introduced to 0 ° bank angle (instead of 33 ° in normal law), so that with the sidestick released, the aircraft always returns to a bank angle of 0 ° . The bank angle limit is reduced from 67 ° to 40 ° .

As the speed increases above VMO /MMO, the sidestick nose-down authority is progressively reduced, and a permanent nose-up order is applied to aid recovery to normal flight conditions.

Therefore, in a dive situation:

- If there is no sidestick input on the sidestick, the aircraft will slightly overshoot VMO /MMO and fly back towards the envelope.
- If the sidestick is maintained full forward, the aircraft will significantly overshoot VMO /MMO . At approximately VMO +16 / MMO +0.04, the pitch nose-down authority smoothly reduces to zero (which does not mean that the aircraft stabilizes at that speed).

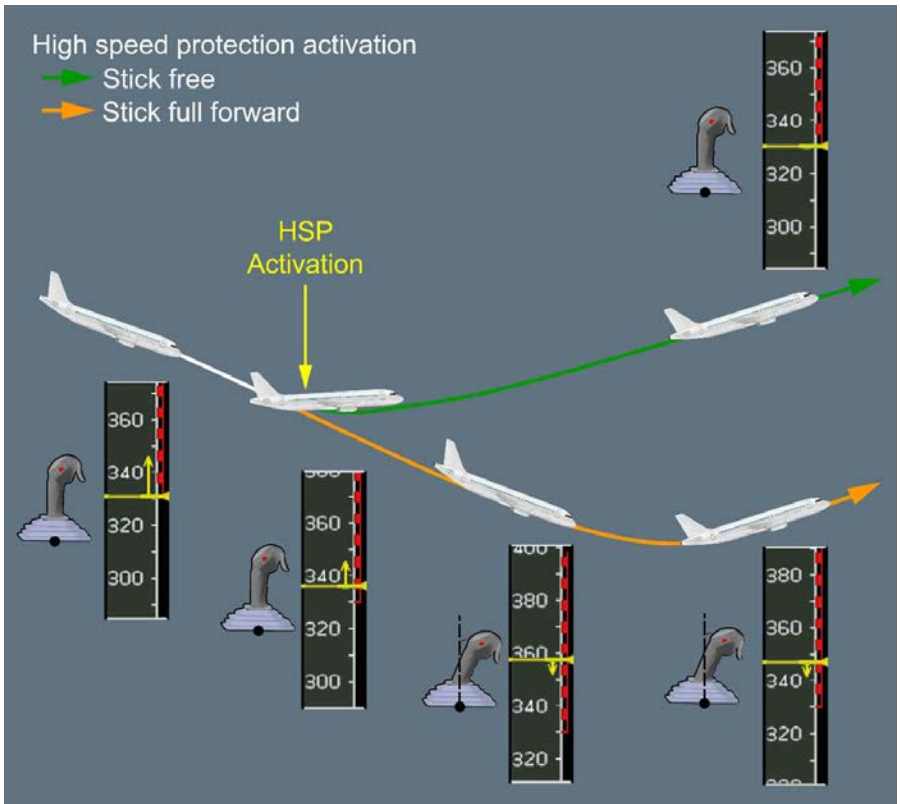

The PF, therefore, has full authority to perform a high speed/steep dive escape maneuver, when required, via a reflex action on the sidestick.

High Speed Protection is deactivated, when the aircraft speed decreases below VMO /MMO, where the usual normal control laws are recovered.

The autopilot disconnects at VMO + 15 kt and MMO + 0.04.

High speed protection symbol: }
 Two green bars at VMO + 6

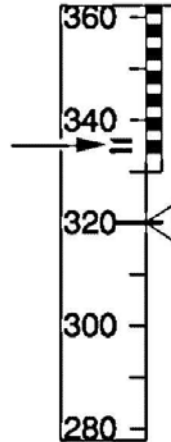

- Note:
1. The ECAM displays an "O/SPEED" warning at VMO + 4 kt and MMO + 0.006.
 2. At high altitude, this may result in activation of the angle of attack protection.
 Depending on the ELAC standard, the crew may have to push on the stick to get out of this protection law.

Ident.: DSC-27-20-10-20-A-00001077.0001001 / 21 MAR 16

LOW ENERGY AURAL ALERT (IF INSTALLED)

The low energy aural alert is computed by the FAC (*Refer to DSC-22_40-10 General*).

Lateral Control

NORMAL LAW

Ident.: DSC-27-20-10-30-00001078.0001001 / 17 MAR 17

Applicable to: ALL

When the aircraft is on the ground (in “on ground” mode), the sidestick commands the aileron and roll spoiler surface deflection. The amount of control surface deflection that results from a given amount of sidestick deflection depends upon aircraft speed. The pedals control rudder deflection through a direct mechanical linkage. The aircraft smoothly transitions to “in flight” mode shortly after liftoff. When the aircraft is in the “in flight” mode, normal law combines control of the ailerons, spoilers (except N° 1 spoilers), and rudder (for turn coordination) in the sidestick. The pilot does not need to use the rudder for turn coordination. While the system thereby gives the pilot control of the roll and heading, it also limits the roll rate and bank angle, coordinates the turns, and damps the dutch roll. The roll rate requested by the pilot during flight is proportional to the sidestick deflection, with a maximum rate of 15 °/s when the sidestick is at the stop. When the aircraft is in “flare” mode, the lateral control is the same as in “in flight” mode. After touchdown, the aircraft smoothly transitions from “in flight” mode to “ground” mode.

BANK ANGLE PROTECTION

Ident.: DSC-27-20-10-30-00001079.0001001 / 17 MAR 17

Applicable to: ALL

Inside the normal flight envelope, the system maintains positive spiral static stability for bank angles above 33 °. If the pilot releases the sidestick at a bank angle greater than 33 °, the bank angle automatically reduces to 33 °. Up to 33 °, the system holds the roll attitude constant when the sidestick is at neutral. If the pilot holds full lateral sidestick deflection, the bank angle goes to 67 ° and no further. If Angle-of-Attack protection is active, and the pilot maintains full lateral deflection on the sidestick, the bank angle will not go beyond 45 °. If High Speed Protection is active, and the pilot maintains full lateral deflection on the sidestick, the bank angle will not go beyond 40 °. If high speed protection is operative, the system maintains positive spiral static stability from a bank angle of 0 °, so that with the sidestick released, the aircraft always returns to a bank angle of 0 °. When bank angle protection is active, auto trim is inoperative. If the bank angle exceeds 45 °, the autopilot disconnects and the FD bars disappear. The FD bars return when the bank angle decreases to less than 40 °.

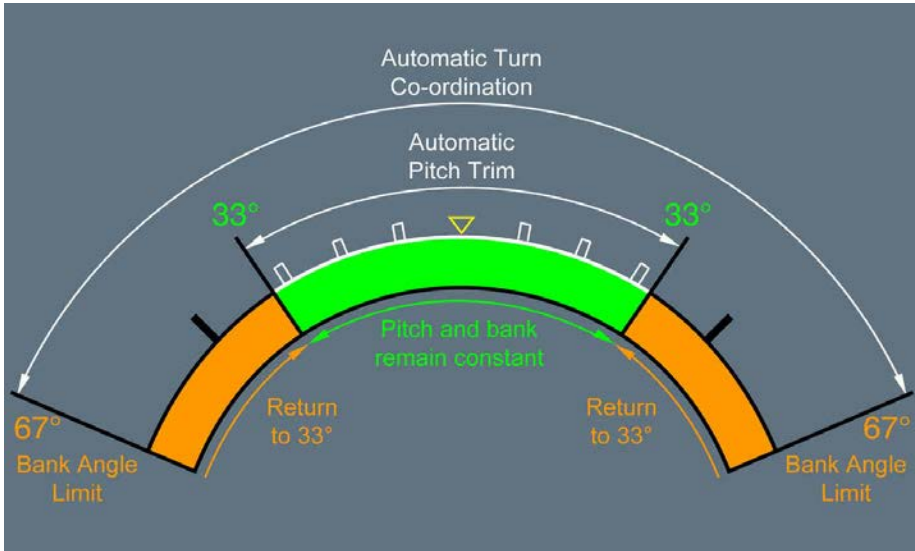

During a normal turn (bank angle less than 33 °), in level flight:

- The PF moves the sidestick laterally (the more the sidestick is moved laterally, the greater the resulting roll rate - e.g. 15 °/s at max deflection)
- It is not necessary to make a pitch correction
- It is not necessary to use the rudder.

In the case of steep turns (bank angle greater than 33 °), the PF must apply:

- Lateral pressure on the sidestick to maintain bank
- Aft pressure on the sidestick to maintain level flight.

Sideslip Target

SIDESLIP TARGET

Ident.: DSC-27-20-10-50-00001081.0001001 / 17 MAR 17

Applicable to: ALL

If one engine fails, the FAC modifies the sideslip indication slightly to show the pilot how much rudder to use to get the best climb performance (ailerons to neutral and spoilers retracted).

In the case of an engine failure at takeoff, or at go-around, the sideslip index on the PFD changes from yellow to blue (to provide the conditions for the blue display of the sideslip target, *Refer to DSC-31-40 Attitude Data*).

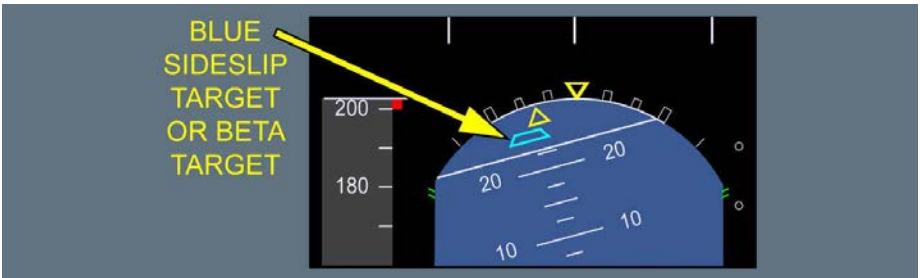

In flight, the lateral normal law commands some rudder surface deflection to minimize the sideslip. The pilot's response is normal and instinctive: zero the slip indication by applying the right amount of rudder to get the best climb performance.



A318/A319/A320/A321
FLIGHT CREW
OPERATING MANUAL

AIRCRAFT SYSTEMS

FLIGHT CONTROLS

FLIGHT CONTROL SYSTEM - NORMAL LAW

Intentionally left blank

Aircraft Trimming

AIRCRAFT TRIMMING

Ident.: DSC-27-20-10-70-00002179.0001001 / 09 DEC 09

Applicable to: ALL

When the aircraft is :

- In normal cruise range (around M .77),
- In straight flight,
- With the autopilot engaged,
- With symmetrical engine thrust, and
- With fuel in the wing tanks distributed symmetrically,

the rudder trim should stay between 1° right and 2.3° left.

Note: *This indication corresponds to a true rudder deflection within $\pm 1.5^\circ$, taking into account the permanent offset of rudder trim indication, when the aircraft is in cruise conditions. (average 0.5° right, 0.8° left).*

An indicated, rudder trim above 1° right or 2.3° left is acceptable, if maintenance personnel establishes that the corresponding real rudder position is within 1.5° left, and 1.5° right.



A318/A319/A320/A321
FLIGHT CREW
OPERATING MANUAL

AIRCRAFT SYSTEMS

FLIGHT CONTROLS

FLIGHT CONTROL SYSTEM - NORMAL LAW

Intentionally left blank

GENERAL

Ident.: DSC-27-20-20-00001082.0001001 / 17 MAR 17

Applicable to: ALL

Depending on the failures occurring to the flight control system, or on its peripherals, there are 3 levels of reconfiguration :

- Alternate law
They are two levels of alternate law : with and without reduced protections.
- Direct law
- Mechanical

The ECAM and PFD indicate any control law degradation.

ON THE ECAM

● **In ALTN Law:**

FLT CTL ALTN LAW (PROT LOST)

MAX SPEED 320 kt (320 kt/M 0.77 on A318)

● **In Direct Law:**

FLT CTL DIRECT LAW (PROT LOST)

MAX SPEED 320 kt/M 0.77

MAN PITCH TRIM USE

ON THE PFD

The PFD enhances the PF's awareness of the status of flight controls.

Specific symbols (= in green), and specific formatting of low speed information on the speed scale in normal law, indicate which protections are available.

When protections are lost, amber crosses (X) appear, instead of the green protection symbols (=).

When automatic pitch trim is no longer available, the PFD indicates this with an amber "USE MAN PITCH TRIM" message below the FMA.

Fly-by-Wire Status Awareness via the PFD

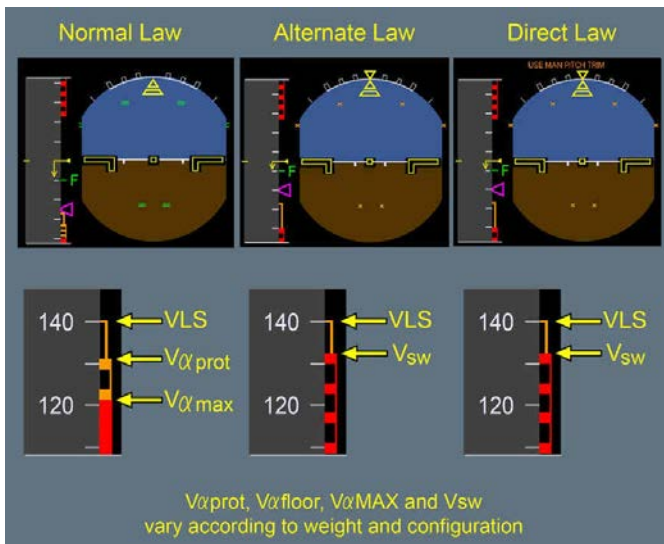

Therefore, by simply looking at this main instrument (PFD), the flight crew is immediately aware of the status of flight controls, and the operational consequences.

FLIGHT CONTROLS LAW RECONFIGURATION

Ident.: DSC-27-20-20-00001083.0001001 / 22 MAY 12

Applicable to: ALL

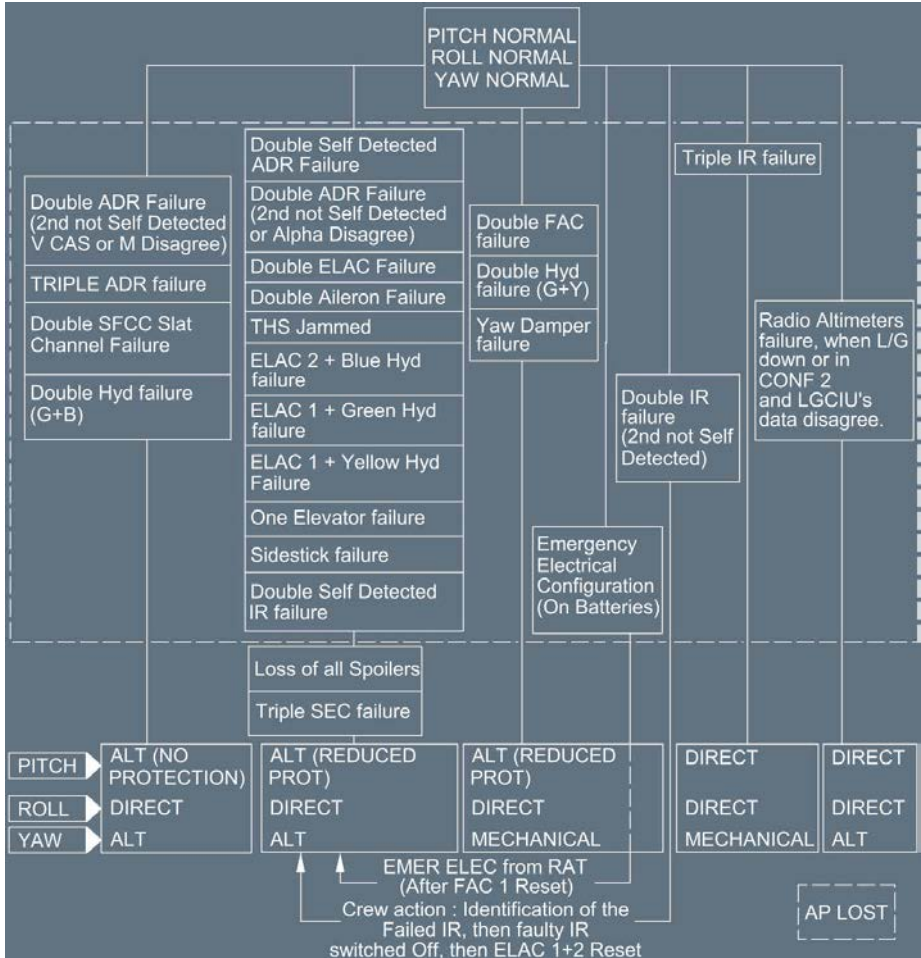

ALTERNATE LAW

Ident.: DSC-27-20-20-00001084.0001001 / 21 AUG 15

Applicable to: **ALL**

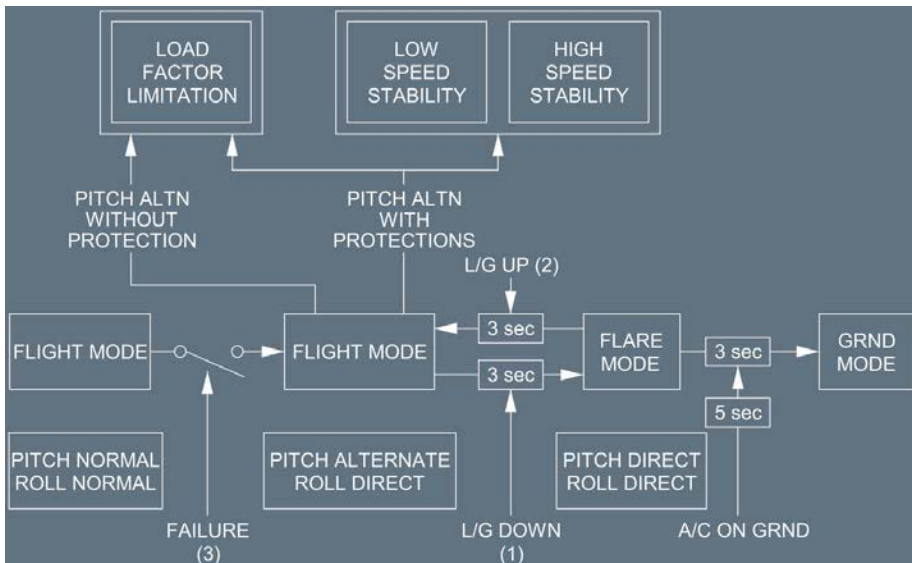

- (1) OR SLATS OR FLAPS ≥ 2 IF L/G INFORMATION NO LONGER AVAILABLE (LGCIU 1+2 FAULT OR SEC 1+2+3 FAULT)
- (2) OR SLATS OR FLAPS < 2 IF L/G INFORMATION NO LONGER AVAILABLE (LGCIU 1+2 FAULT OR SEC 1+2+3 FAULT)
- (3) Refer to DSC-27-20-20 Flight Controls Law Reconfiguration.

PITCH CONTROL

GROUND MODE

Under alternate law the ground mode becomes active on the ground 5 s after touchdown. It is identical to the ground mode of the normal law.

FLIGHT MODE

In flight, the alternate law pitch mode follows a load-factor demand law much as the normal law pitch mode does, but it has less built-in protection (reduced protections).

FLARE MODE

In pitch alternate law the flight mode changes to the flare mode when the pilot selects landing gear down. The flare mode is a direct stick-to-elevator relationship. (*Refer to DSC-27-20-20 Direct Law*).

LATERAL CONTROL

When the aircraft flying in pitch alternate law, lateral control follows the roll direct law associated with yaw alternate or mechanical.

ROLL DIRECT LAW

Refer to DSC-27-20-20 Direct Law.

YAW ALTERNATE LAW

Only the yaw damping function is available. Damper authority is limited to $\pm 5^\circ$ of rudder deflection.

REDUCED PROTECTIONS

LOAD FACTOR LIMITATION

The load factor limitation is similar to that under normal law.

PITCH ATTITUDE PROTECTION

There is no pitch attitude protection. Amber Xs replace the green double bars “=” on the PFD.

LOW SPEED STABILITY

An artificial low speed stability replaces the normal angle-of-attack protection. It is available for all slat/flap configurations, and the low speed stability is active from about 5 kt up to about 10 kt above stall warning speed, depending on the aircraft's gross weight and slats/flaps configuration.

A gentle progressive nose down signal is introduced, which tends to keep the speed from falling below these values. The pilot can override this demand.

The system also injects bank-angle compensation, so that operation effectively maintains a constant angle of attack.

In addition, audio stall warnings (crickets + “STALL” synthetic voice message) is activated at an appropriate margin from the stall condition.

The PFD speed scale is modified to show a black/red barber pole below the stall warning.

The α floor protection is inoperative.

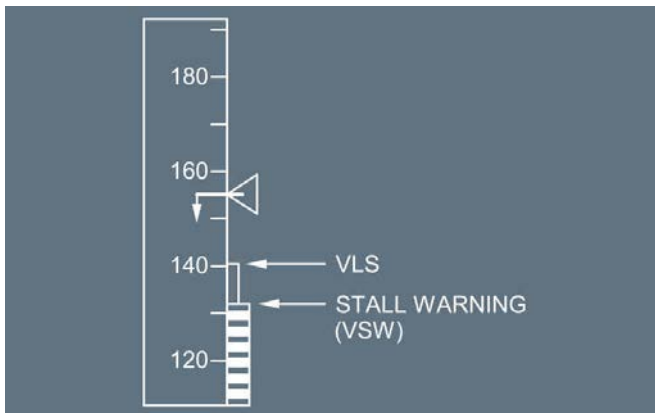

HIGH SPEED STABILITY

Above VMO or MMO, a nose up demand is introduced to avoid an excessive increase in speed. The pilot can override this demand.

In addition, the aural overspeed warning (VMO + 4 or MMO + 0.006) remains available.

BANK ANGLE PROTECTION

Not provided.

Note: The AP will disconnect, if speed exceeds VMO /MMO, or if the bank angle exceeds 45 °.

ALTERNATE LAW WITHOUT REDUCED PROTECTION

Ident.: DSC-27-20-20-00001085.0001001 / 21 MAR 16

Applicable to: **ALL**

This is identical to alternate law except that it does not include the low-speed stability or the high-speed stability. It includes only the load factor limitation.

DIRECT LAW

Ident.: DSC-27-20-20-00001086.0001001 / 21 MAR 16

Applicable to: **ALL**

PITCH CONTROL

The pitch direct law is a direct stick-to-elevator relationship (elevator deflection is proportional to stick deflection).

In all configurations the maximum elevator deflection varies as a function of CG.

It is a compromise between adequate controllability with the CG forward, and not-too-sensitive control with the CG aft.

There is no automatic trim : the pilot must trim manually.

The PFD displays in amber the message "USE MAN PITCH TRIM".

No protections are operative.

The α floor function is inoperative.

Overspeed and stall warnings are available as for alternate law.

LATERAL CONTROL

When flying in "direct law", the roll direct law associated with mechanical yaw control governs lateral control.

ROLL DIRECT LAW

The roll direct law is a direct stick-to-surface-position relationship. System gains are set automatically to correspond to slat/flap configuration.

With the aircraft in the clean configuration, the maximum roll rate is about 30 °/s.

With slats extended, it is about 25 °/s.

To limit roll rate, the roll direct law uses only ailerons and spoilers N° 4 and 5.

If spoiler N° 4 has failed, spoiler N° 3 replaces it.

If the ailerons have failed, all roll spoilers become active.

YAW MECHANICAL CONTROL

The pilot controls yaw with the rudder pedals.

The yaw damping and turn coordination functions are lost.

ABNORMAL ATTITUDE LAWS

Ident.: DSC-27-20-20-00001087.0002001 / 18 JAN 17

Applicable to: ALL

If for any reason the aircraft goes far outside the normal flight envelope and reaches an extreme attitude, the flight control law will be modified.

The abnormal attitude law will engage and will provide the PF with maximum efficiency to recover normal attitude.

☒ The abnormal attitude law engages when one of the following values is reached:

- Bank angle above 125 °
- Pitch attitude above 50 ° nose up or below 30 ° nose down
- Speed below 60 to 90 kt (depending on the aircraft pitch attitude), or above 440 kt
- Mach above 0.91
- Angle of attack above 30 ° to 40 °, or below -10 °

ⓘ When the abnormal attitude law engages:

- The pitch alternate law is active with no protection, except load-factor protection and without autotrim.
- The roll direct law is active
- The yaw mechanical law is active.

When the aircraft returns within the normal flight envelope, the abnormal attitude law disengages and the following conditions remains for the remainder of the flight:

- The pitch alternate law is active with no protection and with autotrim.
- The roll direct law is active
- The yaw alternate law is active.

MECHANICAL BACK-UP

Ident.: DSC-27-20-20-00001088.0001001 / 17 MAR 17

Applicable to: **ALL**

The purpose of the mechanical backup is to achieve all safety objectives in MMEL dispatch condition: to manage a temporary and total electrical loss, the temporary loss of five fly-by-wire computers, the loss of both elevators, or the total loss of ailerons and spoilers.

PITCH

The pilot manually applies trim to the THS to control the aircraft in pitch.
 The PFDs display “MAN PITCH TRIM ONLY” in red.

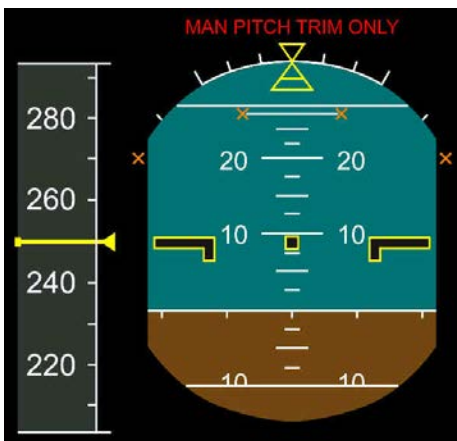

LATERAL

The pilot uses the rudder pedals as the mechanical backup to laterally control the aircraft .



A318/A319/A320/A321
FLIGHT CREW
OPERATING MANUAL

AIRCRAFT SYSTEMS

FLIGHT CONTROLS

FLIGHT CONTROL SYSTEM - RECONFIGURATION CONTROL LAWS

Intentionally left blank

PEDESTAL

Ident.: DSC-27-20-30-00001090.0002001 / 08 JUL 15

Applicable to: ALL

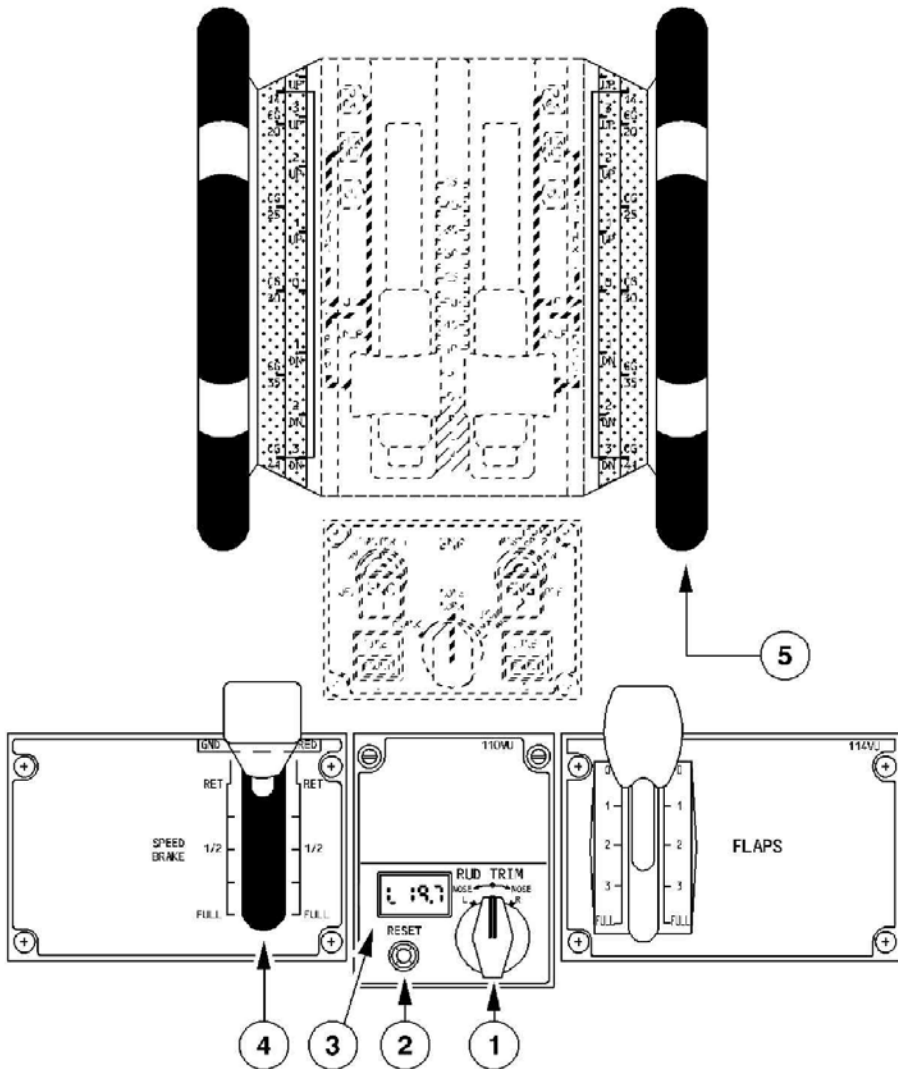

(1) RUD TRIM rotary selector

Controls the rudder trim actuator, which moves the neutral point of the artificial feel by the equivalent of one degree of rudder travel per second.

Note: The rudder trim rotary selector has no effect, when the autopilot is engaged.

(2) RESET pb

By pushing the RESET pb, the zero trim position is ordered at 1.5 °/s.

After the reset, an indication of up to 0.3° (L or R) may be observed in the rudder trim position indication.

Note: The RESET pb is not active, when the autopilot is engaged.

(3) Position Indicator

Displays the rudder trim direction (L or R) and value.

(4) SPEEDBRAKE lever

The lever controls:

- The position of the speedbrake surfaces.

To set speedbrake surfaces to a required position, the lever has to be pushed down and set to the required position. A “hardpoint” is provided at “½” SPEEDBRAKE position.

- The manual preselection of the ground spoilers.

To arm the ground spoilers, the lever must be pulled up when in the RET position.

When the lever is armed (or reverse thrust is selected), all spoiler's surfaces will automatically extend at landing, or in case of a rejected takeoff.

(5) PITCH TRIM Wheel

Both pitch trim wheels provide mechanical control of the THS and have priority over electrical control. A pilot action on the pitch trim wheel disconnects the autopilot.

Note: Crew action on the pitch trim wheel does not disconnect the ELACs (micro-switches, actuated by the override mechanism, ensure that the computers remain synchronized with the manually-selected position).

The THS is manually-controlled on ground for the THS setting, before takeoff and in flight, when in direct law.

- Before takeoff, the pilot sets the THS to the angular value, determined as a function of the aircraft CG , using the CG scale on the wheel. The relationship between the aircraft CG and the THS setting shown on the trim wheel is only applicable for takeoff. The limits of the THS normal setting range for takeoff are indicated by a green band on the pitch trim wheel.
- In flight, when in direct law, the pilot uses the THS conventionally to fly in trim. In flight, the aircraft pitch trim setting depends on aircraft CG , weight, altitude and speed. Consequently, the relation between the aircraft CG , and the THS setting displayed on the pitch trim wheel, does not apply in flight.

Following nosewheel touchdown, as the pitch attitude becomes less than 2.5 ° for more than 5 s, pitch trim is automatically reset to zero.

Note: This function is inoperative, when the green or yellow hydraulic system is not pressurized.

LATERAL CONSOLES

Ident.: DSC-27-20-30-00001091.0004001 / 17 MAR 17

Applicable to: ALL

SIDESTICKS

Each pilot has on his lateral console a sidestick he can use to control pitch and roll manually. Each sidestick is springloaded to neutral.

When the autopilot is engaged, a solenoid-operated detent locks both sidesticks in the neutral position. If the pilot applies a force above a given threshold (5 daN in pitch, 3.5 daN in roll) the stick becomes free and the autopilot disengages.

The hand grip has two switches:

- Autopilot disconnect and sidestick takeover pushbutton.
- Push-to-talk button.

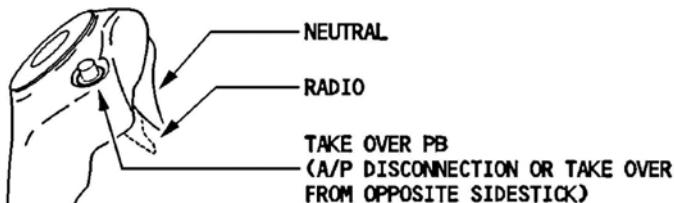

Sidestick priority logic

- When only one pilot operates the sidestick, it sends his control signals to the computers.
- When the pilots move both side stick simultaneously in the same or opposite direction and neither takes priority, the system adds the signals of both pilots algebraically. The total is limited to the signal that would result from the maximum deflection of a single sidestick.

Note: In the event of simultaneous input on both sidesticks (2 ° deflection off the neutral position in any direction) the two green SIDE STICK PRIORITY lights on the glareshield come on and "DUAL INPUT" voice message is activated.

A pilot can deactivate the other stick and take full control by pressing and keeping pressed his priority takeover pushbutton.

For latching the priority condition, it is recommended to press the takeover push button for more than 40 s.

This allows the pilot to release his takeover push button without losing priority.

However, a pilot can at any time reactivate a deactivated stick by momentarily pressing the takeover push button on either stick.

If both pilots press their takeover pushbuttons, the pilot that presses last gets priority.

In case of a "SIDE STICK FAULT" ECAM warning, due to an electrical failure, the affected sidestick order (sent to the computer) is forced to zero. This automatically deactivates the affected sidestick. This explains why there is no procedure associated with this warning.

Note: If an autopilot is engaged, any action on a takeover pushbutton disengages it.

In a priority situation

- A red light comes on in front of the pilot whose stick is deactivated.
- A green light comes on in front of the pilot who has taken control, if the other stick is not in the neutral position (to indicate a potential and unwanted control demand).

Note: If the aircraft is on the ground and commencing its takeoff run and one stick is deactivated, this triggers the takeoff "CONFIG" warning.

GLARESHIELD

Ident.: DSC-27-20-30-00001092.0002001 / 21 MAR 16

Applicable to: ALL

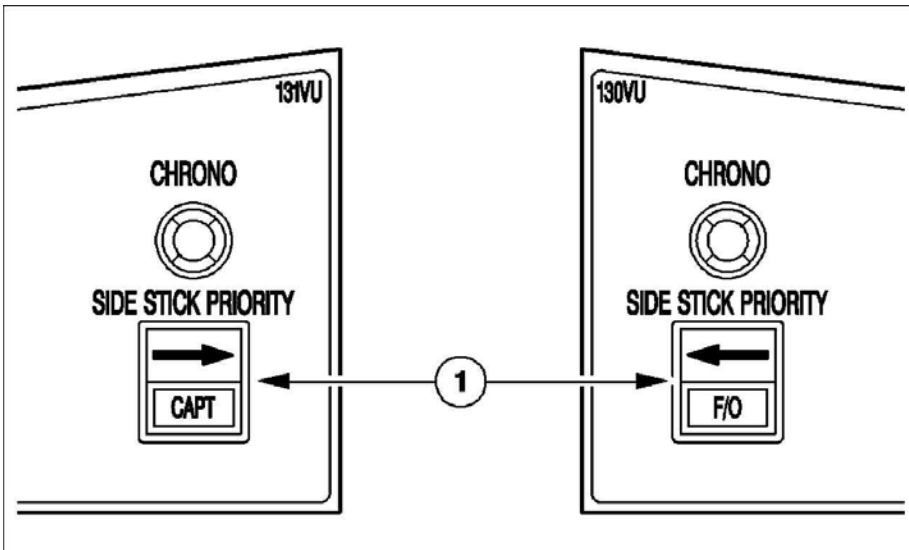

(1) SIDE STICK PRIORITY It

- Red arrow light :
- comes on in front of the pilot losing authority.
 - goes out if he has recovered his authority
 - if the other pilot releases his TAKEOVER pushbutton prior the priority condition is latched.
 - or
 - If he has used his takeover push button to cancel a latched priority situation.
- Sidestick priority audio : A “PRIORITY LEFT” or “PRIORITY RIGHT” audio voice message is given each time priority is taken.

Green CAPT and F/O lights :

- Both lights flash when the pilots move both sidesticks simultaneously and neither takes priority.
- When a pilot has taken priority by pressing the takeover pushbutton and the other pilot's sidestick is not at neutral, the light in front of the pilot with priority lights up. It goes out when the other pilot returns his stick to the neutral position.



OVERHEAD PANEL

Ident.: DSC-27-20-30-00017869.0001001 / 19 SEP 16

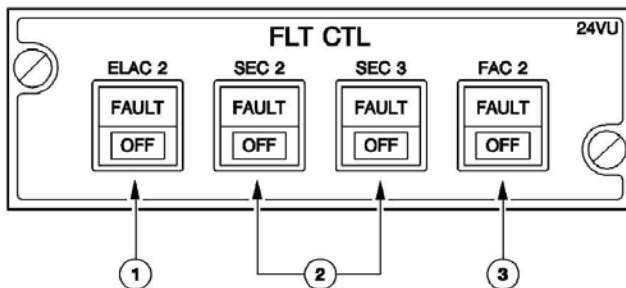
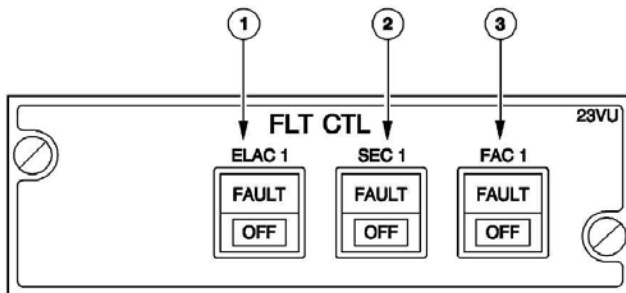
Applicable to: ALL



- (1) ELAC 1(2) pushbutton
 Controls the Elevator and Aileron Computer (ELAC) 1(2).

- ON : ELAC 1(2) performs the following functions :
- Normal pitch and roll, normal LAF 
 - Alternate pitch, alternate LAF 
 - Direct pitch and roll
 - Abnormal attitude
 - Aileron droop
 - Acquisition of autopilot orders.
- OFF : The corresponding computer is not active. Switching it OFF, then ON, resets the computer.
- FAULT : Comes on amber, along with an ECAM caution:
- When a failure is detected
 - During ELAC power-up test (eight seconds).

Note: The ELAC power-up test occurs when electrical power is turned on, or after the occurrence of an electrical transient lasting longer than 25 ms.

The FAULT light goes off, when the pilot selects OFF, or at the end of the ELAC power-up test, if its results are satisfactory.

(2) SEC 1(2)(3) pushbutton

Controls the Spoiler and Elevator Computer (SEC) 1(2)(3).

- ON : SEC 1(2)(3) performs the following functions:
- Normal roll (by controlling the spoilers)
 - Speed brakes and ground spoilers
 - Alternate pitch (SEC 1 and SEC 2 only)
 - Direct pitch (SEC 1 and SEC 2 only)
 - Direct roll
 - Alternate LAF 
 - Abnormal attitude.
- OFF : The corresponding computer is not active. Switching it OFF, then ON, resets the computer.
- FAULT : Comes on amber, along with an ECAM caution, when a failure is detected.
The FAULT light goes off, when the pilot selects OFF.

(3) FAC 1(2) pushbutton

Controls the Flight Augmentation Computer (FAC) 1(2).

- ON** : Both FACs perform the following functions:
- Normal roll (coordinating turns and damping dutch roll)
 - Rudder trim
 - Rudder travel limit
 - Alternate yaw
- OFF** : The corresponding computer is not active. Switching it OFF, and then ON, resets the computer.
- FAULT**: Comes on amber, along with an ECAM caution, when a failure is detected. The FAULT light goes off, when the pilot selects OFF.

SIDE STICK INDICATIONS ON PFD

Ident.: DSC-27-20-30-00001094.0001001 / 21 MAR 16

Applicable to: ALL

On the ground, after the first engine start, sidestick position indications appear white on both PFDs. The indications disappear when the aircraft goes from the ground into flight.

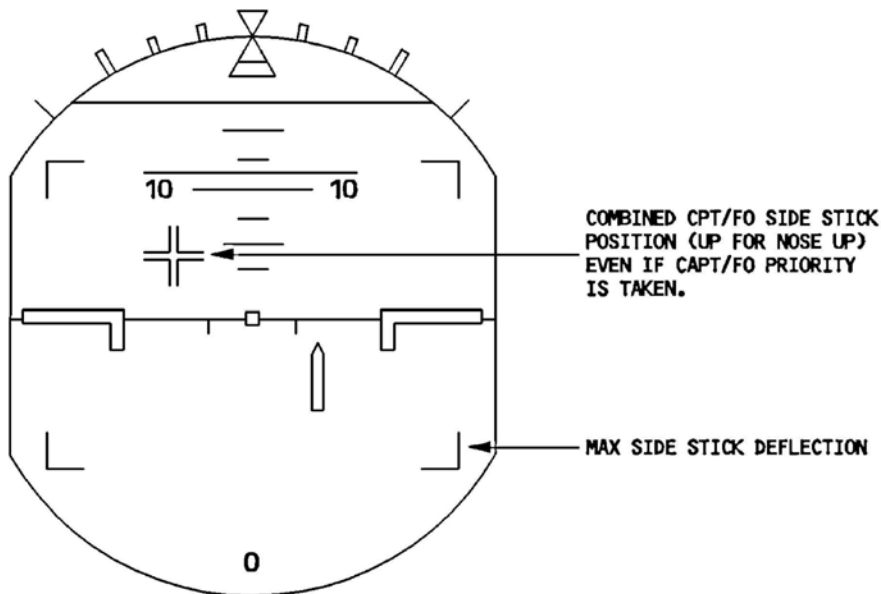

ECAM F/CTL PAGE

Ident.: DSC-27-20-30-00001095.0004001 / 15 OCT 12

Applicable to: ALL

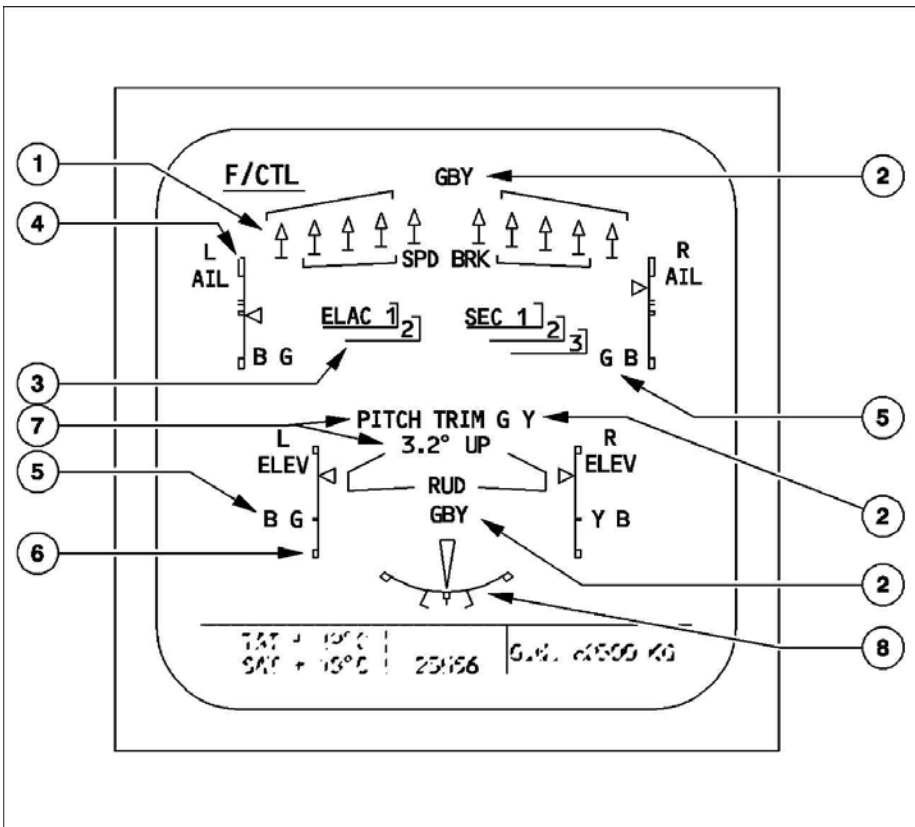

(1) Spoilers/Speedbrakes' Indication

- Δ : Spoiler deflected by more than 2.5 ° (green)
- : Spoiler retracted (green)
- Δ : Spoiler fault deflected (amber)
- 1 : Spoiler fault retracted (amber)
- x : Spoiler position not valid (amber)

(2) Hydraulic System Pressure Indication

It is normally green. It becomes amber, if the hydraulic system's pressure decreases.

(3) ELAC /SEC Indication

- ELAC and SEC labels are always displayed in white
- The computer number is normally in green, and boxed in grey.
 The number and box become amber, if the computer fails, or is switched OFF.

(4) Aileron position indication

It is indicated with a white scale and green index. It changes to amber, when neither (green nor blue) servojack is available.

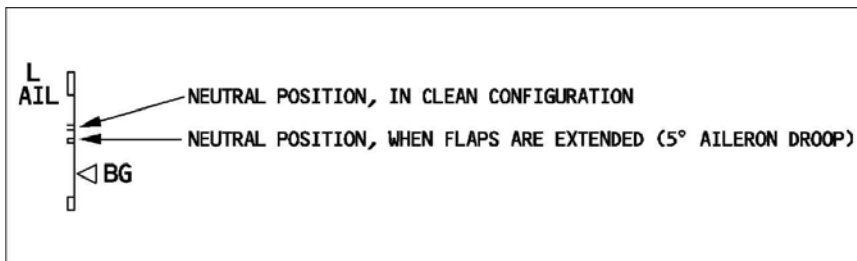

(5) Aileron and elevator actuator indication

“G” and “B” are normally displayed in green.

They become amber, in the case of a green or blue hydraulic system low pressure. The partial box also becomes amber, if the associated computer or actuator fails.

(6) Elevator position indication

It is indicated with a white scale and green index. The index becomes amber, when both associated actuators are not available.

(7) Pitch trim position indication

The pitch trim numbers are in green. They become amber, if green and yellow hydraulic system pressure decreases.

The “PITCH TRIM” legend is in white. It becomes amber, if the pitch trim jams.

(8) Yaw control indications

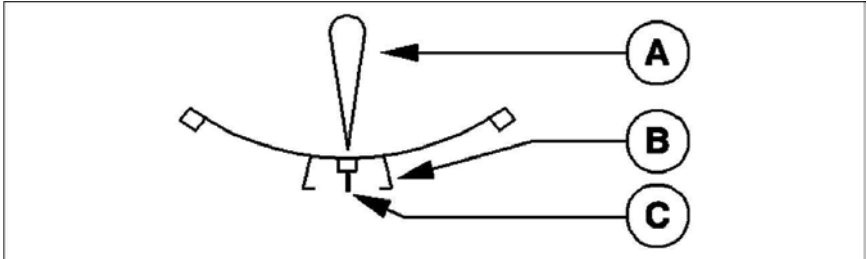

(A) Rudder position indication

It is normally in green. The rudder symbol becomes amber, if the blue, green, and yellow hydraulic pressures are low.

(B) Rudder travel limiter

It is normally in green. It becomes amber when travel limiter 1 and 2 are faulty. Two TLU messages are displayed in amber when the TLU indexes are suppressed.

(C) Rudder trim position

It is normally in blue. It becomes amber, if the rudder trim reset fails.

ECAM WHEEL PAGE

Ident.: DSC-27-20-30-00001096.0002001 / 15 FEB 11

Applicable to: ALL

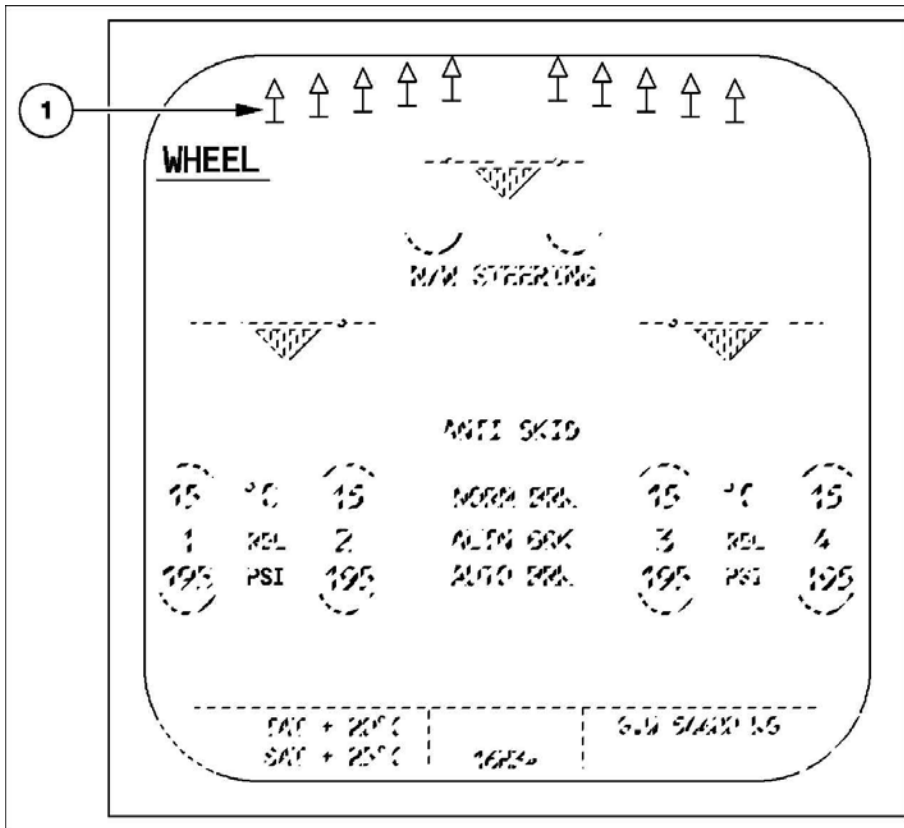

(1) Spoilers/Speedbrakes' Indication

These indications are identical to those displayed on the FLT CTL page.

MEMO DISPLAY

Applicable to: ALL

Ident.: DSC-27-20-30-A-00016860.0001001 / 21 MAR 16

GND SPLRS ARMED : This memo appears in green when the ground spoilers are armed.

Ident.: DSC-27-20-30-A-00016859.0001001 / 21 MAR 16

SPEED BRK : This memo appears in green when the speedbrakes are extended.

SPEED BRK : This memo appears in amber when the speedbrakes should be retracted.



A318/A319/A320/A321
FLIGHT CREW
OPERATING MANUAL

AIRCRAFT SYSTEMS

FLIGHT CONTROLS

FLIGHT CONTROL SYSTEM - CONTROLS AND INDICATORS

Intentionally left blank

GENERAL

Ident.: DSC-27-30-10-00001097.0001001 / 21 MAR 16

Applicable to: ALL

Each wing has the following lift augmentation devices :

- Two flap surfaces.
- Five slat surfaces.

These surfaces are electrically controlled and hydraulically operated.

The pilot extends slats and flaps by moving the FLAPS lever on the center pedestal.

It has five positions.

MAIN COMPONENTS

Ident.: DSC-27-30-10-00001098.0001001 / 21 MAR 16

Applicable to: ALL

The slat and flap systems are similar, comprising :

- Two slat flap control computers (SFCCs), each containing one slat channel and one flap channel.
- A power control unit (PCU) consisting of two independent hydraulic motors coupled by a differential gearbox.

The motors use green and blue hydraulic power for the slats and yellow and green power for the flaps.

Pressure-off brakes (POBs) lock the transmission when the slat or flap surfaces have reached the selected position or if hydraulic power fails.

- Five slat surfaces and two flap surfaces per wing.
- An assymetry position pick-off unit (APPU) that measures the assymetry between the left and right wings.
- A flap disconnect detection system, which detects attachment failure and inhibits flap operation in order to prevent further damage. A sensor detects the failure by measuring excessive differential movement between the inner and the outer flaps.
- Wingtip brakes (WTBs), activated in case of assymetry, mechanism overspeed, symmetrical runaway, or uncommanded movement of the surfaces. They cannot be released in flight. They use blue and green hydraulic power for the slats and for the right wing flaps, and blue and yellow hydraulic power for the left wing flaps.
- Feedback position pick-off units (FPPU s) that feed back position information to the SFCCs.
- An instrumentation position pick-off unit (IPPU) that sends position data to the ECAM.

Note: *If the flap wingtip brakes are on, the pilot can still operate the slats, and if the slat wingtip brakes are on, he can still operate the flaps.
If one SFCC is inoperative, slats and flaps both operate at half speed.
If one hydraulic system is inoperative, the corresponding surfaces (slats or flaps) operate at half speed.*

ARCHITECTURE

Ident.: DSC-27-30-10-00001099.0001001 / 21 MAR 16

Applicable to: ALL

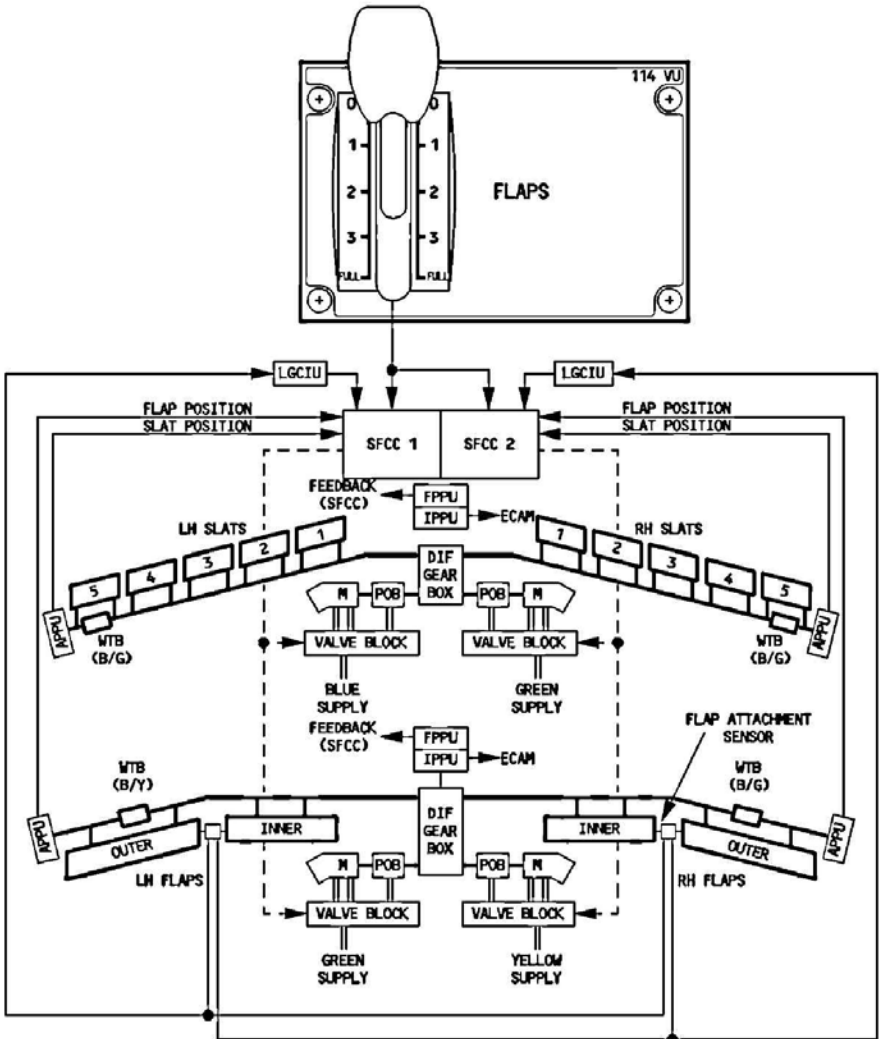

CONFIGURATIONS

Ident.: DSC-27-30-10-00001100.0001001 / 09 OCT 12

Applicable to: **ALL**

The FLAPS lever has five positions: 0, 1, 2, 3 and FULL.

Two configurations correspond to position 1: Configuration 1 and Configuration 1 + F.

The pilot selects these as follows:

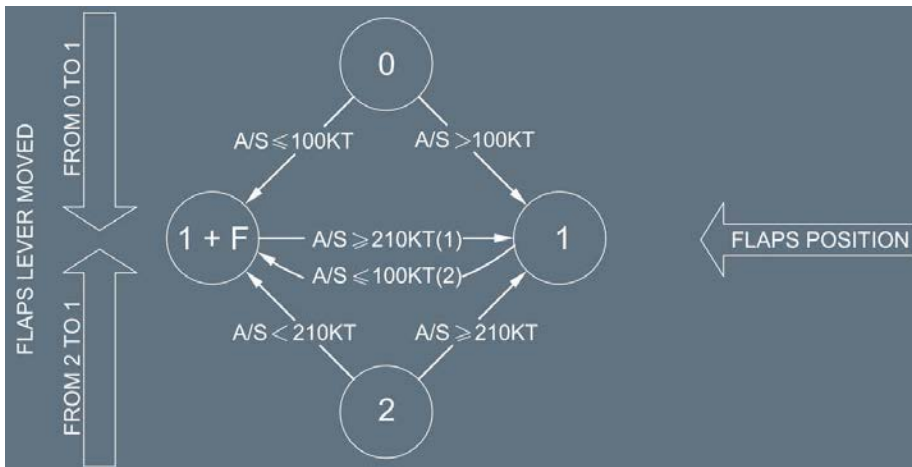

- (1) When in Configuration 1 + F, the flaps retract to 0 ° automatically at 210 kt (before the airspeed reaches VFE).
- (2) When in configuration 1, the flaps extend to 10 ° automatically at 100 kt.

ALPHA/SPEED LOCK FUNCTION (SLATS)

Ident.: DSC-27-30-10-00001101.0001001 / 13 SEP 16

Applicable to: **ALL**

This function inhibits slat retraction at high angles-of-attack and low speeds.

The SFCC s use corrected angle-of-attack (alpha) or airspeed information from the ADIRUs to inhibit slat retraction.

When the FLAPS lever is set to 0, the slats alpha/speed lock function activates and inhibits slats retraction, if:

- The AOA is above 8.5 °, or
- The speed is less than 148 kt.

Note: *If the FLAPS lever is already set to 0, when either of the above conditions occurs, the function will not activate therefore the slats will continue to retract or will remain at 0.*

Once the slats alpha/speed lock function is active, the slats retract to 0 when:

- The AOA is less than 7.6° and
- The speed is above 154 kt.

Note: *When the aircraft is on ground and its speed is less than 60 kt, then the function will not activate.*



A318/A319/A320/A321
FLIGHT CREW
OPERATING MANUAL

AIRCRAFT SYSTEMS

FLIGHT CONTROLS

FLAPS AND SLATS - DESCRIPTION

Intentionally left blank

PEDESTAL

Ident.: DSC-27-30-20-00001102.0001001 / 18 MAR 11

Applicable to: ALL

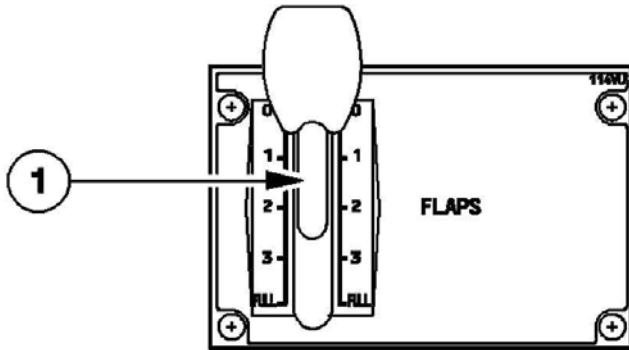

The five lever positions correspond to the following surface positions :

| Position | SLATS | FLAPS | Indications on ECAM | | | |
|-------------|-------|---------|---------------------|---------|--------|------|
| 0 | 0 | 0 | | TAKEOFF | CRUISE | HOLD |
| 1 | 18 | 0 10 | 1 1 + F | | LDG | APPR |
| 2 | 22 | 15 | 2 | | | |
| 3 | 22 | 20 | 3 | | | |
| FULL | 27 | 35 | FULL | | | |

Before selecting any position, the pilot must pull the lever out of the detent. Balks at positions 1 and 3 prevent the pilot from calling for excessive flap/slat travel with a single action.

Note: The pilot cannot select an intermediate lever position.

TAKEOFF IN CONFIGURATION 1

1 + F (18 °/10 °) is selected. If the pilot does not select configuration 0 after takeoff, the flaps retract automatically at 210 kt.

TAKEOFF OR GO-AROUND IN CONFIGURATION 2 OR 3

If the pilot selects configuration 1, he gets 1 + F (18 °/10 °) if airspeed is under 210 kt.
 If the pilot does not select configuration 0 after takeoff, the flaps retract automatically at 210 kt.

CONFIGURATION 0 TO CONFIGURATION 1 IN FLIGHT

Configuration 1 (18 °/0 °) is selected.

Note: After flap retraction, configuration 1 + F is no longer available until the airspeed is 100 kt or less, unless configuration 2, 3, or FULL has been selected previously.

ECAM UPPER DISPLAY

Ident.: DSC-27-30-20-00001103.0002001 / 14 NOV 11

Applicable to: ALL

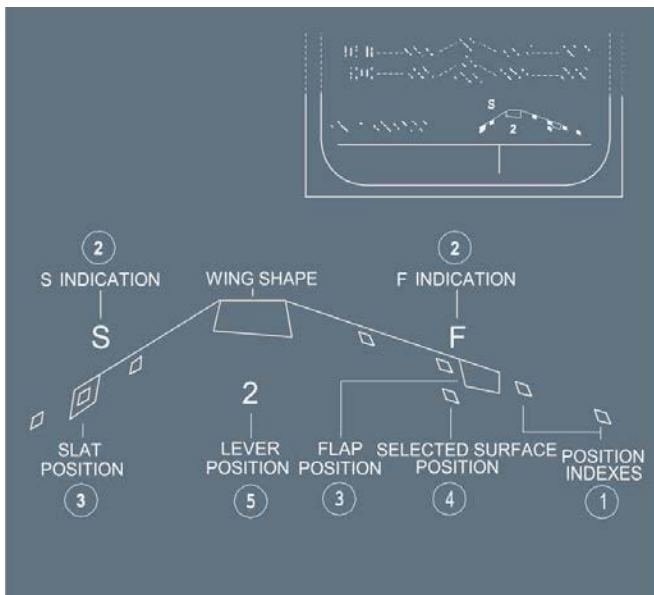

(1) Position indexes

These white points indicate that the slats and flaps are in a selectable position. They do not appear, when the aircraft is in clean configuration.

(2) F and S

“F” and “S” normally appear in white. They become amber, if:

- Both relevant hydraulic systems fail, unless the aircraft is on ground with both engines stopped.
- The wingtip brakes are on.
- There is a slats or flaps fault.

“S (F) LOCKED” legend, appears in amber, in association with an ECAM caution, when the wingtip brakes are applied, or when the system detects a non-alignment between two flaps.

The “A-LOCK” legend pulses in green, when the slat alpha/speedlock function is active.

(3) Flaps/Slats’ actual position

These green boxes indicate the actual flaps/slats position.

They become amber, if:

- Both relevant hydraulic systems fail, unless the aircraft is on ground with both engines stopped.
- The wingtip brakes are on.
- There is a slats or flaps fault.

(4) Selected position

It is in blue, when the surfaces are in transit.

It disappears, when the selected position is reached.

(5) Flap lever position

The “0”, “1 + F”, “1”, “2”, “3”, or “FULL” legend appears.

- It is green, when the slats and flaps are in the selected position. “0” is not displayed, when the aircraft attains clean configuration.
- It becomes cyan, when the slats and flaps are in transit.

Intentionally left blank

AIRCRAFT SYSTEMS

FUEL

Intentionally left blank

DSC-28-10 Description

DSC-28-10-10 General

GENERAL..... A

DSC-28-10-20 Tanks

Tanks..... A

DSC-28-10-30 Engine Feed

GENERAL..... A

Main Components..... B

Engine Feed..... C

Fuel Feed Sequence..... D

DSC-28-10-50 APU Feed

APU FEED..... A

DSC-28-10-60 Fuel Recirculation System

Fuel Recirculation System..... A

DSC-28-10-70 Refueling and Defueling

Refueling - Defueling..... A

DSC-28-10-80 Fuel Quantity Indication and Level Sensing

FUEL QUANTITY INDICATION (FQI) SYSTEM..... A

FUEL LEVEL SENSING CONTROL UNIT (FLSCU)..... B

Fuel System Architecture..... C

DSC-28-20 Controls and Indicators

Overhead Panel..... A

Refueling Control Panel..... B

Maintenance Panel..... C

ECAM Fuel Page..... D

ECAM Upper Display..... E

Memo Display..... F



A318/A319/A320/A321
FLIGHT CREW
OPERATING MANUAL

AIRCRAFT SYSTEMS

FUEL

PRELIMINARY PAGES - TABLE OF CONTENTS

Intentionally left blank



A318/A319/A320/A321
FLIGHT CREW
OPERATING MANUAL

AIRCRAFT SYSTEMS

FUEL

DESCRIPTION - GENERAL

GENERAL

Ident.: DSC-28-10-10-00001107.0001001 / 13 NOV 13

Applicable to: ALL

The fuel system :

- Stores fuel in the tanks.
- Supplies fuel, in the correct quantities, to the fuel tanks during refueling.
- Supplies fuel to the engines and the Auxiliary Power Unit (APU).
- Circulates fuel to cool the Integrated Drive Generator (IDG).
- Keeps fuel in the outer tanks for wing bending and flutter relief.



A318/A319/A320/A321
FLIGHT CREW
OPERATING MANUAL

AIRCRAFT SYSTEMS

FUEL

DESCRIPTION - GENERAL

Intentionally left blank

| | |
|---|---|
|  A318/A319/A320/A321 FLIGHT CREW OPERATING MANUAL | AIRCRAFT SYSTEMS FUEL DESCRIPTION - TANKS |
|---|---|

TANKS

Applicable to: ALL

Ident.: DSC-28-10-20-A-00020195.0001001 / 17 MAR 17

The fuel is stored in the wings, in the center tank, and in the Additional Center Tank (ACT ). The wings have inner and outer tanks. There is a vent surge tank outboard of the outer tank in each wing. When the aircraft has been refueled to maximum capacity, the fuel can expand by 2 % (20 °C temperature rise) without spilling. There is an overpressure protector in each vent, outer and inner tank and between the center tank and the left inner tank.

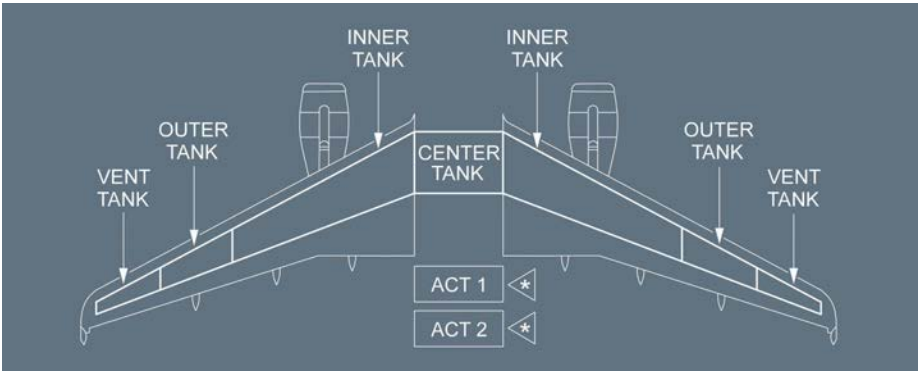

Ident.: DSC-28-10-20-A-00020196.0003001 / 17 MAR 17

| USABLE FUEL | | | | | | | | |
|-----------------------|--------------|-------------|-------------|-------------|-------|------------|--------|--------|
| | | OUTER TANKS | INNER TANKS | CENTER TANK | ACT | TOTAL WITH | | |
| | | | | | | NO ACT | 1 ACT | 2 ACTs |
| VOLUME | (liters) | 880 x 2 | 7 099 x 2 | 8 250 | 2 992 | 24 209 | 27 201 | 30 193 |
| | (US gallons) | 232 x 2 | 1 875 x 2 | 2 179 | 790 | 6 395 | 7 185 | 7 975 |
| WEIGHT ⁽¹⁾ | (KG) | 691 x 2 | 5 573 x 2 | 6 476 | 2 349 | 19 004 | 21 353 | 23 702 |
| | (LB) | 1 523 x 2 | 12 286 x 2 | 14 278 | 5 175 | 41 893 | 47 068 | 52 243 |

⁽¹⁾ Fuel density : 0.785 kg/l or 6.551 lb/US Gal.



A318/A319/A320/A321
FLIGHT CREW
OPERATING MANUAL

AIRCRAFT SYSTEMS

FUEL

DESCRIPTION - TANKS

Intentionally left blank

| | |
|---|--|
|  <p>A318/A319/A320/A321 FLIGHT CREW OPERATING MANUAL</p> | <p>AIRCRAFT SYSTEMS</p> <p>FUEL</p> <p>DESCRIPTION - ENGINE FEED</p> |
|---|--|

GENERAL

Ident.: DSC-28-10-30-00001109.0002001 / 10 DEC 09
Applicable to: ALL

The main fuel pump system supplies fuel from the center tank or the inner wing tanks to the engines. The system has six main fuel pumps.

MAIN COMPONENTS

Applicable to: ALL
 Ident.: DSC-28-10-30-A-00001110.0002001 / 01 FEB 13

TANK PUMPS

In normal operation each engine is supplied by one pump in the center tank or two pumps in its own side inner tank.
 All wing tank pumps remain on throughout the flight. They are fitted with pressure relief sequence valves which ensure that, when all pumps are running, the center tank pumps will deliver fuel preferentially.

Ident.: DSC-28-10-30-A-00001111.0001001 / 31 JAN 13

INTERTANK TRANSFER VALVES

Two electrical transfer valves are mounted in each wing to permit fuel transfer from outer to inner tank.

Ident.: DSC-28-10-30-A-00001112.0001001 / 10 DEC 09

CROSS FEED VALVE

A cross feed valve controlled by a double motor allows both engines to be fed from one side or one engine to be fed from both sides.

Ident.: DSC-28-10-30-A-00001113.0001001 / 20 MAR 17

ENGINE LP VALVES

The engine fuel flow can be stopped by its low pressure (LP) fuel valve. The LP fuel valve is closed by either :

- The engine master switch, or
- The ENG FIRE PUSH pushbutton.

Ident.: DSC-28-10-30-A-00001114.0002001 / 29 MAR 12

SUCTION VALVES

Closed by pumps pressure in normal operation, they allow engines to be fed by gravity if the inner tank pumps fail.

Note: Center tank pumps are not fitted with suction valves. Therefore, gravity feeding is not possible from the center tank.

ENGINE FEED

Ident.: DSC-28-10-30-00001115.0002001 / 18 MAR 14

Applicable to: **ALL**

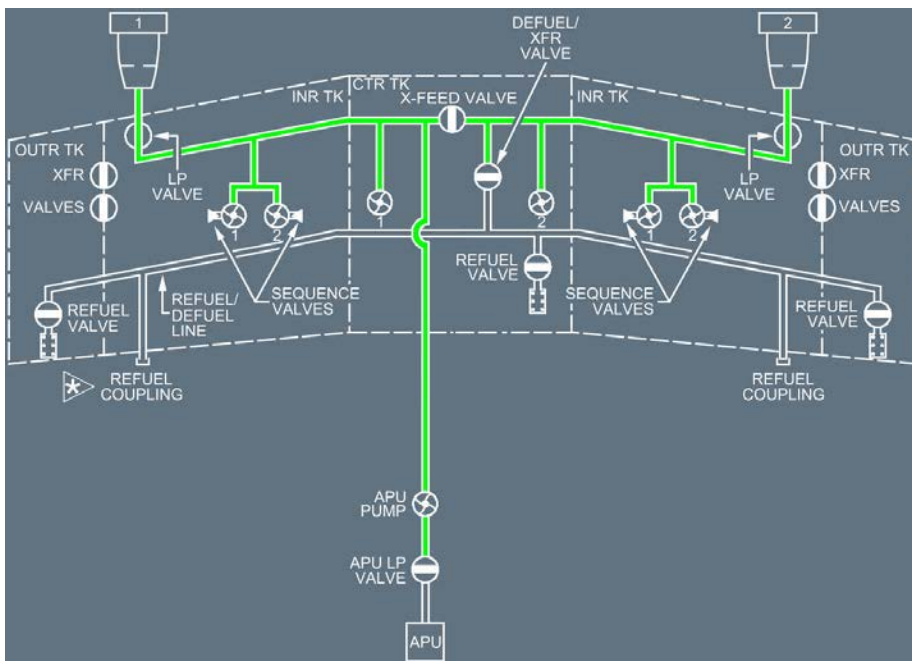



FUEL FEED SEQUENCE

Ident.: DSC-28-10-30-00021263.0001001 / 21 MAR 17

Applicable to: **ALL**

The tanks empty in the following sequence :

1. The ACT2  : Fuel transfers into the center tank.
2. The ACT1  : Fuel transfers into the center tank.
3. The center tank.
4. The inner tanks: Each inner tank empties down to 750 kg (1 650 lb).
5. The outer tanks: Fuel transfers into the inner tanks.

| | |
|---|--|
|  <p>A318/A319/A320/A321 FLIGHT CREW OPERATING MANUAL</p> | <p style="text-align: center;">AIRCRAFT SYSTEMS</p> <p style="text-align: center;">FUEL</p> <p style="text-align: center;">DESCRIPTION - ENGINE FEED</p> |
|---|--|

CENTER TANK FUEL TRANSFER

The center tank feeds fuel to the engines, when the center tank pumps are not stopped by the control logic described below. The inner tanks feed the engines when the center tank pumps are stopped.

CENTER TANK TRANSFER VALVE CONTROL LOGIC

Each center tank pump stops, until approximately 500 kg (1 100 lb) of the fuel in its associated inner tank fuel has been used (when the fuel level reaches the underfull sensors).

With the MODE SEL in the MAN position, the center tank pumps will run. In manual mode, the CTR TK PUMP pb-sw must be selected OFF, when the center tank is empty.

FUEL TRANSFER FROM OUTER TO INNER TANKS

The transfer valves automatically open, when the inner tank fuel reaches the low level (about 750 kg/1 650 lb), thus enabling the fuel to drain from the outer to inner tanks.

When open, the valves are latched open. They will automatically close at the next refueling operation.

- Note:*
1. Two level sensors are installed in each inner tank. Each sensor controls two transfer valves, one in each wing, ensuring simultaneous transfer to both wings.
 2. The 750 kg/1 650 lb value is based on a level aircraft attitude, with no acceleration. During steep descent or accelerations/decelerations, the transfer valves may open with more than 750 kg/1 650 lb of fuel in each inner tank, and the low level warning may be triggered.

IF THE AIRCRAFT HAS ONE ACT : ACT TO CENTER TANK TRANSFER

ACT transfer automatically starts after takeoff at slats' retraction, if the center tank high-level sensor has been dry for 10 min, and the ACT is not empty.

Fuel transfers from the ACT to the center tank via pressurization of the tank, by closing the ACT vent valve and opening the air shutoff valve.

When the ACT is empty, the ACT transfer valve, the air shutoff valve and inlet valve close, and the ACT vent valve opens.

- Note:* ACT transfer stops, if the center tank high level becomes wet, by closing the ACTs transfer valve. The transfer valve reopens when the center tank high-level sensor becomes dry for 10 min.

Selecting the ACT pb-sw to FWD opens the ACT transfer valve, the ACT inlet valve, and starts the ACT transfer pump. It must be returned to AUTO, when the ACT is empty.

Center tank overflow is prevented, by returning the ACT pb-sw to AUTO, when the center tank is full.

IF THE AIRCRAFT HAS TWO ACTS ◀ : ACT 1 + 2 TO CENTER TANK TRANSFER

ACT transfer automatically starts after takeoff at slats' retraction, if the center tank high-level sensor has been dry for 10 min, and the ACT is not empty.

Fuel transfers from the ACT to the center tank via pressurization of the tank, by closing the ACT vent valve and opening the air shutoff valve.

ACT2 transfers first, via the ACT transfer valve and the ACT2 inlet valve.

When ACT2 is empty, the ACT2 inlet valve shuts, and the ACT1 inlet valve opens.

When ACT1 is empty, the ACT transfer valve and ACT1 inlet valve close.

When the aircraft is on ground after landing, the air shutoff valve closes and both ACT vent valves open, depressurizing the ACTs.

Note: ACT transfer stop, if the center tank high level becomes wet, by closing the ACT transfer valve. The transfer valve reopens when the center tank high-level sensor becomes dry for 10 min.

Selecting the ACT pb-sw to FWD opens the ACT transfer valve and starts the ACT transfer pump.

ACT2 empties first, then ACT1. It must be returned to AUTO, when the ACT is empty.

Center tank overflow is prevented, by returning the ACT pb-sw to AUTO, when the center tank is full.



A318/A319/A320/A321
FLIGHT CREW
OPERATING MANUAL

AIRCRAFT SYSTEMS

FUEL

DESCRIPTION - APU FEED

APU FEED

Ident.: DSC-28-10-50-00001120.0001001 / 10 DEC 09

Applicable to: ALL

A special fuel pump supplies fuel for APU startup when fuel feed pressure is low (due to loss of tank pumps or loss of normal AC electrical supply). This pump normally runs off the AC ESS SHED, but runs off the AC STAT INV BUS if the AC ESS SHED fails.



A318/A319/A320/A321
FLIGHT CREW
OPERATING MANUAL

AIRCRAFT SYSTEMS

FUEL

DESCRIPTION - APU FEED

Intentionally left blank

FUEL RECIRCULATION SYSTEM

Applicable to: ALL

Ident.: DSC-28-10-60-B-00020316.0001001 / 17 MAR 17

Illustration - For information only

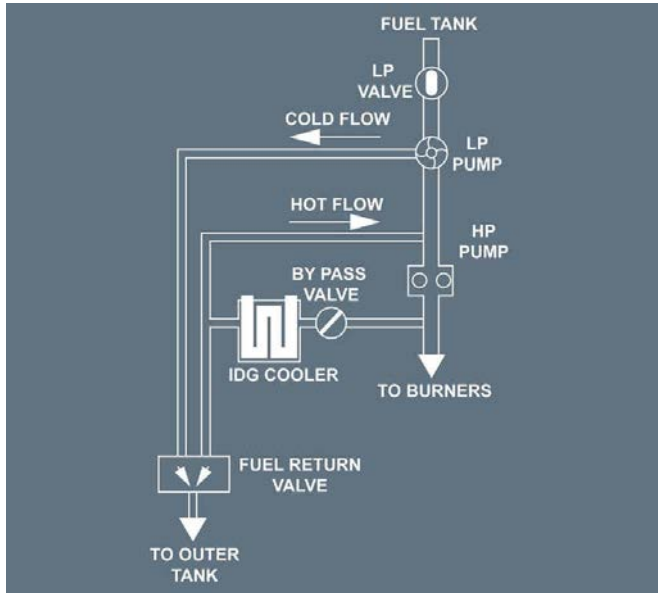

Ident.: DSC-28-10-60-B-00020317.0004001 / 17 MAR 17

Refer to DSC-70-40 IDG Cooling System.

Some of the fuel supplied to each engine goes from the high-pressure fuel line in that engine, through the integrated drive generator (IDG) heat exchanger (where it absorbs heat), to the fuel return valve and back to the outer fuel tank.

This operation ensures the IDG cooling when the oil temperature is high or when at low engine power.

The FADEC controls the fuel return valve.

If the outer tank is already full, the fuel overflows to the inner tank through a spill pipe. On ground, the fuel recirculation is not inhibited if there is an overflow in the surge tanks (*Refer to DSC-70-40 IDG Cooling System*).

■ **If the FUEL MODE SEL pb-sw is in AUTO mode:**

If center tank is feeding, the wing tank will tend to overflow and the system automatically selects the CTR TK PUMP off when the inner tank is full. The wing tank pumps will feed until the engine

have used approximately 500 kg (1 100 lb) of fuel when the fuel level reaches the underfull sensors. The logic circuits then restart the center tank pumps.



■ **If the FUEL MODE SEL pb-sw is in MAN mode:**

If center tank is feeding, the wing tanks will tend to overfill but the system does not automatically select the CTR TK PUMPs OFF when the inner tank is full. Therefore, an overflow of the wing tanks can occur on ground if the CTR TK PUMPs are not switched OFF.

REFUELING - DEFUELING

Ident.: DSC-28-10-70-00021235.0002001 / 21 MAR 17

Applicable to: ALL

- During automatic refueling, fuel goes into the ACTs , the center tank and the outer cell of the wing tanks simultaneously. When the outer cell of the wing tank is full, fuel overflows into the inner cell. During manual refueling, fill the wing tanks first, then the center tank, then the ACTs .
- Electrical transients (caused by switching among the APU, the external and the engine electrical supply) during automatic refueling may stop the process. If the automatic refueling process is stopped, it is necessary to re-enter the Preselected Fuel Quantity.
- One (two) refueling point(s) is (are) installed under the wings, enabling the aircraft to be refueled from either the right or left (if installed) side.
- A refuel panel is located on the fuselage side beneath the right wing, or under the right or left wing adjacent to the refuel coupling.
- Another refuel panel is located on the cockpit overhead maintenance panel.
- A "READY FOR FUELING" green light is installed adjacent to the refuel coupling.

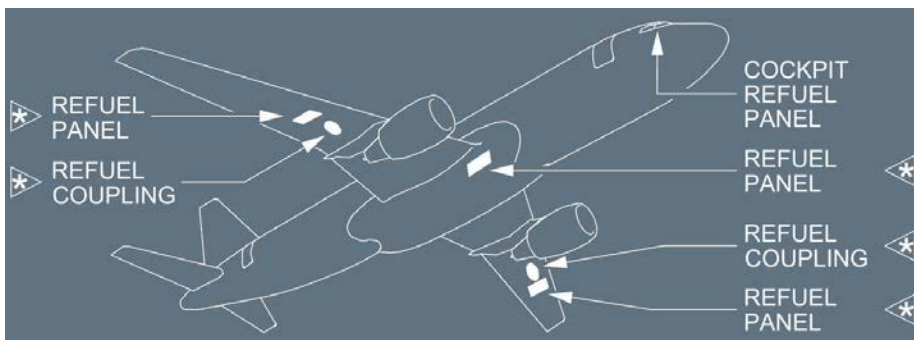

A gallery connects the refuel coupling to each tank's refuel valve.

Refueling is normally automatic, the required fuel load being set on the preselector.

Manual control is also available.

Automatic refueling starts with the outer tanks. If the selected fuel load exceeds the wing tank capacity, the center tank is simultaneously refueled.

When an outer tank is full, the fuel overflows into the inner tank through a spill pipe.

Refuel valves close automatically, when the tanks contain the preselected load, or when sensors detect a high fuel level.



The aircraft can be refueled, when only battery power is available.

The wing tanks can be refueled by gravity, through refueling points on top of the wings.

A transfer valve, between the engine feed system and the refueling gallery, allows :

- The tank pumps to transfer fuel from one tank to another
- Defueling through the refuel coupling.

Approximate refueling time at nominal pressure is:

- 17 min for wing tanks
- 20 min for all tanks (without ACT )
- 25 min for all tanks (with one ACT )
- 27 min for all tanks (with two ACTs ).

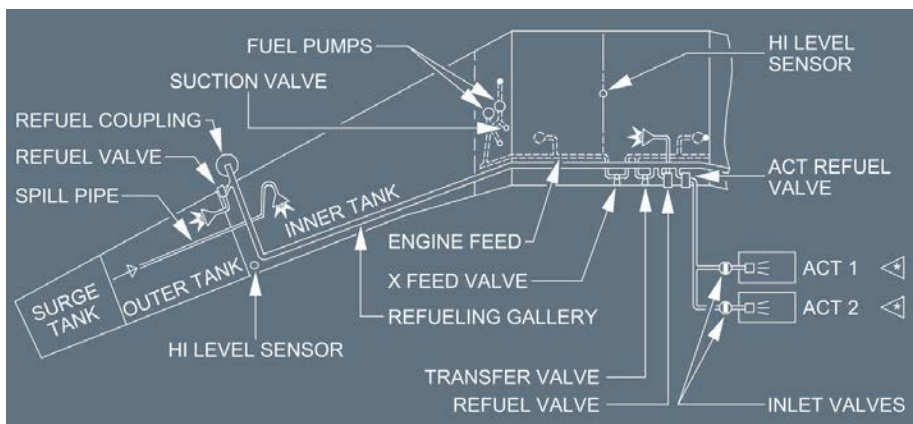

| | |
|---|---|
|  <p>A318/A319/A320/A321 FLIGHT CREW OPERATING MANUAL</p> | <p style="text-align: center;">AIRCRAFT SYSTEMS</p> <p style="text-align: center;">FUEL</p> <p style="text-align: center;">DESCRIPTION - FUEL QUANTITY INDICATION AND LEVEL SENSING</p> |
|---|---|

FUEL QUANTITY INDICATION (FQI) SYSTEM

Ident.: DSC-28-10-80-00001123.0001001 / 10 DEC 09
Applicable to: ALL

The FQI is a computerized system that :

- transmits the actual total fuel mass, as well as the quantity and temperature of fuel in the tanks, to the ECAM.
- controls automatic refueling.

Two channels perform fuel computations : channel 2 activates automatically if channel 1 fails.

The FQI system has :

- an FQI computer.
- a set of capacitance probes in each tank to measure fuel level and temperature.
- one densitometer (cadensicon) sensor in each wing inner tank permitting the calculation of the fuel quantity.
- one Capacitance Index Compensator (CIC) in each inner tank giving the dielectric constant of the fuel in case of cadensicon failure.
- a quantity indicator for each tank installed on the refuel/defuel panel.
- a preselector on the refuel/defuel panel that shows the preselected and actual total fuel quantity.

FUEL LEVEL SENSING CONTROL UNIT (FLSCU)

Ident.: DSC-28-10-80-00001124.0001001 / 16 MAR 15
Applicable to: ALL

The fuel level system generates fuel-level and fuel-temperature signals in order to operate the appropriate switching functions for refueling and defueling and control the IDG cooling recirculation system and the center-tank-to-wing-tank fuel transfer system.

The FLSCU comprises :

- fuel level sensors in the tanks to sense high, low, and overflow levels.
- a fuel temperature sensor to control the IDG cooling recirculation.

When fuel quantity in one wing tank goes below 750 kg (1 650 lb), the low-level sensor triggers the LO LVL warning on ECAM. The LO LVL warning is totally independent from the displayed fuel quantity indication of the tank.

FUEL SYSTEM ARCHITECTURE

Ident.: DSC-28-10-80-00001125.0001001 / 22 MAY 12

Applicable to: ALL

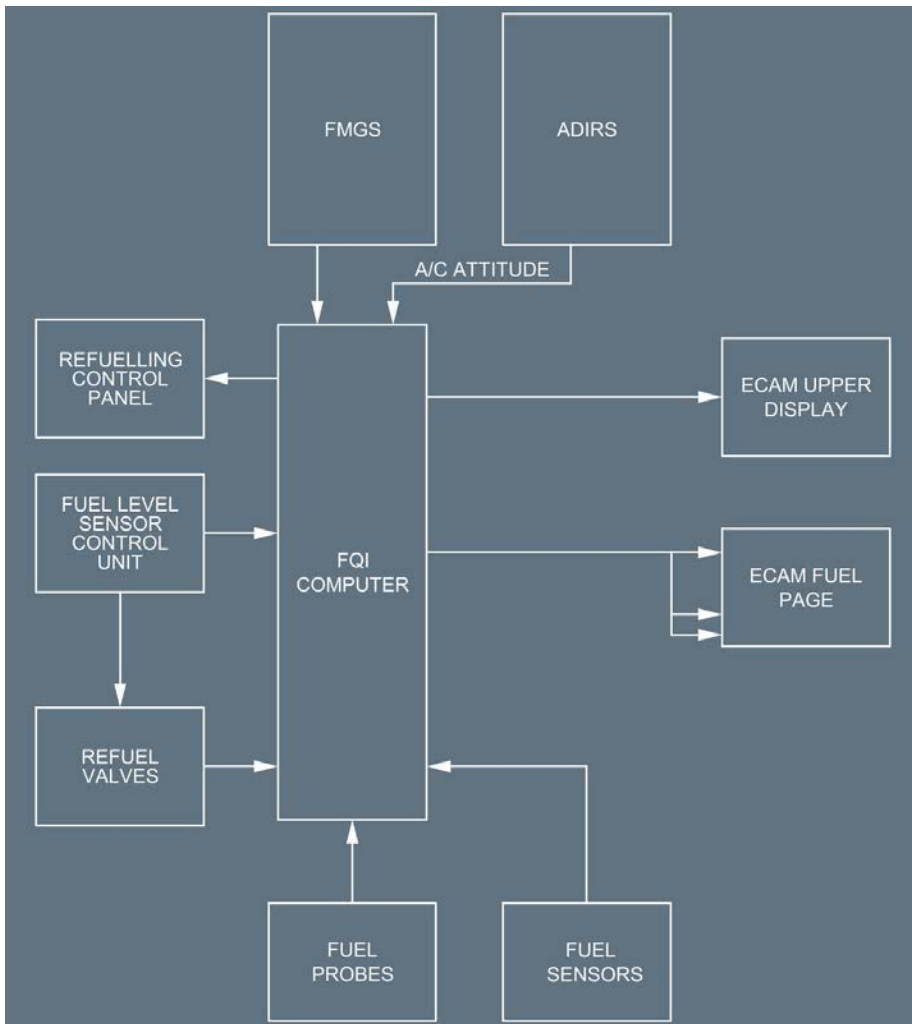

OVERHEAD PANEL

Applicable to: ALL

Ident.: DSC-28-20-G-00020183.0001001 / 17 MAR 17

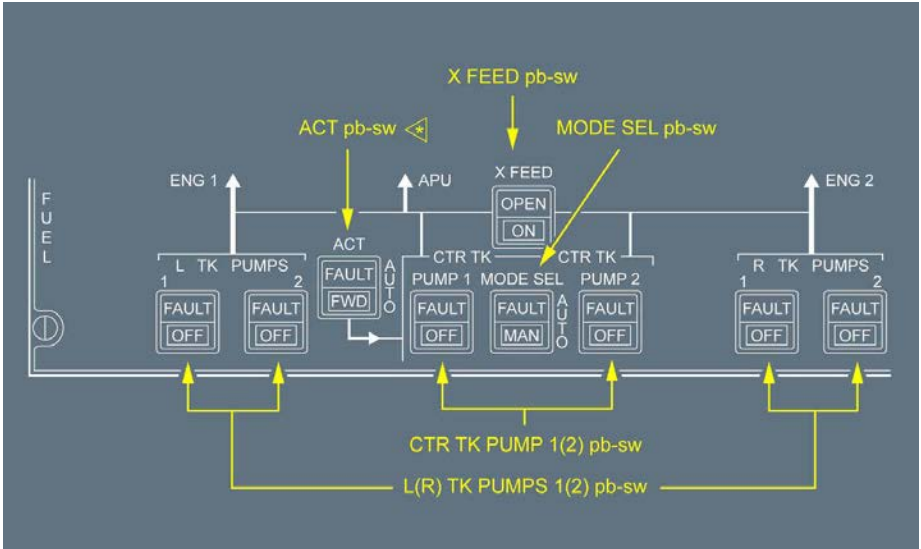

Ident.: DSC-28-20-G-00020239.0001001 / 17 MAR 17

L(R) TK PUMPS 1(2) pb-sw

- On : Pump is on (but only fuel feeds) when the delivery pressure of the center tank pumps drops below the threshold.
- OFF : Pump is off, and the OFF button comes on white.
- FAULT light : Amber light and ECAM caution come on, when the delivery pressure drops. It does not come on when OFF is selected.

Ident.: DSC-28-20-G-00020240.0001001 / 17 MAR 17

MODE SEL pb-sw

- AUTO : Control of center tank pumps is automatic:
 - They run at engine start for 2 min,
 - Before or after the engine start sequence, the pumps run if the slats are retracted,
 - They stop automatically 5 min after center tank low level is reached.

- MAN** : Flight crew manually controls the center tank pumps with the center tank pumps' pushbutton.
- FAULT light** : Amber light comes on, and ECAM caution comes on when center tank has more than 250 kg (550 lb) of fuel and the left or right wing tank has less than 5 000 kg (11 000 lb).

Ident.: DSC-28-20-G-00020256.0001001 / 17 MAR 17

CTR TK PUMP 1(2) pb-sw

- On** : Pump runs, if MAN mode is selected on the MODE SEL pb-sw. Pump is automatically controlled when AUTO mode is selected.
- OFF** : Pump is off and OFF button comes on white.
- FAULT light** : Amber light and associated ECAM caution come on, when the pump is in operation and the delivery pressure drops.

Ident.: DSC-28-20-G-00020257.0001001 / 17 MAR 17

X FEED pb-sw

- ON** : The valve opens, and the ON pushbutton comes on in white.
- OFF** : The valve closes, and the pushbutton does not come on.
- OPEN light** : This green light comes on, when the valve is fully open.

Ident.: DSC-28-20-G-00020258.0001001 / 17 MAR 17

ACT pb-sw 

- AUTO** : Control of the ACT transfer is automatic.
- The automatic forward transfer occurs, if:
 - The aircraft is in flight, and
 - The slats are retracted, and
 - At least one ACT low-level sensor is wet, and
 - The center tank high-level sensor has been dry for at least 10 min.
 - The automatic forward transfer stops, as soon as one of the above conditions is not met.
- FWD** : The manual transfer to the center tank is initiated by opening:
- The ACT transfer valve,
 - The ACT 1 or ACT 2 (if available) inlet valve.
- The ACT transfer pump is then commanded on.
- FAULT light** : Amber light and associated ECAM caution come on, when:
- The center tank has less than 3 000 kg (6 614 lb) of fuel, and 1 ACT has more than 250 kg (550 lb) of fuel, and
 - The ACT pb-sw is on AUTO.

Note: When no ACT is installed, the pushbutton is inoperative.

REFUELING CONTROL PANEL

Applicable to: ALL

Ident.: DSC-28-20-C-00020185.0001001 / 17 MAR 17

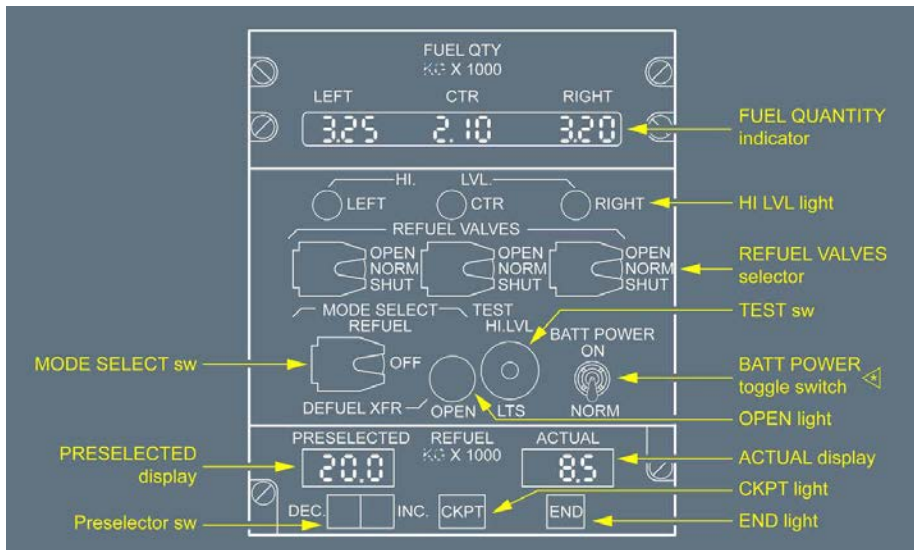

Ident.: DSC-28-20-C-00020265.0001001 / 21 MAR 17

FUEL QUANTITY INDICATOR

The number shows the quantity of fuel in each tank.
Units may either be in kg x 1 000 or lb x 1 000 depending on the aircraft configuration.

Ident.: DSC-28-20-C-00020266.0001001 / 21 MAR 17

HI LVL light

This blue light comes on, when the system detects a high fuel level.
The corresponding refuel valve closes automatically.

Ident.: DSC-28-20-C-00020267.0001001 / 21 MAR 17

REFUEL VALVES selector (GUARDED IN NORM)

NORM : Automatic refueling logic controls the refuel valves.

OPEN : Valves open when the MODE SELECT sw is set to the REFUEL or DEFUEL XFR position. Each refuel valve closes, when the system detects a high level in the associated tank.

SHUT : Valves close.

Ident.: DSC-28-20-C-00020268.0001001 / 17 MAR 17

MODE SELECT sw (GUARDED AT OFF)

OFF : Refuel system is de-energized. Refuel valves are closed.

REFUEL : Refuel valves operate in automatic or in manual mode depending on the position of REFUEL VALVES sw.

DEFUEL XFR : Refuel/Defuel transfer valve opens.
Refuel valve opens if the associated REFUEL VALVE sw is at OPEN.

Ident.: DSC-28-20-C-00020270.0001001 / 21 MAR 17

OPEN light

This amber light comes on when the defuel transfer valve is open.

Ident.: DSC-28-20-C-00020271.0001001 / 17 MAR 17

TEST sw

HI LVL : The HI LVL lights come on if high level sensors and associated circuits are serviceable.

Note: If tanks are full (HI LVL lights on) during this test, the HI LVL lights go out if high level sensors and associated circuits are serviceable.

LTS : Lights on panel and all 8's on FQI and preselector come on.

Ident.: DSC-28-20-C-00020272.0001001 / 21 MAR 17

PRESELECTED DISPLAY

This display shows the preselected total fuel quantity in kg (lb) × 1 000 (multiply by 1 000 to get actual amount).

Ident.: DSC-28-20-C-00020273.0001001 / 17 MAR 17

Preselector sw

Pressing the left or right side of the switch decreases or increases the preselected quantity.

Ident.: DSC-28-20-C-00020274.0001001 / 21 MAR 17

ACTUAL DISPLAY

This display shows the total fuel on board.

Ident.: DSC-28-20-C-00020275.0001001 / 21 MAR 17

END light

This green light comes on steady when automatic refueling is completed.
It flashes green if refueling is aborted.

Ident.: DSC-28-20-C-00020276.0002001 / 21 MAR 17

CKPT light

Indicates that cockpit refuel panel has priority.
Illuminates when electrical PWR pb-sw on cockpit refuel is pressed.

Ident.: DSC-28-20-C-00020277.0001001 / 21 MAR 17

BATT POWER TOGGLE SWITCH 

ON : When the flight crew momentarily switches this to ON position and releases it, HOT BUS 1 supplies the FQI.

After completion of the FQI tests (about 40 s), the fuel quantity indications appear and refuel operation can be selected.

The electrical supply is automatically cut off:

- After 10 min, if no refuel operation is selected, or
- At the end of refueling.

NORM : The FQI is not supplied by batteries.

MAINTENANCE PANEL

Applicable to: ALL

Ident.: DSC-28-20-D-00020187.0007001 / 17 MAR 17

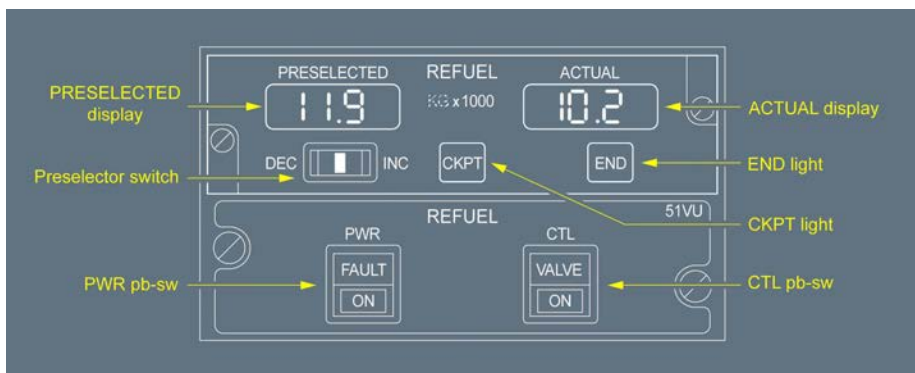

Ident.: DSC-28-20-D-00020286.0001001 / 21 MAR 17

PRESELECTED DISPLAY

This display shows the preselected total fuel quantity in KG (or in LB depending on aircraft configuration) × 1 000 (multiply by 1 000 to get actual amount).

Ident.: DSC-28-20-D-00020287.0001001 / 21 MAR 17

ACTUAL DISPLAY

This display shows the total fuel on board.

Ident.: DSC-28-20-D-00020288.0001001 / 17 MAR 17

Preselector sw

Pressing the left or the right side of the switch decreases or increases the preselected quantity.

Ident.: DSC-28-20-D-00020289.0001001 / 21 MAR 17

END light

This green light comes on steady when automatic refueling is achieved (associated with the green refuel light on wing extinguishing ).
 It flashes green if refueling is aborted.

Ident.: DSC-28-20-D-00020290.0001001 / 17 MAR 17

PWR pb-sw

- ON : - Refuel system is energized
 - Cockpit refuel control/preselector panels takes priority (cockpit lights illuminate on cockpit and external refuel control panels)
 - Automatic high level test
 - REFUEL caption is displayed on ECAM.
- OFF : - Refuel system is deenergized
 - ECAM "REFUEL" caption is cleared
 - Priority is cleared.
- FAULT : This amber light comes on when auto high level test not satisfied.

Ident.: DSC-28-20-D-00020291.0001001 / 17 MAR 17

CTL pb-sw

- ON : - Start of refuel, (associated with refuel green light illumination on wing )
 - Auto shut off occurs when the selected load is reached or in case of HI level detection
 - VALVE light comes amber if REFUEL VALVE CTL switch are not at NORM position (on refueling control panel).

Off : Refuel stops. The selected load can be reset.

Ident.: DSC-28-20-D-00020294.0001001 / 21 MAR 17

CKPT light

Comes on when PWR pb-sw switch is ON associated with the CKPT light on the external refuel control panel.

ECAM FUEL PAGE

Applicable to: ALL

Ident.: DSC-28-20-F-00020188.0004001 / 17 MAR 17

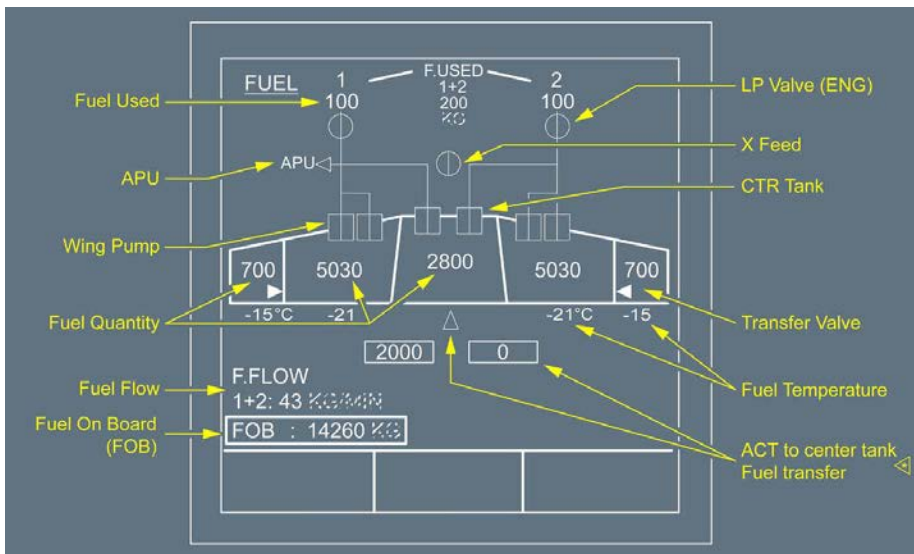

Ident.: DSC-28-20-F-00020213.0001001 / 17 MAR 17

WING PUMP INDICATIONS

- Inline - Green : Pump pressure is normal (pump contactor on).
- “LO” - Amber : Pump pressure is low (pump contactor on).
- Crossline - Amber : Pump contactor is off.

Ident.: DSC-28-20-F-00020214.0002001 / 17 MAR 17

CTR TANKS PUMPS INDICATIONS

- Inline - Green : Pump pressure is normal (pump contactor on).
- “LO” - Amber : Pump pressure is low (pump contactor on).
- Crossline - Green : Pump contactor is off, and auto shut-off is required.
- Crossline - Amber : Pump contactor is off, and auto shut-off is not required.

Ident.: DSC-28-20-F-00020216.0001001 / 17 MAR 17

LP VALVE (ENG) INDICATIONS

- Inline - Green : The valve is open.
- Inline - Amber : The valve is open, with the ENG MASTER switch OFF.
- Crossline - Amber : The ENG valve is fully closed.
- Transit - Amber : The valve is in transit.

Ident.: DSC-28-20-F-00020217.0001001 / 17 MAR 17

X FEED INDICATIONS

- Inline - Green : The valve is open.
- Inline - Amber : The valve is open, with X Feed pb off.
- Crossline - Green : The valve is closed.
- Crossline - Amber : The valve is closed with X feed pb ON.
- Transit - Amber : The valve is in transit.

Ident.: DSC-28-20-F-00020218.0002001 / 17 MAR 17

TRANSFER VALVE INDICATIONS

Outer to Inner Transfer



- ▷ : The triangle is green, during a transfer to inner.
- ▶ : The triangle is in solid amber, when the valves are open, while commanded closed.
- ▷ : The triangle is in amber, when a valve is in transit.
- XX : The valve position information is not available
- No display : valves are closed

Ident.: DSC-28-20-F-00020219.0001001 / 17 MAR 17

APU INDICATIONS

APU ← : APU is in white and the triangle is in green: the APU valve is open.
 APU ← : APU and solid triangle are in amber : the APU valve is open, with the APU Fire Pushbutton out, or the APU MASTER switch OFF.
 APU : APU is in amber : APU valve is closed and APU Fire pushbutton is out / or APU MASTER switch ON.
 APU ◁ : APU and triangle are in white : the APU valve is closed.

Ident.: DSC-28-20-F-00020220.0001001 / 17 MAR 17

FUEL TEMPERATURE INDICATION

This appears when its associated temperature sensor is wet. It is normally in green.

An advisory only appears in phases 2 and 6, when the fuel temperature is:

- Above 45 °C for the inner cell, or 55 °C for the outer cell.
- Below -40 °C.

It becomes amber, and the ECAM displays a caution, if the temperature goes above the high limit or below the low limit.

Ident.: DSC-28-20-F-00020221.0002001 / 17 MAR 17

FUEL QUANTITY INDICATION

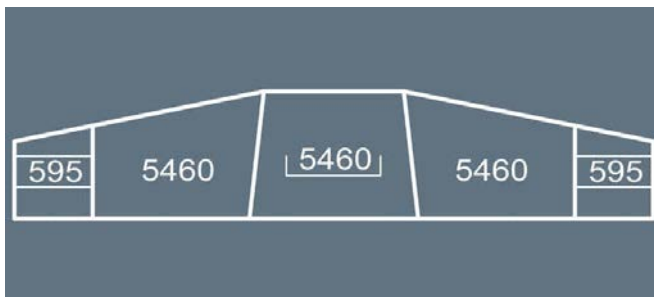

- It is normally in green.
- The units may either be in KG or LB, depending on the DMC pin program.
- Two dashes appear across the last two digits when the FQI is inaccurate (*Refer to DSC-28-20 Total Fuel Indication*).

Ident.: DSC-28-20-F-00020340.0001001 / 17 MAR 17

FUEL QUANTITY - BOXED INDICATIONS

- The outer indication is boxed amber, if both transfer valves fail to open when the inner is at low level.
- The center tank indication is boxed amber, if both center tank pumps are failed, or are switched OFF.

Ident.: DSC-28-20-F-00020345.0001001 / 17 MAR 17

FUEL QUANTITY - ADVISORY

An advisory appears in flight phases 2 and 6, when the difference between the fuel quantities in the two wings is greater than 1 500 kg (3 300 lb). The wing inner and outer tank indications pulse with the highest fuel level.

Ident.: DSC-28-20-F-00020346.0003001 / 17 MAR 17

FUEL ON BOARD (FOB) INDICATION

It is normally in green. It indicates the total of all tanks (Including the ACTs ).
Two dashes appear across the last two digits when the FQI is inaccurate (*Refer to DSC-28-20 Total Fuel Indication*).

Units may either be in KG or LB, depending on the DMC pin program.

The indication is half-boxed in amber, if:

- Center tank pumps fail, or are switched OFF.
- Both transfer valves fail to open, when the inner tank is at low level.
- Any ACT  is not usable.

Ident.: DSC-28-20-F-00020347.0001001 / 17 MAR 17

FUEL USED INDICATION

- The engine identification number is in amber, when the engine is below idle. It is in white color, when it is at, or above, idle.
- The fuel used indication is green from flight phase 2, until electrical power is cut off at the end of the flight. It is automatically reset, when the engine is started on ground.
- Units may either be in KG or LB, depending on the DMC pin program.

Ident.: DSC-28-20-F-00020348.0002001 / 17 MAR 17

ACT TO CENTER TANK FUEL TRANSFER INDICATION

- It is normally in green.
- The ACT quantity is displayed in a grey box.
- This box becomes amber in case of a transfer fault.
- ACT 1 is indicated on the left and ACT 2 is indicated on the right.
- Units may either be in KG or LB, depending on the DMC pin program.
- A triangle indicates that the fuel transfer to the center tank has started:
 - △ : Green, when the automatic transfer begins.
 - ▲ : Fully green, when the manual transfer begins.

Ident.: DSC-28-20-F-00020351.0001001 / 17 MAR 17

FUEL FLOW INDICATION

- The Total Fuel Flow is displayed in KG/MIN or LB/MIN.
Units may either be in KG or LB, depending on the DMC pin program.
- It is normally in green.
 - It is replaced by an amber XX if there is no valid data.

ECAM UPPER DISPLAY

Applicable to: ALL

Ident.: DSC-28-20-E-00020189.0002001 / 17 MAR 17

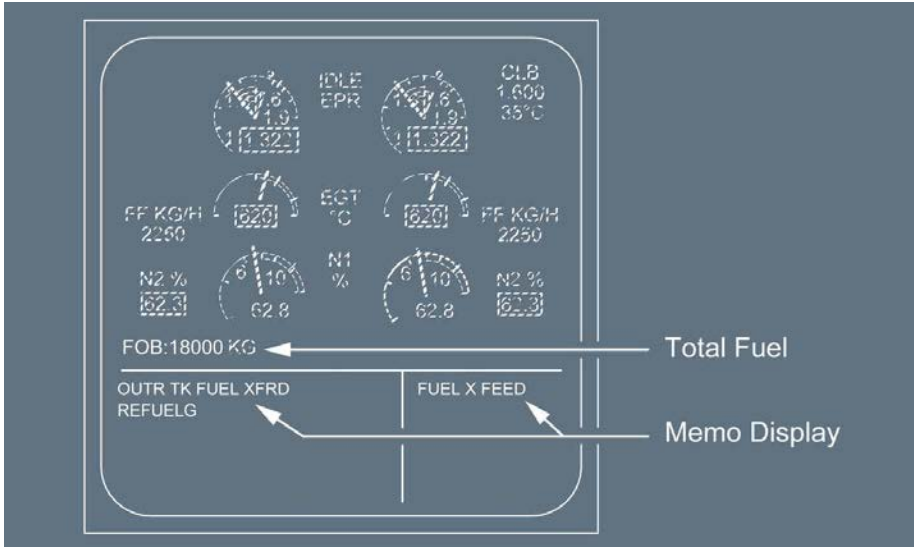

Ident.: DSC-28-20-E-00020193.0001001 / 17 MAR 17

TOTAL FUEL INDICATION

An amber half box appears around FOB, when the displayed quantity is not all usable (intercell transfer valve failure or loss of center tank pumps).

Units may either be in KG or LB, depending on the DMC pin program.

If the FOB indication is displayed with two dashes across the two least significant digits, the FQI is in degraded mode. In this case, the ECAM FUEL page can be called on ECAM lower display to determine which tank is affected.

The loss of accuracy resulting from the loss of FQI normal mode is as follows :

- Wing outer tank affected : +20 kg (+44 lb), -200 kg (-440 lb).
- Wing inner tank affected : ±110 kg (240 lb).
- Center tank affected : ±130 kg (290 lb).
- All tanks affected : +390 kg (+860 lb), -750 kg (-1660 lb).

Ident.: DSC-28-20-E-00020194.0001001 / 17 MAR 17

MEMO DISPLAY

Memos are normally in green color, but they may be in amber color in abnormal situations.

MEMO DISPLAY

Applicable to: ALL

Ident.: DSC-28-20-A-00016777.0001001 / 21 MAR 16

CTR TK FEEDG : This memo appears in green, if at least one center tank pump is energized.

Ident.: DSC-28-20-A-00016778.0001001 / 21 MAR 16



FUEL X FEED : This memo appears in green, if the fuel X FEED pb-sw is ON, and the X FEED valve is not fully closed. It appears in amber in flight phases 3,4, or 5.

Ident.: DSC-28-20-A-00016776.0001001 / 21 MAR 16

OUTR TK FUEL XFRD : This memo appears in green, if at least one transfer valve is open in one wing tank.

Ident.: DSC-28-20-A-00016779.0001001 / 21 MAR 16

REFUELG : This memo appears in green, when :

- The door of the refuel control panel  on the fuselage or on the wing is open, or
- The PWR pb-sw of the refuel control panel  in the cockpit is ON.



A318/A319/A320/A321
FLIGHT CREW
OPERATING MANUAL

AIRCRAFT SYSTEMS

FUEL

CONTROLS AND INDICATORS

Intentionally left blank

AIRCRAFT SYSTEMS

HYDRAULIC

Intentionally left blank

DSC-29-10 Description

DSC-29-10-10 General

| | |
|--------------|---|
| General..... | A |
|--------------|---|

DSC-29-10-20 Generation

| | |
|--------------------------------|---|
| Green System Pump..... | A |
| Blue System Pumps..... | B |
| Yellow System Pumps..... | C |
| Power Transfer Unit (PTU)..... | D |
| Ram Air Turbine (RAT)..... | E |
| System Accumulators..... | F |
| Priority Valves..... | G |
| Fire Shutoff Valves..... | H |
| Leak Measurement Valves..... | I |
| Filters..... | J |
| Generation..... | K |
| Reservoir Pressurization..... | L |
| Indications..... | M |

DSC-29-10-30 Distribution

| | |
|-------------------|---|
| Distribution..... | A |
|-------------------|---|

DSC-29-20 Controls and Indicators

| | |
|------------------------|---|
| Overhead Panel..... | A |
| Maintenance Panel..... | B |
| ECAM HYD Page..... | C |
| Memo Display..... | D |



A318/A319/A320/A321
FLIGHT CREW
OPERATING MANUAL

AIRCRAFT SYSTEMS

HYDRAULIC

PRELIMINARY PAGES - TABLE OF CONTENTS

Intentionally left blank



A318/A319/A320/A321
FLIGHT CREW
OPERATING MANUAL

AIRCRAFT SYSTEMS

HYDRAULIC

DESCRIPTION - GENERAL

GENERAL

Ident.: DSC-29-10-10-00001133.0001001 / 21 MAR 16

Applicable to: ALL

The aircraft has three continuously operating hydraulic systems : blue, green, and yellow. Each system has its own hydraulic reservoir. Normal system operating pressure is 3 000 PSI (2 500 PSI when powered by the RAT). Hydraulic fluid cannot be transferred from one system to another.



A318/A319/A320/A321
FLIGHT CREW
OPERATING MANUAL

AIRCRAFT SYSTEMS

HYDRAULIC

DESCRIPTION - GENERAL

Intentionally left blank

GREEN SYSTEM PUMP

Ident.: DSC-29-10-20-00001134.0001001 / 21 MAR 16

Applicable to: ALL

A pump driven by engine 1 pressurizes the green system.

BLUE SYSTEM PUMPS

Ident.: DSC-29-10-20-00001135.0001001 / 21 MAR 16

Applicable to: ALL

An electric pump pressurizes the blue system. A pump driven by a ram air turbine (RAT) pressurizes this system in an emergency.

YELLOW SYSTEM PUMPS

Ident.: DSC-29-10-20-00001136.0001001 / 21 MAR 16

Applicable to: ALL

A pump driven by engine 2 pressurizes the yellow system.

An electric pump can also pressurize the yellow system, which allows yellow hydraulics to be used on the ground when the engines are stopped.

Crew members can also use a hand pump to pressurize the yellow system in order to operate the cargo doors when no electrical power is available.

POWER TRANSFER UNIT (PTU)

Ident.: DSC-29-10-20-00001137.0001001 / 21 MAR 16

Applicable to: ALL

A bidirectional power transfer unit enables the yellow system to pressurize the green system and vice versa.

The power transfer unit comes into action automatically when the differential pressure between the green and the yellow systems is greater than 500 PSI.

The PTU therefore allows the green system to be pressurized on the ground when the engines are stopped.

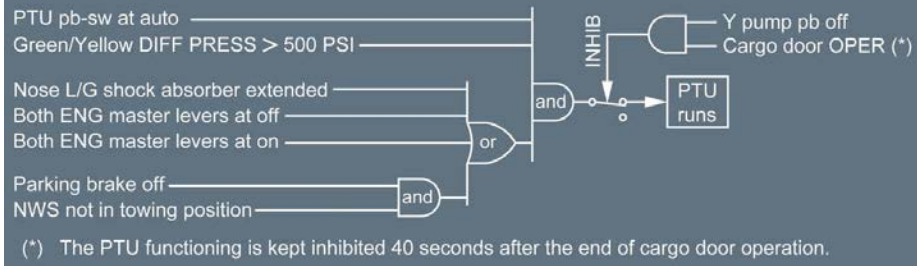

RAM AIR TURBINE (RAT)

Ident.: DSC-29-10-20-00001138.0001001 / 21 MAR 16

Applicable to: ALL

A drop-out RAT coupled to a hydraulic pump allows the blue system to function if electrical power is lost or both engines fail. The RAT deploys automatically if AC BUS 1 and AC BUS 2 are both lost. It can be deployed manually from the overhead panel. It can be stowed only when the aircraft is on the ground.

SYSTEM ACCUMULATORS

Ident.: DSC-29-10-20-00001139.0001001 / 21 MAR 16

Applicable to: ALL

An accumulator in each system helps to maintain a constant pressure by covering transient demands during normal operation.

PRIORITY VALVES

Ident.: DSC-29-10-20-00001141.0001001 / 21 MAR 16

Applicable to: ALL

Priority valves cut off hydraulic power to heavy load users if hydraulic pressure in a system gets low.

FIRE SHUTOFF VALVES

Ident.: DSC-29-10-20-00001142.0001001 / 21 MAR 16

Applicable to: ALL

Each of the green and yellow systems has a fire shutoff valve in its line upstream of its engine-driven pump. The flight crew can close it by pushing the ENG 1(2) FIRE pushbutton.

LEAK MEASUREMENT VALVES

Ident.: DSC-29-10-20-00001143.0001001 / 21 MAR 16

Applicable to: ALL

Each system has a leak measurement valve upstream of the primary flight controls. These valves, which measure the leakage in each circuit, are closed by operation of the LEAK MEASUREMENT VALVES pushbutton switch on the maintenance panel.

FILTERS

Ident.: DSC-29-10-20-00001144.0001001 / 21 MAR 16

Applicable to: ALL

 Filters clean the hydraulic fluid as follows :

- HP filters on each system and on the reservoir filling system and the normal braking system
- return line filters on each line
- case drain filters on engine pumps and the blue electric pump (which permit maintenance crew to monitor pump wear by inspecting the filters for the presence of metallic particles).

GENERATION

Ident.: DSC-29-10-20-00001145.0001001 / 08 FEB 13

Applicable to: ALL

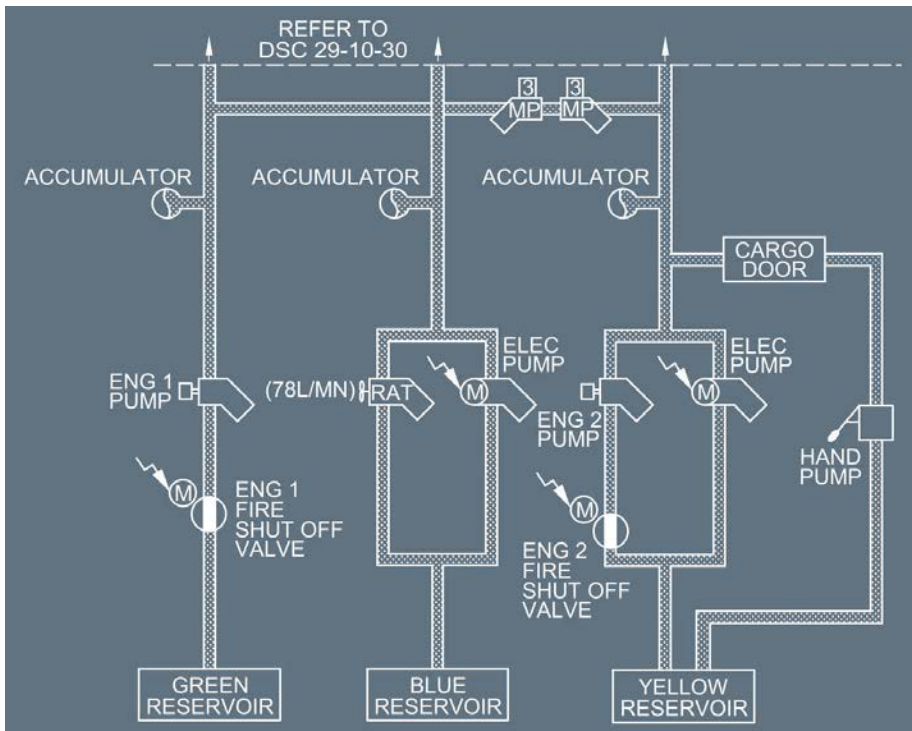

RESERVOIR PRESSURIZATION

Ident.: DSC-29-10-20-00001146.0001001 / 08 FEB 13

Applicable to: ALL

Normally, HP bleed air from engine 1 pressurizes the hydraulic reservoirs automatically.
If the bleed air pressure is too low, the system takes bleed air pressure from the crossbleed duct.
The systems maintain a high enough pressure to prevent their pumps from cavitating.

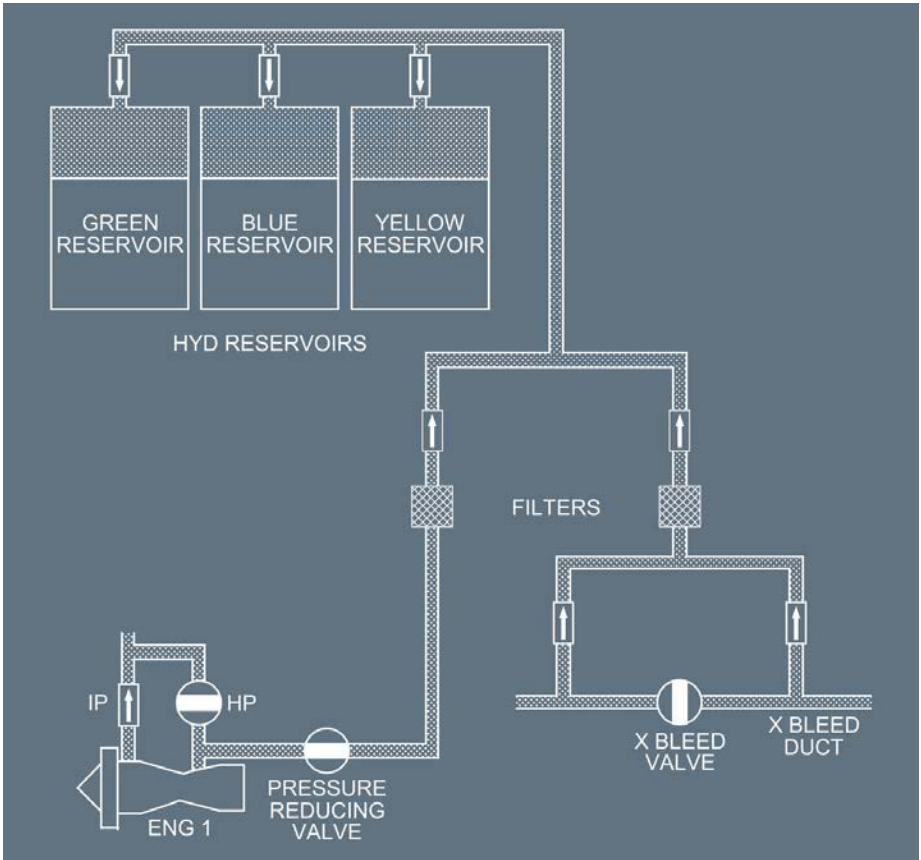

INDICATIONS

Ident.: DSC-29-10-20-00001147.0002001 / 09 OCT 12

Applicable to: ALL

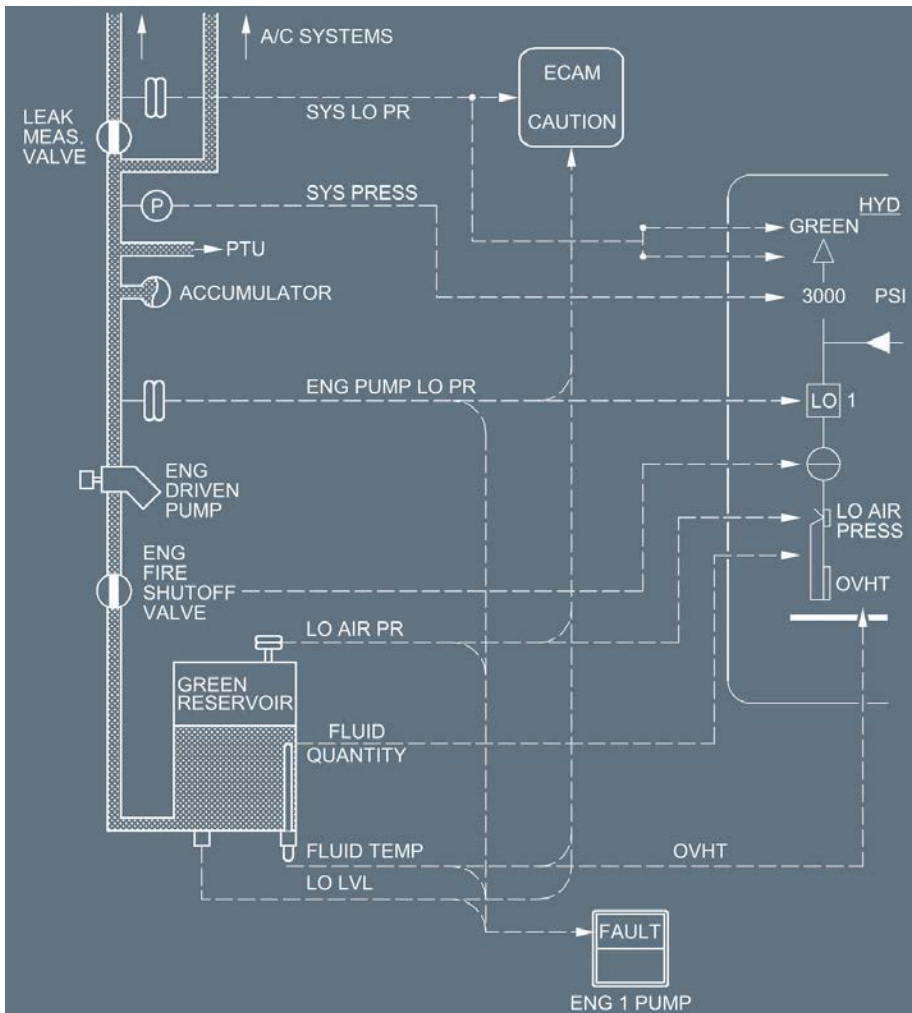

DISTRIBUTION

Ident.: DSC-29-10-30-00001148.0003001 / 08 FEB 13

Applicable to: ALL

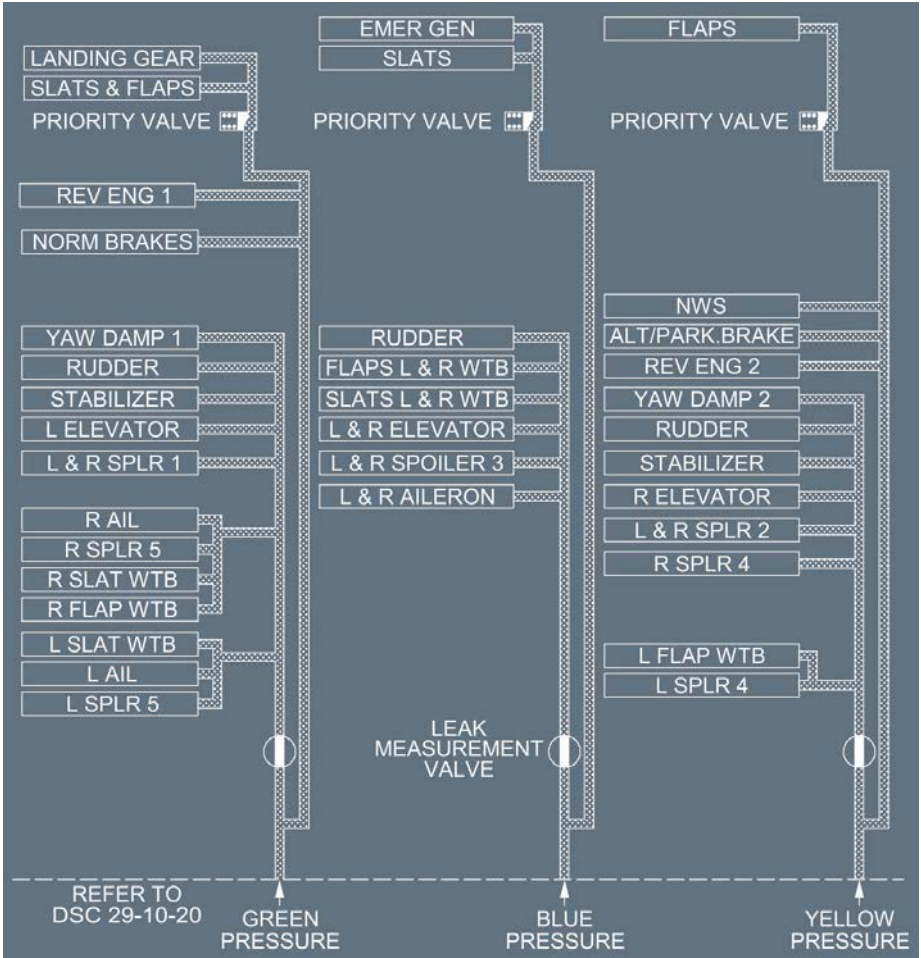



A318/A319/A320/A321
FLIGHT CREW
OPERATING MANUAL

AIRCRAFT SYSTEMS

HYDRAULIC

DESCRIPTION - DISTRIBUTION

Intentionally left blank

OVERHEAD PANEL

Ident.: DSC-29-20-00001149.0001001 / 21 MAR 16

Applicable to: ALL

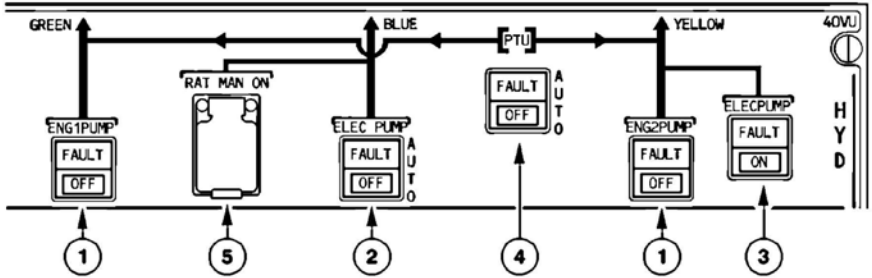

(1) ENG 1 (2) PUMP pb

On : The pump pressurizes the system when the engine is running.

OFF : The pump is depressurized. The generation of hydraulic power stops.

FAULT It : This amber light comes on, and the ECAM caution appears, if :

- The reservoir level is low
- The reservoir overheats
- The reservoir air pressure is low
- The pump pressure is low (inhibited on the ground, when the engine is stopped).

This light goes out, when the crew selects OFF, except during an overheat. (The light stays on as long as the overheat lasts).

(2) BLUE ELEC PUMP pb (guarded)

AUTO : If AC power is available, the electric pump operates :

- In flight
- On the ground, if one engine is running or if the crew has pressed the BLUE PUMP OVRD pushbutton on the maintenance panel.

OFF : The pump is de-energized.

FAULT It : This amber light comes on, and a caution appears on the ECAM, if :

- The reservoir level is low
- The reservoir overheats
- The air pressure in the reservoir is low
- The pump is delivering low pressure (inhibited on the ground, when the engines are stopped)
- The pump overheats.

The light goes out, when the crew selects OFF, except during an overheat. (The light stays on as long as the overheat lasts).

(3) YELLOW ELEC PUMP pb sw (springloaded)

ON : The electric pump is ON.
 If the electrical power supply is removed, the pump will remain off when electrical power is applied again.

Off : The pump is off.
 It comes on automatically when a crewman sets the lever of the cargo door manual selector valve to OPEN or CLOSE.
 This inhibits the operation of other yellow system functions (except alternate braking and engine 2 reverse).

FAULT It : This amber light, accompanied by an ECAM caution, comes on if :

- the reservoir level is low
- air pressure in the reservoir is low
- the reservoir overheats
- pump pressure is low
- the pump overheats.

The light goes out when the crew selects OFF, except during an overheat. (The light stays on as long as the overheat lasts).

(4) PTU pb sw

AUTO : The bidirectional power transfer unit is armed and both the yellow and the green electrohydraulic valves are open.
 The power transfer unit runs automatically when the differential pressure between the green and yellow systems is more than 500 PSI.

***Note:** The PTU is inhibited during the first engine start and automatically tested during the second engine start.*

OFF : Both the green and the yellow PTU electrohydraulic valves close. Power transfer stops.

FAULT It : This amber light comes on, and a caution appears on the ECAM, if :

- the green or the yellow reservoir overheats
- the green or the yellow reservoir has low air pressure
- the green or the yellow reservoir has a low fluid level.

The light goes out when the crew selects OFF, except during an overheat. (The light stays on as long as the overheat lasts).

(5) **RAT MAN ON pb**

The flight crew may extend the RAT at any time by pressing the RAT MAN ON pushbutton.

Note: The RAT extends automatically if AC BUS 1 and AC BUS 2 are lost. (Refer to DSC-24-20 Overhead Panel (Cont'd)).

MAINTENANCE PANEL

Ident.: DSC-29-20-00001150.0001001 / 21 MAR 16

Applicable to: ALL

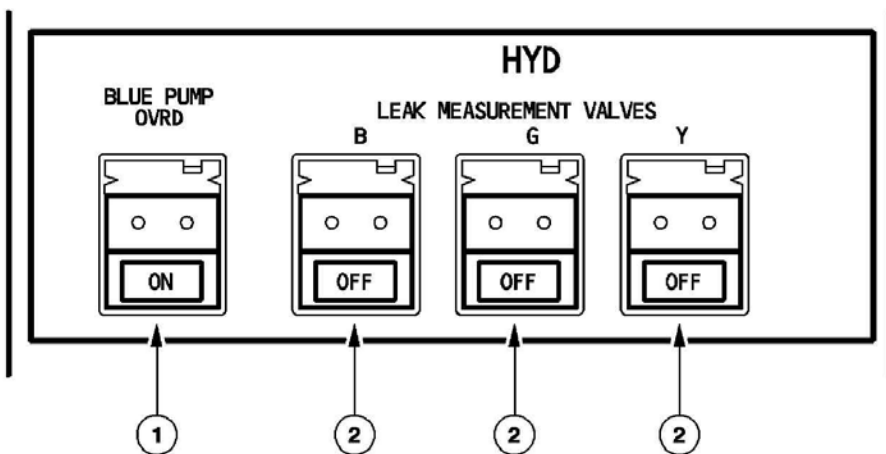

(1) **BLUE PUMP OVRD pb sw (guarded)**

ON : The blue electric pump is on if the ELEC PUMP pushbutton switch on the HYD panel is at AUTO.

Off : The blue electric pump is off.

(2) LEAK MEASUREMENT VALVES pb sw (guarded)

- OFF: The corresponding electrohydraulic valve closes and shuts off hydraulic supply to the primary flight controls.
- On : The corresponding electrohydraulic valve opens to go back to normal hydraulic supply.

ECAM HYD PAGE

Ident.: DSC-29-20-00001151.0002001 / 23 JUN 15

Applicable to: **ALL**

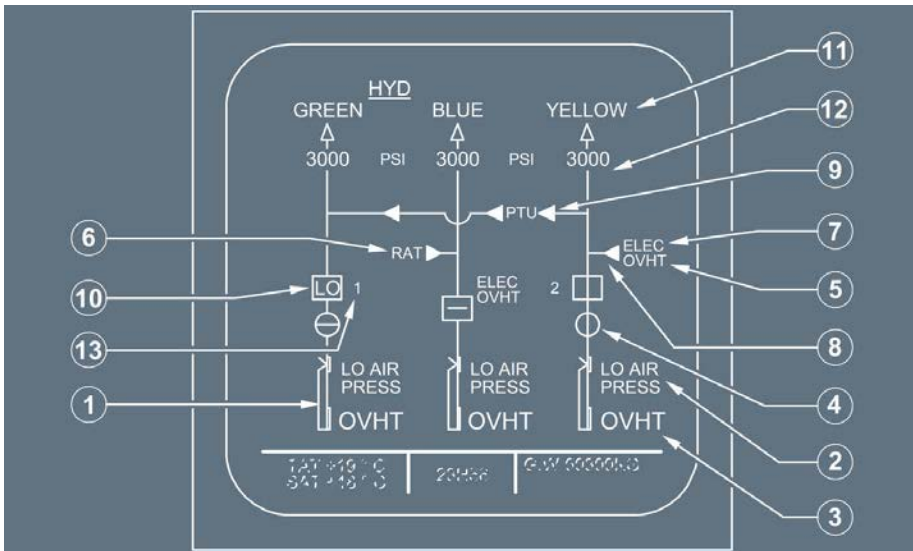

(1) Reservoir quantity

It is in green, unless the fluid level goes below the warning level, in which case it becomes amber.

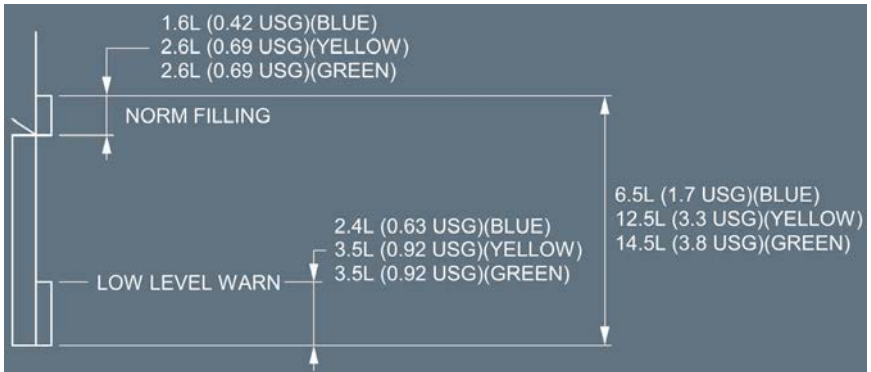

- (2) Reservoir LO AIR PRESS
 This appears in amber, and a caution appears on ECAM, if the air pressure for the indicated reservoir drops below normal.
- (3) Reservoir OVHT
 This appears in amber, and a caution appears on ECAM, if the temperature of returning hydraulic fluid temperature at the inlet to its reservoir is above normal.
- (4) FIRE VALVE
 Cross line - Amber : The valve is fully closed.
 In line - Green : The valve is not fully closed.
- (5) OVHT
 This appears in amber if the electric pump for that system (blue or yellow) overheats.
- (6) RAT
 RAT ▷ White : The RAT is stowed.
 RAT ▣ Green : The RAT is not stowed.
 RAT ► Amber : Pressure for stowing the RAT has been applied, or the RAT pump is not available.
- (7) ELEC
 This legend, normally white, becomes amber if the associated power supply fails.
- (8) YELLOW ELEC PUMP control
 ◁ White : The electric pump is off.
 ▣ Green : The electric pump is ON.

◀ Amber : The electric pump is ON and the yellow system has low pressure.

(9) PTU control

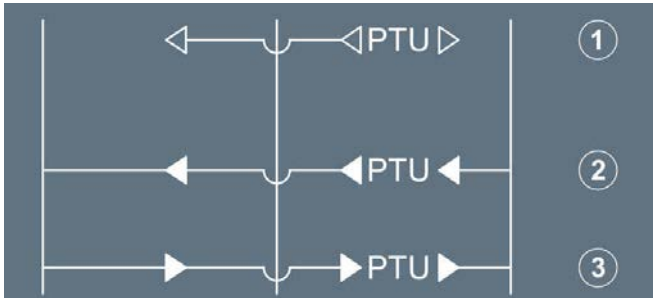

(1)

Green : The power transfer unit (PTU) pushbutton switch is in AUTO and the PTU is not transferring pressure.

Amber : The PTU pb-sw is OFF.

(2)

Green : The PTU is supplying the green hydraulic system.

(3)

Green : The PTU is supplying the yellow hydraulic system.

(10) ENG PUMP control and low pressure indication

In line (Green) : The pushbutton switch for the designated PUMP is on and hydraulic pressure is normal.

Cross line (Amber) : The pushbutton switch for the designated PUMP is OFF.

“LO” (Amber) : The pushbutton switch for the designated PUMP is on and hydraulic pressure is low.

(11) System label

| | pressure > 1 450 PSI | pressure < 1 450 PSI |
|---------------|--------------------------------|--------------------------------|
| YELLOW | white | amber |
| △ | green | amber |

(12) System pressure

This legend, normally green, becomes amber when system pressure is below 1 450 PSI.

(13) PUMP

This legend, normally white, becomes amber when N2 is below idle.

MEMO DISPLAY

Applicable to: ALL

Ident.: DSC-29-20-A-00016787.0001001 / 21 MAR 16

HYD PTU : This memo appears in green, when the power transfer unit is running.

Ident.: DSC-29-20-A-00016786.0001001 / 21 MAR 16

RAT OUT : This memo appears in green, if the Ram Air Turbine is not fully stowed. The color changes to amber during flight phases 1 and 2.



A318/A319/A320/A321
FLIGHT CREW
OPERATING MANUAL

AIRCRAFT SYSTEMS

HYDRAULIC

CONTROLS AND INDICATORS

Intentionally left blank

AIRCRAFT SYSTEMS

ICE AND RAIN PROTECTION

Intentionally left blank

DSC-30-10 General

DSC-30-10-10 Description

| | |
|-------------------|---|
| General..... | A |
| Anti-Ice..... | B |
| Rain Removal..... | C |

DSC-30-20 Wing Anti-Ice

DSC-30-20-10 Description

| | |
|------------------|---|
| Description..... | A |
|------------------|---|

DSC-30-20-20 Controls And Indicators

| | |
|----------------------|---|
| Overhead Panel..... | A |
| ECAM BLEED Page..... | B |
| Memo Display..... | C |

DSC-30-30 Engine Anti-Ice

DSC-30-30-10 Description

| | |
|------------------|---|
| Description..... | A |
|------------------|---|

DSC-30-30-20 Controls and Indicators

| | |
|---------------------|---|
| Overhead Panel..... | A |
| Memo Display..... | B |

DSC-30-40 Window Heat

DSC-30-40-10 Description

| | |
|------------------|---|
| Description..... | A |
|------------------|---|

DSC-30-40-20 Controls and Indicators

| | |
|---------------------|---|
| Overhead Panel..... | A |
|---------------------|---|

DSC-30-50 Probes Heat

DSC-30-50-10 Description

| | |
|------------------|---|
| Description..... | A |
|------------------|---|

DSC-30-50-20 Controls and Indicators

| | |
|---------------------|---|
| Overhead Panel..... | A |
|---------------------|---|

Continued on the following page

Continued from the previous page

DSC-30-60 Rain Removal

DSC-30-60-10 Description

| | |
|--|---|
| Wipers..... | A |
| Rain Repellent  | B |

DSC-30-60-20 Controls and Indicators

| | |
|---|---|
| Overhead Panel..... | A |
| Rain Repellent  System Indicators..... | B |

DSC-30-70 Ice Detection System

DSC-30-70-10 Description

| | |
|---------------------------|---|
| Visual Ice Indicator..... | A |
|---------------------------|---|

GENERAL

Ident.: DSC-30-10-10-00001154.0001001 / 16 MAR 11

Applicable to: ALL

The ice and rain protection system allows unrestricted operation of the aircraft in icing conditions and heavy rain.

ANTI-ICE

Ident.: DSC-30-10-10-00001155.0001001 / 29 MAR 12

Applicable to: ALL

Either hot air or electrical heating protects critical areas of the aircraft as follows:

HOT AIR

- Three outboard leading-edge slats of each wing
- Engine air intakes.

ELECTRICAL HEATING

- Flight compartment windows
- Sensors, pitot probes and static ports
- Waste-water drain mast.

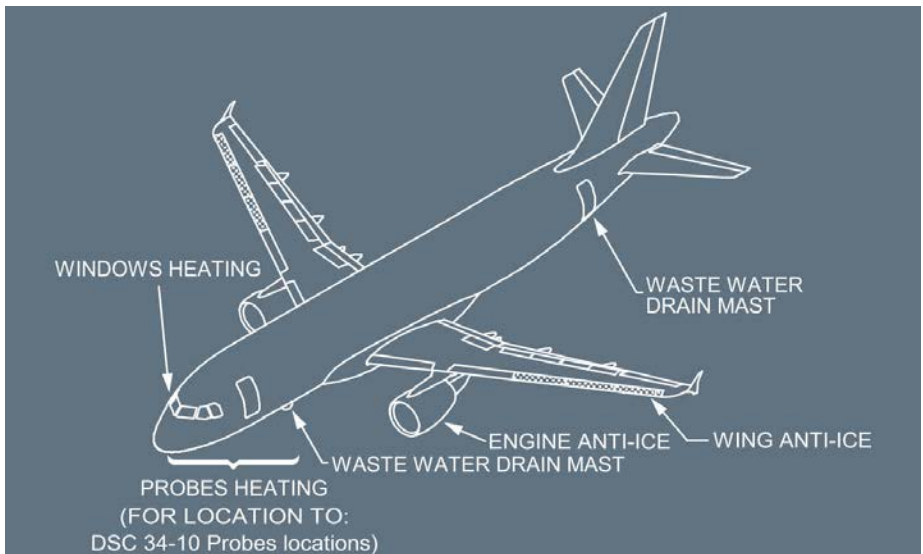

RAIN REMOVAL

Ident.: DSC-30-10-10-00017416.0001001 / 21 MAR 16

Applicable to: **ALL**

Wipers and fluid rain repellent  , remove rain from the front windshield panels.

DESCRIPTION

Ident.: DSC-30-20-10-00017417.0001001 / 21 MAR 16

Applicable to: ALL

In flight, hot air from the pneumatic system heats the three outboard slats (3-4-5) of each wing. Air is supplied through one valve in each wing. The WING pushbutton on the ANTI ICE panel controls the valves. When the aircraft is on ground, the flight crew can initiate a 30 s test sequence by turning the system ON. If the system detects a leak during normal operation, the affected side's wing anti-ice valve automatically closes (*Refer to DSC-36-10-50 Leak Detection*). When wing anti-ice is selected, the N1 or EPR limit is automatically reduced, and the idle N1 or EPR is automatically increased. If the electrical power supply fails, the valves close.

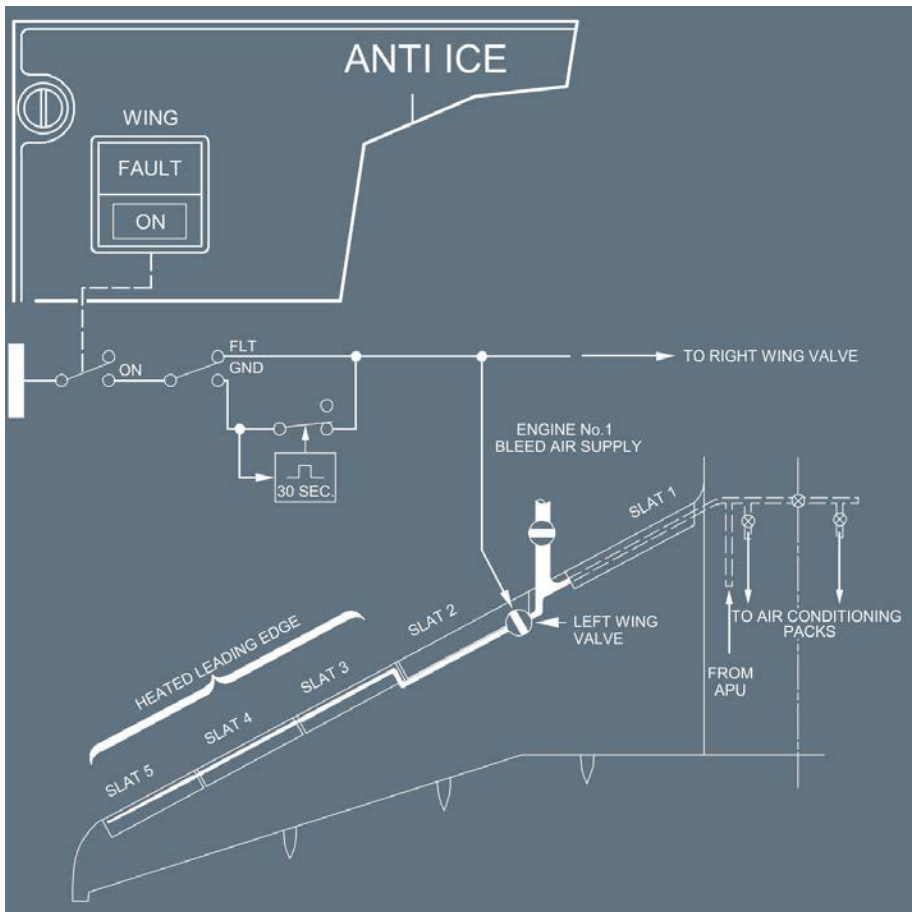

OVERHEAD PANEL

Ident.: DSC-30-20-20-00017418.0001001 / 21 MAR 16

Applicable to: ALL

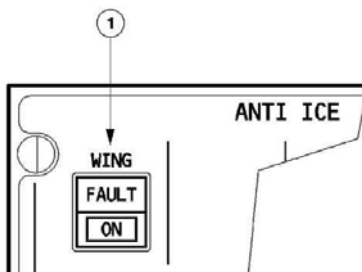

(1) WING ANTI ICE pb sw

This switch controls the wing anti ice system on the left and right sides simultaneously.

Off : ON light goes off.
Wing anti-icing control valves close.

FAULT : Light comes on amber, and caution appears on ECAM, if:
- The position of the anti-icing control valve is not the required position, or
- Low pressure is detected.

Note: The amber FAULT light comes on briefly as the valves transit.

ON : Light comes on blue.
WING A. ICE appears on the ECAM MEMO page.
Wing anti ice control valves open if a pneumatic supply is available.
On the ground the wing anti-icing control valves open for 30 s only (test sequence).

ECAM BLEED PAGE

Ident.: DSC-30-20-20-00001159.0001001 / 21 MAR 16

Applicable to: ALL

Refer to DSC-36-20 ECAM Bleed Page

MEMO DISPLAY

Applicable to: ALL

Ident.: DSC-30-20-20-A-00016939.0001001 / 21 MAR 16

WING A.ICE : This memo appears in green, if the WING ANTI ICE pb-sw is ON.

Intentionally left blank

DESCRIPTION

Ident.: DSC-30-30-10-00017422.0001001 / 21 MAR 16

Applicable to: ALL

An independent air bleed from the high pressure compressor protects each engine nacelle from ice. Air is supplied through a two-position (open and closed) valve that the flight crew controls with two pushbuttons, one for each engine.

The valve automatically closes, if air is unavailable (engine not running).

When an engine anti-ice valve is open, the N1 or EPR limit is automatically reduced and, if necessary, the idle N1 or EPR is automatically increased for both engines in order to provide the required pressure.

If electrical power fails, the valves open.

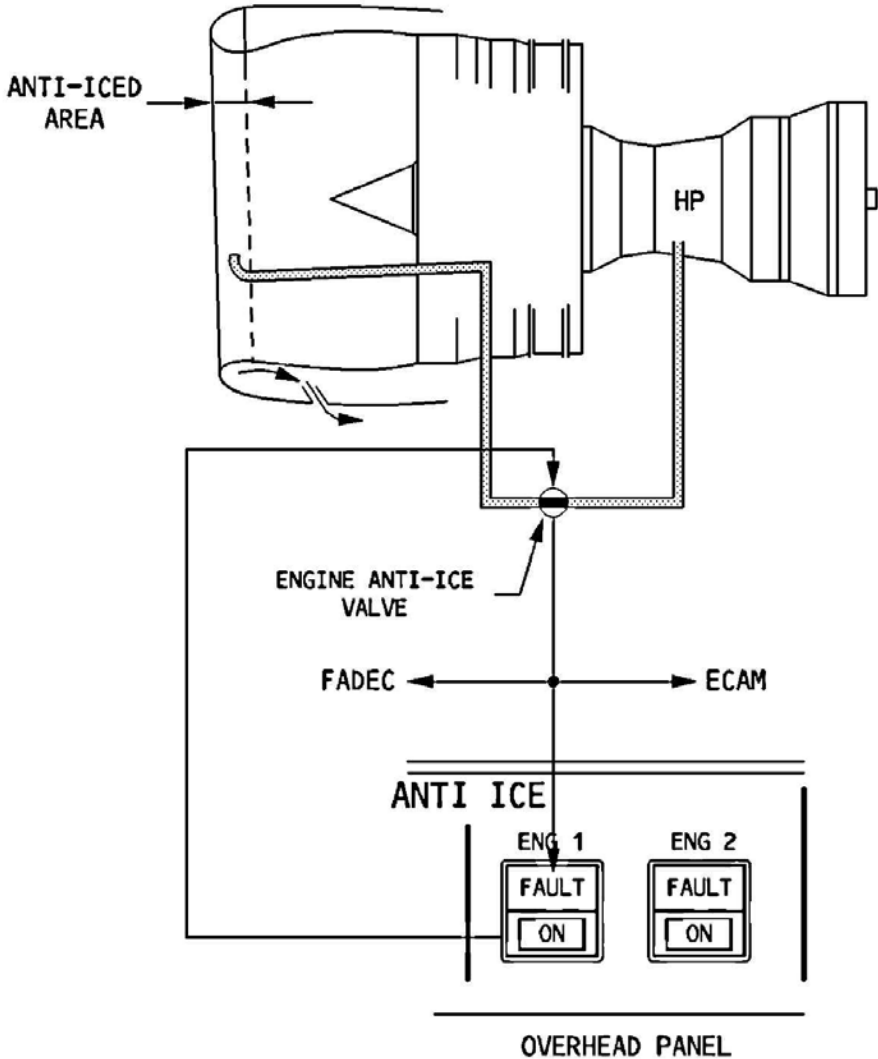

OVERHEAD PANEL

Ident.: DSC-30-30-20-00017425.0003001 / 21 MAR 16

Applicable to: ALL

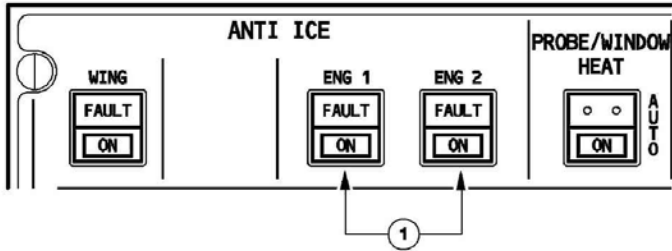

(1) ENG 1 (2) ANTI ICE pb-sw

Off : ON light goes off.
Engine anti-ice valve closes.

FAULT : Light comes on amber, and caution message appears on ECAM, if the position of the anti-ice valve disagrees with the ENG 1 (2) pushbutton selection.

Note: The amber FAULT light comes on briefly as valve transits.

ON : Light comes on blue.
ECAM MEMO displays “ENG A. ICE”.
Engine anti-icing valve opens if bleed air is available from the engine.

MEMO DISPLAY

Applicable to: ALL

Ident.: DSC-30-30-20-A-00016945.0001001 / 21 MAR 16

ENG A.ICE : This memo appears in green, if one or both ENG ANTI ICE pb-sw are ON.

Intentionally left blank

DESCRIPTION

Ident.: DSC-30-40-10-00017458.0001001 / 21 MAR 16

Applicable to: ALL

The aircraft uses electrical heating for anti-icing each windshield and defogging the cockpit side windows.

Two independent Window Heat Computers (WHCs), one on each side, automatically regulate the system, protect it against overheating, and indicate faults.

Window heating comes on:

- automatically when at least one engine is running, or when the aircraft is in flight.
- manually, before engine start, when the flight crew switches ON the PROBE/WINDOW HEAT pushbutton switch.

Windshield heating operates at low power on the ground and at normal power in flight. The takeover is automatic.

Only one heating level exists for the windows.



A318/A319/A320/A321
FLIGHT CREW
OPERATING MANUAL

AIRCRAFT SYSTEMS

ICE AND RAIN PROTECTION

WINDOW HEAT - DESCRIPTION

Intentionally left blank



A318/A319/A320/A321
FLIGHT CREW
OPERATING MANUAL

AIRCRAFT SYSTEMS
ICE AND RAIN PROTECTION

WINDOW HEAT - CONTROLS AND INDICATORS

OVERHEAD PANEL

Ident.: DSC-30-40-20-00001165.0001001 / 21 MAR 16

Applicable to: ALL

Refer to DSC-30-50-20 Overhead Panel

Intentionally left blank

DESCRIPTION

Ident.: DSC-30-50-10-00017459.0001001 / 21 MAR 16

Applicable to: ALL

Electrical heating protects:

- Pitot probes
- Static ports
- Angle-Of-Attack (AOAs) probes
- Total Air Temperature (TAT) probes.

Three independent Probe Heat Computers (PHCs) automatically control and monitor:

- Captain probes
- F/O probes
- STBY probes.

They protect against overheating and indicate faults.

The probes are heated:

- Automatically when at least one engine is running, or when the aircraft is in flight.
- Manually, when the flight crew switches ON the PROBE/WINDOW HEAT pb.

On the ground, the TAT probes are not heated and pitot heating operates at a low level (the changeover to normal power in flight is automatic).



A318/A319/A320/A321
FLIGHT CREW
OPERATING MANUAL

AIRCRAFT SYSTEMS
ICE AND RAIN PROTECTION
PROBES HEAT - DESCRIPTION

Intentionally left blank

OVERHEAD PANEL

Ident.: DSC-30-50-20-00017460.0001001 / 21 MAR 16

Applicable to: ALL

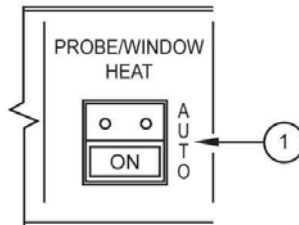

(1) PROBE/WINDOW HEAT pb

AUTO : Probes/Windows are heated automatically :

- In flight, or
- On the ground (except TAT probes) provided one engine is running.

ON : Light comes on blue. Probes and windows are heated permanently.



A318/A319/A320/A321
FLIGHT CREW
OPERATING MANUAL

AIRCRAFT SYSTEMS
ICE AND RAIN PROTECTION

PROBES HEAT - CONTROLS AND INDICATORS

Intentionally left blank

WIPERS

Ident.: DSC-30-60-10-00017461.0001001 / 21 MAR 16

Applicable to: ALL

Each front windshield has an electrical wiper with two speeds, and with an intermittent sweep function  . A rotary selector controls each wiper.

RAIN REPELLENT 

Ident.: DSC-30-60-10-00017462.0001001 / 01 JUN 17

Applicable to: ALL

In moderate to heavy rain, the flight crew can spray a rain repellent liquid on the windshield to improve visibility.

After about 30 s, the windows are covered with spray.

Separate pushbuttons control rain repellent application on each side of the windshield.

AIRCRAFT SYSTEMS
ICE AND RAIN PROTECTION

RAIN REMOVAL - DESCRIPTION

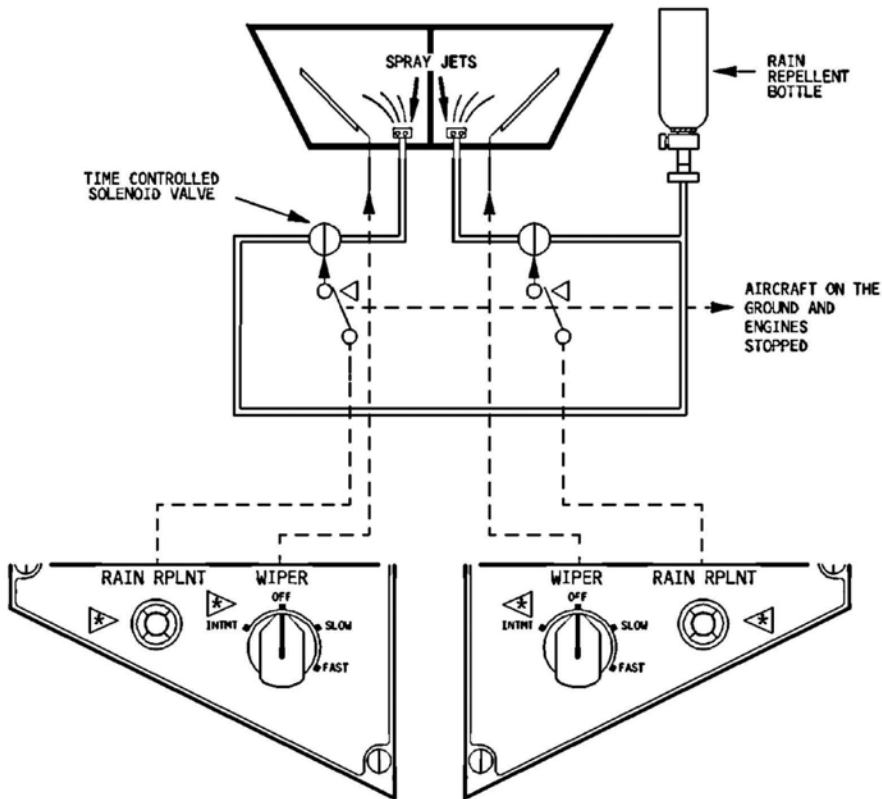

OVERHEAD PANEL

Ident.: DSC-30-60-20-00017466.0001001 / 21 MAR 16

Applicable to: ALL

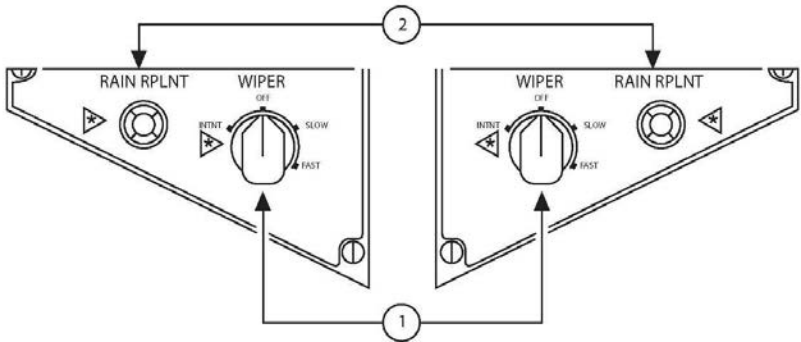

- (1) WIPER rotary selector
Each rotary selector controls its wiper at low speed, high speed, or intermittent sweeping . When turned off, the wiper stops out of view.
- (2) RAIN RPLNT pb-sw
Each of these buttons controls the application of rain repellent fluid to the corresponding side of the front windshield. When the flight crew pushes the button, the timer applies a measured quantity of rain repellent to the windshield. To repeat the cycle, the flight crew must push the button again. This function is inhibited when the aircraft is on the ground and the engines are stopped.

RAIN REPELLENT ◀ SYSTEM INDICATORS

Ident.: DSC-30-60-20-00017587.0001001 / 21 MAR 16

Applicable to: ALL

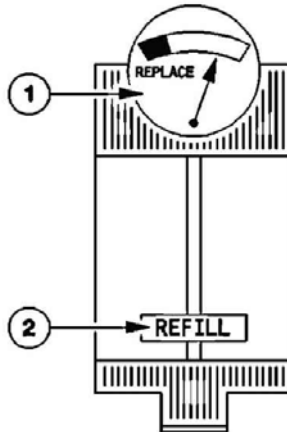

- (1) Rain Repellent pressure indicator
This gauge shows the nitrogen pressure and therefore the remaining fluid in the rain repellent bottle. When the needle is in the yellow sector the bottle should be replaced.
- (2) Rain Repellent low level indicator (depending on aircraft configuration)
When the REFILL float is in view the bottle should be replaced.

VISUAL ICE INDICATOR

Ident.: DSC-30-70-10-00017471.0001001 / 21 MAR 16

Applicable to: ALL

An external visual ice indicator is installed between the two windshields.
There can be also an external ice detector light 

Intentionally left blank

AIRCRAFT SYSTEMS

INDICATING/RECORDING SYSTEMS

Intentionally left blank

DSC-31-05 EIS General

DSC-31-05-10 Introduction

Introduction.....A

DSC-31-05-20 Cockpit Arrangement

Cockpit Arrangement.....A

DSC-31-05-30 Architecture

Display Unit (DU).....A
 Display Management Computer (DMC).....B
 System Data Acquisition Concentrator (SDAC).....C
 Flight Warning Computer (FWC).....D
 Attention - Getters.....E
 Loudspeaker.....F
 EIS Block Diagram.....G

DSC-31-05-40 Controls and Switching

ECAM Control Panel (ECP).....A
 EIS DMC Switching Selector.....B
 ECAM/ND Switching.....C
 EFIS Switching.....D

DSC-31-05-50 Reconfiguring the DMC

Reconfiguring the Display Management Computer (DMC).....A

DSC-31-05-60 Reconfiguring DUs

Failure of Upper ECAM DU (or CTL/Brightness Knob Turned to Off).....A
 Failure of Lower ECAM DU (or CTL/Brightness Knob Turned to Off).....B
 Failure of both ECAM DUs.....C
 PFDU/NDU Reconfiguration.....D
 DU Reconfiguration.....E
 General.....F
 Failure of a DU.....G
 Feedback Messages.....H
 Side1/Side2 Discrepancy Messages.....I
 DU Reset.....J

Continued on the following page

Continued from the previous page

DSC-31-10 ECAM Description

| | |
|-------------------------------------|---|
| ECAM DU Arrangement..... | A |
| Color Code..... | B |
| Warning/Caution Classification..... | C |
| Priority Rules..... | D |
| Types of Failures..... | E |
| Audio Indicators..... | F |

DSC-31-15 Indications on E/WD

| | |
|------------------------------------|---|
| General..... | A |
| Independent Failure..... | B |
| Primary and Secondary Failure..... | C |
| Flight Phases..... | D |
| Memos..... | E |
| Configuration Warnings..... | F |

DSC-31-20 Indications on SD

| | |
|-----------------------------------|---|
| General..... | A |
| System Pages..... | B |
| Status Page..... | C |
| Permanent Data..... | D |
| Amber Crosses "XX" on the SD..... | E |
| Amber dashes on the SD..... | F |

DSC-31-25 ECAM Sequence

DSC-31-25-10 General

| | |
|--------------|---|
| General..... | A |
|--------------|---|

DSC-31-25-20 Example

| | |
|--|---|
| 1 - The Ecam Detects No Failure..... | A |
| 2 - The ECAM Detects a Failure..... | B |
| 3 - The Flight Crew Follows the Instruction Displayed on the E/WD..... | C |
| 4 - One of the Pilots Pushes the CLR Pushbutton on the ECP..... | D |
| 5 - One of the Pilots Pushes the CLR Pushbutton a Second Time..... | E |
| 6 - One of the Pilots Pushes the CLR Pushbutton a Third Time..... | F |

DSC-31-27 OEB Reminder

| | |
|-------------------|---|
| General..... | A |
| Description..... | B |
| OEB Database..... | C |

Continued on the following page

Continued from the previous page

DSC-31-30 ECAM Controls

| | |
|-------------------------|---|
| ECAM Control Panel..... | A |
| Switching Panel..... | B |
| Attention Getters..... | C |
| Memo Display..... | D |

DSC-31-40 Indications on PFD

| | |
|--|---|
| General..... | A |
| Specific Ground Indications..... | B |
| Attitude Data..... | C |
| Airspeed..... | D |
| Altitude..... | E |
| Altitude (CONT'D)..... | F |
| Vertical Speed..... | G |
| Heading..... | H |
| Flight Path Vector..... | I |
| Guidance..... | J |
| Trajectory Deviation..... | K |
| Flight Mode Annunciator..... | L |
| Tailstrike Pitch Limit Indicator  | M |
| Altitude Alert..... | N |
| Flags and Messages Displayed on PFD..... | O |

DSC-31-45 Indications on ND

| | |
|--|---|
| General..... | A |
| ROSE Modes..... | B |
| ROSE LS Mode..... | C |
| Rose VOR Mode..... | D |
| ROSE NAV Mode/ARC Mode..... | E |
| Plan Mode..... | F |
| Weather Radar indications..... | G |
| PWS  indications..... | H |
| EGPWS..... | I |
| Flags and Messages Displayed on ND..... | J |

DSC-31-50 EFIS Controls

| | |
|--------------------------|---|
| EFIS Control Panel..... | A |
| Other EFIS Controls..... | B |
| Chronometer..... | C |

Continued on the following page

Continued from the previous page

DSC-31-55 Clock

DSC-31-55-10 General

General..... A

DSC-31-55-20 Controls and Indicators

General..... A

Operation in Internal Mode..... B

DSC-31-60 FLT Recorders

DSC-31-60-10 Flight Data Recording System

Description..... A

DSC-31-60-20 Controls and Indicators

Overhead Panel..... A

Pedestal..... B

DSC-31-60-30 Aircraft Integrated Data System

Description..... A

Controls On Pedestal..... B

INTRODUCTION

Ident.: DSC-31-05-10-00001182.0001001 / 21 MAR 16

Applicable to: ALL

The Electronic Instrument System (EIS) presents data on six identical Display Units (DUs):

- The Electronic Flight Instrument System (EFIS) displays mostly flight parameters and navigation data on the Primary Flight Displays (PFD s) and Navigation Displays (NDs).
- The Electronic Centralized Aircraft Monitor (ECAM) presents data on the Engine/Warning Display (E/WD) and System Display (SD) :
 - Primary engine indications, fuel quantity, flap and slat position
 - Warning and caution alerts, or memos
 - Synoptic diagrams of aircraft systems, and status messages
 - Permanent flight data



A318/A319/A320/A321
FLIGHT CREW
OPERATING MANUAL

AIRCRAFT SYSTEMS
INDICATING/RECORDING SYSTEMS

EIS GENERAL - INTRODUCTION

Intentionally left blank

COCKPIT ARRANGEMENT

Ident.: DSC-31-05-20-00001183.0001001 / 09 OCT 12

Applicable to: ALL

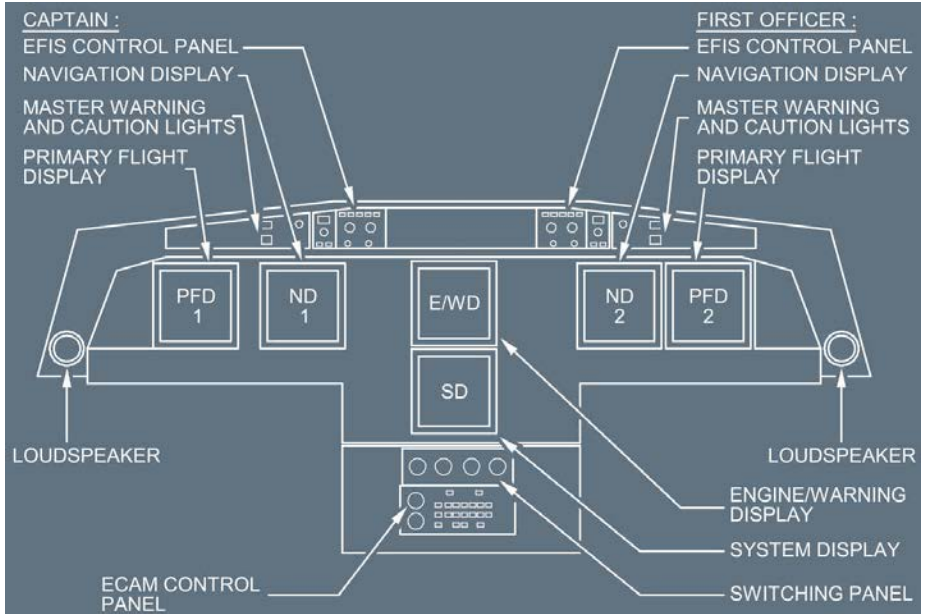



A318/A319/A320/A321
FLIGHT CREW
OPERATING MANUAL

AIRCRAFT SYSTEMS

INDICATING/RECORDING SYSTEMS

EIS GENERAL - COCKPIT ARRANGEMENT

Intentionally left blank

DISPLAY UNIT (DU)

Ident.: DSC-31-05-30-00001184.0002001 / 21 MAR 16

Applicable to: ALL

The instrument panels have six identical units.
These DUs are full-color Liquid Crystal Displays (LCD).

DISPLAY MANAGEMENT COMPUTER (DMC)

Ident.: DSC-31-05-30-00001185.0002001 / 20 DEC 10

Applicable to: ALL

Three identical Display Management Computers (DMC s) obtain data from the different sensors and computers, and send it to the display units. The display units then generate and display the applicable images. Each DMC has a single DMC channel, and can simultaneously supply one PFD , one ND and both ECAM display units (E/WD and SD).

SYSTEM DATA ACQUISITION CONCENTRATOR (SDAC)

Ident.: DSC-31-05-30-00001186.0001001 / 21 MAR 16

Applicable to: ALL

The two identical SDAC s acquire data, then generate signals. Some of these signals go to the three DMC s, which use them to generate displays of system pages and engines parameters. Others go to the flight warning computers, which use them to generate ECAM messages and aural alerts.

FLIGHT WARNING COMPUTER (FWC)

Ident.: DSC-31-05-30-00001187.0001001 / 13 JAN 14

Applicable to: ALL

The two identical FWCs generate alert messages, memos, aural alerts, and synthetic voice messages. For this purpose they acquire data:

- Directly from aircraft sensors, or systems, to generate red warnings
- Through the SDACs to generate amber cautions.

The ECAM display units display the alert messages generated by the FWCs.

The FWCs also generate:

- Radio height callouts
- Decision height callouts
- Landing distance and landing speed increments.

ATTENTION - GETTERS

Ident.: DSC-31-05-30-00001188.0001001 / 21 MAR 16

Applicable to: **ALL**

The FWCs also drive the attention-getters. Each pilot has a set of these on the panel under the glareshield. They are :

- A master warning light, that flashes "MASTER WARN" in red, for red warnings.
- A master caution light, that illuminates "MASTER CAUT" in amber, for amber cautions.

LOUDSPEAKER

Ident.: DSC-31-05-30-00001189.0001001 / 21 MAR 16

Applicable to: **ALL**

The communications loudspeakers announce aural alerts and voice messages, and do so even when they are turned off.

EIS BLOCK DIAGRAM

Ident.: DSC-31-05-30-00001190.0002001 / 06 JUL 17

Applicable to: ALL

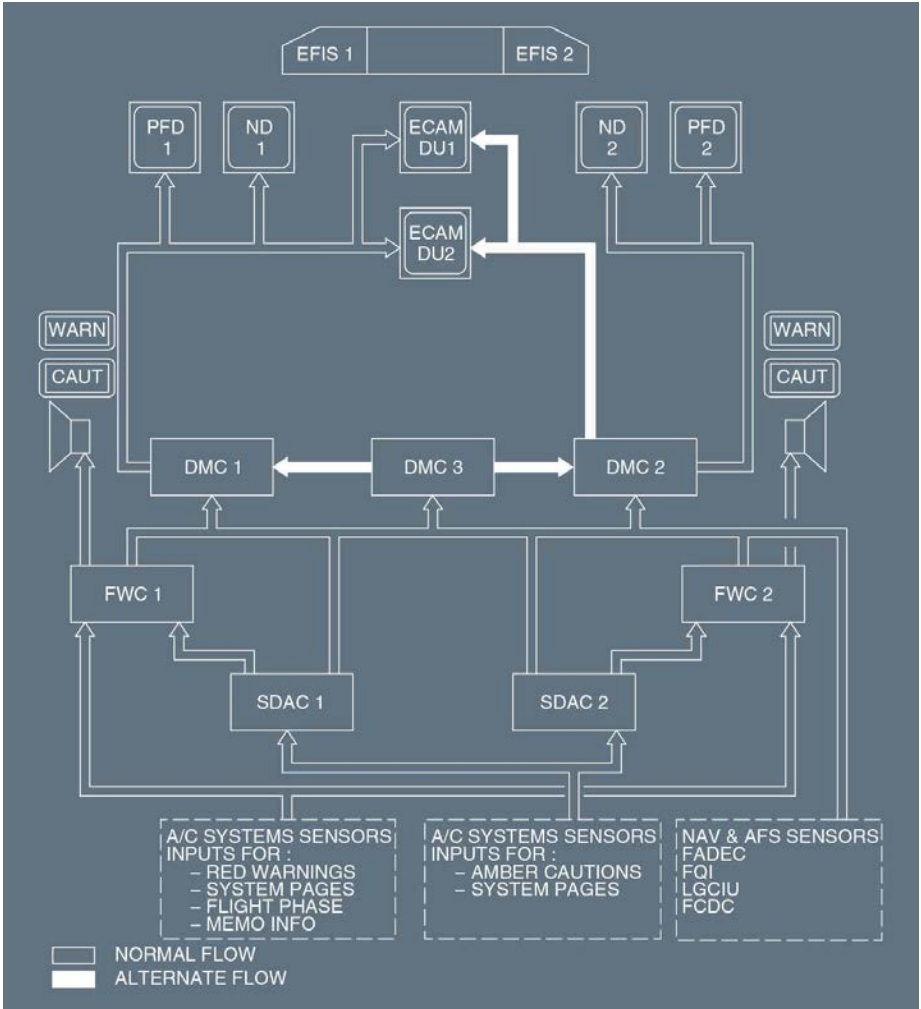



A318/A319/A320/A321
FLIGHT CREW
OPERATING MANUAL

AIRCRAFT SYSTEMS
INDICATING/RECORDING SYSTEMS

EIS GENERAL - ARCHITECTURE

Intentionally left blank

ECAM CONTROL PANEL (ECP)

Ident.: DSC-31-05-40-00001191.0001001 / 21 MAR 16

Applicable to: ALL

The ECAM Control Panel, located on the pedestal, includes :

- Such E/WD controls, as CLR , STS, and the brightness control knob.
- Such SD controls, as ENG, BLEED, PRESS..., system page selector, and the brightness control knob.

EIS DMC SWITCHING SELECTOR

Ident.: DSC-31-05-40-00001192.0001001 / 22 MAR 16

Applicable to: ALL

A switch near the center of the SWITCHING panel which is located just above the ECAM control panel, enables the flight crew to replace the Captain or First Officer's Display Management Computer (DMC 1, or DMC 2) by DMC 3.

ECAM/ND SWITCHING

Ident.: DSC-31-05-40-00001193.0001001 / 21 MAR 16

Applicable to: ALL

A switch on the right-hand side of the SWITCHING panel enables the flight crew to transfer the ECAM System Display to either the Captain or First Officer's Navigation Display.

EFIS SWITCHING

Ident.: DSC-31-05-40-00001194.0001001 / 21 MAR 16

Applicable to: ALL

A PFD/ND XFR pushbutton on each side console enables the pilot to swap displays to the respective outside DUs.



A318/A319/A320/A321
FLIGHT CREW
OPERATING MANUAL

AIRCRAFT SYSTEMS

INDICATING/RECORDING SYSTEMS

EIS GENERAL - CONTROLS AND SWITCHING

Intentionally left blank

RECONFIGURING THE DISPLAY MANAGEMENT COMPUTER (DMC)

Ident.: DSC-31-05-50-00001195.0002001 / 21 MAR 16

Applicable to: ALL

In normal operation, each DMC drives the following Display Units :

- DMC 1 drives the CAPT PFD, CAPT ND and the ECAM DUs.
- DMC 2 drives the F/O PFD and F/O ND.
- DMC 3 is on standby, ready to drive any DU.

If DMC 1 or 2 fails (the "INVALID DATA" message is displayed on the DU s), the crew manually selects the DMC 3 source ("CAPT 3" or "F/O 3").

If DMC 1 fails (or DMC 3, if "CAPT 3" was selected), DMC 2 automatically drives the ECAM.

Intentionally left blank

FAILURE OF UPPER ECAM DU (OR CTL/BRIGHTNESS KNOB TURNED TO OFF)

Ident.: DSC-31-05-60-00001196.0001001 / 21 MAR 16

Applicable to: ALL

If the upper ECAM display fails, or is switched off :

- The engine/warning page automatically replaces the system/status page on the lower ECAM DU.

The flight crew can display the system/status page by :

- Using the "ECAM/ND XFR" switch, on the SWITCHING panel, to move it to a Navigation Display Unit (NDU), or
- Pushing and holding (for a maximum of 3 min) the related system page pushbutton, on the ECAM control panel, to temporarily display it on the lower ECAM DU (instead of the engine/warning page).

FAILURE OF LOWER ECAM DU (OR CTL/BRIGHTNESS KNOB TURNED TO OFF)

Ident.: DSC-31-05-60-00001197.0001001 / 21 MAR 16

Applicable to: ALL

If the lower ECAM display fails, or is switched off, the flight crew can display the system/status page by :

- Using the "ECAM/ND XFR" switch, on the SWITCHING panel, to display it on the NDU, or
- Pushing and holding (for a maximum of 3 min) the related system page pushbutton, on the ECAM control panel, to temporarily display it on the upper ECAM DU (instead of the engine/warning page).

FAILURE OF BOTH ECAM DUs

Ident.: DSC-31-05-60-00001198.0001001 / 21 MAR 16

Applicable to: ALL

If both ECAM displays fail, the flight crew may :

- Use the "ECAM/ND XFR", on the SWITCHING panel, to display the engine/warning page on a navigation display and, if needed,
- Push and hold (for a maximum of 3 min) the related system page pushbutton, on the ECAM control panel, to temporarily display the system/status page on an ND.

PFDU/NDU RECONFIGURATION

Ident.: DSC-31-05-60-00001199.0001001 / 21 MAR 16

Applicable to: ALL

If a PFDU fails, the system automatically transfers the PFD image to the NDU.

The pilot can also make this transfer manually by :

- turning the PFD ON-OFF/brightness control OFF, or
- pressing the PFD/ND/XFR pushbutton, which cross-changes the images between the PFDU and the NDU.

If an NDU fails, the pilot can use the PFD/ND/XFR pushbutton to transfer the ND image to the PFDU.

DU RECONFIGURATION

Ident.: DSC-31-05-60-00001200.0001001 / 21 MAR 16

Applicable to: ALL

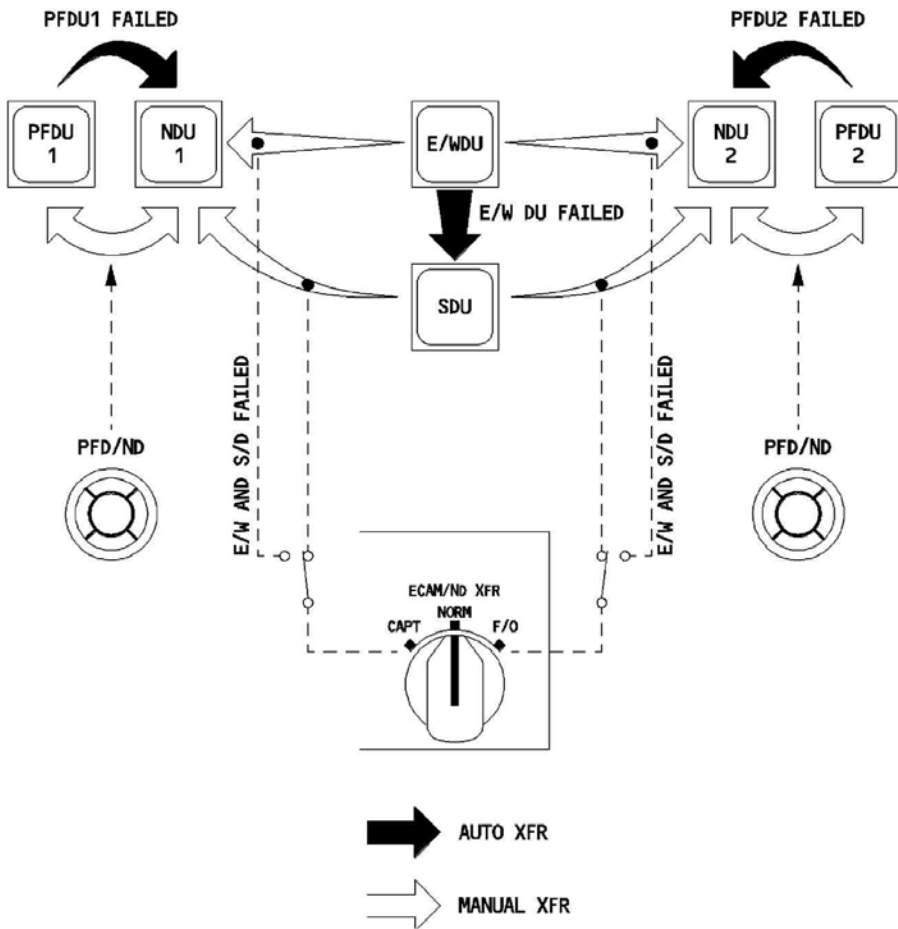

AIRCRAFT SYSTEMS

INDICATING/RECORDING SYSTEMS

EIS GENERAL - RECONFIGURING DUS

GENERAL

Ident.: DSC-31-05-60-00012844.0001001 / 20 DEC 10

Applicable to: **ALL**

These messages are displayed on either the EFIS or the ECAM Display Unit (DU) depending on the current EFIS or ECAM configuration.

FAILURE OF A DU

Ident.: DSC-31-05-60-00012846.0001001 / 20 DEC 10

Applicable to: **ALL**

If a DU fails, the flight crew may find one of the following displays:

- A blank screen with an "F" letter in amber, or
- A distorted display, or
- A blank screen with the "INVALID DISPLAY UNIT" message in amber.

FEEDBACK MESSAGES

Ident.: DSC-31-05-60-00012847.0001001 / 20 DEC 10

Applicable to: **ALL**

The DU displays the following messages in amber when the Display Management Computer (DMC) detects a discrepancy between the parameters obtained by the DMC and the operational parameters displayed on the DU:

- "CHECK CAPT PFD " ("CHECK F/O PFD ") if the discrepancy concerns the PFD parameters
- "CHECK CAPT ND " ("CHECK F/O ND ") if the discrepancy concerns the ND parameters
- "CHECK EWD " if the discrepancy concerns the E/WD parameters
- "CHECK SD " if the discrepancy concerns the SD parameters.

In addition, if the aircraft is on ground, the "DU NOT MONITORED" message is displayed in amber when there is only one DMC , instead of two DMC s, that provides the affected DU with feedback information.

This message means that there is either a DMC test in progress or that there is an EIS failure.

In the case of an EIS failure, a maintenance action is necessary.

SIDE1/SIDE2 DISCREPANCY MESSAGES

Ident.: DSC-31-05-60-00012848.0001001 / 20 DEC 10

Applicable to: ALL

The DU displays the following messages along with a caution on the ECAM E/WD when there is a discrepancy between the parameters displayed on the Captain's EFIS and the First Officer's EFIS:

- Both PFD s display the message "CHECK ATT" if there is a discrepancy of at least 5 ° between the attitude values, pitch and/or roll
- Both PFD s display the message "CHECK ALT " if there is a discrepancy between the altitude values greater than 250 ft when the flight crew selects a QNH different from STD , or 500 ft when the flight crew selects a QNH STD
- Both PFD s and ND s display the message "CHECK HDG" if there is a discrepancy of at least 5 ° between the heading values.

Note: The message "CHECK HDG " flashes for a few seconds on the ND s, and then it remains steady. If the flight crew selects the PLAN mode on the ND s the message "CHECK HDG" does not appear.

DU RESET

Ident.: DSC-31-05-60-00012849.0001001 / 20 DEC 10

Applicable to: ALL

In the case of a DU reset, the message "SELF TEST IN PROGRESS" can be displayed in green and/or the message "WAITING FOR DATA" may be displayed in green during the EIS initialization.

Intentionally left blank

ECAM DU ARRANGEMENT

Ident.: DSC-31-10-00017519.0001001 / 21 MAR 16

Applicable to: ALL

The ECAM has two display units:

- One for the engine/warning display (E/WD).
- One for the system/status display (SD).

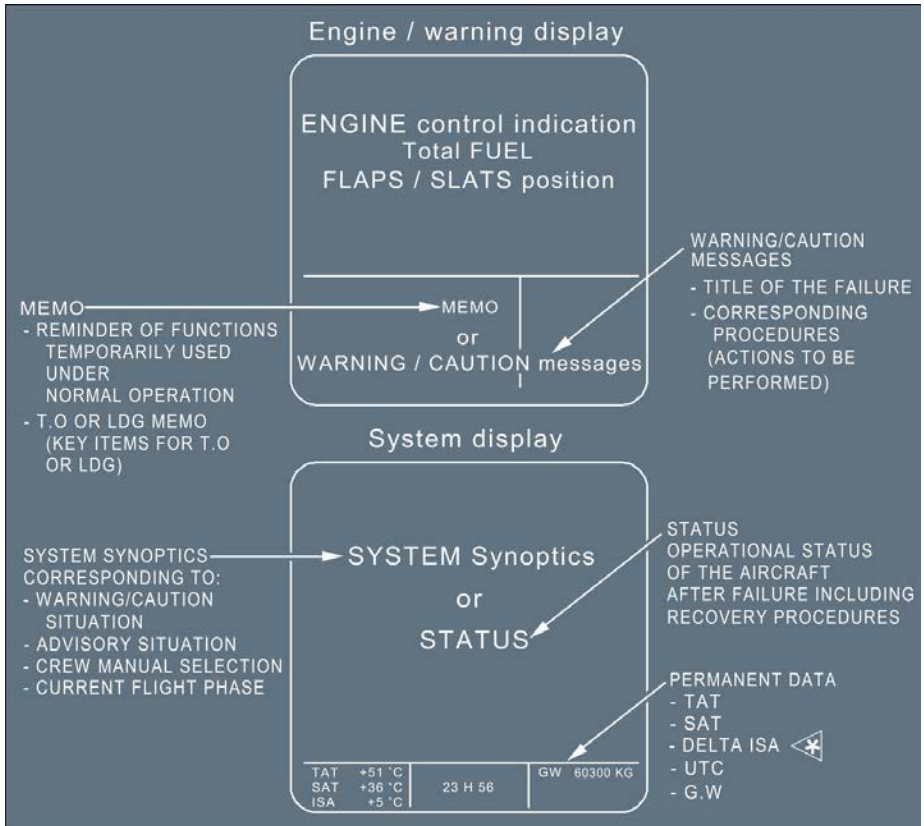

COLOR CODE

Ident.: DSC-31-10-00001202.0001001 / 21 MAR 16

Applicable to: **ALL**

The ECAM display uses a color code that indicates the importance of the failure or the indication.

- RED : The configuration or failure requires immediate action.
- AMBER : The flight crew should be aware of the configuration or failure, but need not take immediate action.
- GREEN : The item is operating normally.
- WHITE : These titles and remarks guide the flight crew, as they execute various procedures.
- BLUE : These are actions to be carried out, or limitations.
- MAGENTA : These are particular messages that apply to particular pieces of equipment or situations (inhibition messages, for example).

WARNING/CAUTION CLASSIFICATION

Ident.: DSC-31-10-00001203.0001001 / 21 MAR 16

Applicable to: ALL

| | LEVEL | SIGNIFICATION | AURAL | VISUAL |
|---------------------|----------|---|--|---|
| FAILURE MODE | Level 3 | Red warning : The configuration, or failure requires immediate action : - Aircraft in dangerous configuration, or limit flight conditions (eg: stall, o/speed) - System failure altering flight safety (eg : Eng fire, excess cab alt) | Continuous Repetitive Chime (CRC) or specific sound or synthetic voice | - MASTER WARN light red flashing or specific red light - Warning message (red) on E/WD - Automatic call of the relevant system page on the S/D ⁽¹⁾ . |
| | Level 2 | Amber caution : The flight crew should be aware of the configuration or failure, but does not need to take any immediate action. However, time and situation permitting, these cautions should be considered without delay to prevent any further degradation of the affected system : - System failure without any direct consequence on the flight safety (eg: HYD G SYS LO PR) | Single Chime (SC) | - MASTER CAUT light amber steady - Caution message (amber) on E/WD - Automatic call of the relevant system page on the S/D ⁽¹⁾ . |
| | Level 1 | Amber caution : Requires crew monitoring : - Failures leading to a loss of redundancy or system degradation (eg : FCDC fault) | NONE | - Caution message (amber) on E/WD generally without procedure. |
| INFORMATION | ADVISORY | System parameters monitoring | NONE | - Automatic call of the relevant system page on the S/D. The affected parameter pulses green. |
| | MEMO | Information : Recalls normal or automatic selection of functions which are temporarily used | NONE | - Green, Amber, or Magenta message on E/WD |

⁽¹⁾ except in some cases

PRIORITY RULES

Ident.: DSC-31-10-00001204.0001001 / 17 MAR 17

Applicable to: **ALL**

There are three priority levels for warnings and cautions :

- A level 3 warning has priority over a level 2 caution which has priority over a level 1 caution.

The FWC observes these priorities.

INFORMATION PROVIDED WHEN NEEDED

One of the main advantages of the ECAM is that it displays applicable information to the flight crew, on an "as needed" basis. The following outlines the ECAM's operating modes:

- **Normal Mode:**
Automatically displays systems and memos, in accordance with the flight phase.
- **Failure Mode:**
Automatically displays the appropriate emergency/abnormal procedures, in addition to their associated system synoptic.
- **Advisory Mode:**
Automatically displays the appropriate system synoptic, associated with a drifting parameter.
- **Manual Mode:**
Enables the flight crew to manually select any system synoptic via the ECAM Control Panel (ECP).

Most warnings and cautions are inhibited during critical phases of flight (T/O INHIBIT – LDG INHIBIT), because most system failures will not affect the aircraft's ability to continue a takeoff or landing.

TYPES OF FAILURES

Ident.: DSC-31-10-00001205.0001001 / 21 MAR 16

Applicable to: **ALL**

- Independent : a failure that affects an isolated system or item of equipment without degrading the performance of others in the aircraft.
- Primary : a failure of a system or an item of equipment that costs the aircraft the use of other systems or items of equipment.
- Secondary : the loss of a system or an item of equipment resulting from a primary failure.

| | |
|---|--|
|  A318/A319/A320/A321 FLIGHT CREW OPERATING MANUAL | AIRCRAFT SYSTEMS INDICATING/RECORDING SYSTEMS ECAM DESCRIPTION |
|---|--|

| |
|-------------------------|
| AUDIO INDICATORS |
|-------------------------|

Applicable to: ALL

| AUDIO INDICATORS | MEANING | DURATION | AUDIO INDICATOR CANCELLATION ^(a) |
|------------------|---------|----------|---|
|------------------|---------|----------|---|

Ident.: DSC-31-10-A-00015446.0001001 / 22 JUL 16

| | | | |
|-----------------------------|--------------|-----------|----------------------|
| CONTINUOUS REPETITIVE CHIME | RED WARNINGS | PERMANENT | Press MASTER WARN It |
|-----------------------------|--------------|-----------|----------------------|

Ident.: DSC-31-10-A-00015447.0001001 / 22 JUL 16

| | | | |
|--------------|---------------|-------|--|
| SINGLE CHIME | AMBER CAUTION | 0.5 s | |
|--------------|---------------|-------|--|

Ident.: DSC-31-10-A-00015448.0001001 / 04 FEB 14

| | | | |
|----------------|-----------------------------------|-----------|--------------------------------------|
| CAVALRY CHARGE | A/P DISCONNECTION BY TAKE OVER pb | 1.5 s | Second push on TAKE OVER pb |
| | A/P DISCONNECTION DUE TO FAILURE | PERMANENT | Press MASTER WARN It or TAKE OVER pb |

Ident.: DSC-31-10-A-00015449.0006001 / 22 JUL 16

| | | | |
|--------------|--|------------------|--|
| TRIPLE CLICK | Landing capability downgrade or some cases of mode reversion | 0.5 s (3 pulses) | |
|--------------|--|------------------|--|

Ident.: DSC-31-10-A-00015450.0001001 / 04 FEB 14

| | | | |
|--|-------|-----------|-----|
| CRICKET + "STALL" message (synthetic voice) | STALL | PERMANENT | NIL |
|--|-------|-----------|-----|

Ident.: DSC-31-10-A-00015451.0001001 / 23 JUN 15

| | | | |
|--------|-----------------|-------------------------------|----------------------|
| BUZZER | CABIN CALL | 3 s | NIL |
| | EMER CABIN CALL | 3 s REPEATED 3 TIMES | NIL |
| | MECH CALL | As long as outside pb pressed | Press MASTER CAUT pb |

Ident.: DSC-31-10-A-00015452.0001001 / 23 JUN 15

| | | | |
|-------------------|-------------|-----------|--|
| CONTINUOUS BUZZER | SELCAL CALL | PERMANENT | Press RESET key on ACP or press MASTER CAUT pb |
|-------------------|-------------|-----------|--|

Continued on the following page

Continued from the previous page

| AUDIO INDICATORS | MEANING | DURATION | AUDIO INDICATOR CANCELLATION ^(a) |
|------------------|---------|----------|---|
|------------------|---------|----------|---|

Ident.: DSC-31-10-A-00015453.0002001 / 06 APR 17

| | | | |
|---|---|------------------|-----|
| "WINDSHEAR" (synthetic voice) | WINDSHEAR | REPEATED 3 TIMES | NIL |
| "GO AROUND WINDSHEAR AHEAD" (synthetic voice) | Windshear ahead detected during the landing phase | PERMANENT | NIL |
| "WINDSHEAR AHEAD" (twice) (synthetic voice) | Windshear ahead detected during the takeoff phase | PERMANENT | NIL |
| "MONITOR RADAR DISPLAY" (synthetic voice) | Windshear ahead detected caution message | PERMANENT | NIL |

Ident.: DSC-31-10-A-00015454.0001001 / 04 FEB 14

| | | | |
|---------|--|--------------------------|---|
| C CHORD | ALTITUDE ALERT (Refer to DSC-31-40 <i>Altitude Alert</i>) | 1.5 s or PERMANENT | new ALTITUDE selection or press MASTER WARN pb |
|---------|--|--------------------------|---|

Ident.: DSC-31-10-A-00015455.0001001 / 21 MAR 16

| | | | |
|---------------------------------|---|-----------|-----|
| AUTO CALL OUT (synthetic voice) | HEIGHT ANNOUNCEMENT BELOW 2 500 ft (Refer to DSC-34-NAV-40-10 <i>Automatic Callout</i>) | PERMANENT | NIL |
|---------------------------------|---|-----------|-----|

Ident.: DSC-31-10-A-00015456.0001001 / 21 MAR 17

| | | | |
|--|---|-----------|-----|
| GROUND PROXIMITY WARNING (synthetic voice) | (Refer to DSC-34-SURV-40-10 <i>Overview</i>) | PERMANENT | NIL |
|--|---|-----------|-----|

Ident.: DSC-31-10-A-00015457.0001001 / 04 FEB 14

| | | | |
|--|------------------|-----|-----|
| "PRIORITY LEFT" "PRIORITY RIGHT" (synthetic voice) | A/P TAKE OVER pb | 1 s | NIL |
|--|------------------|-----|-----|

Ident.: DSC-31-10-A-00015458.0001001 / 04 FEB 14

| | | | |
|----------------------------|---|---|--|
| "RETARD" (synthetic voice) | Thrust levers not in IDLE or REVERSE position for landing | ONE TIME at 20 ft (10 ft in autoland with A/THR ON), Then PERMANENT | All Thrust levers are set to IDLE or REVERSE |
|----------------------------|---|---|--|

Continued on the following page

| | |
|---|--|
|  A318/A319/A320/A321 FLIGHT CREW OPERATING MANUAL | AIRCRAFT SYSTEMS INDICATING/RECORDING SYSTEMS ECAM DESCRIPTION |
|---|--|

Continued from the previous page

| AUDIO INDICATORS | MEANING | DURATION | AUDIO INDICATOR CANCELLATION ^(a) |
|------------------|---------|----------|---|
|------------------|---------|----------|---|

Ident.: DSC-31-10-A-00015459.0001001 / 04 FEB 14

| | | | |
|--------------------------------------|--|------------------------|--|
| "RETARD-RETARD" (synthetic voice) | At least one Thrust Lever above IDLE after touchdown | Above 40 kt, PERMANENT | All Thrust levers are set to IDLE or REVERSE |
|--------------------------------------|--|------------------------|--|

Ident.: DSC-31-10-A-00015460.0001001 / 04 FEB 14

| | | | |
|---------------------------|--|-----------|-----|
| TCAS (synthetic voice) | <i>(Refer to DSC-34-SURV-60-20 Aural Messages)</i> | PERMANENT | NIL |
|---------------------------|--|-----------|-----|

Ident.: DSC-31-10-A-00015461.0001001 / 04 FEB 14

| | | | |
|--|---|-------------------------------------|-----------------|
| "SPEED, SPEED, SPEED" (Synthetic voice) | Current thrust is not sufficient to recover a positive flight through pitch control | Every 5 s until thrust is increased | THRUST LEVER(s) |
|--|---|-------------------------------------|-----------------|

Ident.: DSC-31-10-A-00015463.0001001 / 04 FEB 14

| | | | |
|-----------------------------------|--|-----------|---------------------------|
| "DUAL INPUT" (synthetic voice) | Both sidesticks are moved simultaneously | Every 5 s | One sidestick deactivated |
|-----------------------------------|--|-----------|---------------------------|

Ident.: DSC-31-10-A-00015465.0001001 / 04 FEB 14

| | | | |
|-------------------------------------|---|----------|-----|
| "PITCH, PITCH" (synthetic voice) | The aircraft pitch attitude is becoming excessive during flare and landing. | one time | NIL |
|-------------------------------------|---|----------|-----|

Ident.: DSC-31-10-A-00015466.0001001 / 04 FEB 14

| | | | |
|--|---|-------------------------------------|-----|
| "STOP RUDDER INPUT" (synthetic voice) | Inappropriate rudder pedal inputs detected in cruise at high speed. | Message repeated at least TWO TIMES | NIL |
|--|---|-------------------------------------|-----|

- ^(a) *The pilot can cancel any audio indicator, by pressing:*
- *The EMER CANC pb on the ECAM control panel, or*
 - *The MASTER WARN pushbutton, except for OVERSPEED or L/G NOT DOWN warnings.*



A318/A319/A320/A321
FLIGHT CREW
OPERATING MANUAL

AIRCRAFT SYSTEMS
INDICATING/RECORDING SYSTEMS

ECAM DESCRIPTION

Intentionally left blank

GENERAL

Ident.: DSC-31-15-00001207.0003001 / 21 MAR 17

Applicable to: ALL

The Engine Warning Display (E/WD) appears on the ECAM 's upper Display Unit (DU).

- The upper part of this DU displays:
 - Engine parameters (*Refer to DSC-70-90-40 Engine Warning Display*)
 - Feedback messages (*Refer to DSC-31-05-60 Feedback Messages*)
 - Fuel On Board (FOB) (*Refer to DSC-28-20 ECAM Upper Display*)
 - Slats/Flaps' position (*Refer to DSC-27-20-30 ECAM F/CTL Page*)
- The lower part of this DU displays messages generated by the FWC:
 - Warning and caution messages, when a failure occurs
 - Memos when there is no failure.

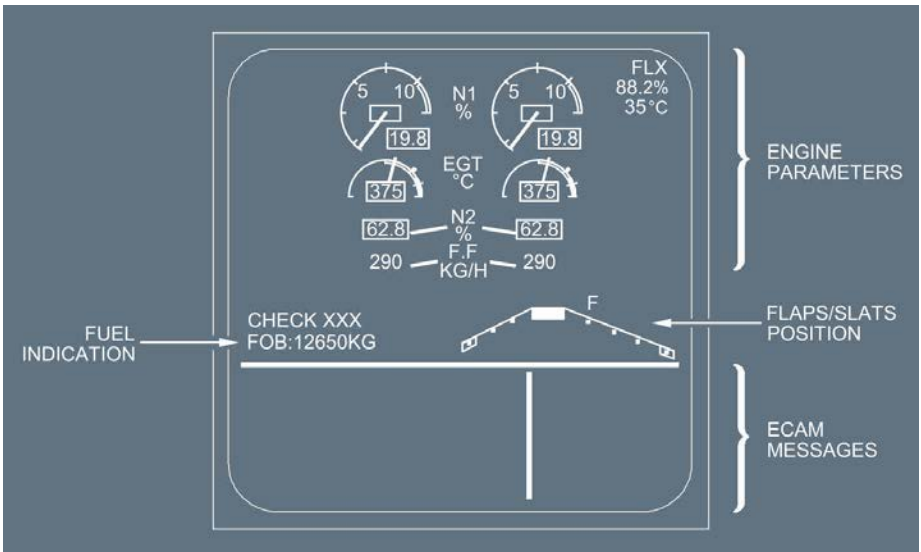

The lower part of the DU , dedicated to ECAM messages, is divided into two sections that have several lines each.

- Bottom left : - Primary or independent warnings and cautions, or
 - Memo information.
- Bottom right : - Title of the system affected by a primary or independent warning or caution, in the case of overflow on the bottom left part, or
 - Secondary failure, or
 - Memo, or
 - Special lines (such as “AP OFF”, “LAND ASAP”).

As soon as the FWC detects a failure, and if there is no flight phase inhibition active, the E/WD displays the title of the failure and actions that the flight crew must perform.

The action line automatically clears, when the flight crew has performed the necessary action.

Note: Some action lines do not disappear from the E/WD even after the flight crew performs the necessary action.

INDEPENDENT FAILURE

Ident.: DSC-31-15-00001208.0001001 / 03 FEB 11

Applicable to: ALL

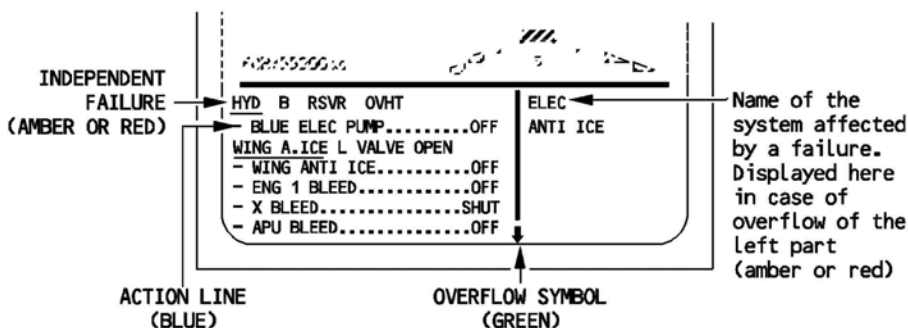

If there are too many ECAM messages for the amount of space available in the lower part of the E/WD, a green arrow appears at the bottom of the display, pointing down to show that the information has overflowed off the screen. The pilot can scroll down to view additional messages by pushing the CLR pushbutton on the ECAM control panel (on the pedestal, just below the lower ECAM DU).

PRIMARY AND SECONDARY FAILURE

Ident.: DSC-31-15-00001209.0001001 / 03 FEB 11

Applicable to: ALL

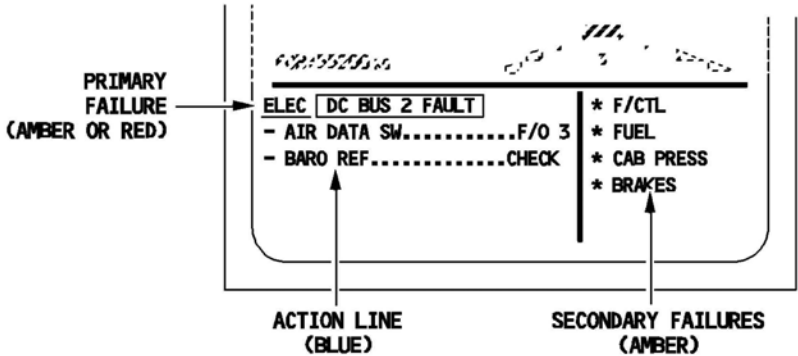

The ECAM DU displays a primary failure as a boxed title. It identifies a secondary failure by putting a star in front of the title of the affected system.

Note: The DU displays the overflow symbol, if primary or secondary failures overflow. In case of ELEC EMER CONFIG, the secondary failures are inhibited.

FLIGHT PHASES

Ident.: DSC-31-15-00001210.0001001 / 21 MAR 16

Applicable to: ALL

GENERAL

The FWC divides its functions according to these ten flight phases :

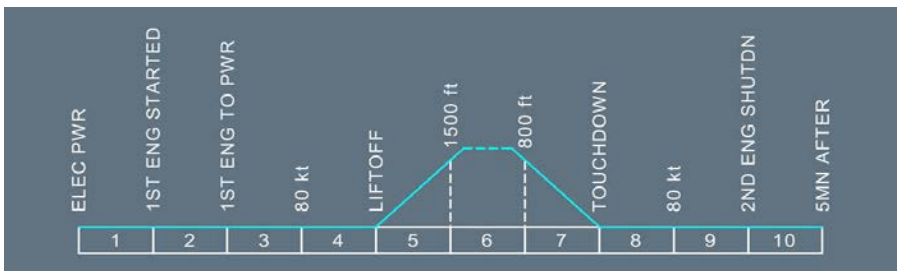

To improve its operational efficacy, the computer inhibits some warnings and cautions for certain flight phases. It does so to avoid alerting the pilots unnecessarily at times when they have high

workloads, such as during takeoff or landing. In these two phases, the DU displays magenta memos : “T.O. INHIBIT” (flight phases 3, 4, and 5), and “LDG INHIBIT” (flight phases 7 and 8).

Note: These flight phases are different from and independent of the ones that the FMGC uses.

FLIGHT PHASE INHIBITION

Two cases are possible (for instance) :

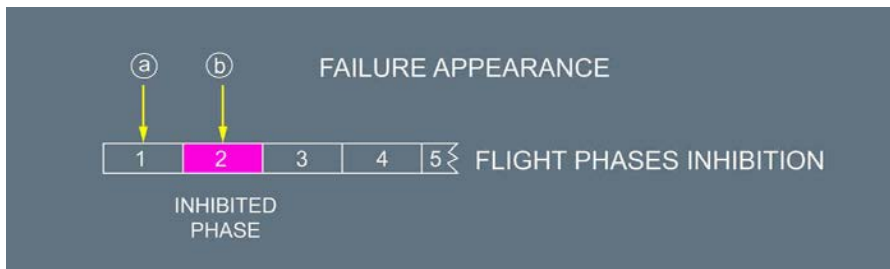

Effect on E/WD :

- (a) The failure occurs during phase 1. The E/WD displays the warning immediately and continues to display it as long as the failure is present, even in phase 2.
- (b) The failure occurs during phase 2. The E/WD displays the warning only when the aircraft has entered phase 3, where it is not inhibited. Then the warning remains displayed as long as the failure is present.

MEMOS

Applicable to: ALL

Ident.: DSC-31-15-A-00001211.0001001 / 21 MAR 16

DISPLAY

Memos appear in the lower part of the E/WD. They are normally in green, but may be amber in abnormal situations.

Memos list functions or systems that are temporarily used in normal operations.

Ident.: DSC-31-15-A-00001212.0002001 / 22 APR 16

TO AND LDG MEMOS

During the takeoff and landing phases, the right side of the memo area displays specific TO INHIBIT or LDG INHIBIT (magenta) memos.

Takeoff and landing memos are displayed, as follows, during the related flight phases:

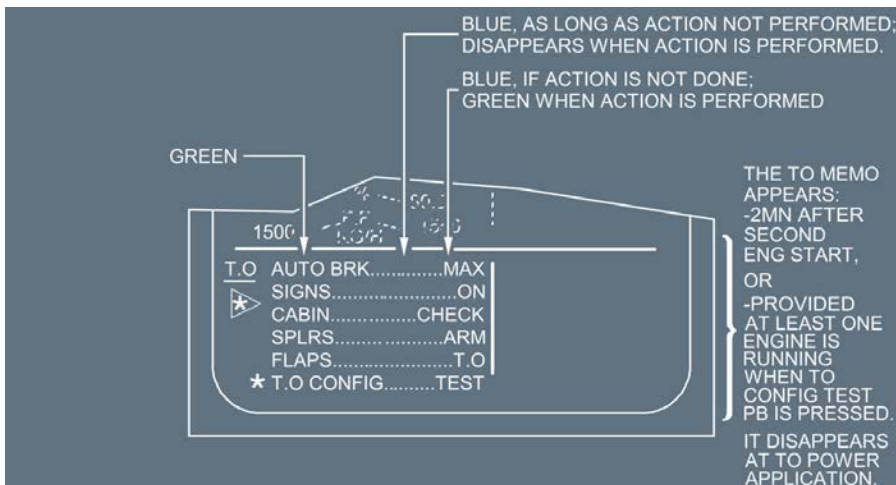

- (*) This line disappears when the test is completed. It is replaced by “TO CONFIG NORMAL”, if aircraft configuration is correct.
 The test is requested again, if the configuration becomes abnormal.

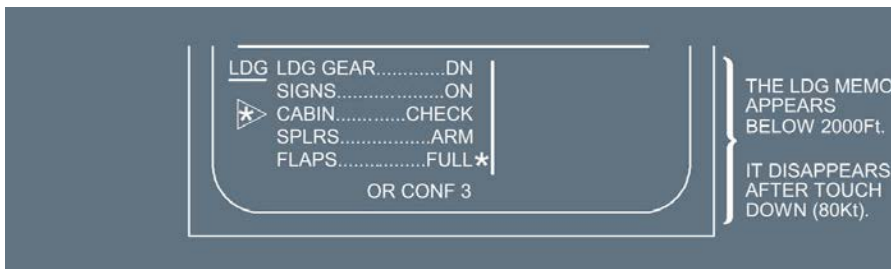

- (*) “CONF 3” is displayed in alternate or direct law, or if the GPWS LDG FLAP 3 pushbutton is ON.

Note: After a go-around, if the aircraft does not climb above 2 200 ft RA, the landing memo appears only below 800 ft RA during the subsequent approach.

CONFIGURATION WARNINGS

Ident.: DSC-31-15-00001214.0015001 / 16 MAR 11

Applicable to: ALL

The following warnings and cautions appear in the lower part of the E/WD if the aircraft is not in takeoff configuration when the flight crew presses the TO CONFIG pushbutton on the ECAM control panel or applies takeoff power.

| WARNINGS/CAUTIONS | TO CONFIG TEST | TO POWER |
|---------------------------------------|-------------------------------------|---------------|
| CONFIG RUD TRIM NOT IN TO RANGE (R) | TRIGGERED | TRIGGERED |
| CONFIG PITCH TRIM NOT IN TO RANGE (R) | | |
| CONFIG FLAPS NOT IN TO CONFIG (R) | | |
| CONFIG SPD BRK NOT RETRACTED (R) | | |
| CONFIG SLATS NOT IN TO CONFIG (R) | | |
| CONFIG L SIDESTICK FAULT (R) | | |
| CONFIG R SIDESTICK FAULT (R) | | |
| DOOR (A) | | |
| FWS OEB /FWC DISCREPANCY (A) | | |
| BRAKES HOT (A) | | |
| FUEL R(L) TK PUMP 1+2 LO PR (A) | TRIGGERED if the two GENs are inop. | NOT TRIGGERED |
| HYD G(Y) ENG 1(2) PUMP LO PR (A) | | |
| HYD G(Y)(B) SYS LO PR (A) | | |
| ELEC IDG 1(2) DISCONNECTED (A) | NOT TRIGGERED | TRIGGERED |
| ELEC GEN 1(2) FAULT (A) | | |
| ELEC GEN 1(2) OFF (A) | | |
| CONFIG PARK BRK ON (R) | NOT TRIGGERED | TRIGGERED |
| ENG THR LEVERS NOT SET (A) | | |

(R) Red warning

(A) Amber caution

GENERAL

Ident.: DSC-31-20-00001215.0001001 / 21 MAR 16

Applicable to: ALL

The system/status display (SD) uses the lower ECAM DU to display :

- pages showing synoptic diagrams of the aircraft systems, or
- the status page.

SYSTEM PAGES

Ident.: DSC-31-20-00001216.0002001 / 21 MAR 16

Applicable to: ALL

The lower ECAM DU can display 12 system pages (For description see relevant FCOM chapter):

- ENGINE (secondary engine parameters)
- BLEED (air bleed)
- CAB PRESS (cabin pressurization)
- ELEC (electric power)
- HYD (hydraulic)
- FUEL (fuel)
- APU (auxiliary power unit)
- COND (air conditioning)
- DOOR/OXY (doors/oxygen)
- WHEEL (landing gear, braking, ground spoilers, etc.)
- F/CTL (flight controls)
- CRUISE (cruise)

The pilot may manually call up a system page for display on the lower ECAM DU, or the system may automatically display a page.

- Manual:
 - The pilot can, at any time, use the pushbutton on the ECAM's control panel to call up and display any system page, except the CRUISE page.
 - The corresponding pushbutton on the ECAM control panel lights up.
 - A failure-related or advisory display automatically replaces a page the pilot has manually called up.
- Automatic, related to a failure:
 - The relevant system page automatically appears, as soon as any fault or malfunction triggers a caution or warning message.

- Automatic, advisory:
 - The relevant system page automatically appears, when a parameter drifts out of its normal range.
 - The value (shown in green) pulses, as long as it is outside its limits.
 - The advisory mode is inhibited in some flight phases.

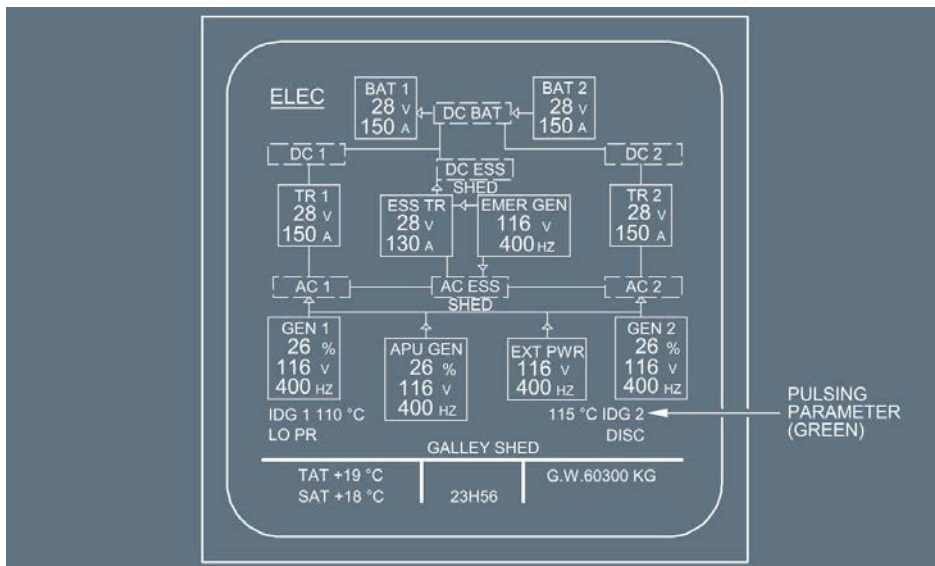

Note: If an advisory is triggered, when the ECAM is in the single-display configuration, an advisory message appears on the upper part of the E/WD, and the associated key on the ECAM control panel flashes to identify the appropriate system page.



- Automatic, flight phase mode
 - If no other mode is engaged, the SD displays the system page related to the present flight phase, as shown in the following diagram.

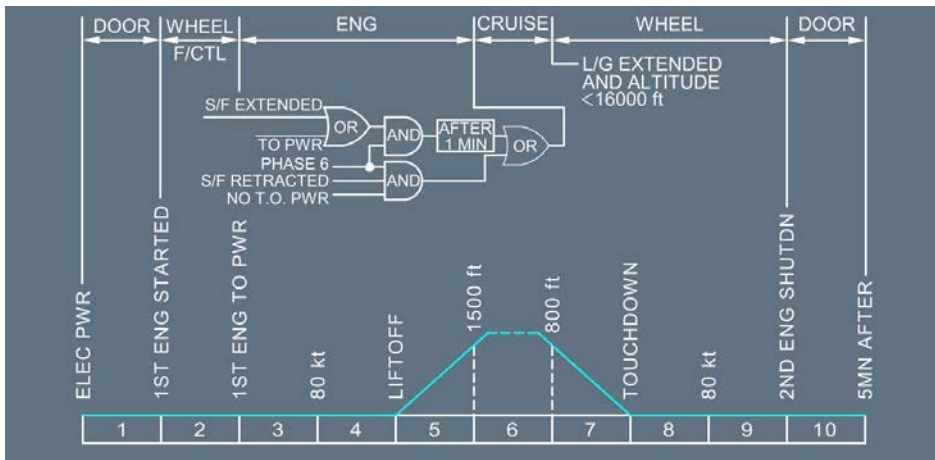

- Phase 2 : The F/CTL page replaces the WHEEL page for 20 s when either pilot moves his sidestick (more than 3 ° in pitch or roll) or when the rudder pedal deflection is more than 22 °.
- The APU page appears when the APU MASTER switch is ON. It disappears when APU RPM has been above 95 % for 10 s, or when the APU MASTER switch is switched OFF.
- The ENGINE page appears at the beginning of start sequence or when a pilot selects “CRANK”. It disappears 10 s after the end of the start sequence, when the ENG MODE sel is set to NORM.

For a description of the ENGINE and AIR indications that appear when the SD is displaying the CRUISE page, see the relevant FCOM chapter.

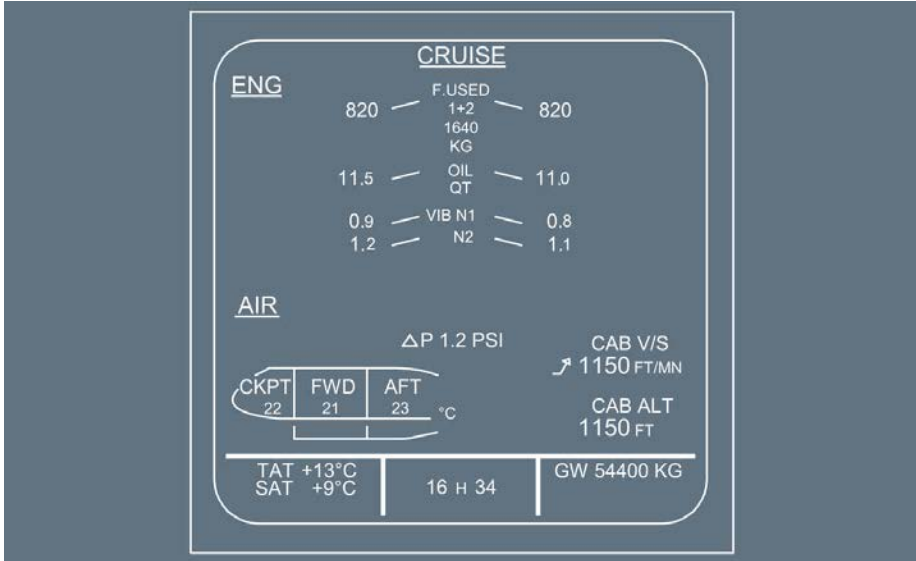

STATUS PAGE

Ident.: DSC-31-20-00001217.0001001 / 12 APR 16

Applicable to: ALL

PURPOSE

The STATUS page provides an operational summary of the state of the aircraft. As illustrated in the following image, this operational summary includes all of the following:

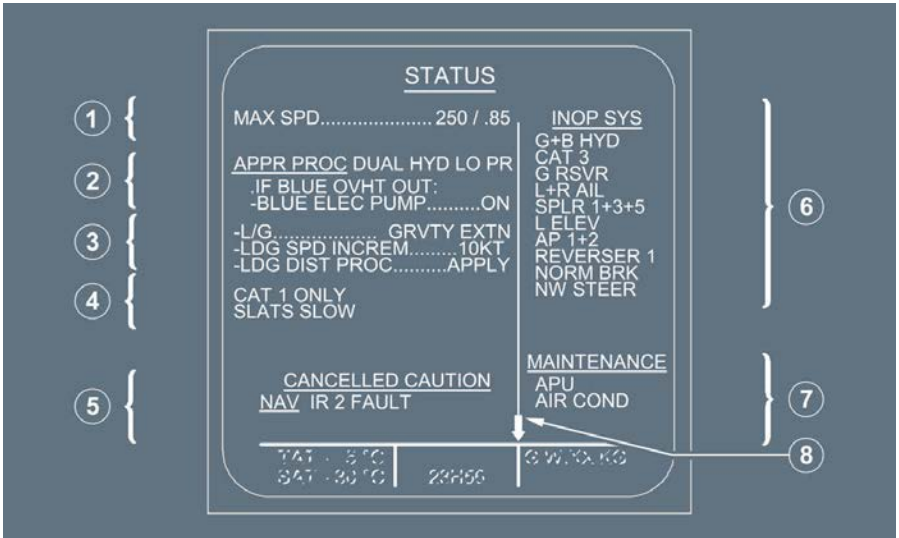

- (1) Limitations (speed, flight level): Blue
- (2) Approach procedures: White (Red) (Amber)
- (3) Procedures (corrections to apply for landing): Blue
- (4) Information: Green
- (5) Cancelled caution: White
- (6) Inoperative system: Amber
- (7) Maintenance status: White
- (8) The arrow appears if the data on the STATUS page overflows the left or right area of the page.

The flight crew can press the CLR pb, in order to scroll the display to view the overflow.

Note: The titles of the different parts of the display appear in white and underlined.

STATUS PAGE DISPLAY

The STATUS page appears when the flight crew presses the STS pb on the ECAM Control Panel (ECP).

The STATUS page automatically appears in abnormal operations if one of the following applies:

- The STATUS page is not empty, and the flight crew clears the last alert on the E/WD, or
- The STATUS page is not empty, and the flight crew selects the CONF1 for approach.

BLANK LINES

Each block that is described above (limitation block (1), approach procedure block (2), etc.) is separated by a blank line.

Therefore, a condition that is included in a limitation block (1) and the associated action line that is included in the procedure block (3) are separated by a blank line.

Example : Illustration with the ECAM alert **ENG 1(2) SHUTDOWN**.

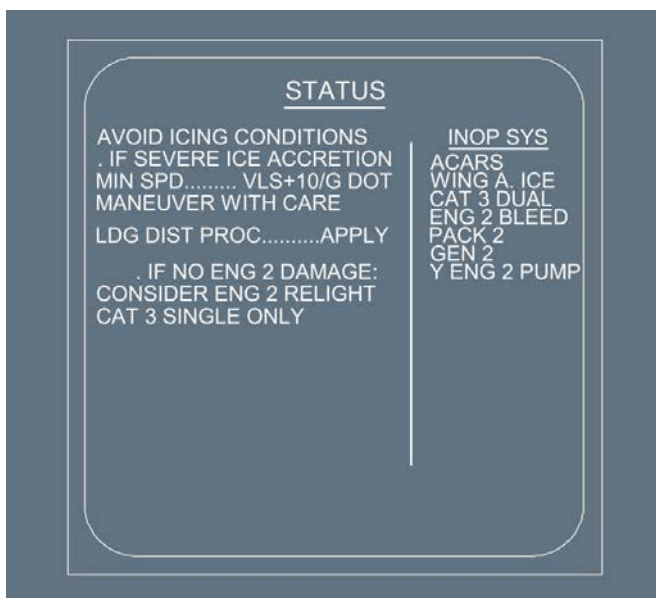

In this example, the action line “LDG DIST PROC ... APPLY” applies only in the case of severe ice accretion.

STS REMINDER

The STS reminder appears on the E/WD if both the following conditions apply:

- The STATUS page is not empty: The STATUS page displays message other than “CANCELLED CAUTION” or MAINTENANCE status.
- There is a MAINTENANCE status at engines shutdown.

The MAINTENANCE status can appear only when the aircraft is on the ground, before engine start or after engine shutdown.

PERMANENT DATA

Ident.: DSC-31-20-00017520.0011001 / 25 JUL 16

Applicable to: ALL

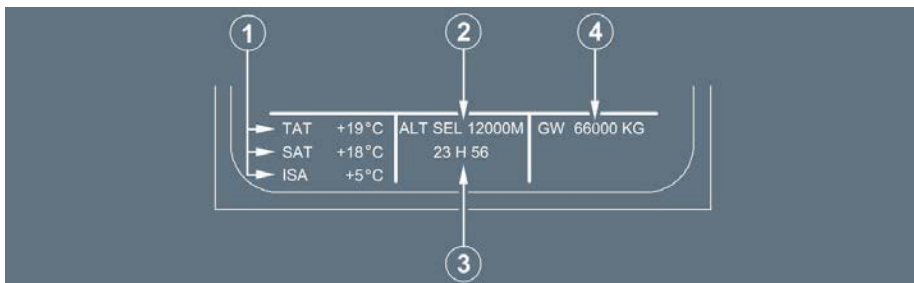

(1) Temperature

The screen displays the Total Air Temperature (TAT) and Static Air Temperature (SAT) in green.

The difference between the SAT and the International Standard Atmosphere temperature (ISA) temperature (Delta ISA Δ) is displayed in green, in standard altitude mode and when the SAT is valid.

(2) G LOAL - ALT SEL

The screen displays one of the following items:

- Load factor (G LOAD) in amber, when the value is above 1.4 g or below 0.7 g for more than 2 s. The G LOAD amber indication remains displayed 5 s after the excessive load occurrence. The display of the load factor is inhibited during flight phases 1, 2, 3, 9 and 10.
- Altitude in green selected via the Flight Control Unit (FCU), if the flight crew selects metric units, and provided the load factor is not displayed.
- “CHECK CAPT (F/O) PFD”, “CHECK CAPT (F/O) ND” or “CHECK SD” all in amber (*Refer to DSC-31-05-20 Cockpit Arrangement*).

Note: The display of the feedback messages takes priority over the load factor indication.

(3) UTC

The screen displays the Universal Time Coordinated (UTC), synchronized with the cockpit clock, in green.

(4) GW

The screen displays the Gross Weight (GW) in green, as soon as the flight crew starts the first engine. The last two digits are dashed, if accuracy is degraded. On ground, blue dashes are displayed instead of the indication, if no computed data is available.

AMBER CROSSES "XX" ON THE SD

Ident.: DSC-31-20-00013602.0001001 / 18 MAR 11

Applicable to: **ALL**

If a parameter value on any SD page is not available for display, amber crosses "XX" appear instead of the value.

AMBER DASHES ON THE SD

Ident.: DSC-31-20-00015526.0001001 / 01 APR 14

Applicable to: **ALL**

If the accuracy of a parameter value on any SD page is degraded, amber dashes are displayed over the last digits.

GENERAL

Ident.: DSC-31-25-10-00001219.0001001 / 22 MAR 16

Applicable to: ALL

If ECAM detects a failure :

- The E/WD displays warning or caution messages.
- The master warning or master caution lights light up (except in the case of a level 1 caution).
- The system sounds an aural signal (except in the case of a level 1 caution).
- The system display (SD) shows the system page for the affected system.
- The CLR pushbutton on the ECAM control panel lights up.

In addition, a local warning light controlled directly by the affected system can light up.

After completing remedial procedures, the flight crew must push the CLR pushbutton repeatedly until the displays return to their normal configurations :

- MEMO messages on the E/WD
- The system page related to the present flight phase on the SD.
- The CLR light on the ECAM control panel turned off.

Intentionally left blank

1 - THE ECAM DETECTS NO FAILURE

Ident.: DSC-31-25-20-00001220.0004001 / 09 OCT 12

Applicable to: ALL

| | |
|--|--|
| <p>ECAM UPPER DISPLAY (E/WD)</p> <ul style="list-style-type: none"> - ENGINE CONTROL PARAMETERS - FUEL QUANTITY INDICATION - FLAPS/SLATS POSITION - MEMO INFORMATION | <p>ECAM UPPER DISPLAY (E/WD)</p> <ul style="list-style-type: none"> - ENGINE CONTROL PARAMETERS - FUEL QUANTITY INDICATION - FLAPS/SLATS POSITION - MEMO INFORMATION |
| <p>ECAM LOWER DISPLAY (SD)</p> <ul style="list-style-type: none"> - FLIGHT PHASE RELATED SYSTEM PAGE (CRUISE PAGE IN THIS EXAMPLE) - PERMANENT DATA | <p>ECAM LOWER DISPLAY (SD)</p> <ul style="list-style-type: none"> - FLIGHT PHASE RELATED SYSTEM PAGE (CRUISE PAGE IN THIS EXAMPLE) - PERMANENT DATA |

2 - THE ECAM DETECTS A FAILURE

Ident.: DSC-31-25-20-00001221.0004001 / 09 OCT 12

Applicable to: ALL

For example, a hydraulic reservoir is overheat.

COCKPIT INDICATIONS

- A single chime sounds
- Both MASTER CAUTION lights come on, and stay on
- A FAULT light, on the overhead HYD panel, comes on
- The memo space on the E/WD displays the “HYD B RSVR OVHT ” message, and the “BLUE ELEC PUMP OFF” instruction
- The lower ECAM display (SD) automatically calls up the hydraulic system's diagram, and displays “OVHT” in amber next to the blue system
- The ECAM 's CLR pushbutton lights up.

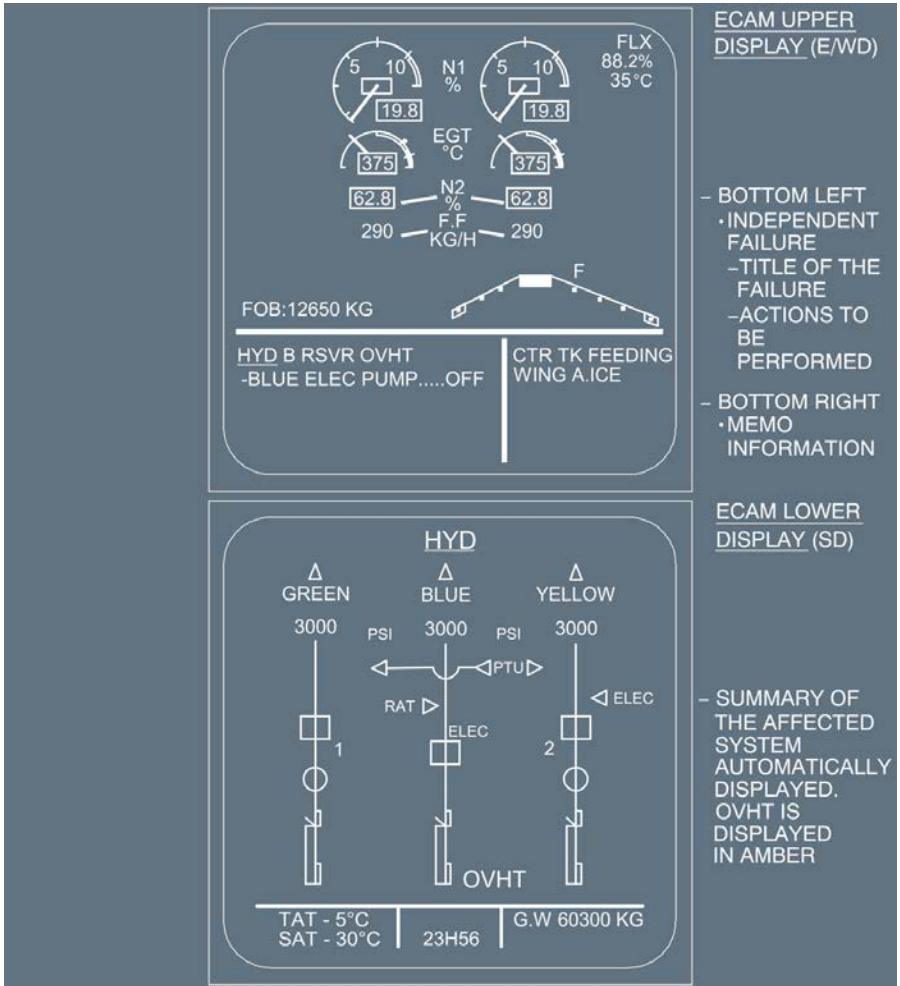

ECAM UPPER DISPLAY (E/W)

- BOTTOM LEFT
- INDEPENDENT FAILURE
- TITLE OF THE FAILURE
- ACTIONS TO BE PERFORMED
- BOTTOM RIGHT
- MEMO INFORMATION

ECAM LOWER DISPLAY (SD)

- SUMMARY OF THE AFFECTED SYSTEM
- AUTOMATICALLY DISPLAYED.
- OVHT IS DISPLAYED IN AMBER

3 - THE FLIGHT CREW FOLLOWS THE INSTRUCTION DISPLAYED ON THE EWD

Ident.: DSC-31-25-20-00001222.0002001 / 09 OCT 12

Applicable to: ALL

The flight crew switches off the BLUE ELEC PUMP pushbutton, depressurizing the blue hydraulic circuit.

COCKPIT INDICATIONS

- A single chime sounds.
- Both MASTER CAUTION lights stay on.
- A FAULT/OFF light, on the overhead panel, comes on.
- The second part of the message on the E/WD changes to “B SYS LO PR”.
- The SD 's system diagram shows an amber zero for the pressure in the blue system, along with the amber “OVHT”.
- The right side of the memo area indicates a secondary failure in the flight control system.
- The ECAM control panel's CLR pushbutton remains on.

AIRCRAFT SYSTEMS
INDICATING/RECORDING SYSTEMS

ECAM SEQUENCE - EXAMPLE

FLX
88.2%
35°C

FOB: 12650 KG

HYD B RSVR OVHT
B SYS LO PR

FLT CTL

ECAM UPPER DISPLAY (E/WD)

- BOTTOM LEFT
- INDEPENDENT FAILURE AND PRIMARY FAILURE
- BOTTOM RIGHT
- SECONDARY FAILURE

HYD

GREEN BLUE YELLOW

3000 PSI 3000 PSI 3000 PSI

RAT ELEC ELEC OVHT

1 2

OVHT

TAT - 5°C 23H56 G.W 60300 KG

SAT - 30°C

ECAM LOWER DISPLAY (SD)

- THE SYNOPTIC OF THE SYSTEM PAGE IS CHANGED ACCORDING TO THE NEW SYSTEM CONFIGURATION OVHT AND THE PRESSURE ARE DISPLAYED IN AMBER

4 - ONE OF THE PILOTS PUSHES THE CLR PUSHBUTTON ON THE ECP

Ident.: DSC-31-25-20-00001223.0003001 / 09 OCT 12

Applicable to: ALL

COCKPIT INDICATIONS

- The CLR pushbutton stays on.
- The FAULT/OFF light stays on.
- Hydraulic system messages disappear from the E/WD, and the right side of the memo area indicates a secondary failure in the flight control system.
- The SD automatically calls up the flight control system page, with surface actuator indications (associated with the blue hydraulic system) shown in amber.

AIRCRAFT SYSTEMS
INDICATING/RECORDING SYSTEMS

ECAM SEQUENCE - EXAMPLE

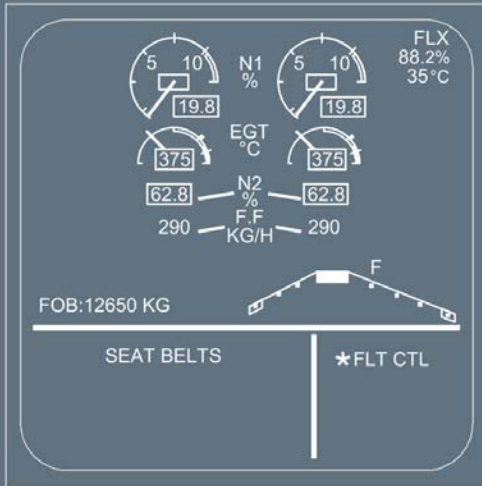

ECAM UPPER
 DISPLAY (E/WD)

- BOTTOM LEFT
 • MEMO INFORMATION
- BOTTOM RIGHT
 • SECONDARY FAILURE

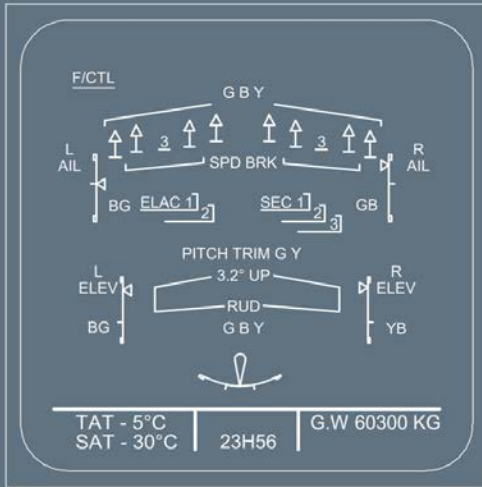

ECAM LOWER
 DISPLAY (SD)

- F/CTL SYSTEM PAGE
 AUTOMATICALLY DISPLAYS
 FAULTY SPOILERS (n°3)
 AND SURFACE ACTUATOR B
 PRESSURE INDICATIONS IN
 AMBER

5 - ONE OF THE PILOTS PUSHES THE CLR PUSHBUTTON A SECOND TIME

Ident.: DSC-31-25-20-00001224.0003001 / 09 OCT 12

Applicable to: ALL

COCKPIT INDICATIONS

- The ECP 's CLR and STS pushbuttons light up.
- The FAULT/OFF lights stay on.
- The E/WD's memo area returns to normal.
- The STATUS page automatically appears on the SD, displaying the procedures for completing the flight with a faulty blue system.

AIRCRAFT SYSTEMS
INDICATING/RECORDING SYSTEMS

ECAM SEQUENCE - EXAMPLE

| | |
|--|--|
| <p>ECAM UPPER DISPLAY (E/WD)</p> <p>FLX 88.2% 35°C</p> <p>N1 % 19.8</p> <p>EGT °C 375</p> <p>N2 % 62.8</p> <p>F.F 290 KG/H</p> <p>FOB: 12650 KG</p> <p>SEAT BELTS</p> <p>CTR TK FEEDG WING A.ICE</p> | <p>- FULL MEMO DISPLAYED</p> |
| <p>STATUS</p> <p>APPR PROC HYD LO PR .IF BLUE OVHT OUT: -BLUE ELEC PUMP..AUTO</p> <p>LDG DIST.....x 1.1</p> <p>SLATS SLOW CAT 3 SINGLE ONLY</p> <p>INOP SYS CAT 3 DUAL BLUE HYD SPLR 3 B ELEC PUMP</p> <p>TAT - 5°C SAT - 30°C</p> <p>23H56</p> <p>G.W 60300 KG</p> | <p>ECAM LOWER DISPLAY (SD)</p> <p>- THE STATUS PAGE IS AUTOMATICALLY DISPLAYED TO:</p> <ul style="list-style-type: none"> · PROVIDE THE PROCEDURE TO BE APPLIED FOR APPROACH. · PROVIDE LANDING DISTANCE FACTORS AND INFORMATION. · LIST THE INOPERATIVE SYSTEMS. |

6 - ONE OF THE PILOTS PUSHES THE CLR PUSHBUTTON A THIRD TIME

Ident.: DSC-31-25-20-00001225.0003001 / 09 OCT 12

Applicable to: ALL

COCKPIT INDICATIONS

- The CLR pushbutton light goes off.
- The FAULT/OFF lights stay on.
- A status reminder appears at the bottom of the E/WD.
- The SD automatically displays the system page corresponding to the flight phase.

AIRCRAFT SYSTEMS
INDICATING/RECORDING SYSTEMS

ECAM SEQUENCE - EXAMPLE

The upper display shows engine parameters: N1 at 19.8%, EGT at 375°C, N2 at 62.8%, and Fuel Flow (F.F) at 290 KG/H. It also displays fuel flow (FLX) at 88.2% and cabin temperature at 35°C. Cabin status includes 'SEAT BELTS', 'CTR TK FEEDG WING A.ICE', and 'STS' (Status Reminder).

ECAM UPPER
 DISPLAY (E/WD)

- FULL MEMO
 DISPLAYED

STATUS
 REMINDER

The lower display is divided into 'ENG' and 'AIR' sections. The 'ENG' section shows fuel used (820 KG), oil quantity (11.5 VIB), and engine vibration (0.9 N1, 1.2 N2). The 'AIR' section shows cabin pressure differential (ΔP 1.2 PSI), cabin altitude (1150 FT), and cabin temperature (TAT +13°C, SAT +9°C). It also shows flight time (23H56) and gross weight (G.W 60300 KG).

ECAM LOWER
 DISPLAY (SD)

- RETURN TO THE
 FLIGHT PHASE
 RELATED
 SYSTEM PAGE :
 CRUISE PAGE

Intentionally left blank

| | |
|---|--|
|  <p>A318/A319/A320/A321 FLIGHT CREW OPERATING MANUAL</p> | <p style="text-align: center;">AIRCRAFT SYSTEMS INDICATING/RECORDING SYSTEMS</p> <p style="text-align: center;">OEB REMINDER</p> |
|---|--|

| |
|----------------|
| GENERAL |
|----------------|

Ident.: DSC-31-27-00001226.0001001 / 21 MAR 16

Applicable to: ALL

The OEB reminder function provides operational help to the crew by enabling them to clearly identify (on the ECAM) all procedures and status messages affected by an OEB.

When a situation leading to a warning/caution occurs, a message informs the crew in real time that an OEB exists for the displayed warning and/or status and, consequently, that the procedure and/or status presented on the ECAM is not applicable.

Then the crew must refer to the QRH where the correct information is provided.

| |
|--------------------|
| DESCRIPTION |
|--------------------|

Ident.: DSC-31-27-00001227.0003001 / 22 MAY 12

Applicable to: ALL

The OEB reminder flag may apply to the:

- ECAM procedure only,
- ECAM procedure and corresponding status messages,
- Status message only.

PROCEDURE ONLY AFFECTED

- The ECAM warning title remains unaltered,
- All corresponding actions are suppressed and replaced by the "REFER TO QRH /OEB PROC" message,
- The related status messages on the ECAM system display remains unaltered.

COCKPIT INDICATION

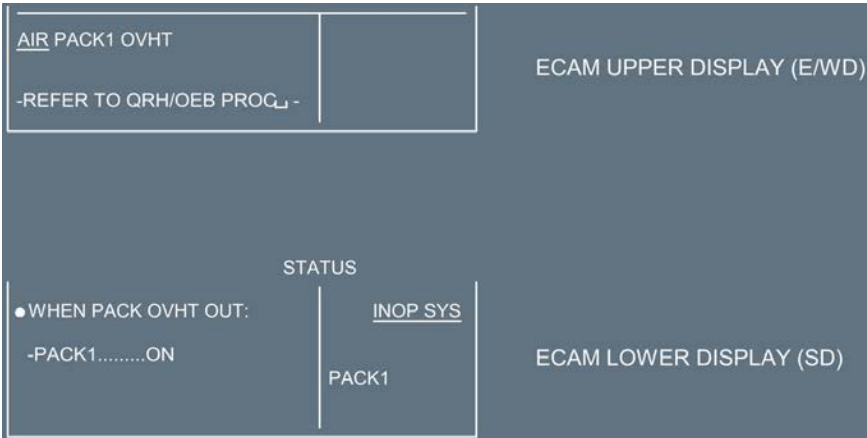

PROCEDURE AND STATUS AFFECTED

- The ECAM warning title remains unaltered,
- All corresponding actions are suppressed and replaced by the “REFER TO QRH /OEB PROC” message,
- The related status messages on the ECAM system display remains unchanged, except for the additional “REFER TO QRH /OEB PROC” title.

COCKPIT INDICATION

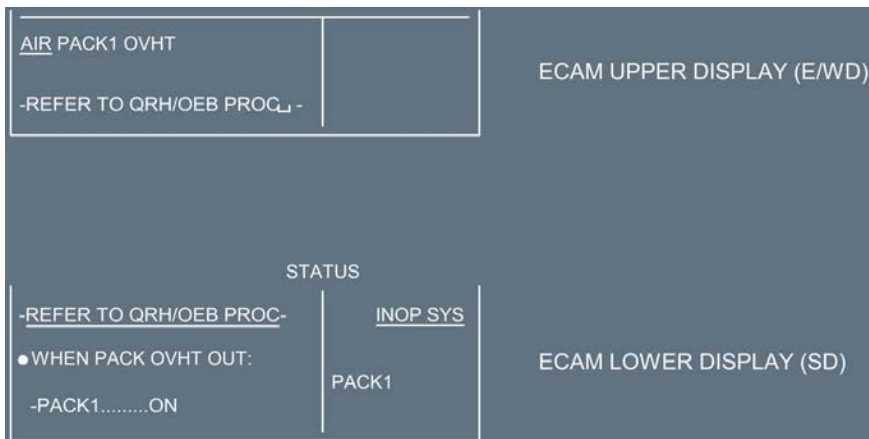

STATUS MESSAGE ONLY AFFECTED

- The ECAM warning title remains unaltered,
- The corresponding procedure remains unchanged, except for the additional "FOR STS REFER TO OEB" line.
- The related status messages on the ECAM system display remains unchanged, except for the additional "REFER TO QRH /OEB PROC" title.

COCKPIT INDICATION

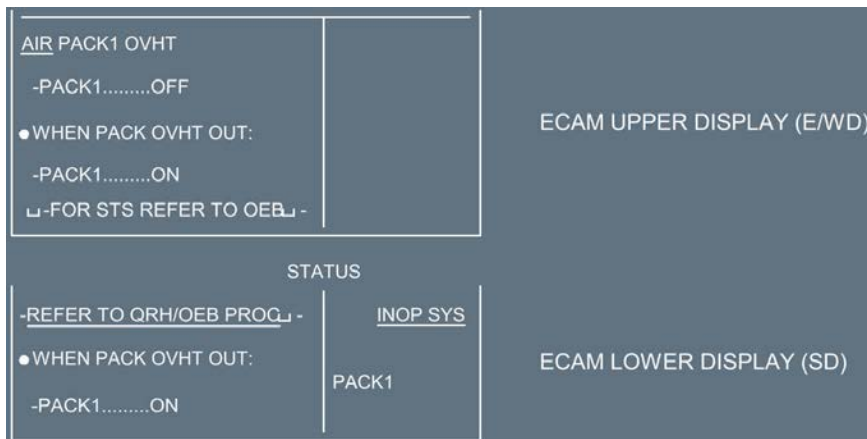

OEB DATABASE

Ident.: DSC-31-27-00001228.0001001 / 21 MAR 16

Applicable to: ALL

The OEB database lists the warnings and cautions affected by an OEB.

The OEB database can be :

- Loaded manually on the aircraft via the MCDU , and stored in both FWCs.
- Crossloaded from one FWC to the other FWC.
- Updated by entering a code via the MCDU.
- Checked via the MCDU.

Note: The code provided on the OEB is designed to ensure that the OEB database is not updated before the OEB is available.

ECAM CONTROL PANEL

Ident.: DSC-31-30-00001229.0002001 / 26 JUL 17

Applicable to: ALL

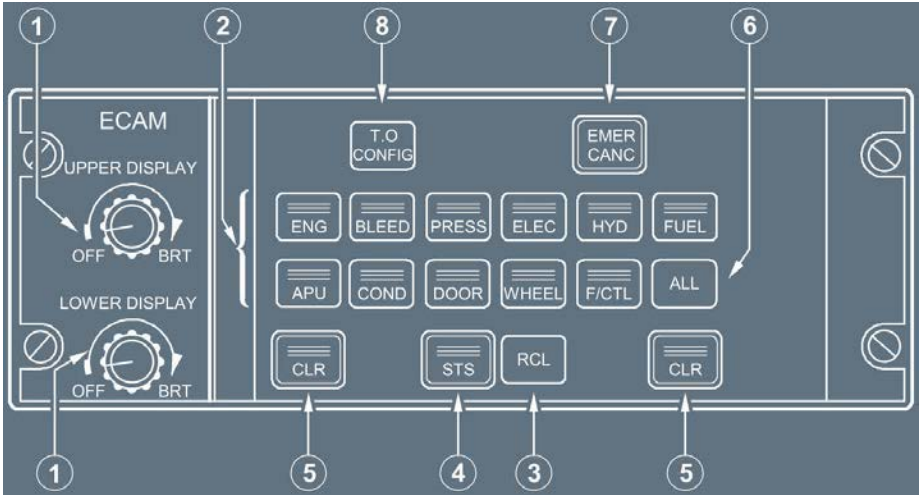

(1) OFF / BRT knobs

Used to turn the ECAM DUs on and off, and to control their brightness (automatic adjustment of brightness for ambient light conditions is superimposed on this manual control).

Note: When the pilot turns the UPPER DISPLAY knob to OFF, the engine/warning (E/W) display appears on the lower display unit (automatic transfer).

(2) System page pushbuttons

- Call up the corresponding system pages on the SD
- Light up, when pushed for manual selection, or when an advisory is detected
- Call up the aircraft system page corresponding to the present flight phase or the current warning when pushed a second time.

When only one ECAM display is on, the pilot can display a system page for up to 3 min by pushing and holding the system page pushbutton.

- If an advisory condition arises, the relevant system page is not automatically displayed, but the pushbutton light pulses
- If an ECAM warning is triggered, the relevant system page is not automatically displayed, and the system page pushbutton does not light up.

(3) RCL pb

- When pressed, the E/WD displays all alerts previously cleared via the CLR pb that are still active.
- When pressed for more than 3 s, the E/WD displays:
 - All alerts previously cleared via the CLR pb that are still active
 - All alerts previously cancelled via the EMER CANC pb.

Note: 1. If there is no alert to recall, the "NORMAL" message appears for 3 s on the E/WD.
2. This action on the RCL pb also suppresses the flight phase inhibition function until the next flight phase. As a consequence, all new alerts that should normally be inhibited will be displayed.

(4) STS pb

The pilot pushes this pushbutton to display the STATUS page on the lower SD . The pushbutton remains lit, as long as the SD displays the STS page. If the system has no status messages, the status page displays "NORMAL" for 3 s.

The pilot can clear the STATUS page by pushing the CLR pb, or by pushing the STS pb a second time.

When only one ECAM display is on :

- It displays the STATUS page only when the pilot pushes the STATUS pushbutton and holds it. He can display the next STATUS page, if any, by releasing the pushbutton and pushing it again (before 2 s have elapsed). The new page then appears after a short delay.
- The pilot can keep the STS pb pressed to display the STATUS page for a maximum of 3 min, after which the ECAM automatically displays the engine/warning page.

(5) CLR pb

This pushbutton remains lit as long as the E/WD is displaying a warning or caution message, or a status message on the SD.

If it is lit, pressing it changes the ECAM display.

(6) ALL pb

When this pushbutton is pressed and held down, the SD successively displays all the system pages at 3 s intervals.

If the ECAM control panel fails, the pilot can use this pushbutton to page through the system pages until he comes to the one he wants to look at. He then releases the pushbutton to select that page.

(7) EMER CANC pb

This pushbutton affects the following :

- Warnings :

- Cancels (stops) an aural warning for as long as the failure condition continues
- Extinguishes the MASTER WARNINGS lights
- Does not affect the ECAM message display.

- Cautions :

- Cancels any present caution (single chime, MASTER CAUTION lights, ECAM message) for the rest of the flight.

The flight crew can press the RCL pb for more than 3 s in order to restore all the alerts previously canceled via the EMER CANC pb.

All the alerts previously canceled via the EMER CANC pb automatically reappear on the E/WD in flight phase 1 or 2, immediately after the alignment of IRs 1 and 2.

Note: This pushbutton should only be used to suppress spurious MASTER CAUTIONS.

(8) T.O CONFIG pb

This pushbutton simulates the application of takeoff power. This is a test that triggers a warning, if the aircraft is not in takeoff configuration. (*Refer to DSC-31-15 Configuration Warnings*).

If the configuration is correct, the E/WD displays the "TO CONFIG NORMAL" message in the TO MEMO section.

Note: If the ECAM control panel fails, the CLR, RCL, STS, EMER CANC, and ALL pushbuttons remain operative, because their contacts are directly wired to the flight warning and display management computers.

SWITCHING PANEL

Ident.: DSC-31-30-00001230.0002001 / 17 MAR 11

Applicable to: ALL

ON PEDESTAL

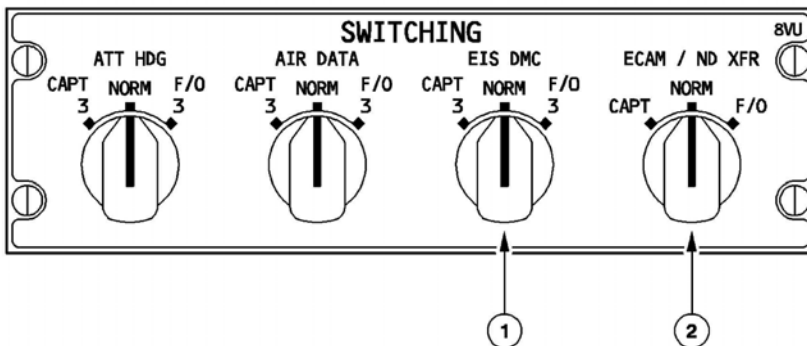

(1) EIS DMC rotary selector

NORM : DMC 1 supplies the CAPT's PFD, the CAPT's ND, and the ECAM's DUs.
 DMC 2 supplies the F/O's PFD and the F/O's ND.

CAPT 3 : DMC 3 replaces DMC 1.

F/O 3 : DMC 3 replaces DMC 2.

Note: If a DMC fails, each of its associated DUs displays an "INVALID DATA" message.

(2) ECAM/ND XFR rotary selector

Transfers the system/status display to either the Captain's or the First Officer's ND.
 The "ECAM ON ND" message is displayed on the lower ECAM display.

Note: If both ECAM DU s (E/WD and SD) fail, the flight crew may use this switch to transfer the E/WD display to either navigation display. In this case, the "ECAM ON ND" message is not displayed.

ATTENTION GETTERS

Ident.: DSC-31-30-00001231.0001001 / 09 OCT 12

Applicable to: ALL

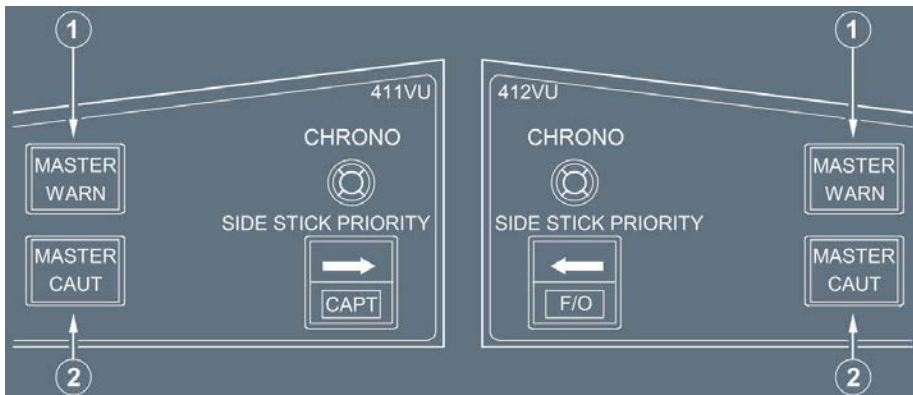

(1) MASTER WARN lights

- Flash red for level 3 warning
- Accompanied by an aural warning (continuous repetitive chime, specific sounds or synthetic voice).

(2) MASTER CAUT lights

- Light up steady amber for a level 2 caution
- Accompanied by a single chime.

These lights go out when :

- One pilot presses the light (except for some red warnings, such as the overspeed and stall warnings)
- The warning/caution situation is over
- The pilot presses the CLR pb on the ECAM control panel (except for some red warnings, such as the overspeed and stall warnings).
- The pilot presses the EMER CANC pb on the ECAM control panel.

The aural warnings cease when :

- One pilot presses the MASTER WARN light (except for some red warnings, such as the overspeed and stall warnings)
- The warning situation is over
- The pilot presses the EMER CANC pb on the ECAM control panel.

MEMO DISPLAY

Ident.: DSC-31-30-00018053.0001001 / 21 MAR 16

Applicable to: **ALL**

SWITCHING : This memo appears in green, when:

PNL



1. PFD/ND XFR pb is pressed and ECAM/ND XFR rotary selector is selected at CAPT or F/O side simultaneously, or
2. ATT HDG rotary selector is selected at CAPT or F/O side, or
3. AIR DATA rotary selector is selected at CAPT or F/O side, or
4. EIS DMC rotary selector is selected at CAPT or F/O side.

GENERAL

Ident.: DSC-31-40-00017531.0003001 / 21 MAR 16

Applicable to: ALL

The Primary Flight Display (PFD) provides the following information to the flight crew:

- Attitude and guidance
- Airspeed
- Altitude (BARO and radio) and vertical speed
- Heading and track
- FMGS modes (Flight Mode Annunciator)
- Vertical and lateral deviations
- Radio navigation information (ILS , MLS  , FLS  , GLS  , DME).

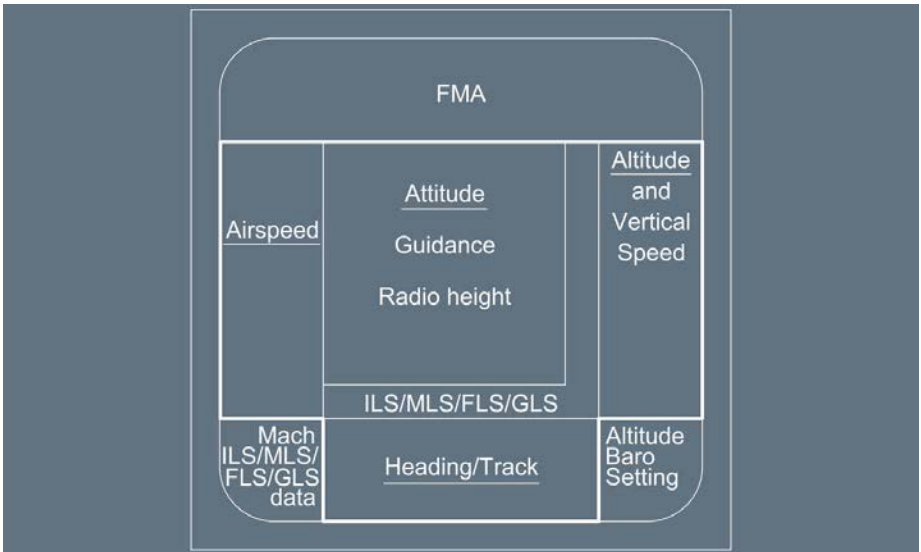

The FWC monitors main parameters such as attitude, heading, and altitude. For more information, Refer to DSC-31-40 Flags and Messages Displayed on PFD.

SPECIFIC GROUND INDICATIONS

Ident.: DSC-31-40-00001233.0001001 / 13 JAN 14

Applicable to: ALL

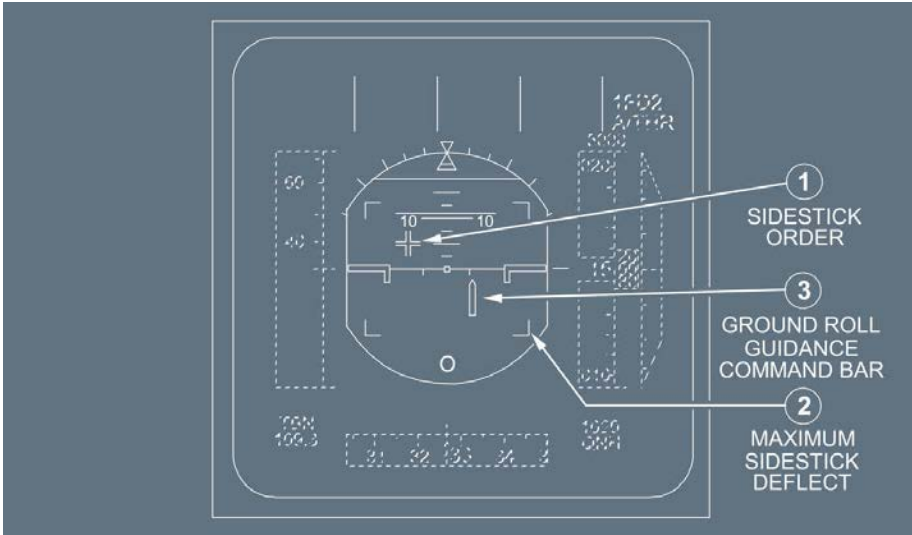

(1) Sidestick order indication

This symbol is in white, and appears as soon as one engine is started.

It indicates the total of the Captain's and First Officer's sidestick orders (shown here as left wing down, pitch up).

(2) Max Sidestick Deflection

This symbol is in white, and appears as soon as one engine is started.

(3) Ground Roll Guidance Command Bar

This symbol is in green, and appears when the aircraft is on ground, or below 30 ft radio

height, provided that a localizer signal is available. It indicates the Flight Director yaw orders, to maintain the aircraft on the runway centerline.

ATTITUDE DATA

Ident.: DSC-31-40-00001234.0003001 / 09 OCT 12

Applicable to: ALL

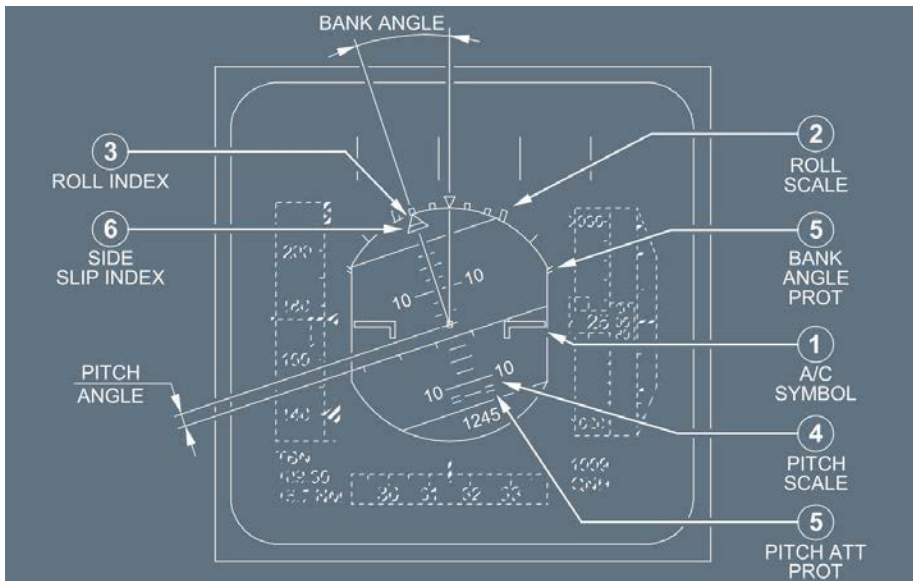

- (1) Fixed Aircraft Symbol
This symbol is in black, and outlined in yellow. The yellow outline is dimmed if the crew selects TRK -FPA , unless the FMA is in the TOGA or FLX mode.
- (2) Roll Scale
This scale is in white, and has markers at 0, 10, 20, 30, and 45 ° of bank.
- (3) Roll Index (yellow)
This pointer indicates the bank angle. When the bank angle exceeds 45 °, all the PFD symbols, except those for attitude, speed, heading, altitude, and vertical speed, disappear. The display returns to normal when the bank angle decreases below 40 ° .
- (4) Pitch Scale (white)
This scale has markers every 10 ° between 80 ° nose up and 80 ° nose down (every 2.5 ° between 10 ° nose down and 30 ° nose up). When pitch angle exceeds 25 ° nose up or 13 ° nose down, all the PFD displays except attitude, speed, speed trend, heading, altitude, and vertical speed disappear. Beyond 30 ° , large red arrowheads indicate that the attitude has

become excessive and show the direction to move the nose in order to reduce it. The display returns to normal when pitch angle becomes less than 22 ° nose up or 10 ° nose down.

(5) Flight Control Protection Symbols

The display shows these symbols (=) in green:

- On the roll scale to mark the bank angle protection availability.
- On the pitch scale at 15 ° nose down or 30 ° nose up to mark the pitch limits.

An amber x replaces these symbols if the corresponding protection is lost.

(Refer to DSC-27-20-10-20 Protections - General)

(6) Sideslip Index (yellow)

This trapezoidal index moves beneath the roll index. On ground, it represents the lateral acceleration of the aircraft. In flight, it shows sideslip (as computed by the FAC). One centimeter of displacement indicates 0.2 g. The sideslip index is against its stop at 0.3 g.



In case of engine failure at takeoff or go around, the sideslip index changes from yellow to blue.

Note: The sideslip target is blue, if:

- CONF 1, 2, or 3 is selected, and
- Any ENG N1 > 80 % or one Thrust Lever > MCT (≥ FLX if FLX or DERATED TO), and
- The difference between the ENG N1's exceeds 35 %.

In this case, the sideslip index is called β target.

When this index is centered with the roll index, the sideslip equals the sideslip target for optimum aircraft performance.

AIRSPED

Ident.: DSC-31-40-00001235.0004001 / 21 MAR 17

Applicable to: ALL

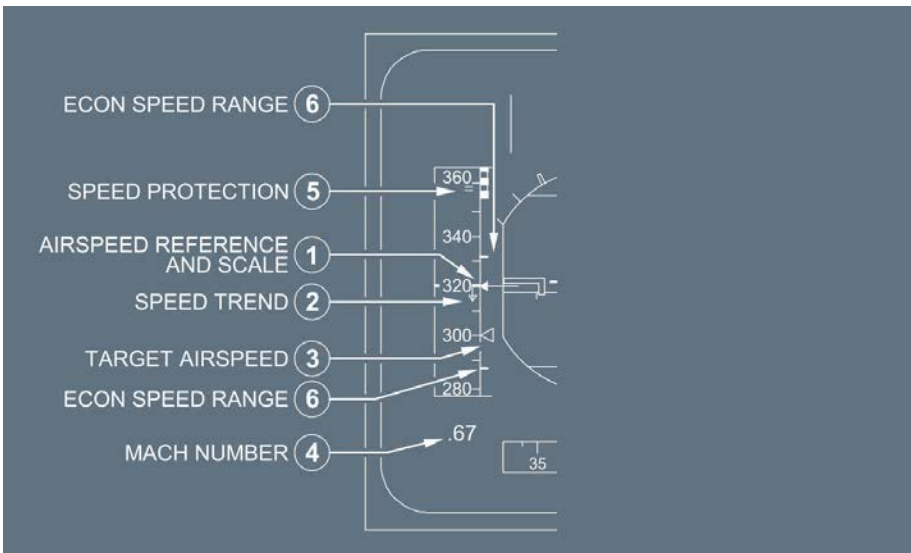

- (1) Actual Airspeed Reference Line and Scale
 A white scale, on a grey background, moves in front of a fixed yellow reference line (next to a yellow triangle) to indicate airspeed. The minimum airspeed indication is 30 kt.
- (2) Speed Trend (yellow)
 This pointer starts at the speed symbol. The tip indicates the speed the aircraft will reach in 10 s, if its acceleration remains constant. The pointer only appears, when it is greater than 2 kt, and disappears when it is less than 1 kt.
 It also disappears, if the FACs fail.
- (3) Target Airspeed (magenta or blue)
 This symbol gives the target airspeed, or the airspeed corresponding to the target Mach number.
 The target airspeed is the airspeed computed by FMGC in managed speed mode (magenta), or the airspeed manually entered on the FCU in selected speed mode (blue). The target speed is indicated by a magenta or blue triangle.
 When the target speed is off the speed scale, its value is displayed as numbers, either above or below the speed scale.

(4) Mach Number (green)

It is displayed, when it is greater than 0.5.

(5) Speed Protection (green)

This symbol indicates the speed ($V_{MO} +6$ kt or $MMO +0.01$) at which overspeed protection becomes active (*Refer to DSC-27-20-10-20 Protections - General*).

(6) ECON Speed Range (magenta)

In descent mode with the ECON /AUTO SPD mode active, these two thick lines replace the selected speed symbol. It shows the upper and lower limits, calculated by the FMGC.

- The upper speed is target speed +20 kt, limited to V_{MAX} or $V_{MO} -3$ kt or $MMO -0.006$, whichever is lowest.

If a speed limit or a speed constraint applies, the upper margin is limited to ECON SPD +5 kt.

- The lower speed margin is the target speed -20 kt, limited to green dot, F, S, or VLS, whichever is higher.

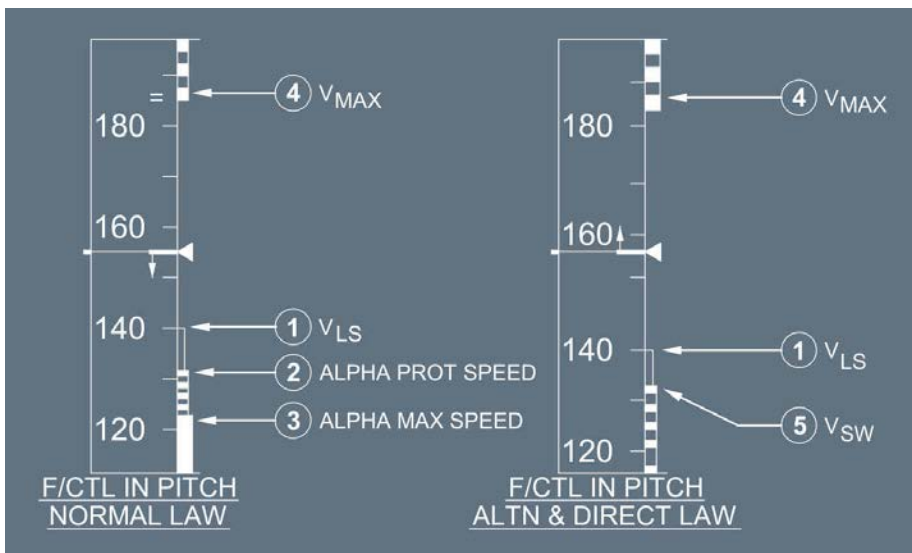

(1) Minimum Selectable Speed (VLS)

The top of the amber strip along the speed scale indicates this speed. It represents the lowest selectable speed providing an appropriate margin to the stall speed. (*Refer to DSC-27-20-10-20 Protections - High Speed Protection*)

VLS information is inhibited from touchdown until 10 s after liftoff.

(2) Alpha Protection Speed

The top of a black and amber strip along the speed scale indicates this speed.

It represents the speed corresponding to the angle of attack at which alpha protection becomes active (*Refer to DSC-27-20-10-20 Protections - General*).

It is displayed when in pitch normal law.

(3) Alpha MAX Speed

The top of a red strip along the speed scale indicates this speed. It represents the speed corresponding to the maximum angle of attack that the aircraft can attain in pitch normal law (*Refer to DSC-27-20-10-20 Protections - General*).

It is displayed when in pitch normal law.

(4) VMAX

The lower end of a red and black strip along the speed scale defines this speed.

It is the lowest of the following:

- VMO or the speed corresponding to MMO
- VLE
- VFE

(*Refer to DSC-27-20-10-20 Protections - High Speed Protection*)

(5) Stall Warning Speed (VSW)

The top of a red and black strip along the speed scale defines this speed.

It is the speed corresponding to the stall warning. (*Refer to DSC-27-20-10-20 Protections - General*).

VSW information is inhibited from touchdown until 5 s after liftoff.

It is displayed when operating in pitch alternate or pitch direct law.

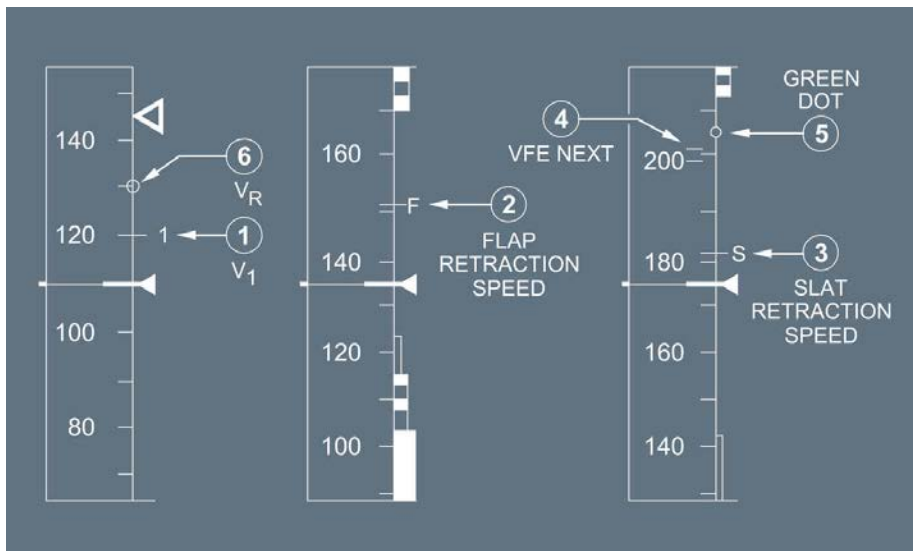

(1) Decision Speed (V1)

This is a blue symbol (numeral one) that the crew manually inserts via the MCDU. When it is off the scale, the upper part of the scale shows it in numbers.

It disappears after liftoff (*Refer to DSC-22_10-50-50 Other Speeds*).

(2) Minimum Flap Retraction Speed

This is a green symbol (letter F).

It appears when the flap selector is in position 3 or 2. (*Refer to DSC-27-20-10-20 Protections - High Speed Protection*).

(3) Minimum Slat Retraction Speed

This is a green symbol (letter S).

It appears when the flap selector is in position 1. (*Refer to DSC-27-20-10-20 Protections - High Speed Protection*).

(4) VFE NEXT

The VFE next symbol is an amber equal sign showing the VFE corresponding to the next flap lever position.

It appears when the aircraft altitude is below 15 000 ft or 20 000 ft, depending upon the FAC standard (*Refer to DSC-22_10-50-30 Limit Speeds*).

(5) Green Dot (Engine-out operating speed in clean configuration)

This green dot appears, when the aircraft is flying in the clean configuration.

It shows the speed corresponding to the best lift-to-drag ratio.

(6) Rotation speed: (VR)

VR is entered on the PERF takeoff page of the MCDU, and is indicated by a cyan circle. This cyan circle is visible during takeoff.

Note: V2 is represented by the target speed index during takeoff.
V2 is manually inserted by the crew via the MCDU.

ALTITUDE

Ident.: DSC-31-40-00001237.0023001 / 29 OCT 13

Applicable to: ALL

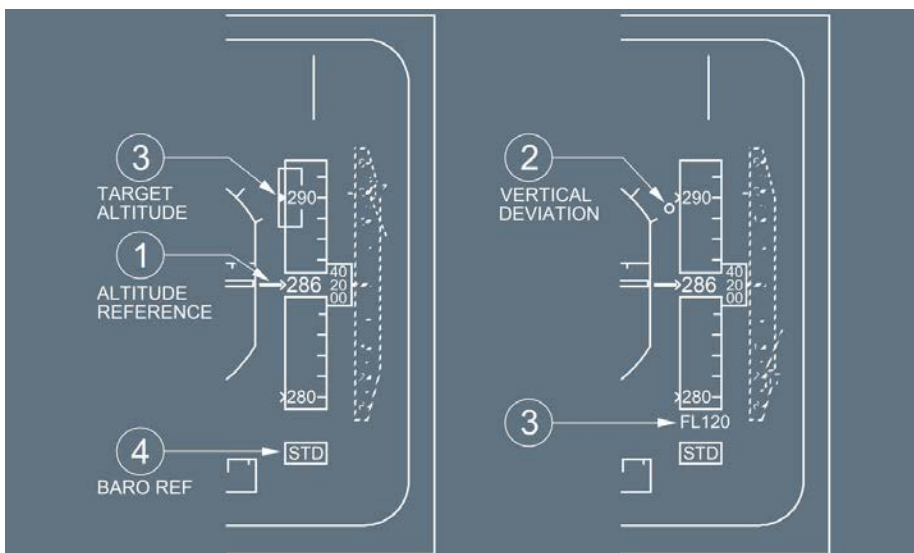

(1) Altitude Indication

This appears both as a white moving scale, and as a green digital readout on a grey background. Small white marks are positioned on the scale against the round values (e.g. 280, 290...). “NEG” appears in the window in white for negative values. The altitude window changes from yellow to amber, if the aircraft deviates from the FCU-selected altitude or flight level.

On any approach for which an minimum is entered in the FMGS, the altitude numbers change from green to amber, when the aircraft goes below the minimum.

(2) Vertical Deviation (magenta)

This symbol appears next to the altitude corresponding to the theoretical vertical profile computed by the FMGC . It is displayed from the top of descent down to the MAP altitude. The pilot can read the VDEV directly from the altitude scale. The range is ± 500 ft. When the VDEV value exceeds ± 500 ft, the symbol stays at the range limit and the PROG page displays the exact value.

(3) Target Altitude or Selected Flight Level Symbol (blue)

This symbol shows the FCU selected altitude (if QNH BARO reference is selected) or the selected flight level (if STD BARO reference is selected.)

When the FMGC operates in the vertical managed mode, this symbol is magenta if it represents a flight plan altitude constraint that the FMGC will follow. If the target altitude or flight level is on the scale, the symbol is displayed and the numerical value appears inside the symbol.

If it is off the scale, the symbol is not displayed, and the numerical value appears above or underneath the scale.

(4) Barometric Reference

The display shows “STD ” or it shows “QNH” and the numerical setting in hectoPascals or inches of mercury.

It pulses when the selection made by the pilot is not correct (STD not selected above transition altitude in climb or STD still selected in approach below transition level).

APPROACH MINIMUM INDICATION

Approach minimum is displayed on the altitude scale by an amber indication.

ALTITUDE (CONT'D)

Ident.: DSC-31-40-00006121.0002001 / 13 JAN 14

Applicable to: ALL

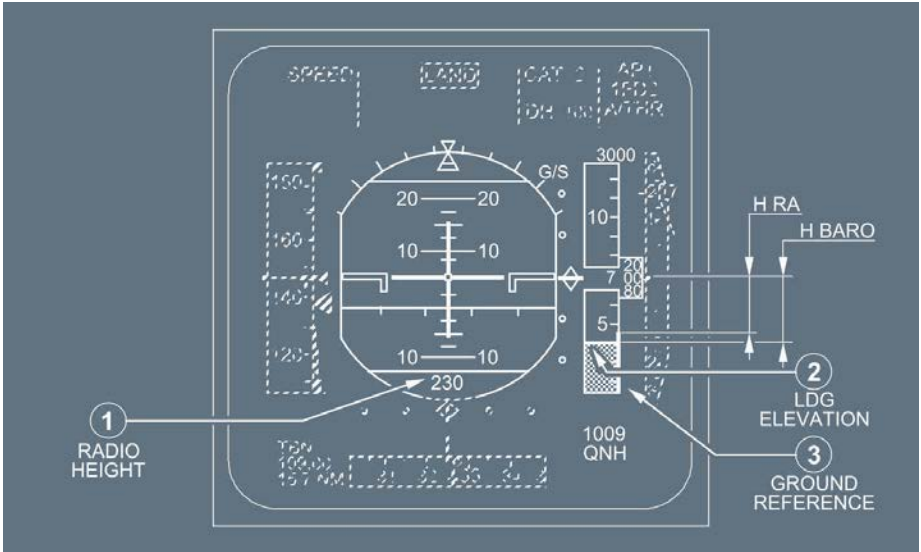

(1) Radio Height

A value appears, when the aircraft is lower than 2 500 ft.

- If a DH has been entered, the radio height appears:

- In green, when $DH + 100 \text{ ft} < RA < 2\,500 \text{ ft}$
- In amber, when $RA < DH + 100 \text{ ft}$

If "NO" is entered as the DH on the MCDU APPROACH page, 0 ft becomes a default value.

When the aircraft reaches the decision height selected on the MCDU , DH letters flash amber for 9 s, then remain amber above the radio height indication.

- If no DH has been entered, or if both FMGCs fail, the radio height appears:

- In green, when $400 \text{ ft} < RA < 2\,500 \text{ ft}$
- In amber, when $RA \leq 400 \text{ ft}$

The radio height indication changes every 10 ft down to 50 ft, then every 5 ft down to 10 ft, then every foot.

(2) Landing Elevation (brown)

The top of the brown surface on the altitude scale represents the landing elevation at the flight-planned destination.

It is displayed:

- during flight phases 7 and 8 and
- if the STD reference mode is not selected.

(3) Ground reference

A red ribbon on the right of the altitude scale represents the field elevation. This ribbon, which is driven by the radio altimeter signal, is displayed below 570 ft.

It moves up, as does the lower line of the attitude sphere, with the altitude scale as the aircraft descends. When the aircraft has touched down, the top of this ribbon is at the middle of the altitude window.

VERTICAL SPEED

Ident.: DSC-31-40-00001239.0002001 / 21 MAR 17

Applicable to: ALL

The displayed vertical speed information is normally based on both inertial and barometric data. If inertial data is not available, it is automatically replaced by barometric information.

In this case, the window around the numerical value becomes amber.

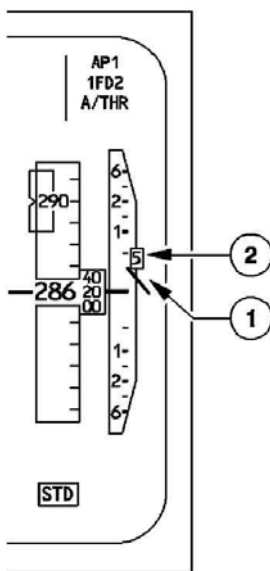

(1) Analog pointer

This pointer, which is normally in green, points to a white vertical speed scale, displayed on a grey background and graduated at intervals of 500 ft/min.

If the V/S is greater than 6 000 ft/min, the pointer stays at the end of the scale.

(2) Digital indication

This number, normally in green, is the vertical speed in hundreds of feet per minute. It disappears, if the vertical speed is less than 200 ft/min.

The analog pointer and the digital indication become amber, if:

- V/S is greater than 6 000 ft/min, (climb or descent)
- V/S is greater than 2 000 ft/min, during descent when 1 000 ft < RA < 2 500 ft, or
- V/S is greater than 1 200 ft/min, during descent and RA < 1 000 ft.

Note: For TCAS, Refer to DSC-34-SURV-60-20 TCAS Messages.

HEADING

Ident.: DSC-31-40-00001240.0002001 / 07 MAY 13

Applicable to: ALL

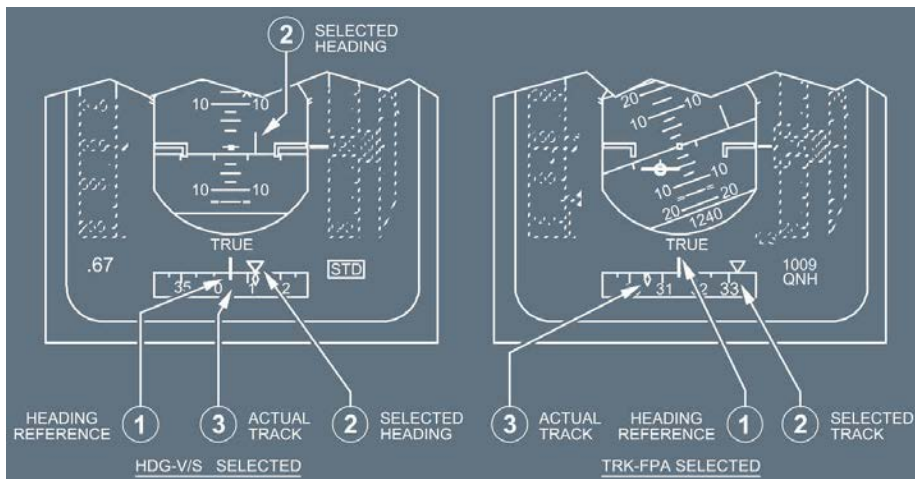

(1) Heading Reference Line and Scale

A white scale on a grey background moves in front of a fixed yellow reference line to indicate the actual magnetic heading.

“TRUE” appears, when the display indicates the true heading, rather than the magnetic heading (latitude above 73 ° North or below 60 ° South).

(2) Selected Heading or Track Index (blue)

This pointer is in blue, and indicates the heading or track displayed on the FCU HDG-TRK window.

The index is replaced by digits on the right or left side of the scale, when the selected value is off the scale.

If the FD pushbutton is OFF, a second heading/track symbol appears on the horizon line, and markers are displayed every 10 °.

(3) Actual Track Symbol

This symbol is a small green diamond.

FLIGHT PATH VECTOR

Ident.: DSC-31-40-00001241.0001001 / 17 MAR 17

Applicable to: ALL

The Flight Path Vector (FPV) is the flight reference with the TRK and FPA as basic guidance parameters. When the TRK /FPA is selected on the FCU , the FPV appears on the PFD.

INFORMATION PRESENTATION

The FPV appears on the PFD as a symbol, known as the "bird". The bird indicates the track and flight patch angle in relation to the ground.

The track is indicated on the PFD by a green diamond on the compass, in addition to the lateral movement of the bird in relation to the fixed aircraft symbol. On the ND, the track is indicated by a green diamond on the compass scale. The difference in angle between track and heading indicates the drift.

The flight path angle is indicated on the PFD by the vertical movement of the bird in relation to the pitch scale.

With the flight directors (FD) ON, the Flight Path Director (FPD) replaces the HDG -VS Flight Director (FD). With both FD pb set to OFF, the blue track index appears on the PFD horizon.

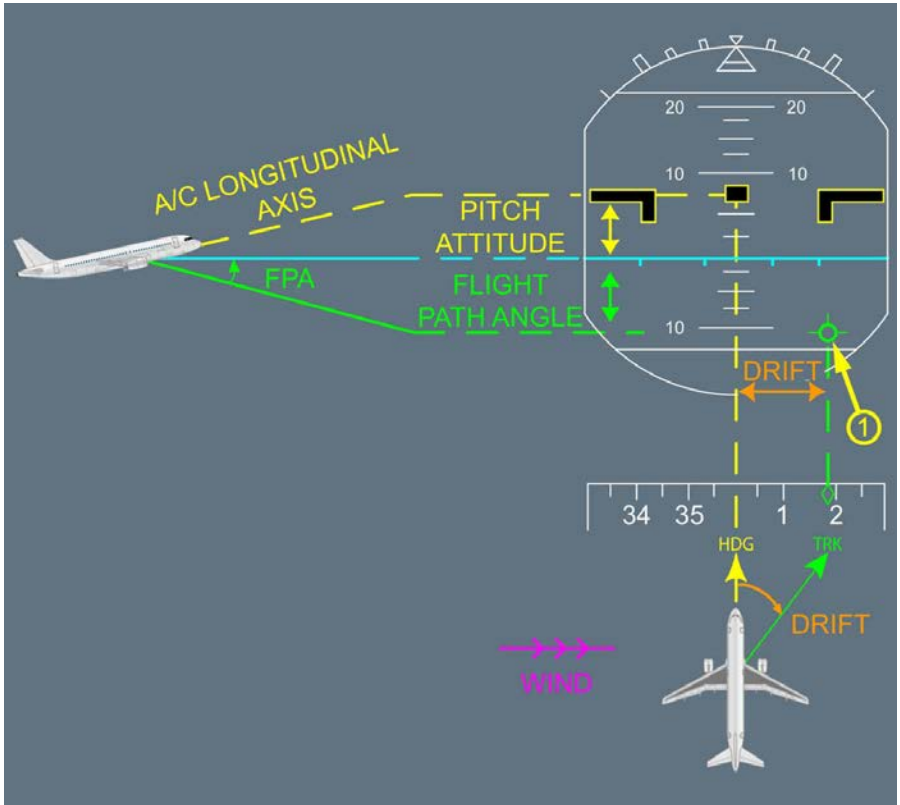

(1) Flight Path Vector (FPV)

This symbol appears, when the pilot selects TRK /FPA on the FCU.

The flight path vector represents the lateral and vertical trajectory of the aircraft with respect to the ground.

- On the lateral scale, it indicates the aircraft's track.
- On the vertical scale, it indicates the aircraft's flight path angle.

Example : The aircraft flies a track of 009 ° (heading 360 °, wind from west) and descends with a flight path angle of minus 7.5 °.

USE OF FPV

The bird is the flying reference that should be used when flying a stabilized segment of trajectory, e.g.: non-precision approach when the FLS function is not used or visual circuit.

In dynamic manoeuvres, the bird is directly affected by the aircraft inertia and has a delayed reaction. As a result, the bird should not be used as a flight reference in dynamic manoeuvres. Refer to *FCTM/AS-BIRD Introduction* for more information.

GUIDANCE

Ident.: DSC-31-40-00001242.0001001 / 13 JAN 14

Applicable to: **ALL**

Two completely different flight director modes are available, each with its own characteristic symbols. The symbol displayed corresponds to the basic operating reference the pilot has selected – either HDG V/S or TRK FPA.

In normal operation, PFD 1 displays FD1 orders.

If FD 1 fails, PFD 1 automatically displays FD 2 orders on PFD 1, the FD 2 indication in the right column of the FMA flashes for a few seconds.

This is also applicable to FD 2 orders, that are displayed on PFD2.

IF THE CREW HAS SELECTED HDG V/S TO BE THE BASIC REFERENCE:

The PFD displays FD bars in green. They automatically move out of view at touchdown in ROLL OUT mode.

They flash for 10 s, and then remain steady, if the following occur:

- A reversion to the HDG V/S basic mode (manual or automatic), or
- The selected flight level is changed, when ALT CAPTURE mode is engaged, or
- The loss of LOC or G/S in LAND mode or loss of LAND mode, or
- At the first AP or FD engagement.

The PFD displays a yaw bar in green below 30 ft radio height, if a localizer signal is available:

- During takeoff (in RWY mode)
- Upon landing (in FLARE and ROLL OUT mode).

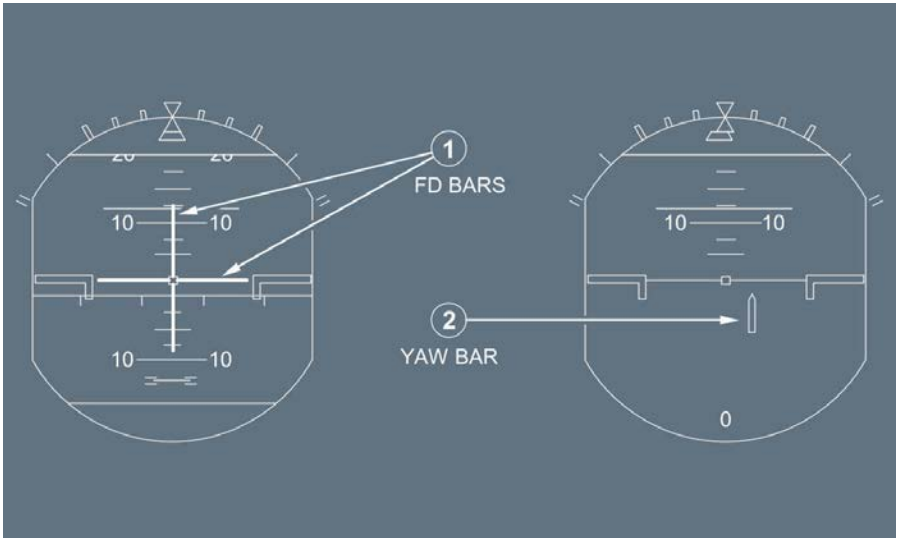

- (1) FD Crossed Bars (green)
- (2) Yaw Bar (green)

THE CREW HAS SELECTED TRK FPA AS THE BASIC REFERENCE:

An inertial flight path vector defines the aircraft's horizontal and vertical track, taking wind effect into account.

An associated flight path director symbol guides the flight crew onto the vertical and horizontal flight path targets.

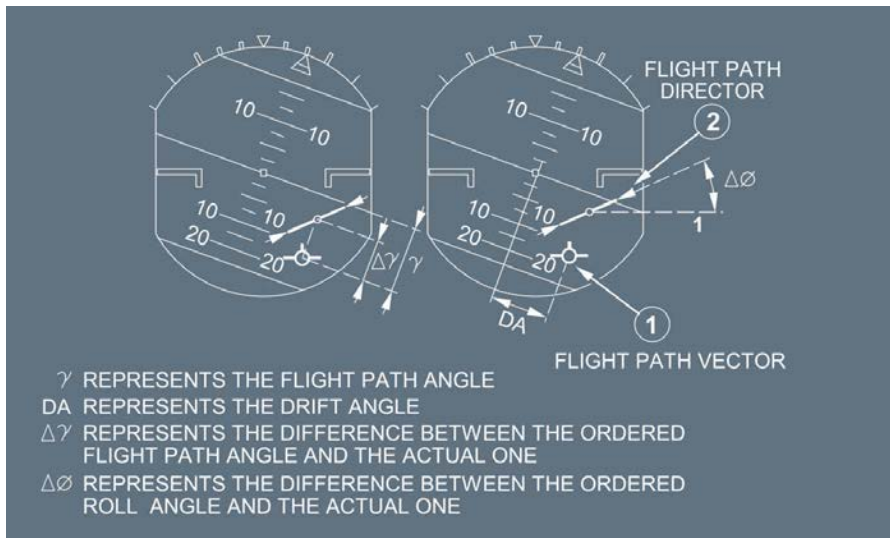

- (1) Flight Path Vector (green)
- (2) Flight Path Director (green)

TRAJECTORY DEVIATION

Applicable to: ALL
 Ident.: DSC-31-40-A-00017532.0001001 / 21 MAR 16

ILS/GLS /MLS APPROACH

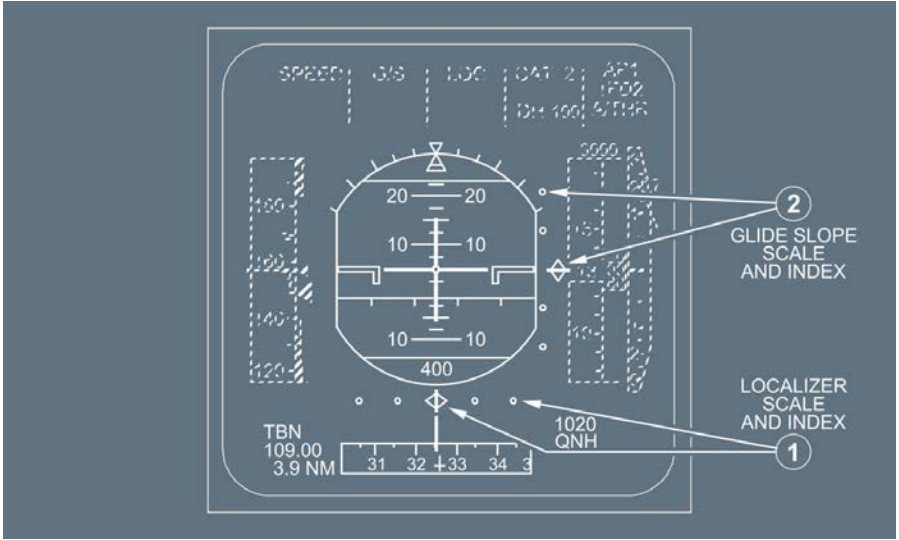

(1) Localizer Deviation Scale and Index

(2) Glide slope Deviation Scale and Index

Deviation scales appear as soon as the flight crew presses an LS/ILS pb on the EFIS control panel. Deviation indexes appear when the glide slope and localizer signals of the ILS/GLS (or the elevation and azimuth signals of the MLS) are valid, if deviation scales are displayed.

When a deviation index is out of the displayed range, only half a symbol appears at the end of the scale.

The LOC scale flashes and continues to flash if the deviation exceeds 1/4 dot for two seconds while the aircraft is between 15 ft and 1 000 ft, and CAT 2 or CAT 3 capability displayed on the FMA , and either LOC , LAND, or FLARE is engaged. The glideslope scale flashes and continues to flash if the deviation exceeds one dot for two seconds (above 100 ft RA).

"LOC" and the glideslope scale half index symbols flash, and continue to flash, when the deviation exceeds two dots for two seconds.

One dot represents a deviation of $\pm 0.8^\circ$ on the localizer scale, and $\pm 0.4^\circ$ on the glideslope scale.

Ident.: DSC-31-40-A-00017533.0004001 / 21 MAR 16

ILS/GLS  /MLS  APPROACH (CONT'D)

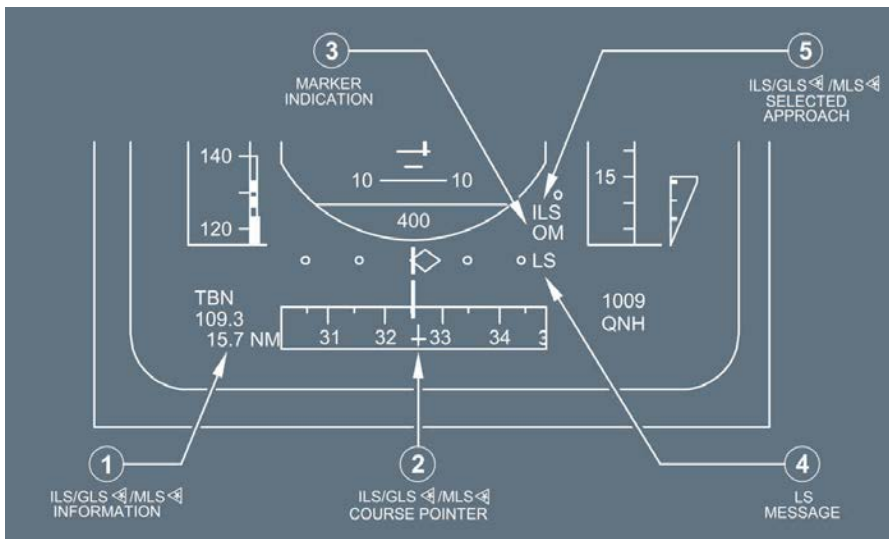

(1) ILS/GLS  /MLS  information (magenta)

The following information appears on the PFD , when the crew has selected an ILS frequency/GLS channel/MLS channel and course, and pressed the LS pb:

- ILS /GLS /MLS identification, as decoded by the ILS /GLS /MLS receiver;
- ILS frequency/GLS channel/MLS channel;
- For ILS /MLS : DME distance, if the ILS /MLS has a DME . For GLS : distance to runway threshold computed by the MMR.

(2) ILS/GLS  /MLS  course Pointer (magenta)

This pointer appears on the PFD , when the crew has selected an ILS frequency/GLS channel/MLS channel and course, and pressed the LS pb.

It is a dagger-shaped symbol on the heading scale.

The ILS /GLS /MLS course pointer is replaced by digits on the right or left hand of the heading scale (in a white box) when the ILS /GLS /MLS course value is outside the displayed portion of the heading scale.

- (3) Marker Indications
 OM appears in blue, when the aircraft flies over the outer marker.
 MM appears in amber, when it flies over the middle marker.
 IM appears in white, when it flies over an airways marker beacon or the ILS/GLS  inner marker.
- (4) LS Message
 This flashes amber, when the APPR mode is armed, but the LS pb has not been selected.
- (5) Selected approach
 The ILS /GLS /MLS indication is displayed in magenta according to the approach selected by the crew.

Ident.: DSC-31-40-A-00001245.0022001 / 09 OCT 12

NON PRECISION APPROACH

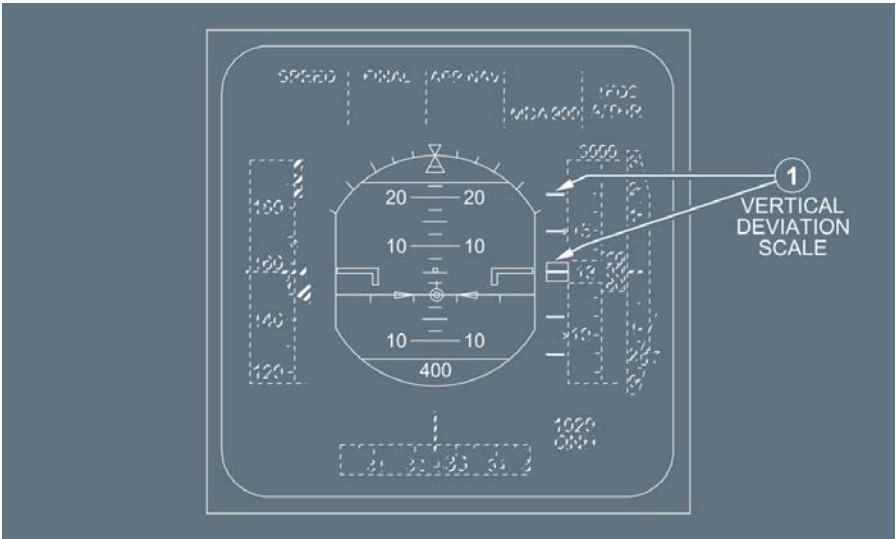

- (1) Vertical Deviation Scale and Index
 These symbols appear when in the approach phase and, when either FINAL is armed/engaged or a non-LS approach has been entered. They are displayed in the approach or go-around phase, until the MDA has been reached, or the MAP or the runway has been sequenced. They give the vertical deviation from the trajectory defined by the FMGC. Each index scale graduation represents 100 ft. The range is ± 200 ft.

Note: If the LS pb is pressed, glide deviation has priority over vertical deviation information. As long as VDEV display conditions are met, and the LS pb is selected, an amber VDEV message flashes above the glide scale.

FLIGHT MODE ANNUNCIATOR

Ident.: DSC-31-40-00001246.0002001 / 09 OCT 12

Applicable to: **ALL**

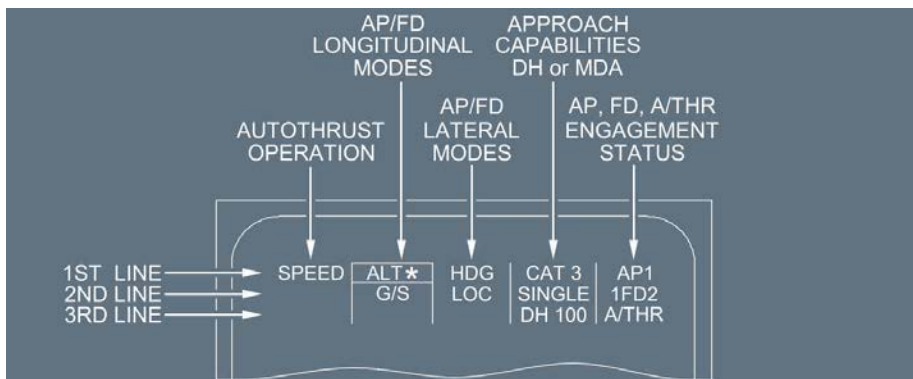

For a detailed discussion of legends and messages that may appear during FMGS operations, see FLIGHT GUIDANCE chapter (Refer to DSC-22_30-100 Flight Mode Annunciator (FMA) - General).

TAILSTRIKE PITCH LIMIT 

Ident.: DSC-31-40-00017534.0003001 / 21 MAR 16

Applicable to: ALL

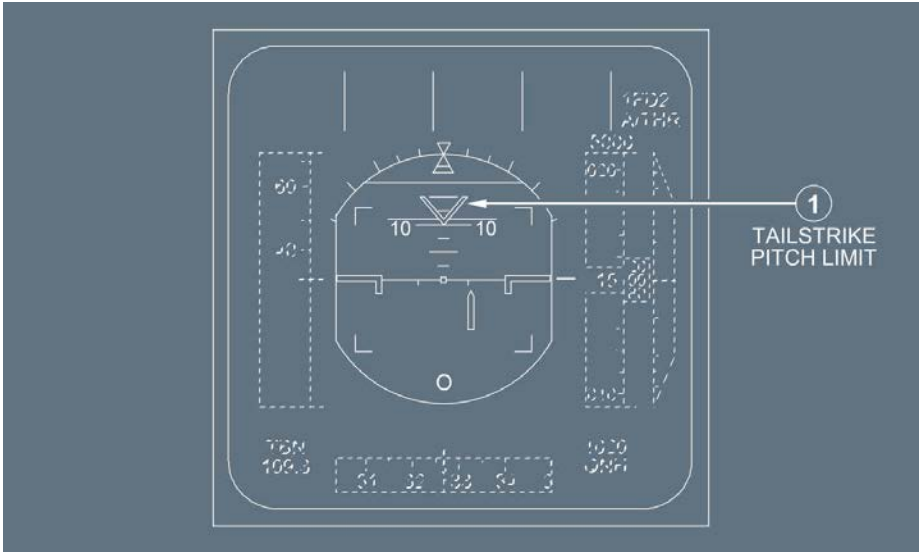

(1) Tailstrike Pitch Limit

The pitch limit indicates the maximum pitch attitude to avoid the tailstrike risk at landing. The indication is a fixed value corresponding to the main landing gear compressed. The indication appears at 400 ft radio height. The indication disappears, when there is no longer a risk of tailstrike.

ALTITUDE ALERT

Ident.: DSC-31-40-00001247.0002001 / 22 MAY 12

Applicable to: ALL

The FWC generates an altitude warning (C chord sound and PFD's altitude window pulses in yellow or flashes in amber), when the aircraft approaches a preselected altitude or flight level, or when it deviates from its selected altitude or flight level.

This warning results from a comparison between the altitude (ADIRS) and the preselected altitude displayed on FCU.

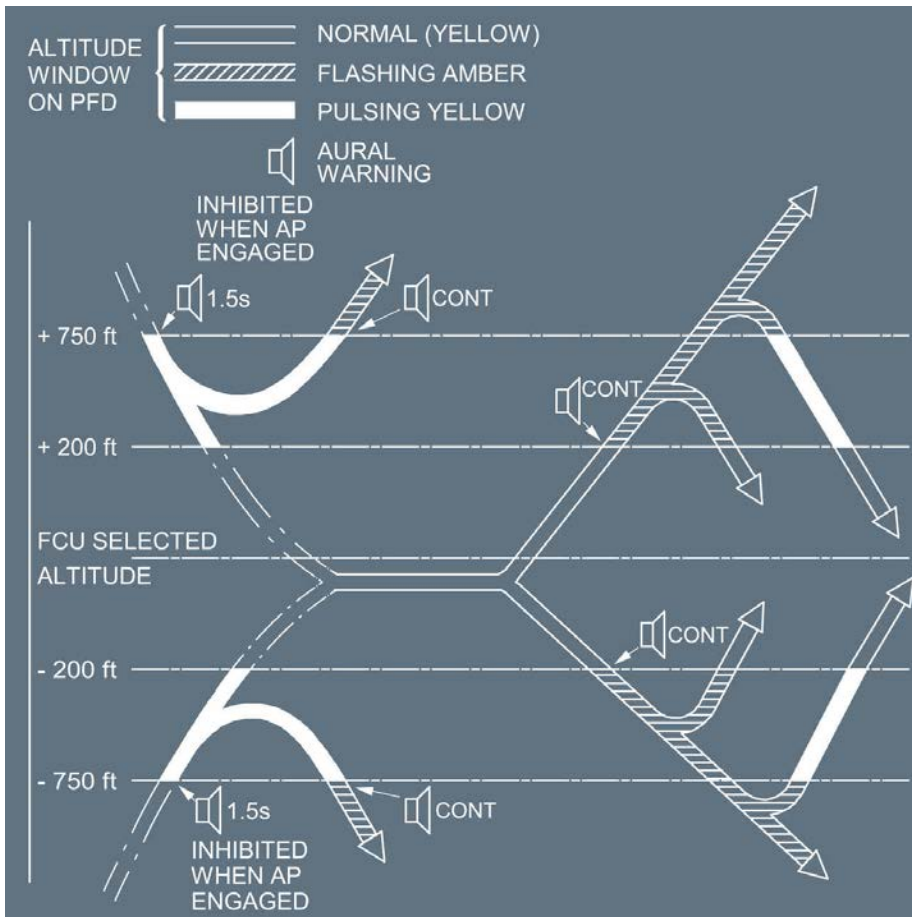

- Selecting a new altitude, or pushing the ECAM's EMER CANC pushbutton, or pressing either MASTER WARN pushbutton, cancels the continuous C chord.
- Selecting a new altitude stops the flashing of the altitude window.
- The altitude alert is inhibited:
 - When the slats are out, with the landing gear is selected down, or
 - In approach after the aircraft captures the glideslope, or
 - When the landing gear is locked down.

FLAGS AND MESSAGES DISPLAYED ON PFD

Ident.: DSC-31-40-00001248.0012001 / 21 MAR 17

Applicable to: ALL

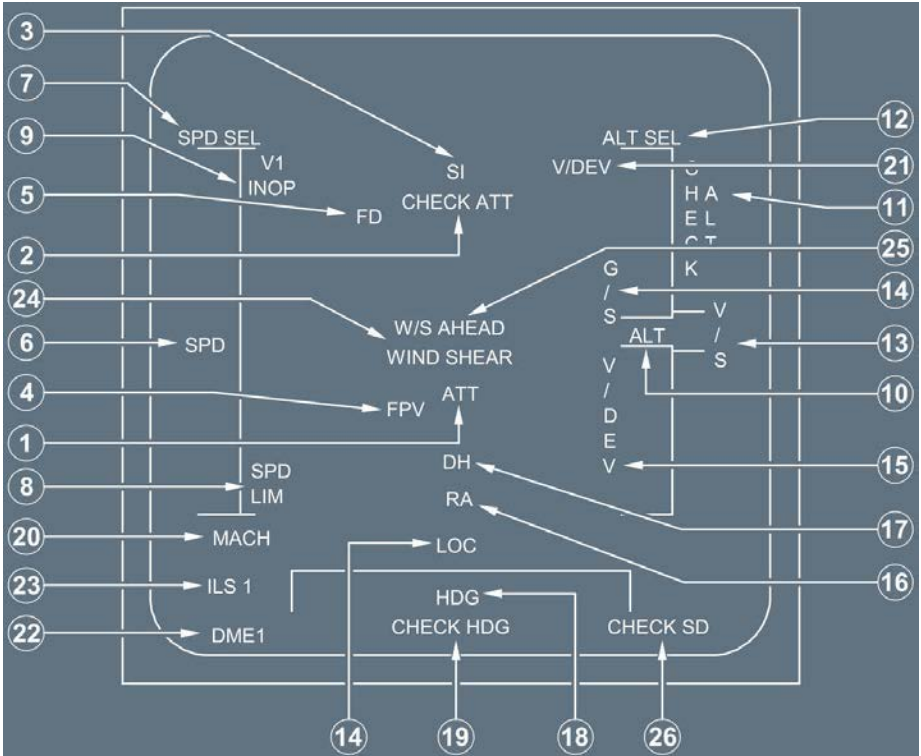

- (1) ATT flag (red)
If the PFD loses all attitude data, its entire sphere is cleared to display the ATT flag.
- (2) CHECK ATT , CHECK CAPT (F/O) PFD , CHECK EWD , DU NOT MONITORED (amber)
For CHECK ATT, Refer to DSC-31-05-60 Side1/Side2 Discrepancy Messages
For more information, Refer to DSC-31-05-10 Introduction
- (3) SI flag (red)
If the sideslip information is lost or any reverse is deployed in flight, the index disappears and a red SI flag appears.

- (4) FPV flag (red)
In the TRK FPA mode, when the drift angle or flight path angle is not valid, an FPV flag appears.
- (5) FD flag (red)
If both FMGC s fail, or if both FD s are disengaged and the FD pushbutton is on and the attitude is valid, a red FD flag appears.
- (6) SPD flag (red)
If the speed information fails, a SPD flag replaces the speed scale.
- (7) SPD SEL flag (red)
If the selected speed information fails, a SPD SEL flag appears.
- (8) SPD LIM flag (red)
This flag appears when both FAC s are inoperative, or in case of SFCC dual flap/slat channel failure.
In this case, the following PFD information is lost : VLS , S, F, Green Dot, Vtrend, Vmax, VFE next, VSW.
- (9) V1 INOP flag (red)
When the V1 signal is not valid, a V1 INOP flag replaces the digital value.
- (10) ALT flag (red)
If the altitude information fails, the ALT flag replaces the altitude scale.
- (11) CHECK ALT flag (amber)
For more information, *Refer to DSC-31-05-60 Side1/Side2 Discrepancy Messages*
- (12) ALT SEL flag (red)
If the selected altitude information fails, an ALT SEL flag appears.
- (13) V/S flag (red)
If the vertical speed information fails, the V/S flag replaces the vertical speed scale.
- (14) LOC and G/S flags (red)
If the localizer or glideslope receiver fails, a LOC or G/S flag appears on the deviation scale.
- (15) VDEV flag (red)
If the vertical deviation information fails, and the LS pb is not pressed, a VDEV flag replaces the VDEV scale.
- (16) RA flag (red)
If both radio altimeters fail, this flag appears in place of the radio height indication.

- (17) DH flag (amber)
A DH flag appears, when the aircraft reaches the selected DH.
- (18) HDG flag (red)
If the heading information fails, the HDG flag replaces the heading scale.
- (19) CHECK HDG flag (amber)
For more information, *Refer to DSC-31-05-60 Side1/Side2 Discrepancy Messages*
- (20) MACH flag (red)
This flag appears, if the Mach data fails.
- (21) VDEV (amber)
At the top of the glide scale, this message flashes in approach phase and, when either the FINAL mode is armed/engaged, or a non-LS approach has been selected, and the LS pushbutton is selected.
- (22) DME 1 flag (red)
When the DME distance is not valid, a DME 1 (on PFD 1) or DME 2 (on PFD 2) flag replaces the DME distance indication.
- (23) ILS1 flag (red)
If an ILS frequency fails, or if either the LOC or G/S signals fail, an ILS 1 (on PFD 1) or ILS 2 (on PFD 2) flag replaces the ILS frequency indication.
- (24) WINDSHEAR warning (red)
This message is displayed, when windshear is detected (reactive windshear warning) by the FAC.
Refer to DSC-22_40-40 Windshear Detection Function
- (25) W/S AHEAD
This message is displayed, when the predictive windshear system has detected windshear ahead of the aircraft.
The message is in amber or red, depending on the alert level.
Refer to DSC-34-SURV-30-20 Windshear Alerts Inhibition
Note: 1. All flags, except, V1 INOP which is steady, flash for 9 s, then remain steady.
2. For information on the TCAS flag, *Refer to DSC-34-SURV-60-20 PFD Indications.*
- (26) CHECK SD , CHECK CAPT (F/O) ND (amber)
For more information, *Refer to DSC-31-05-10 Introduction.*



A318/A319/A320/A321
FLIGHT CREW
OPERATING MANUAL

AIRCRAFT SYSTEMS
INDICATING/RECORDING SYSTEMS

INDICATIONS ON PFD

Intentionally left blank

GENERAL

Ident.: DSC-31-45-00001249.0003001 / 21 MAR 16

Applicable to: ALL

There are five different displays (five modes to display navigation information) :

- ROSE LS
- ROSE VOR
- ROSE NAV
- ARC
- PLAN

The Navigation Display (ND) can provide a weather radar image in all modes, except PLAN.

ROSE MODES

Ident.: DSC-31-45-00001250.0002001 / 19 MAY 14

Applicable to: ALL

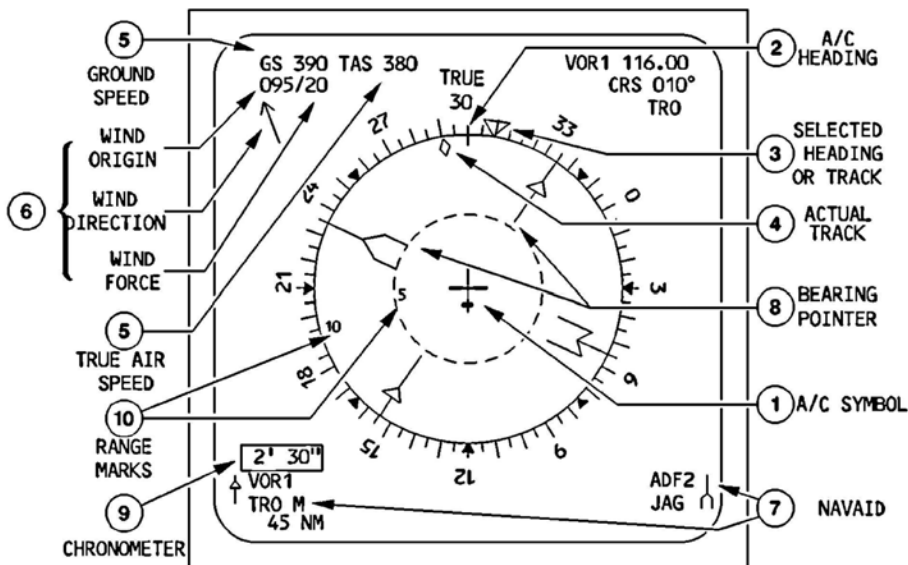

- (1) Aircraft symbol (yellow)
Fixed and centered in the display, this symbol points to the yellow lubber line.

(2) Aircraft heading

The fixed yellow lubber line points to the aircraft magnetic heading on the moving white compass rose. Small white triangles are fixed at 45 ° intervals on the circumference of the compass rose.

“TRUE” appears at the top of the compass rose, when it is displaying true heading instead of magnetic heading (latitude above 73 ° North or 60 ° South).

(3) Selected heading or track (blue)

This pointer shows the heading or track indicated on the FCU 's HDG TRK counter.

(4) Actual aircraft track (green)

This symbol is a small green diamond.

(5) Ground speed and true air speed (green)

ADIRS furnishes these speeds.

(6) Wind direction and speed

ADIRS provides the wind direction and speed. The digital direction and the analog direction (indicated by the green arrow) both reflect the true north reference. The green arrow only appears, if the wind speed is above two knots.

If the display does not receive either wind speed or direction, dashes replace the numbers on the display.

(7) NAVAIDs

When the ADF -OFF-VOR selector switch on either the pilot's or copilot's EFIS control panel is set to ADF or VOR , the inside ND displays the following characteristics of the corresponding NAVAID in white for VOR or in green for ADF (left side for receiver 1 and right side for receiver 2):

- Type of NAVAID (ADF or VOR)
- Shape and color of the associated bearing pointer (if the bearing pointer is in view).
- NAVAID identification (or frequency by default)
- DME distance if a DME is collocated with the selected VOR . ADF and DME distance are never displayed at the same time.
- Mode of tuning
 - M for a NAVAID tuned manually by the pilot through the MCDU (underlined and dimmed),
 - R for a NAVAID tuned from an RMP (Radio Management Panel) (underlined and dimmed),
 - Nothing for a NAVAID tuned automatically by the FMGC.

If reception fails, the ND stops displaying the associated data (except for the identification or frequency).

- (8) Bearing pointer (green for ADF , white for VOR)
 This pointer appears when bearing data is available.
 If the aircraft is not receiving the beacon or if a receiver fails, the associated bearing pointer disappears.
- (9) Chronometer Indication (white)
 These numbers appear when the onside chronometer is started.
 They display the elapsed time.
 The indication is in minutes and seconds from 0 to 59 min 59 s, and in hours and minutes from 1 h to 99 h 59 min (Seconds are not displayed beyond 59 min 59 s).
- (10) Range marks
 The range scale value selected on the EFIS control panel (10 to 320 NM) governs the scale of the ND.

ROSE LS MODE

Ident.: DSC-31-45-00009584.0065001 / 24 NOV 15

Applicable to: ALL

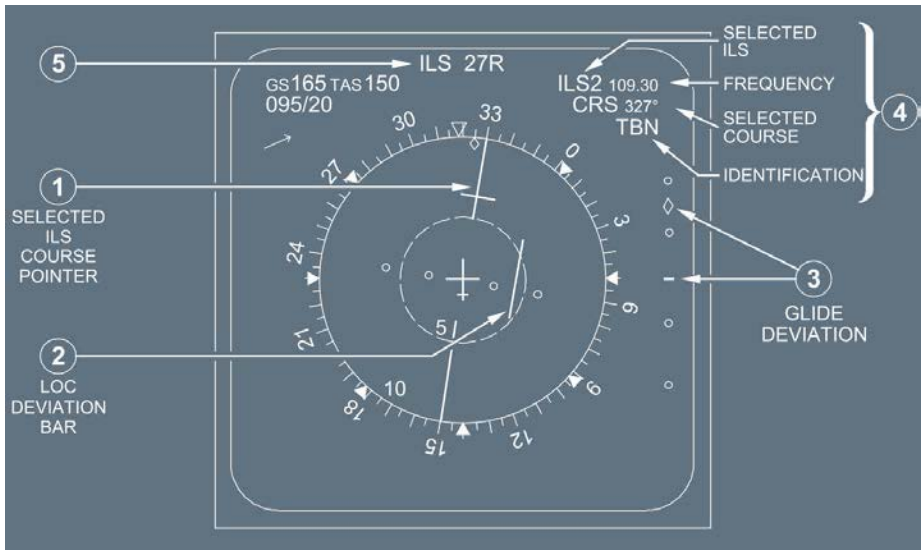

- (1) ILS Course Pointer (Magenta)
 This symbol points at the selected ILS course.

The ILS is either selected by the FMGC (autotuned or manually) or manually selected by the flight crew via the RMP backup mode. If no course has been entered, the default value is 360 °.

(2) Localizer Deviation Bar (Magenta)

This bar moves laterally with respect to the course pointer. Its scale has two white dots on each side of the zero deviation. Each dot corresponds to a deviation of approximately $\pm 0.8^\circ$. If the lateral deviation exceeds 1/4 dot (0.2°) above 15 ft RA, both the bar and the scale flash.

(3) Glide Deviation (Magenta)

This diamond moves on a vertical scale that has two white dots on each side of the yellow reference line. Each dot corresponds to a deviation of approximately $\pm 0.4^\circ$. If the deviation exceeds one dot above 100 ft RA, both the scale and the diamond flash.

(4) Selected ILS Information

This area displays the ILS frequency (magenta), selected course (magenta), and identification (magenta).

(5) ILS Message (Green)

This message indicates the full runway name of the selected approach. This message appears:

- The flight crew selects an ILS approach on the MCDU, and
- The FMS flight phase is DES , APP or GA , or the FMS phase is CRZ and the along track distance to destination is less than 250 NM.

Note: ILS 1 information appears on PFD 1 and ND 2.
ILS 2 information appears on PFD 2 and ND 1.

ROSE VOR MODE

Ident.: DSC-31-45-00001252.0029001 / 05 NOV 15

Applicable to: ALL

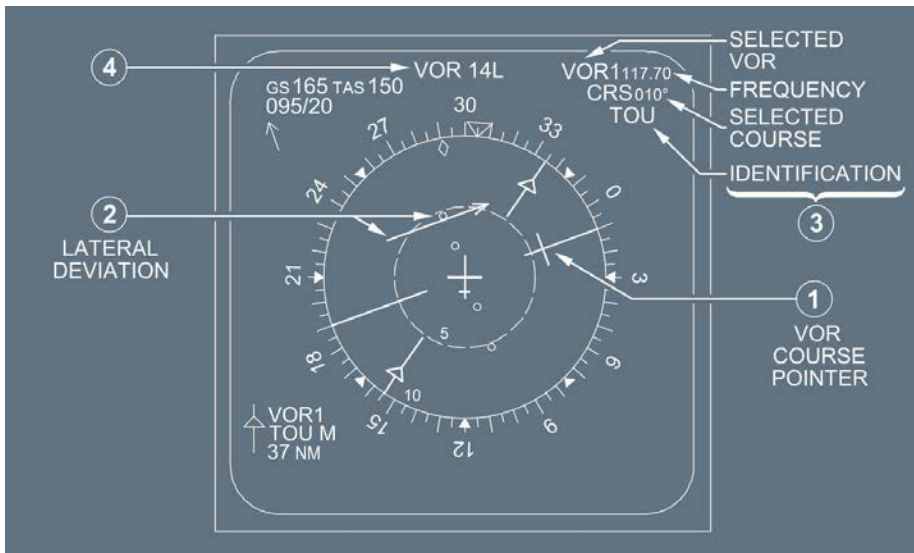

- (1) VOR Course Pointer (Cyan)
 This symbol points to the selected VOR course.
 The VOR course is either automatically selected by the FMGC or manually selected by the flight crew via the MCDU pages or the RMP backup mode.
- (2) Lateral Deviation Bar (Cyan)
 This bar indicates the VOR deviation on a lateral scale.
 Each dot corresponds to 5 ° of lateral deviation. When the lateral deviation exceeds 10 °, the bar remains displayed on the outer dot.
 The arrow on the bar provides the TO/FROM indication.
- (3) VOR Information (White and cyan)
 This area displays the frequency and identification (if decoded by the receiver) of the selected VOR in white, the selected course in cyan, and the tuning mode in white.
- (4) VOR or GPS Message (Green)
 VOR 14L appears when the flight crew selects a VOR approach on the MCDU.
 GPS 14L appears when the flight crew selects a GPS approach.

ROSE NAV MODE/ARC MODE

Ident.: DSC-31-45-00001253.0017001 / 08 FEB 13

Applicable to: ALL

ROSE NAV and ARC modes give the pilot the same information, but ARC mode limits it to the forward 90° sector.

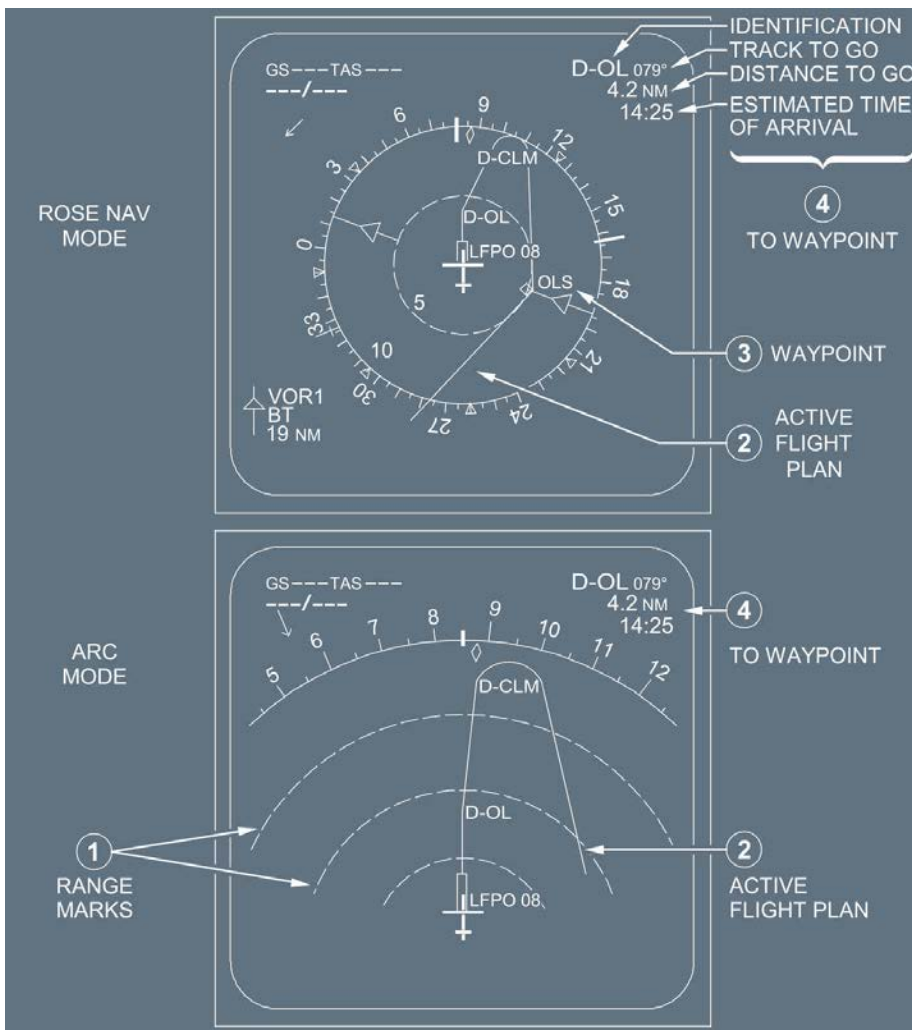

(1) Range Marks and Values

The values displayed on the ND are:

- | | |
|------------------|---|
| In ROSE NAV mode | 1/4 of the selected range for the inner circle. |
| | 1/2 of the selected range for the heading scale circle. |
| In ARC mode | 1/4 of the selected range for the first inner arc. |
| | 1/2 of the selected range for the second inner arc. |
| | 3/4 of the selected range for the third inner arc. |

(2) Flight Plan

The crew can use the MCDU to select various types of flight plan:

- The active flight plan (the flight plan the aircraft is actually following when the NAV mode is engaged) is represented by a continuous green line. The ND shows only the part of the flight plan that is ahead of the aircraft, as well as the waypoints that are still to be overflown and the waypoint from which the aircraft is coming.

The ND does not show a SID or a STAR, except for the last waypoint of the SID and the first waypoint of the STAR, when the selected range is 160 or 320 NM.

If the primary flight plan is not active, it is represented by a dotted green line.

- A continuous blue line portrays the missed approach procedure, and a dashed blue line portrays the flight plan to the alternate.

The missed approach and the alternate flight plan are displayed when:

- In ARC or ROSE NAV mode, a missed approach waypoint or an alternate flight plan waypoint is displayed on the outside MCDU.
- In PLAN mode a missed approach or alternate waypoint is displayed in the 2L field of the outside MCDU.

- The secondary flight plan is represented by a continuous white line. The ND continues to display the active flight plan

- Temporary flight plan

The revised portion of the flight plan is represented by a dotted yellow line

- Flight plan capture

When the aircraft is off the primary flight plan and is flying toward it in HDG mode with the NAV mode armed, the ND shows the new active flight plan as a continuous green line if the FMGC has computed the intercept path.

The part of the flight plan before the interception point shows as a dotted green line.



(3) Waypoint



The ND can display various kinds of waypoints:

Flight plan waypoints

The ND displays these as green diamonds (white, for TO waypoints). When the flight crew selects the WPT option on his EFIS control panel, all waypoints other than flight plan waypoints are displayed in magenta.







Pseudo waypoint

Point of the flight path where the aircraft is predicted to reach a selected altitude or speed.

| Pseudo waypoint | Definition |
|--|---|
|  | Level symbol (top of climb or level-off position), when the aircraft reaches: - The FCU-selected altitude (blue arrow), or - The constrained altitude, if it is more restrictive than the FCU altitude and if appropriate modes are engaged (magenta) |
|  | - It does not appear when the aircraft is within 100 ft above, or below, the selected altitude. |
|  | Top of descent symbol, or continue descent symbol: - White, if DES is not armed - Blue, if DES is armed. |

Continued on the following page

Continued from the previous page

| Pseudo waypoint | Definition |
|--|--|
|  | <p>Start of CLIMB symbol:</p> <ul style="list-style-type: none"> - White, if CLB is not armed - Blue, if CLB is armed. |
|  | <p>Intercept point symbol:</p> <ul style="list-style-type: none"> - White, if only the NAV mode is engaged - Blue, if DES mode is engaged - Indicates the point at which the aircraft is predicted to intercept the descent path, if there is any vertical deviation while the aircraft is in DES mode. |
|  | <p>Speed change symbol (magenta):</p> <p>Indicates the point at which the aircraft will start an automatic acceleration or deceleration from the current speed to a new computed speed for SPD LIM , SPD CSTR , or HOLDING SPD.</p> |
|  | <p>Decelerate point symbol:</p> <ul style="list-style-type: none"> - Indicates the point at which the aircraft is predicted to decelerate for approach (and thus switch to the approach phase) - Magenta, if in managed speed and NAV or approach mode is engaged - White, if in selected speed or HDG /TRK mode - Automatic decelerations only occur when displayed in magenta. |
|  | <p>ALT CSTR symbol set around the constrained waypoint:</p> <ul style="list-style-type: none"> - Magenta, when the ALT CSTR is predicted to be met - Amber, when the ALT CSTR is predicted to be missed - White, when the ALT CSTR is not taken into account by the FMGS , and NAV mode is engaged. |
|  | <p>Energy circle symbol (green arc) centered on the aircraft position and oriented to the current track line. Represents the Required Distance to Land.</p> <p>Only displayed if the lateral guidance mode is heading or track, and the current FMS flight phase is in cruise, descent or approach, and the aircraft is within 180 NM of the destination.</p> |

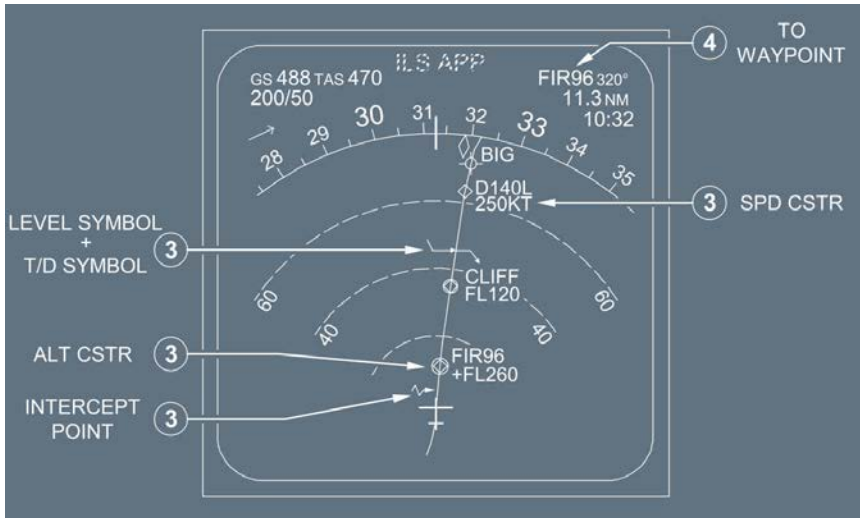

(4) TO waypoint

This is the next waypoint to be overflown.

This area of the screen also shows:

- Waypoint identification (white)
- Track to go (green)
- Distance to go (green)
- Estimated time of arrival (green), assuming the aircraft will fly directly from its present position to the TO waypoint at the current ground speed.

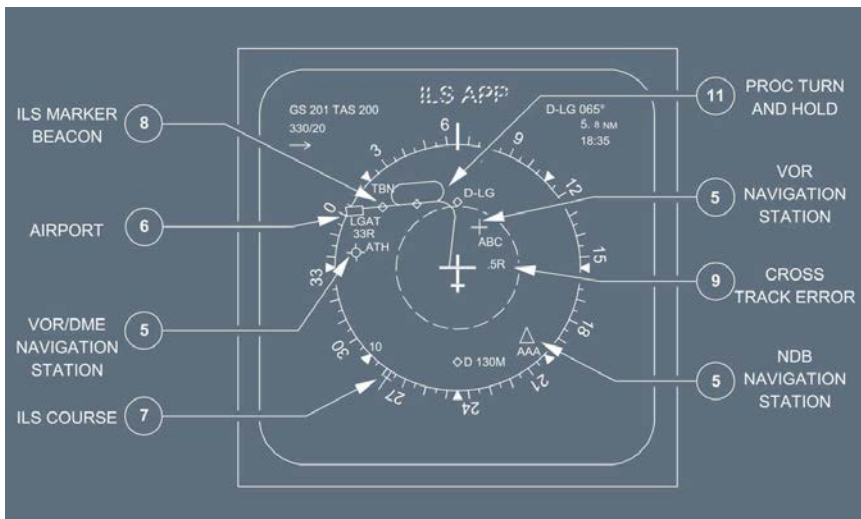

(5) NAVAIDs

The display uses specific symbols for NAVAIDs:



DME or TACAN



VOR



VOR /DME



NDB

The symbol appears:

- In green if the NAVAID is a current waypoint of the flight plan
- In white if it is the TO waypoint
- In blue when the NAVAID is tuned for display either automatically by the FMGC or manually through the MCDU
- In magenta when the NAVAID is not part of the flight plan and is called for display as an option (corresponding option pushbutton pressed on the FCU EFIS control panel).

(6) Airport

Airport included in the flight plan:

- If the runway is not specified, the airport is represented by a star and the identification is displayed in white.

Example: * LSGG

- If the runway is specified, it is represented by an oriented runway symbol in white.



LSGG
33R

The runway is drawn to scale (paved length) if the selected range is 10, 20 or 40 NM.

Optional airport information

The airports that are not displayed as part of the flight plan may be called for display (ARPT pb on the EFIS control panel).

They are represented by a star and the identification in magenta.

(7) ILS Course (Magenta)

When the pilot pushes the LS pb-sw on the EFIS control panel, and if an ILS station has been selected, the display shows an ILS course symbol.

(8) ILS Marker Beacons

The screen shows these as waypoints (diamonds).

When the aircraft overflies a marker beacon, the corresponding symbol flashes:

Blue for the outer marker.

Amber for the middle marker.

White for the inner marker.

(9) Cross Track Error

This is the aircraft's lateral deviation from the active leg of the flight plan (related to the great circle route). It is indicated in nautical miles (NM), with the letter R (right) or L (left), according to the position of the aircraft with respect to the flight plan.

(10) Track Line

This line appears in green only in the ROSE NAV or ARC mode when HDG or TRK has been selected on the FCU.

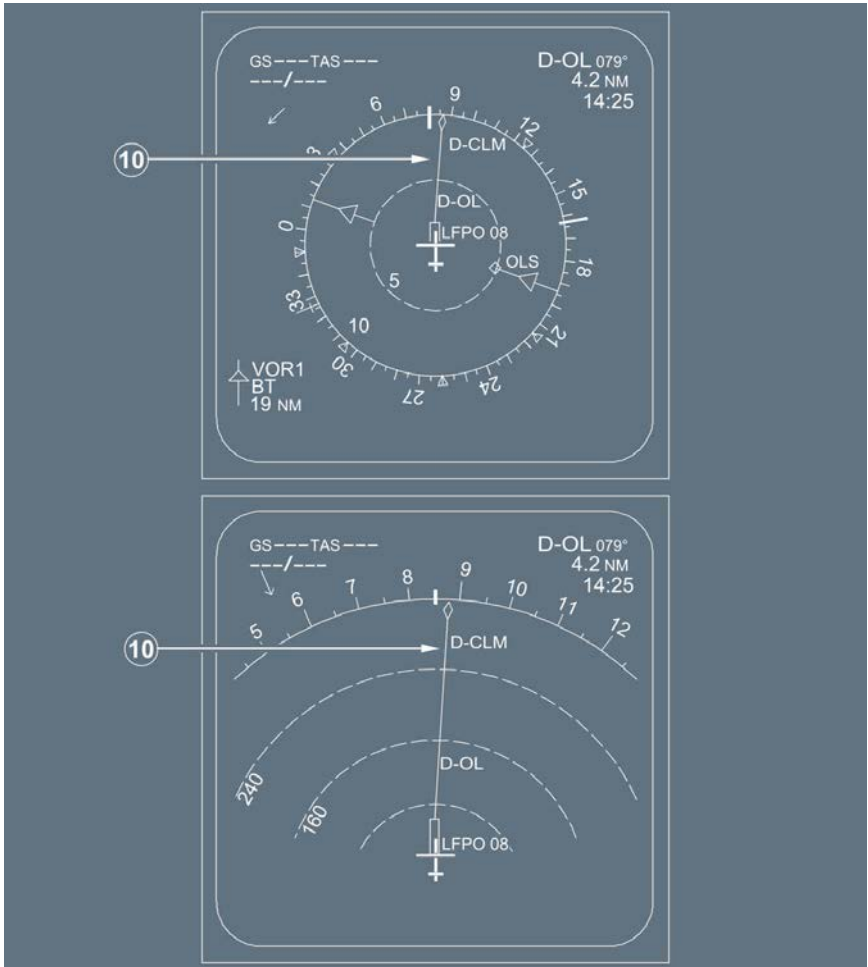

(11) Procedure turns and holding patterns

These only appear when they are part of the flight plan. For the 160 and 320 NM range scales, each one is represented by a white arrow that originates at the associated fix and indicates the direction of the turn.

AIRCRAFT SYSTEMS
INDICATING/RECORDING SYSTEMS

INDICATIONS ON ND

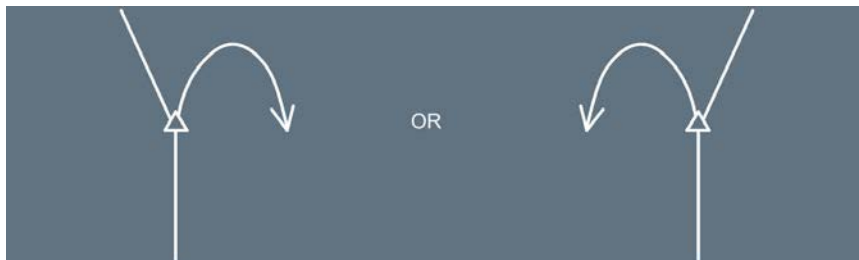

For shorter range scales, and if the procedure turn or the holding pattern is in the next or the active leg, the display shows the full circuit or pattern.



PLAN MODE

Ident.: DSC-31-45-00001254.0002001 / 24 FEB 11

Applicable to: **ALL**

This mode statically displays the flight plan legs on a map oriented to true north. The map is centered on a map reference point, that the pilot selects by scrolling to it on his MCDU.

The map reference point is the waypoint displayed on the second line of the MCDU 's F-PLN page. It can either be the active waypoint (next waypoint to be overflown), or any other waypoint of the flight plan.

The pilot can scroll through the overall flight plan, and display it in PLAN mode.

The pilot chooses the scale of the map with the range selector (the diameter of the outer circle corresponds to the selected range).

Data on NAVAIDS and on their characteristics and associated bearing pointers are not available in this mode.

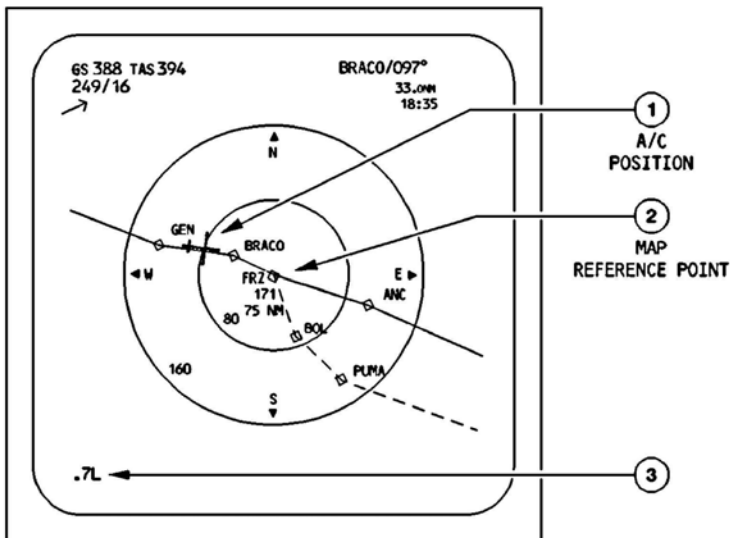

- (1) Aircraft Position and True Track
The orientation of the yellow aircraft symbol always indicates the true track of the aircraft. Its position represents the aircraft position given by the FMGS.
- (2) Map Reference Point
If the CSTR option is not selected, the track and distance from the map reference point to the next F-PLN waypoint is displayed in magenta.
- (3) Cross Track Error
Refer to DSC-31-45 ROSE NAV Mode/ARC Mode.

WEATHER RADAR INDICATIONS

Ident.: DSC-31-45-00015503.0001001 / 21 MAR 17

Applicable to: ALL

Refer to DSC-34-SURV-30-30 Weather Radar indication on ND.

PWS  INDICATIONS

Ident.: DSC-31-45-00015504.0001001 / 21 MAR 17

Applicable to: ALL

Refer to DSC-34-SURV-30-30 PWS (if installed) indication on PFD and ND

EGPWS

Ident.: DSC-31-45-00009586.0013001 / 08 AUG 13

Applicable to: ALL

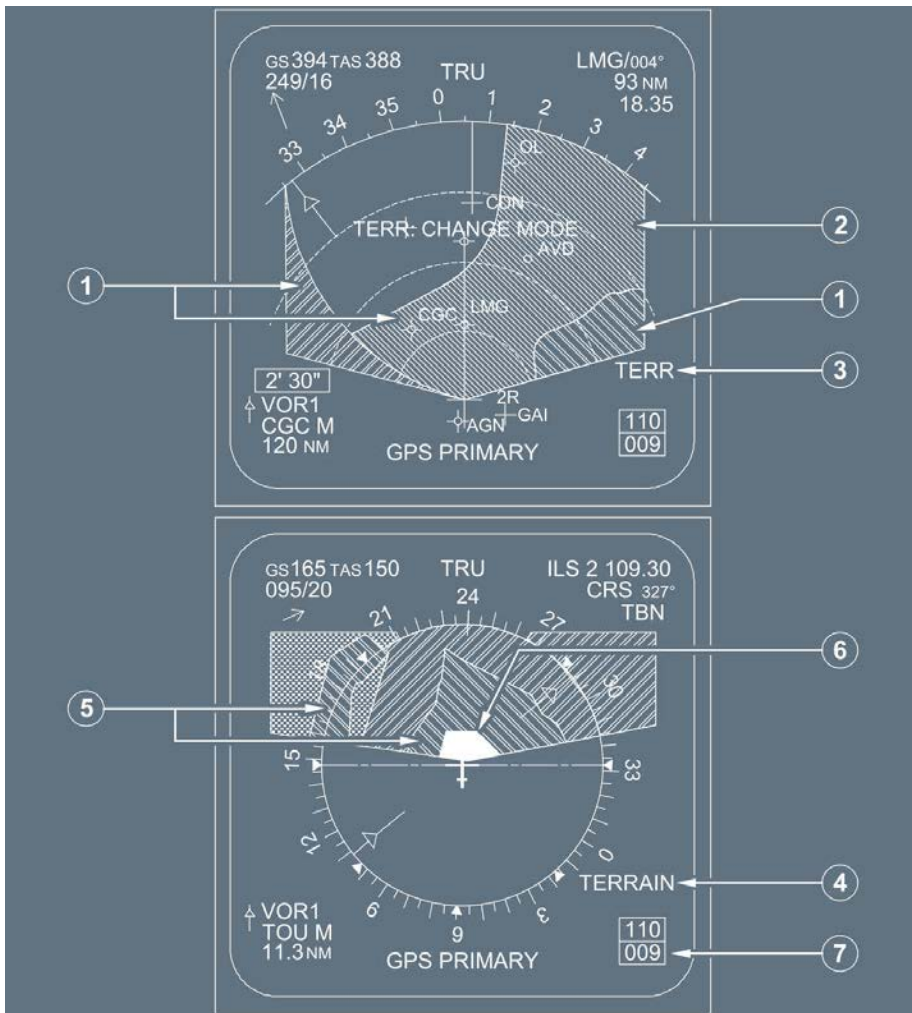

(1) EGPWS terrain picture

The ND displays the EGPWS terrain picture, when the TERR ON ND switch is selected ON, and the ND is not in PLAN mode. The terrain picture replaces the weather radar image. Terrain data is displayed independently of the aircraft relative altitude.

The terrain appears in different colors and densities, in accordance with its relative height:

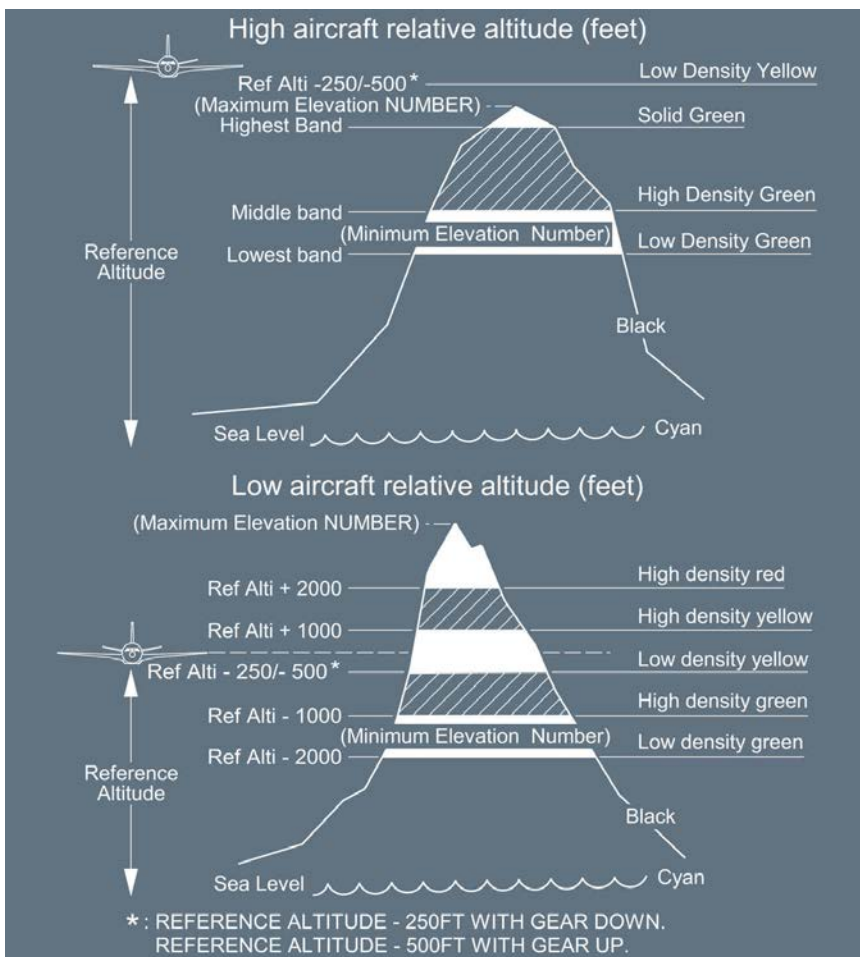

- Note:*
- Areas without available terrain data in the EGPWS database appear in magenta
 - The reference altitude is computed based on the current aircraft altitude or, if descending more than 1 000 ft/min, the altitude expected in 30 s
 - In case of flight above the maximum elevation number, the relief between the minimum and maximum displayed elevations is displayed by using three different green levels.

(2) Center Part Messages

- The “TERR CHANGE MODE” indication is displayed in red (or amber), in the case of a Terrain Awareness Display (TAD) warning (or caution) alert, if the current selected display mode is PLAN
- The “TERR REDUCE RANGE” indication is displayed in red (or amber), in the case of a Terrain Awareness Display (TAD) warning (or caution) alert, if the selected range is 160 NM or 320 NM.

(3) TERR indication

To differentiate between the terrain and the weather display, the weather radar TILT is replaced by a blue TERR, and the terrain display sweeps from the center outward to both ND sides.

(4) Warning and caution messages

TERRAIN or OBST (amber) : For a caution.

TERRAIN or OBST (red) : For a warning.

When triggered, these messages flash for 9 s, then remain steady until the caution or warning alert condition disappears.

TERR RNG (red) : For a RANGE error warning.

TERR TST (amber) : Appears during the EGPWS test, when the terrain pattern is displayed, and there is no failure.

(5) Terrain or obstacle caution alert

Generated when a conflict exists between the terrain caution envelope, ahead of the aircraft, and database-stored terrain/obstacles. The conflict area is shown in solid yellow.

(6) Terrain or obstacle warning alert

Generated when a conflict exists between the terrain warning envelope, ahead of the aircraft, and terrain/obstacles data stored in the database. The conflict area is shown in solid red.

- Note:* When an alert is generated (either caution or warning) and TERR ON ND is not selected, the terrain is automatically displayed and the TERR ON ND's pushbutton ON light comes on.

(7) Lowest and highest elevations

Minimum and maximum elevations encountered ahead of the aircraft, within the selected ND range. The color code of the elevation figures is the same as for the EGPWS terrain picture.

Note: *The elevations shown on the ND correspond to the terrain included in the selected ND range, ahead of the aircraft. In ARC mode, the elevations are linked with the terrain displayed on the ND. In ROSE mode, the elevations may not represent the lowest and highest terrain currently displayed on the ND.*

FLAGS AND MESSAGES DISPLAYED ON ND

Ident.: DSC-31-45-00001256.0425001 / 21 MAR 17

Applicable to: ALL

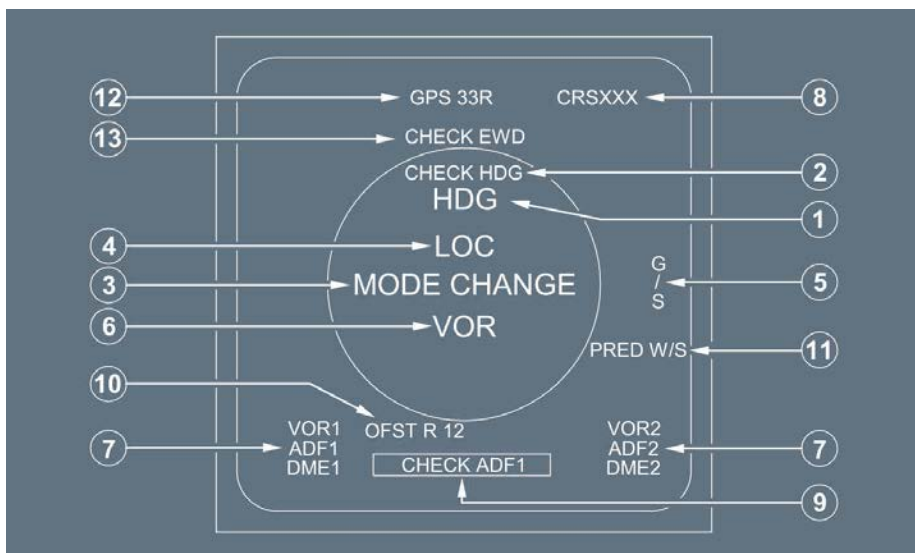

(1) HDG Flag (red)

If the heading data fails, the rose, arc and associated symbols disappear. A HDG flag flashes for 9 s, then remains steady in the upper part of the ND.

(2) CHECK HDG Flag (amber)

For more information: *Refer to DSC-31-05-60 Side1/Side2 Discrepancy Messages*

(3) Center Part Messages

- The screen displays a MODE CHANGE message in green if there is a discrepancy between the selected mode on the EFIS control panel and the mode sent from the outside FMGC , or while the DMC is preparing a new page for display
- The screen displays a RANGE CHANGE message in green if there is a discrepancy between the range selected on the EFIS control panel and the range sent from the outside FMGC. A MODE CHANGE message has priority over a RANGE CHANGE message
- The screen displays a MAP NOT AVAIL message in red for several reasons:
 - The MODE CHANGE or RANGE CHANGE message has been displayed more than 6 s, or
 - The FMGC has failed, or
 - The FMGC has delivered an invalid aircraft position.
- The screen displays a W/S SET RNG 10 NM message if a predictive windshear alert is triggered and the range is above 10 NM.
The message is displayed in the color corresponding to the windshear alert: red for a warning, amber for a caution
- The screen displays a W/S CHANGE MODE message if a predictive windshear alert is triggered and the ND is not in ARC or ROSE mode. The message appears in red for a warning, or amber for a caution.

(4) LOC Flag (red)

If LOC data fails, this flag flashes for 9 s, then remains steady.

(5) G/S Flag (red)

If G/S data fails, this flag flashes for 9 s, then remains steady.

(6) VOR Flag (red)

In ROSE VOR mode, when the VOR bearing is not valid, this flag flashes for 9 s, then remains steady.

(7) VOR 1(2) or ADF 1(2) or DME 1(2) Flag (red)

If a navigation receiver fails, the appropriate one of these flags flashes for 9 s, then remains steady.

(8) VOR Course Flag

If the VOR course fails, a red CRSXXX flag appears.

If there is non-computed data (NCD), a blue CRS - - - flag appears.

(9) Other messages

- MAP PARTLY DISPLAYED (amber) : In case of incomplete data transmission between the FMGC (priority criteria) and the DMC , or if the DMC cannot draw the complete MAP.
This message is also displayed when a very long leg exists in the flight plan. A leg is considered as “very long” when the starting point (or endpoint) is located at more than 45 ° from the aircraft location (45 ° of longitude or latitude).
This DMC limitation results from a compromise between accurate drawing precision and maximum leg length that can be displayed.
- NAV ACCUR UPGRAD, or (white) NAV ACCUR DOWNGRAD (amber) : Signals a change in navigation accuracy.
- SPECIFIC VOR/D UNAVAIL (amber) : If the NAVAID, that is tuned for the selected approach or departure, is not available.
- BACK-UP NAV (amber) : If the MCDU back-up navigation mode is activated (*Refer to DSC-22_10-40-10 MCDU - MCDU Interface*)
- SET OFFSIDE RNG/MODE (amber) : Displayed on ND 1(2), in case of an FMGC 1(2) failure when the two ND ranges or modes selected on the EFIS control panels are different.
- OFFSIDE FM CONTROL (amber) : If the offside FM supplies the onside ND.
- GPS PRIMARY (white, boxed white) : This message appears when GPS PRIMARY mode is available, or has been recovered. The pilot can clear this message by pressing the CLR key on the MCDU.
- GPS PRIMARY LOST (amber, boxed white) : This message appears when GPS PRIMARY is not available, and not clearable by pilot action.
- ↓ (green) : Overflow arrow, displayed when more than one of the following messages are present at the same time:
- NAV ACCUR DOWNGRAD
 - NAV ACCUR UPGRAD
 - SPECIF VOR-D UNAVAIL
 - MAP PARTLY DISPLAYED
 - SET OFFSIDE RNG/MODE
 - GPS PRIMARY
 - GPS PRIMARY LOST

Note: For information about the TCAS messages: Refer to DSC-34-SURV-60-20 TCAS Messages.

(10) OFST R(L) XX message (yellow)

The screen displays this message, when a temporary or an offset flight plan is entered. The offset value is given in NM.

Note: For information about the TCAS messages: Refer to DSC-34-SURV-60-20 TCAS Messages.

(11) PRED W/S flag (amber)

The WINDSHEAR sw on the weather radar panel is set to AUTO, and a Predictive Windshear System fault is detected. This message appears on ground, or when flaps and slats are extended.

It is associated with a single chime. The radar image remains available, provided that the fault does not affect the radar mode.

(12) GPS message (green)

This message shows the full runway name of the selected approach. It is displayed, when the flight crew selects a GPS approach.

(13) CHECK EWD , CHECK CAPT (F/O) PFD , CHECK SD , CHECK CAPT (F/O) ND (amber)

For more information: *Refer to DSC-31-05-60 Feedback Messages*

EFIS CONTROL PANEL

Ident.: DSC-31-50-00001257.0003001 / 09 OCT 12

Applicable to: ALL

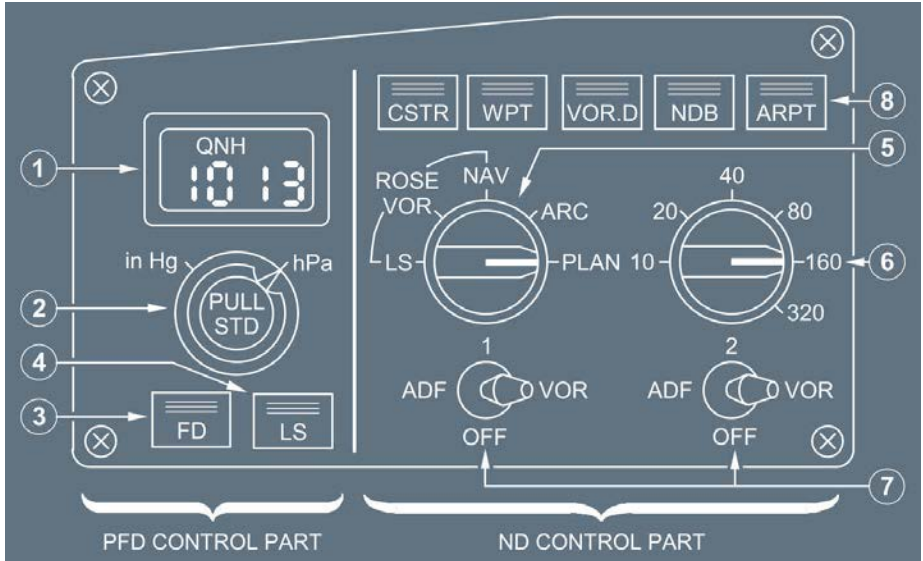

(1) Barometer Reference Display Window

Range : 745 hPa to 1 100 hPa.

(2) Barometer Reference Selector

- a. Outer ring : For selection of the units for the barometer reference-either hectoPascals or inches of mercury.

Note: The unit selected does not appear on the PFD.

- b. Inner knob : For selection of the reference value displayed in the barometer reference display window and on the PFD below the altitude scale.

At FCU initialization, the window displays 1 013 or 29.92, depending on the unit selected.

- Pulling the knob selects the standard BARO reference setting. The PFD then displays "STD." (Rotating the knob has no effect.)
- Pushing the knob from the STD position makes the last selected QNH BARO setting available.

(3) FD pb

Pushing this button removes the FD bars from the associated PFD (or removes the flight path director symbol if the TRK FPA reference is selected).

The pushbutton light goes out.

Pushing it again restores the FD bars (or the FPD symbol) and the green pushbutton light comes on.

(4) LS pb

Pushing this button displays the localizer and glide slope scales on the PFD.

Deviation symbols appear if there is a valid ILS signal.

The green pushbutton light comes on.

(5) Mode Select Switch

This switch selects a navigation display for the outside ND.

(6) Range Select Switch

This switch selects a range scale for the outside ND.

Note: If the mode or the range data fails, the default selection is the ROSE NAV mode and 80 NM range.

(7) ADF -VOR Select Switches

These switches select ADF or VOR bearing pointers and DME distance on the outside ND, as well as the corresponding NAVAID data characteristics in any mode except PLAN mode.

(8) Optional Data Display Pushbutton

Pushing this button displays optional data in addition to the data permanently displayed in PLAN, ARC, or ROSE NAV modes. The green pushbutton light comes on.

Only one option can be activated at a time.

OTHER EFIS CONTROLS

Ident.: DSC-31-50-00001258.0002001 / 15 FEB 11

Applicable to: ALL

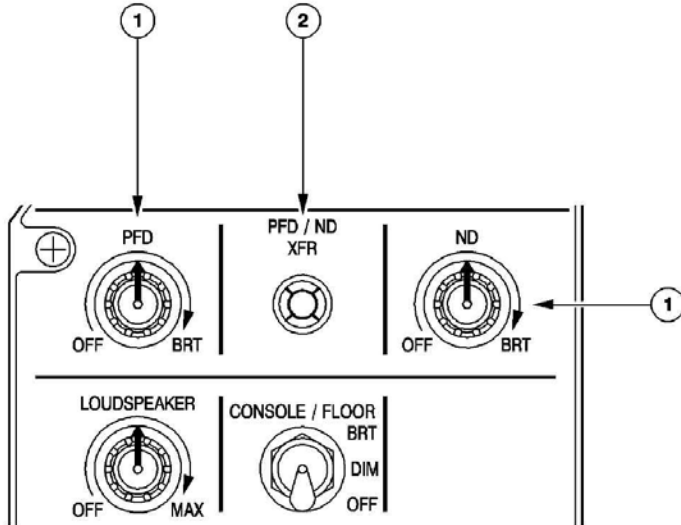

(1) OFF/BRT knobs

- These knobs turn the PFD and ND display units on and off, and control their brightness.
- The display brightness adjusts automatically for changing light conditions, and is also adjusted manually.

PFD Brightness Control Knob

Rotating this knob all the way counterclockwise switches off the PFD . In this case, the PFD image is automatically displayed on the NDU, but the pilot may recover the ND by means of the PFD -ND XFR pushbutton .

ND Brightness Control Knob

The outer knob controls the brightness of both the weather radar image and EGPWS terrain display.

The inner knob controls the general brightness of the ND symbols.

Rotating this knob all the way counterclockwise switches off the NDU.

(2) PFD /ND Pushbutton

Pushing this button interchanges the PFD and the ND.

If the PFDU fails, the PFD automatically transfers to the NDU.

CHRONOMETER

Ident.: DSC-31-50-00001259.0001001 / 15 FEB 11

Applicable to: ALL

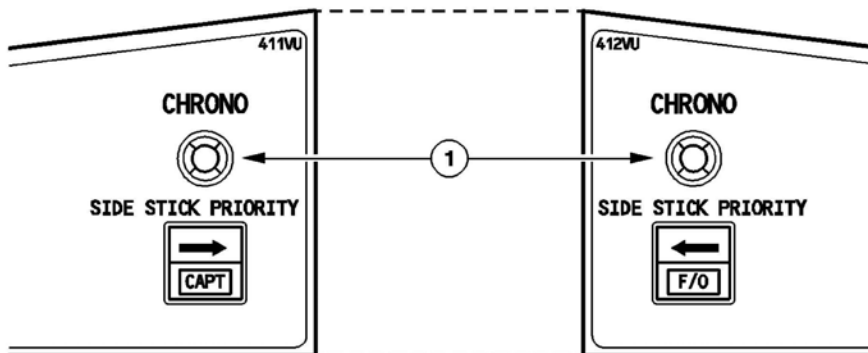

(1) CHRONO Pushbutton

Pushing this button displays chronometer time on the outside ND.

Pushing it again freezes the displayed value.

Pushing it a third time resets the chronometer, and the chronometer time disappears from the display.

GENERAL

Ident.: DSC-31-55-10-00001260.0002001 / 21 MAR 16

Applicable to: ALL

A fully independent clock is on the right side of the control panel.

It sends time to the centralized fault data interface unit, the flight data interface unit, and the flight management and guidance computer.

The clock has two electrical supplies, one of which is a direct connection to the aircraft battery hot bus.

The clock performs four functions :

- It displays "UTC" (GMT) time in hours, minutes and seconds on the center counter.
- It displays elapsed time (ET) (from engine startup) in hours and minutes on the lower counter.
- It drives the chronometer (CHR), which measures a time interval (from the pushing of the CHRONO button) in minutes and seconds.
- It can replace the UTC with the date.



A318/A319/A320/A321
FLIGHT CREW
OPERATING MANUAL

AIRCRAFT SYSTEMS
INDICATING/RECORDING SYSTEMS

CLOCK - GENERAL

Intentionally left blank

GENERAL

Ident.: DSC-31-55-20-00001261.0003001 / 16 MAR 11

Applicable to: ALL

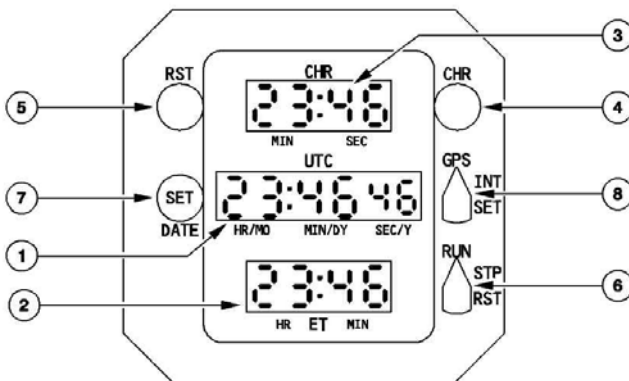

- (1) UTC (GMT) counter
 This counter displays the present time in 24 h format from 0 to 23 h 59 min 59 s.
- (2) Elapsed Time (ET)
 This counter registers the elapsed time up to 99 h and 59 min.
- (3) Chrono (CHR) counter
 This Counter registers elapsed time from 0 to 99 min 59 s. It is controlled by the CHR pushbutton.
- (4) CHR pushbutton
 First push : starts the CHR counter
 Second push : stops the CHR counter, keeps the display at its last indication.
- (5) Reset (RST) pushbutton
 When pressed, the CHR counter restarts from 0 if the chrono is running.

(6) ET selector

- “RUN” : the ET counter starts
- “STP” : the ET counter stops counting
- spring loaded “RST” : the ET counter is blanked. The selector returns to its STP position when the selector is released.

Note: A cumulative elapsed time can be realized by alternatively setting this switch in “RUN” and “STP” position.

(7) DATE/SET pushbutton

First push : sets the clock to date mode. The UTC time display is replaced by the date (day month year).

Second push : sets the clock to time mode. The date display disappears.

Note: in order to select the date mode, the UTC selector must be set on “GPS” or “INT” position.

(8) UTC selector

“GPS” : Time (or date, if selected) is displayed, and this data is synchronized on GPS information.

- Note:*
- If the signal between the GPS and the clock is not detected, dashes are displayed. Only the “INT” and “SET” positions are then available.
 - If the signal is detected, but GPS data is invalid, the clock automatically runs on its internal time.
 - The clock will automatically resynchronize on the GPS information, as soon as the GPS data becomes available.

“INT” : Internal time (or date, if selected) is displayed.

- Note:*
- The clock’s internal time is initialized with the latest valid GPS information.
 - If there is no valid GPS information at power up, the internal time will be 00:00:00, until the clock is initialized.

“SET” : Allows the internal time and date to be initialized.

OPERATION IN INTERNAL MODE

Ident.: DSC-31-55-20-00007126.0001001 / 21 MAR 17

Applicable to: ALL

DATE INITIALIZATION

Set the UTC selector on “SET”. The minute digits flash, and the seconds' digits are blank.

To increase data, turn the DATE/SET button clockwise.

To decrease data, turn the DATE/SET button counterclockwise.

- First, push on DATE/SET : To set the hour.
- Second, push on DATE/SET : To set the year.
- Third, push on DATE/SET : To set the month.
- Fourth, push on DATE/SET : To set the day.

Switch the UTC selector to the "INT" position, and the clock starts with the seconds' digits at 00.

Note: This process must be completed in less than one minute. Otherwise, it will be necessary to reset the CFDS in order to synchronize the lower ECAM time display with the cockpit clock display. Resetting the CFDS is a maintenance operation.

PRECAUTION IN CASE OF ATC DATALINK COMMUNICATION

If the clock is set to internal (INT) mode and the flight crew manually sets the time and date, the clock does not comply with the time precision required for ATC datalink communication (+/-1 s UTC). This may lead to the rejection of messages, or to the acceptance of obsolete messages:

- The CPDLC function will send CPDLC messages with an erroneous date/time
- The CPDLC function will accept obsolete uplink messages and may reject uplink messages with a correct date/time
- The uplink messages for oceanic and departure clearance will be displayed in the Datalink Control and Display Unit (DCDU) with an erroneous time
- The ADS-C function will continue to operate, but in a degraded mode.

To comply with the time precision requirement for ATC datalink communication, the flight crew must either:

- Use the clock in GPS mode, or
- Use the clock in INT mode and synchronize the clock with the GPS at least one time per day. This synchronization ensures that the UTC time drift is below +/- 1 s UTC.

GPS SYNCHRONIZATION IN INTERNAL MODE

When the clock is set to INT mode, the UTC time is only based on the internal clock and is not synchronized with the GPS. To reset the drift that results from the UTC internal time, the flight crew must perform the following actions:

- Set the UTC selector of the clock to the GPS mode and keep this setting during at least 10 seconds
- Then reset the UTC selector of the clock to INT mode.

These actions result in a resynchronization of the internal clock with the GPS.

AIRCRAFT SYSTEMS

INDICATING/RECORDING SYSTEMS

CLOCK - CONTROLS AND INDICATORS

Intentionally left blank

| |
|--------------------|
| DESCRIPTION |
|--------------------|

Ident.: DSC-31-60-10-00001262.0002001 / 09 OCT 12

Applicable to: ALL

The Flight Data Recording System, which records the mandatory parameters, consists of the following components:

- A Flight Data Interface and Management Unit (FDIMU)
- A Digital Flight Data Recorder (DFDR)
- A three-axis Linear Accelerometer (LA)

The FDIMU collects and processes parameters from the SDAC s, DMC s, FWC s, FCDC s, BSCU , the DFDR event pushbutton, the GND CTL pushbutton and the Clock.

It stores the mandatory flight parameters in the DFDR.

The DFDR can store the last 25 h data, at least. It stores this data on a fireproof and shockproof device. An underwater locator beacon is attached to the DFDR.

The linear accelerometer measures the acceleration of the aircraft along each of the three axes.

The QAR is an operational recorder that stores the same data as the DFDR . However the QAR is more accessible for the maintenance crew.

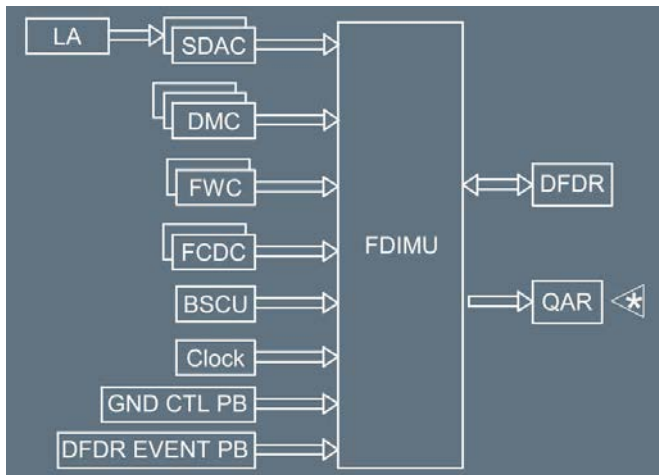

The recording system is automatically active:

- On the ground, during the first five minutes after the aircraft electric network is energized.
- On the ground, after the first engine start.
- In flight (whether the engines are running or not).

On the ground, the recording system stops automatically five minutes after the second engine shuts down.

On the ground, the crew can start the recording system manually by pressing the GND CTL pushbutton.

OVERHEAD PANEL

Ident.: DSC-31-60-20-00001263.0001001 / 09 OCT 12

Applicable to: ALL

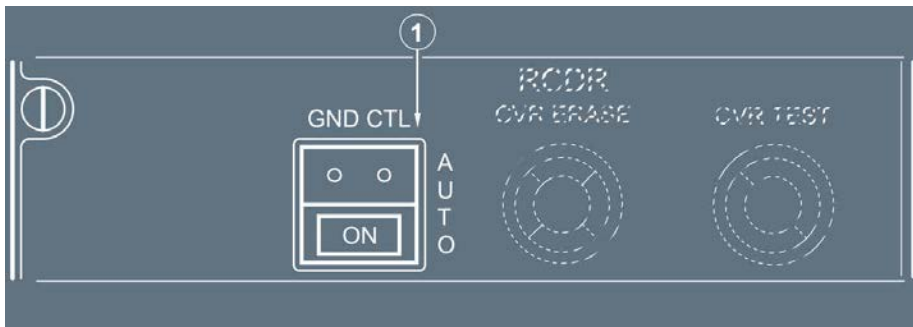

(1) GND CTL pushbutton (springloaded)

ON : The Cockpit Voice Recorder (CVR) and the Flight Data Recorders are active. The ON light is on.

AUTO: The Cockpit Voice Recorder (CVR) and the Flight Data Recorders are active, according to the logic.

The system automatically switches from ON to AUTO at the first engine start, and also in case of an electrical transient.

PEDESTAL

Ident.: DSC-31-60-20-00001264.0001001 / 22 MAY 12

Applicable to: ALL

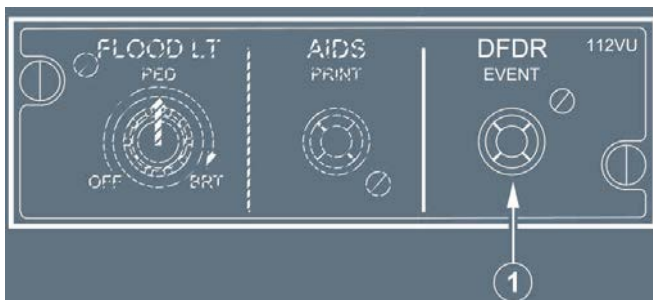

(1) DFDR EVENT pushbutton

Pressing this button (briefly) sets an event mark on the Flight Data records.

DESCRIPTION

Ident.: DSC-31-60-30-00005369.0002001 / 09 OCT 12

Applicable to: ALL

The AIDS is used to monitor various aircraft system parameters in order to make maintenance easier and to allow formulating operational recommendations.

The AIDS can generate system reports. The Airbus Standard Reports are preprogrammed reports available at aircraft delivery. The operator can create its own reports.

The AIDS uses the Flight Data Interface and Management Unit (FDIMU) to acquire the relevant aircraft system parameters. The FDIMU is connected to the rest of the AIDS as shown below.

The system may be programmed using the MCDU s. The crew can select any report to be displayed on the MCDUs.

The Printer prints the flight phase programmed reports or any report selected on the MCDU.

This printing may be automatic or in response to the AIDS PRINT pushbutton.

The AIDS may send automatic reports via ACARS ✈️.

An optional Digital Recorder may be installed to extend the recording capacity.

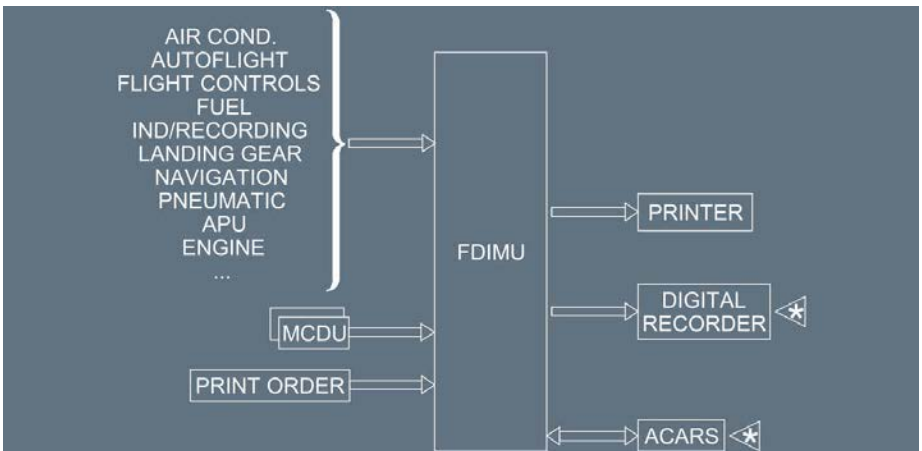

CONTROLS ON PEDESTAL

Ident.: DSC-31-60-30-00005370.0001001 / 20 DEC 10

Applicable to: ALL

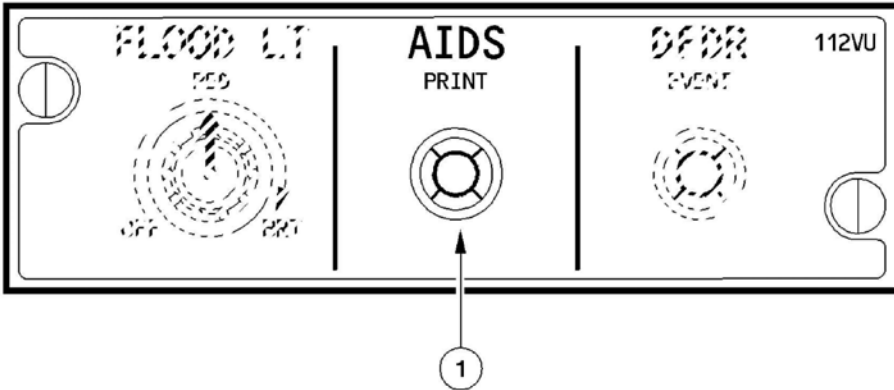

(1) AIDS PRINT pushbutton

Pushing this pushbutton causes the immediate printing of a specific report, depending on the flight phase. The crew may then use the MCDU to select another report for immediate printing.

AIRCRAFT SYSTEMS

LANDING GEAR

Intentionally left blank

DSC-32-10 Gears and Doors

DSC-32-10-10 Description

| | |
|--|---|
| General..... | A |
| Main Landing Gear (MLG)..... | B |
| Nose Landing Gear (NLG)..... | C |
| Landing Gear Extension and Retraction Equipment..... | D |
| Landing Gears and Doors Operation..... | E |

DSC-32-10-20 Landing Gear System/Interface

| | |
|--|---|
| Landing Gear Control Interface Unit (LGCIU)..... | A |
| Proximity Detector Output Signals..... | B |
| Proximity Detector Output Signals (Cont'd)..... | C |

DSC-32-10-30 Interactions between Landing Gear and Aircraft Systems

| | |
|---|---|
| GENERAL..... | A |
| Proximity Detectors on Shock Absorbers..... | B |
| Proximity Detectors on Uplocks..... | C |
| Proximity Detectors on Doors..... | D |
| Proximity Detectors on Downlocks..... | E |
| Proximity Detectors on Cargo Doors..... | F |
| Proximity Detectors on Flaps Attachments..... | G |

DSC-32-10-40 Controls and Indicators

| | |
|-------------------------------------|---|
| Landing Gear Indicator Panel..... | A |
| Landing Gear Selector Lever..... | B |
| Landing Gear Gravity Extension..... | C |
| WHEEL SD Page..... | D |
| Memo Display..... | E |

DSC-32-20 Nose Wheel Steering

DSC-32-20-10 Description

| | |
|-------------------|---|
| Description..... | A |
| Architecture..... | B |

DSC-32-20-20 Controls and Indicators

| | |
|--------------------|---|
| Side Consoles..... | A |
| WHEEL SD Page..... | B |
| Memo Display..... | C |

Continued on the following page

Continued from the previous page

DSC-32-30 Brakes and Antiskid

DSC-32-30-10 Description

| | |
|------------------------|---|
| General..... | A |
| Anti-Skid System..... | B |
| Auto Brake..... | C |
| Braking Modes..... | D |
| Braking Schematic..... | E |

DSC-32-30-20 Controls and Indicators

| | |
|---|---|
| Center Instrument Panel..... | A |
| Auto BRK Panel..... | B |
| Brake Fan  | C |
| Pedestal..... | D |
| WHEEL SD Page..... | E |
| Memo Display..... | F |

| | |
|---|---|
|  <p>A318/A319/A320/A321 FLIGHT CREW OPERATING MANUAL</p> | <p align="center">AIRCRAFT SYSTEMS LANDING GEAR GEARS AND DOORS - DESCRIPTION</p> |
|---|---|

GENERAL

Ident.: DSC-32-10-10-00018598.0001001 / 21 MAR 16
Applicable to: ALL

The landing gear consists of :

- Two main landing gears that retract inboard
- One nose landing gear that retracts forward.

Doors enclose the landing gear bays. Gear and doors are electrically controlled and hydraulically operated.

The doors, which are fitted to the landing gear struts, are operated mechanically by the gear and close at the end of gear retraction.

All gear doors open while the gear is retracting or extending.

Two Landing Gear Control and Interface Units (LGCIU s) control the extension and retraction of the gear and the operation of the doors. They also supply information about the landing gear to ECAM for display, and send signals indicating whether the aircraft is in flight or on the ground to other aircraft systems.

A hand crank on the center pedestal allows the flight crew to extend the landing gear if the aircraft loses hydraulic systems or electrical power.

MAIN LANDING GEAR (MLG)

Ident.: DSC-32-10-10-00018599.0001001 / 21 MAR 16
Applicable to: ALL

Each main gear has twin wheels and an oleopneumatic shock absorber.
Each main wheel has an antiskid brake.

NOSE LANDING GEAR (NLG)

Ident.: DSC-32-10-10-00018600.0001001 / 21 MAR 16
Applicable to: ALL

The two-wheeled nose gear has an oleopneumatic shock strut and a nose wheel steering system.

LANDING GEAR EXTENSION AND RETRACTION EQUIPMENT

Ident.: DSC-32-10-10-00018601.0001001 / 21 MAR 16

Applicable to: ALL

MAIN LANDING GEAR

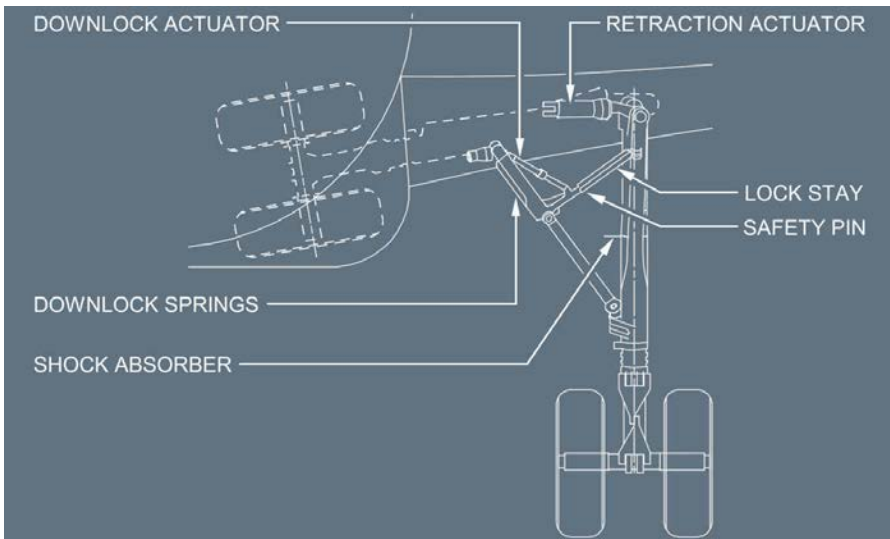

NOSE LANDING GEAR

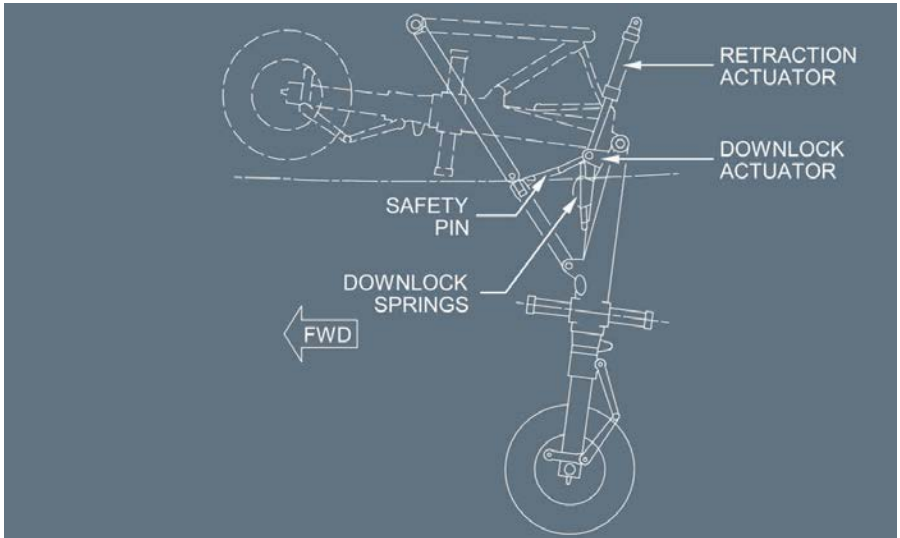

LANDING GEARS AND DOORS OPERATION

Applicable to: ALL

Ident.: DSC-32-10-10-A-00018602.0001001 / 21 MAR 16

NORMAL OPERATION

The flight crew normally operates the landing gear by means of the lever on the center instrument panel.

The LGCIU s control the sequencing of gear and doors electrically. One LGCIU controls one complete gear cycle, then switches over automatically to the other LGCIU at the completion of the retraction cycle. It also switches over in case of failure.

The green hydraulic system actuates all gear and doors. When the aircraft is flying faster than 260 kt, a safety valve automatically cuts off hydraulic supply to the landing gear system. Below 260 kt, the hydraulic supply remains cut off as long as the landing gear lever is up.

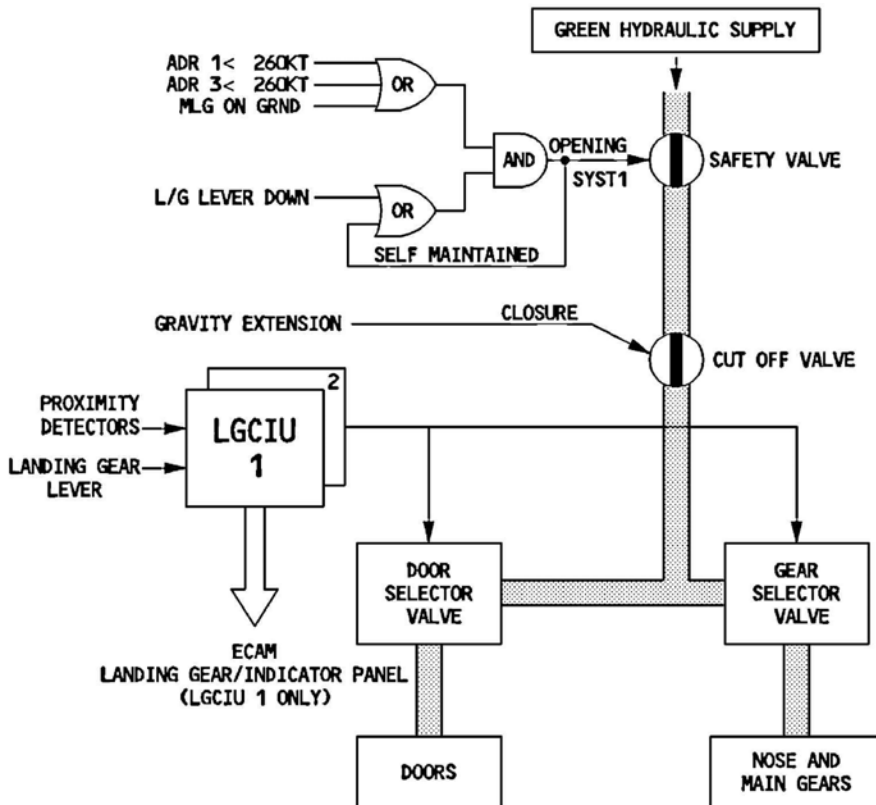

Ident.: DSC-32-10-10-A-00018603.0001001 / 21 MAR 16

LANDING GEAR GRAVITY EXTENSION

If the normal system fails to extend the landing gear hydraulically, the flight crew can use a crank to extend it mechanically.

When a crew member turns the crank, it :

- Isolates the landing gear hydraulics from the green hydraulic system
- Unlocks the landing gear doors and the main and nose main gear
- Allows gravity to drop the gear into the extended position.

Locking springs help the crew to crank the main gear into the locked condition, and aerodynamic forces assist in the locking of the nose gear.

The gear doors remain open.

The flight crew can reset the emergency extension system in flight after using it for training (if green hydraulic pressure is available).

Intentionally left blank

LANDING GEAR CONTROL INTERFACE UNIT (LGCIU)

Applicable to: ALL

Ident.: DSC-32-10-20-A-00018604.0001001 / 21 MAR 16

GENERAL

The LGCIUs receive position information from the landing gear, cargo door, and landing flap systems.

Ident.: DSC-32-10-20-A-00018605.0001001 / 21 MAR 16

LANDING GEAR INFORMATION

The LGCIUs receive landing gear position information from proximity detectors when:

- The landing gears are locked down or up, or
- The shock absorbers are compressed or extended, or
- The landing gear doors are open, or closed, or
- The bogie are aligned or not.

The LGCIUs send the landing gear position data to other aircraft systems.

In case of a LGCIU failure, the landing gear is controlled by the remaining healthy LGCIU.

Ident.: DSC-32-10-20-A-00018606.0001001 / 21 MAR 16

CARGO DOORS INFORMATION

Sensors send to the LGCIUs the position of the following components :

- Manuel selector valves
- Locking shaft
- Locking handle
- Safety shaft
- Door sills  .

The LGCIUs detect electrical failures only in certain proximity switches in the cargo door system :

- Locking shaft
- Locking handle
- Safety shaft.

When an LGCIU makes such a detection, it indicates the NON LOCKED condition for that component.

Ident.: DSC-32-10-20-A-00018607.0001001 / 21 MAR 16

LANDING FLAPS INFORMATION

The LGCIU s process the signals from four flap disconnect proximity switches, then send them to the Slat/Flap Control Computers (SFCCs).

The LGCIU s do not monitor failures in the SFCC system.

PROXIMITY DETECTOR OUTPUT SIGNALS

Ident.: DSC-32-10-20-00001278.0001001 / 22 MAY 12

Applicable to: ALL

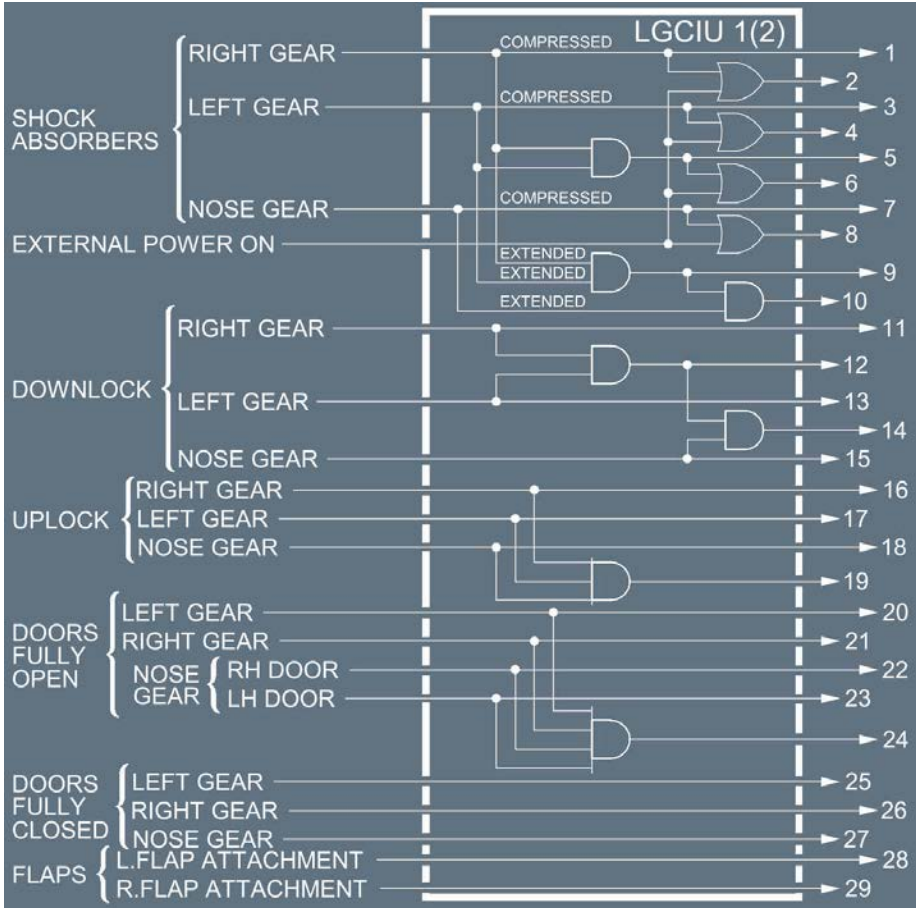

PROXIMITY DETECTOR OUTPUT SIGNALS (CONT'D)

Ident.: DSC-32-10-20-00001279.0001001 / 21 MAR 16

Applicable to: ALL

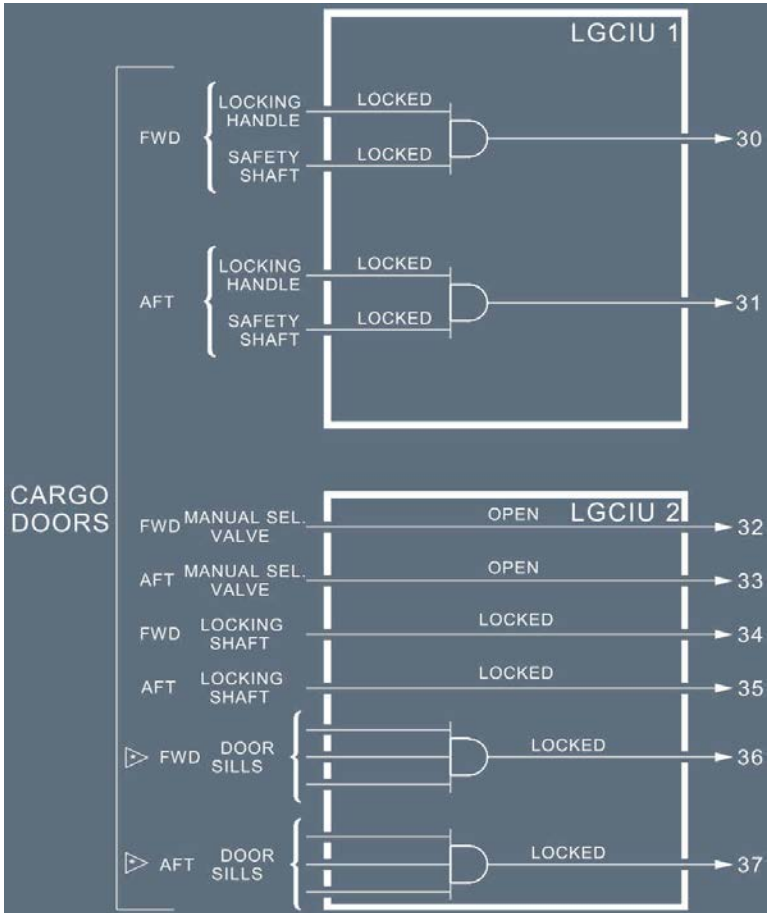



A318/A319/A320/A321
FLIGHT CREW
OPERATING MANUAL

AIRCRAFT SYSTEMS

LANDING GEAR

GEARS AND DOORS - LANDING GEAR SYSTEM/INTERFACE

Intentionally left blank

AIRCRAFT SYSTEMS

LANDING GEAR

GEARS AND DOORS - INTERACTIONS BETWEEN
 LANDING GEAR AND AIRCRAFT SYSTEMS

GENERAL

Ident.: DSC-32-10-30-00001285.0001001 / 10 DEC 09

Applicable to: ALL

The following tables present the operational effects of the proximity detectors on aircraft systems.
 How to read the tables :

| SYSTEM | LGCIU 1 | LGCIU 2 | A/C IN FLT | A/C ON GROUND |
|--------------------|---------|---------|------------|---------------|
| SERVICE INTERPHONE | 6 | 6 | | |
| SFCC 1(2) | 5 | (5) | | |

The above lines mean that the service interphone receives the output n° 6 from both LGCIU s, while SFCC 1 receive the output 5 from LGCIU 1 and SFCC 2 the output 5 from LGCIU 2.

The two additional columns give the system functioning when the aircraft is in flight and on the ground.

PROXIMITY DETECTORS ON SHOCK ABSORBERS

Ident.: DSC-32-10-30-00018608.0003001 / 06 SEP 16

Applicable to: ALL

| | SYSTEM | LGCIU 1 OUTPUT | LGCIU 2 OUTPUT | A/C IN FLT | A/C ON GRND |
|----------------|--|-------------------|-------------------|--|--|
| GENERAL | STROBE lts | | 5 | On when AUTO selected | Off when AUTO selected |
| | LOGO lts | | 5 | Off when flaps retracted | On |
| | AIRSTAIRS  | 3 | 1 | Control inhibited ⁽¹⁾ | Control not inhibited ⁽²⁾ |
| | CARGO DOOR ⁽⁵⁾ | | 5 | Normal control not available | Normal control available |
| | WATER FILLING | | 5 | Preselect water servicing inhibited | Preselect water servicing available |

Continued on the following page

Continued from the previous page

| | SYSTEM | LGCIU 1 OUTPUT | LGCIU 2 OUTPUT | A/C IN FLT | A/C ON GRND |
|-----------------|--|-------------------|-------------------|--|--|
| AIR COND | AVNCS COOLING | 5 | 5 | <ul style="list-style-type: none"> • Skin temp. < 35 °C : The system is in closed conf. ⁽¹⁾ • Skin temp. > 35 °C : The system is in intermediate conf. ⁽¹⁾ | <ul style="list-style-type: none"> • Skin temp. < 5 °C : The system is in closed conf. ⁽²⁾ • Skin temp. > 5 °C : The system is in open conf. ⁽²⁾ |
| | GRND COOLING  | 1 3 | 1 3 | Inhibited ⁽¹⁾ | Not inhibited ⁽²⁾ |
| | FWD CARGO VENT | | 5 | Extract fan stopped when $\Delta P > 1$ PSI | Extract fan on |
| | CAB PRESS | 5 | 5 | Climb mode active ⁽⁴⁾ | <ul style="list-style-type: none"> - Prepressurization active before TO ⁽³⁾ - Depressurization active after LDG ⁽³⁾ |
| | PACK 1(2) TEMP CONTROL | | 3 (1) | Pack air inlet flaps opened | Pack air inlet flap fully closed at TO and LDG |
| APU | APU AUTO SHUTDOWN | 5 | | <ul style="list-style-type: none"> - In case of oil low press, the automatic shutdown is delayed by : <ul style="list-style-type: none"> • 15.5 s if the oil temp < -4 °C • 0.05 s if oil temp > -4 °C | |

Continued on the following page

AIRCRAFT SYSTEMS

LANDING GEAR

GEARS AND DOORS - INTERACTIONS BETWEEN LANDING GEAR AND AIRCRAFT SYSTEMS

Continued from the previous page

| | SYSTEM | LGCIU 1 OUTPUT | LGCIU 2 OUTPUT | A/C IN FLT | A/C ON GRND |
|-----------------------|-----------------------------------|-------------------|---|--|---|
| COMMUNICATIONS | SERVICE INTERPHONE | 6 | 6 | Inhibited ⁽⁶⁾ | Available ⁽⁷⁾ |
| | PUBLIC ADDRESS | 1 3 | 1 3 | P.A. increased level ⁽⁶⁾ | P.A. low level ⁽⁷⁾ |
| | ADIRU and AVIONICS ground warning | 1 3 | 1 3 | External horn and light inhibited ⁽⁶⁾ | External horn and light not inhibited ⁽⁷⁾ |
| | FLT INTERPHONE | 9 | | Communication with ground mechanic inhibited | Communication with ground mechanic available |
| | COCKPIT CALL LIGHT | 9 | | Inhibited | Not inhibited |
| | ACARS (ACARS MU or ATSU) | 7 | | Available | Available |
| | CVR | 1 3 7 | 1 3 | Runs ⁽⁶⁾ | Runs: ⁽⁷⁾ - during the first 5 min following energization - with one engine running Stops: ⁽⁷⁾ 5 min after second engine shutdown |
| CVR | | 5 | <ul style="list-style-type: none"> • ERASE function inhibited • No low frequency signal in the loudspeakers if test performed | <ul style="list-style-type: none"> • ERASE function not inhibited • Low frequency signal in the loudspeakers if test performed | |
| ELEC | DC generation | 5 | | APU start on batteries only, is delayed by 45 s | No APU start delay when on batteries only |
| | GALLEY supply | | 5 | Main galley not supplied when APU GEN only is supplying | Main galley supplied when APU GEN only is supplying |
| EIS | EIS | 5 | | Display test inhibited when ANN LT TEST is selected | Display test not inhibited |
| FIRE | APU | 5 | | No APU fire automatic extinguishing | Automatic extinguishing not inhibited |

Continued on the following page

AIRCRAFT SYSTEMS

LANDING GEAR

**GEARS AND DOORS - INTERACTIONS BETWEEN
LANDING GEAR AND AIRCRAFT SYSTEMS**

Continued from the previous page

| | SYSTEM | LGCIU 1 OUTPUT | LGCIU 2 OUTPUT | A/C IN FLT | A/C ON GRND |
|-----------------|---|-------------------|-------------------|---|--|
| FLT CTL | SFCC 1(2) | 5 | (5) | <ul style="list-style-type: none"> For SFCC 1(2): Slats alpha/speed lock function active For SFCC (2): No flaps movement inhibition if the cargo door is opened | <ul style="list-style-type: none"> For SFCC 1(2): Slats alpha/speed lock function active if speed > 60 kt For SFCC (2): Flaps movement inhibition if cargo door is opened |
| FLT INST | <ul style="list-style-type: none"> DFDR QAR  | 1 3 7 | 1 3 | Runs ⁽⁶⁾ | Runs: ⁽⁷⁾ <ul style="list-style-type: none"> During the first 5 min following energization With one engine running Stops: ⁽⁷⁾ 5 min after second engine shut down |
| FUEL | FQI | 5 | | FQI uses flight attitude correction due to wing bending | FQI uses ground attitude correction |
| HYD | BLUE and GREEN pumps | 1 3 | | Blue or green pump "FAULT" light not inhibited when related pump is stopped ⁽⁶⁾ | Blue or green pump "FAULT" light inhibited when related pump is stopped ⁽⁷⁾ |
| | BLUE pump | 7 | | Runs when electrical power is available | Runs when at least one engine is running |
| | BLUE and YELLOW pumps | | 1 3 | Blue or yellow pump "FAULT" light not inhibited when related pump is stopped ⁽⁶⁾ | Blue or yellow pump "FAULT" light inhibited when related pump is stopped ⁽⁶⁾ |
| | PTU | | 7 | PTU runs if green/yellow diff. press > 500 PSI | PTU runs if green/yellow diff. press > 500 PSI and <ul style="list-style-type: none"> both MASTER LEVERS are at OFF or Both MASTER LEVERS are at ON or Nose wheel steering is not in towing position with parking brake released. PTU is inhibited during the use of the cargo door hand pump and for 40 s after its use. |

Continued on the following page

AIRCRAFT SYSTEMS

LANDING GEAR

GEARS AND DOORS - INTERACTIONS BETWEEN LANDING GEAR AND AIRCRAFT SYSTEMS

Continued from the previous page

| | SYSTEM | LGCIU 1 OUTPUT | LGCIU 2 OUTPUT | A/C IN FLT | A/C ON GRND |
|----------------------|--|--------------------|--------------------|--|---|
| ICE RAIN PROT | CAPT , (F/O), ((STBY)) probes and CAPT , (F/O) windows heating | 4, (2) ((8)) | 4, (2) ((8)) | <ul style="list-style-type: none"> CAPT , (F/O), ((STBY)) pitots and CAPT , (F/O) windows : high heating level applied All other probes and windows are heated⁽⁶⁾ | <ul style="list-style-type: none"> With engines stopped: no heating⁽⁶⁾ With at least one engine running: CAPT , (F/O), ((STBY)) pitots and CAPT , (F/O) windows are heated at low level⁽⁶⁾ |
| | WING ANTI ICE | 3 | 1 | Wing anti ice valves open when the WING ANTI ICE pb is at ON ⁽⁶⁾ | Wing anti ice valves open for 30 s when the WING ANTI ICE pb is at ON ⁽⁶⁾ |
| | RAIN REPELLENT | 1 3 | 1 3 | Not inhibited ⁽⁶⁾ | Inhibited if engines are stopped ⁽⁷⁾ |
| | DRAIN MAST ⁽¹⁰⁾ | | 9 | High heating level is applied | Low heating level is applied |
| LANDING GEAR | L/G SAFETY VALVE | 6 | | Safety valve closes if aircraft speed > 260 kt | Safety valve opened |
| | L/G control | 10 | 10 | Retraction not inhibited ⁽⁶⁾ | Retraction inhibited ⁽⁹⁾ |
| | TIRE PRESS  | | 5 | "TYRE LO PRESS" warning threshold set to its flight level | "TYRE LO PRESS" warning threshold set to its ground level |
| NAVIGATION | STAND BY ALTI | 5 | | VIBRATION function active | VIBRATION function inhibited |
| | ATC 1(2) | 3 | (1) | ATC 1(2) available in AUTO mode | ATC 1(2) inhibited in AUTO mode |
| | ADIRU 1 ⁽¹⁰⁾ | 7 | | No external horn when ADIRU supplied from batteries only | External horn not inhibited |

Continued on the following page

AIRCRAFT SYSTEMS

LANDING GEAR

GEARS AND DOORS - INTERACTIONS BETWEEN
LANDING GEAR AND AIRCRAFT SYSTEMS

Continued from the previous page

| | SYSTEM | LGCIU 1 OUTPUT | LGCIU 2 OUTPUT | A/C IN FLT | A/C ON GRND |
|--------------------|------------|-------------------|-------------------|---|--|
| POWER PLANT | FADEC 1(2) | 1 | (1) | <u>On ENG 1(2):</u> ⁽⁶⁾ <ul style="list-style-type: none"> • Reverse inhibited • No automatic start abort • FADEC always supplied • FLEX not available • If installed, BUMP not selectable | <u>On ENG 1(2):</u> ⁽⁸⁾ <ul style="list-style-type: none"> • Reverse available • Automatic start abort available • 5 min after eng-shut down FADEC 1(2) no more supplied • FLEX available • If installed, BUMP selectable |
| | | 3 | (3) | | |
| | | 8 | (8) | | |

- (1) *When either LGCIU indicates flight.*
- (2) *When both LGCIU indicate ground.*
- (3) *When either LGCIU indicates ground.*
- (4) *When both LGCIU indicate flight.*
- (5) *Valid from MSN 44.*
- (6) *When either output indicates flight.*
- (7) *When all outputs indicate ground.*
- (8) *When both outputs indicate ground.*
- (9) *One valid output is sufficient.*
- (10) *Valid from MSN 22.*

| | |
|---|---|
|  A318/A319/A320/A321 FLIGHT CREW OPERATING MANUAL | AIRCRAFT SYSTEMS LANDING GEAR GEARS AND DOORS - INTERACTIONS BETWEEN LANDING GEAR AND AIRCRAFT SYSTEMS |
|---|---|

PROXIMITY DETECTORS ON UPLOCKS

Ident.: DSC-32-10-30-00018610.0002001 / 21 MAR 16
Applicable to: ALL

| | SYSTEM | LGCIU 1 OUTPUT | LGCIU 2 OUTPUT | L/G UNLOCKED | L/G NOT UNLOCKED |
|---------------------|---------------------|----------------|----------------|--|--|
| LANDING GEAR | L/G control | 19 | 19 | If UP selected ^{:(1)} L/G doors will close | If UP selected ^{:(1)} L/G doors will not close |
| | ECAM WHEEL page | 16 | 16 | If UP selected ^{:(2)} L/G uplocked indications | If UP selected ^{:(2)} L/G in transit indications |
| | | 17 18 | 17 18 | | |
| | L/G indicator panel | 16 17 18 | | If UP selected ^{:(2)} no indication | If UP selected ^{:(2)} "UNLK" red indications |

- (1) One valid output is sufficient.
 (2) When all outputs indicate the same position.

PROXIMITY DETECTORS ON DOORS

Ident.: DSC-32-10-30-00018611.0001001 / 21 MAR 16
Applicable to: ALL

| | SYSTEM | LGCIU 1 OUTPUT | LGCIU 2 OUTPUT | DOORS FULLY OPENED | DOORS CLOSED |
|---------------------|--------------------|----------------|----------------|---|--|
| LANDING GEAR | L/G control | 24 | 24 | L/G extension or retraction possible ⁽¹⁾ | L/G extension or retraction inhibited ⁽¹⁾ |
| | ECAM WHEEL page | 20 | 20 | Doors fully opened indication | Doors closed indication |
| | | 21 | 21 | | |
| | | 22 23 | 22 23 | | |

- (1) One valid output is sufficient.

PROXIMITY DETECTORS ON DOWNLOCKS

Ident.: DSC-32-10-30-00018613.0001001 / 21 MAR 16
Applicable to: ALL

| | SYSTEM | LGCIU 1 OUTPUT | LGCIU 2 OUTPUT | L/G DOWNLOCKED | L/G NOT DOWNLOCKED |
|-------------|-----------------|----------------|----------------|---|--|
| GEN | TAXI/T.O lights | | 15 | Lights not inhibited | Lights inhibited |
| COMM | SIGNS | 12 | 12 | "NO SMOKING" ⁽¹⁾ and "EXIT" signs on when AUTO selected ⁽²⁾ | "NO SMOKING" ⁽¹⁾ and "EXIT" signs inhibited when AUTO selected ⁽³⁾ |



Continued on the following page

AIRCRAFT SYSTEMS

LANDING GEAR

GEARS AND DOORS - INTERACTIONS BETWEEN LANDING GEAR AND AIRCRAFT SYSTEMS

Continued from the previous page

| | SYSTEM | LGCIU 1 OUTPUT | LGCIU 2 OUTPUT | L/G DOWNLOCKED | L/G NOT DOWNLOCKED |
|--|---|-------------------|------------------------------------|--|---|
| FLT INST | WBS  | 15 | 15 | Active ⁽⁴⁾ | Inhibited ⁽⁵⁾ |
| FMGS | FAC 1(2) | 12 | 12 | VLE indication displayed on PFD 1(2) | No VLE indication |
| LANDING GEAR | L/G control | 14 | 14 | If DOWN selected : ⁽⁶⁾ L/G doors will close | If DOWN selected : ⁽⁶⁾ L/G doors will not close |
| | ECAM WHEEL page | 11 | 11 | If DOWN selected : ⁽⁷⁾ L/G down indications | If DOWN selected : ⁽⁷⁾ L/G in transit indications |
| | | 13 | 13 | | |
| | 15 | 15 | | | |
| | L/G INDIC panel | 11 13 15 | | If DOWN selected : ⁽⁷⁾ L/G down indications | If DOWN selected : ⁽⁷⁾ L/G in transit indications |
| BRAKING STEERING | 15 | 15 | BSCU test operative ⁽²⁾ | BSCU test inhibited ⁽³⁾ | |
| BRAKE COOLING FANS  | | | 13 | Cooling available when ON selected | Cooling inhibited when ON selected |
| NAV | GPWS | 13 | | "TOO LOW-FLAPS" or "TOO LOW TERRAIN" warning operative | "TOO LOW-GEAR" or "TOO LOW TERRAIN" warning operative |

- (1) For cabin not configured for non smoking flight
- (2) When either output indicates DOWNLOCK.
- (3) When both outputs indicate NOT DOWNLOCK.
- (4) When both outputs indicate DOWNLOCK.
- (5) When either output indicates NOT DOWNLOCK.
- (6) One valid output is sufficient.
- (7) When all outputs indicate the same position.

| | |
|---|---|
|  A318/A319/A320/A321 FLIGHT CREW OPERATING MANUAL | AIRCRAFT SYSTEMS LANDING GEAR GEARS AND DOORS - INTERACTIONS BETWEEN LANDING GEAR AND AIRCRAFT SYSTEMS |
|---|---|

PROXIMITY DETECTORS ON CARGO DOORS

Ident.: DSC-32-10-30-00018614.0001001 / 21 MAR 16

Applicable to: ALL

LOCKING HANDLE OR SHAFT, DOOR SILLS

| | SYSTEM | LGCIU 1 OUTPUT | LGCIU 2 OUTPUT | LOCKED | UNLOCKED |
|------------------|----------------------|--------------------|--------------------|---|--|
| CRG DOORS | ECAM DOOR PAGE | 30 (31) | | Forward (aft) door symbol appears green | Forward (aft) door symbol appears amber, associated with "CARGO" amber |
| | CARGO DOOR OPERATION | | 34 (35) | Forward (aft) door normal opening inhibition | Forward (aft) door normal opening possible |
| | | | 36 (37) |  | Forward (aft) door normal operation possible |

MANUAL SELECTOR VALVE

| | SYSTEM | LGCIU 1 OUTPUT | LGCIU 2 OUTPUT | CLOSE | OPEN |
|------------------|----------------------|----------------|--------------------|--|--|
| CRG DOORS | CARGO DOOR OPERATION | | 32 (33) | Forward (aft) door normal opening inhibition | Forward (aft) door normal opening possible |

PROXIMITY DETECTORS ON FLAPS ATTACHMENTS

Ident.: DSC-32-10-30-00001291.0001001 / 22 MAR 16

Applicable to: ALL

| | SYSTEM | LGCIU 1 OUTPUT | LGCIU 2 OUTPUT | FLAP ATTACHMENT | FLAP ATTACHMENT FAILURE |
|----------------|--------|--------------------|--------------------|--|---------------------------------------|
| FLT CTL | SFCC | 28 (29) | 28 (29) | L(R) FLAPS normal operation ⁽¹⁾ | "FLAPS LOCKED" warning ⁽²⁾ |

⁽¹⁾ When at least one SFCC detects normal operation

⁽²⁾ When both SFCCs detect attachment failure

AIRCRAFT SYSTEMS

LANDING GEAR

GEARS AND DOORS - INTERACTIONS BETWEEN
LANDING GEAR AND AIRCRAFT SYSTEMS

Intentionally left blank

LANDING GEAR INDICATOR PANEL

Ident.: DSC-32-10-40-00018615.0001001 / 21 MAR 16

Applicable to: ALL

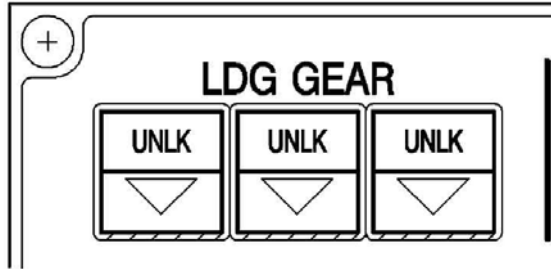

This panel is connected to LGCIU1, which receives signals from proximity detectors.

▽ light: comes on green if the gear is locked down.

UNLK: comes on red if the gear is not locked in the selected position.
 light

Note: This panel is connected to the LGCIU1 only, therefore, the lights on the LDG GEAR indicator panel come on as long as the LGCIU1 is electrically supplied. If one UNLK indication remains on, the landing gear position can be confirmed using the WHEEL SD page (information from LGCIU 1 & 2). Only one green triangle on each landing gear is sufficient to confirm that the landing gear is downlocked.

LANDING GEAR SELECTOR LEVER

Ident.: DSC-32-10-40-00018616.0001001 / 20 MAY 16

Applicable to: ALL

A two-position selector lever sends electrical signals to the two LGCIUs. These control the green hydraulic supply to the landing gear system by means of selector valves.

The flight crew must always move the L/G lever in one continuous movement (i.e. with no stop between both positions).

When the flight crew selects UP or DOWN (and if the airspeed is below 260 kt):

- All landing gear doors open
- Each landing gear moves to the selected position
- All landing gear doors close.

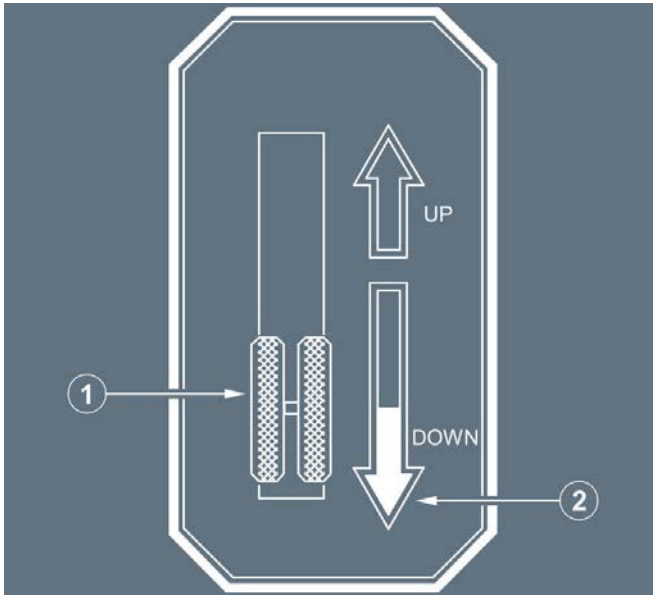

(1) L/G LEVER

- UP** : This position selects landing gear retraction.
 While the landing gear doors are opening, the normal brake system brakes the wheels of the main landing gear automatically.
 A brake band in the nose landing gear well brakes the nose landing gear wheels as the doors close (for aircraft equipped with nose landing gear rubbing strips).
- DOWN** : This position selects landing gear extension.
 An interlock mechanism prevents anyone from accidentally retracting the gear while the aircraft is on the ground. It does so by locking the lever in DOWN position when the shock absorber on either main gear is compressed (aircraft on ground) or the nose wheel steering is not centered.
 The landing gear hydraulic system remains pressurized as long as the landing gear is extended (if green hydraulic pressure is available).

(2) RED ARROW

This red arrow lights up if the landing gear is not locked down when the aircraft is in the landing configuration, and a red warning appears on ECAM.

LANDING GEAR GRAVITY EXTENSION

Ident.: DSC-32-10-40-00018617.0001001 / 21 MAR 16

Applicable to: ALL

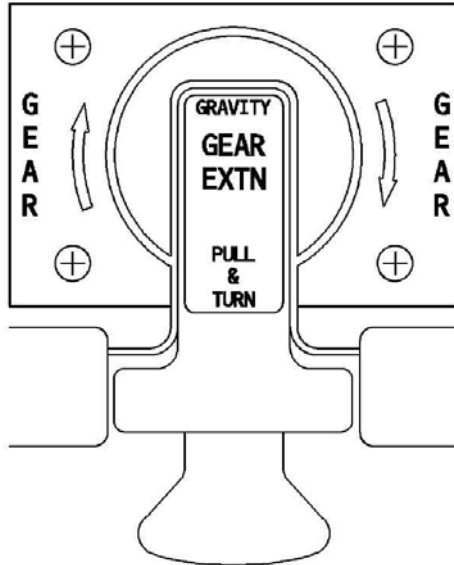

To put the landing gear down by gravity, the flight crew must pull the gear crank out, then turn it clockwise for 3 turns.

When the flight crew operates the crank handle, the cutout valve shuts off hydraulic pressure to the landing gear system and depressurizes it.

WHEEL SD PAGE

Ident.: DSC-32-10-40-00018618.0004001 / 21 MAR 16

Applicable to: ALL

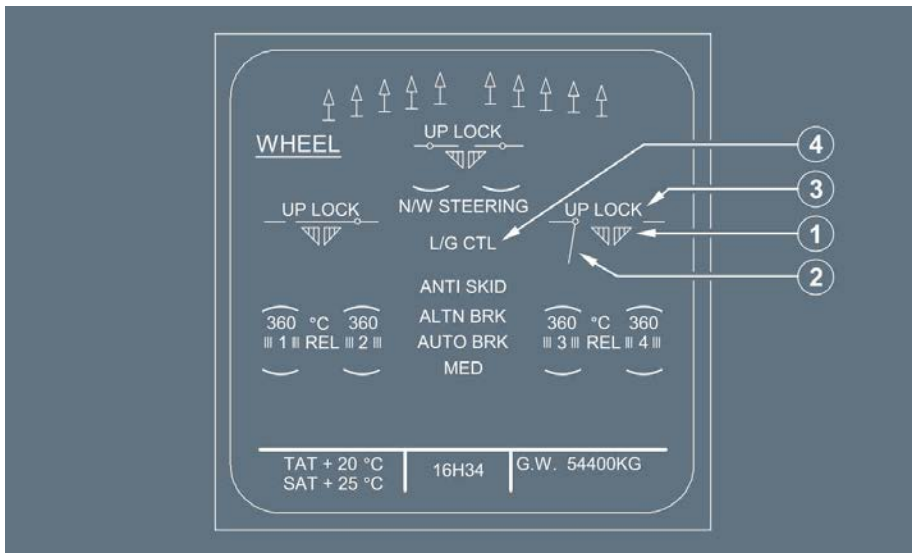

(1) Landing gear position indication

The landing gear positions are indicated by 2 triangles for each gear:

- Green triangle indicates that one LGCIU detects a landing gear downlocked
- Red triangle indicates that one LGCIU detects a landing gear in transit
- No triangle indicates that one LGCIU detects a landing gear uplocked
- Amber crosses on one triangle indicate that LGCIU 1 or LGCIU2 is failed.

Note: Only one green triangle on each landing gear strut is sufficient to confirm that the landing gear is downlocked.

(2) Landing gear door position indication



(3) UP LOCK

This legend appears amber along with a caution on the ECAM if the landing gear uplock is engaged when the landing gear is down locked.

(4) L/G CTL

This legend appears amber along with an ECAM caution if the landing gear lever and the landing gear position do not agree. This legend only appears when the landing gear is moving to the selected position.

MEMO DISPLAY

Ident.: DSC-32-10-40-00018778.0001001 / 22 MAR 16

Applicable to: ALL

FLT L/G DOWN : This memo appears in green if the aircraft is operated in ferry flight conditions with landing gear down.



A318/A319/A320/A321
FLIGHT CREW
OPERATING MANUAL

AIRCRAFT SYSTEMS

LANDING GEAR

GEARS AND DOORS - CONTROLS AND INDICATORS

Intentionally left blank

DESCRIPTION

Ident.: DSC-32-20-10-00018619.0007001 / 21 MAR 16

Applicable to: ALL

A hydraulic actuating cylinder steers the nose wheel. The yellow hydraulic system supplies pressure to the cylinder, and electric signals from the Brake and Steering Control Unit (BSCU) control it.

The BSCU receives orders from:

- Captain's, and the First Officer's steering hand wheels (orders added algebraically), or
- Rudder pedals, or
- Autopilot.

The BSCU transforms these orders into nose wheel steering angle. That angle has the following limits, which depend on ground speed and the origin of the orders.

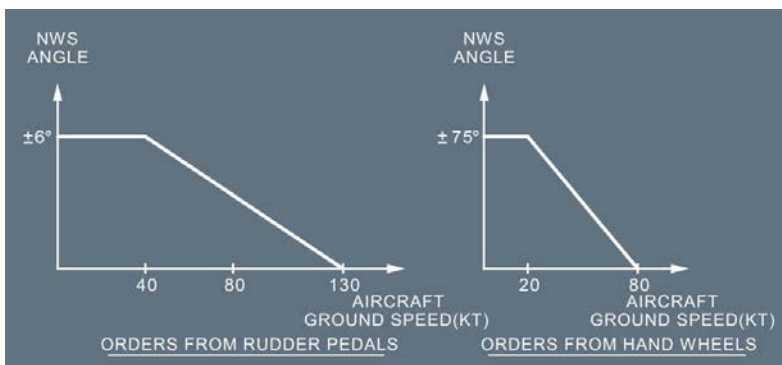

The steering system receives actuating hydraulic pressure when:

- A/SKID & N/W STRG switch is ON
- Towing control lever is in normal position
- At least one engine is running
- Aircraft is on ground.

The handwheel can turn the nosewheel up to 75 ° in either direction. A lever, on the towing electrical box (on nose landing gear), enables ground crew to deactivate the steering system for towing. Then the wheel can be turned 95 ° in either direction.

To prevent rudder pedal orders, or autopilot orders, from going to the BSCU, the pilots can use the pushbutton on either steering handwheel.

00000An internal cam mechanism returns the nose wheel to the centered position after takeoff.



A318/A319/A320/A321
FLIGHT CREW
OPERATING MANUAL

AIRCRAFT SYSTEMS

LANDING GEAR

NOSE WHEEL STEERING - DESCRIPTION

ARCHITECTURE

Ident.: DSC-32-20-10-00001298.0002001 / 21 MAR 16

Applicable to: ALL

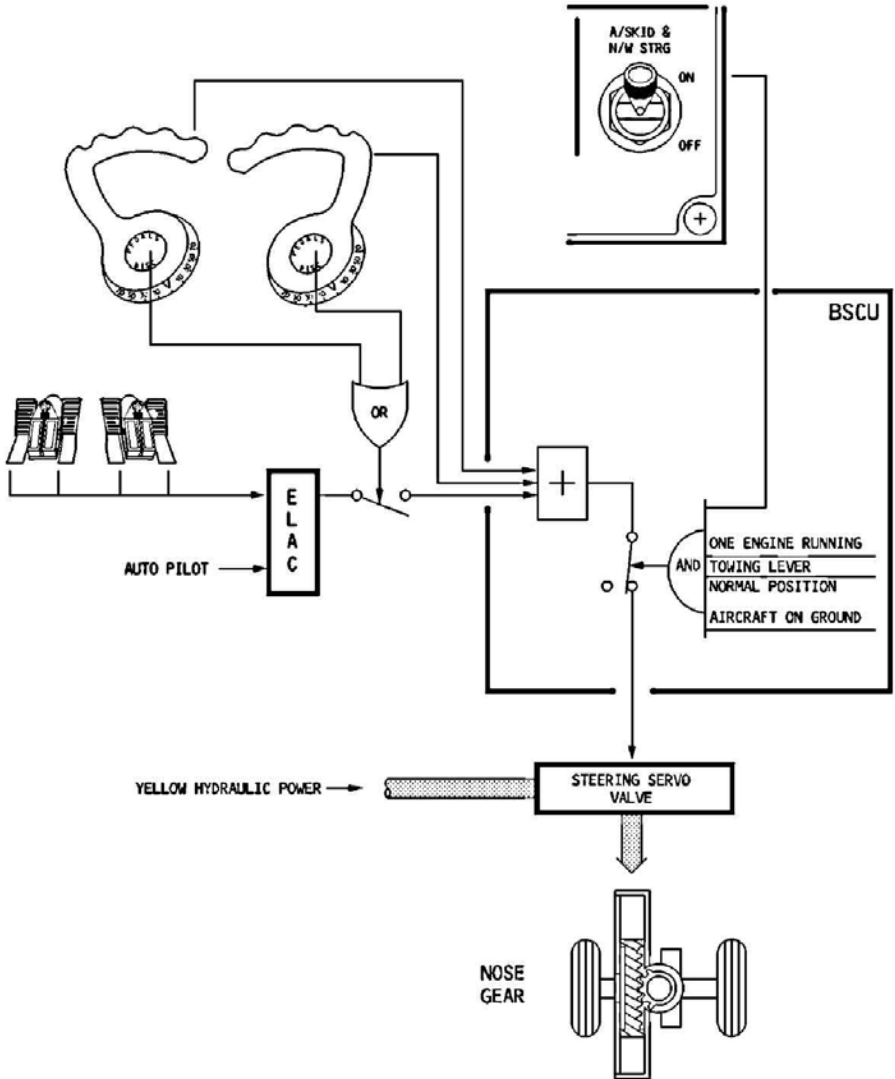

Intentionally left blank

SIDE CONSOLES

Ident.: DSC-32-20-20-00018620.0001001 / 21 MAR 16

Applicable to: ALL

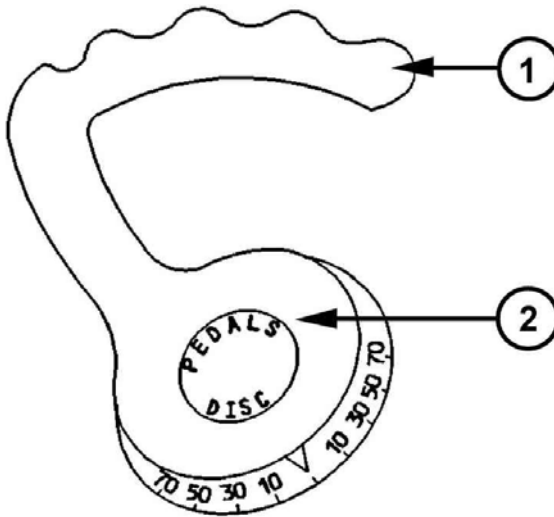

(1) Steering handwheels

The steering handwheels, which are interconnected, can steer the nose wheel up to 75 ° in either direction.

Note: The steering system centers the nose wheel automatically after liftoff.

(2) Rudder PEDALS DISC pb

Pressing this button on either handwheel removes control of nose wheel steering from the rudder pedals until the button is released.

WHEEL SD PAGE

Ident.: DSC-32-20-20-00018622.0004001 / 21 MAR 16

Applicable to: ALL

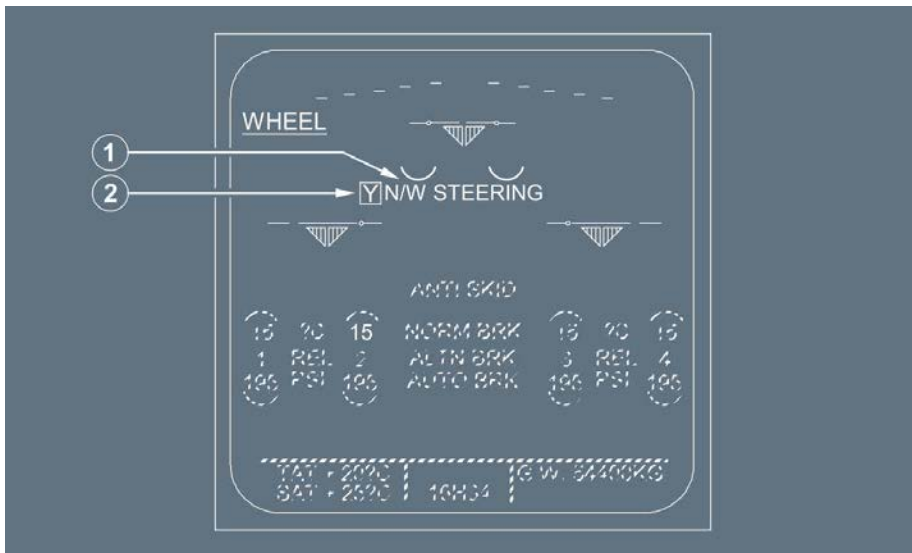

(1) N/W STEERING indication

It appears in amber, when nosewheel steering is lost, due to failure of the nosewheel steering system, or of both BSCU channels, or in case of a yellow hydraulic system low pressure, or if the A/SKID & N/W STRG switch is OFF.

(2) N/W STEERING hydraulic supply indication:

Only when the N/W STEERING indication is displayed, Y is displayed:

- In green when the yellow hydraulic system is not failed, or
- In amber when the yellow hydraulic system low pressure.

MEMO DISPLAY

Ident.: DSC-32-20-20-00016853.0001001 / 10 AUG 15

Applicable to: ALL

NW STRG DISC : This memo appears in green, when the nose wheel steering selector is in the towing position.

NW STRG DISC : This memo appears in amber, if one engine is running.

| | |
|---|---|
|  <p>A318/A319/A320/A321 FLIGHT CREW OPERATING MANUAL</p> | <p style="text-align: center;">AIRCRAFT SYSTEMS LANDING GEAR</p> <p style="text-align: center;">BRAKES AND ANTISKID - DESCRIPTION</p> |
|---|---|

| |
|----------------|
| GENERAL |
|----------------|

Ident.: DSC-32-30-10-00018623.0002001 / 21 MAR 16

Applicable to: ALL

The main wheels are equipped with carbon multidisc brakes, which can be actuated by either of two independent brake systems.

The normal system uses green hydraulic pressure, whereas the alternate system uses the yellow hydraulic system backed up by the hydraulic accumulator.

An anti-skid and autobrake system is also provided.

Braking commands come from either the brake pedals (pilot action), or the autobrake system (deceleration rate selected by the crew).

In normal operation, a dual channel Brake and Steering Control Unit (BSCU) controls normal braking and antiskid.

Depending on the failure, braking may revert to:

- Alternate braking with antiskid. This braking mode is controlled by the Alternate Braking Control Unit (ABCU), and the antiskid is controlled by the BSCU
- Alternate braking without antiskid. This braking mode is fully-controlled by the ABCU
- Alternate braking without antiskid on accumulator. This braking mode is fully-controlled by the ABCU.

All the normal and alternate braking components are fully-monitored. Any detected failure is signaled to the crew via ECAM warnings.

The BSCU performs the following secondary functions:

- Checks the residual pressure in the brakes
- Monitors the brake temperature
- Provides discrete wheel speed information to other aircraft systems.

A changeover between the two BSCU channels takes place at each DOWN landing gear lever selection, or in case one channel fails.

The main gear wheels are fitted with fusible plugs which protect against tire burst, in the event of overheating.

Main gear wheels are also equipped with brake cooling fans  , which permit a high speed cooling of brakes.

| |
|-------------------------|
| ANTI-SKID SYSTEM |
|-------------------------|

Ident.: DSC-32-30-10-00018624.0001001 / 21 MAR 16

Applicable to: ALL

The antiskid system provides maximum braking efficiency by maintaining the wheels at the limit of an impending skid.

At skid onset, brake release orders are sent to the normal and alternate servovalves, as well as to the ECAM system which displays the released brakes.

Without using autobrake, full braking performance is achieved only with brake pedals at full deflection.

The antiskid system is deactivated below 20 kt (ground speed).

An ON/OFF switch activates, or deactivates, the antiskid and nosewheel steering systems.

PRINCIPLE

The speed of each main gear wheel (given by a tachometer) is compared to the aircraft speed (reference speed). When the speed of a wheel decreases below approximately 0.87 times (depending on conditions) reference speed, brake release orders are given to maintain the wheel slip at that value (best braking efficiency).

In normal operation, the reference speed is determined by the BSCU from the horizontal acceleration of ADIRU 1, or ADIRU 2, or ADIRU 3.

In case all ADIRUs fail, reference speed equals the maximum of either main landing gear wheel speeds.

AUTO BRAKE

Applicable to: ALL

Ident.: DSC-32-30-10-A-00018625.0001001 / 21 MAR 16

GENERAL

The purposes of the autobrake system are the following:

- Reduce the braking distance in case of an aborted takeoff
- Establish and maintain a selected deceleration rate during landing, thereby improving passenger comfort and reducing crew workload.

Ident.: DSC-32-30-10-A-00018626.0002001 / 21 MAR 16

SYSTEM ARMING

The crew may arm the system by pressing the LO, MED, or MAX pushbutton provided all the following arming conditions are met :

- Green pressure available
- Anti-skid electrically-powered
- No failure in the braking system
- At least one ADIRU is available.

- Note:*
1. Auto brake may be armed with the parking brake on.
 2. MAX autobrake mode cannot be armed in flight.

Ident.: DSC-32-30-10-A-00018627.0002001 / 21 MAR 16

SYSTEM ACTIVATION

Automatic braking is activated when:

- The command for ground spoilers extension is detected (*Refer to DSC-27-10-20 Speed Brakes and Ground Spoilers - Speed Brake Control*), for LO and MED mode, or
- The command for ground spoilers extension is detected, and the aircraft speed is above 40 kt, for MAX mode.

Therefore, if the aircraft makes an acceleration stop and begins to decelerate when its speed is under 72 kt, the automatic braking will not activate because the ground spoilers will not extend. For autobrake to activate, at least two SEC's must be operative.

Ident.: DSC-32-30-10-A-00018628.0001001 / 21 MAR 16

SYSTEM DEACTIVATION

The system deactivates when:

- The system disarmed (*Refer to DSC-32-30-10 Auto Brake - System Disarming*), or
- The ground spoilers retract. In this case it remains armed.

Ident.: DSC-32-30-10-A-00018629.0002001 / 21 MAR 16

The system disarms when:

- Flight crew presses the pushbutton switch, or
- One or more arming conditions is lost, or
- After take-off/touch and go, or
- Flight crew applies enough deflection to at least one brake pedal when autobrake is active in MAX, MED or LO mode.

BRAKING MODES

Applicable to: ALL

Ident.: DSC-32-30-10-B-00018630.0001001 / 21 MAR 16

GENERAL

There are four modes of operation:

- Normal braking
- Alternate braking with antiskid
- Alternate braking without antiskid
- Parking brake.

Ident.: DSC-32-30-10-B-00018631.0001001 / 21 MAR 16

NORMAL BRAKING

Normal braking is operative when:

- Green hydraulic pressure is available
- A/SKID & N/W STRG switch is ON.

During normal braking, antiskid is operative and autobrake is available.

Braking is electrically-controlled through the BSCU from:

- Pilot's pedals, or
- Automatically activates when:
 - On ground by the autobrake system, or
 - In flight when the landing gear lever is up.

The antiskid system is controlled by the BSCU via the normal servo valves.

There is no brake pressure indication in the cockpit.

Ident.: DSC-32-30-10-B-00018632.0002001 / 17 MAR 17

ALTERNATE BRAKING WITH ANTI-SKID

Autobrake is inoperative.

Braking uses this mode when green hydraulic pressure is insufficient, and :

- Yellow hydraulic pressure is available
- A/SKID & N/W STRG switch is ON
- Parking brake is not ON.

Braking inputs are made by the brake pedals and sent to the ABCU . Then, taking into account the brake pedal input, the ABCU:

- Energizes the alternate brake selector valve to pressurize the yellow hydraulic circuit
- Electrically controls the Alternate Servo Valve to obtain the correct pressure for the related brakes.

Antiskid is controlled by the BSCU.

A triple indicator on the center instrument panel indicates the pressure delivered to the left and right brakes, as well as the accumulator pressure.

Note: Initial pedal force or displacement produces more braking action in alternate mode than in normal mode.

Ident.: DSC-32-30-10-B-00018633.0002001 / 17 MAR 17

ALTERNATE BRAKING WITHOUT ANTI-SKID

Autobrake and antiskid are inoperative.

The antiskid system is either deactivated:

- Electrically (A/SKID & N/W STRG sw OFF, or power supply failure, or BSCU failure), or
- Hydraulically (Y + G system low pressure, the brakes are supplied by the brake accumulator only).

Depending on the brake pedals' demand, the ABCU controls the alternate brake selector and the alternate servovalves.

Brake pressure and accumulator pressure are indicated on a triple indicator, located on the center instrument panel. To avoid wheel locking and limit the risk of tire burst, brake pressure is automatically limited to 1 000 PSI.

The accumulator can supply at least 7 full brake applications.

Note: Initial pedal force or displacement produces more braking action in alternate mode than in normal mode.

Ident.: DSC-32-30-10-B-00018634.0002001 / 21 MAR 16

PARKING BRAKE

Brakes are supplied by the yellow hydraulic system, or by accumulator pressure via the parking brake control valve, which opens allowing full pressure application on the main gear wheel brakes. The accumulator maintains the parking pressure for at least 12 h.

If the parking brake is activated and no yellow hydraulic or accumulator brake pressure is available, then the normal braking system can be applied via the brake pedals.

Yellow accumulators can be pressurized by pressing the yellow electrical pump switch.

A triple indicator on the center instrument panel indicates the pressure delivered to the left and right brakes, as well as the accumulator pressure.

BRAKING SCHEMATIC

Ident.: DSC-32-30-10-00001316.0003001 / 09 OCT 12

Applicable to: ALL

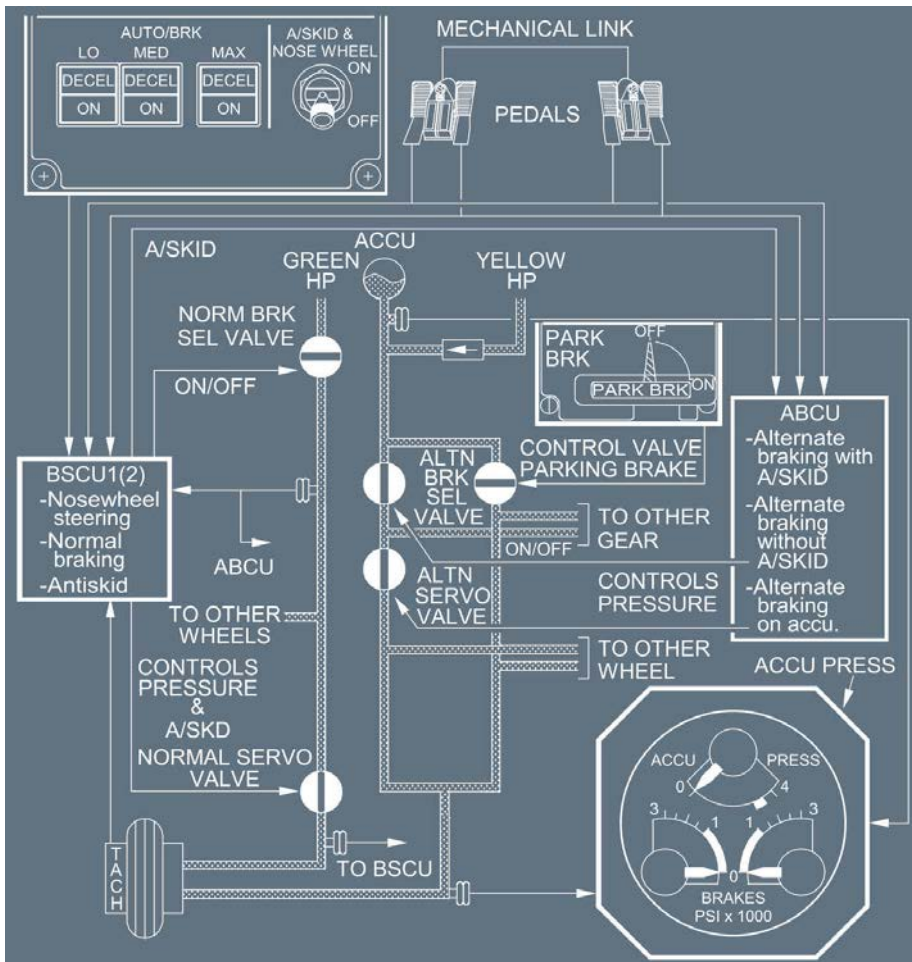

CENTER INSTRUMENT PANEL

Ident.: DSC-32-30-20-00018635.0002001 / 21 MAR 16

Applicable to: ALL

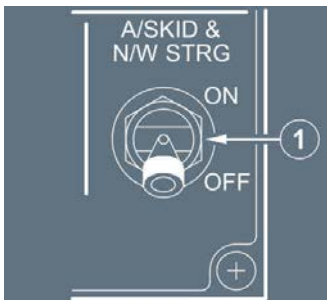

(1) A/SKID & N/W STRG sw

ON : If green hydraulic pressure is available, then antiskid is available.

If green hydraulic pressure is lost, then:

- Yellow hydraulic pressure automatically takes over to supply the brakes
- Antiskid and nosewheel steering remain available
- Triple indicator shows yellow system brake pressure.

OFF : The yellow hydraulic system supplies pressure to the brakes.

- Antiskid is deactivated. The pilot must refer to the triple indicator to limit brake pressure and avoid locking a wheel
- Nosewheel steering is lost
- Differential braking remains available through the pedals
- Triple indicator displays yellow system brake pressure.

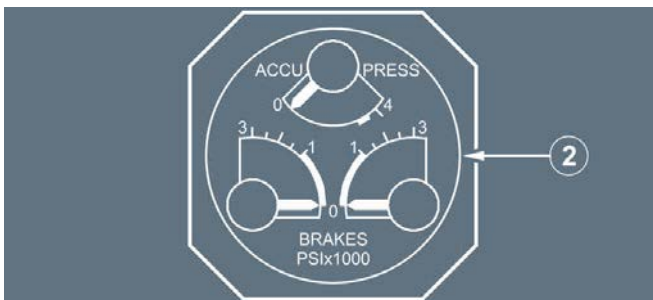

(2) BRAKES and ACCU PRESS indicator

Brake pressure is only indicated when the yellow hydraulic system controls the brake pressure, This is when the:

- Alternate braking system is activated, or
- Parking brake is applied.

ACCU : Indicates the pressure in the yellow brake accumulator.

PRESS

BRAKES : Indicates the yellow pressure delivered to the left and right brakes, as measured upstream of the alternate servovalves.

AUTO BRK PANEL

Ident.: DSC-32-30-20-00018636.0002001 / 21 MAR 16

Applicable to: ALL

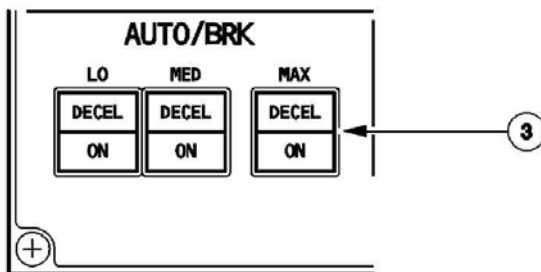

(3) AUTO/BRK panel

The springloaded MAX , MED , and LO pushbutton switches arm the appropriate deceleration rate. The usage for each mode are as follow:

- MAX mode is normally selected for takeoff.
 In the case of an aborted takeoff, maximum pressure goes to the brakes, as soon as the system generates the ground spoiler deployment order
- MED or LO mode is normally selected for landing:
 - MED mode sends progressive pressure to the brakes 2 s after the ground spoilers deploy in order to decelerate the aircraft at 3 m/s² (9.8 ft/s²)
 - LO mode sends progressive pressure to the brakes 4 s after the ground spoilers deploy, in order to decelerate the aircraft at 1.7 m/s² (5.6 ft/s²).

The lighting on the pushbutton switches are as follow:

ON light : comes on blue to indicate positive arming

DECEL light : comes on green when the actual deceleration is 80 % of the selected rate

Note: On slippery runways, the predetermined deceleration may not be reached, due to antiskid operation. In this case, the DECEL light will not come on. This does not mean that autobrake is not working.

Off : The corresponding autobrake mode is not armed

BRAKE FAN 

Ident.: DSC-32-30-20-00018637.0001001 / 21 MAR 16

Applicable to: ALL

BRK FAN

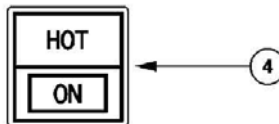

(4) **BRK FAN pb-sw** 

ON light : The brake fans run if the lefthand main landing gear is down and locked

Off : The brake fans stop

HOT : This amber light comes on when the brakes get too hot (A caution appears on light ECAM, also)

PEDESTAL

Ident.: DSC-32-30-20-00018638.0001001 / 21 MAR 16

Applicable to: ALL



- (1) PARKING BRK handle
Flight crew pulls this handle, then turns it clockwise, to apply the parking brake.
The ECAM memo page displays "PARK BRK".

CAUTION If the pointer is not at ON, the parking brake is not on.

WHEEL SD PAGE

Ident.: DSC-32-30-20-00018639.0008001 / 21 MAR 16

Applicable to: ALL

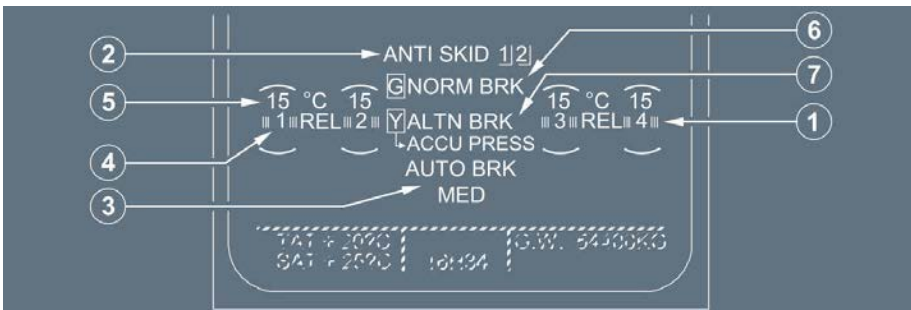

(1) Release indicators

 It appears in amber in case of brake released fault.

(2) ANTI SKID indication



(A) ANTISKID label

It appears in amber, a long with an ECAM caution, in case of a total BSCU failure, or when the A/SKID & N/W STRG sw is OFF, or if the BSCU detects an ANTI-SKID failure, or in case of normal braking and yellow hydraulic system low pressure.
It appears in green in case of autobrake, normal braking, or alternate braking failure, and antiskid is still available.

(B) BSCU channel indication

When ANTISKID label is displayed, the number of the failed system(s) is (are) displayed in amber, if any.

(3) AUTO BRK

This legend appears:

- In green when auto brake is armed, or
- Flashing green for 10 s after autobrake disengagement, or
- In amber, along with an ECAM caution, to indicate a system failure.

MED , LO, or MAX appears underneath in green to show which rate has been selected.

(4) Wheel number

This white number identifies individual wheels of the main landing gear.

(5) Brake temperature

- Temperature normally appears in green.
- Green arc appears on the hottest wheel when one brake temperature exceeds 100 °C.
- Green arc becomes amber, and an ECAM caution appears, when the corresponding brake temperature exceeds 300 °C.

(6) NORM BRK indication



(A) NORM BRK label

This indication appears in green when autobrake or alternate braking is failed, and normal braking is still available.

The legend appears in amber when normal braking is failed due to total BSCU failure, or to the loss of the green hydraulic pressure, or to the loss of antiskid.

(B) NORM BRK hydraulic supply indication

G is displayed when the NORM BRK label is displayed. It is green when green hydraulic pressure is available and amber, in case of green hydraulic low pressure.

(7)



(A) ALTN BRK label

This indication appears in green, if the braking system is in alternate mode and not failed, or in case autobrake or normal braking is failed and alternate braking is still available.

This indication appears in amber when alternate braking is failed.

(B) ALTN BRK hydraulic supply indication

Y is displayed when the ALTN BRK label is displayed. It is green when yellow hydraulic pressure is available and amber, in case of yellow hydraulic low pressure.

(C) ACCU indications



- (*) Appears in green, when the ALTN BRK label is displayed, and the yellow hydraulic pressure is available.
 Appears in amber, with no arrow, when the yellow hydraulic system and the accumulator are in low pressure.
- (**) Appears in green when the alternate braking is pressurized by the yellow accumulator.

MEMO DISPLAY

Applicable to: ALL

Ident.: DSC-32-30-20-A-00016854.0001001 / 22 MAR 16

AUTO BRK LO/MED/MAX : This memo appears in green, depending on the selection of the AUTO BRK pb.

Ident.: DSC-32-30-20-A-00016855.0001001 / 22 MAR 16

AUTO BRK OFF : This memo appears in green if the auto brake is failed.

Ident.: DSC-32-30-20-A-00016856.0001001 / 22 MAR 16

BRK FAN : This memo appears in green if the BRK FAN pb  is ON.

Ident.: DSC-32-30-20-A-00016857.0001001 / 22 MAR 16

PARK BRK : This memo appears in green, if the parking brake is ON, during flight phases 1, 2, 9 and 10.

AIRCRAFT SYSTEMS

LANDING GEAR

BRAKES AND ANTISKID - CONTROLS AND INDICATORS

Intentionally left blank

AIRCRAFT SYSTEMS

LIGHTS

Intentionally left blank

DSC-33-10 Cockpit Lighting

DSC-33-10-10 General

General.....A

DSC-33-10-20 Description

Description.....A
Schematic.....B

DSC-33-10-30 Controls and Indicators

Overhead Panel.....A
Maintenance Panel.....B
Lateral Window.....C
Pedestal.....D
Glareshield.....E
Main Inst Panel.....F

DSC-33-20 Exterior Lighting

DSC-33-20-10 General

General.....A

DSC-33-20-20 Controls and Indicators

Schematic.....A
Overhead Panel.....B
Memo Display.....C

DSC-33-30 Emergency Lighting

DSC-33-30-10 Description

General.....A
Proximity Emergency Escape Path Marking System/Exit Signs.....B

DSC-33-30-20 Controls and Indicators

Controls and Indicators.....A

DSC-33-40 Signs

DSC-33-40-10 Controls and Indicators

Overhead Panel.....A
Memo Display.....B



A318/A319/A320/A321
FLIGHT CREW
OPERATING MANUAL

AIRCRAFT SYSTEMS

LIGHTS

PRELIMINARY PAGES - TABLE OF CONTENTS

Intentionally left blank



A318/A319/A320/A321
FLIGHT CREW
OPERATING MANUAL

AIRCRAFT SYSTEMS

LIGHTS

COCKPIT LIGHTING - GENERAL

GENERAL

Ident.: DSC-33-10-10-00017615.0001001 / 21 MAR 16

Applicable to: ALL

The instrument panel has both integral instrument lighting and flood lighting.

The brightness of all panel lighting is adjustable.

Spot lights and flood lights provide lighting for all work surfaces and the side consoles.

Two dimmable dome lights provide lighting for the overall cockpit. When the batteries are supplying electrical power, only the right-hand dome light is on line.



A318/A319/A320/A321
FLIGHT CREW
OPERATING MANUAL

AIRCRAFT SYSTEMS

LIGHTS

COCKPIT LIGHTING - GENERAL

Intentionally left blank

DESCRIPTION

Ident.: DSC-33-10-20-00017616.0001001 / 21 MAR 16

Applicable to: ALL

INTEGRATED LIGHTING FOR INSTRUMENTS AND PANELS

All instruments and panels in the cockpit (other than display units) have integral lighting. The flight crew can adjust the brightness of all integral lighting.

ANNUNCIATOR LIGHTS

The ANN LT sw on the overhead panel controls the brightness of all the annunciator lights in the cockpit.

The ANN LT sw sets the brightness of all annunciator lights at the same level.

The flight crew can test the annunciator lights with the following procedure: Set the ANN LT sw to the TEST position, and check to see that all the annunciator lights come on.

DOME LIGHTS

Two dome lights provide the cockpit with shadow-free lighting.

MAP HOLDER LIGHTING 

Each flight crewmember has a map holder that can be lighted.

CONSOLE AND BRIEFCASE LIGHTING

Each flight crewmember has lighting for briefcase stowage, the side console, and the floor.

CENTER INSTRUMENT PANEL

Lights under the glareshield provide lighting for the center instrument panel.

STANDBY COMPASS

The standby compass has integral lighting.

READING LIGHTS

Each flight crewmember has a reading light.

PEDESTAL LIGHTING

A flood light in the middle of the overhead panel provides lighting for the center pedestal.

SCHEMATIC

Ident.: DSC-33-10-20-00001336.0002001 / 05 FEB 14

Applicable to: ALL

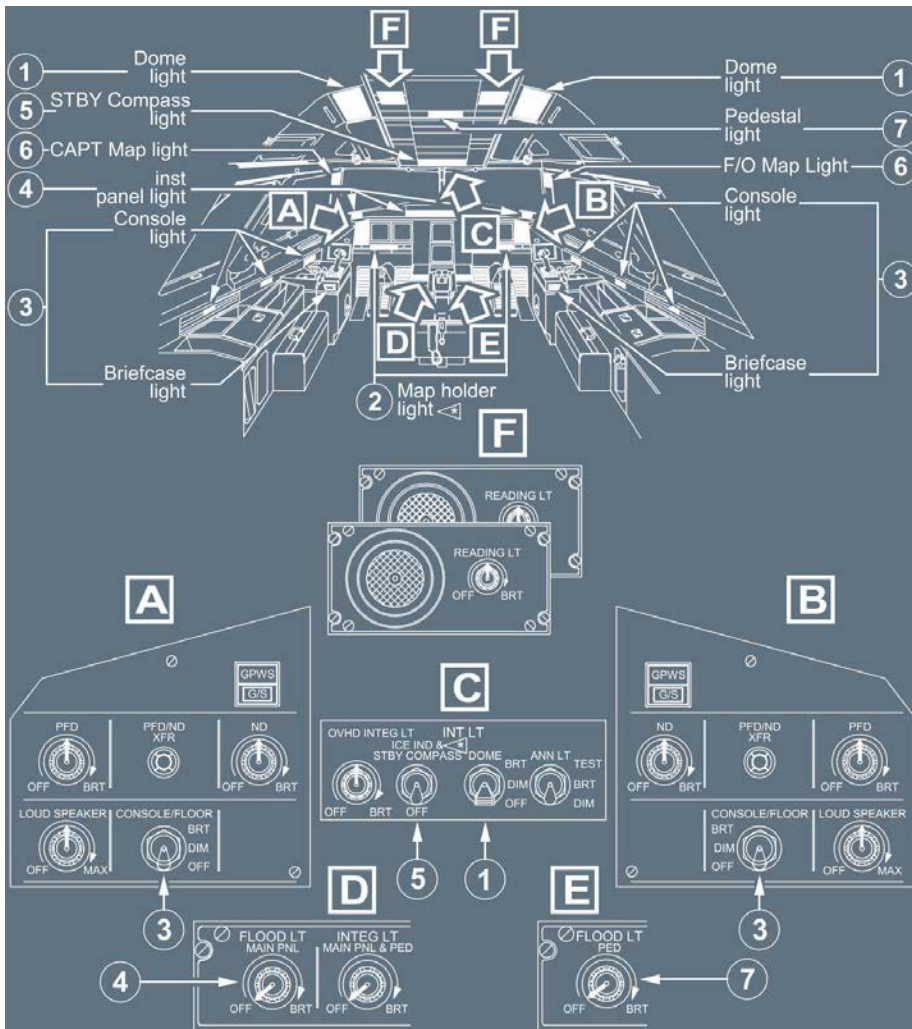



OVERHEAD PANEL

Ident.: DSC-33-10-30-00017617.0001001 / 21 MAR 16

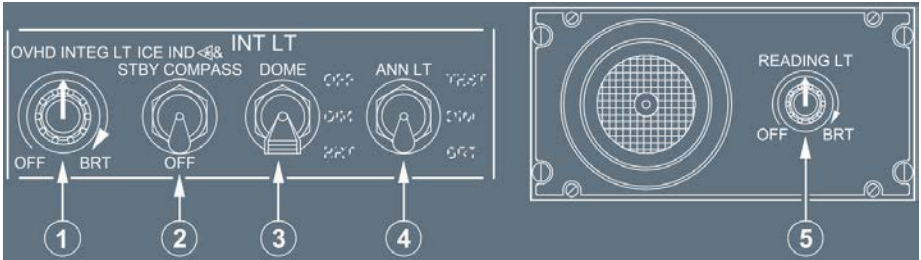
Applicable to: ALL



- (1) OVHD INTEG LT knob
This knob turns the overhead panel's integral lighting on and off, and adjusts its brightness.
- (2) ICE IND  & STBY COMPASS sw
This switch turns the standby compass light and the external ice detector light  on and off.
- (3) DOME sw
The DOME sw controls both dome lights.
The DOME sw can have one of the two following configurations:



- BRT : Both dome lights are on and bright.
- DIM : Both dome lights are on and dim.
- OFF : Both dome lights are off.

- (4) ANN LT sw
The ANN LT sw controls all the flight deck annunciator lights.
The ANN LT sw can have one of the two following configurations:



TEST : All flight deck annunciator lights turn On.
 The figure '8' is displayed on all Liquid Crystal Display (LCD) of the FCU.

DIM : Reduces the brightness of all flight deck annunciator lights.

BRT : All flight deck annunciator lights operate normally.

***Note:** When the ANN LT sw is set to TEST, do not reconfigure the DU (ECAM /ND transfer) or the DMC (DMC switching).*

(5) READING LT knob

The reading light on each side of the overhead panel has its own control knob that turns it on and off and adjusts its brightness.

MAINTENANCE PANEL

Ident.: DSC-33-10-30-00001338.0001001 / 22 MAY 12

Applicable to: ALL



(1) AVIONICS COMPT LT pushbutton switch

AUTO : avionic compartment lighting is automatically controlled by door opening.

ON : avionic compartment lighting is on.

LATERAL WINDOW

Ident.: DSC-33-10-30-00001339.0002001 / 05 FEB 14

Applicable to: ALL

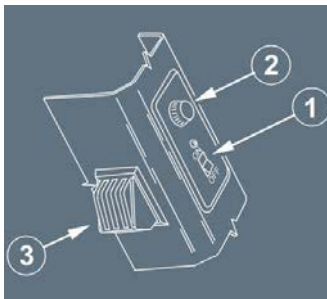

- (1) Map light sw (Captain and F/O)
- (2) Brightness adjustment knob
- (3) Light

PEDESTAL

Ident.: DSC-33-10-30-00017619.0001001 / 21 MAR 16

Applicable to: ALL



- (1) FLOOD LT MAIN PNL knob
 Turns on or off, and adjusts the brightness of the main instrument panel.
- (2) INTEG LT MAIN PNL & PED knob
 Turns on or off, and adjusts the brightness of the integral lights of:
 - The main instrument panel
 - The center pedestal.
- (3) FLOOD LT PED knob
 Turns on or off, and adjusts the brightness of the pedestal.

(3) FLOOD LT PED knob



Turns on or off, and adjusts the brightness of the pedestal lights.

GLARESHIELD

Ident.: DSC-33-10-30-00001341.0002001 / 21 JAN 14

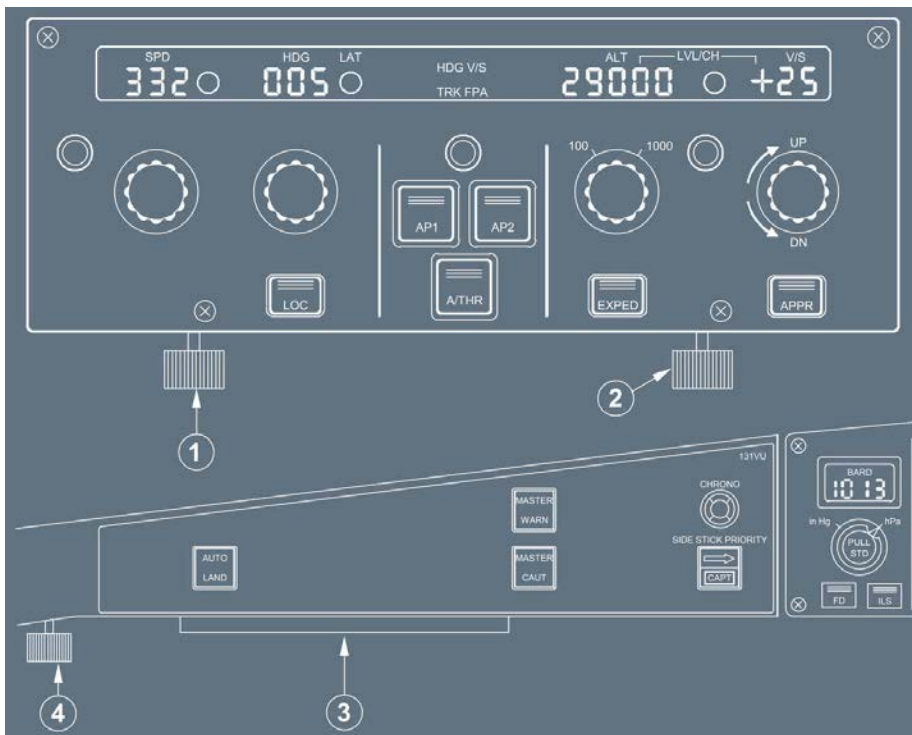
Applicable to: **ALL**



- (1) This knob adjusts the brightness of the integral lighting on the glareshield.
- (2) This knob adjusts the brightness of the FCU displays.
- (3) This lighting  illuminates the sliding table and map holder.
- (4) This knob  adjusts the brightness of the sliding table and map holder lighting.

MAIN INST PANEL

Ident.: DSC-33-10-30-00017620.0001001 / 21 MAR 16

Applicable to: ALL

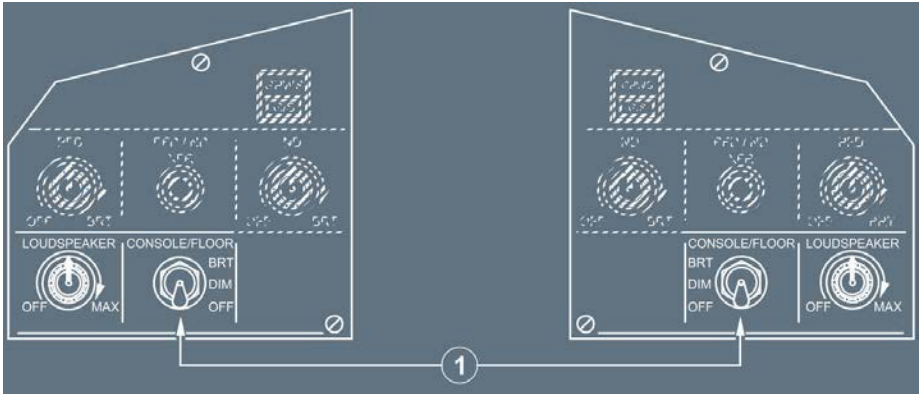

(1) CONSOLE/FLOOR sw

Each switch controls the lights of the side console and of the briefcase on each side of the cockpit. In addition, each switch controls the lighting of the floor around each flight crew member's seat. The lights can either be bright, dim, or off.

Intentionally left blank

GENERAL

Ident.: DSC-33-20-10-00017621.0001001 / 21 MAR 16

Applicable to: ALL

Exterior lighting includes the following lights:

- The navigation lights
- The landing lights
- The runway turn off lights
- The TO and TAXI lights
- The logo lights 
- The anticollision lights
- The wing and engine scan lights.



A318/A319/A320/A321
FLIGHT CREW
OPERATING MANUAL

AIRCRAFT SYSTEMS

LIGHTS

EXTERIOR LIGHTING - GENERAL

Intentionally left blank



A318/A319/A320/A321
FLIGHT CREW
OPERATING MANUAL

AIRCRAFT SYSTEMS

LIGHTS

EXTERIOR LIGHTING - CONTROLS AND INDICATORS

SCHEMATIC

Ident.: DSC-33-20-20-00017622.0001001 / 21 MAR 16

Applicable to: ALL

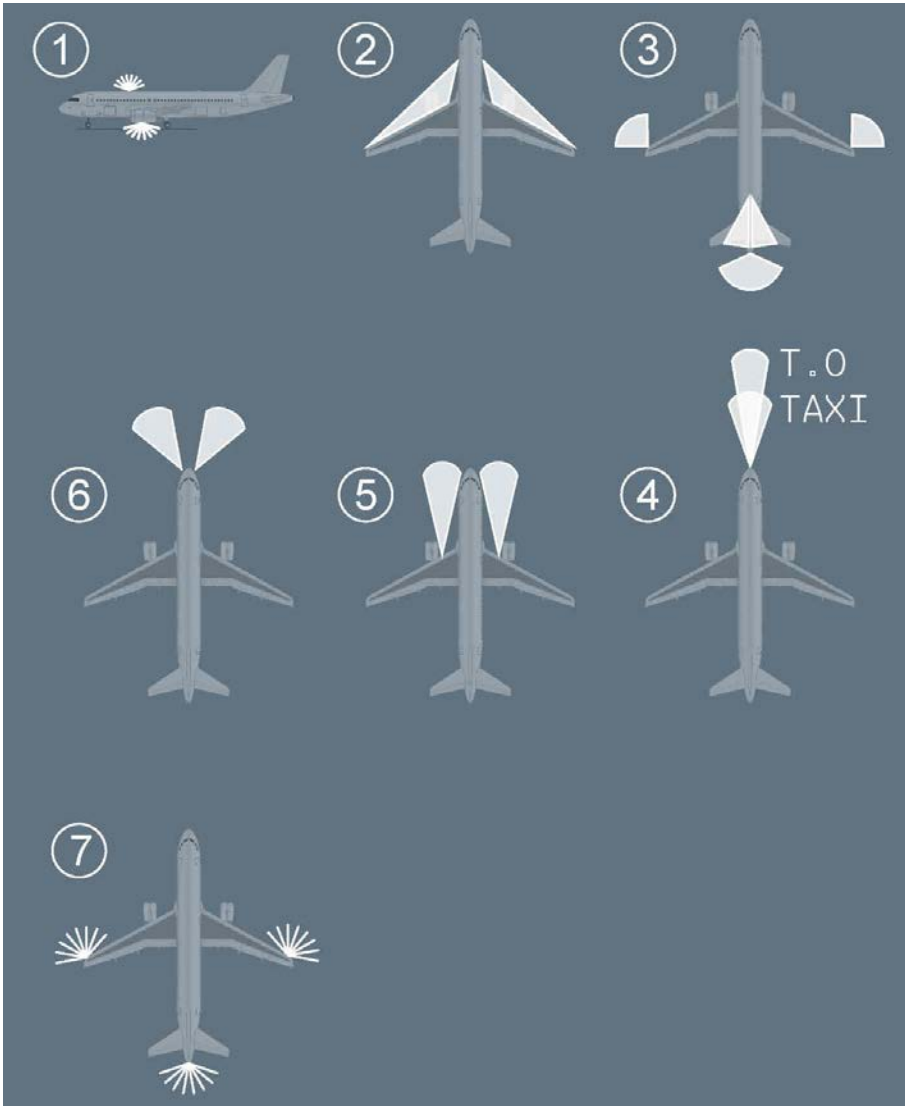





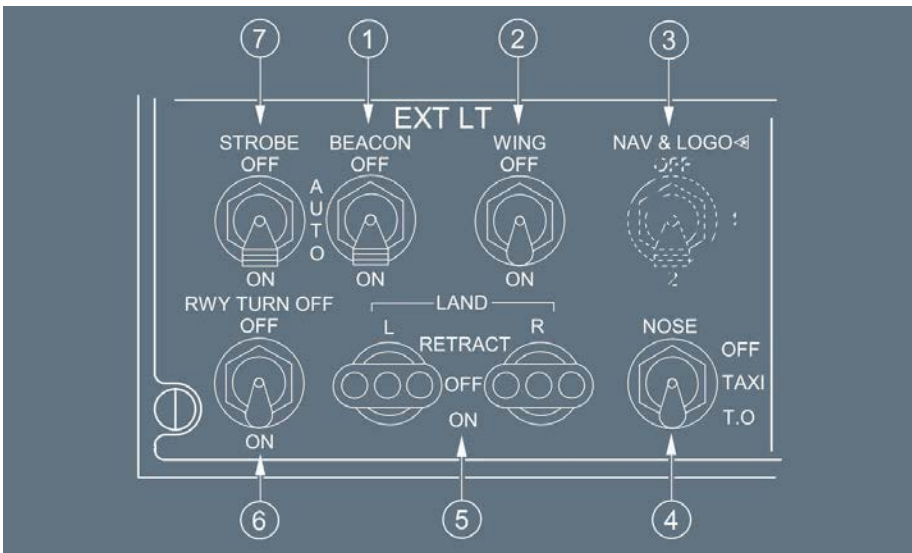

OVERHEAD PANEL

Ident.: DSC-33-20-20-00017623.0004001 / 21 MAR 16



Applicable to: ALL



- (1) BEACON sw
 This switch turns on and off the two flashing red lights, one on top and one on the bottom of the fuselage.
- (2) WING sw
 This switch turns on and off two beam lights on each side of the fuselage. These lights provide lighting on the wing leading edge and on the engine air intake to detect ice accretion.
- (3) NAV & LOGO  sw
 There are single navigation light, or dual navigation lights  on each wing and in the APU tail cone.
 A blue light  below each navigation light allows to monitor the navigation light wear (LED technology). When the NAV & LOGO  sw is ON, this light  flashes in blue if the navigation light replacement should be planned.
 There are logo lights  in the upper surface of each horizontal stabilizer. These light provide lighting for the company logo on the vertical stabilizer provided the main landing gears are compressed, or depending on the aircraft configuration, when flaps are extended (at least 15 ° on some aircraft) or slats are extended.



The NAV & LOGO  sw can have one of the following configuration:



- ON : Turns on the NAV and the LOGO lights .
- OFF : The NAV and the LOGO lights  are off.

or



- 2 : Turns on NAV 2 and the LOGO lights .
- 1 : Turns on NAV 1 and the LOGO lights .
- OFF : The NAV and the LOGO lights  are off.

(4) **NOSE sw**

This switch turns the taxi and takeoff lights on and off.

- TO : Turns on both taxi and takeoff lights.
- TAXI : Turns on only taxi light.
- OFF : Taxi and takeoff lights off.

Note: These two lights, attached to the nose gear strut, go off automatically when landing gear is retracted.

(5) **L and R LAND sel**

These selectors control the landing lights.

- ON : Extends the (left or right) landing lights which come on automatically when fully extended.
- OFF : Shuts off the landing lights which remain extended.
- RETRACT : Shuts off and retracts the landing lights.



(6) **RWY TURN OFF sw**

This switch turns the runway turn-off lights on and off.

Note: These lights go off automatically when landing gear is retracted.

(7) **STROBE sw**

This switch turns on and off the three synchronized strobe lights, one on each wing and one below the tail cone.

A blue light  below each strobe light allows to monitor the strobe light wear (LED technology). When STROBE sw is OFF or BEACON sw is ON, this light  flashes in blue if the strobe light replacement should be planned.

ON : The strobe lights flash white.

AUTO : The strobe lights come on automatically when the main landing gear is not compressed.

OFF : The strobe lights are off.

MEMO DISPLAY

Applicable to: ALL

Ident.: DSC-33-20-20-M-00016785.0001001 / 21 MAR 16

LDG LT : The message is displayed in green, if one landing light is extended.

Ident.: DSC-33-20-20-M-00016784.0001001 / 21 MAR 16

STROBE LT OFF : The message is displayed in green, if the STROBE sw is OFF in flight.

Intentionally left blank

| | |
|---|---|
|  <p>A318/A319/A320/A321 FLIGHT CREW OPERATING MANUAL</p> | <p style="text-align: center;">AIRCRAFT SYSTEMS</p> <p style="text-align: center;">LIGHTS</p> <p style="text-align: center;">EMERGENCY LIGHTING - DESCRIPTION</p> |
|---|---|

| |
|----------------|
| GENERAL |
|----------------|



Ident.: DSC-33-30-10-00017632.0024001 / 21 MAR 16

Applicable to: ALL

The emergency lighting system consists of the following:

- Proximity emergency escape path marking systems (escape path and exit markers)
- Overhead emergency lights
- EXIT signs
- Lavatory auxiliary lights
- Overwing escape route  lighting
- Escape slide lighting.

When in operation:

- The proximity emergency escape path marking system is powered by internal batteries for at least 12 min.
- The DC SHED ESS BUS supplies the cabin emergency lighting.
- If DC SHED ESS BUS fails, batteries inside the light provides power to cabin emergency lighting.
- In nominal case, the DC SHED ESS BUS charges these internal batteries if:
 - The EMER LT sw is not at ON
 - The EMER pb on the Purser's panel is not pressed
 - The DC BUS 1 is supplied
 - Depending on the CIDS/CAM programming, when:
 - The NO SMOKING sw  , or
 - The NO PORTABLE ELEC DEVICE sw  , or
 - The EXIT sw  is set to OFF or AUTO when the landing gear is retracted.

Lavatory auxiliary lights are always on. They are supplied by 28 V DC ESS BUS.

The escape slides have an integral lighting system. The escape slide lights and overwing escape route  lights come on automatically when the slide is armed and the door or emergency exit is open. They are supplied by internal batteries.

PROXIMITY EMERGENCY ESCAPE PATH MARKING SYSTEM/EXIT SIGNS

Ident.: DSC-33-30-10-00017646.0013001 / 21 MAR 16

Applicable to: ALL

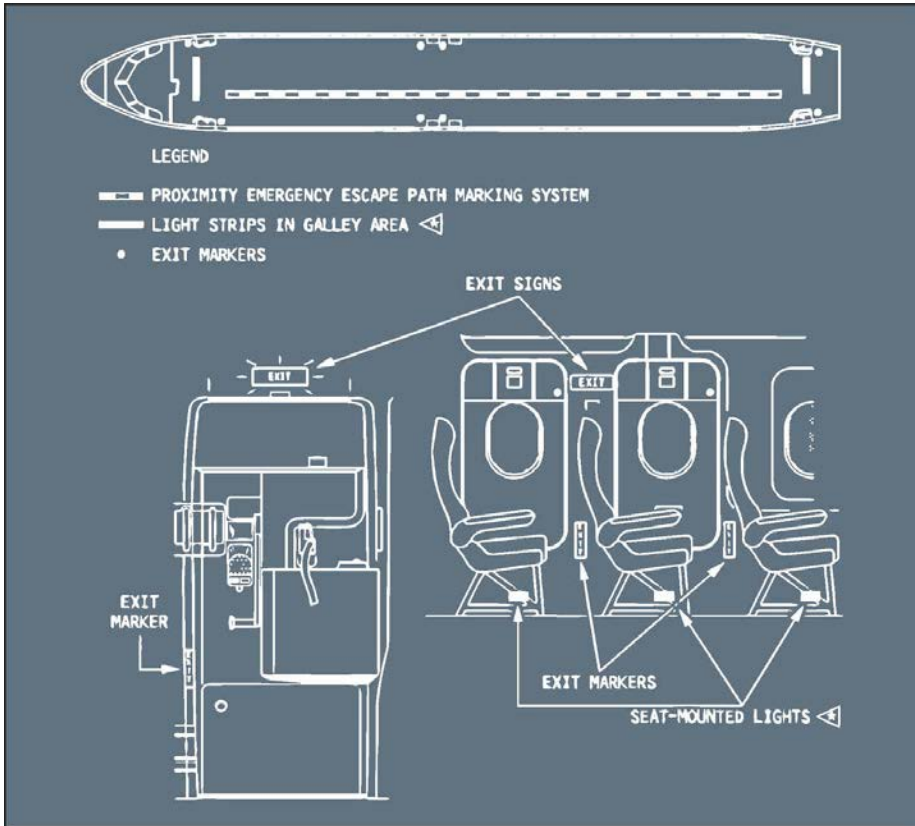

CONTROLS AND INDICATORS

Ident.: DSC-33-30-20-00017708.0027001 / 21 MAR 16

Applicable to: ALL

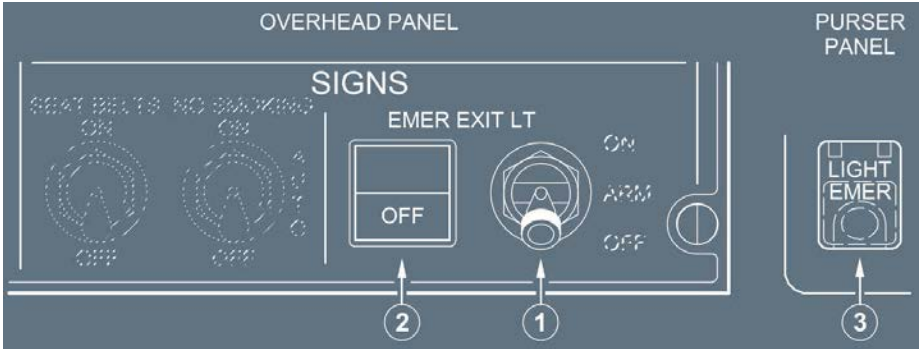

(1) EMER EXIT LT sw

The EMER EXIT LT sw can have one of the following configuration:



ON : Overhead emergency lights, EXIT signs and proximity marking system come on.

OFF : Above lights are off.

- ARM :
- Exit markers come on when the normal aircraft electrical power or DC SHED ESS BUS is lost.
 - The overhead emergency lights come on if:
 - Normal aircraft electrical power system fails or
 - DC SHED ESS BUS fails or
 - AC BUS 1 fails.
 - Exit signs come on if:
 - Normal aircraft electrical power system fails or
 - DC SHED ESS BUS fails or

Note: The LIGHT EMER pb on the Purser's panel can turn on the emergency lighting regardless of the position of the EMER EXIT LT sw.

(2) EMER EXIT LT-OFF It

OFF : The amber EMER EXIT LT-OFF It comes on when the EMER EXIT LT sw is set to OFF.

(3) LIGHT EMER pb

When pressed, this button performs the same function as the EMER EXIT LT sw when it is set to ON.

OVERHEAD PANEL

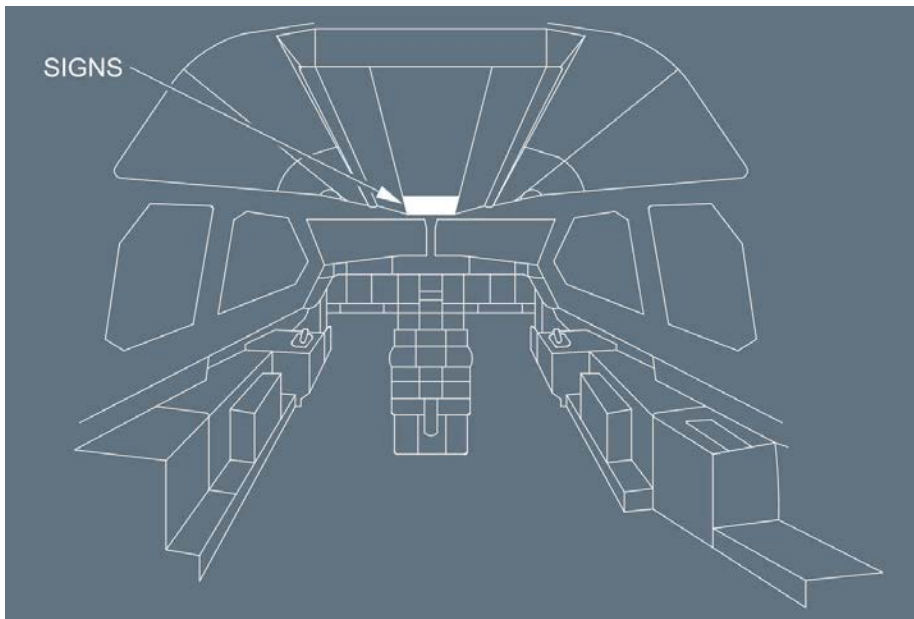

Ident.: DSC-33-40-10-00017709.0001001 / 21 MAR 16

Applicable to: ALL





The switches described below are installed on the SIGNS panel on the overhead panel.

The cabin signs consist of the following:

- A SEAT BELTS sw, and
- A NO SMOKING sw , or
- An EXIT sw , or
- A NO PORTABLE ELEC DEVICE sw .

The SEAT BELTS sw activates the FASTEN SEAT BELT and RETURN TO YOUR SEAT signs.

The NO SMOKING sw  or EXIT sw  activate the EXIT and NO SMOKING signs.

The NO PORTABLE ELEC DEVICE sw  activates the EXIT and NO MOBILE signs.

A low tone chime sounds (depending on CIDS/CAM programming) each time a sign goes on or off.

Each switch has 3 positions:



ON : Signs are on in the cabin

AUTO : Signs are on in the cabin when either landing gear is extended or flaps/slats are extended
 (position 1, 2, 3, or FULL)

OFF : Signs are off in the cabin

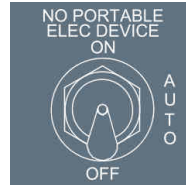
Example of switches layout:



- Note:**
1. If the cabin altitude goes above 11 300 ft (\pm 350 ft), the cabin lights (depending on CIDS/CAM programming) and all the cabin signs, except the NO PORTABLE ELEC DEVICE signs  come on regardless of switches position.
 2. For NON SMOKER , the NO SMOKING signs are always on.

MEMO DISPLAY

Ident.: DSC-33-40-10-00016783.0001001 / 21 MAR 16

Applicable to: ALL

When the corresponding signs are on, the ECAM displays in green the SEAT BELTS message, the NO SMOKING message or the NO PED, depending on aircraft customization.

AIRCRAFT SYSTEMS

NAVIGATION

Intentionally left blank

DSC-34-NAV-10 ADIRS

DSC-34-NAV-10-10 Description

| | |
|-----------------------|---|
| General..... | A |
| Probes Location..... | B |
| Probes Schematic..... | C |
| ADIRS Schematic..... | D |

DSC-34-NAV-10-20 Controls and Indicators

| | |
|---|---|
| Overhead Panel..... | A |
| Pedestal..... | B |
| Memo Display..... | C |
| Maximum Differences Between Speed/Mach Indications..... | D |

DSC-34-NAV-15 GPS

DSC-34-NAV-15-10 Description

| | |
|------------------|---|
| Description..... | A |
|------------------|---|

DSC-34-NAV-20 Standby Instruments

| | |
|------------------------------|---|
| Compass..... | A |
| Description of the ISIS..... | B |
| Attitude..... | C |
| Airspeed..... | D |
| Altimeter..... | E |
| Landing System Function..... | F |
| Bugs Function..... | G |
| Flags..... | H |

DSC-34-NAV-30 Radio Nav

DSC-34-NAV-30-10 Tuning

| | |
|-------------------|---|
| General..... | A |
| Architecture..... | B |

DSC-34-NAV-30-20 Nav aids

| | |
|--|---|
| VOR..... | A |
| ILS/GLS /MLS | B |
| ADF | C |
| DME..... | D |
| Marker Beacon..... | E |

Continued on the following page

Continued from the previous page

DSC-34-NAV-30-30 Controls and Indicators

| | |
|--|---|
| Digital Distance and Radio Magnetic Indicator  (DDRMI)..... | A |
| Radio Management Panel (RMP)..... | B |

DSC-34-NAV-40 Radio Altimeter

DSC-34-NAV-40-10 Description

| | |
|------------------------|---|
| General..... | A |
| Automatic Callout..... | B |

| | |
|---|--|
|  <p>A318/A319/A320/A321 FLIGHT CREW OPERATING MANUAL</p> | <p style="text-align: center;">AIRCRAFT SYSTEMS</p> <p style="text-align: center;">NAVIGATION</p> <p style="text-align: center;">ADIRS - DESCRIPTION</p> |
|---|--|

GENERAL

Ident.: DSC-34-NAV-10-10-00018524.0001001 / 21 MAR 16

Applicable to: ALL

The Air Data and Inertial Reference System (ADIRS) supplies temperature, anemometric, barometric and inertial parameters to the EFIS system (PFD and ND) and to other user systems (FMGC , FADEC , ELAC , SEC , FAC , FWC , SFCC , ATC , GPWS , CFDIU , CPC).

The system includes:

- Three identical ADIRUs (Air Data and Inertial Reference Units).

Each ADIRU is divided in two parts, either of which can work separately in case of failure in the other:

- The ADR part (Air Data Reference) which supplies barometric altitude, airspeed, Mach, angle of attack, temperature and overspeed warnings.
- The IR part (Inertial Reference) which supplies attitude, flight path vector, track, heading, accelerations, angular rates, ground speed and aircraft position.

- One ADIRS control panel on the overhead panel for selection of modes (NAV , ATT, OFF) and indications of failures.

- Four types of sensors:

- Pitot probes (3)
- Static pressure probes (STAT) (6)
- Angle of attack sensors (AOA) (3)
- Total air temperature probes (TAT) (2)

These sensors are electrically heated to prevent from icing up.

- Eight ADM s (Air Data Modules) which convert pneumatic data from PITOT and STAT probes into numerical data for the ADIRUs.
- A switching facility for selecting ADR 3 or IR 3 for instrument displays in case of ADIRU1 or 2 failure.

PROBES LOCATION

Ident.: DSC-34-NAV-10-10-00018525.0001001 / 21 MAR 16

Applicable to: **ALL**

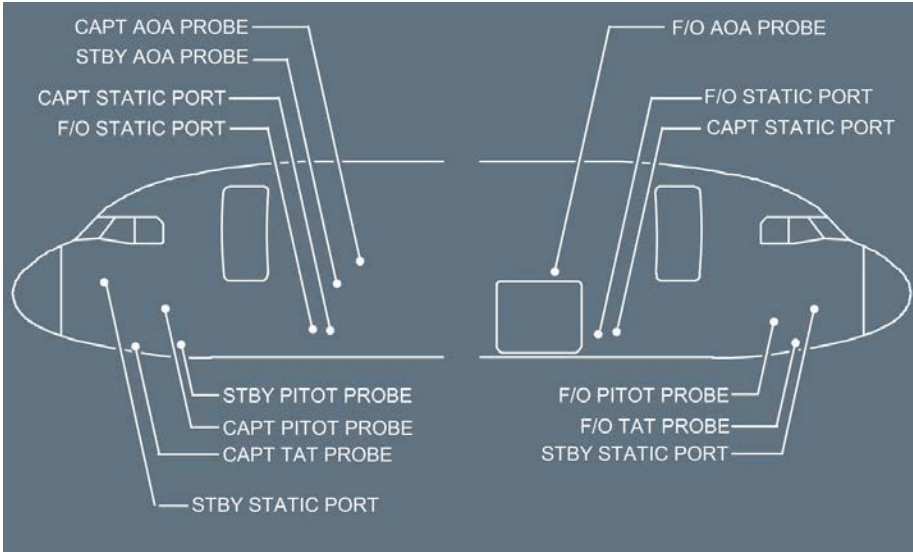

PROBES SCHEMATIC

Ident.: DSC-34-NAV-10-10-00018526.0001001 / 21 MAR 16

Applicable to: ALL

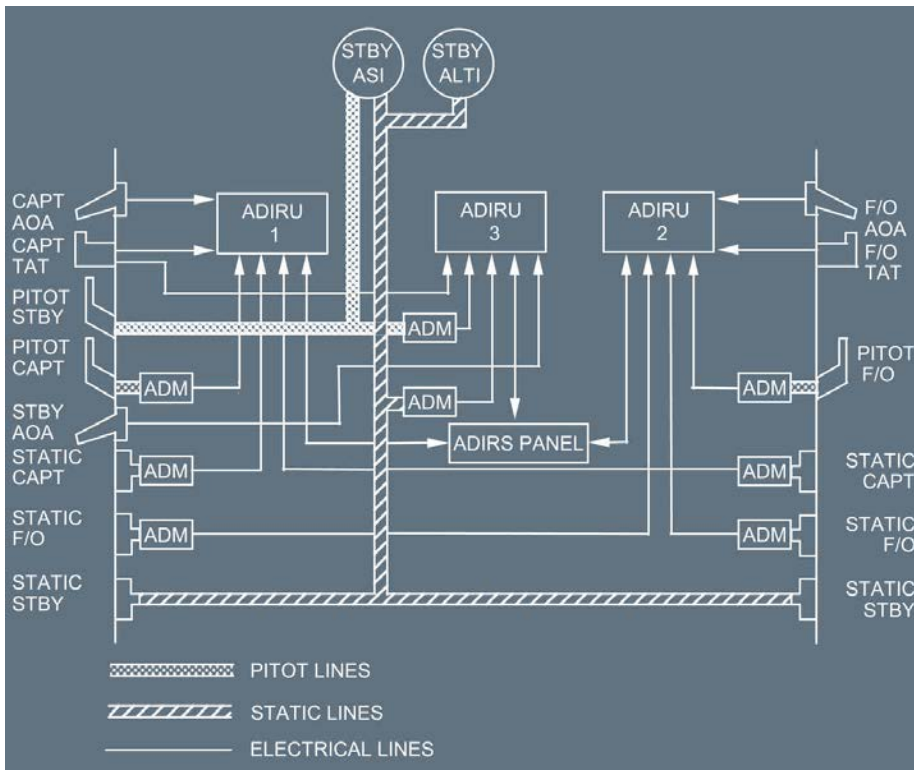

Note: ADIRU (1) is supplied by CAPT probes,
ADIRU (2) is supplied by F/O probes,
ADIRU (3) is supplied by STBY probes and CAPT TAT.

ADIRS SCHEMATIC

Ident.: DSC-34-NAV-10-10-00018527.0001001 / 21 MAR 16

Applicable to: **ALL**

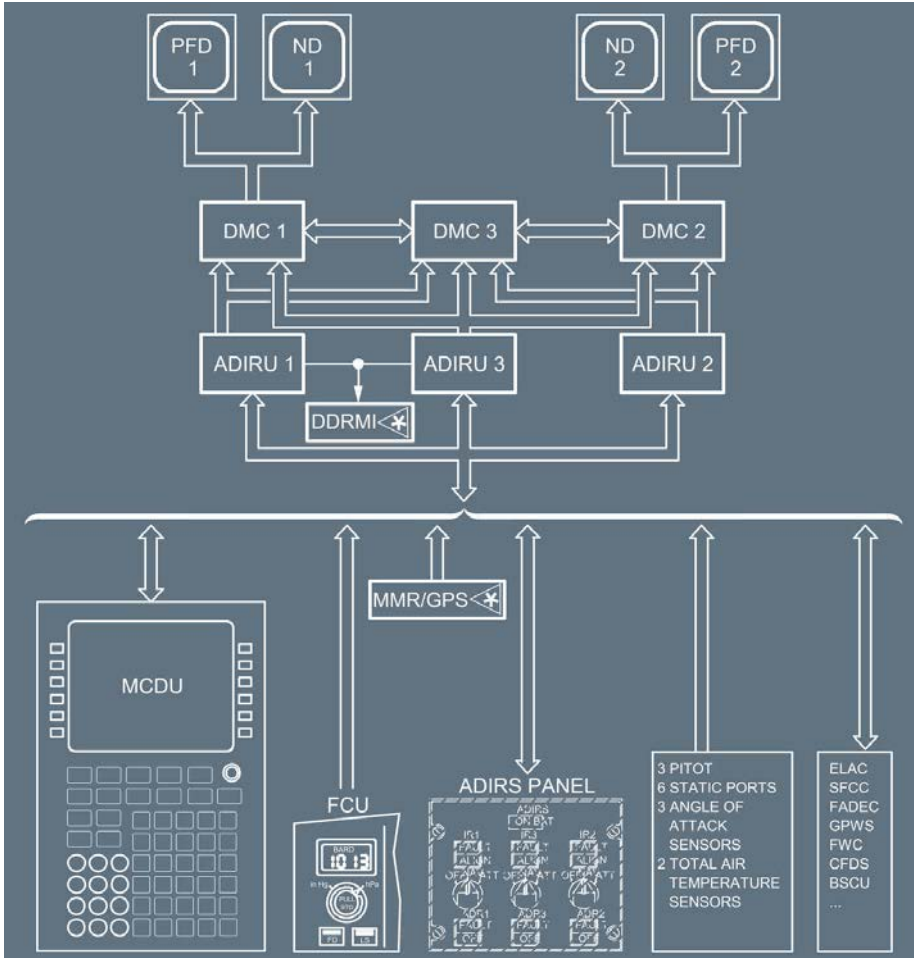

OVERHEAD PANEL

Ident.: DSC-34-NAV-10-20-00018528.0002001 / 21 MAR 16

Applicable to: ALL

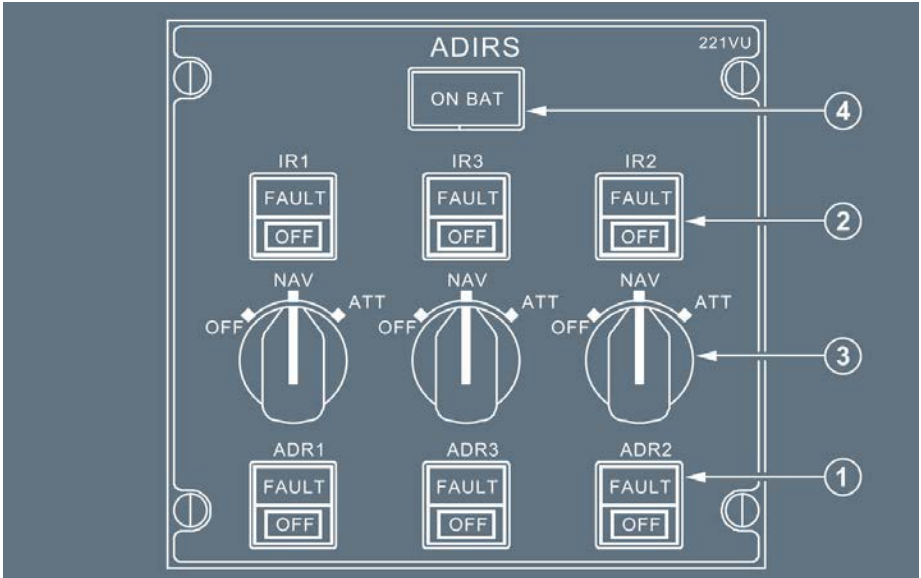

(1) ADR 1(2)(3) pb sw

OFF light : Air data output disconnected.

FAULT light : This amber light comes on with an ECAM caution if a fault is detected in the air data reference part.

(2) IR 1(2)(3) pb sw

OFF light : Inertial data output disconnected.

FAULT light : This amber light comes on with an ECAM caution when a fault affects the respective IR.

Steady : the respective IR is lost.

Flashing : the attitude and heading information may be recovered in ATT mode.

(3) IR 1(2)(3) mode rotary sel

OFF : The ADIRU is not energized.

ADR and IR data are not available.

- NAV : Normal mode of operation.
 Supplies full inertial data to aircraft systems.
- ATT : IR mode supplying only attitude and heading information if the system loses its ability to navigate.
 The heading must be entered through the MCDU and has to be reset frequently (about every 10 min).

(4) **ON BAT light**

The ON BAT light comes on in amber when the aircraft battery supplies at least one IRS . The ON BAT light also comes on for a few seconds at the beginning of a complete IRS alignment. The light does not come on in the case of a fast alignment.

Note: When the aircraft is on ground and if at least one ADIRU is supplied by aircraft batteries:

- An external horn sounds
- The ADIRU and AVNCS light comes on amber on the EXTERNAL POWER panel.

PEDESTAL

Ident.: DSC-34-NAV-10-20-00018529.0001001 / 21 MAR 16

Applicable to: ALL

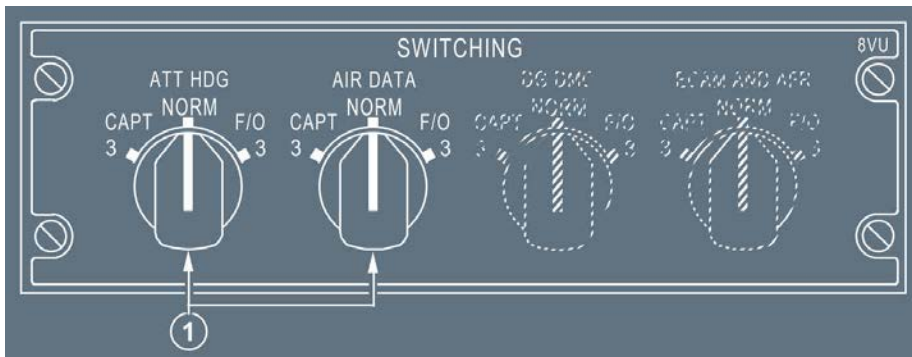

(1) **ATT HDG and AIR DATA sel**

- NORM : ADIRU 1 supplies data to PFD 1, ND 1, DDRMI and VOR /DME.
 ADIRU 2 supplies data to PFD 2, and ND2.
- CAPT 3 : ADR 3 or IR 3 replaces ADR 1 or IR1.
- F/O 3 : ADR 3 or IR 3 replaces ADR 2 or IR2.

| | |
|---|---|
|  A318/A319/A320/A321 FLIGHT CREW OPERATING MANUAL | AIRCRAFT SYSTEMS NAVIGATION ADIRS - CONTROLS AND INDICATORS |
|---|---|

MEMO DISPLAY

Applicable to: ALL

Ident.: DSC-34-NAV-10-20-A-00017043.0002001 / 21 MAR 16

IR IN ATT ALIGN : This memo appears in green during the IR alignment in Attitude mode.

Ident.: DSC-34-NAV-10-20-A-00017041.0002001 / 21 MAR 16

The memo "IRS IN ALIGN X MN" appears during IRS alignment in flight phase 1 or 2. X MN indicates the number of remaining minutes (1 < X < 10), until NAV mode is reached.

Before any engine is started:

IRS IN ALIGN X MN : This memo appears in green when at least one active IRS is being aligned.

IRS IN ALIGN X MN : This memo pulses in green, if the alignment of one IRS is faulty.

When one engine is started:

IRS IN ALIGN X MN : This memo appears in amber during IRS alignment. If the alignment of one IRS is faulty, this memo is replaced by the "IR NOT ALIGNED" ECAM caution.

MAXIMUM DIFFERENCES BETWEEN SPEED/MACH INDICATIONS

Ident.: DSC-34-NAV-10-20-00021130.0002001 / 17 MAR 17

Applicable to: ALL

| FL | SPEED | SPEED/MACH COMPARISON BETWEEN | | | | | |
|-----------|--------|-------------------------------|---------|-------------------------------------|---------|--|---|
| | | ADR 1 and ADR 2 (on PFD) | | ADR 3 and ADR 1, or ADR 3 and ADR 2 | | Standby Airspeed Indicator and any ADR 1, or 2, or 3 | |
| | | kt | Mach | kt | Mach | kt | Mach on ISIS  (1) |
| GND CHECK | - | 6 kt | M 0.008 | 6 kt | M 0.008 | 6 kt | - |
| FL 50 | 250 kt | 4 kt | M 0.005 | 4 kt | M 0.007 | 7 kt | - |
| FL 100 | 250 kt | 4 kt | M 0.005 | 5 kt | M 0.008 | 8 kt | M 0.032 |
| FL 200 | 300 kt | 3 kt | M 0.007 | 5 kt | M 0.011 | 9 kt | M 0.033 |
| FL 300 | M 0.78 | 3 kt | M 0.010 | 5 kt | M 0.014 | 9 kt | M 0.025 |
| FL 390 | M 0.78 | 3 kt | M 0.010 | 4 kt | M 0.014 | 8 kt | M 0.025 |

(1) Mach values lower than M 0.50 in climb, and M 0.45 in descent, are not displayed on ISIS  .



A318/A319/A320/A321
FLIGHT CREW
OPERATING MANUAL

AIRCRAFT SYSTEMS

NAVIGATION

ADIRS - CONTROLS AND INDICATORS

Intentionally left blank

| | |
|---|---|
|  <p>A318/A319/A320/A321 FLIGHT CREW OPERATING MANUAL</p> | <p align="center">AIRCRAFT SYSTEMS</p> <p align="center">NAVIGATION</p> <p align="center">GPS - DESCRIPTION</p> |
|---|---|

| |
|--------------------|
| DESCRIPTION |
|--------------------|

Ident.: DSC-34-NAV-15-10-00018530.0001001 / 21 MAR 16

Applicable to: ALL

The Global Positioning System (GPS) is a satellite-based radio navigation aid. Worldwide, 24 satellites broadcast accurate navigation data that the aircraft use for precise determination of its position.

The aircraft has two independent GPS receivers. Depending of the aircraft configuration, each receiver consists:

- Of a GPS Sensor Unit (GPSSU), or
- Is integrated in the Multi Mode Receiver (MMR). The GPS 1 receiver in MMR 1, and the GPS 2 receiver in MMR2.

The GPSSU or the MMR processes the received data, and transfers them to the ADIRU s. Then each ADIRU performs the GP-IRS hybrid position calculation. FMGCs use this hybrid position.

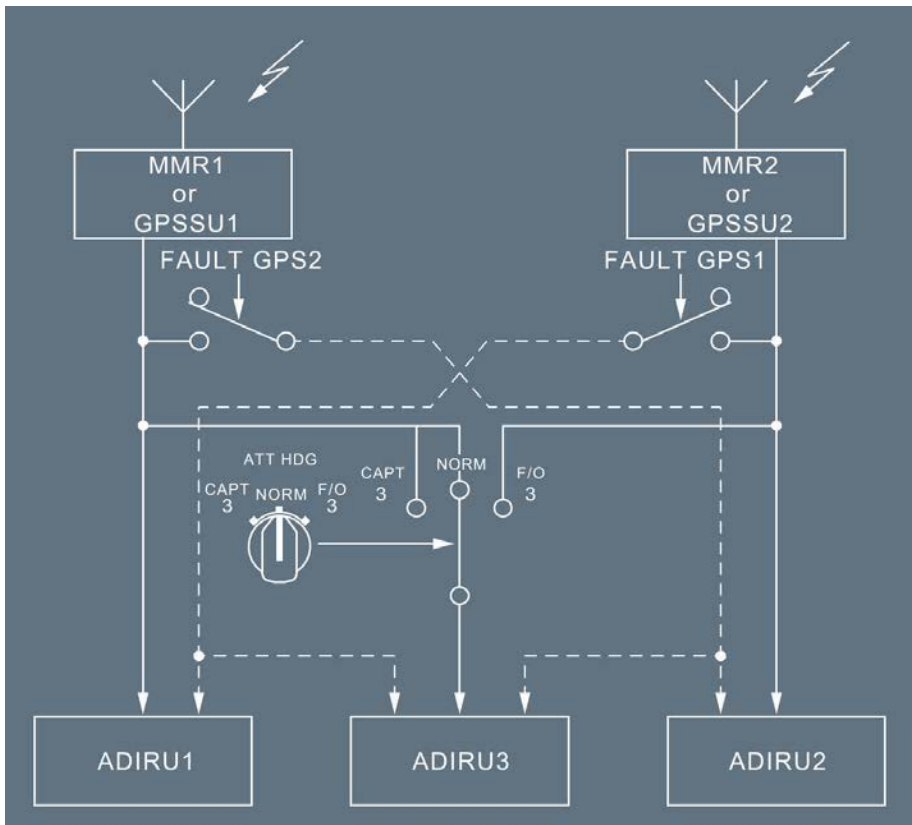

OPERATIONS

GPS information are available on the FMS – GPS Monitor Page. *Refer to DSC-22_20-50-10 Pages descriptions.*

- During normal operations
The GPS receiver 1 supplies the ADIRU 1 and the ADIRU 3, and the GPS receiver 2 supplies the ADIRU 2.
- In case of failure of one GPS receiver
All ADIRU s use the operative GPS receiver.
- In case of failure of ADIRUs
 - If the ADIRU 1 fails, ADIRU 3 is supplied by the GPS receiver 1, and ADIRU 2 is supplied by the GPS receiver 2.
 - If the ADIRU 2 fails, the ATT HDG selector has to be set to F/O 3 in order to maintain Side 1 and Side 2 segregation. In this case, the ADIRU 3 will be supplied with GPS receiver 2.
 - If two ADIRU s fail, the remaining ADIRU is supplied by its own side GPS receiver.



A318/A319/A320/A321
FLIGHT CREW
OPERATING MANUAL

AIRCRAFT SYSTEMS

NAVIGATION

GPS - DESCRIPTION

Intentionally left blank

COMPASS

Ident.: DSC-34-NAV-20-00001367.0001001 / 19 DEC 12

Applicable to: ALL

There is a compass located on top of the windshield center post.
The deviation card is located above the compass.

Note: Because of the location of the APU power on contactor in the cockpit, the APU start sequence may disturb the compass reading.

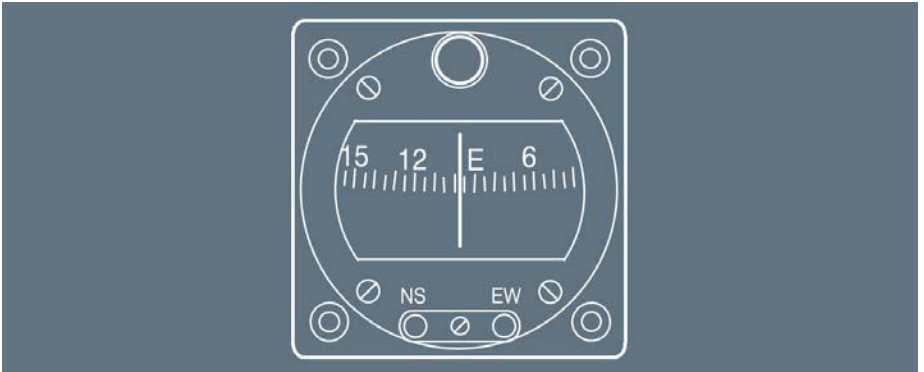

DESCRIPTION OF THE ISIS

Ident.: DSC-34-NAV-20-00018543.0002001 / 21 MAR 16

Applicable to: ALL

GENERAL

The ISIS system displays the following information:

- Attitude
- Airspeed and mach
- Altitude
- Barometric pressure
- LS function
- Bugs

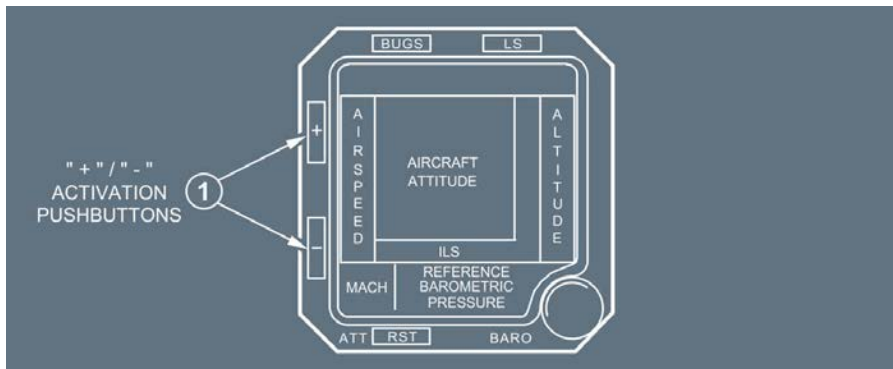

(1) "+"/"- activation pushbuttons

Two pushbuttons labelled “+” and “-” are used to adjust the level of brightness. The brightness of the screen automatically adjusts after power-up tests. This is because of the photosensitive cell located on the surface of the ISIS system display. The “+” and “-” pushbuttons then allow this initial brightness to be manually adjusted and changed.

Note: The system must be reset after 350 h of continuous electrical supply using the « ATT RST » pushbutton.

ARCHITECTURE

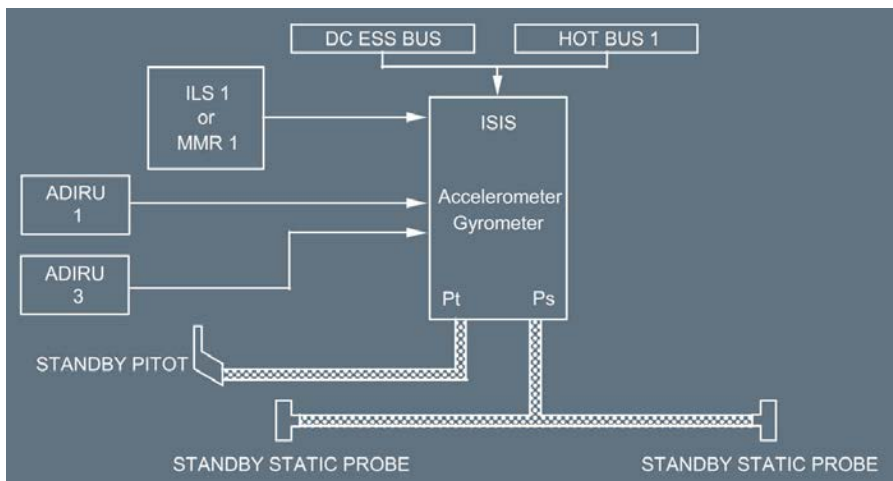

ATTITUDE

Ident.: DSC-34-NAV-20-00018575.0002001 / 21 MAR 16

Applicable to: ALL

Note: When leveling the wings after performing a small turn of a small bank angle, the displayed roll attitude may temporarily be incorrect by a few degrees.

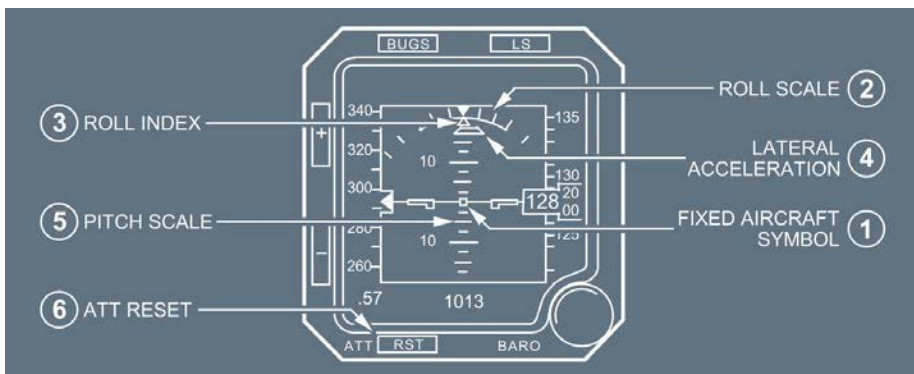

- (1) Fixed aircraft symbol
 The fixed aircraft symbol is in black, and outlined in yellow.
 Depending of the aircraft configuration, the center of the fixed aircraft symbol is a point (like on the illustration above) or "V-bars".
- (2) Roll scale
 The roll scale is in white.
 The markers are at 0 (small yellow triangle), 10, 20, 30, 45, 60 ° of bank.
- (3) Roll index
 The roll index is in black, and outlined in white. It indicates the bank angle.
- (4) Lateral acceleration index
 The trapezoidal index moves beneath the roll index. It represents the aircraft's lateral acceleration.
- (5) Pitch scale
 The pitch scale is in white. The scale shows markers every 2.5 ° between 30 ° nose up and 30 ° nose down. Beyond 30 °, large red arrowheads (V-shaped) indicate that the attitude has become excessive, and show the direction to follow in order to reduce it. The minimum pitch scale displayed is -17.5 ° +15 ° at 0 ° pitch.

(6) ATT RST

The attitude indication can be reset by pressing this pushbutton for at least 2 s. The aircraft must be level during this procedure. During the reset time (approximately 10 s), the “ATT 10 s” message is displayed on the screen. This pushbutton is also used to realign the system, if excessive aircraft movement is detected during the alignment phase.

AIRSPEED

Ident.: DSC-34-NAV-20-00018576.0002001 / 21 MAR 16

Applicable to: **ALL**

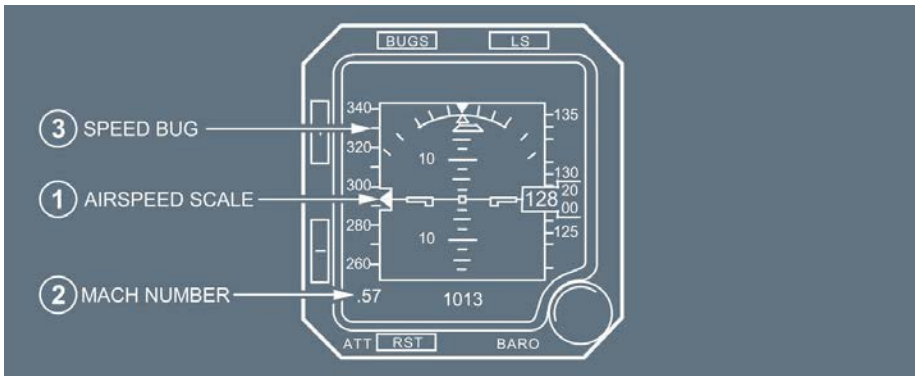

(1) Airspeed scale

A white scale moves in front of a yellow triangle indicating the airspeed. The scale ranges from 5 to 250 kt, with a mark every 5 kt, and from 250 to 520 kt, with a mark every 10 kt.

(2) Mach Number

The Mach number is displayed in green it goes greater than 0.5. And it disappears only when it goes below 0.45.

(3) Speed bug

When a speed bug is entered via the BUGS function, the corresponding speed mark is indicated by a cyan dash.

ALTIMETER

Ident.: DSC-34-NAV-20-00018577.0002001 / 21 MAR 16

Applicable to: ALL

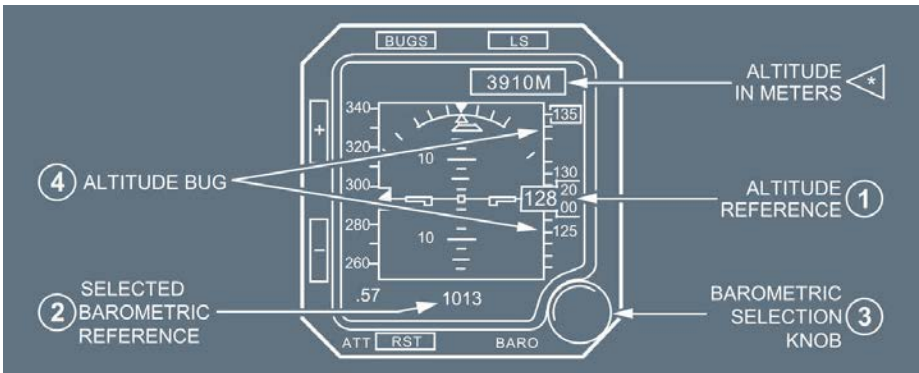

(1) Altitude indication

The altitude indication is given as a white moving scale, and a green digital readout on a gray background.

The altitude scale ranges from -2 000 to 50 000 ft every 100 ft, with altitude digital indications every 500 ft.

For negative altitudes, "NEG" appears in the window in white.

The altitude box changes to cyan, when it also corresponds to a bug value.

Depending of the aircraft configuration, the altitude in meters is displayed above the altitude scale.

(2) Barometric reference

The barometric reference pressure is displayed in cyan.

The displayed barometric reference is:

- The standard barometric reference "STD", or
- Depending of the aircraft configuration, the barometric pressure is "hPa" or "hPa/ inHg".

(3) Barometric selection knob

This knob enables the selection of a barometric pressure, setting a variation of 10 hPa per knob rotation.

The standard barometric pressure can be selected by pressing the barometric knob. "STD" is then displayed, in place of the pressure value.

Pressing the knob again will display the selected barometric pressure.

(4) Altitude bug

When an altitude bug is entered through the bugs function, the corresponding altitude mark is indicated by a cyan dash, or by a cyan box when the dash covers the digital indication on the scale.

LANDING SYSTEM FUNCTION

Ident.: DSC-34-NAV-20-00001377.0005001 / 22 JUL 14

Applicable to: **ALL**

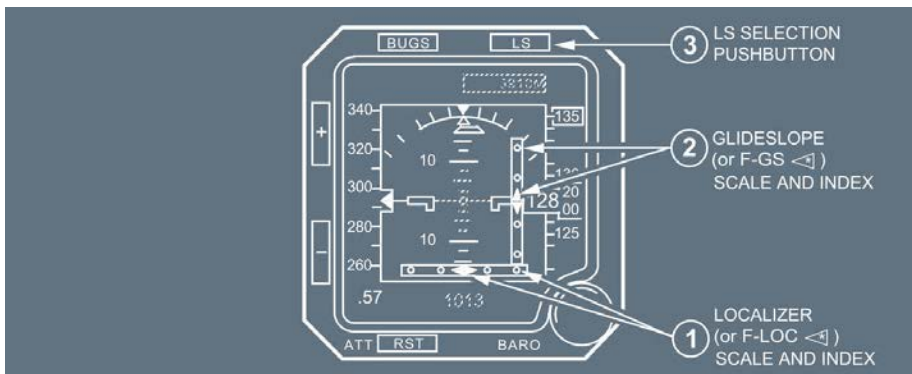

(1) Localizer / scale and index

(2) Glideslope / scale and index

When the LS pb is pressed, the deviation scales are displayed.

When deviation scales are displayed and the LS deviations are valid, the indexes appear.

The LS deviations that are displayed correspond to the LS approach:

- Selected on the MCDU, or
- Tuned on the RMP.

Note: The LS approach corresponds to either ILS approach, or MLS \triangleleft approach, or GLS \triangleleft approach, or non precision approach using FLS \triangleleft .

(3) LS selection pushbutton

Pressing the LS pb will display the LS scales. Pressing the LS pb again will remove the LS scales.

CAUTION Do not use the ISIS LS for takeoff using the localizer of the opposite runway, or for a back-course localizer approach. The LOC deviations are given in the wrong sense.

BUGS FUNCTION

Ident.: DSC-34-NAV-20-00018578.0001001 / 21 MAR 16

Applicable to: ALL

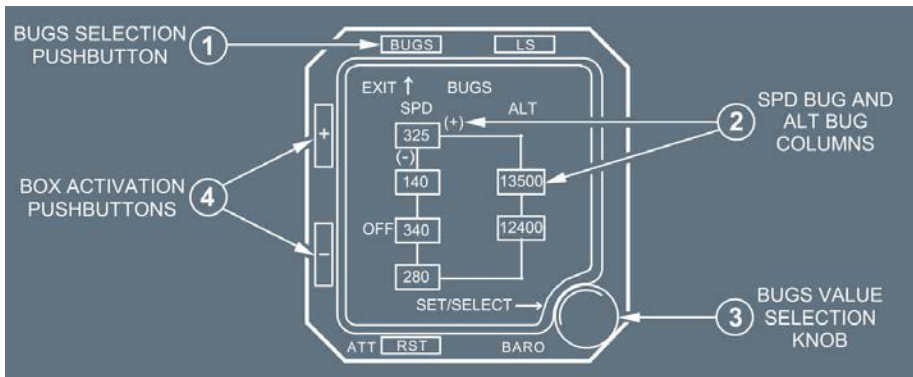

- (1) BUGS function selection pushbutton
 Pressing the BUGS pushbutton will activate the BUGS function and display the bug values to be selected.
- (2) SPD BUG and ALT BUG columns
 The SPD BUG column gives four speed values (in knots) that can be selected by the crew.
 The ALT BUG column gives two altitude values (feet) to be selected by the crew.
- (3) BUGS value selection knob
 It allows the bug value to be set by rotating the BARO knob. This value cannot be lower than 30 kt for a speed bug, or a negative value for an altitude bug.
 Pressing the BARO setting knob, once a bug value box is activated, will deselect the bug value. The "OFF" label comes on close to the activated box.
 The entered values are memorized by the system, when exiting the screen, by pressing the BUGS pushbutton (1), or after 15 s without any pilot action.
- (4) "+" / "-" box activation buttons
 Access from one box to another is obtained by pressing the "+" or "-" pushbutton.
 When a bug value is entered, access to the next box is obtained by pressing the "-" pushbutton. The box becomes active and flashes.
 The "+" pushbutton can be used to return to a previous box.

Note: Use of the ISIS bugs function is not recommended because, in the event that both PFDs are lost in flight, when the ISIS bugs were previously set for takeoff, then for the approach, the bugs would remain at the takeoff characteristic speed settings.

FLAGS

Ident.: DSC-34-NAV-20-00018580.0002001 / 21 MAR 16

Applicable to: **ALL**

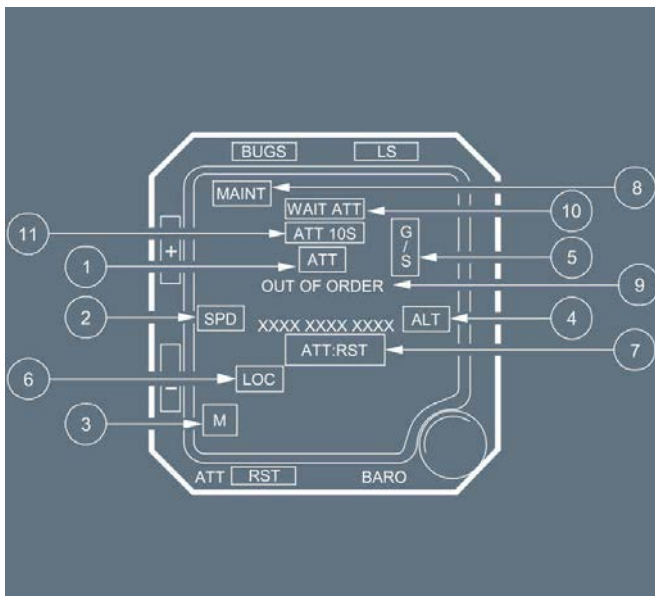

- (1) ATT flag (red)
 When attitude data is lost, the red ATT flag appears.
- (2) SPD flag (red)
 When airspeed data is lost, the red SPD flag appears.
- (3) M flag (red)
 When mach number is lost, the red M flag appears.
- (4) ALT flag (red)
 When altitude data is lost, the red ALT flag appears.

(5) G/S flag (red)

When glideslope information is lost, the red G/S flag appears.

(6) LOC flag (red)

When localizer data is lost, the red LOC flag appears.

(7) ATT: RST (yellow)

The “ATT: RST” flag appears:

- When excessive aircraft movement is detected during the alignment phase, or
- After 350 h of continuous electrical supply, or
- When the “WAIT ATT” flag is displayed during more than 10 s.

In both cases, press the ATT RST pb to reset/realign and recover the attitude indication.

(8) MAINT flag (white)

Maintenance required. This “MAINT flag” does not affect ISIS operation.

Displayed only on ground phase (speed < 60 kt).

(9) OUT OF ORDER (white)

When an internal failure of the ISIS indicator occurs, the “OUT OF ORDER” message appears, accompanied by a fault code.

(10) WAIT ATT flag (yellow)

If the ISIS loses attitude data, its entire sphere is cleared to display the: “WAIT ATT” flag.

- If the “WAIT ATT” flag is displayed during less than 10 s, a normal operation is recovered.
- If attitude data are lost for more than 10 s, the “WAIT ATT” flag is then replaced by the “ATT: RST” flag.

(11) ATT 10 s flag (yellow)

This count down flag appears, when the flight crew press the ATT RST pb, in order to indicate that the attitude reset function is in progress.



A318/A319/A320/A321
FLIGHT CREW
OPERATING MANUAL

AIRCRAFT SYSTEMS

NAVIGATION

STANDBY INSTRUMENTS

Intentionally left blank

GENERAL

Ident.: DSC-34-NAV-30-10-00018581.0001001 / 21 MAR 16

Applicable to: ALL

Three modes of tuning are available.

1. Automatic Tuning

This is the basic means for tuning nav aids.

In normal operation, the FMGC tunes nav aids automatically, with each FMGC controlling its own receivers.

If one FMGC fails, the remaining FMGC controls both sides receivers.

2. Manual Tuning

The flight crew can use the MCDU to override the automatic tuning of nav aids by FMGC in order to select a specific nav aid for visual display.

This does not affect the automatic function of the FMGC.



Any entry on one MCDU is sent to both FMGC in dual mode, or the remaining FMGC in single mode.

3. Back Up Tuning

If both FMGC s fail, the flight crew can use the RMPs (Radio Management Panels 1 and 2) on the pedestal for back up tuning.

The CAPT RMP controls VOR1 and ADF 1 .

The F/O RMP controls VOR2 and ADF 2 .

Either RMP controls ILS /GLS  / MLS , provided "STBY NAV" is selected on RMP 1 and RMP2. RMP3  is not used for nav aids tuning.

ARCHITECTURE

Ident.: DSC-34-NAV-30-10-00018582.0001001 / 21 MAR 16

Applicable to: ALL

NORMAL OPERATION

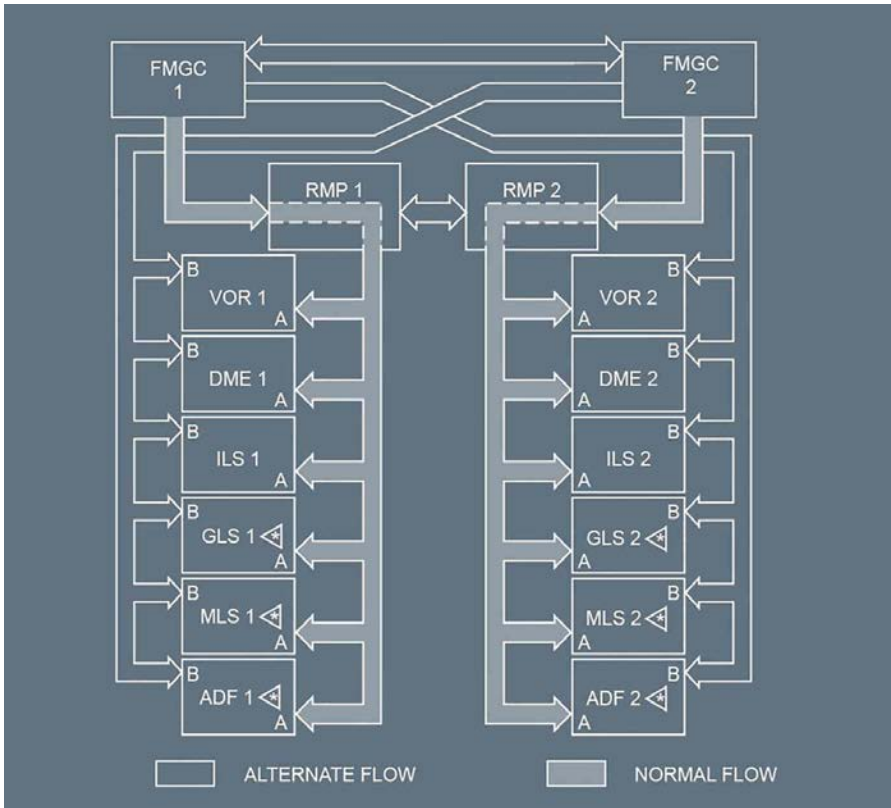

FMGC 1 FAILURE

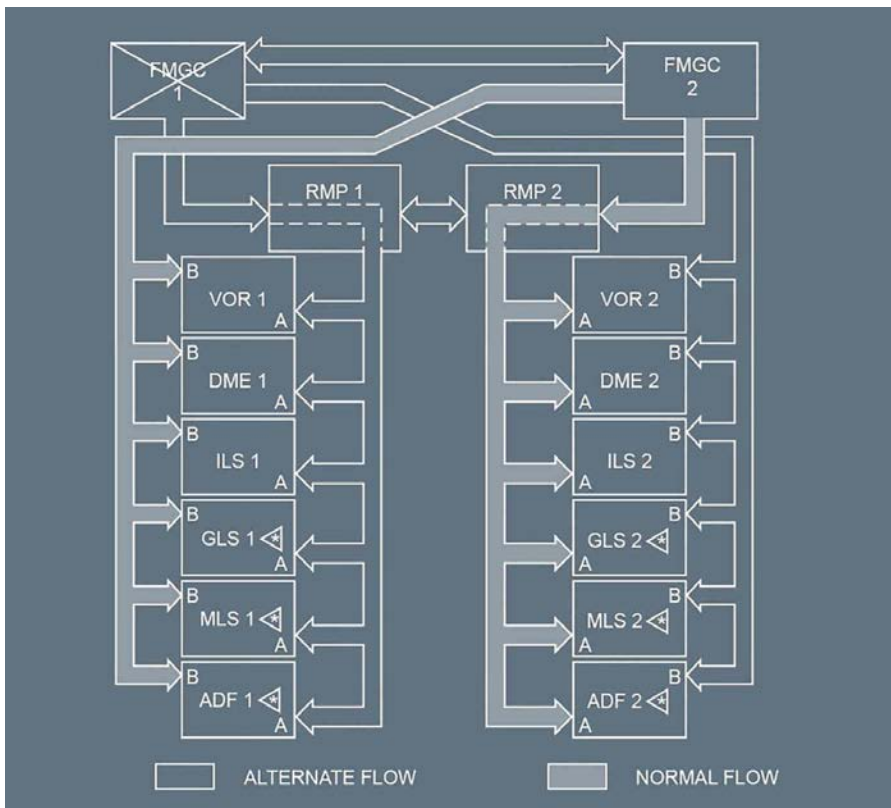

BACK UP TUNING

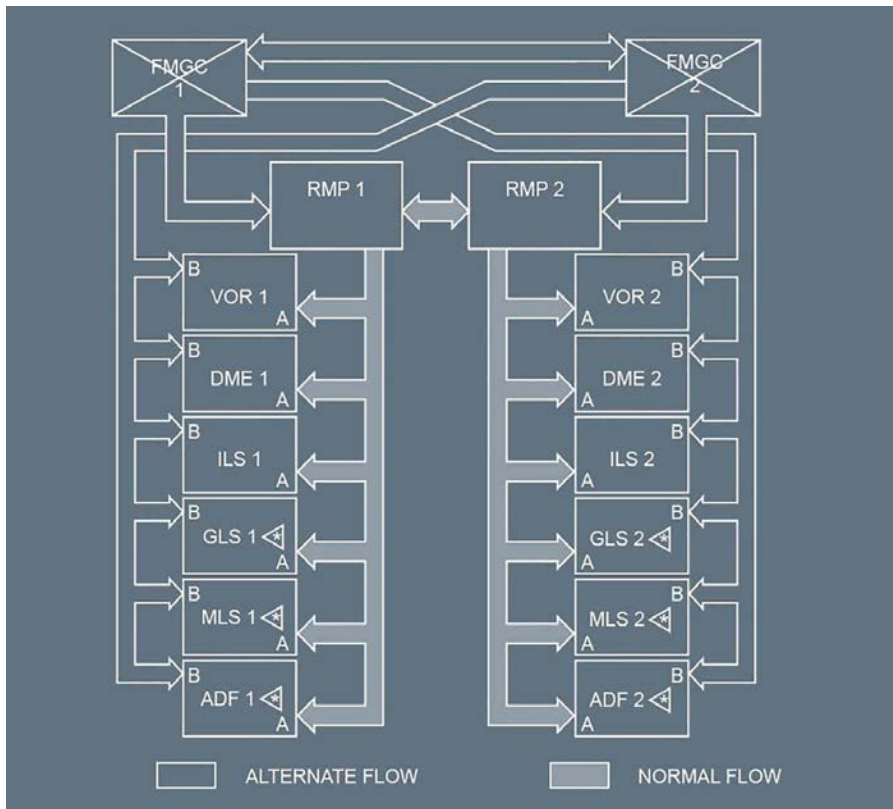



VOR

Ident.: DSC-34-NAV-30-20-00018657.0001001 / 21 MAR 16

Applicable to: ALL

The aircraft has two VOR receivers.







- The Navigation Displays (ND s) display VOR 1 and VOR 2 information, in accordance with the position of the ADF  /VOR selectors on the EFIS control panel (*Refer to DSC-31-45 ROSE Modes*).
- The DDRMI  also displays VOR 1 and VOR2 bearings, if the heading signal is valid.









ILS/GLS  /MLS 

Ident.: DSC-34-NAV-30-20-00018658.0001001 / 21 MAR 16

Applicable to: ALL

The aircraft has two ILS /GLS  /MLS  receivers.

Note: *When the aircraft is equipped with MMR s, ILS and GLS  and MLS  receivers are in the MMR s (ILS 1/GLS1  /MLS1  in the MMR 1 and the ILS 2/GLS2  /MLS2  in the MMR2)*

- PFD 1 and ND 2 display ILS1/GLS1  /MLS1  information.
- PFD 2 and ND 1 display ILS2/GLS2  /MLS2  information.
- The PFD display the ILS /GLS  /MLS  information if the flight crew press the LS pb or ILS pb (depending of the aircraft configuration) on the EFIS control panel (*Refer to DSC-31-50 EFIS Control Panel*).
- The ND s display the ILS /GLS  /MLS  information if the flight crew selects the ROSE LS mode or the ROSE ILS mode (depending of the aircraft configuration) on the EFIS control panel (*Refer to DSC-31-50 EFIS Control Panel*).





ADF 

Ident.: DSC-34-NAV-30-20-00018659.0001001 / 21 MAR 16

Applicable to: ALL

The aircraft may be fitted with 1 ADF  or 2 ADF .

The ND s display ADF  information, depending on the position of the ADF /VOR selectors on the EFIS control panel (*Refer to DSC-31-45 ROSE Modes*).

The DDRMI  also displays ADF 1  and ADF 2  bearings, depending on the position of the ADF /VOR selector on the DDRMI .



A318/A319/A320/A321
FLIGHT CREW
OPERATING MANUAL

AIRCRAFT SYSTEMS

NAVIGATION



RADIO NAV - NAVAIDS

DME



Ident.: DSC-34-NAV-30-20-00018660.0001001 / 21 MAR 16

Applicable to: **ALL**

The aircraft has two DMEs.

The frequency that is automatically set on the DME corresponds to the frequency/channel that is set on the VOR, or ILS, or GLS , or MLS .

The NDs and the DDRMI  can display DME information associated with VOR.

The PFDs can display DME information associated with ILS/GLS /MLS  (*Refer to DSC-31-40 Trajectory Deviation - ILS Approach*).

MARKER BEACON

Ident.: DSC-34-NAV-30-20-00001389.0001001 / 21 MAR 16

Applicable to: **ALL**

One marker beacon system is included in VOR receiver 1.

The PFD displays the outer, middle, and inner marker signals (*Refer to DSC-31-40 Trajectory Deviation - ILS Approach*).

DIGITAL DISTANCE AND RADIO MAGNETIC INDICATOR  (DDRMI)

Ident.: DSC-34-NAV-30-30-00018583.0001001 / 21 MAR 16

Applicable to: ALL

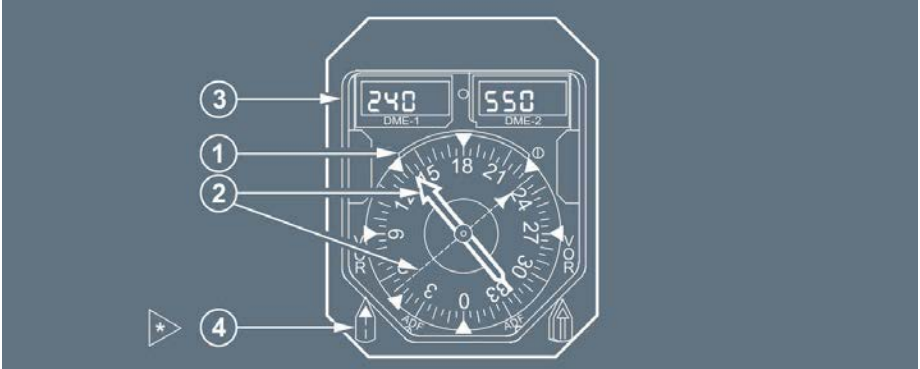



(1) Compass card

ADIRU1 normally supplies the signal that positions the compass card.

ADIRU 3 supplies this signal when selected by the ATT HDG SWITCHING selector.

(2) Bearings pointers

Indicate the magnetic bearing to the station received by VOR 1 or ADF 1  (dashed pointer) and VOR2 or ADF 2  (double pointer).

Note: Depending on the quality of the VOR beacon's signal, and mainly at distances greater than 25 NM from the station, the processing of the signal, on aircraft equipped with COLLINS or BENDIX VOR may lead to bearing pointer oscillations.

(3) DME1(2) counters

Indicates distance in nautical miles to/from DME station.



The counters indicate distances:

- in NM when the station is at more than 20 NM
- 1/10th of NM when the station is at less than 20 NM.

When the station is at less than 1 NM, 0 is shown.

The DME 1 and DME2 display are blanked or dashed when a fault is detected or data invalid.

(4) VOR/ADF selector 

- VOR1 or ADF 1  on the dashed pointer.
- VOR 2 or ADF 2  on the double pointer (if ADF 2 is not installed, then ADF1 may be selected).

The DDRMI  has also VOR /ADF flags and HDG flags when the associated information is not available.

The indicators display these flags if:

- The VOR or ADF receiver fails (associated to the VOR /ADF flag only)
- The DDRMI  has an internal failure
- The heading signal from ADIRS is not valid
- The power supply fails.

As long as the VOR /ADF flag is shown, and depending of the aircraft configuration, the associated bearing pointer remains:

- At the last valid position, or
- Into the horizontal line.

RADIO MANAGEMENT PANEL (RMP)

Ident.: DSC-34-NAV-30-30-00018584.0001001 / 21 MAR 16



Applicable to: ALL





(1) ON/OFF sw

This switch controls the power supply to the panel.

(2) NAV key (transparent switchguard)

- Pressing this key engages the radio navigation backup mode. It takes control of the VOR , ILS , GLS  , MLS  and ADF  receivers away from the FMGC and gives it to the RMP.
- The green monitor light comes on.
- Pressing the NAV key a second time returns control of the navigation radios to the FMGC.



Note: - The flight crew must select this backup tuning mode on both RMP 1 and RMP 2 if both FMGC s or both MCDU s fail. In the emergency electrical configuration, only RMP1 receives power

- Pressing the NAV key on RMP3  has no effect
- In the NAV backup mode, the flight crew can select radio communication systems as it would in the normal mode.
 Setting one RMP to NAV backup mode removes nav aids tuning from both FMGCs.
- When the flight crew uses an RMP to tune an ILS /DME or GLS  /DME or MLS  /DME , the PFD s do not display the DME distance.

(3) STBY NAV keys

When the NAV key is on and the flight crew presses one of these STBY NAV keys, the ACTIVE window displays the frequency/channel to which that receiver is tuned. The green monitor light on the selected key comes on, and the one on the previously selected STBY NAV or COM key goes out.

(4) Frequency/channel selector knob

Two concentric knobs allow the flight crew to preselect frequencies/channels for communication radios and stand-by navigation systems and select courses for VOR , ILS , GLS  and MLS .

The desired frequency, channel or course is set in the STBY/CRS window.

The outer and the inner knobs set a frequency/channel: the outer knob controls the most significant digits, the inner knob controls the least significant digits. A rate multiplier speeds up the tuning when the knob is rotated quickly.

The inner knob only sets a course.

(5) Transfer key

The flight crew presses this key to interchange ACTIVE and STBY frequencies/channels. This action tunes the selected receiver to the new ACTIVE frequency/channel.

(6) STBY /CRS window

The flight crew can make the displayed frequency /channel by rotating the tuning knob. The frequency/channel displayed in the window becomes the active frequency/channel when the flight crew presses the Transfer Key.

If this window displays a course, then the ACTIVE window displays the associated frequency/channel.

Note: If the STBY /CRS window is displaying a course, then pressing the transfer key displays the active frequency/channel in both windows.



(7) ACTIVE window

This window displays the frequency/channel of the selected navaid, which is identified by a green monitor light on the selection key.

(8) LOAD FUNCTION 

The flight crew can load the VHF frequency from the CPDLC CONTACT/MONITOR messages to the STBY/CRS window.

(9) BFO key 

If the ADF  is selected, pressing this key activates the BFO (Beat Frequency Oscillator). For most ADF, with BFO activated, the audio identification is heard. However there are some ADF where the BFO must be deactivated in order to hear the audio identification.



A318/A319/A320/A321
 FLIGHT CREW
 OPERATING MANUAL

AIRCRAFT SYSTEMS

NAVIGATION

RADIO ALTIMETER - DESCRIPTION

GENERAL

Ident.: DSC-34-NAV-40-10-00018585.0001001 / 21 MAR 16

Applicable to: ALL

The aircraft has two radio altimeters (RA).
 CAPT PFD displays the RA 1 height, and the F/Os PFD displays the RA2 height.
 If one RA fails, both PFD s display the height from the remaining RA.
 For indication on the PFD, *Refer to DSC-31-40 Altitude (CONT'D)*.

AUTOMATIC CALLOUT

Ident.: DSC-34-NAV-40-10-00018656.0001001 / 21 MAR 16

Applicable to: ALL

GENERAL

The FWC generates a synthetic voice for radio height announcement below 2 500 ft. These announcements come through the cockpit loudspeakers, even if the speakers are turned off.

PREDETERMINED CALL OUT

The altitude call out uses the following predetermined threshold:

| Height (feet) | Call out |
|------------------------|---|
| 2 500 | TWO THOUSAND FIVE HUNDRED OR TWENTY FIVE HUNDRED |
| 2 000 | TWO THOUSAND |
| 1 000 | ONE THOUSAND |
| 500 | FIVE HUNDRED |
| 400 | FOUR HUNDRED |
| 300 | THREE HUNDRED |
| 200 | TWO HUNDRED |
| 115 | STANDBY ⁽¹⁾ |
| 100 | ONE HUNDRED |
| 90 | STANDBY ⁽¹⁾ |
| 65 | FLARE ⁽¹⁾ |
| 50 | FIFTY |
| 40 | FORTY |
| 30 | THIRTY |
| 20 | TWENTY |
| 10 | TEN |
| 5 | FIVE |
| DH (or MDA /MDH) + 100 | HUNDRED ABOVE |
| DH (or MDA /MDH) | MINIMUM |

⁽¹⁾ These callouts are triggered only if the Steep Approach and Landing function  is active. In this case, the "ONE HUNDRED" callout is inhibited.

Note: The reference altitude for callouts is the radio height for precision approaches (DH), and baro altitude (MDA /MDH) for non precision approaches.

Pin programming enables Operators to select the required callouts. If the aircraft remains at a height that is in the detection zone for a height callout, the corresponding message is repeated at regular intervals.

INTERMEDIATE CALL OUT

If time between two consecutive predetermined call outs exceeds a certain threshold, the present height is repeated at regular intervals.

The threshold is:

- 11 s above 50 ft
- 4 s below 50 ft

The repeating interval is 4 s.

RETARD ANNOUNCEMENT

The loudspeaker announces RETARD at:

- 20 ft, or
- at 10 ft if autothrust is active and one autopilot is in LAND mode.

AIRCRAFT SYSTEMS

SURVEILLANCE

Intentionally left blank

DSC-34-SURV-10 ATC

DSC-34-SURV-10-10 Description

Principle.....A

DSC-34-SURV-10-20 Controls and Indicators

Control Panels.....A

DSC-34-SURV-30 Weather Radar

DSC-34-SURV-30-10 Description

Description.....A

DSC-34-SURV-30-20 Predictive Windshear System

General.....A

Windshear Alerts During Takeoff Roll, Up to 100 knots.....B

Windshear Alerts Above 50 feet.....C

Windshear Alerts Inhibition.....D

DSC-34-SURV-30-30 Controls and Indicators

Control Panel.....A

Weather Radar indication on ND.....B

PWS  indication on PFD and NDC

Memo Display.....D

DSC-34-SURV-40 GPWS

DSC-34-SURV-40-10 Description

Overview.....A

Principle.....B

DSC-34-SURV-40-20 GPWS Basics Modes

Mode 1 : Excessive Rate of Descent.....A

Mode 2 : Excessive Terrain Closure Rate.....B

Mode 3 : Altitude Loss After Takeoff.....C

Mode 4 : Unsafe Terrain Clearance when Not in Landing Configuration.....D

Mode 5 : Descent Below Glideslope.....E

DSC-34-SURV-40-35 Predictive GPWS Functions

Terrain Awareness and Display.....A

Terrain Caution and Warning Envelope.....B

Terrain Clearance Floor.....C

Runway Field Clearance Floor.....D

Continued on the following page

Continued from the previous page

DSC-34-SURV-40-40 Controls and Indicators

| | |
|------------------------|---|
| Overhead Panel..... | A |
| Instrument Panels..... | B |
| Memo Display..... | C |

DSC-34-SURV-60 TCAS

DSC-34-SURV-60-10 Description

| | |
|------------------------------------|---|
| Overview..... | A |
| Principle..... | B |
| Main Components..... | C |
| Intruder Detection Categories..... | D |
| TCAS Modes..... | E |
| Advisory Inhibition..... | F |

DSC-34-SURV-60-20 Controls and Indicators

| | |
|----------------------|---|
| ATC/TCAS Panel..... | A |
| ND Indications..... | B |
| TCAS Messages..... | C |
| PFD Indications..... | D |
| Aural Messages..... | E |
| Memo Display..... | F |

PRINCIPLE

Ident.: DSC-34-SURV-10-10-00020602.0002001 / 17 MAR 17

Applicable to: ALL

The aircraft has two ATC transponders (XPDR) which are controlled by a control panel (ATC /TCAS) on the center pedestal.

Only the selected XPDR operates.

The XPDR automatically responds to requests:

- From the ATC, to ensure effective air traffic surveillance
- From other aircraft that have a TCAS, to ensure that traffic alerts are triggered.

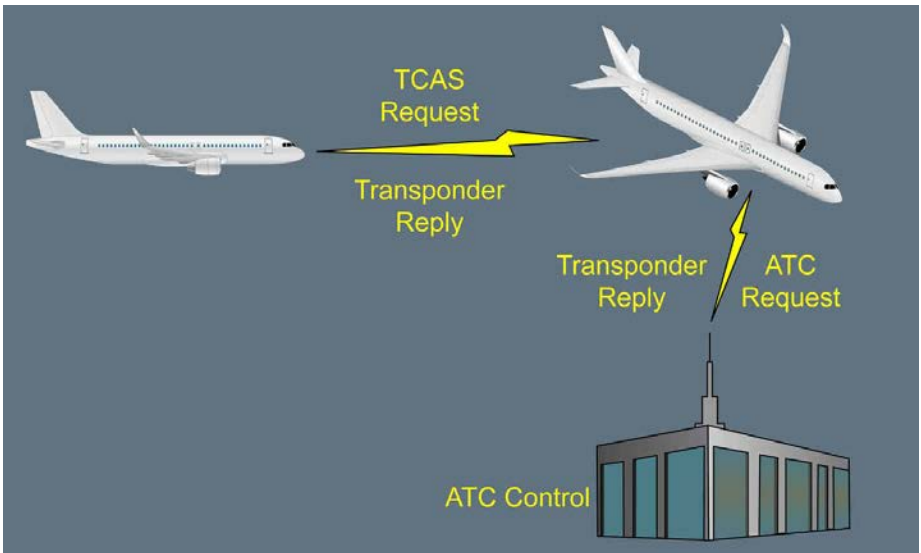

The XPDR is capable of elementary surveillance (ELS) and enhanced surveillance (EHS). It transmits the following data to the ATC center:

- The aircraft 24 bit address, the aircraft altitude, the flight number, the RA report
- The indicated airspeed, the Mach number, and the barometric vertical speed that are all supplied by the ADRs
- The magnetic heading, the roll angle, the ground speed, the track angle, the track angle rate, and the inertial vertical speed, that are all supplied by the IRs
- The selected altitude and barometric reference settings supplied by the FCUs.



A318/A319/A320/A321
FLIGHT CREW
OPERATING MANUAL

AIRCRAFT SYSTEMS

SURVEILLANCE

ATC - DESCRIPTION

Intentionally left blank

CONTROL PANELS

Ident.: DSC-34-SURV-10-20-00020607.0012001 / 17 MAR 17

Applicable to: ALL

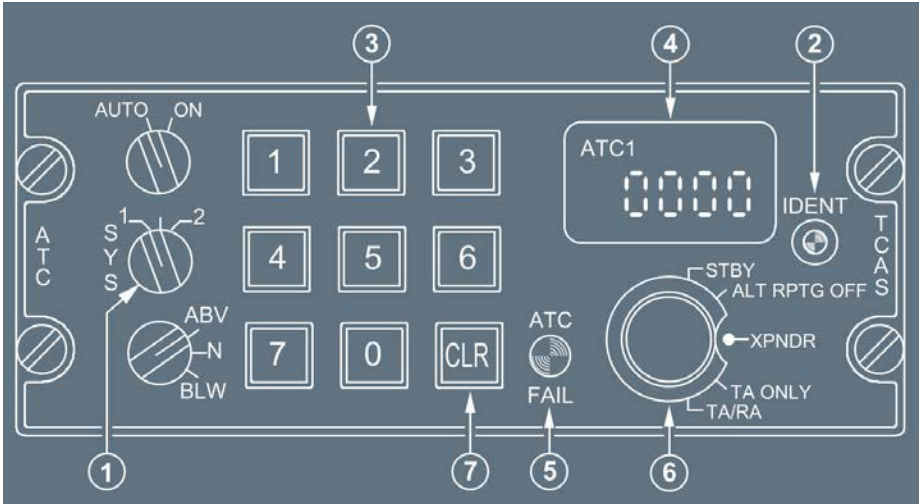

- (1) XPDR Selector
 Selects XPDR 1 or 2.
- (2) IDENT Switch
 The flight crew presses this button to send the aircraft identification signal.
- (3) Keypad
 The flight crew uses these key to set the code assigned by ATC.
- (4) Code Display
 The window displays the selected code.
- (5) ATC FAIL Light
 This light comes on if the selected XPDR fails.
- (6) Mode Selector
 STBY : Both XPDR and TCAS are electrically-supplied, but are on standby.
 ALT RPTG : No altitude data is transmitted.
 OFF

- XPNDR : In flight : Selected XPDR operates in all modes.
Baro altitude data is transmitted.
ATC 1 uses ADR 1 or ADR 3. ATC 2 uses ADR 2 or ADR 3.
The TCAS is on standby.
- XPNDR : On ground : Selected XPDR only operates in mode S (Selective aircraft interrogation mode).
- TA-RA/TA : *Refer to DSC-34-SURV-60-20 ATC/TCAS Panel.*

(7) CLR Key

The flight crew uses this key to clear the code display.



Note: *As long as the four figures of the new code are not entirely written, the previous code remains.*

| | |
|---|---|
|  <p>A318/A319/A320/A321 FLIGHT CREW OPERATING MANUAL</p> | <p style="text-align: center;">AIRCRAFT SYSTEMS SURVEILLANCE</p> <p style="text-align: center;">WEATHER RADAR - DESCRIPTION</p> |
|---|---|

| |
|--------------------|
| DESCRIPTION |
|--------------------|

Ident.: DSC-34-SURV-30-10-00014867.0002001 / 22 MAR 17

Applicable to: ALL

The aircraft is fitted with one or two  Multiscan weather radar systems with a Predictive WindShear (PWS ) function and a weather hazard prediction function  .
The flight crew can display weather data on the CAPT and/or F/O NDs in either ARC or ROSE mode.
The flight crew can adjust the brightness of the weather image on the ND thanks the outer knob of the ND Brightness Control knob (*Refer to DSC-31-50 Other EFIS Controls*).

Note: *A low brightness setting of the weather display may reduce the visibility of weather data, and therefore reduce crew awareness of the weather situation.*

The flight crew can use the radar in the following modes:

- Multiscan Automatic mode: MULTISCAN sw set to AUTO (recommended), or
- Manual mode: MULTISCAN sw set to MAN.

When in Multiscan Automatic mode:

- The radar alternatively scans at two antenna tilt settings. The weather radar image that is displayed is the result of the stored and combined information from each beam.
- When the gain selector is set to the Calibrated position (CAL), the radar automatically adjusts the gain based on various parameters (aircraft altitude, geographical area, season, time of the day) to obtain the best weather display.
- To prevent unnecessary clutter display, the “Quiet and Dark cockpit” philosophy removes the weather that:
 - is not on the aircraft flight path
 - is not a threat to the aircraft (post convective cell).
- The Ground Clutter Suppression (GCS) function removes the ground returns from the ND.

Multiscan Principle

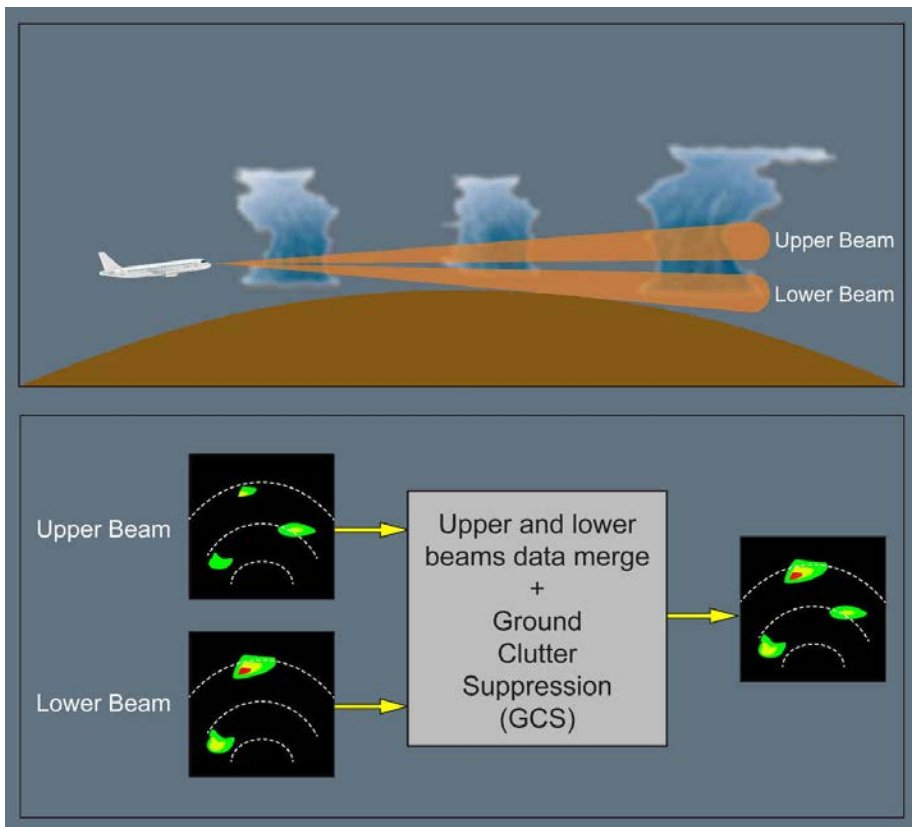

When in Manual mode:

- The flight crew can adjust manually the antenna tilt settings, and can adjust gain either automatically or manually using knobs located on the radar control panel
- The GCS function is not available
- When the gain selector is set to CAL, there is no automatic gain adjustment based on altitude, geographical area, season and time of the day.

As a consequence, when the flight crew switches from the Multiscan Automatic mode with CAL gain to the Manual mode with CAL gain, the weather displayed on the ND may be significantly different.

GENERAL

Ident.: DSC-34-SURV-30-20-00020942.0004001 / 17 MAR 17

Applicable to: ALL

The weather radar has a Predictive WindShear system (PWS) that operates when the PWS switch is in the AUTO position , and the aircraft radio height is below 2 300 ft, and

- Weather radar is ON (Radar sw on position 1 or 2), or
- Weather radar is OFF, and
 - At least one engine is running, and
 - Aircraft ground speed is greater than 30 kt, or
 - Aircraft longitudinal acceleration is above a given threshold during at least 0.5 s.

Note: If two weather radars are installed, when the selected weather radar fails, the flight crew can recover the PWS function by selecting the operative system on the Radar sw of the radar control panel.

The system scans the airspace for windshear within a range of 5 NM ahead of the aircraft. When the system detects windshear, a windshear symbol appears on the ND (*Refer to DSC-34-SURV-30-30 PWS (if installed) indication on PFD and ND*).

Predictive windshear warnings and cautions are associated to an aural alert and to a red (warning) or amber (caution) "W/S AHEAD" message on the PFD , whereas windshear advisories are only displayed on the ND (*Refer to DSC-34-SURV-30-30 PWS (if installed) indication on PFD and ND*) without message on the PFD.

| Alert Level | Aural Warning | PFD | ND (<i>Refer to DSC-34-SURV-30-30 PWS (if installed) indication on PFD and ND</i>) |
|--------------------|-----------------------------|-------------------|---|
| Warning (Approach) | «GO AROUND WINDSHEAR AHEAD» | W/S AHEAD (red) | Windshear icon |
| Warning (Takeoff) | «WINDSHEAR AHEAD» (twice) | W/S AHEAD (red) | Windshear icon |
| Caution | «MONITOR RADAR DISPLAY» | W/S AHEAD (amber) | Windshear icon |
| Advisory | Nil | Nil | Windshear icon |

WINDSHEAR ALERTS DURING TAKEOFF ROLL, UP TO 100 KNOTS

Ident.: DSC-34-SURV-30-20-00020944.0001001 / 17 MAR 17

Applicable to: ALL

Windshear Alerts During Takeoff Roll, Up to 100 knots

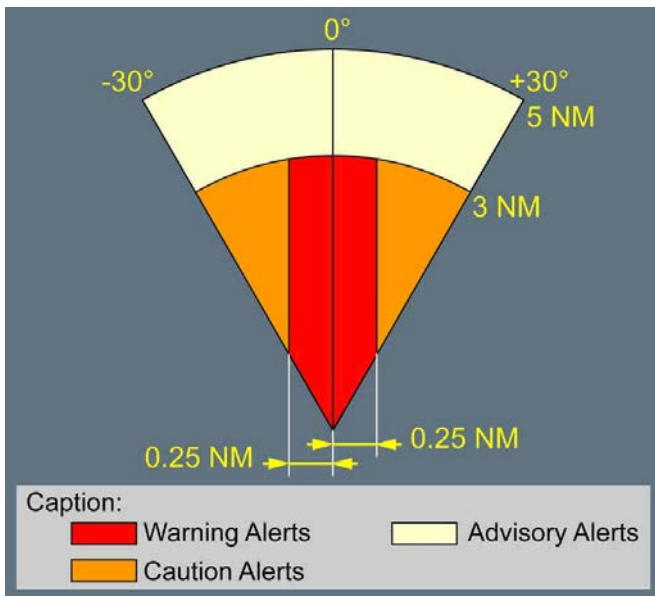

During the takeoff roll, up to 100 kt, both warnings and cautions are available within a range of 3 NM.

Note: This is also applicable during taxi when weather radar is set to ON.

WINDSHEAR ALERTS ABOVE 50 FEET

Ident.: DSC-34-SURV-30-20-00006422.0001001 / 12 APR 16

Applicable to: ALL

Windshear Alerts Above 50 feet

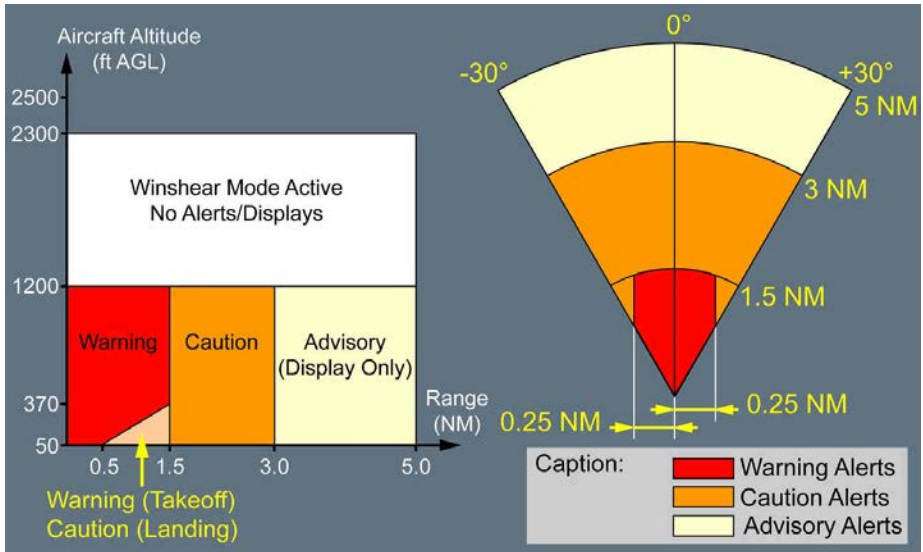

During final approach, the visual and aural warning alerts are downgraded to caution alerts between 370 ft AGL and 50 ft AGL, and range between 1.5 NM and 0.5 NM.

WINDSHEAR ALERTS INHIBITION

Ident.: DSC-34-SURV-30-20-00006426.0002001 / 20 JUL 15

Applicable to: ALL

At takeoff, alerts are inhibited above 100 kt and up to 50 ft.

During landing, alerts are inhibited below 50 ft.

The aural alerts of the Predictive WindShear system (PWS):

- Have priority over TCAS , GPWS , and other FWC aural warnings
- Are inhibited by reactive windshear detection and aural messages of stall warnings.



A318/A319/A320/A321
FLIGHT CREW
OPERATING MANUAL

AIRCRAFT SYSTEMS

SURVEILLANCE

WEATHER RADAR - PREDICTIVE WINDSHEAR SYSTEM

Intentionally left blank

CONTROL PANEL

Ident.: DSC-34-SURV-30-30-00001402.0002001 / 21 MAR 17

Applicable to: ALL

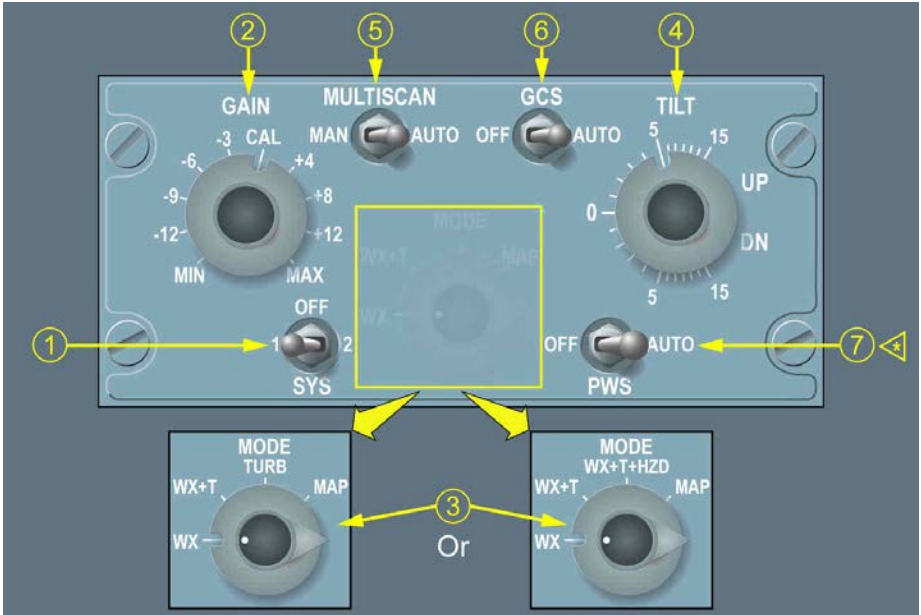

(1) Radar sw

This switch sets one radar to ON or turns both radars to OFF.

Note: If only one radar is installed on the aircraft, either:

- a "INOP" or "DEACT" sticker replaces the "2", or
- a "ON/OFF" Radar sw replaces the "1/OFF/2" Radar sw.

Note: If only one radar is installed on the aircraft, no weather image is displayed on the Navigation Display (ND) when the "1/OFF/2" SYS sw is set to "2".

(2) GAIN knob

This knob adjusts the sensitivity of the radar.

CAL is the normal position of the knob :

- When in Multiscan Automatic mode and gain set to CAL, the radar automatically adjusts the gain according to various parameters (aircraft altitude, geographical area, season, time of the day) to obtain the best weather display
- When in Manual mode and gain set to CAL, the radar adjusts the gain to a calibrated setting.

(3) Display mode selector

WX : Weather mode :

Colors indicate the intensity of precipitation (black for the lowest intensity, green, amber and red indicate progressively higher intensity).

WX+T : Weather and Turbulence mode :

The ND indicates precipitation and turbulence areas. Turbulence areas are displayed in magenta (within 40 NM).

TURB  : Turbulence mode :

The ND only displays turbulence areas in magenta (within 40 NM).

WX+T+HZD: Weather, Turbulence and Hazard mode (recommended position) :



The ND indicates precipitation, turbulence areas in magenta (within 40 NM) and hazard prediction risk areas (*Refer to DSC-34-SURV-30-30 Weather Hazard Prediction Function Indication on ND*).

Hazard prediction function is only available when the MULTISCAN sw is set to AUTO.

Note: When MULTISCAN sw is set to MAN, WX+T+HZD mode is equivalent to WX+T mode.

MAP : Map mode :

The radar operates in ground mapping mode: black indicates water, green indicates the ground, and amber indicates cities and mountains.

(4) TILT knob

This knob adjusts the antenna tilt when MULTISCAN sw is set to MAN. Zero indicates the horizon reference provided by the IRS.

(5) MULTISCAN sw

AUTO : Activates Multiscan mode

Multiscan controls the tilt automatically and combines two scans done at different tilt angles to optimize weather detection and minimize ground clutter.

MAN : When set to MAN, the crew can manually adjust the tilt by using the TILT knob.

(6) GCS sw

The Ground Clutter Suppression (GCS) switch is spring-loaded to the AUTO position.

- AUTO : - If MULTISCAN sw is set to AUTO, the radar is in normal use. Ground clutter is not displayed on the screen
 - If MUTLISCAN sw is set to MAN, the GCS sw has no utility. Ground clutter is displayed on the screen.

OFF : Ground clutter is displayed on the screen.

(7) PWS sw 

AUTO : Activates the Predictive WindShear function in accordance with activation conditions (*Refer to DSC-34-SURV-30-20 Windshear Alerts Above 50 feet*).

OFF : The Predictive WindShear function is off.

WEATHER RADAR INDICATION ON ND

Ident.: DSC-34-SURV-30-30-00001255.0007001 / 21 MAR 16

Applicable to: ALL

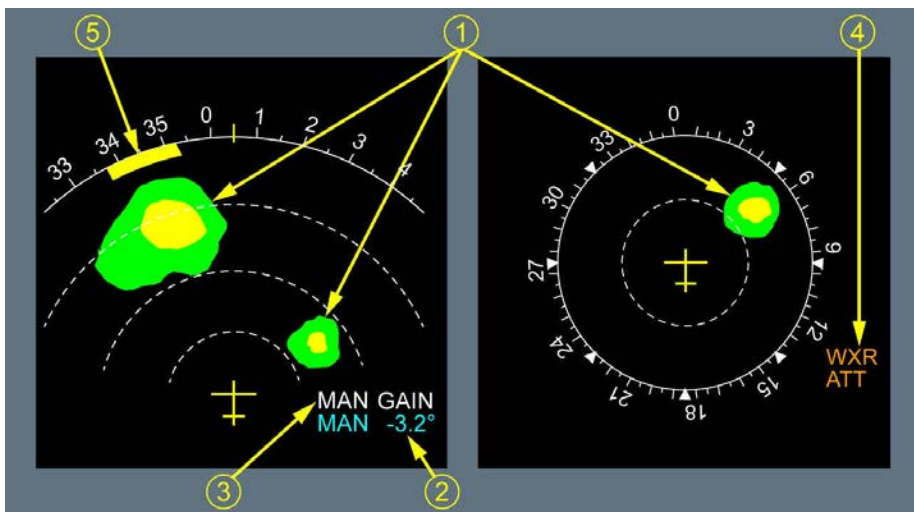

(1) Weather Radar Picture

- When the radar is operating, and when the ND is not in PLAN mode, the ND displays the weather radar picture.
- The weather echoes appear in different colors, depending on the precipitation rates (black, green, yellow, red or magenta for turbulence).
- The selected ND range will determine how often the image is refreshed.

(2) Tilt Angle

- The multiscan function of the weather radar alternatively scans at low and high beam, and automatically sets the tilt of these beams to optimize the weather radar detection. The displayed weather radar picture is the result of the storing and merging of the information from each beam.
- The tilt angle is the angle between the horizon and the radar beam axis. The value of the tilt angle is in degrees, and quarters of a degree. It appears in the lower right corner of the screen:
 - In green, when the MULTISCAN sw is set to AUTO. This value represents the average of the lower and the upper beam tilts.
 - In blue, next to the blue “MAN ” indication, when the flight crew sets the MULTISCAN sw to MAN.
 - When the multiscan function is lost, the tilt value is dashed and the “NO AUTO TILT” message appears in amber on the ND , until the flight crew sets the MULTISCAN sw to MAN.

(3) Gain Mode

- “MAN GAIN” appears in white, when the flight crew selects the manual gain mode.

(4) Failure Messages

The ND lists the detected failures.

If the message is in “red”, the ND does not display a radar image.

If the message is in “amber”, the image is not affected.

| | | |
|----------------------|---|---|
| NO WXR (red) | : | Radar System failure. |
| WXR RT (red) | : | Radar transceiver failure. |
| WXR ANT (red) | : | Radar antenna failure. |
| WXR CTL (red) | : | Radar control unit failure. |
| WXR RNG (red) | : | Range error. |
| WXR WEAK (amber) | : | Calibration failure. |
| WXR ATT (amber) | : | Attitude control failure. |
| WXR STAB (amber) | : | Antenna stabilization failure. |
| PRED W/S (amber) | : | PWS  function failure. |
| NO AUTO TILT (amber) | : | Automatic tilt adjustment failure. |
| WXR TEST (amber) | : | Radar System test. |

(5) PAC alert

When the flight crew sets the display mode selector to WX or WX+T, or WX+T+HZD  and sets the gain to CAL, and when the aircraft is within 80 NM of a storm cell, the Path Attenuation Compensation (PAC) alert is available.

The PAC alert displays a yellow arc on the outermost scale of the ND, when an intervening rainfall creates an attenuated area behind a storm cell (also called a radar shadow or attenuation effect).

Note: The PAC alert is only available when the MULTISCAN sw is in the AUTO position.

PWS  INDICATION ON PFD AND ND

Ident.: DSC-34-SURV-30-30-00020941.0002001 / 17 MAR 17

Applicable to: ALL

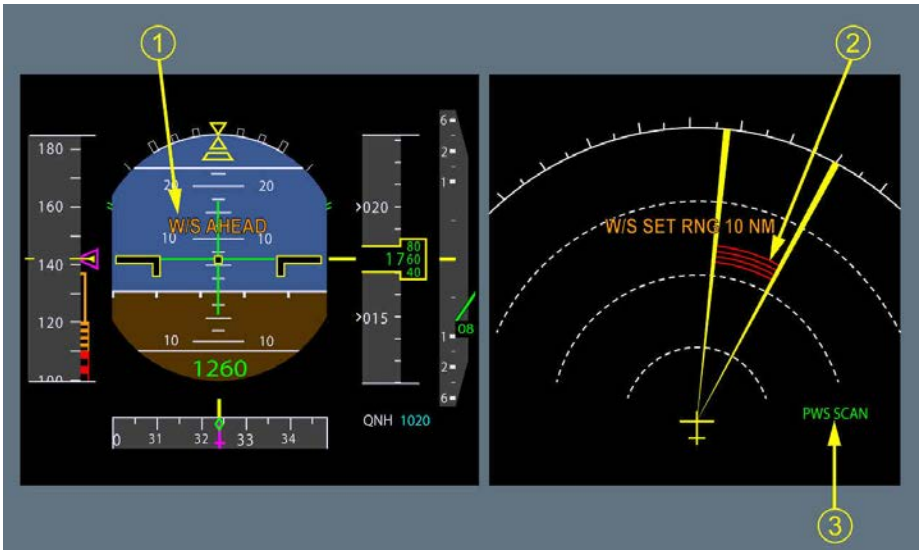

(1) W/S AHEAD message on the PFD

This message is displayed, when the Predictive WindShear system detects windshear ahead of the aircraft.

The message is in amber or red, depending on the level of the alert. *Refer to DSC-34-SURV-30-20 General.*

(2) Predictive WindShear area indication

A red and black symbol and two yellow radial lines indicate the predicted windshear area.

AIRCRAFT SYSTEMS

SURVEILLANCE

WEATHER RADAR - CONTROLS AND INDICATORS

Windshear indication is available in ARC and ROSE ND modes.

When the radar detects a windshear event and the ND range is set above 10 NM, a W/S SET RNG 10 NM (Windshear, set range to 10 NM) message appears. This message requests the flight crew to adjust the range on the corresponding ND.

Depending on the windshear alert level, ND indication may be associated with an aural message and a PFD message. *Refer to DSC-34-SURV-30-20 General.*

(3) PWS SCAN message on the ND

If only the PWS detection is active, the ND displays a PWS SCAN message when the PWS is active. In this mode, when the radar detects a windshear event, a windshear symbol and the weather returns appear automatically on the ND.

MEMO DISPLAY

Ident.: DSC-34-SURV-30-30-00017051.0001001 / 21 MAR 16

Applicable to: ALL

The "PRED W/S OFF" message appears when windshear is set to OFF on the weather radar panel.

PRED W/S OFF : This memo appears in green during flight phases 2 and 6.

PRED W/S OFF : This memo appears in amber when:

- The aircraft is in flight phases 3, 4, 5, 7, 8, and 9.
- The T.O. CONFIG pb is pressed during flight phase 2.

| | |
|---|--|
|  A318/A319/A320/A321 FLIGHT CREW OPERATING MANUAL | AIRCRAFT SYSTEMS SURVEILLANCE GPWS - DESCRIPTION |
|---|--|

OVERVIEW

Ident.: DSC-34-SURV-40-10-00021292.0001001 / 17 MAR 17

Applicable to: ALL

The purpose of the Ground Proximity Warning System (GPWS) is to warn the flight crew of potentially hazardous situations, such as a collision with terrain. It detects terrain collision threats and triggers applicable aural and visual indications.

The GPWS includes:

- Five basic modes active up to radio height of 2 500 ft.
 - Excessive rate of descent (Mode 1)
 - Excessive terrain closure rate (Mode 2)
 - Altitude loss after takeoff or go-around (Mode 3)
 - Terrain clearance not sufficient, if not in landing configuration (Mode 4)
 - Excessive descent below the glide slope (Mode 5).
- A predictive GPWS  function, based on a GPWS database, to display terrain information. It can be provided:
 - By Honeywell through Enhanced GPWS (EGPWS)
 - By ACSS as Ground Collision Avoidance System (GCAS), through T2CAS or T3CAS.

The predictive GPWS is composed of:

- Mandatory functions such as the Forward Looking Terrain Alerting function
- Optional functions such as the obstacle database.

Note: The terrain data are displayed on the ND and the brightness is controlled via the weather radar brightness control knob. If the weather radar brightness was set to low (due to bad weather) and a terrain alert occurs, then the brightness of the terrain display will also be low.



PRINCIPLE

Ident.: DSC-34-SURV-40-10-00021293.0001001 / 17 MAR 17

Applicable to: ALL

The GPWS computes the geometric altitude of the aircraft by using:

- Pressure altitude
- Radio altitude
- Temperature
- Barometric references

- GPS altitude for predictive GPWS 
- Data from the GPWS database for predictive GPWS  .

MODE 1 : EXCESSIVE RATE OF DESCENT

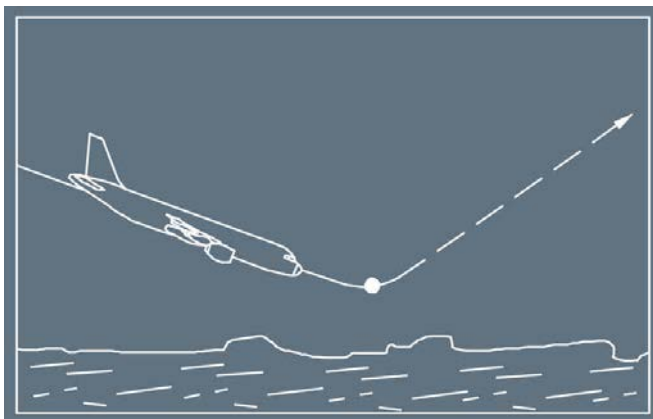

Ident.: DSC-34-SURV-40-20-00015115.0004001 / 13 JAN 14

Applicable to: ALL



Mode 1 triggers aural and visual alerts about excessive rates of descent, based on the radio height, and the rate of descent of the aircraft.

Mode 1 is active for all phases of the flight.

| | CAUTION | | WARNING | |
|---------------------|--|-------------------------------|--|--------------------------------|
| AURAL ALERT | "SINK RATE, SINK RATE" | | "PULL UP" (repeated as long as MODE 1 is triggered) | |
| VISUAL ALERT |  | The GPWS amber lights come on |  | The PULL UP red lights come on |

MODE 2 : EXCESSIVE TERRAIN CLOSURE RATE

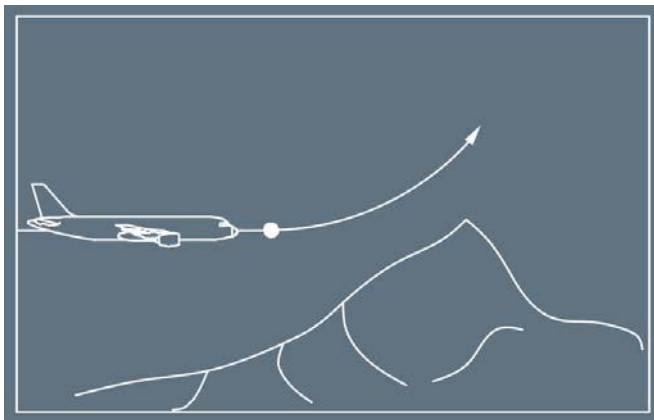

Ident.: DSC-34-SURV-40-20-00015116.0004001 / 03 AUG 17

Applicable to: ALL



Mode 2 triggers aural and visual alerts, based on the landing gear/flaps configuration of the aircraft, the radio height, and the RA rate of change.

There are two types of Mode 2 alerts, Mode 2A (active during climb, cruise, and initial approach), and Mode 2B (active during approach and 60 s after takeoff).

| CONFIGURATION | Flaps not in Landing Position + Landing Gear Up (Mode 2A) Flaps in landing position + Landing Gear Up (Mode 2B) | | |
|---------------|--|---|---|
| | CAUTION | WARNING | |
| AURAL ALERT | "TERRAIN, TERRAIN" | "PULL UP" (repeated as long as MODE 2 is triggered in the warning conditions) | "TERRAIN" (repeated as long as MODE 2 is triggered after leaving the warning conditions) |
| VISUAL ALERT |  The GPWS amber lights come on |  The PULL UP red lights come on |  The PULL UP red lights stay on |

| | |
|---|---|
|  <p>A318/A319/A320/A321 FLIGHT CREW OPERATING MANUAL</p> | <p>AIRCRAFT SYSTEMS</p> <p>SURVEILLANCE</p> <p>GPWS - GPWS BASICS MODES</p> |
|---|---|

| | |
|----------------------|---|
| CONFIGURATION | Flaps in landing position + Landing Gear Down (Mode 2B) |
| AURAL ALERT | CAUTION |
| | <p style="color: orange;">"TERRAIN"</p> <p>(repeated as long as MODE 2 is triggered)</p> |
| VISUAL ALERT | <div style="display: flex; align-items: center;">  <p>The GPWS amber lights come on</p> </div> |

MODE 3 : ALTITUDE LOSS AFTER TAKEOFF

Ident.: DSC-34-SURV-40-20-00015117.0004001 / 19 SEP 13
Applicable to: ALL

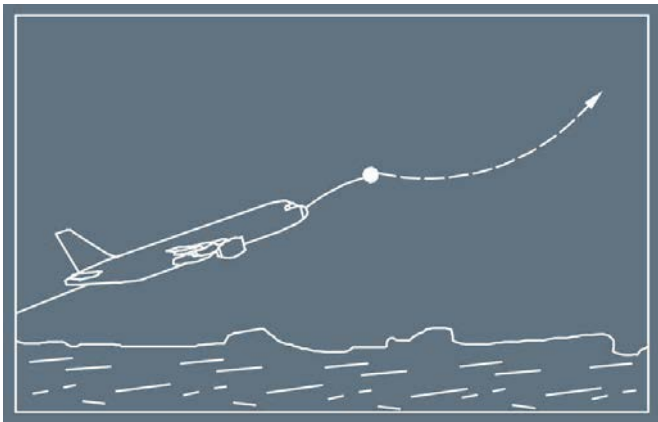

Mode 3 triggers aural and visual alerts when the altitude significantly decreases after takeoff, and go-arounds with landing gear or flaps not in landing configuration.

| | |
|---------------------|---|
| | CAUTION |
| AURAL ALERT | <p style="color: orange;">"DON'T SINK, DON'T SINK"</p> <p>(repeated as long as MODE 3 is triggered)</p> |
| VISUAL ALERT | <div style="display: flex; align-items: center;">  <p>The GPWS amber lights come on</p> </div> |

MODE 4 : UNSAFE TERRAIN CLEARANCE WHEN NOT IN LANDING CONFIGURATION

Ident.: DSC-34-SURV-40-20-00015118.0005001 / 13 JAN 14

Applicable to: ALL

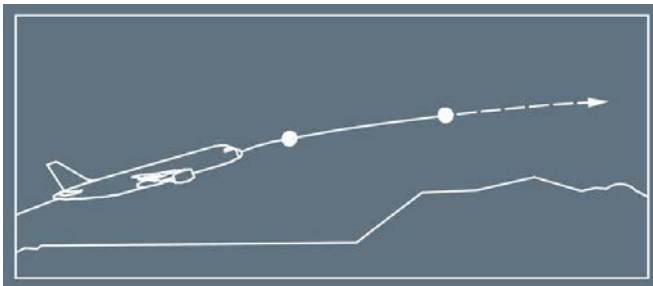
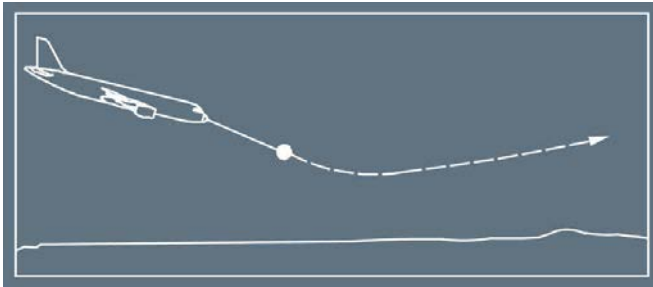

There are three types of Mode 4 alerts, Mode 4A and Mode 4B (both active during cruise and approach), and Mode 4C (active during takeoff*).

Mode 4A and Mode 4B trigger aural and visual alerts when terrain clearance is not sufficient based on the phase of flight, the configuration of the landing gear and the flaps, and the speed. Mode 4C triggers aural and visual alerts based on the minimum terrain clearance and the radio height of the aircraft. *(Only EGPWS not T2CAS)

| | |
|---|---|
|  <p>A318/A319/A320/A321 FLIGHT CREW OPERATING MANUAL</p> | <p>AIRCRAFT SYSTEMS</p> <p>SURVEILLANCE</p> <p>GPWS - GPWS BASICS MODES</p> |
|---|---|

| | | | | | |
|----------------------|--|---|-------------------|--|-------------------|
| CONFIGURATION | Landing gear Up (Mode 4A) | Flaps not in landing position + Landing gear down (Mode 4B) | | Flaps not in landing position OR Landing Gear Up (Mode 4C) | |
| AURAL ALERT | CAUTION | | | | |
| | "TOO LOW TERRAIN" | "TOO LOW GEAR" | "TOO LOW TERRAIN" | "TOO LOW FLAPS" | "TOO LOW TERRAIN" |
| VISUAL ALERT |  <p>The GPWS amber lights come on</p> | | | | |

MODE 5 : DESCENT BELOW GLIDESLOPE

Ident.: DSC-34-SURV-40-20-00015119.0004001 / 19 SEP 13
Applicable to: ALL



Mode 5 triggers aural and visual alerts, when the aircraft descends below the glide slope.

| | |
|---------------------|--|
| | CAUTION |
| AURAL ALERT | <p>"GLIDESLOPE"</p> <p>(repeated as long as MODE 5 is triggered)</p> |
| VISUAL ALERT |  <p>The GPWS amber lights come on</p> |



A318/A319/A320/A321
FLIGHT CREW
OPERATING MANUAL

AIRCRAFT SYSTEMS

SURVEILLANCE

GPWS - GPWS BASICS MODES

Intentionally left blank

| | |
|---|--|
|  A318/A319/A320/A321 FLIGHT CREW OPERATING MANUAL | AIRCRAFT SYSTEMS SURVEILLANCE GPWS - PREDICTIVE GPWS FUNCTIONS |
|---|--|

TERRAIN AWARENESS AND DISPLAY

Ident.: DSC-34-SURV-40-35-00001417.0114001 / 29 JUN 16
Applicable to: ALL

The Terrain Awareness and Display (TAD) function computes a caution and a warning envelope in front of the aircraft, depending on the aircraft altitude, the nearest runway altitude, the distance to the nearest runway threshold, the ground speed, and the turn rate. When the boundary of these envelopes conflicts with the terrain, or with an obstacle memorized in the database, the system generates the relevant alert:

| Alert Level | Aural Warning | ND (Refer to DSC-31-45 Flags and Messages Displayed on ND) | Local Warning |
|----------------|---------------------------------------|---|--|
| Warning | TERRAIN TERRAIN PULL UP | - Automatic terrain display See * - Solid red areas - TERRAIN (red) | On each pilot's instrument panel, The pushbutton light comes on. |
| | OBSTACLE OBSTACLE, PULL UP | - Automatic terrain display See * - Solid red areas - OBST (red) | |
| Caution | CAUTION TERRAIN | - Automatic terrain display See * - Solid yellow areas - TERRAIN (amber) | |
| | CAUTION OBSTACLE | - Automatic terrain display See * - Solid yellow areas - OBST (amber) | |

* When the TERR pb-sw ON ND is set to ON, and ARC or ROSE mode is selected, the ND displays the terrain and the obstacles memorized in the database, depending on the aircraft's position. The terrain is displayed in various densities of green, yellow, red, or magenta, depending on the threat (Refer to DSC-31-45 Flags and Messages Displayed on ND). If an alert is generated (caution or warning), and TERR pb-sw ON ND is not selected, the terrain and the obstacles are automatically displayed, and the ON light of the TERR pb-sw ON ND comes on.

- Note:*
1. When **TERR pb-sw ON ND** is selected, the weather radar image is not displayed.
 2. The Geometric Altitude function can protect against certain **BARO** setting errors, provided the components used to compute the Geometric Altitude are valid and accurate enough.
 3. The **TAD** and **Terrain Clearance Floor (TCF)** functions operate using the pure lateral **GPS** position and, the **FMS1** position as backup.

If the crew identifies that navigation accuracy is low, it must set the enhanced modes to off, via the **TERR pb-sw**. The 5 GPWS modes remain active.

TERRAIN CAUTION AND WARNING ENVELOPE

Ident.: DSC-34-SURV-40-35-00006161.0002001 / 19 DEC 12

Applicable to: **ALL**

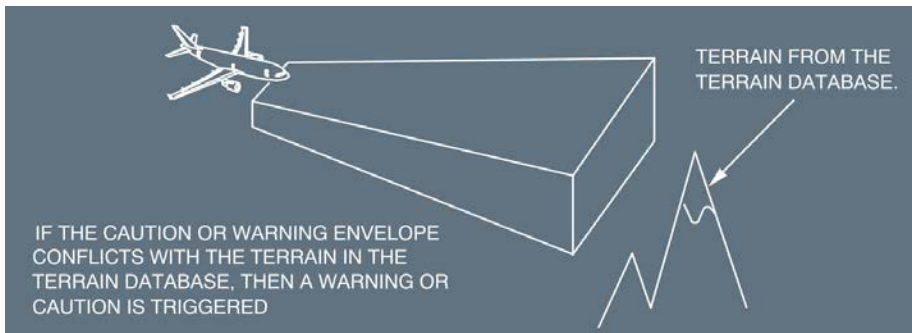

VERTICAL ENVELOPE

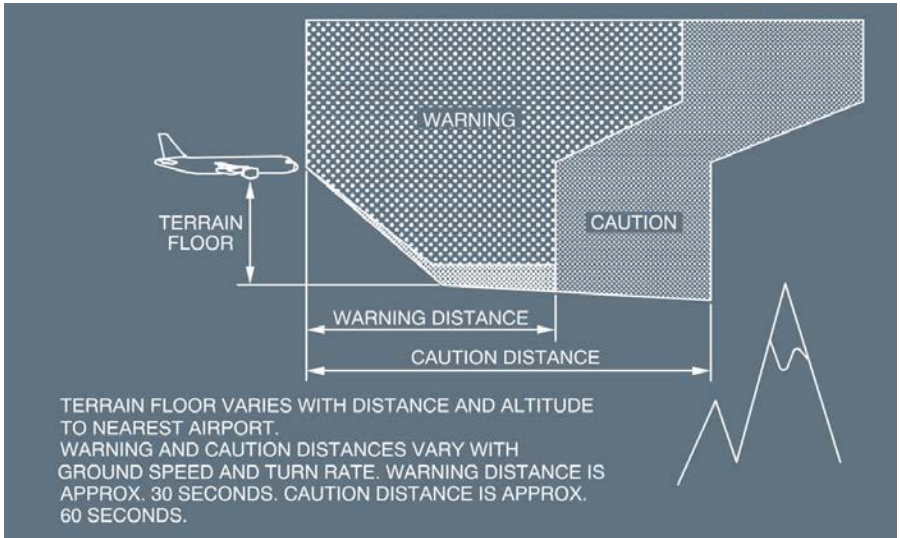

HORIZONTAL ENVELOPE

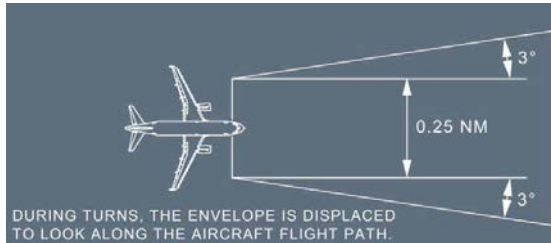

TERRAIN CLEARANCE FLOOR

Ident.: DSC-34-SURV-40-35-00006162.0002001 / 03 JUN 14

Applicable to: ALL

A terrain clearance floor envelope is stored in the database for each runway for which terrain data exist. The Terrain Clearance Floor (TCF) function warns of a premature descent below this floor, regardless of aircraft configuration.

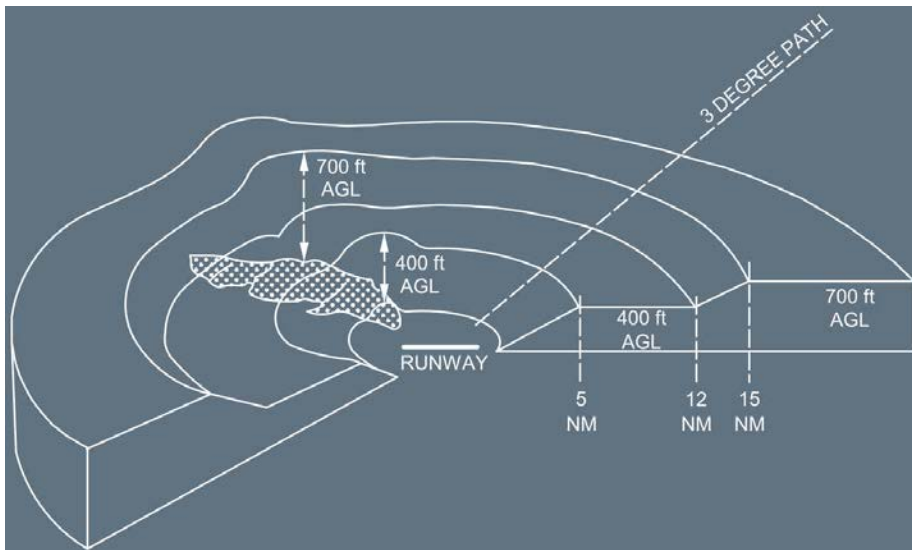

If the airplane descends below this floor, a TOO LOW TERRAIN aural warning is announced, and the pushbutton light comes on, on the glareshield.

RUNWAY FIELD CLEARANCE FLOOR

Ident.: DSC-34-SURV-40-35-00006163.0002001 / 19 DEC 12

Applicable to: ALL

The Runway Field Clearance Floor (RFCF) provides an additional envelope protection, for runways that are significantly higher than the surrounding terrain. It is contained in a circle within the 5.5 NM of the runway threshold and it is based on the geometric altitude and the runway elevation.

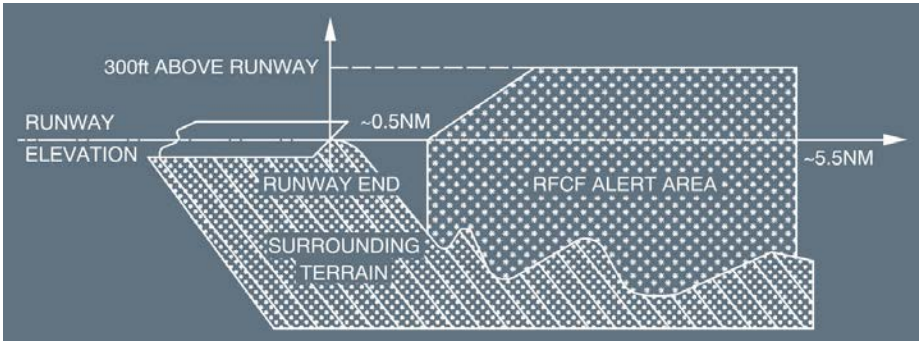



A318/A319/A320/A321
FLIGHT CREW
OPERATING MANUAL

AIRCRAFT SYSTEMS

SURVEILLANCE

GPWS - PREDICTIVE GPWS FUNCTIONS

Intentionally left blank

OVERHEAD PANEL

Ident.: DSC-34-SURV-40-40-00001418.0002001 / 21 MAR 17

Applicable to: ALL

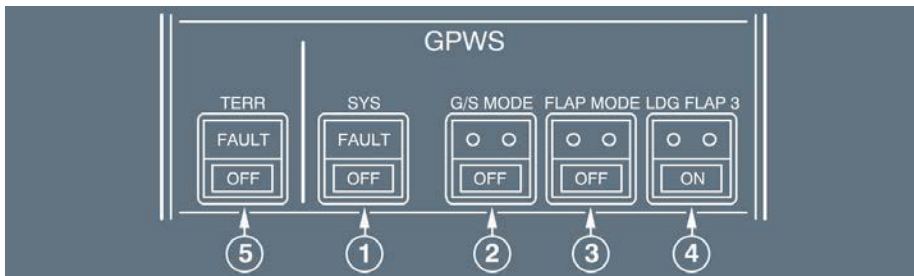

(1) SYS pushbutton

OFF : All basic GPWS alerts (Mode 1 to 5) are inhibited.

FAULT light : This amber light comes on, along with an ECAM caution, if the basic GPWS mode 1 to 5 malfunction.

Note: If ILS 1 fails, only mode 5 is inhibited. Consequently, the FAULT light does not come on and the GPWS FAULT warning is not triggered.

(2) G / S MODE pushbutton

OFF : Glideslope mode (mode 5) is inhibited.

(3) FLAP MODE pushbutton

OFF : Flap mode ("TOO LOW FLAPS" mode 4) is inhibited.
 (To avoid nuisance warning in case of landing with flaps setting reduced).

(4) LDG FLAP 3 pushbutton

ON : Flap mode is inhibited when FLAPS CONF 3 is selected (to avoid nuisance warning in case of landing in CONF 3).
 In this case, LDG MEMO displays "FLAPS ... 3" instead of "CONF ... FULL".

(5) TERR pushbutton

OFF : Inhibits the Terrain Awareness Display (TAD) and Terrain Clearance Floor (TCF) modes, and does not affect the basic GPWS mode 1 to 5. If OFF is selected the ECAM caution NAV GPWS TERR DET FAULT is displayed.

FAULT light : This amber light comes on, along with an ECAM caution, if the TAD or TCF mode fails. The terrain is not shown on the ND . The basic GPWS mode 1 to mode 5 are still operative if the SYS pushbutton OFF or FAULT lights are not illuminated.

INSTRUMENT PANELS

Ident.: DSC-34-SURV-40-40-00001419.0003001 / 19 DEC 12

Applicable to: **ALL**

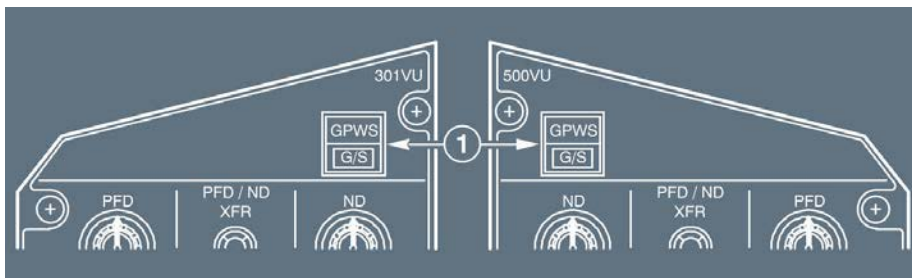

(1) GPWS – G/S pushbutton

GPWS : This red light comes on when any mode from 1 to 4, or any TAD or TCF alert is activated. A specific voice alert accompanies it.

G/S : Comes on amber when Mode 5 is activated. It is accompanied by the aural “GLIDE SLOPE” warning.

- Note:*
1. If the flight crew presses this button briefly when a glide slope warning is on, the G/S light goes out and the “GLIDE SLOPE” aural warning (soft or loud) stops.
 2. On ground, the GPWS can be tested by pressing this pushbutton. If the pushbutton is pressed briefly, some of the aural warnings sound and pushbutton captions, related to the GPWS, come on. If the pushbutton is pressed continuously, then all the aural warnings sound.

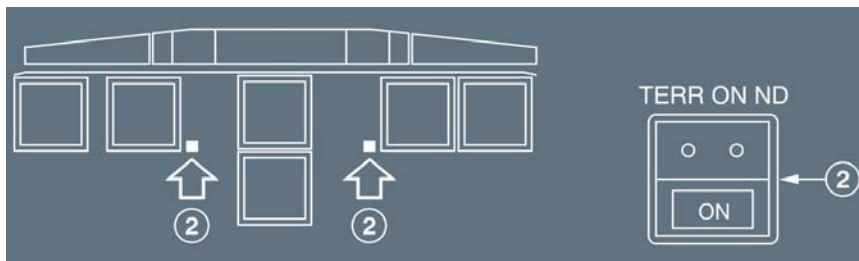

(2) TERR ON ND pushbutton

These pushbuttons are located on either side of the ECAM. Each pushbutton controls the onside terrain display.

ON : The terrain is displayed on the ND if the:

- TERR pb-sw is selected ON, and
- TERR FAULT light is not on.

The ON light comes on.

OFF : The terrain data is not displayed on the ND.

- Note:*
- If the Terrain Awareness Display (TAD) mode generates a caution or a warning, while the TERR ON ND is not switched ON, the terrain is automatically displayed on the ND s (see EGPWS specific caution and warning due to TAD mode) and the ON light of the TERR ON ND pushbutton come on.
 - To differentiate between the terrain and the weather display, the terrain display sweeps from the center outward to both sides of the ND.

MEMO DISPLAY

Applicable to: ALL

Ident.: DSC-34-SURV-40-40-A-00017057.0001001 / 21 MAR 16

GPWS FLAP 3 : This memo appears in green when GPWS LDG FLAP 3 pb-sw is ON.

Ident.: DSC-34-SURV-40-40-A-00017058.0001001 / 21 MAR 16

GPWS FLAP MODE OFF : This memo appears in green when GPWS FLAP MODE pb-sw is OFF.

Ident.: DSC-34-SURV-40-40-A-00017060.0004001 / 21 MAR 16

The TERR OFF memo appears when the TERR pb-sw is OFF.

TERR OFF : This memo appears in green when:

- The aircraft is in flight phase 2, before the Take Off Configuration test is launched.
- The aircraft is in flight phase 6.

TERR OFF : This memo appears in amber when:

- The aircraft is in flight phase 2, after the Take Off Configuration test.
- The aircraft is in flight phases 3, 4, 5, 7, 8 and 9.

Ident.: DSC-34-SURV-40-40-A-00017059.0007001 / 21 MAR 16

TERR STBY : Airborne TERR STBY memo appears in green when the aircraft position accuracy (computed by the EGPWS) is not sufficient to allow the enhanced TCF and TAD modes to operate. These modes are not available until the TERR STBY memo disappears. If selected, the terrain data display on ND is automatically deselected when the TERR STBY memo is triggered.

| | |
|---|--|
|  <p>A318/A319/A320/A321 FLIGHT CREW OPERATING MANUAL</p> | <p align="center">AIRCRAFT SYSTEMS SURVEILLANCE TCAS - DESCRIPTION</p> |
|---|--|

OVERVIEW

Ident.: DSC-34-SURV-60-10-00020407.0001001 / 21 MAR 17
Applicable to: ALL

The Traffic alert and Collision Avoidance System (TCAS):

- Detects and displays surrounding aircraft that have a transponder
- Calculates and display possible collision threats
- Triggers vertical speed orders, in order to avoid collisions.

PRINCIPLE

Ident.: DSC-34-SURV-60-10-00020408.0001001 / 21 MAR 17
Applicable to: ALL

The TCAS detection capability is limited to intruders flying within a maximum range of 30 NM on either sides and approximately 30 NM to 80 NM longitudinally (depending on aircraft configuration and external conditions), and within a maximum altitude range of 9 900 ft above and below the aircraft.

TCAS Range

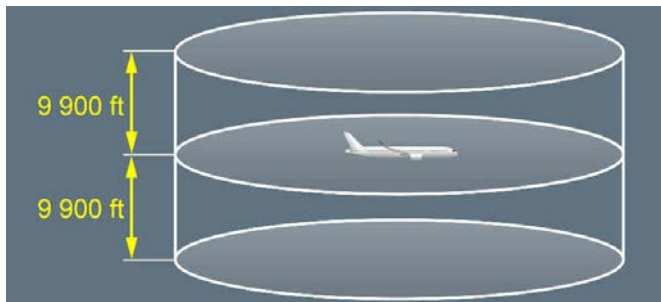

The TCAS obtains data transmitted by the transponders of nearby aircraft, and uses this data to evaluate possible collision threats.

The TCAS determines:

- The bearing of intruders, in relation to the bearing of the aircraft.
- The distance between the aircraft and intruders, and the rate of separation or closure.
- The relative altitude of intruders, if intruders have a Mode-C or Mode-S transponder.

The TCAS then calculates the intruder trajectory, the Closest Point of Approach (CPA), and the estimated time (TAU) before reaching the CPA.

The TAU is the ratio between the distance that separates both aircraft, and the sum of their speed.

TAU Definition

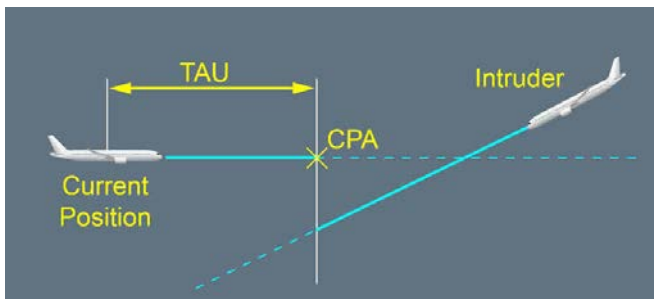

If the TCAS detects that the trajectory of an intruder may be a collision threat, it triggers:

- Audio and visual indicators
- Vertical speed orders, to ensure a sufficient trajectory separation and a minimal vertical speed variation considering all intruders.

MAIN COMPONENTS

Ident.: DSC-34-SURV-60-10-00020409.0001001 / 21 MAR 17

Applicable to: **ALL**

The system includes:

- A single channel TCAS computer
- Two TCAS antennas
- Two mode S ATC transponders, one active the other in standby

These transponders allow:

- Interface between the ATC /TCAS control panel and the TCAS computer
 - Communication between the aircraft and intruders equipped with a TCAS system.
- An ATC /TCAS control panel.

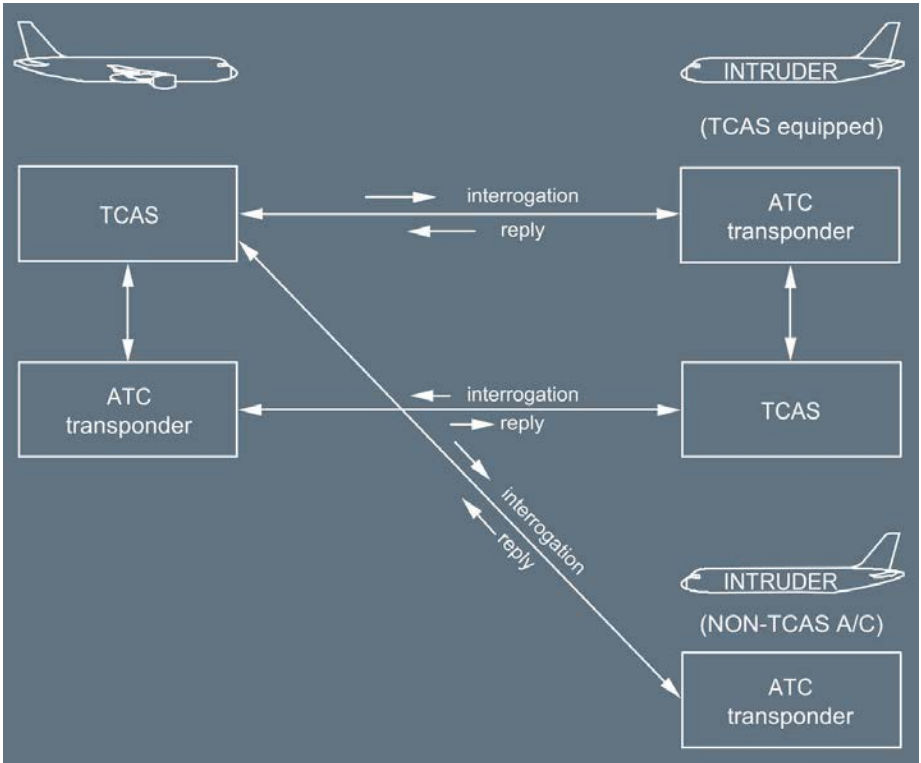

INTRUDER DETECTION CATEGORIES

Ident.: DSC-34-SURV-60-10-00020410.0001001 / 21 MAR 17

Applicable to: ALL

The TCAS divides the space surrounding the aircraft into the following four zones, in order to evaluate and categorize possible collision threats:



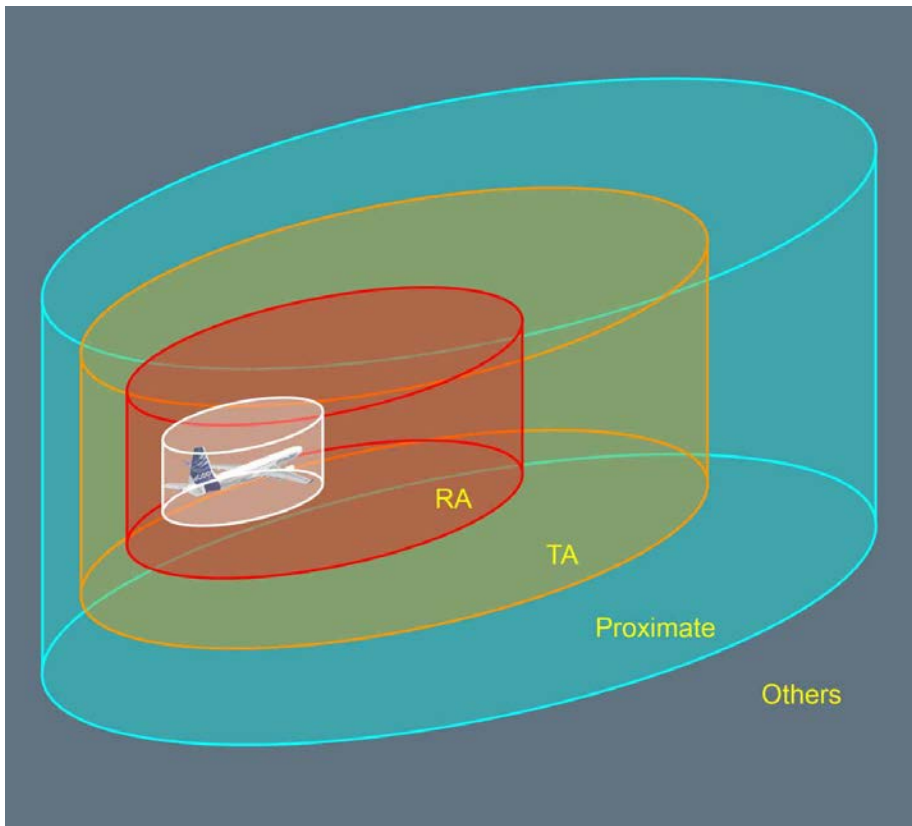

- Resolution Advisory (RA)
- Traffic Advisory (TA)
- Proximate intruders
- Other intruders.

TCAS Envelopes





Depending on the level of the collision threat, the TCAS triggers audio and visual indicators::

| | |
|---|--|
|  <p>A318/A319/A320/A321 FLIGHT CREW OPERATING MANUAL</p> | AIRCRAFT SYSTEMS SURVEILLANCE TCAS - DESCRIPTION |
|---|--|

| LEVEL | INTRUDER POSITION | DISPLAYED INFORMATION AND MESSAGE | |
|---------------------------------|--|---|--|
| Other intruders | <ul style="list-style-type: none"> - No collision threat - Any non proximate, TA , RA within the surveillance envelope (lateral range: Closer than 30 NM) | <ul style="list-style-type: none"> - ND: Intruder position |  |
| Proximate | <ul style="list-style-type: none"> - No collision threat - Intruder in the vicinity of the A/C (closer than 6 NM laterally and ±1200 ft vertically) | <ul style="list-style-type: none"> - ND: Intruder position |  |
| Traffic Advisory (TA) | <ul style="list-style-type: none"> - Potential collision threat - TAU is about 40 s | <ul style="list-style-type: none"> - ND: Intruder position - Aural messages |  |
| Resolution Advisory (RA) | <ul style="list-style-type: none"> - Real collision threat - TAU is about 25 s | <ul style="list-style-type: none"> - ND: Intruder position - Aural messages - PFD: Vertical orders • Maintain actual V/S (Preventive Advisory) or • Modify V/S (Corrective Advisory) |  |

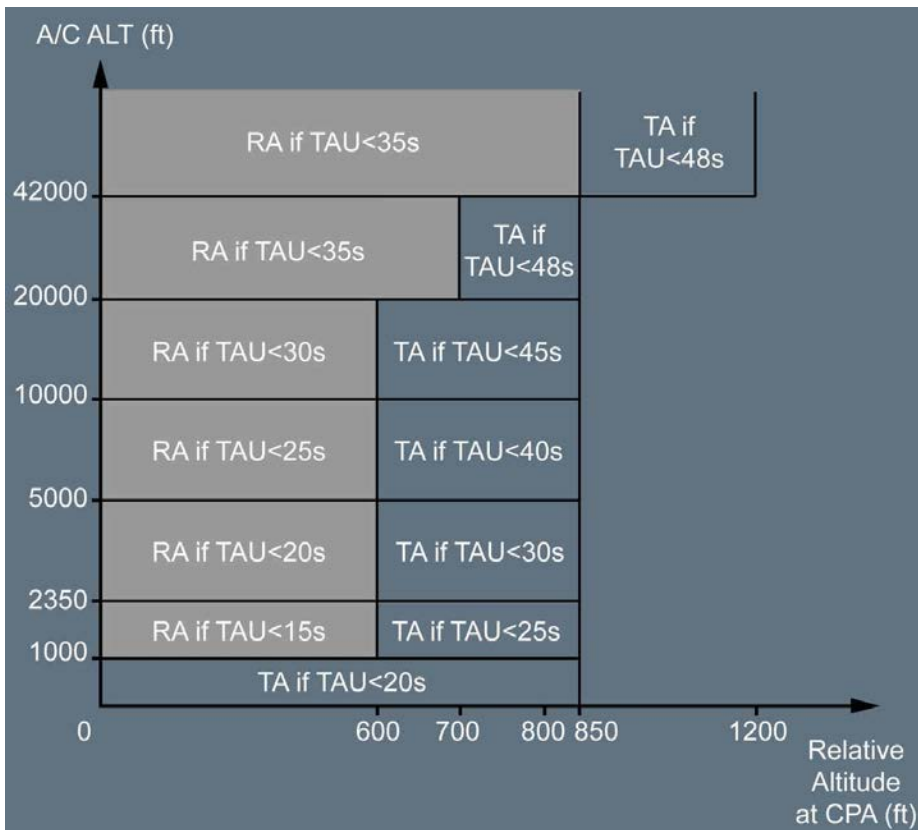
TA /RA thresholds



| | |
|---|--|
|  A318/A319/A320/A321 FLIGHT CREW OPERATING MANUAL | AIRCRAFT SYSTEMS SURVEILLANCE TCAS - DESCRIPTION |
|---|--|

| |
|-------------------|
| TCAS MODES |
|-------------------|

Applicable to: ALL

Ident.: DSC-34-SURV-60-10-10-00020411.0001001 / 21 MAR 17

TCAS MODES

The TCAS has three different modes of operations that can be selected on the ATC / TCAS control panel:

- The Traffic Advisory/Resolution Advisory (TA/RA) mode
- The Traffic Advisory Only (TA ONLY) mode
- The standby (STBY) mode.

Ident.: DSC-34-SURV-60-10-10-00020412.0001001 / 21 MAR 17

TRAFFIC ADVISORY/RESOLUTION ADVISORY (TA/RA) MODE

The TA/RA mode is the normal TCAS operating mode that enables:

- The ND to display all intruders
- The PFD to display the vertical speed orders that indicate the vertical direction that the aircraft should take, in order to avoid a collision.

Ident.: DSC-34-SURV-60-10-10-00020413.0001001 / 21 MAR 17

TRAFFIC ADVISORY ONLY (TA ONLY) MODE

The TA ONLY mode can be selected:

- Manually in case of aircraft degraded performance (engine failure, landing gear extended), or in specific airports, and for specific procedures (identified by operators) that may provide RA that are neither wanted nor appropriate (e.g. closely-spaced parallel or converging runways)
- Automatically, if TA/RA mode is previously selected and:
 - The windshear alert is triggered
 - The stall warning is triggered
 - GPWS alerts are triggered
 - Aircraft is below 1 000 ft AGL.

When the TCAS is operating in TA ONLY mode:

- All RA s are inhibited and converted into TAs
- TA threshold is set to TAU ≤ 20 s, irrespective of the aircraft altitude
- No vertical speed advisories are indicated on the PFDs
- "TA ONLY" is displayed on the NDs

Ident.: DSC-34-SURV-60-10-10-00020414.0001001 / 21 MAR 17

STANDBY MODE

In the standby mode, the advisory generation and surveillance functions are not active. The TCAS does not trigger any alert. No TCAS information can be displayed on the PFD s and NDs.

ADVISORY INHIBITION

Ident.: DSC-34-SURV-60-10-00020416.0007001 / 17 MAR 17

Applicable to: ALL

Some advisories are inhibited depending on the aircraft altitude:

- All intruders flying below 380 ft AGL when the own aircraft altitude is below 1 700 ft AGL
- All RA below 1 100 ft in climb and 900 ft in descent. In this case, the RA s are converted into TAs
- “Descend” RA below 1 100 ft AGL
- “Increase Descent” RA below 1 550 ft AGL
- All TA aural messages below 600 ft AGL in climb and below 400 ft AGL in descent
- The AP/FD TCAS  flight guidance mode is inhibited below 900 ft.

ATC/TCAS PANEL

Ident.: DSC-34-SURV-60-20-00001429.0064001 / 01 OCT 12

Applicable to: ALL

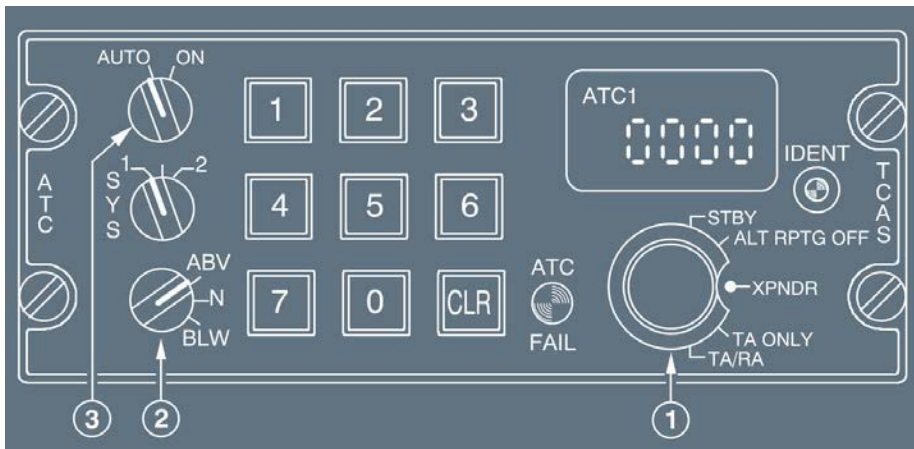

(1) Mode selector

TA/RA : Normal position.

TA s, RAs, proximate and other intruders are displayed.

TA ONLY : This mode should be used, in case of degraded aircraft performance (engine failure, landing gear extended, or approach on parallel runways). All RA s are converted into TA s. TAs, proximate and other intruders are displayed.

STBY : The TCAS and ATC are on standby.

XPNDR : - The TCAS is on standby
- On ground : The selected ATC Transponder only operates in the selective aircraft interrogation mode of Mode S
- In flight : The selected ATC Transponder operates.

(2) TRAFFIC selector

ABV : The altitude range is set to +7 000 ft above the aircraft, and -2 700 ft below the aircraft.

N : The altitude range is set to -2 700 ft below the aircraft, and +2 700 ft above the aircraft.

BLW : The altitude range is set to -7 000 ft below the aircraft, and +2 700 ft above the aircraft.

(3) AUTO/ON selector or THRT/ALL selector

ON (or ALL) : All intruders are displayed.

AUTO (or THRT) : Proximate and other intruders are only displayed, if a TA or RA is already presented.

Note: Some TCAS control panels are equipped with a THRT/ALL selector, instead of the AUTO/ON selector. The associated functions remain unchanged.

ND INDICATIONS

Ident.: DSC-34-SURV-60-20-00020418.0002001 / 17 MAR 17

Applicable to: ALL

The traffic is displayed in all ROSE modes and ARC mode when 10, 20 or 40 NM range is selected. Only the 8 most threatening intruders are displayed.



(1) Proximate intruder

Indicated by a white filled diamond.

(2) TA intruder

Indicated by an amber circle.

Associated with the TRAFFIC-TRAFFIC aural message.

(3) RA intruder

Indicated by a red square.

Associated with vertical orders displayed on the PFD and aural messages.

(4) Other intruders 

Indicated by a white empty diamond.

Note: If the range of an intruder is not available, the intruder is not displayed. An intruder may be partially displayed when its range is out of scale.

(5) Relative altitude

Indicated in hundred of feet above or below the symbol depending on the intruder position.

(6) Vertical speed arrow

Displayed only if the intruder V/S > 500 ft/min.

Relative altitude and vertical speed arrow are displayed in the same color as the associated intruder symbol.

Note: If the altitude of an intruder is not available, neither altitude nor vertical speed indications are displayed.

(7) No bearing intruder

If the bearing of TA or RA intruder is not available the following data is presented in digital form at the bottom of the ND:

- range
- relative altitude and vertical speed arrow if available.

Displayed amber or red according to threat level.

(8) Range ring

A 2.5 NM white range ring is displayed when a 10 NM or 20 NM range is selected.

TCAS MESSAGES

Ident.: DSC-34-SURV-60-20-00020419.0001001 / 17 MAR 17

Applicable to: **ALL**



(1) Mode and range messages

Following messages can be displayed to draw pilot's attention:

TCAS : REDUCE RANGE : Displayed when a TA or RA is detected and ND range above 40 NM.

TCAS : CHANGE MODE : Displayed when a TA or RA is detected and ND mode is PLAN.

Displayed amber or red depending on the advisory level (TA or RA).

(2) TCAS operation messages

TCAS : Displayed in case of TCAS internal failure.

TA ONLY : Displayed white when the TA mode is selected automatically, or manually by the flight crew.

PFD INDICATIONS

Ident.: DSC-34-SURV-60-20-00020420.0005001 / 17 MAR 17

Applicable to: **ALL**

In case of RA detection, the vertical speed scale becomes rectangular and the PFD presents vertical orders on the vertical speed scale. The vertical speed scale background is normally grey, but may be partially replaced by green and/or red areas.

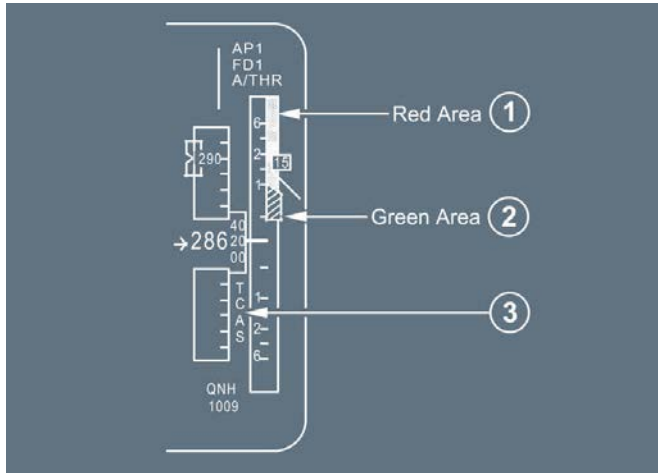

(1) Red area

Indicates the vertical speed range, when there is a high risk of conflict.

(2) Green area

Indicates the recommended vertical speed range. It is wider than the red area.

Note: - The aircraft can also fly in the grey vertical speed range, without the risk of conflict (preventive RA).

- The color of the digits corresponds to the appropriate area.

- In case of RA detection, the vertical speed needle that is normally green, becomes white.

(3) TCAS message

Appears in amber provided that the TCAS is not in standby, when the TCAS cannot deliver RA data, or in case of an internal TCAS failure.

AURAL MESSAGES

Ident.: DSC-34-SURV-60-20-00001433.0018001 / 08 FEB 13

Applicable to: ALL

TA /RA detection is associated with the following messages:

"TRAFFIC TRAFFIC"

: Only in case of TA detection.

"CLIMB CLIMB"

: Climb at the vertical speed indicated by the green area on the PFD.

AIRCRAFT SYSTEMS

SURVEILLANCE

TCAS - CONTROLS AND INDICATORS

- "CLIMB, CROSSING CLIMB" (twice) : Same as above. Indicates that you will cross through the intruder altitude.
- "INCREASE CLIMB" (twice) : Triggered after the CLIMB message, if vertical speed is insufficient to achieve safe vertical separation.
- "DESCEND DESCEND" : Descend at the vertical speed indicated by the green area on the PFD.
- "DESCEND, CROSSING DESCEND" (twice) : Same as above. Indicates that you will cross through the intruder altitude.
- "INCREASE DESCEND" (twice) : Triggered after the DESCEND message, if the vertical speed is insufficient to achieve safe vertical separation.
- "LEVEL OFF, LEVEL OFF" : Set the Vertical Speed to 0.
- "CLIMB CLIMB NOW" (twice) : Triggered after the DESCEND message, if the intruder trajectory has changed.
- "DESCEND DESCEND NOW" (twice) : Triggered after the CLIMB message, if the intruder trajectory has changed.
- "MONITOR VERTICAL SPEED" : Ensure that the vertical speed remains outside the red area.
Triggered only once, in case of preventive RA.
- "MAINTAIN VERTICAL SPEED, MAINTAIN" : Maintain the vertical speed indicated on the green area of the PFD.
- "MAINTAIN VERTICAL SPEED, CROSSING MAINTAIN" : Maintain the vertical speed indicated on the green area of the PFD.
Indicates that you will cross through the intruder altitude.
- "CLEAR OF CONFLICT" : The range increases and separation is adequate.
Return to assigned clearance.

MEMO DISPLAY

Ident.: DSC-34-SURV-60-20-00020422.0002001 / 17 MAR 17

Applicable to: **ALL**

- TCAS STBY** : This memo appears in green when:
- ATC STBY is selected by the crew, or
 - TCAS STBY is selected by the crew during flight phases other than 6, or
 - ALT RPTG sw is OFF, or
 - both ATC s or both RAs are failed.

TCAS STBY : This memo appears in amber when the flight crew sets the TCAS on STBY in flight phase 6.



A318/A319/A320/A321
FLIGHT CREW
OPERATING MANUAL

AIRCRAFT SYSTEMS

SURVEILLANCE

TCAS - CONTROLS AND INDICATORS

Intentionally left blank

AIRCRAFT SYSTEMS

OXYGEN

Intentionally left blank

DSC-35-10 General

Description..... A

DSC-35-20 Fixed Oxygen System for Cockpit

DSC-35-20-10 Description

General..... A
 Operation..... B
 Schematic..... C
 Mask Setting..... D
 Mask Stowage..... E

DSC-35-20-20 Controls and Indicators

Overhead Panel..... A
 Stowage Box..... B
 Crew Oxygen Mask..... C
 Pressure Regulator..... D
 ECAM DOOR/OXY Page..... E

DSC-35-30 Fixed Oxygen System for Cabin

DSC-35-30-10 Description

General..... A
 Operation..... B
 Schematic..... C

DSC-35-30-20 Controls and Indicators

Overhead Panel..... A
 Overhead Maintenance Panel..... B
 Memo Display..... C

DSC-35-40 Portable Oxygen System

DSC-35-40-10 Description

Flight Crews Portable Oxygen System..... A
 Using the Hood..... B



A318/A319/A320/A321
FLIGHT CREW
OPERATING MANUAL

AIRCRAFT SYSTEMS

OXYGEN

PRELIMINARY PAGES - TABLE OF CONTENTS

Intentionally left blank

| | |
|---|--|
|  <p>A318/A319/A320/A321 FLIGHT CREW OPERATING MANUAL</p> | <p>AIRCRAFT SYSTEMS</p> <p>OXYGEN</p> <p>GENERAL</p> |
|---|--|

| |
|--------------------|
| DESCRIPTION |
|--------------------|

Ident.: DSC-35-10-00001448.0001001 / 20 DEC 10

Applicable to: ALL

The oxygen system consists of:

- A cockpit-fixed oxygen system, which supplies adequate breathing oxygen to the cockpit occupants in case of depressurization, or emission of smoke and noxious gases.
- A cabin-fixed oxygen system, which supplies oxygen for cabin occupants (passengers and cabin crew) in case of depressurization.
- A portable oxygen system, which is provided in both the cockpit and cabin and is to be used:
 - As PROTECTION for the crew during on board emergencies.
 - For FIRST AID purposes.



A318/A319/A320/A321
FLIGHT CREW
OPERATING MANUAL

AIRCRAFT SYSTEMS

OXYGEN

GENERAL

Intentionally left blank

GENERAL

Ident.: DSC-35-20-10-00017801.0001001 / 21 MAR 16

Applicable to: ALL

The cockpit's fixed oxygen system consists of :

- A high-pressure cylinder, located in the left-hand lower fuselage.
- A pressure regulator, connected directly to the cylinder that delivers oxygen, at a pressure suitable for users.
- Two overpressure safety systems to vent oxygen overboard, through a safety port, if the pressure becomes too high.
- A supply solenoid valve that allows the crew to shut off the distribution system.
- Three (or four ) full-face quick-donning masks, stowed in readily-accessible boxes adjacent to the crewmembers' seats (one at each seat).

OPERATION

Ident.: DSC-35-20-10-00001450.0001001 / 21 MAR 16

Applicable to: ALL

The crewmember squeezes the red grips to pull the mask out of its box, and this action causes the mask harness to inflate.

A mask-mounted regulator supplies a mixture of air and oxygen or pure oxygen, or performs emergency pressure control. With the regulator set to NORMAL, the user breathes a mixture of cabin air and oxygen up to the cabin altitude at which the regulator supplies 100 % oxygen. The user can select 100 %, in which case the regulator supplies pure oxygen at all cabin altitudes.

If the situation calls for it, the user can use the emergency overpressure rotating knob and receive pure oxygen at positive pressure.

The storage box contains a microphone lead, with a quick-disconnect, for connection to the appropriate mask microphone cable.

Note: *Each mask may have a removable film that protects the visor against scratches. This strip is optional and may be removed from the mask at any time.*

SCHEMATIC

Ident.: DSC-35-20-10-00017802.0001001 / 21 MAR 16

Applicable to: ALL

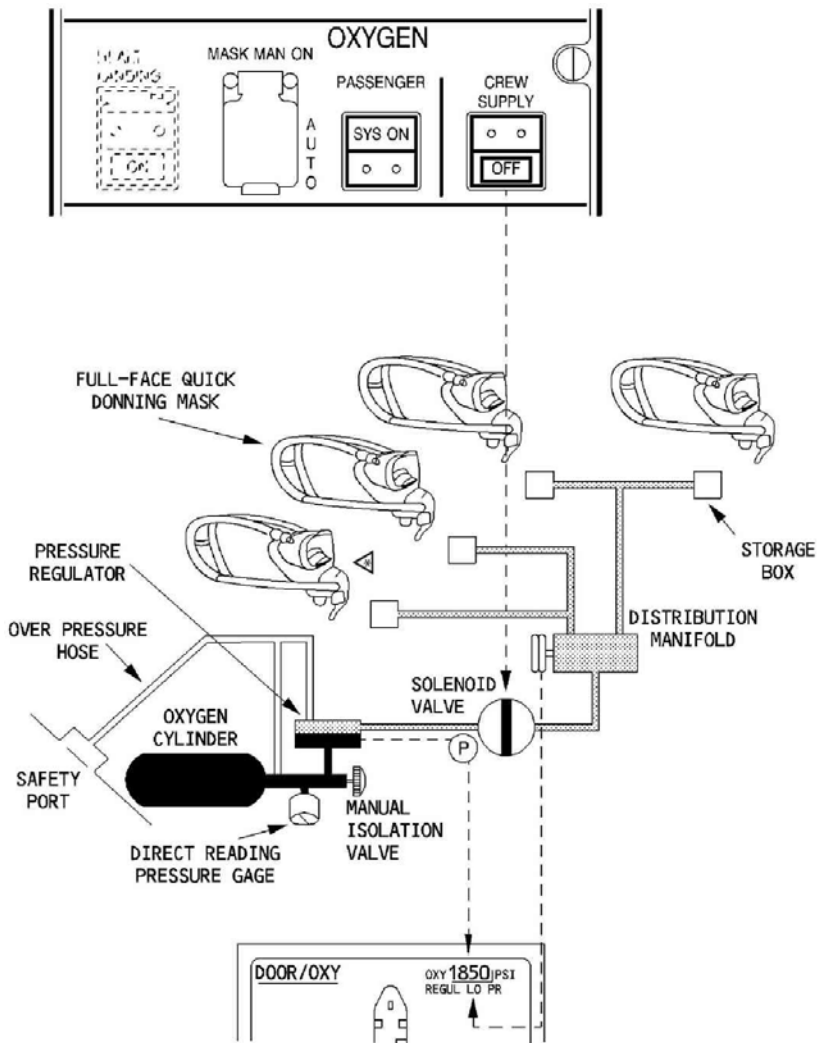

MASK SETTING

Ident.: DSC-35-20-10-00016919.0001001 / 21 MAR 16

Applicable to: ALL

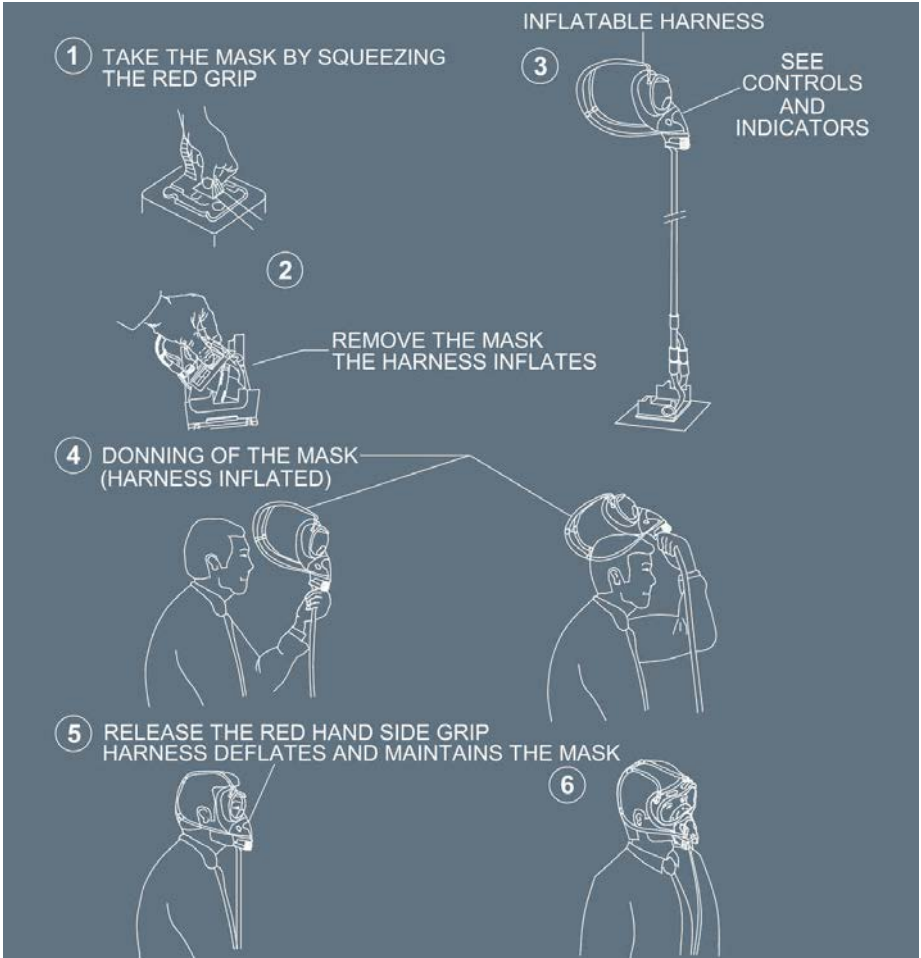

Note: The captain (first officer) must exercise caution and turn the head to the right (left) in the direction of the first officer (captain) in order to ensure fast donning of the mask when the HUD  on the captain (first officer) side is deployed.

MASK STOWAGE

Ident.: DSC-35-20-10-00001453.0001001 / 21 MAR 16

Applicable to: ALL

- ① - COIL THE HOSE AND PLACE IT IN THE BOTTOM OF THE STOWAGE BOX.



- ③ - PLACE THE MASK IN THE STOWAGE BOX.
- MAKE SURE THE MASK REGULATOR IS FULLY SEATED AGAINST THE STOP IN THE STOWAGE BOX.



- ② - POSITION THE REMAINING HOSE IN THE MIDDLE OF THE MASK.
- FOLD THE TWO HARNESS PORTIONS TOGETHER.



- ④ - CLOSE THE DOORS, THEN FULLY PRESS THE "RESET TEST" BUTTON.
- ONCE THE "RESET TEST" BUTTON IS RELEASED, CHECK THAT THE "OXY ON" FLAG COMPLETELY DISAPPEARS.
- PRESS THE EMERGENCY PRESSURE SELECTOR, AND CHECK THAT THE BLINKER REMAINS BLACK.
- THEN, RETURN THE N/100% SELECTOR AT THE 100% POSITION.

CAUTION: Maintaining the pressure selector in the "EMERGENCY" position can deplete the crew oxygen cylinder.



OVERHEAD PANEL

Ident.: DSC-35-20-20-00017803.0001001 / 21 MAR 16

Applicable to: ALL

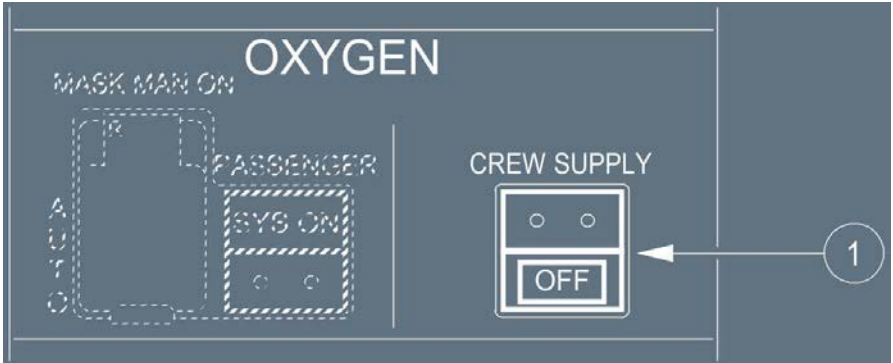

(1) CREW SUPPLY pb

This pushbutton controls the solenoid valve.

On : The valve is open, and supplies low pressure oxygen to the masks (normal position in flight).

OFF: The valve is closed, and the white light comes on.

STOWAGE BOX

Ident.: DSC-35-20-20-00001455.0001001 / 22 MAY 12

Applicable to: **ALL**

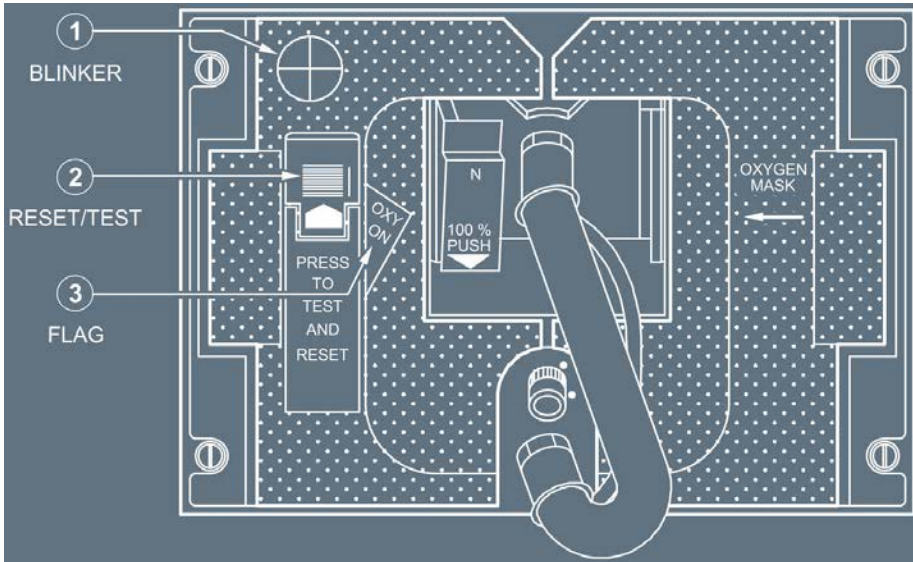

- (1) Blinker flowmeter (yellow)
 This indicator flashes when oxygen is flowing.
- (2) RESET/TEST control slide
 The crewmember presses the slide, and pushes it in the direction of the arrow to test: the operation of the blinker; the regulator supply; system sealing downstream of the valve; and the regulator sealing and system operation. Pressing the RESET control slide, after the oxygen mask has been used, cuts off the oxygen, and the mask microphone.
- (3) OXY ON flag
 As soon as the left flap door opens, the mask is supplied with oxygen and, once it closes (mask still supplied with oxygen), the "OXY ON" flag appears.

CREW OXYGEN MASK

Ident.: DSC-35-20-20-00001456.0001001 / 21 MAR 16

Applicable to: ALL

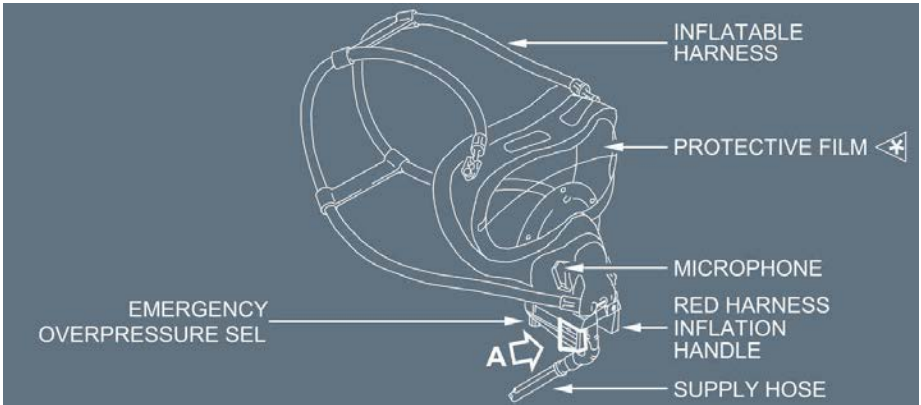

PRESSURE REGULATOR

Ident.: DSC-35-20-20-00001457.0001001 / 24 NOV 15

Applicable to: ALL

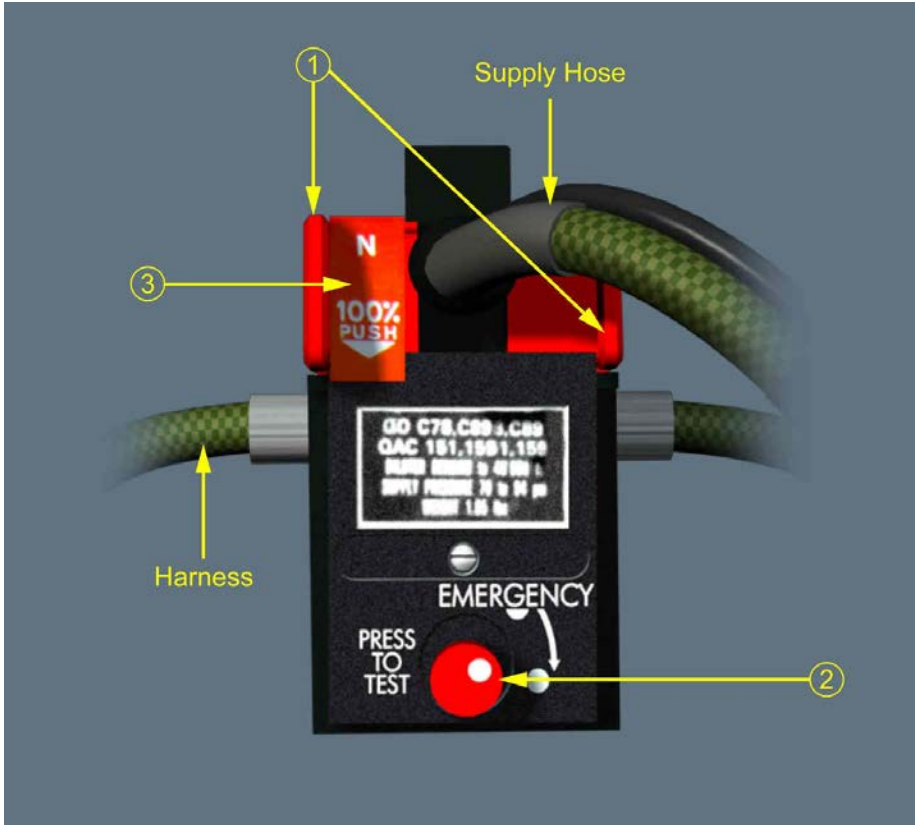

- (1) Red grips
Squeezing the right-hand side grip unlocks the two-flap door, and permits the harness to inflate.

(2) EMERGENCY pressure selector

Use of this selector creates an overpressure which eliminates condensation or fogging of the mask, and prevents smoke, smell or ashes from entering the mask.

- Pressing this knob generates an overpressure for a few seconds.
- Turning the knob, in the direction of the arrow, generates a permanent overpressure.

- Note:
1. *Overpressure supply is automatically started, when cabin altitude exceeds 30 000 ft.*
 2. *Overpressure supply is available only when the N/100% selector is set on the 100 % position.*

(3) N/100 % selector

This two-position button is locked down (100% position) when the crewmember pulls the mask out of the stowage. Pushing the button up from underneath releases it, and it pops up to the N (normal) position. Pressing it again returns it to 100 %.

100 % : The mask delivers 100 % oxygen.

N : The mask provides the flight crew with a mixture of air and oxygen. This mixture changes with cabin altitude. The higher the cabin altitude, the more oxygen the mask provides, until the mask supplies 100 % oxygen.

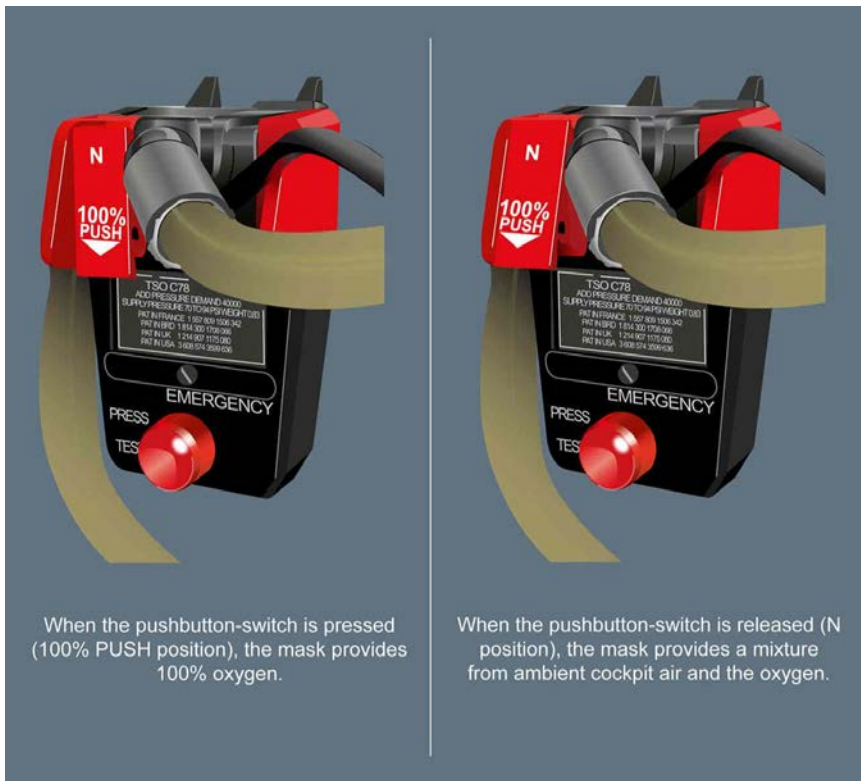

ECAM DOOR/OXY PAGE

Ident.: DSC-35-20-20-00001458.0004001 / 21 MAR 17

Applicable to: ALL

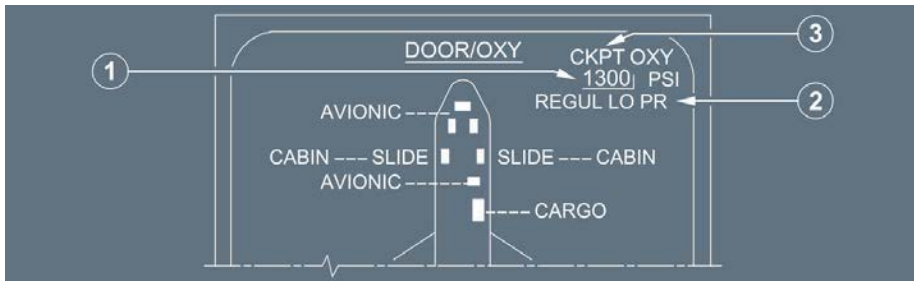

(1) OXY pressure indication

It is in green, when the pressure is ≥ 800 PSI.

It pulses in green, when the pressure is < 800 PSI (the DOOR/OXY SD page is automatically displayed).

It is in amber, when the pressure is < 400 PSI.

On ground, an amber half frame appears when oxygen pressure is $< 1\ 500$ PSI.

In this case, the flight crew must check that the remaining quantity is not below the minimum (*Refer to LIM-OXY Minimum Flight Crew Oxygen Pressure*).

(2) REGUL LO PR indication

It is in amber, if oxygen pressure on the low-pressure circuit is low (50 PSI).

(3) CKPT OXY indication

It is normally in white.

It becomes amber, when:

- Pressure goes below 400 PSI
- Low oxygen pressure is detected
- The overhead panel's OXYGEN CREW SUPPLY pb is OFF.



A318/A319/A320/A321
FLIGHT CREW
OPERATING MANUAL

AIRCRAFT SYSTEMS

OXYGEN



FIXED OXYGEN SYSTEM FOR COCKPIT - CONTROLS AND INDICATORS

Intentionally left blank

| | |
|---|---|
|  <p>A318/A319/A320/A321 FLIGHT CREW OPERATING MANUAL</p> | <p style="text-align: center;">AIRCRAFT SYSTEMS OXYGEN</p> <p style="text-align: center;">FIXED OXYGEN SYSTEM FOR CABIN - DESCRIPTION</p> |
|---|---|





GENERAL

Ident.: DSC-35-30-10-00017804.0001001 / 13 MAY 16
Applicable to: ALL

In the case of depressurization, the fixed oxygen system in the cabin supplies oxygen to the cabin occupants.
 Chemical generators produce the oxygen. Each generator feeds a group of 2, 3, or 4 masks.
 Oxygen masks are located in containers above the passenger seats, in the lavatories, in each galley , and at each cabin crew station.
Note: Gaseous generators  replace chemical generators in the lavatories.

OPERATION

Ident.: DSC-35-30-10-00016920.0001001 / 21 MAR 16
Applicable to: ALL

Each container has an electrical latching mechanism that opens automatically to allow the masks to drop, if the cabin pressure altitude exceeds 14 000 ft (+250, -750 ft), or 16 000 ft (+250, -750 ft) for the operation on high altitude airfields .
 Members of the flight crew can override the automatic control.
 When the masks are released, the passenger address system automatically broadcasts prerecorded instructions .
 The generation of oxygen begins when the passenger pulls the mask towards the passenger seat. The chemical reaction used for oxygen generation creates heat. Therefore, the smell of burning, smokes and cabin temperature increase may be associated with the normal operation of the oxygen generators. The mask receives pure oxygen under positive pressure for about 13 min , 15 min , or up to 22 min , until the generator is exhausted.
 A reset is available for the rearming of the system after the masks are restowed. A manual release tool allows crew members to open the doors manually in case of electrical failure.

SCHEMATIC

Ident.: DSC-35-30-10-00001461.0001001 / 16 MAY 12

Applicable to: **ALL**

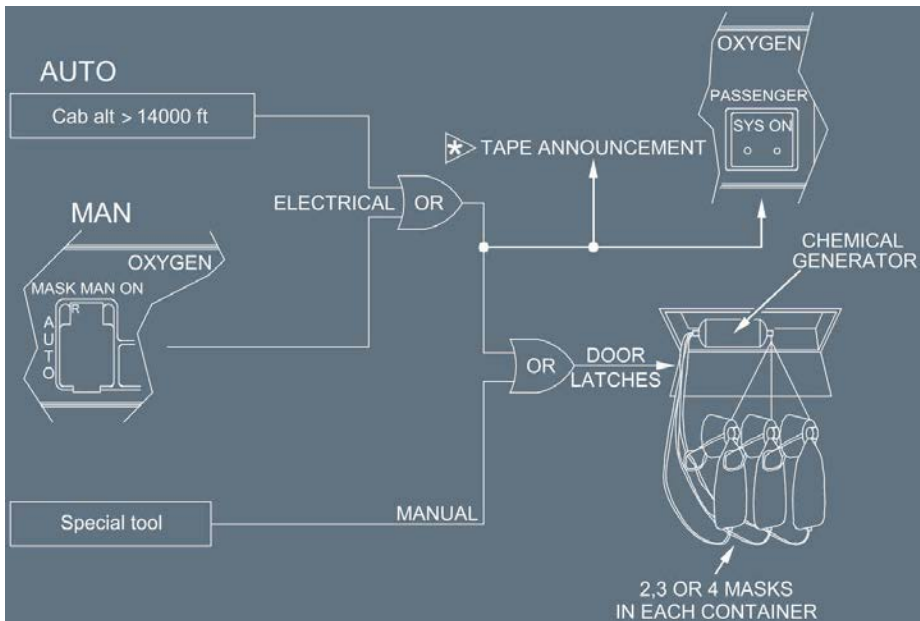



OVERHEAD PANEL

Ident.: DSC-35-30-20-00017805.0001001 / 21 MAR 16

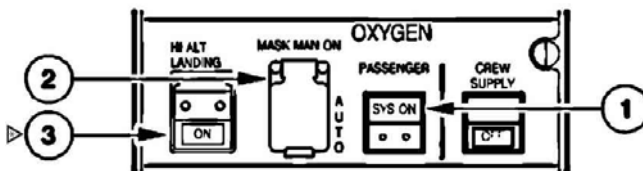
Applicable to: ALL



- (1) PASSENGER SYS ON light
 This light comes on in white, when the control for the oxygen mask doors is activated, and it remains on until the TMR RESET pb is pressed (*Refer to DSC-35-30-20 Overhead Maintenance Panel*).
- (2) MASK MAN ON pb
 The guard keeps this button in the AUTO position.
 AUTO : The mask doors open automatically, when the cabin altitude exceeds 14 000 ft, or 16 000 ft if the HI ALT LANDING pb-sw  is set to ON.
 Pressed : The mask doors open.
- (3) HI ALT LANDING pb-sw 
 This pushbutton-switch changes the altitude threshold for the deployment of the passenger oxygen masks.
 OFF: The masks drop, if the cabin pressure exceeds 14 000 ft (+250, -750 ft).
 ON : The masks drop, if the cabin pressure exceeds 16 000 ft (+250, -750 ft).

OVERHEAD MAINTENANCE PANEL

Ident.: DSC-35-30-20-00001463.0001001 / 11 FEB 11

Applicable to: ALL

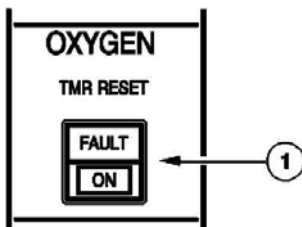

(1) TMR RESET pushbutton

The maintenance crew uses this pushbutton to reset the control circuit, after the system has operated.

ON : The PASSENGER SYS ON light goes off.

FAULT : This light comes on in white, when the door latch solenoids are energized for more than 30 s.

MEMO DISPLAY

Applicable to: ALL

Ident.: DSC-35-30-20-A-00016865.0001001 / 21 MAR 16

HI ALT SET : This memo appears in green if the crew sets the HI ALT LANDING pb-sw to ON. In this case, the passenger mask release altitude is 16 000 ft (+250 ft, -750 ft).

FLIGHT CREWS PORTABLE OXYGEN SYSTEM

Ident.: DSC-35-40-10-00001465.0004001 / 17 MAR 11

Applicable to: ALL

The flight crew smoke hood located on the right back side of the cockpit, ensures the eyes and respiratory system protection of one flight crew member when fighting a fire and in case of smoke or noxious gas emissions or cabin depressurization.

The smoke hood is equipped with one solid state oxygen supply source and one CO₂ absorption system, contained in a life support pack which furnish an effective time of use of 15 min.

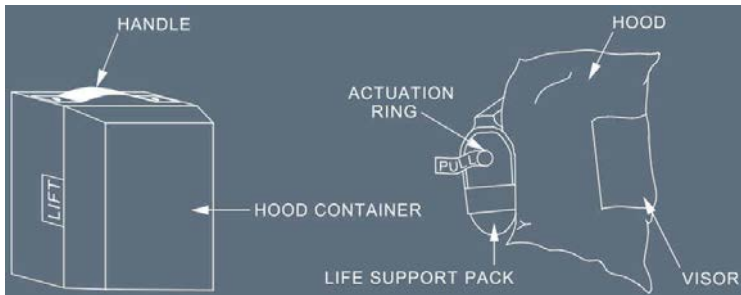

USING THE HOOD

Ident.: DSC-35-40-10-00006226.0004001 / 22 MAY 12

Applicable to: **ALL**

- 1** REMOVE UNIT FROM CASE AND TEAR OFF RED PULL STRIP AND REMOVE UNIT FROM BAG.



- 2** PULL OUT ACTUATION RING.

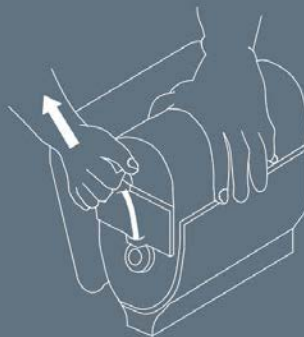

- 3** BEND DOWN AND GRASP HOOD OPENING WITH THUMBS AND PULL HOOD OVER HEAD. **4** PULL HOOD DOWN ON FOREHEAD TO ASSURE A SECURE FIT. CHECK NECK SEAL.



AIRCRAFT SYSTEMS

PNEUMATIC

Intentionally left blank

DSC-36-10 Description

DSC-36-10-10 General

| | |
|--------------|---|
| General..... | A |
|--------------|---|

DSC-36-10-20 Engine Bleed System

| | |
|--|---|
| General..... | A |
| Architecture..... | B |
| Air Bleed Selection..... | C |
| Pressure Regulation and Limitation..... | D |
| Temperature Regulation and Limitation..... | E |

DSC-36-10-30 APU Bleed Air Supply

| | |
|--------------|---|
| General..... | A |
|--------------|---|

DSC-36-10-40 Crossbleed

| | |
|----------------------|---|
| General..... | A |
| ECAM Indication..... | B |

DSC-36-10-50 Leak Detection

| | |
|---------------------|---|
| Leak Detection..... | A |
|---------------------|---|

DSC-36-10-60 Operation Following Failures

| | |
|------------------|---|
| BMC Failure..... | A |
|------------------|---|

DSC-36-20 Controls and Indicators

| | |
|----------------------|---|
| Overhead Panel..... | A |
| ECAM Bleed Page..... | B |
| Memo Display..... | C |



A318/A319/A320/A321
FLIGHT CREW
OPERATING MANUAL

AIRCRAFT SYSTEMS

PNEUMATIC

PRELIMINARY PAGES - TABLE OF CONTENTS

Intentionally left blank



| | |
|---|--|
|  <p>A318/A319/A320/A321 FLIGHT CREW OPERATING MANUAL</p> | <p style="text-align: center;">AIRCRAFT SYSTEMS PNEUMATIC</p> <p style="text-align: center;">DESCRIPTION - GENERAL</p> |
|---|--|

GENERAL

Ident.: DSC-36-10-10-00020804.0001001 / 17 MAR 17

Applicable to: ALL

The pneumatic system supplies high-pressure air for :

- Air conditioning
- Engine starting
- Wing anti-icing
- Water pressurization
- Hydraulic reservoir pressurization
- FWD cargo heating 
- AFT cargo heating 
- Fuel Tank Inerting System (FTIS) 

High-pressure air has three sources :

- Engine bleed systems
- APU load compressor
- HP ground connection

Note: An external HP source may be used for air conditioning.

A crossbleed duct interconnects the engine bleed systems and receives air from the APU and ground sources when appropriate.

A valve mounted on the crossbleed duct allows the left side (engine 1) and right side (engine 2) to be interconnected.

Two Bleed Monitoring Computers (BMC 1 and BMC 2), the overhead control panel, and the ECAM control and monitor the operation of the pneumatic system.

A leak detection system detects any overheating in the vicinity of hot air ducts.



A318/A319/A320/A321
FLIGHT CREW
OPERATING MANUAL

AIRCRAFT SYSTEMS

PNEUMATIC

DESCRIPTION - GENERAL

Intentionally left blank

GENERAL

Ident.: DSC-36-10-20-00001469.0001001 / 21 MAR 16

Applicable to: ALL

The aircraft has two similar engine bleed air systems.

Each system is designed to :

- select the compressor stage to use as a source of air
- regulate the bleed air temperature
- regulate the bleed air pressure.

A Bleed Monitoring Computer (BMC) controls and monitors each system.

Each BMC receives information about bleed pressure and temperature and valve position.

Each is connected with :

- other systems using air or information from the bleed system
- the other BMC.

Each supplies indications and warnings to the ECAM and CFDS.

If one BMC fails, the other one takes over most of the monitoring functions.

Each bleed valve is pneumatically operated and controlled electrically by its associated BMC.

ARCHITECTURE

Ident.: DSC-36-10-20-00001470.0005001 / 15 MAR 17

Applicable to: ALL

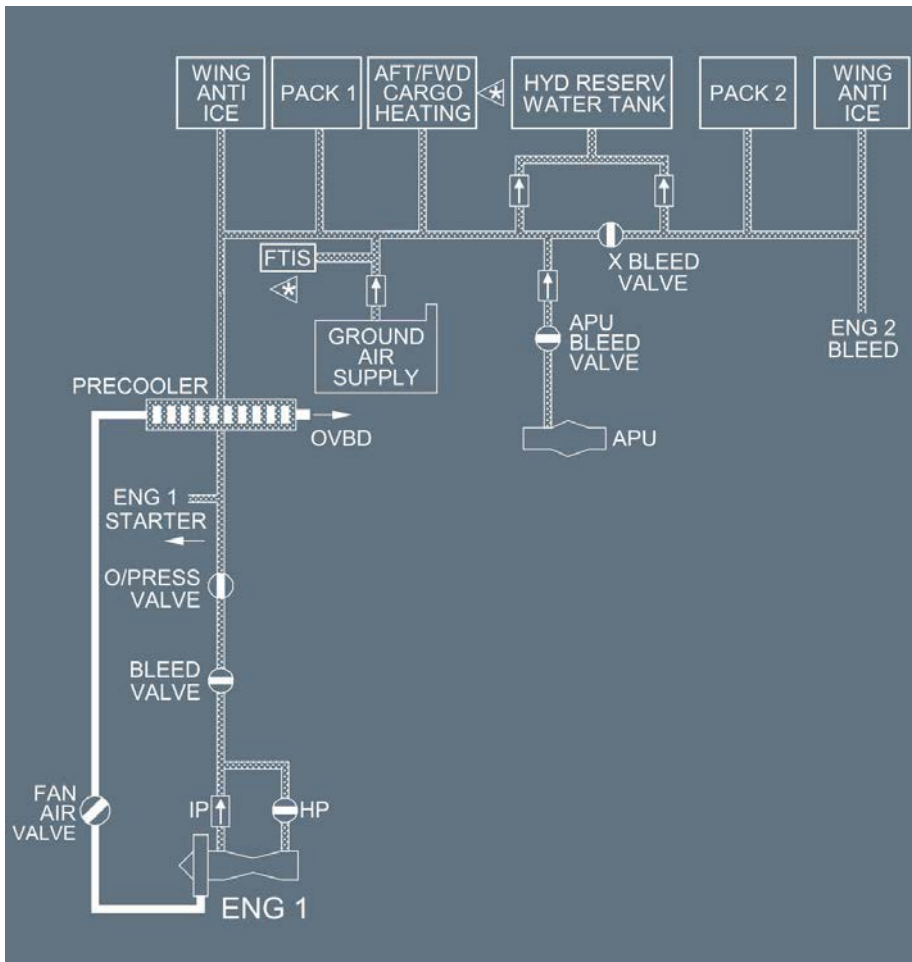

AIR BLEED SELECTION

Ident.: DSC-36-10-20-00001471.0003001 / 09 OCT 12

Applicable to: ALL

Air is normally bled from the intermediate pressure stage (IP) of engine's high-pressure (HP) compressor to minimize fuel penalty.

At low engine speed, when the pressure and temperature of the IP air are too low, the system bleeds air from the HP stage and maintains it at 36 ± 4 PSI.

An intermediate pressure check valve downstream of the IP port closes to prevent air from the HP stage from being circulated to the IP stage.

✎ The HP valve closes automatically

- • In case of low upstream pressure
- • in case of excessive upstream pressure
- electrically when the bleed valve is closed electrically.

ECAM INDICATION

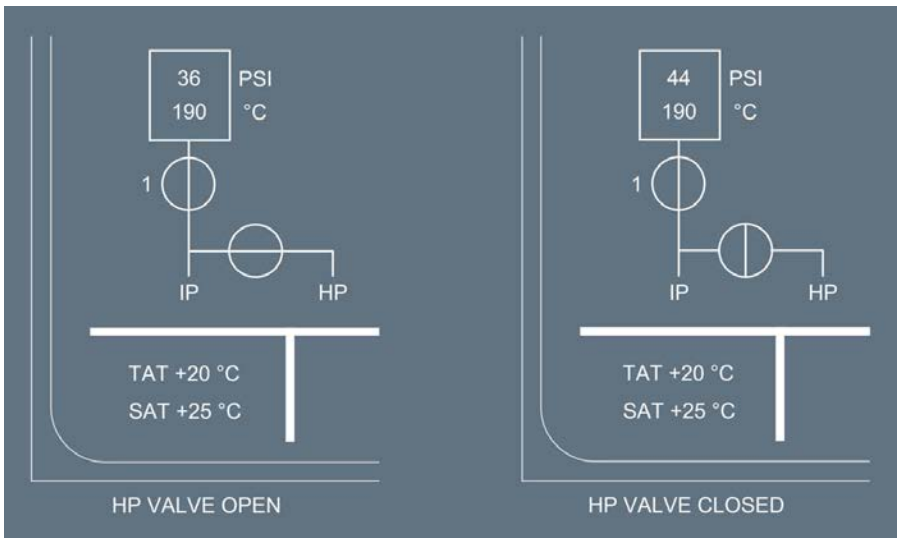

PRESSURE REGULATION AND LIMITATION

Ident.: DSC-36-10-20-00001472.0004001 / 15 MAR 17

Applicable to: **ALL**

The bleed valve, which is downstream of the junction of HP and IP ducting, acts as a shut-off and pressure regulating valve.

It maintains delivery pressure at 45 ± 5 PSI.

Note: Bleed pressure may fluctuate between 38 and 56 PSI (with a maximum peak to peak pressure of 16 PSI) particularly at high engine power (takeoff or climb) up to FL 100.

The bleed valve is fully closed:

- Pneumatically:

- If upstream pressure goes below 8 PSI
- If there is return flow

- Electrically by means of:

- The BLEED pushbutton switch (switched OFF)
- The ENG FIRE pushbutton (pushed)
- The Bleed air Monitoring Computer (BMC) in the following cases:
 - Overtemperature
 - Overpressure
 - Leak
 - Open starter valve
 - Engine shutdown
 - APU bleed being ON.

If pressure regulation fails, the overpressure valve closes when the pressure goes over 85 PSI.

Note: If APU Bleed is ON and the crossbleed valve is SHUT, the Engine bleed valve 2, remains open.

TEMPERATURE REGULATION AND LIMITATION

Ident.: DSC-36-10-20-00001473.0001001 / 21 MAR 16

Applicable to: **ALL**

A precooler downstream of the bleed valve regulates the temperature of the bleed air.

The precooler is an air-to-air heat exchanger that uses cooling air bleed from the engine fan to regulate the temperature to approximately 200 °C.

The fan air valve controls fan air flow.

A spring keeps the fan air valve closed in the absence of pressure.



A318/A319/A320/A321
FLIGHT CREW
OPERATING MANUAL

AIRCRAFT SYSTEMS

PNEUMATIC

DESCRIPTION - ENGINE BLEED SYSTEM

Intentionally left blank

GENERAL

Ident.: DSC-36-10-30-00001474.0001001 / 15 MAR 17

Applicable to: ALL

Air from the APU load compressor is available on ground and in flight.

The APU bleed valve operates as a shut-off valve to control APU bleed air.

The APU BLEED pb-sw, on the AIR COND panel, controls the APU bleed valve. When the flight crew selects ON with the pushbutton, APU bleed air supplies the pneumatic system, if the APU speed is above 95 %. This opens the crossbleed valve and closes the engine bleed automatically. If the APU bleed valve is opened, it automatically closes in the case of APU leak, left wing leak, or engine 1 leak (except during engine start). *Refer to DSC-36-10-50 Leak Detection.*

A check valve near the crossbleed duct protects the APU, when bleed air comes from another source.



A318/A319/A320/A321
FLIGHT CREW
OPERATING MANUAL

AIRCRAFT SYSTEMS

PNEUMATIC

DESCRIPTION - APU BLEED AIR SUPPLY

Intentionally left blank

GENERAL

Ident.: DSC-36-10-40-00001476.0001001 / 21 MAR 16

Applicable to: ALL

A crossbleed valve on the crossbleed duct allows the air supply systems of the two engines to be isolated or interconnected.

On the AIR COND panel, a rotary selector controls the crossbleed valve electrically.

Two electric motors, one for automatic mode and one for manual mode, control the valve.

In automatic mode, the crossbleed valve opens when the system uses APU bleed air. It closes, if the system detects an air leak (except during engine start).

ECAM INDICATION

Ident.: DSC-36-10-40-00001478.0002001 / 21 MAR 16

Applicable to: ALL

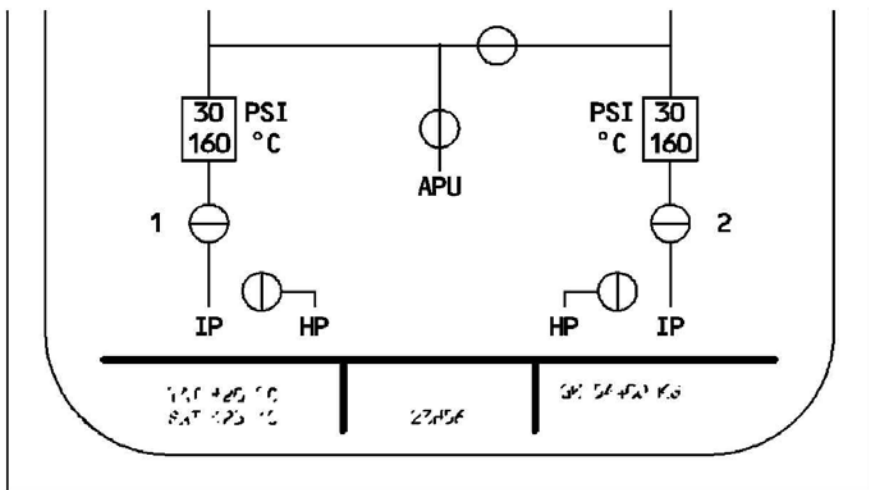

X-BLEED VALVE OPEN. AIR SUPPLIED FROM APU



A318/A319/A320/A321
FLIGHT CREW
OPERATING MANUAL

AIRCRAFT SYSTEMS

PNEUMATIC

DESCRIPTION - CROSSBLEED

Intentionally left blank

LEAK DETECTION

Ident.: DSC-36-10-50-00001479.0001001 / 15 MAR 17

Applicable to: ALL

Leak detection loops detect any overheating near the hot air ducts in the fuselage, pylons, and wings.

For the pylon and APU, the sensing elements are tied to form a single loop and for the wing, a double loop.

When the two wing loops detect a leak, or when one loop detects the leak and the other one is inoperative, they activate a wing leak signal.

BMC 1 and BMC2 each contain identical control logic for the system.

- A wing leak signal causes :
 - the bleed valve on the related side to close automatically
 - the associated FAULT light on the AIR COND panel to come on
 - the x-bleed valve to close automatically (except during an engine start)
 - the APU bleed valve to close automatically if the APU bleed valve is open and if the leak concerns the left wing (except during engine start).
- A pylon leak signal causes :
 - the bleed valve on the related side to close automatically
 - the FAULT light for the related engine on the AIR COND panel to come on
 - the x-bleed valve to close automatically (except during an engine start).
 - the APU bleed valve to close automatically if the APU bleed valve is open and if the leak concerns the pylon 1 (except during engine start).
- An APU leak signal causes :
 - the APU bleed valve to close automatically (except during engine start).
 - the FAULT light the APU BLEED pushbutton switch on the AIR COND panel to come on
 - the x-bleed valve to close automatically (except during an engine start).

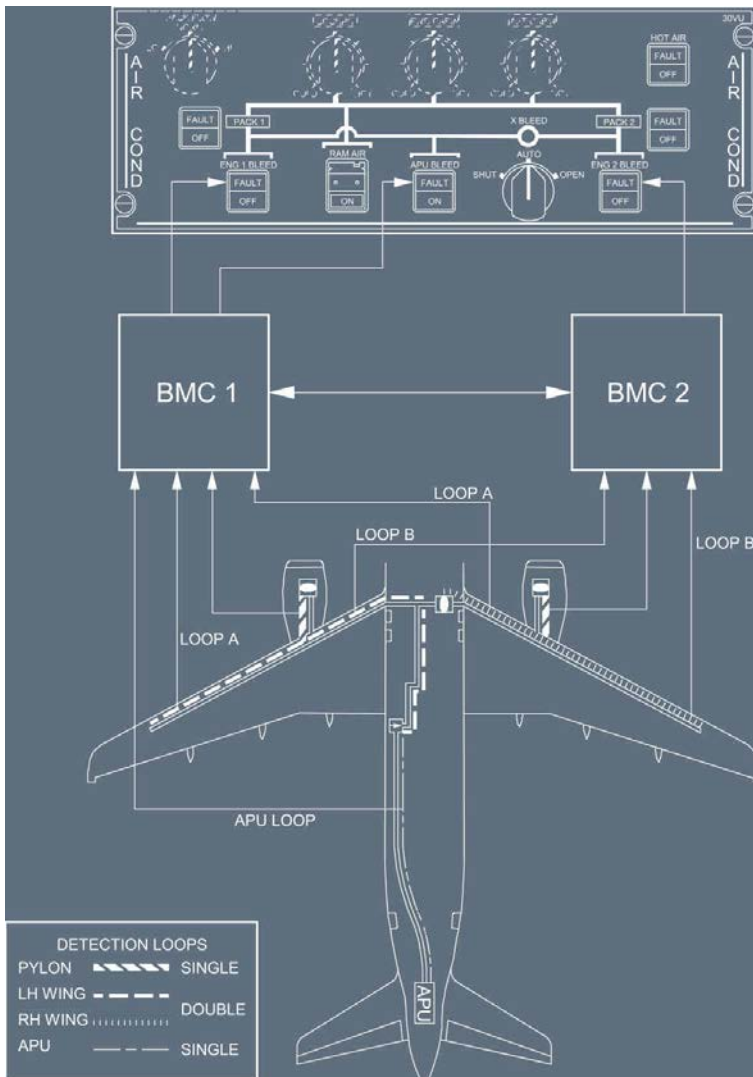

BMC FAILURE

Ident.: DSC-36-10-60-00001480.0001001 / 21 MAR 16

Applicable to: ALL

If one BMC fails, the adjacent BMC takes over the monitoring of the bleed system to issue the following ECAM warnings if necessary :

- overpressure
- overtemperature
- wing leak.

Nevertheless, the associated FAULT light on the AIR COND panel is lost, and the associated bleed valve does not close automatically.

ENG BLEED LEAK warning is lost for the associated engine, as is also the APU BLEED LEAK warning if BMC1 has failed.

AIRCRAFT SYSTEMS

PNEUMATIC

DESCRIPTION - OPERATION FOLLOWING FAILURES

Intentionally left blank

OVERHEAD PANEL

Ident.: DSC-36-20-00001481.0001001 / 20 DEC 16

Applicable to: ALL

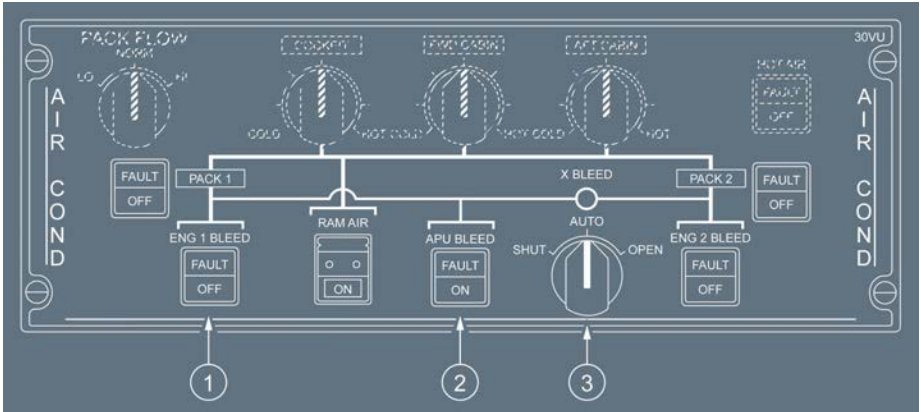

(1) ENG 1 and ENG 2 BLEED pb sw

On : Bleed valve opens if :

- Upstream pressure is above 8 PSI.
- APU BLEED pushbutton switch is off or APU bleed valve is closed.
- There is no outside wing or pylon leak, and no overpressure or overtemperature has been detected.
- The ENG FIRE pushbutton has not been popped out.
- The engine start valve is closed.

FAULT It : This amber light comes on, and an ECAM caution appears, if :

- There is an overpressure downstream of the bleed valve.
- There is a bleed air overheat.
- There is a wing or engine leak on the related side.
- The bleed valve is not closed during engine start.
- The bleed valve is not closed with APU bleed ON.

It goes out when the ENG BLEED pushbutton switch is OFF if the fault has disappeared.

OFF : The bleed valve and HP valve close. The white OFF light comes on.

(2) APU BLEED pb sw

ON : The APU valve opens if N > 95 % and there is no leak in the APU or in the left side bleed. (If there is a leak on the right side, the x-bleed valve closes.)
 The blue ON light comes on.

Off : The APU valve closes.

FAULT : This amber light comes on, and an ECAM caution appears, when the system light detects an APU leak.

(3) X-BLEED selector sw

AUTO : The crossbleed valve is open if the APU bleed valve is open.
 The crossbleed valve is closed if the APU bleed valve is closed or, in case of a wing, pylon, or APU leak (except during engine start).

OPEN : The crossbleed valve is open.

SHUT : The crossbleed valve is closed.

ECAM BLEED PAGE

Ident.: DSC-36-20-00001482.0002001 / 09 OCT 12

Applicable to: ALL

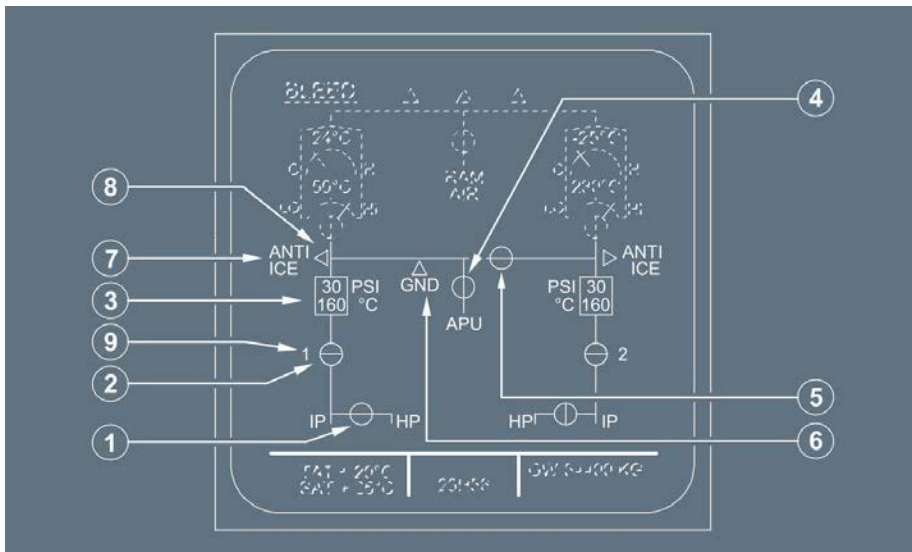

(1) HP VALVES

- Crossline - Green : HP valve normally fully closed
- In line - Green : HP valve not fully closed
- Crossline - Amber : HP valve not in commanded (closed) position

(2) ENGINE BLEED VALVES

- In line - Green : BLEED valve normally open
- Crossline - Green : BLEED valve normally fully closed
- In line - Amber : BLEED valve not in commanded (open) position
- Crossline - Amber : BLEED valve not in commanded (closed) position

(3) ENGINE BLEED INDICATIONS

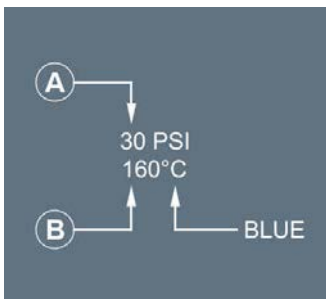

(A) Precooler inlet pressure

It is normally in green.

It becomes amber, if under 4 PSI, or if overpressure is detected by the BMC (threshold between 57 and 60 PSI).

(B) Precooler outlet temperature

It is normally in green.

It becomes amber, if the BMC detects an overheat or low temperature.

Overheat: Temperature exceeds:

- 290 °C for more than 5 s, or
- 270 °C for more than 15 s, or
- 257 °C for more than 55 s

Low temperature is detected, if the temperature is lower than 150 °C.

Note: When the engines are at idle, and depending on the ambient temperature, the precooler outlet temperature may be below 150 °C (displayed amber).

(4) APU BLEED VALVE

- Crossline - Green : The APU valve is not fully open, and the APU master switch is ON.
 In line - Green : The APU valve is fully open, and the APU master switch is ON.
 Crossline - Amber : The APU valve is fully closed, the APU master switch is ON, and the APU bleed switch is ON for more than 10 s.

(5) CROSSBLEED VALVE

- Crossline - Green : The crossbleed valve is normally closed.
 In line - Green : The crossbleed valve is normally open.
 Crossline - Amber : The crossbleed valve is not in the commanded (closed) position.
 In line - Amber : The crossbleed valve is not in the commanded (open) position.
 Transit - Amber : The crossbleed valve is in transit.

(6) GND HP ground connection indication



: Displayed in white when the aircraft is on ground.

(7) ANTI ICE indication

It is displayed in white, when the WING pushbutton on the ANTI-ICE panel is ON.

(8) Arrow



- : - It is normally not displayed, when the corresponding valve is closed.
 - It is normally displayed in green, when the corresponding valve is open.
 - It becomes amber, when the
- Valve is open and air pressure is low or high, or
 - Valve is open on ground for more than 10 s.

(9) Engine identification (1-2)

It is normally in white.

It becomes amber, when engine N2 is below idle.

MEMO DISPLAY

Ident.: DSC-36-20-00016746.0001001 / 21 MAR 16

Applicable to: **ALL**

APU BLEED : This memo appears in green, if the APU is available and the APU BLEED pb-sw is ON.

AIRCRAFT SYSTEMS

WATER / WASTE

Intentionally left blank



A318/A319/A320/A321
FLIGHT CREW
OPERATING MANUAL

AIRCRAFT SYSTEMS

WATER / WASTE

PRELIMINARY PAGES - TABLE OF CONTENTS

DSC-38-10 Description

| | |
|------------------------|---|
| General..... | A |
| Potable Water..... | B |
| Wastewater System..... | C |
| Toilet System..... | D |



A318/A319/A320/A321
FLIGHT CREW
OPERATING MANUAL

AIRCRAFT SYSTEMS

WATER / WASTE

PRELIMINARY PAGES - TABLE OF CONTENTS

Intentionally left blank

| | |
|---|---|
|  <p>A318/A319/A320/A321 FLIGHT CREW OPERATING MANUAL</p> | <p style="text-align: center;">AIRCRAFT SYSTEMS</p> <p style="text-align: center;">WATER / WASTE</p> <p style="text-align: center;">DESCRIPTION</p> |
|---|---|

GENERAL

Ident.: DSC-38-10-00017274.0001001 / 21 MAR 16
Applicable to: ALL

- The water and waste systems :
- Distribute potable water to the toilets and the galleys
 - Dispose waste water
 - Store toilet wastes.

The systems are insulated to prevent water leaks and ice build up.
 Controls of the water and waste systems are located on the Forward Attendant Panel (FAP).



POTABLE WATER

Applicable to: ALL

Ident.: DSC-38-10-A-00017286.0002001 / 21 MAR 16

Potable water is stored in a 200 l water tank located in front of the wing box, behind the FWD cargo compartment.

On ground, the water system is pressurized by the air from the service panel pressure port. In flight, the water system is pressurized by the bleed air.

Potable water is piped to the galleys and lavatories. Manual shutoff valves  isolate wet galleys, the FWD lavatory, the MID lavatory  and the AFT lavatory from the water system. Manual shutoff valves are located under the washbasins or toilet bowls. The position of each valve is indicated by OPEN and SHUT legend.

The system can be filled or drained from the service panel under the fuselage. The indication of the water quantity in the water tank is displayed on the FAP and the aft service panel.

Ident.: DSC-38-10-A-00017435.0001001 / 21 MAR 16

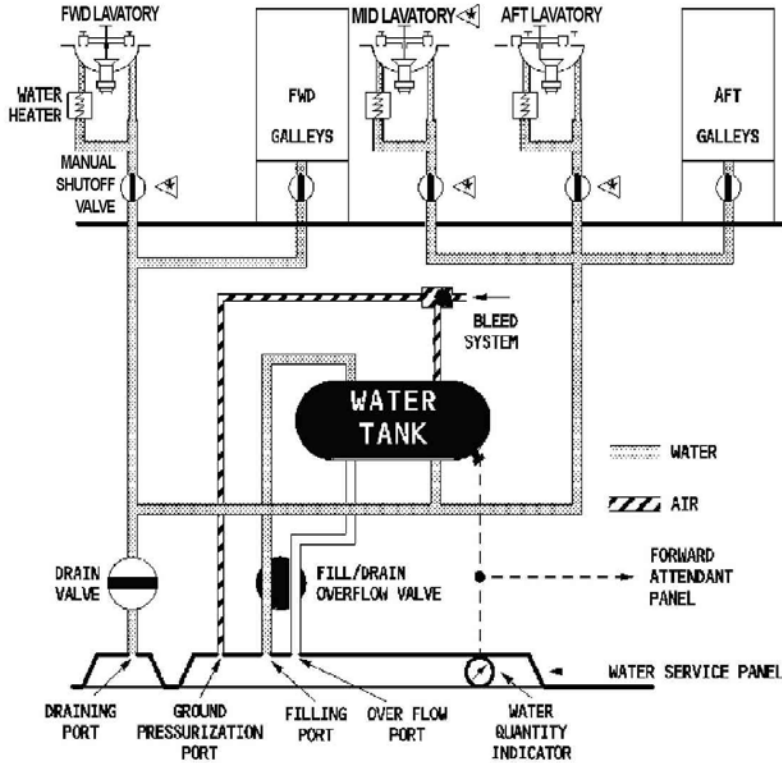

WASTEWATER SYSTEM

Ident.: DSC-38-10-00017287.0001001 / 21 MAR 16

Applicable to: ALL

The waste/water (from galleys and lavatories) drains overboard through two heated drain masts. The forward mast drains the waste/water from the forward cabin. The aft mast drains the waste/water from the aft cabin.

The waste and water are discharged by:

- Gravity, on ground
- Differential pressure, in flight.

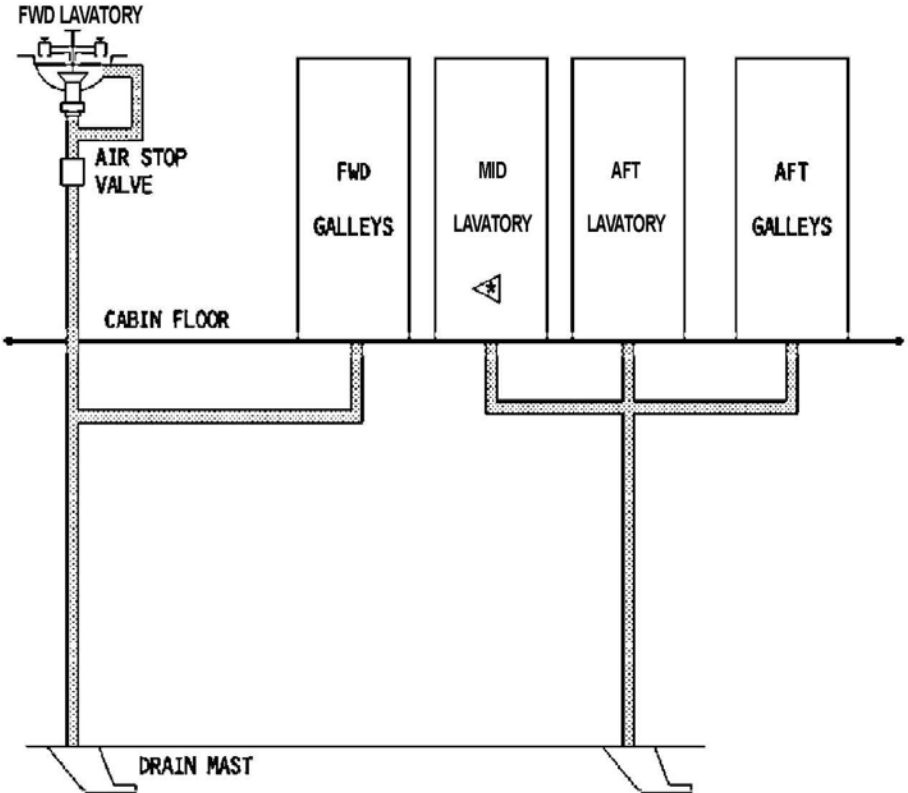

TOILET SYSTEM

Ident.: DSC-38-10-00017288.0002001 / 21 MAR 16

Applicable to: ALL

Differential pressure forces the waste from the toilet bowls into the waste tank. The waste tank has a usable capacity of 170 l. On ground, and in flight below 16 000 ft , the differential pressure is generated by the vacuum generator.

Clean water from the potable water system flushes toilets.

A flush control unit controls the flush sequence in each toilet.

The Vacuum System Controller (VSC) ensures system control, monitoring and fault reporting.

The VSC transmits information to:

- Flight attendant panel to indicate the waste tank levels and report system defects
- Centralized Fault Display System (CFDS) to signal the system defects to the maintenance.

Ground personnel services the waste tank via a service panel, located under the fuselage.

A manual shutoff valve isolates an inoperative toilet. In the case of an electrical failure of flush valve, the manual flush control  can be used. The manual flush control is located under each toilet bowl.

ARCHITECTURE

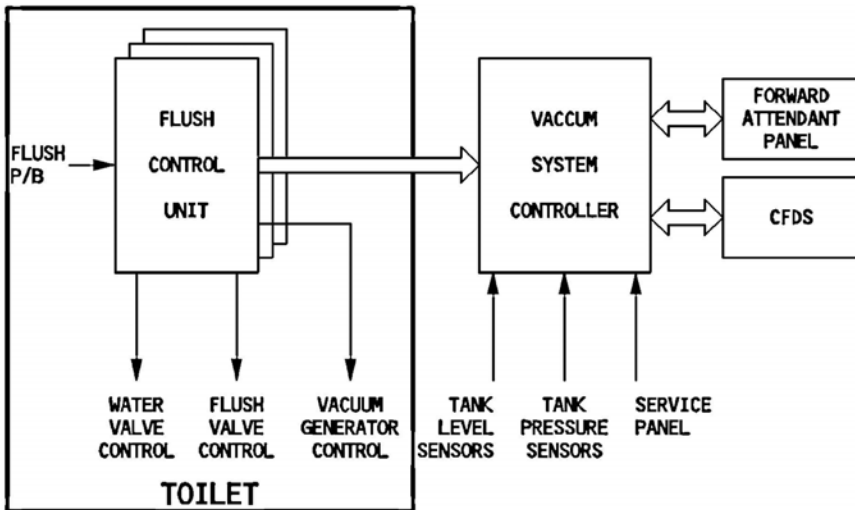

SCHEMATIC

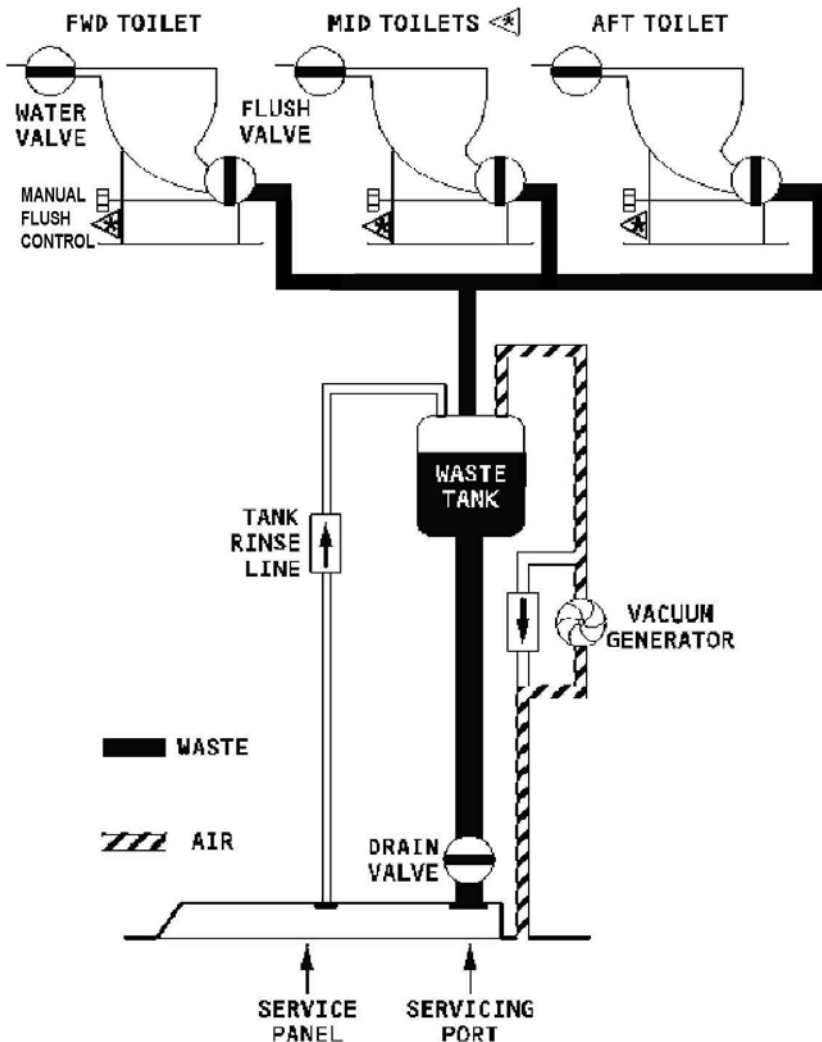



A318/A319/A320/A321
FLIGHT CREW
OPERATING MANUAL

AIRCRAFT SYSTEMS

WATER / WASTE

DESCRIPTION

Intentionally left blank

AIRCRAFT SYSTEMS

MAINTENANCE SYSTEM

Intentionally left blank

DSC-45-10 Description

| | |
|---|---|
| General..... | A |
| Components..... | B |
| Modes of Operation..... | C |
| Architecture..... | D |
| Failure/Fault Classification..... | E |
| Functions of the Centralized Fault Display System (CFDS)..... | F |
| Cockpit/CFDS Interface..... | G |

DSC-45-20 System Operation

| | |
|--|---|
| Maintenance Menu..... | A |
| Last (or Current) Leg Report..... | B |
| Last (or Current) Leg ECAM Report..... | C |
| Previous Leg Report..... | D |
| Avionics Status..... | E |
| System Report/Test..... | F |
| GMT/Date Initialization..... | G |
| Backup Mode..... | H |
| ACARS Print Program..... | I |

DSC-45-25 Data Loading

| | |
|--|---|
| General..... | A |
| Data Loading Selector on the Overhead Panel..... | B |

DSC-45-30 Printer

| | |
|-------------------------|---|
| General..... | A |
| System Description..... | B |



A318/A319/A320/A321
FLIGHT CREW
OPERATING MANUAL

AIRCRAFT SYSTEMS
MAINTENANCE SYSTEM

PRELIMINARY PAGES - TABLE OF CONTENTS

Intentionally left blank

| | |
|---|---|
|  <p>A318/A319/A320/A321 FLIGHT CREW OPERATING MANUAL</p> | <p style="text-align: center;">AIRCRAFT SYSTEMS MAINTENANCE SYSTEM</p> <p style="text-align: center;">DESCRIPTION</p> |
|---|---|

GENERAL

Ident.: DSC-45-10-00001490.0001001 / 21 MAR 16
Applicable to: ALL

The purpose of the Centralized Fault Display System (CFDS) is to make the maintenance task easier by displaying fault messages in the cockpit and permitting the flight crew to make some specific tests.

There are two levels of maintenance :

- at the line stop : removal and replacement of equipment
- at the main base : troubleshooting

COMPONENTS

Ident.: DSC-45-10-00001491.0001001 / 21 MAR 16
Applicable to: ALL

The CFDS includes :

- the BITE (Built-In Test Equipment) for each electronic system
- a central computer, the Centralized Fault Display Interface Unit (CFDIU)
- two MCDU s (Multipurpose Control and Display Units), used also for FMGS (Flight Management and Guidance System), AIDS (Aircraft Integrated Data System), and ACARS (Aircraft Communication And Reporting System, if installed), which work with the CFDIU to display information or initiate tests
- one printer.

If a main channel of the CFDIU fails, the backup channel takes over.

MODES OF OPERATION

Ident.: DSC-45-10-00001492.0001001 / 22 MAR 16
Applicable to: ALL

The CFDS operates in two main modes :

- the NORMAL mode or REPORTING mode (in flight)
- the INTERACTIVE mode or MENU mode (on ground).

In NORMAL mode, the CFDS records and displays the failure messages transmitted by each system BITE.

In INTERACTIVE mode, the CFDS allows any BITE to be connected with the MCDU in order to display the maintenance data stored and formatted by the BITE or to initiate a test.

ARCHITECTURE

Ident.: DSC-45-10-00001493.0002001 / 19 DEC 12

Applicable to: ALL

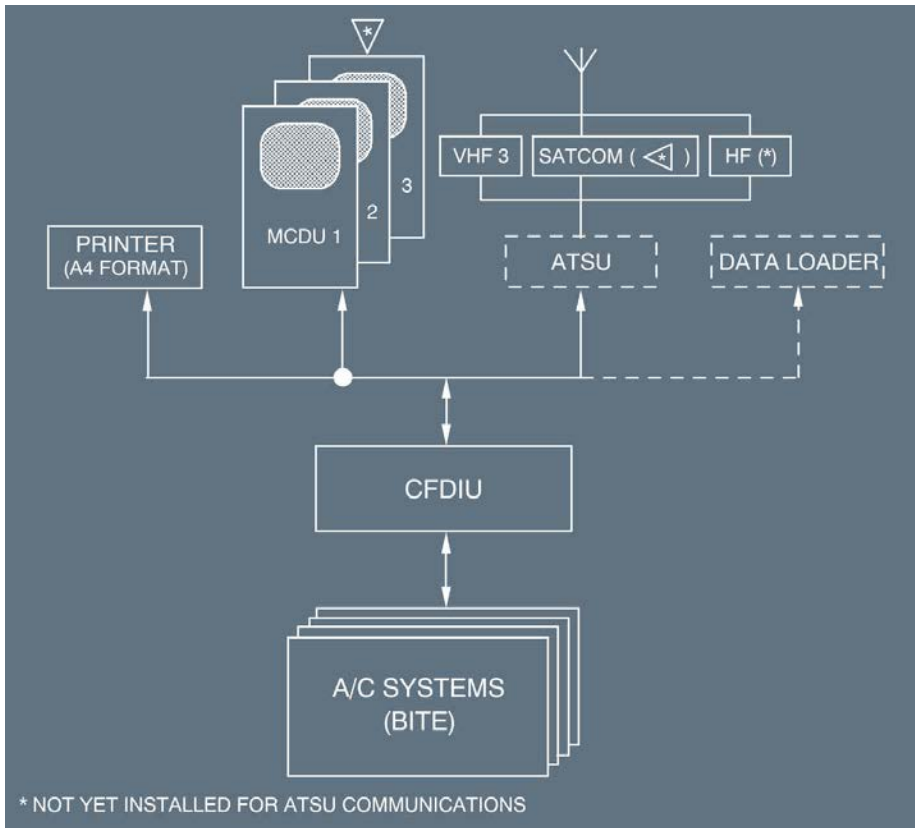

| | |
|---|---|
|  A318/A319/A320/A321 FLIGHT CREW OPERATING MANUAL | AIRCRAFT SYSTEMS MAINTENANCE SYSTEM DESCRIPTION |
|---|---|

FAILURE/FAULT CLASSIFICATION

Ident.: DSC-45-10-00017082.0001001 / 21 MAR 16

Applicable to: ALL

The Centralized Fault Display System (CFDS) identifies the faulty system and puts any failures or faults into one of three classes :

- Class 1: Failures indicated to the flight crew by means of the ECAM , or other flight deck effect. They must be repaired or entered in the MEL (Minimum Equipment List) before the aircraft can depart.
- Class 2: Faults indicated to maintenance personnel by the CFDS and which trigger a MAINT status entry on the maintenance part of the ECAM status page. The aircraft can operate with these faults, but they must be rectified within the timescale defined in the Trouble Shooting Manual (TSM).
- Class 3: Faults indicated to maintenance personnel by the CFDS , but which do not trigger a MAINT status. The operator may have these faults corrected at his convenience.

| Failure/fault classes | Class 1 | Class 2 | Class 3 |
|---|---|---|--|
| Operational consequences | YES | NO | NO |
| Indication to the flight crew | YES Automatically displayed - Warning or caution messages on Engine Warning Display - Flag or indication in the flight deck. | YES Available on ECAM status page. | NO |
| Dispatch consequences | Refer to MEL may be : "GO" "GO IF" "NO GO" | <i>Refer to MMEL/MI-00-08 ECAM and MAINTENANCE STATUS</i> | MEL not applicable |
| Indication to the maintenance team | YES Automatically print out at the end of each flight : Fault messages on the CFDS Post Flight Report. | | YES Available on request through system report/Test |

FUNCTIONS OF THE CENTRALIZED FAULT DISPLAY SYSTEM (CFDS)

Ident.: DSC-45-10-00001495.0002001 / 21 MAR 16

Applicable to: ALL

The main functions of the CFDS are :

- obtaining and storing messages transmitted by the connected system BITEs, or by the Flight Warning Computer (Warning and Caution titles)
- Detailing the maintenance phases.

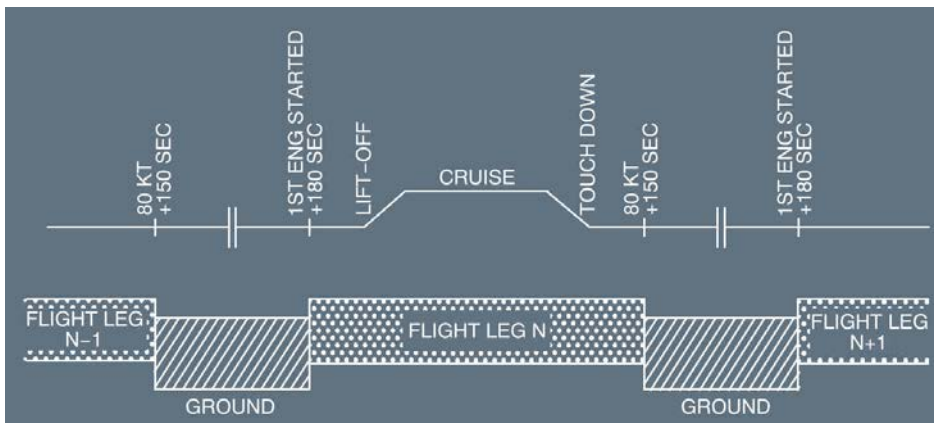

- Presenting maintenance reports :
 - Last leg report
 - Last leg ECAM report
 - Previous leg report
 - Avionics status
 - System report test
 - Post-flight report.

COCKPIT/CFDS INTERFACE

Ident.: DSC-45-10-00001496.0001001 / 22 MAR 16

Applicable to: ALL

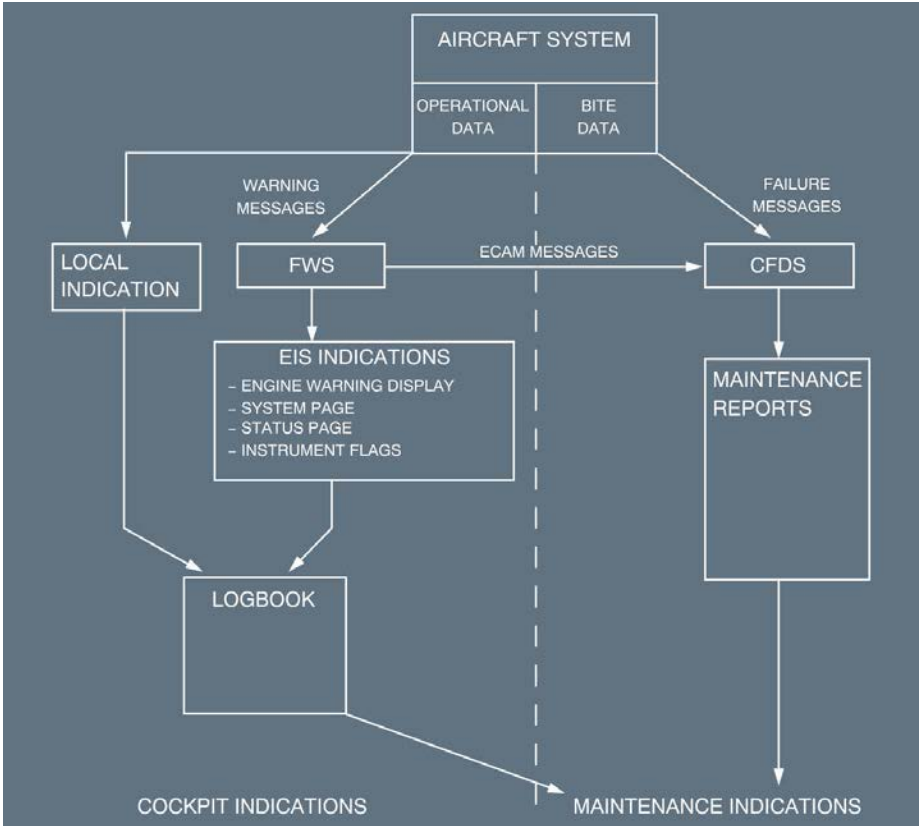



A318/A319/A320/A321
FLIGHT CREW
OPERATING MANUAL

AIRCRAFT SYSTEMS
MAINTENANCE SYSTEM

DESCRIPTION

Intentionally left blank



A318/A319/A320/A321
FLIGHT CREW
OPERATING MANUAL

AIRCRAFT SYSTEMS
MAINTENANCE SYSTEM

SYSTEM OPERATION

MAINTENANCE MENU

Ident.: DSC-45-20-00001497.0002001 / 14 MAY 12

Applicable to: ALL

The CFDS uses menus displayed on the MCDU. The operator selects functions or reports from these menus.

Pressing the MCDU MENU key and then selecting CFDS brings up the MAINTENANCE MENU page (different pages for the aircraft in flight and the aircraft on the ground).

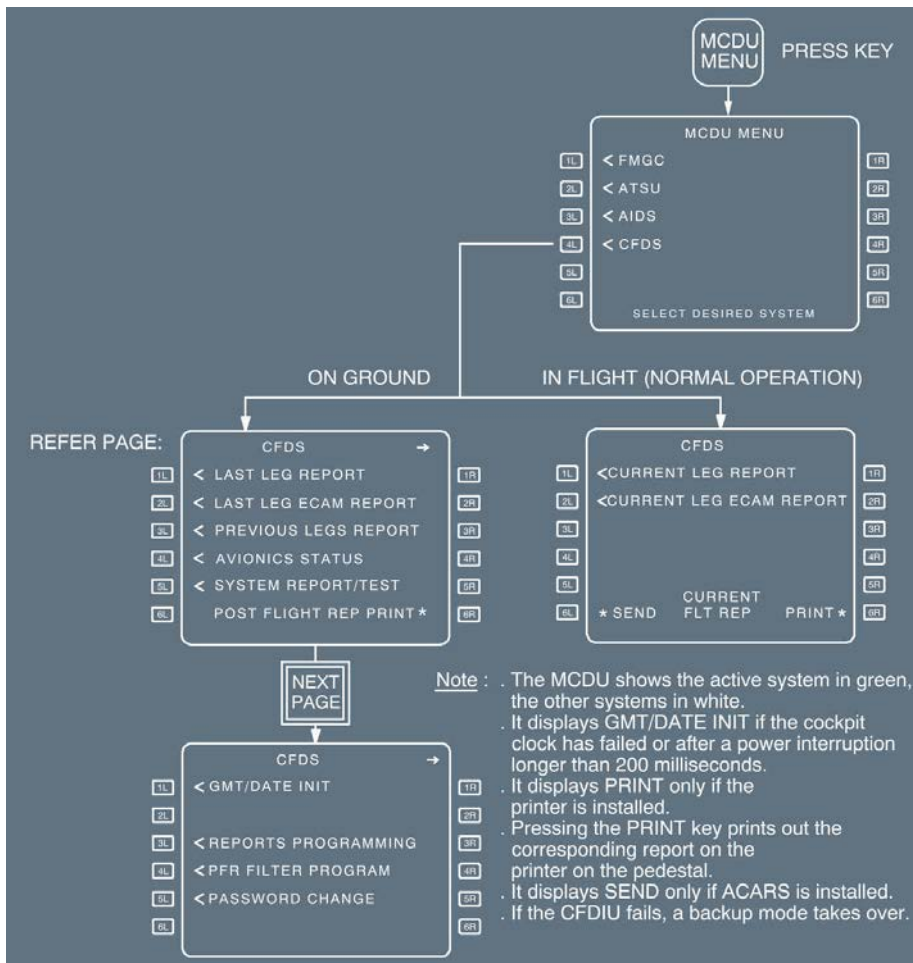

LAST (OR CURRENT) LEG REPORT

Ident.: DSC-45-20-00001498.0001001 / 21 MAR 16

Applicable to: ALL

The LAST LEG REPORT (on the ground) or the CURRENT LEG REPORT (in flight), list all class 1 failures and class 2 faults and all system failure and system fault messages received by the CFDS during the last flight leg or the current flight leg. Pressing the IDENT key displays a list of the systems

(called identifiers) affected by the failure or fault, which helps the pilot or maintenance person to identify the failure or fault.

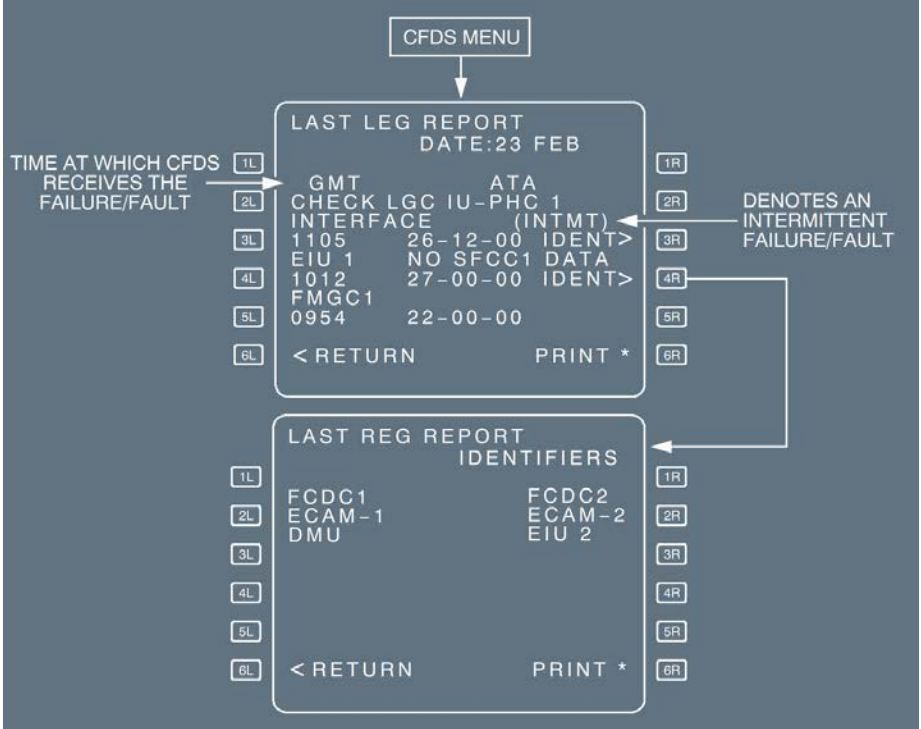

LAST (OR CURRENT) LEG ECAM REPORT

Applicable to: ALL

Ident.: DSC-45-20-A-00001499.0001001 / 21 MAR 16

GENERAL

- In flight : The CURRENT LEG ECAM REPORT displays the primary and independent warning (class I) messages and MAINTENANCE STATUS (class II) messages of the current flight leg.
- On the ground : The LAST LEG ECAM REPORT displays the primary and independent warning (class I) messages plus MAINTENANCE STATUS (class II) messages of the last flight leg.

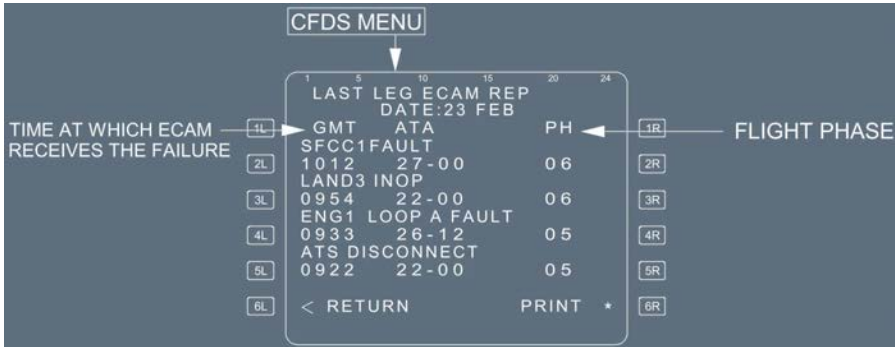

Note: This screen displays PRINT only if the printer is installed.

Ident.: DSC-45-20-A-00001500.0001001 / 14 MAY 12

POST FLIGHT REPORT PRINT

At the end of a flight, LAST LEG and LAST LEG ECAM REPORTS are printed out automatically after the last engine shutdown. The flight or ground crew can also print them out by selecting POST FLIGHT REP PRINT.

The report first lists the ECAM warnings, then the FAULT messages.

CFDS POST FLIGHT REPORT

| A/C IDENT | DATE | GMT | FLTN | CITY PAIR |
|-----------|-------|------|---------|-----------|
| XY-ABCD | FEB23 | 2355 | XY-1234 | LFBO/LFPO |

ECAM WARNINGS

| GMT | ATA PH | |
|------|----------|------------------------|
| 1012 | 27-00 06 | SFCC 1 FAULT |
| 0954 | 22-00 06 | LAND3 INOP |
| 0933 | 26-12 05 | ENG 1 LOOP A FAULT |
| 0922 | 22-00 05 | ATS DISCONNECT |
| 0915 | 28-21 04 | FUEL L TK PUMP 1 LO PR |
| 0904 | 36-22 04 | BLEED LOOP |

FAULT MESSAGES

| GMT | ATA | |
|------|----------|-------------------------------------|
| 1105 | 26-12-00 | CHECK LGCIU-PHC 1 INTERFACE (INTMT) |
| 1012 | 27-00-00 | EIU 1--NO SFCC 1 DATA |
| 0954 | 22-00-00 | FMGC 1 |
| 0933 | 36-11-00 | BMC 1 |
| 0915 | 28-21-00 | FUEL L TK PUMP 1 QM |
| 0904 | 26-12-00 | CHECK R WING LOOP A |

COMMENTS

| | |
|--|--|
| | |
| | |
| | |
| | |
| | |

PREVIOUS LEG REPORT

Ident.: DSC-45-20-00001501.0001001 / 21 MAR 16

Applicable to: ALL

This report gives access to the POST FLIGHT REPORTS of the previous 63 flight legs.

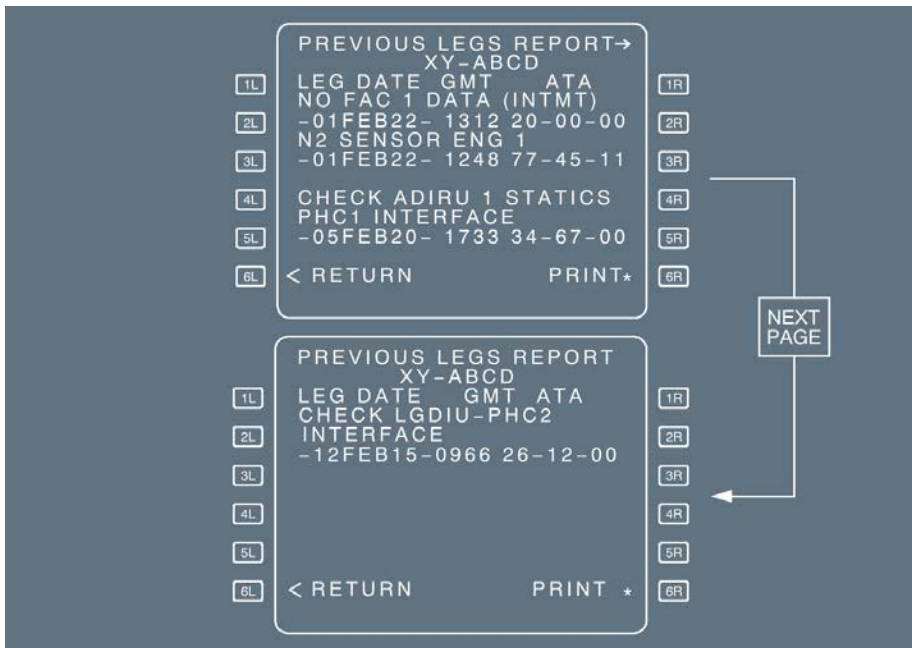

On ground, the Operator can print copies of the screen. If ACARS is installed, the Operator can send the flight report (*Refer to DSC-45-20 Last (or Current) Leg ECAM Report - Post Flight Report Print*).

AVIONICS STATUS

Ident.: DSC-45-20-00001502.0001001 / 21 MAR 16

Applicable to: ALL

This screen displays the list of systems affected by a failure or fault. If a system is affected by at least a Class 3 fault, CLASS 3 appears beside it. The display is continuously updated.

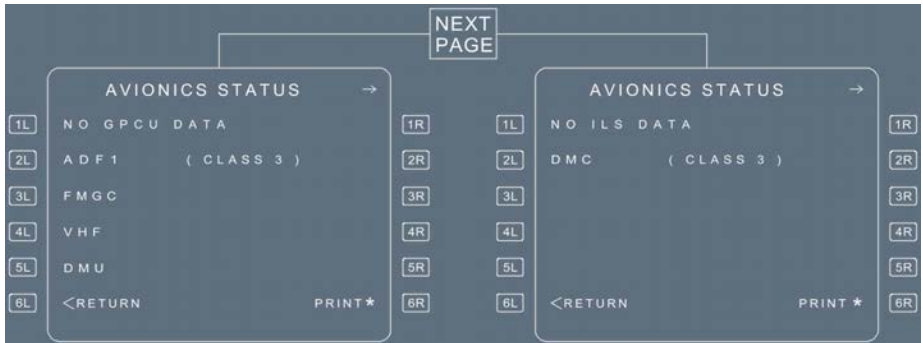

SYSTEM REPORT/TEST

Ident.: DSC-45-20-00001503.0001001 / 21 MAR 16

Applicable to: ALL

This screen gives the operator access to all electronic systems. The CFDIU enters into interactive dialogue with the selected system.

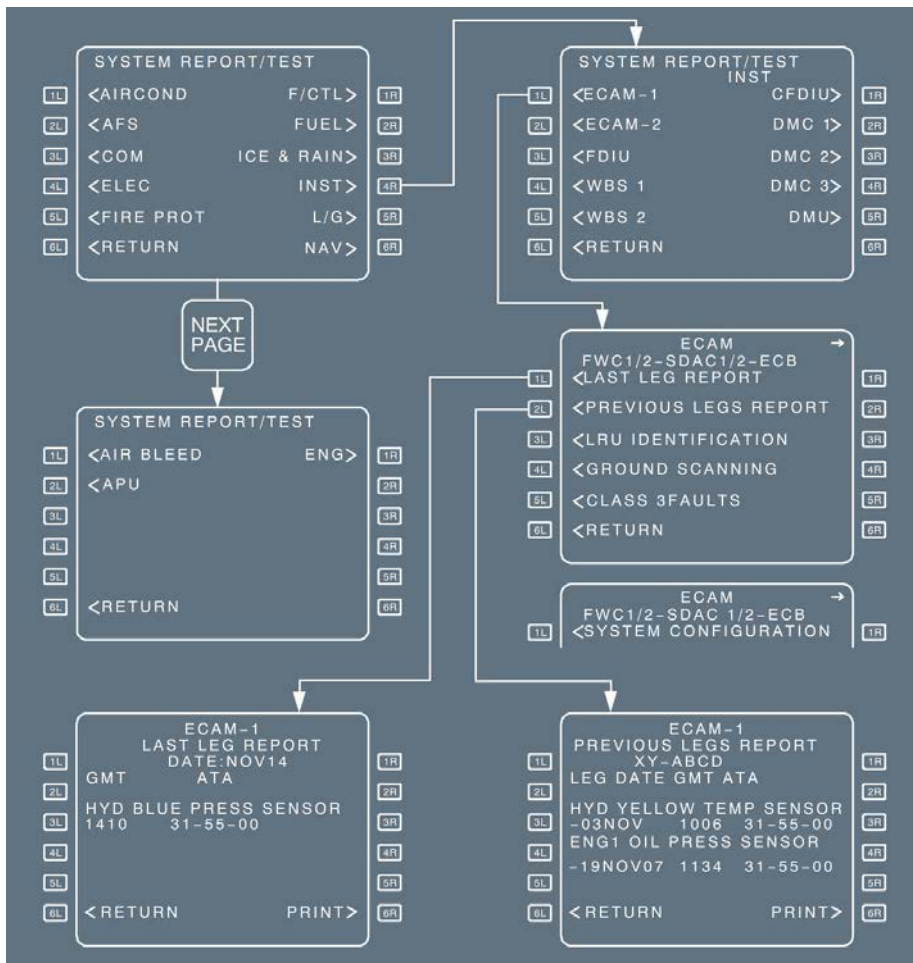

In the above example, the operator has called up menus of the selected systems :

- LAST or PREVIOUS LEG REPORT presents the list of Line-Replaceable Units (LRUs) affected by a failure.
- LRU IDENTIFICATION contains the part numbers of all LRUs in the system.
- GND SCANNING runs the flight monitoring on the ground and indicates the faulty LRU.
- CLASS 3 FAULTS lists class 3 faults detected by the system during the last flight leg.
- SYSTEM CONFIGURATION presents the system configuration in a digital form.

Note: These screens (except LAST or PREVIOUS LEG REPORT) are not shown above.

GMT/DATE INITIALIZATION

Ident.: DSC-45-20-00001504.0001001 / 21 MAR 16

Applicable to: ALL

A CFDIU clock is synchronized with the cockpit clock in order to keep GMT (UTC) displayed on the ECAM lower display (except in flight Phases 1 and 2, if the weight and balance system is installed). If the cockpit clock fails, the CFDIU clock continues to display GMT (UTC) on the ECAM lower display.

If electrical power is interrupted for more than 200 ms, the crew initializes GMT (UTC) and the DATE via the MCDU :

- Write GMT (UTC) in the scratchpad, then press the "INIT GMT" key.
- Do the same for the month and day.

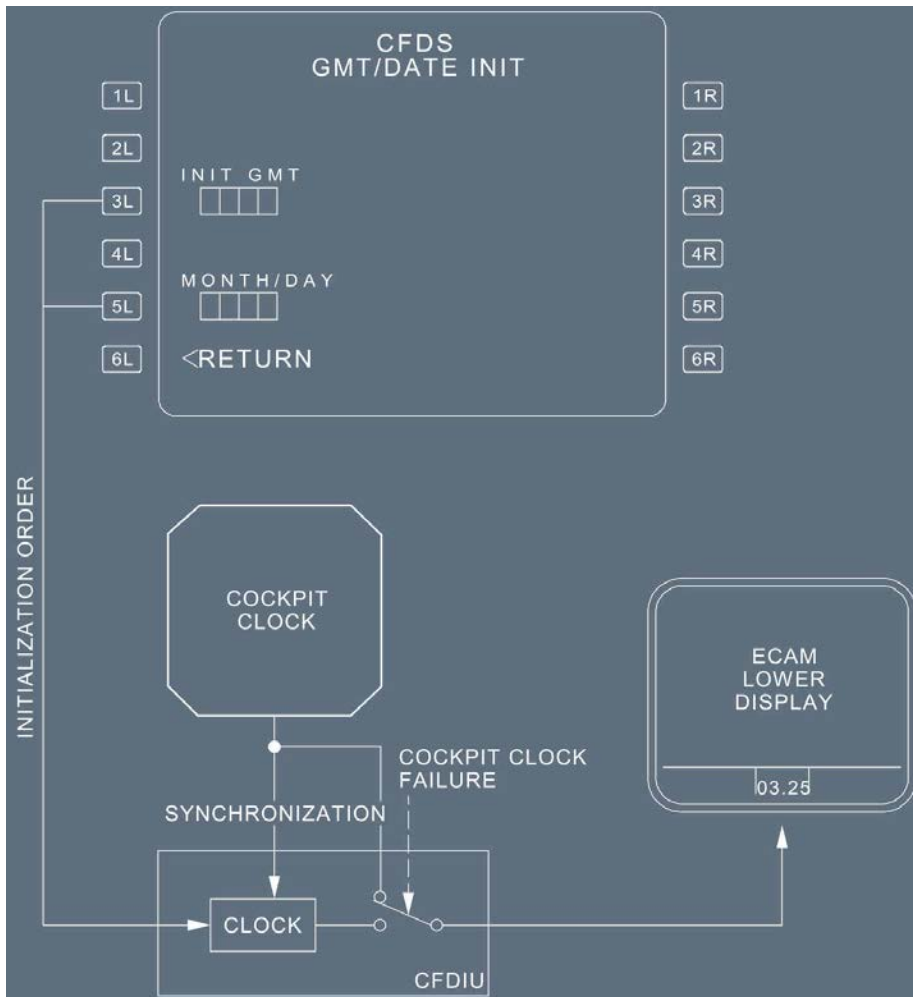

BACKUP MODE

Ident.: DSC-45-20-00017066.0001001 / 21 MAR 16

Applicable to: ALL

If the main channel of the CFDIU fails, the backup channel allows the CFDS to operate in backup mode :

- On the ground only
- Through MCDU1 or MCDU3 
- In one mode of operation only : SYSTEM REPORT/TEST
- Without the PRINTER or ACARS.

The system changes over from main channel to backup channel :

- Automatically in case of an important failure (power supply, for example). In this case, when the operator selects CFDS on the MCDU MENU, it displays the BACKUP MODE page.
- Manually if the operator selects BACKUP MODE on the CFDS menu after a minor failure.

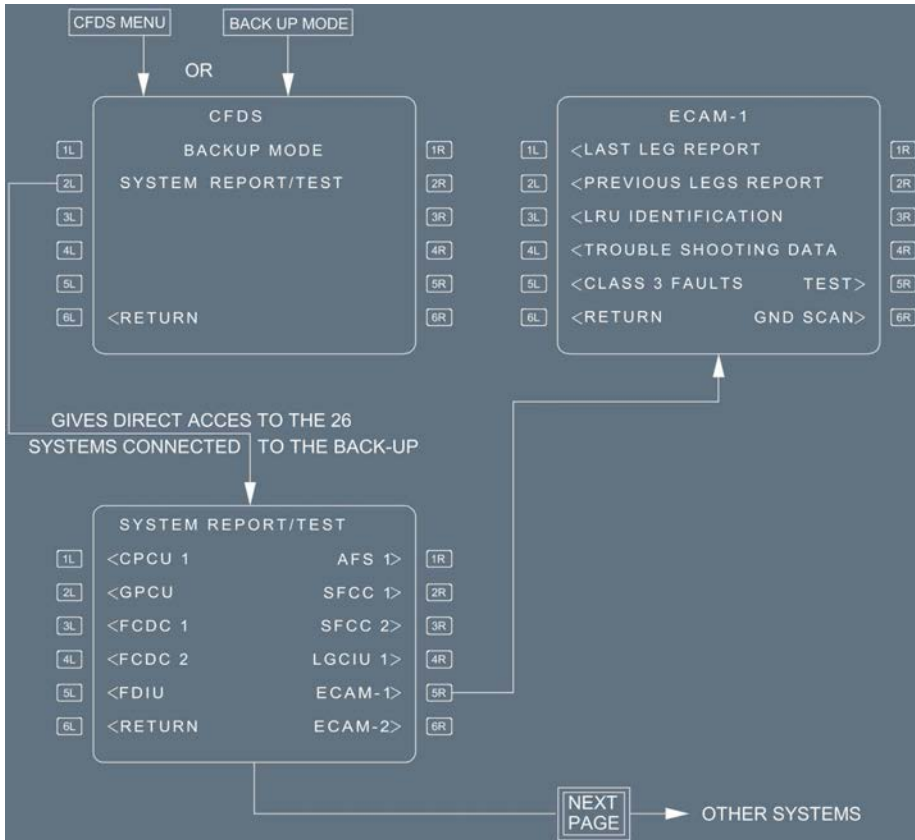

ACARS PRINT PROGRAM

Ident.: DSC-45-20-00005361.0001001 / 14 FEB 11

Applicable to: **ALL**

This function gives access to reprogramming page.

The programming is provided by the ACARS or manually (on the ground or in flight) :

No star indicates an ACARS programming. The YES indicates that the REAL TIME FAIL will be automatically transmitted to the ACARS.

The star indicates a manually modified programming: pressing the corresponding key changes the YES into a NO. The YES indicates that the REAL TIME FAIL page will be printed simultaneously with the transmission to the ACARS.

ACARS/PRINT PROGRAM

| | | | | |
|----|-------------------------|---------|--|----|
| 1L | SEND | PRINT | | 1R |
| | NO POST FLT REP NO * | | | |
| 2L | YES REAL TIME FAIL YES* | | | 2R |
| 3L | YES REAL TIME WARN NO* | | | 3R |
| 4L | *YES AVIONICS DATA YES | | | 4R |
| 5L | | | | 5R |
| 6L | <RETURN | PRINT * | | 6R |

Note: The CFDIU memorizes all manual programming so that at initialisation the last configuration will be retained.



A318/A319/A320/A321
FLIGHT CREW
OPERATING MANUAL

AIRCRAFT SYSTEMS
MAINTENANCE SYSTEM
SYSTEM OPERATION

Intentionally left blank

| | |
|---|---|
|  <p>A318/A319/A320/A321 FLIGHT CREW OPERATING MANUAL</p> | <p style="text-align: center;">AIRCRAFT SYSTEMS MAINTENANCE SYSTEM</p> <p style="text-align: center;">DATA LOADING</p> |
|---|---|

GENERAL

Ident.: DSC-45-25-00001506.0001001 / 10 JAN 11
Applicable to: ALL

With the data loading system, it is possible to upload databases and operational software, or to download system reports from various onboard computers.
 The data transfer is performed via 3.5 in disks and a portable data loader, or the aircraft fixed Multipurpose Disk Drive Unit (MDDU).

DATA LOADING SELECTOR ON THE OVERHEAD PANEL

Ident.: DSC-45-25-00001507.0001001 / 19 DEC 12
Applicable to: ALL



When the data loading selector is ON, the 3 keys (NEXT, PREV, SEL CTRL) enable the display and selection of various applicable aircraft systems (FMGC , TCAS etc...).



A318/A319/A320/A321
FLIGHT CREW
OPERATING MANUAL

**AIRCRAFT SYSTEMS
MAINTENANCE SYSTEM**

DATA LOADING

Intentionally left blank

GENERAL

Ident.: DSC-45-30-00001508.0001001 / 21 MAR 16

Applicable to: ALL

The printer prints reports from the following systems (if installed) : ACARS , AIDS , FMGC , CFDIU and EVMU. It prints these on paper, and does so either on the ground or in flight.

The printer is installed at the rear of the pedestal on the right side.

SYSTEM DESCRIPTION

Ident.: DSC-45-30-00001509.0001001 / 21 MAR 16

Applicable to: ALL

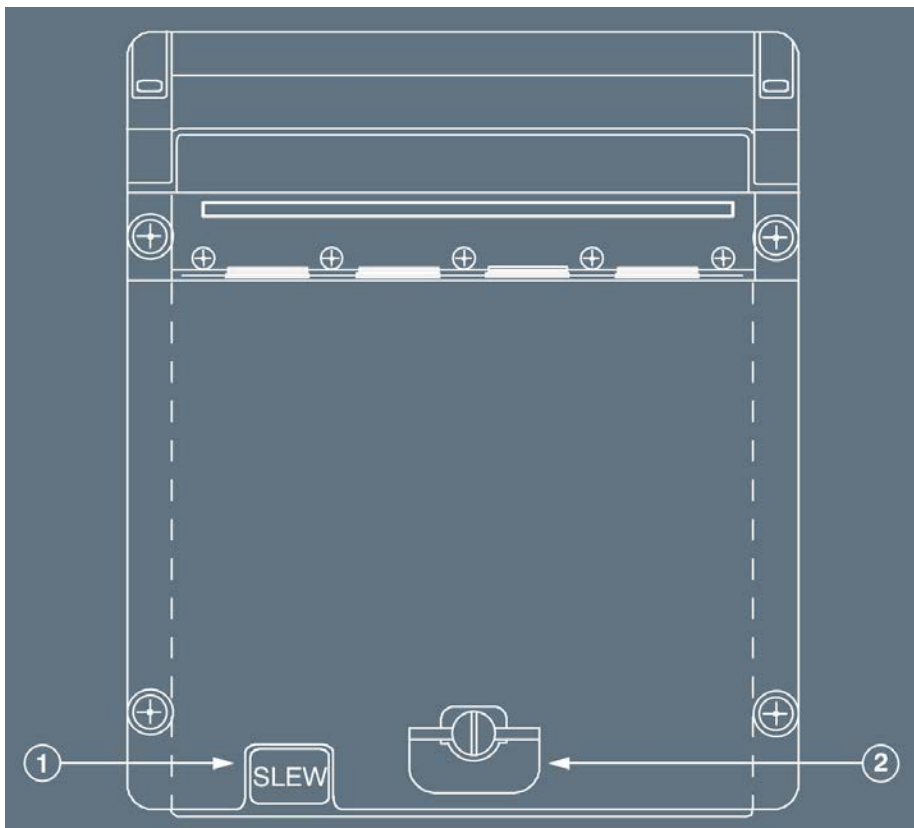

- (1) SLEW sw :
The SLEW switch is used to feed paper after having loaded a new roll.
- (2) PRINTER DOOR LATCH :
The printer door latch locks the door used for loading paper.

AIRCRAFT SYSTEMS

INFORMATION SYSTEMS

Intentionally left blank

DSC-46-10 Datalink

DSC-46-10-10 General System Description

| | |
|------------------------|---|
| Overview..... | A |
| Architecture..... | B |
| Cockpit Interface..... | C |

DSC-46-10-20 AOC Applications

DSC-46-10-20-10 General

| | |
|--------------|---|
| General..... | A |
|--------------|---|

DSC-46-10-40 Controls and Indicators

DSC-46-10-40-30 MCDU Datalink Pages

| | |
|-----------------------|---|
| ATSU DATALINK..... | A |
| COMM MENU..... | B |
| VHF3 SCAN SELECT..... | C |

DSC-46-10-40-40 MCDU Scratchpad Messages

| | |
|-------------------------------|---|
| MCDU Scratchpad Messages..... | A |
|-------------------------------|---|

DSC-46-10-40-60 ECAM

| | |
|-------------------|---|
| Memo Display..... | A |
|-------------------|---|

DSC-46-10-50 How To

| | |
|-----------------------------|---|
| Introduction..... | A |
| How to Initialize..... | B |
| How to Modify FLT Plan..... | C |

DSC-46-20 Electronic Flight Bag (EFB)

DSC-46-20-20 Applications

| | |
|------------------------------|---|
| Introduction..... | A |
| General..... | B |
| Landing Application..... | C |
| Takeoff Application..... | D |
| Loadsheet Application..... | E |
| OPS Library Application..... | F |
| Manager Application..... | G |

DSC-46-30 Electronic QRH (eQRH)

| | |
|--------------|---|
| General..... | A |
|--------------|---|

Continued on the following page

Continued from the previous page

DSC-46-40 Pax Entertainment & Connectivity Systems (If Installed)

DSC-46-40-10 General

General..... A

DSC-46-40-20 In Seat Power Supply System

IN SEAT POWER SUPPLY SYSTEM  A

DSC-46-40-30 Controls and Indicators

MOBILE COM PB-SW  A

DISC IN PROG Light  B

CINS RESET PB  C

PAX COM PB-SW  D

PAX SYS PB-SW  E

PAX PERSONAL ELEC SPLY PB-SW  F







MEMO DISPLAY..... G

OVERVIEW

Ident.: DSC-46-10-10-00020333.0001001 / 17 MAR 17

Applicable to: ALL

The datalink has:

- AOC applications 
-  The flight crew uses the AOC applications to communicate with Airline Operational Center (AOC).
-  - ATC applications 
-  The flight crew uses the ATC applications to communicate with Air Traffic Control (ATC) centers.
-  The ATC datalink provides communication, navigation, and surveillance for Air Traffic Management (ATM) services.

The ATC datalink applications enable air traffic controllers to follow the aircraft navigation, and enhance the air traffic flow.

The datalink communication (messages exchange) between the aircraft and the ground is achieved:



- Automatically (without a flight crew action)
- Manually (with a flight crew action via the DCDU /MCDU and/or RMP).

The datalink messages are:







- Uplink (from a ground facilities to the flight crew), or
- Downlink (from the flight crew to an ground facilities).

COMMUNICATION AND NAVIGATION FOR AIR TRAFFIC MANAGEMENT

At the beginning of the flight, the flight crew sends a notification message to the ATC center, via the MCDU, notification application  .



-  Refer to *DSC-46-10-30-10 Notification* for more information.
-  Then, an air traffic controller will establish a connection between the aircraft and the ATC center. As a result, the flight crew can exchange messages with the ATC center, via the DCDU (CPDLC application ). The messages that the flight crew sends to the ATC center can be built with present frames and modified via the MCDU.

Depending on the type of datalink exchange, the datalink uses one of the following communication networks:

- ACARS (*Refer to DSC-23-30-30-10 Introduction*) for FANS A  / FANS A+  applications
- ACARS Air Traffic Services (ATS 623) for optional applications 
- Aeronautical Telecommunication Network (ATN) for FANS B  / FANS B+  applications
-  The ATN supports increasing volume of ATC and AOC communication.

L1 FUTURE AIR NAVIGATION SYSTEM (FANS)

The ATC datalink provides:

- FANS A  applications, for operations in remote and in oceanic areas:
 - Notification
 - Controller-Pilot Data Link Communication (CPDLC)
 - Automatic Dependent Surveillance Contract (ADS-C).
- FANS B  applications, for operations in high-density continental areas:
 - Notification
 - Controller-Pilot Data Link Communication (CPDLC).
- Optional applications  (compatible only with FANS A+ or FANS B+):
 - Departure Clearance
 - Oceanic Clearance
 - Digital - Automatic Terminal Information Service (D-ATIS).

NAVIGATION AND SURVEILLANCE FOR AIR TRAFFIC MANAGEMENT

The Automatic Dependent Surveillance (ADS) system sends aircraft position and aircraft navigation data to ATC centers and other aircraft.



There are two different ADS applications:

- ADS-Contract (ADS-C) 

The ADS-C automatically sends aircraft surveillance data to connected ATC centers via ATC Datalink  in remote or oceanic areas.

L2 Refer to DSC-46-10-30-30 ADS-C for more information, about ADS-C application.

- L1** - ADS-Broadcast (ADS-B) 

The ADS-B automatically broadcasts the aircraft position and navigation data to other users (ATC centers or other aircraft) equipped with a Mode S transponder. The ATC Datalink  does not host the ADS-B .

L2 Refer to DSC-34-SURV-10-10 ADS-B OUT for more information, about the ADS-B.

L1 SERVICE PROVIDERS

The role of a communication service provider is to deliver a message from the A/C to a ground end system and vice versa.

A datalink service provider ensures routing of datalink messages between the aircraft and ATC center.

- L2** For VHF communication, the two main providers are ARINC and SITA that operate worldwide networks.

| | |
|---|--|
|  <p>A318/A319/A320/A321 FLIGHT CREW OPERATING MANUAL</p> | <p style="text-align: center;">AIRCRAFT SYSTEMS INFORMATION SYSTEMS</p> <p style="text-align: center;">DATALINK - GENERAL SYSTEM DESCRIPTION</p> |
|---|--|

LT REVERSION TO VOICE COMMUNICATION

Voice communication is a primary means of communication on board.

The flight crew must revert from datalink communication to voice communication, if:

- There is an emergency situation (exchange of a critical or urgent message)
- There is a doubt about a datalink message, the voice should be used for clarification
- An operational timer of datalink message exchange times out
- A response to an ATC message was not correctly transmitted via datalink.

CLOCK ACCURACY

The required time precision for ATC datalink communications is +/-1 s UTC. If this constraint is not respected, a rejection of datalink message or acceptance of obsolete datalink message may occur.

Not respecting this constraint may lead to the rejection of messages or to the acceptance of obsolete messages.

For FANS operations, the flight crew should not manually set the clock during cockpit preparation.

ARCHITECTURE

Applicable to: ALL



Ident.: DSC-46-10-10-00020329.0001001 / 17 MAR 17

AIR TRAFFIC SERVICE UNIT (ATSU)

The ATSU controls all datalink communication and automatically selects the best available communication media:

- VHF
- HF 
- SATCOM  .

The ATSU hosts:

- AOC applications 
- ATC applications 
- Router services

The ATSU routers automatically select VHF frequency, depending on the aircraft position, in accordance with an entered scan mask (airline policy).

The scan mask means that a list of VHF datalink service providers, selected via the VHF3 SCAN SELECT page, is scanned, in accordance with their priority level. The VHF scan mask is compulsory for correct router operation. If there is no scan mask, the ECAM displays DATALINK ATSU FAULT – ATSU INIT FAULT.

Refer to DSC-46-10-40-30 VHF3 SCAN SELECT for more information about the VHF3 SCAN SELECT page.

Ident.: DSC-46-10-10-10-00020319.0001001 / 17 MAR 17

SATELLITE COMMUNICATIONS (SATCOM)

The SATCOM system  provides voice and data services. The voice/data are transmitted via satellite, from the aircraft to the ground earth stations, and then switched through international telecommunications networks (ARINC, SITA, etc.) to anywhere in the world (airline operational centers, ATC centers, etc).

The ATSU (router) manages switching to/from SATCOM  (ACARS environments only).

Ident.: DSC-46-10-10-10-00020321.0002001 / 17 MAR 17

VERY HIGH FREQUENCY (VHF)

The communication between the aircraft and VHF ground stations is established on a VHF frequency. The datalink system primarily uses the VHF 3 radio communication system. The ATSU router automatically selects a VHF frequency, depending on entered configuration, the scan mask for VHF DataLink (VDL), and the aircraft position.

VHF data link service providers are available in each geographical area. *Refer to DSC-23-30-30-40 World Map ACARS Frequencies* for a world map of VHF ACARS frequencies.

The VHF3 radio communication system has:

- Data mode
- Voice mode.

DATALINK/VOICE SWITCHING

The VHF 3 can be used in the voice mode, in case of:

- VHF 1 failure
- VHF 2 failure
- Specific AOC functions (operator's customization).

The flight crew can switch datalink/voice via the RMP , or via VHF3 VOICE DIRECTORY page of the MCDU.

The voice frequency can be tuned by:

- ATSU automatically
- Fight crew, via the RMP.

Green **HF VOICE** memo indicates that VHF 3 datalink communication is interrupted, when the VHF 3 transceiver operates in the voice mode.



COCKPIT INTERFACE

Ident.: DSC-46-10-10-00020373.0001001 / 17 MAR 17

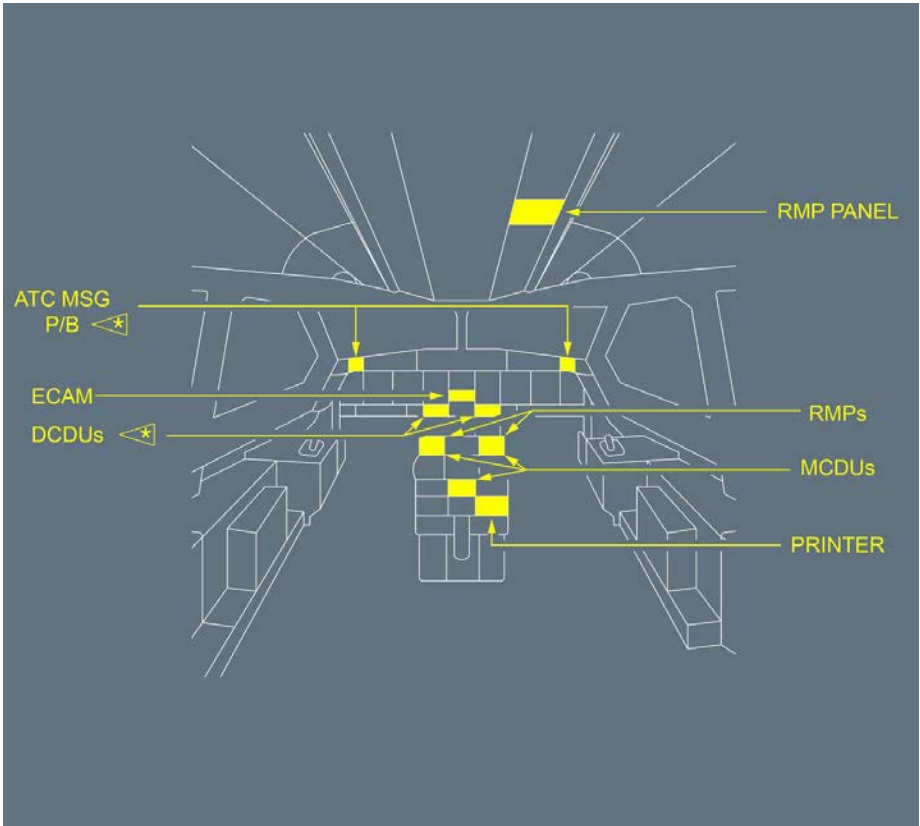
Applicable to: ALL



The cockpit interface of the datalink system has:

- Datalink Control and Display Unit (DCDU)  on the CAPT and F/O side
The DCDU displays the uplink and downlink messages and enable the flight crew to control the datalink message exchange.
- ATC MSG pb-sw  on the CAPT and F/O side of the glareshield
The ATC MSG pb-sw alerts when an uplink message is received and enables the flight crew to cancel the alert.

- Multipurpose Control and Display Unit (MCDU)
The MCDU enables to manage AOC and ATC functions and data transfer to the DCDU 
- Printer
Datalink messages can be printed, when displayed on the DCDU.
- RMP
The RMP enables frequency tuning.
- ECAM
The ECAM informs about the abnormal operation.

| | |
|---|--|
|  A318/A319/A320/A321 FLIGHT CREW OPERATING MANUAL | AIRCRAFT SYSTEMS INFORMATION SYSTEMS DATALINK - AOC APPLICATIONS |
|---|--|

General

GENERAL

Ident.: DSC-46-10-20-10-00020385.0001001 / 17 MAR 17

Applicable to: ALL

The AOC applications  are datalink applications. The AOC applications enable an exchange of specific messages between the flight crew and the Airline Operational Control (AOC). The AOC applications are customized by each operator and depend on operator's choices and the datalink service provider.

Note: Details about AOC applications cannot be provided due to the wide range of customization by the operator.
 Airbus does not supervise customization of AOC applications. It is recommended to insert AOC application description into this chapter in accordance with AOC applications installed on the aircraft.

The AOC applications can offer the following functions:

| | |
|----------------|--|
| EXAMPLE | <ul style="list-style-type: none"> - Preflight Functions: <ul style="list-style-type: none"> - Flight log - Departure Delay Message - Takeoff Delay Message - Weather Request - NOTAM Request - Loadsheets Request - Others - En-Route Functions: <ul style="list-style-type: none"> - Flight log - Diversion Message - En-route Delay - Estimated Time of Arrival (ETA) Message - Weather Request - NOTAM Request - Others - Postflight Functions: <ul style="list-style-type: none"> - Flight log - Flight summary - Gate delay - Others |
|----------------|--|

The flight crew uses the datalink cockpit interface for the AOC applications.

EXAMPLE

Flight Plan Modification

This flight plan modification example is based on following assumptions:

- The AOC sends a flight plan modification message to the flight crew.
- The flight crew loads the flight plan modification in the FMGS , into the secondary F-PLN.
- The crew obtains ATC clearance before activating the modified flight plan.
- *Refer to DSC-46-10-50 How to Modify FLT Plan for the flight plan modification based on an AOC request.*

MCDU Datalink Pages

ATSU DATALINK

Ident.: DSC-46-10-40-30-00021081.0003001 / 17 MAR 17
Applicable to: ALL



- | | |
|---------------|--|
| [1R] AOC MENU | When selected, the MCDU displays the AOC MENU page. |
| [6R] COMM | When selected, the MCDU displays the COMM MENU page. |

COMM MENU

Ident.: DSC-46-10-40-30-00021090.0003001 / 17 MAR 17
Applicable to: ALL

| | |
|----------------|--|
| EXAMPLE | This is an example of the COMM MENU page. Information, that are displayed on the COMM MENU page and subsequent pages, accessible via the COMM MENU page, depend on datalink customization, selected by each operator for AOC applications. |
|----------------|--|



| | | |
|----------------|---------------------------|---|
| EXAMPLE | [1L] COMM INIT | When selected, the DCDU displays the COMM INIT page. |
| | [2L] VHF3 DATA MODE | When selected, the DCDU displays the VHF3 DATA MODE page. |
| | [3L] VHF3 VOICE DIRECTORY | When selected, the DCDU displays the VHF3 VOICE DIRECTORY page. |
| | [6L] RETURN TO ATSU DLK | When selected, the MCDU displays the ATSU DATALINK page. |
| | [1R] COMM STATUS | When selected, the DCDU displays the COMM STATUS page. |
| | [2R] COMPANY CALL | When selected, the DCDU displays the COMM CONFIG page. |
| | [4R] MAINTENANCE | When selected, the MCDU displays the MAINTENANCE page. |
| | [6R] AUTO PRINT | Sets the auto-print on or off. |

VHF3 SCAN SELECT

Ident.: DSC-46-10-40-30-00021254.0001001 / 17 MAR 17
Applicable to: ALL

| | |
|----------------|---|
| EXAMPLE | This is an example of VHF3 SCAN SELECT pages. Information, that are displayed on the VHF3 SCAN SELECT pages, depend on datalink customization, selected by each operator. |
|----------------|---|

THE VHF 3 SCAN SELECT PAGE 1/4



| | | |
|---------------------|--|---|
| EXAMPLE | [1L] SITA EUR/AF | Selects the SITA Europe/Africa (datalink service provider). |
| | [5L]: NEW SCAN SELECT : | Selects the scan mask. |
| | ACTIVE SEL DISPLAY : | Displays the scan mask used by ATSU. |
| | [6L] RETURN | When selected, the MCDU displays the COMM CONFIG page. |
| | [1R] ARINC EUROPE | Selects the ARINC Europe (datalink service provider). |
| | [2R] ARINC MIDDLE EAST | Selects the ARINC Middle East (datalink service provider). |
| | [3R] ARINC INDIA | Selects the ARINC India (datalink service provider). |
| | [5R] EMPTY SCAN ACTIVATE | Activates an empty scan mask to inhibit VHF datalink communication. |
| [6R] SCAN SEL PRINT | When selected, the printer prints information. | |

THE VHF 3 SCAN SELECT PAGE 2/4



| EXAMPLE | | |
|---------|-----------------------------|---|
| | [1L] SITA PACIFIC | Selects the SITA Pacific (datalink service provider). |
| | [4L] AVICOM JAPAN | Selects the AVCOM Japan (datalink service provider). |
| | [5L]: | |
| | NEW SCAN SELECT : | Selects the scan mask. |
| | ACTIVE SEL DISPLAY : | Displays the scan mask used by ATSU. |
| | [6L] RETURN | When selected, the MCDU displays the COMM CONFIG page. |
| | [1R] ARINC RUSSIA | Selects the ARINC Russia (datalink service provider). |
| | [2R] ARINC ASIA | Selects the ARINC Asia (datalink service provider). |
| | [3R] ARINC AUSTRAL | Selects the ARINC Australia (datalink service provider). |
| | [4R] ARINC KOREA | Selects the ARINC Korea (datalink service provider). |
| | [5R] EMPTY SCAN ACTIVATE | Activates an empty scan mask, in order to inhibit VHF datalink communication. |
| | [6R] SCAN SEL PRINT | When selected, the printer prints information. |

THE VHF 3 SCAN SELECT PAGE 3/4



| | | |
|---------------------|--|---|
| EXAMPLE | [1L] SITA NORTH AM | Selects the SITA North America (datalink service provider). |
| | [2L] SITA SOUTH AM | Selects the SITA South America (datalink service provider). |
| | [3L] DEP V BRASIL | Selects the DEP V Brasil (datalink service provider). |
| | [5L]: NEW SCAN SELECT : | Selects the scan mask. |
| | ACTIVE SEL DISPLAY : | Displays the scan mask used by ATSU. |
| | [6L] RETURN | When selected, the MCDU displays the COMM CONFIG page. |
| | [1R] ARINC AMERICA | Selects the ARINC America (datalink service provider). |
| | [5R] EMPTY SCAN ACTIVATE | Activates an empty scan mask, in order to inhibit VHF datalink communication. |
| [6R] SCAN SEL PRINT | When selected, the printer prints information. | |

THE VHF 3 SCAN SELECT PAGE 4/4

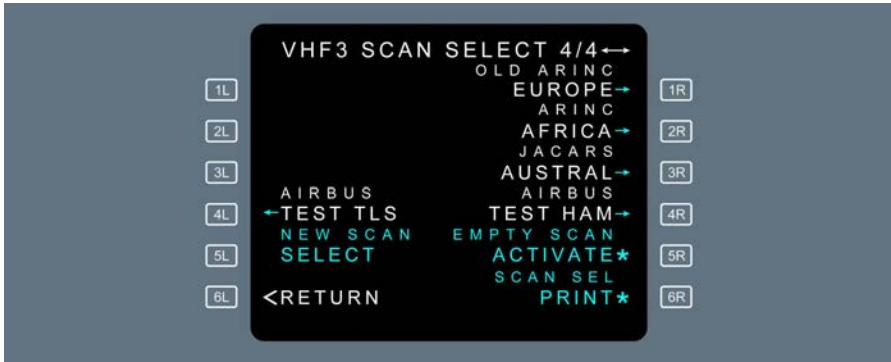

| EXAMPLE | |
|---------|--|
| | [5L]: NEW SCAN SELECT : Selects the scan mask. ACTIVE SEL DISPLAY : Displays the scan mask used by ATSU. |
| | [6L] RETURN When selected, the MCDU displays the COMM CONFIG page. |
| | [1R] OLD ARINC EUROPE Selects the OLD ARINC Europe (datalink service provider). |
| | [2R] ARINC AFRICA Selects the ARINC Africa (datalink service provider). |
| | [3R] JACARS AUSTRAL Selects the JACARS Australia (datalink service provider). |
| | [5R] EMPTY SCAN Activates an empty scan mask, in order to inhibit VHF datalink communication. |
| | [6R] SCAN SEL PRINT When selected, the printer prints information. |

MCDU Scratchpad Messages

MCDU SCRATCHPAD MESSAGES

Applicable to: ALL

Ident.: DSC-46-10-40-10-00021338.0001001 / 17 MAR 17

SCRATCHPAD MESSAGES ON THE COMM MENU PAGE

| MESSAGE | CONDITIONS |
|---------------------------|---|
| COMMAND NOT AVAIL | The command is not available. |
| DEFAULT VHF SP LIST | The new SCAN MASK is not available. The system displays the default SCAN MASK instead. |
| ENTER A/C REGISTR | The aircraft registration number is not valid. To enter this parameter, <i>Refer to DSC-46-10-50 How to Initialize.</i> |
| ENTER A/L ID | The airline identification number is not valid. To enter this parameter, <i>Refer to DSC-46-10-50 How to Initialize.</i> |
| ENTER VHF 3 SCAN MASK | No service provider has been selected. |
| FAILED COMMAND | The command, selected by the flight crew, cannot currently be performed. |
| FORMAT ERROR | The message was entered in an inappropriate format. |
| NOT ALLOWED | It is not permitted to press this key. |
| PRINT FAILED | A print command is not successful. |
| PRT MSG PRINT FAIL | Automatic print of an AOC uplink message was not successful. |
| VHF 3 CAN BE SET IN VOICE | VHF 3 datalink communications are lost. However, VHF 3 can be used in voice mode. |
| VHF 3 SWITCH IMPOSSIBLE | It is not possible to switch from VHF 3 voice mode to VHF 3 data mode. |



A318/A319/A320/A321
FLIGHT CREW
OPERATING MANUAL

AIRCRAFT SYSTEMS
INFORMATION SYSTEMS

DATALINK - CONTROLS AND INDICATORS

Intentionally left blank

ECAM

MEMO DISPLAY

Applicable to: ALL

Ident.: DSC-46-10-40-A-00016906.0001001 / 21 MAR 16

COMPANY ALERT : This memo appears in green when the aircraft receives an uplink alert message, or when an AOC special condition requires a pilot action on the MCDU (depends on AOC programming). This memo pulses green for 180 s, then remains steady. It is associated with a buzzer for 1 s.

Ident.: DSC-46-10-40-A-00016904.0001001 / 21 MAR 16

COMPANY CALL : This memo appears in green when the aircraft receives a message from the ground requesting voice communication on VHF.

Ident.: DSC-46-10-40-A-00016903.0001001 / 21 MAR 16

COMPANY DATALINK STBY : This memo appears in green when AOC datalink air-ground communication is temporarily unavailable, but not lost.

Ident.: DSC-46-10-40-A-00016905.0001001 / 21 MAR 16

COMPANY MSG : This memo appears in green when the aircraft receives a message from the ground.



A318/A319/A320/A321
FLIGHT CREW
OPERATING MANUAL

AIRCRAFT SYSTEMS

INFORMATION SYSTEMS

DATALINK - CONTROLS AND INDICATORS

Intentionally left blank

INTRODUCTION

Ident.: DSC-46-10-50-00021191.0002001 / 17 MAR 17

Applicable to: ALL

How To chapter contains examples of:

- How to initialize the datalink
- How to modify the flight plan.

Illustrations in How To are generic and do not reflect differences depending on the datalink standard installed in the aircraft.

HOW TO INITIALIZE

Ident.: DSC-46-10-50-00021142.0002001 / 17 MAR 17

Applicable to: ALL

Datalink may be initialized:

- Automatically
Datalink initializes automatically, provided that a list of service providers is scanned, and all required parameters are received, and validated by the ATSU.
- Manually
Datalink may be initialized manually, when the system is not correctly initialized automatically.

The VHF3 SCAN SELECT page of the MCDU displays the list of service providers.
The COMM CONFIG / COMM INIT page, on the MCDU displays required parameters.

MANUAL INITIALIZATION

If one of required parameters is not valid, one or more manual entries may be required:

- **If ARN is not valid:**

The MCDU scratchpad displays ENTER A/C REGISTER:

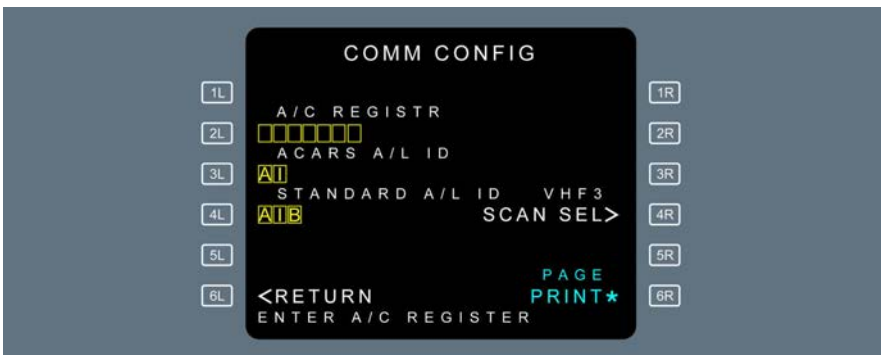

The flight crew clears the scratchpad, and inserts the A/C registration via the MCDU scratchpad.

A/C REGISTR..... INSERT

The flight crew inserts A/C ICAO registration via the MCDU scratchpad to A/C REGISTR.

CONFIG ACTIVATE..... SELECT

The flight crew selects 1R/CONFIG ACTIVATE to activate manual entry of the A/C registration.

● **If the A/L ID is not valid:**

The MCDU scratchpad displays ENTER A/L IDENT:

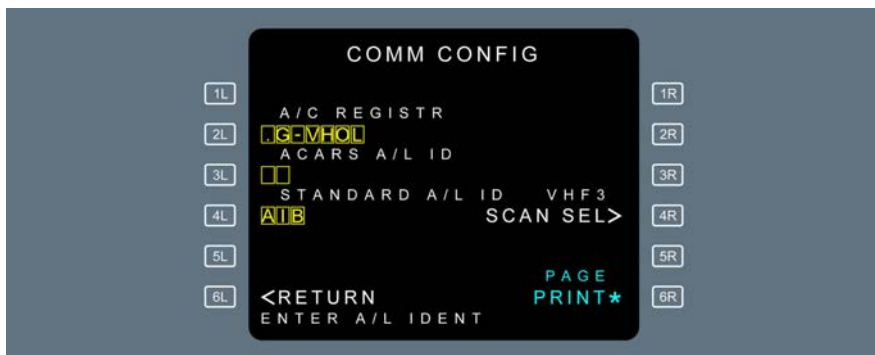

The flight crew clears the scratchpad, and inserts the two-letter A/L ID code via the MCDU scratchpad.

A/L ID..... INSERT

The flight crew inserts A/L ID code via the MCDU scratchpad to A/L ID.

CONFIG ACTIVATE..... SELECT

The flight crew selects 1R/CONFIG ACTIVATE to activate manual entry of the A/C registration.

● **If VHF service provider is not selected**

and

if the VHF3 SCAN/MASK SELECT menu can be accessed:

The MCDU scratchpad displays ENTER VHF3 SCAN SELECT:



On the VHF3 SCAN SELECT page, select service providers, in the airline priority order, and activate the VHF SCAN SELECT function.



EXAMPLE OF SELECTION OF DATALINK SERVICE PROVIDERS:

Selection of SITA 725 and ARINC service providers :

1. Press 5L key: The asterisk next to SELECT indication disappears, then reappears.
2. Press 1L key to select SITA 725: SELECT indication goes off, and the priority number of selection 1 appears.
3. Press 1R key to select ARINC: SELECT indication goes off, and the priority number of selection 2 appears.
4. Press 5R key to activate the VHF SCAN SELECT function: The star next to SCAN SELECT ACTIVATE indication disappears, then reappears.

Note: Modification of the SCAN SELECT setting may result in the loss of air-ground VHF datalink communication, and the increase of datalink service provider charges. Therefore, the SCAN SELECT setting should not be modified by the flight crew, unless the flight crew is instructed to do so.

HOW TO MODIFY FLT PLAN

Ident.: DSC-46-10-50-00021153.0001001 / 21 MAR 17

Applicable to: ALL

● **When the scratchpad (1) displays the AOC SEC F-PLN UPLINK message:**

● **On the MCDU:**

SEC INDEX Page:

AOC F-PLN INSERT.....SELECT See (2)

The flight plan is inserted in the secondary F-PLN See (3).

The flight can review and modify the flight plan.

SEC F-PLN REQ DISPLAY.....SELECT See (4)

 *The DCDU automatically displays a datalink message See (5).*

 *The flight crew sends the message to the ATC from the DCDU.*



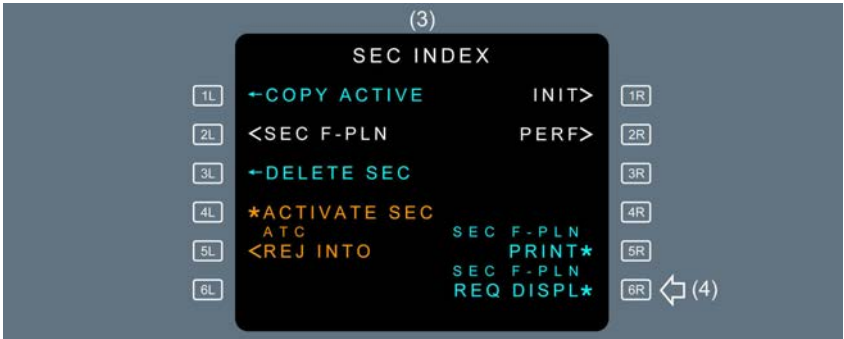

● **When ATC clearance is received:**

● **On the glareshield:**

ATC MSG pb..... PRESS
The aural and visual alerts stop.

● **On the DCDU:**

STBY..... SELECT See (1)

L2 The message status changes to STBY on a blue background See (2).

L1 SEND.....SELECT See (3)

L2 The background color of the STBY message status changes to green.

L1 LOAD.....SELECT See (4)

LOAD must be selected. Other selection may prevent loading of the clearance.

The LOAD SEC OK displays in the information field of the DCDU, if loading is successful.

L2 The flight crew can review the clearance on the MCDU, in SEC F-PLN pages.

L1



■ **If the flight crew accepts the clearance:**

WILCO.....SELECT See (5)

The flight crew can activate the secondary F-PLN.

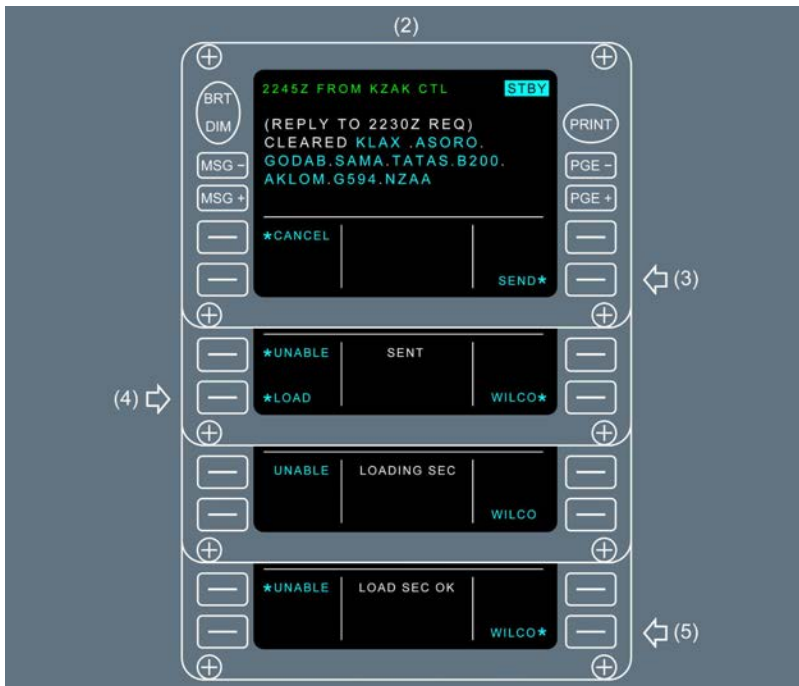

■ **If the flight crew decides to modify the clearance:**

- The flight crew loads the clearance into the SEC F-PLN , on the MCDU and modifies it.
- The flight crew rejects the clearance by selecting UNABLE on the DCDU.
- The flight crew sends a new request (with the modified F-PLN) to the ATC.



A318/A319/A320/A321
FLIGHT CREW
OPERATING MANUAL

AIRCRAFT SYSTEMS
INFORMATION SYSTEMS

DATALINK - HOW TO

Intentionally left blank

INTRODUCTION

Ident.: DSC-46-20-20-00021223.0001001 / 25 JUL 17

Applicable to: ALL

The FlySmart with Airbus application suite is composed of:

- TAKEOFF application
- LANDING application
- LOADSHEET application
- IN-FLIGHT application (available on the latest FlySmart with Airbus applications for Windows version)
- Operational Documentation applications (OLB)
- Manager application (available for iPad version).

The FlySmart with Airbus application suite is designed to:

- Improve access to flight crew's operational information
- Reduce the quantity of paper documents in the cockpit by replacing them with electronic documents
- Enable reduced revision and distribution cycles to ensure better technical data accuracy
- Ease and improve the operational data updating process
- Provide an accurate and optimized computation of performance.

The FlySmart with Airbus application suite can be used by the flight crew on a Portable Electronic Device (PED). The flight crew can use the power outlets  (110 VAC / 60 Hz) installed on each lateral console to plug their PED.

Note: The power outlets (115 VAC / 400 Hz) located on the rear of the cockpit are for maintenance use only.

GENERAL

Ident.: DSC-46-20-20-00021224.0001001 / 20 MAR 17

Applicable to: ALL

The My Flight page enables:

- To check that FlySmart with Airbus applications are up to date. The My Flight page provides the version of the installed applications and data (EFB version)
- To start the Manager application, that enables to update the operational data (performance, manuals)
- To initialize the applications with the applicable aircraft tail number, flight number and citypair. This avoids multiple entries of the same data in the different applications.

There is one My Flight page per application. All the inputs that the user has entered on one My Flight page are retrieved by the other applications.

Note: On the My Flight page of OLB application, the user can only enter the a/c type and a/c registration.

LANDING APPLICATION

Ident.: DSC-46-20-20-00021225.0001001 / 20 MAR 17

Applicable to: ALL

The Landing application aims at computing the landing performance data (maximum landing weight, approach speed) according to the aircraft configuration and external conditions (runway, surrounding obstacles, weather).

The Landing application allows straightforward computations and provides the optimized landing performance for the given conditions.

TAKEOFF APPLICATION

Ident.: DSC-46-20-20-00021226.0001001 / 20 MAR 17

Applicable to: ALL

The Takeoff application aims at computing the takeoff performance data (maximum takeoff weight, takeoff speeds, flexible temperature) according to the aircraft configuration and external conditions (runway, surrounding obstacles, weather).

The Takeoff application allows straightforward computations and provides the optimized takeoff performance for the given conditions.

LOADSHEET APPLICATION

Ident.: DSC-46-20-20-00021227.0001001 / 20 MAR 17

Applicable to: ALL

The Loadsheets application allows the flight crew users to prepare the aircraft loading and to check that all weights and CG remain within the loading operational envelope. This eases the computation of the ZFWCG, ZFW, TOW and TOCG, and enables last-minute changes to the passenger/cargo/fuel distribution.

Depending on airline's authority requirements, the Loadsheets application can also generate a load and trim sheet.

OPS LIBRARY APPLICATION

Ident.: DSC-46-20-20-00021228.0001001 / 20 MAR 17

Applicable to: ALL

The OLB application enables the onboard consultation of any flight operations document published in the relevant format (e.g. airline's manuals), including the ones delivered by Airbus (FCOM, MEL, AFM, CDL, FCTM).



A318/A319/A320/A321
FLIGHT CREW
OPERATING MANUAL

AIRCRAFT SYSTEMS
INFORMATION SYSTEMS

ELECTRONIC FLIGHT BAG (EFB) - APPLICATIONS

MEL and CDL items (including missing items) selected on OLB application are automatically transferred to Takeoff and Landing applications.

MANAGER APPLICATION

Ident.: DSC-46-20-20-00021229.0001001 / 20 MAR 17

Applicable to: **ALL**

The Manager application aims at updating on the iPad the operational data used by FlySmart with Airbus applications for iPad: performance data and operational manuals.



A318/A319/A320/A321
FLIGHT CREW
OPERATING MANUAL

AIRCRAFT SYSTEMS

INFORMATION SYSTEMS

ELECTRONIC FLIGHT BAG (EFB) - APPLICATIONS

Intentionally left blank



A318/A319/A320/A321
FLIGHT CREW
OPERATING MANUAL

AIRCRAFT SYSTEMS
INFORMATION SYSTEMS
ELECTRONIC QRH (EQRH)

GENERAL

Ident.: DSC-46-30-00021515.0001001 / 17 MAR 17

Applicable to: ALL

The electronic QRH (eQRH) is an EFB application that enables the flight crew to:

- Manage the Normal Checklists and some Abnormal Procedures
- Access to some important operational data (OEBs, system architectures, performance...)

The eQRH has several main interfaces:

- My Aircraft page:

The My Aircraft page enables:

- To check that the eQRH application is up to date. The My Aircraft page provides the version of the installed application and data (EFB version)
- To initialize the eQRH application with the applicable aircraft tail number. The My Aircraft page retrieves automatically the aircraft tail number when defined in other FlySmart with Airbus applications

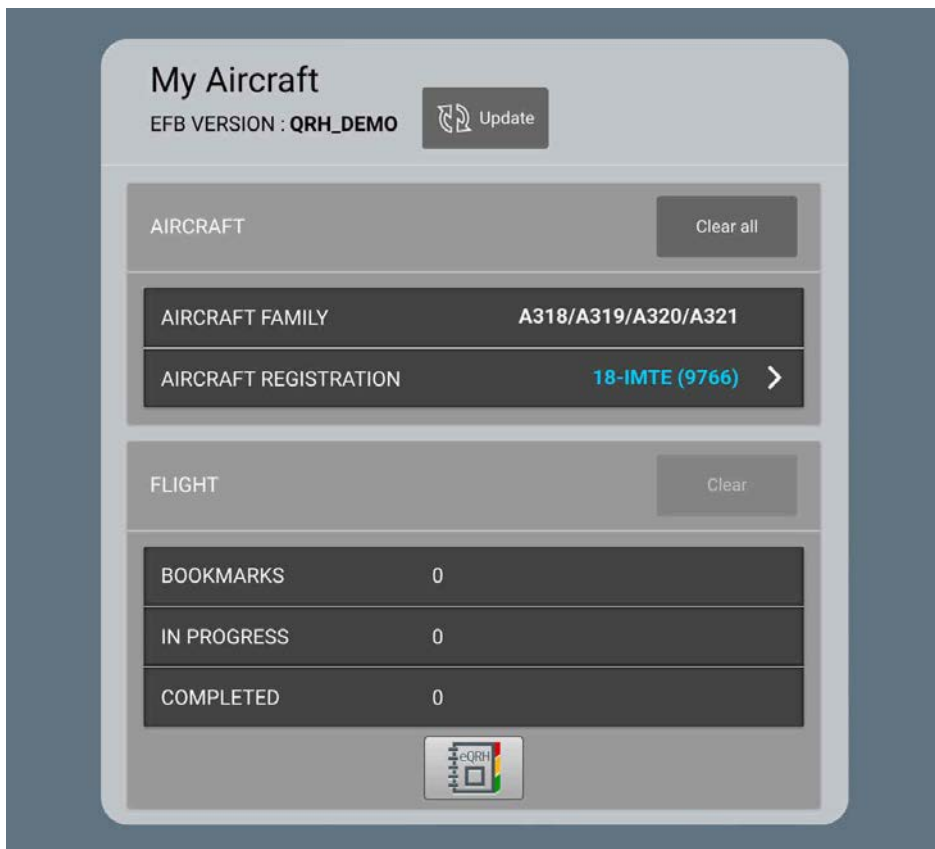

- EFB version:

If required, each flight crew member compares the EFB version with the valid version information that is given as reference by the airline. This ensures that the eQRH application and the data installed on their devices correspond to the latest updated version, provided by their airline's flight operations.

- eQRH application:

The eQRH application enables the pilot to manage the normal checklists and non-sensed Abnormal Procedures. It also gives access to some important operational data that may be required during the flight.

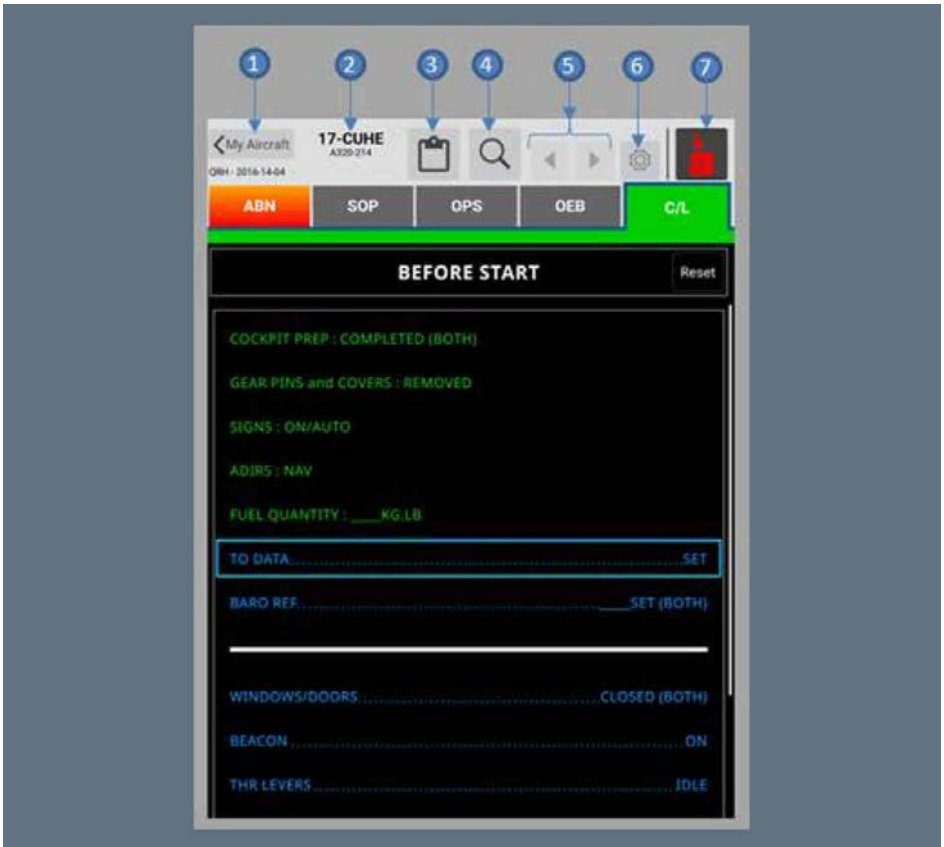

- (1) Access to My Aircraft page
- (2) Aircraft tail number and type
- (3) Working list

- (4) Search
- (5) Previous/Next Navigation
- (6) eQRH options
- (7) Rapid Access

| | |
|---|---|
|  A318/A319/A320/A321 FLIGHT CREW OPERATING MANUAL | AIRCRAFT SYSTEMS INFORMATION SYSTEMS PAX ENTERTAINMENT & CONNECTIVITY SYSTEMS (IF INSTALLED) - GENERAL |
|---|---|

GENERAL

Ident.: DSC-46-40-10-00017604.0001001 / 21 MAR 16

Applicable to: ALL

The aircraft is equipped with cabin connectivity systems which enable passengers to use:

- Mobile phones for voice and data services, and/or
- Internet wireless connection for access to the World Wide Web

The use of mobile phones is prohibited in cockpit and lavatories.

The following table provides the list of controls dedicated to Pax Entertainment & Connectivity Systems:

| P/B  | EQUIPMENTS (FUNCTIONS) | DESCRIPTIONS |
|---|--|---|
| GALLEY | Mobile, Wifi, IFE | <i>Refer to DSC-24-20 Overhead Panel</i> |
| COMMERCIAL | Mobile, Wifi, IFE | <i>Refer to DSC-24-20 Overhead Panel</i> |
| NO PED | Signs | <i>Refer to DSC-33-40-10 Overhead Panel</i> |
| PAX SYS | Mobile, Wifi, IFE, Seat actuators, PED | <i>Refer to DSC-46-40-30 PAX SYS PB-SW</i> |
| PAX PERSONAL ELEC SPLY | Mobile, Wifi, IFE, Seat actuators, PED | <i>Refer to DSC-46-40-30 PAX PERSONAL ELEC SPLY PB-SW</i> |
| MOBILE COM | Mobile, Wifi | <i>Refer to DSC-46-40-30 MOBILE COM PB-SW</i> |
| CINS reset | Mobile, Wifi | <i>Refer to DSC-46-40-30 CINS RESET PB</i> |



A318/A319/A320/A321
FLIGHT CREW
OPERATING MANUAL

AIRCRAFT SYSTEMS

INFORMATION SYSTEMS

PAX ENTERTAINMENT & CONNECTIVITY
SYSTEMS (IF INSTALLED) - GENERAL

Intentionally left blank

IN SEAT POWER SUPPLY SYSTEM ◀

Ident.: DSC-46-40-20-00017606.0001001 / 10 NOV 15

Applicable to: ALL

The In-Seat Power Supply System (ISPSS) provides electrical power to the In-Seat Power Supply Unit (ISPSU) outlets, and enables passengers to use Portable Electronic Devices (PED) and the In-Flight Entertainment (IFE) system.

It is possible for the flight crew to simultaneously disconnect power from all ISPSUs, In-Flight Entertainment (IFE) and Cabin Connectivity systems, via the PAX SYS pb-sw or the PAX PERSONAL ELEC SPLY pb-sw.

In the case of rapid cabin decompression, both the ISPSS and IFE system are automatically disconnected.



A318/A319/A320/A321
FLIGHT CREW
OPERATING MANUAL

AIRCRAFT SYSTEMS

INFORMATION SYSTEMS

PAX ENTERTAINMENT & CONNECTIVITY SYSTEMS
(IF INSTALLED) - IN SEAT POWER SUPPLY SYSTEM

Intentionally left blank

MOBILE COM PB-SW 

Ident.: DSC-46-40-30-00017631.0001001 / 19 APR 16

Applicable to: ALL

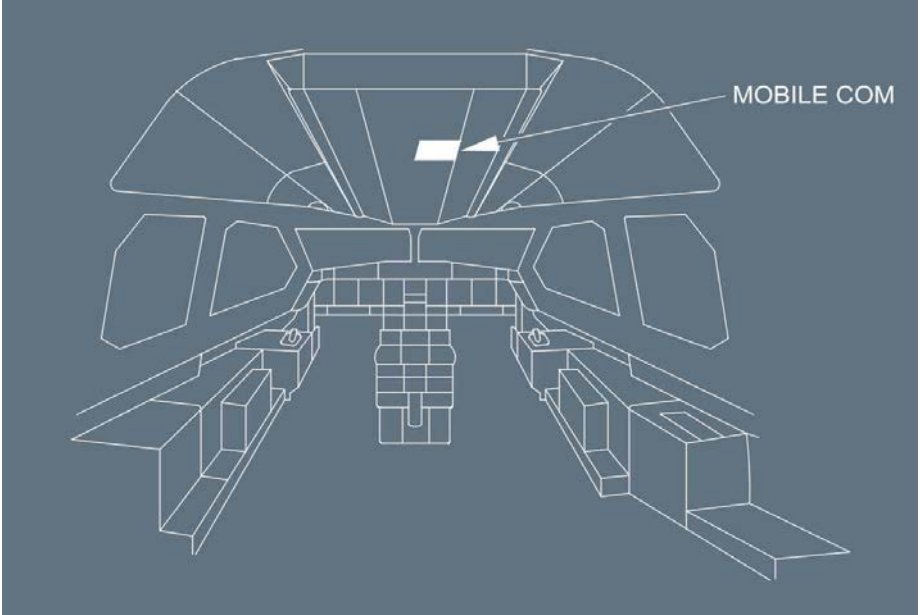

The pushbutton-switch described here below is installed on the 45 VU panel on the overhead panel.



- ON : The mobile phone system is activated.
- OFF : The mobile phone system is deactivated.

Note: When the pushbutton is released, the OFF light comes on in white however the system takes approximately 4 min to disconnect. During this disconnection process, the passengers can use their mobile phones.

DISC IN PROG LIGHT ◀

Ident.: DSC-46-40-30-00019278.0001001 / 21 MAR 17

Applicable to: **ALL**

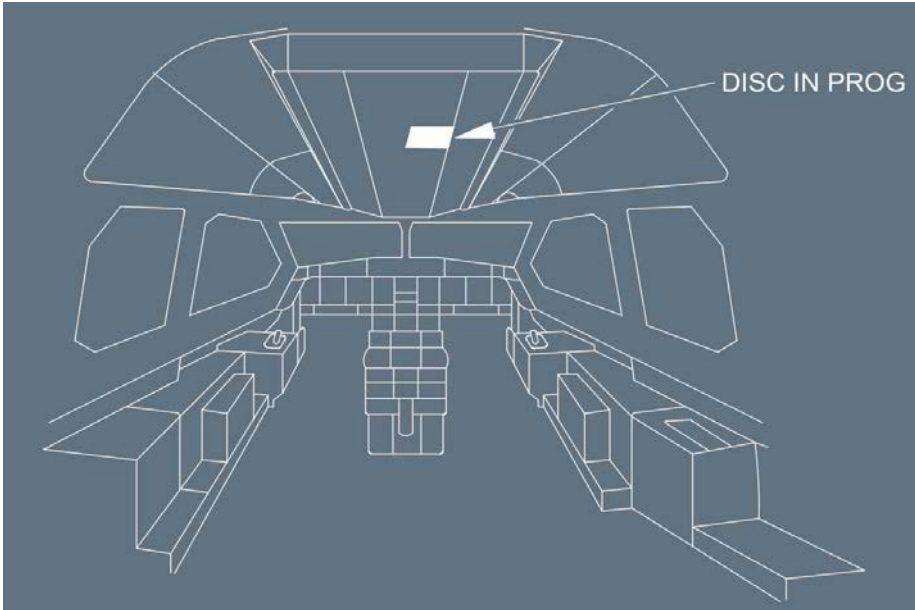

The pushbutton-switch described here below is installed on the 45 VU panel on the overhead panel.



Note: After the release of Mobile Com pushbutton, the DISC IN PROG light comes in blue and remains on until the total disconnection of the system.

CINS RESET PB ◀

Ident.: DSC-46-40-30-00017630.0001001 / 10 NOV 15

Applicable to: ALL

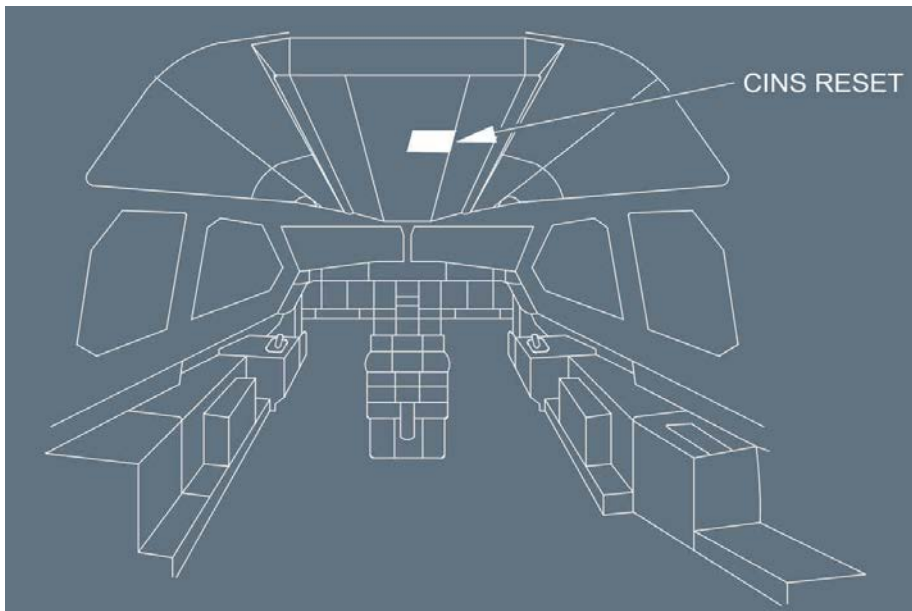

The pushbutton-switch described here below is installed on the 45 VU panel on the overhead panel.



When pressed, it resets all Cabin Connectivity systems.

PAX COM PB-SW 

Ident.: DSC-46-40-30-00021654.0001001 / 02 MAY 17

Applicable to: **ALL**

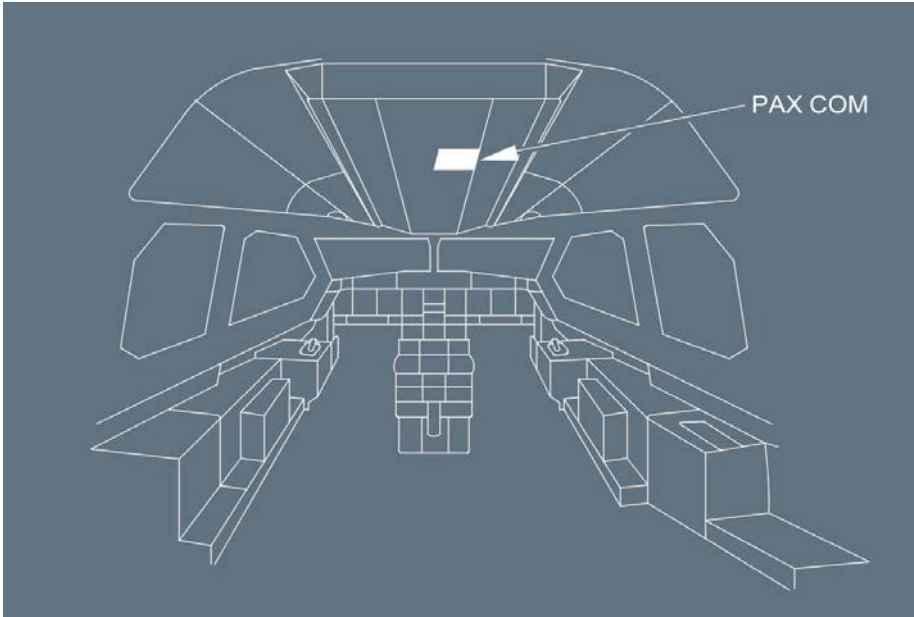

The pushbutton-switch described here below is installed on the 45 VU panel on the overhead panel.



OFF : The Cabin Connectivity system is cut-off. When the pushbutton-switch is released, the OFF light comes on in white.

PAX SYS PB-SW 

Ident.: DSC-46-40-30-00017735.0001001 / 10 NOV 15

Applicable to: ALL

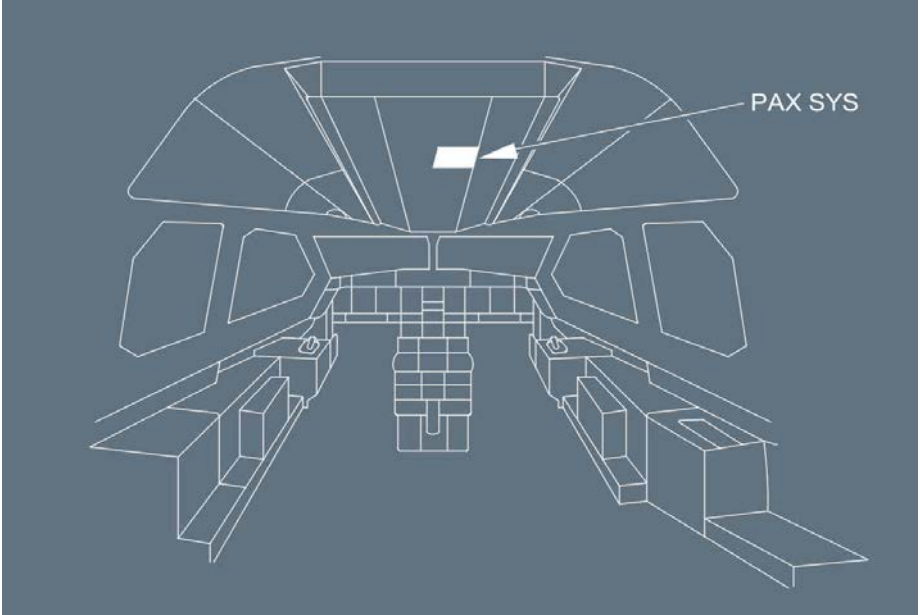

The pushbutton-switch described here below is installed on the 56VU panel on the overhead panel.



- AUTO** : All ISPSUs, In-Flight Entertainment (IFE) and Cabin Connectivity systems are powered.
- OFF** : Simultaneously turns off all ISPSUs, In-Flight Entertainment (IFE) and Cabin Connectivity systems.

PAX PERSONAL ELEC SPLY PB-SW 

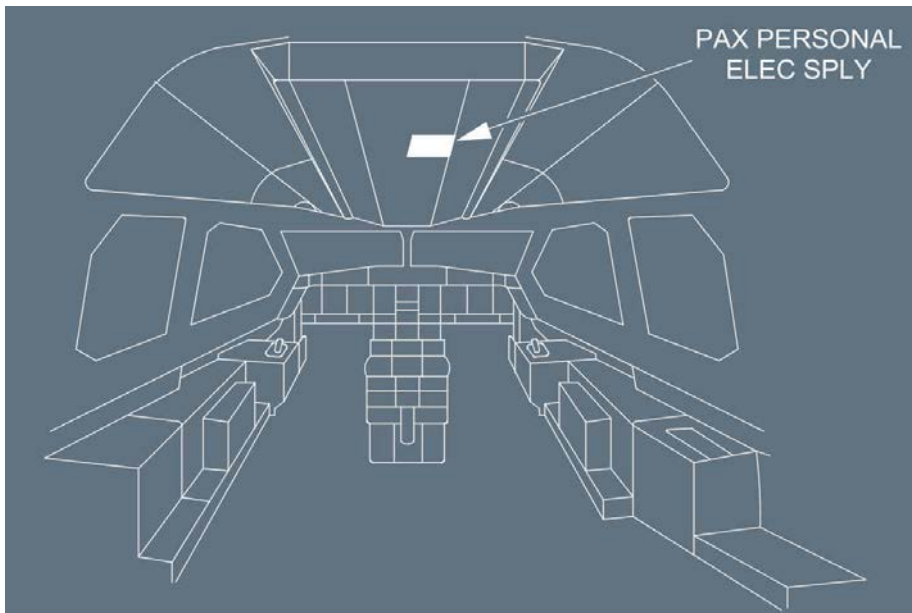

Ident.: DSC-46-40-30-00017629.0001001 / 21 MAR 17

Applicable to: **ALL**



The pushbutton-switch described here below is installed on the 56VU panel on the overhead panel.



- AUTO  : All ISPSUs, In-Flight Entertainment (IFE) and Cabin Connectivity systems are powered, if the pushbutton-switch located in the forward cabin is also in the on position
- OFF : Simultaneously turns off all ISPSUs, In-Flight Entertainment (IFE) system and Cabin Connectivity systems.
- INOP  : This label indicates that the ISPSS has been deactivated and is inoperative.



A318/A319/A320/A321
FLIGHT CREW
OPERATING MANUAL

AIRCRAFT SYSTEMS

INFORMATION SYSTEMS

PAX ENTERTAINMENT & CONNECTIVITY SYSTEMS
(IF INSTALLED) - CONTROLS AND INDICATORS

MEMO DISPLAY

Ident.: DSC-46-40-30-00017628.0001001 / 10 NOV 15

Applicable to: ALL

“GSM DISC < 4 MN” : This memo appears in green, if the cockpit switch “Mobile Com” is pushed. It initiates a shutdown of the Cabin Connectivity systems within 4 minutes. The message disappears when the shutdown is completed.



A318/A319/A320/A321
FLIGHT CREW
OPERATING MANUAL

AIRCRAFT SYSTEMS

INFORMATION SYSTEMS

PAX ENTERTAINMENT & CONNECTIVITY SYSTEMS
(IF INSTALLED) - CONTROLS AND INDICATORS

Intentionally left blank

AIRCRAFT SYSTEMS

APU

Intentionally left blank

DSC-49-10 Description

DSC-49-10-10 General

General.....A

DSC-49-10-20 Main Components

APU Engine.....A
Electronic Control Box.....B
Air Intake System.....C
Starter.....D
Fuel System.....E
Oil System.....F
Inlet Guide Vanes (IGV).....G
Air Bleed System.....H
Controls.....I
Ground Operation Safety Devices.....J

DSC-49-20 Controls and Indicators

Overhead Panel.....A
External Controls.....B
ECAM APU Page.....C
Memo Display.....D



A318/A319/A320/A321
FLIGHT CREW
OPERATING MANUAL

AIRCRAFT SYSTEMS

APU

PRELIMINARY PAGES - TABLE OF CONTENTS

Intentionally left blank

| | |
|---|--|
|  <p>A318/A319/A320/A321 FLIGHT CREW OPERATING MANUAL</p> | <p align="center">AIRCRAFT SYSTEMS</p> <p align="center">APU</p> <p align="center">DESCRIPTION - GENERAL</p> |
|---|--|

GENERAL

Applicable to: ALL

Ident.: DSC-49-10-10-A-00017436.0001001 / 21 MAR 17

The Auxiliary Power Unit (APU) is a self-contained unit that supplies the aircraft with pneumatic and electrical power.

On the ground

- It supplies bleed air for starting the engines and for the air conditioning system
- It supplies electrical power to the electrical system.

During takeoff

- It supplies bleed air for air conditioning (for example, when optimum aircraft performance is required).

In flight

- It backs up the electrical system
- It backs up the air conditioning
- It can be used to start the engines.

The APU may obtain power for starting from the aircraft's batteries or normal electrical system, or from ground service.

APU starting is permitted throughout the normal flight envelope (*Refer to LIM-APU Operational Envelope*).

Ident.: DSC-49-10-10-A-00017437.0002001 / 21 MAR 16

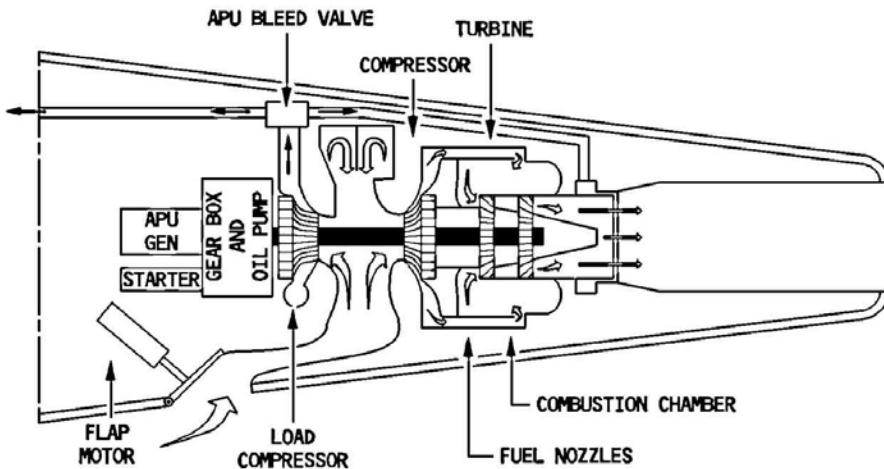

APU ENGINE

Ident.: DSC-49-10-20-00001528.0001001 / 21 MAR 16

Applicable to: ALL

The basic element of the APU is a single-shaft gas turbine that delivers mechanical shaft power for driving the accessory gearbox (electrical generator, starter, etc.) and produces bleed air (engine starting and pneumatic supply).

ELECTRONIC CONTROL BOX

Ident.: DSC-49-10-20-00001529.0001001 / 21 MAR 16

Applicable to: ALL

The Electronic Control Box (ECB) is a full-authority digital electronic controller that performs the bulk of the APU system logic for all modes of engine operation, such as :

- Sequences the start and monitors it.
- Monitors speed and temperature.
- Monitors bleed air.
- Sequences the shutdown.
- Controls the automatic shutdown.

AIR INTAKE SYSTEM

Ident.: DSC-49-10-20-00001530.0001001 / 21 MAR 16

Applicable to: ALL

The air intake and an electrically operated flap allow external air to reach the compressor inlet.

STARTER

Ident.: DSC-49-10-20-00001531.0001001 / 21 MAR 16

Applicable to: ALL

The ECB controls the electric starter. The starter engages if the air intake is fully open and the MASTER SW and the START pushbutton are ON.

FUEL SYSTEM

Ident.: DSC-49-10-20-00001532.0001001 / 21 MAR 16

Applicable to: ALL

The left fuel feed line supplies the APU.

The required pressure is normally available from tank pumps.

If pressure is not available (batteries only or pumps off) the APU FUEL PUMP starts automatically.

The ECB controls the fuel flow.

AIRCRAFT SYSTEMS

APU

DESCRIPTION - MAIN COMPONENTS

OIL SYSTEM

Ident.: DSC-49-10-20-00001533.0001001 / 21 MAR 16

Applicable to: ALL

The APU has an integral independent lubrication system (for lubrication and cooling).

INLET GUIDE VANES (IGV)

Ident.: DSC-49-10-20-00001534.0001001 / 21 MAR 16

Applicable to: ALL

The IGVs control bleed air flow, and a fuel-pressure-powered actuator positions the IGVs. The ECB controls the actuator in response to aircraft demand.

AIR BLEED SYSTEM

Ident.: DSC-49-10-20-00001535.0002001 / 03 FEB 11

Applicable to: ALL

The air bleed system is fully automatic.
The APU speed is always 100 % whatever the air bleed system demand and the ground/flight configuration are.

CONTROLS

Ident.: DSC-49-10-20-00001536.0001001 / 21 MAR 16

Applicable to: ALL

The flight crew uses the controls on the APU panel for routine shutdown. For emergency shutdown :

- the flight crew can push the APU FIRE handle, or
- the ground crew can push the APU SHUT OFF pushbutton on the interphone panel under the nose fuselage.

GROUND OPERATION SAFETY DEVICES

Ident.: DSC-49-10-20-00001537.0001001 / 21 MAR 16

Applicable to: ALL

The APU may run without cockpit crew supervision when the aircraft is on the ground. In case of fire in the APU compartment :

- APU fire warnings operate in the cockpit.
- A horn in the nose gear bay sounds.
- The AVAIL light goes out.
- The FAULT light in the MASTER SW lights up.

- The APU shuts down.
- The APU fire extinguisher discharges.



A318/A319/A320/A321
FLIGHT CREW
OPERATING MANUAL

AIRCRAFT SYSTEMS

APU

DESCRIPTION - MAIN COMPONENTS

Intentionally left blank

OVERHEAD PANEL

Applicable to: ALL

Ident.: DSC-49-20-A-00017438.0001001 / 21 MAR 16

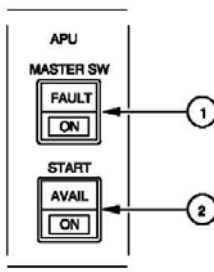

Ident.: DSC-49-20-A-00017685.0003001 / 21 MAR 16

(1) MASTER SW pb-sw

This switch controls the electric power supply for the operation of the APU and its protective features. It also controls the starting and shutdown sequences.

- ON** : The blue ON light comes on.
Electric power goes to the APU system; the ECB performs a power-up test.
The APU air intake flap opens.
The APU fuel isolation valve opens.
If no fuel tank pump is running, the APU fuel pump operates.
If the aircraft has ground power or main generator power, the APU page appears on the ECAM display.
- OFF** : Manual shutdown sequence.
- The ON light on the MASTER SW pb-sw, and the AVAIL light on the START pb go out.
 - If the aircraft was using APU bleed air, the APU keeps running for a cooling period of 60 to 120 s.
 - At 7 % the air inlet flap closes.

FAULT It : Depending on version of the ECB , this amber light comes on, and a caution appears on ECAM, when an automatic APU shutdown occurs, which can happen in case of:

- Fire (on ground only)
- Air inlet flap closed
- Overspeed
- No acceleration
- Slow start
- EGT overtemperature
- No flame
- Reverse flow
- Low oil pressure
- High oil temperature
- DC power lost (BAT OFF when aircraft on batteries only)
- Overcurrent
- Sensor failure
- IGV failure
- ECB failure
- No speed
- Underspeed
- Loss of overspeed protection
- Oil system shutdown
- Inlet overheat
- Clogged oil filter
- Loss of EGT thermocouples

Note: *In the case of an automatic, non-emergency shutdown, the air inlet flap closes 15 min after the APU speed is lower than 7%. If an automatic, non-emergency shutdown happens on ground, the 15 min countdown starts after liftoff.*

Ident.: DSC-49-20-A-00017439.0002001 / 21 MAR 16

(2) START pb-sw

- ON :** Blue ON light comes on.
- When the flap is completely open, the APU starter is energized.
 - 1.5 s after the starter is energized, the ignition is turned ON.
 - When N = 55 %. The APU starter is de-energized. The ignition is turned off.
 - 2 s after N reached 95 %, or when N is above 99.5 %:
 The ON light on the START pb goes out.
 The APU may now supply bleed air and electrical power to the aircraft systems.
 - 10 s later, the APU page disappears from the ECAM display.

AVAIL It : This green light comes on when N is above 99.5 % or 2 s after N reaches 95 %.



A318/A319/A320/A321
FLIGHT CREW
OPERATING MANUAL

AIRCRAFT SYSTEMS

APU

CONTROLS AND INDICATORS

EXTERNAL CONTROLS

Ident.: DSC-49-20-00001539.0001001 / 21 MAR 16

Applicable to: ALL

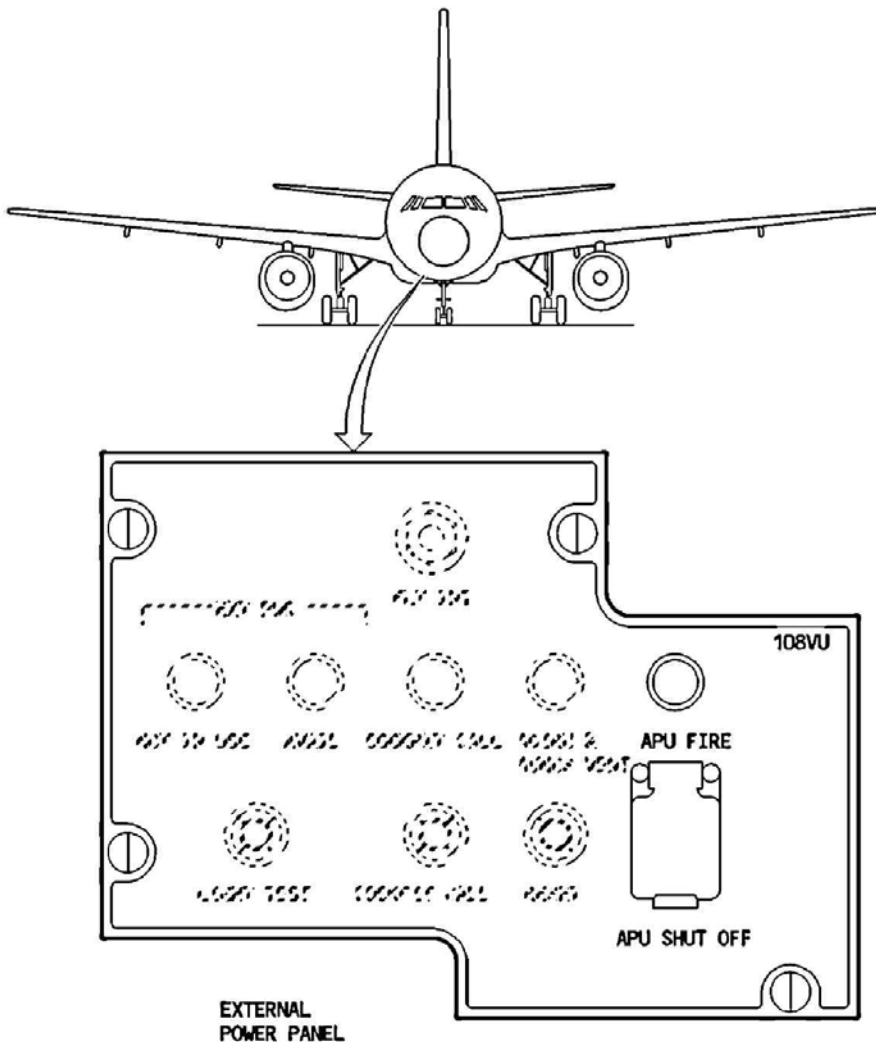

ECAM APU PAGE

Applicable to: ALL

Ident.: DSC-49-20-B-00017440.0001001 / 21 MAR 16

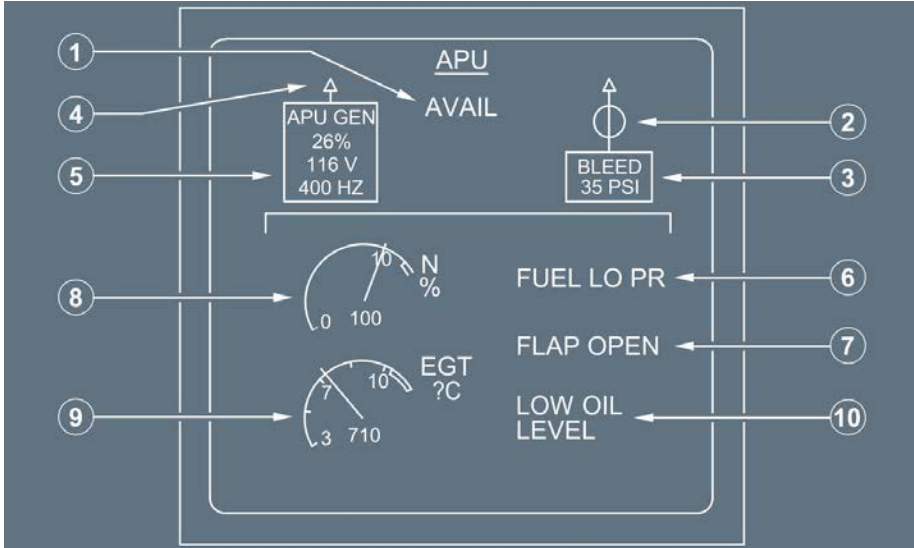

Ident.: DSC-49-20-B-00017441.0002001 / 21 MAR 16

(1) AVAIL

Displayed in green when APU N is above 99.5 % or 2 s after N is above 95 %.

Ident.: DSC-49-20-B-00017442.0001001 / 21 MAR 16

(2) APU bleed air valve position

- Inline-Green : The APU bleed air valve is not closed.
- Crossline-Green : The APU bleed air valve is closed.
- Crossline-Amber : The APU bleed air valve is closed and the APU bleed is ON.
- XX-Amber : The APU bleed air valve status information is not available, or the APU BLEED pb status is not available.

Ident.: DSC-49-20-B-00017443.0001001 / 21 MAR 16

(3) APU bleed air pressure

This box displays the relative bleed air pressure in green.

It shows an amber XX when the ADIRS 1 or the ADIRS 2 is not available or selected OFF or the data from the ECB are invalid or not transmitted.

Ident.: DSC-49-20-B-00017444.0001001 / 21 MAR 16

(4) APU GEN line contactor indication

Displayed in green when the APU GEN line contactor is closed.

Ident.: DSC-49-20-B-00017445.0001001 / 21 MAR 16

(5) APU GEN parameters

Identical to the APU GEN parameters on the ELEC page.

Ident.: DSC-49-20-B-00017446.0001001 / 21 MAR 16

(6) FUEL LO PR

Displayed in amber if APU fuel pressure gets low.

Ident.: DSC-49-20-B-00017447.0003001 / 21 MAR 16

(7) FLAP OPEN

- Displayed in green when APU air intake flap is fully open.
- Advisory if the flap is not fully closed 3 min after the MASTER sw has been turned OFF.

Ident.: DSC-49-20-B-00017448.0001001 / 21 MAR 16

(8) APU N

- Displays APU speed in green.
- Becomes amber when $N \geq 102\%$.
- Becomes red when $N \geq 107\%$.

Ident.: DSC-49-20-B-00017449.0002001 / 06 SEP 16

(9) APU EGT

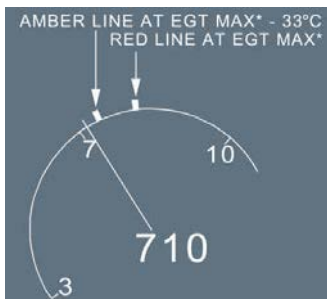

- Displays APU EGT in green.
- Becomes amber when $EGT \geq EGT\ MAX - 33\ ^\circ C$.
- Becomes red when $EGT \geq EGT\ MAX$ (automatic shutdown begins).

Note: ECB calculates EGT MAX and transmits it to the ECAM . It is a function of N during start, and a function of ambient temperature when the APU is running.

Maximum EGT during start: 982 °C.

Maximum EGT with APU running:

- 682 °C during at least 5 s.
- or, 700 °C to 742 °C depending on the ambient temperature.

Ident.: DSC-49-20-B-00017450.0001001 / 21 MAR 16

(10) LOW OIL LEVEL

Advisory: Displayed if the ECB detects a low APU oil level when the aircraft is on the ground, and the APU is not running.

MEMO DISPLAY

Ident.: DSC-49-20-00016689.0001001 / 21 MAR 16

Applicable to: **ALL**

APU AVAIL : This memo appears in green, when APU N is above 99.5 % or 2 s after N is above 95 % (depending on the aircraft configuration).

AIRCRAFT SYSTEMS

DOORS

Intentionally left blank

DSC-52-10 Description

DSC-52-10-10 General

Description..... A

DSC-52-10-20 Passenger Doors

General..... A

Outside..... B

Inside..... C

DSC-52-10-30 Emergency Exits

Cockpit..... A

Cabin..... B

DSC-52-10-40 Cargo Doors

General..... A

Fwd and Aft Cargo Doors..... B

Bulk Cargo Door ..... C

Location of Service Panels..... D

DSC-52-10-50 Avionics Compartment Access Door

Avionics Compartment Access Door..... A

DSC-52-10-60 Cockpit Door

Cockpit Door..... A

DSC-52-10-80 Escape Slides/Rafts

Door Slides..... A

Wing Slides..... B

Escape Slide Arrangement..... C

DSC-52-20 Controls and Indicators

DOOR/OXY SD Page..... A

DSC-52-40 Cockpit Door Security System

DSC-52-40-10 Description

Cockpit Door Description..... A

DSC-52-40-20 Cockpit Door Locking System (CDLS)

COCKPIT DOOR LOCKING SYSTEM (CDLS)..... A

Controls..... B

Continued on the following page

Continued from the previous page

DSC-52-40-30 Cockpit Door Surveillance System (CDSS)

General.....A
Controls.....B

DSC-52-50 How to

How to Operate the Cockpit Door A
How to Operate the Fwd and Aft Cargo Door..... B
How to Operate the Fwd and Aft Cargo Doors (Auxiliary Operation)..... C

DESCRIPTION

Ident.: DSC-52-10-10-00001544.0002001 / 22 MAY 12

Applicable to: ALL

The A320's fuselage has:

- Four passenger doors
- Four emergency exits in the cabin
- Cockpit emergency exits (two sliding windows)
- Three cargo compartment doors
- Four avionic compartment access doors.

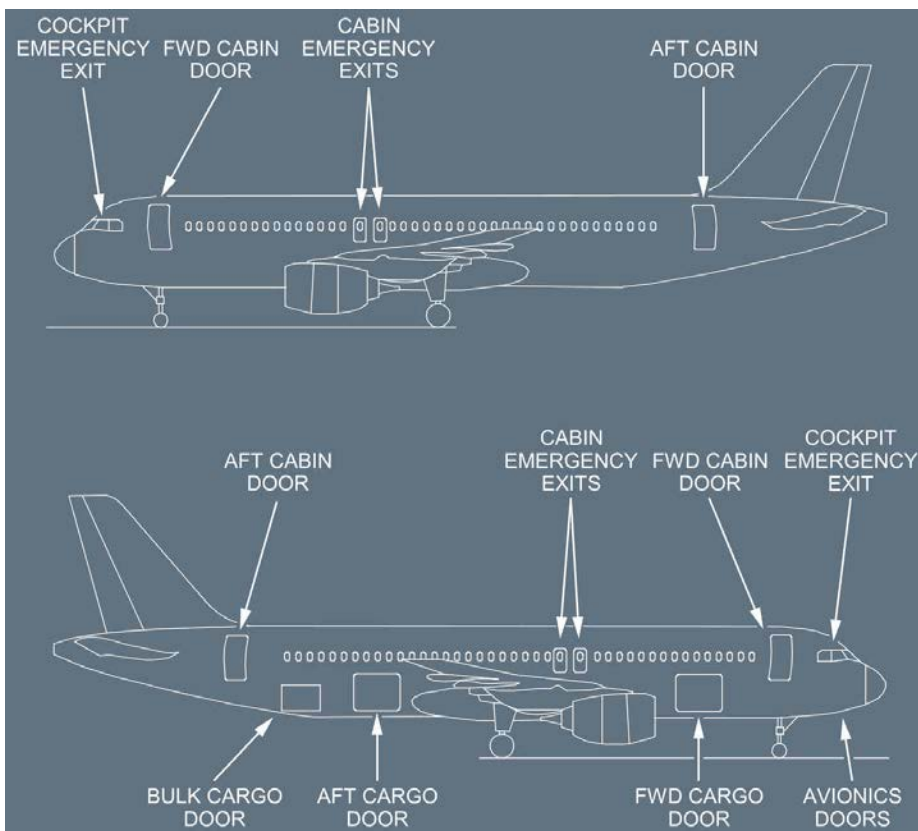



A318/A319/A320/A321
FLIGHT CREW
OPERATING MANUAL

AIRCRAFT SYSTEMS

DOORS

DESCRIPTION - GENERAL

Intentionally left blank

| | |
|---|--|
|  <p>A318/A319/A320/A321 FLIGHT CREW OPERATING MANUAL</p> | <p style="text-align: center;">AIRCRAFT SYSTEMS DOORS</p> <p style="text-align: center;">DESCRIPTION - PASSENGER DOORS</p> |
|---|--|

GENERAL

Ident.: DSC-52-10-20-00017564.0001001 / 21 MAR 16

Applicable to: ALL

The aircraft has four plug-type doors that open outward and forward. There are two doors on each side of the fuselage (one door in the FWD section and one door in the AFT section).

The doors are operated from inside or outside of the aircraft. Normal operation is manual, with hydraulic damping.

Each door has emergency features:

- An escape slide stowed in a container attached to the inboard lower side of the door
- A damper actuator in normal mode, the damper actuator limits the door travel; in emergency mode, the damper actuator drives the automatic door opening
- A slide arming lever.

When the slide arming lever is in the ARMED position, the slide is connected to the floor brackets on both sides of the door. When the door is open, the slide inflates and deploys automatically. If the inflation bottle fails to discharge automatically, a crew member can open its valve to make it discharge. Opening the door from outside disarms the door and the escape slide.

Each passenger door has :

- A mechanical locking indicator that confirms the locked or unlocked position of the door
- One warning light to show the ARMED or DISARMED indication of the escape slides
- One CABIN PRESSURE warning light that illuminates in the case of a residual pressure in the cabin.

OUTSIDE

Ident.: DSC-52-10-20-00017565.0001001 / 21 MAR 16

Applicable to: ALL

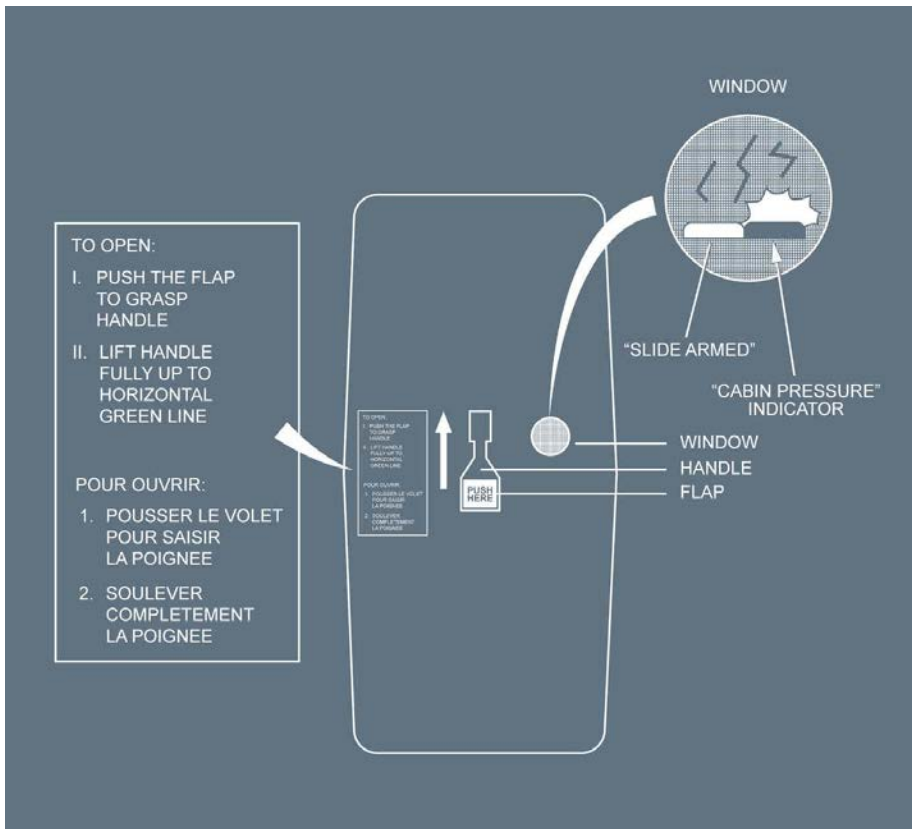

INSIDE

Ident.: DSC-52-10-20-00001547.0002001 / 22 MAY 12

Applicable to: ALL

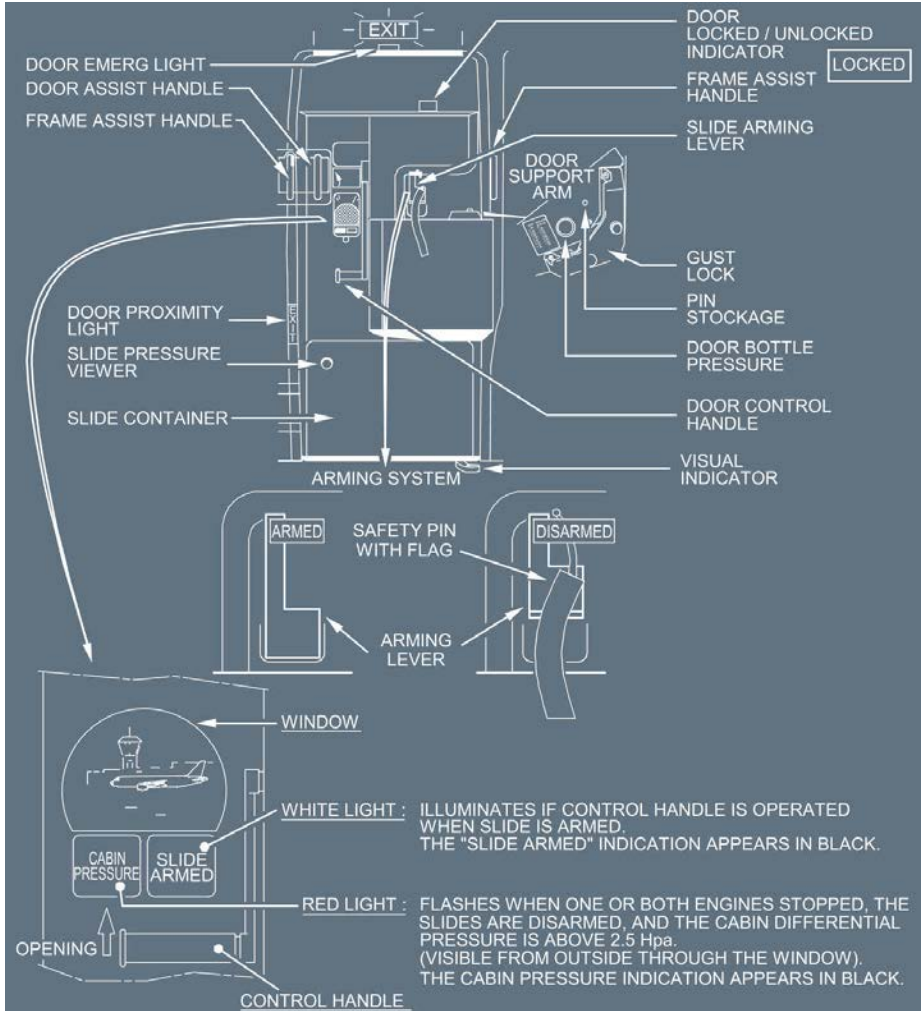



A318/A319/A320/A321
FLIGHT CREW
OPERATING MANUAL

AIRCRAFT SYSTEMS

DOORS

DESCRIPTION - PASSENGER DOORS

Intentionally left blank

COCKPIT

Ident.: DSC-52-10-30-00017567.0001001 / 21 MAR 16

Applicable to: ALL

The two sliding windows in the cockpit are flight crew emergency exits.

A small compartment, located above each window, contains an escape rope that is long enough to reach the ground when lowered through either sliding window. The cockpit windows can only be opened from inside.

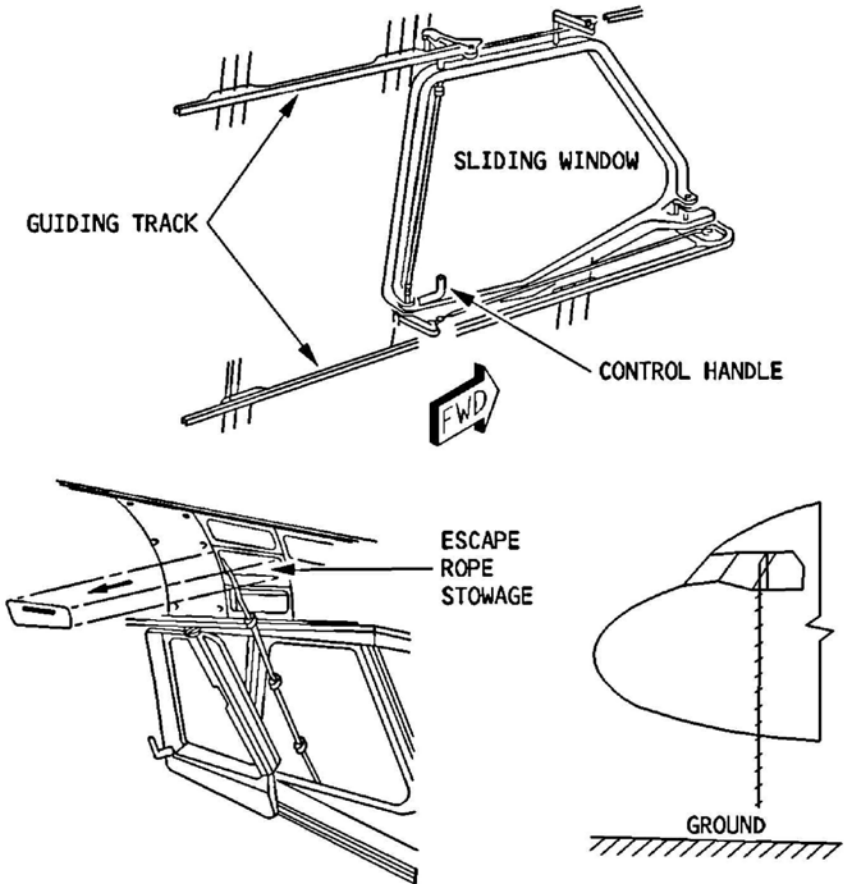

Emergency cockpit evacuation is also possible through the cockpit door escape panel . This panel is designed to be pushed open in the direction of the cabin after removal of the quick-release pins.

CABIN

Ident.: DSC-52-10-30-00017568.0001001 / 06 DEC 16

Applicable to: **ALL**

Two emergency exits are located on each side of the cabin, in addition to the passenger doors. The emergency exits are also equipped with escape slides. In the case of an emergency, the exits open inwards.

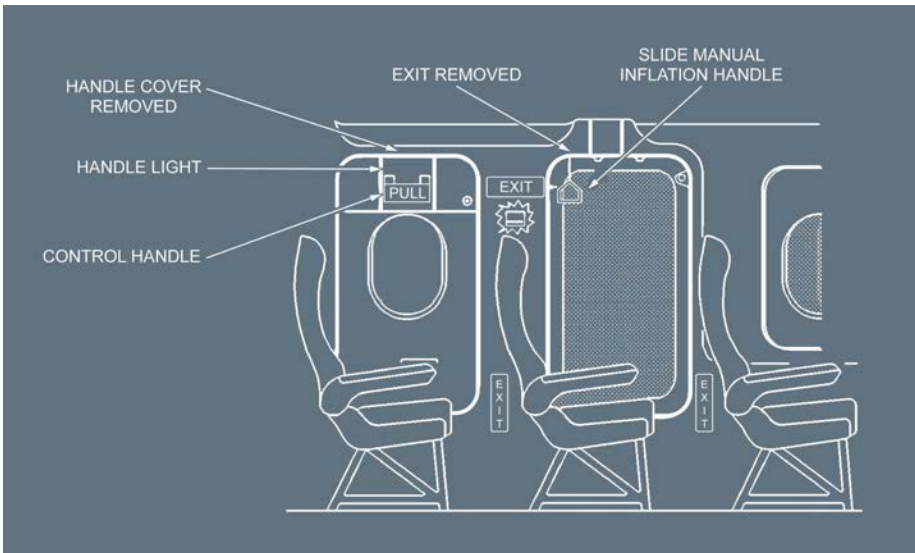

The slides of the overwing emergency exits are always in armed configuration.

To open :

- Remove HANDLE COVER : The HANDLE LIGHT and SLIDE ARMED indicator illuminate
- Pull CONTROL HANDLE : The EXIT moves inwards
- Lift EXIT from frame by holding the HANDLE RECESS
- Throw EXIT out.

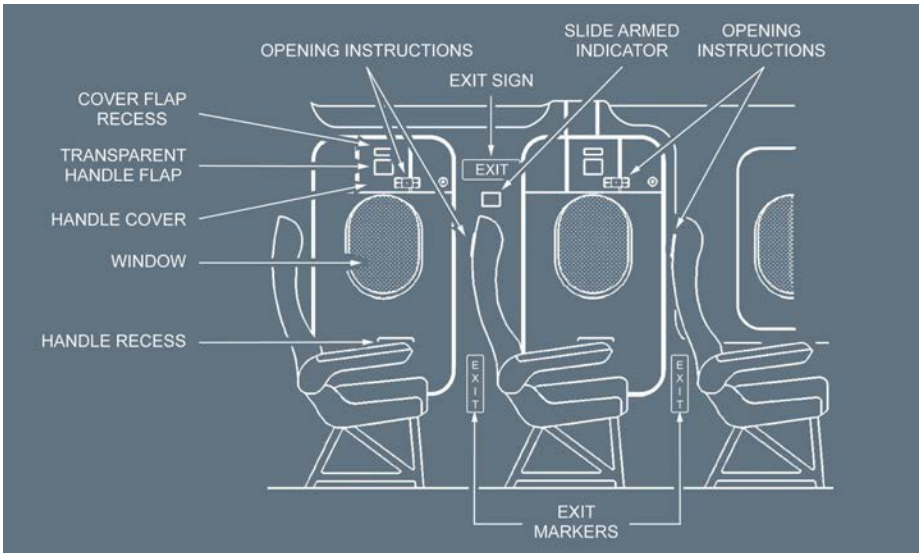



A318/A319/A320/A321
FLIGHT CREW
OPERATING MANUAL

AIRCRAFT SYSTEMS

DOORS

DESCRIPTION - EMERGENCY EXITS

Intentionally left blank

| | |
|---|--|
|  <p>A318/A319/A320/A321 FLIGHT CREW OPERATING MANUAL</p> | <p style="text-align: center;">AIRCRAFT SYSTEMS DOORS</p> <p style="text-align: center;">DESCRIPTION - CARGO DOORS</p> |
|---|--|

GENERAL

Ident.: DSC-52-10-40-00017569.0001001 / 21 MAR 16
Applicable to: ALL

The aircraft has two cargo doors (FWD and AFT cargo doors) on the right side of the fuselage below the cabin floor.

FWD AND AFT CARGO DOORS

Ident.: DSC-52-10-40-00017570.0001001 / 21 MAR 16
Applicable to: ALL

The FWD and AFT cargo doors hydraulically open outward and upward. The doors are hydraulically operated by the yellow hydraulic system. The door locking system (locked open/locked closed) is mechanical.

If the electric pump of the yellow hydraulic system fails, the system can be powered by using a hand pump, located on the hydraulic maintenance panel.

The FWD and AFT cargo doors open only from outside.

Note: When the electric pump operates the FWD or AFT cargo door, the remaining yellow system devices that operate are the brakes and the engine 2 thrust reverser.

BULK CARGO DOOR 

Ident.: DSC-52-10-40-00017571.0001001 / 21 MAR 16
Applicable to: ALL

The bulk cargo door opens inward and upward. The bulk cargo door is a plug-type door. The door is mechanically locked and manually operated.

The bulk cargo door opens from the outside or from the inside.



A318/A319/A320/A321
FLIGHT CREW
OPERATING MANUAL

AIRCRAFT SYSTEMS

DOORS

DESCRIPTION - CARGO DOORS

LOCATION OF SERVICE PANELS

Ident.: DSC-52-10-40-00020676.0002001 / 17 MAR 17

Applicable to: ALL

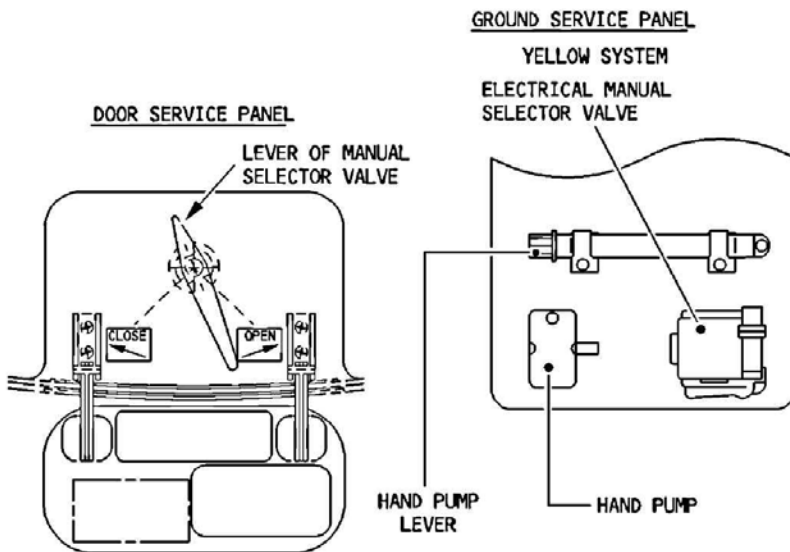
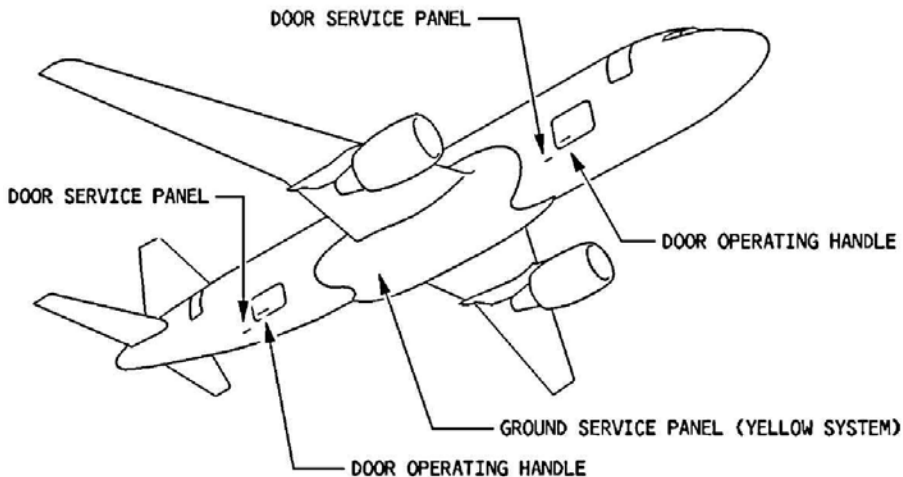



A318/A319/A320/A321
FLIGHT CREW
OPERATING MANUAL

AIRCRAFT SYSTEMS

DOORS

DESCRIPTION - CARGO DOORS

Intentionally left blank

AVIONICS COMPARTMENT ACCESS DOOR

Ident.: DSC-52-10-50-00017579.0001001 / 21 MAR 16

Applicable to: ALL

Four avionics compartment access doors enable an external access to the avionics compartment. The doors are manually operated, hinged doors. The doors open inwards. These doors are in the lower fuselage, around the nose landing gear bay.



A318/A319/A320/A321
FLIGHT CREW
OPERATING MANUAL

AIRCRAFT SYSTEMS

DOORS

DESCRIPTION - AVIONICS COMPARTMENT ACCESS DOOR

Intentionally left blank



A318/A319/A320/A321
FLIGHT CREW
OPERATING MANUAL

AIRCRAFT SYSTEMS

DOORS

DESCRIPTION - COCKPIT DOOR

COCKPIT DOOR

Ident.: DSC-52-10-60-00017573.0002001 / 21 MAR 17

Applicable to: ALL

Refer to DSC-52-40-10 Cockpit Door Description for information about the secured cockpit door.



A318/A319/A320/A321
FLIGHT CREW
OPERATING MANUAL

AIRCRAFT SYSTEMS

DOORS

DESCRIPTION - COCKPIT DOOR

Intentionally left blank

DOOR SLIDES

Ident.: DSC-52-10-80-00001555.0001001 / 09 OCT 12

Applicable to: ALL

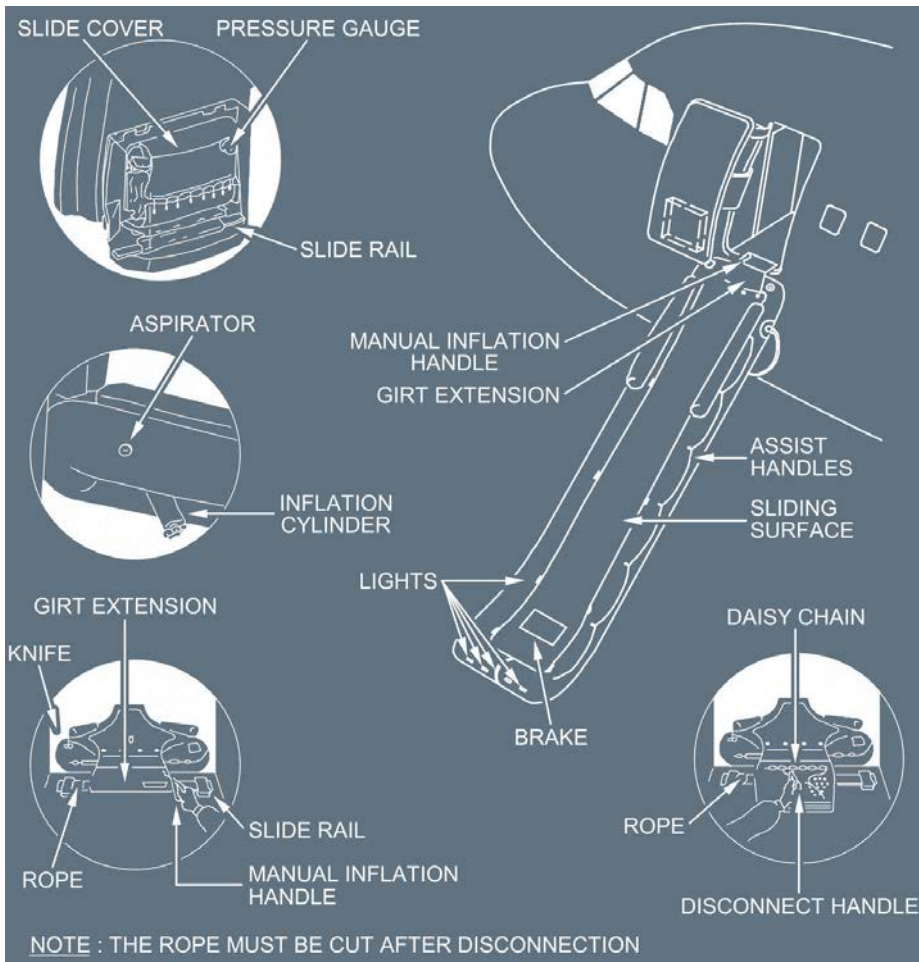

WING SLIDES

Ident.: DSC-52-10-80-00001556.0001001 / 09 OCT 12

Applicable to: ALL

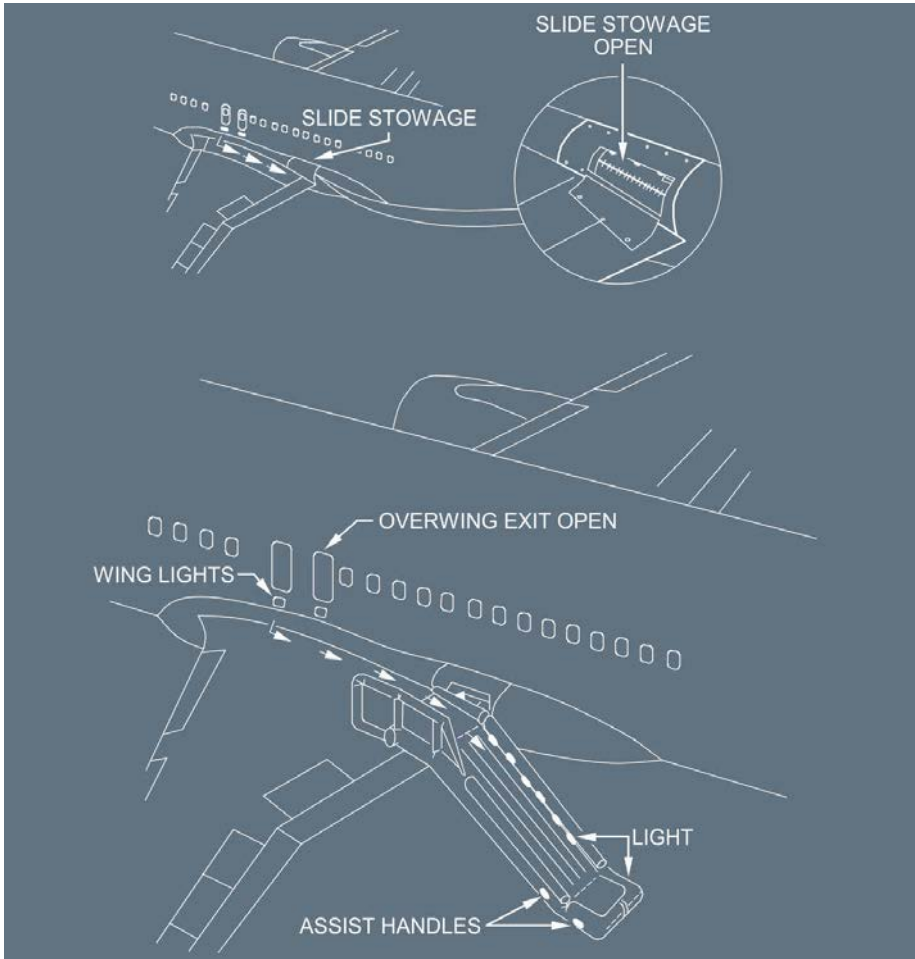

ESCAPE SLIDE ARRANGEMENT

Ident.: DSC-52-10-80-00017577.0001001 / 21 MAR 16

Applicable to: ALL

There are two types of emergency slides: a single-lane escape slide/slideraft or a dual-lane escape slide/slideraft.

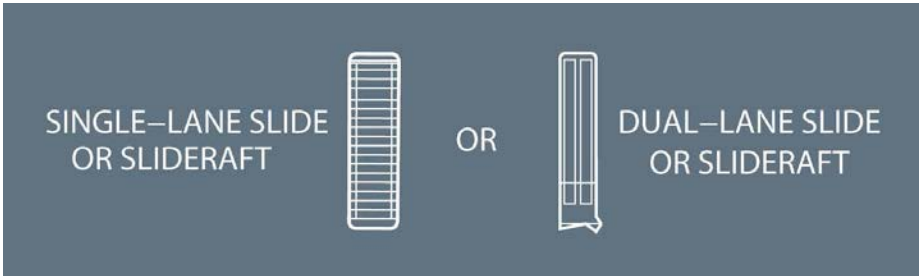

Each passenger door either has a single-lane escape slide, or a single-lane slideraft, and each emergency exit has a dual-lane escape slide.

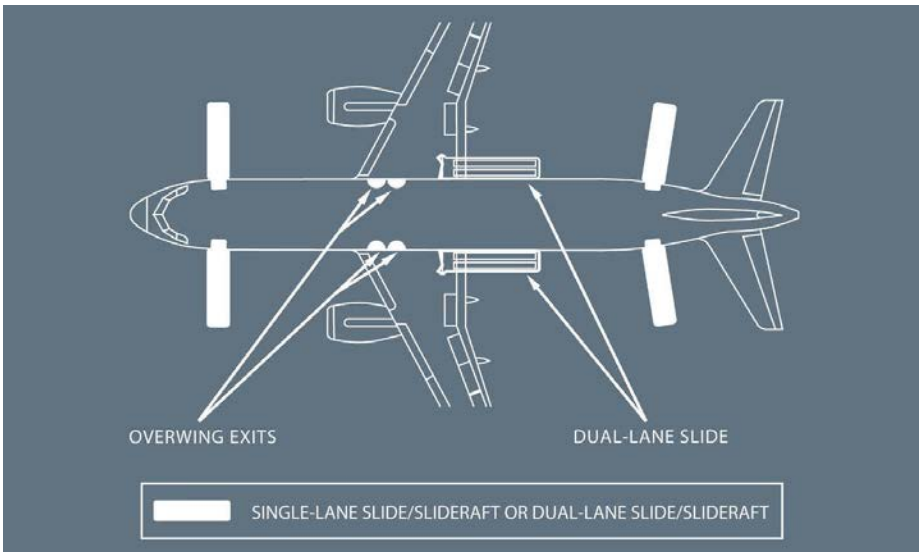



A318/A319/A320/A321
FLIGHT CREW
OPERATING MANUAL

AIRCRAFT SYSTEMS

DOORS

DESCRIPTION - ESCAPE SLIDES/RAFTS

Intentionally left blank

DOOR/OXY SD PAGE

Ident.: DSC-52-20-00017645.0001001 / 21 MAR 16

Applicable to: ALL

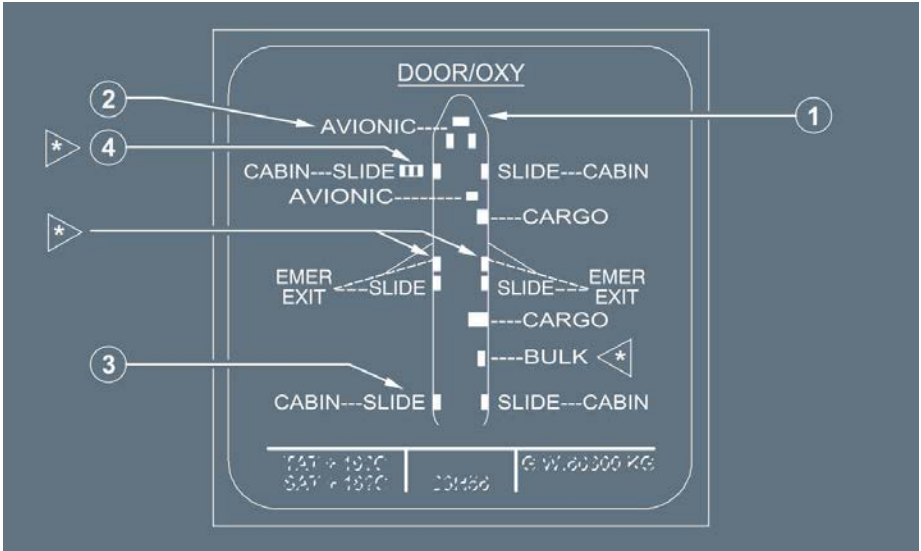

(1) Door symbol

Green : The door is closed and locked.

Amber : The door is not locked.

(2) Door indication

This appears in amber, when the door is not locked.

(3) SLIDE indication

This appears in white, when the slide is armed.

(4) Stair symbol

This appears in amber, when the stair door is not closed.

Note: For aircraft without FWD EMER EXIT doors, the FWD EMER EXIT door symbols are always displayed in green.

Intentionally left blank

COCKPIT DOOR DESCRIPTION

Ident.: DSC-52-40-10-00017010.0001001 / 17 MAR 17

Applicable to: ALL

A forward-opening hinge door separates the cockpit from the passenger compartment. It has three electric locking strikes, controlled by the flight crew. In normal conditions, when the door is closed, they remain locked. When there is a request to enter the cockpit, the flight crew can authorize entry by unlocking the door, that remains closed until it is pushed open.

When the flight crew does not respond to requests for entry, the door can also be unlocked by the cabin crew, by entering a two to seven-digit code (programmed by the airline) on the keypad, installed on the lateral side of the Forward Attendant Panel (FAP).

The door is bulletproof and fully compliant with rapid decompression requirements.

A mechanical override enables the flight crew to open the door from the cockpit side.

A deadbolt  is installed at the level of the center latch area of the cockpit door. This deadbolt bolts the door from the cockpit side, in the event that more than one locking latch strike fails, or in the case of a total CLS failure.

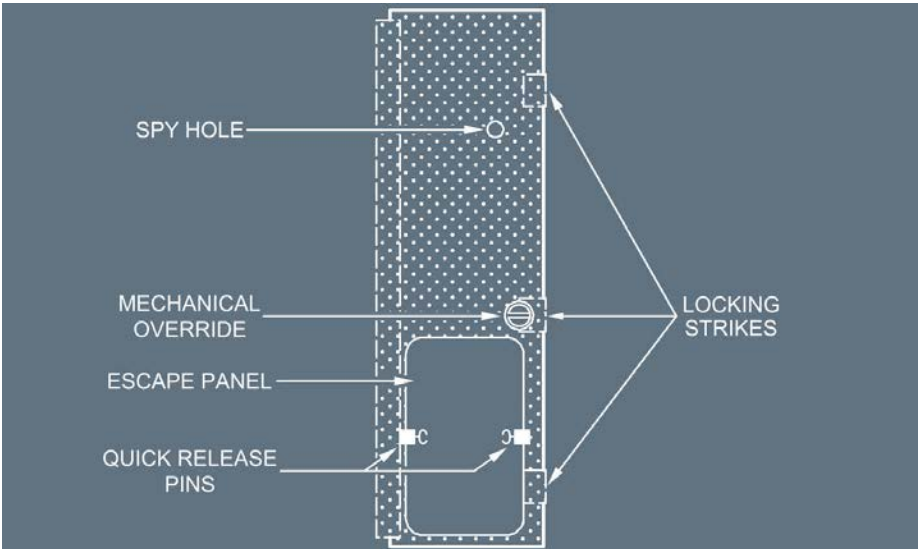

- Note:
- 1. The escape panel enables the flight crew to evacuate the cockpit, in case of an emergency, when the door is jammed. This panel can only be removed from the cockpit side by pulling the quick release pins towards the center of the flap and kicking the panel open.*
 - 2. In case of an electrical supply failure, the door is automatically unlocked, but remains closed.*

COCKPIT DOOR LOCKING SYSTEM (CDLS)

Ident.: DSC-52-40-20-00001007.0001001 / 21 MAR 17

Applicable to: ALL

The Cockpit Door Locking System (CDLS) provides a means of electrically locking and unlocking the cockpit door. This system is mainly composed of :

- A keypad, located in the forward cabin, near the cockpit door,
- A toggle switch, located in the center pedestal's Cockpit Door panel,
- A control unit and its CKPT DOOR CONT normal panel, located on the overhead panel,
- A buzzer.

The keypad enables the cabin crew to request access to the cockpit. There are two different access request types : "Routine" and "Emergency" access request.

The toggle switch enables the flight crew to lock or unlock the cockpit door, following an access request, thereby allowing or denying the entry to the cockpit.

The cockpit door control unit is the system controller, in charge of :

- Locking or unlocking the door latches, upon flight crew action.
- Unlocking the door, in case of cockpit decompression (the door then opens towards the cockpit under differential pressure).
- Indicating system failures of electrical latches and pressure sensors.
- Activating the access request buzzer and turning on the keypad LEDs.

The buzzer sounds in the cockpit for 1 to 9 s to indicate that a routine access request has been made, or sounds continuously if an emergency access procedure has been initiated.

CONTROLS

Applicable to: ALL

Ident.: DSC-52-40-20-A-00001008.0001001 / 21 MAR 17

KEYPAD

The keypad is used by the cabin crew to request pilots to open the door.

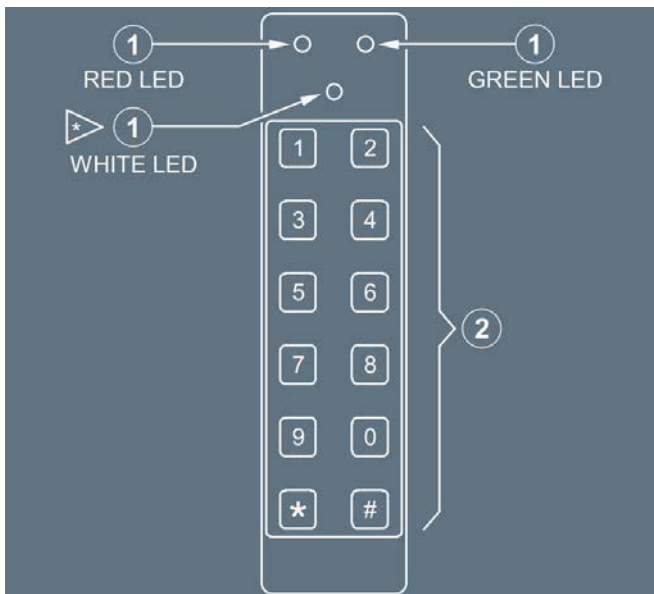

(1) Locked/Unlocked Door Indicator

- GREEN light ON : The door has been unlocked either by a flight crew action, or automatically (during 5 s) when no flight crew action is performed during the delay following an emergency access request. The door can be pushed open.
- GREEN light flashes : An emergency request to enter the cockpit has been made; the buzzer will sound continuously in the cockpit, but no action has yet been taken by the flight crew.
- RED light ON : The flight crew has denied access, and the door remains locked.
- WHITE light ON  : The light comes on each time the cabin crew presses a key on the keypad.

(2) Digital Keypad

The keypad is used to sound the buzzer in the cockpit for 1 to 9 s (3 s by default), by entering a zero to seven-digit code, as programmed by the airline, followed by the '#' key. It is also used to enter the two to seven-digit emergency code, followed by the '#' key, when the flight crew does not respond.

*Note: During the test performed by the cockpit door control unit, the CDLS keypad remains operational, and the CDLS operates as follows:
The control unit will store access codes that are entered, and the LOCKED/UNLOCKED DOOR INDICATOR (RED/GREEN LEDs) of the keypad will remain on, as long as the test is running.*

- *If the correct access code is entered on the keypad, the buzzer will not sound, until the test is completed.*
- *If the emergency access code is entered, the door will unlock. The cockpit buzzer and the LOCKED/UNLOCKED DOOR INDICATOR will be inoperative.*

Ident.: DSC-52-40-20-A-00018437.0001001 / 17 MAR 17

CENTRAL PEDESTAL COCKPIT DOOR PANEL

The secured cockpit door opening is controlled by a toggle switch, located on the central pedestal.



(1) COCKPIT DOOR toggle switch

- UNLOCK position** : This position is used to enable the cabin crewmember to open the door. The switch must be pulled and maintained in the unlock position until the door is pushed open.
- NORM position** : All latches are locked, and EMERGENCY access is possible for the cabin crew.
- LOCK position** : Once the button has been moved to this position, the door is locked ; emergency access, the buzzer, and the keypad are inhibited for a preselected time (5 to 20 min).

Note:

1. *If the LOCK position has not been used by the pilot, for at least 5 to 20 min, the cabin crew is able to request emergency access to open the cockpit door.*
2. *The UNLOCK position overrides and resets any previous selection.*
3. *In case of an electrical supply failure, the cockpit door is automatically unlocked, but remains closed.*

(2) COCKPIT DOOR Fault Open indicator

OPEN light ON : The door is not closed.

OPEN light flashes : The cabin crew has started an emergency access procedure. If there is no reaction from the flight crew, the door will unlock at the end of the adjustable time delay (15 to 120 s).

FAULT : This light comes on when a system failure has been identified (Example : Latch, pressure sensors, control unit).
 The inoperative item can be identified by checking the strike and pressure sensor status lights on the CKPT DOOR CONT panel.

Ident.: DSC-52-40-20-A-00001010.0001001 / 09 OCT 12

OVERHEAD CONTROL PANEL

The Cockpit Door Locking System's control panel is located on the overhead panel.



(1) Strikes' status lights

Off : The corresponding (upper, mid, or lower) locking latch is operative.

On : The corresponding (upper, mid, or lower) locking latch is faulty.

(2) Pressure sensor

Two redundant differential pressure sensors enable rapid pressure variation in the cockpit to be detected, in order to command simultaneous opening of all latches when a defined pressure drop is detected.

(3) Pressure sensor status lights

Off : The corresponding (1 or 2) pressure sensor is operative.

On : The corresponding (1 or 2) pressure sensor is faulty.

Note: *These indicators enable the crew to identify the faulty item, when the Central Pedestal Fault indicator light is ON.*

GENERAL

Ident.: DSC-52-40-30-00018415.0001001 / 17 MAR 17

Applicable to: ALL

The Cockpit Door Surveillance System (CDSS) consists of three video cameras, that enable the flight crew to identify persons prior to authorizing their entry into the cockpit. The lower ECAM display displays the various camera views. A control panel, located on the central pedestal allows the flight crew members to select the CDSS display on the SD and to swap between the different camera views.

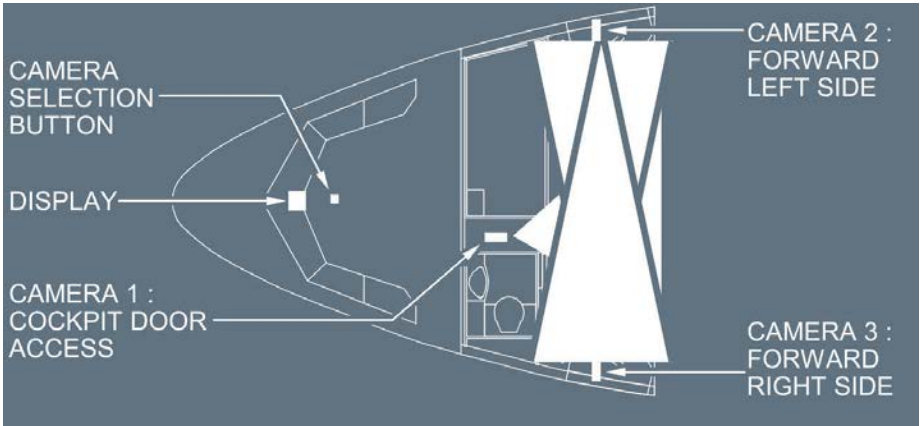

CONTROLS

Applicable to: ALL

Ident.: DSC-52-40-30-A-00018416.0003001 / 17 MAR 17

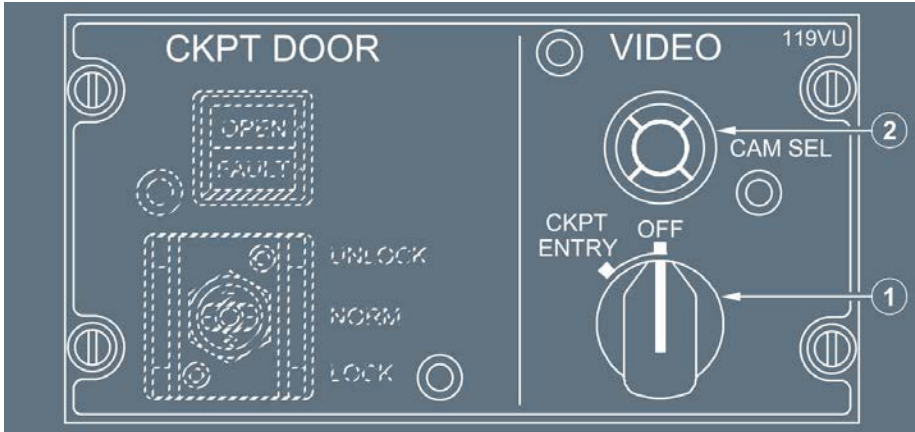

(1) Lower ECAM rotary selector

CKPT ENTRY : The lower ECAM displays the camera 1 image.

The camera images are not displayed on the Lower ECAM display in the case of:

- A subsequent automatic system page call following a warning, a caution, or an advisory, or
- A subsequent manual selection of a system page on the ECAM Control Panel (ECP), or
- A SD failure, or
- An EWD failure.

OFF : The lower ECAM display operates normally.

(2) Lower ECAM CAM SEL

Selects various camera image displays, when the lower ECAM rotary selector is set to the CKPT ENTRY position.

The image from camera 1 appears:

- Automatically, when the lower ECAM rotary selector is set to the CKPT ENTRY position.
- When images from cameras 2 and 3 are displayed, and after the flight crew presses the lower ECAM CAM SEL pb
- Automatically, when images from cameras 2 and 3 are displayed, and after a crew member uses the cabin keypad to make an entry request at least 30 s after a previous entry request.

Images from cameras 2 and 3 are displayed simultaneously on a split screen, when the image from camera 1 is displayed, and after the flight crew presses the lower ECAM CAM SEL pb.

- Note:
1. The message "PLEASE WAIT" is displayed during the transition between two video images when the flight crew requests an image change.
 2. The message "VIDEO NOT AVAIL" is displayed when the flight crew requests a video image and no image can be displayed.



A318/A319/A320/A321
FLIGHT CREW
OPERATING MANUAL

AIRCRAFT SYSTEMS

DOORS

COCKPIT DOOR SECURITY SYSTEM - COCKPIT
DOOR SURVEILLANCE SYSTEM (CDSS)

Intentionally left blank

| | |
|---|--|
|  <p>A318/A319/A320/A321 FLIGHT CREW OPERATING MANUAL</p> | <p style="text-align: center;">AIRCRAFT SYSTEMS</p> <p style="text-align: center;">DOORS</p> <p style="text-align: center;">HOW TO</p> |
|---|--|

HOW TO OPERATE THE COCKPIT DOOR

Ident.: DSC-52-50-00020495.0001001 / 17 MAR 17

Applicable to: ALL

The secured cockpit door operation is controlled by a toggle sw that is located on the COCKPIT DOOR panel (central pedestal).

DOOR OPENING FROM THE COCKPIT

To enable access to the cockpit, set and maintain the COCKPIT DOOR sw to the UNLOCK position until the door is fully opened. When the door is fully opened, the COCKPIT DOOR sw can be released to the NORM position.

DOOR CLOSING FROM THE COCKPIT

Close the door and check that the OPEN indicator goes off. If the COCKPIT DOOR sw is in the NORM position, the door is locked and emergency access is possible from the cabin. When the door is fully closed, if the cockpit door FAULT light is ON, *Refer to PRO-ABN-DOOR [QRH] COCKPIT DOOR FAULT.*

Note: If the OPEN indicator is ON when the door is closed, the door may be unlocked. Repeat the above-mentioned opening/closing procedure.

When the COCKPIT DOOR sw is in the LOCK position the door is locked. In this position, the emergency access, the buzzer, and the keypad are inhibited for a preselected time (5 to 20 min).

ROUTINE ACCESS TO THE COCKPIT FROM THE CABIN (I.E. NORMAL ACCESS)

To request access to the cockpit from the cabin, use the keypad to enter the code and validate with the “#” key.

L2 The Operator defines this code (between 0 and 7 digits).

L1 The buzzer sounds in the cockpit for 1 to 9 s (3 s by default).

After identification of the person (using the Cockpit Door Surveillance System ) that requests access, set the COCKPIT DOOR sw to UNLOCK position to unlock the door. A steady green light on the keypad comes on, that indicates that the door is unlocked.

If the flight crew refuses access to the cockpit by setting the COCKPIT DOOR sw to LOCK position, a steady red light on the keypad comes on, that indicates that the door is locked. The keypad and the buzzer are inhibited for a defined period of time.

If the flight crew does not respond, the door remains locked. If the flight crew does not take any action after a routine cabin request, the cabin crew will be able to open the door with the emergency access procedure.

EMERGENCY ACCESS FROM CABIN TO THE COCKPIT

To request emergency access to the cockpit, use the keypad to enter the emergency code and validate with the “#” key.

- L2** The Operator defines this emergency code (between 2 and 7 digits).
- L1** The buzzer continuously sounds in the cockpit and the OPEN light flashes on the COCKPIT DOOR panel (central pedestal). In the cabin, the green light on the keypad flashes until the flight crew uses the COCKPIT DOOR sw to either lock or unlock the cockpit door. After identification of the person (via the Cockpit Door Surveillance system ) that requests access, use the COCKPIT DOOR sw to unlock the door. If the flight crew refuses access by setting the COCKPIT DOOR sw to LOCK position, the keypad and the buzzer are inhibited for a defined period of time. If the flight crew does not respond, after a preselected time between 15 and 120 s, the door automatically unlocks for 5 s and a steady green light on the keypad comes. The buzzer stops and indicates that the door is unlocked.

EVACUATION THROUGH THE DECOMPRESSION AND EVACUATION PANEL

Pull the quick-release pins of the escape panel towards the center of the flap.
Kick the escape panel toward the cabin and evacuate the cockpit.

HOW TO OPERATE THE FWD AND AFT CARGO DOOR

Ident.: DSC-52-50-00020574.0003001 / 17 MAR 17

Applicable to: ALL

NORMAL OPERATION

OPENING

On the cargo door, push the door handle flap inward to release the door handle from the recess of the door structure. Then, pull the door handle away and upward from the LOCKED to the UNLOCKED position.

Open the access door of the service panel to get access to the selector valve lever. Set the selector valve lever to the OPEN position and maintain the lever in this position until the green indicator light comes on. The green indicator light indicates that the door is fully opened and locked.

*Note: The yellow hydraulic system is pressurized (the YELLOW ELEC PUMP is energized).
The operation of the flight controls and PTU is inhibited.*

When the door is fully open, release the selector valve lever. When released, the selector valve lever returns to the neutral position and shuts down the electrical pump.

CLOSING

In order to close the cargo door, set the selector valve lever to the CLOSE position and maintain the lever in this position until the green indicator light goes off. When this light goes off, it means that the door is fully closed and locked.

| | |
|---|--|
|  <p>A318/A319/A320/A321 FLIGHT CREW OPERATING MANUAL</p> | <p style="text-align: center;">AIRCRAFT SYSTEMS</p> <p style="text-align: center;">DOORS</p> <p style="text-align: center;">HOW TO</p> |
|---|--|

Note: At first the selector valve lever locks in an intermediate position maintaining a preset pressurization to prevent the door from dropping open.

When the door is fully closed, the selector valve lever returns to the neutral position and shuts down the electrical pump.

On the cargo door, push the door handle flap downwards to the LOCKED position. When the door is locked, the cargo door symbol appears in green on the DOOR/OXY SD page. The CARGO door indication on the ECAM goes off, and the handle flap mechanism locks the operating handle.

Close the access door of the service panel.

HOW TO OPERATE THE FWD AND AFT CARGO DOORS (AUXILIARY OPERATION)

Ident.: DSC-52-50-00020577.0002001 / 17 MAR 17

Applicable to: ALL

AUXILIARY OPERATION

If there is an electrical failure or if the yellow hydraulic electric pump fails, the operator can open or close the cargo door with the use of the hand pump that is accessible via the ground service panel.

Note: Two persons are necessary for this operation.

MANUAL OPENING

To open the cargo door with the use of the hand pump, unlock the cargo door by using the operating handle as for normal operation.

Open the ground service panel of the yellow hydraulic system that is in the belly fairing area.

Open the access door of the door service panel. Set the selector valve lever to the OPEN position and maintain the lever in this position during the operation of the hand pump.

Operate the hand pump until the cargo door is in the fully open position. The green light comes on and indicates that the door is fully opened and locked.

When the cargo door is fully opened, release the selector valve lever of the door service panel.

MANUAL CLOSING

To close the cargo door, set the selector valve lever (on the door service panel) to the CLOSE position and maintain the lever in this position during the operation of the hand pump.

Operate the hand pump until the cargo door is in the fully closed position.

When the cargo door is fully closed, release the selector valve lever of the door service panel.

Lock the cargo door with the use of the operating handle as for normal operation.

Close the access door of the door service panel and of the ground service panel.

Intentionally left blank

AIRCRAFT SYSTEMS

COCKPIT WINDOWS

Intentionally left blank



A318/A319/A320/A321
FLIGHT CREW
OPERATING MANUAL

AIRCRAFT SYSTEMS

COCKPIT WINDOWS

PRELIMINARY PAGES - TABLE OF CONTENTS

DSC-56-10 General

General.....A

DSC-56-20 Fixed Windows

Fixed Windows.....A

DSC-56-30 Sliding Windows

Sliding Windows.....A

DSC-56-40 Description

Description..... A



A318/A319/A320/A321
FLIGHT CREW
OPERATING MANUAL

AIRCRAFT SYSTEMS

COCKPIT WINDOWS

PRELIMINARY PAGES - TABLE OF CONTENTS

Intentionally left blank



A318/A319/A320/A321
FLIGHT CREW
OPERATING MANUAL

AIRCRAFT SYSTEMS

COCKPIT WINDOWS

GENERAL

GENERAL

Ident.: DSC-56-10-00000998.0001001 / 17 MAR 17

Applicable to: ALL

The cockpit has fixed and sliding windows.



A318/A319/A320/A321
FLIGHT CREW
OPERATING MANUAL

AIRCRAFT SYSTEMS

COCKPIT WINDOWS

GENERAL

Intentionally left blank



A318/A319/A320/A321
FLIGHT CREW
OPERATING MANUAL

AIRCRAFT SYSTEMS

COCKPIT WINDOWS

FIXED WINDOWS

FIXED WINDOWS

Ident.: DSC-56-20-00000999.0001001 / 17 MAR 17

Applicable to: ALL

There are four fixed windows :

- two windshields
- two fixed side windows



A318/A319/A320/A321
FLIGHT CREW
OPERATING MANUAL

AIRCRAFT SYSTEMS

COCKPIT WINDOWS

FIXED WINDOWS

Intentionally left blank

SLIDING WINDOWS

Ident.: DSC-56-30-00018432.0001001 / 17 MAR 17

Applicable to: ALL

The flight crew can use the sliding windows as emergency exits. Therefore they are not permitted to stow any object so that it protrudes into the window area from the side console. Members of the flight crew can use the control handle to slide each of the windows rearward, and can use a locking pin to lock each window open.

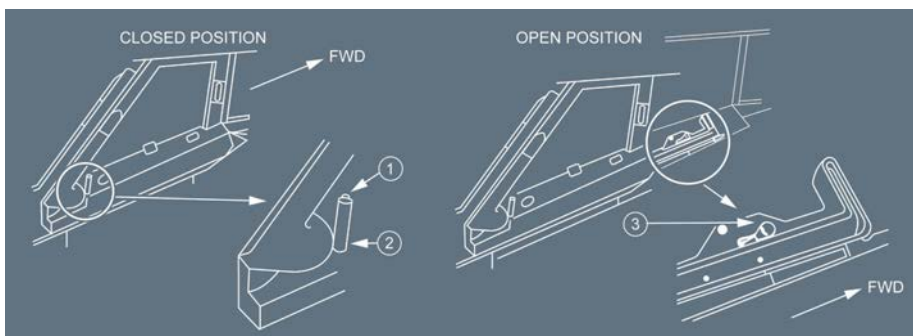

- (1) Unlocking button
 Flight crew presses this button to unlock the control handle.
- (2) Control handle
 - To open the window, the crew member pulls inward and rearward.
 - To close the window, the crew member pushes forward.
- (3) Locking pin
 This pin locks the window open.
 It is near the window's lower guide track and is visible when the window is open.
 - Forward
 Between the closed position and the one-third open position, the window is free to move forward and aft.
 When the window is more than one-third open, this pin prevents it from moving forward.
 - Aft
 Flight crew must move the locking pin aft in order to close the window. Left sliding window.



A318/A319/A320/A321
FLIGHT CREW
OPERATING MANUAL

AIRCRAFT SYSTEMS

COCKPIT WINDOWS

SLIDING WINDOWS

Intentionally left blank

| | |
|---|--|
|  <p>A318/A319/A320/A321 FLIGHT CREW OPERATING MANUAL</p> | <p align="center">AIRCRAFT SYSTEMS COCKPIT WINDOWS</p> <p align="center">DESCRIPTION</p> |
|---|--|

DESCRIPTION

Ident.: DSC-56-40-00013772.0001001 / 17 MAR 17

Applicable to: ALL

COCKPIT WINDSHIELD AND WINDOWS DESCRIPTION

All cockpit windows are fail-safe design.

The windows are made of:

- A non structural ply, the Outer ply (1), which is only a protective layer
- Two structural plies, the Middle ply (2) and the Inner ply (3)
Each structural ply is able to sustain individually the pressurization loads
- A heating film (4) to defog and/or de-ice the windshield/window
- Two interlayers (5).

Typical Structure Of A Cockpit Window (Cut View)

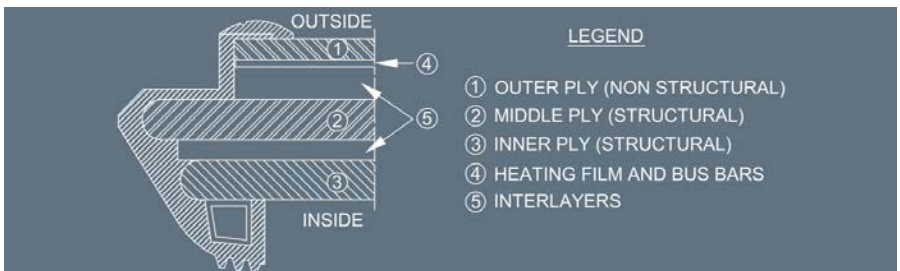

For information on cockpit window damage procedure, description and evaluation method, Refer to *FCTM/PR-AEP-MISC Cockpit Windshield/Window Cracked*.



A318/A319/A320/A321
FLIGHT CREW
OPERATING MANUAL

AIRCRAFT SYSTEMS

COCKPIT WINDOWS

DESCRIPTION

Intentionally left blank

AIRCRAFT SYSTEMS

ENGINES

Intentionally left blank

DSC-70-05 Overview

Overview..... A

DSC-70-10 System Description

Engine..... A
 Engine..... B
 LP Compressor Turbine Assembly..... C
 HP Compressor Turbine Assembly..... D
 Combustion Chamber..... E
 Accessory Gearbox..... F

DSC-70-20 FADEC

General..... A
 Architecture..... B
 Functions C
 Idle Control..... D

DSC-70-30 Thrust Control System (CFM+PW)

DSC-70-30-10 General

General..... A

DSC-70-30-20 Thrust Levers

Thrust Levers..... A

DSC-70-30-30 Thrust Rating Limit

Thrust Rating Limit..... A

DSC-70-30-40 Thrust Control

Manual Mode..... A
 Automatic Mode..... B

DSC-70-40 Fuel System (CFM56)

General..... A
 Fuel pump Unit..... B
 Shut-Off Valves..... C
 Hydromechanical Unit..... D
 IDG Cooling System E

DSC-70-50 Oil System

General..... A

Continued on the following page

Continued from the previous page

DSC-70-60 Airbleed System (CFM56)

General.....A
Cooling.....B

DSC-70-70 Thrust Reverser System

General.....A
Actuation Logic.....B
Protection.....C
Schematic.....D

DSC-70-80 Ignition and Starting

DSC-70-80-10 General

General.....A

DSC-70-80-20 Architecture

Architecture.....A

DSC-70-80-30 Ignition System

General.....A
Ignition for Starting.....B
Continuous Ignition.....C

DSC-70-80-40 Engine Starting System

General.....A
Automatic Starting.....B
Automatic Starting Sequence.....C
Manual Starting.....D
Engine Ventilation (Dry Cranking).....E

DSC-70-90 Controls and Indicators

DSC-70-90-10 Overhead Panel

ENG MAN START Panel.....A

DSC-70-90-20 Pedestal

ENG MODE Selector and ENG MASTER Levers.....A
Thrust Levers.....B

DSC-70-90-30 Maintenance Panel

ENG FADEC GND PWR Panel.....A

Continued on the following page



A318/A319/A320/A321
FLIGHT CREW
OPERATING MANUAL

AIRCRAFT SYSTEMS

ENGINES

PRELIMINARY PAGES - TABLE OF CONTENTS

Continued from the previous page

DSC-70-90-40 Engine Display

| | |
|-----------------------------|---|
| Engine/Warning Display..... | A |
| ENG SD Page..... | B |

DSC-70-90-50 Memo Display

| | |
|-------------------|---|
| Memo Display..... | A |
|-------------------|---|



A318/A319/A320/A321
FLIGHT CREW
OPERATING MANUAL

AIRCRAFT SYSTEMS

ENGINES

PRELIMINARY PAGES - TABLE OF CONTENTS

Intentionally left blank

OVERVIEW

Applicable to: ALL

Ident.: DSC-70-05-10-00018242.0002001 / 21 MAR 16

The aircraft has two CFM International CFM56-5B engines that supply power to the aircraft.

Ident.: DSC-70-05-10-00018265.0001001 / 21 MAR 16

The engines are turbofan engines that have:

- A high bypass ratio,
- A Full Authority Digital Engine Control (FADEC),
- A fuel system,
- An oil system,
- An air system,
- A thrust reverser system,
- An ignition system and a start system.

Overview

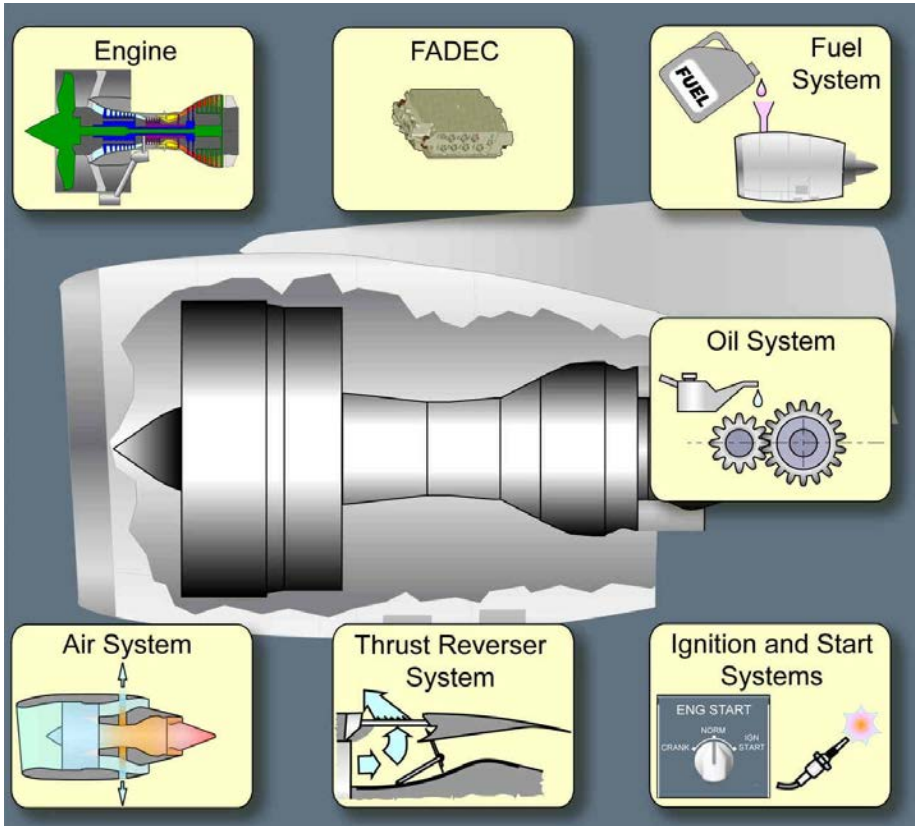

| | |
|---|--|
|  <p>A318/A319/A320/A321 FLIGHT CREW OPERATING MANUAL</p> | <p style="text-align: center;">AIRCRAFT SYSTEMS ENGINES SYSTEM DESCRIPTION</p> |
|---|--|

| |
|---------------|
| ENGINE |
|---------------|

Ident.: DSC-70-10-00018361.0001001 / 21 MAR 16

Applicable to: ALL

The engine has:

- Two compressor turbine assemblies:
 - The Low Pressure (LP) compressor turbine assembly,
 - The High Pressure (HP) compressor turbine assembly.

L2 Each turbine operates its associated compressor via a shaft.

- L1**- One accessory gearbox,
- One combustion chamber.

The engine operates as follows:

1. The LP compressor, compresses the air.
2. Then, the air is divided into two flows:
 - Most of the air flows out of the core engine, and provides most of the engine thrust.
 - The remaining air enters the core engine.
3. The HP compressor compresses the air that enters the core engine.
4. The fuel is added to and mixed with the compressed air of the core engine. The mixture is ignited in the combustion chamber.
5. The gas that results from combustion drives the HP and the LP turbines.

The rotation speed of the fan provides the N1 engine parameter.

The rotation speed of the HP rotor provides the N2 engine parameter.

The N1 and N2 engine parameters appear on the Engine/Warning Display (E/WD).

L2 The N1 and N2 engine parameters are current rotation speeds displayed in percentage.

L1 The FADEC uses:

- The N1 engine parameter to compute the applicable engine thrust,
- The N1 and N2 engine parameters for engine control and monitoring.

ENGINE

Ident.: DSC-70-10-00018362.0002001 / 21 MAR 16

Applicable to: ALL

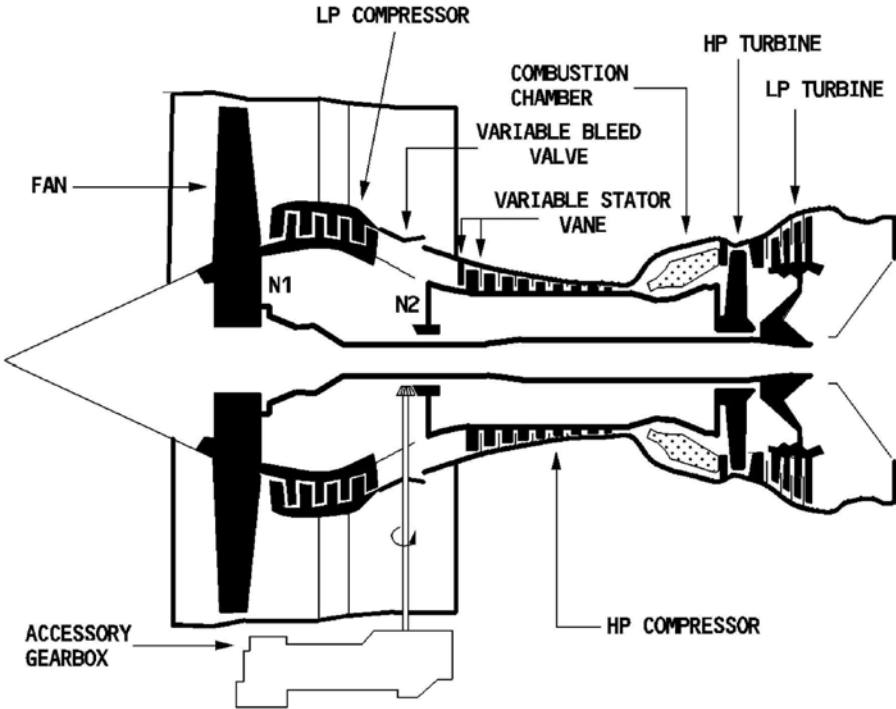

LP COMPRESSOR TURBINE ASSEMBLY

Ident.: DSC-70-10-00018289.0002001 / 21 MAR 16

Applicable to: ALL

LP COMPRESSOR TURBINE ASSEMBLY

The LP compressor turbine assembly has:

- One LP compressor,
 - L2 - One LP shaft,
 - L1 - One LP turbine.
- L2 The LP shaft connects the LP compressor to the LP turbine.

| | |
|---|--|
|  <p>A318/A319/A320/A321 FLIGHT CREW OPERATING MANUAL</p> | <p>AIRCRAFT SYSTEMS ENGINES SYSTEM DESCRIPTION</p> |
|---|--|

L3 The LP compressor has a fan and 4 stages, and the LP turbine has 4 stages.

HP COMPRESSOR TURBINE ASSEMBLY

Ident.: DSC-70-10-00018290.0001001 / 21 MAR 16
Applicable to: ALL

HP COMPRESSOR TURBINE ASSEMBLY

The HP compressor turbine assembly has:

- One HP compressor,
- L2** - One HP shaft,
- L1** - One HP turbine.

L2 The HP shaft connects the HP compressor to the HP turbine.

L3 The HP compressor has 9 stages, and the HP turbine has a single stage.

COMBUSTION CHAMBER

Ident.: DSC-70-10-00018292.0001001 / 21 MAR 16
Applicable to: ALL

COMBUSTION CHAMBER

The combustion chamber burns a mixture of fuel and HP air. The FADEC controls the fuel/air mixture in accordance with the position of the thrust lever and the aircraft operating conditions.

- L3** The combustion chamber is an annular assembly with fuel nozzles and two igniters.
The combustion chamber is between the HP compressor and the HP turbine.

ACCESSORY GEARBOX

Ident.: DSC-70-10-00018364.0001001 / 21 MAR 16
Applicable to: ALL

ACCESSORY GEARBOX

The accessory gearbox drives various accessories with mechanical power via the HP shaft for the operation of the engine and the aircraft systems.

- L2** The accessory gearbox of each engine operates:
- The oil feed pump that provides the oil system with oil.
 - The main engine fuel pump that provides the combustion chamber with fuel.
 - The engine-driven hydraulic pumps that pressurize the GREEN and the YELLOW hydraulic systems.
 - The engine-driven generators that are the primary source of electrical power.

- The FADEC alternator that provides the FADEC with electrical power.
- The pneumatic starter that enables the engine start.

GENERAL

Ident.: DSC-70-20-00020869.0001001 / 17 MAR 17

Applicable to: ALL

Each powerplant has a FADEC (Full Authority Digital Engine Control) system.
FADEC is a digital control system that performs complete engine management.
FADEC has two-channel redundancy, with one channel active and one in standby.
If one channel fails, the other automatically takes control.
The system has a magnetic alternator for an internal power source.
FADEC is mounted on the fan case.
The Engine Interface Unit (EIU) transmits to FADEC the data it uses for engine management.



A318/A319/A320/A321
FLIGHT CREW
OPERATING MANUAL

AIRCRAFT SYSTEMS

ENGINES

FADEC

ARCHITECTURE

Ident.: DSC-70-20-00001566.0005001 / 21 MAR 16

Applicable to: ALL

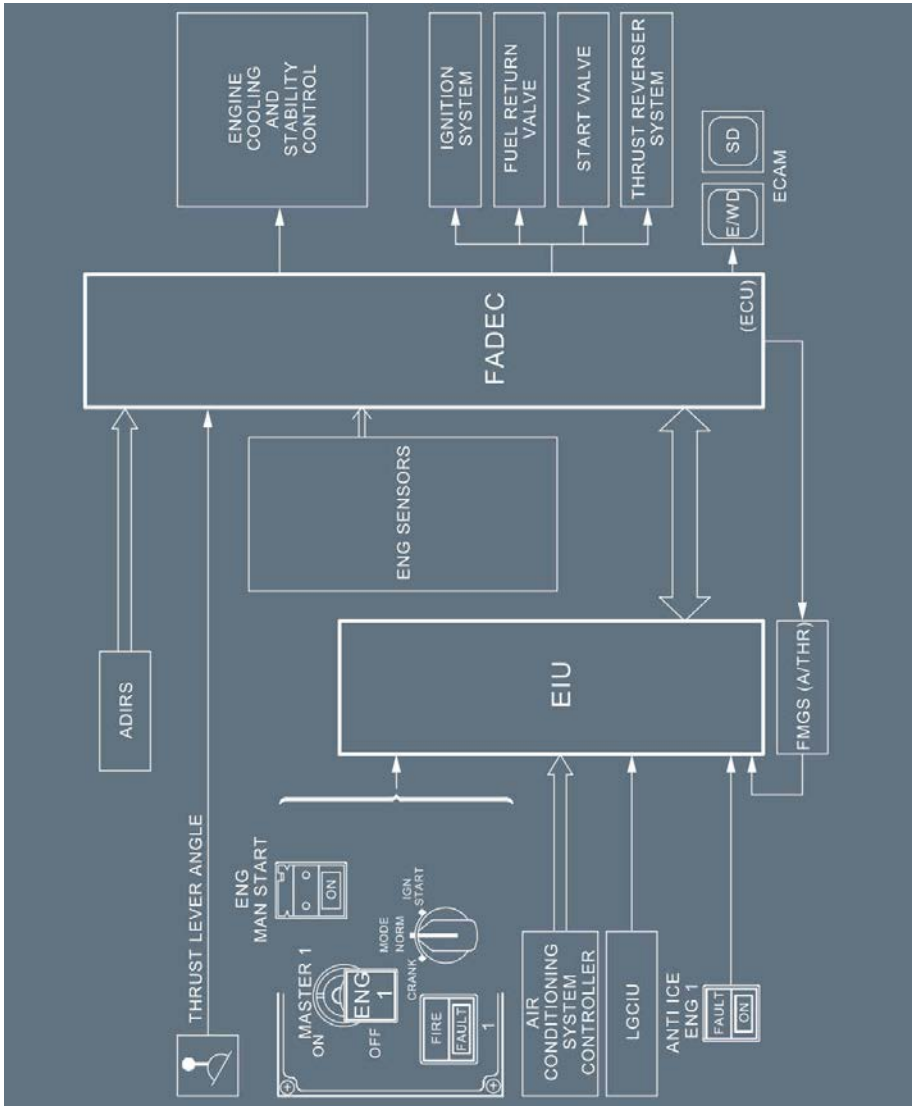

FUNCTIONS

Ident.: DSC-70-20-00001567.0001001 / 21 MAR 16

Applicable to: ALL

The FADEC system performs the following functions :

Control of gas generator

- control of fuel flow
- acceleration and deceleration schedules
- variable bleed valve and variable stator vane schedules
- control of turbine clearance
- idle setting

Protection against engine exceeding limits

- protection against N1 and N2 overspeed
- monitoring of EGT during engine start

Power management

- automatic control of engine thrust rating
- computation of thrust parameter limits
- manual management of power as a function of thrust lever position
- automatic management of power (A/THR demand).

Automatic engine starting sequence

- control of :
 - the start valve (ON/OFF)
 - the HP fuel valve
 - the fuel flow
 - the ignition (ON/OFF)
- monitoring of N1, N2, FF and EGT
- initiation of abort and recycle (on the ground only)

Manual engine starting sequence

- passive monitoring of engine
- control of :
 - the start valve
 - the HP fuel valve
 - the ignition

Thrust reverser control

- Actuation of the blocker doors
- Engine setting during reverser operation

Fuel recirculation control

- Recirculation of fuel to the fuel tanks, depending on the engine oil temperature, the fuel system configuration, and the flight phase.

| | |
|---|---|
|  <p>A318/A319/A320/A321 FLIGHT CREW OPERATING MANUAL</p> | <p style="text-align: center;">AIRCRAFT SYSTEMS</p> <p style="text-align: center;">ENGINES</p> <p style="text-align: center;">FADEC</p> |
|---|---|

Transmission of engine parameters and engine monitoring information to cockpit indicators

- Primary engine parameters
- Starting system status
- Thrust reverser system status
- FADEC system status

Detection, isolation, and recording of failures

FADEC cooling

IDLE CONTROL

Ident.: DSC-70-20-00015374.0001001 / 17 NOV 14

Applicable to: ALL

The FADEC has the following three idle modes :

Modulated idle

- Is regulated according to :
 - bleed system demand
 - ambient conditions
- Is selected :
 - In flight, when the flaps are retracted (FLAPS lever at zero position)
 - On ground, provided reverse is not selected.

Approach idle

- Is regulated according to aircraft altitude, regardless of bleed system demand.
- Is selected in flight, when the flaps are extended (FLAPS lever not at zero position)
- Allows the engine to accelerate rapidly from idle to go-around thrust.

Reverse idle

- Is selected on ground, when the thrust lever is in REV IDLE position.
- Is slightly higher than forward idle thrust.

Intentionally left blank



A318/A319/A320/A321
FLIGHT CREW
OPERATING MANUAL

AIRCRAFT SYSTEMS

ENGINES

THRUST CONTROL SYSTEM (CFM+PW) - GENERAL

GENERAL

Ident.: DSC-70-30-10-00020872.0002001 / 17 MAR 17

Applicable to: ALL

A FADEC dedicated to each engine controls the thrust.

The pilot uses the thrust levers to set the thrust in manual mode, and the FMGS sets the thrust in automatic mode (A/THR function).

The FADEC prevents the thrust from exceeding the limit for the thrust lever position in both manual and automatic modes.



A318/A319/A320/A321
FLIGHT CREW
OPERATING MANUAL

AIRCRAFT SYSTEMS

ENGINES

THRUST CONTROL SYSTEM (CFM+PW) - GENERAL

Intentionally left blank

THRUST LEVERS

Ident.: DSC-70-30-20-00020873.0002001 / 17 MAR 17

Applicable to: ALL

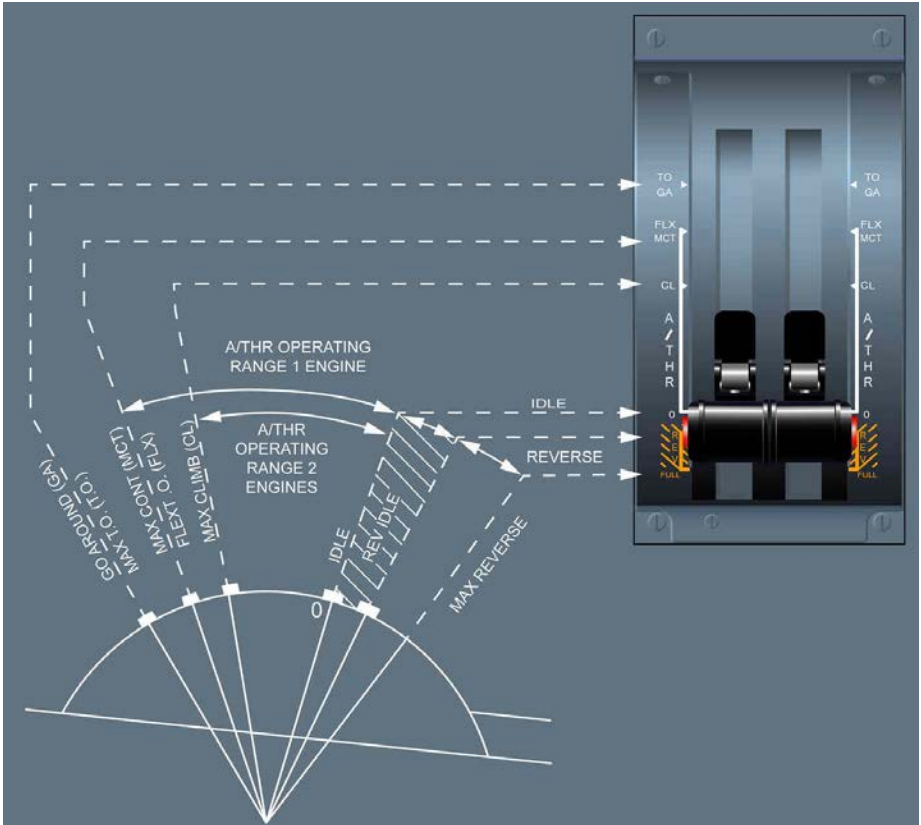

The thrust levers can only be moved manually.

They move over a sector that is divided into four operating segments.

The sector has five positions defined by detents or stops.

Thrust lever position is transmitted to the FADEC , which computes and displays the thrust rating limit and the N1 for that Thrust Lever Angle (TLA).

Note: There is no reverse idle detent. When the pilot moves the lever out of the idle stop by pulling up the reverse lever on the front of the thrust lever, he/she selects reverse idle.



A318/A319/A320/A321
FLIGHT CREW
OPERATING MANUAL

AIRCRAFT SYSTEMS

ENGINES

THRUST CONTROL SYSTEM (CFM+PW) - THRUST LEVERS

Intentionally left blank

THRUST RATING LIMIT

Ident.: DSC-70-30-30-00001571.0001001 / 21 MAR 16

Applicable to: ALL

The FADEC computes the thrust rating limit for each thrust lever position, as shown below. If the thrust lever is set in a detent, the FADEC selects the rating limit corresponding to this detent. If the thrust lever is set between two detents, the FADEC selects the rating limit corresponding to the higher detent.

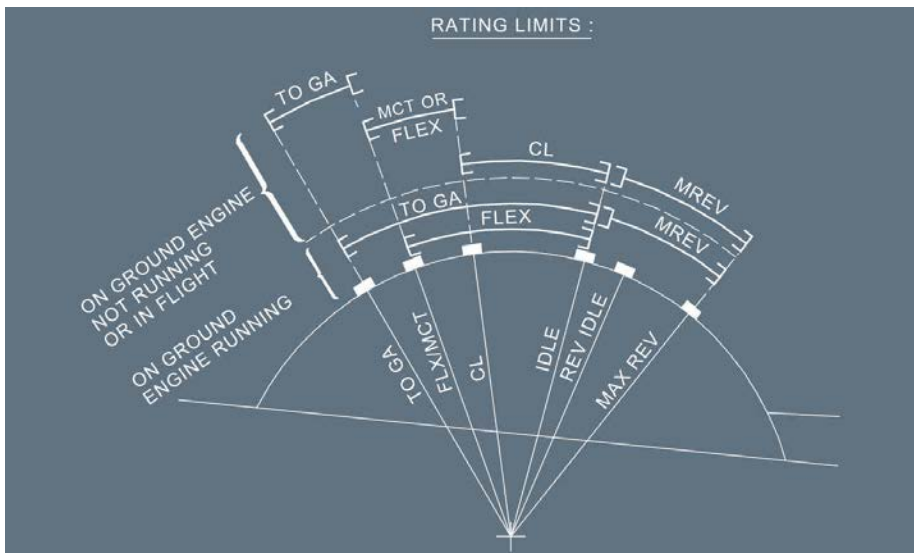



A318/A319/A320/A321
FLIGHT CREW
OPERATING MANUAL

AIRCRAFT SYSTEMS

ENGINES

THRUST CONTROL SYSTEM (CFM+PW) - THRUST RATING LIMIT

Intentionally left blank

MANUAL MODE

Ident.: DSC-70-30-40-00001572.0001001 / 17 NOV 14

Applicable to: ALL

The engines are in the manual mode provided the A/THR function is:

- not armed or
- armed and not active (thrust lever not in the A/THR operating range and no alpha floor).

In these conditions, each engine is controlled by the position of its thrust lever.

The pilot controls thrust by moving the thrust lever between the IDLE and TOGA positions. Each position of the thrust lever within these limits corresponds to an N1.

When the thrust lever is in a detent, the corresponding N1 is equal to the N1 rating limit computed by the FADEC for that engine.

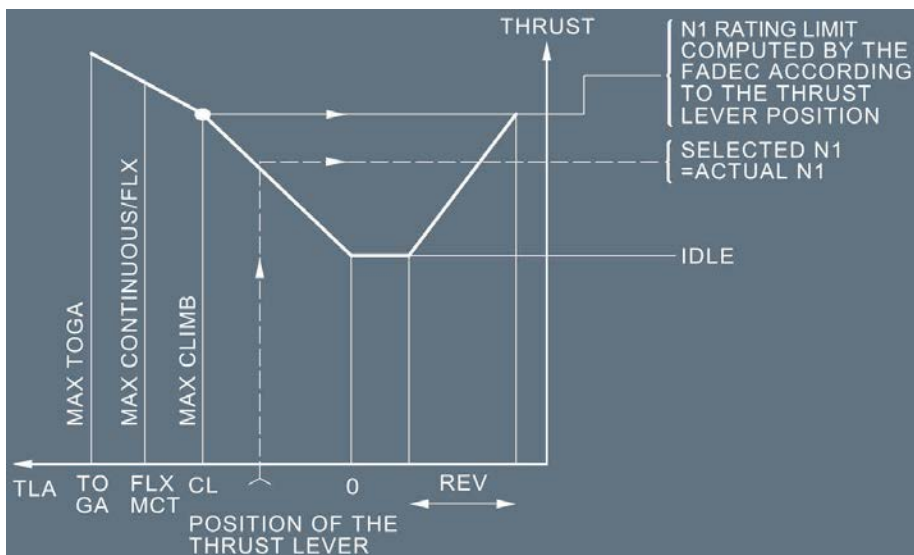

When the thrust lever is in the FLX/MCT detent:

- **On the ground**

The engine runs at the flex takeoff thrust rating if the crew has selected a flex takeoff temperature on the MCDU that is higher than the current Total Air Temperature (TAT).

Otherwise the engine produces Maximum Continuous Thrust (MCT).

- **After takeoff**

The pilot can change from FLX to MCT by moving the thrust lever to TOGA or CL, then back to MCT. After that, he cannot use the FLX rating.

Note: Setting the thrust lever out of FLX/MCT detent without reaching TOGA or CL detent has no effect.

The pilot can always get MAX TO thrust by setting the thrust levers to TOGA.

AUTOMATIC MODE

Ident.: DSC-70-30-40-00020874.0003001 / 17 MAR 17

Applicable to: ALL

In the autothrust mode (A/THR function active), the FMGC computes the thrust which is limited to the value corresponding to the thrust lever position (unless the alpha-floor mode is activated).

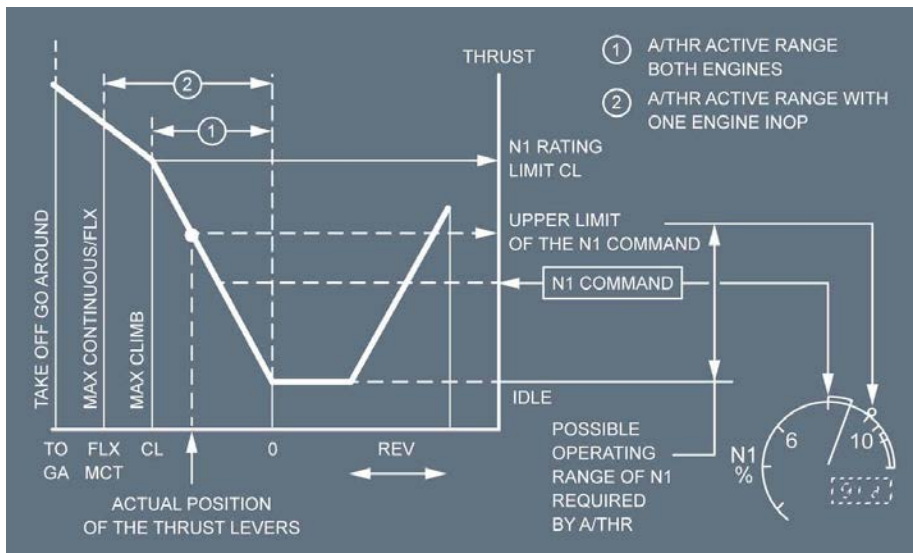

INDICATIONS ON FMA

The FADEC s monitor the positions of the thrust levers, and trigger appropriate indications on the FMA. *Refer to DSC-22_30-100 Autothrust Annunciations (FMA Column 1) - Third Line.*



A318/A319/A320/A321
FLIGHT CREW
OPERATING MANUAL

AIRCRAFT SYSTEMS

ENGINES

THRUST CONTROL SYSTEM (CFM+PW) - THRUST CONTROL

Intentionally left blank

GENERAL

Ident.: DSC-70-40-00020868.0001001 / 17 MAR 17

Applicable to: ALL

The fuel system supplies fuel to the combustion chamber at the required flow rate, pressure, and temperature.

The fuel flows from the tank, via the fuel pump unit and the fuel/oil heat exchanger, to the Hydromechanical Unit (HMU) and to the fuel nozzles.

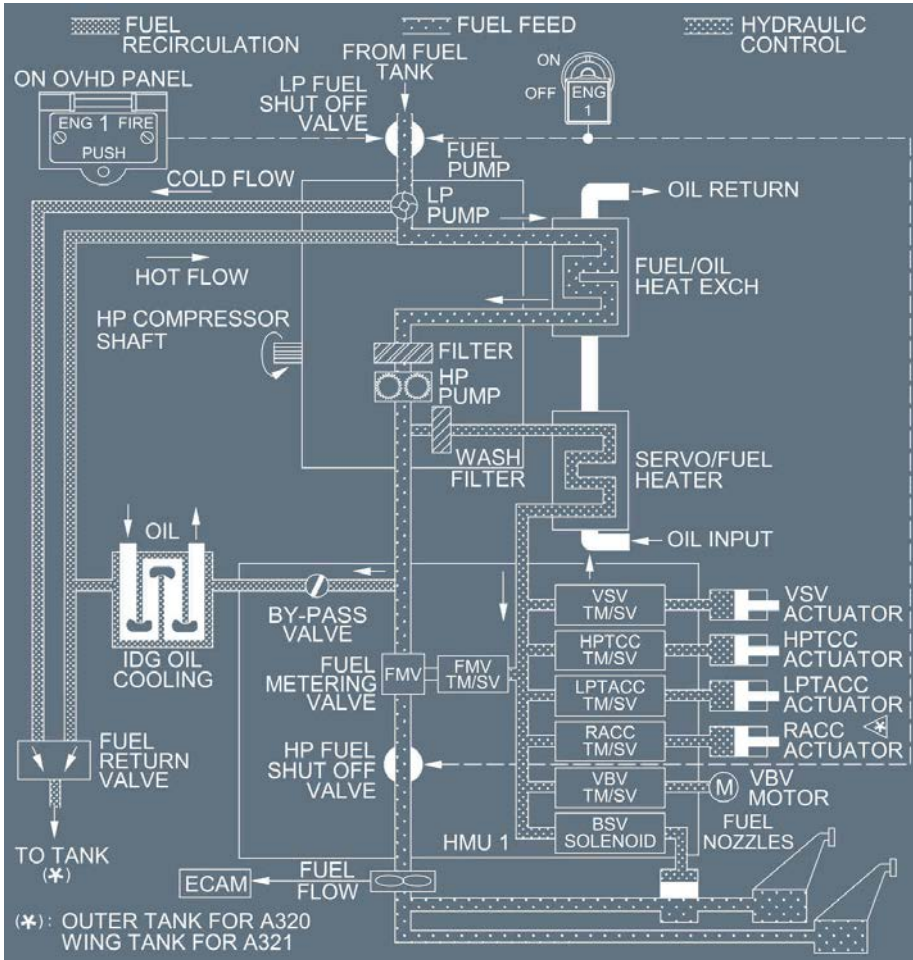

FUEL PUMP UNIT

Ident.: DSC-70-40-00001586.0001001 / 21 MAR 16

Applicable to: ALL

The HP compressor shaft drives the HP fuel pump assembly. Fuel flows through the LP pump, then through the fuel/oil heat exchanger and the HP pump (gear pump).

The fuel then divides into a filtered flow for the servo fuel heater and the servo valves of the HMU , and an unfiltered flow for the metering valve of the HMU.

SHUT-OFF VALVES

Ident.: DSC-70-40-00001587.0001001 / 12 MAY 16

Applicable to: ALL

Moving the ENG 1 (ENG 2) MASTER switch to OFF directly commands the closing of the LP and HP fuel shut off valves for that engine's fuel system.

It also closes the fuel return valve and opens the bypass valve.

HYDROMECHANICAL UNIT

Applicable to: ALL

Ident.: DSC-70-40-A-00001588.0001001 / 17 MAR 17

GENERAL

The FADEC controls the HMU, which :

- controls fuel flow to the engine combustion chamber
- controls fuel hydraulic signals to actuators
- protects against overspeeding.

Ident.: DSC-70-40-A-00020880.0001001 / 17 MAR 17

FUEL FLOW

L3 The Fuel Metering Valve (FMV) transforms FADEC orders through a torque motor and servo valve into fuel flow to the engine fuel nozzles.

The FMV resolver generates a feedback signal proportional to the FMV position.

The bypass valve maintains a constant pressure drop across the FMV to ensure that the metered fuel flow is proportional to the FMV position.

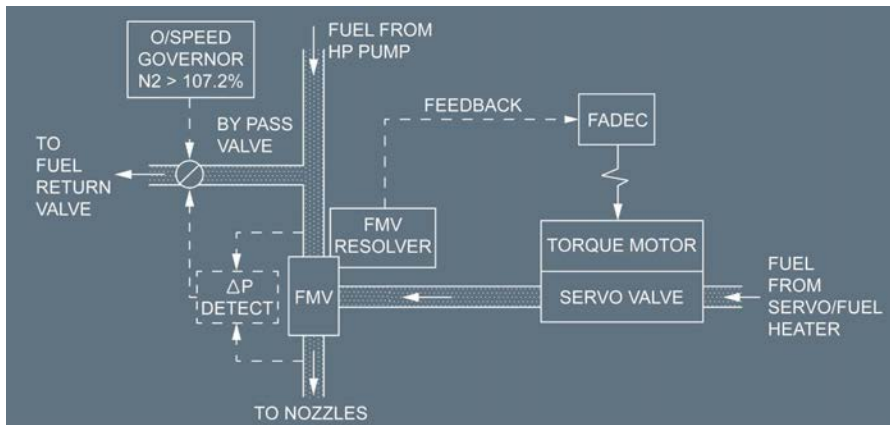

L1 The FADEC computes the fuel flow that will maintain the target N1.

As the FADEC maintains this N1, it allows N2 to vary while remaining between N2 minimum and N2 maximum. The FADEC also controls the engine parameters to :

- Limit acceleration and deceleration ;
- Avoid engine stall or flameout ;
- Limit maximum N1 and N2 ;
- Maintain air bleed pressure requirement.

The FADEC computes an N2 correction according to the bleed configuration.

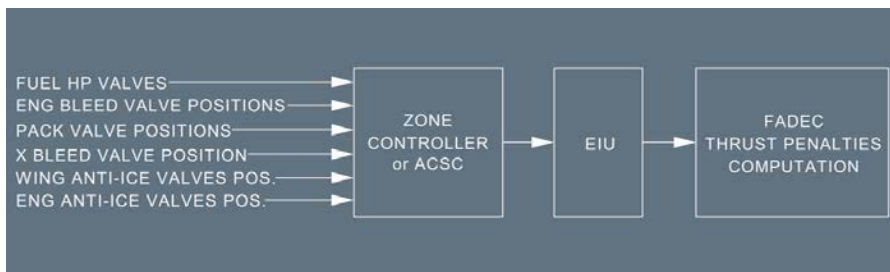

Ident.: DSC-70-40-A-00001590.0001001 / 17 MAR 17

OVERSPEED GOVERNOR SYSTEM

Independent of the FADEC, the overspeed governor limits the N2 by opening the fuel bypass valve, in the event of a malfunction that could lead to an overspeed condition.

Ident.: DSC-70-40-A-00001592.0002001 / 17 MAR 17

FUEL HYDRAULIC SIGNALS

- Fuel hydraulic signals go to :
 - Low Pressure Turbine Clearance Control (LPTCC) valves
(Refer to DSC-70-60 General)
 - High Pressure Turbine Clearance Control (HPTCC) valves
(Refer to DSC-70-60 General)
 - Rotor Active Clearance Control (RACC) system
(Refer to DSC-70-60 General)
 - Variable Stator Vanes (VSV)

The VSV system positions the compressor variable vanes.

The FADEC maintains optimum compressor efficiency at a steady state and an adequate stall margin for transient engine operation.

VSVs are fully closed during engine start and are fully open at high thrust.

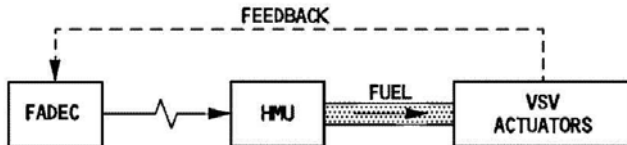

- Variable Bleed Valves (VBV)

The FADEC controls the VBV s, upstream of the HP compressor. Their setting depends on compressor inlet temperature and on N2. It varies between full open (start, low thrust, and during fast deceleration) and full closed (high thrust) positions.

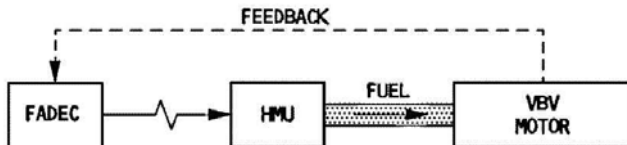

IDG COOLING SYSTEM

Ident.: DSC-70-40-00001593.0001001 / 26 JUL 12

Applicable to: ALL

Some of the fuel flowing out of the HMU goes to cool the oil systems of the Integrated Drive Generators (IDGs). It then returns to the fuel pump unit or to the tank.

The Fuel Return Valve (FRV), controlled by the FADEC, ensures that this flow is adequate.

ⓘ At low engine thrust, if the oil going into the IDG is too hot, the cooling fuel is sent back to the tank (300 kg/h).

If oil temperature continues to rise, the ECU increases the minimum N2.

If oil temperature still keeps rising, the FADEC increases the fuel flow to the tank (from 300 to 600 kg/h, depending on fuel return temperature).

The fuel return valve is always mixing hot fuel with cold fuel so that the temperature of fuel returning to the tank stays below 100 °C (from 200 to 400 kg/h, depending on fuel return temperature).

Fuel recirculation to the tank is inhibited (FRV closed) in the following cases :

- at engine shutdown
- during takeoff and climb
- if :
 - wing tank level is below about 300 kg (660 lb).
 - there is fuel overflow in the surge tank
 - fuel feed is by gravity only.
- when fuel temperature in the wing tank in flight is above 52.5 °C

Note: *On the ground, high fuel temperature in the wing tank or fuel overflow in the surge tank does not inhibit the fuel recirculation to the wing tank (FRV remains open).*

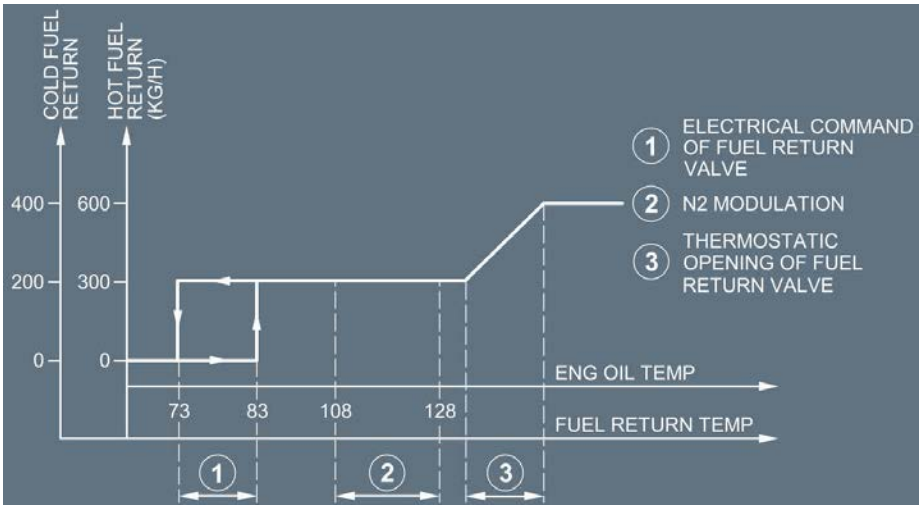
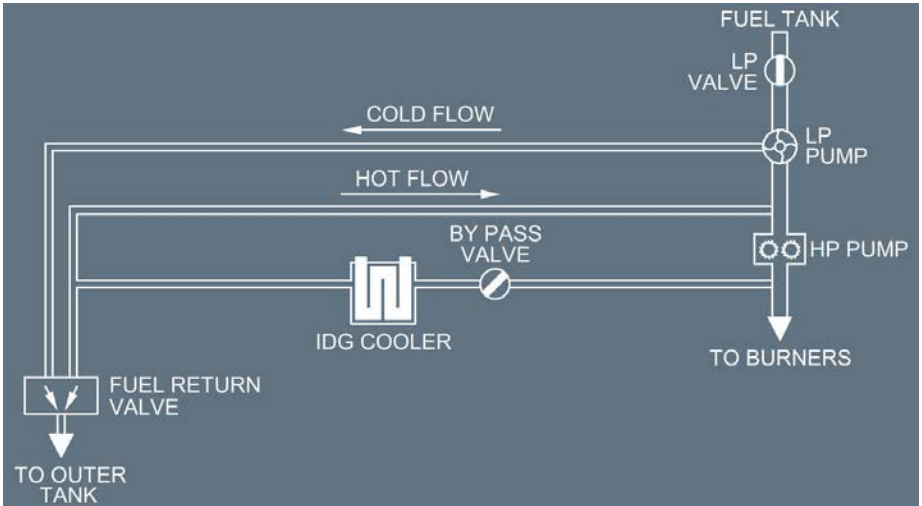



A318/A319/A320/A321
FLIGHT CREW
OPERATING MANUAL

AIRCRAFT SYSTEMS

ENGINES

FUEL SYSTEM (CFM56)

Intentionally left blank

GENERAL

Ident.: DSC-70-50-00001603.0001001 / 21 MAR 16

Applicable to: ALL

The oil system lubricates the engine components.

It contains :

- the oil tank
- the lube and scavenge pump modules
- the fuel/oil heat exchanger
- the filters, chip detectors, pressure relief and bypass valves.

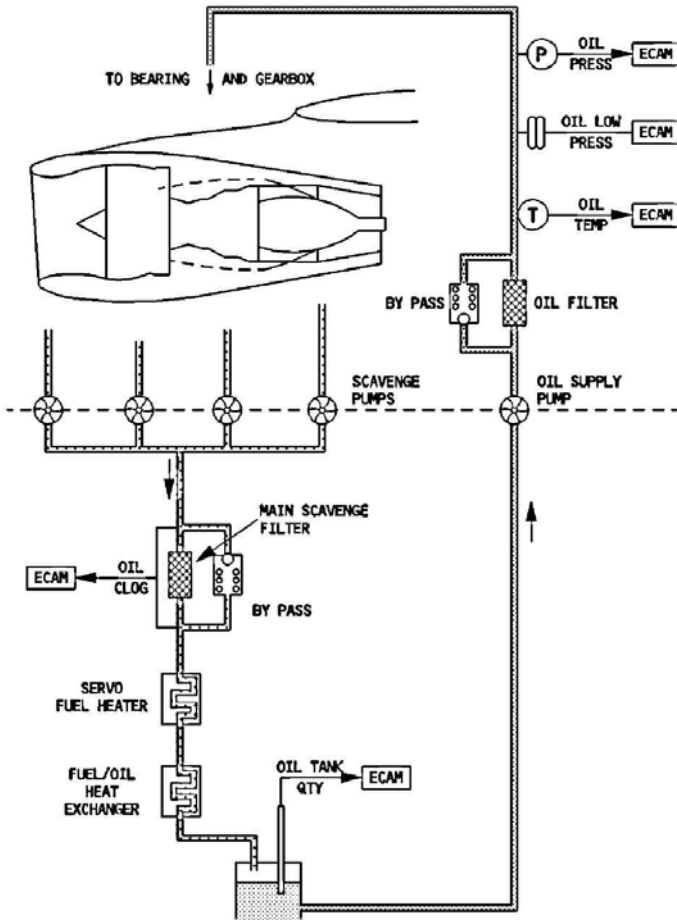

GENERAL

Ident.: DSC-70-60-00001604.0002001 / 21 MAR 17

Applicable to: **ALL**

The air bleed system supplies the aircraft with compressed air.

It uses the air for:

- pneumatic system (*Refer to DSC-36-10-10 General*)
- cooling the engine compartment and the turbines.

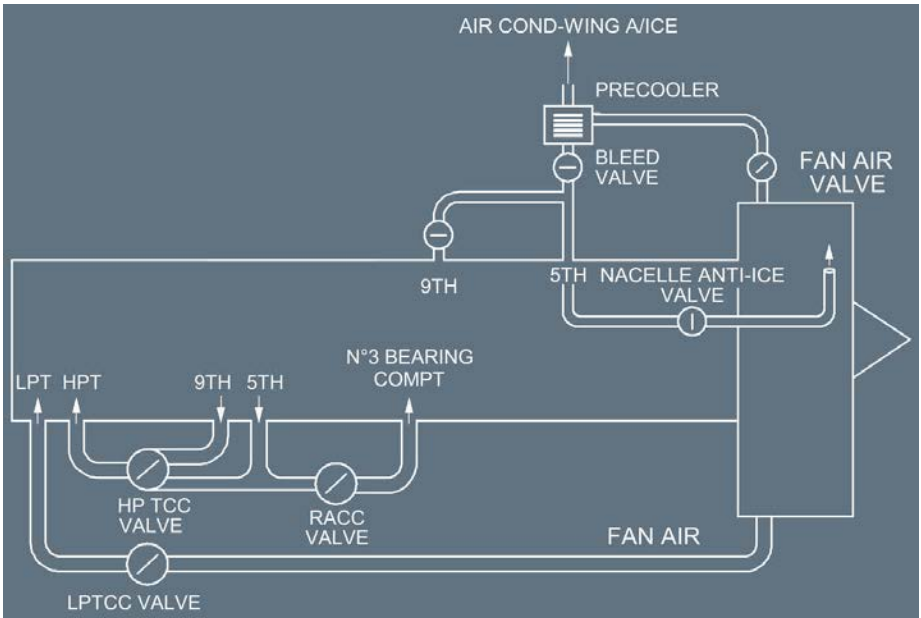

COOLING

Ident.: DSC-70-60-00001605.0002001 / 21 MAR 16

Applicable to: **ALL**

ROTOR ACTIVE CLEARANCE CONTROL (RACC) SYSTEM

The FADEC controls the RACC system through the HMU . The RACC system controls the clearance between the rotor blades of the HP compressor and its stator case.

The RACC system uses fifth-stage compressor bleed air that has been modulated according to the N2 and the flight parameters. The bleed air goes to the N°3 bearing compartment, where it is mixed with fan boost discharge.

Clearances are at the maximum when the RACC valve is closed.

HP TURBINE CLEARANCE CONTROL (HPTCC) SYSTEM

The FADEC controls the HPTCC system through the HMU . The HPTCC system controls the HP turbine clearance by modulating the HP compressor bleed air flow for cooling the HP turbine case. It optimizes HP turbine performance and reduces exhaust gas temperature.

LP TURBINE CLEARANCE CONTROL (LPTCC) SYSTEM

The FADEC controls the LPTCC system through the HMU . The LPTCC system controls LP turbine clearance by modulating the fan bleed air flow for cooling the LP turbine case.

GENERAL

Ident.: DSC-70-70-00020918.0003001 / 17 MAR 17

Applicable to: ALL

The aircraft reverses engine thrust by using four pivoting blocker doors on each engine to deflect the fan airstream.

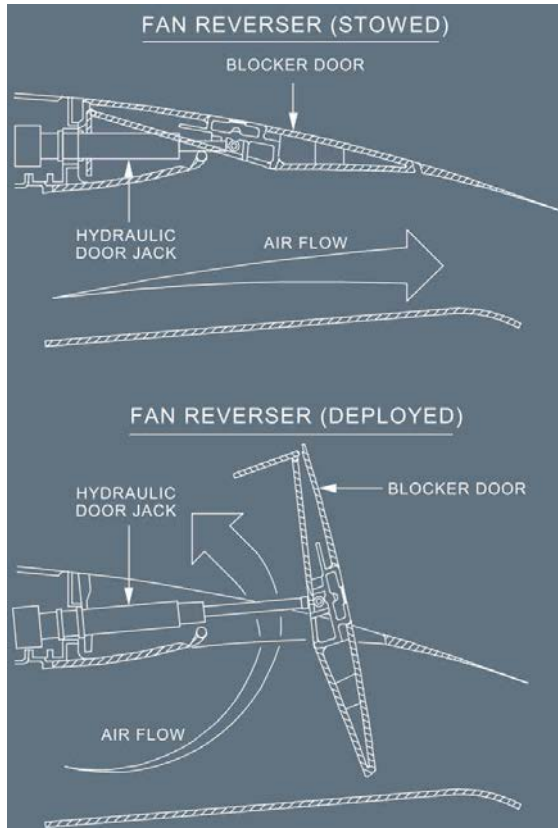

A hydraulic door jack positions each door.

- The green circuit powers the doors on ENG 1.
- The yellow circuit powers the doors on ENG 2.

The FADEC controls the thrust reverser system. Each FADEC channel performs control and monitoring functions. The systems for the two engines are independent of each other.

The thrust reverser system on each engine has :

- 4 actuators,
- 4 latches,
- Door position switches,
- A Hydraulic Control Unit (HCU) that :
 - Pressurizes the thrust reverser hydraulic system,
 - Regulates the speed of the blocker doors, and
 - Supplies actuators with hydraulic power.
- A hydraulic shutoff valve which allows hydraulic pressure to the HCU.

Each pivoting door moves independently (the doors are not synchronized).

The total actuation time is less than two seconds.

ACTUATION LOGIC

Ident.: DSC-70-70-00020920.0001001 / 17 MAR 17

Applicable to: **ALL**

Deployment requires :

- One FADEC channel, operating with its associated throttle reverse signal ;
- Right and left main gear compressed signal from the corresponding LGCIUs ;
- A Thrust Lever Angle (TLA) reverse signals from at least one Spoiler Elevator Computer (SEC).

Before deployment is completed, the FADEC sets reverse idle thrust on the engine that is having its thrust reversed.

PROTECTION

Ident.: DSC-70-70-00020921.0006001 / 17 MAR 17

Applicable to: **ALL**

- IDLE PROTECTION

The FADEC will automatically select the thrust to idle :

- In case of inadvertent thrust reverser deployment (while thrust reversers are commanded stowed), as soon as the thrust reverser feedback position is above 15 % deployed (thrust decreasing toward idle, when the detected position is between 10 % and 15 %).
- In case of inadvertent thrust reverser stowage (while thrust reversers are commanded deployed), as soon as the thrust reverser feedback position is below 78 % deployed (thrust decreasing toward idle between 90 % and 78 %).

SCHEMATIC

Ident.: DSC-70-70-00020919.0006001 / 17 MAR 17

Applicable to: ALL

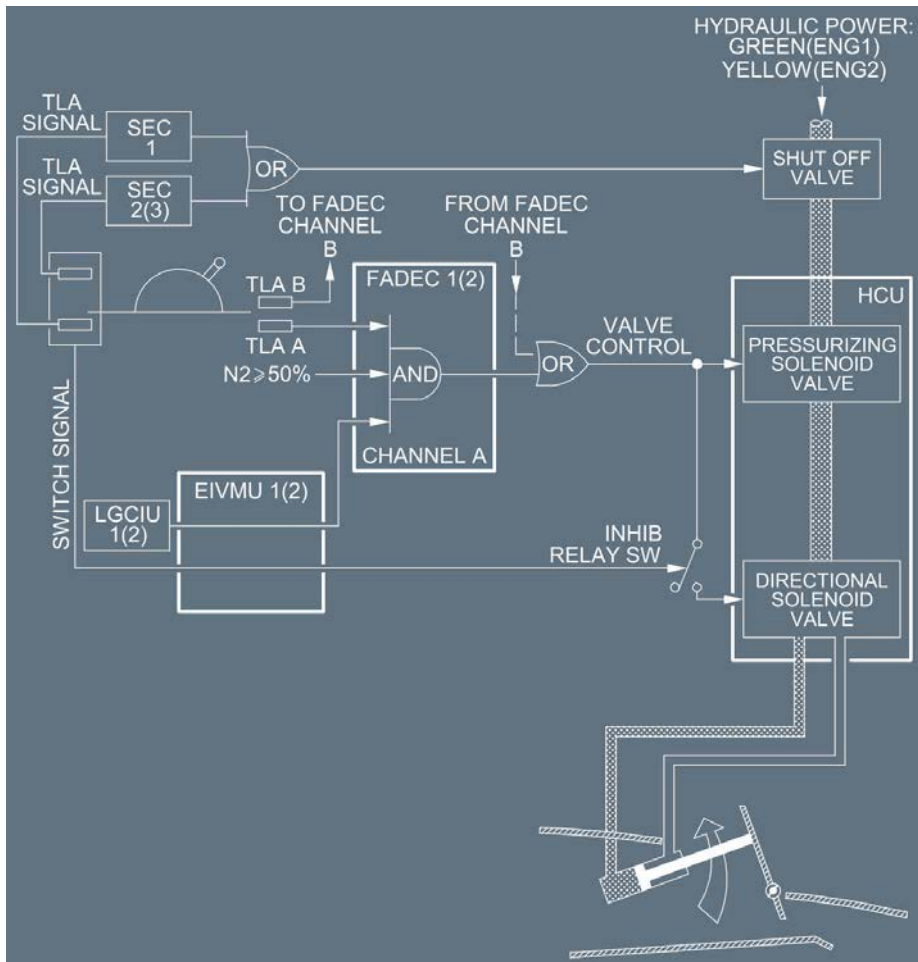



A318/A319/A320/A321
FLIGHT CREW
OPERATING MANUAL

AIRCRAFT SYSTEMS

ENGINES

THRUST REVERSER SYSTEM

Intentionally left blank

GENERAL

Ident.: DSC-70-80-10-00020922.0001001 / 17 MAR 17

Applicable to: ALL

The FADEC controls and monitors the ignition and starting system according to:

- The position of the ENG MODE selector
- The position of the ENG MASTER sw
- The position of the ENG MAN START pb-sw
- The aircraft status (flight or ground)

The FADEC receives the previous inputs from the EIVMU /EIU.



A318/A319/A320/A321
FLIGHT CREW
OPERATING MANUAL

AIRCRAFT SYSTEMS

ENGINES

IGNITION AND STARTING - GENERAL

Intentionally left blank

ARCHITECTURE

Ident.: DSC-70-80-20-00001617.0002001 / 21 MAR 16

Applicable to: ALL

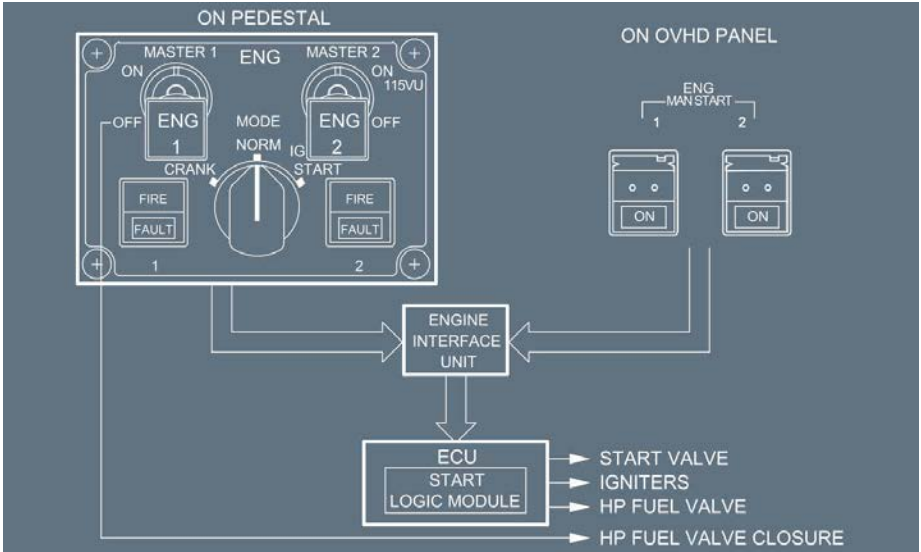



A318/A319/A320/A321
FLIGHT CREW
OPERATING MANUAL

AIRCRAFT SYSTEMS

ENGINES

IGNITION AND STARTING - ARCHITECTURE

Intentionally left blank

GENERAL

Ident.: DSC-70-80-30-00020923.0001001 / 17 MAR 17

Applicable to: ALL

The ignition system is for engine starting on the ground and restarting in flight. It consists of two identical independent circuits for each engine, normally controlled by the FADEC channel A and channel B. Each FADEC channel can control both igniters.

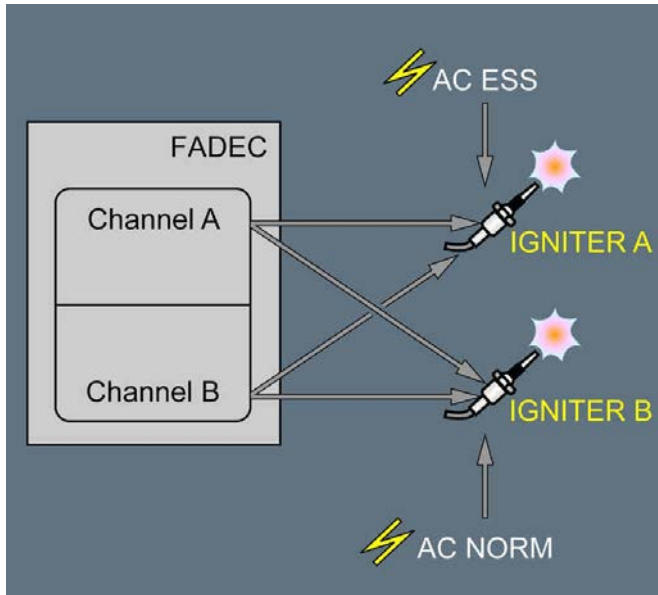

Note: Supply for igniter A switches to the STAT INV BUS BAR as soon as the static inverter is operative.

IGNITION FOR STARTING

Ident.: DSC-70-80-30-00020924.0002001 / 17 MAR 17

Applicable to: ALL

ON THE GROUND

Automatic start:

- During a first automatic start attempt only one igniter is supplied. The FADEC automatically alternates the igniters and/or channels used in successive start sequences.
- The ignition comes on automatically when N2 reaches 16 % and cuts off automatically when N2 reaches 50 %.

- During an automatic start, if the first attempt fails, the FADEC automatically initiates a new start attempt with both igniters energized.
- Manual start:
 - During a manual start both igniters are supplied, when the ENG MASTER sw is ON.
 - Both igniters are cut off when N2 reaches approximately 50 %.

IN FLIGHT

In case of start attempt in flight, when the ENG MASTER sw is ON, both igniters are supplied.

CONTINUOUS IGNITION

Ident.: DSC-70-80-30-00001620.0004001 / 21 MAR 16

Applicable to: ALL

Continuous ignition may be selected either manually or automatically to maintain engine combustion.

MANUAL SELECTION

In flight, continuous ignition is on when the ENG MODE selector is on IGN/START, if the corresponding engine is running.

Only one igniter is selected. If failed, both igniters are automatically selected.

On the ground after the engine is started, because ignition cuts off automatically, the flight crew must switch the ENG MODE selector to NORM then back to IGN/START to turn on continuous ignition.

AUTOMATIC SELECTION

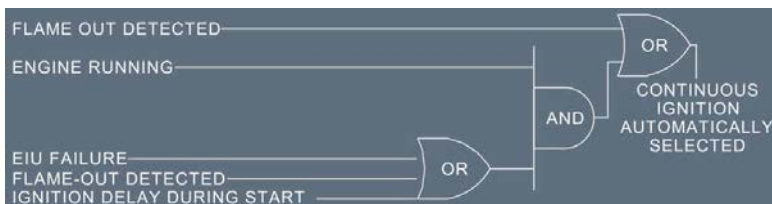

GENERAL

Ident.: DSC-70-80-40-00001621.0001001 / 21 MAR 16

Applicable to: ALL

The engine starting system consists of an air turbine starter and a start valve.

The start valve admits air supplied by the pneumatic system to operate the starter.

The FADEC controls the start valve electrically and bleed pressure is required for opening the start valve. If electrical control fails when the aircraft is on the ground, a handle allows the start valve to be operated manually.

AUTOMATIC STARTING

Applicable to: ALL

Ident.: DSC-70-80-40-10-00020932.0001001 / 21 MAR 17

GENERAL

This sequence is under the full authority of the FADEC, which controls:

- The start valve
- The igniters
- The fuel HP valves.

Ident.: DSC-70-80-40-10-00020933.0001001 / 21 MAR 17

PROTECTION

The FADEC :

- Detects a hot start, a hung start, a stall, or no light up
- Announces FAULT and identifies the fault in an ECAM message
- Runs an abort sequence if a start aborts on the ground
 - Closes the HP valve
 - Closes the start valve
 - Turns off ignition
 - Cranks the engine crank after the start abort in order to clear out fuel vapors
 - Controls any additional start attempts.

Ident.: DSC-70-80-40-10-00020934.0001001 / 21 MAR 17

DRY CRANKING

Depending on the engine thermal state, the FADEC can initiate a pre-start motoring (dry cranking) up to 60 s. Pre-start motoring is active during all ground starts and ground cranking procedures to limit the engine core speed below the bow rotor critical speed (bow rotor protection). The motoring time will vary depending on the residual thermal condition of the engine and depending on the

engine vibration level. During the engine motoring, the FADEC logic limits the maximum N2 around 30 %.

Ident.: DSC-70-80-40-10-00020935.0001001 / 21 MAR 17

WINDMILLING

For an in-flight start, the FADEC decides whether the engine is windmilling fast enough or needs assistance from the starter in view of current engine parameters and flight environment parameters.

Flight crew may interrupt this start sequence by moving the ENG MASTER sw to OFF.

AUTOMATIC STARTING SEQUENCE

Applicable to: ALL

Ident.: DSC-70-80-40-20-00020925.0001001 / 21 MAR 17

SEQUENCE OF THE AUTOMATIC START

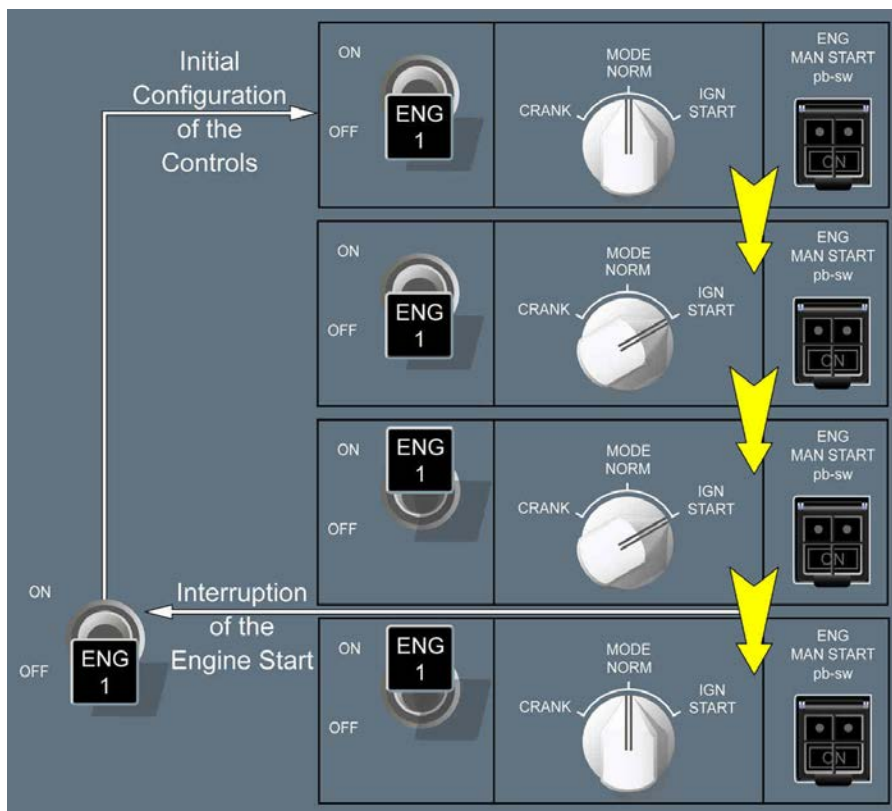

Ident.: DSC-70-80-40-20-00020926.0001001 / 21 MAR 17

INITIAL CONFIGURATION OF THE CONTROLS

The initial configuration prior an automatic engine start is the following :

- The ENG MASTER sw is set to OFF
- The ENG MODE selector is set to NORM
- The ENG MAN START pb-sw is set to OFF.

Ident.: DSC-70-80-40-20-00020927.0001001 / 21 MAR 17

FIRST STEP

The flight crew must set the ENG MODE selector to IGN/START, leading to the following:

- The ENG SD page appears on the SD
- All engine parameters are available
- Pack valves automatically close.

After 30 s, if the flight crew does not set the ENG MASTER sw to ON (*Refer to DSC-70-80-40 Second Step*), pack valves automatically open again.

Ident.: DSC-70-80-40-20-00020928.0001001 / 21 MAR 17

SECOND STEP

The flight crew must set the ENG MASTER sw to ON, and the following steps occur:

- The LP fuel valve opens
- The engine start valve opens
- The ignition starts:
 - On ground: when $N_2 > 16\%$
 - In flight: Immediately.
- The HP fuel valve opens:
 - On ground: when $N_2 > 22\%$
 - In flight: when $N_2 > 15\%$.
- When $N_2 > 50\%$:
 - The engine start valve closes
 - The ignition stops if on ground
 - The pack valves reopen if another engine is not started within 30 s.

Ident.: DSC-70-80-40-20-00020929.0001001 / 21 MAR 17

THIRD STEP

The automatic engine start is finished.

The flight crew must set the ENG START selector to NORM.

Ident.: DSC-70-80-40-20-00020930.0001001 / 21 MAR 17

INTERRUPTION OF THE AUTOMATIC START

When required by ECAM and after confirmation, the flight crew must set the ENG MASTER lever to OFF.

If the flight crew sets the ENG MASTER sw to OFF, the FADEC automatically :

- Closes the LP and the HP fuel shutoff valves
- Stops to energize the ignitor
- Closes the engine start valve.

MANUAL STARTING

Ident.: DSC-70-80-40-00020937.0001001 / 17 MAR 17

Applicable to: ALL

If an automatic start is not successful, the flight crew can perform a manual start.

In the manual start sequence, the FADEC has limited control. As a result, the flight crew must monitor engine acceleration.

To perform a manual start, the flight crew must :

- Set the ENG MODE selector to IGN/START
- Set the ENG MAN START pb-sw to ON
- Set the ENG MASTER sw to ON.

The FADEC:

- Opens the engine start valve when the flight crew :
 - Sets the ENG MODE selector to IGN/START
 - Sets the ENG MAN START pb-sw to ON
- Opens the HP shutoff valve, and operates both igniters when the flight crew sets the ENG MASTER sw to ON
- Closes the engine start valve, and cuts off the ignition when N2 reaches 50 %.

For more information about the manual start sequence, *Refer to PRO-NOR-SUP-ENG Manual Engine Start - General.*

The FADEC makes a passive survey of the engine during the starting sequence : the flight crew is made aware of an abnormal start by a proper ECAM warning and has to interrupt the start sequence. The FADEC has not the authority to abort the manual start :

- in flight
- on ground, except if the start EGT limit is exceeded before reaching 50 % N2. In this case only, the FADEC aborts the start.

In flight, the FADEC always commands a starter-assisted air start.

ENGINE VENTILATION (DRY CRANKING)

Ident.: DSC-70-80-40-00020938.0001001 / 21 MAR 17

Applicable to: ALL

A dry cranking cycle ventilates the engine to remove fuel vapors after an unsuccessful start attempt on the ground.

The flight crew can manually select cranking by setting the ENG MODE selector to CRANK and the ENG MAN START pb-sw to ON (ENG MASTER sw OFF). Flight crew can stop the cranking by setting the ENG MAN START pb-sw to OFF.

ENG MAN START PANEL

Applicable to: ALL

Ident.: DSC-70-90-10-20-00018366.0001001 / 21 MAR 16

ENG MAN START Panel

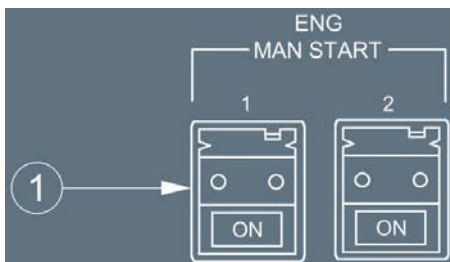

Ident.: DSC-70-90-10-20-00018370.0001001 / 12 MAY 16

ENG MAN START pb-sw

- Off : - Aborts the manual start sequence of the associated engine, when the ENG MODE selector is set to IGN/START and the ENG MASTER lever is set to OFF, or
- Stops the dry crank process of the associated engine, when the ENG MODE selector is set to CRANK and the ENG MASTER lever is set to OFF.

L13

- ON (in blue) : - Initiates the manual start sequence of the associated engine, when the ENG MODE selector is set to IGN/START, or
- Initiates the wet crank process of the associated engine, when the ENG MODE selector is set to CRANK and the ENG MASTER lever is set to ON, or
 - Initiates the dry crank process of the associated engine, when the ENG MODE selector is set to CRANK and the ENG MASTER lever is set to OFF.



A318/A319/A320/A321
FLIGHT CREW
OPERATING MANUAL

AIRCRAFT SYSTEMS

ENGINES

CONTROLS AND INDICATORS - OVERHEAD PANEL

Intentionally left blank

ENG MODE SELECTOR AND ENG MASTER LEVERS

Applicable to: ALL

Ident.: DSC-70-90-20-30-00018367.0001001 / 12 OCT 16

ENG MODE selector and ENG MASTER Levers



Ident.: DSC-70-90-20-30-00018373.0001001 / 21 MAR 17

ENG MODE START selector

NORM : Normal mode of operation.

IGN/START : Use the IGN/START position to:

- Initiate the automatic or manual start sequences of the associated engine, when the ENG MASTER lever is set to OFF, or
- Initiate the ignitors in flight as required.

L18

- CRANK : Use the CRANK position to:
- Initiate the dry crank process of the associated engine, when the ENG MASTER lever is set to OFF and the ENG MAN START pb-sw is set to ON.
 - Initiate the wet crank process of the associated engine for maintenance purpose, when the ENG MASTER lever, and the ENG MAN START pb-sw are set to ON.

Ident.: DSC-70-90-20-30-00018371.0001001 / 12 MAY 16

ENG MASTER lever

Also called ENG MASTER sw.

- ON : The FADEC:
- Initiates the automatic start sequence of the associated engine, when the ENG MODE selector is set to IGN/START, or
 - Initiates the manual start sequence of the associated engine, when the ENG MODE selector is set to IGN/START and the ENG MAN START pb-sw is set to ON.
- OFF : The FADEC:
- Shuts down the associated engine, or
 - Aborts the start sequence of the associated engine.

Ident.: DSC-70-90-20-30-00018372.0001001 / 21 MAR 17

ENG 1(2) FIRE light

FIRE Light :

A fire is detected in the corresponding engine.

Refer to DSC-26-20-20 ENG 1(2) FIRE Light

ENG 1(2) FAULT light

FAULT light :

This amber light comes on, and a caution appears on ECAM, if there is:

- The position of the HP fuel shutoff valve is abnormal, or
- The automatic start sequence of the associated engine aborts, or
- There is a malfunction of the thrust control.

THRUST LEVERS

Applicable to: ALL

Ident.: DSC-70-90-20-40-00018368.0001001 / 28 JUL 16

Thrust Levers

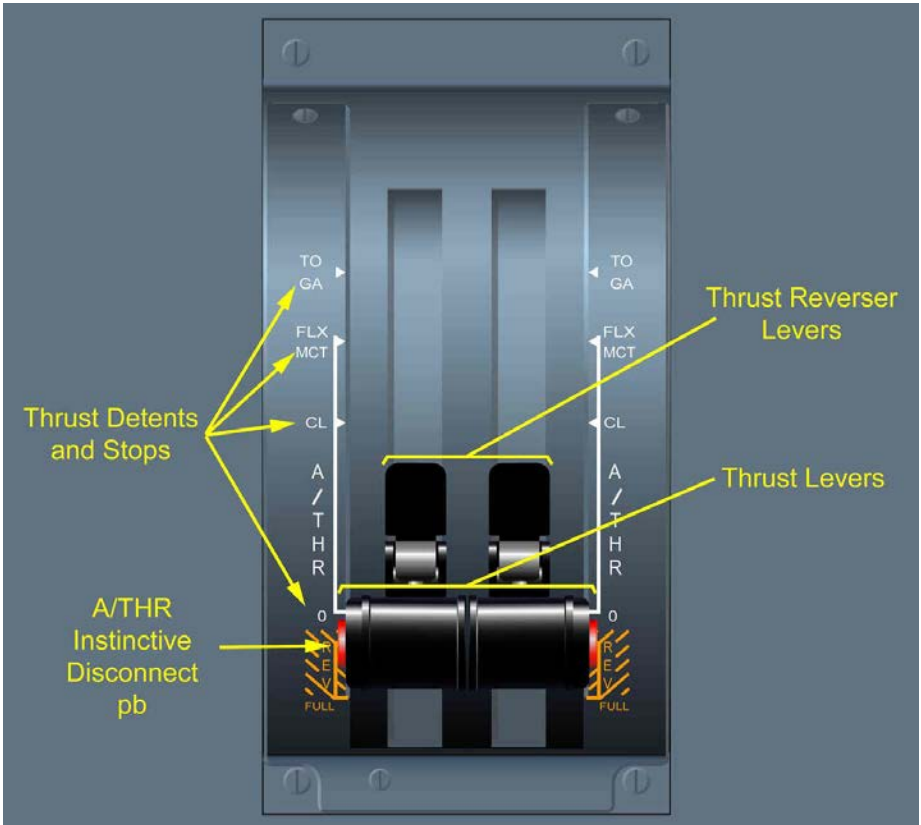

Ident.: DSC-70-90-20-40-00018376.0001001 / 21 MAR 16

THRUST LEVERS

The flight crew uses the thrust levers in order to:

- Adjust the thrust, or
- Select a thrust stop or detent, or

- Control the deployment and the stowage of the associated reversers, or
- Adjust the associated reverse thrust.

The flight crew can move each thrust lever individually.

L2 The position of the thrust levers appears on the E/WD, via a blue circle on the thrust gauge.

L1 The flight crew can move each thrust lever forward the Idle (0) stop, when the associated thrust reverser lever is set to the locked position.

The flight crew can move each thrust lever backward the Idle (0) stop, when the associated thrust reverser lever is in the unlocked position.

Ident.: DSC-70-90-20-40-00018377.0001001 / 12 OCT 16

THRUST DETENTS AND STOPS

There are two stops and four detents:

- The Idle (0) stop,
- The Climb (CL) detent,
- The Maximum Continuous Thrust (MCT)/Flexible Take Off (FLX) detent,
- The Takeoff (TO)/Go-Around (GA) detent,
- The Rev Idle (R or REV) detent,
- The Rev Max (F or FULL) stop.

Ident.: DSC-70-90-20-40-00018378.0001001 / 21 MAR 16

THRUST REVERSER LEVERS

The flight crew uses the thrust reverser levers in order to unlock the associated thrust lever.

The flight crew can move each thrust reverser lever upward to the unlocked position, when the associated thrust lever is set to the Idle (0) stop.

The thrust reverser levers are automatically reset to the locked position, when the flight crew moves the thrust levers forward the Idle (0) stop.

Ident.: DSC-70-90-20-40-00018379.0001001 / 21 MAR 16

A/THR Instinctive Disconnect pb

Pressing the A/THR instinctive disconnect pb disconnects the A/THR.

L2 For more information about A/THR instinctive disconnect pb, *Refer to DSC-22_30-90 A/THR Disconnection - General.*

ENG FADEC GND PWR PANEL

Applicable to: ALL

Ident.: DSC-70-90-30-10-00018365.0001001 / 12 OCT 16

ENG FADEC GND PWR Panel

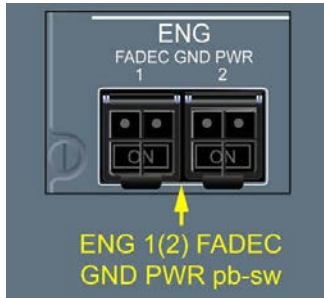

Ident.: DSC-70-90-30-10-00018369.0001001 / 21 MAR 16

ENG FADEC GND PWR PB-SW

- Off : The electrical network of the aircraft or the FADEC alternator automatically supplies the FADEC.
- ON : On ground, when pressed the electrical network of the aircraft supplies the FADEC when:
- The ENG FIRE pb-sw is not pressed,
 - The FADEC alternator does not supply the FADEC.

Intentionally left blank

ENGINE/WARNING DISPLAY

Applicable to: ALL

Ident.: DSC-70-90-40-50-00017843.0003001 / 12 OCT 16

Engine/Warning Display

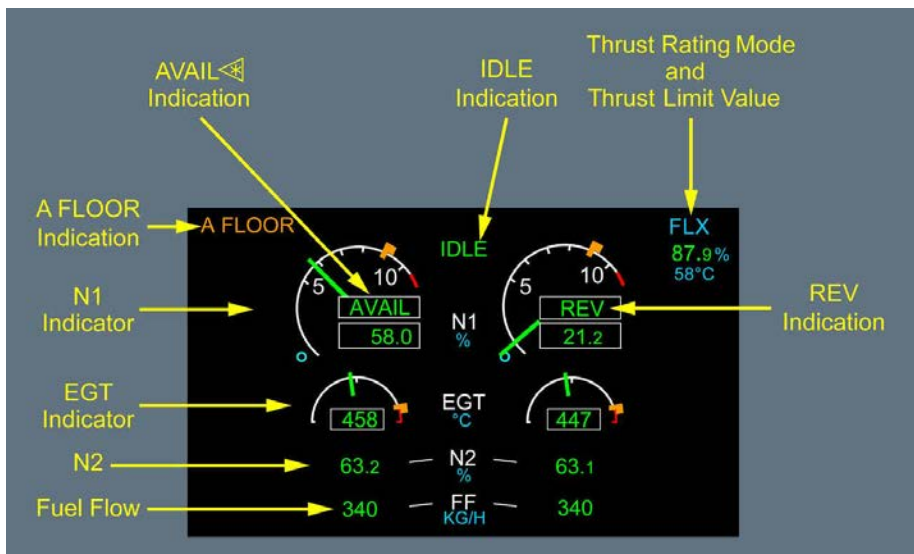

Ident.: DSC-70-90-40-50-00017845.0001001 / 21 MAR 16

A FLOOR INDICATION

The alpha floor protection is active.

For more information, Refer to DSC-22_30-90 A/THR Modes - ALPHA FLOOR

Ident.: DSC-70-90-40-50-00017846.0001001 / 21 MAR 16

THRUST RATING MODE AND THRUST LIMIT VALUE

Indicates the thrust limit value and the associated thrust rating mode based on:

- The position of the thrust levers,
- Aircraft on ground or in flight,
- The engine status, i.e. running or not running,
- The data entered in the T.O and CLB panels of the FMS ACTIVE/PERF page.



Ident.: DSC-70-90-40-50-00017847.0003001 / 21 MAR 16



Ident.: DSC-70-90-40-50-00018201.0001001 / 21 MAR 16

THRUST RATING MODE

The thrust rating modes are:

- TOGA : Takeoff or go-around (TOGA) thrust rating mode is selected.
- MCT : Maximum Continuous Thrust (MCT) rating mode is selected.
- CLB : Climb (CLB) thrust rating mode is selected.
- FLX : Flexible (FLX) takeoff thrust rating mode is selected.
- DCLB : Derated Climb  (DCLB) thrust rating mode is selected.
- D04 : Derated Takeoff  thrust rating mode is selected.
There are several levels of derated takeoff: D04, D08, D12, D16, D20, ...
- GA SOFT : Go-around Soft  (GA SOFT) thrust rating mode is selected.
- MREV : Maximum Reverse (MREV) thrust rating mode is selected.

Ident.: DSC-70-90-40-50-00018203.0001001 / 21 MAR 16

THRUST LIMIT VALUE

N1 value : Indicates the N1 limit value associated with the thrust rating mode.

 The thrust limit value disappears when the thrust reversers are selected.

Ident.: DSC-70-90-40-50-00017849.0001001 / 21 MAR 16

FLEX TEMPERATURE

Cyan : Indicates the flexible temperature that the flight crew entered in the T.O panel of the FMS PERF page, when the FLX rating mode is selected

Dashes in cyan : Indicates that the Static Air Temperature is above the flexible temperature.

Ident.: DSC-70-90-40-50-00018209.0001001 / 21 MAR 16

IDLE INDICATION

Both engines are at idle speed, and the aircraft is in flight.

- L2 Pulses during 10 s, and then remains steady.

Ident.: DSC-70-90-40-50-00018210.0001001 / 21 MAR 16

AVAIL INDICATION 

The engine is started, and at or above idle.

- L2 On ground, appears steady during 10 s after a successful start. In flight, pulses during 1 min after a successful relight.

The AVAIL Indication  disappears when the flight crew moves the thrust lever forward the idle detent.

Ident.: DSC-70-90-40-50-00018211.0001001 / 21 MAR 16

REV INDICATION

REV in green : On ground, the thrust reverser system is fully deployed.

L12

REV in amber : The thrust reverser system is unlocked.
In flight, the REV indication pulses during 9 s and then remains steady.

Ident.: DSC-70-90-40-50-00018213.0001001 / 21 MAR 16

EGT INDICATOR

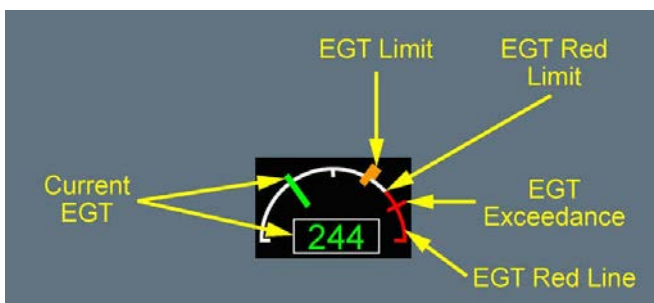

Ident.: DSC-70-90-40-50-00018216.0002001 / 21 MAR 16

CURRENT EGT

L12

Green : The current EGT is in normal range.
The scale goes from 0 °C to 1 000 °C.

Amber : The current EGT exceeds the EGT amber limit.

Red : The current EGT exceeds the EGT red limit.

Ident.: DSC-70-90-40-50-00018218.0003001 / 21 MAR 16

EGT LIMIT

The amber line indicates the maximum EGT (i.e. the EGT limit).

L2 The maximum EGT is:

- 725 °C, during the engine start sequence on ground, or
- 915 °C, in all other cases.

The EGT limit does not appear:

- When a takeoff or a go-around mode is selected, or
- When the thrust reversers are selected, or
- If the alpha floor protection is activated.

Ident.: DSC-70-90-40-50-00018219.0001001 / 21 MAR 16

EGT EXCEEDANCE

The EGT exceedance is the highest value that the EGT reached.

The EGT exceedance appears when:

- The current EGT exceeds the EGT red limit, or
- The EGT exceeded the EGT red limit.

L2 The red mark no longer appears at the next engine start sequence on ground, or after a maintenance action.

Ident.: DSC-70-90-40-50-00018220.0003001 / 21 MAR 16

EGT RED LINE

The EGT red line appears between the EGT red limit and the end of the scale.

L2 The EGT red limit is 950 °C.

Ident.: DSC-70-90-40-50-00018228.0001001 / 21 MAR 16

N1 INDICATOR



Ident.: DSC-70-90-40-50-00018229.0003001 / 04 JUL 17

CURRENT N1

Green : The current N1 is in normal range.

Amber : The current N1 exceeds the N1 limit.

L12

Red : The current N1 exceeds the N1 red limit.
N1 red limit is 104 %.

L12

Dashed : The accuracy of the N1 measurement is degraded.
Two amber dashes appear over the last digit.

Ident.: DSC-70-90-40-50-00018231.0001001 / 21 MAR 16

N1 TREND

The green triangle indicates the direction of the N1 trend, when the A/THR mode is active.

Ident.: DSC-70-90-40-50-00018232.0001001 / 21 MAR 16

N1 COMMAND

Indicates the N1 target, when the A/THR mode is active.

Ident.: DSC-70-90-40-50-00018233.0001001 / 21 MAR 16

TRANSIENT N1

The four green arcs indicate the difference between the N1 command and the current N1 , when the A/THR is active.

Ident.: DSC-70-90-40-50-00018235.0001001 / 21 MAR 16

THRUST LEVER POSITION

The blue circle indicates the position of the thrust lever.

In manual mode, the blue circle corresponds to the N1 value reached after the stabilization of the engine parameters.

Ident.: DSC-70-90-40-50-00018236.0001001 / 21 MAR 16

N1 LIMIT

The amber mark indicates the N1 limit.

L2 This corresponds to the maximum N1 value when the thrust levers are in TO/GA detent.

Ident.: DSC-70-90-40-50-00018237.0001001 / 21 MAR 16

N1 EXCEEDANCE

The N1 exceedance is the highest value that the N1 reached.

The N1 exceedance appears when the current N1 exceeds the N1 red limit.

The N1 exceedance remains even if the N1 value decreases below the N1 red limit.

L2 The red mark no longer appears at the next engine start sequence on ground, or after a maintenance action.

Ident.: DSC-70-90-40-50-00018238.0003001 / 21 MAR 16

N1 RED LINE

The N1 red line appears between the N1 red limit and the end of the scale.

L2 The N1 red limit is 104 %.

Ident.: DSC-70-90-40-50-00018239.0002001 / 21 MAR 16

N2

In a grey box : The engine start sequence or the crank process is in progress.

Green: : N2 is in normal range.

L12

Red : N2 exceeds the N2 red limit.

N2 red limit is 105 %.

A red cross appears.

The red cross no longer appears at the next engine start sequence on ground, or after a maintenance action.

L12

Dashed : The accuracy of the N2 measurement is degraded.

Two amber dashes appear over the last digit.

Ident.: DSC-70-90-40-50-00018243.0001001 / 21 MAR 16

FUEL FLOW

Green : The fuel flow is normal.

Note: If the system detects a discrepancy between the N1 , N2 , EGT and fuel flow values on the FADEC -DMC bus and the corresponding displayed values, an amber CHECK appears underneath the affected parameter.

Ident.: DSC-70-90-40-50-00018244.0001001 / 21 MAR 16

THRUST BUMP  INDICATION

Green : Indicates that the thrust bump is engaged.

Amber : When on the ground, indicates that the thrust bump is selected but not engaged.

Cyan : When on the ground, Indicates that the thrust bump is selected.

ENG SD PAGE

Applicable to: ALL

Ident.: DSC-70-90-40-60-00018259.0006001 / 21 MAR 16

ENG SD page

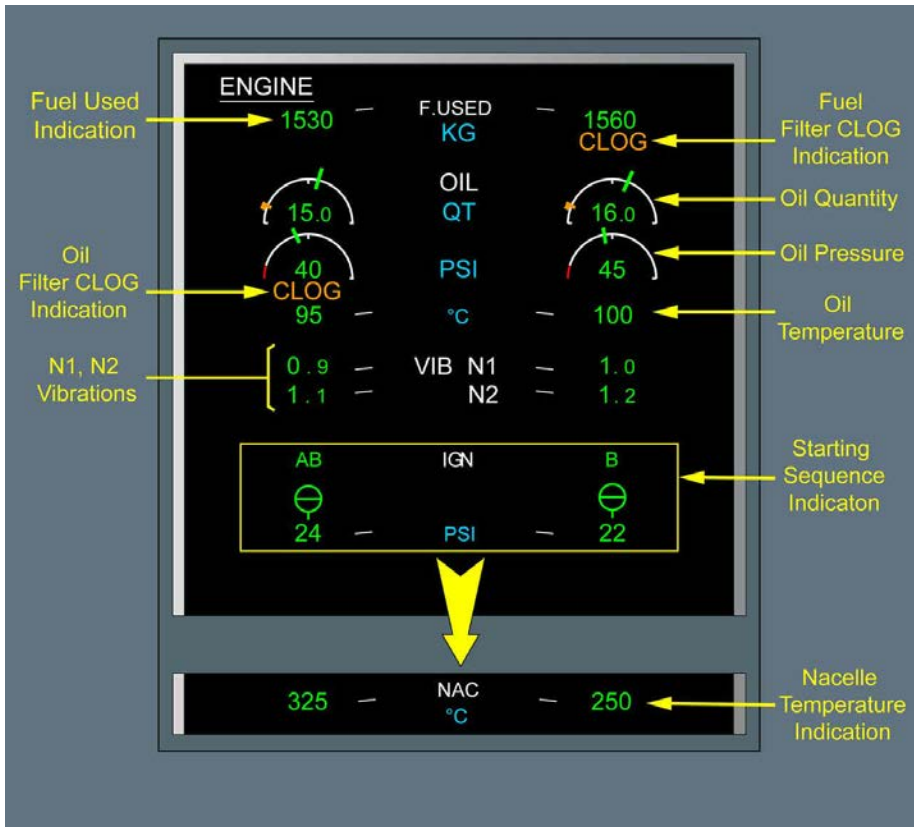

Ident.: DSC-70-90-40-60-00018230.0001001 / 21 MAR 16

FUEL USED INDICATION

L12

Green : Indicates the fuel used by each engine.
 This value automatically resets on ground, at the next engine start.
 Appears in multiples of 10 kg (20 lb).

L12

- Dashed : The value accuracy is degraded.
Two amber dashes appear over all five digits.
This occurs when the Fuel Flow is not valid in flight, for more than 1 min.

Ident.: DSC-70-90-40-60-00018260.0001001 / 21 MAR 16

FUEL FILTER CLOG INDICATION

Indicates that the pressure loss across the fuel filter is excessive.

Ident.: DSC-70-90-40-60-00018262.0002001 / 22 MAR 16

OIL QUANTITY

L12

- Green : The oil quantity is in normal range.
The scale goes from 0 to 22 QT.
- Pulses green : The oil quantity goes below the oil advisory limit (3 QT), that corresponds to the amber mark.
The needle and the oil quantity value pulse green.
The indication pulses, when oil quantity goes below 3.25 QT , and remains pulsing as long as oil quantity is below 4.75 QT.

Ident.: DSC-70-90-40-60-00018261.0002001 / 21 MAR 16

OIL PRESSURE

L12

- Green : The oil pressure is in normal range.
The scale goes from 0 to 100 PSI.

L12

- Pulses green : The oil pressure is:
- Above the upper advisory limit, or
The upper advisory limit is 90 PSI.
The oil pressure stops pulsing when oil pressure goes below 85 PSI.
 - Between the upper red threshold and the lower advisory limit, when N2 is above 75 %.
The advisory limit is 16 PSI.
The oil pressure stops pulsing, when oil pressure goes below 20 PSI.

L12

- Red : The oil pressure is in the red range.
The red range is between 0 and 13 PSI.

Ident.: DSC-70-90-40-60-00018263.0002001 / 21 MAR 16

OIL TEMPERATURE

- Green : The oil temperature is in normal range.
- Pulses green : The oil temperature is between 140 °C and 155 °C for less than 15 min.
- Amber : The oil temperature is:
 - Between 140 °C and 155 °C for more than 15 min, or
 - Above 155 °C.

Ident.: DSC-70-90-40-60-00018266.0001001 / 21 MAR 16

OIL FILTER CLOG INDICATION

Indicates that the pressure loss across the oil filter is excessive.

Ident.: DSC-70-90-40-60-00018267.0001001 / 21 MAR 16

N1 , N2 VIBRATIONS

- Green : The vibration of the LP (HP) rotor is in normal range.
- Pulses green : The level of LP (HP) rotor vibration is excessive.

Ident.: DSC-70-90-40-60-00018268.0002001 / 21 MAR 16

STARTING SEQUENCE INDICATION

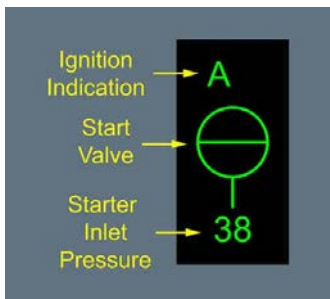

Ident.: DSC-70-90-40-60-00018269.0001001 / 21 MAR 16

IGNITION INDICATION



: The igniter A (B) is used for the engine start sequence.



: Both igniters A and B are used for the engine start sequence or continuous ignition.

Ident.: DSC-70-90-40-60-00018270.0001001 / 21 MAR 16

START VALVE



: The engine start valve is fully closed.



: The engine start valve is fully open.

Ident.: DSC-70-90-40-60-00018271.0001001 / 21 MAR 16

STARTER INLET PRESSURE

Green : The starter inlet pressure is normal.

Amber : The starter inlet pressure is either:

- Abnormally high, or
- Abnormally low (below 21 PSI, when N2 is above 10 % and the starter valve is not closed).

Ident.: DSC-70-90-40-60-00018272.0006001 / 21 MAR 16

NACELLE TEMPERATURE INDICATION

The nacelle temperature indication appears when the nacelle temperature of at least one engine goes above the advisory limit if not during the start sequence.

Green : The nacelle temperature is normal.

L12

Pulses green : The nacelle temperature goes above the advisory limit.
The advisory limit is 240 °C.



A318/A319/A320/A321
FLIGHT CREW
OPERATING MANUAL

AIRCRAFT SYSTEMS

ENGINES

CONTROLS AND INDICATORS - ENGINE DISPLAY

Intentionally left blank



A318/A319/A320/A321
FLIGHT CREW
OPERATING MANUAL

AIRCRAFT SYSTEMS

ENGINES

CONTROLS AND INDICATORS - MEMO DISPLAY

MEMO DISPLAY

Applicable to: ALL

Ident.: DSC-70-90-50-A-00018777.0001001 / 13 MAY 16

IGNITION : This memo appears in green when continuous ignition is activated on any engine.

Intentionally left blank

PROCEDURES

Intentionally left blank



A318/A319/A320/A321
FLIGHT CREW
OPERATING MANUAL

PROCEDURES
PRELIMINARY PAGES
TABLE OF CONTENTS

PRO-ABN Abnormal and Emergency Procedures

PRO-NOR Normal Procedures

PRO-SPO Special Operations



A318/A319/A320/A321
FLIGHT CREW
OPERATING MANUAL

PROCEDURES
PRELIMINARY PAGES
TABLE OF CONTENTS

Intentionally left blank

| M ⁽¹⁾ | Localization | DU Title | DU identification | DU date |
|---|-------------------|-----------------------------------|-------------------|-----------|
| | PRO-ABN-ABN-RESET | System Reset Table | NG01118 | |
| | PRO-ABN-ABN-RESET | System Reset Table - AIR | 00021167.0001001 | 20 MAR 17 |
| <p>Criteria: K10463, K6443, K9458 Applicable to: ALL Impacted DU: 00021069 System Reset Table - AIR <u>Reason for issue:</u> The TDU is issued to provide the ACSC C/B reset procedure to apply in the case of "PACK 1(2) REGUL FAULT" triggered on ground for aircraft equipped with ACSC 1803B0000-02.</p> | | | | |
| | PRO-ABN-ABN-RESET | System Reset Table - WHEEL | 00021059.0001001 | 20 MAR 17 |
| <p>Criteria: SA Applicable to: ALL Impacted DU: 00021058 System Reset Table - WHEEL <u>Reason for issue:</u> The BSCU reset procedure for WHEEL N/W STRG FAULT is amended with a temporary procedure, in order to better address the spurious alerts that are currently encountered in-service.</p> <ul style="list-style-type: none"> - Under the very specific conditions defined in the procedure, the flight crews can continue the flight without troubleshooting after a successful BSCU reset. - For aircraft with BSCU standard 10: The root cause of the spurious alerts that were triggered during taxiing with BSCU standard 10 has been cancelled. Therefore, the associated reset procedure has been removed. | | | | |

| | | | | |
|--|-------------|---|------------------|-----------|
| | PRO-ABN-FWS | [QRH] Multiple Undue ECAM Alerts | 00012928.0001001 | 17 MAR 17 |
| <p>Criteria: P8671, P9824 Applicable to: ALL Impacted DU: NONE <u>Reason for issue:</u> This TDU was re-issued to update the list of possible undue ECAM alerts. This TDU is cancelled with the EIS2 S8-2 Standard (MP P10527)</p> | | | | |
| | PRO-ABN-NAV | NAV TCAS FAULT | NG01075 | |
| | PRO-ABN-NAV | NAV TCAS FAULT | 00015480.0017001 | 14 FEB 14 |
| <p>Criteria: 31-1373, 31-1414, P2590, P5669 Applicable to: ALL Impacted DU: 00012434 NAV TCAS FAULT (If Installed)</p> | | | | |

Continued on the following page

PROCEDURES
PRELIMINARY PAGES

LIST OF EFFECTIVE TEMPORARY DOCUMENTARY UNITS

Continued from the previous page

| M ⁽¹⁾ | Localization | DU Title | DU identification | DU date |
|------------------|--|----------|-------------------|---------|
| | <p><u>Reason for issue:</u> Following the introduction of a TCAS monitoring function in the Flight Warning Computer (FWC) F6 and F7, an issue has been detected on aircraft equipped with HONEYWELL TCAS computers. To operate, the TCAS needs to receive the ADR barometric altitude through the active transponder and the aircraft heading through IR1.</p> <p>As a consequence, on ground, an undue NAV TCAS FAULT alert is triggered when:</p> <ul style="list-style-type: none"> - The ADIRUs are set to OFF or, - IR 1 is not aligned: at aircraft power up before IR 1 alignment or during transit when performing a fast or a complete alignment of IR1. <p>As soon as the ADIRU s are powered and the IR 1 is aligned, the NAV TCAS FAULT automatically disappears. Therefore, on ground, if the alert is triggered while the ADIRU s are OFF, or while IR1 is not yet aligned, the flight crew can disregard the alert. The FWC F8 corrects the issue.</p> | | | |

| | | | | |
|--|-------|--|------------------|-----------|
| PRO-NOR-SOP-10 | Taxi | | NG00715 | |
| PRO-NOR-SOP-10 | Radar | | 00015299.0002001 | 03 AUG 17 |
| <p>Criteria: P7929, P9902 Applicable to: ALL Impacted DU: 00015298 Taxi - Radar</p> | | | | |
| <p><u>Reason for issue:</u> When in the AUTO position, the MultiScan AUTO mode adjusts the tilt according to the altitude of the aircraft. In cruise, MULTISCAN function provides a large view of the weather ahead, ie display of weather cells located on and below aircraft path. At low altitudes (below FL 200), the tilt is adjusted upward to manage clutter from strong ground targets. In some cases, the weather may be low-lying and therefore may be below the radar beam and not be displayed until the aircraft descends closer to the precipitation level. Therefore, this Temporary Revision is issued to indicate that, when the Multiscan is in the AUTO position, the GAIN should be manually set to +4 when the aircraft is below FL 200.</p> <p>In addition, the flight crew should temporarily set the MULTISCAN sw to MAN, if:</p> <ul style="list-style-type: none"> - If the weather is good, or not significant, in order to check that the radar is operating correctly: down tilt until displaying ground echoes - The weather display is ambiguous or unexpected, in order to better analyze the weather situation using manual tilt according to standard technique - In particular below FL 200, for situations with low-level weather, weather with low reflectivity or in front of suspected active cells, the flight crew should switch to Manual mode and adjust the tilt setting downward until the weather is detected or the ground clutter appears on the upper part of the display. <p>In addition, the flight crew may increase the manual gain control to display lower reflectivity targets. The manual gain control can be increased in both AUTO and Manual modes to display lower levels of weather. In both cases, ground clutter may also be displayed as a result of low settings and/or increased gain.</p> | | | | |

Continued on the following page

Continued from the previous page

| M ⁽¹⁾ | Localization | DU Title | DU identification | DU date |
|------------------|--|------------------------------|-------------------|-----------|
| | PRO-NOR-SOP-14 | Climb | NG00723 | |
| | PRO-NOR-SOP-14 | Climb - Initial Climb | 00013057.0006001 | 29 JUN 16 |
| | <p>Criteria: P3379, P7425, P9207, SA</p> <p>Applicable to: ALL</p> <p><i>Impacted DU: 00010245 Climb - Initial Climb</i></p> <p><u>Reason for issue:</u></p> <p><u>Issue 2:</u></p> <p><i>The temporary information is reissued to provide more information concerning BPS issue in line with EASA SIB 2016-05.</i></p> <p><u>Issue 1:</u></p> <p><i>The temporary revision is issued to advise operators that above the transition level, when the flight crew selects "STD" on the FCU, the last QNH or QFE barometric pressure setting is transmitted to the ground, instead of the standard pressure value (1 013 hPa).</i></p> <p><i>Only the FCU selected altitude, if used by the ATC on ground, may be misinterpreted. The real aircraft altitude transmitted to the ground is not affected, because the standard barometric altitude is transmitted, regardless of the barometric setting selected on the FCU.</i></p> <p><i>In addition, the "STD" value is correctly transmitted to other aircraft systems.</i></p> | | | |
| | PRO-NOR-SOP-14 | Climb - Radar | 00013047.0003001 | 03 MAR 14 |
| | <p>Criteria: P7929, P9902, SA</p> <p>Applicable to: ALL</p> <p><i>Impacted DU: 00010259 Climb - Radar</i></p> <p><u>Reason for issue:</u></p> <p><i>When in the AUTO position, the MultiScan AUTO mode adjusts the tilt according to the altitude of the aircraft. In cruise, MULTISCAN function provides a large view of the weather ahead, ie display of weather cells located on and below aircraft path.</i></p> <p><i>At low altitudes (below FL 200), the tilt is adjusted upward to manage clutter from strong ground targets. In some cases, the weather may be low-lying and therefore may be below the radar beam and not be displayed until the aircraft descends closer to the precipitation level.</i></p> <p><i>Therefore, this Temporary Revision is issued to indicate that, when the Multiscan is in the AUTO position, the GAIN should be manually set to +4 when the aircraft is below FL 200.</i></p> <p><i>In addition, the flight crew should temporarily set the MULTISCAN sw to MAN, if:</i></p> <ul style="list-style-type: none"> - <i>If the weather is good, or not significant, in order to check that the radar is operating correctly: down tilt until displaying ground echoes</i> - <i>The weather display is ambiguous or unexpected, in order to better analyze the weather situation using manual tilt according to standard technique</i> - <i>In particular below FL 200, for situations with low-level weather, weather with low reflectivity or in front of suspected active cells, the flight crew should switch to Manual mode and adjust the tilt setting downward until the weather is detected or the ground clutter appears on the upper part of the display.</i> <p><i>In addition, the flight crew may increase the manual gain control to display lower reflectivity targets. The manual gain control can be increased in both AUTO and Manual modes to display lower levels of weather. In both cases, ground clutter may also be displayed as a result of low settings and/or increased gain.</i></p> | | | |

Continued on the following page

PROCEDURES
PRELIMINARY PAGES

LIST OF EFFECTIVE TEMPORARY DOCUMENTARY UNITS

Continued from the previous page

| M ⁽¹⁾ | Localization | DU Title | DU identification | DU date |
|------------------|--|----------------------------|-------------------|-----------|
| | PRO-NOR-SOP-15 | Cruise | NG00734 | |
| | PRO-NOR-SOP-15 | Cruise - Radar Tilt | 00013068.0006001 | 20 SEP 16 |
| | <p>Criteria: P7929, P9902, SA</p> <p>Applicable to: ALL</p> <p>Impacted DU: 00010291 Cruise - Radar Tilt</p> <p><u>Reason for issue:</u></p> <p>When in the AUTO position, the MultiScan AUTO mode adjusts the tilt according to the altitude of the aircraft. In cruise, MULTISCAN function provides a large view of the weather ahead, ie display of weather cells located on and below aircraft path.</p> <p>At low altitudes (below FL 200), the tilt is adjusted upward to manage clutter from strong ground targets. In some cases, the weather may be low-lying and therefore may be below the radar beam and not be displayed until the aircraft descends closer to the precipitation level.</p> <p>Therefore, this Temporary Revision is issued to indicate that, when the Multiscan is in the AUTO position, the GAIN should be manually set to +4 when the aircraft is below FL 200.</p> <p>In addition, the flight crew should temporarily set the MULTISCAN sw to MAN, if:</p> <ul style="list-style-type: none"> - The weather is good, or not significant, in order to check that the radar is operating correctly: down tilt until displaying ground echoes - The weather display is ambiguous or unexpected, in order to better analyze the weather situation using manual tilt according to standard technique - In particular below FL 200, for situations with low-level weather, weather with low reflectivity or in front of suspected active cells, the flight crew should switch to Manual mode and adjust the tilt setting downward until the weather is detected or the ground clutter appears on the upper part of the display. <p>In addition, the flight crew may increase the manual gain control to display lower reflectivity targets. The manual gain control can be increased in both AUTO and Manual modes to display lower levels of weather. In both cases, ground clutter may also be displayed as a result of low settings and/or increased gain.</p> | | | |

| | | | | |
|--|---|------------------------------------|------------------|-----------|
| | PRO-NOR-SOP-16 | Descent Preparation | NG00916 | |
| | PRO-NOR-SOP-16 | Descent PREPARATION - Radar | 00013353.0003001 | 03 MAR 14 |
| | <p>Criteria: P7929, P9902, SA</p> <p>Applicable to: ALL</p> <p>Impacted DU: 00011545 Descent Preparation - Radar</p> | | | |

Continued on the following page

Continued from the previous page

| M ⁽¹⁾ | Localization | DU Title | DU identification | DU date |
|------------------|---|----------|-------------------|---------|
| | <p><u>Reason for issue:</u></p> <p><i>When in the AUTO position, the MultiScan AUTO mode adjusts the tilt according to the altitude of the aircraft. In cruise, MULTISCAN function provides a large view of the weather ahead, ie display of weather cells located on and below aircraft path.</i></p> <p><i>At low altitudes (below FL 200), the tilt is adjusted upward to manage clutter from strong ground targets. In some cases, the weather may be low-lying and therefore may be below the radar beam and not be displayed until the aircraft descends closer to the precipitation level.</i></p> <p><i>Therefore, this Temporary Revision is issued to indicate that, when the Multiscan is in the AUTO position, the GAIN should be manually set to +4 when the aircraft is below FL 200.</i></p> <p><i>In addition, the flight crew should temporarily set the MULTISCAN sw to MAN, if:</i></p> <ul style="list-style-type: none"> - <i>If the weather is good, or not significant, in order to check that the radar is operating correctly: down tilt until displaying ground echoes</i> - <i>The weather display is ambiguous or unexpected, in order to better analyze the weather situation using manual tilt according to standard technique</i> - <i>In particular below FL 200, for situations with low-level weather, weather with low reflectivity or in front of suspected active cells, the flight crew should switch to Manual mode and adjust the tilt setting downward until the weather is detected or the ground clutter appears on the upper part of the display.</i> <p><i>In addition, the flight crew may increase the manual gain control to display lower reflectivity targets. The manual gain control can be increased in both AUTO and Manual modes to display lower levels of weather. In both cases, ground clutter may also be displayed as a result of low settings and/or increased gain.</i></p> | | | |

| | | | | |
|---|---------------------------------|--|------------------|-----------|
| PRO-NOR-SOP-18-B | Initial Approach | | NG01260 | |
| PRO-NOR-SOP-18-B | Initial Approach - Radar | | 00014648.0003001 | 03 MAR 14 |
| <p>Criteria: P7929, P9902, SA</p> <p>Applicable to: ALL</p> <p><i>Impacted DU: 00014647 Initial Approach - Radar</i></p> | | | | |

Continued on the following page

Continued from the previous page

| M ⁽¹⁾ | Localization | DU Title | DU identification | DU date |
|------------------|--------------|---|-------------------|---------|
| | | <p><u>Reason for issue:</u></p> <p>When in the AUTO position, the MultiScan AUTO mode adjusts the tilt according to the altitude of the aircraft. In cruise, MULTISCAN function provides a large view of the weather ahead, ie display of weather cells located on and below aircraft path.</p> <p>At low altitudes (below FL 200), the tilt is adjusted upward to manage clutter from strong ground targets. In some cases, the weather may be low-lying and therefore may be below the radar beam and not be displayed until the aircraft descends closer to the precipitation level.</p> <p>Therefore, this Temporary Revision is issued to indicate that, when the Multiscan is in the AUTO position, the GAIN should be manually set to +4 when the aircraft is below FL 200.</p> <p>In addition, the flight crew should temporarily set the MULTISCAN sw to MAN, if:</p> <ul style="list-style-type: none"> - If the weather is good, or not significant, in order to check that the radar is operating correctly: down tilt until displaying ground echoes - The weather display is ambiguous or unexpected, in order to better analyze the weather situation using manual tilt according to standard technique - In particular below FL 200, for situations with low-level weather, weather with low reflectivity or in front of suspected active cells, the flight crew should switch to Manual mode and adjust the tilt setting downward until the weather is detected or the ground clutter appears on the upper part of the display. <p>In addition, the flight crew may increase the manual gain control to display lower reflectivity targets. The manual gain control can be increased in both AUTO and Manual modes to display lower levels of weather. In both cases, ground clutter may also be displayed as a result of low settings and/or increased gain.</p> | | |

(1) Evolution code : N=New, R=Revised, E=Effectivity

PROCEDURES

ABNORMAL AND EMERGENCY PROCEDURES

Intentionally left blank

PRO-ABN-ABN-00 INTRODUCTION

| | |
|--------------------------------------|---|
| Content..... | A |
| Procedure Layout..... | B |
| Abnormal and Emergency Callouts..... | C |

PRO-ABN-ABN-ADV [ADV] ECAM ADVISORY

| | |
|-------------------------------|---|
| ECAM Advisory Conditions..... | A |
|-------------------------------|---|

PRO-ABN-ABN-MEM [MEM] MEMORY ITEMS

| | |
|-------------------------|---|
| [MEM] Memory Items..... | A |
|-------------------------|---|

PRO-ABN-ABN-QRH [QRH] PROCEDURES

| | |
|-----------------------|---|
| [QRH] Procedures..... | A |
|-----------------------|---|

PRO-ABN-ABN-RESET [RESET] SYSTEM RESET

| | |
|-----------------------------|---|
| System Reset - General..... | A |
| System Reset Table..... | B |

PRO-ABN-A-ICE A-ICE

| | |
|---|---|
| [QRH] DOUBLE AOA HEAT FAILURE..... | A |
| <u>ANTI ICE</u> ALL PITOT..... | B |
| <u>ANTI ICE</u> CAPT(F/O) TAT..... | C |
| <u>ANTI ICE</u> CAPT + F/O PITOT..... | D |
| <u>ANTI ICE</u> CAPT + STBY PITOT..... | E |
| <u>ANTI ICE</u> CAPT PITOT or L(R) STAT or AOA..... | F |
| <u>ANTI ICE</u> CAPT PROBES..... | G |
| <u>ANTI ICE</u> ENG 1(2) VALVE CLSD..... | H |
| <u>ANTI ICE</u> ENG 1(2) VALVE OPEN..... | I |
| <u>ANTI ICE</u> F/O + STBY PITOT..... | J |
| <u>ANTI ICE</u> F/O PITOT or L(R) STAT or AOA..... | K |
| <u>ANTI ICE</u> F/O PROBES..... | L |
| <u>ANTI ICE</u> L + R WINDSHIELD..... | M |
| <u>ANTI ICE</u> L(R) WINDOW..... | N |
| <u>ANTI ICE</u> L(R) WINDSHIELD..... | O |
| <u>ANTI ICE</u> STBY PITOT or L(R) STAT or AOA..... | P |
| <u>ANTI ICE</u> STBY PROBES..... | Q |

Continued on the following page

Continued from the previous page



PRO-ABN-AIR AIR

| | |
|--|---|
| [QRH] Engine 1+2 Bleed Fault..... | A |
| <u>AIR</u> APU BLEED FAULT..... | B |
| <u>AIR</u> APU BLEED LEAK..... | C |
| <u>AIR</u> BLEED 1(2) OFF..... | D |
| <u>AIR</u> COND CTL 1(2) - A(B) FAULT..... | E |
| <u>AIR</u> ENG 1(2) BLEED ABNORM PR..... | F |
| <u>AIR</u> ENG 1(2) BLEED FAULT..... | G |
| <u>AIR</u> ENG 1(2) BLEED LO TEMP (OPPOSITE BLEED AVAILABLE)..... | H |
| <u>AIR</u> ENG 1(2) BLEED LO TEMP (OPPOSITE BLEED NOT AVAILABLE)..... | I |
| <u>AIR</u> ENG 1+2 BLEED LO TEMP..... | J |
| <u>AIR</u> ENG 1(2) BLEED HI TEMP..... | K |
| <u>AIR</u> ENG 1(2) BLEED NOT CLSD..... | L |
| <u>AIR</u> ENG 1(2) HP VALVE FAULT..... | M |
| <u>AIR</u> ENG 1(2) LEAK DET FAULT..... | N |
| <u>AIR</u> FWD(AFT) CRG VENT FAULT  | O |
| <u>AIR</u> L(R) WING or ENG 1(2) BLEED LEAK..... | P |
| <u>AIR</u> L(R) WNG LEAK DET FAULT..... | Q |
| <u>AIR</u> PACK 1(2) FAULT..... | R |
| <u>AIR</u> PACK 1+2 FAULT..... | S |
| <u>AIR</u> PACK 1(2) OFF..... | T |
| <u>AIR</u> PACK 1(2) OVHT..... | U |
| <u>AIR</u> PACK 1(2) REGUL FAULT..... | V |
| <u>AIR</u> X BLEED FAULT..... | W |

PRO-ABN-APU APU

| | |
|---------------------------------------|---|
| <u>APU</u> AUTO (EMER) SHUT DOWN..... | A |
| <u>APU</u> FIRE DET FAULT..... | B |
| <u>APU</u> FIRE LOOP A(B) FAULT..... | C |

PRO-ABN-APUF APU FIRE

| | |
|---|---|
|  <u>APU</u> FIRE  | A |
|---|---|

Continued on the following page

Continued from the previous page

PRO-ABN-AUTO_FLT AUTO FLT

| | |
|---|---|
| <u>AUTO FLT A/THR LIMITED</u> | A |
| <u>AUTO FLT A/THR OFF</u> | B |
| ■ <u>AUTO FLT AP OFF</u> ■..... | C |
| <u>AUTO FLT FAC 1(2) FAULT</u> | D |
| <u>AUTO FLT FAC 1 + 2 FAULT</u> | E |
| <u>AUTO FLT FCU 1(2) FAULT</u> | F |
| <u>AUTO FLT FCU 1 + 2 FAULT</u> | G |
| <u>AUTO FLT REAC W/S DET FAULT</u> | H |
| <u>AUTO FLT RUD TRIM 1(2) FAULT</u> | I |
| <u>AUTO FLT RUD TRIM SYS</u> | J |
| <u>AUTO FLT RUD TRV LIM 1(2)</u> | K |
| <u>AUTO FLT RUD TRV LIM SYS</u> | L |
| <u>AUTO FLT YAW DAMPER 1(2)</u> | M |
| <u>AUTO FLT YAW DAMPER SYS</u> | N |

PRO-ABN-AVNCS AVIONICS SMOKE

| | |
|-----------------------------|---|
| <u>AVIONICS SMOKE</u> | A |
|-----------------------------|---|

PRO-ABN-BLEED BLEED

| | |
|---|---|
| <u>BLEED MONITORING FAULT</u> | A |
| <u>BLEED MONIT SYS 1(2) FAULT</u> | B |

PRO-ABN-BRAKES BRAKES

| | |
|---|---|
| ■ [MEM] <u>LOSS OF BRAKING</u> ■..... | A |
| [QRH] <u>ASYMMETRIC BRAKING</u> | B |
| [QRH] <u>RESIDUAL BRAKING</u> | C |
| <u>BRAKES A/SKID N/WS FAULT or ANTI SKID N/WS OFF</u> | D |
| <u>BRAKES ALTN BRK FAULT</u> | E |
| <u>BRAKES ALTN L(R) RELEASED</u> | F |
| <u>BRAKES AUTO BRK FAULT</u> | G |
| <u>BRAKES BRK Y ACCU LO PR</u> | H |
| <u>BRAKES HOT</u> | I |
| <u>BRAKES NORM + ALTN FAULT</u> | J |

Continued on the following page





Continued from the previous page

| | |
|--|---|
| <u>BRAKES</u> NORM BRK FAULT..... | K |
| <u>BRAKES</u> PARK BRK FAULT  | L |
| <u>BRAKES</u> PARK BRK LO PR..... | M |
| <u>BRAKES</u> PARK BRK ON..... | N |
| <u>BRAKES</u> RELEASED..... | O |
| <u>BRAKES</u> SYS 1(2) FAULT..... | P |

PRO-ABN-NWS BRAKES-NWS

| | |
|------------------------------------|---|
| <u>BRAKES-NWS</u> MINOR FAULT..... | A |
|------------------------------------|---|







PRO-ABN-CAB_PR CAB PR

| | |
|--|---|
| [QRH] CABIN OVERPRESSURE..... | A |
|  CAB PR EXCESS CAB ALT  | B |
|  CAB PR EXCES RESIDUAL PR  | C |
| CAB PR LDG ELEV FAULT..... | D |
| CAB PR LO DIFF PR..... | E |
| CAB PR OFV NOT OPEN | F |
| CAB PR SAFETY VALVE OPEN..... | G |
| CAB PR SYS 1(2) FAULT..... | H |
| CAB PR SYS 1+2 FAULT..... | I |

PRO-ABN-C_B C/B

| | |
|-------------------------|---|
| <u>C/B</u> TRIPPED..... | A |
|-------------------------|---|



PRO-ABN-COM COM

| | |
|--|---|
| <u>COM</u> ACARS FAULT  | A |
| <u>COM</u> CIDS 1 + 2 FAULT..... | B |
| <u>COM</u> HF 1(2) DATA FAULT  | C |
| <u>COM</u> SATCOM DATA FAULT  | D |
| <u>COM</u> SATCOM FAULT  | E |
| <u>COM</u> SINGLE PTT STUCK  | F |
| <u>COM</u> VHF 1(2)(3) /HF 1(2) EMITTING  | G |
| <u>COM</u> VHF 3 DATA FAULT  | H |













Continued on the following page

Continued from the previous page

PRO-ABN-COND COND

COND FWD CAB/AFT CAB/CKPT DUCT OVHT..... A
COND FWD(AFT) CARGO DUCT OVHT  B
COND FWD(AFT) CRG HEAT FAULT  C
COND FWD(AFT) CRG ISOL VALVE  D
COND HOT AIR FAULT..... E
COND L+R CAB FAN FAULT..... F
COND LAV + GALLEY FAN FAULT..... G
COND TRIM AIR SYS FAULT..... H

PRO-ABN-CONFIG CONFIG

 CONFIG L(R) SIDESTICK FAULT (BY TAKE OVER)  A
 CONFIG PARK BRK ON  B
 CONFIG PITCH TRIM NOT IN T.O RANGE  C
 CONFIG RUD TRIM NOT IN T.O RANGE  D
 CONFIG SLATS (FLAPS) NOT IN T.O CONFIG  E
 CONFIG SPD BRK NOT RETRACTED  F

PRO-ABN-DATALINK DATALINK

DATALINK ATSU FAULT..... A
DATALINK COMPANY FAULT..... B

PRO-ABN-DOOR DOOR

[QRH] COCKPIT DOOR FAULT..... A
DOOR L(R)(FWD)(AFT) AVIONICS (IN FLIGHT)..... B
DOOR L(R)(FWD)(AFT) AVIONICS (ON GROUND)..... C
DOOR L(R) FWD(AFT) CABIN (IN FLIGHT)..... D
DOOR L(R) FWD(AFT) CABIN (ON GROUND)..... E
DOOR L(R) FWD(AFT) EMER EXIT (IN FLIGHT)..... F
DOOR L(R) FWD(AFT) EMER EXIT (ON GROUND)..... G
DOOR FWD(AFT)(BULK) CARGO (IN FLIGHT)..... H
DOOR FWD(AFT)(BULK) CARGO (ON GROUND)..... I

PRO-ABN-EIS EIS

[QRH] Display Unit Failure..... A
EIS DMC 1(2)(3) FAULT..... B
EIS DMC/FWC COM FAULT..... C

Continued on the following page

Continued from the previous page

PRO-ABN-ELEC ELEC

| | |
|---|----|
| [QRH] C/B Tripped..... | A |
| [QRH] ELEC EMER CONFIG SYS REMAINING..... | B |
| <u>ELEC</u> AC BUS 1 FAULT..... | C |
| <u>ELEC</u> AC BUS 2 FAULT..... | D |
| <u>ELEC</u> AC ESS BUS ALTN..... | E |
| <u>ELEC</u> AC ESS BUS FAULT..... | F |
| <u>ELEC</u> AC ESS BUS SHED..... | G |
| <u>ELEC</u> APU GEN FAULT..... | H |
| <u>ELEC</u> BAT 1(2) FAULT..... | I |
| <u>ELEC</u> BAT 1(2) OFF..... | J |
| <u>ELEC</u> BCL 1(2) FAULT..... | K |
| <u>ELEC</u> DC BAT BUS FAULT..... | L |
| <u>ELEC</u> DC BUS 1 FAULT..... | M |
| <u>ELEC</u> DC BUS 2 FAULT..... | N |
| <u>ELEC</u> DC BUS 1+2 FAULT..... | O |
| <u>ELEC</u> DC EMER CONFIG..... | P |
| <u>ELEC</u> DC ESS BUS FAULT..... | Q |
| <u>ELEC</u> DC ESS BUS SHED..... | R |
| ■ <u>ELEC</u> EMER CONFIG ■..... | S |
| <u>ELEC</u> EMER GEN 1 LINE OFF..... | T |
| ■ <u>ELEC</u> ESS BUSES ON BAT ■..... | U |
| <u>ELEC</u> GEN 1(2) or APU GEN OVERLOAD..... | V |
| <u>ELEC</u> GEN 1(2) FAULT..... | W |
| <u>ELEC</u> GEN 1(2) OFF..... | X |
| <u>ELEC</u> IDG 1(2) DISCONNECTED..... | Y |
| <u>ELEC</u> IDG 1(2) OIL LO PR/OVHT..... | Z |
| <u>ELEC</u> STATIC INV FAULT..... | AA |
| <u>ELEC</u> TR 1(2) FAULT..... | AB |

PRO-ABN-ENG ENG

| | |
|--|---|
| ■ [QRH] ENG DUAL FAILURE - FUEL REMAINING ■..... | A |
| ■ [QRH] ENG DUAL FAILURE - NO FUEL REMAINING ■..... | B |
| [QRH] ENG RELIGHT IN FLIGHT..... | C |
| [QRH] ENGINE TAILPIPE FIRE..... | D |
| [QRH] HIGH ENGINE VIBRATION..... | E |
| [QRH] On Ground - Non ENG Shutdown after ENG Master OFF..... | F |

Continued on the following page

Continued from the previous page

| | |
|--|----|
| [QRH] One Engine Inoperative - Circling Approach..... | G |
| [QRH] One Engine Inoperative - Straight-In Approach..... | H |
| ENG 1(2) BLEED STATUS FAULT (IN FLIGHT)..... | I |
| ENG 1(2) BLEED STATUS FAULT (ON GROUND)..... | J |
| ENG COMPRESSOR VANE..... | K |
| ENG 1(2) COMPRESSOR VANE..... | L |
| ENG 1(2) CTL VALVE FAULT..... | M |
| ENG DUAL FAILURE..... | N |
| ENG 1(2) EIU FAULT..... | O |
| ENG 1(2) FADEC A(B) FAULT..... | P |
| ENG 1(2) FADEC ALTERNATOR..... | Q |
| ENG 1(2) FADEC FAULT..... | R |
| ENG 1(2) FADEC HI TEMP..... | S |
| ENG 1(2) FAIL..... | T |
| ENG 1(2) FIRE (IN FLIGHT)..... | U |
| ENG 1(2) FIRE (ON GROUND)..... | V |
| ENG 1(2) FIRE DET FAULT..... | W |
| ENG 1(2) FIRE LOOP A(B) FAULT..... | X |
| ENG 1(2) FUEL CTL FAULT..... | Y |
| ENG 1(2) FUEL FILTER CLOG..... | Z |
| ENG 1(2) FUEL RETURN VALVE..... | AA |
| ENG 1(2) HP FUEL VALVE..... | AB |
| ENG 1(2) IGN FAULT (IGN A or B Fault)..... | AC |
| ENG 1(2) IGN FAULT (IGN A+B FAULT)..... | AD |
| ENG 1(2) LOW N1 (On Ground)..... | AE |
| ENG 1(2) N1 or N2 or EGT or FF DISCREPANCY..... | AF |
| ENG 1(2) N1/N2/EGT OVER LIMIT..... | AG |
| ENG 1(2) OIL FILTER CLOG..... | AH |
| ENG 1(2) OIL HI TEMP..... | AI |
| ENG 1(2) OIL LO PR..... | AJ |
| ENG 1(2) ONE TLA FAULT..... | AK |
| ENG 1(2) OVSPD PROT FAULT..... | AL |
| ENG 1(2) PROBES FAULT..... | AM |
| ENG 1(2) REV ISOL FAULT..... | AN |
| ENG 1(2) REV PRESSURIZED..... | AO |
| ENG REV SET..... | AP |
| ENG 1(2) REV SWITCH FAULT..... | AQ |

Continued on the following page

Continued from the previous page

| | |
|----------------------------------|----|
| ENG 1(2) REVERSE UNLOCKED..... | AR |
| ENG 1(2) REVERSER FAULT..... | AS |
| ENG 1(2) SENSOR FAULT..... | AT |
| ENG 1(2) SHUT DOWN..... | AU |
| ENG 1(2) STALL..... | AV |
| ENG 1(2) START FAULT..... | AW |
| ENG 1(2) START VALVE FAULT..... | AX |
| ENG 1(2) THR LEVER ABV IDLE..... | AY |
| ENG 1(2) THR LEVER DISAGREE..... | AZ |
| ENG 1(2) THR LEVER FAULT..... | BA |
| ENG THR LEVERS NOT SET..... | BB |
| ENG THRUST LOCKED..... | BC |
| ENG TYPE DISAGREE..... | BD |
| ENG VIB SYS FAULT..... | BE |

PRO-ABN-F CTL F/CTL



| | |
|---|---|
| [QRH] Landing with Slats or Flaps Jammed..... | A |
| [QRH] RUDDER JAM..... | B |
| [QRH] STABILIZER JAM..... | C |
| ACTIVE CONTROL LAW..... | D |
| ELEVATORS AND STABILIZER CONTROL AFTER FAILURE..... | E |
| F/CTL AIL SERVO FAULT..... | F |
| F/CTL ALTN LAW..... | G |
| F/CTL DIRECT LAW..... | H |
| F/CTL ELAC 1(2) FAULT (ONE COMPUTER FAILED)..... | I |
| F/CTL ELAC 1(2) FAULT (BOTH COMPUTERS FAILED)..... | J |
| F/CTL ELAC 1(2) PITCH FAULT..... | K |
| F/CTL ELEV SERVO FAULT..... | L |
| F/CTL FCDC 1(2) FAULT..... | M |
| F/CTL FCDC 1+2 FAULT..... | N |
| F/CTL FLAP ATTACH SENSOR..... | O |
| F/CTL FLAPS FAULT/LOCKED..... | P |
| F/CTL FLAP LVR NOT ZERO..... | Q |
| F/CTL FLAP SYS 1(2) FAULT..... | R |
| F/CTL FLAPS/SLATS FAULT/LOCKED..... | S |
| F/CTL GND SPLR 5 FAULT..... | T |
| F/CTL GND SPLR / 1+2 / 3+4 / FAULT..... | U |
| F/CTL GND SPLR NOT ARMED..... | V |

Continued on the following page

Continued from the previous page

| | |
|---|----|
| F/CTL L(R) AIL FAULT..... | W |
| F/CTL L(R) ELEV FAULT..... | X |
| ■ F/CTL L+R ELEV FAULT ■..... | Y |
| F/CTL L(R) SIDESTICK FAULT..... | Z |
| F/CTL PITCH TRIM/MCDU/CG DISAGREE..... | AA |
| F/CTL SEC 1(2)(3) FAULT..... | AB |
| F/CTL SIDESTICK PRIORITY..... | AC |
| F/CTL SLAT(FLAP) TIP BRK FAULT..... | AD |
| F/CTL SLATS AND FLAPS FAULT IN CONF 0..... | AE |
| F/CTL SLATS FAULT/LOCKED..... | AF |
| F/CTL SLAT SYS 1(2) FAULT..... | AG |
| F/CTL SPD BRK 2 (3+4) FAULT..... | AH |
| F/CTL SPD BRK DISAGREE (SURFACES 3+4 AFFECTED)..... | AI |
| F/CTL SPD BRK DISAGREE (SURFACES 2+3+4 AFFECTED)..... | AJ |
| F/CTL SPD BRK FAULT..... | AK |
| F/CTL SPD BRK STILL OUT..... | AL |
| F/CTL SPLR FAULT..... | AM |
| F/CTL STABILIZER JAM..... | AN |

PRO-ABN-FUEL FUEL

| | |
|---|---|
| [QRH] FUEL IMBALANCE..... | A |
| [QRH] FUEL LEAK..... | B |
| [QRH] GRAVITY FUEL FEEDING..... | C |
| FUEL ACT XFR FAULT  | D |
| FUEL ACT PUMP LO PR  | E |
| FUEL APU LP VALVE FAULT..... | F |
| FUEL AUTO FEED FAULT..... | G |
| FUEL CTR TK PUMP 1(2) LO PR..... | H |
| FUEL CTR TK PUMPS LO PR..... | I |
| FUEL CTR TK PUMPS OFF..... | J |
| FUEL ENG 1(2) LP VALVE OPEN..... | K |
| FUEL FQI CH 1(2) FAULT..... | L |
| FUEL L (R) OUTER (INNER) TK HI TEMP..... | M |
| FUEL L (R) OUTER (INNER) TK LO TEMP..... | N |
| FUEL L (R) OUTER XFR CLOSED..... | O |
| FUEL L (R) OUTER XFR OPEN..... | P |

Continued on the following page

Continued from the previous page

| | |
|---|---|
| FUEL L (R) TK PUMP 1(2) LO PR..... | Q |
| FUEL L (R) TK PUMP 1 + 2 LO PR (CENTER TANK EMPTY)..... | R |
| FUEL L (R) TK PUMP 1 + 2 LO PR (CENTER TANK NOT EMPTY)..... | S |
| FUEL L (R) WING TK LO LVL..... | T |
| FUEL L + R WING TK LO LVL..... | U |
| FUEL X FEED VALVE FAULT..... | V |

PRO-ABN-FWS FWS

| | |
|---------------------------------------|---|
| [QRH] Multiple Undue ECAM Alerts..... | A |
| FWS FWC 1 + 2 FAULT..... | B |
| FWS FWC 1(2) FAULT..... | C |
| FWS OEB/FWC DISCREPANCY..... | D |
| FWS SDAC 1 + 2 FAULT..... | E |
| FWS SDAC 1(2) FAULT..... | F |

PRO-ABN-HYD HYD

| | |
|---|---|
| HYD B ELEC PUMP LO PR or OVHT..... | A |
| HYD B RSVR LO AIR PR..... | B |
| HYD B RSVR LO LVL..... | C |
| HYD B RSVR OVHT..... | D |
| HYD G ENG 1 PUMP LO PR (PTU OPERATIVE)..... | E |
| HYD G ENG 1 PUMP LO PR (PTU INOPERATIVE)..... | F |
| HYD G RSVR LO AIR PR..... | G |
| HYD G RSVR LO LVL..... | H |
| HYD G RSVR OVHT..... | I |
| HYD Y ELEC PUMP LO PR or OVHT..... | J |
| HYD Y ENG 2 PUMP LO PR (PTU OPERATIVE)..... | K |
| HYD Y ENG 2 PUMP LO PR (PTU INOPERATIVE)..... | L |
| HYD Y RSVR LO AIR PR..... | M |
| HYD Y RSVR LO LVL..... | N |
| HYD Y RSVR OVHT..... | O |
| ■ HYD B+Y SYS LO PR ■..... | P |
| ■ HYD G+B SYS LO PR ■..... | Q |
| ■ HYD G+Y SYS LO PR ■..... | R |
| HYD PTU FAULT..... | S |
| HYD RAT FAULT..... | T |

Continued on the following page

Continued from the previous page

PRO-ABN-LG L/G

[QRH] Landing with Abnormal L/G.....A
 [QRH] L/G GRAVITY EXTENSION.....B
 L/G DOORS NOT CLOSED.....C
 ■■■ L/G GEAR NOT DOWN ■■■.....D
 ■■■ L/G GEAR NOT DOWNLOCKED ■■■.....E
 L/G GEAR NOT UNLOCKED.....F
 L/G GEAR UNLOCK FAULT.....G
 L/G LGCIU 1(2) FAULT.....H
 L/G LGCIU 1+2 FAULT.....I
 L/G SHOCK ABSORBER FAULT (SHOCK ABSORBER EXTENDED ON GROUND).....J
 L/G SHOCK ABSORBER FAULT (SHOCK ABSORBER NOT EXTENDED AFTER LIFTOFF).....K
 L/G SYS DISAGREE.....L

PRO-ABN-MISC MISC







■■■ [MEM] EMER DESCENT ■■■.....A
 ■■■ [MEM] Stall Recovery ■■■.....B
 ■■■ [MEM] Stall Warning At Lift-Off ■■■.....C
 [QRH] BOMB ON BOARD.....D
 [QRH] COCKPIT WINDSHIELD / WINDOW ARCING.....E
 [QRH] COCKPIT WINDSHIELD / WINDOW CRACKED.....F
 ■■■ [QRH] DITCHING ■■■.....G
 ■■■ [QRH] EMER EVAC ■■■.....H
 ■■■ [QRH] EMER LANDING ALL ENG FAILURE ■■■.....I
 ■■■ [QRH] FORCED LANDING ■■■.....J
 [QRH] OVERWEIGHT LANDING.....K
 [QRH] Severe Turbulence.....L
 [QRH] TAILSTRIKE.....M
 [QRH] VOLCANIC ASH ENCOUNTERN

PRO-ABN-NAV NAV

[MEM] Unreliable Speed Indication.....A
 [QRH] ADR 1+2+3 FAULT.....B
 [QRH] ADR CHECK PROC.....C
 [QRH] IR Alignment in ATT Mode.....D
 NAV ADR 1(2)(3) FAULT.....E
 NAV ADR 1+2(1+3)(2+3) FAULT.....F
 NAV ADR DISAGREE.....G

Continued on the following page

Continued from the previous page

| | |
|---|----|
| NAV ALTI DISCREPANCY..... | H |
| NAV CAPT(F/O)(STBY) AOA FAULT..... | I |
| NAV ATT DISCREPANCY..... | J |
| NAV BARO REF DISCREPANCY..... | K |
| NAV FM/GPS POS DISAGREE  | L |
| NAV GPS 1(2) FAULT  | M |
| NAV GPWS FAULT..... | N |
| NAV GPWS TERR DET FAULT..... | O |
| NAV HDG DISCREPANCY..... | P |
| NAV IAS DISCREPANCY..... | Q |
| NAV ILS 1(2)(1+2) FAULT..... | R |
| NAV IR 1(2)(3) FAULT..... | S |
| NAV IR 1+2(1+3)(2+3) FAULT..... | T |
| NAV IR DISAGREE..... | U |
| NAV IR NOT ALIGNED..... | V |
| NAV PRED W/S DET FAULT  | W |
| NAV RA 1 AND 2 FAULT (DUAL RA FAILURE)..... | X |
| NAV RA 1(2) FAULT..... | Y |
| NAV RA DEGRADED..... | Z |
| NAV TCAS FAULT  | AA |
| NAV TCAS STBY..... | AB |
|  Stall Warning  | AC |









PRO-ABN-OVERSPEED OVERSPEED

| | |
|--|---|
|  <u>OVERSPEED</u>  | A |
|--|---|

PRO-ABN-RECORDER RECORDER

| | |
|--------------------------|---|
| RECORDER DFDR FAULT..... | A |
| RECORDER SYS FAULT..... | B |

PRO-ABN-SMOKE SMOKE

| | |
|--|---|
|  [QRH] SMOKE / FUMES / AVNCS SMOKE  | A |
|  [QRH] REMOVAL OF SMOKE / FUMES  | B |
| [QRH] SMOKE / FIRE FROM LITHIUM BATTERY..... | C |
|  <u>SMOKE</u> AFT CARGO SMOKE   | D |
| SMOKE AFT CRG DET FAULT  | E |

Continued on the following page

Continued from the previous page

| | |
|---|---|
| ■ SMOKE FWD CARGO SMOKE <A> ■ | F |
| SMOKE FWD(AFT) CRG BTL 1(2) FAULT <A> | G |
| SMOKE FWD CRG DET FAULT <A> | H |
| SMOKE DET FAULT..... | I |
| SMOKE LAVATORY DET FAULT..... | J |
| ■ SMOKE LAVATORY SMOKE ■ | K |

PRO-ABN-SURV SURV

| | |
|---------------------------------|---|
| [MEM] EGPWS Cautions..... | A |
| ■ [MEM] EGPWS Warnings ■ | B |
| ■ [MEM] TCAS WARNINGS ■ | C |
| ■ [MEM] WINDSHEAR ■ | D |
| ■ [MEM] WINDSHEAR AHEAD ■ | E |

PRO-ABN-VENT VENT

| | |
|----------------------------|---|
| VENT AVNCS SYS FAULT..... | A |
| VENT BLOWER FAULT..... | B |
| VENT EXTRACT FAULT..... | C |
| VENT SKIN VALVE FAULT..... | D |

PRO-ABN-WHEEL WHEEL

| | |
|--|---|
| [QRH] WHEEL TIRE DAMAGE SUSPECTED..... | A |
| WHEEL HYD SEL FAULT..... | B |
| WHEEL N/W STRG FAULT..... | C |
| WHEEL TYRE LO PR <A> | D |

PRO-ABN-W_A_ICE WING A.ICE

| | |
|---|---|
| WING A.ICE L(R) HI PR..... | A |
| WING A.ICE L(R) VALVE OPEN (FAILURE DETECTED IN FLIGHT)..... | B |
| WING A.ICE L(R) VALVE OPEN (FAILURE DETECTED ON GROUND)..... | C |
| WING A.ICE OPEN ON GND..... | D |
| WING A.ICE SYS FAULT (ONE WING VALVE REMAINS CLOSED WHEN THE WING ANTI-ICE IS TURNED ON)..... | E |
| WING A.ICE SYS FAULT (THE WING ANTI-ICE IS TURNED ON AFTER ONE ENGINE SHUTDOWN OR AFTER THE LOSS OF ONE BLEED)..... | F |

Continued on the following page

Continued from the previous page

PRO-ABN-90 Detailed Cabin / Cockpit Evacuation Procedure

| | |
|---|---|
| General..... | A |
| Cockpit-Assigned Duties for Evacuation..... | B |
| Cabin Crew-Assigned Areas for Evacuation..... | C |
| Communications..... | D |
| On Ground Evacuation..... | E |
| Cockpit Evacuation through Window..... | F |
| Evacuation on Water..... | G |

CONTENT

Ident.: PRO-ABN-ABN-00-00020862.0001001 / 20 APR 17

Applicable to: ALL

Abnormal and Emergency procedures involve actions that the flight crew must perform to ensure the overall safety of the flight, and adequate workload.

- L2 For more information about the management of abnormal operations, *Refer to FCTM/AOP-30-10 Introduction.*

Abnormal and Emergency Procedure Overview

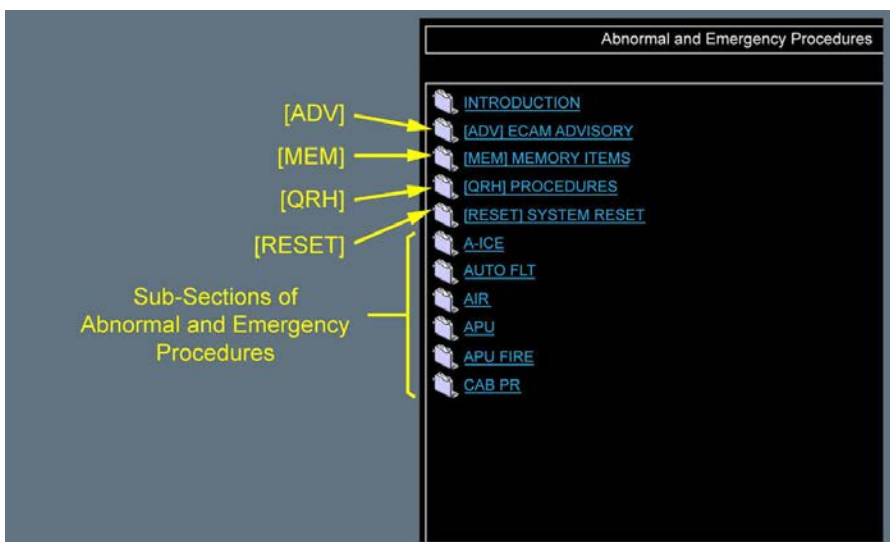

L1 [ADV] ECAM ADVISORY

The [ADV] ECAM ADVISORY section provides direct access to the list of all advisories that can be displayed on the ECAM SD pages. The [ADV] section is also available in the QRH.

- L2 For more information, *Refer to [ADV] ECAM Advisory.*
- L1 Advisories are system parameters that start to deviate from their usual operational range. However, an advisory does not require flight crew actions, except monitoring.
- L2 For more information about Advisory function, *Refer to DSC-31-20 System Pages.*

L1 [MEM] MEMORY ITEMS

The [MEM] MEMORY ITEMS menu provides direct access to the list of memory items.

- L2 For more information, *Refer to [MEM] Memory Items.*

- L1** The content of the memory items are described in the applicable sub-sections of the abnormal and emergency procedures.
Memory items are procedures, or critical immediate actions of an ECAM /QRH /OEB procedure, that the flight crew must apply by memory to ensure a safe flight path. In some time-critical situations, the flight crew has no time to refer to the ECAM and/or to the QRH.
- L2** For more information, *Refer to FCTM/AOP-10-40 Abnormal and Emergency Procedures.*

L1 **[QRH] PROCEDURES**

The [QRH] PROCEDURES menu provides direct access to the list of all the FCOM abnormal and emergency procedures that are also in the QRH.

- L2** For more information, *Refer to [QRH] Procedures.*

- L1** The content of the QRH procedures are described in the applicable sub-sections of the abnormal and emergency procedures.

Note: Only the FCOM version of a procedure provides layer 2 and 3 information for consultation purpose.

[RESET] SYSTEM RESET

The [RESET] SYSTEM RESET section provides direct access to the table listing all the system resets that are permitted, and the condition to apply them. The [RESET] section is also available in the QRH.

- L2** For direct access to the table, *Refer to [RESET] System Reset.*

L1 **SUB-SECTIONS OF ABNORMAL AND EMERGENCY PROCEDURES**

This part of the FCOM describes the detailed content of all abnormal and emergency procedures. All procedures are grouped in sub-sections that can be system related (e.g. AIR, FUEL, etc.) or non-system related (e.g. MISC, T.O, CONFIG, etc.).

The sub-sections are sorted by alphabetic order.

For each sub-section, procedures are listed in the following order:

1. The memory items
The title of the memory items starts with the [MEM] prefix
2. The abnormal and emergency procedures of the QRH
The title of these procedures starts with the [QRH] prefix
3. The ECAM procedures.

PROCEDURE LAYOUT

Applicable to: ALL

Ident.: PRO-ABN-ABN-00-A-00020863.0001001 / 17 MAR 17

GENERAL

The presentation of procedures is, as far as practicable, identical to the way it is displayed on the ECAM. The abbreviations are identical to those used on the cockpit panels. All actions and information displayed on ECAM are provided in large letters. Other information, not on ECAM, is provided in small letters.

Expanded information is as far as practicable provided in layer 2. This information:

- Identifies the particular failures
- Explains actions for which the reason is not self-evident
- Provides some background on the reasons and /or the effects of a given action.

FCOM presentation of ABN or EMER procedures

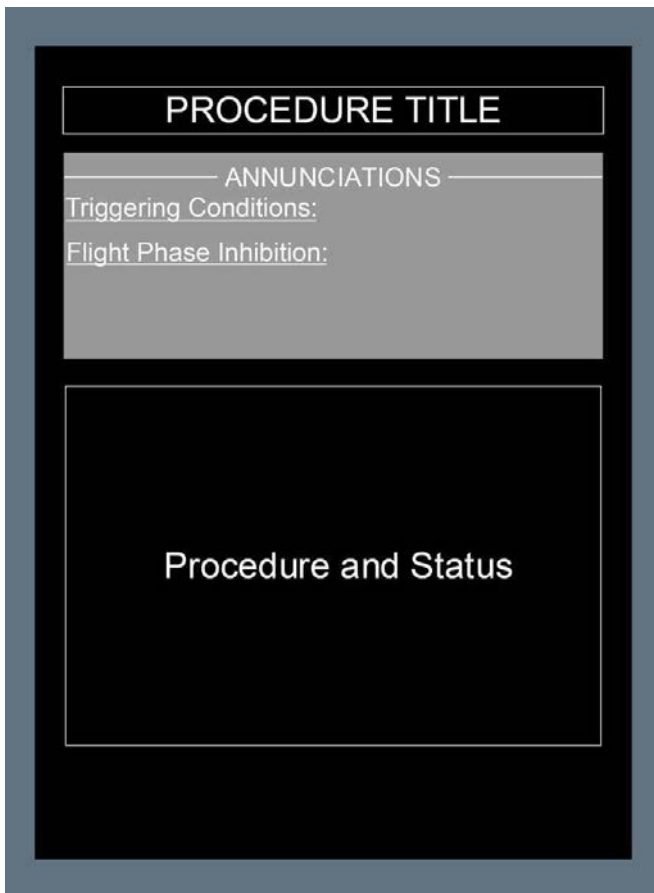

Ident.: PRO-ABN-ABN-00-A-00020864.0001001 / 17 MAR 17

PROCEDURE TITLE

The title of an abnormal or emergency procedure, displayed on the ECAM, appears on white background.

Abnormal procedure displayed on ECAM (amber caution) :

CAB PR SAFETY VALVE OPEN

Emergency procedure displayed on ECAM (red warning) :



The title of an abnormal or emergency procedure, that does not appear on the ECAM is on a grey background.

Abnormal procedure not displayed on ECAM :



Emergency procedure not displayed on ECAM :

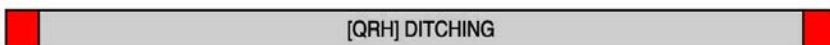

SEVERAL ALERTS UNDER THE SAME TITLE

When applicable, several alerts may be grouped under the same procedure title. However, depending on the failure, the actions that the flight crew should perform may differ.

Note: Alerts that have the same procedure title may be differentiated by a subtitle (e.g. ENG FIRE (On Ground) versus ENG FIRE (In Flight)).

Ident.: PRO-ABN-ABN-00-A-00020865.0001001 / 17 MAR 17

ANNUNCIATIONS

When applicable, the annunciations section provides:

- The triggering conditions, that describe the cause of the alert activation
- The flight phase inhibition.

FLIGHT PHASE INHIBITION

The Flight Phase Inhibition section indicates the flight phases during which the alert is inhibited. In the below example, the alert is inhibited in flight phase 1, and 10.

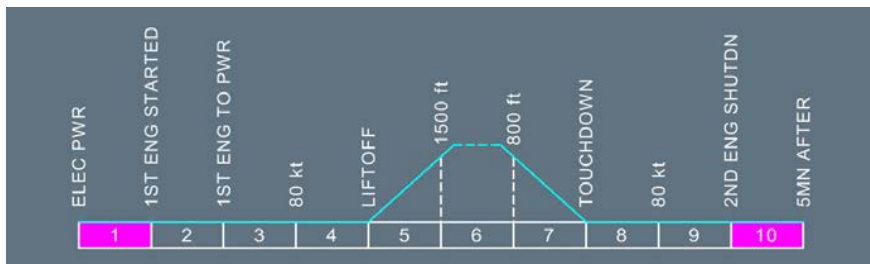

L2 For more information, Refer to DSC-31-15 Flight Phases.

Ident.: PRO-ABN-ABN-00-A-00020866.0001001 / 17 MAR 17

PROCEDURES AND STATUS

The Procedure and Status section provides the procedure and the Status (including approach procedure, limitations, inoperative systems, etc.), with additional information when relevant.

CONDITIONS

BLACK SQUARE

When several procedures appear under the same title, a black square marks the starting point of each procedure.

For example:

| <u>ANTI ICE CAPT (F/O) (STBY) PROBES</u> | |
|---|-----------------------------|
| <input type="checkbox"/> <u>CAPT PROBES</u> | } a procedure to be applied |
| <input type="checkbox"/> <u>F / O PROBES</u> | } b a or b or c |
| <input type="checkbox"/> <u>STBY PROBES</u> | } c |

Black squares also indicate parts of a procedure among which only one is applicable.

For example:

| <u>BRAKES HOT</u> | |
|---|-----------------------------|
| BRK FAN (if installed) ON | } a procedure to be applied |
| <input type="checkbox"/> <u>ON GROUND</u> | } b (a+b) or (a+c) |
| <input type="checkbox"/> <u>IN FLIGHT</u> | } c |

The ECAM does not display black squares.

BLACK DOT

If an action depends on a precondition, a black dot identifies the precondition. If the precondition appears on ECAM, it appears in LARGE LETTERS. If not, it appears in small letters.

For example:

| | |
|----------------------------|---|
| F / CTL FLAPS FAULT | |
| FLAPS LEVERRECYCLE | "If unsuccessful" does not appear on ECAM |
| ● If unsuccessful : | |
| GPWS FLAP MODE OFF | |

INDENTATION

Indentation is used in order to identify when an action depends on a precondition/flight phase/procedure.

For example:

| |
|---|
| <p>■ IN FLIGHT</p> <ul style="list-style-type: none"> ● If Flaps locked <p style="padding-left: 40px;">APPR SPEEDVREF +30</p> <p style="padding-left: 40px;">MAX SPEED 250 kt</p> |
|---|

- The APPR SPEED is equal to VREF +30 kt only if the flaps are locked, because "APPR SPEED.....VREF +30" is indented below "● If flaps locked".
- The MAX SPEED of 250 kt does not depend on the flaps locked condition because it is aligned with "● If Flaps locked". Therefore, MAX SPEED has to be respected whether the flaps are locked or not.

MEMORY ITEMS

Memory items are items that the flight crew must memorize, in order to be able to rapidly apply them, without referring to the ECAM , and/or to the QRH.

Memory items are surrounded by a black box in the FCOM /QRH procedure , in order to enable the flight crew to easily identify them.

Memory items



ABNORMAL AND EMERGENCY CALLOUTS

Applicable to: ALL

Ident.: PRO-ABN-ABN-00-B-00011915.0001001 / 17 MAR 17

ECAM PROCEDURES

1. "ECAM ACTION" is commanded by PF when required.
2. "CLEAR __ (title of the system) ?" is asked by the PM for confirmation by the PF, that all actions have been taken/reviewed on the present WARNING/CAUTION or SYSTEM PAGE. e.g.: CLEAR HYDRAULIC ?
3. "CLEAR __ (title of the system)" is the command by the PF that the action and review is confirmed. For status page; REMOVE STATUS will be used.
4. "ECAM ACTIONS COMPLETE" is the announcement by the PM that all APPLICABLE ACTIONS have been completed.
5. Should the PF require an action from the PM during ECAM procedures, the order "STOP ECAM" will be used. When ready to resume the ECAM the order "CONTINUE ECAM" will be used.

Ident.: PRO-ABN-ABN-00-B-00020059.0001001 / 17 MAR 17

EMERGENCY CALL

Some abnormal/emergency procedures require flight and cabin crews to use specific phraseology when communicating with each other. To ensure effective communication between the flight and cabin crews, the standard phraseology may be recalled at the preflight phase.

| FROM | TO | PHRASEOLOGY | REMARKS |
|---------|-------|---|---|
| cockpit | cabin | Passenger Address (PA) System: "PURSER TO COCKPIT, PLEASE!" | The Purser, or any other cabin crewmember, must go to the cockpit |
| Cockpit | Cabin | Passenger Address (PA) System: "ATTENTION CREW! AT STATIONS!" | An emergency evacuation may soon be required. |
| cockpit | cabin | Passenger Address (PA) System: "CABIN CREW and PASSENGERS REMAIN SEATED!" | The captain decides that an evacuation is not required |

Continued on the following page

| | |
|---|---|
|  A318/A319/A320/A321 FLIGHT CREW OPERATING MANUAL | PROCEDURES ABNORMAL AND EMERGENCY PROCEDURES INTRODUCTION |
|---|---|

Continued from the previous page

| | | | |
|---------|---------|--|---|
| cockpit | cabin | Passenger Address (PA) System: "PASSENGERS EVACUATE!" | The captain orders an immediate evacuation |
| cabin | cockpit | Interphone: "PRIO CAPT" | Any crew member can make such a call. The flight crew must reply. |

Ident.: PRO-ABN-ABN-00-B-00011916.0001001 / 31 AUG 17

MEMORY ITEMS

The aim of such callouts is to callout the appropriate procedure by calling out, in most cases, the title of the procedure. This will allow the crew to be aware of the situation and be prepared to properly react (crew coordination, task sharing and communication).

GPWS

As soon as avoidance manoeuvre is envisaged.
"PULL UP TOGA"

REACTIVE WINDSHEAR

"WINDSHEAR TOGA"

UNRELIABLE SPEED INDICATION

"UNRELIABLE SPEED"

TCAS

■ For aircraft equipped with AP/FD TCAS function :

As soon as a Traffic Advisory (TA) is triggered:

- If the AP/FD TCAS mode is armed : "TCAS blue"
- If the AP/FD TCAS mode does not arm : "TCAS, I have control"

■ For aircraft not equipped with AP/FD TCAS function :

As soon as a Traffic Advisory (TA) is triggered: "TCAS, I have control".

EMERGENCY DESCENT

"EMERGENCY DESCENT"

LOSS OF BRAKING

"LOSS OF BRAKING"

STALL RECOVERY

As soon as any stall indication is recognized.
"STALL, I have control"

STALL WARNING AT LIFT-OFF

"STALL, TOGA 15^o"

| | |
|---|--|
|  A318/A319/A320/A321 FLIGHT CREW OPERATING MANUAL | PROCEDURES ABNORMAL AND EMERGENCY PROCEDURES [ADV] ECAM ADVISORY |
|---|--|

ECAM ADVISORY CONDITIONS

Applicable to: ALL

| SYSTEM | CONDITIONS | RECOMMENDED ACTION |
|--------|------------|--------------------|
|--------|------------|--------------------|

Ident.: PRO-ABN-ABN-ADV-A-00012117.0003001 / 17 MAR 17

| | | |
|-----|---|--|
| APU | EGT > EGT MAX -33 °C (inhibited during APU start) | |
| | OIL QTY (message LOW OIL LEVEL pulsing) | If there is no oil leak, then the remaining oil quantity allows normal APU operation for about 10 h. |

Ident.: PRO-ABN-ABN-ADV-A-00012107.0004001 / 31 AUG 17

| | | |
|--------|--|--|
| CAB PR | CAB VERTICAL SPEED V/S > 1 800 ft/min | CPC changeover is recommended: MODE SEL : MAN Wait 10 s then: MODE SEL: AUTO |
| | CAB ALTITUDE altitude ≥ 8 800 ft | PACK FLOW: HI MODE SEL : MAN Manual pressure control If the cargo freight permits, set FWD ISOL VALVE: OFF to reduce the rate of cabin altitude increase. |
| | ΔP ≥ 1.5 PSI in phase 7 | LDG ELEV : ADJUST If unsuccessful: MODE SEL : MAN Manual pressure control |

Ident.: PRO-ABN-ABN-ADV-A-00012112.0001001 / 17 MAR 17

| | | |
|------|-----------------------|--|
| ELEC | IDG OIL TEMP ≥ 147 °C | Reduce IDG load if possible (GALLEY or GEN OFF). If required, restore when temperature has dropped. Restrict use of generator to short time, if temperature rises again excessively. |
|------|-----------------------|--|

Continued on the following page

PROCEDURES

ABNORMAL AND EMERGENCY PROCEDURES

A318/A319/A320/A321
FLIGHT CREW
OPERATING MANUAL

[ADV] ECAM ADVISORY

Continued from the previous page

| SYSTEM | CONDITIONS | RECOMMENDED ACTION |
|--------|------------|--------------------|
|--------|------------|--------------------|

Ident.: PRO-ABN-ABN-ADV-A-00012122.0002001 / 02 MAY 17

| | | |
|-----|---|--|
| ENG | OIL PRESS P < 16 PSI | <ul style="list-style-type: none"> - If oil pressure is between 16 and 13 PSI (advisory), continue normal operation. - If oil pressure is below 13 PSI (red indication) without the ENG OIL LO PR ECAM warning, continue normal engine operation (it can be assumed that the oil pressure transducer is faulty). <p>In both cases, monitor other engine parameters especially oil temperature and oil quantity.</p> |
| | OIL PRESS P > 90 PSI | <p>Monitor other engine parameters closely for symptoms of engine malfunction.</p> <p>If high oil pressure is not accompanied by other abnormal indications operate engine normally for remainder of flight. Record high oil pressure and corresponding N2 readings for maintenance action.</p> |
| | OIL TEMP T > 140 °C | <p>A rise in oil temperature during normal steady-state operation indicates a system malfunction and should be closely monitored for other symptoms of engine malfunction.</p> <p><i>Note: If the OIL TEMP rise follows thrust reduction, increasing thrust may reduce oil temperature.</i></p> <p>In addition, a rise in oil temperature could be related to the IDG oil cooling system. To reduce oil temperature rise before limits are reached, the following are recommended:</p> <ol style="list-style-type: none"> 1. Low Speed - Increase engine speed to increase fuel flow and thereby cool IDG oil. 2. High Speed - Reduce generator load or turn off generator. If oil temperature continues to rise, mechanically disconnect IDG. |
| | OIL QTY < 3 qt | <p>If oil quantity low at high power setting, expect level increase after power reduction.</p> <p>Monitor affected engine oil parameters and crosscheck with other engine - If pressure and temperature remain normal, continue normal operation.</p> |
| | NAC TEMP ≥ 240 °C | <p>Monitor engine parameters and crosscheck with other engine</p> |
| | VIBRATION N1 ≥ 6 units N2 ≥ 4.3 units | <p><i>Refer to PRO-ABN-ENG [QRH] HIGH ENGINE VIBRATION</i></p> |

Continued on the following page

| | |
|---|--|
|  A318/A319/A320/A321 FLIGHT CREW OPERATING MANUAL | PROCEDURES ABNORMAL AND EMERGENCY PROCEDURES [ADV] ECAM ADVISORY |
|---|--|

Continued from the previous page

| SYSTEM | CONDITIONS | RECOMMENDED ACTION |
|--------|------------|--------------------|
|--------|------------|--------------------|

Ident.: PRO-ABN-ABN-ADV-A-00012114.0001001 / 21 MAR 17

| | | |
|------|--|---|
| FUEL | Difference between wing fuel quantities greater than 1 500 kg (3 307 lb) | FUEL MANAGEMENT: CHECK If a fuel leak is suspected, <i>Refer to PRO-ABN-FUEL [QRH] FUEL LEAK.</i> For limitations, <i>Refer to LIM-FUEL Maximum Allowed Fuel Imbalance</i> |
| | Fuel temp greater than 45 °C in inner cell, or 55 °C in outer cell | GALLEY: OFF |
| | Fuel temp lower than -40 °C in inner or outer cell | Consider descending to a lower altitude and/or increasing Mach to increase TAT. |

Ident.: PRO-ABN-ABN-ADV-A-00012119.0028001 / 17 MAR 17

| | | |
|-----|---|---|
| OXY | CKPT OXY Pulsing green: When pressure is < 800 PSI. Amber: When pressure is < 400 PSI. | If mask is not being used, check if it is correctly stowed, <i>Refer to DSC-35-20-10 Mask Stowage.</i> |
|-----|---|---|



A318/A319/A320/A321
FLIGHT CREW
OPERATING MANUAL

PROCEDURES
ABNORMAL AND EMERGENCY PROCEDURES

[ADV] ECAM ADVISORY

Intentionally left blank

[MEM] MEMORY ITEMS

Applicable to: ALL

Ident.: PRO-ABN-ABN-MEM-ABN-MEM-00020871.0001001 / 17 MAR 17

BRAKES

[MEM] **LOSS OF BRAKING** (*Refer to procedure*)

Ident.: PRO-ABN-ABN-MEM-ABN-MEM-00020948.0001001 / 17 MAR 17

MISC

[MEM] **EMER DESCENT** (*Refer to procedure*)

[MEM] **STALL RECOVERY** (*Refer to procedure*)

[MEM] **STALL WARNING AT LIFT OFF** (*Refer to procedure*)

Ident.: PRO-ABN-ABN-MEM-ABN-MEM-00020949.0001001 / 01 JUN 17

NAV

[MEM] **UNRELIABLE SPEED INDICATION** (*Refer to procedure*)

Ident.: PRO-ABN-ABN-MEM-ABN-MEM-00020950.0002001 / 17 MAR 17

SURV

[MEM] **GPWS/EGPWS CAUTIONS** (*Refer to procedure*)

[MEM] **GPWS/EGPWS WARNINGS** (*Refer to procedure*)

[MEM] **TCAS WARNINGS** (*Refer to procedure*)

[MEM] **WINDSHEAR** (*Refer to procedure*)

[MEM] **WINDSHEAR AHEAD** (*Refer to procedure*)

PROCEDURES
ABNORMAL AND EMERGENCY PROCEDURES

[MEM] MEMORY ITEMS

Intentionally left blank

[QRH] PROCEDURES

Applicable to: ALL

Ident.: PRO-ABN-ABN-QRH-ABN-QRH-00021342.0002001 / 17 MAR 17

A-ICE

[QRH] **DOUBLE AOA HEAT FAILURE** (*Refer to procedure*)

Ident.: PRO-ABN-ABN-QRH-ABN-QRH-00021355.0001001 / 17 MAR 17

AIR

[QRH] **ENGINE 1+2 BLEED FAULT** (*Refer to procedure*)

Ident.: PRO-ABN-ABN-QRH-ABN-QRH-00021352.0002001 / 17 MAR 17

BRAKES

[QRH] **ASYMMETRIC BRAKING** (*Refer to procedure*)

[QRH] **RESIDUAL BRAKING** (*Refer to procedure*)

Ident.: PRO-ABN-ABN-QRH-ABN-QRH-00021343.0001001 / 17 MAR 17

CAB PR

[QRH] **CABIN OVERPRESSURE** (*Refer to procedure*)

Ident.: PRO-ABN-ABN-QRH-ABN-QRH-00021346.0001001 / 17 MAR 17

DOOR

[QRH] **COCKPIT DOOR FAULT** (*Refer to procedure*)

Ident.: PRO-ABN-ABN-QRH-ABN-QRH-00021511.0001001 / 17 MAR 17

EIS

[QRH] **DISPLAY UNIT FAILURE** (*Refer to procedure*)

Ident.: PRO-ABN-ABN-QRH-ABN-QRH-00021345.0002001 / 17 MAR 17

ELEC

[QRH] **C/B TRIPPED** (*Refer to procedure*)

[QRH] **ELEC EMER CONFIG SYS REMAINING** (*Refer to procedure*)

Ident.: PRO-ABN-ABN-QRH-ABN-QRH-00021356.0001001 / 17 MAR 17

ENG

[QRH] **ENG DUAL FAILURE - FUEL REMAINING** (*Refer to procedure*)

[QRH] **ENG DUAL FAILURE - NO FUEL REMAINING** (*Refer to procedure*)

- [QRH] **ENG RELIGHT IN FLIGHT** (Refer to procedure)
- [QRH] **ENG STALL** (Refer to procedure)
- [QRH] **ENG TAILPIPE FIRE** (Refer to procedure)
- [QRH] **HIGH ENGINE VIBRATION** (Refer to procedure)
- [QRH] **ON GROUND - NON ENG SHUTDOWN AFTER ENG MASTER OFF** (Refer to procedure)
- [QRH] **ONE ENGINE INOPERATIVE - CIRCLING APPROACH** (Refer to procedure)
- [QRH] **ONE ENGINE INOPERATIVE - STRAIGHT-IN APPROACH** (Refer to procedure)

Ident.: PRO-ABN-ABN-QRH-ABN-QRH-00021347.0001001 / 17 MAR 17

F/CTL

- [QRH] **LANDING WITH SLATS OR FLAPS JAMMED** (Refer to procedure)
- [QRH] **RUDDER JAM** (Refer to procedure)
- [QRH] **STABILIZER JAM** (Refer to procedure)

Ident.: PRO-ABN-ABN-QRH-ABN-QRH-00021348.0001001 / 17 MAR 17

FUEL

- [QRH] **FUEL IMBALANCE** (Refer to procedure)
- [QRH] **FUEL LEAK** (Refer to procedure)
- [QRH] **GRAVITY FUEL FEEDING** (Refer to procedure)

Ident.: PRO-ABN-ABN-QRH-ABN-QRH-00021350.0002001 / 17 MAR 17

FWS

- [QRH] **MULTIPLE UNDUE ECAM ALERTS** (Refer to procedure)

Ident.: PRO-ABN-ABN-QRH-ABN-QRH-00021353.0001001 / 17 MAR 17

L/G

- [QRH] **LANDING WITH ABNORMAL L/G** (Refer to procedure)
- [QRH] **L/G GRAVITY EXTENSION** (Refer to procedure)

Ident.: PRO-ABN-ABN-QRH-ABN-QRH-00021358.0001001 / 22 MAR 17

MISC

- [QRH] **BOMB ON BOARD** (Refer to procedure)
- [QRH] **COCKPIT WINDSHIELD / WINDOW ARCING** (Refer to procedure)
- [QRH] **COCKPIT WINDSHIELD / WINDOW CRACKED** (Refer to procedure)
- [QRH] **DITCHING** (Refer to procedure)
- [QRH] **EMER EVAC** (Refer to procedure)
- [QRH] **EMER LANDING** (Refer to procedure)
- [QRH] **FORCED LANDING** (Refer to procedure)

[QRH] **OVERWEIGHT LANDING** (*Refer to procedure*)

[QRH] **SEVERE TURBULENCE** (*Refer to procedure*)

[QRH] **TAILSTRIKE** (*Refer to procedure*)

[QRH] **VOLCANIC ASH ENCOUNTER** (*Refer to procedure*)

Ident.: PRO-ABN-ABN-QRH-ABN-QRH-00021354.0001001 / 17 MAR 17

NAV

[QRH] **ADR 1+2+3 FAULT** (*Refer to procedure*)

[QRH] **ADR CHECK PROC** (*Refer to procedure*)

[QRH] **IR ALIGNMENT IN ATT MODE** (*Refer to procedure*)

[QRH] **NAV FM / GPS POS DISAGREE** (*Refer to procedure*)

Ident.: PRO-ABN-ABN-QRH-ABN-QRH-00020870.0001001 / 17 MAR 17

SMOKE

[QRH] **SMOKE / FUMES / AVNCS SMOKE** (*Refer to procedure*)

[QRH] **REMOVAL OF SMOKE / FUMES** (*Refer to procedure*)

[QRH] **SMOKE / FIRE FROM LITHIUM BATTERY** (*Refer to procedure*)

Ident.: PRO-ABN-ABN-QRH-ABN-QRH-00021512.0001001 / 17 MAR 17

WHEEL

[QRH] **WHEEL TIRE DAMAGE SUSPECTED** (*Refer to procedure*)



A318/A319/A320/A321
FLIGHT CREW
OPERATING MANUAL

PROCEDURES
ABNORMAL AND EMERGENCY PROCEDURES

[QRH] PROCEDURES

Intentionally left blank

| | |
|---|--|
|  <p>A318/A319/A320/A321 FLIGHT CREW OPERATING MANUAL</p> | <p>PROCEDURES</p> <p>ABNORMAL AND EMERGENCY PROCEDURES</p> <p>[RESET] SYSTEM RESET</p> |
|---|--|

SYSTEM RESET - GENERAL

Applicable to: ALL

Ident.: PRO-ABN-ABN-RESET-A-00012644.0001001 / 17 MAR 17

Some systems that operate abnormally can be recovered by a reset. The flight crew can perform a system reset with the use of:

- The associated cockpit control, or
- The associated circuit breaker.

WARNING Only perform one reset at a time, unless indicated differently.

Ident.: PRO-ABN-ABN-RESET-A-00012645.0001001 / 17 MAR 17

Guidelines to reset a system:

- Set the related normal cockpit control to OFF, or pull the corresponding circuit breaker
- Wait 3 s if a normal cockpit control is used, or 5 s if a circuit breaker is used (unless a different time is indicated)
- Set the related normal cockpit control to ON, or push the corresponding circuit breaker
- Wait 3 s for the end of the reset.

Note: The flight crew should report any in-flight reset to the maintenance.

Ident.: PRO-ABN-ABN-RESET-A-00014340.0001001 / 22 MAR 17

■ **On ground:**

Reset ECU (CFM) or EEC (IAE) or EIU only when engine shut down.

Reset BSCU only when aircraft stopped.

Systems not listed in the System Reset Table can be reset following the guidelines described above.

■ **In flight:**

WARNING The flight crew can attempt a system reset only when:

- An ECAM /OEB /FCOM /QRH procedure requests to reset the system, or
- The System Reset Table permits.

CAUTION Do not pull the following circuit breakers:

- SFCC
- ECU or EEC or EIU.

Note: Before taking any action on the cockpit C/B s, both the PF and PM must crosscheck and ensure the C/B label corresponds to the affected system.



A318/A319/A320/A321
FLIGHT CREW
OPERATING MANUAL

PROCEDURES
ABNORMAL AND EMERGENCY PROCEDURES

[RESET] SYSTEM RESET

Refer to System Reset Table.



A318/A319/A320/A321
FLIGHT CREW
OPERATING MANUAL

PROCEDURES
ABNORMAL AND EMERGENCY PROCEDURES

[RESET] SYSTEM RESET

SYSTEM RESET TABLE

Applicable to: ALL

| ECAM System | System malfunction or ECAM Alert (Affected System) | Reset Procedure |
|-------------|--|-----------------|
|-------------|--|-----------------|

Ident.: PRO-ABN-ABN-RESET-B-00012654.0001001 / 20 MAR 17

| | | |
|-------|--|---|
| A-ICE | ANTI ICE L(R)/WINDSHIELD (WINDOW) (WHC) | Refer to PRO-ABN-A-ICE ANTI ICE L(R) WINDSHIELD, if applicable. |
|-------|--|---|

Continued on the following page

Continued from the previous page

| ECAM System | System malfunction or ECAM Alert (Affected System) | Reset Procedure |
|-------------|--|-----------------|
|-------------|--|-----------------|

Ident.: PRO-ABN-ABN-RESET-B-00021069.0001001 / 20 MAR 17
Impacted by TDU: 00021167 System Reset Table - AIR

| | | |
|-----|--|--|
| AIR | <p>AIR ENG 1(2) BLEED FAULT or AIR ENG 1(2) BLEED ABNORM PR (Engine Bleed Supply System)</p> | <p><i>Note:</i> Do not attempt more than one reset.</p> <p>On ground or in flight</p> <ul style="list-style-type: none"> • If the PACK (non-affected side) is operative, and If the Wing Anti-Ice is OFF: <ul style="list-style-type: none"> - ENG BLEED (affected side).....OFF ■ If the ENG BLEED (affected side) pb-sw FAULT light is on: <ul style="list-style-type: none"> - Delay application of the reset until FAULT light extinguishes. ■ If the ENG BLEED (affected side) pb-sw FAULT light is off: <ul style="list-style-type: none"> - X BLEED.....AUTO - PACK (affected side).....ON - ENG BLEED (affected side).....ON - Check that the affected Engine Bleed Valve is open on the BLEED SD page. • If AIR ENG (AFFECTED) BLEED FAULT alert or AIR ENG (AFFECTED) BLEED ABNORM PR alert reoccurs, or If Engine Bleed Valve (affected side) not open on the BLEED SD page: <ul style="list-style-type: none"> - ENG BLEED (affected side).....OFF - X BLEED.....OPEN <p><i>Note:</i> Record the ENG BLEED reset in the logbook (successful or unsuccessful).</p> |
| | <p>AIR ENG 1(2) BLEED NOT CLSD (Engine Bleed Supply System)</p> | <p><i>Note:</i> Do not attempt more than one reset.</p> <p>On ground only</p> <ul style="list-style-type: none"> - ENG BLEED (affected side).....OFF ■ If the ENG BLEED (affected side) pb-sw FAULT light is on: <ul style="list-style-type: none"> - Delay application of the reset until FAULT light extinguishes. ■ If the ENG BLEED (affected side) pb-sw FAULT light is off: <ul style="list-style-type: none"> - ENG BLEED (affected side).....ON <p>- Check that the affected Engine Bleed Valve is closed on the BLEED SD page.</p> |

Continued on the following page



A318/A319/A320/A321
FLIGHT CREW
OPERATING MANUAL

PROCEDURES
ABNORMAL AND EMERGENCY PROCEDURES

[RESET] SYSTEM RESET

Continued from the previous page

| ECAM System | System malfunction or ECAM Alert (Affected System) | Reset Procedure |
|-------------|--|--|
| | | <i>Note:</i> Record the ENG BLEED reset in the logbook (successful or unsuccessful). |
| | | |

Continued on the following page

Continued from the previous page

| ECAM System | System malfunction or ECAM Alert (Affected System) | Reset Procedure |
|-------------|--|-----------------|
|-------------|--|-----------------|

Ident.: TDU / PRO-ABN-ABN-RESET-B-00021167.0001001 / 20 MAR 17
Impacted DU: 00021069 System Reset Table - AIR

| | | |
|-----|---|--|
| | <p>AIR PACK 1(2) REGUL FAULT (ACSC)</p> | <p>On ground only:</p> <ul style="list-style-type: none"> - Pull C/B s W21 and W22 on 122VU - Pull C/B s X21 and X22 on 122VU - Pull C/B s Y18, Y20 and Y21 on 122VU - Pull C/B D8 on 49VU - Wait 5 s before pushing all the C/Bs. <p><i>Note:</i> During the reset, a small increase of the engine thrust may be observed (N1 or EPR, as applicable). If the parking brake is set, vibrations can occur.</p> |
| AIR | <p>AIR ENG 1(2) BLEED FAULT or AIR ENG 1(2) BLEED ABNORM PR (Engine Bleed Supply System)</p> | <p><i>Note:</i> Do not attempt more than one reset.</p> <p>On ground or in flight</p> <ul style="list-style-type: none"> • If the PACK (non-affected side) is operative, and If the Wing Anti-Ice is OFF: - ENG BLEED (affected side).....OFF <ul style="list-style-type: none"> ■ If the ENG BLEED (affected side) pb-sw FAULT light is on: <ul style="list-style-type: none"> - Delay application of the reset until FAULT light extinguishes. ■ If the ENG BLEED (affected side) pb-sw FAULT light is off: <ul style="list-style-type: none"> - X BLEED.....AUTO - PACK (affected side).....ON - ENG BLEED (affected side).....ON - Check that the affected Engine Bleed Valve is open on the <u>BLEED</u> SD page. <ul style="list-style-type: none"> • If AIR ENG (AFFECTED) BLEED FAULT alert or AIR ENG (AFFECTED) BLEED ABNORM PR alert reoccurs, or If Engine Bleed Valve (affected side) not open on the <u>BLEED</u> SD page: <ul style="list-style-type: none"> - ENG BLEED (affected side).....OFF - X BLEED.....OPEN <p><i>Note:</i> Record the ENG BLEED reset in the logbook (successful or unsuccessful).</p> |

Continued on the following page

PROCEDURES
ABNORMAL AND EMERGENCY PROCEDURES

[RESET] SYSTEM RESET

Continued from the previous page

| ECAM System | System malfunction or ECAM Alert (Affected System) | Reset Procedure |
|-------------|---|--|
| | <p>AIR ENG 1(2) BLEED NOT CLSD (Engine Bleed Supply System)</p> | <p><i>Note:</i> Do not attempt more than one reset.</p> <p>On ground only</p> <ul style="list-style-type: none"> - ENG BLEED (affected side).....OFF <ul style="list-style-type: none"> ■ If the ENG BLEED (affected side) pb-sw FAULT light is on: <ul style="list-style-type: none"> - Delay application of the reset until FAULT light extinguishes. ■ If the ENG BLEED (affected side) pb-sw FAULT light is off: <ul style="list-style-type: none"> - ENG BLEED (affected side).....ON - Check that the affected Engine Bleed Valve is closed on the <u>BLEED SD</u> page. <p><i>Note:</i> Record the ENG BLEED reset in the logbook (successful or unsuccessful).</p> |

Continued on the following page

Continued from the previous page



| ECAM System | System malfunction or ECAM Alert (Affected System) | Reset Procedure |
|-------------|--|-----------------|
|-------------|--|-----------------|

Ident.: PRO-ABN-ABN-RESET-B-00021067.0001001 / 21 MAR 17

| | | |
|----------|--|---|
| | <p>AUTO FLT FCU 1(2) FAULT (FCU)</p> | <p>In flight:</p> <ul style="list-style-type: none"> - Pull the C/B B05 on 49VU for FCU 1, or M21 on 121VU for FCU 2 - Push it after 5 s - Check the displayed targets and the barometer reference, and correct them if necessary. <p>On ground:</p> <ul style="list-style-type: none"> - Pull the C/B B05 on 49VU for FCU 1, or M21 on 121VU for FCU 2 - Push it after 5 s - If AUTO FLT FCU 1+2 FAULT disappears, check the displayed targets and barometer reference, and correct them if necessary (RESET successful) - If AUTO FLT FCU 1+2 FAULT remains, pull both C/B B05 on 49VU and M21 on 121VU - Push them after 7 min , with a delay of less than 5 s between side 1 and 2 - Wait at least 30 s for FCU 1 and FCU 2 safety tests completion - Check the displayed targets and barometer reference, and correct them if necessary (RESET successful). |
| AUTO FLT | <p>AUTO FLT FCU 1 + 2 FAULT (FCU)</p> | <p>In flight:</p> <ul style="list-style-type: none"> - Pull the C/B B05 on 49VU for FCU 1, and then pull M21 on 121VU for FCU 2 - Push them after 5 s - Check the displayed targets and the barometer reference, and correct them if necessary. <p>On ground:</p> <ul style="list-style-type: none"> - Pull the C/B B05 on 49VU for FCU 1, and then pull M21 on 121VU for FCU 2 - Push the C/Bs after 5 s - If AUTO FLT FCU 1(2) FAULT disappears, check the displayed targets and barometer reference, and correct them if necessary (RESET successful) - If AUTO FLT FCU 1(2) FAULT remains, pull again both C/B B05 on 49VU and M21 on 121VU - Push them after 7 min , with a delay of less than 5 s between side 1 and 2 - Wait at least 30 seconds for FCU 1 and FCU 2 safety tests completion - Check the displayed targets and barometer reference, and correct them if necessary (RESET successful) |

Continued on the following page

Continued from the previous page

| ECAM System | System malfunction or ECAM Alert (Affected System) | Reset Procedure |
|-------------|---|--|
| | | <p>FCU targets are synchronized on current aircraft values and displayed as selected targets.</p> <ul style="list-style-type: none"> - Re-enter the barometer altimeter setting value, if necessary. |
| | AUTO FLT YAW DAMPER 1(2) FAULT (FAC 1(2)) | Refer to PRO-ABN-AUTO_FLT AUTO FLT YAW DAMPER 1(2), if applicable. |
| | AUTO FLT REAC W/S DET FAULT  (FAC 1+2) | For Reactive Windshear Detection  Fault. Depending on aircraft configuration, Refer to PRO-ABN-AUTO_FLT AUTO FLT REAC W/S DET FAULT or Refer to PRO-ABN-W_S WINDSHEAR DET FAULT. |
| | One MCDU locked or blank (MCDU) | <p>On ground, or in flight:</p> <ul style="list-style-type: none"> - Pull the C/B for the locked or blank MCDU and push it back after 10 s. <p>The circuit breakers for the MCDUs are:</p> <ul style="list-style-type: none"> • AUTO FLT /MCDU 1 B1 ON 49 VU (Overhead Panel) • AUTO FLT /MCDU 2 N20 ON 121 VU (Right Rear Maintenance Panel) • AUTO FLT /MCDU 3 N21 ON 121 VU (Right Rear Maintenance Panel) |
| | Both MCDU locked or blank or FMGC malfunction (FMGC) | <p>On ground:</p> <ul style="list-style-type: none"> - Apply external power or APU generator power - Wait 2 min before resetting the FMGC circuit breakers - FD 1(or 2) (OFF) - Pull the C/B of the affected FMGC and reset it after 10 s. <p>The circuit breakers for the FMGCs are:</p> <ul style="list-style-type: none"> • AUTO FLT /FMGC 1 B2 ON 49 VU (Overhead Panel) • AUTO FLT /FMGC 2 M17 ON 121 VU (Right Rear Maintenance Panel) <div style="border: 1px solid black; padding: 5px; margin-top: 10px;"> <p>CAUTION Always wait 1 min after the "PLEASE WAIT" message disappears from the MCDU , before engaging or reengaging the FD s and the AP of the reset FMGC.</p> </div> <p><i>Note:</i> Due to electrical transient, MANUAL FMGS RESET procedure may be unsuccessful. If so, the flight crew may attempt the same procedure with engines not running.</p> <p>In flight:</p> <ul style="list-style-type: none"> - FD 1(or 2) (OFF) - Pull the C/B of the affected FMGC and reset it after 10 s. <p>The circuit breakers for the FMGCs are:</p> <ul style="list-style-type: none"> • AUTO FLT /FMGC 1 B2 ON 49 VU (Overhead Panel) |

Continued on the following page

PROCEDURES
ABNORMAL AND EMERGENCY PROCEDURES

[RESET] SYSTEM RESET

Continued from the previous page

| ECAM System | System malfunction or ECAM Alert (Affected System) | Reset Procedure |
|-------------|--|--|
| | | <ul style="list-style-type: none"> • AUTO FLT /FMGC 2 M17 ON 121 VU (Right Rear Maintenance Panel) <div style="border: 1px solid orange; padding: 5px; margin-top: 10px;"> <p>CAUTION Always wait 1 min after the "PLEASE WAIT" message disappears from the MCDU , before engaging or reengaging the FD s and the AP of the reset FMGC.</p> </div> |

Ident.: PRO-ABN-ABN-RESET-B-00021056.0001001 / 20 MAR 17





| | | |
|--------|---|---|
| BRAKES | <p>BRAKES SYS 1(2) FAULT or BRAKES BSCU CH 1(2) FAULT (BSCU)</p> | <p>On ground:</p> <ul style="list-style-type: none"> - STOP aircraft - Set PARK BRK handle to ON - Confirm that towing bar is disconnected - Set A/SKID & N/W STRG sw to OFF - Set A/SKID & N/W STRG sw to ON. <ul style="list-style-type: none"> • IF UNSUCCESSFUL: <ul style="list-style-type: none"> - Pull C/B s M33 and M34 on 121VU for BSCU channel 1 - Pull C/B s M36 and M35 on 121VU for BSCU channel 2 - Push C/Bs. <p>After a successful reset, resume to normal operation.</p> <p><u>Note:</u> After any BSCU reset:</p> <ol style="list-style-type: none"> 1. Check brake efficiency 2. Record BSCU reset in the logbook. <p>In flight:</p> <p>When landing gear is up only:</p> <ul style="list-style-type: none"> - Set A/SKID & N/W STRG sw to OFF - Set A/SKID & N/W STRG sw to ON - If required, rearm the autobrake. <p>When landing gear is down: reset not authorized.</p> <p><u>Note:</u> After any BSCU reset:</p> <ul style="list-style-type: none"> - Record BSCU reset in the logbook. |
|--------|---|---|

Continued on the following page

Continued from the previous page

| ECAM System | System malfunction or ECAM Alert (Affected System) | Reset Procedure |
|-------------|--|-----------------|
|-------------|--|-----------------|

Ident.: PRO-ABN-ABN-RESET-B-00021089.0010001 / 20 MAR 17

| | | |
|-----|--|--|
| | <p>COM CIDS 1+2 FAULT and/or Loss of Passenger Address and/or Loss of Cabin Interphone (CIDS)</p> | <p>On ground, or in flight:</p> <ul style="list-style-type: none"> - Pull the C/Bs in the following order: P13  and P14  on 121VU G01 and G02 on 49VU M05 and M06 on 121VU - Wait 10 s, then - Push the C/Bs in the following order: M05, M06, G01, G02, P13 , P14  - After CIDS reset, wait approximately 4 min, before recovering normal operation. |
| COM | <p>Uncommanded EVAC horn activation  (CIDS)</p> | <p>On ground, or in flight:</p> <p>Press the EVAC HORN SHUT OFF pb. Set the EVAC CAPT & PURS/CAPT sw to the CAPT only position. Wait for 3 s.</p> <ul style="list-style-type: none"> • IF UNSUCCESSFUL: <ul style="list-style-type: none"> - Pull the C/B s for DIR 2 in the following order: G02 on 49VU , M06 on 121VU. • IF UNSUCCESSFUL: <ul style="list-style-type: none"> - Pull the C/B s for DIR 1 in the following order: G01 on 49VU , M05 on 121VU - Wait for 1 min, then: - Push the C/B s for DIR 2 in the following order: M06 , G02 . - After CIDS reset, wait approximately 4 min, before recovering normal operation. |
| | <p>Frozen RMP (RMP)</p> | <p>On ground, or in flight:</p> <p>The flight crew must reset all the RMP s one after the other via the RMP control panel:</p> <ul style="list-style-type: none"> - Set RMP ON/OFF sw to OFF position - Wait 5 s - Set RMP ON/OFF sw to ON position. |
| | <p>FAP freezing (FAP)</p> | <p>On ground, or in flight:</p> <ul style="list-style-type: none"> - Pull FAP C/B s in the following order: H01 C/B on 49VU , Q14 on 121VU - Wait 10 s, then - Push the C/Bs in the following order: Q14, H01 C/B. |

Continued on the following page

PROCEDURES
ABNORMAL AND EMERGENCY PROCEDURES

[RESET] SYSTEM RESET

Continued from the previous page

| ECAM System | System malfunction or ECAM Alert (Affected System) | Reset Procedure |
|-------------|--|-----------------|
|-------------|--|-----------------|

Ident.: PRO-ABN-ABN-RESET-B-00012659.0001001 / 03 AUG 17

| | | |
|-----------------|--------------------------------|---|
| <p>DATALINK</p> | <p>ATSU Malfunction (ATSU)</p> | <p>The ATSU reset should be attempted, only if:</p> <ul style="list-style-type: none"> - Key selection has no effect on the DCDU or any of the MCDU ATSU DATALINK submenus - ADS-C or CPDLC are inoperative <p>When the ATSU is reset, the following connections are no longer active:</p> <ul style="list-style-type: none"> - CPDLC: <ul style="list-style-type: none"> • The flight crew should send a notification to the ATC center to re-establish the CPDLC connection - ADS-C: <ul style="list-style-type: none"> • As no ADS-C disconnect message is sent, the ATC center(s) assumes that the ADS-C connection is still alive • The flight crew must check that ADS-C is ARMED or ON. <p>On ground or in flight:</p> <ul style="list-style-type: none"> - Pull the C/B s in the following order: L16, L15 on 121VU - Wait 5 s, then - Push the C/Bs in the following order: L15, L16. |
|-----------------|--------------------------------|---|

Ident.: PRO-ABN-ABN-RESET-B-00014274.0001001 / 20 MAR 17

| | | |
|-------------|--|--|
| <p>DOOR</p> | <p>Flickering or total loss of the video camera display (on the SD) accompanied by the "VIDEO NOT AVAIL" message. (CDSS)</p> | <p>On ground, or in flight:</p> <ul style="list-style-type: none"> - Set the VIDEO rotary selector to OFF, on the center pedestal VIDEO panel - Set the COCKPIT DOOR VIDEO pb-sw to OFF, on the overhead panel - Wait 2 min, then - Set the COCKPIT DOOR VIDEO pb-sw back to ON, on the overhead panel - Wait 15 s, then - Set the VIDEO rotary selector to "CKPT ENTRY", on the center pedestal VIDEO panel. |
|-------------|--|--|

Continued on the following page

| | |
|---|---|
|  A318/A319/A320/A321 FLIGHT CREW OPERATING MANUAL | PROCEDURES ABNORMAL AND EMERGENCY PROCEDURES [RESET] SYSTEM RESET |
|---|---|

Continued from the previous page

| ECAM System | System malfunction or ECAM Alert (Affected System) | Reset Procedure |
|-------------|--|-----------------|
|-------------|--|-----------------|

Ident.: PRO-ABN-ABN-RESET-B-00012650.0001001 / 20 MAR 17

| | | |
|------|---|--|
| ELEC | GPU cannot be connected to the aircraft (GAPCU) | <p>On ground only:</p> <p>The GPU cannot be connected to the electrical network of the aircraft (AVAIL light is OFF):</p> <ul style="list-style-type: none"> • If at least one power source (IDG 1 or 2, APU GEN or batteries) is connected to the electrical network of the aircraft <ul style="list-style-type: none"> - Reset the EXT PWR pb switch on 35VU (Press and release). • If no power source is connected to the electrical network of the aircraft <ul style="list-style-type: none"> - Set the BAT 1 pb-sw and BAT 2 pb-sw to AUTO. |
|------|---|--|

Ident.: PRO-ABN-ABN-RESET-B-00012660.0001001 / 20 MAR 17

| | | |
|-----|-----------------------------------|--|
| ENG | ENG 1(2) FADEC A(B) FAULT (FADEC) | Refer to PRO-ABN-ENG ENG 1(2) FADEC A(B) FAULT, if applicable. |
|-----|-----------------------------------|--|

Ident.: PRO-ABN-ABN-RESET-B-00012652.0001001 / 20 MAR 17

| | | |
|-------|---|---|
| F/CTL | F/CTL ELAC 1(2) FAULT F/CTL ALTN LAW F/CTL ELAC 1(2) PITCH FAULT (ELAC) | Refer to PRO-ABN-F/CTL section for associated procedure, if applicable. |
| F/CTL | ELAC or SEC malfunction (ELAC or SEC) | <p>ELAC or SEC may be reset.</p> <div style="border: 2px solid red; padding: 5px; margin: 10px 0;"> <p>WARNING Do not reset more than one computer at a time. It is possible to reset flight control computers in flight, event if not requested by the ECAM, provided only one reset is performed at a time.</p> </div> <p><i>Note:</i> When an ELAC reset is performed on ground the crew must check the pitch trim position. If a reset is performed on ground, the flight crew must then perform a flight control check, Refer to PRO-NOR-SOP-10-TAXI.</p> |

Continued on the following page

PROCEDURES
ABNORMAL AND EMERGENCY PROCEDURES

[RESET] SYSTEM RESET

Continued from the previous page

| ECAM System | System malfunction or ECAM Alert (Affected System) | Reset Procedure |
|-------------|--|-----------------|
|-------------|--|-----------------|

Ident.: PRO-ABN-ABN-RESET-B-00012653.0018001 / 20 MAR 17

| | | |
|------|--|---|
| FUEL | Loss of fuel quantity indication or Simultaneous triggering of FUEL L OUTER XFR CLOSED and FUEL R OUTER XFR CLOSED , although FUEL SD indicates no anomaly. (FQIC) | <p>On ground, or in flight:</p> <ul style="list-style-type: none"> - Pull the 3 C/Bs: <ul style="list-style-type: none"> • Channel 1 (A13 on 49VU) • Channel 2 (M27 on 121VU) • Channel 1 and 2 (L26 on 121VU). - Wait 5 s, before pushing the 3 C/Bs. <p><i>Note:</i> The fuel quantity indication will be re-established within 1 min.</p> |
|------|--|---|

Ident.: PRO-ABN-ABN-RESET-B-00012655.0002001 / 20 MAR 17

| | | |
|-----|---------------------------------|---|
| FWC | EWS FWC 1(2) FAULT (FWC) | <p>On ground:</p> Pull, then push, the C/B of the affected FWC: <ul style="list-style-type: none"> - FWC 1 (F01 on 49VU) - FWC 2 (Q7 on 121VU). Wait 50 s after pushing the C/Bs. <p>In flight:</p> Pull, then push, the C/B of the affected FWC: <ul style="list-style-type: none"> - FWC 1 (F01 on 49VU) - FWC 2 (Q7 on 121VU). |
|-----|---------------------------------|---|

Ident.: PRO-ABN-ABN-RESET-B-00021057.0001001 / 21 MAR 17

| | | |
|-----|--|--|
| L/G | L/G LGCIU 1(2) FAULT (LGCIU 1(2)) | <p>On ground only:</p> The flight crew must depressurize the green hydraulic system before resetting the LGCIU: <ul style="list-style-type: none"> - ENG 1 PUMP OFF - PTU OFF. When there is no green hydraulic pressure: <ul style="list-style-type: none"> - To reset LGCIU 1: <ul style="list-style-type: none"> • Pull C/B Q34 on 121VU , then C09 on 49VU • Wait for 15 s , then push the C/Bs. - To reset LGCIU 2: <ul style="list-style-type: none"> • Pull C/B Q35 on 121VU • Wait for 15 s , then push the C/B. After the LGCIU reset, restore green hydraulic pressure (ENG 1 PUMP ON, PTU AUTO). |
|-----|--|--|

Continued on the following page

| | |
|---|---|
|  A318/A319/A320/A321 FLIGHT CREW OPERATING MANUAL | PROCEDURES ABNORMAL AND EMERGENCY PROCEDURES [RESET] SYSTEM RESET |
|---|---|

Continued from the previous page

| ECAM System | System malfunction or ECAM Alert (Affected System) | Reset Procedure |
|-------------|--|-----------------|
|-------------|--|-----------------|

Ident.: PRO-ABN-ABN-RESET-B-00012657.0048001 / 20 MAR 17

| | | |
|-----|--|---|
| NAV | NAV GPWS FAULT and NAV GPWS TERR DET FAULT (EGPWS) | On ground, or in flight: Perform the following reset when both alerts are displayed at the same time. <ul style="list-style-type: none"> - Pull C/B P07 on 121VU, - Set GPWS SYS pb and GPWS TERR pb to ON, - Wait 5 s, then push the C/B. |
| | NAV TCAS FAULT (TCAS) | On ground only: <ul style="list-style-type: none"> - Pull C/B K10 on 121VU. - Wait 5 s, then push the C/B. |
| | ISIS malfunction (ISIS) | On ground only: With aircraft not moving: <ul style="list-style-type: none"> - Pull C/B F12 on 49VU, - Wait 5 s, then push the C/B, - Normal operation is expected after approximately 2 min. <p><i>Note:</i> <i>In the case of small aircraft motion during the C/B reset (refueling, cargo loading conditions, etc.), the ATT red flag may appear on the ISIS. In this case, press the RST P/B for 2 s wait 2 min additional to recover normal operation.</i></p> |

Continued on the following page



PROCEDURES
ABNORMAL AND EMERGENCY PROCEDURES

[RESET] SYSTEM RESET

Continued from the previous page

| ECAM System | System malfunction or ECAM Alert (Affected System) | Reset Procedure |
|-------------|--|-----------------|
|-------------|--|-----------------|

Ident.: PRO-ABN-ABN-RESET-B-00012651.0016001 / 20 MAR 17

| | | |
|-------|--|---|
| | <p>SMOKE DET FAULT (CIDS-SDF)</p> | <p>On ground, or in flight: Apply the following actions in the presented order:</p> <ul style="list-style-type: none"> - Pull the C/B s C05 and C06 on 49VU , T17 and T18 on 122VU - Wait 10 s, then - Push simultaneously the C/B s C05 and C06 on 49VU - Within 2 s push simultaneously the C/B s T17 and T18 on 122VU - After CIDS reset, wait approximately 4 min before recovering normal operation. |
| SMOKE | <p>SMOKE LAVATORY DET FAULT with all lavatories declared inoperative on the FAP (CIDS or CIDS-SDF)</p> | <p>On ground, or in flight: Apply the following actions in the presented order:</p> <ul style="list-style-type: none"> - Pull the C/B s P13 and P14  on 121VU , G01 and G02 on 49VU , M05 or M06 and M06 or M07 on 121VU - Wait 10 s, then - Push the C/B s in the following order: M05 or M06 and M06 or M07 on 121VU , G01 and G02 on 49VU, P13 and P14  on 121VU. - After CIDS reset, wait approximately 4 min before recovering normal operation. <p>If unsuccessful, on ground only: Apply the following actions in the presented order:</p> <ul style="list-style-type: none"> - Pull the C/B s C06 and C05 on 49VU , T17 and T18 on 122VU. - Wait 10 s, then - Push simultaneously the C/B s C06 and C05 on 49VU - Within 2 s push simultaneously the C/B s T17 and T18 on 122VU - After CIDS reset, wait approximately 4 min before recovering normal operation. |
| | <p>SMOKE FWD (AFT) CARGO DET FAULT SMOKE FWD (AFT) CRG 1/2 BTL FAULT (CIDS-SDF)</p> | <p>On ground: Apply the following actions in the presented order:</p> <ul style="list-style-type: none"> - Pull the C/B s C06 and C05 on 49VU , T17 and T18 on 122VU - Wait 10 s, then - Push simultaneously the C/B s C06 and C05 on 49VU - Within 2 s push simultaneously the C/B s T17 and T18 on 122VU - After CIDS reset, wait approximately 4 min before recovering normal operation. |

Continued on the following page



Continued from the previous page

| ECAM System | System malfunction or ECAM Alert (Affected System) | Reset Procedure |
|-------------|--|-----------------|
|-------------|--|-----------------|

Ident.: PRO-ABN-ABN-RESET-B-00021071.0001001 / 20 MAR 17

| | | |
|------|------------------------------------|--|
| VENT | VENT AVNCS SYS FAULT (AEVC) | On ground only: <ul style="list-style-type: none"> - Pull C/B Y17 on 122VU - Wait 5 s before pushing the C/B. |
|------|------------------------------------|--|

Ident.: PRO-ABN-ABN-RESET-B-00021068.0001001 / 20 MAR 17

| | | |
|-----------|--|--|
| WINDSHEAR | WINDSHEAR DET FAULT  or AUTO FLT REAC W/S DET FAULT  (FAC 1+2) | For Reactive Windshear Detection  Fault. Depending on aircraft configuration, refer to PRO-ABN-22 AUTO FLT REAC W/S DET FAULT or to PRO-ABN-22 WINDSHEAR DET FAULT. |
|-----------|--|--|

Ident.: PRO-ABN-ABN-RESET-B-00021058.0001001 / 20 MAR 17

Impacted by TDU: 00021059 System Reset Table - WHEEL

| | | |
|-------|--|---|
| WHEEL | WHEEL N/W STEER FAULT or WHEEL N/W STRG FAULT (BSCU) | On ground only: <ul style="list-style-type: none"> - STOP aircraft - Set PARK BRK handle to ON - Confirm that towing bar is disconnected - Set A/SKID & N/W STRG sw to OFF - Set A/SKID & N/W STRG sw to ON. <p>In the case of a WHEEL N/W STRG FAULT, the flight crew may attempt a BSCU reset. However, even if the BSCU reset is successful, the flight crew must return to the gate for troubleshooting. The taxi speed must not exceed 10 kt.</p> <p><i>Note:</i> After any BSCU reset:</p> <ol style="list-style-type: none"> 1. Check brake efficiency 2. Record the BSCU reset in the logbook. |
|-------|--|---|

Continued on the following page

Continued from the previous page

| ECAM System | System malfunction or ECAM Alert (Affected System) | Reset Procedure |
|-------------|--|-----------------|
|-------------|--|-----------------|

Ident.: TDU / PRO-ABN-ABN-RESET-B-00021059.0001001 / 20 MAR 17
Impacted DU: 00021058 System Reset Table - WHEEL

| | | |
|-------|---|--|
| WHEEL | <p>WHEEL N.W STEER FAULT or WHEEL N/W STRG FAULT (BSCU)</p> | <p>On ground only:</p> <p>Case A</p> <p>If the three conditions below are fulfilled:</p> <ul style="list-style-type: none"> - the WHEEL N/W STRG FAULT alert was triggered just after engine start - the N/W STRG DISC memo was displayed before the start of the pushback (before the aircraft starts moving) - the N/W STRG DISC memo remained displayed even after the pushback is finished (nosewheel steering selector bypass pin is in the steering position). <p>Apply the below reset procedure.</p> <p>If the ECAM alert disappears after the reset, the flight crew may continue the flight without troubleshooting.</p> <p>Case B</p> <p>In all other cases, including in case of doubt on the above conditions, troubleshooting must be performed before continuing the flight, even if the ECAM alert disappears after the reset. For a return to the gate :</p> <ul style="list-style-type: none"> - Apply the below reset procedure - The taxi speed must not exceed 10 kt. <p>Reset Procedure:</p> <ul style="list-style-type: none"> - STOP aircraft - Set PARK BRK handle to ON - Confirm that towing bar is disconnected - Set A/SKID & N/W STRG sw to OFF - Set A/SKID & N/W STRG sw to ON. <p>Note: After any BSCU reset:</p> <ol style="list-style-type: none"> 1. Check brake efficiency 2. Check absence of aircraft veering 3. Record the BSCU reset in the logbook. |
|-------|---|--|

[QRH] DOUBLE AOA HEAT FAILURE

Ident.: PRO-ABN-A-ICE-00010253.0002001 / 17 MAR 17

Applicable to: **ALL**

In the case of double failure of alpha probe heaters, the choice made by the computers among the 3 ADR values may be erroneous.

One of affected ADRs.....OFF

Keep preferably ADR 1 available as ADR1 is supplied in EMER ELEC config.

NAV ADR 1(2)(3) FAULT

In the case of disagreement between the two remaining ADR s, the **NAV ADR DISAGREE** ECAM alert will trigger.

ANTI ICE ALL PITOT

Applicable to: **ALL**

Ident.: PRO-ABN-A-ICE-U-00017184.0003001 / 21 MAR 16

ANNUNCIATIONS

Triggering Conditions:

L2

This alert triggers when the heating systems of the CAPT , F/O and STBY pitot probes are failed.

Flight Phase Inhibition:

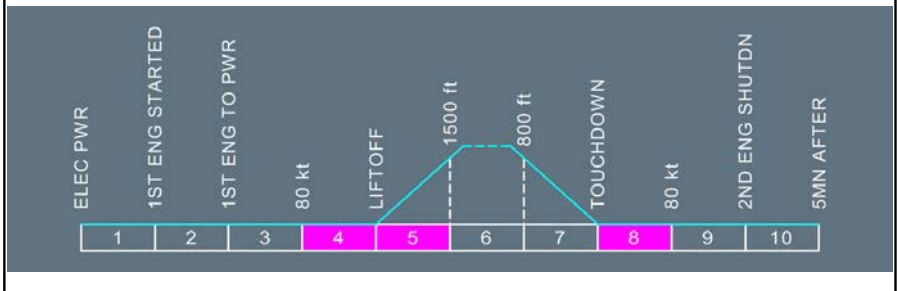

Continued on the following page

ANTI ICE ALL PITOT (Cont'd)

Ident.: PRO-ABN-A-ICE-U-00018180.0004001 / 21 MAR 17

L2 In the case of simultaneous pitot icing and in the same amount, ADR 1, ADR 2, and ADR 3 speeds will be in agreement, but incorrect. The following ECAM procedure avoids that the flight controls use erroneous, but coherent, sources.

L1 **ADR 1(2)(3) P/B**..... **OFF**

L2 Depending on the status of the static, AOA , and TAT heating, the ECAM requires that either ADR 1, 2 or 3 be switched OFF.

Note: In the case of subsequent, significant, speed discrepancy between the two remaining ADR s, the "ADR DISAGREE" ECAM caution will trigger.

L1 ● **IF ICING EXPECTED:**
ADR 2(3) P/B..... **OFF**

L2 Depending on the status of the static, AOA , and TAT heating, the ECAM requires that either ADR 2 or 3 be switched OFF.

L1 **UNREL SPD PROC**..... **APPLY**

L2 Only one ADR is available, and the corresponding pitot probe may be affected by ice accretion. Be prepared to use the UNRELIABLE SPEED INDICATION procedure (Refer to procedure).

L12

ASSOCIATED PROCEDURES

NAV ADR FAULT

Single ADR FAULT or double ADR FAULT ECAM cautions may trigger, depending on the number of ADRs switched OFF.

L12

ASSOCIATED PROCEDURES

F/CTL ALTN LAW
(PROT LOST)

Alternate law becomes active, if:

- One ADR was already switched OFF, and the two remaining ADRs are not in agreement, or
- Two ADRs were switched OFF.

Continued on the following page



A318/A319/A320/A321
 FLIGHT CREW
 OPERATING MANUAL

PROCEDURES
ABNORMAL AND EMERGENCY PROCEDURES

A-ICE

ANTI ICE ALL PITOT (Cont'd)

Ident.: PRO-ABN-A-ICE-U-00018298.0002001 / 21 MAR 16

STATUS

● **IF ICING EXPECTED:**

ADR 2(3) P/B..... OFF
 UNREL SPD PROC..... APPLY

INOP SYS

CAPT PITOT
 F/O PITOT
 STBY PITOT
 CAPT PROBES ⁽¹⁾
 F/O PROBES ⁽²⁾
 STBY PROBES ⁽³⁾
 STEEP APPR  (If in ALTN
 LAW)

⁽¹⁾ (If all CAPT PROBES heating is lost)

⁽²⁾ (If all F/O PROBES heating is lost)

⁽³⁾ (If all STBY PROBES heating is lost)

ANTI ICE CAPT(F/O) TAT

Applicable to: ALL

Ident.: PRO-ABN-A-ICE-E-00017171.0001001 / 21 MAR 16

ANNUNCIATIONS

Triggering Conditions:

L2 This alert triggers when the heating system of the corresponding probe is failed.

Flight Phase Inhibition:

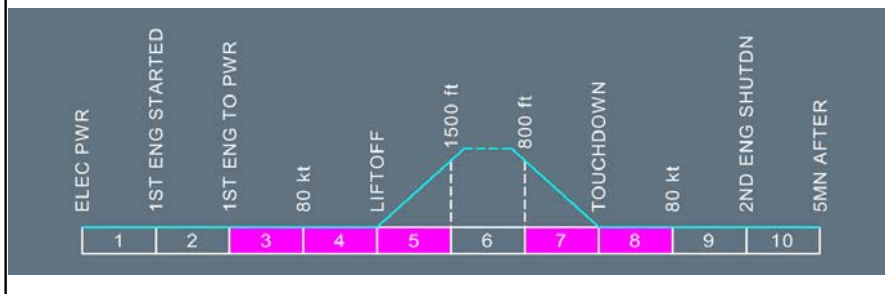

Ident.: PRO-ABN-A-ICE-E-00018299.0001001 / 21 MAR 16

Crew awareness.

Ident.: PRO-ABN-A-ICE-E-00018889.0001001 / 21 MAR 16

STATUS

INOP SYS

CAPT(F/O) TAT

ANTI ICE CAPT + F/O PITOT

Applicable to: ALL

Ident.: PRO-ABN-A-ICE-R-00017177.0003001 / 21 MAR 16

ANNUNCIATIONS

Triggering Conditions:

L2

This alert triggers when the heating systems of the CAPT and F/O pitot probes are failed.

Flight Phase Inhibition:

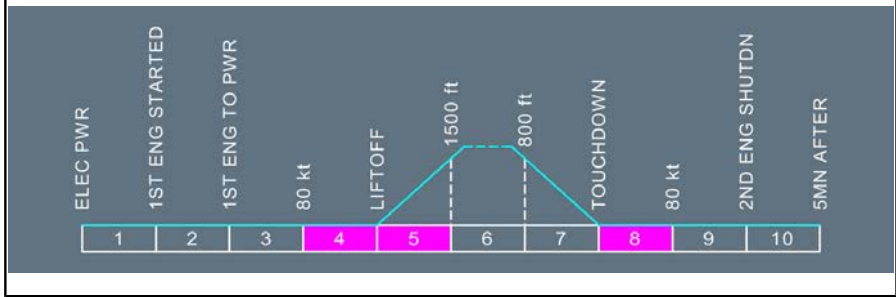

Continued on the following page

ANTI ICE CAPT + F/O PITOT (Cont'd)

Ident.: PRO-ABN-A-ICE-R-00018300.0002001 / 21 MAR 17

[L2] In the case of simultaneous pitot icing and in the same amount, ADR 1 and ADR 2 speeds will be in agreement, but incorrect. Therefore, flight controls will consider the remaining correct source as being faulty, and will reject the only correct source. The following ECAM procedure avoids that the flight controls use two erroneous, but coherent, sources.

[L1] ■ **If ADR 3 operative and ON:**
 ADR 1(2) P/B..... OFF

[L2] Depending on the status of the static, AOA, and TAT heating, the ECAM requires that either ADR 1 or 2 be switched OFF

Note: In the case of subsequent, significant, speed discrepancy between the two remaining ADR s, the “ADR DISAGREE” ECAM caution will trigger.

[L1] ■ **If ADR 3 failed or OFF:**

[L2] No action is required, as long as there are no icing conditions, in order to keep two independent speed sources.

[L1] ● **IF ICING EXPECTED:**
 ADR 1(2) P/B..... APPLY

[L2] Depending on the status of the static, AOA, and TAT heating, the ECAM requires that either ADR 1 or 2 be switched OFF.

[L1] UNREL SPD PROC.....APPLY

[L2] Only one ADR is available, and the corresponding pitot probe may be affected by ice accretion. Be prepared to use the UNRELIABLE SPEED INDICATION procedure (Refer to procedure).

ASSOCIATED PROCEDURES

NAV ADR FAULT

Continued on the following page

ANTI ICE CAPT + F/O PITOT (Cont'd)

Ident.: PRO-ABN-A-ICE-R-00018301.0002001 / 21 MAR 16

| | |
|---|--|
| <p style="text-align: right; margin-bottom: 0;">STATUS</p> <ul style="list-style-type: none"> ● If ADR 3 failed or OFF: ● IF ICING EXPECTED: <ul style="list-style-type: none"> ADR 1(2) P/B.....OFF UNREL SPD PROC.....APPLY | <p style="text-align: center; margin-bottom: 0;">INOP SYS</p> <p style="color: orange; margin-top: 10px;">CAPT PITOT F/O PITOT CAPT PROBES ⁽¹⁾ F/O PROBES ⁽²⁾</p> |
|---|--|

(1) (If all CAPT PROBES heating is lost)
 (2) (If all F/O PROBES heating is lost)

ANTI ICE CAPT + STBY PITOT

Applicable to: ALL

Ident.: PRO-ABN-A-ICE-S-00017178.0003001 / 21 MAR 16

ANNUNCIATIONS

Triggering Conditions:

L2 This alert triggers when the heating systems of the CAPT and STBY pitot probes are failed.

Flight Phase Inhibition:

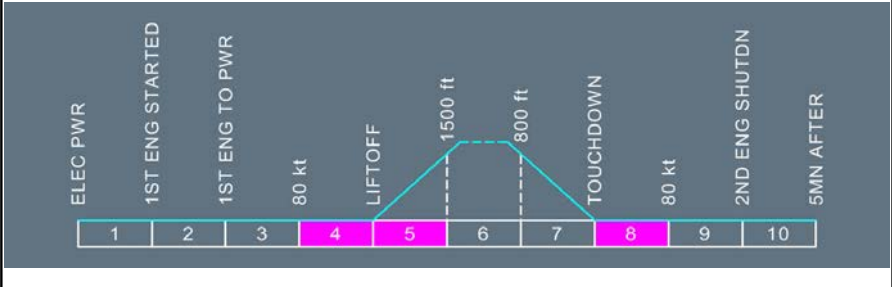

Continued on the following page

ANTI ICE CAPT + STBY PITOT (Cont'd)

Ident.: PRO-ABN-A-ICE-S-00018302.0002001 / 21 MAR 17

[L2] In the case of simultaneous pitot icing and in the same amount, ADR 1 and ADR 3 speeds will be in agreement, but incorrect. Flight controls will consider the remaining correct source as being faulty, and will reject the only correct source. The following ECAM procedure avoids that the flight controls use two erroneous, but coherent, sources.

[L1] ■ **If ADR 2 operative and ON:**
ADR 1(3) P/B..... OFF

[L2] Depending on the status of the static, AOA, and TAT heating, the ECAM requires that either ADR 1 or 3 be switched OFF

Note: In the case of subsequent, significant, speed discrepancy between the two remaining ADR s, the “ADR DISAGREE” ECAM caution will trigger.

[L1] ■ **If ADR 2 failed or OFF:**

[L2] No action is required, as long as there are no icing conditions, in order to keep two independent speed sources.

[L1] ● **IF ICING EXPECTED:**
ADR 1(3) P/B..... APPLY

[L2] Depending on the status of the static, AOA, and TAT heating, the ECAM requires that either ADR 1 or 3 be switched OFF.

[L1] UNREL SPD PROC.....APPLY

[L2] Only one ADR is available, and the corresponding pitot probe may be affected by ice accretion. Be prepared to use the UNRELIABLE SPEED INDICATION procedure (Refer to procedure).

[L1]

ASSOCIATED PROCEDURES

NAV ADR FAULT

Continued on the following page

ANTI ICE CAPT + STBY PITOT (Cont'd)

Ident.: PRO-ABN-A-ICE-S-00018303.0002001 / 21 MAR 16

| | | STATUS |
|---|--|---|
| <ul style="list-style-type: none"> ● If ADR 2 failed or OFF: ● IF ICING EXPECTED: ADR 1(3) P/B.....OFF UNREL SPD PROC.....APPLY | | INOP SYS CAPT PITOT STBY PITOT CAPT PROBES ⁽¹⁾ STBY PROBES ⁽²⁾ |
| <p>⁽¹⁾ (If all CAPT PROBES heating is lost) ⁽²⁾ (If all STBY PROBES heating is lost)</p> | | |

ANTI ICE CAPT PITOT OR L(R) STAT OR AOA

Applicable to: ALL

Ident.: PRO-ABN-A-ICE-C-00017169.0001001 / 21 MAR 16

ANNUNCIATIONS

Triggering Conditions:

L2 This alert triggers when the heating system of the corresponding probe is failed.

Flight Phase Inhibition:

The diagram shows a horizontal timeline from 1 to 10. Above the timeline, various flight events are marked: ELEC PWR (1), 1ST ENG STARTED (2), 1ST ENG TO PWR (3), 80 kt (4), LIFTOFF (5), 1500 ft (6), 800 ft (7), TOUCHDOWN (8), 80 kt (9), 2ND ENG SHUTDN (10), and 5MN AFTER (10). A green line graph shows a climb from 5 to 6 (1500 ft), a level cruise at 6, and a descent from 6 to 8 (800 ft). A shaded grey area below the timeline indicates inhibition from phase 1 to 8.

Continued on the following page

ANTI ICE CAPT PITOT OR L(R) STAT OR AOA (Cont'd)

Ident.: PRO-ABN-A-ICE-C-00018310.0002001 / 21 MAR 16

AIR DATA SWTG **CAPT 3**

L2 ADR 3 supplies data to PFD 1 and ND 1.

Note: AIR DATA SWTG should not be selected to CAPT 3 if ADR 3 is not available.

Ident.: PRO-ABN-A-ICE-C-00018900.0001001 / 21 MAR 16

STATUS

INOP SYS

CAPT PITOT
CAPT L(R) STAT
CAPT AOA

ANTI ICE CAPT PROBES

Applicable to: ALL

Ident.: PRO-ABN-A-ICE-G-00017173.0001001 / 21 MAR 16

ANNUNCIATIONS

Triggering Conditions:

L2 This alert triggers when the captain probe heat computer is failed.

Flight Phase Inhibition:

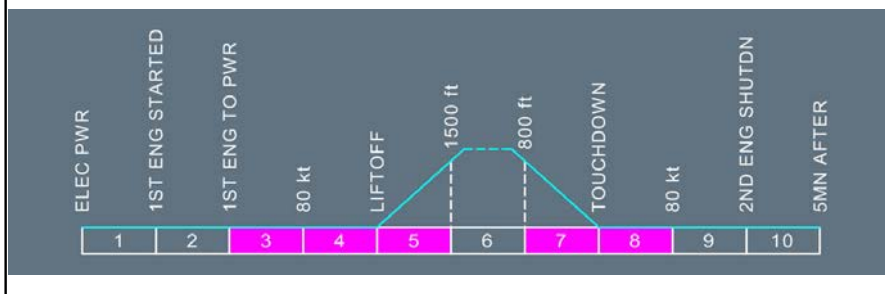

Continued on the following page



A318/A319/A320/A321
 FLIGHT CREW
 OPERATING MANUAL

PROCEDURES
ABNORMAL AND EMERGENCY PROCEDURES

A-ICE

ANTI ICE CAPT PROBES (Cont'd)

Ident.: PRO-ABN-A-ICE-G-00010255.0002001 / 05 AUG 10

AIR DATA SWTG.....CAPT 3

L2 Note: AIR DATA SWTG should not be selected to CAPT 3 if ADR 3 is not available.

Ident.: PRO-ABN-A-ICE-G-00010256.0001001 / 05 AUG 10

STATUS

INOP SYS

CAPT PROBES

ANTI ICE ENG 1(2) VALVE CLSD

Applicable to: ALL

Ident.: PRO-ABN-A-ICE-J-00017163.0001001 / 21 MAR 16

ANNUNCIATIONS

Triggering Conditions:

L2 This alert triggers when the valve is abnormally closed.

Flight Phase Inhibition:

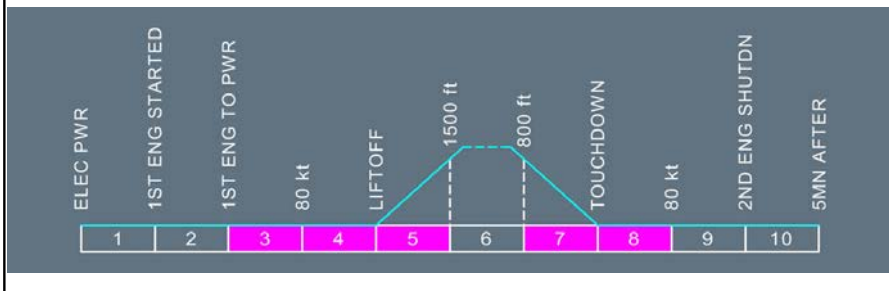

Ident.: PRO-ABN-A-ICE-J-00010269.0001001 / 05 AUG 10

AVOID ICING CONDITIONS

Continued on the following page

ANTI ICE ENG 1(2) VALVE CLSD (Cont'd)

Ident.: PRO-ABN-A-ICE-J-00010270.0001001 / 05 AUG 10

STATUS

AVOID ICING CONDITIONS

INOP SYS

ENG 1 (2) A. ICE

ANTI ICE ENG 1(2) VALVE OPEN

Applicable to: ALL

Ident.: PRO-ABN-A-ICE-K-00017162.0001001 / 21 MAR 16

ANNUNCIATIONS

Triggering Conditions:

L2 This alert triggers when the valve is abnormally open.

Flight Phase Inhibition:

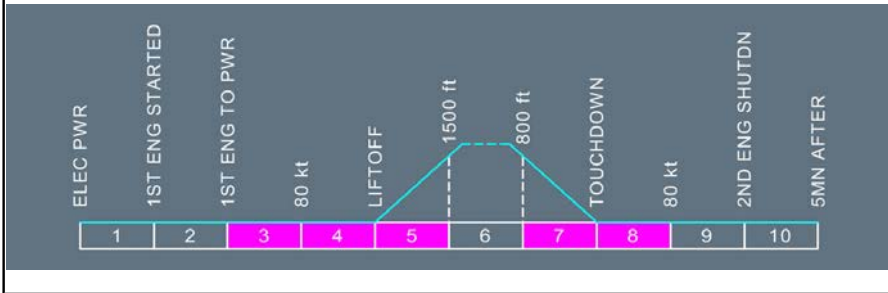

Ident.: PRO-ABN-A-ICE-K-00010272.0001001 / 05 AUG 10

THRUST LIM PENALTY

Continued on the following page

ANTI ICE ENG 1(2) VALVE OPEN (Cont'd)

Ident.: PRO-ABN-A-ICE-K-00010273.0001001 / 05 AUG 10

STATUS

THRUST LIM PENALTY

ANTI ICE F/O + STBY PITOT

Applicable to: ALL

Ident.: PRO-ABN-A-ICE-T-00017179.0003001 / 21 MAR 16

ANNUNCIATIONS

Triggering Conditions:

L2

This alert triggers when the heating systems of the F/O and STBY pitot probes are failed.

Flight Phase Inhibition:

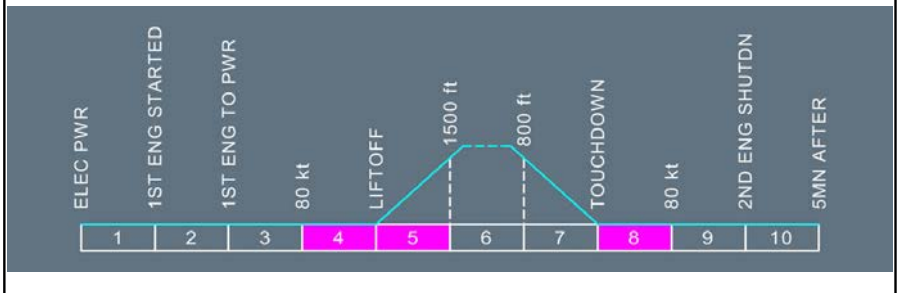

Continued on the following page

ANTI ICE F/O + STBY PITOT (Cont'd)

Ident.: PRO-ABN-A-ICE-T-00018307.0002001 / 21 MAR 17

[L2] In the case of simultaneous pitot icing and in the same amount, ADR 2 and ADR 3 speeds will be in agreement, but incorrect. Therefore, flight controls will consider the remaining correct source as being faulty, and will reject the only correct source. The following ECAM procedure avoids that the flight controls use two erroneous, but coherent, sources.

[L1] ■ **If ADR 1 operative and ON:**
 ADR 2(3) P/B..... OFF

[L2] Depending on the status of the static, AOA , and TAT heating, the ECAM requires that either ADR 2 or 3 be switched OFF.

Note: In the case of subsequent, significant, speed discrepancy between the two remaining ADR s, the “ADR DISAGREE” ECAM caution will trigger.

[L1] ■ **If ADR 1 failed or OFF:**

[L2] No action is required, as long as there are no icing conditions, in order to keep two independent speed sources.

[L1] ● **IF ICING EXPECTED:**
 ADR 2(3) P/B..... APPLY

[L2] Depending on the status of the static, AOA , and TAT heating, the ECAM requires that either ADR 2 or 3 be switched OFF.

[L1] UNREL SPD PROC.....APPLY

[L2] Only one ADR is available, and the corresponding pitot probe may be affected by ice accretion. Be prepared to use the UNRELIABLE SPEED INDICATION procedure (Refer to procedure).

[L1]

ASSOCIATED PROCEDURES

NAV ADR FAULT

Continued on the following page

ANTI ICE F/O + STBY PITOT (Cont'd)

Ident.: PRO-ABN-A-ICE-T-00018308.0002001 / 21 MAR 16

| | | STATUS |
|---|--|---|
| <ul style="list-style-type: none"> ● If ADR 1 failed or OFF: ● IF ICING EXPECTED: ADR 2(3) P/B.....OFF UNREL SPD PROC.....APPLY | | INOP SYS F/O PITOT STBY PITOT F/O PROBES ⁽¹⁾ STBY PROBES ⁽²⁾ |
| <p>⁽¹⁾ (If all F/O PROBES heating is lost) ⁽²⁾ (If all STBY PROBES heating is lost)</p> | | |

ANTI ICE F/O PITOT OR L(R) STAT OR AOA

Applicable to: ALL

Ident.: PRO-ABN-A-ICE-D-00017170.0001001 / 21 MAR 16

ANNUNCIATIONS

Triggering Conditions:

L2 This alert triggers when the heating system of the corresponding probe is failed.

Flight Phase Inhibition:

The diagram shows a horizontal timeline from 1 to 10. Above the timeline, key events are marked with vertical lines: ELEC PWR at phase 1, 1ST ENG STARTED at phase 2, 1ST ENG TO PWR at phase 3, 80 kt at phase 4, LIFTOFF at phase 5, 1500 ft at phase 6, 800 ft at phase 7, TOUCHDOWN at phase 8, 80 kt at phase 9, 2ND ENG SHUTDN at phase 10, and 5MN AFTER at phase 10. The background of the diagram is dark grey.

Continued on the following page

ANTI ICE F/O PITOT OR L(R) STAT OR AOA (Cont'd)

Ident.: PRO-ABN-A-ICE-D-00018309.0002001 / 21 MAR 16

AIR DATA SWTG.....**F/O 3**

L2 ADR 3 supplies data to PFD 2 and ND 2.

Note: AIR DATA SWTG should not be selected to F/O 3 if ADR 3 is not available.

Ident.: PRO-ABN-A-ICE-D-00018901.0001001 / 21 MAR 16

STATUS

INOP SYS

F/O PITOT
F/O L(R) STAT
F/O AOA

ANTI ICE F/O PROBES

Applicable to: ALL

Ident.: PRO-ABN-A-ICE-H-00017174.0001001 / 21 MAR 16

ANNUNCIATIONS

Triggering Conditions:

L2 This alert triggers when the F/O probe heat computer is failed.

Flight Phase Inhibition:

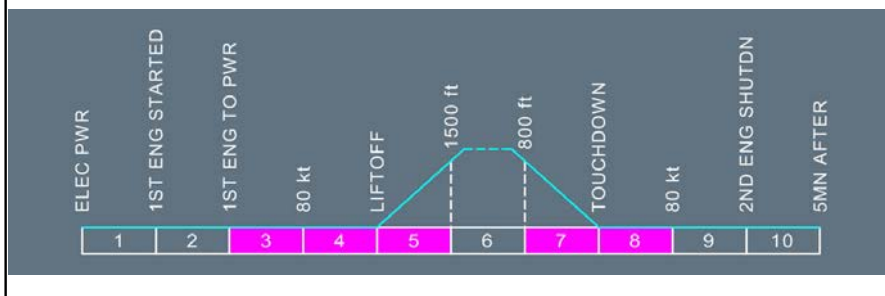

Continued on the following page



A318/A319/A320/A321
 FLIGHT CREW
 OPERATING MANUAL

PROCEDURES
ABNORMAL AND EMERGENCY PROCEDURES

A-ICE

ANTI ICE F/O PROBES (Cont'd)

Ident.: PRO-ABN-A-ICE-H-00010261.0002001 / 05 AUG 10

AIR DATA SWTG.....F/O 3

L2 Note: AIR DATA SWTG should not be selected to F/O 3 if ADR 3 is not available.

Ident.: PRO-ABN-A-ICE-H-00010263.0001001 / 05 AUG 10

STATUS

INOP SYS

F/O PROBES

ANTI ICE L + R WINDSHIELD

Applicable to: ALL

Ident.: PRO-ABN-A-ICE-B-00017167.0001001 / 21 MAR 16

ANNUNCIATIONS

Triggering Conditions:

L2 This alert triggers when the heating system of both windshields is failed.

Flight Phase Inhibition:

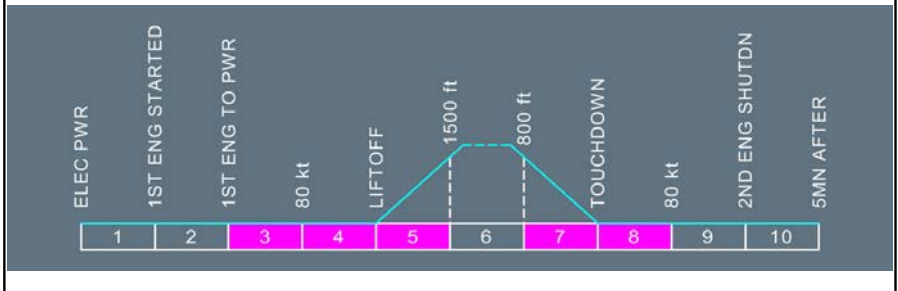

Ident.: PRO-ABN-A-ICE-B-00010236.0001001 / 25 FEB 14

Crew awareness.

Continued on the following page

ANTI ICE L + R WINDSHIELD (Cont'd)

Ident.: PRO-ABN-A-ICE-B-00010237.0001001 / 05 AUG 10

STATUS

INOP SYS

WSHLD HEAT

ANTI ICE L(R) WINDOW

Applicable to: ALL

Ident.: PRO-ABN-A-ICE-V-00017168.0001001 / 21 MAR 16

ANNUNCIATIONS

Triggering Conditions:

[L2] This alert triggers when the heating system of the left(right) cockpit window is failed.

Flight Phase Inhibition:

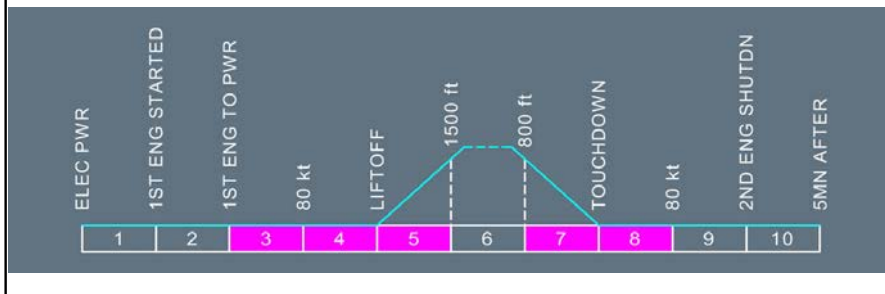

Ident.: PRO-ABN-A-ICE-V-00010234.0001001 / 25 FEB 14

Crew awareness.

Continued on the following page

ANTI ICE L(R) WINDOW (Cont'd)

Ident.: PRO-ABN-A-ICE-V-00010235.0001001 / 05 AUG 10

| | |
|--|---|
| | <p>STATUS</p> <hr style="border: 0; border-left: 1px solid black; width: 100%;"/> <p style="text-align: center;"><u>INOP SYS</u></p> <p style="text-align: center; color: orange;">L(R) WNDW HEAT</p> |
|--|---|

ANTI ICE L(R) WINDSHIELD

Applicable to: ALL

Ident.: PRO-ABN-A-ICE-A-00017166.0001001 / 21 MAR 16

ANNUNCIATIONS

Triggering Conditions:

L2 This alert triggers when the heating system of the left(right) windshield is failed.

Flight Phase Inhibition:

Ident.: PRO-ABN-A-ICE-A-00010232.0001001 / 25 FEB 14

Crew awareness.

Continued on the following page

ANTI ICE L(R) WINDSHIELD (Cont'd)

Ident.: PRO-ABN-A-ICE-A-00010233.0001001 / 05 AUG 10

STATUS

INOP SYS

L(R) WSHLD HEAT

ANTI ICE STBY PITOT OR L(R) STAT OR AOA

Applicable to: ALL

Ident.: PRO-ABN-A-ICE-F-00017172.0001001 / 21 MAR 16

ANNUNCIATIONS

Triggering Conditions:

[L2] This alert triggers when the heating system of the corresponding probe is failed.

Flight Phase Inhibition:

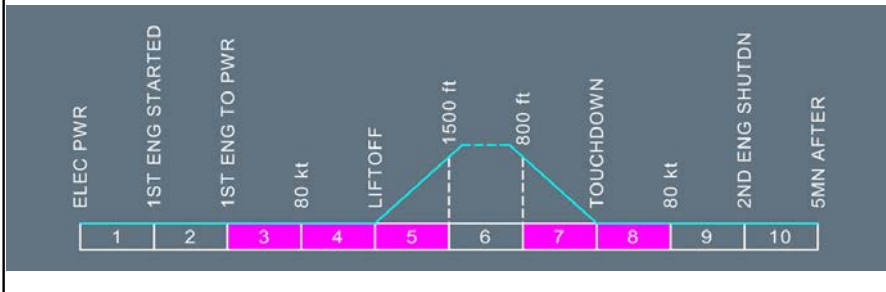

Ident.: PRO-ABN-A-ICE-F-00010250.0001001 / 25 FEB 14

Crew awareness.

[L2] If standby instruments are used, monitor air data information.

Continued on the following page

ANTI ICE STBY PITOT OR L(R) STAT OR AOA (Cont'd)

Ident.: PRO-ABN-A-ICE-F-00010251.0001001 / 05 AUG 10

STATUS

INOP SYS

STBY PITOT
 STBY L(R) STAT
 STBY AOA

ANTI ICE STBY PROBES

Applicable to: ALL

Ident.: PRO-ABN-A-ICE-I-00017176.0001001 / 21 MAR 16

ANNUNCIATIONS

Triggering Conditions:

L2

This alert triggers when the standby probe heat computer is failed.

Flight Phase Inhibition:

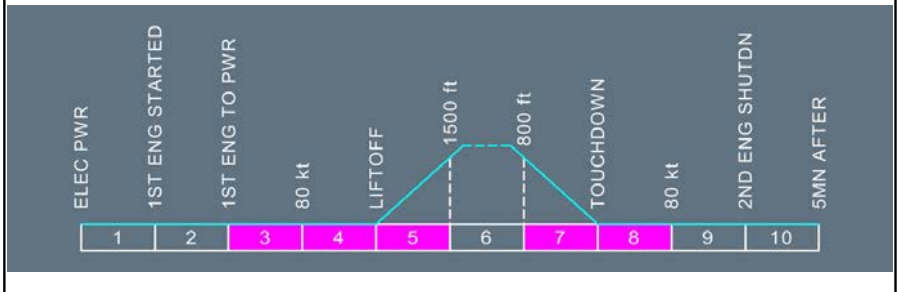

Ident.: PRO-ABN-A-ICE-I-00010265.0001001 / 25 FEB 14

Crew awareness.

Continued on the following page



AEROLINEAS GALAPAGOS S.A.

A318/A319/A320/A321
FLIGHT CREW
OPERATING MANUAL

PROCEDURES
ABNORMAL AND EMERGENCY PROCEDURES

A-ICE

ANTI ICE STBY PROBES (Cont'd)

Ident.: PRO-ABN-A-ICE-I-00010266.0001001 / 05 AUG 10

STATUS

INOP SYS

STBY PROBES

[QRH] ENGINE 1+2 BLEED FAULT

Ident.: PRO-ABN-AIR-00017611.0001001 / 21 MAR 17

Applicable to: ALL

Apply this procedure when both engine bleed supply systems are failed.

- **At ANY TIME of the procedure, if CAB PR EXCESS CAB ALT alert triggers: APPLY ECAM PROC**

- **If AIR ENG 1 BLEED FAULT alert or AIR ENG 1 BLEED ABNORM PR alert and**

If AIR ENG 2 BLEED FAULT alert or AIR ENG 2 BLEED ABNORM PR alert:

X BLEED SHUT
 ENG 1 BLEED OFF THEN ON
 ENG 2 BLEED OFF THEN ON

- **If reset unsuccessful (NO engine bleed recovered):**

DESCENT TO FL 100 / MEA -MORA..... INITIATE

L2

Descend rapidly to FL 100 / MEA -MORA, to prevent excessive cabin altitude.

L1

ENG 1 BLEED..... OFF

ENG 2 BLEED..... OFF

APU BLEED..... OFF

APU..... START

WING A.ICE..... OFF

AVOID ICING CONDITIONS

- **If APU available:**

- **When at or below FL 200:**

KEEP WING A.ICE OFF

L2

APU BLEED must not be used for wing anti-ice.

L1

APU BLEED..... ON

L2

When APU BLEED is ON and pressurization is recovered, reduce rate of descent and consider MAX FL 200.

L1

- **If APU bleed available:**

MAX FL: 200

ENG 1 BLEED..... ON

ENG 2 BLEED..... ON

APU BLEED..... OFF

Continued on the following page

[QRH] ENGINE 1+2 BLEED FAULT (Cont'd)

- **If no engine bleed recovered:**
 APU BLEED..... ON
 ENG 1 BLEED..... OFF
 ENG 2 BLEED..... OFF

WING A.ICE NOT AVAILABLE

- **If PACK 1 inoperative:**
 X BLEED..... OPEN

To supply the PACK 2 from the APU bleed.

L2

L1

- **If APU bleed not available:**
 CONTINUE DESCENT TO FL 100 / MEA-MORA
 APU BLEED..... OFF

- **When at or below FL 100 / MEA-MORA:**
 ENG 1 BLEED..... ON
 ENG 2 BLEED..... ON

- **If no engine bleed recovered:**
 ENG 1 BLEED..... OFF
 ENG 2 BLEED..... OFF

WING A.ICE NOT AVAILABLE

- **When CAB PR ΔP < 1 psi:**
 RAM AIR..... ON
 MAX FL: 100 / MEA-MORA

- **If APU not available:**
 CONTINUE DESCENT TO FL 100 / MEA-MORA
 APU BLEED..... OFF

- **When at or below FL 100 / MEA-MORA:**
 ENG 1 BLEED..... ON
 ENG 2 BLEED..... ON

- **If no engine bleed recovered:**
 ENG 1 BLEED..... OFF
 ENG 2 BLEED..... OFF

WING A.ICE NOT AVAILABLE

Continued on the following page

[QRH] ENGINE 1+2 BLEED FAULT (Cont'd)

- **When CAB PR Δ P < 1 psi:**
 RAM AIR..... ON
 MAX FL: 100 / MEA-MORA

■ **If at least one engine bleed failed due to bleed leak or engine fire or Start Air Valve failed open:**

DESCENT TO FL 100 / MEA -MORA..... INITIATE

L2 *Descend rapidly to FL 100 / MEA -MORA, to prevent excessive cabin altitude.*

- L1** X BLEED..... SHUT
- ENG 1 BLEED..... OFF
- ENG 2 BLEED..... OFF
- APU BLEED..... OFF
- APU..... START
- WING A.ICE..... OFF

AVOID ICING CONDITIONS

■ **If AIR ENG 2 BLEED FAULT alert or AIR ENG 2 BLEED ABNORM PR alert:**

- **When at or below FL 100 / MEA-MORA:**
 ENG 2 BLEED..... ON

- **If engine 2 bleed not recovered:**
 ENG 2 BLEED..... OFF

WING A.ICE NOT AVAILABLE

- **When CAB PR Δ P < 1 psi:**
 RAM AIR..... ON
 MAX FL: 100 / MEA-MORA

■ **If AIR ENG 1 BLEED FAULT alert or AIR ENG 1 BLEED ABNORM PR alert:**

■ **If APU available:**

- **When at or below FL 200:**

KEEP WING A.ICE OFF

L2 *APU BLEED must not be used for wing anti-ice.*

L1 APU BLEED..... ON

L2 *When APU BLEED is ON and pressurization is recovered, reduce rate of descent and consider MAX FL 200.*

Continued on the following page

[QRH] ENGINE 1+2 BLEED FAULT (Cont'd)

L1

■ **If APU bleed available:**

MAX FL: 200

ENG 1 BLEED.....ON

APU BLEED.....OFF

● **If engine 1 bleed not recovered:**

APU BLEED.....ON

ENG 1 BLEED..... OFF

WING A.ICE NOT AVAILABLE

■ **If APU bleed not available:**

CONTINUE DESCENT TO FL 100 / MEA-MORA

APU BLEED.....OFF

● **When at or below FL 100 / MEA-MORA:**

ENG 1 BLEED..... ON

● **If engine 1 bleed not recovered:**

ENG 1 BLEED..... OFF

WING A.ICE NOT AVAILABLE

● **When CAB PR ΔP < 1 psi:**

RAM AIR.....ON

MAX FL: 100 / MEA-MORA

■ **If APU not available:**

CONTINUE DESCENT TO FL 100 / MEA-MORA

APU BLEED.....OFF

● **When at or below FL 100 / MEA-MORA:**

ENG 1 BLEED..... ON

● **If engine 1 bleed not recovered:**

ENG 1 BLEED..... OFF

WING A.ICE NOT AVAILABLE

● **When CAB PR ΔP < 1 psi:**

RAM AIR.....ON

MAX FL: 100 / MEA-MORA

Continued on the following page

[QRH] ENGINE 1+2 BLEED FAULT (Cont'd)

- If neither **AIR ENG 1(2) BLEED FAULT** alert nor **AIR ENG 1(2) BLEED ABNORM PR** alert on any side:

NO ENGINE BLEED CAN BE RECOVERED
 WING A.ICE NOT AVAILABLE

- **When at or below FL 100 / MEA-MORA**

and

CAB PR ΔP < 1 psi:

RAM AIR.....ON

MAX FL: 100 / MEA-MORA

AIR APU BLEED FAULT

Applicable to: ALL

Ident.: PRO-ABN-AIR-G-00017375.0001001 / 21 MAR 16

ANNUNCIATIONS

Triggering Conditions:

L2

This alert triggers when the APU is running and the position of the APU bleed valve disagrees with the selected position of the APU BLEED pb-sw.

Flight Phase Inhibition:

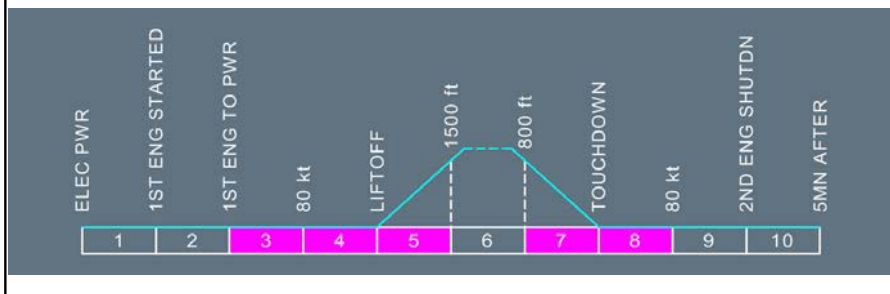

Ident.: PRO-ABN-AIR-G-00017552.0001001 / 21 MAR 16

Crew awareness.

Continued on the following page

AIR APU BLEED FAULT (Cont'd)

Ident.: PRO-ABN-AIR-G-00011266.0001001 / 05 AUG 10

STATUS

INOP SYS

APU BLEED (If valve closed)

AIR APU BLEED LEAK

Applicable to: ALL

Ident.: PRO-ABN-AIR-F-00017376.0001001 / 21 MAR 16

ANNUNCIATIONS

Triggering Conditions:

- [L2] This alert triggers when the APU bleed leak detection loop detects a temperature above 124 °C.

Flight Phase Inhibition:

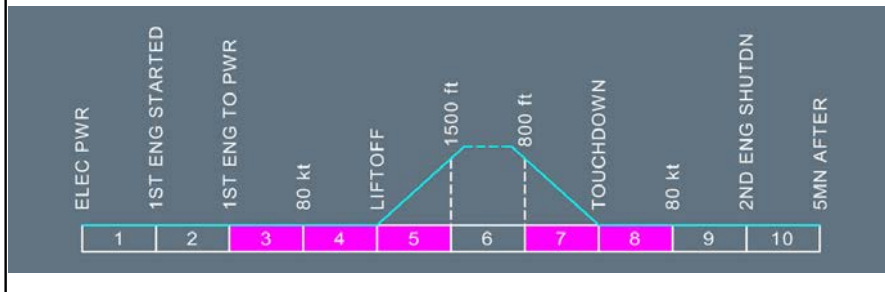

Ident.: PRO-ABN-AIR-F-00017553.0001001 / 21 MAR 16

APU BLEED (IF NOT CLOSED).....OFF

- [L2] When the APU BLEED pb-sw is ON, the FAULT light remains on.
When the APU BLEED pb-sw is OFF, the FAULT light goes off when the overheat disappears.

Continued on the following page

AIR APU BLEED LEAK (Cont'd)

Ident.: PRO-ABN-AIR-F-00011100.0001001 / 05 AUG 10

STATUS

INOP SYS

APU BLEED

AIR BLEED 1(2) OFF

Applicable to: ALL

Ident.: PRO-ABN-AIR-AA-00017374.0001001 / 21 MAR 16

ANNUNCIATIONS

Triggering Conditions:

L2

This alert triggers when the ENG 1(2) BLEED pb-sw is abnormally set to OFF.

Flight Phase Inhibition:

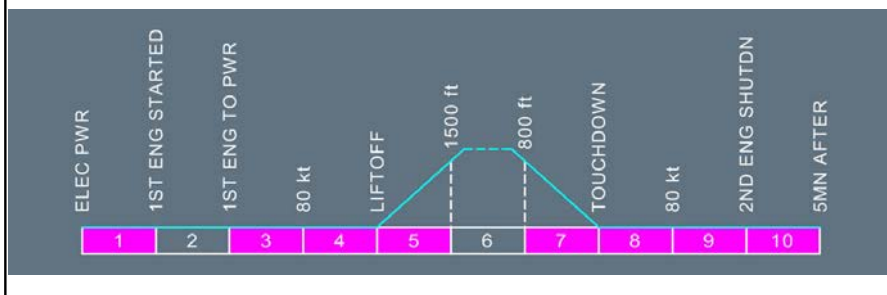

Ident.: PRO-ABN-AIR-AA-00017555.0001001 / 21 MAR 16

Crew awareness.

AIR COND CTL 1(2) - A(B) FAULT

Applicable to: ALL

Ident.: PRO-ABN-AIR-AC-00017315.0001001 / 21 MAR 16

ANNUNCIATIONS

Triggering Conditions:

L2 This alert triggers when the lane A(B) of ACSC 1(2) is failed.

Flight Phase Inhibition:

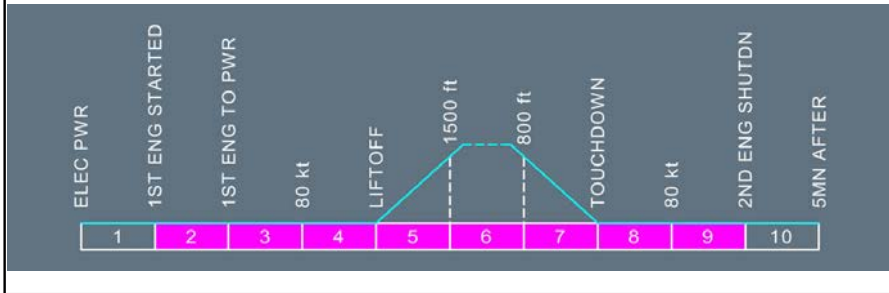

Ident.: PRO-ABN-AIR-AC-00018084.0001001 / 21 MAR 16

Crew awareness.

Ident.: PRO-ABN-AIR-AC-00010777.0001001 / 05 AUG 10

STATUS

INOP SYS

COND CTL 1(2)-A(B)

AIR ENG 1(2) BLEED ABNORM PR

Applicable to: ALL

Ident.: PRO-ABN-AIR-B-00017378.0001001 / 21 MAR 16

ANNUNCIATIONS

Triggering Conditions:

L2 This alert triggers when the regulated pressure in the engine bleed duct is abnormal.

Flight Phase Inhibition:

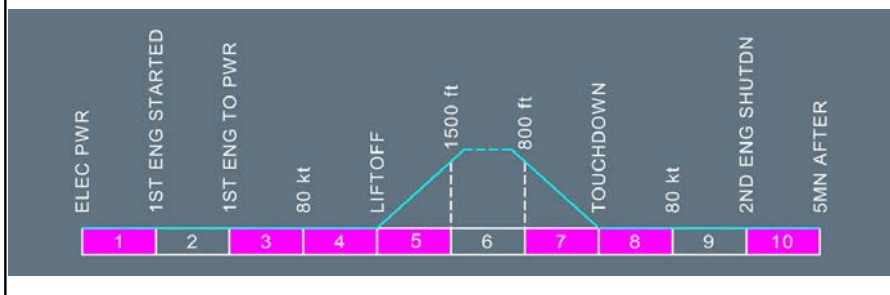

Ident.: PRO-ABN-AIR-B-00017584.0005001 / 21 MAR 16

● **If wing anti-ice is off, and both packs are on:**
PACK FLOW..... LO

L2 The PACK FLOW selector must be set to LO, due to precooler performance.

L1 ● **If wing anti-ice is on, and both packs are on:**
PACK (AFFECTED)..... OFF

L2 One pack must be closed when the flight crew uses wing anti-ice because of precooler performance.

L1 X BLEED..... OPEN

Continued on the following page

AIR ENG 1(2) BLEED ABNORM PR (Cont'd)

Ident.: PRO-ABN-AIR-B-00011089.0001001 / 05 AUG 10

STATUS

ONE PACK ONLY IF WAI ON

INOP SYS

ENG 1(2) BLEED
PACK 1(2) (If closed)

AIR ENG 1(2) BLEED FAULT

Applicable to: **ALL**

Ident.: PRO-ABN-AIR-C-00017369.0001001 / 21 MAR 16

ANNUNCIATIONS

Triggering Conditions:

- 12 This alert triggers when the engine 1(2) is running and:
- The engine bleed air pressure is above 57 PSI (+3/-0), or
 - The engine bleed air temperature is above:
 - 257 °C for more than 55 s
 - 270 °C for more than 15 s
 - 290 °C for more than 5 s.

Flight Phase Inhibition:

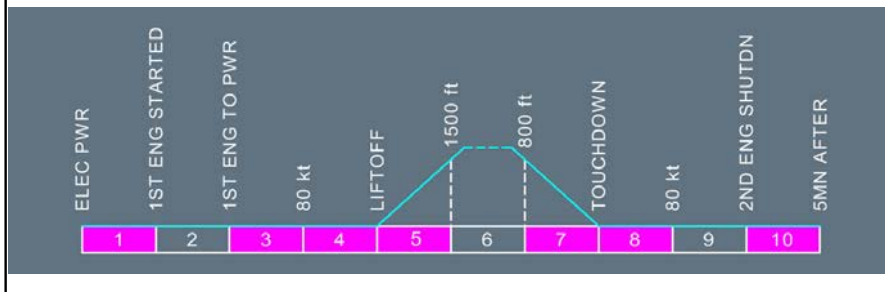

Continued on the following page



A318/A319/A320/A321
 FLIGHT CREW
 OPERATING MANUAL

PROCEDURES
ABNORMAL AND EMERGENCY PROCEDURES

AIR

AIR ENG 1(2) BLEED FAULT (Cont'd)

Ident.: PRO-ABN-AIR-C-00017605.0005001 / 21 MAR 16

ENG BLEED (AFFECTED, IF NOT AUTOMATICALLY CLOSED).....OFF

L2 When the ENG BLEED pb-sw is ON, the FAULT light remains on.
 When the ENG BLEED pb-sw is OFF, the FAULT light goes off when the failure (overheat or overpressure) disappears.

L1 ● If wing anti-ice is off and both packs are on:
 PACK FLOW.....LO

The PACK FLOW selector must be set to LO, due to precooler performance.

● If wing anti-ice is on and both packs are on:
 PACK (AFFECTED).....OFF

L2 One pack must be closed when the flight crew uses wing anti-ice because of precooler performance.

L1 X BLEED.....OPEN

Ident.: PRO-ABN-AIR-C-00011092.0001001 / 05 AUG 10

STATUS

INOP SYS

ONE PACK ONLY IF WAI ON

ENG 1(2) BLEED
 PACK 1(2) (If closed)

AIR ENG 1(2) BLEED LO TEMP
(OPPOSITE BLEED AVAILABLE)

Applicable to: ALL

Ident.: PRO-ABN-AIR-M-00017379.0001001 / 21 MAR 16

ANNUNCIATIONS

Triggering Conditions:

- L2** This alert triggers when the associated engine bleed supplies bleed air at a temperature below 150 °C in flight and the WING A-ICE pb-sw is set to ON.

Flight Phase Inhibition:

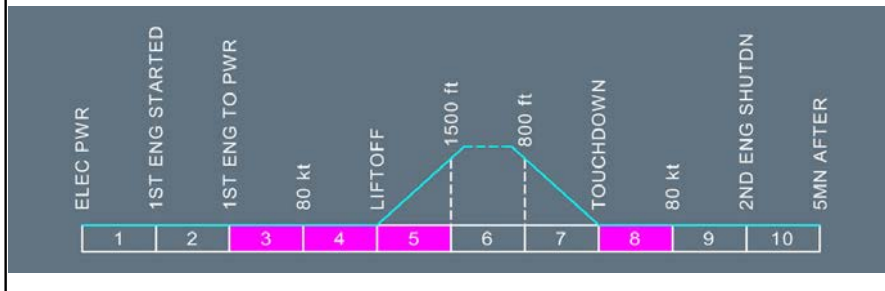

Ident.: PRO-ABN-AIR-M-00017560.0001001 / 21 MAR 16

A/THR..... OFF
 THR LEVER (AFFECTED ENGINE)..... ADVANCE

- L2** The thrust lever of the affected engine must be advanced, with the autothrust OFF.
 Low bleed temperature may be due to low outside air temperature. Therefore, increasing engine thrust may increase bleed temperature and clear the ECAM caution.

- L1** ● **IF UNSUCCESSFUL:**
 X BLEED..... OPEN
 ENG BLEED (AFFECTED)..... OFF
 ASSOCIATED PACK (IF OPPOSITE PACK ON)..... OFF

- L2** One pack must be closed, when the flight crew uses wing anti-ice, due to precooler performance.

Continued on the following page

AIR ENG 1(2) BLEED LO TEMP (Cont'd)
(OPPOSITE BLEED AVAILABLE)

Ident.: PRO-ABN-AIR-M-00011115.0001001 / 21 AUG 15

| | |
|---------------|--|
| STATUS | <p style="text-align: center; margin: 0;">INOP SYS</p> <p style="margin: 5px 0;">ENG 1(2) BLEED PACK 1(2) (If selected OFF)</p> |
|---------------|--|

AIR ENG 1(2) BLEED LO TEMP
(OPPOSITE BLEED NOT AVAILABLE)

Applicable to: ALL

Ident.: PRO-ABN-AIR-N-00018208.0001001 / 21 MAR 16

ANNUNCIATIONS

Triggering Conditions:

L2 This alert triggers when the associated engine bleed supplies bleed air at a temperature below 150 °C in flight and the WING A-ICE pb-sw is set to ON.

Flight Phase Inhibition:

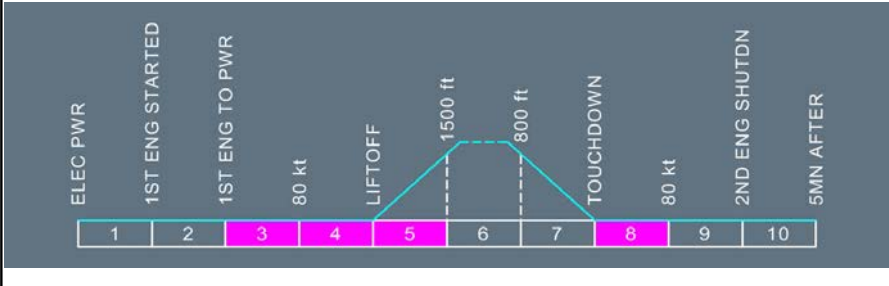

Continued on the following page

PROCEDURES
ABNORMAL AND EMERGENCY PROCEDURES

AIR

AIR ENG 1(2) BLEED LO TEMP (Cont'd)
 (OPPOSITE BLEED NOT AVAILABLE)

Ident.: PRO-ABN-AIR-N-00017561.0001001 / 21 MAR 16

A/THR..... OFF
 THR LEVER (AFFECTED ENGINE).....ADVANCE

[L2] *The thrust lever of the affected engine must be advanced, with the autothrust OFF.
 Low bleed temperature may be due to low outside air temperature. Therefore, increasing engine thrust may increase bleed temperature and clear the ECAM caution.*

[L1] ● **IF UNSUCCESSFUL:**
 WING A. ICE..... OFF
 AVOID ICING CONDITIONS

Ident.: PRO-ABN-AIR-N-00011117.0003001 / 17 MAR 17

STATUS

AVOID ICING CONDITIONS

INOP SYS

● **IF SEVERE ICE ACCRETION:**
 MIN SPD.....VLS +10 / G DOT
 MANEUVER WITH CARE
 LDG DIST PROC.....APPLY

WING A. ICE

AIR ENG 1+2 BLEED LO TEMP

Applicable to: ALL

Ident.: PRO-ABN-AIR-O-00017381.0001001 / 21 MAR 16

ANNUNCIATIONS

Triggering Conditions:

L2

This alert triggers when both engine bleeds supply bleed air at a temperature below 150 °C in flight and the WING A-ICE pb-sw is set to ON.

Flight Phase Inhibition:

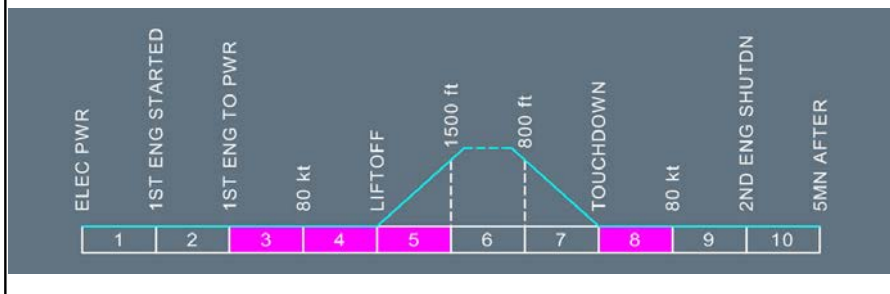

Ident.: PRO-ABN-AIR-O-00011118.0001001 / 05 AUG 10

A/THROFF
THR LEVERS.....ADVANCE

L2

The thrust lever of the affected engine must be advanced, with the autothrust OFF.
Low bleed temperature may be due to low outside air temperature. Therefore, increasing engine thrust may increase bleed temperature and clear the ECAM caution.

L1

- **IF UNSUCCESSFUL:**
WING A. ICE.....OFF
AVOID ICING CONDITIONS

Continued on the following page

AIR ENG 1+2 BLEED LO TEMP (Cont'd)

Ident.: PRO-ABN-AIR-O-00011119.0003001 / 17 MAR 17

STATUS

AVOID ICING CONDITIONS

INOP SYS

● **IF SEVERE ICE ACCRETION:**

WING A. ICE

MIN SPD.....VLS +10 / G DOT

MANEUVER WITH CARE

LDG DIST PROC.....APPLY

AIR ENG 1(2) BLEED HI TEMP

Applicable to: ALL

Ident.: PRO-ABN-AIR-P-00017391.0002001 / 21 MAR 16

ANNUNCIATIONS

Triggering Conditions:

L2 This alert triggers when the precooler outlet temperature is above 240 °C.

Flight Phase Inhibition:

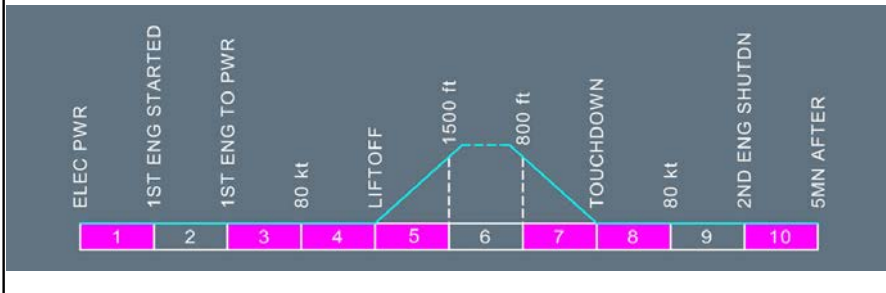

Continued on the following page

AIR ENG 1(2) BLEED HI TEMP (Cont'd)

Ident.: PRO-ABN-AIR-P-00014306.0001001 / 21 AUG 15

■ **If wing anti-ice off:**

PACK 2 (1)..... OFF

■ **If wing anti-ice on and opposite pack off:**

Note: If Wing Anti-Ice is required (icing conditions) while operating with one PACK, consider switching OFF the remaining pack, if aircraft's altitude permits.

PACK 1 (2) OR WAI.....OFF

■ **If wing anti-ice on and affected pack off:**

PACK 2 (1) OR WAI.....OFF

Ident.: PRO-ABN-AIR-P-00014307.0005001 / 17 MAR 17

L12

STATUS

AVOID ICING CONDITIONS

● **IF SEVERE ICE ACCRETION:**

MIN SPD..... VLS+10/G DOT

Note: In the case of severe ice accretion, with wing anti-ice failed, the Angle-of-Attack (AOA) protections remain efficient.

MANEUVER WITH CARE

LDG DIST PROC.....APPLY

INOP SYS

WING A. ICE

AIR ENG 1(2) BLEED NOT CLSD

Applicable to: ALL

Ident.: PRO-ABN-AIR-A-00017372.0001001 / 21 MAR 16

ANNUNCIATIONS

Triggering Conditions:

- [L2] This alert triggers when the engine bleed valve fails to close:
 - During engine start or when APU BLEED pb-sw is set to ON
 - At engine shutdown or when APU BLEED pb-sw is set to OFF with engine not running.

Flight Phase Inhibition:

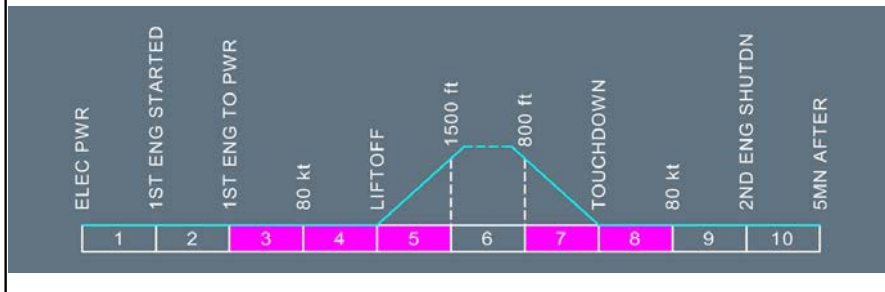

Ident.: PRO-ABN-AIR-A-00017562.0001001 / 21 MAR 16

ENG BLEED (AFFECTED)..... OFF

- [L2] Note: *The warning may be triggered due to residual pressure between the HP or IP valves and the engine bleed valve after:*
 - Engine shutdown, or
 - APU BLEED pb-sw is selected OFF with engine not running.

Ident.: PRO-ABN-AIR-A-00011087.0001001 / 05 AUG 10

STATUS

INOP SYS

ONE PACK ONLY IF WAI ON

ENG 1(2) BLEED

AIR ENG 1(2) HP VALVE FAULT

Applicable to: ALL

Ident.: PRO-ABN-AIR-H-00017384.0001001 / 21 MAR 16

ANNUNCIATIONS

Triggering Conditions:

L2

This alert triggers when the HP valve is abnormally closed.

Flight Phase Inhibition:

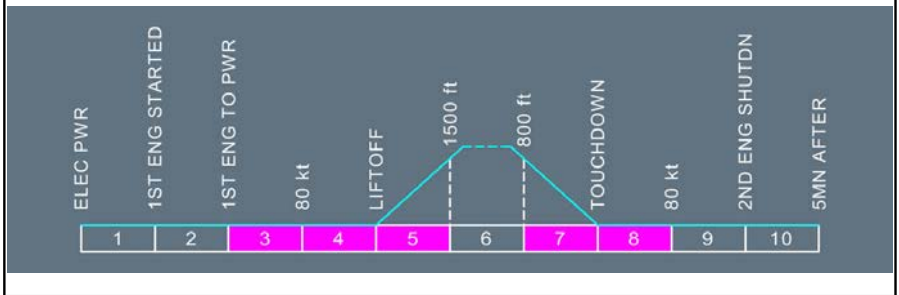

Ident.: PRO-ABN-AIR-H-00011103.0001001 / 25 FEB 14

Crew awareness.

Ident.: PRO-ABN-AIR-H-00011104.0001001 / 05 AUG 10

STATUS

AIR PRESS LOW AT IDLE

AIR ENG 1(2) LEAK DET FAULT

Applicable to: ALL

Ident.: PRO-ABN-AIR-I-00017389.0002001 / 21 MAR 16

ANNUNCIATIONS

Triggering Conditions:

L2 This alert triggers when the pylon bleed leak detection loop is inoperative.

Flight Phase Inhibition:

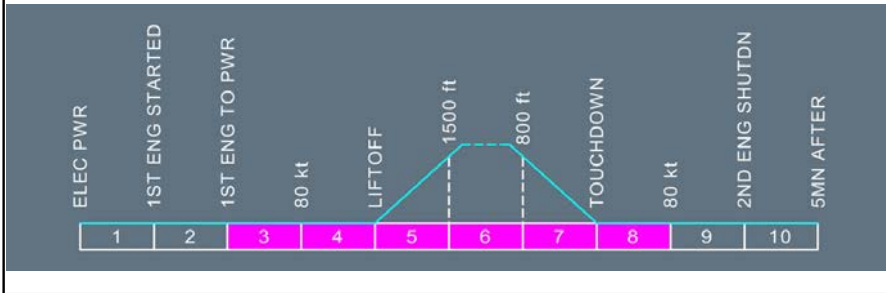

Ident.: PRO-ABN-AIR-I-00011105.0004001 / 25 FEB 14

Crew awareness.

Ident.: PRO-ABN-AIR-I-00011106.0004001 / 17 MAR 11

STATUS

INOP SYS

ENG 1(2) LK DET

AIR FWD(AFT) CRG VENT FAULT ⚠

Applicable to: ALL

Ident.: PRO-ABN-AIR-AE-00017337.0001001 / 21 MAR 16

ANNUNCIATIONS

Triggering Conditions:

L2

This alert triggers when the forward(aft) cargo ventilation fan is failed.

Flight Phase Inhibition:

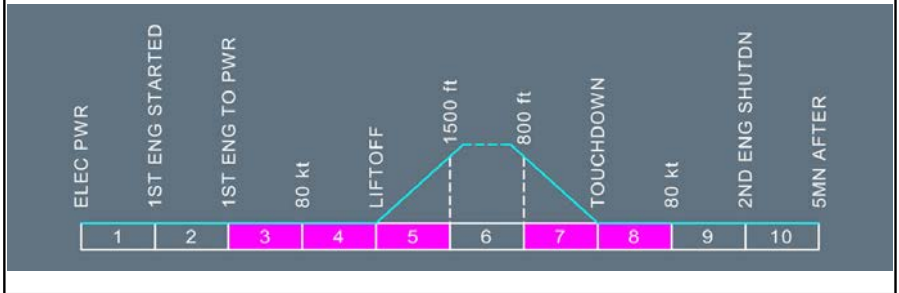

Ident.: PRO-ABN-AIR-AE-00017933.0001001 / 21 MAR 16

Crew awareness.

Ident.: PRO-ABN-AIR-AE-00017934.0001001 / 21 MAR 16

STATUS

INOP SYS

FWD(AFT) CRG HEAT ⚠
 FWD(AFT) CRG VENT

AIR L(R) WING OR ENG 1(2) BLEED LEAK

Applicable to: ALL

Ident.: PRO-ABN-AIR-D-00017370.0001001 / 21 MAR 16

ANNUNCIATIONS

Triggering Conditions:

- [L2] The **AIR L(R) WING LEAK** alert triggers when both wing bleed leak detection loops detect a temperature above 124 °C .
- The **AIR ENG 1(2) BLEED LEAK** alert triggers when the pylon bleed leak detection loop detects a temperature above 204 °C and engine 1(2) is running.

Flight Phase Inhibition:

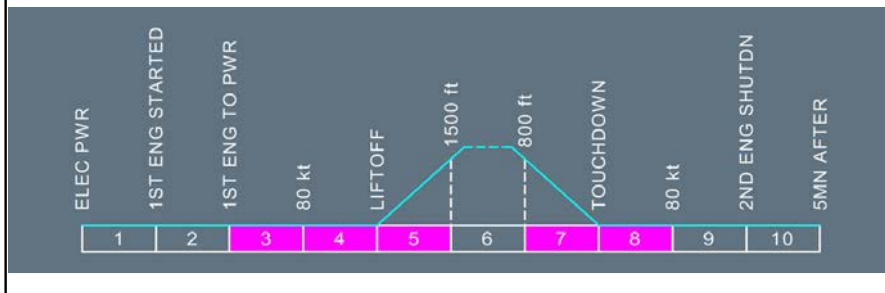

Ident.: PRO-ABN-AIR-D-00017563.0001001 / 21 MAR 16

ENG BLEED (AFFECTED, IF NOT AUTOMATICALLY CLOSED).....OFF

- [L2] When the **ENG BLEED pb-sw** is ON, the **FAULT** light remains on.
- When the **ENG BLEED pb-sw** is OFF, the **FAULT** light goes off when the overheat disappears.

- [L1] ● If left wing or engine 1 bleed leak:
 - APU BLEED (IF NOT CLOSED)..... OFF**
 - X BLEED (IF NOT CLOSED)..... SHUT**
 - WING ANTI-ICE..... OFF**
 - AVOID ICING CONDITIONS**

Continued on the following page

AIR L(R) WING OR ENG 1(2) BLEED LEAK (Cont'd)

Ident.: PRO-ABN-AIR-D-00011096.0003001 / 17 MAR 17

| STATUS | |
|--|---|
| <p>AVOID ICING CONDITIONS</p> <ul style="list-style-type: none"> ● IF SEVERE ICE ACCRETION: MIN SPD.....VLS +10 / G DOT MANEUVER WITH CARE LDG DIST PROC.....APPLY | <p style="text-align: center;"><u>INOP SYS</u></p> <p style="color: orange;">WING A.ICE ENG 1(2) BLEED PACK 1(2)</p> |

AIR L(R) WNG LEAK DET FAULT

Applicable to: ALL

Ident.: PRO-ABN-AIR-J-00017387.0001001 / 21 MAR 16

ANNUNCIATIONS

Triggering Conditions:

L2 This alert triggers when both wing bleed leak detection loops are inoperative in one wing.

Flight Phase Inhibition:

Ident.: PRO-ABN-AIR-J-00011107.0001001 / 25 FEB 14

Crew awareness.

Continued on the following page

AIR L(R) WNG LEAK DET FAULT (Cont'd)

Ident.: PRO-ABN-AIR-J-00011108.0005001 / 17 MAR 11

STATUS

INOP SYS

L(R) WNG LK DET

AIR PACK 1(2) FAULT

Applicable to: ALL

Ident.: PRO-ABN-AIR-AF-00017290.0002001 / 21 MAR 16

ANNUNCIATIONS

Triggering Conditions:

[L2]

This alert triggers when:

- The position of the pack flow control valve disagrees with the commanded position, or
- The pack valve is closed.

Flight Phase Inhibition:

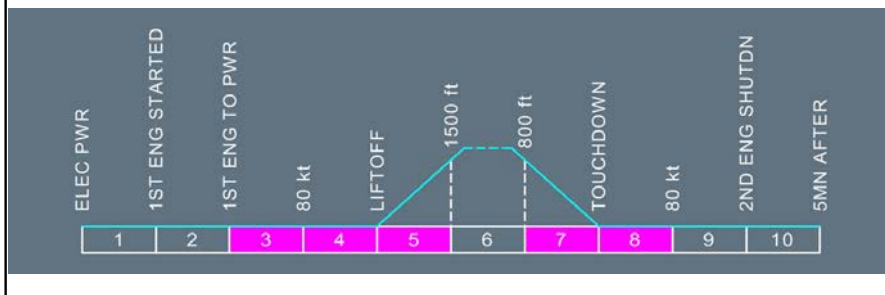

Ident.: PRO-ABN-AIR-AF-00010712.0001001 / 05 AUG 10

PACK (AFFECTED)..... OFF

Continued on the following page

AIR PACK 1(2) FAULT (Cont'd)

Ident.: PRO-ABN-AIR-AF-00010713.0002001 / 16 NOV 11

STATUS

- **If ACSC 1 failed:**
CKPT AT FIXED TEMP
- **If ACSC 2 failed:**
CAB AT FIXED TEMP

INOP SYS

PACK 1(2)
COND CTL 1(2)
FWD CRG HEAT  (If ACSC
1 failed)

AIR PACK 1+2 FAULT

Applicable to: ALL

Ident.: PRO-ABN-AIR-AG-00017292.0002001 / 21 MAR 16

ANNUNCIATIONS

Triggering Conditions:

L2 This alert triggers when both ACSCs are failed.

Flight Phase Inhibition:

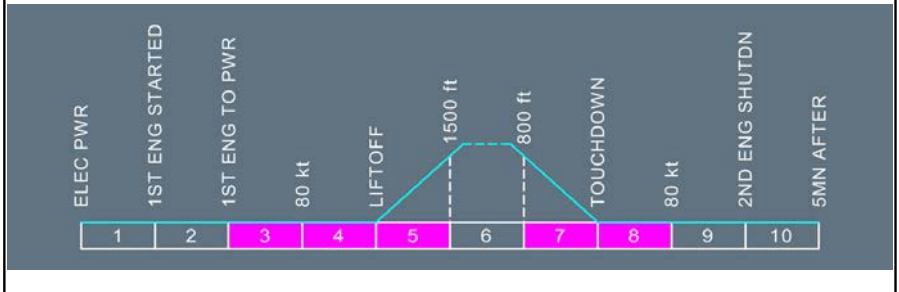

Continued on the following page

AIR PACK 1+2 FAULT (Cont'd)

Ident.: PRO-ABN-AIR-AG-00017935.0001001 / 21 MAR 16

PACK (AFFECTED)..... OFF

[L2] The fault light goes off, when the failure disappears.

Note: The rate at which the cabin altitude increases may be minimized by closing the FWD CARGO ISOL VALVE , if the cargo freight permits.

[L1] **DESCENT TO FL 100/MEA.**

[L2] Descend to FL 100, or MEA, whichever is higher.

[L1] ● **WHEN DIFF PR < 1 PSI AND FL BELOW 100:**

RAM AIR.....ON
MAX FL..... 100/MEA

● If FAULT was due to an overheat:

_____ ASSOCIATED PROCEDURES _____

AIR PACK 1 (2) OVHT

● **WHEN PACK OVHT OUT:**

PACK (AFFECTED).....ON

Ident.: PRO-ABN-AIR-AG-00017936.0002001 / 17 MAR 17

STATUS

INOP SYS

● **If packs not recovered:**

MAX FL..... 100/MEA
CKPT AT FIXED TEMP
CAB AT FIXED TEMP

PACK 1 + 2
COND CTL 1
COND CTL 2
FWD CRG HEAT 

● **If FAULT was due to an overheat:**

● **WHEN PACK OVHT OUT:**

PACK (AFFECTED).....ON

AIR PACK 1(2) OFF

Applicable to: ALL

Ident.: PRO-ABN-AIR-AJ-00017294.0001001 / 21 MAR 16

ANNUNCIATIONS

Triggering Conditions:

L2

This alert triggers when the PACK 1(2) pb-sw is set to OFF and no failure is detected.

Flight Phase Inhibition:

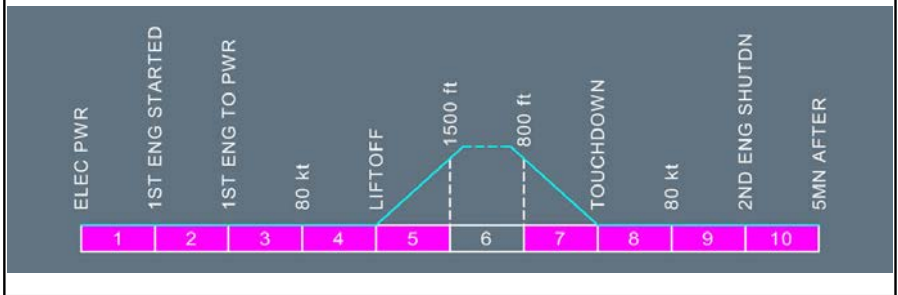

Ident.: PRO-ABN-AIR-AJ-00017941.0001001 / 21 MAR 16

Crew awareness.

Ident.: PRO-ABN-AIR-AJ-00010715.0001001 / 05 AUG 10

STATUS

INOP SYS

PACK 1(2)

AIR PACK 1(2) OVHT

Applicable to: ALL

Ident.: PRO-ABN-AIR-AK-00017284.0002001 / 21 MAR 16

ANNUNCIATIONS

Triggering Conditions:

L2 This alert triggers when the pack compressor outlet temperature rises above 260 °C.

Flight Phase Inhibition:

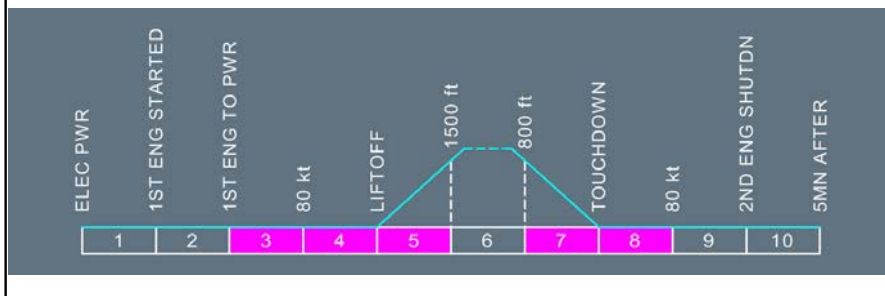

Ident.: PRO-ABN-AIR-AK-00017942.0001001 / 21 MAR 16

PACK (AFFECTED)..... OFF

L2 High flow is automatically selected on the remaining pack.
 Fault light goes off, when the overheat disappears.

L1 ● **WHEN PACK OVHT OUT:**
PACK (AFFECTED)..... ON

Ident.: PRO-ABN-AIR-AK-00010711.0001001 / 10 JAN 11

STATUS

● **WHEN PACK OVHT OUT:**
PACK (AFFECTED)..... ON

INOP SYS

PACK 1(2)⁽¹⁾

⁽¹⁾ (If pack not recovered)

AIR PACK 1(2) REGUL FAULT

Applicable to: ALL

Ident.: PRO-ABN-AIR-AL-00017298.0002001 / 21 MAR 16

ANNUNCIATIONS

Triggering Conditions:

L2

This alert triggers when the temperature regulation performance is degraded.

Flight Phase Inhibition:

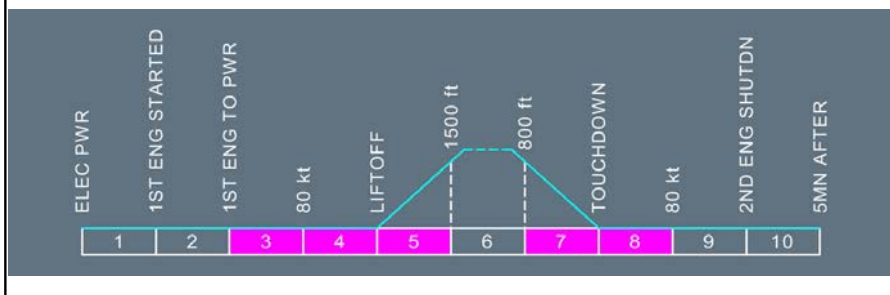

Ident.: PRO-ABN-AIR-AL-00018089.0001001 / 21 MAR 16

Crew awareness.

Ident.: PRO-ABN-AIR-AL-00010719.0003001 / 10 JAN 11

STATUS

INOP SYS

PACK 1(2) REGUL ⁽¹⁾
HOT AIR ⁽²⁾

⁽¹⁾ (In case of By Pass Valve or RAM Air Inlet failure)

⁽²⁾ (In case of Flow Control Valve in backup mode)

AIR X BLEED FAULT

Applicable to: ALL

Ident.: PRO-ABN-AIR-E-00017383.0001001 / 21 MAR 16

ANNUNCIATIONS

Triggering Conditions:

- [L2]** This alert triggers when the crossbleed valve position disagrees with the X-BLEED selector position.

Flight Phase Inhibition:

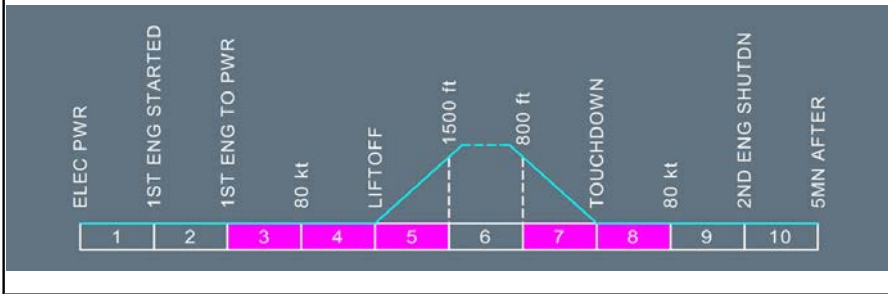

Ident.: PRO-ABN-AIR-E-00011097.0001001 / 05 AUG 10

X BLEED.....MAN CTL

- [L2]** Select OPEN, when the APU BLEED pb-sw is ON, or for engine start, or when WING ANTI-ICE pb-sw is ON and one bleed is inoperative.
 Select SHUT in other cases.

- [L1]** ● If manual opening inoperative, and only one bleed available:
 WING ANTI ICE.....OFF
 AVOID ICING CONDITIONS

Continued on the following page



A318/A319/A320/A321
 FLIGHT CREW
 OPERATING MANUAL

PROCEDURES
ABNORMAL AND EMERGENCY PROCEDURES

AIR

AIR X BLEED FAULT (Cont'd)

Ident.: PRO-ABN-AIR-E-00017612.0002001 / 21 MAR 16

STATUS

- If manual opening inoperative, and only one bleed available:
 AVOID ICING CONDITIONS
 - IF SEVERE ICE ACCRETION:
 MIN SPD..... VLS +10 / G DOT
 MANEUVER WITH CARE
 LDG DIST PROC.....APPLY
- X BLEED MAN CTL

INOP SYS

WING A.ICE
 X BLEED



A318/A319/A320/A321
FLIGHT CREW
OPERATING MANUAL

PROCEDURES
ABNORMAL AND EMERGENCY PROCEDURES

AIR

Intentionally left blank

APU AUTO (EMER) SHUT DOWN

Applicable to: ALL

Ident.: PRO-ABN-APU-A-00016876.0001001 / 21 MAR 16

ANNUNCIATIONS

Triggering Conditions:

L2

The APU AUTO SHUT DOWN alert triggers when an automatic shutdown of the APU occurs for a reason other than a fire.

The APU EMER SHUT DOWN triggers when:

- The APU SHUT OFF sw on the External Power Panel is pushed or,
- The APU FIRE pb is pushed or,
- An APU fire on ground is detected.

Flight Phase Inhibition:

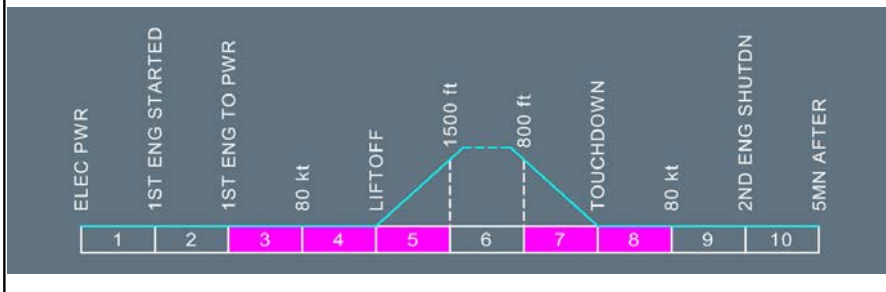

Ident.: PRO-ABN-APU-A-00018193.0001001 / 21 MAR 16

MASTER SW.....OFF

Ident.: PRO-ABN-APU-A-00010106.0001001 / 05 AUG 10

STATUS

INOP SYS

APU

APU FIRE DET FAULT

Applicable to: ALL

Ident.: PRO-ABN-APU-D-00021359.0001001 / 17 MAR 17

ANNUNCIATIONS

Triggering Conditions:

L2 This alert triggers when:

- Both loops are inoperative, or
- Fire Detector Unit is inoperative.

Flight Phase Inhibition:

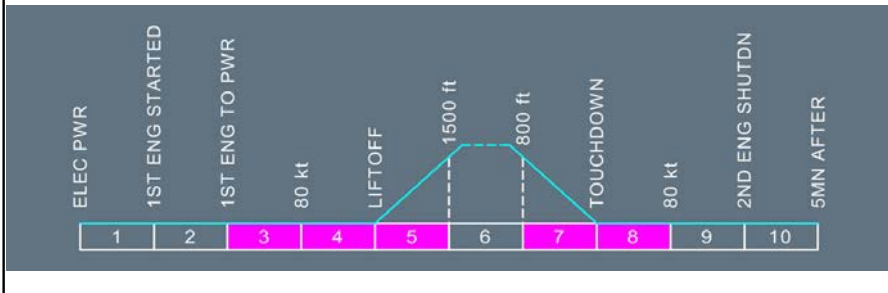

Ident.: PRO-ABN-APU-D-00021360.0001001 / 17 MAR 17

Crew awareness.

Ident.: PRO-ABN-APU-D-00021361.0001001 / 17 MAR 17

STATUS

INOP SYS

APU FIRE DET

APU FIRE LOOP A(B) FAULT

Applicable to: ALL

Ident.: PRO-ABN-APU-B-00021362.0001001 / 17 MAR 17

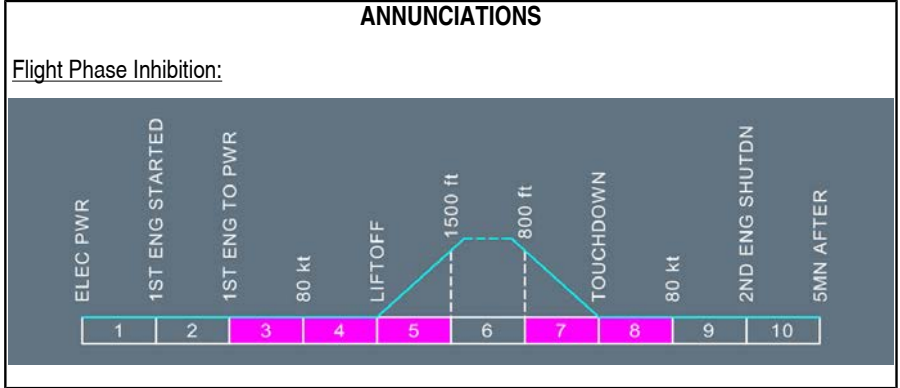

Ident.: PRO-ABN-APU-B-00021363.0001001 / 17 MAR 17

L2 Crew awareness.

Ident.: PRO-ABN-APU-B-00021364.0001001 / 17 MAR 17

STATUS

INOP SYS

APU LOOP A(B)

Intentionally left blank

APU FIRE

Applicable to: ALL

Ident.: PRO-ABN-APUF-C-00017402.0001001 / 21 MAR 16

ANNUNCIATIONS

Triggering Conditions:

L2

This alert triggers when:

- Fire is detected by both loops, or
- Fire is detected by one loop when the other loop is faulty, or
- A rupture occurs in both loops within 5 s.

Flight Phase Inhibition:

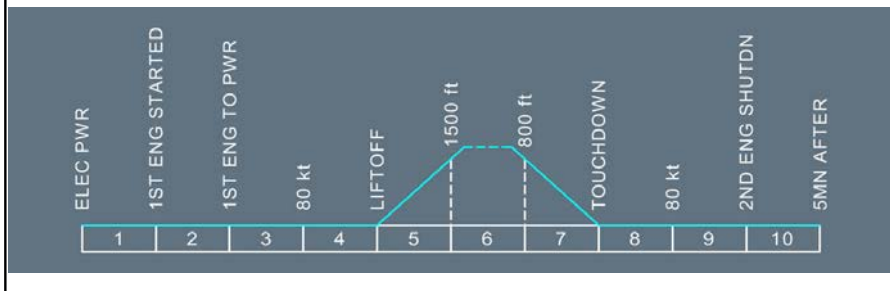

Ident.: PRO-ABN-APUF-C-00017925.0001001 / 21 MAR 16

LAND ASAP

APU FIRE P/B.....PUSH

L2

APU LP valve closes.

Aural warning stops.

APU FIRE pb-sw remains on, as long as a fire is detected.

L1

AGENT AFTER 10 S.....DISCH

L2

The 10 s delay allows the airflow to decrease, which increases the effect of the agent.

Automatic countdown on the ECAM.

L1

MASTER SW.....OFF

L2

Do not attempt to restart the APU.

Continued on the following page



AEROLINEAS GALAPAGOS S.A.

A318/A319/A320/A321
FLIGHT CREW
OPERATING MANUAL

PROCEDURES
ABNORMAL AND EMERGENCY PROCEDURES

APU FIRE

APU FIRE (Cont'd)

Ident.: PRO-ABN-APUF-C-00012211.0001001 / 16 NOV 11

STATUS

INOP SYS

APU

AUTO FLT A/THR LIMITED

Applicable to: ALL

Ident.: PRO-ABN-AUTO_FLT-S-00016943.0001001 / 21 MAR 16

ANNUNCIATIONS

Triggering Conditions:

L2

This alert triggers when A/THR is active but thrust levers are set below CL detent (2 engines), or MCT detent (1 engine).

This caution is repeated every 5 s as long as the thrust lever are not moved.

Flight Phase Inhibition:

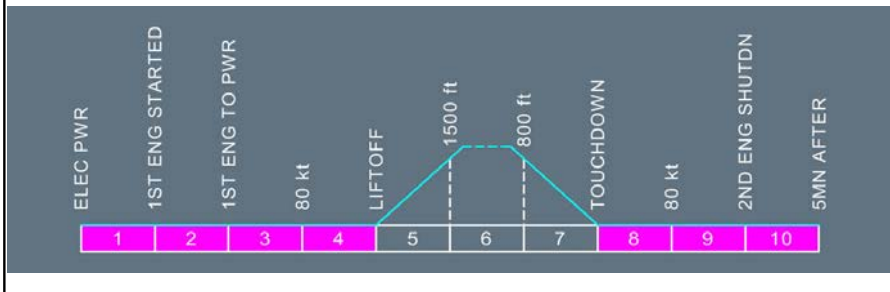

Ident.: PRO-ABN-AUTO_FLT-S-00018689.0001001 / 21 MAR 16

THR LEVERS.....MOVE

L2

Thrust lever must be set in the relevant detent.

AUTO FLT A/THR OFF

Applicable to: ALL

Ident.: PRO-ABN-AUTO_FLT-L-00016941.0002001 / 20 APR 17

ANNUNCIATIONS

Triggering Conditions:

- L2 This alert triggers when this warning is displayed only for involuntary disconnection. The amber **A/THR OFF** and **ENG THRUST LOCKED** messages are displayed in the left lower part of ECAM upper DU.
 For voluntary disconnection, an amber **A/THR OFF** message is displayed on the right lower part of ECAM upper DU.

Flight Phase Inhibition:

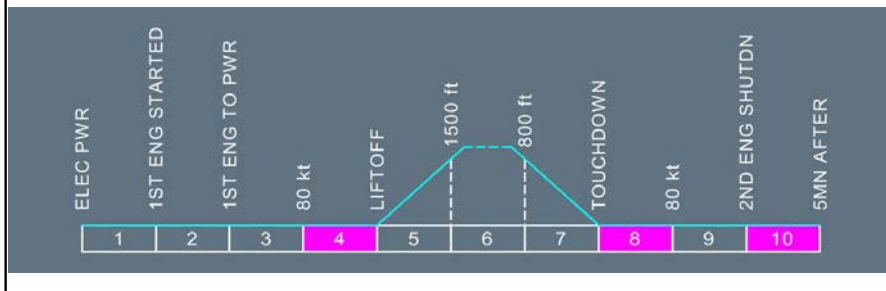

Ident.: PRO-ABN-AUTO_FLT-L-00018694.0002001 / 21 MAR 16

- L2 If the A/THR is failed, the flight crew may recover it by engaging the other AP , and then trying to re-engage the A/THR.

Note: If the A/THR is recovered with AP 2, A/THR will be lost again at AP 2 disengagement.

L1 **THR LEVERS**.....**MOVE**

- L2 If the thrust levers are not moved within 5 s, the “**ENG THRUST LOCKED**” warning is displayed (Refer to PRO-ABN-ENG ENG THRUST LOCKED).

Continued on the following page

AUTO FLT A/THR OFF (Cont'd)

Ident.: PRO-ABN-AUTO_FLT-L-00010469.0001001 / 05 AUG 10

STATUS

CAT 2 ONLY

INOP SYS

A/THR
 CAT 3

AUTO FLT AP OFF

Applicable to: ALL

Ident.: PRO-ABN-AUTO_FLT-K-00016947.0001001 / 21 MAR 16

ANNUNCIATIONS

Triggering Conditions:

L2

This alert triggers when this warning is displayed only for involuntary disconnection. For voluntary disconnection, a red **AP OFF** message is displayed in the right lower part of ECAM upper DU.

Flight Phase Inhibition:

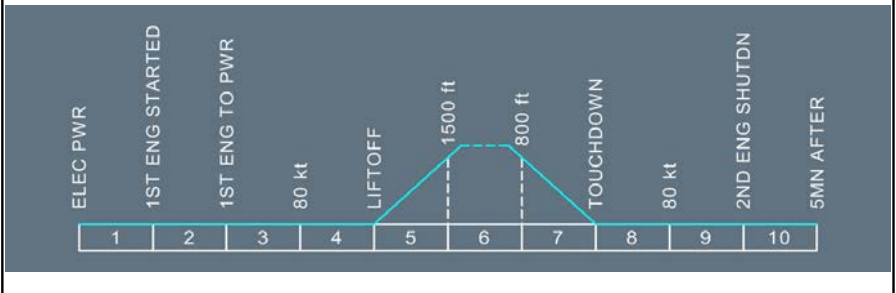

Ident.: PRO-ABN-AUTO_FLT-K-00018695.0001001 / 21 MAR 16

Crew awareness.

Continued on the following page

AUTO FLT AP OFF (Cont'd)

Ident.: PRO-ABN-AUTO_FLT-K-00017453.0002001 / 21 MAR 16

STATUS

INOP SYS

AP (Affected)
 CAT 2 ⁽¹⁾
 GLS AUTOLAND  ⁽¹⁾

⁽¹⁾ (If both AP lost)

AUTO FLT FAC 1(2) FAULT

Applicable to: ALL

Ident.: PRO-ABN-AUTO_FLT-G-00016911.0001001 / 21 MAR 16

ANNUNCIATIONS

Triggering Conditions:

 This alert triggers when one FAC computer is failed.

Flight Phase Inhibition:

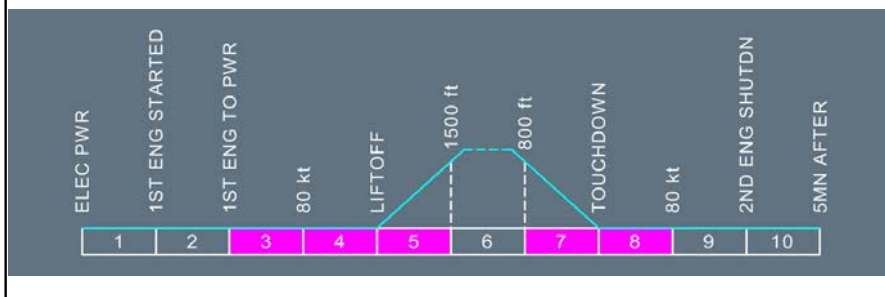

Continued on the following page



A318/A319/A320/A321
 FLIGHT CREW
 OPERATING MANUAL

PROCEDURES
ABNORMAL AND EMERGENCY PROCEDURES

AUTO FLT

AUTO FLT FAC 1(2) FAULT (Cont'd)

Ident.: PRO-ABN-AUTO_FLT-G-00010457.0001001 / 05 AUG 10

FAC (AFFECTED)..... OFF THEN ON

● **IF UNSUCCESSFUL:**

FAC (AFFECTED)..... OFF

L2 All functions are performed by the remaining FAC.

Ident.: PRO-ABN-AUTO_FLT-G-00017506.0001001 / 21 MAR 16

L12

STATUS

INOP SYS

BOTH PFD ON SAME FAC

See ⁽¹⁾

CAT 3 SINGLE ONLY

CAT 3 DUAL
 FAC 1(2)

⁽¹⁾ Characteristic speeds, displayed on the two PFD s, are computed by the same FAC.

AUTO FLT FAC 1 + 2 FAULT

Applicable to: ALL

Ident.: PRO-ABN-AUTO_FLT-H-00016926.0001001 / 21 MAR 16

ANNUNCIATIONS

Triggering Conditions:

L2 This alert triggers when the two FAC computers are failed.

Flight Phase Inhibition:

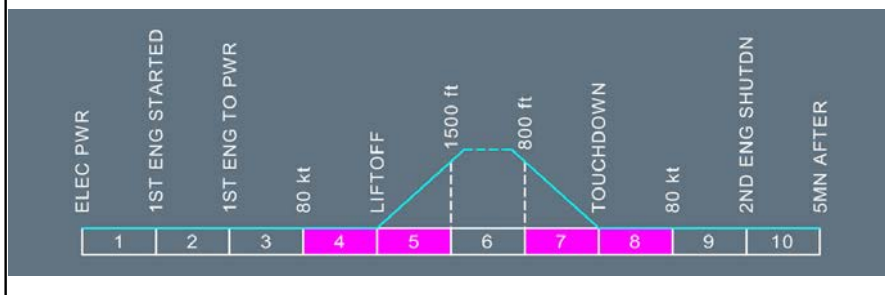

Continued on the following page

AUTO FLT FAC 1 + 2 FAULT (Cont'd)

Ident.: PRO-ABN-AUTO_FLT-H-00017454.0002001 / 22 MAR 17

RUD WITH CARE ABV 160 KT

L2 Depending on when the failure occurs, the rudder travel limiter system may not be in the correct position for the flight speed. Therefore, to prevent damage to the aircraft structure, use the rudder with care, when the speed is above 160 kt.
 At slats' extension, full rudder travel authority is recovered.

L1 FAC 1 OFF THEN ON
 FAC 2..... OFF THEN ON

● **IF UNSUCCESSFUL:**

FAC 1 + 2..... OFF

L2 With FAC 1 + 2 inoperative, the rudder travel limit system, rudder trim control, yaw damper and PFD characteristic speeds are lost.

L12

ASSOCIATED PROCEDURES

F/CTL ALTN LAW
(PROT LOST)

F/CTL normal laws are lost. All protections, except maneuver protections, are lost.

L1 **MAX SPEED**..... 320 KT

L2 Speed is limited, due to the loss of high-speed protections.

Continued on the following page

AUTO FLT FAC 1 + 2 FAULT (Cont'd)

Ident.: PRO-ABN-AUTO_FLT-H-00017456.0006001 / 22 MAR 17

L12

STATUS

MAX SPEED..... 320 KT
 RUD WITH CARE ABV 160 KT

APPR PROC

FOR LDG..... USE FLAP 3

*This line is replaced by "FOR LDG : USE FLAP 3" when
 CONF 3 is selected, as a reminder.*

GPWS LDG FLAP 3..... ON

Displayed, when flaps in CONF 3.

APPR SPD..... VREF + 10 KT

LDG DIST PROC..... APPLY

ALTN LAW : PROT LOST
WHEN L/G DN : DIRECT LAW

See ⁽²⁾

INOP SYS

- WINDSHEAR DET ⁽¹⁾
- REAC W/S DET ⁽¹⁾
- F/CTL PROT
- FAC 1 + 2
- AP 1 + 2
- A/THR
- CAT 2
- GLS AUTOLAND 
- STEEP APPR 
- ROW/ROP 

⁽¹⁾ (The REAC W/S DET inop sys replaces the WINDSHEAR DET inop sys on aircraft equipped with the PWS )

⁽²⁾ At landing gear extension, control reverts to direct law in pitch, as well as in roll (Refer to PRO-ABN-F_CTL F/CTL DIRECT LAW).

AUTO FLT FCU 1(2) FAULT

Applicable to: ALL

Ident.: PRO-ABN-AUTO_FLT-J-00016923.0001001 / 21 MAR 16

ANNUNCIATIONS

Triggering Conditions:

L2

This alert triggers when only one FCU channel remain operative.

Flight Phase Inhibition:

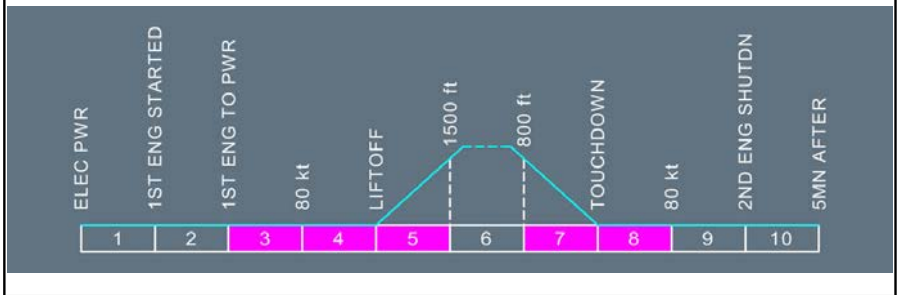

Ident.: PRO-ABN-AUTO_FLT-J-00010464.0001001 / 05 AUG 10

BARO REF..... X CHECK

L2

One FCU channel is lost:

Therefore, crosscheck the barometric reference settings on the FCU and PFDs.

Ident.: PRO-ABN-AUTO_FLT-J-00010465.0001001 / 05 AUG 10

STATUS

INOP SYS

FCU 1(2)

AUTO FLT FCU 1 + 2 FAULT

Applicable to: ALL

Ident.: PRO-ABN-AUTO_FLT-I-00016946.0001001 / 21 MAR 16

ANNUNCIATIONS

Triggering Conditions:

L2 This alert triggers when the FCU is completely loss.

Flight Phase Inhibition:

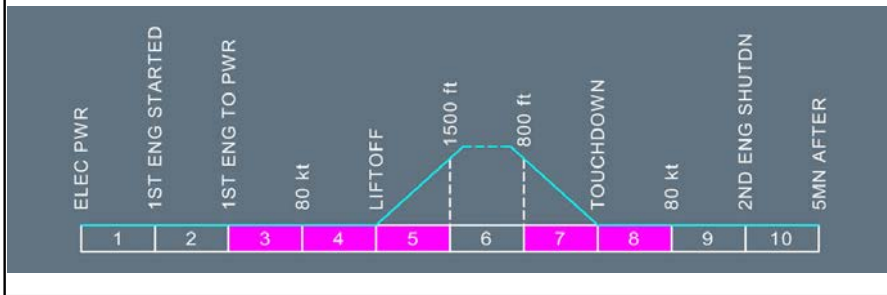

Continued on the following page

AUTO FLT FCU 1 + 2 FAULT (Cont'd)

Ident.: PRO-ABN-AUTO_FLT-I-00017463.0001001 / 21 MAR 16

PFD BARO REF: STD ONLY





L2 With both FCU channels failed, the barometer reference automatically goes to 1 013 hPa.

Use standby altimeter, and change this to the actual barometer setting.

Do not insert the MDA (MDH) value on the MCDU PERF APPR Page (because the PFD altitude is referenced to STD, and not to the correct barometric value).

The PM must then perform the standard callouts ("HUNDRED ABOVE" and "MINIMUM"), using the STBY altimeter.

In addition:

- All FCU controls are inoperative.
- A/THR, AP 1 + 2, and FD 1 + 2 are not available.
 (Except in LAND or GO AROUND mode where only A/THR is lost).
- On PFD:
 - Altitude alert is inoperative.
 - ILS/GLS  /MLS  deviation scales are displayed.
 - Flight path vector is displayed.
 - Mach indication is inoperative.
 - FMA is lost except in LAND or GA mode.
- On ND:
 - ROSE NAV mode with map (80 NM range) is displayed.
 - VOR /ADF needles:
 - Needle 1 is related to VOR1 only.
 - Needle 2 is related to ADF 2 only (ADF 1 if ADF2 not installed).
 - (VOR selection on DDRMI  is not affected)
 - (ADF selection on DDRMI  (if available) is not affected).
 - The weather radar image may be lost. If the image remains displayed it must be disregarded.
 In all cases, red "WXR RNG" message is displayed.

Continued on the following page

AUTO FLT FCU 1 + 2 FAULT (Cont'd)

Ident.: PRO-ABN-AUTO_FLT-I-00017512.0002001 / 21 MAR 16

STATUS

INOP SYS

PFD BARO REF : STD ONLY

- If in LAND or GA:
CAT 2 ONLY

- FCU 1 + 2
- AP 1 + 2 ⁽¹⁾
- A/THR
- CAT 3 ⁽²⁾
- CAT 2 ⁽¹⁾
- GPWS TERR

⁽¹⁾ (If not LAND or GA)

⁽²⁾ (If in LAND or GA mode)

AUTO FLT REAC W/S DET FAULT

Applicable to: ALL

Ident.: PRO-ABN-AUTO_FLT-N-00017473.0001001 / 21 MAR 16

ANNUNCIATIONS

Triggering Conditions:

- This alert triggers when the reactive windshear function is lost.

Flight Phase Inhibition:

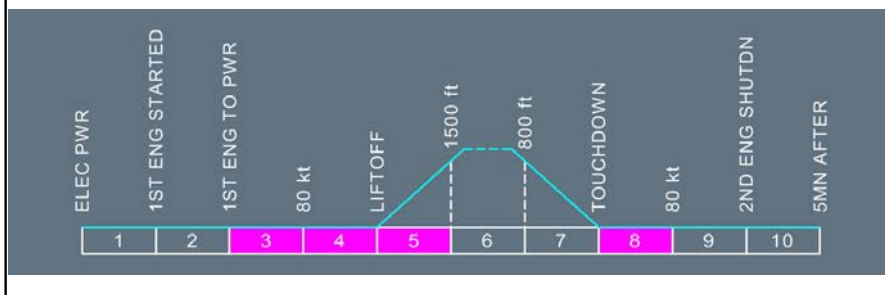

Continued on the following page

AUTO FLT REAC W/S DET FAULT (Cont'd)

Ident.: PRO-ABN-AUTO_FLT-N-00017479.0001001 / 21 MAR 16

Crew awareness.

Ident.: PRO-ABN-AUTO_FLT-N-00017480.0001001 / 21 MAR 16

L12

STATUS

INOP SYS

REAC W/S DET

Note: On ground, this warning may appear spuriously. This warning is cancelled by resetting both FACs, one after the other.

- FAC 1: Pull then push AUTO FLT/FAC 1/26VAC and 28VDC circuit breakers BO3 and B04 on 49VU.
- FAC 2: Pull then push AUTO FLT/FAC 2/26VAC and 28VDC circuit breakers M18 and M19 on 121VU.

AUTO FLT RUD TRIM 1(2) FAULT

Applicable to: ALL

Ident.: PRO-ABN-AUTO_FLT-C-00016921.0001001 / 21 MAR 16

ANNUNCIATIONS

Triggering Conditions:

L2 This alert triggers when one rudder trim actuator is failed.

Flight Phase Inhibition:

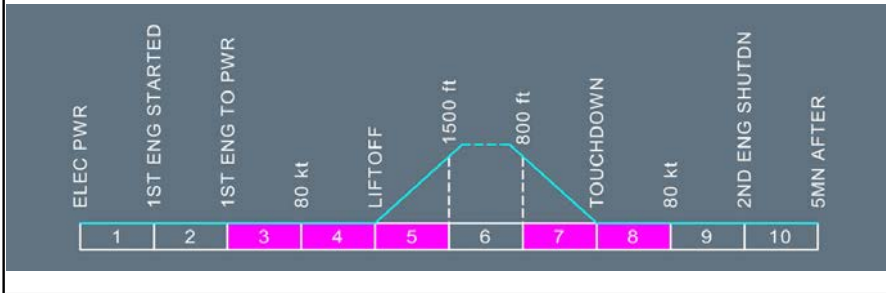

Ident.: PRO-ABN-AUTO_FLT-C-00010449.0001001 / 25 FEB 14

Crew awareness.

Ident.: PRO-ABN-AUTO_FLT-C-00017513.0001001 / 21 MAR 16

STATUS

INOP SYS

CAT 3 SINGLE ONLY

CAT 3 DUAL
 RUD TRIM 1(2)

AUTO FLT RUD TRIM SYS

Applicable to: ALL

Ident.: PRO-ABN-AUTO_FLT-D-00016928.0001001 / 21 MAR 16

ANNUNCIATIONS

Triggering Conditions:

L2

This alert triggers when the rudder trim system is failed.

Flight Phase Inhibition:

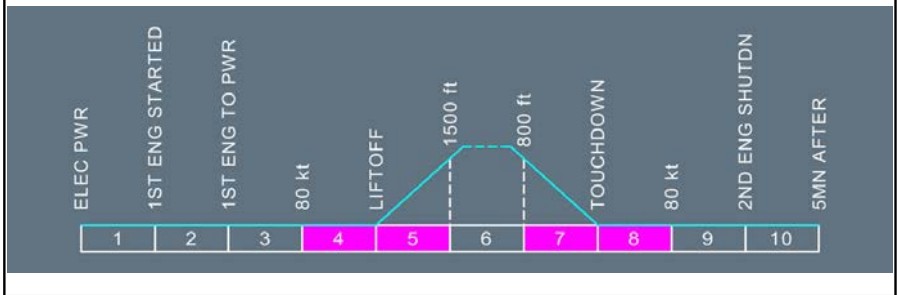

Ident.: PRO-ABN-AUTO_FLT-D-00010451.0002001 / 05 AUG 10

FAC 1..... OFF THEN ON
 FAC 2..... OFF THEN ON

Ident.: PRO-ABN-AUTO_FLT-D-00017464.0002001 / 21 MAR 16

STATUS

INOP SYS

- RUD TRIM
- AP 1 + 2
- CAT 2
- GLS AUTOLAND

AUTO FLT RUD TRV LIM 1(2)

Applicable to: ALL

Ident.: PRO-ABN-AUTO_FLT-E-00016922.0001001 / 21 MAR 16

ANNUNCIATIONS

Triggering Conditions:

L2 This alert triggers when one rudder travel limitation actuator is failed.

Flight Phase Inhibition:

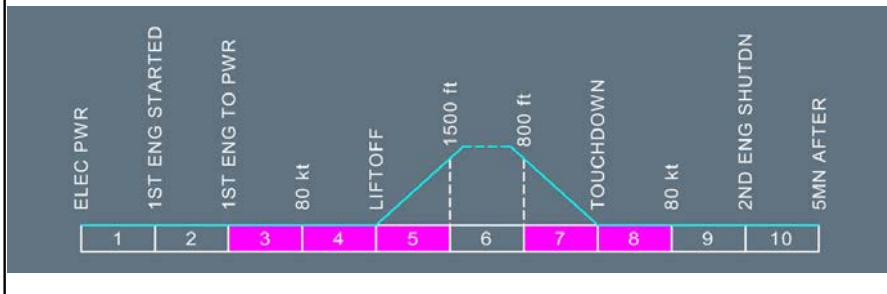

Ident.: PRO-ABN-AUTO_FLT-E-00010453.0001001 / 25 FEB 14

Crew awareness.

Ident.: PRO-ABN-AUTO_FLT-E-00010454.0001001 / 05 AUG 10

STATUS

INOP SYS

RUD TRV LIM 1(2)

AUTO FLT RUD TRV LIM SYS

Applicable to: ALL

Ident.: PRO-ABN-AUTO_FLT-F-00016929.0002001 / 21 MAR 16

ANNUNCIATIONS

Triggering Conditions:

L2 This alert triggers when the rudder travel limitation system is failed.

Flight Phase Inhibition:

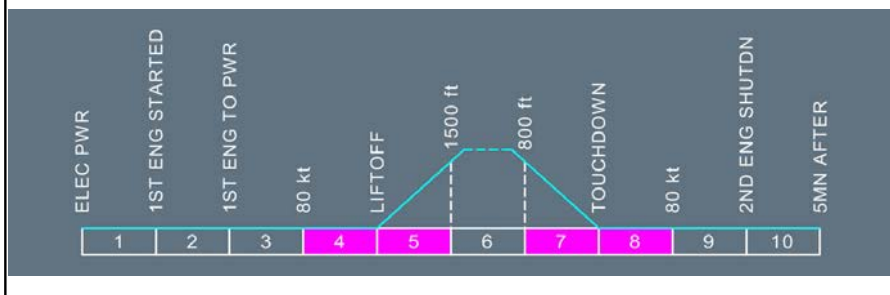

Ident.: PRO-ABN-AUTO_FLT-F-00017465.0003001 / 22 MAR 17

RUD WITH CARE ABV 160 KT

L2 Depending on when the failure occurs, the rudder travel limiter system may not be in the correct position for the flight speed. Therefore, to prevent damage to the aircraft structure, use the rudder with care, when the speed is greater than 160 kt.
At slats' extension, full rudder travel authority can be recovered.

L1 FAC 1..... OFF THEN ON
FAC 2..... OFF THEN ON

- If TLU (rudder or pedals) remains locked at high speed after slat extension:
MAX X WIND FOR LDG 15 KT
AUTO BRK.....DO NOT USE

L2 Do not use the autobrake, so as not to delay the application of differential braking at landing roll.

L1 ● AT LDG ROLL:
DIFF BRAKING..... AS RQRD

Continued on the following page

AUTO FLT RUD TRV LIM SYS (Cont'd)

Ident.: PRO-ABN-AUTO_FLT-F-00017467.0003001 / 22 MAR 17

L12

STATUS

RUD WITH CARE ABV 160 KT

- If TLU (rudder or pedals) remains locked at high speed after slat extension:

MAX X WIND FOR LDG 15 KT

AUTO BRK..... DO NOT USE

Do not use the autobrake, so as not to delay the application of differential braking at landing roll.

- AT LDG ROLL:

DIFF BRAKING..... AS RQRD

CAT 3 SINGLE ONLY

Note: An autoland must not be performed with a crosswind greater than 12 kt.

INOP SYS

RUD TRV LIM

AUTO FLT YAW DAMPER 1(2)

Applicable to: ALL

Ident.: PRO-ABN-AUTO_FLT-A-00016912.0001001 / 21 MAR 16

ANNUNCIATIONS

Triggering Conditions:

L2

This alert triggers when one yaw damper actuator is failed.

Flight Phase Inhibition:

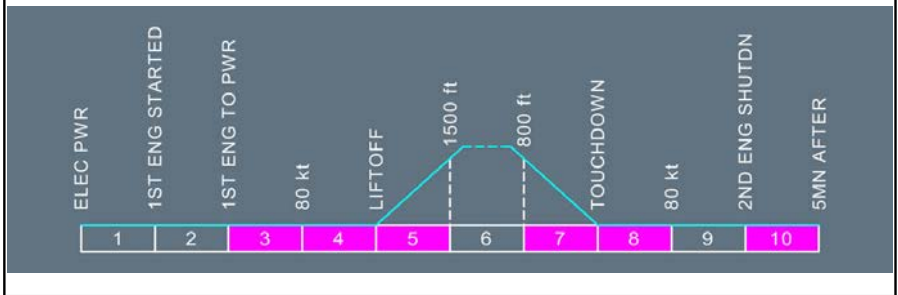

Ident.: PRO-ABN-AUTO_FLT-A-00010444.0001001 / 25 FEB 14

Crew awareness.

Ident.: PRO-ABN-AUTO_FLT-A-00017515.0001001 / 21 MAR 16

STATUS

CAT 3 SINGLE ONLY

INOP SYS

CAT 3 DUAL
 YAW DAMPER 1(2)

AUTO FLT YAW DAMPER SYS

Applicable to: ALL

Ident.: PRO-ABN-AUTO_FLT-B-00016927.0001001 / 21 MAR 16

ANNUNCIATIONS

Triggering Conditions:

L2 This alert triggers when the yaw damper system is failed.

Flight Phase Inhibition:

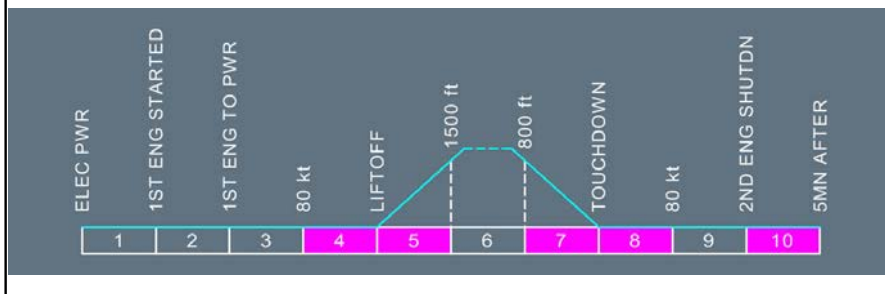

Ident.: PRO-ABN-AUTO_FLT-B-00017469.0002001 / 22 MAR 17

L2 Loss of yaw dampers 1 + 2.

L1 FAC 1..... OFF THEN ON
FAC 2..... OFF THEN ON

● If fault remains:

L12 **ASSOCIATED PROCEDURES**

F/CTL ALTN LAW
(PROT LOST)

F/CTL normal laws are lost. All protections, except maneuver protections, are lost.

MAX SPEED..... 320 KT

Continued on the following page

AUTO FLT YAW DAMPER SYS (Cont'd)

Ident.: PRO-ABN-AUTO_FLT-B-00017470.0003001 / 22 MAR 17

L12

STATUS

MAX SPEED..... 320 KT

Speed is limited, due to the loss of high-speed protections.

APPR PROC

FOR LDG..... **USE FLAP 3**

This line is replaced by "FOR LDG : USE FLAP 3" when CONF 3 is selected, as a reminder.

GPWS LDG FLAP 3..... **ON**

Will be displayed, when flaps in CONF 3.

APPR SPD..... **VREF + 10 KT**

LDG DIST PROC..... **APPLY**

ALTN LAW : PROT LOST
WHEN L/G DN : DIRECT LAW

See ⁽¹⁾

INOP SYS

F/CTL PROT
YAW DAMPER
AP 1 + 2
CAT 2

STEEP APPR 
GLS AUTOLAND 

⁽¹⁾ *At landing gear extension, control reverts to direct law in pitch, as well as in roll
Refer to PRO-ABN-F_CTL F/CTL DIRECT LAW.*

PROCEDURES
ABNORMAL AND EMERGENCY PROCEDURES

AUTO FLT

Intentionally left blank

AVIONICS SMOKE

Applicable to: ALL

Ident.: PRO-ABN-AVNCS-M-00017405.0001001 / 21 MAR 16

ANNUNCIATIONS

Triggering Conditions:

L2

This alert triggers when smoke in the ventilation extraction duct is detected.

Flight Phase Inhibition:

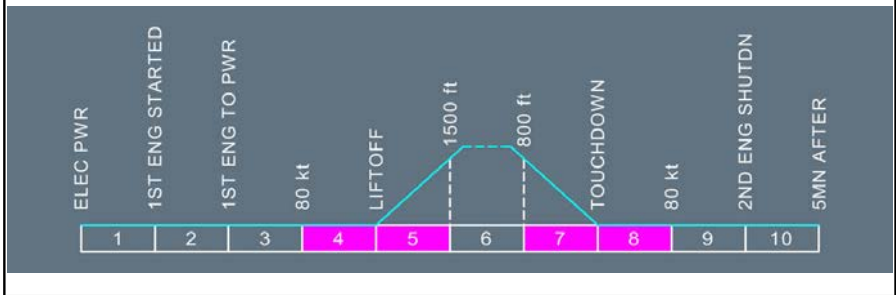

Ident.: PRO-ABN-AVNCS-M-00014922.0001001 / 22 MAR 17

L2

The description of this procedure is included in the SMOKE/FUMES/AVNCS SMOKE procedure
 (Refer to procedure)

PROCEDURES
ABNORMAL AND EMERGENCY PROCEDURES

AVIONICS SMOKE

Intentionally left blank

BLEED MONITORING FAULT

Applicable to: ALL

Ident.: PRO-ABN-BLEED-L-00017385.0001001 / 21 MAR 16

ANNUNCIATIONS

Triggering Conditions:

L2 This alert triggers when both BMC are failed.

Flight Phase Inhibition:

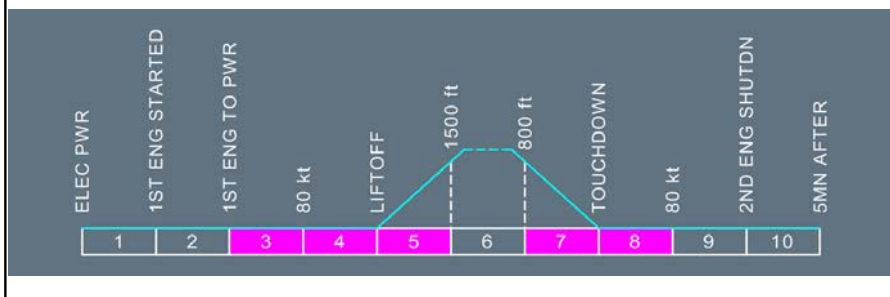

Ident.: PRO-ABN-BLEED-L-00011111.0001001 / 25 FEB 14

Crew awareness.

Ident.: PRO-ABN-BLEED-L-00011112.0001001 / 05 AUG 10

STATUS

INOP SYS

BMC 1 + 2

BLEED MONIT SYS 1(2) FAULT

Applicable to: ALL

Ident.: PRO-ABN-BLEED-K-00017388.0002001 / 21 MAR 16

ANNUNCIATIONS

Triggering Conditions:

L2 This alert triggers when the BMC 1(2) is failed.

Flight Phase Inhibition:

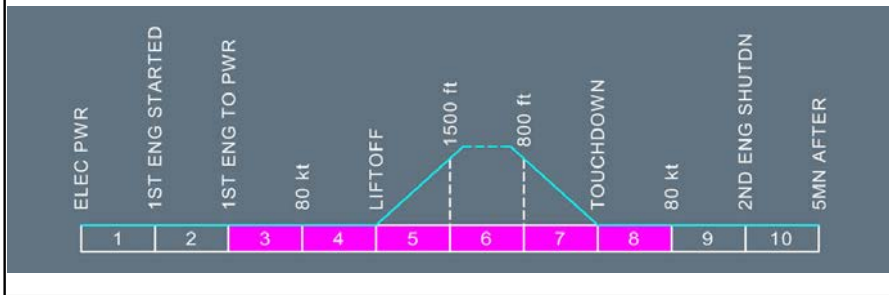

Ident.: PRO-ABN-BLEED-K-00011109.0004001 / 25 FEB 14

Crew awareness.

Ident.: PRO-ABN-BLEED-K-00011110.0004001 / 17 MAR 11

STATUS

INOP SYS

BMC 1(2)

[MEM] LOSS OF BRAKING

Ident.: PRO-ABN-BRAKES-00011315.0001001 / 17 MAR 17

Applicable to: ALL

● **IF NO BRAKING AVAILABLE:**

REV..... MAX
BRAKE PEDALS..... RELEASE

Brake pedals should be released when the A/SKID & N/W STRG sw is switched OFF, since the pedal force or displacement produces more braking action in alternate mode than in normal mode.

A/SKID OFF..... ORDER

L2 The PF orders the PM to set the A/SKID & N/W STRG sw to OFF.

L1 A/SKID & N/W STRG..... OFF

Braking system reverts to alternate mode.

BRAKE PEDALS.....PRESS

Apply brake with care, since initial pedal force or displacement produces more braking action in alternate mode than in normal mode.

MAX BRK PR.....1000 PSI

Monitor brake pressure or BRAKES PRESS indicator. Limit brake pressure to approximately 1 000 PSI and, at low ground speed, adjust brake pressure as required.

● **If STILL NO BRAKING:**

PARKING BRAKE.....SHORT AND SUCCESSIVE APPLICATIONS

Use short successive parking brake applications to stop the aircraft. Brake onset asymmetry may be felt at each parking brake application. If possible, delay the use of the parking brake until low speed, to reduce the risk of tire burst and lateral control difficulties.



A318/A319/A320/A321
 FLIGHT CREW
 OPERATING MANUAL

PROCEDURES
ABNORMAL AND EMERGENCY PROCEDURES

BRAKES

[QRH] ASYMMETRIC BRAKING

Ident.: PRO-ABN-BRAKES-00011331.0001001 / 17 MAR 17

Applicable to: ALL

Apply this procedure when all brakes of one gear are released.

AVOID XWIND > 10 KT FROM SIDE OF AVAILABLE BRAKE

APPLY BRAKE PROGRESSIVELY ON AVAILABLE SIDE

USE RUDDER TO COUNTER LATERAL DEVIATION

- **If reverser inoperative on same side as inoperative brakes:** DO NOT USE REVERSERS

LDG DIST PROC.....APPLY

[QRH] RESIDUAL BRAKING

Ident.: PRO-ABN-BRAKES-00011318.0001001 / 17 MAR 17

Applicable to: ALL

- **In flight:**

BRAKE PEDALS.....PRESS SEVERAL TIMES

Press the brake pedals several times. This could zero a residual pressure on the alternate system.

- **If residual pressure remains:**

A/SKID & N/W STRG sel.....KEEP ON

- **For landing:**

AUTO/BRK..... MED

Using MED mode gives immediate priority to normal braking upon landing gear touchdown, which cancels residual alternate pressure.

- **If autobrake not available:**

APPLY BRAKING JUST AFTER TOUCHDOWN

POSSIBLE BRAKING ASYMMETRY

Note: *If tire damage is suspected after landing, Refer to LIM-LG Taxi with Deflated or Damaged Tires.*

BRAKES A/SKID N/W/S FAULT OR ANTI SKID N/W/S OFF

Applicable to: ALL

Ident.: PRO-ABN-BRAKES-J-00017807.0002001 / 21 MAR 16

ANNUNCIATIONS

Triggering Conditions:

L2

This alert triggers when:

- There is a loss of normal brake system associated with Y HYD SYS LO PRESS, or
- Both BSCU channels are failed, or
- The A/SKID & N/W STRG sw is set to OFF.

Flight Phase Inhibition:

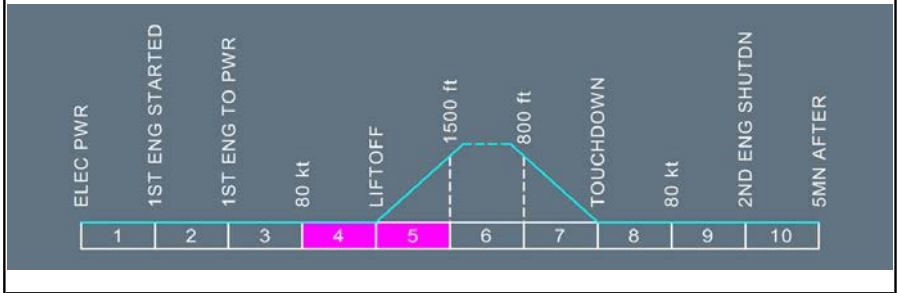

Ident.: PRO-ABN-BRAKES-J-00018571.0001001 / 21 MAR 16

MAX BRK PR..... 1000 PSI

L2 Monitor brake pressure on the BRAKES PRESS indicator. Limit brake pressure to approximately 1 000 PSI and, at low ground speed, adjust brake pressure as required. Avoid landing on an icy runway.

Continued on the following page



A318/A319/A320/A321
 FLIGHT CREW
 OPERATING MANUAL

PROCEDURES
ABNORMAL AND EMERGENCY PROCEDURES
 BRAKES

BRAKES A/SKID N/WS FAULT OR ANTI SKID N/WS OFF (Cont'd)

Ident.: PRO-ABN-BRAKES-J-00018670.0003001 / 21 MAR 16

L12

STATUS

MAX BRK PR..... 1000 PSI

LDG DIST PROC..... APPLY

- **If Y SYS LO PR:**
 BRK Y ACCU PR ONLY
 CAT 3 SINGLE ONLY

See ⁽¹⁾

INOP SYS

CAT 3 DUAL
 ANTI SKID
 N/W STRG
 NORM BRK
 AUTO BRK

⁽¹⁾ Note: Automatic rollout is not permitted as specified in QRH (Refer to QRH/OPS Required Equipment for CAT2 and CAT3).

BRAKES ALTN BRK FAULT

Applicable to: ALL

Ident.: PRO-ABN-BRAKES-R-00017816.0001001 / 21 MAR 16

ANNUNCIATIONS

Triggering Conditions:

L2

This alert triggers when the alternate braking function is lost.

Flight Phase Inhibition:

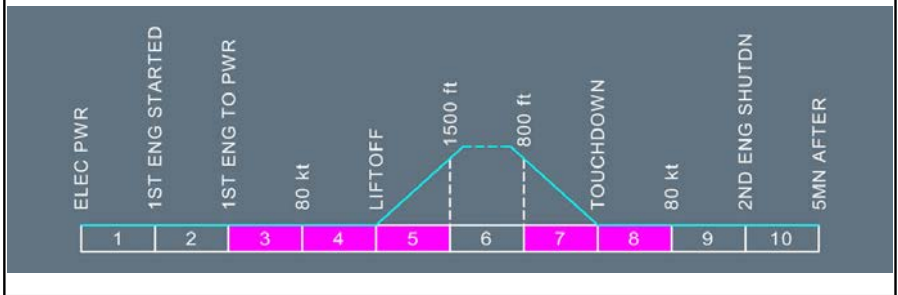

Ident.: PRO-ABN-BRAKES-R-00018357.0001001 / 21 MAR 16

Crew awareness.

Ident.: PRO-ABN-BRAKES-R-00011328.0001001 / 05 AUG 10

STATUS

INOP SYS

ALTN BRK

BRAKES ALTN L(R) RELEASED

Applicable to: ALL

Ident.: PRO-ABN-BRAKES-S-00017817.0001001 / 21 MAR 16

ANNUNCIATIONS

Triggering Conditions:

- [L2] This alert triggers when the brakes of one gear is released. It is detected when the landing gear is downlocked, at least one engine is running, and alternate braking is active.

Flight Phase Inhibition:

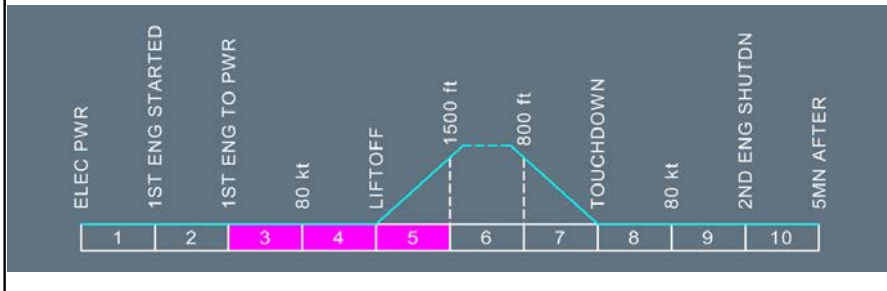

Ident.: PRO-ABN-BRAKES-S-00011329.0001001 / 05 AUG 10

- [L2] As long as the normal braking system is available, braking is normal. In alternate braking mode, braking of all wheels on one gear is lost.

- [L1] ● **If normal braking is lost:**
 ASYM BRK PROC..... **APPLY**

Ident.: PRO-ABN-BRAKES-S-00011330.0001001 / 11 MAY 12

STATUS

- **If normal braking is lost:**
 LDG DIST PROC..... **APPLY**

INOP SYS

ALTN L(R) BRK

BRAKES AUTO BRK FAULT

Applicable to: ALL

Ident.: PRO-ABN-BRAKES-N-00017806.0002001 / 21 MAR 16

ANNUNCIATIONS

Triggering Conditions:

L2

This alert triggers when the autobrake is failed, after being armed.

Flight Phase Inhibition:

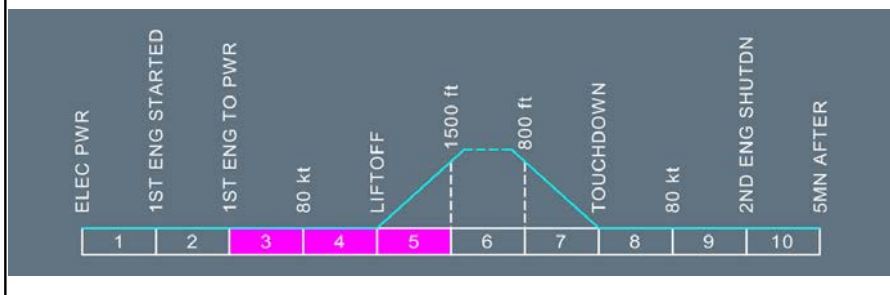

Ident.: PRO-ABN-BRAKES-N-00018672.0004001 / 21 MAR 16

Crew awareness.

Ident.: PRO-ABN-BRAKES-N-00011314.0004001 / 29 MAR 12

STATUS

INOP SYS

AUTO BRK

BRAKES BRK Y ACCU LO PR

Applicable to: ALL

Ident.: PRO-ABN-BRAKES-T-00017820.0001001 / 21 MAR 16

ANNUNCIATIONS

Triggering Conditions:

L2 This alert triggers when the yellow accumulator is in low pressure.

Flight Phase Inhibition:

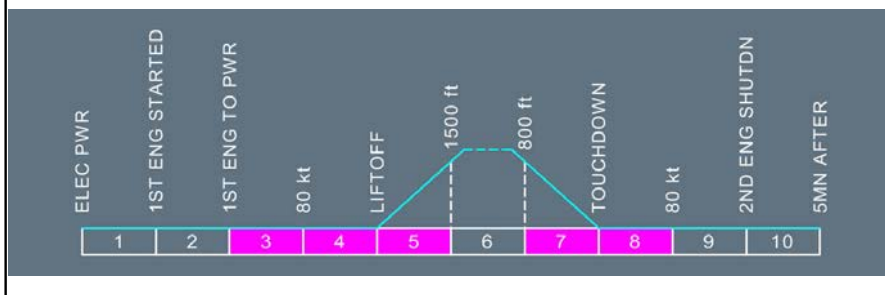

Ident.: PRO-ABN-BRAKES-T-00011332.0002001 / 05 AUG 10

L2 The yellow electrical pump can be used to pressurize the accumulator. If the accumulator pressure is still low, chocks are required before Engine 1 shut down. This message is replaced on ground by **BRAKES PARK BRK LO PR** if parking brake is on and yellow hydraulic system pressure is low.

- L1** ● **On ground:**
 - **BEFORE ENG SHUT DOWN:**
CHOCKS CONSIDER

Ident.: PRO-ABN-BRAKES-T-00011333.0001001 / 05 AUG 10

STATUS

INOP SYS

- **If Y SYS LO PR**
NORM BRK ONLY

BRK Y ACCU

BRAKES HOT

Applicable to: ALL

Ident.: PRO-ABN-BRAKES-M-00017786.0002001 / 21 MAR 16

ANNUNCIATIONS

Triggering Conditions:

L2

This alert triggers when one brake temperature is above 300 °C. The alert disappears when the highest brake temperature is below 290 °C.

Flight Phase Inhibition:

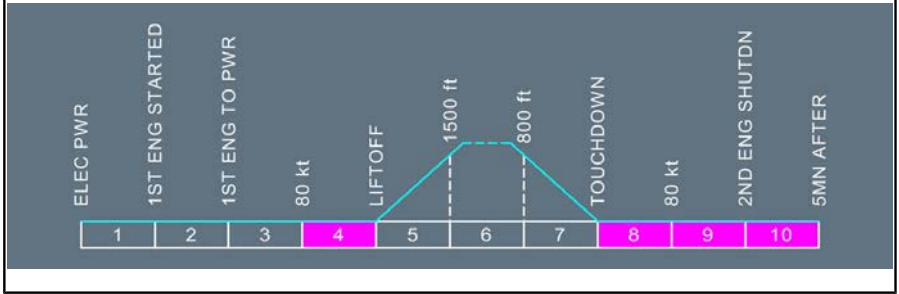

Continued on the following page

BRAKES HOT (Cont'd)

Ident.: PRO-ABN-BRAKES-M-00018675.0008001 / 21 MAR 17

■ **On ground:**

PARK BRK: PREFER CHOCKS

[L2] If the **BRAKES HOT** alert is still on when the aircraft is parked, the flight crew should not set the **PARKING BRK ON**.

[L1] **BRK FAN**  **ON**

[L2] **Note:** Before they select the brake fans  at the gate, the flight crew should first warn the ground personnel in order to avoid blowing carbon brake dust on them.

[L1] **DELAY T.O. FOR COOL**

- [L2] - Delay takeoff, until the brake temperature is below 300 °C with the brake fans **OFF**, and 150 °C with the brake fans  **ON**
- [L2] - Refer to PRO-NOR-SOP-21 After Landing - Brake Temperature for brake temperature limitations requiring maintenance actions.

[L1] ■ **In flight:**

● **IF PERF PERMITS:**

MAX SPEED.....250/.60
L/G.....**DN FOR COOL**

[L2] If performance permits, the landing gear should be extended or, if already extended, it should remain so, to improve brake cooling.

[L1] ● **FOR L/G RETRACTION:**

MAX SPEED.....220/.54

[L2] Reduce speed for landing gear retraction, when the brake temperature is within limits.

Continued on the following page

BRAKES HOT (Cont'd)

Ident.: PRO-ABN-BRAKES-M-00011312.0001001 / 05 AUG 10

L12

STATUS

MAX SPEED..... 280/67

See ⁽¹⁾

⁽¹⁾ As long as the landing gear is extended, limit the speed to 280 kt/M 0.67.
 For landing gear retraction when the brake temperature is within limits, reduce the speed to 220 kt.

BRAKES NORM + ALTN FAULT

Applicable to: ALL

Ident.: PRO-ABN-BRAKES-Q-00017819.0001001 / 21 MAR 16

ANNUNCIATIONS

Triggering Conditions:

L2

This alert triggers when the normal and alternate braking functions are lost. The parking brake is still available.

Flight Phase Inhibition:

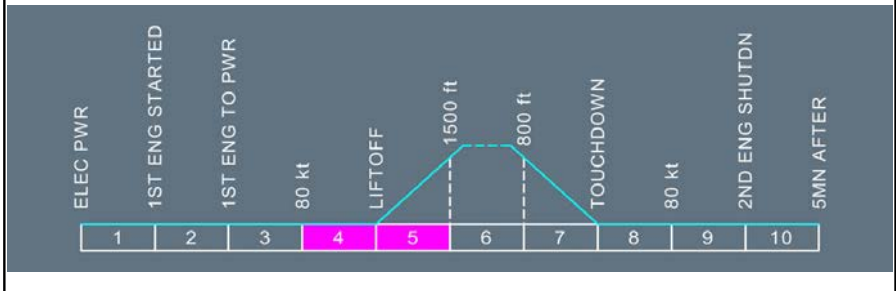

Ident.: PRO-ABN-BRAKES-Q-00018358.0001001 / 21 MAR 16

PARK BRK ONLY

Continued on the following page

BRAKES NORM + ALTN FAULT (Cont'd)

Ident.: PRO-ABN-BRAKES-Q-00011325.0001001 / 11 MAY 12

STATUS

PARK BRK ONLY

LDG DIST PROC..... APPLY

CAT 2 ONLY

INOP SYS

- CAT 3
- ANTI SKID
- N/W STRG
- NORM BRK
- AUTO BRK
- ALTN BRK

BRAKES NORM BRK FAULT

Applicable to: ALL

Ident.: PRO-ABN-BRAKES-O-00017814.0001001 / 21 MAR 16

ANNUNCIATIONS

Triggering Conditions:

[L2] This alert triggers when the normal braking function is lost.

Flight Phase Inhibition:

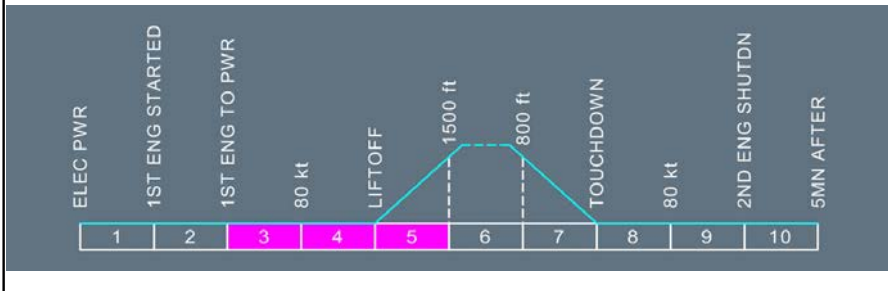

Ident.: PRO-ABN-BRAKES-O-00018679.0001001 / 21 MAR 16

Crew awareness.

Continued on the following page

BRAKES NORM BRK FAULT (Cont'd)

Ident.: PRO-ABN-BRAKES-O-00011321.0001001 / 11 MAY 12

STATUS

LDG DIST PROC..... APPLY

ALTN Y BRK WITH A/SKID
 CAT 2 ONLY

INOP SYS

CAT 3
 NORM BRK
 AUTO BRK

BRAKES PARK BRK FAULT ⚠

Applicable to: ALL

Ident.: PRO-ABN-BRAKES-X-00017823.0001001 / 21 MAR 16

ANNUNCIATIONS

Triggering Conditions:

L2

This alert triggers when a discrepancy between the position of the parking brake handle and the applied parking brake pressure is detected.

Flight Phase Inhibition:

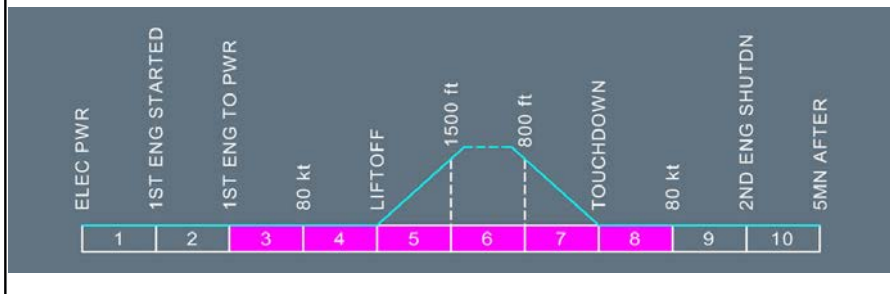

Continued on the following page

BRAKES PARK BRK FAULT ⚠ (Cont'd)

Ident.: PRO-ABN-BRAKES-X-00018359.0002001 / 20 MAY 16

- **On ground:**
 - If **PARKING BRK** handle is **OFF** and parking brake pressure is still applied:
BRK PRESS STILL APPLIED
 - If **PARKING BRK** handle is **ON** and no parking brake pressure is applied:
BRK PRESS RELEASED
PARK BRK..... **OFF**
 - **BEFORE ENG SHUT DOWN:**
CHOCKS..... **CONSIDER**

BRAKES PARK BRK LO PR

Applicable to: ALL

Ident.: PRO-ABN-BRAKES-U-00017821.0003001 / 21 MAR 16

ANNUNCIATIONS

Triggering Conditions:

- L2** This alert triggers when the pressure in the yellow accumulator and hydraulic system is low and the parking brake is on.

Flight Phase Inhibition:

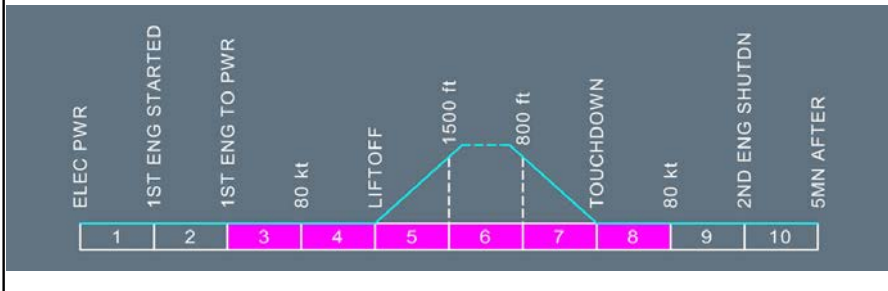

Continued on the following page

BRAKES PARK BRK LO PR (Cont'd)

Ident.: PRO-ABN-BRAKES-U-00018572.0003001 / 21 MAR 16

L2 Chocks are required before Engine 1 shut down.

- L1** ● **On ground:**
- **BEFORE ENG SHUT DOWN:**
CHOCKS CONSIDER

Ident.: PRO-ABN-BRAKES-U-00011335.0003001 / 05 AUG 10

STATUS

NORM BRK ONLY

INOP SYS

BRK Y ACCU

BRAKES PARK BRK ON

Applicable to: ALL

Ident.: PRO-ABN-BRAKES-Y-00017815.0001001 / 21 MAR 16

ANNUNCIATIONS

Triggering Conditions:

L2 This alert triggers when the parking brake is ON in flight.

Flight Phase Inhibition:

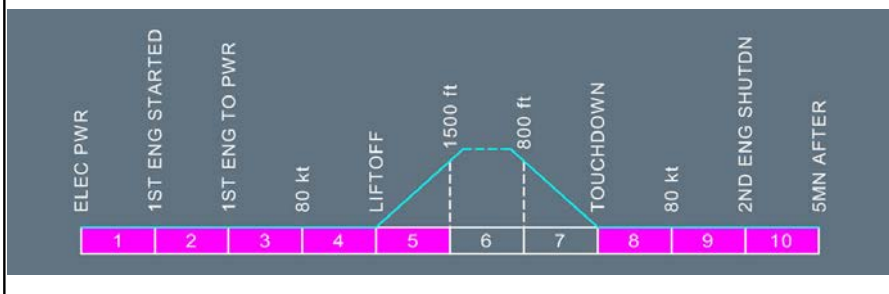

Continued on the following page

BRAKES PARK BRK ON (Cont'd)

Ident.: PRO-ABN-BRAKES-Y-00018360.0001001 / 21 MAR 16

PARK BRK..... OFF

BRAKES RELEASED

Applicable to: ALL

Ident.: PRO-ABN-BRAKES-P-00017813.0001001 / 21 MAR 16

ANNUNCIATIONS

Triggering Conditions:

- This alert triggers when the brake of one wheel is released. It is detected when the landing gear is downlocked, at least one engine is running, and normal braking is active.

Flight Phase Inhibition:

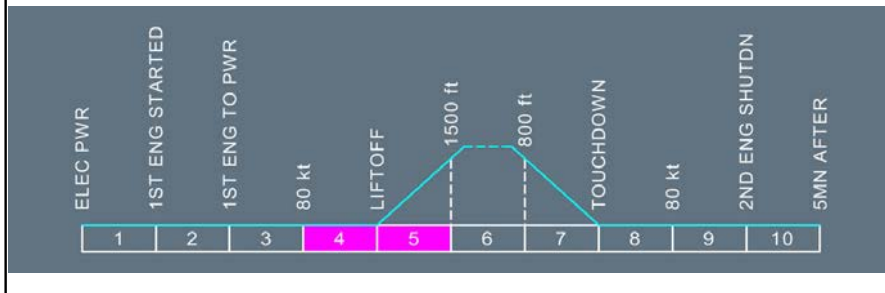

Ident.: PRO-ABN-BRAKES-P-00018663.0001001 / 21 MAR 16

Crew awareness.

Ident.: PRO-ABN-BRAKES-P-00011323.0001001 / 11 MAY 12

STATUS

LDG DIST PROC..... APPLY

INOP SYS

AUTO BRK

BRAKES SYS 1(2) FAULT

Applicable to: ALL

Ident.: PRO-ABN-BRAKES-L-00017812.0001001 / 21 MAR 16

ANNUNCIATIONS

Triggering Conditions:

L2

This alert triggers when one BSCU channel is failed.

Flight Phase Inhibition:

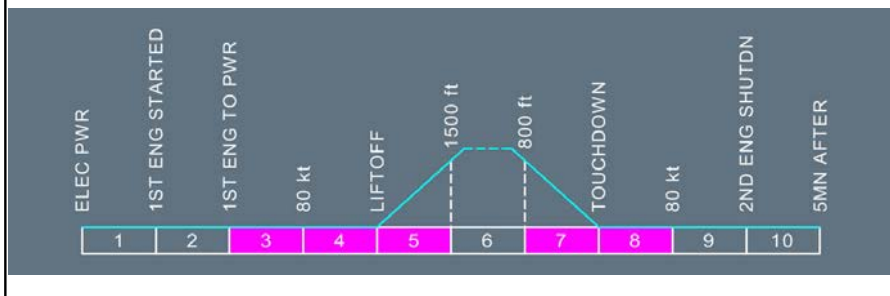

Ident.: PRO-ABN-BRAKES-L-00011309.0001001 / 25 FEB 14

Crew awareness.

Ident.: PRO-ABN-BRAKES-L-00011310.0001001 / 05 AUG 10

STATUS

INOP SYS

BRK SYS 1(2)

PROCEDURES
ABNORMAL AND EMERGENCY PROCEDURES

BRAKES

Intentionally left blank

BRAKES-N/W MINOR FAULT

Applicable to: ALL

Ident.: PRO-ABN-NWS-W-00017730.0001001 / 21 MAR 16

ANNUNCIATIONS

Triggering Conditions:

L2

This alert triggers when a minor fault of the nose wheel steering system is detected.

Flight Phase Inhibition:

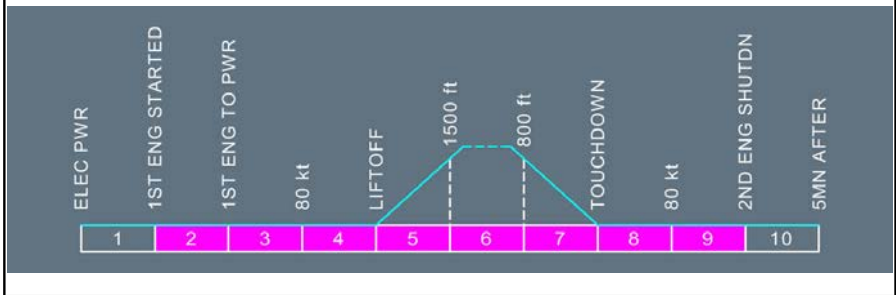

Ident.: PRO-ABN-NWS-W-00011326.0001001 / 25 FEB 14

Crew awareness.



A318/A319/A320/A321
FLIGHT CREW
OPERATING MANUAL

PROCEDURES
ABNORMAL AND EMERGENCY PROCEDURES

BRAKES-N/WWS

Intentionally left blank

[QRH] CABIN OVERPRESSURE

Ident.: PRO-ABN-CAB_PR-00010761.0001001 / 17 MAR 17

Applicable to: ALL

Apply the following procedure (not displayed on ECAM) in case of total loss of cabin pressure control leading to overpressure.

PACK 1 OR 2.....OFF
 VENTILATION BLOWER..... OVRD
 VENTILATION EXTRACT..... OVRD

Cabin air is extracted overboard

ΔP FREQUENTLY MONITOR

● **If $\Delta P > 9$ PSI:**

LAND ASAP

PACK 1..... OFF
 PACK 2..... OFF

● **10 min before landing:**

PACK 1..... OFF
 PACK 2..... OFF
 VENTILATION BLOWER..... AUTO
 VENTILATION EXTRACT..... AUTO

● **Before door opening: CHECK ΔP ZERO**

CAB PR EXCESS CAB ALT

Applicable to: ALL

Ident.: PRO-ABN-CAB_PR-T-00017316.0005001 / 21 MAR 16

ANNUNCIATIONS

Triggering Conditions:

- L2 This alert triggers when:
- In climb or descent, the cabin altitude is above the higher of:
 - 9 550 ft, or
 - 1 000 ft above the airfield pressure altitude.
 - In cruise, the cabin altitude is above 9 550 ft.

Flight Phase Inhibition:

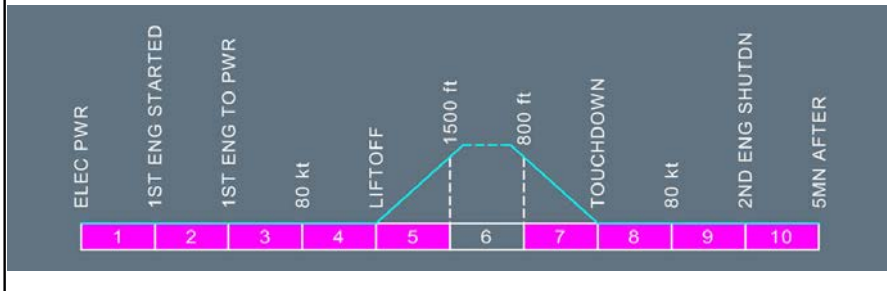

Continued on the following page

CAB PR EXCESS CAB ALT (Cont'd)

Ident.: PRO-ABN-CAB_PR-T-00018066.0004001 / 20 DEC 16

Rely on the CAB PR EXCESS CAB ALT warning even if not confirmed on the CAB PRESS SD page. The warning can be triggered by a cabin pressure sensor different from the one used to control the pressure and display the cabin altitude on the SD.

● **If above FL 100:**
 CREW OXY MASK.....USE

■ **If below FL 160:**
 DESCENT.....INITIATE
 MAX FL.....100/MEA

■ **If above FL 160:**
 SIGNS.....ON

EMER DESCENT:
 DESCENT.....INITIATE

● **If A/THR is not active:**
 THR LEVERS.....IDLE

L2 *If the A/THR is active, check A/THR is at IDLE on the ED.*

L1 SPD BRK.....FULL

L2 *Extension of speedbrakes will significantly increase VLS.
 In order to avoid autopilot disconnection and automatic retraction of speedbrakes due to possible activation of angle of attack protection, allow the speed to increase before starting to use speedbrakes.*

L1 SPD.....MAX/APPROPRIATE

L2 *Descend at maximum appropriate speed. However, if structural damage is suspected use the flight controls with care and reduce speed as appropriate. The landing gear may be extended. In this case, speed must be reduced to VLO/VLE.*

L1 ENG MODE SEL.....IGN
 ATC.....NOTIFY

L2 *Notify ATC of the nature of the emergency, and state intention. The flight crew can communicate with the ATC using voice, or CPDLC when the voice contact cannot be established or has a poor quality.
 Squawk 7700 unless otherwise specified by ATC.*

L12 *Note: To save oxygen, set the oxygen diluter selector to N position.*

Continued on the following page



PROCEDURES
ABNORMAL AND EMERGENCY PROCEDURES

A318/A319/A320/A321
FLIGHT CREW
OPERATING MANUAL

CAB PR

CAB PR EXCESS CAB ALT (Cont'd)

With the oxygen diluter left to 100 %, oxygen quantity may not be sufficient for the entire descent profile.

Ensure that the flight crew can communicate wearing oxygen masks. Avoid the continuous use of the interphone position to minimize the interference from the noise of the oxygen mask.

L1 MAX FL..... 100/MEA

● **IF CAB ALT > 14 000 FT:**

PAX OXY MASKS..... MAN ON

L2 *This action confirms that the passenger oxygen masks are released.*

Note: *When descent is established and if time permits, check that the **OUTFLOW VALVE** is closed on the **CAB PRESS SD** page. If it is not closed and ΔP is positive, select the other CPC. If the **OUTFLOW VALVE** is still not closing set the cabin pressure **MODE SEL** pb to **MAN** and the **V/S CTL** sw to full down.*

Notify the cabin crew when the aircraft reaches a safe flight level, and when cabin oxygen is no longer necessary.

Ident.: PRO-ABN-CAB_PR-T-00010755.0001001 / 05 AUG 10

STATUS

MAX FL..... 100/MEA

CAB PR EXCES RESIDUAL PR

Applicable to: ALL

Ident.: PRO-ABN-CAB_PR-AE-00017328.0001001 / 21 MAR 16

ANNUNCIATIONS

Triggering Conditions:

L2

This alert triggers when the differential pressure is still above 2.5 hPa (0.036 PSI) 12 s after the last engine shutdown.

Flight Phase Inhibition:

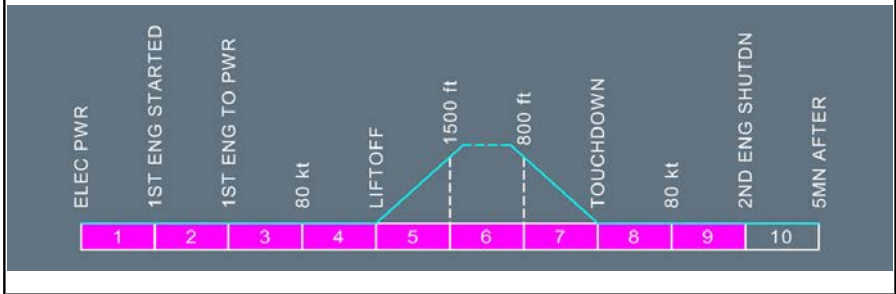

Ident.: PRO-ABN-CAB_PR-AE-00018790.0002001 / 21 MAR 16

PACK 1.....OFF
 PACK 2.....OFF
 CABIN CREW.....ALERT

CAB PR LDG ELEV FAULT

Applicable to: ALL

Ident.: PRO-ABN-CAB_PR-AF-00017325.0001001 / 21 MAR 16

ANNUNCIATIONS

Triggering Conditions:

- [L2] This alert triggers when the LDG ELEV selector is set to AUTO and the landing field elevation of the FMGS is not available.

Flight Phase Inhibition:

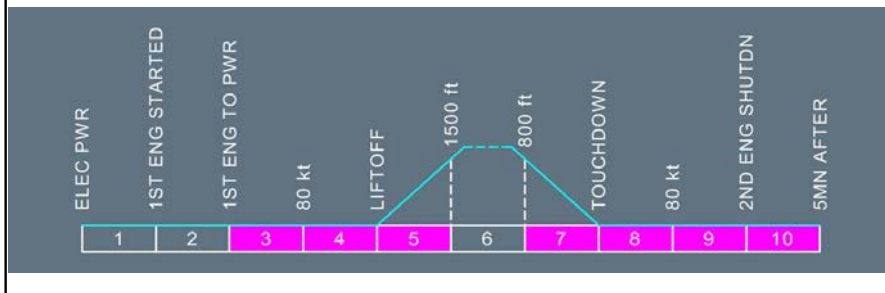

Ident.: PRO-ABN-CAB_PR-AF-00018936.0002001 / 21 MAR 16

LDG ELEV.....ADJUST

- [L2] The flight crew must select the landing field elevation manually with the LDG ELEV selector. Refer to the LDG ELEV indication on the CRUISE page on the CAB PRESS SD page to adjust the required landing field elevation.

Note: If the landing is performed on QFE, set 0 ft on LDG ELEV selector.

CAB PR LO DIFF PR

Applicable to: ALL

Ident.: PRO-ABN-CAB_PR-AG-00017320.0001001 / 21 MAR 16

ANNUNCIATIONS

Triggering Conditions:

L2

This alert triggers when:

- The time to reach $\Delta P = 0$ is less than 1.5 min, and
- The time to reach $\Delta P = 0$ is less than the time for CAB ALT to reach landing field elevation +30 s, and
- The aircraft is at least 3 000 ft above the landing field elevation.

Note: *The alert remains, when the aircraft descends within 3 000 ft of the landing field elevation.*

Flight Phase Inhibition:

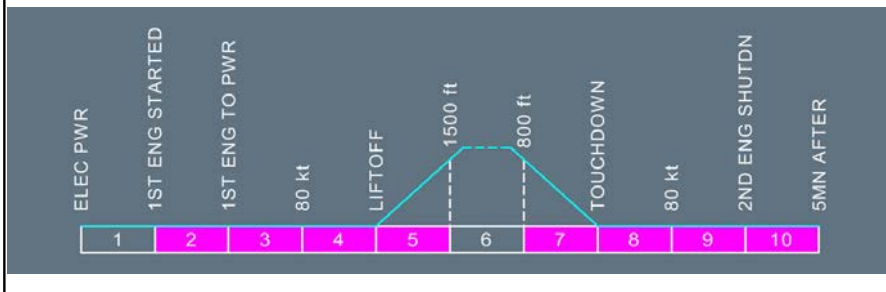

Ident.: PRO-ABN-CAB_PR-AG-00010762.0002001 / 05 AUG 10

EXPECT HI CAB RATE

A/C V/S.....REDUCE

L2 This line is not displayed in case of Emergency Descent due to Excessive Cabin Altitude.

CAB PR OFV NOT OPEN

Applicable to: ALL

Ident.: PRO-ABN-CAB_PR-AH-00017323.0002001 / 21 MAR 16

ANNUNCIATIONS

Triggering Conditions:

L2 This alert triggers, on ground, when the outflow valve is not fully open (time delay 70 s).

Flight Phase Inhibition:

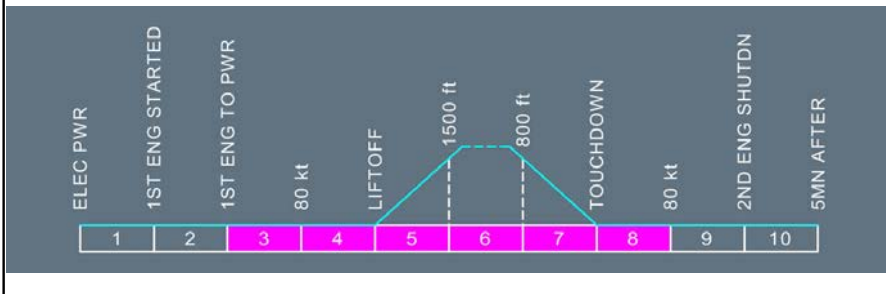

Ident.: PRO-ABN-CAB_PR-AH-00018802.0001001 / 21 MAR 16

MODE SEL..... MAN
 MAN V/S CTL..... FULL UP

L2 It may take 10 s in manual mode before the crew notices a change of the outflow valve position.

L1 ● **IF UNSUCCESSFUL :**
 PACK 1..... OFF
 PACK 2..... OFF

CAB PR SAFETY VALVE OPEN

Applicable to: ALL

Ident.: PRO-ABN-CAB_PR-W-00017324.0001001 / 21 MAR 16

ANNUNCIATIONS

Triggering Conditions:

L2

This alert triggers:

- On ground, if the safety valve is not fully closed, or
- In flight, if the safety valve is not fully closed for more than 1 min.

Flight Phase Inhibition:

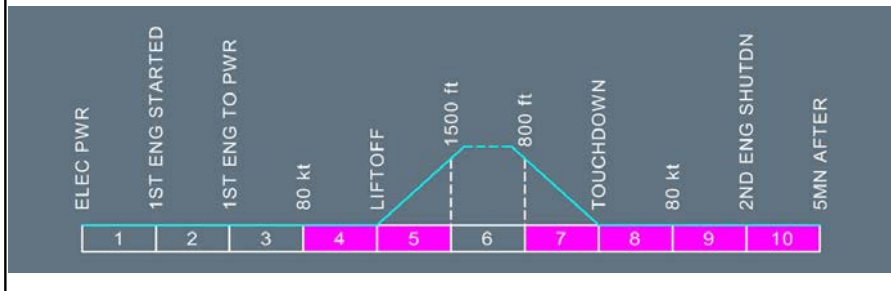

Ident.: PRO-ABN-CAB_PR-W-00018092.0002001 / 21 MAR 16

■ **IF DIFF PR ABV 8 PSI:**

MODE SEL.....MAN
 MAN V/S CTL.....AS QRDR

L2

If overpressure is confirmed, reduce cabin ΔP.
 It may take 10 s in manual mode before the flight crew notices a change of the outflow valve position.

L1

● **IF UNSUCCESSFUL:**

A/C FL.....REDUCE

■ **IF DIFF PR BELOW 0 PSI:**

EXPECT HI CAB RATE
 A/C V/S.....REDUCE

Continued on the following page



A318/A319/A320/A321
 FLIGHT CREW
 OPERATING MANUAL

PROCEDURES
ABNORMAL AND EMERGENCY PROCEDURES

CAB PR

CAB PR SAFETY VALVE OPEN (Cont'd)

Ident.: PRO-ABN-CAB_PR-W-00018093.0003001 / 21 MAR 16

STATUS

MAN CAB PR CTL

TGT V/S: CLIMB 500 FT/MIN

TGT V/S: DESC 300 FT/MIN

A/C FL

390
 350
 300
 250
 < 200

CAB ALT TGT

8 000
 7 000
 5 500
 3 000
 0

● **DURING FINAL APPR :**

MAN V/S CTL.....FULL UP

CAUTION

Check that ΔP is zero before opening the doors.

CAB PR SYS 1(2) FAULT

Applicable to: ALL

Ident.: PRO-ABN-CAB_PR-U-00017326.0001001 / 21 MAR 16

ANNUNCIATIONS

Triggering Conditions:

L2 This alert triggers when the cabin pressure controller is failed.

Flight Phase Inhibition:

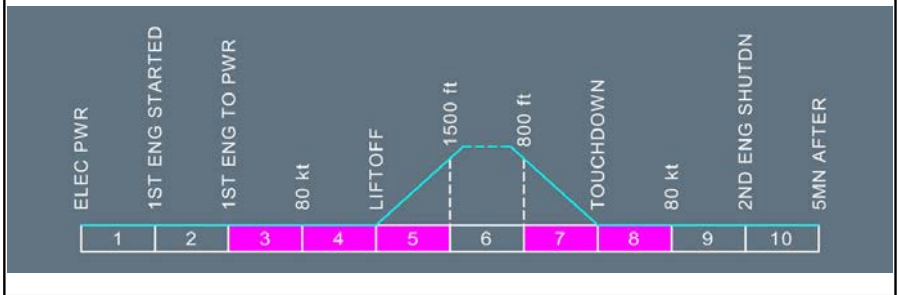

Ident.: PRO-ABN-CAB_PR-U-00010756.0001001 / 25 FEB 14

Crew awareness.

Ident.: PRO-ABN-CAB_PR-U-00010758.0001001 / 05 AUG 10

STATUS

INOP SYS

CAB PR 1 (2)

CAB PR SYS 1+2 FAULT

Applicable to: ALL

Ident.: PRO-ABN-CAB_PR-V-00017319.0001001 / 21 MAR 16

ANNUNCIATIONS

Triggering Conditions:

- [L2] This alert triggers when both cabin pressure controllers are failed.

Flight Phase Inhibition:

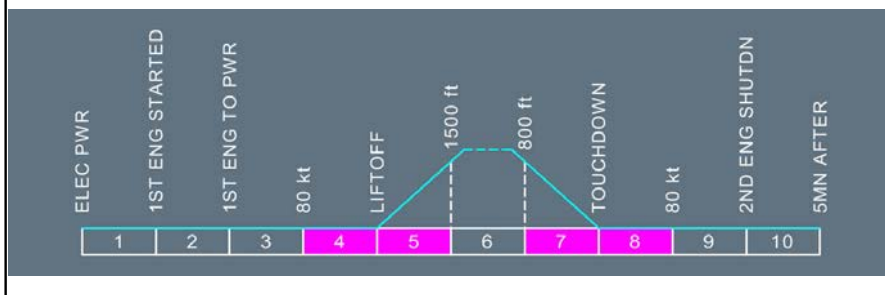

Ident.: PRO-ABN-CAB_PR-V-00010759.0001001 / 05 AUG 10

- [L2] Due to the slow closure of the outflow valve in manual pressurization mode and depending on the failure, the following procedure may not avoid the depressurization.

[L1] **MODE SEL**..... **MAN**
MAN V/S CTL..... **AS RQRD**

- [L2] - It may take 10 s in manual mode before the crew notices a change of the outflow valve position. Use the cabin V/S indication to confirm the outflow valve operation.
- Monitor cabin V/S and CAB ALT frequently and adjust as necessary. Maintain aircraft altitude at or above cabin altitude.
- The two safety valves limit ΔP to 8.6 PSI.

Continued on the following page

CAB PR SYS 1+2 FAULT (Cont'd)

Ident.: PRO-ABN-CAB_PR-V-00018107.0003001 / 21 MAR 16

L12

STATUS

MAN CAB PR CTL

TGT V/S : CLIMB 500 FT/MIN

TGT V/S : DESC 300 FT/MIN

A/C FL

390
 350
 300
 250
 < 200

CAB ALT TGT

8 000
 7 000
 5 500
 3 000
 0

INOP SYS

CAB PR 1+2

● **DURING FINAL APPR :**

V/S CTL.....FULL UP

When on intermediate approach (below airfield pressure altitude +2 500 ft), adjust $\Delta P = 0$.

CAUTION

Check that ΔP is zero before opening the doors.



A318/A319/A320/A321
FLIGHT CREW
OPERATING MANUAL

PROCEDURES
ABNORMAL AND EMERGENCY PROCEDURES

CAB PR

Intentionally left blank

C/B TRIPPED

Applicable to: ALL

Ident.: PRO-ABN-C_B-Y-00017390.0001001 / 21 MAR 16

ANNUNCIATIONS

Triggering Conditions:

L2 This alert triggers when one C/B is tripped in the designated zone.

Flight Phase Inhibition:

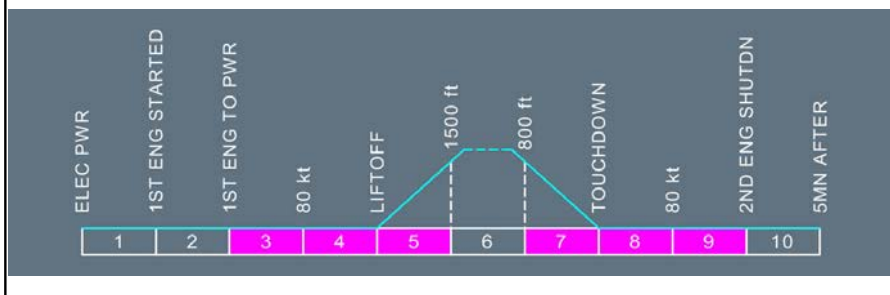

Ident.: PRO-ABN-C_B-Y-00012551.0001001 / 25 FEB 14

Crew awareness.

- If one green circuit breaker (C/B) is tripped, one of the following messages appears after one minute, depending on the location of the affected C/B:

C/B TRIPPED ON OVHD PNL

C/B TRIPPED ON L(R) ELEC BAY

C/B TRIPPED REAR PNL J-M OR N-R OR S-V OR W-Z

L2 Note: In flight, do not reengage a C/B that has tripped by itself, unless the Captain judges it necessary to do so for the safe continuation of the flight. This procedure should be adopted only as a last resort, and only one reengagement should be attempted. On ground, do not reengage the C/B of the fuel pump(s) of any tank. For all other C/B s, if the flight crew coordinates the action with maintenance, the flight crew may reengage a tripped C/B , provided that the cause of the tripped C/B is identified.



A318/A319/A320/A321
FLIGHT CREW
OPERATING MANUAL

PROCEDURES
ABNORMAL AND EMERGENCY PROCEDURES

C/B

Intentionally left blank

COM ACARS FAULT 

Applicable to: ALL

Ident.: PRO-ABN-COM-B-00016895.0001001 / 21 MAR 16

ANNUNCIATIONS

Triggering Conditions:

L2

This alert triggers when there is a failure of ACARS.

Flight Phase Inhibition:

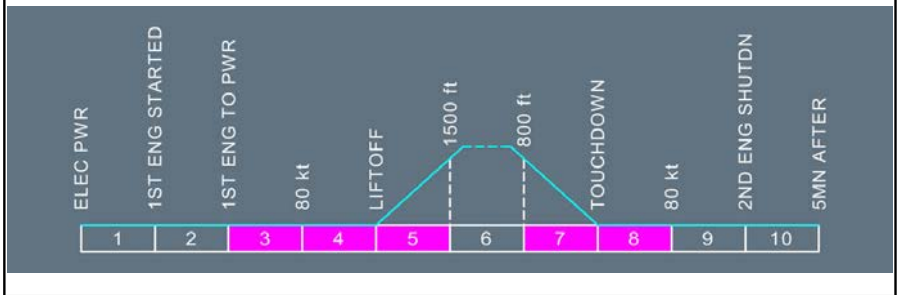

Ident.: PRO-ABN-COM-B-00017538.0001001 / 21 MAR 16

Crew awareness.

Ident.: PRO-ABN-COM-B-00010037.0001001 / 05 AUG 10

STATUS

INOP SYS

ACARS

COM CIDS 1 + 2 FAULT

Applicable to: ALL

Ident.: PRO-ABN-COM-A-00016887.0001001 / 21 MAR 16

ANNUNCIATIONS

Triggering Conditions:

L2 This alert triggers when there is a total loss of CIDS.

Flight Phase Inhibition:

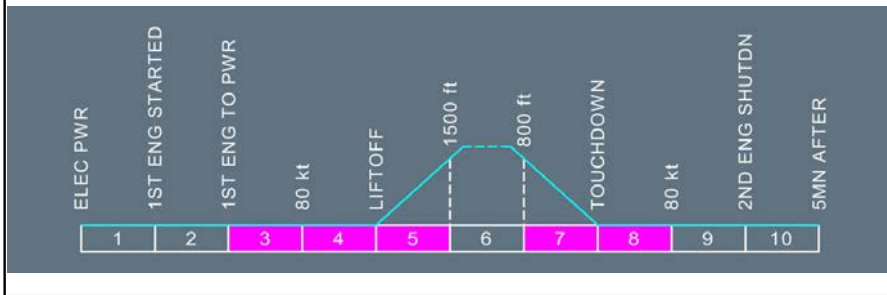

Ident.: PRO-ABN-COM-A-00010033.0001001 / 25 FEB 14

L2 Passenger address, cabin and service interphone, and passenger signs are inoperative.

L1 Crew awareness.

Ident.: PRO-ABN-COM-A-00010034.0001001 / 05 AUG 10

STATUS

INOP SYS

CIDS

COM HF 1(2) DATA FAULT 

Applicable to: ALL

Ident.: PRO-ABN-COM-F-00016896.0001001 / 21 MAR 16

ANNUNCIATIONS

Triggering Conditions:

L2

This alert triggers when data communications via HF 1(2) are inoperative.

Flight Phase Inhibition:

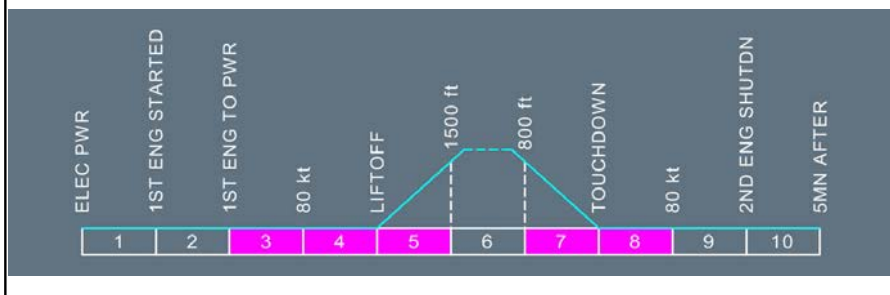

Ident.: PRO-ABN-COM-F-00017499.0001001 / 21 MAR 16

Crew awareness.

Ident.: PRO-ABN-COM-F-00010045.0001001 / 17 MAR 11

STATUS

INOP SYS

HF 1(2) DATA

COM SATCOM DATA FAULT ⚠

Applicable to: ALL

Ident.: PRO-ABN-COM-D-00016899.0001001 / 21 MAR 16

ANNUNCIATIONS

Triggering Conditions:

L2 This alert triggers when the ACARS transmissions via SATCOM are lost.

Flight Phase Inhibition:

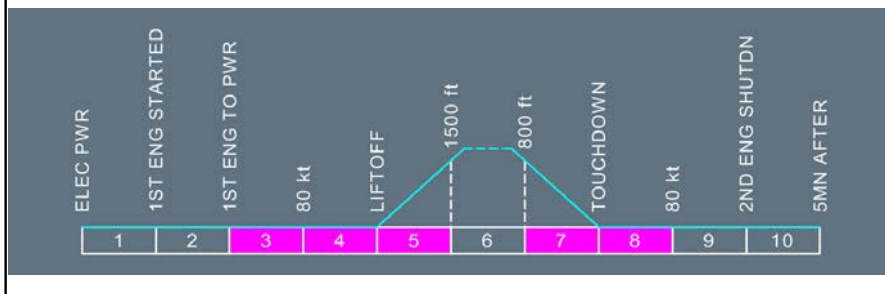

Ident.: PRO-ABN-COM-D-00017548.0001001 / 21 MAR 16

L2 Telephone transmissions are still available. ACARS ⚠ communications are inoperative.

L1 Crew awareness.

Ident.: PRO-ABN-COM-D-00010041.0001001 / 21 MAR 16

STATUS

INOP SYS

SATCOM DATA

COM SATCOM FAULT ⚠

Applicable to: ALL

Ident.: PRO-ABN-COM-C-00016894.0001001 / 21 MAR 16

ANNUNCIATIONS

Triggering Conditions:

L2 This alert triggers when the telephone and the ACARS ⚠ transmission are lost.

Flight Phase Inhibition:

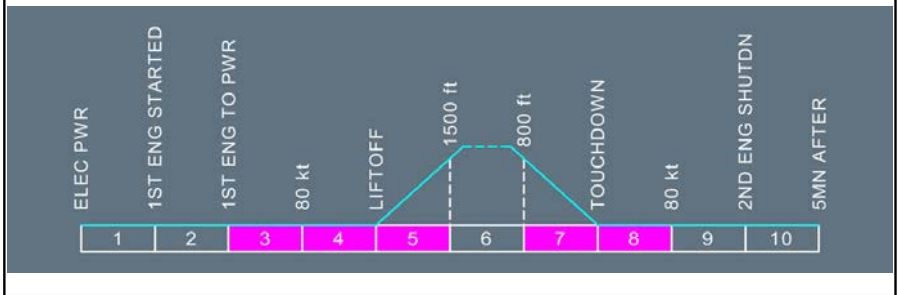

Ident.: PRO-ABN-COM-C-00017500.0001001 / 21 MAR 16

L2 ACARS ⚠ and telephone communications are inoperative.

L1 Crew awareness.

Ident.: PRO-ABN-COM-C-00017502.0001001 / 21 MAR 16

STATUS

INOP SYS

SATCOM

COM SINGLE PTT STUCK 

Applicable to: ALL

Ident.: PRO-ABN-COM-G-00016902.0001001 / 21 MAR 16

ANNUNCIATIONS

Triggering Conditions:

- L2 This alert triggers when any PTT transmission selector is jammed in the transmit position for more than 40 s (VHF) or for more than 180 s (HF).

Flight Phase Inhibition:

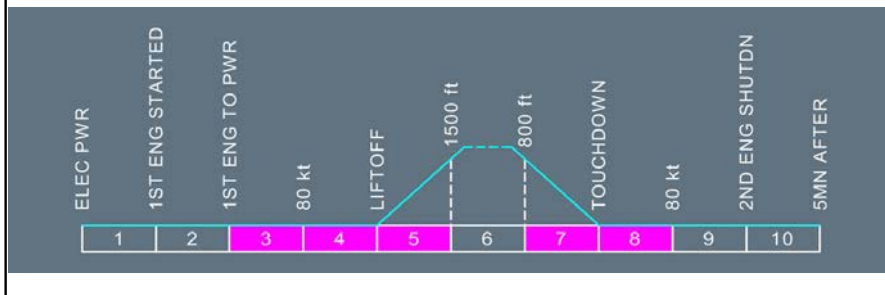

Continued on the following page



A318/A319/A320/A321
 FLIGHT CREW
 OPERATING MANUAL

PROCEDURES
ABNORMAL AND EMERGENCY PROCEDURES

COM

COM SINGLE PTT STUCK (Cont'd)

Ident.: PRO-ABN-COM-G-00017503.0001001 / 21 MAR 16

ACP1 VHF 1(2)(3) TX..... DESELECT
 ACP1 HF 1(2) TX..... DESELECT

● **IF UNSUCCESSFUL:**

ACP2 VHF 1(2)(3) TX..... DESELECT
 ACP2 HF 1(2) TX..... DESELECT

● **IF UNSUCCESSFUL:**

ACP3 VHF 1(2)(3) TX..... DESELECT
 ACP3 HF 1(2) TX..... DESELECT

When the ACP linked to the faulty PTT is detected, the previous ECAM actions are replaced by the following ones:

AUDIO SWTG..... DO NOT USE

● **ON AFFECTED ACP:**

ALL TX KEYS..... DO NOT USE

● **ON ALL OTHER ACP:**

VHF 1(2)(3) TX..... RESELECT
 HF 1(2) TX..... RESELECT

Ident.: PRO-ABN-COM-G-00014765.0001001 / 26 NOV 12

STATUS

AUDIO SWTG..... DO NOT USE

INOP SYS

SINGLE PTT

COM VHF 1(2)(3) /HF 1(2) EMITTING ⚠

Applicable to: ALL

Ident.: PRO-ABN-COM-I-00016892.0001001 / 21 MAR 16

ANNUNCIATIONS

Triggering Conditions:

- ⓘ For VHF 1(2)(3) EMITTING, the alert triggers when the transmitter emits more than 30 s or 60 s depending on aircraft configuration.
For HF 1(2) EMITTING, the alert triggers when the transmitter emits more than 60 s.

Flight Phase Inhibition:

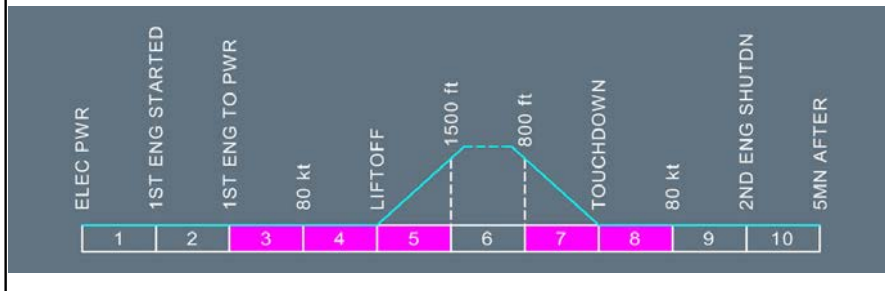

Ident.: PRO-ABN-COM-I-00017549.0001001 / 21 MAR 16

- ⓘ 1. If any Push To Talk (PTT) transmission selector (sidestick PTT ⚠, hand mike PTT ⚠, or ACP PTT switch ⚠) is jammed in the transmit position, try to release it in order to remove the caution.
2. If unsuccessful, deselect the identified failed VHF /HF transmission keys on the associated Audio Control Panel (ACP) to remove the caution. This ACP should only be used in reception mode. The associated PTT transmission selectors must not be used.

Note: In this case, the ACP of the unaffected side may be used to recover the deselected VHF /HF channel.

3. If no transmission key on the ACP is found in the "transmit" position, pull the affected VHF /HF C/B associated to the ECAM message : COM\HF1 C/B HA 14 on 49 VU , COM NAV\HF2 C/B L13 on 121 VU , COM\HF1 C/B G09 on 49 VU , COM NAV\HF2 C/B L04 on 121 VU , COM \HF3 C/B L05 on 121 VU.

COM VHF 3 DATA FAULT ⚠

Applicable to: ALL

Ident.: PRO-ABN-COM-E-00016897.0001001 / 21 MAR 16

ANNUNCIATIONS

Triggering Conditions:

L2

This alert triggers when data communication via VHF 3 are inoperative.

Flight Phase Inhibition:

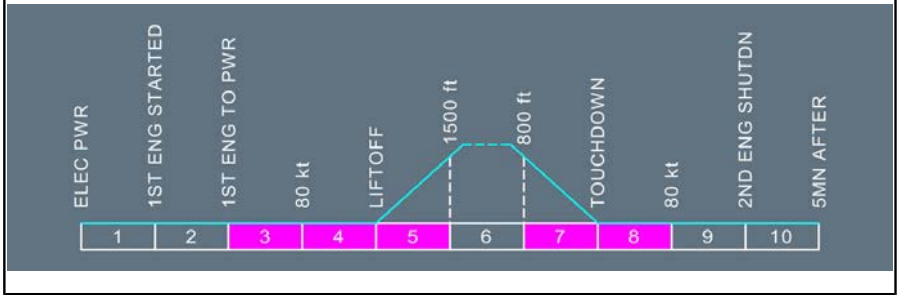

Ident.: PRO-ABN-COM-E-00017550.0001001 / 21 MAR 16

Crew awareness.

Ident.: PRO-ABN-COM-E-00010043.0001001 / 17 MAR 11

STATUS

INOP SYS

VHF 3 DATA



A318/A319/A320/A321
FLIGHT CREW
OPERATING MANUAL

PROCEDURES
ABNORMAL AND EMERGENCY PROCEDURES

COM

Intentionally left blank

COND FWD CAB/AFT CAB/CKPT DUCT OVHT

Applicable to: ALL

Ident.: PRO-ABN-COND-F-00017295.0002001 / 21 MAR 16

ANNUNCIATIONS

Triggering Conditions:

L2

This alert triggers when:

- The duct temperature rises above 88 °C, or
- The duct temperature rises above 80 °C four times during the same flight.

Flight Phase Inhibition:

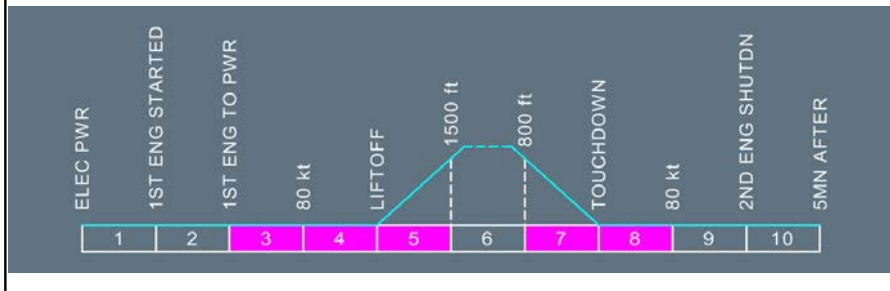

Ident.: PRO-ABN-COND-F-00010720.0001001 / 05 AUG 10

● **WHEN DUCT TEMP < 70 DEG C:**

HOT AIR.....OFF THEN ON

L2

Hot air pressure regulating valve reopens.

Ident.: PRO-ABN-COND-F-00018037.0001001 / 21 MAR 16

L12

STATUS

INOP SYS

● **If system not recovered:**

CAB TEMP BY PACK ONLY

Basic temperature regulation is by packs only (remains automatic).

HOT AIR
FWD CRG HEAT ⚠

COND FWD(AFT) CARGO DUCT OVHT 

Applicable to: ALL

Ident.: PRO-ABN-COND-G-00017339.0002001 / 21 MAR 16

ANNUNCIATIONS

Triggering Conditions:

- L2 This alert triggers when the duct temperature in the forward(aft) cargo compartment rises above 88 °C.

Flight Phase Inhibition:

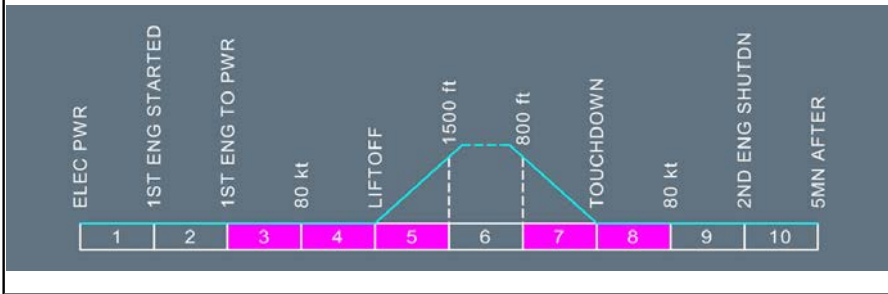

Ident.: PRO-ABN-COND-G-00018038.0001001 / 21 MAR 16

- **WHEN DUCT TEMP < 70 DEG C:**
HOT AIR.....**OFF THEN ON**

- L2 *Hot air pressure regulating valve reopens.*

Ident.: PRO-ABN-COND-G-00018039.0001001 / 21 MAR 16

- L12 **STATUS**

- **If system not recovered:**
CAB TEMP BY PACK ONLY
Basic temperature regulation is by packs only (remains automatic).

INOP SYS
FWD(AFT) CRG HEAT

COND FWD(AFT) CRG HEAT FAULT 

Applicable to: ALL

Ident.: PRO-ABN-COND-N-00017341.0002001 / 21 MAR 16

ANNUNCIATIONS

Triggering Conditions:

L2

This alert triggers if the heating controller of the forward(aft) cargo compartment is failed.

Flight Phase Inhibition:

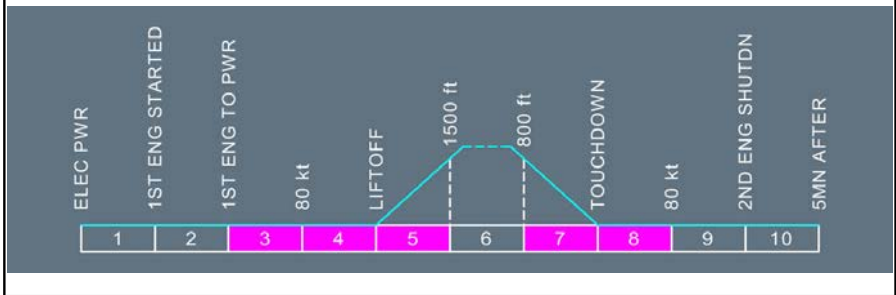

Ident.: PRO-ABN-COND-N-00018040.0001001 / 21 MAR 16

Crew awareness.

Ident.: PRO-ABN-COND-N-00018041.0001001 / 21 MAR 16

STATUS

INOP SYS

FWD(AFT) CRG HEAT

COND FWD(AFT) CRG ISOL VALVE ⚠

Applicable to: ALL

Ident.: PRO-ABN-COND-M-00017335.0001001 / 21 MAR 16

ANNUNCIATIONS

Triggering Conditions:

L2 This alert triggers if the forward(aft) cargo isolation valve disagrees with the selected position.

Flight Phase Inhibition:

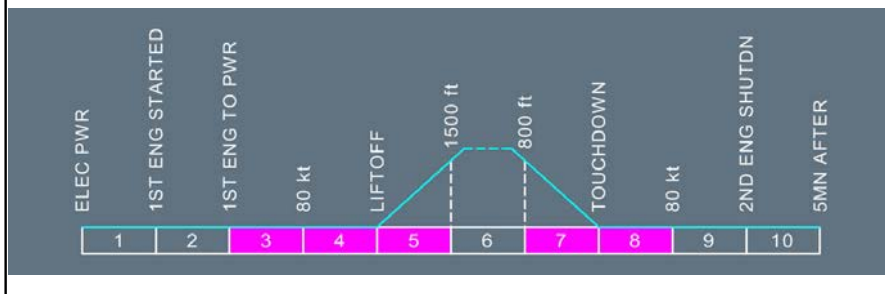

Ident.: PRO-ABN-COND-M-00018042.0001001 / 21 MAR 16

Crew awareness.

Ident.: PRO-ABN-COND-M-00018043.0001001 / 21 MAR 16

STATUS

INOP SYS

FWD(AFT) CRG HEAT ⚠
FWD(AFT) CRG VENT

COND HOT AIR FAULT

Applicable to: ALL

Ident.: PRO-ABN-COND-I-00017296.0001001 / 21 MAR 16

ANNUNCIATIONS

Triggering Conditions:

L2 This alert triggers when the position of the hot air pressure regulating valve disagrees with the commanded position.

Flight Phase Inhibition:

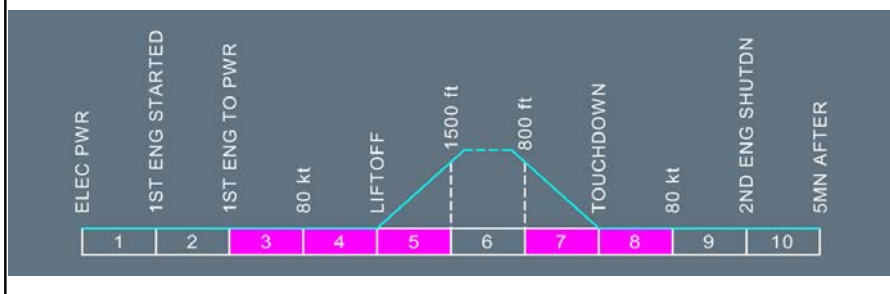

Ident.: PRO-ABN-COND-I-00018940.0001001 / 21 MAR 16

HOT AIR (IF NOT CLOSED)..... OFF

● **IF HOT AIR STILL OPEN and DUCT OVHT persists:**

PACK 1..... OFF

PACK 2..... OFF

DESCENT TO FL 100/MEA

L2 Descend to FL 100, or MEA, whichever is higher.

L1 ● **WHEN DIFF PR < 1 PSI AND FL BELOW 100:**

RAM AIR..... ON

MAX FL..... 100/MEA

Continued on the following page

COND HOT AIR FAULT (Cont'd)

Ident.: PRO-ABN-COND-I-00018044.0001001 / 21 MAR 16

L12

STATUS

INOP SYS

- **If HOT AIR closed only:**
CAB TEMP BY PACK ONLY
Basic temperature regulation by packs only (remains automatic).

PACK 1+2 (If PACKS OFF)
HOT AIR
FWD CRG HEAT 

COND L+R CAB FAN FAULT

Applicable to: ALL

Ident.: PRO-ABN-COND-R-00017297.0001001 / 21 MAR 16

ANNUNCIATIONS

Triggering Conditions:

- L2 This alert triggers if both recirculation fans are failed.

Flight Phase Inhibition:

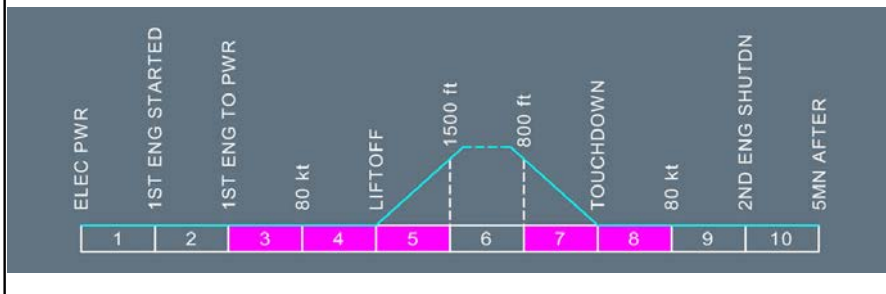

Ident.: PRO-ABN-COND-R-00018045.0001001 / 22 MAR 17

PACK FLOW.....HI

Continued on the following page

COND L+R CAB FAN FAULT (Cont'd)

Ident.: PRO-ABN-COND-R-00018046.0001001 / 21 MAR 16

| | |
|--|------------------------|
| | STATUS |
| | <u>INOP SYS</u> |
| | L+R CAB FAN |

COND LAV + GALLEY FAN FAULT

Applicable to: ALL

Ident.: PRO-ABN-COND-S-00017300.0001001 / 21 MAR 16

ANNUNCIATIONS

Triggering Conditions:

L2 This alert triggers if the extraction fan of the lavatory and galley is failed.

Flight Phase Inhibition:

The diagram shows a horizontal timeline from 1 to 10. Key events are marked above the timeline: ELEC PWR (1), 1ST ENG STARTED (2), 1ST ENG TO PWR (3), 80 kt (4), LIFTOFF (5), 1500 ft (6), 800 ft (7), TOUCHDOWN (8), 80 kt (9), 2ND ENG SHUTDN (10), and 5MN AFTER (10). A shaded area from phase 5 to 8 indicates the inhibition period.

Ident.: PRO-ABN-COND-S-00010751.0002001 / 25 FEB 14

L2 Cabin zone temperature sensors are normally ventilated by the air extracted by the fan. Therefore, cabin zone temperature regulation is lost.

L1 Crew awareness.

Continued on the following page

COND LAV + GALLEY FAN FAULT (Cont'd)

Ident.: PRO-ABN-COND-S-00010752.0011001 / 05 AUG 10

L12

STATUS

INOP SYS

● **If ACSC 2 is operative:**
CAB TEMP CKPT CTL ONLY

- To adjust the cabin zone temperature, use the FWD CABIN and AFT CABIN zone temperature selectors (overhead panel). The selectors control the cabin duct temperature directly.
- Cockpit temperature regulation is normal.

● **If ACSC 2 is inoperative:**
CAB AT FIXED TEMP

- FWD CABIN and AFT CABIN zone temperature selectors are inoperative.
- To adjust the cabin zone temperature, use the COCKPIT zone temperature selector (overhead panel). Cabin duct temperature is the same as cockpit duct temperature.
- Cockpit temperature regulation is normal.

GALLEY FAN
 PACK 2 ⁽¹⁾
 COND CTL 2 ⁽¹⁾

⁽¹⁾ (If ACSC 2 is inoperative)

COND TRIM AIR SYS FAULT

Applicable to: ALL

Ident.: PRO-ABN-COND-AI-00017305.0001001 / 21 MAR 16

ANNUNCIATIONS

Triggering Conditions:

L2

This alert triggers when:

- One trim air valve is failed, or
- There is an overpressure downstream of the hot air valve.

Flight Phase Inhibition:

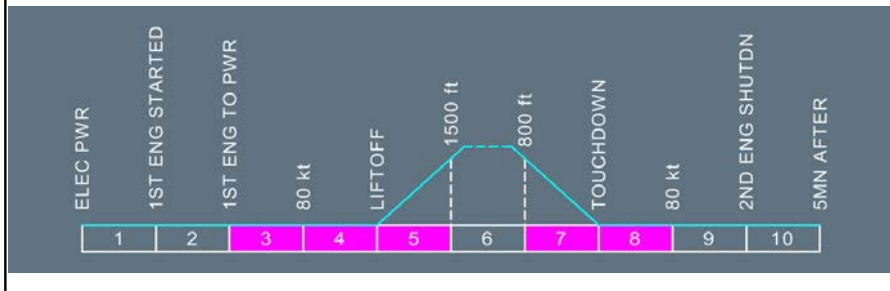

Ident.: PRO-ABN-COND-AI-00010730.0001001 / 05 AUG 10

■ **One trim valve failed:**

A message corresponding to the affected valve is displayed:

- AFT CAB TRIM VALVE
- FWD CAB TRIM VALVE
- CKPT TRIM VALVE

■ **High pressure detected downstream of the hot air pressure regulating valve:**

TRIM AIR HI PR

L2

Note: If the warning and the TRIM AIR HI PR message are triggered when all trim air valves are closed (during the first 30 s after the packs are selected on, or in flight, if all zone heating demands are fulfilled), disregard them.



A318/A319/A320/A321
FLIGHT CREW
OPERATING MANUAL

PROCEDURES
ABNORMAL AND EMERGENCY PROCEDURES

COND

Intentionally left blank

**CONFIG L(R) SIDESTICK FAULT
 (BY TAKE OVER)**

Applicable to: ALL

Ident.: PRO-ABN-CONFIG-AA-00018894.0001001 / 21 MAR 16

ANNUNCIATIONS

Triggering Conditions:

L2

This alert triggers when the L or R sidestick is inoperative (takeover pb pressed more than 30 s) and when thrust levers are set at TO , or Flex TO, or when pressing T.O CONFIG pb.

Flight Phase Inhibition:

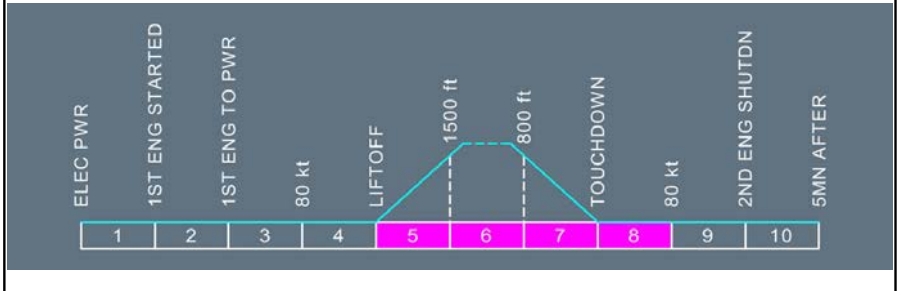

Ident.: PRO-ABN-CONFIG-AA-00018411.0001001 / 21 MAR 16

L(R) TAKEOVERDEPRESS

L2

The affected stick becomes operative.

CONFIG PARK BRK ON

Applicable to: ALL

Ident.: PRO-ABN-CONFIG-Z-00017858.0002001 / 21 MAR 16

ANNUNCIATIONS

Triggering Conditions:

- L2 This alert triggers when the parking brake is on and thrust levers are set at TO or FLXTO power position.

Flight Phase Inhibition:

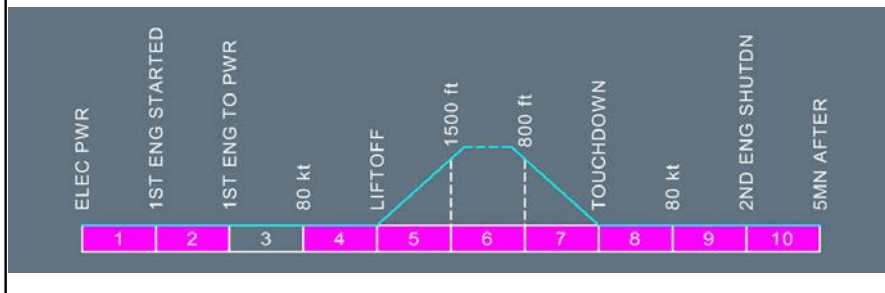

Ident.: PRO-ABN-CONFIG-Z-00011302.0001001 / 05 AUG 10

- L2 Check that the parking brake handle is in the OFF position. If warning stays on, check that the brake pressure is at zero on the BRAKES PRESSURE indicator.

CONFIG PITCH TRIM NOT IN T.O RANGE

Applicable to: ALL

Ident.: PRO-ABN-CONFIG-AB-00018895.0001001 / 21 MAR 16

ANNUNCIATIONS

Triggering Conditions:

L2

If the PITCH TRIM is not in TO configuration, this alert triggers:

- when thrust levers are set at TO , or Flex TO, or
- when pressing T.O CONFIG pb.

Flight Phase Inhibition:

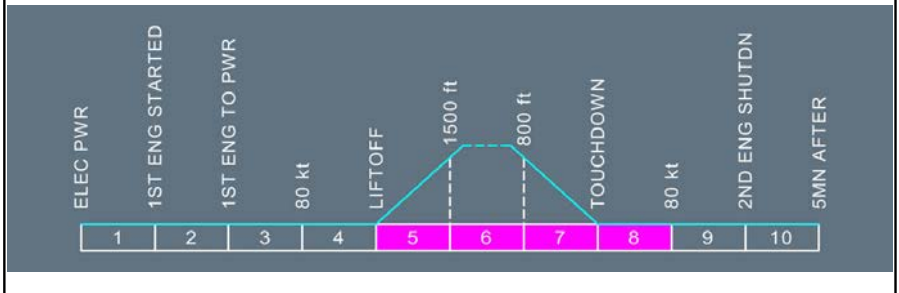

Ident.: PRO-ABN-CONFIG-AB-00011773.0001001 / 25 FEB 14

Crew awareness.

CONFIG RUD TRIM NOT IN T.O RANGE

Applicable to: ALL

Ident.: PRO-ABN-CONFIG-AC-00018896.0001001 / 21 MAR 16

ANNUNCIATIONS

Triggering Conditions:

- L2 If the RUD TRIM is not in TO configuration, this alert triggers:
- when thrust levers are set at TO , or Flex TO, or
 - when pressing T.O CONFIG pb.

Flight Phase Inhibition:

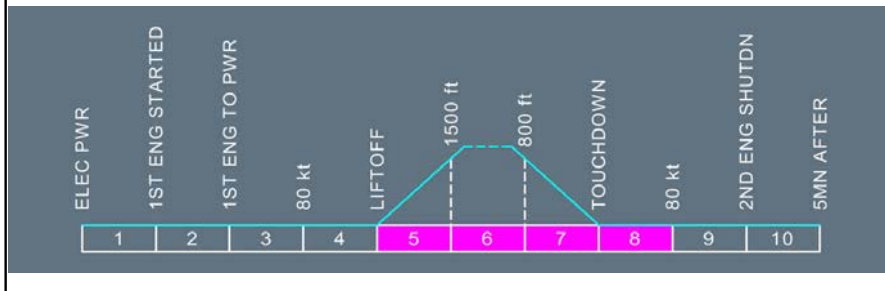

Ident.: PRO-ABN-CONFIG-AC-00011776.0001001 / 25 FEB 14

Crew awareness.

CONFIG SLATS (FLAPS) NOT IN T.O CONFIG

Applicable to: ALL

Ident.: PRO-ABN-CONFIG-AD-00018897.0001001 / 21 MAR 16

ANNUNCIATIONS

Triggering Conditions:

L2

If the slats or flaps are not in TO configuration, this alert triggers:

- when thrust levers are set at TO , or Flex TO, or
- when pressing T.O CONFIG pb.

Flight Phase Inhibition:

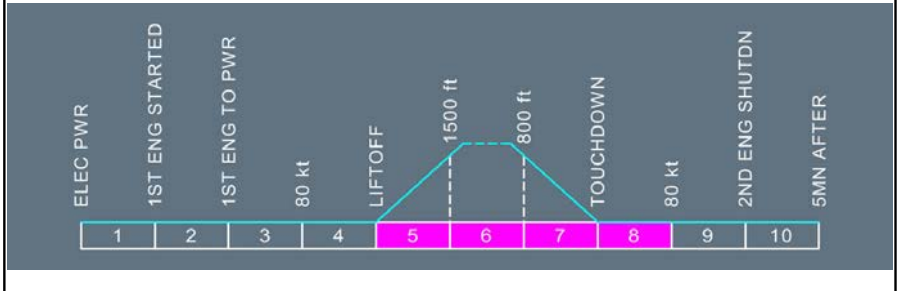

Ident.: PRO-ABN-CONFIG-AD-00011758.0001001 / 25 FEB 14

Crew awareness.

CONFIG SPD BRK NOT RETRACTED

Applicable to: ALL

Ident.: PRO-ABN-CONFIG-AE-00018898.0001001 / 21 MAR 16

ANNUNCIATIONS

Triggering Conditions:

- L2** If the speed brakes are not retracted, this alert triggers:
- when thrust levers are set at TO , or Flex TO, or
 - when pressing T.O CONFIG pb.

Flight Phase Inhibition:

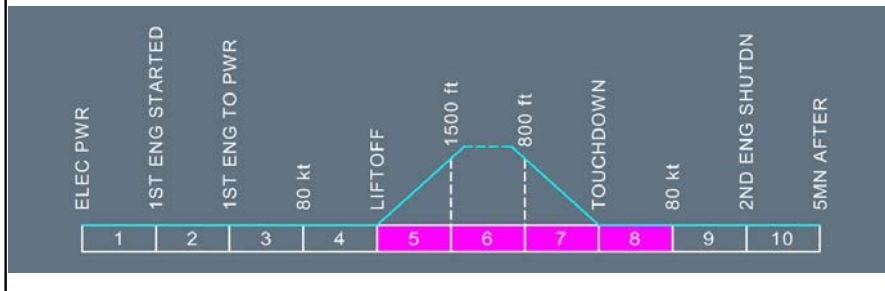

Ident.: PRO-ABN-CONFIG-AE-00011766.0001001 / 09 FEB 16

Crew awareness.

DATALINK ATSU FAULT

Applicable to: ALL

Ident.: PRO-ABN-DATALINK-A-00017150.0001001 / 21 MAR 16

ANNUNCIATIONS

Triggering Conditions:

L2

This alert triggers when there is a failure in ATSU initialization associated with ATSU INIT FAULT ECAM message.

Flight Phase Inhibition:

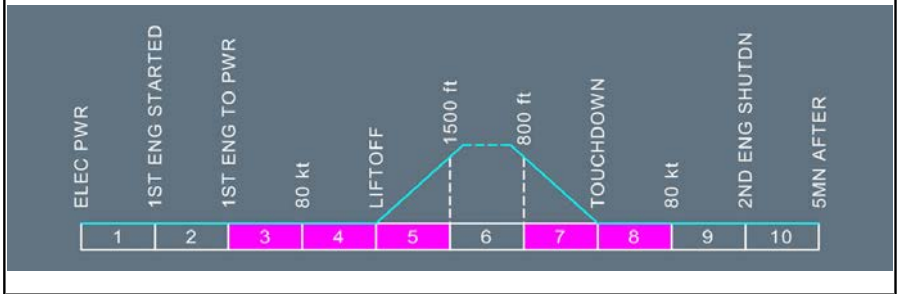

Ident.: PRO-ABN-DATALINK-A-00018462.0001001 / 21 MAR 17

Crew awareness.

ATSU INIT FAULT

L2

Displayed, in case of failure upon ATSU initialization. Refer to DSC-46-10-50 How to Initialize.

Ident.: PRO-ABN-DATALINK-A-00018463.0001001 / 21 MAR 16

STATUS

INOP SYS

ATSU
 DATA COMPANY

DATALINK COMPANY FAULT

Applicable to: ALL

Ident.: PRO-ABN-DATALINK-C-00017151.0001001 / 21 MAR 16

ANNUNCIATIONS

Triggering Conditions:

L2 This alert triggers when there is a failure in the AOC datalink communications.

Flight Phase Inhibition:

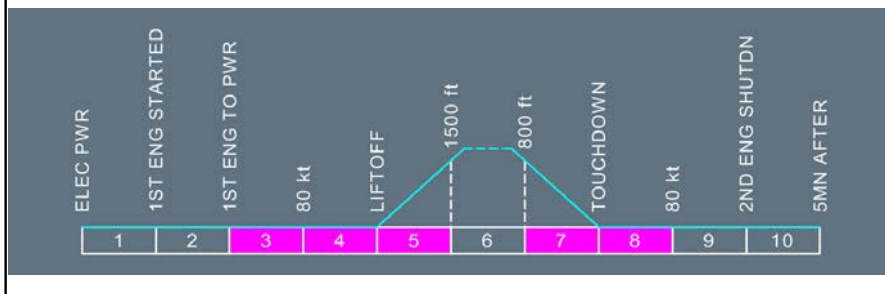

Ident.: PRO-ABN-DATALINK-C-00018458.0001001 / 21 MAR 16

Crew awareness.

Ident.: PRO-ABN-DATALINK-C-00018459.0001001 / 21 MAR 16

STATUS

INOP SYS
DATA COMPANY

[QRH] COCKPIT DOOR FAULT

Ident.: PRO-ABN-DOOR-00009968.0003001 / 17 MAR 17

Applicable to: ALL

CKPT DOOR CONT [OVHD PANEL] CHECK

● **If one or more STRIKE status light on:**

COCKPIT DOOR..... OPEN

COCKPIT DOOR sw UNLOCK 10 s THEN NORM

● **If two or more STRIKE status lights on:**

COCKPIT DOOR NOT INTRUSION PROOF.

● **If two CHAN status lights on:**

Automatic latch release is not available, in case of cockpit decompression.

● **If no status light on:**

TO UNLOCK THE DOOR: COCKPIT DOOR HANDLE AVAIL

DOOR L(R)(FWD)(AFT) AVIONICS
(IN FLIGHT)

Applicable to: ALL

Ident.: PRO-ABN-DOOR-A-00016888.0001001 / 21 MAR 16

ANNUNCIATIONS

Triggering Conditions:

- L2 This alert triggers when the L(R)(FWD)(AFT) avionics door is not detected closed by the proximity sensors.

Flight Phase Inhibition:

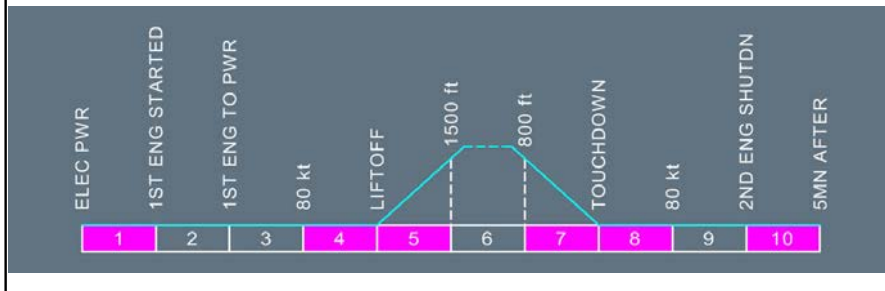

Ident.: PRO-ABN-DOOR-A-00018945.0001001 / 21 MAR 16

- L2 No crew action required as long as cabin pressure is normal.

- L1 ● **IF ABN CAB V/S:**
MAX FL..... 100/MEA

- L2 *Limit maximum flight level to FL 100, or MEA, or minimum obstacle clearance altitude. Avionics doors are of plug type. Therefore full depressurization is not recommended.*

Ident.: PRO-ABN-DOOR-A-00018944.0002001 / 21 MAR 16

STATUS

- **IF ABN CAB V/S:**
MAX FL..... 100/MEA

DOOR L(R)(FWD)(AFT) AVIONICS
(ON GROUND)

Applicable to: ALL

Ident.: PRO-ABN-DOOR-C-00019100.0001001 / 21 MAR 16

ANNUNCIATIONS

Triggering Conditions:

L2

This alert triggers when the L(R)(FWD)(AFT) avionics door is not detected closed by the proximity sensors.

Flight Phase Inhibition:

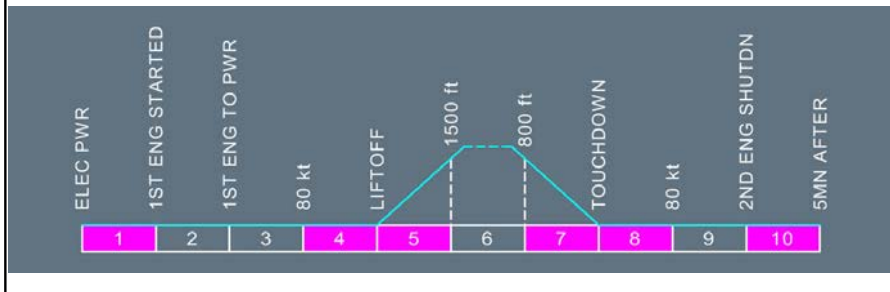

Ident.: PRO-ABN-DOOR-C-00019096.0001001 / 21 MAR 16

Crew awareness.

DOOR L(R) FWD(AFT) CABIN
(IN FLIGHT)

Applicable to: ALL

Ident.: PRO-ABN-DOOR-D-00019103.0001001 / 21 MAR 16

ANNUNCIATIONS

Triggering Conditions:

- L2 This alert triggers when the L(R) FWD(AFT) cabin door is not detected closed by the proximity sensors.

Flight Phase Inhibition:

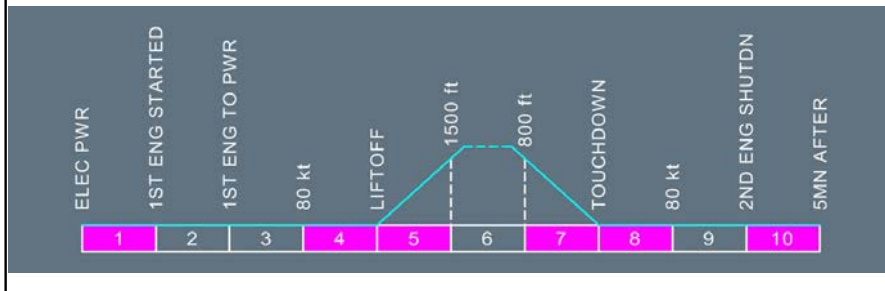

Ident.: PRO-ABN-DOOR-D-00019101.0001001 / 21 MAR 16

No crew action required as long as cabin pressure is normal.

● **IF ABN CAB V/S:**

MAX FL..... 100/MEA

- L2 Limit maximum flight level to FL 100, or MEA, or minimum obstacle clearance altitude. If door warning is accompanied by abnormal increase of cabin altitude, flight crew must reduce cabin ΔP and altitude by descending.

Ident.: PRO-ABN-DOOR-D-00019104.0002001 / 21 MAR 16

STATUS

● **IF ABN CAB V/S:**

MAX FL..... 100/MEA

DOOR L(R) FWD(AFT) CABIN
(ON GROUND)

Applicable to: ALL

Ident.: PRO-ABN-DOOR-E-00019106.0001001 / 21 MAR 16

ANNUNCIATIONS

Triggering Conditions:

L2

This alert triggers when the L(R) FWD(AFT) cabin door is not detected closed by the proximity sensors.

Flight Phase Inhibition:

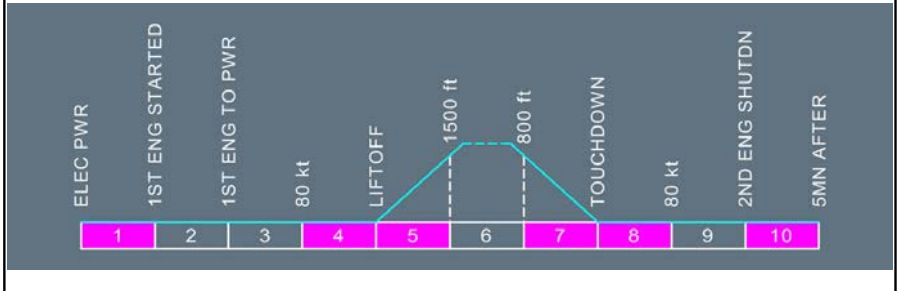

Ident.: PRO-ABN-DOOR-E-00019102.0001001 / 21 MAR 16

L2

The crew may confirm a cabin door warning by checking the visual indicator on the door.

L1

Crew awareness.

DOOR L(R) FWD(AFT) EMER EXIT
(IN FLIGHT)

Applicable to: ALL

Ident.: PRO-ABN-DOOR-F-00019121.0001001 / 21 MAR 16

ANNUNCIATIONS

Triggering Conditions:

- L2 This alert triggers when the L(R) FWD(AFT) emergency exit door is not detected closed by the proximity sensors.

Flight Phase Inhibition:

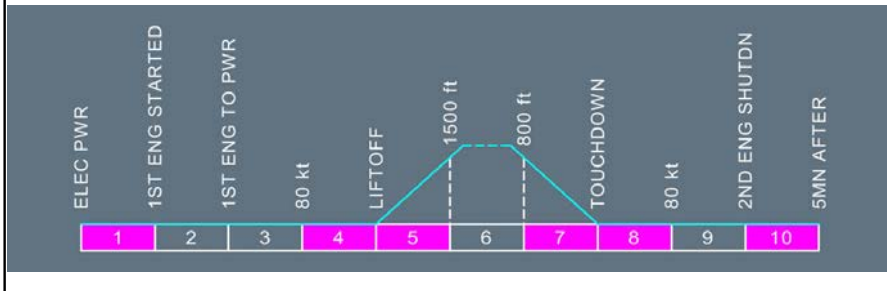

Ident.: PRO-ABN-DOOR-F-00019120.0001001 / 21 MAR 16

No crew action required as long as cabin pressure is normal.

● **IF ABN CAB V/S:**

MAX FL..... 100/MEA

- L2 *Limit maximum flight level to FL 100, or MEA, or minimum obstacle clearance altitude. If door warning is accompanied by abnormal increase of cabin altitude, flight crew must reduce cabin ΔP and altitude by descending.*

Ident.: PRO-ABN-DOOR-F-00019122.0004001 / 21 MAR 16

STATUS

● **IF ABN CAB V/S:**

MAX FL..... 100/MEA

DOOR L(R) FWD(AFT) EMER EXIT
 (ON GROUND)

Applicable to: ALL

Ident.: PRO-ABN-DOOR-G-00019125.0001001 / 21 MAR 16

ANNUNCIATIONS

Triggering Conditions:

L2

This alert triggers when the L(R) FWD(AFT) emergency exit door is not detected closed by the proximity sensors.

Flight Phase Inhibition:

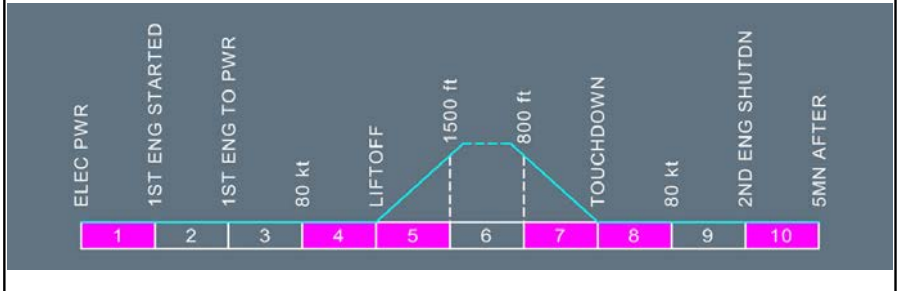

Ident.: PRO-ABN-DOOR-G-00019124.0001001 / 21 MAR 16

L2 The crew may confirm an emergency exit door warning by checking the visual indicator on the door.

L1

Crew awareness.

DOOR FWD(AFT)(BULK) CARGO
 (IN FLIGHT)

Applicable to: ALL

Ident.: PRO-ABN-DOOR-B-00016890.0001001 / 21 MAR 16

ANNUNCIATIONS

Triggering Conditions:

- ② This alert triggers when the FWD(AFT)(BULK) cargo door is not detected closed by the proximity sensors.

Flight Phase Inhibition:

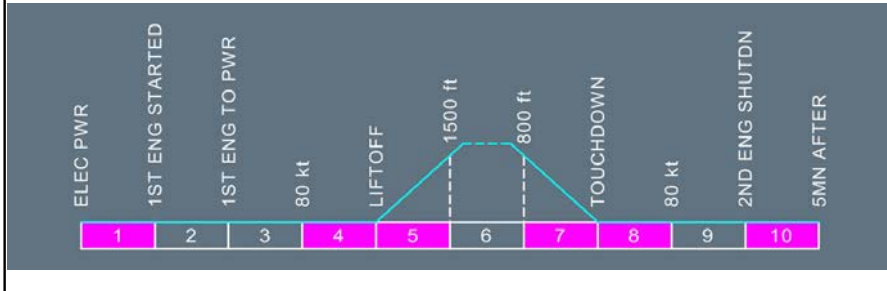

Ident.: PRO-ABN-DOOR-B-00019126.0001001 / 21 MAR 16

No crew action required as long as cabin pressure is normal.

- **IF ABN CAB V/S:**
 MAX FL..... 100/MEA

- ② *Limit maximum flight level to FL 100, or MEA, or minimum obstacle clearance altitude. If door warning is accompanied by abnormal increase of cabin altitude, flight crew must reduce cabin ΔP and altitude by descending.*

Ident.: PRO-ABN-DOOR-B-00018946.0002001 / 21 MAR 16

STATUS

- **IF ABN CAB V/S:**
 MAX FL..... 100/MEA

DOOR FWD(AFT)(BULK) CARGO
(ON GROUND)

Applicable to: ALL

Ident.: PRO-ABN-DOOR-H-00019129.0001001 / 21 MAR 16

ANNUNCIATIONS

Triggering Conditions:

L2

This alert triggers when the FWD(AFT)(BULK) cargo door is not detected closed by the proximity sensors.

Flight Phase Inhibition:

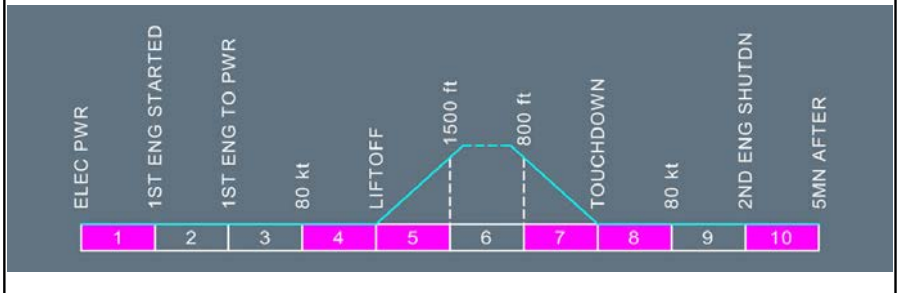

Ident.: PRO-ABN-DOOR-H-00018947.0002001 / 21 MAR 16

L2

The crew may confirm a cargo door warning by checking the indication on the cargo door.

L1

Crew awareness.

PROCEDURES
ABNORMAL AND EMERGENCY PROCEDURES

DOOR

Intentionally left blank

[QRH] DISPLAY UNIT FAILURE

Ident.: PRO-ABN-EIS-00021170.0002001 / 17 MAR 17

Applicable to: ALL

■ **If DU flashes:**

This phenomenon may be due to Intermittent Electrical Power Supply Interruptions. It is evidenced by one, or a combination, of the following :

- Flashing of PFD , ND , ECAM DUs (blank screen or INVALID DATA message),
- Flashing of MCDU,
- Intermittent flight control law reversion.

■ **If captain PFD, ND, ECAM DUs or MCDU 1 affected:**

GEN 1.....OFF

■ **If DUs flash continues :**

GEN 1.....ON

■ **If DUs flash stops :**

KEEP GEN 1 OFF

Keep the generator OFF for the rest of the flight.

RUD TRIM.....CHECK/RESET

Use the slide slip indication to reset the rudder trim if necessary. Intermittent Electrical Power Supply Interruptions may cause offset in the rudder trim.

APU START.....CONSIDER

■ **If first officer PFD, ND, lower ECAM or MCDU 2 affected:**

GEN 2.....OFF

■ **If DUs flash continues:**

GEN 2.....ON

■ **If DUs flash stops:**

KEEP GEN 2 OFF

Keep the generator OFF for the rest of the flight.

RUD TRIM.....CHECK/RESET

Use the slide slip indication to reset the rudder trim if necessary. Intermittent Electrical Power Supply Interruptions may cause offset in the rudder trim.

APU START.....CONSIDER

■ **If DU blank (with or without large amber “F”), or distorted:**

DU brightness knob (affected DU)..... AS RQRD

Continued on the following page

[QRH] DISPLAY UNIT FAILURE (Cont'd)

The DU can be switched off.

CONSIDER ECAM/ND XFR

CONSIDER PFD/ND XFR

■ **If INVALID DISPLAY UNIT message displayed:**

This may be caused by a DU failure.

WAIT AT LEAST 40 s FOR AUTOMATIC DU RECOVERY

● **If DU not recovered:**

DU brightness knob..... AS RQRD

The DU can be switched off.

■ **If INVALID DATA message displayed (not on all DUs):**

CONSIDER EIS DMC SWITCHING

● **If unsuccessful:**

DU brightness knob (affected DU)..... OFF THEN ON

Note: The ND display may disappear if too many waypoints and associated information are displayed. Reduce ND range, or deselect WPT or CSTR, and the ND display may automatically recover, after about 30 s.

■ **If INVALID DATA message displayed on all DUs:**

AP, A/THR AND MCDU NAVIGATION DATA AVAILABLE

WAIT AT LEAST 40 s FOR AUTOMATIC DU RECOVERY

● **If one or more DUs not recovered:**

DUs brightness knob (all affected DUs)..... OFF

WAIT AT LEAST 40 s

DUs brightness knob (one by one)..... ON

● **If INVALID DATA message displayed on all DUs, when switching a given DU back ON:**

FAULTY DU brightness knob..... OFF AND KEEP OFF

REPEAT PROCEDURE

Repeat the procedure starting at: If INVALID DATA message displayed on all DUs.

■ **If inversion of E/WD and SD:**

ECAM UPPER DISPLAY brightness knob..... OFF THEN ON

The same action on the EIS DMC SWITCHING selector produces the same effect.

EIS DMC 1(2)(3) FAULT

Applicable to: ALL

Ident.: PRO-ABN-EIS-F-00017307.0002001 / 21 MAR 16

ANNUNCIATIONS

Triggering Conditions:

L2 This alert triggers when DMC 1, or DMC 2, or DMC 3 is failed.

Flight Phase Inhibition:

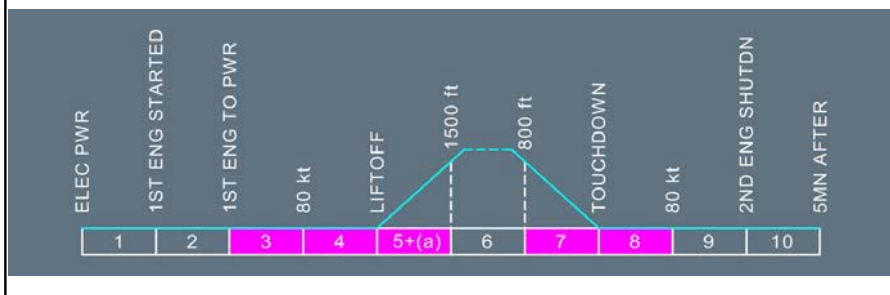

L1 Note: (a) Inhibited only during first 15 s of Flight Phase 5.

Ident.: PRO-ABN-EIS-F-00010057.0002001 / 10 AUG 10

■ **DMC 1**
EIS DMC SWITCH CAPT 3

L2 DMC 3 replaces DMC 1.

L1 ■ **DMC 2**
EIS DMC SWITCH..... F/O 3

L2 DMC 3 replaces DMC 2.

L1 ■ **DMC 3**
Crew awareness.

Continued on the following page

EIS DMC 1(2)(3) FAULT (Cont'd)

Ident.: PRO-ABN-EIS-F-00010058.0001001 / 10 AUG 10

STATUS

INOP SYS

DMC 1(2)(3)

EIS DMC/FWC COM FAULT

Applicable to: ALL

Ident.: PRO-ABN-EIS-I-00017317.0002001 / 21 MAR 16

ANNUNCIATIONS

Triggering Conditions:

- [L2] This alert triggers when at least one of the FWC detects the loss of both DMC 1/3 and DMC2/3 busses.

Flight Phase Inhibition:

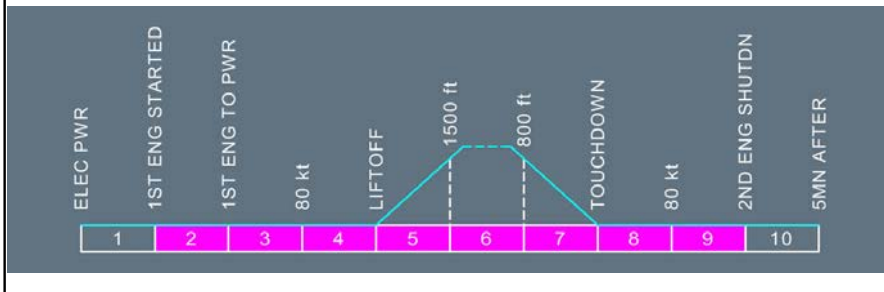

Ident.: PRO-ABN-EIS-I-00014308.0001001 / 25 FEB 14

Crew awareness.

[QRH] C/B TRIPPED

Ident.: PRO-ABN-ELEC-00012643.0001001 / 17 MAR 17

Applicable to: ALL

■ **On ground:**

Do not reengage the circuit breaker (C/B) of the fuel pump(s) of any tank. For all other C/B , if the flight crew coordinates the action with maintenance, the flight crew may reengage a tripped C/B, provided that the cause is identified.

■ **In flight:**

Do not reengage a circuit breaker (C/B), unless the captain judges it necessary to do so for the safe continuation of the flight. Only one reengagement should be attempted.

PROCEDURES
ABNORMAL AND EMERGENCY PROCEDURES

ELEC

[QRH] ELEC EMER CONFIG SYS REMAINING

Applicable to: ALL

| ELEC EMER CONFIG SYS REMAINING | EMER GEN RUNNING | BAT ONLY | |
|--------------------------------|------------------|-----------|---------------|
| | | IN FLIGHT | ON THE GROUND |

Ident.: PRO-ABN-ELEC-S-00018562.0004001 / 17 MAR 17

| | | | | |
|---------------------|------------------|--------------|--------------|-----------------------------|
| AIR COND PRESS | PRESS AUTO SYS 1 | NORM | NORM | NORM |
| | MAN PRESS CTL | INOP | INOP | INOP ^(a) |
| | RAM AIR | NORM | NORM | NORM |
| | PACK VALVE 1 | NORM | Closure Inop | Closure Inop |
| | PACK VALVE 2 | Closure Inop | Closure Inop | Closure Inop ^(a) |
| | AVIONIC VENT | NORM | NORM | Partial |
| FWD CRG ISOL VALVES | NORM | INOP | INOP | |

Ident.: PRO-ABN-ELEC-S-00012522.0001001 / 17 MAR 17

| | | | | |
|------|---------------------|-----------|-----------|-----------|
| FMGS | FMGC (NAV FUNCTION) | N°1 only | Inop | Inop |
| | MCDU | N°1 only | Inop | Inop |
| | FAC | N°1 only | Inop | Inop |
| | FCU | ch 1 only | ch 1 only | ch 1 only |

Ident.: PRO-ABN-ELEC-S-00018533.0002001 / 17 MAR 17

| | | | | |
|---------------|------------------|------|------|------|
| COM | VHF 1 | NORM | NORM | NORM |
| | HF 1 | NORM | INOP | INOP |
| | RMP 1 | NORM | NORM | NORM |
| | ACP (CAPT , F/O) | NORM | NORM | NORM |
| | CIDS | NORM | NORM | NORM |
| | INTERPHONE | NORM | NORM | NORM |
| | CVR | NORM | INOP | INOP |
| LOUDSPEAKER 1 | NORM | NORM | NORM | |

Ident.: PRO-ABN-ELEC-S-00012524.0001001 / 17 MAR 17

| | | | | |
|-----------|--------------------------------------|------|---------------------|---------------------|
| EMER EQPT | CREW OXY | NORM | NORM ^(b) | NORM ^(b) |
| | PAX OXY mask release (auto + man) | NORM | INOP | INOP |
| | SLIDES ARM/WARN | NORM | NORM | NORM |

Continued on the following page

Continued from the previous page

| ELEC EMER CONFIG SYS REMAINING | EMER GEN RUNNING | BAT ONLY | |
|--------------------------------|------------------|-----------|---------------|
| | | IN FLIGHT | ON THE GROUND |

Ident.: PRO-ABN-ELEC-S-00012525.0002001 / 17 MAR 17

| FIRE | ENG 1 LOOP | A only | A only | A only |
|------|-----------------|---------------|---------------|---------------------|
| | ENG 2 LOOP | B only | B only | B only |
| | APU LOOP | INOP | INOP | INOP ^(a) |
| | CARGO SMOKE DET | ch 1 only | INOP | INOP |
| | ENG FIRE EXT. | Bottle 1 only | Bottle 1 only | Bottle 1 only |
| | APU FIRE EXT. | Squib A only | Squib A only | Squib A only |
| | CARGO FIRE EXT. | INOP | INOP | INOP ^(a) |
| | APU AUTO EXT. | INOP | INOP | INOP ^(a) |

Ident.: PRO-ABN-ELEC-S-00018017.0001001 / 17 MAR 17

| FLT CTL | ELAC | N°1 only | N°1 + N°2 | N°1 + N°2 ^(d) |
|---------|---------------|----------|-----------|--------------------------|
| | SEC | N°1 only | N°1 only | N°1 only |
| | FCDC | N°1 only | INOP | INOP |
| | SFCC | N°1 only | N°1 only | N°1 only |
| | Flaps pos ind | NORM | NORM | NORM ^(e) |

Ident.: PRO-ABN-ELEC-S-00018018.0001001 / 17 MAR 17

| FUEL | LP VALVE | NORM | NORM | NORM |
|------|--------------------------|------|------|------|
| | FQI channel 1 | NORM | INOP | INOP |
| | X FEED VALVE | NORM | INOP | INOP |
| | INTERTANK TRANSFER VALVE | NORM | INOP | INOP |

Ident.: PRO-ABN-ELEC-S-00012528.0001001 / 17 MAR 17

| HYD | FIRE VALVES | NORM | NORM | NORM |
|-----|-------------|------|------|------|
|-----|-------------|------|------|------|

Ident.: PRO-ABN-ELEC-S-00018539.0002001 / 17 MAR 17

| ICE-RAIN | WING A.ICE | NORM | INOP | INOP |
|----------|---|------|------|---------------------|
| | ENG A.ICE VALVE | OPEN | OPEN | OPEN |
| | CAPT PITOT | NORM | NORM | NORM ^(c) |
| | CAPT AOA | NORM | INOP | INOP |
| | RAIN REPELLENT (CAPT)  | NORM | NORM | NORM |

Continued on the following page

PROCEDURES
ABNORMAL AND EMERGENCY PROCEDURES

A318/A319/A320/A321
FLIGHT CREW
OPERATING MANUAL

ELEC

Continued from the previous page

| ELEC EMER CONFIG SYS REMAINING | EMER GEN RUNNING | BAT ONLY | |
|--------------------------------|------------------|-----------|---------------|
| | | IN FLIGHT | ON THE GROUND |

Ident.: PRO-ABN-ELEC-S-00018538.0002001 / 17 MAR 17

| | | | | |
|---------|------------------|------|------|---------------------|
| EIS | PFD 1 | NORM | NORM | NORM ^(c) |
| | ND 1 | NORM | INOP | INOP |
| | ECAM upper disp. | NORM | NORM | NORM ^(c) |
| | DMC 1 or 3 | NORM | NORM | NORM ^(c) |
| | SDAC 1, FWC 1 | NORM | NORM | NORM ^(c) |
| | ECAM CONT. panel | NORM | NORM | NORM |
| FLT INS | CLOCKS | NORM | NORM | NORM |



Ident.: PRO-ABN-ELEC-S-00018537.0002001 / 17 MAR 17

| | | | | |
|-----|---------------|------|------|------|
| L/G | LGCIU SYS 1 | NORM | NORM | NORM |
| | BRK PRESS IND | NORM | NORM | NORM |
| | PARK BRK | NORM | NORM | NORM |
| | ABCU | NORM | NORM | NORM |

Ident.: PRO-ABN-ELEC-S-00012532.0001001 / 17 MAR 17

| | | | | |
|--------|-----------|------|------|------|
| LIGHTS | EMER CKPT | NORM | NORM | NORM |
| | EMER CAB | NORM | NORM | NORM |

Ident.: PRO-ABN-ELEC-S-00018550.0005001 / 17 MAR 17

| | | | | |
|-----|---|-------------------------|-------------------------|-------------------------|
| NAV | IR | N°1 only ^(e) | N°1 only ^(e) | N°1 only ^(e) |
| | ADR | N°1 only | N°1 only | N°1 only |
| | ADF  | N°1 only | INOP | INOP |
| | VOR | N°1 only | N°1 only | N°1 only ^(c) |
| | MMR | N°1 only | N°1 only | N°1 only ^(c) |
| | DME | N°1 only | INOP | INOP |
| | DDRMI  | NORM | NORM | NORM ^(c) |
| | ATC | N°1 only | INOP | INOP |
| | ISIS | NORM | NORM | NORM |

Ident.: PRO-ABN-ELEC-S-00018541.0002001 / 17 MAR 17

| | | | | |
|------|-------------------|------------|------------|---------------------|
| PNEU | ENG 1 BLEED | NORM | BMC 1 INOP | BMC 1 INOP |
| | ENG 2 BLEED | BMC 2 INOP | BMC 2 INOP | BMC 2 INOP |
| | APU BLEED | INOP | INOP | INOP ^(a) |
| | X BLEED (MAN CTL) | NORM | INOP | INOP |

Continued on the following page

| | |
|---|---|
|  A318/A319/A320/A321 FLIGHT CREW OPERATING MANUAL | PROCEDURES ABNORMAL AND EMERGENCY PROCEDURES ELEC |
|---|---|

Continued from the previous page

| ELEC EMER CONFIG SYS REMAINING | EMER GEN RUNNING | BAT ONLY | |
|--------------------------------|------------------|-----------|---------------|
| | | IN FLIGHT | ON THE GROUND |

Ident.: PRO-ABN-ELEC-S-00018019.0002001 / 17 MAR 17

| | | | | |
|-----|---------------|---------------------|---------------------|---------------------|
| APU | ECB-STARTER | NORM ^(f) | NORM ^(g) | INOP ^(a) |
| | FUEL LP VALVE | NORM | NORM | NORM |
| | FUEL PUMP | NORM | NORM | NORM |

Ident.: PRO-ABN-ELEC-S-00018540.0002001 / 17 MAR 17

| | | | | |
|---------|-----------------------|--------------------|--------------------|--------------------|
| PWR PLT | FADEC | A+B ^(h) | A+B ^(h) | A+B ^(h) |
| | IGNITION | A only | A only | A only |
| | HP FUEL VALVE closure | NORM | NORM | NORM |

Ident.: PRO-ABN-ELEC-S-00012537.0001001 / 17 MAR 17

| | | | | |
|------|-----------|------|------|------|
| MISC | MECH HORN | NORM | NORM | NORM |
|------|-----------|------|------|------|

- (a) Restored, when speed is below 100 kt.
- (b) Crew supply solenoid valve inoperative.
- (c) Lost, when the speed is below 50 kt.
- (d) Lost, 30 s after the last engine shutdown.
- (e) IR 2 and IR 3 are lost 5 min after failure of main generators but if IR 3 replaces IR 1 (ATT -HDG selector at CAPT 3), IR 3 remains supplied.
- (f) For APU start only.
- (g) Not available for 45 s, after the loss of both engine generators.
- (h) Channels A and B are self powered above 10 % N2 for IAE or PW engines, 12 % N2 for CFM56 engines, or 8 % N2 for CFM LEAP-1A engines. If N2 is below these values, only Channel A is powered.

ELEC AC BUS 1 FAULT

Applicable to: ALL

Ident.: PRO-ABN-ELEC-I-00017346.0001001 / 21 MAR 16

ANNUNCIATIONS

Triggering Conditions:

L2 This alert triggers when the AC 1 busbar is not supplied.

Flight Phase Inhibition:

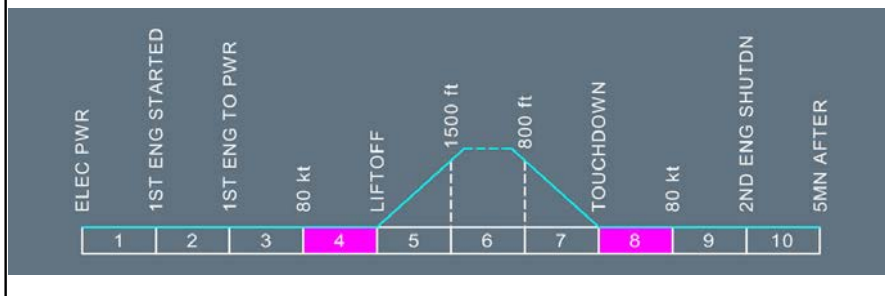

Continued on the following page

ELEC AC BUS 1 FAULT (Cont'd)

Ident.: PRO-ABN-ELEC-I-00017853.0004001 / 21 MAR 16

L2 AC BUS 1 normally supplies the AC ESS BUS and, through TR1, the DC ESS BUS. In the case of an AC BUS 1 FAULT, both the AC and DC ESS BUS will be lost and therefore the AC ESS BUS FAULT and the DC ESS BUS FAULT will be displayed on the ECAM.

However, for aircraft equipped with AC ESS FEED Auto Switching , the AC ESS BUS and the DC ESS BUS will automatically recover, due to the fact that the AC BUS 2 will automatically supply the AC ESS BUS.

The flight crew can manually recover the AC ESS BUS and the DC ESS BUS by setting the AC ESS FEED pb-sw to ALTN, as requested by the AC ESS BUS FAULT ECAM procedure

L1 **BLOWER**..... **OVRD**

L2 *The avionics ventilation system is in the closed circuit configuration.
 Air conditioning is added to the ventilation air.*

L1 **FUEL CONSUMPT INCRSD**
FMS PRED UNRELIABLE

L12

ASSOCIATED PROCEDURES

ENG 1 EPR MODE FAULT

*This associated procedure is only applicable to aircraft equipped with IAE engines.
 Refer to PRO-ABN-ENG ENG 1(2) EPR MODE FAULT (First Threshold).*

SECONDARY FAILURES

- * AVNCS VENT
- * HYD
- * FUEL
- * F/CTL

Continued on the following page

ELEC AC BUS 1 FAULT (Cont'd)

Ident.: PRO-ABN-ELEC-I-00017867.0028001 / 22 MAR 17

L12

STATUS

INOP SYS

See below

LDG DIST PROC..... APPLY

FUEL CONSUMPT INCRSD

See ⁽¹⁾

FMS PRED UNRELIABLE

See ⁽²⁾

SLATS SLOW

CAT 2 ONLY

INOP SYS

BLUE HYD

RA 1

L WNDW HEAT

CTR TK PUMP 1 

CRG HEAT (if both FWD and aft crg
heat installed) 

FWD CRG HEAT 

GND COOL 

BRK SYS 1/BSCU CH 1

LAV DET

STEEP APPR 

SPLR 3

CAPT TAT

CAT 3

VENT BLOWER

CRG vent (if both FWD and aft crg
heat installed) 

AFT CRG VENT 

MAIN GALLEY

DMC 3

REVERSER 1

ADR 3

L WSHLD HEAT

L+R TK PUMP 1

GALLEY FAN

AFT CRG HEAT 

FWD CRG VENT 

B ELEC PUMP

GPWS

GPWS TERR 

Other INOP SYS

Left cabin fan

ADF 1 

HUD 

EVMU eng 1 and eng 2

Hydraulic quantity indication

TCAS 

Radar 1

ACARS  /ATSU 

MCDU 3 

Printer

Partial galley

Stby Pitot/AOA

Brake fans 5, 6, 7 and 8 

Engine 1 ignition B

COND Controller Lane A

PVI 

Continued on the following page

ELEC AC BUS 1 FAULT (Cont'd)

Note: The warning may be caused by a sub BUS failure. Consequently, only a part of the above-listed systems may be lost.

- (1) This message is triggered when the failure (or combination of failures) affects the nominal aerodynamic characteristics of the aircraft.
- (2) Disregard FMS fuel predictions and refer to QRH/OPS Operational Data- Fuel Penalty Factors Tables in order to find the applicable Fuel Penalty Factor.

ELEC AC BUS 2 FAULT

Applicable to: ALL

Ident.: PRO-ABN-ELEC-J-00017348.0001001 / 21 MAR 16

ANNUNCIATIONS

Triggering Conditions:

L2

This alert triggers when the AC 2 busbar is not supplied.

Flight Phase Inhibition:

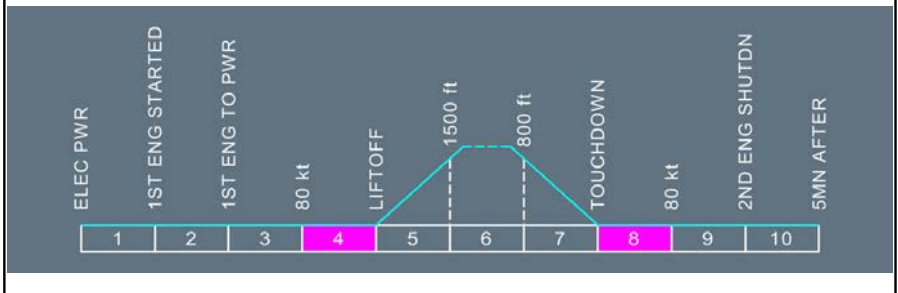

Continued on the following page

ELEC AC BUS 2 FAULT (Cont'd)

Ident.: PRO-ABN-ELEC-J-00017877.0002001 / 21 MAR 16

EXTRACT.....OVRD

L2 The avionics ventilation system is in the closed circuit configuration.
 Air conditioning is added to the ventilation air.

L1 ATC/XPDR.....SYS 1

————— ASSOCIATED PROCEDURES —————

L/G LGCIU 2 FAULT

L12

————— ASSOCIATED PROCEDURES —————

ENG 2 EPR MODE FAULT

*This associated procedure is only applicable to aircraft equipped with IAE engines.
 Refer to PRO-ABN-ENG ENG 1(2) EPR MODE FAULT (First Threshold).*

SECONDARY FAILURES

- * AVNCS VENT
- * FUEL

Continued on the following page

ELEC AC BUS 2 FAULT (Cont'd)

Ident.: PRO-ABN-ELEC-J-00017878.0005001 / 22 MAR 17

L12

STATUS



ENG 2 APPR IDLE ONLY
FLS  : F-APP+RAW ONLY

INOP SYS

See below

INOP SYS



ADR 2
FWC 2
R WSHLD HEAT
F/O PITOT
R WNDW HEAT
REVERSER 2
PACK 2 REGUL
RUD TRIM 2
CTR TK PUMP 2 
ILS 2 (OR LS 2 for aircraft equipped
with MLS  /GLS  /FLS )
GLS AUTOLAND 



Y ELEC PUMP
DMC 2
LGCIU 2
F/O AOA
L+R TK PUMP 2
VENT EXTRACT
MAIN GALLEY
FAC 2
ACT PUMP 
GPS 2 
ROW/ROP 

SDAC 2
RECORDER SYS (OR FDIU)
RA 2
F/O TAT
RUD TRV LIM 2
GND COOL 
YAW DAMPER 2
CAT 2
BRK SYS 2 /BSCU CH 2
ATC 2 or ATC/XPDR 2

Other INOP SYS

Right cabin fan
DME 2
MCDU 2
F/O PFD and ND
HF 2 

Brake fans 1, 2, 3 and 4 
RADAR 2 
ENG 2 ignition B
QAR

ADF 2 
WXR 2 
VOR 2
ECAM lower DU

Note: The warning may be caused by a sub BUS failure. Consequently, only a part of the above-listed systems may be lost.

ELEC AC ESS BUS ALTN

Applicable to: ALL

Ident.: PRO-ABN-ELEC-Z-00017356.0001001 / 21 MAR 16

ANNUNCIATIONS

Triggering Conditions:

- L2 This alert triggers when the AC ESS busbar is supplied from the AC 2 busbar although the AC ESS FEED pb-sw is set to normal.

Flight Phase Inhibition:

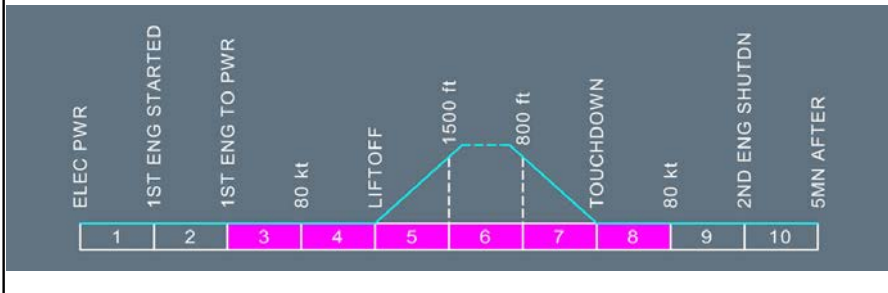

Ident.: PRO-ABN-ELEC-Z-00017893.0001001 / 21 MAR 16

Crew awareness.

ELEC AC ESS BUS FAULT

Applicable to: ALL

Ident.: PRO-ABN-ELEC-K-00017357.0001001 / 21 MAR 16

ANNUNCIATIONS

Triggering Conditions:

L2

This alert triggers when the AC ESS busbar is not supplied.

Flight Phase Inhibition:

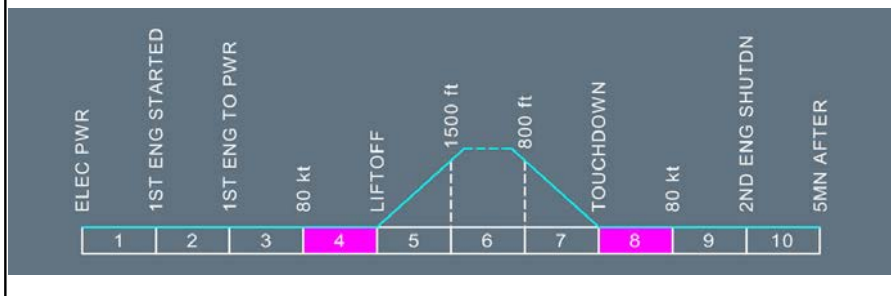

Ident.: PRO-ABN-ELEC-K-00012502.0002001 / 24 MAR 11

AC ESS FEED..... ALTN

L2 AC BUS 2 supplies AC ESS BUS.

L1 ATC/XPDR..... SYS 2

Continued on the following page

ELEC AC ESS BUS FAULT (Cont'd)

Ident.: PRO-ABN-ELEC-K-00018552.0014001 / 01 JUN 16

L12

STATUS

INOP SYS

See below

INOP SYS

ADR 1
 CAPT PITOT
 SDAC 1
 GPWS
 RUD TRIM 1
 ATC 1 or ATC/XPDR 1

LS 1
 CAPT AOA
 FWC 1
 GPWS terr
 RUD TRV LIM 1
 ROW/ROP 

GPS 1
 CAT 2
 DMC 1
 YAW DAMPER 1
 GLS AUTOLAND 

Other INOP SYS

RMP's lighting (RMP's still operative)
 CVR
 CAPT PFD
 DDRMI 

VOR 1
 ECAM upper display
 DME 1
 HF 1

MCDU 1
 CAPT ND
 APU fuel pump
 Passenger oxygen masks (auto + manual)

Note: *The warning may be caused by a sub BUS failure. As a result, only a part of the above-listed systems may be lost.*

ELEC AC ESS BUS SHED

Applicable to: ALL

Ident.: PRO-ABN-ELEC-L-00017349.0001001 / 21 MAR 16

ANNUNCIATIONS

Triggering Conditions:

L2

This alert triggers when the AC SHED ESS busbar is not supplied.

Flight Phase Inhibition:

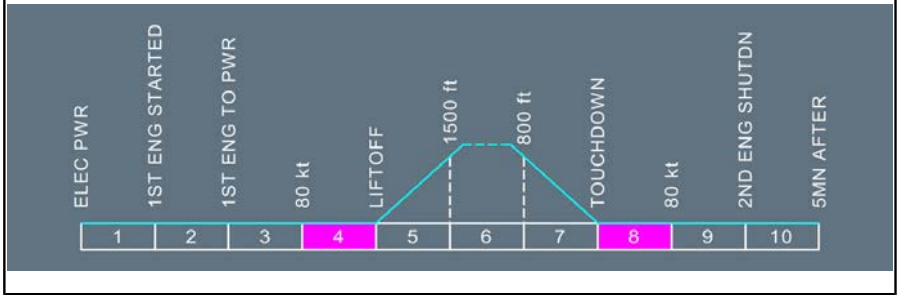

Ident.: PRO-ABN-ELEC-L-00012504.0002001 / 03 DEC 13

ATC/XPDR..... SYS 2

Continued on the following page

PROCEDURES
ABNORMAL AND EMERGENCY PROCEDURES

ELEC

ELEC AC ESS BUS SHED (Cont'd)

Ident.: PRO-ABN-ELEC-L-00018554.0004001 / 21 MAR 16

L12

STATUS

INOP SYS

CAPT AOA
ATC 1 or ATC/XPDR 1
See below

Other INOP SYS

MCDU 1
CVR
Passenger oxygen masks (auto
+ manual)
DME 1
CAPT AOA heat
APU fuel pump
CAPT ND
HF 1

Note: The warning may be caused by a failure in a sub BUS. Consequently only a part of the systems listed above may be lost.

ELEC APU GEN FAULT

Applicable to: ALL

Ident.: PRO-ABN-ELEC-E-00017362.0001001 / 21 MAR 16

ANNUNCIATIONS

Triggering Conditions:

L2

This alert triggers when:

- The protection trip is initiated by the associated GCU, or
- The line contactor is open with APU GEN pb-sw set to ON.

Flight Phase Inhibition:

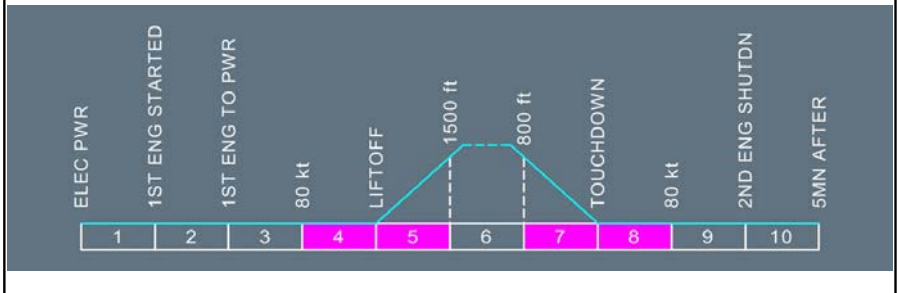

Ident.: PRO-ABN-ELEC-E-00012490.0002001 / 18 MAR 11

APU GEN..... OFF THEN ON

● IF UNSUCCESSFUL:

APU GEN..... OFF

Continued on the following page

ELEC APU GEN FAULT (Cont'd)

Ident.: PRO-ABN-ELEC-E-00012491.0001001 / 18 MAR 11

STATUS

INOP SYS

MAIN GALLEY ⁽¹⁾
APU GEN

⁽¹⁾ (When only one GEN operating)

ELEC BAT 1(2) FAULT

Applicable to: ALL

Ident.: PRO-ABN-ELEC-F-00017367.0001001 / 21 MAR 16

ANNUNCIATIONS

Triggering Conditions:

^[2] This alert triggers when the charging current increases at an abnormal rate.

Flight Phase Inhibition:

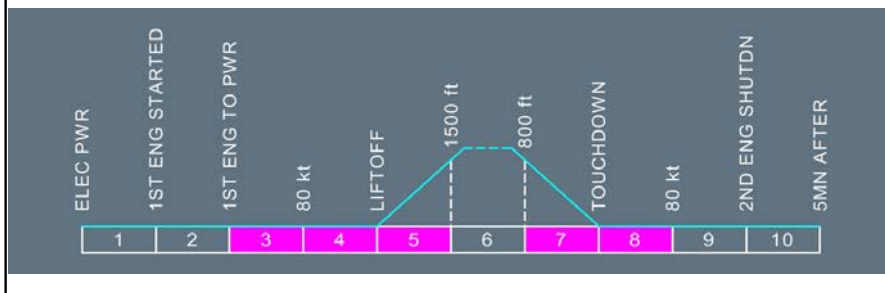

Ident.: PRO-ABN-ELEC-F-00017894.0001001 / 21 MAR 16

^[2] Battery contactor is opened automatically by the battery charge limiter.

^[1] Crew awareness.

Continued on the following page

ELEC BAT 1(2) FAULT (Cont'd)

Ident.: PRO-ABN-ELEC-F-00017895.0001001 / 21 MAR 16

STATUS

APU BAT START NOT AVAIL

INOP SYS

BAT 1(2)

ELEC BAT 1(2) OFF

Applicable to: ALL

Ident.: PRO-ABN-ELEC-G-00017371.0001001 / 21 MAR 16

ANNUNCIATIONS

Triggering Conditions:

L2

This alert triggers when the BAT 1(2) pb-sw is set to OFF and no failure is detected.

Flight Phase Inhibition:

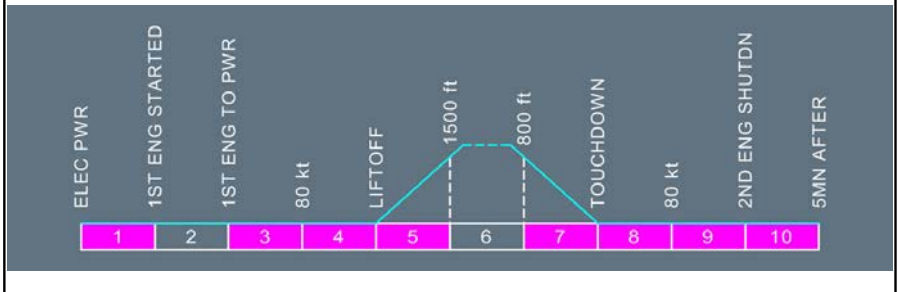

Ident.: PRO-ABN-ELEC-G-00018943.0001001 / 21 MAR 16

Crew awareness.

Continued on the following page

ELEC BAT 1(2) OFF (Cont'd)

Ident.: PRO-ABN-ELEC-G-00012495.0001001 / 19 AUG 10

STATUS

APU BAT START NOT AVAIL

ELEC BCL 1(2) FAULT

Applicable to: ALL

Ident.: PRO-ABN-ELEC-H-00017377.0001001 / 21 MAR 16

ANNUNCIATIONS

Triggering Conditions:

[L2] This alert triggers when the battery charge limiter 1(2) is failed.

Flight Phase Inhibition:

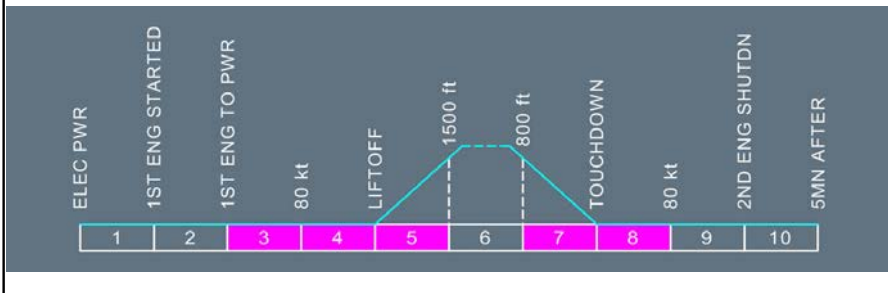

Ident.: PRO-ABN-ELEC-H-00012496.0001001 / 25 FEB 14

Crew awareness.

Continued on the following page

ELEC BCL 1(2) FAULT (Cont'd)

Ident.: PRO-ABN-ELEC-H-00012497.0001001 / 19 AUG 10

STATUS

APU BAT START NOT AVAIL

INOP SYS

BCL 1(2)

ELEC DC BAT BUS FAULT

Applicable to: ALL

Ident.: PRO-ABN-ELEC-W-00017358.0001001 / 21 MAR 16

ANNUNCIATIONS

Triggering Conditions:

L2

This alert triggers when the DC BAT busbar is not supplied.

Flight Phase Inhibition:

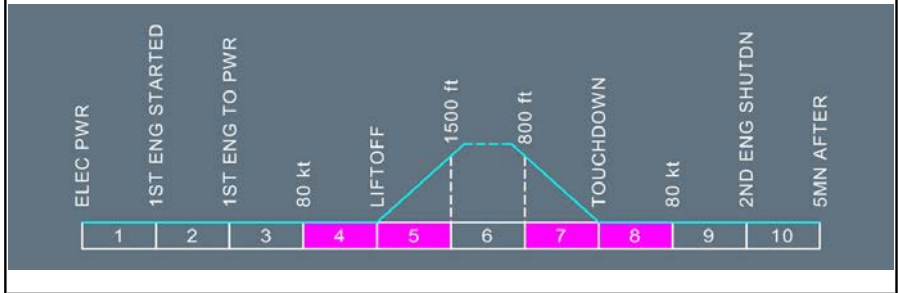

Ident.: PRO-ABN-ELEC-W-00012545.0001001 / 22 MAR 16

Crew awareness.

Continued on the following page

ELEC DC BAT BUS FAULT (Cont'd)

Ident.: PRO-ABN-ELEC-W-00012546.0021001 / 21 MAR 16

L12



APU BAT START NOT AVAIL
ECB is no longer supplied

STATUS

INOP SYS

APU FIRE DET

Other INOP SYS

APU ECB
Stick and rudder pedals lock
(by AP)
Forward (aft) cargo fire
extinguishing 
Forward (aft) cargo heat
controller 
AFT Cargo isol valves 
APU fuel LP valve
Manual pressure control

Note: *The warning may
be caused by a
sub BUS failure.
Consequently,
only a part of
the above-listed
systems may be
lost.*

ELEC DC BUS 1 FAULT

Applicable to: ALL

Ident.: PRO-ABN-ELEC-M-00017350.0001001 / 21 MAR 16

ANNUNCIATIONS

Triggering Conditions:

L2

This alert triggers when the DC 1 busbar is not supplied.

Flight Phase Inhibition:

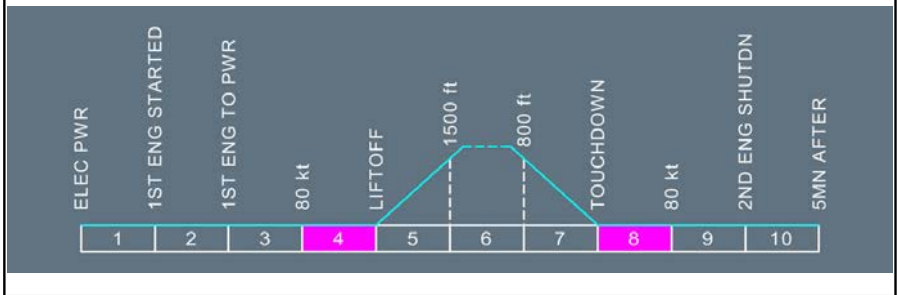

Ident.: PRO-ABN-ELEC-M-00012507.0001001 / 15 DEC 15

BLOWER..... OVRD
 EXTRACT..... OVRD

L2

The Air conditioning system provides ventilation to the avionics. This ventilation air is exhausted overboard.

L1

SECONDARY FAILURES

*AVNCS VENT

Continued on the following page

ELEC DC BUS 1 FAULT (Cont'd)

Ident.: PRO-ABN-ELEC-M-00018555.0012001 / 22 MAR 17

L12

STATUS

INOP SYS

See below

CAT 3 SINGLE ONLY

INOP SYS



ACP 3
 L. WSHLD HEAT
 AVNCS VENT
 REVERSER 1
 CAT 3 DUAL

CAPT STAT heat
 L. WNDW HEAT
 GALLEY FAN
 BRAKES SYS 1

STBY STAT heat
 CTR TK PUMP 1 
 GND COOL 
 LAV DET

Other INOP SYS

Left cab fan
 CFDIU
 L CTR TK XFR valve 
 Eng 1 oil press and qty ind.

COND controller lane A
 VHF 3 
 Hot air
 TPIS 

Sel cal
 RMP 3 
 Capt wiper
 Brake temps ind.

Note: The warning may be caused by a sub BUS failure. Consequently, only a part of the above-listed systems may be lost.

ELEC DC BUS 2 FAULT

Applicable to: ALL

Ident.: PRO-ABN-ELEC-N-00017352.0001001 / 21 MAR 16

ANNUNCIATIONS

Triggering Conditions:

L2 This alert triggers when the DC 2 busbar is not supplied.

Flight Phase Inhibition:

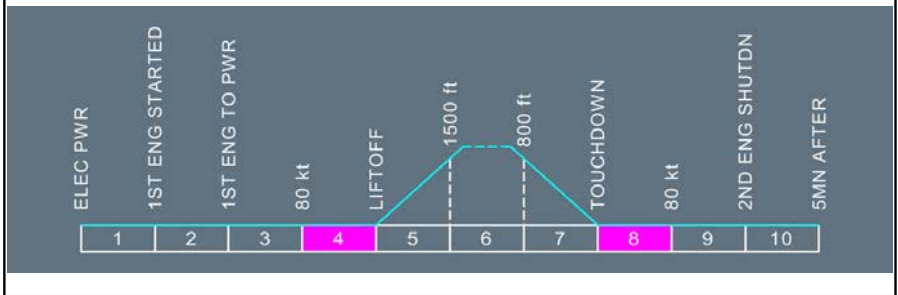

Ident.: PRO-ABN-ELEC-N-00017898.0004001 / 21 MAR 16

AIR DATA SWTG..... F/O3
BARO REF..... CHECK

L2 Since one FCU channel is lost, crosscheck the barometer reference settings on the FCU and PFD.

L1 ● If DC ESS BUS is failed:
L/G..... GRVTY EXTN

L2 Refer to PRO-ABN-LG [QRH] L/G GRAVITY EXTENSION.

L1 FUEL CONSUMPT INCRSD
FMS PRED UNRELIABLE

SECONDARY FAILURES

- * CAB PRESS
- * FUEL
- * WHEEL
- * F/CTL

Continued on the following page

ELEC DC BUS 2 FAULT (Cont'd)

Ident.: PRO-ABN-ELEC-N-00017899.0013001 / 22 MAR 17

L12

STATUS

- **IF ABN CAB V/S:**
MAX FL..... 100/MEA
 - **If DC ESS BUS is failed:**
L/G..... GRVTY EXTN
- LDG DIST PROC..... APPLY

INOP SYS

See below

FUEL CONSUMPT INCRSD

See ⁽³⁾

FMS PRED UNRELIABLE

See ⁽⁴⁾

**ENG 2 APPR IDLE ONLY
BOTH PFD ON SAME FAC**

- **If DC ESS BUS is failed:**
L/G CONTROL NOT AVAIL
- SLATS/FLAPS SLOW**
- CAT 3 SINGLE ONLY**

INOP SYS

SPLR 1+2+5

VHF 2

R WNDW HEAT

CAT 3 DUAL

R TK PUMP 2

REVERSER 2

Y ELEC PUMP (if selected ON)

ENG 2 LOOP A

ROW/ROP 

ELAC 2⁽¹⁾

F/O STAT

AP 2

FAC 2

CTR TK PUMP 2 

CAB PR 2

BRK SYS 2

FCDC 2

SEC 2+3

R WSLHD HEAT

FCU 2

L TK PUMP 2

LGCIU 2

MAIN GALLEY





ENG 1 LOOP B

LGCIU 1 ⁽²⁾

Other INOP SYS

Continued on the following page

ELEC DC BUS 2 FAULT (Cont'd)

| | | |
|---|--|--|
| SFCC 2 | R cabin fan | F/O wiper |
| F/O rain rplnt | Eng 1 and 2 fire ext btl 2 | Autobrake (due to loss of 2 SECS) |
| BMC 2 | Bleed X feed auto control | RMP 2 |
| FQI channel 2 | CTR TK XFR valve R  | SDCU 2 or CIDS  2 SMOKE DETECT |
| Brake fan  | Eng 2 oil low press and qty ind | R loudspeaker |
| rudder trim ind | FMGC 2 | CDLS  |

- Note:**
- The warning may be caused by a sub BUS failure. Consequently, only a part of the above-listed systems may be lost.
 - The flight crew must monitor the CAB V/S, because the proximity sensor of the bulk cargo door  is no longer electrically supplied.

(1) Lost after 30 s, but recovered at landing gear extension.

(2) (If DC ESS BUS is failed)

(3) This message is triggered when the failure (or combination of failures) affects the nominal aerodynamic characteristics of the aircraft.

(4) Disregard FMS fuel predictions and refer to QRH/OPS Operational Data - Fuel Penalty Factors Tables in order to find the applicable Fuel Penalty Factor.

ELEC DC BUS 1+2 FAULT

Applicable to: ALL

Ident.: PRO-ABN-ELEC-Q-00017353.0001001 / 21 MAR 16

ANNUNCIATIONS

Triggering Conditions:

L2 This alert triggers when the DC 1 and DC 2 busbars are not supplied.

Flight Phase Inhibition:

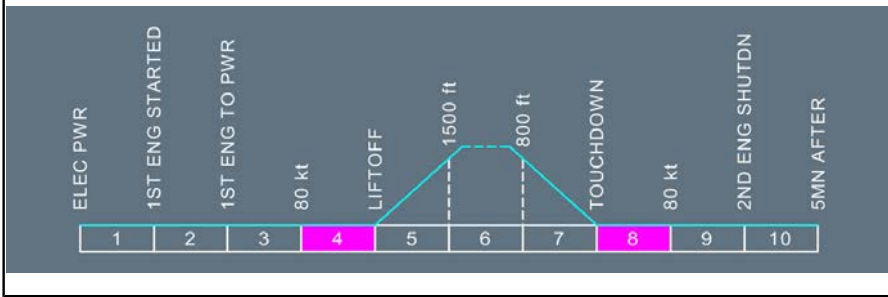

Continued on the following page

ELEC DC BUS 1+2 FAULT (Cont'd)

Ident.: PRO-ABN-ELEC-Q-00018565.0004001 / 21 MAR 16

BLOWER..... OVRD
 EXTRACT..... OVRD
 BARO REF..... CHECK

L2 Crosscheck the barometer reference settings on the FCU and PFDs.

L1 FUEL CONSUMPT INCRSD

FMS PRED UNRELIABLE

MAX BRK PR..... 1 000 PSI

L2 Brake pressure must be limited to approximately 1 000 PSI, since antiskid is lost.

L1

ASSOCIATED PROCEDURES

ELEC DC BAT BUS FAULT

SECONDARY FAILURES

- * CAB PRESS
- * FUEL
- * AIR COND
- * BRAKES
- * F/CTL

Continued on the following page

ELEC DC BUS 1+2 FAULT (Cont'd)

Ident.: PRO-ABN-ELEC-Q-00018566.0018001 / 22 MAR 17

L12

STATUS

MAX BRK PR..... 1000 PSI

INOP SYS

LDG DIST PROC..... APPLY

See below

FUEL CONSUMPT INCRSD

See ⁽²⁾

FMS PRED UNRELIABLE

See ⁽³⁾

ENG 1 APPR IDLE ONLY

ENG 2 APPR IDLE ONLY

BOTH PFD ON SAME FAC

CTR TK FUEL UNUSABLE

APU BAT START NOT AVAIL

SLATS/FLAPS SLOW

CAT 3 SINGLE ONLY

FLS  LIMITED TO F-APP+RAW

INOP SYS

SPLR 1+2+5

ELAC 2⁽¹⁾

SEC 2+3

VHF 2

ACP 3

CAPT STAT heat

F/O STAT heat

STBY STAT heat

WSHLD HEAT

WNDW HEAT

AP 2

FCU 2

CAT 3 DUAL

FAC 2

SDCU

ANTI SKID

N/W STRG

LGCIU 2

REVERSER 1+2

CAB PRESS 2

AVNCS VENT

L+R CAB FAN

GALLEY FAN

CRG HEAT 

GND COOL 

MAIN GALLEY

Y ELEC PUMP

Brk sys 1+2

APU FIRE DET

LAV DET

ENG 1 LOOP B

ENG 2 LOOP A

PACK 2

FCDC 2

CTR TK PUMPS









L TK PUMP 2

R TK PUMP 2

Continued on the following page

ELEC DC BUS 1+2 FAULT (Cont'd)

Other INOP SYS

| | | |
|---|--|---|
| Selcal | Brake temp indication | Brake fans  |
| TPIS  | Capt and F/O wipers | Eng 1 and 2 oil pressure and quantity indication |
| AUTO BRK | Forward (aft) cargo isolation valves  | Manual pressure control |
| VHF 3  | RMP 2 | RMP 3  |
| CFDIU | Right loudspeakers | SFCC 2 |
| APU ECB | Forward (aft) cargo heat controller  | CDLS  |
| FMGC 2 | Rudder trim indication | BMC 2 |
| FQI channel 2 | Eng 1 and 2 fire ext btl 2 | X Bleed auto and manual control |
| Stick and rudder pedals lock (by AP) | Forward (aft) cargo fire extinguishing  | SDCU 2 or CIDS  2 SMOKE DETECT |

Note: *The warning may be caused by a failure in a sub BUS. Consequently, only a part of the above-listed systems may be lost.*

(1) Lost after 30 s, but is recovered at landing gear extension.

(2) This message is triggered when the failure (or combination of failures) affects the nominal aerodynamic characteristics of the aircraft.

(3) Disregard FMS fuel predictions and refer to QRH/OPS Operational Data - Fuel Penalty Factors Tables in order to find the applicable Fuel Penalty Factor.

ELEC DC EMER CONFIG

Applicable to: ALL

Ident.: PRO-ABN-ELEC-X-00017359.0001001 / 21 MAR 16

ANNUNCIATIONS

Triggering Conditions:

L2 This alert triggers when the DC 1, DC 2 and DC ESS busbars are not supplied.

Flight Phase Inhibition:

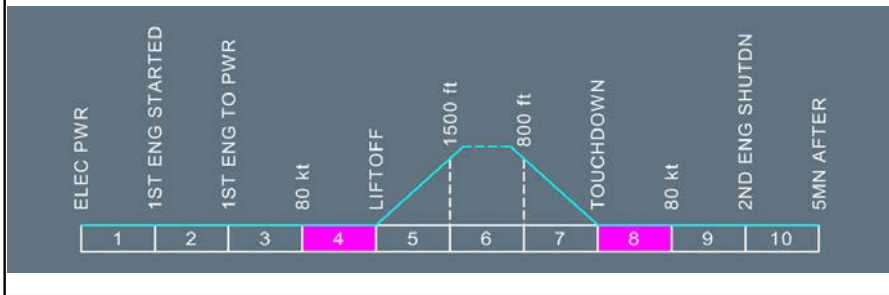

Continued on the following page

ELEC DC EMER CONFIG (Cont'd)

Ident.: PRO-ABN-ELEC-X-00018557.0006001 / 21 MAR 16

LAND ASAP

EMER ELEC PWR.....MAN ON

L2 *The emergency generator supplies DC ESS BUS.
But, DC BUS 1, DC BUS 2, and DC BAT BUS are still not supplied.*

L1 FUEL CONSUMPT INCRSD
FMS PRED UNRELIABLE

ASSOCIATED PROCEDURES

ELEC **DC BUS 1 + 2 FAULT**

BLOWER.....OVRD
EXTRACT.....OVRD
BARO REF.....CHECK

L2 *Crosscheck the barometer reference settings on the FCU and PFDs.*

L1 MAX BRK PR.....1 000 PSI

L2 *Brake pressure must be limited to approximately 1 000 PSI, since antiskid is lost.*

L1 FUEL CONSUMPT INCRSD
FMS PRED UNRELIABLE

ASSOCIATED PROCEDURES

ELEC **DC BAT BUS FAULT**

SECONDARY FAILURES

- * CAB PRESS
- * HYD
- * FUEL
- * AIR COND
- * BRAKES
- * WHEEL
- * F/CTL

Continued on the following page

ELEC DC EMER CONFIG (Cont'd)

Ident.: PRO-ABN-ELEC-X-00018558.0003001 / 21 MAR 16

L12

STATUS

MIN RAT SPEED..... 140 KT
 PROC: GRVTY FUEL FEEDING
 MAX BRK PR..... 1 000 PSI
 FUEL GRVTY FEED

 LDG DIST PROC..... APPLY

*Refer to the list of STATUS INFO of the ELEC DC BUS 1+2
 BUS FAULT ECAM alert
 See ⁽¹⁾*

INOP SYS

*Refer to the list of INOP SYS ON
 ECAM of the ELEC DC BUS 1+2
 FAULT ECAM alert*

Note: *To verify the other
 INOP SYS not
 displayed on the
 ECAM, Refer to
 PRO-ABN-ELEC
 ELEC DC BUS
 1+2 FAULT
 - FWSPAGE
 and Refer to
 PRO-ABN-ELEC
 ELEC DC BAT
 BUS FAULT -
 FWSPAGE.*

⁽¹⁾ **Note:** *DC ESS BUS is lost at landing gear extension.
 Consequently, all means of communications are lost since all ACPs are lost.
 To verify the list of STATUS INFO, Refer to PRO-ABN-ELEC ELEC DC BUS 1+2
 FAULT - FWSPAGE*

ELEC DC ESS BUS FAULT

Applicable to: ALL

Ident.: PRO-ABN-ELEC-O-00017354.0001001 / 21 MAR 16

ANNUNCIATIONS

Triggering Conditions:

L2

This alert triggers when the DC ESS busbar is not supplied.

Flight Phase Inhibition:

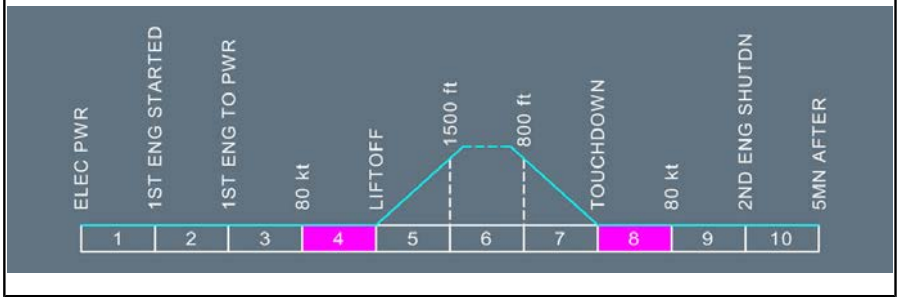

Continued on the following page

ELEC DC ESS BUS FAULT (Cont'd)

Ident.: PRO-ABN-ELEC-O-00012511.0005001 / 05 MAR 13

VHF 2 OR 3..... USE
AUDIO SWTG..... SELECT

[2] *ACP 1 and 2 are lost. Therefore, set the AUDIO SWTG rotary selector to CAPT 3 or F/O 3 to recover communications.*

[1] **BARO REF**..... CHECK

[2] *Crosscheck the barometer reference settings on the FCU and the PFD.*

[1] **GPWS SYS**..... OFF

● **If DC BUS 2 is failed:**

L/G..... GRVTY EXTN

[2] *Refer to PRO-ABN-LG [QRH] L/G GRAVITY EXTENSION.*

[1] **FUEL CONSUMPT INCRSD**
FMS PRED UNRELIABLE
AVOID ICING CONDITIONS

ASSOCIATED PROCEDURES

NAV GPWS FAULT

GPWS..... OFF

[2] *Note: To shut down the engines on ground, use the ENG FIRE pb-sw.*

[1]

SECONDARY FAILURES

- * CAB PRESS
- * HYD
- * F/CTL

Continued on the following page

ELEC DC ESS BUS FAULT (Cont'd)

Ident.: PRO-ABN-ELEC-O-00018671.0012001 / 25 JUL 17

L12



STATUS

- **If DC BUS 2 is failed:**
L/G.....GRVTY EXTN
LDG DIST PROC..... APPLY
FUEL CONSUMPT INCRSD
See ⁽³⁾
FMS PRED UNRELIABLE
See ⁽⁴⁾
ENG 1 APPR IDLE ONLY
ENG 2 APPR IDLE ONLY
BOTH PFD ON SAME FAC
- **If DC BUS 2 is failed:**
L/G CONTROL NOT AVAIL
SLATS/FLAPS SLOW
CAT 3 SINGLE ONLY

INOP SYS

See below

INOP SYS

- | | | |
|--------------|---|--|
| B HYD | SPLR 3 | VHF 1 |
| ACP 1+2 | WING A. ICE | AP 1 |
| A/THR | FCU 1 | FAC 1 |
| L TK PUMP 1 | R TK PUMP 1 | REV 2 |
| ENG 2 START | CAB PR 1 | STEEP APPR  |
| VENT EXTRACT | B ELEC PUMP | GPWS |
| ENG 1 LOOP A | ENG 2 LOOP B | FDC 1 |
| LGCIU 1 | LGCIU 2 ⁽¹⁾ | ALTN BRK |
| AUTO BRK | ROW/ROP  | |

Other INOP SYS

BRK PRESS indicator

Flight interphone

EIU 2 ⁽²⁾

Continued on the following page

ELEC DC ESS BUS FAULT (Cont'd)

| | | |
|---|-------------------------|-----------------------|
| Capt rain repellent  | Avionics air cond valve | Standby compass light |
| HP fuel shutoff valves | SFCC 1 | RMP 1 |
| Hyd fire valves Eng 1 and 2 | Ram air inlet | ECAM Control Panel |
| Left loudspeaker | DC SHED ESS BUS | |

Note: 1. The warning may be caused by a sub BUS failure. Consequently, only a part of the above-listed systems may be lost.

- (1) (If DC BUS 2 is failed)
- (2) Autothrust, eng start and reverser inop.
- (3) This message is triggered when the failure (or combination of failures) affects the nominal aerodynamic characteristics of the aircraft.
- (4) Disregard FMS fuel predictions and refer to QRH/OPS Operational Data - Fuel Penalty Factors Tables in order to find the applicable Fuel Penalty Factor.

ELEC DC ESS BUS SHED

Applicable to: ALL

Ident.: PRO-ABN-ELEC-P-00017355.0001001 / 21 MAR 16

ANNUNCIATIONS

Triggering Conditions:

 This alert triggers when the DC SHED ESS busbar is not supplied.

Flight Phase Inhibition:

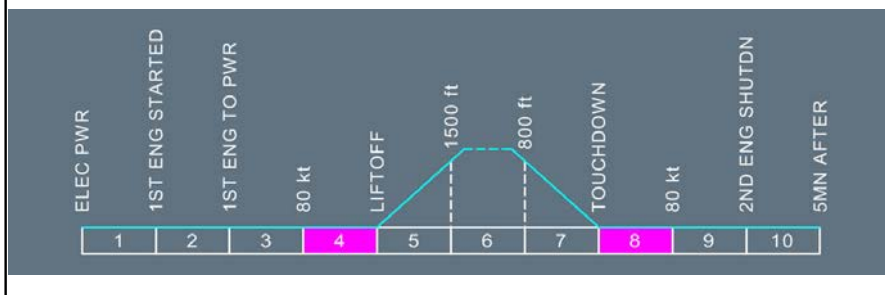

Continued on the following page



A318/A319/A320/A321
 FLIGHT CREW
 OPERATING MANUAL

PROCEDURES
ABNORMAL AND EMERGENCY PROCEDURES

ELEC

ELEC DC ESS BUS SHED (Cont'd)

Ident.: PRO-ABN-ELEC-P-00012513.0001001 / 30 MAR 12

EXTRACT.....OVRD

L2 Cooling air is supplied by the air conditioning system, without overboard extraction.

L1 AVOID ICING CONDITIONS

SECONDARY FAILURES

*AVNCS VENT

Continued on the following page

ELEC DC ESS BUS SHED (Cont'd)

Ident.: PRO-ABN-ELEC-P-00018561.0005001 / 17 MAR 17

L12

STATUS

AVOID ICING CONDITIONS

● **IF SEVERE ICE ACCRETION**

MIN SPD.....VLS + 10/G DOT

MANEUVER WITH CARE

LDG DIST PROC.....APPLY

BOTH PFD ON SAME FAC

CAT 3 SINGLE ONLY

INOP SYS

WING A. ICE

AP 1

CAT 3 DUAL

FAC 1

VENT EXTRACT

AFT CRG HEAT 

FWD CRG HEAT 

AFT CRG VENT 

FWD CRG VENT 

FCDC 1

ROW/ROP 

See below

Other INOP SYS

Passenger oxygen mask (auto drop out)

X BLEED valve man ctl

FMGC 1

STBY ALTI vib

FQ1 channel 1

BMC 1

SDCU 1 or CIDS  1 SMOKE DETECT

Note: *The warning may be caused by a failure in a sub BUS. Consequently only a part of the systems listed above may be lost.*

Continued on the following page

ELEC DC ESS BUS SHED (Cont'd)

ELEC EMER CONFIG

Applicable to: ALL

Ident.: PRO-ABN-ELEC-R-00018283.0001001 / 21 MAR 16

ANNUNCIATIONS

Triggering Conditions:

L2

This alert triggers when the AC 1 and AC 2 busbars are not supplied.

Flight Phase Inhibition:

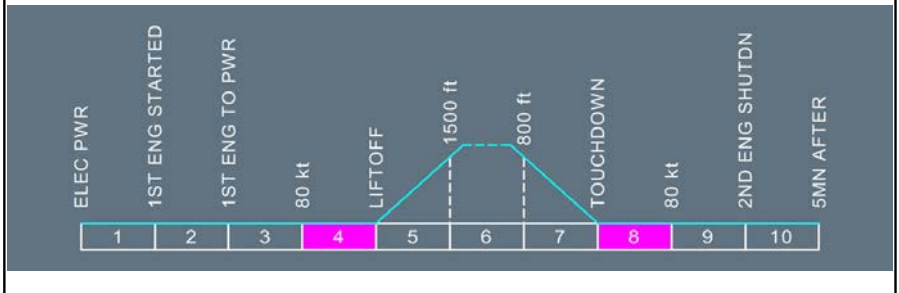

Continued on the following page

ELEC EMER CONFIG (Cont'd)

Ident.: PRO-ABN-ELEC-R-00018642.0006001 / 22 MAR 17

LAND ASAP

MIN RAT SPEED.....140 KT

CAUTION The RAT is capable of supplying the EMER GEN down to 125 kt, except during flare.

GEN 1 + 2..... OFF THEN ON

● **IF UNSUCCESSFUL:**

BUS TIE..... OFF

^{L2} Setting BUS TIE pb-sw to OFF segregates both generator channels.

^{L1} GEN 1 + 2.....OFF THEN ON

^{L2} Note: If any generator reset is successful, reset both FAC's.

^{L1} EMER ELEC PWR (IF EMER GEN NOT IN LINE)..... MAN ON
 ENG MODE SEL..... IGN

^{L2} Engines are fed by gravity only.

^{L1} VHF1/HF1 \leftrightarrow /ATC1.....USE

^{L2} Only VHF 1, HF 1 and ATC 1 are supplied in the electrical emergency configuration.

Note: FMGC 1, which is lost temporarily, can be regained by flight crew passing through the MCDU MENU page.

^{L1} **FUEL GRVTY FEED**

^{L2} Engines are fed by gravity only. Avoid negative Gs.

^{L1} **PROC: GRVTY FUEL FEEDING**

^{L2} Apply GRVTY FUEL FEEDING procedure (Refer to PRO-ABN-FUEL [QRH] GRAVITY FUEL FEEDING).

^{L1} FAC 1..... OFF THEN ON

^{L2} The rudder trim is recovered, although no indication is available.

^{L1} BUS TIE.....AUTO

^{L2} Setting BUS TIE pb-sw to AUTO enables the APU to take an available electrical channel.

^{L1} APU (IF AVAIL)..... START

^{L2} APU start is not available for 45 s after the loss of both engine generators. This 45 s delay prevents any interference with emergency generator coupling.

Continued on the following page

ELEC EMER CONFIG (Cont'd)

If the APU is available, the APU may be started when below FL 250.

L1 **BLOWER + EXTRACT**OVRD

L2 Cooling air is supplied by the air conditioning system and exhausted overboard through the extract valve.

L1 **FUEL CONSUMPT INCRSD**
FMS PRED UNRELIABLE

L2 **Note:** On IAE powered aircraft, the warning "EPR MODE FAULT N1 DEGRADED MODE" is displayed.

L1

ASSOCIATED PROCEDURES

FLT CTL ALTN LAW
(PROT LOST)

MAX SPEED320 KT

L2 Speed limited due to loss of flight control normal laws.

Continued on the following page

ELEC EMER CONFIG (Cont'd)

Ident.: PRO-ABN-ELEC-R-00018643.0023001 / 22 MAR 17

L12

STATUS

INOP SYS

MIN RAT SPEED..... 140 KT
 MAX SPEED..... 320 KT
 MAX BRK PR..... 1 000 PSI
 FUEL GRVTY FEED
 AVOID NEGATIVE G FACTOR

F/CTL PROT
 REVERSER 1+2
 ADR 2+3
 IR 2
 RA 1+2
 SPLR 1+2+5
 ELAC 2
 SEC 2+3
 A/CALL OUT
 AP 1+2
 A/THR
 FUEL PUMPS
 ANTI SKID
 N/W STRG
 CAT 2
 STEEP APPR 

Note: If there are discrepancies between airspeed indications on the Captain's PFD and on the STBY indicator, disregard the STBY indication (probe not deiced).

APPR PROC

FOR LDG..... USE FLAP 3
 This line is replaced by "FOR LDG : USE FLAP 3" when CONF 3 is selected, as a reminder.

APPR SPD..... VREF +10/140 KT
 The approach speed must be at least minimum RAT speed (140 kt).

LDG DIST PROC..... APPLY

FUEL CONSUMPT INCRSD

See ⁽²⁾

FMS PRED UNRELIABLE

See ⁽³⁾

ALTN LAW: PROT LOST
WHEN L/G DN: DIRECT LAW

SLATS/FLAPS SLOW

FLS  LIMITED TO F-APP + RAW

See ⁽⁴⁾

See ⁽¹⁾

⁽¹⁾ For other systems' status: Refer to the "ELEC EMER CONFIG SYS REMAINING" table.

Continued on the following page

ELEC EMER CONFIG (Cont'd)

- (2) *This message is triggered when the failure (or combination of failures) affects the nominal aerodynamic characteristics of the aircraft.*
- (3) *Disregard FMS fuel predictions and refer to QRH/PER-B Fuel Penalty Factors Tables in order to find the applicable Fuel Penalty Factor.*
- (4) Note: *In ELEC EMER configuration, the center tank fuel is unusable.*

ELEC EMER GEN 1 LINE OFF

Applicable to: ALL

Ident.: PRO-ABN-ELEC-AB-00017382.0001001 / 21 MAR 16

ANNUNCIATIONS

Triggering Conditions:

- L2 This alert triggers when the GEN 1 LINE pb-sw is abnormally set to OFF position.

Flight Phase Inhibition:

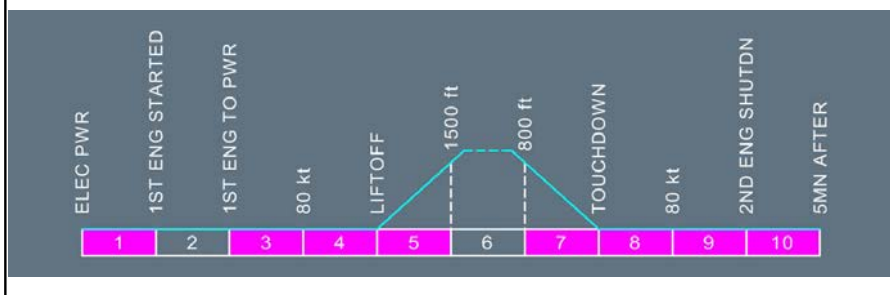

Ident.: PRO-ABN-ELEC-AB-00012550.0001001 / 25 FEB 14

- L2 With the GEN 1 LINE pb-sw (on the EMER ELEC PWR panel) in the OFF position, the GEN 1 line contactor is open and GEN 2 supplies the AC BUS 1 channel.

- L1 Crew awareness.

- L2 Set the GEN 1 LINE pb-sw to ON.

ELEC ESS BUSES ON BAT

Applicable to: ALL

Ident.: PRO-ABN-ELEC-AA-00018284.0001001 / 21 MAR 16

ANNUNCIATIONS

Triggering Conditions:

- [L2] This alert triggers when the DC ESS and AC ESS busbars are supplied by the batteries.

Flight Phase Inhibition:

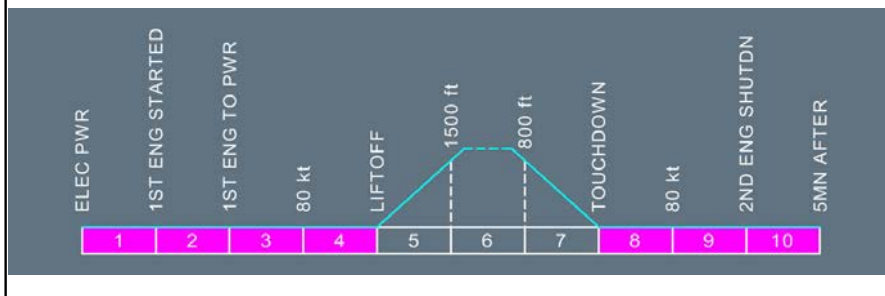

Ident.: PRO-ABN-ELEC-AA-00018021.0002001 / 21 MAR 16

- [L2] AC ESS BUS is supplied via the static inverter.

[L1] **LAND ASAP**

MIN RAT SPEED.....140 KT

- [L2] *Displayed, if the RAT is extended.*

[L1] EMER ELEC PWR.....MAN ON

- [L2] ESS BUSES are supplied by the emergency generator

ELEC GEN 1(2) OR APU GEN OVERLOAD

Applicable to: ALL

Ident.: PRO-ABN-ELEC-T-00017363.0001001 / 21 MAR 16

ANNUNCIATIONS

Triggering Conditions:

L2

This alert triggers when the load of one generator is above 100% of rated output.

Flight Phase Inhibition:

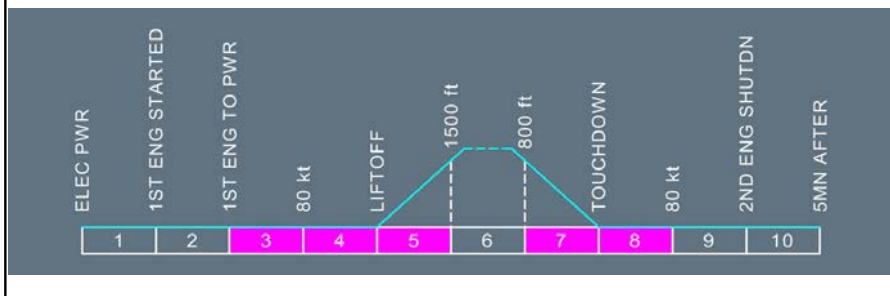

Ident.: PRO-ABN-ELEC-T-00018023.0002001 / 21 MAR 16

GALY/CAB.....OFF

Ident.: PRO-ABN-ELEC-T-00018024.0002001 / 21 MAR 16

STATUS

INOP SYS

GALY/CAB

ELEC GEN 1(2) FAULT

Applicable to: ALL

Ident.: PRO-ABN-ELEC-B-00017360.0001001 / 21 MAR 16

ANNUNCIATIONS

Triggering Conditions:

L2

This alert triggers when:

- The protection trip is initiated by the associated GCU, or
- The line contactor is open with the associated GEN pb-sw set to ON.

Flight Phase Inhibition:

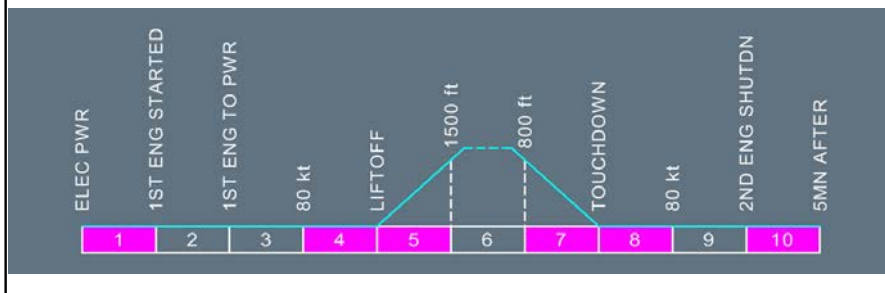

Ident.: PRO-ABN-ELEC-B-00018025.0001001 / 21 MAR 16

GEN (AFFECTED).....OFF THEN ON

● **IF UNSUCCESSFUL:**

GEN (AFFECTED).....OFF

Continued on the following page

ELEC GEN 1(2) FAULT (Cont'd)

Ident.: PRO-ABN-ELEC-B-00018026.0001001 / 21 MAR 16

L12

STATUS

Note: If available, the APU may be started, and the APU GEN used.

CAT 3 SINGLE ONLY

INOP SYS

MAIN GALLEY ⁽¹⁾
GEN 1(2)
CAT 3 DUAL

⁽¹⁾ (only if APU GEN is not online)

ELEC GEN 1(2) OFF

Applicable to: ALL

Ident.: PRO-ABN-ELEC-C-00017361.0001001 / 21 MAR 16

ANNUNCIATIONS

Triggering Conditions:

L2

This alert triggers when the GEN 1(2) pb-sw is set to OFF and no failure is detected.

Flight Phase Inhibition:

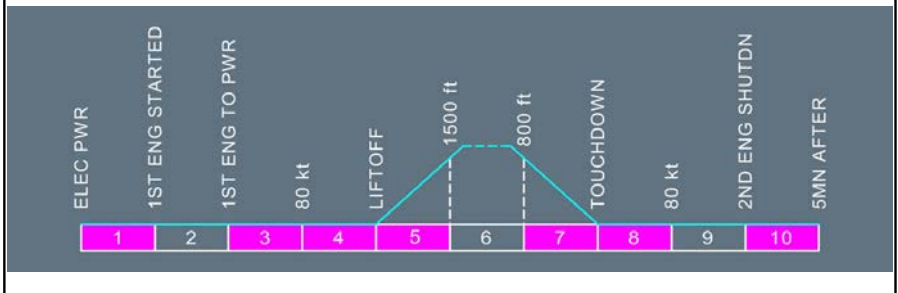

Continued on the following page

ELEC GEN 1(2) OFF (Cont'd)

Ident.: PRO-ABN-ELEC-C-00018027.0001001 / 21 MAR 16

L2 Turn the affected GEN ON.

L1 Crew awareness.

Ident.: PRO-ABN-ELEC-C-00018028.0001001 / 21 MAR 16

STATUS

INOP SYS

CAT 3 SINGLE ONLY

MAIN GALLEY ⁽¹⁾
GEN 1(2)
CAT 3 DUAL

⁽¹⁾ (only if APU GEN is not online)

ELEC IDG 1(2) DISCONNECTED

Applicable to: ALL

Ident.: PRO-ABN-ELEC-D-00017366.0001001 / 21 MAR 16

ANNUNCIATIONS

Triggering Conditions:

L2

This alert triggers when the IDG 1(2) is disconnected.

Flight Phase Inhibition:

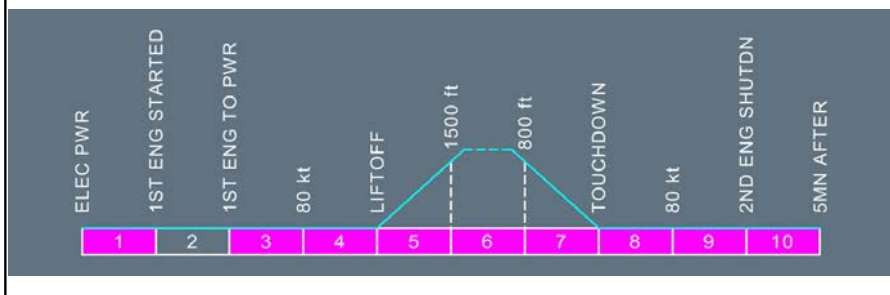

Ident.: PRO-ABN-ELEC-D-00018029.0001001 / 21 MAR 16

Crew awareness.

Ident.: PRO-ABN-ELEC-D-00018030.0001001 / 21 MAR 16

L12

STATUS

Note: If available, the APU may be started, and the APU GEN used.

CAT 3 SINGLE ONLY

INOP SYS

MAIN GALLEY ⁽¹⁾
 GEN 1(2)
 CAT 3 DUAL

⁽¹⁾ (only if APU GEN is not online)

ELEC IDG 1(2) OIL LO PR/OVHT

Applicable to: ALL

Ident.: PRO-ABN-ELEC-A-00018285.0001001 / 21 MAR 16

ANNUNCIATIONS

Triggering Conditions:

- L2 The alert **ELEC IDG 1(2) OIL LO PR** triggers when the IDG 1(2) oil pressure is low.
 The alert **ELEC IDG 1(2) OIL OVHT** triggers when the IDG 1(2) outlet oil temperature rises above 185 °C.

Flight Phase Inhibition:

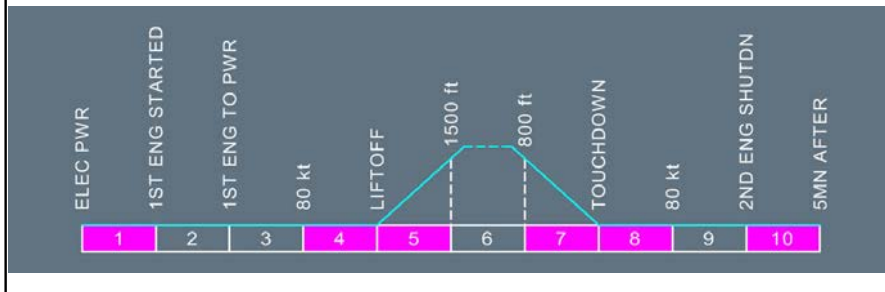

Ident.: PRO-ABN-ELEC-A-00018031.0001001 / 21 MAR 16

IDG (AFFECTED).....OFF

- L2 If the associated engine is running, the IDG (integrated drive generator) must be disconnected from the engine at, or above, idle to prevent damage to the disconnect mechanism.
 Press the IDG pb-sw until the GEN FAULT light comes on. However, do not press for more than 3 s, to avoid damage to the disengage solenoid
 The IDG FAULT light goes off, when the IDG is disconnected.

Continued on the following page

ELEC IDG 1(2) OIL LO PR/OVHT (Cont'd)

Ident.: PRO-ABN-ELEC-A-00018032.0001001 / 21 MAR 16

L12

STATUS

Note: If available, the APU may be started and the APU GEN used.

CAT 3 SINGLE ONLY

INOP SYS

MAIN GALLEY ⁽¹⁾
 GEN 1(2)
 CAT 3 DUAL

⁽¹⁾ (only if APU GEN is not online)

ELEC STATIC INV FAULT

Applicable to: ALL

Ident.: PRO-ABN-ELEC-AC-00017380.0001001 / 21 MAR 16

ANNUNCIATIONS

Triggering Conditions:

L2

The alert triggers when the static inverter is failed.

Flight Phase Inhibition:

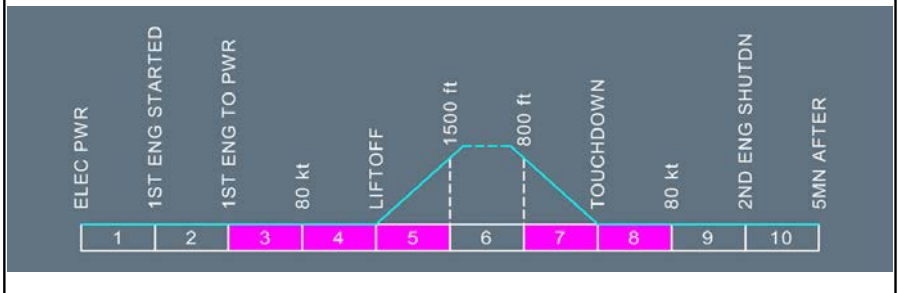

Ident.: PRO-ABN-ELEC-AC-00012549.0001001 / 25 FEB 14

Crew awareness.

ELEC TR 1(2) FAULT

Applicable to: ALL

Ident.: PRO-ABN-ELEC-U-00017373.0001001 / 21 MAR 16

ANNUNCIATIONS

Triggering Conditions:

L2 This alert triggers when the TR 1(2) is failed.

Flight Phase Inhibition:

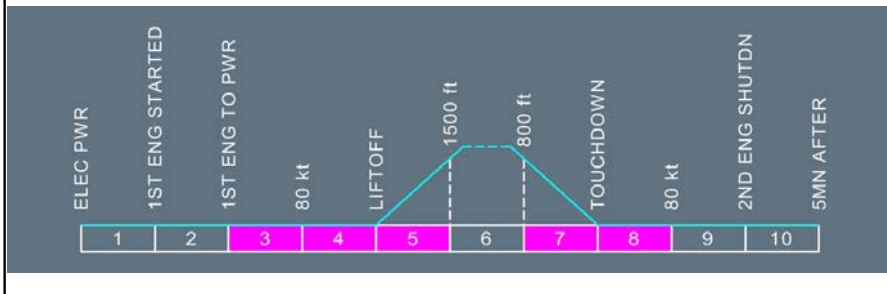

Ident.: PRO-ABN-ELEC-U-00012541.0001001 / 25 FEB 14

Crew awareness.

Ident.: PRO-ABN-ELEC-U-00018531.0001001 / 21 MAR 16

STATUS

INOP SYS

CAT 3 SINGLE ONLY

TR 1(2)
 CAT 3 DUAL

[QRH] ENG DUAL FAILURE - FUEL REMAINING

Applicable to: ALL

Ident.: PRO-ABN-ENG-X-00012309.0061001 / 17 MAR 17

As long as none of the engines recover, the flight crew must apply this paper procedure when required by the ECAM **ENG DUAL FAILURE** procedure. If time permits, clear ECAM alerts, and check the ECAM STATUS page.

LAND ASAP

OPTIMUM RELIGHT SPD..... 300 kt

PITCH TARGET In case of speed indication failure:

| Gross Weight | Pitch (°) |
|----------------------------------|-----------|
| At or below 50 000 kg/110 000 lb | -4.5 |
| 60 000 kg/132 000 lb | -3.5 |
| 70 000 kg/154 000 lb | -2.5 |

AVERAGE GLIDING DISTANCE : 2 NM / 1000 FT (300kt NO WIND)

DETERMINE LANDING STRATEGY

VHF1/HF1  /ATC1.....USE
 ATC.....NOTIFY
 TRANSPONDER.....SELECT A7700

Notify air traffic control of the nature of the emergency, and state intentions. If there is no contact with air traffic control Switch to code A7700, or transmit a distress message on one of the following frequencies: VHF frequency 121.5 MHz, HF 2 182 kHz or 8 364 kHz.

● **If no relight after 30 s:**

ENG MASTERS.....OFF 30 S / ON
 Unassisted start attempts can be repeated until successful, or until APU bleed is available.

● **If unsuccessful:**

CREW OXY MASKS (above FL 100)..... ON
 Cabin altitude will increase, due to the lack of engine bleed: The **EXCESS CAB ALT** warning could be triggered. Depending on the situation, to gain gliding distance, the flight crew may disregard the ECAM emergency descent requirement, because passengers will be provided with oxygen for a sufficient period of time.

APU (IF AVAIL).....START
 If the APU is available, it may be started when below FL 250 and the APU BLEED may be used for engine start below FL 200.

WING ANTI ICE.....OFF

Continued on the following page

[QRH] ENG DUAL FAILURE - FUEL REMAINING (Cont'd)

APU BLEED.....ON

● **In sequence:**

ENG MASTERS (all non running engines)..... OFF

After 30 s

ENG MASTERS (one at a time).....ON

*Between each attempt to relight the same engine, wait at least 30 s with the associated
 ENG MASTER lever set to OFF.*

Continued on the following page

[QRH] ENG DUAL FAILURE - FUEL REMAINING (Cont'd)

Ident.: PRO-ABN-ENG-X-00012310.0041001 / 17 MAR 17

- **When APU bleed is available or if engine restart is definitively considered impossible:**

| OPTIMUM SPEED WITH ALL ENGINES INOPERATIVE (KNOTS) | | | |
|--|--------------------|--------|--------|
| Gross Weight (1 000 kg) | At or below FL 200 | FL 300 | FL 400 |
| 78 | 241 | 251 | 261 |
| 76 | 237 | 247 | 257 |
| 72 | 229 | 239 | 249 |
| 68 | 221 | 231 | 241 |
| 64 | 213 | 223 | 233 |
| 60 | 205 | 215 | 225 |
| 56 | 197 | 207 | 217 |
| 52 | 189 | 199 | 209 |
| 48 | 181 | 191 | 201 |
| 44 | 173 | 183 | 193 |
| 40 | 165 | 175 | 185 |

AVERAGE GLIDING DISTANCE: 2.5 NM / 1000 FT (NO WIND)

AVERAGE RATE OF DESCENT: 1 600 FT/MIN

PREPARE CABIN AND COCKPIT

- Loose equipment secured.
- Survival equipments prepared.
- Belts and shoulder harnesses locked.

SIGNS..... ON

COMMERCIAL..... OFF

USE RUDDER WITH CARE

As hydraulic power is only available from the RAT, avoid large and rapid rudder deflection.

- **When below FL 150:**

RAM AIR..... ON

Ident.: PRO-ABN-ENG-X-00012311.0001001 / 17 MAR 17

BARO REF..... SET

CREW MASKS/OXY SUPPLY (below FL 100)..... OFF

ELT  (when conditions permit)..... ON

Continued on the following page

[QRH] ENG DUAL FAILURE - FUEL REMAINING (Cont'd)

Ident.: PRO-ABN-ENG-X-00012312.0065001 / 09 MAY 17

● **If forced landing anticipated:**

AVERAGE GLIDING DISTANCE 1.2NM / 1000FT (CONF3, L/G DOWN, NO WIND)

● **For approach:**

FOR LANDING : USE FLAP 3

SLATS AVAIL ONLY

MIN APPR SPEED : 150 kt

VAPP..... DETERMINE

| | | | | | | | | | | | |
|-------------------------|-----|-----|-----|-----|-----|-----|-----|-----|-----|-----|-----|
| Gross Weight (1 000 kg) | 40 | 44 | 48 | 52 | 56 | 60 | 64 | 68 | 72 | 76 | 78 |
| VAPP | 150 | 150 | 150 | 150 | 150 | 155 | 159 | 163 | 167 | 171 | 173 |

● **At a suitable altitude (not below 3 000 ft AGL):**

● **When in CONF 3 and VAPP:**

GRAVITY GEAR EXTN handcrank..... PULL AND TURN

FLT CTL DIRECT LAW

MAN PITCH TRIM NOT AVAILABLE

● **When L/G downlocked:**

L/G lever..... DOWN

APPROACH SPEED..... ADJUST

MAX SPEED : 200 kt

ADJUST SPEED TO REACH LANDING FIELD

SPLRs..... ARM

MAX BRK PR : 1 000 PSI

● **At 2 000 ft AGL:**

CABIN CREW..... NOTIFY FOR LANDING

● **At 500 ft AGL:**

BRACE FOR IMPACT..... ORDER

● **At touchdown:**

ENG MASTERS..... OFF

APU MASTER SW..... OFF

BRAKES ON ACCU ONLY

Continued on the following page

[QRH] ENG DUAL FAILURE - FUEL REMAINING (Cont'd)

● **When aircraft stopped:**

PARKING BRK.....ON
 ATC.....NOTIFY
 FIRE pb (ENGs & APU).....PUSH
 AGENT (ENGs & APU).....DISCH

■ **If evacuation required:**

EVACUATION..... INITIATE

Make a short and precise announcement to order the emergency evacuation.

Press the EVAC COMMAND pb .

ELT CHECK EMITTING

If not, switch on the transmitter.

■ **If evacuation not required:**

CABIN CREW and PASSENGERS (PA).....NOTIFY

Continued on the following page

[QRH] ENG DUAL FAILURE - FUEL REMAINING (Cont'd)

Ident.: PRO-ABN-ENG-X-00012313.0065001 / 17 MAR 17

- **If ditching anticipated:**
 - **For approach:**
FOR LANDING : USE FLAP 3
SLATS AVAIL ONLY
MIN APPR SPEED : 150 kt
VAPP..... DETERMINE

| | | | | | | | | | | | |
|-------------------------|-----|-----|-----|-----|-----|-----|-----|-----|-----|-----|-----|
| Gross Weight (1 000 kg) | 40 | 44 | 48 | 52 | 56 | 60 | 64 | 68 | 72 | 76 | 78 |
| VAPP | 150 | 150 | 150 | 150 | 150 | 155 | 159 | 163 | 167 | 171 | 173 |

- **At a suitable altitude (not below 3 000 ft AGL):**

KEEP LANDING GEAR UP
FOR FLARE: TARGET PITCH 11 ° & MIN V/S

Note: Prefer ditching parallel to the swell. If that causes a strong crosswind, ditch into the wind.

- **At 2 000 ft AGL:**
CABIN CREW..... NOTIFY FOR DITCHING
DITCHING pb..... ON
- **At 500 ft AGL:**
BRACE FOR IMPACT..... ORDER
- **At touchdown:**
ENG MASTERS..... OFF
APU MASTER SW..... OFF
- **After ditching:**
ATC (VHF 1)..... NOTIFY
FIRE pb (ENGs & APU)..... PUSH
AGENTs (ENGs & APU)..... DISCH
EVACUATION..... INITIATE
ELT  CHECK EMITTING
If not, switch on the transmitter.



A318/A319/A320/A321
 FLIGHT CREW
 OPERATING MANUAL

PROCEDURES
ABNORMAL AND EMERGENCY PROCEDURES

ENG

[QRH] ENG DUAL FAILURE - NO FUEL REMAINING

Applicable to: ALL

Ident.: PRO-ABN-ENG-Y-00012602.0108001 / 17 MAR 17

The flight crew must apply this paper procedure when required by the **ENG DUAL FAILURE** procedure. If time permits, clear ECAM alerts, and check the ECAM STATUS page.

OPTIMUM SPEED..... 220 kt / GREEN DOT
Initially, fly 220 kt, because the PFD may not display the correct green dot speed. Then fly the green dot speed according to the following table:

GREEN DOT SPEED WITH ALL ENGINES INOPERATIVE (KNOTS)

| Gross Weight (1000 kg) | At or below FL 200 | FL 300 | FL 400 |
|---------------------------|-----------------------|--------|--------|
| 68 | 221 | 231 | 241 |
| 64 | 213 | 223 | 233 |
| 60 | 205 | 215 | 225 |
| 56 | 197 | 207 | 217 |
| 52 | 189 | 199 | 209 |
| 48 | 181 | 191 | 201 |
| 44 | 173 | 183 | 193 |
| 40 | 165 | 175 | 185 |

AVERAGE GLIDING DISTANCE: 2.5 NM / 1000 FT (GREEN DOT NO WIND)
 AVERAGE RATE OF DESCENT: 1600 FT/MIN

DETERMINE LANDING STRATEGY

VHF1/HF1  /ATC1.....USE
 ATC.....NOTIFY
 TRANSPONDER.....SELECT A7700

Notify air traffic control of the nature of the emergency, and state intentions. Switch to code A7700, or transmit a distress message on one of the following frequencies: VHF frequency 121.5 MHz, HF 2 182 kHz or 8 364 kHz.

CREW OXY MASKS (above FL 100).....ON

*Cabin altitude will increase due to the lack of engine bleed: The **EXCESS CAB ALT** warning could be triggered. Depending on the situation, to gain gliding distance, the flight crew may disregard the ECAM emergency descent requirement, because passengers will be provided with oxygen for a sufficient period of time.*

PREPARE CABIN AND COCKPIT

- Loose equipment secured.

Continued on the following page

[QRH] ENG DUAL FAILURE - NO FUEL REMAINING (Cont'd)

- Survival equipments prepared.
- Belts and shoulder harnesses locked.

SIGNS.....ON

COMMERCIAL.....OFF

USE RUDDER WITH CARE

As hydraulic power is only available from the RAT, avoid large and rapid rudder deflection.

● **When below FL 150:**

RAM AIR.....ON

Switch ON the RAM AIR to ensure complete depressurization.

Ident.: PRO-ABN-ENG-Y-00012317.0001001 / 17 MAR 17

BARO REF..... SET

CREW MASKS/OXY SUPPLY (below FL 100)..... OFF

ELT  (when conditions permit)..... ON

Continued on the following page



A318/A319/A320/A321
 FLIGHT CREW
 OPERATING MANUAL

PROCEDURES
ABNORMAL AND EMERGENCY PROCEDURES

ENG

[QRH] ENG DUAL FAILURE - NO FUEL REMAINING (Cont'd)

Ident.: PRO-ABN-ENG-Y-00012318.0065001 / 09 MAY 17

● **If forced landing anticipated:**

AVERAGE GLIDING DISTANCE 1.2NM / 1000FT (CONF3, L/G DOWN, NO WIND)

● **For approach:**

FOR LANDING : USE FLAP 3

SLATS AVAIL ONLY

MIN APPR SPEED : 150 kt

VAPP..... DETERMINE

| | | | | | | | | | | | |
|------------------------|-----|-----|-----|-----|-----|-----|-----|-----|-----|-----|-----|
| Gross Weight (1000 kg) | 40 | 44 | 48 | 52 | 56 | 60 | 64 | 68 | 72 | 76 | 78 |
| VAPP | 150 | 150 | 150 | 150 | 150 | 155 | 159 | 163 | 167 | 171 | 173 |

● **At a suitable altitude (not below 3 000 ft AGL):**

● **When in CONF 3 and VAPP :**

GRAVITY GEAR EXTN handcrank..... PULL AND TURN
 FLT CTL DIRECT LAW

MAN PITCH TRIM NOT AVAILABLE

● **When L/G downlocked :**

L/G lever.....DOWN
 APPROACH SPEED..... ADJUST
 ADJUST SPEED TO REACH LANDING FIELD

MAX SPEED : 200 kt

SPLRs..... ARM

MAX BRK PR : 1 000 PSI

● **At 2 000 ft AGL:**

CABIN CREW..... NOTIFY FOR LANDING

● **At 500 ft AGL:**

BRACE FOR IMPACT..... ORDER

● **At touchdown:**

ENG MASTERS..... OFF

BRAKES ON ACCU ONLY

Continued on the following page

[QRH] ENG DUAL FAILURE - NO FUEL REMAINING (Cont'd)

● **When aircraft stopped:**

PARKING BRK.....ON
 ATC.....NOTIFY

■ **If evacuation required:**

EVACUATION..... INITIATE

Make a short and precise announcement to order the emergency evacuation.

Press the EVAC COMMAND pb .

ELT  CHECK EMITTING

If not, switch on the transmitter

■ **If evacuation not required:**

CABIN CREW and PASSENGERS (PA).....NOTIFY

Continued on the following page

[QRH] ENG DUAL FAILURE - NO FUEL REMAINING (Cont'd)

Ident.: PRO-ABN-ENG-Y-00012319.0065001 / 17 MAR 17

- **If ditching anticipated:**
 - **For approach:**
FOR LANDING : USE FLAP 3
SLATS AVAIL ONLY
MIN APPR SPEED : 150 kt
VAPP..... DETERMINE

| | | | | | | | | | | | |
|-------------------------|-----|-----|-----|-----|-----|-----|-----|-----|-----|-----|-----|
| Gross Weight (1 000 kg) | 40 | 44 | 48 | 52 | 56 | 60 | 64 | 68 | 72 | 76 | 78 |
| VAPP | 150 | 150 | 150 | 150 | 150 | 155 | 159 | 163 | 167 | 171 | 173 |

- **At a suitable altitude (not below 3 000 ft AGL):**
KEEP LANDING GEAR UP
FOR FLARE: TARGET PITCH 11 ° & MIN V/S
Note: Prefer ditching parallel to the swell. If that causes a strong crosswind, ditch into the wind.
- **At 2 000 ft AGL:**
CABIN CREW..... NOTIFY FOR DITCHING
DITCHING pb..... ON
- **At 500 ft AGL:**
BRACE FOR IMPACT..... ORDER
- **At touchdown:**
ENG MASTERS..... OFF
- **After ditching:**
ATC (VHF 1)..... NOTIFY
EVACUATION..... INITIATE
ELT  CHECK EMITTING
If not, switch on the transmitter.

**[QRH] ENG RELIGHT
IN FLIGHT**

Ident.: PRO-ABN-ENG-00012594.0026001 / 17 MAR 17

Applicable to: ALL

Engine Relight Envelope

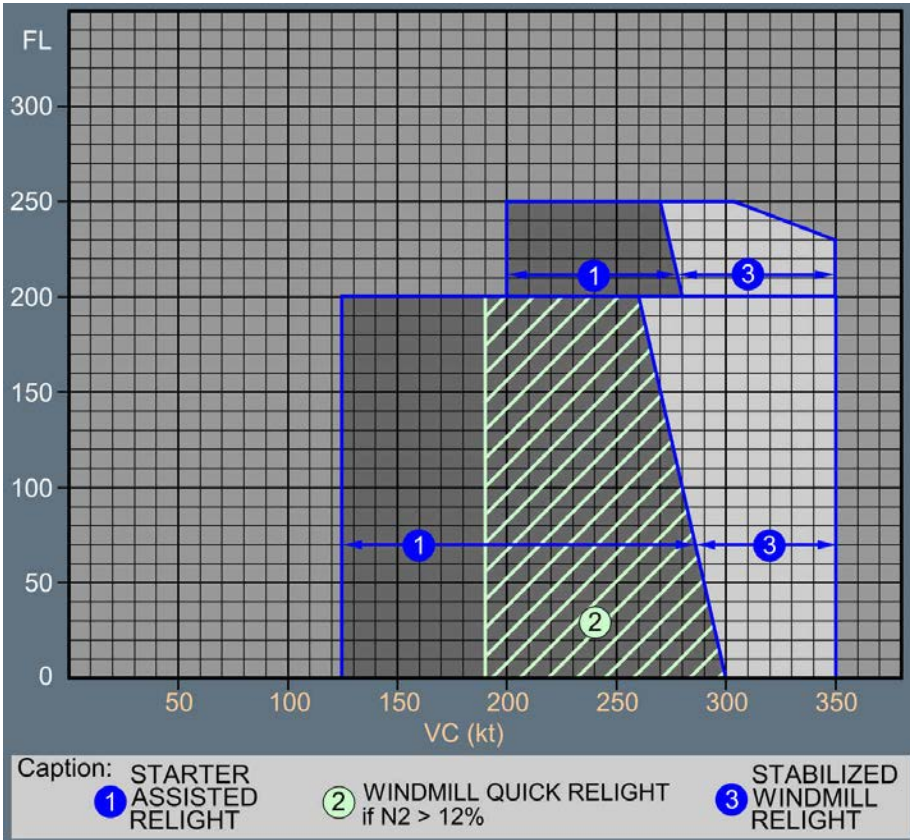

ENG MASTER (affected engine)..... OFF
 THR LEVER (affected engine).....Check IDLE
 ENG MODE sel.....IGN
 X BLEED..... OPEN

Continued on the following page

[QRH] ENG RELIGHT (Cont'd)
IN FLIGHT

If outside the windmilling start envelope, the FADEC will open the starter valve.

WING ANTI ICE (for starter assist).....OFF
 ENG MASTER (affected engine)..... ON
 ENG PARAMETERS (N2, EGT)..... MONITOR

Engine light up should be achieved within 30 s after fuel flow increases.

AUTOMATIC START ABORT NOT AVAIL

Be aware that, unlike the procedure for auto start on ground, the crew must take appropriate action in case of an abnormal start.

Monitor N2. If uncertain about successful relight, move the thrust lever forward and check engine response.

■ **When idle reached (ENG AVAIL):**

ENG MODE sel..... NORM
 TCAS MODE sel  TA/RA

*Check that the selector is at TA /RA since, if the **ENG SHUT DOWN** procedure (Refer to PRO-ABN-ENG ENG 1(2) SHUT DOWN) has been applied, the TCAS mode selector may have been set to the TA position.*

X BLEED..... AUTO
 Affected SYS..... RESTORE

■ **If no relight:**

ENG MASTER (affected engine).....OFF

Wait 30 s before attempting a new start (to drain the engine).

[QRH] ENGINE TAILPIPE FIRE

Ident.: PRO-ABN-ENG-00017781.0001001 / 17 MAR 17

Applicable to: ALL

Internal engine fire may be encountered during engine start or engine shutdown.
Internal engine fire may be seen by the ground crew, or the EGT may fail to decrease after the ENG MASTER lever is set to OFF.

CAUTION External fire agents can cause severe corrosive damage. Consider the use of external fire agents only if the following procedure does not stop engine tailpipe fire.

ENG MASTER (affected engine) OFF

Note: Do not press the engine fire pushbutton, since this would cut off the FADEC power supply, which would prevent motoring sequence.

ENG MAN START pb (affected engine)..... OFF
ESTABLISH AIR BLEED PRESS

Select the APU, or opposite BLEED, to motor the engine.

If APU BLEED is not available, and the opposite engine is shut down, connect external pneumatic power (if readily available).

BEACON ON
ENG MODE sel..... CRANK
ENG MAN START pb (affected engine)..... ON

For aircraft equipped with IAE or PW6000 engines, the start valve automatically reopens, when N2 is below 10 %.

For aircraft equipped with CFM 56-5A/5B engines, the start valve automatically reopens, when N2 is below 20 %

For aircraft equipped with CFM LEAP-1A engines, the start valve automatically reopens, when N2 is below approximately 60 %

● **When fire stopped:**

ENG MAN START pb (affected engine).....OFF
ENG MODE sel.....NORM

Maintenance action is due.

[QRH] HIGH ENGINE VIBRATION

Ident.: PRO-ABN-ENG-00012294.0006001 / 17 MAR 17

Applicable to: ALL

The VIB advisory on ECAM (N1 ≥ 6 units, N2 ≥ 4.3 units) is mainly a guideline for the flight crew to monitor engine parameters more closely.

The ECAM vibration advisory alone does not require engine shut down.

- Note:
1. High engine vibration may be accompanied by cockpit and cabin smoke and/or the smell of burning. This may be due only to compressor blade tip contact with associated abradable seals.
 2. High N1 vibration are generally accompanied by perceivable airframe vibrations. High N2 vibration can occur without perceivable airframe vibrations.

ENG PARAMETERS CHECK

Check engine parameters and especially EGT; crosscheck with other engine. Report in maintenance log.

■ **If icing suspected:**

An increase of engine vibration in icing conditions with or without engine anti-ice may be due to fan blades and/or spinner icing. Icing may be suspected if N1 vibration occurs without other engine parameters variation.

A/THR OFF
 THRUST (one engine at a time)..... IDLE THEN INCREASE N1 > 80 %

Reduce thrust to idle if flight conditions permit.

If ENG ANTI ICE is off, switch it ON at idle fan speed, one engine after the other with approximately 30 s interval.

To shed ice, it may be necessary to perform several thrust variations between idle and a thrust compatible with the flight phase. For efficient ice shedding, thrust should be increased to at least 80% N1 if flight conditions permit.

After each thrust variation, vibrations should decrease, indicating the progress of the ice shedding.

When the ice is shed, vibrations should return to normal and the flight crew can resume normal engine operation.

■ **If icing not suspected:**

● **If above vibration advisory and flight conditions permit:**

THRUST (affected engine)..... REDUCE BELOW ADVISORY THRESHOLD

● **After landing: SHUT DOWN ENGINE WHEN POSSIBLE**

[QRH] ON GROUND - NON ENG SHUTDOWN AFTER ENG MASTER OFF

Ident.: PRO-ABN-ENG-00020795.0001001 / 17 MAR 17

Applicable to: ALL

The normal procedure to shut down an engine is to set the ENG MASTER lever to OFF. In the case where the engine does not shut down as expected, use the following procedure:

ECAM FUEL PAGE..... SELECT
LP FUEL VALVE POSITION (affected engine)..... CHECK

■ **If LP fuel valve closed (cross line amber):**

NO CREW ACTION

■ **If LP fuel valve open:**

ENG FIRE pb-sw (affected engine)..... PRESS

Using the ENG FIRE pb-sw will force the LP fuel valve to close. The engine will shut down after a time delay.

GROUND STAFF..... NOTIFY

IN BOTH CASES, ENGINE WILL SHUT DOWN AFTER A TIME DELAY UP TO 2 MIN 30 S

The engine shuts down when the remaining fuel between the LP fuel valve and the nozzles is burned. The time delay for engine shutdown depends on airport altitude and fuel recirculation system operation.

[QRH] ONE ENGINE INOPERATIVE - CIRCLING APPROACH

Ident.: PRO-ABN-ENG-00010682.0004001 / 17 MAR 17

Applicable to: ALL

| MAXIMUM WEIGHT FOR CIRCLING IN CONF 3 WITH GEAR DOWN (1000 KG) | | | | | | | | |
|--|--------------------------|-------|-------|-------|-------|--------|--------|--------|
| OAT (°C) | AIRPORT ELEVATION (feet) | | | | | | | |
| | 0 | 2 000 | 4 000 | 6 000 | 8 000 | 10 000 | 12 000 | 14 000 |
| 0 | 77 | 76 | 69 | 63 | 58 | 53 | 48 | 45 |
| 5 | 77 | 76 | 69 | 63 | 58 | 53 | 48 | 45 |
| 10 | 77 | 76 | 69 | 63 | 58 | 53 | 48 | 45 |
| 15 | 77 | 76 | 69 | 63 | 58 | 53 | 48 | 45 |
| 20 | 77 | 76 | 69 | 63 | 58 | 53 | 48 | 45 |
| 25 | 77 | 75 | 69 | 63 | 58 | 53 | 48 | 45 |
| 30 | 77 | 72 | 68 | 63 | 58 | 53 | 48 | |
| 35 | 74 | 70 | 66 | 63 | 56 | 51 | | |
| 40 | 71 | 67 | 63 | 59 | | | | |
| 45 | 69 | 65 | 61 | | | | | |
| 50 | 67 | 63 | | | | | | |
| 55 | 64 | | | | | | | |

● **If aircraft weight above maximum weight for circling in CONF 3 with gear down:**

DELAY GEAR EXTENSION TO MAINTAIN LEVEL FLIGHT

The aircraft cannot maintain level flight, in CONF 3 and with the landing gear down.

FOR LANDING: USE FLAP 3

CONF 3 is preferred, to minimize a configuration change in short final.

GPWS LDG FLAP 3.....ON

- Note:
- If circling below 750 ft RA, "L/G GEAR NOT DOWN" alert will trigger. The pilot can cancel the aural warning by pressing the EMER CANC pb.
 - If the landing gear is not downlocked at 500 ft RA , GPWS "TOO LOW GEAR" aural alert will trigger.

[QRH] ONE ENGINE INOPERATIVE - STRAIGHT-IN APPROACH

Ident.: PRO-ABN-ENG-00010681.0001001 / 17 MAR 17

Applicable to: ALL

- If NO level off expected during final approach:
 DELAY CONF FULL UNTILL ESTABLISHED ON FINAL DESCENT
- If level off expected during final approach:
 FOR LANDING: USE CONF 3

ENG 1(2) BLEED STATUS FAULT
(IN FLIGHT)

Applicable to: ALL

Ident.: PRO-ABN-ENG-W-00017963.0001001 / 21 MAR 16

ANNUNCIATIONS

Triggering Conditions:

L2 This alert triggers when the status of one of the following valves is not received by the FADEC active channel:

- Bleed valves, or
- Pack valves, or
- Wing and engine anti ice valves, or
- Cross-bleed valve.

Flight Phase Inhibition:

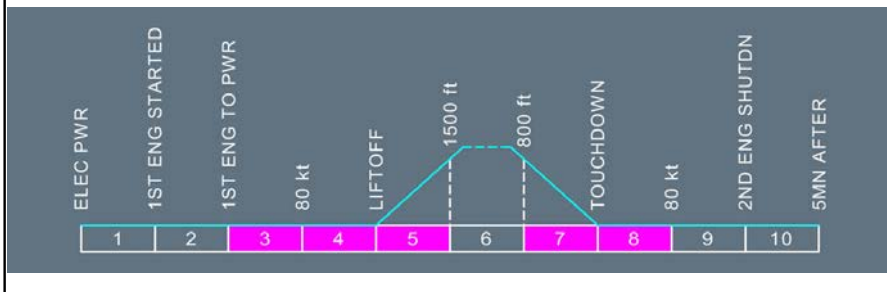

Continued on the following page



A318/A319/A320/A321
 FLIGHT CREW
 OPERATING MANUAL

PROCEDURES
ABNORMAL AND EMERGENCY PROCEDURES

ENG

ENG 1(2) BLEED STATUS FAULT (Cont'd)
(IN FLIGHT)

Ident.: PRO-ABN-ENG-W-00018707.0001001 / 21 MAR 16

- If ENG ANTI ICE on:
 ENG MODE SEL.....IGN

Ident.: PRO-ABN-ENG-W-00012303.0001001 / 17 AUG 10

STATUS

ENG 1(2) HI GND IDLE

**ENG 1(2) BLEED STATUS FAULT
(ON GROUND)**

Applicable to: ALL

Ident.: PRO-ABN-ENG-V-00017965.0001001 / 21 MAR 16

ANNUNCIATIONS

Triggering Conditions:

L2 This alert triggers when the status of one of the following valves is not received by the FADEC active channel:

- Bleed valves, or
- Pack valves, or
- Wing and engine anti ice valves, or
- Cross-bleed valve.

Flight Phase Inhibition:

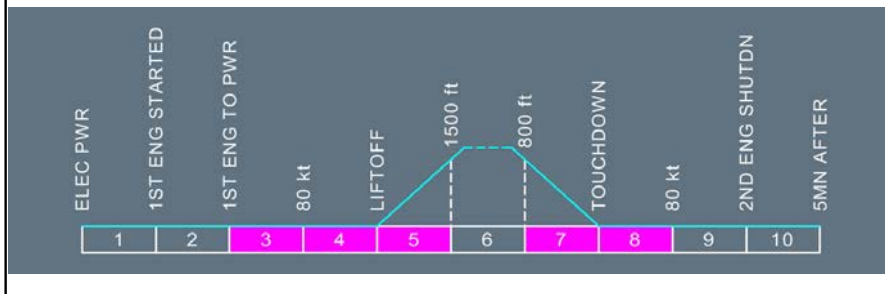

Continued on the following page

ENG 1(2) BLEED STATUS FAULT (Cont'd)
(ON GROUND)

Ident.: PRO-ABN-ENG-V-00018708.0001001 / 21 MAR 16

L2 HI GND IDLE

FADEC increases minimum idle as if valves were opened.

L1 ● If ENG ANTI ICE on:
ENG MODE SEL..... IGN

L2 *When ENG anti ice is on, there is no automatic selection of continuous relight since FADEC does not know position of engine anti ice valves position.*

L1 ● BEFORE T.O.:
PACK (ASSOCIATED SIDE)..... OFF

L2 *Associated pack must be closed to reduce risk of excessive EGT.*

Ident.: PRO-ABN-ENG-V-00012301.0001001 / 17 AUG 10

STATUS

ENG 1(2) HI GND IDLE

ENG COMPRESSOR VANE

Applicable to: ALL

Ident.: PRO-ABN-ENG-CY-00017907.0001001 / 31 AUG 17

ANNUNCIATIONS

Triggering Conditions:

- [L2] This alert triggers when there is a loss of the redundancy (i.e. one channel is detected faulty) of the compressor vane (i.e. VBV, VSV) control system on both engines. The control of the compressor vane is still fully operative on both engines.

Flight Phase Inhibition:

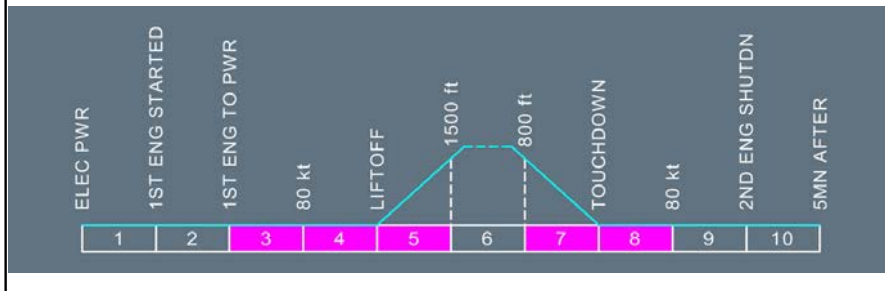

Ident.: PRO-ABN-ENG-CY-00017757.0001001 / 21 MAR 16

Crew awareness.

ENG 1(2) COMPRESSOR VANE

Applicable to: ALL

Ident.: PRO-ABN-ENG-N-00017966.0001001 / 21 MAR 16

ANNUNCIATIONS

Triggering Conditions:

L2

This alert triggers when either Variable Bleed Valve (VBV) or Variable Stator Vane (VSV) is failed.

Flight Phase Inhibition:

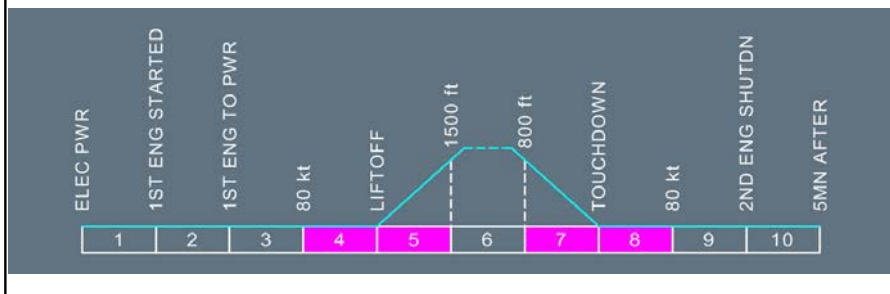

Ident.: PRO-ABN-ENG-N-00017655.0003001 / 21 MAR 17

● **On ground:**

THR LEVERS (AFFECTED).....IDLE
ENG MASTER (AFFECTED).....OFF

Depending on the type of failure, one of the following two messages is displayed:

AVOID RAPID THR CHANGES or

If the A/THR is engaged, adjust the thrust levers to align the thrust lever commands with actual N1 and disconnect A/THR.

ENG (AFFECTED) SLOW RESPONSE

Continued on the following page

ENG 1(2) COMPRESSOR VANE (Cont'd)

Ident.: PRO-ABN-ENG-N-00012155.0001001 / 17 AUG 10

STATUS

AVOID RAPID THR CHANGES

ENG (affected) SLOW RESPONSE

ENG 1(2) CTL VALVE FAULT

Applicable to: ALL

Ident.: PRO-ABN-ENG-Q-00017967.0001001 / 21 MAR 16

ANNUNCIATIONS

Triggering Conditions:

- [L2] This alert triggers when:
- The Burner Staging Valve (BSV) is failed, or
 - The HP Turbine Clearance (HPTC) system is failed, or
 - The Rotor Active Clearance Control (RACC) system is failed.

Flight Phase Inhibition:

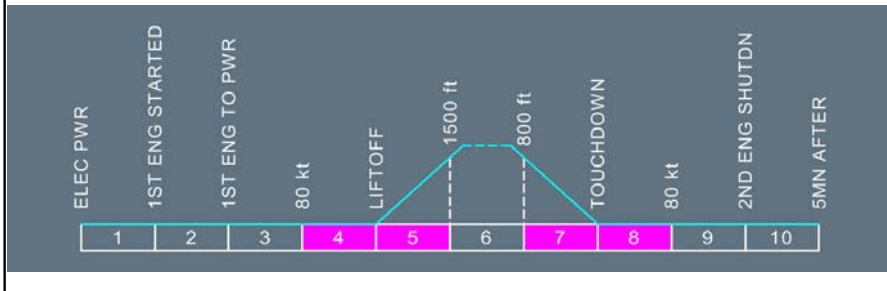

Ident.: PRO-ABN-ENG-Q-00018709.0001001 / 21 MAR 16

MAX N2.....96 %

- [L2] Retard associated thrust lever to limit N2 to 96 %.

Continued on the following page

ENG 1(2) CTL VALVE FAULT (Cont'd)

Ident.: PRO-ABN-ENG-Q-00012233.0001001 / 17 AUG 10

| STATUS | |
|----------------------------|------|
| MAX ENG (AFFECTED) N2..... | 96 % |

ENG DUAL FAILURE

Applicable to: ALL

Ident.: PRO-ABN-ENG-S-00017909.0002001 / 21 MAR 16

ANNUNCIATIONS

Triggering Conditions:

This alert triggers when the two engines are failed.

Flight Phase Inhibition:

| | | | | | | | | | | |
|----------|-----------------|----------------|-------|---------|---------|--------|-----------|-------|----------------|-----------|
| ELEC PWR | 1ST ENG STARTED | 1ST ENG TO PWR | 80 kt | LIFTOFF | 1500 ft | 800 ft | TOUCHDOWN | 80 kt | 2ND ENG SHUTDN | 5MN AFTER |
| 1 | 2 | 3 | 4 | 5 | 6 | 7 | 8 | 9 | 10 | |

Continued on the following page

ENG DUAL FAILURE (Cont'd)

Ident.: PRO-ABN-ENG-S-00012282.0370001 / 21 MAR 17

[L2] This warning inhibits the **ELEC EMER CONFIG** warning, and provides the flight crew with the immediate actions to take in the case of a dual engine failure. This procedure then directs the flight crew to apply the applicable QRH procedure, depending on if there is fuel or not.

When applying the **ENG DUAL FAILURE** QRH procedure:

- If one or more engines are recovered, apply the corresponding ECAM procedure instead
- If no engines are recovered, continue to apply the **ENG DUAL FAILURE** QRH procedure. If time permits, clear ECAM alerts, and check the ECAM STATUS page.

[L1] **LAND ASAP**

EMER ELEC PWR (IF EMER GEN NOT IN LINE).....MAN ON

[L2] *Pressing EMER ELEC PWR MAN ON pb allows extension of RAT and emergency generator coupling.*

[L1] **THR LEVERS..... IDLE**
FAC 1..... OFF THEN ON

[L2] *Resetting FAC 1 enables the recovery of characteristics speed displayed on the PFD. Resetting FAC 1 also enables rudder trim recovery, even if no indication is available. When the hydraulic power is lost, the right aileron is lost, and is in the upfloat position. Rudder trim may be used to compensate for this upfloating aileron.*

[L1] ■ **IF NO FUEL:**
OPT SPD.....220 KT/GREEN DOT

[L2] *If there is no fuel remaining, the optimum speed is the green dot speed. Initially fly 220 kt then refer to the QRH procedure to get the accurate green dot speed.*

[L1] **ENG/NO FUEL PROC.....APPLY**

[L2] *Refer to procedure.*

[L1] ■ **IF FUEL REMAINS:**
ENG MODE SEL.....IGN
OPT RELIGHT SPD.....300 KT

[L2] *If there is fuel remaining, the optimum speed is the optimum relight speed. The ECAM provides reference to an envelope speed. In case of speed indication failure (volcanic ash), pitch attitude for optimum relight is provided in the QRH procedure.*

[L1] **ENG/FUEL PROC..... APPLY**

[L2] *Refer to procedure.*

Continued on the following page

ENG DUAL FAILURE (Cont'd)

Ident.: PRO-ABN-ENG-S-00012283.0044001 / 21 MAR 16

L12

STATUS

MIN RAT SPEED..... 140 KT
 MAX SPEED 320/0.77
 MAX BRK PR..... 1000 PSI
 MANEUVER WITH CARE
 FUEL GRVTY FEED
 AVOID NEGATIVE G FACTOR

INOP SYS

See below

APPR PROC

- **IF HYD NOT RECOVERED:**
 FOR LDG.....USE FLAP 3
- **WHEN CONF 3 AND VAPP:**
 L/GGRVTY EXTN
(Refer to PRO-ABN-LG [QRH] L/G GRAVITY EXTENSION). Being stabilized at VAPP before selecting the gear down enables the aircraft to be trimmed for approach.
 APPR SPD.....VREF +25 KT
Approach speed must be increased, due to the loss of flaps.

LDG DIST PROC..... APPLY

ALTN LAW: PROT LOST
 WHEN L/G DN: DIRECT LAW

See ⁽¹⁾

BRK Y ACCU PR ONLY

See ⁽²⁾

SLATS SLOW

INOP SYS

G+Y HYD

F/CTL PROT

STABILIZER

Continued on the following page

ENG DUAL FAILURE (Cont'd)

| | | |
|-------------|--------------|--------------|
| R AIL | REVERSER 1+2 | ADR 2+3 |
| IR 2+3 | RA 1+2 | SPLR 1+2+4+5 |
| ELAC 2 | SEC 2+3 | FLAPS |
| YAW DAMPER | A/CALL OUT | AP 1+2 |
| A/THR | FUEL PUMPS | ANTI SKID |
| N/W. STEER | AUTO BRK | CAT 2 |
| L/G RETRACT | CAB PR 1+2 | PACK 1+2 |

- (1) At landing gear extension, control reverts to direct law in pitch as well as in roll (Refer to PRO-ABN-F_CTL F/CTL DIRECT LAW).
- (2) 7 full brake applications are available.

ENG 1(2) EIU FAULT

Applicable to: ALL

Ident.: PRO-ABN-ENG-B-00017970.0001001 / 21 MAR 16

ANNUNCIATIONS

Triggering Conditions:

- L2** This alert triggers when the data bus between the EIU and ECU is failed.

Flight Phase Inhibition:

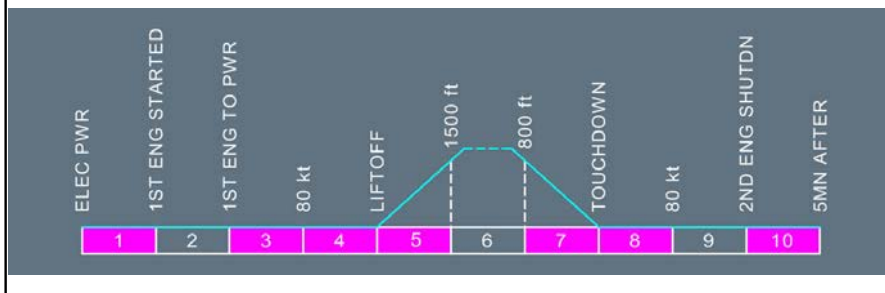

Continued on the following page

ENG 1(2) EIU FAULT (Cont'd)

Ident.: PRO-ABN-ENG-B-00017658.0002001 / 21 MAR 17

Crew awareness.

L2 The following consequences affect the aircraft when this alert is triggered:

- Affected engine start is lost
- Autothrust control is lost
- Thrust reverser on the affected engine is lost
- When idle is selected, only approach idle is available
- Bleed corrections on N1 limit are lost (*Refer to PRO-ABN-ENG ENG 1(2) BLEED STATUS FAULT (In Flight)*).

Ident.: PRO-ABN-ENG-B-00017659.0001001 / 21 MAR 16

L12

STATUS

INOP SYS

ENG 1(2) APPR IDLE ONLY

Minimum idle is lost.

A/THR
REVERSER 1(2)
ENG 1(2) START

ENG 1(2) FADEC A(B) FAULT

Applicable to: ALL

Ident.: PRO-ABN-ENG-AZ-00017972.0002001 / 21 MAR 16

ANNUNCIATIONS

Triggering Conditions:

L2 This alert triggers when the associated FADEC channel is lost.

Flight Phase Inhibition:

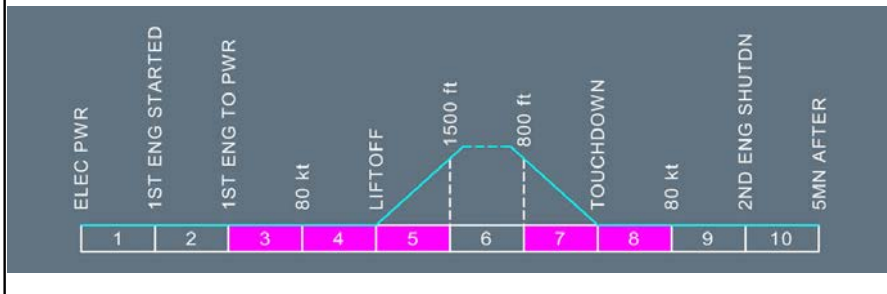

Ident.: PRO-ABN-ENG-AZ-00017661.0001001 / 31 AUG 17

Crew awareness.

● **For aircraft equipped with CFM engines:**

L2 Note: Some cases of spurious FADEC fault have been experienced at engine start on ground.

The caution can be considered as spurious, if it disappears after application of the following procedure:

- Set the master sw to OFF, and wait until N2 speed goes below 5 % (If N2 indication is not available, wait 2 minutes before going to next step).
- Pull and reset the C/B 's of the affected ECU electrical supply (A04 or A05 on 49 VU or R41 or Q40 on 121 VU).
- Wait 10 s for the ECU power-up sequence, and restart the engine.

ENG 1(2) FADEC ALTERNATOR

Applicable to: ALL

Ident.: PRO-ABN-ENG-BA-00017974.0001001 / 21 MAR 16

ANNUNCIATIONS

Triggering Conditions:

L2

This alert triggers when the electrical auto supply for the FADEC system is lost.

Flight Phase Inhibition:

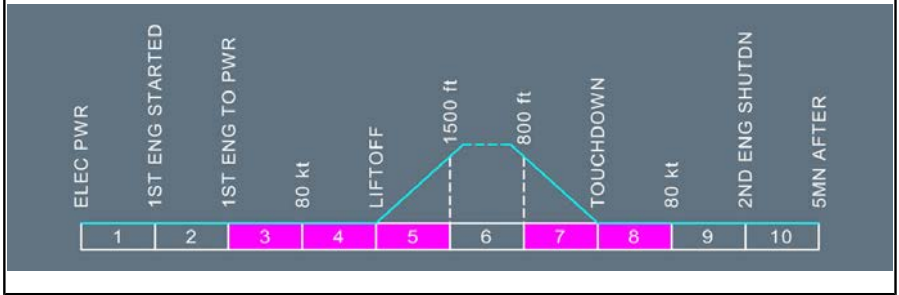

Ident.: PRO-ABN-ENG-BA-00017662.0001001 / 21 MAR 16

Crew awareness.

ENG 1(2) FADEC FAULT

Applicable to: ALL

Ident.: PRO-ABN-ENG-BC-00017975.0001001 / 21 MAR 16

ANNUNCIATIONS

Triggering Conditions:

L2 This alert triggers when both FADEC channels are lost.

Flight Phase Inhibition:

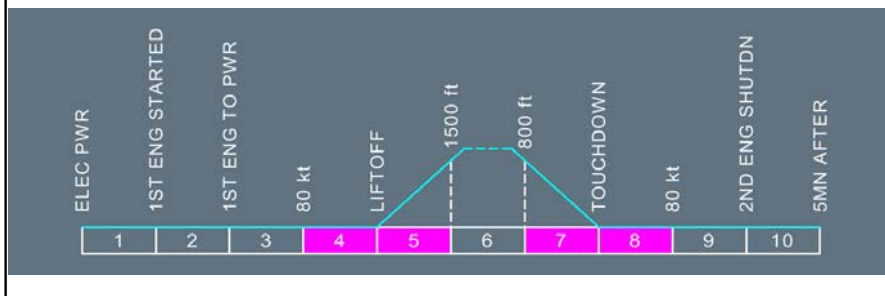

Continued on the following page

ENG 1(2) FADEC FAULT (Cont'd)

Ident.: PRO-ABN-ENG-BC-00017663.0005001 / 21 MAR 17

■ **On ground:**

THR LVR (AFFECTED) NOT ABOVE IDLE

ENG (AFFECTED) PARAMETERS.....CHECK

L2 Due to the fact that engine indications are lost, other system pages such as HYD SD page, ELEC SD page or BLEED SD page must be used to check engine status.

L1 ● **IF ABN ENG OPERATION:**

ENG MASTER (AFFECTED)..... OFF

■ **In flight:**

THR LEVER (AFFECTED)..... IDLE

ENG (AFFECTED) PARAMETERS.....CHECK

L2 Due to the fact that engine indications are lost, other system pages such as HYD SD page, ELEC SD page or BLEED SD page must be used to check engine status.

L1 ● **IF ABN ENG OPERATION:**

ENG MASTER (AFFECTED)..... OFF

L12

ASSOCIATED PROCEDURES

ENG 1(2) SHUT DOWN

(Refer to PRO-ABN-ENG ENG 1(2) SHUT DOWN).

Ident.: PRO-ABN-ENG-BC-00019553.0001001 / 13 MAY 16

STATUS

● **On ground:**

THR LVR 1(2) NOT ABOVE IDLE

ENG 1(2) FADEC HI TEMP

Applicable to: ALL

Ident.: PRO-ABN-ENG-BD-00017976.0001001 / 21 MAR 16

ANNUNCIATIONS

Triggering Conditions:

L2 This alert triggers when high temperature is detected by one or both channels.

Flight Phase Inhibition:

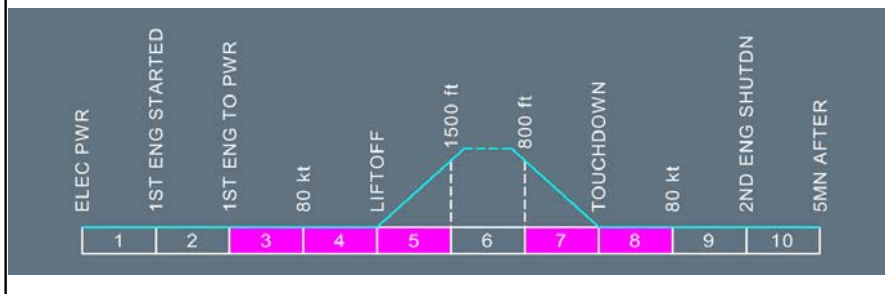

Continued on the following page

ENG 1(2) FADEC HI TEMP (Cont'd)

Ident.: PRO-ABN-ENG-BD-00017664.0004001 / 21 MAR 17

- **If the ECU TEMP is above 105 °C:**

FADEC OVHT

L2

*Reducing engine power should decrease temperature in the ECU area.
If overheating is severe enough, ECU failure could result in a significant loss of engine functions.*

L1

- **On the ground:**

THR LEVER (AFFECTED)..... IDLE
 ENG MASTER (ASSOCIATED ENGINE).....OFF
 ENG MODE SEL.....NORM
 FADEC GND PWR..... CHECK OFF

- **In flight:**

ENG (AFFECTED) PARAMETERS.....CHECK

- **IF ABN ENG OPERATION:**

THR LEVER (AFFECTED)..... IDLE
 ENG MASTER (ASSOCIATED ENGINE)..... OFF

L12

_____ **ASSOCIATED PROCEDURES** _____

ENG 1(2) SHUT DOWN

(Refer to PRO-ABN-ENG ENG 1(2) SHUT DOWN).

ENG 1(2) FAIL

Applicable to: ALL

Ident.: PRO-ABN-ENG-BJ-00017982.0002001 / 06 JUN 16

ANNUNCIATIONS

Triggering Conditions:

- L2 This alert triggers when the engine core speed is below idle, with the ENG MASTER lever set to ON, and ENG FIRE pb not pushed.

Flight Phase Inhibition:

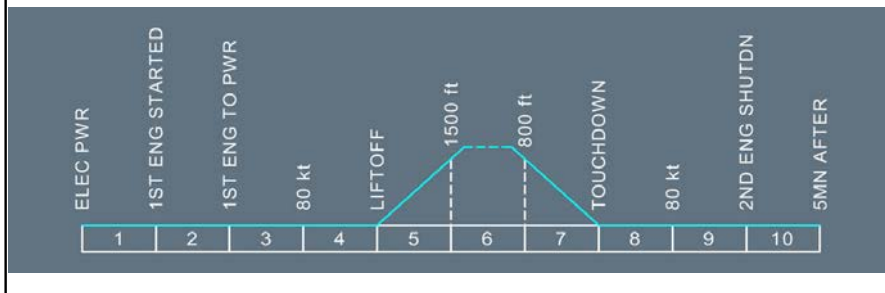

Continued on the following page

ENG 1(2) FAIL (Cont'd)

Ident.: PRO-ABN-ENG-BJ-00017667.0003001 / 21 MAR 17

L2 An engine flame-out may be recognized by a rapid decrease in EGT , N2 , FF , followed by decrease in N1 for CFM engines, or EPR for IAE engines.

Engine damage may be accompanied by:

- Loud noise,
- Significant increase in aircraft vibrations and/or buffeting,
- Repeated or uncontrollable engine stalls,
- Associated abnormal indications such as hydraulic fluid loss, or no N2 indication.

L1

LAND ASAP

■ Before takeoff or after landing:

THR LEVER (AFFECTED ENGINE)..... IDLE
ENG MASTER (AFFECTED ENGINE)..... OFF

■ IF DAMAGE:

ENG FIRE P/B (AFFECTED ENGINE)..... PUSH
AGENT 1..... DISCH

■ IF NO DAMAGE:

L2

For CFM engines, if conditions permit, do not restart the engine. A new engine start would erase FADEC troubleshooting data.

L1

ENG (AFFECTED) RELIGHT..... CONSIDER

L2

If no damage, a new start sequence may be initiated.

L12

ASSOCIATED PROCEDURES

ENG 1(2) SHUT DOWN

Apply the ENG SHUT DOWN procedure (Refer to PRO-ABN-ENG ENG 1(2) SHUT DOWN), if damage or if engine relight is unsuccessful.

L1

■ In flight:

ENG MODE SEL..... IGN

L2



Selection of continuous ignition confirms the immediate relight attempt made by the FADEC.

L1

THR LEVER (AFFECTED ENGINE)..... IDLE

Continued on the following page

ENG 1(2) FAIL (Cont'd)

L2 *Note:* In case of GPWS (EGPWS ) alerts, reduce speed with care below VLS with flaps extended (at light weights VMCA may be reached before α_{Max}) when applying the GPWS (EGPWS ) procedure.

L1 ● **IF NO ENG RELIGHT AFTER 30 S:**

L2 The 30 s countdown starts as soon as the **ENG 1(2) FAIL** alert is triggered.

L1 **ENG MASTER (AFFECTED ENGINE)..... OFF**

■ **IF DAMAGE:**

ENG FIRE P/B (AFFECTED ENGINE)..... PUSH
AGENT 1 (AFTER 10 SECONDS IN FLIGHT)..... DISCH

L12

ASSOCIATED PROCEDURES

ENG 1(2) SHUT DOWN

L2 Apply the **ENG SHUT DOWN** procedure (Refer to **PRO-ABN-ENG ENG 1(2) SHUT DOWN**), if damage or if engine relight is unsuccessful.
 If high vibration occurs and continues after engine shutdown, reduce airspeed and descent to a safe altitude.
 Attempt to determine and use a practical airspeed and altitude for minimum vibrations.

L1 ■ **IF NO DAMAGE:**

ENG (AFFECTED) RELIGHT..... CONSIDER

L2 Apply **ENG RELIGHT** (in flight) procedure (Refer to **PRO-ABN-ENG [QRH] ENG RELIGHT IN FLIGHT**).

ENG 1(2) FIRE
(IN FLIGHT)

Applicable to: ALL

Ident.: PRO-ABN-ENG-DQ-00017401.0001001 / 21 MAR 16

ANNUNCIATIONS

Triggering Conditions:

L2

This alert triggers when:

- Fire is detected by both loops, or
- Fire is detected by one loop when the other loop is faulty, or
- A rupture occurs in both loops within 5 s.

Flight Phase Inhibition:

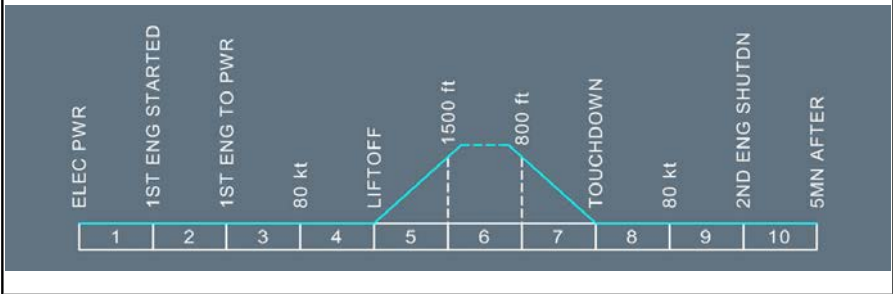

Continued on the following page

ENG 1(2) FIRE (Cont'd)
(IN FLIGHT)

Ident.: PRO-ABN-ENG-DQ-00018190.0002001 / 21 MAR 17

LAND ASAP

THR LEVER (AFFECTED)..... IDLE
 ENG MASTER (AFFECTED)..... OFF

L2 LP and HP valves close.

L1 ENG FIRE P/B (AFFECTED)..... PUSH

L2 When pushed:

- Aural warning stops
- The light remains on, until the fire is extinguished, regardless of the position of the ENG FIRE pb-sw
- FADEC is no longer supplied.

L1 AGENT 1 AFTER 10 S..... DISCH

L2 The 10 s delay allows N1 to decrease, reducing nacelle ventilation, and thereby increasing the effect of the agent.
 Automatic countdown on the ECAM.

L1 ATC..... NOTIFY

L2 Notify ATC of the nature of the emergency, and state intentions

L1 ● IF FIRE AFTER 30 S:

AGENT 2..... DISCH

L2 Discharge the second agent, if the fire warning remains 30 s after the discharge of the first agent.

L12

ASSOCIATED PROCEDURES

ENG 1(2) SHUTDOWN

Do not attempt to restart the engine.

For the ENG SHUTDOWN procedure, see the ENG section (Refer to PRO-ABN-ENG ENG 1(2) SHUT DOWN).

ENG 1(2) FIRE
(ON GROUND)

Applicable to: ALL

Ident.: PRO-ABN-ENG-DR-00018553.0001001 / 21 MAR 16

ANNUNCIATIONS

Triggering Conditions:

L2

This alert triggers when:

- Fire is detected by both loops, or
- Fire is detected by one loop when the other loop is faulty, or
- A rupture occurs in both loops within 5 s.

Flight Phase Inhibition:

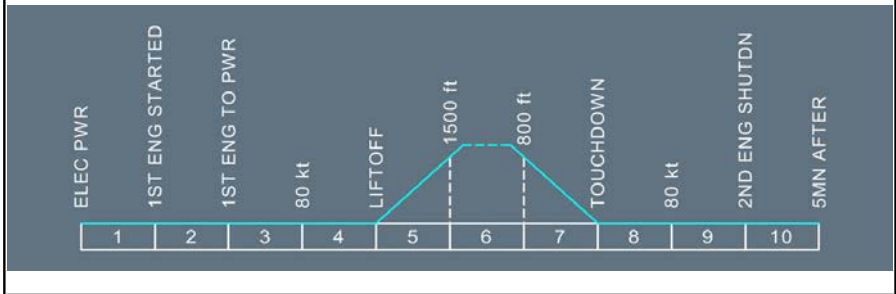

Continued on the following page

ENG 1(2) FIRE (Cont'd)
(ON GROUND)

Ident.: PRO-ABN-ENG-DR-00018192.0004001 / 14 FEB 17

THR LEVERS..... IDLE

L2 Full reverse may be used to stop the aircraft.

L1 ● **WHEN A/C IS STOPPED:**

PARKING BRK..... ON

ATC (VHF 1)..... NOTIFY

L2 Notify ATC of the nature of the emergency, and state intentions.
 Only VHF 1 is available on batteries.

L1 CABIN CREW (PA)..... ALERT
 ENG MASTER (AFFECTED)..... OFF

L2 Associated LP and HP valves close.

L1 ENG FIRE P/B (AFFECTED)..... PUSH

L2 When pushed:

- Aural warning stops
- The light remains on, until the fire is extinguished, regardless of the position of the ENG FIRE pb-sw
- FADEC is no longer supplied.

L1 AGENT 1+2..... DISCH

EMER EVAC PROC..... APPLY

L2 Refer to PRO-ABN-MISC [QRH] EMER EVAC or Refer to QRH/ABN-25 EMER EVAC

ENG 1(2) FIRE DET FAULT

Applicable to: ALL

Ident.: PRO-ABN-ENG-DO-00020838.0001001 / 17 MAR 17

ANNUNCIATIONS

Triggering Conditions:

L2

This alert triggers when:

- Both loops are inoperative, or
- Fire Detector Unit is inoperative.

Flight Phase Inhibition:

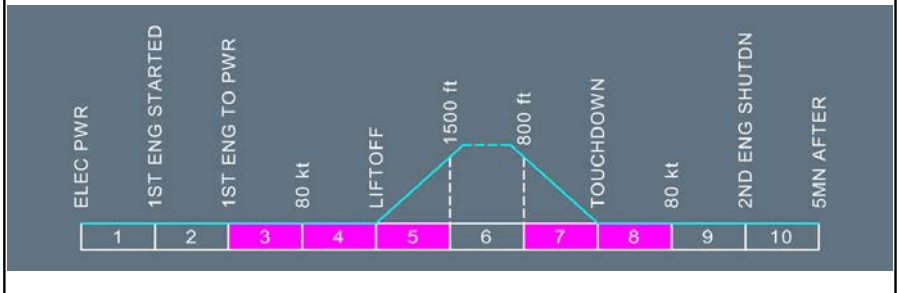

Ident.: PRO-ABN-ENG-DO-00020837.0001001 / 17 MAR 17

Crew awareness.

Ident.: PRO-ABN-ENG-DO-00020839.0001001 / 17 MAR 17

STATUS

INOP SYS

FIRE DET 1(2)

ENG 1(2) FIRE LOOP A(B) FAULT

Applicable to: ALL

Ident.: PRO-ABN-ENG-DP-00020841.0001001 / 17 MAR 17

ANNUNCIATIONS

Flight Phase Inhibition:

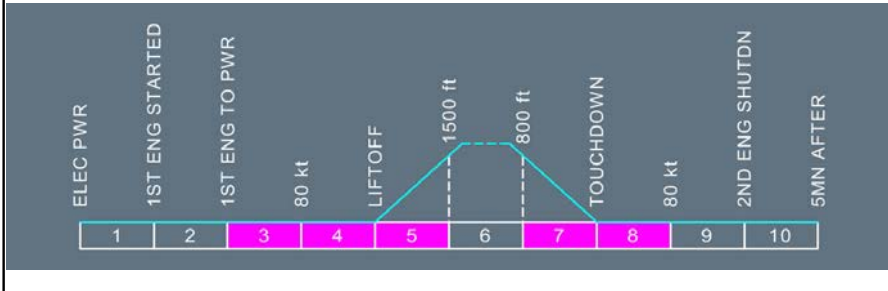

Ident.: PRO-ABN-ENG-DP-00020840.0001001 / 17 MAR 17

L2 Crew awareness.

Ident.: PRO-ABN-ENG-DP-00020842.0001001 / 17 MAR 17

STATUS

INOP SYS

ENG 1(2) LOOP A(B)

ENG 1(2) FUEL CTL FAULT

Applicable to: ALL

Ident.: PRO-ABN-ENG-O-00017983.0001001 / 21 MAR 16

ANNUNCIATIONS

Triggering Conditions:

L2

This alert triggers when:

- The Fuel Metering Valve (FMV) position is failed, or
- The FMV command is failed, or
- The FMV position feedback is failed.

Flight Phase Inhibition:

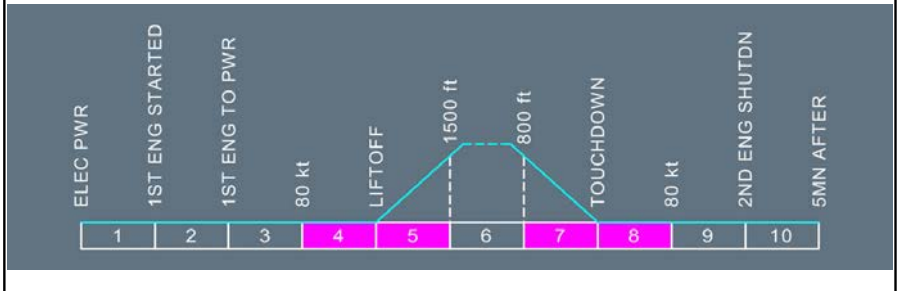

Ident.: PRO-ABN-ENG-O-00017679.0003001 / 21 MAR 16

● **On ground:**

THR LEVER (AFFECTED)..... IDLE
 ENG MASTER (AFFECTED)..... OFF

AVOID RAPID THR CHANGES, or
 ENG (AFFECTED) SLOW RESPONSE

L2 Depending on the type of failure, one of the above two messages is displayed.

Continued on the following page

ENG 1(2) FUEL CTL FAULT (Cont'd)

Ident.: PRO-ABN-ENG-O-00017681.0001001 / 21 MAR 16

STATUS

AVOID RAPID THR CHANGES or

ENG (affected) SLOW RESPONSE

ENG 1(2) FUEL FILTER CLOG

Applicable to: ALL

Ident.: PRO-ABN-ENG-BK-00017984.0002001 / 21 MAR 16

ANNUNCIATIONS

Triggering Conditions:

^[2] This alert triggers when the fuel filter is clogged.

Flight Phase Inhibition:

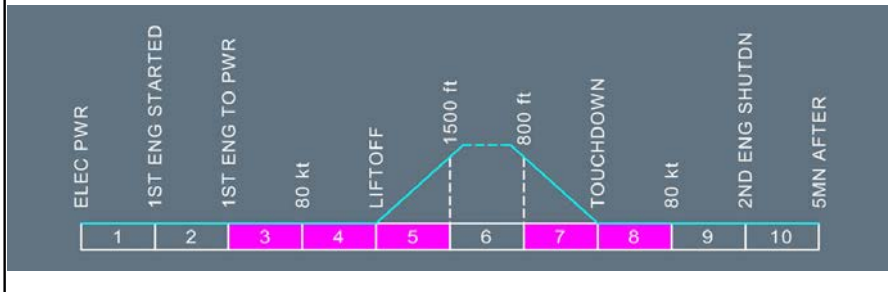

Ident.: PRO-ABN-ENG-BK-00012068.0001001 / 18 AUG 14

Crew awareness.

^[2] Maintenance action is due.

ENG 1(2) FUEL RETURN VALVE

Applicable to: ALL

Ident.: PRO-ABN-ENG-BP-00017986.0001001 / 13 MAY 16

ANNUNCIATIONS

Triggering Conditions:

L2 This alert triggers when the fuel return valve is failed in closed, or in open position.

Flight Phase Inhibition:

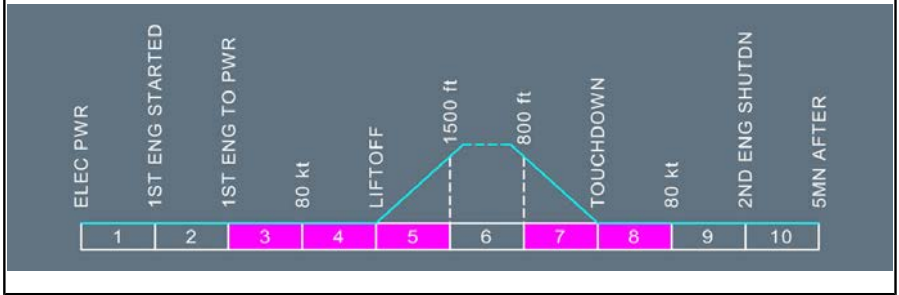

Ident.: PRO-ABN-ENG-BP-00012277.0001001 / 25 FEB 14

■ **VALVE NOT OPEN**

L2 The valve is failed closed.

L1 Crew awareness.

■ **VALVE NOT CLOSED**

L2 The valve is failed open.

L1 Crew awareness.

ENG 1(2) HP FUEL VALVE

Applicable to: ALL

Ident.: PRO-ABN-ENG-BY-00017955.0001001 / 13 MAY 16

ANNUNCIATIONS

Triggering Conditions:

L2 This alert triggers when HP fuel valve is failed in closed or open position.

Flight Phase Inhibition:

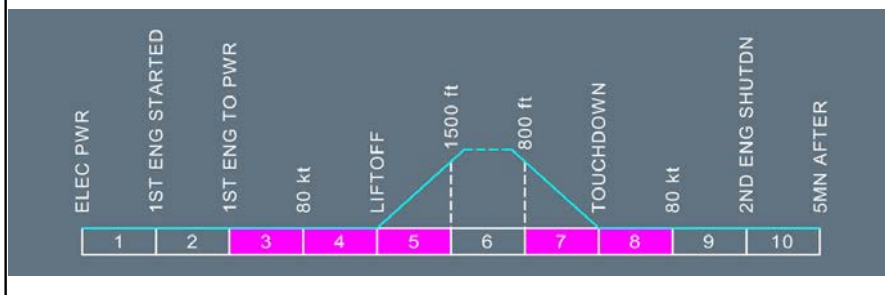

Ident.: PRO-ABN-ENG-BY-00012096.0001001 / 13 MAY 16

■ **HP fuel valve failed closed, and associated engine below idle:**

HP FUEL VALVE NOT OPEN

● **On the ground:**

MAN START (IF MAN START PERFORMED).....OFF

ENG MASTER (AFFECTED).....OFF

■ **HP fuel valve failed open, and associated engine below idle**

or

■ **HP fuel valve failed closed, and associated engine at or above idle:**

HP FUEL POS SWT FAULT

ENG 1(2) IGN FAULT (IGN A OR B FAULT)

Applicable to: ALL

Ident.: PRO-ABN-ENG-J-00017956.0002001 / 20 APR 17

ANNUNCIATIONS

Triggering Conditions:

L2

This alert triggers when ignition circuit A or B is failed.

Flight Phase Inhibition:

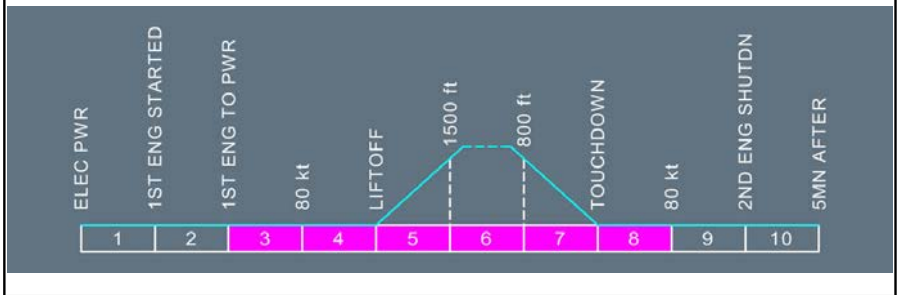

Ident.: PRO-ABN-ENG-J-00012134.0001001 / 25 FEB 14

Crew awareness.

Ident.: PRO-ABN-ENG-J-00012136.0001001 / 17 AUG 10

STATUS

INOP SYS

ENG 1(2) IGN A (B)

ENG 1(2) IGN FAULT (IGN A+B FAULT)

Applicable to: ALL

Ident.: PRO-ABN-ENG-K-00017957.0001001 / 21 MAR 16

ANNUNCIATIONS

Triggering Conditions:

L2 This alert triggers when both ignition circuits are failed.

Flight Phase Inhibition:

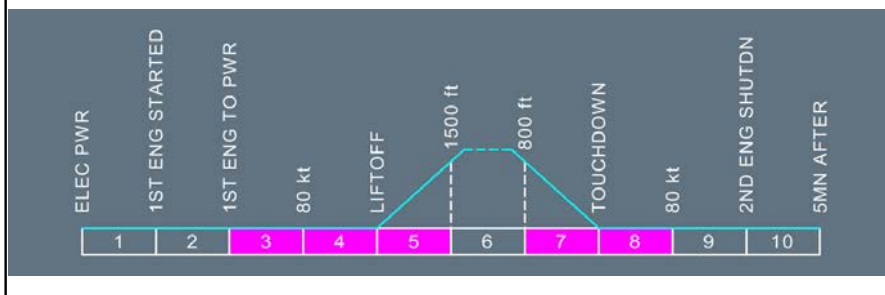

Ident.: PRO-ABN-ENG-K-00012139.0001001 / 12 JAN 11

AVOID ADVERSE CONDITIONS

Ident.: PRO-ABN-ENG-K-00012141.0001001 / 12 JAN 11

STATUS

INOP SYS

ENG 1(2) IGN

ENG 1(2) LOW N1 (ON GROUND)

Applicable to: ALL

Ident.: PRO-ABN-ENG-CA-00017958.0001001 / 21 MAR 16

ANNUNCIATIONS

Triggering Conditions:

L2 This alert triggers when N1 rotation is failed during start.

Flight Phase Inhibition:

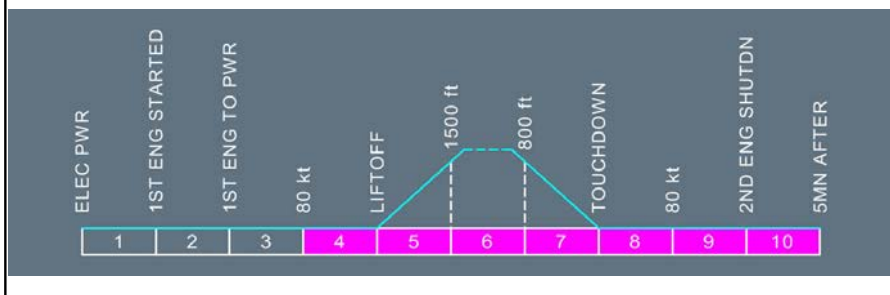

Ident.: PRO-ABN-ENG-CA-00012101.0004001 / 16 NOV 11

L2 No N1 rotation during start.

L1 ● **IF CONFIRMED:**

THR LEVER (AFFECTED)..... IDLE
 ENG MASTER (AFFECTED)..... OFF

ENG 1(2) N1 OR N2 OR EGT OR FF DISCREPANCY

Applicable to: ALL

Ident.: PRO-ABN-ENG-CC-00017959.0001001 / 21 MAR 16

ANNUNCIATIONS

Triggering Conditions:

L2 This alert triggers when a discrepancy between real and displayed values is detected.

Flight Phase Inhibition:

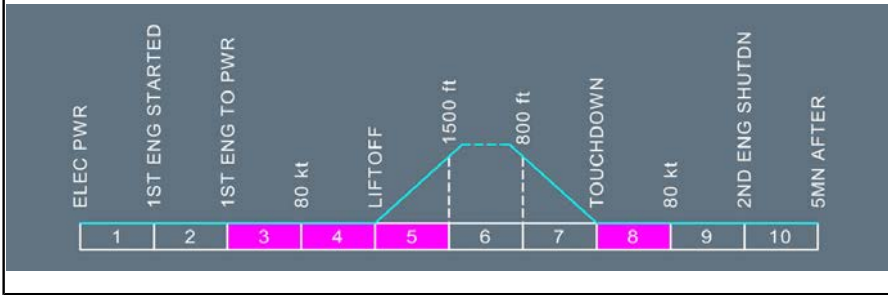

Ident.: PRO-ABN-ENG-CC-00017696.0001001 / 21 MAR 16

L2 The upper ECAM upper displays a CHECK (or CHK) message below the affected indication. Normal indication may be recovered by switching from DMC 1 to DMC 3. If unsuccessful, and if both thrust levers are at the same position, crosscheck with the opposite parameter.

L1 Crew awareness.

ENG 1(2) N1/N2/EGT OVER LIMIT

Applicable to: ALL

Ident.: PRO-ABN-ENG-CD-00018006.0002001 / 21 MAR 16

ANNUNCIATIONS

Triggering Conditions:

L2

This alert triggers when:

- N1 is above 104 %, or
- N2 is above 105 %, or
- EGT is above 725 °C during start, or above 950 °C when the thrust levers are at TOGA or FLX/MCT position, or 915 °C in the other cases.

Flight Phase Inhibition:

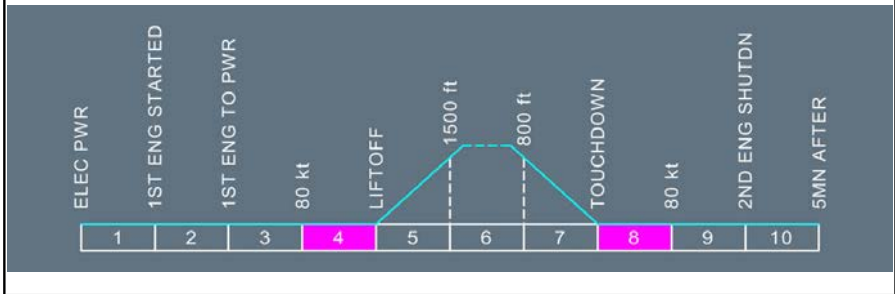

Continued on the following page

ENG 1(2) N1/N2/EGT OVER LIMIT (Cont'd)

Ident.: PRO-ABN-ENG-CD-00012079.0013001 / 21 MAR 17

■ **Max pointer indication:**

- [L2] EGT between 915 °C and 950 °C (except during takeoff, alpha floor activation, or reverse selected), or EGT between 950 °C and 970 °C, or
 N1 between 104.0 % and 105.8 % or
 N2 between 105.0 % and 105.8 %

[L1] **THR LEVER (OF AFFECTED ENGINE)..... BELOW LIMIT**

- [L2] *Normal operation may be resumed and maintained until next landing. Report in maintenance log.*

[L1] ■ **Max pointer indication:**

- [L2] EGT above 970 °C or
 N1 above 105.8 % or
 N2 above 105.8 %

[L1] **THR LEVER (OF AFFECTED ENGINE)..... IDLE**
ENG MASTER (OF AFFECTED ENGINE)..... OFF

- [L2] *If conditions do not permit engine shutdown land ASAP using the minimum thrust required to sustain safe flight.*

[L12]

ASSOCIATED PROCEDURES

ENG 1(2) SHUT DOWN

Apply the **ENG SHUT DOWN** procedure (Refer to PRO-ABN-ENG ENG 1(2) SHUT DOWN).

ENG 1(2) OIL FILTER CLOG

Applicable to: ALL

Ident.: PRO-ABN-ENG-CF-00017964.0002001 / 21 MAR 16

ANNUNCIATIONS

Triggering Conditions:

L2 This alert triggers when the oil filter is clogged.

Flight Phase Inhibition:

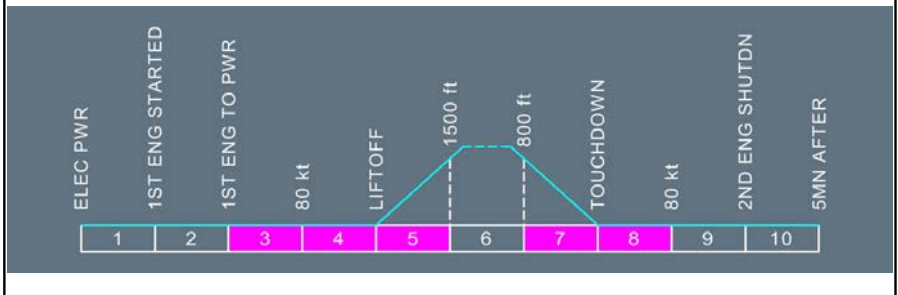

Ident.: PRO-ABN-ENG-CF-00012078.0003001 / 18 AUG 14

Crew awareness.

L2 Maintenance action is due, except if the caution is temporarily displayed during cold engine start with engine oil temperature lower than 40 °C.

ENG 1(2) OIL HI TEMP

Applicable to: ALL

Ident.: PRO-ABN-ENG-CH-00017969.0001001 / 21 MAR 16

ANNUNCIATIONS

Triggering Conditions:

- L2** This alert triggers when the oil temperature is:
- Between 140 °C and 155 °C for more than 15 min, or
 - Above 155 °C.

Flight Phase Inhibition:

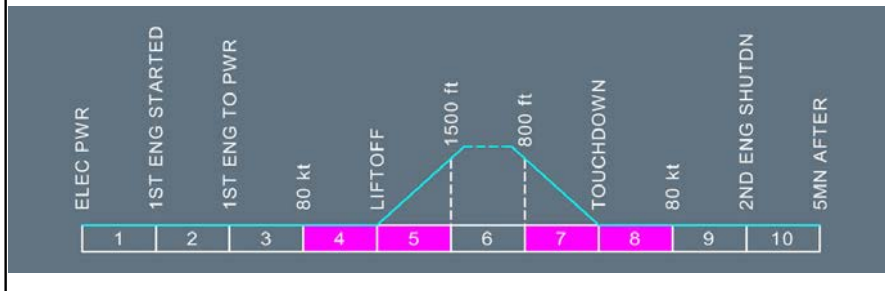

Ident.: PRO-ABN-ENG-CH-00017822.0002001 / 21 MAR 17

THR LEVER (AFFECTED ENGINE)..... IDLE
ENG MASTER (AFFECTED ENGINE)..... OFF

- L2** For aircraft equipped with IAE or PW6000 engines, operation above the maximum temperature require engine shutdown.

L12

ASSOCIATED PROCEDURES

ENG 1 (2) SHUT DOWN

Apply the **ENG SHUT DOWN** procedure (Refer to PRO-ABN-ENG ENG 1(2) SHUT DOWN).

ENG 1(2) OIL LO PR

Applicable to: ALL

Ident.: PRO-ABN-ENG-CI-00018002.0006001 / 21 MAR 16

ANNUNCIATIONS

Triggering Conditions:

L2 This alert triggers when oil pressure is below 13 PSI.

Flight Phase Inhibition:

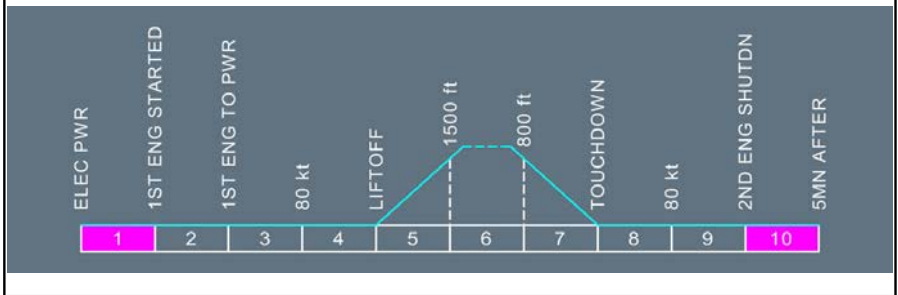

Ident.: PRO-ABN-ENG-CI-00018796.0001001 / 21 MAR 17

L2 Check oil pressure indication on ENG SD page.

L1 THR LEVER (OF AFFECTED ENGINE).....IDLE
ENG MASTER (OF AFFECTED ENGINE).....OFF

L12

ASSOCIATED PROCEDURES

ENG 1(2) SHUT DOWN

Carry out ENG SHUT DOWN procedure (Refer to PRO-ABN-ENG ENG 1(2) SHUT DOWN).

Note: If oil pressure is low (< 13 PSI) is indicated only on ENG SD page (red indication) without the ENG OIL LO PR warning, it can be assumed, that the oil pressure transducer is faulty. Flight crew may continue engine operation while monitoring other engine parameters.

ENG 1(2) ONE TLA FAULT

Applicable to: ALL

Ident.: PRO-ABN-ENG-CM-00017977.0001001 / 21 MAR 16

ANNUNCIATIONS

Flight Phase Inhibition:

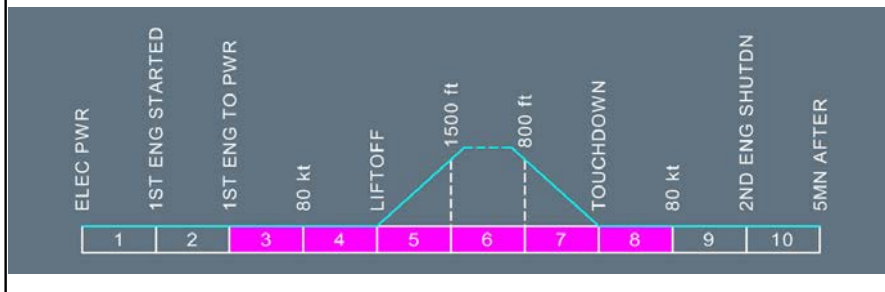

Ident.: PRO-ABN-ENG-CM-00012144.0001001 / 25 FEB 14

Crew awareness.

ENG 1(2) OVSPD PROT FAULT

Applicable to: ALL

Ident.: PRO-ABN-ENG-CN-00017980.0003001 / 21 MAR 16

ANNUNCIATIONS

Triggering Conditions:

L2

This alert triggers when the overspeed protection is lost.

Flight Phase Inhibition:

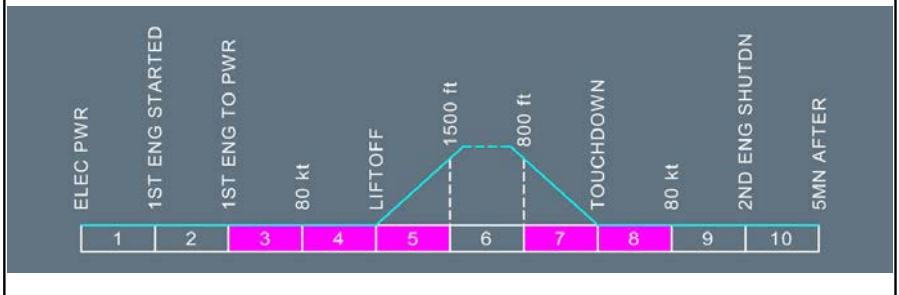

Ident.: PRO-ABN-ENG-CN-00012166.0001001 / 25 FEB 14

Crew awareness.

L12

Note: If the warning appears during engine start, shut down the engine. Restart the engine. If the warning still appears, maintenance action is due.

ENG 1(2) PROBES FAULT

Applicable to: ALL

Ident.: PRO-ABN-ENG-CO-00017981.0001001 / 21 MAR 16

ANNUNCIATIONS

Triggering Conditions:

L2 This alert triggers when T12, PO or PT2 data are unavailable on both channels.

Flight Phase Inhibition:

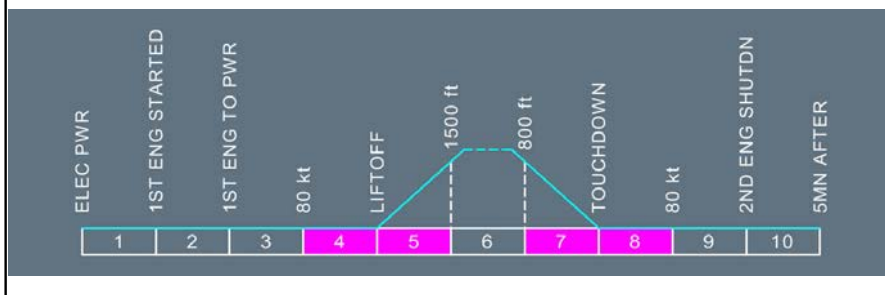

Ident.: PRO-ABN-ENG-CO-00018734.0001001 / 21 MAR 16

Crew awareness.

ENG 1(2) REV ISOL FAULT

Applicable to: ALL

Ident.: PRO-ABN-ENG-CP-00017989.0001001 / 21 MAR 16

ANNUNCIATIONS

Triggering Conditions:

L2

This alert triggers when the thrust reverser shut off valve is failed in open position.

Flight Phase Inhibition:

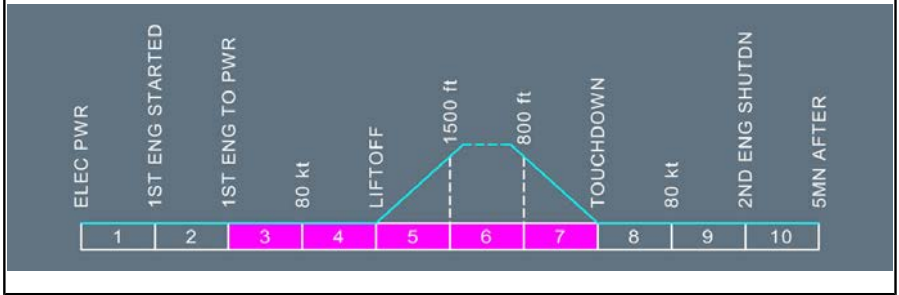

Ident.: PRO-ABN-ENG-CP-00018735.0001001 / 21 MAR 16

Crew awareness.

ENG 1(2) REV PRESSURIZED

Applicable to: ALL

Ident.: PRO-ABN-ENG-CR-00017992.0001001 / 13 MAY 16

ANNUNCIATIONS

Triggering Conditions:

- [L2] This alert triggers when thrust reverser system is pressurized while:
 - For CFM engines: The reverser doors are stowed and locked, or
 - For IAE and PW engines: There is no reverse deployment order.

Flight Phase Inhibition:

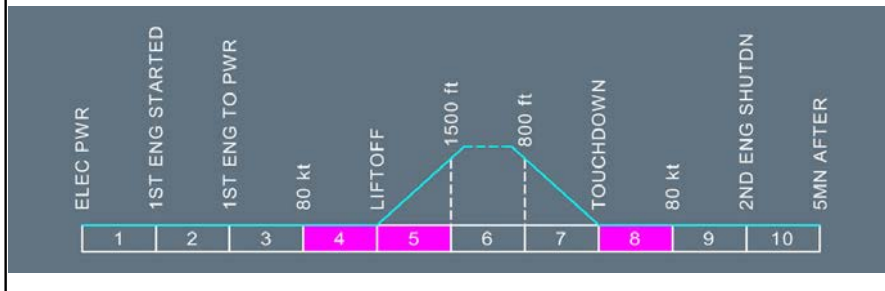

Ident.: PRO-ABN-ENG-CR-00017702.0002001 / 21 MAR 16

■ **In flight:**

THR LEVER 1(2)..... IDLE

- [L2] *If flight conditions permit, reduce the thrust of the affected engine to IDLE as a precautionary measure.*

[L1] ■ **On ground:**

THR LVR 1(2) NOT ABOVE IDLE

ENG REV SET

Applicable to: ALL

Ident.: PRO-ABN-ENG-DA-00017905.0001001 / 21 MAR 16

ANNUNCIATIONS

Triggering Conditions:

L2

This alert triggers when the reverse thrust is selected in flight.

Flight Phase Inhibition:

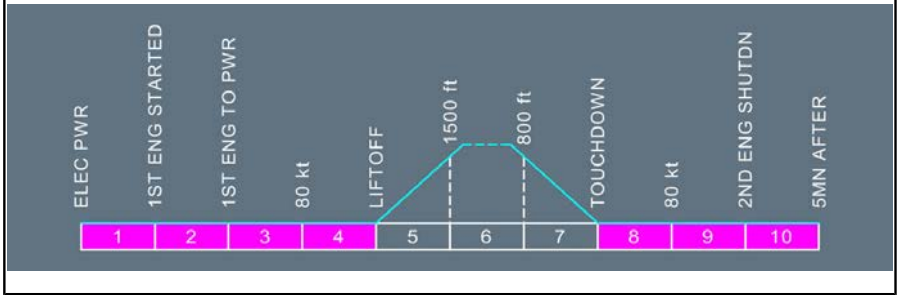

Ident.: PRO-ABN-ENG-DA-00017776.0001001 / 21 MAR 16

THR LEVER (AFFECTED ENGINE)..... FWD THR

ENG 1(2) REV SWITCH FAULT

Applicable to: ALL

Ident.: PRO-ABN-ENG-CS-00017870.0001001 / 21 MAR 16

ANNUNCIATIONS

Triggering Conditions:

L2 This alert triggers when the reverser permission switch is failed.

Flight Phase Inhibition:

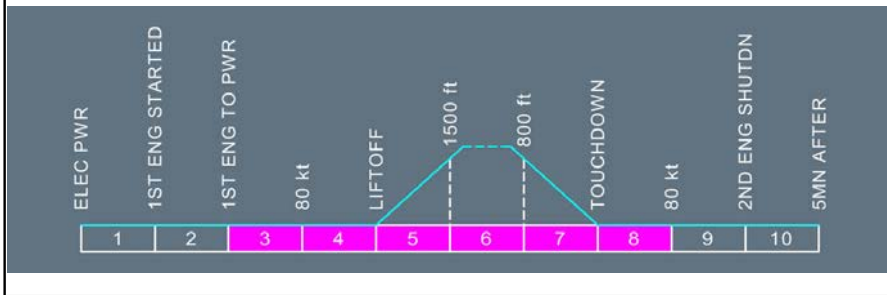

Ident.: PRO-ABN-ENG-CS-00012098.0001001 / 25 FEB 14

Crew awareness.

ENG 1(2) REVERSE UNLOCKED

Applicable to: ALL

Ident.: PRO-ABN-ENG-CT-00017871.0001001 / 21 MAR 16

ANNUNCIATIONS

Triggering Conditions:

L2

This alert triggers when one or more reverser doors are not locked in stowed position in flight, or on ground with no deploy order.

Flight Phase Inhibition:

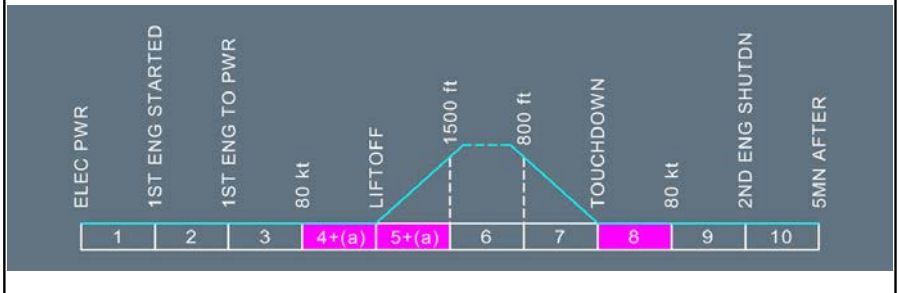

Note: (a) Alert not inhibited in the flight phases 4 and 5, if the engine thrust is automatically set to idle.

Continued on the following page

ENG 1(2) REVERSE UNLOCKED (Cont'd)

Ident.: PRO-ABN-ENG-CT-00012084.0007001 / 21 MAR 17

L2 One or more reverser doors are not stowed.

If N1 is above 70 %, the auto-restow function is inhibited in flight and on ground.

L1 ■ **On ground:**

ENG 1(2) AT IDLE

L2 Only displayed, if the FADEC automatically sets the engine at idle (i.e. when 4 reverser doors are not stowed, or 1, 2, or 3 reverser doors are not stowed with the reverser pressurized).

L1 **THR LEVER (AFFECTED ENGINE)..... IDLE**
ENG MASTER (AFFECTED ENGINE)..... OFF

■ **In flight:**

LAND ASAP

ENG 1(2) AT IDLE

L2 Only displayed, if the engine is automatically set at idle.

L1 **THR LEVER (AFFECTED ENGINE)..... IDLE**
MAX SPEED..... 300/.78

● **IF BUFFET:**

L2 The warning alone, without buffet or vibration, may be a false warning.

L1 **MAX SPEED 240 KT**
ENG MASTER (AFFECTED ENGINE)..... OFF

● **If reverser is actually deployed:**

RUD TRIM FULL R (L)
CONTROL HDG WITH ROLL

L12

ASSOCIATED PROCEDURES

ENG 1(2) SHUT DOWN

Apply the **ENG SHUT DOWN** procedure (Refer to PRO-ABN-ENG ENG 1(2) SHUT DOWN).

ENG 1(2) REVERSER FAULT

Applicable to: ALL

Ident.: PRO-ABN-ENG-A-00017872.0001001 / 21 MAR 16

ANNUNCIATIONS

Triggering Conditions:

L2 This alert triggers when the thrust reverser on one engine is failed (due to system components or inputs).

Flight Phase Inhibition:

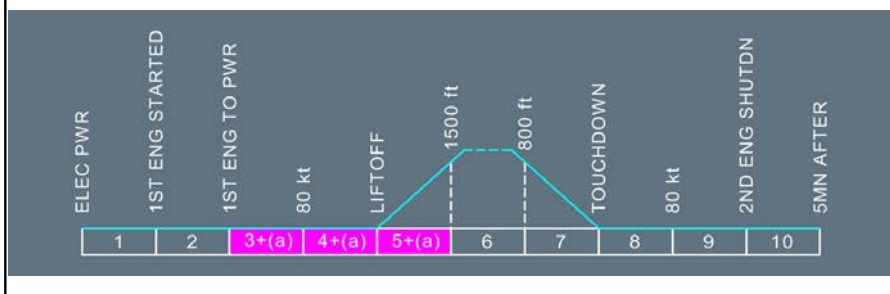

Note: (a) Alert not inhibited in the flight phases 3, 4, 5, if engine thrust is automatically set to idle.

Ident.: PRO-ABN-ENG-A-00017703.0003001 / 21 MAR 16

- If reverser position fault with reverser pressurized:

LAND ASAP

ENG 1(2) AT IDLE

L2 Thrust of the affected engine is locked at idle.

L1 **THR LEVER 1(2)**..... IDLE

L2 Set thrust lever of affected engine at idle.

Continued on the following page

ENG 1(2) REVERSER FAULT (Cont'd)

Ident.: PRO-ABN-ENG-A-00012070.0001001 / 17 AUG 10

STATUS

INOP SYS

REVERSER 1(2)

ENG 1(2) SENSOR FAULT

Applicable to: ALL

Ident.: PRO-ABN-ENG-R-00017873.0001001 / 21 MAR 16

ANNUNCIATIONS

Triggering Conditions:

L2 This alert triggers when PS3 or T25 or T3 or N1 or N2 data is unavailable on both channels.

Flight Phase Inhibition:

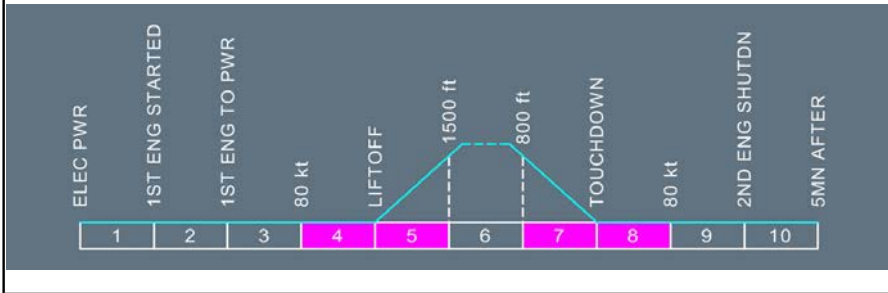

Continued on the following page



A318/A319/A320/A321
 FLIGHT CREW
 OPERATING MANUAL

PROCEDURES
ABNORMAL AND EMERGENCY PROCEDURES

ENG

ENG 1(2) SENSOR FAULT (Cont'd)

Ident.: PRO-ABN-ENG-R-00012235.0003001 / 16 NOV 11

L2 PS3, T25, T3, N1 , N2 data not available on both ECU channels.

L1 ■ **On ground:**
 THR LEVER (AFFECTED)..... IDLE
 ENG MASTER (AFFECTED).....OFF

■ **In flight:**
 AVOID RAPID THR CHANGES.

Ident.: PRO-ABN-ENG-R-00017707.0001001 / 21 MAR 16

STATUS

AVOID RAPID THR CHANGES.



ENG 1(2) SHUT DOWN

Applicable to: ALL

Ident.: PRO-ABN-ENG-I-00017874.0001001 / 21 MAR 16

ANNUNCIATIONS

Triggering Conditions:

- L2 This alert triggers when ENG master is at off in phases 3 to 8, or ENG FIRE pb is pushed in phases 1, 2, 9 and 10.

Flight Phase Inhibition:

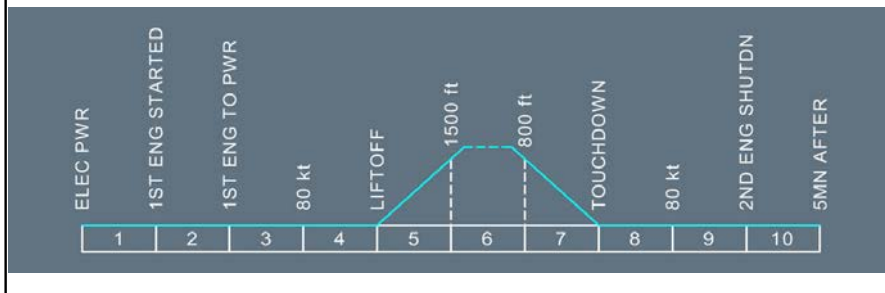

Continued on the following page

ENG 1(2) SHUT DOWN (Cont'd)

Ident.: PRO-ABN-ENG-I-00017837.0006001 / 20 MAR 17

LAND ASAP

● **If wing anti-ice ON:**

■ **If Elec Emer Config:**

PACK 1.....OFF

L2

In Elec Emer config, only Pack 1 pb-sw can be set to off.

L1

■ **If not Elec Emer Config:**

PACK (AFFECTED SIDE) OFF

L2

One pack must be closed when wing anti-ice is in use due to precooler performance.

L1

● **If ENG FIRE pb not pushed:**

X BLEED (IF ENG FIRE PB NOT PUSHED)..... OPEN

L2

X BLEED selector must be opened to have symmetrical wing anti-icing.

L1

ENG MODE SEL.....IGN

L2

Continuous ignition is selected, in order to protect the remaining engine.

L1

● **IF NO FUEL LEAK:**

IMBALANCE.....MONITOR

TCAS MODE SEL TA

● **If REV unlocked:**

● **IF BUFFET:**

MAX SPEED 240 KT

● **If ENG FIRE pb-sw pushed:**

X BLEED SHUT

WING ANTI ICE.....OFF

AVOID ICING CONDITIONS

SECONDARY FAILURES

- * HYD
- * ELEC
- * AIR BLEED

Continued on the following page

ENG 1(2) SHUT DOWN (Cont'd)

L2 Note: *In some conditions, with full asymmetric power, the aircraft may be control-limited before reaching the protection system limit. Therefore, in extreme conditions, where low speed may be advantageous (GPWS , WINDSHEAR, etc.), reduce speed with care below VLS and respect the minimum control speed.*

Continued on the following page

ENG 1(2) SHUT DOWN (Cont'd)

Ident.: PRO-ABN-ENG-I-00017852.0005001 / 22 MAR 17

L12

STATUS

INOP SYS

- If ENG 1(2) FIRE pb-sw pushed:
 AVOID ICING CONDITIONS
- IF SEVERE ICE ACCRETION:
 MIN SPD..... VLS + 10/G DOT
 MANEUVER WITH CARE
 LDG DIST PROC..... APPLY
- If REV unlocked:
 MAX SPEED..... 300/0.78

- CAT 3 DUAL
- ENG 1(2) BLEED
- PACK 1(2)
- MAIN GALLEY
- GEN 1(2)
- G ENG 1 PUMP or
 Y ENG 2 PUMP
- WING A. ICE ⁽¹⁾
- AFT CRG HEAT
- STEER APPR

APPR PROC

- If REV unlocked:
 - 4 doors not stowed (CFM) or reverser deployed (IAE/PW):
 - IF BUFFET:
 FOR LDG.....USE FLAP 1
This line is replaced by "FOR LDG : USE FLAP 1" when CONF 1 is selected, as a reminder.
 APPR SPD.....VREF + 55 KT
 RUD TRIM.....5 DEG R(L)
When committed to land, set 5 ° rudder trim towards live engine.
 A/THR.....OFF
 GPWS FLAP MODE..... OFF
 - WHEN LDG ASSURED:
 L/G.....DOWN
 - AT 800 FT AGL:
 TARGET SPD..... VREF + 40 KT
 LDG DIST PROC.....APPLY

Continued on the following page

ENG 1(2) SHUT DOWN (Cont'd)

■ **1, 2, or 3 doors not stowed (CFM), or reverse detected unlocked (IAE/PW):**

● **IF BUFFET:**

FOR LDG.....USE FLAP 3

This line is replaced by "FOR LDG : USE FLAP 3" when CONF 3 is selected, as a reminder.

GPWS LDG FLAP 3..... ON

APPR SPD.....VREF + 10 KT

LDG DIST PROC.....APPLY

● **If WING A/ICE off and ENG 1(2) FIRE pb-sw not pressed:**

● **IF PERF PERMITS:**

X BLEED.....OPEN

*If no obstacle constraint exists, open the XBLEED.
To determine the single engine gross ceiling, decrease by 1 200 ft the result provided by the QRH table (Refer to QRH/PER-L Ceilings (Paper Only)) or by the performance application of FlySmart with Airbus.*

● **For A321 aircraft:**

ECON FLOW.....ON

AFT CRG HOT AIR  OFF

The ECON FLOW must be selected ON, and the aft cargo heat  must be selected OFF, due to precooler performance.

● **IF NO ENG 1(2) DAMAGE:**

CONSIDER ENG 1(2) RELIGHT

CAT 3 SINGLE ONLY

ONE PACK ONLY IF WAI ON

See ⁽²⁾

⁽¹⁾ (if affected ENG FIRE pb-sw pushed)

⁽²⁾ Note: - If available, the APU may be started and the APU GEN used
- If the ENG 1 FIRE pb-sw is pushed, APU bleed must not be used.

Continued on the following page

ENG 1(2) SHUT DOWN (Cont'd)

If ENG 2 FIRE pb-sw is pushed, APU bleed may be used, provided the X BLEED rotary selector is set at SHUT.

- *After landing, the Fuel Used value of the engine, shutdown in flight, becomes incorrect.*

ENG 1(2) STALL

Applicable to: ALL

Ident.: PRO-ABN-ENG-Z-00017876.0001001 / 21 MAR 16

ANNUNCIATIONS

Triggering Conditions:

L2

This alert triggers when an engine stall is detected.

Flight Phase Inhibition:

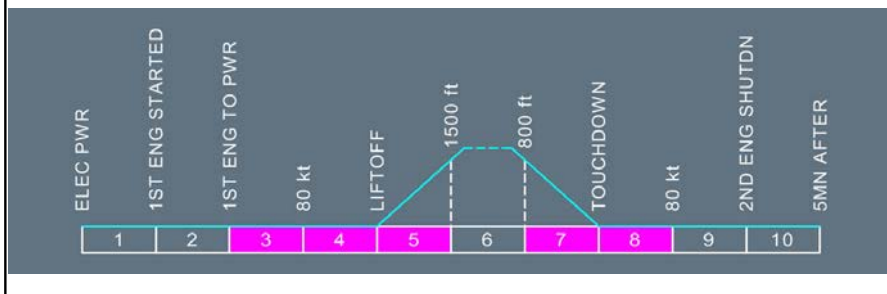

Continued on the following page

ENG 1(2) STALL (Cont'd)

Ident.: PRO-ABN-ENG-Z-00017749.0003001 / 17 MAR 17

L2 A stall may be indicated by varying degrees of abnormal engine noises, accompanied by flame from the engine exhaust (and possibly from the engine inlet in severe case), fluctuating performance parameters, sluggish or no thrust lever response, high EGT and/or a rapid EGT rise when thrust lever is advanced. Engine stalls must be reported for maintenance action.

L1 THR LEVER (AFFECTED ENGINE)..... IDLE
 ENG MASTER (AFFECTED ENGINE)..... OFF

ASSOCIATED PROCEDURES

ENG 1(2) SHUT DOWN

● **If N2 is above IDLE:**

L2 This caution is not displayed on the ECAM.
 Consequently, if the crew detects a stall, it must apply the following procedure:

L1 ■ **On ground:**
 THR LEVER (AFFECTED ENGINE)..... IDLE
 ENG MASTER (AFFECTED ENGINE)..... OFF

■ **In flight:**
 THR LEVER (AFFECTED ENGINE)..... IDLE
 ENG PARAMETERS (AFFECTED ENGINE)..... CHECK

■ **If abnormal ENG parameters:**
 ENG MASTER (AFFECTED ENGINE)..... OFF

L12 **ASSOCIATED PROCEDURES**

ENG 1(2) SHUT DOWN

Apply the **ENG SHUT DOWN** procedure (Refer to PRO-ABN-ENG ENG 1(2) SHUT DOWN).

■ **If normal ENG parameters:**
 ENG ANTI ICE (AFFECTED ENGINE)..... ON
 WING ANTI ICE..... ON

L2 Operation of ENG and WING ANTI ICE will increase the stall margin but EGT increases accordingly.

L1 THR LEVER (AFFECTED ENGINE)..... SLOWLY MOVE FORWARD

Continued on the following page



A318/A319/A320/A321
 FLIGHT CREW
 OPERATING MANUAL

PROCEDURES
ABNORMAL AND EMERGENCY PROCEDURES

ENG

ENG 1(2) STALL (Cont'd)

- **If stall recurs:**
 THR LEVER (AFFECTED ENGINE).....MOVE BACKWARD

L2

Reduce thrust and operate below the stall threshold where stall recurs.

L1

- **If stall does not recur:**
 CONTINUE NORMAL ENGINE OPERATION

L2

Ident.: PRO-ABN-ENG-Z-00017748.0001001 / 21 MAR 16

STATUS

CONSIDER ENG 1(2) RELIGHT

ENG 1(2) START FAULT

Applicable to: ALL

Ident.: PRO-ABN-ENG-AD-00017995.0001001 / 13 MAY 16

ANNUNCIATIONS

Triggering Conditions:

- L2** This alert triggers when start fault due to:
- No light up, or
 - Engine stall, or
 - Engine overtemperature (above 725 °C), or
 - Starter time exceeded, or
 - Low start air pressure, or
 - Thrust lever not at idle.

Flight Phase Inhibition:

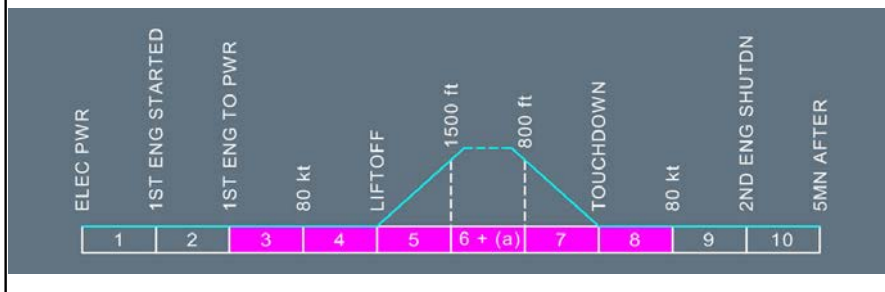

Note: Alert inhibited in the flight phase 6, only if it is due to thrust lever not at idle.

Continued on the following page

ENG 1(2) START FAULT (Cont'd)

Ident.: PRO-ABN-ENG-AD-00012100.0005001 / 13 MAY 16

■ **ENG 1(2) IGNITION FAULT:**

L2 The engine does not start within the 18 s that follow the ignition start.

L1 ● **In flight:**
 ENG MASTER (AFFECTED)..... OFF

L2 Wait 30 s before attempting a new start (to drain the engine).

L1 ● **On the ground (auto start) :**

L2 If the engine does not start, the FADEC can attempt an additional engine restart. After any start attempt that is not successful, a dry crank phase automatically occurs. The ECAM displays the following messages:

L1 AUTO CRANK IN PROGRESS
 NEW START IN PROGRESS

L1 ● **When the final dry cranking process is finished:**
 ENG MASTER (AFFECTED)..... OFF

L2 Following starter cooldown, the pilot must decide whether to attempt auto or manual start, or to report the no start condition for appropriate maintenance action.

L1 ● **On the ground (manual start):**
 ENG MASTER (AFFECTED)..... OFF
 MAN START (AFFECTED)..... OFF
 MODE SEL..... CRANK
 MAN START (AFFECTED)..... ON

L2 Note: ECAM does not display the last two lines of the above procedure.
 Dry crank the engine for 30 s. The start valve automatically reopens when N2 is below 20 %.
 After the starter cools, and for any subsequent attempt to start the engine, the flight crew must perform a manual start, or must report the “no start condition” to maintenance for appropriate action.

L1 ■ **ENG 1(2) STALL, ENG 1(2) EGT OVERLIMIT:**

L1 ● **In flight:**
 ENG MASTER (AFFECTED)..... OFF

L2 Wait 30 s before attempting a new start (to drain the engine).

Continued on the following page

ENG 1(2) START FAULT (Cont'd)

L1

● **On ground (auto start):**

L2

If the FADEC detects a stall or a potential EGT overheat, the FADEC will reduce the fuel schedule in stages, if necessary, to achieve a normal condition. The following message will be displayed on the ECAM:

L1

NEW START IN PROGRESS

● **If restart not possible:**

L2

If normal conditions cannot be achieved, the FADEC shuts off fuel and turn off ignition. Then a dry crank phase automatically occurs. The ECAM displays the following message:

L1

AUTO CRANK IN PROGRESS

ENG MASTER (AFFECTED).....OFF

L2

- *The fuel metering valve and starter air valve are automatically closed. Both igniters are turned off*
- *Setting ENG MASTER to OFF confirms automatic start abort*
- *In case of ENG STALL, consider making a XBLEED start, if pressure is low.*

L1

● **On ground (manual start):**

ENG MASTER (AFFECTED)..... OFF

MAN START (AFFECTED)..... OFF

MODE SEL.....CRANK

MAN START (AFFECTED).....ON

L2

*Note: ECAM does not display the last two lines of the above procedure.
 Dry crank the engine for 30 s. The start valve automatically reopens when N2 is below 20 %.
 After the starter cools, and for any subsequent attempt to start the engine, the flight crew must perform a manual start, or must report the "no start condition" to maintenance for appropriate action.*

L1

■ **STARTER TIME EXCEEDED:**

MAN START (IF MANUAL START IS PERFORMED).....OFF

ENG MASTER (AFFECTED).....OFF

■ **LO START AIR PRESS:**

BLEED AIR SUPPLY..... CHECK

Continued on the following page

ENG 1(2) START FAULT (Cont'd)

■ **THR LEVER NOT AT IDLE:**
 THR LEVER..... IDLE

ENG 1(2) START VALVE FAULT

Applicable to: ALL

Ident.: PRO-ABN-ENG-D-00017932.0002001 / 21 MAR 16

ANNUNCIATIONS

Triggering Conditions:

L2 This alert triggers when the start valve is stuck in closed or open position.

Flight Phase Inhibition:

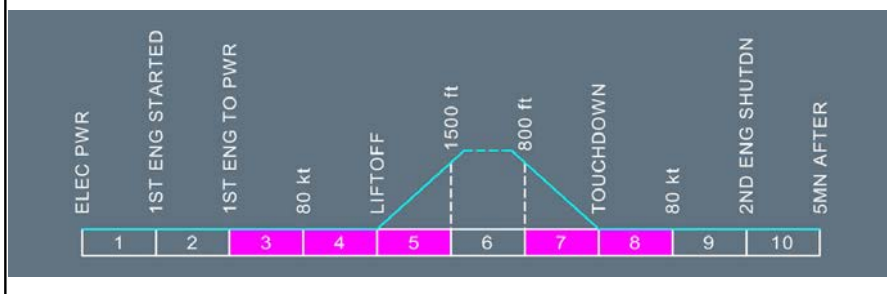

Continued on the following page

ENG 1(2) START VALVE FAULT (Cont'd)

Ident.: PRO-ABN-ENG-D-00018010.0002001 / 21 MAR 17

■ **START VALVE NOT CLOSED**

- [L2] Remove all bleed sources supplying the faulty start valve.
- [L1]

| | |
|------------------------------------|------|
| APU BLEED (IF ENG 1 AFFECTED)..... | OFF |
| X BLEED..... | SHUT |

 - **In flight:**

| | |
|--------------------------------|-----|
| ENG BLEED (AFFECTED SIDE)..... | OFF |
|--------------------------------|-----|
 - **On the ground:**

| | |
|---|-----|
| MAN START (IF MAN START PERFORMED)..... | OFF |
| ENG MASTER (AFFECTED SIDE)..... | OFF |

[L2] *On the ground, consider application of "START VALVE MANUAL OPERATION" procedure.*

[L1] ■ **START VALVE NOT OPEN**

- **If opposite engine running:**

| | |
|--------------|------|
| X BLEED..... | OPEN |
|--------------|------|
- **If APU AVAIL below FL 200:**

| | |
|----------------|----|
| APU BLEED..... | ON |
|----------------|----|
- **If UNSUCCESSFUL:**

| | |
|--|-----|
| MAN START (IF MAN START PERFORMED)..... | OFF |
| ENG MASTER (AFFECTED) (IF AUTO START PERFORMED)..... | OFF |

[L2] *MAN START procedure is useless since in both cases, the start valve is controlled by FADEC.*
On the ground, consider application of "START VALVE MANUAL OPERATION" procedure.

[L1] ● **EEC control of start valve failed (for IAE or PW 6000 engines):**

- **On the ground:**
START VALVE MAN ONLY
- [L2] *Start valve must be manually opened (Refer to PRO-NOR-SUP-ENG Engine Start Valve Manual Operation).*
- [L1] ● **In flight:**
WINDMILL START ONLY.
- [L2] *Windmilling start only is available since EEC cannot control the start valve.*

ENG 1(2) THR LEVER ABV IDLE

Applicable to: ALL

Ident.: PRO-ABN-ENG-CW-00017922.0002001 / 21 MAR 16

ANNUNCIATIONS

Triggering Conditions:

L2

This alert triggers when:

- One thrust lever is above idle while the other thrust lever is in the reverse detent at landing.
- One thrust lever is above idle while the other thrust lever is at idle, at reverser deselection during landing roll.

Flight Phase Inhibition:

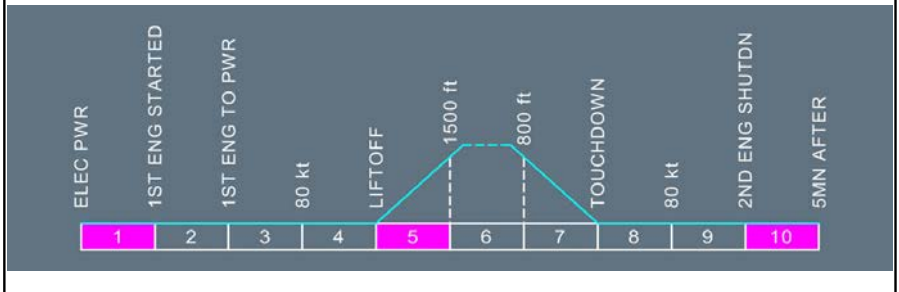

Ident.: PRO-ABN-ENG-CW-00018748.0002001 / 21 MAR 16

L2

The repetitive "RETARD-RETARD" synthetic voice is triggered at landing.

L1

THR LEVER (AFFECTED ENGINE)..... IDLE

ENG 1(2) THR LEVER DISAGREE

Applicable to: ALL

Ident.: PRO-ABN-ENG-L-00017999.0004001 / 06 SEP 16

ANNUNCIATIONS

Triggering Conditions:

L2 This alert triggers when a discrepancy between both resolvers of a thrust lever is detected.

Flight Phase Inhibition:

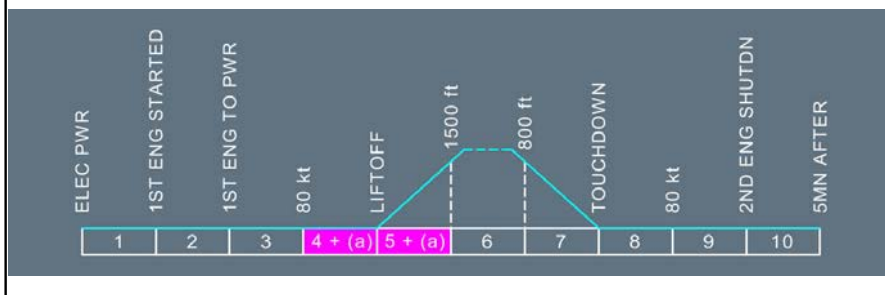

Note: (a) Alert not inhibited in the flight phases 4 and 5, if the FADEC automatically selects IDLE thrust.

Continued on the following page

ENG 1(2) THR LEVER DISAGREE (Cont'd)

Ident.: PRO-ABN-ENG-L-00012146.0017001 / 02 MAY 17

L2 Both Thrust Lever Angle (TLA) sensors not in agreement on one engine.

L1

LAND ASAP

■ **On ground (if both TLA not at TOGA or FLX/MCT or if only one TLA is at TOGA or FLX/MCT and the other is below IDLE):**

ENG (AFFECTED) IDLE POWER ONLY.

L2

In that situation, the FADEC automatically selects IDLE.

L1

THR LEVER (AFFECTED)..... IDLE

■ **During take-off (if both TLA are above IDLE):**

ENG (AFFECTED) TO, FLX, OR DRT TO 

L2

If both TLA are above IDLE, the FADEC automatically selects TO , FLX TO, or DRT TO  thrust until thrust reduction, after which the maximum available thrust is CLB.

L1

■ **In cruise (with slats retracted):**

AVAIL MAX POWER : CLB

L2

In flight, if the failure occurs while the thrust lever is between idle and MCT , and if the slats are not extended, (or when MN > 0.55, if the outside EIU is failed) the FADEC selects the larger TLA power limited to CLB.

L1

A/THR (IF ENGAGED) KEEP ON
A/THR (IF NOT ENGAGED AND IF SLATS ARE NOT EXTENDED) ON

L2

With A/THR engaged, thrust is automatically managed between IDLE and higher TLA position.

L1

■ **In approach (with slats extended):**

ENG (AFFECTED) AT IDLE (WHEN SLATS ARE EXTENDED FOR APPROACH)..

L2

If TLA at, or below, MCT and if the slats are extended for approach, (or when MN < 0.47, if the outside EIU is failed).

L1

THR LEVER (AFFECTED)..... IDLE

Continued on the following page

ENG 1(2) THR LEVER DISAGREE (Cont'd)

Ident.: PRO-ABN-ENG-L-00018067.0013001 / 21 MAR 16

L12

STATUS

INOP SYS

- If TLA at, or below, MCT

- **WHEN SLATS OUT:**

(Displayed, if slats not extended), or

- **WHEN MN < 0.47:**

(Displayed, if the onside EIU is failed)

ENG (AFFECTED) AT IDLE

For any case of thrust lever disagree (TO, FLEX, or between Idle and MCT), the FADEC will command idle thrust for the approach when slats are extended (or when the Mach number is less than 0.47, if associated EIU is failed). It is independent of the autothrust condition. The affected engine's thrust remains definitively at idle, even for go-around.

ENG 1(2) THR

ENG (affected) AVAIL MAX PWR: CLB
 ON GND ENG (affected) MAX PWR: IDLE.

ENG 1(2) THR LEVER FAULT

Applicable to: ALL

Ident.: PRO-ABN-ENG-M-00018000.0003001 / 01 JUN 16

ANNUNCIATIONS

Triggering Conditions:

L2

This alert triggers when both resolvers on one thrust lever are failed.

Flight Phase Inhibition:

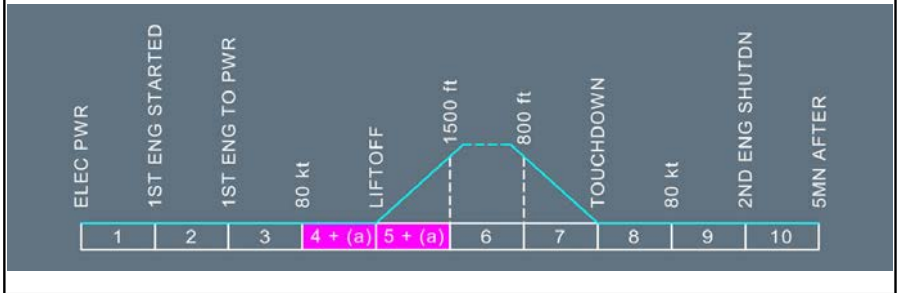

Note: (a) Alert not inhibited in flight phases 4 and 5 if the FADEC automatically selects IDLE thrust.

Continued on the following page

ENG 1(2) THR LEVER FAULT (Cont'd)

Ident.: PRO-ABN-ENG-M-00018069.0009001 / 21 MAR 16

LAND ASAP

■ **On the ground:**

ENG (AFFECTED) IDLE POWER ONLY.

L2

Idle power is automatically selected by FADEC.

If associated thrust reverser is already deployed, FADEC commands restow.

L1

THR LEVER (AFFECTED)..... IDLE

■ **In flight:**

L2

If the selected thrust lever position at the time of fault detection is:

TO or FLEX: FADEC freezes TO or FLEX TO thrust until slat retraction. At slat retraction it selects CLB thrust.

Between IDLE and MCT: in manual thrust setting mode, engine rating freezes at CLB , or

IDLE with slats extended (or MN < 0.47 if the FADEC no longer receives the slats position due to EIU failure). It is possible to activate autothrust. If selected, autothrust mode manages thrust between idle and CLB.

L1

ENG (AFFECTED) AT IDLE

L2

For any case of thrust lever fault (TO, FLEX or between IDLE and MCT) the FADEC will command idle thrust for the approach when slats are extended (or when MN < 0.47 if associated EIU is failed). It is independant of the autothrust condition. Thrust of affected engine remains definitively at idle even for go around.

L1

THR LEVER (AFFECTED) IDLE

L2

When slats are extended or MN < 0.47, if on side EIU is failed.

L1

■ **A/THR engaged:**

A/THR..... KEEP ON

■ **A/THR not engaged:**

ENG (AFFECTED) HI PWR IN MAN THR.

L2

Inhibited when the FADEC commands the affected engine at IDLE.

L1

● **BEFORE SLATS IN:**

A/THR ON

HI PWR ONLY

L2

If thrust lever angle failed in TO or flex position.

Continued on the following page

ENG 1(2) THR LEVER FAULT (Cont'd)

Ident.: PRO-ABN-ENG-M-00012152.0002001 / 14 NOV 11

L12

STATUS

- **WHEN SLATS OUT:**
(Displayed if slats not extended) or,
- **WHEN MN < 0.47:**
(Displayed if the onside EIU is failed).

ENG 1(2) AT IDLE

INOP SYS

REVERSER 1(2)
ENG 1(2) THR

ENG THR LEVERS NOT SET

Applicable to: ALL

Ident.: PRO-ABN-ENG-DD-00017892.0001001 / 21 MAR 16

ANNUNCIATIONS

Triggering Conditions:

L2

This alert triggers when the levers position does not correspond to TO power mode.

Flight Phase Inhibition:

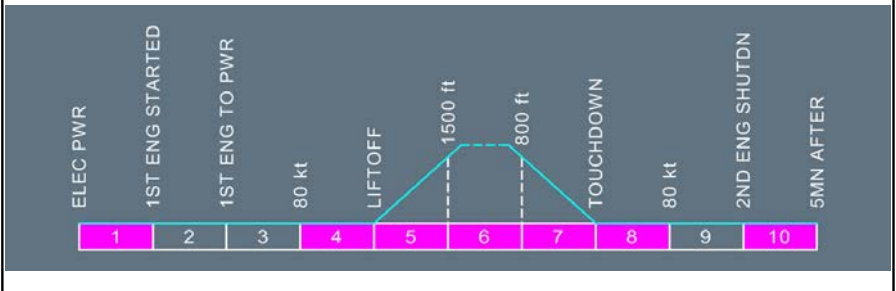

Continued on the following page

ENG THR LEVERS NOT SET (Cont'd)

Ident.: PRO-ABN-ENG-DD-00017863.0003001 / 21 MAR 16

[L2] At least one FADEC engaged a takeoff thrust mode that is not in accordance with the position of the thrust levers.

- Note:
1. The takeoff thrust mode is engaged when the flight crew sets the thrust levers above the CL position.
 2. The flex takeoff thrust mode is armed only if the flight crew entered a FLEX TO TEMP on the MCDU that is above the OAT.

- [L1]** ■ If the flex mode is not armed, and the flight crew sets the thrust levers below or at the MCT/FLX position:
 THR LEVERS..... TO/GA
- If the flex mode is armed, and the flight crew sets the thrust levers below the MCT/FLX position:
 THR LEVERS MCT/FLX

ENG THRUST LOCKED

Applicable to: ALL

Ident.: PRO-ABN-ENG-DE-00017888.0001001 / 21 MAR 16

ANNUNCIATIONS

Triggering Conditions:

L2

This alert triggers when thrust levers are not moved within 5 s, following an involuntary disconnection of the A/THR (or disconnection through the FCU pb).

Flight Phase Inhibition:

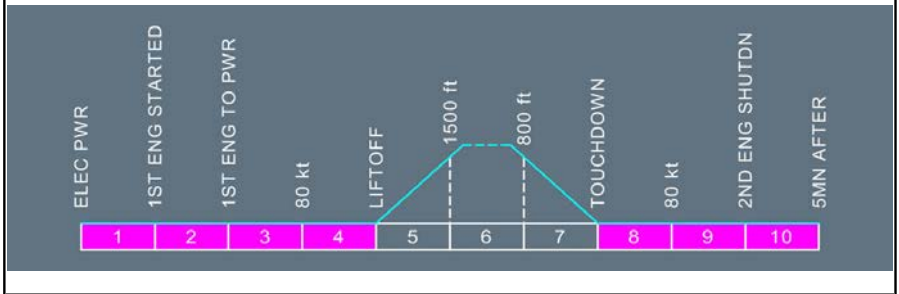

Ident.: PRO-ABN-ENG-DE-00017865.0002001 / 21 MAR 16

THR LEVERS.....MOVE

ENG TYPE DISAGREE

Applicable to: ALL

Ident.: PRO-ABN-ENG-DF-00017881.0001001 / 21 MAR 16

ANNUNCIATIONS

Triggering Conditions:

L2 This alert triggers when a rating discrepancy between two engines is detected.

Flight Phase Inhibition:

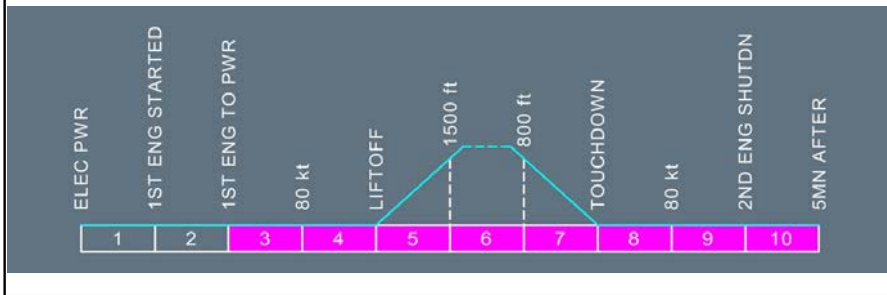

Ident.: PRO-ABN-ENG-DF-00017868.0001001 / 21 MAR 16

Crew awareness.

ENG VIB SYS FAULT

Applicable to: ALL

Ident.: PRO-ABN-ENG-DG-00017879.0001001 / 21 MAR 16

ANNUNCIATIONS

Triggering Conditions:

L2

This alert triggers when the vibration detection system is failed.

Flight Phase Inhibition:

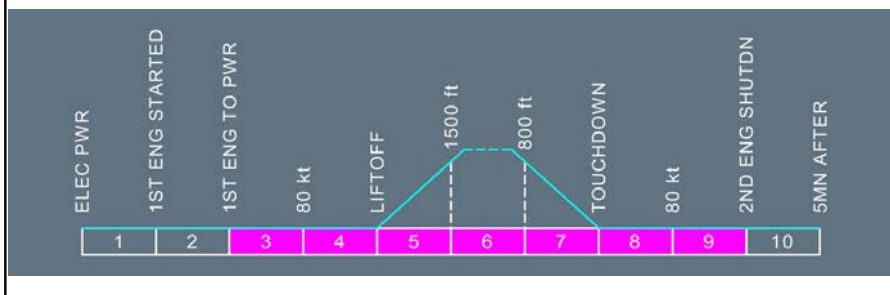

Ident.: PRO-ABN-ENG-DG-00012074.0001001 / 25 FEB 14

Crew awareness.



A318/A319/A320/A321
FLIGHT CREW
OPERATING MANUAL

PROCEDURES
ABNORMAL AND EMERGENCY PROCEDURES

ENG

Intentionally left blank

[QRH] LANDING WITH SLATS OR FLAPS JAMMED

Ident.: PRO-ABN-F_CTL-00010683.0001001 / 17 MAR 17

Applicable to: ALL

LDG DIST PROC.....APPLY

Determine flap lever position for landing

- Repeat the following until landing configuration is reached:

SPD SEL..... VFE NEXT - 5 kt

AT VFE NEXT: SELECT FLAPS LEVER ONE STEP DOWN

Note:

- **OVERSPEED** alert, and **VLS** displayed on the **PFD**, are computed according to the actual flaps/slats position
- **VFE** and **VFE NEXT** are displayed on the **PFD** according to the **FLAPS** lever position. If not displayed, use the placard speeds
- If **VLS** is greater than **VFE NEXT** (overweight landing case), the **FLAPS** lever can be set in the required next position, while the speed is reduced to follow **VLS** reduction as surfaces extend. The **VFE** warning threshold should not be triggered. In this case, disconnect the **A/THR**. **A/THR** can be re-engaged when the landing configuration is established.

- When in landing **CONF** and in final approach:

DECELERATE TO CALCULATED **VAPP**

AP BELOW 500 ft AGL : DO NOT USE

- For Go-around:

| | | MAX SPEED | | | | |
|-------|------------------------|---------------|-----------|-----------|-----------|-------------------------|
| Slats | Flaps | F = 0 | 0 < F ≤ 1 | 1 < F ≤ 2 | 2 < F ≤ 3 | F > 3 |
| | S = 0 | NO LIMITATION | 215 kt | 200 kt | 185 kt | 177 kt (Not allowed) |
| | 0 < S < 1 | 230 kt | | | | 177 kt |
| | S = 1 | | 200 kt | 185 kt | 177 kt | |
| | 1 < S ≤ 3 | 177 kt | | | | 177 kt |
| | S > 3 | 177 kt | 177 kt | 177 kt | 177 kt | |

- If **SLATS FAULT**:

- For circuit:

MAINTAIN SLATS/FLAPS CONFIGURATION

Recommended speed: **MAX SPEED - 10 kt**

Continued on the following page

[QRH] LANDING WITH SLATS OR FLAPS JAMMED (Cont'd)

● **For diversion:**

SELECT CLEAN CONFIGURATION

Recommended speed for flaps retraction: between MAX SPEED - 10 kt and MAX SPEED.

Recommended diversion speed: MAX SPEED - 10 kt.

INCREASED FUEL CONSUMPTION

■ **If FLAPS FAULT:**

● **For circuit:**

MAINTAIN SLATS/FLAPS CONFIGURATION

Recommended speed: MAX SPEED - 10 kt

● **For diversion:**

■ **If FLAPS jammed at 0:**

SELECT CLEAN CONFIGURATION

Recommended speed for slats retraction: between MAX SPEED - 10 kt and MAX SPEED

USE NORMAL OPERATING SPEEDS

■ **If FLAPS jammed > 0:**

MAINTAIN SLAT/FLAP CONFIGURATION

Recommended speed for diversion: MAX SPEED - 10 kt

*Note: In case of a go-around with CONF FULL selected, the **L/G NOT DOWN** warning is triggered at landing gear retraction.*

INCREASED FUEL CONSUMPTION

CAUTION

For flight with SLATS or FLAPS extended, fuel consumption is increased. Refer to the fuel flow indication. As a guideline, determine the fuel consumption in clean configuration at the same altitude without airspeed limitation (e.g. From ALTERNATE FLIGHT PLANNING tables) and multiply this result by the applicable Fuel Penalty Factor provided in the QRH, to obtain the fuel penalty required to reach the destination in the current configuration. Refer to QRH/OPS Fuel Penalty Factors/ECAM Alert Table.

[QRH] RUDDER JAM

Ident.: PRO-ABN-F_CTL-00011807.0001001 / 17 MAR 17

Applicable to: ALL

- L2** Rudder jamming may be detected by undue (and adverse) pedal movement during rolling maneuvers.
This is because the yaw damper orders can no longer be sent to the rudder, but are fed back to the pedals.
Use F/CTL SD page for a visual check of the rudder position.
- L1** ● **For approach:**
AVOID LANDING WITH CROSSWIND FROM THE SIDE WHERE THE RUDDER IS DEFLECTED
MAX CROSSWIND FOR LDG: 15 kt
AUTO BRK.....DO NOT USE
- L2** *Do not use the autobrake, so as not to delay the application of differential braking at landing roll.*
- L1** FOR LANDING..... USE NORMAL CONF
SPEED AND TRAJECTORY.....STABILIZE ASAP
LDG DIST PROC..... APPLY
- **For landing:**
DIFFERENTIAL BRAKING..... USE ASAP
REVERSER: SYMMETRIC USE ONLY
- L2** *Use nosewheel steering handle below 70 kt.*

[QRH] STABILIZER JAM

Ident.: PRO-ABN-F_CTL-00011806.0001001 / 17 MAR 17

Applicable to: ALL

[L2] The ELACs may not detect a stabilizer jam when the pitch trim wheel is jammed.
 The flight control normal law remains active in this case and there is no ECAM warning.
 Apply the following procedure.

[L1] AP OFF
 MAN PITCH TRIM CHECK

[L2] *The pitch trim wheel may not be fully jammed, the force needed may be higher than pre-takeoff manual setting.*

[L1] ● **If MAN PITCH TRIM available:**
 TRIM FOR NEUTRAL ELEV

[L2] *If manual pitch trim is available, trim to maintain the elevator at the zero position (indications on F/CTL SD page).*

[L1] ● **If MAN PITCH TRIM not available:**
 FOR LANDING: USE FLAP 3

[L2] *Do not select configuration full so as not to degrade the handling qualities.*

[L1] GPWS LDG FLAP 3 ON

CAT 1 ONLY

ACTIVE CONTROL LAW

Ident.: PRO-ABN-F_CTL-00018549.0001001 / 21 MAR 16

Applicable to: ALL

| ACTIVE LAW ▶ | PITCH | | ROLL | YAW |
|--------------------------------------|--|---------------------------------------|--|--------------------------------------|
| | LAW | PROTEC | | |
| ELAC 1 or 2 or SEC 1 or 2 | NORM | NORM | NORM | NORM |
| ELAC 1 and 2 or both ailerons | ALTN | REDUCED | DIRECT | ALTN |
| 2 SEC | NORM | NORM | NORM | NORM |
| 3 SEC | ALTN | REDUCED | DIRECT | ALTN |
| 2 FAC | ALTN | REDUCED | DIRECT | MECH |
| Yaw damper | ALTN | REDUCED | DIRECT | MECH |
| 2 SFCC (slat channel) | ALTN | NO | DIRECT | ALTN |
| 2 ADR or 2 IR (2nd self detected) | ALTN | REDUCED | DIRECT | ALTN |
| 2 ADR (2nd not self detec.) | ALTN | NO ----- REDUCED ⁽¹⁾ | DIRECT | ALTN |
| 2 IR (2nd not self detec.) | DIRECT ----- ALTN ⁽²⁾ | NO ----- REDUCED ⁽²⁾ | DIRECT | MECH ----- ALTN ⁽²⁾ |
| 3 ADR | ALTN | NO | DIRECT | MECH |
| 3 IR | DIRECT | NO | DIRECT | MECH |
| 2 RADIO ALT | NORM ----- DIRECT ⁽⁴⁾ | NORM ----- NO ⁽⁴⁾ | NORM ----- DIRECT ⁽⁴⁾ | NORM ----- MECH ⁽⁴⁾ |
| SPOILER 4 or 5 or (4 and 5) | NORM | NORM | NORM | NORM |
| All SPOILERS | ALTN | REDUCED | DIRECT | ALTN |
| 1 AIL SERVO or 1 AILERON | NORM | NORM | NORM | NORM |
| 1 ELEV SERVO | NORM | NORM | NORM | NORM |
| 1 ELEVATOR | ALTN | REDUCED | DIRECT | ALTN |
| THS (jammed) ⁽⁵⁾ | NORM | NORM | NORM | NORM |
| | ALTN | REDUCED | DIRECT | ALTN |
| HYD G or Y or B | NORM | NORM | NORM | NORM |
| HYD G + Y | ALTN | REDUCED | DIRECT | MECH |
| HYD G + B | ALTN | NO | DIRECT | ALTN |
| HYD Y + B | NORM | NORM | NORM | NORM |
| on BATTERIES | ALTN | REDUCED | DIRECT | MECH |
| on EMER GEN | ALTN | REDUCED | DIRECT | MECH |

Continued on the following page

ACTIVE CONTROL LAW (Cont'd)

| ACTIVE LAW ▶ SYS FAILED▼ | PITCH | | ROLL | YAW |
|-----------------------------|-------|--------|------|------------------------------|
| | LAW | PROTEC | | |
| | | | | ----- ALTN ⁽³⁾ |

- (1) *In case of AOA disagree*
- (2) *After the faulty IR is selected OFF*
- (3) *After FAC 1 is reset*
- (4) *When landing gear down (or CONF 2, if both LGCIUs faulty)*
- (5) *Depending where the failure is, control law may revert to alternate law*

ELEVATORS AND STABILIZER CONTROL AFTER FAILURE

Ident.: PRO-ABN-F_CTL-00018591.0001001 / 09 FEB 16

Applicable to: ALL

| | LEFT ELEVATOR | | THS | RIGHT ELEVATOR | |
|-----------------------|---------------|--------|------------------|----------------|--------|
| | BLUE | GREEN | GREEN AND YELLOW | YELLOW | BLUE |
| <u>NORM OPERATION</u> | | ELAC 2 | ELAC 2 | ELAC 2 | |
| <u>SINGLE FAILURE</u> | | | | | |
| ELAC 2 | ELAC 1 | | ELAC 1 | | ELAC 1 |
| ELAC 1 | | ELAC 2 | ELAC 2 | ELAC 2 | |
| SEC 2 | | ELAC 2 | ELAC 2 | ELAC 2 | |
| SEC 1 | | ELAC 2 | ELAC 2 | ELAC 2 | |
| G | ELAC 1 | | ELAC 1 | | ELAC 1 |
| Y | ELAC 1 | | ELAC 1 | | ELAC 1 |
| B | | ELAC 2 | ELAC 2 | ELAC 2 | |
| <u>DOUBLE FAILURE</u> | | | | | |
| ELAC + ELAC 1 | | SEC 2 | SEC 2 | SEC 2 | |
| 2 | | | | | |
| + SEC 2 | ELAC 1 | | ELAC 1 | | ELAC 1 |
| + SEC 1 | ELAC 1 | | ELAC 1 | | ELAC 1 |
| + G | ELAC 1 | | ELAC 1 | | ELAC 1 |
| + Y | ELAC 1 | | ELAC 1 | | ELAC 1 |
| + B | | SEC 2 | SEC 2 | SEC 2 | |
| ELAC + SEC 2 | | ELAC 2 | ELAC 2 | ELAC 2 | |
| 1 | | | | | |
| + SEC 1 | | ELAC 2 | ELAC 2 | ELAC 2 | |
| + G | SEC 1 | | SEC 2 | SEC 2 | |
| + Y | | SEC 2 | SEC 2 | | SEC 1 |
| + B | | ELAC 2 | ELAC 2 | ELAC 2 | |
| SEC 2 + SEC 1 | | ELAC 2 | ELAC 2 | ELAC 2 | |
| + G | ELAC 1 | | ELAC 1 | | ELAC 1 |
| + Y | ELAC 1 | | ELAC 1 | | ELAC 1 |
| + B | | ELAC 2 | ELAC 2 | ELAC 2 | |
| SEC 1 + G | ELAC 1 | | ELAC 1 | | ELAC 1 |
| + Y | ELAC 1 | | ELAC 1 | | ELAC 1 |
| + B | | ELAC 2 | ELAC 2 | ELAC 2 | |
| G + Y | ELAC 1 | | INOP | | ELAC 1 |
| B + G | | Damped | ELAC 2 | ELAC 2 | |
| B + Y | | ELAC 2 | ELAC 2 | | Damped |
| <u>TRIPLE FAILURE</u> | | | | | |
| <u>ELAC 2</u> | | | | | |
| ELAC + SEC 2 | SEC 1 | | SEC 1 | | SEC 1 |
| 1 | | | | | |
| + SEC 1 | | SEC 2 | SEC 2 | SEC 2 | |
| + G | SEC 1 | | SEC 2 | SEC 2 | |

Continued on the following page

ELEVATORS AND STABILIZER CONTROL AFTER FAILURE (Cont'd)

| | | | | | |
|---------------|----------|--------|------------|----------|--------|
| + Y | | SEC 2 | SEC 2 | | SEC 1 |
| + B | | SEC 2 | SEC 2 | SEC 2 | |
| SEC 2 + SEC 1 | ELAC 1 | | ELAC 1 | | ELAC 1 |
| + G | ELAC 1 | | ELAC 1 | | ELAC 1 |
| + Y | ELAC 1 | | ELAC 1 | | ELAC 1 |
| + B | Centered | | Mechanical | Centered | |
| SEC 1 + G | ELAC 1 | | ELAC 1 | | ELAC 1 |
| + Y | ELAC 1 | | ELAC 1 | | ELAC 1 |
| + B | | SEC 2 | SEC 2 | SEC 2 | |
| G + Y | ELAC 1 | | INOP | | ELAC 1 |
| B + G | Damped | | SEC 2 | SEC 2 | |
| B + Y | | SEC 2 | SEC 2 | | Damped |
| <u>ELAC 1</u> | | | | | |
| SEC 2 + SEC 1 | | ELAC 2 | ELAC 2 | ELAC 2 | |
| + G | SEC 1 | | SEC 1 | | SEC 1 |
| + Y | SEC 1 | | SEC 1 | | SEC 1 |
| + B | | ELAC 2 | ELAC 2 | ELAC 2 | |
| SEC 1 + G | Damped | | SEC 2 | SEC 2 | |
| + Y | | SEC 2 | SEC 2 | | Damped |
| + B | | ELAC 2 | ELAC 2 | ELAC 2 | |
| G + Y | SEC 1 | | INOP | | SEC 1 |
| B + G | Damped | | ELAC 2 | ELAC 2 | |
| B + Y | | ELAC 2 | ELAC 2 | | Damped |
| SEC 2 | | | | | |
| SEC 1 + G | ELAC 1 | | ELAC 1 | | ELAC 1 |
| + Y | ELAC 1 | | ELAC 1 | | ELAC 1 |
| + B | | ELAC 2 | ELAC 2 | ELAC 2 | |
| G + Y | ELAC 1 | | INOP | | ELAC 1 |
| B + G | Damped | | ELAC 2 | ELAC 2 | |
| B + Y | | ELAC 2 | ELAC 2 | | Damped |
| SEC 1 | | | | | |
| G + Y | ELAC 1 | | INOP | | ELAC 1 |
| B + G | Damped | | ELAC 2 | ELAC 2 | |
| B + Y | | ELAC 2 | ELAC 2 | | Damped |

F/CTL AIL SERVO FAULT

Applicable to: ALL

Ident.: PRO-ABN-F_CTL-AF-00016986.0001001 / 21 MAR 16

ANNUNCIATIONS

Triggering Conditions:

L2

This alert triggers when there is a loss of one servojack on one aileron, or loss of one or both ELAC 1 rudder pedal transducers.

Flight Phase Inhibition:

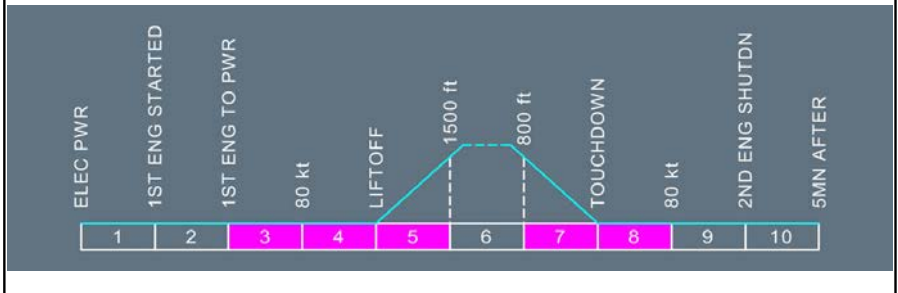

Ident.: PRO-ABN-F_CTL-AF-00018412.0001001 / 21 MAR 16

Crew awareness.

F/CTL ALTN LAW

Applicable to: ALL

Ident.: PRO-ABN-F_CTL-K-00016965.0001001 / 21 MAR 16

ANNUNCIATIONS

Triggering Conditions:

L2 This alert triggers when alternate laws are active.

Flight Phase Inhibition:

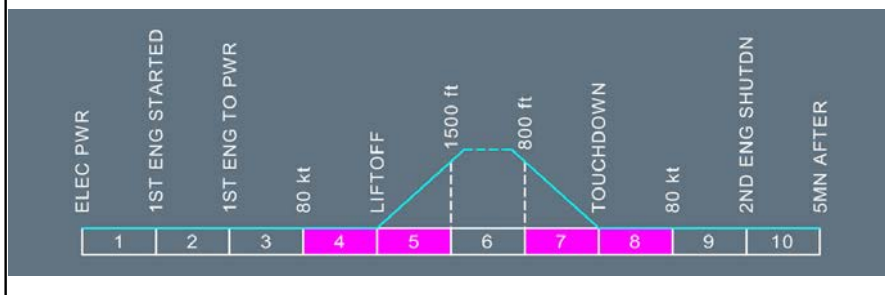

Ident.: PRO-ABN-F_CTL-K-00018413.0001001 / 22 MAR 17

L2 Refer to DSC-27-20-20 General for flight characteristics.
 With autopilot engaged the FMGC (AP mode) controls the aircraft.

L1 (PROT LOST)

L2 All protections, except maneuver protections, are lost. Depending on the failure, static stability may be introduced.

L1 Note: In case of GPWS (EGPWS \triangleleft) alerts, since protections are lost, respect stall warnings when applying the GPWS (EGPWS \triangleleft) procedure.

MAX SPEED..... **320 KT**

L2 (320/.77 if dual hydraulic system low pressure). Speed is limited to 320/.82 or 320/.77 for dual hydraulic failure, due to the loss of high-speed protection.

L1 SPD BRK (IF L OR R ELEVATOR FAULT) **DO NOT USE**

Continued on the following page

F/CTL ALTN LAW (Cont'd)

Ident.: PRO-ABN-F_CTL-K-00018414.0003001 / 22 MAR 17

L12

STATUS

MAX SPEED..... 320 KT
(320/.77, if dual hydraulic system low pressure).
SPD BRK (IF L OR R ELEVATOR FAULT)..... DO NOT USE

APPR PROC

FOR LDG..... **USE FLAP 3**
This line is replaced by "FOR LDG : USE FLAP 3" when CONF 3 is selected, as a reminder.
GPWS LDG FLAP 3ON
APPR SPD VREF+10
LDG DIST PROC APPLY

● **If no AP engaged:**

WHEN L/G DN: DIRECT LAW

At landing gear extension, control reverts to direct law in pitch, as well as in roll. Refer to PRO-ABN-F_CTL F/CTL DIRECT LAW.

● **If AP engaged:**

WHEN L/G DN AND AP OFF: DIRECT LAW

If the autopilot is disengaged:

- Before landing gear extension, flight control alternate law is active.
- After landing gear extension, flight control direct law is active. Refer to PRO-ABN-F_CTL F/CTL DIRECT LAW.

ALTN LAW: PROT LOST

INOP SYS

F/CTL PROT
STEEP APPR 

F/CTL DIRECT LAW

Applicable to: ALL

Ident.: PRO-ABN-F_CTL-J-00016964.0001001 / 21 MAR 16

ANNUNCIATIONS

Triggering Conditions:

L2 This alert triggers when direct law is active.

Flight Phase Inhibition:

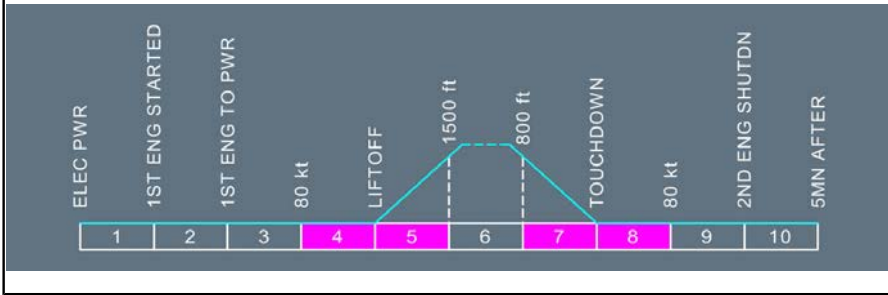



Continued on the following page

F/CTL DIRECT LAW (Cont'd)

Ident.: PRO-ABN-F_CTL-J-00018420.0001001 / 22 MAR 17

L2 PFD displays « USE MAN PITCH TRIM » in amber. *Refer to DSC-27-20-10-70 Aircraft Trimming*

L1 (PROT LOST)

L2 **Note:** *In case of GPWS (EGPWS ) alerts, since protections are lost, respect stall warning when applying the GPWS (EGPWS ) procedure.*

L1 **MAX SPEED**.....320/.77

L2 *Speed is limited, due to the loss of high-speed protection. Do not exceed M 0.77, so as not to degrade handling qualities.*

L1 **MAN PITCH TRIM (EXCEPT IF HYD Y + G SYS LO PR)**..... **USE**

L2 *Automatic trim is inoperative in direct law.*

L1 **MANEUVER WITH CARE**

L2 *Use small control inputs at high speed, since in direct law the controls are powerful. Use of manual thrust is recommended. Avoid large thrust changes.*

L1 **USE SPD BRK WITH CARE**

L2 *At high Mach numbers, use speed brakes with care to avoid too strong nose up changes.*

Continued on the following page

F/CTL DIRECT LAW (Cont'd)

Ident.: PRO-ABN-F_CTL-J-00018422.0003001 / 22 MAR 17

L12

STATUS

MAX SPEED..... 320/.77
 MANEUVER WITH CARE
 USE SPD BRK WITH CARE

APPR PROC

FOR LDG..... USE FLAPS 3

*This line is replaced by "FOR LDG : USE FLAP 3" when
 CONF 3 is selected, as a reminder.*

GPWS LDG FLAP 3..... ON
 MAN PITCH TRIM..... USE
 APPR SPD..... VREF+10
 LDG DIST PROC..... APPLY

DIRECT LAW

INOP SYS

F/CTL PROT
 STEEP APPR 

F/CTL ELAC 1(2) FAULT
(ONE COMPUTER FAILED)

Applicable to: ALL

Ident.: PRO-ABN-F_CTL-F-00016960.0001001 / 21 MAR 16

ANNUNCIATIONS

Triggering Conditions:

L2 This alert triggers when there is a failure of ELAC (FAULT It on ELAC pb), or when one sidestick transducer is faulty.

Flight Phase Inhibition:

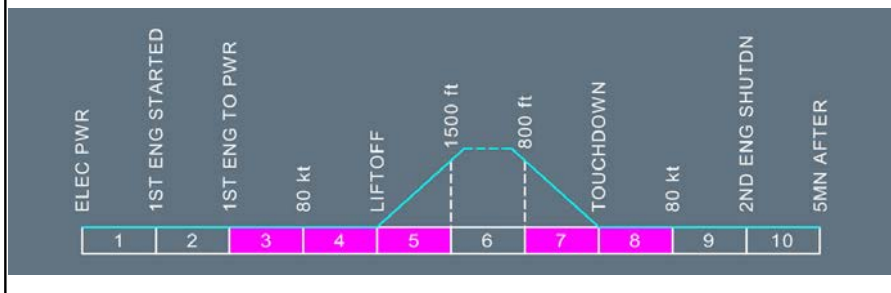

Ident.: PRO-ABN-F_CTL-F-00018425.0006001 / 21 MAR 16

ELAC (AFFECTED)..... OFF THEN ON

L2 Note: 1. In some sidestick transducer failure cases, ELAC 1(2) FAULT is triggered without the procedure, and FAULT It on associated pb does not come on.
 2. If the ELAC 1 computer is reset on ground the pitch trim returns to the ground setting position (0°).

L1 ● **IF UNSUCCESSFUL:**
ELAC (AFFECTED)..... OFF

L2 Functions are performed by other ELAC.

L1 **FUEL CONSUMPT INCRSD**
FMS PRED UNRELIABLE

Continued on the following page

F/CTL ELAC 1(2) FAULT (Cont'd)
(ONE COMPUTER FAILED)

Ident.: PRO-ABN-F_CTL-F-00018426.0003001 / 21 MAR 17

L12

STATUS

INOP SYS

CAT 3 SINGLE ONLY
FUEL CONSUMPT INCRSD

See ⁽¹⁾

FMS PRED UNRELIABLE

See ⁽²⁾

ELAC 1(2)
 CAT 3 DUAL

⁽¹⁾ This message is triggered when the failure (or combination of failures) affects the nominal aerodynamic characteristics of the aircraft.

⁽²⁾ Disregard FMS fuel predictions and refer to QRH/OPS chapter in order to find the applicable Fuel Penalty Factor.

F/CTL ELAC 1(2) FAULT
(BOTH COMPUTERS FAILED)

Applicable to: ALL

Ident.: PRO-ABN-F_CTL-G-00018899.0001001 / 21 MAR 16

ANNUNCIATIONS

Triggering Conditions:

L2

This alert triggers when there is a failure of ELAC (FAULT It on ELAC pb), or when one sidestick transducer is faulty.

Flight Phase Inhibition:

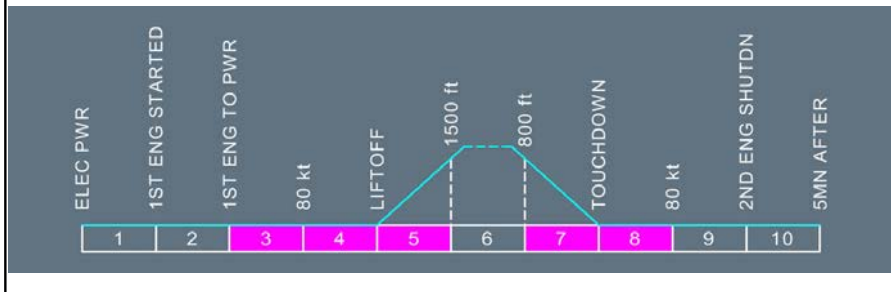

Continued on the following page

F/CTL ELAC 1(2) FAULT (Cont'd)
(BOTH COMPUTERS FAILED)

Ident.: PRO-ABN-F_CTL-G-00018433.0009001 / 22 MAR 17

ELAC 1..... OFF THEN ON

[2] Note: If the ELAC 1 computer is reset on ground, the pitch trim returns to the ground setting position (0°).

[L1] ELAC 2..... OFF THEN ON

● **If both ELAC FAULT remain:**

ELAC 1..... OFF

ELAC 2..... OFF

ASSOCIATED PROCEDURES

F/CTL ALTN LAW
(PROT LOST)

[2] Pitch and roll normal laws are lost: Refer to PRO-ABN-F_CTL F/CTL ALTN LAW. THS motor 1 and both ailerons are lost. LAF is degraded and uses spoilers only.

[L1] MAX SPEED..... 320 KT

FUEL CONSUMPT INCRSD
FMS PRED UNRELIABLE

Continued on the following page

F/CTL ELAC 1(2) FAULT (Cont'd)
(BOTH COMPUTERS FAILED)

Ident.: PRO-ABN-F_CTL-G-00018434.0004001 / 22 MAR 17

L12

STATUS

MAX SPEED..... 320 KT

INOP SYS

APPR PROC

F/CTL PROT

L+R AIL

ELAC 1+2

AP 1+2

CAT 2

STEEP APPR 

FOR LDG..... USE FLAP 3

*This line is replaced by "FOR LDG : USE FLAP 3" when
CONF 3 is selected, as a reminder.*

GPWS LDG FLAP 3..... ON

Will be displayed when flaps in CONF 3

APPR SPD..... VREF+10 KT

LDG DIST PROC..... APPLY

ALTN LAW: PROT LOST
WHEN L/G DOWN: DIRECT LAW

See ⁽¹⁾

FUEL CONSUMPT INCRSD

See ⁽²⁾

FMS PRED UNRELIABLE

See ⁽³⁾

- ⁽¹⁾ At landing gear extension, control reverts to direct law in pitch, as well as in roll (Refer to PRO-ABN-F_CTL F/CTL DIRECT LAW).
- ⁽²⁾ This message is triggered when the failure (or combination of failures) affects the nominal aerodynamic characteristics of the aircraft.
- ⁽³⁾ Disregard FMS fuel predictions and refer to QRH/OPS chapter in order to find the applicable Fuel Penalty Factor.

F/CTL ELAC 1(2) PITCH FAULT

Applicable to: ALL

Ident.: PRO-ABN-F_CTL-H-00016977.0001001 / 21 MAR 16

ANNUNCIATIONS

Triggering Conditions:

L2 This alert triggers when there is a failure of pitch channel in ELAC 1(2).

Flight Phase Inhibition:

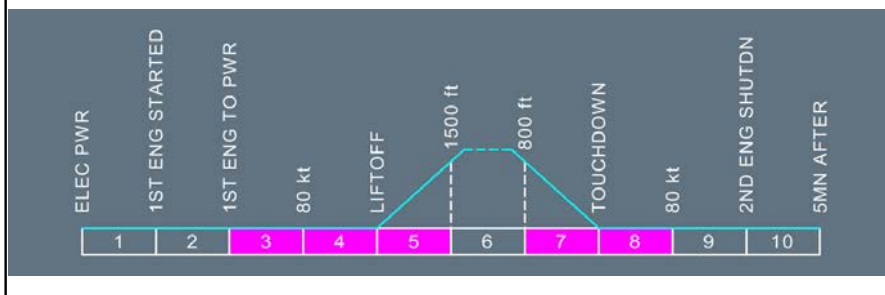

Ident.: PRO-ABN-F_CTL-H-00018447.0001001 / 21 MAR 16

Crew awareness.

Ident.: PRO-ABN-F_CTL-H-00018448.0001001 / 21 MAR 16

STATUS

CAT 3 SINGLE ONLY

INOP SYS

ELAC PITCH ⁽¹⁾
CAT 3 DUAL

⁽¹⁾ (If ELAC 1 and 2 PITCH FAULT)

F/CTL ELEV SERVO FAULT

Applicable to: ALL

Ident.: PRO-ABN-F_CTL-P-00016979.0001001 / 21 MAR 16

ANNUNCIATIONS

Triggering Conditions:

L2

This alert triggers when there is a loss of one servojack on one elevator.

Flight Phase Inhibition:

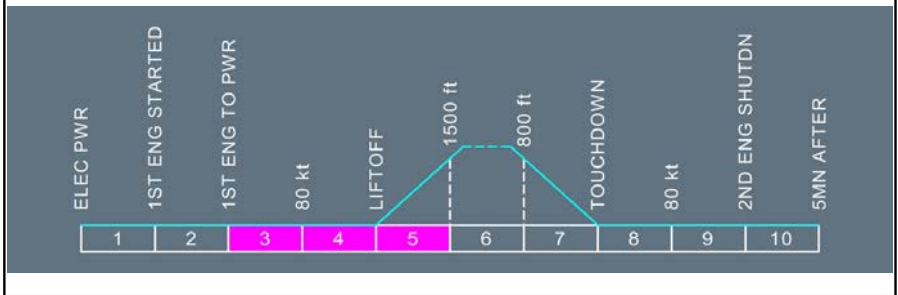

Ident.: PRO-ABN-F_CTL-P-00018449.0001001 / 21 MAR 16

Crew awareness.

CAUTION Do not use speedbrakes above 350 kt/M 0.82 (VMO /MMO).

Ident.: PRO-ABN-F_CTL-P-00018450.0001001 / 21 MAR 16

STATUS

CAT 3 SINGLE ONLY

INOP SYS

CAT 3 DUAL

F/CTL FCDC 1(2) FAULT

Applicable to: ALL

Ident.: PRO-ABN-F_CTL-L-00016981.0001001 / 21 MAR 16

ANNUNCIATIONS

Triggering Conditions:

L2 This alert triggers when there is a failure of one FCDC.

Flight Phase Inhibition:

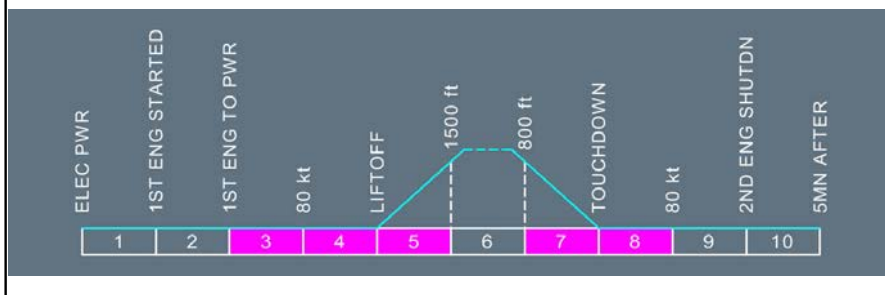

Ident.: PRO-ABN-F_CTL-L-00011777.0001001 / 25 FEB 14

Crew awareness.

Ident.: PRO-ABN-F_CTL-L-00011778.0001001 / 18 AUG 10

STATUS

INOP SYS

FCDC 1(2)

F/CTL FCDC 1+2 FAULT

Applicable to: ALL

Ident.: PRO-ABN-F_CTL-M-00016963.0001001 / 21 MAR 16

ANNUNCIATIONS

Triggering Conditions:

L2

This alert triggers when there is a failure of both FCDCs.

Flight Phase Inhibition:

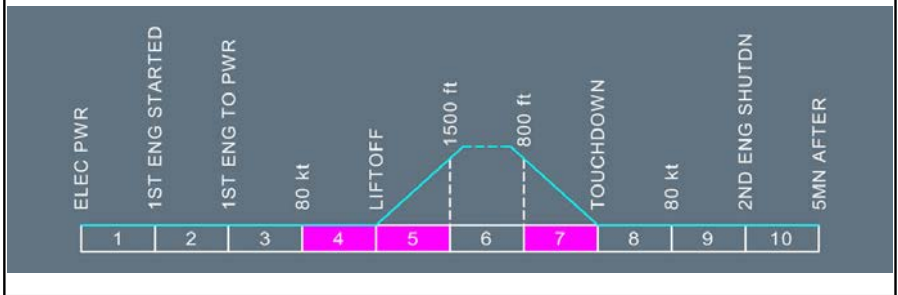

Ident.: PRO-ABN-F_CTL-M-00011779.0001001 / 18 AUG 10

MONITOR F/CTL OVHD PNL

L2

F/CTL data on ECAM is lost.

Control laws remains normal.

Note: When both FCDCs fails:

- F/CTL warning are not available on the ECAM.
- Stall warning may be triggered as in alternate or direct law (it may occur at speeds greater than $V_{\alpha \max}$).
- Bank and pitch limits are no longer displayed on the PFD.
- $V_{\alpha \text{ prot}}$, $V_{\alpha \text{ max}}$ are lost on the PFD.
- V_{sw} , displayed on the PFD, corresponds to the stall warning of the alternate or direct law.

Continued on the following page

F/CTL FCDC 1+2 FAULT (Cont'd)

Ident.: PRO-ABN-F_CTL-M-00018451.0001001 / 21 MAR 16

STATUS

F/CTL INDICATIONS LOST

INOP SYS

FCDC 1 + 2
STEEP APPR 

F/CTL FLAP ATTACH SENSOR

Applicable to: ALL

Ident.: PRO-ABN-F_CTL-AH-00016989.0001001 / 21 MAR 16

ANNUNCIATIONS

Triggering Conditions:

L2 This alert triggers when there is failure of flap attachment's failure detection sensor.

Flight Phase Inhibition:

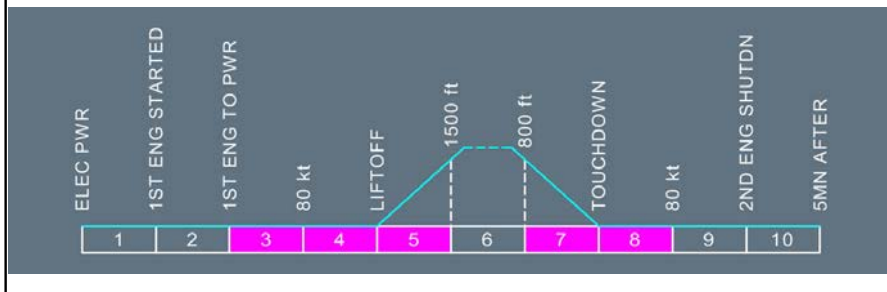

Ident.: PRO-ABN-F_CTL-AH-00018453.0001001 / 21 MAR 16

Crew awareness.

F/CTL FLAPS FAULT/LOCKED

Applicable to: ALL

Ident.: PRO-ABN-F_CTL-A-00011744.0002001 / 21 MAR 16

- **If flaps locked:**
 WING TIP BRK ON OR ALIGNMENT FAULT

MAX SPEED..... REFER TO PRO-ABN-F_CTL F/CTL FLAPS/SLATS FAULT/LOCKED

L2 Limit speed to the VFE corresponding to the next flap position

- L1** ● **If flaps not locked:**
 FLAPS LEVER..... RECYCLE

L2 Return to the previous selection, then back to the desired position.

- L1** ● **If flaps extended:**
 FUEL CONSUMPT INCRSD
 FMS PRED UNRELIABLE

- L2** ● **If unsuccessful:**

Refer to PRO-ABN-F_CTL [QRH] Landing with Slats or Flaps Jammed .

The autopilot may be used down to 500 ft AGL. As it is not tuned for abnormal configurations, its behavior can be less than optimum and must be monitored.

Continued on the following page

F/CTL FLAPS FAULT/LOCKED (Cont'd)

Ident.: PRO-ABN-F_CTL-A-00018456.0004001 / 21 MAR 17

L12

STATUS

INOP SYS

APPR PROC

FOR LDG (IF FLAPS \leq 3).....USE FLAP 3

This line is replaced by "FOR LDG : USE FLAP 3" when CONF 3 is selected, as a reminder

FLAPS (IF FLAPS > 3).....KEEP CONF FULL

GPWS FLAP MODE (IF FLAPS < 3).....OFF

GPWS LDG FLAP 3 (IF FLAPS \geq 3).....ON

APPR SPD..... REFER

TO PRO-ABN-F_CTL F/CTL FLAPS/SLATS FAULT/LOCKED

LDG DIST PROC..... APPLY

ENG 1 APPR IDLE ONLY (Only in case of FLAPS FAULT)

ENG 2 APPR IDLE ONLY (Only in case of FLAPS FAULT)

FUEL CONSUMPT INCRSD

See ⁽²⁾

FMS PRED UNRELIABLE

See ⁽³⁾

FLAPS

AP 1+2 ⁽¹⁾

A/THR ⁽¹⁾

Moreover, both FDs are lost ⁽¹⁾

CAT 2 ⁽¹⁾

GLS AUTOLAND 

STEEP APPR 

⁽¹⁾ (If both flap channels fault.)

⁽²⁾ This message is triggered when the failure (or combination of failures) affects the nominal aerodynamic characteristics of the aircraft.

⁽³⁾ Disregard FMS fuel predictions and refer to QRH/OPS chapter in order to find the applicable Fuel Penalty Factor.

F/CTL FLAP LVR NOT ZERO

Applicable to: ALL

Ident.: PRO-ABN-F_CTL-AI-00018902.0001001 / 21 MAR 16

ANNUNCIATIONS

Triggering Conditions:

L2

This alert triggers when the FLAP lever is not in the zero position, and the aircraft is above 22 000 ft.

Flight Phase Inhibition:

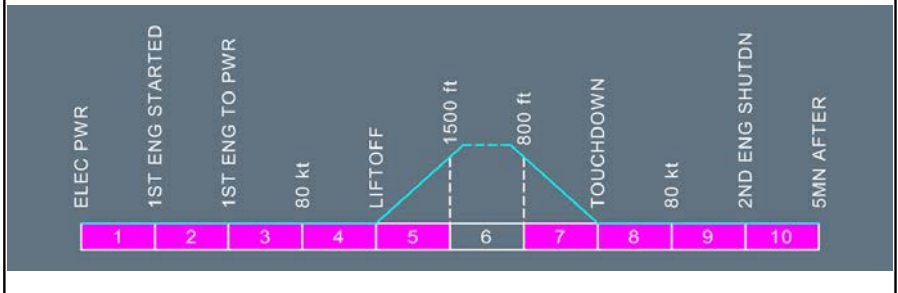

Ident.: PRO-ABN-F_CTL-AI-00018454.0001001 / 21 MAR 16

Crew awareness.

F/CTL FLAP SYS 1(2) FAULT

Applicable to: ALL

Ident.: PRO-ABN-F_CTL-E-00016990.0001001 / 21 MAR 16

ANNUNCIATIONS

Triggering Conditions:

L2 This alert triggers when there is failure of flap channel in one SFCC.

Flight Phase Inhibition:

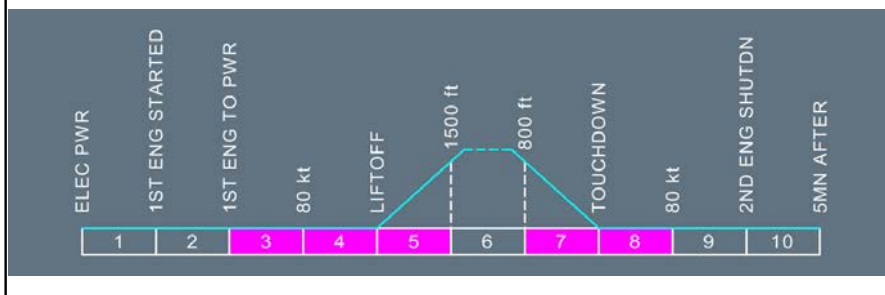

Ident.: PRO-ABN-F_CTL-E-00011753.0002001 / 25 FEB 14

Crew awareness.

Ident.: PRO-ABN-F_CTL-E-00011754.0002001 / 30 MAR 12

L12

STATUS

APPR PROC

- **In case of FLAP SYS 1 FAULT:**

GPWS FLAP MODE.....OFF

Flap position signal to GPWS is lost.

ENG 1(2) APPR IDLE ONLY
FLAPS SLOW

F/CTL FLAPS/SLATS FAULT/LOCKED

Ident.: PRO-ABN-F_CTL-00018457.0001001 / 17 MAR 17

Applicable to: ALL

| MAX SPEED | | | | | |
|--|---------------|-----------|-----------|-----------|-------------------------|
| Flaps ⁽¹⁾ Slats ⁽¹⁾ | F = 0 | 0 < F ≤ 1 | 1 < F ≤ 2 | 2 < F ≤ 3 | F > 3 |
| S = 0 | NO LIMITATION | 215 kt | 200 kt | 185 kt | Not allowed (177 kt) |
| 0 < S < 1 | 230 kt | | | | |
| S = 1 | | | | | |
| 1 < S ≤ 3 | 200 kt | | | | |
| S > 3 | | | | | 177 kt |

⁽¹⁾ Slats/Flaps position displayed on the upper ECAM display.

| APPR SPD | | | | | |
|--|--|-----------|-----------|-----------|--|
| Flaps ⁽¹⁾ Slats ⁽¹⁾ | F = 0 | 0 < F < 1 | 1 ≤ F < 2 | 2 ≤ F < 3 | F ≥ 3 |
| S = 0 | VREF +60 (Appr) VREF +50 (Touch Down) | VREF +45 | VREF +30 | VREF +25 | (FLAPS > 3 not allowed) VREF +25 |
| 0 < S < 1 | | | | | |
| 1 ≤ S ≤ 3 | VREF +25 | VREF +15 | VREF +10 | VREF +10 | VREF +5 |
| S > 3 | | | | | |

⁽¹⁾ Slats/Flaps position displayed on the upper ECAM display.

CAUTION

For flight with SLATS or FLAPS extended, fuel consumption is increased. Refer to the fuel flow indication.

As a guideline, determine the fuel consumption in clean configuration, at the same altitude without airspeed limitation (e.g. from ALTERNATE FLIGHT PLANNING tables, Refer to PER-FPL-FLP-ALN-20 ALTERNATE PLANNING ISA), and multiply this result by the applicable Fuel Penalty Factor provided in the QRH (Refer to QRH/OPS Fuel Penalty Factors/ECAM Alert Table) to obtain the fuel penalty required to reach the destination in the current configuration.

F/CTL GND SPLR 5 FAULT

Applicable to: ALL

Ident.: PRO-ABN-F_CTL-Z-00016967.0001001 / 21 MAR 16

ANNUNCIATIONS

Triggering Conditions:

L2 This alert triggers when there is a loss of ground spoiler function in SEC 2.

Flight Phase Inhibition:

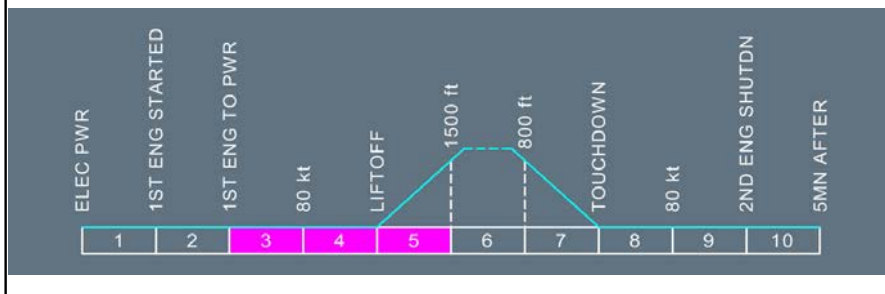

Ident.: PRO-ABN-F_CTL-Z-00018903.0001001 / 21 MAR 16

Crew awareness.

Ident.: PRO-ABN-F_CTL-Z-00014253.0001001 / 23 MAY 12

L12

STATUS

LDG DIST PROC.....APPLY

INOP SYS

GND SPLR 5

F/CTL GND SPLR / 1+2 / 3+4 / FAULT

Applicable to: ALL

Ident.: PRO-ABN-F_CTL-S-00016968.0001001 / 21 MAR 16

ANNUNCIATIONS

Triggering Conditions:

L2

- GND SPLR FAULT :
 Loss of ground spoiler function in SEC 1+3, or 1+2, or 2+3, or 1+2+3.
 If ground spoiler function is lost in SEC (1+2) or (1+3), one reverser is inoperative.
 If ground spoiler function is lost in SEC (1+2+3), both reversers are inoperative.
 In any case, the autobrake function is lost.
- GND SPLR 1+2(3+4) FAULT:
 Loss of ground spoiler function in SEC 3 (or 1).

Flight Phase Inhibition:

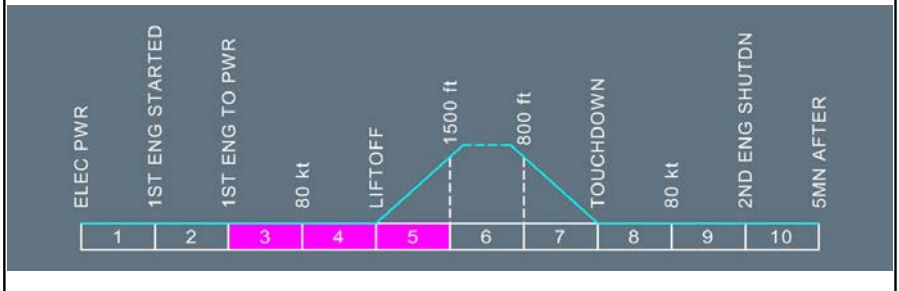

Ident.: PRO-ABN-F_CTL-S-00018466.0001001 / 21 MAR 16

Crew awareness.

Ident.: PRO-ABN-F_CTL-S-00011793.0001001 / 11 MAY 12

STATUS

LDG DIST PROC..... APPLY

INOP SYS

GND SPLR (affected)

F/CTL GND SPLR NOT ARMED

Applicable to: ALL

Ident.: PRO-ABN-F_CTL-AJ-00016966.0001001 / 21 MAR 16

ANNUNCIATIONS

Triggering Conditions:

L2 This alert triggers when ground spoilers are not armed before landing.

Flight Phase Inhibition:

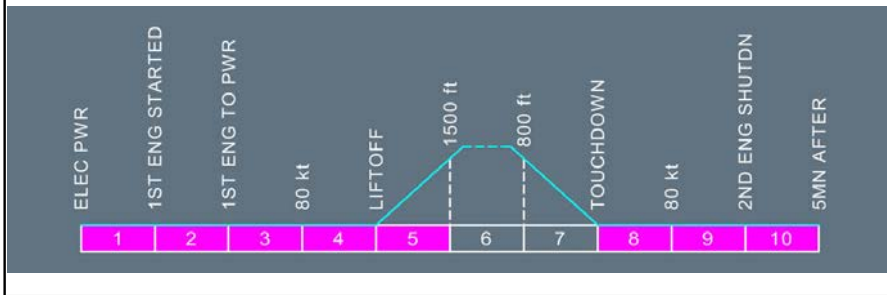

Ident.: PRO-ABN-F_CTL-AJ-00018905.0001001 / 21 MAR 16

Crew awareness.

F/CTL L(R) AIL FAULT

Applicable to: ALL

Ident.: PRO-ABN-F_CTL-N-00016975.0001001 / 21 MAR 16

ANNUNCIATIONS

Triggering Conditions:

L2

This alert triggers when there is a loss of both servojacks on one aileron.

Flight Phase Inhibition:

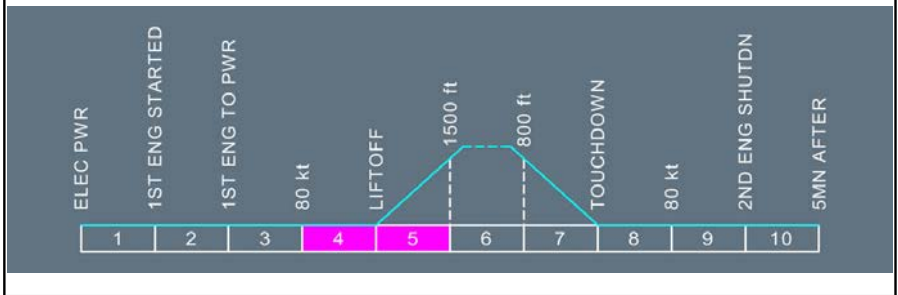

Ident.: PRO-ABN-F_CTL-N-00018474.0002001 / 21 MAR 16

Crew awareness.

FUEL CONSUMPT INCRSD
FMS PRED UNRELIABLE

Continued on the following page

F/CTL L(R) AIL FAULT (Cont'd)

Ident.: PRO-ABN-F_CTL-N-00011783.0003001 / 21 MAR 17

L12

STATUS

INOP SYS

FUEL CONSUMPT INCRSD

See ⁽¹⁾

FMS PRED UNRELIABLE

See ⁽²⁾

L (R) AIL

⁽¹⁾ This message is triggered when the failure (or combination of failures) affects the nominal aerodynamic characteristics of the aircraft.

⁽²⁾ Disregard FMS fuel predictions and refer to QRH/OPS chapter in order to find the applicable Fuel Penalty Factor.

F/CTL L(R) ELEV FAULT

Applicable to: ALL

Ident.: PRO-ABN-F_CTL-Q-00016974.0001001 / 21 MAR 16

ANNUNCIATIONS

Triggering Conditions:

L2 This alert triggers when there is a loss of both servojacks on one elevator, or activation of elevator flutter protection in ELAC.

Flight Phase Inhibition:

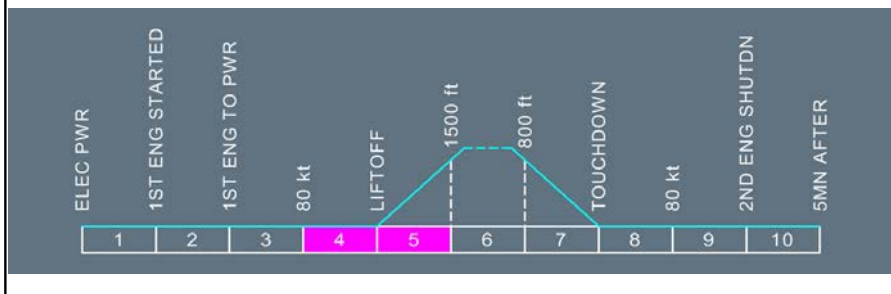

Ident.: PRO-ABN-F_CTL-Q-00018484.0001001 / 22 MAR 17

ASSOCIATED PROCEDURES

F/CTL ALTN LAW
(PROT LOST)

L2 Note: If the L(R) elevator fails, the ELAC s loose pitch control through the elevator. Therefore, the SEC s control pitch in alternate law. This is not the case, if the right elevator is lost, due to the failure of B+Y hydraulic circuits. Pitch normal law remains active in ELAC.

L1 **MAX SPEED**.....**320 KT**

L2 Speed is limited, due to the loss of high-speed protection.

L1 **SPD BRK**.....**DO NOT USE**

Continued on the following page

F/CTL L(R) ELEV FAULT (Cont'd)

Ident.: PRO-ABN-F_CTL-Q-00018490.0003001 / 22 MAR 17

L12

STATUS

MAX SPEED..... 320 KT
 SPD BRK.....DO NOT USE

APPR PROC

FOR LDG..... USE FLAP 3

*This line is replaced by "FOR LDG : USE FLAP 3" when
 CONF 3 is selected, as a reminder.*

GPWS LDG FLAP 3.....ON

Will be displayed, when flaps in CONF 3.

APPR SPD.....VREF+10 KT
 LDG DIST PROC..... APPLY

ALTN LAW: PROT LOST
WHEN L/G DN: DIRECT LAW

See ⁽¹⁾

INOP SYS

F/CTL PROT
 L (R) ELEV
 ELAC PITCH
 AP 1+2
 CAT 2
 GLS AUTOLAND 
 STEEP APPR 

⁽¹⁾ At landing gear extension, control reverts to direct law in pitch, as well as in roll. Refer to PRO-ABN-F_CTL F/CTL DIRECT LAW.

F/CTL L+R ELEV FAULT

Applicable to: ALL

Ident.: PRO-ABN-F_CTL-O-00016958.0001001 / 21 MAR 16

ANNUNCIATIONS

Triggering Conditions:

L2 This alert triggers when both elevators are lost.

Flight Phase Inhibition:

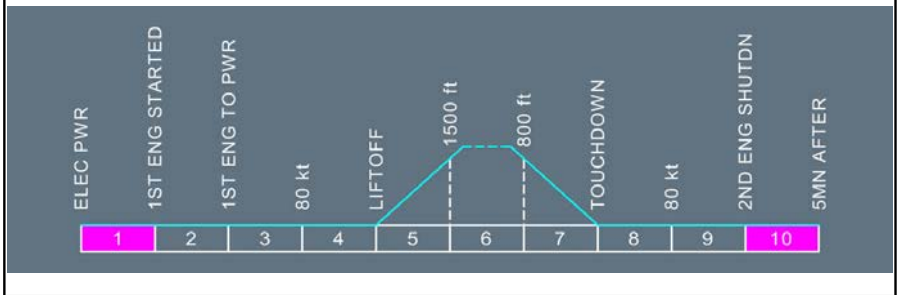

Ident.: PRO-ABN-F_CTL-O-00018491.0001001 / 22 MAR 17

MAX SPEED.....320/.77

L2 Due to loss of high speed protections.

L1 MAN PITCH TRIM..... USE

L2 Only manual trim is available for pitch control.

L1 SPD BRK.....DO NOT USE

L2 Do not use speed brakes, because it is difficult to control the induced pitch moment with manual pitch trim only.

Continued on the following page

F/CTL L+R ELEV FAULT (Cont'd)

Ident.: PRO-ABN-F_CTL-O-00018492.0009001 / 22 MAR 17

L12

STATUS

MAX SPEED..... 320/.77
 SPD BRK.....DO NOT USE

APPR PROC

FOR LDG..... USE FLAP 3

*This line is replaced by "FOR LDG : USE FLAP 3" when
 CONF 3 is selected, as a reminder*

GPWS LDG FLAP 3.....ON

Will be displayed when flaps in CONF 3.

MAN PITCH TRIM..... USE

APPR SPD..... VREF+10

LDG DIST PROC..... APPLY

PITCH MECH BACK UP
 ROLL DIRECT LAW

INOP SYS

L+R ELEV
 ELAC PITCH
 AP 1+2
 CAT 2
 GLS AUTOLAND 
 STEEP APPR 

F/CTL L(R) SIDESTICK FAULT

Applicable to: ALL

Ident.: PRO-ABN-F_CTL-Y-00016959.0001001 / 21 MAR 16

ANNUNCIATIONS

Triggering Conditions:

L2

This alert triggers when transducers, on pitch or roll axis, are failed on one sidestick.

Flight Phase Inhibition:

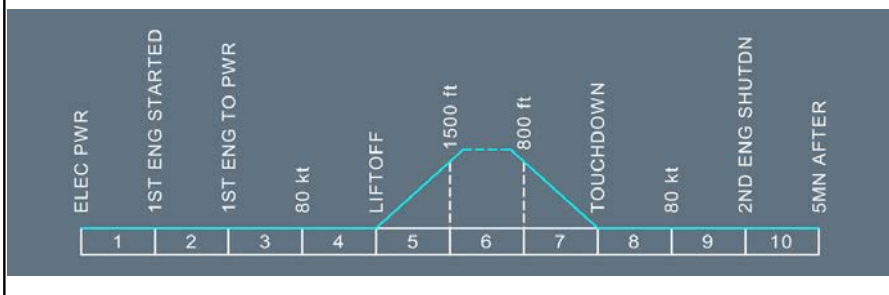

Ident.: PRO-ABN-F_CTL-Y-00011756.0001001 / 25 FEB 14

Crew awareness.

Ident.: PRO-ABN-F_CTL-Y-00014250.0001001 / 30 MAR 12

STATUS

INOP SYS

L(R) SIDESTICK

F/CTL PITCH TRIM/MCDU/CG DISAGREE

Applicable to: ALL

Ident.: PRO-ABN-F_CTL-AL-00016956.0003001 / 21 MAR 16

ANNUNCIATIONS

Triggering Conditions:

- L2** This alert triggers when the system detects that any of the following disagree:
- The real pitch trim value,
 - The pitch trim value calculated by the FAC , based on the CG,
 - The pitch trim value entered in the MCDU.

Flight Phase Inhibition:

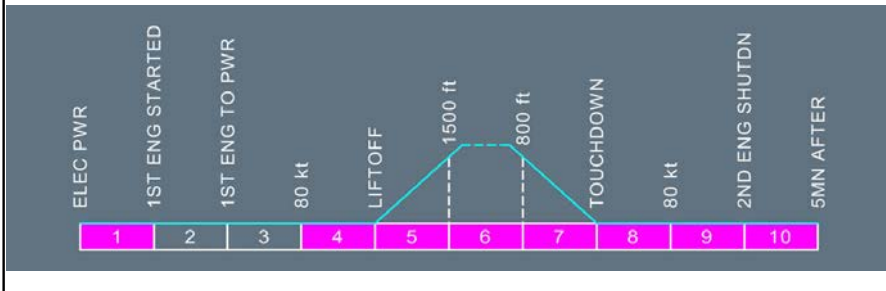

Ident.: PRO-ABN-F_CTL-AL-00018906.0025001 / 21 MAR 16

Crew awareness.

F/CTL SEC 1(2)(3) FAULT

Applicable to: ALL

Ident.: PRO-ABN-F_CTL-I-00016961.0001001 / 21 MAR 16

ANNUNCIATIONS

Triggering Conditions:

L2 This alert triggers when there is a failure of one SEC.

Flight Phase Inhibition:

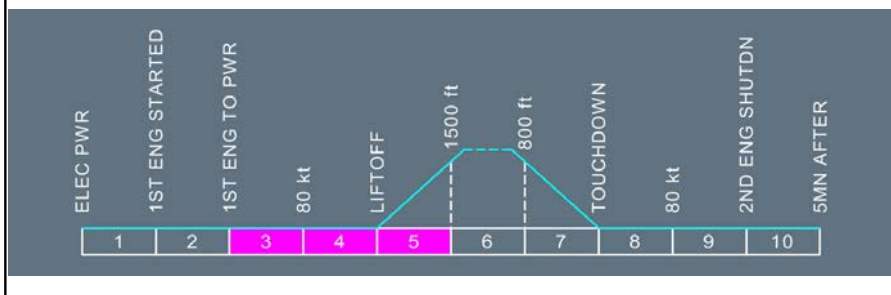

Ident.: PRO-ABN-F_CTL-I-00018502.0002001 / 21 MAR 16

SEC (AFFECTED)..... OFF THEN ON

● **IF UNSUCCESSFUL:**
SEC (AFFECTED)..... OFF

L2 Associated spoilers are lost.
If all spoilers are inoperative (3 SECs failed), roll direct law and pitch alternate law become active.

L1 SPD BRK (IF SEC 1 AFFECTED)..... DO NOT USE

L2 VLS would not be corrected, if speed brakes 2 extend (no speed brake position sent to FACs).

L1 ● If SEC 1 + 2 + 3 fail

ASSOCIATED PROCEDURES

F/CTL ALTN LAW
PROT LOST

Continued on the following page

F/CTL SEC 1(2)(3) FAULT (Cont'd)

Ident.: PRO-ABN-F_CTL-I-00018504.0004001 / 01 JUN 16

L12

STATUS

SPD BRK.....DO NOT USE

(If SEC 1 is affected.)

● **If SEC 1 + 2 + 3 fail:**

FOR LDG.....USE FLAP 3

APPR SPD.....VREF + 10KT

LDG DIST PROC.....APPLY

● **(If SEC 1 + 2 + 3 fail).**

ALTN LAW: PROT LOST

● If no AP engaged
and

SEC 1 + 2 + 3 fail.

WHEN L/G DN: DIRECT LAW

If SEC 1 + 2 + 3 fail. In such a case, the LGCIU information can no longer be sent to the ELAC . For the activation of DIRECT law, the ELAC uses the condition "slats and flaps in CONF 2", instead of "landing gear down".

● If AP engaged
and

SEC 1 + 2 + 3 fail.

WHEN L/G DN AND AP OFF: DIRECT LAW

If SEC 1 + 2 + 3 fail. In such a case, the LGCIU information can no longer be sent to the ELAC . For the activation of DIRECT law, the ELAC uses the condition "slats and flaps in CONF 2", instead of "landing gear down".

INOP SYS

F/CTL PROT ⁽¹⁾

SPLR (associated)

SEC (affected)

REVERSER 1(2) ⁽²⁾

AUTO BRK ⁽³⁾

STEEP APPR  ⁽⁴⁾

ROW/ROP 

⁽¹⁾ (If SEC 1 + 2 + 3 fail)

⁽²⁾ (If SEC 1 + 2 fail, reverser 1 is not available for landing. If SEC 1 + 3 fail, reverser 2 is not available for landing)

⁽³⁾ (If at least 2 SECs fail)

Continued on the following page

F/CTL SEC 1(2)(3) FAULT (Cont'd)

(4) (If at least SEC 1 fails.)

F/CTL SIDESTICK PRIORITY

Applicable to: ALL

Ident.: PRO-ABN-F_CTL-AM-00016983.0001001 / 21 MAR 16

ANNUNCIATIONS

Triggering Conditions:

L2

This alert triggers when there is failure in a sidestick priority logic circuit.

Flight Phase Inhibition:

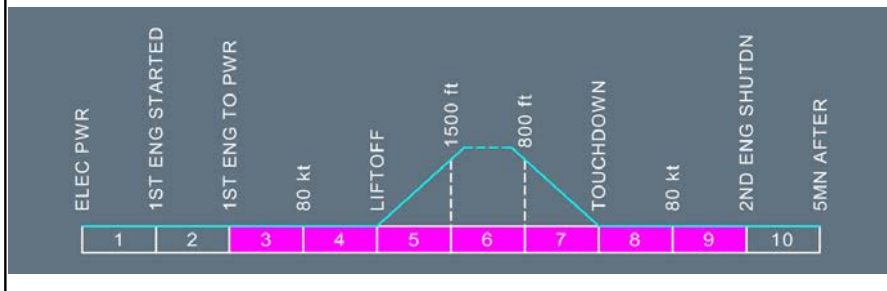

Continued on the following page

F/CTL SIDESTICK PRIORITY (Cont'd)

Ident.: PRO-ABN-F_CTL-AM-00018509.0001001 / 21 MAR 16

CHECK PRIORITY LOGIC

L2 Check the integrity of flight control priority, as follows (not displayed on ECAM) :

L1 ELAC 1..... OFF THEN ON

L2 Note: When the ELAC 1 computer is reset on ground, the pitch trim returns to the ground setting position (0°).

L1 ELAC 2..... OFF THEN ON

L2 ■ **If the warning disappears:**

CAPT TAKE OVER pb..... PRESS (at least 3 seconds)

Check that the :

- Aural "priority left" message is activated.
- F/O red arrow light is on.

CAPT TAKE OVER pb..... RELEASE

F/O TAKE OVER pb..... PRESS (at least 3 seconds)

Check that the:

- Aural "priority right" message is activated
- CAPT red arrow light is on.

F/O TAKE OVER pb..... RELEASE

Check that the warning does not reappear.

Note: There is no need to move the sidestick for the check.

■ **If the warning does not disappear, or if the warning reappears after the above check:**

Maintenance action is due.

F/CTL SLAT(FLAP) TIP BRK FAULT

Applicable to: ALL

Ident.: PRO-ABN-F_CTL-AN-00016996.0001001 / 21 MAR 16

ANNUNCIATIONS

Triggering Conditions:

L2

This alert triggers when there is failure of one wing tip brake on slats or flaps, or failure of one wing tip brake solenoid on slats, or flaps.

Flight Phase Inhibition:

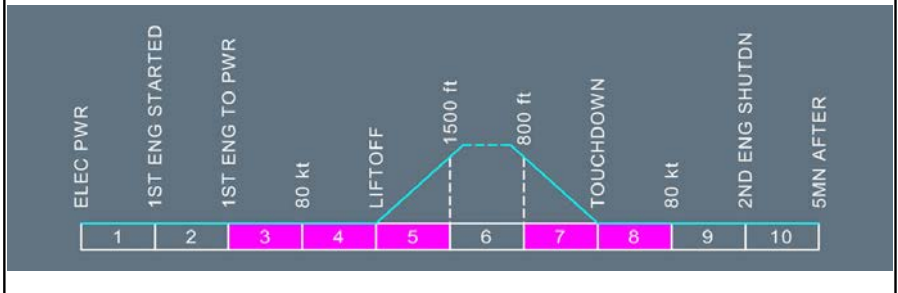

Ident.: PRO-ABN-F_CTL-AN-00018510.0001001 / 21 MAR 16

Crew awareness.

F/CTL SLATS AND FLAPS FAULT IN CONF 0

Applicable to: ALL

Ident.: PRO-ABN-F_CTL-C-00018511.0001001 / 22 MAR 17

FLAPS LEVER.....RECYCLE

- If both slat channels fail:

ASSOCIATED PROCEDURES

F/CTL ALTN LAW
 (PROT LOST)

MAX SPEED..... 320 KT

Continued on the following page

F/CTL SLATS AND FLAPS FAULT IN CONF 0 (Cont'd)

Ident.: PRO-ABN-F_CTL-C-00018512.0002001 / 22 MAR 17

L12

STATUS

MAX SPEED..... 320 KT

ALTN LAW: PROT LOST

APPR PROC

FOR LDG..... **USE FLAP 1**

With FLAPS lever set at 1, AP /FD GO AROUND mode is available.

CTR TK PUMPS..... **OFF**

GPWS FLAP MODE..... **OFF**

APPR SPD..... **VREF +60 KT**

Approach with A/THR in selected mode is recommended.

- **If both slat channels fail:**
WHEN L/G DN: DIRECT LAW

- **AT 300 FT AGL:**
TARGET SPD..... **VREF +50 KT**

Reduce speed between 500 ft and 300 ft to reach VREF +50 kt at runway threshold, and disconnect A/THR, as the target speed may be below VLS.

LDG DIST PROC..... **APPLY**

- **Only in case of FLAPS FAULT:**
ENG 1 APPR IDLE ONLY
ENG 2 APPR IDLE ONLY

INOP SYS

- F/CTL PROT ⁽¹⁾
- SLATS
- FLAPS
- AP 1+2 ⁽²⁾
- A/THR ⁽²⁾
- Moreover, both FDs are lost ⁽²⁾
- CAT 2 ⁽²⁾
- STEEP APPR 

⁽¹⁾ (If both slat channels fail.)

⁽²⁾ (If both slat or flap channels fail.)

F/CTL SLATS FAULT/LOCKED

Applicable to: ALL

Ident.: PRO-ABN-F_CTL-B-00018517.0006001 / 22 MAR 17

● **If slats locked:**

WING TIP BRK ON

MAX SPEED..... REFER TO PRO-ABN-F_CTL F/CTL FLAPS/SLATS FAULT/LOCKED

^{L2} Speed is limited to the VFE corresponding to the next slat position.

^{L1} ● **If slats not locked:**

FLAPS LEVER..... RECYCLE

^{L2} Return to the previous selection, then back to the desired position.

^{L1} ● **If slats extended:**

FUEL CONSUMPT INCRSD
 FMS PRED UNRELIABLE

● **If unsuccessful:**

^{L2} Refer to PRO-ABN-F_CTL [QRH] Landing with Slats or Flaps Jammed.

The autopilot may be used down to 500 ft AGL. As it is not tuned for the abnormal configurations, its behavior could be less than optimum and must be monitored.

^{L1}
^{L12} Note: If there is a SLATS FAULT after both slat channels fail, alternate law becomes active (Refer to PRO-ABN-F_CTL F/CTL ALTN LAW).

● **If slats not at zero:**

FUEL MODE SEL.....MAN

^{L2} To allow CTR TK feeding.

^{L1} CTR TK PUMPS.....AS RQRD

^{L2} Set CTR TK PUMPS pb to OFF when CTR TK is empty or during approach.

Continued on the following page

F/CTL SLATS FAULT/LOCKED (Cont'd)

Ident.: PRO-ABN-F_CTL-B-00018518.0004001 / 22 MAR 17

L12

STATUS

INOP SYS

APPR PROC

FOR LDG..... USE FLAP 3

This line is replaced by "FOR LDG : USE FLAP 3" when CONF 3 is selected, as a reminder.

CTR TK PUMPS..... OFF

GPWS LDG FLAP 3..... ON

APPR SPD..... REFER

TO PRO-ABN-F_CTL F/CTL FLAPS/SLATS FAULT/LOCKED

LDG DIST PROC..... APPLY

CTR TK FEED: MAN ONLY

● **If both slat channels fail, or slats are locked in clean configuration and flaps are at, or above, CONF 2:**

ALTN LAW: PROT LOST

WHEN L/G DN: DIRECT LAW

FUEL CONSUMPT INCRSD

See ⁽²⁾

FMS PRED UNRELIABLE

See ⁽³⁾

F/CTL PROT ⁽¹⁾

SLATS

AP 1+2 ⁽¹⁾

A/THR ⁽¹⁾

Moreover, both FDs are lost ⁽¹⁾

CAT 2 ⁽¹⁾

STEEP APPR  ⁽¹⁾

GLS AUTOLAND  ⁽¹⁾

⁽¹⁾ (If both slat channels fail.)

⁽²⁾ This message is triggered when the failure (or combination of failures) affects the nominal aerodynamic characteristics of the aircraft.

⁽³⁾ Disregard FMS fuel predictions and refer to QRH/OPS chapter in order to find the applicable Fuel Penalty Factor.

F/CTL SLAT SYS 1(2) FAULT

Applicable to: ALL

Ident.: PRO-ABN-F_CTL-D-00016995.0001001 / 21 MAR 16

ANNUNCIATIONS

Triggering Conditions:

L2

This alert triggers when there is failure of slat channel in one SFCC.

Flight Phase Inhibition:

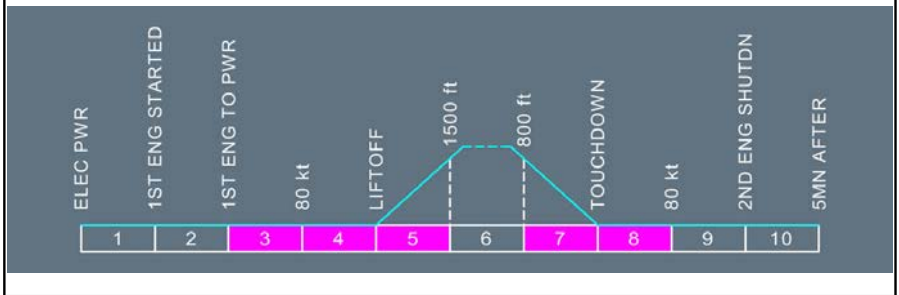

Ident.: PRO-ABN-F_CTL-D-00011751.0001001 / 25 FEB 14

Crew awareness.

Ident.: PRO-ABN-F_CTL-D-00011752.0001001 / 18 AUG 10

STATUS

SLATS SLOW

F/CTL SPD BRK 2 (3+4) FAULT

Applicable to: ALL

Ident.: PRO-ABN-F_CTL-W-00016980.0001001 / 21 MAR 16

ANNUNCIATIONS

Triggering Conditions:

L2 This alert triggers when speedbrake lever transducers to SEC 3 (1) failed.

Flight Phase Inhibition:

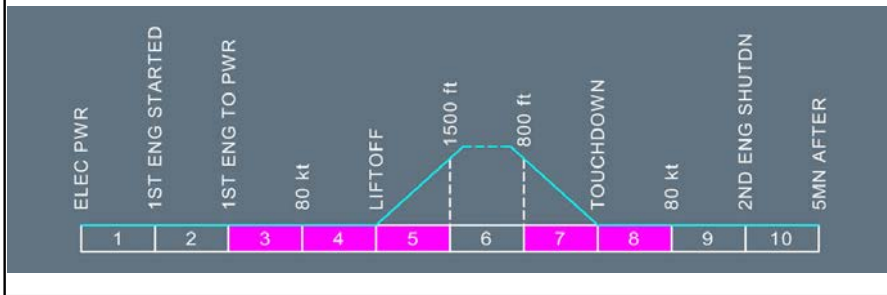

Ident.: PRO-ABN-F_CTL-W-00018519.0001001 / 21 MAR 16

● **If SPD BRK 3+4 affected:**

SPD BRK..... DO NOT USE

L2 Do not use speedbrakes since it is not efficient to use only surfaces n° 2, and would active the SPD BRK DISAGREE caution.

Ident.: PRO-ABN-F_CTL-W-00018520.0001001 / 21 MAR 16

STATUS

● **If SPD BRK 3+4 affected:**

SPD BRK..... DO NOT USE

INOP SYS

SPD BRK (affected)
 STEEP APPR  (1)

LDG DIST PROC..... APPLY

(1) (if SPD BRK 3 and 4 are affected)

F/CTL SPD BRK DISAGREE
(SURFACES 3+4 AFFECTED)

Applicable to: ALL

Ident.: PRO-ABN-F_CTL-T-00016970.0001001 / 21 MAR 16

ANNUNCIATIONS

Triggering Conditions:

L2

This alert triggers when there is a position disagree between surfaces and lever position.

Flight Phase Inhibition:

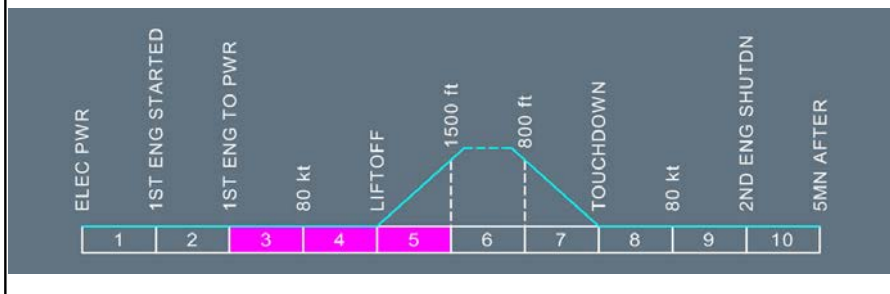

Ident.: PRO-ABN-F_CTL-T-00018521.0001001 / 21 MAR 16

SPD BRK LEVER.....RETRACT
SPD BRK.....DO NOT USE

Ident.: PRO-ABN-F_CTL-T-00018522.0001001 / 21 MAR 16

STATUS

SPD BRK.....DO NOT USE

INOP SYS

SPD BRK 3+4
STEEP APPR

F/CTL SPD BRK DISAGREE
(SURFACES 2+3+4 AFFECTED)

Applicable to: ALL

Ident.: PRO-ABN-F_CTL-U-00018907.0001001 / 21 MAR 16

ANNUNCIATIONS

Triggering Conditions:

L2 This alert triggers when there is a position disagree between surfaces and lever position.

Flight Phase Inhibition:

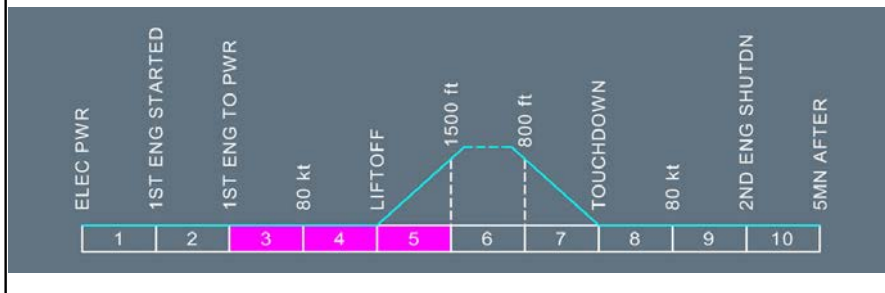

Ident.: PRO-ABN-F_CTL-U-00018523.0001001 / 21 MAR 16

SPD BRK LEVER.....RETRACT

F/CTL SPD BRK FAULT

Applicable to: ALL

Ident.: PRO-ABN-F_CTL-V-00016971.0001001 / 21 MAR 16

ANNUNCIATIONS

Triggering Conditions:

L2 This alert triggers when speedbrake lever transducers to SEC 1 and 3 failed.

Flight Phase Inhibition:

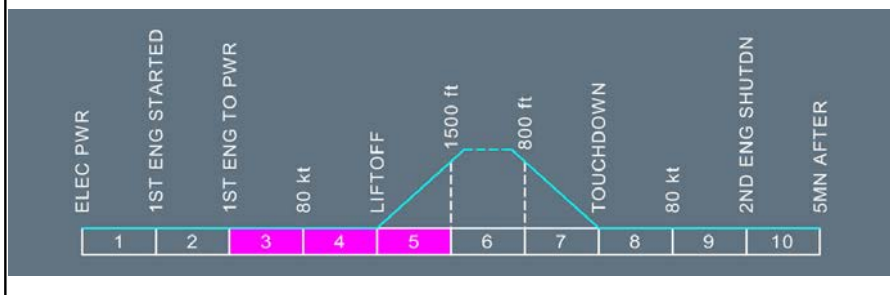

Ident.: PRO-ABN-F_CTL-V-00018534.0001001 / 21 MAR 16

L2 In addition, associated ground spoilers are available only through reverse selection.

L1 Crew awareness.

Ident.: PRO-ABN-F_CTL-V-00018535.0002001 / 22 MAR 17

STATUS

SPD BRK.....DO NOT USE

INOP SYS

STEPP APPR  ⁽¹⁾

⁽¹⁾ (if SPD BRK 3 or 4 are affected)

F/CTL SPD BRK STILL OUT

Applicable to: ALL

Ident.: PRO-ABN-F_CTL-AO-00016972.0002001 / 21 MAR 16

ANNUNCIATIONS

Flight Phase Inhibition:

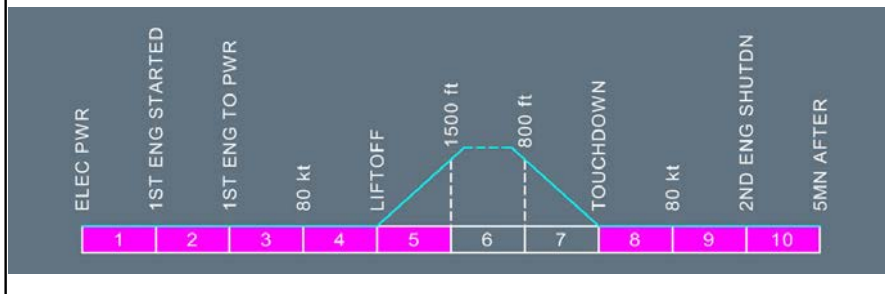

Ident.: PRO-ABN-F_CTL-AO-00011810.0014001 / 25 FEB 14

Crew awareness.

F/CTL SPLR FAULT

Applicable to: ALL

Ident.: PRO-ABN-F_CTL-R-00016976.0001001 / 21 MAR 16

ANNUNCIATIONS

Triggering Conditions:

L2

This alert triggers when there is a loss of one or more spoilers.

Flight Phase Inhibition:

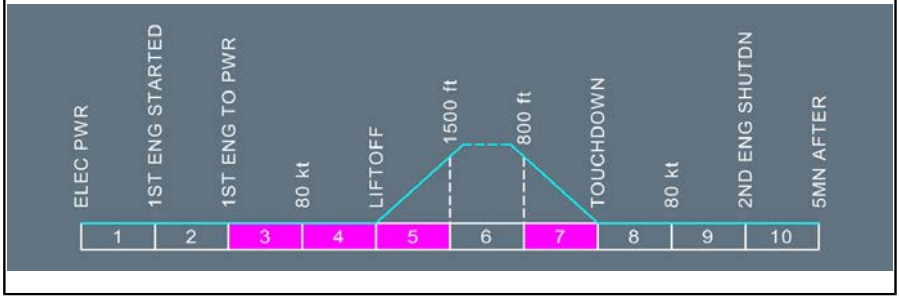

Continued on the following page

F/CTL SPLR FAULT (Cont'd)

Ident.: PRO-ABN-F_CTL-R-00018536.0003001 / 22 MAR 17

[L2] Note: *If heavy vibrations are felt, CONF 3 may be used for landing in order to reduce the buffeting.*

[L1] ● If one or more spoilers are fully extended:

Current Flight Level (FL) may not be maintained due to increased drag. Maintain a cruise FL as high as possible.

OPT SPD..... G DOT+10KT

[L2] *Whenever possible, target green dot speed +10 kt to minimize fuel consumption. However, if buffet is encountered at GDOT speed +10 kt, increase speed to fly out of buffet condition.*

[L1] AP DO NOT USE

[L2] *Depending on the failed spoiler position, the AP may not have enough authority to counteract the roll induced by spoiler runaway.*

[L1] SPD BRK (IF SPOILERS 3+4 AFFECTED)..... DO NOT USE

[L2] *Do not use speedbrakes, since using only surfaces N° 2 is not efficient and would activate the SPD BRK DISAGREE caution.*

[L1] ● If one or more spoilers are extended:

FUEL CONSUMPT INCRSD
FMS PRED UNRELIABLE

Continued on the following page

F/CTL SPLR FAULT (Cont'd)

Ident.: PRO-ABN-F_CTL-R-00018544.0004001 / 21 MAR 17

L12

STATUS

- **If one or more spoilers are fully extended:**
AP..... DO NOT USE
- **If spoilers 3+4 affected:**
SPD BRK..... DO NOT USE

INOP SYS

SPLR (affected)
SPD BRK ⁽¹⁾
STEEP APPR ⁽²⁾

APPR PROC

- **If one or more spoilers are fully extended:**
In clean configuration, if VLS is above VFE_{NEXT}, the flight crew should deselect A/THR, decelerate to VFE_{NEXT}, and select CONF 1 when below VFE_{NEXT}. When established at CONF 1, the flight crew can reengage the A/THR and use managed speed again.
FOR LDG.....USE FLAP 3
This line is replaced by "FOR LDG : USE FLAP 3" when CONF 3 is selected, as a reminder.
GPWS LDG FLAP 3 ON
APPR SPD : VREF + 10 KT

LDG DIST PROC..... APPLY

FUEL CONSUMPT INCRSD

See ⁽³⁾

FMS PRED UNRELIABLE

See ⁽⁴⁾

⁽¹⁾ (If spoilers 2+3+4 affected)
⁽²⁾ (if spoilers 3 and/or 4 affected)
⁽³⁾ This message is triggered when the failure (or combination of failures) affects the nominal aerodynamic characteristics of the aircraft.
⁽⁴⁾ Disregard FMS fuel predictions and refer to QRH/OPS chapter in order to find the applicable Fuel Penalty Factor.

F/CTL STABILIZER JAM

Applicable to: ALL

Ident.: PRO-ABN-F_CTL-X-00016973.0001001 / 21 MAR 16

ANNUNCIATIONS

Triggering Conditions:

- L2 This alert triggers when there is a loss of the electrical control of the stabilizer (with or without jamming of the stabilizer).

Flight Phase Inhibition:

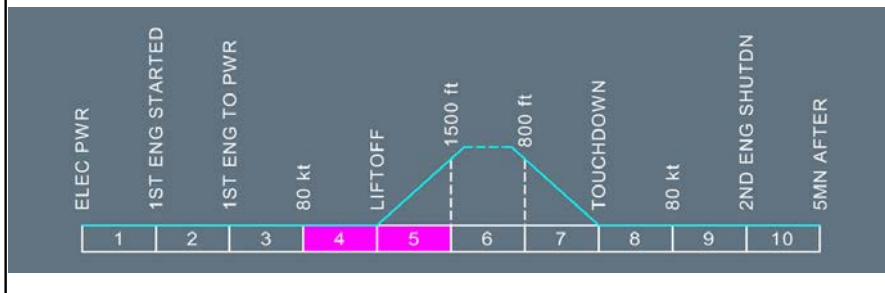

Continued on the following page

F/CTL STABILIZER JAM (Cont'd)

Ident.: PRO-ABN-F_CTL-X-00018545.0001001 / 22 MAR 17

L2 When the Flight Control Computers detect a loss of electrical control of the stabilizer, pitch control law reverts to alternate law. Depending on the type of failure, the MAN PITCH TRIM may still be available.

L1 **MAN PITCH TRIM**..... **CHECK**

L2 *The force needed on the PITCH TRIM wheel may be higher than during pre-takeoff manual setting.*

L1 ● **IF MAN TRIM AVAIL:**

TRIM FOR NEUTRAL ELEV

L2 *If manual pitch trim is available, trim to maintain the elevator at the zero position (indications on F/CTL SD page).*

L1

ASSOCIATED PROCEDURES

F/CTL ALTN LAW
(PROT LOST)

MAX SPEED..... **320 KT**

Continued on the following page

F/CTL STABILIZER JAM (Cont'd)

Ident.: PRO-ABN-F_CTL-X-00018546.0003001 / 22 MAR 17

L12

STATUS

MAX SPEED..... 320 KT

INOP SYS

APPR PROC:

- F/CTL PROT
- STABILIZER
- ELAC PITCH
- AP 1 + 2
- CAT 2
- GLS AUTOLAND 
- STEEP APPR 

FOR LDG..... USE FLAP 3

This line is replaced by "FOR LDG : USE FLAP 3" when CONF 3 is selected, as a reminder.

GPWS LDG FLAP 3..... ON

Will be displayed when flaps in CONF 3

● **IF MAN TRIM NOT AVAIL:**

● **WHEN CONF 3 AND VAPP:**

L/G..... DN

Landing gear extension is delayed, in order to delay the switching to direct law.

APPR SPD:..... VREF + 10 KT

LDG DIST PROC..... APPLY

ALTN LAW: PROT LOST

WHEN L/G DN: DIRECT LAW

At landing gear extension, control reverts to direct law in pitch, as well as in roll. Refer to PRO-ABN-F_CTL F/CTL DIRECT LAW.

[QRH] FUEL IMBALANCE

Ident.: PRO-ABN-FUEL-00011257.0002001 / 17 MAR 17

Applicable to: ALL

FOB..... CHECK

Compare the FOB + FU , with the FOB at departure.

If the difference is significant, or if the FOB + FU decreases, suspect a fuel leak.

CAUTION

A fuel imbalance may indicate a fuel leak.
 Do not apply this procedure, if a fuel leak is suspected.
Refer to PRO-ABN-FUEL [QRH] FUEL LEAK.

FUEL X FEED..... ON

● **On lighter side and in center tank:**

FUEL PUMPS..... OFF

● **When fuel balanced:**

FUEL PUMPS..... ON

FUEL X FEED..... OFF

Note: There is no requirement to correct an imbalance, until the ECAM fuel advisory is displayed.

[QRH] FUEL LEAK

Ident.: PRO-ABN-FUEL-00018665.0003001 / 17 MAR 17

Applicable to: ALL

A fuel leak may be detected, if:

- The sum of FOB and FU significantly less than FOB at engine start or is decreasing, or
- A passenger observes fuel spray from engine/pylon or wingtip/sharklet, or
- The total fuel quantity is decreasing at an abnormal rate, or
- A fuel imbalance is developing, or
- Fuel quantity in a tank is decreasing too fast (leak from engine/pylon, or hole in a tank), or
- The Fuel flow is excessive (leak from engine), or
- Fuel is smelt in the cabin.
- The destination EFOB turns to amber on the F-PLN (or on the FUEL PRED) page, or
- "DEST EFOB BELOW MIN" appears on the MCDU scratchpad.

If visibility permits, leak source may be identified by a visual check from the cabin.

WHEN A LEAK IS CONFIRMED

LAND ASAP

■ **Leak from engine/pylon confirmed by excessive fuel flow or visual check:**

THR LEVER (affected engine).....IDLE
 ENG MASTER (affected engine)..... OFF
 FUEL X FEED..... AS RQRD

If the leak stops, the crossfeed valve can now be opened to re-balance fuel quantity, or to enable use of fuel from both wings.

DO NOT RESTART AFFECTED ENGINE

■ **Leak from engine/pylon not confirmed or leak not located:**

Stop any fuel transfer, and then monitor the depletion rate of each inner tank, to determine if the leak is from an engine or a wing, or from the Center tank, or the APU feeding line.

FUEL X FEED.....MAINTAIN CLOSED

The crossfeed valve must remain closed to prevent the leak from affecting both sides.

CTR TK PUMP 1..... OFF
 CTR TK PUMP 2..... OFF

Each engine is fed via its associated inner tank only.

INNER TANK FUEL QUANTITIES..... MONITOR

Monitor the depletion rate of each inner tank.

Continued on the following page

[QRH] FUEL LEAK (Cont'd)

- **If one inner tank depletes faster than other by at least 300 kg (660 lb) in less than 30 min:**

An engine leak may still be suspected. Therefore:

THR LEVER (engine on leaking side)..... IDLE
 ENG MASTER (engine on leaking side)..... OFF
 CTR TK PUMP 1..... ON
 CTR TK PUMP 2..... ON
 FUEL LEAK..... MONITOR

- **If leak stops:**

ENGINE LEAK CONFIRMED
 FUEL X FEED..... AS RQRD
 DO NOT RESTART AFFECTED ENGINE

- **If leak continues (after engine shutdown):**

WING LEAK SUSPECTED
 ENGINE RESTART..... CONSIDER

CAUTION Do not apply the FUEL IMBALANCE procedure. Approach and landing can be done, even with one full wing/one empty wing.

- **If both inner tanks deplete at a similar rate:**

LEAK FROM CENTER TANK OR APU FEEDING LINE SUSPECTED

- **If fuel smell in cabin:**

APU..... OFF
This prevents additional fuel loss through the APU feeding line.

- **When fuel quantity in one inner tank less than 3 000 kg (6 600 lb):**

CTR TK PUMP 1..... ON
 CTR TK PUMP 2..... ON

- **For landing: DO NOT USE REVERSERS**

[QRH] GRAVITY FUEL FEEDING

Ident.: PRO-ABN-FUEL-00011261.0001001 / 17 MAR 17

Applicable to: ALL

ENG MODE SEL.....IGN

AVOID NEGATIVE G FACTOR

MAX FL: GRAVITY FEED CEILING

- Current FL if flight time above FL 300 > 30 min.
- FL 300 if flight time above FL 300 < 30 min.
- Highest of FL 150 or 7 000 ft above takeoff airport if FL 300 never exceeded.
- FL 100 for JET B.

● **When reaching gravity feed ceiling:**

FUEL X FEED..... OFF

● **If no fuel leak and with one engine running (fed by gravity):**

FUEL X FEED..... ON

BANK ANGLE..... 1° WING DOWN ON LIVE ENG SIDE

The fuel from the wing tank on the engine running side is used.

RUDDER TRIM..... USE

Use rudder trim to maintain constant course and neutral stick.

● **When fuel imbalance reaches 1 000 kg (2 200 lb):**

BANK ANGLE..... 2° or 3° WING DOWN ON LIVE ENG SIDE

Use fuel from the opposite wing tank, until fuel imbalance is reduced to 0.

FUEL ACT XFR FAULT ⚠

Applicable to: ALL

Ident.: PRO-ABN-FUEL-R-00016820.0001001 / 21 MAR 16

ANNUNCIATIONS

Triggering Conditions:

L2

This alert triggers when:

- The ACT quantity > 250 kg (550 lb) and
- The CTR TK quantity < 3 000 kg (6 600 lb).

Flight Phase Inhibition:

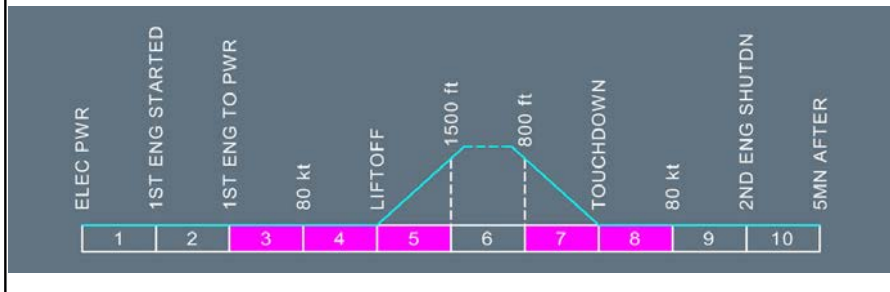

Continued on the following page

FUEL ACT XFR FAULT ⚠ (Cont'd)

Ident.: PRO-ABN-FUEL-R-00017614.0001001 / 21 MAR 16

ACT.....FWD

● **IF NECESSARY:**

DESCEND TO FL270

- L2** Note:
- ACT transfer rate depends on altitude and on remaining ACT fuel quantity.
 - If ACT transfer is uncertain, set the ACT pb to AUTO to avoid pump dry running.
 - ACT pb can be set back to FWD at lower Flight Level to recover remaining ACT fuel.

L1 ● **WHEN ACT EMPTY:**

ACT.....AUTO

- For A321 aircraft equipped with 1 ACT ⚠ :
 ACT UNUSABLE (IF AUTOMATIC AND MANUAL MODES ARE FAILED)
- For aircraft equipped with 2 ACTs ⚠ :
- **IF NO XFR:**

ACT UNUSABLE

PROC.....APPLY

FUEL ACT PUMP LO PR 

Applicable to: ALL

Ident.: PRO-ABN-FUEL-BB-00016811.0001001 / 21 MAR 16

ANNUNCIATIONS

Triggering Conditions:

L2 This alert triggers when the ACT pump is in low pressure.

Flight Phase Inhibition:

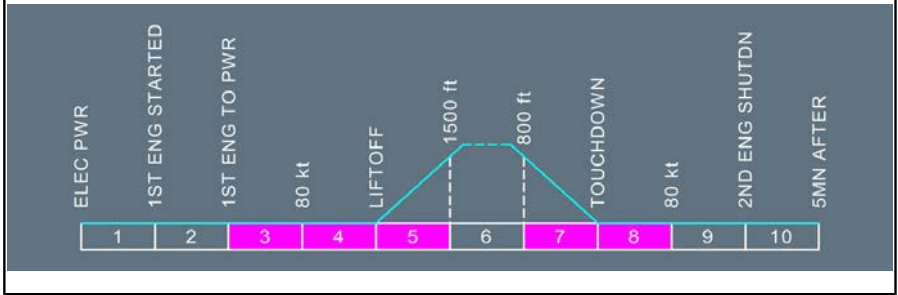

Ident.: PRO-ABN-FUEL-BB-00018877.0001001 / 21 MAR 16

ACT LO LVL

L2 Note: Displayed if ACT is empty.

L1 ACT.....OFF

FUEL APU LP VALVE FAULT

Applicable to: ALL

Ident.: PRO-ABN-FUEL-BC-00016826.0001001 / 21 MAR 16

ANNUNCIATIONS

Triggering Conditions:

L2 This alert triggers when the valve position disagrees with the selected position.

Flight Phase Inhibition:

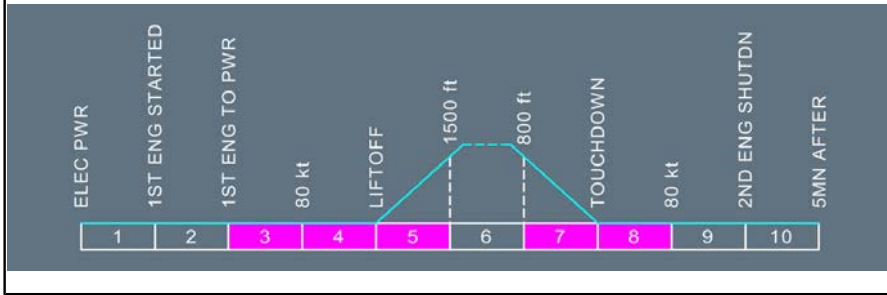

Ident.: PRO-ABN-FUEL-BC-00017633.0002001 / 21 MAR 16

Crew awareness.

FUEL AUTO FEED FAULT

Applicable to: ALL

Ident.: PRO-ABN-FUEL-Q-00016698.0001001 / 21 MAR 16

ANNUNCIATIONS

Triggering Conditions:

L2

This alert triggers when:

- CTR TK quantity > 250 kg (550 lb) and left or right wing tanks quantity < 5 000 kg (11 000 lb), or
- CTR TK pumps do not stop after slat extension or CTR TK level is low.

Flight Phase Inhibition:

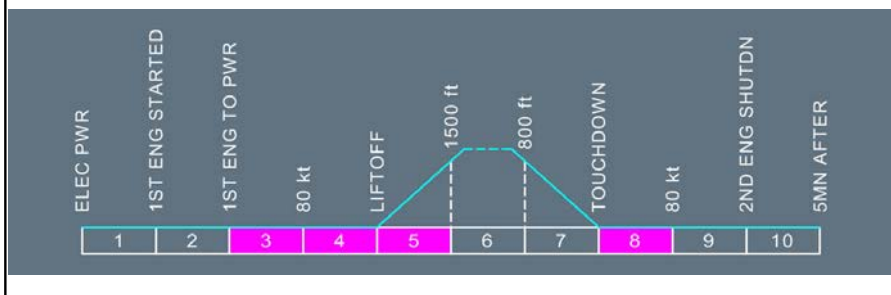

Continued on the following page

PROCEDURES
ABNORMAL AND EMERGENCY PROCEDURES

FUEL

FUEL AUTO FEED FAULT (Cont'd)

Ident.: PRO-ABN-FUEL-Q-00017666.0001001 / 21 MAR 16

FUEL MODE SEL.....MAN

^[L2] The center tank pumps will run and feed the engines.

- ^[L1] ■ Fuel in one wing tank < 5 000 kg (11 000 lb) and in center tank > 250 kg (550 lb):
 - CTR TK PUMP 1.....ON
 - CTR TK PUMP 2.....ON

^[L2] When the center tank is empty, CTR TK PUMP LO PR alert will come on.
For aircraft equipped with CFM engines only : If the center tank is not empty at slat extension, CTR TK PUMPS should be switched OFF. This action will prevent a possible wing tank overflow on ground, due to IDG fuel recirculation.

- ^[L1] ■ CTR TK PUMPS running after slat extension, or LO LVL in center tank:
 - CTR TK PUMP 1.....OFF
 - CTR TK PUMP 2.....OFF

Ident.: PRO-ABN-FUEL-Q-00018882.0001001 / 21 MAR 16

STATUS

CTR TK FEED : MAN ONLY

FUEL CTR TK PUMP 1(2) LO PR

Applicable to: ALL

Ident.: PRO-ABN-FUEL-M-00016843.0001001 / 21 MAR 16

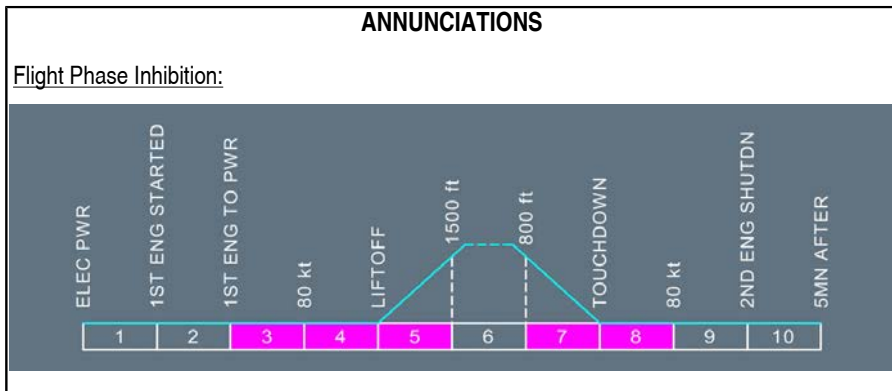

Ident.: PRO-ABN-FUEL-M-00018914.0003001 / 21 MAR 16

- **IF NO FUEL LEAK:**
FUEL X FEED..... ON
CTR TK PUMP (AFFECTED)..... OFF

L2 A fuel imbalance may occur, if the performance of the pumps of one wing is different from that of the other wing, and the CTR TK PUMP that is not affected stops automatically because:

- The L(R) INR TK is full, or
- The CTR TK is empty.

In this case, apply the FUEL IMBALANCE procedure, as required.

- L1** ● **WHEN CTR TK EMPTY:**
FUEL X FEED..... OFF
- L2** When the CTR TK is empty, the X FEED pb-sw must be turned off, to avoid a possible fuel imbalance.

Continued on the following page

FUEL CTR TK PUMP 1(2) LO PR (Cont'd)

Ident.: PRO-ABN-FUEL-M-00018918.0002001 / 21 MAR 16

STATUS

● **WHEN CTR TK EMPTY:**

FUEL X FEED.....OFF

INOP SYS

CTR TK PUMP 1(2)

FUEL CTR TK PUMPS LO PR

Applicable to: ALL

Ident.: PRO-ABN-FUEL-N-00016845.0001001 / 21 MAR 16

ANNUNCIATIONS

Triggering Conditions:

L2 This alert triggers when the pressure of the CTR TK pumps is low.

Flight Phase Inhibition:

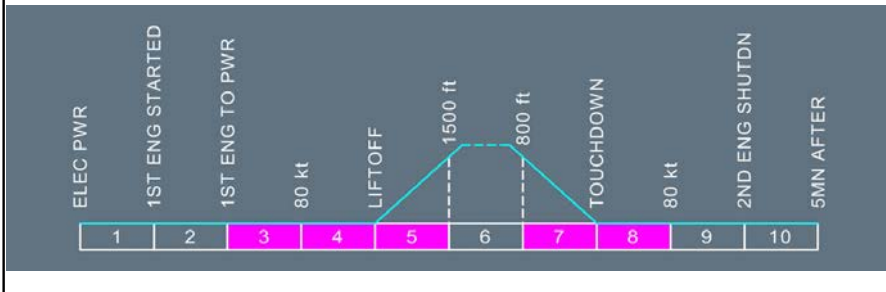

Continued on the following page



A318/A319/A320/A321
 FLIGHT CREW
 OPERATING MANUAL

PROCEDURES
ABNORMAL AND EMERGENCY PROCEDURES

FUEL

FUEL CTR TK PUMPS LO PR (Cont'd)

Ident.: PRO-ABN-FUEL-N-00011221.0003001 / 30 MAR 12

L2 Set FUEL MODE SEL pb-sw to MAN, to avoid the possible triggering of the **FUEL CTR TK PUMPS OFF** ECAM caution.

L1 CTR TK PUMP 1..... OFF
 CTR TK PUMP 2..... OFF
 FUEL X FEED..... OFF
 CTR TK UNUSABLE

L2 Gravity feeding from the center tank is not possible (no by-pass valve fitted on the center tank pumps).

Ident.: PRO-ABN-FUEL-N-00011222.0001001 / 13 AUG 10

STATUS

CTR TK FUEL UNUSABLE

INOP SYS

CTR TK PUMPS

FUEL CTR TK PUMPS OFF

Applicable to: ALL

Ident.: PRO-ABN-FUEL-BE-00016846.0001001 / 21 MAR 16

ANNUNCIATIONS

Triggering Conditions:

- L2 This alert triggers when both CTR TK PUMP 1 pb-sw and CTR TK PUMP 2 pb-sw are at OFF with no failure.

Flight Phase Inhibition:

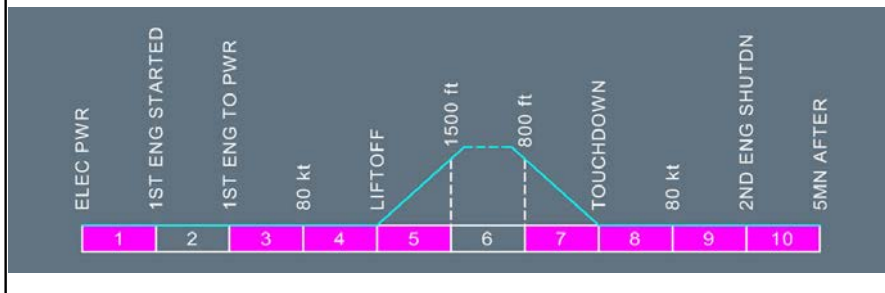

Ident.: PRO-ABN-FUEL-BE-00011260.0002001 / 10 JAN 11

- L2 The center tank pumps pushbuttons are OFF, with slats retracted.

- L1 CTR TK PUMP 1..... ON
- CTR TK PUMP 2..... ON

FUEL ENG 1(2) LP VALVE OPEN

Applicable to: ALL

Ident.: PRO-ABN-FUEL-BG-00016814.0001001 / 21 MAR 16

ANNUNCIATIONS

Triggering Conditions:

L2

This alert triggers when the valve remains in the open position.

Flight Phase Inhibition:

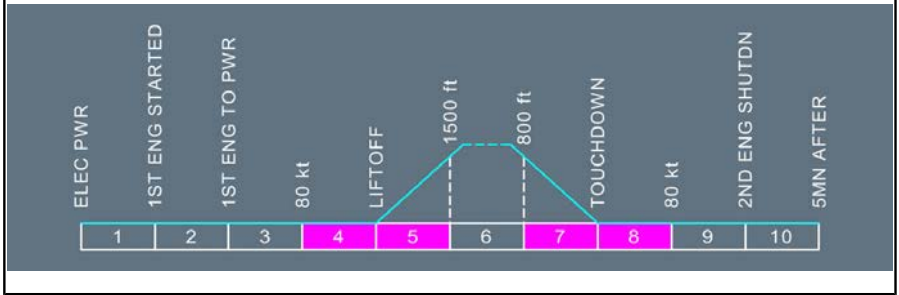

Ident.: PRO-ABN-FUEL-BG-00011217.0001001 / 25 FEB 14

Crew awareness.

FUEL FQI CH 1(2) FAULT

Applicable to: ALL

Ident.: PRO-ABN-FUEL-BI-00016817.0001001 / 21 MAR 16

ANNUNCIATIONS

Triggering Conditions:

L2 This alert triggers when a FQI channel is failed.

Flight Phase Inhibition:

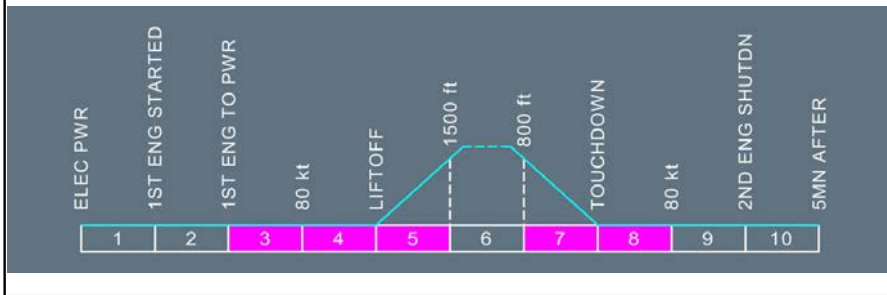

Ident.: PRO-ABN-FUEL-BI-00011216.0001001 / 25 FEB 14

Crew awareness.

FUEL L (R) OUTER (INNER) TK HI TEMP

Applicable to: ALL

Ident.: PRO-ABN-FUEL-BL-00016825.0001001 / 21 MAR 16

ANNUNCIATIONS

Triggering Conditions:

L2

This alert triggers when the fuel temperature:

- In outer cell, is above 55 °C on ground
- In outer cell, is above 60 °C in flight
- In inner cell, is above 45 °C on ground
- In inner cell, is above 54 °C in flight.

Flight Phase Inhibition:

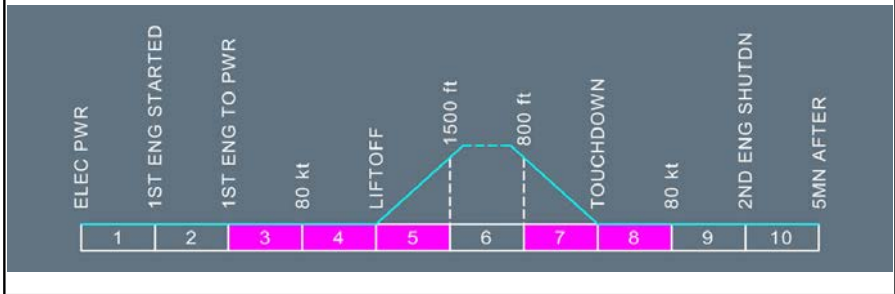

Continued on the following page

FUEL L (R) OUTER (INNER) TK HI TEMP (Cont'd)

Ident.: PRO-ABN-FUEL-BL-00011214.0001001 / 13 AUG 10

[L2] This caution may spuriously trigger due to interference from communication equipment. Therefore, the flight crew should wait 2 min while the fuel temperature measurement is updated. After 2 min, if the ECAM caution has not disappeared, the flight crew must apply the following procedure:

[L1] GALLEY..... OFF

[L2] Reducing electrical loads reduce heat emitted by IDG.

[L1] ■ **On the ground:**

LIMITED TAXI TIME

- If temp reaches 60° C in outer cell or 54° C in inner cell:

DELAY T.O.

ENG MASTER (AFFECTED SIDE)..... OFF

■ **In flight:**

ENG F. FLOW (AFFECTED SIDE)..... INCREASE

[L2] Disconnect autothrust. Adjust the thrust lever to increase fuel flow through the IDG oil heat exchanger and decrease the temperature of the fuel returning to the outer cell.

[L1] ● **IF TEMP ABV 65 DEG C in outer cell or 57 DEG C in inner cell:**

APU..... AS RQRD

[L2] APU if available may be started and APU GEN used to allow IDG disconnection.

[L1] ● **If opposite GEN avail:**

IDG (AFFECTED SIDE)..... OFF

FUEL L (R) OUTER (INNER) TK LO TEMP

Applicable to: ALL

Ident.: PRO-ABN-FUEL-BM-00016827.0001001 / 21 MAR 16

ANNUNCIATIONS

Triggering Conditions:

L2 This alert triggers when the fuel temperature is approximately below -43 °C.

Flight Phase Inhibition:

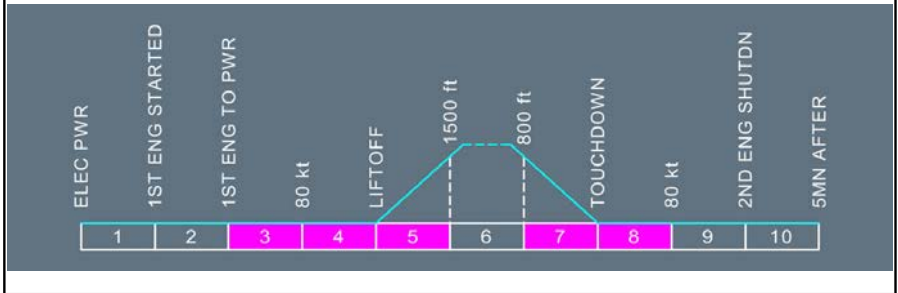

Ident.: PRO-ABN-FUEL-BM-00011208.0001001 / 25 FEB 14

■ **On the ground before takeoff:**

DELAY T.O

L2 Do not takeoff until temperatures are within limits.

L1 ■ **In flight:**

Crew awareness.

L2 Consider descending to a lower altitude and/or increasing Mach to increase TAT.

FUEL L (R) OUTER XFR CLOSED

Applicable to: ALL

Ident.: PRO-ABN-FUEL-V-00016829.0001001 / 21 MAR 16

ANNUNCIATIONS

Triggering Conditions:

- L2 This alert triggers when both transfer valves remain closed after inner tank reaches the low level.

Flight Phase Inhibition:

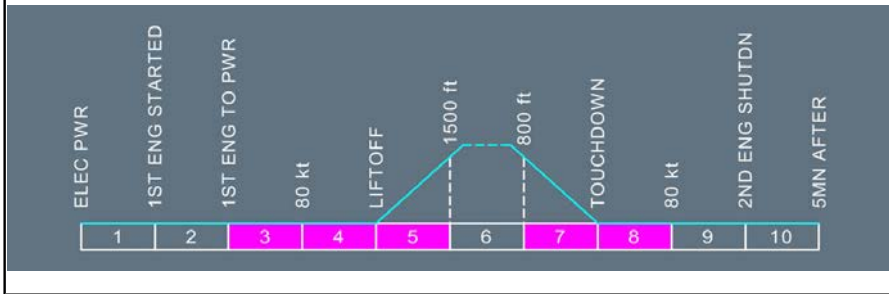

Ident.: PRO-ABN-FUEL-V-00014879.0006001 / 07 MAR 13

Note: When fuel quantity in affected wing reaches low level, corresponding FUEL WING TK LO LVL warning is triggered.

L (R) OUTER TK UNUSABLE

Ident.: PRO-ABN-FUEL-V-00014881.0006001 / 07 MAR 13

STATUS

L (R) OUTER TK UNUSABLE

FUEL L (R) OUTER XFR OPEN

Applicable to: ALL

Ident.: PRO-ABN-FUEL-W-00016831.0001001 / 21 MAR 16

ANNUNCIATIONS

Triggering Conditions:

L2

This alert triggers when either transfer valve opens before inner tank reaches low level.

Flight Phase Inhibition:

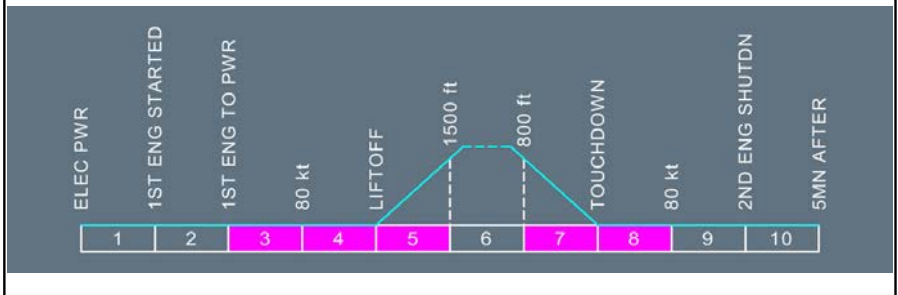

Ident.: PRO-ABN-FUEL-W-00014882.0006001 / 25 FEB 14

Crew awareness.

Ident.: PRO-ABN-FUEL-W-00014883.0006001 / 07 MAR 13

STATUS

INOP SYS

L (R) CELL VALVE

FUEL L (R) TK PUMP 1(2) LO PR

Applicable to: ALL

Ident.: PRO-ABN-FUEL-D-00016832.0001001 / 21 MAR 16

ANNUNCIATIONS

Triggering Conditions:

L2 This alert triggers when the pressure of one tank pump is low.

Flight Phase Inhibition:

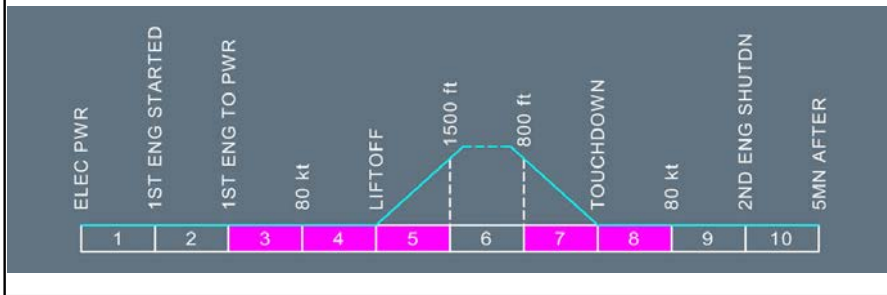

Ident.: PRO-ABN-FUEL-D-00011177.0002001 / 13 AUG 10

TK PUMP (AFFECTED).....OFF

L2 Note: Aircraft altitude must be limited to 35 000 ft if a single fuel pump feeds both engines with hot JET B (JP4) fuel (fuel temperature above 30 °C).

Ident.: PRO-ABN-FUEL-D-00011178.0001001 / 13 AUG 10

STATUS

INOP SYS

TK PUMP (affected)

FUEL L (R) TK PUMP 1 + 2 LO PR
 (CENTER TANK EMPTY)

Applicable to: ALL

Ident.: PRO-ABN-FUEL-C-00018184.0001001 / 21 MAR 16

ANNUNCIATIONS

Triggering Conditions:

L2

This alert triggers when the pressure of the tank pumps is low.

Flight Phase Inhibition:

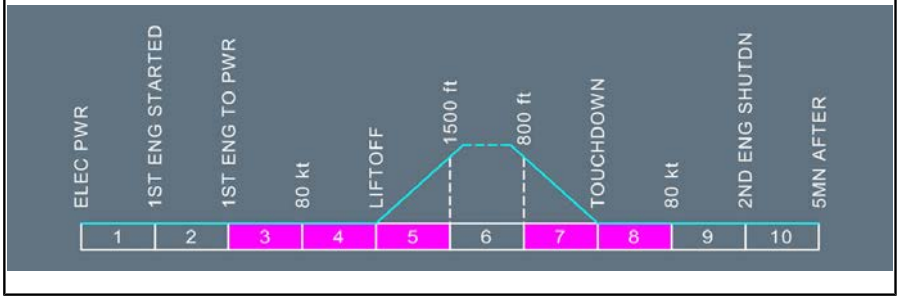

Continued on the following page

PROCEDURES
ABNORMAL AND EMERGENCY PROCEDURES

FUEL

FUEL L (R) TK PUMP 1 + 2 LO PR (Cont'd)
(CENTER TANK EMPTY)

Ident.: PRO-ABN-FUEL-C-00017648.0004001 / 21 MAR 16

● **IF NO FUEL LEAK:**

FUEL X FEED (IF ABOVE FL150)..... ON
 ENG MODE SEL.....IGN

^[L2] *The selection of continuous relight protects against flame-out, caused by possible fuel supply surging.*

^[L1] TK PUMP 1 (AFFECTED).....OFF
 TK PUMP 2 (AFFECTED).....OFF

● **WHEN TK (affected) FUEL RQRD:**

TK (AFFECTED) FEED.....GRVTY ONLY

^[L2] *Apply GRVTY FUEL FEED procedure, (Refer to PRO-ABN-FUEL [QRH] GRAVITY FUEL FEEDING).*

Fuel from the affected tank may be used immediately if there is no ceiling limitation for gravity fuel feeding.

^[L1] FUEL X FEED (IF BELOW FL150).....OFF

● **If FUEL X FEED off:**

^[L2] As long as fuel X feed is closed, associated engine is fed by gravity only.

^[L1] **PROC: GRVTY FUEL FEEDING**

^[L2] *Apply GRVTY FUEL FEED procedure, (Refer to PRO-ABN-FUEL [QRH] GRAVITY FUEL FEEDING).*

^[L1] **AVOID NEGATIVE G FACTOR**

^[L2] *Avoiding negative g will prevent fuel surging and therefore reduce the risk of engine malfunction.*

Ident.: PRO-ABN-FUEL-C-00011175.0001001 / 13 AUG 10

STATUS

● **If FUEL X FEED off:**

PROC:GRVTY FUEL FEEDING
AVOID NEGATIVE G FACTOR

INOP SYS

TK PUMPS (affected)

TK (AFFECTED) GRVTY FEED ONLY

FUEL L (R) TK PUMP 1 + 2 LO PR
(CENTER TANK NOT EMPTY)

Applicable to: ALL

Ident.: PRO-ABN-FUEL-B-00018196.0001001 / 21 MAR 16

ANNUNCIATIONS

Triggering Conditions:

L2 This alert triggers when the pressure of the tank pumps is low.

Flight Phase Inhibition:

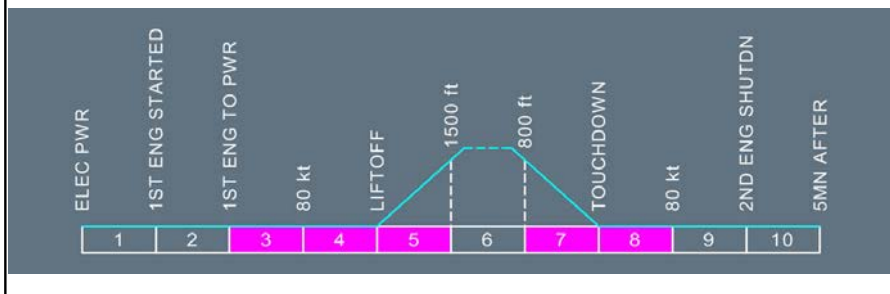

Ident.: PRO-ABN-FUEL-B-00011170.0003001 / 26 JUL 12

FUEL MODE SEL (IF CTR TK NOT FEEDING).....MAN

L2 Setting FUEL MODE SEL pb-sw to MAN will allow center tank pumps to run. If the center tank is not empty at slat extension, CTR TK PUMPs should be switched OFF. This action will prevent a possible wing tank overflow on ground, due to IDG fuel recirculation.

L1 TK PUMP 1 (AFFECTED).....OFF
TK PUMP 2 (AFFECTED).....OFF

● **WHEN TK (affected) FUEL RQRD:**

L2 Apply the GRVTY FUEL FEEDING procedure, (Refer to PRO-ABN-FUEL [QRH] GRAVITY FUEL FEEDING).

L1 TK (AFFECTED) FEED.....GRVTY ONLY
PROC: GRVTY FUEL FEEDING

Continued on the following page

FUEL L (R) TK PUMP 1 + 2 LO PR (Cont'd)
(CENTER TANK NOT EMPTY)

Ident.: PRO-ABN-FUEL-B-00011171.0001001 / 13 AUG 10

STATUS

PROC:GRVTY FUEL FEEDING

INOP SYS

TK (AFFECTED) GRVTY FEED ONLY

TK PUMPS (affected)

CTR TK FEED: MAN ONLY

FUEL L (R) WING TK LO LVL

Applicable to: ALL

Ident.: PRO-ABN-FUEL-E-00016837.0001001 / 21 MAR 16

ANNUNCIATIONS

Triggering Conditions:

- [2] This alert triggers when left or right wing tanks quantity is below 750 kg (1 650 lb). This alert is triggered by sensors getting dry and is independent from the fuel quantity indications.

Flight Phase Inhibition:

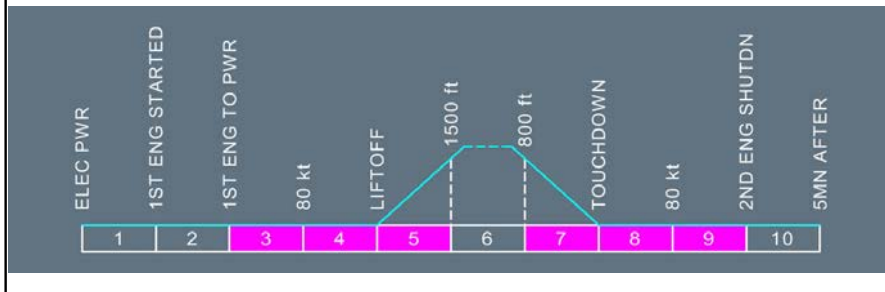

Continued on the following page



AEROLINEAS GALAPAGOS S.A.

A318/A319/A320/A321

FLIGHT CREW
OPERATING MANUAL

PROCEDURES
ABNORMAL AND EMERGENCY PROCEDURES

FUEL

FUEL L (R) WING TK LO LVL (Cont'd)

Ident.: PRO-ABN-FUEL-E-00018927.0002001 / 21 MAR 16

- **If center tank not empty:**

FUEL MODE SEL..... MAN

- **IF NO FUEL LEAK AND FUEL IMBALANCE:**

FUEL X FEED..... ON

TK PUMP 1 (ON SIDE WITH LO LVL)..... OFF

TK PUMP 2 (ON SIDE WITH LO LVL)..... OFF

L2 *Note:* TK PUMP 1+2 (on side with LO LVL) LO PR warning will be triggered.

Ident.: PRO-ABN-FUEL-E-00018928.0001001 / 21 MAR 16

STATUS

INOP SYS

- **If center tank not empty:**

CTR TK FEED: MAN ONLY

TK PUMPS

FUEL L + R WING TK LO LVL

Applicable to: ALL

Ident.: PRO-ABN-FUEL-BO-00016810.0001001 / 21 MAR 16

ANNUNCIATIONS

Triggering Conditions:

- L2 This alert triggers when the low level is detected in both wing inner tanks. The alert is triggered by sensors getting dry and is independent from the fuel quantity indications.

Flight Phase Inhibition:

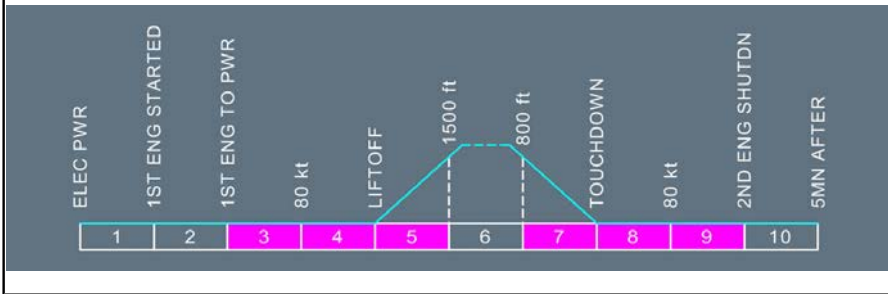

Ident.: PRO-ABN-FUEL-BO-00018673.0003001 / 21 MAR 16

LAND ASAP

FUEL MODE SEL (IF CENTER TANK NOT EMPTY).....MAN
 ALL TK PUMPS.....ON

- L2 All pumps in center tank and in wing tanks will run.

- L1 ■ **IF NO FUEL LEAK:**
 FUEL X FEED.....ON
- **IF GRVTY FEED:**
 FUEL X FEED.....OFF

FUEL X FEED VALVE FAULT

Applicable to: ALL

Ident.: PRO-ABN-FUEL-J-00016842.0001001 / 21 MAR 16

ANNUNCIATIONS

Triggering Conditions:

L2 This alert triggers when the valve position disagrees with the selected position.

Flight Phase Inhibition:

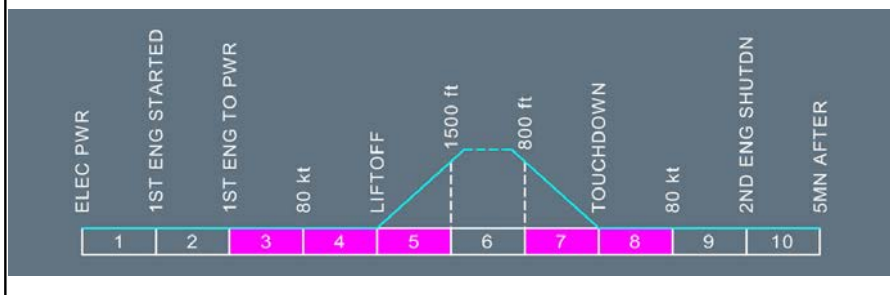

Ident.: PRO-ABN-FUEL-J-00011206.0001001 / 25 FEB 14

L2 If valve failed open, maintain fuel balance with selective use of pumps.
 If valve failed closed and if unable to maintain an acceptable balance, land as soon as possible.

L1 Crew awareness.

Ident.: PRO-ABN-FUEL-J-00011207.0001001 / 13 AUG 10

STATUS

INOP SYS

FUEL X FEED



A318/A319/A320/A321
FLIGHT CREW
OPERATING MANUAL

PROCEDURES
ABNORMAL AND EMERGENCY PROCEDURES

FUEL

Intentionally left blank

[QRH] MULTIPLE UNDUE ECAM ALERTS

Ident.: TDU / PRO-ABN-FWS-00012928.0001001 / 17 MAR 17

Applicable to: ALL
 Impacted DU: NONE

In the case of multiple undue ECAM alerts:

- ENG 1(2) N1 (N2) (EGT) OVER LIMIT, or
- ENG 1(2) N1 (N2) (EGT)(EPR) (FF) DISCREPANCY, or
- NAV ATT (ALTI) (HDG) DISCREPANCY, or
- NAV FM /GPS POS DISAGREE, or
- MINIMUM or HUNDRED ABOVE callouts.

Possibly associated with EFIS red flags, apply the procedure below:

AFFECTED PARAMETERS.....CROSSCHECK

Crosscheck the affected parameters on the E/WD , PFD , ND or on the related SD page to confirm that the alerts are spurious.

● **If spurious alerts:**

SWITCHING EIS DMC..... CAPT 3

DMC 3 replaces DMC 1. If the undue alerts stop, DMC 1 is the faulty DMC.

● **If unsuccessful :**

SWITCHING EIS DMC.....F/O 3

DMC 3 replaces DMC 2. If the undue alerts stop, DMC 2 is the faulty DMC.

FWS FWC 1 + 2 FAULT

Applicable to: ALL

Ident.: PRO-ABN-FWS-H-00017311.0001001 / 21 MAR 16

ANNUNCIATIONS

Triggering Conditions:

- L2 This alert triggers when both FWC 1 and FWC 2 are failed, or when the communication between the FWC and the EIS is lost.

Flight Phase Inhibition:

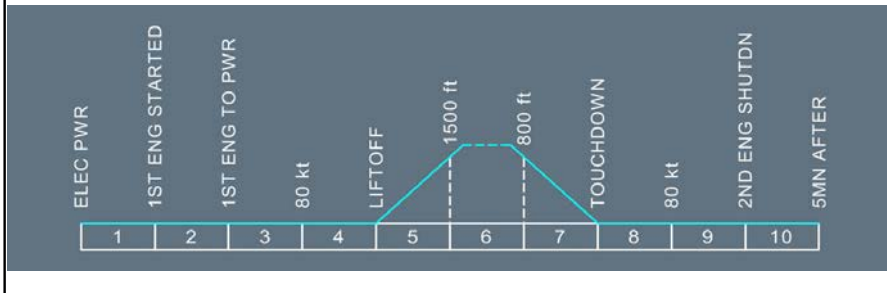

Ident.: PRO-ABN-FWS-H-00010055.0001001 / 14 FEB 13

MONITOR SYS
 MONITOR OVERHEAD PANEL

NOT AVAIL

ECAM WARN
 ALTI ALERT
 STATUS
 A/CALL OUT
 MEMO

Continued on the following page

FWS FWC 1 + 2 FAULT (Cont'd)

Ident.: PRO-ABN-FWS-H-00010056.0001001 / 14 FEB 13

L2

Other INOP SYS

CAT2

ECAM Cautions and Warnings, aural warnings, master caution and warning lights are lost. ECAM system pages are still available. therefore check regularly (more often than usual) cockpit panels for local warnings and ECAM system pages for system checks. Check the general status of the systems for the DES /APPR preparation.

FWS FWC 1(2) FAULT

Applicable to: ALL

Ident.: PRO-ABN-FWS-G-00017310.0001001 / 21 MAR 16

ANNUNCIATIONS

Triggering Conditions:

L2

This alert triggers when either FWC 1 or, FWC 2 is failed.

Flight Phase Inhibition:

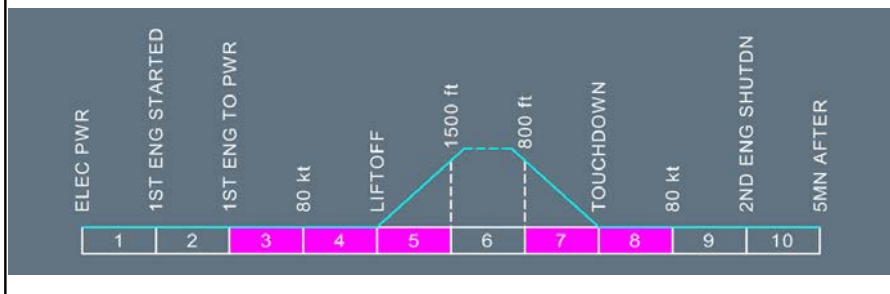

Ident.: PRO-ABN-FWS-G-00010059.0001001 / 10 AUG 10

Crew awareness.

Continued on the following page

FWS FWC 1(2) FAULT (Cont'd)

Ident.: PRO-ABN-FWS-G-00010060.0001001 / 10 AUG 10

STATUS

CAT 3 SINGLE ONLY

INOP SYS

CAT 3 DUAL
FWC 1(2)

FWS OEB/FWC DISCREPANCY

Applicable to: ALL

Ident.: PRO-ABN-FWS-J-00017314.0002001 / 21 MAR 16

ANNUNCIATIONS

Triggering Conditions:

- [2] This alert triggers when FWC 1 and FWC 2 do not have the same OEB s listed in their OEB reminder database.

Flight Phase Inhibition:

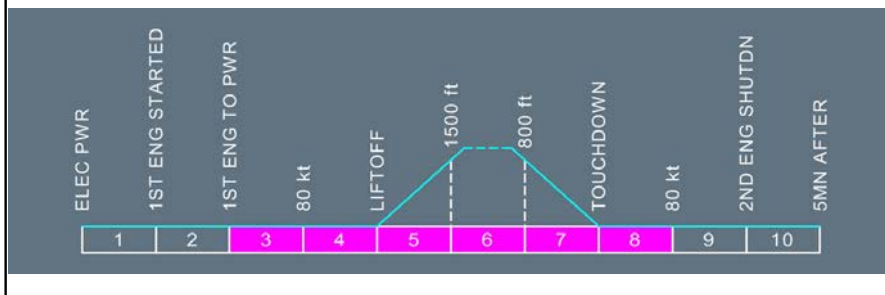

Ident.: PRO-ABN-FWS-J-00010050.0001001 / 10 AUG 10

OEB DATABASE..... XCHECK

- [2] This action is normally performed by maintenance.

FWS SDAC 1 + 2 FAULT

Applicable to: ALL

Ident.: PRO-ABN-FWS-E-00017306.0001001 / 21 MAR 16

ANNUNCIATIONS

Triggering Conditions:

L2 This alert triggers when both SDAC 1 and SDAC 2 are failed.

Flight Phase Inhibition:

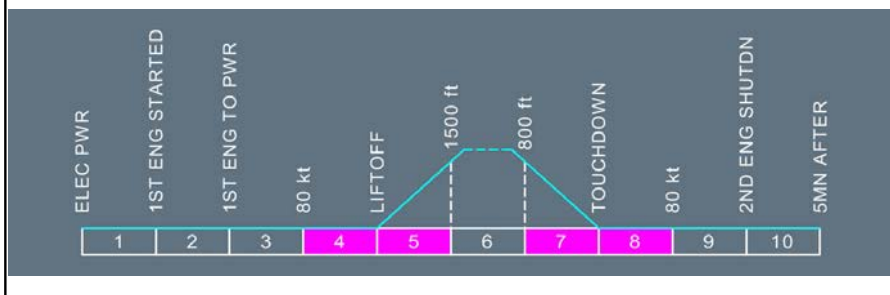

Ident.: PRO-ABN-FWS-E-00010053.0001001 / 10 AUG 10

MONITOR OVERHEAD PANEL

L2 Amber cautions are lost. Aircraft status on the ECAM STATUS page is lost.
 Only red warnings, engine and fuel parameters, and slat/flap positions are available on the upper ECAM DU.

L1 ECAM ENG FUEL F/CTL WHEEL (L/G POS IND) SYS PAGES AVAIL.

Ident.: PRO-ABN-FWS-E-00010054.0002001 / 10 AUG 10

STATUS

INOP SYS

SDAC 1 + 2

FWS SDAC 1(2) FAULT

Applicable to: ALL

Ident.: PRO-ABN-FWS-D-00017308.0001001 / 21 MAR 16

ANNUNCIATIONS

Triggering Conditions:

L2 This alerts triggers when either SDAC 1 or, SDAC 2 is failed.

Flight Phase Inhibition:

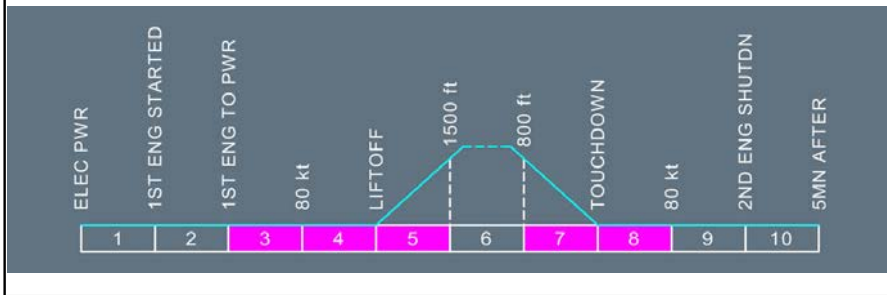

Ident.: PRO-ABN-FWS-D-00010051.0001001 / 25 FEB 14

Crew awareness.

Ident.: PRO-ABN-FWS-D-00010052.0001001 / 10 AUG 10

L12

STATUS

INOP SYS

SDAC 1(2)

Note: Although the ECAM may display some symbols and/or parameters in amber, this does not always signify that additional systems are failed.

HYD B ELEC PUMP LO PR OR OVHT

Applicable to: ALL

Ident.: PRO-ABN-HYD-T-00017137.0001001 / 21 MAR 16

ANNUNCIATIONS

Triggering Conditions:

L2

LO PR: This alert triggers when the pump outlet pressure $\leq 1\ 450$ PSI (the alert resets if pressure $\geq 1\ 750$ PSI).

OVHT: This alert triggers when the blue electric pump overheats.

Flight Phase Inhibition:

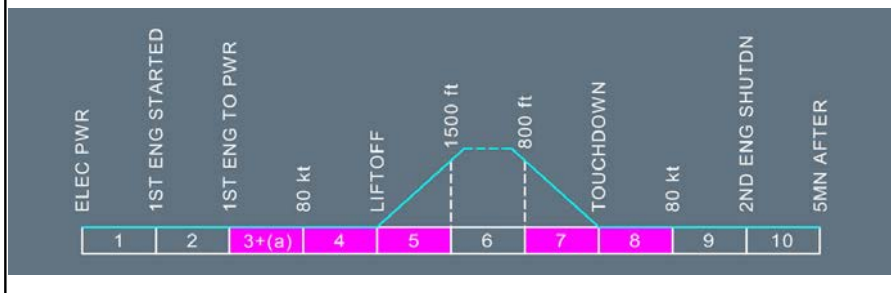

Note: (a) The Flight Phase Inhibition 3 is only available for HYD B ELEC PUMP OVHT.

Ident.: PRO-ABN-HYD-T-00011661.0002001 / 27 NOV 12

BLUE ELEC PUMP.....OFF
 FUEL CONSUMPT INCRSD
 FMS PRED UNRELIABLE

ASSOCIATED PROCEDURES

B SYS LO PR

FUEL CONSUMPT INCRSD
 FMS PRED UNRELIABLE

SECONDARY FAILURES

*F/CTL

Continued on the following page

HYD B ELEC PUMP LO PR OR OVHT (Cont'd)

Ident.: PRO-ABN-HYD-T-00018313.0003001 / 21 MAR 17

L12

STATUS

APPR PROC

HYD LO PR

● **IF BLUE OVHT OUT:**

BLUE ELEC PUMP..... AUTO

LDG DIST PROC..... APPLY

FUEL CONSUMPT INCRSD

See ⁽¹⁾

FMS PRED UNRELIABLE

See ⁽²⁾

SLATS SLOW

CAT 3 SINGLE ONLY

INOP SYS

BLUE HYD

SPLR 3

CAT 3 DUAL

B ELEC PUMP

STEEP APPR 

⁽¹⁾ This message is triggered when the failure (or combination of failures) affects the nominal aerodynamic characteristics of the aircraft.

⁽²⁾ Disregard FMS fuel predictions and refer to QRH/OPS Operational Data - Fuel Penalty Factors Tables in order to find the applicable Fuel Penalty Factor.

HYD B RSVR LO AIR PR

Applicable to: ALL

Ident.: PRO-ABN-HYD-A-00017106.0002001 / 21 MAR 16

ANNUNCIATIONS

Triggering Conditions:

L2

This alert triggers when the reservoir air pressure \leq 22 PSI (the alert resets if pressure \geq 25 PSI).

This alert triggers when the reservoir air pressure \leq 30 PSI (detected in flight but only displayed on ground after landing).

Flight Phase Inhibition:

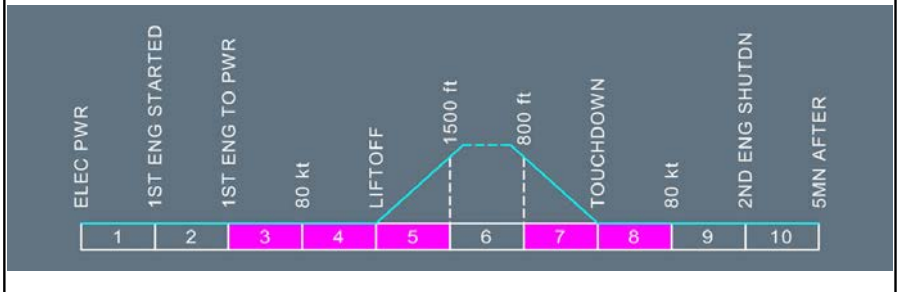

Ident.: PRO-ABN-HYD-A-00011602.0002001 / 05 MAR 13

● **IF PRESS FLUCTUATES:**

BLUE ELEC PUMP.....OFF

ASSOCIATED PROCEDURES

B SYS LO PR

FUEL CONSUMPT INCRSD
FMS PRED UNRELIABLE

SECONDARY FAILURES

*F/CTL

Continued on the following page

HYD B RSVR LO AIR PR (Cont'd)

Ident.: PRO-ABN-HYD-A-00018312.0003001 / 21 MAR 17

L12

STATUS

INOP SYS

APPR PROC

The probability of cavitation increases with altitude. Therefore, it may be possible to restore the system after descending to a lower altitude.

HYD LO PR
BLUE ELEC PUMP.....AUTO

● **If sys not recovered:**
LDG DIST PROC.....APPLY

FUEL CONSUMPT INCRSD

See ⁽¹⁾

FMS PRED UNRELIABLE

See ⁽²⁾

SLATS SLOW

CAT 3 SINGLE ONLY

BLUE HYD
SPLR 3
CAT 3 DUAL
B ELEC PUMP
STEEP APPR 

⁽¹⁾ This message is triggered when the failure (or combination of failures) affects the nominal aerodynamic characteristics of the aircraft.

⁽²⁾ Disregard FMS fuel predictions and refer to QRH/OPS Operational Data - Fuel Penalty Factors Tables in order to find the applicable Fuel Penalty Factor.

HYD B RSVR LO LVL

Applicable to: ALL

Ident.: PRO-ABN-HYD-C-00017144.0001001 / 21 MAR 16

ANNUNCIATIONS

Triggering Conditions:

L2

The alert triggers when the fluid quantity < 2.4 l (0.63 US Gal).

Flight Phase Inhibition:

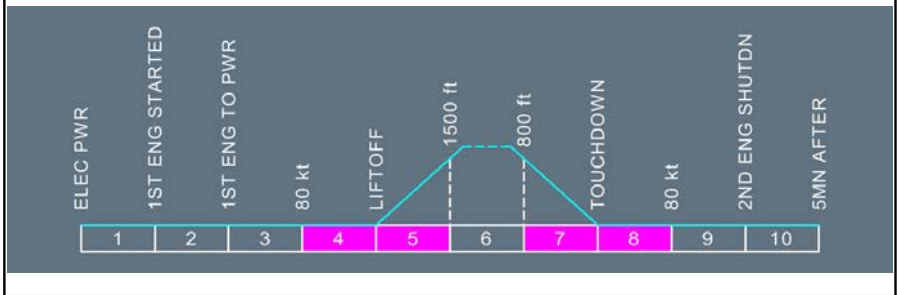

Ident.: PRO-ABN-HYD-C-00011606.0002001 / 05 MAR 13

BLUE ELEC PUMP OFF

ASSOCIATED PROCEDURES

B SYS LO PR

FUEL CONSUMPT INCRSD

FMS PRED UNRELIABLE

SECONDARY FAILURES

*F/CTL

Continued on the following page

HYD B RSVR LO LVL (Cont'd)

Ident.: PRO-ABN-HYD-C-00018314.0003001 / 21 MAR 17

L12

STATUS

INOP SYS

LDG DIST PROC..... APPLY

FUEL CONSUMPT INCRSD

See ⁽¹⁾

FMS PRED UNRELIABLE

See ⁽²⁾

SLATS SLOW

CAT 3 SINGLE ONLY

BLUE HYD
SPLR 3
CAT 3 DUAL
EMER GEN
B ELEC PUMP
STEEP APPR 

⁽¹⁾ This message is triggered when the failure (or combination of failures) affects the nominal aerodynamic characteristics of the aircraft.

⁽²⁾ Disregard FMS fuel predictions and refer to QRH/OPS Operational Data - Fuel Penalty Factors Tables in order to find the applicable Fuel Penalty Factor.

HYD B RSVR OVHT

Applicable to: ALL

Ident.: PRO-ABN-HYD-B-00017108.0001001 / 21 MAR 16

ANNUNCIATIONS

Triggering Conditions:

L2

This alert triggers when the fluid temperature ≥ 93 °C (the alert resets if temperature ≤ 88 °C).

Flight Phase Inhibition:

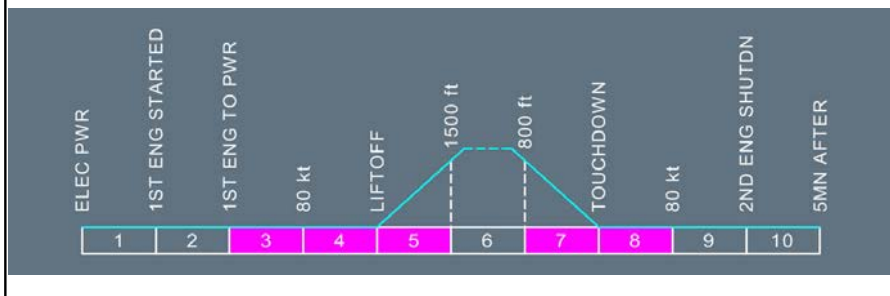

Ident.: PRO-ABN-HYD-B-00011604.0002001 / 05 MAR 13

BLUE ELEC PUMP OFF

ASSOCIATED PROCEDURES

B SYS LO PR

FUEL CONSUMPT INCRSD
FMS PRED UNRELIABLE

SECONDARY FAILURES

*F/CTL

Continued on the following page

HYD B RSVR OVHT (Cont'd)

Ident.: PRO-ABN-HYD-B-00018315.0003001 / 21 MAR 17

L12

STATUS

APPR PROC

HYD LO PR

- **IF BLUE OVHT OUT:**
 BLUE ELEC PUMP..... AUTO
- **If sys not recovered:**
 LDG DIST PROC.....APPLY

FUEL CONSUMPT INCRSD

See ⁽¹⁾

FMS PRED UNRELIABLE

See ⁽²⁾

SLATS SLOW

CAT 3 SINGLE ONLY

INOP SYS

- BLUE HYD
- SPLR 3
- CAT 3 DUAL
- B ELEC PUMP
- STEEP APPR 

⁽¹⁾ This message is triggered when the failure (or combination of failures) affects the nominal aerodynamic characteristics of the aircraft.

⁽²⁾ Disregard FMS fuel predictions and refer to QRH/OPS Operational Data - Fuel Penalty Factors Tables in order to find the applicable Fuel Penalty Factor.

HYD G ENG 1 PUMP LO PR
 (PTU OPERATIVE)

Applicable to: ALL

Ident.: PRO-ABN-HYD-N-00017136.0001001 / 21 MAR 16

ANNUNCIATIONS

Triggering Conditions:

L2

This alert triggers when the pump outlet pressure ≤ 1 750 PSI (the alert resets if pressure ≥ 2 200 PSI).

Flight Phase Inhibition:

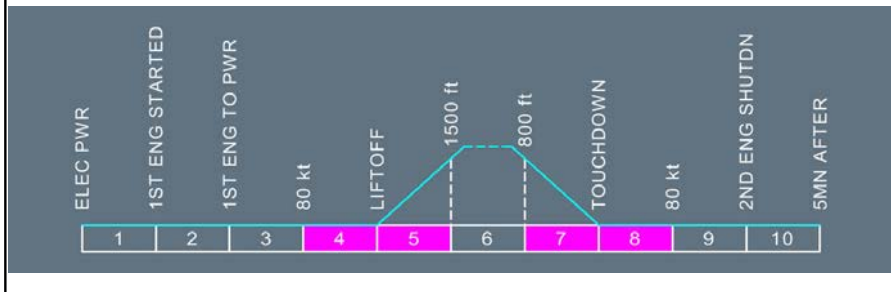

Ident.: PRO-ABN-HYD-N-00011648.0001001 / 18 AUG 10

GREEN ENG 1 PUMP.....OFF

Ident.: PRO-ABN-HYD-N-00011649.0001001 / 17 MAR 11

STATUS

INOP SYS

G ENG 1 PUMP

HYD G ENG 1 PUMP LO PR
(PTU INOPERATIVE)

Applicable to: ALL

Ident.: PRO-ABN-HYD-P-00018805.0001001 / 21 MAR 16

ANNUNCIATIONS

Triggering Conditions:

- L2** This alert triggers when the pump outlet pressure ≤ 1 750 PSI (the alert resets if pressure ≥ 2 200 PSI).

Flight Phase Inhibition:

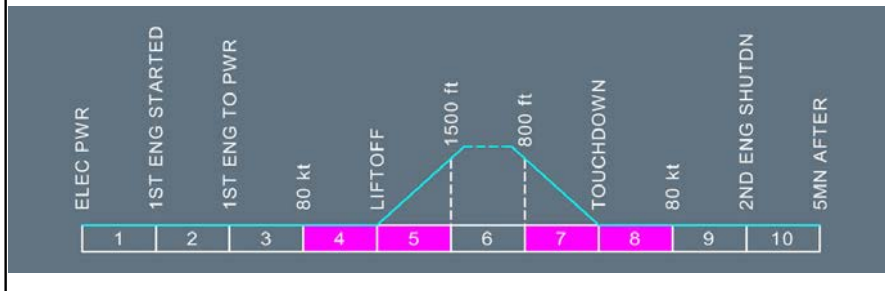

Ident.: PRO-ABN-HYD-P-00011652.0001001 / 18 AUG 10

GREEN ENG 1 PUMP OFF

ASSOCIATED PROCEDURES

G SYS LO PR

SECONDARY FAILURES

- *WHEEL
- *F/CTL

Continued on the following page



A318/A319/A320/A321
 FLIGHT CREW
 OPERATING MANUAL

PROCEDURES
ABNORMAL AND EMERGENCY PROCEDURES

HYD

HYD G ENG 1 PUMP LO PR (Cont'd)
(PTU INOPERATIVE)

Ident.: PRO-ABN-HYD-P-00018316.0002001 / 21 MAR 16

STATUS

L/G..... GRVTY EXTN
 LDG DIST PROC..... APPLY

SLATS/FLAPS SLOW
 CAT 3 SINGLE

INOP SYS

GREEN HYD
 SPLR 1+5
 CAT 3 DUAL
 AUTO BRK
 NORM BRK
 L/G RETRACT
 REVERSER 1
 PTU
 G ENG 1 PUMP
 YAW DAMPER 1

HYD G RSVR LO AIR PR

Applicable to: ALL

Ident.: PRO-ABN-HYD-D-00017104.0001001 / 21 MAR 16

ANNUNCIATIONS

Triggering Conditions:

- L2 This alert triggers when the reservoir air pressure ≤ 22 PSI (the alert resets if air pressure ≥ 25 PSI).

Flight Phase Inhibition:

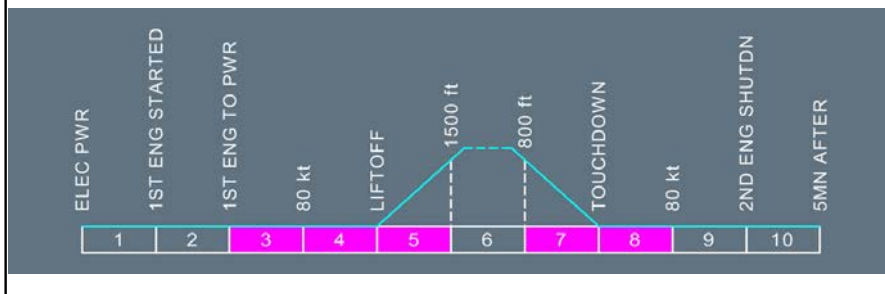

Ident.: PRO-ABN-HYD-D-00011609.0002001 / 05 MAR 13

● **IF PRESS FLUCTUATES:**

- PTU..... OFF
- GREEN ENG 1 PUMP..... OFF

G ENG 1 PUMP LO PR

ASSOCIATED PROCEDURES

G SYS LO PR

- FUEL CONSUMPT INCRSD
- FMS PRED UNRELIABLE

SECONDARY FAILURES

- *WHEEL
- *F/CTL

Continued on the following page

HYD G RSVR LO AIR PR (Cont'd)

Ident.: PRO-ABN-HYD-D-00018317.0007001 / 21 MAR 17

L12

STATUS

APPR PROC

HYD LO PR

The probability of cavitation increases with altitude. Therefore, it may be possible to restore the system after descending to a lower altitude.

GREEN ENG 1 PUMP..... ON

● **IF HYD NOT RECOVERED:**

L/G.....GRVTY EXTN

Refer to PRO-ABN-LG [QRH] L/G GRAVITY EXTENSION

LDG DIST PROC.....APPLY

FUEL CONSUMPT INCRSD

See ⁽¹⁾

FMS PRED UNRELIABLE

See ⁽²⁾

ALTN Y BRK WITH A/SKID

SLATS/FLAPS SLOW

CAT 3 SINGLE ONLY

INOP SYS

GREEN HYD
 SPLR 1 + 5
 CAT 3 DUAL
 AUTO BRK
 NORM BRK
 L/G RETRACT
 REVERSER 1
 YAW DAMPER 1

⁽¹⁾ This message is triggered when the failure (or combination of failures) affects the nominal aerodynamic characteristics of the aircraft.

⁽²⁾ Disregard FMS fuel predictions and refer to QRH/OPS Operational Data - Fuel Penalty Factors Tables in order to find the applicable Fuel Penalty Factor.

HYD G RSVR LO LVL

Applicable to: ALL

Ident.: PRO-ABN-HYD-F-00017142.0002001 / 21 MAR 16

ANNUNCIATIONS

Triggering Conditions:

L2 This alert triggers when the fluid quantity < 3.5 l (0.92 US Gal).

Flight Phase Inhibition:

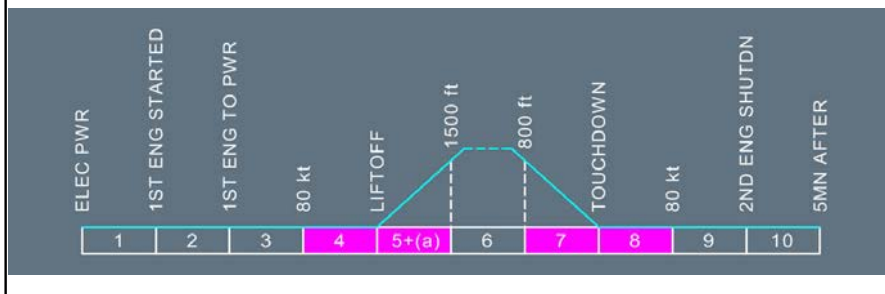

L1 Note: The HYD G RSVR LO LVL alert is inhibited for the first 15 s of flight phase 5.

Ident.: PRO-ABN-HYD-F-00011614.0002001 / 05 MAR 13

PTU.....OFF
 GREEN ENG 1 PUMP.....OFF
 G ENG 1 PUMP LO PR

ASSOCIATED PROCEDURES

G SYS LO PR

FUEL CONSUMPT INCRSD
 FMS PRED UNRELIABLE

SECONDARY FAILURES

*WHEEL
 *F/CTL

Continued on the following page

HYD G RSVR LO LVL (Cont'd)

Ident.: PRO-ABN-HYD-F-00018320.0007001 / 21 MAR 17

L12

STATUS

INOP SYS

L/G..... GRVTY EXTN

Refer to PRO-ABN-LG [QRH] L/G GRAVITY EXTENSION

LDG DIST PROC..... APPLY

FUEL CONSUMPT INCRSD

See ⁽¹⁾

FMS PRED UNRELIABLE

See ⁽²⁾

ALTN Y BRK WITH A/SKID

SLATS/FLAPS SLOW

CAT 3 SINGLE ONLY

GREEN HYD
 SPLR 1 + 5
 CAT 3 DUAL
 AUTO BRK
 NORM BRK
 L/G RETRACT
 REVERSER 1
 YAW DAMPER 1

⁽¹⁾ This message is triggered when the failure (or combination of failures) affects the nominal aerodynamic characteristics of the aircraft.

⁽²⁾ Disregard FMS fuel predictions and refer to QRH/OPS Operational Data - Fuel Penalty Factors Tables in order to find the applicable Fuel Penalty Factor.

HYD G RSVR OVHT

Applicable to: ALL

Ident.: PRO-ABN-HYD-E-00017107.0001001 / 21 MAR 16

ANNUNCIATIONS

Triggering Conditions:

L2 This alert triggers when the fluid temperature ≥ 93 °C (the alert resets if temperature ≤ 88 °C).

Flight Phase Inhibition:

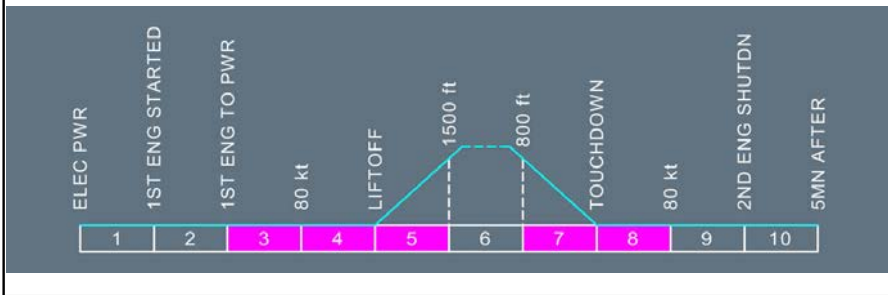

Ident.: PRO-ABN-HYD-E-00011612.0002001 / 05 MAR 13

PTU..... OFF
 GREEN ENG 1 PUMP..... OFF
 G ENG 1 PUMP LO PR

ASSOCIATED PROCEDURES

G SYS LO PR

FUEL CONSUMPT INCRSD
 FMS PRED UNRELIABLE

SECONDARY FAILURES

*WHEEL
 *F/CTL

Continued on the following page

HYD G RSVR OVHT (Cont'd)

Ident.: PRO-ABN-HYD-E-00018321.0007001 / 02 MAY 17

L12

STATUS

INOP SYS

APPR PROC

HYD LO PR

● **IF GREEN OVHT OUT:**

GREEN ENG 1 PUMP.....ON

● **IF HYD NOT RECOVERED:**

L/G.....GRVTY EXTN

Refer to PRO-ABN-LG [QRH] L/G GRAVITY
EXTENSION

LDG DIST PROC.....APPLY

FUEL CONSUMPT INCRSD

See ⁽¹⁾

FMS PRED UNRELIABLE

See ⁽²⁾

ALTN Y BRK WITH A/SKID

SLATS/FLAPS SLOW

CAT 3 SINGLE ONLY

GREEN HYD
SPLR 1 + 5
CAT 3 DUAL
AUTO BRK
NORM BRK
L/G RETRACT
REVERSER 1
YAW DAMPER 1

⁽¹⁾ This message is triggered when the failure (or combination of failures) affects the nominal aerodynamic characteristics of the aircraft.

⁽²⁾ Disregard FMS fuel predictions and refer to QRH/OPS Operational Data - Fuel Penalty Factors Tables in order to find the applicable Fuel Penalty Factor.

HYD Y ELEC PUMP LO PR OR OVHT

Applicable to: ALL

Ident.: PRO-ABN-HYD-M-00017133.0001001 / 21 MAR 16

ANNUNCIATIONS

Triggering Conditions:

L2 LO PR: This alert triggers when the yellow system pressure ≤ 1 450 PSI (the alert resets if pressure ≥ 1 750 PSI) with:

- Y ELEC PUMP pb at ON
- Y ENG PUMP and PTU not available.

OVHT: This alert triggers when the yellow electric pump overheats.

Flight Phase Inhibition:

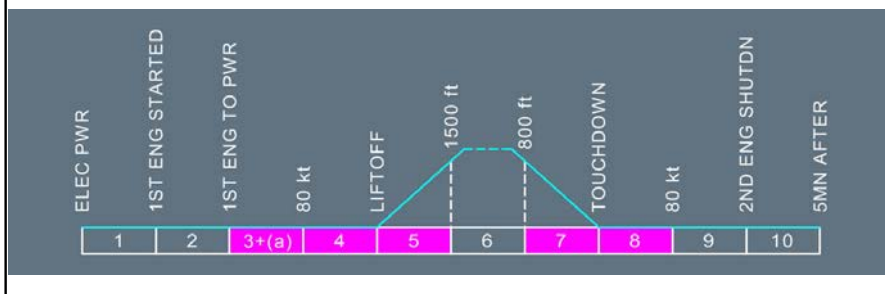

Note: (a) The Flight Phase Inhibition 3 is only available for HYD Y ELEC PUMP OVHT.

Continued on the following page



A318/A319/A320/A321
 FLIGHT CREW
 OPERATING MANUAL

PROCEDURES
ABNORMAL AND EMERGENCY PROCEDURES

HYD

HYD Y ELEC PUMP LO PR OR OVHT (Cont'd)

Ident.: PRO-ABN-HYD-M-00019032.0003001 / 21 MAR 16

YELLOW ELEC PUMP..... OFF

ASSOCIATED PROCEDURES

Y SYS LO PR
BRK Y ACCU PR MONITOR

L2 This check is recommended to cover the case of a pipe rupture, which could lead to the simultaneous loss of the hydraulic system and the accumulator fluid. If this occurs, the loss of the accumulator should be observed on the indicator within 10 min. In that case: The only remaining braking means is the normal braking using green pressure, the parking brake should not be used since it is not available and the chocks should be in place before engine 1 shutdown.

L1 **FUEL CONSUMPT INCRSD**
FMS PRED UNRELIABLE

SECONDARY FAILURES

*F/CTL

Continued on the following page

HYD Y ELEC PUMP LO PR OR OVHT (Cont'd)

Ident.: PRO-ABN-HYD-M-00018322.0004001 / 21 MAR 17

L12

STATUS

INOP SYS

APPR PROC

HYD LO PR

● **IF YELLOW OVHT OUT:**

YELLOW ENG 2 PUMP.....ON
PTU.....AUTO

The above two lines are only displayed, in case of an electrical pump overheat.

LDG DIST PROC..... APPLY

FUEL CONSUMPT INCRSD

See ⁽¹⁾

FMS PRED UNRELIABLE

See ⁽²⁾

FLAPS SLOW

CAT 3 SINGLE ONLY

YELLOW HYD
 SPLR 2+4
 CAT 3 DUAL
 N/W STRG
 REVERSER 2
 Y ELEC PUMP
 YAW DAMPER 2
 STEEP APPR 

⁽¹⁾ This message is triggered when the failure (or combination of failures) affects the nominal aerodynamic characteristics of the aircraft.

⁽²⁾ Disregard FMS fuel predictions and refer to QRH/OPS Operational Data - Fuel Penalty Factors Tables in order to find the applicable Fuel Penalty Factor.

HYD Y ENG 2 PUMP LO PR
 (PTU OPERATIVE)

Applicable to: ALL

Ident.: PRO-ABN-HYD-O-00017135.0001001 / 21 MAR 16

ANNUNCIATIONS

Triggering Conditions:

L2

This alert triggers when the pump outlet pressure ≤ 1 750 PSI (the alert resets if pressure ≥ 2 200 PSI).

Flight Phase Inhibition:

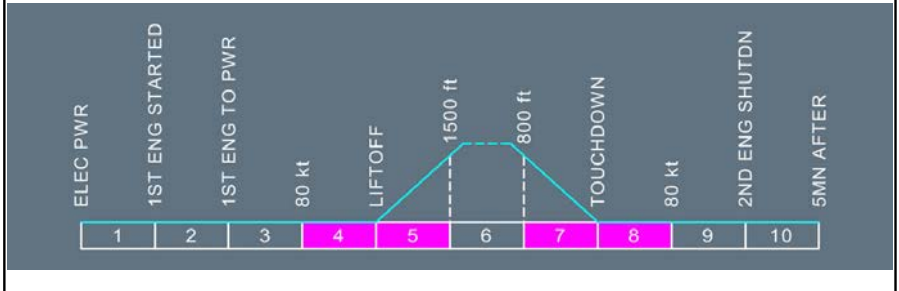

Ident.: PRO-ABN-HYD-O-00011650.0001001 / 18 AUG 10

YELLOW ENG 2 PUMP **OFF**

Ident.: PRO-ABN-HYD-O-00011651.0001001 / 18 AUG 10

STATUS

INOP SYS

Y ENG 2 PUMP

HYD Y ENG 2 PUMP LO PR
(PTU INOPERATIVE)

Applicable to: ALL

Ident.: PRO-ABN-HYD-Q-00018806.0001001 / 21 MAR 16

ANNUNCIATIONS

Triggering Conditions:

- L2 This alert triggers when the pump outlet pressure ≤ 1 750 PSI (the alert resets if pressure ≥ 2 200 PSI).

Flight Phase Inhibition:

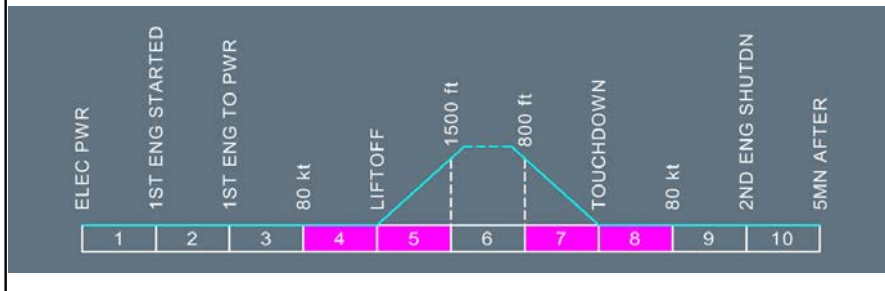

Ident.: PRO-ABN-HYD-Q-00011654.0001001 / 18 AUG 10

YELLOW ENG 2 PUMPOFF

ASSOCIATED PROCEDURES

Y SYS LO PR

- L2 Note: If yellow system is affected, the yellow electrical pump may be used.

L1

SECONDARY FAILURES

*F/CTL

Continued on the following page

HYD Y ENG 2 PUMP LO PR (Cont'd)
(PTU INOPERATIVE)

Ident.: PRO-ABN-HYD-Q-00018323.0002001 / 21 MAR 16

L12

STATUS

LDG DIST PROC..... APPLY

FLAPS SLOW
 CAT 3 SINGLE
 See ⁽¹⁾

INOP SYS

YELLOW HYD
 SPLR 2+4
 CAT 3 DUAL
 N/W STRG
 REVERSER 2
 PTU
 Y ENG 2 PUMP
 YAW DAMPER 2
 STEEP APPR

⁽¹⁾ Note: Following a yellow hydraulic system failure, the parking brake may be inoperative due to a yellow accumulator low pressure.

HYD Y RSVR LO AIR PR

Applicable to: ALL

Ident.: PRO-ABN-HYD-G-00017105.0001001 / 21 MAR 16

ANNUNCIATIONS

Triggering Conditions:

- L2 This alert triggers when the reservoir air pressure ≤ 22 PSI (the alert resets if pressure ≥ 25 PSI).

Flight Phase Inhibition:

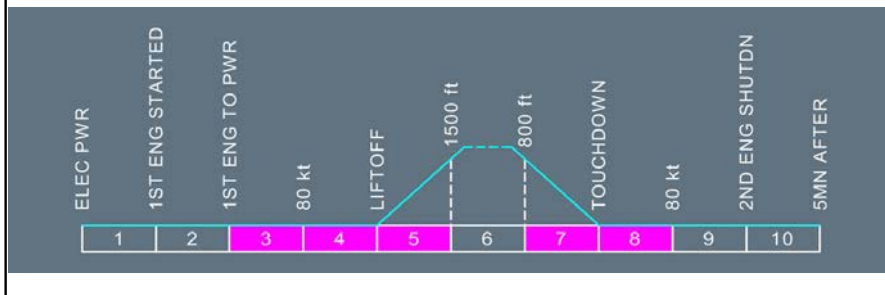

Continued on the following page

HYD Y RSVR LO AIR PR (Cont'd)

Ident.: PRO-ABN-HYD-G-00011626.0003001 / 27 NOV 12

● **IF PRESS FLUCTUATES:**

PTU..... OFF
 YELLOW ENG 2 PUMP..... OFF
 YELLOW ELEC PUMP..... OFF

BRK Y ACCU PR MONITOR

L2 This check is recommended to cover the case of a pipe rupture, which could lead to the simultaneous loss of the hydraulic system and the accumulator fluid. If this occurs, the loss of the accumulator should be observed on the indicator within 10 min. In that case : The only remaining braking means is normal braking, using green pressure. The parking brake should not be used since, it is not available. And, the chocks should be in place before Engine 1 shutdown.

L1 **Y ENG 2 PUMP LO PR**

ASSOCIATED PROCEDURES

Y SYS LO PR

FUEL CONSUMPT INCRSD
 FMS PRED UNRELIABLE

SECONDARY FAILURES

*F/CTL

Continued on the following page

HYD Y RSVR LO AIR PR (Cont'd)

Ident.: PRO-ABN-HYD-G-00018324.0007001 / 21 MAR 17

L12 The probability of cavitation increases with altitude.
 Therefore, it may be possible to restore the system after descending to a lower altitude.

L12 **STATUS**

APPR PROC

HYD LO PR
 YELLOW ENG 2 PUMP ON

● **If sys not recovered:**
 LDG DIST PROC.....APPLY

FUEL CONSUMPT INCRSD

See ⁽¹⁾

FMS PRED UNRELIABLE

See ⁽²⁾

FLAPS SLOW

CAT 3 SINGLE

INOP SYS

YELLOW HYD
 SPLR 2 + 4
 CAT 3 DUAL
 N/W STRG
 REVERSER 2
 YAW DAMPER 2
 STEEP APPR 

⁽¹⁾ This message is triggered when the failure (or combination of failures) affects the nominal aerodynamic characteristics of the aircraft.

⁽²⁾ Disregard FMS fuel predictions and refer to QRH/OPS Operational Data - Fuel Penalty Factors Tables in order to find the applicable Fuel Penalty Factor.

HYD Y RSVR LO LVL

Applicable to: ALL

Ident.: PRO-ABN-HYD-I-00017143.0002001 / 06 SEP 16

ANNUNCIATIONS

Triggering Conditions:

L2

This alert triggers when the fluid quantity < 3.5 l (0.92 US Gal).

Flight Phase Inhibition:

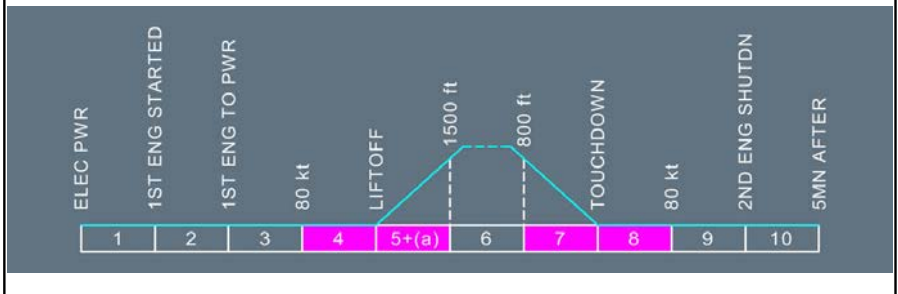

L1 Note: (a) The HYD Y RSVR LO LVL alert is inhibited for the first 15 s of flight phase 5.

Continued on the following page

HYD Y RSVR LO LVL (Cont'd)

Ident.: PRO-ABN-HYD-I-00011631.0003001 / 05 MAR 13

PTU..... OFF
 YELLOW ENG 2 PUMP..... OFF
 YELLOW ELEC PUMP..... OFF
 BRK Y ACCU PR MONITOR

[L2] *This check is recommended to cover the case of a pipe rupture, which could lead to the simultaneous loss of the hydraulic system and the accumulator fluid. If this occurs, the loss of the accumulator should be observed on the indicator within 10 min. In that case: The only remaining braking means is normal braking, using green pressure. The parking brake should not be used since, it is not available. And, the chocks should be in place before Engine 1 shutdown.*

[L1] Y ENG 2 PUMP LO PR

ASSOCIATED PROCEDURES

Y SYS LO PR

FUEL CONSUMPT INCRSD
 FMS PRED UNRELIABLE

SECONDARY FAILURES

*F/CTL

Continued on the following page

HYD Y RSVR LO LVL (Cont'd)

Ident.: PRO-ABN-HYD-I-00018326.0006001 / 21 MAR 17

L12

STATUS

INOP SYS

LDG DIST PROC..... APPLY

FUEL CONSUMPT INCRSD

See ⁽¹⁾

FMS PRED UNRELIABLE

See ⁽²⁾

FLAPS SLOW

CAT 3 SINGLE

See ⁽³⁾

YELLOW HYD
SPLR 2 + 4
CAT 3 DUAL
N/W STRG
REVERSER 2
CARGO DOOR
YAW DAMPER 2
STEER APPR 

⁽¹⁾ This message is triggered when the failure (or combination of failures) affects the nominal aerodynamic characteristics of the aircraft.

⁽²⁾ Disregard FMS fuel predictions and refer to QRH/OPS Operational Data - Fuel Penalty Factors Tables in order to find the applicable Fuel Penalty Factor.

⁽³⁾ Note: Following a yellow hydraulic system failure, the parking brake may be inoperative due to a yellow accumulator low pressure.

HYD Y RSVR OVHT

Applicable to: ALL

Ident.: PRO-ABN-HYD-H-00017109.0001001 / 21 MAR 16

ANNUNCIATIONS

Triggering Conditions:

L2 This alert triggers when the fluid temperature ≥ 93 °C (the alert resets if temperature ≤ 88 °C).

Flight Phase Inhibition:

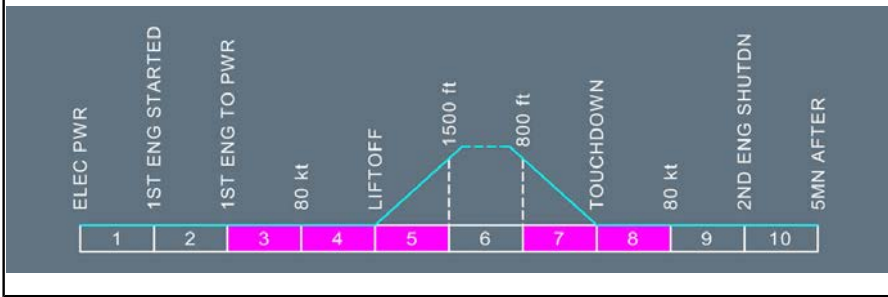

Continued on the following page

HYD Y RSVR OVHT (Cont'd)

Ident.: PRO-ABN-HYD-H-00011629.0003001 / 05 MAR 13

- PTU.....OFF
- YELLOW ENG 2 PUMP.....OFF
- YELLOW ELEC PUMP.....OFF
- BRK Y ACCU PR MONITOR

L2 This check is recommended to cover the case of a pipe rupture, which could lead to the simultaneous loss of the hydraulic system and the accumulator fluid. If this occurs, the loss of the accumulator should be observed on the indicator within 10 min. In that case: The only remaining braking means is normal braking, using green pressure. The parking brake should not be used since, it is not available. And, the chocks should be in place before Engine 1 shutdown.

L1 Y ENG 2 PUMP LO PR

ASSOCIATED PROCEDURES

Y SYS LO PR

FUEL CONSUMPT INCRSD
 FMS PRED UNRELIABLE

SECONDARY FAILURES

*F/CTL

Continued on the following page

HYD Y RSVR OVHT (Cont'd)

Ident.: PRO-ABN-HYD-H-00018327.0007001 / 21 MAR 17

L12

STATUS

INOP SYS

APPR PROC

HYD LO PR

- **IF YELLOW OVHT OUT:**
YELLOW ENG 2 PUMP.....ON
- **If not recovered:**
LDG DIST PROC.....APPLY

FUEL CONSUMPT INCRSD

See ⁽¹⁾

FMS PRED UNRELIABLE

See ⁽²⁾

FLAPS SLOW

CAT 3 SINGLE

- YELLOW HYD
- SPLR 2 + 4
- CAT 3 DUAL
- N/W STRG
- REVERSER 2
- YAW DAMPER 2
- STEEP APPR 

⁽¹⁾ This message is triggered when the failure (or combination of failures) affects the nominal aerodynamic characteristics of the aircraft.

⁽²⁾ Disregard FMS fuel predictions and refer to QRH/OPS Operational Data - Fuel Penalty Factors Tables in order to find the applicable Fuel Penalty Factor.

HYD B+Y SYS LO PR

Applicable to: ALL

Ident.: PRO-ABN-HYD-L-00018917.0001001 / 21 MAR 16

ANNUNCIATIONS

Triggering Conditions:

L2

This alert triggers when the blue and yellow systems pressure ≤ 1 450 PSI (the alert resets if pressure ≥ 1 750 PSI).

Flight Phase Inhibition:

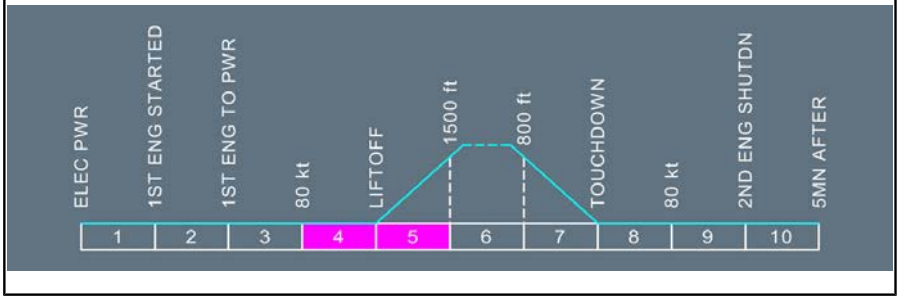

Continued on the following page

HYD B+Y SYS LO PR (Cont'd)

Ident.: PRO-ABN-HYD-L-00018727.0002001 / 21 MAR 16

[L2] Note: If the yellow hydraulic system is lost due to low level, the "HYD PTU FAULT" ECAM message may appear, and requests that the flight crew switches the PTU off.

[L1] **LAND ASAP**

● If yellow sys lost by ENG 2 PUMP LO PR:
YELLOW ELEC PUMP.....ON

● If blue sys lost by ELEC PUMP LO PR:
RAT.....MAN ON

[L2] To extend the RAT, the flight crew must press the RAT MAN ON pb located on the Hydraulic overhead panel.

[L1] MIN RAT SPD.....140 KT

AFFECTED PUMPS.....OFF

MAX SPEED.....320/0.77

[L2] Note: Flight controls remain in normal law.

[L1] MANEUVER WITH CARE
FUEL CONSUMPT INCRSD
FMS PRED UNRELIABLE

[L2] ● If blue or yellow sys recovered:
See procedure for single failure.

[L1] ● If neither system recovered:

SECONDARY FAILURES

*F/CTL

Continued on the following page

HYD B+Y SYS LO PR (Cont'd)

Ident.: PRO-ABN-HYD-L-00018342.0009001 / 21 MAR 17

L12

STATUS

MIN RAT SPD..... 140 KT
(If B PUMP LO PR)
MAX SPEED..... 320/0.77
MANEUVER WITH CARE

APPR PROC

DUAL HYD LO PR

(Line not displayed for dual LO LVL)

● **If sys lost by RSVR LO AIR PR:**

In approach, system lost by RSVR LO AIR PR may be recovered at low altitude.

RELATED PUMP..... ON

● **If sys lost by RSVR OVHT:**

In approach, system lost by RSVR OVHT may be recovered if OVHT indication disappears.

● **IF BLUE OVHT OUT:**

BLUE ELEC PUMP.....AUTO

● **IF YELLOW OVHT OUT:**

YELLOW ENG 2 PUMP..... ON

● **IF HYD NOT RECOVERED (line not displayed for dual LO LVL):**

● **For A321 aircraft:**



FOR LDG..... USE FLAP 3

This line is replaced by "FOR LDG : USE FLAP 3" when CONF 3 is selected, as a reminder.

GPWS LDG FLAP 3..... ON

L/G.....GRVTY EXTN

INOP SYS

B+Y HYD
R ELEV
SPLR 2+3+4
SPD BRK
AP 1+2
N/W STRG
CARGO DOOR (If Y RSVR LO LVL)
REVERSER 2
B ELEC PUMP
EMER GEN (If B RSVR LO LVL)
YAW DAMPER 2
CAT 2
GLS AUTOLAND 
STEEP APPR 

Continued on the following page

HYD B+Y SYS LO PR (Cont'd)

Landing gear is extended by gravity to preserve green system integrity Refer to PRO-ABN-LG [QRH] L/G GRAVITY EXTENSION.

● **For A321 aircraft:**

APPR SPD.....VREF +10 KT

LDG DIST PROC.....APPLY

SLATS/FLAPS SLOW

See ⁽¹⁾

FUEL CONSUMPT INCRSD

See ⁽²⁾

FMS PRED UNRELIABLE

See ⁽³⁾

- ⁽¹⁾ *Note: Following a yellow hydraulic system failure, the parking brake may be inoperative due to yellow accumulator low pressure.*
- ⁽²⁾ *This message is triggered when the failure (or combination of failures) affects the nominal aerodynamic characteristics of the aircraft.*
- ⁽³⁾ *Disregard FMS fuel predictions and refer to QRH/OPS - Operational Data - Fuel Penalty Factors Tables in order to find the applicable Fuel Penalty Factor.*

HYD G+B SYS LO PR

Applicable to: ALL

Ident.: PRO-ABN-HYD-J-00018920.0001001 / 21 MAR 16

ANNUNCIATIONS

Triggering Conditions:

L2

This alert triggers when the green and blue systems pressure ≤ 1 450 PSI (the alert resets if pressure ≥ 1 750 PSI).

Flight Phase Inhibition:

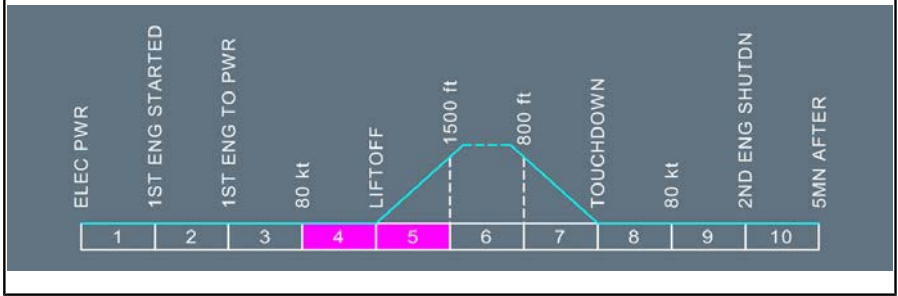

Continued on the following page

HYD G+B SYS LO PR (Cont'd)

Ident.: PRO-ABN-HYD-J-00018349.0002001 / 22 MAR 17

^[L2] **Note:** *If the green hydraulic system is lost due to low level, the "HYD PTU FAULT" ECAM message may appear, and requests the flight crew to switch the PTU off.*

^[L1] **LAND ASAP**

● **If blue sys lost by ELEC PUMP LO PR:**

RAT.....MAN ON
MIN RAT SPD.....140 KT

AFFECTED PUMPS.....OFF

MANEUVER WITH CARE
FUEL CONSUMPT INCRSD
FMS PRED UNRELIABLE

ASSOCIATED PROCEDURES

F/CTL ALTN LAW
(PROT LOST)

^[L2] The flight control normal laws and associated protections are lost. Only load factor limitation is furnished (alternate law without protection).

^[L1] **MAX SPEED**.....320/0.77

^[L2] *Speed is limited due to loss of high speed protection.*

^[L1] **SPD BRK**.....DO NOT USE

■ **If blue sys recovered:**

See procedure for single failure.

■ **If blue sys not recovered:**

Refer to PRO-ABN-F_CTL [QRH] Landing with Slats or Flaps Jammed.

SECONDARY FAILURES

*WHEEL
*F/CTL

Continued on the following page

HYD G+B SYS LO PR (Cont'd)

Ident.: PRO-ABN-HYD-J-00018350.0013001 / 22 MAR 17

L12

STATUS

MIN RAT SPD (IF RAT OUT)..... 140 KT
(If B PUMP LO PR)
MAX SPEED..... 320/0.77
MANEUVER WITH CARE
SPD BRK.....DO NOT USE

APPR PROC

DUAL HYD LO PR

(Line not displayed for a double LO LVL):

- If sys lost by RSVR LO AIR PR:
RELATED PUMPS..... ON
- If sys lost by RSVR OVHT:
 - IF BLUE OVHT OUT:
BLUE ELEC PUMP.....AUTO
 - IF GREEN OVHT OUT:
GREEN ENG 1 PUMP..... ON
- IF HYD NOT RECOVERED (line not displayed for a double LO LVL):
A/THR..... OFF
Select the target speed on the FCU . Due to the loss of slats and some flight control surfaces, the A/THR may not satisfactorily maintain speed.
FOR LDG.....USE FLAP 3
This line is replaced by "FOR LDG : USE FLAP 3" when CONF 3 is selected, as a reminder.
GPWS LDG FLAP 3..... ON
- WHEN SPD 200 KT (displayed when slats are retracted):
L/G..... GRVTY EXTN

INOP SYS

G+B HYD
F/CTL PROT
L ELEV
L+R AIL
SPLR 1+3+5
SLATS
AP 1+2
AUTO BRK
NORM BRK
L/G RETRACT
REVERSER 1
EMER GEN (If B RSVR LO LVL)
B ELEC PUMP
YAW DAMPER 1
CAT 2
GLS AUTOLAND 
STEEP APPR 

Continued on the following page

HYD G+B SYS LO PR (Cont'd)

Refer to PRO-ABN-LG [QRH] L/G GRAVITY EXTENSION

Extend the landing gear at 200 kt to revert sooner in direct law. This provides, below 200 kt, a better pitch control than in alternate law with one elevator lost and all slats lost.

APPR SPD..... VREF +25 KT

Approach speed must be increased, due to the loss of ailerons and slats.

LDG DIST PROC..... APPLY

ALTN LAW: PROT LOST
 WHEN L/G DN: DIRECT LAW

See ⁽¹⁾

FUEL CONSUMPT INCRSD

See ⁽²⁾

FMS PRED UNRELIABLE

See ⁽³⁾

FLAPS SLOW

- ⁽¹⁾ *At landing gear extension, control reverts to direct law in pitch, as well as in roll (Refer to PRO-ABN-F_CTL F/CTL DIRECT LAW).*
- ⁽²⁾ *This message is triggered when the failure (or combination of failures) affects the nominal aerodynamic characteristics of the aircraft.*
- ⁽³⁾ *Disregard FMS fuel predictions and refer to QRH/OPS Operational Data - Fuel Penalty Factors Tables in order to find the applicable Fuel Penalty Factor.*

HYD G+Y SYS LO PR

Applicable to: ALL

Ident.: PRO-ABN-HYD-K-00018921.0001001 / 21 MAR 16

ANNUNCIATIONS

Triggering Conditions:

L2

This alert triggers when the green and yellow systems pressure $\leq 1\ 450$ PSI (the alert resets if pressure $\geq 1\ 750$ PSI).

Flight Phase Inhibition:

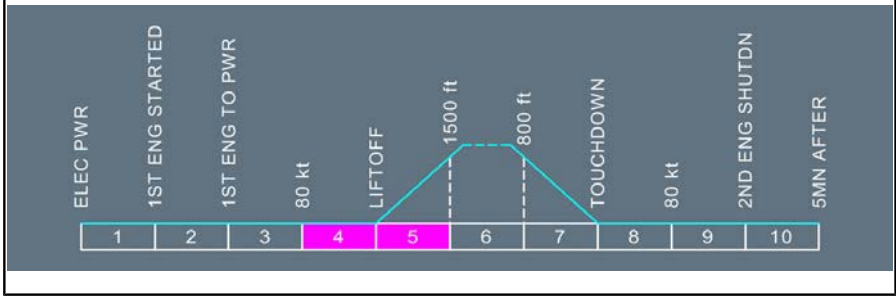

Continued on the following page

HYD G+Y SYS LO PR (Cont'd)

Ident.: PRO-ABN-HYD-K-00018352.0003001 / 22 MAR 17

LAND ASAP

PTU..... OFF

AFFECTED PUMPS..... OFF

● **If yellow sys lost by ENG 2 PUMP LO PR:**

 YELLOW ELEC PUMP..... ON

MANEUVER WITH CARE
 FUEL CONSUMPT INCRSD
 FMS PRED UNRELIABLE

ASSOCIATED PROCEDURES

F/CTL ALTN LAW
(PROT LOST)

^{L2} Flight control normal laws and associated protections are lost. Only load factor limitation, high and low speed stability are provided (alternate law with reduced protection).

^{L1} **MAX SPEED**..... 320/0.77

^{L2} *Speed is limited due to loss of high speed protection.*

^{L1} ■ **If yellow sys recovered:**

 See procedure for single failure.

■ **If yellow sys not recovered:**

Refer to PRO-ABN-F_CTL [QRH] Landing with Slats or Flaps Jammed.

SECONDARY FAILURES

*F/CTL
 *WHEEL

Continued on the following page

HYD G+Y SYS LO PR (Cont'd)

Ident.: PRO-ABN-HYD-K-00018353.0014001 / 22 MAR 17

L12

STATUS

MAX SPEED..... 320/0.77
MAX BRK PR..... 1 000 PSI
MANEUVER WITH CARE



APPR PROC

DUAL HYD LO PR

(Line not displayed for a double LO LVL)

- **If sys lost by RSVR LO AIR PR:**
RELATED PUMP..... ON
 - **If sys lost by RSVR OVHT:**
 - **IF GREEN OVHT OUT:**
GREEN ENG 1 PUMP..... ON
 - **IF YELLOW OVHT OUT:**
YELLOW ENG 2 PUMP..... ON
 - **IF HYD NOT RECOVERED (line not displayed for a double LO LVL):**
FOR LDG.....USE FLAP 3
This line is replaced by "FOR LDG : USE FLAP 3" when CONF 3 is selected, as a reminder.
GPWS FLAP MODE.....OFF
 - **WHEN CONF 3 AND VAPP:**
L/G..... GRVTY EXTN
Refer to PRO-ABN-LG [QRH] L/G GRAVITY EXTENSION. Being stabilized at VAPP, before selecting the gear down, enables the aircraft to be trimmed for approach.
- APPR SPD..... VREF +25 KT
Approach speed must be increased, due to the loss of flaps.
LDG DIST PROC..... APPLY

INOP SYS

G+Y HYD
F/CTL PROT
STABILIZER
REVERSER 1+2
SPLR 1+2+ 4+5
FLAPS
LAF 
YAW DAMPER
AP 1+2
ANTI SKID
N/W STRG
NORM BRK
AUTO BRK
L/G RETRACT
CARGO DOOR (if Y RSVR LO LVL)
CAT 2
GLS AUTOLAND 
STEEP APPR 

Continued on the following page

HYD G+Y SYS LO PR (Cont'd)

ALTN LAW: PROT LOST
WHEN L/G DN: DIRECT LAW

See ⁽¹⁾

BRK Y ACCU PR ONLY

See ⁽²⁾

FUEL CONSUMPT INCRSD

See ⁽³⁾

FMS PRED UNRELIABLE

See ⁽⁴⁾

SLATS SLOW

See ⁽⁵⁾

- ⁽¹⁾ At landing gear extension, control reverts to direct law in pitch, as well as in roll (Refer to PRO-ABN-F_CTL F/CTL DIRECT LAW).
- ⁽²⁾ 7 full brake applications are available.
- ⁽³⁾ This message is triggered when the failure (or combination of failures) affects the nominal aerodynamic characteristics of the aircraft.
- ⁽⁴⁾ Disregard FMS fuel predictions and refer to QRH/OPS Operational Data - Fuel Penalty Factors Tables in order to find the applicable Fuel Penalty Factor.
- ⁽⁵⁾ Note: Following a yellow hydraulic system failure, the parking brake may be inoperative due to yellow accumulator low pressure.

HYD PTU FAULT

Applicable to: ALL

Ident.: PRO-ABN-HYD-R-00017140.0001001 / 21 MAR 16

ANNUNCIATIONS

Triggering Conditions:

L2

This alert triggers when:

- On ground, PTU does not run if the differential pressure is higher than 650 PSI between G and Y system, or
- In flight, PTU at AUTO position does not run when G or Y reservoir level is low, and G or Y system pressure is low.

Flight Phase Inhibition:

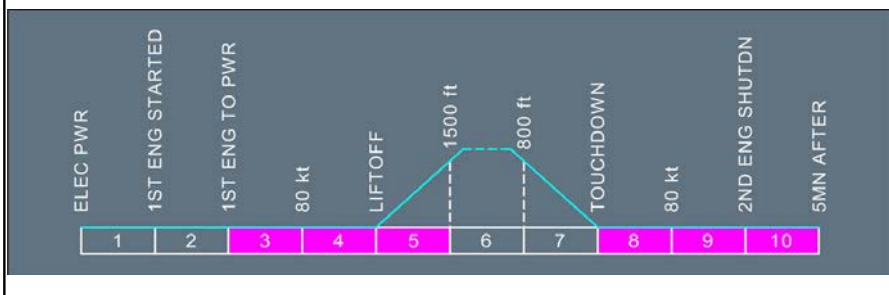

Ident.: PRO-ABN-HYD-R-00011657.0001001 / 31 AUG 17

L2

Note: This warning is triggered, if the last engine is started within 40 s following the end of the cargo doors operation. In this case, reset the warning by switching the yellow ELEC pump ON, then OFF.

L1

● If green or yellow reservoir low level and system low press:

PTU..... OFF

Continued on the following page

HYD PTU FAULT (Cont'd)

Ident.: PRO-ABN-HYD-R-00011658.0001001 / 18 AUG 10

STATUS

INOP SYS

PTU

HYD RAT FAULT

Applicable to: ALL

Ident.: PRO-ABN-HYD-S-00017141.0001001 / 21 MAR 16

ANNUNCIATIONS

Triggering Conditions:

- L2** This alert triggers when:
- The RAT is not fully stowed, or
 - Pressure is present in the RAT stowing actuator, or
 - The RAT pump is not available.

Flight Phase Inhibition:

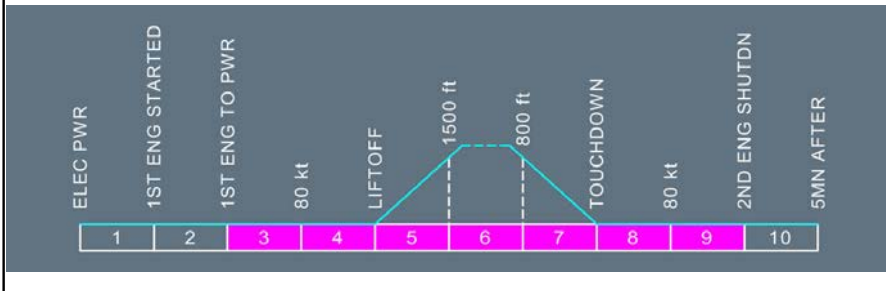

Ident.: PRO-ABN-HYD-S-00011659.0001001 / 16 NOV 11

Crew awareness.

Continued on the following page



A318/A319/A320/A321
FLIGHT CREW
OPERATING MANUAL

PROCEDURES
ABNORMAL AND EMERGENCY PROCEDURES

HYD

HYD RAT FAULT (Cont'd)

Ident.: PRO-ABN-HYD-S-00011660.0001001 / 18 AUG 10

STATUS

INOP SYS

RAT



A318/A319/A320/A321
FLIGHT CREW
OPERATING MANUAL

PROCEDURES
ABNORMAL AND EMERGENCY PROCEDURES

HYD

Intentionally left blank

[QRH] LANDING WITH ABNORMAL L/G

Applicable to: ALL

Ident.: PRO-ABN-LG-AD-00018650.0002001 / 17 MAR 17

The procedure is intended for use when the nose or main landing gear fail to extend and/or lock down following the application of the L/G GRVTY EXTN procedure.
 It is preferable to use any available landing gear, rather than carry out a belly landing.
 Under these circumstances, a hard surface runway landing is recommended.
 Full advantage should be taken of any foam, spread on the runway.

CAUTION Do not apply this procedure if at least one green triangle is displayed on each landing gear on the WHEEL SD page. This is sufficient to confirm that the landing gear is downlocked. Disregard any possible GPWS "TOO LOW GEAR" aural alert.

Ident.: PRO-ABN-LG-AD-00018651.0002001 / 17 MAR 17

CABIN CREW.....NOTIFY
Notify the cabin crew of the nature of the emergency encountered and state intentions. Specify the amount of available preparation time.

ATC.....NOTIFY
Notify ATC of the nature of the emergency and state intentions.

GALY & CAB.....OFF

CONSIDER FUEL REDUCTION. This reduces VREF and, consequently, the load factor at impact and the energy to be dissipated.

● **If NOSE L/G abnormal:**

SHIFT CG AFT IF POSSIBLE

- 10 pax from front to rear moves the CG roughly 4 % aft
- 10 pax from mid to rear moves the CG roughly 2.5 aft.

● **If one MAIN L/G abnormal:**

FUEL DISTRIBUTION.....CONSIDER
Open the fuel X-FEED valve and switch off the pumps on the side with landing gear normally extended.

OXYGEN CREW SUPPLY.....OFF

SIGNS.....ON

CABIN and COCKPIT (LOOSE EQPT).....SECURE

Continued on the following page

[QRH] LANDING WITH ABNORMAL L/G (Cont'd)

Ident.: PRO-ABN-LG-AD-00018652.0001001 / 17 MAR 17

● **For approach:**

GPWS SYS..... OFF

L/G lever..... CHECK DOWN

GRVTY GEAR EXTN handcrank..... TURN BACK TO NORMAL

Rotating three turns back to normal may, in certain cases, pressurize the landing gear down actuators, thereby reducing the probability of gear collapse after touchdown.

DO NOT ARM AUTOBRAKE

Manual braking will enable better pitch and roll control. Moreover, with at least one main landing gear in the abnormal position the autobrake cannot be activated (ground spoilers not armed).

EMER EXIT LT..... ON

CABIN REPORT..... OBTAIN

A/SKID & N/W STRG..... OFF

With one main landing gear not extended, the reference speed used by the anti-skid to detect a wheel blockage is not correctly initialized. As a result, the anti-skid must be switched off to prevent permanent brake release.

MAX BRAKE PR : 1 000 PSI

Modulate the brake pressure to 1 000 PSI because the anti-skid is off.

● **If one or both MAIN L/G abnormal: DO NOT ARM GROUND SPOILERS**

To keep as much roll authority as possible for maintaining the wings level.

Ground spoiler extension would prevent spoilers from acting as roll surfaces.

RAM AIR..... ON

To ensure full depressurization of the aircraft before impact.

DOME LT..... DIM

Set the dome light to DIM to ensure that there is a light source after both engines are shut down after landing, in order to see and read the BRAKE PRESS indicator.

● **At 500 ft AGL:**

BRACE FOR IMPACT..... ORDER

Continued on the following page

[QRH] LANDING WITH ABNORMAL L/G (Cont'd)

Ident.: PRO-ABN-LG-AD-00018654.0001001 / 17 MAR 17

● **At flare, touchdown and rollout:**

Engines should be shut down sufficiently early to ensure fuel is shut off before the nacelles impact, but sufficiently late to ensure adequate hydraulic supplies for the flight controls. Engine pumps continue to supply adequate hydraulic pressure for 30 s after engine shutdown. DO NOT USE REVERSE

● **If NOSE L/G abnormal:**

KEEP NOSE UP

After touchdown, keep the nose off the runway by the use of the elevator. Then, lower the nose on to the runway before elevator control is lost.

BRAKES..... SMOOTHLY APPLY

Adapt braking to the efficiency of the elevator.

BEFORE NOSE IMPACT : ALL ENG MASTERS OFF

● **If one MAIN L/G abnormal:**

AT TOUCHDOWN : ALL ENG MASTERS OFF

KEEP AFFECTED SIDE WING UP

Use roll control, as necessary, to maintain the unsupported wing up as long as possible.

● **If both MAIN L/G abnormal:**

DURING FLARE : ALL ENG MASTERS OFF

MIN PITCH ATT : 6 °

Continued on the following page

[QRH] LANDING WITH ABNORMAL L/G (Cont'd)

Ident.: PRO-ABN-LG-AD-00018655.0001001 / 09 MAY 17

● **When aircraft stopped:**

PARK BRK.....ON
 ALL FIRE pb (ENG s & APU)..... PUSH
 ALL AGENT (ENG s & APU)..... DISCH

■ **If evacuation required:**

EVACUATION..... INITIATE

Make a short and precise announcement to order the emergency evacuation.

Press the EVAC COMMAND pb .

■ **If evacuation not required:**

CABIN CREW and PASSENGERS (PA)..... NOTIFY

Ensure that all the landing gears are secured before initiating the disembarkation (before switching OFF the seat belts signs).

Continued on the following page

[QRH] LANDING WITH ABNORMAL L/G (Cont'd)

Ident.: PRO-ABN-LG-AD-00018711.0001001 / 17 MAR 17

REFERENCE AIRCRAFT ATTITUDE AFTER IMPACT

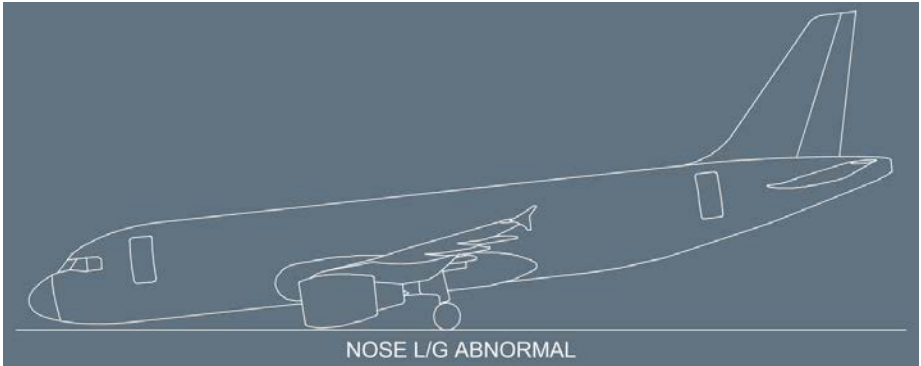

[QRH] L/G GRAVITY EXTENSION

Ident.: PRO-ABN-LG-00011286.0011001 / 17 MAR 17

Applicable to: ALL

CAUTION Do not apply this procedure if at least one green triangle is displayed on each landing gear on the WHEEL SD page. This is sufficient to confirm that the landing gear is downlocked. Disregard any possible GPWS "TOO LOW GEAR" aural alert.

GRAVITY GEAR EXTN handcrank..... PULL AND TURN
Rotate the handle clockwise 3 turns until reaching the mechanical stop, even if resistance is felt.
 L/G lever DOWN

The landing gear lever should be confirmed in the DOWN position for the following reasons:

- *To extinguish the UNLK lights on the landing gear indication panel*
- *To prevent the L/G CTL message from appearing on the WHEEL SD page*
- *To minimize the risk of landing gear retraction on the ground, due to an unknown system fault, when the free-fall system is reset.*

GEAR DOWN indications (if available).....CHECK

The L/G LGCIU 2 FAULT or BRAKES SYS 1(2) FAULT alert may be spuriously triggered after a gravity extension.

- Note:
1. *Depending on aircraft speed, the display may show the landing gear doors in the amber transit position.*
 2. *In the event of gravity extension, caused by the failure of both LGCIU s, landing gear position indication on ECAM are lost. LDG GEAR lights on LDG GEAR control panel remain available, if LGCIU 1 is electrically supplied.*
 3. *If the three green downlock arrows are not on, it is possible that the handcrank is not at the mechanical stop. Check that the handcrank is firmly against the mechanical stop.*

■ **If successful:**

DO NOT RESET LDG GEAR GRVTY EXTN

Do not reset the free-fall system. This will avoid such undesirable effects as further loss of fluid, in the event of a leak, or possible landing gear unlocking, in the event of a gear selector valve jamming in the UP position.

- Note: *The free-fall system may be reset in flights used for training. If the green hydraulic system is available, resetting the free-fall system allows the landing gear doors to be closed and the nosewheel steering to operate.*
The flight crew should not reset the free-fall system on the ground after flight.

Continued on the following page

[QRH] L/G GRAVITY EXTENSION (Cont'd)

■ **If unsuccessful:**

LDG WITH ABNORMAL L/G PROC.....APPLY

Refer to PRO-ABN-LG [QRH] Landing with Abnormal L/G.

L/G DOORS NOT CLOSED

Applicable to: ALL

Ident.: PRO-ABN-LG-D-00017734.0001001 / 21 MAR 16

ANNUNCIATIONS

Triggering Conditions:

L2

This alert triggers when one gear door is not unlocked.

Flight Phase Inhibition:

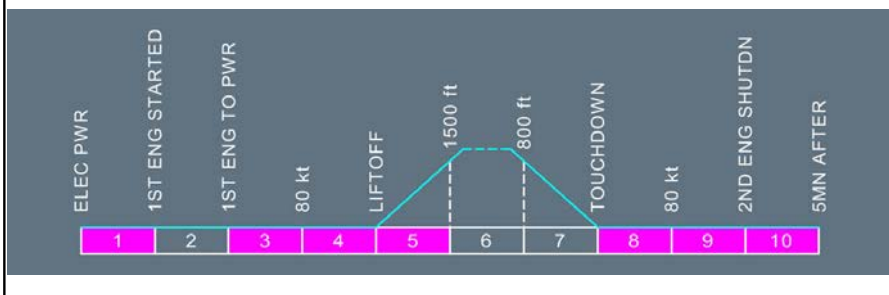

Continued on the following page

L/G DOORS NOT CLOSED (Cont'd)

Ident.: PRO-ABN-LG-D-00011287.0003001 / 01 DEC 14

- If the L/G lever is UP:
 - WHEN SPD < 220/0.54:
 L/G LEVER..... RECYCLE

L2 Note: To recycle the landing gear, the flight crew must perform the following actions:

- Move the landing gear lever down
- Wait for the landing gear to downlock and for the landing gear doors to close. Simultaneously monitor the WHEEL page on the System Display (SD)
- Move the landing gear lever up.

The active LGCIU changes when the landing gear is recycled.

- L1** ● IF UNSUCCESSFUL:
 MAX SPEED..... 250/0.60
 FUEL CONSUMPT INCRSD
 FMS PRED UNRELIABLE

Ident.: PRO-ABN-LG-D-00011288.0002001 / 17 MAR 17

| | |
|---|--------------------------|
| L12 | STATUS |
| MAX SPEED..... 250/.60 FUEL CONSUMPT INCRSD See ⁽¹⁾ FMS PRED UNRELIABLE See ⁽²⁾ | INOP SYS L/G DOOR |

⁽¹⁾ This message is triggered when the failure (or combination of failures) affects the nominal aerodynamic characteristics of the aircraft.

⁽²⁾ Disregard FMS fuel predictions and Refer to QRH/OPS Fuel Penalty Factors/ECAM Alert Table in order to find the applicable Fuel Penalty Factor.

L/G GEAR NOT DOWN

Applicable to: ALL

Ident.: PRO-ABN-LG-AA-00017859.0001001 / 21 MAR 16

ANNUNCIATIONS

Triggering Conditions:

L2

This alert triggers when:

1. L/G is not downlocked and radio height is lower than 750 ft and both engines N1 lower than 75% (or if engine shutdown N1 of remaining engine lower than 97%) or
2. L/G is not downlocked and radio height is lower than 750 ft and both engines are not at T.O power and flaps at 1, 2, 3 or FULL or
3. L/G is not downlocked and flaps at 3 or FULL and both radio altimeters are failed.

Note: In the cases 2 and 3 above, the aural warning can only be cancelled by the emergency cancel pushbutton.

Flight Phase Inhibition:

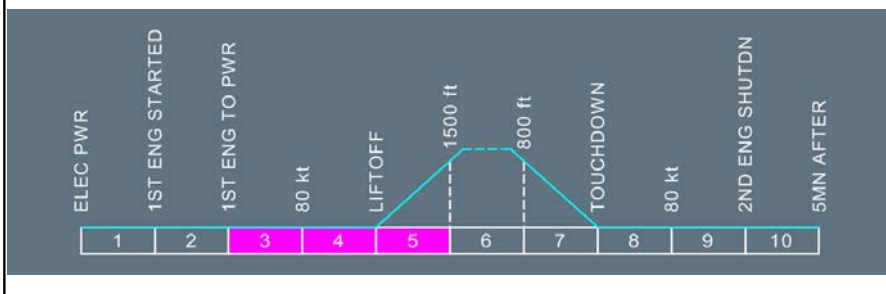

Ident.: PRO-ABN-LG-AA-00018573.0002001 / 21 MAR 16

L2 When this warning appears, the red arrow on the instrument panel comes on.

L1

Crew awareness.

L/G GEAR NOT DOWNLOCKED

Applicable to: ALL

Ident.: PRO-ABN-LG-C-00017860.0002001 / 21 MAR 16

ANNUNCIATIONS

Triggering Conditions:

- [L2] This alert triggers when one gear is not downlocked and L/G is selected down.

Flight Phase Inhibition:

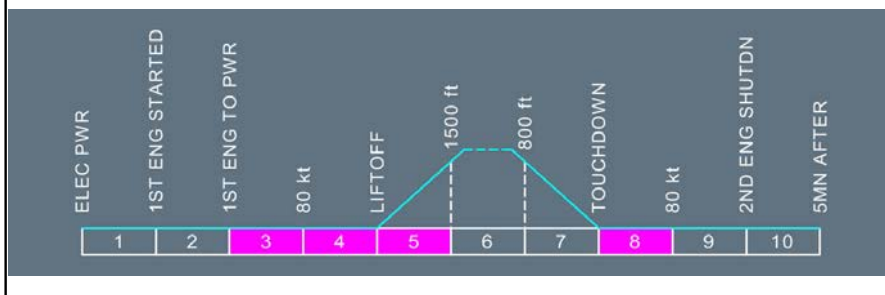

Ident.: PRO-ABN-LG-C-00011284.0002001 / 01 DEC 14

- [L2] This warning appears, if the landing gear sequence is not completed after 30 s.

[L1] **L/G LEVER..... RECYCLE**

[L2] **Note:** To recycle the landing gear, the flight crew must perform the following actions:

- Move the landing gear lever up
 - Wait for the landing gear to uplock and for the landing gear doors to close. Simultaneously monitor the WHEEL page on the System Display (SD)
 - Move the landing gear lever down.
- The active LGCIU changes when the landing gear is recycled.

[L1] ● **IF UNSUCCESSFUL AFTER 120 s:**
L/G..... GRVTY EXTN

- [L2] Rotate the handle clockwise about 3 turns until reaching the mechanical stop. Refer to PRO-ABN-LG [QRH] L/G GRAVITY EXTENSION.

Continued on the following page

L/G GEAR NOT DOWNLOCKED (Cont'd)

Ident.: PRO-ABN-LG-C-00011285.0003001 / 21 MAR 16

L12

STATUS

L/G..... GRVTY EXTN

CAT 3 SINGLE ONLY

See ⁽¹⁾

INOP SYS

CAT 3 DUAL

⁽¹⁾ If gravity extension is unsuccessful, Refer to PRO-ABN-LG [QRH] Landing with Abnormal L/G.

L/G GEAR NOT UNLOCKED

Applicable to: ALL

Ident.: PRO-ABN-LG-B-00017736.0001001 / 21 MAR 16

ANNUNCIATIONS

Triggering Conditions:

L2

This alert triggers when one gear is not unlocked and L/G is not selected down.

Flight Phase Inhibition:

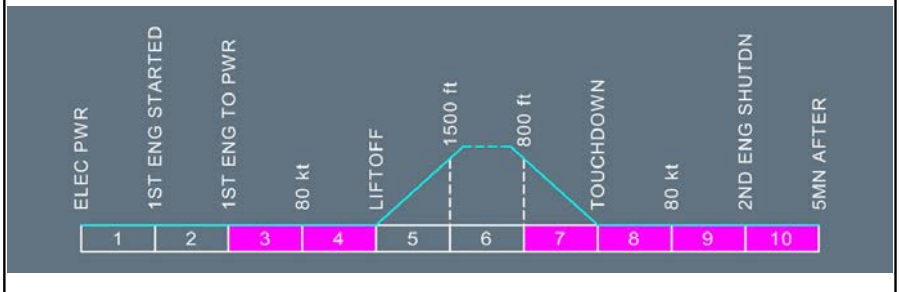

Continued on the following page

L/G GEAR NOT UNLOCKED (Cont'd)

Ident.: PRO-ABN-LG-B-00011061.0003001 / 01 DEC 14

[L2] This warning appears if the landing gear sequence is not completed after 30 s.

[L1] ■ **L/G doors closed:**

AVOID EXCESS G FACTOR

[L2] *Because the gear rests on the doors, avoid excessive load factors in order not to damage door structure.*

[L1] ■ **L/G doors not closed and shock absorber fault:**

MAX SPEED..... 220/0.54
 L/G..... DOWN
 MAX SPEED..... 280/0.67

■ **L/G doors not closed and no shock absorber fault:**

MAX SPEED..... 220/0.54
 L/G LEVER.....RECYCLE

[L2] *Note: To recycle the landing gear, the flight crew must perform the following actions:*

- Move the landing gear lever down
 - Wait for the landing gear to downlock and for the landing gear doors to close.
Simultaneously monitor the WHEEL page on the System Display (SD)
 - Move the landing gear lever up.
- The active LGCIU changes when the landing gear is recycled.*

[L1] ● **IF UNSUCCESSFUL:**

L/G..... DOWN
 MAX SPEED.....280/0.67

FUEL CONSUMPT INCRSD
FMS PRED UNRELIABLE

Continued on the following page

L/G GEAR NOT UNLOCKED (Cont'd)

Ident.: PRO-ABN-LG-B-00018687.0002001 / 25 JUL 17

L12

STATUS

MAX SPEED..... 280/67

INOP SYS

FUEL CONSUMPT INCRSD

L/G RETRACT

FMS PRED UNRELIABLE

See ⁽¹⁾

⁽¹⁾

If the flight is continued (to destination or to alternate) with landing gear extended:

- *Disregard FMS fuel predictions. Refer to QRH/OPS Fuel Penalty Factors/ECAM Alert Table in order to find the applicable Fuel Penalty Factor*
- *Disregard FMS altitude and speed predictions. Time predictions are only valid in cruise*
- *Do not use the managed speed mode (except in approach)*
- *Do not use the CLB and the DES autopilot modes.*

Also Refer to PRO-NOR-SUP-L/G- Flight with Gear Down.

L/G GEAR UNLOCK FAULT

Applicable to: ALL

Ident.: PRO-ABN-LG-E-00017737.0001001 / 21 MAR 16

ANNUNCIATIONS

Triggering Conditions:

L2 This alert triggers when one gear uplock is engaged with corresponding gear downlocked.

Flight Phase Inhibition:

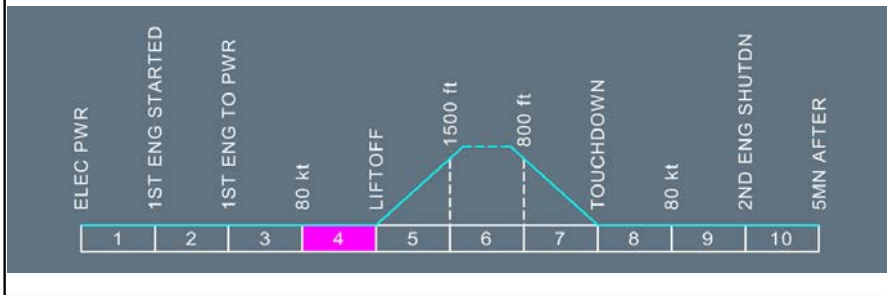

Ident.: PRO-ABN-LG-E-00011289.0002001 / 27 NOV 12

L/G.....KEEP DOWN

L2 The landing gear must be left down to avoid structural damage, because the uplock device will stay in the locked position.

L1 MAX SPEED.....280/.67

FUEL CONSUMPT INCRSD

FMS PRED UNRELIABLE

Continued on the following page

L/G GEAR UNLOCK FAULT (Cont'd)

Ident.: PRO-ABN-LG-E-00018719.0002001 / 25 JUL 17

L12

STATUS

MAX SPEED..... 280/67
 L/G..... KEEP DOWN

INOP SYS

L/G RETRACT

FUEL CONSUMPT INCRSD

See ⁽¹⁾

FMS PRED UNRELIABLE

See ⁽²⁾

⁽¹⁾ This message triggers when the failure (or combination of failures) affects the nominal aerodynamic characteristics of the aircraft.

- ⁽²⁾ If the flight is continued (to destination or to alternate) with landing gear extended:
- Disregard FMS fuel predictions. Refer to QRH/OPS Fuel Penalty Factors/ECAM Alert Table in order to find the applicable Fuel Penalty Factor
 - Disregard FMS altitude and speed predictions. Time predictions are only valid in cruise
 - Do not use the managed speed mode (except in approach)
 - Do not use the CLB and the DES autopilot modes.
- Also Refer to PRO-NOR-SUP-L/G- Flight with Gear Down.

L/G LGCIU 1(2) FAULT

Applicable to: ALL

Ident.: PRO-ABN-LG-G-00018059.0002001 / 21 MAR 16

ANNUNCIATIONS

Triggering Conditions:

L2 This alert triggers when LGCIU 1(2) is failed.

Flight Phase Inhibition:

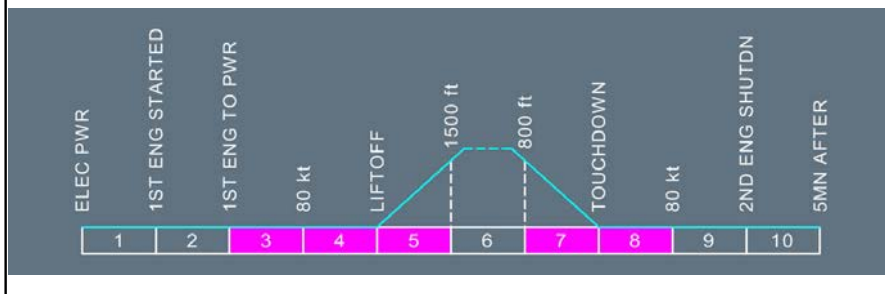

Ident.: PRO-ABN-LG-G-00018681.0002001 / 21 MAR 16

● **If LGCIU 1 is failed:**

GPWS SYS.....OFF

L2 GPWS receives "L/G in up position" information even if the landing gear is down.
 Set the GPWS SYS pb-sw to OFF in order to prevent untimely warnings during the approach.

Continued on the following page

L/G LGCIU 1(2) FAULT (Cont'd)

Ident.: PRO-ABN-LG-G-00018682.0001001 / 21 MAR 16

L12

STATUS

INOP SYS

ENG 1(2) APPR IDLE ONLY

See ⁽²⁾

LGCIU 1(2)
 REVERSER 1(2)
 GPWS ⁽¹⁾

- Note:**
1. The partial spoiler extension  at landing when only one main landing gear is compressed is not available. The spoilers extend normally on ground when wheel speed greater than 72 kt.
 2. Depending on the LGCIU failure, only a part of the above systems may be lost.

⁽¹⁾ (If LGCIU 1 is failed)

⁽²⁾ When idle is selected on ground with slats extended, only approach idle is available.

L/G LGCIU 1+2 FAULT

Applicable to: ALL

Ident.: PRO-ABN-LG-V-00017739.0002001 / 21 MAR 16

ANNUNCIATIONS

Triggering Conditions:

L2 This alert triggers when both LGCIUs are failed.

Flight Phase Inhibition:

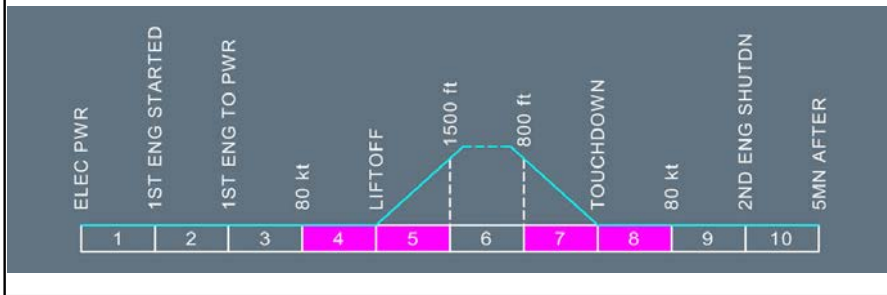

Ident.: PRO-ABN-LG-V-00018683.0002001 / 21 MAR 16

L2 Normal landing gear control and position indications are lost. LDG GEAR lights on LDG GEAR control panel remain available if LGCIU 1 is electrically supplied.

L1 L/G..... GRVY EXTN

L2 Refer to PRO-ABN-LG [QRH] L/G GRAVITY EXTENSION.

L1 GPWS SYS..... OFF

L2 As LGCIU 1 is lost, GPWS receives "L/G in up position" information even if the landing gear is down.

Set the GPWS SYS pb-sw to OFF in order to prevent untimely warnings during approach.

Continued on the following page

L/G LGCIU 1+2 FAULT (Cont'd)



Ident.: PRO-ABN-LG-V-00018684.0006001 / 05 OCT 16

L12

STATUS

INOP SYS

- **If the selected configuration is not FLAP 3:**
 FOR LDG.....USE FLAP 3
 - **If the selected configuration is FLAP 3:**
 FOR LDG: USE FLAP 3
- L/G..... GRVTY EXTN

- REVERSER 1+2
- AP 1+2 ⁽¹⁾
- CAT 2 ⁽¹⁾
- A/THR
- GLS AUTOLAND 
- LGCIU 1
- LGCIU 2
- GPWS
- ROW/ROP 

L/G CONTROL NOT AVAIL
 ENG 1 APPR IDLE ONLY
 ENG 2 APPR IDLE ONLY

Note: 1. The partial spoiler extension  at landing when only one main landing gear is compressed is not available. The spoilers extend normally on ground when wheel speed greater than 72 kt.

2. In flight with both LGCIU s "faulty", whatever the landing gear configuration, when the flight crew switches ON Wing Anti-Ice pb, the Wing Anti-Ice pb will illuminate "on" and there will be only 30 s of heating. This loss of Wing Anti-ice will not have an ECAM/Aural warning, although BLEED SD page shows a "no-Anti-ice" legend.

⁽¹⁾ (Except in LAND mode)

L/G SHOCK ABSORBER FAULT
(SHOCK ABSORBER EXTENDED ON GROUND)

Applicable to: ALL

Ident.: PRO-ABN-LG-AB-00017733.0001001 / 21 MAR 16

ANNUNCIATIONS

Triggering Conditions:

L2 This alert triggers when one shock absorber is not compressed after landing.

Flight Phase Inhibition:

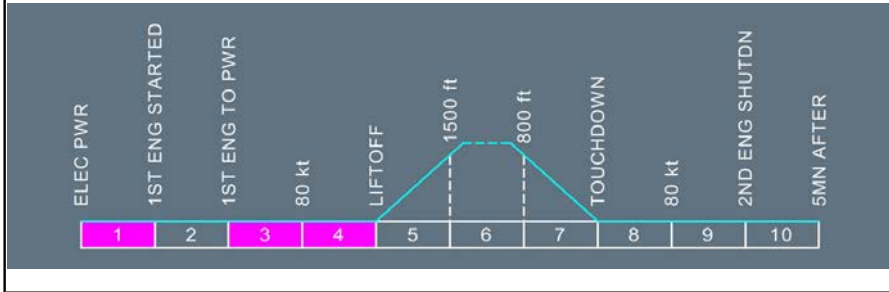

Ident.: PRO-ABN-LG-AB-00011056.0001001 / 25 FEB 14

Crew awareness.

L/G SHOCK ABSORBER FAULT
(SHOCK ABSORBER NOT EXTENDED AFTER LIFTOFF)

Applicable to: ALL

Ident.: PRO-ABN-LG-A-00018062.0001001 / 21 MAR 16

ANNUNCIATIONS

Triggering Conditions:

L2

This alert triggers when one shock absorber is not extended when airborne.

Flight Phase Inhibition:

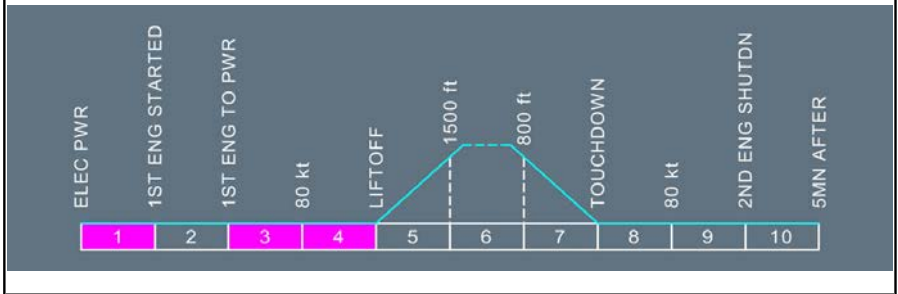

Ident.: PRO-ABN-LG-A-00011058.0003001 / 25 FEB 14

■ **Shock absorber not extended after liftoff and L/G unpluged :**

Crew awareness.

■ **Shock absorber not extended after liftoff and L/G not unpluged :**

MAX SPEED..... 280/67

■ **If L/G lever still down :**

L/G..... KEEP DOWN

■ **If L/G lever selected up :**

L/G..... DOWN

FUEL CONSUMPT INCRSD

FMS PRED UNRELIABLE

Continued on the following page

L/G SHOCK ABSORBER FAULT (Cont'd)
(SHOCK ABSORBER NOT EXTENDED AFTER LIFTOFF)

Ident.: PRO-ABN-LG-A-00011059.0003001 / 25 JUL 17

L12

STATUS

● **If L/G not uplocked:**

MAX SPEED.....280/.67
L/G.....KEEP DOWN

INOP SYS

L/G RETRACT

FUEL CONSUMPT INCRSD

FMS PRED UNRELIABLE

See ⁽¹⁾

⁽¹⁾

If the flight is continued (to destination or to alternate) with landing gear extended:

- Disregard FMS fuel predictions. Refer to QRH/OPS Fuel Penalty Factors/ECAM Alert Table in order to find the applicable Fuel Penalty Factor
 - Disregard FMS altitude and speed predictions. Time predictions are only valid in cruise
 - Do not use the managed speed mode (except in approach)
 - Do not use the CLB and the DES autopilot modes.
- Also Refer to PRO-NOR-SUP-L/G- Flight with Gear Down.

Note: In few cases, autothrust and autopilot may also be lost.

If **WHEEL N.W. STEER FAULT** is also displayed, then the nose wheels may be at maximum deflection. (Turned 90 ° from center.) During landing, delay nose wheel touchdown for as long as possible.

L/G SYS DISAGREE

Applicable to: ALL

Ident.: PRO-ABN-LG-AC-00017861.0002001 / 21 MAR 16

ANNUNCIATIONS

Triggering Conditions:

L2

This alert triggers when LGCIU 1 and LGCIU 2 detect a discrepancy between the landing gear positions.

Flight Phase Inhibition:

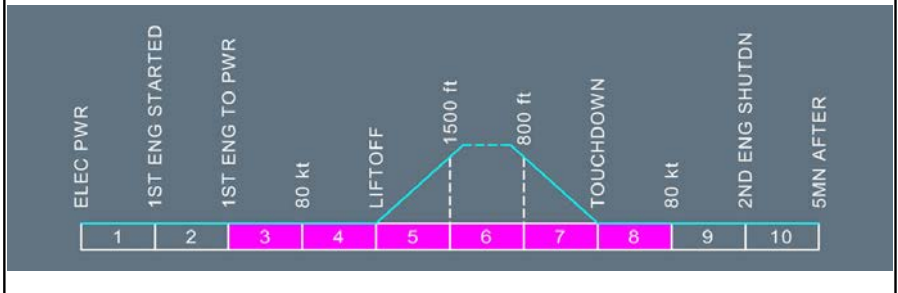

Ident.: PRO-ABN-LG-AC-00018664.0002001 / 21 MAR 16

Crew awareness.



A318/A319/A320/A321
FLIGHT CREW
OPERATING MANUAL

PROCEDURES
ABNORMAL AND EMERGENCY PROCEDURES

L/G

Intentionally left blank

[MEM] EMER DESCENT

Ident.: PRO-ABN-MISC-00012092.0001001 / 17 MAR 17

Applicable to: ALL

CREW OXY MASKS..... USE
 SIGNS..... ON
 EMER DESCENT..... INITIATE

● **If A/THR not active:**

THR LEVERS..... IDLE

SPD BRK..... FULL

● **When descent established:**

SPEED..... MAX/APPROPRIATE

● **If structural damage suspected: MANEUVER WITH CARE**

CONSIDER L/G EXTENSION

ENG MODE SEL..... IGN

ATC..... NOTIFY

Notify ATC of the nature of the emergency, and state intention. The flight crew can communicate with the ATC using voice, or CPDLC when the voice contact cannot be established or has poor quality.

EMER DESCENT (PA)..... ANNOUNCE

The flight crew must inform the cabin of emergency descent on the PA system.

ATC XPDR 7700..... CONSIDER

Squawk 7700 unless otherwise specified by ATC.

CREW OXY MASKS DILUTION..... NORM

- To save oxygen, set the oxygen diluter selector to the N position
- If the oxygen diluter selector remains set to 100 %, oxygen quantity may be insufficient to cover the entire emergency descent profile
- Ensure that crew communication is established with oxygen masks. Avoid the continuous use of the interphone to minimize interference with the breathing noise in the oxygen mask.

MAX FL: 100/MEA-MORA

● **If CAB ALT above 14 000 ft:**

OXYGEN PAX MASK MAN ON..... PRESS

This action confirms that the passenger oxygen masks are released.

Continued on the following page

[MEM] EMER DESCENT (Cont'd)

Note: Notify the cabin crew, when the aircraft reaches a safe flight level, and when cabin oxygen is no more necessary.

[MEM] STALL RECOVERY

Ident.: PRO-ABN-MISC-00013768.0001001 / 17 MAR 17

Applicable to: ALL

As soon as any stall indication (could be aural warning, buffet...) is recognized, apply the immediate actions:

NOSE DOWN PITCH CONTROL.....APPLY

This will reduce angle of attack

Note: In case of lack of pitch down authority, reducing thrust may be necessary.

BANK.....WINGS LEVEL

● **When out of stall (no longer stall indications) :**

THRUST.....INCREASE SMOOTHLY AS NEEDED

Note: In case of one engine inoperative, progressively compensate the thrust asymmetry with rudder.

SPEEDBRAKES.....CHECK RETRACTED

FLIGHT PATH.....RECOVER SMOOTHLY

● **If in clean configuration and below 20 000 ft :**

FLAP1.....SELECT

Note: If a risk of ground contact exists, once clearly out of stall (no longer stall indications), establish smoothly a positive climb gradient.



A318/A319/A320/A321
 FLIGHT CREW
 OPERATING MANUAL

PROCEDURES
ABNORMAL AND EMERGENCY PROCEDURES

MISC

[MEM] STALL WARNING AT LIFT-OFF

Ident.: PRO-ABN-MISC-00013769.0001001 / 17 MAR 17

Applicable to: ALL

Spurious stall warning may sound in NORMAL law, if an angle of attack probe is damaged. In this case, apply immediately the following actions:

THRUST..... TOGA

At the same time:

PITCH ATTITUDE.....15 °

BANK.....WINGS LEVEL

Note: When a safe flight path and speed are achieved and maintained, if stall warning continues, consider it as spurious.

[QRH] BOMB ON BOARD

Ident.: PRO-ABN-MISC-00012095.0002001 / 17 MAR 17

Applicable to: ALL

COCKPIT PROCEDURES

BACKGROUND

To avoid the activation of an altitude-sensitive bomb, the cabin altitude should not exceed the value at which the bomb has been discovered.

To reduce the effects of the explosion, the aircraft should fly as long as possible with approximately 1 PSI differential pressure, to help the blast go outwards. 1 PSI differential pressure corresponds to a 2 500 ft difference between the aircraft and the cabin altitude. These conditions are achieved by using the manual pressure control.

PROCEDURE

The following procedure assumes that it is initiated during climb or cruise:

First, maintain the cabin altitude using manual pressure mode.

While maintaining the cabin altitude, descend the aircraft to the cabin altitude + 2 500 ft and maintain delta P at 1 PSI.

During further steps of descent, maintain delta P at 1 PSI using the cabin V/S target selector. During the approach, use automatic pressure mode in order to reduce the differential pressure to zero at touchdown.

If flight conditions are different, the crew should adapt the procedure, bearing in mind the above-mentioned principles (background paragraph).

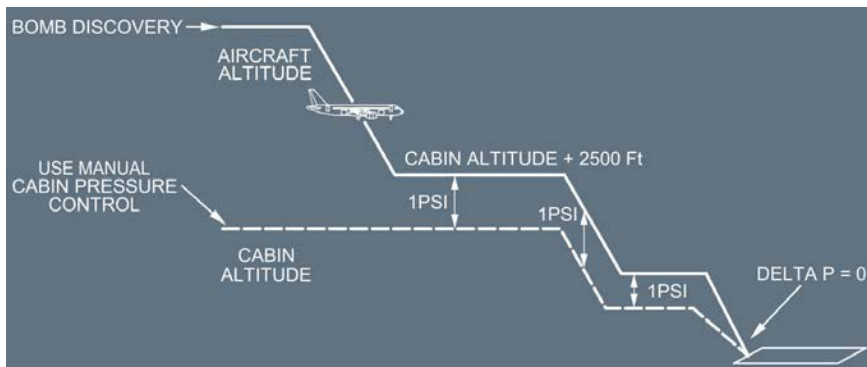

CKPT / CAB COM..... ESTABLISH

Continued on the following page

[QRH] BOMB ON BOARD (Cont'd)

■ **If landing and evacuation possible within 30 min:**

ATC / COMPANY..... NOTIFY
 EVAC..... PREPARE

■ **If landing and evacuation NOT possible within 30 min:**

AIRCRAFT (IF CLIMBING)..... LEVEL OFF
 CABIN PRESS MODE SEL..... MAN

The purpose is to immediately prevent the cabin altitude from increasing, in order to avoid the activation of an altitude-sensitive bomb.

MAINTAIN CAB ALT

Use MAN V/S CTL selector to maintain the cabin altitude at the value it had when the bomb was discovered.

ATC / COMPANY..... NOTIFY

To obtain expert advice from explosive specialists.

TRGT SPEED: PREFER LO IAS

Low speed could reduce the consequences of possible structural damage, if the bomb explodes.

DESCENT TO CAB ALT + 2 500 ft or MEA - MORA..... INITIATE

Descending to 2 500 ft above the cabin altitude gives a cabin differential pressure of approximately 1 PSI, which helps to ensure that the blast goes outwards, if the bomb explodes.

AVOID SHARP MANEUVERS

Which might result in the bomb moving.

MAINTAIN CAB ALT

Use MAN V/S CTL selector to maintain the cabin altitude. Initially brief UP input should be required; but, be careful not to increase the cabin altitude.

● **When at CAB ALT + 2 500 ft:**

MAINTAIN 1 PSI ΔP

Use MAN V/S CTL selector to adjust delta P to 1 PSI. Brief DN input should be initially required to set 0 ft/min cabin vertical speed.

GALLEY..... OFF

FUEL RESERVES..... DETERMINE

When flying at cabin altitude + 2 500 ft, fuel consumption in CONF 1, with landing gear down, will be about 2.1 times that consumed in clean configuration.

Continued on the following page

[QRH] BOMB ON BOARD (Cont'd)

● **When bomb secured at the LRBL or cannot be moved:**

Least Risk Bomb Location (LRBL) is the center of the RH aft cabin door

EMER EXIT LT..... ON

To recover minimum cabin lighting when the COMMERCIAL pb-sw will be switched OFF

COMMERCIAL..... OFF

● **If fuel permits:**

FLAPS..... AT LEAST CONF 1

L/G lever (except for flight over water)..... DOWN

The detonation could damage the landing systems. Therefore, if fuel permits, configure the aircraft for landing as soon as possible. Reducing the speed will minimize stress on the aircraft structure.

USE NORMAL CONF FOR LANDING

DURING FURTHER DESCENT: MAINTAIN MAX 1 PSI ΔP

Use MAN V/S CTL selector to DN to adjust delta P to 1 PSI.

● **During approach:**

CABIN PRESS MODE SEL..... AUTO

This allows CPC to automatically control the cabin altitude to 0 during final approach.

● **When aircraft on ground and stopped in a remote area (if possible):**

Refer to PRO-ABN-MISC [QRH] EMER EVAC

CABIN PROCEDURES

If a suspect device is found in the cabin:

WARNING Do not cut or disconnect any wires and do not open or attempt to gain entry to internal components of a closed or concealed suspect device. Any attempt may result in an explosion. Booby-trapped closed devices have been used on aircraft in the past.

WARNING Alternate locations must not be used without consulting with an aviation explosives security specialist. Never take a suspect device to the flight deck.

CAUTION The least risk bomb location for the aircraft structure and systems is center of the RH aft cabin door.

EOD PERSONNEL ON BOARD..... CHECK

Continued on the following page

[QRH] BOMB ON BOARD (Cont'd)

Announce "Is there any EOD personnel on board ?". By using the initials, only persons familiar with EOD (Explosive Ordnance Disposal) will be made aware of the problem.

- DO NOT OPEN THE BOMB
- DO NOT CUT BOMB'S WIRES
- SECURE BOMB AGAINST SLIPPING
- PROTECT BOMB AGAINST SHOCKS

Secure in the attitude found and do not lift before having checked for an anti-lift ignition device.

PASSENGERS..... LEAD AWAY FROM BOMB

Move passengers at least 4 seat rows away from the bomb location. On full flights, it may be necessary to double up passengers to achieve standoff from the suspect device.

Passengers near the bomb should protect their heads with pillows, blankets.

All passengers must remain seated with seatbelts on and, if possible, head below the top of the head rest. Seat backs and tray tables should be in their full upright position.

Service items may need to be collected in order to secure tray tables.

PORTABLE ELECTRONIC DEVICES..... SWITCH OFF

The cabin crews must command passengers to switch off all portable electronic devices.

BOMB.....CHECK NO ANTI-LIFT DEVICE

To check for an anti-lift switch or lever, slide a string or stiff card, (such as the emergency information card) under the bomb, without disturbing the bomb.

If the string or card cannot be slipped under the bomb, it may indicate that an anti-lift switch or lever is present and that the bomb cannot be moved.

If a card is used and can be slid under the bomb, leave it under the bomb and move together with the bomb.

If it is not possible to move the bomb, then it should be surrounded with a single thin sheet of plastic (e. g. trash bag), then with wetted materials, and other blast attenuation materials such as seat cushions and soft carry-on baggage. Move personnel as far away from the bomb location as possible.

EMERGENCY EQUIPMENT..... REMOVE AND STOW

Emergency equipment (PBE, fire extinguisher, ...) located close to the LRBL must be removed and stowed in alternate location.

GALLEY/IFE POWER.....OFF

All galley and IFE equipment located close to the LRBL must be switched off.

● **If the bomb can be moved:**

RH AFT CABIN DOOR SLIDE..... DISARM

LEAST RISK BOMB LOCATION (LRBL)..... PREPARE

Continued on the following page

[QRH] BOMB ON BOARD (Cont'd)

Build up a platform of solid baggage against the door up to about 25 cm (10 in) below the middle of the door.

On top of this, build up at least 25 cm (10 in) of wetted material such as blankets and pillows. Place a single thin sheet of plastic (e. g. trash bag) on top of the wetted materials. This prevents any possible short circuit.

| | |
|----------------|--|
| CAUTION | DO NOT OMIT THE PLASTIC SHEETS, AS THE SUSPECT DEVICE COULD GET WET AND POSSIBLY SHORT CIRCUIT ELECTRONIC COMPONENTS CAUSING INADVERTENT DEVICE ACTIVATION. |
|----------------|--|

BOMB INDICATION LINE.....POSITION

Note: A bomb location indicator line is a 6 to 8 ft (1.8 to 2.4 m) (e.g. neckties, headset cord, or belts connected together) preferably of contrasting color, that helps the responding bomb squad find the precise location of the suspect device within the LRBL stack once constructed.

*Position the bomb indication line from the location on the platform where you will place the suspect device, **EXTENDING** outward into the aisle.*

BOMB.....MOVE TO LRBL

Carefully carry in the attitude found and place on top of the wetted materials in the same attitude and as close to the door structure as possible.

| | |
|----------------|---|
| CAUTION | Ensure that the suspect device, when placed on the stack against the door, is above the slide pack but not against the door handle, and if possible, avoid placement in the view port. |
|----------------|---|

LEAST RISK BOMB LOCATION (LRBL).....COMPLETE

Place an additional single thin sheet of plastic over the bomb.

| | |
|----------------|--|
| CAUTION | DO NOT OMIT THE PLASTIC SHEETS, AS THE SUSPECT DEVICE COULD GET WET AND POSSIBLY SHORT CIRCUIT ELECTRONIC COMPONENTS CAUSING INADVERTENT DEVICE ACTIVATION. |
|----------------|--|

Build up at 25 cm (10 in) of wetted material around the sides and on top of the bomb.

DO NOT PLACE ANYTHING BETWEEN THE BOMB AND THE DOOR, AND MINIMIZE AIRSPACE AROUND THE BOMB.

The idea is to build up a protective surrounding of the bomb so that the explosive force is directed in the only unprotected area into the door structure.

Fill the area around the bomb with seat cushions and other soft materials such as hand luggage (saturated with water or any other nonflammable liquid) up to the cabin ceiling,

Continued on the following page

[QRH] BOMB ON BOARD (Cont'd)

compressing as much as possible. Secure the LRBL stack in place using belt, ties or other appropriate materials. The more material stacked around the bomb, the less the damage will be.

USE ONLY SOFT MATERIAL. AVOID USING MATERIALS CONTAINING ANY INFLAMMABLE LIQUID AND ANY METAL OBJECTS WHICH COULD BECOME DANGEROUS PROJECTILES.

LRBL STACK

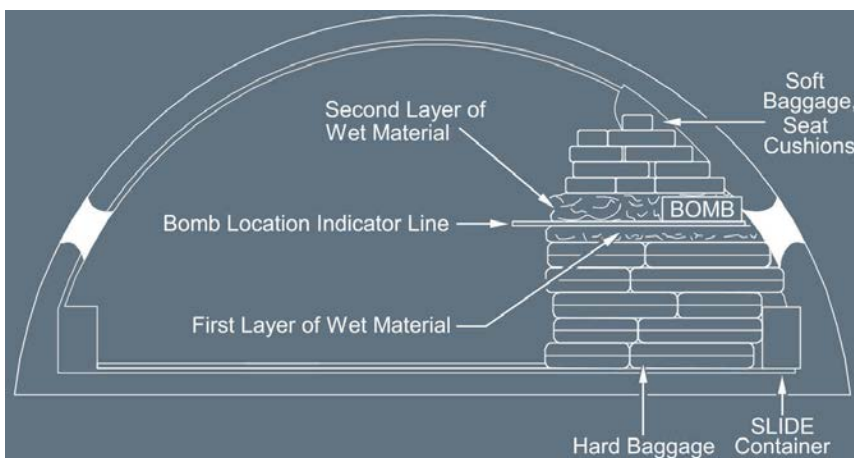

PASSENGERS..... MOVE/ADVISE

Move passengers at least 4 seat rows away from the least risk bomb location (RH aft cabin door). On full flights, it may be necessary to double up passengers to achieve standoff from the suspect device.

Passengers near the bomb should protect their heads with pillows, blankets. All passengers must remain seated with seatbelts on and, if possible, head below the top of the head rest. Seat backs and tray tables must be in their full upright position.

CABIN CREW..... NOTIFY COCKPIT CREW

Cabin crew notify the flight crew that the bomb is secured at the LRBL.

EVACUATION/DISEMBARKATION..... EXECUTE

Evacuate through normal and emergency exits on the opposite side of the "bomb" location. Do not use the door just opposite the "bomb".

Continued on the following page



PROCEDURES
ABNORMAL AND EMERGENCY PROCEDURES

A318/A319/A320/A321
FLIGHT CREW
OPERATING MANUAL

MISC

[QRH] BOMB ON BOARD (Cont'd)

Use all available airport facilities to disembark without delay.

[QRH] COCKPIT WINDSHIELD / WINDOW ARCING

Ident.: PRO-ABN-MISC-00012099.0001001 / 17 MAR 17

Applicable to: ALL

Affected WINDOW / WINDSHIELD ANTI-ICE C/B..... PULL

Pull the circuit breaker of the affected window/windshield heating system, in case of:

- *Electrical arcing of the cockpit windshield/window, or*
- *Burning smell or smoke identified as coming from the bottom right corner of CAPT windshield or bottom left corner of the F/O windshield.*

On the rear C/B panel:

- ANTI-ICE L WSHLD AF10 C/B [123VU],
- ANTI-ICE R WSHLD AF03 C/B [123VU],
- ANTI-ICE/WINDOWS L X14 C/B [122VU],
- ANTI-ICE/WINDOWS R W14 C/B [122VU].

[QRH] COCKPIT WINDSHIELD / WINDOW CRACKED

Ident.: PRO-ABN-MISC-00012097.0001001 / 17 MAR 17

Applicable to: ALL

TOUCH THE CRACK WITH A PEN (OR CAREFULLY WITH FINGERNAIL)

■ **If no crack on cockpit side:**

NO LIMITATION

The inner ply is not affected. Therefore, the window/windshield is still able to sustain the differential pressure up to the maximum flight level.

■ **If cracks on cockpit side:**

MAX FL: 230 / MEA-MORA

The inner ply is affected. The flight crew is not able to easily determine if other plies are affected. Descend to FL 230/MEA and reduce differential pressure to 5 PSI .

Note: *The maximum flight level is restricted to FL 230/MEA to obtain ΔP 5 PSI , without resulting in an excessive cabin altitude and an EXCESS CAB ALT warning.*

The following procedure enables maintaining ΔP 5 PSI in manual cabin pressure mode.

CAB PRESS MODE SEL..... MAN

DISREGARD THE CAB ALT TARGET TABLE DISPLAYED ON THE ECAM

MAN V/S CTL.....AS RQRD

SET THE CABIN ALTITUDE ACCORDING TO THE TABLE BELOW TO MAINTAIN ΔP 5 PSI

| FL | 100 | 150 | 200 | 230 |
|----------------|-----|-------|-------|-------|
| CABIN ALTITUDE | 0 | 3 000 | 6 000 | 8 000 |

● **When starting the descent for approach:**

CAB PRESS MODE SEL..... AUTO

Note: *Due to the increased noise level, pay particular attention to visual warnings.*

● **If visibility not sufficient for approach due to damage:**

CONSIDER AUTOLAND

● **For approach, if AUTOLAND not available:**

CAB PRESS MODE SEL..... MAN

MAN V/S CTL..... FULL UP

MAX SPEED: 200 kt

PF SLIDING WINDOW..... OPEN

[QRH] DITCHING

Ident.: PRO-ABN-MISC-00012087.0056001 / 17 MAR 17

Applicable to: ALL

This procedure applies when engines are running. If engines are not running, *Refer to QRH/ABN-19 ENG DUAL FAILURE - FUEL REMAINING - DITCHING* or *Refer to QRH/ABN-19 ENG DUAL FAILURE - NO FUEL REMAINING - DITCHING*

ATC.....NOTIFY
 ATC XPDR 7700.....CONSIDER

PREPARE CABIN AND COCKPIT

Notify the cabin crew of the nature of the emergency and state intentions.

Specify the available time:

- *Loose equipment secured*
- *Survival equipment prepared*
- *Belts and shoulder harnesses locked*

GPWS SYS..... OFF
 GPWS TERR..... OFF

Pressing OFF the SYS pb and TERR pb avoids nuisance warnings.

SIGNS.....ON
 EMER EXIT LT.....ON
 COMMERCIAL.....OFF
 LDG ELEV.....SELECT 00
 BARO.....SET
 DISREGARD NORM C/Ls
 ELT (when conditions permit).....ON

● **For approach and ditching:**

KEEP LANDING GEAR UP
 SLATS / FLAPS.....MAX AVAIL
 FOR FLARE: TARGET PITCH 11 ° & MIN V/S

Note: Prefer ditching parallel to the swell. If that causes a strong crosswind, ditch into the wind.

● **At 2 000 ft AGL:**

CAB PRESS MODE SEL..... AUTO
The outflow valve would remain open, if the MODE SEL pb were not at AUTO.
 ALL BLEEDS (ENGs & APU)..... OFF

Continued on the following page

[QRH] DITCHING (Cont'd)

CABIN CREW.....NOTIFY FOR DITCHING
DITCHING pb ON

The outflow valve, emergency ram air inlet, avionics ventilation inlet and extract valves, and pack flow control valves, and the forward cargo outlet isolation valve, close.

● **At 500 ft AGL:**

BRACE FOR IMPACT..... ORDER

● **At touchdown:**

ALL ENG MASTERS..... OFF

APU MASTER SW.....OFF

● **After ditching:**

ATC (VHF 1)..... NOTIFY

With engine and APU shut down, only VHF 1 is supplied.

ALL FIRE pb (ENGs & APU).....PUSH

ALL AGENTS (ENGs and APU).....DISCH

EVACUATION..... INITIATE

ELT.....CHECK EMITTING

If not, switch on the transmitter.

After impact the lowest point of the passenger exits (aft door) remains above the waterline for more than 7 min.

[QRH] EMER EVAC

Ident.: PRO-ABN-MISC-00012083.0001001 / 09 MAY 17

Applicable to: ALL

Apply this procedure when considering an emergency evacuation, or when required by the ECAM. Carefully analyze the situation before deciding to evacuate passengers. However do not waste valuable time.

AIRCRAFT / PARKING BRK.....STOP / ON
 ATC (VHF1).....NOTIFY

Notify ATC of the nature of the emergency, and state intentions.

Only VHF 1 is available on batteries.

CABIN CREW (PA).....ALERT

Make a short and precise announcement to warn that an emergency evacuation may be required.

ΔP (only if MAN CAB PR has been used).....CHECK ZERO

If ΔP is not at zero, MODE selector on MAN and V/S CTL FULL UP, to fully open the outflow valve.

● **If ΔP not at zero:**

CAB PR MODE SEL.....MAN

V/S CTL.....FULL UP

ALL ENG MASTER.....OFF

Associated LP and HP valves close.

ALL FIRE pb (ENGs & APU).....PUSH

ALL AGENTS (ENGs & APU).....AS RQRD

Engine Agent 2 is not available.

The use of agents is required if the ENG FIRE or APU FIRE is displayed.

■ **If evacuation required:**

EVACUATION.....INITIATE

Make a short and precise announcement to order the emergency evacuation.

Press the EVAC COMMAND pb .

■ **If evacuation not required:**

CABIN CREW AND PASSENGERS (PA).....NOTIFY



A318/A319/A320/A321
 FLIGHT CREW
 OPERATING MANUAL

PROCEDURES
ABNORMAL AND EMERGENCY PROCEDURES

MISC

[QRH] EMER LANDING
ALL ENG FAILURE

Ident.: PRO-ABN-MISC-00015075.0009001 / 17 MAR 17

Applicable to: ALL

Apply the following if not able to maintain altitude after the loss of thrust near the ground.

■ **If ditching anticipated:**

APU..... START
 L/G LEVER..... CHECK UP
 FOR LANDING..... USE FLAP 2

L2 Only slats extend, and slowly.

L1 VAPP..... DETERMINE

| | | | | | | | |
|---------------|------------------|-------------------|-------------------|-------------------|-------------------|-------------------|-------------------|
| Weight | 40 t / 90 klb | 50 t / 110 klb | 60 t / 130 klb | 70 t / 155 klb | 80 t / 175 klb | 90 t / 200 klb | 95 t / 210 klb |
| VAPP | 150 kt | 150 kt | 163 kt | 173 kt | 183 kt | 193 kt | 198 kt |

DITCHING pb ON

L2 Ditch the aircraft parallel to the swell. If that causes a strong crosswind, ditch the aircraft into the wind.

L1 ● **At 500 ft AGL or below:**

BRACE FOR IMPACT..... ORDER

● **For flare:**

TOUCH DOWN AT MIN V/S
 TARGET PITCH ATT 11 °

● **At touchdown:**

ALL ENG MASTERS..... OFF
 APU MASTER SW..... OFF
 EMER EVAC PROC..... APPLY

L2 Refer to PRO-ABN-MISC [QRH] EMER EVAC

L1 ■ **If forced landing anticipated:**

APU..... START
 FOR LANDING..... USE FLAP 2

L2 Only slats extend, and slowly.

L1 VAPP..... DETERMINE

| | | | | | | | |
|---------------|------|------|------|------|------|------|------|
| Weight | 40 t | 50 t | 60 t | 70 t | 80 t | 90 t | 95 t |
|---------------|------|------|------|------|------|------|------|

Continued on the following page

[QRH] EMER LANDING (Cont'd)
ALL ENG FAILURE

| | / 90 klb | / 110 klb | / 130 klb | / 155 klb | / 175 klb | / 200 klb | / 210 klb |
|-------------|----------|-----------|-----------|-----------|-----------|-----------|-----------|
| VAPP | 150 kt | 150 kt | 163 kt | 173 kt | 183 kt | 193 kt | 198 kt |

GND SPLRs..... ARM

● **At 1 000 ft AGL at the latest:**

GRAVITY GEAR EXTN handcrank..... PULL AND TURN

[L2] *Flight controls revert to direct law at landing gear extension. To ensure correct aircraft trimming for approach, extend the landing gear only when the aircraft is in CONF 2 and at VAPP. Disregard the "USE MAN PITCH TRIM" message on the PFD, because the stabilizer is jammed, due to not sufficient hydraulic power.*

[L1] ● **When L/G downlocked:**

L/G LEVER..... DOWN

● **At 500 ft AGL or below:**

BRACE FOR IMPACT..... ORDER

● **For flare:**

TOUCH DOWN AT MIN V/S

● **At touchdown:**

ALL ENG MASTERS..... OFF

APU MASTER SW..... OFF

EMER EVAC PROC..... APPLY

[L2] *Refer to PRO-ABN-MISC [QRH] EMER EVAC*

[QRH] FORCED LANDING

Ident.: PRO-ABN-MISC-00012090.0032001 / 09 MAY 17

Applicable to: ALL

If engines are not running, *Refer to QRH/ABN-19 ENG DUAL FAILURE - FUEL REMAINING - FORCED LANDING* or *Refer to QRH/ABN-19 ENG DUAL FAILURE - NO FUEL REMAINING - FORCED LANDING*

ATC.....NOTIFY
ATC XPDR 7700..... CONSIDER

PREPARE CABIN AND COCKPIT

Notify the cabin crew of the nature of the emergency and state intentions.

Specify the available time:

- *Loose equipment secured.*
- *Survival equipment prepared.*
- *Belts and shoulder harnesses locked.*

GPWS SYS..... OFF
GPWS TERR..... OFF

Switching the SYS pb and TERR pb OFF avoids nuisance warnings.

SIGNS..... ON
EMER EXIT LT..... ON
COMMERCIAL..... OFF
LDG ELEV..... SET

If not known, select an approximate value.

BARO..... SET
DISREGARD NORM C/Ls
ELT (when conditions permit)..... ON

● **For approach and landing:**

RAM AIR..... ON

Switch ON the RAM AIR to ensure complete cabin depressurization on ground.

L/G lever DOWN

SLATS / FLAPS..... MAX AVAIL

GND SPLR..... ARM

MAX BRK PR: 1000 PSI

● **At 2 000 ft AGL:**

CABIN CREW..... NOTIFY FOR LANDING

Continued on the following page

[QRH] FORCED LANDING (Cont'd)

- **At 500 ft AGL:**
 BRACE FOR IMPACT..... ORDER

- **At touchdown:**
 ALL ENG MASTERS..... OFF
 APU MASTER SW..... OFF
 BRAKES ON ACCU ONLY

- **When aircraft stopped:**
 PARKING BRK..... ON
 ATC (VHF 1)..... USE
With both engines and APU shut down, only VHF 1 is supplied.
 ALL FIRE pb (ENGs & APU)..... PUSH
 ALL AGENTS (ENGs & APU)..... DISCH

- **If evacuation required:**
 EVACUATION..... INITIATE
Make a short and precise announcement to order the emergency evacuation.
Press the EVAC COMMAND pb .
 ELT..... CHECK EMITTING
If not, switch on the transmitter.

- **If evacuation not required:**
 CABIN CREW AND PASSENGERS (PA)..... NOTIFY

[QRH] OVERWEIGHT LANDING

Ident.: PRO-ABN-MISC-00012093.0057001 / 17 MAR 17

Applicable to: ALL

USE CONF FULL FOR LANDING UNLESS SPECIFIED BY ABN PROC OR LIMITED BY LANDING PERF

| MAX WEIGHT (1 000 kg) FOR LANDING IN CONF FULL (GO AROUND IN CONF 3 CLIMB GRADIENT 2.1 %) | | | | | | | | |
|---|--------------------------|-------|-------|-------|-------|--------|--------|--------|
| OAT (°C) | AIRPORT ELEVATION (feet) | | | | | | | |
| | 0 | 2 000 | 4 000 | 6 000 | 8 000 | 10 000 | 12 000 | 14 000 |
| <10 | 85 | 83 | 84 | 81 | 77 | 71 | 66 | 61 |
| 15 | 85 | 83 | 83 | 81 | 77 | 70 | 64 | 57 |
| 20 | 85 | 83 | 83 | 81 | 75 | 67 | 61 | 55 |
| 25 | 85 | 83 | 83 | 79 | 72 | 64 | 58 | |
| 30 | 84 | 83 | 81 | 77 | 69 | | | |
| 35 | 84 | 83 | 79 | 73 | 66 | | | |
| 40 | 84 | 81 | 75 | 69 | | | | |
| 45 | 82 | 76 | 70 | | | | | |
| 50 | 78 | 72 | | | | | | |
| 55 | | | | | | | | |

- If aircraft weight above maximum weight for landing in conf FULL: USE FLAP 3 FOR LANDING

LDG DIST.....CHECK

- For approach:

PACK 1.....OFF OR SUPPLIED BY APU

PACK 2.....OFF OR SUPPLIED BY APU

Selecting packs OFF (or supplied from APU) will increase the maximum thrust available from the engines, in the event of a go-around.

- If landing CONF other than full: USE CONF 1+F FOR GO AROUND

SPEED AT RUNWAY THRESHOLD: VLS

Reduce the selected speed on the FCU to reach VLS at runway threshold.

MINIMIZE V/S AT TOUCHDOWN

- At main landing gear touchdown: USE MAX REVERSER
- After nosewheel touchdown: APPLY BRAKES AS NECESSARY

Continued on the following page

[QRH] OVERWEIGHT LANDING (Cont'd)

Maximum braking may be used after nosewheel touchdown. But, if landing distance permits, delay or reduce braking to take full benefit of the available runway length.

● **When landing completed:**

BRAKE FANS  ON

Be prepared for tire deflation, if temperatures exceed 800 °C.

[QRH] SEVERE TURBULENCE

Applicable to: ALL

Ident.: PRO-ABN-MISC-10-00002202.0001001 / 17 MAR 17

Whenever possible, avoid areas with known or forecasted severe turbulence. If turbulence is unavoidable, aim to keep the speed in the region of the target speed given in this section, so as to provide the best protection against the effect of gust on the structural limits, whilst maintaining an adequate margin above VLS.

Sufficient buffet margin exists at optimum altitude. In order to further increase the margin to buffet onset, consider descending to a lower altitude.

Severe turbulence is defined as turbulence that causes large, abrupt changes in altitude and/or attitude. It usually causes large variations in airspeed. Occupants are forced violently against their seat belts and loose objects will move around the aircraft.

If severe turbulence occurs during a flight, the flight crew must make a logbook entry in order to initiate maintenance action.

Note: Recommendations for severe turbulence are also applicable to extreme turbulence.

Ident.: PRO-ABN-MISC-10-00002203.0001001 / 22 FEB 17

Before the aircraft enters an area where turbulence is expected:

- All loose equipment must be secured in the cockpit and in the cabin
- The flight crew must set the SEAT BELTS sw to ON.

Ident.: PRO-ABN-MISC-10-00002301.0001001 / 09 DEC 09

Keep the autopilot ON.

When thrust changes become excessive : Disconnect Autothrust.

For approach : Use A/THR for managed speed.

Ident.: PRO-ABN-MISC-10-00002208.0002001 / 22 MAY 12

Set the thrust to give the recommended speed (*Refer to PRO-ABN-MISC [QRH] Thrust Setting (N1) for Recommended Speed*). This thrust setting attempts to obtain, in stabilized conditions, the speed for turbulence penetration given in the graph below.

Only change thrust in case of an extreme variation in airspeed, and do not chase your Mach or airspeed.

A transient increase is preferable to a loss of speed, that decreases buffet margins and is difficult to recover.

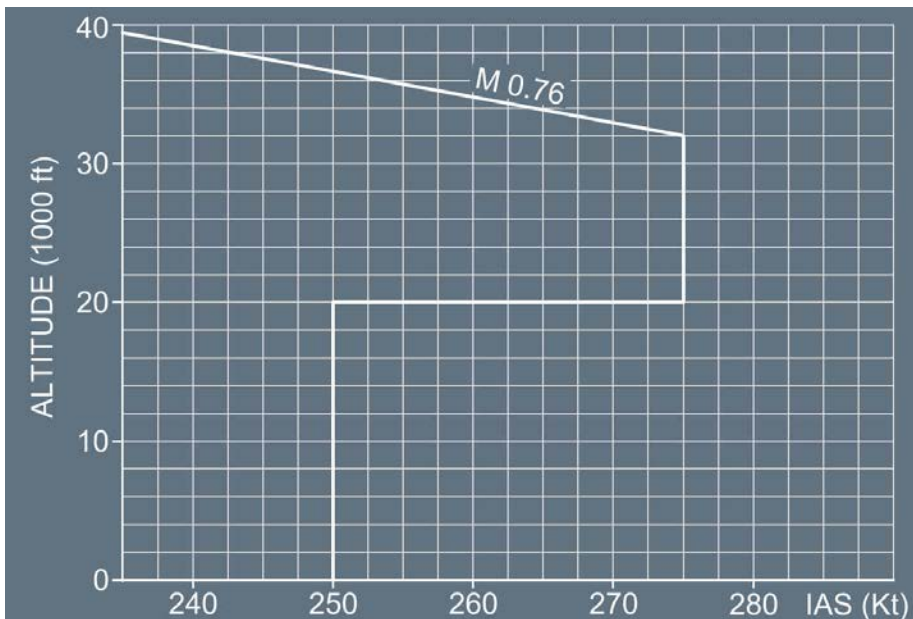

Ident.: PRO-ABN-MISC-10-00007380.0009001 / 16 NOV 11

| SEVERE TURBULENCE | | | | | | | | | | |
|---|-------------------|------------------------|------|------|------|------|------|------|------|------|
| SPEED AND THRUST SETTING FOR RECOMMENDED TURBULENCE SPEED | | | | | | | | | | |
| FL | SPD or Mach | GROSS WEIGHT (1000 kg) | | | | | | | | |
| | | 44 | 48 | 52 | 56 | 60 | 64 | 68 | 72 | 76 |
| | | N1 % | | | | | | | | |
| 390 | 0.76 | 80.0 | 81.0 | 82.0 | 83.1 | – | – | – | – | – |
| 370 | 0.76 | 79.1 | 79.8 | 80.7 | 81.6 | 82.6 | 83.6 | – | – | – |
| 350 | 0.76 | 78.8 | 79.3 | 80.0 | 80.7 | 81.5 | 82.4 | 83.3 | 84.3 | – |
| 330 | 0.76 | 78.8 | 79.3 | 79.8 | 80.4 | 81.0 | 81.8 | 82.6 | 83.4 | 84.2 |
| 310 | 275 | 78.1 | 78.6 | 79.2 | 79.8 | 80.3 | 80.9 | 81.5 | 82.3 | 83.1 |
| 290 | 275 | 76.6 | 77.1 | 77.6 | 78.2 | 78.9 | 79.6 | 80.3 | 81.0 | 81.7 |
| 270 | 275 | 75.1 | 75.6 | 76.1 | 76.7 | 77.3 | 78.0 | 78.7 | 79.6 | 80.5 |
| 250 | 275 | 73.5 | 74.0 | 74.5 | 75.1 | 75.8 | 76.5 | 77.2 | 77.9 | 78.8 |
| 200 | 275 | 69.9 | 70.3 | 70.7 | 71.2 | 71.8 | 72.4 | 73.0 | 73.7 | 74.4 |
| 150 | 250 | 61.9 | 62.6 | 63.3 | 64.0 | 64.9 | 65.9 | 66.9 | 68.0 | 68.9 |
| 100 | 250 | 58.3 | 59.0 | 59.6 | 60.2 | 61.0 | 61.8 | 62.6 | 63.5 | 64.5 |
| 50 | 250 | 54.3 | 54.9 | 55.6 | 56.3 | 57.1 | 58.0 | 59.0 | 60.0 | 60.8 |

Ident.: PRO-ABN-MISC-10-00007386.0001001 / 09 JUN 15

If the flight crew flies the aircraft manually:

- The flight crew may expect large variations in altitude, but should not chase altitude.
- The flight crew should consider descending to or below OPT FL, in order to increase the margin to buffet.

Ident.: PRO-ABN-MISC-10-00007388.0002001 / 29 SEP 15

Configuration FULL, or 3, can be used.

CONF FULL provides better handling capability in turbulent conditions, however, CONF 3 provides more energy and less drag.



A318/A319/A320/A321
 FLIGHT CREW
 OPERATING MANUAL

PROCEDURES
ABNORMAL AND EMERGENCY PROCEDURES

MISC

[QRH] TAILSTRIKE

Ident.: PRO-ABN-MISC-00012273.0001001 / 17 MAR 17

Applicable to: ALL

LAND ASAP

MAX FL: 100 / MEA-MORA

500 ft/min should be targeted for the climb, to minimize pressure changes, and for passenger and crew comfort. Similarly, the rate of descent must be limited to about 1 000 ft/min, except for the final approach that must be performed normally.

Notify the ATC of the aircraft's rate of climb.

RAM AIR..... ON
 PACK 1.....OFF
 PACK 2.....OFF

[QRH] VOLCANIC ASH ENCOUNTER

Ident.: PRO-ABN-MISC-00012176.0001001 / 17 MAR 17

Applicable to: ALL

180° TURN.....INITIATE

The performance of a 180 ° turn will usually enable the aircraft to exit the volcanic ash clouds as quickly as possible, because volcanic ash clouds can extend for hundreds of nautical miles.

ATC.....NOTIFY

Note: *Electrostatic conditions may cause communication problems.*

A/THR..... OFF

This prevents the autothrust from generating thrust variations.

THRUST (IF CONDS PERMIT)..... REDUCE

Reduced thrust minimizes ash ingestion.

If altitude permits, reduce thrust to idle. This maximizes engine surge margin and lowers engine turbine temperature.

CREW OXY MASKS..... USE / 100 % / EMER

CABIN CREW.....NOTIFY

OXYGEN PASSENGER MASK MAN ON..... AS RQRD

Depending on contamination.

ENG ANTI ICE..... ON

WING ANTI ICE..... ON

PACK FLOW..... HI

Maximum air bleed gives the engines additional stall margin.

CARGO ISOL VALVES  OFF

Note: *To prevent a cargo smoke warning being triggered*

ENGINE PARAMETERS..... MONITOR

Monitor particularly EGT . If EGT exceeds limits, it may become necessary to consider a precautionary engine shutdown and engine restart in flight.

Note: *In the case of precautionary shutdown:*

- *restart when clear of the volcanic ash cloud*
- *Upon restart, the engine may accelerate very slowly. Do not misinterpret this as a failure to start*
- *Consider that the compressor and turbine blades have been eroded and avoid sudden changes in thrust. Fuel flow and EGT may increase.*

Continued on the following page

[QRH] VOLCANIC ASH ENCOUNTER (Cont'd)

AIRSPPEED INDICATIONS.....MONITOR

If airspeed is unreliable or lost, Refer to PRO-ABN-NAV UNRELIABLE SPEED INDICATION - Memory Items.

Note: *If both engines flame out and speed indications are lost, Refer to DUAL ENGINE FAILURE procedure to get the required pitch attitude for the optimum relight speed. In case of engine failure, switch off the wing anti ice before engine restart.*

● **If visibility not sufficient for approach due to windshield damage:**

CONSIDER AUTOLAND

● **For approach, if AUTOLAND is not available:**

CAB PRESS MODE SEL.....MAN

MAN V/S CTL.....FULL UP

Due to the increased noise level, pay particular attention to visual warnings.

MAX SPEED: 200 kt

PF SLIDING WINDOW..... OPEN



A318/A319/A320/A321
FLIGHT CREW
OPERATING MANUAL

PROCEDURES
ABNORMAL AND EMERGENCY PROCEDURES

MISC

Intentionally left blank

[MEM] UNRELIABLE SPEED INDICATION

Applicable to: ALL

Ident.: PRO-ABN-NAV-AM-00017720.0002001 / 17 MAR 17

● **If the safe conduct of the flight is impacted:**

AP..... OFF
A/THR..... OFF
FD..... OFF

PITCH/THRUST:

Below THRUST RED ALT..... 15° / TOGA
Above THRUST RED ALT and Below FL 100..... 10° / CLB
Above THRUST RED ALT and Above FL 100..... 5° / CLB
FLAPS (if CONF 0(1)(2)(3))..... MAINTAIN CURRENT CONF
FLAPS (if CONF FULL)..... SELECT CONF 3 AND MAINTAIN
SPEEDBRAKES..... CHECK RETRACTED
L/G..... UP

When at, or above MSA or Circuit Altitude: Level off for troubleshooting.

Continued on the following page

[MEM] UNRELIABLE SPEED INDICATION (Cont'd)

Ident.: PRO-ABN-NAV-AM-00017722.0008001 / 17 MAR 17

- **To level off:**
 AP..... OFF
 A/THR..... OFF
 FD..... OFF
 SPEEDBRAKES..... CHECK RETRACTED
 PITCH/THRUST TABLE..... APPLY

PITCH / THRUST FOR LEVEL OFF

| | | 70 t 155 000 lb | 60 t 130 000 lb | 50 t 110 000 lb |
|-------------------------------|-------|-------------------------------|--------------------|--------------------|
| SLATS / FLAPS EXTENDED | | | | |
| CONF | PITCH | THRUST % N1 (Resultant speed) | | |
| 3 | 7° | 64% (155 kt) | 60% (140 kt) | 56% (130 kt) |
| 2 | 5.5° | 62% (170 kt) | 58% (160 kt) | 54% (145 kt) |
| 1+F | 5° | 62% (190 kt) | 58% (175 kt) | 54% (160 kt) |
| 1 | 6.5° | 62% (205 kt) | 58% (190 kt) | 54% (170 kt) |
| CLEAN | | | | |
| PITCH | FL | THRUST % N1 (Resultant speed) | | |
| 4° | 100 | 62% (245 kt) | 60% (225 kt) | 54% (205 kt) |
| at or below FL250 | 200 | 70% (245 kt) | 66% (225 kt) | 62% (205 kt) |
| 3° | 300 | 80% (265 kt) | 76% (245 kt) | 72% (225 kt) |
| above | 350 | 84% (255 kt) | 80% (240 kt) | 76% (220 kt) |
| FL250 | 400 | / | 86% (235 kt) | 80% (220 kt) |

FLYING TECHNIQUE TO STABILIZE SPEED

Stabilize the altitude. When altitude is stabilized:

- If the pitch is above the target pitch, increase the thrust and maintain the altitude.
- If the pitch is below the target pitch, decrease the thrust and maintain the altitude.

When the pitch reaches the target pitch, adjust the thrust to keep this target pitch.

Continued on the following page

[MEM] UNRELIABLE SPEED INDICATION (Cont'd)

Ident.: PRO-ABN-NAV-AM-00017724.0002001 / 17 MAR 17

● **When flight path is stabilized:**

AP.....OFF
 A/THR.....OFF
 FD.....OFF
 SPEEDBRAKES.....CHECK RETRACTED
 FLIGHT PATH.....KEEP STABILIZED

RESPECT STALL WARNING

Ident.: PRO-ABN-NAV-AM-00017725.0001001 / 17 MAR 17

AFFECTED ADR IDENTIFICATION

PROBE/WINDOW HEAT.....ON
 ALL SPEED INDICATIONS.....CROSSCHECK
ADR 3 and STBY speeds use the data of the same probe.

■ **If at least one ADR confirmed reliable:**

RELIABLE AIR DATA.....USE
 UNRELIABLE ADR pb(s).....OFF

■ **If affected ADR(s) cannot be identified, or all ADRs affected:**

KEEP ONE ADR ON
 TWO ADR pbs.....OFF

This prevents the flight control laws from using two coherent but unreliable ADR data.

FOR LANDING: USE FLAP 3

APP SPDVLS +10 kt
 LDG DIST PROC.....APPLY

● **For flight continuation: USE PITCH/THRUST TABLES**

Continued on the following page

[MEM] UNRELIABLE SPEED INDICATION (Cont'd)

Ident.: PRO-ABN-NAV-AM-00017726.0008001 / 17 MAR 17

CLIMB

CLIMB IN CLEAN CONFIGURATION

| | | 70 t 155 000 lb | 60 t 130 000 lb | 50 t 110 000 lb |
|------------|------------|-------------------------|--------------------|--------------------|
| THRUST | FL | PITCH (Resultant speed) | | |
| CLB | 50 | 11° (235 kt) | 13° (215 kt) | 16° (195 kt) |
| | 100 | 10° (235 kt) | 12° (215 kt) | 14° (195 kt) |
| | 200 | 7° (235 kt) | 8° (220 kt) | 10° (195 kt) |
| | 300 | 5° (235 kt) | 6° (220 kt) | 7° (200 kt) |
| | 400 | / | 4° (215 kt) | 5° (195 kt) |

CRUISE

FLYING TECHNIQUE TO STABILIZE SPEED

Stabilize the altitude. When altitude is stabilized:

- If the pitch is above the target pitch, increase the thrust and maintain the altitude.
- If the pitch is below the target pitch, decrease the thrust and maintain the altitude.

When the pitch reaches the target pitch, adjust the thrust to keep this target pitch.

LEVEL FLIGHT IN CLEAN CONFIGURATION

| | | 70 t 155 000 lb | 60 t 130 000 lb | 50 t 110 000 lb |
|---------------------------------|------------|-------------------------------|--------------------|--------------------|
| PITCH | FL | THRUST % N1 (Resultant speed) | | |
| 4° at or below FL250 | 100 | 62% (245 kt) | 60% (225 kt) | 54% (205 kt) |
| | 200 | 70% (245 kt) | 66% (225 kt) | 62% (205 kt) |
| 3° above FL250 | 300 | 80% (265 kt) | 76% (245 kt) | 72% (225 kt) |
| | 350 | 84% (255 kt) | 80% (240 kt) | 76% (220 kt) |
| | 400 | / | 86% (235 kt) | 80% (220 kt) |

Note: If the failure is due to radome destruction, the drag will increase and therefore N1 must be increased by 5 %. Fuel flow will increase by about 27 %.

DESCENT

DESCENT IN CLEAN CONFIGURATION

| | | 70 t 155 000 lb | 60 t 130 000 lb | 50 t 110 000 lb |
|-------------|-----------|--------------------|--------------------|--------------------|
| THRUST | PITCH | Resultant speed | | |
| IDLE | 1° | 245 kt | 230 kt | 210 kt |

Continued on the following page

[MEM] UNRELIABLE SPEED INDICATION (Cont'd)

INITIAL / INTERMEDIATE APPROACH

APPLY FLYING TECHNIQUE TO STABILIZE SPEED

| LEVEL FLIGHT | | | | | |
|------------------------|-------|-------------------------------|--------------------|--------------------|--|
| | | 70 t 155 000 lb | 60 t 130 000 lb | 50 t 110 000 lb | |
| WITH LANDING GEAR UP | | | | | |
| CONF | PITCH | THRUST % N1 (Resultant speed) | | | |
| 0 | 5.5° | 58% (225 kt) | 54% (205 kt) | 50% (185 kt) | |
| 1 | 6.5° | 62% (205 kt) | 58% (190 kt) | 54% (170 kt) | |
| 1+F | 5° | 62% (190 kt) | 58% (175 kt) | 54% (160 kt) | |
| 2 | 5.5° | 62% (170 kt) | 58% (160 kt) | 54% (145 kt) | |
| WITH LANDING GEAR DOWN | | | | | |
| 3 | 7° | 70% (155 kt) | 64% (140 kt) | 60% (130 kt) | |

FINAL APPROACH AT -3° DESCENT FLIGHT PATH

| APPROACH IN CONF 3 AND L/G EXTENDED | | | | | |
|-------------------------------------|-------|--------------------|--------------------|--------------------|--|
| | | 70 t 155 000 lb | 60 t 130 000 lb | 50 t 110 000 lb | |
| CONF | PITCH | THRUST (% N1) | | | |
| 3 | 4° | 54% | 50% | 46% | |



A318/A319/A320/A321
 FLIGHT CREW
 OPERATING MANUAL

PROCEDURES
ABNORMAL AND EMERGENCY PROCEDURES

NAV

[QRH] ADR 1+2+3 FAULT

Applicable to: ALL

Ident.: PRO-ABN-NAV-C-00017828.0002001 / 17 MAR 17

In case of a triple ADR failure, ECAM only displays dual ADR alerts.
 All dual ADR alerts trigger: **NAV ADR 1+2 FAULT**, and **NAV ADR 1+3 FAULT**, and **NAV ADR 2+3 FAULT**.

^[2] Note: In case of a simultaneous ADR and IR (same ADIRU) failure, apply the ADR FAULT procedure prior to the IR FAULT procedure.

^[1] ALL ADR pbs..... OFF

WHEN ALL ADR OFF BOTH FMS LOST

STBY INST.....USE

BACK UP NAV.....USE

Revert to Back Up Nav via the NAV B/UP Prompt on the MCDU MENU page.

USE RMP FOR NAVAID TUNING

DISREGARD ECAM ACTIONS FOR AIR DATA SWTG AND ATC

Air data switching and ATC have no effect.

TCAS & ATC ALT RPTG INOP

Ident.: PRO-ABN-NAV-C-00017830.0002001 / 22 MAR 17

MAX SPEED..... 320/0.82

See the following table for the IAS/M relationship for 0.82

| | | | | | | | |
|---------|-----|-----|-----|-----|-----|-----|---------------|
| FL | 390 | 370 | 350 | 330 | 310 | 290 | 280 and below |
| MAX SPD | 252 | 265 | 278 | 290 | 305 | 315 | 320 |

WHEN L/G DN: DIRECT LAW

At landing gear extension, control reverts to direct law in pitch, as well as in roll (Refer to PRO-ABN-F_CTL F/CTL DIRECT LAW).

Note: Use manual control of cabin pressurization:

MODE SEL..... MAN

MAN V/S CTL..... AS RQRD

These lines are not displayed on the ECAM. (For details, Refer to PRO-ABN-CAB_PR CAB PR SYS 1+2 FAULT - FWSPAGE).

Continued on the following page



A318/A319/A320/A321
FLIGHT CREW
OPERATING MANUAL

PROCEDURES
ABNORMAL AND EMERGENCY PROCEDURES

NAV

[QRH] ADR 1+2+3 FAULT (Cont'd)

Ident.: PRO-ABN-NAV-C-00021399.0009001 / 17 MAR 17

EXPECT ALTN LAW

| | | | | | | | |
|----------------|-----|-----|-----|-----|-----|-----|---------------|
| FL | 390 | 370 | 350 | 330 | 310 | 290 | 280 and below |
| MAX SPEED (kt) | 252 | 265 | 278 | 290 | 305 | 315 | 320 |

This table provides IAS/MACH 0.82 relationship at or above FL 280.

USE RUDDER WITH CARE

At slats extension, full rudder travel authority is recovered.

WHEN L/G DOWN: DIRECT LAW

At landing gear extension, flight controls revert to direct law in pitch and in roll.

CABIN PRESS MODE SEL..... MAN

MAN V/S CTL..... AS RQRD

Target CAB PRESS V/S:

- *Climb: 500 ft/min*

- *Descent: 300 ft/min*

| AIRCRAFT CRZ FL | CAB ALT TARGET (ft) |
|-----------------|---------------------|
| 410 | 8000 |
| 350 | 7000 |
| 300 | 5500 |
| 250 | 3000 |
| <200 | 0 |

Continued on the following page

[QRH] ADR 1+2+3 FAULT (Cont'd)

Ident.: PRO-ABN-NAV-C-00021262.0001001 / 17 MAR 17

● **For approach:**

CAT 1 ONLY

FOR LANDING: USE FLAP 3

GPWS LDG FLAP 3.....ON

LDG DIST PROC..... APPLY

● **For L/G GRVTY EXTN:**

LDG GEAR GRVTY EXTN handcrank..... PULL AND TURN

● **When L/G downlocked:**

L/G lever.....DOWN

GEAR DOWN indications..... CHECK

L/G DOORS REMAIN OPEN

● **During final approach:**

MAN V/S CTL.....FULL UP

● **Before door opening: CHECK ΔP ZERO**

Continued on the following page

[QRH] ADR 1+2+3 FAULT (Cont'd)

Ident.: PRO-ABN-NAV-C-00016863.0002001 / 22 MAR 17

STATUS

MAX SPEED..... 320/0.82
 MANEUVER WITH CARE
 RUD WITH CARE ABV 160 KT
 See ⁽¹⁾

APPR PROC

FOR LDG..... USE FLAP 3
Do not select CONF FULL, so as not to degrade handling qualities.
 GPWS LDG FLAP 3..... ON
Displayed, when CONF 3 is selected.
 APPR SPD..... VREF +10 KT
 LDG DIST PROC..... APPLY

Note: As the landing gear safety valve is closed, landing gear extension must be performed by gravity (Refer to PRO-ABN-LG [QRH] L/G GRAVITY EXTENSION).

WHEN L/G DN : DIRECT LAW
At landing gear extension, control reverts to direct law in pitch, as well as in roll.



● **DURING FINAL APPR**

MAN V/S CTL.....FULL UP

Note: In case of a go-around, respect the maximum speed of 215 kt in CONF 1+F, due to loss of flap auto retraction to CONF 1.

| | |
|----------------|--|
| CAUTION | <i>Check that the outflow valve is fully open and that cabin altitude is at airfield elevation before opening the doors.</i> |
|----------------|--|

INOP SYS

F/CTL PROT
 WINDSHEAR DET
 GPWS
 ADR 1+2+3
 AP 1+2
 A/THR
 RUD TRV LIM 1+2
 CAB PR 1+2
 YAW DAMPER
 ATC/XPDR 1
 ATC/XPDR 2
 STEEP APPR 
 ROW/ROP 

Other INOP SYS

ATC ALTI MODE
 TCAS 
 L/G RETRACT
 RAT AUTOMATIC EXTENSION
 CAT 2

Continued on the following page



A318/A319/A320/A321
 FLIGHT CREW
 OPERATING MANUAL

PROCEDURES
ABNORMAL AND EMERGENCY PROCEDURES

NAV

[QRH] ADR 1+2+3 FAULT (Cont'd)

(1) *The rudder travel limit value is frozen at the moment when the failure occurs. Therefore, to prevent damage to the aircraft structure, use the rudder with care, when the speed is above 160 kt. At slats' extension, full rudder travel authority is recovered.*

[QRH] ADR CHECK PROC

Ident.: PRO-ABN-NAV-00015311.0001001 / 17 MAR 17

Applicable to: **ALL**

For the ADR CHECK procedure, apply the UNRELIABLE SPEED INDICATION procedure. *Refer to PRO-ABN-NAV UNRELIABLE SPEED INDICATION - Memory Items.*

[QRH] IR ALIGNMENT IN ATT MODE

Ident.: PRO-ABN-NAV-00012425.0006001 / 17 MAR 17

Applicable to: **ALL**

If IR alignment is lost, the navigation mode is inoperative (red ATT flag on PFD and red HDG flag on ND).

Aircraft attitude and heading may be recovered by applying the following procedure:

IR MODE sel (affected IR)..... ATT

KEEP SPEED, HEADING, AND FL CONSTANT FOR 30 s

FMS DATA page..... SELECT

The DATA INDEX page is displayed

IRS MONITOR key..... PRESS

[SET HDG key] A/C HDG..... ENTER

CROSSCHECK HEADING REGULARLY WITH STBY COMPASS AND UPDATE AS REQUIRED

NAV ADR 1(2)(3) FAULT

Applicable to: ALL

Ident.: PRO-ABN-NAV-A-00018111.0001001 / 21 MAR 16

ANNUNCIATIONS

Triggering Conditions:

L2 This alert triggers when the ADR 1(2)(3) is failed.

Flight Phase Inhibition:

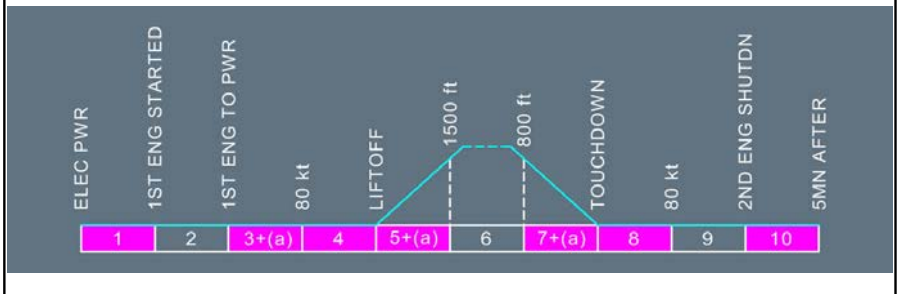

Note: (a) Not inhibited in flight phase 3 in the case of **NAV ADR 3 FAULT** while the ADR 3 is in use.

Not inhibited in flight phases 3, 5, and 7 in the case of **NAV ADR 1(2) FAULT**.

Continued on the following page

NAV ADR 1(2)(3) FAULT (Cont'd)

Ident.: PRO-ABN-NAV-A-00017302.0003001 / 21 MAR 16

Note: *In case of simultaneous failure of ADR and IR (same ADIRU), apply ADR FAULT procedure before IR FAULT procedure.*

ADR 1 FAULT:
AIR DATA SWTG.....CAPT 3

Select ADR 3 to captain side.
For aircraft equipped with EGPWS \triangleleft , T2CAS \triangleleft or T3CAS \triangleleft , the GPWS TERR FAULT light comes on, because the predictive functions of the GPWS are inhibited. As such, the GPWS TERR pb-sw should be switched OFF.

ADR 1 P/B..... OFF

ADR 2 FAULT:
AIR DATA SWTG..... F/O 3

Select ADR 3 to first officer side.

ADR 2 P/B..... OFF
BARO REF..... CHECK

If ADR 2 fails, both baro reference channels are driven by the same FCU channel. Consequently the baro reference displays must be checked.

ADR 3 FAULT:
ADR 3 P/B..... OFF
AIR DATA SWTG (IF ADR 3 IN USE)..... NORM

Ident.: PRO-ABN-NAV-A-00017505.0001001 / 21 MAR 16

STATUS

INOP SYS

CAT 3 SINGLE ONLY

ADR 1(2)(3)
 CAT 3 DUAL
 GPWS ⁽¹⁾

⁽¹⁾ *(in case of ADR 1 FAULT only)*

NAV ADR 1+2(1+3)(2+3) FAULT

Applicable to: ALL

Ident.: PRO-ABN-NAV-B-00018113.0001001 / 21 MAR 16

ANNUNCIATIONS

Triggering Conditions:

L2 This alert triggers when two ADRs are failed.

Flight Phase Inhibition:

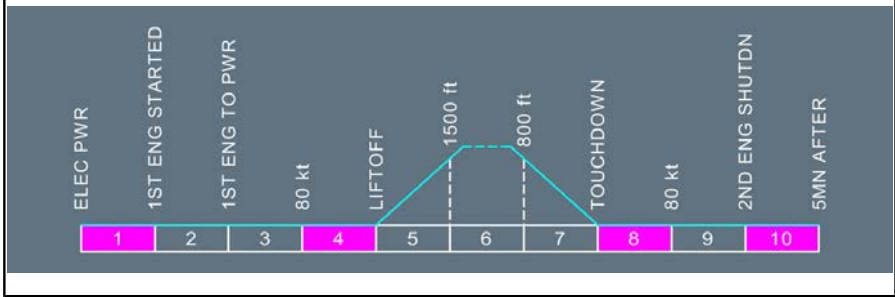

Continued on the following page

NAV ADR 1+2(1+3)(2+3) FAULT (Cont'd)

Ident.: PRO-ABN-NAV-B-00017147.0003001 / 22 MAR 17



L2 Flight control normal laws are lost. Pitch alternate law preserves the neutral static stability. All protections, except maneuver protections are lost.

Note: In case of a simultaneous ADR and IR (same ADIRU) failure, apply the ADR FAULT procedure prior to the IR FAULT procedure.

L1 ● **ADR 1+2 FAULT:**
AIR DATA SWTG.....**CAPT 3**

L2 Set ADR 3 pb-sw (if available) to the captain's side.

L1 **ADR (AFFECTED) P/B**.....**OFF**

L2 As the enhanced functions of the EGPWS  or the predictive functions of the GPWS (for aircraft equipped with T2CAS  or T3CAS ) are inhibited, the GPWS TERR FAULT light comes on. As such, the GPWS TERR pb-sw should be switched OFF.

L1 _____ **ASSOCIATED PROCEDURES** _____

F/CTL ALTN LAW
(PROT LOST)

MAX SPEED.....**320 KT**

L2 Speed is limited, due to the loss of high-speed protections.

L1 ● **ADR 1+3 (or 2+3) FAULT:**

L2 Air data information is lost on one PFD.

Note: In case of an ADR 1+3 FAULT, the landing gear safety valve is controlled closed:



- Landing gear retraction is inoperative
- Landing gear extension must be performed by gravity.

L1 **AIR DATA SWTG**.....**NORM**

ATC/XPDR (IF ADR 1 FAILED).....**SYS 2**

ATC/XPDR (IF ADR 2 FAILED).....**SYS 1**

ADR (AFFECTED) P/B.....**OFF**

L2 As the enhanced functions of the EGPWS  or the predictive functions of the GPWS (for aircraft equipped with T2CAS  or T3CAS ) are inhibited, the GPWS TERR FAULT light comes on in case of an ADR 1+3 FAULT. As such, the GPWS TERR pb-sw should be switched OFF.

Continued on the following page

NAV ADR 1+2(1+3)(2+3) FAULT (Cont'd)

L1

————— **ASSOCIATED PROCEDURES** —————

F/CTL ALTN LAW

(PROT LOST)

MAX SPEED..... 320 KT

L2

Speed is limited, due to the loss of high-speed protections.

Continued on the following page

NAV ADR 1+2(1+3)(2+3) FAULT (Cont'd)

Ident.: PRO-ABN-NAV-B-00017397.0009001 / 22 MAR 17

L12 STATUS

MAX SPEED..... 320 KT

APPR PROC

FOR LDG..... USE FLAP 3

This line is replaced by "FOR LDG : USE FLAP 3" when CONF3 is selected, as a reminder.

GPWS LDG FLAP 3..... ON

Appears when CONF 3 is selected.

● **If ADR 1+3 FAULT:**

L/G..... GRVTY EXTN

Refer to PRO-ABN-LG [QRH] L/G GRAVITY EXTENSION

APPR SPD..... VREF + 10 KT

LDG DIST PROC..... APPLY

ALTN LAW : PROT LOST



WHEN L/G DN : DIRECT LAW

At L/G extension, control reverts to direct law in pitch and roll (Refer to PRO-ABN-F_CTL F/CTL DIRECT LAW).

FLS  LIMITED TO F-APP + RAW

● **If ADR 1 + 3 (or 2 + 3) FAULT:**

BOTH PFD ON THE SAME FAC

As the enhanced functions of the EGPWS  or the predictive functions of the GPWS (for aircraft equipped with T2CAS  or T3CAS ) are inhibited, the GPWS TERR FAULT light comes on in case of an ADR 1+3 FAULT. As such, the GPWS TERR pb-sw should be switched OFF.

INOP SYS

F/CTL PROT

ADR 1 + 2 or (2 + 3) or (1 + 3)

AP 1 + 2

A/THR

ATC/XPDR 1 ⁽¹⁾

ATC/XPDR 2 ⁽²⁾

RUD TRV LIM 1 ⁽²⁾ ⁽³⁾

GPWS (if ADR 1 fault)

CAT 2

GLS AUTOLAND 

STEEP APPR 

ROW/ROP 

⁽¹⁾ (ATC/XPDR 1 in the case of ADR 1 failure)

⁽²⁾ (ATC/XPDR 2 in the case of ADR 2 failure)

Continued on the following page

NAV ADR 1+2(1+3)(2+3) FAULT (Cont'd)

⁽³⁾ (in the case of an ADR 1 + 3 FAULT or in the case of an ADR 2 + 3 FAULT)

NAV ADR DISAGREE

Applicable to: ALL

Ident.: PRO-ABN-NAV-U-00018110.0001001 / 21 MAR 16

ANNUNCIATIONS

Triggering Conditions:

L2

This alert triggers when the following conditions occur:

- The ELAC rejected an ADR , or an ADR is faulty
- The speed or the Angle Of Attack (AOA) from the two remaining ADRs are different.

Flight Phase Inhibition:

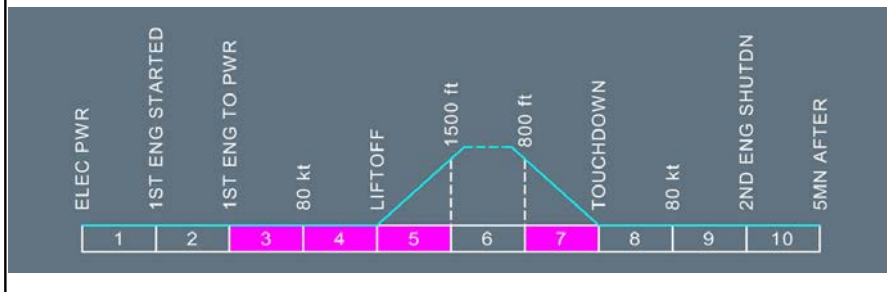

Continued on the following page

NAV ADR DISAGREE (Cont'd)

Ident.: PRO-ABN-NAV-U-00017130.0002001 / 22 MAR 17

[L2] The alternate law activates, and protections are lost.

[L1] AIR SPD.....X CHECK

■ **IF SPD DISAGREE:**

ADR CHECK PROC.....APPLY

[L2] To determine the faulty ADR, *Refer to PRO-ABN-NAV UNRELIABLE SPEED INDICATION - Memory Items.*

[L1] ■ **IF NO SPD DISAGREE:**

AOA DISCREPANCY

ASSOCIATED PROCEDURES

F/CTL ALTN LAW

(PROT LOST)

MAX SPEED.....320 KT

Continued on the following page

NAV ADR DISAGREE (Cont'd)

Ident.: PRO-ABN-NAV-U-00017131.0001001 / 22 MAR 17

L12

STATUS

MAX SPEED..... 320 KT

APPR PROC

FOR LDG..... USE FLAP 3

Do not select CONF FULL, so as not to degrade handling qualities.

GPWS LDG FLAP 3..... ON

Displayed, when CONF 3 is selected.

APPR SPD..... VREF +10

LDG DIST PROC..... APPLY

- **IF NO SPD DISAGREE:**
RISK OF UNDUE STALL WARN

ALTN LAW: PROT LOST
WHEN L/G DN: DIRECT LAW

See ⁽¹⁾

INOP SYS

F/CTL PROT
STEEP APPR 

⁽¹⁾ At landing gear extension, control reverts to direct law in pitch, as well as in roll (Refer to PRO-ABN-F_CTL F/CTL DIRECT LAW).

NAV ALTI DISCREPANCY

Applicable to: ALL

Ident.: PRO-ABN-NAV-AO-00018116.0001001 / 21 MAR 16

ANNUNCIATIONS

Triggering Conditions:

- This alert triggers when the difference between the altitude displayed on the CAPT and F/O PFDs is greater than:
 - 500 ft, if STD BARO reference is selected
 - 250 ft, if QNH or QFE BARO reference is selected.

Flight Phase Inhibition:

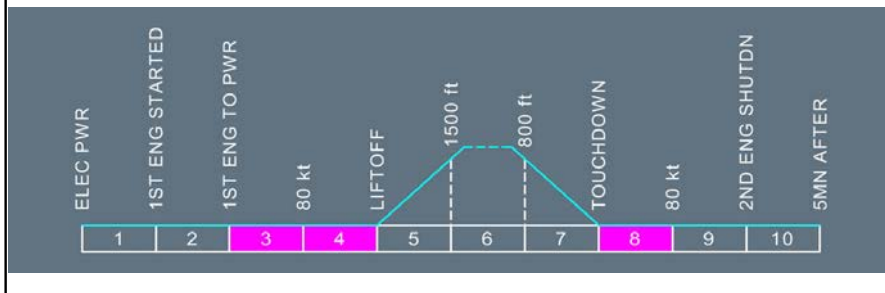

Ident.: PRO-ABN-NAV-AO-00012411.0002001 / 09 APR 14

ALT..... X CHECK

- Crosscheck with the standby altimeter.

AIR DATA SWTG..... AS RQRD

- Select ADR 3 to the faulty side.

NAV CAPT(F/O)(STBY) AOA FAULT

Applicable to: ALL

Ident.: PRO-ABN-NAV-V-00018124.0001001 / 21 MAR 16

ANNUNCIATIONS

Triggering Conditions:

L2

This alert triggers when the CAPT (F/O)(STBY) Angle Of Attack (AOA) sensor is failed.

Flight Phase Inhibition:

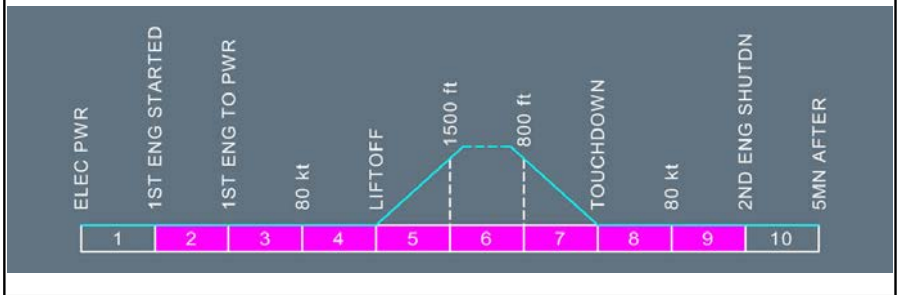

Ident.: PRO-ABN-NAV-V-00012458.0003001 / 25 FEB 14

Crew awareness.

Ident.: PRO-ABN-NAV-V-00012459.0003001 / 19 JUN 12

STATUS

INOP SYS

CAPT (F/O) (STBY)
 AOA

NAV ATT DISCREPANCY

Applicable to: ALL

Ident.: PRO-ABN-NAV-AQ-00018122.0001001 / 21 MAR 16

ANNUNCIATIONS

Triggering Conditions:

- L2 This alert triggers when the difference between the roll or pitch angle displayed on the CAPT and F/O PFDs is greater than 5 °.

Flight Phase Inhibition:

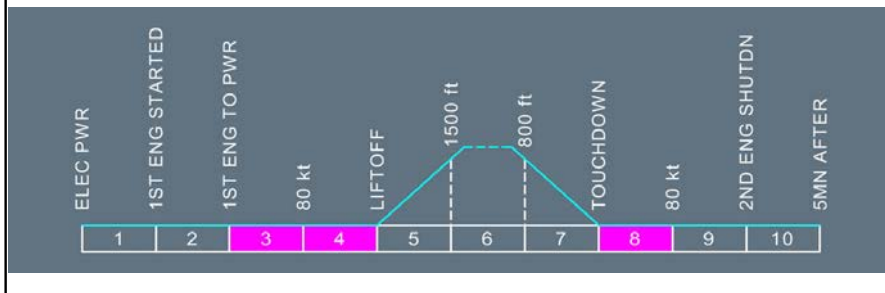

Ident.: PRO-ABN-NAV-AQ-00012410.0001001 / 19 AUG 10

ATT.....X CHECK

- L2 Crosscheck with standby horizon.

L1 ATT HDG SWTG.....AS RQRD

- L2 Select IR 3 (if available) to faulty side.

NAV BARO REF DISCREPANCY

Applicable to: ALL

Ident.: PRO-ABN-NAV-AR-00018123.0001001 / 21 MAR 16

ANNUNCIATIONS

Triggering Conditions:

L2

This alert triggers when the BARO reference is not the same on CAPT and F/O sides.

Flight Phase Inhibition:

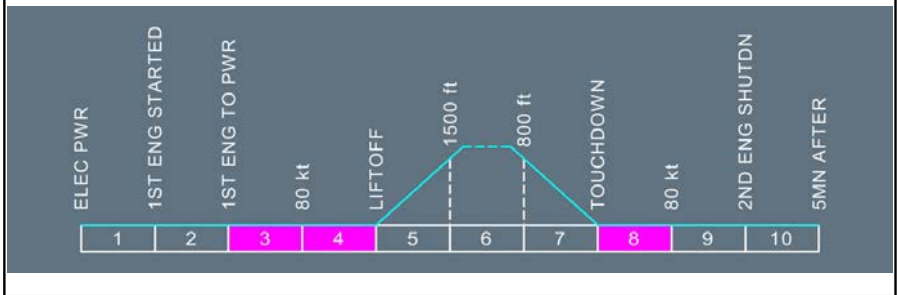

Ident.: PRO-ABN-NAV-AR-00012413.0001001 / 16 NOV 11

BARO REF..... X CHECK

L2

Crosscheck the barometric reference selection, captain side versus first officer side.

NAV FM/GPS POS DISAGREE ⚠

Applicable to: ALL

Ident.: PRO-ABN-NAV-AG-00017090.0002001 / 21 MAR 16

ANNUNCIATIONS

Triggering Conditions:

L2 This alert triggers when the FM and GPS positions disagree.

Flight Phase Inhibition:

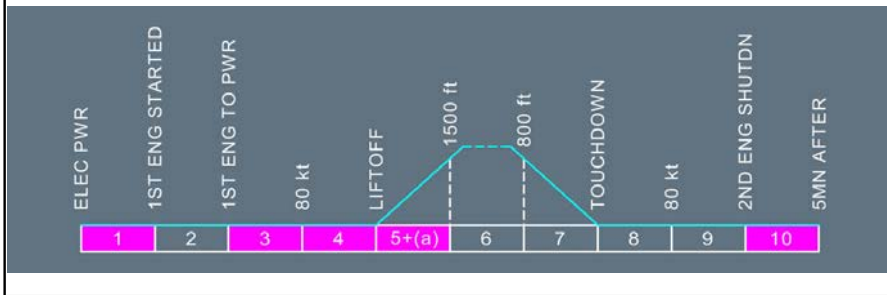

Note: (a) Alert inhibited only for the first 15 s in flight phase 5.

Continued on the following page

NAV FM/GPS POS DISAGREE  (Cont'd)

Ident.: PRO-ABN-NAV-AG-00017148.0003001 / 17 MAR 17

A/C POS.....CHECK

The following procedure is not displayed on the ECAM:

■ **During climb, cruise, or descent:**

Check accuracy on the MCDU PROG page:

■ **If ESTIMATED ACCUR below REQUIRED ACCUR:**

CONSIDER NAV MODE AND ND ARC/ROSE NAV

■ **If ESTIMATED ACCUR above REQUIRED ACCUR:**

HDG/TRK MODE.....SELECT

USE RAW DATA

When possible, compare the positions of both FMs with the GPIRS position, on the MCDU POSITION MONITOR page:

■ **If one FM position agrees with inside GPIRS position:**

USE ASSOCIATED AP/FD

■ **If both FM positions DO NOT agree with inside GPIRS position:**

GPS..... DESELECT

USE RAW DATA

■ **During ILS/MLS  /LOC approach:**

NAV MODE: DO NOT USE

CONTINUE APPROACH

■ **During LOC only approach with FLS  :**

NAV MODE: DO NOT USE

DISREGARD F-G/S DEVIATION

REVERT TO VERTICAL SELECTED MODE

■ **During RNAV GNSS, RNAV RNP, or GLS approach:**

- **If visual references not sufficient:** GO AROUND

■ **During VOR, VOR-DME, NDB, or NDB-DME approach:**

HDG/TRK MODE..... SELECT

USE RAW DATA

Continued on the following page

NAV FM/GPS POS DISAGREE ⚠ (Cont'd)

- If FLS ⚠ used:
LS pb..... PRESS
FLS deviations are removed from PFD.

NAV GPS 1(2) FAULT ⚠

Applicable to: ALL

Ident.: PRO-ABN-NAV-L-00018144.0001001 / 21 MAR 16

ANNUNCIATIONS

Triggering Conditions:

L2 This alert triggers when the GPS 1(2) is failed.

Flight Phase Inhibition:

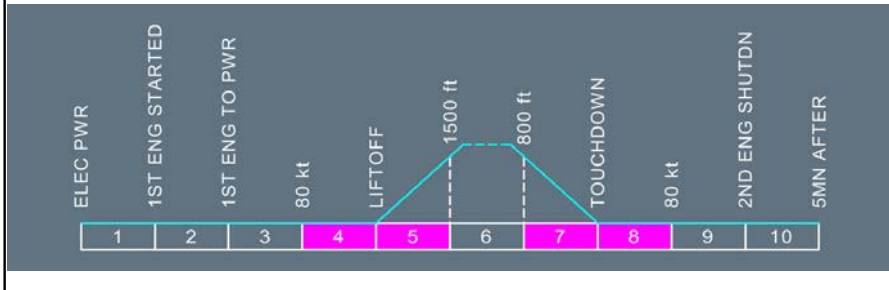

Ident.: PRO-ABN-NAV-L-00017127.0001001 / 21 MAR 16

Crew awareness.

Ident.: PRO-ABN-NAV-L-00017128.0001001 / 21 MAR 16

STATUS

● If both GPS FAULT
FLS ⚠ LIMITED TO F-APP + RAW

INOP SYS

GPS 1(2)

NAV GPWS FAULT

Applicable to: ALL

Ident.: PRO-ABN-NAV-N-00018129.0002001 / 21 MAR 16

ANNUNCIATIONS

Triggering Conditions:

L2 This alerts triggers when the GPWS fails.

Flight Phase Inhibition:

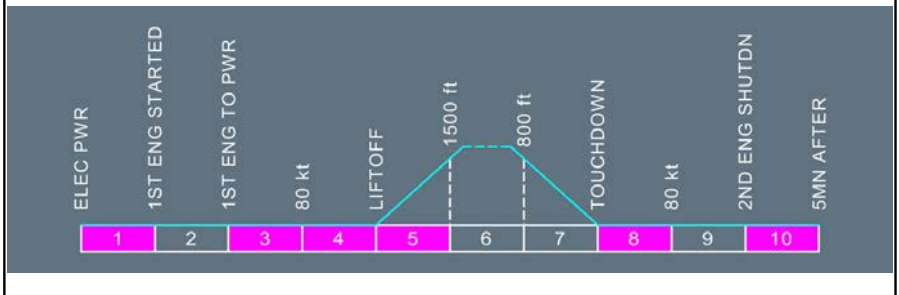

Ident.: PRO-ABN-NAV-N-00012443.0001001 / 16 NOV 11

GPWS.....OFF

L2 This line remains displayed, even after the GPWS pb-sw has been switched OFF.

Ident.: PRO-ABN-NAV-N-00012444.0001001 / 19 AUG 10

STATUS

INOP SYS

GPWS



NAV GPWS TERR DET FAULT

Applicable to: ALL

Ident.: PRO-ABN-NAV-AS-00018130.0001001 / 21 MAR 16

ANNUNCIATIONS

Triggering Conditions:

- ② This alert triggers when the enhanced TCF and TAD modes of the EGPWS  or the predictive function of the GPWS (for aircraft equipped with T2CAS  or T3CAS ) are inoperative.

Flight Phase Inhibition:

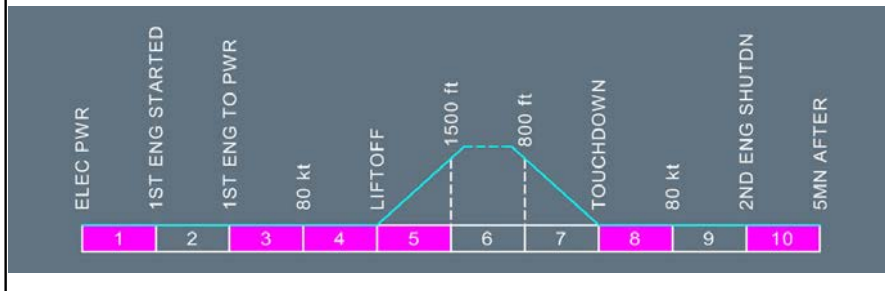

Ident.: PRO-ABN-NAV-AS-00017542.0001001 / 21 MAR 16

GPWS TERR.....OFF

- ② The basic GPWS mode 1 to mode 5 are still operative if SYS pb-sw lights FAULT or OFF are not illuminated.

Ident.: PRO-ABN-NAV-AS-00019752.0001001 / 01 JUN 16

STATUS

INOP SYS

GPWS TERR
ROW/ROP 

NAV HDG DISCREPANCY

Applicable to: ALL

Ident.: PRO-ABN-NAV-AT-00018131.0001001 / 21 MAR 16

ANNUNCIATIONS

Triggering Conditions:

L2

This alert triggers when the difference between the headings on the CAPT and F/O displays (PFD and ND) is greater than 5 °.

Flight Phase Inhibition:

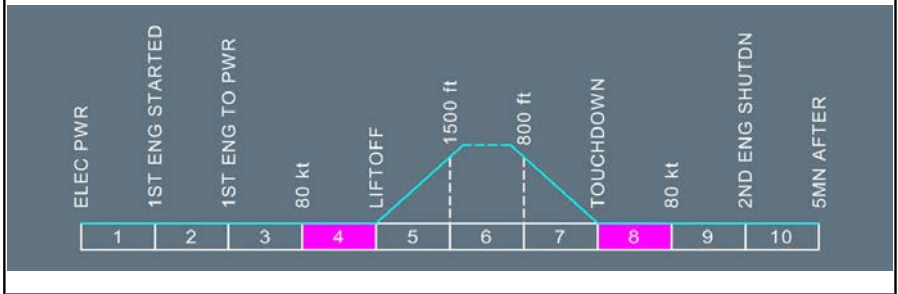

Ident.: PRO-ABN-NAV-AT-00012409.0003001 / 19 AUG 10

HDG.....X CHECK

L2 Compare the 3 IR headings on MCDU or crosscheck with standby compass.

L1 ATT HDG SWTG.....AS RQRD

L2 Select IR 3 (if available) to faulty side.

NAV IAS DISCREPANCY

Applicable to: ALL

Ident.: PRO-ABN-NAV-W-00018146.0003001 / 21 MAR 16

ANNUNCIATIONS

Triggering Conditions:

L2 This alert triggers when the speed displayed on the CAPT and F/O PFDs are different.

Flight Phase Inhibition:

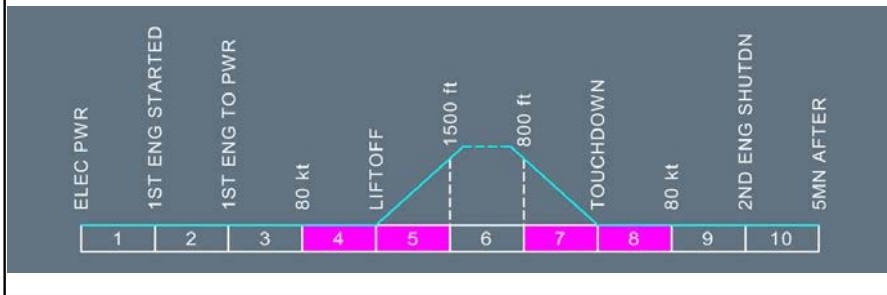

Ident.: PRO-ABN-NAV-W-00017528.0001001 / 21 MAR 16

AIR SPD.....X CHECK
 AIR DATA SWTG.....AS RQRD

Ident.: PRO-ABN-NAV-W-00017525.0001001 / 21 MAR 16

STATUS

INOP SYS

CAT 3 SINGLE ONLY

CAT 3 DUAL

NAV ILS 1(2)(1+2) FAULT

Applicable to: ALL

Ident.: PRO-ABN-NAV-M-00018138.0001001 / 21 MAR 16

ANNUNCIATIONS

Triggering Conditions:

L2

This alert triggers when the ILS 1(2)(1+2) is failed.

Flight Phase Inhibition:

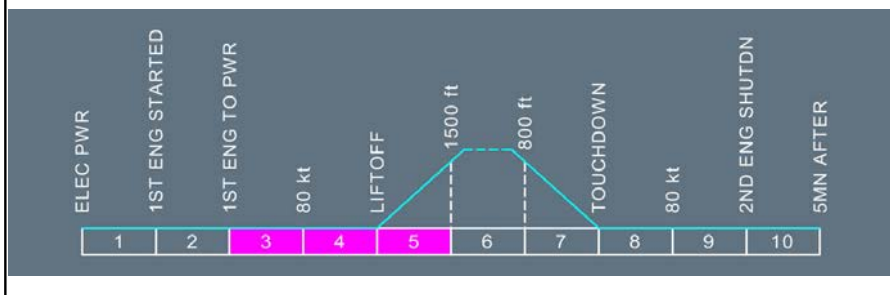

Ident.: PRO-ABN-NAV-M-00017125.0001001 / 21 MAR 16

Crew awareness.

Ident.: PRO-ABN-NAV-M-00017126.0002001 / 21 MAR 16

STATUS

INOP SYS

- ILS 1(2)(1+2)
- CAT 2 ⁽¹⁾
- GPWS ⁽²⁾

⁽¹⁾ (If ILS 1 FAULT or if ILS 2 FAULT)

⁽²⁾ (if ILS 1 FAULT on ground or if ILS 1+2 FAULT)

NAV IR 1(2)(3) FAULT

Applicable to: ALL

Ident.: PRO-ABN-NAV-D-00018140.0001001 / 21 MAR 16

ANNUNCIATIONS

Triggering Conditions:

L2 This alert triggers when the IR 1(2)(3) is failed.

Flight Phase Inhibition:

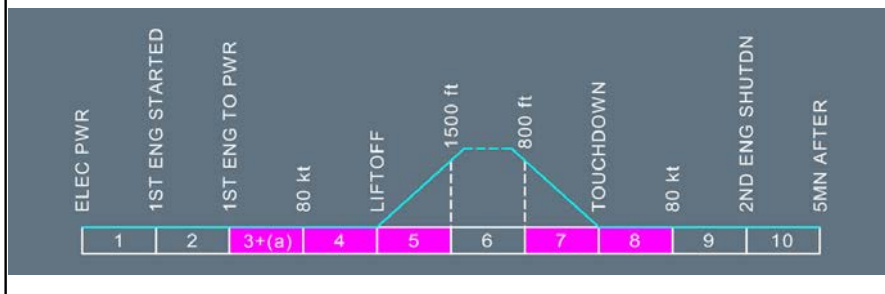

Note: (a) Alert not inhibited in flight phase 3 in the case of **NAV IR 3 FAULT** while the ADR 3 is in use.

Alert not inhibited in flight phase 3 in the case of **NAV IR 1(2) FAULT**.

Continued on the following page

NAV IR 1(2)(3) FAULT (Cont'd)

Ident.: PRO-ABN-NAV-D-00017521.0003001 / 21 MAR 16

L2 Note: In case of a simultaneous ADR and IR (same ADIRU) failure, apply the ADR FAULT procedure before the IR FAULT procedure.

- L1** ■ **IR 1 FAULT:**
 ATT HDG SWTG..... CAPT 3
 ATC/XPDR..... SYS 2
- **IR 2 FAULT:**
 ATT HDG SWTG..... F/O 3
 ATC/XPDR..... SYS 1
- **IR 3 FAULT:**
 ATT HDG SWTG (IF IR 3 IN USE)..... NORM

L2 This line is not displayed on the ECAM.

Ident.: PRO-ABN-NAV-D-00017123.0001001 / 21 MAR 16

L12

STATUS

INOP SYS

IR MAY BE AVAIL IN ATT

Refer to PRO-ABN-NAV [QRH] IR ALIGNMENT IN ATT MODE

CAT 3 SINGLE ONLY

IR 1(2)(3)
 cat 3 DUAL
 GPWS TERR (1)
 TCAS (1)
 ATC/XPDR 1 (1)
 ATC/XPDR 2 (2)
 See (3)

(1) (In case of an IR 1 fault)

(2) (In case of an IR 2 fault)

(3) Note: In Case of an IR 1 fault, the TCAS may be inoperative (depending on the TCAS manufacturer). If the IR 1 is available in ATT mode, the TCAS can be recovered by entering the aircraft magnetic heading into the CDU , as per the IR ALIGNMENT IN ATT MODE procedure.

Continued on the following page

NAV IR 1(2)(3) FAULT (Cont'd)

Ident.: PRO-ABN-NAV-D-00015142.0001001 / 29 JUL 13

The loss or the failure of an Inertial Reference System (IRS) may result in the loss of the FMS.
Refer to DSC-22_20-100-20 Loss Of FMS Position Further To IRS Loss.

NAV IR 1+2(1+3)(2+3) FAULT

Applicable to: ALL

Ident.: PRO-ABN-NAV-E-00018139.0001001 / 21 MAR 16

ANNUNCIATIONS

Triggering Conditions:

- 12 This alert triggers when IR 1+2(1+3)(2+3) are failed.

Flight Phase Inhibition:

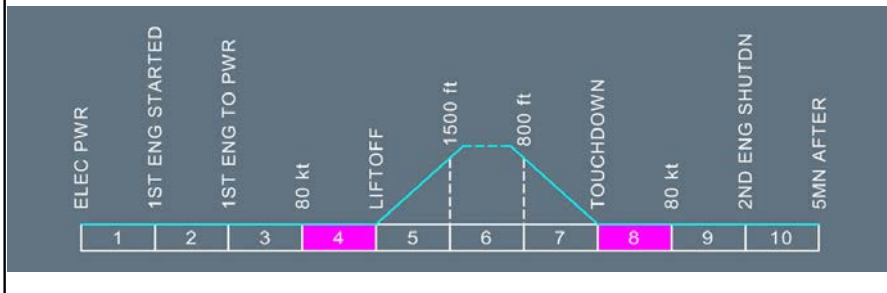

Continued on the following page

NAV IR 1+2(1+3)(2+3) FAULT (Cont'd)

Ident.: PRO-ABN-NAV-E-00017111.0002001 / 22 MAR 17

L2 Note: In case of a simultaneous ADR and IR (same ADIRU) failure, apply the ADR FAULT procedure prior to the IR FAULT procedure.

L1 ● **If IR 1 + 2 FAULT:**
ATT HDG SWTG..... CAPT 3

L2 Set IR 3 (If available) to the Captain's side.
Attitude information is lost on first officer's PFD.

L1 ● **If IR 1 + 3 (or 2 + 3) FAULT:**
ATT HDG SWTG..... NORM

L2 Attitude information is lost on one side (Captain or first officer).

L1

ASSOCIATED PROCEDURES

F/CTL ALTN LAW
(PROT LOST)

L2 Flight control normal laws are lost. Pitch alternate law with static stability becomes active.
All protections, except maneuver protections, are lost.

L1 MAX SPEED..... 320 KT

L2 Speed is limited, due to the loss of high speed protection.

Continued on the following page

NAV IR 1+2(1+3)(2+3) FAULT (Cont'd)

Ident.: PRO-ABN-NAV-E-00016864.0004001 / 22 MAR 17

L12 **STATUS**

MAX SPEED..... 320 KT

INOP SYS

APPR PROC

- F/CTL PROT
- IR 1 (2)(3)
- IR 1+2 or 1+3 or 2+3
- AP 1+2
- A/THR
- YAW DAMPER 1 ⁽¹⁾
- YAW DAMPER 2 ⁽²⁾
- GPWS TERR  (if IR 1 fault)
- TCAS
- CAT 2
- ATC/XPDR 1 ⁽³⁾
- ATC/XPDR 2 ⁽⁴⁾
- GLS AUTOLAND 
- STEEP APPR  (if at least 2 IRs are lost)
- ROW/ROP 

FOR LDG..... **USE FLAP 3**

This line is replaced by "FOR LDG : USE FLAP 3" when CONF 3 is selected, as a reminder.

GPWS LDG FLAP 3..... **ON**

Will appear, when CONF 3 is selected.

APPR SPD : VREF + 10 KT

LDG DIST PROC..... **APPLY**

ALTN LAW : PROT LOST

WHEN L/G DN : DIRECT LAW

At landing gear extension, control reverts to direct law, in pitch, as well as in roll (Refer to PRO-ABN-F_CTL F/CTL DIRECT LAW).

IR (AFFECTED) MAY BE AVAIL IN ATT

Refer to PRO-ABN-NAV [QRH] IR ALIGNMENT IN ATT MODE

FLS  LIMITED TO F-APP + RAW

Note: *In case of an IR 1 fault, the TCAS may be inoperative (depending on the TCAS manufacturer). If the IR 1 is available in ATT mode, the TCAS can be recovered by entering the aircraft magnetic heading into the CDU , as per IR ALIGNMENT IN ATT MODE procedure.*

- ⁽¹⁾ (In case of an IR 1+3 fault)
- ⁽²⁾ (In case of an IR 2+3 fault)
- ⁽³⁾ (In the case of an IR 1 or IR 1+2 or IR 1+3 failure)
- ⁽⁴⁾ (In the case of an IR 2 or IR 1+2 or IR 2+3 failure)

NAV IR DISAGREE

Applicable to: ALL

Ident.: PRO-ABN-NAV-G-00018147.0001001 / 21 MAR 16

ANNUNCIATIONS

Triggering Conditions:

L2

This alert triggers when one IR is failed, and the information received from the two remaining IRs is different.

Flight Phase Inhibition:

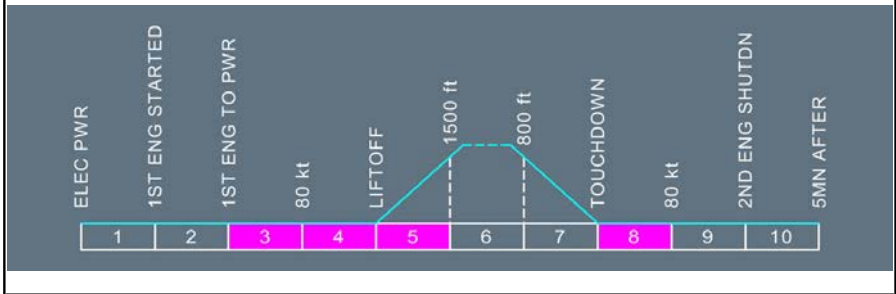

Continued on the following page

NAV IR DISAGREE (Cont'd)

Ident.: PRO-ABN-NAV-G-00016851.0001001 / 22 MAR 17

[L2] Direct law becomes active. All protections (pitch and roll) are lost.
 [L1] ATT.....X CHECK

[L2] Use the standby horizon to determine the faulty IR.

[L1] ● **IF DISAGREE CONFIRMED:**
FAULTY IR..... OFF

- [L2] - If the ADIRS Control Panel has the IR pb, turn off the faulty IR using the associated IR pb.
- [L2] - If the ADIRS Control Panel does not have the IR pb, set the ADIRS selector to OFF. This action will also switch off the associated ADR.

[L1] ELAC 2.....OFF THEN ON
 ELAC 1.....OFF THEN ON

[L2] Note: When the ELAC 1 computer is reset on ground, the pitch trim returns to the ground setting position (0 °).
 After corrective action (faulty IR switched off and ELACs reset), pitch alternate law with reduced protections is recovered.

[L1] _____ **ASSOCIATED PROCEDURES** _____

F/CTL ALTN LAW
(PROT LOST)
MAX SPEED..... 320 KT

Continued on the following page

NAV IR DISAGREE (Cont'd)

Ident.: PRO-ABN-NAV-G-00016852.0001001 / 22 MAR 17

L12

STATUS

MAX SPEED..... 320 KT

APPR PROC

FOR LDG..... USE FLAP 3

Do not select CONF FULL, so as not to degrade handling qualities.

GPWS LDG FLAP 3..... ON

Will be displayed, when CONF 3 is selected.

APPR SPD..... VREF + 10

LDG DIST PROC..... APPLY

ALTN LAW: PROT LOST
WHEN L/G DN: DIRECT LAW

See ⁽¹⁾

INOP SYS

F/CTL PROT
STEEP APPR 

⁽¹⁾ At landing gear extension, control reverts to direct law in pitch, as well as in roll (Refer to PRO-ABN-F_CTL F/CTL DIRECT LAW).

NAV IR NOT ALIGNED

Applicable to: ALL

Ident.: PRO-ABN-NAV-AU-00018141.0002001 / 21 MAR 16

ANNUNCIATIONS

Triggering Conditions:

L2 This alert triggers when there is a problem during IR alignment.

Flight Phase Inhibition:

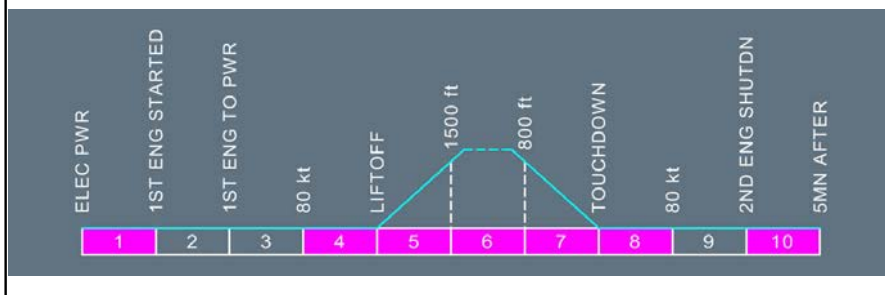

Ident.: PRO-ABN-NAV-AU-00012570.0001001 / 19 AUG 10

L2 This caution is available in Phase 2 (after first engine start, until takeoff)

L1 POSITION DISAGREE

POSITION MISSING

PRESENT POS.....INSERT

EXCESS MOTION

IR 1 (2) (3) (1+2) (2+3) (1+2+3) IN ALIGN

NAV PRED W/S DET FAULT ⚠

Applicable to: ALL

Ident.: PRO-ABN-NAV-F-00018855.0002001 / 21 MAR 16

ANNUNCIATIONS

Triggering Conditions:

L2

This alert triggers when the predictive function is lost.

Flight Phase Inhibition:

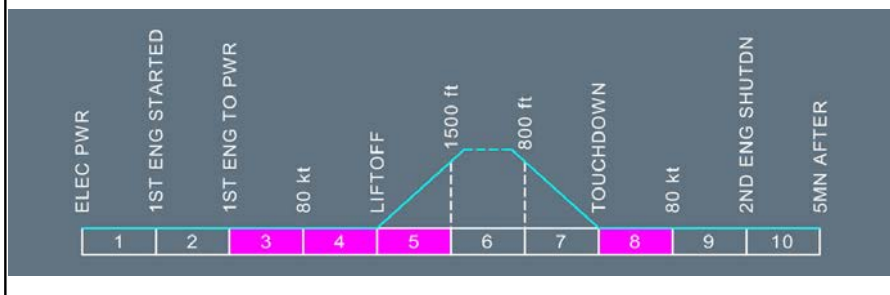

Ident.: PRO-ABN-NAV-F-00018853.0001001 / 21 MAR 16

Crew awareness.

Ident.: PRO-ABN-NAV-F-00018854.0001001 / 21 MAR 16

STATUS

INOP SYS

PRED W/S DET

NAV RA 1 AND 2 FAULT
(DUAL RA FAILURE)

Applicable to: ALL

Ident.: PRO-ABN-NAV-J-00018403.0001001 / 21 MAR 16

ANNUNCIATIONS

Triggering Conditions:

L2 This alert triggers when both RAs are failed.

Flight Phase Inhibition:

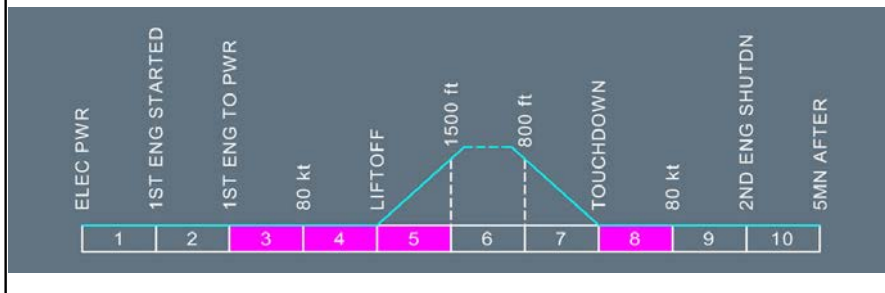

Ident.: PRO-ABN-NAV-J-00012432.0001001 / 25 FEB 14

Crew awareness.

Continued on the following page

NAV RA 1 AND 2 FAULT (Cont'd)
(DUAL RA FAILURE)

Ident.: PRO-ABN-NAV-J-00016850.0003001 / 01 JUN 16

L12

STATUS

INOP SYS

WHEN L/G DN: DIRECT LAW

See ⁽¹⁾

- RA 1+2
- A/CALL OUT
- GPWS
- CAT 2
- GLS AUTOLAND 
- STEEP APPR 
- REAC W/S DET
- TCAS
- ROW/ROP 

⁽¹⁾ At landing gear extension, flight controls revert to direct law in pitch, as well as in roll (Refer to PRO-ABN-F_CTL F/CTL DIRECT LAW).
 ILS APPR mode cannot be engaged, LOC mode is available via the FCU LOC pb.

NAV RA 1(2) FAULT

Applicable to: ALL

Ident.: PRO-ABN-NAV-I-00018135.0001001 / 21 MAR 16

ANNUNCIATIONS

Triggering Conditions:

L2 This alert triggers when the RA 1(2) is failed.

Flight Phase Inhibition:

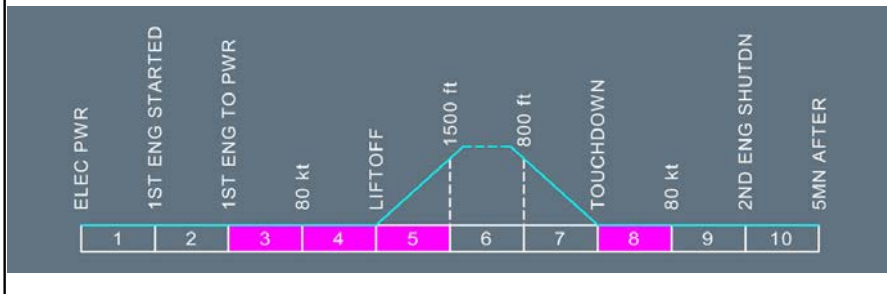

Ident.: PRO-ABN-NAV-I-00012430.0001001 / 25 FEB 14

Crew awareness.

Ident.: PRO-ABN-NAV-I-00016849.0001001 / 01 JUN 16

STATUS

INOP SYS

CAT 2 ONLY

- RA 1(2)
- CAT 3
- GPWS (If RA 1 fault)
- ROW/ROP 

NAV RA DEGRADED

Applicable to: ALL

Ident.: PRO-ABN-NAV-AV-00018134.0001001 / 21 MAR 16

ANNUNCIATIONS

Triggering Conditions:

L2

This alert triggers when the height that RA 1 and RA 2 provide are significantly different.

Flight Phase Inhibition:

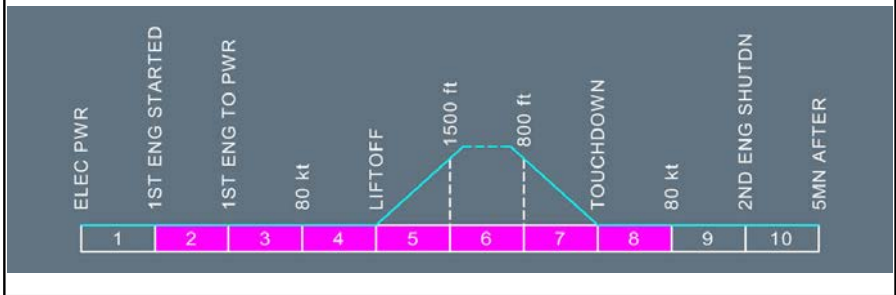

Ident.: PRO-ABN-NAV-AV-00018933.0001001 / 21 MAR 16

Crew awareness.

NAV TCAS FAULT 

Applicable to: ALL

Ident.: PRO-ABN-NAV-K-00018397.0002001 / 21 MAR 16

ANNUNCIATIONS

Triggering Conditions:

 This alert triggers when there is an internal failure of the TCAS.

Flight Phase Inhibition:

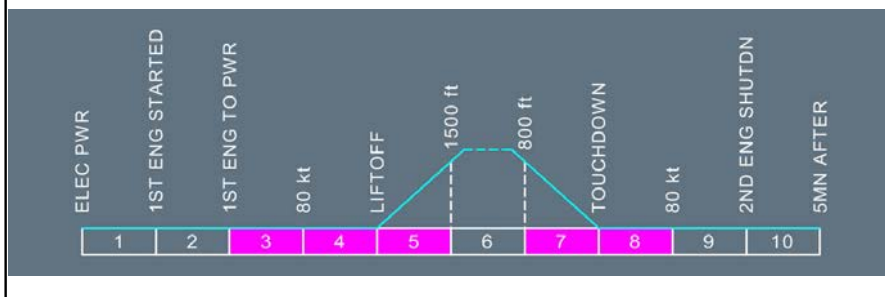

Ident.: TDU / PRO-ABN-NAV-K-00015480.0017001 / 14 FEB 14

Impacted DU: 00012434 NAV TCAS FAULT (If Installed)

Crew awareness.

Note: *On ground, if the alert is triggered while the ADIRU s are OFF, or while IR 1 is not yet aligned, the flight crew can disregard it. The alert automatically disappears once the ADIRU s are powered and upon the alignment of IR1.*

Ident.: PRO-ABN-NAV-K-00012434.0001001 / 25 FEB 14

Impacted by TDU: 00015480 NAV TCAS FAULT

Crew awareness.

Continued on the following page

NAV TCAS FAULT ⚠️ (Cont'd)

Ident.: PRO-ABN-NAV-K-00012435.0001001 / 19 AUG 10

STATUS

INOP SYS

TCAS

NAV TCAS STBY

Applicable to: ALL

Ident.: PRO-ABN-NAV-AW-00018133.0001001 / 21 MAR 16

ANNUNCIATIONS

Triggering Conditions:

L2

This alert triggers when the flight crew sets the TCAS on STBY in flight.

Flight Phase Inhibition:

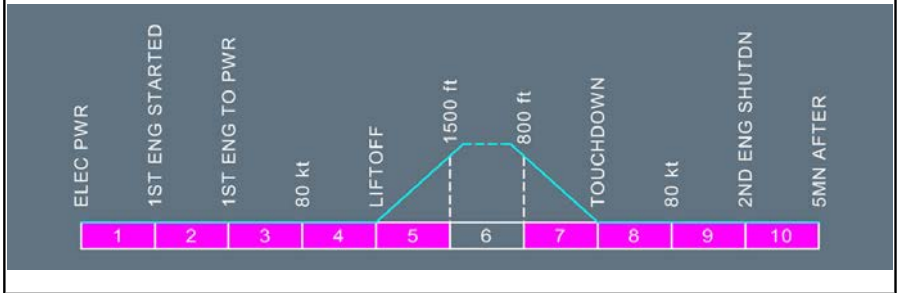

Ident.: PRO-ABN-NAV-AW-00018847.0001001 / 21 MAR 16

Crew awareness.

STALL WARNING

Ident.: PRO-ABN-NAV-00013994.0001001 / 21 MAR 17

Applicable to: **ALL**

When the threshold is reached, a permanent aural warning is triggered "STALL + CRICKET" as long as a correct angle-of-attack is not recovered. (*Refer to PRO-ABN-MISC [MEM] Stall Recovery*).

OVERSPEED

Applicable to: ALL

Ident.: PRO-ABN-OVERSPEED-AX-00018108.0001001 / 20 APR 17

ANNUNCIATIONS

Triggering Conditions:

L2

This alert triggers when:

- The aircraft speed/mach is greater than VMO + 4 kt/MMO + 0.006, or
- The aircraft speed is greater than VLE + 4 kt, with L/G not unlocked or L/G doors not closed, or
- The aircraft speed is greater than VFE + 4 kt, with slats and/or flaps extended.

Flight Phase Inhibition:

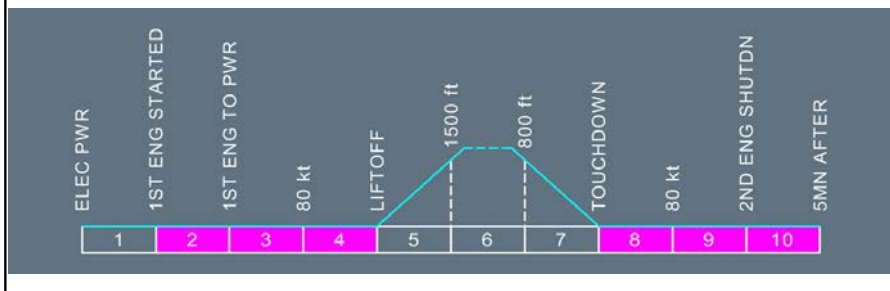

Ident.: PRO-ABN-OVERSPEED-AX-00016848.0001001 / 21 MAR 16

VMO/MMO..... 350/.82

L2 (235/0.60 in case of dispatch with landing gear down).

L1 VLE..... 280/.67

VFE.....SEE BELOW

| CONF | VFE |
|------|-----|
| FULL | 177 |
| 3 | 185 |
| 2 | 200 |
| 1+F | 215 |
| 1 | 230 |

PROCEDURES
ABNORMAL AND EMERGENCY PROCEDURES

OVERSPEED

Intentionally left blank

RECORDER DFDR FAULT

Applicable to: ALL

Ident.: PRO-ABN-RECORDER-A-00017312.0001001 / 21 MAR 16

ANNUNCIATIONS

Triggering Conditions:

L2 This alert triggers when the DFDR is failed.

Flight Phase Inhibition:

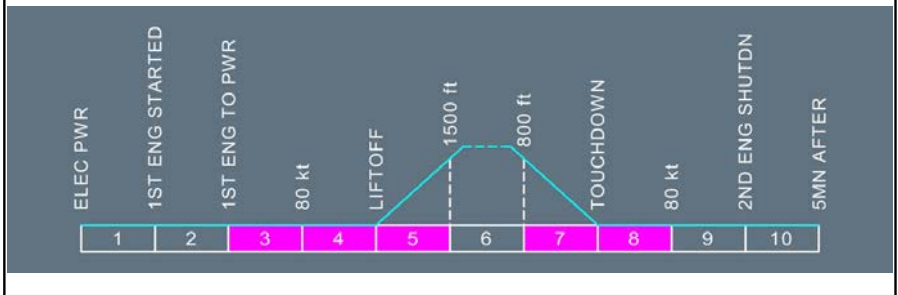

Ident.: PRO-ABN-RECORDER-A-00010046.0001001 / 10 AUG 10

Crew awareness.

Ident.: PRO-ABN-RECORDER-A-00010047.0001001 / 10 AUG 10

STATUS

INOP SYS

DFDR

RECORDER SYS FAULT

Applicable to: ALL

Ident.: PRO-ABN-RECORDER-B-00017313.0002001 / 21 MAR 16

ANNUNCIATIONS

Triggering Conditions:

L2 This alert triggers when the FDIU is failed.

Flight Phase Inhibition:

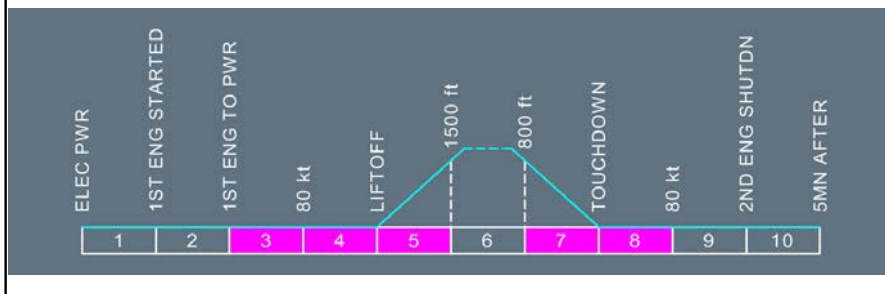

Ident.: PRO-ABN-RECORDER-B-00010048.0002001 / 10 AUG 10

Crew awareness.

Ident.: PRO-ABN-RECORDER-B-00010049.0002001 / 10 AUG 10

STATUS

INOP SYS

RECORDER SYS

[QRH] SMOKE / FUMES / AVNCS SMOKE

Applicable to: ALL

Ident.: PRO-ABN-SMOKE-D-00012212.0004001 / 17 MAR 17

This procedure includes all the steps of the AVIONICS SMOKE ECAM procedure.

Apply this procedure when:

- The flight (cabin) crew suspect that smoke is coming from any of the following:
 - The avionics
 - The air conditioning
 - The cabin equipment
- Requested by the AVIONICS SMOKE ECAM procedure.
- There is a smell of smoke / fumes in the cockpit :
 - If the smell is similar to that of orange peels, suspect a toxic leak of rain repellent fluid.
 - If the smell is similar to that of pine needles, suspect a non-toxic leak.

If any other ECAM SMOKE alert triggers (CARGO, ...), the crew must first apply the ECAM procedure, then consider applying this procedure.

Note that these ECAM alerts may be caused by another source, that should usually first be detected by the flight crew/cabin crew/avionics smoke detectors.

The following explains the layout of this procedure:

- The procedure lines above the text boxes indicate the actions that the flight crew must immediately perform, if smoke is detected (with or without ECAM activation and regardless of the smoke source). These immediate actions correspond to the most common steps to be taken in smoke cases. In all cases, the flight crew must also be prepared to immediately perform a diversion. However, this diversion may be avoided if the smoke source is obvious, accessible and extinguishable or confirmed isolated (after completion of the immediate actions).
- The text boxes indicate the actions that the flight crew must consider, if at any time during the remainder of the procedure but always after the initial steps:
 - Smoke / fumes become the greatest threat and removal of smoke / fumes is required, and/or
 - The situation becomes critical and can no longer be controlled.
- The procedure lines below the text boxes indicate the actions that the flight crew must perform, as soon as they suspect a source of smoke. The actions will depend on whether the smoke is coming from the avionics, and/or air conditioning, and/or cabin equipment.

LAND ASAP

IF PERCEPTIBLE SMOKE APPLY IMMEDIATELY:

Continued on the following page

[QRH] SMOKE / FUMES / AVNCS SMOKE (Cont'd)

If smoke is confirmed, the following procedure must be applied.

OXY MASK / GOGGLE (if required).....USE/100%/EMERG

Ensure crew communication is established. Avoid continuous use of the interphone to minimize interference from the oxygen mask breathing noise.

Turn the emergency knob to remove condensation or smoke from the mask.

VENTILATION BLOWER..... OVRD

VENTILATION EXTRACT..... OVRD

Avionics ventilation air is extracted overboard.

CAB FANS.....OFF

To prevent smoke from entering the cockpit and cabin.

GALY & CAB.....OFF

SIGNS.....ON

CKPT / CABIN COM..... ESTABLISH

Communication must be established with the cabin crew in order to follow up on the smoke origin and dissipation.

● **If smoke source immediately obvious, accessible, and extinguishable:**

FAULTY EQPT..... ISOLATE

● **If smoke source not immediately isolated:**

DIVERSION..... INITIATE

DESCENT TO FL 100 / MEA -MORA INITIATE

● **At ANY TIME of the procedure, if SMOKE / FUMES becomes the GREATEST THREAT:**

REMOVAL OF SMOKE / FUMES..... CONSIDER

Refer to PRO-ABN-SMOKE [QRH] REMOVAL OF SMOKE / FUMES

ELEC EMER CONFIG..... CONSIDER

Refer to PRO-ABN-SMOKE [QRH] SMOKE / FUMES / AVNCS SMOKE - ELEC EMER CONFIG

● **At ANY TIME of the procedure, if situation becomes UNMANAGEABLE:**

IMMEDIATE LANDING..... CONSIDER

Depending on the situation, the Captain can consider an overweight landing, a tailwind landing, a ditching, a forced landing, etc.

Continued on the following page

[QRH] SMOKE / FUMES / AVNCS SMOKE (Cont'd)

^{L1} Guidelines to determine smoke source:

- If smoke initially comes out of the ventilation outlets, the crew may suspect AIR COND SMOKE. In addition, very shortly thereafter, several SMOKE warnings (cargo, lavatory, avionics) will be triggered. The displayed ECAM procedures must be applied.
- After an ENG or APU failure, smoke may come from the faulty item via the bleed system and be perceived in the cockpit and/or cabin. In such a case, it will be recirculated throughout the aircraft, until it completely disappears from the air conditioning system.
- If only the AVIONICS SMOKE warning is triggered, the crew may suspect avionics smoke.
- If the smoke is detected while an equipment is declared faulty, the crew may suspect that smoke is coming from this equipment.
- Avionics or forward galley smoke may be smelt, or may enter in the cockpit before ECAM warning activation.

Continued on the following page

[QRH] SMOKE / FUMES / AVNCS SMOKE (Cont'd)

Ident.: PRO-ABN-SMOKE-D-00012214.0005001 / 17 MAR 17

● **If Air COND smoke suspected:**

APU BLEED..... OFF
 VENTILATION BLOWER and EXTRACT..... AUTO

Note: When both VENTILATION BLOWER and VENTILATION EXTRACT are in the OVRD position, a single pack may not be able to maintain the cabin pressure.

CARGO FWD ISOL VALVE..... OFF

To prevent a cargo smoke warning from being triggered due to cabin smoke.

PACK 1..... OFF

● **If smoke continues:**

PACK 1..... ON
 PACK 2..... OFF

● **If smoke persists:**

PACK 2..... ON

Restore normal configuration if PACK 2 is not suspected to cause smoke

VENTILATION BLOWER..... OVRD

VENTILATION EXTRACT..... OVRD

REMOVAL OF SMOKE / FUMES..... CONSIDER

Refer to PRO-ABN-SMOKE [QRH] REMOVAL OF SMOKE / FUMES

● **If CABIN EQPT smoke suspected:**

● **If smoke continues:**

EMER EXIT LIGHT..... ON
 COMMERCIAL..... OFF
 SMOKE DISSIPATION..... CHECK
 FAULTY EQPT..... SEARCH / ISOLATE

Once the cabin has been secured, try to find the smoke source and isolate it.

Cabin lights, reading lights, passenger systems, galleys have dedicated control C/B in the cabin or cockpit.

● **If smoke persists or if faulty equipment confirmed isolated:**

COMMERCIAL..... NORM

REMOVAL OF SMOKE / FUMES..... CONSIDER

Refer to PRO-ABN-SMOKE [QRH] REMOVAL OF SMOKE / FUMES

Continued on the following page

PROCEDURES
ABNORMAL AND EMERGENCY PROCEDURES

SMOKE

[QRH] SMOKE / FUMES / AVNCS SMOKE (Cont'd)

Ident.: PRO-ABN-SMOKE-D-00012215.0001001 / 17 MAR 17

- **If smoke source cannot be determined and persists or AVNCS / ELECTRICAL smoke suspected:**
ELEC EMER CONFIG..... CONSIDER
Refer to the end of the procedure to set ELEC EMER CONFIG.

- **If smoke disappears within 5 min:**
NORMAL VENTILATION..... RESTORE

Continued on the following page

[QRH] SMOKE / FUMES / AVNCS SMOKE (Cont'd)

Ident.: PRO-ABN-SMOKE-D-00012565.0019001 / 17 MAR 17

TO SET ELEC EMER CONFIG

EMER ELEC GEN 1 LINE..... OFF

GEN 1 LINE contactor opens. GEN 1 remains running and supplies one fuel pump in each wing tank. AC BUS 1 is supplied by GEN 2 through the bus tie contactor.

EMER ELEC PWR.....MAN ON

RAT is extended and the EMER GEN is connected to the aircraft network. Check emergency generator parameters on the ELEC SD page (displayed automatically).

● **When EMER GEN AVAIL:**

APU GEN..... OFF

GEN 2..... OFF

ELEC EMER CONFIG

Two different procedures can be displayed on the ECAM, depending on whether the AVIONICS SMOKE ECAM caution is triggered or not before the flight crew sets the electrical emergency configuration.

■ **If AVIONICS SMOKE not triggered:**

APPLY ELEC EMER CONFIG PROCEDURE, BUT DO NOT RESET GEN, EVEN IF REQUESTED BY ECAM

● **At 3 min or 2 000 ft AAL before landing:**

Restore all generators only 3 min before landing or at 2 000 ft AAL to recover normal braking, while minimizing possible reactivation of a smoke source.

GEN 2..... ON

EMER ELEC GEN 1 LINE..... ON

● **When aircraft stopped:**

ALL GENs..... OFF

■ **If AVIONICS SMOKE triggered:**

The ECAM displays a specific ELEC EMER CONFIG procedure. The flight crew must apply the following ECAM procedure.

MIN RAT SPEED..... 140 KT

Note: *The electrical configuration is the same as for loss of both generators (except that one fuel pump in each wing tank remains supplied).*

Continued on the following page

[QRH] SMOKE / FUMES / AVNCS SMOKE (Cont'd)

VHF 1 / HF 1 / ATC 1..... USE

Only VHF 1, HF 1 and ATC 1 are supplied in this configuration. Notify the ATC of the nature of the emergency, and state intentions. If there is no contact with the ATC, switch to code A7700, or transmit a distress message on one of the emergency frequencies.

FAC 1..... OFF THEN ON

Rudder trim is recovered, despite the fact that no indication is available.

● **At 3 min or 2 000 ft AAL before landing:**

Restore all generators only 3 min before landing or at 2 000 ft AAL to recover normal braking, while minimizing possible reactivation of a smoke source.

GEN 2..... ON

EMER ELEC GEN 1 LINE..... ON

F/CTL ALTN LAW (PROT LOST)

Flight control normal laws and associated protections are lost. Only the load factor limitation, and the high and low speed stability remain (ALTN law with reduced protection).

MAX SPEED..... 320 KT

Continued on the following page

[QRH] SMOKE / FUMES / AVNCS SMOKE (Cont'd)

Ident.: PRO-ABN-SMOKE-D-00012217.0057001 / 31 AUG 17

ECAM lower display is not available. STATUS SD page is displayed on the upper ECAM display, as long as the STATUS pb is pressed.

L12

STATUS

INOP SYS

*Refer to PRO-ABN-ELEC-[QRH]
 ELEC EMER CONFIG SYS
 REMAINING.*

MIN RAT SPEED..... 140 KT
 MAX SPEED..... 320 KT
 MAX BRK PR..... 1000 PSI

FOR LDG..... USE FLAPS 3
 GPWS LDG FLAP 3..... ON
 APPR SPD..... VREF +10 KT
 LDG DIST PROC..... APPLY

ENG 1+2 APPR IDLE ONLY
 ENG 1+2 N1 DEGRADED MODE
 (IAE-powered aircraft)
 ALTN LAW: PROT LOST
 WHEN L/G DN: DIRECT LAW
 CTR TK FUEL UNUSABLE
 FUEL CONSUMPT INCRSD

This message is triggered when the failure (or combination of failures) affects the nominal aerodynamic characteristics of the aircraft.

FMS PRED UNRELIABLE

Disregard FMS fuel predictions and refer to QRH/OPS-Operational Data - Fuel Penalty Factors Tables in order to find the applicable Fuel Penalty Factor.

SLATS/FLAPS SLOW

- **After recovery of normal electrical supply, the following STATUS will be displayed:**

MAX SPEED..... 320 KT
 APPR SPD..... VREF +10 KT
 LDG DIST PROC..... APPLY

Continued on the following page

[QRH] SMOKE / FUMES / AVNCS SMOKE (Cont'd)

APPR PROC

- **3 MN/2000 FT BEFORE LDG:**
 GEN 2..... ON
 EMER ELEC GEN 1 LINE..... ON
- **WHEN A/C IS STOPPED:**
 ALL GEN..... OFF

ALTN LAW: PROT LOST

See ⁽¹⁾

WHEN L/G DN: DIRECT LAW

See ⁽²⁾

⁽¹⁾ Flight controls remain in alternate law, due to the loss of IR 2 and 3.

⁽²⁾ At landing gear extension, control reverts to direct law in pitch, as well as in roll (Refer to PRO-ABN-F_CTL F/CTL DIRECT LAW).

[QRH] REMOVAL OF SMOKE / FUMES

Ident.: PRO-ABN-SMOKE-00012218.0003001 / 17 MAR 17

Applicable to: ALL

Apply the REMOVAL OF SMOKE / FUMES QRH procedure, if smoke / fumes become the greatest threat when applying the SMOKE / FUMES / AVNCS SMOKE QRH procedure.

EMER EXIT LIGHT..... ON

■ **If fuel vapors:**

CAB FANS..... ON

The recirculating air ventilates the air mixer bay and other fuselage area. This prevents fuel vapors from accumulating and the risk of explosion. Passenger health is not affected.

PACK 1..... OFF

PACK 2..... OFF

■ **If no fuel vapors:**

CAB FANS..... OFF

To prevent smoke from entering the cockpit and cabin.

PACK FLOW..... HI

To provide maximum airflow from the packs.

Do not shut down the air conditioning packs, and do not reduce ventilation in an attempt to smother the fire.

Do not deploy oxygen masks, if fire is suspected in the cabin.

LDG ELEV..... 10 000 ft / MEA-MORA

DESCENT TO FL 100 / MEA -MORA INITIATE

The most effective means of smoke removal is use of ram air. Therefore, descent is initiated to FL 100 or the MEA -MORA , while the cabin altitude is increased to 10 000 ft or the MEA -MORA.

The increase in cabin altitude also reduces, at least temporarily, the smoke concentration. Cabin depressurization starts, when descent is initiated.

ATC..... NOTIFY

SMOKE / FUMES / AVNCS SMOKE PROC..... CONTINUE

Refer to PRO-ABN-SMOKE [QRH] SMOKE / FUMES / AVNCS SMOKE - GENERAL

● **At FL 100 or MEA-MORA:**

● **If in ELEC EMER CONFIG:**

APU MASTER sw ON

Continued on the following page

[QRH] REMOVAL OF SMOKE / FUMES (Cont'd)

In electrical emergency configuration, when the APU MASTER sw is ON, the battery contactors will automatically close for a maximum of 3 min. This will enable the flight crew to manually control the outflow valve that is powered by the DC BAT BUS.

- PACK 1..... OFF
- PACK 2..... OFF
- MODE SEL.....MAN
- MAN V/S CTL..... FULL UP
- RAM AIR..... ON

At FL 100, or MEA -MORA, it is possible to open the RAM AIR valve when ΔP is 1 PSI or below. Opening the RAM AIR enables flying with both packs OFF.

- APU MASTER swOFF

● **If smoke persists:**

If there is smoke in the cockpit, open the cockpit (CKPT) window to evacuate the smoke.

- MAX SPEED: 200 kt
- COCKPIT DOOR..... OPEN
- HEADSETS..... ON
- PM SLIDING WINDOW..... OPEN

● **When window open:**

- NON-AFFECTED PACK(s)..... ON
- VISUAL WARNINGS (noisy CKPT)..... MONITOR

Due to the increased noise level, pay particular attention to visual warnings.

- SMOKE / FUMES / AVNCS SMOKE PROC..... CONTINUE

Refer to PRO-ABN-SMOKE [QRH] SMOKE / FUMES / AVNCS SMOKE - GENERAL

[QRH] SMOKE / FIRE FROM LITHIUM BATTERY

Ident.: PRO-ABN-SMOKE-00016024.0001001 / 17 MAR 17

Applicable to: ALL

If necessary, transfer control to the flight crew member seated on the opposite side of the fire.

CKPT / CAB COM..... ESTABLISH
STORAGE AFTER Li BAT FIRE cabin procedure..... REQUEST INITIATION

● **If flames:**

CREW OXY MASK (PF)..... USE
SMOKE HOOD (PM)..... USE
HALON EXTINGUISHER..... USE

● **If no flames or when flames extinguished:**

■ **If not possible to remove device from the cockpit:**

WATER or NON-ALCOHOLIC LIQUID..... POUR ON DEVICE
DEVICE..... MONITOR

■ **If possible to remove device from the cockpit:**

DEVICE..... TRANSFER TO CABIN

● **At ANY TIME of the procedure, if SMOKE becomes the GREATEST THREAT:**

REMOVAL OF SMOKE / FUMES procedure..... CONSIDER
Refer to PRO-ABN-SMOKE [QRH] REMOVAL OF SMOKE / FUMES

● **At ANY TIME of the procedure, if situation becomes UNMANAGEABLE:**

IMMEDIATE LANDING..... CONSIDER
Depending on the situation, the Captain can consider an overweight landing, a tailwind landing, a ditching, a forced landing, etc.

L2

SMOKE AFT CARGO SMOKE 

Applicable to: ALL

Ident.: PRO-ABN-SMOKE-O-00018698.0001001 / 21 MAR 16

ANNUNCIATIONS

Triggering Conditions:

L2

This alert triggers when smoke in the AFT cargo compartment is detected.

Flight Phase Inhibition:

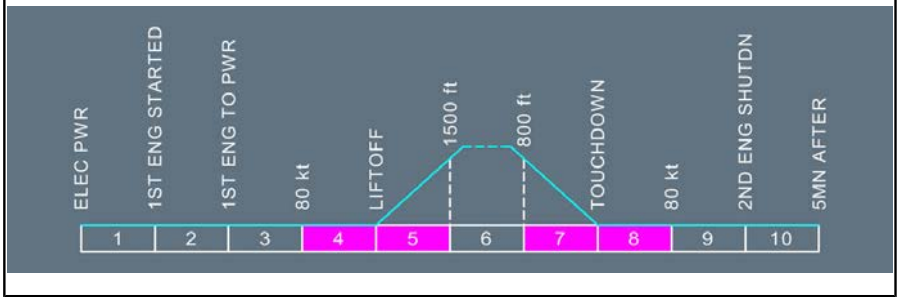

Continued on the following page

SMOKE AFT CARGO SMOKE  (Cont'd)

Ident.: PRO-ABN-SMOKE-O-00018589.0007001 / 21 MAR 16

LAND ASAP

AFT ISOL VALVE  (IF NOT AUTOMATICALLY CLOSED).....OFF
 CAB FANS.....OFF

● **IF AFT CRG CLOSED (displayed on ground only):**



 Order the ground crew not to open the door of the affected cargo compartment, unless the passengers have disembarked and fire services are present. Also ensure that the AFT cargo door is closed before discharging the extinguishing agent.

 **AGENT**.....DISCH

 Note: Expect the **SMOKE** warning to remain after agent discharge, even if the smoke source is extinguished. Gases from the smoke source are not evacuated, and smoke detectors are also sensitive to the extinguishing agent.

 ● **ON GROUND BEFORE OPEN CRG DOOR:**

PAX.....DISEMBARK

 Note: For aircraft equipped with AFT Cargo Ventilation , if the warning has been displayed temporarily, and agent has not been discharged, normal cargo ventilation may be recovered when ventilation is required for livestock transportation:
 C/B of CARGO VENT controller (S20 on 122VU, or C7 on 49VU, as installed for AFT CARGO) PULL then PUSH

Ident.: PRO-ABN-SMOKE-O-00018590.0002001 / 21 MAR 16

STATUS

● **BEFORE OPEN CRG DOORS (displayed on ground only):**

PAX.....DISEMBARK

INOP SYS

AFT CRG VENT 
 AFT CRG HEAT 

SMOKE AFT CRG DET FAULT 

Applicable to: ALL

Ident.: PRO-ABN-SMOKE-P-00018699.0001001 / 21 MAR 16

ANNUNCIATIONS

Triggering Conditions:

L2

This alert triggers when the AFT smoke detection is failed.

Flight Phase Inhibition:

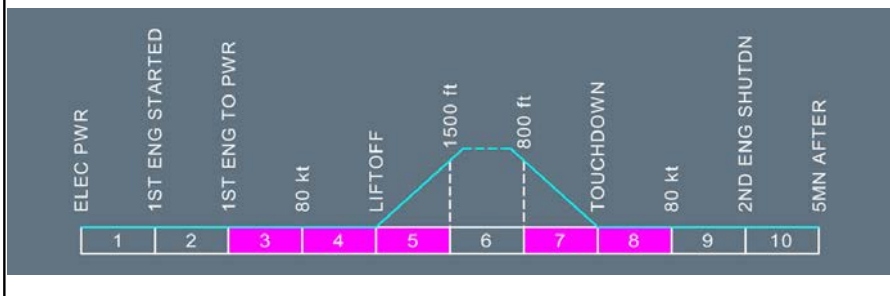

Ident.: PRO-ABN-SMOKE-P-00018592.0001001 / 21 MAR 16

● **IF NO LIVE STOCK:**

AFT ISOL VALVE  **OFF**

Ident.: PRO-ABN-SMOKE-P-00018593.0001001 / 21 MAR 16

STATUS

INOP SYS

AFT CRG DET 

SMOKE FWD CARGO SMOKE ⚠

Applicable to: ALL

Ident.: PRO-ABN-SMOKE-E-00017408.0001001 / 21 MAR 16

ANNUNCIATIONS

Triggering Conditions:

L2 This alert triggers when smoke in the FWD cargo compartment is detected.

Flight Phase Inhibition:

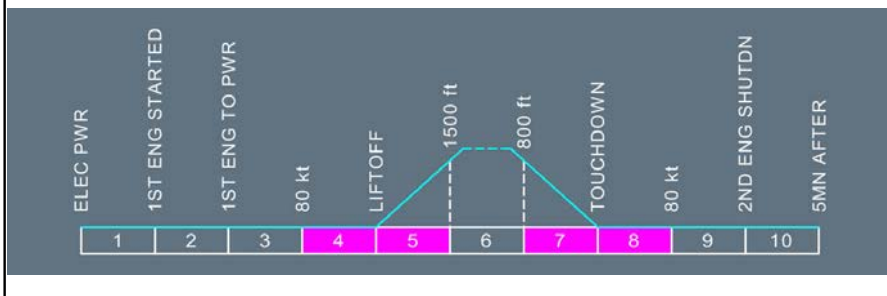

Continued on the following page

SMOKE FWD CARGO SMOKE  (Cont'd)

Ident.: PRO-ABN-SMOKE-E-00018287.0005001 / 21 MAR 16

LAND ASAP

FWD ISOL VALVE  (IF NOT AUTOMATICALLY CLOSED)..... OFF
CAB FANS.....OFF

● **IF FWD CRG CLOSED (displayed on ground only):**

L2

Order the ground crew not to open the door of the affected cargo compartment, unless the passengers have disembarked and fire services are present. Also ensure that the FWD Cargo Door is closed before discharging the extinguishing agent.

L1

AGENT..... DISCH

L2

Note: Expect the SMOKE warning to remain after agent discharge, even if the smoke source is extinguished. Gases from the smoke source are not evacuated, and smoke detectors are also sensitive to the extinguishing agent.

L1

● **ON GROUND BEFORE OPEN CRG DOOR:**

PAX..... DISEMBARK

L2

Note: For aircraft equipped with FWD Cargo Ventilation , if the warning has been displayed temporarily, and agent has not been discharged, normal cargo ventilation may be recovered when ventilation is required for livestock transportation:
C/B of CARGO VENT controller (T20 on 122VU, or C8 on 49VU, as installed for FWD CARGO) PULL then PUSH

Ident.: PRO-ABN-SMOKE-E-00018588.0002001 / 21 MAR 16

STATUS

● **BEFORE OPEN CRG DOOR (displayed on ground only):**

PAX.....DISEMBARK

INOP SYS

FWD CRG VENT 
FWD CRG HEAT 

SMOKE FWD(AFT) CRG BTL 1(2) FAULT ⚠

Applicable to: ALL

Ident.: PRO-ABN-SMOKE-L-00017414.0001001 / 21 MAR 16

ANNUNCIATIONS

Triggering Conditions:

L2 This alert triggers when:

- FWD or AFT bottle 1 (2) ⚠ squib is failed, or
- FWD or AFT bottle 1 (2) ⚠ is at low pressure.

Flight Phase Inhibition:

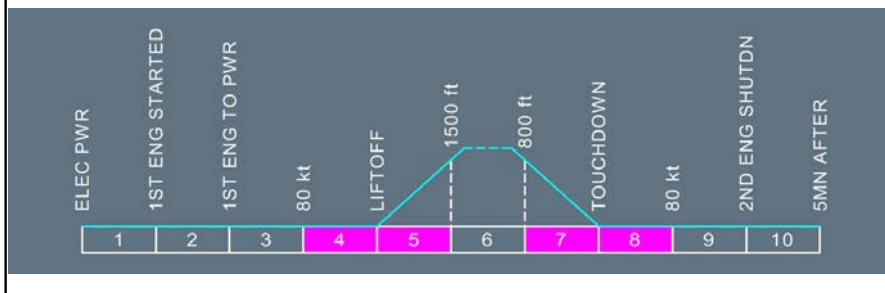

Ident.: PRO-ABN-SMOKE-L-00018325.0001001 / 21 MAR 16

- L2** If bottle 1 is lost, fire extinguishing capability is lost in the FWD(AFT) cargo compartment.
If bottle 2 is lost, agent concentration will not be ensured after fire extinguishing.

L1 Crew awareness.

SMOKE FWD CRG DET FAULT ⚠

Applicable to: ALL

Ident.: PRO-ABN-SMOKE-F-00017689.0001001 / 21 MAR 16

ANNUNCIATIONS

Triggering Conditions:

L2

This alert triggers when the FWD smoke detection is failed.

Flight Phase Inhibition:

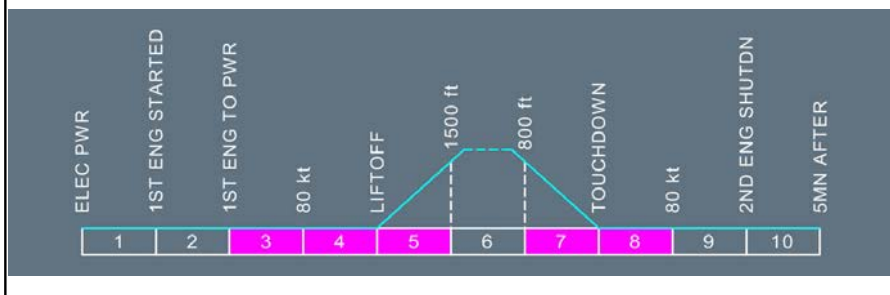

Ident.: PRO-ABN-SMOKE-F-00018336.0001001 / 21 MAR 16

● **IF NO LIVE STOCK:**

FWD ISOL VALVE ⚠OFF

Ident.: PRO-ABN-SMOKE-F-00018337.0001001 / 21 MAR 16

STATUS

INOP SYS

FWD CRG DET ⚠

SMOKE DET FAULT

Applicable to: ALL

Ident.: PRO-ABN-SMOKE-G-00017400.0002001 / 21 MAR 16

ANNUNCIATIONS

Triggering Conditions:

L2 This alert triggers when both SDCU or CIDS-SDF  are failed.

Flight Phase Inhibition:

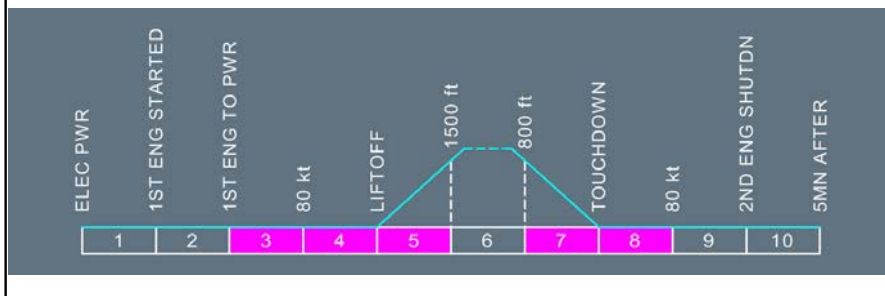

Ident.: PRO-ABN-SMOKE-G-00018423.0002001 / 21 MAR 16

● **IF NO LIVE STOCK:**

FWD ISOL VALVE  OFF

AFT ISOL VALVE  OFF

PAX SYS  OFF

Ident.: PRO-ABN-SMOKE-G-00012226.0011001 / 01 APR 11

STATUS

INOP SYS

SMOKE DET

SMOKE LAVATORY DET FAULT

Applicable to: ALL

Ident.: PRO-ABN-SMOKE-H-00017407.0002001 / 21 MAR 16

ANNUNCIATIONS

Triggering Conditions:

L2

This alert triggers when the lavatory smoke detection is failed.

Flight Phase Inhibition:

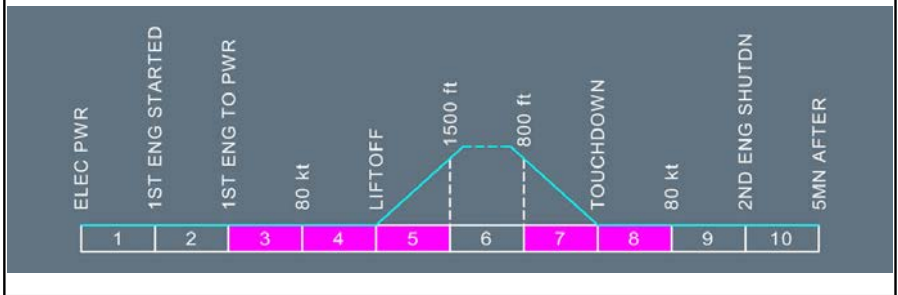

Ident.: PRO-ABN-SMOKE-H-00018724.0001001 / 21 MAR 16

Crew awareness.

Ident.: PRO-ABN-SMOKE-H-00012228.0001001 / 18 AUG 10

STATUS

INOP SYS

LAV DET

SMOKE LAVATORY SMOKE

Applicable to: ALL

Ident.: PRO-ABN-SMOKE-N-00017406.0001001 / 21 MAR 16

ANNUNCIATIONS

Triggering Conditions:

L2 This alert triggers when smoke in one of the lavatory is detected.

Flight Phase Inhibition:

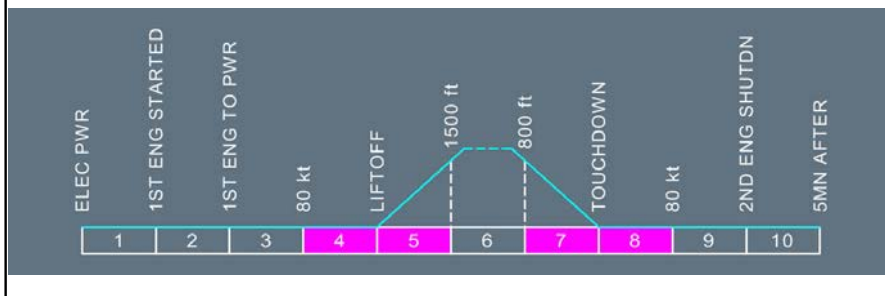

Ident.: PRO-ABN-SMOKE-N-00018427.0002001 / 21 MAR 17

L2 Communication must be established with the cabin crew in order to follow up on the smoke origin and dissipation.
Consider applying the SMOKE/FUMES/AVNCS SMOKE QRH procedure.

L1 CKPT/CAB COM.....ESTABLISH

[MEM] EGPWS CAUTIONS

Ident.: PRO-ABN-SURV-00018751.0009001 / 17 MAR 17

Applicable to: ALL

■ **"TERRAIN TERRAIN" - "TOO LOW TERRAIN" - "CAUTION TERRAIN" - "CAUTION OBSTACLE"**

■ **During night or IMC:**

Simultaneously:

| | |
|------------|---------|
| AP..... | OFF |
| PITCH..... | PULL UP |

L2

Pull to full backstick and maintain in that position.

L1

| | |
|-------------------------|-----------------------|
| THRUST LEVERS..... | TOGA |
| SPEED BRAKES lever..... | CHECK RETRACTED |
| BANK..... | WINGS LEVEL or ADJUST |

L2

Aircraft achieve the best climb performance when the wings are as level as possible.

L1

Note: For some airports, the operator may define a specific procedure.

■ **During daylight and VMC, with terrain and obstacles clearly in sight:**

| | |
|------------------|--------|
| FLIGHT PATH..... | ADJUST |
|------------------|--------|

L2

Adjust pitch, bank and thrust to silence the alert.

L1

Note: For some airports, the operator may define a specific procedure.

■ **"SINK RATE"**

■ **Above 1 000 ft AAL in IMC or above 500 ft AAL in VMC:**

| | |
|------------------|--------|
| FLIGHT PATH..... | ADJUST |
|------------------|--------|

L2

Adjust pitch and thrust to silence the alert.

L1

■ **Below 1 000 ft AAL in IMC or below 500 ft AAL in VMC:**

| | |
|----------------|----------|
| GO-AROUND..... | CONSIDER |
|----------------|----------|

■ **"DON'T SINK"**

| | |
|------------------|--------|
| FLIGHT PATH..... | ADJUST |
|------------------|--------|

L2

Adjust pitch and thrust to silence the alert.

Continued on the following page

[MEM] EGPWS CAUTIONS (Cont'd)

- L1 ■ **"TOO LOW GEAR" - "TOO LOW FLAPS"**

| | |
|----------------|---------|
| GO-AROUND..... | PERFORM |
|----------------|---------|
- **"GLIDESLOPE"**
 - **Above 1 000 ft AAL in IMC or above 500 ft AAL in VMC:**

| | |
|------------------|--------|
| FLIGHT PATH..... | ADJUST |
|------------------|--------|
- L2 Adjust pitch and thrust to reduce the vertical deviation from the glideslope.
- L1 ● **When conditions require a deliberate approach below glideslope:**

| | |
|---------------|-----|
| G/S MODE..... | OFF |
|---------------|-----|
- **Below 1 000 ft AAL in IMC or below 500 ft AAL in VMC:**

| | |
|----------------|----------|
| GO-AROUND..... | CONSIDER |
|----------------|----------|

[MEM] EGPWS WARNINGS

Ident.: PRO-ABN-SURV-00016878.0020001 / 17 MAR 17

Applicable to: ALL

- **"PULL UP" - "TERRAIN TERRAIN PULL UP" - "OBSTACLE OBSTACLE PULL UP"**
 Simultaneously:

| | |
|------------|---------|
| AP..... | OFF |
| PITCH..... | PULL UP |
- L2 Pull to full backstick and maintain in that position.
- L1

| | |
|-------------------------|-----------------------|
| THRUST LEVERS..... | TOGA |
| SPEED BRAKES lever..... | CHECK RETRACTED |
| BANK..... | WINGS LEVEL or ADJUST |
- L2 Aircraft achieve the best climb performance when the wings are as level as possible.
 If the "TERRAIN TERRAIN PULL UP" or "OBSTACLE OBSTACLE PULL UP" aural alert triggers, a turning maneuver can be initiated if the flight crew concludes that turning is the safest action. The PULL UP maneuver must be performed before the turn towards the safe direction, as climbing increases the terrain clearance.

[MEM] TCAS WARNINGS

Ident.: PRO-ABN-SURV-00012455.0022001 / 17 MAR 17

Applicable to: ALL

■ **Traffic advisory: “TRAFFIC” messages:**

Do not perform a maneuver based on a TA alone.

■ **Resolution advisory: All “CLIMB” and “DESCEND” or “MAINTAIN VERTICAL SPEED MAINTAIN” or “LEVEL OFF, LEVEL OFF” or “MONITOR VERTICAL SPEED” type messages:**

AP (if engaged).....OFF
 BOTH FDs..... OFF

Respond promptly and smoothly to a RA by adjusting or maintaining the pitch, as required, to reach the green area and/or avoid the red area of the vertical speed scale.

Note: Avoid excessive maneuvers while aiming to keep the vertical speed just outside the red area of the VSI, and within the green area. If necessary, use the full speed range between $V_{\alpha max}$ and V_{MAX} .

Respect stall, GPWS, or windshear warning.

Notify ATC.

● **GO AROUND procedure must be performed when a RA “CLIMB” or “INCREASE CLIMB” is triggered on final approach:**

Note: Resolution Advisories (RA) are inhibited below 900 ft.

■ **When “CLEAR OF CONFLICT” is announced:**

Resume normal navigation in accordance with ATC clearance.

AP/FD can be reengaged as desired.

[MEM] WINDSHEAR

Ident.: PRO-ABN-SURV-00012271.0002001 / 17 MAR 17

Applicable to: ALL

A red flag “WINDSHEAR” is displayed on each PFD associated with an aural synthetic voice “WINDSHEAR” repeated three times.
If windshear is detected either by the system or by pilot observation, apply the following recovery technique:

■ **At Takeoff:**

■ **If before V1:**

The takeoff should be rejected only if significant airspeed variations occur below indicated V1 and the pilot decides that there is sufficient runway remaining to stop the airplane.

■ **If after V1:**

THR LEVERS.....TOGA
REACHING VR.....ROTATE
SRS ORDERS..... FOLLOW

If necessary the flight crew may pull the sidestick fully back.

*Note: If the FD bars are not displayed, move toward an initial pitch attitude of 17.5 °.
Then, if necessary, to prevent a loss in altitude, increase the pitch attitude.*

■ **Airborne, initial climb or landing:**

THR LEVERS AT TOGA..... SET OR CONFIRM
AP (if engaged)..... KEEP ON
SRS ORDERS..... FOLLOW

If necessary the flight crew may pull the sidestick fully back.

*Note: 1. Autopilot disengages if the angle of attack value goes above α prot.
2. If the FD bars are not displayed, move toward an initial pitch attitude of 17.5 °.
Then, if necessary, to prevent a loss in altitude, increase the pitch attitude.*

DO NOT CHANGE CONFIGURATION (SLATS/FLAPS, GEAR) UNTIL OUT OF WINDSHEAR.

CLOSELY MONITOR FLIGHT PATH AND SPEED.

RECOVER SMOOTHLY TO NORMAL CLIMB OUT OF WINDSHEAR.

[MEM] WINDSHEAR AHEAD

Ident.: PRO-ABN-SURV-00012272.0001001 / 17 MAR 17

Applicable to: ALL

The “W/S AHEAD” message is displayed on each PFD. The color of the message depends on the severity and location of the windshear

Note: *When a predictive windshear alert (“WINDSHEAR AHEAD” or “GO AROUND WINDSHEAR AHEAD”) is triggered, if the flight crew makes a positive verification that no hazard exists, then the alert may be disregarded, as long as:*

- *There are no other signs of possible windshear conditions, and*
- *The reactive windshear system is operational.*

Known cases of spurious predictive windshear alerts have been reported at some airports, during either takeoff or landing, due to the specific obstacle environment. However, always rely on any reactive windshear (“WINDSHEAR”).

W/S AHEAD RED

■ **Takeoff**

Associated with an aural synthetic voice “WINDSHEAR AHEAD, WINDSHEAR AHEAD”.

● **Before takeoff:**

Delay takeoff, or select the most favorable runway.

● **During the takeoff run:**

Reject takeoff.

Note: *Predictive windshear alerts are inhibited above 100 kt until 50 ft.*

● **When airborne:**

THR LEVERS.....TOGA

As usual, the slat/flap configuration can be changed, provided the windshear is not entered.

AP (if engaged).....KEEP ON
 SRS ORDERS..... FOLLOW

If necessary the flight crew may pull the sidestick fully back.

Note: *1. Autopilot disengages if the angle of attack value goes above α prot.
 2. If the FD bars are not displayed, move toward an initial pitch attitude of 17.5 °. Then, if necessary, to prevent a loss in altitude, increase the pitch attitude.*

Continued on the following page

[MEM] WINDSHEAR AHEAD (Cont'd)

■ **Landing:**

Associated with an aural synthetic voice "GO AROUND, WINDSHEAR AHEAD".

| | |
|----------------------|---------|
| GO-AROUND..... | PERFORM |
| AP (if engaged)..... | KEEP ON |

If necessary the flight crew may pull the sidestick fully back.

- Note:
1. Autopilot disengages if the angle of attack value goes above α prot.
 2. If the FD bars are not displayed, move toward an initial pitch attitude of 17.5 °.
 Then, if necessary, to prevent a loss in altitude, increase the pitch attitude.

W/S AHEAD AMBER

Apply precautionary measures, as indicated in FCTM Windshear Operational Recommendations
 Refer to FCTM/PR-NP-SP-10-10-3 Operational Recommendations.

VENT AVNCS SYS FAULT

Applicable to: ALL

Ident.: PRO-ABN-VENT-AA-00017332.0001001 / 21 MAR 16

ANNUNCIATIONS

Triggering Conditions:

L2

This alert triggers when:

- The power up test is not satisfactory, or
- The AEVC is not supplied, or
- The valve position disagrees with the commanded position.

Flight Phase Inhibition:

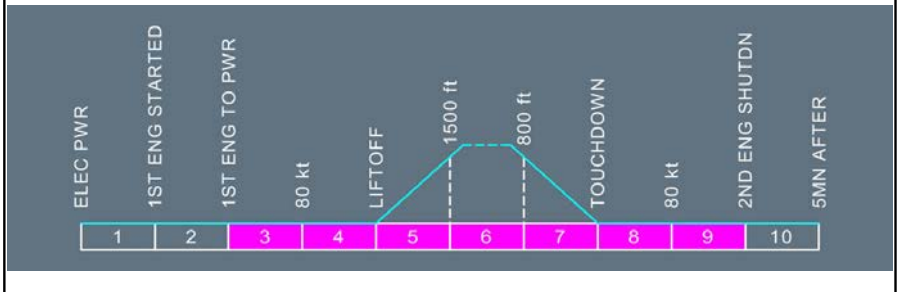

Ident.: PRO-ABN-VENT-AA-00018047.0001001 / 21 MAR 16

Crew awareness.

Ident.: PRO-ABN-VENT-AA-00010775.0001001 / 05 AUG 10

STATUS

INOP SYS

- AVNCS VENT
- VENT BLOWER ⁽¹⁾
- VENT EXTRACT ⁽¹⁾

⁽¹⁾ (If AEVC not supplied)

VENT BLOWER FAULT

Applicable to: ALL

Ident.: PRO-ABN-VENT-X-00017329.0001001 / 21 MAR 16

ANNUNCIATIONS

Triggering Conditions:

L2 The alert triggers when the blowing pressure is low or there is a duct overheat.

Flight Phase Inhibition:

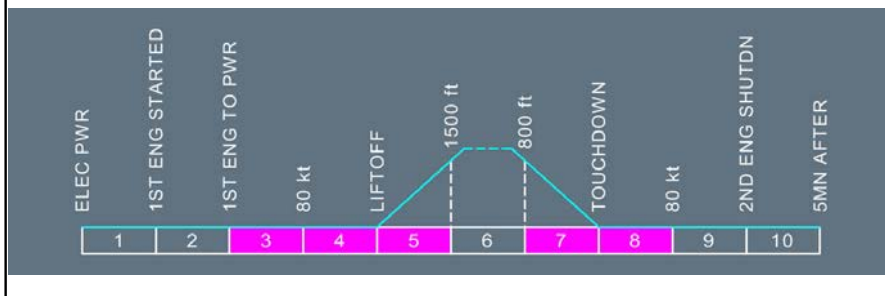

Ident.: PRO-ABN-VENT-X-00010768.0005001 / 12 APR 16

■ **If NO DC ESS BUS FAULT:**

BLOWER.....OVRD

L2 The ventilation system is in closed circuit configuration and air from air conditioning is added to the ventilation air.

L1 ■ **If DC ESS BUS FAULT:**

LAND ASAP

Ident.: PRO-ABN-VENT-X-00010769.0005001 / 27 MAY 13

STATUS

INOP SYS

VENT BLOWER

VENT EXTRACT FAULT

Applicable to: ALL

Ident.: PRO-ABN-VENT-Y-00017330.0001001 / 21 MAR 16

ANNUNCIATIONS

Triggering Conditions:

L2 This alert triggers when the extract pressure is low.

Flight Phase Inhibition:

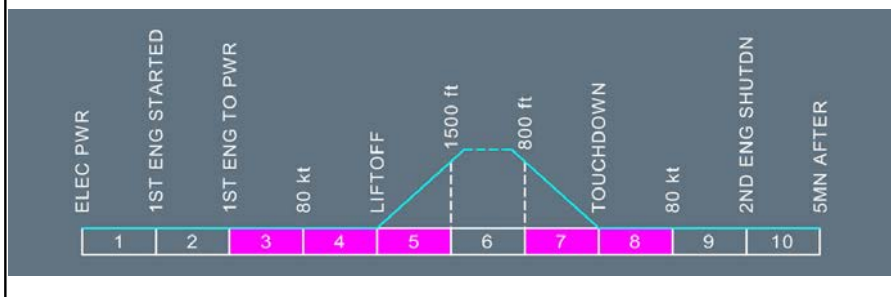

Ident.: PRO-ABN-VENT-Y-00010770.0001001 / 05 AUG 10

EXTRACT.....**OVRD**

L2 The ventilation system is in closed circuit configuration and air from air conditioning is added to the ventilation air.

Ident.: PRO-ABN-VENT-Y-00010771.0001001 / 05 AUG 10

STATUS

INOP SYS

VENT EXTRACT

VENT SKIN VALVE FAULT

Applicable to: ALL

Ident.: PRO-ABN-VENT-Z-00017331.0001001 / 21 MAR 16

ANNUNCIATIONS

Triggering Conditions:

L2

This alert triggers when:

- The extract valve is fully open in phase 3, or
- The extract valve is fully open in flight, or
- The inlet valve is not fully closed in flight.

Flight Phase Inhibition:

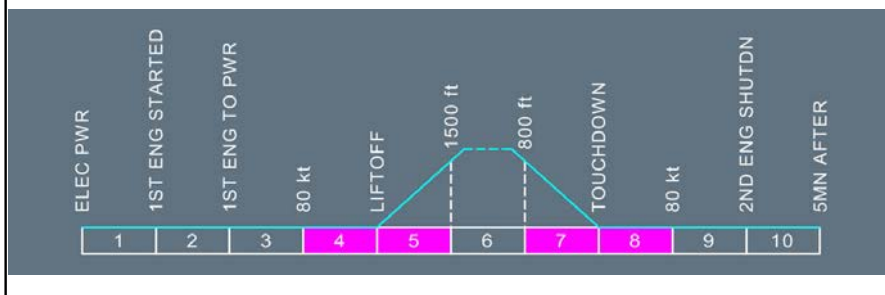

Continued on the following page

VENT SKIN VALVE FAULT (Cont'd)

Ident.: PRO-ABN-VENT-Z-00018941.0001001 / 21 MAR 16

● **If INLET valve not fully closed in flight:**

Crew awareness.

L2 No action is required, since there is a non return valve in the air inlet.

L1 ● **If EXTRACT valve affected:**

BLOWER.....OVRD
EXTRACT.....OVRD

L2 *These actions send additional closure signals to the inlet and extract valves.
The weather radar image on both NDs may be lost, in case of insufficient ventilation.*

L1 ● **IF UNSUCCESSFUL:**

MAX FL.....100/MEA
CAB PR MODE SEL.....MAN
MAN V/S CTL.....FULL UP

L2 *The aircraft is manually depressurized.
It may take 10 s in manual mode before the crew notices a change of the outflow valve position.*

Ident.: PRO-ABN-VENT-Z-00018942.0002001 / 21 MAR 16

STATUS

MAX FL: 100/MEA

MAN CAB PR CTL

TGT V/S: CLIMB 500 FT/MIN

TGT V/S: DESC 300 FT/MIN

INOP SYS

AVNCS VALVE

A/C FL

390
350
300
250
< 200

CAB ALT TGT

8 000
7 000
5 500
3 000
0

PROCEDURES
ABNORMAL AND EMERGENCY PROCEDURES

VENT

Intentionally left blank

[QRH] WHEEL TIRE DAMAGE SUSPECTED

Ident.: PRO-ABN-WHEEL-00019841.0001001 / 22 MAR 17

Applicable to: ALL

LDG DIST PROC.....APPLY

Performance impact of one burst tire is equivalent to one brake released.

TAXI WITH CARE

Refer to LIM-LG Taxi with Deflated or Damaged Tires

WHEEL HYD SEL FAULT

Applicable to: ALL

Ident.: PRO-ABN-WHEEL-AE-00017810.0001001 / 21 MAR 16

ANNUNCIATIONS

Triggering Conditions:

L2

This alert triggers when the brake normal selector valve is failed, or the NWS selector valve is at open position.

Flight Phase Inhibition:

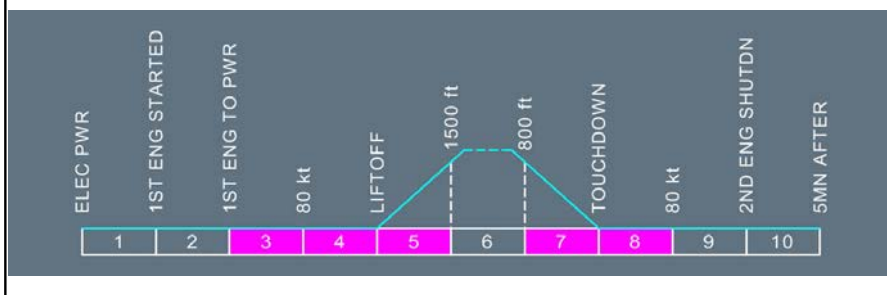

Continued on the following page

WHEEL HYD SEL FAULT (Cont'd)

Ident.: PRO-ABN-WHEEL-AE-00018363.0003001 / 21 MAR 16

- [L2] - If the normal brake selector valve is failed open, full green hydraulic pressure is present at normal servovalves' entry.
Nosewheel steering remains available.
- On ground, do not tow the aircraft with the yellow hydraulic system pressurized: If the steering selector valve is failed open, nosewheel steering remains pressurized, and so towing may either break the towbar shear pin, or the nose gear (if towbarless towing).
- If the steering selector valve is failed open, setting A/SKID & N/W STRG sw to OFF will cause the nosewheel to go to maximum deflection.

[L1] A/SKID & N/W STRG.....KEEP ON

[L2] As long as antiskid is operative, brake pressure is regulated by normal servovalves.

WHEEL N/W STRG FAULT

Applicable to: ALL

Ident.: PRO-ABN-WHEEL-AF-00017744.0001001 / 21 MAR 16

ANNUNCIATIONS

Triggering Conditions:

- [L2] This alert triggers when the nose wheel steering system is failed.

Flight Phase Inhibition:

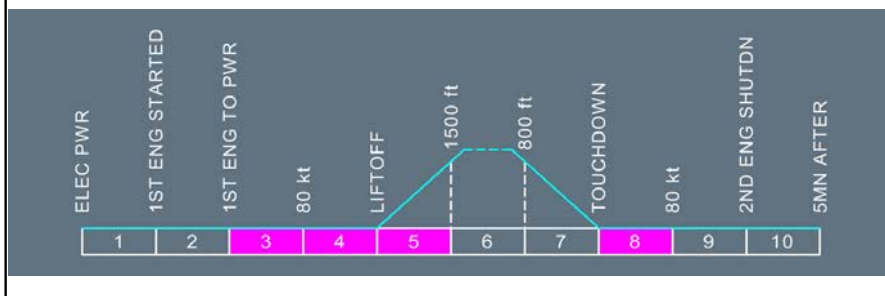

Continued on the following page

WHEEL N/W STRG FAULT (Cont'd)

Ident.: PRO-ABN-WHEEL-AF-00018712.0001001 / 21 MAR 16

Crew awareness.

Ident.: PRO-ABN-WHEEL-AF-00018713.0001001 / 21 MAR 16

L12

STATUS

INOP SYS

CAT 3 SINGLE ONLY

See ⁽¹⁾

CAT 3 DUAL
 N/W STRG

- ⁽¹⁾ **Note:**
1. If the **L/G SHOCK ABSORBER FAULT** is also displayed, then the nose wheels may be at maximum deflection (turned 90 ° from center). During landing, delay nose wheel touchdown as long as possible.
 2. Automatic rollout is not permitted (Refer to QRH/OPS Required Equipment for CAT2 and CAT3).

WHEEL TYRE LO PR ⚠

Applicable to: ALL

Ident.: PRO-ABN-WHEEL-AG-00017824.0003001 / 21 MAR 16

ANNUNCIATIONS

Triggering Conditions:

L2 This alert triggers when one of the following cases occurs:

- One tire pressure is below:
 - 74% of nominal pressure between liftoff and engines shutdown, or
 - 89% of nominal pressure in other cases.
- There is difference of pressure between two wheels of the same axle that is above:
 - 21% of nominal pressure between liftoff and engines shutdown, or
 - 15% of nominal pressure in other cases.

Flight Phase Inhibition:

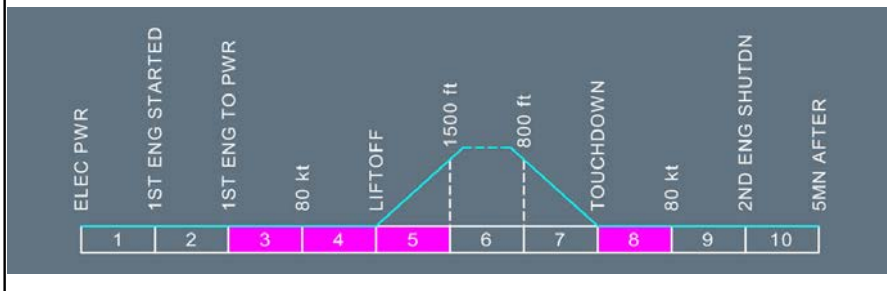

Ident.: PRO-ABN-WHEEL-AG-00018714.0001001 / 21 MAR 16

Crew awareness.

WING A.ICE L(R) HI PR

Applicable to: ALL

Ident.: PRO-ABN-W_A_ICE-Q-00017161.0001001 / 21 MAR 16

ANNUNCIATIONS

Triggering Conditions:

L2

This alert triggers when the WING ANTI ICE pb-sw is set to ON and the pressure sensor (downstream of the valve) indicates a high pressure in the duct.

Flight Phase Inhibition:

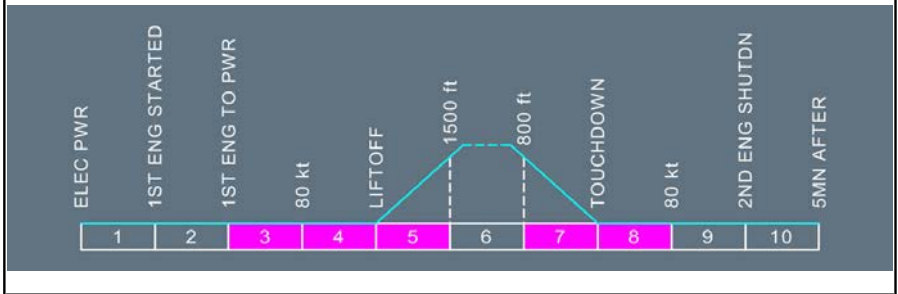

Ident.: PRO-ABN-W_A_ICE-Q-00018328.0001001 / 21 MAR 16

THRUST LIM PENALTY

Ident.: PRO-ABN-W_A_ICE-Q-00018330.0001001 / 21 MAR 16

STATUS

THRUST LIM PENALTY

INOP SYS

WAI REGUL

WING A.ICE L(R) VALVE OPEN
 (FAILURE DETECTED IN FLIGHT)

Applicable to: ALL

Ident.: PRO-ABN-W_A_ICE-N-00017160.0001001 / 21 MAR 16

ANNUNCIATIONS

Triggering Conditions:

- [L2] This alert triggers when the WING ANTI ICE pb-sw is set to OFF and one wing anti ice valve remains open, in flight.

Flight Phase Inhibition:

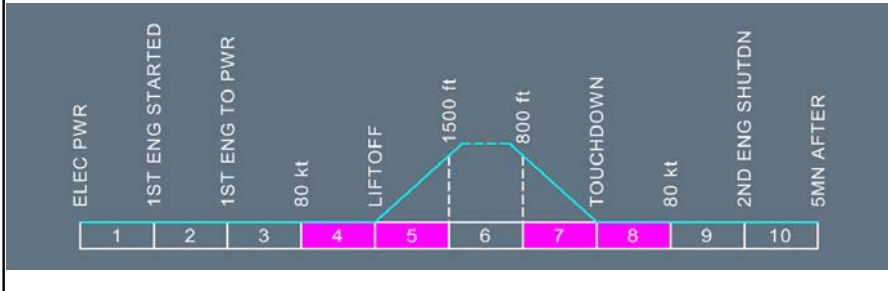

Ident.: PRO-ABN-W_A_ICE-N-00018331.0001001 / 21 MAR 16

WAI AVAIL IN FLT
 WING ANTI ICE.....AS RQRD

- [L2] Wing anti-ice is available if needed and anyway is continually on, on failed side.

[L1] **THRUST LIM PENALTY**

- **After landing (automatic recall):**
 - ENG BLEED (AFFECTED SIDE)..... OFF
 - X BLEED (IF NOT CLOSED)..... SHUT
 - APU BLEED (IF LEFT WING AFFECTED)..... OFF
 - WING ANTI ICE..... OFF

Continued on the following page

WING A.ICE L(R) VALVE OPEN (Cont'd)
 (FAILURE DETECTED IN FLIGHT)

Ident.: PRO-ABN-W_A_ICE-N-00018332.0001001 / 21 MAR 16

| STATUS | |
|---|--|
| <ul style="list-style-type: none"> ● In flight: THRUST LIM PENALTY WAI AVAIL IN FLT | <p style="text-align: center;"><u>INOP SYS</u></p> <p>ENG 1(2) BLEED (On ground only) PACK 1(2) (On ground only)</p> |

WING A.ICE L(R) VALVE OPEN
 (FAILURE DETECTED ON GROUND)

Applicable to: ALL

Ident.: PRO-ABN-W_A_ICE-M-00017495.0001001 / 21 MAR 16

ANNUNCIATIONS

Triggering Conditions:

L2 This alert triggers when the WING ANTI ICE pb-sw is set to OFF and one wing anti ice valve remains open, on ground.

Flight Phase Inhibition:

Continued on the following page

PROCEDURES
ABNORMAL AND EMERGENCY PROCEDURES

WING A.ICE

WING A.ICE L(R) VALVE OPEN (Cont'd)
(FAILURE DETECTED ON GROUND)

Ident.: PRO-ABN-W_A_ICE-M-00018333.0001001 / 21 MAR 16

WING ANTI ICE..... OFF
 ENG BLEED (AFFECTED SIDE)..... OFF
 X BLEED (IF NOT CLOSED)..... SHUT
 APU BLEED (IF LEFT WING AFFECTED AND IF APU RUNNING)..... OFF
 WAI AVAIL IN FLT

■ **After takeoff when above 1 500 ft (automatic recall):**

WAI AVAIL IN FLT
 ENG BLEED (AFFECTED SIDE)..... ON
 WING ANTI ICE..... AS RQRD

L2 *Wing anti ice is available if needed and anyway is continually on, on failed side.*

L1 THRUST LIM PENALTY

■ **After landing (automatic recall):**

WING ANTI ICE..... OFF
 ENG BLEED (AFFECTED SIDE)..... OFF
 X BLEED (IF NOT CLOSED)..... SHUT
 APU BLEED (IF LEFT WING AFFECTED)..... OFF

Ident.: PRO-ABN-W_A_ICE-M-00018334.0001001 / 21 MAR 16

STATUS

INOP SYS

● **Before takeoff:**

WAI AVAIL IN FLT

● **In flight:**

THRUST LIM PENALTY

ENG 1 (2) BLEED (On ground only)

PACK 1 (2) (On ground only)

WING A.ICE OPEN ON GND

Applicable to: ALL

Ident.: PRO-ABN-W_A_ICE-O-00017158.0001001 / 21 MAR 16

ANNUNCIATIONS

Triggering Conditions:

L2

This alert triggers when the aircraft is on ground and the wing anti ice valves remain open for more than 35 s after the WING ANTI ICE pb-sw is set to ON.

Flight Phase Inhibition:

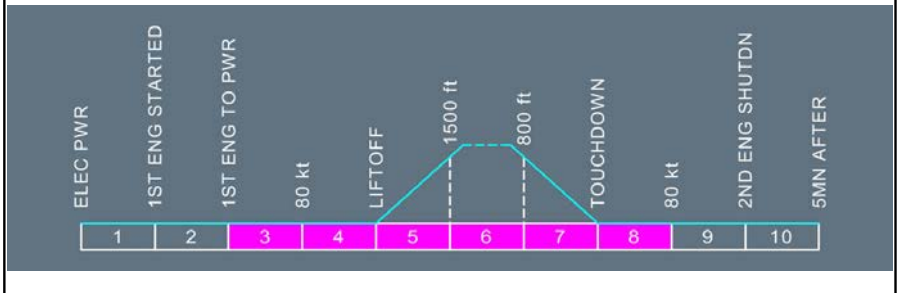

Ident.: PRO-ABN-W_A_ICE-O-00018311.0001001 / 21 MAR 16

WING ANTI ICE..... OFF

Ident.: PRO-ABN-W_A_ICE-O-00018335.0001001 / 21 MAR 17

STATUS

WAI AVAIL IN FLT

WING A.ICE SYS FAULT

(ONE WING VALVE REMAINS CLOSED WHEN THE WING ANTI-ICE IS TURNED ON)

Applicable to: ALL

Ident.: PRO-ABN-W_A_ICE-P-00017159.0001001 / 21 MAR 16

ANNUNCIATIONS

Triggering Conditions:

- L2** This alert triggers when the WING ANTI ICE pb-sw is set to ON and one wing anti ice valve remains closed.

Flight Phase Inhibition:

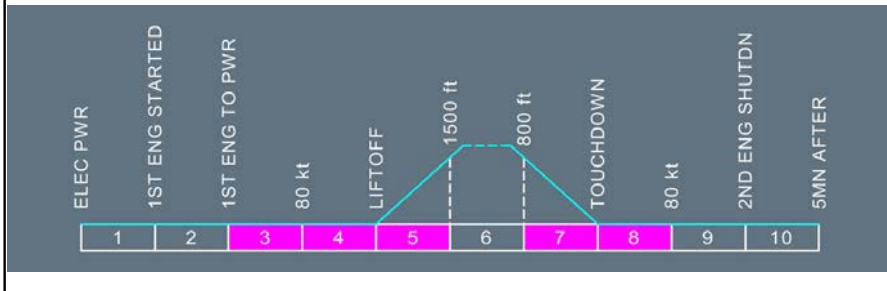

Ident.: PRO-ABN-W_A_ICE-P-00018338.0002001 / 21 MAR 16

WING ANTI ICE..... OFF
 AVOID ICING CONDITIONS

Continued on the following page

WING A.ICE SYS FAULT (Cont'd)
 (ONE WING VALVE REMAINS CLOSED WHEN THE WING ANTI-ICE IS TURNED ON)

Ident.: PRO-ABN-W_A_ICE-P-00018339.0004001 / 17 MAR 17

L12

STATUS

AVOID ICING CONDITIONS

● **IF SEVERE ICE ACCRETION:**

MIN SPD..... VLS +10/G DOT
 MANEUVER WITH CARE

Note: In the case of severe ice accretion, with wing anti-ice failed, the Angle-of-Attack (AOA) protections remain efficient. Manoeuvre with care: avoid large roll inputs at high AOA and high thrust setting. In the case of abnormal response in pitch or roll, release the backstick and reduce thrust.

LDG DIST PROC.....APPLY

INOP SYS

WING ANTI ICE

WING A.ICE SYS FAULT

(THE WING ANTI-ICE IS TURNED ON AFTER ONE ENGINE SHUTDOWN OR AFTER THE LOSS OF ONE BLEED)

Applicable to: ALL

Ident.: PRO-ABN-W_A_ICE-AA-00017496.0001001 / 21 MAR 16

ANNUNCIATIONS

Triggering Conditions:

- ② This alert triggers when the WING ANTI ICE pb-sw is set to ON and one wing anti ice valve remains closed.

Flight Phase Inhibition:

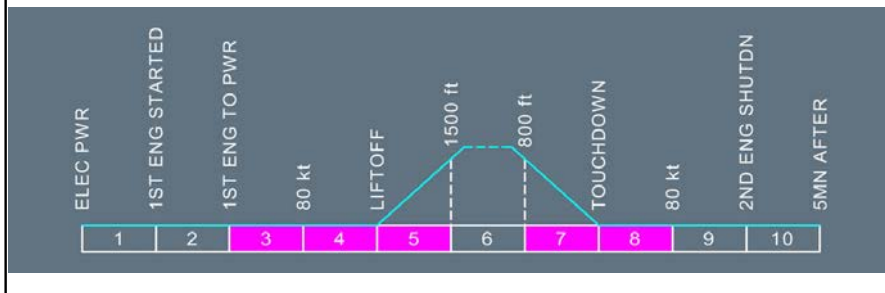

Ident.: PRO-ABN-W_A_ICE-AA-00018340.0001001 / 21 MAR 16

X BLEED..... OPEN

- ② Note: The affected pack has to be selected OFF due to precooler performance.

| | |
|---|--|
|  A318/A319/A320/A321 FLIGHT CREW OPERATING MANUAL | PROCEDURES ABNORMAL AND EMERGENCY PROCEDURES DETAILED CABIN / COCKPIT EVACUATION PROCEDURE |
|---|--|

GENERAL

Ident.: PRO-ABN-90-00010415.0001001 / 15 OCT 12
Applicable to: ALL

A successful outcome for an emergency situation depends, first of all, upon each crew member's perfect knowledge and execution of the duties assigned to him.

The captain should check frequently that all crew members know exactly their assigned positions and their specific duties, as well as the duties of the other crew members, in case of an abnormal or an emergency condition.

Since it is not possible to cover all the situations that may occur, the captain will be responsible for adapting the following instructions to obtain the best coordination of the emergency operation. Should it be physically impossible for the captain to carry out his duties, another crew member will substitute for him according to the chain of command. The procedures in this manual are AIRBUS procedures and should be considered to be a reference.

COCKPIT-ASSIGNED DUTIES FOR EVACUATION

Ident.: PRO-ABN-90-00010416.0001001 / 05 AUG 10
Applicable to: ALL

■ **If it is NOT POSSIBLE to reach the passenger cabin:**

The cockpit crew should evacuate the aircraft via the cockpit clearview windows, by using the escape ropes.

On ground, each crewmember must help passengers, and direct them away from the aircraft.

■ **If it is POSSIBLE to reach the passenger cabin:**

| | |
|-------------|---|
| CAPT | <ul style="list-style-type: none"> - Is the last person to leave the cockpit: Proceeds to the cabin, and helps with passenger evacuation, as necessary - Is the last person to leave the aircraft: Checks that all persons have evacuated the aircraft - Evacuates the aircraft, via the rear door, or any other available exit, if he/she cannot reach the rear door. - On ground, he/she takes command of operations until rescue units arrive. |
| F/O | <ul style="list-style-type: none"> - Proceeds to the cabin, and takes the emergency equipment. - Evacuates the aircraft, using any available exit. - Helps passengers on ground, and directs them away from the aircraft. |

PROCEDURES

ABNORMAL AND EMERGENCY PROCEDURES

DETAILED CABIN / COCKPIT EVACUATION PROCEDURE

CABIN CREW-ASSIGNED AREAS FOR EVACUATION

Ident.: PRO-ABN-90-00010607.0001001 / 17 MAR 11

Applicable to: **ALL**

| CABIN CREW DESIGNATION | ASSIGNED JUMPSEAT AND DOOR | ASSIGNED DOOR | ASSIGNED AREA |
|------------------------|----------------------------|---------------|---------------|
| 1 PURSER | DOOR 1 LH | FWD OUTBOARD | FWD/MID |
| 1 CABIN CREW | DOOR 1 RH /LH | FWD INBOARD | FWD/MID |
| 1 CABIN CREW | DOOR 2 RH | AFT CENTER | MID/AFT |
| 1 CABIN CREW | DOOR 2 LH | REARWARD | MID/AFT |

Note: These procedures are established for the minimum required number of 4 cabin crews.

COMMUNICATIONS

Ident.: PRO-ABN-90-00010418.0001001 / 04 JUL 17

Applicable to: **ALL**

| 1. EMERGENCY CALL | | | |
|-------------------|---------|---|---|
| FROM | TO | COMMUNICATION METHOD(S) | REMARKS |
| COCKPIT | CABIN | <ul style="list-style-type: none"> - Press EMER pb-sw on the CALLS panel, or - Passenger Address (PA) System: "PURSER TO COCKPIT PLEASE!" | Purser must immediately go to the cockpit. |
| CABIN | COCKPIT | <ul style="list-style-type: none"> - Interphone: "PRIO CAPT" | Any cabin crewmember can make such a call. The cockpit crew must reply. |

PROCEDURES
ABNORMAL AND EMERGENCY PROCEDURES
DETAILED CABIN / COCKPIT EVACUATION PROCEDURE

2. EMERGENCY ALERT

| FROM | TO | COMMUNICATION METHOD(S) | REMARKS |
|----------------|-------|---|--|
| COCKPIT | CABIN | - PA System: "ATTENTION CREW! AT STATIONS!" | The cockpit crew makes a short and precise announcement to warn that an emergency evacuation may soon be required. Cabin crews must proceed to their emergency stations, and fasten their seatbelts. |

3. NOTIFICATION TO PASSENGERS

| FROM | TO | COMMUNICATION METHOD(S) | REMARKS |
|----------------|-------|-------------------------------------|---|
| COCKPIT | CABIN | - SIGNS ON - PA System | For psychological reasons, the cockpit crew should be the first to inform of an intended emergency landing. |
| PURSER | CABIN | - CABIN LIGHTS 100 % - PA System | Purser informs passengers that they have to pay special attention to these warnings: - "FINISH PREPARATION" - "BRACE FOR IMPACT" - "PASSENGERS EVACUATE" |



4. FINISH PREPARATION

| FROM | TO | COMMUNICATION METHOD(S) | REMARKS |
|----------------|-------|---|---|
| COCKPIT | CABIN | - Passenger Address (PA) System: "FINISH PREPARATION" | The cockpit crew gives this order a short time before an emergency landing. |

5. BRACE FOR IMPACT

| FROM | TO | COMMUNICATION METHOD(S) | REMARKS |
|----------------|-------|----------------------------------|--|
| COCKPIT | CABIN | - PA System: "BRACE FOR IMPACT!" | The cockpit crew announces to brace for impact approximately 1 min before landing. |

6. INITIATE EVACUATION (RESTRICTED EXITS)

| FROM | TO | COMMUNICATION METHOD(S) | REMARKS |
|----------------|-------------------|---|---|
| COCKPIT | CABIN | - PA System: "PASSENGERS EVACUATE" - Activate EVAC signals  | The cockpit crew orders an immediate evacuation, and the cabin crew directs passengers to all available exists. |
| CABIN | COCKPIT AND CABIN | - EVAC SIGNAL SYSTEM  on FWD ATTND panel (FAP) - PA System or megaphone | Used by the cabin crew, if there is no signal or order from the cockpit, and if it is unmistakably clear that the aircraft must be evacuated. |
| CABIN | CABIN | - Verbal | The cabin crew stands up and shouts: - "SEATBELTS OFF!" - "LEAVE EVERYTHING!" - "GET OUT!" - "COME THIS WAY!" |



A318/A319/A320/A321
FLIGHT CREW
OPERATING MANUAL

PROCEDURES

ABNORMAL AND EMERGENCY PROCEDURES

DETAILED CABIN / COCKPIT EVACUATION PROCEDURE

7. EVACUATION NOT REQUIRED

| FROM | TO | COMMUNICATION METHOD(S) | REMARKS |
|---------|-------|---|---|
| COCKPIT | CABIN | - PA System: "CABIN CREW and PASSENGERS REMAIN SEATED!" | When the Captain decides that an evacuation is not required, the cockpit crew makes an immediate announcement to this effect. |

ON GROUND EVACUATION

Applicable to: ALL

Ident.: PRO-ABN-90-A-00010419.0001001 / 05 AUG 10

COCKPIT CREW PROCEDURES

The cockpit crew notifies the cabin crew of the nature of the emergency, and states intentions. The cockpit crew uses the Passenger Address system to make an appropriate announcement, such as: "PASSENGERS EVACUATE", and presses the EVAC COMMAND pb.

Ident.: PRO-ABN-90-A-00010420.0001001 / 05 AUG 10

CABIN CREW PROCEDURES

When the cabin receives the order to evacuate, each cabin crewmember must proceed as follows:
 STAND UP AND SHOUT....."UNFASTEN SEATBELTS"
 OUTSIDE CONDITIONS..... CHECK

■ **If outside conditions are safe:**

DOOR IN ARMED POSITION..... OPEN FIRMLY
 SHOUT..... "COME THIS WAY"

● **If the door does not open automatically:**

DOOR.....PUSH AND OPEN MANUALLY
 SLIDE (or SLIDERAFT) DEPLOYMENT.....CHECK FULL DEPLOYMENT
It takes approximately 4 s for the slide (or slideraft) to deploy.

● **If the slide (or slideraft) does not automatically inflate:**

RED, MANUAL INFLATION HANDLE.....PULL
The red, manual inflation handle is located on the right-hand side of the slide (or slideraft) girt extension.

ORDER..... "PASSENGERS EVACUATE"
 PASSENGER EVACUATIONEXPEDITE

● **If the slide (or slideraft) becomes unserviceable:**

PASSENGER EVACUATION.....STOP
 PASSENGERS TO ANOTHER USABLE EXIT..... REDIRECT
 TOTAL ZONE EVACUATION.....CHECK



A318/A319/A320/A321
FLIGHT CREW
OPERATING MANUAL

PROCEDURES
ABNORMAL AND EMERGENCY PROCEDURES
 DETAILED CABIN / COCKPIT EVACUATION PROCEDURE

CABIN CREW..... EVACUATE
 PASSENGERS AWAY FROM THE AIRCRAFT.....DIRECT

■ **If outside conditions are unsafe:**

EXIT DOOR.....BLOCK
 PASSENGERS TO NEAREST USABLE EXIT..... REDIRECT

COCKPIT EVACUATION THROUGH WINDOW

Applicable to: ALL

Ident.: PRO-ABN-90-B-00010421.0001001 / 05 AUG 10

OPENING THE SLIDING WINDOW

HANDLE..... PUSH DOWN AND PULL BACK
Pulling the handle backwards, opens the sliding window.

Ident.: PRO-ABN-90-B-00010422.0001001 / 24 NOV 15

COCKPIT EVACUATION WITH ESCAPE ROPE

ESCAPE ROPE STOWAGE.....OPEN
The escape rope stowage is located above the sliding window, on either side of the overhead panel.

ESCAPE ROPE..... UNROLL
Unroll the escape rope, and throw it through the window.

SEAT.....STEP ON
 ESCAPE ROPE..... GRASP
Grasp the escape rope firmly with both hands, and slide down along the rope.

EVACUATION ON WATER

Applicable to: ALL

Ident.: PRO-ABN-90-C-00010423.0002001 / 17 MAR 11

CABIN CREW RESPONSIBLE FOR TYPE "I" DOORS

When the cabin receives the order to evacuate, each cabin crewmember must proceed as follows:
 CHILDREN LIFEVESTS..... DISTRIBUTE
 STAND UP AND SHOUT..... “UNFASTEN SEATBELTS – PUT ON YOUR LIFEVEST”
Inflate the lifevest, only once outside the aircraft.
 ORDER.....“REMOVE SHOES”

● **If the Type I door is usable:**

DOOR IN ARMED POSITION..... OPEN
 SLIDERAFT.....DEPLOY
 RED, MANUAL INFLATION HANDLE..... PULL

Do not wait for automatic inflation of the slideraft.

■ **If the water level is close to the door sill:**

The slideraft inflates on the water.

SLIDERAFT..... LEAVE ATTACHED TO CABIN FLOOR
 PASSENGER LIFEVESTS..... INFLATE WHEN BOARDING SLIDERAFT
 PASSENGERS..... BOARD SLIDERAFT
 TOTAL ZONE EVACUATION..... CHECK
 LAST CREWMEMBER..... BOARD SLIDERAFT
 SLIDERAFT..... SEPARATE FROM DOOR SILL

The last crewmember must separate the slideraft from the door sill, and board with all the necessary safety equipment.

MOORING LINE.....CUT
 SURVIVAL KIT..... RETRIEVE

The survival kit is attached to the slideraft via a lanyard.

■ **If the water level is too far away from the door sill:**

SLIDERAFT..... DISCONNECT FROM DOOR SILL

The slideraft remains tied to the aircraft by a 6 m (20 ft) mooring line.

MOORING LINE..... HOLD

To keep the slideraft close to the exit, hold the mooring line.

PASSENGER LIFEVESTS..... INFLATE WHEN BOARDING SLIDERAFT
 PASSENGERS..... BOARD SLIDERAFT
 TOTAL ZONE EVACUATION..... CHECK
 LAST CREWMEMBER..... BOARD SLIDERAFT

The last crewmember must board with all the necessary safety equipment.

MOORING LINE.....CUT
 SURVIVAL KIT..... RETRIEVE

The survival kit is attached to the slideraft via a lanyard.

Note: *Evacuation is usually done through the passenger doors. However, if one of the passenger doors is not usable, the overwing exit may be used for evacuation. The cabin crew should install the lifeline to help passenger to stay on the wing. These passengers will, however, be obliged to wait on the wing until the slideraft arrives, and until all other passengers have evacuated from the passenger door exits, and have finished boarding the sliderafts.*

PROCEDURES

ABNORMAL AND EMERGENCY PROCEDURES

DETAILED CABIN / COCKPIT EVACUATION PROCEDURE

Intentionally left blank

PROCEDURES

NORMAL PROCEDURES

Intentionally left blank

PRO-NOR-SOP Standard Operating Procedures

PRO-NOR-SOP-01 General Information

Foreword..... A

PRO-NOR-SOP-02 Flight Preparation

Technical Condition of the Aircraft..... A
Weather Briefing..... B
NOTAMs..... C
GPS PRIMARY Availability (If Installed)..... D
Flight Plan and Operational Requirements..... E
Optimum Flight Level..... F
Fuel Requirements..... G

PRO-NOR-SOP-03 Safety Exterior Inspection

Safety Exterior Inspection..... A

PRO-NOR-SOP-04 Preliminary Cockpit Preparation

General..... A
Aircraft Setup..... B
Battery Check/Setup..... C
APU Fire Test/APU Start..... D
AIR COND..... E
Cargo Heat  F
Cockpit Lights..... G
ECAM..... H
FMGS Pre-Initialization..... I
EFB..... J
Before Walkaround..... K

PRO-NOR-SOP-05 Exterior Walkaround

General..... A
Exterior Walkaround..... B

PRO-NOR-SOP-06 Cockpit Preparation

Introduction..... A
Overhead Panel..... B
CTR Instrument Panel..... C
Pedestal..... D
RMP..... E
ACARS..... F
FMGS Preparation..... G

Continued on the following page

Continued from the previous page

| | |
|---|---|
| Glareshield..... | H |
| Lateral Consoles..... | I |
| Instrument Panels..... | J |
| ECAM Control Panel..... | K |
| ADIRS..... | L |
| Takeoff Briefing..... | M |
| PC Dedicated to Maintenance  | N |
| Flow Pattern..... | O |

PRO-NOR-SOP-07 Before Pushback or Start

| | |
|-----------------------------|---|
| Before Start Clearance..... | A |
| At Start Clearance..... | B |

PRO-NOR-SOP-08 Engine Start

| | |
|-----------------------------------|---|
| Automatic Engine Start..... | A |
| Ground Run Up - Danger Areas..... | B |

PRO-NOR-SOP-09 After Start

| | |
|------------------|---|
| After Start..... | A |
|------------------|---|

PRO-NOR-SOP-10 Taxi

| | |
|-----------|---|
| Taxi..... | A |
|-----------|---|

PRO-NOR-SOP-11 Before Takeoff

| | |
|---------------------|---|
| Before Takeoff..... | A |
|---------------------|---|

PRO-NOR-SOP-12 Takeoff

| | |
|--------------|---|
| Takeoff..... | A |
|--------------|---|

PRO-NOR-SOP-13 After Takeoff

| | |
|--------------------|---|
| After Takeoff..... | A |
|--------------------|---|

PRO-NOR-SOP-14 Climb

| | |
|------------|---|
| Climb..... | A |
|------------|---|

PRO-NOR-SOP-15 Cruise

| | |
|-------------|---|
| Cruise..... | A |
|-------------|---|

PRO-NOR-SOP-16 Descent Preparation

| | |
|--------------------------|---|
| Descent Preparation..... | A |
|--------------------------|---|

Continued on the following page

Continued from the previous page

PRO-NOR-SOP-17 Descent

| | |
|-----------------------------|---|
| Descent Initiation..... | A |
| Descent Monitoring..... | B |
| Descent Adjustment..... | C |
| Approach Checklist..... | D |
| 10 000 ft Flow Pattern..... | E |

PRO-NOR-SOP-18 Approach

PRO-NOR-SOP-18-A Approach General

| | |
|-------------------------------|---|
| Introduction..... | A |
| Cross-Reference Table..... | B |
| Flying Reference..... | C |
| Stabilization Criteria..... | D |
| Approach Speed Technique..... | E |
| Discontinued Approach..... | F |

PRO-NOR-SOP-18-B Aircraft Configuration Management

| | |
|----------------------------------|---|
| Initial Approach..... | A |
| Intermediate/Final Approach..... | B |

PRO-NOR-SOP-18-C Aircraft Guidance Management

| | |
|--|---|
| Approach using LOC G/S Guidance..... | A |
| Approach using FINAL APP Guidance..... | B |
| Approach using FPA Guidance..... | C |
| Circling Approach..... | D |
| RNAV Visual Approach..... | E |
| Visual Approach..... | F |

PRO-NOR-SOP-19 Landing

| | |
|---------------------|---|
| Manual Landing..... | A |
| Autoland..... | B |

PRO-NOR-SOP-20 Go-Around

| | |
|------------------------|---|
| Go Around with FD..... | A |
|------------------------|---|

PRO-NOR-SOP-21 After Landing

| | |
|--------------------|---|
| After Landing..... | A |
|--------------------|---|

PRO-NOR-SOP-22 Parking

| | |
|--------------|---|
| Parking..... | A |
|--------------|---|

Continued on the following page

Continued from the previous page

PRO-NOR-SOP-23 Securing the Aircraft

Securing the Aircraft..... A

PRO-NOR-SOP-90 Standard Callouts

Communications and Standard Terms..... A
 Checklist Callouts..... B
 Actions Commanded by PF..... C
 FMA..... D
 Altitude..... E
 Flaps or Gear Callouts..... F
 Flight Parameters..... G
 PF/PM Duties Transfer..... H
 Summary for Each Phase..... I

PRO-NOR-SUP Supplementary Procedures

PRO-NOR-SUP-SUP Supplementary Procedures Menu

Supplementary Procedures..... A

PRO-NOR-SUP-ADVWXR Adverse Weather

Airframe Deicing/Anti-Icing Procedure on Ground..... A
 Ground Operations in Cold Weather Conditions..... B
 Ground Operations in Heavy Rain..... C
 Minimum Speed with Ice Accretion..... D
 Operations on Contaminated Airports..... E
 Operations with Volcanic Ash, Sand or Dust..... F
 Securing the Aircraft for Cold Soak..... G
 For Draining Water Procedure..... H
 Water System Draining..... I

PRO-NOR-SUP-COM Communication

VHF, HF Utilization..... A

Continued on the following page

Continued from the previous page

PRO-NOR-SUP-ENG Engines

| | |
|---|---|
| Manual Engine Start..... | A |
| Engine Start with External Pneumatic Power..... | B |
| Crossbleed Engine Start..... | C |
| Engine Start Valve Manual Operation..... | D |
| Engine Ventilation (Dry Cranking)..... | E |
| One Engine Taxi - General..... | F |
| One Engine Taxi - At Departure..... | G |
| One Engine Taxi - At Arrival..... | H |

PRO-NOR-SUP-FUEL Fuel

| | |
|--|---|
| Refueling..... | A |
| Refueling with One Engine Running..... | B |
| Ground Fuel Transfer..... | C |
| Defueling..... | D |

PRO-NOR-SUP-LG L/G

PRO-NOR-SUP-LG-LG_DN Flight with Landing Gear Down

| | |
|-----------------------------|---|
| General..... | A |
| Limitations..... | B |
| Procedures..... | C |
| Takeoff..... | D |
| Flight Planning..... | E |
| Climb..... | F |
| Cruise..... | G |
| Holding..... | H |
| Descent..... | I |
| Go-Around..... | J |
| One Engine Inoperative..... | K |

PRO-NOR-SUP-LG-LG Operation with Nosewheel Steering Offset

| | |
|---|---|
| Operation with Nosewheel Steering Offset..... | A |
|---|---|

PRO-NOR-SUP-MISC Miscellaneous

PRO-NOR-SUP-MISC-D Pushback with Power Push Unit

| | |
|--|---|
| Pushback with Power Push Unit Via the Main Landing Gear..... | A |
|--|---|

PRO-NOR-SUP-MISC-A Hight Altitude Airport Operations

| | |
|---------------------------------------|---|
| High Altitude Airport Operations..... | A |
|---------------------------------------|---|

Continued on the following page

Continued from the previous page

PRO-NOR-SUP-MISC-C Operations at QNH Above 1050 hPa

| | |
|-------------------|---|
| General..... | A |
| Consequences..... | B |
| Procedures..... | C |

PRO-NOR-SUP-NAV Navigation

| | |
|-----------------------------------|---|
| Insertion of Approach Minima..... | A |
|-----------------------------------|---|

PRO-NOR-SRP Systems Related Procedures

PRO-NOR-SRP-01 FMS

PRO-NOR-SRP-01-05 Introduction

| | |
|-------------------|---|
| Introduction..... | A |
|-------------------|---|

PRO-NOR-SRP-01-10 Cockpit Preparation

| | |
|---|---|
| FMGS Initialization..... | A |
| Flight Plan Initialization..... | B |
| FMGS Data Insertion..... | C |
| FMGS Re-Initialization After a Canceled Flight..... | D |

PRO-NOR-SRP-01-15 Before Pushback or Start

| | |
|--------------------------------|---|
| Change of Runway..... | A |
| TAKEOFF FROM INTERSECTION..... | B |

PRO-NOR-SRP-01-20 Taxi

| | |
|--|---|
| FCU Selection for Takeoff..... | A |
| FMA Mode Check..... | B |
| Selecting a Navigation Display..... | C |
| Selecting Takeoff Displays for Pilot's and Copilot's MCDU..... | D |

PRO-NOR-SRP-01-30 Takeoff

| | |
|---|---|
| Monitoring the Takeoff..... | A |
| PRESELECTING A HDG OR A TRK..... | B |
| Normal Takeoff Profile..... | C |
| No Flight Director Takeoff..... | D |
| TAKEOFF WITH NO V2 ENTRY..... | E |
| Takeoff Using the Localizer of the Opposite Runway..... | F |

PRO-NOR-SRP-01-40 Climb

| | |
|---|---|
| Monitoring the Climb Phase..... | A |
| Expedite Climb..... | B |
| Immediate Return to Origin Airport..... | C |

Continued on the following page

Continued from the previous page

PRO-NOR-SRP-01-50 Cruise

| | |
|--|---|
| Reaching Cruise Flight Level..... | A |
| Monitoring the Navigation Accuracy..... | B |
| Monitoring the Fuel Predictions..... | C |
| Entering a Step Climb or a Step Descent..... | D |
| Immediate Change of Level in Cruise..... | E |
| Preparation for Descent and Approach..... | F |

PRO-NOR-SRP-01-60 Descent

| | |
|---|---|
| DESCENT INITIATION..... | A |
| Descent Monitoring..... | B |
| Expedite Descent (If installed)..... | C |
| Monitoring the Navigation in the Terminal Control Area..... | D |
| Too Steep Path..... | E |
| Holding Pattern..... | F |
| MANUAL TERMINATION..... | G |

PRO-NOR-SRP-01-70 Approach

| | |
|---|---|
| Initial Approach..... | A |
| ILS/MLS/GLS/FLS Approach..... | B |
| Switching from Non ILS to ILS Approach..... | C |
| Landing Categories..... | D |
| Warnings for ILS Approach..... | E |

PRO-NOR-SRP-01-80 Go-Around

| | |
|--------------------------------------|---|
| MONITORING THE GO-AROUND..... | A |
| Go-Around Profile..... | B |
| Missed Approach: Try Again..... | C |
| Missed Approach: Divert..... | D |
| Task Sharing During a Go-Around..... | E |



A318/A319/A320/A321
FLIGHT CREW
OPERATING MANUAL

PROCEDURES

NORMAL PROCEDURES

PRELIMINARY PAGES - TABLE OF CONTENTS

Intentionally left blank

| | |
|---|--|
|  <p>A318/A319/A320/A321 FLIGHT CREW OPERATING MANUAL</p> | <p align="center">PROCEDURES NORMAL PROCEDURES</p> <p align="center">STANDARD OPERATING PROCEDURES - GENERAL INFORMATION</p> |
|---|--|

FOREWORD

Ident.: PRO-NOR-SOP-01-00010142.0001001 / 02 MAY 17

Applicable to: ALL

The procedures contained in this Chapter are recommended by Airbus, and are consistent with the other Chapters of this manual.

The Authorities do not certificate Standard Operating Procedures. The manufacturer presents them herein as the best way to proceed, from a technical and operational standpoint. They are continually updated and the revisions take into account Operator input, as well as manufacturer experience. In addition, Operators may amend them, as needed. However, the manufacturer recommends that Operators using the FCOM as onboard operational manual submit suggested changes to expedite publication, and maintain consistency of the manual. The Operator should note that they may rewrite this Chapter, at their own responsibility; this could, however, make it difficult to update the manual and keep it consistent with the other Chapters.

The following sections contain expanded information on normal procedures.

Standard Operating Procedures consist of inspections, preparations, and normal procedures. All items of a given procedure are listed in a sequence that follows a standardized scan of the cockpit panels, unless that sequence goes against the action priority logic, to ensure that all actions are performed in the most efficient way.

These procedures assume that all systems are operating normally, and that all automatic functions are used normally.

The FCOM also contains normal procedures that are non-routine procedures in the Supplementary Procedures chapter and in the Special Operations chapter.



A318/A319/A320/A321
FLIGHT CREW
OPERATING MANUAL

PROCEDURES

NORMAL PROCEDURES

STANDARD OPERATING PROCEDURES - GENERAL INFORMATION

Intentionally left blank

TECHNICAL CONDITION OF THE AIRCRAFT

Ident.: PRO-NOR-SOP-02-00010147.0001001 / 05 AUG 10

Applicable to: ALL

The crew will verify the technical state of the aircraft (deferred defect list), with regard to airworthiness, acceptability of malfunctions (MEL), and influence on the flight plan.

WEATHER BRIEFING

Ident.: PRO-NOR-SOP-02-00010148.0001001 / 05 AUG 10

Applicable to: ALL

- The crew will get a weather briefing
- The briefing should include:
 - Actual and expected weather conditions, including runway conditions for takeoff and climb-out
 - Significant weather enroute, including winds and temperatures
 - Terminal forecasts for destination and alternate airports
 - Actual weather for destination and alternates, for short range flights and recent past weather, if available
 - Survey of the meteorological conditions at airports along the planned route.

Weather can affect the choice of routing (for example, influence which route is quickest) and the choice of flight level. The flight crew must also consider the possibility of runways being contaminated at the departure and destination airfields. The flight crew must also verify ISA deviations and enroute icing conditions, and must consider the possibility of holding due to weather at the destination.

NOTAMS

Ident.: PRO-NOR-SOP-02-00010149.0002001 / 29 MAY 13

Applicable to: ALL

- The flight crew must examine NOTAMs for changes to routings, unserviceable nav aids, availability of runways and approach aids etc, all of which may affect the final fuel requirement
- In order to prevent the risks of projection of debris towards the trimmable horizontal stabilizer and the elevators, it is not recommended to takeoff from runways in bad condition (loose surface, under repair, covered with debris...)

GPS PRIMARY AVAILABILITY (IF INSTALLED)

Ident.: PRO-NOR-SOP-02-00014998.0002001 / 20 MAR 17

Applicable to: ALL

- **For RNP1 operations, RNAV(GNSS) approaches and RNAV (RNP)  approaches:**
RAIM/AIME has been demonstrated to be available 100% of the time with 24 healthy satellites.

If required by operational regulation, for specific conditions (e.g RNAV(RNP), mountainous terrain or less than 24 satellites) an appropriate Ground-Based Prediction Program should be used to check the RAIM/AIME for each intended procedure (arrival, departure and alternate if required)

FLIGHT PLAN AND OPERATIONAL REQUIREMENTS

Ident.: PRO-NOR-SOP-02-00010150.0001001 / 18 MAR 11

Applicable to: ALL

- The crew will check the company flight plan for routing, altitudes, and flight time
- The Captain will check the ATC flight plan and ensure that:
 - It is filled in and filed, in accordance with the prescribed procedures
 - It agrees with the fuel flight plan routing.
- The crew will check the estimated load figures, and will calculate the maximum allowable takeoff and landing weights.

OPTIMUM FLIGHT LEVEL

Ident.: PRO-NOR-SOP-02-00010151.0001001 / 22 MAR 17

Applicable to: ALL

The flight crew should choose a flight level that is as close to the optimum as possible. To determine the optimum flight level, *Refer to QRH/PER-M Optimum & Maximum Altitudes (Paper Only)* or use the performance application of FlySmart with Airbus.

As a general rule, an altitude that is 4 000 ft below the optimum produces a significant penalty (approximately 5 % of fuel). Flight 8 000 ft below the optimum altitude produces a penalty of more than 10 % against trip fuel. (The usual contingency allowance is 5 %).

FUEL REQUIREMENTS

Ident.: PRO-NOR-SOP-02-00010152.0001001 / 05 AUG 10

Applicable to: ALL

COMPUTERIZED FLIGHT PLAN CHECK

In most cases the flight crew uses a computer-derived flight plan to obtain the correct fuel requirements. Although these computerized requirements are normally accurate, the flight crew must check them for gross errors.

The easiest way to do this is to use the "Quick Determination of F-PLN" tables (*Refer to PER-FPL-FLP-QFP-40 FLIGHT PLANNING M.78*). Although the aircraft will fly at ECON MACH that is based on the cost index, the M 0.78 table is accurate enough to permit the crew to check for gross error.

Ensure that both the captain and the first officer have verified that the fuel calculations and required fuel on board are correct and that the figure complies with the applicable regulations.

FUEL TRANSPORTATION

The flight crew must check the policy covering the “tankering” of fuel on sectors where there is a favourable fuel price differential or operational requirement.

Remember that carrying unnecessary extra fuel increases the fuel consumption for that sector and therefore reduces the economy of the operation (lower flex temperature, more tire and brake wear, more time in climb phase, lower optimum flight level etc).



A318/A319/A320/A321
FLIGHT CREW
OPERATING MANUAL

PROCEDURES

NORMAL PROCEDURES

STANDARD OPERATING PROCEDURES - FLIGHT PREPARATION

Intentionally left blank

| | |
|---|---|
|  <p>A318/A319/A320/A321 FLIGHT CREW OPERATING MANUAL</p> | <p align="center">PROCEDURES</p> <p align="center">NORMAL PROCEDURES</p> <p align="center">STANDARD OPERATING PROCEDURES - SAFETY EXTERIOR INSPECTION</p> |
|---|---|

SAFETY EXTERIOR INSPECTION

Applicable to: ALL

Ident.: PRO-NOR-SOP-03-A-00010153.0001001 / 05 AUG 10

Items marked by (*) are the only steps to be completed during a transit stop.
 This inspection ensures that the aircraft and its surroundings are safe for operations.
 On arriving at the aircraft, check for obstructions in the vicinity, engineering activity, refueling, etc.

Ident.: PRO-NOR-SOP-03-A-00010154.0001001 / 04 MAR 14

* WHEEL CHOCKS..... CHECK
If the wheel chocks are not in position, the flight crew must check that the parking brake is set with sufficient accumulator pressure.

Ident.: PRO-NOR-SOP-03-A-00010155.0001001 / 18 MAR 11

* LANDING GEAR DOORS.....CHECK POSITION

| | |
|----------------|--|
| WARNING | <i>Do not pressurize the green hydraulic system without clearance from ground personnel, if any gear door is open. Remember that the green hydraulic system is pressurized if the yellow system is pressurized and the PTU is on AUTO.</i> |
|----------------|--|

Ident.: PRO-NOR-SOP-03-A-00010156.0001001 / 05 AUG 10

* APU AREA..... CHECK
Observe that the APU inlet and outlet are clear.



A318/A319/A320/A321
FLIGHT CREW
OPERATING MANUAL

PROCEDURES

NORMAL PROCEDURES

STANDARD OPERATING PROCEDURES
- SAFETY EXTERIOR INSPECTION

Intentionally left blank

| | |
|---|---|
|  A318/A319/A320/A321 FLIGHT CREW OPERATING MANUAL | PROCEDURES NORMAL PROCEDURES STANDARD OPERATING PROCEDURES - PRELIMINARY COCKPIT PREPARATION |
|---|---|

GENERAL

Ident.: PRO-NOR-SOP-04-00010164.0001001 / 20 MAR 17

Applicable to: ALL

Items marked by asterisks (*) are the only steps to be completed after a transit stop without flight crew change. Otherwise, the new flight crew performs all the items.

The following procedure, performed by the PM, ensures that all the required checks are performed before applying electrical power to avoid inadvertent operation of systems and danger to the aircraft and personnel.

Included is APU starting and the establishment of electrical and pneumatic power.

For EFB operations, the following procedure performed by both pilots is based on the use of two EFBs/eQRH in order to reduce the risk of erroneous inputs.

Airbus recommends operating with two EFBs.

DOCUMENTATION AND MAINTENANCE

On entering the aircraft, obtain the technical (maintenance) log and verify that the certificate of maintenance and daily inspection (or similar) are up to date and signed. Check the deferred or carried-forward defects. If refueling has already been completed, check the uplift.

AIRCRAFT SETUP

Applicable to: ALL

Ident.: PRO-NOR-SOP-04-A-00021906.0001001 / 30 AUG 17

WARNING Do not pressurize the hydraulic systems until clearance is obtained from ground personnel.

Ident.: PRO-NOR-SOP-04-A-00010165.0001001 / 03 MAR 14

ENG

ENG MASTERS 1, 2..... OFF
 ENG MODE selector..... NORM

Ident.: PRO-NOR-SOP-04-A-00011188.0001001 / 22 APR 16

***WEATHER RADAR**

* RADAR sw OFF
 * WINDSHEAR / PWS sw  OFF
 * GAIN knob AUTO/CAL
 * MODE selector AS RQRD



A318/A319/A320/A321
FLIGHT CREW
OPERATING MANUAL

PROCEDURES

NORMAL PROCEDURES

STANDARD OPERATING PROCEDURES
 - PRELIMINARY COCKPIT PREPARATION

Ident.: PRO-NOR-SOP-04-A-00010166.0001001 / 03 MAR 14

L/G

L/G lever..... DOWN

Ident.: PRO-NOR-SOP-04-A-00010167.0001001 / 03 MAR 14

WIPERS

Both WIPER selectors..... OFF

BATTERY CHECK/SETUP

Ident.: PRO-NOR-SOP-04-00010168.0001001 / 30 AUG 17

Applicable to: ALL

- **If the aircraft has not been electrically supplied for 6 h or more, perform the following check:**
 BAT 1 pb and BAT 2 pb..... CHECK OFF
 BAT 1 and 2 VOLTAGE..... CHECK ABOVE 25.5 V
Battery voltage above 25.5 V ensures a charge above 50 %.
- **If the battery voltage is at or below 25.5 V:**
 A charging cycle of about 20 min is required.
 BAT 1 pb and BAT 2 pb.....AUTO
 EXT PWR pb-sw..... ON
Check on ELEC SD page, that the battery contactor is closed and the batteries are charging.
- **After 20 min:**
 BAT 1 + 2 pb..... OFF
 BAT 1 and 2 VOLTAGE..... CHECK ABOVE 25.5 V
 BAT 1 + 2 pb..... AUTO
- **If the battery voltage is above 25.5 V:**
 BAT 1 pb and BAT 2 pb.....AUTO
If the APU is started on batteries only, it should be started within 30 min after the selection of batteries to AUTO (35 min after battery selection to AUTO, the battery charge is less than 25 % of maximum capacity).
- **If the aircraft has been electrically supplied during the last 6 h:**
 BAT 1 pb and BAT 2 pb..... AUTO

| | |
|---|---|
|  <p>A318/A319/A320/A321 FLIGHT CREW OPERATING MANUAL</p> | <p align="center">PROCEDURES</p> <p align="center">NORMAL PROCEDURES</p> <p>STANDARD OPERATING PROCEDURES - PRELIMINARY COCKPIT PREPARATION</p> |
|---|---|

- If the AVAIL light is on:
EXT PWR pb-sw..... ON

APU FIRE TEST/APU START

Applicable to: ALL

Ident.: PRO-NOR-SOP-04-B-00010170.0001001 / 07 JUN 16

APU FIRE

APU FIRE pb-sw.....CHECK IN and GUARDED
AGENT lightsCHECK OFF
APU FIRE TEST pb.....PRESS and MAINTAIN

Check :

- APU FIRE warning on ECAM + CRC + MASTER WARN light (if AC Power available).
- APU FIRE pb-sw lighted red.
- SQUIB light and DISCH light on

Ident.: PRO-NOR-SOP-04-B-00010171.0015001 / 17 MAR 17

APU START

- If the EXT PWR pb-sw ON light is on:
APU MASTER SW pb-sw ON
APU START pb-swON

Note: Wait at least 3 s before selecting APU START pb-sw.

For more information on the APU start, Refer to DSC-49-20 Overhead Panel - Illustration.

For more information on APU starter limitations and APU operations during refueling:

- Refer to LIM-APU APU Start
- Refer to LIM-APU APU Start/Shutdown during Refueling/Defueling.

EXT PWR pb-sw AS RQRD

The flight crew should keep ON the external power units to reduce the APU load, particularly in hot weather conditions.

- If the EXT PWR pb-sw ON light is off:
APU MASTER SW pb-sw ON
APU START pb-swON

Note: Wait at least 3 s before selecting APU START pb-sw.

For more information on the APU start, Refer to DSC-49-20 Overhead Panel - Illustration.



A318/A319/A320/A321
 FLIGHT CREW
 OPERATING MANUAL

PROCEDURES

NORMAL PROCEDURES

STANDARD OPERATING PROCEDURES
 - PRELIMINARY COCKPIT PREPARATION

For more information on APU starter limitations and APU operations during refueling:

- Refer to LIM-APU APU Start
- Refer to LIM-APU APU Start/Shutdown during Refueling/Defueling.

AIR COND

Ident.: PRO-NOR-SOP-04-00010177.0001001 / 14 OCT 15

Applicable to: ALL

AIR COND

● **When the APU is AVAIL:**

APU BLEED pb-sw..... ON

Do not use APU BLEED, if the ground personnel confirms that a LP or HP ground air unit is connected to the aircraft.

To determine if an HP ground air unit is connected, the flight crew should also check on the BLEED SD page, if there is pressure in the bleed air system.

ALL WHITE LIGHTS..... OFF

X BLEED selector..... AUTO

Zone temperature selectors..... AS RQRD

Full range temperature 24 ± 6 °C (75 ± 11 °F).

CARGO HEAT

Ident.: PRO-NOR-SOP-04-00010178.0001001 / 03 MAR 14

Applicable to: ALL

CARGO HEAT

TEMPERATURE selector AS RQRD

COCKPIT LIGHTS

Ident.: PRO-NOR-SOP-04-00010172.0002001 / 23 JUN 15

Applicable to: ALL

COCKPIT LIGHTS

* COCKPIT LIGHTS..... AS RQRD

Set INT LT, FLOOD LT, INTEG LT (included glareshield and FCU).

| | |
|---|--|
|  <p>A318/A319/A320/A321 FLIGHT CREW OPERATING MANUAL</p> | <p align="center">PROCEDURES</p> <p align="center">NORMAL PROCEDURES</p> <p align="center">STANDARD OPERATING PROCEDURES - PRELIMINARY COCKPIT PREPARATION</p> |
|---|--|

ECAM

Ident.: PRO-NOR-SOP-04-00010204.0001001 / 04 SEP 17
Applicable to: ALL

*** ECAM**

* RCL pbPRESS 3 s
This action recalls all the warnings that the flight crew cleared or cancelled during the last flight.

* Check MEL if required.

● **On the DOOR SD page:**

* OXY CHECK PRESSURE

● **If the OXY pressure is half boxed in amber:**

MIN FLT CREW OXY CHART.....CHECK PRESSURE

Verify that the pressure is sufficient for the scheduled flight (Refer to LIM-OXY Minimum Flight Crew Oxygen Pressure).

● **On the HYD SD page:**

* RESERVOIR FLUID LEVEL.....CHECK WITH NORMAL RANGE

Note: *The volume of the hydraulic fluid in the reservoirs may change with Outside Air Temperature. As a result, the reservoir fluid level that appears on the HYD SD page may be outside of the normal range with no HYD RSVR LO AIR PR or HYD RSVR LO LVL warning. If the fluid level is outside of the normal range, contact maintenance to determine if service is required.*

● **On the ENG SD page:**



* ENG OIL QUANTITY..... CHECK NORMAL

Check that the oil quantity is at or above 9.5 qt + estimated consumption (average estimated consumption ~ 0.5 qt/h).

FMGS PRE-INITIALIZATION

Applicable to: ALL

Ident.: PRO-NOR-SOP-04-C-00014422.0001001 / 20 MAR 17

Perform FMGS Pre-Initialization in the case of ACARS  operations, or EFB operations with SYNCHRO AVIONICS .

At electrical power-up, the FMGS s and FCU run through various internal tests. Allow enough time (3 min) for tests' completion, and do not start to press pushbuttons until the tests are over. If the "PLEASE WAIT" message appears, do not press any MCDU key until the message clears.

* FLT NBR.....INSERT

* FROM/TO.....INSERT



AEROLÍNEAS GALAPAGOS S.A.

A318/A319/A320/A321
FLIGHT CREW
OPERATING MANUAL

PROCEDURES

NORMAL PROCEDURES

STANDARD OPERATING PROCEDURES
- PRELIMINARY COCKPIT PREPARATION

EFB

Applicable to: ALL

Ident.: PRO-NOR-SOP-04-F-00021232.0001001 / 21 MAR 17

EFB/EQRH START

ALL EFB/eQRH..... START

● **In accordance with the Operator's policy or if required by operational regulation:**

EFB/eQRH VERSION..... CHECK

If required, the flight crew performs this check unless a specific procedure is established as per Operator's policy to ensure that the correct version is onboard.

On the EFB STATUS page and the eQRH My aircraft page, check the EFB VERSION number and compare it with the valid version number given as reference by the Operator (e.g. on the company flight plan).

*OPERATION ENGINEERING BULLETINS (OEB)

* OEB in eQRH..... CHECK

Go to the OEB section of the eQRH and review all OEB s (particularly red OEBs) that are applicable to the aircraft.

Note: If there is a transfer of duties during this flight, the flight crew must remind the incoming flight crew of the applicable OEB(s) during the briefing that is done when transferring the duties.

* EFB SYNCHRO AVIONICS  CLICK

Each flight crewmember checks (if retrieved from FMS) or enters:

- Aircraft Type
- Aircraft Registration
- Flight Number
- The departure and arrival airports

Both flight crewmembers crosscheck all the data.

REQUIRED APPLICATIONS..... START

Ident.: PRO-NOR-SOP-04-F-00021234.0001001 / 20 MAR 17

*ECAM/LOGBOOK CHECK

* RCL pb..... PRESS 3 s

This action recalls all the warnings that the flight crew cleared or cancelled during the last flight

* Check MEL if required.

| | |
|---|---|
|  <p>A318/A319/A320/A321 FLIGHT CREW OPERATING MANUAL</p> | <p align="center">PROCEDURES</p> <p align="center">NORMAL PROCEDURES</p> <p>STANDARD OPERATING PROCEDURES - PRELIMINARY COCKPIT PREPARATION</p> |
|---|---|

- * LOGBOOK or EFB E-LOGBOOK  CHECK
- *In the logbook or EFB e-logbook, check the technical condition of the aircraft (deferred defect list) with regard to airworthiness, acceptability of the MEL , or the Configuration Deviation List (CDL), and influence on the flight plan.*
- *Crosscheck with ECAM recall.*
- * MEL /CDL ITEMS (as appropriate)..... CHECK DISPATCH CONDITIONS
Access the MEL and CDL items via the Ops Library Browser.
- * MEL ITEMS (as appropriate)..... ACTIVATE
As appropriate, the activated MEL items are sent to the applicable performance applications.
- * CDL ITEMS (as appropriate)..... ACTIVATE & COMPLETE
Complete missing items of CDL items. As appropriate, the activated CDL items are sent to the applicable performance applications.
- * AIRCRAFT ACCEPTANCE..... PERFORM

Ident.: PRO-NOR-SOP-04-F-00021233.0001001 / 20 MAR 17

***PRELIMINARY PERFORMANCE DATA CALCULATION**

Each flight crewmember independently computes the preliminary performance data in accordance with the technical condition of the aircraft and/or any other criteria that may impact the aircraft performance (e.g. NOTAM, runway condition, aircraft configuration).

- * AIRFIELD DATA..... OBTAIN
Obtain data needed for initializing the system, preparing the cockpit and for preliminary takeoff performance computation. The airfield data should include: RUNWAY IN USE, ALTIMETER SETTING, and WEATHER DATA.

- **If the LOADSHEET application is used :**
PRELIMINARY LOADING..... COMPUTE AND CROSSCHECK

- **If dispatch under MEL and in accordance with the logbook:**
 - * MEL /CDL ITEMS (as appropriate)..... CHECK ACTIVATED
As appropriate, check that the MEL and CDL items are activated in the applicable performance application.

PRELIMINARY TAKEOFF PERF..... COMPUTE AND CROSSCHECK

PROCEDURES

NORMAL PROCEDURES

STANDARD OPERATING PROCEDURES
 - PRELIMINARY COCKPIT PREPARATION

BEFORE WALKAROUND

Applicable to: ALL

Ident.: PRO-NOR-SOP-04-E-00010173.0001001 / 05 AUG 10

F/CTL

FLAPS.....CHECK POSITION

Check the upper ECAM display to confirm that the FLAPS position agrees with the handle position.

* SPEEDBRAKE lever..... CHECK RETRACTED and DISARMED

WARNING *If flight control surface positions do not agree with the control handle positions, check with the maintenance crew before applying hydraulic power.*

Ident.: PRO-NOR-SOP-04-E-00010174.0001001 / 18 MAY 16

*** PARKING BRAKE**

ACCU PRESS indicator..... CHECK

The ACCU PRESS indication must be in the green band. If required use the electric pump on yellow hydraulic system to recharge the brake accumulator.

PARKING BRAKE handle..... ON

When one brake temperature is above 500 °C, avoid applying the parking brake, unless operationally necessary.

BRAKES PRESS indicator.....CHECK

Check for normal indications.

WARNING *Yellow and green hydraulic systems are pressurized from yellow electric pump. Get ground crew clearance before using the electric pump.*

Ident.: PRO-NOR-SOP-04-E-00010206.0001001 / 23 JUN 15

EMERGENCY EQUIPMENT

EMER EQPT..... CHECK

Check the emergency equipments as follows:

- Life jackets stowed
- Axe stowed
- Smoke hoods ☒ or portable oxygen equipment and full face masks ☒ stowed and serviceable
- Portable fire extinguisher lockwired and pressure in the green area
- Smoke goggles stowed (smoke hoods ☒)
- Oxygen masks stowed

| | |
|---|--|
|  <p>A318/A319/A320/A321 FLIGHT CREW OPERATING MANUAL</p> | <p align="center">PROCEDURES</p> <p align="center">NORMAL PROCEDURES</p> <p align="center">STANDARD OPERATING PROCEDURES - PRELIMINARY COCKPIT PREPARATION</p> |
|---|--|

- Flashlights stowed
- Escape ropes stowed

Ident.: PRO-NOR-SOP-04-E-00010207.0001001 / 14 SEP 12

RAIN REPELLENT

RAIN RPLNT indicators..... CHECK PRESSURE and QUANTITY

CAUTION Never use rain repellent to wash the windshield and never use it on a dry windshield.

Ident.: PRO-NOR-SOP-04-E-00010208.0001001 / 05 AUG 10

REAR AND OVERHEAD CIRCUIT BREAKERS PANELS

REAR and OVERHEAD CIRCUIT BREAKERS panels..... CHECK
Check that all circuit breakers are set. Reset as necessary.

Ident.: PRO-NOR-SOP-04-E-00010209.0001001 / 25 JAN 17

LANDING GEAR PINS AND COVERS

* GEAR PINS and COVERS..... CHECK ONBOARD and STOWED
Check that three are on board and stowed.



A318/A319/A320/A321
FLIGHT CREW
OPERATING MANUAL

PROCEDURES

NORMAL PROCEDURES

STANDARD OPERATING PROCEDURES
- PRELIMINARY COCKPIT PREPARATION

Intentionally left blank

GENERAL

Ident.: PRO-NOR-SOP-05-00010360.0001001 / 17 MAY 17

Applicable to: ALL

The exterior walkaround ensures that the general condition of the aircraft is satisfactory and that the visible aircraft components and equipment are safe for the flight:

- There is no impact damage to the structure
- There is no evident fuel, oil, or hydraulic leak
- All ground access doors are closed.

The flight crew must perform a complete walkaround before each flight.

The parking brake must be set to ON during the exterior walkaround, in order to enable the flight crew to check brake wear indicators.

WARNING If any landing gear door is open, do not apply hydraulic power until clearance is obtained from ground personnel.

EXTERIOR WALKAROUND

Applicable to: ALL

Ident.: PRO-NOR-SOP-05-A-00010361.0001001 / 04 MAY 15

SCHEMATIC

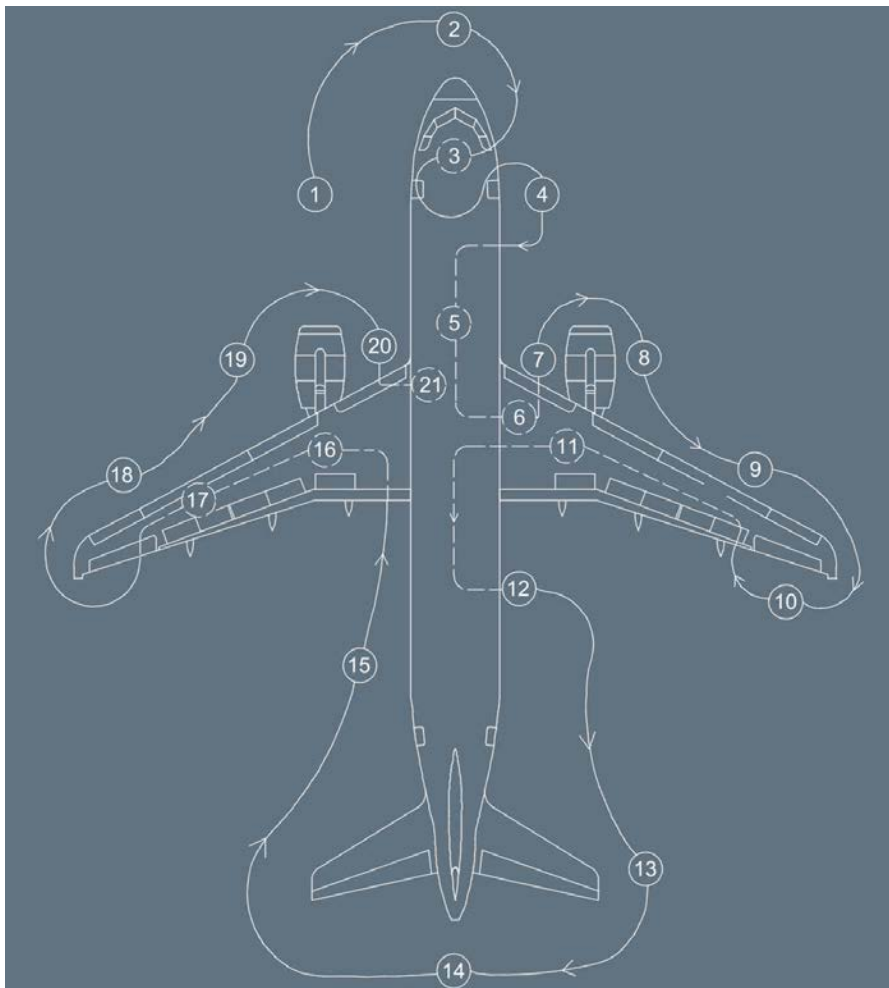

(1) Refer to PRO-NOR-SOP-05 Exterior Walkaround - LH FWD Fuselage

- (2) Refer to PRO-NOR-SOP-05 Exterior Walkaround - Nose Section
- (3) Refer to PRO-NOR-SOP-05 Exterior Walkaround - Nose L/G
- (4) Refer to PRO-NOR-SOP-05 Exterior Walkaround - RH FWD Fuselage
- (5) Refer to PRO-NOR-SOP-05 Exterior Walkaround - Lower Center Fuselage
- (6) Refer to PRO-NOR-SOP-05 Exterior Walkaround - RH Center Wing
- (7) Refer to PRO-NOR-SOP-05 Exterior Walkaround - ENG 2 LH Side
- (8) Refer to PRO-NOR-SOP-05 Exterior Walkaround - ENG 2 RH Side
- (9) Refer to PRO-NOR-SOP-05 Exterior Walkaround - RH Wing Leading Edge
- (10) Refer to PRO-NOR-SOP-05 Exterior Walkaround - RH Wing Trailing Edge
- (11) Refer to PRO-NOR-SOP-05 Exterior Walkaround - RH L/G and Fuselage
- (12) Refer to PRO-NOR-SOP-05 Exterior Walkaround - RH AFT Fuselage
- (13) Refer to PRO-NOR-SOP-05 Exterior Walkaround - TAIL
- (14) Refer to PRO-NOR-SOP-05 Exterior Walkaround - APU
- (15) Refer to PRO-NOR-SOP-05 Exterior Walkaround - LH AFT Fuselage
- (16) Refer to PRO-NOR-SOP-05 Exterior Walkaround - LH Landing Gear
- (17) Refer to PRO-NOR-SOP-05 Exterior Walkaround - LH Wing Trailing Edge
- (18) Refer to PRO-NOR-SOP-05 Exterior Walkaround - LH Wing Leading Edge
- (19) Refer to PRO-NOR-SOP-05 Exterior Walkaround - ENG 1 LH Side
- (20) Refer to PRO-NOR-SOP-05 Exterior Walkaround - ENG 1 RH Side
- (21) Refer to PRO-NOR-SOP-05 Exterior Walkaround - LH Center Wing

Ident.: PRO-NOR-SOP-05-A-00010363.0001001 / 17 MAY 17

LH FWD FUSELAGE

| | |
|---|-----------|
| AOA probes..... | CONDITION |
| F/O and CAPT static ports..... | CLEAR |
| Avionics equipment vent air inlet valve..... | CONDITION |
| Oxygen bay..... | CLOSED |
| Oxygen overboard discharge indicator..... | GREEN |
| Toilet servicing door  | CLOSED |

Ident.: PRO-NOR-SOP-05-A-00010364.0001001 / 17 MAY 17

NOSE SECTION

Pitot probes.....CONDITION
 STBY static ports..... CLEAR
 TAT probes..... CONDITION
 Radome and latches..... CONDITION/LATCHED
 Forward avionics compartment door.....CLOSED
 Ground electrical power door (if not required.)..... CLOSED

Ident.: PRO-NOR-SOP-05-A-00010365.0001001 / 17 MAY 17

NOSE L/G

Nose wheel chocks..... IN PLACE
 Wheels and tires.....CONDITION
 Nose gear structure..... CONDITION
 Taxi, TO, turn-off lights.....CONDITION
 Hydraulic lines and electrical wires..... CONDITION
 Wheel well..... CHECK
 Safety pin..... REMOVED

Ident.: PRO-NOR-SOP-05-A-00010366.0001001 / 17 MAY 17

RH FWD FUSELAGE

RH + AFT avionic compartment doors..... CLOSED
 Avionic equipment vent air outlet valve.....CONDITION
 F/O -CAPT static ports..... CLEAR
 AOA probe..... CONDITION
 Forward cargo door and selector panel..... CHECK

Ident.: PRO-NOR-SOP-05-A-00010367.0001001 / 20 DEC 16

LOWER CENTER FUSELAGE

Potable water drain panel  CLOSED
 Antennas..... CONDITION
 Drain mast.....CONDITION
 Emergency ram air inlet flap..... CONDITION
 LP and HP ground connection doors..... CLOSED
 Anticollision light.....CHECK
 CTR TK magnetic fuel level.....FLUSH
 Pack air intakes and outlets..... CLEAR

Ident.: PRO-NOR-SOP-05-A-00010368.0002001 / 17 MAY 17

RH CENTER WING

Yellow hydraulic bay door..... CLOSED
 Fuel panel..... CLOSED
 Inner tank magnetic fuel..... FLUSH
 Fuel water drain valve inner tank..... NO LEAK
 Landing light..... CONDITION
 Slat 1..... CONDITION

Ident.: PRO-NOR-SOP-05-A-00010370.0015001 / 17 MAY 17

ENG 2 LH SIDE

Oil fill access door..... CLOSED
 Thrust reversers..... CLOSED/LATCHED
 Fan cowl doors..... CLOSED/LATCHED
 Drain mast..... CONDITION/NO LEAK
 Engine inlet and fan blades..... CHECK

Ident.: PRO-NOR-SOP-05-A-00010371.0006001 / 17 MAY 17

ENG 2 RH SIDE

Vent inlet..... CLEAR
 Pressure-relief/Start valve handle access door..... CLOSED
 Thrust reversers..... CLOSED/LATCHED
 Fan cowl doors..... CLOSED/LATCHED
 Turbine exhaust CLEAR
 Pylon/access panel..... CONDITION/CLOSED

Ident.: PRO-NOR-SOP-05-A-00010372.0001001 / 17 MAY 17

RH WING LEADING EDGE

Slats 2, 3, 4, 5..... CONDITION
 Inner and outer cells magnetic fuel level..... FLUSH
 Fuel water drain valve (outer cell, surge tank)..... NO LEAK
 Refuel coupling..... CLOSED
 Surge tank air inlet..... CLEAR
 Fuel ventilation overpressure disc..... INTACT
 Navigation light..... CONDITION
 Wing tip..... CONDITION

Ident.: PRO-NOR-SOP-05-A-00010373.0001001 / 01 SEP 17

RH WING TRAILING EDGE

Static dischargers.....CHECK
 Control surfaces.....CONDITION
 Flaps and fairings.....CONDITION
 ANTENNAS ON TOP OF FUSELAGE.....CHECK CONDITION

Ident.: PRO-NOR-SOP-05-A-00010374.0001001 / 17 MAY 17

RH L/G AND FUSELAGE

Chocks.....REMOVED
 Wheels and tires.....CONDITION
 Brakes and brake wear ind.....CONDITION
 Torque link damper CONDITION
 Hydraulic lines.....CHECK
 Landing gear structure.....CHECK
 Downlock springs.....CHECK
 Safety pin.....REMOVED
 Ground hydraulic connection yellow.....CLOSED
 Shroud fuel drain.....CONDITION/NO LEAK

Ident.: PRO-NOR-SOP-05-A-00010375.0001001 / 17 MAY 17

RH AFT FUSELAGE

RA Antennas.....CONDITION
Check that the RA antennas are clean.
 Cargo door and selector panel.....CHECK
 Bulk door CHECK
 Toilet service access door.....CLOSED
 Outflow valve.....CONDITION
 Drain mastCONDITION
 Flight recorder access doorCLOSED

Ident.: PRO-NOR-SOP-05-A-00010376.0001001 / 17 MAY 17

TAIL

Stabilizer, elevator, fin, and rudder.....CONDITION
 Static dischargers.....CHECK
 Lower fuselage structure (tail impact on runway).....CONDITION

Ident.: PRO-NOR-SOP-05-A-00010377.0001001 / 05 AUG 10

APU

Access doors..... CLOSED
 Air intake..... CONDITION
 Drain..... CONDITION/NO LEAK
 Oil cooler air outlet CLEAR
 Exhaust..... CLEAR
 Navigation light..... CONDITION
 Fire extinguisher overpressure indication (red disc)..... IN PLACE

Ident.: PRO-NOR-SOP-05-A-00010378.0001001 / 17 MAY 17

LH AFT FUSELAGE

Stabilizer, elevator, fin, and rudder..... CONDITION
 Potable water service door..... CLOSED
 Ground hydraulic connection blue door..... CLOSED
 Ground hydraulic connection green and reservoir filling door..... CLOSED

Ident.: PRO-NOR-SOP-05-A-00010379.0001001 / 17 MAY 17

LH LANDING GEAR

Chocks..... REMOVED
 Wheels and tires..... CONDITION
 Brakes and brake wear indicator..... CONDITION
 Torque link damper  CONDITION
 Hydraulic lines..... CHECK
 Landing gear structure..... CHECK
 Downlock springs..... CHECK
 Safety pin..... REMOVED

Ident.: PRO-NOR-SOP-05-A-00010380.0001001 / 01 SEP 17

LH WING TRAILING EDGE

Flaps and fairing..... CONDITION
 Control surfaces..... CONDITION
 Static dischargers..... CHECK
 ANTENNAS ON TOP OF FUSELAGE..... CHECK CONDITION

Ident.: PRO-NOR-SOP-05-A-00010381.0001001 / 17 MAY 17

LH WING LEADING EDGE

Wing tip..... CONDITION

Navigation light..... CONDITION
 Surge tank air inlet..... CLEAR
 Fuel ventilation overpressure disc..... INTACT
 Fuel water drain valve..... NO LEAK
 Inner and outer cell magnetic fuel level..... FLUSH
 Slats 2, 3, 4, 5..... CONDITION

Ident.: PRO-NOR-SOP-05-A-00010384.0007001 / 17 MAY 17

ENG 1 LH SIDE

Oil fill access door.....CLOSED
 Thrust reversers..... CLOSED/LATCHED
 Fan cowl doors..... CLOSED/LATCHED
 Drain mast.....CONDITION/NO LEAK
 Engine inlet and fan blades..... CHECK
 Pylon/access panel..... CONDITION/CLOSED

Ident.: PRO-NOR-SOP-05-A-00010386.0007001 / 17 MAY 17

ENG 1 RH SIDE

Vent inlet..... CLEAR
 Pressure relief/Start valve handle access door..... CLOSED
 Thrust reversers..... CLOSED/LATCHED
 Fan cowl doors..... CLOSED/LATCHED
 Turbine exhaust..... CLEAR

Ident.: PRO-NOR-SOP-05-A-00010387.0001001 / 17 MAY 17

LH CENTER WING

Slat 1.....CONDITION
 Wing leading edge ventilation intake  CLEAR
 Fuel water drain valves.....NO LEAK
 Inner tank magnetic fuel..... FLUSH
 Landing lights.....CONDITION
 Hydraulic reservoir pressurization door..... CLOSED
 RAT doors..... CLOSED

| | |
|---|--|
|  <p>A318/A319/A320/A321 FLIGHT CREW OPERATING MANUAL</p> | <p style="text-align: center;">PROCEDURES NORMAL PROCEDURES</p> <p style="text-align: center;">STANDARD OPERATING PROCEDURES - COCKPIT PREPARATION</p> |
|---|--|

INTRODUCTION

Ident.: PRO-NOR-SOP-06-00011153.0001001 / 20 MAR 17

Applicable to: ALL

Items marked by asterisks (*) are the only steps to be completed after a transit stop without flight crew change. Otherwise, the new flight crew performs all the items.
 The PF and PM should perform the cockpit preparation according to the panel scan sequence defined below (*Refer to Panel Scan Sequence*), and the task sharing defined in the QRH (*Refer to QRH/Normal Procedures - Cockpit Preparation*).

OVERHEAD PANEL

Applicable to: ALL

Ident.: PRO-NOR-SOP-06-A-00011155.0001001 / 31 JUL 13

WHITE LIGHTS ON THE OVERHEAD PANEL

- **During the scan sequence of the overhead panel:**
 - * ALL WHITE LIGHTS..... EXTINGUISH

It is a general rule to turn off all the white lights during the scan sequence; therefore, these actions are not listed here.

Ident.: PRO-NOR-SOP-06-A-00015476.0001001 / 12 APR 16

RCDR

- * RCDR GND CTL pb-sw..... ON
- In order to perform the test, ensure that the PARK BRK is on.*
- LOUDSPEAKER VOLUME knob..... OFF (BOTH SIDES)
- ACP INT/RAD sw (CAPT and F/O).....SET to INT
- INTERPHONE VOLUME RECEPTION KNOB (CAPT and F/O)..... RELEASE
- Turn down the volume to the minimum.*
- CVR TEST pb.....PRESS AND MAINTAIN
- The CVR test is successful when an audio test signal is heard through the loudspeakers and the CVR TEST pb is pressed and maintained.*
- Depending on the CVR model, the audio test signal is:*

- For CVR 30 minutes:
 - A continuous tone, or
 - A short tone.
- For CVR 120 minutes:
 - A short tone, or
 - A short tone and a beep every 4 s, or
 - Two short tones and a beep every 4 s.

The audio test signal stops when the CVR TEST pb is released.

- Note:
- The flight crew may also hear an acoustic feedback (i.e. Larsen effect) during the test. The test is still valid even if this acoustic feedback (i.e. Larsen effect) is heard.
 - If the flight crew cannot hear the audio test signal through the loudspeakers, and if the CVR maintenance headset (22RK headset) is available, the flight crew can perform the CVR TEST through the CVR maintenance headset.
 - If an acoustic feedback (i.e. Larsen effect) is still heard, the flight crew can perform the CVR TEST using the 22RK headset and with the parking brake set to off. Before setting the parking brake to off, the flight crew must ensure that chocks are in place or brakes are applied. Set the parking brake to on when the CVR TEST is achieved.

Ident.: PRO-NOR-SOP-06-A-00011158.0001001 / 06 MAR 17

EVAC

CAPT & PURS/CAPT swAS RQRD
 Set the CAPT & PURS/CAPT sw on the EVAC panel as per Company Policy.

Ident.: PRO-NOR-SOP-06-A-00011159.0009001 / 17 MAR 17

***ADIRS**

All IR MODE selector..... NAV
 Align or realign IRS as appropriate. Refer to FCTM/PR-NP-SOP-60 ADIRS Operations.

L2 A complete IRS alignment must be performed in the following cases:

- Before the first flight of the day, or
- When there is a crew change, or
- When the GPS is not available and the NAVAIDS coverage is poor on the expected route, or
- When the GPS is not available and the expected flight time is more than 3 h.

A fast IRS alignment must be performed if a complete IRS alignment is not necessary.

To perform an alignment, the aircraft must be stopped on ground. Any aircraft movement will automatically restart the IRS alignment.

| | |
|---|--|
|  <p>A318/A319/A320/A321 FLIGHT CREW OPERATING MANUAL</p> | <p style="text-align: center;">PROCEDURES NORMAL PROCEDURES</p> <p style="text-align: center;">STANDARD OPERATING PROCEDURES - COCKPIT PREPARATION</p> |
|---|--|

Do not align IRS during engine start, or while the engines are running.

Ident.: PRO-NOR-SOP-06-A-00011160.0001001 / 05 JAN 15



EXTERIOR LIGHTS

STROBE sw..... AUTO
 BEACON sw..... OFF
 REMAINING EXTERIOR LIGHTS..... AS RQRD

Ident.: PRO-NOR-SOP-06-A-00011161.0001001 / 14 SEP 12

***SIGNS**

* SIGNS sw..... ON/AUTO
 * EMER EXIT LT selector..... ARM

Note: Leaving the EXIT selector or NO SMOKING selector or NO PORTABLE/ELEC DEVICE selector  ON prevents the emergency batteries from charging. If the CIDS has been programmed (option) for a non-smoking flight, NO SMOKING or NO PORTABLE/ELEC DEVICE  signs are permanently on, with the EXIT sw or NO SMOKING sw or NO PORTABLE/ELEC DEVICE sw  at AUTO (with permanent charge of emergency batteries).

Ident.: PRO-NOR-SOP-06-A-00010176.0001001 / 03 MAR 14

PROBE/WINDOW HEAT

PROBE/WINDOW HEAT pb..... CHECK AUTO

Ident.: PRO-NOR-SOP-06-A-00011162.0001001 / 13 AUG 10

CABIN PRESS

LDG ELEV knob..... AUTO

Ident.: PRO-NOR-SOP-06-A-00011163.0010001 / 20 SEP 16

***AIR COND**

* PACK FLOW selector..... AS RQRD

Select:

LO : If the number of occupants is below 141.

HI : For abnormally hot and humid conditions.

NORM : For all other normal operating cases.

If the APU is supplying, pack controllers select HI flow automatically, independent of the selector position.

Ident.: PRO-NOR-SOP-06-A-00011164.0001001 / 09 APR 15

ELEC

Scan and check that there are no amber lights, except GEN FAULT lights.

ELEC pb (on the ECAM Control Panel).....PRESS
 BAT 1 pb-sw and BAT 2 pb-sw.....OFF then ON

This action initiates a charging cycle of the batteries.

10 s after setting all BAT pb-sw ON, check on the ELEC SD page that the current charge of the battery is below 60 A, and is decreasing.

- **If the charge of at least one battery is not below 60 A:**

Wait until the end of the charging cycle of the batteries and perform this check again.

Ident.: PRO-NOR-SOP-06-A-00011166.0002001 / 23 JUN 15

***FUEL**

- **If the center tank is less than 200 kg (440 lb) for the flight:**

Apply the following procedure, if your airline is affected by FUEL CTR TK PUMPS LO PR cautions on ground or in flight when the center tank is less than 200 kg (440 lb):

FUEL MODE SEL pb-sw.....MAN
 CTR TK PUMP 1 pb-sw and CTR TK PUMP 2 pb-sw..... OFF

- **If the center tank is NOT less than 200 kg (440 lb) for the flight:**

CAUTION If the FUEL MODE SEL pb is unduly left in the MAN position on ground, when the CTR TK PUMP 1 pb & CTR TK PUMP 2 pb are not in the OFF position: There is a possibility of fuel spillage, if there are any hidden failures.

FUEL MODE SEL pb..... CHECK AUTO

Ident.: PRO-NOR-SOP-06-A-00011167.0001001 / 21 MAR 17

ENG 1 - ENG 2 FIRE

ENG 1 FIRE pb-sw and ENG 2 FIRE pb-swCHECK IN and GUARDED
 AGENT 1 light and AGENT 2 light CHECK OFF
 ENG 1 TEST pb and ENG 2 TEST pb PRESS and MAINTAIN

For ENG FIRE TEST description, Refer to DSC-26-20-20 FIRE Panel

Ident.: PRO-NOR-SOP-06-A-00011169.0001001 / 14 SEP 12

AUDIO SWITCHING PANEL

AUDIO SWITCHING selector NORM

A318/A319/A320/A321
 FLIGHT CREW
 OPERATING MANUAL

PROCEDURES
NORMAL PROCEDURES
 STANDARD OPERATING PROCEDURES - COCKPIT PREPARATION

Ident.: PRO-NOR-SOP-06-A-00010185.0001001 / 26 MAY 14

VENT

ALL LIGHTS.....CHECK OFF

Ident.: PRO-NOR-SOP-06-A-00011174.0001001 / 14 SEP 12

THIRD OCCUPANT AUDIO CONTROL PANEL

PA knobRECEPT

- This allows cabin attendant announcements to be recorded on the CVR.
- For proper recording, set volume at or above medium range.

Ident.: PRO-NOR-SOP-06-A-00011176.0001001 / 14 SEP 12

MAINTENANCE PANEL

ALL LIGHTS.....CHECK OFF

CTR INSTRUMENT PANEL

Applicable to: ALL

Ident.: PRO-NOR-SOP-06-B-00011184.0001001 / 21 MAR 16

CTR INSTRUMENT PANEL - ISIS

* ISIS..... CHECK

- Adjust brightness, check IAS, altimeter readings, altimeter settings and attitude display.
- Check no flags - Reset attitude, if necessary.

Note: Use of the ISIS bugs function is not recommended (Refer to DSC-34-NAV-20 Bugs Function)



AEROLINEAS GALAPAGOS S.A.

A318/A319/A320/A321
FLIGHT CREW
OPERATING MANUAL

PROCEDURES

NORMAL PROCEDURES

STANDARD OPERATING PROCEDURES - COCKPIT PREPARATION

Ident.: PRO-NOR-SOP-06-B-00011185.0009001 / 20 SEP 16

***CLOCK**

CLOCK.....CHECK/SET

Note: 1. If the date is incorrect, set the date manually then set and keep the clock mode to internal (INT) mode for the whole flight.

2. To comply with the time precision requirement (+/- 1 s UTC) for ATC datalink communication, the flight crew must either:

- Use the clock in GPS mode, or
- Use the clock in INT mode and synchronize the clock with the GPS at least one time per day. This synchronization ensures that the UTC time drift is below +/- 1 s UTC.

For more information on the setting of the clock, Refer to DSC-31-55-10 General.

For more information on the use of the internal (INT) mode, Refer to DSC-31-55-20 Operation in Internal Mode.

Ident.: PRO-NOR-SOP-06-B-00011186.0001001 / 13 AUG 10

NOSEWHEEL STEERING

* A/SKID & N/W STRG sw..... ON

PEDESTAL

Applicable to: ALL

Ident.: PRO-NOR-SOP-06-C-00011187.0001001 / 13 AUG 10

ACP

INT knob PRESS OUT / VOLUME CHECK

Make sure that INT volume is turned up to permit contact with the ground crew.

VHF CHECK

Check transmission and reception.

HF (if required for flight).....CHECK

- Check transmission and reception.
- Do not transmit on HF during refueling.

Ident.: PRO-NOR-SOP-06-C-00011191.0001001 / 23 JUN 15

COCKPIT DOOR

If required by local Airworthiness Authorities:

ANN LT selector..... TEST

Check that the OPEN and FAULT lights (on the pedestal), and the three LED lights (on the overhead panel) come on.

ANN LT selector..... BRT

Check that all lights go off.

CKPT DOOR..... CHECK CORRECT OPERATION

- Set the COCKPIT DOOR sw to the UNLOCK position. Check that the door opens, and that the OPEN light comes on
- Then, with the door fully open, release the COCKPIT DOOR sw (check that it returns to NORM position). Close the door. Check that it is locked, and that the OPEN Indication goes off.

CKPT DOOR MECHANICAL OVERRIDE..... CHECK

Check that the door opens normally, and that it closes when the mechanical override is used.

Ident.: PRO-NOR-SOP-06-C-00011189.0001001 / 14 SEP 12

SWITCHING PANEL

All selectors..... CHECK NORM

Ident.: PRO-NOR-SOP-06-C-00011192.0001001 / 12 JUL 13

***ENG**

* THRUST lever IDLE

* ENG MASTER sw OFF

* ENG MODE selector..... NORM

Ident.: PRO-NOR-SOP-06-C-00011195.0001001 / 06 SEP 16

***PARKING BRK**

ACCU PRESS indicator..... CHECK

The ACCU PRESS indication must be in the green band. If required, use the electric pump on yellow hydraulic system to recharge the brake accumulator.

WARNING Yellow and green hydraulic systems are pressurized from yellow electric pump. Get ground crew clearance before using the electric pump.

* PARK BRK handle..... CHECK ON

* BRAKES PRESS indicator..... CHECK

Check for normal indications.



AEROLINEAS GALAPAGOS S.A.

A318/A319/A320/A321

**FLIGHT CREW
OPERATING MANUAL**

PROCEDURES

NORMAL PROCEDURES

STANDARD OPERATING PROCEDURES - COCKPIT PREPARATION

● **If brakes are hot and chocks are in place:**

PARK BRK handleOFF

This action increases the brake cooling.

Ident.: PRO-NOR-SOP-06-C-00011198.0001001 / 07 FEB 11

GRAVITY GEAR EXTN

GRAVITY GEAR EXTN..... CHECK STOWED

Ident.: PRO-NOR-SOP-06-C-00011199.0001001 / 21 MAR 17

ATC

* ATC STBY

ATC and TCAS are on standby. To prevent possible interference to radar surveillance systems, TCAS should not be selected before the holding point/lining up.

ALT RPTGON

ATC SYS 1..... SELECT

For RVSM operations (Refer to PRO-SPO-50 General), select SYS 1 if AP 1 is used, and SYS 2 if AP 2 is used.

Only system 1 is available, in emergency electrical configuration.

RMP

Ident.: PRO-NOR-SOP-06-00011202.0001001 / 30 JUN 14

Applicable to: ALL

RMP..... CHECK ON

Green NAV light.....CHECK OFF

SEL light.....CHECK OFF

COM FREQUENCIES..... TUNE

Use VHF 1 for ATC (only VHF 1 is available in emergency electrical configuration), VHF 2 for ATIS and company frequencies. VHF 3 is normally devoted to ACARS.

ACARS

Ident.: PRO-NOR-SOP-06-00011224.0001001 / 24 SEP 14

Applicable to: ALL

* Initialize ACARS at that point or after FMGS PREPARATION, as per company policy.

FMGS PREPARATION

Applicable to: ALL

Ident.: PRO-NOR-SOP-06-D-00011226.0001001 / 13 AUG 10

At electrical power-up, the FMGS s and FCU run through various internal tests. Allow enough time (3 min) for tests' completion, and do not start to press pushbuttons until the tests are over. If the "PLEASE WAIT" message appears, do not press any MCDU key until the message clears.

Ident.: PRO-NOR-SOP-06-D-00011227.0001001 / 03 MAR 14

* ENGINE & AIRCRAFT TYPE..... CHECK
Press the DATA key, and display the STATUS page (if not displayed).

Ident.: PRO-NOR-SOP-06-D-00011228.0001001 / 17 JUN 14

* FM database validity..... CHECK

- Check DATA BASE validity and stored WPT /NAVAID S/RWY/ROUTES, if any.
If applicable, review the stored data for deletion decision.
- On Honeywell FMS , the double AIRAC cycle of the NDB has one day in common (AIRAC#1 day 28 / AIRAC#2 day1) (Refer to DSC-22_20-50-10-25 Aircraft Status Page).



If the CHECK DATA BASE CYCLE message triggers, the active database is no longer valid. Therefore, on Day 28 of AIRAC Cycle #1, select AIRAC Cycle#2 prior to the first flight of the day.

Ident.: PRO-NOR-SOP-06-D-00011229.0001001 / 28 MAR 11

* NAVAID DESELECTION.....AS RQRD
If NOTAMs warn of any unreliable DME or VOR /DME , display DATA, then POSITION MONITOR. Access the SEL NAVAID page, and deselect the related NAVAID.

Ident.: PRO-NOR-SOP-06-D-00011231.0003001 / 20 AUG 12

* FLIGHT PLAN INITIALIZATION.....COMPLETE

- Press the INIT key
- Insert CO RTE or city pair, and check FROM/TO
- Check/modify ALTN /CO RTE

- Enter flight number

Note: For ATC needs, the crew should enter exactly the entire flight number, as shown on the ICAO flight plan, without inserting any space, on the MCDU INIT page.

- Enter (and/or check) cost index
- Enter intended initial CRZ FL, or check if it was already supplied by the database. Modify it, if necessary, taking into account ATC constraints or expected gross weight
- Check and modify CRZ FL TEMP and tropopause level to agree with forecast
- Enter (and/or check) the expected ground temperature for take off (GND TEMP) 
- PRESS IRS INIT prompt
- Check alignment latitude/longitude.

Ident.: PRO-NOR-SOP-06-D-00011232.0001001 / 17 MAR 17

* ADIRS POSITION INITIALIZATION.....AS APPROPRIATE
Confirm or insert position coordinates for the IRS alignment. Refer to FCTM/PR-NP-SOP-60 FMGS Preparation.

 IRS Alignment Based on GPS  Position available:

The position initialization is automatic. The position for the initialization of the IRS is the GPS position. However, the flight crew can manually override the automatic position initialization. The IRS crosschecks the flight crew's manual entry with the GPS position.

IRS Alignment Based on GPS  Position not available:

Apply the manual position initialization procedure.

Ident.: PRO-NOR-SOP-06-D-00011233.0015001 / 20 JUL 15

* F-PLN A page.....COMPLETE AND CHECK
If CO RTE has been inserted, the F-PLN should automatically include the preferential or probable takeoff runway approach and landing runway, associated SID s, STAR s, transition and en-route waypoints. However some databases will only include departure and arrival airport IDENTs and en-route waypoints.

The flight crew must check, modify, or insert (as applicable) the F-PLN in the following order, according to the data given by ATIS , ATC, or MET:

- Lateral revision at departure airport. Select RWY , then SID , then TRANS using scroll keys.

Note: On the MCDU departure page, select only a runway associated with an ILS or NO NAVAIDS.

- Lateral revision at WPT for ROUTE modification if needed. (Refer to DSC-22_20-30-10-05 Lateral Revisions).
- Vertical revision. Check or enter climb speed limit, constraints according to ATC clearance. Enter step altitude as appropriate.

* WINDS..... AS APPROPRIATE

Choose between using trip wind and the forecast wind for CLB , CRZ and DES phases.(Refer to DSC-22_20-30-20-05 Flight Phases).

* F-PLN CHECK

- Check the F-PLN using F-PLN page and ND PLAN mode versus the computer (paper) flight plan or navigation chart.
- Check DIST TO DEST along the F-PLN. Compare it with the total distance computed for the flight with the computer (paper) flight plan.

Ident.: PRO-NOR-SOP-06-D-00011234.0001001 / 18 MAR 11







* SECONDARY FLIGHT PLAN..... AS APPROPRIATE

This is routinely a copy of the active flight plan. However, consideration may be given to the following:

- Copy the active F-PLN , but modify it at a suitable WPT for an immediate return to the departure airfield in the event of, for example, engine failure
- If weather is below landings minima at the departure airfield, the secondary flight plan should be that required for a diversion immediately after takeoff
- If there is a chance of a change in runway or SID during taxi, prepare for it by copying the active flight plan and making the necessary modifications.

Ident.: PRO-NOR-SOP-06-D-00011235.0001001 / 10 JUN 16

* RADIO NAV..... CHECK

- Check the VOR , ILS / GLS  / MLS  , and ADF  tuned by the FMGC
- Modify them if required, and check that the correct identifier is displayed on the ND and PFD (VOR , ILS / GLS  / MLS ). If unsatisfactory, go through the audio check. For GLS  / MLS  , no audio check is necessary.

CAUTION Do not enter an IDENT or channel associated with a GLS  / MLS  .

Ident.: PRO-NOR-SOP-06-D-00011238.0003001 / 20 MAR 17

GROSS WEIGHT INSERTION (INIT B PAGE):

- * ZFW/ZFWCG..... INSERT
- * BLOCK FUEL.....INSERT

If the LOADSHEET application is used, the PF enters the ZFWCG and ZFW as computed on his EFB.

CAUTION The characteristic speeds displayed on the MCDU (green dot, F, S, VLS) are computed from the ZFW and ZFWCG entered by the crew on the MCDU. Therefore, this data must be carefully checked (Captain's responsibility).

- The flight crew should insert the weights after completing all other insertions. This is to avoid cycles of prediction computations at each change in flight plan, constraints, etc.
- If ZFW and ZFWCG are unavailable, it is acceptable to enter the expected values in order to obtain predictions. Similarly, the flight crew may enter the expected fuel on board, if refueling has not been completed at that time.
- If ZFW , ZFWCG, and BLOCK FUEL are inserted, the FM will provide all predictions, as well as the EXTRA fuel, if any.

Ident.: PRO-NOR-SOP-06-D-00011240.0001001 / 20 MAR 17

TAKEOFF DATA INSERTION (PERF TAKEOFF PAGE):

The PF inserts the takeoff data (computed on his EFB) in the PERF TAKEOFF page of the MCDU.

- * V1 , VR , V2..... INSERT
- * FLX TO TEMP.....INSERT
- * THR RED/ACC altitude..... SET or CHECK
- * ENG OUT ACC altitude.....SET or CHECK
- * FLAPS/THS reminder..... INSERT
- * TO SHIFT..... AS RQRD

Enter the takeoff SHIFT distance, if takeoff is to be from an intersection. This is essential for position updating at takeoff and, consequently, for navigation accuracy.

- * EFB / MCDU GREEN DOT..... COMPARE

Ident.: PRO-NOR-SOP-06-D-00011243.0001001 / 13 AUG 10

CLIMB, CRUISE, DESCENT, SPEED PRESELECTION

- * PRESET SPEEDS.....AS RQRD

If the flight is cleared for a close-in turn or close-in altitude constraint, the flight crew may preselect green dot speed on the PERF CLB page. Once the CLB phase is active, the preselected speed

will be displayed in the FCU speed window and on the PFD (blue symbol). Once the turn is completed or the altitude cleared, the pilot will resume the managed speed profile by pressing the SPD selector on the FCU.

Similarly the pilot may select a CRZ MACH number on the PERF CRZ page (constant CRZ Mach segment, for example). When the CRZ phase is active, the preselected CRZ MACH number will be displayed in the FCU speed window and on the PFD . When ECON MACH number may be resumed, the crew presses the FCU SPD selector.

In either of the above cases, the pilot may cancel the CLB or CRZ preselected SPD /MACH prior to activating the related phase, by selecting ECON on the PERF CLB or CRZ pages.

SPD LIM is defaulted to 250 kt below 10 000 ft in the managed speed profile. This may be either cleared or modified on the VERT REV page at the origin (or a climb waypoint).

Ident.: PRO-NOR-SOP-06-D-00015496.0001001 / 20 MAR 17

CHECK OF FMGS PREPARATION:

* FMS PREPARATION..... CHECK

After the PF prepared the FMS , the PM checks:

- *The airfield data.*
- *All FMS entered data.*
- *The takeoff performance data with the data computed on his EFB.*

GROSS WEIGHT INSERTION..... CHECK/CROSSCHECK

If the LOADSHEET application is used, the PM checks the ZFWCG and ZFW that the PF has entered in the FMGS with the loadsheet data computed on PM 's EFB.

TAKEOFF DATA INSERTION.....CROSSCHECK

The PM crosschecks the takeoff data that the PF has entered in the FMGS , with the takeoff data computed on PM 's EFB using the TAKEOFF application.

EFB /MCDU GREEN DOT..... COMPARE

The PM compares Green Dot speed computed by the FMGS and the Green Dot speed computed using the TAKEOFF application. A discrepancy indicates a difference in the TOW used in both systems (EFB /FMGS).

GLARESHIELD

Applicable to: ALL

Ident.: PRO-NOR-SOP-06-E-00020832.0001001 / 17 MAR 17

***EFIS CONTROL PANEL**

* BAROMETRIC REFERENCE..... SET

- Set QNH (or QFE $\langle \text{✂} \rangle$) on the EFIS control panel and on the standby altimeter
- Check the barometric reference and altitude indications on the PFDs and on the standby altimeter.

The maximum difference is:

± 20 ft between both PFDs

And depending on the aircraft configuration:

± 60 ft between ISIS $\langle \text{✂} \rangle$ and PFDs, or

± 300 ft between mechanical standby altimeter and PFDs.

* FD..... CHECK ON

* ILS/LS..... AS RQRD

* ND MODE and RANGE AS RQRD

* ADF/VOR sw AS RQRD

Display VOR and ADF pointers as needed.

Ident.: PRO-NOR-SOP-06-E-00011248.0001001 / 24 SEP 14

***FCU**

* SPD MACH window..... DASHED

* HDG V/S -TRK FPA pb..... HDG V/S

* ALT window..... INITIAL EXPECTED CLEARANCE ALT

Note: *Do not engage the autothrust on ground, as it may generate the AUTO FLT A/THR OFF warning at engine start.*

LATERAL CONSOLES

Ident.: PRO-NOR-SOP-06-00011249.0002001 / 23 JUN 15

Applicable to: ALL

OXYGEN MASK TEST

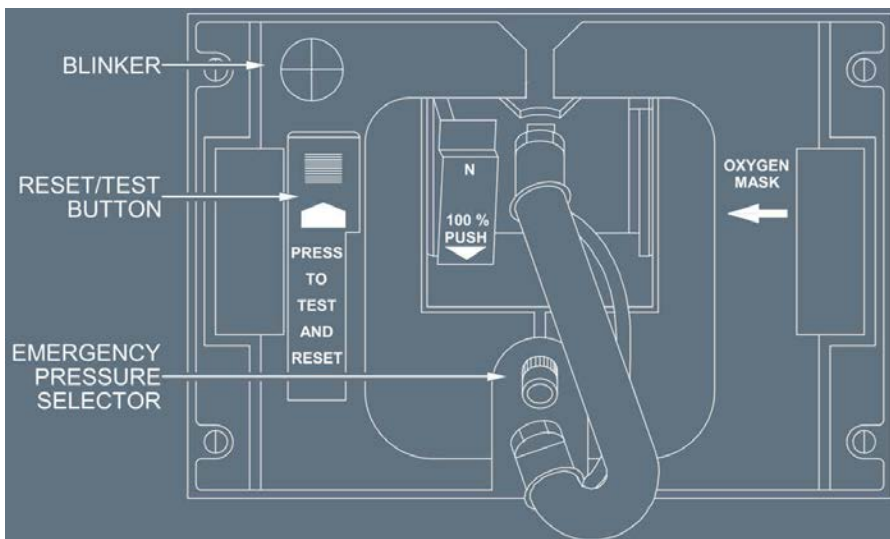

WARNING To prevent hearing damage to ground mechanics connected to the intercom system, inform them that a loud noise may be heard in the headset when performing this test.

On the OXYGEN panel:

CREW SUPPLY pb..... CHECK ON

On the glareshield:

LOUDSPEAKERS.....ON

On the audio control panel:

INT reception knob..... PRESS OUT-ADJUST

INT/RAD sw.....INT

On the mask stowage box:

PROCEDURES
NORMAL PROCEDURES

STANDARD OPERATING PROCEDURES - COCKPIT PREPARATION

- Press and hold the reset/test button in the direction of the arrow.
 - Check that the blinker turns yellow for a short time, and then goes black.
- Hold the reset/test button down, and press the emergency pressure selector.
 - Check that the blinker turns yellow and remains yellow, as long as the emergency pressure selector is pressed.
 - Listen for oxygen flow through the loudspeakers. Warn any engineer, whose headset may be connected to the nose intercom, that a loud noise may be heard when performing this check.
- Check that the reset/test button returns to the up position and the N 100 % selector is in the 100 % position.
- Press the emergency pressure selector again, and check that the blinker does not turn yellow. This ensures that the mask is not supplied.

On the ECAM DOOR/OXY page:

REGUL LO PR message.....CHECK OFF

The crew must perform this check after having checked all masks. It ensures that the LP valve is open, (due to residual pressure between the LP valve and the oxygen masks, an LP valve failed in the closed position may not be detected during the oxygen mask test).

INSTRUMENT PANELS

Ident.: PRO-NOR-SOP-06-00011252.0001001 / 17 MAR 16

Applicable to: ALL

PFD and ND brightness knob.....AS RQRD

Check the ND outer ring is set to maximum brightness (radar/terrain display).

LOUDSPEAKER knobSET

Set the LOUDSPEAKER knob around the 1 o'clock position.

* PFD.....CHECK

- *Check PFD /ND not transferred.*
- *Check for correct display, when ATT and HDG are available.*
- *Check IAS , FMA , initial target ALT , altimeter readings, VSI, altimeter settings, heading and attitude display.*

* ND.....CHECK

- *Check for correct display.*
- *Crosscheck compass indication on the ND and DDRMI.*
- *Check heading, initial waypoint, VOR ADF indications.*

| | |
|---|--|
|  <p>A318/A319/A320/A321 FLIGHT CREW OPERATING MANUAL</p> | <p align="center">PROCEDURES NORMAL PROCEDURES</p> <p align="center">STANDARD OPERATING PROCEDURES - COCKPIT PREPARATION</p> |
|---|--|

ECAM CONTROL PANEL

Ident.: PRO-NOR-SOP-06-00011190.0001001 / 24 FEB 15
Applicable to: ALL

***ECAM CONTROL PANEL**

- * PRESS pb PRESS
Check that the CAB PRESS page displays LDG ELEV AUTO, to confirm the correct position of the LDG ELEV knob.
- * STS pbPRESS
*Check that INOP SYS display is compatible with MEL.
 If a message is displayed in MAINTENANCE STATUS, Refer to MMEL/MI-00-08 ECAM and MAINTENANCE STATUS.*

ADIRS

Ident.: PRO-NOR-SOP-06-00011253.0002001 / 20 MAR 17
Applicable to: ALL

- * IRS ALIGN.....CHECK
On the POSITION MONITOR page, check that the IRS are in NAV mode, and check that the distance between each IRS and the FMS position is lower than 5 NM. Select ND in ROSE-NAV or ARC mode, and confirm that the aircraft position is consistent with the position of the airport, the SID and the surrounding NAVAIDs.
- NAV CHARTS CLIPBOARD.....PREPARE

TAKEOFF BRIEFING

Ident.: PRO-NOR-SOP-06-00011256.0001001 / 20 MAR 17
Applicable to: ALL

- * TAKEOFF BRIEFING.....PERFORM

PC DEDICATED TO MAINTENANCE 

Ident.: PRO-NOR-SOP-06-00011258.0001001 / 07 FEB 11
Applicable to: ALL

- Check that the Personal Computer (PC) dedicated to maintenance use and located in front of lower stowage at RH rear corner is stowed.
- Check that the light of its manual switch is off. If not, switch it off.
- Check that its associated printer located in front of RH rear of the cockpit is stowed.

FLOW PATTERN

Ident.: PRO-NOR-SOP-06-00020280.0001001 / 17 MAR 17

Applicable to: ALL

COCKPIT PREPARATION - FLOW PATTERN

The scan pattern varies, depending on the pilot status, i.e PF , PM , CM1 , or CM2, and the areas of responsibility:

1. Overhead panel
2. Center instrument panel
3. Pedestal
4. FMGS preparation, and when both pilots are seated:
5. Glareshield
6. Lateral consoles and CM1/CM2 panels.

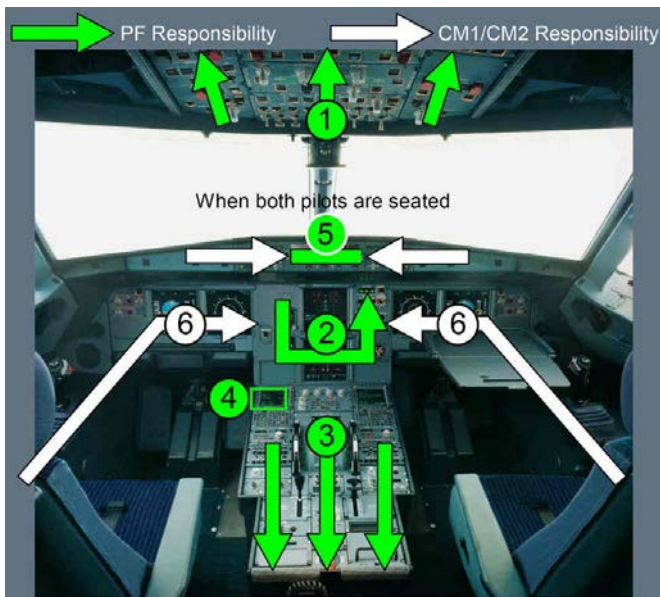

| | |
|---|--|
|  <p>A318/A319/A320/A321 FLIGHT CREW OPERATING MANUAL</p> | <p>PROCEDURES</p> <p>NORMAL PROCEDURES</p> <p>STANDARD OPERATING PROCEDURES - BEFORE PUSHBACK OR START</p> |
|---|--|

BEFORE START CLEARANCE

Applicable to: ALL

Ident.: PRO-NOR-SOP-07-A-00021624.0001001 / 19 APR 17

LOADSHEET

FINAL LOADSHEET.....CHECK

Both crew members carefully check the Load and Trim Sheet (LTS), particularly for gross errors. Make sure that the load sheet data is correct (e.g correct flight, correct aircraft, dry operating index, configuration, Fuel on Board, etc.).

ZFW /ZFWCG..... CHECK/REVISE

The PF compares the ZFW and the ZFWCG with the previously-entered data, and adjust if necessary.

ZFW /ZFWCG.....CROSSCHECK

The PM crosschecks the ZFW and the ZFWCG entered in the FMS

Check that the takeoff CG is within LTS operational limits.

FINAL LOADSHEET (CM1).....SIGN and EXPORT

If the loadsheet is modified, or if required by the authorities or by the airline policy, the CM1 sends the loadsheet to the ground via the EXPORT function on the LOADSHEET application.

Ident.: PRO-NOR-SOP-07-A-00011255.0009001 / 09 JUN 15

FOB..... CHECK

- Check that ECAM fuel on board corresponds to the F-PLN.
- Check that fuel imbalance is within limits.
- Crosscheck that the sum of the Fuel On Board (FOB) recorded at the end of the last flight and the fuel uplift (if any) is consistent with the current FOB. If an abnormal discrepancy is found, a maintenance action is due.

| | |
|---|------------------------------------|
| <i>FOB after refuelling:</i> | <i>Abnormal discrepancy above:</i> |
| <i>Up to 6 tons (13200 lb)</i> | <i>400 kg (900 lb)</i> |
| <i>Between 6 tons (13200 lb) and 12 tons (26500 lb)</i> | <i>500 kg (1100 lb)</i> |
| <i>More than 12 tons (26500 lb)</i> | <i>600 kg (1300 lb)</i> |

PROCEDURES

NORMAL PROCEDURES

STANDARD OPERATING PROCEDURES
- BEFORE PUSHBACK OR START

Ident.: PRO-NOR-SOP-07-A-00010189.0002001 / 20 MAR 17

TAKEOFF DATA

FINAL TAKEOFF DATA..... CONFIRM or RECOMPUTE

- *If takeoff conditions did not change, verify and confirm that the preliminary takeoff data are still valid*
- *If takeoff conditions have changed, calculate the final takeoff performance, using the T.O. PERF application on the EFB.*

FMS TAKEOFF DATA.....CHECK/REVISE AS RQRD

The PF checks (or revises) the takeoff data on the INIT B and PERF pages of the MCDU.

REVISED FMS TAKEOFF DATA.....CROSSCHECK

The PM crosschecks the takeoff data on the MCDU (i.e. weights, speeds, flexible temperature, takeoff configuration), with the PM 's EFB takeoff data.

EFB /MCDU GREEN DOT..... COMPARE

The PM compares Green Dot speed computed by the FMGS and the Green Dot speed computed using the TAKEOFF application. A discrepancy indicates a difference in the TOW used in both systems (EFB /FMGS).

Ident.: PRO-NOR-SOP-07-A-00010190.0001001 / 04 MAR 14

SEATING POSITION

SEATING POSITION..... ADJUST

The seat is correctly adjusted, when the pilot's eyes are in line with the red and white balls.

Ident.: PRO-NOR-SOP-07-A-00010192.0001001 / 23 DEC 14

MCDU

FMS PERF TO page..... SELECT

It is recommended to display the PERF TO page on the PF side.

FMS F-PLN page.....SELECT

It is recommended to display the F-PLN page on the PM side

Ident.: PRO-NOR-SOP-07-A-00010193.0001001 / 17 MAR 16

ELEC

EXT PWR.....CHECK AVAIL

WARNING Disconnection of the external power with the EXT PWR pb-sw ON may cause injury to the ground engineer. Request disconnection of the external power only with the EXT PWR pb-sw AVAIL.

EXT PWR DISCONNECTION..... REQUEST
 Ident.: PRO-NOR-SOP-07-A-00021505.0001001 / 20 MAR 17

EFB/eQRH transmitting mode..... CONSIDER
In accordance with the Operator's policy or, as required by operational regulations.
 Ident.: PRO-NOR-SOP-07-A-00010194.0001001 / 12 FEB 13

BEFORE START CHECKLIST DOWN TO THE LINE
 BEFORE START CHECKLIST down to the line.....COMPLETE

AT START CLEARANCE

Applicable to: ALL
 Ident.: PRO-NOR-SOP-07-B-00010197.0001001 / 04 MAR 14

PUSHBACK/START UP CLEARANCE
 PUSHBACK/START CLEARANCE..... OBTAIN
Obtain ATC pushback/startup clearance.
Obtain ground crew clearance.
 Ident.: PRO-NOR-SOP-07-B-00015568.0001001 / 20 JAN 15

ATC.....SET FOR OPERATION
ATC is set in accordance with airport requirements.
 Ident.: PRO-NOR-SOP-07-B-00010199.0002001 / 04 MAR 14

WINDOWS AND DOORS
 WINDOWS and DOORS..... CHECK CLOSED

- To ensure that the sliding window is correctly closed and locked, push the handle of the sliding window fully forward to the closed position, and check that the red indicator is visible
- Check, on the ECAM lower display, that all the aircraft doors are closed
- When required by local airworthiness authorities, check that the cockpit door is closed and locked (no cockpit door open/fault indication).

If entry is requested, identify the person requesting entry before unlocking the door. With the cockpit door sw on NORM, the cockpit door is closed and locked. If entry is requested from the cabin, and if no further action is performed by the pilot, the cabin crew will be able to unlock the door by using the emergency access procedure. Except for crew entry/exit, the cockpit door should remain closed until engine shutdown.

PROCEDURES

NORMAL PROCEDURES

STANDARD OPERATING PROCEDURES
 - BEFORE PUSHBACK OR START

SLIDES.....CHECK ARMED

- Check, on the ECAM lower display, that all slides are armed.

ident.: PRO-NOR-SOP-07-B-00010200.0001001 / 04 MAR 14

EXTERIOR LIGHTS

BEACON sw..... ON

ident.: PRO-NOR-SOP-07-B-00010201.0001001 / 04 MAR 14

THRUST LEVERS

THRUST LEVERS..... IDLE

CAUTION Engines will start, regardless of the thrust lever position; thrust will rapidly increase to the corresponding thrust lever position, causing a hazardous situation, if thrust levers are not at IDLE.

ident.: PRO-NOR-SOP-07-B-00016807.0001001 / 06 SEP 16

ACCU PRESSURE

ACCU PRESS indicator..... CHECK

The ACCU PRESS indication must be in the green band. If required, use the electric pump on yellow hydraulic system to recharge the brake accumulator.

WARNING Yellow and green hydraulic systems are pressurized from yellow electric pump. Get ground crew clearance before using the electric pump.

ident.: PRO-NOR-SOP-07-B-00010202.0002001 / 24 NOV 15

PARKING BRAKE AND NOSEWHEEL STEERING

● **If pushback is not required:**

PARK BRK handle..... CHECK ON

BRAKES PRESS indicator..... CHECK

Check for normal indications.

BEFORE START CHECKLIST below the line.....COMPLETE

ident.: PRO-NOR-SOP-07-B-00010198.0002001 / 21 MAR 17

● **If pushback is required:**

N/W STRG DISC MEMO..... CHECK DISPLAYED

In case of pushback (conventional or towbarless), the nosewheel steering selector bypass pin must be in the tow position. The ECAM's NW STRG DISC, or N WHEEL STEERG DISC memos indicate this to the flight crew.

PROCEDURES

NORMAL PROCEDURES

STANDARD OPERATING PROCEDURES
 - BEFORE PUSHBACK OR START

CAUTION *If the ECAM does not display the N WHEEL STEERG DISC memo, but the ground crew confirms that the tow pin is in the towing position, the flight crew should not start the engine during pushback. This is to avoid possible nose landing gear damage upon yellow hydraulic pressurization. To dispatch the aircraft in such a case, Refer to MMEL/MI-32-51 NWS Electrical Deactivation Box.*

In case of a powerpush by the main landing gear, the nosewheel steering selector should remain in the normal position to steer the aircraft (Refer to PRO-NOR-SUP-MISC-D Pushback with Power Push Unit via the Main Landing Gear - Procedure 1/2).

BEFORE START CHECKLIST below the line..... COMPLETE
 PARK BRK handle OFF

CAUTION *Do not use the brakes during pushback, unless required due to an emergency.*

● **When pushback is completed:**

PARK BRK handle ON
 BRAKE PRESS indicator..... CHECK

Check for normal indications.

Ask the ground crew for towbar disconnection.



A318/A319/A320/A321
FLIGHT CREW
OPERATING MANUAL

PROCEDURES

NORMAL PROCEDURES

STANDARD OPERATING PROCEDURES
- BEFORE PUSHBACK OR START

Intentionally left blank

| | |
|---|---|
|  A318/A319/A320/A321 FLIGHT CREW OPERATING MANUAL | PROCEDURES NORMAL PROCEDURES STANDARD OPERATING PROCEDURES - ENGINE START |
|---|---|

AUTOMATIC ENGINE START

Ident.: PRO-NOR-SOP-08-00010162.0060001 / 31 AUG 17

Applicable to: ALL

Use the automatic engine start procedure in most circumstances. However, if the start aborts due to insufficient starter inlet air pressure (e.g. on high airfields, or in case of low pressure from an external pneumatic power group), it is recommended to use the manual start procedure, instead the automatic procedure.

If, during the engine start, the ground crew reports a fuel leak from the engine drain mast, run the engine at idle for 5 min. If the leak disappears during these 5 min, the aircraft can be dispatched without maintenance action. If the leak is still present after 5 min, shut down the engine and request the maintenance personnel to investigate the leakage source.

ENG MODE selector IGN/START

The lower ECAM displays the ENG SD page.

ENGINE 2 START.....ANNOUNCE

Engine 2 is usually started first. It powers the yellow hydraulic system, that pressurizes the parking brake.

ENG MASTER 2.....ON

- Do not set the ENG MASTER 2 lever to ON before all amber crosses and messages have disappeared on the engine parameters (upper ECAM display).
- Parameter callouts are not mandatory.
- In case the electrical power supply is interrupted during the start sequence (indicated by the loss of ECAM DUs), abort the start by setting to OFF the ENG MASTER 2 lever. Then, perform a 30 s dry crank.

| ON ECAM UPPER DISPLAY | ON ECAM LOWER DISPLAY |
|--|---|
| N2 increases | Corresponding start valve in line. Bleed pressure indication green. Oil pressure increases. |
| At 16 % N2 | Indication of the active igniter (A or B). |
| At 22 % N2 - FF increases 15 s (maximum) after fuel is on - EGT increases - N1 increases | |
| At 50 % N2 | Start valve starts closing. (It is fully closed between 50 % and 56 % N2). Igniter indication off. |

● **When idle is reached (AVAIL indication is displayed):**

ENG IDLE PARAMETERS..... CHECK

At ISA sea level : N1 about 19.5 %
N2 about 58.5 %
EGT about 390 °C
FF about 275 kg/h (600 lb/h)

Grey background on N2 indication disappears.

ENGINE 1 START..... ANNOUNCE

ENG MASTER 1..... ON

Same procedure as for engine 2.

Both pack valves reopen with 30 s delay after the second engine N2 is above 50 %.

Note: A PTU FAULT is triggered, if the last engine is started within 40 s following the end of the cargo doors operation. Refer to PRO-ABN-HYD HYD PTU FAULT.

GROUND RUN UP - DANGER AREAS

Ident.: PRO-NOR-SOP-08-00010163.0006001 / 06 JAN 16

Applicable to: ALL

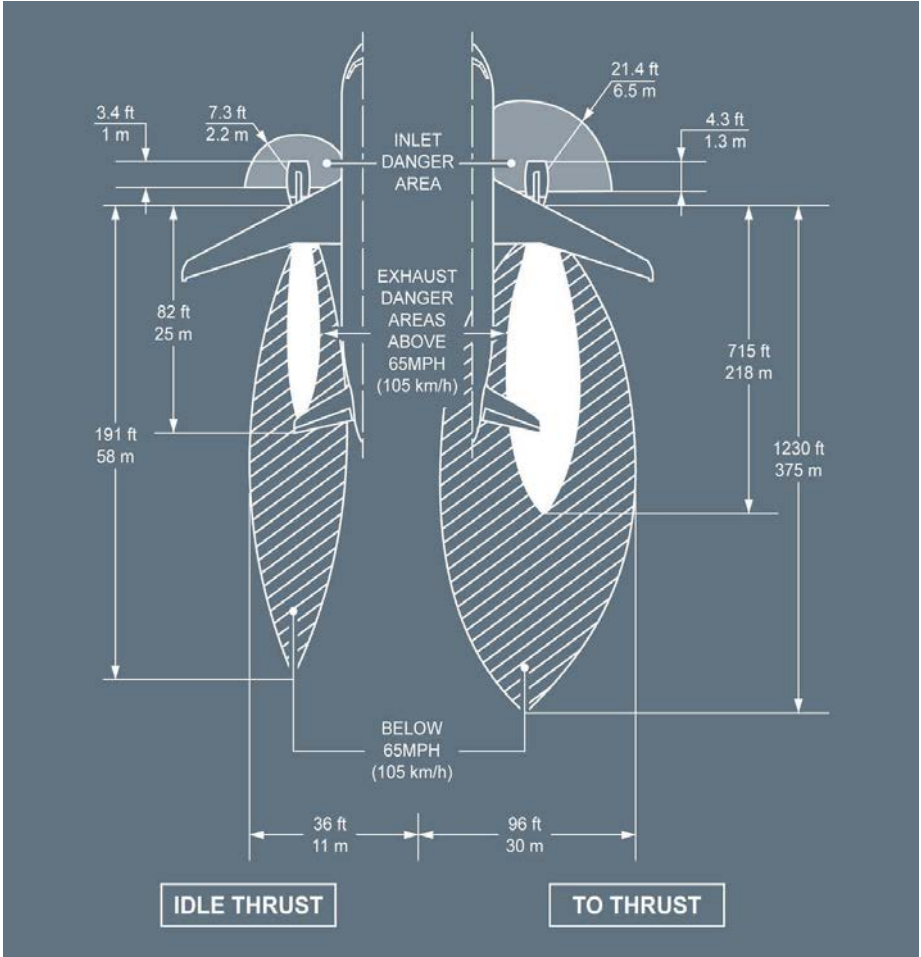

PROCEDURES

NORMAL PROCEDURES

STANDARD OPERATING PROCEDURES - ENGINE START

Intentionally left blank

| | |
|---|--|
|  <p>A318/A319/A320/A321 FLIGHT CREW OPERATING MANUAL</p> | <p align="center">PROCEDURES NORMAL PROCEDURES</p> <p align="center">STANDARD OPERATING PROCEDURES - AFTER START</p> |
|---|--|

AFTER START

Applicable to: ALL

Ident.: PRO-NOR-SOP-09-A-00010210.0002001 / 21 MAR 17

ENG MODE

ENG MODE selector NORM

For additional information on the automatic starting sequence, Refer to DSC-70-80-40 Sequence of the Automatic Start.

After start, to avoid thermal shock, the pilot should operate the engine at idle or near idle for at least 2 min before advancing the thrust lever to high power. Taxi time at idle may be included in the warm-up period.

The last engine started must run for at least 2 min before takeoff initiation, to ensure that takeoff is not initiated before the center tank pumps test is finished, since takeoff on center tank is prohibited.

Ident.: PRO-NOR-SOP-09-A-00010211.0001001 / 26 OCT 12

APU BLEED

APU BLEED pb-sw..... OFF

- This action enables to avoid ingestion of engine exhaust gases.
- APU BLEED valve closes, ENG BLEED valves open.

Ident.: PRO-NOR-SOP-09-A-00010212.0005001 / 17 MAR 17

ANTI-ICE

CAUTION In icing conditions (*Refer to LIM-ICE_RAIN Definition of Icing Conditions*), the flight crew must turn on the engine anti-ice and should not wait until seeing ice building up.

ENG ANTI-ICE pb-sw AS RQRD

Engine anti-ice must be set to ON during all ground operation, when icing conditions exist or are anticipated.

During ground operation, when in icing conditions for more than 30 min, the following procedure should be applied for ice shedding :

CAUTION If, during thrust increase, the aircraft starts to move, immediately retard the thrust levers to IDLE.

If ground surface conditions and the environment permit, the flight crew should accelerate the engines to approximately 70 % of N1 for 30 s at intervals not greater than 30 min.

PROCEDURES
NORMAL PROCEDURES

STANDARD OPERATING PROCEDURES - AFTER START

In addition, this engine acceleration should also be performed just before take-off, with particular attention to engine parameters to ensure normal engine operation. If ground surface or environment do not permit to accelerate the engine to 70 % N1, then power setting and dwell time should be as high as practical.

When operating in conditions of freezing rain, freezing drizzle, freezing fog or heavy snow, ice shedding may be enhanced, by additional run ups at intervals, to not exceed 10 min, advancing throttles to 70 % N1 momentarily (no hold time).

Ident.: PRO-NOR-SOP-09-A-00010213.0001001 / 21 MAR 17

WING ANTI-ICE pb-sw..... AS QRDR

When icing conditions are encountered:

- *The flight crew may turn on the wing anti-ice to prevent ice accretion on the wing leading edge.*
- *The flight crew must turn on the wing anti-ice if there is evidence of ice accretion, such as ice on the visual indicator, or on the wipers, or with the **SEVERE ICE DETECTED** alert. This is to remove any ice accumulation from the wing leading edge.*

Ident.: PRO-NOR-SOP-09-A-00010214.0001001 / 04 MAR 14

APU

- **If the APU is not required:**

APU MASTER SW..... OFF

Ident.: PRO-NOR-SOP-09-A-00010215.0001001 / 26 OCT 12

GROUND SPOILERS

GROUND SPOILERS..... ARM

Ident.: PRO-NOR-SOP-09-A-00010216.0001001 / 26 OCT 12

RUDDER TRIM

RUD TRIM position indication.....CHECK ZERO

- **If the RUD TRIM position indication is not at zero:**

RESET pb..... PRESS

Note: After the reset, the flight crew may observe an indication of up to 0.3 ° (L or R) in the RUD TRIM position indication.

Ident.: PRO-NOR-SOP-09-A-00010217.0001001 / 26 OCT 12

FLAPS

FLAPS lever..... SET FOR TAKEOFF

| | |
|---|--|
|  <p>A318/A319/A320/A321 FLIGHT CREW OPERATING MANUAL</p> | <p align="center">PROCEDURES NORMAL PROCEDURES</p> <p align="center">STANDARD OPERATING PROCEDURES - AFTER START</p> |
|---|--|

FLAPS..... CHECK POSITION

Check the position of the flaps on the ECAM upper display.

● **If taxiing in icing conditions with rain, slush or snow:**

Maintain the flaps retracted until the aircraft reaches the holding point of the takeoff runway.

This action prevents contamination of the slats/flaps mechanism.

Ident.: PRO-NOR-SOP-09-A-00010218.0001001 / 26 OCT 12

PITCH TRIM

PITCH TRIM handwheel..... SET

Set takeoff CG on pitch trim handwheel.

Ident.: PRO-NOR-SOP-09-A-00010220.0001001 / 01 DEC 14

ECAM STATUS

STATUS REMINDER..... CHECK NOT DISPLAYED

● **If STS reminder is displayed:**

STS pb..... PRESS

Review the ECAM Status page.

Ident.: PRO-NOR-SOP-09-A-00015495.0001001 / 23 JUN 15

N/W STEER DISC MEMO

N/W STEER DISC MEMO..... CHECK NOT DISPLAYED

Ident.: PRO-NOR-SOP-09-A-00010221.0001001 / 05 NOV 15

GROUND CREW

CLEAR TO DISCONNECT..... ANNOUNCE

The ground crew:

- *Removes the chocks*
- *Disconnects the interphone*
- *Makes the hand signal on the left or right side.*

Ident.: PRO-NOR-SOP-09-A-00010222.0001001 / 26 OCT 12

AFTER START CHECKLIST

AFTER START CHECKLIST..... COMPLETE

Ident.: PRO-NOR-SOP-09-A-00020074.0001001 / 17 MAR 17

AFTER START - FLOW PATTERN

When the engines have started, the PF sets the ENG MODE selector to NORM to permit normal pack operation. At this time, the After Start Flow Pattern begins.

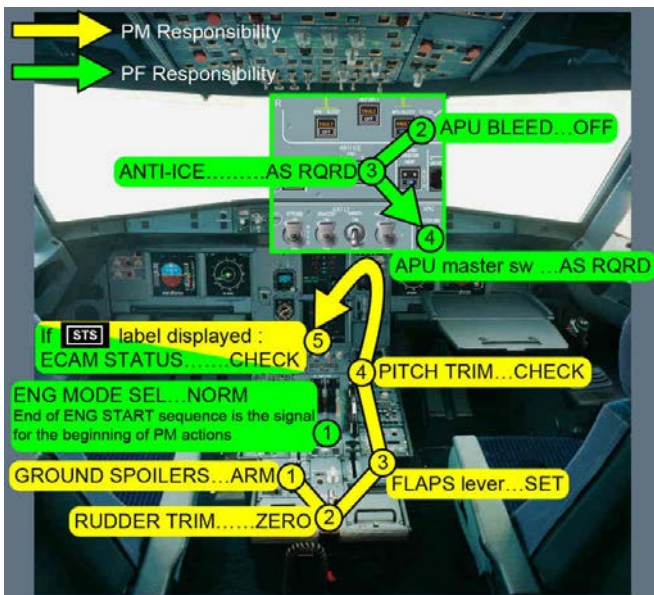

| | |
|---|--|
|  <p>A318/A319/A320/A321 FLIGHT CREW OPERATING MANUAL</p> | <p style="text-align: center;">PROCEDURES NORMAL PROCEDURES STANDARD OPERATING PROCEDURES - TAXI</p> |
|---|--|

TAXI

Applicable to: ALL

Ident.: PRO-NOR-SOP-10-A-00010226.0001001 / 15 MAY 13

TAXI CLEARANCE

TAXI clearance.....OBTAIN

Ident.: PRO-NOR-SOP-10-A-00010227.0001001 / 21 MAR 17

EXTERIOR LIGHTS

NOSE sw.....TAXI

● **When crossing a runway:**

STROBE sw.....ON

RWY TURN OFF & CAMERA sw ON

 *The PF may ask the PM to set the exterior lights.*

Ident.: PRO-NOR-SOP-10-A-00010228.0001001 / 15 MAY 13

PARK BRK

PARK BRK handle.....OFF

BRAKES PRESSURE.....CHECK AT ZERO

The flight crew may observe slight residual pressure on the triple indicator for a short period of time.

Ident.: PRO-NOR-SOP-10-A-00010230.0001001 / 19 APR 17

THRUST LEVER

THRUST leverAS RQRD

The flight crew will need a little power above idle thrust to move the aircraft.

 For additional information on the thrust use during taxi, *Refer to FCTM/PR-NP-SOP-100 Taxi Roll and Steering.*

Ident.: PRO-NOR-SOP-10-A-00010231.0002001 / 17 MAR 17

BRAKES

CAUTION If the aircraft was parked in wet conditions for a long time, the first brake application at low speed is less effective.

BRAKE PEDALS.....PRESS

PROCEDURES

NORMAL PROCEDURES

STANDARD OPERATING PROCEDURES - TAXI

BRAKESCHECK
If an arc is displayed above the brake temperature on the WHEEL SD page, set the brake fans  to ON.

 For more information, Refer to FCTM/PR-NP-SOP-100 Brake Check.

ident.: PRO-NOR-SOP-10-A-00016023.0001001 / 17 MAR 17

NOSEWHEEL STEERING

TILLER or RUDDER PEDALS..... USE AS RQRD

 For information on the nosewheel steering limitation, Refer to FCTM/PR-NP-SOP-100 Taxi Roll and Steering.

ident.: PRO-NOR-SOP-10-A-00010243.0001001 / 22 MAR 17

FLIGHT CONTROLS

FLIGHT CONTROLS.....CHECK

 For additional information on the flight controls check, Refer to FCTM/PR-NP-SOP-100 Flight Controls.

ident.: PRO-NOR-SOP-10-A-00010244.0001001 / 15 MAY 13

ATC CLEARANCE

ATC clearance.....CONFIRM

ident.: PRO-NOR-SOP-10-A-00010248.0001001 / 20 MAR 17

TAKEOFF DATA/CONDITIONS

If the takeoff data has changed, or in the case of a runway change, prepare updated takeoff:

FINAL TAKEOFF DATA..... CONFIRM or RECOMPUTE

If takeoff conditions changed, the PF and the PM independently compute again the takeoff data.

FMS TAKEOFF DATA.....CHECK/REVISE AS RQRD

If takeoff conditions changed, the PF revises the takeoff data in the FMS.

REVISED FMS TAKEOFF DATA.....CROSSCHECK

The PM crosschecks the takeoff data entered by the PF on the MCDU (i.e. weights, speeds, flexible temperature, takeoff configuration), with the PM 's EFB takeoff data.

EFB/MCDU GREEN DOT.....COMPARE

The PM compares Green Dot speed computed by the FMGS and the Green Dot speed computed using the TAKEOFF application. A discrepancy indicates a difference in the TOW used in both systems (EFB /FMGS).

F-PLN (Runway)..... REVISE

FLAPS lever AS APPROPRIATE
Select takeoff position.
 V1 , VR , V2..... REINSERT
 FLX TO temperature.....REINSERT

Ident.: PRO-NOR-SOP-10-A-00015301.0001001 / 17 MAR 17

AFS/FLIGHT INSTRUMENTS

F-PLN (SID ,TRANS)..... REVISE or CHECK
Carefully confirm that the ATC clearance agrees with the FMS , if NAV mode is to be used.
 INITIAL CLIMB SPEED AND SPEED LIMIT..... MODIFY or CHECK
Use VERT REV at departure, or at a CLB waypoint.
 CLEARED ALTITUDE ON FCU SET
 HDG ON FCUIF REQUIRED, PRESET
If a heading is required by the ATC after takeoff, in case of a radar vector departure, preset the heading on the FCU . NAV mode will be disarmed.
RWY TRK mode will keep the aircraft on the runway track.
 BOTH FDCHECK ON
 PFD /ND CHECK
 TAKEOFF BRIEFING..... CONFIRM

L2 *For additional information on the takeoff briefing confirmation, Refer to FCTM/PR-NP-SOP-100 Takeoff Briefing Confirmation.*

Ident.: TDU / PRO-NOR-SOP-10-A-00015299.0002001 / 03 AUG 17
 Impacted DU: 00015298 Taxi - Radar

RADAR..... ON
To check the radar and the departure path, set the MULTISCAN sw to MAN. The flight crew can then set the radar to the AUTO position.
Gain must be manually set to +4, when MULTISCAN selector is set to AUTO and when flying below FL 200.

- Note:*
1. If the weather is good, or not significant, in order to check that the radar is operating correctly: down tilt until displaying ground echoes
 2. If the weather display is ambiguous or unexpected, in order to better analyze the weather situation, use manual tilt according to standard technique.
 3. In particular below FL 200, for situations with low-level weather, weather with low reflectivity or in front of suspected active cells, the flight crew should switch to Manual mode and adjust the tilt setting downward until the weather is detected or the ground clutter appears on the upper part of the display.
 4. In addition, the flight crew may increase the manual gain control to display lower reflectivity targets. The manual gain control can be increased in both AUTO and Manual modes to display lower levels of weather. In both cases, ground clutter may also be displayed as a result of low settings and/or increased gain.

PREDICTIVE WINDSHEAR SYSTEM AUTO

Ident.: PRO-NOR-SOP-10-A-00015298.0002001 / 03 AUG 17
 Impacted by TDU: 00015299 Taxi - Radar

RADAR..... ON

To check the radar and the departure path, set the MULTISCAN sw to MAN. The flight crew can then set the radar to the AUTO position.

PREDICTIVE WINDSHEAR SYSTEM AUTO

Ident.: PRO-NOR-SOP-10-A-00010252.0001001 / 20 JAN 15

ATC

ATC code/mode..... CONFIRM/SET FOR TAKEOFF

Ident.: PRO-NOR-SOP-10-A-00010254.0001001 / 03 AUG 17

TERR ON ND

TERR ON ND AS RQRD

Consider selecting the radar display on the PF side, and TERR ON ND on the PM side only.

Ident.: PRO-NOR-SOP-10-A-00010264.0001001 / 15 MAY 13

AUTO BRK

AUTO BRK MAX pb-sw..... ON

Ident.: PRO-NOR-SOP-10-A-00010268.0001001 / 04 MAR 14

FINAL CHECK

T.O CONFIG pb.....TEST
Check that ECAM upper display shows "T.O CONFIG NORMAL".
 T.O MEMO.....CHECK NO BLUE
 CABIN REPORT.....RECEIVE
Obtain cabin report from the purser, as a minimum : "CABIN SECURED FOR TAKEOFF"

Ident.: PRO-NOR-SOP-10-A-00010271.0001001 / 15 MAY 13

BEFORE TAKEOFF CHECKLIST

BEFORE TAKEOFF CHECKLIST down to the line.....COMPLETE

Ident.: PRO-NOR-SOP-10-A-00020075.0001001 / 17 MAR 17

TAXI FLOW PATTERN

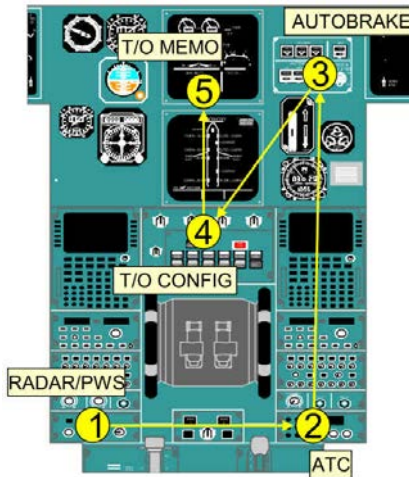



A318/A319/A320/A321
FLIGHT CREW
OPERATING MANUAL

PROCEDURES

NORMAL PROCEDURES

STANDARD OPERATING PROCEDURES - TAXI

Intentionally left blank

| | |
|---|---|
|  <p>A318/A319/A320/A321 FLIGHT CREW OPERATING MANUAL</p> | <p style="text-align: center;">PROCEDURES NORMAL PROCEDURES</p> <p style="text-align: center;">STANDARD OPERATING PROCEDURES - BEFORE TAKEOFF</p> |
|---|---|

BEFORE TAKEOFF

Applicable to: ALL

Ident.: PRO-NOR-SOP-11-A-00010396.0001001 / 05 AUG 10

- If the brake fans  are running:
BRAKE TEMP..... CHECK
 - If brake temperature is above 150 °C, delay takeoff.
 - If brake temperature is below 150 °C, select brake fans off.

Ident.: PRO-NOR-SOP-11-A-00010388.0001001 / 05 AUG 10

TAKEOFF OR LINE UP CLEARANCE..... OBTAIN

Ident.: PRO-NOR-SOP-11-A-00010392.0002001 / 29 SEP 15

EXTERIOR LIGHTS



- RWY TURN OFF sw..... ON
- NOSE sw..... T.O
- STROBE sw..... ON
- Set the STROBE sw to ON when entering the runway.*
- LAND LIGHTS sw..... ON
- Set the LAND LIGHTS sw to ON when entering the runway and takeoff clearance is received.*

 The PF may ask the PM to set the exterior lights.

 **Note:** Setting the RWY TURN OFF sw, the LAND LIGHTS sw and the NOSE sw to ON/T.O minimizes bird strike hazard during takeoff.

Ident.: PRO-NOR-SOP-11-A-00010389.0001001 / 04 MAR 14

TCAS

- TCAS  Mode selector..... TA or TA /RA
-  The flight crew should use the TA /RA mode as the default mode of the TCAS.
The flight crew may use the TA ONLY mode in specific airports, and for specific procedures (identified by Operators) that may provide resolution advisories that are neither wanted nor appropriate (e.g. closely-spaced parallel or converging runways).

Ident.: PRO-NOR-SOP-11-A-00010390.0001001 / 04 MAR 14

APPROACH PATH CLEARED OF TRAFFIC

- APPROACH PATH..... CLEARED OF TRAFFIC
- Check that the approach path is clear of traffic, visually and using TCAS display on ND.*

Ident.: PRO-NOR-SOP-11-A-00010399.0001001 / 16 MAR 11

CABIN CREW.....ADVISE
Advise the cabin crew that takeoff is imminent.

Ident.: PRO-NOR-SOP-11-A-00010397.0004001 / 16 MAR 11

ENG MODE selector.....AS RQRD
Select IGN, if:
- *The runway has standing water, or*
- *Heavy rain is falling, or*
- *Heavy rain or severe turbulence is expected after takeoff.*

Ident.: PRO-NOR-SOP-11-A-00010394.0001001 / 20 MAR 17

SLIDING TABLE/EFB

SLIDING TABLE.....STOW
EFB/eQRH transmitting mode..... CONSIDER
In accordance with the Operator's policy or, as required by operational regulations.
EFB/eQRH (with no mounted equipment)..... STOW
In flight, both flight crewmembers should not use at the same time Flysmart with Airbus applications.

Ident.: PRO-NOR-SOP-11-A-00010393.0001001 / 21 MAR 17

TAKEOFF RUNWAY.....CONFIRM
Confirm that the line up is performed on the intended runway. Useful aids are:
- *The runway markings,*
- *The runway lights,*
Be careful that in low visibility, edge lights could be mixed up with the center line lights.
- *The ILS signal,*
If the runway is ILS equipped, the flight crew can press the ILS pb (or LS pb): The LOC deviation should be centered after line up.
- *The runway symbol on the ND,*
- *The Runway Awareness and Advisory System .*

Ident.: PRO-NOR-SOP-11-A-00010391.0001001 / 05 AUG 10

PACK 1 and 2.....AS RQRD
Consider selecting packs OFF, or APU bleed ON.
This will improve performance when using TOGA thrust.
In case of a FLEX takeoff, selecting packs OFF or APU bleed ON will reduce takeoff EGT, and thus reduce maintenance costs.



A318/A319/A320/A321
FLIGHT CREW
OPERATING MANUAL

PROCEDURES
NORMAL PROCEDURES

STANDARD OPERATING PROCEDURES - BEFORE TAKEOFF

The use of flex thrust may reduce maintenance costs. The effect is particularly significant with the first degrees of FLEX.

Use of APU bleed is not authorized, if wing anti-ice is to be used.

Ident.: PRO-NOR-SOP-11-A-00010400.0001001 / 16 MAR 11

BEFORE TAKEOFF CHECKLIST below the line..... COMPLETE

Read the checklist below the line, when line-up clearance is obtained.

PROCEDURES

NORMAL PROCEDURES

STANDARD OPERATING PROCEDURES - BEFORE TAKEOFF

Intentionally left blank

TAKEOFF

Applicable to: ALL

Ident.: PRO-NOR-SOP-12-A-00011559.0001001 / 28 JUL 14

The below procedure is the standard takeoff procedure. However, rolling takeoff is permitted.

TAKEOFF..... ANNOUNCE

Ident.: PRO-NOR-SOP-12-A-00011560.0006001 / 23 JUN 15

THRUST SETTING

THRUST LEVERS.....50 % N1 (1.05 EPR)

● **If the crosswind is at or below 20 kt and there is no tailwind:**

To counter the nose-up effect of setting engine takeoff thrust, apply half forward sidestick until the airspeed reaches 80 kt. Release the sidestick gradually to reach neutral at 100 kt.

BRAKES.....RELEASE

THRUST LEVERS..... FLX or TOGA

Once the thrust levers are set to FLX or TOGA detent, the Captain keeps his hand on the thrust levers until the aircraft reaches V1.

● **In case of tailwind, or if crosswind is greater than 20 kt:**

The PF applies full forward sidestick.

BRAKES.....RELEASE

THRUST LEVERS..... FLX or TOGA

- *The PF rapidly increases thrust to about 70 % N1 (1.15 EPR) then progressively to reach takeoff thrust by 40 kt ground speed, while maintaining sidestick full forward up to 80 kt. Release the sidestick gradually to reach neutral at 100 kt.*

- *Once the thrust levers are set to FLX or TOGA detent, the Captain keeps his hand on the thrust levers until the aircraft reaches V1.*

Note: ENG SD page replaces WHEEL SD page on the ECAM lower display.

DIRECTIONAL CONTROL..... USE RUDDER

At 130 kt (wheel speed), the connection between nosewheel steering and the rudder pedals is removed. Therefore, in strong crosswinds, more rudder input will be required at this point to prevent the aircraft from turning into the wind.

CHRONO.....START

PFD /ND.....MONITOR

1. Check the FMA on the PFD . The following modes are displayed: MAN TOGA (or MAN FLX xx) /SRS /RWY (or blank) / A/THR (in blue).



A318/A319/A320/A321
 FLIGHT CREW
 OPERATING MANUAL

PROCEDURES
NORMAL PROCEDURES

STANDARD OPERATING PROCEDURES - TAKEOFF

Note: If an ILS that corresponds to the departure runway is tuned, RWY mode appears. If not, no lateral mode appears until the aircraft lifts off.

2. Check the FMS position on the ND (aircraft on runway centerline).

Note: If GPS PRIMARY is not available, check the FMS position update.

FMA..... ANNOUNCE

Ident.: PRO-NOR-SOP-12-A-00011561.0001001 / 04 MAR 14

BELOW 80 KT

TAKEOFF N1..... CHECK

Check that the actual N1 of the individual engines has reached the N1 rating limit, before the aircraft reaches 80 kt. Check EGT.

THRUST SET..... ANNOUNCE

PFD and ENG indications..... MONITOR

Scan airspeed, N1, and EGT throughout the takeoff.

Ident.: PRO-NOR-SOP-12-A-00011562.0001001 / 13 AUG 10

REACHING 100 KT

ONE HUNDRED KNOTS..... ANNOUNCE

- *The PF crosschecks and confirms the speed indicated on the PFD*
- *Below 100 kt the Captain may decide to abort the takeoff, depending on the circumstances*
- *Above 100 kt, rejecting the takeoff is a more serious matter.*

Ident.: PRO-NOR-SOP-12-A-00011563.0001001 / 13 AUG 10

AT V1

V1..... ANNOUNCE

Ident.: PRO-NOR-SOP-12-A-00011564.0001001 / 13 AUG 10

AT VR

ROTATION ORDER

ROTATION..... PERFORM

- *At VR, initiate the rotation to achieve a continuous rotation with a rate of about 3 °/s, towards a pitch attitude 15 ° (12.5 °, one engine is failed)*
- *Minimize the lateral inputs on ground and during the rotation, to avoid spoiler extension*

| | |
|---|--|
|  <p>A318/A319/A320/A321 FLIGHT CREW OPERATING MANUAL</p> | <p align="center">PROCEDURES NORMAL PROCEDURES</p> <p align="center">STANDARD OPERATING PROCEDURES - TAKEOFF</p> |
|---|--|

- *In strong crosswind conditions, small lateral stick inputs may be used, if necessary, to aim at maintaining wings level*
- *After lift-off, follow the SRS pitch command bar.*

CAUTION If a tailstrike occurs, avoid flying at an altitude requiring a pressurized cabin, and return to the originating airport for damage assessment.

Ident.: PRO-NOR-SOP-12-A-00011565.0001001 / 04 MAR 14

WHEN POSITIVE CLIMB

POSITIVE CLIMB..... ANNOUNCE
L/G UP..... ORDER
L/G..... SELECT UP
AP..... AS RQRD

Above 100 ft AGL , AP 1 or 2 may be engaged.

Ident.: PRO-NOR-SOP-12-A-00011566.0002001 / 28 JUL 15

AT THRUST REDUCTION ALTITUDE

THRUST LEVERS..... CL
Move the thrust levers to the CL detent, when the flashing LVR CLB prompt appears on the FMA . A/THR is now active.
In manual flight, the pilot must anticipate the change in pitch attitude in order to prevent the speed from decaying when thrust is reduced.

PACK 1 and 2 (if applicable)..... ON
Select PACK 1 on after CLB thrust reduction.
Select PACK 2, at least 10 s after PACK 1 is selected on, for passenger comfort.

Note: 1. *Selecting pack on before reducing takeoff thrust would result in an EGT increase.*
2. *If packs are not switched on after the takeoff phase, an ECAM caution will be triggered.*

Ident.: PRO-NOR-SOP-12-A-00011567.0002001 / 04 MAR 14

AT ACCELERATION ALTITUDE

Check the target speed change from V2 + 10 to the first CLB speed (either preselected or managed).

Note: 1. *When THR RED and ACC ALT are equal, the FMA will change from MAN FLX/SRS /NAV to THR CLB /CLB /NAV.*
2. *If FCU -selected altitude is equal to or close to the acceleration altitude, then the FMA will switch from SRS to ALT*.*

ABOVE ACCELERATION ALTITUDE (OR ONCE IN CLIMB PHASE)

The following procedure ensures that the aircraft is effectively accelerating toward climb speed.

● **At F speed:**

Note: For takeoff in CONF 1 + F, “F” speed does not appear.

FLAPS 1..... ORDER

FLAPS 1..... SELECT

● **At S speed:**

FLAPS 0..... ORDER

FLAPS 0..... SELECT

GND SPLRS..... DISARM

NOSE sw..... OFF

RWY TURN OFF sw..... OFF

OTHER EXTERIOR LIGHTS..... AS RQRD

The flight crew can maintain the LAND LIGHTS selector set to ON, according to airline policy or regulatory recommendations.

Note: The CRUISE SD page replaces the ENG SD page.

Ident.: PRO-NOR-SOP-12-A-00011570.0001001 / 18 DEC 12

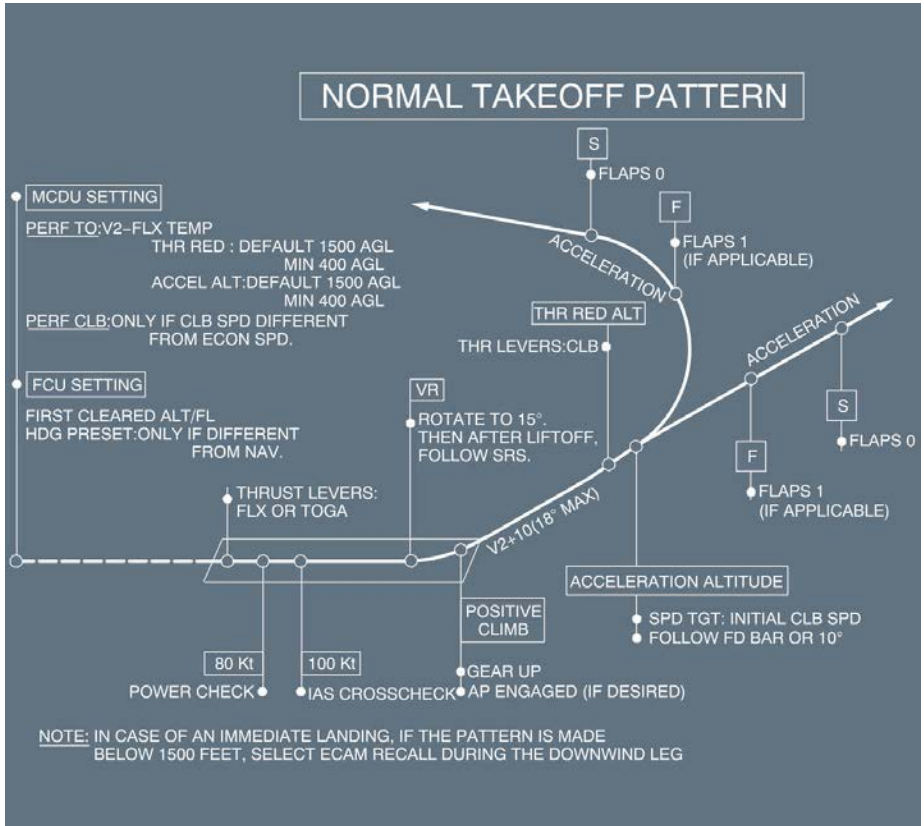

PROCEDURES

NORMAL PROCEDURES

STANDARD OPERATING PROCEDURES - TAKEOFF

Intentionally left blank

| | |
|---|--|
|  <p>A318/A319/A320/A321 FLIGHT CREW OPERATING MANUAL</p> | <p style="text-align: center;">PROCEDURES NORMAL PROCEDURES</p> <p style="text-align: center;">STANDARD OPERATING PROCEDURES - AFTER TAKEOFF</p> |
|---|--|

AFTER TAKEOFF

Applicable to: ALL

Ident.: PRO-NOR-SOP-13-A-00010157.0001001 / 21 MAR 17

APU BLEED pb AS RQRD
*If the APU has been used to supply air conditioning during takeoff, set the APU BLEED pb to OFF.
For use of the APU BLEED, Refer to LIM-APU Operational Envelope.*

APU MASTER SW pb AS RQRD

Ident.: PRO-NOR-SOP-13-A-00010158.0001001 / 05 AUG 10

ENG MODE selector.....AS RQRD
Select IGN, if severe turbulence or heavy rain is encountered.

Ident.: PRO-NOR-SOP-13-A-00010159.0001001 / 05 AUG 10

TCAS  Mode selectorTA/RA
Select TA/RA, if the takeoff has been performed with TA only.

Ident.: PRO-NOR-SOP-13-A-00010160.0002001 / 21 MAR 17

ENG ANTI-ICE pb-sw AS RQRD
Engine anti-ice must be set to ON when icing conditions (Refer to LIM-ICE_RAIN Definition of Icing Conditions) exist or are anticipated, except during climb when the SAT is below -40 °C (-40 °F).

WING ANTI-ICE pb-sw AS RQRD

- When icing conditions are encountered:*
- *The flight crew may turn on the wing anti-ice to prevent ice accretion on the wing leading edge.*
 - *The flight crew must turn on the wing anti-ice if there is evidence of ice accretion, such as ice on the visual indicator, or on the wipers, or with the **SEVERE ICE DETECTED**  alert. This is to remove any ice accumulation from the wing leading edge.*

Ident.: PRO-NOR-SOP-13-A-00010161.0001001 / 05 AUG 10

AFTER TAKEOFF/CLIMB CHECKLIST down to the line..... COMPLETE



A318/A319/A320/A321
FLIGHT CREW
OPERATING MANUAL

PROCEDURES

NORMAL PROCEDURES

STANDARD OPERATING PROCEDURES - AFTER TAKEOFF

Intentionally left blank

CLIMB

Applicable to: ALL

Ident.: PRO-NOR-SOP-14-A-00010245.0002001 / 09 JUN 15
 Impacted by TDU: 00013057 Climb - Initial Climb

Normal vertical mode is CLB or OP CLB with managed speed active.

PF MCDU PERF CLB

- PF MCDU should be showing the PERF CLB page (allowing PF to monitor when the aircraft will reach the FCU selected altitude) but he may select other pages such as F-PLN page as may be tactically necessary.

With the AP engaged, the PF may revise the flight plan.

- The MCDU PROG page displays OPT FL and MAX REC FL. It is worth noting that this OPT FL is a function of the cost index (CI).

- The displayed MAX REC FL gives the aircraft at least a 0.3 g buffet margin. The pilot may enter a cruise flight level above this level into the MCDU and the FMGS will accept it, provided that it does not exceed the level at which the margin is reduced to 0.2 g.

PM MCDU F-PLN

PM MCDU should be showing the F-PLN page (allowing him to enter any ATC long-term revisions to the lateral or vertical flight plan).

CLIMB SPEED MODIFICATIONS

- If ATC, turbulence or operational considerations lead to a speed change:

Select the new speed with FCU SPD knob and pull.

Speed target is now "selected".

To return to managed speed mode, push FCU SPD knob.

The speed target is now "managed".

Note: The best speed (and rate of climb) for long-term situations lies between green dot speed and ECON speed. At high altitude, acceleration from green dot to ECON speed can take a long time.

EXPEDITE CLIMB 

- If ATC requires a rapid climb through a particular level:

Push the EXP pb on the FCU.

The target speed is now green dot speed. FMA :THR CLB /EXP CLB/NAV

Note: Use EXP only for short-term tactical situations. For the best overall economy fly at ECON IAS.

*To return to ECON CLB speed:
 Push ALT knob.
 Check FMA : THR CLB /CLB /NAV*

BAROMETRIC REFERENCE..... SET STD/CROSSCHECK

At transition altitude (baro setting flashing on PFD) set STD on the EFIS control panel and standby altimeter.

Cross-check baro settings and altitude readings.

CRZ FL..... SET AS RQRD

- If ATC clears the aircraft to its intended CRZ FL or above, there is no need to modify the CRZ FL entered in the INIT A page during cockpit preparation. The MCDU will automatically take into account a higher CRZ FL selected with the FCU ALT knob.

- If ATC limits CRZ FL to a lower level than the one entered in the INIT A page (or present on the PROG page) the flight crew must insert this lower CRZ FL in the PROG page.

Otherwise there is no transition into CRZ phase : the managed speed targets and Mach are not modified, and SOFT ALT mode is not available. In that case FMA will display: MACH/ALT /NAV instead of MACH/ALT CRZ /NAV.

Ident.: TDU / PRO-NOR-SOP-14-A-00013057.0006001 / 29 JUN 16

Impacted DU: 00010245 Climb - Initial Climb

Normal vertical mode is CLB or OP CLB with managed speed active.

PF MCDU.....PERF CLB

- PF MCDU should be showing the PERF CLB page (allowing PF to monitor when the aircraft will reach the FCU selected altitude) but he may select other pages such as F-PLN page as may be tactically necessary.

With the AP engaged, the PF may revise the flight plan.

- The MCDU PROG page displays OPT FL and MAX REC FL . It is worth noting that this OPT FL is a function of the cost index (CI).

- The displayed MAX REC FL gives the aircraft at least a 0.3 g buffet margin. The pilot may enter a cruise flight level above this level into the MCDU and the FMGS will accept it, provided that it does not exceed the level at which the margin is reduced to 0.2 g.

PM MCDU..... F-PLN

PM MCDU should be showing the F-PLN page (allowing him to enter any ATC long-term revisions to the lateral or vertical flight plan).

CLIMB SPEED MODIFICATIONS

- **If ATC, turbulence or operational considerations lead to a speed change:**

Select the new speed with FCU SPD knob and pull.

Speed target is now “selected”.

To return to managed speed mode, push FCU SPD knob.

The speed target is now “managed”.

Note: The best speed (and rate of climb) for long-term situations lies between green dot speed and ECON speed. At high altitude, acceleration from green dot to ECON speed can take a long time.

EXPEDITE CLIMB 

- **If ATC requires a rapid climb through a particular level:**

Push the EXP pb on the FCU.

The target speed is now green dot speed. FMA :THR CLB /EXP CLB/NAV

Note: Use EXP  only for short-term tactical situations. For the best overall economy fly at ECON IAS.

To return to ECON CLB speed:

Push ALT knob.

Check FMA : THR CLB /CLB /NAV

BAROMETRIC REFERENCE..... SET STD/CROSSCHECK

At transition altitude (baro setting flashing on PFD) set STD on the EFIS control panel and standby altimeter.

Cross-check baro settings and altitude readings.

Note: When STD is set on the EFIS control panel, the transponder does not transmit to the Air Traffic Control (ATC) the standard barometric reference but the last QNH or QFE previously selected. The transmitted aircraft altitude is not affected. Only the FCU selected altitude, if used by the ATC, may be misinterpreted.

Upon ATC notification of an incorrect barometric reference value, the flight crew can select manually a barometric reference of 1 013 hPa and set again STD on the EFIS control panel.



LIneas GALAPAGOS S.A.

A318/A319/A320/A321
FLIGHT CREW
OPERATING MANUAL

PROCEDURES

NORMAL PROCEDURES

STANDARD OPERATING PROCEDURES - CLIMB

CRZ FL..... SET AS RQRD

- If ATC clears the aircraft to its intended CRZ FL or above, there is no need to modify the CRZ FL entered in the INIT A page during cockpit preparation. The MCDU will automatically take into account a higher CRZ FL selected with the FCU ALT knob.
- If ATC limits CRZ FL to a lower level than the one entered in the INIT A page (or present on the PROG page) the flight crew must insert this lower CRZ FL in the PROG page. Otherwise there is no transition into CRZ phase : the managed speed targets and Mach are not modified, and SOFT ALT mode is not available. In that case FMA will display: MACH/ALT /NAV instead of MACH/ALT CRZ /NAV.

Ident.: PRO-NOR-SOP-14-A-00010257.0001001 / 05 AUG 10

AFTER TAKEOFF/CLIMB CHECKLIST below the line..... COMPLETE

Ident.: PRO-NOR-SOP-14-A-00010258.0001001 / 17 MAR 17

ENG ANTI-ICE pb-sw AS RQRD

Engine anti-ice must be set to ON when icing conditions (Refer to LIM-ICE_RAIN Definition of Icing Conditions) exist or are anticipated, except during climb when the SAT is below - 40 °C (-40 °F).

Ident.: TDU / PRO-NOR-SOP-14-A-00013047.0003001 / 03 MAR 14

Impacted DU: 00010259 Climb - Radar

RADAR..... AS APPROPRIATE

Gain must be manually set to +4, when MULTISCAN selector is set to AUTO and when flying below FL 200.

- Note:
1. If the weather is good, or not significant, in order to check that the radar is operating correctly: down tilt until displaying ground echoes.
 2. If the weather display is ambiguous or unexpected, in order to better analyze the weather situation, use manual tilt according to standard technique.
 3. In particular below FL 200, for situations with low-level weather, weather with low reflectivity or in front of suspected active cells, the flight crew should switch to Manual mode and adjust the tilt setting downward until the weather is detected or the ground clutter appears on the upper part of the display.
 4. In addition, the flight crew may increase the manual gain control to display lower reflectivity targets. The manual gain control can be increased in both AUTO and Manual modes to display lower levels of weather. In both cases, ground clutter may also be displayed as a result of low settings and/or increased gain.

Ident.: PRO-NOR-SOP-14-A-00010259.0002001 / 16 MAR 11

Impacted by TDU: 00013047 Climb - Radar

RADAR..... AS APPROPRIATE

Ident.: PRO-NOR-SOP-14-A-00010260.0001001 / 04 MAR 14

AT 10.000FT

- LAND LIGHTS selector.....RETRACT
- SEAT BELTS sw.....AS RQRD
- EFIS option.....AS RQRD
- Select CSTR on one side, for grid MORA (if available), and ARPT on the other side.*
- ECAM MEMO..... REVIEW
- NAVAIDS..... CLEAR
- Clear manually tuned VOR s from MCDU RAD NAV page.*
- SEC F-PLN page..... AS RQRD
- Recopy the active flight plan in the secondary if an immediate return flight plan has been constructed previously.*
- OPT/MAX ALT.....CHECK

Ident.: PRO-NOR-SOP-14-A-00020076.0001001 / 17 MAR 17

10 000 ft FLOW PATTERN

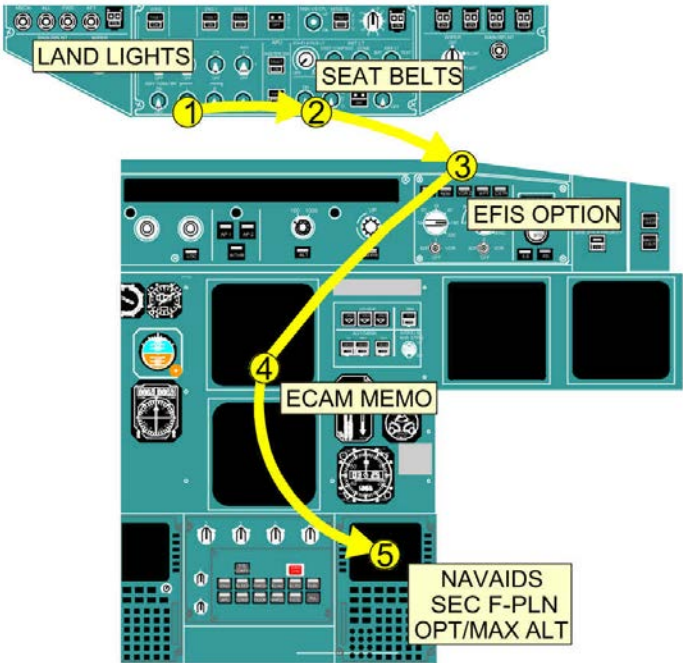

PROCEDURES

NORMAL PROCEDURES

STANDARD OPERATING PROCEDURES - CLIMB

EFIS Option:

The PF will select CSTR for grid MORA

The PM will select ARPT

| | |
|---|--|
|  <p>A318/A319/A320/A321 FLIGHT CREW OPERATING MANUAL</p> | <p>PROCEDURES NORMAL PROCEDURES STANDARD OPERATING PROCEDURES - CRUISE</p> |
|---|--|

CRUISE

Applicable to: ALL

Ident.: PRO-NOR-SOP-15-A-00010287.0001001 / 25 AUG 16

| | |
|--------------------|--------|
| ECAM MEMO..... | REVIEW |
| ECAM SD PAGES..... | REVIEW |

Periodically review system display pages and, in particular:

- ENG : Oil pressure and temperature*
- BLEED : BLEED parameters*
- ELEC : Parameters, GEN loads*
- HYD : A slight decrease in quantity is normal.
Fluid contraction during cold soak can be expected.
Green system is lower than on ground, following landing gear retraction.*
- FUEL : Fuel distribution.*
- COND : Duct temperature, compared with zone temperature.
Avoid large differences for passenger comfort.*
- FLT CTL : Note any unusual control surface position.*
- DOOR : Oxygen pressure.*

Ident.: PRO-NOR-SOP-15-A-00010288.0001001 / 17 MAR 17

| | |
|----------------------|-------|
| FLIGHT PROGRESS..... | CHECK |
|----------------------|-------|

Monitor flight progress in the conventional way.

When overflying a waypoint:

- *Check track and distance to the next waypoint.*

When overflying the waypoint, or at least every 30 min:

- *Check FUEL : Check FOB (ECAM), and fuel prediction (FMGC), and compare with the computer flight plan or the in-cruise quick-check table (Refer to QRH/PER-M In Cruise Quick Check at a Given Mach Number (Paper Only) or use the performance application of FlySmart with Airbus). Check that the sum of the fuel on board and the fuel used is consistent with the fuel on board at departure. If the sum is unusually greater than the fuel on board at departure, suspect a fuel quantity over read. If the sum is unusually smaller than the fuel on board at departure, or if it decreases, suspect a fuel leak.
For more information about fuel leak, Refer to FCTM/PR-AEP-FUEL Fuel Leak.*

CAUTION *This check must also be performed each time a FUEL IMBALANCE procedure is necessary. Perform the check before applying the FUEL IMBALANCE procedure. If a fuel leak is confirmed, apply the FUEL LEAK procedure.*



AEROLÍNEAS GALAPAGOS S.A.

A318/A319/A320/A321
FLIGHT CREW
OPERATING MANUAL

PROCEDURES

NORMAL PROCEDURES

STANDARD OPERATING PROCEDURES - CRUISE

Ident.: PRO-NOR-SOP-15-A-00010289.0001001 / 01 DEC 14

STEP FLIGHT LEVEL.....AS APPROPRIATE

Ident.: PRO-NOR-SOP-15-A-00010290.0001001 / 21 MAR 17

NAV ACCURACY.....MONITOR

On aircraft equipped with GPS primary, no navigation accuracy check is required, as long as GPS PRIMARY is available.

Otherwise, a navigation accuracy check must be performed especially when any of the following occurs:

- *GPS PRIMARY LOST appears on the ND (GPS \leftarrow)*
- *IRS only navigation*
- *The PROG page displays LOW accuracy*
- *“NAV ACCUR DOWNGRAD” appears on the MCDU.*

Refer to DSC-22_20-20-20 Estimated Position Uncertainty.

Note: *Methods for checking accuracy:*

- **If the check is positive (error \leq 3 N.m): FM position is reliable.**
Use ND (ARC or NAV) and managed lateral guidance.
- **If the check is negative (error $>$ 3 N.m): FM position is not reliable.**
Use raw data for navigation and monitor it.
- **If there is a significant mismatch between the display and the real position:**
Disengage MANAGED NAV mode and use raw data navigation (possibly switching to ROSE VOR, so as not to be misled by FM data).

Ident.: TDU / PRO-NOR-SOP-15-A-00013068.0006001 / 20 SEP 16

Impacted DU: 00010291 Cruise - Radar Tilt

RADARAS APPROPRIATE

Gain must be manually set to +4, when MULTISCAN selector is set to AUTO and when flying below FL 200.

- Note:
1. If the weather is good, or not significant, in order to check that the radar is operating correctly: down tilt until displaying ground echoes.
 2. If the weather display is ambiguous or unexpected, in order to better analyze the weather situation, use manual tilt according to standard technique.
 3. In particular below FL 200, for situations with low-level weather, weather with low reflectivity or in front of suspected active cells, the flight crew should switch to Manual mode and adjust the tilt setting downward until the weather is detected or the ground clutter appears on the upper part of the display.
 4. In addition, the flight crew may increase the manual gain control to display lower reflectivity targets. The manual gain control can be increased in both AUTO and Manual modes to display lower levels of weather. In both cases, ground clutter may also be displayed as a result of low settings and/or increased gain.

Ident.: PRO-NOR-SOP-15-A-00010291.0002001 / 07 MAR 13
 Impacted by TDU: 00013068 Cruise - Radar Tilt

RADAR **AS APPROPRIATE**

Ident.: PRO-NOR-SOP-15-A-00010296.0001001 / 21 MAR 16

- **If the oxygen mask has been used:**
 OXYGEN MASK CHECK
Check that the oxygen mask has been properly stowed, Refer to DSC-35-20-10 General.



A318/A319/A320/A321
FLIGHT CREW
OPERATING MANUAL

PROCEDURES

NORMAL PROCEDURES

STANDARD OPERATING PROCEDURES - CRUISE

Intentionally left blank

| | |
|---|--|
|  <p>A318/A319/A320/A321 FLIGHT CREW OPERATING MANUAL</p> | <p style="text-align: center;">PROCEDURES NORMAL PROCEDURES</p> <p style="text-align: center;">STANDARD OPERATING PROCEDURES - DESCENT PREPARATION</p> |
|---|--|

DESCENT PREPARATION

Applicable to: ALL

Ident.: PRO-NOR-SOP-16-A-00011551.0001001 / 30 JUN 14

Descent preparation and approach briefing should be completed before top of descent.

Ident.: PRO-NOR-SOP-16-A-00011552.0006001 / 20 MAR 17

WEATHER AND LANDING INFORMATION.....OBTAIN
Check weather reports at ALTERNATE and DESTINATION airports. Airfield data should include runway in use for arrival.

Note: *When operating in cold weather conditions, consider altitude correction. Refer to PER-OPD-GEN ALTITUDE TEMPERATURE CORRECTION.*

NAV CHARTS CLIPBOARD.....PREPARE

Ident.: PRO-NOR-SOP-16-A-00014394.0001001 / 27 APR 17

EFB LDG PERFORMANCE.....CHECK

Perform an in-flight landing performance assessment if the landing conditions changed compared with the landing computation at dispatch, or with a previous computation (e.g. runway, weather conditions, in-flight failure affecting performance, diversion).

Note:

1. *If the weather conditions are expected to change at the landing airport, or in the event of significant precipitation, the flight crew should consider a second calculation of the in-flight landing distance with the worst possible runway condition.*
2. *The selection of REV MAX is the standard practice for landing. However, on dry runways the flight crew may select REV IDLE. On WET runways (runway surface condition GOOD), the flight crew may select REV IDLE, if all the following conditions are satisfied:*

- *A landing distance assessment has been made with the following parameters:*
 - *MEDIUM TO POOR landing performance level for the in-flight landing distance computation*
 - *No reverser credit*
- *The result of this landing distance assessment is within the LDA.*

● **If landing conditions changed:**

LDG PERFORMANCE.....(RE)COMPUTE

In the LDG PERF application, modify the selections in accordance with the estimated arrival conditions:

- *In the AIRPORT/RUNWAY part, select the applicable runway*
- *In the CONDITIONS part, enter the estimated landing conditions*
- *In the AIRCRAFT STATUS part, check the selected items, if any*
- *Launch the computation and check the results versus Airline policy or applicable regulations.*

LDG PERFORMANCE.....CROSSCHECK

Ident.: PRO-NOR-SOP-16-A-00020100.0001001 / 17 MAY 17

ARRIVAL page..... COMPLETE/CHECK

Insert APPR , STAR , APPR VIA and TRANS if applicable. (Access by lateral revision at destination.)

F-PLN A page..... CHECK

- *Ensure that the inserted F-PLN agrees with planned approach and missed approach.*
- *Use the scroll key to check the F-PLN thoroughly, using ND in PLAN mode as necessary.*

Tracks and distances between waypoints are displayed on the second line from the top of the MCDU. Approach and Missed Approach tracks and distances must be checked from the appropriate navigation charts.

- *Check speed constraints. Add new speed constraints if required.*
- *Check altitude constraints. Add new altitude constraints if required.*

Note: *The FMS may have deleted the altitude constraints that are at or above the CRZ FL , or at or above any previous lower CRZ FL in the case of step climbs (Refer to DSC-22_20-30-20-05 Vertical Constraints (Speed, Altitude, Time)).*

In that case,

- *Insert again the affected procedures (STAR , APPR VIA or TRANS)*
The FMS keeps the altitude constraints that are below the CRZ FL , and deletes again the altitude constraints that are above current CRZ FL . The FMS may also delete the altitude constraints that are at current CRZ FL , and the altitude constraint windows that have a constraint at or above current CRZ FL .
- *Manually enter the altitude constraints that are below current CRZ FL using the MCDU Vertical Revision pages.*



It is not possible to enter an altitude constraint at the CRZ FL.

In the case of an "AT" or "AT OR ABOVE" altitude constraint at the CRZ FL , the flight crew must select the DES mode only after the aircraft reaches the position of the altitude constraint to prevent an early descent.

- In all cases, do not modify the final approach (FAF to runway or MAP), including altitude constraints.
- Identify the position and the altitude of Final Descent Point (FDP) and check the value of the FPA after this FDP.
- If a TOO STEEP PATH message is displayed after the FDP, do not use FINAL APP guidance for approach.
- Identify the Missed Approach Point.

Ident.: PRO-NOR-SOP-16-A-00020101.0001001 / 20 SEP 16

DES WIND page..... CHECK
 Enter winds for descent before T/D.

Note: With DPO , as the idle thrust margins are reduced, accurate winds have to be entered to be able to follow the computed vertical profile and thus maximize the benefits of DPO . Refer to DSC-22_20-60-150 Descent Profile Optimization (if installed).

PERF CRUISE page..... CHECK
 Modify the cabin descent rate if different pressure rate is required.

PERF DES page..... CHECK
 Prior to descent, access PERF DES page and check ECON MACH/SPD. If a speed other than ECON is required, insert that MACH or SPD into the ECON field. This new MACH or SPD is now the one for the descent path and T/D computation, and it will be used for the managed speed descent profile (instead of ECON).
 A speed limit of 250 kt below 10 000 ft is the defaulted speed, in the managed speed descent profile. The flight crew may delete or modify it if necessary on the VERT REV at DEST page.

Ident.: PRO-NOR-SOP-16-A-00020102.0002001 / 21 MAR 17

PERF APPR page..... COMPLETE/CHECK
 Enter the QNH, temperature, and wind at destination.

L13

Note: Insert the average wind given by the ATC or ATIS. Do not insert the gust value. During approach, the Ground Speed Mini function (manage speed mode) takes into account the instantaneous gust.
 For more information: Refer to Ground Speed Mini Function.
 For example, if the wind is 15020G35KT, insert 150/20.

Insert the minimum.

Note: To avoid undershooting the published minimum during go-around, due to aircraft inertia during pull-up, some Authorities may require Operators to add a specific number of feet to the published minimum.

CAUTION If the QNH altimeter setting is used for an aircraft with the QFE option  , Refer to PRO-NOR-SUP-NAV QNH use for aircraft equipped with QFE option.

Note: Changing the RWY or the type of approach automatically erases the previous minimum.

Note: After the activation of the SEC F-PLN , check the VAPP , and modify if necessary.

Check or modify the landing configuration. Always select the landing configuration on the PERF APP page: CONF FULL in the normal landing configuration. CONF 3 should be considered, depending on the available runway length and go-around performance, or if windshear/severe turbulence is considered possible during approach.

If the forecasted tailwind at landing is greater than 10 kt , refer to "LIM-12-Airport Operations and Wind Limitations" for the recommended/required landing configuration.



Check or modify the transition altitude.

PERF GO-AROUND page..... CHECK/MODIFY

Check THR RED ALT and ACC ALT , and modify, if necessary.

Ident.: PRO-NOR-SOP-16-A-00020103.0001001 / 20 SEP 16

RAD NAV page..... CHECK

- Set nav aids, as required, and check idents on the ND s (VOR -ADF) and PFD s (ILS , GLS  , MLS ). If a VOR /DME exists close to the airfield, select it and enter its ident in the BRG /DIST field of the PROG page, for NAV ACCY monitoring during descent.
- When the flight plan calls for an NDB approach, the system automatically tunes the ADF , only when the aircraft is passing the first fix of the approach. Therefore, it is convenient to manually tune the ADF earlier (before activating the approach phase).

Ident.: PRO-NOR-SOP-16-A-00020104.0001001 / 20 SEP 16

SEC F-PLN page..... AS RQRD

Before the top of descent, the SEC F-PLN should either be set to an alternate runway for destination, or to the landing runway in case of circling. In all cases, routing to the alternate should be available. If there is a last-minute runway change, then the flight crew only needs to activate the secondary F-PLN , without forgetting to check/set the new minimum and nav aids.

Ident.: PRO-NOR-SOP-16-A-00011554.0001001 / 03 MAR 14

GPWS LDG FLAP 3 pb-sw.....AS RQRD

If the pilot plans on landing in FLAPS 3 configuration, the GPWS LDG FLAP 3 pb-sw should be set to ON.

| | |
|---|--|
|  <p>A318/A319/A320/A321 FLIGHT CREW OPERATING MANUAL</p> | <p style="text-align: center;">PROCEDURES NORMAL PROCEDURES</p> <p style="text-align: center;">STANDARD OPERATING PROCEDURES - DESCENT PREPARATION</p> |
|---|--|

Ident.: PRO-NOR-SOP-16-A-00015490.0001001 / 03 MAR 14

LDG ELEV.....CHECK
Check that the LDG ELEV AUTO green is displayed on the ECAM CRUISE page, and check the associated value.

Ident.: PRO-NOR-SOP-16-A-00011556.0001001 / 17 MAR 17

AUTO BRKAS RQRD
*Use of autobrake is preferable.
 Use of MAX mode is not recommended at landing.
 On short or contaminated runways, use MED mode.
 On long runways, LO mode is recommended.*

 *For more information, Refer to FCTM/PR-NP-SOP-160 Brakes Oxidation.*

 *Note: If, on very long runways, the flight crew anticipates that braking will not be needed, use of the autobrake is not necessary.*

Firmly press the appropriate pushbutton, according to the runway length and condition, and check that the related ON light comes on.

Ident.: PRO-NOR-SOP-16-A-00011555.0001001 / 10 JUL 14

APPROACH BRIEFING.....PERFORM

Ident.: PRO-NOR-SOP-16-A-00011547.0001001 / 23 JUN 15

TERR ON ND AS RQRD

- *In mountainous areas, consider displaying terrain on ND.*
- *If use of radar is required, consider selecting the radar display on the PF side, and TERR ON ND on the PM side only.*
- *If NAV ACCURACY is LOW, do not use TERR on ND.*

Ident.: TDU / PRO-NOR-SOP-16-A-00013353.0003001 / 03 MAR 14

Impacted DU: 00011545 Descent Preparation - Radar

RADAR.....ADJUST AS APPROPRIATE
Gain must be manually set to +4, when MULTISCAN selector is set to AUTO and when flying below FL 200.

- Note:**
1. If the weather is good, or not significant, in order to check that the radar is operating correctly: down tilt until displaying ground echoes.
 2. If the weather display is ambiguous or unexpected, in order to better analyze the weather situation, use manual tilt according to standard technique.
 3. In particular below FL 200, for situations with low-level weather, weather with low reflectivity or in front of suspected active cells, the flight crew should switch to Manual mode and adjust the tilt setting downward until the weather is detected or the ground clutter appears on the upper part of the display.
 4. In addition, the flight crew may increase the manual gain control to display lower reflectivity targets. The manual gain control can be increased in both AUTO and Manual modes to display lower levels of weather. In both cases, ground clutter may also be displayed as a result of low settings and/or increased gain.

Ident.: PRO-NOR-SOP-16-A-00011545.0001001 / 03 MAR 14
Impacted by TDU: 00013353 Descent Preparation - Radar

RADAR.....**ADJUST AS APPROPRIATE**

Ident.: PRO-NOR-SOP-16-A-00011558.0004001 / 02 MAY 17

CAUTION In icing conditions (*Refer to LIM-ICE_RAIN Definition of Icing Conditions*), the flight crew must turn on the engine anti-ice and should not wait until seeing ice building up.

ENG ANTI-ICE pb-swAS RQRD
Engine anti-ice must be set to ON before and during descent, event if the SAT is below -40 °C (-40 °F).

When ENG ANTI ICE is ON, the FADEC selects a higher idle thrust which gives better protection against flame-out.

WING ANTI ICE pb-swAS RQRD

When icing conditions are encountered:

- *The flight crew may turn on the wing anti-ice to prevent ice accretion on the wing leading edge.*
- *The flight crew must turn on the wing anti-ice if there is evidence of ice accretion, such as ice on the visual indicators, or on the wipers, or with the **SEVERE ICE DETECTED**  alert. This is to remove any ice accumulation from the wing leading edge.*

ANTI ICE ON reduces the descent path angle (when the engines are at idle). The pilot can compensate for this by increasing the descent speed, or by extending up to half speedbrakes.

Ident.: PRO-NOR-SOP-16-A-00011557.0001001 / 03 MAR 14

DESCENT CLEARANCE.....OBTAIN



A318/A319/A320/A321
 FLIGHT CREW
 OPERATING MANUAL

PROCEDURES
NORMAL PROCEDURES

STANDARD OPERATING PROCEDURES - DESCENT PREPARATION

CLEARED ALTITUDE ON FCU..... SET
When clearance is obtained, set the ATC -cleared altitude (FL) on the FCU (also considering what is the safe altitude).
If the lowest safe altitude is higher than the ATC -cleared altitude, check with the ATC that this constraint applies.
If it is confirmed, set the FCU altitude to the safe altitude, until it is safe to go to the ATC-cleared altitude.



A318/A319/A320/A321
FLIGHT CREW
OPERATING MANUAL

PROCEDURES

NORMAL PROCEDURES

STANDARD OPERATING PROCEDURES - DESCENT PREPARATION

Intentionally left blank

DESCENT INITIATION

Ident.: PRO-NOR-SOP-17-00011541.0001001 / 03 NOV 14
Applicable to: ALL

DESCENT..... INITIATE

The normal method of initiating the descent is to select DES mode at the FMGS calculated top of descent (T/D).

■ If ATC requires an early descent:

Use DES mode which will guide the aircraft down at a lower vertical speed in order to converge on the required descent path. (The pilot may use a V/S of -1 000 ft/min).

■ If ATC delays the descent:

Beyond T/D, the PFD and the MCDU display either "DECELERATE" or "T/D REACHED" message. This suggests to the crew that it starts reducing speed towards green dot speed (with ATC permission). When cleared to descend, select DES mode with managed speed active.

DESCENT MONITORING

Ident.: PRO-NOR-SOP-17-00011542.0003001 / 23 DEC 14
Applicable to: ALL

PF MCDU PROG /PERF DES

PF MCDU should be set to PROG or PERF DES page:
 - PROG page in order to get VDEV or RQD DIST TO LAND/DIRECT DIST TO DEST information
 - PERF DES in order to get predictions down to any inserted altitude in DES /OP DES modes and EXP mode  .

PM MCDU F-PLN

DESCENT..... MONITOR/ADJUST

Refer to PRO-NOR-SRP-01-60 Descent Monitoring - DES Mode Engaged

- When flying in NAV mode, use DES mode.

The aircraft descends along the descent flight path: the PFD and PROG page display VDEV, and so it can be monitored. All constraints of the flight plan are taken into account for the guidance.

- When the aircraft is flying in HDG or TRK mode, and thus out of the lateral F-PLN, DES mode is not available.

The ND s show a level-off symbol  along the flight path. Its position is based on the current active modes .AP /FD and A/THR

The flight crew can use this symbol to monitor the descent.

MCDU predictions assume a return to the lateral F-PLN and descent flight path.

Note that whenever the lateral mode is changed from NAV to HDG /TRK the vertical mode reverts to V/S at the value pertaining at the time of the mode change.

- From time to time during stabilized descent, the flight crew may select FPA to check that the remaining distance to destination is approximately the altitude change required divided by the FPA in degrees.

$$FPA (^{\circ}) = \Delta FL/DIST (NM)$$

DESCENT ADJUSTMENT

Applicable to: ALL

Ident.: PRO-NOR-SOP-17-A-00011543.0002001 / 09 MAR 15

To increase the rate of descent:

- Increase descent speed (by use of selected speed) if comfort and ATC permit. It is economically better (Time/Fuel) than the following procedures.
- Maintain high speed as long as possible. (SPD LIM may be suspended, subject to ATC clearance).
- If the aircraft is high and at high speed, it is more efficient to keep the high speed to ALT* and decelerate, rather than to mix descent and deceleration.
- If the aircraft goes below the desired profile, use SPEED and the V/S mode to adjust the rate of descent.

Note: EXPEDITE DESCENT.

If a high rate of descent is required, push the EXPED pushbutton  on the FCU . The target speed for the descent now becomes M 0.8 or 340 kt, whichever is lower. The FMA will display THRIDLE/EXP DES/NAV.

To return to DES mode, push the FCU ALT knob.

To return to SPEED/V/S modes, pull the FCU V/S knob.

In all cases, monitor the FMA to ensure that the mode engages properly.

Ident.: PRO-NOR-SOP-17-A-00011544.0001001 / 03 MAR 14

If engine anti-ice is selected in descent, the flight idle is increased. So, to maintain the rate of descent that the airplane had before engine anti-ice selection it may be necessary to use up to half speedbrakes to maintain the required rate of descent, in OPEN DES vertical mode. If the rate of descent has to be increased, full speedbrakes may be used.

In DES mode: If the aircraft is on, or below, the flight path and the ATC requires a higher rate of descent, do not use speedbrakes because the rate of descent is dictated by the planned flight path. Thus, the A/THR may increase thrust to compensate for the increase in drag. In this case, use OPEN DES with speedbrakes.

- Note:**
1. If speedbrakes are used above 315 kt/M .75, with the AP engaged, their rate of retraction is low (total time for retraction from full extension is approximately 25 s). The ECAM memo page displays SPD BRAKES in amber until retraction is complete.
 2. In order to avoid overshooting the altitude, due to speedbrake retraction in ALT* mode, retract the speedbrakes at least 2 000 ft before the selected altitude.

Ident.: PRO-NOR-SOP-17-A-00011546.0001001 / 14 JAN 16

BAROMETRIC REFERENCE..... SET

Set QNH on the EFIS control panel and on the standby altimeter, when approaching the transition level and when cleared for an altitude.

Crosscheck BARO settings and altitude readings.

Ident.: PRO-NOR-SOP-17-A-00011548.0001001 / 13 AUG 10

ECAM STATUS..... CHECK

- Check that there is no status reminder on the upper ECAM display.
- If there is a status reminder, check the aircraft STATUS.
- Check the ECAM status page before completing the approach checks. Take particular note of any degradation in landing capability, or any other aspect affecting the approach and landing.

Ident.: PRO-NOR-SOP-17-A-00021715.0001001 / 04 SEP 17

AT 10 000 FT

LAND lights selector..... SET

LAND lights may be switched ON, according to the airline policy/regulatory recommendations.

SEAT BELTS sw..... ON

EFIS option pb..... CSTR

Select CSTR on both sides.



AEROLINEAS GALAPAGOS S.A.

A318/A319/A320/A321
FLIGHT CREW
OPERATING MANUAL





PROCEDURES

NORMAL PROCEDURES

STANDARD OPERATING PROCEDURES - DESCENT

ILS/LS pb.....AS QRDR

Press the ILS/LS pb, if one of the following approaches is planned:

- ILS, GLS  , MLS 
- ILS G/S out, LOC only or LOC B/C 
- Approach with the FLS function 

The flight crew checks that:

- Deviation scales are displayed on the PFD
- The IDENT is properly displayed on the PFD

RAD NAVAIDS.....SELECTED/IDENTIFIED

Ensure that appropriate radio NAVAIDS are tuned and identified.

For NDB approaches, manually select the reference NAVAID.

Ident.: PRO-NOR-SOP-17-A-00015500.0001001 / 03 MAR 14

ENG MODE selector.....AS QRDR

- Select IGN if the runway is covered with standing water, or if heavy rain or severe turbulence is expected during approach or go-around area.

Ident.: PRO-NOR-SOP-17-A-00015501.0001001 / 03 MAR 14

NAV ACCURACY.....CHECK

On aircraft equipped with GPS primary, no navigation accuracy check is required, as long as GPS PRIMARY function is available.

Otherwise, crosscheck NAV ACCURACY using the PROG page (BRG /DIST computed data), and the ND (VOR /DME raw data).

APPROACH CHECKLIST

Ident.: PRO-NOR-SOP-17-00014491.0001001 / 03 MAR 14

Applicable to: ALL

APPROACH CHECKLIST

APPROACH CHECKLIST.....PERFORMED

10 000 FT FLOW PATTERN

Ident.: PRO-NOR-SOP-17-00020073.0001001 / 17 MAR 17

Applicable to: ALL

10 000 ft FLOW PATTERN

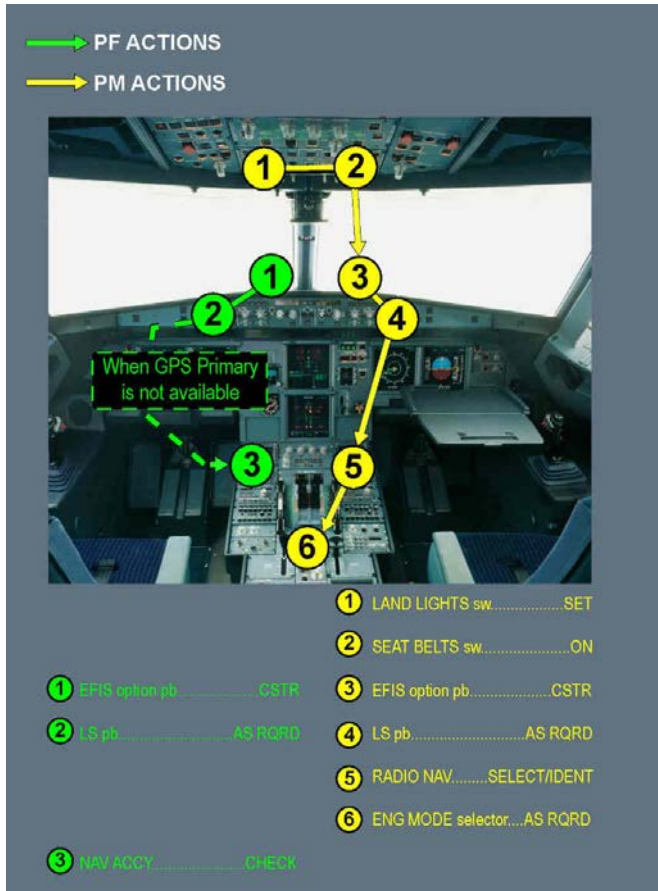

PROCEDURES

NORMAL PROCEDURES

STANDARD OPERATING PROCEDURES - DESCENT

Intentionally left blank



| | |
|---|---|
|  A318/A319/A320/A321 FLIGHT CREW OPERATING MANUAL | PROCEDURES NORMAL PROCEDURES STANDARD OPERATING PROCEDURES - APPROACH |
|---|---|

Approach General

INTRODUCTION

Ident.: PRO-NOR-SOP-18-A-00014490.0001001 / 29 MAY 13
 Applicable to: ALL

The APPROACH section provides the standard operating procedures for the following approach types:

- ILS / MLS  / GLS  approaches
- Conventional approaches: VOR , VOR -DME , NDB , NDB -DME
- Approaches based on a LOC signal without any G/S signal: LOC ONLY, ILS G/S OUT, LOC B/C
- RNAV approaches including:
 - RNAV (GNSS) approaches with LNAV minimum or LNAV/VNAV minimum
 - RNAV (RNP) approaches for which Authorization is Required (AR) - If capability installed.



Note: In relation to the names in the ICAO Performance-Based Navigation (PBN) Manual:

- "RNP APCH operations" corresponds to RNAV (GNSS) approaches
- "RNP AR APCH operations" corresponds to RNAV (RNP) approaches.

CROSS-REFERENCE TABLE

Ident.: PRO-NOR-SOP-18-A-00014489.0001001 / 29 MAY 13
 Applicable to: ALL

This table provides Guidance Modes that may be used depending on the Approach Types.

| | Guidance Modes per Approach Types | | | | |
|--|------------------------------------|---|---|---|---|
| | LOC G/S | FINAL APP | LOC FPA | NAV FPA | TRK FPA |
| ILS / MLS  / GLS  | <i>Refer to APPR using LOC G/S</i> | N/A | N/A | N/A | N/A |
| LOC ONLY ILS G/S OUT | N/A | N/A | <i>Refer to APPR using FPA Guidance</i> | N/A | N/A |
| LOC B/C | N/A | N/A | N/A | N/A | <i>Refer to APPR using FPA Guidance</i> |
| RNAV (GNSS) with LNAV/VNAV minima | N/A | <i>Refer to APPR using FINAL APP</i> | N/A | Not Authorized | Not Authorized |
| RNAV (GNSS) with LNAV minima | N/A | <i>Refer to APPR using FINAL APP ⁽¹⁾</i> | N/A | <i>Refer to APPR using FPA Guidance</i> | Not Authorized |

Continued on the following page

PROCEDURES
NORMAL PROCEDURES

STANDARD OPERATING PROCEDURES - APPROACH

Continued from the previous page

| | Guidance Modes per Approach Types | | | | |
|--|--|---|----------------|---|---|
| | LOC G/S | FINAL APP | LOC FPA | NAV FPA | TRK FPA |
| RNAV (GNSS) with LPV minima | N/A | Not Authorized | N/A | Not Authorized | Not Authorized |
| VOR VOR -DME NDB NDB -DME | N/A | <i>Refer to APPR using FINAL APP ⁽¹⁾</i> | N/A | <i>Refer to APPR using FPA Guidance</i> | <i>Refer to APPR using FPA Guidance</i> |

⁽¹⁾ *The FINAL APP is the recommended guidance mode for this type of approach.*

For Visual Approach, *Refer to Visual Approach*

For Circling Approach, *Refer to Circling Approach*

FLYING REFERENCE

Ident.: PRO-NOR-SOP-18-A-00014488.0001001 / 29 MAY 13

Applicable to: ALL

Use the following recommended flying reference:

- In vertical managed modes: HDG -V/S reference associated with the FD crossbars
- In vertical selected modes: TRK -FPA reference associated with FPD.

STABILIZATION CRITERIA

Ident.: PRO-NOR-SOP-18-A-00014487.0002001 / 06 DEC 16

Applicable to: ALL

The stabilization height is defined as one of the following:

- 1 000 ft above airfield elevation (AAL) in Instrument Meteorological Conditions (IMC), or
- 500 ft above airfield elevation (AAL) in Visual Meteorological Conditions (VMC), or
- Any other height defined in Operator policies or regulations.

In order for the approach to be stabilized, all of the following conditions must be satisfied before, or at the stabilization height:

- The aircraft is on the correct lateral and vertical flight path
- The aircraft is in the desired landing configuration

- The thrust is stabilized, usually above idle, and the aircraft is at target speed for approach

Note: In IMC, if the ATC requests a speed constraint that is not compatible with the speed and thrust stabilization at 1 000 ft AAL, a later speed and thrust stabilization can be acceptable provided that:

- The aircraft is in deceleration toward the target approach speed
 - The flight crew stabilizes speed and thrust as soon as possible and not later than 500 ft AAL.
- The flight crew does not detect any excessive flight parameter deviation.

If one of the above-mentioned conditions is not satisfied, the flight crew must initiate a go-around, unless they estimate that only small corrections are required to recover stabilized approach conditions.



Note: If the predicted tailwind at landing is greater than 10 kt, decelerated approach is not permitted, and the aircraft speed should be stabilized at around VREF + 5 kt in final.

APPROACH SPEED TECHNIQUE

Ident.: PRO-NOR-SOP-18-A-00014485.0001001 / 29 MAY 13

Applicable to: ALL

DECELERATED APPROACH

The decelerated approach with FD or AP /FD guidance is the standard flying technique for ILS / MLS  / GLS  approaches and approaches using FLS  or FINAL APP guidance.

EARLY STABILIZED APPROACH

Under certain circumstances, the flight crew may decide to reduce the speed down to VAPP in the landing configuration at the Final Descent Point (i.e. approach via selected guidance, high glide path angle, low altitude intermediate approach, etc.). In order to obtain a valuable deceleration pseudo waypoint and to ensure a timely deceleration, the flight crew should enter VAPP as a speed constraint at the Final Descent Point.

DISCONTINUED APPROACH

Ident.: PRO-NOR-SOP-18-A-00015226.0001001 / 03 DEC 13

Applicable to: ALL

In order to discontinue an approach when the aircraft is at or above the altitude selected on the FCU, the flight crew can either:

- Apply the GO AROUND procedure, or
- Apply the discontinued approach technique.

When the aircraft is below the FCU altitude, the flight crew must apply the GO AROUND procedure.

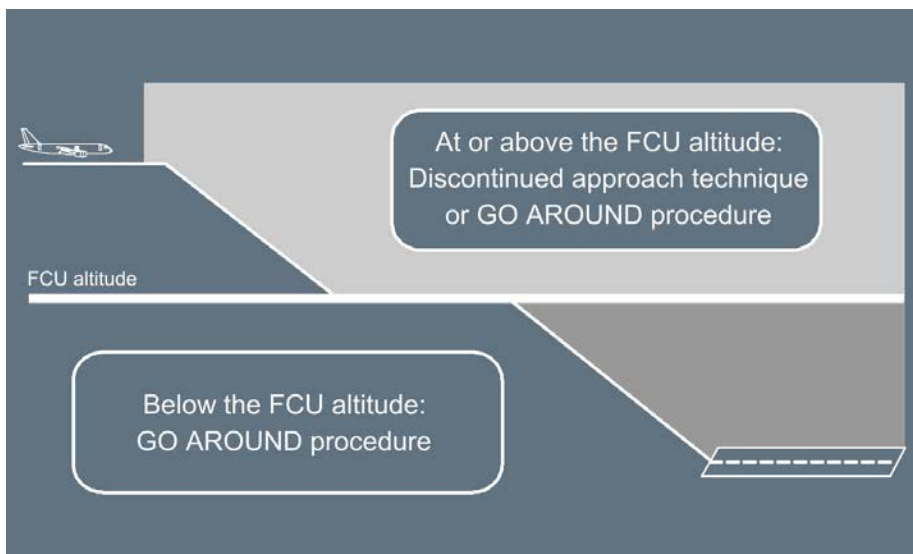

● **If at or above the FCU altitude:**

Announce "CANCEL APPROACH".

To disarm any AP/FD approach mode, press APPR pb or LOC pb.

Note: Valid only for ILS / MLS  / GLS  / FLS  or FINAL APP guidance.

Select lateral mode as required (NAV or HDG mode).

Select vertical mode as required (level off or adjust V/S).

Select SPEED and adjust.

● **If F-PLN has no destination anymore:**

Perform a LAT REV at the last waypoint and redefine the destination in the NEW DEST field.

- Note:
1. *The FMS does not automatically string the previous flown approach in the active F-PLN when the aircraft overflies the last waypoint. The FMS has no more destination in the F-PLN.*
 2. *Because the thrust levers are not set to TOGA detent, the FMS remains in approach phase.*

PROCEDURES

NORMAL PROCEDURES

STANDARD OPERATING PROCEDURES - APPROACH

Intentionally left blank

| | |
|---|---|
|  <p>A318/A319/A320/A321 FLIGHT CREW OPERATING MANUAL</p> | <p align="center">PROCEDURES NORMAL PROCEDURES</p> <p align="center">STANDARD OPERATING PROCEDURES - APPROACH</p> |
|---|---|

Aircraft Configuration Management

INITIAL APPROACH

Applicable to: ALL

Ident.: PRO-NOR-SOP-18-B-A-00014494.0001001 / 29 MAY 13

GENERAL

The initial approach procedure described here is a general guidance whatever the type of approach expected.

Ident.: PRO-NOR-SOP-18-B-A-00014493.0001001 / 03 MAR 14

INITIAL APPROACH

F-PLN SEQUENCING.....ADJUST

- *The NAV mode will be available after GO AROUND if the F-PLN is properly sequenced. A good cue to monitor the proper F-PLN sequencing is the TO waypoint on the upper right side of the ND, which should remain meaningful.*
- *In NAV mode, the F-PLN will sequence automatically.*
- *In HDG /TRK mode, the F-PLN will sequence automatically only if the aircraft flies close to the F-PLN route.*

APPROACH PHASE.....CHECK/ACTIVATE

- *If the aircraft overflies the DECEL pseudo waypoint in NAV mode, the APPR phase activates automatically.*
- *If the aircraft is in HDG /TRK mode, approximately 15 NM from touchdown, activate and confirm APPROACH phase on the MCDU (PERF DES page).*

MANAGED SPEED..... CHECK

- *If ATC requires a particular speed, use selected speed. When the ATC speed constraint no longer applies, return to managed speed.*

FLIGHT PATH.....MONITOR

- *In NAV mode, use VDEV information on the PFD and PROG page.*
- *In HDG /TRK mode, use the energy circle on ND representing the required distance to land.*

SPEED BRAKES lever.....AS QRDR

- If the flight crew uses the speed brakes to increase the rate of deceleration or to increase the rate of descent, the VLS will increase as well:
 - The flight crew should ensure that appropriate speed margin exists before the extension of the speed brakes
 - If the speed brakes are extended, the flight crew should ensure that appropriate speed margin exists before the beginning of a turn.

This will avoid the activation of the Alpha-Floor protection.

Note: In clean configuration, the VLS with speed brakes fully extended may be higher than green dot speed or VFE FLAP 1.

Ident.: TDU / PRO-NOR-SOP-18-B-A-00014648.0003001 / 03 MAR 14
 Impacted DU: 00014647 Initial Approach - Radar

RADAR

RADAR.....ADJUST AS APPROPRIATE

- Gain must be manually set to +4 when MULTISCAN selector is set to AUTO and when flying below FL 200.
- If the weather is good, or not significant, in order to check that the radar is operating correctly: down tilt under displaying ground echoes.
- If the weather display is ambiguous or unexpected, in order to better analyze the weather situation, use manual tilt according to standard technique.
- In particular below FL 200, for situations with low level weather, weather with low reflectivity or in front of suspected active cells, the flight crew should switch to manual mode and adjust the tilt setting downward until the weather is detected or the ground clutter appears on the upper part of the display.
- In addition, the flight crew may increase the manual gain control to display lower reflectivity targets. The manual gain control can be increased in both AUTO and manual modes to display lower levels of weather. In both cases, ground clutter may also be displayed as a result of low settings and/or increased gain.

Ident.: PRO-NOR-SOP-18-B-A-00014647.0001001 / 29 MAY 13
 Impacted by TDU: 00014648 Initial Approach - Radar

RADAR

RADAR.....ADJUST AS APPROPRIATE

Ident.: PRO-NOR-SOP-18-B-A-00014492.0001001 / 29 MAY 13

NAVIGATION ACCURACY

NAV ACCURACY.....MONITOR

- *When GPS PRIMARY is available, no NAV ACCURACY monitoring is required.*
- *If GPS PRIMARY is lost, or GPS not installed, check on PROG page that the required navigation accuracy is appropriate to the phase of flight.*
- *If NAV ACCURACY is LOW, at least one ND must be in ROSE LS /VOR depending on the approach.*

INTERMEDIATE/FINAL APPROACH

Applicable to: ALL

Ident.: PRO-NOR-SOP-18-B-B-00014501.0001001 / 29 MAY 13

GENERAL

The intermediate and final approach procedure described here is general guidance whatever the type of approach expected.

Ident.: PRO-NOR-SOP-18-B-B-00014500.0001001 / 17 MAR 17

AT GREEN DOT SPEED

| | |
|----------------|---|
| CAUTION | The flight crew should avoid extended flight in icing conditions with the slats extended. |
|----------------|---|

FLAPS 1..... ORDER
 FLAPS 1.....SELECT

- *FLAPS 1 should be selected more than 3 NM before the Final Descent Point.*
- *Check deceleration toward "S" speed.*
- *For decelerated approaches, the aircraft must reach or be established on the final descent with FLAPS 1 and "S" speed at or above 2 000 ft AGL.*
- *If the aircraft does not decelerate on the flight path or aircraft speed is significantly higher than "S" speed, extend the landing gear in order to slow down. The use of speedbrakes is possible. The flight crew should be aware that the use of speedbrakes causes an increase in VLS.*



LINEAS GALAPAGOS S.A.

A318/A319/A320/A321

FLIGHT CREW
OPERATING MANUAL

PROCEDURES

NORMAL PROCEDURES

STANDARD OPERATING PROCEDURES - APPROACH



TCAS Mode selector..... TA or TA /RA

- FAA recommends to select TA only mode:
 - In case of known nearby traffic which is in visual contact
 - At particular airports and during particular procedures identified by an Operator as having a significant potential for unwanted or inappropriate resolution advisories (closely spaced parallel runways, converging runway, low terrain along the final approach, etc.).

Ident.: PRO-NOR-SOP-18-B-B-00014499.0001001 / 09 MAR 15

AT 2 000 FT AGL MINIMUM

FLAPS 2..... ORDER
 FLAPS 2.....SELECT

- Check deceleration toward "F" speed.
- For ILS / MLS  / GLS  and approaches using FLS  , if the aircraft intercepts the flight path below 2 000 ft AGL, select FLAPS 2 at one dot below the flight path.
- If the aircraft speed is significantly higher than "F" speed on the flight path, or the aircraft does not decelerate on the flight path, extend the landing gear in order to slow down the aircraft. The use of speed brakes is not recommended.
- When the speed brakes are deployed, extending the flaps beyond FLAPS 1 may induce a slight roll movement, and in calm conditions a small lateral control asymmetry may remain until disturbed by a control input or by an atmospheric disturbance.

Ident.: PRO-NOR-SOP-18-B-B-00014498.0001001 / 05 JAN 15

WHEN FLAPS ARE AT 2

L/G DOWNORDER
 L/G lever..... SELECT DOWN
 AUTO BRKCONFIRM

- If the runway conditions have changed from the approach briefing, consider another braking mode.

GROUND SPOILERSARM
 NOSE sw.....TAXI
 RWY TURN OFF sw..... ON

Ident.: PRO-NOR-SOP-18-B-B-00014497.0002001 / 20 MAR 17

WHEN LANDING GEAR IS DOWN

FLAPS 3.....ORDER
 FLAPS 3.....SELECT

| | |
|---|---|
|  <p>A318/A319/A320/A321 FLIGHT CREW OPERATING MANUAL</p> | <p style="text-align: center;">PROCEDURES NORMAL PROCEDURES</p> <p style="text-align: center;">STANDARD OPERATING PROCEDURES - APPROACH</p> |
|---|---|

ECAM WHEEL SD page CHECK

- *WHEEL SD page appears below 15 500 ft when landing gear is extended.*
- *Check for three green indications on the landing gear indicator panel. At least one green triangle on each landing gear strut on the WHEEL SD page is sufficient to indicate that the landing gear is downlocked. Rely also on the "LDG GEAR DN" green LDG MEMO message to confirm that the landing gear is downlocked.*

● **If residual pressure is indicated on the triple indicator:**

RESIDUAL BRAKING PROC..... APPLY

- *Due to the accomplishment of the alternate braking functional test after the landing gear is downlocked, brief brake pressure indications may be observed on BRAKES PRESS.*

FLAPS FULL..... ORDER

FLAPS FULL..... SELECT

- *Retract the speed brakes before selecting FLAPS FULL to prevent a pitch down when the speed brakes automatically retract.*
- *Check deceleration towards VAPP.*
- *Check correct TO waypoint on the ND.*

A/THR.....CHECK IN SPEED MODE OR OFF

WING ANTI-ICE pb-sw..... OFF

- *Switch the WING ANTI ICE pb-sw to ON, only in severe icing conditions.*

SLIDING TABLE STOW

EFB/eQRH (with no mounted equipment)..... STOW

LDG MEMO.....CHECK NO BLUE

CABIN REPORT..... RECEIVE

CABIN CREW..... ADVISE

LANDING CHECKLIST..... COMPLETE

FLIGHT PARAMETERS.....MONITOR

- The PF announces any FMA modification.
- The PM calls out, if:
 - The speed goes lower than the speed target -5 kt , or greater than the speed target +10 kt
 - The pitch attitude goes lower than -2.5 °, or greater than +10 ° nose up
 - The bank angle becomes greater than 7 °
 - The descent rate becomes greater than 1 000 ft/min
- Following PM flight parameter exceedance callout, the suitable PF response will be:
 - Acknowledge the PM callout, for proper crew coordination purposes
 - Take immediate corrective action to control the exceeded parameter back into the defined stabilized conditions
 - Assess whether stabilized conditions will be recovered early enough prior to landing, otherwise initiate a go-around.

Ident.: PRO-NOR-SOP-18-B-B-00014495.0001001 / 29 MAY 13

PATTERN (DECELERATED)

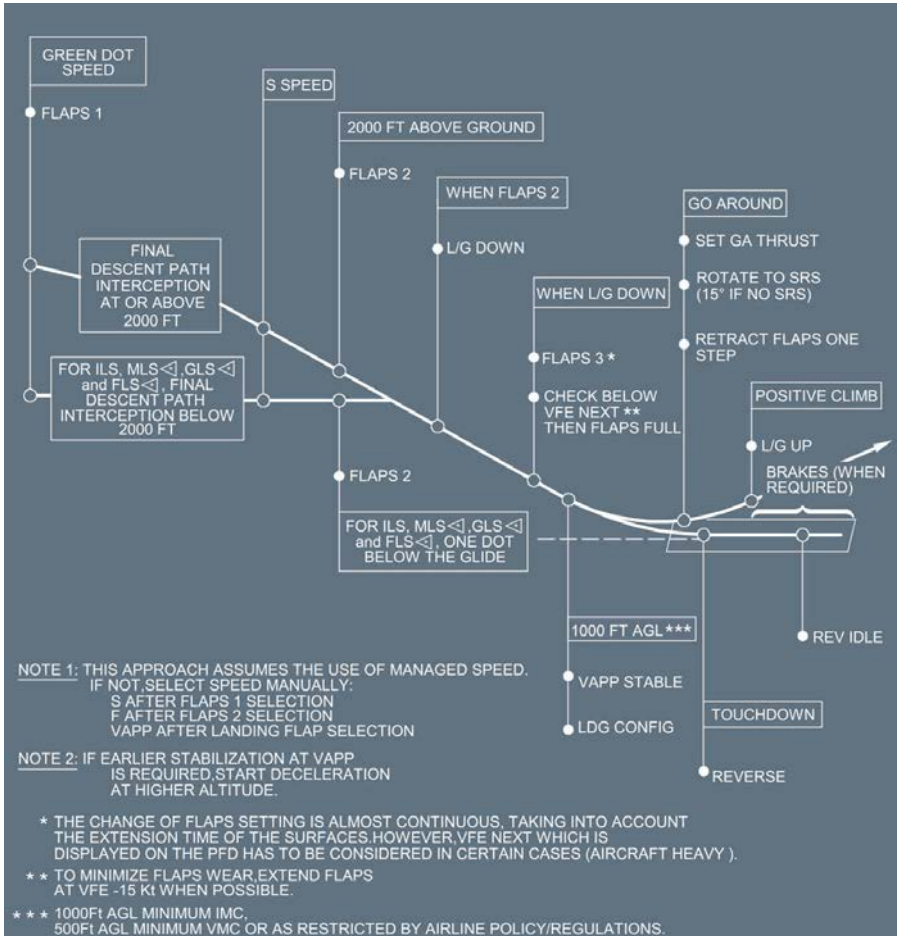

PROCEDURES

NORMAL PROCEDURES

STANDARD OPERATING PROCEDURES - APPROACH

Intentionally left blank

| | |
|---|---|
|  <p>A318/A319/A320/A321 FLIGHT CREW OPERATING MANUAL</p> | <p align="center">PROCEDURES NORMAL PROCEDURES</p> <p align="center">STANDARD OPERATING PROCEDURES - APPROACH</p> |
|---|---|



Aircraft Guidance Management

APPROACH USING LOC G/S GUIDANCE

Applicable to: ALL

Ident.: PRO-NOR-SOP-18-C-A-00014508.0001001 / 29 MAY 13

GENERAL

The following items are to be performed in addition to previous SOP chapters for ILS / MLS  / GLS  approach.

Ident.: PRO-NOR-SOP-18-C-A-00020896.0001001 / 20 MAR 17

DESCENT PREPARATION

APPROACH MINIMUM.....DETERMINE

- For CATII, CATIII approaches, always choose the lowest achievable minimum. The approach minimum is limited by:

- Crew qualification
- Airline Operating Manual requirement
- Aircraft technical status
- Airport status

- For CATIII with no DH, the flight crew should enter "NO" in the DH field of the MCDU to avoid false "HUNDRED ABOVE" or "MINIMUM" auto callouts which would not be applicable.

APPROACH BRIEFING.....PERFORM

For CATII, CATIII approaches, review the following items on top of the usual briefing:

- Task sharing and callouts
- Management of degraded guidance
- Low visibility procedures at the airport

Ident.: PRO-NOR-SOP-18-C-A-00014509.0001001 / 09 FEB 16

INITIAL/INTERMEDIATE APPROACH

APPR pb on FCU..... PRESS

- Press the APPR pb when:
 - Cleared for the approach
 - On the intercept trajectory for the final approach course
 - LOC deviation is available.

This arms the LOC and G/S modes.

Note: In NAV mode, the aircraft may leave the F-PLN to capture the LOC.

- LOC and/or G/S capture modes will engage no sooner than 3 s after being armed.
- ICAO defines the envelope where the quality of the G/S signal ensures a normal capture. This envelope is within 10 NM, $\pm 8^\circ$ of the centerline of the ILS glide path and up to 1.75θ and down to 0.3θ (θ = nominal glide path angle). When arming the approach well outside of the normal G/S capture envelope, a spurious G/S * engagement may occur due to a wrong G/S deviation signal. Whenever the pilot notices the pitch movement, or the spurious G/S *, or the trajectory deviation, he will immediately disconnect the AP, if engaged, to re-establish a normal attitude and will disengage APPR mode. It is then recommended to arm/rearm APPR (ILS) mode within the normal capture zone.

BOTH APs..... ENGAGE

- When APPR mode is selected, AP 1 and AP2 should be engaged.
- Above 5 000 ft AGL, the FMA displays CAT 1.
- Below 5 000 ft AGL, the FMA displays the correct approach capability for the intended approach.

LOC..... CHECK ARMED
 G/S..... CHECK ARMED
 LOC CAPTURE..... MONITOR
 G/S CAPTURE..... MONITOR
 GO AROUND ALTITUDE..... SET

Ident.: PRO-NOR-SOP-18-C-A-00014510.0002001 / 03 MAR 14

GLIDE INTERCEPTION FROM ABOVE

The following procedure should only be applied when established on the localizer. The flight crew must react without delay to meet the stabilization criteria.

In order to get the best rate of descent when cleared by ATC and below the limiting speeds, the flight crew should lower the landing gear and select flaps as required (at least CONF 2 should be selected to ensure that the aircraft speed will not increase).

● **If above the glideslope:**

APPR mode ARM / CHECK ARMED
 FCU ALTITUDE..... SET ABOVE A/C ALTITUDE
 V/S MODE..... SELECT

- Select V/S 1 500 ft/min initially. V/S in excess of 2 000 ft/min will result in the speed increasing towards VFE.
- When reaching VFE , the AP maintains VFE and reduces the V/S without MODE REVERSION.

Ident.: PRO-NOR-SOP-18-C-A-00014511.0001001 / 04 JUL 17

FINAL APPROACH

FLIGHT PARAMETERS.....MONITOR

- The PM calls out if excessive deviation occurs:

- LOC: ½ dot
- GLIDE: ½ dot

Refer to PRO-NOR-SOP-90 Approach

AT 350 ft RA

LAND mode..... CHECK ENGAGED/ANNOUNCE

If no LAND mode, autoland is not authorized.

FOR CAT I, CAT II, CAT III WITH DH APPROACH

AT ENTERED MINIMUM +100 ft

ONE HUNDRED ABOVE.....MONITOR OR ANNOUNCE

AT ENTERED MINIMUM

MINIMUM..... MONITOR OR ANNOUNCE

Below minimum, the visual references must be the primary reference until landing.

For more information regarding transition to visual references, *Refer to*

FCTM/PR-NP-SOP-250 Transition to Visual References.

■ **If visual references are sufficient:**

CONTINUE.....ANNOUNCE

AP.....AS RQRD

For Minimum Use Height of the AP Refer to LIM-AFS-10 Flight Management Function

For Manual Landing and Autoland procedure Refer to PRO-NOR-SOP-19 Landing - Flare

■ **If visual references are not sufficient:**

GO AROUND..... ANNOUNCE

Initiate a go around.

FOR CAT III WITHOUT DH APPROACH

At 100 ft (Alert Height) if no failure

CONTINUE..... ANNOUNCE

Ident.: PRO-NOR-SOP-18-C-A-00021062.0002001 / 31 AUG 17

MANAGEMENT OF DEGRADED GUIDANCE

EARLY/UNTIMELY FLARE MODE ENGAGEMENT

- Perform a go around (thrust levers set to TOGA), or
- Disconnect AP , set both FDs to OFF and continue the approach using raw data or external visual references.

In association to an early/untimely FLARE mode engagement on the FMA, the following effects may occur:

- On the Primary Flight Display (PFD):
 - The RA height indication may be frozen at a positive or negative value,
 - Discrepancies between both PFDs may happen on the following indications:
 - RA heights,
 - FD orders,
 - FMA indications when both APs are engaged.
- Warnings and/or Callouts:
 - Untimely activation of the AUTOLAND warning light. *Refer to DSC-22_30-30 Autoland Warning,*
 - Untimely Terrain Awareness and Warning System (TAWS) alerts,
 - Untimely or absence of "RETARD" callout,
 - Untimely L/G GEAR NOT DOWN ECAM warning,
 - Absence or interruption of RA automatic callout (height announcement),
- On the System Display (SD): A pulsing cabin differential pressure advisory may appear on the ECAM - CAB PRESS PAGE

Note: *This ECAM advisory has no consequence on the real cabin pressure.*

FOR CAT II, CAT III OPERATIONS

● **In the case of:**

- Amber caution (single chime), or
- Landing capability degradation.

Above 1000 ft:

ECAM / QRH PROCEDURE..... COMPLETE

REQUIRED EQUIPMENT..... CHECK

Refer to QRH/OPS Required Equipment for CAT2 and CAT3

APPROACH AND LANDING CAPABILITY..... CHECK

If required:

RVR..... CHECK

DH..... ADJUST

BRIEFING..... CONFIRM

● **If the flight crew does not complete all the above actions at 1 000 ft:**

GO AROUND..... PERFORM

Below 1000 ft:

● **If external visual references are not sufficient:**

GO AROUND..... PERFORM

Below 100 ft (Alert Height) for CAT 3 DUAL:

Approach may be continued unless autoland light comes on.

● **In the case of Autoland warning light:**

■ **Visual references not sufficient:**

GO AROUND..... PERFORM

■ **Visual references sufficient:**

Approach may be continued manually



A318/A319/A320/A321
FLIGHT CREW
OPERATING MANUAL

PROCEDURES
NORMAL PROCEDURES

STANDARD OPERATING PROCEDURES - APPROACH

APPROACH USING FINAL APP GUIDANCE

Applicable to: ALL

Ident.: PRO-NOR-SOP-18-C-C-00014521.0002001 / 29 MAY 13

GENERAL

The following items are to be performed in addition to previous SOP chapters in the following cases:

- RNAV (GNSS) approaches with LNAV and LNAV/VNAV minima
- Conventional approaches based on VOR or NDB using FINAL APP guidance.

Ident.: PRO-NOR-SOP-18-C-C-00014522.0003001 / 09 SEP 14

AIRCRAFT EQUIPMENT

For RNAV (GNSS) approaches, *Refer to PRO-SPO-51 RNP APCH / RNAV(GNSS) - Required RNP APCH Equipment*

Ident.: PRO-NOR-SOP-18-C-C-00015860.0001001 / 09 SEP 14

FLIGHT PREPARATION

For RNAV (GNSS) approaches, GPS PRIMARY availability should be confirmed.
Refer to PRO-NOR-SOP-02 GPS PRIMARY Availability (If Installed)

Ident.: PRO-NOR-SOP-18-C-C-00014524.0002001 / 08 AUG 17

DESCENT PREPARATION

WEATHER AND LANDING INFORMATION.....OBTAIN

- *The FMS vertical profile does not take into account the effect of low OAT. Therefore, vertical managed guidance:*
 - *Must not be used when the actual OAT is below the minimum temperature indicated on the approach chart or defined by the Operator, or*
 - *May not be used when temperature corrections are required (FINAL APP mode may not engage).*
- *For RNAV (GNSS) approach with LNAV VNAV minima, use of QNH from a remote station is prohibited.*

F-PLN A page..... CHECK

- *If a TOO STEEP PATH is displayed after the Final Descent Point (FDP), do not use FINAL APP guidance for approach. Use NAV FPA, TRK FPA or FLS  for approach.*
- *0.1 degree of difference between the MCDU and the charted final vertical path is acceptable*

| | |
|---|---|
|  <p>A318/A319/A320/A321 FLIGHT CREW OPERATING MANUAL</p> | <p style="text-align: center;">PROCEDURES NORMAL PROCEDURES</p> <p style="text-align: center;">STANDARD OPERATING PROCEDURES - APPROACH</p> |
|---|---|

- 1 degree of difference between the MCDU and the charted final lateral track is acceptable

Note: A higher lateral track value can be acceptable if the navigation database has been validated to exclude potential coding error.

- 3 degree of difference between the MCDU and the charted final lateral track is acceptable for conventional radio NAVAID approach.

PROG page.....COMPLETE

- Insert the reference RWY threshold in the BRG /DIST field for position monitoring during approach.

GO AROUND STRATEGY.....REVIEW

- The briefing should include a review of the "Management of Degraded Navigation" chapter.

Ident.: PRO-NOR-SOP-18-C-C-00014525.0003001 / 23 JUN 15

DESCENT

At 10 000 ft:

NAV ACCURACY.....CHECK

- If NAV accuracy is LOW, use TRK FPA mode for approach (Refer to APPR using FPA guidance).

● **For RNAV(GNSS) approach:**

GPS PRIMARY.....CHECK

- GPS PRIMARY must be available on at least 1 FMS.

BARO REF.....SET

- The vertical guidance requires a precise baro setting. The maximum acceptable discrepancy between altimeters is 100 ft.

Ident.: PRO-NOR-SOP-18-C-C-00014526.0002001 / 08 AUG 17

INITIAL/INTERMEDIATE/FINAL APPROACH

POSITION.....MONITOR

- Check that ATC clearances allow the aircraft to fly through the capture area of vertical profile. After a radar vectoring, consider a DIR TO RDL IN to sequence the F-PLN.

PROCEDURES

NORMAL PROCEDURES

STANDARD OPERATING PROCEDURES - APPROACH

APPR pb on FCUPRESS

Press the APPR pb when all of the following conditions are satisfied:

- The aircraft is cleared for approach
- TO waypoint is the Final Descent Point.

APP NAV.....CHECK ARMED or ENGAGED

FINAL.....CHECK ARMED

- Check that the V/DEV scale is displayed on the PFD.
- At the Final Descent Point, a blue arrow on ND indicates that FINAL APP engagement conditions are met.

At the Final Descent Point :

FINAL APP.....CHECK ENGAGED

GO AROUND ALTITUDE.....SET

FLIGHT PARAMETERS.....MONITOR

- Monitor XTK error on ND.
- Monitor V/DEV on PFD.
- Crosscheck distances versus altitudes as published on the charts.
- If approaching on a conventional radio NAVAID procedure, monitor the lateral and vertical guidance using raw data.
- The PM calls out if excessive deviation occurs:
 - XTK > 0.1 NM
 - V/DEV > ½ dot

 On the vertical scale, one dot corresponds to 100 ft. Thus ½ dot is 50 ft.

 Refer to PRO-NOR-SOP-90 Approach

Ident.: PRO-NOR-SOP-18-C-C-00015015.0001001 / 29 MAY 13

AT ENTERED MINIMUM +100 FT

ONE HUNDRED ABOVE.....MONITOR OR ANNOUNCE

Ident.: PRO-NOR-SOP-18-C-C-00014527.0003001 / 04 JUL 17

AT ENTERED MINIMUM

MINIMUM.....MONITOR OR ANNOUNCE

Below minimum, the visual references must be the primary references until landing.
 For more information regarding transition to visual references, Refer to FCTM/PR-NP-SOP-250
 Transition to Visual References.

■ **If visual references are sufficient:**

CONTINUE.....ANNOUNCE

| | |
|---|---|
|  <p>A318/A319/A320/A321 FLIGHT CREW OPERATING MANUAL</p> | <p style="text-align: center;">PROCEDURES NORMAL PROCEDURES</p> <p style="text-align: center;">STANDARD OPERATING PROCEDURES - APPROACH</p> |
|---|---|

At the latest at the MAP or Minimum Use Height of the AP (whichever occurs first):
APOFF

- For Minimum Use Height of the AP, Refer to LIM-AFS-10 Autopilot Function
- The AP will automatically disengage at the MAP.

FDAS RQRD

CAUTION - From minima down to the MAP the FD provides an additional guidance.
The FD must be switched off if the guidance is not relevant or not followed.
- After the MAP, disregard the FD as it reverts to HDG V/S.

■ **If visual references are not sufficient:**

GO AROUND.....ANNOUNCE

- Initiate a go around.

Ident.: PRO-NOR-SOP-18-C-C-00014528.0002001 / 23 JUN 15

MANAGEMENT OF DEGRADED NAVIGATION

● **For VOR and NDB approaches, be prepared to continue the approach with reference to appropriate raw data by reverting to:**

- NAV FPA, if the vertical guidance is not satisfactory
- TRK FPA, if the lateral guidance is not satisfactory.

● **For RNAV(GNSS) approaches with LNAV minima and LNAV/VNAV minima:**

- Use the appropriate remaining AP /FDin the following cases:
 - GPS PRIMARY LOST on one ND
 - NAV ACCUR DOWNGRAD on one FMGS.
- Discontinue the approach in the following cases, if external visual references are not sufficient to proceed visually:
 - GPS PRIMARY LOST on both NDs
 - XTK > 0.3 NM
 - NAV FM /GPS POS DISAGREE on ECAM
 - NAV ACCUR DOWNGRAD on both FMGS.

● **For RNAV(GNSS) approaches with LNAV/VNAV minima:**

- Discontinue the approach in the case of deviation of 75 ft below the vertical path (V/DEV>¾ dot).



A318/A319/A320/A321
FLIGHT CREW
OPERATING MANUAL

PROCEDURES
NORMAL PROCEDURES

STANDARD OPERATING PROCEDURES - APPROACH

APPROACH USING FPA GUIDANCE

Applicable to: ALL

Ident.: PRO-NOR-SOP-18-C-E-00014561.0002001 / 29 MAY 13

GENERAL

The following items are to be performed in addition to previous SOP chapters in the following cases:

- RNAV (GNSS) approaches using mixed NAV FPA guidance with LNAV minima only
- Conventional approaches based on VOR and NDB using selected TRK FPA or mixed NAV FPA guidance
- ILS G/S OUT, LOC ONLY and back course localizer approaches.

The approach is flown in TRK FPA when:

- The approach is not stored in the database or
- NAV accuracy is LOW.

Ident.: PRO-NOR-SOP-18-C-E-00014560.0003001 / 09 SEP 14

AIRCRAFT EQUIPMENT

For RNAV (GNSS) approaches, *Refer to PRO-SPO-51 RNP APCH / RNAV(GNSS) - Required RNP APCH Equipment*

Ident.: PRO-NOR-SOP-18-C-E-00015861.0001001 / 09 SEP 14

FLIGHT PREPARATION

For RNAV (GNSS) approaches, GPS PRIMARY availability should be confirmed.

Refer to PRO-NOR-SOP-02 GPS PRIMARY Availability (If Installed)

Ident.: PRO-NOR-SOP-18-C-E-00014558.0002001 / 20 SEP 16

DESCENT PREPARATION

F-PLN A page..... CHECK

- *If a TOO STEEP PATH message is displayed after the Final Descent Point (FDP), disregard the V/DEV or yoyo information on the PFD.*
- *For approaches using NAV FPA:*
 - *1 degree of difference between the MCDU and the charted final lateral track is acceptable.*
 - *3 degree of difference between the MCDU and the charted final lateral track is acceptable for conventional radio NAVAID approach.*
- *In all other cases, use TRK FPA mode for approach.*

| | |
|---|---|
|  <p>A318/A319/A320/A321 FLIGHT CREW OPERATING MANUAL</p> | <p align="center">PROCEDURES NORMAL PROCEDURES</p> <p align="center">STANDARD OPERATING PROCEDURES - APPROACH</p> |
|---|---|

PROG page.....COMPLETE

- Insert the reference RWY threshold in the BRG /DIST field for position monitoring during approach.

GO AROUND STRATEGY..... REVIEW

- The briefing should include a review of the "Management of Degraded Navigation" chapter.

Ident.: PRO-NOR-SOP-18-C-E-00014557.0003001 / 03 MAR 14

DESCENT

At 10 000 ft:

NAV ACCURACY..... CHECK

- If NAV accuracy is LOW, use TRK mode for approach.

● **For RNAV(GNSS) approach:**

GPS PRIMARY..... CHECK

- GPS PRIMARY must be available on at least 1 FMS.

Ident.: PRO-NOR-SOP-18-C-E-00014556.0002001 / 21 MAR 17

INITIAL/INTERMEDIATE/FINAL APPROACH

LATERAL GUIDANCE MODE..... SET FOR APPROACH

- Arm NAV or LOC mode as appropriate.

● **For LOC ONLY and ILS G/S OUT:**

LOC pb-sw PRESS

- Press the LOC pb-sw when cleared for approach and on the intercept trajectory for the final approach course.

Note: In NAV mode, the aircraft may leave the F-PLN to capture the LOC.

LOC CHECK ARMED

CAUTION Do not press the APPR pb

● **For back course localizer approaches:**

TRK FPA MODE..... USE FOR APPROACH

- Refer to FCTM/PR-NP-SOP-190-GUI Back Course Localizer Approach.

LATERAL PATH..... INTERCEPT

- Monitor NAV or LOC engagement as appropriate.

TRK FPA pb (Bird).....SELECT
FPA FOR FINAL APPROACH.....SET

At 0.3 nm from the Final Descent Point:

FPA selector PULL
FPA MODE.....CHECK ENGAGED

- Check NAV FPA , TRK FPA or LOC FPA is engaged.

POSITION/FLIGHT PATH MONITOR/ADJUST
GO AROUND ALTITUDE..... SET

- Set when below the go around altitude to avoid unexpected altitude capture.

FLIGHT PARAMETERS.....MONITOR

- Crosscheck distances versus altitudes as published on the charts.
- If approaching on a conventional radio NAVAID procedure, monitor the lateral and vertical guidance using raw data.
- For approaches using NAV FPA , monitor XTK error on ND to check the lateral guidance.
- The PM calls out if excessive lateral deviation occurs:
 - Approach using NAV MODE: XTK > 0.1 NM
 - Approach using LOC MODE: LOC ½ dot
 - Approach using TRK MODE:
 - VOR: ½ dot or 2.5 °
 - NDB: 5 °

Refer to PRO-NOR-SOP-90 Flight Parameters in Approach

ident.: PRO-NOR-SOP-18-C-E-00015017.0001001 / 29 MAY 13

AT ENTERED MINIMUM +100 FT

ONE HUNDRED ABOVE.....MONITOR OR ANNOUNCE

ident.: PRO-NOR-SOP-18-C-E-00014555.0002001 / 04 JUL 17

AT ENTERED MINIMUM

MINIMUM.....MONITOR OR ANNOUNCE

Below minimum, the visual references must be the primary references until landing.
For more information regarding transition to visual references, *Refer to FCTM/PR-NP-SOP-250 Transition to Visual References.*

■ **If visual references are sufficient:**

CONTINUE.....ANNOUNCE
APOFF

| | |
|---|--|
|  <p>A318/A319/A320/A321 FLIGHT CREW OPERATING MANUAL</p> | <p>PROCEDURES NORMAL PROCEDURES STANDARD OPERATING PROCEDURES - APPROACH</p> |
|---|--|

FDOFF

- The PF orders the PM to set both FDs OFF.

RUNWAY TRACK.....CHECK/SET

- If needed, the PF orders the PM to set the runway track.

■ **If visual references are not sufficient:**

GO AROUND.....ANNOUNCE

- Initiate a go around.

Ident.: PRO-NOR-SOP-18-C-E-00014554.0002001 / 23 JUN 15

MANAGEMENT OF DEGRADED NAVIGATION

● **For VOR and NDB approaches in NAV FPA, if lateral guidance is not satisfactory:**

- Be prepared to continue the approach with reference to appropriate raw data by reverting to TRK FPA.

● **For RNAV(GNSS) approaches, with LNAV minima:**

- Use the appropriate remaining AP FD in the following cases:
 - GPS PRIMARY LOST on one ND
 - NAV ACCUR DOWNGRAD on one FMGS
- Discontinue the approach in the following cases, if external visual references are not sufficient to proceed visually:
 - GPS PRIMARY LOST on both NDs
 - XTK > 0.3 NM
 - NAV FM /GPS POS DISAGREE on ECAM
 - NAV ACCUR DOWNGRAD on both FMGS

CIRCLING APPROACH

Applicable to: ALL

Ident.: PRO-NOR-SOP-18-C-F-00014570.0001001 / 29 MAY 13

GENERAL

The circling approach is the visual phase of an instrument approach to bring an aircraft into position for landing on a runway which is not suitably located for a straight-in approach.

CAUTION The flight crew must conduct the flight within the circling area, while maintaining required visual references at all times.

Ident.: PRO-NOR-SOP-18-C-F-00014569.0001001 / 29 MAY 13

APPROACH PREPARATION

For a circling approach, the approach preparation should include the following additional items in the FMS programming.

F-PLN

Introduce the instrument approach procedure, including the missed approach procedure for instrument approach.

SEC F-PLN

The landing runway must be inserted into the SEC F-PLN.

Update the SEC F-PLN as follows:

- Copy the active F-PLN
- Revise the landing runway.

Ident.: PRO-NOR-SOP-18-C-F-00014568.0001001 / 29 MAY 13

INSTRUMENT APPROACH

The flight crew flies a stabilized approach at "F" speed, configuration 3 and landing gear down.

Ident.: PRO-NOR-SOP-18-C-F-00014567.0001001 / 29 MAY 13

CIRCLING APPROACH

● At the Circling MDA(H) at the latest:

Perform a level off

● At MAP, if the flight crew finds no visual reference:

Initiate a go around

● When required conditions for circling are satisfied:

Select TRK FPA

Proceed to downwind leg

At any time in the downwind leg, activate the SEC F-PLN

Disconnect the AP and remove the FDs at the latest before starting the descent toward the runway

Set the landing configuration when appropriate, but ensure early stabilization in final.

If, at any time during the circling procedure, the required visual references are lost, initiate a go around following the missed approach of the initial instrument approach (unless otherwise specified).

Ident.: PRO-NOR-SOP-18-C-F-00014566.0001001 / 30 JUN 16

CIRCLING APPROACH PATTERN

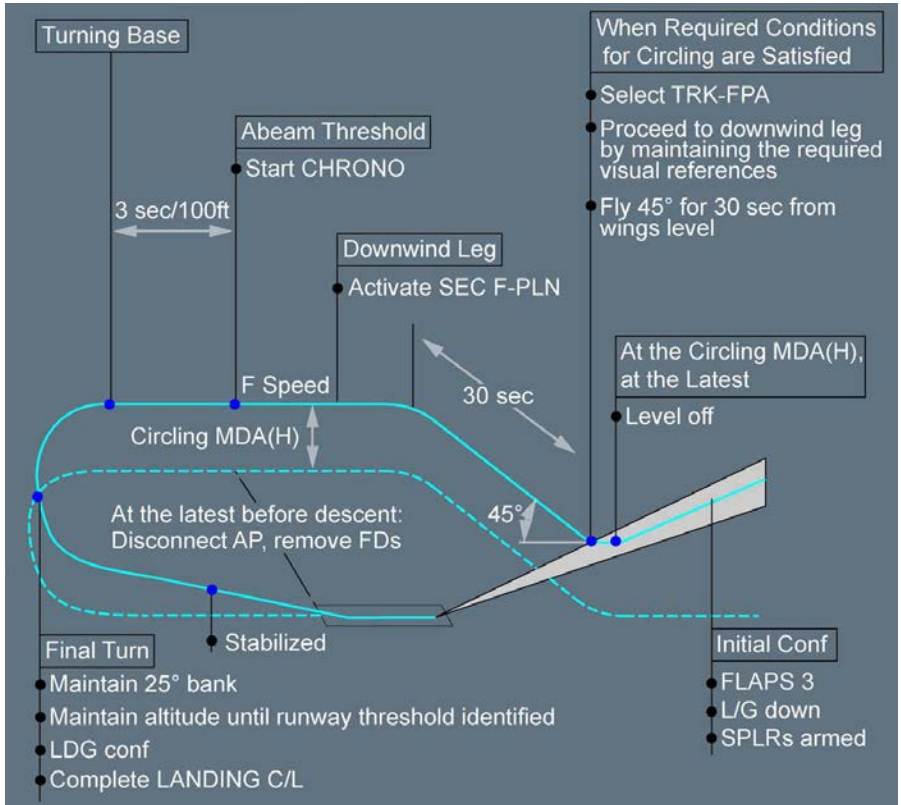

RNAV VISUAL APPROACH

Applicable to: ALL

Ident.: PRO-NOR-SOP-18-C-G-00016048.0001001 / 23 DEC 14

GENERAL

The aircraft navigates using the RNAV system, but the position is monitored by visual reference to the ground, obstacles and other traffic.

RNAV visual approach must be stored and retrievable from the Navigation Database.

Ident.: PRO-NOR-SOP-18-C-G-00016049.0001001 / 23 DEC 14

EQUIPMENT REQUIRED

- 1 FMS
- 1 GPS or 2 DME to update FM position
- Additional requirement if indicated on the approach chart.

Ident.: PRO-NOR-SOP-18-C-G-00016050.0001001 / 17 MAR 17

FMGC GUIDANCE MODE

● **If no required accuracy is published:**

The use of FMGC guidance mode is at flight crew discretion.

● **If RNAV 1 or RNP 1 is required on the published approach chart:**

The flight crew should use adequate FMGC guidance modes.

Note: The use of lateral and vertical managed guidance modes reduces the crew workload and improves energy management.

For RNAV VISUAL approach including RF legs, *Refer to FCTM/PR-NP-SP-30 General for RF leg flying technic.*

Ident.: PRO-NOR-SOP-18-C-G-00016051.0001001 / 23 DEC 14

DESCENT PREPARATION

For approach data insertion in the FMS , keep the BARO /MDA field empty on the PERF APPR Page.

Ident.: PRO-NOR-SOP-18-C-G-00016052.0001001 / 23 DEC 14

DESCENT

For RNAV VISUAL approaches requiring GPS , check that GPS PRIMARY is available on at least 1 FMS.

Ident.: PRO-NOR-SOP-18-C-G-00016053.0001001 / 21 MAR 17

FINAL APPROACH

The flight crew must disconnect the AP at the latest at the Minimum Use Height of the AP.
Refer to LIM-AFS-10 Autopilot Function

| | |
|---|--|
|  <p>A318/A319/A320/A321 FLIGHT CREW OPERATING MANUAL</p> | <p style="text-align: center;">PROCEDURES NORMAL PROCEDURES</p> <p style="text-align: center;">STANDARD OPERATING PROCEDURES - APPROACH</p> |
|---|--|

VISUAL APPROACH

Applicable to: ALL

Ident.: PRO-NOR-SOP-18-C-H-00014574.0002001 / 29 MAY 13

GENERAL

Perform the approach on a nominal 3° glideslope using visual references. Approach to be stabilized by 500 ft AGL on the correct approach path, in the landing configuration, at VAPP.

Method:

- The AP is not used
- Both FDs are OFF
- FPV use is recommended
- A/THR use is recommended with managed speed.

Bear in mind the possible risk of optical illusions due to hindered night vision.

Note: If the forecasted tailwind at landing is greater than 10 kt, decelerated approach is not allowed, and the speed should be stabilized around VREF + 5 kt in final.

Ident.: PRO-NOR-SOP-18-C-H-00014573.0001001 / 08 AUG 13

INITIAL/INTERMEDIATE APPROACH

The flight plan selected on the MCDU should include the selection of the landing runway. The downwind leg may also be part of the flight plan. This may be a useful indication of the aircraft position in the circuit on the ND.

However, visual references must be used.

Therefore, at the beginning of the downwind leg:

- Manually ACTIVATE APPR
- Select FDs to OFF
- Select TRK FPA to have FPV displayed
- Check A/THR active.

Extend the downwind leg to 3 s/100 ft (± 1 s/1 kt of headwind / tailwind).

Turn into base leg with a maximum of 30° of bank. Descent with approximate FPA, in FLAPS 2, at F speed.

Ident.: PRO-NOR-SOP-18-C-H-00014572.0001001 / 29 MAY 13

FINAL APPROACH

The speed trend arrow and FPV help the flight crew make timely and correct thrust settings (if in manual thrust), and approach path corrections.

PROCEDURES

NORMAL PROCEDURES

STANDARD OPERATING PROCEDURES - APPROACH

Avoid descending through the correct approach path with idle thrust. (Late recognition of this situation without a prompt thrust increase may lead to considerable speed decay and altitude loss).

Ensure that the aircraft is stabilized on the final descent path at VAPP (or ground speed mini) in the landing configuration with the thrust stabilized (usually above idle) at 500 ft above airfield elevation or as restricted by Operator policies/regulations.

If the aircraft is not stabilized, the flight crew must initiate a go around, unless they think that only small corrections are necessary to rectify minor deviations from stabilized conditions due, amongst others, to external perturbations.

Avoid any tendency to “duck under” in the late stages of the approach.

Avoid destabilizing the approach in the last 100 ft, in order to have the best chance of performing a good touchdown at the desired position.

Ident.: PRO-NOR-SOP-18-C-H-00014571.0001001 / 08 DEC 14

VISUAL APPROACH (1 OR 2 ENGINES) PATTERN

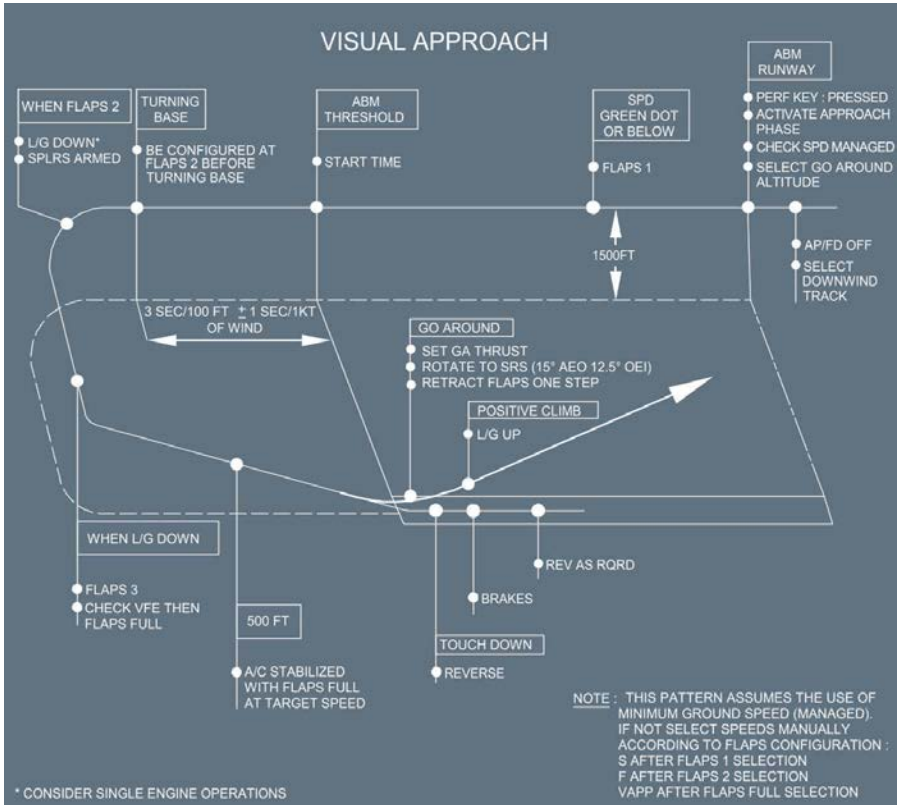



A318/A319/A320/A321
FLIGHT CREW
OPERATING MANUAL

PROCEDURES

NORMAL PROCEDURES

STANDARD OPERATING PROCEDURES - APPROACH

Intentionally left blank

| | |
|---|--|
|  <p>A318/A319/A320/A321 FLIGHT CREW OPERATING MANUAL</p> | <p style="text-align: center;">PROCEDURES NORMAL PROCEDURES</p> <p style="text-align: center;">STANDARD OPERATING PROCEDURES - LANDING</p> |
|---|--|

MANUAL LANDING

Applicable to: ALL

Ident.: PRO-NOR-SOP-19-A-00010351.0011001 / 25 APR 17

FLARE

The cockpit cut-off angle is 20 °.

- In stabilized approach conditions, the flare height is approximately 30 ft:

FLARE..... PERFORM

Avoid flaring high. Refer to Ground Clearance Diagram.

ATTITUDE..... MONITOR

THRUST levers..... IDLE

If autothrust is engaged, it automatically disconnects when the pilot sets both thrust levers to the IDLE detent.

In manual landing conditions, the "RETARD" callout is triggered at 20 ft radio height, in order to remind the pilot to retard the thrust levers.

Note: The ground spoilers extension is inhibited if:

- Both thrust levers remain above the idle detent, or
- One thrust lever is above idle and one thrust lever is at idle detent.

Ident.: PRO-NOR-SOP-19-A-00010352.0001001 / 30 JUN 15

AT TOUCHDOWN

DEROTATION..... INITIATE

- Lower the nosewheel without undue delay.
- The PM continues to monitor the attitude.

ALL THRUST LEVERS..... REV MAX or REV IDLE

The flight crew must select reverse thrust immediately after main landing gear touchdown.

The flight crew must immediately select REV MAX, if any of the following occurs at any time during the landing:

- An emergency
- The deceleration is not as expected
- A failure affects the landing performance
- A long flare or a long touchdown
- An unexpected tailwind.

A small pitch up may occur during thrust reversers deployment before nose landing gear touchdown. However, the flight crew can easily control this pitch up.

As soon as the flight crew selects reverse thrust, they must perform a full-stop landing.

GROUND SPOILERS..... CHECK/ANNOUNCE

Check that the WHEEL SD page displays the ground spoilers extended after touchdown.

If no ground spoilers are extended:

- Verify and confirm that both thrust levers are set to IDLE or REV detent.
- Set both thrust reverser levers to REV MAX, and fully press the brake pedals.

Note: If ground spoilers are not armed, ground spoilers extend at reverser thrust selection.

REVERSERS..... CHECK/ANNOUNCE

Check that the ECAM E/WD displays that the reverse deployment is as expected (REV green).

DIRECTIONAL CONTROL..... MONITOR/ENSURE

- Monitor directional control, if the rollout is automatic.
- Ensure directional control, if rollout is manual. Use rudder pedals for directional control.
- Do not use the nosewheel steering control handle before reaching taxi speed.
- During rollout, the flight crew should avoid sidestick inputs (either lateral or longitudinal).
- If directional control problems are encountered, the flight crew should reduce thrust to reverse idle until directional control is satisfactory.

BRAKES..... AS RQRD

- Monitor the autobrake, if it is ON. When required, brake with the pedals
- Although the green hydraulic system supplies the braking system, if pedals are pressed rapidly, a brake pressure indication appears briefly on the BRAKE PRESS indicator.
- Braking may begin before the nosewheel has touched down, if required for performance reasons. However, when comfort is the priority, the flight crew should delay braking until the nosewheel has touched down.

Note: If no ground spoilers are extended, the autobrake is not activated.

DECELERATION..... CHECK/ANNOUNCE

The deceleration is felt by the flight crew, and confirmed by the speed trend on the PFD.

Ident.: PRO-NOR-SOP-19-A-00010353.0001001 / 17 JUL 13

AT 70 KT

SEVENTY KNOTS..... ANNOUNCE

BOTH THRUST LEVERS..... REV IDLE

It is better to reduce thrust when passing 70 kt. However, high levels of reverse thrust may be used in order to control aircraft speed in the case of an emergency.

| | |
|---|--|
|  <p>A318/A319/A320/A321 FLIGHT CREW OPERATING MANUAL</p> | <p>PROCEDURES NORMAL PROCEDURES</p> <p>STANDARD OPERATING PROCEDURES - LANDING</p> |
|---|--|

CAUTION *Avoid the use of high levels of reverse thrust at low airspeed, unless required due to an emergency. The distortion of the airflow, caused by gases reentering the compressor, can cause engine stalls that may result in excessive EGT.*

Ident.: PRO-NOR-SOP-19-A-00010354.0001001 / 17 MAR 11

AT TAXI SPEED

BOTH THRUST LEVERS..... FWD IDLE

- *When reaching taxi speed, and before leaving the runway, deselect the reversers.*
- *On snow-covered grounds, the reversers should be stowed when the aircraft speed reaches 25 kt.*
- *When deselecting the reversers, be careful not to apply forward thrust by moving the thrust levers beyond the FWD IDLE position.*

CAUTION *Except in an emergency, do not use the reverse thrust to control the aircraft speed while on taxiways.*

On taxiways, the use of reversers, even when restricted to idle thrust, would have the following effects:

- *The engines may ingest fine sand and debris that may be detrimental to the engines and airframe systems.*
- *On snow-covered areas, snow will recirculate into the air inlet, and may cause an engine flameout or rollback.*

Ident.: PRO-NOR-SOP-19-A-00010355.0001001 / 30 MAR 15

BEFORE 20 KT

AUTO BRK..... DISENGAGE

*Disengage the autobrake to avoid some brake jerks at low speed.
The flight crew should use brake pedals to disengage the autobrake.*

AUTOLAND

Applicable to: ALL

Ident.: PRO-NOR-SOP-19-B-00020897.0001001 / 20 MAR 17

The following items must be performed in addition to previous *Refer to PRO-NOR-SOP-APPROACH USING LOC G/S.*



A318/A319/A320/A321
FLIGHT CREW
OPERATING MANUAL

PROCEDURES
NORMAL PROCEDURES

STANDARD OPERATING PROCEDURES - LANDING

Ident.: PRO-NOR-SOP-19-B-00020898.0001001 / 20 MAR 17

AT 350 FT RA

ILS /GLS ∇ /MLS ∇ COURSE on PFD.....CHECK
If the ILS /GLS ∇ /MLS ∇ course pointer and the runway track differ by more than 5 °, autoland is not authorized.

Ident.: PRO-NOR-SOP-19-B-00020899.0001001 / 20 MAR 17

AT 40 FT RA

FLARE mode..... CHECK ENGAGED/ANNOUNCE
Monitor flare by flight instrument.
If NO FLARE mode at 30 ft, discontinue the approach or perform a manual landing if visual references are acquired.

Ident.: PRO-NOR-SOP-19-B-00020900.0001001 / 20 MAR 17

AT 30 FT RA

THRUST IDLE..... CHECK
Monitor thrust reduction.

Ident.: PRO-NOR-SOP-19-B-00020901.0001001 / 20 MAR 17

AT 10 FT RA

BOTH THRUST LEVERS..... IDLE
Retard thrust levers at the "RETARD" autocalout.
 LATERAL GUIDANCE..... MONITOR
Monitor the lateral guidance by using external references.

Ident.: PRO-NOR-SOP-19-B-00020902.0001001 / 11 JUL 17

AT TOUCHDOWN

Note: In the case of NWS or Anti-Skid failure, set the AP OFF at touchdown.

ROLL OUT mode.....CHECK ENGAGED/ANNOUNCE
 BOTH THRUST LEVERS.....REV MAX or REV IDLE
The flight crew must select reverse thrust immediately after main landing gear touchdown.

The flight crew must immediately select REV MAX, if any of the following occurs at any time during the landing:

- An emergency
- The deceleration is not as expected
- A failure affects the landing performance

| | |
|---|---|
|  <p>A318/A319/A320/A321 FLIGHT CREW OPERATING MANUAL</p> | <p align="center">PROCEDURES NORMAL PROCEDURES</p> <p align="center">STANDARD OPERATING PROCEDURES - LANDING</p> |
|---|---|

- A long flare or a long touchdown
- An unexpected tailwind.

A small pitch up may occur during thrust reversers deployment before nose landing gear touchdown. However, the auto-flight system will control this pitch up.

As soon as the flight crew selects reverse thrust, they must perform a full-stop landing.

GROUND SPOILERS..... CHECK/ANNOUNCE

Check that the WHEEL SD page displays the ground spoilers extended after touchdown.

If no ground spoilers are extended:

- Verify and confirm that both thrust levers are set to IDLE or REV detent.
- Set both thrust reverser levers to REV MAX, and fully press the brake pedals.

Note: *If ground spoilers are not armed, ground spoilers extend at reverser thrust selection.*

REVERSERS..... CHECK/ANNOUNCE

Check that the ECAM E/WD displays that the reverse deployment is as expected (REV green).

DIRECTIONAL CONTROL.....MONITOR/ENSURE

- Monitor directional control, if the rollout is automatic.
- Ensure directional control, if rollout is manual. Use rudder pedals for directional control.
- Do not use the nosewheel steering control handle before reaching taxi speed.
- During rollout, the flight crew should avoid sidestick inputs (either lateral or longitudinal).
- If directional control problems are encountered, the flight crew should reduce thrust to reverse idle until directional control is satisfactory.

BRAKES..... AS RQRD

- Monitor the autobrake, if it is ON. When required, brake with the pedals
- Although the green hydraulic system supplies the braking system, if pedals are pressed rapidly, a brake pressure indication appears briefly on the BRAKE PRESS indicator.
- Braking may begin before the nosewheel has touched down, if required for performance reasons. However, when comfort is the priority, the flight crew should delay braking until the nosewheel has touched down.

Note: *If no ground spoilers are extended, the autobrake is not activated.*

DECELERATION..... CHECK/ANNOUNCE

The deceleration is felt by the flight crew, and confirmed by the speed trend on the PFD.

Ident.: PRO-NOR-SOP-19-B-00020904.0001001 / 11 JUL 17

AT 70 KT

SEVENTY KNOTS..... ANNOUNCE

BOTH THRUST LEVERS..... REV IDLE

It is better to reduce thrust when passing 70 kt. However, high levels of reverse thrust may be used in order to control aircraft speed in the case of an emergency.

CAUTION Avoid the use of high levels of reverse thrust at low airspeed, unless required due to an emergency. The distortion of the airflow, caused by gases reentering the compressor, can cause engine stalls that may result in excessive EGT.

Ident.: PRO-NOR-SOP-19-B-00020905.0001001 / 20 MAR 17

BEFORE 20 KT

AUTO BRK..... DISENGAGE

*Disengage autobrake before 20 kt to avoid some brake jerks at low speed.
The flight crew should use brake pedals to disengage the autobrake.*

Ident.: PRO-NOR-SOP-19-B-00020906.0001001 / 20 MAR 17

END OF ROLL OUT

BOTH THRUST LEVERS.....FWD IDLE

- *When reaching taxi speed, and before leaving the runway, deselect the reversers.*
- *On snow-covered grounds, the reversers should be stowed when the aircraft speed reaches 25 kt.*
- *When deselecting the reversers, be careful not to apply forward thrust by moving the thrust levers beyond the FWD IDLE position.*

CAUTION Except in an emergency, do not use the reverse thrust to control the aircraft speed while on taxiways.

On taxiways, the use of reversers, even when restricted to idle thrust, would have the following effects:

- *The engines may ingest fine sand and debris that may be detrimental to the engines and airframe systems.*
- *On snow-covered areas, snow will recirculate into the air inlet, and may cause an engine flameout or rollback.*

AP.....OFF

Disengage the APs at the end of the roll out (when leaving the runway at the latest).

| | |
|---|--|
|  <p>A318/A319/A320/A321 FLIGHT CREW OPERATING MANUAL</p> | <p style="text-align: center;">PROCEDURES NORMAL PROCEDURES</p> <p style="text-align: center;">STANDARD OPERATING PROCEDURES - GO-AROUND</p> |
|---|--|

GO AROUND WITH FD

Applicable to: ALL

Ident.: PRO-NOR-SOP-20-A-00011576.0006001 / 30 JUN 15

Apply the following three actions simultaneously:

THRUST LEVERS..... TOGA

If TOGA thrust is not required, set the thrust levers to TOGA detent then retard the thrust levers as required. This enables to engage the GO-AROUND phase, with associated AP /FD modes. The flight crew may use CL detent to have benefit of A/THR.

Note: *If the thrust levers are not set briefly to TOGA detent, the FMS does not engage the GO-AROUND phase, and flying over, or close to the airport will sequence the Destination waypoint in the F-PLN.*

ROTATION..... PERFORM

Initiate rotation towards 15 ° of pitch with all engines operative (approximately 12.5 ° if one engine is out) to get a positive rate of climb, then follow the SRS Flight Director pitch bars orders. When near the ground, avoid excessive rotation rate in order to prevent a tail strike.

GO AROUND ANNOUNCE
FLAPS lever..... SELECT AS RQRD

Retract one step of flaps.

FMA..... ANNOUNCE

The following modes are displayed: MAN TOGA / SRS / GA TRK / A/THR (in blue).

POSITIVE CLIMB ANNOUNCE

L/G UP ORDER

L/G..... SELECT UP

NAV or HDG mode..... AS RQRD

Reselect NAV or HDG, as required (minimum height 100 ft).

AP AS RQRD

Note: *Go-around may be flown with both autopilots engaged. Whenever any other mode engages, AP 2 disengages.*

Ident.: PRO-NOR-SOP-20-A-00011579.0002001 / 13 AUG 10

AT GO-AROUND THRUST REDUCTION ALTITUDE

THRUST levers..... CL

LVR CLB flashing on FMA.

AT GO-AROUND ACCELERATION ALTITUDE

Monitor that the target speed increases to green dot.

● **If the target speed does not increase to green dot:**

ALT knob..... CHECK and PULL

● **At F speed:**

FLAPS 1..... ORDER

FLAPS 1..... SELECT

● **At S speed:**

FLAPS 0..... ORDER

FLAPS 0..... SELECT

GND SPLRS..... DISARM

NOSE sw..... OFF

RWY TURN OFF sw..... OFF

OTHER EXTERIOR LIGHTS..... AS RQRD

The flight crew can maintain the LAND LIGHTS selector set to ON, according to airline policy or regulatory recommendations.

Note: Consider the next step:

- Engage NAV mode, to follow the published missed approach procedure, or
- Prepare for a second approach by selecting the ACTIVATE APP PHASE, and CONFIRM on the PERF page.

AFTER TAKEOFF/CLIMB CHECKLIST down to the line..... COMPLETE

| | |
|---|--|
|  <p>A318/A319/A320/A321 FLIGHT CREW OPERATING MANUAL</p> | <p style="text-align: center;">PROCEDURES NORMAL PROCEDURES</p> <p style="text-align: center;">STANDARD OPERATING PROCEDURES - AFTER LANDING</p> |
|---|--|

AFTER LANDING

Applicable to: ALL



Ident.: PRO-NOR-SOP-21-A-00011841.0001001 / 06 DEC 16

GRND SPLRS..... DISARM

Ident.: PRO-NOR-SOP-21-A-00011840.0001001 / 29 SEP 15

LAND LIGHTS selector RETRACT
OTHER EXTERIOR LIGHTS..... AS RQRD

External lights can be turned off, unless they are needed.

Set the NAV & LOGO  to ON, as required, to turn on the navigation and logo lights .

 *The PF may ask the PM to set the exterior lights.*

Ident.: PRO-NOR-SOP-21-A-00011842.0001001 / 22 APR 16

RADAR..... OFF

Ident.: PRO-NOR-SOP-21-A-00011843.0001001 / 06 JAN 16

PREDICTIVE WINDSHEAR SYSTEM  OFF

Switching the radar and predictive windshear system to OFF after landing avoids risk of radiating persons at the gate area.

Ident.: PRO-NOR-SOP-21-A-00011844.0001001 / 13 DEC 10

ENG MODE selector..... NORM

Ident.: PRO-NOR-SOP-21-A-00011845.0001001 / 08 AUG 13

FLAPS..... RETRACT

Set the FLAPS lever to position 0.

If the approach was made in icing conditions, or if the runway was contaminated with slush or snow, do not retract the flaps and slats until after engine shutdown and after the ground crew has confirmed that flaps and slats are clear of obstructing ice.

On ground, hot weather conditions may cause overheating to be detected around the bleed ducts in the wings, resulting in "AIR L (R) WING LEAK" warnings. Such warnings may be avoided during transit by keeping the slats in Configuration 1 when the OAT is above 30 °C.

To avoid damage on the RTL (Rudder Travel Limit Unit) mechanical stop, the SLATS/FLAPS should be retracted before all ADIRS are set to OFF simultaneously.

Ident.: PRO-NOR-SOP-21-A-00011846.0001001 / 04 JUL 17

TCAS..... STBY

Ident.: PRO-NOR-SOP-21-A-00011847.0001001 / 20 JAN 15

ATC..... AS RQRD

ATC is set in accordance with airport requirements.

Ident.: PRO-NOR-SOP-21-A-00011848.0001001 / 17 MAR 15

APU..... START

APU START may be delayed until just prior to engine shutdown.

Note: *Prolonged use of the APU may cause a fuel imbalance. Pay particular attention to the fuel imbalance limitation for the next take-off.*

Ident.: PRO-NOR-SOP-21-A-00011849.0005001 / 17 MAR 17

CAUTION

In icing conditions (*Refer to LIM-ICE_RAIN Definition of Icing Conditions*), the flight crew must turn on the engine anti-ice and should not wait until seeing ice building up.

ANTI ICE..... AS RQRD

- *If engine anti-ice is used, take care to control taxi speed, especially on wet or slippery surfaces. (N1 ground idle is increased).*
- *During ground operation, when in icing conditions for more than 30 min, the following procedure should be applied for ice shedding:*

CAUTION

If, during thrust increase, the aircraft starts to move, immediately retard the thrust levers to IDLE.

If ground surface conditions and the environment permit, the flight crew should accelerate the engines to approximately 70 % of N1 for 30 s at intervals not greater than 30 min.

If ground surface or environment do not permit to accelerate the engine to 70 % N1, then power setting and dwell time should be as high as practical.

When operating in conditions of freezing rain, freezing drizzle, freezing fog or heavy snow, ice shedding may be enhanced, by additional run ups at intervals, to not exceed 10 min, advancing throttles to 70 % N1 momentarily (no hold time).

Ident.: PRO-NOR-SOP-21-A-00011850.0001001 / 17 MAR 17

BRAKE TEMPERATURE..... CHECK

- Check brake temperature on the WHEEL SD page for discrepancies and high temperature
- Maintenance action is due in the following cases:
 - The temperature difference between two brakes of a gear is more than 150 °C, and the temperature of one of these brakes is above or equal to 600 °C, or
 - The temperature difference between two brakes of a gear is more than 150 °C, and the temperature of one of these brakes is below or equal to 60 °C, or
 - The difference between the average temperature of the left gear brakes (combination of body and wing L/G s) and right brakes (combination of body and wing L/Gs) is above or equal to 200 °C, or
 - The temperature of one brake exceeds 900 °C.

BRK FAN pb-sw  AS REQUIRED

When the turnaround time is short or if the temperature of any brake is likely to exceed 500 °C, use the brake fans without delay. In other cases, the flight crew should delay brake fans selection to 5 min after landing, or approaching the gate, whichever occurs first.

 For more information, Refer to FCTM/PR-NP-SOP-270 Use of Brake Fans.

Ident.: PRO-NOR-SOP-21-A-00011851.0001001 / 10 AUG 10

AFTER LANDING CHECKLIST..... COMPLETE

Ensure that the after-landing checks are completed, once the aircraft has cleared the runway.

Ident.: PRO-NOR-SOP-21-A-00020077.0001001 / 17 MAR 17

AFTER LANDING - FLOW PATTERN

After Landing Flow Pattern

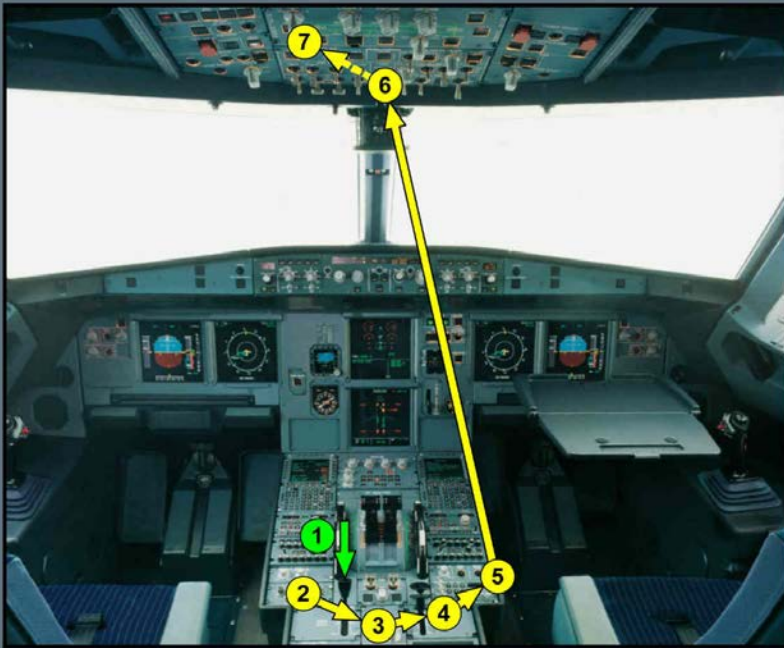

➡ PF ACTIONS

➡ PM ACTIONS

① GRND SPLRSDISARM

② RADAR/PREDICTIVE WINDSHEAR....OFF

③ ENG MODE SEL.....NORM

④ FLAPS.....RETRACT

⑤ { ATC.....AS RQRD
TCAS.....SET on standby

⑥ APU.....START

⑦ ANTI ICE.....AS RQRD

| | |
|---|---|
|  <p>A318/A319/A320/A321 FLIGHT CREW OPERATING MANUAL</p> | <p>PROCEDURES NORMAL PROCEDURES STANDARD OPERATING PROCEDURES - PARKING</p> |
|---|---|

PARKING

Applicable to: ALL

Ident.: PRO-NOR-SOP-22-A-00011852.0001001 / 21 MAR 17

Prior to performing this check, consider “GROUND OPERATIONS IN HEAVY RAIN” (*Refer to PRO-NOR-SUP-ADVWXR Ground Operations in Heavy Rain*).

Ident.: PRO-NOR-SOP-22-A-00011853.0003001 / 20 JUL 15

- ACCU PRESS indicator..... CHECK
The ACCU PRESS indication must be in the green band. In case of low accumulator pressure, chocks are required before engine 1 shutdown.
- PARKING BRAKE handle..... ON
When one brake temperature is above 500 °C (or 350 °C with brake fans  ON), avoid applying the parking brake, unless operationally necessary.
- BRAKES PRESS indicator..... CHECK
Check for normal indications.

Ident.: PRO-NOR-SOP-22-A-00011854.0001001 / 13 AUG 10

ANTI-ICE..... OFF

Ident.: PRO-NOR-SOP-22-A-00011855.0001001 / 13 AUG 10

APU BLEED pb-sw.....ON
Select APU bleed ON, just before engine shutdown, to prevent engine exhaust fumes from entering the air conditioning.

Ident.: PRO-NOR-SOP-22-A-00011856.0004001 / 17 MAR 17

- **If the APU is not available:**
EXT PWR pb..... ON
- **No less than 3 min after high thrust operations:**
ALL ENG MASTERS OFF

CAUTION *If JP4 fuel is used at ambient temperatures higher than 10 °C, dry motor the engines for 2 min after engine shutdown. This dry motor period should start approximately 90 s after the master lever is selected OFF.*

Check that engine parameters decrease.
The DOOR/OXY SD page is displayed on the lower ECAM display.

L2 Note: *The flight crew should operate the engines at or near idle thrust for a cooling period of 3 min before engine shutdown, in order to thermally stabilize the engines.*

Idle reverse thrust and normal thrust to maneuver during taxi (i.e. at or near idle), are not considered as high thrust operations. Therefore, both of the following applies:

- *If the flight crew uses idle reverse thrust for landing and normal thrust to maneuver during taxi after landing, the cooling period starts when the flight crew retards the thrust lever during the flare*
- *If the flight crew uses maximum reverse for landing, the cooling period starts when the flight crew sets the thrust lever to idle reverse during the landing rollout.*

However, if operationally necessary, all engines can be shut down when the aircraft arrives at the gate, regardless of the time necessary for landing.

Before engine shutdown, routine cooling periods that last less than the recommended time, can result in engine degradation.

Ident.: PRO-NOR-SOP-22-A-00011858.0001001 / 04 MAR 14

SLIDES.....CHECK DISARMED

Check slides disarmed on the DOOR/OXY SD page. Warn the cabin crew, if any slide is not disarmed.

Ident.: PRO-NOR-SOP-22-A-00011860.0001001 / 04 MAR 14

SEAT BELTS sw..... OFF

Ident.: PRO-NOR-SOP-22-A-00011859.0001001 / 23 JUN 15

BEACON lights..... OFF

Turn off the BEACON lights, when all engines are spooled down.

OTHER EXTERIOR LIGHTS..... AS RQRD

Ident.: PRO-NOR-SOP-22-A-00011857.0001001 / 13 AUG 10

GROUND CONTACT..... ESTABLISH

Establish ground communication.

Check chocks in place.

Ident.: PRO-NOR-SOP-22-A-00011862.0001001 / 13 AUG 10

FUEL PUMPS..... OFF

Ident.: PRO-NOR-SOP-22-A-00011864.0001001 / 04 JUL 17

ATC..... STBY

Ident.: PRO-NOR-SOP-22-A-00011865.0001001 / 20 OCT 16

IRS PERFORMANCE.....CHECK

- The NAV TIME is the cumulated block time since the latest IRS alignment (fast or complete).
- On the MCDU POSITION MONITOR page, read the deviation of each IRS position from the FMGC position and check that the value does not exceed the following:

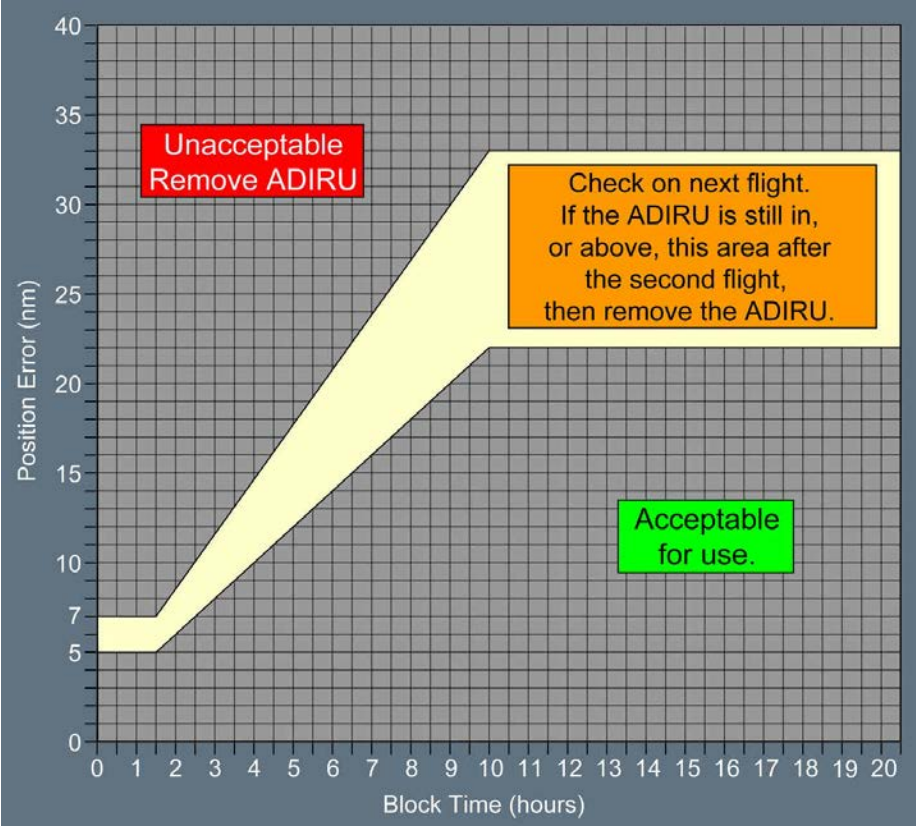

Ident.: PRO-NOR-SOP-22-A-00011866.0001001 / 13 AUG 10

FUEL QUANTITY.....CHECK

Check that the sum of the fuel on board and the fuel used is consistent with the fuel on board at departure. If an unusual discrepancy is found, maintenance action is due.

Ident.: PRO-NOR-SOP-22-A-00011867.0001001 / 24 FEB 15

STS pb (ECAM Control panel).....PRESS
Check the STATUS page.

Ident.: PRO-NOR-SOP-22-A-00011868.0001001 / 13 AUG 10

(BRAKE FAN )..... OFF
Switch off, when not required.

Ident.: PRO-NOR-SOP-22-A-00011869.0002001 / 13 AUG 10

PARKING BRAKE..... AS RQRD
The parking brake should be released after chocks are in place, if one brake temperature is above 300 °C (or above 150 °C with brake fans  ON).
Releasing the parking brake prevents the critical structures from being exposed to high temperature levels for an extended time. However, if operational conditions dictate (e.g. slippery tarmac), the parking brake may remain applied.
When parking with a flat tire on the nose gear, keep the parking brake on, to avoid aircraft yawing at parking brake release.

Ident.: PRO-NOR-SOP-22-A-00011870.0001001 / 13 AUG 10

DUs..... DIM
Dim EFIS , ECAM and MCDU display units.

Ident.: PRO-NOR-SOP-22-A-00014395.0001001 / 20 MAR 17

EFB

EFB/eQRH transmitting mode..... CONSIDER
In accordance with the Operator's policy or, as required by operational regulations.

● **If performing transit stop:**

eQRH My Aircraft/FLIGHT..... CLEAR

Ident.: PRO-NOR-SOP-22-A-00011873.0001001 / 13 AUG 10

PARKING CHECKLIST..... COMPLETE

Ident.: PRO-NOR-SOP-22-A-00011874.0001001 / 13 AUG 10

REPORT SEVERE ICING CONDITIONS

Report severe icing conditions in the log book, requiring inspections of the fan accoustic panels of the engines during the walkaround.

| | |
|---|--|
|  <p>A318/A319/A320/A321 FLIGHT CREW OPERATING MANUAL</p> | <p align="center">PROCEDURES NORMAL PROCEDURES</p> <p align="center">STANDARD OPERATING PROCEDURES - SECURING THE AIRCRAFT</p> |
|---|--|

SECURING THE AIRCRAFT

Applicable to: ALL

Ident.: PRO-NOR-SOP-23-A-00010336.0001001 / 17 MAR 17

GENERAL

Prior to performing this check, the following SUP Adverse Weather procedures should be taken into account when appropriate:

- Securing the aircraft for cold soak (*Refer to PRO-NOR-SUP-ADVWXR Securing the Aircraft for Cold Soak*).
- Water system draining (*Refer to PRO-NOR-SUP-ADVWXR For Draining Water Procedure - Introduction*).
- Ground operations in heavy rain (*Refer to PRO-NOR-SUP-ADVWXR Ground Operations in Heavy Rain*).
- Operations on contaminated airports (*Refer to PRO-NOR-SUP-ADVWXR Parking*).
- Operations with volcanic ash, sand or dust (*Refer to PRO-NOR-SUP-ADVWXR Securing the Aircraft*).

Ident.: PRO-NOR-SOP-23-A-00010337.0001001 / 30 JUN 15

PARKING BRAKE

PARK BRK handle.....CHECK ON
To reduce hydraulic leak rate in the brake accumulator, keep the parking brake on.

Ident.: PRO-NOR-SOP-23-A-00010338.0001001 / 05 AUG 10

OXYGEN CREW SUPPLY

OXYGEN CREW SUPPLY pb.....OFF

Ident.: PRO-NOR-SOP-23-A-00010339.0001001 / 21 AUG 15

ADIRS

ALL IR MODE selectors..... OFF
After the shutdown of the ADIRS , the flight crew must wait 10 s before the shutdown of the electrical supply. This time ensures that the ADIRS memorize the most recent data.

Ident.: PRO-NOR-SOP-23-A-00010340.0001001 / 05 AUG 10

EXTERIOR LIGHTS

EXTERIOR LIGHTS.....OFF



AEROLINEAS GALAPAGOS S.A.

A318/A319/A320/A321
FLIGHT CREW
OPERATING MANUAL

PROCEDURES

NORMAL PROCEDURES

STANDARD OPERATING PROCEDURES - SECURING THE AIRCRAFT

Ident.: PRO-NOR-SOP-23-A-00010341.0001001 / 05 AUG 10

MAINTENANCE BUS

MAINT BUS sw..... AS RQRD
Should electrical power be required for the crew or servicing personnel, consider setting the overhead MAINT BUS sw (in the forward cabin) to the ON position, prior to setting aircraft power to off.

Ident.: PRO-NOR-SOP-23-A-00010342.0001001 / 04 MAR 14

APU

APU BLEED pb-sw..... OFF
APU MASTER SW..... OFF
Switch off the APU after the passengers have disembarked.

Ident.: PRO-NOR-SOP-23-A-00010343.0004001 / 04 MAR 14

EMER LIGHTS AND SIGNS

EMER EXIT LT sw..... OFF
NO PORTABLE/ELEC DEVICE sw..... OFF

Ident.: PRO-NOR-SOP-23-A-00010344.0001001 / 05 AUG 10

EXTERNAL POWER

EXT PWR pb..... AS RQRD

Ident.: PRO-NOR-SOP-23-A-00010345.0001001 / 05 AUG 10

BAT 1 AND 2

BAT 1 pb-sw and BAT 2 pb-sw..... OFF
*Wait until the APU flap is fully closed (about 2 min after the APU AVAIL light goes out), before switching off the batteries. Switching the batteries off before the APU flap is closed may cause smoke in the cabin during the next flight.
If the batteries are off while the APU is running, APU fire extinguishing is not available.*

Ident.: PRO-NOR-SOP-23-A-00010346.0001001 / 05 AUG 10

SECURING THE AIRCRAFT CHECKLIST

SECURING THE AIRCRAFT CHECKLIST..... COMPLETE



A318/A319/A320/A321
 FLIGHT CREW
 OPERATING MANUAL

PROCEDURES
NORMAL PROCEDURES

STANDARD OPERATING PROCEDURES - SECURING THE AIRCRAFT

Ident.: PRO-NOR-SOP-23-A-00014412.0001001 / 20 MAR 17

ELECTRONIC FLIGHT BAG EFB

EFB/eQRH LAPTOPS..... SWITCH OFF



A318/A319/A320/A321
FLIGHT CREW
OPERATING MANUAL

PROCEDURES

NORMAL PROCEDURES

STANDARD OPERATING PROCEDURES - SECURING THE AIRCRAFT

Intentionally left blank

COMMUNICATIONS AND STANDARD TERMS

Ident.: PRO-NOR-SOP-90-00011900.0001001 / 13 AUG 10

Applicable to: ALL

Standard phraseology is essential to ensure effective crew communication. The phraseology should be concise and exact. The following Chapter lists the callouts that should be used as standard. They supplement the callouts identified in the SOP.

These standard Airbus callouts are also designed to promote situational awareness, and to ensure crew understanding of systems and their use in line operation.

CHECKLIST CALLOUTS

Ident.: PRO-NOR-SOP-90-00011901.0001001 / 20 DEC 10

Applicable to: ALL

- "CHECK": A command for the other pilot to check an item.
- "CHECKED": A response that an item has been checked.
- "CROSSCHECKED": A callout verifying information from both pilot stations.

If a checklist needs to be interrupted, announce: "HOLD CHECKLIST AT ___" and "RESUME CHECKLIST AT ___" for the continuation.

Upon completion of a checklist announce: "___CHECKLIST COMPLETE".

ACTIONS COMMANDED BY PF

Applicable to: ALL

Ident.: PRO-NOR-SOP-90-A-00011902.0001001 / 13 AUG 10

GENERAL

The following commands do not necessarily initiate a guidance mode change, eg.: selected to managed/managed to selected. The intent is to ensure clear, consistent, standard communication between crewmembers.

All actions performed on the FCU and MCDU must be checked on the PFD and ND (eg.: "FL 350 blue", "FL 200 magenta"). Ensure that the correct FCU knob is used, then verify indications on the PFD /ND.

Ident.: PRO-NOR-SOP-90-A-00011904.0001001 / 09 JUN 15

SET

The "SET" command means using an FCU knob to set a value, but not to change a mode. SET is accomplished by only rotating the appropriate selection knob.

Example:

- "SET GO AROUND ALTITUDE __ FT"
- "SET FL __"
- "SET HDG __"

Ident.: PRO-NOR-SOP-90-A-00011905.0001001 / 20 DEC 10

MANAGE/PULL

The "MANAGE" command means pushing an FCU knob to engage, or arm, a managed mode or target.

The "PULL" command means pulling an FCU knob to engage a selected mode or target. Example:

- "PULL HDG 090" (HDG/TRK knob is pulled and turned).
- "MANAGE NAV" (HDG/TRK knob is pushed).
- "FL 190 PULL" (ALT knob is turned and pulled).
- "FL 190 MANAGE" (ALT knob is turned and pushed).
- "PULL SPEED 250 KNOTS" (SPD/MACH knob is pulled and turned).
- "MANAGE SPEED" (SPD/MACH knob is pushed).

*Note: If the value was previously set, there is no requirement to repeat the figure.
Simply call e.g. PULL HDG: PULL SPEED: FL PULL.*

The VS/FPA knob has no managed function. The standard callouts for the use of this knob are as follows:

V/S Plus (or Minus) 700 PULL, or

FPA Minus 3 ° PULL (V/S/FPA knob is turned and pulled)

PUSH TO LEVEL OFF (V/S/FPA knob is pushed)

Ident.: PRO-NOR-SOP-90-A-00011906.0001001 / 13 AUG 10

ARM

The "ARM __" command means arming a system by pushing the specified FCU button.

e.g. : "ARM APPROACH"

e.g. : "ARM LOC."

Ident.: PRO-NOR-SOP-90-A-00011907.0001001 / 13 AUG 10

ON/OFF

The simple ON or OFF command is used for the autopilot, flight directors, autothrust and the bird (flight path vector).

e.g.: BIRD ON (The HDG-V/S / TRK-FPA pb is pushed.)

| | |
|---|--|
|  A318/A319/A320/A321 FLIGHT CREW OPERATING MANUAL | PROCEDURES NORMAL PROCEDURES STANDARD OPERATING PROCEDURES - STANDARD CALLOUTS |
|---|--|

FMA

Ident.: PRO-NOR-SOP-90-00011908.0001001 / 23 DEC 14
Applicable to: ALL

The PF should call out any FMA change, unless specified differently (e.g. CAT II & III task sharing). Therefore, the PF should announce:

- All armed modes with the associated color (e.g. blue, magenta): "G/S blue", "LOC blue".
- All active modes without the associated color (e.g. green, white): "NAV", "ALT".

The PM should check and respond, "CHECKED" to all FMA changes called out by the PF.

ALTITUDE

Ident.: PRO-NOR-SOP-90-00011909.0001001 / 23 DEC 14
Applicable to: ALL

The PM calls out "one thousand to go" when passing 1 000 ft before the cleared altitude or FL , and the PF calls out "checked".

FLAPS OR GEAR CALLOUTS

Applicable to: ALL

Ident.: PRO-NOR-SOP-90-B-00011910.0001001 / 23 DEC 14

FLAPS' CALLOUTS

| FLAPS' CONFIGURATION | CALLOUT |
|----------------------|--------------|
| 1 | "FLAPS ONE" |
| 1 + F | "FLAPS ONE" |
| 0 | "FLAPS ZERO" |

The reply will be given when selecting the new flap position.
 e.g.:

| | CALLOUT | REMARK |
|----|-----------------|--|
| PF | "FLAPS ONE" | |
| PM | "SPEED CHECKED" | PM checks the speed: - Above the S or F speed and accelerating (Takeoff) - Below VFE next and decelerating (Approach) |
| | "FLAPS ONE" | PM selects the FLAPS lever position and replies after checking the blue number on the ECAM flaps indicator to confirm the correct selection has been made. |

Ident.: PRO-NOR-SOP-90-B-00011911.0001001 / 23 DEC 14

GEAR CALLOUTS

| | CALLOUT | REMARKS |
|----|------------------|--|
| PF | "GEAR UP (DOWN)" | |
| PM | "GEAR UP (DOWN)" | The PM selects the L/G lever position and replies after checking the red lights on the LDG GEAR indicator to confirm gear operation. |

FLIGHT PARAMETERS

Applicable to: ALL

Ident.: PRO-NOR-SOP-90-C-00011912.0001001 / 22 MAR 17

APPROACH

During approach, the PM announces:

- "SPEED" if the speed decreases below the speed target -5 kt or increases above the speed target +10 kt.
- "SINK RATE" when the descent rate exceeds 1 000 ft/min
- "BANK" when bank angle becomes greater than 7 °
- "PITCH" when pitch attitude becomes lower than -2.5 ° or higher than +10 °
- "LOC" or "GLIDE" when either localizer or glide slope deviation is:
 - ½ dot LOC
 - ½ dot GS.
- "CROSS TRACK" when the XTK is greater than 0.1 NM
- "V/DEV" when the vertical deviation is greater than ½ dot
- "COURSE" when greater than ½ dot or 2.5 ° (VOR) or 5 ° (ADF).
- "___ FT HIGH (LOW)" at altitude checks points.

Note: The PM announces the attitude deviations until landing.

Ident.: PRO-NOR-SOP-90-C-00021570.0001001 / 22 MAR 17

LANDING

During landing, the PM announces:

- "PITCH PITCH", if the pitch attitude approaches the tail strike pitch limit indicator , or reaches 10 °
- "BANK BANK", if the bank angle reaches 7 °.

Ident.: PRO-NOR-SOP-90-C-00011913.0001001 / 22 MAR 17

GO-AROUND

During a go-around, the PM announces:

- "BANK", if the bank angle becomes greater than 7 °
- "PITCH", if the pitch attitude becomes greater than 20 ° up or less than 10 ° up
- "SINK RATE", if there is no climb rate.

PF/PM DUTIES TRANSFER

Ident.: PRO-NOR-SOP-90-00011914.0001001 / 23 DEC 14

Applicable to: ALL

To transfer control, flight crewmembers must use the following callouts:

- To give control : The pilot calls out "YOU HAVE CONTROL". The other pilot accepts this transfer by calling out "I HAVE CONTROL", before assuming PF duties.
- To take control : The pilot calls out "I HAVE CONTROL". The other pilot accepts this transfer by calling out "YOU HAVE CONTROL", before assuming PM duties.

SUMMARY FOR EACH PHASE

Applicable to: ALL

Ident.: PRO-NOR-SOP-90-D-00011917.0001001 / 23 DEC 14

TO REMOVE GROUND SUPPLY

| EVENT | PF or PM | GND Mech |
|---------------------------|-----------------------|-----------------------|
| Initial ground contact | GROUND (from) COCKPIT | COCKPIT (from) GROUND |
| External __ disconnection | REMOVE EXTERNAL __ | EXTERNAL__ REMOVED |

Ident.: PRO-NOR-SOP-90-D-00011918.0001001 / 23 DEC 14

BEFORE ENGINE START/PUSH BACK

| EVENT | PF | PM |
|------------------------------------|------------------|---------------------------|
| Before start up clearance received | BEFORE START C/L | DOWN TO THE LINE |
| After start up clearance received | BELOW THE LINE | BEFORE START C/L COMPLETE |

PROCEDURES
NORMAL PROCEDURES

STANDARD OPERATING PROCEDURES - STANDARD CALLOUTS

Ident.: PRO-NOR-SOP-90-D-00011919.0001001 / 17 MAR 16

PUSH BACK/ENGINE START

| EVENT | PF | GND Mech. |
|--|--|--|
| When ready for pushback, and pushback clearance received from ATC | GROUND (from) COCKPIT, CLEARED FOR PUSH | COCKPIT (from) GROUND, RELEASE BRAKES |
| Start of push | BRAKES RELEASED READY TO PUSH | |
| When ready to start engines | CLEAR TO START ? STARTING ENG(S)___ | CLEAR TO START |
| When pushback completed | BRAKES SET | SET BRAKES |
| When ready to disconnect (after engine started, and parameters are stabilized) | CLEAR TO DISCONNECT (hand signals on left/right) | DISCONNECTING (hand signals on left/right) |

Ident.: PRO-NOR-SOP-90-D-00011920.0001001 / 23 DEC 14

AFTER ENGINE START

| EVENT | PF | PM |
|--|-----------------|--------------------------|
| All engines started and stabilized and GND is disconnected | AFTER START C/L | AFTER START C/L COMPLETE |

Ident.: PRO-NOR-SOP-90-D-00011921.0002001 / 23 DEC 14

TAXI

| EVENT | PF | PM |
|---|-------------------------|--------------------------------|
| When taxi clearance obtained | CLEAR LEFT (RIGHT) SIDE | CLEAR RIGHT (LEFT) SIDE |
| Brake check | BRAKE CHECK | |
| Flight control check in the following sequence (the check is possible before the start of taxi) | FLIGHT CONTROL CHECK | |
| 1. Elevators | | FULL UP, FULL DOWN, NEUTRAL |
| 2. Ailerons/Spoilers | | FULL LEFT, FULL RIGHT, NEUTRAL |
| 3. Rudder ⁽¹⁾ | RUDDER | FULL LEFT, FULL RIGHT, NEUTRAL |
| During taxi | BEFORE TAKEOFF C/L | DOWN TO THE LINE |
| Line up on the runway | BELOW THE LINE | BEFORE TAKEOFF C/L COMPLETE |

⁽¹⁾ The PM should follow pedal movement with his/her feet

| | |
|---|--|
|  A318/A319/A320/A321 FLIGHT CREW OPERATING MANUAL | PROCEDURES NORMAL PROCEDURES STANDARD OPERATING PROCEDURES - STANDARD CALLOUTS |
|---|--|

Ident.: PRO-NOR-SOP-90-D-00011922.0001001 / 23 DEC 14

| TAKEOFF | | |
|--|-------------------------|----------------------------------|
| EVENT | PF | PM |
| Setting thrust levers to initial stabilization value | TAKEOFF | |
| Before passing 80 kt | | THRUST SET |
| At 100 kt | CHECKED | ONE HUNDRED KNOTS |
| At V1 | | V1 |
| At VR | | ROTATE |
| Gear retraction | GEAR UP | POSITIVE CLIMB GEAR UP |
| If AP is engaged by PM | AP 1(2) ON | |
| Checklist | AFTER TAKEOFF/CLIMB C/L | DOWN TO THE LINE |
| At transition altitude | BELOW THE LINE | AFTER TAKEOFF/CLIMB C/L COMPLETE |

Ident.: PRO-NOR-SOP-90-D-00011923.0001001 / 17 MAR 16

| MALFUNCTION BEFORE V1 AT TAKEOFF | | |
|--------------------------------------|------|--|
| EVENT | CAPT | F/O |
| If GO decision | GO | |
| If RTO decision | STOP | |
| - REV green on EWD - Deceleration | | REVERSE GREEN ⁽¹⁾ DECEL ⁽²⁾ |

- (1) *If the reverse deployment is not as expected, call NO REVERSE ENGINE__ or NO REVERSE, as appropriate*
- (2) *In case of failure or no positive deceleration, NO DECEL DECEL callout means that the deceleration is felt by the crew, and confirmed by the speed trend on the PFD.*

Ident.: PRO-NOR-SOP-90-D-00011924.0001001 / 12 MAY 16

| ALTIMETER SETTING CHANGES TO/FROM QNH /QFE-STD | | |
|--|--|--|
| EVENT | PF | PM |
| Barometric setting change and subsequent altimeter cross-check | SET STANDARD (SET QNH/QFE) CHECKED | STANDARD (QNH/QFE) CROSS-CHECKED PASSING FL__(__FT) NOW |

PROCEDURES
NORMAL PROCEDURES

STANDARD OPERATING PROCEDURES - STANDARD CALLOUTS

Ident.: PRO-NOR-SOP-90-D-00011925.0001001 / 17 MAR 16

APPROACH AND LANDING

| EVENT | PF | PM |
|--|-------------------------|---|
| Approach checklist | APPROACH C/L | APPROACH C/L COMPLETE |
| Activation of approach Phase | ACTIVATE APPROACH PHASE | APPROACH PHASE ACTIVATED |
| RA alive | CHECKED | RADIO ALTIMETER ALIVE ⁽¹⁾⁽²⁾ |
| At G/S *, FINAL APP engagement, or below GA altitude for approach using FPA guidance | SET GA ALTITUDE __ FT | GA ALTITUDE - SET, |
| FAF | CHECKED | PASSING__(Fix Name),__ FT, |
| Landing checklist | LANDING C/L | LANDING C/L COMPLETE |
| 1 000 ft RA | CHECKED | ONE THOUSAND ⁽²⁾ |
| 100 ft above MDA /DH | CHECKED | ONE HUNDRED ABOVE ⁽²⁾ |
| MDA /DH visual reference | CONTINUE | MINIMUM ⁽²⁾ |
| MDA /DH no visual reference | GO AROUND-FLAPS | MINIMUM ⁽²⁾ |
| | | ONE HUNDRED ⁽²⁾ FIFTY ⁽²⁾ |
| After touchdown Ground spoilers extended REV green on EWD | | SPOILERS ⁽³⁾ REVERSE GREEN ⁽⁴⁾ |
| Deceleration | | DECEL ⁽⁵⁾ |
| At 70 kt | CHECKED | SEVENTY KNOTS |

(1) Crew awareness, crew should now keep RA in scan to landing

(2) PM monitors pin-programmed auto callout, or announces if inoperative.

(3) If the spoilers are not extended, call NO SPOILERS

(4) If the reverse deployment is not as expected, call NO REVERSE ENGINE__ or NO REVERSE, as appropriate.

(5) DECEL Callout means that the deceleration is felt by the crew, and confirmed by the speed trend on the PFD .If no positive deceleration, NO DECEL.

Ident.: PRO-NOR-SOP-90-D-00015353.0001001 / 23 DEC 14

| DISCONTINUED APPROACH | | |
|--------------------------------|-----------------|----|
| EVENT | PF | PM |
| DISCONTINUED APPROACH decision | CANCEL APPROACH | |

Ident.: PRO-NOR-SOP-90-D-00011926.0001001 / 17 MAR 16

| GO AROUND | | |
|------------------------|-------------------------|----------------------------------|
| EVENT | PF | PM |
| GO AROUND decision | GO AROUND - FLAPS | |
| Flaps retraction | | FLAPS__ |
| Gear retraction | GEAR UP | POSITIVE CLIMB GEAR UP |
| Checklist | AFTER TAKEOFF/CLIMB C/L | DOWN TO THE LINE |
| At transition altitude | BELOW THE LINE | AFTER TAKEOFF/CLIMB C/L COMPLETE |

Ident.: PRO-NOR-SOP-90-D-00011927.0001001 / 23 DEC 14

| AFTER LANDING | | |
|---------------|-------------------|----------------------------|
| EVENT | PF | PM |
| Checklist | AFTER LANDING C/L | AFTER LANDING C/L COMPLETE |

Ident.: PRO-NOR-SOP-90-D-00011928.0001001 / 23 DEC 14

| PARKING | | |
|-----------|-------------|----------------------|
| EVENT | PF | PM |
| Checklist | PARKING C/L | PARKING C/L COMPLETE |

Ident.: PRO-NOR-SOP-90-D-00011929.0001001 / 23 DEC 14

| SECURING THE AIRCRAFT | | |
|-----------------------|------------------------------|------------------------------------|
| EVENT | PF | PM |
| Checklist | SECURING THE AIRCRAFT C/L | SECURING THE AIRCRAFT C/L COMPLETE |



A318/A319/A320/A321
FLIGHT CREW
OPERATING MANUAL

PROCEDURES

NORMAL PROCEDURES

STANDARD OPERATING PROCEDURES - STANDARD CALLOUTS

Intentionally left blank

SUPPLEMENTARY PROCEDURES

Applicable to: ALL

Ident.: PRO-NOR-SUP-SUP-SUP-00-00020244.0001001 / 17 MAR 17

ADVERSE WEATHER

- [SUP] AIRFRAME DEICING/ANTI-ICING PROCEDURE ON GROUND (*Refer to procedure*)
- [SUP] GROUND OPERATIONS IN COLD WEATHER CONDITIONS (*Refer to procedure*)
- [SUP] GROUND OPERATION IN HEAVY RAIN (*Refer to procedure*)
- [SUP] MINIMUM SPEED WITH ICE ACCRETION (*Refer to procedure*)
- [SUP] OPERATIONS ON CONTAMINATED AIRPORTS (*Refer to procedure*)
- [SUP] OPERATIONS WITH VOLCANIC ASH, SAND OR DUST (*Refer to procedure*)
- [SUP] SECURING THE AIRCRAFT FOR COLD SOAK (*Refer to procedure*)
- [SUP] FOR DRAINING WATER PROCEDURE (*Refer to procedure*)
- [SUP] WATER SYSTEM DRAINING (*Refer to procedure*)

Ident.: PRO-NOR-SUP-SUP-SUP-00-00020245.0001001 / 20 MAR 17

COMMUNICATION

- [SUP] VHF, HF UTILIZATION (*Refer to procedure*)

Ident.: PRO-NOR-SUP-SUP-SUP-00-00020248.0001001 / 17 MAR 17

ENGINE

- [SUP] MANUAL ENGINE START (*Refer to procedure*)
- [SUP] ENGINE START WITH EXTERNAL PNEUMATIC POWER (*Refer to procedure*)
- [SUP] CROSSBLEED ENGINE START (*Refer to procedure*)
- [SUP] ENGINE START VALVE MANUAL OPERATION (*Refer to procedure*)
- [SUP] ENGINE VENTILATION (DRY CRANKING) (*Refer to procedure*)
- [SUP] ONE ENGINE TAXI (*Refer to procedure*)

Ident.: PRO-NOR-SUP-SUP-SUP-00-00020249.0001001 / 17 MAR 17

FUEL

- [SUP] REFUELING (*Refer to procedure*)
- [SUP] REFUELING WITH ONE ENGINE RUNNING (*Refer to procedure*)
- [SUP] GROUND FUEL TRANSFER (*Refer to procedure*)
- [SUP] DEFUELING (*Refer to procedure*)

Ident.: PRO-NOR-SUP-SUP-SUP-00-00020251.0001001 / 17 MAR 17

LANDING GEAR

- [SUP] OPERATION WITH NOSEWHEEL STEERING OFFSET (*Refer to procedure*)
- [SUP] FLIGHT WITH GEAR DOWN (*Refer to procedure*)



A318/A319/A320/A321
FLIGHT CREW
OPERATING MANUAL

PROCEDURES

NORMAL PROCEDURES

SUPPLEMENTARY PROCEDURES -
SUPPLEMENTARY PROCEDURES MENU

Ident.: PRO-NOR-SUP-SUP-SUP-00-00020254.0001001 / 17 MAR 17

MISCELLANEOUS

[SUP] MISCELLANEOUS (*Refer to procedure*)

Ident.: PRO-NOR-SUP-SUP-SUP-00-00020252.0001001 / 17 MAR 17

NAVIGATION

[SUP] INSERTION OF APPROACH MINIMA (*Refer to procedure*)

AIRFRAME DEICING/ANTI-ICING PROCEDURE ON GROUND

Applicable to: ALL

Ident.: PRO-NOR-SUP-ADVWXR-A-00020694.0001001 / 21 MAR 17

BEFORE FLUID SPRAYING

In all situations, it is the captain's responsibility to decide if the ground crew must deice/anti-ice the aircraft, and/or if additional deicing/anti-icing treatment are required.

| | |
|----------------|---|
| CAUTION | <ul style="list-style-type: none"> - Make sure that the low or high-pressure ground connectors do not supply any external air to the aircraft. - If it is necessary for the ground crew to repeatedly anti-ice the aircraft, they must deice the surfaces with a hot fluid mixture before applying a new layer of anti-icing fluid. |
|----------------|---|

COMMUNICATION WITH GROUND CREW.....ESTABLISH

L2 Establish communication with the crew that will apply the procedure.

L1 DEICING/ANTI-ICING FLUIDS TYPE..... CHECK APPROPRIATE

L2 Check that the ground crew uses the correct deicing/anti-icing fluids, in accordance with the applicable operator requirements and aircraft maintenance manual (AMM).

L1 DO NOT START THE ENGINES DURING FLUID SPRAYING

L2 Engines and APU can be either stopped or running during deicing/anti-icing.

| | |
|----------------|--|
| CAUTION | <ul style="list-style-type: none"> - The ground crew should take care when spraying deicing fluid, and make sure that the engines and APU do not ingest any fluid. - Do not move flaps, slats, ailerons, spoilers or elevators if they are not free of ice. - Always ensure that both left and right side of the aircraft receive the same complete and symmetrical deicing/anti-icing treatment. |
|----------------|--|

L2 *Note:* In case of frost formation on one or several areas of the wing, the Captain can request a local deicing application only on the affected areas. The Captain shall take care that both wings receive the same symmetrical treatment, even if frost formation does not affect both wing symmetrically. For more information, refer to AMM.

L1 CAB PRESS MODE SEL.....CHECK AUTO
 ENG 1 BLEED..... OFF
 ENG 2 BLEED..... OFF
 APU BLEED..... OFF

DITCHING pb..... ON

L2 *Outflow valve, pack valves, and avionic ventilation inlet and extract valves close. This prevents deicing/anti-icing fluid from entering the aircraft. Avionic ventilation is in a closed circuit with both fans running. In view of the low OAT, there is no time limit for this configuration.*

L1 *Note: For passenger comfort reason, it is not recommended to operate on ground with both PACKS set to OFF for more than 20 min.*

*Note: If the “**VENT AVNCS SYS FAULT**” alert appears, reset the AEVC circuit breaker at the end of the aircraft deicing/anti-icing procedure.
 AIR COND /AVNCS VENT/CTL D06 on 49VU.
 AIR COND /AVNCS /VENT/MONG Y17 on 122 VU.*

THRUST LEVERS.....CHECK IDLE
 “AIRCRAFT PREPARED FOR SPRAYING”..... INFORM GROUND CREW

Ident.: PRO-NOR-SUP-ADVWXR-A-00002311.0001001 / 20 SEP 16

UPON COMPLETION OF THE SPRAYING OPERATION

DITCHING pb.....OFF
 OUTFLOW VALVE.....CHECK OPEN

On the ECAM PRESS page, confirm that the outflow valve indication reaches the open green position to avoid any unexpected aircraft pressurization.

ENG BLEED 1 + 2.....ON
 PITOTS and STATICS (ground crew).....CHECK

CAUTION When the OAT is low (below -5 °C) during snow/freezing rain precipitations , melted snow or raindrops may drip from the cockpit windshields and freeze on the fuselage below. This could create ice build up on the forward fuselage that could possibly disturb the airflow around the static/pitot/angle-of-attack probes, and result in unreliable air data measurements during takeoff. Therefore, during taxi out before takeoff, beware of this possible build up of ice. The area around static/pitot/angle-of-attack probes must be free of ice/snow before starting takeoff.

GROUND EQUIPMENT..... REMOVE
 DEICING/ANTI-ICING REPORT.....RECEIVED

The information from ground personnel, who performed the deicing/anti-icing and post-application check, must include (ANTI-ICING CODE):

- *Type of fluid used*
- *The mix ratio of fluid to water (for example 75/25)*
- *When the holdover time began.*

| | |
|---|---|
|  <p>A318/A319/A320/A321 FLIGHT CREW OPERATING MANUAL</p> | <p align="center">PROCEDURES NORMAL PROCEDURES</p> <p align="center">SUPPLEMENTARY PROCEDURES - ADVERSE WEATHER</p> |
|---|---|

● **At least 5 minutes after completion of spraying operation:**

APU BLEED.....AS RQRD

Note: There is a risk of de-icing fluid ingestion by the APU air intake, resulting in specific odors, or smoke warnings. Therefore:

- Keep the APU running with the APU BLEED OFF for 5 min after spraying completion before setting the APU BLEED to ON (if required),
- Consider APU BLEED OFF for takeoff.

NORMAL PROCEDURE..... RESUME

Apply appropriate normal procedures. Pay special attention to the flight control check. In freezing precipitation, perform the appropriate checks to evaluate aircraft icing. Base the decision on whether to takeoff, or to re-protect the aircraft, on the amount of ice that has built up on the critical surfaces since the last deicing/anti-icing, as revealed by a personal inspection from the inside and outside of the aircraft. Make this inspection before the holdover time expires, or just before takeoff.

GROUND OPERATIONS IN COLD WEATHER CONDITIONS

Applicable to: ALL

Ident.: PRO-NOR-SUP-ADVWXR-B-00020703.0001001 / 21 MAR 17

GENERAL

For ground operations on contaminated runways, Refer to PER-TOF-CTA-10 GENERAL and Refer to PRO-NOR-SUP-ADVWXR General.

The following procedures supplement the normal operating procedures.

Ident.: PRO-NOR-SUP-ADVWXR-B-00020698.0001001 / 21 MAR 17

SAFETY EXTERIOR INSPECTION

PROTECTIVE COVERS..... REMOVED
 APU INTAKE.....CHECK FREE OF SNOW AND ICE
 PACKS INLET/OUTLET DOORS.....CHECK FREE OF SNOW AND ICE
 OUTFLOW VALVES.....CHECK FREE OF SNOW AND ICE
 PRESSURE RELIEF VALVES.....CHECK FREE OF SNOW AND ICE
 ABOVE ITEMS.....DEICE IF NECESSARY

Ident.: PRO-NOR-SUP-ADVWXR-B-00020699.0001001 / 21 MAR 17

PRELIMINARY COCKPIT PREPARATION

PRELIMINARY COCKPIT PREPARATION - SOP.....COMPLETED

 APU is started and the air conditioning is on.

Note: - Ground power should be used to start the APU if the OAT is -15 °C (5 °F) or below.
 - With cockpit temperatures below -15 °C (5 °F), the display units may not be available.

L1 ● If the avionics bay is cold soaked:

L2 The aircraft was parked without electrical ground supply or without air conditioning.
L1 IRS..... INITIATE ALIGNMENT

L2 For temperatures at or below -15 °C (5 °F) in the avionics bay, the IRS alignment requires 15 min.

L1 WINDSHIELD AND UPPER COCKPIT FUSELAGE..... ICE/SNOW REMOVED

CAUTION With ice or snow accumulated on the windshield and/or the upper cockpit fuselage, and if the PROBE/WINDOW HEAT is on, melted ice or snow running down from these areas could re-freeze on the fuselage area below, if the temperature is very low. This could create ice build-up on the forward fuselage that could possibly disturb the airflow around the static/pitot/angle-of-attack probes.

PROBE COVERS..... CHECK REMOVED

L2 Ensure that the probe covers are removed in order to prevent the covers from melting.

L1 PROBE/WINDOW HEAT..... ON

Ident.: PRO-NOR-SUP-ADVWXR-B-00020700.0001001 / 21 MAR 17

EXTERIOR WALKAROUND

SURFACES CHECK FREE OF FROST, ICE AND SNOW

L2 Check critical surfaces: leading edges, upper wing surfaces, vertical and horizontal stabilizers, all control surfaces, slats and flaps.

Note: Thin hoarfrost is acceptable on the upper surface of the fuselage. Refer to LIM-ICE_RAIN Definition of Thin Hoarfrost

On the underside of the wing tank areas, a maximum layer of 3 mm (0.125 in) of frost is acceptable.

L1 LANDING GEAR..... CHECK FREE OF FROST, ICE AND SNOW

L2 Check gear assemblies, lever locks, tires and doors

L1 ENGINES..... CHECK FREE OF FROST, ICE AND SNOW

L2 Check inlets, inlet lips, fans, spinners, fan exhaust ducts, reversers assemblies.

L1 ENGINE FANS..... CHECK FREE ROTATION

| | |
|---|---|
|  A318/A319/A320/A321 FLIGHT CREW OPERATING MANUAL | PROCEDURES NORMAL PROCEDURES SUPPLEMENTARY PROCEDURES - ADVERSE WEATHER |
|---|---|

- L2 Check that engine fans are not stuck and can rotate freely.
- L1 DRAINS, BLEEDS, PROBES.....CHECK FREE OF FROST, ICE AND SNOW
- L2 Probes: pitot tubes, static ports, TAT sensors and AOA sensors.
- L1 FUEL TANK VENTS..... CHECK FREE OF FROST, ICE AND SNOW
- RADOME..... CHECK FREE OF FROST, ICE AND SNOW
- WATER SUPPLIES..... CHECK NOT FROZEN AND REFILLED
- L2 Commercial water supplies should have been previously emptied prior to aircraft cold soak.

Ident.: PRO-NOR-SUP-ADVWXR-B-00020701.0001001 / 21 MAR 17

AFTER START

- **After first engine start:**
- PROBE/WINDOW HEAT.....AUTO
- L2 Heating will continue to operate automatically.
- L1 NORMAL PROCEDURE..... RESUME

GROUND OPERATIONS IN HEAVY RAIN

Ident.: PRO-NOR-SUP-ADVWXR-00020720.0001001 / 21 MAR 17

Applicable to: ALL

On ground (Aircraft taxiing or parked) in case of heavy rain, water may enter the avionics ventilation system via the skin air inlet valve.

- **When on ground:**
- EXTRACT.....OVRD
- L2 This closes the skin air inlets, preventing rainwater from entering the avionics bay.
- L1 PACK 1 ON..... CHECK
- PACK 2 ON..... CHECK
- L2 Air conditioning compensates the avionics cooling reduction when the skin air inlet is closed.
- L1 ● **If air conditioning not available:**
- L2 When the aircraft avionics are powered, closing the skin air inlet valve reduces avionics cooling capability. With air conditioning not available, the reduced cooling is efficient for a limited period of time, depending on the outside temperature.

- L1 Aircraft should not remain powered more than:
- OAT ≤ 39 °C (102 °F): no limit
 - 39 °C (102 °F) < OAT ≤ 45 °C (113 °F): 3 h
 - 45 °C (113 °F) < OAT: 30 min

● **After takeoff:**

EXTRACT AUTO

MINIMUM SPEED WITH ICE ACCRETION

Ident.: PRO-NOR-SUP-ADVWXR-00020722.0002001 / 21 MAR 17

Applicable to: ALL

Evidence of ice accretion can be ice on the visual indicator (between the two cockpit windshields) or on the windshield wipers.

CAUTION Extended flight in icing conditions with the slats extended should be avoided.

■ **If wing anti ice is operative:**

■ **In CONF clean, 1, 2 or 3:**

MIN SPEED: VLS + 10 kt

■ **In CONF FULL:**

MIN SPEED: VLS + 5 kt

The minimum speed takes into account ice accretion on non-heated structure.

■ **If wing anti ice is not operative:**

MIN SPEED: VLS + 10 kt/GREEN DOT

The minimum speed takes into account ice accretion on the entire airframe when anti-ice is inoperative.

OPERATIONS ON CONTAMINATED AIRPORTS

Applicable to: ALL

Ident.: PRO-NOR-SUP-ADVWXR-C-00020729.0001001 / 21 MAR 17

GENERAL

If the ground surfaces are not contaminated but the weather corresponds to icing conditions with falling rain, slush or snow, anticipate a probable resulting runway/surfaces contamination.

There is a low probability of fluid ingestion by the engines which should anyway not degrade the safety. The risk of ingestion is independent of the depth of the contaminant.

| | |
|---|---|
|  <p>A318/A319/A320/A321 FLIGHT CREW OPERATING MANUAL</p> | <p style="text-align: center;">PROCEDURES NORMAL PROCEDURES</p> <p style="text-align: center;">SUPPLEMENTARY PROCEDURES - ADVERSE WEATHER</p> |
|---|---|

Ident.: PRO-NOR-SUP-ADVWXR-C-00020726.0002001 / 21 MAR 17

SPURIOUS ALERTS

The radio altimeter indication may fluctuate on contaminated surfaces and trigger auto callouts or GPWS warnings. These alerts can be disregarded.

Note: Spurious GPWS warnings may trigger at the apron, during taxi, takeoff and landing runs.

The radio altimeter may also not compute valid data:

- On surfaces covered with snow, ice or deicing fluid, and/or
- Due to deicing fluid on the antenna.

Note: As a result, the "**NAV RA 1(2)(1+2) FAULT**" ECAM alert may be triggered. This alert may disappear when the radio altimeter provides valid data again, when:

- The aircraft is on a non-contaminated surface, or
- The antenna is cleaned, or
- A period of time elapses after deicing, allowing the fluid covering the antenna to dry. The taxi time between deicing spot and holding point may be sufficient.

In case of invalid LGCIU information, disregard the following alerts if triggered:

- **ENG DUAL FAILURE**
- **ANTI-ICE CAPT(F/O) TAT FAULT**
- **L/G SHOCK ABSORBER FAULT**

Ident.: PRO-NOR-SUP-ADVWXR-C-00020725.0001001 / 21 MAR 17

PARKING

- **After engine shutdown and before shutting down electrical supply:**
FLAPS/SLATS..... CONFIRM FREE OF CONTAMINATION

L2 Perform a visual inspection to determine if the flaps/slats mechanism is free of contamination. If necessary, perform decontamination.

L1 YELLOW ELEC PUMP pb..... ON
 BLUE ELEC PUMP pb..... AUTO
 BLUE PUMP OVRD pb..... ON
 SLATS/FLAPS..... RETRACT

L2 Monitor slats/flaps retraction on ECAM upper display.

- **When slats and flaps are retracted:**
 YELLOW ELEC PUMP pb..... OFF
 BLUE PUMP OVRD pb..... OFF
 NORMAL PROCEDURE..... RESUME

OPERATIONS WITH VOLCANIC ASH, SAND OR DUST

Applicable to: ALL

Ident.: PRO-NOR-SUP-ADVWXR-G-00020733.0001001 / 21 MAR 17

PRELIMINARY COCKPIT PREPARATION

APU..... AVOID USE

L2 Request ground power for air conditioning and electricity. If ground power is not available, the APU should be used only to start the engines.

L1 WINDSHIELD WIPERS..... DO NOT USE

L2 Do not use the windshield wipers to remove ash, sand or dust.

L1 ● For takeoff performance:

BRAKING PERFORMANCE MAY BE DEGRADED

L2 A layer of volcanic ash, sand or dust on the runway may degrade the braking efficiency.

Ident.: PRO-NOR-SUP-ADVWXR-G-00020734.0001001 / 21 MAR 17

EXTERIOR WALKAROUND

SURFACES AND EQUIPMENT.....CHECK FREE OF DEPOSITS

L2 Ground maintenance should remove ash, sand or dust that has settled on exposed lubricated surfaces and could penetrate seals or enter the engine gas path, air conditioning system, air data probes, access doors and panels and other orifices on the aircraft.

L1 ENGINE/APU INLETS..... CHECK FREE OF DEPOSITS

L2 Inspect the inlets and order them cleaned of deposit. Have the area within 8 m (25 ft) of the engine inlet cleaned of volcanic ash, as much as practical.

Ident.: PRO-NOR-SUP-ADVWXR-G-00020735.0001001 / 21 MAR 17

ENGINE START

Use external pneumatic supply, if available, to start the engines. Refer to PRO-NOR-SUP-ENG Engine Start with External Pneumatic Power.

ENGINE..... CRANK

L2 Before starting the engines, ventilate them by dry cranking at maximum motoring speed for two minutes. This will blow away any contaminant ash that may have entered the booster area.

Ident.: PRO-NOR-SUP-ADVWXR-G-00020736.0001001 / 21 MAR 17

TAXI

- ONE ENGINE TAXI.....DO NOT PERFORM
- L2** *Minimize the thrust during taxi.*
- L1** ENG 1 BLEED..... OFF
- ENG 2 BLEED..... OFF
- L2** Keep engine bleed valves closed for taxiing, especially in volcanic ash.
- L1** FOR 180 ° TURN ON RUNWAY: INITIATE THE TURN DOWNWIND
- L2** In order to prevent ash, sand or dust ingestion.

Ident.: PRO-NOR-SUP-ADVWXR-G-00020737.0001001 / 21 MAR 17

TAKEOFF

- ASH, SAND OR DUST..... ALLOW TO SETTLE
- L2** *Allow ash, sand or dust to settle on runway before starting the takeoff roll.*
- L1** PACK OFF TAKEOFF..... CONSIDER
- L2** *This will prevent air conditioning system contamination.*
- L1** ROLLING TAKEOFF..... CONSIDER

Ident.: PRO-NOR-SUP-ADVWXR-G-00020738.0001001 / 21 MAR 17

AFTER TAKEOFF

- MINIMIZE TIME IN SAND OR DUST CLOUD
- L2** *Climb to quickly exit the sand/dust cloud. If possible, altitude constraints may be disregarded in coordination with ATC.*
- L1** ENG 1 BLEED..... ON
- ENG 2 BLEED..... ON

Ident.: PRO-NOR-SUP-ADVWXR-G-00020739.0001001 / 21 MAR 17

IN FLIGHT

- AVOID ASH, SAND OR DUST CLOUD
- **If sand or dust cloud encounter:**
- MINIMIZE TIME IN SAND OR DUST CLOUD
- L2** *If possible and in coordination with ATC, adapt flight path (route and altitude) to exit the cloud.*
- L1** ● **If ash cloud encounter:**
- VOLCANIC ASH ENCOUNTER PROCEDURE..... APPLY



A318/A319/A320/A321
FLIGHT CREW
OPERATING MANUAL

PROCEDURES
NORMAL PROCEDURES

SUPPLEMENTARY PROCEDURES - ADVERSE WEATHER

Refer to PRO-ABN-MISC [QRH] VOLCANIC ASH ENCOUNTER .

ident.: PRO-NOR-SUP-ADVWXR-G-00020740.0001001 / 21 MAR 17

DESCENT PREPARATION

AUTOLAND RECOMMENDED

L2 *Deposits on the windshield and landing lights may significantly reduce visibility during approach and landing. Consider a diversion to an airport where autoland is possible.*

L1 ● **For landing performance:**
 CONSIDER IDLE REVERSE
 BRAKING PERFORMANCE MAY BE DEGRADED

L2 *A layer of volcanic ash, sand or dust on the runway may degrade the braking efficiency.*

ident.: PRO-NOR-SUP-ADVWXR-G-00020741.0001001 / 21 MAR 17

DESCENT

AVOID LEVEL FLIGHT IN ASH, SAND OR DUST CLOUD

If possible and in coordination with ATC, perform holding patterns and last level off before final descent outside of the cloud.

ident.: PRO-NOR-SUP-ADVWXR-G-00020742.0001001 / 21 MAR 17

LANDING

● **Before Landing:**
 ENG 1 BLEED..... OFF
 ENG 2 BLEED..... OFF
 PACK 1 and 2..... AS REQUIRED

L2 *Consider to set the packs OFF in order to avoid contamination of the air conditioning system.*

L1 ● **During Landing:**
 REVERSERS.....AS REQUIRED

L2 *If it appears that maximum reverse thrust is needed, apply reverse thrust when the main landing gear touches down. Limit the use of reverse thrust as much as possible, because reverse flow may throw up ash, sand or dust and impair visibility.*

ident.: PRO-NOR-SUP-ADVWXR-G-00020744.0001001 / 21 MAR 17

AFTER LANDING

ONE ENGINE TAXI.....DO NOT PERFORM

L2 *Minimize thrust during taxi.*

L1 APU..... AVOID USE

| | |
|---|---|
|  <p>A318/A319/A320/A321 FLIGHT CREW OPERATING MANUAL</p> | <p style="text-align: center;">PROCEDURES NORMAL PROCEDURES</p> <p style="text-align: center;">SUPPLEMENTARY PROCEDURES - ADVERSE WEATHER</p> |
|---|---|

FOR 180 ° TURN ON RUNWAY: INITIATE THE TURN DOWNWIND

Ident.: PRO-NOR-SUP-ADVWXR-G-00020745.0001001 / 21 MAR 17

SECURING THE AIRCRAFT

If the aircraft is parked at an airport covered with volcanic ash, sand or dust, install engine inlet covers and other protective covers and plugs.

In addition:

- **After switching off all bleeds and before switching off the electrical AC power:**
DITCHING pb..... ON
- L2 *This closes the outflow valve, pack valves and avionics ventilation inlet and extract valves.*
- L1 ● **After switching off the electrical AC power and the batteries:**
DITCHING pb..... OFF
- L2 *All the applicable valves will open at the next power-up.*
- L1 PROTECTIVE COVERS..... INSTALL
- L2 *Request ground crew to install protective covers and plugs, in order to protect the aircraft and engines from volcanic ash, sand or dust.*
- L1 LOGBOOK..... REPORT ASH, SAND OR DUST CLOUD ENCOUNTER

SECURING THE AIRCRAFT FOR COLD SOAK

Ident.: PRO-NOR-SUP-ADVWXR-00020772.0001001 / 21 MAR 17
Applicable to: ALL

WHEN SECURING THE AIRCRAFT

- **After switching off all bleeds and before switching off the electrical AC power:**
DITCHING pb ON
- L2 *This closes the outflow valve, pack valves and avionics ventilation inlet and extract valves.*
- L1 ● **When the chocks are in place:**
PARKING BRAKE pb OFF
- L2 *Releasing the parking brake prevents the brakes from freezing.*
- L1 ● **After switching off the electrical AC power and the batteries:**
DITCHING pb OFF
- L2 *All the applicable valves will open at the next power-up.*
- L1 PROTECTIVE COVERS..... INSTALL
- L2 *Request ground crew to install protective covers and plugs, in order to protect the wheels, the engines and the probes from snow and ice.*

- L1 WATER SYSTEM DRAINING.....REQUEST
- L2 *Request maintenance actions to drain the water system for cold soak prevention purposes.
 Refer to PRO-NOR-SUP-ADVWXR Water System Draining.*

FOR DRAINING WATER PROCEDURE

Applicable to: ALL

Ident.: PRO-NOR-SUP-ADVWXR-D-00002313.0001001 / 21 MAR 17

INTRODUCTION

This procedure uses electrical power.

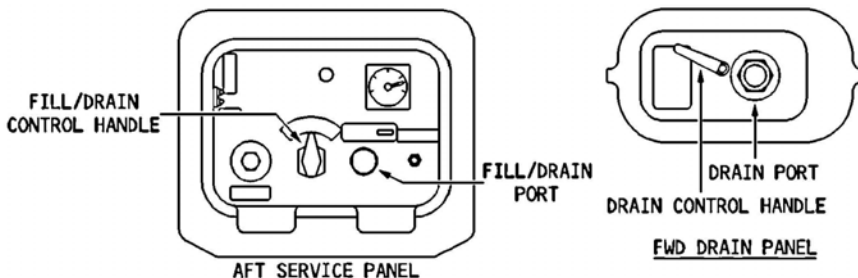

- ACCESS PLATFORM(S).....PUT IN POSITION
- SHUTOFF VALVE IN GALLEYS/TOILETS..... CHECK OPEN
- FWD/AFT ACCESS PANEL DOORS..... OPEN
- DRAIN PORT CAPS..... REMOVE

Remove drain port caps on forward drain and aft service panels.

- DRAIN HOSES.....CONNECT

Connect drain hoses to :

- the drain port on the forward drain panel.
- the full/drain port on the aft service panel.

Ident.: PRO-NOR-SUP-ADVWXR-D-00002314.0001001 / 21 MAR 17

ON THE FORWARD DRAIN PANEL

- DRAIN CONTROL HANDLE.....TURN LEFT

Turn the control handle to drain.

Ident.: PRO-NOR-SUP-ADVWXR-D-00002315.0001001 / 21 MAR 17

ON THE AFT SERVICE PANEL

FILL/DRAIN CONTROL HANDLE.....TURN TO “DRAIN” AND PULL
*Turn the handle to the “DRAIN” position and pull it out to its mechanical stop to drain.
 The indicator light comes on.*

Ident.: PRO-NOR-SUP-ADVWXR-D-00002316.0001001 / 21 MAR 17

WHEN THE WATER SYSTEM IS DRAINED

In freezing conditions, the drain valves must stay open to prevent damage to the system. Do not put on the caps and leave the access door open.

DRAIN HOSES.....DISCONNECT
 PANELS..... CLEAN AND DRY
 ACCESS PLATFORM(S)..... REMOVE

WATER SYSTEM DRAINING

Ident.: PRO-NOR-SUP-ADVWXR-00002205.0001001 / 21 MAR 17

Applicable to: ALL

Drain the water system, if the OAT requires it, as shown below :

| Configuration | | | Exposure time | Water tank drain |
|------------------|---------------------------|---|---------------|------------------|
| Air Conditioning | Cabin temperature | Outside Air Temperature | | |
| ON | Above 10 °C (50 °F) | Between 0 °C and -15 °C (32 °F and 5 °F) | None | Not required |
| OFF | | Below -15 °C (5 °F) | 1 h 15 min | Required |
| | | Between 0 °C and -7 °C (32 °F and 19.4 °F) | 1 h 30 min | |
| | | Between -7 °C and -15 °C (19.4 °F and 5 °F) | 0 h 30 min | |
| | | Below -15 °C (5 °F) | Any | |



A318/A319/A320/A321
FLIGHT CREW
OPERATING MANUAL

PROCEDURES

NORMAL PROCEDURES

SUPPLEMENTARY PROCEDURES - ADVERSE WEATHER

Intentionally left blank

VHF, HF UTILIZATION

Applicable to: ALL

Ident.: PRO-NOR-SUP-COM-A-00002210.0001001 / 21 MAR 17

- Note:
1. Reception of some frequencies could be noisy, on one or more VHF's. In such cases, try selecting an unaffected one.
 2. If two frequencies are closer than 2 MHz (between VHF 1 and 2, or between VHF 3 and 2), or closer than 6 MHz (between VHF1 and 3), some interference may occur.

Ident.: PRO-NOR-SUP-COM-A-00002211.0002001 / 22 MAR 17

TUNING

The pilot should normally use his inside RMP to tune any one of the VHF or HF radios. If the SEL lights come on, when tuning the radio, the pilot should turn them off by selecting the appropriate radio system dedicated to his RMP.

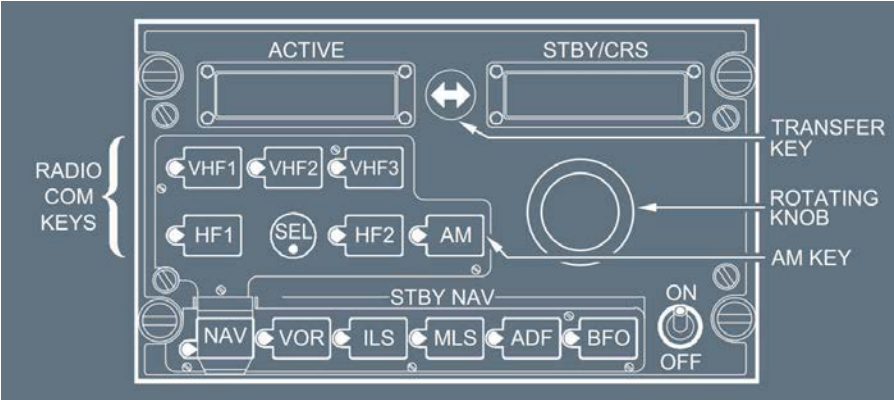

ON/OFF switch..... CHECK ON
VHF or HF key..... PRESS

The green light comes on.
ACTIVE and STBY/CRS windows display active and preset frequencies, respectively.

Note: When an RMP tunes a transceiver that is normally associated with another RMP, the SEL lights on both RMPs come on.

TO CHANGE FREQUENCY

Rotating knob..... TURN
Make the STBY/CRS window display the new frequency.

Outer knob is for units, inner knob for decimals.

Transfer key..... PRESS

This interchanges the ACTIVE and STBY frequencies.

The receiver is now tuned to the new ACTIVE frequency.

AM key (if necessary)..... PRESS

Green light comes on.

SEL It..... CHECK OFF

If SEL light is on, select the appropriate radio systems dedicated to the on side RMP.

FAILURE CASES

When an RMP fails :

- The affected RMP no longer controls the selected receiver.
- The frequency displays disappear and the green VHF or HF lights go out.

Affected RMP..... SWITCH OFF

One RMP can control all receivers.

- *if RMP 1 fails tune VHF 1 through RMP 3*
- *if RMP 2 fails tune VHF 2 through RMP 3*
- *if RMP 3 fails tune, HF1 through RMP 1, HF2 through RMP 2*
- *if two RMP 's fail, tune all receivers through the remaining RMP.*

Ident.: PRO-NOR-SUP-COM-A-00002212.0004001 / 03 JAN 11

TRANSMISSION AND RECEPTION

Note: *If the VHF3 VOICE DIRECTORY page is customized with user frequencies:*

- *Use it as a pure directory*
- *Do not press the key adjacent to the desired frequency for direct turning*
- *VHF 3 in VOICE mode should either be tuned using the MANUAL FREQ field, or using the RMP.*



VHF or HF transmission key..... PRESS

Green bars on the selected system key light up.

Microphones and PTT command are connected to the selected system.

VHF or HF reception key..... PRESS

The integrated white light comes on.

The receiver brings in the selected system.

To adjust the volume, turn the key.

Note: Do not use VHF 3 for communications with ATC , if ACARS is installed, unless VHF 1 and VHF 2 are inoperative.



A318/A319/A320/A321
FLIGHT CREW
OPERATING MANUAL

PROCEDURES

NORMAL PROCEDURES

SUPPLEMENTARY PROCEDURES - COMMUNICATION

Intentionally left blank

MANUAL ENGINE START

Applicable to: ALL

Ident.: PRO-NOR-SUP-ENG-A-00009443.0001001 / 21 MAR 17

Pilots normally use automatic starting to start an engine.

However, manual starting is recommended in the following cases:

- **After aborting a start, because of:**
 - Engine stall
 - Engine EGT overlimit
 - Low start air pressure
- **When expecting a start abort, because of:**
 - Degraded bleed performance, due to hot conditions, or at a high-altitude airfields.
 - An engine with a reduced EGT margin, in hot conditions, or at a high-altitude airfields.
 - Marginal performance of the external pneumatic power group.

Ident.: PRO-NOR-SUP-ENG-A-00020858.0003001 / 17 MAR 17

MANUAL ENGINE START PROCEDURE

Note: During a manual engine start, if the flight crew suspects an engine start malfunction, or if an engine-related ECAM alert is triggered, the PF must abort the start sequence as follows:

- Before the PF sets the ENG MASTER lever to ON, the PF must set the ENG MAN START pb-sw to OFF
- After the PF sets the ENG MASTER lever to ON, the PF must set the ENG MASTER lever to OFF, and then the ENG MAN START pb-sw to OFF.

In that case, the flight crew should consider a dry crank cycle of the affected engine before they perform another start attempt (Refer to PRO-NOR-SUP-ENG Engine Ventilation (Dry Cranking)).

Then, in the case of an ECAM alert, the PF must announce "ECAM actions", in accordance with the ECAM management philosophy.

THR LEVERS.....IDLE

CAUTION The engines start regardless of the thrust lever position. If the thrust levers are not set to IDLE, the thrust rapidly increases to the corresponding thrust lever position, causing a hazardous situation.

ENG MODE sel..... NORM THEN IGN/START

 The lower ECAM displays the engine page.

L1 *Note:* If both engines are started manually, the following procedure applies one engine at a time.

- **When all engines parameters are available on the upper ECAM display (no amber crosses displayed):**

ENG MAN START pb-sw..... ON
 START VALVE.....CHECK IN-LINE
 OIL PRESS INCREASE..... CHECK
 N2 INCREASE..... CHECK

- **If the N2 does not reach 20 %:**

PACK VALVES.....CHECK CLOSED

- **If the APU bleed is used for engine start and the pack valves are closed, shed the APU electrical loads as follows:**

Shedding APU electrical loads enables to increase bleed air pressure.

L1 GALY & CAB.....OFF

- **If needed, shed also:**

BLUE ELEC PUMP (on ground only).....OFF
 FUEL X FEED..... ON
 FUEL PUMPS (except R TK PUMP 2)..... OFF
 BLOWER..... OVRD
 CAB FANS.....OFF

- **When N2 reaches 22 % or the maximum motoring speed (20 % minimum):**

Note: The maximum motoring speed is defined as the speed at which N2 acceleration is less than 1 % in approximately 5 s.

ENG MASTER..... ON
 CHRONO..... START

L2 The PM starts the timing in order to monitor the light-up duration.

L1 IGNITERS A AND B..... CHECK ON
 FUEL FLOW INCREASE..... CHECK

- **15 s maximum after fuel flow increase:**

EGT INCREASE..... CHECK
 N1 INCREASE..... CHECK

If the electrical power supply is interrupted during the start sequence (indicated by loss of ECAM displays), abort the start by setting the ENG MASTER lever to OFF. Then perform a 30 s dry crank (*Refer to PRO-NOR-SUP-ENG Engine Ventilation (Dry Cranking)*).

● **When N2 reaches 50 %:**

START VALVE (between 50 and 56 % N2)..... CHECK CROSS LINE
 IGNITERS A AND B..... CHECK OFF
 MAIN ENG PARAMETERS..... CHECK NORMAL
 SECONDARY ENG PARAMETERS..... CHECK NORMAL

L2 *The gray background on the N2 indication disappears.*

L1

Note: CFM 56-5B1/B2 engines, N2 accelerates slowly from 50 % to idle. Start abort is not required as long as N2 increases.

ENG MAN START pb-sw..... OFF
 ENG MODE sel..... NORM

● **When no other engine requires to be started manually:**

SHEDDED SYSTEMS..... RESTORE
 SOP - ENGINE START..... RESUME

ENGINE START WITH EXTERNAL PNEUMATIC POWER

Ident.: PRO-NOR-SUP-ENG-00020859.0002001 / 17 MAR 17

Applicable to: ALL

● **Before connecting external pneumatic power :**

PACK 1..... OFF
 PACK 2..... OFF

L2

Packs are selected off to prevent any possible contamination of the packs by the external pneumatic power.

L1

APU BLEED..... OFF
 ENG 1 BLEED..... OFF
 ENG 2 BLEED..... OFF
 X BLEED..... OPEN

EXTERNAL PNEUMATIC POWER CONNECTION..... REQUEST

● **When cleared to start :**

ENG 2..... START

Note: As necessary, engine 1 can also be started by using the external pneumatic power.
 If engine 1 is started first, check the brake ACCU pressure prior to engine start.
 The minimum recommended starter air supply pressure is 30 PSI, when the start valve is open.
 Two external pneumatic power units may be used in parallel if necessary.

● **After Engine 2 is started :**

EXT PWR..... CHECK AVAIL

WARNING Disconnection of the external power with the EXT PWR pb-sw ON may cause injury to the ground engineer. Request disconnection of the external power only with the EXT PWR pb-sw AVAIL.

EXT PWR DISCONNECTION..... REQUEST

Note: The external electrical power can be removed after the second engine start.

■ **If external pneumatic power is used to start engine 1 :**

ENG 1..... START

● **When engine 1 is started:**

EXTERNAL PNEUMATIC POWER REMOVAL..... REQUEST
 X BLEED..... AUTO
 ENG 1 BLEED..... ON
 ENG 2 BLEED..... ON
 PACK 1..... ON
 PACK 2..... ON

■ **If the crossbleed engine start procedure is used to start engine 1 :**

EXTERNAL PNEUMATIC POWER REMOVAL..... REQUEST
 PACK 1..... ON
 PACK 2..... ON
 ENG 2 BLEED..... ON
 CROSSBLEED ENGINE START PROC..... APPLY

Refer to PRO-NOR-SUP-ENG Crossbleed Engine Start

CROSSBLEED ENGINE START

Ident.: PRO-NOR-SUP-ENG-00020860.0001001 / 17 MAR 17

Applicable to: ALL

CAUTION Do not perform the crossbleed engine start procedure during pushback. Simultaneous use of engine bleed supply and external pneumatic power supply is prohibited.

One engine must be running in order to supply air for other engine start.

● **Before second engine start :**

APU BLEED..... OFF

L2 The BLEED valve of the supplying engine reopens and the cross bleed valve closes.

L1 ENG BLEED (supplying engine)..... ON

| | |
|---|---|
|  A318/A319/A320/A321 FLIGHT CREW OPERATING MANUAL | PROCEDURES NORMAL PROCEDURES SUPPLEMENTARY PROCEDURES - ENGINES |
|---|---|

- ENG BLEED (receiving engine)..... OFF
- L2** The bleed valve of receiving engine is closed to avoid reverse flow leakage.
- L1** X BLEED..... OPEN
- **When cleared to start :**
 AREA CLEAR OF OBSTACLES..... CONFIRM
- L2** Ensure increased power jet wake does not constitute any hazard to people or installation behind the aircraft.
- L1** THR LEVER (supplying engine)..... ADJUST FOR BLEED PRESSURE
 Adjust thrust of supplying engine to obtain an engine bleed pressure of 30 PSI before start initiation, and at least 25 PSI during the start sequence.
 If the thrust required to obtain the appropriate engine bleed pressure exceeds 40 % N1, pay particular attention to the surrounding area.
- Note:* If the supplying engine is a DAC engine, preset a 30 % N1 before launching the start sequence.
- RECEIVING ENGINE..... START
 Apply the normal engine start procedure.
- **After start :**
 THR LEVER (supplying engine)..... IDLE
 X BLEED..... AUTO
 ENG BLEED (receiving engine)..... ON
 PACK 1..... ON
 PACK 2..... ON

ENGINE START VALVE MANUAL OPERATION

Ident.: PRO-NOR-SUP-ENG-00020861.0001001 / 17 MAR 17

Applicable to: ALL

BEFORE ENGINE START

Advise ground crew to prepare for manual engine start valve operation.

WARNING To ensure safety of the ground crew when starting an engine with manual operation of the start valve, the flight crew should start the affected engine first.

ENGINE START

AUDIO CONTROL PANEL..... CAB
 GROUND CREW CLEARANCE..... OBTAIN

PROCEDURES

NORMAL PROCEDURES

SUPPLEMENTARY PROCEDURES - ENGINES

- **When the ground crew is ready:**
 “ENGINE 1(2) START”..... ANNOUNCE
 ENG MODE sel..... IGN/START
 ENG MASTER..... ON
 “OPEN START VALVE AND KEEP OPEN”.....ORDER
If not maintained in the OPEN position by the ground crew, the start valve closes.
- **When N2 at 50 %:**
 “CLOSE START VALVE”..... ORDER
 SOP – ENGINE START..... RESUME

ENGINE VENTILATION (DRY CRANKING)

Ident.: PRO-NOR-SUP-ENG-00020943.0001001 / 17 MAR 17

Applicable to: ALL

On ground, after:

- An unsuccessful manual engine start, or
- An unsuccessful automatic start not followed by an automatic dry crank,

the flight crew can perform a dry crank cycle on the affected engine to remove the fuel vapors.

- **Before dry crank:**
 ENG MASTER (affected engine)..... CHECK OFF
 ENG MODE sel..... CHECK NORM
 ENG MAN START pb-sw (affected engine).....CHECK OFF
- **Dry crank:**
 ENG MODE sel..... CRANK
 ENG MAN START pb-sw (affected engine)..... ON

Note: To clear fuel vapors, a 30 seconds dry crank cycle is the minimum required.

L2 *Note:* A manual start sequence can be initiated following a dry crank cycle (Refer to PRO-NOR-SUP-ENG Manual Engine Start - Procedure). The flight crew should consider the starter limitations (Refer to LIM-ENG Starter).

- L1** ● **When the dry crank is completed:**
 ENG MAN START pb-sw (affected engine)..... OFF
 ENG MODE sel..... NORM

| | |
|---|--|
|  <p>A318/A319/A320/A321 FLIGHT CREW OPERATING MANUAL</p> | <p>PROCEDURES NORMAL PROCEDURES SUPPLEMENTARY PROCEDURES - ENGINES</p> |
|---|--|

ONE ENGINE TAXI - GENERAL

Applicable to: ALL

Ident.: PRO-NOR-SUP-ENG-CA-00021004.0001001 / 17 MAR 17

Except in some operational conditions (e.g. uphill slopes, slippery taxiways or high gross weights), brake life and fuel savings may govern company policy on permitting aircraft to taxi with one engine shut down.

Before applying this procedure, the flight crew should be aware of the following:

- Taxi with one engine shut down may require higher thrust than usual. Caution must therefore be exercised to avoid excessive jet-blast and the risk of Foreign Object Damage (FOD)
- Slow or tight turns in the direction of the operating engine may not be possible at high gross weights
- When one engine taxi is planned, pay particular attention to the fuel imbalance limitation for the next take-off.

ONE ENGINE TAXI - AT DEPARTURE

Applicable to: ALL

Ident.: PRO-NOR-SUP-ENG-CB-00021005.0002001 / 17 MAR 17

BRAKE ACCU PRESS.....CHECK

If necessary, use the Y ELEC PUMP to pressurize the brake accumulator.

ENG 1..... START

Engine 1 pressurizes the green hydraulic system, providing normal braking.

X BLEED.....OPEN

Open the cross bleed valve in order to supply both packs with engine 1.

APPLY THE "AFTER START" NORMAL PROCEDURE, BUT:

- Keep the APU running and switch the APU BLEED to OFF.
- The APU generator provides power to the engine fire extinguisher, prevents electrical transients and enables galley operation. Closing the APU BLEED prevents engine exhaust gases ingestion in the air conditioning system.
- Delay the ECAM STATUS check and the wing anti-ice setting until all engines are started.

Ident.: PRO-NOR-SUP-ENG-CB-00021007.0002001 / 17 MAR 17

BEFORE RELEASING THE PARKING BRAKE

Y ELEC PUMP..... ON

This pressurizes the yellow hydraulic system, providing nosewheel steering without using the PTU.

- L1** APPLY THE “TAXI” NORMAL PROCEDURE, BUT:
- Delay the flight controls check until all engines are started
 - Arm the autobrake after the flight controls check.

Ident.: PRO-NOR-SUP-ENG-CB-00021008.0006001 / 01 JUN 17

BEFORE TAKEOFF

ENGINE WARM-UP TIME BEFORE TAKEOFF (remaining engine).....CONSIDER

The second engine must be started soon enough before takeoff, in order to take into account the engine start time and ensure the applicable engine warm-up time (Refer to PRO-NOR-SOP-09 After Start - ENG Mode Selector).

● **For ENG 2 start and when taxiing in a straight line:**

Note: During the engine start, a slight jerk forward may occur if the brakes are applied while the aircraft is moving.

Note: Maintain taxi in a straight line during at least 5 s after the selection of the ENG 2 master lever to ON, in order to ensure the PTU auto-test is completed.

Y ELEC PUMP.....OFF

- L2** *The yellow electric pump must be set to OFF to enable PTU automatic test during engine 2 start.*

L1 APU BLEED..... ON
 ENG 2..... START

APU..... AS RQRD
 X BLEED..... AUTO

APPLY THE “AFTER START” NORMAL PROCEDURE, INCLUDING:

- ECAM STATUS check
- Selection of the ENG 2 anti-ice and wing anti-ice, as required.

AFTER START CHECKLIST..... COMPLETE
 FLIGHT CONTROLS.....CHECK
 AUTO BRK..... MAX

| | |
|---|--|
|  <p>A318/A319/A320/A321 FLIGHT CREW OPERATING MANUAL</p> | <p>PROCEDURES NORMAL PROCEDURES SUPPLEMENTARY PROCEDURES - ENGINES</p> |
|---|--|

ONE ENGINE TAXI - AT ARRIVAL

Applicable to: ALL

Ident.: PRO-NOR-SUP-ENG-CC-00021009.0001001 / 17 MAR 17

APU..... START

Start the APU before shutting down one engine, in order to provide power to the engine fire extinguisher and avoid electrical transients.

Ident.: PRO-NOR-SUP-ENG-CC-00021010.0001001 / 17 MAR 17

● **After high thrust operations:**

ENGINE MINIMUM COOLING TIME..... CONSIDER
Refer to PRO-NOR-SOP-22 Parking - ENG MASTER Levers.

● **When the APU indicates AVAIL and taxiing in a straight line:**

Note: During engine shutdown, a slight jerk forward may occur if the brakes are applied while the aircraft is moving.

ENG 2..... SHUT DOWN
Y ELEC PUMP..... ON

This avoids running the PTU.

Ident.: PRO-NOR-SUP-ENG-CC-00021011.0001001 / 17 MAR 17

● **At parking:**

Y ELEC PUMP..... OFF
ENG 1..... SHUT DOWN

PROCEDURES

NORMAL PROCEDURES

SUPPLEMENTARY PROCEDURES - ENGINES

Intentionally left blank

| | |
|---|---|
|  <p>A318/A319/A320/A321 FLIGHT CREW OPERATING MANUAL</p> | <p>PROCEDURES NORMAL PROCEDURES SUPPLEMENTARY PROCEDURES - FUEL</p> |
|---|---|

REFUELING

Applicable to: ALL

Ident.: PRO-NOR-SUP-FUEL-A-00021256.0002001 / 25 JUL 17

- WARNING**
1. Prior initiation of any ground fuel operations, obey the below fuel safety precautions. This will prevent injury to people and/or damage to the aircraft.
 2. Do not request or perform any ground fuel operations if a fire or engine overheat warning is displayed.
 3. If the APU fails during any ground fuel operations, do not restart the APU. For APU use during refueling/defueling *Refer to LIM-APU APU Start/Shutdown during Refueling/Defueling.*
 4. Do not refuel in bad weather conditions and electrical storms.

PREPARATION

SAFETY PRECAUTIONS.....APPLY

During refueling operations, ensure that:

- HF transmission (including HF transmission via the HF DATA LINK  pb) is not performed
- The aircraft is properly bonded to the tanker
- The tanker and the aircraft grounding requirement is based on local regulations. Always connect the ground cable to the parking ground point (or to the tanker) before connecting it to the aircraft.
- The external lighting is not operated (except for NAV & LOGO).

In the cockpit, check that the PARK BRK is ON and that the ACCU PRESS has sufficient pressure. If the PARK BRK cannot be set to ON, check that the chocks are in place.

ACCESS PLATFORM.....IN POSITION

MAX REFUELING PRESSURE: 50 PSI (3.5 bar)

● **On refueling control panel:**

TEST sw..... LTS

Lights on the panel come on. FUEL QTY and the PRESELECTED and ACTUAL displays show 8's.

TEST sw..... HI.LVL

HI LVL lights change state if the high level sensors and their circuits are serviceable.

Ident.: PRO-NOR-SUP-FUEL-A-00021257.0002001 / 21 MAR 17

AUTOMATIC REFUELING

● **On cockpit refueling control panel:**

REFUEL PWR pb-sw.....ON
Cockpit panel takes priority. The CKPT light comes on and REFUELG is displayed on the ECAM MEMO.

[PRESELECTOR sw] REQUESTED BLOCK FUEL..... SET
REFUEL CTL pb-sw..... ON
Refueling starts. When refueling is finished, the END light comes on.

REFUEL CTL pb-sw.....OFF
REFUEL PWR pb-sw..... OFF

● **On refueling control panel:**

REFUEL VALVES sel.....CHECK NORM and GUARDED
[PRESELECTOR sw] REQUESTED BLOCK FUEL..... SET
MODE SELECT sw..... REFUEL
START REFUELING

When the refueling is finished the END light comes on.

ACTUAL QUANTITY.....CHECK
The actual quantity must be within 100 kg (220 lb) of the preselected quantity.
MODE SELECT sw.....OFF and GUARDED

Ident.: PRO-NOR-SUP-FUEL-A-00021260.0001001 / 21 MAR 17

MANUAL REFUELING

REFUEL VALVES sel..... SHUT
MODE SELECT sw..... REFUEL
REFUEL VALVES sel (tanks to be filled)..... OPEN
START REFUELING
FUEL QTY.....MONITOR

● **When the contents of the tanks reach the required level :**

Corresponding REFUEL VALVES sel..... SHUT
MODE SELECT sw.....OFF and GUARDED
REFUEL VALVES sel..... NORM and GUARDED

REFUELING WITH ONE ENGINE RUNNING

Ident.: PRO-NOR-SUP-FUEL-00001677.0003001 / 21 MAR 17

Applicable to: ALL

- Refuel with one engine running only at airports where no external ground pneumatic power is available and only when APU is unserviceable.
- Only the RH fuel couplings can be used.
- Overwing gravity filling is not permitted.
- Disembark all passengers.
- Obtain airport authorization.
The Airport Fire Department should standby at the aircraft during the entire refueling procedure.
- Point the aircraft into the wind at a location where the slope is negligible.
Set the parking brake and check its pressure.
Run engine n° 1 at ground idle with its generator connected.
- Do not start engine n° 2, do not shut down engine n° 1 or do not attempt to start the APU before all fueling operations have been completed.
- Position the fuel truck under the extremity of the right wing. Its pressure should not exceed 30 PSI.
- Follow manual refueling procedure.

OPERATION MONITORING

DURING THE ENTIRE REFUELING PROCEDURE :

- Monitor the fuel truck shut off valve.
- Be sure that the fueling company is keeping permanent control of the emergency fuel shut off device.
- Have a flight crew member in the cockpit monitoring all systems and the running engine.
- Have a qualified ground crew member at the fueling station to operate the refuel valve switches.
- Monitor the refueling closely and be prepared to close the refuel valves in order not to exceed the following fuel quantities :

| | | | | | | | |
|----------------|-------|-------|-------|-------|-------|-------|-------|
| DENSITY (kg/l) | 0.77 | 0.78 | 0.79 | 0.8 | 0.81 | 0.82 | 0.83 |
| L(R) WING (kg) | 5 710 | 5 780 | 5 860 | 5 930 | 6 005 | 6 080 | 6 160 |
| CENTER (kg) | 6 030 | 6 110 | 6 190 | 6 270 | 6 350 | 6 430 | 6 500 |

AFTER SECOND ENGINE START :

- **Reset the 3DMCs in order to reinitialize the fuel used values :**
 - DMC 1 SPLY C/B (E11 on 49VU)..... PULL
 - DMC 2 SPLY C/B (Q8 on 121 VU).....PULL
 - DMC 3 SPLY C/B (Q9 on 121 VU).....PULL
 - DMC 3 SPLY STBY (E10 on 49 VU).....PULL

- **After 5 s :**
 All C/B's.....PUSH

Note: The T.O MEMO does not appear automatically since one engine is kept running.

GROUND FUEL TRANSFER

Ident.: PRO-NOR-SUP-FUEL-00021258.0001001 / 25 JUL 17

Applicable to: ALL

WARNING

1. Prior initiation of any ground fuel operations, obey the below fuel safety precautions. This will prevent injury to people and/or damage to the aircraft.
2. Do not request or perform any ground fuel operations if a fire or engine overheat warning is displayed.
3. If the APU fails during any ground fuel operations, do not restart the APU. For APU use during refueling/defueling *Refer to LIM-APU APU Start/Shutdown during Refueling/Defueling.*

SAFETY PRECAUTIONS.....APPLY

During ground operations, ensure that:

- HF transmission is not performed (including HF transmission via the HF DATA LINK  pb)
- If connected :
 - The aircraft is properly bonded to the tanker
 - The tanker and the aircraft grounding requirement is based on local regulations. Always connect the ground cable to the parking ground point (or to the tanker) before connecting it to the aircraft
 - The external lighting is not operated (except for NAV & LOGO).

In the cockpit, check that the PARK BRK is ON and that the ACCU PRESS has sufficient pressure. If the PARK BRK cannot be set to ON, check that the chocks are in place.

ACCESS PLATFORM.....IN POSITION

- **On cockpit overhead FUEL panel:**
 PUMPS (of the tanks not to be defueled)..... OFF
 MODE SEL pb-swMAN
 PUMPS (of the tank to be defueled)..... ON
- **if left wing and/or center tanks is (are) to be defueled :**
 X FEED.....ON
OPEN light comes on.
- **On refueling control panel :**
 REFUEL VALVES sel (of tanks not to be filled)..... SHUT
 REFUEL VALVES sel (of tanks to be filled)..... OPEN

| | |
|---|--|
|  <p>A318/A319/A320/A321 FLIGHT CREW OPERATING MANUAL</p> | <p align="center">PROCEDURES</p> <p align="center">NORMAL PROCEDURES</p> <p align="center">SUPPLEMENTARY PROCEDURES - FUEL</p> |
|---|--|

MODE SELECT sw DEFUEL/XFR

OPEN light comes on.

FUEL QTY..... MONITOR

● **When the tank contents reach the required level :**

Corresponding REFUEL VALVES sel..... SHUT

MODE SELECT swOFF and GUARDED

OPEN light goes out.

REFUEL VALVES sel.....NORM and GUARDED

Set cockpit FUEL panel to normal configuration.

| |
|------------------|
| DEFUELING |
|------------------|

Ident.: PRO-NOR-SUP-FUEL-00021259.0001001 / 25 JUL 17

Applicable to: ALL

| | |
|----------------|--|
| WARNING | <ol style="list-style-type: none"> 1. Prior initiation of any ground fuel operations, obey the below fuel safety precautions. This will prevent injury to people and/or damage to the aircraft. 2. Do not request or perform any ground fuel operations if a fire or engine overheat warning is displayed. 3. If the APU fails during any ground fuel operations, do not restart the APU. For APU use during refueling/defueling <i>Refer to LIM-APU APU Start/Shutdown during Refueling/Defueling.</i> 4. Do not defuel in bad weather conditions and electrical storms. 5. Defueling by suction is not possible |
|----------------|--|

SAFETY PRECAUTIONS.....APPLY

During defueling operations, ensure that:

- HF transmission (including HF transmission via the HF DATA LINK  pb) is not performed
- The aircraft is properly bonded to the tanker
- The tanker and the aircraft grounding requirement is based on local regulations. Always connect the ground cable to the parking ground point (or to the tanker) before connecting it to the aircraft
- The external lighting is not operated (except for NAV & LOGO).

In the cockpit, check that the PARK BRK is ON and that the ACCU PRESS has sufficient pressure. If the PARK BRK cannot be set to ON, check that the chocks are in place.

ACCESS PLATFORM.....IN POSITION

MAX DEFUELING PRESSURE: 11 PSI (0.75 bar)

● **On cockpit overhead FUEL panel:**

PUMPS..... OFF

PROCEDURES

NORMAL PROCEDURES

SUPPLEMENTARY PROCEDURES - FUEL

● **On refueling control panel:**

REFUEL VALVES sel..... NORM
 MODE SELECT sw DEFUEL/XFR
OPEN light comes on

● **On cockpit overhead FUEL panel :**

MODE SEL pb-sw MAN
 PUMPS (of the tank(s) to be defueled)..... ON
 X FEED..... ON
OPEN light comes on
 FUEL QTY..... MONITOR

● **When tank contents reach required level**

Corresponding PUMPS..... OFF

● **On refueling control panel:**

MODE SELECT sw OFF and GUARDED
OPEN light goes out
 REFUEL VALVES sel..... NORM and GUARDED
 Set cockpit FUEL panel to normal configuration.

Flight with Landing Gear Down

GENERAL

Ident.: PRO-NOR-SUP-LG-LG_DN-00001997.0001001 / 04 SEP 17

Applicable to: ALL

It is possible to perform a flight with the landing gear locked down and the doors closed.

This chapter applies to either of the following two situations:

- The dispatch of an aircraft with the landing gear down, or
- The continuation of the flight when a landing gear retraction failure happens after takeoff.

The limitations, procedures and performance associated to a flight with the landing gear down are described below.

LIMITATIONS

Ident.: PRO-NOR-SUP-LG-LG_DN-00001999.0002001 / 04 SEP 17

Applicable to: ALL

For a flight with the landing gear down, all of the following supplementary limitations apply:

- Consider a VMO /MMO of 235 kt/M 0.60
- Landing gear doors must be closed
- Avoid icing conditions
- Do not use managed speeds, except during the approach
- Do not use CLB and DES autopilot modes
- Disregard FMS fuel, altitude, speed, and time prediction. Time prediction is valid on waypoints in cruise only
- Use the TCAS in TA ONLY mode
- The ALTITUDE ALERT feature is not available
- Do not perform ETOPS flight.

Note: Ditching with the landing gear down is not assessed.

PROCEDURES

Applicable to: ALL

Ident.: PRO-NOR-SUP-LG-LG_DN-B-00002000.0002001 / 04 SEP 17

PREFLIGHT

In addition to the SOPs apply the following:

● **VMO/MMO setting:**

VMO/MMO sw.....L/G DOWN

L2 *The switch is located in the avionics compartment (on the 188VU panel). This switch changes the VMO/MMO to 235 kt/M 0.60. As a result, an alert is triggered if the speed exceeds the flight with gear down speed limitation.*

L1 **CAUTION** *In the case of continuation of the flight after a gear retraction failure, the flight crew can not access the VMO/MMO switch. Therefore, the airspeed/Mach number must be carefully monitored in order not to exceed 235 kt/M 0.60 as there is no alert if the aircraft exceeds this limitation.*

Ident.: PRO-NOR-SUP-LG-LG_DN-B-00002003.0012001 / 04 SEP 17

FLIGHT CONTROLS

Failure cases, which would normally lead to ALTN law, will degrade F/CTL laws down to DIRECT law, if the landing gear is extended.

FAILURE OF BOTH ENGINES

When both engines are failed, to ease the handling of all the different ECAM procedures resulting from this all engine flame out situation, it is recommended to use the ENG DUAL FAILURE QRH procedure, and if time permits, to clear the ECAM.

Follow all the steps of the QRH procedure, except those that are modified by the procedure below :

■ **If APU is not available**

- Attempt an APU start
- . If APU start is unsuccessful, a windmilling relight can be performed, as long as the speed is above 300 kt (corresponding N2 above 12 %). In this case, increase the aircraft speed and disregard VMO warning.

■ **If APU is available :** perform an assisted relight, when below FL 200.

- Flight controls are in direct laws. Use manual pitch trim as necessary (not indicated on PFD if APU GEN not available).

TAKEOFF

Applicable to: ALL

Ident.: PRO-NOR-SUP-LG-LG_DN-C-00021928.0006001 / 04 SEP 17

GENERAL

The recommended takeoff configuration is 1 + F, as this provides the best climb gradient.

| | |
|---|--|
|  <p>A318/A319/A320/A321 FLIGHT CREW OPERATING MANUAL</p> | <p>PROCEDURES NORMAL PROCEDURES SUPPLEMENTARY PROCEDURES - L/G</p> |
|---|--|

It is not recommended to takeoff with tailwind.

To take into account the most limiting aspects of the takeoff, the second segment condition and the final segment condition are considered.

Once the takeoff weight determined, read the corresponding speeds in the RTOW chart.

Ident.: PRO-NOR-SUP-LG-LG_DN-C-00002006.0017001 / 04 SEP 17

SECOND SEGMENT CONDITIONS

The MTOW for a flight with gear down can be determined with use of the basic RTOW chart published for a normal flight.

To simplify calculations, a weight reduction percentage is applied for each configuration, regardless of the limitation. This weight reduction takes into account the most critical case which is obstacle clearance.

| | | | |
|------------------------------|--------------|----------|----------|
| Takeoff configuration | 1 + F | 2 | 3 |
| Weight reduction | 22 % | 19 % | 19 % |

MTOW DETERMINATION

Enter the basic RTOW chart with the runway conditions (temperature, pressure, etc.) desired aircraft configuration, and obtain the basic MTOW.

Obtain the weight reduction percentage corresponding to the desired takeoff configuration from the above table.

Reduce the previous basic MTOW by this percentage to obtain the MTOW, limited by the second segment condition.

Ident.: PRO-NOR-SUP-LG-LG_DN-C-00002007.0405001 / 04 SEP 17

| FINAL SEGMENT CONDITIONS - LANDING GEAR DOWN - ONE ENGINE INOP | | |
|---|---------|----------------------|
| MAX. CLIMB THRUST SPEED VLS AIR CONDITIONING ON ANTI ICING OFF | CG 25 % | GROSS GRADIENT 1.2 % |

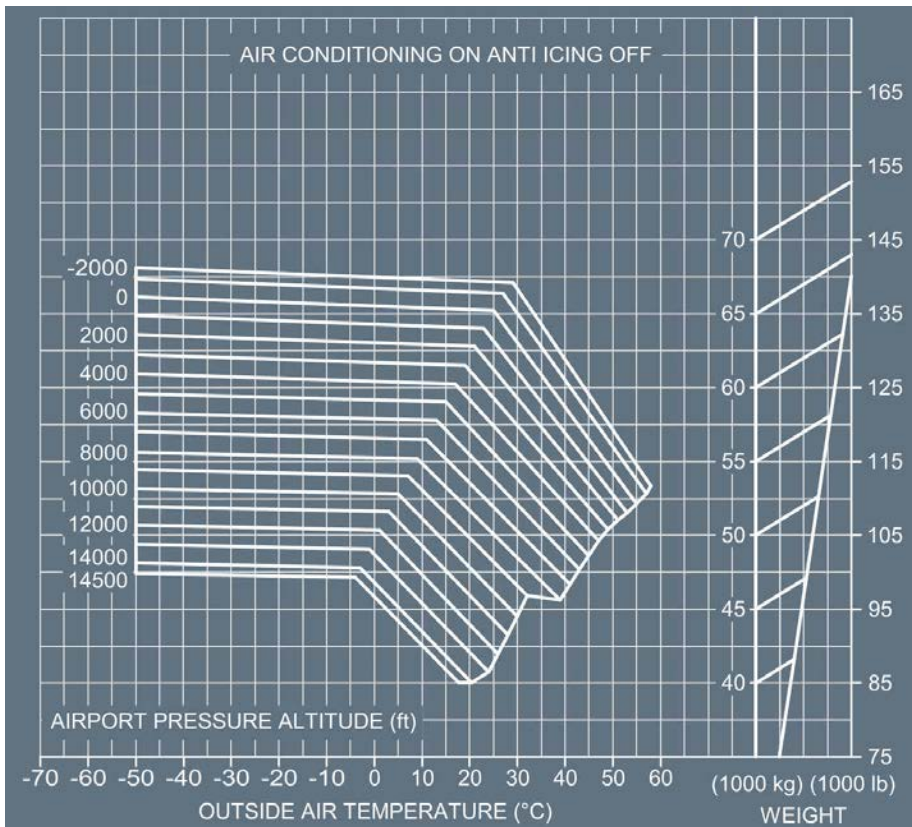

MTOW DETERMINATION

Enter the chart with the airport's OAT . Move up to the position corresponding to the airport's pressure altitude. Then, move right and obtain the MTOW limited by the final segment condition. In the case of CG forward of 25 %, decrease the obtained weight by 400 kg (900 lb).

| | |
|---|--|
|  <p>A318/A319/A320/A321 FLIGHT CREW OPERATING MANUAL</p> | <p style="text-align: center;">PROCEDURES NORMAL PROCEDURES SUPPLEMENTARY PROCEDURES - L/G</p> |
|---|--|

FLIGHT PLANNING

Ident.: PRO-NOR-SUP-LG-LG_DN-00002011.0001001 / 04 SEP 17

Applicable to: ALL

GENERAL

Flying with the gear down induces additional drag and therefore deteriorates aircraft performance. This drag affects all phases of the flight where the landing gear is normally retracted.

MAXIMUM TAKEOFF WEIGHT DETERMINATION

The MTOW for the flight with gear down is determined by keeping the lowest of the weights given by:

- The second segment condition
- The final segment condition
- The en-route conditions
- The go-around conditions.

To determine the MTOW for a flight with the gear down, perform all following steps:

1. Determine the MTOW limited by the second segment condition (*Refer to PRO-NOR-SUP-LG-LG_DN Second Segment Conditions*).
2. Determine the MTOW limited by the final segment condition (*Refer to PRO-NOR-SUP-LG-LG_DN Final Segment Conditions*).
3. Keep the lowest of the above weights as the MTOW.
4. With the MTOW determined in step 3, check the obstacle clearance along the planned route (en-route).

To determine the One Engine Inoperative (OEI) obstacle clearance:

- *Refer to PRO-NOR-SUP-LG-LG_DN Driftdown Net Flight Path - One Engine Inoperative*
- *Refer to PRO-NOR-SUP-LG-LG_DN Gross Ceilings - One Engine Inoperative.*

If necessary, reduce the takeoff weight, in order to obtain the appropriate obstacle clearance.

5. Determine the go-around limiting weight (*Refer to PRO-NOR-SUP-LG-LG_DN Go-Around*). If necessary, reduce the MTOW to comply with this requirement.
6. Keep the lowest MTOW from steps 3, 4, and 5.

FLIGHT PLAN

The flight planning can be performed with the use of the tables provided in this procedure, or with a planning software (PEP, FlySmart, etc.).

FUEL BURN CORRECTION

The climb, cruise, and descent tables are determined for ISA conditions. For each degree Celsius above ISA and per nautical mile of air distance, add a fuel burn correction of 0.05 kg/°C/NM air distance (0.11 lb/°C/NM air distance).

CLIMB

Climb at 230 kt/M 0.50 with the use of maximum climb thrust.

Refer to PRO-NOR-SUP-LG-LG_DN Climb.

CRUISE

The recommended cruise speed is 230 kt/M 0.50.

Refer to PRO-NOR-SUP-LG-LG_DN Cruise.

HOLDING

The holding configuration is CONF 1.

Refer to PRO-NOR-SUP-LG-LG_DN Holding.

DESCENT

The recommended descent speed is 230 kt/M 0.50.

Refer to PRO-NOR-SUP-LG-LG_DN Descent.

GO-AROUND

Refer to PRO-NOR-SUP-LG-LG_DN Go-Around.

LANDING

The landing is standard.

ENGINE FAILURE

In case of engine failure, select maximum continuous thrust (MCT) on the remaining engine and adopt the specified driftdown speed.

For obstacle clearance and depending on the chosen strategy:

- *Refer to PRO-NOR-SUP-LG-LG_DN Driftdown Net Flight Path - One Engine Inoperative*
- *Refer to PRO-NOR-SUP-LG-LG_DN Gross Ceilings - One Engine Inoperative.*

Note: *The OEI required obstacle clearances are 1 000 ft in climb or level flight, and 2 000 ft in descent.*

For fuel burn calculations with one engine inoperative and landing gear down, use the standard OEI cruise fuel flow and apply the fuel penalty as per QRH/OPERATIONAL DATA/FUEL PENALTY FACTORS.



A318/A319/A320/A321
FLIGHT CREW
OPERATING MANUAL

PROCEDURES
NORMAL PROCEDURES

SUPPLEMENTARY PROCEDURES - L/G

CLIMB

Ident.: PRO-NOR-SUP-LG-LG_DN-00002012.0009001 / 14 FEB 11

Applicable to: ALL

| CLIMB 230KT/M.50 - ALL ENGINES - L/G DOWN | | | | | | | | | |
|---|---------|---------|---------|----------|---------|--------------------|---------|-----------|---------|
| MAX. CLIMB THRUST LIMITS | | | | ISA | | FROM BRAKE RELEASE | | | |
| NORMAL AIR CONDITIONING | | | | CG=25.0% | | TIME (MIN) | | FUEL (KG) | |
| ANTI-ICING OFF | | | | | | DISTANCE (NM) | | TAS (KT) | |
| WEIGHT AT BRAKE RELEASE (1000KG) | | | | | | | | | |
| FL | 50 | 52 | 54 | 56 | 58 | 60 | 62 | 64 | 66 |
| 290 | 21 1651 | 23 1778 | 25 1921 | 27 2085 | 30 2277 | 33 2507 | | | |
| | 98 279 | 106 280 | 116 281 | 127 282 | 140 283 | 156 284 | | | |
| 270 | 18 1500 | 20 1607 | 21 1725 | 23 1858 | 25 2009 | 27 2183 | 30 2389 | | |
| | 85 277 | 92 278 | 99 279 | 108 279 | 117 280 | 129 281 | 143 282 | | |
| 250 | 16 1356 | 17 1447 | 19 1546 | 20 1655 | 21 1778 | 23 1915 | 25 2073 | 28 2257 | 31 2475 |
| | 74 274 | 79 275 | 85 275 | 92 276 | 99 277 | 107 278 | 117 279 | 129 280 | 143 282 |
| 240 | 15 1295 | 16 1369 | 17 1459 | 18 1559 | 20 1669 | 21 1792 | 23 1932 | 25 2091 | 27 2277 |
| | 68 272 | 73 273 | 78 273 | 84 274 | 91 275 | 98 276 | 106 277 | 116 278 | 128 279 |
| 220 | 13 1143 | 14 1214 | 15 1289 | 16 1371 | 17 1461 | 18 1559 | 19 1668 | 21 1790 | 22 1928 |
| | 58 267 | 62 268 | 66 268 | 70 269 | 75 270 | 81 271 | 87 272 | 94 273 | 102 274 |
| 200 | 11 999 | 12 1057 | 12 1119 | 13 1185 | 14 1256 | 15 1333 | 16 1417 | 17 1509 | 18 1610 |
| | 48 260 | 51 260 | 54 261 | 57 262 | 61 263 | 65 263 | 69 264 | 74 265 | 80 266 |
| 180 | 9 845 | 9 892 | 10 940 | 11 992 | 11 1047 | 12 1105 | 12 1167 | 13 1233 | 14 1304 |
| | 37 250 | 40 250 | 42 251 | 44 251 | 47 252 | 50 253 | 53 253 | 56 254 | 59 255 |
| 160 | 7 718 | 8 756 | 8 795 | 9 837 | 9 880 | 10 926 | 10 975 | 11 1026 | 11 1080 |
| | 29 240 | 31 240 | 33 241 | 35 241 | 37 242 | 38 242 | 41 243 | 43 244 | 45 244 |
| 140 | 6 611 | 6 642 | 7 675 | 7 709 | 7 744 | 8 781 | 8 820 | 9 861 | 9 904 |
| | 23 230 | 25 231 | 26 231 | 27 232 | 29 232 | 30 233 | 32 233 | 34 234 | 35 234 |
| 120 | 5 517 | 5 543 | 6 570 | 6 598 | 6 627 | 6 657 | 7 689 | 7 722 | 7 756 |
| | 19 220 | 20 221 | 21 221 | 22 222 | 23 222 | 24 223 | 25 223 | 26 224 | 28 224 |
| 100 | 4 432 | 4 454 | 5 475 | 5 498 | 5 522 | 5 546 | 5 572 | 6 598 | 6 626 |
| | 14 209 | 15 210 | 16 211 | 17 211 | 18 212 | 18 212 | 19 213 | 20 213 | 21 214 |
| 50 | 2 243 | 2 254 | 2 266 | 3 278 | 3 290 | 3 303 | 3 317 | 3 330 | 3 344 |
| | 6 171 | 7 172 | 7 173 | 7 173 | 8 174 | 8 175 | 9 175 | 9 176 | 9 177 |
| 15 | 1 123 | 1 128 | 1 133 | 1 139 | 1 145 | 1 151 | 1 157 | 2 163 | 2 170 |
| | 2 108 | 2 109 | 2 110 | 2 110 | 3 111 | 3 112 | 3 113 | 3 113 | 3 114 |

11.0-08FOA320.214 CFM56-5B4/P SA211010005K250 0 018590 0 0 2 1.0 500.0 300.00 1 02230.000 .500.000 0 FCOM-N0-02-04-25-007-140

PROCEDURES
NORMAL PROCEDURES

SUPPLEMENTARY PROCEDURES - L/G

CRUISE

Ident.: PRO-NOR-SUP-LG-LG_DN-00002014.0009001 / 14 FEB 11

Applicable to: ALL

| CRUISE - 230KT/M.50 - ALL ENGINES - L/G DOWN | | | | | | | | | | | | |
|--|-------|------|-------|------|-------------------|------|---------------------------------|------|------------------------------|------|-------|------|
| MAX. CRUISE THRUST LIMITS NORMAL AIR CONDITIONING ANTI-ICING OFF | | | | | ISA CG = 25.0% | | N1 (%) KG/H/ENG NM/1000KG | | MACH IAS (KT) TAS (KT) | | | |
| WEIGHT (1000KG) | FL100 | | FL200 | | FL220 | | FL240 | | FL270 | | FL290 | |
| 48 | 73.9 | .417 | 83.4 | .500 | 83.2 | .500 | 83.2 | .500 | 83.3 | .500 | 83.5 | .500 |
| | 1768 | 230 | 1810 | 228 | 1687 | 219 | 1577 | 210 | 1435 | 197 | 1359 | 188 |
| | 75.2 | 266 | 84.8 | 307 | 90.3 | 305 | 95.8 | 302 | 104.0 | 298 | 108.9 | 296 |
| 50 | 74.2 | .417 | 83.6 | .500 | 83.5 | .500 | 83.5 | .500 | 83.6 | .500 | 84.0 | .500 |
| | 1781 | 230 | 1825 | 228 | 1704 | 219 | 1596 | 210 | 1459 | 197 | 1387 | 188 |
| | 74.6 | 266 | 84.1 | 307 | 89.4 | 305 | 94.7 | 302 | 102.3 | 298 | 106.7 | 296 |
| 52 | 74.4 | .417 | 83.8 | .500 | 83.7 | .500 | 83.8 | .500 | 84.0 | .500 | 84.5 | .500 |
| | 1795 | 230 | 1841 | 228 | 1722 | 219 | 1616 | 210 | 1485 | 197 | 1417 | 188 |
| | 74.1 | 266 | 83.4 | 307 | 88.5 | 305 | 93.5 | 302 | 100.5 | 298 | 104.4 | 296 |
| 54 | 74.6 | .417 | 84.0 | .500 | 84.0 | .500 | 84.1 | .500 | 84.5 | .500 | 85.1 | .500 |
| | 1810 | 230 | 1857 | 228 | 1741 | 219 | 1638 | 210 | 1513 | 197 | 1454 | 188 |
| | 73.4 | 266 | 82.7 | 307 | 87.5 | 305 | 92.3 | 302 | 98.6 | 298 | 101.7 | 296 |
| 56 | 74.9 | .417 | 84.3 | .500 | 84.3 | .500 | 84.4 | .500 | 84.9 | .500 | 85.7 | .500 |
| | 1826 | 230 | 1875 | 228 | 1761 | 219 | 1662 | 210 | 1543 | 197 | 1497 | 188 |
| | 72.8 | 266 | 81.9 | 307 | 86.5 | 305 | 90.9 | 302 | 96.7 | 298 | 98.9 | 296 |
| 58 | 75.1 | .417 | 84.5 | .500 | 84.6 | .500 | 84.8 | .500 | 85.4 | .500 | 86.3 | .500 |
| | 1843 | 230 | 1894 | 228 | 1782 | 219 | 1687 | 210 | 1574 | 197 | 1541 | 188 |
| | 72.1 | 266 | 81.1 | 307 | 85.5 | 305 | 89.6 | 302 | 94.8 | 298 | 96.0 | 296 |
| 60 | 75.4 | .417 | 84.8 | .500 | 84.9 | .500 | 85.1 | .500 | 86.0 | .500 | | |
| | 1861 | 230 | 1914 | 228 | 1805 | 219 | 1714 | 210 | 1616 | 197 | | |
| | 71.5 | 266 | 80.2 | 307 | 84.4 | 305 | 88.2 | 302 | 92.3 | 298 | | |
| 62 | 75.7 | .417 | 85.1 | .500 | 85.2 | .500 | 85.5 | .500 | 86.6 | .500 | | |
| | 1879 | 230 | 1935 | 228 | 1829 | 219 | 1742 | 210 | 1660 | 197 | | |
| | 70.8 | 266 | 79.4 | 307 | 83.3 | 305 | 86.8 | 302 | 89.9 | 298 | | |
| 64 | 76.0 | .417 | 85.3 | .500 | 85.5 | .500 | 85.9 | .500 | | | | |
| | 1898 | 230 | 1957 | 228 | 1856 | 219 | 1772 | 210 | | | | |
| | 70.0 | 266 | 78.5 | 307 | 82.1 | 305 | 85.3 | 302 | | | | |
| 66 | 76.3 | .417 | 85.6 | .500 | 85.9 | .500 | 86.3 | .500 | | | | |
| | 1918 | 230 | 1981 | 228 | 1883 | 219 | 1804 | 210 | | | | |
| | 69.3 | 266 | 77.5 | 307 | 80.9 | 305 | 83.7 | 302 | | | | |
| 68 | 76.6 | .417 | 85.9 | .500 | 86.2 | .500 | | | | | | |
| | 1939 | 230 | 2005 | 228 | 1912 | 219 | | | | | | |
| | 68.6 | 266 | 76.6 | 307 | 79.7 | 305 | | | | | | |

HOLDING

Ident.: PRO-NOR-SUP-LG-LG_DN-00002017.0009001 / 04 SEP 17

Applicable to: ALL

| RACE TRACK HOLDING PATTERN - S SPEED - ALL ENGINES - L/G DOWN | | | | | | | | |
|--|--------------|--------------|--------------|--------------|--------------|--------------|---------------|--------------|
| MAX. CRUISE THRUST LIMITS | | | | | ISA | | N1 (%) | |
| CONFIGURATION 1 | | | | | CG=25.0% | | FF (KG/H/ENG) | |
| NORMAL AIR CONDITIONING | | | | | | | | |
| ANTI-ICING OFF | | | | | | | | |
| WEIGHT (1000KG) | FL 15 | FL 50 | FL100 | FL120 | FL140 | FL160 | FL180 | FL200 |
| 46 | 56.3 1248 | 59.1 1223 | 62.9 1206 | 64.7 1202 | 66.5 1198 | 68.3 1194 | 70.1 1192 | 71.9 1187 |
| 48 | 57.4 1297 | 60.3 1274 | 64.1 1260 | 66.0 1255 | 67.8 1251 | 69.5 1248 | 71.3 1243 | 73.2 1239 |
| 50 | 58.6 1347 | 61.3 1327 | 65.3 1313 | 67.2 1308 | 69.0 1304 | 70.7 1300 | 72.5 1296 | 74.4 1293 |
| 52 | 59.7 1398 | 62.3 1380 | 66.6 1366 | 68.3 1361 | 70.1 1357 | 71.8 1353 | 73.7 1348 | 75.5 1347 |
| 54 | 60.8 1449 | 63.3 1434 | 67.7 1419 | 69.5 1415 | 71.1 1410 | 72.9 1405 | 74.8 1402 | 76.7 1402 |
| 56 | 61.7 1501 | 64.3 1488 | 68.8 1472 | 70.5 1467 | 72.2 1463 | 74.0 1458 | 75.9 1457 | 77.8 1457 |
| 58 | 62.6 1554 | 65.4 1541 | 69.8 1525 | 71.5 1520 | 73.2 1516 | 75.1 1512 | 77.0 1512 | 78.9 1514 |
| 60 | 63.5 1607 | 66.4 1594 | 70.8 1578 | 72.4 1573 | 74.2 1569 | 76.1 1567 | 78.0 1568 | 79.8 1571 |
| 62 | 64.4 1659 | 67.4 1645 | 71.7 1631 | 73.4 1626 | 75.2 1622 | 77.1 1622 | 79.0 1624 | 80.8 1627 |
| 64 | 65.3 1713 | 68.4 1699 | 72.6 1684 | 74.4 1680 | 76.2 1677 | 78.1 1678 | 79.9 1681 | 81.7 1684 |
| 66 | 66.3 1766 | 69.3 1753 | 73.5 1738 | 75.3 1734 | 77.1 1733 | 79.1 1735 | 80.8 1738 | 82.6 1743 |
| 68 | 67.2 1819 | 70.2 1806 | 74.4 1792 | 76.2 1789 | 78.1 1789 | 80.0 1792 | 81.7 1796 | 83.4 1804 |
| 70 | 68.1 1872 | 71.1 1859 | 75.3 1847 | 77.1 1845 | 79.0 1846 | 80.8 1850 | 82.6 1854 | 84.2 1865 |
| 72 | 69.0 1926 | 71.9 1913 | 76.2 1901 | 78.0 1901 | 79.9 1904 | 81.6 1908 | 83.3 1914 | 85.0 1928 |
| 74 | 69.8 1981 | 72.7 1967 | 77.0 1957 | 78.9 1958 | 80.7 1962 | 82.4 1966 | 84.1 1975 | 85.7 1990 |
| 76 | 70.6 2033 | 73.4 2021 | 77.8 2013 | 79.7 2015 | 81.5 2019 | 83.2 2024 | 84.8 2036 | |
| 78 | 71.4 2085 | 74.2 2075 | 78.6 2069 | 80.5 2073 | 82.2 2077 | 83.9 2084 | 85.5 2099 | |

PROCEDURES
NORMAL PROCEDURES

SUPPLEMENTARY PROCEDURES - L/G

DESCENT

Ident.: PRO-NOR-SUP-LG-LG_DN-00002016.0021001 / 14 FEB 11

Applicable to: **ALL**

| DESCENT - M.50/230KT - ALL ENGINES - L/G DOWN | | | | | | | | | |
|--|-----|---------------|--------------|---------------|-----|---------------|--|---------------|-------------|
| IDLE THRUST | | | ISA | | | | MAXIMUM CABIN RATE OF DESCENT 350FT/MIN | | |
| NORMAL AIR CONDITIONING | | | CG=25.0% | | | | | | |
| ANTI-ICING OFF | | | | | | | | | |
| WEIGHT (1000KG) | 45 | | | | 55 | | | | IAS (KT) |
| | FL | TIME (MIN) | FUEL (KG) | DIST. (NM) | N1 | TIME (MIN) | FUEL (KG) | DIST. (NM) | |
| 290 | 7.1 | 67 | 33 | IDLE | 8.2 | 77 | 38 | IDLE | 188 |
| 270 | 6.6 | 63 | 30 | IDLE | 7.6 | 74 | 35 | IDLE | 197 |
| 250 | 6.1 | 60 | 28 | IDLE | 7.1 | 70 | 32 | IDLE | 205 |
| 240 | 5.8 | 58 | 26 | IDLE | 6.8 | 68 | 31 | IDLE | 210 |
| 220 | 5.4 | 55 | 24 | IDLE | 6.3 | 64 | 28 | IDLE | 219 |
| 200 | 4.9 | 51 | 22 | IDLE | 5.8 | 60 | 26 | IDLE | 228 |
| 180 | 4.5 | 47 | 20 | IDLE | 5.2 | 55 | 23 | IDLE | 230 |
| 160 | 4.0 | 41 | 17 | IDLE | 4.6 | 48 | 20 | IDLE | 230 |
| 140 | 3.4 | 34 | 15 | IDLE | 4.0 | 40 | 17 | IDLE | 230 |
| 120 | 2.9 | 28 | 12 | IDLE | 3.4 | 32 | 14 | IDLE | 230 |
| 100 | 2.3 | 21 | 10 | IDLE | 2.7 | 25 | 11 | IDLE | 230 |
| 50 | 1.0 | 9 | 4 | IDLE | 1.2 | 10 | 5 | IDLE | 230 |
| 15 | .0 | 0 | 0 | IDLE | .0 | 0 | 0 | IDLE | 230 |

11.0-08FOA320-214 CFM56-5B4/P 23101000C5KG250 0 018990 0 0-1-350.0 15.0 .00 0 02 .500230.000 .000 0 FCOM-NO-02-04-25-008-170

GO-AROUND

Ident.: PRO-NOR-SUP-LG-LG_DN-00002010.0001001 / 04 SEP 17

Applicable to: **ALL**

Refer to *PER-GOA-GEN GENERAL* for go-around requirements.

Further decrease the basic limiting weight by 15 %.



A318/A319/A320/A321
FLIGHT CREW
OPERATING MANUAL

PROCEDURES
NORMAL PROCEDURES

SUPPLEMENTARY PROCEDURES - L/G

ONE ENGINE INOPERATIVE

Applicable to: ALL

Ident.: PRO-NOR-SUP-LG-LG_DN-D-00002019.0013001 / 04 SEP 17

EN ROUTE NET FLIGHT PATH - L/G DOWN - ONE ENGINE INOP

| | | |
|--|------------------|----------------|
| MAX. CONTINUOUS THRUST GREEN DOT SPEED HIGH AIR CONDITIONING ANTI ICE OFF | ISA CG = 23 % | MINIMUM ENGINE |
|--|------------------|----------------|

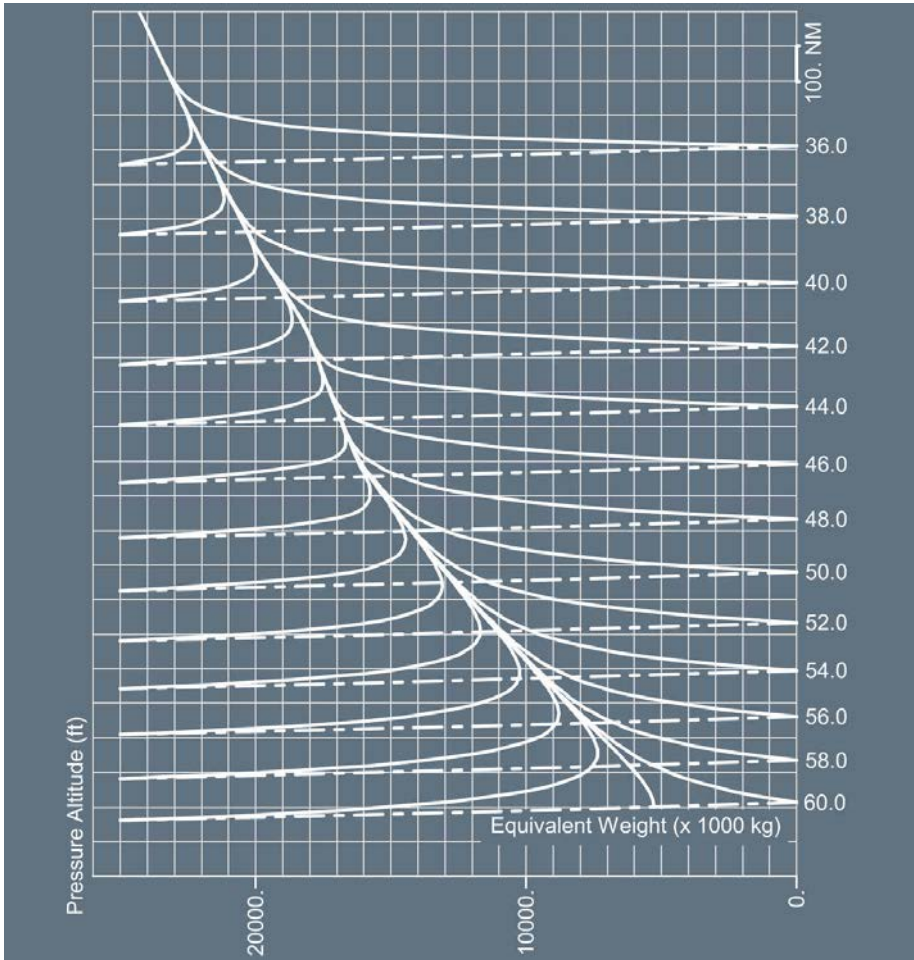

Ident.: PRO-NOR-SUP-LG-LG_DN-D-00004080.0005001 / 04 SEP 17

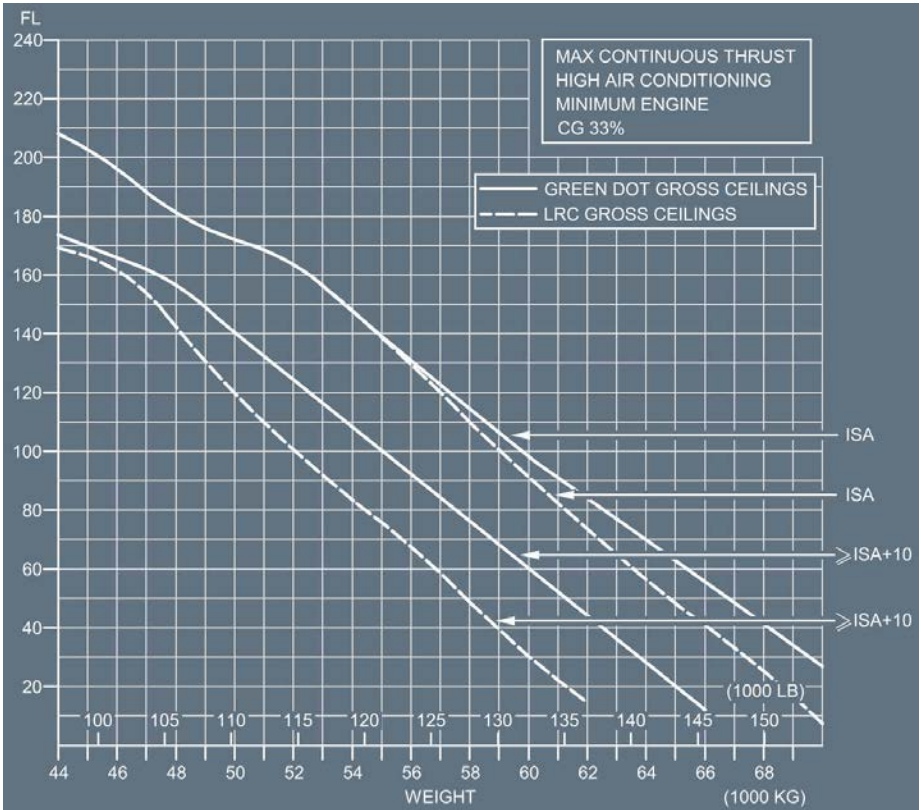

BLEED CORRECTIONS

| | | ISA | ≥ ISA +10 |
|------------|--------------------|-----------|-----------|
| LONG RANGE | ENGINE ANTI ICE ON | -500 ft | -2 800 ft |
| | TOTAL ANTI ICE ON | -1 300 ft | -4 600 ft |
| GREEN DOT | ENGINE ANTI ICE ON | -200 ft | -1 700 ft |
| | TOTAL ANTI ICE ON | -1 200 ft | -3 500 ft |



A318/A319/A320/A321
FLIGHT CREW
OPERATING MANUAL

PROCEDURES

NORMAL PROCEDURES

SUPPLEMENTARY PROCEDURES - L/G

Intentionally left blank

| | |
|---|---|
|  A318/A319/A320/A321 FLIGHT CREW OPERATING MANUAL | PROCEDURES NORMAL PROCEDURES SUPPLEMENTARY PROCEDURES - L/G |
|---|---|

Operation with Nosewheel Steering Offset

OPERATION WITH NOSEWHEEL STEERING OFFSET

Applicable to: ALL

Ident.: PRO-NOR-SUP-LG-LG-A-00020945.0001001 / 17 MAR 17

During taxi in a straight line, the crew may notice aircraft veering tendency. This can be due to external conditions (crosswind, slope....), or to a nosewheel steering offset.
 A nosewheel steering offset is usually notified through consecutive crew reports. The NWS offset value is determined regarding the necessary rudder trim input used to cancel the veering tendency.

Ident.: PRO-NOR-SUP-LG-LG-A-00020946.0001001 / 17 MAR 17

When the NWS offset is within admissible limits, the flight crew can operate the aircraft as follows:

CAUTION A rudder trim reset must be performed before takeoff.
 When the rudder trim adjustment is above the maintenance tolerance ($\pm 0.5^\circ$ NWS offset corresponding to $\pm 3^\circ$ rudder trim necessary to taxi straight), the flight crew must systematically and accurately report the rudder trim value in the logbook.

| NWS Offset | Necessary Rudder Trim Input | Procedure |
|--|--|--|
| Offset $\leq 0.5^\circ$ | Trim $\leq 3^\circ$ | <ul style="list-style-type: none"> ● Taxi: RUDDER TRIM.....ADJUST Adjust trim until the aircraft taxis in a straight line. Check input value. ● Before takeoff: RUDDER TRIM.....RESET |
| $0.5^\circ < \text{Offset} \leq 1.5^\circ$ | $3^\circ < \text{Trim} \leq 8.8^\circ$ | <ul style="list-style-type: none"> ● Taxi: RUDDER TRIM.....ADJUST Adjust trim until the aircraft taxis in a straight line. Check input value. ● Before takeoff: RUDDER TRIM.....RESET ● Landing: <ul style="list-style-type: none"> ● For autoland: MAX CROSSWIND.....10 kt |
| Offset $> 1.5^\circ$ | Trim $> 8.8^\circ$ | MAINTENANCE ACTION.....REQUEST Do not attempt takeoff. Request for troubleshooting. |



A318/A319/A320/A321
FLIGHT CREW
OPERATING MANUAL

PROCEDURES

NORMAL PROCEDURES

SUPPLEMENTARY PROCEDURES - L/G

Intentionally left blank

Pushback with Power Push Unit

PUSHBACK WITH POWER PUSH UNIT VIA THE MAIN LANDING GEAR

Applicable to: ALL

Ident.: PRO-NOR-SUP-MISC-D-A-00020472.0002001 / 17 MAR 17

When pushback is performed with a Power Push Unit (PPU) via the main landing gear, this procedure replaces the BEFORE PUSHBACK OR START SOP.

● **Before start clearance**

SOP - BEFORE START CLEARANCE.....PERFORM

L2 Refer to PRO-NOR-SOP-07 Before Start Clearance.

L1 BEFORE START CHECKLIST down to the line..... COMPLETE
 NW STRG DISC MEMO.....CHECK NOT DISPLAYED

L2 The ground crew should check that the towing lever is in the normal position.

L1 ● **At start clearance**

PUSHBACK/START CLEARANCE.....OBTAIN

L2 Obtain ATC pushback/start clearance.
 Obtain ground crew clearance.

L1 ATC..... SET FOR OPERATION

L2 ATC is set in accordance with airport requirements.

L1 WINDOWS AND DOORS.....CHECK CLOSED

L2 - To ensure that the sliding window is correctly closed, push the handle of the sliding window fully forward to the closed position, and check that the red indicator is visible.

- Check, on the ECAM lower display, that all the aircraft doors are closed.

- When required by local airworthiness authorities, check that the cockpit door is closed and locked (no cockpit door open/fault indication).

If entry is requested, identify the person requesting entry before unlocking the door. With the cockpit door sw on NORM, the cockpit door is closed and locked. If entry is requested from the cabin, and if no further action is performed by the pilot, the cabin crew will be able to unlock the door by using the emergency access procedure. Except for crew entry/exit, the cockpit door should remain closed until engine shutdown.

L1 SLIDES..... CHECK ARMED

L2 - Check, on the ECAM lower display, that all slides are armed.

L1 BEACON sw.....ON

THRUST LEVERS.....IDLE

CAUTION Engines will start, regardless of the thrust lever position; thrust will rapidly increase to the corresponding thrust lever position, causing a hazardous situation, if thrust levers are not at IDLE.

ACCU PRESS indicator.....CHECK

L2 The ACCU PRESS indication must be in the green band. If required, use the electric pump on yellow hydraulic system to recharge the brake accumulator.

L1 PARK BRK handle.....CHECK ON
 BRAKES PRESS indicator..... CHECK

L2 Check for normal indication.

L1 BEFORE START CHECKLIST below the line..... COMPLETE

Ident.: PRO-NOR-SUP-MISC-D-A-00020473.0002001 / 17 MAR 17

ENG 2..... START

L2 Engine 2 is usually started first to pressurize the yellow hydraulic system, making the nosewheel steering and parking brake available.

Ident.: PRO-NOR-SUP-MISC-D-A-00020474.0001001 / 17 MAR 17

PUSHBACK

Due to a face-to-face situation between the ground personnel and the flight crew, a clear understanding of directional phraseology is essential.

PARK BRK handle.....OFF
 BRAKES PRESS indicator.....CHECK ZERO

L2 A slight residual pressure may remain for a short period of time on the triple indicator. Advise the ground crew that the parking brake is off and that the pushback can be started.

L1 **CAUTION** Do not use the brakes during pushback, except in case of emergency.
 Do not move flight controls or flap lever.

L2 In case of emergency, order the ground crew to separate the PPU and move it away from the evacuation areas. Nevertheless, evacuation is possible with the PPU in place.

L1 STEERING HANDWHEEL.....AS REQUIRED

L2 Steer the aircraft using guidance from the ground crew.

L1 ● **When pushback is completed:**

PARK BRK handle.....ON
 BRAKES PRESS indicator..... CHECK
 GROUND CREW..... ADVISED TO REMOVE PPU



A318/A319/A320/A321
 FLIGHT CREW
 OPERATING MANUAL

PROCEDURES
NORMAL PROCEDURES

SUPPLEMENTARY PROCEDURES - MISCELLANEOUS

● **When PPU is removed and ground crew clearance obtained:**

ENG 1..... START

SOP - AFTER START..... RESUME

Refer to PRO-NOR-SOP-09 After Start

PROCEDURES

NORMAL PROCEDURES

SUPPLEMENTARY PROCEDURES - MISCELLANEOUS

Intentionally left blank

High Altitude Airport Operations

HIGH ALTITUDE AIRPORT OPERATIONS

Applicable to: ALL

Ident.: PRO-NOR-SUP-MISC-A-A-00020650.0017001 / 20 MAR 17

TAKEOFF ON AIRPORT WITH AN ELEVATION OF 9 200 FT OR ABOVE

COCKPIT PREPARATION

HIGH ALT LDG pb-sw (for all on ground operation).....ON

BEFORE PUSHBACK OR START

ACCU PRESS..... CHECK

L2

If required, use the HYD YELLOW ELEC PUMP to recharge the brake accumulator.

L1

GEN 1..... OFF

GEN 2..... OFF

G ENG PUMP..... OFF

Y ENG PUMP..... OFF

ENGINE START

● **When idle is reached**

GEN 1..... ON

GEN 2..... ON

G ENG PUMP..... ON

Y ENG PUMP..... ON

TAKEOFF

Note: For A/C operating under FAA requirements, as long as the cabin altitude is above 12 000 ft in flight, at least one pilot must use the oxygen mask continuously.

APU BLEED..... AS RQRD

L2

Packs may be supplied for takeoff by the engine bleed, or by the APU bleed up to 17 000 ft depending on the takeoff performance requirement.

L1

CRUISE

LDG ELEV AUTO [CRUISE page].....CHECK

● **When cabin altitude below 12 000 ft and decreasing:**

HIGH ALT LDG pb-sw..... OFF

CHECK THAT CABIN ALTITUDE DECREASES BELOW 9 550 ft +/- 350 ft

L2 This will allow the CAB PR EXCESS CAB ALT alert to trigger again if necessary despite the clear action.

L1 LANDING ON AIRPORTS WITH AN ELEVATION OF 9 200 FT OR ABOVE

CRUISE

- If **CAB ALT** exceeds 8 000 ft:
 LDG ELEV: 8 000 ft:..... SET

L2 Manually selecting a landing field elevation overrides the FMGS landing field elevation for the remaining time of cruise.

L1 Note: A step descent or turbulence conditions may trigger an early CPC descent mode detection, leading the CPC to start controlling to the landing field elevation pressure.

DESCENT PREPARATION

Note: For A/C operating under FAA requirements, at least one pilot must use the oxygen mask continuously until landing.

HIGH ALT LDG pb-sw..... ON

L2 Passengers oxygen masks would drop when cabin altitude is above 14 000 ft +250/-750 ft if HIGH ALT LDG pushbutton switch is OFF.

L1 Note: Passengers oxygen masks drop above 16 000 ft +250/-750 ft cabin altitude if HIGH ALT LDG pushbutton switch is ON.

LDG ELEV..... AUTO

L2 CPC starts controlling the pressure to the landing field elevation at beginning of descent.

L1 **AFTER LANDING**

HIGH ALT LDG pb-sw (for all on ground operation)..... ON

| | |
|---|---|
|  <p>A318/A319/A320/A321 FLIGHT CREW OPERATING MANUAL</p> | <p align="center">PROCEDURES NORMAL PROCEDURES SUPPLEMENTARY PROCEDURES - MISCELLANEOUS</p> |
|---|---|

Operations at QNH Above 1050 hPa

GENERAL

Ident.: PRO-NOR-SUP-MISC-C-00002100.0015001 / 03 FEB 11
Applicable to: ALL

Some airlines may occasionally experience high barometric correction settings above 1 050 hPa, or 31.0 inHg on some airfields, due to polar anticyclonic air mass conditions occurring near the polar area during winter.

The FMS , FCU , ISIS instrument, PFD , and CPCS are capable of operating at QNH /QFE up to 1 100 hPa, or 32.48 inHg.

However, the ATC/TCAS operates only up to 1050 hPa (i.e. as long as the aircraft altitude remains above –1000 feet standard pressure altitude).

Therefore, when using QNH , or QFE for QFE pin-programmed aircraft, for departure and arrival, the crew should be aware of the following consequences, and should apply the following procedures. It is necessary for the airline to obtain operational approval from its national airworthiness authorities.

CONSEQUENCES

Ident.: PRO-NOR-SUP-MISC-C-00002102.0038001 / 17 MAR 11
Applicable to: ALL

ON THE ATC-TCAS:



For takeoff, approach and landing, the ATC altitude reporting and the TCAS TA/RA function may generate erroneous altitude information and nuisance TCAS alerts for other aircraft, if the aircraft standard altitude is below -1 000 ft standard pressure altitude.

To avoid this, it is recommended to set ALT RPTG to OFF when the QNH exceeds 1 050 hPa, and to inform the ATC . As a consequence the TCAS reverts to STBY mode.

PROCEDURES

Ident.: PRO-NOR-SUP-MISC-C-00002104.0015001 / 20 MAR 17
Applicable to: ALL

BEFORE TAKEOFF

- ALT RPTG OFF
-  ALT RPTG OFF memo and TCAS STBY memo appear on the WD.
-  ATC..... NOTIFY
-  *Notify the ATC that the altitude reporting is not available.*

L1 TAKEOFF

- Above 1 000 ft, when time permits:

ALT RPTG ON

- L2** As a result, the TCAS automatically reverts to its previous setting.

L1 APPROACH

- Before final approach:

ATC.....NOTIFY

- L2** Notify the ATC that the altitude reporting will be turned off.

L1 ALT RPTG OFF

INSERTION OF APPROACH MINIMA

Applicable to: ALL

Ident.: PRO-NOR-SUP-NAV-A-00015220.0011001 / 21 MAR 17

QNH USE FOR AIRCRAFT NOT EQUIPPED WITH QFE OPTION

This table explains how the flight crew must insert the approach minimum on the MCDU PERF APPR page.

| | | Guidance Modes | | | |
|------------------------|-------------|---|-----------------------------|-----------|--|
| | | LOC G/S CAT II & CAT III approaches | LOC G/S CAT I approaches | FINAL APP | NAV FPA LOC FPA LOC B/C FPA  TRK FPA |
| MCDU PERF APPR page | BARO field | --- | DA | DA or MDA | MDA |
| | RADIO field | DH or RA | --- | | |
| FMA display | | "RADIO XXX" | "BARO XXXX" | | |

Ident.: PRO-NOR-SUP-NAV-A-00015222.0001001 / 21 MAR 17

QFE USE FOR AIRCRAFT NOT EQUIPPED WITH QFE OPTION

The crew should not use QFE on aircraft with a "QNH only" pin programming (incorrect profile computation of the managed vertical modes CLB , DES and FINAL APPR, possible false GPWS warnings in mountainous areas).

PROCEDURES

NORMAL PROCEDURES

SUPPLEMENTARY PROCEDURES - NAVIGATION

Intentionally left blank

Introduction

INTRODUCTION

Ident.: PRO-NOR-SRP-01-05-00003959.0001001 / 09 OCT 12

Applicable to: ALL

Note: This chapter is an amplification of the SOP. Anytime it was feasible, the same chapters and the same titles of paragraph were retained.

The following discussion of the FMGS uses this flight plan as an example.

PROCEDURES
NORMAL PROCEDURES

SYSTEMS RELATED PROCEDURES - FMS

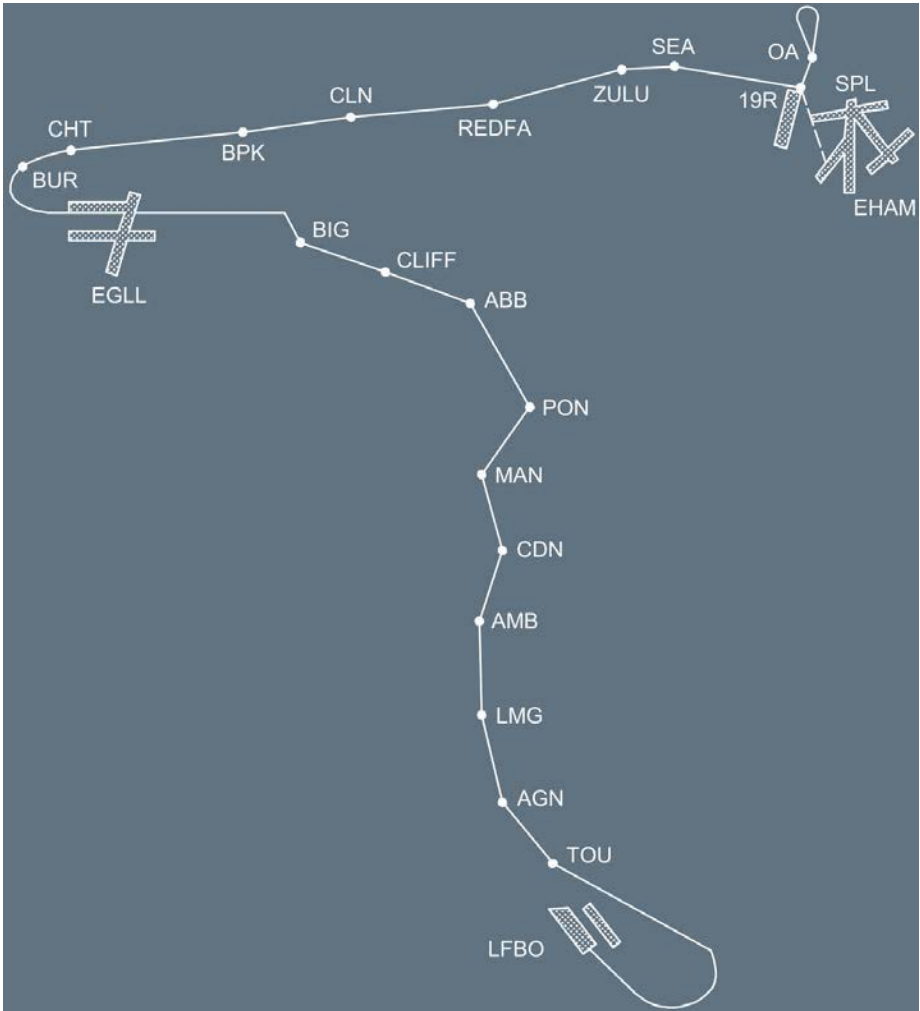

Cockpit Preparation

FMGS INITIALIZATION

Ident.: PRO-NOR-SRP-01-10-00003960.0002001 / 22 MAY 12

Applicable to: ALL

CHECKING THE CLOCK DATE

CHECK the CLOCK DATE and ADJUST, if necessary.

If the date in the active database does not match the clock date, the MCDU displays “CHECK DATA BASE CYCLE”. If this message appears, check the period of validity in the second database and select it, if required.



CAUTION

Cycling the navigation database deletes the active and secondary flight plans. Do not cycle it while airborne because doing so will delete the flight plan, eliminate all speed predictions, and blank the ND. If the aircraft is in managed speed, Green Dot becomes the speed target.

CHECKING STORED WAYPOINTS, NAVAIDS, RUNWAYS, OR ROUTES

PRESS the DATA key.

PRESS the next page key.

SELECT, successively, as required:

- STORED WAYPOINT
- STORED NAVAIDS
- STORED RUNWAYS
- STORED ROUTES

CHECK the contents of each of these data storages and DELETE items, as appropriate.

NAVAIDS DESELECTION

- If NOTAMS indicate that selected NAVAIDs are unreliable or unserviceable, deselect them as follows:

PRESS the DATA key.

SELECT the POSITION MONITOR page.

SELECT the SELECTED NAVAIDS page.

Under “Deselect”, INSERT the NAVAID identifier in the brackets.

The pilot can only make six deselections.

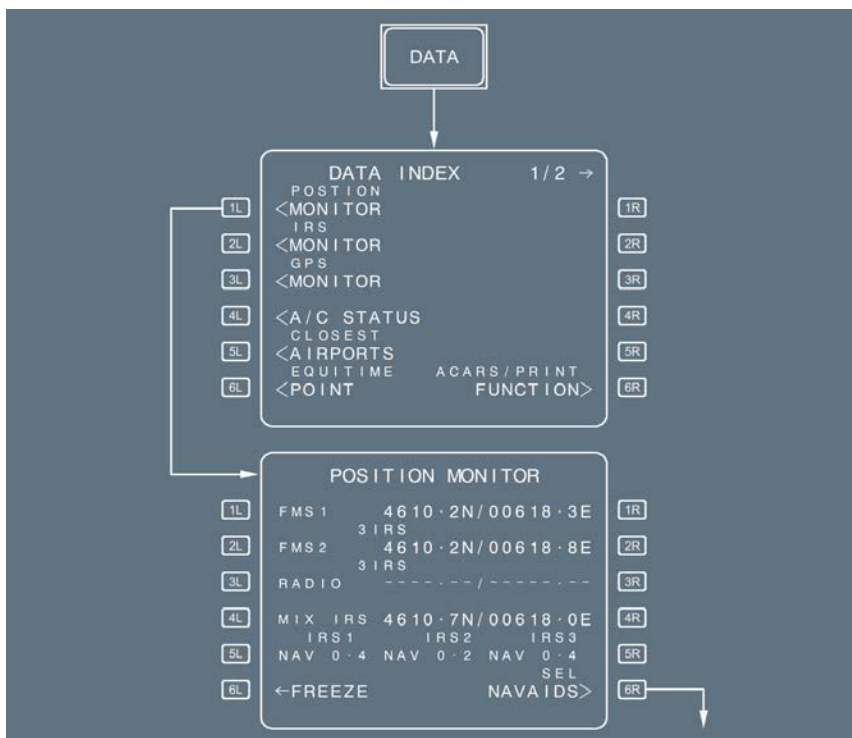

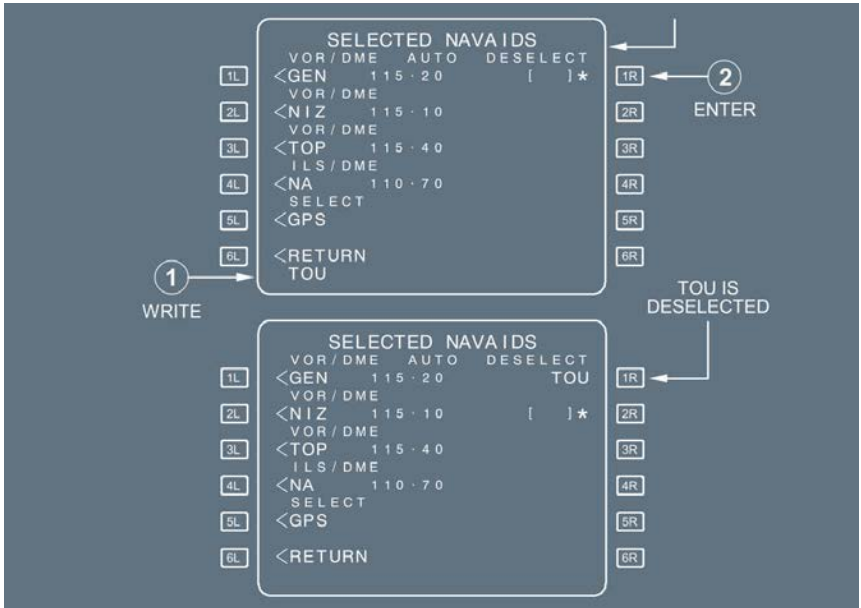

FLIGHT PLAN INITIALIZATION

Applicable to: ALL

Ident.: PRO-NOR-SRP-01-10-A-00003961.0025001 / 22 MAY 12

GENERAL

Follow SOP instructions, when the route is a company route stored in the database.

- If the company route is unknown, proceed as follows:

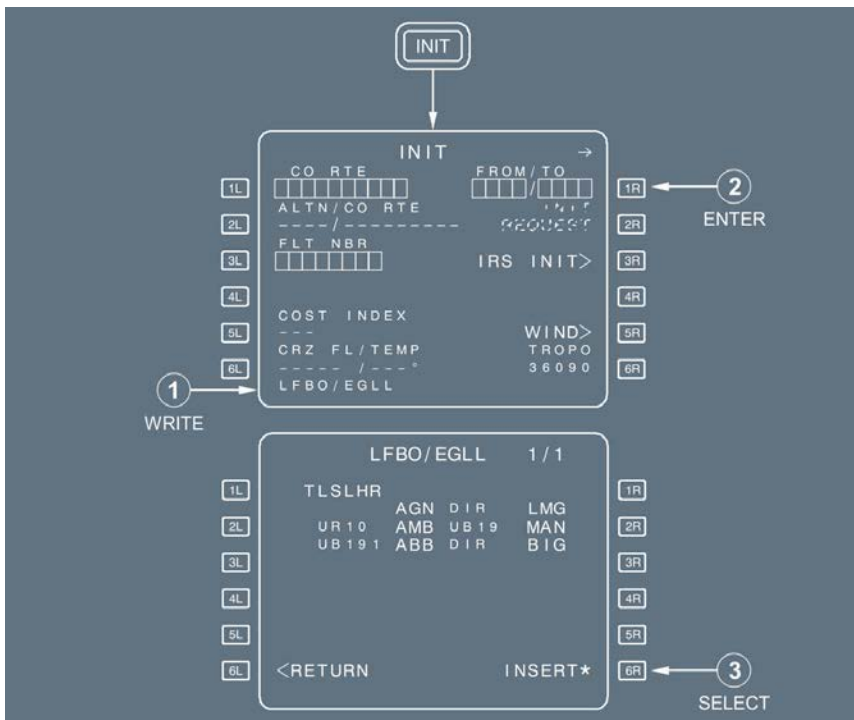

WRITE a "FROM/TO" city pair, then ENTER it:

If one or more company routes run between the cities, the ROUTE SELECTION page appears and defines them.

INSERT the preferred company route.

- If the database does not contain a company route:

The flight plan must be constructed manually:

PRESS the INIT key

ENTER a city pair in the FROM/TO field.

The ROUTE SELECTION page comes up with "NONE"

SELECT RETURN [6L] key then construct the flight plan manually.

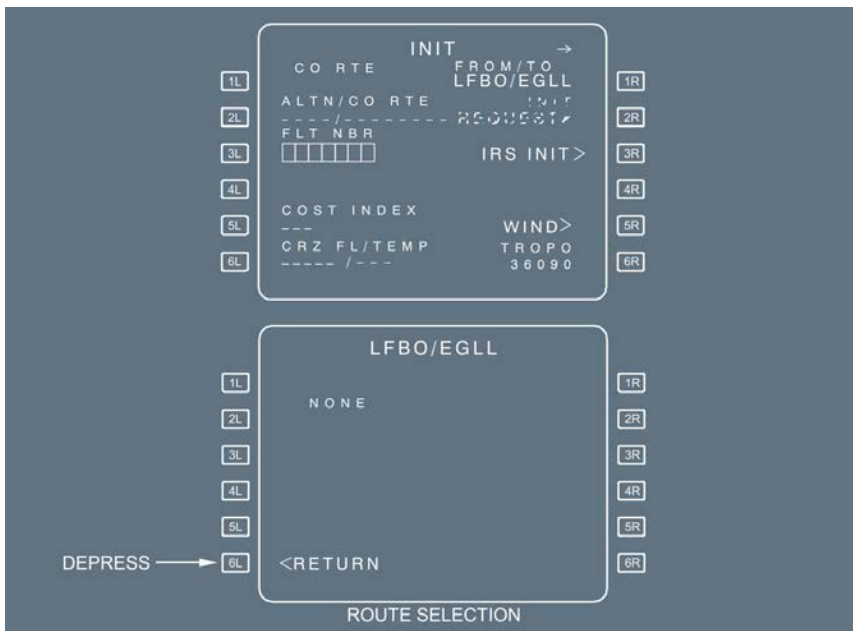

If waypoints, NAVAIDs or airports are not in the NAV database, the crew must define and store them manually, using the “data stored” function.

Ident.: PRO-NOR-SRP-01-10-A-00003962.0046001 / 23 JUN 15

ALIGNING IRS

The alignment phase is completed, when the ADIRS is initialized to an appropriate position. If the GPS is available, initialization is automatic, using the GPS position. Flight crew intervention is not necessary.

However, automatic initialization may be manually overridden by flight crew entry, at any moment during the alignment phase. In this case, perform the following procedure as soon as possible, to prevent delays if an alignment error occurs:

PRESS the INIT key, and then the IRS INIT prompt.

IRS INIT page is displayed with the airport reference point as default coordinates.

If necessary, PRESS [1L] and/or [1R] and use scroll keys to adjust the latitude and/or longitude values.

For example, this can be used to enter the gate precise coordinates when the aircraft is intended to fly without GPS on long segments without radio coverage.

PROCEDURES

NORMAL PROCEDURES

SYSTEMS RELATED PROCEDURES - FMS

PRESS the ALIGN ON REF prompt and CONFIRM ALIGN* prompt.

The displayed coordinates are sent to ADIRS for initialization.

The alignment status changes to ALIGNING ON REF.

- **If the "CHECK IRS/AIRPORT POS" or "REF/GPS POS DIF" or "REF/LAST IRS POS DIF" message is displayed:**

CHECK the departure airport on INIT A page and CORRECT it if necessary.

REALIGN the IRS per the procedure described previously.

- **If a new FROM or a new CO RTE is entered after IRS alignment is already completed, the ALIGN ON REF prompt is displayed in [6R]:**

REALIGN the IRS per the procedure described previously.

Ident.: PRO-NOR-SRP-01-10-A-00003963.0010001 / 22 MAY 12

LATERAL FLIGHT PLAN

SELECTING A DEPARTURE

1 SELECT [1L] [2L] [3L] [4L] [5L] [6L] FROM LFBO32L TIME H326 SPD/ALT 900 [1R] [2R] [3R] [4R] [5R] [6R]

2 SELECT [1L] [2L] [3L] [4L] [5L] [6L] LAT REV FROM LFBO 43°37.4N/001°22.8E <DEPARTURE FIX INFO> LL XING/INCR/NO []°/[]°/[] NEXT WPT [] [1R] [2R] [3R] [4R] [5R] [6R]

3 SELECT [1L] [2L] [3L] [4L] [5L] [6L] DEPARTURES FROM LFBO RWY SID TRANS 33L AFR1D NONE AVAILABLE RUNWAYS ←15L 3000M 146 ILS TG/108.90 ←15R 3500M 146 ILS TBS/110.70 33L 3500M 326 ILS TBN/109.30 ←33R 3000M 326 <RETURN [1R] [2R] [3R] [4R] [5R] [6R]

PROCEDURES
NORMAL PROCEDURES

SYSTEMS RELATED PROCEDURES - FMS

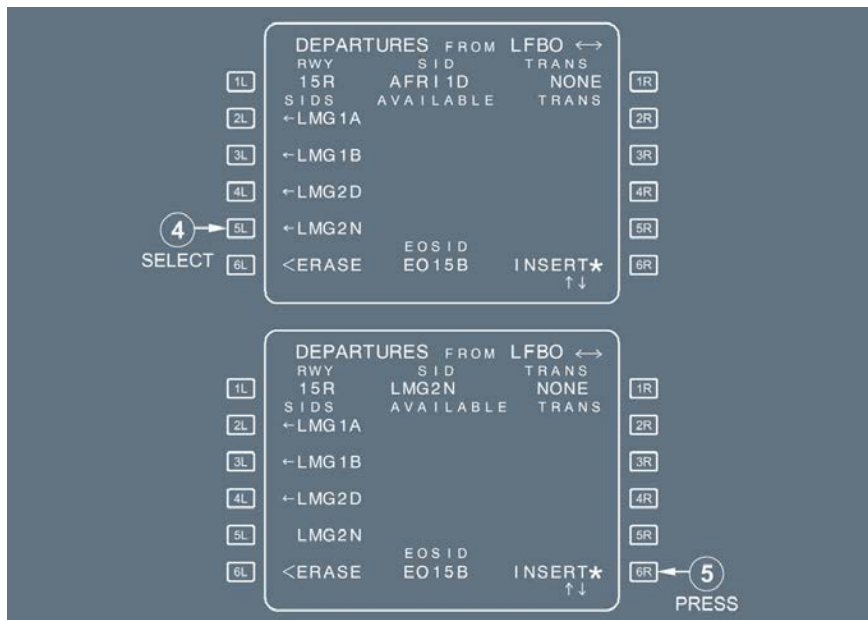

You may use the "NEXT PAGE" , or the "←" or "→" keys to gain access to the listings of runways, SIDs, and transitions.

Procedure

- PRESS the F-PLN key on MCDU
- SELECT the DEPARTURE prompt [1L] key
- SELECT the RWY in USE, SID and TRANS
- CHECK the resulting temporary F-PLN
- If it is correct, INSERT it using [6R] key.
- If it is not correct, ERASE it using [6L] key.

Ident.: PRO-NOR-SRP-01-10-A-00003964.0004001 / 22 MAY 12

VERTICAL FLIGHT PLAN

ENTERING/MODIFYING A SPEED LIMIT

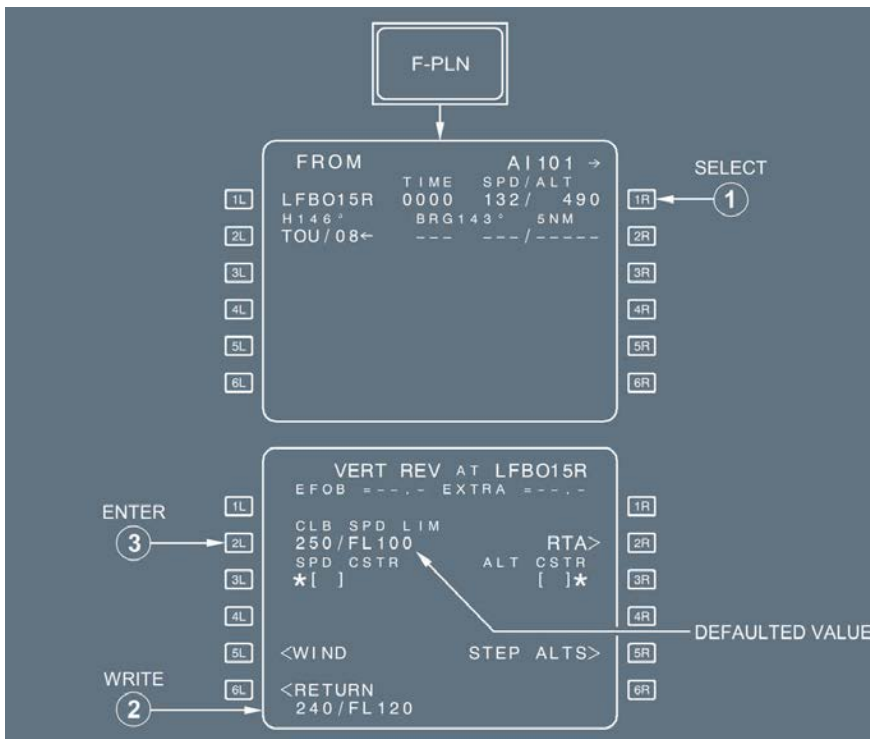

PRESS the F-PLN key on the MCDU.
SELECT VERTICAL REVISION at the FROM waypoint.
WRITE a new speed limit/altitude and ENTER.

The crew can insert one climb speed limit and one descent speed limit into the vertical flight plan, or modify or clear the limits that are already in it.

The speed limit is defined by a speed and an altitude (for example, 230/9 000), which means that the managed speed target will be limited by the speed limit when the aircraft flies below the specified altitude.

In both climb and descent, 250 kt at 10 000 ft is the default speed limit in the vertical flight plan.

The vertical revision page presents the climb speed (CLB SPD) limit if the revised waypoint is between departure and top of descent.

The vertical revision page shows the descent speed (DES SPD) limit, if the revised waypoint is between top of descent and destination.

It can be deleted by a clear action, the field reverts to brackets. It can also be cleared directly on the F-PLN A page by clearing the SPD LIM pseudo-waypoint.

ENTERING A SPEED CONSTRAINT

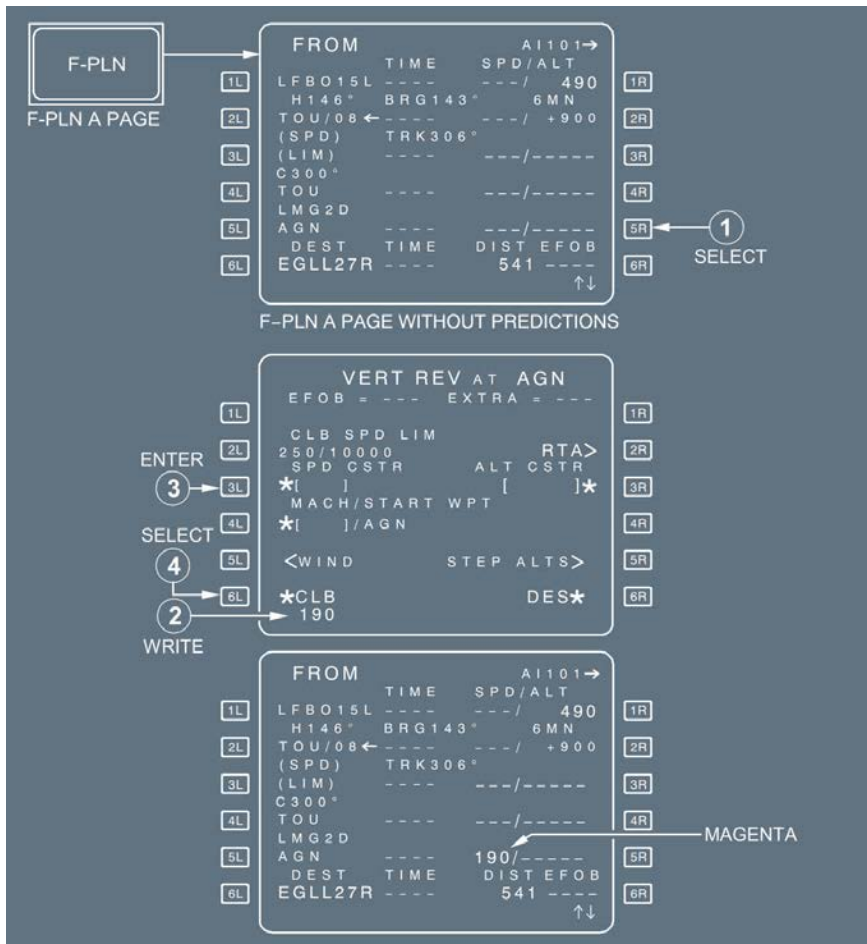

F-PLN A PAGE

| 1L | 2L | 3L | 4L | 5L | 6L | 1R | 2R | 3R | 4R | 5R | 6R |
|---------|---------|----------|--------|----|----|----|----|----|----|----|----|
| FROM | TIME | SPD/ALT | AI101→ | | | | | | | | |
| LFBO15L | ---- | ---/ | 490 | | | | | | | | |
| H146° | BRG143° | 6MN | | | | | | | | | |
| TOU/08← | ---- | ---/ | +900 | | | | | | | | |
| (SPD) | TRK306° | | | | | | | | | | |
| (LIM) | ---- | ---/---- | | | | | | | | | |
| C300° | | | | | | | | | | | |
| TOU | ---- | ---/---- | | | | | | | | | |
| LMG2D | | | | | | | | | | | |
| AGN | ---- | ---/---- | | | | | | | | | |
| DEST | TIME | DIST | EFOB | | | | | | | | |
| EGLL27R | ---- | 541 | ---- | | | | | | | | |

F-PLN A PAGE WITHOUT PREDICTIONS

VERT REV AT AGN

| 1L | 2L | 3L | 4L | 5L | 6L | 1R | 2R | 3R | 4R | 5R | 6R |
|------------|--------|---------|------|----|----|----|----|----|----|----|----|
| EFOB = | --- | EXTRA = | --- | | | | | | | | |
| CLB | SPD | LIM | RTA> | | | | | | | | |
| 250 | /10000 | | | | | | | | | | |
| SPD | CSTR | ALT | CSTR | | | | | | | | |
| *[|] | [|]* | | | | | | | | |
| MACH/START | WPT | | | | | | | | | | |
| *[|]/AGN | | | | | | | | | | |
| <WIND | STEP | ALTS> | | | | | | | | | |
| *CLB | DES* | | | | | | | | | | |
| 190 | | | | | | | | | | | |

F-PLN A PAGE

| 1L | 2L | 3L | 4L | 5L | 6L | 1R | 2R | 3R | 4R | 5R | 6R |
|---------|---------|----------|--------|----|----|----|----|----|----|----|----|
| FROM | TIME | SPD/ALT | AI101→ | | | | | | | | |
| LFBO15L | ---- | ---/ | 490 | | | | | | | | |
| H146° | BRG143° | 6MN | | | | | | | | | |
| TOU/08← | ---- | ---/ | +900 | | | | | | | | |
| (SPD) | TRK306° | | | | | | | | | | |
| (LIM) | ---- | ---/---- | | | | | | | | | |
| C300° | | | | | | | | | | | |
| TOU | ---- | ---/---- | | | | | | | | | |
| LMG2D | | | | | | | | | | | |
| AGN | ---- | 190/---- | | | | | | | | | |
| DEST | TIME | DIST | EFOB | | | | | | | | |
| EGLL27R | ---- | 541 | ---- | | | | | | | | |

Procedure

PRESS the F-PLN key on the MCDU.

SELECT the VERT REV page at the revised waypoint.

WRITE the speed constraint value into the scratchpad and ENTER it in 3L.

INSERT the constraint using the appropriate *CLB or DES * prompt when displayed. If CLB and DES are not displayed, insertion occurs when the value is entered in 3L.

The system displays the climb (CLB) or the descent (DES) prompt at [6L] or [6R] when the predictions are not yet available or when the waypoint is part of the cruise phase as originally defined.

When predictions are not yet available, the constraints are displayed on the F-PLN A page in magenta.

When predictions are available, the speed constraint is highlighted by a star ().*

** If the predicted speed matches the constraint, the star is magenta.*

** If the prediction is that the aircraft will miss the speed constraint, the star is amber.*

If a speed constraint cannot be met (by more than 10 kt), the FMGS generates the message "SPD ERROR AT WPT XX".

A speed constraint may be assigned to any waypoint in the climb or the descent phase except the FROM, origin, or destination waypoints, and any pseudo waypoint.

When a speed constraint is assigned to a waypoint, the constraint will limit the managed speed target as follows:

- In takeoff or climb phase until you pass the constrained waypoint.
- In descent an approach phase, after passing the constrained waypoint.

Speed constraints are observed by the FMGS when NAV mode and speed managed are active.

ENTERING A SPEED CONSTRAINT THROUGH F-PLN A PAGE

You may also enter a speed constraint through the F-PLN A page.

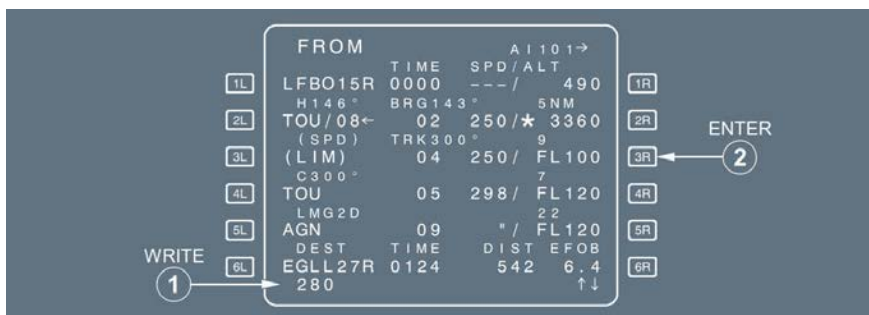

Note: You may delete the constraint using the clear key on the relevant right hand key.
 However if there is an altitude constraint assigned at that point, the clear action deletes it too.

ENTERING AN ALTITUDE CONSTRAINT

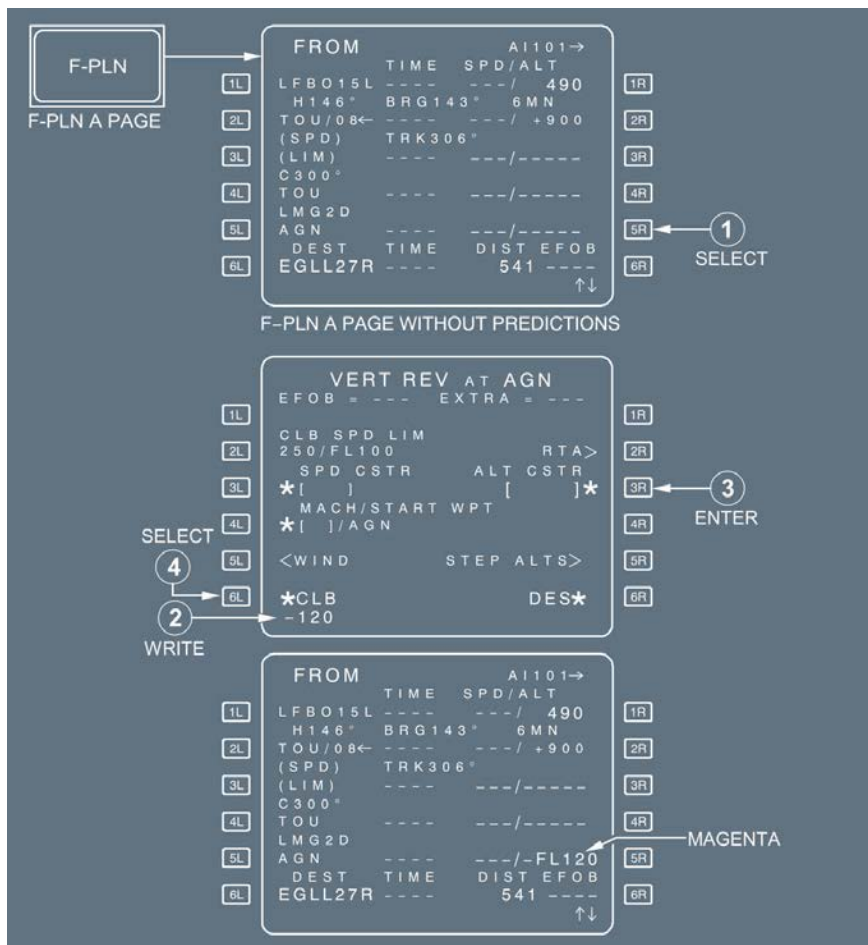

Procedure

PRESS the F-PLN key on the MCDU.

SELECT the “VERT REV” page at the revised waypoint.

WRITE an altitude constraint in the scratchpad and ENTER it in 3R.

INSERT the constraint using *CLB or DES* prompt when it is displayed. Otherwise the value is inserted when it is entered in 3R field.

*The system displays the *CLB or DES* prompt, when the predictions are not yet available, or when the waypoint is part of the cruise phase as originally defined.*

Note: *In case of QFE operations, the altitude constraints must be converted and entered as an altitude in feet.*

You or the database may assign an altitude constraint to any waypoint in the climb or descent phases except the FROM, origin, or destination waypoints, or any pseudo waypoint.

An altitude constraint may be defined as an “at”, an “at or above”, or an “at or below” constraint. In certain procedures, the database may define an altitude constraint as a window in which the aircraft should fly.

Enter “AT” constraints with no sign.

Enter “AT or ABOVE” constraints preceded by a + sign (+FL 130, for example).

Enter “AT or BELOW” constraints preceded by a – sign (-15 000, for example).

enter four or five-digit number when entering altitude. Include the lead zero (0 500 ft , for example).

For flight level, enter a two- or three-digit number, with or without the letters “FL”. The lead zero is optional. (Examples : +FL 120 or +120 ; -FL 090 or -90 or -090)

Enter the altitude value as either altitude or flight level ; the MCDU displays the selected value as an “ALT ” or “FL,” as appropriate for the transition altitude.

The constraint must be higher than the thrust reduction altitude and lower than the cruise flight level.

Once inserted in the flight plan, the altitude constraint (ALT CSTR) is displayed in magenta as long as predictions are not available.

When predictions are available, the altitude constraints are replaced by the predicted altitude at relevant waypoints highlighted by a star.

** If the predicted altitude matches the constraint the star is magenta. If the predicted altitude is missed (by more than 250 ft), the star is amber.*

PROCEDURES
NORMAL PROCEDURES

SYSTEMS RELATED PROCEDURES - FMS

MAGENTA

| | FROM | TIME | SPD / ALT | A 110 | → |
|----|---------|---------|-----------|-------|----|
| 1L | LFBO15L | ---- | ---/ | 490 | |
| | H146° | BRG143° | 5NM | | |
| 2L | TOU/08← | ---- | ---/ | +900 | |
| | (SPD) | TRK306° | | | |
| 3L | (LIM) | ---- | ---/ | ---- | |
| | C300° | | | | |
| 4L | TOU | ---- | ---/ | ---- | |
| | LMG2D | | | | |
| 5L | AGN | --- | ---/ | FL120 | |
| | DEST | TIME | DIST | EFOB | |
| 6L | EGLL27R | ---- | 541 | ---- | ↑↓ |

F-PLN A PAGE WITHOUT PREDICTIONS

| | FROM | TIME | SPD / ALT | A 110 | → |
|----|---------|---------|-----------|-------|----|
| 1L | LFBO15R | 0000 | ---/ | 490 | |
| | H146° | BRG143° | 5NM | | |
| 2L | TOU/08← | 02 | 250/★3360 | | |
| | (SPD) | TRK300° | 9 | | |
| 3L | (LIM) | 04 | 250/FL100 | | |
| | C300° | | 7 | | |
| 4L | TOU | 05 | 298/FL120 | | |
| | LMG2D | | 22 | | |
| 5L | AGN | 09 | */★FL120 | | |
| | DEST | TIME | DIST | EFOB | |
| 6L | EGLL27R | 0124 | 542 | 6.4 | ↑↓ |

F-PLN A PAGE WITH PREDICTIONS AND STARS

The vertical revision page displays “ALT ERROR”, along with the difference between the constraint and the predicted altitude at the revised waypoint.

| VERT REV AT LACOU | |
|-------------------|-------------|
| EFOB=14.5 | EXTRA=0.8 |
| 1L | CLB SPD LIM |
| 2L | 210/ 7000 |
| | SPD CSTR |
| 3L | ★[] |
| | ALT CSTR |
| 4L | ALI ERROR |
| | -500 |
| 5L | <WIND |
| | STEP ALTS> |
| 6L | <RETURN |

ND Display

An altitude-constrained waypoint is marked by a circle (⊙) on the navigation display.

This circle is white when the guidance does not take the altitude constraint into account. It is magenta if the guidance system takes the altitude constraint into account and predicts that it will be matched.

It is amber if the guidance system takes the altitude constraint into account and predicts that it will not be matched.

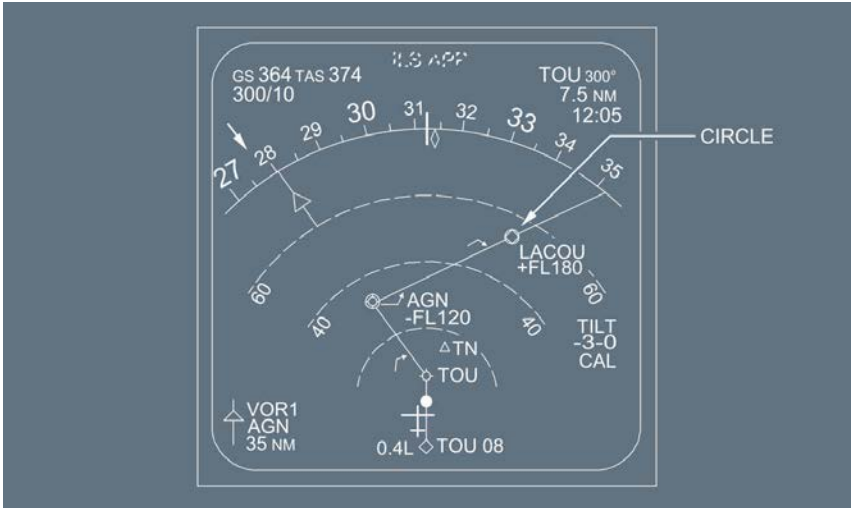

The aircraft should be at or below FL 120 at AGN and above FL 180 at LACOU.

Entering an Altitude Constraint Through F-PLN A Page

The pilot may also enter an altitude constraint directly through the F-PLN A page. When entering the value into the scratchpad do not forget the slash e.g. /-120 or /-FL 120. If the slash is omitted the value will be considered as a speed constraint if it is within the range value.

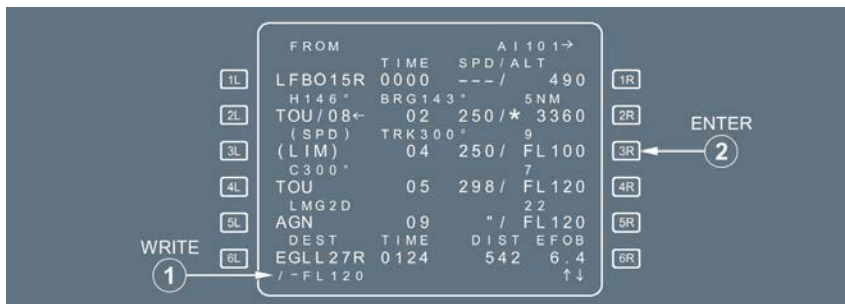

Use CLR to delete them directly from the flight plan page, as well. However, if there is also a speed constraint assigned at that waypoint, the clear action deletes it too.

ENTERING AN ESTIMATED TIME OF TAKEOFF (ETT)

In Preflight Phase:

SELECT the SEC F-PLN key on the MCDU.

SELECT a VERT REV at any waypoint.

SELECT the Required Time of Arrival (RTA) prompt (2R).

The MCDU displays the RTA page.

ENTER the Estimated Takeoff Time in the [6R] field.

The format is HHMMSS (entry of seconds is not mandatory).

ENTER it in the 6R field

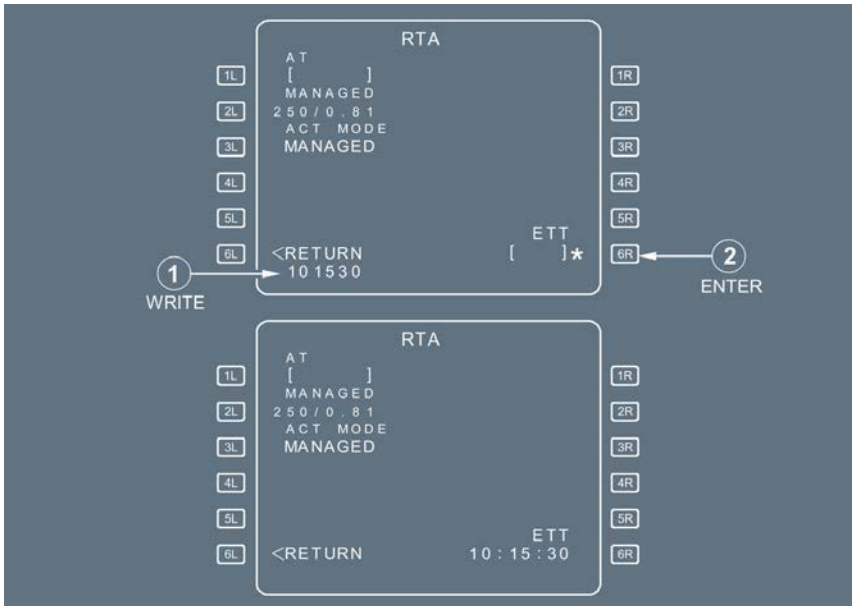

If the aircraft has not taken off by the time entered as estimated takeoff time, the MCDU displays the “CLK IS TAKE OFF TIME” message, meaning that the system will replace your estimated takeoff time with the actual time.

When beginning the takeoff roll, the system automatically adopts that clock time as the takeoff time.

If the origin airport is changed, or the clock time is invalid, the system automatically deletes the estimated takeoff time.

Ident.: PRO-NOR-SRP-01-10-A-00003965.0001001 / 15 FEB 11

FLIGHT PLAN CHECK

CHECK the EOSID on the ND plan mode (yellow line).

Note: If the details of the EOSID require review, select the EOSID as a TMPY F-PLN and review it as TMPY. Then ERASE it.

Ident.: PRO-NOR-SRP-01-10-A-00003966.0001001 / 09 DEC 09

SECONDARY F-PLN

For details : Refer to DSC-22_20-60-50 Secondary Flight Plan.

Ident.: PRO-NOR-SRP-01-10-A-00003967.0001001 / 15 FEB 11

RADIO NAV

Whenever a NAVAID IDENT is correctly decoded, in agreement with that published, no audio check is necessary.

Morse decoding is displayed on the ND for VOR/DME, VOR/TAC, DME , ADF , and on the PFD for ILS.

Preferably use the identifier for NAVAID entry.

If the ADF IDENT is not in the database, be sure to include a decimal point when tuning the frequency (e.g 315. or 325.7).



Note: Whenever, the runway ILS is intended to be retained for guidance after the takeoff phase, it is recommended to manually tune the ILS by its identifier.

FMGS DATA INSERTION

Applicable to: ALL

Ident.: PRO-NOR-SRP-01-10-B-00003968.0024001 / 05 OCT 16

WEIGHT/CG INSERTION AND FUEL PLANNING

The flight crew must enter the Zero Fuel Weight (ZFW) and Zero Fuel Weight Center of Gravity (ZFWCG) values on the INIT B page, to allow the FMS to perform the fuel planning computations.

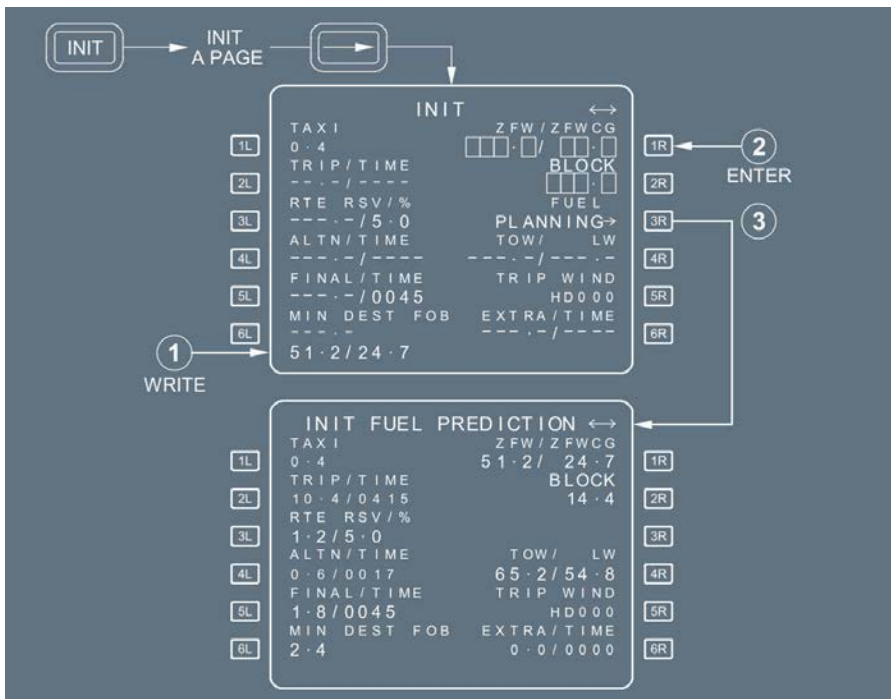

PROCEDURE

PRESS the INIT key, and the Next (“→”) key to access the INIT B page.

ENTER the ZFW and ZFWCG value in the [1R] field.

The “FUEL PLANNING →” prompt appears in the [3R] field.

Note: As long as the final Load and Trim Sheet is not available, the crew should insert the estimated ZFW /ZFWCG in order to get fuel estimates. The ZFW and ZFWCG values must be updated with the final Load and Trim Sheet values.

CHECK/MODIFY the TAXI [1L], RTE RSV [3L] and FINAL TIME [5L] values.

The TAXI, RTE RSV and FINAL TIME fields display the default values specified in the AMI file (for example, “0.4” for TAXI, “5.0 %” for RTE RSV and “0045” for FINAL TIME). The flight crew may modify these values.

Note: At takeoff, the RTE RSV field will automatically be reset to 0. The RTE RSV fuel is then added to the EXTRA fuel, which ensures that the EXTRA fuel and MIN DEST FOB values are consistent in flight.

ENTER an ALTN fuel value in the [4L] field, as necessary.

The flight crew may enter the ALTN fuel value planned on the Computerized Flight Plan (CFP), as necessary.

ENTER a MIN DEST FOB value in the [6L] field, as necessary.

Note: MIN DEST FOB (equal to ALTN + FINAL) can be increased at flight crew discretion (e.g. when HOLD is expected at destination).

ENTER the TRIP WIND value in the [5R] field, as necessary.

In no wind profile has been entered in the F-PLN, the crew may enter an average TRIP WIND in this field, to obtain more realistic fuel/time predictions before departure.

Note:

1. The flight crew should only enter a TRIP WIND to obtain realistic fuel/time predictions, on ground. Then, the flight crew should enter a wind profile using the WIND pages, for fuel/time predictions in flight. As soon as flight crew has entered a wind profile on the WIND pages, the TRIP WIND will be erased.
2. If the crew has already defined a wind profile, even partially (such as climb wind), it is not possible to enter a TRIP WIND.

ENTER the planned BLOCK fuel, as indicated in the computerized flight plan (CFP)

If the planned BLOCK fuel is not available, the crew may obtain a prediction of the minimum BLOCK fuel required for the flight by pressing the FUEL PLANNING prompt [3R].

Pressing this prompt makes the FMS compute the minimum required BLOCK fuel, which is the BLOCK fuel required to have EXTRA fuel = 0, based on the parameters entered on the INIT and F-PLN pages.

The computed BLOCK fuel value is displayed in the [2R] field, and a BLOCK CONFIRM prompt appears in the [3R] field.

Note: In order to obtain a realistic fuel computation, the flight crew should ensure that the F-PLN initialization has been completed (including insertion of the ALTN F-PLN and/or ALTN fuel and/or MIN DEST FOB if necessary), and that flight parameters, such as CRZ FL, steps climbs (if any), and winds, have been inserted.

- When the final Load and Trim Sheet (LTS) data are available:

INIT FUEL PLANNING ↔

| | | | |
|----|--------------|--------------|----|
| 1L | TAXI | ZFW / ZFWCG | 1R |
| | 0.4 | 51.2 / 24.7 | |
| 2L | TRIP / TIME | BLOCK | 2R |
| | 10.4 / 0415 | 14.4 | |
| 3L | RTE RSV / % | CONFIRM* | 3R |
| | 1.2 / 5.0 | | |
| 4L | ALTN / TIME | TOW / LW | 4R |
| | 0.6 / 0017 | 65.2 / 54.8 | |
| 5L | FINAL / TIME | TRIP WIND | 5R |
| | 1.8 / 0045 | HD000 | |
| 6L | MIN DEST FOB | EXTRA / TIME | 6R |
| | 2.4 | 0.0 / 0000 | |
| | 1.6 | | |

1 WRITE →

2 ENTER ←

INIT FUEL PREDICTION ↔

| | | | |
|----|--------------|--------------|----|
| 1L | TAXI | ZFW / ZFWCG | 1R |
| | 0.4 | 51.2 / 24.7 | |
| 2L | TRIP / TIME | BLOCK | 2R |
| | 10.4 / 0415 | 16.0 | |
| 3L | RTE RSV / % | | 3R |
| | 1.2 / 5.0 | | |
| 4L | ALTN / TIME | TOW / LW | 4R |
| | 0.6 / 0017 | 66.8 / 56.4 | |
| 5L | FINAL / TIME | TRIP WIND | 5R |
| | 1.8 / 0045 | HD000 | |
| 6L | MIN DEST FOB | EXTRA / TIME | 6R |
| | 2.4 | 1.6 / 0020 | |

ENTER the final ZFW/ZFWCG [1R], and the required BLOCK fuel [2R].

The FMS computes the predictions, based on the entered BLOCK fuel, and estimates the EXTRA fuel value.

CHECK the resulting computed data, against the data planned on the CFP: TRIP fuel, RTE RSV fuel, ALTN fuel, FINAL and EXTRA fuel values.

If necessary, the flight crew may modify the ALTN or FINAL fuel values.

PRINT the PREFLIGHT REPORT, if necessary.

When the final Load and Trim Sheet values (ZFW /ZFWCG /BLOCK) have been entered, the crew may print the pre-flight report, which provides a copy of the F-PLN with the associated FMS predictions.

Ident.: PRO-NOR-SRP-01-10-B-00003969.0010001 / 15 FEB 11

TAKEOFF WITH NO WEIGHT/CG DATA

If the crew does not enter ZFW /ZFWCG data prior takeoff, or if the FMGC loses these values due to a power interruption, the following will occur:

- At takeoff, the Speed Reference System (SRS) mode is available (provided a V2 has been inserted)
- When the aircraft leaves the SRS mode, the target speed becomes the current speed and reverts to selected.

Note: If the AP /FD has reverted to ALT or V/S (FPA) mode, the associated A/THR mode is SPEED. In this case, the system will probably reduce thrust, because the speed will be equal to, or greater than, the target speed.

● **When appropriate, to regain FMS predictions and associated managed modes:**

INSERT the ZFW/ZFWCG values on the FUEL PRED page.

Ident.: PRO-NOR-SRP-01-10-B-00003970.0007001 / 15 FEB 11

INSERTING WEIGHT/CG DATA AFTER ENGINE START

The flight crew must enter the ZFW /ZFWCG values on INIT B page prior to engine start. If these data have not been entered at engine start, the MCDU displays the "INITIALIZE WEIGHTS" amber message in the scratchpad. After engine start, the crew should enter the ZFW /ZFWCG values on the FUEL PRED page.

PRESS to the FUEL PRED key.

INSERT the ZFW /ZFWCG values in the [4R] field.

This allows predictions and performance computation.

CHECK the resulting computed data, against the data planned on the CFP: TRIP fuel, RTE RSV fuel, ALTN fuel, FINAL and EXTRA fuel values.

If necessary, the flight crew may modify the ALTN or FINAL fuel values.

PRINT the PREFLIGHT REPORT, if necessary.

When the final load sheet values (ZFW /ZFWCG /BLOCK) have been entered, the crew may print the pre-flight report, which provides a copy of the F-PLN with the associated FMS predictions.

Ident.: PRO-NOR-SRP-01-10-B-00003971.0001001 / 22 MAR 16

TAKEOFF DATA INSERTION

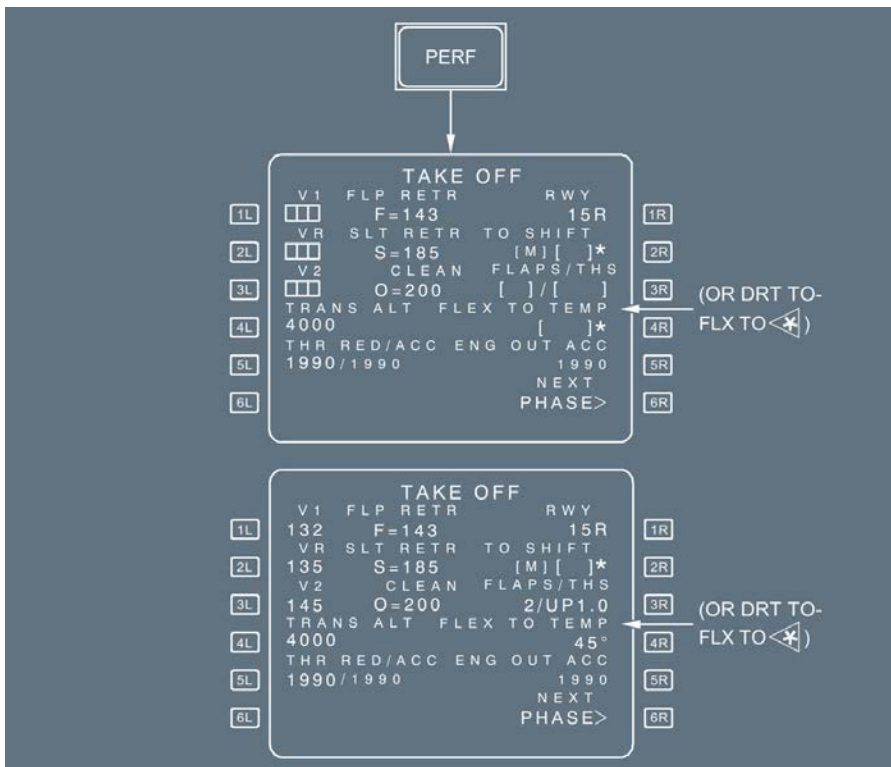

PROCEDURE

- PRESS the PERF key on the MCDU.
- WRITE successively and ENTER : V1 , VR , V2.
- WRITE and ENTER FLX TEMP or DRT TO \triangleleft .
- CHECK/MODIFY the THR RED ALT (Thrust reduction altitude) See *.
- CHECK/MODIFY the ACC ALT (acceleration altitude) See *.
- CHECK/MODIFY the ENG OUT ACC (engine out acceleration altitude) See *.
- CHECK/MODIFY the TRANS ALT (transition altitude) See *.
- WRITE and ENTER T.O. SHIFT.

CHECK V1 , V2 on PFD See **

- * *Altitudes less than 400 ft above airfield elevation cannot be selected.*
- ** *If the PFD does not display V2 at the top of its speed scale, check that at least one FD is ON.*

ENTERING A FLEX TEMPERATURE

WRITE the desired flex temperature in the scratchpad and ENTER using the [4R] key.

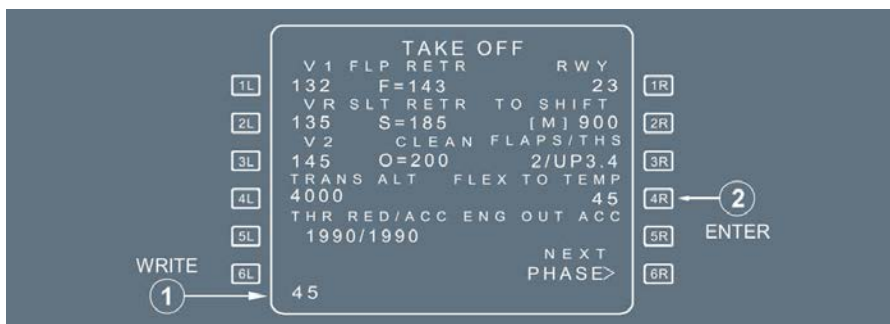

Ident.: PRO-NOR-SRP-01-10-B-00003972.0003001 / 22 MAY 12

CLIMB SPEED PRESELECTION

If the managed speeds for the initial climb are not suitable, the pilot can preselect an appropriate climb speed on the “PERF CLB” page, as long as the climb phase is not active.

The CLB SPD preselection applies, when the:

- ATC specifies an initial climb speed.
- Initial climb speed must be lower than normal because:
 - There are to be turns greater than 120 ° in the initial climb out.
 - Obstacle clearance, or some other situation, requires a high climb angle.
 - The airfield has a risk area to be quickly cleared (birds reported, for example).

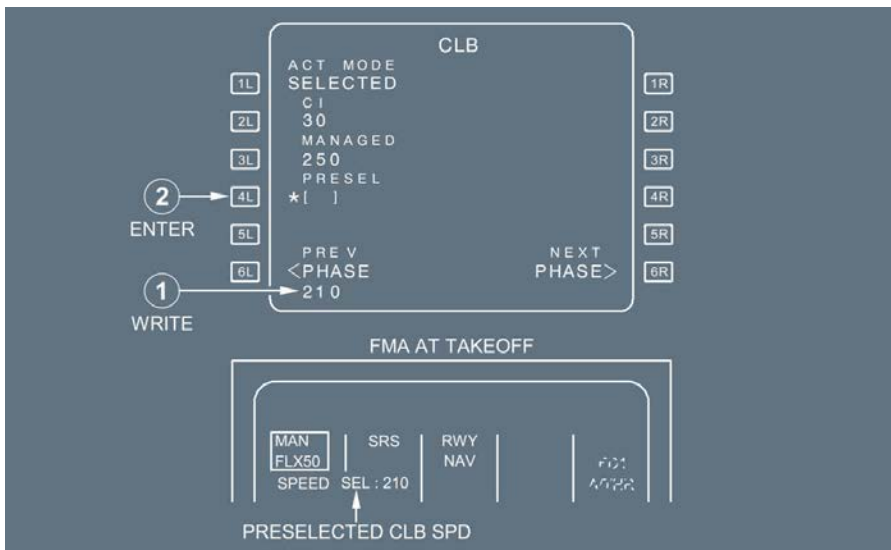

PROCEDURE

PRESS the PERF key on the MCDU.

The PERF TAKE OFF page is displayed.

SELECT the “NEXT PHASE” [6R] key to display the CLB page.

WRITE a climb speed and ENTER it.

To revert to managed speed, select MANAGED by pressing [3L].

When the aircraft is transitioning into the climb phase, the preselected value becomes the target speed:

- The selected speed target is active.
- The primary flight display shows the target speed in blue.
- The FCU’s speed window displays the new speed or Mach number.

Ident.: PRO-NOR-SRP-01-10-B-00003973.0003001 / 09 OCT 12

CRUISE MACH (SPEED) PRESELECTION

The pilot preselects a cruise Mach, when a Mach number other than the ECON cruise Mach number is required.

When the aircraft transitions to the cruise phase, the speed target symbol goes to the preselected value and “SELECTED” becomes the active speed mode (blue target on PFD , target MACH shown in the speed/Mach window of the FCU).

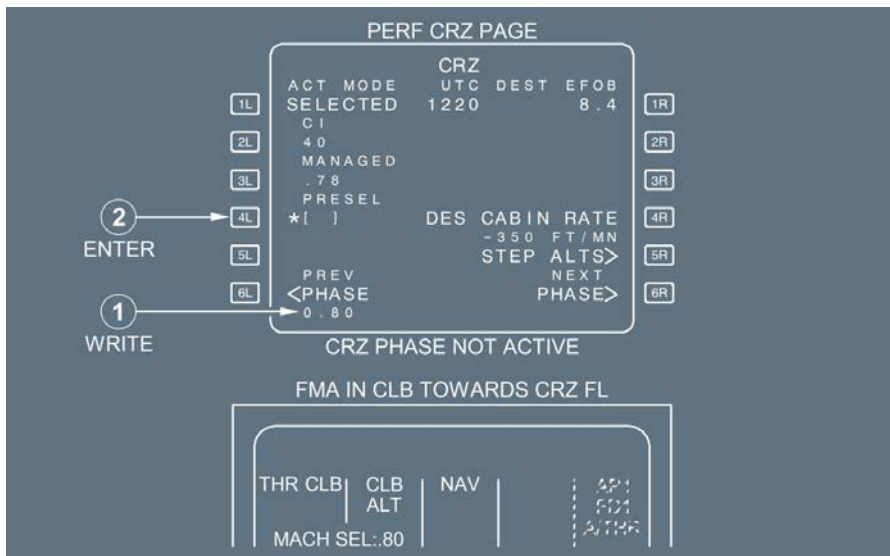

PROCEDURE

PRESS the PERF key on the MCDU.
 PRESS the “NEXT PHASE” [6R] key on the MCDU , until the CRZ page is accessed.
 WRITE a cruise Mach (or speed) in the scratchpad and ENTER it in [4L].
 To revert to managed speed, PRESS [3L].
When the cruise phase is active, you cannot preselect a cruise Mach or speed.

Ident.: PRO-NOR-SRP-01-10-B-00004095.0001001 / 09 OCT 12

ENTERING A HEADING/TRACK PRESET FUNCTION

The heading/track preset allows the pilot to preset a takeoff or go-around heading or track before commanding the aircraft to take up that heading or track (manual activation).
 The flight crew can enter a heading or a track preset while the aircraft is on the ground and until takeoff.

PROCEDURE

- **Before takeoff:**
 SET the appropriate HDG or TRK in the FCU window.
This disarms the navigation mode and allows the runway mode to remain engaged after takeoff.

● **After takeoff:**

PULL HDG/TRK knob.

The heading or track mode engages on the preset value.

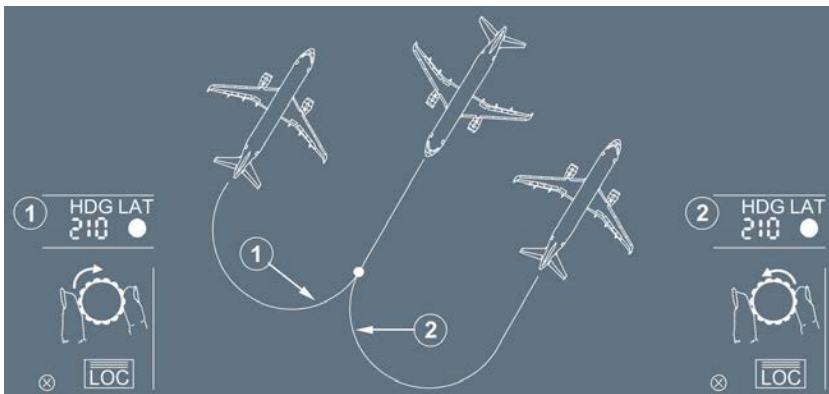

The direction in which the pilot rotates the HDG/TRK selection knob usually determines the direction of the turn. A left rotation (decreasing heading) produces a left turn; a right rotation produces a right turn.

However, when a heading has been preset before takeoff or go-around, the direction of the turn will be such as to cause the shortest turn at the moment of engagement.

CANCELLING THE HEADING/TRACK PRESET FUNCTION

The pilot can cancel the heading preset by pushing the HDG/TRK knob back in again. This engages or arms the NAV mode.

FMGS RE-INITIALIZATION AFTER A CANCELED FLIGHT

Ident.: PRO-NOR-SRP-01-10-00013064.0001001 / 16 NOV 11

Applicable to: ALL

If the flight crew initially prepared a flight with all the data associated with this flight (takeoff speeds, winds, etc.), and if this flight is later canceled and replaced by another flight, the flight crew may use the following procedure to initialize the FMGS again:

PREPARE the new flight data in the secondary flight plan, using SEC INIT A, SEC INIT B, and SEC PERF pages

ACTIVATE the secondary flight plan.

Note: When the flight crew activates the secondary flight plan, the following data of the primary flight plan is lost if the secondary flight plan does not include any replacement data:

- Alternate data
- Winds and cruise TEMP at waypoints as inserted on CRZ WIND pages
- Departure and arrival selection (STAR , APP, RWY) and approach parameters (QNH , TEMP , WIND, TRANS ALT , VAPP , MDA /MDH , DH , LDG CONF)
- Altitude, speed, and time constraints
- Steps
- CMS
- Offsets
- Flaps/THS
- Preselected cruise and descent speeds.

Before Pushback or Start

CHANGE OF RUNWAY

Ident.: PRO-NOR-SRP-01-15-00003975.0003001 / 22 MAY 12

Applicable to: ALL

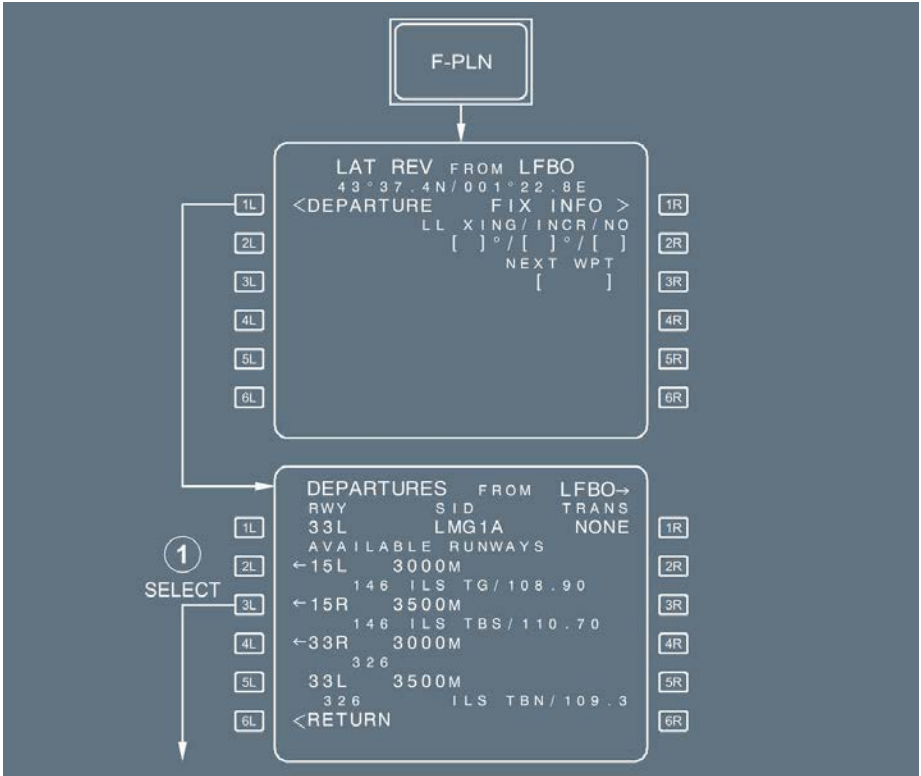

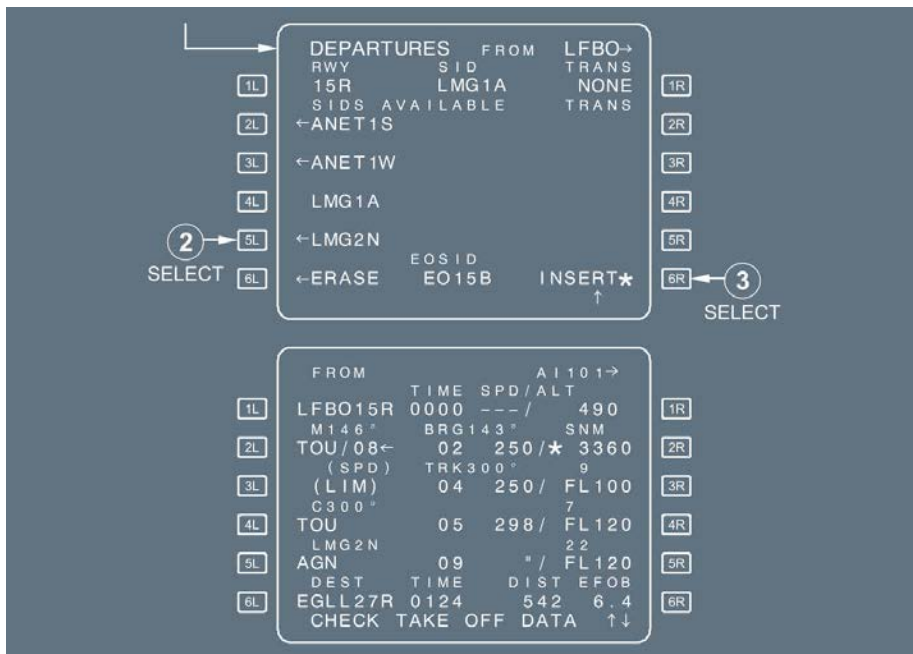

PRESS the F-PLN key on the MCDU.
 SELECT the LAT REV at origin.
 SELECT the DEPARTURE prompt [1L].
 SELECT the new RWY in use.
 SELECT the appropriate SID and TRANS.
 CHECK the resulting temporary F-PLN and INSERT it.

CHECK TAKE OFF DATA comes up in the scratchpad if the PERF TO page had been filled in.

ENTER the new V1 , VR , V2 , FLEX TEMP or CONF, as appropriate.

Note: *If the previously selected SID is compatible with the new runway, it automatically appears in the temporary flight plan. Any revision the pilot may have made to the previous SID will not be transferred.*

If the pilot still wants it, he has to reenter it.

TAKEOFF FROM INTERSECTION

Ident.: PRO-NOR-SRP-01-15-00003976.0001001 / 09 DEC 09

Applicable to: ALL

Use RTOW or FCOM to revise takeoff parameters :
PRESS the [PERF] key on MCDU
ENTER the takeoff shift
ENTER the new V1 , VR , V2 , FLX TEMP, or CONF, as appropriate

Note: The insertion of the shift in takeoff position permits the system to make an accurate revision to its navigation data at takeoff.

PROCEDURES

NORMAL PROCEDURES

SYSTEMS RELATED PROCEDURES - FMS

Intentionally left blank

Taxi

FCU SELECTION FOR TAKEOFF

Ident.: PRO-NOR-SRP-01-20-00003978.0004001 / 09 OCT 12

Applicable to: ALL



PROCEDURE

- ENSURE that HDG – V/S modes are selected (change over pb).
- CONFIRM or SELECT the first cleared altitude
- CROSS CHECK on PFD the target altitude
- CONFIRM both FDs ON

FMA MODE CHECK

Ident.: PRO-NOR-SRP-01-20-00003979.0002001 / 22 MAY 12

Applicable to: ALL

- CHECK that the FMA CLB (or ALT) mode is armed

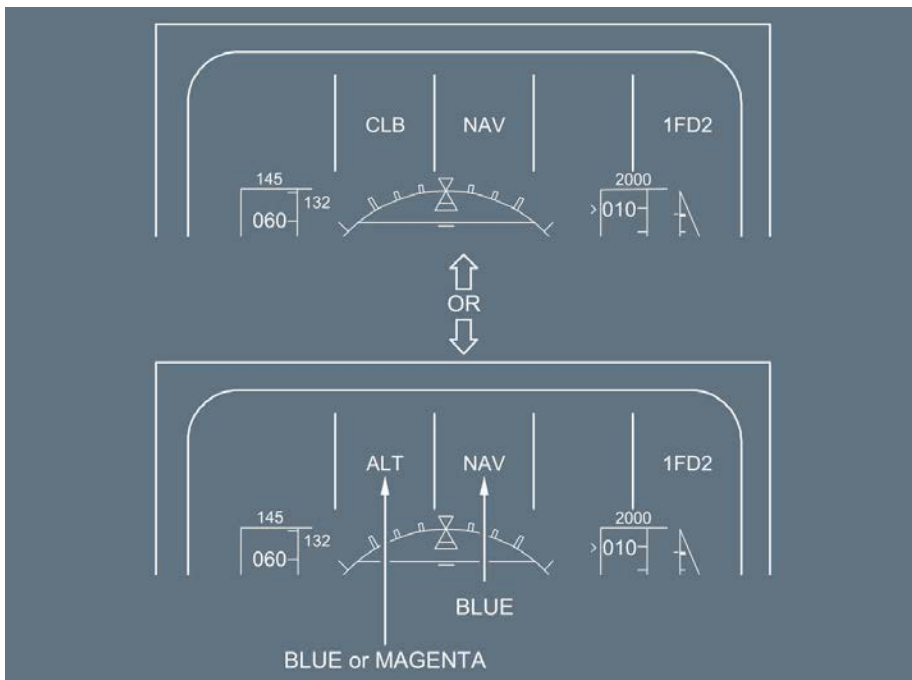

Note: ALT (in blue or magenta) may be displayed instead of CLB if the FCU altitude or a constraint is set at or below the acceleration altitude.

If a HDG /TRK was preset, NAV is disarmed.



SELECTING A NAVIGATION DISPLAY

Ident.: PRO-NOR-SRP-01-20-00003980.0001001 / 22 MAY 12

Applicable to: ALL

SET the minimum range to display the first waypoint after departure or as required for weather radar.

ARC mode
 FOR DEPARTURE
 IN GENERAL
 DIRECTION
 OF RUNWAY
 HEADING



Rose NAV mode
 FOR DEPARTURE
 IN DIRECTION
 OPPOSITE TO
 THAT OF RUNWAY
 HEADING



PROCEDURES
NORMAL PROCEDURES

SYSTEMS RELATED PROCEDURES - FMS

SELECTING TAKEOFF DISPLAYS FOR PILOT'S AND COPILOT'S MCDU

Ident.: PRO-NOR-SRP-01-20-00003981.0001001 / 23 DEC 14

Applicable to: ALL

TAKE OFF

| | | | |
|----|------------------------|----------|-----------|
| | V1 | FLP RETR | RWY |
| 1L | 132 | F=143 | 15R |
| 2L | VR | SLT RETR | TO SHIFT |
| | 134 | S=185 | [M][]* |
| 3L | V2 | CLEAN | FLAPS/THS |
| | 145 | O=200 | 2/UP1.0 |
| 4L | TRANS ALT FLEX TO TEMP | | |
| | 4000 | | 45° |
| 5L | THR RED/ACC | ENG OUT | ACC |
| | 1990/1990 | | 1990 |
| 6L | | NEXT | |
| | | PHASE> | |

PF SELECTS PERF T.O. PAGE

FROM A1101→

| | | | |
|----|---------|---------|--------------|
| | TIME | SPD/ALT | |
| 1L | LFBO15R | 0000 | 132 / 490 |
| 2L | H146° | BRG143° | 5NM |
| | TOU/08← | 02 | 250 / * 3360 |
| 3L | (SPD) | TRK300° | 9 |
| | (LIM) | 04 | 250 / FL100 |
| 4L | C300° | | 7 |
| | TOU | 05 | 298 / FL120 |
| 5L | LMG2D | | 22 |
| | AGN | 09 | " / * FL120 |
| 6L | DEST | TIME | DIST EFOB |
| | EGLL27R | 0124 | 542 6.4 |

↑↓

PM SELECTS F-PLN A PAGE

Takeoff

MONITORING THE TAKEOFF

Ident.: PRO-NOR-SRP-01-30-00003983.0007001 / 09 OCT 12

Applicable to: ALL

● **At power set (thrust levers in FLX or TOGA position)**

CHECK that the navigation is updated to the runway threshold by verifying that the aircraft symbol is centered on the runway threshold of the navigation display.

CHECK the FMA for appropriate mode selection

Note: - RWY mode appears if an ILS is tuned to a station corresponding to the departure runway. Otherwise no lateral mode comes up until the aircraft has lifted off.

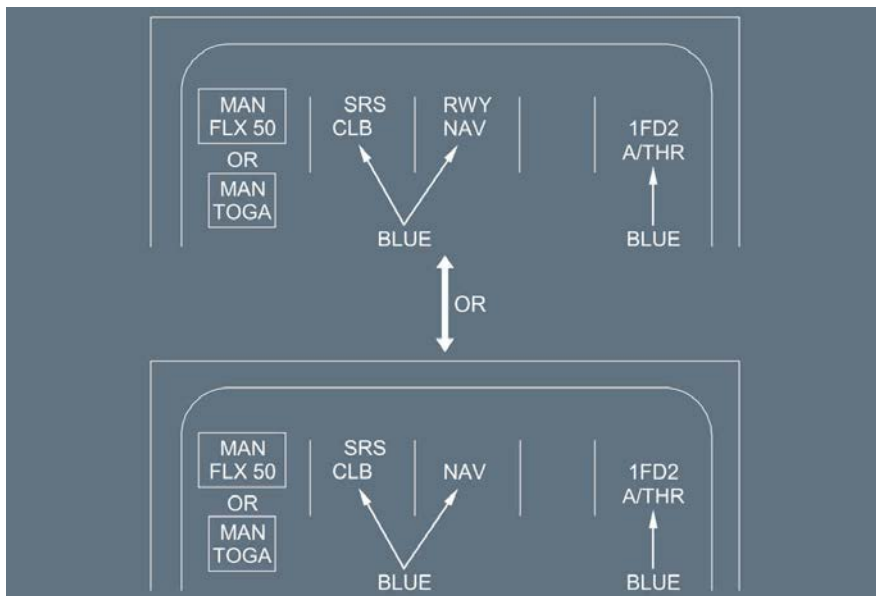

● **At 30 ft**

- **If NAV is armed**, it engages automatically.
- **If NAV is not armed**, RWY TRK mode engages and remains displayed until the crew selects another lateral mode.

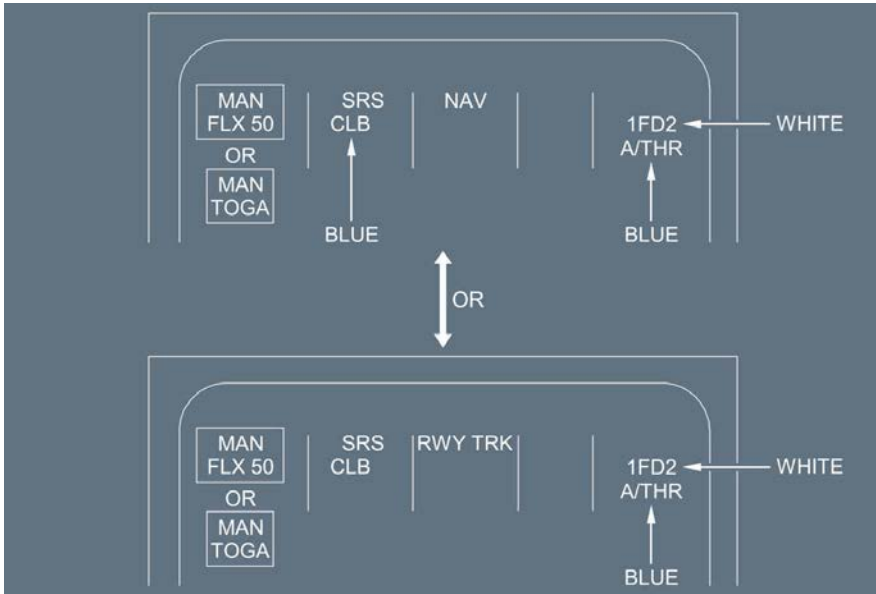

● **At 100 ft**

Engage AP1 or AP2.

The FMGS has an internal delay that prevents the AP from engaging 5 s after liftoff and if the aircraft is below 100 ft.

● **At thrust reduction altitude**

“LVR CLB” flashes in the first column of the FMA

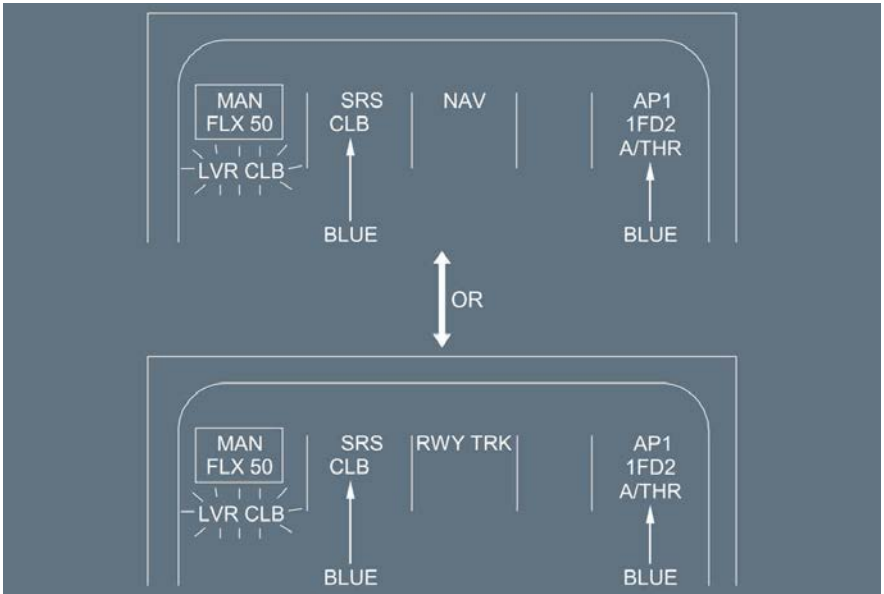

Procedure

SET the thrust levers to the CL detent

A/THR activates automatically

CHECK that A/THR turns to white in the 5th FMA column.

CHECK that THR CLB appears in green in the first column.

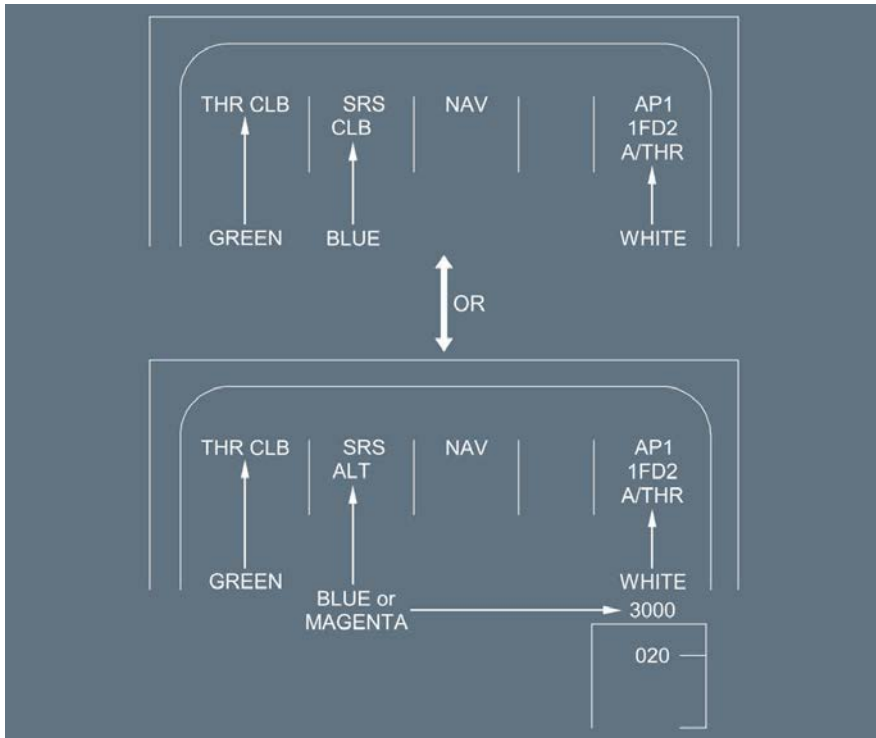

Depending on the next level off altitude, CLB or ALT is armed and displayed in the second column.

ALT is armed:

- in blue if the next predicted level-off is the FCU -selected altitude (target altitude blue at the top of the ALT scale)
- in magenta if the next predicted level-off is an ALT CSTR (target altitude magenta at the top of the ALT scale)

● **At acceleration altitude**

The vertical phase automatically switches to climb.

CLB mode engages. The target speed jumps to initial climb speed on the PFD.

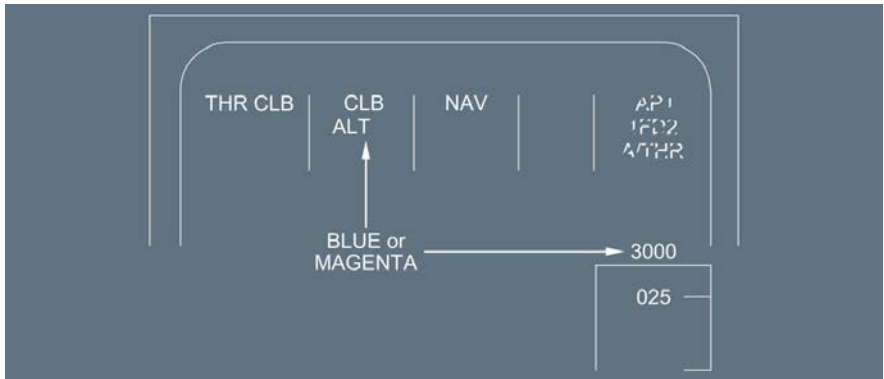

Procedure

CHECK that “CLB” appears in green in the second FMA column.

- The speed reference system (SRS) mode remains engaged until CLB phase is engaged, which occurs at ACCEL ALT or at any other vertical mode engagement, whichever comes first.
- If during takeoff the FCU altitude is set below the current aircraft altitude, the system ignores the FCU altitude and the aircraft remains in SRS mode until the pilot selects an altitude above the aircraft altitude or engages any other mode.

PRESELECTING A HDG OR A TRK

Ident.: PRO-NOR-SRP-01-30-00003984.0001001 / 16 NOV 11

Applicable to: ALL

PROCEDURE

- **If a HDG or a TRK was preselected on the ground :**
 PULL OUT the HDG/TRK selector knob when required
 CHECK that the HDG/TRK mode is active and displayed on the FMA
 When a HDG or TRK is preset, OP CLB mode will engage at the acceleration altitude. (CLB mode is not available in HDG/TRK mode).

NORMAL TAKEOFF PROFILE

Ident.: PRO-NOR-SRP-01-30-00003985.0002001 / 22 MAY 12

Applicable to: ALL

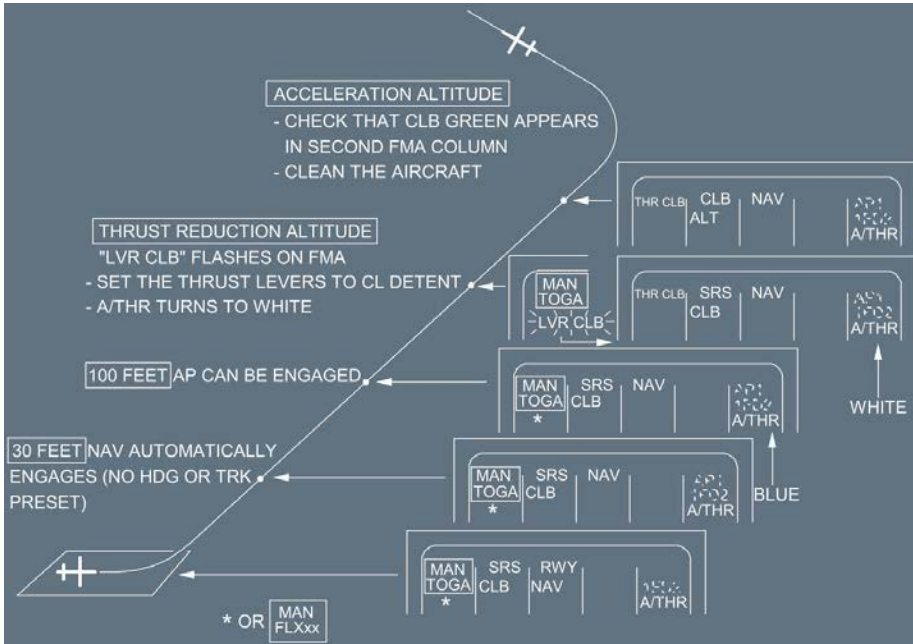

NO FLIGHT DIRECTOR TAKEOFF

Ident.: PRO-NOR-SRP-01-30-00003986.0004001 / 09 OCT 12

Applicable to: ALL

If a takeoff is initiated without FDs, the system responds as follow:

- There are no FD bars.
- There is no A/THR arming.
- There is no guidance available.
- The target speed on the PFD is that selected on the FCU or is defaulted to 100 kt.
- Setting the thrust levers to the CL detent does not activate A/THR.

Note: Do not engage the autothrust prior to selecting a target speed on the FCU.

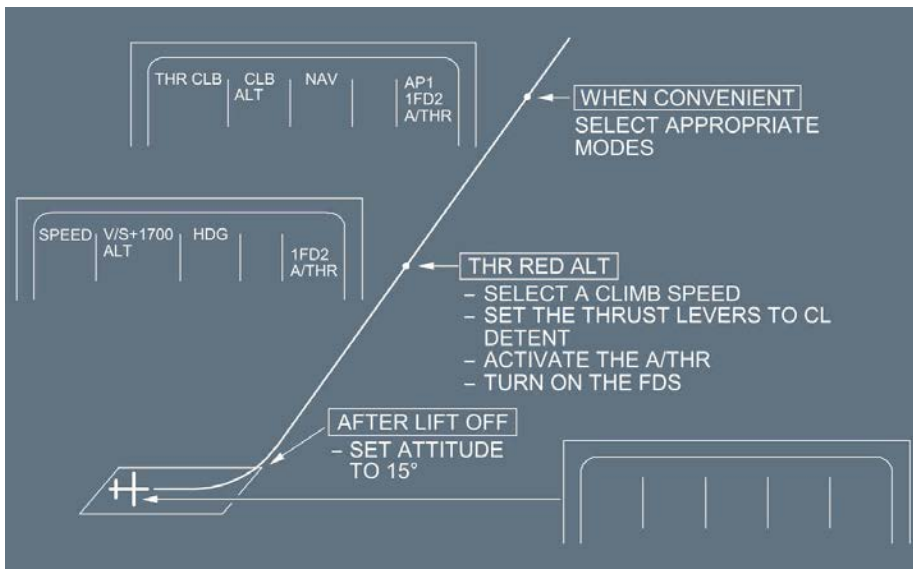

PROCEDURE

Establish initial climb of 15 °

● **When reaching the thrust reduction altitude (THR RED ALT):**

- SELECT a climb speed.
- SET the thrust levers to CL detent.
- ACTIVATE the autothrust.
- TURN ON the FDs (basic modes engage).
- SELECT appropriate mode.
- Failure of both FDs after the start of takeoff:

- The FD bars disappear.
- The FCU window displays the target speed, which synchronizes on V2, or the current speed (if it is higher).
- The autothrust remains armed.
- At thrust reduction altitude, LVR CLB flashes. If the pilot set the thrust levers to the CLB detent, the autothrust becomes active in selected SPD mode (no FDs selected). If the current speed is greater than the target speed, the thrust decreases.
- At acceleration altitude the target speed does not change, since it is selected.

TAKEOFF WITH NO V2 ENTRY

Ident.: PRO-NOR-SRP-01-30-00003987.0001001 / 16 NOV 11

Applicable to: ALL

If V2 is not inserted, the speed reference system (SRS) will not engage for takeoff. 5 s after lift off, V/S mode will engage. When V/S engages the current airspeed becomes the FCU target speed.

To regain a normal speed target, the pilot must :

SELECT the appropriate climb speed on the FCU and PULL out the knob.

● **At ACC ALT :**

PUSH the A/THR pb on the FCU.

SET the thrust levers to CL detent.

PUSH in the SPD selector knob to get a managed speed target.

TAKEOFF USING THE LOCALIZER OF THE OPPOSITE RUNWAY

Ident.: PRO-NOR-SRP-01-30-00003988.0005001 / 09 OCT 12

Applicable to: ALL

● **If the localizer, of the ILS associated with the opposite runway, must be used for takeoff:**

SELECT the RAD NAV PAGE.

ENTER the ILS IDENT.

If the ILS is in the database, the system tunes the proper frequency.

Check that the ILS front course is displayed in the CRS field.

Note: *This may trigger the "RWY /ILS MISMATCH" message. Disregard it.*

● **If the ILS is not in the database:**

SET the appropriate frequency, and SET the ILS front course in the CRS field.

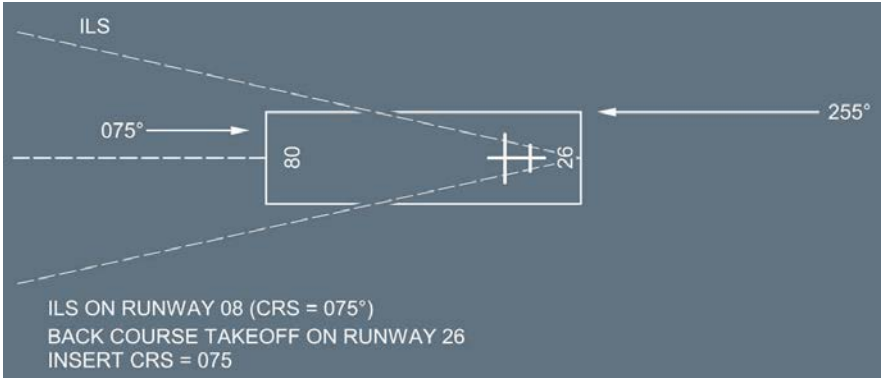

DESELECT the LS pb on the FCU.

Since the PFD displays reverse deviation.

DESELECT the LS pb on ISIS.

Since ISIS displays LOC reverse deviation.

SELECT ROSE-ILS on one ND.



A318/A319/A320/A321
FLIGHT CREW
OPERATING MANUAL

PROCEDURES

NORMAL PROCEDURES

SYSTEMS RELATED PROCEDURES - FMS

Intentionally left blank

Climb

MONITORING THE CLIMB PHASE

Ident.: PRO-NOR-SRP-01-40-00003989.0031001 / 23 DEC 14
Applicable to: ALL

The PF MCDU should display the PERF CLB page allowing him to monitor the climb.
The PM MCDU should display the F-PLN page to allow the pilot to monitor time, speed and altitude predictions. This page also displays matched or missed information for constraints.

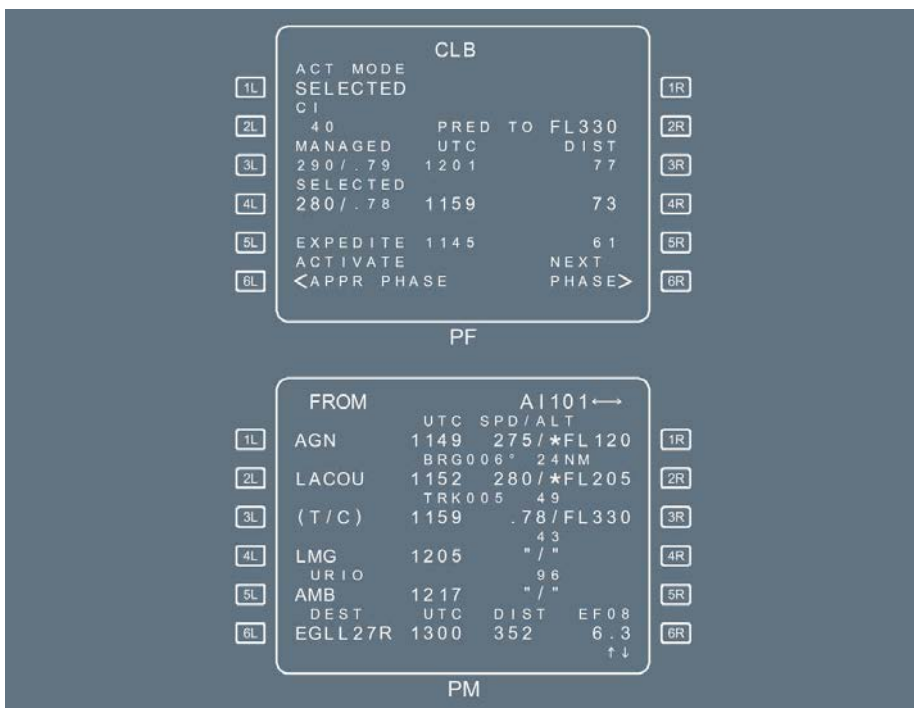

CHECK vertical mode CLB if NAV is engaged.
CHECK vertical mode OP CLB if HDG /TRK is engaged.

MONITORING THE ND (ROSE NAV OR ARC)

Displays the lateral and vertical paths, in the current AP /FD active modes.



THE ↗ BLUE SYMBOL INDICATES WHERE THE FCU ALTITUDE WILL BE REACHED.

THE ↗ MAGENTA SYMBOL INDICATES WHERE THE NEXT F-PLN ALT CSTR WILL BE REACHED.

IF THE FCU ALTITUDE IS SET AT NEXT ALT CSTR, THE ↗ SYMBOL IS BLUE.

○ SYMBOL AROUND WAYPOINT INDICATES AN ALTITUDE CONSTRAINT :

- WHITE : DISREGARDED IN THE CURRENT AP/FD MODES.
- MAGENTA : PREDICTED AS MATCHED IN THE CURRENT MODES.
- AMBER : PREDICTED AS MISSED IN THE CURRENT MODES.

MONITORING THE AP /FD MODES AND FMA

If CLB mode is engaged, the flight mode annunciator (FMA) and the navigation display (ND) show the tactical situation as follows:

CASE 1

The FCU selected altitude is set above the next altitude constraint

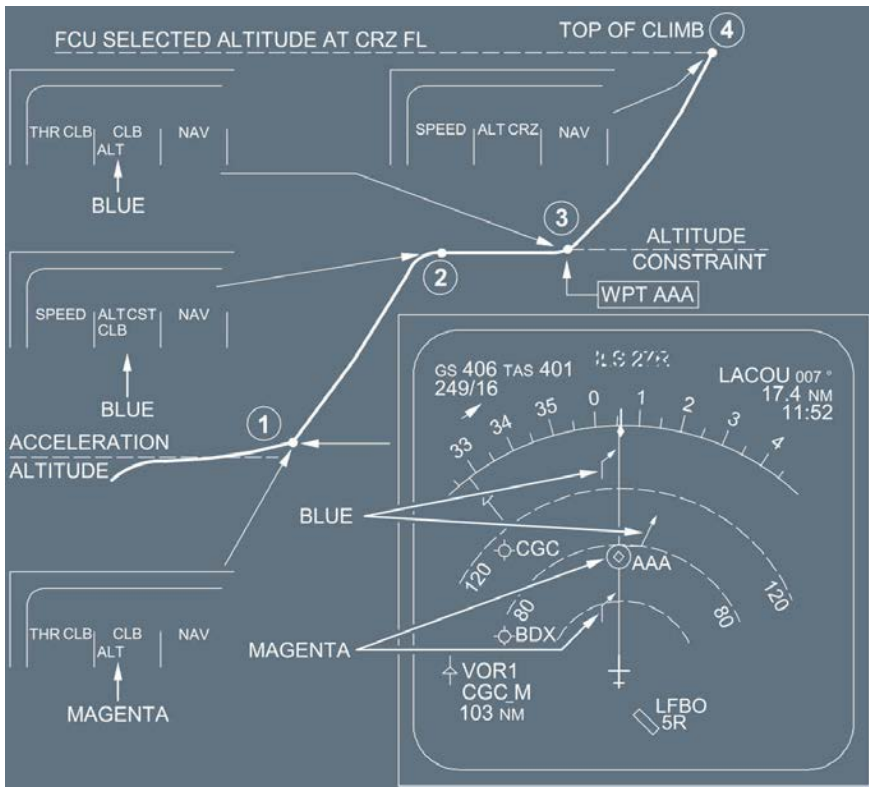

CASE 2

The FCU selected altitude is set at the next altitude constraint
 The aircraft will automatically levels off at this altitude.

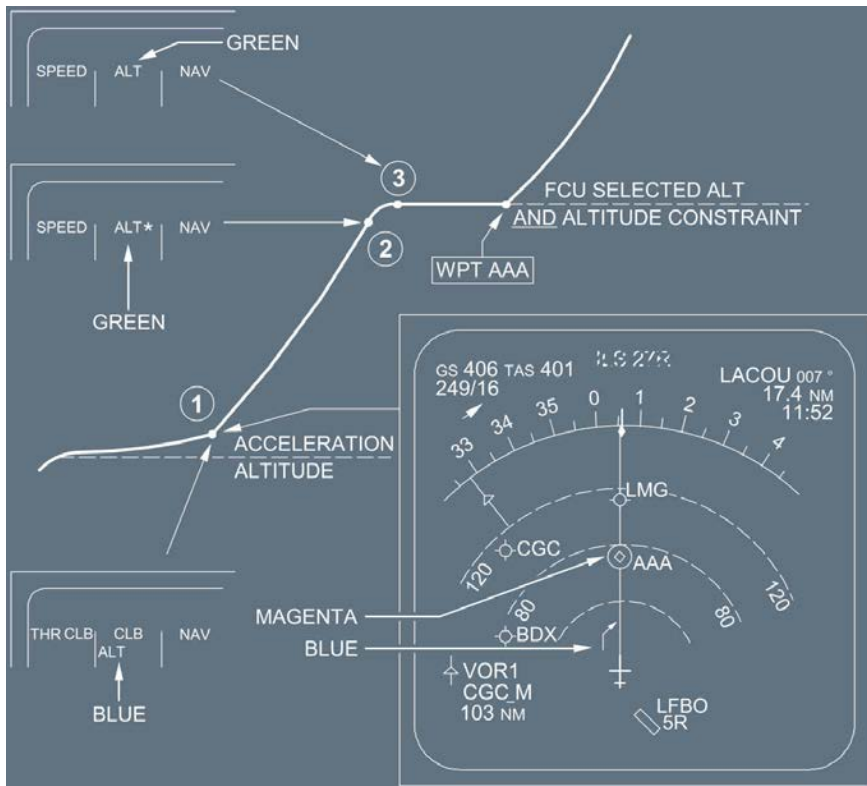

To resume the climb automatically when the waypoint AAA is reached, apply the following procedure during the level off (Position 4):

SELECT the FCU altitude to the next constraint (if any) or the cruise FL.
PUSH the FCU ALT selector knob to arm CLB mode.

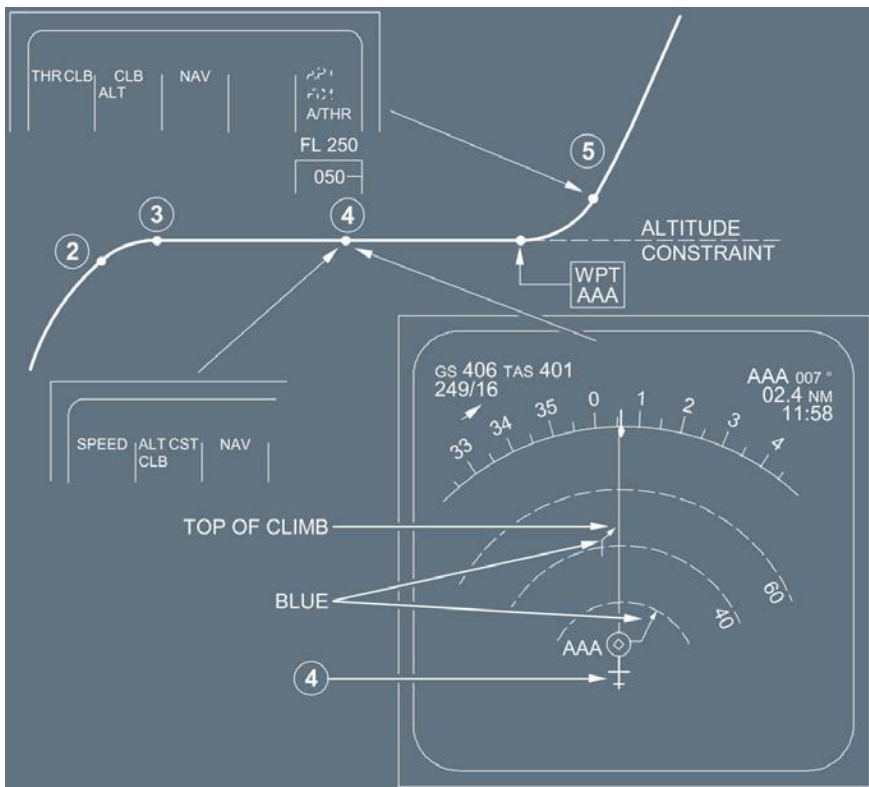

RECOMMENDATION:

To ensure that you will not miss the next constraint, it is recommended to select the FCU altitude to the next constraint as described above.

MONITORING THE CONSTRAINTS

SPEED, ALTITUDE and TIME constraint can be checked using MCDUs. Each constraint is preceded by a star that indicates if the constraint is matched (magenta star) or missed (amber star).

ALTITUDE CONSTRAINT

- If an altitude constraint is predicted as missed, use the following procedure:

SET the FCU ALT to the next ALT CSTR
 CHECK the position of the level off symbol on the ND (blue arrow) with respect to the waypoint with the constraint.
 DECREASE the target speed until the constraint is met.



SPEED CONSTRAINT

CHECK the SPD CSTR predictions on the MCDU.
A magenta or amber star () indicates that the aircraft will match or miss the constraint.
 If the aircraft is to miss the constraint by more than 10 kt, the MCDU scratchpad displays "SPD ERROR AT WPT ----".*

"CHECK WEIGHT" MESSAGE.

Refer to DSC-22_20-90-20 "CHECK WEIGHT" Message

HDG /TRK MODE ENGAGEMENT

- If HDG/TRK is engaged, the guidance does not consider any F-PLN constraint. Therefore if the flight crew disengages NAV, CLB mode reverts to OP CLB.

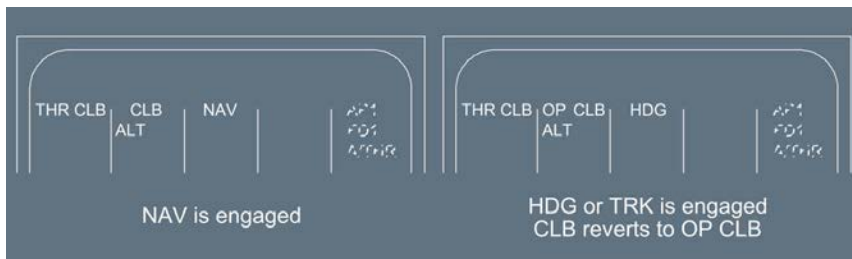

SPEED SELECTION

- **If a specific speed is required:**
 TURN and PULL the SPD selector knob. (This changes the target speed to blue on the PFD speed scale).
 Predictions on the F-PLN page assume that the speed remains selected until the next SPD LIM or SPD CSTR, or the next phase, whichever comes first.

EXPEDITE CLIMB

Ident.: PRO-NOR-SRP-01-40-00003990.0002001 / 11 FEB 11

Applicable to: ALL

The flight may use the expedite mode temporarily to clear a specified altitude or to match a constraint.

PRESS EXPED pb on the FCU.

The AP acquires and maintains Green Dot speed. There is no benefit to use expedite mode above FL 250. The mach corresponding to green dot is too low to maintain an increased vertical speed.

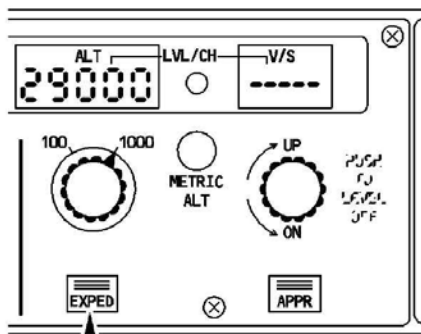

DEPRESS

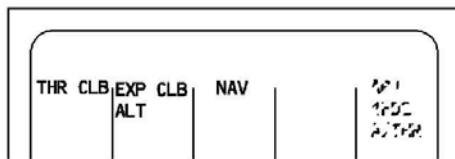

FMA in EXPEDITE CLB

To revert to normal climb:
 PUSH ALT knob CLB mode will engage.

PROCEDURES
NORMAL PROCEDURES

SYSTEMS RELATED PROCEDURES - FMS

*Note: Pulling ALT knob or V/S knob or SPD/MACH knob also disengages EXPEDITE.
 PRESSING EXPED pb never disengages the mode.*

IMMEDIATE RETURN TO ORIGIN AIRPORT

Ident.: PRO-NOR-SRP-01-40-00003991.0003001 / 23 JUN 15

Applicable to: ALL

- If the SEC F-PLN has been prepared for an immediate return to the airport of origin:
 ACTIVATE the SEC F-PLN.
 PERFORM a DIR TO the appropriate waypoint.
- If the SEC F-PLN has not been prepared for an immediate return to the airport of origin:

1 SELECT

1L

2L

3L

4L

5L

6L

FROM UTC SPD/ALT

AGN 10 13 FL220

LMG1 BRG004 93NM

LMG 10 25 .78 / FL290

UR10 TRK006 97

AMB 10 38 . / .

UR10 16

1R

2R

3R

4R

5R

6R

2 WRITE

1L

2L

3L

4L

5L

6L

LAT REV FROM LMG

45° 49.0N / 001° 01.6E

LL XING / INCR / NO

[]° / []° / []

NEXT WPT []

NEW DEST []

AIRWAYS >

< RETURN

LFBO

3 ENTER

1R

2R

3R

4R

5R

6R

PERFORM a lateral revision at TO waypoint
 ENTER the departure airport ident in the NEW DEST field and INSERT the temporary flight plan.
 PERFORM a lateral revision at the new destination
 SELECT: APPR – STAR – VIA – TRANS and INSERT

● **When cleared to divert:**

PERFORM a DIR TO the suitable waypoint.

ENTER QNH, WIND, MDA/MDH, LDG CONF.

CHECK RAD NAV page.



A318/A319/A320/A321
FLIGHT CREW
OPERATING MANUAL

PROCEDURES

NORMAL PROCEDURES

SYSTEMS RELATED PROCEDURES - FMS

Intentionally left blank

| | |
|---|--|
|  <p>A318/A319/A320/A321 FLIGHT CREW OPERATING MANUAL</p> | <p style="text-align: center;">PROCEDURES NORMAL PROCEDURES SYSTEMS RELATED PROCEDURES - FMS</p> |
|---|--|

Cruise

REACHING CRUISE FLIGHT LEVEL

Ident.: PRO-NOR-SRP-01-50-00003992.0002001 / 03 NOV 14

Applicable to: ALL

On reaching the cruise flight level, the flight crew should be sure that the FMA displays “ALT CRZ ” in its second column, which ensures that the aircraft is at cruise flight level and at Economy Cruise Mach (ECON CRZ MACH).

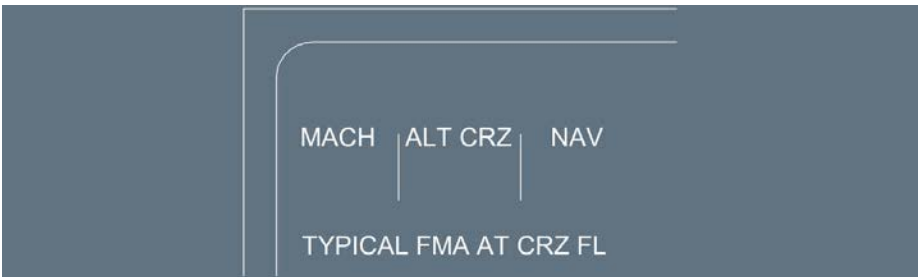

The FMGS engages the “soft altitude” (SOFT ALT) mode 2 min after the cruise flight level is captured and Mach stabilized. (SOFT ALT) mode allows the aircraft to deviate ± 50 ft from the target altitude to minimize the thrust variation and reduce the fuel consumption.

- **If the FMA does not display ALT CRZ at the assigned flight level**, soft altitude mode will not engage and the predictions will be computed at the preplanned flight level. This will occur when the ATC assigned flight level is lower than the preplanned flight level entered on the PROG page.
- **If the FMA does not display ALT CRZ at the assigned FL (as may occur when the ATC-assigned FL is lower than the preplanned FL selected initially):**

PRESS the [PROG].

ENTER the current cruise flight level.

Note: If the current cruise flight level is above the preplanned FL , selecting the FCU updates it automatically.

“SET SPD AUTO” OR “SET MANAGED SPD” OR “CHECK SPEED MODE”

- **If the climb phase was flown in selected speed and if the cruise phase is planned to be flown in managed speed (ECON MACH/SPEED) , “SET SPD AUTO” or “SET MANAGED SPEED” or “CHECK SPEED MODE” appears on the PFD and MCDU as a reminder.**

PRESS the FCU speed selector knob to activate the managed Mach.

MONITORING THE NAVIGATION ACCURACY

Applicable to: ALL

Ident.: PRO-NOR-SRP-01-50-A-00003993.0001001 / 22 MAY 12

GENERAL

On aircraft equipped with GPS PRIMARY, the navigation accuracy check is not required as long as GPS PRIMARY  is available.

Otherwise, navigation accuracy shall be checked periodically in cruise.

The PROG page displays an estimated accuracy as being high or low (center of sixth line):

- “HIGH” means that the FMGS estimates the FM position accurate enough to meet the EN ROUTE criteria,
- “LOW” means that the pilot must compare raw data from tuned nav aids with corresponding data computed by FM and shown on the ND or MCDU PROG page. The appearance of the message “NAV ACCUR DOWNGRAD” on the MCDU calls for a similar crosscheck.

Note: The pilot should make such a comparison periodically, even if the PROG page is displaying “HIGH” and nav aids are available: this allows him to quantify the FM position error.

The method for checking the accuracy is explained in the SOP and in Evaluation of position accuracy chapter (*Refer to DSC-22_20-20-20 General*).

A quick check is explained here below when the TO waypoint is a DME type. (VOR /DME or VOR /TAC or DME or TAC)

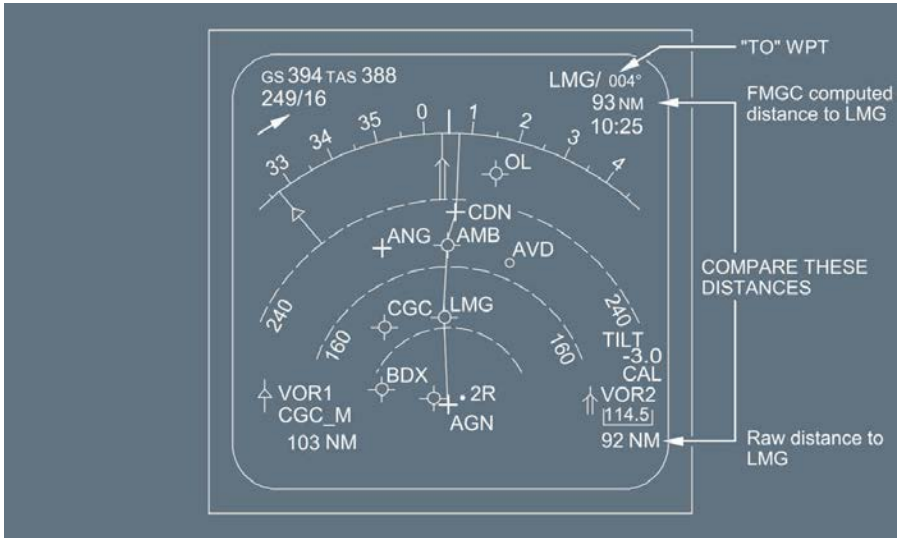

Ident.: PRO-NOR-SRP-01-50-A-00003994.0013001 / 22 NOV 11

POSITION DISCREPANCY

- If there is a discrepancy between the raw data position and the FM position:

PRESS the DATA key on the MCDU.

SELECT the POSITION MONITOR page.

SELECT "FREEZE".

On the other MCDU : Select the GPS MONITOR page.

| | | | | | | | | | | | | | | | | | |
|-------------------------|---------|------------------|---------|----|---------------|--------------------|----------|----|-------|----------|-------|-------|----------|---------------|--------------------|----------|----|
| POSITION FROZEN AT 1035 | | | | | | GPS MONITOR | | | | | | | | | | | |
| 1L | FMS 1 | 4610.2N/00618.3E | 1R | 1L | GPS1 POSITION | 46°10.2N/006°13.3E | 1R | 2L | TTRK | UTC | GS | 359.9 | 10:37:42 | 450 | 2R | | |
| 2L | FMS 2 | 4610.2N/00618.8E | 2R | 2L | MERIT | GPS ALT | MODE/SAT | 3L | 100M | 32000 | NAV/6 | 3R | 4L | GPS2 POSITION | 46°10.2N/006°13.3E | 4R | |
| 3L | GPS | 4610.1N/00618.2E | 3R | 3L | TTRK | UTC | GS | 4L | 359.9 | 10:37:42 | 450 | 4R | 5L | MERIT | GPS ALT | MODE/SAT | 5R |
| 4L | MIX IRS | 4609.7N/00618.0E | 4R | 4L | 100M | 32000 | NAV/6 | 5L | 100M | 32000 | NAV/6 | 5R | 6L | ← UNFREEZE | NAVAIDS> | 6R | 6L |
| 5L | NAV 0.4 | NAV 0.2 | NAV 0.4 | 5R | 5L | 5R | 5L | 6L | 6L | 6R | 6L | 6R | | | | | |

MONITORING THE FUEL PREDICTIONS

Ident.: PRO-NOR-SRP-01-50-00003995.0013001 / 14 FEB 11

Applicable to: ALL

The F-PLN and FUEL PRED pages display fuel and time predictions throughout the flight. These predictions are meaningful if the lateral and vertical flight plan, and the entered winds are kept accurate enough as the flight progresses.

PROCEDURE

In addition to the Fuel Management procedure described in the SOPs (*Refer to PRO-NOR-SOP-15 Cruise - Flight Progress*), periodically apply the following actions:

KEEP ACCURATE FMS PREDICTIONS

Periodically UPDATE the F-PLN elements (F-PLN waypoints, step altitudes, predicted winds).

CHECK the MIN DEST FOB value on the FUEL PRED page

The MIN DEST FOB value is computed by the FMS and by default it is equals to ALTN + FINAL. ALTN , FINAL and MIN DEST FOB can be modified by the flight crew.

At the beginning of the CRZ phase, and/or after any change of destination or alternate airport, check that the MIN DEST FOB value is meaningful. Otherwise, update the MIN DEST FOB value, as appropriate.

CHECK the DEST EFOB value on the F-PLN or FUEL PRED page

MONITOR the EFOB at destination on the F-PLN or FUEL PRED page. If necessary, ADAPT the flight strategy.

"DEST EFOB BELOW MIN" MESSAGE

If the predicted EFOB at destination becomes less than the MIN DEST FOB value displayed on the FUEL PRED page:

- The destination EFOB turns to amber on the F-PLN , FUEL PRED and PERF (CLB , CRZ , DES) pages, and REPORT page.
- The "DEST EFOB BELOW MIN " amber message is displayed on the MCDU scratchpad, after 2 min (if the FMS is in CRZ or DES phase).

Note: If the flight crew has cleared the "DEST EFOB BELOW MIN " message, and if the predicted EFOB at destination is still less than the MIN DEST FOB value, the "DEST EFOB BELOW MIN" message will appear again at the beginning of the descent phase.

PROCEDURE

- **If the "DEST EFOB BELOW MIN" message is triggered on the MCDU:**

CHECK the DEST EFOB value on the F-PLN or FUEL PRED page,

CHECK the hypothesis used by the FMS to compute the fuel predictions,
Check that the F-PLN elements (F-PLN waypoints, step altitudes, predicted winds) are up-to-date, to ensure that the FMS predictions are accurate.
Check that the MIN DEST FOB fuel value is meaningful and corresponds to the planned fuel strategy.
ADAPT the flight strategy as required.

ENTERING A STEP CLIMB OR A STEP DESCENT

Ident.: PRO-NOR-SRP-01-50-00003996.0002001 / 22 MAY 12

Applicable to: ALL

The crew may use the STEP ALTS page to enter up to four geographic step points or one optimal step (computed by the FMGS) at any waypoint of the cruise.

PROCEDURE

PRESS the PERF key.

SELECT "STEP ALTS" prompt.

The PERF PAGE displays this prompt in cruise phase. The crew may also call up the STEP ALTS page using a vertical revision at any cruise waypoint.

ENTERING AN OPTIMAL STEP (ONLY STEP CLIMB)

WRITE a step altitude or FL into the scratchpad.

ENTER the step altitude or FL in the [1R] field.

CHECK the FUEL and TIME SAVINGS predictions on the 5L and 5R fields.

PUSH the INSERT prompt [6R] if adequate.

After insertion, the optimum step climb is updated only when the flight crew presses the UPDATE prompt [6R].

The ND shows symbols for the start of climb (S/C) and the top of climb (T/C). The MCDU shows the associated pseudo-waypoints.

It is possible to convert an optimum step to a geographic step by overwriting the [1L] field (see geographic step).

● **When reaching the step climb pseudo-waypoint:**

REQUEST climb clearance.

ADJUST the FCU altitude to the STEP ALT, and PUSH.

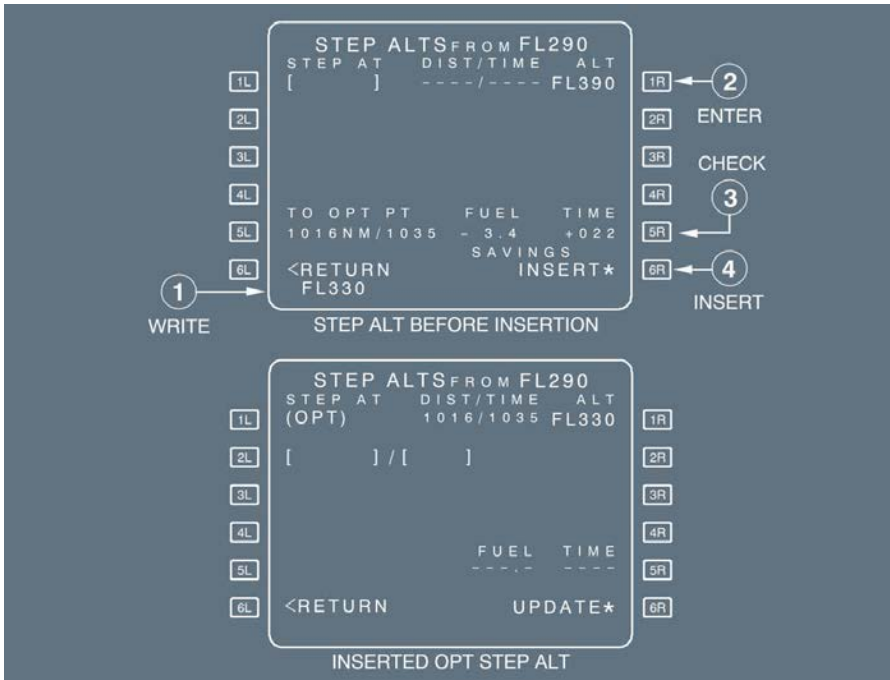

ENTERING A GEOGRAPHIC STEP

WRITE a step altitude into the scratchpad.

The format is position/altitude (or FL). The position can be a waypoint or waypoint/distance to waypoint. The waypoint/distance is an along track offset waypoint.

ENTER it in [1L] to [4L] field.

The entry of the initial geographic step point requires both a valid waypoint and altitude entries. When a step has been entered, the flight crew may change the position and the altitude independently. The flight crew cannot modify the position and the altitude in a single entry: To modify both, they should modify the position first, and then the altitude.

CHECK the predictions

● **When reaching the step climb or descent pseudo-waypoint (S/C or S/D):**

REQUEST climb or descent clearance.

ADJUST the FCU altitude to the STEP ALT, and PUSH.



The DIST/TIME field may display the following messages:

- ABOVE MAX if the step altitude exceeds the MAX ALT.
- IGNORED if the start step point is less than 50 NM from the top of descent.
- STEP NOW when the aircraft is within 20 NM of the step point.

If the aircraft overflies the step waypoint without commencing a climb or a descent, the system deletes the step from the vertical F-PLN automatically (a "STEP DELETED" message is displayed on the MCDU scratchpad), and recomputes the predictions.

A step is not deleted if the FCU altitude is moved only partially towards the step altitude.

The flight phase remains "cruise" whenever a step is initiated.

Note: For an altitude restriction defined at a waypoint less than 50 NM before the top of descent and lower than the CRZ FL, it is recommended to enter an altitude constraint rather than a step.

IMMEDIATE CHANGE OF LEVEL IN CRUISE

Ident.: PRO-NOR-SRP-01-50-00003997.0001001 / 14 FEB 11

Applicable to: ALL

When the pilot changes his flight level without inserting a step:

- If the FCU -selected altitude is above the previous CRZ FL , the CRZ FL on the PROG page changes to the new flight level.
- If the FCU -selected altitude is lower than the previous CRZ FL and if the distance to DEST is more than 200 NM, the CRZ FL on the PROG page changes.

In that case Mach target is managed as follows:

- At the start of the descent, the Mach target is the managed Mach number at the initial cruise flight level.
- When the aircraft reaches the new flight level, the Mach target switches either to the Mach number for the lower CRZ FL , or to the speed for the lower CRZ FL if the aircraft reaches the crossover altitude. This logic prevents the aircraft from exceeding VMO during descent.
- If the FCU -selected altitude is lower than the previous CRZ FL and the aircraft is within 200 NM of its destination, the system activates the descent phase.

The pilot may reactivate the cruise phase by entering a new cruise flight level in the PROG page.

PREPARATION FOR DESCENT AND APPROACH

Applicable to: ALL

Ident.: PRO-NOR-SRP-01-50-B-00003998.0001001 / 09 DEC 09

GENERAL

The preparation for descent and approach consists of :

- Entering PERF and WIND data
- Defining the lateral and vertical F-PLN
- Checking the tuning (auto or manual) of the appropriate nav aids

After receiving the arrival information, the flight crew should use the following procedure.

Ident.: PRO-NOR-SRP-01-50-B-00003999.0001001 / 22 MAY 12

REVISION OF LATERAL F-PLN

The screenshot shows the FMS Lateral Flight Plan (F-PLN) revision screen. It is divided into three main sections, each with a selection arrow and a circled number (1, 2, or 3).

Section 1 (Top): A box containing flight plan data for EGLL. The text reads: "LAT REV FROM EGLL", "51° 28.6N / 000° 25.9W", "ARRIVAL>", and "NEXT WPT []". A selection arrow labeled "1" points to the right side of this box.

Section 2 (Middle): A box titled "ARRIVAL TO EGLL" with a right-pointing arrow. It contains a table of arrival data:

| APPL | VIA | STAR | TRANS |
|---------|----------------|------|-------|
| ←ILS27L | 3658M | | |
| 275 | ILL / 109 . 50 | | |
| ←ILS27R | 3902M | | |
| 275 | IRR / 110 . 30 | | |
| ←05 | 2357M | | |
| 047 | | | |
| <RETURN | | | |

A selection arrow labeled "2" points to the left side of this box.

Section 3 (Bottom): A box titled "ARRIVAL TO EGLL" with a right-pointing arrow. It contains a table of arrival data:

| APPR | VIA | STAR | TRANS |
|--------|-----------|---------|-------|
| ILS27R | ----- | | |
| APPR | | | TRANS |
| <VIAS | | | ----- |
| STARS | AVAILABLE | TRANS | |
| ←BIG1A | | | |
| ←BIG1B | | | |
| ←BIG1C | | | |
| ←ERASE | | | |
| | | INSERT* | |

A selection arrow labeled "3" points to the left side of this box.

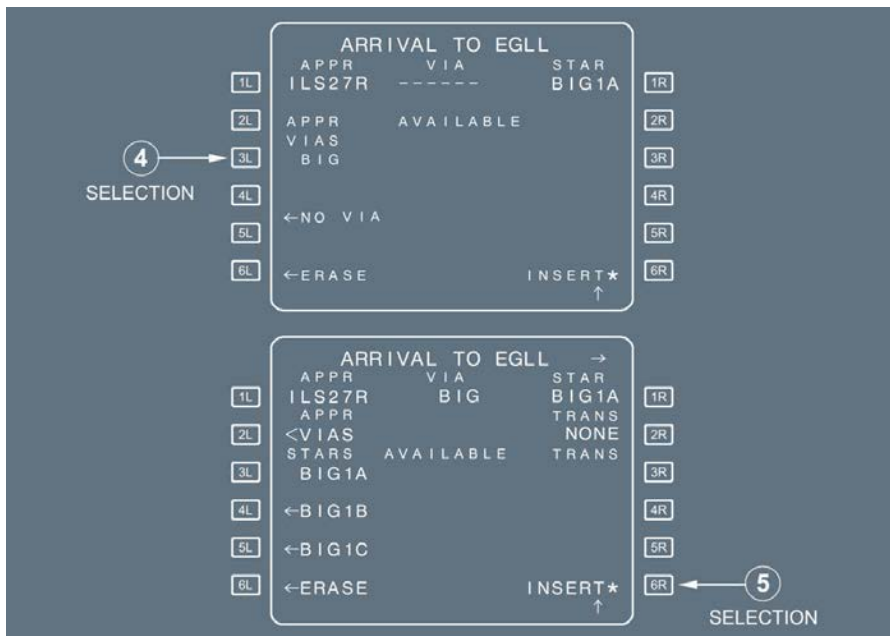

PERFORM a lateral revision at destination

SELECT an ARRIVAL

SELECT an APPROACH, a STAR, a TRANSITION, a VIA.

When the pilot selects successive items, the page are automatically sequenced. But pressing "NEXT PAGE" key brings up the APPR and STAR page successively.

CHECK the temporary revision including the missed approach.

INSERT the temporary revision, [6R] key.

Ident.: PRO-NOR-SRP-01-50-B-00004000.0001001 / 22 MAY 12

REVISION OF VERTICAL FLIGHT PLAN

CHECK that the speed and altitude constraints as displayed on the ND . (Use the CSTR pusbutton).

ENTER any additional speed or altitude constraints using the vertical revision page.

In order not to be too fast when commencing the approach, you may insert a speed constraint at the FAF (Final Approach Fix).

When all computations are completed.

REVIEW the flight plan, using the approach chart.

When the destination runway changes and if the previously selected STAR is compatible with the new runway, the system selects it automatically in the temporary F-PLN . If the flight crew has entered any revision or constraint on this STAR, it will not be transferred. The pilot must reenter it in order to retain it for this approach.

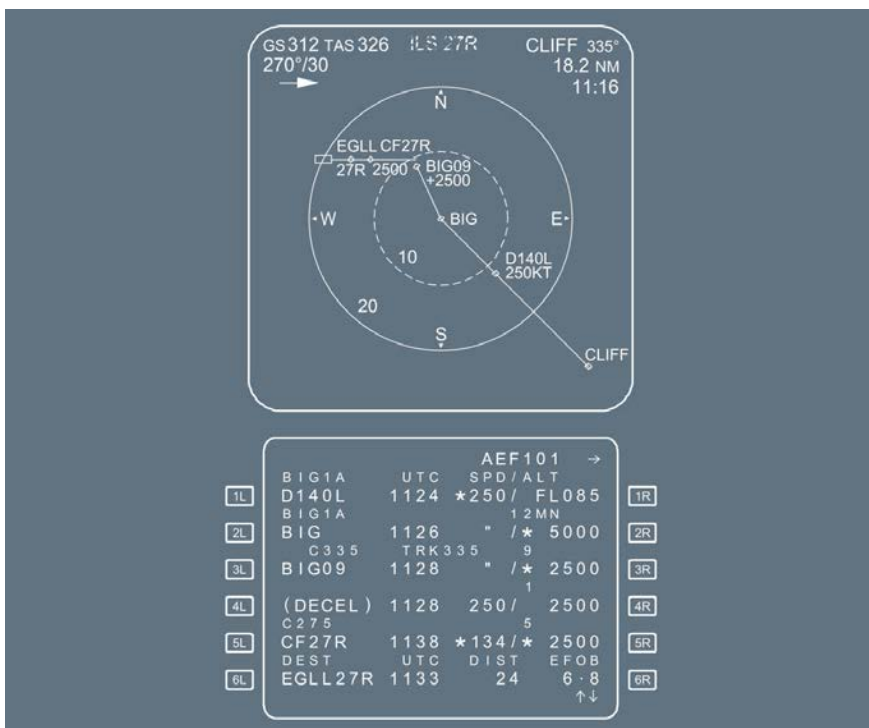

Ident.: PRO-NOR-SRP-01-50-B-00004001.0002001 / 14 FEB 11

ENTERING THE WINDS FOR DESCENT

Refer to DSC-22_20-30-20-25 Wind - Temperature - QNH - General.

Ident.: PRO-NOR-SRP-01-50-B-00004002.0002001 / 22 MAY 12

PRESELECTING A MANAGED SPEED/MACH

As long as the descent phase is not active, the PERF DES page may either be used to select a speed, or a Mach number, or both, to replace the optimum descent speed.

The Flight Guidance Computer then uses the entered speed, instead of the optimum speed for computing the descent profile.

When the system switches to the descent phase, it sets the MANAGED target speed to the entered speed. From there, the speed may only be modified by using the FCU selector knob. Once in descent phase, the pilot cannot modify the MANAGED speed again.

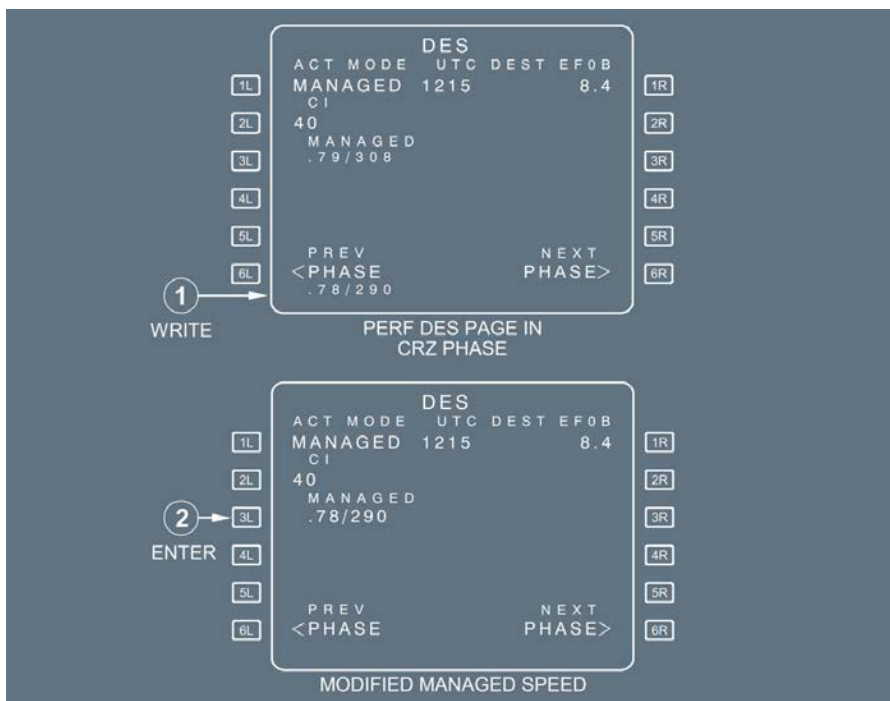

PROCEDURE

PRESS the PERF on MCDU.

SELECT the “NEXT PHASE” prompt.

WRITE the descent speed into the scratchpad and ENTER it.

The 3L field displays the imposed managed speed value.

Ident.: PRO-NOR-SRP-01-50-B-00004003.0003001 / 16 NOV 11

MODIFICATION OF THE CABIN RATE

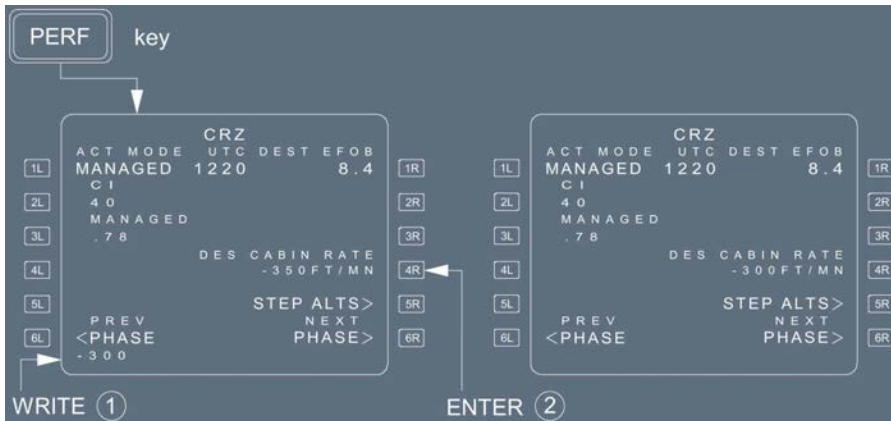

PROCEDURE

- PRESS the MCDU's PERF.
- WRITE the new cabin rate in the scratchpad.
- ENTER it in the [4R] field.

Ident.: PRO-NOR-SRP-01-50-B-00004004.0010001 / 22 MAY 12

ENTERING THE APPROACH DATA

From PERF DES page, SELECT "NEXT PHASE" [6R] key to display the APPR page.
ENTER QNH , TEMP , WIND at destination (magnetic north reference), minimum in the RADIO or BARO fields.

(The PFD displays the entered BARO or RADIO minimum value, only when the distance to destination is less than 250 NM).

CHECK and, if necessary, MODIFY

- LDG CONF (landing configuration),
- VAPP (the FM-computed value may be modified),
- TRANS ALT (transition altitude).



The scratchpad displays “ENTER DEST DATA” if the approach page is not completed when the aircraft is 180 NM from destination.

SELECT “NEXT PHASE” in order to display the GO AROUND page.

CHECK and, if necessary, MODIFY the THR RED ALT and the ACC ALT.



Ident.: PRO-NOR-SRP-01-50-B-00004005.0001001 / 22 MAY 12

SELECTING THE RADIO NAVAIDS

CHECK or SELECT the NAVAIDS appropriate for the approach.

For an ILS procedure, the ILS will be autotuned.

NDBs must be manually entered.

Note: When the destination has a VOR /DME , ENTER it manually in the VOR field. ENTER its identifier in the BRG /DIST field of the PROG page. This allows you to perform a permanent NAV accuracy check.



Ident.: PRO-NOR-SRP-01-50-B-00004006.0003001 / 08 DEC 16

COST INDEX FOR LONG-RANGE CRUISE

The flight crew can use the table below to find an approximate Cost Index value that is calculated for cruise at long-range cruise speed. This value is valid for CRZ FL = OPT ALT ± 1 000 ft.

| AIRCRAFT | ENGINE | CILRC | |
|---------------------|--|--------|----------|
| | | kg/min | 100 lb/h |
| A318/A319/A320/A321 | CFM 56-5-A1/A3 | 45 | 60 |
| | CFM 56-5-A4/A5 | 40 | 55 |
| | CFM 56-5-B1/B2/B3 | 65 | 85 |
| | CFM 56-5-B4 (A321) | 65 | 85 |
| | CFM 56-5-B4 (A320) | 55 | 75 |
| | CFM 56-5-B4/P | 25 | 35 |
| | CFM 56-5-B5/B6/B7 | 25 | 35 |
| | CFM 56-5-B5/2P CFM 56-5-B6/2P CFM 56-5-B7/2P | 30 | 40 |
| | CFM 56-5-B8/B9 | 15 | 20 |
| | CFM LEAP-1A | 40 | 55 |
| | PW6122/PW6124 | 20 | 30 |
| | PW1100G-JM | 40 | 55 |
| | V2500-A1 | 45 | 60 |
| | V2522-A5/V2524-A5/ V2527M-A5 | 50 | 70 |
| V2530-A5/V2533-A5 | 50 | 70 | |
| V2527-A5/V2527E-A5 | 40 | 55 | |



A318/A319/A320/A321
FLIGHT CREW
OPERATING MANUAL

PROCEDURES

NORMAL PROCEDURES

SYSTEMS RELATED PROCEDURES - FMS

Intentionally left blank

Descent

DESCENT INITIATION

Ident.: PRO-NOR-SRP-01-60-00004007.0001001 / 14 FEB 11

Applicable to: ALL

The top of descent, displayed on the F-PLN page (T/D) and on the ND (ND), is a position that the system calculates, assuming that the aircraft will begin its descent in DES mode with managed speed, and that the system will guide the aircraft along the descent profile computed with all the vertical F-PLN data (ALT CSTR, ECON or AUTO MACH/SPD, SPD CSTR, SPD LIMIT) to reach VAPP at 1 000 ft AGL.

Note: The ND does not display the top of descent when HDG (or TRACK) mode is engaged.

PROCEDURES

● **When the aircraft reaches the top of descent (F/D) :**

SELECT the altitude target.

PUSH the ALT selector knob. DES mode engages.

CHECK the FMA annunciators.

DESCENT MONITORING

Applicable to: ALL

Ident.: PRO-NOR-SRP-01-60-A-00004008.0007001 / 06 JUN 16

DES MODE ENGAGED

When DES mode is engaged, NAV mode is engaged, and the system takes into account all altitude and speed constraints of the F-PLN.

The key parameter for monitoring the descent is the vertical deviation (VDEV) displayed on the PFD and on the PROG page, which indicates whether the aircraft is on, above, or below the descent profile.

PROCEDURE

SET the ATC -cleared altitude on the FCU (considering also what is the safe altitude).

If the lowest safe altitude is higher than the ATC -cleared altitude, check with ATC that this constraint applies.

If it is confirmed, SET the FCU altitude to the safe altitude until it is safe to go to the ATC-cleared altitude.

MONITOR vertical deviation (VDEV) on the PFD and the PROG page.

MONITOR the speed change that occurs, when the aircraft reaches a speed change symbol (magenta ball) under managed speed.

MONITOR the FMA (ALT *, ALT CST*, ALT , ALT CST), when the aircraft reaches level symbols.

■ **If the aircraft is on the descent profile:**

The aircraft is considered to be on the vertical profile, when it is within 50 ft of it. VDEV is close to zero, and the system predicts that it will match constraints until the aircraft levels off at the next FCU altitude.

MONITOR the predicted descent point after the next level-off.

A/THR adjusts thrust for the particular segment. The first FMA column may display “THR IDLE” or “SPEED”.

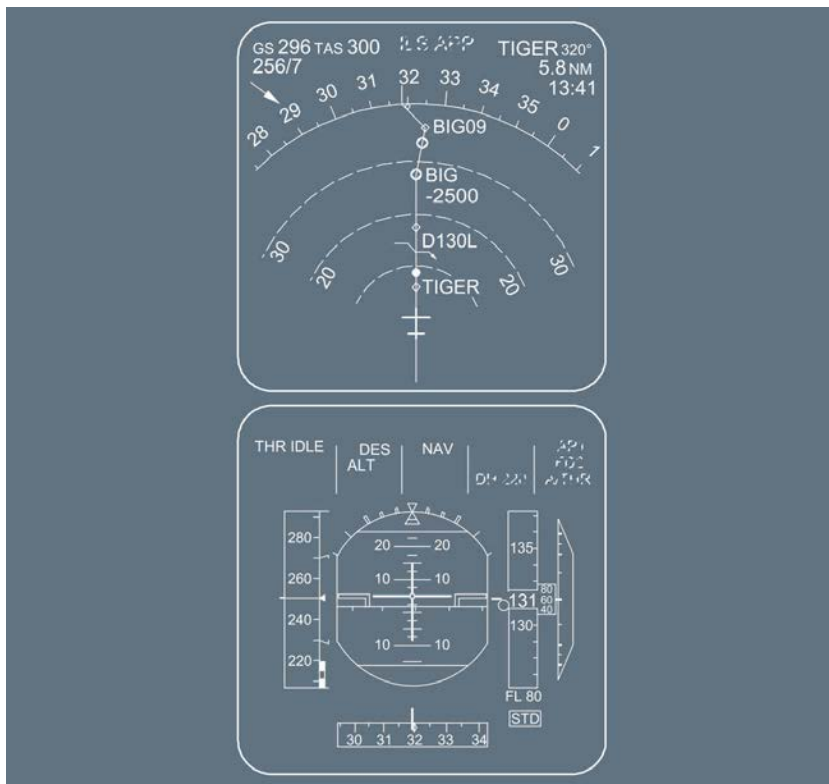

■ **If the aircraft is above the descent profile:**

VDEV is down on the PFD and positive on the PROG page.

A/THR sets IDLE thrust and the AP increases speed by calling for down elevator. If the aircraft reaches the upper limit of the managed speed range, the aircraft diverges and maintains the upper limit speed.

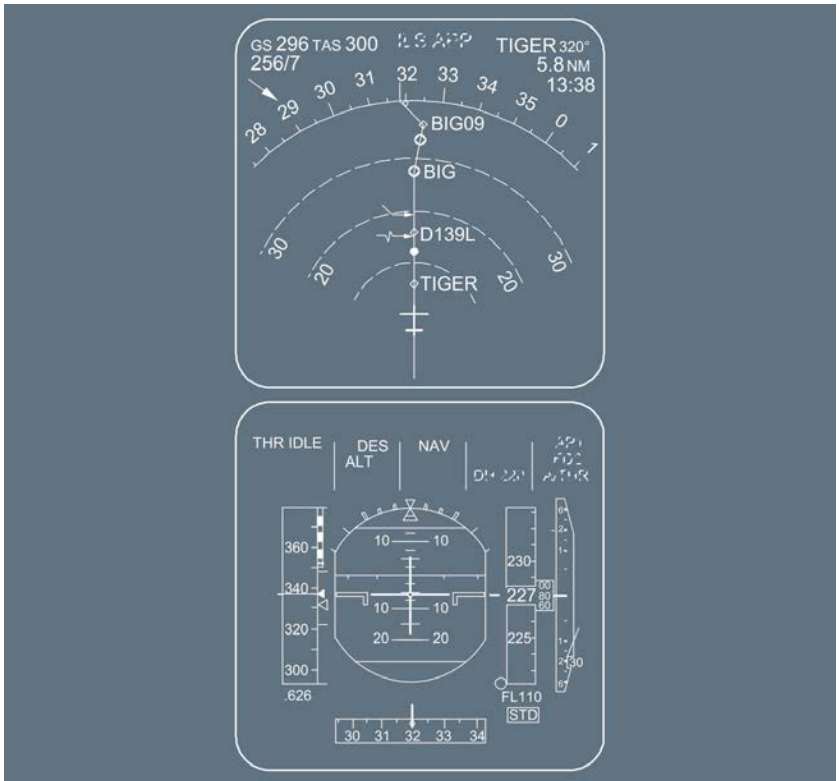



Procedure

SELECT a descent speed higher than the upper limit when possible.

MONITOR the intercept symbol 

When this symbol reaches the next ALT CSTR waypoint, "MORE DRAG" appears on the PFD, indicating that speedbrakes must be extended in order to match the next altitude constraint. This is an advisory message.

Note: With DPO , when above the descent profile, the flight crew may have to extend the speed brakes in order to go back on the descent profile.

- If an altitude constraint is predicted to be missed by more than 250 ft, the vertical revision page shows ALT ERROR at the waypoint.

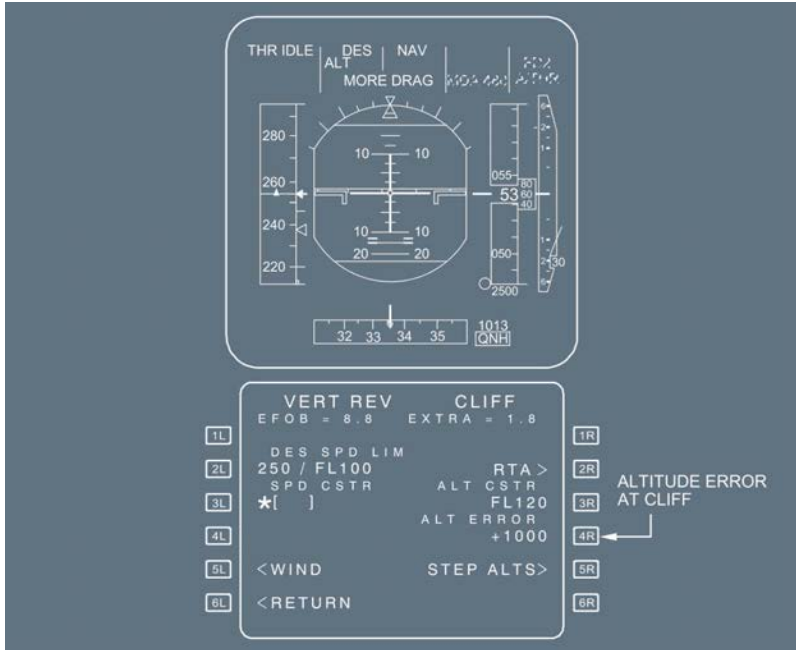

- If a speed constraint is predicted to be missed by more than 10 kt:
 SELECT an appropriate speed.
 RESUME managed speed when the aircraft is back on the descent path.
- If the aircraft is below the descent profile:
 VDEV is up on the PFD and negative on the PROG page. The system maintains the target speed (managed or selected speed).
 MONITOR the intercept symbol () on the ND and any leveling off at the next ALT CSTR.
- If the aircraft is flying at an altitude that is higher than both the descent speed limit altitude and the destination elevation +5 000 ft:
 The FMGS maintains the V/S at -1 000 ft/min and the target speed, until the aircraft reaches the altitude constraint or intercepts the descent profile.

PROCEDURES

NORMAL PROCEDURES

SYSTEMS RELATED PROCEDURES - FMS

- **If the aircraft is flying at an altitude that is lower than either the descent speed limit altitude, or the destination elevation +5 000 ft:**

The FMGS maintains the V/S at -500 ft/min and the target speed, until the aircraft reaches the altitude constraint or intercepts the descent profile.



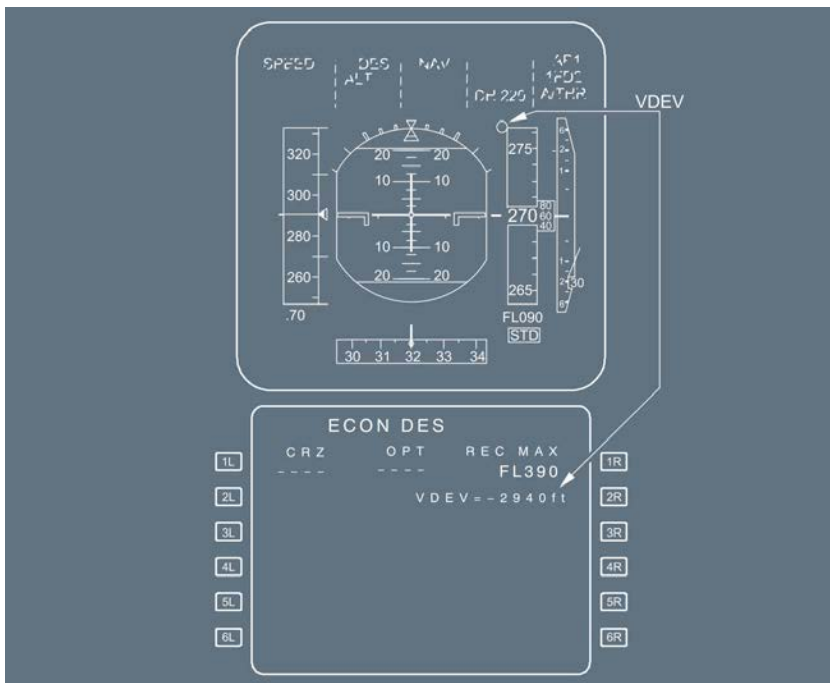

● **If the rate of descent has to be increased (ATC requirement):**

SELECT OP DES mode

Increase the target speed or extend the speedbrakes.

Ident.: PRO-NOR-SRP-01-60-A-00004009.0002001 / 22 MAY 12

OP DES , V/S OR FPA MODE ENGAGED

- In either case, the aircraft is no longer guided on the descent profile and altitude constraints are disregarded. If NAV mode is engaged the ND displays a white circle on waypoint with an altitude constraint. If NAV mode is disengaged, the circle is removed.
- The PFD still shows VDEV for reference purposes.
- The target altitude is always the FCU selected altitude (shown in blue).
On the ND , level-off symbol is blue (no constraint). If NAV mode is engaged and the speed target managed, speed constraints are considered.

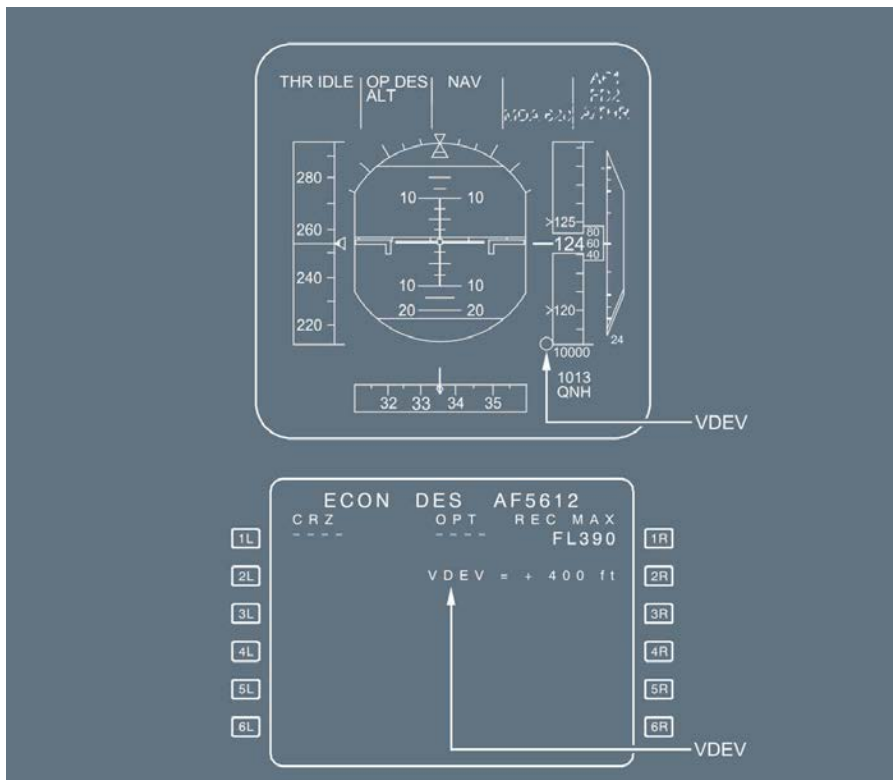

When HDG or TRK mode is engaged, vertical position may also be assessed on the ND using the energy circle. It is displayed as a green arc oriented on the current track and centered on the aircraft current position.

Note: Altitude and speed predictions displayed on the F-PLN page assume an immediate return to DES mode.

PROCEDURE

SET the FCU altitude as cleared by ATC, while considering the applicable safe altitude.

If the next safe altitude is higher than the ATC -cleared altitude, check with the ATC to verify that this constraint applies.

If confirmed, set the FCU altitude to the safe altitude, until it is safe to fly at the cleared altitude.

MONITOR the speed target, when the aircraft reaches the speed change symbol.

MONITOR the FMA ALT *, ALT, upon reaching the level symbol.

When in HDG /TRK mode, MONITOR the energy circle  on the ND.

The MCDU F-PLN page presents SPD /ALT constraint-matching predictions, which assume that DES mode is immediately re-engaged.

CHECK the predictions before re-engaging DES mode (in order to resume the descent profile).

Note: VDEV is available on the PFD even in HDG mode; it is a valuable tool for monitoring the descent, as long as crosstrack error (XTK) is less than 5 NM.

The aircraft automatically decelerates for approach, only if it flies over the DECEL pseudo waypoint with NAV mode engaged (or LOC *, LOC).

EXPEDITE DESCENT (IF INSTALLED)

Ident.: PRO-NOR-SRP-01-60-00004010.0001001 / 22 MAY 12

Applicable to: ALL

● **When ATC requires a rapid descent:**

DEPRESS THE EXPED pushbutton

Flight guidance (FG) pitches the aircraft to acquire and maintain 0.80/340. FG orders a pitch rate that produces no more than 0.15 g. The pilot can use this mode to initiate an emergency descent. To resume normal descent, PUSH the ALT selection knob or engage any other vertical mode.

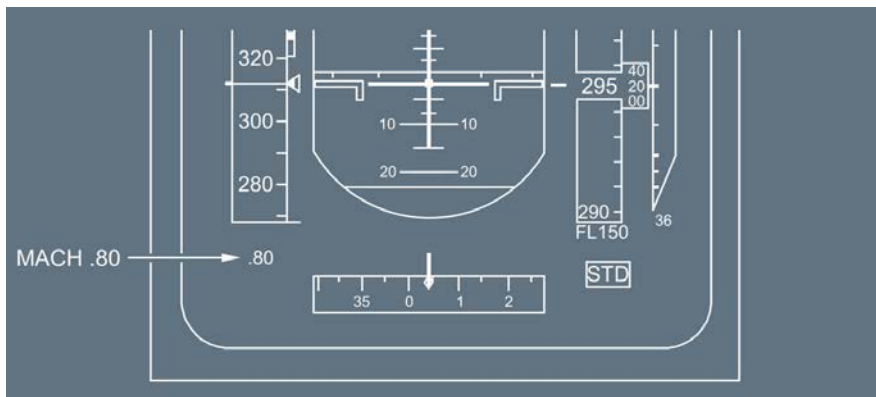

PROCEDURES
NORMAL PROCEDURES

SYSTEMS RELATED PROCEDURES - FMS

MONITORING THE NAVIGATION IN THE TERMINAL CONTROL AREA

Ident.: PRO-NOR-SRP-01-60-00004012.0002001 / 14 FEB 11

Applicable to: **ALL**

If the MCDU “AREA RNP IS XX.X” message or “PROCEDURE RNP IS XX.X” message is displayed, the pilot will manually-entered RNP value in the REQUIRED field of the PROG page and clear or modify it, if it is not in accordance with the RNP value specified in the area (NAV or approach chart).

TOO STEEP PATH

Ident.: PRO-NOR-SRP-01-60-00004013.0007001 / 22 MAY 12

Applicable to: **ALL**

“TOO STEEP PATH AHEAD” appears on the MCDU scratchpad, when the system predicts this situation, and TOO STEEP PATH is displayed on the F-PLN page.

When the aircraft is crossing the first waypoint of a TOO STEEP PATH, the system computes a flyable descent profile (with an idle segment). The VDEV makes a jump because it is related to a new profile.

| | | |
|----|-----------------------|----|
| 1L | VERT REV AT FIR96 | 1R |
| | EFOB=6.4 EXTRA=3.0 | |
| | TOO STEEP PATH BEYOND | |
| | DES SPD LIM | |
| 2L | 250/FL100 RTA> | 2R |
| | SPD CSTR ALT CSTR | |
| 3L | *[] +FL260 | 3R |
| 4L | | 4R |
| 5L | <WIND STEP ALTS> | 5R |
| 6L | <RETURN | 6R |

| | | |
|----|---|----|
| 1L | UB191 UTC SPD/ALT A1101→ ABB 1238 .78/FL330 (T/D) 1239 .79/FL330 BIG1A TRK320° 21 FIR96 1242 310/ * FL260 | 1R |
| 2L | | 2R |
| 3L | | 3R |
| 4L | -----TOO STEEP PATH----- | 4R |
| 5L | BIG1A | 5R |
| 6L | CLIFF 1246 293/ * FL120 | 6R |
| | DEST UTC DIST EFOB | |
| | EGLL27R 1301 149 6.1 | |
| | TOO STEEP PATH AHEAD↑↓ | |

F.PLN A PAGE WITH A TOO STEEP PATH

PROCEDURE

- **When passing the first waypoint of the TOO STEEP PATH:**
 MONITOR VDEV and predictions at the next CSTR waypoint.
 If required, EXTEND the speedbrakes before seeing the “MORE DRAG” message.
 CONSIDER using a holding pattern, if necessary.

HOLDING PATTERN

Ident.: PRO-NOR-SRP-01-60-00004014.0001001 / 09 OCT 12

Applicable to: ALL

A hold may be required during the descent, and may be manually inserted.

PROCEDURE

PRESS the F-PLN key.

SELECT the lateral revision page.

SELECT the HOLD prompt.

CHECK the HOLDING data, and MODIFY it if necessary.

CHECK the temporary flight plan and INSERT the holding pattern in it.

Note: If the holding fix is close to the DECEL pseudo waypoint and the speed is managed, manually activate the approach phase to change the managed target speed to approach speed (VAPP). This will avoid having an increase of speed not appropriate.

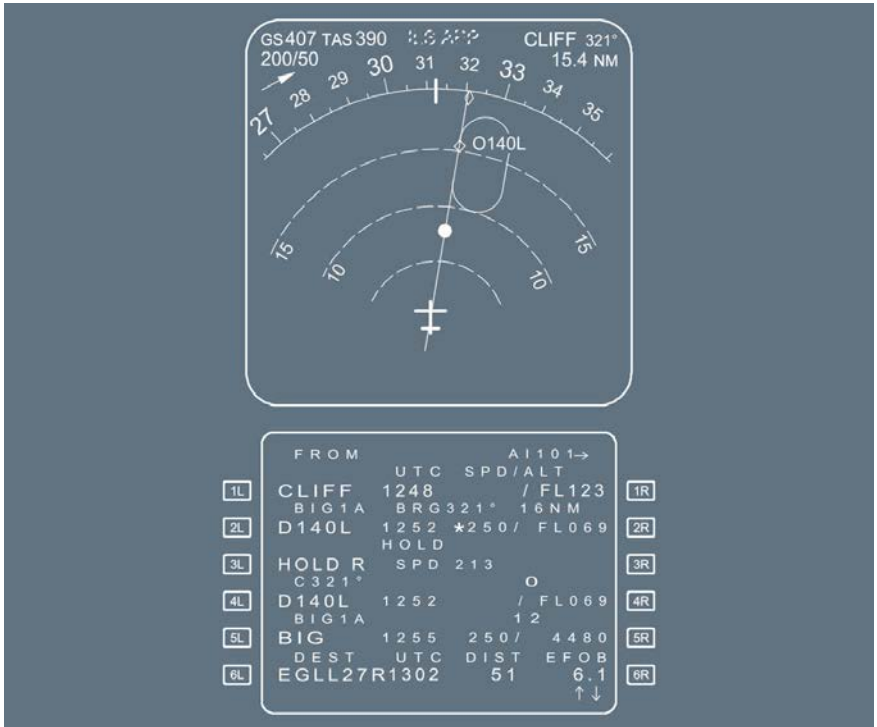

MANUAL TERMINATION

Ident.: PRO-NOR-SRP-01-60-00004016.0001001 / 09 DEC 09

Applicable to: ALL

You should not use DES mode when entering a leg with manual termination. Manual termination, which is defined as a track or a heading with no termination, is always part of a database procedure. The computed descent flight profile may not be adequate when flying this type of leg.



A318/A319/A320/A321
FLIGHT CREW
OPERATING MANUAL

PROCEDURES

NORMAL PROCEDURES

SYSTEMS RELATED PROCEDURES - FMS

Intentionally left blank

Approach

INITIAL APPROACH

Ident.: PRO-NOR-SRP-01-70-00004017.0002001 / 17 MAR 11

Applicable to: ALL

UPON REACHING THE INITIAL APPROACH AREA

- Approach phase will activate automatically when flying over the DECEL pseudo waypoint with NAV , APPR NAV or LOC * or LOC mode engaged.
- You will activate manually the approach phase on the PERF page if:
 - HDG or TRK mode is engaged, or
 - You are flying a go around, or
 - An early deceleration is required

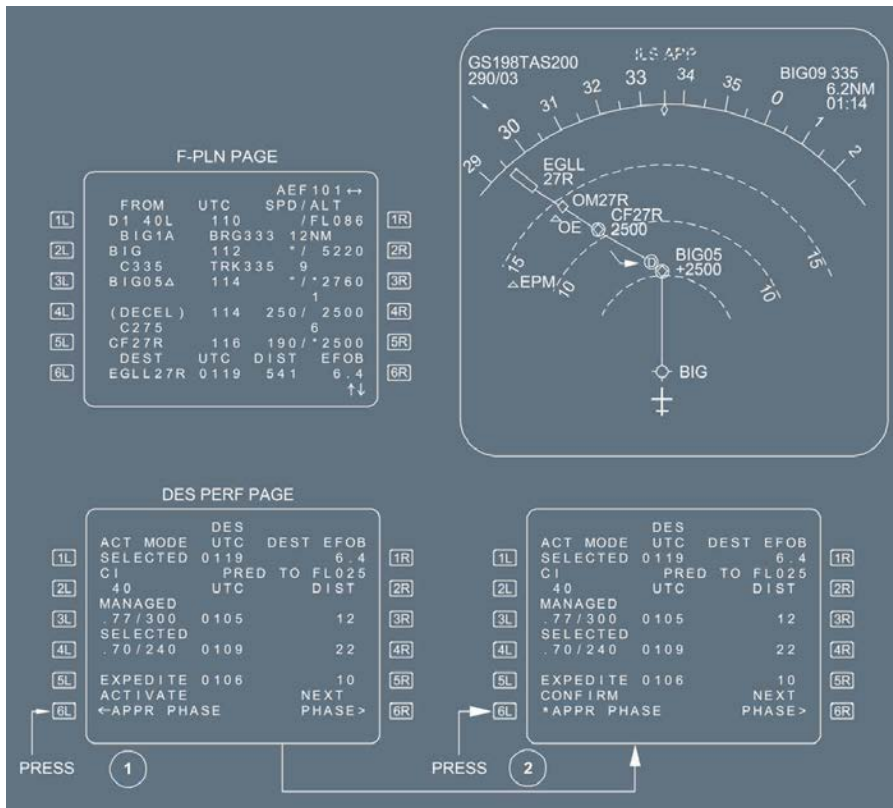

F-PLN PAGE

| | FROM | UTC | AEF 101 ↔ | SPD/ALT | |
|----|---------|--------|--------------|---------|----|
| 1L | D1 40L | 110 | | /FL086 | 1R |
| | BIG1A | BRG333 | 12NM | | |
| 2L | BIG | 112 | * / 5220 | | 2R |
| | C335 | TRK335 | 9 | | |
| 3L | BIG05Δ | 114 | * / * 2760 | | 3R |
| | | | 1 | | |
| 4L | (DECEL) | 114 | 250 / 2500 | | 4R |
| | C275 | | 6 | | |
| 5L | CF27R | 116 | 190 / * 2500 | | 5R |
| | DEST | UTC | DIST | EFOB | |
| 6L | EGLL27R | 0119 | 541 | 6.4 | 6R |
| | | | | ↑↓ | |

DES PERF PAGE

| | ACT MODE | DES | UTC | DEST | EFOB | |
|----|--------------|---------|-------|---------|------|----|
| 1L | SELECTED | 0119 | | 6.4 | | 1R |
| | CI | PRED TO | FL025 | | | |
| 2L | 40 | UTC | | DIST | | 2R |
| | MANAGED | | | | | |
| 3L | .77 / 300 | 0105 | | 12 | | 3R |
| | SELECTED | | | | | |
| 4L | .70 / 240 | 0109 | | 22 | | 4R |
| | EXPEDITE | 0106 | | 10 | | |
| 5L | ACTIVATE | | | NEXT | | 5R |
| | ← APPR PHASE | | | PHASE > | | |
| 6L | | | | | | 6R |

DES PERF PAGE (Detailed View)

| | ACT MODE | DES | UTC | DEST | EFOB | |
|----|--------------|---------|-------|---------|------|----|
| 1L | SELECTED | 0119 | | 6.4 | | 1R |
| | CI | PRED TO | FL025 | | | |
| 2L | 40 | UTC | | DIST | | 2R |
| | MANAGED | | | | | |
| 3L | .77 / 300 | 0105 | | 12 | | 3R |
| | SELECTED | | | | | |
| 4L | .70 / 240 | 0109 | | 22 | | 4R |
| | EXPEDITE | 0106 | | 10 | | |
| 5L | CONFIRM | | | NEXT | | 5R |
| | * APPR PHASE | | | PHASE > | | |
| 6L | | | | | | 6R |

GRAPHICAL APPROACH CHART

GS198TAS200 290/03 | ILS APP | BIG09 335 6.2NM 01:14

28 30 31 32 33 34 35 0 2

EGLL 27R | OM27R | CF27R | OE 2500 | BIG05 +2500 | ΔEPM/10 | BIG

MANAGED SPEED

CHECK that managed speed is active: MONITOR the target speed.

During the approach, the autothrust limits the speed of the current configuration. (GD, S, F, VAPP).

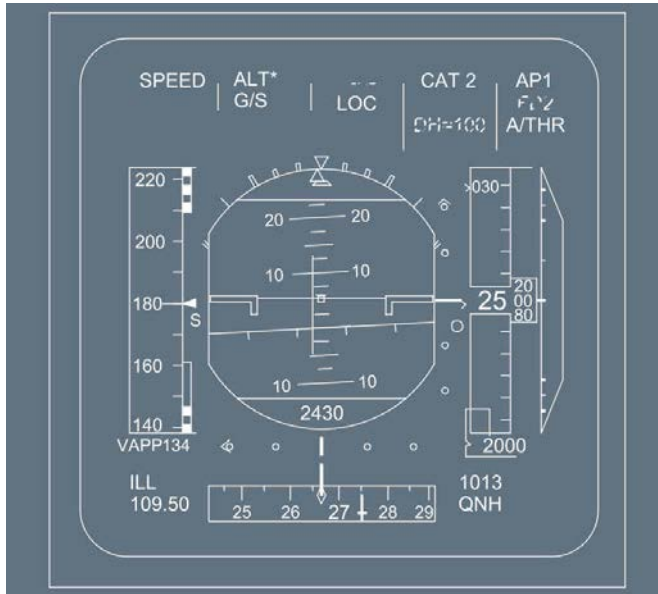

● **If ATC requires a specific speed:**

SWITCH to selected speed (turn and pull the speed selector knob on the FCU).
ADJUST the aircraft configuration accordingly.

● **If ATC orders successive step descents down to the final approach flight path:**

Use the V/S or FPA mode.
MONITOR VDEV.

NAV ACCURACY

As required by the SOP.

Without installed GPS and when no DME is available for the accuracy check, use HIGH/LOW on the PROG page.

In this case, consider a “HIGH” to be equivalent to a positive crosscheck.

ATC CLEARANCE

MODIFY the F-PLN , RAD NAV , and PERF APPR data to agree with the latest clearance and landing information.

ILS/MLS/GLS/FLS APPROACH

Applicable to: ALL

Ident.: PRO-NOR-SRP-01-70-A-00004018.0001001 / 17 MAR 11

INTERMEDIATE/FINAL APPROACH (ILS APPROACH ENTERED IN THE F-PLN)

The preferred technique for flying an ILS approach is to fly a decelerated approach using the AP /FD s, the LOC and G/S modes, A/THR in the SPEED mode, managed speed target is recommended.

DECELERATED APPROACH

The decelerated approach technique brings the aircraft down to 1 000 ft, at VAPP . In most cases, the interception of the final descent path is achieved with CONF 1 at S speed.

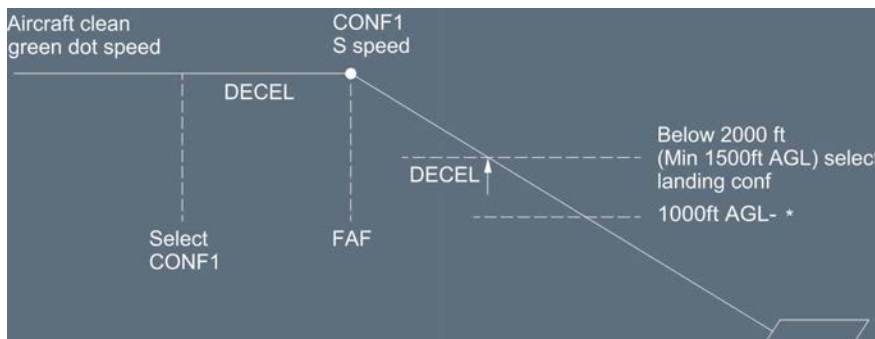

(*) The approach must be stabilized at approach speed (minimum ground speed) in the landing configuration before reaching 1 000 ft AGL.

Ident.: PRO-NOR-SRP-01-70-A-00004019.0009001 / 17 MAR 11

APPROACH MODE ACTIVATION (LOC -G/S)

● **When cleared by ATC and when appropriate:**

DEPRESS the APPR pushbutton to arm the APPR mode for the approach entered in the flight plan.

Note: If a NON PRECISION approach is selected in the active flight plan and if the flight crew manually tunes an ILS on the RAD NAV page, the MCDU and the PFD display "CHECK APPR SELECTION". This message is a reminder to the flight crew that, although an ILS is tuned on RAD NAV page, the available approach guidance modes are APP NAV -FINAL when the APPR pushbutton is pressed in on the FCU.

The FCU APPR pushbutton arms or engages LOC and G/S modes, if:

- An ILS approach is entered in the flight plan, or
- No approach, or only a runway, is entered in the flight plan, and an ILS is manually-tuned on the RAD NAV page, or
- Both RMP s are set to NAV , and an ILS is selected.

Ident.: PRO-NOR-SRP-01-70-A-00004020.0002001 / 17 MAR 11

AUTOLAND

CHECK that the FMA displays the aircraft capability (CAT 2 or CAT 3) for the intended ILS approach.

MONITOR the radio automatic callout.

● **At 350 ft RA:**

CHECK that “LAND” is displayed on the FMA.

CHECK ILS course.

If LAND is not displayed or if the ILS course is not correct, do not perform an autoland. The flight crew should perform a go-around, if visual references are not sufficient.

● **Between 50 and 40 ft RA:**

CHECK that “FLARE” is displayed on the FMA.

● **At approximately 30 ft RA:**

CHECK that “IDLE” is displayed on the FMA, and that autothrust starts to reduce thrust toward IDLE.

● **At 10 ft, “RETARD” callout comes up:**

MOVE the thrust levers to IDLE.

Autothrust disconnects.

● **At touchdown:**

CHECK that “ROLL OUT” appears on the FMA.

Note: *In the case of tailwind during an automatic rollout, it is recommended to use manual braking without delay or automatic braking for an optimised runway centerline tracking.*

● **At the end of the Rollout:**

Disconnect the autopilot.

If the flight crew does not disconnect the AP at the end of the rollout, and uses the nosewheel steering handwheel to taxi the aircraft off the runway, the following will occur:

- *The AP will try to steer the aircraft back to the runway centerline, if the nosewheel steering handwheel is released and the aircraft heading is less than 20 ° off the runway centerline.*
- *The AP will automatically disconnect, if the aircraft heading is 20 ° or more off the runway centerline.*

Ident.: PRO-NOR-SRP-01-70-A-00004021.0001001 / 17 MAR 11

MANUAL LANDING

● **At DH:**

DISCONNECT the APs. SPEED mode remains engaged.

● **At 20 ft “RETARD” automatic call out comes up:**

MOVE the thrust levers to IDLE if they are not there already. (The A/THR disconnects).

● **At touch down:**

“ROLL OUT” appears on the FMA and the yaw bar comes up on the PFD.

Note: *The retard call out is only a reminder when a manual landing is performed.*

Ident.: PRO-NOR-SRP-01-70-A-00004022.0011001 / 22 MAY 12

STANDARD ILS AUTOMATIC APPROACH

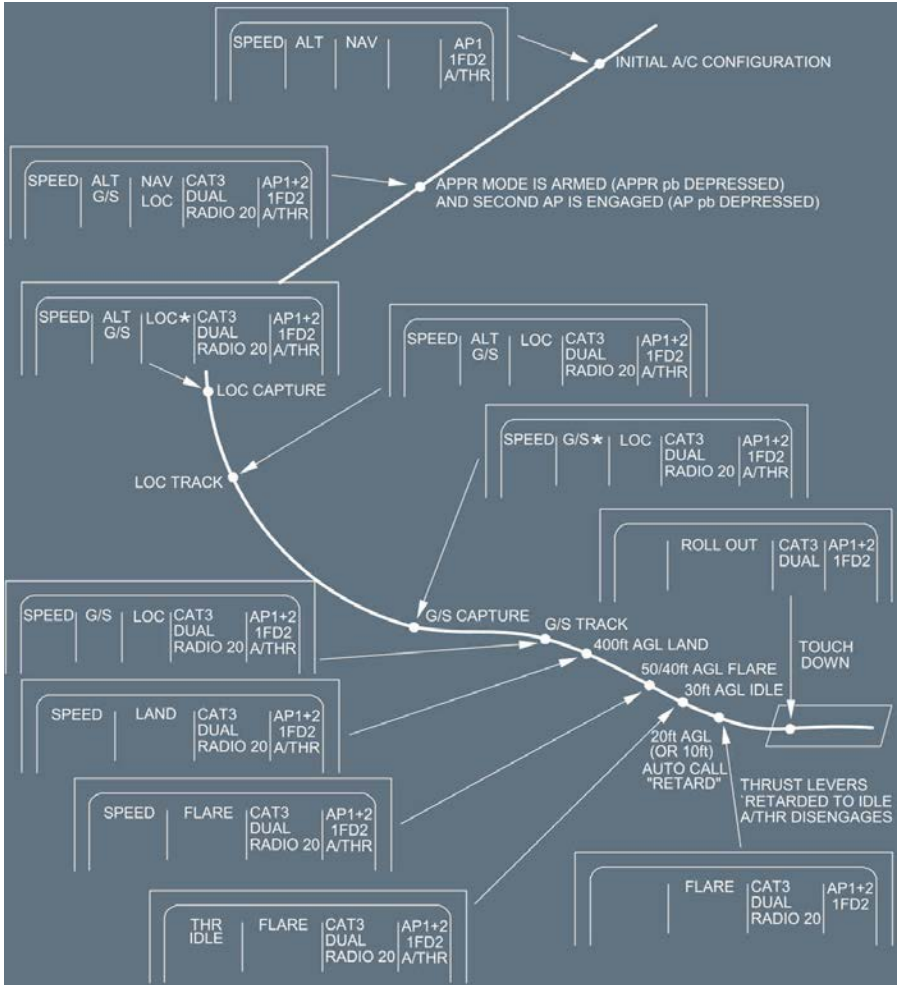



Ident.: PRO-NOR-SRP-01-70-A-00004023.0001001 / 26 NOV 13

EARLY SELECTION OF APPROACH MODE LOC -G/S

Pressing the APPR pushbutton arms LOC and G/S.

When the aircraft is above 5 000 ft AGL , the Radio altimeter signals may not be valid. As long as the Radio altimeter signals are invalid, the FMA displays CAT 1.

- **When the aircraft is cleared for an ILS/MLS  /GLS  approach:**
PRESS the APPR pb on the FCU.
- **When the aircraft is below 5 000 ft AGL:**
Check that the FMA displays the correct capability for the intended approach.

Ident.: PRO-NOR-SRP-01-70-A-00004024.0002001 / 29 MAY 13

GLIDESLOPE INTERCEPTION FROM ABOVE

If the aircraft is above the glideslope, the system will not capture the G/S automatically. The pilot must bring the aircraft onto the glideslope beam, and select an appropriate V/S to intercept it. *Refer to PRO-NOR-SOP-18-C Approach using LOC G/S Guidance - General.*

Ident.: PRO-NOR-SRP-01-70-A-00004025.0001001 / 17 MAR 11

DATA LOCK

When the aircraft reaches 700 ft RA with APPR mode (LOC and G/S) armed or engaged, the ILS FREQ and course are frozen in the receiver.

This function (ILS tune inhibit) is available, when at least one AP /FD is engaged. Any attempt to change the ILS frequency or CRS , via the MCDU or RMP, does not affect the receiver.

If the speed is managed, the system does not accept any modifications the pilot may enter on the PERF APPR page (surface wind, selected landing configuration, or VAPP) for speed guidance purposes below this altitude.

When the aircraft reaches 400 ft RA, LAND mode engages. The flight crew can only disengage this mode by engaging the GO AROUND mode.

Ident.: PRO-NOR-SRP-01-70-A-00004026.0001001 / 17 MAR 11

USE OF RMP S FOR ILS /DME

If both FMGC s fail, the flight crew can use the RMP s (Radio Management Panels 1 and 2) for back up tuning. Either RMP controls ILS . Prior to select an ILS frequency on one of the RMP s, the flight crew has to select "NAV " button from RMP 1 and RMP 2.

If the ILS has a DME , the PFD will not display the DME distance. In this situation, the flight crew will fly without DME information. If necessary, increase the Decision height (DH) accordingly.

Ident.: PRO-NOR-SRP-01-70-A-00004027.0001001 / 22 MAY 12

LOCALIZER (LOC) BEAM CAPTURE

The flight crew must always monitor the capture of a LOC beam. During this evolution, the PFD and ND must indicate that associated deviation indications move toward the centre of the scale. To avoid performing a false capture, the flight crew must be careful not to arm the LOC too early. The following graph shows the angle of interception versus distance to the runway threshold that ensures that the aircraft will not overshoot the axis by more than one and a half dot.

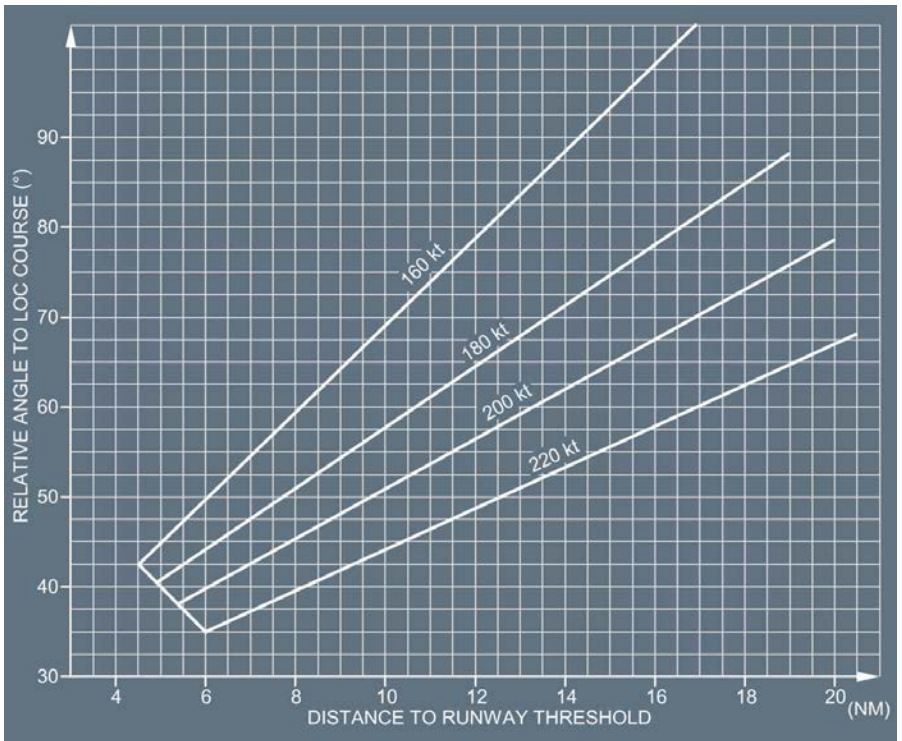

The capture begins when the deviation is two dots or less. It is programmed to line the aircraft up on the beam with a single overshoot, even if the intercept angle is large.

Note: ICAO requires LOC beam to ensure a normal capture within 10 NM and plus or minus 35 ° from the course centerline. Some ILS systems just meet the requirement and are subject to false capture outside these limits.

SWITCHING FROM NON ILS TO ILS APPROACH

Ident.: PRO-NOR-SRP-01-70-00004028.0002001 / 17 MAR 11

Applicable to: ALL

If an ILS approach is possible when a non ILS was previously scheduled, use one of the following procedures:

USE OF SECOND FLIGHT PLAN

Use a secondary flight plan to prepare the alternate ILS approach, time permitting.

COPY the ACTIVE flight plan.

REVISE the ARRIVAL: insert the ILS approach and the applicable STAR/VIA.

On the RAD NAV page, TUNE in the ILS manually.

REVISE the PERF APPR page.

CHANGE OF THE CLEARANCE

ATC changes the clearance from the non-ILS to the ILS approach.

● **If a secondary flight plan has been prepared:**

ACTIVATE the SEC F-PLN and adjust.

Follow subsequent standard procedures.

● **If a secondary flight plan has not been prepared:**

REVISE the ARRIVAL on the primary F-PLN, inserting the ILS approach.

REVISE the PERF APPR page.

Follow subsequent standard procedures.

CAUTION

If the pilot decides to fly the ILS approach without revising the arrival of the primary flight plan (a non ILS approach is in the F-PLN), LOC and G/S modes will not be available when he presses the APPR pushbutton.

Consequently, he should:

- Manually TUNE in the ILS on the RAD NAV page: CHECK that the "CHECK APPR SELECTION" message comes up.
- Press the ILS pushbutton and select ROSE ILS on the EIS CONTROL panel.
- Use HDG , V/S or TRK , FPA modes to fly the ILS.

| | |
|---|--|
|  <p>A318/A319/A320/A321 FLIGHT CREW OPERATING MANUAL</p> | <p>PROCEDURES NORMAL PROCEDURES SYSTEMS RELATED PROCEDURES - FMS</p> |
|---|--|

LANDING CATEGORIES

Ident.: PRO-NOR-SRP-01-70-00004038.0001001 / 16 NOV 11

Applicable to: ALL

Each FMGC computes its own landing category : CAT 1, CAT 2, CAT 3 single, and CAT 3 dual and displays the corresponding landing category on the FMAs.

Each category depends upon the availability of aircraft systems and functions.

When the landing capability downgrades, a triple click aural warning is activated.

FAIL-OPERATIONAL AUTOMATIC LANDING SYSTEM

An automatic landing system is fail-operational if, in the event of a failure below alert height, the remaining part of the automatic system allows the aircraft to complete the approach, flare, and landing. A CAT 3 DUAL system is a fail-operational automatic landing system.

Note: In the event of a failure, the automatic landing system operates as a fail-passive system.

FAIL-PASSIVE AUTOMATIC LANDING SYSTEM

An automatic landing system is fail-passive if, in the event of a failure, there is no significant out-of-trim condition or deviation of flight path or attitude, but the landing is not completed automatically. A CAT3 single system is a fail-passive automatic landing system.

Note: With a fail-passive automatic landing system the pilot assumes control of the aircraft after a failure.

Below 100 ft (radio altimeter), the FMGS freezes the landing capability until LAND mode is disengaged or both APs are off.

Therefore a failure occurring below 100 ft does not change the category of the system.

ALERT HEIGHT

The alert height is the height above touch down, above which a CAT3 autoland would be discontinued and a missed approach executed, if a failure occurred in either the airplane systems or the relevant ground equipments.

Below the alert height, if such a failure occurs, the flare, touchdown and roll out may be accomplished using the remaining automatic system.

WARNINGS FOR ILS APPROACH

Ident.: PRO-NOR-SRP-01-70-00004039.0002001 / 17 MAR 17

Applicable to: ALL

AUTOLAND WARNING

With "LAND" or "FLARE" green on the FMA and at least one AP engaged, the AUTOLAND red light appears on the glareshield when the aircraft is below 200 ft RA and one of the following events occurs:

- The autopilots are lost, or
- The aircraft gets too far off the beam (LOC or G/S flash on PFD), or
- Loss of LOC signal above 15 ft, or loss of glide signal above 100 ft (transmitter or receivers).
- The difference between both radio altimeter indications is greater than 15 ft.

WARNING OF EXCESSIVE BEAM DEVIATION

This warning is a flashing of the LOC and G/S scales on the PFD and ND ROSE ILS. It occurs whenever:

- G/S deviation is greater than 1 dot (above 100 ft RA).
- LOC deviation is greater than 1/4 dot (above 15 ft RA).

WARNING ASSOCIATED WITH ILS "LANDING CAPABILITY"

Any downgrading in the aircraft's capability for automatic approach and landing sounds a triple-click aural warning.

FAILURE OF BOTH LOCALIZER AND GLIDESLOPE RECEIVERS

The PFD and ND (rose ILS mode) display red LOC and G/S flags (if the ILS pushbutton has been pressed green). LOC and G/S scales disappear from the PFD.

If LOC or G/S modes are engaged and at least one AP /FD is engaged

- The AP disengages.
- The FD reverts to its HDG -V/S or TRK -FPA modes.

FAILURE OF LOCALIZER OR GLIDESLOPE TRANSMITTER (WHEN CAPTURED)

- The corresponding index is lost.
- The LOC and G/S scales flash.
- The corresponding FD bar flashes.

Above 200 ft RA , if the transmitter failure lasts less than 7 s, the FMA retains the LOC and G/S modes (or the LAND mode) and the AP s are able to regain these modes. If the failure lasts longer than 7 s, the AP disengages and the FD reverts to its basic modes. Below 200 ft RA , if

the transmitter failure occurs, the AUTOLAND warning appears, indicating that the crew must perform a GO AROUND (if insufficient visual references) with one or 2 APs engaged.



A318/A319/A320/A321
FLIGHT CREW
OPERATING MANUAL

PROCEDURES

NORMAL PROCEDURES

SYSTEMS RELATED PROCEDURES - FMS

Intentionally left blank

| | |
|---|--|
|  <p>A318/A319/A320/A321 FLIGHT CREW OPERATING MANUAL</p> | <p>PROCEDURES</p> <p>NORMAL PROCEDURES</p> <p>SYSTEMS RELATED PROCEDURES - FMS</p> |
|---|--|

Go-Around

MONITORING THE GO-AROUND

Ident.: PRO-NOR-SRP-01-80-00004054.0002001 / 09 DEC 09
 Applicable to: ALL

Engage the GO-AROUND phase and GO-AROUND modes by setting the thrust levers to the TOGA position, if at least CONF1 is selected.

When the GO-AROUND phase is engaged, the previously-flown approach is automatically strung back into the flight plan at the end of the missed approach procedure.

In the GO-AROUND phase, the system makes no predictions. Consequently, CLB and DES modes are not available, and the flight crew must monitor constraints.

When the aircraft leaves the GO-AROUND phase, all predictions and modes become available again. During a GO-AROUND phase, the managed speed is Green Dot.

4L
5L
6L

 THR RED/ACC
 1500/2000
 ACTIVATE
 ← APPR PHASE

 ENG OUT ACC
 2000
 NEXT
 PHASE>

4R
5R
6R

ACTIVATE THE APPROACH PHASE MANUALLY
 THIS WILL SWITCH THE MANAGED
 SPEED TO APPROPRIATE
 SPEED (S,F,VAPP,VAPP TARGET)

PERF PAGE, GO-AROUND PHASE ACTIVE

HEADING/TRACK PRESET FUNCTION IN GO-AROUND PHASE

The flight crew can use the heading/track preset, when LOC *, LOC , LAND, FINAL or GA is engaged.

SET the appropriate heading, or track value, in the window of the FCU.

When necessary, PULL the HDG/TRK selection knob to engage the mode on the preset value.

GO-AROUND PROFILE

Ident.: PRO-NOR-SRP-01-80-00004055.0014001 / 22 MAY 12
 Applicable to: ALL

- **WITH FD ON:**
Apply SOP procedures

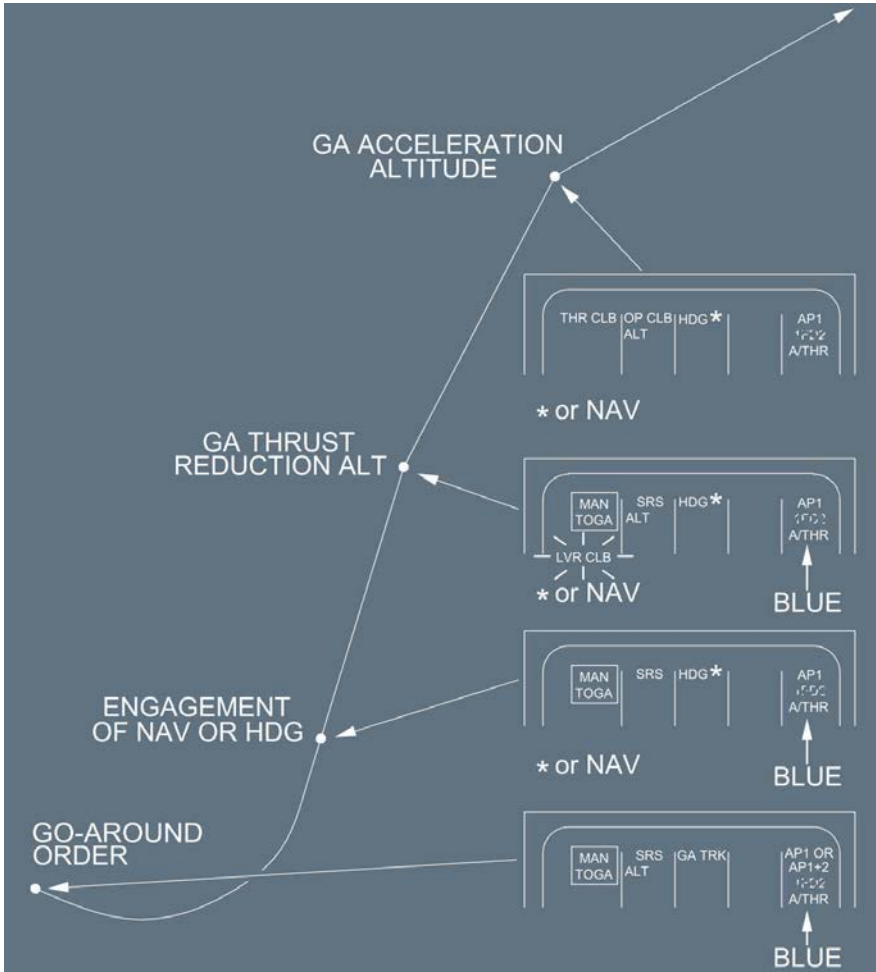

MISSED APPROACH: TRY AGAIN

Ident.: PRO-NOR-SRP-01-80-00004057.0008001 / 14 FEB 11

Applicable to: ALL

If the pilot intends to fly another approach to the destination:

- The flight plan has all the necessary data for the missed approach
- Green Dot is the target speed.

- **When cleared by the ATC to follow the missed approach procedure:**
ENGAGE NAV mode, or
TURN and PULL the HDG selector knob to set a heading
HDG , or TRK , or NAV modes can only be engaged above 100 ft.
- **When entering the initial approach area:**
Activate the approach phase on the MCDU's PERF GO AROUND page
 - **If the APPR phase is not activated:**
 - Managed approach speed will not be available
 - The system will not furnish predictions
 - BARO /RADIO minima displays will not appear on the PFD.

MISSED APPROACH: DIVERT

Ident.: PRO-NOR-SRP-01-80-00004058.0001001 / 14 FEB 11

Applicable to: ALL

- **If the crew decides to divert to the alternate:**
ENABLE ALTN, preferably at the TO waypoint.
- **When cleared to a waypoint:**
PERFORM a DIRECT TO.

The system automatically reverts to CLB phase, and modifies the target speed from Green Dot to initial speed.

The system automatically sets the CRZ FL to the defaulted alternate CRZ FL (FL 220 or 310), and retains the previous cost index.



The pilot may adjust these as necessary.

Note: *Diversion may also be initiated by entering a NEW DEST in the LAT REV page at the TO waypoint, or by using the secondary F-PLN, if prepared. Refer to DSC-22_20-60-30 General.*

TASK SHARING DURING A GO-AROUND

Ident.: PRO-NOR-SRP-01-80-00004059.0002001 / 20 JUL 15

Applicable to: **ALL**

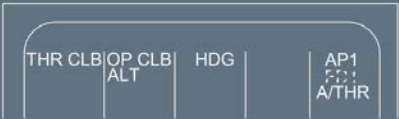
| PF | PM |
|---|---|
| <p>-Announce "GO AROUND, FLAPS". Simultaneously set thrust levers to TO GA.</p> <p>-Monitor the flight path.</p> | <p>-Announce "FLAPS_". Retract flaps one step, and monitor engine parameters.</p> |
|  | |
| <p><u>When rate of climb is positive:</u></p> | |
| <p>-Announce "GEAR UP"</p> | <p>-Announce "POSITIVE CLIMB". -Retract the gear and confirm "GEAR UP".</p> |
| <p><u>When LVR CLB flashes on FMA:</u></p> | |
| <p>-Set thrust levers to CL detent.</p> <p>-Push or Turn/pull HDG/TRK sel knob on FCU, according to ATC clearance.</p> | |
|  | |
| <p><u>At go-around acceleration altitude:</u></p> | |
| <p>-Monitor that the target speed increases to Green Dot.</p> | |
|  | |
| <p>● If the speed target does not increase to Green Dot: -CHECK and PULL the altitude selector knob to engage OP CLB The speed target increases to Green Dot -Retract flaps on schedule.</p> | |

PROCEDURES

SPECIAL OPERATIONS

Intentionally left blank

PRO-SPO-20 Flight Without Cabin Pressurization

| | |
|--|---|
| General..... | A |
| Oxygen Requirements..... | B |
| Flight Planning and Execution..... | C |
| Systems..... | D |
| Performance Data..... | E |
| Flight Planning from Brake Release to Landing..... | F |
| Ground Distance/Air Distance Conversion..... | G |

PRO-SPO-40 Extended Range Operations

PRO-SPO-40-10 General

| | |
|--------------|---|
| General..... | A |
|--------------|---|

PRO-SPO-40-20 Operational Limitations

| | |
|------------------------|---|
| Definitions..... | A |
| Area of Operation..... | B |

PRO-SPO-40-30 Dispatch Consideration

| | |
|-----------------------------------|---|
| MMEL..... | A |
| ETOPS Fuel Scenarios..... | B |
| ETOPS Critical Fuel Reserves..... | C |
| ETOPS Fuel Requirements..... | D |
| Weather Minima..... | E |

PRO-SPO-40-40 Diversion During Extended Range Operations

| | |
|---|---|
| Diversion Decision Making..... | A |
| Diversion Performance Data..... | B |
| Guidelines for Diversion Procedure..... | C |

PRO-SPO-40-50 Procedures

| | |
|--|---|
| General..... | A |
| Normal Procedures..... | B |
| Abnormal and Emergency Procedures..... | C |

PRO-SPO-40-60 Performance

| | |
|---|---|
| General..... | A |
| Maximum Diversion Distance..... | B |
| ETOPS Fuel Requirement from Critical Point to Landing - All Engines - Cruise at LRC..... | C |
| ETOPS Fuel Requirement from Critical Point to Landing - One Engine Out - Cruise at 350kt..... | D |
| ETOPS Fuel Requirement from Critical Point to Landing - One Engine Out - Cruise at 320kt..... | E |
| ETOPS Fuel Requirement from Critical Point to Landing - Example..... | F |

Continued on the following page

Continued from the previous page

PRO-SPO-45 Engine Intermix Operations

| | |
|-----------------------------|---|
| Engine Intermix Type 1..... | A |
| Engine Intermix Type 2..... | B |

PRO-SPO-50 Reduced Vertical Separation Minimum - RVSM

| | |
|---|---|
| General..... | A |
| Required Equipments/Functions for RVSM..... | B |
| RVSM Normal Procedure..... | C |
| RVSM Abnormal and Emergency Procedure..... | D |

PRO-SPO-51 Required Navigation Performance (RNP)

| | |
|---|---|
| General..... | A |
| RNAV 10 / RNP 10..... | B |
| RNAV 5 / BRNAV..... | C |
| RNAV 1 RNAV 2 / P-RNAV - Terminal RNAV..... | D |
| RNP 4..... | E |
| RNP 2 in Oceanic and Remote Continental Area..... | F |
| RNP 2 in Domestic Area..... | G |
| RNP 1 / Terminal RNP 1- Basic RNP 1..... | H |
| RNP APCH / RNAV(GNSS)..... | I |

PRO-SPO-60 Operations on Narrow Runways

| | |
|------------------|---|
| General..... | A |
| Limitations..... | B |
| Procedures..... | C |
| Performance..... | D |

PRO-SPO-85 ILS PRM Approach

| | |
|---|---|
| Overview..... | A |
| Break out Turn and Climb Procedure..... | B |
| Break out Turn and Descent Procedure..... | C |

GENERAL

Ident.: PRO-SPO-20-00001883.0001001 / 12 NOV 15

Applicable to: ALL

Flight without cabin pressurization can result of:

- Dispatch under MEL
- Departure following a structural damage
- Depressurization in flight

The flight crew must decide the flight level and the airspeed depending on:

- The cause of the depressurization
- The distance to fly
- The topographic conditions
- The meteorological conditions, and
- The passengers on board the aircraft.

Revenue flight is permitted without cabin pressurization, provided that the oxygen requirements below are achieved.

After a MEL dispatch with both PACKs inoperative, the flight without cabin pressurization is permitted provided the flight is performed without passengers.

OXYGEN REQUIREMENTS

Ident.: PRO-SPO-20-00001884.0001001 / 21 MAR 17

Applicable to: ALL

CREW MEMBERS

See FAR 121.329 or AIR-OPS CAT.IDE.A.235

PASSENGERS

For flight at cabin pressure altitudes above 10 000 ft, up to and including 14 000 ft, there must be enough oxygen to supply 10 % of the passengers for the flight at those altitudes that lasts more than 30 min.

For flight at cabin pressure altitudes above 14 000 ft, up to and including 15 000 ft, there must be enough oxygen for 30 % of the passengers.

For flight at cabin pressure altitudes above 15 000 ft, there must be enough oxygen for all passengers.

FLIGHT PLANNING AND EXECUTION

Applicable to: ALL

Ident.: PRO-SPO-20-A-00001981.0001001 / 21 MAR 17

ALTITUDE

Flight route planning should consider the above-stated restriction in cabin altitude. If cabin altitude exceeds $9\,550 \pm 350$ ft, the EXCESS CAB ALT warning on the ECAM will be activated. When above 14 000 ft, the passenger oxygen masks will drop automatically. Therefore, the recommended maximum altitude for prolonged flight is FL 100. The minimum altitude should be selected by respecting :

- The Minimum Safe Altitude (MSA),
- Turbulence, which is uncomfortable for passengers and,
- Low Outside Air Temperature (OAT), which can be uncomfortable for passengers when the cabin is ventilated by ram air only.

Ident.: PRO-SPO-20-A-00001983.0001001 / 21 MAR 17

AIRPEED

If decompression is due to structural damage, consider airspeed reduction. Use slats and flaps, as necessary, to establish low speed conditions. In addition, turbulent conditions are uncomfortable for passengers, and gust response should be minimized by reducing airspeed.

Ident.: PRO-SPO-20-A-00001984.0001001 / 21 MAR 17

CLIMB AND DESCENT RATE

Takeoff must be performed normally, and the rate of climb must be limited to about 500 ft/min, to ease the pressure change felt by passengers and crew.

Likewise, the rate of descent must be limited to about 1 000 ft/min, except for the final approach which must be performed normally. Notify the ATC of any performance deficiency by a remark in the flight plan.

Ident.: PRO-SPO-20-A-00001985.0004001 / 21 MAR 17

EMER DESCENT IN CASE OF RAPID DEPRESSURIZATION

In the event of depressurization, oxygen is supplied to passengers through an individual mask. The capacity of the units is such that the aircraft must descend and remain below the following profile.



SYSTEMS

Ident.: PRO-SPO-20-00001990.0002001 / 23 JUN 15

Applicable to: ALL

FAILURE OCCURRING IN FLIGHT

Apply the abnormal and emergency procedures required by ECAM.

FAILURE PRESENT AT DISPATCH

● **If flight with both packs inoperative:**

In that case, the flight must be performed with no passengers.

PACK 1 and 2..... OFF
RAM AIR..... ON

Note: If the "AVIONICS SMOKE" procedure has to be applied, the following flight time limitations have to be considered to protect the avionic equipment :

- At ISA +40 : 0.5 h*
- At ISA +30 : 1.5 h*
- At ISA +20 : 4 h*
- At ISA +10 and below : No limitation.*

MAX FL100 or MSA

● **If both CAB PRESS systems are inoperative, or if there is structural damage:**

TEST OF THE MANUAL OPERATION OF THE OUTFLOW VALVE ON GROUND:

PACK 1 pb-sw and PACK 2 pb-sw OFF
OUTFLOW VALVE FULLY OPEN.....CHECK

Check that the outflow valve is fully open on the CAB PRESS SD page

RPCU CB (X23 ON 122VU)..... PULL
MODE SEL pb MAN

MAN V/S CTL DN

Check that the outflow valve is fully closed on the CAB PRESS SD page

MAN V/S CTL UP

Check that the outflow valve is fully open on the CAB PRESS SD page

MODE SEL pb AUTO

RPCU CB (X23 ON 122VU)..... PUSH

PACK 1 pb-sw and PACK 2 pb-sw ON

MAX FL 100 or MSA

Between FL 80 and FL 150, oxygen must be provided for 2 % of the passengers. This is provided by the portable oxygen system. When it is no longer available, descend to FL 80. For performance at FL 80/250 kt : Use data for FL 100/LRC (Refer to PER-CRZ-CRT-30 LONG RANGE CRUISE - ISA) and increase fuel consumption by 6 %.

TAKEOFF

Limit the aircraft's rate of climb to about 500 ft/min.

- **If both CAB PRESS systems are inoperative, or if there is structural damage:**

- **WHEN IN CLEAN CONFIGURATION:**

MODE SEL pb MAN

V/S CTL sw AS RQRD

Use V/S CTL pb to set the outflow valve opening to 50 %.

OUTFLOW VALVE HALF OPEN..... CHECK

The outflow valve opening is limited to 50 %, to prevent the cabin air suction effect.

CLIMB

Note: The EXCESS CAB ALT warning may occur.

Use the ECAM CLR pb to clear the warning.

DESCENT

Limit the aircraft's rate of descent to about 1 000 ft/min. Perform the final approach normally.

PERFORMANCE DATA

Ident.: PRO-SPO-20-00001991.0002001 / 10 JAN 11

Applicable to: ALL

The following table enables the fuel consumption and the time needed from takeoff to landing to be determined in case of flight without cabin pressurization.

The table is established for :

- Takeoff
- Climb from 1 500 ft at 250 kt
- Long range cruise speed at FL 100
- Descent to 1 500 ft at 250 kt
- Approach and landing : IMC procedure 120 kg or 260 lb (6 min)
- ISA temperature
- CG = 25 %
- Normal air conditioning
- Anti ice OFF

The table (*Refer to PRO-SPO-20 Ground Distance/Air Distance Conversion*) gives the conversion from ground distance to air distance

Following tables have been calculated using databases for CFM 56–5–B /P. If the engines fitted on the aircraft are not /P, the fuel consumption has to be increased by 3 %.

Note: For each degree Celcius above ISA temperature apply a correction of 0.01 (kg/°C/NM) or 0.022 (lb/°C/NM).

FLIGHT PLANNING FROM BRAKE RELEASE TO LANDING

Ident.: PRO-SPO-20-00001992.0022001 / 10 JAN 11

Applicable to: ALL

| FLIGHT PLANNING FROM BRAKE RELEASE TO LANDING | | | | | | | |
|--|-------------------------|---------------------------|--------------|--------------|--------------------------|--------------|--------------|
| CLIMB : 250 KT - CRUISE : LONG RANGE - DESCENT : 250KT | | | | | | | |
| IMC PROCEDURE : 120 KG (6MIN) | | | | | | | |
| FL 100 | | | | | | | |
| NORMAL AIR CONDITIONING | | ISA | | | FUEL CONSUMED (KG) | | |
| ANTI-icing OFF | | CG = 25.0% | | | TIME (H.MIN) | | |
| AIR DIST. (NM) | INITIAL WEIGHT (1000KG) | | | | | | |
| | 50 | 55 | 60 | 65 | 70 | 75 | 80 |
| 220 | 1895 0.55 | 1968 0.53 | 2040 0.52 | 2110 0.51 | 2183 0.51 | 2257 0.50 | 2336 0.50 |
| 240 | 2039 0.59 | 2119 0.57 | 2197 0.55 | 2271 0.55 | 2348 0.54 | 2426 0.54 | 2509 0.54 |
| 260 | 2183 1.04 | 2270 1.01 | 2353 0.59 | 2432 0.58 | 2513 0.58 | 2595 0.57 | 2682 0.57 |
| 280 | 2326 1.08 | 2420 1.05 | 2509 1.03 | 2593 1.02 | 2678 1.01 | 2763 1.01 | 2854 1.01 |
| 300 | 2470 1.13 | 2571 1.09 | 2665 1.07 | 2753 1.05 | 2842 1.04 | 2932 1.04 | 3026 1.04 |
| 320 | 2613 1.17 | 2721 1.13 | 2821 1.10 | 2914 1.09 | 3007 1.08 | 3100 1.07 | 3199 1.07 |
| 340 | 2756 1.21 | 2871 1.17 | 2977 1.14 | 3074 1.12 | 3171 1.11 | 3269 1.11 | 3371 1.11 |
| 360 | 2899 1.26 | 3020 1.21 | 3133 1.18 | 3234 1.16 | 3336 1.15 | 3437 1.14 | 3543 1.14 |
| 380 | 3042 1.30 | 3170 1.25 | 3288 1.21 | 3394 1.20 | 3500 1.18 | 3605 1.18 | 3715 1.17 |
| 400 | 3185 1.35 | 3319 1.30 | 3444 1.25 | 3554 1.23 | 3664 1.22 | 3773 1.21 | 3886 1.21 |
| 420 | 3327 1.39 | 3468 1.34 | 3599 1.29 | 3713 1.27 | 3828 1.25 | 3941 1.24 | 4058 1.24 |
| 440 | 3469 1.44 | 3616 1.38 | 3754 1.33 | 3873 1.30 | 3992 1.29 | 4108 1.28 | 4229 1.28 |
| 460 | 3611 1.48 | 3765 1.42 | 3909 1.36 | 4032 1.34 | 4155 1.32 | 4276 1.31 | 4400 1.31 |
| 480 | 3753 1.53 | 3913 1.46 | 4064 1.40 | 4192 1.38 | 4319 1.36 | 4443 1.35 | 4572 1.34 |
| 500 | 3895 1.57 | 4061 1.50 | 4219 1.44 | 4351 1.41 | 4482 1.39 | 4611 1.38 | 4743 1.38 |
| 520 | 4036 2.01 | 4209 1.55 | 4373 1.48 | 4510 1.45 | 4645 1.43 | 4778 1.41 | 4913 1.41 |
| 540 | 4177 2.06 | 4357 1.59 | 4528 1.52 | 4668 1.48 | 4808 1.46 | 4945 1.45 | 5084 1.45 |
| 560 | 4318 2.10 | 4505 2.03 | 4682 1.55 | 4827 1.52 | 4971 1.50 | 5112 1.48 | 5255 1.48 |
| 580 | 4459 2.15 | 4652 2.07 | 4836 1.59 | 4986 1.56 | 5134 1.53 | 5279 1.52 | 5425 1.51 |
| 600 | 4600 2.19 | 4799 2.12 | 4990 2.03 | 5144 1.59 | 5297 1.57 | 5446 1.55 | 5595 1.55 |
| 620 | 4741 2.24 | 4946 2.16 | 5144 2.07 | 5302 2.03 | 5460 2.00 | 5612 1.58 | 5766 1.58 |
| 640 | 4881 2.28 | 5093 2.20 | 5298 2.11 | 5460 2.07 | 5622 2.04 | 5779 2.02 | 5936 2.01 |
| 660 | 5021 2.33 | 5240 2.25 | 5451 2.14 | 5618 2.10 | 5784 2.07 | 5945 2.05 | 6106 2.05 |
| 680 | 5161 2.37 | 5386 2.29 | 5605 2.18 | 5776 2.14 | 5946 2.11 | 6112 2.09 | 6275 2.08 |
| 700 | 5301 2.42 | 5532 2.34 | 5758 2.22 | 5934 2.18 | 6108 2.14 | 6278 2.12 | 6445 2.12 |
| AIR CONDITIONING OFF | | ENGINE ANTI ICE ON | | | TOTAL ANTI ICE ON | | |
| ΔFUEL = - 2.5 % | | ΔFUEL = + 5 % | | | ΔFUEL = + 9 % | | |

GROUND DISTANCE/AIR DISTANCE CONVERSION

Ident.: PRO-SPO-20-00001994.0001001 / 10 JAN 11

Applicable to: ALL

| GROUND DIST. (NM) | AIR DISTANCE (NM) | | | | | | |
|-------------------------|-------------------|------|----------------------|------------|-----|-----------|------|
| | TAIL WIND | | WIND COMPONENTS (KT) | | | HEAD WIND | |
| | +150 | +100 | + 50 | 0 | -50 | -100 | -150 |
| 40 | 27 | 30 | 35 | 40 | 48 | 59 | 76 |
| 60 | 41 | 46 | 52 | 60 | 71 | 88 | 115 |
| 80 | 54 | 61 | 69 | 80 | 95 | 117 | 153 |
| 100 | 68 | 76 | 86 | 100 | 119 | 146 | 191 |
| 120 | 81 | 91 | 104 | 120 | 143 | 176 | 229 |
| 140 | 95 | 106 | 121 | 140 | 166 | 205 | 267 |
| 160 | 108 | 121 | 138 | 160 | 190 | 234 | 305 |
| 180 | 122 | 137 | 155 | 180 | 214 | 264 | 344 |
| 200 | 135 | 152 | 173 | 200 | 238 | 293 | 382 |
| 220 | 149 | 167 | 190 | 220 | 261 | 322 | 420 |
| 240 | 163 | 182 | 207 | 240 | 285 | 352 | 458 |
| 260 | 176 | 197 | 224 | 260 | 309 | 381 | 496 |
| 280 | 190 | 213 | 242 | 280 | 333 | 410 | 534 |
| 300 | 203 | 228 | 259 | 300 | 357 | 439 | 573 |
| 320 | 217 | 243 | 276 | 320 | 380 | 469 | 611 |
| 340 | 230 | 258 | 293 | 340 | 404 | 498 | 649 |
| 360 | 244 | 273 | 311 | 360 | 428 | 527 | 687 |
| 380 | 257 | 288 | 328 | 380 | 452 | 557 | 725 |
| 400 | 271 | 304 | 345 | 400 | 475 | 586 | 763 |
| 420 | 285 | 319 | 362 | 420 | 499 | 615 | 802 |
| 440 | 298 | 334 | 380 | 440 | 523 | 645 | 840 |
| 460 | 312 | 349 | 397 | 460 | 547 | 674 | 878 |
| 480 | 325 | 364 | 414 | 480 | 571 | 703 | 916 |
| 500 | 339 | 380 | 432 | 500 | 594 | 732 | 954 |
| 520 | 352 | 395 | 449 | 520 | 618 | 762 | 992 |
| 540 | 366 | 410 | 466 | 540 | 642 | 791 | 1031 |
| 560 | 379 | 425 | 483 | 560 | 666 | 820 | 1069 |
| 580 | 393 | 440 | 501 | 580 | 689 | 850 | 1107 |
| 600 | 406 | 455 | 518 | 600 | 713 | 879 | 1145 |



A318/A319/A320/A321
FLIGHT CREW
OPERATING MANUAL

PROCEDURES
SPECIAL OPERATIONS

FLIGHT WITHOUT CABIN PRESSURIZATION

Intentionally left blank

| | |
|---|---|
|  <p>A318/A319/A320/A321 FLIGHT CREW OPERATING MANUAL</p> | <p align="center">PROCEDURES SPECIAL OPERATIONS</p> <p align="center">EXTENDED RANGE OPERATIONS - GENERAL</p> |
|---|---|

GENERAL

Ident.: PRO-SPO-40-10-00002029.0001001 / 23 JUN 15

Applicable to: ALL

The system design and the reliability of the engine installation of this airplane comply with the criteria for Extended Twin Operations (ETOPS) flights set forth in AMC 20-6 rev. 2 (EASA) or FAR 25.1535 (FAA), when the aircraft is configured, maintained and operated in accordance with the Airbus CMP (Configuration, Maintenance and Procedure) document.

This statement of ability does not constitute an approval to conduct Extended-Range Operations. The ETOPS EXTENDED OPERATIONS Chapter of the AFM APPENDICES AND SUPPLEMENTS Section refers to the approved Standard for Extended-Range Operations and the applicable limitations, procedures and performance references.

The operator is responsible for showing that he is complying with the regulation of his nation and for obtaining operational approval from his national authorities. The operator may amend this chapter, as needed.

The airplane must be configured in accordance with the Airbus Standard for Extended-Range Operations. However, the authorities may under certain conditions allow the operator to conduct ETOPS flights with limited maximum diversion time (for example, 75 min diversion time in a benign area of operation) without showing full compliance with these standards.



A318/A319/A320/A321
FLIGHT CREW
OPERATING MANUAL

PROCEDURES
SPECIAL OPERATIONS

EXTENDED RANGE OPERATIONS - GENERAL

Intentionally left blank

DEFINITIONS

Ident.: PRO-SPO-40-20-00002031.0001001 / 23 JUN 15

Applicable to: ALL

For the purpose of EU-OPS 1-245 and FAR 121-161, Extended-Range Operations are those intended to be conducted over a route that contains a point beyond 60 min from an adequate airport at the selected one-engine-inoperative speed in still air and ISA (or prevailing delta ISA) conditions. An adequate airport is an airport which satisfies the aircraft performance requirements applicable at the expected landing weight, and sufficiently equipped to be safely used. In particular, at the anticipated time of use, it should be available and equipped with the necessary services, including ATC, weather information, nav aids and emergency services. An ETOPS (en-route) alternate airport is a confirmed adequate airport which satisfies the dispatch weather minima requirements for ceiling and visibility within the required validity period.

AREA OF OPERATION

Ident.: PRO-SPO-40-20-00002032.0001001 / 21 MAR 17

Applicable to: ALL

The ETOPS area of operations is the airspace within which the distance to an ETOPS adequate airport is less than the ETOPS Max Diversion distance.

The ETOPS maximum diversion distance from an adequate airport must be determined for ISA (or prevailing delta ISA) and no-wind conditions, taking into account aircraft performance with one engine inoperative and the remaining engine operating at MCT.

To determine the ETOPS maximum diversion distance from an adequate airport, the operator must define a One Engine Inoperative diversion speed for performance computation.

The same approved one-engine-inoperative diversion speed (*Refer to PER-OEI-GEN STRATEGY*) must be considered for :

- Establishing the area of operation,
- Calculating the single-engine fuel planning,
- Conducting the diversion in case of engine failure (conditions permitting).

The operator has to define an aircraft weight at diversion that is considered for the ETOPS Maximum Diversion Distance calculation. This aircraft weight can be taken as a representative but conservative value of the aircraft gross weight at the critical point of the route or at the various critical points of all the routes included in a given sector.

The approved one-engine-inoperative descent and cruise speed must be chosen so that the associated net flight path clears the en-route obstacles with the regulatory margin. However, a speed other than the approved one-engine-inoperative speed may be used as the basis for obstacle clearance as long as the fuel required with that speed is covered by the critical fuel scenario.

Refer to PER-OEI-GEN STRATEGY for these two one-engine-inoperative speeds.

When the one-engine-inoperative diversion speed is chosen, the maximum distance from a diversion airport, can be directly determined for different maximum diversion times, with the help of the tables provided in this section. The area of possible ETOPS operation can then be drawn on plotting charts. Another way to determine the maximum distance to a diversion airport is to read the one-engine-inoperative cruise TAS (for the reference gross weight and at the FL for best TAS) in the cruise tables (*Refer to PER-OEI-GEN STRATEGY*) taking into consideration the appropriate speed strategy and the minimum altitude for clearing possible obstacles. The maximum distance the aircraft can travel to a diversion airport is this one-engine-inoperative-TAS multiplied by the maximum allowed diversion time granted to the operator.

Operators whose authorities require that an approved one-engine-inoperative speed be published in the Flight Manual must use this approved speed.

M MEL

Ident.: PRO-SPO-40-30-00002035.0001001 / 03 DEC 13

Applicable to: ALL

The M MEL has been approved taking into consideration the duration of the average ETOPS flight and the maximum diversion time granted to the airframe/engine combination.

The M MEL published by Airbus and approved by the EASA can be used to establish the airline MEL, which must be approved by the operator's national authorities.

This MEL will probably be adapted to the airline network, environment and organization.

Other determining parameters will be :

- The maximum and the average diversion times on the route.
- The equipment of the enroute alternates.
- The navigation and communication facilities.
- The average meteorological conditions.

ETOPS FUEL SCENARIOS

Ident.: PRO-SPO-40-30-00012899.0001001 / 23 JUN 15

Applicable to: ALL

According to EASA AMC20-6 rev 2 and FAA 121.646 for establishing the ETOPS critical fuel reserves, the operator must consider three diversion scenarios:

- Pressurization Failure + Engine Failure

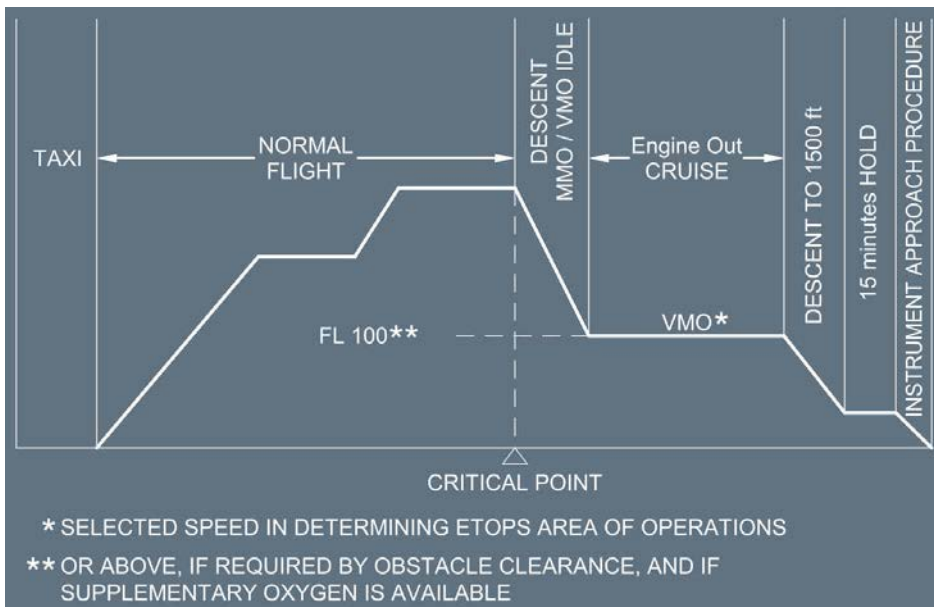

- Pressurization Failure
 Same Flight Profile as above, but all engines operating and Diversion Cruise Speed* set to LRC.
- Engine Failure
 Same Flight Profile as above, but standard descent speed and Diversion Cruise at the FL ** appropriate to gross engine out ceiling at the selected ETOPS diversion speed.
- FAA Fuel Requirements
 For the first two scenarios, involving depressurization, the required block fuel must be calculated in accordance with the operator's ETOPS fuel policy and using the regulatory ETOPS critical fuel reserves *Refer to PRO-SPO-40-30 ETOPS Critical Fuel Reserves.*
 Depending on the approved one-engine-inoperative speed selected for the single-engine diversion strategy, either of these two scenarios may result in the higher fuel requirement.
 The scenario resulting in the higher fuel requirement is called the ETOPS critical fuel scenario, and the associated minimum block fuel requirement is the ETOPS critical fuel plan.
 Note that, it is not necessary to calculate the 3rd scenario (engine failure), as this scenario is never critical, due to the higher diversion flight level.

ETOPS CRITICAL FUEL RESERVES

Ident.: PRO-SPO-40-30-00012901.0001001 / 23 JUN 15

Applicable to: ALL

For the computation of the ETOPS critical fuel reserves and of the complete ETOPS critical fuel planning according to EASA AMC 20-6 rev 2 and FAR 121.646, the diversion fuel must include the following fuel provisions:

- Fuel burn-off from the critical point to the end of descent at the alternate airport
- Fuel for 15 min of holding at 1 500 ft and green dot speed at the alternate
- Fuel for an instrument approach and landing
- Fuel to account for errors in wind forecasting (5 % wind speed factor on actual forecast wind speeds or 5 % fuel if actual forecast wind speeds are not used)
- Fuel to account for aircraft deterioration (use a demonstrated performance factor or 5 %)
- Fuel to account for any Configuration Deviation List (CDL) or MEL item
- Fuel to account for Icing Effects (if forecast) for the critical mission
- Fuel to account for APU use (only for the one-engine-inoperative scenario, if APU is operative)

WIND ERRORS

A 5 % wind speed factor (i.e. an increment to headwind or a decrement to tailwind) on the actual forecast wind should be used to account for potential errors. However if the operator is not using the actual forecast wind based on a wind model acceptable to the certification authorities then 5 % of the fuel for the critical scenario is required as a reserve fuel.

ICING

The most critical scenario must be compensated for the greater of:

- A. The effect of airframe icing during 10 % of the time during which icing is forecast, including ice accumulation on unprotected surfaces, and the fuel used by engine and wing anti-ice during this period.
- B. Fuel for engine and wing anti-ice for the entire time during which icing is forecast.

Note: The ETOPS icing fuel reserve is always limited by (B)

Unless a reliable icing forecast is available, icing may be presumed to occur when the Total Air Temperature (TAT) is less than +10 °C, or if the outside air temperature is between 0 °C and -20 °C with a relative humidity of 55 % or more.

APU

Fuel consumption of 80 kg/h / or 176 lb/h (APU GEN ON, APU BLEED OFF).

In view of our experience, Airbus recommends that the operator includes a contingency fuel provision from departure to the Critical Point (CP), when computing the ETOPS critical fuel planning.

ETOPS FUEL REQUIREMENTS

Ident.: PRO-SPO-40-30-00012902.0001001 / 17 NOV 11

Applicable to: **ALL**

The operator must compare the entire ETOPS critical fuel planning for the ETOPS critical fuel scenario with the standard fuel planning computed in accordance with the company fuel policy and applicable operational requirements. The higher of the two fuel requirements must be considered as the minimum required block fuel for the flight.

WEATHER MINIMA

Ident.: PRO-SPO-40-30-00002046.0001001 / 23 JUN 15

Applicable to: **ALL**

Weather forecasts for en-route alternates must meet the operator's applicable weather minimum requirements.

This paragraph provides the applicable minima required by EASA (EU-OPS 1/AMC 20-6 rev. 2) and FAA (AC120-42B).

A. EASA DISPATCH WEATHER MINIMA (EU-OPS 1/AMC 20-6 REV. 2)

An airplane cannot be dispatched unless the meteorological forecasts at ETOPS en-route alternate airports meet the weather minima listed here for a period commencing at the earliest potential time of landing and ending one hour after the latest expected time of landing:

| Approach Type | Min ETOPS Ceiling | Min ETOPS Visibility |
|------------------------------------|----------------------------|--------------------------------|
| Precision approach | DH /DA +200 ft | Authorised visibility +800 m |
| Non-Precision or Circling approach | MDH /MDA +400 ft | Authorised visibility +1 500 m |
| CAT II/CAT III approach | Specific approval required | Specific approval required |

B. FAA DISPATCH WEATHER MINIMA (AC 120-42B)

An airplane cannot be dispatched unless the meteorological forecasts at ETOPS en-route alternate airports meet the weather minima listed here for a period commencing at the earliest potential time of landing and ending at the latest expected time of landing:

| Approach Type | Min ETOPS Ceiling | Min ETOPS Visibility |
|--|--|--|
| Two or more instrument approaches | Higher of the two (M)DH /DA +200 ft | Higher of the two authorised visibility +800 m |
| Single Precision approach or Non-Precision approach or Circling approach | (M)DH /DA +400 ft | Authorised visibility +1 600 m |
| CAT II approach | 300 ft | 1 200 m or RVR1 200 m |
| CAT III approach | 200 ft | 800 m or RVR550 m |

Intentionally left blank

| | |
|---|---|
|  <p>A318/A319/A320/A321 FLIGHT CREW OPERATING MANUAL</p> | <p align="center">PROCEDURES</p> <p align="center">SPECIAL OPERATIONS</p> <p align="center">EXTENDED RANGE OPERATIONS - DIVERSION DURING EXTENDED RANGE OPERATIONS</p> |
|---|---|

DIVERSION DECISION MAKING

Ident.: PRO-SPO-40-40-00002048.0001001 / 21 MAR 17
Applicable to: ALL

The technical criteria governing a re-routing or diversion decision can be classified into four categories, as follows :

- Loss of MNPS capability, before entering the MNPS area (as applicable).
- Weather minima at diversion airport(s) going below the company/crew en-route minima, before reaching the ETOPS Entry Point, or diversion airport(s) becoming unsuitable for any reason.
- Failure cases requiring a diversion to the nearest airport (cases leading to a LAND ASAP message on the ECAM and/or in the QRH).
- Failure cases resulting in increased fuel consumption, exceeding the available fuel reserves.

Comments and Recommendations

- Electrical generation

If one IDG fails, a diversion is required in case of :

- Blue hydraulic circuit low level, low pressure or overheat, or
- APU no start, or
- APU or APU generator inoperative, or
- Second IDG failure.

- Fuel system

Some failure cases may lead to fuel gravity feeding which implies flight at lower altitude or to some fuel being unusable. The flight crew's evaluation of the actual situation and the fuel remaining may lead to the decision that a diversion is required.

- Hydraulic system :

If low level, low pressure or overheat on blue hydraulic circuit, a diversion is required in case of :

- One IDG failure, or
- APU no start, or
- APU/APU GEN failure.

- APU :

If APU/APU GEN fails, a diversion is required in case of :

- Blue hydraulic circuit low level, low pressure or overheat, or
- One IDG failure.

PROCEDURES
SPECIAL OPERATIONS

EXTENDED RANGE OPERATIONS - DIVERSION
DURING EXTENDED RANGE OPERATIONS

DIVERSION PERFORMANCE DATA

Ident.: PRO-SPO-40-40-00002049.0001001 / 21 MAR 17

Applicable to: ALL

Chapter PER-OEI-GEN contains three single engine descent and cruise procedures:

1. The standard strategy,
2. The obstacle strategy,
3. Fixed speed strategies (ETOPS).

For ETOPS operations, any one of the above diversion strategies can be used provided that the selected strategy and speed schedule are used in :

- Establishing the area of operation (maximum diversion distance),
- Calculating the diversion fuel requirements for the single-engine ETOPS fuel scenario,
- Demonstrating the applicable obstacle clearance requirements (net flight path and net ceiling).

During the diversion, the flight crew is expected to use the planned speed schedule.

However, based on the evaluation of the actual situation, the pilot in command has the authority to deviate from this planned one-engine-inoperative speed.

GUIDELINES FOR DIVERSION PROCEDURE

Ident.: PRO-SPO-40-40-00002050.0001001 / 21 MAR 17

Applicable to: ALL

- Complete the related failure procedure,
- Inform ATC,
- Initiate the descent,
- Determine which en route alternate is the most suitable (per company procedure),
- Divert to the chosen en route alternate,
- Comply with the pre-planned diversion strategy and speed schedule, or adjust the speed schedule, as dictated by the evaluation of the actual situation.

Note: For detailed guidelines and procedures for conducting the diversion (lateral and vertical navigation), Refer to DSC-22_20-60-30 - How to Execute a Diversion.

| | |
|---|--|
|  <p>A318/A319/A320/A321 FLIGHT CREW OPERATING MANUAL</p> | <p align="center">PROCEDURES SPECIAL OPERATIONS</p> <p align="center">EXTENDED RANGE OPERATIONS - PROCEDURES</p> |
|---|--|

GENERAL

Ident.: PRO-SPO-40-50-00002051.0001001 / 26 JUN 17
Applicable to: ALL

For ETOPS flights, the flight crew must apply the below procedures, in addition to the SOP (refer to chapter PRO-NOR-SOP) and the ABNORMAL and EMERGENCY procedures (refer to chapter PRO-ABN).

NORMAL PROCEDURES

Applicable to: ALL
 Ident.: PRO-SPO-40-50-A-00021794.0002001 / 26 JUN 17

COCKPIT PREPARATION

FUEL

Before each ETOPS flight, the flight crew must check that the fuel crossfeed valve is operating correctly :

FUEL X FEED ON

On the ECAM FUEL page, check that the fuel crossfeed valve is open (indication is inline green).

FUEL X FEED..... OFF

Check that the fuel crossfeed valve is closed.

ABNORMAL AND EMERGENCY PROCEDURES

Ident.: PRO-SPO-40-50-00002053.0007001 / 21 MAR 17
Applicable to: ALL

ELECTRICAL EMERGENCY CONFIGURATION

The flight crew must complete the ECAM procedure using the following:

AIR CONDITIONING

As cockpit and cabin temperature control is lost, it is recommended to open the cockpit door.

PRESSURIZATION

If one engine (or one bleed system) is failed, forward cargo ventilation must be closed to avoid CAB PR EXCESS CAB ALT from being triggered on the ECAM during descent or cruise.

FUEL

As all fuel pumps are lost, the engines are fed by gravity. *Refer to GRVTY FUEL FEEDING Procedure.*

ENGINE ANTI-ICE

Engine anti-ice valves are permanently open, although the ECAM memo ENG A. ICE is not displayed on the ECAM (except if the ENG A. ICE pushbutton is at ON).

WING ANTI-ICE

If only one ENG BLEED is available, PACK 1 must be switched OFF, to avoid having both packs and wing anti-ice supplied by a single bleed source.

BLUE HYDRAULIC CIRCUIT LOW LEVEL OR LOW PRESSURE OR OVERHEAT

Start the APU to ensure availability of the APU generator.

ENGINE OR IDG FAILURE

Start the APU and use the APU electrical channel.

GENERAL

Ident.: PRO-SPO-40-60-00002054.0001001 / 25 AUG 15

Applicable to: ALL

The two following cases result in a fuel consumption increase:

- RAT extended
- In electrical emergency configuration, the engine anti-ice valves are permanently open.

MAXIMUM DIVERSION DISTANCE

Ident.: PRO-SPO-40-60-00002055.0035001 / 21 MAR 17

Applicable to: ALL



The following computation conditions have been used in accordance with the interpretation of the EU-OPS 1.245 and FAR 121.161:

- ISA conditions
- No wind
- Optimum diversion level after engine failure
- Single engine diversion speed schedule.

Note: Obstacles have not to be considered to determine if a route is or is not an ETOPS route.

MAXIMUM DIVERSION DISTANCE

| SPEED SCHEDULE | A/C WEIGHT AT CRITICAL POINT (KG) | FL FOR DIVERSION | DIVERSION TIME (MIN) | | | | |
|-------------------|-----------------------------------|------------------|----------------------|-----|-----|-------|-------|
| | | | 60 | 90 | 120 | 150 | 180 |
| MCT /VMO | 50 000 | 160 | 414 | 616 | 818 | - | - |
| | 55 000 | 160 | 413 | 614 | 815 | 1 017 | 1 219 |
| | 60 000 | 160 | 412 | 612 | 812 | 1 012 | 1 213 |
| | 65 000 | 160 | 410 | 608 | 807 | 1 007 | 1 206 |
| | 70 000 | 160 | 408 | 605 | 802 | 1 000 | 1 198 |
| | 75 000 | 160 | 405 | 600 | 795 | 992 | 1 188 |
| MCT/320 kt | 50 000 | 160 | 412 | 613 | 814 | - | - |
| | 55 000 | 160 | 412 | 613 | 814 | 1 015 | 1 215 |
| | 60 000 | 160 | 412 | 612 | 812 | 1 012 | 1 213 |
| | 65 000 | 160 | 410 | 608 | 807 | 1 007 | 1 206 |
| | 70 000 | 160 | 408 | 605 | 802 | 1 000 | 1 198 |
| | 75 000 | 160 | 405 | 600 | 795 | 992 | 1 188 |

**ETOPS FUEL REQUIREMENT FROM CRITICAL POINT
TO LANDING - ALL ENGINES - CRUISE AT LRC**

Ident.: PRO-SPO-40-60-00002056.0018001 / 21 MAR 17

Applicable to: ALL

Assumptions:

- EMER descent
- Long range cruise at FL 100
- Final descent 250 kt
- Holding 15 min at FL 15
- IFR procedure

Not included: 5 % correction on wind value - Anti icing if icing is forecast - performance factor.

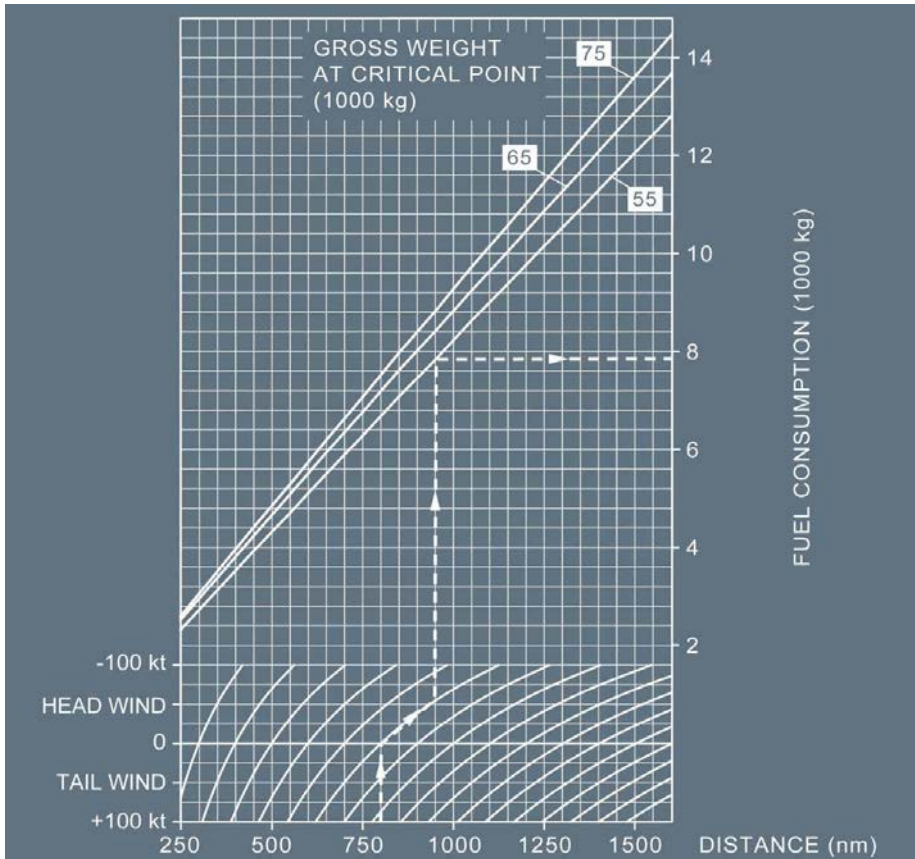

**ETOPS FUEL REQUIREMENT FROM CRITICAL POINT
TO LANDING - ONE ENGINE OUT - CRUISE AT 350KT**

Ident.: PRO-SPO-40-60-00002057.0017001 / 21 MAR 17

Applicable to: ALL

Assumptions:

- EMER descent
- Cruise 350 kt at FL 100
- Final descent 250 kt
- Holding 15 min at FL 15

- IFR procedure
- APU fuel burn.

Not included: 5 % correction on wind value - Anti icing if icing is forecast - performance factor.

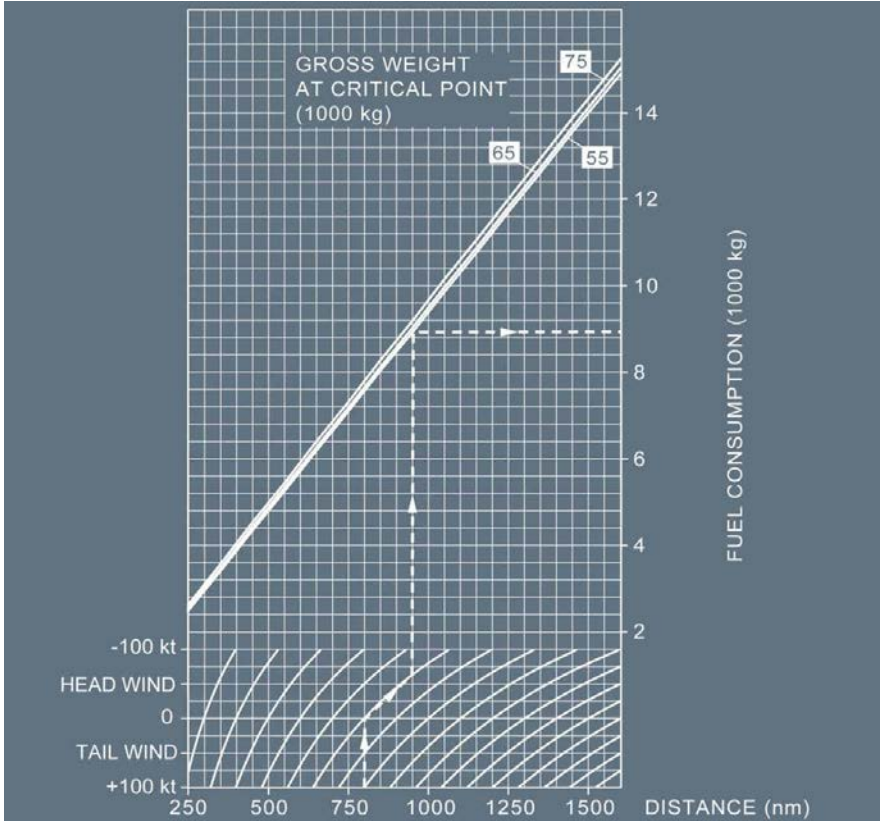

**ETOPS FUEL REQUIREMENT FROM CRITICAL POINT
 TO LANDING - ONE ENGINE OUT - CRUISE AT 320KT**

Ident.: PRO-SPO-40-60-00002058.0018001 / 21 MAR 17

Applicable to: ALL

Assumptions:

- EMER descent
- Cruise 320 kt at FL 100

- Final descent 250 kt
- Holding 15 min at FL 15
- IFR procedure
- APU fuel burn.

Not included: 5 % correction on wind value - Anti icing if icing is forecast - performance factor.

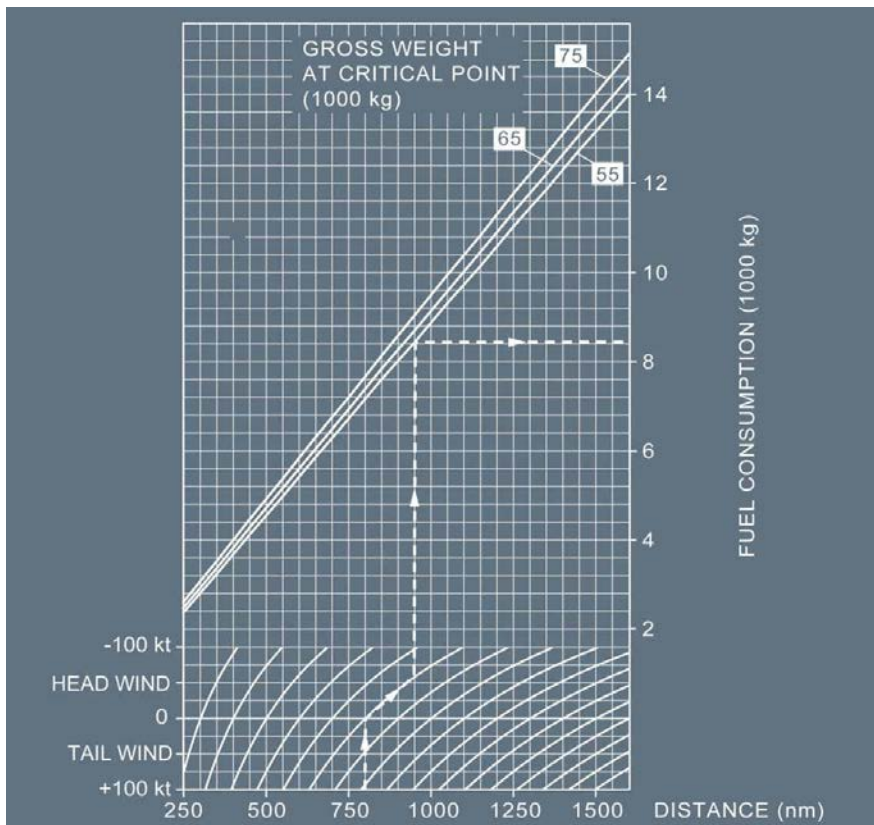

ETOPS FUEL REQUIREMENT FROM CRITICAL POINT TO LANDING - EXAMPLE

Ident.: PRO-SPO-40-60-00014769.0001001 / 21 MAR 17

Applicable to: ALL

Note: The following data and graphs are for example only, and are not for operational use. Even if the data in the following example is in "kg", the same method can be applied for "lb".

Assumptions:

- Aircraft weight at critical point: 65 000 kg
- Diversion speed: 320 kt
- Diversion time: 120 min
- Distance from Critical point to diversion airport: 700 NM
- Wind: 50 kt headwind
- Forecasted icing condition on diversion: 40 min
- Aircraft perf factor: 5 %

For the determination of the ETOPS fuel requirement, the greatest fuel quantity of the two following scenarios must be considered (the scenario Engine failure only, without pressurization failure, is never limiting):

1. Pressurization failure - One Engine Inoperative - 320 kt

- Determine the corrected wind for diversion taking into account the 5 % wind speed factor: $50 \times 1.05 = 52.5$ kt
- Enter the ETOPS Fuel from Critical Point to Landing - One Engine Out - Cruise at 320kt graph to determine the corresponding fuel consumption: 6 900 kg

ETOPS FUEL FROM CRITICAL POINT TO LANDING - ONE ENGINE OUT - CRUISE AT 320KT

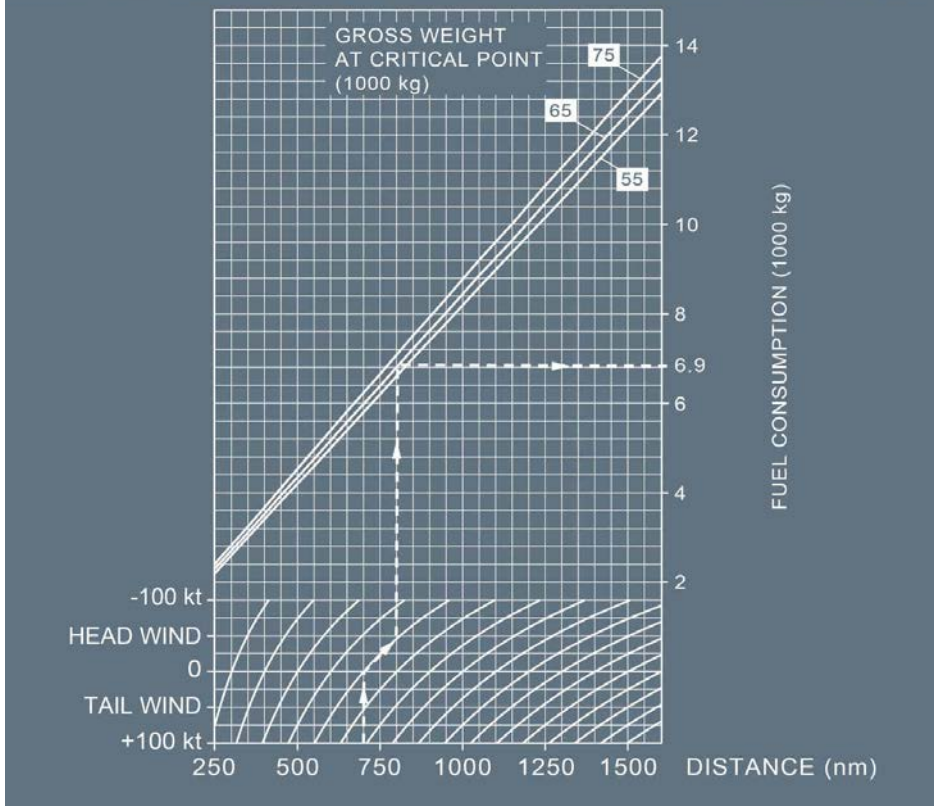

- Determine the final ETOPS fuel requirement, sum of perf factor fuel, icing fuel and fuel determined the step before:
 - Fuel for icing condition (Total anti-ice scenario is limiting): $3.5\% \times 40 / 120 = 1.17\%$
 - Fuel for perf factor: 5 %
 - Final ETOPS fuel requirement: $6\,900 \times 1.0117 \times 1.05 = 7\,330$ kg

2. Pressurization failure - All Engines Operative - LRC speed

- Determine the corrected wind for diversion taking into account the 5 % wind speed factor: $50 \times 1.05 = 52.5$ kt
- Enter the ETOPS Fuel from Critical Point to Landing - All Engines - Cruise at LRC graph to determine the corresponding fuel consumption: 6 700 kg

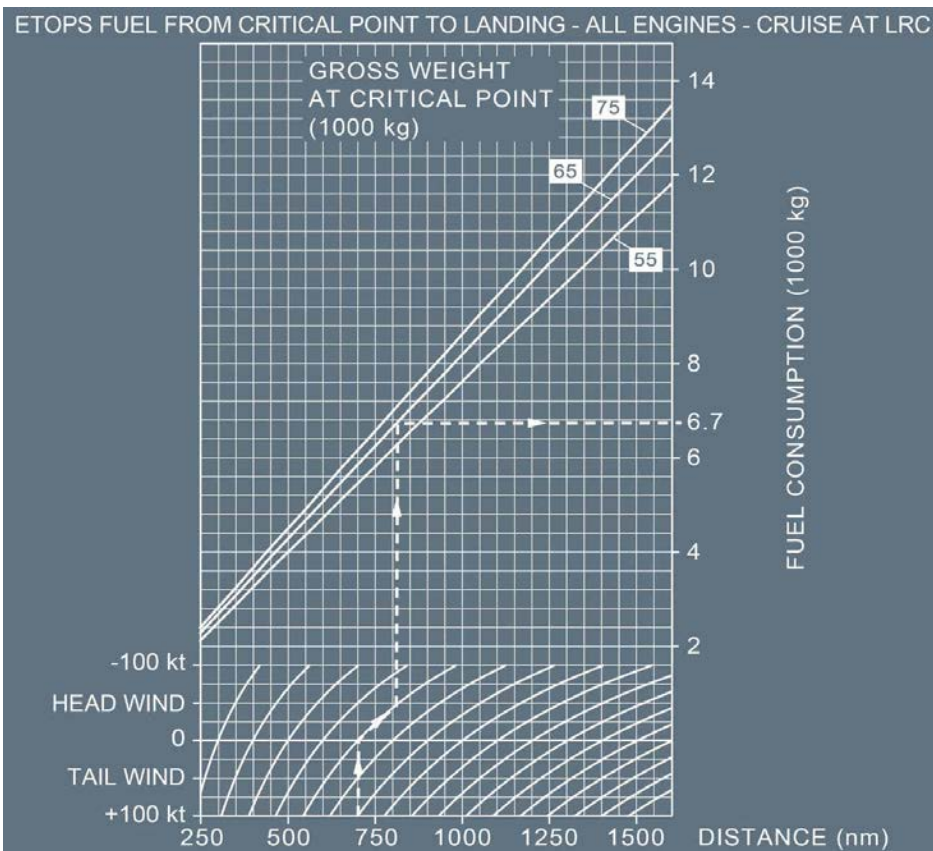

- Determine the final ETOPS fuel requirement, sum of perf factor fuel, icing fuel and fuel determined the step before:
 - Fuel for icing condition (total anti-ice scenario is limiting): $6\% \times 40 / 120 = 2\%$
 - Fuel for perf factor: 5%
 - Final ETOPS fuel requirement: $6\,700 \times 1.02 \times 1.05 = 7\,176$ kg

The final ETOPS fuel requirement for this diversion is 7 330 kg. The limiting scenario is a pressurization failure and One Engine Out at a diversion speed of 320 kt.

ENGINE INTERMIX TYPE 1

Applicable to: ALL

Ident.: PRO-SPO-45-A-00002059.0001001 / 30 JUN 14

The following information provides the conditions and procedures necessary in order to temporarily operate an A318/A319/A320/A321 aircraft when a CFM56–5B Single Annular Combustor (SAC) engine is intermixed with a CFM56–5B Double Annular Combustor (DAC) engine.

This engine intermix configuration is indicated in the cockpit with the following placard: "CAUTION: ENGINE INTERMIX TYPE 1" or "CAUTION: ENGINE INTERMIX".

Ident.: PRO-SPO-45-A-00002060.0001001 / 07 DEC 10

ENGINE PARAMETERS

Engine parameters differ significantly, when the engines are at idle:

- EGT : Up to 250 °C higher on the DAC engine.
- FUEL FLOW : Up to 25 % higher on the DAC engine.
- N1 : Higher on the DAC engine.
- N2 : Lower on ground on the DAC engine; higher in flight on the DAC engine.

Ident.: PRO-SPO-45-A-00002061.0001001 / 07 DEC 10

CROSSBLEED ENG START

The DAC engine has insufficient acceleration capability to sustain idle speed with a large bleed offtake, when it operates with only 20 injectors. Therefore, it is necessary to preset a 30 % N1 on the supplying engine before launching the start sequence.

Ident.: PRO-SPO-45-A-00004068.0001001 / 07 DEC 10

TAKEOFF PROCEDURE

- The PF must progressively adjust engine thrust in two steps:
 - Step 1 : Idle to 50 % N1.
Brakes released, when the 50 % N1 is stabilized on both engines.
 - Step 2 : Both engines N1 to takeoff thrust.

This procedure enables a significantly slower acceleration from ground idle to N1 = 50 % for the double annular combustor.

- Other standard operating procedures apply for takeoff.

Ident.: PRO-SPO-45-A-00002062.0001001 / 07 DEC 10

ENGINE RESPONSE

In flight, when the aircraft is in clean configuration, the DAC engine may accelerate from idle more slowly than the SAC engine. This is particularly evident, if the acceleration follows a deceleration.

There is no significant effect on aircraft handling. This difference in engine response disappears when the slats are extended.

Ident.: PRO-SPO-45-A-00004067.0001001 / 09 OCT 12

ENGINE RELIGHT

The DAC engine relight envelope is more restrictive than the SAC engine relight envelope. Therefore, in case of engine intermix, the flight crew must use the DAC engine relight procedure with the corresponding chart (See chart below).

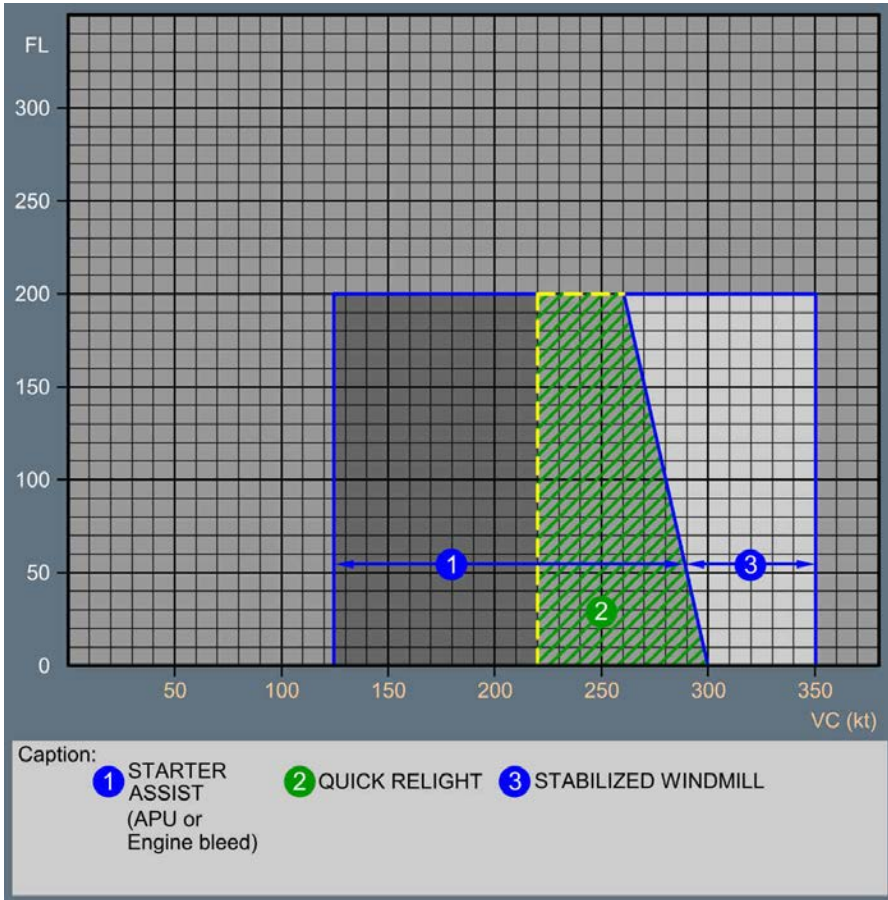

| | |
|---|--|
|  A318/A319/A320/A321 FLIGHT CREW OPERATING MANUAL | PROCEDURES SPECIAL OPERATIONS ENGINE INTERMIX OPERATIONS |
|---|--|

ENGINE INTERMIX TYPE 2

Applicable to: ALL

Ident.: PRO-SPO-45-B-00012731.0007001 / 06 MAR 17

The following information provides the necessary conditions and procedures in order to temporarily operate an A318/A319/A320/A321 with engine intermix configuration between two different SAC engines among CFM56–5Bx classic, the CFM56–5Bx/P, the CFM56-5Bx/3 and the CFM56-5Bx/P “TI HPC kit”.

FADEC intermix configuration 5BM software (installed on CFM56-5B classic) with FADEC 5BR software is indicated in the cockpit with the following placard: “CAUTION: ENGINE INTERMIX TYPE 2”.

Note: When FADEC Standard “5BR” or subsequent is installed on both engines, engine thrust behavior is harmonized (transient thrust dissymmetry no longer exist). Therefore, a placard is not necessary and is not displayed.

Ident.: PRO-SPO-45-B-00012732.0001001 / 07 DEC 10

ENGINE PARAMETERS

In the case of only one operative pack configuration (only one pack OFF):

- N1 : At idle up to 9 % higher on the CFM56-5B/3 TI engine, on ground or in flight in clean configuration.
- N2 : At idle up to 11 % higher on the CFM56-5B/3 TI engine, on ground or in flight in clean configuration.

Ident.: PRO-SPO-45-B-00012733.0001001 / 07 DEC 10

TAKEOFF PROCEDURE

In the case of only one operative pack configuration, due to the difference in N2 at idle between engines, the following takeoff procedure is recommended:

- The PF progressively adjusts engine thrust in two steps:
 - Step 1 : From idle to about 50 % N1 on brakes.
 - Step 2 : From both engines at similar N1 to takeoff thrust after brakes release.
- Other standard operative procedures apply for takeoff.

Ident.: PRO-SPO-45-B-00012734.0007001 / 14 MAY 12

ENGINE RESPONSE

In the case of only one operative pack configuration, due to the difference in N2 at idle between engines, the CFM56–5B/3 TI engine may accelerate from idle to high thrust faster than the CFM56–5B/P SAC engine when the aircraft is on ground or in flight in clean configuration. There is no significant effect on aircraft handling.

The difference in engine response disappears in flight when the slats are extended.

Note: Depending on the FADEC standard, the flight crew may observe a different deceleration between the two engines (CFM56-5B/P engine is faster to decelerate) when the aircraft is above FL 100 and in unsymmetrical bleed configuration or with the APU BLEED ON.

Ident.: PRO-SPO-45-B-00016162.0010001 / 02 MAY 17

ENGINE RELIGHT

For SAC-TI engine the maximum altitude for the engine relight envelope is reduced, compared with the SAC engine relight envelope. Therefore, in case of engine intermix, the flight crew must use the SAC-TI engine relight envelope below.

Engine Relight Envelope

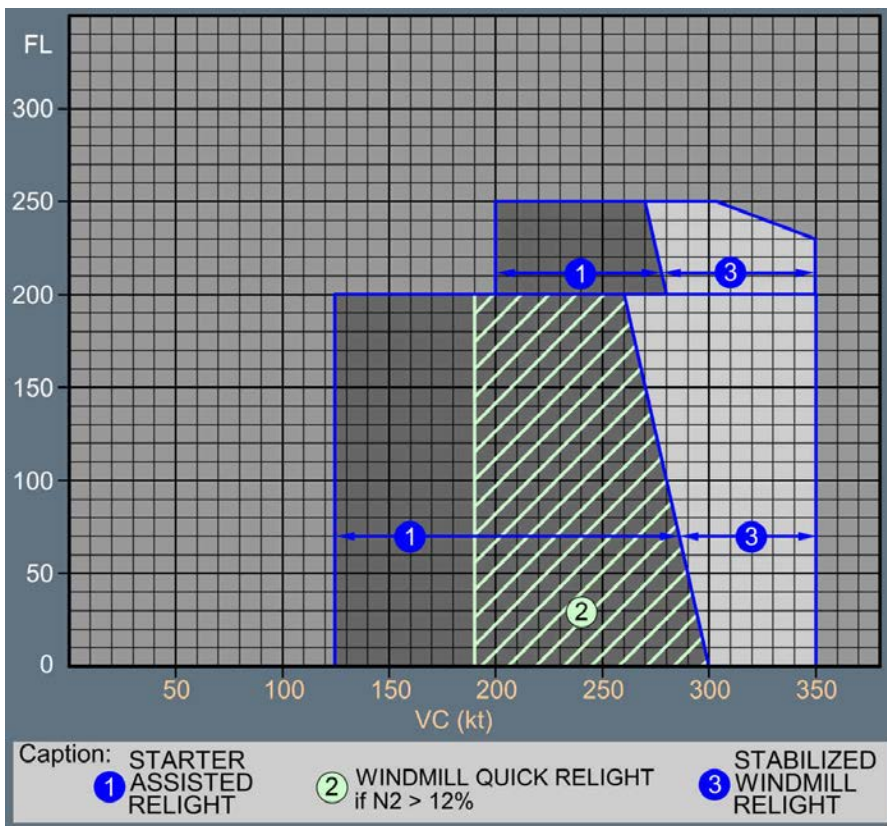

| | |
|---|--|
|  A318/A319/A320/A321 FLIGHT CREW OPERATING MANUAL | PROCEDURES SPECIAL OPERATIONS REDUCED VERTICAL SEPARATION MINIMUM - RVSM |
|---|--|

GENERAL

Ident.: PRO-SPO-50-00020828.0001001 / 17 MAR 17

Applicable to: ALL

The A318/A319/A320/A321 aircraft systems are designed to comply with the design criteria of the EASA and FAA regulations (documents references provided in the AFM) for the RVSM capability. In addition, operators must obtain an operational approval from their national airworthiness authorities, in order to operate within the RVSM airspace. The EASA and FAA regulations (documents references provided in the AFM) also indicate the requirements for obtaining operational approval.

REQUIRED EQUIPMENTS/FUNCTIONS FOR RVSM

Ident.: PRO-SPO-50-00020955.0002001 / 17 MAR 17

Applicable to: ALL

RVSM regulations require the following equipment/functions in order to be operative:

- 2 ADR s + 2 DMCs
- 1 transponder
- 1 Autopilot function
- 1 FCU channel (for altitude target selection and OP CLB /OP DES mode engagement)
- 2 PFD functions (for altitude indication)
- 1 FWC (for altitude alert function).

RVSM NORMAL PROCEDURE

Ident.: PRO-SPO-50-00020830.0002001 / 17 MAR 17

Applicable to: ALL

For flights in RVSM airspace, the flight crew must apply the standard procedures, in addition to the following RVSM procedures.

FLIGHT PREPARATION

The flight crew must take into account the conditions that may affect operations in RVSM airspace, including:

RVSM APPROVAL..... CHECK

L2 *Verify that the aircraft is approved for RVSM operations.*

L1 WEATHER..... CHECK

L2 *Review the weather forecasted for the flight route. If severe turbulence is expected, this may affect the ability to maintain aircraft altitude.*

L1 REQUIRED EQUIPMENT FOR RVSM..... CHECK

L2 *Check that the required equipment is operative (MEL).*

The flight crew should review the maintenance logs and forms, in order to ensure that the equipment required for RVSM is satisfactory.

L1 ALTITUDES..... CHECK

L2 Check that the difference between each altitude indication (in the QNH reference) displayed on PFDs and the airport elevation is less than 75 ft.

Check that the difference between the two primary altitude indications on the PFDs is less than the tolerance specified in SOP. Refer to PRO-NOR-SOP-06 Glareshield - EFIS Control Panel.

L1 **IN FLIGHT**

BEFORE ENTERING RVSM AIRSPACE

REQUIRED EQUIPMENT FOR RVSMOPERATIVE

L2 If any of the required equipment fails before the aircraft enters RVSM airspace, the flight crew must request new clearance, to avoid this airspace.

L1 ALTITUDES..... CHECK

L2 Check on the PFDs that the difference between altitude indications (in the standard baro setting) is less than the specified tolerance in the table below.

If only two ADR s are operative, the altimeter indications on PFD and standby altimeter should be recorded. This information may be useful in case of subsequent PFD altitude discrepancy, or loss of both remaining ADRs.

| | | Comparison of Altitude Indication (ft) | | |
|--------------|----------------------|--|--|---------------------------------------|
| Flight Level | Speed or Mach Number | Difference between ADR 1 and ADR 2 (on PFDs) | Difference between ADR 3 and ADR 1/2 (on PFDs) | Difference between STBY ALTI and ADRs |
| FL 50 | 250 kt | 50 (15 m) | 65 (20 m) | 130 (40 m) |
| FL 100 | 250 kt | 55 (17 m) | 80 (24 m) | 185 (56 m) |
| FL 200 | 300 kt | 90 (27 m) | 135 (41 m) | 295 (90 m) |
| FL 300 | M 0.78 | 130 (40 m) | 195 (59 m) | 390 (119 m) |
| FL 390 | M 0.78 | 130 (40 m) | 195 (59 m) | 445 (136 m) |

IN RVSM AIRSPACE

AP.....KEEP ENGAGED

L2 Ensure that autopilot is engaged for cruise, and for flight level changes.

L1 AP GUIDANCE..... MONITOR

L2 During flight level transitions, do not exceed or go below the assigned flight level by more than 150 ft.

L1 ● **Approximately every hour:**
ALTITUDES.....CHECK

L2 Check that the difference between the altitude indications on PFD s is less than the specified tolerance. For more information, See table in "Before Entering RVSM airspace".

| | |
|---|--|
|  <p>A318/A319/A320/A321 FLIGHT CREW OPERATING MANUAL</p> | <p align="center">PROCEDURES SPECIAL OPERATIONS</p> <p align="center">REDUCED VERTICAL SEPARATION MINIMUM - RVSM</p> |
|---|--|

Regular check of the flight deck instruments should be sufficient.

L1 AT THE END OF THE FLIGHT

ANY MALFUNCTIONS or DEVIATIONS..... REPORT

- L2** *Report any malfunction of the systems that enable the aircraft to maintain altitude, including:*
- *Any malfunction or loss of required equipment*
 - *Any deviation involving the functions that enable the aircraft to maintain altitude.*

RVSM ABNORMAL AND EMERGENCY PROCEDURE

Ident.: PRO-SPO-50-00020831.0002001 / 17 MAR 17

Applicable to: ALL

ATC..... NOTIFY

When the aircraft is in RVSM airspace, the flight crew must notify the ATC of the following situations, because they may affect the aircraft's ability to maintain the flight level:

- *The failure of both autopilots*
- *The loss of altimeter system redundancy (only one PFD indication remaining)*
- *An excessive discrepancy in altitude indications, and no way to identify the valid indication*
- *The failure of any other equipment, that affects the aircraft's ability to maintain flight level*
- *The encounter of greater than moderate turbulence.*

If the flight crew cannot notify the ATC or obtain the ATC clearance before deviating from the assigned flight level, they should follow the established contingency procedure and obtain the ATC clearance as soon as possible.

Intentionally left blank

GENERAL

Applicable to: ALL

Ident.: PRO-SPO-51-A-00015857.0001001 / 20 MAR 17

GENERAL

The Performance Based Navigation (PBN) concept implies that the aircraft follows the defined track with a requested navigation performance. The PBN includes RNAV and RNP operations. For RNAV and RNP operations, an operational approval from the airline's national authorities may be required.

The AFM provides regulatory compliances associated with PBN operations.

Ident.: PRO-SPO-51-A-00015859.0001001 / 09 SEP 14

RNAV/RNP CAPABILITY

Before the aircraft enters an RNAV /RNP airspace, RNAV /RNP capability is based on:

- The required RNAV /RNP equipment that is described in each RNAV /RNP section of the FCOM
- Navigation Accuracy HIGH displayed on the MCDU PROG page
- Any specific local requirements published in the Aeronautical Information Publication (AIP).

When the aircraft flies in RNAV /RNP airspace, RNAV /RNP capability is based on:

- Navigation Accuracy HIGH displayed on the MCDU PROG page
- Any specific local requirements published in the Aeronautical Information Publication (AIP).

RNAV 10 / RNP 10

Applicable to: ALL

Ident.: PRO-SPO-51-B-00015854.0001001 / 09 SEP 14

GENERAL

RNAV 10 operations correspond to RNP 10 operations.

In RNAV 10 airspace, the aircraft is expected to fly for a long period of time outside radio navaid coverage.

Ident.: PRO-SPO-51-B-00015855.0001001 / 09 SEP 14

REQUIRED RNAV 10 EQUIPMENT







The minimum navigation equipment required to enter RNAV 10 airspace is:

- Two FMGC s (or one FMGC and one BACK UP NAV )
- Two MCDUs
- Two IRS

Ident.: PRO-SPO-51-B-00015863.0001001 / 11 APR 17

PROCEDURE

MANAGEMENT OF DEGRADED NAVIGATION

- **If one of the following messages is displayed, the flight crew should resume navigation with the FMGC that provides the correct position:**
 - GPS PRIMARY LOST  on one ND /MCDU
 - NAV ACCUR DOWNGRAD on one ND /MCDU.
- **If the GPS PRIMARY LOST  message is displayed on both NDs/MCDUs, RNAV 10 operations can be continued:**
 - With no time restriction if radio navaids update is available
 - For 5.7 hr from the time of the last position update if radio navaids update is not available. After 5.7 hr, the navigation accuracy must be considered LOW regardless of the navigation accuracy that is displayed on the MCDU PROG page.
- **If one of the following MCDU or ECAM messages is displayed, the flight crew should crosscheck the position data using the POSITION MONITOR page, the IRS 1(2)(3) pages, and the GPS MONITOR page  in order to identify which FMGC position is correct:**
 - FMS 1/FMS 2 POS DIFF
 - CHECK IRS 1(2)(3)/FM POSITION 
 - CHECK A/C POSITION 
 - NAV FM/GPS POS DISAGREE 

The flight crew should resume navigation with the FMGC that provides the correct position.

- **If NAV ACCUR DOWNGRAD is displayed on both sides:**
 - As per design FMS REQ ACCUR is set by default; this default value (e.g. 2 NM in cruise, 1 NM in terminal area) is more restrictive than overflown airspace required navigation performance.
 - Any change on FMS REQ ACCUR to be in accordance with airspace requirement is at flight crew's discretion; and should be set back to default value when leaving intended airspace.

If NAV ACCUR DOWNGRAD remains displayed, the flight crew should inform ATC that the RNAV 10 capability is lost.

RNAV 5 / BRNAV

Applicable to: ALL

Ident.: PRO-SPO-51-C-00015851.0001001 / 20 MAR 17

GENERAL

RNAV 5 operations correspond to European BRNAV operations.

Ident.: PRO-SPO-51-C-00015852.0001001 / 06 JUL 17

REQUIRED RNAV 5 EQUIPMENT





The minimum navigation equipment required to enter RNAV 5 airspace is:

- One FMGC
- One MCDU
- One GPS or one DME receiver to update FM position
- Two ND s (the temporary display of ND information via the PFD /ND switch is permitted on one side)
- One IRS.

Ident.: PRO-SPO-51-C-00015864.0001001 / 11 APR 17

PROCEDURE

MANAGEMENT OF DEGRADED NAVIGATION

- **If one of the following messages is displayed, the flight crew should resume navigation with the FMGC that provides the correct position:**
 - GPS PRIMARY LOST  on one ND /MCDU
 - NAV ACCUR DOWNGRAD on one ND /MCDU.
- **If one of the following MCDU or ECAM messages is displayed, the flight crew should check the navigation accuracy with navaid raw data via the MCDU PROG page in order to identify which FMGC position is correct:**
 - GPS PRIMARY LOST  on both ND s/MCDUs
 - FMS 1/FMS 2 POS DIFF
 - CHECK IRS 1(2)(3)/FM POSITION 
 - CHECK A/C POSITION 
 - NAV FM/GPS POS DISAGREE 

The flight crew should resume navigation with the FMGC that provides the correct position.

● **If NAV ACCUR DOWNGRAD is displayed on both sides:**

- As per design FMS REQ ACCUR is set by default; this default value (e.g. 2 NM in cruise, 1 NM in terminal area) is more restrictive than overflow airspace required navigation performance.
- Any change on FMS REQ ACCUR to be in accordance with airspace requirement is at flight crew's discretion; and should be set back to default value when leaving intended airspace.

If NAV ACCUR DOWNGRAD remains displayed, the flight crew should inform ATC that the RNAV 5 capability is lost.

RNAV 1 RNAV 2 / P-RNAV - TERMINAL RNAV

Applicable to: ALL

Ident.: PRO-SPO-51-D-00015848.0001001 / 20 MAR 17

GENERAL

RNAV 1(2) operations correspond to P-RNAV TERMINAL RNAV operations.
The AIP may specify that GPS equipment is required.

Ident.: PRO-SPO-51-D-00015849.0001001 / 06 JUL 17

REQUIRED RNAV 1(2) EQUIPMENT

The minimum navigation equipment required to enter RNAV 1/RNAV2 airspace is:

- One FMGC
- One MCDU
- One GPS or one DME receiver to update the FM position
- Two IRS
- One FD in NAV mode
- Two ND s (the temporary display of ND information via the PFD /ND switch is permitted on one side).

Ident.: PRO-SPO-51-D-00015865.0001001 / 20 MAR 17





PROCEDURE

BEFORE ENTERING RNAV 1(2) AIRSPACE

The FMS navigation database provides the terminal procedure (RNAV SID , RNAV STAR , RNAV TRANSITION, etc.) of the flight plan. The flight crew must crosscheck the terminal procedure from the published charts with the FMS navigation database on the F-PLN page (waypoint sequences, tracks, distances, and altitude or speed constraints). The flight crew must

not modify the procedure that is provided by the navigation database, unless required by the ATC (DIR TO, radar vectoring, insertion of waypoints from the navigation database).

MANAGEMENT OF DEGRADED NAVIGATION

- **If one of the following messages is displayed, the flight crew should resume navigation with the FMGC that provides the correct position:**
 - GPS PRIMARY LOST  on one ND /MCDU
 - NAV ACCUR DOWNGRAD on one ND /MCDU.
- **If one of the following messages is displayed, the flight crew should check the navigation accuracy with navaid raw data via the MCDU PROG page in order to identify which FMGC position is correct:**
 - GPS PRIMARY LOST  on both ND s/MCDUs
 - FMS 1/FMS 2 POS DIFF
 - CHECK IRS 1(2)(3)/FM POSITION 
 - CHECK A/C POSITION 
 - NAV FM/GPS POS DISAGREE 

The flight crew should resume navigation with the FMGC that provides the correct position.

- **If NAV ACCUR DOWNGRAD is displayed on both sides:**

The flight crew should inform the ATC that the RNAV 1(2) capability is lost.

RNP 4

Applicable to: ALL

Ident.: PRO-SPO-51-E-00015845.0001001 / 09 SEP 14

GENERAL

In this airspace, the aircraft is expected to fly for a long period of time outside radio navaid coverage.

Ident.: PRO-SPO-51-E-00015846.0001001 / 09 SEP 14

REQUIRED RNP 4 EQUIPMENT

The minimum navigation equipment required to enter RNP 4 airspace is:



- Two FMGC s (or one FMGC and one BACK UP NAV 
- Two MCDUs
- Two IRS

- One GPS
- Two ND s (the temporary display of ND information via the PFD /ND switch is permitted on one side).

Ident.: PRO-SPO-51-E-00015866.0001001 / 11 APR 17

PROCEDURE

MANAGEMENT OF DEGRADED NAVIGATION

- **If one of the following messages is displayed, the flight crew should resume navigation with the FMGC that provides the correct position:**
 - GPS PRIMARY LOST on one ND /MCDU
 - NAV ACCUR DOWNGRAD on one ND /MCDU.
- **If one of the following MCDU or ECAM messages is displayed, the flight crew should crosscheck the position data using the POSITION MONITOR page, the IRS 1(2)(3) pages, and the GPS MONITOR page in order to identify which FMGC position is correct:**
 - GPS PRIMARY LOST on both ND s/MCDUs
 - FMS 1/FMS 2 POS DIFF
 - CHECK IRS 1(2)(3)/FM POSITION 
 - CHECK A/C POSITION 
 - NAV FM /GPS POS DISAGREE

The flight crew should resume navigation with the FMGC that provides the correct position.

- **If NAV ACCUR DOWNGRAD is displayed on both sides:**
 - As per design FMS REQ ACCUR is set by default; this default value (e.g. 2 NM in cruise, 1 NM in terminal area) is more restrictive than overflown airspace required navigation performance.
 - Any change on FMS REQ ACCUR to be in accordance with airspace requirement is at flight crew's discretion; and should be set back to default value when leaving intended airspace.

If NAV ACCUR DOWNGRAD remains displayed, the flight crew should inform ATC that the RNAV 4 capability is lost.

RNP 2 IN OCEANIC AND REMOTE CONTINENTAL AREA

Applicable to: ALL

Ident.: PRO-SPO-51-I-00021541.0001001 / 20 MAR 17

GENERAL

In this airspace, the aircraft is expected to fly for a long period of time outside radio navaid coverage.

Ident.: PRO-SPO-51-I-00021542.0001001 / 20 MAR 17

REQUIRED RNP 2 IN OCEANIC AND REMOTE CONTINENTAL AREA EQUIPMENT

The minimum navigation equipment required to enter RNP 2 oceanic and remote continental airspace is:

- Two FMGC s (or one FMGC and one BACK UP NAV )
- Two MCDUs
- Two IRS
- One GPS
- Two ND s (the temporary display of ND information via the PFD /ND switch is permitted on one side).

Ident.: PRO-SPO-51-I-00021544.0001001 / 20 MAR 17

PROCEDURE



FLIGHT PREPARATION

RAIM /AIME availability should be confirmed for RNP 2 in oceanic and remote continental area operations.

Refer to PRO-NOR-SOP-02 GPS PRIMARY Availability (If Installed)

MANAGEMENT OF DEGRADED NAVIGATION

- **If one of the following messages is displayed, the flight crew should resume navigation with the FMGC that provides the correct position:**
 - GPS PRIMARY LOST on one ND /MCDU
 - NAV ACCUR DOWNGRAD on one ND /MCDU.
- **If one of the following MCDU or ECAM messages is displayed, the flight crew should crosscheck the position data using the POSITION MONITOR page, the IRS 1(2)(3) pages, and the GPS MONITOR page in order to identify which FMGC position is correct:**
 - GPS PRIMARY LOST on both ND s/MCDUs
 - FMS 1/FMS 2 POS DIFF

- CHECK IRS 1(2)(3)/FM POSITION 
- CHECK A/C POSITION 
- NAV FM /GPS POS DISAGREE

The flight crew should resume navigation with the FMGC that provides the correct position.

● **If NAV ACCUR DOWNGRAD is displayed on both sides:**

The flight crew should inform the ATC that the RNP 2 capability is lost.

RNP 2 IN DOMESTIC AREA

Applicable to: **ALL**

Ident.: PRO-SPO-51-J-00021545.0001001 / 20 MAR 17

REQUIRED RNP 2 IN DOMESTIC AREA EQUIPMENT

The minimum navigation equipment required to enter RNP 2 domestic airspace is:

- One FMGC
- One MCDU
- One GPS
- Two IRS
- Two ND s (the temporary display of ND information via the PFD /ND switch is permitted on one side).

Ident.: PRO-SPO-51-J-00021546.0001001 / 20 MAR 17

PROCEDURE

FLIGHT PREPARATION

RAIM /AIME availability should be confirmed for RNP 2 in domestic area operations.

Refer to PRO-NOR-SOP-02 GPS PRIMARY Availability (If Installed)

MANAGEMENT OF DEGRADED NAVIGATION



● **If one of the following messages is displayed, the flight crew should resume navigation with the FMGC that provides the correct position:**

- GPS PRIMARY LOST  on one ND /MCDU
- NAV ACCUR DOWNGRAD on one ND /MCDU.

● **If one of the following MCDU or ECAM messages is displayed, the flight crew should check the navigation accuracy with navaid raw data via the MCDU PROG page in order to identify which FMGC position is correct:**

- GPS PRIMARY LOST  on both ND s/MCDUs
- FMS 1/FMS 2 POS DIFF

| | |
|---|---|
|  <p>A318/A319/A320/A321 FLIGHT CREW OPERATING MANUAL</p> | <p style="text-align: center;">PROCEDURES SPECIAL OPERATIONS</p> <p style="text-align: center;">REQUIRED NAVIGATION PERFORMANCE (RNP)</p> |
|---|---|

- CHECK IRS 1(2)(3)/FM POSITION 
- CHECK A/C POSITION 
- NAV FM/GPS POS DISAGREE 

The flight crew should resume navigation with the FMGC that provides the correct position.

● **If NAV ACCUR DOWNGRAD is displayed on both sides:**

The flight crew should inform the ATC that the RNP 2 capability is lost.

RNP 1 / TERMINAL RNP 1- BASIC RNP 1

Applicable to: ALL

Ident.: PRO-SPO-51-F-00015842.0001001 / 20 MAR 17

GENERAL

RNP 1 operations correspond to RNP 1 Terminal operations.

Ident.: PRO-SPO-51-F-00015843.0001001 / 17 MAR 16

REQUIRED RNP 1 EQUIPMENT

The minimum navigation equipment required to enter RNP 1 airspace is:

- One FMGC
- One MCDU
- One GPS
- Two IRS
- One FD in NAV mode
- Two ND s (the temporary display of ND information via the PFD /ND switch is permitted on one side).

Ident.: PRO-SPO-51-F-00015867.0001001 / 20 MAR 17

PROCEDURE

FLIGHT PREPARATION

RAIM/AIME availability should be confirmed for RNP 1 operations.

Refer to PRO-NOR-SOP-02 GPS PRIMARY Availability (If Installed)





BEFORE ENTERING RNP 1 AIRSPACE

The FMS navigation database provides the terminal procedure (RNAV SID , RNAV STAR , RNAV TRANSITION, etc.) of the flight plan. The flight crew must check the terminal procedure from the published charts with the FMS navigation database on the F-PLN page (waypoint sequences, tracks, distances, and altitude or speed constraints). The flight crew must not

modify the procedure that is provided by the navigation database, unless required by the ATC (DIR TO, radar vectoring, insertion of waypoints from the navigation database).

MANAGEMENT OF DEGRADED NAVIGATION

- **If one of the following messages is displayed, the flight crew should resume navigation with the FMGC that provides the correct position:**
 - GPS PRIMARY LOST  on one ND /MCDU
 - NAV ACCUR DOWNGRAD on one ND /MCDU.

- **If one of the following MCDU or ECAM messages is displayed, the flight crew should check the navigation accuracy with navaid raw data via the MCDU PROG page in order to identify which FMGC position is correct:**
 - GPS PRIMARY LOST  on both ND s/MCDUs
 - FMS 1/FMS 2 POS DIFF
 - CHECK IRS 1(2)(3)/FM POSITION 
 - CHECK A/C POSITION 
 - NAV FM/GPS POS DISAGREE 

The flight crew should resume navigation with the FMGC that provides the correct position.

- **If NAV ACCUR DOWNGRAD is displayed on both sides:**

The flight crew should inform the ATC that the RNP 1 capability is lost.

RNP APCH / RNAV(GNSS)

Applicable to: ALL

Ident.: PRO-SPO-51-G-00015839.0001001 / 20 MAR 17

GENERAL

RNP APCH operations correspond to RNAV (GNSS) or RNAV (GPS) operations.

Ident.: PRO-SPO-51-G-00015840.0001001 / 11 JUL 17

REQUIRED RNP APCH EQUIPMENT

The minimum equipment required to start RNP APCH operations is:

- One FMGC
- One GPS
- Two IRS
- One MCDU
- One FD
- One PFD on the PF side

- Two ND s (the temporary display of ND information via the PFD /ND switch is permitted on PM side)
- Two FCU channels.

Ident.: PRO-SPO-51-G-00015868.0001001 / 09 SEP 14

PROCEDURE

Refer to PRO-NOR-SOP-18-C Approach using FINAL APP Guidance - General

Refer to PRO-NOR-SOP-18-C Approach using FPA Guidance - General



A318/A319/A320/A321
FLIGHT CREW
OPERATING MANUAL

PROCEDURES
SPECIAL OPERATIONS

REQUIRED NAVIGATION PERFORMANCE (RNP)

Intentionally left blank

| | |
|---|--|
|  <p>A318/A319/A320/A321 FLIGHT CREW OPERATING MANUAL</p> | <p align="center">PROCEDURES SPECIAL OPERATIONS</p> <p align="center">OPERATIONS ON NARROW RUNWAYS</p> |
|---|--|

GENERAL

Ident.: PRO-SPO-60-00002094.0002001 / 03 JAN 11

Applicable to: ALL

This chapter gives the limitations, procedures and performance for operations from/to runways with a width below 45 m .

This chapter does not constitute an operational approval to operate on narrow runways. Such authorization must be obtained by the operator from the appropriate authorities.

LIMITATIONS

Ident.: PRO-SPO-60-00006122.0002001 / 21 MAR 17

Applicable to: ALL

Minimum runway width.....30 m

The dispatch from/to narrow runways is not allowed in case of :

- Nose wheel steering inoperative
- One brake or more inoperative

Autoland is not allowed.

PROCEDURES

Ident.: PRO-SPO-60-00006123.0003001 / 21 MAR 17

Applicable to: ALL

Diversion to a 45 m wide runway is recommended in case of :

- Rudder jam
- Rudder pedal jam
- Yaw damper system fault
- Rudder Travel Limit system fault
- All failures leading to the loss of the nose wheel steering (HYD Yellow system loss, double hydraulic failure, double BSCU fault, double LGCIU fault)

Maximum demonstrated crosswind for takeoff and landing:

Dry runway.....38 kt (gust included) for takeoff and landing

Wet runway.....33 kt (gust included) for takeoff and landing

Contaminated runway..... 10 kt (gust included) for takeoff and landing

Note: *These maximum demonstrated crosswind values are based on the assumption that the crew have been trained accordingly.*

Operations on icy runways have not been demonstrated.

PROCEDURES
SPECIAL OPERATIONS

OPERATIONS ON NARROW RUNWAYS

PERFORMANCE

Ident.: PRO-SPO-60-00006124.0001001 / 23 JUN 15

Applicable to: **ALL**

For runways with a width above or equal to 40 m ., the basic takeoff performance remains unchanged.

For runways with a width below 40 m , the VMCG must be increased by the values indicated in the following table :

| Runway Width | 30 m | 35 m | 40 m |
|--------------|-------|-------|------|
| Δ VMCG(kt) | + 2.5 | + 1.5 | + 0 |

No correction is required, when takeoff performance is determined by using the applicable approved data.

The minimum V1 values, published in the *Refer to PER-TOF-TOD-25-10 SPEEDS LIMITED BY VMCG/VMCA*, must be increased by 3 kt .

When using the takeoff performance for contaminated runways *Refer to PER-TOF-CTA-10 GENERAL*, the resulting V1 must be crosschecked with the corrected minimum V1.

Further decrease the takeoff weight by 3 t per knot increase in V1.

| | |
|---|--|
|  A318/A319/A320/A321 FLIGHT CREW OPERATING MANUAL | PROCEDURES SPECIAL OPERATIONS ILS PRM APPROACH |
|---|--|

OVERVIEW

Ident.: PRO-SPO-85-00020844.0001001 / 17 MAR 17
Applicable to: ALL

The Precision Runway Monitor (PRM) system enables simultaneous close parallel ILS approaches. The air traffic controllers use the PRM system to monitor the aircraft position. If necessary, the ATC orders a break out, turn and climb or descent.

To perform PRM operations:

- The air traffic controllers and the flight crew must satisfy specific training requirements
- The ATC and the aircraft equipment must comply with specific requirements.

BREAK OUT TURN AND CLIMB PROCEDURE

Ident.: PRO-SPO-85-00020845.0001001 / 17 MAR 17
Applicable to: ALL

Simultaneously:

AP..... OFF
 BREAK OUT LEFT(RIGHT), HDG___, ALT..... ANNOUNCE
 THRUST LEVERS..... TOGA, and back to CL

- [L2]** *The SRS GA and the GA TRK modes engage. The THR CLB mode engages. The speed is managed. The speed target is the aircraft speed at SRS GA engagement. The FMS GO-AROUND phase becomes active. Therefore, the FMS reinserts the approach.*

[L1] TURN LEFT(RIGHT) AND CLIMB

- [L2]** *As the situation is urgent, the flight crew should temporarily disregard the FD orders.*

Then

[L1] HDG..... TURN AND PULL

- [L2]** *The GA TRK mode disengages, and the HDG mode engages.*

[L1] ALT.....TURN AND PULL

- [L2]** *The SRS GA mode disengages, and the OP CLB mode engages. The speed target becomes the FMS speed target of the CLIMB phase.*

[L1] SPEED.....PULL AND ADJUST

- [L2]** *For the initial break out procedure, adjust the speed (e.g. 160 kt), in order to avoid a significant acceleration, and an increase in workload.*

[L1] ● **When established on the break out path:**

AP.....ON

- [L2]** *Before engaging the AP , ensure that the FD bar orders correspond to the aircraft current path.*

- L1 SPEED.....SELECT AS RQRD
- FLAPS.....AS RQRD
- GEAR.....AS RQRD
- TCAS MODE SEL.....TA/RA AS RQRD

BREAK OUT TURN AND DESCENT PROCEDURE

Ident.: PRO-SPO-85-00020846.0001001 / 17 MAR 17

Applicable to: ALL

Simultaneously:

AP..... OFF
 TURN LEFT(RIGHT) AND MAINTAIN RATE OF DESCENT
 BREAK OUT LEFT(RIGHT), HDG __, ALT..... ANNOUNCE

- L2 *As the situation is urgent, the flight crew should temporarily disregard the FD orders.*

Then

- L1 HDG..... TURN AND PULL

- L2 *The HDG mode engages. The vertical mode reverts to the V/S mode. The vertical speed target is the aircraft vertical speed at V/S engagement.*

- L1 ALT.....TURN AND PULL

- L2 *This action defines an altitude target. The OP DES mode and the THR IDLE mode engage. The speed target does not change.*

- L1 V/S.....MONITOR

CAUTION Depending on the speed target, the vertical speed may become excessive. If the rate of descent exceeds 1 000 ft/min, engage the V/S mode and limit the rate of descent to 1 000 ft/min.

● **When established on the break out path:**

AP.....ON

- L2 *Before engaging the AP, ensure that the FD bar orders correspond to the aircraft current path.*

- L1 ● **When cleared by ATC:**

ALT..... TURN

- L2 *Select an altitude target for go-around, in accordance with the ATC clearance.*

- L1 THRUST LEVERS..... TOGA, and back to CL

- L2 *The SRS GA and the GA TRK modes engage. The THR CLB mode engages.
 The speed is managed. The speed target is the aircraft speed at SRS GA engagement.
 The FMS GO-AROUND phase becomes active.*



AEROLINEAS GALAPAGOS S.A.

A318/A319/A320/A321

FLIGHT CREW
OPERATING MANUAL

**PROCEDURES
SPECIAL OPERATIONS**

ILS PRM APPROACH

- L1 HDG.....PULL
- L2 *The GA TRK mode disengages, and the HDG mode engages. The SRS GA mode remains engaged, until ALT* engagement.*
- L1 SPEED.....SELECT AS RQRD
- FLAPS.....AS RQRD
- GEAR.....AS RQRD
- TCAS MODE SEL.....TA/RA AS RQRD



A318/A319/A320/A321
FLIGHT CREW
OPERATING MANUAL

PROCEDURES
SPECIAL OPERATIONS

ILS PRM APPROACH

Intentionally left blank

LIMITATIONS

Intentionally left blank

LIM-INT Introduction

LIM-AG Aircraft General

LIM-AIR Air Bleed/Cond/Press/Vent

LIM-AFS Auto Flight System

LIM-APU Auxiliary Power Unit

LIM-CAB Cabin Systems

LIM-COM Communication

LIM-ENG Engines

LIM-F_CTL Flight Controls

LIM-FUEL Fuel

LIM-ICE_RAIN Ice and Rain Protection

LIM-LG Landing Gear

LIM-NAV Navigation

LIM-OXY Oxygen

LIM-SURV Surveillance



A318/A319/A320/A321
FLIGHT CREW
OPERATING MANUAL

LIMITATIONS
PRELIMINARY PAGES
TABLE OF CONTENTS

Intentionally left blank

| M ⁽¹⁾ | Localization | DU Title | DU identification | DU date |
|-------------------------|--|--|--------------------------|----------------|
| | LIM-AFS-20 Criteria: A320 Applicable to: ALL <i>Impacted DU: NONE</i> | Automatic Landing in Johannesburg | 00013685.0001001 | 25 APR 13 |
| | LIM-AFS-20 Criteria: P3510, P3790, P4087, P4419, P4425, P6125, P6985, P7397, P9333, SA Applicable to: ALL <i>Impacted DU: NONE</i> | Autoland Databases with Honeywell ADIRU | 00016880.0070001 | 25 NOV 15 |

(1) Evolution code : N=New, R=Revised, E=Effectivity



A318/A319/A320/A321
FLIGHT CREW
OPERATING MANUAL

LIMITATIONS

PRELIMINARY PAGES

LIST OF EFFECTIVE TEMPORARY DOCUMENTARY UNITS

Intentionally left blank

LIMITATIONS

INTRODUCTION

Intentionally left blank



A318/A319/A320/A321
FLIGHT CREW
OPERATING MANUAL

LIMITATIONS

INTRODUCTION

PRELIMINARY PAGES - TABLE OF CONTENTS

Introduction.....A



A318/A319/A320/A321
FLIGHT CREW
OPERATING MANUAL

LIMITATIONS

INTRODUCTION

PRELIMINARY PAGES - TABLE OF CONTENTS

Intentionally left blank



A318/A319/A320/A321
FLIGHT CREW
OPERATING MANUAL

LIMITATIONS
INTRODUCTION

INTRODUCTION

Ident.: LIM-INT-00019839.0001001 / 04 SEP 17

Applicable to: ALL

This FCOM chapter contains operational limitations, related to the aircraft and associated systems. All references to airspeed, Mach and altitude relate to indicated airspeed, indicated Mach, and pressure altitude, unless otherwise noted.

Intentionally left blank

LIMITATIONS

AIRCRAFT GENERAL

Intentionally left blank

LIM-AG-F_CTL Flight Maneuvering Load Acceleration Limits

Flight Maneuvering Load Acceleration Limits..... A

LIM-AG-OPS Operational Parameters

Environmental Envelope..... A

Airport Operations and Wind Limitations..... B

LIM-AG-SPD Speeds

Cockpit Window Open Maximum Speed..... A

Maximum Flaps/Slats Speeds..... B

Maximum Operating Speed VMO/MMO..... C

Maximum Speeds with the Landing Gear Extended..... D

Maximum Tire Speed..... E

Minimum Control Speeds..... F

Taxi Speed..... G

Wipers Maximum Operating Speed..... H

LIM-AG-WGHT Weights

Weight Limitations..... A



A318/A319/A320/A321
FLIGHT CREW
OPERATING MANUAL

LIMITATIONS

AIRCRAFT GENERAL

PRELIMINARY PAGES - TABLE OF CONTENTS

Intentionally left blank



A318/A319/A320/A321
FLIGHT CREW
OPERATING MANUAL

LIMITATIONS
AIRCRAFT GENERAL

FLIGHT MANEUVERING LOAD ACCELERATION LIMITS

FLIGHT MANEUVERING LOAD ACCELERATION LIMITS

Ident.: LIM-AG-F_CTL-00020793.0001001 / 17 MAR 17

Applicable to: ALL

Clean configuration.....-1 g to +2.5 g
Other configurations..... 0 g to +2 g

LIMITATIONS

AIRCRAFT GENERAL

FLIGHT MANEUVERING LOAD ACCELERATION LIMITS

Intentionally left blank

ENVIRONMENTAL ENVELOPE

Ident.: LIM-AG-OPS-00021818.0043001 / 19 JUL 17

Applicable to: ALL

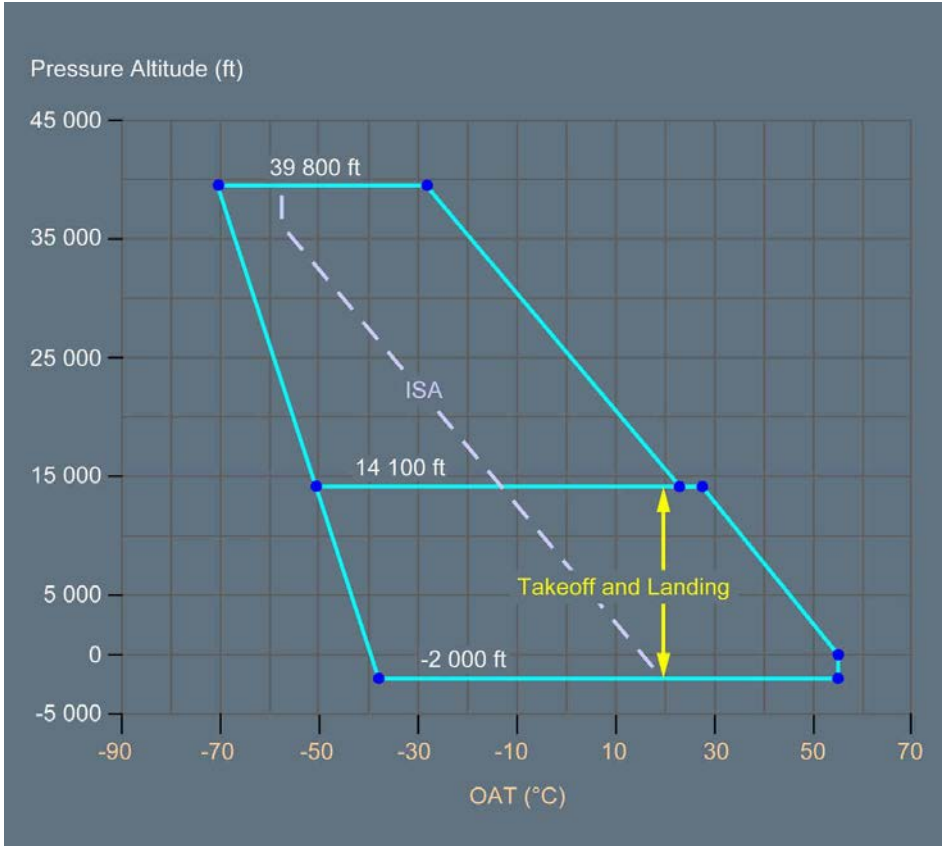

AIRPORT OPERATIONS AND WIND LIMITATIONS

Applicable to: ALL

Ident.: LIM-AG-OPS-ARPT_WIND-00020145.0001001 / 17 MAR 17

RUNWAY SLOPE

Runway slope (mean)..... ±2 %



AEROLINEAS GALAPAGOS S.A.

A318/A319/A320/A321
FLIGHT CREW
OPERATING MANUAL

LIMITATIONS

AIRCRAFT GENERAL

OPERATIONAL PARAMETERS

Ident.: LIM-AG-OPS-ARPT_WIND-00020135.0009001 / 17 MAR 17

RUNWAY ALTITUDE

Runway altitude..... 14 100 ft

Ident.: LIM-AG-OPS-ARPT_WIND-00020146.0002001 / 17 MAR 17

NOMINAL RUNWAY WIDTH

Nominal runway width..... 45 m

Minimal runway width..... 30 m

Ident.: LIM-AG-OPS-ARPT_WIND-00020148.0001001 / 17 MAR 17

WIND FOR TAKEOFF AND LANDING

Maximum demonstrated crosswind (takeoff and landing)..... 38 kt (gust included)

- Note:
- *The maximum demonstrated crosswind value is not an Airplane Flight Manual (AFM) limitation : It is the maximum crosswind condition experienced during the aircraft certification campaign.*
 - *Airbus recommends that operators should not intentionally operate in crosswinds that exceed this value.*

Ident.: LIM-AG-OPS-ARPT_WIND-00020157.0003001 / 17 MAR 17

TAILWIND TAKEOFF

Maximum tailwind for takeoff..... 15 kt

Ident.: LIM-AG-OPS-ARPT_WIND-00020159.0003001 / 21 MAR 17

TAILWIND LANDING

Maximum tailwind for landing 15 kt

- Note: *For maximum tailwind for automatic landing and rollout, Refer to LIM-AFS-20 Maximum Wind Conditions for ILS/MLS (If Installed) CAT II or CAT III and for GLS (If Installed) CAT I.*

Ident.: LIM-AG-OPS-ARPT_WIND-00020168.0002001 / 22 MAR 17

- Note: *For landing with a tailwind greater than 10 kt, use FLAPS FULL only.*

| | |
|---|---|
|  A318/A319/A320/A321 FLIGHT CREW OPERATING MANUAL | LIMITATIONS AIRCRAFT GENERAL OPERATIONAL PARAMETERS |
|---|---|

Ident.: LIM-AG-OPS-ARPT_WIND-00020166.0001001 / 04 JUL 17

PASSENGER AND CARGO DOORS OPERATION

The following are the wind limitations for passenger and cargo doors operation:

- The maximum wind for passenger door operation is 65 kt
- The maximum wind for FWD and AFT cargo door operation is 40 kt (or 50 kt, if the aircraft nose is into the wind, or if the FWD and AFT cargo doors are on the leeward side)
- The FWD and AFT cargo doors must be closed before the wind speed exceeds 65 kt.

Ident.: LIM-AG-OPS-ARPT_WIND-00020046.0003001 / 17 MAR 17

MAXIMUM RECOMMENDED CROSSWIND ON WET AND CONTAMINATED RUNWAYS

| Runway Surface Conditions | | Maximum Crosswind for Takeoff (Gust included) | Maximum Crosswind for Landing (Gust included) |
|--|--|---|---|
| Runway State or / and Runway Contaminant | ESF ⁽¹⁾ or PIREP ⁽²⁾ | | |
| Damp Wet Up to 3 mm (1/8") of water Slush Up to 3 mm (1/8") Dry snow Up to 3 mm (1/8") Wet snow Up to 3 mm (1/8") Frost | Good | 38 kt | 38 kt |
| Compacted snow OAT at or below -15 °C | Good to Medium | 29 kt | 29 kt |
| Dry snow More than 3 mm (1/8"), up to 100 mm (4") Wet snow More than 3 mm (1/8"), up to 30 mm (6/5") Compacted snow OAT above -15 °C Dry snow over compacted snow Wet snow over compacted snow Slippery when wet | Medium | 25 kt | 25 kt |
| Water More than 3 mm (1/8"), up to 12.7 mm (1/2") Slush More than 3 mm (1/8"), up to 12.7 mm (1/2") | Medium to Poor | 20 kt | 20 kt |
| Ice (cold & dry) | Poor | 15 kt | 15 kt |

(1) *ESF: Estimated Surface Friction*

(2) *PIREP: Pilot Report of Braking Action*

Note: The maximum crosswind values given in the above table are recommended values based on computations.

Ident.: LIM-AG-OPS-ARPT_WIND-00014451.0001001 / 22 MAY 12

TAKEOFF LIMITATIONS ON CONTAMINATED RUNWAYS

Takeoff is not recommended on the following runway conditions:

- Wet ice
- Water on top of Compacted Snow
- Dry Snow or Wet Snow over Ice

| | |
|---|---|
|  A318/A319/A320/A321 FLIGHT CREW OPERATING MANUAL | LIMITATIONS AIRCRAFT GENERAL SPEEDS |
|---|---|

COCKPIT WINDOW OPEN MAXIMUM SPEED

Ident.: LIM-AG-SPD-00001904.0001001 / 17 MAR 17
Applicable to: ALL

Maximum speed.....200 kt

MAXIMUM FLAPS/SLATS SPEEDS

Ident.: LIM-AG-SPD-00020087.0001001 / 17 MAR 17
Applicable to: ALL

| Flaps Lever Position | Configuration on Slat/Flap Display | Max Speed | Flight Phase |
|----------------------|------------------------------------|-----------|--------------------------|
| 0 | | VMO /MMO | CRUISE |
| 1 | 1 | 230 kt | HOLDING |
| | 1 + F | 215 kt | TAKEOFF |
| 2 | 2 | 200 kt | TAKEOFF/APPROACH |
| 3 | 3 | 185 kt | TAKEOFF/APPROACH/LANDING |
| FULL | FULL | 177 kt | LANDING |

MAXIMUM OPERATING SPEED VMO/MMO

Ident.: LIM-AG-SPD-00019991.0002001 / 17 MAR 17
Applicable to: ALL

VMO..... 350 kt
 MMO..... M 0.82

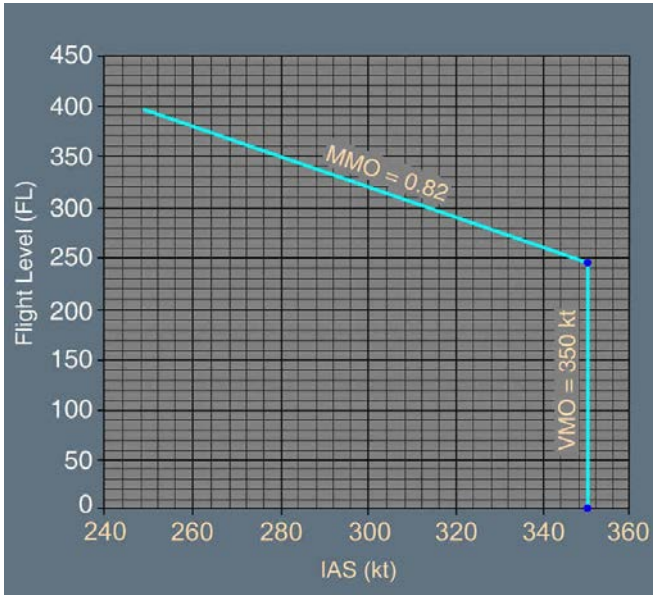

MAXIMUM SPEEDS WITH THE LANDING GEAR EXTENDED

Ident.: LIM-AG-SPD-00001901.0001001 / 17 MAR 17

Applicable to: ALL

- Maximum speed with the landing gear extended (VLE).....280 kt /M 0.67
- Maximum speed at which the landing gear may be extended (VLO extension) 250 kt /M 0.60
- Maximum speed at which the landing gear may be retracted (VLO retraction) 220 kt /M 0.54

MAXIMUM TIRE SPEED

Ident.: LIM-AG-SPD-00001902.0001001 / 17 MAR 17

Applicable to: ALL

- Maximum ground speed..... 195 kt

MINIMUM CONTROL SPEEDS

Ident.: LIM-AG-SPD-00020161.0015001 / 17 MAR 17

Applicable to: ALL

MINIMUM CONTROL SPEED FOR LANDING (VMCL)

- VMCL..... 113 kt

MINIMUM CONTROL SPEEDS IN THE AIR (VMCA) AND ON THE GROUND (VMCG)

| Altitude (ft) | VMCA (kt IAS) | VMCG (kt IAS) | | |
|------------------|------------------|---------------|--------|--------|
| | | CONF 1 + F | CONF 2 | CONF 3 |
| -2 000 | 112 | 112 | 110 | 109 |
| 0 | 110 | 111 | 109 | 109 |
| 2 000 | 108 | 109 | 107 | 107 |
| 4 000 | 108 | 109 | 107 | 107 |
| 6 000 | 107 | 108 | 106 | 105 |
| 8 000 | 104 | 105 | 103 | 103 |
| 10 000 | 100 | 101 | 99 | 99 |
| 12 000 | 97 | 99 | 97 | 96 |
| 14 100 | 94 | 95 | 93 | 93 |

When the Thrust Bump  is used, consider the following VMCA / VMCG:

| Altitude (ft) | VMCA (kt IAS) | VMCG (kt IAS) | | |
|------------------|------------------|---------------|--------|--------|
| | | CONF 1 + F | CONF 2 | CONF 3 |
| -2 000 | 111 | 112 | 110 | 109 |
| 0 | 110 | 111 | 109 | 109 |
| 2 000 | 108 | 109 | 107 | 107 |
| 4 000 | 108 | 109 | 107 | 107 |
| 6 000 | 108 | 109 | 107 | 106 |
| 8 000 | 105 | 106 | 104 | 104 |
| 10 000 | 102 | 103 | 101 | 101 |
| 12 000 | 99 | 100 | 98 | 97 |
| 14 100 | 95 | 97 | 95 | 95 |

| |
|-------------------|
| TAXI SPEED |
|-------------------|

Ident.: LIM-AG-SPD-00019838.0001001 / 17 MAR 17

Applicable to: ALL

- When the taxi weight is higher than 76 000 kg (167 550 lb):

CAUTION Do not exceed a taxi speed of 20 kt during a turn.

| |
|---------------------------------------|
| WIPERS MAXIMUM OPERATING SPEED |
|---------------------------------------|

Ident.: LIM-AG-SPD-00001903.0001001 / 17 MAR 17

Applicable to: ALL

Maximum speed.....230 kt

 **Note:** This limitation is applicable when the wipers are sweeping. It is not applicable if the wipers are not sweeping for any reasons.



A318/A319/A320/A321
FLIGHT CREW
OPERATING MANUAL

LIMITATIONS
AIRCRAFT GENERAL
SPEEDS

Intentionally left blank



A318/A319/A320/A321
 FLIGHT CREW
 OPERATING MANUAL

LIMITATIONS
AIRCRAFT GENERAL
 WEIGHTS

WEIGHT LIMITATIONS

Ident.: LIM-AG-WGHT-00001893.0268001 / 18 MAR 11

Applicable to: ALL

| | |
|---|------------------------|
| Maximum taxi weight..... | 77 400 kg (170 637 lb) |
| Maximum takeoff weight (brake release)..... | 77 000 kg (169 755 lb) |
| Maximum landing weight..... | 66 000 kg (145 505 lb) |
| Maximum zero fuel weight..... | 62 500 kg (137 788 lb) |
| Minimum weight..... | 37 230 kg (82 079 lb) |

In exceptional cases (in flight turn back or diversion), an immediate landing at weight above maximum landing weight is permitted, provided the pilot follows the overweight landing procedure.



A318/A319/A320/A321
FLIGHT CREW
OPERATING MANUAL

LIMITATIONS
AIRCRAFT GENERAL

WEIGHTS

Intentionally left blank

LIMITATIONS

AIR BLEED/COND/PRESS/VENT

Intentionally left blank



A318/A319/A320/A321
FLIGHT CREW
OPERATING MANUAL

LIMITATIONS

AIR BLEED/COND/PRESS/VENT

PRELIMINARY PAGES - TABLE OF CONTENTS

| | |
|--|---|
| General..... | A |
| APU Bleed Use with HP Air Start Unit..... | B |
| Avionics Ventilation..... | C |
| Cabin Pressure..... | D |
| Packs Use with LP Air Conditioning Unit..... | E |



A318/A319/A320/A321
FLIGHT CREW
OPERATING MANUAL

LIMITATIONS

AIR BLEED/COND/PRESS/VENT

PRELIMINARY PAGES - TABLE OF CONTENTS

Intentionally left blank

| | |
|---|--|
|  A318/A319/A320/A321 FLIGHT CREW OPERATING MANUAL | LIMITATIONS AIR BLEED/COND/PRESS/VENT |
|---|--|

GENERAL

Ident.: LIM-AIR-00020807.0001001 / 17 MAR 17

Applicable to: ALL

With passengers on board, it is not recommended to exceed 20 min without air conditioning supply. The lack of fresh air supply will significantly reduce the cabin's air quality.

APU BLEED USE WITH HP AIR START UNIT

Ident.: LIM-AIR-00020084.0001001 / 17 MAR 17

Applicable to: ALL

The flight crew must not use bleed air from the APU BLEED and from the HP Air Start Unit at the same time, to prevent any adverse effect on the Bleed Air System.

AVIONICS VENTILATION

Ident.: LIM-AIR-00020086.0001001 / 17 MAR 17

Applicable to: ALL

During ground operations and depending on the Outside Air Temperature (OAT), the flight crew must limit the time that the aircraft electric power supply is used, in normal avionics ventilation system configuration, as follows:

| | |
|---------------------|---------------|
| OAT ≤ 49 °C | No limitation |
| 49 °C < OAT ≤ 55 °C | 2 h |
| 55 °C < OAT ≤ 60 °C | 1 h |
| 60 °C < OAT ≤ 64 °C | 0.5 h |

CABIN PRESSURE

Ident.: LIM-AIR-00020085.0003001 / 17 MAR 17

Applicable to: ALL

Maximum positive differential pressure..... 9.0 PSI
 Maximum negative differential pressure.....-1.0 PSI
 Safety relief valve setting..... 8.6 PSI

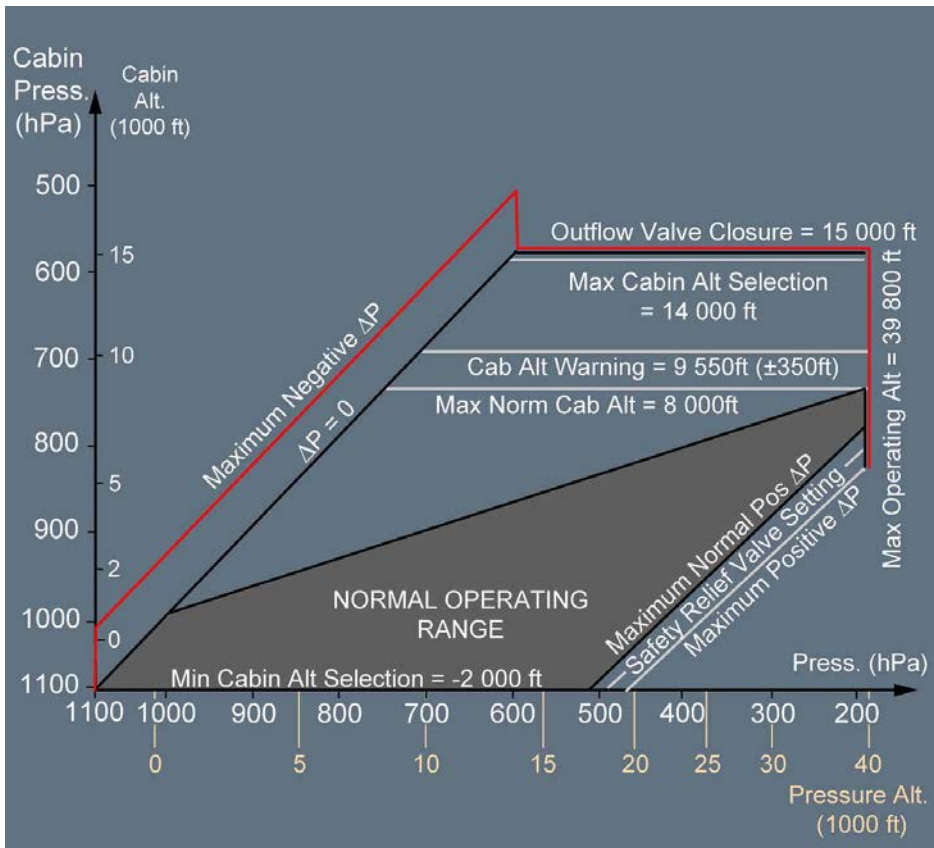

Note: Maximum differential pressure (Δp) and safety valve setting tolerance = ± 7 hPa (0.1 PSI).

PACKS USE WITH LP AIR CONDITIONING UNIT

Ident.: LIM-AIR-00020083.0001001 / 17 MAR 17

Applicable to: ALL

The flight crew must not use conditioned air from the packs and from the LP Air Conditioning Unit at the same time, to prevent any adverse effect on the Air Conditioning system.

LIMITATIONS



AUTO FLIGHT SYSTEM

Intentionally left blank

LIM-AFS-10 General

| | |
|--|---|
| Autopilot Function..... | A |
| Flight Management Function..... | B |
| Use of NAV Mode..... | C |
| Use of FLS  | D |
| Navigation Database Validation..... | E |

LIM-AFS-20 Automatic Approach, Landing and Rollout

| | |
|--|---|
| ILS Category II..... | A |
| Special Authorization CAT II (SA CAT II)..... | B |
| Other than Standard CAT II (OTS CAT II)..... | C |
| ILS Category III Fail Passive (Single)..... | D |
| ILS Category III Fail Operational (Dual)..... | E |
| Engine-Out..... | F |
| Maximum Wind Conditions for ILS/MLS  CAT II or CAT III and for GLS  CAT I..... | G |
| Automatic Landing..... | H |
| Automatic Landing in Johannesburg..... | I |
| Autoland Databases with Honeywell ADIRU..... | J |



A318/A319/A320/A321
FLIGHT CREW
OPERATING MANUAL

LIMITATIONS

AUTO FLIGHT SYSTEM

PRELIMINARY PAGES - TABLE OF CONTENTS

Intentionally left blank

| | |
|---|--|
|  A318/A319/A320/A321 FLIGHT CREW OPERATING MANUAL | LIMITATIONS AUTO FLIGHT SYSTEM GENERAL |
|---|--|

AUTOPILOT FUNCTION

Applicable to: ALL



Ident.: LIM-AFS-10-10-00019567.0001001 / 17 MAR 17

The autopilot can be used with the following minimum values:

Ident.: LIM-AFS-10-10-00019753.0001001 / 17 MAR 17

| | |
|------------|---------------------------------|
| At takeoff | 100 ft AGL or 5 s after liftoff |
|------------|---------------------------------|

Ident.: LIM-AFS-10-10-00019568.0001001 / 03 AUG 17

| | |
|---|------------|
| In non-precision approach using F-LOC  or F-G/S  (FLS  function) | 200 ft AGL |
|---|------------|

| | |
|--|------------|
| In non-precision approach using FINAL APP  , NAV FPA, NAV V/S, TRK FPA, HDG V/S, LOC V/S, LOC FPA | 250 ft AGL |
|--|------------|

Ident.: LIM-AFS-10-10-00019746.0005001 / 09 JUN 17

| | |
|----------------------|--|
| In circling approach | 500 ft AGL for aircraft category C (600 ft AGL for aircraft category D). |
|----------------------|--|

Ident.: LIM-AFS-10-10-00019747.0001001 / 17 MAR 17

| | |
|---|------------|
| ILS /MLS  approach when CAT1 is displayed on the FMA | 160 ft AGL |
|---|------------|

| | |
|--|------------|
| GLS  approach when AUTOLAND is not displayed on the FMA | 160 ft AGL |
|--|------------|

| | |
|--|----------------------|
| ILS /MLS  approach when CAT2 or CAT3 (single or dual) is displayed on the FMA | 0 ft AGL if autoland |
|--|----------------------|

Ident.: LIM-AFS-10-10-00019750.0001001 / 17 MAR 17

| | |
|--------------------------|------------|
| After a manual go-around | 100 ft AGL |
|--------------------------|------------|

Ident.: LIM-AFS-10-10-00019751.0001001 / 06 JUL 17

| | |
|---------------------|------------|
| In all other phases | 500 ft AGL |
|---------------------|------------|

The AP or FD in OP DES or DES mode can be used in approach. However, its use is only permitted if the FCU selected altitude is set to, or above, the higher of the two: MDA /MDH or 500 ft AGL.

FLIGHT MANAGEMENT FUNCTION

Applicable to: ALL

Ident.: LIM-AFS-10-20-00020069.0001001 / 17 MAR 17

- FMGS lateral and vertical navigation is certified for:
- After takeoff, en route, and terminal area operations
 - Navigation within RNAV /RNP airspace

- Instrument approach procedures (except ILS , LOC , LOC B/C , LDA , SDF, GLS \triangleleft , MLS \triangleleft and FLS \triangleleft final approaches)
- Missed approach procedures.

The FLS \triangleleft function is certified for:

- RNAV , RNAV (GNSS) , GPS , VOR , VOR /DME , NDB , NDB /DME instrument approach procedures, using FMS navigation for lateral and vertical navigation
- LOC , ILS (GS out), or LOC B/C instrument approaches, using FMS navigation for vertical navigation, associated with LOC or LOC B/C for lateral navigation.

Approval of the FMGS is based on the assumption that the navigation database is validated for intended use.

Obstacle clearance and adherence to airspace constraints remains a flight crew responsibility. Fuel, time predictions/performance information is provided for advisory purposes only.

TAKEOFF IN GPS PRIMARY \triangleleft

For certain airports, where the difference between the local coordinate system and WGS 84 (geodesic standard used by GPS , FMS) is not negligible, a map shift may occur after takeoff. The flight crew must deselect the GPS for takeoff from these airports, until a safe altitude is reached.

Ident.: LIM-AFS-10-20-00020070.0002001 / 17 MAR 17

NAVIGATION PERFORMANCE

The navigation accuracy depends on:

- IRS drift, or
- One of the following:
 - Radio navaid availability, or
 - Elapsed time since last computation of radio navaid position.

RNP accuracy with GPS PRIMARY \triangleleft is:

| | With AP ON ⁽¹⁾ | With AP OFF and FD ON ⁽¹⁾ | With AP OFF and FD OFF |
|-------------------------|---------------------------|--------------------------------------|---|
| En route | 1 NM | 1 NM | 1.1 NM |
| In terminal area | 0.5 NM | 0.51 NM | 0.51 NM |
| In approach | 0.3 NM | 0.3 NM | 0.3 NM with F-LOC \triangleleft deviation Not authorized without F-LOC \triangleleft deviation |

⁽¹⁾ - In NAV (all phases), or
 - In F-LOC \triangleleft (approach phase)

| | |
|---|--|
|  A318/A319/A320/A321 FLIGHT CREW OPERATING MANUAL | LIMITATIONS AUTO FLIGHT SYSTEM GENERAL |
|---|--|

Ident.: LIM-AFS-10-20-00020389.0001001 / 17 MAR 17

DEGRADED SITUATION

If GPS PRIMARY LOST  is displayed on the PFD , the navigation accuracy remains sufficient for RNP operations provided that, the RNP value is checked or entered on the MCDU and HIGH ACCURACY is displayed.

USE OF NAV MODE

Applicable to: ALL

Ident.: LIM-AFS-10-30-00020334.0001001 / 17 MAR 17

AFTER TAKEOFF

NAV mode may be used after takeoff provided that:

- GPS PRIMARY  is available, or
- The flight crew checked the FMGS takeoff updating.

Ident.: LIM-AFS-10-30-00020335.0001001 / 17 MAR 17

IN TERMINAL AREA

NAV mode may be used in terminal area provided that:

- GPS PRIMARY  is available, or
- the appropriate RNP is checked or entered on the MCDU, and HIGH accuracy is displayed, or
- FMS navigation is crosschecked with navaid raw data.

Ident.: LIM-AFS-10-30-00020336.0001001 / 17 MAR 17

APPROACH BASED ON RADIO NAVAIDS

A nav aids approach may be performed in NAV , APP NAV or FINAL APP , with AP or FD engaged, provided that:

- If GPS PRIMARY  is available, the reference navaid may be unserviceable, or the airborne radio equipment may be inoperative, or not installed, provided that an operational approval is obtained
- If GPS PRIMARY is not available, the reference navaid and the corresponding airborne radio equipment must be serviceable, tuned and monitored during the approach.

Note: FLS  is the recommended managed lateral and vertical guidance mode for radio nav aids approach.

Ident.: LIM-AFS-10-30-00020337.0001001 / 17 MAR 17

RNAV APPROACH

An RNAV (RNP) approach may be performed, with GPS PRIMARY not available, only if the radio navaid coverage supports the RNP value and HIGH accuracy is displayed on the MCDU with the specified RNP, and an operational approval is obtained.

An RNAV (GNSS) approach may be performed provided that GPS PRIMARY  is available.

Refer to Guidance Modes per Approach Types

Note: FLS  is the recommended managed lateral and vertical guidance mode for RNAV approach.

USE OF FLS

Ident.: LIM-AFS-10-00020808.0001001 / 17 MAR 17

Applicable to: ALL

APPROACH BASED ON RADIO NAVAIDS

A navaids approach may be flown with the FLS provided that:

- F-APP capability is displayed on FMA
In this case, the reference navaids may be unserviceable, or the airborne radio equipment may be inoperative, or not installed, provided that an operational approval is obtained.
- F-APP + RAW capability is displayed on FMA.
In this case, the reference navaids and the corresponding airborne radio equipment must be serviceable, tuned and monitored during the approach.

An ILS (G/S out), LOC , or LOC -B/C approach may be flown with the lateral LOC (LOC -B/C) mode and with the F-G/S mode of FLS function provided that:

- F-APP capability is displayed on FMA
In this case, the reference navaids may be unserviceable, or the airborne radio equipment may be inoperative, or not installed, provided that an operational approval is obtained.
- F-APP + RAW capability is displayed on FMA.
In this case, the reference navaids and the corresponding airborne radio equipment must be serviceable, tuned and monitored during the approach.

RNAV (GNSS) APPROACH

An RNAV (GNSS) approach with LNAV minimum may be flown with the FLS provided that the F-APP capability is displayed on FMA.

An RNAV (GNSS) approach with LNAV /VNAV minimum must be flown with the FLS provided that the F-APP capability is displayed on FMA.

| | |
|---|--|
|  <p>A318/A319/A320/A321 FLIGHT CREW OPERATING MANUAL</p> | <p>LIMITATIONS AUTO FLIGHT SYSTEM</p> <p>GENERAL</p> |
|---|--|

NAVIGATION DATABASE VALIDATION

Applicable to: ALL

Ident.: LIM-AFS-10-40-00021656.0002001 / 08 AUG 17

RNAV (GNSS) APPROACHES AND APPROACHES BASED ON VOR /NDB

To fly an approach in lateral managed mode or lateral and vertical managed mode, the approach stored in the Navigation database must be either:

- Produced by an approved supplier compliant with ED76/DO200A requirements, or
- Validated and approved by the Operator.

Note: RNAV (GNSS) approaches lateral trajectories are geometrically based on waypoints coordinates. Thus, validating waypoints coordinate ensure no coding error on the approach and correct lateral trajectory. Observed lateral track degree of difference between MCDU F-PLN page display and charts may come from inconsistency between FMS MagVar and charted MagVar, which has no effect on lateral trajectory.



A318/A319/A320/A321
FLIGHT CREW
OPERATING MANUAL

LIMITATIONS
AUTO FLIGHT SYSTEM

GENERAL

Intentionally left blank

| | |
|---|---|
|  <p>A318/A319/A320/A321 FLIGHT CREW OPERATING MANUAL</p> | <p>LIMITATIONS</p> <p>AUTO FLIGHT SYSTEM</p> <p>AUTOMATIC APPROACH, LANDING AND ROLLOUT</p> |
|---|---|

ILS CATEGORY II

Ident.: LIM-AFS-20-00020136.0001001 / 17 MAR 17

Applicable to: ALL

Minimum decision height..... 100 ft AGL
 At least one autopilot must be engaged in APPR mode, and CAT 2 or CAT 3 SINGLE or CAT 3 DUAL must be displayed on the FMA.
 For manual landing, AP should be disconnected no later than 80 ft AGL.

SPECIAL AUTHORIZATION CAT II (SA CAT II)

Ident.: LIM-AFS-20-00020138.0001001 / 17 MAR 17

Applicable to: ALL

Minimum decision height..... 100 ft AGL
 At least one autopilot must be engaged in APPR mode, and CAT 2 or CAT 3 SINGLE or CAT 3 DUAL must be displayed on the FMA.
 With HUD , the flight crew must use the HUD to monitor the approach and perform an automatic landing or a manual landing. If the flight crew performs an automatic approach without automatic landing, the autopilot must be disengaged no later than at 80 ft AGL.
 Without HUD, the flight crew must perform an automatic landing.

OTHER THAN STANDARD CAT II (OTS CAT II)

Ident.: LIM-AFS-20-00020139.0001001 / 17 MAR 17

Applicable to: ALL

Minimum decision height..... 100 ft AGL
 At least one autopilot must be engaged in APPR mode, and CAT 2 or CAT 3 SINGLE or CAT 3 DUAL must be displayed on the FMA.
 With HUD , the flight crew must use the HUD to monitor the approach and perform an automatic landing or a manual landing. If the flight crew performs an automatic approach without automatic landing, the autopilot must be disengaged no later than at 80 ft AGL.
 Without HUD, the flight crew must perform an automatic landing.

ILS CATEGORY III FAIL PASSIVE (SINGLE)

Ident.: LIM-AFS-20-00020140.0001001 / 17 MAR 17

Applicable to: ALL

Minimum decision height..... 50 ft AGL
 A/THR must be used in selected or managed speed.
 At least one autopilot must be engaged in APPR mode, and CAT 3 SINGLE or CAT 3 DUAL must be displayed on the FMA.



A318/A319/A320/A321
FLIGHT CREW
OPERATING MANUAL

LIMITATIONS

AUTO FLIGHT SYSTEM

AUTOMATIC APPROACH, LANDING AND ROLLOUT

ILS CATEGORY III FAIL OPERATIONAL (DUAL)

Ident.: LIM-AFS-20-00020141.0008001 / 17 MAR 17

Applicable to: ALL

Alert height..... 100 ft AGL

A/THR must be used in selected or managed speed.

Both autopilots must be engaged in APPR mode, and CAT 3 DUAL must be displayed on the FMA.

■ **CAT III with DH:**

Minimum Decision Height..... 20 ft AGL

■ **CAT III without DH:**

Minimum Runway Visual Range..... 75 m

ENGINE-OUT

Ident.: LIM-AFS-20-00020142.0001001 / 17 MAR 17

Applicable to: ALL

CAT II and CAT III fail passive autoland are only approved in configuration FULL, and if engine-out procedures are completed before reaching 1 000 ft in approach.

MAXIMUM WIND CONDITIONS FOR ILS/MLS ⚠ CAT II OR CAT III AND FOR GLS ⚠ CAT I

Ident.: LIM-AFS-20-00020144.0001001 / 17 MAR 17

Applicable to: ALL

Headwind : 30 kt

Tailwind : 10 kt

Crosswind : 20 kt

Note: Wind limitation is based on the surface wind reported by ATC . If the wind displayed on the ND exceeds the above-noted autoland limitations, but the tower reports a surface wind within the limitations, then the autopilot can remain engaged. If the tower reports a surface wind beyond limitations, only CAT I automatic approach without autoland can be performed.



A318/A319/A320/A321
FLIGHT CREW
OPERATING MANUAL

LIMITATIONS AUTO FLIGHT SYSTEM

AUTOMATIC APPROACH, LANDING AND ROLLOUT

AUTOMATIC LANDING

Applicable to: ALL

Ident.: LIM-AFS-20-10-00020149.0001001 / 17 MAR 17

ILS/MLS CAT II and CAT III autoland and GLS CAT I autoland are approved in CONF 3 and CONF FULL.

Ident.: LIM-AFS-20-10-00020150.0001001 / 17 MAR 17

Automatic landing is demonstrated:

- With CAT II and CAT III ILS /MLS beam and CAT I GLS beam.

Ident.: LIM-AFS-20-10-00020151.0001001 / 17 MAR 17

- With a glide slope angle between -2.5° and -3.15°

Ident.: LIM-AFS-20-10-00020152.0003001 / 17 MAR 17

- With an airport elevation at or below 9 200 ft

Ident.: LIM-AFS-20-10-00020155.0001001 / 17 MAR 17

Automatic landing is not allowed below -1 000 ft pressure altitude.

Ident.: LIM-AFS-20-10-00020156.0001001 / 17 MAR 17

Automatic rollout performance is approved on dry and wet runways, but performance on snow-covered or icy runways was not demonstrated.

Ident.: LIM-AFS-20-10-00020158.0001001 / 17 MAR 17

Automatic landing system performance is demonstrated with CAT II or CAT III ILS/MLS airport installation. However, automatic landing in CAT I or better weather conditions is possible on CAT I ground installations or on CAT II/III ground installations when ILS/MLS sensitive areas are not protected, if the following precautions are taken:

- The airline checked that the ILS /MLS beam quality, and the effect of the terrain profile before the runway have no adverse effect on AP /FD guidance. Particularly, the effect of terrain profile within 300 m before the runway threshold must be evaluated
- The flight crew is aware that LOC or G/S beam fluctuations, independent of the aircraft system, may occur. The PF is prepared to immediately disconnect the autopilot, and to take the appropriate action, should not satisfactory guidance occur
- At least CAT2 capability is displayed on the FMA and the flight crew uses CAT II/III procedures
- Visual references are obtained at an altitude appropriate for the CAT I approach. If not, a go-around must be performed.

AUTOMATIC LANDING IN JOHANNESBURG

Ident.: TDU / LIM-AFS-20-00013685.0001001 / 25 APR 13

Applicable to: ALL
Impacted DU: NONE

Automatic landing is not permitted on Johannesburg 03R/21L runways.

LIMITATIONS

AUTO FLIGHT SYSTEM

AUTOMATIC APPROACH, LANDING AND ROLLOUT

AUTOLAND DATABASES WITH HONEYWELL ADIRU

Ident.: TDU / LIM-AFS-20-00016880.0070001 / 25 NOV 15

Applicable to: **ALL**

Impacted DU: NONE

The below table provides for each concerned airport, the dates when the following limitations begin:

- AUTOLAND is not allowed
- ROLLOUT is not allowed.

CAT II approaches without AUTOLAND are still allowed.

| Airport code | Airport Location | Month/Year |
|--------------|-----------------------|----------------|
| PAFA | FAIRBANKS INTL AK USA | September 2016 |
| PANC | ANCHORAGE INTL AK USA | June 2018 |

Note: This limitation is applicable until end of 2020. From 2021, without a revision of this limitation, AUTOLAND and ROLLOUT will not be allowed on any airport.

The above limitations do not apply if three new ADIRU with updated magnetic variation tables are installed and Operators ensure previous standards are not installed.

LIMITATIONS

AUXILIARY POWER UNIT

Intentionally left blank



A318/A319/A320/A321
FLIGHT CREW
OPERATING MANUAL

LIMITATIONS

AUXILIARY POWER UNIT

PRELIMINARY PAGES - TABLE OF CONTENTS

General.....A
APU Start/Shutdown during Refueling/Defueling..... B
Operational Envelope..... C



A318/A319/A320/A321
FLIGHT CREW
OPERATING MANUAL

LIMITATIONS

AUXILIARY POWER UNIT

PRELIMINARY PAGES - TABLE OF CONTENTS

Intentionally left blank

| | |
|---|---|
|  <p>A318/A319/A320/A321 FLIGHT CREW OPERATING MANUAL</p> | <p>LIMITATIONS AUXILIARY POWER UNIT</p> |
|---|---|

| |
|----------------|
| GENERAL |
|----------------|

Applicable to: ALL

Ident.: LIM-APU-10-00020088.0001001 / 17 MAR 17

APU START

After three consecutive APU start attempts, the flight crew must wait 60 min before a new start attempt.

Ident.: LIM-APU-10-00020089.0001001 / 17 MAR 17

ROTOR SPEED

Maximum N speed..... 107 %

Ident.: LIM-APU-10-00020090.0002001 / 17 MAR 17

EGT

Maximum EGT for APU start (below 25 000 ft)..... 900 °C
Maximum EGT for APU start (above 25 000 ft)..... 982 °C
Maximum EGT for APU running (with 5 s confirmation for shutdown)..... 682 °C
Maximum EGT for APU running (for immediate shutdown)..... 700 °C to 742 °C

| |
|--|
| APU START/SHUTDOWN DURING REFUELING/DEFUELING |
|--|

Ident.: LIM-APU-00020091.0001001 / 17 MAR 17

Applicable to: ALL

During refuel/defuel procedures, APU starts or shutdown are permitted with the following restrictions:

- If the APU failed to start or following an automatic APU shutdown, do not start the APU
- If a fuel spill occurs, perform a normal APU shutdown.

OPERATIONAL ENVELOPE

Applicable to: ALL

Ident.: LIM-APU-20-00019832.0026001 / 17 MAR 17

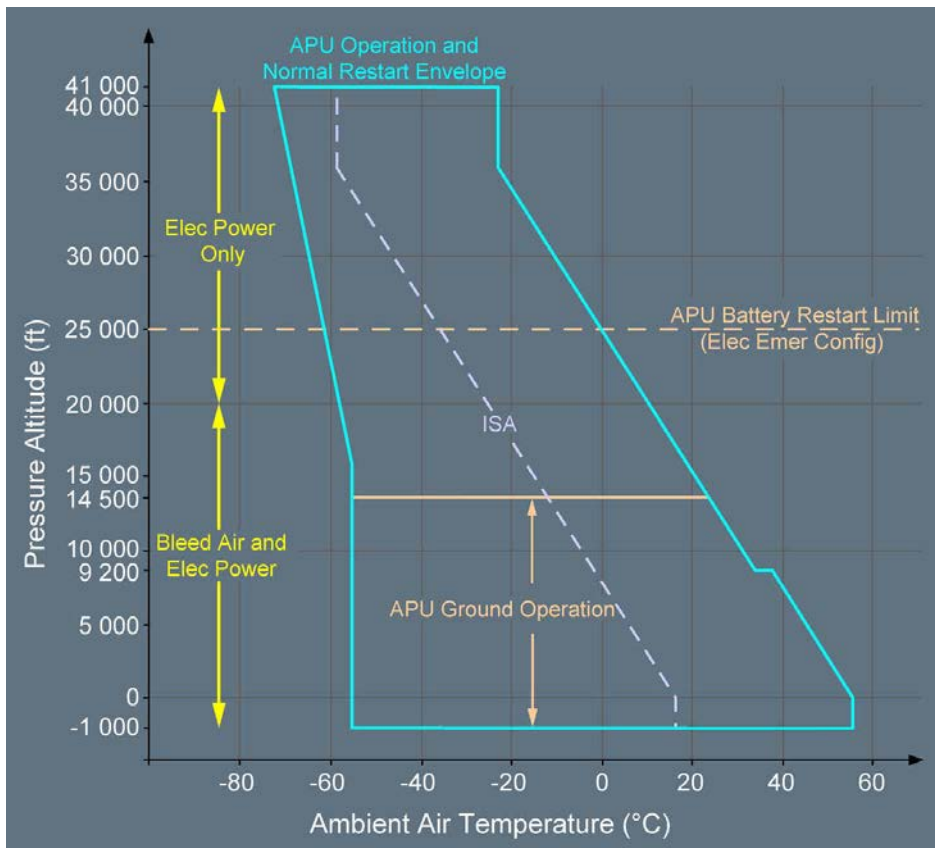

Ident.: LIM-APU-20-00021771.0001001 / 04 JUL 17

APU BLEED

- Max altitude to assist engine start..... 20 000 ft
- Max altitude for air conditioning and pressurization (single pack operation)..... 20 000 ft
- Max altitude for air conditioning and pressurization (dual pack operation)..... 15 000 ft
- Use of APU bleed air for wing anti-ice is not permitted.

LIMITATIONS

CABIN SYSTEMS

Intentionally left blank



A318/A319/A320/A321
FLIGHT CREW
OPERATING MANUAL

LIMITATIONS
CABIN SYSTEMS

PRELIMINARY PAGES - TABLE OF CONTENTS

Power Supply for Portable Electronic Device (PED)..... A



A318/A319/A320/A321
FLIGHT CREW
OPERATING MANUAL

LIMITATIONS
CABIN SYSTEMS

PRELIMINARY PAGES - TABLE OF CONTENTS

Intentionally left blank



A318/A319/A320/A321
FLIGHT CREW
OPERATING MANUAL

LIMITATIONS
CABIN SYSTEMS

POWER SUPPLY FOR PORTABLE ELECTRONIC DEVICE (PED)

Ident.: LIM-CAB-00020226.0001001 / 22 MAR 17

Applicable to: ALL

The In-Seat Power Supply System (ISPSS) for the Portable Electronic Device (PED) carried by the passengers must be turned off during takeoff and landing.



A318/A319/A320/A321
FLIGHT CREW
OPERATING MANUAL

LIMITATIONS
CABIN SYSTEMS

Intentionally left blank

LIMITATIONS

COMMUNICATION

Intentionally left blank



A318/A319/A320/A321
FLIGHT CREW
OPERATING MANUAL

**LIMITATIONS
COMMUNICATION**

PRELIMINARY PAGES - TABLE OF CONTENTS

GSM Onboard A



A318/A319/A320/A321
FLIGHT CREW
OPERATING MANUAL

LIMITATIONS
COMMUNICATION

PRELIMINARY PAGES - TABLE OF CONTENTS

Intentionally left blank

GSM ONBOARD 

Ident.: LIM-COM-00020293.0001001 / 17 MAR 17

Applicable to: ALL

The use of mobile phones is prohibited in the toilets and the cockpit.

It is prohibited to use the GSM Onboard System:

- Below 3 000 m AGL (approximately 10 000 ft)
- In some geographical areas (refer to the “Regional Operation Data for the Onboard Mobile Telephony System” document for the identification of these geographical areas).

Note: The GSM Onboard System is able to identify the above-mentioned flight conditions. If the system identifies any of these conditions, it automatically turns off.



A318/A319/A320/A321
FLIGHT CREW
OPERATING MANUAL

**LIMITATIONS
COMMUNICATION**

Intentionally left blank

LIMITATIONS

ENGINES

Intentionally left blank

| | |
|--|---|
| Thrust Setting/EGT Limits..... | A |
| Shaft Speeds..... | B |
| Oil..... | C |
| Starter..... | D |
| Reverse Thrust..... | E |
| Reduced Thrust Takeoff..... | F |
| Soft Go-Around  | G |



A318/A319/A320/A321
FLIGHT CREW
OPERATING MANUAL

LIMITATIONS

ENGINES

PRELIMINARY PAGES - TABLE OF CONTENTS

Intentionally left blank

| | |
|---|--------------------------------------|
|  A318/A319/A320/A321 FLIGHT CREW OPERATING MANUAL | LIMITATIONS ENGINES |
|---|--------------------------------------|

THRUST SETTING/EGT LIMITS

Ident.: LIM-ENG-00019960.0004001 / 20 MAR 17
Applicable to: ALL

| Operating Conditions | | Time Limit | EGT Limit |
|--------------------------------------|------------------------|-------------|-----------|
| Takeoff ⁽¹⁾ and Go-around | All engines operative | 5 min | 950 °C |
| | One engine inoperative | 10 min | |
| Maximum Continuous Thrust (MCT) | | Not limited | 915 °C |
| Starting | On ground | | 725 °C |
| | In flight | | |

⁽¹⁾ Includes TOGA, FLEX, and DERATE  thrust modes.

SHAFT SPEEDS

Ident.: LIM-ENG-00020355.0002001 / 20 MAR 17
Applicable to: ALL

Maximum N1 104 %

Note: The N1 limit depends on the ambient conditions and on the configuration of the engine air bleed. These parameters may limit N1 to a value that is less than the above-mentioned N1 value (Refer to PER-THR-MTO MAXIMUM TAKEOFF).

Maximum N2 105 %

OIL

Ident.: LIM-ENG-00020354.0001001 / 20 MAR 17
Applicable to: ALL

OIL TEMPERATURE

Maximum continuous temperature..... 140 °C
 Maximum transient temperature (15 min)..... 155 °C
 Minimum starting temperature..... -40 °C
 Minimum temperature before takeoff..... -10 °C

OIL QUANTITY

Minimum oil quantity..... Refer to PRO-NOR-SOP-04 ECAM

OIL PRESSURE

MIN/MAX Oil Pressure (ECAM Indication)

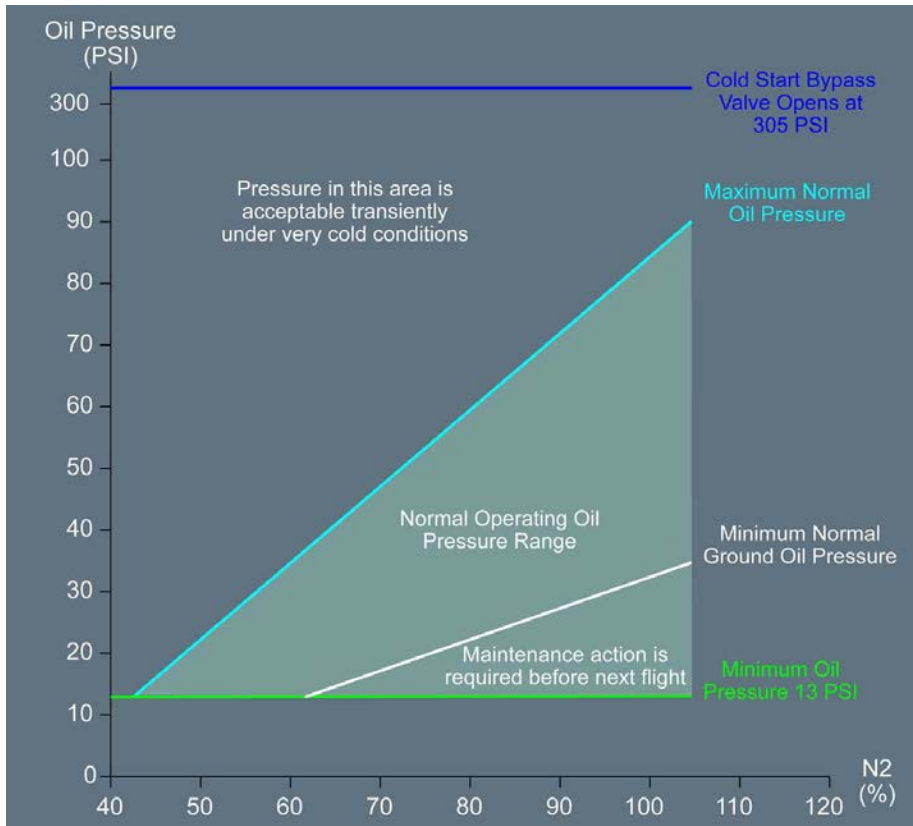

STARTER

Ident.: LIM-ENG-00020356.0001001 / 20 MAR 17

Applicable to: **ALL**

- A standard automatic start that includes up to three start attempts, is considered one cycle
- For ground starts (automatic or manual), a 20 s pause is required between successive cycles
- A 15 min cooling period is required, subsequent to four failed cycles
- The starter must not be run when N2 is above 20 %.

| | |
|---|--------------------------------------|
|  A318/A319/A320/A321 FLIGHT CREW OPERATING MANUAL | LIMITATIONS ENGINES |
|---|--------------------------------------|

REVERSE THRUST

Ident.: LIM-ENG-00020357.0002001 / 20 MAR 17

Applicable to: ALL

Selection of the reverse thrust is prohibited in flight.
 Backing the aircraft with reverse thrust is not permitted.
 Maximum reverse should not be used below 70 kt.

REDUCED THRUST TAKEOFF

Applicable to: ALL

Ident.: LIM-ENG-10-00020358.0020001 / 20 MAR 17

FLEX TAKEOFF

Takeoff at reduced thrust, so-called as FLEX takeoff, is permitted only if the airplane meets all performance requirements at the takeoff weight, with the operating engines at the thrust available for the flexible temperature (TFLEX).

Takeoff at reduced thrust is permitted with any inoperative item affecting the performance only if the associated performance shortfall has been applied to meet the above requirements.

FLEX takeoff is not permitted on contaminated runways.

TFLEX cannot be:

- Higher than TMAXFLEX, equal to ISA + 70 °C.
- Lower than the flat temperature (TREF).
- Lower than the actual OAT.

Ident.: LIM-ENG-10-00020359.0001001 / 20 MAR 17

DERATED TAKEOFF 

Selection of TOGA thrust is not permitted when a derated takeoff is performed, except when requested in any abnormal or emergency procedures.

The use of reduced thrust takeoff (FLEX takeoff) is not permitted in association with derated takeoff.

The use of derated takeoff is permitted regardless of the runway condition (dry, wet, or contaminated).

SOFT GO-AROUND 

Ident.: LIM-ENG-00020363.0001001 / 20 MAR 17

Applicable to: ALL

The use of soft go-around is prohibited with one engine inoperative.

Intentionally left blank

LIMITATIONS

FLIGHT CONTROLS

Intentionally left blank



A318/A319/A320/A321
FLIGHT CREW
OPERATING MANUAL

LIMITATIONS
FLIGHT CONTROLS

PRELIMINARY PAGES - TABLE OF CONTENTS

| | |
|--|---|
| Flight Maneuvering Load Acceleration Limits..... | A |
| Maximum Altitude Flaps/Slats Extended..... | B |
| Maximum Flaps/Slats Speeds..... | C |
| Use of Flight Controls..... | D |



A318/A319/A320/A321
FLIGHT CREW
OPERATING MANUAL

LIMITATIONS
FLIGHT CONTROLS

PRELIMINARY PAGES - TABLE OF CONTENTS

Intentionally left blank

| | |
|---|--|
|  <p>A318/A319/A320/A321 FLIGHT CREW OPERATING MANUAL</p> | LIMITATIONS FLIGHT CONTROLS |
|---|--|

FLIGHT MANEUVERING LOAD ACCELERATION LIMITS

Ident.: LIM-F_CTL-00020162.0001001 / 17 MAR 17
Applicable to: ALL

Refer to LIM-AG-F_CTL Flight Maneuvering Load Acceleration Limits.

MAXIMUM ALTITUDE FLAPS/SLATS EXTENDED

Ident.: LIM-F_CTL-00020160.0001001 / 17 MAR 17
Applicable to: ALL

Maximum operating altitude with slats and/or flaps extended.....20 000 ft

MAXIMUM FLAPS/SLATS SPEEDS

Ident.: LIM-F_CTL-00020163.0001001 / 17 MAR 17
Applicable to: ALL

Refer to LIM-AG-SPD Maximum Flaps/Slats Speeds.

USE OF FLIGHT CONTROLS

Ident.: LIM-F_CTL-00020000.0001001 / 17 MAR 17
Applicable to: ALL

| | |
|----------------|---|
| CAUTION | Rapid and large alternating control inputs, especially in combination with large changes in pitch, roll or yaw (e.g. large sideslip angles) may result in structural failures at any speed. |
|----------------|---|

Intentionally left blank

LIMITATIONS

FUEL

Intentionally left blank



A318/A319/A320/A321
FLIGHT CREW
OPERATING MANUAL

LIMITATIONS

FUEL

PRELIMINARY PAGES - TABLE OF CONTENTS

| | |
|--|---|
| Certified Fuel..... | A |
| Fuel Mixability..... | B |
| Fuel Temperature..... | C |
| Fuel Temperature Limits when JP4 and JET B Fuels are Used..... | D |
| Maximum Allowed Fuel Imbalance..... | E |
| Minimum Fuel Quantity for Takeoff..... | F |



A318/A319/A320/A321
FLIGHT CREW
OPERATING MANUAL

LIMITATIONS

FUEL

PRELIMINARY PAGES - TABLE OF CONTENTS

Intentionally left blank

| | |
|---|---------------------------------------|
|  A318/A319/A320/A321 FLIGHT CREW OPERATING MANUAL | LIMITATIONS FUEL |
|---|---------------------------------------|

| |
|-----------------------|
| CERTIFIED FUEL |
|-----------------------|

Ident.: LIM-FUEL-00019707.0001001 / 17 MAR 17

Applicable to: ALL

The fuel system is certified with: JET A, JET A1, JET B, JP4, JP5, JP8, N° 3 JET, RT, and TS-1, in accordance with engine manufacturers and fuel specifications.

| |
|------------------------|
| FUEL MIXABILITY |
|------------------------|

Ident.: LIM-FUEL-00012852.0001001 / 03 JAN 11

Applicable to: ALL

The various types of fuel can be mixed in all proportions.

The freezing point of a fuel mixture varies, based on non-linear laws. If required, determine the fuel freezing point of the fuel mixture.

| |
|-------------------------|
| FUEL TEMPERATURE |
|-------------------------|

Ident.: LIM-FUEL-00019708.0001001 / 17 MAR 17

Applicable to: ALL

| | JET A1/JP8/ N°3 JET | JET A | JP5 | RT | TS-1 | JET B | JP4 |
|-------------|------------------------|-----------------------|--------|--------|--------|--------|--------|
| MINI | -43 °C | -36 °C ⁽¹⁾ | -42 °C | -45 °C | -45 °C | -46 °C | -54 °C |
| MAXI | 54 °C | | | | | 49 °C | |

⁽¹⁾ For JET A only, if TAT reaches -34 °C, monitor the fuel temperature on the FUEL SD page, to ensure that it remains above -36 °C.

| |
|--|
| FUEL TEMPERATURE LIMITS WHEN JP4 AND JET B FUELS ARE USED |
|--|

Ident.: LIM-FUEL-00019709.0001001 / 17 MAR 17

Applicable to: ALL

If the wing fuel temperature exceeds 30 °C at engine start, the altitude must be limited to 35 000 ft until the center tank is empty.

If the wing fuel temperature exceeds 40 °C at engine start, the altitude must be limited to 30 000 ft until the center tank is empty.

If the wing fuel temperature exceeds 49 °C at engine start, the altitude must be limited to 25 000 ft until the center tank is empty.

Reason : At high altitude with high fuel temperature, the pressure supplied by the center tank pumps becomes lower than the pressure supplied by the wing tank pumps.

LIMITATIONS

FUEL

MAXIMUM ALLOWED FUEL IMBALANCE

Ident.: LIM-FUEL-00020435.0001001 / 17 MAR 17

Applicable to: ALL

The following tables indicate the maximum allowed wing imbalance at takeoff, in flight, and at landing.

FUEL IMBALANCE AT TAKEOFF

INNER TANKS (OUTER TANKS BALANCED)

| Tank Fuel Quantity (Heavier Tank) | Maximum Asymmetry |
|--------------------------------------|---------------------|
| Full | 500 kg (1 102 lb) |
| 3 000 kg (6 613 lb) | 1 050 kg (2 314 lb) |
| 1 450 kg (3 196 lb) | 1 450 kg (3 196 lb) |

The variation is linear between these values.

OUTER TANKS (INNER TANKS BALANCED)

| | |
|--------------------------|-----------------|
| Maximum Asymmetry | 370 kg (815 lb) |
|--------------------------|-----------------|

FUEL IMBALANCE IN FLIGHT AND AT LANDING

INNER TANKS (OUTER TANKS BALANCED)

| Tank Fuel Quantity (Heavier Tank) | Maximum Asymmetry |
|--------------------------------------|---------------------|
| Full | 1 500 kg (3 306 lb) |
| 4 300 kg (9 479 lb) | 1 600 kg (3 527 lb) |
| 2 250 kg (4 960 lb) | 2 250 kg (4 960 lb) |

The variation is linear between these values, and there is no limitation below 2 250 kg (4 960 lb).

OUTER TANKS

| | |
|--------------------------|----------------------------------|
| Maximum Asymmetry | 690 kg (1 521 lb) ⁽¹⁾ |
|--------------------------|----------------------------------|

⁽¹⁾ The maximum fuel imbalance in the outer wing fuel tanks (one full/one empty) is allowed provided that:

- The fuel quantity of the outer and inner wing fuel tanks of one side is equal to the fuel quantity of the outer and inner wing fuel tanks on the other side, or
- On the side of the lighter outer tank, the fuel quantity of the inner tank is more than the fuel quantity of the opposite inner tank. The difference between the fuel quantity in the inner tanks should not be more than 3 000 kg (6 613 lb).

| | |
|---|--|
|  <p>A318/A319/A320/A321 FLIGHT CREW OPERATING MANUAL</p> | <p>LIMITATIONS</p> <p>FUEL</p> |
|---|--|

Note: In exceptional conditions (i.e. fuel system failure), the above-mentioned values for maximum fuel imbalance may be exceeded without significant effect to the aircraft handling qualities. The aircraft remains fully controllable in all flight phases.

| |
|--|
| MINIMUM FUEL QUANTITY FOR TAKEOFF |
|--|

Ident.: LIM-FUEL-00019771.0001001 / 17 MAR 17

Applicable to: ALL

Minimum fuel quantity for takeoff.....1 500 kg (3 307 lb)
 The ECAM alerts that are related to fuel low level in the wing tanks (**FUEL WING TK LO LVL**, etc.) must not appear for takeoff.

Intentionally left blank

LIMITATIONS

ICE AND RAIN PROTECTION

Intentionally left blank

Definition of Icing Conditions.....A
Definition of Severe Ice Accretion.....B
Definition of Thin Hoarfrost.....C
Rain Repellent D
Wipers Maximum Operating Speed.....E



A318/A319/A320/A321
FLIGHT CREW
OPERATING MANUAL

LIMITATIONS

ICE AND RAIN PROTECTION

PRELIMINARY PAGES - TABLE OF CONTENTS

Intentionally left blank

LIMITATIONS

ICE AND RAIN PROTECTION

DEFINITION OF ICING CONDITIONS

Ident.: LIM-ICE_RAIN-00020608.0001001 / 17 MAR 17

Applicable to: ALL

- Icing conditions exist when the OAT (on ground or after takeoff) or the TAT (in flight) is at or below 10 °C and visible moisture in any form is present (such as clouds, fog with visibility of one nautical mile or less, rain, snow, sleet or ice crystals).
- Icing conditions also exist when the OAT on the ground and for takeoff is at or below 10 °C and operating on ramps, taxiways or runways where surface snow, standing water or slush may be ingested by the engines, or freeze on engines, nacelles or engine sensor probes.

DEFINITION OF SEVERE ICE ACCRETION

Ident.: LIM-ICE_RAIN-00020609.0001001 / 17 MAR 17

Applicable to: ALL

Ice accretion is considered severe when the ice accumulation on the airframe reaches approximately 5 mm (0.2 in) thick or more.

DEFINITION OF THIN HOARFROST

Ident.: LIM-ICE_RAIN-00020610.0001001 / 17 MAR 17

Applicable to: ALL

Thin hoarfrost is typically a white crystalline deposit which usually develops uniformly on exposed surfaces on cold and cloudless nights.
It is so thin that surface features (lines or markings) can be distinguished beneath it.

RAIN REPELLENT

Ident.: LIM-ICE_RAIN-00020224.0001001 / 17 MAR 17

Applicable to: ALL

The flight crew should only use the rain repellent in the case of moderate to heavy rain.

WIPERS MAXIMUM OPERATING SPEED

Ident.: LIM-ICE_RAIN-00020225.0001001 / 17 MAR 17

Applicable to: ALL

Refer to LIM-AG-SPD Wipers Maximum Operating Speed.

Intentionally left blank

LIMITATIONS

LANDING GEAR

Intentionally left blank



A318/A319/A320/A321
FLIGHT CREW
OPERATING MANUAL

LIMITATIONS
LANDING GEAR

PRELIMINARY PAGES - TABLE OF CONTENTS

| | |
|--|---|
| Braking System..... | A |
| Brake Temperature..... | B |
| Maximum Speeds with the Landing Gear Extended..... | C |
| Maximum Tire Speed..... | D |
| Nosewheel Steering (NWS)..... | E |
| Taxi with Deflated or Damaged Tires..... | F |



A318/A319/A320/A321
FLIGHT CREW
OPERATING MANUAL

LIMITATIONS

LANDING GEAR

PRELIMINARY PAGES - TABLE OF CONTENTS

Intentionally left blank

| | |
|---|---|
|  A318/A319/A320/A321 FLIGHT CREW OPERATING MANUAL | LIMITATIONS LANDING GEAR |
|---|---|

BRAKING SYSTEM

Ident.: LIM-LG-00020233.0001001 / 17 MAR 17

Applicable to: ALL

The braking system is not designed to hold the aircraft in a stationary position when a high thrust level is applied on at least one engine.
 During ground procedures that require a thrust increase with braking, the flight crew must ensure that the aircraft remains stationary, and must be ready to immediately retard the thrust levers to IDLE.

BRAKE TEMPERATURE

Ident.: LIM-LG-00020255.0001001 / 17 MAR 17

Applicable to: ALL

Maximum brake temperature for takeoff (brake fans  off).....300 °C

MAXIMUM SPEEDS WITH THE LANDING GEAR EXTENDED

Ident.: LIM-LG-00020237.0001001 / 17 MAR 17

Applicable to: ALL

Refer to LIM-AG-SPD Maximum Speeds with the Landing Gear Extended.

MAXIMUM TIRE SPEED

Ident.: LIM-LG-00020238.0001001 / 17 MAR 17

Applicable to: ALL

Refer to LIM-AG-SPD Maximum Tire Speed.

NOSEWHEEL STEERING (NWS)

Ident.: LIM-LG-00020236.0001001 / 17 MAR 17

Applicable to: ALL

For NWS angle limit, *Refer to DSC-20-30 Taxiing.*
 Towbarless operation on the nose landing gear (towing and pushback) is approved when using the accepted towbarless towing vehicles listed in the Airbus WISE ISI 09.11.00001, with the following information:
 Maximum NWS angle..... 85 °

TAXI WITH DEFLATED OR DAMAGED TIRES

Ident.: LIM-LG-00020235.0001001 / 01 JUN 17

Applicable to: **ALL**

To vacate the runway or taxi at low speed with tire(s) deflated (not damaged), all of the following limitations apply:

- If maximum one tire per gear is deflated (consider three gears)
Maximum taxi speed during turn..... 7 kt
- If two tires are deflated on the same main gear (maximum one main gear)
Maximum taxi speed..... 3 kt
- For the nosewheel steering (NWS) angle
Maximum NWS angle..... 30 °

In addition, if tire damage is suspected, the flight crew must ask for an aircraft inspection prior to vacate the runway or taxi. If the ground crew suspects that a tire burst may damage the landing gear, maintenance action is due.

For more information, *Refer to FCTM/PR-AEP-LG Taxi with Deflated or Damaged Tires.*

LIMITATIONS

NAVIGATION

Intentionally left blank



A318/A319/A320/A321
FLIGHT CREW
OPERATING MANUAL

LIMITATIONS

NAVIGATION

PRELIMINARY PAGES - TABLE OF CONTENTS

Inertial Reference System (IRS).....A



A318/A319/A320/A321
FLIGHT CREW
OPERATING MANUAL

LIMITATIONS

NAVIGATION

PRELIMINARY PAGES - TABLE OF CONTENTS

Intentionally left blank

INERTIAL REFERENCE SYSTEM (IRS)

Ident.: LIM-NAV-00020081.0001001 / 17 MAR 17

Applicable to: ALL

IR GROUND ALIGNMENT

Ground alignment of the IRS is possible in latitudes between 73 ° North and 73 ° South.

MAGNETIC (MAG) REFERENCE

■ **If all ADIRUs have the same magnetic variation table:**

In NAV mode, the IR will not provide valid magnetic heading and magnetic track angle:

- North of 73 ° North, and
- South of 60 ° South.

Flying at latitudes beyond these limits is prohibited.

■ **If one ADIRU has a different magnetic variation table:**

In NAV mode, the IR will not provide valid magnetic heading and magnetic track angle:

- North of 60 ° North, between 30 ° West and 160 ° West, and
- North of 73 ° North, and
- South of 55 ° South.

Flying at latitudes beyond these limits is prohibited.



A318/A319/A320/A321
FLIGHT CREW
OPERATING MANUAL

LIMITATIONS
NAVIGATION

Intentionally left blank

LIMITATIONS

OXYGEN

Intentionally left blank



A318/A319/A320/A321
FLIGHT CREW
OPERATING MANUAL

LIMITATIONS

OXYGEN

PRELIMINARY PAGES - TABLE OF CONTENTS

Minimum Flight Crew Oxygen Pressure.....A



A318/A319/A320/A321
FLIGHT CREW
OPERATING MANUAL

LIMITATIONS

OXYGEN

PRELIMINARY PAGES - TABLE OF CONTENTS

Intentionally left blank

| | |
|---|-------------------------------------|
|  A318/A319/A320/A321 FLIGHT CREW OPERATING MANUAL | LIMITATIONS OXYGEN |
|---|-------------------------------------|

MINIMUM FLIGHT CREW OXYGEN PRESSURE

Ident.: LIM-OXY-00020232.0004001 / 17 MAR 17

Applicable to: ALL

| REF Temperature ⁽¹⁾ | | °C | -10 | 0 | 10 | 20 | 30 | 40 | 50 |
|--|-----------------------|----|-------|-------|-------|-------|-------|-------|-------|
| | | °F | 14 | 32 | 50 | 68 | 86 | 104 | 122 |
| MIN Bottle Pressure (PSI)⁽²⁾ | 2 Crewmembers | | 716 | 744 | 771 | 798 | 826 | 853 | 880 |
| | 2 Crewmembers + 1 OBS | | 874 | 907 | 940 | 974 | 1 007 | 1 040 | 1 073 |
| | 2 Crewmembers + 2 OBS | | 1 103 | 1 145 | 1 187 | 1 229 | 1 270 | 1 312 | 1 354 |

(1) REF Temperature :

- On ground : REF Temperature = (OAT + Cockpit TEMP) / 2
- In flight : REF Temperature = CAB TEMP (°C) - 10 °C, or
REF Temperature = CAB TEMP (°F) - 18 °F

(2) Minimum Bottle Pressure to Cover:

- Preflight checks
- The use of oxygen, when only one flight crewmember is in the cockpit
- Unusable quantity (to ensure regulator operation with minimum pressure)
- Normal system leakage
- The most demanding case among the following:
 - Protection after loss of cabin pressure, with mask regulator on NORMAL (diluted oxygen):
 - During emergency descent for all flight crewmembers and observers for 22 min
 - During cruise at FL 100 for two flight crewmembers for 98 min.
 - Protection against smoke with 100 % oxygen for all flight crewmembers and observers during 15 min at 8 000 ft cabin altitude.

Note: The above times that are based on the use of a sealed mask may be shorter for bearded crew (in terms of performance, pressure, or duration).

Intentionally left blank

LIMITATIONS

SURVEILLANCE

Intentionally left blank



A318/A319/A320/A321
FLIGHT CREW
OPERATING MANUAL

LIMITATIONS
SURVEILLANCE

PRELIMINARY PAGES - TABLE OF CONTENTS

GPWS / Predictive GPWS A



A318/A319/A320/A321
FLIGHT CREW
OPERATING MANUAL

LIMITATIONS

SURVEILLANCE

PRELIMINARY PAGES - TABLE OF CONTENTS

Intentionally left blank

GPWS / PREDICTIVE GPWS 

Ident.: LIM-SURV-00019775.0001001 / 17 MAR 17

Applicable to: ALL

Aircraft navigation must not be based on the use of the terrain display .

The terrain display is intended to serve as a situation awareness tool only, and may not provide the accuracy on which to solely base terrain avoidance maneuvering.

The predictive GPWS  functions should be inhibited (TERR pushbutton to OFF, on the GPWS panel) when the aircraft position is less than 15 NM from the airfield:

- For operations from/to runways not incorporated in the predictive GPWS database.
- For specific approach procedures, which were previously identified as potentially causing false terrain alerts.

Only aircraft with Man-made Obstacle Function  can display obstacles on ND and trigger alerts, based on a dedicated database which includes artificial obstacles worldwide.

Intentionally left blank

**OPERATIONS
ENGINEERING BULLETINS**

Intentionally left blank

| M⁽¹⁾ | Identification | T⁽²⁾ | E⁽³⁾ | Rev. Date | Title |
|------------------------|--|------------------------|------------------------|------------------|--|
| | OEB41 issue 3 | W | N | 15 OCT 15 | Erroneous Alternate Fuel Predictions Upon Modification of a Company Route in the Alternate Flight Plan |
| | Criteria: 22-1269 Applicable to: ALL | | | | |
| | OEB46 issue 1 | W | N | 05 NOV 13 | No Engagement of Guidance Mode |
| | Criteria: 27-1238 Applicable to: ALL | | | | |
| | OEB47 issue 1 | W | Y | 20 DEC 13 | HYD ENG PUMP LO PR followed by HYD RSVR OVHT |
| | Criteria: SA Applicable to: ALL | | | | |

(1) Evolution code : N=New, R=Revised, E=Effectivity

(2) Type of OEB: R=Red, W=White

(3) Affects ECAM: Y=Yes, N=No



A318/A319/A320/A321
FLIGHT CREW
OPERATING MANUAL

OPERATIONS ENGINEERING BULLETINS

PRELIMINARY PAGES

LIST OF EFFECTIVE OPERATIONS ENGINEERING BULLETIN

Intentionally left blank



A318/A319/A320/A321
FLIGHT CREW
OPERATING MANUAL

OPERATIONS ENGINEERING BULLETINS

PRELIMINARY PAGES

LIST OF EFFECTIVE TEMPORARY DOCUMENTARY UNITS

| M | Localization | DU Title | DU identification | DU date |
|---|--------------|----------|-------------------|---------|
|---|--------------|----------|-------------------|---------|

No Temporary Documentary Unit



A318/A319/A320/A321
FLIGHT CREW
OPERATING MANUAL

OPERATIONS ENGINEERING BULLETINS

PRELIMINARY PAGES

LIST OF EFFECTIVE TEMPORARY DOCUMENTARY UNITS

Intentionally left blank

OPERATIONS ENGINEERING BULLETINS

GENERAL DESCRIPTION

Intentionally left blank



A318/A319/A320/A321
FLIGHT CREW
OPERATING MANUAL

OPERATIONS ENGINEERING BULLETINS

GENERAL DESCRIPTION

PRELIMINARY PAGES - TABLE OF CONTENTS

General Description..... A



A318/A319/A320/A321
FLIGHT CREW
OPERATING MANUAL

OPERATIONS ENGINEERING BULLETINS

GENERAL DESCRIPTION

PRELIMINARY PAGES - TABLE OF CONTENTS

Intentionally left blank

GENERAL DESCRIPTION

Applicable to: ALL

Ident.: OEB-GEN-A-00014181.0001001 / 23 NOV 11

An Operations Engineering Bulletin (OEB) is issued to rapidly inform operators of any deviations from initial design objectives that have a significant operational impact. An OEB provides the operators with technical information and temporary operational procedures that address these deviations.

Ident.: OEB-GEN-A-00014182.0001001 / 23 NOV 11

TYPE OF OEB

OEBs can either be red or white, depending on their level of priority.

- RED OEBs are issued to indicate that non-compliance with the recommended procedures may have a significant impact on the safe operation of the aircraft.
- WHITE OEBs are issued to indicate that non-compliance with the recommended procedures may have a significant impact on aircraft operation.

Airbus strongly recommends that all Operators rapidly apply the OEB corrective actions as soon as they become available, particularly for red OEBs.

Ident.: OEB-GEN-A-00014183.0001001 / 23 JUN 15

OEB CONTENT AND MANAGEMENT

An OEB:

- Is temporary and usually focuses on one operational subject only,
- Is included in the OEB section of both the FCOM and QRH . The procedural part of each white or red OEB (OEB PROC) is provided in the OEB section of the QRH, so that the flight crew can easily access the procedures,
- Remains applicable until the appropriate corrective actions are completed.

Note: After installation of the OEB corrective modification/Service Bulletins (SB): if an Operator reinstalls any spare equipment for which there was an associated OEB , it is Operator's responsibility to ensure that this OEB be applied again for the applicable aircraft.

OEB IN THE FCOM

The content of each OEB includes:

- The reason for issue,
- Technical explanations of the deviation from the initial design objectives,
- The operational impact if the flight crew does not apply the OEB procedure,

Continued on the following page

GENERAL DESCRIPTION (Cont'd)

- The conditions for applying the OEB procedures :
 - ECAM warning/caution affected by the OEB,
 - Cockpit effects,
 - Flight phases,
 - Specific event.
- The OEB operational procedure(s) to be applied,
- The corrective actions that cancel the OEB (if available),
- The OEB REMINDER codes, (if applicable).

OEB IN THE QRH

Each FCOM OEB has an associated "OEB PROC" in the OEB section of the QRH, that includes:

- The title of the OEB PROC,
- The "ECAM ENTRY" field:
This section identifies whether or not one of the possible conditions for applying the OEB PROC is an ECAM warning/caution.
The flight crew must disregard the ECAM procedure and/or STATUS of the ECAM alerts listed in the "ECAM ENTRY" field and must apply the QRH 's OEB procedure instead.
- The OEB operational procedure(s) that the flight crew must apply.

FCOM LIST OF EFFECTIVE OEB

The List of Effective Operations Engineering Bulletins (LEOEB) enables to review all the Operations Engineering Bulletins (OEB s) that are applicable to the fleet. Each time an OEB is issued or revised, the LEOEB is updated.

| M ⁽¹⁾ | Identification | T ⁽²⁾ | E ⁽³⁾ | REV. Date | Title |
|------------------------------------|----------------|------------------|------------------|-----------|---|
| | OEB38 issue 1 | R | N | 18 MAR 11 | Erroneous Radio Altimeter Height Indication |
| Criteria: SA Applicable to: ALL | | | | | |

(1) Evolution code: N=New, R=Revised, E=Effectivity

(2) Type of OEB: R=Red, W=White

(3) Affects ECAM: Y=Yes, N=No

The FCOM LEOEB consists of:

Continued on the following page

GENERAL DESCRIPTION (Cont'd)

The "M" field that may provide the following Evolution Code:

- The "N" letter indicates a new OEB, or
- The "R" letter indicates a revised OEB, or
- The "E" letter indicates an aircraft validity change on the OEB.

The "Identification" field which identifies the OEB with its identification number.

Note: The FCOM OEB and associated QRH OEB PROC have the same OEB number in order to be consistent. However, the issue number of the QRH OEB PROC and the FCOM OEB may be different, because a revision of an FCOM OEB does not necessarily result in a revision of the corresponding QRH OEB PROC, that only provides the procedure part.

The "T" field indicates the Type of OEB:

- The "W" letter indicates a white OEB, or
- The "R" letter indicates a red OEB.

Note: OEBs are listed by type of OEB (RED OEBs first, then WHITE OEBs), and in numerical order for each type of OEB. This enables the flight crew to easily review the OEBs before flight.

The "E" field indicates whether or not the OEB affects ECAM procedure(s). This enables the flight crew to easily review the OEBs before flight particularly for Operators that use the OEB REMINDER function:

- The "Y" letter indicates that the OEB affects only ECAM procedure(s),
- The "N" letter indicates that at least one of the procedures provided in the OEB does not affect ECAM procedure(s).

CAUTION

When Airbus provides the Operator with the LEOEB, the information "AFFECTS ECAM : Y" ("E" field) does not necessarily mean that (for Operators using the OEB REMINDER function) the Operator's maintenance personnel has activated the OEB REMINDER codes for this OEB onboard the aircraft. It is the Operator's responsibility to define a suitable process for providing the flight crew with confirmation that the OEB REMINDER codes are activated for the ECAM alerts affected by OEBs.

The "Rev Date" field indicates the date at which the OEB content was issued/changed

The "Title" field provides the OEB title.

Continued on the following page

GENERAL DESCRIPTION (Cont'd)

QRH LIST OF EFFECTIVE OEB

The List of Effective Operations Engineering Bulletins (LEOEB) enables to review all the Operations Engineering Bulletins (OEBs) that are applicable to the fleet. Each time an OEB is issued or revised, the LEOEB is updated.

| Identification | Title |
|--------------------------------|---|
| OEB26 Issue 1 | Erroneous Radio Altimeter (RA) Height Indication ECAM Entry None |
| OEB33 Issue 1 | Pack Flow Monitoring ECAM Entry None |
| OEB34 Issue 1 | NAV ADR 1+2+3 FAULT ECAM Warning Undue Activation ECAM Entry NAV ADR 1+2+3 FAULT |
| OEB35 Issue 2 | Loss of AP and ATHR Associated with Alternate Law Reversion ECAM Entry None |

The QRH LEOEB consists of:

The "Identification" field which identifies the OEB with its identification and issue number.

Note: The FCOM OEB and associated QRH OEB PROC have the same OEB number in order to be consistent. However, the issue number of the QRH OEB PROC and the FCOM OEB may be different, because a revision of an FCOM OEB does not necessarily result in a revision of the corresponding QRH OEB PROC, that only provides the procedure part.

Red OEB identification number and title are in bold font. White OEB identification number and title are in regular font. This enables the flight crew to easily review the OEBs before flight.

Note: OEBs are listed in numerical order regardless of the type of OEB (red or white).

The "Title" field provides the OEB title and the "ECAM Entry" part of the OEB PROC. This enable the flight crew to easily review the OEBs before flight particularly for Operators that use the OEB REMINDER function.

Continued on the following page

GENERAL DESCRIPTION (Cont'd)

CAUTION

When Airbus provides the Operator with the LEOEB, the information “ECAM Entry” does not necessarily mean that (for Operators using the OEB REMINDER function) the Operator’s maintenance personnel has activated the OEB REMINDER codes for this OEB onboard the aircraft. It is the Operator’s responsibility to define a suitable process for providing the flight crew with confirmation that the OEB REMINDER codes are activated for the ECAM alerts affected by OEBs.

A vertical bar in the margin of the QRH LEOEB identifies that the OEB is either new, revised or has an aircraft validity change.

Ident.: OEB-GEN-A-00014184.0001001 / 23 NOV 11

REVIEW OF THE OEB

In accordance with the Standard Operating Procedures, and before each flight, the flight crew must review all OEBs that are applicable to their aircraft. If the OEB conditions are applicable, the flight crew must apply the operational procedure(s) that is in the QRH OEB section.

Ident.: OEB-GEN-A-00014185.0001001 / 23 NOV 11

DISTRIBUTION

OEB are distributed to all affected Operators. The Operators shall provide flight crews with the content of the OEB without delay.

Ident.: OEB-GEN-A-00014186.0001001 / 23 JUN 15

OEB REMINDER FUNCTION

The OEB reminder function provides operational help to the flight crew by enabling them to clearly identify on the ECAM all procedures and STATUS messages superseded by an OEB procedure. When a situation causes an ECAM warning/caution to trigger, a message informs the flight crew in real time that there is an OEB for the displayed ECAM warning/caution and/or STATUS, and as a result, that the ECAM procedure and/or STATUS is changed. In this case, a specific ECAM message informs the flight crew to refer to the QRH. For more information *Refer to FCOM DSC-31-OEB Reminder.*

The OEB reminder function may not be activated for some OEBs. For example, when an OEB procedure supersedes an ECAM procedure, under specific conditions only, the OEB reminder function is not activated, in order to let the flight crew assess the need to apply the OEB procedure or the ECAM procedure.

The OEB reminder function does not relieve the flight crew of their responsibility to review the applicable OEBs during the cockpit preparation.

Continued on the following page

GENERAL DESCRIPTION (Cont'd)

OEB REMINDER CODE

The maintenance personnel must enter specific OEB REMINDER code(s) in the FWC OEB database in order to update the ECAM.

These OEB REMINDER codes are provided in the FCOM OEB chapter only, and are sent to the Operator's Flight Operations department along with the associated QRH OEB PROC . This is to ensure that the OEB database is not updated before the OEB procedure is available in the QRH and FCOM onboard documentation.

Good coordination between the Airline's/Operator's Flight Operations department and the Airline's/Operator's Engineering department must be established, in order to:

- Ensure that the QRH OEB section is updated onboard the aircraft before the activation of the OEB REMINDER function for a specific OEB.
- Rapidly send information about the OEB REMINDER codes to the Engineering department for a rapid update of the ECAM.
- Provide the flight crew with confirmation that the OEB REMINDER codes are activated onboard the aircraft for the ECAM alerts affected by OEBs.

CAUTION

As soon as the maintenance personnel has embodied the corrective action that cancels the OEB on a specific aircraft, the Operator must ensure that:

1. Maintenance personnel has deactivated the OEB REMINDER function for the specific OEB , before informing their Flight Operations department of the installation of the OEB correction action.
2. The QRH OEB section onboard the aircraft is updated to remove the specific OEB from the applicable aircraft.

OPERATIONS ENGINEERING BULLETINS

ERRONEOUS ALTERNATE FUEL
PREDICTIONS UPON MODIFICATION OF
A COMPANY ROUTE IN THE ALTERNATE
FLIGHT PLAN

Intentionally left blank



A318/A319/A320/A321
FLIGHT CREW
OPERATING MANUAL

OPERATIONS ENGINEERING BULLETINS
ERRONEOUS ALTERNATE FUEL PREDICTIONS UPON MODIFICATION
OF A COMPANY ROUTE IN THE ALTERNATE FLIGHT PLAN
PRELIMINARY PAGES - TABLE OF CONTENTS

Erroneous Alternate Fuel Predictions Upon Modification of a Company Route in the Alternate Flight Plan..... A
Erroneous Alternate Fuel Predictions Upon Modification of a Company Route in the Alternate Flight Plan..... B



A318/A319/A320/A321
FLIGHT CREW
OPERATING MANUAL

**OPERATIONS ENGINEERING BULLETINS
ERRONEOUS ALTERNATE FUEL PREDICTIONS UPON MODIFICATION
OF A COMPANY ROUTE IN THE ALTERNATE FLIGHT PLAN
PRELIMINARY PAGES - TABLE OF CONTENTS**

Intentionally left blank

OEB41 Issue 3

Associated with QRH OEB Proc N°: OEB41/1.0
ERRONEOUS ALTERNATE FUEL PREDICTIONS UPON MODIFICATION
OF A COMPANY ROUTE IN THE ALTERNATE FLIGHT PLAN

Ident.: OEB-41-00013609.0001001 / 15 OCT 15

Applicable to: ALL

Approved by: Head of Airbus Flight Operations & Training Support

- This OEB covers a significant operational issue. Non-compliance with this OEB may have a significant impact on the operations of the aircraft. The Operators shall distribute its content to all flight crews without delay. An extract of this OEB is provided for insertion in the QRH.
- It is recommended that all Operators accelerate the incorporation of all corrective Service Bulletins as soon as they become available.

Reason for issue:

Issue 3:

This OEB is reissued to update the "Cancelled by" section with the name of the FMS standards cancelling the OEB. There is no technical change.

Issue 2:

This OEB is reissued to enhance the display of the MCDU FUEL PRED page (without technical change).

The objective is to address format standardization and enhanced readability.

Issue 1:

This OEB replaces the A320 OEB 204

This OEB is issued to inform the operators of the following: Erroneous alternate (ALTN) fuel predictions are experienced when the flight crew modifies a company route (CO RTE) previously inserted in the alternate Flight Plan (F-PLN).

This OEB provides an explanation and operational recommendations in case of erroneous ALTN fuel predictions.

Applicable to:

Aircraft with Honeywell FMGC Release 1A "H2" (MOD 38778, Airbus SB A320 22-1269 and MOD 38779, Airbus SB A320 22-1270)

Cancelled by:

FMS Honeywell standard H2C and subsequent.

The FMS standard H2C is installed by the following FMGC standards:

**OPERATIONS ENGINEERING BULLETINS
ERRONEOUS ALTERNATE FUEL PREDICTIONS UPON MODIFICATION
OF A COMPANY ROUTE IN THE ALTERNATE FLIGHT PLAN**

- FMGC standard H2CC14 (MOD 157166)
- FMGC standard H2CPC14 (MOD 161459)
- FMGC standard H2CI14 (MOD 156957)
- FMGC standard H2CPI13 (MOD 155494)

Note: The interchangeability code, given in the Illustrated Part Catalog (IPC), indicates the conditions for interchangeability of equipment. After installation of corrective modification(s)/SB(s), if an Operator reinstalls any equipment affected by this OEB, it is the Operator's responsibility to ensure that the recommendations given in this OEB are applied again for the applicable aircraft.

Operations Engineering Bulletins are issued by Airbus, as the need arises, to quickly transmit technical and procedural information. They are distributed to all FCOM holders and to others who need advice of changes to operational information.

The information in the OEB is recommended by Airbus, but may not be approved by Airworthiness Authorities. If the procedures contained in this OEB differ from the procedures in the AFM, the AFM remains the reference.



A318/A319/A320/A321
FLIGHT CREW
OPERATING MANUAL

OPERATIONS ENGINEERING BULLETINS
ERRONEOUS ALTERNATE FUEL PREDICTIONS UPON MODIFICATION
OF A COMPANY ROUTE IN THE ALTERNATE FLIGHT PLAN

| M | Localization | T | DU Title | DU identification | DU date |
|---|--|---|--|-------------------|-----------|
| | OEB-41 | | Erroneous Alternate Fuel Predictions Upon Modification of a Company Route in the Alternate Flight Plan | 00013609.0001001 | 15 OCT 15 |
| | Criteria: 22-1269 Applicable to: ALL | | | | |
| | OEB-41 | | Erroneous Alternate Fuel Predictions Upon Modification of a Company Route in the Alternate Flight Plan | 00013610.0001001 | 15 OCT 15 |
| | Criteria: 22-1269 Applicable to: ALL | | | | |

**ERRONEOUS ALTERNATE FUEL PREDICTIONS UPON MODIFICATION
OF A COMPANY ROUTE IN THE ALTERNATE FLIGHT PLAN**

Ident.: OEB-41-00013610.0001001 / 15 OCT 15

Applicable to: ALL

EXPLANATION

When the flight crew modifies the CO RTE in the ALTN F-PLN , the FMS no longer computes the ALTN fuel predictions (refer to the below illustration).

This CO RTE could be extracted from the Navigation database or stored by the flight crew.

The modification of the CO RTE by the flight crew could be for example an entry of a departure or an arrival procedure.

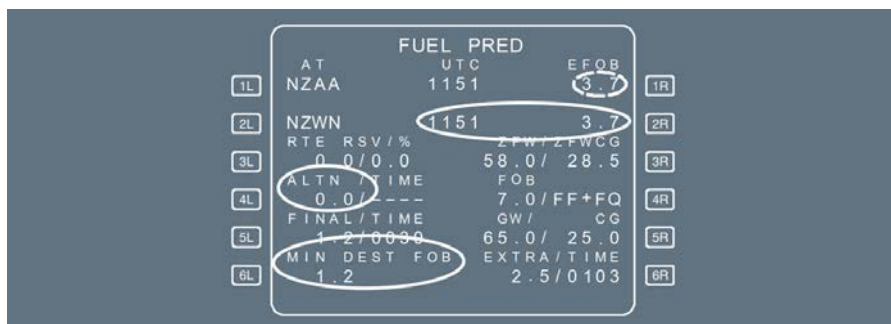

The consequences of the CO RTE modification are:

- The fuel predictions are set to zero for the ALTN (solid circles) on FUEL PRED page (also on INIT FUEL PRED if done on ground)
This condition is sufficient to apply the operational recommendations provided in the "PROCEDURE" paragraph.
- The Estimated Fuel On Board (EFOB) and the predicted UTC (solid circles) at ALTN destination becomes equal to the EFOB and the UTC at the Primary Destination
- If the ALTN fuel and the MIN DEST FOB values on FUEL PRED page are both at their default value (i.e. have not been modified by the crew), the MIN DEST FOB (solid circle) becomes erroneous (equal to FINAL instead of FINAL+ ALTN). Therefore, the MCDU scratchpad message "DEST EFOB BELOW MIN", is no longer triggered on the expected threshold
- If the flight crew had entered a value for the ALTN fuel, the entry is correctly used (but no more modifiable unless a new ALTN is entered)

Continued on the following page

ERRONEOUS ALTERNATE FUEL PREDICTIONS UPON MODIFICATION
OF A COMPANY ROUTE IN THE ALTERNATE FLIGHT PLAN (Cont'd)

- If the flight crew had manually entered the MIN DEST FOB value on FUEL PRED page (but not the ALTN fuel value), then the message "CHECK MIN DEST FOB" is no longer triggered at the correct threshold

However, the new ALTN F-PLN is correctly displayed on the F-PLN page, the Navigation Display (ND) and the INIT page correctly shows the ALTN identifier.

Note: The EFOB of the primary destination remains correctly computed (dashed circle).

The reason for the anomaly is that when the ALTN CO RTE is modified, the FMS erroneously assumes there is no alternate F-PLN anymore for the fuel predictions. An additional modification of the ALTN F-PLN enables to recover correct ALTN fuel predictions.

PROCEDURE

This procedure only applies when a CO RTE is used for ALTN F-PLN . In the case of ALTN fuel predictions erroneously set to zero further to a modification of this ALTN F-PLN:

ENTER manually a waypoint in the en-route F-PLN (neither in the departure, nor in the arrival), to start a new computation of ALTN fuel predictions

Maintain or delete the entered waypoint at convenience

Check the ALTN fuel predictions are correct

CORRECTIVE ACTION

Honeywell FMS standard H2C cancels this OEB (*Refer to OEB-41 Erroneous Alternate Fuel Predictions Upon Modification of a Company Route in the Alternate Flight Plan - Approval "Cancelled by" section.*)

END OF OEB41

Intentionally left blank

OPERATIONS ENGINEERING BULLETINS

NO ENGAGEMENT OF GUIDANCE MODE

Intentionally left blank



A318/A319/A320/A321
FLIGHT CREW
OPERATING MANUAL

OPERATIONS ENGINEERING BULLETINS

NO ENGAGEMENT OF GUIDANCE MODE

PRELIMINARY PAGES - TABLE OF CONTENTS

No Engagement of Guidance Mode.....A
No Engagement of Guidance Mode.....B



A318/A319/A320/A321
FLIGHT CREW
OPERATING MANUAL

OPERATIONS ENGINEERING BULLETINS

NO ENGAGEMENT OF GUIDANCE MODE

PRELIMINARY PAGES - TABLE OF CONTENTS

Intentionally left blank

OEB46 Issue 1
Associated with QRH OEB Proc N°: OEB46/1.0
NO ENGAGEMENT OF GUIDANCE MODE

Ident.: OEB-46-00015286.0001001 / 05 NOV 13

Applicable to: ALL

Approved by: Head of Airbus Flight Operations & Training Support

- This OEB covers a significant operational issue. Non-compliance with this OEB may have a significant impact on the operations of the aircraft. The Operators shall distribute its content to all flight crews without delay. An extract of this OEB is provided for insertion in the QRH.
- It is recommended that all Operators accelerate the incorporation of all corrective Service Bulletins as soon as they become available.

Reason for issue:

The objective of this OEB is to highlight that in the event of an erroneous Radio Altimeter (RA) height indication, guidance modes may not engage as expected.

Applicable to:

All A318/A319/A320/A321 aircraft equipped with the ELAC L97 standard (or subsequent ELAC standards).

Cancelled by:

FG C14 or FG PC14 or FG I15 or FG PI13 standards.

Note: The interchangeability code, given in the Illustrated Part Catalog (IPC), indicates the conditions for interchangeability of equipment. After installation of corrective modification(s)/SB(s), if an Operator reinstalls any equipment affected by this OEB, it is the Operator's responsibility to ensure that the recommendations given in this OEB are applied again for the applicable aircraft.

Operations Engineering Bulletins are issued by Airbus, as the need arises, to quickly transmit technical and procedural information. They are distributed to all FCOM holders and to others who need advice of changes to operational information.

The information in the OEB is recommended by Airbus, but may not be approved by Airworthiness Authorities. If the procedures contained in this OEB differ from the procedures in the AFM, the AFM remains the reference.



AEROLINEAS GALAPAGOS S.A.

A318/A319/A320/A321
FLIGHT CREW
OPERATING MANUAL

OPERATIONS ENGINEERING BULLETINS
NO ENGAGEMENT OF GUIDANCE MODE

| M | Localization | T | DU Title | DU identification | DU date |
|---|--|---|--------------------------------|-------------------|-----------|
| | OEB-46 | | No Engagement of Guidance Mode | 00015286.0001001 | 05 NOV 13 |
| | Criteria: 27-1238 Applicable to: ALL | | | | |
| | OEB-46 | | No Engagement of Guidance Mode | 00015287.0001001 | 05 NOV 13 |
| | Criteria: 27-1238 Applicable to: ALL | | | | |

NO ENGAGEMENT OF GUIDANCE MODE

Ident.: OEB-46-00015287.0001001 / 05 NOV 13

Applicable to: ALL

EXPLANATION

If a RA transmits an erroneous height indication, this may have any of the following effects on the auto flight system depending on the flight phase. However, these effects may not necessarily occur in every case of an erroneous RA height indication.

Auto Flight System mode changes (indicated on FMA):

- NAV mode engagement is not possible after takeoff,
- In case of go-around and if the RA is still frozen at a very low height indication:
 - SRS and GA TRK modes engage,
 - NAV, HDG or TRK lateral modes cannot be selected,
 - LVR CLB will not be displayed on the FMA at THR RED ALT,
 - ALT* and ALT will not engage at FCU altitude.

Disconnecting AP and resetting both FDs enable to recover basic mode (HDG and V/S).

PROCEDURE

■ **During go-around**

- **If SRS and GA TRK modes remain engaged and other guidance modes cannot be selected or engaged as expected:**

Note: - At the thrust reduction altitude, LVR CLB will not be displayed on the FMA,
- ALT* and ALT will not engage at the FCU altitude.

Disconnect APs.

Set both FDs to OFF then ON. FDs revert to basic modes (HDG - V/S).

Re-engage guidance modes as appropriate.

- **For the approach that follows the go-around:** Do not arm the G/S mode.

Flight crews must report, in the technical logbook, any of the above-listed consequences of erroneous RA height.

CORRECTIVE ACTION

FG C14 or FG PC14 or FG I15 or FG PI13.

END OF OEB46

Intentionally left blank

OPERATIONS ENGINEERING BULLETINS

HYD ENG PUMP LO PR FOLLOWED BY
HYD RSVR OVHT

Intentionally left blank



A318/A319/A320/A321
FLIGHT CREW
OPERATING MANUAL

OPERATIONS ENGINEERING BULLETINS
HYD ENG PUMP LO PR FOLLOWED BY HYD RSVR OVHT
PRELIMINARY PAGES - TABLE OF CONTENTS

HYD ENG PUMP LO PR followed by HYD RSVR OVHT A
HYD ENG PUMP LO PR followed by HYD RSVR OVHT..... B



A318/A319/A320/A321
FLIGHT CREW
OPERATING MANUAL

OPERATIONS ENGINEERING BULLETINS
HYD ENG PUMP LO PR FOLLOWED BY HYD RSVR OVHT

PRELIMINARY PAGES - TABLE OF CONTENTS

Intentionally left blank

OEB47 Issue 1
Associated with QRH OEB Proc N°: OEB47/2.0
HYD ENG PUMP LO PR FOLLOWED BY HYD RSVR OVHT

Ident.: OEB-47-00015327.0001001 / 20 DEC 13

Applicable to: ALL

Approved by: Head of Airbus Flight Operations & Training Support

- This OEB covers a significant operational issue. Non-compliance with this OEB may have a significant impact on the operations of the aircraft. The Operators shall distribute its content to all flight crews without delay. An extract of this OEB is provided for insertion in the QRH.
- It is recommended that all Operators accelerate the incorporation of all corrective Service Bulletins as soon as they become available.

Reason for issue:

This OEB is issued to provide operational recommendations in the case of a :

- **HYD G ENG 1 PUMP LO PR** ECAM caution followed by a **HYD Y RSVR OVHT** ECAM caution
- **HYD Y ENG 2 PUMP LO PR** ECAM caution followed by a **HYD G RSVR OVHT** ECAM caution

Applicable to:

All A318/A319/A320/A321 Aircraft.

Cancelled by:

Power Transfer Unit (PTU) inhibition logic (MOD 35938 or MOD153173)

Note: The interchangeability code, given in the Illustrated Part Catalog (IPC), indicates the conditions for interchangeability of equipment. After installation of corrective modification(s)/SB(s), if an Operator reinstalls any equipment affected by this OEB, it is the Operator's responsibility to ensure that the recommendations given in this OEB are applied again for the applicable aircraft.

Operations Engineering Bulletins are issued by Airbus, as the need arises, to quickly transmit technical and procedural information. They are distributed to all FCOM holders and to others who need advice of changes to operational information.

The information in the OEB is recommended by Airbus, but may not be approved by Airworthiness Authorities. If the procedures contained in this OEB differ from the procedures in the AFM, the AFM remains the reference.

OPERATIONS ENGINEERING BULLETINS
HYD ENG PUMP LO PR FOLLOWED BY HYD RSVR OVHT

A318/A319/A320/A321
FLIGHT CREW
OPERATING MANUAL

| M | Localization | T | DU Title | DU identification | DU date |
|---|--------------|---|--|-------------------|-----------|
| | OEB-47 | | HYD ENG PUMP LO PR followed by HYD RSVR OVHT | 00015327.0001001 | 20 DEC 13 |
| Criteria: SA Applicable to: ALL | | | | | |
| | OEB-47 | | HYD ENG PUMP LO PR followed by HYD RSVR OVHT | 00015328.0001001 | 20 DEC 13 |
| Criteria: SA Applicable to: ALL | | | | | |

HYD ENG PUMP LO PR FOLLOWED BY HYD RSVR OVHT

Ident.: OEB-47-00015328.0001001 / 20 DEC 13

Applicable to: ALL

REASON FOR ISSUE

A fluid leakage from the green (yellow) hydraulic system causes a decrease in hydraulic pressure. When the difference in pressure between the green and yellow systems reaches 500 PSI, the PTU is automatically activated to transfer hydraulic power between the two systems. However, due to the fluid leakage, the PTU cannot pressurize the green (yellow) system and starts to run at high speed, heating up the hydraulic fluid in the yellow (green) hydraulic system. This results in an overheat of the yellow (green) hydraulic reservoir and the associated ECAM caution triggers. When the flight crew applies the successive ECAM procedures, both yellow and green hydraulic systems are lost and the Flight Warning Computer (FWC) triggers the **HYD G+Y SYS LO PR** ECAM warning.

The purpose of this OEB is to inform operators about the operational effect of such a failure, and to provide an operational procedure to prevent a dual hydraulic system loss in the described conditions.

EXPLANATION

The main cause of these dual hydraulic loss events is a fluid leakage from the green hydraulic system during landing gear retraction. The decrease in pressure due to this leakage triggers the **HYD G ENG 1 PUMP LO PR** ECAM caution and automatically activates the PTU . However, because of the leakage, the PTU operates at high speed due to its inability to pressurize the green hydraulic system. This causes the yellow hydraulic reservoir to overheat, and the FWC to trigger the **HYD Y RSVR OVHT** ECAM caution.

The ECAM **HYD G ENG 1 PUMP LO PR** and **HYD Y RSVR OVHT** procedures specify to set their respective pumps to off. When the flight crew applies these procedures, this results in a loss of the yellow and green hydraulic systems and a **HYD G+Y SYS LO PR** ECAM warning.

During the initial climb, the **HYD G RSVR LO LVL** ECAM caution is inhibited. Therefore the action requested by this procedure to turn off the PTU may appear when the overheat is already present.

A similar scenario may occur, in the case of a slow fluid leakage from the green (yellow) hydraulic system.

In all cases, the **HYD Y(G) RSVR OVHT** ECAM caution is triggered between 2 to 10 min after the triggering of the **HYD G(Y) ENG 1(2) PUMP LO PR** ECAM caution.

Continued on the following page

HYD ENG PUMP LO PR FOLLOWED BY HYD RSVR OVHT (Cont'd)

PROCEDURE

- If a **HYD G ENG 1 PUMP LO PR ECAM** caution is followed by a **HYD Y RSVR OVHT ECAM** caution, disregard the **HYD Y RSVR OVHT ECAM** procedure, and apply the following procedure to stop the overheat situation:

HYD Y RSVR OVHT

PTU..... OFF
 YELLOW ENG 2 PUMP..... KEEP ON

- If a **HYD Y ENG 2 PUMP LO PR ECAM** caution is followed by a **HYD G RSVR OVHT ECAM** caution, disregard the **HYD G RSVR OVHT ECAM** procedure, and apply the following procedure to stop the overheat situation:

HYD G RSVR OVHT

PTU..... OFF
 GREEN ENG 1 PUMP..... KEEP ON

CORRECTIVE ACTION

Installation of the automatic PTU inhibition logic as per MOD 35938 (SB A320–29–1126, or SB A320–29–1145), or MOD 153173 (SB A320–29–1156) cancels this OEB . The PTU inhibition logic detects a low pressure situation for more than 6 s of the green or yellow hydraulic system and, consequently, automatically turns off the PTU . This prevents PTU high speed situation and subsequent hydraulic system overheat.

END OF OEB47

PERFORMANCE

Intentionally left blank

PER-LOD Loading

PER-OPD Operating Data

PER-THR Thrust Ratings

PER-TOF Takeoff

PER-FPL Flight Planning

PER-CLB Climb

PER-CRZ Cruise

PER-HLD Holding

PER-DES Descent

PER-GOA Go Around

PER-LDG Landing

PER-OEI One Engine Inoperative



A318/A319/A320/A321
FLIGHT CREW
OPERATING MANUAL

PERFORMANCE
PRELIMINARY PAGES
TABLE OF CONTENTS

Intentionally left blank



A318/A319/A320/A321
FLIGHT CREW
OPERATING MANUAL

PERFORMANCE
PRELIMINARY PAGES

LIST OF EFFECTIVE TEMPORARY DOCUMENTARY UNITS

| M | Localization | DU Title | DU identification | DU date |
|---|--------------|----------|-------------------|---------|
|---|--------------|----------|-------------------|---------|

No Temporary Documentary Unit



A318/A319/A320/A321
FLIGHT CREW
OPERATING MANUAL

PERFORMANCE
PRELIMINARY PAGES

LIST OF EFFECTIVE TEMPORARY DOCUMENTARY UNITS

Intentionally left blank

PERFORMANCE

LOADING

Intentionally left blank

PER-LOD-GEN GENERAL

DEFINITIONS.....A

PER-LOD-CGO CARGO LOADING

GENERAL.....A

PER-LOD-FUL FUEL

USE OF MANUAL MAGNETIC INDICATORS (MMI).....A

PER-LOD-WBA WEIGHT AND BALANCE

PER-LOD-WBA-LTS LOAD AND TRIM SHEET

GENERAL.....A
DATA.....B
DESCRIPTION.....C
LOAD AND TRIM SHEET.....D

PER-LOD-WBA-FIT FUEL INDEX TABLES

PER-LOD-WBA-FIT-10 FUEL INDEX TABLE

GENERAL.....A
FUEL INDEX TABLE FOR INNER TANK.....B
FUEL INDEX TABLE FOR OUTER TANK.....C
FUEL INDEX TABLE FOR CENTER TANK.....D



A318/A319/A320/A321
FLIGHT CREW
OPERATING MANUAL

PERFORMANCE

LOADING

PRELIMINARY PAGES - TABLE OF CONTENTS

Intentionally left blank

| | |
|---|--|
|  <p>A318/A319/A320/A321 FLIGHT CREW OPERATING MANUAL</p> | <p>PERFORMANCE</p> <p>LOADING</p> <p>GENERAL</p> |
|---|--|

DEFINITIONS

Ident.: PER-LOD-GEN-00001661.0001001 / 09 DEC 09

Applicable to: ALL

MANUFACTURER'S EMPTY WEIGHT (MEW)

The weight of the structure, power plant, furnishings, systems and other items of equipment that are considered as integral part of the aircraft. It is essentially a "dry" weight, including only those fluids contained in closed systems (e.g. hydraulic fluid).

OPERATIONAL EMPTY WEIGHT (OEW)

The manufacturer's weight empty plus the operator's items i.e. the flight and cabin crew and their baggage, unusable fuel, engine oil, emergency equipment, toilet chemicals and fluids, galley structure, catering equipment, seats, documents etc.

DRY OPERATING WEIGHT (DOW)

The total weight of an aircraft ready for a specific type of operation excluding all usable fuel and traffic load.

Operational Empty Weight plus items specific to the type of flight i.e. catering, newspapers, pantry equipment etc.

TAKEOFF FUEL

The weight of the fuel onboard at takeoff.

OPERATING WEIGHT

The weight obtained by addition of the operational empty weight and the takeoff fuel.

TOTAL TRAFFIC LOAD

The weight of the payload including cargo loads, passengers and passengers bags.

ZERO FUEL WEIGHT (ZFW)

The weight obtained by addition of the total traffic load and the dry operating weight.

TAKEOFF WEIGHT (TOW)

The weight at takeoff. It is equal to the addition of the zero fuel weight and takeoff fuel.

TRIP FUEL

The weight of the fuel necessary to cover the normal leg without reserves.

LANDING WEIGHT

The weight at landing. It is equal to takeoff weight minus trip fuel.



A318/A319/A320/A321
FLIGHT CREW
OPERATING MANUAL

PERFORMANCE

LOADING

GENERAL

Intentionally left blank

| | |
|---|--|
|  <p>A318/A319/A320/A321 FLIGHT CREW OPERATING MANUAL</p> | <p>PERFORMANCE</p> <p>LOADING</p> <p>CARGO LOADING</p> |
|---|--|

GENERAL

Ident.: PER-LOD-CGO-00001662.0002001 / 09 DEC 09

Applicable to: ALL

The aircraft has two lower deck cargo compartments :

- Forward cargo compartment, compartment 1.
- Aft cargo compartment, subdivided into compartments 3, 4 and 5.

The main access doors to forward and aft compartments are hydraulically operated.

A bulk cargo door  gives additional access to the aft cargo compartment. It is manually operated.



A318/A319/A320/A321
FLIGHT CREW
OPERATING MANUAL

PERFORMANCE

LOADING

CARGO LOADING

Intentionally left blank

USE OF MANUAL MAGNETIC INDICATORS (MMI)

Applicable to: ALL

Ident.: PER-LOD-FUL-C-00001679.0007001 / 23 JUN 15

GENERAL

Indicators are installed as follows:

- Four in each wing tank: Three in the inner tank and one in the outer tank
- One in the center tank

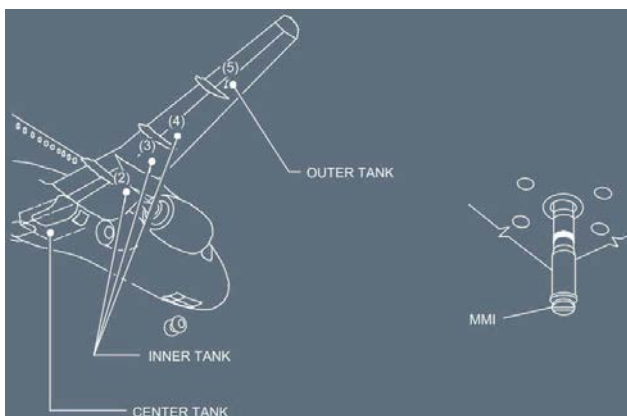

TO DETERMINE AIRCRAFT ATTITUDE

Set ADIRS 1, 2, 3 to the NAV position.

On the LH or RH MCDU , press MCDU MENU pushbutton.

Select CFDS line key (LSK 4L).

Select SYSTEM REPORT/TEST line key (LSK 5L).

Select the line key adjacent to the FUEL indication.

On the MCDU control panel, push the NEXT PAGE key to display the FUEL Main Menu second page.

Select the line key adjacent to the INPUT PARAMETERS VALUES indication.

Use the Table given on the next page to determine the equivalent number and letter from PITCH and ROLL data.

Select RETURN line key (LSK 6L) until CFDS main menu appears.

Press MCDU MENU pushbutton.

PERFORMANCE

LOADING

FUEL

| PITCH | REF | ROLL | REF |
|------------------|-----|------------------|-----|
| Minus 1.5 | 1 | Minus 1.5 | A |
| Minus 1.0 | 2 | Minus 1.0 | B |
| Minus 0.5 | 3 | Minus 0.5 | C |
| 0.0 | 4 | 0.0 | D |
| Plus 0.5 | 5 | Plus 0.5 | E |
| Plus 1.0 | 6 | Plus 1.0 | F |
| Plus 1.5 | 7 | Plus 1.5 | G |

Note: 1. This procedure can only be used if:

- The PITCH and ROLL data is taken from the ADIRS (identified by an "A" after the PITCH and ROLL title).
- The PITCH data displayed for the LEFT, CTR, and RIGHT is no more or less than 0.1 of each other.
- The ROLL data displayed for the LEFT, CTR, and RIGHT is no more or less than 0.1 of each other.

2. The FQIS input parameters are not automatically updated. Use the NEXT PAGE control on the MCDU to cycle the pages to update the screen.

ACCESS PLATFORM.....IN POSITION

Ident.: PER-LOD-FUL-C-00001692.0001001 / 13 JAN 14

TO DETERMINE FUEL QUANTITY IN THE OUTER TANK

MMI number 5..... UNLOCK and WITHDRAW

The crewmember must withdraw the MMI slowly until he feels the magnetic attraction between the rod and float magnets.

Do not use force when withdrawing the MMI as this will disengage the float magnet from the rod magnet and bring the rod down onto the mechanical stop.

ROD GRADUATION (which aligns with bottom wing surface)..... READ MMI..... IN PLACE and LOCKED

Use the table for the applicable aircraft wing side, aircraft attitude (grid square letter and number), and the MMI stick number 5, to find the volume of fuel in the outer tank (See below).

Multiply the result by the specific gravity to find the fuel weight.

Note: The manual magnetic indication accuracy is around 5 %.

| | |
|---|--|
|  <p>A318/A319/A320/A321 FLIGHT CREW OPERATING MANUAL</p> | <p align="center">PERFORMANCE</p> <p align="center">LOADING</p> <p align="center">FUEL</p> |
|---|--|

Ident.: PER-LOD-FUL-C-00001680.0003001 / 24 NOV 14

TO DETERMINE FUEL QUANTITY IN THE INNER TANK

MMI (from number 4 to number 2)..... UNLOCK and WITHDRAW

The crewmember must withdraw the MMI slowly until he feels the magnetic attraction between the rod and float magnets.

Do not use force when withdrawing the MMI as this will disengage the float magnet from the rod magnet and bring the rod down onto the mechanical stop.

ROD GRADUATION (which aligns with bottom wing surface)..... READ

MMI..... IN PLACE and LOCKED

MMIs shall be withdrawn from number 4 to number 2 until one MMI measures fuel.

Use the table for the applicable aircraft wing side, aircraft attitude (grid square letter and number), and the applicable MMI stick number to find the volume of fuel in the inner tank (Refer to FCOM - PER.LOD.FUL FUEL. C.USE OF MANUAL MAGNETIC INDICATORS (MMI) - WING TANKS).

Multiply the result by the specific gravity to find the fuel weight.

Note: *The manual magnetic indication accuracy is around 5 %.*

Ident.: PER-LOD-FUL-C-00009658.0001001 / 13 JAN 14

TO DETERMINE FUEL QUANTITY IN THE CENTER TANK

CENTER TANK MMI..... UNLOCK and WITHDRAW

The crewmember must withdraw the MMI slowly until he feels the magnetic attraction between the rod and float magnets.

Do not use force when withdrawing the MMI as this will disengage the float magnet from the rod magnet and bring the rod down onto the mechanical stop.

ROD GRADUATION (which aligns with bottom wing surface)..... READ

MMI..... IN PLACE and LOCKED

Use the table for the center tank, and for the applicable aircraft attitude (grid square letter and number) to find the volume of fuel in the center tank (See below).

Multiply the result by the specific gravity to find the fuel weight.

Note: *The manual magnetic indication accuracy is around 5 %.*

Ident.: PER-LOD-FUL-C-00001681.0004001 / 17 MAR 11

WING TANKS (LITERS)

| M M I N ^o | R E A D I N G | LITERS ATTITUDE READING | | | | | | | R E A D I N G | LITERS ATTITUDE READING | | | | | | | | |
|-------------------------------|---------------------------------|----------------------------|------|------|------|------|------|------|---------------------------------|----------------------------|------|------|------|------|------|------|-----------|--|
| | | A* | | | | G | | | | A | | | | G | | | LEFT WING | |
| | | 1 | 2 | 3 | 4 | 5 | 6 | 7 | | 1 | 2 | 3 | 4 | 5 | 6 | 7** | | |
| 2 | 2 | 2300 | 2250 | 2200 | 2200 | 2200 | 2200 | 2200 | 2 | 2850 | 2850 | 2850 | 2850 | 2850 | 2850 | 2800 | | |
| | 4 | 2500 | 2450 | 2400 | 2400 | 2350 | 2350 | 2350 | 4 | 3050 | 3050 | 3050 | 3050 | 3050 | 3000 | 3000 | | |
| | 6 | 2650 | 2600 | 2600 | 2600 | 2550 | 2500 | 2500 | 6 | 3200 | 3200 | 3200 | 3200 | 3200 | 3200 | 3150 | | |
| | 8 | 2750 | 2750 | 2750 | 2700 | 2700 | 2650 | 2650 | 8 | 3300 | 3300 | 3300 | 3300 | 3300 | 3300 | 3250 | | |
| | 10 | 2900 | 2900 | 2900 | 2900 | 2850 | 2850 | 2850 | 10 | 3500 | 3500 | 3500 | 3500 | 3450 | 3450 | 3400 | | |
| | 12 | 3100 | 3100 | 3100 | 3100 | 3100 | 3050 | 3000 | 12 | 3650 | 3650 | 3600 | 3600 | 3600 | 3600 | 3600 | | |
| | 14 | 3250 | 3250 | 3250 | 3250 | 3250 | 3250 | 3200 | 14 | 3800 | 3800 | 3750 | 3750 | 3750 | 3750 | 3750 | | |
| | 16 | 3450 | 3450 | 3450 | 3450 | 3450 | 3400 | 3400 | 16 | 3950 | 3900 | 3900 | 3900 | 3900 | 3900 | 3900 | | |
| | 18 | 3700 | 3650 | 3650 | 3650 | 3650 | 3600 | 3600 | 18 | 4050 | 4050 | 4050 | 4050 | 4050 | 4050 | 4050 | | |
| | 20 | 3900 | 3900 | 3900 | 3900 | 3850 | 3850 | 3850 | 20 | 4200 | 4200 | 4200 | 4200 | 4200 | 4200 | 4200 | | |
| | 22 | 4100 | 4100 | 4050 | 4050 | 4050 | 4050 | 4050 | 22 | 4250 | 4250 | 4250 | 4300 | 4300 | 4300 | 4300 | | |
| | 24 | 4300 | 4300 | 4300 | 4300 | 4300 | 4300 | 4300 | 24 | 4400 | 4400 | 4400 | 4400 | 4450 | 4450 | 4450 | | |
| | 26 | 4500 | 4500 | 4500 | 4500 | 4500 | 4500 | 4550 | 26 | 4500 | 4500 | 4550 | 4550 | 4550 | 4600 | 4600 | | |
| | 28 | 4700 | 4700 | 4750 | 4750 | 4750 | 4750 | 4750 | 28 | 4600 | 4650 | 4650 | 4700 | 4700 | 4750 | 4800 | | |
| 30 | 4950 | 4950 | 4950 | 4950 | 5000 | 5000 | 5000 | 30 | 4750 | 4750 | 4800 | 4800 | 4850 | 4850 | 4900 | | | |
| 32 | 5100 | 5100 | 5150 | 5150 | 5150 | 5200 | 5200 | 32 | 4850 | 4850 | 4900 | 4900 | 4950 | 5000 | 5000 | | | |
| | MAX | | | | | | | | MAX | | | | | | | | | |
| 3 | 2 | 4400 | 4350 | 4300 | 4250 | 4200 | 4150 | 4050 | 2 | 5050 | 5050 | 5100 | 5100 | 5100 | 5100 | 5100 | | |
| | 4 | 4700 | 4700 | 4650 | 4600 | 4500 | 4400 | 4300 | 4 | 5150 | 5150 | 5200 | 5200 | 5200 | 5200 | 5200 | | |
| | 6 | 4950 | 4950 | 4900 | 4850 | 4800 | 4700 | 4550 | 6 | 5250 | 5250 | 5300 | 5300 | 5300 | 5300 | 5300 | | |
| | 8 | 5150 | 5100 | 5100 | 5050 | 5000 | 4950 | 4800 | 8 | 5350 | 5350 | 5400 | 5400 | 5400 | 5400 | 5400 | | |
| | 10 | 5250 | 5250 | 5250 | 5250 | 5200 | 5150 | 5050 | 10 | 5450 | 5450 | 5500 | 5500 | 5500 | 5500 | 5500 | | |
| | 12 | 5400 | 5400 | 5400 | 5400 | 5350 | 5300 | 5250 | 12 | 5500 | 5500 | 5550 | 5600 | 5600 | 5600 | 5650 | | |
| | 14 | 5600 | 5600 | 5550 | 5550 | 5500 | 5500 | 5450 | 14 | 5600 | 5650 | 5650 | 5700 | 5700 | 5700 | 5750 | | |
| | 16 | 5750 | 5750 | 5700 | 5700 | 5700 | 5650 | 5600 | 16 | 5650 | 5700 | 5700 | 5750 | 5750 | 5800 | 5800 | | |
| | 18 | 5900 | 5900 | 5850 | 5850 | 5850 | 5850 | 5800 | 18 | 5800 | 5800 | 5850 | 5850 | 5900 | 5900 | 5950 | | |
| | 20 | 6000 | 6000 | 6000 | 6000 | 6000 | 6000 | 6000 | 20 | 5900 | 5900 | 5950 | 5950 | 6000 | 6000 | 6050 | | |

* GRID SQUARE LETTER

** GRID SQUARE NUMBER

PERFORMANCE

LOADING

FUEL

| M M I N° | R E A D I N G | LITERS ATTITUDE READING | | | | | | | M M I N° | R E A D I N G | LITERS ATTITUDE READING | | | | | | |
|----------|---------------|-------------------------|------|------|------|--------------|------|------|----------|---------------|-------------------------|------|------|------|-------------|------|------|
| | | A LEFT WING | | | | G RIGHT WING | | | | | A RIGHT WING | | | | G LEFT WING | | |
| | | 1 | 2 | 3 | 4 | 5 | 6 | 7 | | | 1 | 2 | 3 | 4 | 5 | 6 | 7 |
| 4 | 2 | 5700 | 5600 | 5550 | 5500 | 5450 | 5400 | 5300 | 2 | 6000 | 6050 | 6100 | 6100 | 6100 | 6100 | 6100 | 6100 |
| | 4 | 5850 | 5750 | 5700 | 5650 | 5600 | 5550 | 5500 | 4 | 6100 | 6100 | 6100 | 6150 | 6150 | 6200 | 6200 | |
| | 6 | 6000 | 5900 | 5850 | 5800 | 5750 | 5700 | 5650 | 6 | 6200 | 6200 | 6200 | 6250 | 6250 | 6250 | 6300 | |
| | 8 | 6150 | 6100 | 6050 | 6000 | 5950 | 5900 | 5850 | 8 | 6250 | 6300 | 6300 | 6350 | 6350 | 6350 | 6400 | |
| | 10 | 6300 | 6300 | 6250 | 6200 | 6150 | 6150 | 6100 | 10 | 6350 | 6400 | 6400 | 6400 | 6450 | 6450 | 6450 | |
| | 12 | 6450 | 6400 | 6400 | 6400 | 6350 | 6300 | 6250 | 12 | 6450 | 6450 | 6450 | 6500 | 6500 | 6550 | 6550 | |
| | 14 | 6550 | 6500 | 6500 | 6500 | 6500 | 6450 | 6450 | 14 | 6500 | 6550 | 6550 | 6550 | 6600 | 6600 | 6650 | |
| | 16 | 6600 | 6600 | 6600 | 6600 | 6600 | 6600 | 6550 | 16 | 6600 | 6600 | 6600 | 6650 | 6650 | 6700 | 6750 | |
| | 18 | 6650 | 6650 | 6650 | 6650 | 6650 | 6650 | 6650 | 18 | 6650 | 6700 | 6700 | 6750 | 6750 | 6750 | 6800 | |
| | MAX | | | | | | | | MAX | | | | | | | | |
| 5 | 2 | 650 | 600 | 550 | 550 | 550 | 500 | 500 | 2 | 700 | 700 | 700 | 700 | 700 | 700 | 700 | |
| | 4 | 700 | 650 | 650 | 600 | 600 | 550 | 550 | 4 | 750 | 750 | 750 | 750 | 750 | 750 | 750 | |
| | 6 | 750 | 700 | 700 | 650 | 650 | 650 | 600 | 6 | 800 | 800 | 800 | 800 | 750 | 750 | 750 | |
| | 8 | 750 | 750 | 750 | 750 | 700 | 700 | 700 | 8 | 800 | 800 | 800 | 800 | 800 | 800 | 800 | |
| | 10 | 800 | 800 | 800 | 750 | 750 | 750 | 750 | 10 | 850 | 850 | 850 | 850 | 850 | 850 | 850 | |
| | 12 | 800 | 800 | 800 | 800 | 800 | 800 | 800 | 12 | 850 | 850 | 850 | 850 | 850 | 850 | 850 | |
| | 14 | 850 | 850 | 850 | 850 | 850 | 850 | 850 | 14 | 850 | 850 | 850 | 850 | 850 | 850 | 850 | |
| | MAX | 850 | 850 | 850 | 850 | 850 | 850 | 850 | MAX | 850 | 850 | 850 | 850 | 850 | 850 | 850 | |

| M M I N° | R E A D I N G | LITERS ATTITUDE READING | | | | | | | M M I N° | R E A D I N G | LITERS ATTITUDE READING | | | | | | |
|----------|---------------|-------------------------|------|------|------|--------------|------|------|----------|---------------|-------------------------|------|------|------|-------------|------|-----|
| | | B* LEFT WING | | | | F RIGHT WING | | | | | B RIGHT WING | | | | F LEFT WING | | |
| | | 1 | 2 | 3 | 4 | 5 | 6 | 7 | | | 1 | 2 | 3 | 4 | 5 | 6 | 7** |
| 2 | 2 | 2350 | 2350 | 2300 | 2300 | 2250 | 2200 | 2200 | 2 | 2800 | 2750 | 2750 | 2750 | 2700 | 2700 | 2650 | |
| | 4 | 2550 | 2500 | 2500 | 2450 | 2450 | 2400 | 2400 | 4 | 2950 | 2950 | 2900 | 2900 | 2900 | 2900 | 2850 | |
| | 6 | 2750 | 2700 | 2700 | 2650 | 2650 | 2600 | 2600 | 6 | 3100 | 3100 | 3100 | 3100 | 3100 | 3050 | 3050 | |
| | 8 | 2850 | 2850 | 2800 | 2800 | 2800 | 2750 | 2750 | 8 | 3200 | 3200 | 3200 | 3200 | 3200 | 3200 | 3150 | |
| | 10 | 3000 | 3000 | 3000 | 3000 | 3000 | 2950 | 2900 | 10 | 3400 | 3400 | 3350 | 3350 | 3350 | 3350 | 3300 | |
| | 12 | 3150 | 3150 | 3200 | 3150 | 3150 | 3150 | 3100 | 12 | 3550 | 3550 | 3550 | 3550 | 3500 | 3500 | 3450 | |
| | 14 | 3350 | 3350 | 3350 | 3350 | 3350 | 3300 | 3300 | 14 | 3750 | 3700 | 3700 | 3700 | 3650 | 3650 | 3650 | |
| | 16 | 3550 | 3550 | 3550 | 3550 | 3500 | 3500 | 3450 | 16 | 3900 | 3850 | 3850 | 3850 | 3850 | 3800 | 3800 | |
| | 18 | 3750 | 3750 | 3750 | 3750 | 3700 | 3700 | 3650 | 18 | 4050 | 4000 | 4000 | 4000 | 4000 | 4000 | 3950 | |
| | 20 | 4000 | 3950 | 3950 | 3950 | 3950 | 3900 | 3900 | 20 | 4200 | 4150 | 4150 | 4150 | 4150 | 4150 | 4150 | |
| | 22 | 4150 | 4100 | 4100 | 4100 | 4100 | 4100 | 4100 | 22 | 4250 | 4250 | 4250 | 4250 | 4250 | 4250 | 4250 | |
| | 24 | 4300 | 4300 | 4300 | 4300 | 4300 | 4300 | 4300 | 24 | 4400 | 4400 | 4400 | 4400 | 4400 | 4400 | 4400 | |
| | 26 | 4500 | 4500 | 4500 | 4500 | 4500 | 4500 | 4500 | 26 | 4500 | 4500 | 4500 | 4550 | 4550 | 4550 | 4550 | |
| | 28 | 4700 | 4700 | 4700 | 4700 | 4700 | 4750 | 4750 | 28 | 4650 | 4650 | 4650 | 4650 | 4700 | 4700 | 4750 | |
| | 30 | 4850 | 4900 | 4900 | 4900 | 4950 | 4950 | 4950 | 30 | 4750 | 4750 | 4800 | 4800 | 4850 | 4850 | 4900 | |
| | 32 | 5050 | 5100 | 5100 | 5100 | 5100 | 5150 | 5150 | 32 | 4850 | 4900 | 4900 | 4950 | 4950 | 5000 | 5050 | |
| MAX | | | | | | | | MAX | | | | | | | | | |
| 3 | 2 | 4550 | 4500 | 4500 | 4450 | 4400 | 4350 | 4300 | 2 | 5000 | 5000 | 5000 | 5000 | 5000 | 5000 | 4950 | |
| | 4 | 4800 | 4800 | 4800 | 4750 | 4650 | 4600 | 4500 | 4 | 5100 | 5100 | 5100 | 5100 | 5100 | 5100 | 5100 | |
| | 6 | 5050 | 5000 | 5000 | 5000 | 4900 | 4850 | 4750 | 6 | 5200 | 5200 | 5200 | 5250 | 5200 | 5200 | 5200 | |
| | 8 | 5150 | 5150 | 5150 | 5150 | 5100 | 5000 | 5000 | 8 | 5300 | 5300 | 5350 | 5350 | 5350 | 5350 | 5350 | |
| | 10 | 5300 | 5300 | 5300 | 5300 | 5250 | 5200 | 5150 | 10 | 5400 | 5400 | 5450 | 5450 | 5450 | 5450 | 5450 | |
| | 12 | 5450 | 5450 | 5450 | 5450 | 5400 | 5400 | 5350 | 12 | 5500 | 5500 | 5550 | 5550 | 5550 | 5550 | 5550 | |
| | 14 | 5600 | 5600 | 5600 | 5550 | 5550 | 5550 | 5500 | 14 | 5600 | 5600 | 5650 | 5650 | 5650 | 5650 | 5700 | |
| | 16 | 5700 | 5700 | 5700 | 5700 | 5700 | 5700 | 5700 | 16 | 5700 | 5700 | 5700 | 5750 | 5750 | 5750 | 5800 | |
| | 18 | 5850 | 5850 | 5850 | 5850 | 5850 | 5850 | 5850 | 18 | 5800 | 5800 | 5800 | 5850 | 5850 | 5850 | 5900 | |
| | 20 | 6000 | 6000 | 6050 | 6050 | 6050 | 6000 | 6000 | 20 | 5900 | 5900 | 5950 | 5950 | 6000 | 6000 | 6000 | |
| MAX | | | | | | | | MAX | | | | | | | | | |

* GRID SQUARE LETTER

PERFORMANCE

LOADING

FUEL

** GRID SQUARE NUMBER

| M I N | M M I N G | LITERS ATTITUDE READING | | | | | | | M I N | M M I N G | LITERS ATTITUDE READING | | | | | | |
|----------|--------------|----------------------------|------|------|------|--------------|------|------|----------|--------------|----------------------------|------|------|------|-------------|------|---|
| | | B LEFT WING | | | | F RIGHT WING | | | | | B RIGHT WING | | | | F LEFT WING | | |
| | | 1 | 2 | 3 | 4 | 5 | 6 | 7 | | | 1 | 2 | 3 | 4 | 5 | 6 | 7 |
| 4 | 2 | | | | | | | | 2 | 5950 | 5950 | 6100 | 6000 | 6050 | 6050 | 6050 | |
| | 4 | 5850 | 5750 | 5700 | 5650 | 5600 | 5600 | 5600 | 4 | 6050 | 6050 | 6100 | 6100 | 6100 | 6100 | 6150 | |
| | 6 | 6000 | 6000 | 5950 | 5900 | 5850 | 5800 | 5800 | 6 | 6150 | 6150 | 6200 | 6200 | 6200 | 6200 | 6200 | |
| | 8 | 6150 | 6150 | 6100 | 6100 | 6050 | 6000 | 6000 | 8 | 6250 | 6250 | 6250 | 6300 | 6300 | 6300 | 6300 | |
| | 10 | 6300 | 6300 | 6250 | 6250 | 6250 | 6200 | 6150 | 10 | 6350 | 6350 | 6350 | 6400 | 6400 | 6400 | 6400 | |
| | 12 | 6400 | 6400 | 6400 | 6400 | 6350 | 6350 | 6300 | 12 | 6400 | 6450 | 6450 | 6450 | 6500 | 6500 | 6500 | |
| | 14 | 6500 | 6500 | 6500 | 6500 | 6500 | 6500 | 6450 | 14 | 6500 | 6500 | 6550 | 6550 | 6600 | 6600 | 6600 | |
| | 16 | 6600 | 6600 | 6600 | 6600 | 6550 | 6550 | 6550 | 16 | 6600 | 6600 | 6600 | 6650 | 6650 | 6700 | 6700 | |
| | 18 | 6760 | 6770 | 6770 | 6770 | 6770 | 6770 | 6760 | 18 | 6750 | 6770 | 6800 | 6830 | 6850 | 6870 | 6880 | |
| | MAX | | | | | | | | MAX | | | | | | | | |
| 5 | 2 | 650 | 650 | 600 | 600 | 600 | 550 | 550 | 2 | 750 | 700 | 700 | 700 | 700 | 700 | 700 | |
| | 4 | 750 | 700 | 700 | 650 | 650 | 600 | 600 | 4 | 750 | 750 | 750 | 750 | 750 | 750 | 750 | |
| | 6 | 750 | 750 | 750 | 700 | 700 | 650 | 650 | 6 | 800 | 800 | 800 | 800 | 750 | 750 | 750 | |
| | 8 | 800 | 800 | 750 | 750 | 750 | 750 | 700 | 8 | 800 | 800 | 800 | 800 | 800 | 800 | 800 | |
| | 10 | 800 | 800 | 800 | 800 | 800 | 750 | 750 | 10 | 850 | 850 | 850 | 850 | 800 | 800 | 800 | |
| | 12 | 850 | 850 | 800 | 800 | 800 | 800 | 800 | 12 | 850 | 850 | 850 | 850 | 850 | 850 | 850 | |
| | 14 | 850 | 850 | 850 | 850 | 850 | 850 | 850 | 14 | 850 | 850 | 850 | 850 | 850 | 850 | 850 | |
| | MAX | 850 | 850 | 850 | 850 | 850 | 850 | 850 | MAX | 850 | 850 | 850 | 850 | 850 | 850 | 850 | |

| M I N | M M I N G | LITERS ATTITUDE READING | | | | | | | M I N | M M I N G | LITERS ATTITUDE READING | | | | | | |
|----------|--------------|----------------------------|------|------|------|--------------|------|------|----------|--------------|----------------------------|------|------|------|-------------|------|-----|
| | | C* LEFT WING | | | | E RIGHT WING | | | | | C RIGHT WING | | | | E LEFT WING | | |
| | | 1 | 2 | 3 | 4 | 5 | 6 | 7 | | | 1 | 2 | 3 | 4 | 5 | 6 | 7** |
| 2 | 2 | 2450 | 2400 | 2400 | 2400 | 2350 | 2350 | 2350 | 2 | 2700 | 2650 | 2650 | 2600 | 2600 | 2550 | 2550 | |
| | 4 | 2650 | 2600 | 2600 | 2600 | 2550 | 2550 | 2500 | 4 | 2850 | 2800 | 2800 | 2800 | 2800 | 2750 | 2750 | |
| | 6 | 2800 | 2800 | 2800 | 2800 | 2750 | 2750 | 2700 | 6 | 3000 | 3000 | 3000 | 3000 | 3000 | 2950 | 2900 | |
| | 8 | 2900 | 2900 | 2900 | 2900 | 2900 | 2850 | 2850 | 8 | 3100 | 3100 | 3100 | 3100 | 3100 | 3100 | 3050 | |
| | 10 | 3100 | 3100 | 3100 | 3100 | 3100 | 3050 | 3000 | 10 | 3300 | 3300 | 3300 | 3250 | 3250 | 3250 | 3200 | |
| | 12 | 3250 | 3250 | 3250 | 3250 | 3250 | 3250 | 3200 | 12 | 3450 | 3450 | 3450 | 3450 | 3450 | 3400 | 3350 | |
| | 14 | 3450 | 3450 | 3450 | 3450 | 3400 | 3400 | 3350 | 14 | 3650 | 3650 | 3600 | 3600 | 3600 | 3550 | 3550 | |
| | 16 | 3650 | 3650 | 3650 | 3600 | 3600 | 3550 | 3550 | 16 | 3800 | 3800 | 3800 | 3750 | 3750 | 3750 | 3700 | |
| | 18 | 3850 | 3850 | 3800 | 3800 | 3800 | 3750 | 3750 | 18 | 4000 | 3950 | 3950 | 3950 | 3900 | 3900 | 3900 | |
| | 20 | 4050 | 4050 | 4000 | 4000 | 4000 | 3950 | 3950 | 20 | 4150 | 4100 | 4100 | 4100 | 4100 | 4100 | 4100 | |
| | 22 | 4200 | 4200 | 4150 | 4150 | 4150 | 4100 | 4100 | 22 | 4250 | 4250 | 4200 | 4200 | 4200 | 4200 | 4200 | |
| | 24 | 4350 | 4350 | 4300 | 4300 | 4300 | 4300 | 4300 | 24 | 4350 | 4350 | 4350 | 4350 | 4350 | 4350 | 4350 | |
| | 26 | 4500 | 4500 | 4500 | 4500 | 4500 | 4500 | 4500 | 26 | 4500 | 4500 | 4500 | 4500 | 4500 | 4500 | 4550 | |
| | 28 | 4650 | 4650 | 4650 | 4700 | 4700 | 4700 | 4700 | 28 | 4650 | 4650 | 4650 | 4650 | 4700 | 4700 | 4700 | |
| | 30 | 4850 | 4850 | 4850 | 4850 | 4900 | 4900 | 4900 | 30 | 4750 | 4800 | 4800 | 4800 | 4850 | 4850 | 4850 | |
| | 32 | 5000 | 5000 | 5000 | 5050 | 5050 | 5100 | | 32 | 4900 | 4900 | 4950 | 4950 | 5000 | 5000 | 5050 | |
| MAX | | | | | | | | MAX | | | | | | | | | |
| 3 | 2 | 4650 | 4650 | 4650 | 4600 | 4600 | 4500 | 4500 | 2 | 4900 | 4900 | 4900 | 4900 | 4900 | 4850 | 4800 | |
| | 4 | 4900 | 4900 | 4900 | 4900 | 4900 | 4750 | 4650 | 4 | 5050 | 5100 | 5100 | 5100 | 5100 | 5100 | 5050 | |
| | 6 | 5100 | 5100 | 5100 | 5050 | 5050 | 5000 | 4900 | 6 | 5150 | 5200 | 5200 | 5200 | 5200 | 5150 | 5150 | |
| | 8 | 5200 | 5200 | 5200 | 5200 | 5200 | 5150 | 5100 | 8 | 5250 | 5300 | 5300 | 5300 | 5300 | 5300 | 5300 | |
| | 10 | 5300 | 5350 | 5350 | 5350 | 5300 | 5300 | 5250 | 10 | 5350 | 5400 | 5400 | 5400 | 5400 | 5400 | 5400 | |
| | 12 | 5450 | 5450 | 5450 | 5450 | 5450 | 5450 | 5400 | 12 | 5500 | 5500 | 5500 | 5500 | 5550 | 5550 | 5550 | |
| | 14 | 5600 | 5600 | 5600 | 5600 | 5600 | 5600 | 5550 | 14 | 5600 | 5600 | 5600 | 5650 | 5650 | 5650 | 5650 | |
| | 16 | 5700 | 5700 | 5700 | 5700 | 5700 | 5700 | 5700 | 16 | 5700 | 5700 | 5750 | 5750 | 5750 | 5750 | 5800 | |
| | 18 | 5800 | 5850 | 5850 | 5850 | 5850 | 5850 | 5850 | 18 | 5800 | 5800 | 5850 | 5850 | 5900 | 5900 | 5900 | |
| | 20 | 5950 | 5950 | 6000 | 6000 | 6000 | 6000 | 6000 | 20 | 5900 | 5950 | 5950 | 6000 | 6000 | 6000 | 6000 | |

PERFORMANCE

LOADING

FUEL

* GRID SQUARE LETTER

** GRID SQUARE NUMBER

| MMI ^{Nº} | READING | LITERS ATTITUDE READING | | | | | | | READING | LITERS ATTITUDE READING | | | | | | |
|-------------------|---------|-------------------------|------|------|------|--------------|------|------|---------|-------------------------|------|------|------|-------------|------|------|
| | | C LEFT WING | | | | E RIGHT WING | | | | C RIGHT WING | | | | E LEFT WING | | |
| | | 1 | 2 | 3 | 4 | 5 | 6 | 7 | | 1 | 2 | 3 | 4 | 5 | 6 | 7 |
| 4 | 2 | 5800 | 5750 | 5750 | 5700 | 5700 | 5700 | 5700 | 2 | 5900 | 5900 | 5900 | 5900 | 5950 | 5950 | 5950 |
| | 4 | 5950 | 5900 | 5900 | 5850 | 5850 | 5800 | 5800 | 4 | 6000 | 6000 | 6000 | 6050 | 6050 | 6050 | |
| | 6 | 6050 | 6050 | 6000 | 6000 | 6000 | 6000 | 5950 | 5950 | 6 | 6100 | 6100 | 6150 | 6150 | 6150 | 6150 |
| | 8 | 6200 | 6150 | 6150 | 6150 | 6150 | 6100 | 6100 | 8 | 6200 | 6250 | 6250 | 6250 | 6250 | 6250 | 6250 |
| | 10 | 6300 | 6300 | 6300 | 6300 | 6300 | 6250 | 6250 | 10 | 6300 | 6350 | 6350 | 6350 | 6350 | 6350 | 6350 |
| | 12 | 6400 | 6400 | 6400 | 6400 | 6400 | 6400 | 6400 | 12 | 6400 | 6400 | 6450 | 6450 | 6450 | 6450 | 6450 |
| | 14 | 6500 | 6500 | 6500 | 6500 | 6500 | 6500 | 6500 | 14 | 6500 | 6500 | 6550 | 6550 | 6550 | 6550 | 6550 |
| | 16 | 6600 | 6600 | 6600 | 6600 | 6600 | 6600 | 6600 | 16 | 6550 | 6600 | 6600 | 6600 | 6600 | 6600 | 6600 |
| | 18 | 6730 | 6740 | 6750 | 6750 | 6760 | 6760 | 6770 | 18 | 6750 | 6750 | 6770 | 6790 | 6800 | 6810 | 6820 |
| | MAX | | | | | | | | MAX | | | | | | | |
| 5 | 2 | 700 | 700 | 650 | 650 | 600 | 600 | 600 | 2 | 750 | 700 | 700 | 700 | 700 | 650 | 650 |
| | 4 | 750 | 750 | 700 | 700 | 650 | 650 | 650 | 4 | 750 | 750 | 750 | 750 | 700 | 700 | 700 |
| | 6 | 750 | 750 | 750 | 750 | 700 | 700 | 700 | 6 | 800 | 800 | 750 | 750 | 750 | 750 | 750 |
| | 8 | 800 | 800 | 800 | 750 | 750 | 750 | 750 | 8 | 800 | 800 | 800 | 800 | 800 | 800 | 800 |
| | 10 | 800 | 800 | 800 | 800 | 800 | 800 | 800 | 10 | 850 | 850 | 850 | 800 | 800 | 800 | 800 |
| | 12 | 850 | 850 | 850 | 800 | 800 | 800 | 800 | 12 | 850 | 850 | 850 | 850 | 850 | 850 | 850 |
| | 14 | 850 | 850 | 850 | 850 | 850 | 850 | 850 | 14 | 900 | 900 | 850 | 850 | 850 | 850 | 850 |
| | MAX | | | | | | | | MAX | | | | | | | |

| MMI ^{Nº} | READING | LITERS ATTITUDE READING | | | | | | | READING | LITERS ATTITUDE READING | | | | | | | MMI ^{Nº} |
|-------------------|---------|-------------------------|------|------|------|------|------|------|---------|-------------------------|------|------|------|------|------|------|-------------------|
| | | D* BOTH WINGS | | | | | | | | D BOTH WINGS | | | | | | | |
| | | 1 | 2 | 3 | 4 | 5 | 6 | 7 | | 1 | 2 | 3 | 4 | 5 | 6 | 7** | |
| 2 | 2 | 2550 | 2550 | 2500 | 2500 | 2450 | 2450 | 2450 | 2 | 5900 | 5850 | 5800 | 5800 | 5800 | 5800 | 5800 | |
| | 4 | 2750 | 2700 | 2700 | 2700 | 2650 | 2650 | 2600 | 4 | 6000 | 5950 | 5950 | 5950 | 5950 | 5950 | 5950 | |
| | 6 | 2900 | 2900 | 2850 | 2850 | 2850 | 2800 | 2800 | 6 | 6100 | 6100 | 6050 | 6050 | 6050 | 6050 | 6050 | |
| | 8 | 3000 | 3000 | 2950 | 2950 | 2950 | 2950 | 2900 | 8 | 6200 | 6200 | 6200 | 6200 | 6200 | 6200 | 6200 | |
| | 10 | 3200 | 3150 | 3150 | 3150 | 3150 | 3100 | 3050 | 10 | 6300 | 6300 | 6300 | 6300 | 6300 | 6300 | 6300 | |
| | 12 | 3350 | 3350 | 3350 | 3350 | 3300 | 3300 | 3250 | 12 | 6400 | 6400 | 6400 | 6400 | 6400 | 6400 | 6400 | |
| | 14 | 3550 | 3550 | 3550 | 3500 | 3500 | 3450 | 3450 | 14 | 6500 | 6500 | 6500 | 6500 | 6500 | 6500 | 6500 | |
| | 16 | 3750 | 3750 | 3700 | 3700 | 3650 | 3650 | 3600 | 16 | 6600 | 6600 | 6600 | 6600 | 6600 | 6600 | 6600 | |
| | 18 | 3950 | 3900 | 3900 | 3850 | 3850 | 3850 | 3800 | 18 | 6750 | 6750 | 6770 | 6800 | 6800 | 6810 | 6820 | |
| | 20 | 4100 | 4100 | 4050 | 4050 | 4050 | 4000 | 4000 | MAX | | | | | | | | |
| | 22 | 4200 | 4200 | 4150 | 4150 | 4150 | 4150 | 4150 | | | | | | | | | |
| | 24 | 4350 | 4350 | 4350 | 4300 | 4300 | 4300 | 4300 | 2 | 700 | 700 | 700 | 650 | 650 | 650 | 600 | |
| | 26 | 4500 | 4500 | 4500 | 4500 | 4500 | 4500 | 4500 | 4 | 750 | 750 | 750 | 700 | 700 | 700 | 650 | |
| | 28 | 4650 | 4650 | 4650 | 4650 | 4650 | 4700 | 4700 | 6 | 800 | 800 | 750 | 750 | 750 | 750 | 700 | |
| | 30 | 4800 | 4800 | 4800 | 4850 | 4850 | 4850 | 4900 | 8 | 800 | 800 | 800 | 800 | 800 | 750 | 750 | |
| | 32 | 4950 | 4950 | 5000 | 5000 | 5000 | 5050 | 5100 | 10 | 850 | 800 | 800 | 800 | 800 | 800 | 800 | |
| | MAX | | | | | | | | 12 | 850 | 850 | 850 | 850 | 850 | 850 | 850 | |
| | 3 | 2 | 4800 | 4800 | 4800 | 4800 | 4750 | 4750 | 4600 | 14 | 850 | 850 | 850 | 850 | 850 | 850 | 850 |
| 4 | | 5000 | 5000 | 5000 | 5000 | 4950 | 4900 | 4850 | MAX | 850 | 850 | 850 | 850 | 850 | 850 | 850 | |
| 6 | | 5100 | 5150 | 5150 | 5100 | 5100 | 5100 | 5050 | | | | | | | | | |
| 8 | | 5250 | 5250 | 5250 | 5250 | 5250 | 5200 | 5200 | | | | | | | | | |
| 10 | | 5350 | 5350 | 5350 | 5400 | 5400 | 5350 | 5350 | | | | | | | | | |
| 12 | | 5450 | 5500 | 5500 | 5500 | 5500 | 5500 | 5500 | | | | | | | | | |
| 14 | | 5600 | 5600 | 5600 | 5600 | 5600 | 5600 | 5600 | | | | | | | | | |
| 16 | | 5700 | 5700 | 5700 | 5750 | 5750 | 5750 | 5750 | | | | | | | | | |
| 18 | | 5800 | 5800 | 5850 | 5850 | 5850 | 5900 | 5900 | | | | | | | | | |
| 20 | | 5900 | 5900 | 5950 | 5950 | 5950 | 6000 | 6000 | | | | | | | | | |
| MAX | | | | | | | | | | | | | | | | | |



A318/A319/A320/A321
FLIGHT CREW
OPERATING MANUAL

PERFORMANCE

LOADING

FUEL

- * GRID SQUARE LETTER
- ** GRID SQUARE NUMBER

Ident.: PER-LOD-FUL-C-00001682.0001001 / 16 NOV 11

CENTER TANK (LITERS)

| READING | LITERS ATTITUDE MONITOR READING | | | | | | | READING | LITERS ATTITUDE MONITOR READING | | | | | | |
|---------|---------------------------------|------|------|------|------|------|------|---------|---------------------------------|------|------|------|------|------|------|
| | LINES A AND G* | | | | | | | | LINES B AND F | | | | | | |
| | 1 | 2 | 3 | 4 | 5 | 6 | 7 | | 1 | 2 | 3 | 4 | 5 | 6 | 7** |
| 2 | 300 | 300 | 350 | 350 | 350 | 350 | 350 | 2 | 300 | 300 | 300 | 300 | 300 | 300 | 350 |
| 4 | 400 | 450 | 450 | 500 | 500 | 500 | 500 | 4 | 400 | 450 | 450 | 450 | 500 | 500 | 500 |
| 6 | 600 | 600 | 650 | 650 | 650 | 650 | 650 | 6 | 600 | 600 | 650 | 650 | 650 | 650 | 600 |
| 8 | 750 | 750 | 750 | 750 | 750 | 750 | 750 | 8 | 750 | 750 | 750 | 750 | 750 | 750 | 750 |
| 10 | 900 | 850 | 850 | 850 | 850 | 850 | 900 | 10 | 900 | 850 | 850 | 850 | 850 | 850 | 900 |
| 12 | 1050 | 1000 | 1000 | 1000 | 1000 | 1000 | 1050 | 12 | 1050 | 1000 | 1000 | 1000 | 1000 | 1000 | 1050 |
| 14 | 1250 | 1250 | 1200 | 1200 | 1200 | 1200 | 1200 | 14 | 1250 | 1200 | 1200 | 1200 | 1200 | 1200 | 1200 |
| 16 | 1450 | 1450 | 1400 | 1400 | 1400 | 1400 | 1400 | 16 | 1450 | 1450 | 1450 | 1450 | 1400 | 1400 | 1400 |
| 18 | 1650 | 1650 | 1600 | 1600 | 1600 | 1600 | 1600 | 18 | 1700 | 1700 | 1650 | 1650 | 1600 | 1600 | 1600 |
| 20 | 1900 | 1850 | 1850 | 1850 | 1850 | 1800 | 1800 | 20 | 1900 | 1900 | 1900 | 1850 | 1850 | 1850 | 1800 |
| 22 | 2100 | 2050 | 2050 | 2050 | 2050 | 2000 | 2000 | 22 | 2100 | 2100 | 2100 | 2050 | 2050 | 2000 | 2000 |
| 24 | 2300 | 2250 | 2250 | 2250 | 2200 | 2200 | 2150 | 24 | 2300 | 2300 | 2250 | 2250 | 2200 | 2200 | 2150 |
| 26 | 2450 | 2450 | 2450 | 2450 | 2450 | 2400 | 2350 | 26 | 2500 | 2500 | 2450 | 2450 | 2400 | 2350 | 2350 |
| 28 | 2700 | 2650 | 2650 | 2650 | 2600 | 2550 | 2550 | 28 | 2700 | 2700 | 2650 | 2650 | 2600 | 2550 | 2500 |
| 30 | 2900 | 2850 | 2850 | 2850 | 2800 | 2800 | 2750 | 30 | 2900 | 2900 | 2900 | 2850 | 2800 | 2800 | 2750 |
| 32 | 3050 | 3050 | 3050 | 3050 | 3000 | 3000 | 2950 | 32 | 3100 | 3100 | 3100 | 3050 | 3050 | 3000 | 2950 |
| 34 | 3250 | 3250 | 3250 | 3250 | 3200 | 3200 | 3150 | 34 | 3300 | 3300 | 3300 | 3250 | 3250 | 3200 | 3150 |
| 36 | 3500 | 3500 | 3450 | 3450 | 3450 | 3400 | 3400 | 36 | 3500 | 3500 | 3500 | 3450 | 3450 | 3400 | 3400 |
| 38 | 3700 | 3700 | 3700 | 3700 | 3650 | 3650 | 3600 | 38 | 3700 | 3700 | 3700 | 3700 | 3650 | 3650 | 3600 |
| 40 | 3900 | 3900 | 3900 | 3900 | 3900 | 3850 | 3800 | 40 | 3950 | 3950 | 3950 | 3900 | 3900 | 3850 | 3800 |
| 42 | 4100 | 4100 | 4100 | 4100 | 4100 | 4050 | 4050 | 42 | 4150 | 4150 | 4150 | 4100 | 4100 | 4050 | 4000 |
| 44 | 4350 | 4350 | 4350 | 4300 | 4300 | 4250 | 4250 | 44 | 4350 | 4350 | 4350 | 4300 | 4300 | 4250 | 4200 |
| 46 | 4550 | 4550 | 4550 | 4550 | 4500 | 4500 | 4450 | 46 | 4550 | 4550 | 4550 | 4550 | 4500 | 4500 | 4450 |
| 48 | 4750 | 4750 | 4750 | 4700 | 4700 | 4650 | 4650 | 48 | 4750 | 4750 | 4750 | 4750 | 4700 | 4700 | 4650 |
| 50 | 4950 | 4950 | 4950 | 4950 | 4900 | 4900 | 4850 | 50 | 4950 | 4950 | 4950 | 4950 | 4900 | 4900 | 4850 |
| 52 | 5150 | 5150 | 5150 | 5150 | 5100 | 5100 | 5050 | 52 | 5150 | 5150 | 5150 | 5150 | 5150 | 5100 | 5050 |
| 54 | 5400 | 5400 | 5400 | 5400 | 5350 | 5300 | 5250 | 54 | 5400 | 5400 | 5400 | 5400 | 5350 | 5300 | 5250 |
| 56 | 5600 | 5600 | 5600 | 5600 | 5550 | 5500 | 5450 | 56 | 5600 | 5600 | 5600 | 5600 | 5550 | 5500 | 5450 |
| 58 | 5800 | 5800 | 5800 | 5750 | 5750 | 5700 | 5650 | 58 | 5800 | 5800 | 5800 | 5800 | 5750 | 5750 | 5700 |
| 60 | 6000 | 6000 | 6000 | 5950 | 5950 | 5900 | 5900 | 60 | 6000 | 6000 | 6000 | 6000 | 5950 | 5950 | 5900 |
| 62 | 6200 | 6200 | 6200 | 6150 | 6150 | 6100 | 6100 | 62 | 6200 | 6200 | 6200 | 6200 | 6150 | 6150 | 6100 |
| 64 | 6400 | 6400 | 6400 | 6400 | 6350 | 6300 | 6300 | 64 | 6400 | 6400 | 6400 | 6400 | 6350 | 6350 | 6300 |
| 66 | 6600 | 6600 | 6600 | 6600 | 6550 | 6550 | 6500 | 66 | 6600 | 6600 | 6600 | 6600 | 6550 | 6550 | 6500 |
| 68 | 6800 | 6800 | 6750 | 6750 | 6750 | 6700 | 6700 | 68 | 6800 | 6800 | 6800 | 6800 | 6750 | 6750 | 6700 |
| 70 | 7000 | 6950 | 6950 | 6950 | 6900 | 6900 | 6900 | 70 | 7000 | 7000 | 7000 | 6950 | 6950 | 6950 | 6900 |
| 72 | 7200 | 7200 | 7150 | 7150 | 7100 | 7100 | 7050 | 72 | 7200 | 7200 | 7150 | 7150 | 7150 | 7100 | 7100 |
| 74 | 7400 | 7400 | 7350 | 7350 | 7300 | 7300 | 7300 | 74 | 7400 | 7400 | 7350 | 7350 | 7350 | 7300 | 7300 |
| 76 | 7600 | 7600 | 7600 | 7550 | 7550 | 7500 | 7500 | 76 | 7600 | 7600 | 7600 | 7550 | 7550 | 7500 | 7500 |
| 78 | 7850 | 7800 | 7800 | 7800 | 7750 | 7700 | 7700 | 78 | 7800 | 7800 | 7800 | 7750 | 7750 | 7700 | 7700 |
| MAX | 7950 | 7900 | 7900 | 7900 | 7850 | 7800 | 7800 | MAX | 7900 | 7900 | 7850 | 7850 | 7850 | 7800 | 7800 |

PERFORMANCE

LOADING

FUEL

| M M I N G | LITERS ATTITUDE MONITOR READING LINES C AND E | | | | | | |
|-----------------------|---|------|------|------|------|------|------|
| | 1 | 2 | 3 | 4 | 5 | 6 | 7 |
| | 2 | 250 | 300 | 300 | 300 | 300 | 300 |
| 4 | 400 | 450 | 450 | 500 | 500 | 500 | 450 |
| 6 | 600 | 600 | 650 | 650 | 650 | 600 | 600 |
| 8 | 750 | 750 | 750 | 750 | 750 | 750 | 750 |
| 10 | 850 | 850 | 850 | 850 | 850 | 850 | 850 |
| 12 | 1050 | 1000 | 1000 | 1000 | 1000 | 1000 | 1000 |
| 14 | 1250 | 1200 | 1200 | 1200 | 1200 | 1200 | 1200 |
| 16 | 1450 | 1450 | 1450 | 1400 | 1400 | 1400 | 1400 |
| 18 | 1650 | 1650 | 1650 | 1600 | 1600 | 1600 | 1600 |
| 20 | 1900 | 1900 | 1900 | 1900 | 1900 | 1850 | 1800 |
| 22 | 2100 | 2100 | 2100 | 2100 | 2050 | 2050 | 2000 |
| 24 | 2300 | 2300 | 2250 | 2250 | 2250 | 2200 | 2200 |
| 26 | 2500 | 2500 | 2450 | 2450 | 2400 | 2400 | 2350 |
| 28 | 2700 | 2650 | 2650 | 2650 | 2600 | 2600 | 2550 |
| 30 | 2900 | 2900 | 2850 | 2850 | 2800 | 2800 | 2750 |
| 32 | 3100 | 3100 | 3100 | 3100 | 3050 | 3050 | 3000 |
| 34 | 3300 | 3300 | 3300 | 3250 | 3250 | 3200 | 3200 |
| 36 | 3500 | 3500 | 3500 | 3500 | 3450 | 3450 | 3400 |
| 38 | 3700 | 3700 | 3700 | 3700 | 3700 | 3650 | 3600 |
| 40 | 3950 | 3950 | 3950 | 3950 | 3900 | 3900 | 3850 |
| 42 | 4150 | 4150 | 4150 | 4150 | 4100 | 4100 | 4050 |
| 44 | 4350 | 4350 | 4350 | 4350 | 4300 | 4300 | 4250 |
| 46 | 4550 | 4550 | 4550 | 4550 | 4500 | 4500 | 4450 |
| 48 | 4750 | 4750 | 4750 | 4750 | 4750 | 4700 | 4650 |
| 50 | 4950 | 4950 | 4950 | 4950 | 4900 | 4900 | 4850 |
| 52 | 5150 | 5150 | 5150 | 5150 | 5100 | 5100 | 5050 |
| 54 | 5400 | 5400 | 5400 | 5400 | 5350 | 5300 | 5250 |
| 56 | 5600 | 5600 | 5600 | 5600 | 5550 | 5500 | 5450 |
| 58 | 5800 | 5800 | 5800 | 5800 | 5750 | 5700 | 5650 |
| 60 | 6000 | 6000 | 6000 | 6000 | 5950 | 5950 | 5900 |
| 62 | 6200 | 6200 | 6200 | 6200 | 6150 | 6100 | 6100 |
| 64 | 6400 | 6400 | 6400 | 6400 | 6350 | 6300 | 6300 |
| 66 | 6600 | 6600 | 6600 | 6600 | 6550 | 6550 | 6500 |
| 68 | 6800 | 6800 | 6800 | 6750 | 6750 | 6700 | 6700 |
| 70 | 7000 | 7000 | 7000 | 6950 | 6950 | 6900 | 6900 |
| 72 | 7200 | 7200 | 7150 | 7150 | 7150 | 7150 | 7100 |
| 74 | 7400 | 7400 | 7400 | 7350 | 7350 | 7300 | 7300 |
| 76 | 7600 | 7600 | 7600 | 7550 | 7550 | 7500 | 7500 |
| 78 | 7800 | 7800 | 7800 | 7750 | 7750 | 7700 | 7700 |
| MAX | 7900 | 7900 | 7850 | 7850 | 7850 | 7800 | 7800 |

| M M I N G | LITERS ATTITUDE MONITOR READING LINES D | | | | | | |
|-----------------------|---|------|------|------|------|------|------|
| | 1 | 2 | 3 | 4 | 5 | 6 | 7 |
| | 2 | 300 | 300 | 300 | 300 | 300 | 300 |
| 4 | 450 | 450 | 500 | 500 | 500 | 500 | 500 |
| 6 | 600 | 600 | 650 | 650 | 650 | 650 | 600 |
| 8 | 750 | 750 | 750 | 750 | 750 | 750 | 750 |
| 10 | 900 | 900 | 900 | 900 | 900 | 900 | 900 |
| 12 | 1050 | 1000 | 1000 | 1000 | 1000 | 1000 | 1050 |
| 14 | 1250 | 1250 | 1200 | 1200 | 1200 | 1200 | 1200 |
| 16 | 1500 | 1450 | 1450 | 1450 | 1450 | 1400 | 1400 |
| 18 | 1700 | 1700 | 1700 | 1650 | 1650 | 1650 | 1600 |
| 20 | 1900 | 1900 | 1900 | 1900 | 1900 | 1850 | 1850 |
| 22 | 2100 | 2100 | 2100 | 2100 | 2050 | 2050 | 2000 |
| 24 | 2300 | 2300 | 2300 | 2250 | 2250 | 2200 | 2200 |
| 26 | 2500 | 2500 | 2450 | 2450 | 2400 | 2400 | 2350 |
| 28 | 2700 | 2700 | 2700 | 2650 | 2600 | 2600 | 2550 |
| 30 | 2900 | 2900 | 2900 | 2900 | 2850 | 2850 | 2750 |
| 32 | 3100 | 3100 | 3100 | 3100 | 3050 | 3050 | 3000 |
| 34 | 3300 | 3300 | 3300 | 3300 | 3250 | 3250 | 3200 |
| 36 | 3500 | 3500 | 3500 | 3500 | 3450 | 3450 | 3400 |
| 38 | 3700 | 3750 | 3750 | 3750 | 3700 | 3700 | 3650 |
| 40 | 3950 | 3950 | 3950 | 3950 | 3900 | 3900 | 3850 |
| 42 | 4150 | 4150 | 4150 | 4150 | 4100 | 4100 | 4050 |
| 44 | 4350 | 4350 | 4350 | 4350 | 4300 | 4300 | 4250 |
| 46 | 4550 | 4550 | 4550 | 4550 | 4500 | 4500 | 4450 |
| 48 | 4750 | 4750 | 4750 | 4750 | 4750 | 4700 | 4650 |
| 50 | 4950 | 4950 | 4950 | 4950 | 4900 | 4900 | 4850 |
| 52 | 5200 | 5200 | 5200 | 5150 | 5100 | 5100 | 5050 |
| 54 | 5400 | 5400 | 5400 | 5400 | 5350 | 5300 | 5250 |
| 56 | 5600 | 5600 | 5600 | 5600 | 5550 | 5500 | 5450 |
| 58 | 5800 | 5800 | 5800 | 5800 | 5750 | 5700 | 5650 |
| 60 | 6000 | 6000 | 6000 | 6000 | 5950 | 5950 | 5900 |
| 62 | 6200 | 6200 | 6200 | 6200 | 6150 | 6150 | 6100 |
| 64 | 6400 | 6400 | 6400 | 6400 | 6350 | 6350 | 6300 |
| 66 | 6600 | 6600 | 6600 | 6600 | 6550 | 6550 | 6500 |
| 68 | 6800 | 6800 | 6800 | 6800 | 6750 | 6750 | 6700 |
| 70 | 7000 | 7000 | 7000 | 7000 | 6950 | 6950 | 6900 |
| 72 | 7200 | 7200 | 7200 | 7150 | 7150 | 7150 | 7100 |
| 74 | 7400 | 7400 | 7400 | 7350 | 7350 | 7350 | 7300 |
| 76 | 7600 | 7600 | 7600 | 7550 | 7550 | 7550 | 7500 |
| 78 | 7800 | 7800 | 7800 | 7750 | 7750 | 7700 | 7700 |
| MAX | 7900 | 7900 | 7900 | 7900 | 7850 | 7850 | 7800 |

* GRID SQUARE LETTER

** GRID SQUARE NUMBER

| | |
|---|---|
|  <p>A318/A319/A320/A321 FLIGHT CREW OPERATING MANUAL</p> | <p>PERFORMANCE</p> <p>LOADING</p> <p>WEIGHT AND BALANCE - LOAD AND TRIM SHEET</p> |
|---|---|

GENERAL

Ident.: PER-LOD-WBA-LTS-00001685.0001001 / 09 DEC 09
Applicable to: ALL

This chart allows the determination of Aircraft CG location (MAC) function of dry operating weight, pantry adjustment, cargo loads, passengers and fuel on board.
 The operational limits shown on the load and trim sheet are more restrictive than the certified limits because error margins have been taken into account.

The load and trim sheet needs to be updated when :

- a modification which changes the aircraft certified limits is included or
- a modification (cabin layout, cargo arrangement ...) which influences the operational limits is made.

It is the airline responsibility to define a load and trim sheet and to keep it up to date. *Refer to PER-LOD-WBA-LTS DESCRIPTION* is a description of the Load and Trim Sheet utilization (*Refer to PER-LOD-WBA-LTS LOAD AND TRIM SHEET*), for a typical passenger arrangement.
 Refer to customized load and trim sheet for preparing a revenue flight.

DATA

Ident.: PER-LOD-WBA-LTS-00001686.0002001 / 23 JUN 15
Applicable to: ALL

Dry Operating Weight = 42 500 kg and CG = 27 % (H-arm = 18.93 m)
 Deviation or adjustment = +100 kg in zone F
 Cargo = 5 500 kg with the following distribution:
 cargo 1 = 2 000 kg; cargo 3 = 1 500 kg; cargo 4 = 1 500 kg; cargo 5 = 500 kg
 Passengers = 145 PAX with the following distribution:
 cabin OA = 50; cabin OB = 55; cabin OC = 40
 Ramp Fuel = 13 200 kg; Taxi Fuel = 200 kg; Fuel Density = 0.785 kg/l

DESCRIPTION

Ident.: PER-LOD-WBA-LTS-00001687.0002001 / 12 FEB 11

Applicable to: ALL

- a. Enter Master data in (1).
- b. Compute Dry Operating Weight Index using the formula indicated in (2) and report in (3).
- c. Dry Operating Index = 53.4.
- d. Enter weight deviation or adjustment in (4) and read corresponding index variation in (5): +1.43.
- e. Calculate corrected index and report in (6): 54.83.
- f. Enter master data in table (7) and determine Zero Fuel Weight: 60 280 kg and Takeoff Weight: 73 280 kg.
- g. Enter cargo weight and passenger number per compartment in (8).
- h. Enter index scale (9) with corrected index and proceed through cargo and passenger scales (10).
- i. From the final point draw a vertical line which intersects (12) the zero fuel weight horizontal line (11).
- j. Check if the intersection point is within the Zero Fuel Weight operational limits, if not rearrange cargo loading.
- k. Read in table (13) the fuel index correction corresponding to Ramp Fuel Weight (13 200 kg) and Fuel Density (0.785 kg/l).
 This example will be continued assuming the FUEL INDEX = -2 was found. Carry in fuel scale (14).
- l. From this point draw a vertical line which intersects (16) the takeoff weight horizontal line (15).
- m. Check if the intersection point is within the Takeoff Weight operational limits.
- n. Read zero fuel weight and CG position: 32.7 % and fill in table (17).
- o. Read takeoff CG position: 30.5 % and fill in table (18).

CAUTION

If there is no customized trim sheet for your airline in this section, do not use the information enclosed herein for day to day operation as margins and load CG vary with cabin and cargo layout.

Note: When referring to CG lower than 27 %, an operational margin is taken into account. It is the reason why performance at forward CG (lower than 25 %) must be used for operational CG lower than 27 %.



A318/A319/A320/A321
FLIGHT CREW
OPERATING MANUAL

PERFORMANCE

LOADING

WEIGHT AND BALANCE - LOAD AND TRIM SHEET

LOAD AND TRIM SHEET

Ident.: PER-LOD-WBA-LTS-00001688.0002001 / 23 FEB 11

Applicable to: ALL



LOAD and TRIM SHEET

A320-200
VERSION : 180 YC

| DRY OPERATING WEIGHT CONDITIONS | |
|--|--------------|
| WEIGHT (kg) | lb-oz (m) |
| 1 42 500 | 18.93 |
| 2 $(H_{max} - 18.549) \times W$ 1000 - 50 | |
| 3 WY OPERATING WEIGHT INDEX | 53.4 |

AIRCRAFT REGISTER: _____

DATE: _____ PREPARED BY: _____

FLT No: _____ CAPT. SIGNATURE: _____

FROM: _____ TO: _____

| | |
|---|----------------|
| DRY OPERATING WEIGHT | 42 500 |
| WEIGHT DEVIATION (FAVOUR) | + 100 |
| CORRECTED DRY OPERATING WEIGHT | 42 600 |
| CARGO | 5 500 |
| PASSENGERS: $114 \times 1 \times 18 \times 1 =$ | 7 2 052 |
| ZERO FUEL WEIGHT | 60 280 |
| RAMP FUEL: | 13 200 |
| TAXI FUEL | 200 |
| TAKEOFF WEIGHT | 73 280 |

| 4 ZONES | E | F |
|-----------------------|---|------|
| WEIGHT DEVIATION (kg) | D | +100 |

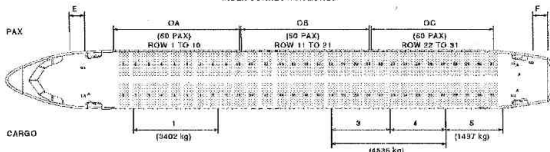

| BASIC INDEX CORRECTION | |
|------------------------------|-------------|
| DRY OPERAT. WEIGHT DEVIATION | ZONES E F |
| +100 kg | -1.22 +1.43 |
| -100 kg | +1.22 -1.43 |

5 INDEX CORRECTION **1.43**

| 8 ZONES | NEW WEIGHT (kg) |
|----------|-----------------|
| GO 1 | 2000 |
| CARGO 3 | 1500 |
| CARGO 4 | 1500 |
| CARGO 5 | 500 |
| CABIN OA | 50 |
| CABIN OB | 55 |
| CABIN OC | 40 |

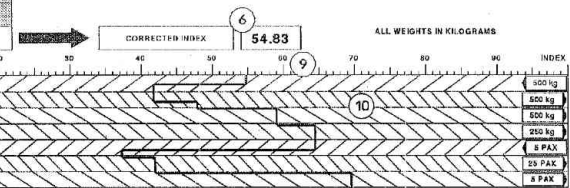

| 15 FUEL INDEX CORRECTION | |
|--------------------------|--------------|
| Weight (kg) | Index |
| 3500 | +1 1500 -2 |
| 4000 | +1 12000 -2 |
| 4500 | +0 12500 -2 |
| 5000 | +0 13000 -2 |
| 5500 | -1 13500 -3 |
| 6000 | -1 14000 -4 |
| 6500 | -2 14500 -4 |
| 7000 | -2 15000 -5 |
| 7500 | -2 15500 -6 |
| 8000 | -3 16000 -7 |
| 8500 | -3 16500 -8 |
| 9000 | -3 17000 -9 |
| 9500 | -3 17500 -9 |
| 10000 | -3 18000 -10 |
| 10500 | -3 18500 -11 |
| 11000 | -3 FULL -11 |

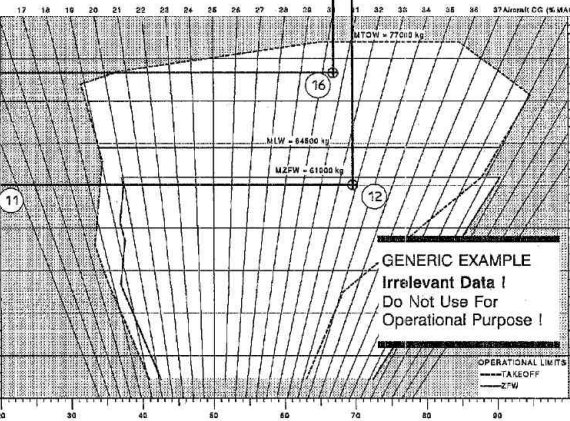

| 18 TAKEOFF | |
|------------|-------|
| CG % MAC | INDEX |
| 30 | 10 |
| 35 | 15 |

| 17 ZFW CDU INPUT | |
|--------------------|---------------------|
| WEIGHT (kg x 1000) | AIRCRAFT CG (% MAC) |
| 16 | 10 |
| 13 | 12 |
| 13 | 17 |

CAUTION: WHEN THE T.O. CG IS LOWER THAN 27% MAC THE BASIC PERFORMANCE MUST BE CORRECTED
- T.O. : Make CG correction at use appropriate RTOW chart.
- LOG : Make CG correction at LOG speed and distance.

FUEL INDEX TABLE

GENERAL

Ident.: PER-LOD-WBA-FIT-10-00012775.0002001 / 21 MAR 17

Applicable to: ALL

The fuel index table has been established assuming a fuel distribution in accordance with refuel distribution given in section *Refer to DSC-28-10-70 Refueling - Defueling* of this volume. If after refueling the actual distribution deviates from the chart values, the actual and the trim sheet CG will show a discrepancy. The following tables allow to determine the fuel index taking into account the actual fuel quantity in each tank. To determine the actual takeoff CG enter the tables with the actual fuel quantities in each tank, read the fuel index for each tank and use their sum to enter the trim sheet. Check that the actual CG is inside the operational limits. If the CG is outside the limits transfer fuel to achieve a distribution in accordance with the chart or rearrange the load.

Note: These tables are valid only when used with the following formula for the index:

$$I = W \times (H\text{-arm} - 18.85) / 1\,000 + K \text{ or } I = [(CG - 25) \times W \times 0.000042] + K$$

(Weight in kg, H-arm in m)

DATA : Fuel in left inner fuel tank = 4 500 kg
 Fuel in right inner fuel tank = 4 500 kg
 Fuel in left outer fuel tank = 200 kg
 Fuel in right outer fuel tank = FULL
 Fuel in center tank = 0 kg

| | | Weight | Index | |
|--------------|-------|--------|-------|---|
| Inner tank | Left | 4 500 | - | 3 |
| | Right | 4 500 | - | 3 |
| Outer tank | Left | 200 | | 0 |
| | Right | 691 | + | 2 |
| Center tank | | 0 | | 0 |
| TOTAL | | 9 891 | - | 4 |

Enter the trim sheet with a fuel index of -4



A318/A319/A320/A321
FLIGHT CREW
OPERATING MANUAL

PERFORMANCE

LOADING

WEIGHT AND BALANCE - FUEL INDEX TABLES

FUEL INDEX TABLE FOR INNER TANK

Ident.: PER-LOD-WBA-FIT-10-00012776.0001001 / 25 JUL 12

Applicable to: ALL

Note: These tables are valid only when used with the following formulae for the index:
 $I = W \times (H - \text{arm} - 18.85) / 1\,000 + K$ or $I = [(CG - 25) \times W \times 0.000042] + K$ (Weight in kg, H-arm in m)

| Weight | Index |
|--------|-------|
| 500 | -1 |
| 1 000 | -1 |
| 1 500 | -2 |
| 2 000 | -2 |
| 2 500 | -2 |
| 3 000 | -3 |
| 3 500 | -3 |
| 4 000 | -3 |
| 4 500 | -3 |
| 5 000 | -3 |
| FULL | -2 |

FUEL INDEX TABLE FOR OUTER TANK

Ident.: PER-LOD-WBA-FIT-10-00012777.0001001 / 25 JUL 12

Applicable to: ALL

Note: These tables are valid only when used with the following formulae for the index:
 $I = W \times (H - \text{arm} - 18.85) / 1\,000 + K$ or $I = [(CG - 25) \times W \times 0.000042] + K$ (Weight in kg, H-arm in m)

| Weight | Index |
|--------|-------|
| 250 | 1 |
| 500 | 1 |
| FULL | 2 |



A318/A319/A320/A321
FLIGHT CREW
OPERATING MANUAL

PERFORMANCE

LOADING

WEIGHT AND BALANCE - FUEL INDEX TABLES

FUEL INDEX TABLE FOR CENTER TANK

Ident.: PER-LOD-WBA-FIT-10-00012778.0001001 / 25 JUL 12

Applicable to: ALL

Note: These tables are valid only when used with the following formulae for the index:
 $I = W \times (H - \text{arm} - 18.85) / 1\,000 + K$ or $I = [(CG - 25) \times W \times 0.000042] + K$ (Weight in kg, H-arm in m)

| Weight | Index |
|--------|-------|
| 500 | -1 |
| 1 000 | -1 |
| 1 500 | -2 |
| 2 000 | -3 |
| 2 500 | -3 |
| 3 000 | -4 |
| 3 500 | -5 |
| 4 000 | -6 |
| 4 500 | -7 |
| 5 000 | -7 |
| 5 500 | -8 |
| 6 000 | -9 |
| FULL | -10 |



A318/A319/A320/A321
FLIGHT CREW
OPERATING MANUAL

PERFORMANCE

LOADING

WEIGHT AND BALANCE - FUEL INDEX TABLES

Intentionally left blank

PERFORMANCE

OPERATING DATA

Intentionally left blank

PER-OPD-GEN GENERAL

| | |
|--|---|
| CONVERSIONS - IAS . MACH - TAS . MACH - SAT . TAT..... | A |
| INTERNATIONAL STANDARD ATMOSPHERE (ISA)..... | B |
| CONVERSIONS - QNH - QFE - PRESSURE ALTITUDE..... | C |
| CONVERSIONS QFE HPA - IN. HG - FT..... | D |
| WIND COMPONENTS (FOR TAKEOFF AND LANDING)..... | E |
| ALTITUDE TEMPERATURE CORRECTION..... | F |

PER-OPD-CON GROUND DISTANCE/AIR DISTANCE CONVERSION

PER-OPD-CON-AEO ALL ENGINES OPERATIVE

| | |
|-----------------------------------|---|
| GENERAL..... | A |
| M.78..... | B |
| LONG RANGE SPEED UP TO FL270..... | C |
| LONG RANGE SPEED ABOVE FL270..... | D |

PER-OPD-CON-OEI ONE ENGINE INOPERATIVE

| | |
|-----------------------|---|
| GENERAL..... | A |
| LONG RANGE SPEED..... | B |
| FIXED SPEEDS..... | C |



A318/A319/A320/A321
FLIGHT CREW
OPERATING MANUAL

**PERFORMANCE
OPERATING DATA**

PRELIMINARY PAGES - TABLE OF CONTENTS

Intentionally left blank

CONVERSIONS - IAS . MACH - TAS . MACH - SAT . TAT

Ident.: PER-OPD-GEN-00001962.0001001 / 23 FEB 11

Applicable to: ALL

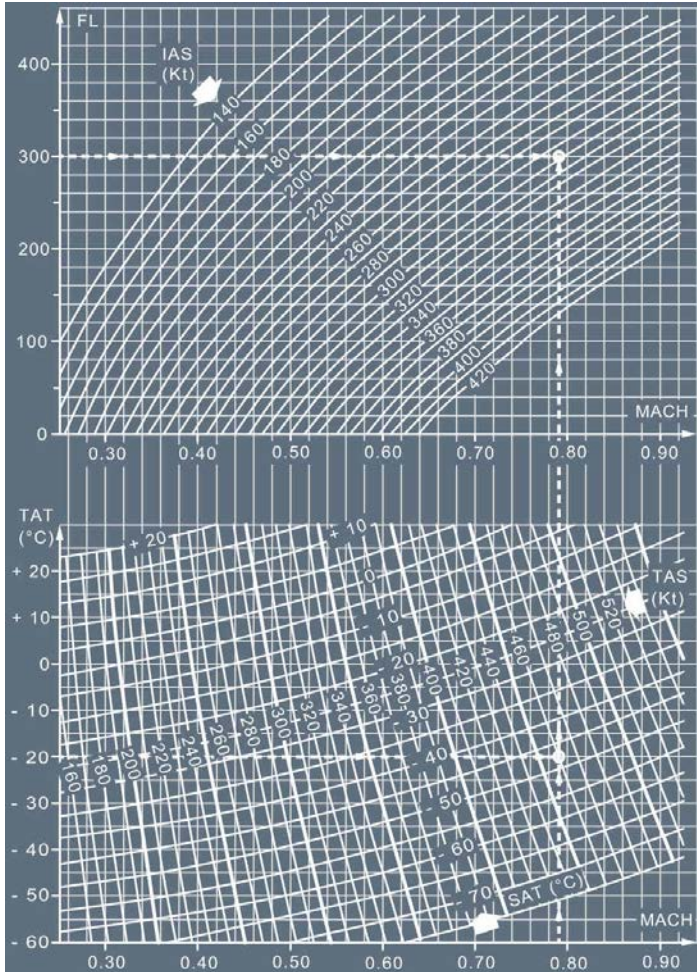

INTERNATIONAL STANDARD ATMOSPHERE (ISA)

Ident.: PER-OPD-GEN-00001963.0001001 / 09 DEC 09

Applicable to: ALL

| ALTITUDE (Feet) | TEMP (°C) | PRESSURE | | | PRESSURE RATIO $\sigma = P / P_0$ | DENSITY $\sigma = \rho / \rho_0$ | SPEED OF SOUND (a) (kt) | ALTITUDE (meters) |
|--------------------|--------------|----------|-------|---------|---|-------------------------------------|-------------------------------|----------------------|
| | | hPa | PS.I. | in. Hg. | | | | |
| 40,000 | -56.5 | 188 | 2.72 | 5.54 | 0.1851 | 0.2462 | 573 | 12,192 |
| 39,000 | -56.5 | 197 | 2.85 | 5.81 | 0.1942 | 0.2563 | 573 | 11,887 |
| 38,000 | -56.5 | 206 | 2.99 | 6.10 | 0.2038 | 0.2710 | 573 | 11,582 |
| 37,000 | -56.5 | 217 | 3.14 | 6.40 | 0.2138 | 0.2844 | 573 | 11,278 |
| 36,000 | -56.3 | 227 | 3.30 | 6.71 | 0.2243 | 0.2961 | 573 | 10,973 |
| 35,000 | -54.3 | 238 | 3.46 | 7.04 | 0.2353 | 0.3099 | 576 | 10,668 |
| 34,000 | -52.4 | 250 | 3.63 | 7.38 | 0.2467 | 0.3220 | 579 | 10,363 |
| 33,000 | -50.4 | 262 | 3.80 | 7.74 | 0.2586 | 0.3345 | 581 | 10,058 |
| 32,000 | -48.4 | 274 | 3.98 | 8.11 | 0.2709 | 0.3473 | 584 | 9,754 |
| 31,000 | -46.4 | 287 | 4.17 | 8.49 | 0.2837 | 0.3605 | 586 | 9,449 |
| 30,000 | -44.4 | 301 | 4.36 | 8.89 | 0.2970 | 0.3741 | 589 | 9,144 |
| 29,000 | -42.5 | 315 | 4.57 | 9.30 | 0.3107 | 0.3881 | 591 | 8,839 |
| 28,000 | -40.5 | 329 | 4.78 | 9.73 | 0.3250 | 0.4025 | 594 | 8,534 |
| 27,000 | -38.5 | 344 | 4.99 | 10.17 | 0.3398 | 0.4173 | 597 | 8,230 |
| 26,000 | -36.5 | 360 | 5.22 | 10.63 | 0.3552 | 0.4325 | 599 | 7,925 |
| 25,000 | -34.5 | 376 | 5.45 | 11.10 | 0.3711 | 0.4481 | 602 | 7,620 |
| 24,000 | -32.5 | 393 | 5.70 | 11.60 | 0.3876 | 0.4642 | 604 | 7,315 |
| 23,000 | -30.6 | 410 | 5.95 | 12.11 | 0.4046 | 0.4806 | 607 | 7,010 |
| 22,000 | -28.6 | 428 | 6.21 | 12.64 | 0.4223 | 0.4975 | 609 | 6,706 |
| 21,000 | -26.6 | 446 | 6.47 | 13.18 | 0.4406 | 0.5150 | 611 | 6,401 |
| 20,000 | -24.6 | 466 | 6.75 | 13.75 | 0.4595 | 0.5328 | 614 | 6,096 |
| 19,000 | -22.6 | 485 | 7.04 | 14.34 | 0.4791 | 0.5511 | 616 | 5,791 |
| 18,000 | -20.7 | 506 | 7.34 | 14.94 | 0.4994 | 0.5699 | 619 | 5,486 |
| 17,000 | -18.7 | 527 | 7.65 | 15.57 | 0.5203 | 0.5892 | 621 | 5,182 |
| 16,000 | -16.7 | 549 | 7.97 | 16.22 | 0.5420 | 0.6090 | 624 | 4,877 |
| 15,000 | -14.7 | 572 | 8.29 | 16.89 | 0.5643 | 0.6292 | 626 | 4,572 |
| 14,000 | -12.7 | 595 | 8.63 | 17.58 | 0.5875 | 0.6500 | 628 | 4,267 |
| 13,000 | -10.8 | 619 | 8.99 | 18.29 | 0.6113 | 0.6713 | 631 | 3,962 |
| 12,000 | -8.8 | 644 | 9.35 | 19.03 | 0.6360 | 0.6932 | 633 | 3,658 |
| 11,000 | -6.8 | 670 | 9.72 | 19.79 | 0.6614 | 0.7156 | 636 | 3,353 |
| 10,000 | -4.8 | 697 | 10.10 | 20.58 | 0.6877 | 0.7385 | 638 | 3,048 |
| 9,000 | -2.8 | 724 | 10.51 | 21.39 | 0.7148 | 0.7620 | 640 | 2,743 |
| 8,000 | -0.8 | 753 | 10.92 | 22.22 | 0.7428 | 0.7860 | 643 | 2,438 |
| 7,000 | +1.1 | 782 | 11.34 | 23.09 | 0.7716 | 0.8106 | 645 | 2,134 |
| 6,000 | +3.1 | 812 | 11.78 | 23.98 | 0.8014 | 0.8359 | 647 | 1,829 |
| 5,000 | +5.1 | 843 | 12.23 | 24.90 | 0.8320 | 0.8617 | 650 | 1,524 |
| 4,000 | +7.1 | 875 | 12.69 | 25.84 | 0.8637 | 0.8881 | 652 | 1,219 |
| 3,000 | +9.1 | 908 | 13.17 | 26.82 | 0.8962 | 0.9151 | 654 | 914 |
| 2,000 | +11.0 | 942 | 13.67 | 27.82 | 0.9298 | 0.9428 | 656 | 610 |
| 1,000 | +13.0 | 977 | 14.17 | 28.86 | 0.9644 | 0.9711 | 659 | 305 |
| 0 | +15.0 | 1013 | 14.70 | 29.92 | 1.0000 | 1.0000 | 661 | 0 |
| -1,000 | +17.0 | 1050 | 15.23 | 31.02 | 1.0366 | 1.0295 | 664 | -305 |



A318/A319/A320/A321
FLIGHT CREW
OPERATING MANUAL

**PERFORMANCE
OPERATING DATA**

GENERAL

CONVERSIONS - QNH - QFE - PRESSURE ALTITUDE

Ident.: PER-OPD-GEN-00001964.0001001 / 09 DEC 09

Applicable to: ALL

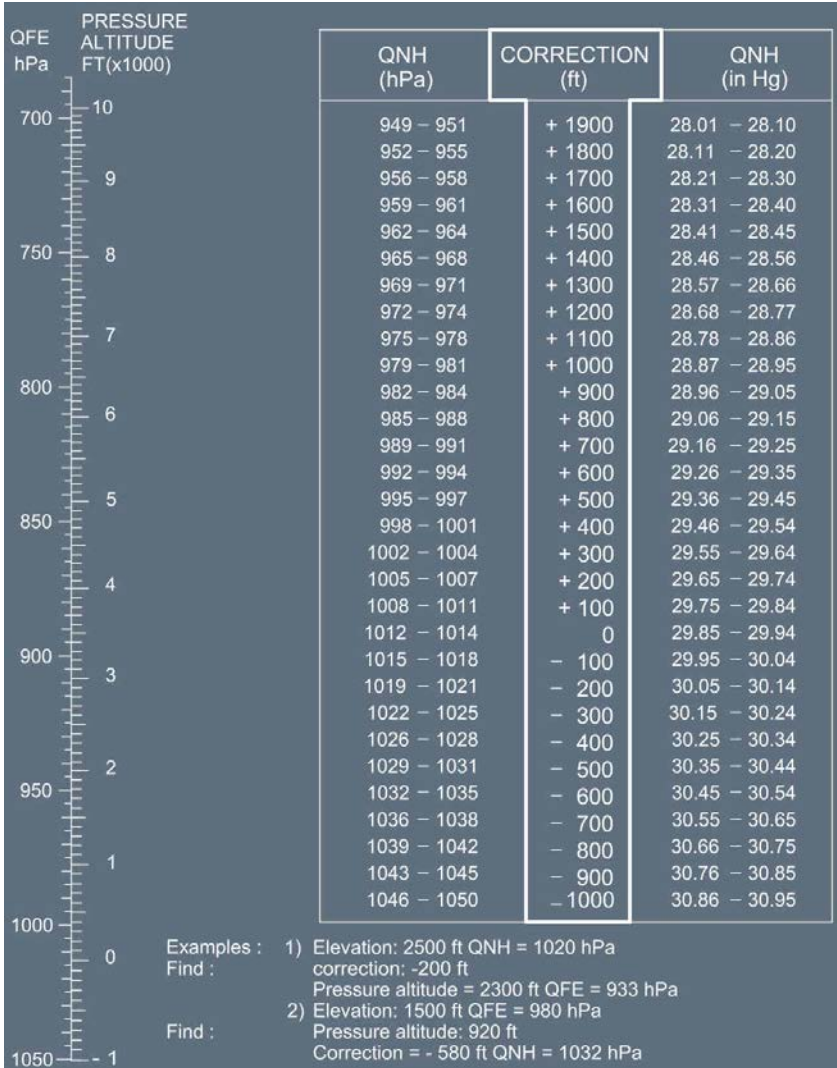



A318/A319/A320/A321
FLIGHT CREW
OPERATING MANUAL

**PERFORMANCE
OPERATING DATA**

GENERAL

CONVERSIONS QFE HPA - IN. HG - FT

Ident.: PER-OPD-GEN-00001965.0001001 / 08 FEB 11

Applicable to: ALL

| QFE hPa | in. Hg | PRESS. ALT. ft | QFE hPa | in. Hg | PRESS. ALT. ft | QFE hPa | in. Hg | PRESS. ALT. ft |
|------------|--------|----------------------|------------|--------|----------------------|------------|--------|----------------------|
| 1050 | 31.01 | - 989 | 960 | 28.35 | 1486 | 870 | 25.69 | 4157 |
| 1048 | 30.95 | - 936 | 958 | 28.29 | 1543 | 868 | 25.63 | 4219 |
| 1046 | 30.89 | - 883 | 956 | 28.23 | 1601 | 866 | 25.57 | 4281 |
| 1044 | 30.83 | - 830 | 954 | 28.17 | 1658 | 864 | 25.51 | 4343 |
| 1042 | 30.77 | - 776 | 952 | 28.11 | 1715 | 862 | 25.45 | 4405 |
| 1040 | 30.71 | - 723 | 950 | 28.05 | 1773 | 860 | 25.40 | 4468 |
| 1038 | 30.65 | - 669 | 948 | 27.99 | 1831 | 858 | 25.34 | 4531 |
| 1036 | 30.59 | - 615 | 946 | 27.94 | 1889 | 856 | 25.28 | 4593 |
| 1034 | 30.53 | - 562 | 944 | 27.88 | 1947 | 854 | 25.22 | 4656 |
| 1032 | 30.47 | - 508 | 942 | 27.82 | 2005 | 852 | 25.16 | 4718 |
| 1030 | 30.42 | - 454 | 940 | 27.76 | 2062 | 850 | 25.10 | 4781 |
| 1028 | 30.36 | - 400 | 938 | 27.70 | 2120 | 848 | 25.04 | 4844 |
| 1026 | 30.30 | - 346 | 936 | 27.64 | 2178 | 846 | 24.98 | 4907 |
| 1024 | 30.24 | - 292 | 934 | 27.58 | 2236 | 844 | 24.92 | 4970 |
| 1022 | 30.18 | - 238 | 932 | 27.52 | 2294 | 842 | 24.86 | 5033 |
| 1020 | 30.12 | - 184 | 930 | 27.46 | 2353 | 840 | 24.81 | 5097 |
| 1018 | 30.06 | - 129 | 928 | 27.40 | 2412 | 838 | 24.75 | 5161 |
| 1016 | 30.00 | - 74 | 926 | 27.34 | 2471 | 836 | 24.69 | 5225 |
| 1014 | 29.94 | - 20 | 924 | 27.29 | 2530 | 834 | 24.63 | 5289 |
| 1012 | 29.88 | 34 | 922 | 27.23 | 2589 | 832 | 24.57 | 5353 |
| 1010 | 29.83 | 89 | 920 | 27.17 | 2647 | 830 | 24.51 | 5417 |
| 1008 | 29.77 | 144 | 918 | 27.11 | 2707 | 828 | 24.45 | 5481 |
| 1006 | 29.71 | 199 | 916 | 27.05 | 2767 | 826 | 24.39 | 5545 |
| 1004 | 29.65 | 254 | 914 | 26.99 | 2826 | 824 | 24.33 | 5610 |
| 1002 | 29.59 | 309 | 912 | 26.93 | 2885 | 822 | 24.27 | 5675 |
| 1000 | 29.53 | 364 | 910 | 26.87 | 2944 | 820 | 24.21 | 5740 |
| 998 | 29.47 | 419 | 908 | 26.81 | 3004 | 818 | 24.16 | 5805 |
| 996 | 29.41 | 475 | 906 | 26.75 | 3064 | 816 | 24.10 | 5870 |
| 994 | 29.35 | 530 | 904 | 26.70 | 3124 | 814 | 24.04 | 5935 |
| 992 | 29.29 | 586 | 902 | 26.64 | 3183 | 812 | 23.98 | 6000 |
| 990 | 29.23 | 641 | 900 | 26.58 | 3243 | 810 | 23.92 | 6065 |
| 988 | 29.18 | 697 | 898 | 26.52 | 3303 | 808 | 23.86 | 6131 |
| 986 | 29.12 | 753 | 896 | 26.46 | 3363 | 806 | 23.80 | 6197 |
| 984 | 29.06 | 809 | 894 | 26.40 | 3424 | 804 | 23.74 | 6263 |
| 982 | 29.00 | 865 | 892 | 26.34 | 3484 | 802 | 23.68 | 6329 |
| 980 | 28.94 | 921 | 890 | 26.28 | 3545 | 800 | 23.62 | 6394 |
| 978 | 28.88 | 977 | 888 | 26.22 | 3606 | 798 | 23.56 | 6461 |
| 976 | 28.82 | 1033 | 886 | 26.16 | 3667 | 796 | 23.51 | 6528 |
| 974 | 28.76 | 1089 | 884 | 26.10 | 3728 | 794 | 23.45 | 6595 |
| 972 | 28.70 | 1145 | 882 | 26.05 | 3789 | 792 | 23.39 | 6661 |
| 970 | 28.64 | 1202 | 880 | 25.99 | 3850 | 790 | 23.33 | 6727 |
| 968 | 28.59 | 1259 | 878 | 25.93 | 3911 | 788 | 23.27 | 6794 |
| 966 | 28.53 | 1316 | 876 | 25.87 | 3973 | 786 | 23.21 | 6861 |
| 964 | 28.47 | 1373 | 874 | 25.81 | 4034 | 784 | 23.15 | 6928 |
| 962 | 28.41 | 1430 | 872 | 25.75 | 4096 | 782 | 23.09 | 6995 |



A318/A319/A320/A321
FLIGHT CREW
OPERATING MANUAL

PERFORMANCE
OPERATING DATA

GENERAL

WIND COMPONENTS (FOR TAKEOFF AND LANDING)

Ident.: PER-OPD-GEN-00001966.0001001 / 08 FEB 11

Applicable to: ALL

| MULTIPLY | BY | TO GET |
|----------|--------|--------|
| kt | 1.852 | km/h |
| kt | 0.5144 | m/s |
| m/s | 3.6 | km/h |
| m/s | 1.9438 | kt |
| km/h | 0.5396 | kt |
| km/h | 0.2778 | m/s |

| GIVEN | FIND |
|--|---|
| WIND DIRECTION RELATIVE TO RUNWAY HEADING=30 DEG WIND SPEED=45 KT | CROSS WIND COMPONENT=22.5 KT HEAD WIND COMPONENT=39.0 KT |

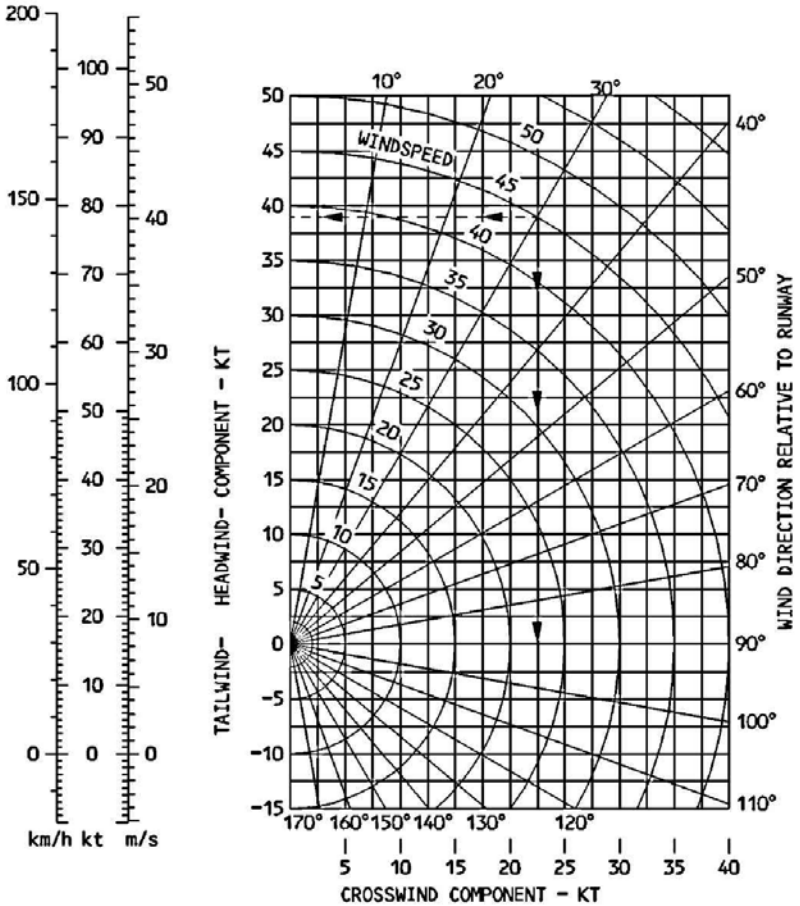

ALTITUDE TEMPERATURE CORRECTION

Ident.: PER-OPD-GEN-00001967.0001001 / 12 FEB 11

Applicable to: ALL

FOR HIGH ALTITUDE USE

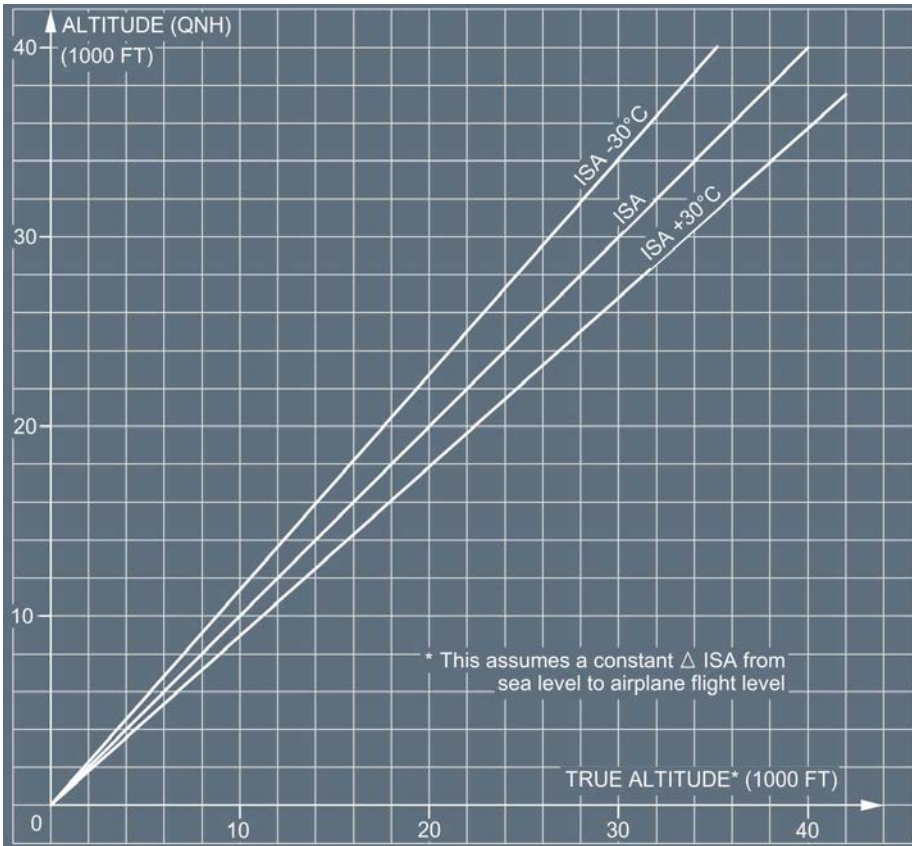

FOR LOW ALTITUDE USE

Values to be added by the pilot to minimum promulgated heights/altitude (ft)

| Airport Temperature °C | Height above the elevation of the altimeter setting source (feet) | | | | | | | | | |
|------------------------|---|-----|-----|-----|-------|-------|-------|-------|-------|--|
| | 200 | 300 | 400 | 500 | 1 000 | 2 000 | 3 000 | 4 000 | 5 000 | |
| 0 | 20 | 20 | 30 | 30 | 60 | 120 | 170 | 230 | 280 | |

Continued on the following page



A318/A319/A320/A321
FLIGHT CREW
OPERATING MANUAL

**PERFORMANCE
OPERATING DATA**

GENERAL

Continued from the previous page

| Airport Temperature °C | Height above the elevation of the altimeter setting source (feet) | | | | | | | | |
|------------------------|---|-----|-----|-----|-------|-------|-------|-------|-------|
| | 200 | 300 | 400 | 500 | 1 000 | 2 000 | 3 000 | 4 000 | 5 000 |
| -10 | 20 | 30 | 40 | 50 | 100 | 200 | 290 | 390 | 490 |
| -20 | 30 | 50 | 60 | 70 | 140 | 280 | 420 | 570 | 710 |
| -30 | 40 | 60 | 80 | 100 | 190 | 380 | 570 | 760 | 950 |
| -40 | 50 | 80 | 100 | 120 | 240 | 480 | 720 | 970 | 1 210 |
| -50 | 60 | 90 | 120 | 150 | 300 | 590 | 890 | 1 190 | 1 500 |



A318/A319/A320/A321
FLIGHT CREW
OPERATING MANUAL

**PERFORMANCE
OPERATING DATA**

GENERAL

Intentionally left blank

GENERAL

Ident.: PER-OPD-CON-AEO-00001657.0001001 / 23 FEB 11

Applicable to: ALL

The ground distance/air distance conversion tables show the air distance for a given ground distance due to the influence of the wind.

The Tables are given for :

- M .78
- Long range speed.

M.78

Ident.: PER-OPD-CON-AEO-00001658.0001001 / 28 JAN 11

Applicable to: ALL

| GROUND DIST. (NM) | AIR DISTANCE (NM) | | | | | | |
|-------------------------|-------------------|-------|----------------------|-------------|------|-----------|-------|
| | TAIL WIND | | WIND COMPONENTS (KT) | | | HEAD WIND | |
| | + 150 | + 100 | + 50 | 0 | - 50 | - 100 | - 150 |
| 10 | 7 | 8 | 9 | 10 | 11 | 13 | 15 |
| 20 | 15 | 16 | 18 | 20 | 23 | 26 | 30 |
| 30 | 22 | 25 | 27 | 30 | 34 | 39 | 45 |
| 40 | 30 | 33 | 36 | 40 | 45 | 51 | 60 |
| 50 | 37 | 41 | 45 | 50 | 56 | 64 | 75 |
| 100 | 75 | 82 | 90 | 100 | 113 | 129 | 150 |
| 200 | 150 | 164 | 180 | 200 | 225 | 257 | 300 |
| 300 | 225 | 245 | 270 | 300 | 338 | 386 | 450 |
| 400 | 300 | 327 | 360 | 400 | 450 | 514 | 600 |
| 500 | 375 | 409 | 450 | 500 | 563 | 643 | 750 |
| 1000 | 750 | 818 | 900 | 1000 | 1125 | 1286 | 1501 |
| 1500 | 1125 | 1227 | 1350 | 1500 | 1688 | 1929 | 2251 |
| 2000 | 1500 | 1636 | 1800 | 2000 | 2248 | 2572 | 3001 |
| 2500 | 1875 | 2045 | 2250 | 2500 | 2813 | 3215 | 3752 |
| 3000 | 2250 | 2454 | 2700 | 3000 | 3375 | 3858 | 4502 |
| 3500 | 2624 | 2863 | 3150 | 3500 | 3938 | 4501 | 5252 |
| 4000 | 2999 | 3272 | 3600 | 4000 | 4500 | 5144 | 6003 |
| 4500 | 3374 | 3681 | 4050 | 4500 | 5063 | 5787 | 6753 |
| 5000 | 3749 | 4090 | 4500 | 5000 | 5626 | 6430 | 7503 |

FLIP23 A320211 M565A1PP 3410 03301.000011 0250300 .7800 00000 0 0300350 0 0 77 64 43 61 18580 FCOM-W0-03-50-002-001

PERFORMANCE

OPERATING DATA

GROUND DISTANCE/AIR DISTANCE
CONVERSION - ALL ENGINES OPERATIVE

LONG RANGE SPEED UP TO FL270

Ident.: PER-OPD-CON-AEO-00001659.0001001 / 28 FEB 11

Applicable to: ALL

| GROUND DIST. (NM) | AIR DISTANCE (NM) | | | | | | |
|-------------------------|-------------------|------|----------------------|-------------|------|-----------|------|
| | TAIL WIND | | WIND COMPONENTS (KT) | | | HEAD WIND | |
| | +150 | +100 | + 50 | 0 | -50 | -100 | -150 |
| 10 | 7 | 8 | 9 | 10 | 12 | 14 | 17 |
| 20 | 14 | 16 | 18 | 20 | 23 | 27 | 33 |
| 30 | 21 | 24 | 26 | 30 | 35 | 41 | 50 |
| 40 | 29 | 32 | 35 | 40 | 46 | 55 | 67 |
| 50 | 36 | 39 | 44 | 50 | 58 | 68 | 83 |
| 100 | 71 | 79 | 88 | 100 | 115 | 136 | 167 |
| 200 | 143 | 158 | 176 | 200 | 231 | 273 | 333 |
| 300 | 214 | 237 | 265 | 300 | 346 | 409 | 500 |
| 400 | 286 | 316 | 353 | 400 | 462 | 545 | 667 |
| 500 | 357 | 395 | 441 | 500 | 577 | 682 | 833 |
| 1000 | 714 | 789 | 882 | 1000 | 1154 | 1364 | 1667 |
| 1500 | 1071 | 1184 | 1324 | 1500 | 1731 | 2046 | 2500 |
| 2000 | 1429 | 1579 | 1765 | 2000 | 2308 | 2727 | 3334 |
| 2500 | 1786 | 1974 | 2206 | 2500 | 2885 | 3409 | 4167 |
| 3000 | 2143 | 2368 | 2647 | 3000 | 3462 | 4091 | 5000 |
| 3500 | 2500 | 2763 | 3088 | 3500 | 4039 | 4773 | 5834 |
| 4000 | 2857 | 3158 | 3529 | 4000 | 4615 | 5455 | 6667 |
| 4500 | 3214 | 3553 | 3971 | 4500 | 5192 | 6137 | 7500 |
| 5000 | 3571 | 3947 | 4412 | 5000 | 5769 | 6818 | 8334 |



A318/A319/A320/A321
FLIGHT CREW
OPERATING MANUAL

PERFORMANCE

OPERATING DATA

GROUND DISTANCE/AIR DISTANCE
 CONVERSION - ALL ENGINES OPERATIVE

LONG RANGE SPEED ABOVE FL270

Ident.: PER-OPD-CON-AEO-00001660.0001001 / 09 DEC 09

Applicable to: ALL

| GROUND DIST. (NM) | AIR DISTANCE (NM) | | | | | | |
|-------------------------|-------------------|-------|----------------------|-------------|------|-----------|-------|
| | TAIL WIND | | WIND COMPONENTS (KT) | | | HEAD WIND | |
| | + 150 | + 100 | + 50 | 0 | - 50 | - 100 | - 150 |
| 10 | 8 | 8 | 9 | 10 | 11 | 13 | 15 |
| 20 | 15 | 16 | 18 | 20 | 22 | 26 | 30 |
| 30 | 23 | 25 | 27 | 30 | 34 | 38 | 45 |
| 40 | 30 | 33 | 36 | 40 | 45 | 51 | 60 |
| 50 | 38 | 41 | 45 | 50 | 56 | 64 | 75 |
| 100 | 75 | 82 | 90 | 100 | 112 | 128 | 149 |
| 200 | 150 | 164 | 180 | 200 | 225 | 256 | 299 |
| 300 | 226 | 246 | 270 | 300 | 337 | 385 | 448 |
| 400 | 301 | 328 | 360 | 400 | 449 | 513 | 597 |
| 500 | 376 | 410 | 450 | 500 | 562 | 641 | 746 |
| 1000 | 752 | 820 | 901 | 1000 | 1124 | 1282 | 1493 |
| 1500 | 1128 | 1230 | 1351 | 1500 | 1685 | 1923 | 2239 |
| 2000 | 1504 | 1639 | 1802 | 2000 | 2247 | 2564 | 2985 |
| 2500 | 1880 | 2049 | 2252 | 2500 | 2809 | 3205 | 3731 |
| 3000 | 2256 | 2459 | 2703 | 3000 | 3371 | 3846 | 4478 |
| 3500 | 2632 | 2869 | 3153 | 3500 | 3933 | 4487 | 5224 |
| 4000 | 3008 | 3279 | 3604 | 4000 | 4494 | 5128 | 5970 |
| 4500 | 3383 | 3689 | 4054 | 4500 | 5056 | 5769 | 6716 |
| 5000 | 3759 | 4098 | 4505 | 5000 | 5618 | 6410 | 7463 |

FLIP23 A320211 M565A1PP 3410 03301.000011 0250300 .7801 .00000 0 0300350 0 0 77 64 43 61 18580 FCOM-W0-03-50-004-001



A318/A319/A320/A321
FLIGHT CREW
OPERATING MANUAL

PERFORMANCE

OPERATING DATA

GROUND DISTANCE/AIR DISTANCE
CONVERSION - ALL ENGINES OPERATIVE

Intentionally left blank



A318/A319/A320/A321
FLIGHT CREW
OPERATING MANUAL

PERFORMANCE

OPERATING DATA

GROUND DISTANCE/AIR DISTANCE
CONVERSION - ONE ENGINE INOPERATIVE

GENERAL

Ident.: PER-OPD-CON-OEI-00004074.0001001 / 09 DEC 09

Applicable to: ALL

The ground distance/air distance conversion tables are used to calculate the air distance for a given ground distance due to the influence of the wind.

Tables are given for :

- LONG RANGE SPEED
- FIXED SPEEDS

PERFORMANCE

OPERATING DATA

GROUND DISTANCE/AIR DISTANCE
CONVERSION - ONE ENGINE INOPERATIVE

LONG RANGE SPEED

Ident.: PER-OPD-CON-OEI-00001960.0001001 / 09 DEC 09

Applicable to: ALL

| GROUND DIST. (NM) | AIR DISTANCE (NM) | | | | | | |
|-------------------------|-------------------|------|----------------------|-------------|------|-----------|------|
| | TAIL WIND | | WIND COMPONENTS (KT) | | | HEAD WIND | |
| | +150 | +100 | + 50 | 0 | -50 | -100 | -150 |
| 10 | 7 | 8 | 9 | 10 | 11 | 13 | 15 |
| 20 | 15 | 16 | 18 | 20 | 23 | 26 | 31 |
| 30 | 22 | 24 | 27 | 30 | 34 | 39 | 46 |
| 40 | 30 | 32 | 36 | 40 | 45 | 52 | 61 |
| 50 | 37 | 41 | 45 | 50 | 57 | 65 | 77 |
| 60 | 44 | 49 | 54 | 60 | 68 | 78 | 92 |
| 70 | 52 | 57 | 63 | 70 | 79 | 91 | 108 |
| 80 | 59 | 65 | 72 | 80 | 91 | 104 | 123 |
| 90 | 67 | 73 | 81 | 90 | 102 | 117 | 138 |
| 100 | 74 | 81 | 90 | 100 | 113 | 130 | 154 |
| 200 | 148 | 162 | 179 | 200 | 226 | 261 | 307 |
| 300 | 222 | 243 | 269 | 300 | 340 | 391 | 461 |
| 400 | 296 | 324 | 358 | 400 | 453 | 521 | 615 |
| 500 | 371 | 406 | 448 | 500 | 566 | 652 | 768 |
| 600 | 445 | 487 | 537 | 600 | 679 | 782 | 922 |
| 700 | 519 | 568 | 627 | 700 | 792 | 913 | 1076 |
| 800 | 593 | 649 | 717 | 800 | 905 | 1043 | 1230 |
| 900 | 667 | 730 | 806 | 900 | 1019 | 1173 | 1383 |
| 1000 | 741 | 811 | 896 | 1000 | 1132 | 1304 | 1537 |
| 1100 | 815 | 892 | 985 | 1100 | 1245 | 1434 | 1691 |
| 1200 | 889 | 973 | 1075 | 1200 | 1358 | 1564 | 1844 |
| 1300 | 963 | 1054 | 1164 | 1300 | 1471 | 1695 | 1998 |
| 1400 | 1038 | 1136 | 1254 | 1400 | 1585 | 1825 | 2152 |
| 1500 | 1112 | 1217 | 1344 | 1500 | 1698 | 1955 | 2305 |
| 1600 | 1186 | 1298 | 1433 | 1600 | 1811 | 2086 | 2459 |
| 1700 | 1260 | 1379 | 1523 | 1700 | 1924 | 2216 | 2613 |
| 1800 | 1334 | 1460 | 1612 | 1800 | 2037 | 2346 | 2766 |
| 1900 | 1408 | 1541 | 1702 | 1900 | 2150 | 2477 | 2920 |
| 2000 | 1482 | 1622 | 1791 | 2000 | 2264 | 2607 | 3074 |

FIXED SPEEDS

Ident.: PER-OPD-CON-OEI-00001961.0001001 / 09 DEC 09

Applicable to: ALL

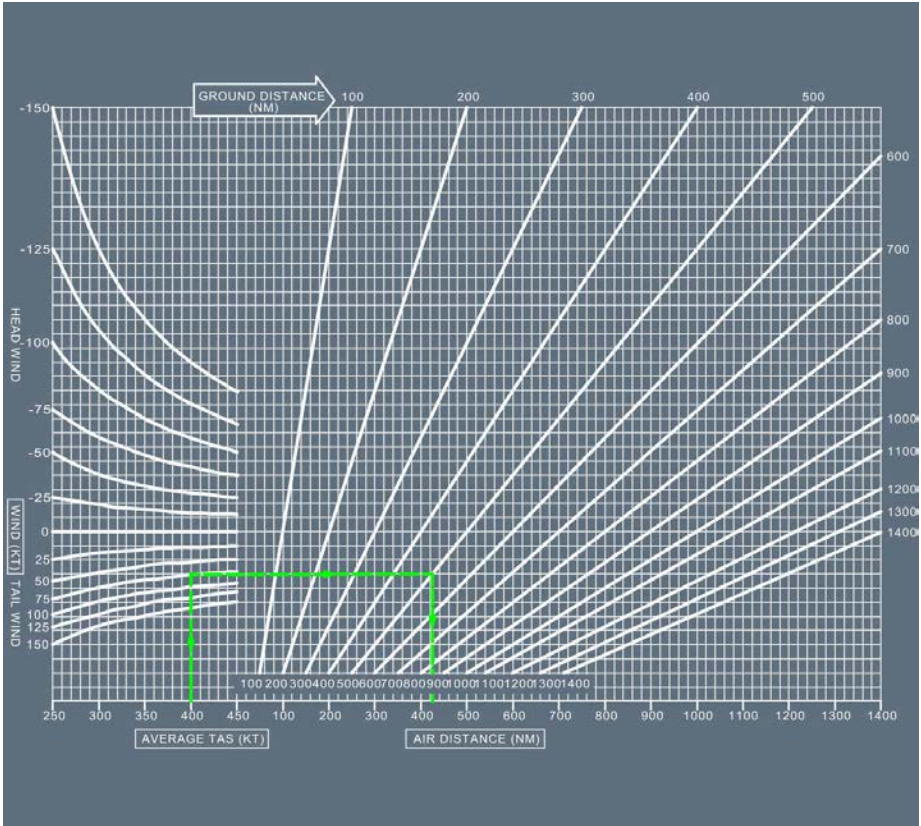



A318/A319/A320/A321
FLIGHT CREW
OPERATING MANUAL

PERFORMANCE

OPERATING DATA

GROUND DISTANCE/AIR DISTANCE
CONVERSION - ONE ENGINE INOPERATIVE

Intentionally left blank

PERFORMANCE

THRUST RATINGS

Intentionally left blank

PER-THR-GEN GENERAL

GENERAL..... A

PER-THR-MTO MAXIMUM TAKEOFF

DEFINITION..... A

MAXIMUM TAKEOFF..... B

PER-THR-MGA MAXIMUM GO AROUND

DEFINITION..... A

MAXIMUM GO AROUND..... B

PER-THR-FLX FLEXIBLE TAKEOFF

DEFINITION..... A

FLEXIBLE TAKEOFF..... B

PER-THR-MCT MAXIMUM CONTINUOUS

DEFINITION..... A

MAXIMUM CONTINUOUS..... B

PER-THR-MCL MAXIMUM CLIMB

DEFINITION..... A

MAXIMUM CLIMB..... B

PER-THR-MCR MAXIMUM CRUISE

DEFINITION..... A

MAXIMUM CRUISE..... B



A318/A319/A320/A321
FLIGHT CREW
OPERATING MANUAL

PERFORMANCE

THRUST RATINGS

PRELIMINARY PAGES - TABLE OF CONTENTS

Intentionally left blank



A318/A319/A320/A321
FLIGHT CREW
OPERATING MANUAL

PERFORMANCE
THRUST RATINGS

GENERAL

GENERAL

Ident.: PER-THR-GEN-00004079.0001001 / 28 FEB 11

Applicable to: ALL

The thrust rating charts have been established for:

- Maximum takeoff
- Maximum go around
- Flexible takeoff
- Maximum continuous
- Maximum climb
- Maximum cruise



A318/A319/A320/A321
FLIGHT CREW
OPERATING MANUAL

PERFORMANCE
THRUST RATINGS

GENERAL

Intentionally left blank



A318/A319/A320/A321
FLIGHT CREW
OPERATING MANUAL

PERFORMANCE
THRUST RATINGS
MAXIMUM TAKEOFF

DEFINITION

Ident.: PER-THR-MTO-00001968.0001001 / 01 MAR 11

Applicable to: ALL

It is the maximum thrust certified for takeoff and is normally limited to five minutes.

This time is extended to ten minutes for engine out contingency, as authorized by the approved AFM.

PERFORMANCE

THRUST RATINGS

MAXIMUM TAKEOFF

MAXIMUM TAKEOFF

Ident.: PER-THR-MTO-00001969.0017001 / 28 JAN 11

Applicable to: ALL

| OAT (°C) | CFM56-5B4 | | | | | | | | | | | | |
|-------------|------------------------------|--------|------|-------|-------|-------|-------|-------|-------|--------------------|-------|--------------------------|--------------------------|
| | N1 CORRECTIONS FOR AIR BLEED | | | | | | | | | | | OAT < CORNER POINT | OAT ≥ CORNER POINT |
| | TAKE OFF | | | | | | | | | | | | |
| | N1 | | | | | | | | | | | | |
| | NO AIR BLEED | | | | | | | | | | | | |
| | MACH = .000 | | | | | | | | | | | | |
| | PRESSURE ALTITUDE (FT) | | | | | | | | | | | | |
| | -2000. | -1000. | 0. | 1000. | 2000. | 3000. | 4000. | 5000. | 6000. | 7000. | 8000. | 9000. | 9200. |
| -54.0 | 76.2 | 77.2 | 78.2 | 79.2 | 80.3 | 82.3 | 84.0 | 85.8 | 86.7 | 87.6 | 88.2 | 88.0 | 88.0 |
| -50.0 | 76.9 | 77.9 | 78.9 | 79.9 | 81.0 | 83.0 | 84.7 | 86.5 | 87.5 | 88.3 | 88.9 | 88.8 | 88.7 |
| -46.0 | 77.5 | 78.6 | 79.6 | 80.6 | 81.7 | 83.7 | 85.4 | 87.3 | 88.2 | 89.0 | 89.7 | 89.5 | 89.5 |
| -42.0 | 78.2 | 79.2 | 80.2 | 81.3 | 82.4 | 84.4 | 86.1 | 88.0 | 88.9 | 89.8 | 90.4 | 90.2 | 90.2 |
| -38.0 | 78.8 | 79.9 | 80.9 | 82.0 | 83.0 | 85.1 | 86.8 | 88.7 | 89.6 | 90.5 | 91.1 | 90.9 | 90.9 |
| -34.0 | 79.5 | 80.5 | 81.5 | 82.6 | 83.7 | 85.7 | 87.5 | 89.4 | 90.3 | 91.2 | 91.8 | 91.6 | 91.6 |
| -30.0 | 80.1 | 81.2 | 82.2 | 83.3 | 84.3 | 86.4 | 88.2 | 90.1 | 91.0 | 91.9 | 92.5 | 92.3 | 92.3 |
| -26.0 | 80.7 | 81.8 | 82.8 | 83.9 | 85.0 | 87.1 | 88.8 | 90.7 | 91.7 | 92.5 | 93.2 | 93.0 | 93.0 |
| -22.0 | 81.4 | 82.4 | 83.5 | 84.6 | 85.6 | 87.7 | 89.5 | 91.4 | 92.4 | 93.2 | 93.9 | 93.7 | 93.7 |
| -18.0 | 82.0 | 83.1 | 84.1 | 85.2 | 86.3 | 88.4 | 90.2 | 92.1 | 93.1 | 93.9 | 94.6 | 94.4 | 94.4 |
| -14.0 | 82.6 | 83.7 | 84.8 | 85.9 | 87.0 | 89.1 | 90.9 | 92.8 | 93.8 | 94.6 | 95.3 | 95.1 | 95.1 |
| -10.0 | 83.2 | 84.3 | 85.4 | 86.5 | 87.6 | 89.7 | 91.5 | 93.4 | 94.4 | 95.3 | 95.9 | 95.7 | 95.7 |
| -6.0 | 83.8 | 84.9 | 86.0 | 87.1 | 88.2 | 90.3 | 92.2 | 94.1 | 95.1 | 95.9 | 96.6 | 96.4 | 96.4 |
| -2.0 | 84.4 | 85.5 | 86.6 | 87.7 | 88.8 | 90.9 | 92.8 | 94.7 | 95.7 | 96.6 | 97.3 | 97.1 | 97.0 |
| 2.0 | 85.0 | 86.1 | 87.2 | 88.3 | 89.4 | 91.6 | 93.4 | 95.4 | 96.4 | 97.2 | 97.9 | 97.7 | 97.7 |
| 6.0 | 85.6 | 86.7 | 87.8 | 88.9 | 90.0 | 92.2 | 94.1 | 96.0 | 97.0 | 97.9 | 98.6 | 98.4 | 98.3 |
| 10.0 | 86.2 | 87.3 | 88.4 | 89.5 | 90.7 | 92.8 | 94.7 | 96.7 | 97.7 | 98.5 | 99.2 | 99.0 | 99.0 |
| 14.0 | 86.8 | 87.9 | 89.0 | 90.2 | 91.3 | 93.5 | 95.3 | 97.3 | 98.3 | 99.2 | 99.9 | 99.7 | 99.6 |
| 18.0 | 87.4 | 88.5 | 89.6 | 90.8 | 91.9 | 94.1 | 95.9 | 97.9 | 98.9 | 99.8 | 100.1 | 99.1 | 98.8 |
| 22.0 | 88.0 | 89.1 | 90.2 | 91.3 | 92.5 | 94.7 | 96.6 | 98.6 | 99.3 | 99.4 | 99.1 | 97.9 | 97.7 |
| 26.0 | 88.5 | 89.7 | 90.7 | 91.9 | 93.1 | 95.3 | 97.2 | 98.3 | 98.5 | 98.5 | 98.0 | 96.8 | 96.6 |
| 30.0 | 89.1 | 90.2 | 91.3 | 92.5 | 93.6 | 95.9 | 97.4 | 97.6 | 97.7 | 97.6 | 97.3 | 96.5 | 96.4 |
| 34.0 | 89.7 | 90.8 | 91.9 | 93.1 | 94.2 | 96.5 | 96.8 | 97.0 | 97.1 | 97.1 | 97.0 | 96.2 | 96.1 |
| 38.0 | 90.2 | 91.4 | 92.5 | 93.7 | 94.8 | 96.1 | 96.3 | 96.4 | 96.6 | 96.6 | 96.6 | | |
| 42.0 | 90.8 | 91.9 | 93.1 | 94.2 | 94.9 | 95.6 | 95.7 | 95.8 | 96.0 | | | | |
| 46.0 | 91.4 | 92.5 | 93.2 | 93.9 | 94.5 | | | | | | | | |
| 50.0 | 91.5 | 92.2 | 92.9 | 93.6 | 94.1 | | | | | | | | |
| 54.0 | 91.2 | 92.0 | 92.7 | | | | | | | | | | |
| | | | | | | | | | | OAT < CORNER POINT | | | |
| | | | | | | | | | | OAT ≥ CORNER POINT | | | |



A318/A319/A320/A321
FLIGHT CREW
OPERATING MANUAL

PERFORMANCE

THRUST RATINGS

MAXIMUM TAKEOFF

| CFM56-5B4 | N1 CORRECTIONS FOR AIR BLEED | | | | | | | | | | OAT < CORNER POINT | OAT > CORNER POINT |
|----------------------------------|--------------------------------------|-------|-------|-------|--------|--------|--------|--------|--------|--------|--------------------|--------------------|
| | TAKE OFF | | | | | | | | | | | |
| N1 NO AIR BLEED MACH= .000 | AIR CONDITIONING ON | | | | | | | | | | -7 | -7 |
| | ENGINE ANTI-ICE ON | | | | | | | | | | 0.0 | -1.6 |
| | ENGINE ANTI-ICE AND WING ANTI-ICE ON | | | | | | | | | | 0.0 | -2.4 |
| OAT (C) | PRESSURE ALTITUDE (FT) | | | | | | | | | | | |
| | 7000. | 8000. | 9000. | 9200. | 10000. | 11000. | 12000. | 13000. | 14000. | 14500. | | |
| -54.0 | 87.6 | 88.2 | 88.0 | 88.0 | 87.8 | 88.2 | 88.4 | 88.6 | 88.6 | 88.5 | | |
| -50.0 | 88.3 | 88.9 | 88.8 | 88.7 | 88.6 | 88.9 | 89.2 | 89.3 | 89.3 | 89.3 | | |
| -46.0 | 89.0 | 89.7 | 89.5 | 89.5 | 89.3 | 89.7 | 89.9 | 90.1 | 90.1 | 90.0 | | |
| -42.0 | 89.8 | 90.4 | 90.2 | 90.2 | 90.0 | 90.4 | 90.7 | 90.8 | 90.8 | 90.8 | | |
| -38.0 | 90.5 | 91.1 | 90.9 | 90.9 | 90.7 | 91.1 | 91.4 | 91.5 | 91.5 | 91.5 | | |
| -34.0 | 91.2 | 91.8 | 91.6 | 91.6 | 91.4 | 91.8 | 92.1 | 92.2 | 92.2 | 92.2 | | |
| -30.0 | 91.9 | 92.5 | 92.3 | 92.3 | 92.1 | 92.5 | 92.8 | 92.9 | 92.9 | 92.9 | | |
| -26.0 | 92.5 | 93.2 | 93.0 | 93.0 | 92.8 | 93.2 | 93.5 | 93.6 | 93.6 | 93.6 | | |
| -22.0 | 93.2 | 93.9 | 93.7 | 93.7 | 93.5 | 93.9 | 94.1 | 94.3 | 94.3 | 94.3 | | |
| -18.0 | 93.9 | 94.6 | 94.4 | 94.4 | 94.2 | 94.6 | 94.8 | 95.0 | 95.0 | 95.0 | | |
| -14.0 | 94.6 | 95.3 | 95.1 | 95.1 | 94.9 | 95.3 | 95.5 | 95.7 | 95.7 | 95.7 | | |
| -10.0 | 95.3 | 95.9 | 95.7 | 95.7 | 95.6 | 95.9 | 96.2 | 96.3 | 96.3 | 96.3 | | |
| -6.0 | 95.9 | 96.6 | 96.4 | 96.4 | 96.2 | 96.6 | 96.9 | 97.0 | 97.0 | 97.0 | | |
| -2.0 | 96.6 | 97.3 | 97.1 | 97.0 | 96.9 | 97.3 | 97.5 | 97.6 | 97.7 | 97.6 | | |
| 2.0 | 97.2 | 97.9 | 97.7 | 97.7 | 97.5 | 97.9 | 98.2 | 98.3 | 98.3 | 98.3 | | |
| 6.0 | 97.9 | 98.6 | 98.4 | 98.3 | 98.2 | 98.6 | 98.8 | 99.0 | 99.0 | 98.9 | | |
| 10.0 | 98.5 | 99.2 | 99.0 | 99.0 | 98.8 | 99.2 | 99.5 | 99.6 | 99.2 | 98.8 | | |
| 14.0 | 99.2 | 99.9 | 99.7 | 99.6 | 99.1 | 99.0 | 98.6 | 98.0 | 97.1 | 96.6 | | |
| 18.0 | 99.8 | 100.1 | 99.1 | 98.8 | 97.9 | 97.6 | 97.0 | 96.1 | 95.7 | 95.6 | | |
| 22.0 | 99.4 | 99.1 | 97.9 | 97.7 | 96.7 | 96.2 | 95.9 | 95.7 | 95.4 | 95.2 | | |
| 26.0 | 98.5 | 98.0 | 96.8 | 96.6 | 96.0 | 95.9 | 95.6 | 95.3 | 95.0 | 94.8 | | |
| 30.0 | 97.6 | 97.3 | 96.5 | 96.4 | 95.8 | 95.7 | 95.4 | | | | | |
| 34.0 | 97.1 | 97.0 | 96.2 | 96.1 | 95.6 | | | | | | | |
| 38.0 | 96.7 | 96.6 | | | | | | | | | | |
| 42.0 | | | | | | | | | | | | |
| 46.0 | | | | | | | | | | | | |
| 50.0 | | | | | | | | | | | | |
| 54.0 | | | | | | | | | | | | |
| | | | | | | | | | | | OAT < CORNER POINT | |
| | | | | | | | | | | | OAT > CORNER POINT | |



A318/A319/A320/A321
FLIGHT CREW
OPERATING MANUAL

PERFORMANCE

THRUST RATINGS

MAXIMUM TAKEOFF

Intentionally left blank



A318/A319/A320/A321
FLIGHT CREW
OPERATING MANUAL

PERFORMANCE

THRUST RATINGS

MAXIMUM GO AROUND

DEFINITION

Ident.: PER-THR-MGA-00001971.0001001 / 23 FEB 11

Applicable to: ALL

It is the maximum permissible thrust during go-around.

MAXIMUM GO AROUND

Ident.: PER-THR-MGA-00001972.0024001 / 28 JAN 11

Applicable to: ALL

| CFM56-5B4 | | N1 CORRECTIONS FOR AIR BLEED | | | | | | OAT < CORNER POINT | OAT ≥ CORNER POINT | | |
|---------------------|--------|--------------------------------------|------|-------|-------|-------|-------|--------------------|--------------------|-------|--|
| GO AROUND | | AIR CONDITIONING OFF | | | | | | 0.7 | 0.7 | | |
| N1 | | ENGINE ANTI ICE ON | | | | | | 0.0 | -1.6 | | |
| AIR CONDITIONING ON | | ENGINE ANTI ICE AND WING ANTI ICE ON | | | | | | 0.0 | -2.4 | | |
| MACH = .225 | | PRESSURE ALTITUDE (FT) | | | | | | | | | |
| TAT (°C) | -2000. | -1000. | 0. | 1000. | 2000. | 3000. | 4000. | 5000. | 6000. | 7000. | |
| -54.0 | 77.7 | 78.7 | 79.6 | 80.2 | 80.9 | 82.1 | 83.4 | 84.8 | 86.2 | 86.8 | |
| -50.0 | 78.4 | 79.4 | 80.3 | 80.9 | 81.6 | 82.8 | 84.2 | 85.5 | 86.9 | 87.6 | |
| -46.0 | 79.1 | 80.1 | 81.0 | 81.6 | 82.3 | 83.5 | 84.9 | 86.2 | 87.6 | 88.3 | |
| -42.0 | 79.8 | 80.7 | 81.7 | 82.3 | 83.0 | 84.2 | 85.6 | 87.0 | 88.4 | 89.0 | |
| -38.0 | 80.4 | 81.4 | 82.3 | 83.0 | 83.6 | 84.9 | 86.3 | 87.6 | 89.1 | 89.7 | |
| -34.0 | 81.1 | 82.0 | 83.0 | 83.6 | 84.3 | 85.5 | 86.9 | 88.3 | 89.7 | 90.4 | |
| -30.0 | 81.7 | 82.7 | 83.6 | 84.3 | 85.0 | 86.2 | 87.6 | 89.0 | 90.4 | 91.1 | |
| -26.0 | 82.4 | 83.3 | 84.3 | 85.0 | 85.6 | 86.9 | 88.3 | 89.7 | 91.1 | 91.8 | |
| -22.0 | 83.0 | 84.0 | 84.9 | 85.6 | 86.3 | 87.5 | 89.0 | 90.4 | 91.8 | 92.5 | |
| -18.0 | 83.7 | 84.6 | 85.6 | 86.3 | 86.9 | 88.2 | 89.6 | 91.1 | 92.5 | 93.2 | |
| -14.0 | 84.3 | 85.3 | 86.2 | 86.9 | 87.6 | 88.9 | 90.3 | 91.7 | 93.2 | 93.9 | |
| -10.0 | 84.9 | 85.9 | 86.8 | 87.5 | 88.2 | 89.5 | 90.9 | 92.4 | 93.8 | 94.5 | |
| -6.0 | 85.5 | 86.5 | 87.5 | 88.2 | 88.8 | 90.1 | 91.6 | 93.0 | 94.5 | 95.2 | |
| -2.0 | 86.1 | 87.1 | 88.1 | 88.8 | 89.5 | 90.8 | 92.2 | 93.7 | 95.1 | 95.8 | |
| 2.0 | 86.7 | 87.7 | 88.7 | 89.4 | 90.1 | 91.4 | 92.9 | 94.3 | 95.8 | 96.5 | |
| 6.0 | 87.3 | 88.3 | 89.3 | 90.0 | 90.7 | 92.0 | 93.5 | 94.9 | 96.4 | 97.1 | |
| 10.0 | 87.9 | 88.9 | 89.9 | 90.6 | 91.3 | 92.6 | 94.1 | 95.6 | 97.1 | 97.8 | |
| 14.0 | 88.5 | 89.6 | 90.5 | 91.3 | 91.9 | 93.3 | 94.8 | 96.2 | 97.7 | 98.4 | |
| 18.0 | 89.1 | 90.1 | 91.1 | 91.8 | 92.5 | 93.9 | 95.4 | 96.8 | 98.3 | 99.0 | |
| 22.0 | 89.7 | 90.7 | 91.7 | 92.4 | 93.1 | 94.5 | 96.0 | 97.4 | 99.0 | 99.6 | |
| 26.0 | 90.3 | 91.3 | 92.3 | 93.0 | 93.7 | 95.1 | 96.6 | 98.1 | 99.0 | 99.0 | |
| 30.0 | 90.8 | 91.9 | 92.9 | 93.6 | 94.3 | 95.7 | 97.2 | 97.7 | 98.5 | 98.4 | |
| 34.0 | 91.4 | 92.5 | 93.5 | 94.2 | 94.9 | 96.3 | 97.2 | 97.4 | 97.9 | 97.7 | |
| 38.0 | 92.0 | 93.0 | 94.0 | 94.8 | 95.5 | 96.7 | 96.9 | 96.9 | 97.2 | 97.0 | |
| 42.0 | 92.6 | 93.6 | 94.6 | 95.4 | 96.1 | 96.3 | 96.2 | 96.0 | 96.3 | 96.2 | |
| 46.0 | 93.1 | 94.2 | 95.2 | 95.7 | 95.7 | 95.5 | 95.3 | 95.2 | 95.4 | | |
| 50.0 | 93.7 | 94.5 | 94.8 | 94.8 | 94.8 | 94.6 | 94.4 | | | | |
| 54.0 | 93.3 | 93.6 | 93.9 | 94.0 | 93.9 | | | | | | |
| 58.0 | 92.4 | 92.8 | 93.1 | | | | | | | | |
| 62.0 | 91.6 | | | | | | | | | | |
| OAT < CORNER POINT | | | | | | | | | | | |
| OAT ≥ CORNER POINT | | | | | | | | | | | |

PERFORMANCE
THRUST RATINGS

MAXIMUM GO AROUND

| CFM56-5B4 | N1 CORRECTIONS FOR AIR BLEED | | | | | | | | | | OAT < CORNER POINT | OAT > CORNER POINT |
|---------------------|--------------------------------------|-------|-------|-------|--------|--------|--------|--------|--------|--------|--------------------|--------------------|
| | AIR CONDITIONING OFF | | | | | | | | | | 0.7 | 0.7 |
| GO AROUND N1 | ENGINE ANTI-ICE ON | | | | | | | | | | 0.0 | -1.6 |
| AIR CONDITIONING ON | ENGINE ANTI-ICE AND WING ANTI-ICE ON | | | | | | | | | | 0.0 | -2.4 |
| MACH = .225 | | | | | | | | | | | | |
| TAT (C) | PRESSURE ALTITUDE (FT) | | | | | | | | | | | |
| | 7000. | 8000. | 9000. | 9200. | 10000. | 11000. | 12000. | 13000. | 14000. | 14500. | | |
| -54.0 | 86.8 | 87.3 | 87.0 | 87.0 | 86.7 | 87.0 | 87.3 | 87.4 | 87.4 | 87.4 | | |
| -50.0 | 87.6 | 88.1 | 87.8 | 87.7 | 87.5 | 87.8 | 88.0 | 88.1 | 88.2 | 88.2 | | |
| -46.0 | 88.3 | 88.8 | 88.5 | 88.4 | 88.2 | 88.5 | 88.8 | 88.9 | 88.9 | 88.9 | | |
| -42.0 | 89.0 | 89.6 | 89.2 | 89.2 | 88.9 | 89.3 | 89.5 | 89.6 | 89.7 | 89.6 | | |
| -38.0 | 89.7 | 90.2 | 89.9 | 89.9 | 89.6 | 89.9 | 90.2 | 90.3 | 90.3 | 90.3 | | |
| -34.0 | 90.4 | 90.9 | 90.6 | 90.6 | 90.3 | 90.6 | 90.9 | 91.0 | 91.0 | 91.0 | | |
| -30.0 | 91.1 | 91.6 | 91.3 | 91.2 | 91.0 | 91.3 | 91.6 | 91.7 | 91.7 | 91.7 | | |
| -26.0 | 91.8 | 92.3 | 92.0 | 91.9 | 91.7 | 92.0 | 92.3 | 92.4 | 92.4 | 92.4 | | |
| -22.0 | 92.5 | 93.0 | 92.7 | 92.6 | 92.4 | 92.7 | 93.0 | 93.1 | 93.1 | 93.1 | | |
| -18.0 | 93.2 | 93.7 | 93.4 | 93.3 | 93.1 | 93.4 | 93.6 | 93.8 | 93.8 | 93.8 | | |
| -14.0 | 93.9 | 94.4 | 94.1 | 94.0 | 93.8 | 94.1 | 94.3 | 94.5 | 94.5 | 94.5 | | |
| -10.0 | 94.5 | 95.1 | 94.7 | 94.7 | 94.4 | 94.7 | 95.0 | 95.1 | 95.2 | 95.1 | | |
| -6.0 | 95.2 | 95.7 | 95.4 | 95.3 | 95.1 | 95.4 | 95.6 | 95.8 | 95.8 | 95.8 | | |
| -2.0 | 95.8 | 96.4 | 96.0 | 96.0 | 95.7 | 96.0 | 96.3 | 96.4 | 96.5 | 96.4 | | |
| 2.0 | 96.5 | 97.0 | 96.7 | 96.6 | 96.4 | 96.7 | 96.9 | 97.1 | 97.1 | 97.1 | | |
| 6.0 | 97.1 | 97.7 | 97.3 | 97.3 | 97.0 | 97.3 | 97.6 | 97.7 | 97.8 | 97.7 | | |
| 10.0 | 97.8 | 98.3 | 98.0 | 97.9 | 97.7 | 98.0 | 98.2 | 98.4 | 98.4 | 98.4 | | |
| 14.0 | 98.4 | 99.0 | 98.6 | 98.6 | 98.3 | 98.6 | 98.9 | 98.6 | 98.0 | 97.7 | | |
| 18.0 | 99.0 | 99.6 | 99.3 | 99.1 | 98.2 | 98.1 | 97.7 | 97.2 | 96.4 | 95.9 | | |
| 22.0 | 99.6 | 99.5 | 98.5 | 98.2 | 97.4 | 97.0 | 96.5 | 95.9 | 95.6 | 95.4 | | |
| 26.0 | 99.0 | 98.7 | 97.6 | 97.4 | 96.5 | 96.1 | 95.8 | 95.5 | 95.1 | 94.9 | | |
| 30.0 | 98.4 | 97.9 | 96.9 | 96.7 | 95.9 | 95.7 | 95.4 | 95.0 | 94.6 | | | |
| 34.0 | 97.7 | 97.3 | 96.3 | 96.2 | 95.5 | 95.3 | 95.0 | | | | | |
| 38.0 | 97.0 | 96.6 | 95.8 | 95.6 | 95.1 | | | | | | | |
| 42.0 | 96.2 | 95.9 | | | | | | | | | | |
| 46.0 | | | | | | | | | | | | |
| 50.0 | | | | | | | | | | | | |
| 54.0 | | | | | | | | | | | | |
| | | | | | | | | | | | OAT < CORNER POINT | |
| | | | | | | | | | | | OAT > CORNER POINT | |



A318/A319/A320/A321
FLIGHT CREW
OPERATING MANUAL

PERFORMANCE

THRUST RATINGS

MAXIMUM GO AROUND

Intentionally left blank



A318/A319/A320/A321
FLIGHT CREW
OPERATING MANUAL

PERFORMANCE

THRUST RATINGS

FLEXIBLE TAKEOFF

DEFINITION

Ident.: PER-THR-FLX-00001973.0001001 / 23 FEB 11

Applicable to: ALL

It is a reduced takeoff thrust as compared to the maximum permissible. The related N1 is calculated as a function of the flexible temperature entered in the FMGS MCDU. The flexible temperature is a function of the aircraft weight and environmental conditions.

It guarantees that the regular performance requirements are met.



A318/A319/A320/A321
FLIGHT CREW
OPERATING MANUAL

PERFORMANCE
THRUST RATINGS
FLEXIBLE TAKEOFF

FLEXIBLE TAKEOFF

Ident.: PER-THR-FLX-00001974.0035001 / 23 FEB 11

Applicable to: ALL

EXAMPLE : PRESS ALT : 2000 FT OAT=-10°C. FLX T=50°C.
 - FLX TEMP 50°C > FLAT RATING TEMP (ISA+29=40°C)

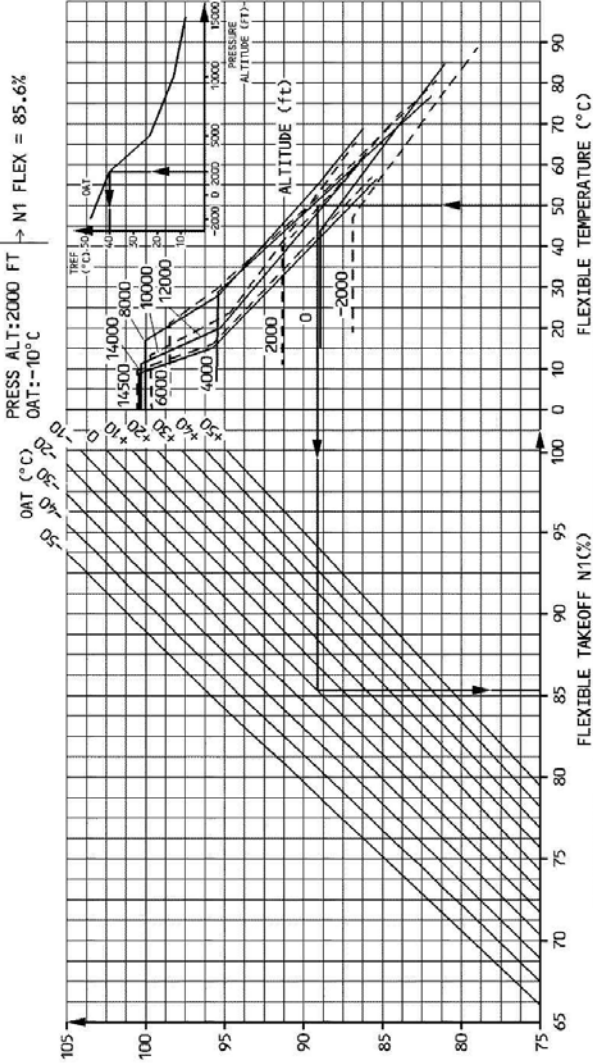

| | | | |
|--------------|------------------------------|-------|--|
| CFM56-5B4 | N1 CORRECTIONS FOR AIR BLEED | | |
| FLEX TAKEOFF | AIR CONDITIONING ON | - 0.7 | |
| N1 | ENGINE ANTI ICE ON | 0.0 | |
| MACH = .000 | ENGINE AND WING ANTI ICE ON | 0.0 | |



A318/A319/A320/A321
FLIGHT CREW
OPERATING MANUAL

PERFORMANCE

THRUST RATINGS

FLEXIBLE TAKEOFF

Intentionally left blank



A318/A319/A320/A321
FLIGHT CREW
OPERATING MANUAL

PERFORMANCE

THRUST RATINGS

MAXIMUM CONTINUOUS

DEFINITION

Ident.: PER-THR-MCT-00001975.0001001 / 28 FEB 11

Applicable to: ALL

It is the maximum thrust certified for continuous use. This rating should be used, at the pilot's discretion, only when required to ensure safe flight (engine failure).

MAXIMUM CONTINUOUS

Ident.: PER-THR-MCT-00001976.0011001 / 28 JAN 11

Applicable to: ALL

| CFM56-5B4 | | N1 CORRECTIONS FOR AIR BLEED | | | | | | | | | | OAT < ISA + 10 | OAT ≥ ISA + 10 |
|---|--------|--------------------------------------|-------|--------|--------|--------|--------|--------|--------|--------|--------|----------------|----------------|
| MAXIMUM CONTINUOUS N1 AIR CONDITIONING ON* IAS = 230 KT | | AIR CONDITIONING OFF | | | | | | | | | | 0.9 | 0.9 |
| | | ENGINE ANTI ICE ON | | | | | | | | | | 0.0 | -1.4 |
| | | ENGINE ANTI ICE AND WING ANTI ICE ON | | | | | | | | | | 0.0 | -3.2 |
| | | PRESSURE ALTITUDE (FT) | | | | | | | | | | | |
| TAT (°C) | -1000. | 3000. | 7000. | 11000. | 15000. | 19000. | 23000. | 27000. | 31000. | 35000. | 39000. | | |
| -54.0 | 75.6 | 77.6 | 79.2 | 81.1 | 85.2 | 87.3 | 87.0 | 83.2 | 84.3 | 85.1 | 84.1 | | |
| -50.0 | 76.2 | 78.3 | 79.9 | 81.8 | 85.9 | 88.0 | 87.7 | 84.0 | 85.0 | 85.8 | 84.9 | | |
| -46.0 | 76.9 | 79.0 | 80.6 | 82.6 | 86.6 | 88.8 | 88.5 | 84.7 | 85.7 | 86.6 | 85.6 | | |
| -42.0 | 77.6 | 79.6 | 81.2 | 83.3 | 87.4 | 89.5 | 89.2 | 85.4 | 86.4 | 87.3 | 86.3 | | |
| -38.0 | 78.2 | 80.3 | 81.9 | 83.9 | 88.0 | 90.2 | 89.9 | 86.1 | 87.1 | 88.0 | 87.0 | | |
| -34.0 | 78.8 | 80.9 | 82.5 | 84.6 | 88.7 | 90.9 | 90.6 | 86.7 | 87.8 | 88.6 | 87.7 | | |
| -30.0 | 79.5 | 81.6 | 83.2 | 85.2 | 89.4 | 91.6 | 91.3 | 87.4 | 88.5 | 89.3 | 88.3 | | |
| -26.0 | 80.1 | 82.2 | 83.8 | 85.9 | 90.1 | 92.3 | 92.0 | 88.1 | 89.2 | 90.0 | 89.0 | | |
| -22.0 | 80.7 | 82.8 | 84.5 | 86.6 | 90.8 | 93.0 | 92.7 | 88.7 | 89.8 | 90.5 | 89.7 | | |
| -18.0 | 81.4 | 83.5 | 85.1 | 87.2 | 91.5 | 93.7 | 93.4 | 89.4 | 90.5 | 90.3 | 89.6 | | |
| -14.0 | 82.0 | 84.1 | 85.8 | 87.9 | 92.1 | 94.3 | 94.0 | 90.1 | 90.4 | 90.0 | 89.3 | | |
| -10.0 | 82.6 | 84.7 | 86.4 | 88.5 | 92.8 | 95.0 | 94.7 | 90.3 | 90.1 | 89.6 | 89.0 | | |
| -6.0 | 83.2 | 85.3 | 87.0 | 89.1 | 93.4 | 95.6 | 95.3 | 90.3 | 89.7 | 89.0 | 88.2 | | |
| -2.0 | 83.8 | 85.9 | 87.6 | 89.8 | 94.1 | 96.3 | 94.6 | 89.7 | 89.0 | 88.4 | 87.5 | | |
| 2.0 | 84.4 | 86.5 | 88.3 | 90.4 | 94.7 | 96.3 | 93.9 | 89.0 | 88.4 | 87.7 | 86.9 | | |
| 6.0 | 85.0 | 87.1 | 88.9 | 91.0 | 95.4 | 95.6 | 93.3 | 88.4 | 87.8 | 87.0 | 86.3 | | |
| 10.0 | 85.5 | 87.8 | 89.5 | 91.6 | 94.8 | 94.8 | 92.8 | 87.8 | 87.2 | 86.2 | 85.7 | | |
| 14.0 | 86.1 | 88.4 | 90.1 | 92.0 | 94.0 | 94.2 | 92.4 | 87.1 | 86.5 | | | | |
| 18.0 | 86.7 | 88.9 | 90.7 | 91.5 | 93.3 | 93.6 | 91.9 | 86.5 | | | | | |
| 22.0 | 87.3 | 89.5 | 90.7 | 91.0 | 92.8 | 93.1 | 91.3 | | | | | | |
| 26.0 | 87.8 | 90.1 | 90.2 | 90.5 | 92.2 | 92.5 | | | | | | | |
| 30.0 | 88.4 | 89.8 | 89.7 | 90.0 | 91.5 | 92.0 | | | | | | | |
| 34.0 | 89.0 | 89.3 | 89.5 | 89.4 | 90.9 | | | | | | | | |
| 38.0 | 88.5 | 88.9 | 89.1 | 88.8 | | | | | | | | | |
| 42.0 | 88.0 | 88.7 | 88.7 | 88.1 | | | | | | | | | |
| 46.0 | 87.4 | 88.3 | 88.2 | | | | | | | | | | |
| 50.0 | 86.8 | 87.9 | 87.7 | | | | | | | | | | |
| 54.0 | 86.2 | 87.5 | | | | | | | | | | | |
| OAT < ISA + 10 | | | | | | | | | | | | OAT ≥ ISA + 10 | |

* One engine inoperative – 1 pack operative on remaining engine.



A318/A319/A320/A321
FLIGHT CREW
OPERATING MANUAL

PERFORMANCE
THRUST RATINGS
MAXIMUM CLIMB

DEFINITION

Ident.: PER-THR-MCL-00001977.0001001 / 23 FEB 11

Applicable to: ALL

It is the maximum thrust approved for normal climb.

MAXIMUM CLIMB

Ident.: PER-THR-MCL-00001978.0011001 / 28 JAN 11

Applicable to: ALL

| CFM56-5B4 | N1 CORRECTIONS FOR AIR BLEED | | | | | | | | | | OAT < ISA + 10 | OAT ≥ ISA + 10 |
|--------------------------------------|------------------------------|-------|-------|--------|--------|--------|--------|--------|--------|--------|----------------|----------------|
| | MAXIMUM CLIMB N1 | | | | | | | | | | | |
| | AIR CONDITIONING OFF | | | | | | | | | | .8 | .8 |
| | ENGINE ANTI ICE ON | | | | | | | | | | 0.0 | -1.3 |
| AIR CONDITIONING ON | | | | | | | | | | 0.0 | -1.3 | |
| ENGINE ANTI ICE AND WING ANTI ICE ON | | | | | | | | | | 0.0 | -2.4 | |
| TAT (°C) | PRESSURE ALTITUDE (FT) | | | | | | | | | | | |
| | -1000. | 3000. | 7000. | 11000. | 15000. | 19000. | 23000. | 27000. | 31000. | 35000. | 39000. | |
| -54.0 | 73.5 | 75.4 | 77.0 | 77.8 | 78.8 | 79.8 | 80.7 | 81.5 | 82.5 | 83.9 | 83.9 | |
| -50.0 | 74.2 | 76.1 | 77.6 | 78.4 | 79.5 | 80.5 | 81.4 | 82.2 | 83.3 | 84.6 | 84.6 | |
| -46.0 | 74.8 | 76.8 | 78.3 | 79.1 | 80.2 | 81.2 | 82.1 | 82.9 | 84.0 | 85.3 | 85.3 | |
| -42.0 | 75.5 | 77.4 | 79.0 | 79.8 | 80.9 | 81.9 | 82.8 | 83.6 | 84.7 | 86.0 | 86.0 | |
| -38.0 | 76.1 | 78.1 | 79.6 | 80.5 | 81.5 | 82.5 | 83.5 | 84.3 | 85.3 | 86.7 | 86.7 | |
| -34.0 | 76.7 | 78.7 | 80.3 | 81.1 | 82.2 | 83.2 | 84.1 | 84.9 | 86.0 | 87.4 | 87.4 | |
| -30.0 | 77.3 | 79.3 | 80.9 | 81.7 | 82.8 | 83.8 | 84.8 | 85.6 | 86.7 | 88.1 | 88.1 | |
| -26.0 | 77.9 | 80.0 | 81.5 | 82.4 | 83.5 | 84.5 | 85.4 | 86.2 | 87.4 | 88.7 | 88.7 | |
| -22.0 | 78.6 | 80.6 | 82.2 | 83.0 | 84.1 | 85.1 | 86.1 | 86.9 | 88.0 | 89.4 | 89.4 | |
| -18.0 | 79.2 | 81.2 | 82.8 | 83.7 | 84.8 | 85.8 | 86.7 | 87.6 | 88.7 | 90.1 | 89.9 | |
| -14.0 | 79.8 | 81.8 | 83.5 | 84.3 | 85.4 | 86.4 | 87.4 | 88.2 | 89.4 | 90.3 | 89.6 | |
| -10.0 | 80.4 | 82.4 | 84.1 | 84.9 | 86.0 | 87.1 | 88.0 | 88.9 | 90.0 | 90.1 | 89.4 | |
| -6.0 | 81.0 | 83.0 | 84.7 | 85.5 | 86.6 | 87.7 | 88.7 | 89.5 | 90.3 | 90.0 | 88.8 | |
| -2.0 | 81.5 | 83.6 | 85.3 | 86.1 | 87.2 | 88.3 | 89.3 | 90.1 | 90.1 | 89.5 | 88.0 | |
| 2.0 | 82.1 | 84.2 | 85.9 | 86.7 | 87.9 | 88.9 | 89.9 | 90.1 | 90.0 | 88.8 | 87.4 | |
| 6.0 | 82.7 | 84.8 | 86.5 | 87.3 | 88.5 | 89.5 | 90.0 | 89.9 | 89.6 | 88.2 | 86.8 | |
| 10.0 | 83.3 | 85.4 | 87.1 | 87.9 | 89.1 | 89.8 | 89.8 | 89.7 | 89.0 | 87.5 | 86.2 | |
| 14.0 | 83.9 | 86.0 | 87.7 | 88.6 | 89.7 | 89.6 | 89.7 | 89.2 | 88.4 | 86.8 | 85.6 | |
| 18.0 | 84.4 | 86.6 | 88.2 | 89.1 | 89.4 | 89.3 | 89.2 | 88.6 | 87.7 | | | |
| 22.0 | 85.0 | 87.1 | 88.7 | 89.2 | 89.0 | 89.0 | 88.6 | 87.9 | 87.0 | | | |
| 26.0 | 85.5 | 87.7 | 88.3 | 88.9 | 88.7 | 88.5 | 88.0 | 87.2 | 86.3 | | | |
| 30.0 | 86.1 | 87.8 | 87.9 | 88.5 | 88.2 | 87.8 | 87.2 | 86.6 | | | | |
| 34.0 | 86.6 | 87.4 | 87.3 | 87.8 | 87.5 | 87.1 | 86.5 | | | | | |
| 38.0 | 86.4 | 86.9 | 86.6 | 87.1 | 86.8 | 86.4 | | | | | | |
| 42.0 | 85.9 | 86.2 | 85.9 | 86.4 | 86.0 | | | | | | | |
| 46.0 | 85.3 | 85.4 | 85.2 | 85.7 | 85.3 | | | | | | | |
| 50.0 | 84.5 | 84.7 | 84.4 | 85.0 | | | | | | | | |
| 54.0 | 83.7 | 84.0 | | | | | | | | | | |
| OAT < ISA + 10 | | | | | | | | | | | | |
| OAT ≥ ISA + 10 | | | | | | | | | | | | |



A318/A319/A320/A321
FLIGHT CREW
OPERATING MANUAL

PERFORMANCE

THRUST RATINGS

MAXIMUM CLIMB

Intentionally left blank

| | |
|---|--|
|  <p>A318/A319/A320/A321 FLIGHT CREW OPERATING MANUAL</p> | <p>PERFORMANCE</p> <p>THRUST RATINGS</p> <p>MAXIMUM CRUISE</p> |
|---|--|

DEFINITION

Ident.: PER-THR-MCR-00001979.0004001 / 02 FEB 11

Applicable to: ALL

It is the maximum thrust approved for normal cruise.

There is no thrust lever position corresponding to this thrust rating.

It is not displayed to the pilot, and the N1 limit which is displayed in cruise is the maximum climb N1.

The FMGS uses the maximum cruise N1 to compute the aircraft maximum speed.

In manual thrust setting, in cruise, the pilot should limit N1 to the maximum cruise N1 that is equal to the displayed maximum climb N1 minus 1.9 %.

MAXIMUM CRUISE

Ident.: PER-THR-MCR-00001980.0018001 / 28 FEB 11

Applicable to: ALL

| CFM56-5B4 | | N1 CORRECTIONS FOR AIR BLEED | | | | | | | | | | OAT < ISA+10 | OAT ≥ ISA+10 |
|---|------------------------|---------------------------------------|-------|--------|--------|--------|--------|--------|--------|--------|--------|--------------|--------------|
| MAXIMUM CRUISE N1 AIR CONDITIONING ON 250/300/.78 | | AIR CONDITIONING OFF | | | | | | | | | | 0.8 | 0.8 |
| | | NACELLE ANTI ICE ON | | | | | | | | | | 0.0 | -1.3 |
| | | NACELLE ANTI ICE AND WING ANTI ICE ON | | | | | | | | | | 0.0 | -2.4 |
| TAT (°C) | PRESSURE ALTITUDE (FT) | | | | | | | | | | | | |
| | -1000. | 3000. | 7000. | 11000. | 15000. | 19000. | 23000. | 27000. | 31000. | 35000. | 39000. | | |
| -54.0 | 71.6 | 73.5 | 75.1 | 75.9 | 76.9 | 77.9 | 78.8 | 79.6 | 80.6 | 82.0 | 82.0 | | |
| -50.0 | 72.3 | 74.2 | 75.7 | 76.5 | 77.6 | 78.6 | 79.5 | 80.3 | 81.4 | 82.7 | 82.7 | | |
| -46.0 | 72.9 | 74.9 | 76.4 | 77.2 | 78.3 | 79.3 | 80.2 | 81.0 | 82.1 | 83.4 | 83.4 | | |
| -42.0 | 73.6 | 75.5 | 77.1 | 77.9 | 79.0 | 80.0 | 80.9 | 81.7 | 82.8 | 84.1 | 84.1 | | |
| -38.0 | 74.2 | 76.2 | 77.7 | 78.6 | 79.6 | 80.6 | 81.6 | 82.4 | 83.4 | 84.8 | 84.8 | | |
| -34.0 | 74.8 | 76.8 | 78.4 | 79.2 | 80.3 | 81.3 | 82.2 | 83.0 | 84.1 | 85.5 | 85.5 | | |
| -30.0 | 75.4 | 77.4 | 79.0 | 79.8 | 80.9 | 81.9 | 82.9 | 83.7 | 84.8 | 86.2 | 86.2 | | |
| -26.0 | 76.0 | 78.1 | 79.6 | 80.5 | 81.6 | 82.6 | 83.5 | 84.3 | 85.5 | 86.8 | 86.8 | | |
| -22.0 | 76.7 | 78.7 | 80.3 | 81.1 | 82.2 | 83.2 | 84.2 | 85.0 | 86.1 | 87.5 | 87.5 | | |
| -18.0 | 77.3 | 79.3 | 80.9 | 81.8 | 82.9 | 83.9 | 84.8 | 85.7 | 86.8 | 88.2 | 88.0 | | |
| -14.0 | 77.9 | 79.9 | 81.6 | 82.4 | 83.5 | 84.5 | 85.5 | 86.3 | 87.5 | 88.4 | 87.7 | | |
| -10.0 | 78.5 | 80.5 | 82.2 | 83.0 | 84.1 | 85.2 | 86.1 | 87.0 | 88.1 | 88.2 | 87.5 | | |
| -6.0 | 79.1 | 81.1 | 82.8 | 83.6 | 84.7 | 85.8 | 86.8 | 87.6 | 88.4 | 88.1 | 86.9 | | |
| -2.0 | 79.6 | 81.7 | 83.4 | 84.2 | 85.3 | 86.4 | 87.4 | 88.2 | 88.2 | 87.6 | 86.1 | | |
| 2.0 | 80.2 | 82.3 | 84.0 | 84.8 | 86.0 | 87.0 | 88.0 | 88.2 | 88.1 | 86.9 | 85.5 | | |
| 6.0 | 80.8 | 82.9 | 84.6 | 85.4 | 86.6 | 87.6 | 88.7 | 88.0 | 87.7 | 86.3 | 84.9 | | |
| 10.0 | 81.4 | 83.5 | 85.2 | 86.0 | 87.2 | 87.9 | 87.9 | 87.8 | 87.1 | 85.6 | 84.3 | | |
| 14.0 | 82.0 | 84.1 | 85.8 | 86.7 | 87.8 | 87.7 | 87.8 | 87.3 | 86.5 | 84.9 | 83.7 | | |
| 18.0 | 82.5 | 84.7 | 86.3 | 87.2 | 87.5 | 87.4 | 87.3 | 86.7 | 85.8 | | | | |
| 22.0 | 83.1 | 85.2 | 86.8 | 87.3 | 87.1 | 87.1 | 86.7 | 86.0 | 85.1 | | | | |
| 26.0 | 83.6 | 85.8 | 86.4 | 87.0 | 86.8 | 86.6 | 86.1 | 85.3 | 84.4 | | | | |
| 30.0 | 84.2 | 85.9 | 86.0 | 86.6 | 86.3 | 85.9 | 85.3 | 84.7 | | | | | |
| 34.0 | 84.7 | 85.5 | 85.4 | 85.9 | 85.6 | 85.2 | 84.6 | | | | | | |
| 38.0 | 84.5 | 85.0 | 84.7 | 85.2 | 84.9 | 84.5 | | | | | | | |
| 42.0 | 84.0 | 84.3 | 84.0 | 84.5 | 84.1 | | | | | | | | |
| 46.0 | 83.4 | 83.5 | 83.3 | 83.8 | 83.4 | | | | | | | | |
| 50.0 | 82.6 | 82.8 | 82.5 | 83.1 | | | | | | | | | |
| 54.0 | 81.8 | 82.1 | | | | | | | | | | | |
| OAT < ISA + 10 | | | | | | | | | | | | | |
| OAT ≥ ISA + 10 | | | | | | | | | | | | | |

PERFORMANCE

TAKEOFF

Intentionally left blank

PER-TOF-THR THRUST OPTIONS

PER-TOF-THR-FLX FLEXIBLE TAKEOFF

PER-TOF-THR-FLX-10 DEFINITION OF FLEXIBLE TAKEOFF

DEFINITION OF FLEXIBLE TAKEOFF.....A

PER-TOF-THR-FLX-20 USE OF FLEXIBLE TAKEOFF

USE OF FLEXIBLE TAKEOFF.....A

PER-TOF-THR-FLX-30 REQUIREMENTS

REQUIREMENTS.....A

PER-TOF-THR-FLX-40 RECOMMENDATION

GENERAL.....A

TAKEOFF PROCEDURE.....B

PER-TOF-TOC TAKEOFF CHARTS

PER-TOF-TOC-05 INTRODUCTION

TAKEOFF CHARTS.....A

PER-TOF-TOC-10 GENERAL (TEMPERATURE ENTRY)

PER-TOF-TOC-10-10 TAKEOFF PERFORMANCE

TAKEOFF PERFORMANCE.....A

PER-TOF-TOC-10-20 TAKEOFF CHART DESCRIPTION

GENERAL.....A

Corrections due to Different Takeoff Conditions.....B

DESCRIPTION OF THE CORRECTIONS ON TAKEOFF CHART.....C

MINIMUM SPEEDS.....D

FLEX TEMPERATURE INDICATOR.....E

PER-TOF-TOC-10-30 ADDITIONAL INFORMATION

ONE ENGINE OUT CLIMB PROCEDURE.....A

TAKEOFF ON A WET RUNWAY.....B

DESCRIPTION OF TAKEOFF CHART.....C

EXAMPLE OF TAKEOFF CHART.....D

Continued on the following page

Continued from the previous page

PER-TOF-TOC-12 MTOW CALCULATION (TEMPERATURE ENTRY)

PER-TOF-TOC-12-10 DETERMINATION OF MAXIMUM TAKEOFF WEIGHT AND SPEEDS

DIRECT CHART READING..... A

CORRECTIONS DUE TO DIFFERENT TAKEOFF CONDITIONS..... B

CONSERVATIVE CORRECTIONS FOR QNH AND BLEEDS..... C

CORRECTIONS FOR WET OR CONTAMINATED RUNWAYS..... D

CORRECTIONS PRODUCED ON THE RTOW CHART..... E

COMBINING CORRECTIONS FROM FCOM AND CHART..... F

PER-TOF-TOC-12-30 EXTRAPOLATION

EXTRAPOLATION..... A

PER-TOF-TOC-12-40 MAXIMUM STRUCTURAL TAKEOFF WEIGHT

MAXIMUM STRUCTURAL TAKEOFF WEIGHT..... A

PER-TOF-TOC-12-50 SUMMARY

SUMMARY..... A

PER-TOF-TOC-14 FLEXIBLE TAKEOFF (TEMPERATURE ENTRY)

PER-TOF-TOC-14-10 DETERMINATION OF FLEXIBLE TAKEOFF TEMPERATURE AND SPEEDS

GENERAL..... A

CORRECTIONS DUE TO DIFFERENT TAKEOFF CONDITIONS..... B

CONSERVATIVE CORRECTIONS FOR QNH AND BLEEDS..... C

CORRECTIONS FOR WET RUNWAY..... D

CORRECTIONS PRODUCED ON THE RTOW CHART..... E

COMBINING CORRECTIONS FROM FCOM AND CHART..... F

PER-TOF-TOC-14-20 FLEXIBLE TAKEOFF NOT POSSIBLE

FLEXIBLE TAKEOFF NOT POSSIBLE..... A

PER-TOF-TOC-14-25 FLEXIBLE TAKEOFF POSSIBLE BUT NOT USED

FLEXIBLE TAKEOFF POSSIBLE BUT NOT USED..... A

PER-TOF-TOC-14-30 SUMMARY

SUMMARY..... A

PER-TOF-TOC-16 GENERAL (WEIGHT ENTRY)

PER-TOF-TOC-16-10 TAKEOFF PERFORMANCE

TAKEOFF PERFORMANCE..... A

Continued on the following page

Continued from the previous page

PER-TOF-TOC-16-20 TAKEOFF CHART DESCRIPTION

| | |
|--|---|
| GENERAL..... | A |
| CORRECTIONS DUE TO DIFFERENT TAKEOFF CONDITIONS..... | B |
| DESCRIPTION OF THE CORRECTIONS ON TAKEOFF CHART..... | C |
| MINIMUM SPEED..... | D |

PER-TOF-TOC-16-30 ADDITIONAL INFORMATION

| | |
|--|---|
| ONE ENGINE OUT CLIMB PROCEDURE..... | A |
| TAKEOFF ON A WET RUNWAY..... | B |
| RTOW CHARTS - COMPLEMENTARY INFORMATION..... | C |
| RTOW EXAMPLE..... | D |

PER-TOF-TOC-18 MTOW CALCULATION (WEIGHT ENTRY)

PER-TOF-TOC-18-10 DETERMINATION OF MAXIMUM TAKEOFF WEIGHT AND SPEEDS

| | |
|--|---|
| GENERAL..... | A |
| MTOW DETERMINATION..... | B |
| CORRECTIONS DUE TO DIFFERENT TAKEOFF CONDITIONS..... | C |
| CONSERVATIVE CORRECTIONS FOR QNH AND BLEEDS..... | D |
| CORRECTIONS FOR WET OR CONTAMINATED RUNWAYS..... | E |
| CORRECTIONS PRODUCED ON THE RTOW CHART..... | F |
| COMBINING CORRECTIONS FROM FCOM AND CHART..... | G |

PER-TOF-TOC-18-20 EXTRAPOLATION

| | |
|--------------------|---|
| EXTRAPOLATION..... | A |
|--------------------|---|

PER-TOF-TOC-18-30 MAXIMUM STRUCTURAL TAKEOFF WEIGHT

| | |
|--|---|
| MAXIMUM STRUCTURAL TAKEOFF WEIGHT..... | A |
|--|---|

PER-TOF-TOC-18-40 SUMMARY

| | |
|--------------|---|
| SUMMARY..... | A |
|--------------|---|

PER-TOF-TOC-20 FLEXIBLE TAKEOFF (WEIGHT ENTRY)

PER-TOF-TOC-20-10 DETERMINATION OF FLEXIBLE TAKEOFF TEMPERATURE AND SPEEDS

| | |
|--|---|
| GENERAL..... | A |
| CORRECTIONS DUE TO DIFFERENT TAKEOFF CONDITIONS..... | B |
| CONSERVATIVE CORRECTIONS FOR QNH AND BLEEDS..... | C |
| CORRECTIONS FOR WET RUNWAY..... | D |
| CORRECTIONS PRODUCED ON THE RTOW CHART..... | E |
| COMBINING CORRECTIONS FROM FCOM AND CHART..... | F |

Continued on the following page

Continued from the previous page

PER-TOF-TOC-20-20 FLEXIBLE TAKEOFF NOT POSSIBLE
FLEXIBLE TAKEOFF NOT POSSIBLE.....A

PER-TOF-TOC-20-30 SUMMARY
SUMMARY.....A

PER-TOF-TOD TAKEOFF DATA

PER-TOF-TOD-24 QNH/BLEEDS CORRECTION
EFFECT OF QNH AND BLEEDS (up to 9200 ft).....A
EXAMPLE.....B
EFFECT OF QNH AND BLEEDS FOR HIGH ALTITUDE OPERATIONS (above 9200 ft).....C
EXAMPLES FOR HIGH ALTITUDE OPERATIONS.....D

PER-TOF-TOD-25 MINIMUM SPEEDS
PER-TOF-TOD-25-10 SPEEDS LIMITED BY VMCG/VMCA
SPEEDS LIMITED BY VMCG/VMCA.....A

PER-TOF-TOD-25-20 V2 LIMITED BY VMU/VMCA
MINIMUM V2 LIMITED BY VMU/VMCA (KT IAS).....A

PER-TOF-CTA RUNWAY CONTAMINATION

PER-TOF-CTA-10 GENERAL
GENERAL.....A

PER-TOF-CTA-20 DEFINITIONS
DEFINITIONS.....A
EQUIVALENCES.....B

PER-TOF-CTA-30 OPERATIONAL CONDITIONS
OPERATIONAL CONDITIONS.....A

PER-TOF-CTA-40 TAKEOFF PERFORMANCE
PER-TOF-CTA-40-10 TAKEOFF PERFORMANCE
TAKEOFF PERFORMANCE.....A

PER-TOF-CTA-40-20 TAKEOFF FROM A WET RUNWAY
HOW TO PROCEED.....A
NO THRUST REVERSERS OPERATIVE (NO CLEARWAY).....B
ALL THRUST REVERSERS OPERATIVE (NO CLEARWAY).....C
NO THRUST REVERSERS OPERATIVE (WITH CLEARWAY).....D
ALL THRUST REVERSERS OPERATIVE (WITH CLEARWAY).....E

Continued on the following page

Continued from the previous page

PER-TOF-CTA-40-30 TAKEOFF FROM A CONTAMINATED RUNWAY

| | |
|---|---|
| TAKEOFF FROM A 6.3 MM (1/4 INCH) WATER COVERED RUNWAY..... | A |
| TAKEOFF FROM A 12.7 MM (1/2 INCH) WATER COVERED RUNWAY..... | B |
| TAKEOFF FROM A 6.3 MM (1/4 INCH) SLUSH COVERED RUNWAY..... | C |
| TAKEOFF FROM A 12.7 MM (1/2 INCH) SLUSH COVERED RUNWAY..... | D |
| TAKEOFF FROM A COMPACTED SNOW COVERED RUNWAY..... | E |

PER-TOF-CTA-40-40 EXAMPLE

| | |
|--|---|
| TAKEOFF PERFORMANCE ON DRY RUNWAY..... | A |
| TAKEOFF PERFORMANCE ON WET RUNWAY..... | B |
| TAKEOFF PERFORMANCE ON RUNWAY COVERED WITH 1/2 INCH SLUSH..... | C |



A318/A319/A320/A321
FLIGHT CREW
OPERATING MANUAL

PERFORMANCE

TAKEOFF

PRELIMINARY PAGES - TABLE OF CONTENTS

Intentionally left blank



A318/A319/A320/A321
FLIGHT CREW
OPERATING MANUAL

PERFORMANCE

TAKEOFF

THRUST OPTIONS - FLEXIBLE TAKEOFF

DEFINITION OF FLEXIBLE TAKEOFF

DEFINITION OF FLEXIBLE TAKEOFF

Ident.: PER-TOF-THR-FLX-10-00001718.0001001 / 28 JAN 11

Applicable to: ALL

In many cases the aircraft takes off with a weight lower than the maximum permissible takeoff weight. When this happens, it can meet the required performance (runway, second segment, obstacle,...) with a decreased thrust that is adapted to the weight : this is called FLEXIBLE TAKEOFF and the thrust is called FLEXIBLE TAKEOFF THRUST.

The use of flexible takeoff thrust saves engine life.



A318/A319/A320/A321
FLIGHT CREW
OPERATING MANUAL

PERFORMANCE

TAKEOFF

THRUST OPTIONS - FLEXIBLE TAKEOFF

Intentionally left blank

USE OF FLEXIBLE TAKEOFF

USE OF FLEXIBLE TAKEOFF

Ident.: PER-TOF-THR-FLX-20-00001719.0001001 / 09 DEC 09

Applicable to: ALL

The pilot can use flexible takeoff when the actual takeoff weight is lower than the maximum permissible takeoff weight for the actual temperature. The maximum permissible takeoff weight decreases when temperature increases, so it is possible to assume a temperature at which the actual takeoff weight would be the limiting one. This temperature is called FLEXIBLE TEMPERATURE or assumed temperature and is entered in the FADEC via the MCDU PERF TO page in order to get the adapted thrust.



A318/A319/A320/A321
FLIGHT CREW
OPERATING MANUAL

PERFORMANCE

TAKEOFF

THRUST OPTIONS - FLEXIBLE TAKEOFF

Intentionally left blank

| | |
|---|---|
|  <p>A318/A319/A320/A321 FLIGHT CREW OPERATING MANUAL</p> | <p align="center">PERFORMANCE TAKEOFF</p> <p align="center">THRUST OPTIONS - FLEXIBLE TAKEOFF</p> |
|---|---|

REQUIREMENTS

REQUIREMENTS

Ident.: PER-TOF-THR-FLX-30-00001792.0027001 / 15 MAR 11
Applicable to: ALL

- Thrust must not be reduced by more than 40 % of the full rated takeoff thrust.
- The flexible takeoff N1 cannot be lower than the Max climb N1 at the same flight conditions. The FADEC takes the above two constraints into account to determine flexible N1. The above two constraints also limit the maximum flexible temperature at ISA + 70 (85 °C at sea level).
- The flexible temperature cannot be lower than the flat rating temperature, TREF (ISA +29 up to 2 000 ft) (See Note) , or the actual temperature (OAT).

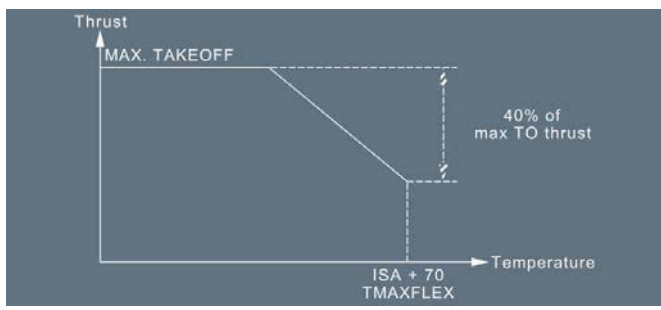

Note: TREF being a function of pressure altitude, read it on the takeoff chart.

- Flexible takeoff is not permitted on contaminated runways.
- The operator should check the maximum thrust (TOGA) at regular intervals in order to detect any engine deterioration, or maintain an adequate engine performance monitoring program to follow up the engine parameters.



A318/A319/A320/A321
FLIGHT CREW
OPERATING MANUAL

PERFORMANCE

TAKEOFF

THRUST OPTIONS - FLEXIBLE TAKEOFF

Intentionally left blank

RECOMMENDATION

GENERAL

Ident.: PER-TOF-THR-FLX-40-00001720.0002001 / 15 DEC 15

Applicable to: ALL

- In order to extend engine life and save maintenance costs, it is recommended to use flexible thrust reduction.
- However, to improve the takeoff performance, the thrust can be increased by selecting a lower flexible temperature.

Using the same takeoff chart, for a given weight it is possible to :

- Select a temperature lower than the maximum determined one and keep the speeds defined at maximum temperature or,
- Move towards the left side (tailwind) of the takeoff chart while remaining within the same configuration and looking for the same actual takeoff weight at lower temperature.

This produces a lower flexible temperature and, in general, lower takeoff speeds ($V1$ /VR /V2).

Using one of the two above possibilities, check that the selected temperature is greater than the actual temperature (OAT) and greater than the flat rating temperature (TREF).

PERFORMANCE

TAKEOFF

THRUST OPTIONS - FLEXIBLE TAKEOFF

TAKEOFF PROCEDURE

Ident.: PER-TOF-THR-FLX-40-00001721.0001001 / 28 JAN 11

Applicable to: **ALL**

Depending on environmental takeoff conditions, the following procedure is recommended.

| CONDITIONS | PROCEDURE | REASON |
|---|---|---|
| Dry or wet well paved runway | <ul style="list-style-type: none"> - Use the flap setting giving the highest flexible temperature. - When flexible temperature difference between two flap settings is low, use the highest flap setting. | Extend engine life and save maintenance costs. |
| High altitude takeoff | Use CONF2/CONF3 | Improve comfort |
| Badly paved runway or Accelerate stop distance limited runway | Use CONF2/CONF3 or Move towards left side of the takeoff chart | Improve comfort Improve stopping distance |
| Windshear expected along takeoff path | Use maximum thrust | Maintain acceleration capability |
| Contaminated runway | Use maximum thrust (flex forbidden) | Improve stopping distance Decrease time on runway. Required by regulations. |

| | |
|---|---|
|  <p>A318/A319/A320/A321 FLIGHT CREW OPERATING MANUAL</p> | <p align="center">PERFORMANCE TAKEOFF TAKEOFF CHARTS - INTRODUCTION</p> |
|---|---|

TAKEOFF CHARTS

Ident.: PER-TOF-TOC-05-00001704.0001001 / 21 MAR 11
Applicable to: ALL

Takeoff charts are required to provide performance at takeoff. It is possible to present the charts in two different ways, one of which is selected by the airline. The different presentations are :

- temperature entry (temperature provided in the left column)
- weight entry (weight provided in the left column).

Both presentations are described here after. Sections PER-TOF-TOC-10, 12 and 14 are relative to temperature entry while PER-TOF-TOC-16, 18 and 20 are relative to weight entry.



A318/A319/A320/A321
FLIGHT CREW
OPERATING MANUAL

PERFORMANCE

TAKEOFF

TAKEOFF CHARTS - INTRODUCTION

Intentionally left blank

TAKEOFF PERFORMANCE

TAKEOFF PERFORMANCE

Ident.: PER-TOF-TOC-10-10-00001705.0001001 / 23 FEB 11

Applicable to: ALL

Takeoff optimization is calculated for a given runway and its obstacles and for given conditions of flap setting, temperature, wind and QNH. The calculation produces a maximum permissible takeoff weight (or a maximum takeoff temperature for an actual weight).

The takeoff thrust produced by the engine varies as follows :

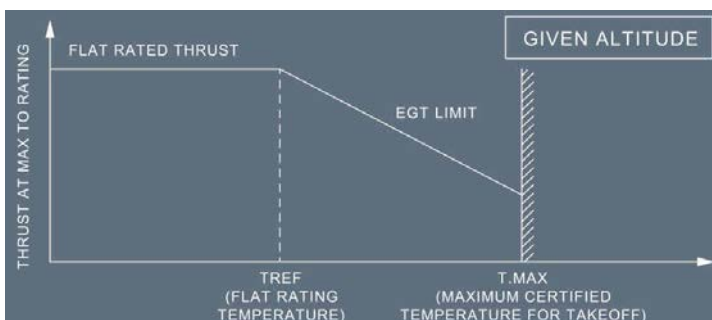

The optimization process calculates the speeds which will produce the maximum takeoff weight. To do so, it takes into account the different takeoff limitations such as TOD , ASD , TOR, second segment..., as shown on the figure charts below.

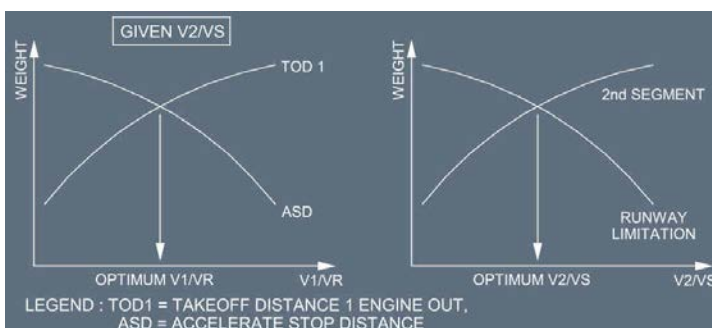

On a typical runway, the performance of a twin engine aircraft, is generally limited by the one engine out operation at takeoff. The optimum V2 /VS and optimum V1 /VR are consequently unique.



A318/A319/A320/A321
FLIGHT CREW
OPERATING MANUAL

PERFORMANCE

TAKEOFF

TAKEOFF CHARTS - GENERAL (TEMPERATURE ENTRY)

Intentionally left blank

TAKEOFF CHART DESCRIPTION

GENERAL

Ident.: PER-TOF-TOC-10-20-00001706.0003001 / 03 MAR 11
 Applicable to: ALL

The takeoff chart (RTOW : Regulatory Takeoff Weight) is calculated for a specific aircraft version and for a particular runway specified at the top of the chart. The top of the chart also gives some information about the runway and lists the calculation assumptions.

The chart is given for 2 different configurations and 5 wind values per configuration. This allows the crew to select the configuration that gives either :

- the highest permissible takeoff weight, or, for a given weight,
- the highest flexible temperature.

If different configurations give equivalent performance, the crew should select the configuration associated with the lowest takeoff speeds.

For each temperature value (and for a given configuration and wind), the chart provides the following information :

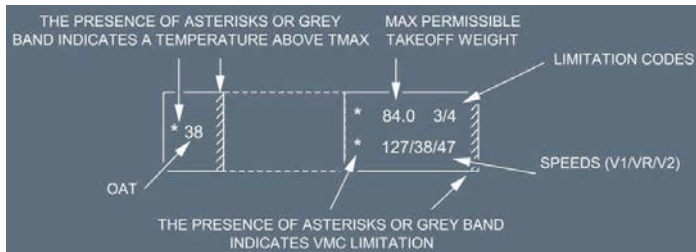

The available limitation codes are :

- First segment : 1
- Second segment : 2
- Runway length : 3
- Obstacles : 4
- Tire speed : 5
- Brake energy : 6
- Maximum computation weight : 7
- Final takeoff : 8
- VMU : 9

CORRECTIONS DUE TO DIFFERENT TAKEOFF CONDITIONS

Ident.: PER-TOF-TOC-10-20-00014608.0001001 / 18 JUL 12

Applicable to: ALL

Each takeoff chart is computed for a given set of conditions (air conditioning, QNH, anti ice...) specified at the top of the chart. If the actual takeoff conditions are different, the crew must apply corrections. Two types of correction are available :

- Conservative corrections on *Refer to PER-TOF-TOD-24 EFFECT OF QNH AND BLEEDS* (to be used when not provided on the chart).
- Corrections (less restrictive) listed on the chart, to be applied as explained below.

Note:

- If the RTOW chart is based on the CG being at 25 %, the crew can find the takeoff performance at a more forward CG by decreasing the takeoff weight by 1 000 kg (2 200 lb) and increasing V1 , VR and V2 by 1 kt.
- 25 % CG is the basic certified limit, on which all takeoff computations are based. To take into account the operational margins, the above penalties must be applied when operational CG is forward 27 % CG.

DESCRIPTION OF THE CORRECTIONS ON TAKEOFF CHART

Ident.: PER-TOF-TOC-10-20-00005368.0001001 / 08 JUL 15

Applicable to: ALL

The corrections are presented on 4 lines:

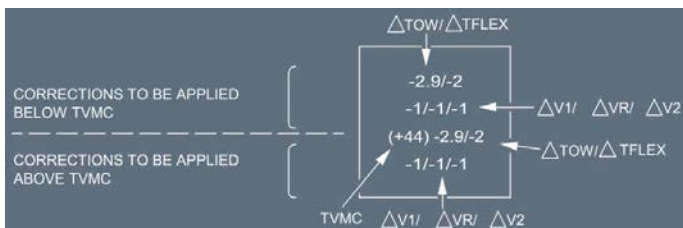

TVMC is a temperature value given per column. This is a fictitious value that indicates the temperature above which the speeds are close to a VMCG /VMCA limitation or are VMCG /VMCA limited.

Note: The lower two lines may be shaded on certain chart formats.



A318/A319/A320/A321
FLIGHT CREW
OPERATING MANUAL

PERFORMANCE

TAKEOFF

TAKEOFF CHARTS - GENERAL (TEMPERATURE ENTRY)

MINIMUM SPEEDS

Ident.: PER-TOF-TOC-10-20-00005372.0001001 / 08 JUL 15

Applicable to: ALL

Minimum V1/VR/V2 due to VMCG /VMCA are provided on the bottom right side of the takeoff chart. They are only applicable in case of speed corrections. These speeds are conservative. They may be slightly higher than V1/VR/V2 displayed on the takeoff chart.

FLEX TEMPERATURE INDICATOR

Ident.: PER-TOF-TOC-10-20-00005373.0001001 / 18 FEB 11

Applicable to: ALL

On the temperature entry chart, the temperature column may display asterisks or have a gray band to indicate temperature values above TMAX and which are flex temperature.



A318/A319/A320/A321
FLIGHT CREW
OPERATING MANUAL

PERFORMANCE

TAKEOFF

TAKEOFF CHARTS - GENERAL (TEMPERATURE ENTRY)

Intentionally left blank

ADDITIONAL INFORMATION

ONE ENGINE OUT CLIMB PROCEDURE

Ident.: PER-TOF-TOC-10-30-00001708.0001001 / 23 FEB 11

Applicable to: ALL

The performance given in the chart is consistent with the flight path specified for the aircraft with one engine out and takes into account significant obstacles.

When the procedure to be followed is not the standard instrument departure, the chart describes a specific procedure (EOSID).

When the specified procedure requires a turn, except if otherwise stated on the RTOW chart, the turn should be performed with a maximum bank of 15 ° until the aircraft reaches 1 500 ft or until green dot.

The acceleration height (or altitude) ensures that the net flight path clears the highest obstacle by at least 35 ft when accelerating in level flight to green dot speed after an engine failure, in the most adverse conditions.

TAKEOFF ON A WET RUNWAY

Ident.: PER-TOF-TOC-10-30-00001709.0002001 / 23 FEB 11

Applicable to: ALL

Takeoff charts computed for wet runway with a 15 ft screen height and/or use of reverse thrust may produce, in some conditions, a maximum takeoff weight (or flexible temperature) higher than that obtained for a dry runway. It is thus mandatory to compare both charts (dry and wet) and retain the lower of the two weights (or flexible temperature) and the associated speeds determined for a wet runway.

Note: *The crew need not compare the charts if the top of the wet runway chart specifies "DRY CHECK". (The comparison has already been inserted in the WET runway calculation).*

DESCRIPTION OF TAKEOFF CHART

Ident.: PER-TOF-TOC-10-30-00001710.0006001 / 23 FEB 11

Applicable to: ALL

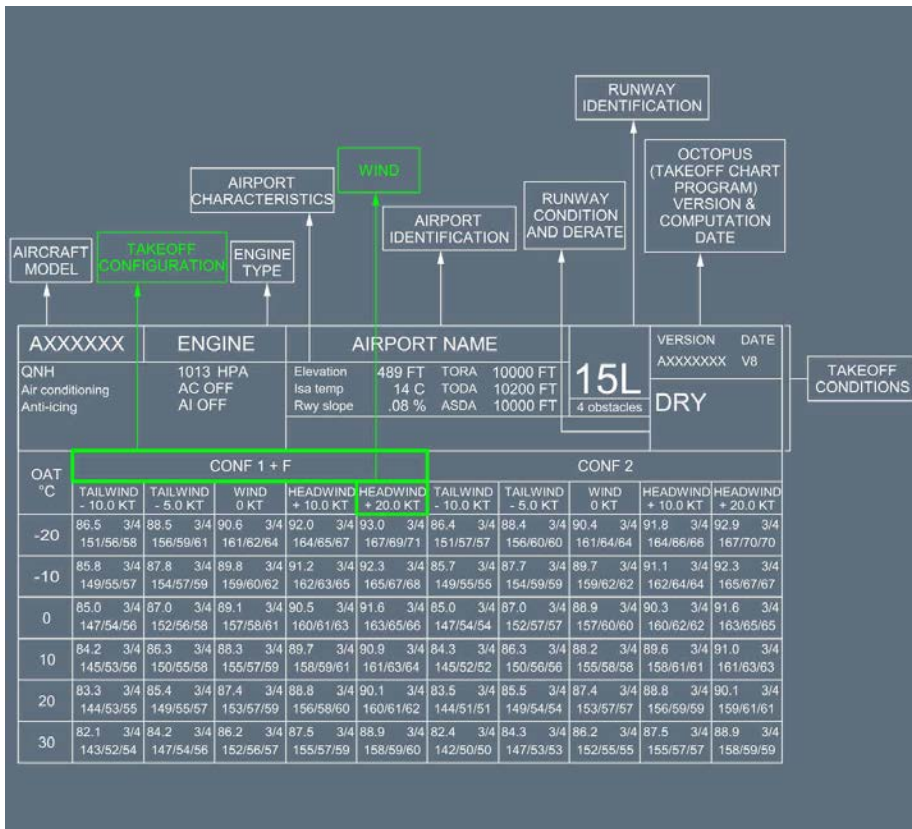

| AXXXXXX | | ENGINE | | AIRPORT NAME | | | | VERSION | | DATE | |
|------------------|-----------------------|-----------------------|-----------------------|---|-----------------------|-----------------------|-----------------------|-----------------------|-----------------------|-----------------------|----|
| QNH | | 1013 HPA | | Elevation | 489 FT | TORA | 10000 FT | 15L | AXXXXXX | | V8 |
| Air conditioning | | AC OFF | | Isa temp | 14 C | TODA | 10200 FT | | DRY | | |
| Anti-icing | | AI OFF | | Rwy slope | .08 % | ASDA | 10000 FT | | + 4 obstacles | | |
| OAT °C | CONF 1 + F | | | | | | CONF 2 | | | | |
| | TAILWIND - 10.0 KT | TAILWIND - 5.0 KT | WIND 0 KT | HEADWIND + 10.0 KT | HEADWIND + 20.0 KT | TAILWIND - 10.0 KT | TAILWIND - 5.0 KT | WIND 0 KT | HEADWIND + 10.0 KT | HEADWIND + 20.0 KT | |
| 46 | 72.8 3/4 141/45/47 | 74.3 3/4 145/48/49 | 75.9 3/4 150/50/51 | 76.9 3/4 153/53/54 | 78.0 3/4 154/54/55 | 72.6 3/4 141/46/46 | 74.2 3/4 145/48/49 | 75.7 3/4 150/51/51 | 76.9 3/4 153/53/53 | 77.9 3/4 155/55/55 | |
| 48 | 71.4 3/4 141/45/46 | 73.0 3/4 145/47/48 | 74.5 3/4 149/50/51 | DO NOT USE FOR OPERATIONAL PURPOSE | | | | 74.3 3/4 150/51/51 | 75.4 3/4 153/53/53 | 76.4 3/4 154/54/54 | |
| 50 | 70.1 3/4 140/44/46 | 71.6 3/4 145/47/48 | 73.1 3/4 149/49/50 | | | | | | | | |
| *52 | 68.8 3/4 140/44/45 | 70.2 3/4 145/46/47 | 71.7 3/4 149/49/50 | 72.6 4/4 150/50/51 | 73.5 4/4 151/51/52 | 68.6 3/4 140/45/45 | 70.0 3/4 145/47/47 | 71.5 3/4 150/50/50 | 72.5 3/4 151/51/51 | 73.4 4/4 153/53/53 | |
| *54 | 67.4 3/4 140/43/44 | 68.9 3/4 145/46/47 | 70.2 3/4 148/48/49 | 71.1 4/4 149/49/50 | 72.0 4/4 150/50/51 | 67.3 3/4 140/44/44 | 68.7 3/4 145/47/47 | 70.1 3/4 149/49/49 | 71.0 4/4 151/51/51 | 71.9 4/4 152/52/52 | |

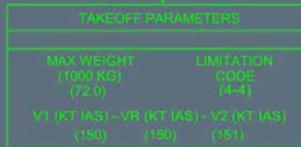

PERFORMANCE

TAKEOFF

TAKEOFF CHARTS - GENERAL (TEMPERATURE ENTRY)

| AXXXXXX | ENGINE | | AIRPORT NAME | | | | VERSION | DATE | | |
|--|---|---|---|---|---|---|--|---|---|---|
| QNH | 1013 HPA | | Elevation | 489 FT | TORA | 10000 FT | 15L | AXXXXXX V8 | | |
| Air conditioning | AC OFF | | Isa temp | 14 C | TODA | 10200 FT | 4 obstacles | DRY | | |
| Anti-icing | AI OFF | | Rwy slope | .08 % | ASDA | 10000 FT | | | | |
| OAT °C | CONF 1 + F | | | | | CONF 2 | | | | |
| | TAILWIND - 10.0 KT | TAILWIND - 5.0 KT | WIND 0 KT | HEADWIND + 10.0 KT | HEADWIND + 20.0 KT | TAILWIND - 10.0 KT | TAILWIND - 5.0 KT | WIND 0 KT | HEADWIND + 10.0 KT | HEADWIND + 20.0 KT |
| INFLUENCE OF RUNWAY CONDITION | | | | | | | | | | |
| WET | +0/+0 0/+0/+0 | +0/+0 -1/+0/+0 | -0/-1 -1/+0/+0 | -0/-1 0/+0/+0 | -2/-1 -1/+0/+0 | +0/+0 -1/+0/+0 | +0/+0 0/+0/+0 | +0/+0 0/+0/+0 | +0/+0 0/+0/+0 | -2/-1 -1/+0/+0 |
| D QNH HPA | INFLUENCE OF DELTA PRESSURE | | | | | | | | | |
| -10 | -8/-2 0/-1/-1 (+54)-8/-2 0/+0/+0 | -9/-2 0/-1/-1 (+54)-9/-2 0/+0/+0 | -1,4/-3 0/-1/-1 (+54)-1,4/-3 0/+0/+0 | -1,0/-2 -1/-1/-1 (+34)-1,0/-2 -1/+0/+0 | -1,0/-2 -1/-1/-1 (+54)-1,0/-2 -1/+0/+0 | -8/-2 0/-1/-1 (+54)-8/-2 0/+0/+0 | -8/-2 0/-1/-1 (+54)-8/-2 0/+0/+0 | -1,0/-2 0/0/0 (+54)-1,0/-2 0/+0/+0 | -1,2/-2 0/0/0 (+54)-1,2/-2 0/+0/+0 | -1,1/-2 0/0/0 (+54)-1,1/-2 0/+0/+0 |
| +10 | +6/+0 +1/+0/+0 (+54)+2/+0 +1/+0/+0 | +6/+0 +1/+0/+0 (+54)+2/+0 +1/+0/+0 | +0/+0 +1/+1/+1 (+54)+0/+0 +1/+1/+1 | +6/+0 +1/+1/+1 (+54)+2/+0 +1/+1/+1 | +6/+0 +1/+1/+1 (+54)+2/+0 +1/+1/+1 | +5/+0 +0/+0/+0 (+54)+3/+0 +0/+0/+0 | +5/+0 +1/+0/+0 (+54)+1/+0 +1/+1/+1 | +4/+0 +1/+1/+1 (+54)+2/+0 +1/+1/+1 | +3/+0 +1/+1/+1 (+54)+1/+0 +1/+1/+1 | +2/+0 +0/+1/+1 (+54)+0/+0 +0/+1/+1 |
| LABEL FOR INFLUENCE DW (1000 KG) DT FLEX DV1-DVR-DV2 (KT) (TVMC OAT C) DW (1000 KG) DT FLEX DV1-DVR-DV2 (KT) | MTOW (1000 KG) codes V1min/VR/V2(KT) | | *VMC *LIMITATION | Tref (OAT) =29 C Tmax (OAT) =50 C | Min acc height 784Ft Max acc height 1965Ft | Min QNH alt 1280Ft Max QNH alt 2461Ft | MIN V1/VR/V2 = 120/22/28 CHECK VMU LIMITATION CORRECT: V1/VR/V2 = .1KI/1000 Kg | | | |
| LIMITATION CODES: 1=1st segment 2=2nd segment 3=runway length 4=obstacles 5=tire speed 6=brake energy 7=max weight 8=final takeoff 9=VMU | | | | | | | | | | |
| INFLUENCE CORRECTION ΔWEIGHT ΔTFLEX ΔV1/ΔVR/ΔV2 (TVMC) ΔWEIGHT ΔTFLEX ΔV1/ΔVR/ΔV2 | | | | | | MINIMUM VALUES OF V1/VR/V2 TO WHICH TAKEOFF SPEEDS MUST BE LIMITED WHEN DECREMENTS ARE APPLIED | | | | |
| | | | | | | V1/VR/V2 DECREMENTS FOR WEIGHTS BELOW THE LOWEST WEIGHT OF A COLUMN | | | | |

MINIMUM &
MAXIMUM
ACC. HEIGHT
AND ALT.



A318/A319/A320/A321
FLIGHT CREW
OPERATING MANUAL

PERFORMANCE

TAKEOFF

TAKEOFF CHARTS - GENERAL (TEMPERATURE ENTRY)

EXAMPLE OF TAKEOFF CHART

Ident.: PER-TOF-TOC-10-30-00014705.0001001 / 29 JUL 16

Applicable to: ALL

The following data and graphs are for example only, and are not for operational use. Even if the data in the following example is in “kg” and “m”, the same method can be applied for “lb” and “ft”.



A318/A319/A320/A321
FLIGHT CREW
OPERATING MANUAL

PERFORMANCE

TAKEOFF

TAKEOFF CHARTS - GENERAL (TEMPERATURE ENTRY)

| A3XXXXX | ENGINES | | AIRPORT NAME | | | | | Version | Date | | |
|---|---|-----------------------|---|-----------------------|----------------------------------|-----------------------|-----------------------------------|---|-----------------------|----------------------------|-------------------|
| QNH | 1013.25 HPA | | Elevation | 489 FT | TORA | 3000 M | 15L | A3XXXXXX | **V20 | | |
| Air cond. | AC OFF | | Isa temp | 14 C | TODA | 3000 M | | 4 obstacles | DRY | | |
| Anti-icing | AI OFF | | Rwy slope | .08 % | ASDA | 3000 M | | | | | |
| All reversers operating No reversers on dry runway | | | | | | | | | | | |
| OAT °C | CONF 1 + F | | | | | CONF 2 | | | | | |
| | TAILWIND -10.0 KT | TAILWIND -5.0 KT | WIND 0 KT | HEADWIND +10.0 KT | HEADWIND +20.0 KT | TAILWIND -10.0 KT | TAILWIND -5.0 KT | WIND 0 KT | HEADWIND +10.0 KT | HEADWIND +20.0 KT | |
| -20 | 80.2 4/6 156/56/58 | 80.2 4/6 162/62/64 | 83.6 3/4 167/67/69 | 84.8 3/4 170/70/72 | 85.8 3/4 173/73/75 | 80.4 4/6 154/54/59 | 81.9 3/4 159/59/64 | 83.4 3/4 164/64/69 | 84.4 3/4 167/67/72 | 85.2 3/4 169/69/74 | |
| -10 | 78.5 4/6 153/56/58 | 81.3 4/6 159/59/62 | 83.1 4/6 164/64/66 | 84.3 3/4 167/67/69 | 85.3 3/4 171/71/72 | 79.7 4/6 151/52/57 | 81.4 4/6 156/56/62 | 82.9 3/4 161/61/66 | 84.0 3/4 164/64/69 | 84.9 3/4 167/67/72 | |
| 0 | 78.8 4/6 151/54/57 | 80.6 4/6 155/57/59 | 82.5 4/6 162/62/64 | 83.7 3/4 165/65/67 | 84.7 3/4 168/68/70 | 80.4 4/6 149/51/56 | 82.4 3/4 159/59/64 | 84.0 3/4 162/62/67 | 85.0 3/4 165/65/70 | 85.4 3/4 168/68/74 | |
| 10 | 78.2 4/6 148/53/55 | 80.0 4/6 154/57/59 | 81.8 4/6 159/60/62 | 83.1 4/6 163/63/65 | 84.2 3/4 166/66/67 | 78.4 4/6 147/50/54 | 80.2 4/6 152/52/58 | 81.9 3/4 156/56/62 | 83.0 3/4 159/59/65 | 83.9 3/4 162/63/68 | |
| 20 | 77.6 4/6 146/51/53 | 79.3 4/6 151/55/57 | 81.1 4/6 157/57/61 | 82.5 4/6 160/60/62 | 83.6 4/6 163/63/65 | 77.7 4/6 145/48/52 | 79.5 4/6 150/51/56 | 81.3 4/6 154/54/60 | 82.4 3/4 157/57/63 | 83.4 3/4 160/61/66 | |
| 30 | 76.9 4/6 144/50/52 | 78.7 4/6 149/54/56 | 80.5 4/6 154/57/60 | 81.8 4/6 158/58/60 | 83.0 4/6 161/61/63 | 77.1 4/6 143/46/50 | 78.9 4/6 148/50/55 | 80.7 4/6 153/53/58 | 81.9 3/4 155/55/61 | 82.9 3/4 158/58/64 | |
| 32 | 76.8 4/6 144/50/52 | 78.6 4/6 149/53/55 | 80.4 4/6 154/56/55 | 81.7 4/6 157/58/60 | 82.9 4/6 161/61/63 | 77.0 4/6 142/45/50 | 78.7 4/6 147/50/55 | 80.6 4/6 152/53/58 | 81.6 4/6 155/55/60 | 82.7 3/4 157/58/64 | |
| 34 | 76.7 4/6 143/50/52 | 78.4 4/6 148/53/55 | 80.2 4/6 154/56/58 | 81.5 4/6 157/57/60 | 82.8 4/6 160/60/62 | 76.9 4/6 142/45/50 | 78.6 4/6 147/52/57 | 80.5 4/6 152/52/57 | 81.7 4/6 154/55/60 | 82.7 3/4 157/58/64 | |
| 36 | 76.6 4/6 143/49/52 | 78.4 4/6 148/52/54 | 80.1 4/6 153/56/58 | 81.4 4/6 156/57/59 | 82.7 4/6 160/60/62 | 76.8 4/6 141/45/50 | 78.5 4/6 148/50/55 | 80.3 4/6 151/52/57 | 81.4 4/6 154/55/60 | 82.6 3/4 157/58/63 | |
| 38 | 76.5 4/6 142/48/52 | 78.3 4/6 147/52/54 | 80.0 4/6 153/56/58 | 81.3 4/6 156/58/60 | 82.6 4/6 159/60/62 | 76.7 4/6 141/45/50 | 78.4 4/6 146/48/53 | 80.2 4/6 151/52/57 | 81.5 4/6 154/54/59 | 82.5 3/4 156/58/63 | |
| 40 | 76.4 4/6 142/48/52 | 78.2 4/6 147/52/54 | 79.9 4/6 152/56/58 | 81.2 4/6 156/58/60 | 82.5 4/6 159/60/61 | 76.6 4/6 141/45/50 | 78.3 4/6 146/48/53 | 80.1 4/6 150/51/56 | 81.4 4/6 153/54/59 | 82.4 3/4 156/57/63 | |
| 42 | 76.3 4/6 142/48/51 | 78.0 4/6 147/52/54 | DO NOT USE FOR OPERATIONAL PURPOSE | | | | | 81.3 4/6 153/54/59 | 82.3 3/4 156/57/62 | 83.4 3/4 157/58/64 | |
| 44 | 76.1 4/6 142/49/51 | 77.9 4/6 146/51/53 | | | | | | 81.1 4/6 153/53/58 | 82.1 3/4 156/57/62 | 83.1 3/4 157/58/64 | |
| 46 | 75.5 4/6 142/48/50 | 77.2 4/6 148/50/52 | 78.9 4/6 152/55/57 | 80.2 4/6 155/56/58 | 80.7 4/6 154/56/58 | 75.7 4/6 141/45/49 | 77.3 4/6 145/47/52 | 79.1 4/6 150/50/55 | 80.5 4/6 152/53/58 | 81.5 4/6 152/55/60 | |
| 48 | 74.5 4/6 143/48/50 | 76.2 4/6 148/50/52 | 77.9 4/6 153/53/55 | 79.1 4/6 155/53/55 | 79.3 2/4 153/55/57 | 74.7 4/6 141/44/48 | 76.4 4/6 146/47/51 | 78.0 3/4 150/50/55 | 79.1 3/4 152/53/57 | 79.5 4/6 155/58/63 | |
| 50 | 73.6 4/6 143/47/49 | 75.3 4/6 148/49/51 | 76.9 4/6 153/53/55 | 77.9 4/6 154/54/55 | 77.9 2/4 151/54/55 | 73.8 4/6 142/42/46 | 75.4 4/6 146/47/51 | 76.9 3/4 150/50/54 | 78.0 3/4 152/52/57 | 78.0 2/4 149/52/57 | |
| 52 | 72.7 4/6 144/46/48 | 74.4 4/6 148/49/51 | 75.8 3/4 153/53/54 | 76.3 2/4 152/52/53 | 76.3 2/4 147/52/53 | 72.9 4/6 142/44/48 | 74.3 3/4 148/48/50 | 75.8 3/4 150/50/54 | 76.8 2/4 150/50/55 | 76.4 2/4 146/50/55 | |
| 54 | 71.8 4/6 145/46/47 | 73.3 3/4 148/49/51 | 74.6 3/4 152/52/54 | 75.0 2/4 150/50/52 | 75.0 2/4 145/50/52 | 71.9 3/4 142/43/47 | 73.3 3/4 146/46/50 | 74.7 3/4 149/49/54 | 75.1 2/4 148/49/54 | 75.1 2/4 144/49/54 | |
| INFLUENCE OF RUNWAY CONDITION | | | | | | | | | | | |
| WET | -2.0/-6 | -1.5/-4 | -1.2/-3 | -1.1/-2 | 1.8/-2 | -0.9/-4 | -1.5/-4 | -1.2/-3 | -1.2/-2 | -1.6/-3 | |
| | -16/1/-1 | -15/-2/-2 | -13/-4/-4 | -11/-3/-3 | -10/-2/-2 | -14/0/-1 | -13/0/-1 | -12/-2/-2 | -10/-1/-1 | -4/-2/-2 | |
| | (+54) +2.0/-5 | (+54) -1.5/-4 | (+50) -1.3/-3 | (+54) -1.1/-2 | (+54) -0.8/-2 | (+50) -0.9/-4 | (+54) -1.5/-4 | (+54) -1.3/-3 | (+54) -1.2/-2 | (+54) -1.3/-3 | |
| | -16/0/0 | -15/0/0 | -13/0/0 | -11/0/0 | -10/0/0 | -14/0/0 | -13/0/0 | -11/0/0 | -10/0/0 | -4/0/0 | |
| INFLUENCE OF DELTA PRESSURE | | | | | | | | | | | |
| D/DW HPA | -10.0 | 0/0/-2 | -0.7/-2 | -0.7/-2 | -1.3/-3 | -0.7/-2 | -0.7/-2 | -1.2/-3 | -0.8/-2 | -0.8/-2 | |
| | 0/0/0 | 0/0/0 | 0/0/0 | 0/0/0 | -1/0/0 | 0/0/0 | 0/0/0 | -1/0/0 | -1/0/0 | -1/0/0 | |
| | (+54) 0.8/-2 | (+54) -0.7/-2 | (+54) -0.7/-2 | (+54) -1.3/-3 | (+54) -0.7/-2 | (+54) -0.7/-2 | (+54) -1.2/-3 | (+54) -0.8/-2 | (+54) -0.8/-2 | (+54) -0.8/-2 | |
| | 0/0/0 | 0/0/0 | 0/0/0 | 0/0/0 | 0/0/0 | 0/0/0 | -1/0/0 | -1/0/0 | -1/0/0 | -1/0/0 | |
| | +10.0 | +0.2/0 | +0.2/0 | 0/0/0 | +0.2/0 | +0.2/0 | +0.2/0 | +0.2/0 | +0.2/0 | +0.2/0 | |
| | 0/0/0 | 0/0/0 | 0/0/0 | 0/0/0 | 0/0/0 | +1/+1/+1 | +1/+1/+1 | 0/0/0 | +1/+1/+1 | +1/+1/+1 | |
| | (+54) +0.2/0 | (+54) +0.2/0 | (+54) +0.0/0 | (+54) +0.2/0 | (+54) +0.2/0 | (+54) +0.2/0 | (+54) +0.2/0 | (+54) +0.2/0 | (+54) +0.2/0 | (+54) +0.2/0 | |
| | 0/0/0 | 0/0/0 | 0/0/0 | 0/0/0 | +1/+1/+1 | +1/+1/+1 | +1/+1/+1 | 0/0/0 | +1/+1/+1 | +1/+1/+1 | |
| LABEL: PRR INFLUENCE DW (1000 KG) DTLEFL DV1-DVR-DV2 (KT) | M/DW (1000 KG) codes Vrmin/VrV2 (kt) | | *M/C LIMITATION | | Trst (CAT) Trmax (CAT) = 54 C | | Min solo height Max alt height | | 454 FT 1917 FT | Min DPH alt Max DPH alt | 553 FT 2406 FT |
| (TM/C) CAT C DW (1000 KG) DTLEFL DV1-DVR-DV2 (KT) | LIMITATION CODES: 1-1st segment 2-2nd segment 3-minute length 4-obstacles 5-8 ft/speed 6-brake energy 7-max weight 8-critical take-off thrust | | | | | | | Min Vr/VrV2 = 108/111/117 CHECK VMM LIMITATION Const. Vr1/VrV2 = 1.0 KT/1000 KG | | | |

DETERMINATION OF MAXIMUM TAKEOFF WEIGHT AND SPEEDS

DIRECT CHART READING

Ident.: PER-TOF-TOC-12-10-00001712.0002001 / 23 FEB 11

Applicable to: ALL

The takeoff chart is computed for a given runway under a set of conditions, which are:

- OAT
- Wind
- Configuration
- QNH, air conditioning, anti ice...

Two configurations are produced on the chart. This enables the crew to select that giving the highest permissible takeoff weight. In case of equivalent performance, retain the configuration giving the lower takeoff speeds.

For a given configuration, enter the chart with the OAT and wind value to determine the maximum permissible weight. For an OAT or wind value not presented on the chart, interpolate between two consecutive temperature rows and/or two consecutive wind columns. Conservative OAT or wind values can also be considered. No extrapolation is allowed.

CORRECTIONS DUE TO DIFFERENT TAKEOFF CONDITIONS

Ident.: PER-TOF-TOC-12-10-00001713.0002001 / 28 JAN 11

Applicable to: ALL

Retain the maximum takeoff weight, associated configuration and speeds from above.
For conditions different from those of the chart, apply relevant corrections.



A318/A319/A320/A321
FLIGHT CREW
OPERATING MANUAL

PERFORMANCE

TAKEOFF

TAKEOFF CHARTS - MTOW CALCULATION (TEMPERATURE ENTRY)

CONSERVATIVE CORRECTIONS FOR QNH AND BLEEDS

Ident.: PER-TOF-TOC-12-10-00014706.0001001 / 29 JUL 16

Applicable to: ALL

The following data and graphs are for example only, and are not for operational use. Even if the data in the following example is in “kg” and “m”, the same method can be applied for “lb” and “ft”.

Corrections are given for QNH ≠ 1 013 hPa, air conditioning ON, anti ice ON(Refer to PER-TOF-TOD-24 EFFECT OF QNH AND BLEEDS).

1. For the given wind and temperature conditions, read the maximum takeoff weight.
2. Apply the published weight correction(s) to the maximum takeoff weight (for each correction) to determine the maximum permissible takeoff weight.
3. Read the speeds associated with the maximum permissible takeoff weight by entering the chart in the wind column.

EXAMPLE 1

DATA: OAT = 25 °C
 Head Wind = 10 kt
 Air conditioning ON
 QNH = 1 013 hPa

Use the chart (Refer to PER-TOF-TOC-10-30 EXAMPLE OF TAKEOFF CHART):

| A3XXXXX | ENGINES | | AIRPORT NAME | | | | | | Version | Date | | | | | | |
|--|---------------------------------|-----------------------|---|-------------------------|-----------------------|----------------------------|-----------------------|-----------------------|-----------------------|-----------------------|-----------------------|-----------------------|-----------------------|-----------------------|-----------------------|-----------------------|
| QNH Air cond Anti-icing All reversers operating No reversers on dry runway | 1013.25 HPA AC OFF AI OFF | | Elevation EAS temp Rwy slope | 489 FT 14 C .08 % | TORA TODA ASDA | 3000 M 3000 M 3000 M | 15L | 4 obstructions | DRY | A3XXXXXX **V20 | | | | | | |
| OAT °C | CONF 1 + F | | | | | | CONF 2 | | | | | | | | | |
| | TAILWIND +10.0 KT | TAILWIND +5.0 KT | WIND 0 KT | HEADWIND +10.0 KT | HEADWIND +20.0 KT | TAILWIND +10.0 KT | TAILWIND +5.0 KT | WIND 0 KT | HEADWIND +10.0 KT | HEADWIND +20.0 KT | | | | | | |
| -20 | 80.2 4/6 150/59/68 | 80.2 4/6 162/62/64 | 83.6 3/4 197/67/89 | 84.8 3/4 170/70/72 | 85.8 3/4 173/73/75 | 80.4 4/6 154/54/59 | 81.9 3/4 159/59/64 | 83.4 3/4 164/64/69 | 84.4 3/4 167/67/72 | 85.2 3/4 169/69/74 | | | | | | |
| -10 | 79.5 4/6 163/66/66 | 81.3 4/6 159/68/62 | 83.1 4/6 164/64/69 | 84.3 3/4 167/67/69 | 85.3 3/4 171/71/72 | 79.7 4/6 151/52/57 | 81.4 4/6 156/56/62 | 82.9 3/4 161/61/66 | 84.0 3/4 164/64/69 | 84.9 3/4 167/67/72 | | | | | | |
| 0 | 78.8 4/6 151/64/57 | 80.6 4/6 160/60/62 | 82.5 4/6 162/62/64 | 83.7 3/4 165/65/67 | 84.7 3/4 168/68/70 | 79.0 4/6 149/51/56 | 80.8 4/6 154/54/60 | 82.4 3/4 159/59/64 | 83.6 3/4 162/62/67 | 84.5 3/4 165/65/70 | | | | | | |
| 10 | 78.2 4/6 148/53/55 | 80.0 4/6 154/57/59 | 81.8 4/6 159/60/62 | 83.1 4/6 163/63/65 | 84.2 3/4 166/66/67 | 78.4 4/6 147/50/54 | 80.2 4/6 152/52/58 | 81.9 3/4 156/56/62 | 83.0 3/4 159/59/65 | 83.9 3/4 162/63/68 | | | | | | |
| 20 | 77.6 4/6 146/51/53 | 79.3 4/6 151/55/57 | 81.1 4/6 157/57/61 | 82.5 4/6 160/60/62 | 83.6 4/6 163/63/65 | 77.7 4/6 145/48/52 | 79.5 4/6 150/51/56 | 81.3 4/6 154/54/60 | 82.4 3/4 157/57/63 | 83.4 3/4 160/61/66 | | | | | | |
| 30 | 76.9 4/6 144/50/52 | 78.7 4/6 149/54/56 | 80.5 4/6 154/57/60 | 81.8 4/6 158/59/60 | 83.0 4/6 161/61/63 | 77.1 4/6 143/46/50 | 78.9 4/6 148/50/55 | 80.7 4/6 153/53/58 | 81.9 3/4 155/56/61 | 82.9 3/4 158/59/64 | | | | | | |
| 32 | 76.8 4/6 144/50/52 | 78.6 4/6 149/53/55 | 80.4 4/6 154/56/55 | 81.7 4/6 157/58/60 | 82.9 4/6 161/61/63 | 77.0 4/6 142/45/50 | 78.7 4/6 147/50/55 | 80.6 4/6 152/53/58 | 81.8 4/6 155/56/60 | 82.8 3/4 157/59/64 | | | | | | |
| 34 | 76.7 4/6 143/50/52 | 78.4 4/6 148/53/55 | DO NOT USE FOR OPERATIONAL PURPOSE | | | | | | 81.7 4/6 154/55/60 | 82.7 3/4 157/58/64 | | | | | | |
| 36 | 76.6 4/6 143/49/52 | 78.4 4/6 148/52/54 | | | | | | | 76.1 4/6 154/55/60 | 76.6 3/4 157/56/63 | | | | | | |
| 38 | 76.5 4/6 142/49/52 | 78.3 4/6 147/52/54 | | | | | | | 80.0 4/6 153/56/58 | 81.3 4/6 156/58/62 | 82.6 4/6 159/60/62 | 76.7 4/6 141/45/50 | 78.4 4/6 146/48/53 | 80.2 4/6 151/52/57 | 81.5 4/6 154/54/59 | 82.5 3/4 156/56/63 |

Enter the 10 kt head wind column and interpolate for 25 °C, CONF 1+F,

- Maximum TO weight (1 000 kg) air conditioning OFF.....82.1
- Enter the 10 kt head wind column and interpolate for 25 °C, CONF 2,
- Maximum TO weight (1 000 kg) air conditioning OFF.....82.1
- Retain CONF 2 as takeoff configuration as the speeds are lower.
- Maximum TO weight (1 000 kg) air conditioning OFF.....82.1

Use the QNH/BLEEDS correction page:(Refer to *PER-TOF-TOD-24 EFFECT OF QNH AND BLEEDS*).

For example:

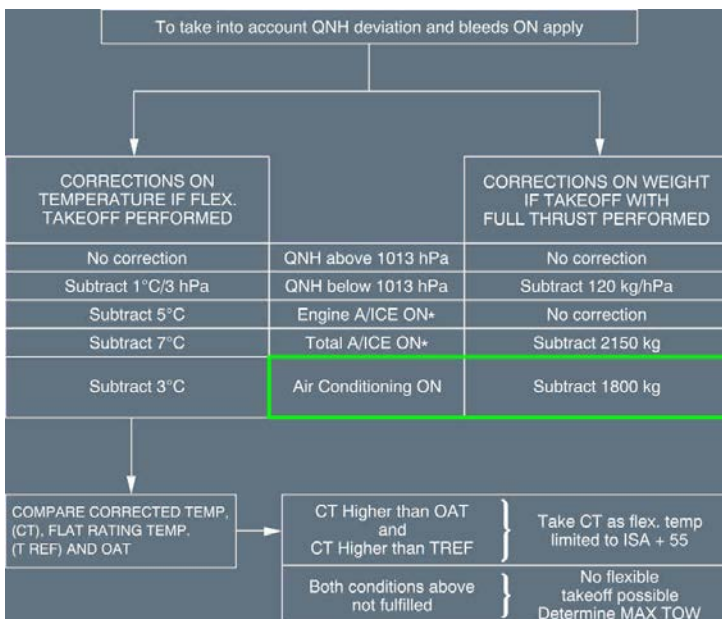

- Air conditioning correction..... -1.8
- Maximum permissible TO weight (1 000 kg) air conditioning ON..... 80.3
- Determine takeoff speeds for 80.3 (1 000 kg) in the 10 kt head wind column CONF 2 (interpolate when necessary).



A318/A319/A320/A321
FLIGHT CREW
OPERATING MANUAL

PERFORMANCE

TAKEOFF

TAKEOFF CHARTS - MTOW CALCULATION (TEMPERATURE ENTRY)

| A3XXXXX | ENGINES | AIRPORT NAME | | | | | | Version | Date | |
|---|-----------------------|-----------------------|-----------------------|-----------------------|-----------------------|-----------------------|-----------------------|-----------------------|-----------------------|-----------------------|
| QNH | 1013.25 HPA | Elevation | 489 FT | TORA | 3000 M | 15L | A3XXXXXX | **V20 | | |
| Air cond. | AC OFF | Isa temp | 14 C | TODA | 3000 M | | 4 obstacles | DRY | | |
| Anti-icing | AI OFF | Rwy slope | .08 % | ASDA | 3000 M | | | | | |
| All reversers operating No reversers on dry runway | | | | | | | | | | |
| OAT °C | CONF 1 + F | | | | | CONF 2 | | | | |
| | TAILWIND - 10.0 KT | TAILWIND - 5.0 KT | WIND 0 KT | HEADWIND + 10.0 KT | HEADWIND + 20.0 KT | TAILWIND - 10.0 KT | TAILWIND - 5.0 KT | WIND 0 KT | HEADWIND + 10.0 KT | HEADWIND + 20.0 KT |
| 44 | 76.1 4/6 142/49/51 | 77.9 4/6 146/51/53 | 75.1 2/3 153/54/55 | 75.7 2/3 156/57/58 | 76.3 2/3 158/59/60 | 73.0 2/3 142/44/47 | 74.1 2/3 146/47/51 | 75.1 2/3 150/51/55 | 81.1 4/6 153/53/58 | 82.1 3/4 155/57/62 |
| 46 | 75.5 4/6 142/48/50 | 77.2 4/6 148/50/52 | 78.9 4/6 152/55/57 | 80.2 4/6 155/58/58 | 80.7 4/6 154/56/58 | 75.7 4/6 141/45/49 | 77.3 4/6 145/47/52 | 79.1 4/6 150/50/55 | 80.3 3/4 152/53/58 | 80.7 2/4 152/55/60 |
| 48 | 74.5 4/6 143/48/50 | 76.2 4/6 148/50/52 | 77.9 4/6 153/53/55 | 79.1 4/6 155/53/55 | 79.3 2/4 153/55/57 | 74.7 4/6 141/44/48 | 76.4 4/6 146/47/51 | 78.0 3/4 150/50/55 | 79.1 3/4 152/53/57 | 79.5 4/6 155/58/63 |

V1 = 152 kt, VR = 153 kt, V2 = 158 kt.

CORRECTIONS FOR WET OR CONTAMINATED RUNWAYS

Ident.: PER-TOF-TOC-12-10-00001715.0001001 / 28 JAN 11

Applicable to: **ALL**

(Refer to PER-TOF-CTA-10 GENERAL)

| | |
|---|---|
|  <p>A318/A319/A320/A321 FLIGHT CREW OPERATING MANUAL</p> | <p style="text-align: center;">PERFORMANCE TAKEOFF</p> <p style="text-align: center;">TAKEOFF CHARTS - MTOW CALCULATION (TEMPERATURE ENTRY)</p> |
|---|---|

CORRECTIONS PRODUCED ON THE RTOW CHART

Ident.: PER-TOF-TOC-12-10-00014707.0001001 / 29 JUL 16

Applicable to: ALL

The following data and graphs are for example only, and are not for operational use. Even if the data in the following example is in “kg” and “m”, the same method can be applied for “lb” and “ft”.

For example: *Refer to PER-TOF-TOC-10-30 EXAMPLE OF TAKEOFF CHART*

A description of this correction is given on *Refer to PER-TOF-TOC-10-20 DESCRIPTION OF THE CORRECTIONS ON TAKEOFF CHART*. The list of corrections is not exhaustive, however the most commonly used corrections are wet runway, QNH, air conditioning and/or anti ice. A maximum of three corrections can be produced on one chart.

To apply the corrections, proceed as follows:

1. Enter the chart with given OAT and wind to determine the maximum takeoff weight before correction.
2. Apply the first correction:
 - If OAT is less than or equal to TVMC (line 3), apply ΔW correction from line 1 and $\Delta V1 / \Delta VR / \Delta V2$ corrections from line 2.
 - Else, (for OAT greater than TVMC), apply ΔW correction from line 3 and $\Delta V1 / \Delta VR / \Delta V2$ corrections from line 4.
3. To combine a second (and third, as applicable) correction:
 - If OAT is less than or equal to TVMC (line 3), apply ΔW correction from line 1 and $\Delta V1 / VR / \Delta V2$ corrections from line 2.
 - Check that the resulting speeds are higher than the minimum speeds displayed on the RTOW chart and that V2 is higher than the VMU limited speed (*Refer to PER-TOF-TOD-25-20 MINIMUM V2 LIMITED BY VMU/VMCA (KT IAS)*).
 - If OAT is higher than TVMC (line 3) or if the above speed check is not fulfilled, apply ΔW correction from line 3 and $\Delta V1 / \Delta VR / \Delta V2$ corrections from line 4. No speed check is required.

- Note:
- QNH correction is given for ± 10 hPa . It is allowed to extrapolate linearly for greater QNH deviation.
 - When using a takeoff chart with failure cases, it is not allowed to combine two failure cases.
 - Corrections from the chart must be applied from top to bottom, i.e. in the RTOW on *Refer to PER-TOF-TOC-10-30 EXAMPLE OF TAKEOFF CHART*, apply the wet correction first.
 - If asterisk or dotted lines appear in the correction boxes, refer to more conservative corrections provided in the FCOM.
 - No speed check is required for the first correction. However, if the first influence correction follows a conservative FCOM correction, a speed check is required.



A318/A319/A320/A321
FLIGHT CREW
OPERATING MANUAL

PERFORMANCE

TAKEOFF

TAKEOFF CHARTS - MTOW CALCULATION (TEMPERATURE ENTRY)

EXAMPLE 2

DATA : CONF 2
 OAT = 25 °C
 Head Wind = 10 kt
 QNH = 1 028 hPa
 WET runway

In this example, we will consider CONF 2 as takeoff configuration. But same computation has to be done in CONF 1 and you must retain the best configuration.

Use the chart (*Refer to PER-TOF-TOC-10-30 EXAMPLE OF TAKEOFF CHART*)

| A3XXXX | ENGINES | | | AIRPORT NAME | | | | Version | Date | |
|----------------------------|-----------------------|-----------------------|---|-----------------------|-----------------------|-----------------------|-----------------------|-----------------------|-----------------------|-----------------------|
| QNH | 1013.25 HPA | | | Elevation | 489 FT | FORA | 3000 M | 15L | A3XXXXXX **V20 | |
| Air cond. | AG OFF | | | Sea level | 14 °C | TODA | 3000 M | | | |
| Anti-brg | AI OFF | | | Rwy slope | .08 % | ASDA | 3000 M | | | |
| All reversers operating | | | | | | | | | | |
| No reversers on dry runway | | | | | | | | | | |
| | CONF 1 + F | | | | | | CONF 2 | | | |
| OAT °C | TAILWIND +10.0 KT | TAILWIND -5.0 KT | WIND 0 KT | HEADWIND +10.0 KT | HEADWIND +20.0 KT | TAILWIND -10.0 KT | TAILWIND -5.0 KT | WIND 0 KT | HEADWIND +10.0 KT | HEADWIND +20.0 KT |
| -20 | 80.2 4/6 156/59/58 | 80.2 4/6 162/62/64 | 83.6 3/4 167/67/69 | 84.8 3/4 170/70/72 | 85.8 3/4 173/73/75 | 80.4 4/6 154/54/59 | 81.9 3/4 159/59/64 | 83.4 3/4 164/64/69 | 84.4 3/4 167/67/72 | 85.2 3/4 169/69/74 |
| -10 | 79.5 4/6 163/59/58 | 81.3 4/6 159/59/62 | 83.1 4/6 164/64/66 | 84.3 3/4 167/67/69 | 85.3 3/4 171/71/72 | 79.7 4/6 151/52/57 | 81.4 4/6 156/56/62 | 82.9 3/4 161/61/66 | 84.0 3/4 164/64/69 | 84.9 3/4 167/67/72 |
| 0 | 78.8 4/6 151/54/57 | 80.6 4/6 156/57/59 | 82.5 4/6 162/62/64 | 83.7 3/4 165/65/67 | 84.7 3/4 168/68/70 | 79.0 4/6 149/51/56 | 80.8 4/6 154/54/60 | 82.4 3/4 159/59/64 | 83.5 3/4 162/62/67 | 84.5 3/4 165/65/70 |
| 10 | 78.2 4/6 148/53/55 | 80.0 4/6 154/57/59 | 81.8 4/6 159/60/62 | 83.1 4/6 163/63/65 | 84.2 3/4 166/66/67 | 78.4 4/6 147/50/54 | 80.2 4/6 152/52/58 | 81.9 3/4 156/56/62 | 83.0 3/4 159/59/65 | 83.9 3/4 162/63/68 |
| 20 | 77.6 4/6 146/51/53 | 79.3 4/6 151/55/57 | 81.1 4/6 157/57/61 | 82.5 4/6 160/60/62 | 83.6 4/6 163/63/65 | 77.7 4/6 145/48/52 | 79.5 4/6 150/51/56 | 81.3 4/6 154/54/60 | 82.4 3/4 157/57/63 | 83.4 3/4 160/61/66 |
| 30 | 76.9 4/6 144/50/52 | 78.7 4/6 149/54/56 | 80.5 4/6 154/57/60 | 81.8 4/6 158/58/60 | 83.0 4/6 161/61/63 | 77.1 4/6 143/46/50 | 78.9 4/6 148/50/55 | 80.7 4/6 153/53/58 | 81.9 3/4 155/55/61 | 82.9 3/4 158/58/64 |
| 32 | 76.8 4/6 144/50/52 | 78.6 4/6 149/53/55 | 80.4 4/6 154/56/55 | 81.7 4/6 157/56/60 | 82.9 4/6 161/61/63 | 77.0 4/6 142/45/50 | 78.7 4/6 147/50/55 | 80.6 4/6 152/53/58 | 81.8 4/6 155/55/60 | 82.8 3/4 157/56/64 |
| 34 | 76.7 4/6 143/50/52 | 78.4 4/6 148/53/55 | DO NOT USE FOR OPERATIONAL PURPOSE | | | | | | | |
| 36 | 76.6 4/6 143/49/52 | 78.4 4/6 148/53/54 | | | | | | | | |
| 38 | 76.5 4/6 142/49/52 | 78.3 4/6 147/52/54 | | | | | | | | |
| | | | | | | | | | | |
| | | | 80.0 4/6 153/56/58 | 81.3 4/6 156/58/60 | 82.6 4/6 159/60/62 | 76.7 4/6 141/45/50 | 78.4 4/6 146/48/53 | 80.2 4/6 151/52/57 | 81.5 4/6 154/54/59 | 82.5 3/4 156/56/63 |

- Enter the 10 kt head wind column and interpolate for 25 °C, CONF 2, max TO weight (1 000 kg).....82.1
- Read associated speeds as V1 = 156 kt, VR = 157 kt, V2 = 162 kt
- Apply WET correction



A318/A319/A320/A321
FLIGHT CREW
OPERATING MANUAL

PERFORMANCE

TAKEOFF

TAKEOFF CHARTS - MTOW CALCULATION (TEMPERATURE ENTRY)

| A3XXXXX | ENGINES | AIRPORT NAME | | | | | | Version | Date | |
|---|-----------------------|----------------------|---------------|-----------------------|-----------------------|-----------------------|----------------------|---------------|-----------------------|-----------------------|
| QNH | 1013.25 HPA | Elevation | 489 FT | TORA | 3000 M | 15L | A3XXXXXX | **V20 | | |
| Air cond. | AC OFF | Isa temp | 14 C | TODA | 3000 M | | | | | |
| Anti-icing | AI OFF | Rwy slope | .08 % | ASDA | 3000 M | 4 obstacles | DRY | | | |
| All reversers operating No reversers on dry runway | | | | | | | | | | |
| OAT °C | CONF 1 + F | | | | | CONF 2 | | | | |
| | TAILWIND - 10.0 KT | TAILWIND - 5.0 KT | WIND 0 KT | HEADWIND + 10.0 KT | HEADWIND + 20.0 KT | TAILWIND - 10.0 KT | TAILWIND - 5.0 KT | WIND 0 KT | HEADWIND + 10.0 KT | HEADWIND + 20.0 KT |
| INFLUENCE OF RUNWAY CONDITION | | | | | | | | | | |
| WET | -2.0/-5 | -1.5/-4 | -1.2/-3 | -1.1/-2 | 1.8/-2 | -0.9/-4 | -1.5/-4 | -1.2/-3 | -1.2/-2 | -1.5/-3 |
| | -16/ -17 -1 | -15/ -2/ -2 | -13/ -4/ -4 | -11/ -3/ -3 | -10/ -2/ 2 | -14/ 0/ 0 | -13/ 0/ 0 | -12/ -2/ -2 | -10/ -1/ -1 | -4/ -2/ -2 |
| | (+54) +2.0/-5 | (+54) -1.5/-4 | (+54) -1.3/-3 | (+54) -1.1/-2 | (+54) -0.8/-2 | (+54) -0.9/-4 | (+54) -1.5/-4 | (+54) -1.3/-3 | (+54) -1.2/-2 | (+54) -1.5/-3 |
| | -16/0/0 | -15/0/0 | -13/0/0 | -11/0/0 | -10/0/0 | -14/0/0 | -13/0/0 | -11/0/0 | -10/0/0 | -4/0/0 |
| INFLUENCE OF DELTA PRESSURE | | | | | | | | | | |
| QNH HPA | -10.0 | -0.8/-2 | -0.7/-2 | -0.7/-2 | -1.3/-3 | -0.7/-2 | -0.7/-2 | -1.2/-3 | -0.8/-2 | -0.8/-1 |
| | (+54) -0.8/-2 | (+54) -0.7/-2 | (+54) -0.7/-2 | (+54) -1.3/-3 | (+54) -0.7/-2 | (+54) -0.7/-2 | (+54) -1.2/-3 | (+54) -0.8/-2 | (+54) -0.8/-2 | (+54) -0.8/-2 |
| | 0/0/0 | 0/0/0 | 0/0/0 | 0/0/0 | 0/0/0 | 0/0/0 | 0/0/0 | -1/0/0 | -1/0/0 | -1/0/0 |
| | +10.0 | +0.2/0 | +0.2/0 | 0/0/0 | +0.2/0 | +0.2/0 | +0.2/0 | +0.2/0 | +0.2/0 | +0.2/0 |
| | (+54) +0.2/0 | (+54) +0.2/0 | (+54) +0.0/0 | (+54) +0.2/0 | (+54) +0.2/0 | (+54) +0.2/0 | (+54) +0.2/0 | (+54) +0.2/0 | (+54) +0.2/0 | (+54) +0.2/0 |
| | 0/0/0 | 0/0/0 | 0/0/0 | 0/0/0 | +1/ +1/ +1 | +1/ +1/ +1 | 0/0/0 | +1/ +1/ +1 | +1/ +1/ +1 | +1/ +1/ +1 |
| LABEL FOR INFLUENCE DW (1000 KG) DTFLX DV1 - DVN - DV2 (KT) (TVMC OAT C) DW (1000 KG) DTFLX DV1 - DVN - DV2 (KT) | | | | | | | | | | |
| MTOW(1000 KG) codes Vmax/VR/V2 (kt) LIMITATION CODES: 1=1st segment 2=2nd segment 3=runway length 4=obstacles 5=ice speed 6=brake energy 7=max weight 8=final take-off 9=VMU | | | | | | | | | | |
| Tref (OAT) = 44 C Tmax (OAT) = 54 C Min acc height 454 FT Max acc height 1917 FT Min QNH at 953 FT Max QNH at 2400 FT Min V1/VR/V2 = 108/114/117 CHECK VMU LIMITATION Correct V1/VR/V2 = 1.0 KT/1000 KG | | | | | | | | | | |

- For OAT < TVMC (54 °C), ΔW = -1.2
 Intermediate weight (1 000 kg)..... = 80.9
 Associated speeds,
 V1 = 156 kt - 10 = 146 kt
 VR = 157 kt - 1 = 156 kt
 V2 = 162 kt - 1 = 161 kt
 (No speed check required for first correction)
 • Apply QNH correction



A318/A319/A320/A321
FLIGHT CREW
OPERATING MANUAL

PERFORMANCE

TAKEOFF

TAKEOFF CHARTS - MTOW CALCULATION (TEMPERATURE ENTRY)

| A3XXXXX | ENGINES | AIRPORT NAME | | | | Version | Date |
|---|--|---|---|---|--|---|--|
| QNH Air cond. Anti-icing All reversers operating No reversers on dry runway | 1013.25 HPA AC OFF AI OFF | Elevation Isa temp Rwy slope | 489 FT 14 C .08 % | TORA TODA ASDA | 3000 M 3000 M 3000 M | 15L 4 obstacles | Version A3XXXXXX Date **/20 |
| OAT | | CONF 1 + F | | | | CONF 2 | |
| TAILWIND -10.0 KT | | TAILWIND -5.0 KT | WIND 0 KT | HEADWIND +10.0 KT | HEADWIND +20.0 KT | TAILWIND -10.0 KT | TAILWIND -5.0 KT |
| | | | | | | WIND 0 KT | HEADWIND +10.0 KT |
| | | | | | | | HEADWIND +20.0 KT |
| INFLUENCE OF RUNWAY CONDITION | | | | | | | |
| WET | -2.0/-5 -18/1/-1 (+54)-2.0/-5 -16/0/0 | -1.5/-4 -15/-2/-2 (+54)-1.5/-4 -15/0/0 | -1.2/-3 -13/-4/-4 (+54)-1.3/-3 -13/0/0 | -1.1/-2 -11/-3/-3 (+54)-1.1/-2 -11/0/0 | 1.8/-2 -10/-2/2 (+54)-0.8/-2 -10/0/0 | -0.9/-4 -14/0/-1 (+54)-0.9/-4 -14/0/0 | -1.5/-4 -13/0/-1 (+54)-1.3/-4 -13/0/0 |
| INFLUENCE OF DELTA PRESSURE | | | | | | | |
| QNH HPA | -10.0 | -0.8/-2 0/0 (+54)-0.8/-2 0/0 | -0.7/-2 0/0 (+54)-0.7/-2 0/0 | -0.7/-2 0/0 (+54)-0.7/-2 0/0 | -1.3/-3 -1/0 (+54)-1.3/-3 0/0 | -0.7/-2 0/0 (+54)-0.7/-2 0/0 | -1.2/-3 0/0 (+54)-1.2/-3 0/0 |
| | +10.0 | +0.2/0 0/0 (+54)+0.2/0 0/0 | +0.2/0 0/0 (+54)+0.2/0 0/0 | +0.2/0 0/0 (+54)+0.2/0 0/0 | +0.2/0 +1/+1 (+54)+0.2/0 +1/+1 | +0.2/0 0/0 (+54)+0.2/0 0/0 | +0.2/0 +1/+1 (+54)+0.2/0 +1/+1 |
| LABEL FOR INFLUENCE DW (1000 KG) DTPLEX DV1-DVR, DV2(KT) TVMC OAT C | MTOW(1000 KG) corrdn V1minVRV2 (kt) | | TVMC LIMITATION | Trif (OAT) = 44 C Tmax (OAT) = 54 C | Min acc height 466 FT Max acc height 1917 FT | Min QNH alt. 953 FT Max QNH alt. 2408 FT | |
| DW (1000 KG) DTPLEX DV1-DVR, DV2 (KT) | LIMITATION CODES: 1=1st segment 2=2nd segment 3=runway length 4=obstacles 5=low speed 6=brake energy 7=max weight 8=final take-off 9=VMU | | | | Min V1/VRV2 = 109/114/117 CHECK VMC LIMITATION Correct: V1/VRV2 = 1.0 KT/1000 KG | | |

For OAT < TVMC (54 °C), $\Delta W = 0.2 \times 15/10 = \dots\dots\dots + 0.3$
 Maximum permissible takeoff weight (1 000 kg)..... = 81.2

Associated speeds,

$V1 = 146 \text{ kt} + 1 \times 15/10 = 147 \text{ kt}$

$VR = 156 \text{ kt} + 1 \times 15/10 = 158 \text{ kt}$

$V2 = 161 \text{ kt} + 1 \times 15/10 = 163 \text{ kt}$

- Check that the speeds are higher than minimum speeds from the chart and from VMU table (Refer to PER-TOF-TOD-25-20 MINIMUM V2 LIMITED BY VMU/VMCA (KT IAS)).

It is reminded that if the speed checks are not fulfilled, the corrections must be recalculated using those provided on lines 3 and 4.

| | Takeoff Configuration : 2 | | | |
|--------------------|---------------------------|-----|-----|-----|
| | TOW | V1 | VR | V2 |
| TOW (RTOW) | 82.1 | 156 | 157 | 162 |
| FCOM correction(s) | | | | |
| Intermediate value | 82.1 | 156 | 157 | 162 |
| WET Correction | - 1.2 | -10 | -1 | -1 |
| Intermediate value | 80.9 | 146 | 156 | 161 |
| QNH Correction | + 0.3 | +1 | +2 | +2 |
| Final value | 81.2 | 147 | 158 | 163 |

COMBINING CORRECTIONS FROM FCOM AND CHART

Ident.: PER-TOF-TOC-12-10-00014713.0001001 / 29 JUL 16

Applicable to: ALL

The following data and graphs are for example only, and are not for operational use. Even if the data in the following example is in “kg” and “m”, the same method can be applied for “lb” and “ft”.

Proceed as follows:

1. Enter the chart with selected configuration, OAT and wind to read the maximum takeoff weight.
2. Apply corrections from FCOM to determine an intermediate weight. Interpolate associated speeds for intermediate weight in the same column (same wind and configuration).
3. Apply corrections from RTOW chart as explained above.

EXAMPLE 3

DATA : CONF 2
 OAT = 25 °C
 Head wind = 10 kt
 Air conditioning ON
 QNH = 1 028 hPa
 WET runway

In this example, we will consider CONF 2 as takeoff configuration. But same computation has to be done in CONF 1 and you must retain the best configuration.

1. Use the chart (*Refer to PER-TOF-TOC-10-30 EXAMPLE OF TAKEOFF CHART*).



A318/A319/A320/A321
FLIGHT CREW
OPERATING MANUAL

PERFORMANCE

TAKEOFF

TAKEOFF CHARTS - MTOW CALCULATION (TEMPERATURE ENTRY)

| A3XXXX | ENGINES | | | | AIRPORT NAME | | | | Version | Date |
|---|---------------------------------|-----------------------|---|-----------------------|------------------------------------|-------------------------|----------------------------------|---------------------------|-----------------------|-------|
| QNH Air cond. Anti-icing All reversers operating No reversers on dry runway | 1013.25 HPA AG OFF AI OFF | | | | Elevation Ist temp Rwy slope | 489 FT 14 C .08 % | TORA ASDA 3000 M 3000 M | 15L 4 obstacles | A3XXXXXX | **V20 |
| CONF 1 + F | | | | | CONF 2 | | | | | |
| OAT °C | TAILWIND -10.0 KT | TAILWIND -5.0 KT | WIND 0 KT | HEADWIND +10.0 KT | TAILWIND -10.0 KT | TAILWIND -5.0 KT | WIND 0 KT | HEADWIND +10.0 KT | HEADWIND +20.0 KT | |
| -20 | 80.2 4/6 156/59/58 | 80.2 4/6 162/62/64 | 83.6 3/4 167/67/69 | 84.8 3/4 170/70/72 | 85.8 3/4 173/73/75 | 80.4 4/6 154/54/59 | 81.9 3/4 158/58/64 | 83.4 3/4 164/64/69 | 85.2 3/4 167/67/72 | |
| -10 | 79.5 4/6 163/59/58 | 81.3 4/6 159/59/62 | 83.1 4/6 164/64/66 | 84.3 3/4 167/67/69 | 85.3 3/4 171/71/72 | 79.7 4/6 151/52/57 | 81.4 4/6 156/56/62 | 82.9 3/4 161/61/66 | 84.0 3/4 164/64/69 | |
| 0 | 78.8 4/6 151/54/57 | 80.6 4/6 156/57/59 | 82.5 4/6 162/62/64 | 83.7 3/4 165/65/67 | 84.7 3/4 168/68/70 | 79.0 4/6 149/51/56 | 80.8 4/6 154/54/60 | 82.4 3/4 159/59/64 | 83.5 3/4 162/62/67 | |
| 10 | 78.2 4/6 148/53/55 | 80.0 4/6 154/57/59 | 81.8 4/6 159/60/62 | 83.1 4/6 163/63/65 | 84.2 3/4 166/66/67 | 78.4 4/6 147/50/54 | 80.2 4/6 152/52/58 | 81.9 3/4 156/56/62 | 83.0 3/4 159/59/65 | |
| 20 | 77.6 4/6 146/51/53 | 79.3 4/6 151/55/57 | 81.1 4/6 157/57/61 | 82.5 4/6 160/60/62 | 83.6 4/6 163/63/65 | 77.7 4/6 145/48/52 | 79.5 4/6 150/51/56 | 81.3 4/6 154/54/60 | 82.4 3/4 157/57/63 | |
| 30 | 76.9 4/6 144/50/52 | 78.7 4/6 149/54/56 | 80.5 4/6 154/57/60 | 81.8 4/6 158/58/60 | 83.0 4/6 161/61/63 | 77.4 4/6 143/46/50 | 78.9 4/6 148/50/55 | 80.7 4/6 153/53/58 | 81.9 3/4 155/55/61 | |
| 32 | 76.8 4/6 144/50/52 | 78.6 4/6 149/53/55 | 80.4 4/6 154/56/55 | 81.7 4/6 157/56/60 | 82.9 4/6 161/61/63 | 77.0 4/6 142/45/50 | 78.7 4/6 147/50/55 | 80.6 4/6 152/53/58 | 81.8 4/6 155/55/60 | |
| 34 | 76.7 4/6 143/50/52 | 78.4 4/6 148/53/55 | DO NOT USE FOR OPERATIONAL PURPOSE | | | | | 81.7 4/6 154/55/60 | 82.7 3/4 157/58/64 | |
| 36 | 76.6 4/6 143/49/52 | 78.4 4/6 148/52/54 | | | | | | 76.1 4/6 154/55/60 | 76.5 3/4 157/58/63 | |
| 38 | 76.5 4/6 142/49/52 | 78.3 4/6 147/52/54 | 80.0 4/6 153/56/59 | 81.3 4/6 156/56/60 | 82.6 4/6 159/60/62 | 76.7 4/6 141/45/50 | 78.4 4/6 146/48/53 | 80.2 4/6 151/52/57 | 81.5 4/6 154/54/59 | |

- Enter the 10 kt head wind column and interpolate for 25 °C, CONF 2,
 Max TO weight (1 000 kg) air conditioning OFF..... 82.1
 2. First, apply the QNH/Bleeds correction (*Refer to PER-TOF-TOD-24 EFFECT OF QNH AND BLEEDS*).

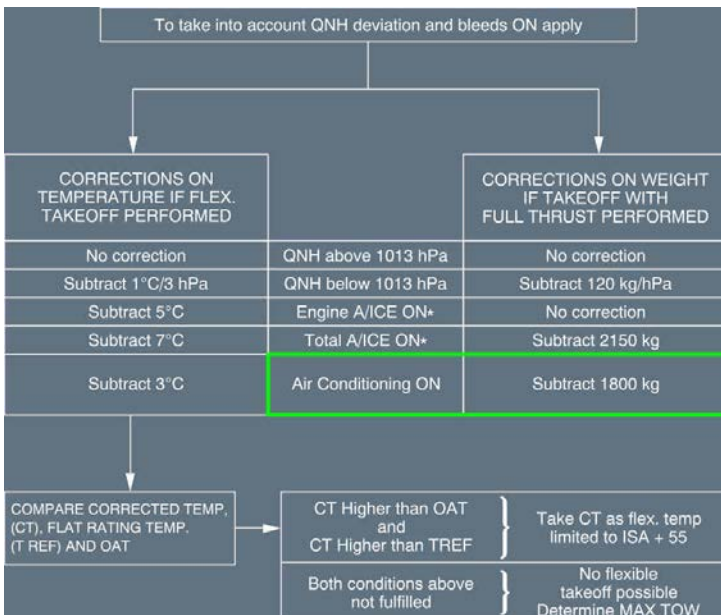

Max TO weight (1 000 kg) air conditioning OFF..... 82.1
 Air conditioning correction..... - 1.8
 Intermediate weight..... = 80.3
 Determine the takeoff speeds for 80.3 (1 000 kg) in the 10 kt head wind column CONF 2 (interpolate when necessary)

| A3XXXXX | ENGINES | AIRPORT NAME | | | | | | 15L | Version | Date |
|---|-----------------------|-----------------------|-----------------------|-----------------------|-----------------------|-----------------------|-----------------------|-----------------------|-----------------------|-----------------------|
| QNH | 1013.25 HPA | Elevation | 489 FT | TORA | 3000 M | | | ADXXXXXX | **v20 | |
| Air cond. | AC OFF | Isa temp | 14 C | TODA | 3000 M | | | | | |
| Anti-icing | AI OFF | Rwy slope | .08 % | ASDA | 3000 M | | 4 obstacles | | | |
| All reversers operating No reversers on dry runway | | | | | | | | | | |
| OAT °C | CONF 1 + F | | | | | | CONF 2 | | | |
| | TAILWIND -10.0 KT | TAILWIND - 5.0 KT | WIND 0 KT | HEADWIND +10.0 KT | HEADWIND +20.0 KT | TAILWIND -10.0 KT | TAILWIND - 5.0 KT | WIND 0 KT | HEADWIND +10.0 KT | HEADWIND +20.0 KT |
| 44 | 76.1 4/6 142/49/51 | 77.9 4/6 146/51/53 | 75.1 2/3 153/54/55 | 75.7 2/3 156/57/58 | 76.3 2/3 158/59/60 | 73.0 2/3 142/44/47 | 74.1 2/3 146/47/51 | 75.1 2/3 150/51/55 | 81.1 4/6 153/53/58 | 82.1 3/4 155/57/62 |
| 46 | 75.5 4/6 142/48/50 | 77.2 4/6 148/50/52 | 78.9 4/6 152/55/57 | 80.2 4/6 155/56/58 | 80.7 4/6 154/56/58 | 75.7 4/6 141/45/49 | 77.3 4/6 145/47/52 | 78.1 4/6 150/50/55 | 80.3 3/4 152/53/58 | 80.7 2/4 152/55/60 |
| 48 | 74.5 4/6 143/48/50 | 76.2 4/6 148/50/52 | 77.9 4/6 153/53/55 | 79.1 4/6 155/53/55 | 79.3 2/4 153/55/57 | 74.7 4/6 141/44/48 | 76.4 4/6 146/47/51 | 78.0 3/4 150/50/55 | 79.1 3/4 152/53/57 | 79.5 4/6 155/58/63 |

V1 = 152 kt , VR = 153 kt , V2 = 158 kt

3. Apply WET correction



A318/A319/A320/A321
FLIGHT CREW
OPERATING MANUAL

PERFORMANCE

TAKEOFF

TAKEOFF CHARTS - MTOW CALCULATION (TEMPERATURE ENTRY)

| A3XXXXX | ENGINES | AIRPORT NAME | | | | Version | Date | | | | |
|---|--|--|--|---|--|--|---|---|--|--|--|
| QNH | 1013.25 HPA | Elevation | 489 FT | TORA | 3000 M | 15L | A3XXXXXX **V20 | | | | |
| Air cond. | AC OFF | Isa temp | 14 C | TODA | 3000 M | 4 obstacles | DRY | | | | |
| Anti-icing | AI OFF | Rwy slope | .08 % | ASDA | 3000 M | | | | | | |
| All reversers operating | | | | | | | | | | | |
| No reversers on dry runway | | | | | | | | | | | |
| OAT °C | CONF 1 + F | | | | CONF 2 | | | | | | |
| | TAILWIND -10.0 KT | TAILWIND -5.0 KT | WIND 0 KT | HEADWIND +10.0 KT | HEADWIND +20.0 KT | TAILWIND -10.0 KT | TAILWIND -5.0 KT | WIND 0 KT | HEADWIND +10.0 KT | HEADWIND +20.0 KT | |
| INFLUENCE OF RUNWAY CONDITION | | | | | | | | | | | |
| WET | -2.0/-5 -16/-1-1 (+54)+2.0/-5 -16/0/0 | -1.5/-4 -15/-2/-2 (+54)+1.5-4 -15/0/0 | -1.2/-3 -13/-4/-4 (+54)-1.3-3 -13/0/0 | -1.1/-2 -11/-3/-3 (+54)-1.1/-2 -11/0/0 | 1.8/-2 -10/-2/2 (+54)+0.8-2 -10/0/0 | -0.9/-4 -14/0/0 (+54)-0.9-4 -14/0/0 | -1.2/-3 -12/-2/-2 (+54)-1.3/-3 -13/0/0 | -1.2/-2 -10/-1/-1 (+54)-1.2-2 -10/0/0 | -1.5/-3 -4/-2/-2 (+54)-1.5-3 -4/0/0 | | |
| INFLUENCE OF DELTA PRESSURE | | | | | | | | | | | |
| QNH HPA | -10.0 | -0.8/-2 0/0/0 (+54)-0.8-2 0/0/0 | -0.7/-2 0/0/0 (+54)-0.7-2 0/0/0 | -0.7/-2 0/0/0 (+54)-0.7-2 0/0/0 | -1.3/-3 0/0/0 (+54)-1.3-3 0/0/0 | -0.7/-2 0/0/0 (+54)-0.7-2 0/0/0 | -0.7/-2 0/0/0 (+54)-0.7-2 0/0/0 | -1.2/-3 0/0/0 (+54)-1.2-3 0/0/0 | -0.8/-2 0/0/0 (+54)-0.8-2 0/0/0 | -0.8/-2 0/0/0 (+54)-0.8-2 0/0/0 | |
| | +10.0 | +0.2/0 0/0/0 (+54)+0.2/0 0/0/0 | +0.2/0 0/0/0 (+54)+0.2/0 0/0/0 | +0.2/0 0/0/0 (+54)+0.2/0 0/0/0 | +0.2/0 0/0/0 (+54)+0.2/0 0/0/0 | +0.2/0 0/0/0 (+54)+0.2/0 0/0/0 | +0.2/0 0/0/0 (+54)+0.2/0 0/0/0 | +0.2/0 0/0/0 (+54)+0.2/0 0/0/0 | +0.2/0 0/0/0 (+54)+0.2/0 0/0/0 | +0.2/0 0/0/0 (+54)+0.2/0 0/0/0 | |
| LABEL FOR INFLUENCE [SW-1000 KG] DIFLEX: DV1-DVR-DV2 [KT] | | MTOW(1000 KG) codes V1min/VRV2 [kt] | | *VMC LIMITATION | | Tref (OAT) Tmax (OAT) = 54 C | | Min acc height 464 FT Max acc height 1917 FT | | Min QNH alt 953 FT Max QNH alt 2400 FT | |
| [VMC OAT C] [SW-1000 KG] DIFLEX: DV1-DVR-DV2 [KT] | | LIMITATION CODES: 1=1st segment 2=2nd segment 3=runway length 4=obstacles 5=tax speed 6=brake energy 7=tax weight 8=final take-off 9=VMU | | | | | | Min V1/VRV2 = 108/116/117 CHECK-MSL LIMITATION Correct V1/VRV2 = 1.0 KT/1000 KG | | | |

For OAT < TVMC (54 °C), ΔW = -1.2
 Intermediate weight..... = 79.1
 Associated speeds,
 V1 = 152 kt - 10 = 142 kt
 VR = 153 kt - 1 = 152 kt
 V2 = 158 kt - 1 = 157 kt
 (No speed check required for first correction).
 Apply QNH correction



A318/A319/A320/A321
FLIGHT CREW
OPERATING MANUAL

PERFORMANCE

TAKEOFF

TAKEOFF CHARTS - MTOW CALCULATION (TEMPERATURE ENTRY)

| A3XXXXX | ENGINES | AIRPORT NAME | | | | Version | Date | | | |
|-------------------------------|----------------------|--|---------------|----------------------|----------------------|----------------------|---------------------|----------------|----------------------|----------------------|
| QNH | 1013.25 HPA | Elevation | 489 FT | TORA | 3000 M | 15L | A3XXXXXX **V20 | | | |
| Air cond. | AC OFF | Isa temp | 14 C | TODA | 3000 M | 4 obstacles | DRY | | | |
| Anti-icing | AI OFF | Rwy slope | .08 % | ASDA | 3000 M | | | | | |
| All reversers operating | | | | | | | | | | |
| No reversers on dry runway | | | | | | | | | | |
| OAT °C | CONF 1 + F | | | | CONF 2 | | | | | |
| | TAILWIND -10.0 KT | TAILWIND -5.0 KT | WIND 0 KT | HEADWIND +10.0 KT | HEADWIND +20.0 KT | TAILWIND -10.0 KT | TAILWIND -5.0 KT | WIND 0 KT | HEADWIND +10.0 KT | HEADWIND +20.0 KT |
| INFLUENCE OF RUNWAY CONDITION | | | | | | | | | | |
| WET | -2.0/-5 | -1.5/-4 | -1.2/-3 | -1.1/-2 | 1.8/-2 | -0.9/-4 | -1.5/-4 | -1.2/-3 | -1.2/-2 | -1.5/-3 |
| | -18/1/-1 | -15/-2/-2 | -13/-4/-4 | -11/-3/-3 | -10/-2/2 | -14/0/- | -13/0/- | -12/-2/-2 | -10/-1/-1 | -4/-2/-2 |
| | (+54) +2.0/-5 | (+54) -1.5/-4 | (+54) -1.3/-3 | (+54) -1.1/-2 | (+54) -0.8/-2 | (+54) -0.9/-4 | (+54) -1.5/-4 | (+54) -1.3/-3 | (+54) -1.2/-2 | (+54) -1.5/-3 |
| | -16/0/0 | -15/0/0 | -13/0/0 | -11/0/0 | -10/0/0 | -14/0/0 | -13/0/0 | -11/0/0 | -10/0/0 | -4/0/0 |
| INFLUENCE OF DELTA PRESSURE | | | | | | | | | | |
| DOWN HPA | -10.0 | -0.8/-2 | -0.7/-2 | -0.7/-2 | -1.3/-3 | -0.7/-2 | -0.7/-2 | -1.2/-3 | -0.8/-2 | -0.8/-1 |
| | 0/0/0 | 0/0/0 | 0/0/0 | -1/0/0 | 0/0/0 | 0/0/0 | 0/0/0 | -1/0/0 | -1/0/0 | -1/0/0 |
| | (+54) -0.8/-2 | (+54) -0.7/-2 | (+54) -0.7/-2 | (+54) -1.3/-3 | (+54) -0.7/-2 | (+54) -0.7/-2 | (+54) -1.2/-3 | (+54) -0.8/-2 | (+54) -0.8/-2 | (+54) -0.8/-2 |
| | 0/0/0 | 0/0/0 | 0/0/0 | 0/0/0 | 0/0/0 | 0/0/0 | 0/0/0 | -1/0/0 | -1/0/0 | -1/0/0 |
| | +10.0 | +0.2/0 | +0.2/0 | 0/0/0 | +0.2/0 | +0.2/0 | +0.2/0 | +0.2/0 | +0.2/0 | +0.2/0 |
| | 0/0/0 | 0/0/0 | 0/0/0 | 0/0/0 | +1/0/0 | +1/0/0 | 0/0/0 | 0/0/0 | +1/0/0 | +1/0/0 |
| | (+54) +0.2/0 | (+54) +0.2/0 | (+54) +0.2/0 | (+54) +0.2/0 | (+54) +0.2/0 | (+54) +0.2/0 | (+54) +0.2/0 | (+54) +0.2/0 | (+54) +0.2/0 | (+54) +0.2/0 |
| | 0/0/0 | 0/0/0 | 0/0/0 | 0/0/0 | +1/0/0 | +1/0/0 | 0/0/0 | 0/0/0 | +1/0/0 | +1/0/0 |
| LABEL FOR INFLUENCE | | MTOW(1000 KG) INDEX | | *VMC | | Trst (OAT) | | Min arc height | | 464 FT |
| DW (1000 KG) DTPLEX | | V1min/V2 94 | | *LIMITATION | | Trmax (OAT) | | Max arc height | | 1917 FT |
| DVI - LEVEL D12 (KT) | | LIMITATION CODES: | | | | | | | | |
| (TVMC OAT C) | | 1-1st segment 2-2nd segment 3-runway length 4-obstacles | | | | | | | | |
| DW (1000 KG) DTPLEX | | Before speed Brake energy 7-max weight 8-final take -0.9-VMU | | | | | | | | |
| DVI - DVI1 DVI2 (KT) | | Min V1/V2/V2c = 108/114/117 | | | | | | | | |
| | | CHECK VMU LIMITATION | | | | | | | | |
| | | Correct: V1/V2/V2c = 110 KT/1000 KG | | | | | | | | |

For OAT < TVMC (54 °C), $\Delta W = 0.2 \times 15/10 = \dots\dots\dots +0.3$
 Max permissible takeoff weight..... = 79.4
 Associated speed,
 $V1 = 142 \text{ kt} + 1 \times 15/10 = 143 \text{ kt}$
 $VR = 152 \text{ kt} + 1 \times 15/10 = 154 \text{ kt}$
 $V2 = 157 \text{ kt} + 1 \times 15/10 = 159 \text{ kt}$

Check that the speeds are higher than minimum speeds from the chart and from VMU table (*Refer to PER-TOF-TOD-25-20 MINIMUM V2 LIMITED BY VMU/VMCA (KT IAS)*)(it is reminded that if the speed checks are not fulfilled, the corrections must be recalculated using those provided on lines 3 and 4).

Since the speed check is fulfilled:
 Max permissible takeoff weight = 79.4 (1 000 kg)
 $V1 = 143 \text{ kt}$, $VR = 154 \text{ kt}$, $V2 = 159 \text{ kt}$.

| | Takeoff Configuration : 2 | | | |
|--------------------|---------------------------|-----|-----|-----|
| | TOW | V1 | VR | V2 |
| TOW (RTOW) | 82.1 | | | |
| FCOM correction(s) | - 1.8 | | | |
| Intermediate value | 80.3 | 152 | 153 | 158 |
| WET Correction | - 1.2 | -10 | -1 | -1 |
| Intermediate value | 79.1 | 142 | 152 | 157 |
| QNH Correction | + 0.3 | +1 | +2 | +2 |

Continued on the following page



AEROLINEAS GALAPAGOS S.A.

A318/A319/A320/A321
FLIGHT CREW
OPERATING MANUAL

PERFORMANCE

TAKEOFF

TAKEOFF CHARTS - MTOW CALCULATION (TEMPERATURE ENTRY)

Continued from the previous page

| | Takeoff Configuration : 2 | | | |
|-------------|---------------------------|-----|-----|-----|
| | TOW | V1 | VR | V2 |
| Final value | 79.4 | 143 | 154 | 159 |



A318/A319/A320/A321
FLIGHT CREW
OPERATING MANUAL

PERFORMANCE

TAKEOFF

TAKEOFF CHARTS - MTOW CALCULATION (TEMPERATURE ENTRY)

EXTRAPOLATION

EXTRAPOLATION

Ident.: PER-TOF-TOC-12-30-00001716.0002001 / 01 MAR 11

Applicable to: ALL

For a takeoff weight lower than those displayed on the chart, associated speeds are calculated as follows :

1. For given configuration and wind, note the speeds associated with the takeoff weight in the row displaying the highest permissible temperature.
2. Apply speed corrections provided at the bottom of the RTOW chart to V1 , VR and V2 limited to the minimum speeds.



A318/A319/A320/A321
FLIGHT CREW
OPERATING MANUAL

PERFORMANCE

TAKEOFF

TAKEOFF CHARTS - MTOW CALCULATION (TEMPERATURE ENTRY)

Intentionally left blank



A318/A319/A320/A321
FLIGHT CREW
OPERATING MANUAL

PERFORMANCE

TAKEOFF

TAKEOFF CHARTS - MTOW CALCULATION (TEMPERATURE ENTRY)

MAXIMUM STRUCTURAL TAKEOFF WEIGHT

MAXIMUM STRUCTURAL TAKEOFF WEIGHT

Ident.: PER-TOF-TOC-12-40-00001717.0001001 / 18 MAR 11

Applicable to: ALL

The maximum structural takeoff weight is a weight limitation depending on the aircraft. This limitation is provided in the Flight Manual and in *Refer to LIM-AG-WGHT Weight Limitations*. Compare the maximum structural takeoff weight to the maximum permissible takeoff weight computed for given conditions and retain the lower of the two values.



A318/A319/A320/A321
FLIGHT CREW
OPERATING MANUAL

PERFORMANCE

TAKEOFF

TAKEOFF CHARTS - MTOW CALCULATION (TEMPERATURE ENTRY)

Intentionally left blank

SUMMARY

SUMMARY

Ident.: PER-TOF-TOC-12-50-00006313.0001001 / 11 MAR 11
 Applicable to: ALL

The following flow diagram gives the different steps to follow.

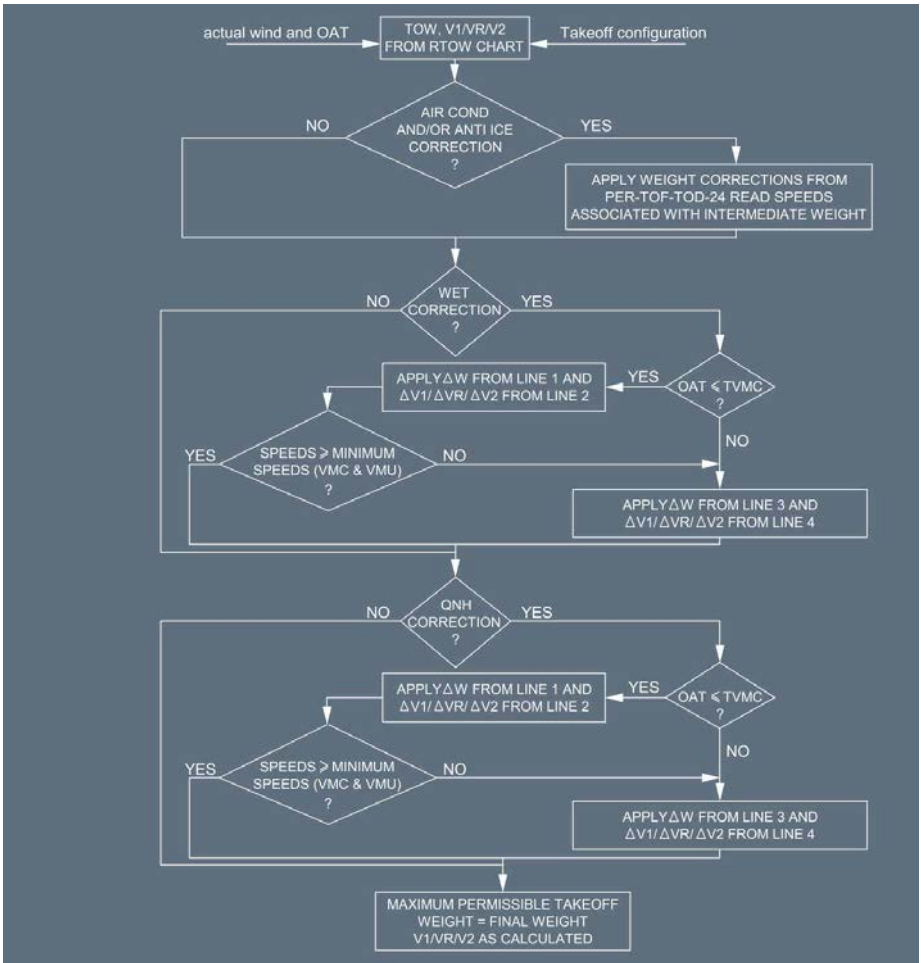



A318/A319/A320/A321
FLIGHT CREW
OPERATING MANUAL

PERFORMANCE

TAKEOFF

TAKEOFF CHARTS - MTOW CALCULATION (TEMPERATURE ENTRY)

Intentionally left blank

DETERMINATION OF FLEXIBLE TAKEOFF TEMPERATURE AND SPEEDS

GENERAL

Ident.: PER-TOF-TOC-14-10-00001722.0002001 / 17 MAR 11

Applicable to: ALL

Before determining the flexible temperature, calculate the maximum permissible takeoff weight (see previous section) and ensure that the actual takeoff weight is lower than the determined maximum takeoff weight.

- Enter the RTOW chart with the wind condition to interpolate for the actual takeoff weight. Read the flexible temperature in the temperature column corresponding to the actual weight.
- Repeat this process for the other configuration available. Select the configuration giving the highest flexible temperature.

CORRECTIONS DUE TO DIFFERENT TAKEOFF CONDITIONS

Ident.: PER-TOF-TOC-14-10-00001723.0001001 / 03 MAR 14

Applicable to: ALL

When the takeoff conditions are different from those provided on the chart, apply the associated corrections.

- Note:*
- If the RTOW chart is based on the CG being at 25 %, the crew can determine the flexible temperature at a more forward CG by decreasing the flexible temperature by 2 °C. V1 , VR and V2 must be increased by 1 kt.
 - 25 % CG is the basic certified limit, on which all takeoff computations are based. To take into account the operational margins, the above penalties must be applied when operational CG is forward 27 % CG.



A318/A319/A320/A321
FLIGHT CREW
OPERATING MANUAL

PERFORMANCE

TAKEOFF

TAKEOFF CHARTS - FLEXIBLE TAKEOFF (TEMPERATURE ENTRY)

CONSERVATIVE CORRECTIONS FOR QNH AND BLEEDS

Ident.: PER-TOF-TOC-14-10-00014714.0001001 / 29 JUL 16

Applicable to: ALL

CONSERVATIVE CORRECTIONS FOR QNH AND BLEEDS

The following data and graphs are for example only, and are not for operational use. Even if the data in the following example is in “kg” and “m”, the same method can be applied for “lb” and “ft”.

Corrections are given for QNH ≠ 1 013 hPa , air conditioning ON, anti ice ON (*Refer to PER-TOF-TOD-24 EFFECT OF QNH AND BLEEDS*).

1. For a given takeoff weight, wind condition and selected configuration, determine the flexible temperature. Retain the takeoff speeds associated with the actual weight.
2. Apply the published temperature correction. To combine two or more corrections, add the different corrections and apply to temperature value.
 (No speed corrections required).

EXAMPLE 2

DATA : Actual takeoff weight = 75 600 kg
 Head wind = 10 kt
 Air conditioning ON
 QNH = 1 013 hPa

Use the chart: (*Refer to PER-TOF-TOC-10-30 EXAMPLE OF TAKEOFF CHART*).

| A3XXXXX | ENGINES | | | AIRPORT NAME | | | | | | 15L | Version | Date |
|---|-----------------------|-----------------------|-----------------------|-----------------------|-----------------------|-----------------------|-----------------------|-----------------------|-----------------------|-----------------------|---------|------|
| QNH | 1013.25 HPA | | | Elevation | 489 FT | TORA | 3000 M | 4 obstacles | DRY | A3XXXXXX | **V20 | |
| Air cond. | AC OFF | | | Sea temp | 14 C | TODA | 3000 M | | | | | |
| Anti-icing | AI OFF | | | Rwy slope | .08 % | ASDA | 3000 M | | | | | |
| All reversers operating No reversers on dry runway | | | | | | | | | | | | |
| OAT °C | CONF 1 + F | | | | | | CONF 2 | | | | | |
| | TAILWIND - 10.0 KT | TAILWIND - 5.0 KT | WIND 0 KT | HEADWIND + 10.0 KT | HEADWIND + 20.0 KT | TAILWIND - 10.0 KT | TAILWIND - 5.0 KT | WIND 0 KT | HEADWIND + 10.0 KT | HEADWIND + 20.0 KT | | |
| 48 | 74.5 4/6 143/48/50 | 76.2 4/6 148/50/52 | 77.9 4/6 153/53/55 | 79.1 4/6 155/53/55 | 79.3 2/4 153/55/57 | 74.7 4/6 141/44/48 | 76.4 4/6 146/47/51 | 78.0 3/4 150/50/55 | 79.1 3/4 152/53/57 | 79.5 4/6 155/58/63 | | |
| 50 | 73.6 4/6 143/47/49 | 75.3 4/6 148/49/51 | 76.9 4/6 153/53/55 | 77.9 4/6 154/54/56 | 77.9 2/4 151/54/55 | 73.8 4/6 142/42/46 | 75.4 4/6 146/47/51 | 76.9 3/4 150/50/54 | 78.0 3/4 152/52/57 | 78.0 2/4 149/52/57 | | |
| 52 | 72.7 4/6 144/46/48 | 74.4 4/6 149/49/51 | 75.8 3/4 153/53/54 | 76.3 2/4 152/52/53 | 76.3 2/4 147/52/53 | 72.9 4/6 142/44/48 | 74.3 3/4 146/46/50 | 75.8 3/4 150/50/54 | 76.4 2/4 150/50/55 | 76.4 2/4 146/50/55 | | |
| 54 | 71.8 4/6 145/46/47 | 73.3 3/4 149/49/51 | 74.8 3/4 152/52/54 | 75.0 2/4 150/50/52 | 75.0 2/4 145/50/52 | 71.9 3/4 142/43/47 | 73.3 3/4 146/46/50 | 74.7 3/4 149/49/54 | 75.1 2/4 148/49/54 | 75.1 2/4 144/49/54 | | |

Determine the maximum permissible takeoff weight. The actual weight being lower than the maximum one, flexible takeoff is possible.

Enter the 10 kt head wind column and interpolate for 75 600 kg, CONF 1+F,

Flexible temperature..... 53 °C

Enter the 10 kt head wind column and interpolate for 75 600 kg, CONF 2,

Flexible temperature..... 53 °C

Retain CONF 2 as the speeds are lower.

Takeoff speeds are V1 = 149 kt, VR = 150 kt, V2 = 155 kt

Flexible temperature with air conditioning OFF..... 53 °C

Use the QNH/Bleeds corrections:(Refer to PER-TOF-TOD-24 EFFECT OF QNH AND BLEEDS).

For example:

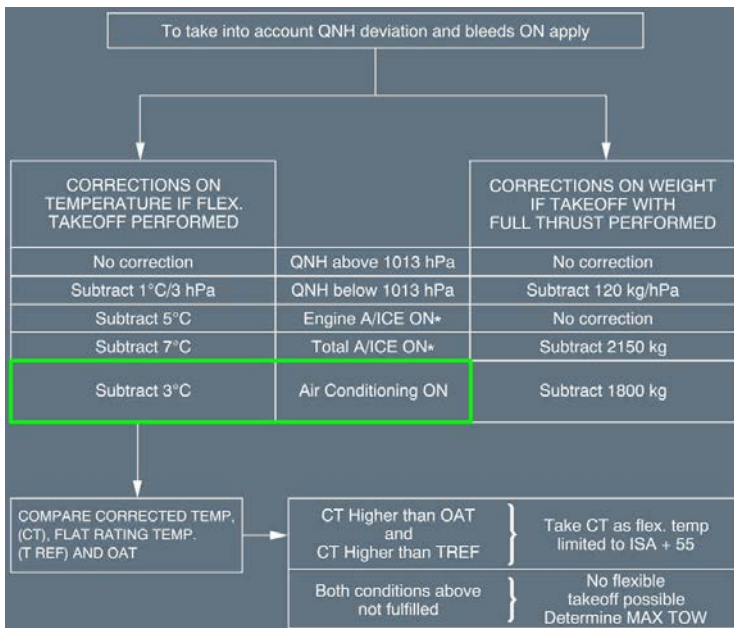

Air conditioning correction -3 °C

Flexible temperature..... = 50 °C

Check that OAT/TREF < flex temperature ≤ TMAXFLEX

TMAXFLEX is specified in LIM-70.

CORRECTIONS FOR WET RUNWAY

Ident.: PER-TOF-TOC-14-10-00001725.0001001 / 28 JAN 11

Applicable to: ALL

CORRECTIONS FOR WET RUNWAY

(Refer to PER-TOF-CTA-10 GENERAL)

CORRECTIONS PRODUCED ON THE RTOW CHART

Ident.: PER-TOF-TOC-14-10-00014717.0001001 / 29 JUL 16

Applicable to: ALL

The following data and graphs are for example only, and are not for operational use. Even if the data in the following example is in “kg” and “m”, the same method can be applied for “lb” and “ft”.

For a description of this correction Refer to *PER-TOF-TOC-10-20 DESCRIPTION OF THE CORRECTIONS ON TAKEOFF CHART*. The list of corrections is not exhaustive, however the most commonly used corrections are wet runway, QNH, air conditioning and/or anti-icing. A maximum of three corrections can be produced on one chart.

To apply the correction, proceed as follows:

1. Enter the chart with wind and selected configuration. Interpolate for actual takeoff weight. Read flexible temperature associated with this weight.

2. Apply the first correction:

Apply ΔT_{flex} correction and apply speed corrections ($\Delta V1 / \Delta VR / \Delta V2$).

Check that the resulting $V2$ is higher than the VMU Limited speed (*Refer to PER-TOF-TOD-25-20 MINIMUM V2 LIMITED BY VMU/VMCA (KT IAS)*). If the speed checks are not fulfilled, flexible takeoff is not possible. Set TOGA thrust and retain the speeds associated with maximum permissible takeoff weight or the speeds read in the chart of the actual weight if they are all lower. No speed correction is required for QNH and bleeds influence (Not applicable to maximum takeoff weight determination).

3. To combine a second and/or a third correction, proceed as per point 2, except that also the resulting speeds must be checked higher than the minimum speed displayed on the RTOW chart.

4. Check that the final flexible temperature is:

- higher than OAT and TREF
- limited to TMAXFLEX

If the check is fulfilled, retain final flexible temperature as the one to be inserted in the MCDU.

If the check is not fulfilled, (final flexible temperature lower than OAT or TREF), no flexible takeoff is possible.

Use TOGA thrust and retain speeds that have been calculated for the maximum permissible takeoff weight. (*Refer to PER-TOF-TOC-14-20 FLEXIBLE TAKEOFF NOT POSSIBLE*)

Note: - QNH correction is given for ± 10 hPa. It is allowed to extrapolate linearly for greater QNH deviation.

- Corrections from the chart must be applied from top to bottom, i.e. in the RTOW on Refer to *PER-TOF-TOC-10-30 EXAMPLE OF TAKEOFF CHART*, apply the wet influence first.

Note: - If asterisk or dotted lines appear in the influence boxes, refer to more conservative corrections provided in the FCOM.



A318/A319/A320/A321
FLIGHT CREW
OPERATING MANUAL

PERFORMANCE

TAKEOFF

TAKEOFF CHARTS - FLEXIBLE TAKEOFF (TEMPERATURE ENTRY)

EXAMPLE 5

DATA : CONF 2
 Actual takeoff weight = 75 600 kg
 Head wind = 10 kt
 WET runway
 Air conditioning OFF
 QNH = 1 023 hPa

In this example, we will consider CONF 2 as takeoff configuration. But same computation has to be done in CONF 1 and you must retain the best configuration.

Use the chart: (Refer to PER-TOF-TOC-10-30 EXAMPLE OF TAKEOFF CHART).

| A3XXXXX | ENGINES | AIRPORT NAME | | | | Version | Date | | | |
|---|-----------------------|-----------------------|-----------------------|-----------------------|-----------------------|-----------------------|-----------------------|-----------------------|-----------------------|-----------------------|
| QNH | 1013,25 HPA | Elevation | 489 FT | TORA | 3000 M | 15L | A3XXXXXX **V20 | | | |
| Air cond. | AC OFF | Isa temp | 14 °C | TODA | 3000 M | | 4 obstacles | DRY | | |
| Anti-icing | AI OFF | Run slope | .08 % | ASDA | 3000 M | | | | | |
| All reversers operating No reversers on dry runway | | | | | | | | | | |
| OAT °C | CONF 1 + F | | | | CONF 2 | | | | | |
| | TAILWIND - 10.0 KT | TAILWIND - 5.0 KT | WIND 0 KT | HEADWIND + 10.0 KT | HEADWIND + 20.0 KT | TAILWIND - 10.0 KT | TAILWIND - 5.0 KT | WIND 0 KT | HEADWIND + 10.0 KT | HEADWIND + 20.0 KT |
| 48 | 74.5 4/6 143/48/50 | 76.2 4/6 148/50/52 | 77.9 4/6 153/53/55 | 79.1 4/6 155/53/55 | 79.3 2/4 153/55/57 | 74.7 4/6 141/44/48 | 76.4 4/6 146/47/51 | 78.0 3/4 150/50/55 | 79.1 3/4 152/53/57 | 79.5 4/6 155/58/63 |
| 50 | 73.8 4/6 143/47/49 | 75.3 4/6 148/49/51 | 76.9 4/6 153/52/55 | 77.9 4/6 154/54/55 | 77.9 2/4 151/54/55 | 73.8 4/6 142/42/46 | 75.4 4/6 146/47/51 | 76.9 3/4 150/50/54 | 78.0 3/4 152/52/57 | 78.0 2/4 149/52/57 |
| 52 | 72.7 4/6 144/46/48 | 74.4 4/6 149/49/51 | 75.8 3/4 153/53/54 | 76.3 2/4 152/52/53 | 76.3 2/4 147/52/53 | 72.9 4/6 142/44/48 | 74.3 3/4 146/46/50 | 75.8 3/4 150/50/54 | 76.4 2/4 150/50/55 | 76.4 2/4 146/50/55 |
| 54 | 71.8 4/6 145/46/47 | 73.3 3/4 149/49/51 | 74.8 3/4 152/52/54 | 75.0 2/4 150/50/52 | 75.0 2/4 145/50/52 | 71.9 3/4 142/43/47 | 73.3 3/4 146/46/50 | 74.7 3/4 149/49/54 | 75.1 2/4 148/49/54 | 75.1 2/4 144/49/54 |

Determine the maximum permissible takeoff weight (see example 2). The actual weight being lower than the maximum one, flexible takeoff is possible.

Enter the 10 kt head wind column and interpolate for 75 600 kg, CONF 2,

Flexible temperature..... 53 °C

Takeoff speeds are V1 = 149 kt, VR = 150 kt, V2 = 155 kt

Apply WET correction



A318/A319/A320/A321
FLIGHT CREW
OPERATING MANUAL

PERFORMANCE

TAKEOFF

TAKEOFF CHARTS - FLEXIBLE TAKEOFF (TEMPERATURE ENTRY)

| A3XXXXX | ENGINES | AIRPORT NAME | | | | | | Version | Date | |
|--|---------------------------------|--|--------------|----------------------|--------------------------------|---|---------------------------|-----------------------|------------------------|----------------------|
| QNH | 1013.25 HPA AC OFF AI OFF | Elevation | 489 FT | TORA | 3000 M | 15L | A3XXXXXX | **V20 | | |
| Air cond. | | Inst temp | 14 C | TODA | 3000 M | | 4 obstacles | DRY | | |
| Anti-icing | | Rwy slope | .08 % | ASDA | 3000 M | | | | | |
| All reversers operating No reversers on dry runway | | | | | | | | | | |
| OAT °C | CONF 1 + F | | | | CONF 2 | | | | | |
| | TAILWIND -10.0 KT | TAILWIND -5.0 KT | WIND 0 KT | HEADWIND +10.0 KT | HEADWIND +20.0 KT | TAILWIND -10.0 KT | TAILWIND -5.0 KT | WIND 0 KT | HEADWIND +10.0 KT | HEADWIND +20.0 KT |
| INFLUENCE OF RUNWAY CONDITION | | | | | | | | | | |
| WET | -2.0/-5 | -1.5/-4 | -1.2/-3 | -1.1/-2 | 1.8/-2 | -0.9/-4 | -1.5/-4 | -1.2/-3 | -1.2/-2 | -1.5/-3 |
| | -16/-1-1 | -15/-2/-2 | -13/-4/-4 | -11/-3/-3 | -10/-2/2 | -14/0/0 | -13/0/0 | -12/-2/-2 | -10/-1/-1 | -4/-2/-2 |
| | (+54)+2.0/-5 | (+54)+1.5-4 | (+54)+1.3-3 | (+54)+1.1/-2 | (+54)+0.8-2 | (+54)+0.9-4 | (+54)+1.3/-3 | (+54)+1.2/-2 | (+54)+1.5-3 | |
| | -16/0/0 | -15/0/0 | -13/0/0 | -11/0/0 | -10/0/0 | -14/0/0 | -13/0/0 | -11/0/0 | -10/0/0 | -4/0/0 |
| INFLUENCE OF DELTA PRESSURE | | | | | | | | | | |
| QNH HPA | -10.0 | -0.8/-2 | -0.7/-2 | -0.7/-2 | -1.3/-3 | -0.7/-2 | -0.7/-2 | -1.2/-3 | -0.8/-2 | -0.8-2 |
| | | 0/0/0 | 0/0/0 | 0/0/0 | -1/0/0 | 0/0/0 | 0/0/0 | 0/0/0 | -1/0/0 | -1/0/0 |
| | (+54)+0.8/-2 | (+54)+0.7/-2 | (+54)+0.7/-2 | (+54)+1.3/-3 | (+54)+0.7/-2 | (+54)+0.7/-2 | (+54)+1.2/-3 | (+54)+0.8/-2 | (+54)+0.8-2 | (+54)+0.8-2 |
| | 0/0/0 | 0/0/0 | 0/0/0 | 0/0/0 | 0/0/0 | 0/0/0 | 0/0/0 | -1/0/0 | -1/0/0 | -1/0/0 |
| | +10.0 | +0.2/0 | +0.2/0 | +0.2/0 | +0.2/0 | +0.2/0 | +0.2/0 | +0.2/0 | +0.2/0 | +0.2/0 |
| | 0/0/0 | 0/0/0 | 0/0/0 | 0/0/0 | +1/+1/+1 | 0/+1/+1 | 0/0/0 | 0/0/0 | +1/+1/+1 | +1/+1/+1 |
| | (+54)+0.2/0 | (+54)+0.2/0 | (+54)+0.2/0 | (+54)+0.2/0 | (+54)+0.2/0 | (+54)+0.2/0 | (+54)+0.2/0 | (+54)+0.2/0 | (+54)+0.2/0 | (+54)+0.2/0 |
| | 0/0/0 | 0/0/0 | 0/0/0 | 0/0/0 | +1/+1/+1 | 0/+1/+1 | 0/0/0 | 0/0/0 | +1/+1/+1 | +1/+1/+1 |
| LABEL FOR INFLUENCE D/W (1000 KG) D/FLEX: D/V1-DVR-D/V2 (KT) | | MTOW(1000 KG) codes V1min/VRV2 (kt) | | *VMC LIMITATION | Thf (DAT) Tmax (DAT) = 54 C | Min acc height 464 FT | Max ext height 1917 FT | Min QNH alt 953 FT | Max QNH alt 2406 FT | |
| (FVAC DAT C) D/W (1000 KG) D/FLEX: D/V1-DVR-D/V2 (KT) | | LIMITATION CODES: 1=1st segment 2=2nd segment 3=runway length 4=obstacles 5=taxi speed 6=brake energy 7=taxi weight 8=final take-off 9=VMU | | | | Min V1/VRV2 = 108/116/117 CHECK-VMS LIMITATION Correct V1/VRV2 = 1.0 KT/1000 KG | | | | |

$\Delta T_{flex} = \dots\dots\dots -2 \text{ } ^\circ\text{C}$
 Intermediate flex temperature..... = $51 \text{ } ^\circ\text{C}$

Associated speeds,
 $V1 = 149 \text{ kt} - 10 = 139 \text{ kt}$
 $VR = 150 \text{ kt} - 1 = 149 \text{ kt}$
 $V2 = 155 \text{ kt} - 1 = 154 \text{ kt}$

Check that V2 is higher than the VMU. (Refer to PER-TOF-TOD-25-20 MINIMUM V2 LIMITED BY VMU/VMCA (KT IAS)).
 Apply QNH correction



A318/A319/A320/A321
FLIGHT CREW
OPERATING MANUAL

PERFORMANCE

TAKEOFF

TAKEOFF CHARTS - FLEXIBLE TAKEOFF (TEMPERATURE ENTRY)

| A3XXXXX | ENGINES | AIRPORT NAME | | | | Version | Date | |
|---|---|---|--|---|--|--|--|--|
| QNH | 1013.25 HPA | Elevation | 489 FT | TORA | 3000 M | 15L | A3XXXXXX- **V20 | |
| Air cond. | AC OFF | Isa temp | 14 C | TODA | 3000 M | 4 obstacles | DRY | |
| Anti-icing | AI OFF | Rwy slope | .08 % | ASDA | 3000 M | | | |
| All reversers operating No reversers on dry runway | | | | | | | | |
| CONF 1 + F | | | | CONF 2 | | | | |
| OAT °C | TAILWIND -10.0 KT | TAILWIND -5.0 KT | WIND 0 KT | HEADWIND +10.0 KT | HEADWIND +20.0 KT | TAILWIND -10.0 KT | TAILWIND -5.0 KT | |
| INFLUENCE OF RUNWAY CONDITION | | | | | | | | |
| WET | -2.0/-5 -16/1/-1 (+54) +2.0/-5 -16/0/0 | -1.5/-4 -15/-2/-2 (+54) -1.5/-4 -15/0/0 | -1.2/-3 -13/-4/-4 (+54) -1.3/-3 -13/0/0 | -1.1/-2 -11/-3/-3 (+54) -1.1/-2 -11/0/0 | 1.8/-2 -10/-2/2 (+54) -0.8/-2 -10/0/0 | -0.9/-4 -14/0/- (+54) -0.9/-4 -14/0/0 | -1.5/-4 -12/-2/-2 (+54) -1.3/-3 -11/0/0 | -1.2/-2 -10/-1/-1 (+54) -1.2/-2 -10/0/0 |
| INFLUENCE OF DELTA PRESSURE | | | | | | | | |
| DOWN HPA | -0.8/-2 (+54) -0.8/-2 0/0/0 | -0.7/-2 (+54) -0.7/-2 0/0/0 | -0.7/-2 (+54) -0.7/-2 0/0/0 | -1.3/-3 (+54) -1.3/-3 0/0/0 | -0.7/-2 (+54) -0.7/-2 0/0/0 | -1.2/-3 (+54) -1.2/-3 0/0/0 | -0.8/-2 (+54) -0.8/-2 -1/0/0 | -0.8/-2 (+54) -0.8/-2 -1/0/0 |
| +10.0 | +0.2/0 (+54) +0.2/0 0/0/0 | +0.2/0 (+54) +0.2/0 0/0/0 | +0.2/0 (+54) +0.2/0 0/0/0 | +0.2/0 (+54) +0.2/0 +1/+1/+1 | +0.2/0 (+54) +0.2/0 0/+1/+1 | +0.2/0 (+54) +0.2/0 0/0/0 | +0.2/0 (+54) +0.2/0 +1/+1/+1 | +0.2/0 (+54) +0.2/0 +1/+1/+1 |
| LABEL FOR INFLUENCE DW (1000 KG) DT FLEX DW (1000 KG) DT FLEX (TVMC OAT C) DW (1000 KG) DT FLEX DW (1000 KG) DT FLEX (TVMC OAT C) | | MTOW (1000 KG) INDEX V1 min/V2 V40 | | *VMC % LIMITATION | Tref (OAT) Tmax (OAT) | Min. a/c height Max. a/c height | 464 FT 1917 FT | Min QRN alt Max QRN alt |
| | | LIMITATION CODES: 1-1st segment 2-2nd segment 3-runway length 4-obstacles Before speed Brake energy 7-max weight 8-final take-off 9-VMU | | Min V1/V2/V2 = 104/114/117 CHECK VMU LIMITATION Correct V1/V2/V2 = 1.0 KT/1000 KG | | | | |

$\Delta T_{flex} = \dots\dots\dots 0 \text{ } ^\circ\text{C}$
 Maximum flexible temperature..... = 51 $^\circ\text{C}$
 No speed correction is required for QNH and bleed influence.
 Takeoff speeds are V1 = 139 kt, VR = 149 kt, V2 = 154 kt
 Check that OAT/TREF < flex temperature \leq TMAXFLEX
 TMAXFLEX is specified in LIM-70.

| | Takeoff Configuration: 1 + F | | | |
|--------------------|------------------------------|-----|-----|-----|
| | Tflex | V1 | VR | V2 |
| Chart temperature | 53 | 149 | 150 | 155 |
| FCOM correction(s) | | | | |
| Intermediate value | 53 | 149 | 150 | 155 |
| WET Correction | -2 | -10 | -1 | -1 |
| Intermediate value | 51 | 139 | 149 | 154 |
| QNH Correction | 0 | 0 | 0 | 0 |
| Final value | 51 | 139 | 149 | 154 |



PERFORMANCE

TAKEOFF

A318/A319/A320/A321
FLIGHT CREW
OPERATING MANUAL

TAKEOFF CHARTS - FLEXIBLE TAKEOFF (TEMPERATURE ENTRY)

COMBINING CORRECTIONS FROM FCOM AND CHART

Ident.: PER-TOF-TOC-14-10-00014718.0001001 / 29 JUL 16

Applicable to: ALL

The following data and graphs are for example only, and are not for operational use. Even if the data in the following example is in “kg” and “m”, the same method can be applied for “lb” and “ft”.

1. Apply corrections from FCOM (*Refer to PER-TOF-TOD-24 EFFECT OF QNH AND BLEEDS*).
 2. Apply corrections from the RTOW chart.
- Apply speed corrections except for QNH and bleed influences.

EXAMPLE 6

DATA: CONF 2
 Actual takeoff weight = 75 600 kg
 Head wind = 10 kt
 Air conditioning ON
 QNH = 1 028 hPa
 WET runway

In this example, we will consider CONF 2 as takeoff configuration. But same computation has to be done in CONF 1 and you must retain the best configuration.
 Use the chart (*Refer to PER-TOF-TOC-10-20 DESCRIPTION OF THE CORRECTIONS ON TAKEOFF CHART*). Determine the maximum permissible takeoff weight (*Refer to PER-TOF-TOC-12-10 COMBINING CORRECTIONS FROM FCOM AND CHART: example 3*). The actual weight being lower than the maximum one, flexible takeoff is possible.

| A3XXXXX | ENGINES | | AIRPORT NAME | | | | Version | | Date | |
|----------------------------|-----------------------|-----------------------|-----------------------|-----------------------|-----------------------|-----------------------|-----------------------|-----------------------|-----------------------|-----------------------|
| QNH | 1013.25 HPA | | Elevation | 489 FT | TORA | 3000 M | 15L | A3XXXXXX **V20 | | |
| Air cond. | AC OFF | | Sea temp | 14 C | TODA | 3000 M | | | | |
| Anti-icing | AI OFF | | Rwy slope | .0B % | ASDA | 3000 M | 4 obstacles | DRY | | |
| All reversers operating | | | | | | | | | | |
| No reversers on dry runway | | | | | | | | | | |
| OAT °C | CONF 1 + F | | | | | CONF 2 | | | | |
| | TAILWIND - 10.0 KT | TAILWIND - 5.0 KT | WIND 0 KT | HEADWIND + 10.0 KT | HEADWIND + 20.0 KT | TAILWIND - 10.0 KT | TAILWIND - 5.0 KT | WIND 0 KT | HEADWIND + 10.0 KT | HEADWIND + 20.0 KT |
| 48 | 74.5 4/6 143/48/50 | 76.2 4/6 148/50/52 | 77.9 4/6 153/53/55 | 79.1 4/6 155/53/55 | 79.3 2/4 153/55/57 | 74.7 4/6 141/44/48 | 76.4 4/6 146/47/51 | 78.0 3/4 150/50/55 | 79.1 3/4 152/53/57 | 79.5 4/6 155/58/63 |
| 50 | 73.6 4/6 143/47/49 | 75.3 4/6 148/49/51 | 76.9 4/6 153/53/55 | 77.9 4/6 154/54/56 | 77.9 2/4 151/54/56 | 73.8 4/6 142/42/46 | 75.4 4/6 146/47/51 | 76.9 3/4 150/50/54 | 78.0 3/4 152/52/57 | 78.0 2/4 149/52/57 |
| 52 | 72.7 4/6 144/48/48 | 74.4 4/6 149/49/51 | 75.8 3/4 153/53/54 | 76.3 2/4 152/52/53 | 76.3 2/4 147/52/53 | 72.9 4/6 142/44/48 | 74.3 3/4 146/46/50 | 75.8 3/4 150/50/54 | 76.4 2/4 150/50/55 | 76.4 2/4 146/50/55 |
| 54 | 71.8 4/6 145/48/47 | 73.3 3/4 149/49/51 | 74.8 3/4 152/52/54 | 75.0 2/4 150/50/52 | 75.0 2/4 145/50/52 | 75.0 2/4 142/43/47 | 74.7 3/4 146/46/50 | 74.7 3/4 149/49/54 | 75.1 2/4 148/49/54 | 75.1 2/4 144/49/54 |

Enter the 10 kt head wind column and interpolate for 75 600 kg, CONF 2,
 Flexible temperature..... 53 °C
 Takeoff speeds are V1 = 149 kt, VR = 150 kt, V2 = 155 kt
 First, apply the correction (*Refer to PER-TOF-TOD-24 EFFECT OF QNH AND BLEEDS*).
 Flexible temperature with air conditioning OFF..... 53 °C

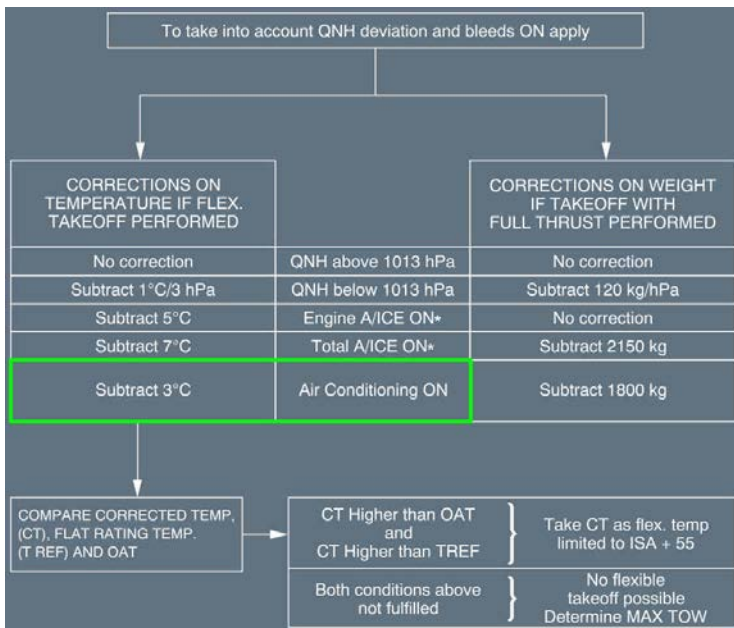

Air conditioning correction..... -3 °C
 Intermediate flexible temperature..... = 50 °C
 No speed correction.
 Apply WET correction



A318/A319/A320/A321
FLIGHT CREW
OPERATING MANUAL

PERFORMANCE

TAKEOFF

TAKEOFF CHARTS - FLEXIBLE TAKEOFF (TEMPERATURE ENTRY)

| A3XXXXX | ENGINES | AIRPORT NAME | | | | | | Version | Date | |
|--|--|--|--|---|--|---|---|---|---|---|
| QNH | 1013.25 HPA | Elevation | 489 FT | TORA | 3000 M | 15L | A3XXXXXX | **V20 | | |
| Air cond. | AC OFF | Isa temp | 14 C | TODA | 3000 M | | 4 obstacles | DRY | | |
| Anti-icing | AI OFF | Rwy slope | .08 % | ASDA | 3000 M | | | | | |
| All reversers operating No reversers on dry runway | | | | | | | | | | |
| OAT °C | CONF 1 + F | | | | | CONF 2 | | | | |
| | TAILWIND -10.0 KT | TAILWIND -5.0 KT | WIND 0 KT | HEADWIND +10.0 KT | HEADWIND +20.0 KT | TAILWIND -10.0 KT | TAILWIND -5.0 KT | WIND 0 KT | HEADWIND +10.0 KT | HEADWIND +20.0 KT |
| INFLUENCE OF RUNWAY CONDITION | | | | | | | | | | |
| WET | -2.0/-5 -16/-1-1 (+54)+2.0/-5 -16.0/0 | -1.5/-4 -15/-2/-2 (+54)+1.5-4 -15.0/0 | -1.2/-3 -13/-4/-4 (+54)-1.3-3 -13.0/0 | -1.1/-2 -11/-3/-3 (+54)-1.1/-2 -11.0/0 | 1.8/-2 -10/-2.2 (+54)-0.8-2 -10.0/0 | 1.8/-2 -14/0/0 (+54)-0.8-4 -14.0/0 | -1.5/-4 -13/0/0 (+54)-1.3/-3 -13.0/0 | -1.2/-3 -12/-2/-2 (+54)-1.3/-3 -11.0/0 | -1.2/-2 -10/-1/-1 (+54)-1.2/-2 -10.0/0 | -1.5/-3 -4/-2/-2 (+54)-1.5-3 -4.0/0 |
| INFLUENCE OF DELTA PRESSURE | | | | | | | | | | |
| QNH HPA | | | | | | | | | | |
| -10.0 | -0.8/-2 0/0 (+54)-0.8/-2 0/0 | -0.7/-2 0/0 (+54)-0.7-2 0/0 | -0.7/-2 0/0 (+54)-0.7-2 0/0 | -1.3/-3 -1/0 (+54)-1.3-3 0/0 | -0.7/-2 0/0 (+54)-0.7-2 0/0 | -0.7/-2 0/0 (+54)-0.7-2 0/0 | -1.2/-3 0/0 (+54)-1.2-3 0/0 | -0.8/-2 -1/0 (+54)-0.8-2 -1/0 | -0.8/-2 -1/0 (+54)-0.8-2 -1/0 | -0.8/-1 -1/-1/-1 (+54)-0.8-2 -1/0 |
| +10.0 | +0.2/0 0/0 (+54)+0.2/0 0/0 | +0.2/0 0/0 (+54)+0.2/0 0/0 | 0.0/0 0/0 (+54)+0.0/0 0/0 | +0.2/0 0/0 (+54)+0.2/0 +1/+1/+1 | +0.2/0 0/0 (+54)+0.2/0 +1/+1/+1 | +0.2/0 0/0 (+54)+0.2/0 +1/+1/+1 | +0.2/0 0/0 (+54)+0.2/0 0/0 | +0.2/0 0/0 (+54)+0.2/0 +1/+1/+1 | +0.2/0 0/0 (+54)+0.2/0 +1/+1/+1 | +0.2/0 +1/+1/+1 (+54)+0.2/0 +1/+1/+1 |
| LABEL FOR INFLUENCE DW (1000 KG) DTRFLEX DV1-DVR-DV2 (KT) | | MTOW(1000 KG) codes V1min/VRV2 (kt) | | *VMC LIMITATION | | Tref (OAT) Tmax (OAT) = 54 C | | Min acc height 464 FT Max exc height 1917 FT | | Min QNH alt 953 FT Max QNH alt 2400 FT |
| LIMITATION CODES: 1=1st segment 2=2nd segment 3=runway length 4=obstacles 5=taxi speed 6=brake energy 7=taxi weight 8=final take-off 9=VMU | | | | | | | | | | Min V1/VRV2 = 108/116/117 CHECK-VMC LIMITATION Correct V1/VRV2 = 1.0 KT/1000 KG |

For flexible temperature < TVMC (54 °C), ΔTflex = -2 °C
 Intermediate flex temperature..... = 48 °C

Associated speeds,
 V1 = 149 kt - 10 = 139 kt
 VR = 150 kt - 1 = 149 kt
 V2 = 155 kt - 1 = 154 kt

Check that V2 is higher than the VMU (Refer to PER-TOF-TOD-25-20 MINIMUM V2 LIMITED BY VMU/VMCA (KT IAS)).

Apply QNH correction



A318/A319/A320/A321
FLIGHT CREW
OPERATING MANUAL

PERFORMANCE

TAKEOFF

TAKEOFF CHARTS - FLEXIBLE TAKEOFF (TEMPERATURE ENTRY)

| A3XXXXX | ENGINES | AIRPORT NAME | | | | Version | Date | | | |
|---|----------------------|---|---------------------|--|----------------------------------|---|----------------------------|-------------------|----------------------|----------------------|
| QNH | 1013.25 HPA | Elevation | 489 FT | TORA | 3000 M | 15L | A3XXXXXX-YYV20 | | | |
| Air cond. | AC OFF | Isa temp | 14 C | TODA | 3000 M | 4 obstacles | DRY | | | |
| Anti-icing | AI OFF | Rwy slope | .08 % | ASDA | 3000 M | | | | | |
| All reversers operating No reversers on dry runway | | | | | | | | | | |
| OAT °C | CONF 1 + F | | | | CONF 2 | | | | | |
| | TAILWIND -10.0 KT | TAILWIND -5.0 KT | WIND 0 KT | HEADWIND +10.0 KT | HEADWIND +20.0 KT | TAILWIND -10.0 KT | TAILWIND -5.0 KT | WIND 0 KT | HEADWIND +10.0 KT | HEADWIND +20.0 KT |
| INFLUENCE OF RUNWAY CONDITION | | | | | | | | | | |
| WET | -2.0/-5 | -1.5/-4 | -1.2/-3 | -1.1/-2 | 1.8/-2 | -0.9/-4 | -1.5/-4 | -1.2/-3 | -1.2/-2 | -1.5/-3 |
| | -18/1/-1 | -15/-2/-2 | -13/-4/-4 | -11/-3/-3 | -10/-2/2 | -14/0/- | -13/0/- | -12/-2/-2 | -10/-1/-1 | -4/-2/-2 |
| | (+54) +2.0/-5 | (+54) -1.5/-4 | (+54) -1.3/-3 | (+54) -1.1/-2 | (+54) -0.8/-2 | (+54) -0.9/-4 | (+54) -1.5/-4 | (+54) -1.3/-3 | (+54) -1.2/-2 | (+54) -1.5/-3 |
| | -16/0/0 | -15/0/0 | -13/0/0 | -11/0/0 | -10/0/0 | -14/0/0 | -13/0/0 | -11/0/0 | -10/0/0 | -4/0/0 |
| INFLUENCE OF DELTA PRESSURE | | | | | | | | | | |
| DOW/HPA | -10.0 | -0.8/-2 | -0.7/-2 | -0.7/-2 | -1.3/-3 | -0.7/-2 | -1.2/-3 | -0.8/-2 | -0.8/-2 | -0.8/-1 |
| | | 0/0/ | 0/0/ | 0/0/ | -1/0/ | 0/0/ | 0/0/ | -1/0/ | -1/0/ | -1/0/ |
| | (+54) -0.8/-2 | (+54) -0.7/-2 | (+54) -0.7/-2 | (+54) -1.3/-3 | (+54) -0.7/-2 | (+54) -0.7/-2 | (+54) -1.2/-3 | (+54) -0.8/-2 | (+54) -0.8/-2 | (+54) -0.8/-2 |
| | 0/0/ | 0/0/ | 0/0/ | 0/0/ | 0/0/ | 0/0/ | 0/0/ | -1/0/ | -1/0/ | -1/0/ |
| | +10.0 | +0.2/0 | +0.2/0 | +0.2/0 | +0.2/0 | +0.2/0 | +0.2/0 | +0.2/0 | +0.2/0 | +0.2/0 |
| | | 0/0/ | 0/0/ | 0/0/ | 0/0/ | +1/0/ | +1/0/ | 0/0/ | 0/0/ | 0/0/ |
| | (+54) +0.2/0 | (+54) +0.2/0 | (+54) +0.2/0 | (+54) +0.2/0 | (+54) +0.2/0 | (+54) +0.2/0 | (+54) +0.2/0 | (+54) +0.2/0 | (+54) +0.2/0 | (+54) +0.2/0 |
| | 0/0/ | 0/0/ | 0/0/ | 0/0/ | 0/0/ | +1/0/ | +1/0/ | 0/0/ | +1/0/ | +1/0/ |
| LABEL FOR INFLUENCE DW (1000 KG) DT FLEX DW (1000 KG) DT FLEX (TVMC OAT C) DW (1000 KG) DT FLEX DW (1000 KG) DT FLEX DW (1000 KG) DT FLEX | | MTOW(1000 KG) 6000 V1min/V1/V2 90 | *VMC %LIMITATION | Tref (OAT) = 44 C Tmax (OAT) = 54 C | Min arc height Max arc height | 464 FT 1917 FT | Min QRH alt Max QRH alt | 563 FT 2405 FT | | |
| | | LIMITATION CODES: 1-1st segment 2-2nd segment 3-runway length 4-obstacles 5-true speed 6-takeoff energy 7-max weight 8-final take-off 9-VMU | | | | Min V1/V2/V2 = 108/114/117 CHECK VMC LIMITATION Correct V1/V2/V2 = 1.0 KT/1000 KG | | | | |

For flexible temperature < TVMC (54 °C), $\Delta T_{flex} = \dots\dots\dots 0 \text{ } ^\circ\text{C}$
 Flexible temperature..... = 48 °C

No speed correction is required for QNH and bleed influence.

Takeoff speeds are,

V1 = 139 kt

VR = 149 kt

V2 = 154 kt

Check that OAT/TREF < flex temperature ≤ TMAXFLEX.

TMAXFLEX is specified in LIM-70.

| | Takeoff Configuration : 2 | | | |
|--------------------|---------------------------|-----|-----|-----|
| | Tflex | V1 | VR | V2 |
| Chart temperature | 53 | 149 | 150 | 155 |
| FCOM correction(s) | -3 | 0 | 0 | 0 |
| Intermediate value | 50 | 149 | 150 | 155 |
| WET Correction | -2 | -10 | -1 | -1 |
| Intermediate value | 48 | 139 | 149 | 154 |
| QNH Correction | 0 | 0 | 0 | 0 |
| Final value | 48 | 139 | 149 | 154 |



A318/A319/A320/A321
FLIGHT CREW
OPERATING MANUAL

PERFORMANCE

TAKEOFF

TAKEOFF CHARTS - FLEXIBLE TAKEOFF (TEMPERATURE ENTRY)

Intentionally left blank

FLEXIBLE TAKEOFF NOT POSSIBLE

FLEXIBLE TAKEOFF NOT POSSIBLE

Ident.: PER-TOF-TOC-14-20-00001726.0001001 / 30 SEP 13

Applicable to: ALL

In some cases when the actual takeoff weight is lower than the maximum permissible takeoff weight, but the flexible temperature is lower than TREF or OAT, flexible takeoff is not possible. It is mandatory to use TOGA thrust.

For speed determination:

- You can retain the speeds that have been calculated for the maximum permissible takeoff weight;
OR
- You can retain the speeds associated with the actual takeoff weight provided they are all lower than the speeds calculated for the maximum permissible takeoff weight.



A318/A319/A320/A321
FLIGHT CREW
OPERATING MANUAL

PERFORMANCE

TAKEOFF

TAKEOFF CHARTS - FLEXIBLE TAKEOFF (TEMPERATURE ENTRY)

Intentionally left blank



A318/A319/A320/A321
FLIGHT CREW
OPERATING MANUAL

PERFORMANCE

TAKEOFF

TAKEOFF CHARTS - FLEXIBLE TAKEOFF (TEMPERATURE ENTRY)

FLEXIBLE TAKEOFF POSSIBLE BUT NOT USED

FLEXIBLE TAKEOFF POSSIBLE BUT NOT USED

Ident.: PER-TOF-TOC-14-25-00015228.0001001 / 30 SEP 13

Applicable to: ALL

If the flexible takeoff is possible, but the flight crew elects to perform the takeoff with TOGA thrust, for speed determination:

- You can retain the speeds that have been calculated for the maximum permissible takeoff weight;
- OR
- You can retain the speeds associated with the actual takeoff weight provided they are all lower than the speeds calculated for the maximum permissible takeoff weight.



A318/A319/A320/A321
FLIGHT CREW
OPERATING MANUAL

PERFORMANCE

TAKEOFF

TAKEOFF CHARTS - FLEXIBLE TAKEOFF (TEMPERATURE ENTRY)

Intentionally left blank



A318/A319/A320/A321
FLIGHT CREW
OPERATING MANUAL

PERFORMANCE

TAKEOFF

TAKEOFF CHARTS - FLEXIBLE TAKEOFF (TEMPERATURE ENTRY)

SUMMARY



A318/A319/A320/A321
FLIGHT CREW
OPERATING MANUAL

PERFORMANCE

TAKEOFF

TAKEOFF CHARTS - FLEXIBLE TAKEOFF (TEMPERATURE ENTRY)

SUMMARY

Ident.: PER-TOF-TOC-14-30-00006034.0001001 / 24 MAR 11

Applicable to: ALL

The flow diagram gives the different steps to follow.

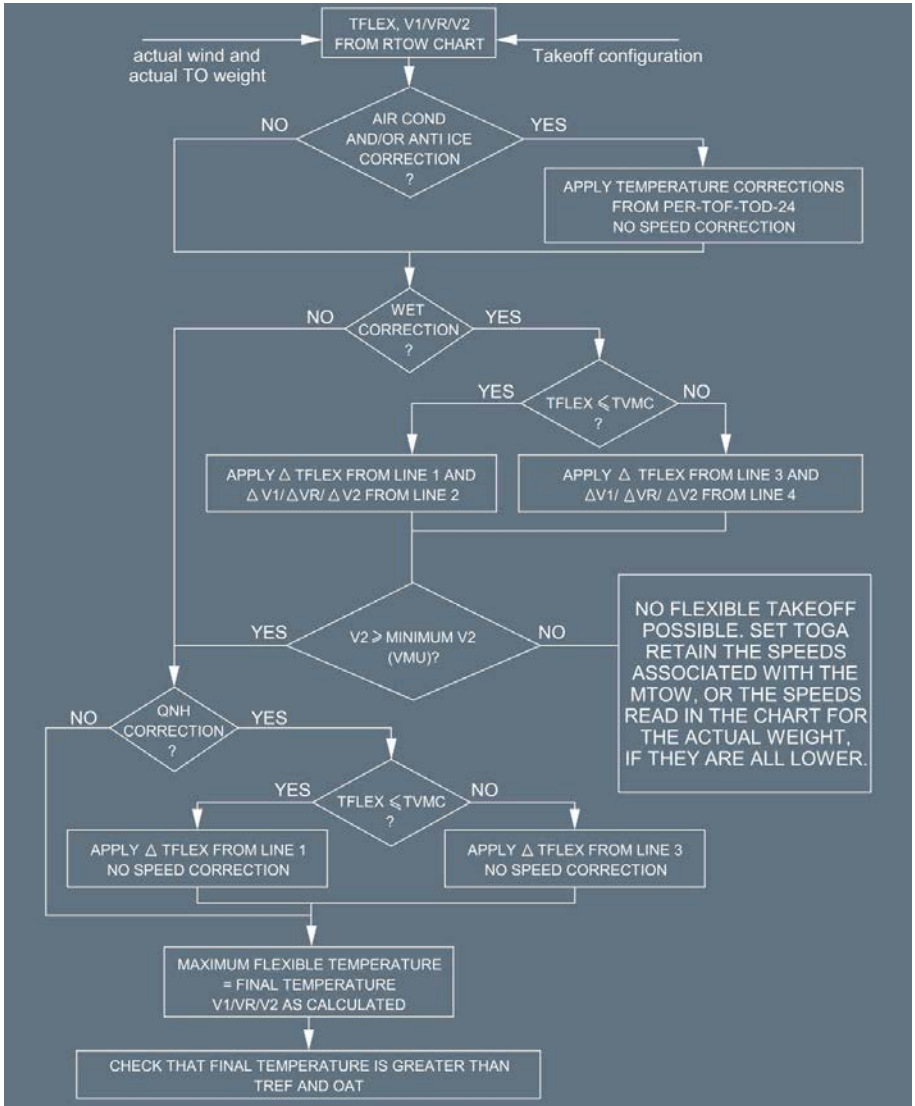



A318/A319/A320/A321
FLIGHT CREW
OPERATING MANUAL

PERFORMANCE

TAKEOFF

TAKEOFF CHARTS - FLEXIBLE TAKEOFF (TEMPERATURE ENTRY)

Intentionally left blank

TAKEOFF PERFORMANCE

TAKEOFF PERFORMANCE

Ident.: PER-TOF-TOC-16-10-00001727.0001001 / 23 JUN 15

Applicable to: ALL

Takeoff optimization is calculated for a given runway and its obstacles and for given conditions of flap setting, temperature, wind and QNH. The calculation produces a maximum permissible takeoff weight (or a maximum takeoff temperature for an actual weight).

The takeoff thrust produced by the engine varies as follows :

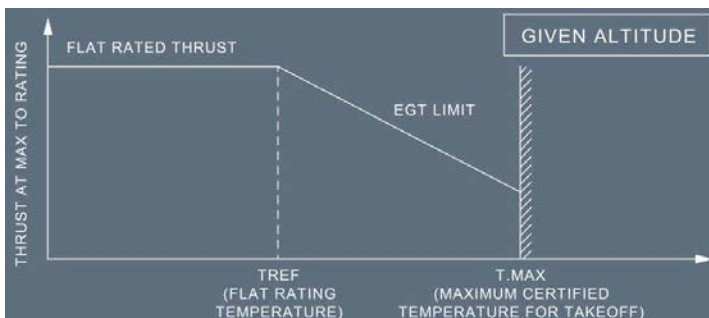

The optimization process calculates the speeds which will produce the maximum takeoff weight. To do so, it takes into account the different takeoff limitations such as TOD , ASD , TOR, second segment..., as shown on the charts below.

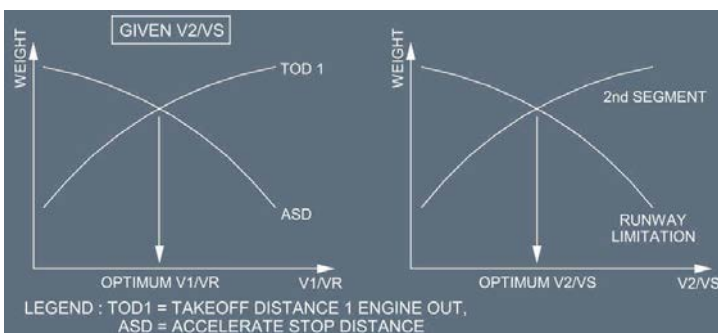

On a typical runway, the performance of a twin engine aircraft, is generally limited by the one engine out operation at takeoff. The optimum V2 /VS and optimum V1 /VR are consequently unique.



A318/A319/A320/A321
FLIGHT CREW
OPERATING MANUAL

PERFORMANCE

TAKEOFF

TAKEOFF CHARTS - GENERAL (WEIGHT ENTRY)

Intentionally left blank

TAKEOFF CHART DESCRIPTION

GENERAL

Ident.: PER-TOF-TOC-16-20-00001728.0003001 / 28 FEB 11

Applicable to: ALL

The takeoff chart (RTOW : Regulatory Takeoff Weight) is calculated for a specific aircraft version and for a particular runway specified at the top of the chart. The top of the chart also gives some information about the runway and lists the calculation assumptions.

The chart is given for 2 different configurations and 4 wind values per configuration. This allows the crew to select the configuration that gives either :

- the highest permissible takeoff weight, or, for a given weight,
- the highest flexible temperature.

If different configurations give equivalent performance, the crew should select the configuration associated with the lowest takeoff speeds.

The left column of the chart contains weight entry. For each weight entry (and for a given configuration and wind), the chart provides the following information :

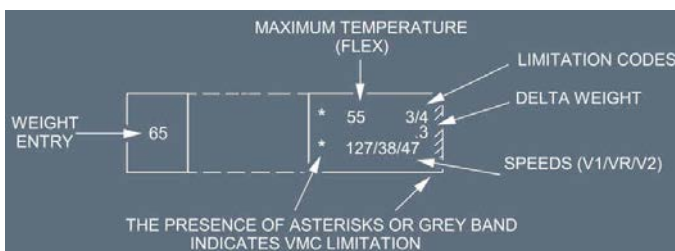

Note: The takeoff weight is the sum of the weight entry and the delta weight.

The available limitation codes are :

- First segment : 1
- Second segment : 2
- Runway length : 3
- Obstacles : 4
- Tire speed : 5
- Brake energy : 6
- Maximum computation weight : 7
- Final takeoff : 8
- VMU : 9

CORRECTIONS DUE TO DIFFERENT TAKEOFF CONDITIONS

Ident.: PER-TOF-TOC-16-20-00001729.0105001 / 19 DEC 14

Applicable to: **ALL**

Each takeoff chart is computed for a given set of conditions (air conditioning, QNH, anti ice...) specified at the top of the chart. If the actual takeoff conditions are different, the crew must apply corrections.

Two types of corrections are available :

- Conservative corrections (*Refer to PER-TOF-TOD-24 EFFECT OF QNH AND BLEEDS*) (to be used when not provided on the chart).
- Corrections (less restrictive) listed on the chart, to be applied as explained below.

- Note:
1. If the RTOW chart is based on the CG being at 25 %, the crew can find the takeoff performance at a more forward CG by decreasing the takeoff weight by 1 000 kg (2 200 lb) and increasing V1 , VR and V2 by 1 kt.
 2. 25 % CG is the basic certified limit, on which all takeoff computations are based. To take into account the operational margins, the above penalties must be applied when operational CG is forward 27 % CG.

DESCRIPTION OF THE CORRECTIONS ON TAKEOFF CHART

Ident.: PER-TOF-TOC-16-20-00006633.0001001 / 08 JUL 15

Applicable to: **ALL**

The corrections are presented on 4 lines :

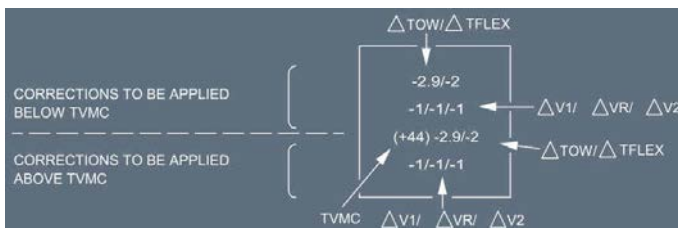

TVMC is a temperature value given per column. This is a fictitious value that indicates the temperature above which the speeds are close to a VMCG /VMCA limitation or are VMCG /VMCA limited.

Note: The lower two lines may be shaded on certain chart formats.



A318/A319/A320/A321
FLIGHT CREW
OPERATING MANUAL

PERFORMANCE

TAKEOFF

TAKEOFF CHARTS - GENERAL (WEIGHT ENTRY)

MINIMUM SPEED

Ident.: PER-TOF-TOC-16-20-00006634.0001001 / 08 JUL 15

Applicable to: ALL

Minimum V1 /VR /V2 due to VMCG /VMCA are provided on the bottom right side of the takeoff chart. They are only applicable in case of speed corrections. These speeds are conservative. They may be slightly higher than V1 /VR /V2 displayed on the takeoff chart.



A318/A319/A320/A321
FLIGHT CREW
OPERATING MANUAL

PERFORMANCE

TAKEOFF

TAKEOFF CHARTS - GENERAL (WEIGHT ENTRY)

Intentionally left blank



A318/A319/A320/A321
FLIGHT CREW
OPERATING MANUAL

PERFORMANCE

TAKEOFF

TAKEOFF CHARTS - GENERAL (WEIGHT ENTRY)

ADDITIONAL INFORMATION

ONE ENGINE OUT CLIMB PROCEDURE

Ident.: PER-TOF-TOC-16-30-00001730.0001001 / 10 DEC 09

Applicable to: ALL

The performance given in the chart is consistent with the flight path specified for the aircraft with one engine out and takes into account significant obstacles.

When the procedure to be followed is not the standard instrument departure, the chart describes a specific procedure (EOSID).

When the specified procedure requires a turn, except if otherwise stated on the RTOW chart, the turn should be performed with a maximum bank of 15 ° until the aircraft reaches 1 500 ft or until green dot.

The acceleration height (or altitude) ensures that the net flight path clears the highest obstacle by at least 35 ft when accelerating in level flight to green dot speed after an engine failure, in the most adverse conditions.

TAKEOFF ON A WET RUNWAY

Ident.: PER-TOF-TOC-16-30-00001731.0002001 / 10 DEC 09

Applicable to: ALL

Takeoff charts computed for wet runway with a 15 ft screen height and/or use of reverse thrust may produce, in some conditions, a maximum takeoff weight (or flexible temperature) higher than that obtained for a dry runway. It is thus mandatory to compare both charts (dry and wet) and retain the lower of the two weights (or flexible temperature) and the associated speeds determined for a wet runway.

Note: The crew need not compare the charts if the top of the wet runway chart specifies "DRY CHECK". (The comparison has already been inserted in the WET runway calculation).

RTOW CHARTS - COMPLEMENTARY INFORMATION

Ident.: PER-TOF-TOC-16-30-00001732.0063001 / 10 DEC 09

Applicable to: ALL

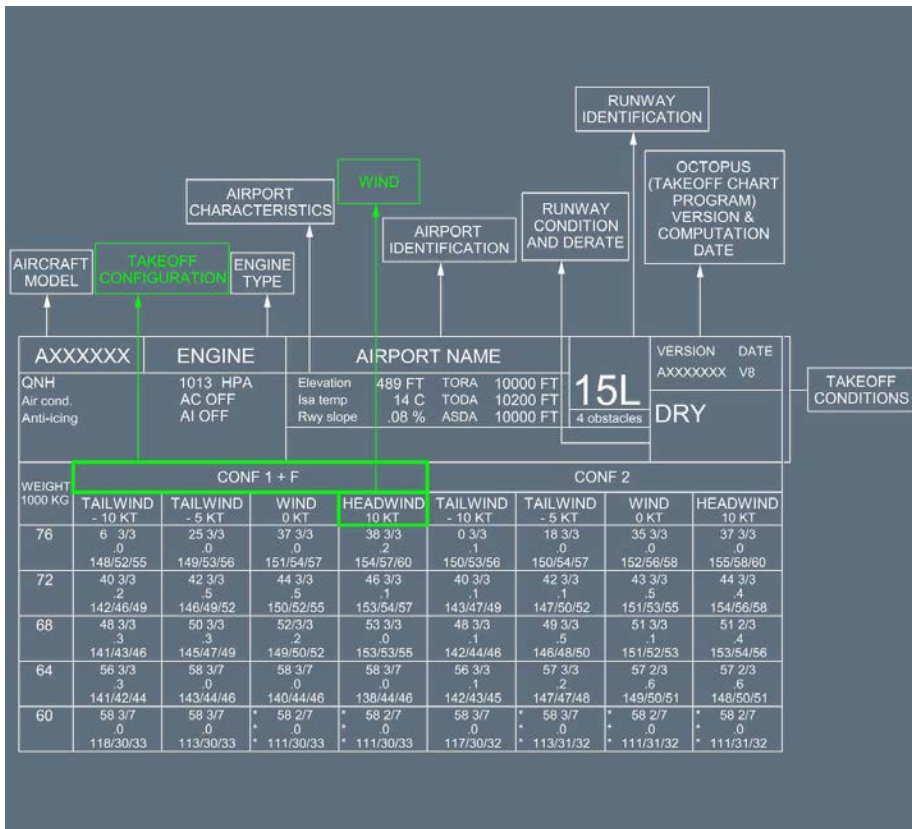

| Axxxxxx | | ENGINE | | AIRPORT NAME | | | | 15L | | VERSION | DATE |
|-------------------|--------------------------------|--------------------------------|---|--------------------------------|--------------------------------|--------------------------------|--------------------------------|--------------------------------|--------------------------------|--------------------------------|--------------------------------|
| QNH | | 1013 HPA | | Elevation | 489 FT | TORA | 10000 FT | 4 obstacles | DRY | AXXXXXX | V8 |
| Air cond. | | AC OFF | | Isa temp | 14 C | TODA | 10200 FT | | | | |
| Anti-icing | | AI OFF | | Rwy slope | 08 % | ASDA | 10000 FT | | | | |
| WEIGHT 1000 KG | CONF 1 + F | | | | CONF 2 | | | | | | |
| | TAILWIND - 10 KT | TAILWIND - 5 KT | WIND 0 KT | HEADWIND 10 KT | TAILWIND - 10 KT | TAILWIND - 5 KT | WIND 0 KT | HEADWIND 10 KT | | | |
| 56 | * 58 7/9 * 0 * 111/21/24 | * 58 7/9 * 0 * 111/21/24 | * 58 7/9 * 0 * 111/21/24 | * 58 7/9 * 0 * 111/21/24 | * 58 7/7 * 0 * 111/19/21 | * 58 7/7 * 0 * 111/19/21 | * 58 7/7 * 0 * 111/19/21 | * 58 7/7 * 0 * 111/19/21 | * 58 7/7 * 0 * 111/19/21 | * 58 7/7 * 0 * 111/19/21 | |
| 52 | * 58 7/7 * 0 * 111/19/22 | * 58 7/7 * 0 * 111/19/22 | * 58 7/7 * 0 * 111/19/22 | * 58 7/7 * 0 * 111/19/22 | * 58 7/7 * 0 * 111/19/21 | * 58 7/7 * 0 * 111/19/22 | * 58 7/7 * 0 * 111/19/22 | * 58 7/7 * 0 * 111/19/21 | * 58 7/7 * 0 * 111/19/21 | * 58 7/7 * 0 * 111/19/21 | |
| 48 | * 58 7/7 * 0 * 111/18/22 | * 58 7/7 * 0 * 111/18/22 | DO NOT USE FOR OPERATIONAL PURPOSE | | | | * 58 7/7 * 0 * 111/19/21 | * 58 7/7 * 0 * 111/19/21 | * 58 7/7 * 0 * 111/19/21 | * 58 7/7 * 0 * 111/19/21 | |
| 46 | * 58 7/7 * 0 * 111/18/22 | * 58 7/7 * 0 * 111/18/22 | | | | | * 58 7/7 * 0 * 112/17/22 | * 58 7/7 * 0 * 112/17/22 | * 58 7/7 * 0 * 112/18/21 | * 58 7/7 * 0 * 112/18/21 | * 58 7/7 * 0 * 112/18/21 |
| 40 | * 58 7/7 * 0 * 112/18/22 | * 58 7/7 * 0 * 112/17/22 | * 58 7/7 * 0 * 112/17/22 | * 58 7/7 * 0 * 112/17/22 | * 58 7/7 * 0 * 112/18/21 | * 58 7/7 * 0 * 112/18/21 | * 58 7/7 * 0 * 112/18/21 | * 58 7/7 * 0 * 112/18/21 | * 58 7/7 * 0 * 112/18/21 | * 58 7/7 * 0 * 112/18/21 | |

| TAKEOFF PARAMETERS | |
|-----------------------------|-----------------------|
| MAX TEMPERATURE (58) | LIMITATION CODE (7-7) |
| DELTA WEIGHT (1000 KG) (0) | |
| V1 (KT IAS) (118) | VR (KT IAS) (117) |
| V2 (KT IAS) (122) | |

| AXXXXXX | ENGINE | AIRPORT NAME | | | | 15L | VERSION | DATE |
|--|---|---|---|--|---|---|--|--|
| QNH Air cond. Anti-icing | 1013 HPA AC OFF AI OFF | Elevation Isa temp Rwy slope | 489 FT 14 C .08 % | TORA TODA ASDA | 10000 FT 10200 FT 10000 FT | | 4 obstacles | AXXXXXX V8 |
| WEIGHT 1000 KG | CONF 1 + F | | | | CONF 2 | | | |
| | TAILWIND - 10 KT | TAILWIND - 5 KT | WIND 0 KT | HEADWIND 10 KT | TAILWIND - 10 KT | TAILWIND - 5 KT | WIND 0 KT | HEADWIND 10 KT |
| GRAD1/GRAD2 (KG/C) | | | | | | | | |
| | 40**** | 40**** | 40/400 | 40/400 | 40**** | 40**** | 30**** | 30/410 |
| INFLUENCE OF RUNWAY CONDITION | | | | | | | | |
| WET | +0/+0 0/+0+0 (+54)-4/-1 0/+0+0 | +0/+0 -1/+0+0 (+54)-4/-1 -1/+0+0 | 0/-1 -1/+0+0 (+54)-2/-1 -1/+0+0 | -2/-1 -1/+0+0 (+54)-5/-1 -1/+0+0 | +0/+0 -1/+0+0 (+54)-2/-1 -1/+0+0 | +0/+0 0/+0+0 (+54)-4/-1 0/+0+0 | +0/+0 0/+0+0 (+54)-2/-1 0/+0+0 | -2/-1 -1/+0+0 (+54)-4/-1 -1/+0+0 |
| INFLUENCE OF DELTA PRESSURE | | | | | | | | |
| D QNH HPA | -8/-2 0/-1/-1 (+54)-8/-2 0/+0+0 | -9/-2 0/-1/-1 (+54)-9/-2 0/+0+0 | -1.4/-3 0/-1/-1 (+54)-1.4/-3 0/+0+0 | -1.0/-2 -1/-1/-1 (+54)-1.0/-2 -1/+0+0 | -8/-2 0/-1/-1 (+54)-8/-2 0/+0+0 | -8/-2 0/-1/-1 (+54)-8/-2 0/+0+0 | -1.0/-2 0/0/0 (+54)-1.0/-2 0/+0+0 | -1.1/-2 -1/-1/-1 (+54)-1.1/-2 -1/+0+0 |
| +10 | +6/+0 +1/+0+0 (+54)+2/+0 +1/+0+0 | +6/+0 +1/+0+0 (+54)+2/+0 +1/+0+0 | +0/+0 +1/+1+1 (+54)+0/+0 +1/+1+1 | +6/+0 +1/+1+1 (+54)+2/+0 +1/+1+1 | +6/+0 +0/+0+0 (+54)+3/+0 +0/+0+0 | +5/+0 +1/+0+0 (+54)+1/+0 +1/+0+0 | +4/+0 +1/+1+1 (+54)+2/+0 +1/+1+1 | +2/+0 +0/+1+1 (+54)+0/+0 +0/+1+1 |
| LABEL FOR INFLUENCE | MTOW(1000 KG) codes | | *VMC | Tref (OAT) =29 C | Min acc height 784Ft | Min QNH alt 1280Ft | MINIMUM & MAXIMUM ACC. HEIGHT AND ALT. | |
| DW (1000 KG) D/FLEX DV1-DVR-DV2 (KT) (TVMC OAT C) | V1min/VVR/V2(KT) | | *LIMITATION | Tmax (OAT) =54 C | Max acc height 1965Ft | Max QNH alt 2461Ft | | |
| DW (1000 KG) D/FLEX DV1-DVR-DV2 (KT) | LIMITATION CODES: | | 1=1st segment 2=2nd segment 3=runway length 4=obstacles 5=time speed 6=brake energy 7=max weight 8=final takeoff 9=VMU | | | MIN V1/VVR/V2 = 111/17/21 CHECK VMU LIMITATION CORRECT. V1/VR/V2 = 1 Kt/1000 Kg | | |
| INFLUENCE CORRECTION ΔV/WEIGHT ΔTFLEX ΔV1/ΔVR/ΔV2 (TVMC) WEIGHT TFLEX ΔV1/ΔVR/ΔV2 | | | | | | | | |
| MINIMUM VALUES OF V1/VR/V2 TO WHICH TAKEOFF SPEEDS MUST BE LIMITED WHEN DECREMENTS ARE APPLIED | | | | | | | | |
| V1/VR/V2 DECREMENTS FOR WEIGHTS BELOW THE LOWEST WEIGHT OF A COLUMN | | | | | | | | |



A318/A319/A320/A321
FLIGHT CREW
OPERATING MANUAL

PERFORMANCE

TAKEOFF

TAKEOFF CHARTS - GENERAL (WEIGHT ENTRY)

RTOW EXAMPLE

Ident.: PER-TOF-TOC-16-30-00014719.0001001 / 29 JUL 16

Applicable to: ALL

The following data and graphs are for example only, and are not for operational use. Even if the data in the following example is in “kg” and “m”, the same method can be applied for “lb” and “ft”.

| A320XXX | ENGINES | | AIRPORT NAME | | | | 15L | VERSION | DATE | | |
|--|---|---|---|---|---|--|---|---|----------------------------------|----------------------------------|----------------------------------|
| ONH Air cond. Anti-icing All reversers operating No reversers on dry runway | 1013.25 HPA AC OFF AI OFF | | Elevation Isa temp Rwy slope | 489 FT 15 C .08 % | TORA TODA ASDA | 3000 M 3000 M 3000 M | | 4 obstacles | AXXXXXX * | *20 | |
| DRY | | | | | | | | | | | |
| WEIGHT | CONF 1 + F | | | | CONF 2 | | | | | | |
| 1000KG | TAILWIND -10 KT | TAILWIND -5 KT | WIND 0 KT | HEADWIND 10 KT | TAILWIND -10 KT | TAILWIND -5 KT | WIND 0 KT | HEADWIND 10 KT | | | |
| 80 | -18 4/6 0.0 155/56/58 | 9 4/6 0.0 154/57/59 | 37 4/6 0.0 153/55/57 | 45 4/6 0.6 155/56/58 | -15 4/6 0.0 153/53/58 | 12 4/6 0.0 151/52/57 | 40 4/6 0.1 150/51/56 | 46 3/4 0.3 152/53/58 | | | |
| 76 | 44 4/6 0.1 141/49/51 | 48 4/6 0.2 148/50/52 | 51 3/4 0.4 153/53/55 | 52 2/4 0.3 152/52/53 | 44 4/6 0.3 140/45/49 | 48 4/6 0.4 146/47/51 | 51 3/4 0.4 150/50/54 | 52 2/4 0.4 150/50/55 | | | |
| 72 | 53 4/6 0.3 145/46/48 | 56 3/4 0.2 148/48/50 | 59 3/4 0.0 152/52/53 | 60 3/4 0.4 154/54/55 | 53 3/4 0.4 142/43/47 | 56 3/4 0.2 146/46/50 | 58 3/4 0.5 149/49/53 | 60 3/4 0.3 151/51/55 | | | |
| 68 | 61 3/4 0.3 144/44/45 | 63 3/4 0.5 148/48/49 | 65 3/4 0.6 151/51/52 | 67 3/4 0.3 153/53/54 | 61 3/4 0.3 142/42/45 | 63 3/4 0.5 145/45/48 | 65 3/4 0.4 148/48/52 | 66 4/4 0.6 149/49/53 | | | |
| 64 | 68 3/4 0.5 143/43/44 | 69 3/4 1.1 147/47/48 | 69 3/4 2.2 151/51/52 | 69 3/4 3.0 153/53/54 | 68 3/4 0.6 141/41/44 | 69 3/4 1.0 144/44/47 | 69 4/4 2.0 147/47/50 | 69 4/4 2.7 147/47/50 | | | |
| 60 | * 69 7/9 * 0.0 * 114/27/29 | * 69 7/9 * 0.0 * 114/27/29 | * 69 7/9 * 0.0 * 114/32/33 | * 69 7/9 * 0.0 * 114/32/33 | * 69 7/9 * 4.0 * 141/41/44 | * 69 7/9 * 0.0 * 112/26/29 | * 69 7/9 * 0.0 * 112/26/29 | * 69 7/9 * 0.0 * 112/26/29 | | | |
| 56 | * 69 7/9 * 0.0 * 114/27/29 | * 69 7/9 * 0.0 * 114/27/29 | DO NOT USE FOR OPERATIONAL PURPOSE | | | | * 69 7/9 * 0.0 * 112/21/24 | * 69 7/9 * 0.0 * 112/21/24 | | | |
| 52 | * 69 7/9 * 0.0 * 114/22/24 | * 69 7/9 * 0.0 * 114/22/24 | | | | | * 69 7/7 * 0.0 * 115/20/22 | * 69 7/7 * 0.0 * 115/20/22 | * 69 7/7 * 0.0 * 113/18/22 | * 69 7/7 * 0.0 * 113/18/22 | * 69 7/7 * 0.0 * 113/18/22 |
| 48 | * 69 7/7 * 0.0 * 115/20/22 | * 69 7/7 * 0.0 * 115/20/22 | | | | | * 69 7/7 * 0.0 * 115/20/22 | * 69 7/7 * 0.0 * 115/20/22 | * 69 7/7 * 0.0 * 113/18/22 | * 69 7/7 * 0.0 * 113/18/22 | * 69 7/7 * 0.0 * 113/18/22 |
| GRAD1/GRAD2 (KG/C) | | | | | | | | | | | |
| | 50**** | 50**** | 60**** | 60/460 | 50**** | 50**** | 60**** | 50/470 | | | |
| INFLUENCE OF RUNWAY CONDITION | | | | | | | | | | | |
| WET | -1.4/-3 -11/-1/-1 (+69)-1.4/-3 -11/0/0 | -1.1/-3 -10/-1/-1 (+69)-1.1/-3 -10/0/0 | -0.7/-2 -9/-2/-2 (+69)-0.7/-2 -9/0/0 | -0.7/-2 -8/-2/-2 (+69)-0.7/-2 -9/0/0 | -1.3/-3 -10/-2/-2 (+69)-1.3/-3 -10/0/0 | -1.3/-3 -9/-4/-4 (+69)-1.3/-3 -9/0/0 | -0.4/-1 -7/-2/-2 (+69)-0.4/-1 -7/0/0 | -0.2/-1 -5/0/0 (+69)-0.2/-1 -5/0/0 | | | |
| D QNH HPA | INFLUENCE OF DELTA PRESSURE | | | | | | | | | | |
| -10.0 | -0.8/-2 0/0/-1 (+61)-0.8/-2 0/0/0 | -1.2/-3 0/0/-1 (+61)-1.2/-3 0/0/0 | -0.7/-2 -1/-1/-1 (+61)-0.7/-2 -1/0/0 | -0.7/-2 -1/-1/-1 (+61)-0.7/-2 -1/0/0 | -0.7/-2 0/0/0 (+61)-0.7/-2 0/0/0 | -0.7/-2 0/0/-1 (+61)-0.7/-2 0/0/0 | -0.7/-2 0/0/-1 (+61)-0.7/-2 0/0/0 | -0.7/-2 0/0/-1 (+61)-0.7/-2 0/0/0 | | | |
| +10.0 | +0.2/0 0/0/0 (+69)+0.2/0 0/0/0 | +0.2/0 0/0/0 (+69)+0.2/0 0/0/0 | 0.0/0 0/0/0 (+69)0.0/0 0/0/0 | +0.2/0 0/0/0 (+69)+0.2/0 0/0/0 | +0.2/0 0/0/0 (+69)+0.2/0 0/0/0 | +0.2/0 0/0/0 (+69)+0.2/0 0/0/0 | +0.2/0 0/0/0 (+69)+0.2/0 0/0/0 | +0.2/0 +1/+1/+1 (+69)+0.2/0 +1/+1/+1 | | | |
| LABEL FOR INFLUENCE DW (1000 KG) DTFLX DV1-DVR-DV2 (KT) [TIME] OAT (C) DW (1000 KG) DTFLX DV1-DVR-DV2 (KT) | OAT C DW CODES V1min-VRVV2 (kt) | | * VMC * LIMITATION | Tref (OAT) = 44 C Tmax(OAT) = 54 C | Min acc height Max acc height | 519 FT 1934 FT | Min QNH alt Max QNH alt | 1004 FT 2423 FT | | | |
| LIMITATION CODES: 1=1st segment 2=2nd segment 3=runway length 4=obstacles 5=1st speed 6=brake energy 7=maximum weight 8=final take-off 9=VMU | | | | | | Min V1/VRV2 = 115/20/22 CHECK VMU LIMITATION Correct. V1/VRV2 > 0.1 KT/1000 KG | | | | | |

DETERMINATION OF MAXIMUM TAKEOFF WEIGHT AND SPEEDS

GENERAL

Ident.: PER-TOF-TOC-18-10-00001734.0002001 / 10 DEC 09

Applicable to: ALL

The takeoff chart is computed for a given runway under a set of conditions, which are :

- OAT
- Wind
- Configuration
- QNH, air conditioning, anti ice...

Two configurations are produced on the chart. This enables the crew to select that giving the highest permissible takeoff weight.

In case of equivalent performance, retain the configuration giving the lower takeoff speeds.

MTOW DETERMINATION

Ident.: PER-TOF-TOC-18-10-00013648.0002001 / 01 MAR 11

Applicable to: ALL

Enter the chart with the given configuration and actual wind column reading the temperature value. This temperature value stands for the OAT. Read the maximum takeoff weight corresponding to the actual OAT. Note that it is allowed to interpolate between two consecutive lines to obtain the maximum takeoff weight.

It is reminded that the takeoff weight is the sum of the weight entry and the delta weight. Similarly determine the takeoff speeds associated with the maximum takeoff weight.

In some cases, it may happen that the first temperature value (displayed for the highest weight entry) is higher than OAT. In this case, it is allowed to extrapolate the weight value to avoid unnecessary penalty. Use the Grad 1/Grad 2 gradients provided at the bottom of the corresponding column.

CORRECTION TO WEIGHT

Grad 1/Grad 2 are gradients provided for both sides of the flat rating temperature (TREF).

Grad 1 applies to temperatures below TREF and Grad 2 applies above TREF.

Read the lowest temperature of the column (corresponding to the highest weight entry).

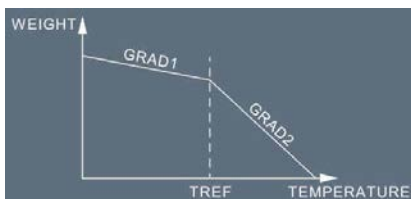

● **If the lowest temperature and OAT are above TREF.**

Obtain weight increment by multiplying Grad 2 by the difference in temperature between OAT and lowest temperature. Add this weight increment to the maximum takeoff weight calculated for the lowest temperature.

● **If the lowest temperature and OAT are below TREF.**

Obtain weight increment by multiplying Grad 1 by the difference in temperature between OAT and lowest temperature. Add this weight increment to the maximum takeoff weight calculated for the lowest temperature.

● **If OAT is below TREF and lowest temperature is above TREF.**

The weight increment is calculated in two steps. Step one is multiplying Grad 2 by temperature difference between lowest temperature and TREF. Step two is multiplying Grad 1 by temperature difference between TREF and OAT. Add results from step one and two to maximum takeoff weight calculated for lowest temperature.

Note: Use the weight gradients only to extrapolate above the maximum weight shown in the RTOW chart. They are not valid for interpolation between two boxes, between filled boxes or between one filled and one blank box.

Repeat the above process for the other available configuration and retain the configuration giving the highest takeoff weight.

CORRECTIONS DUE TO DIFFERENT TAKEOFF CONDITIONS

Ident.: PER-TOF-TOC-18-10-00001736.0002001 / 11 FEB 11

Applicable to: ALL

Retain the maximum takeoff weight, associated configuration and speeds from above.
For conditions different from those of the chart, apply relevant corrections.

CONSERVATIVE CORRECTIONS FOR QNH AND BLEEDS

Ident.: PER-TOF-TOC-18-10-00014720.0001001 / 29 JUL 16

Applicable to: **ALL**

The following data and graphs are for example only, and are not for operational use. Even if the data in the following example is in “kg” and “m”, the same method can be applied for “lb” and “ft”.

Corrections are given for QNH \neq 1 013 hPa, air conditioning ON, anti ice ON.

1. For the given wind and temperature conditions, determine the maximum takeoff weight.
2. Apply the published weight correction(s) to the maximum takeoff weight (for each correction) to determine the maximum permissible takeoff weight.
3. Read the speeds associated with the maximum permissible takeoff weight by entering the chart in the wind column with the retained weight value.

EXAMPLE A

DATA : OAT = 25 °C
Head Wind = 10 kt
Air conditioning ON
QNH = 1 013 hPa

Use the chart from (*Refer to PER-TOF-TOC-16-30 RTOW EXAMPLE*).



A318/A319/A320/A321
FLIGHT CREW
OPERATING MANUAL

PERFORMANCE

TAKEOFF

TAKEOFF CHARTS - MTOW CALCULATION (WEIGHT ENTRY)

| A320XXX | ENGINES | AIRPORT NAME | | | | 15L | VERSION | DATE |
|---|----------------------------------|------------------------------------|---|----------------------------------|----------------------------------|----------------------------------|----------------------------------|----------------------------------|
| QNH Air cond. Anti-icing All reversers operating No reversers on dry runway | 1013.25 HPA AC OFF AI OFF | Elevation Isa temp Rwy slope | 489 FT 15 C .08 % | TORA TODA ASDA | 3000 M 3000 M 3000 M | | 4 obstacles | AXXXXXX * |
| | | | | | | | DRY | |
| WEIGHT 1000KG | CONF 1 + F | | | | CONF 2 | | | |
| | TAILWIND - 10 KT | TAILWIND - 5 KT | WIND 0 KT | HEADWIND 10 KT | TAILWIND - 10 KT | TAILWIND - 5 KT | WIND 0 KT | HEADWIND 10 KT |
| 80 | -18 4/6 0.0 155/50/58 | 9 4/6 0.0 154/57/59 | 37 4/6 0.0 153/55/57 | 45 4/6 0.6 155/56/58 | -15 4/6 0.0 153/53/58 | 12 4/6 0.0 151/52/57 | 40 4/6 0.1 150/51/56 | 48 3/4 0.3 152/53/58 |
| 76 | 44 4/6 0.1 141/49/51 | 48 4/6 0.2 148/50/52 | 51 3/4 0.4 153/53/55 | 52 2/4 0.3 152/52/53 | 44 4/6 0.3 140/45/49 | 48 4/6 0.4 146/47/51 | 51 3/4 0.4 150/50/54 | 52 2/4 0.4 150/50/55 |
| 72 | 53 4/6 0.3 145/48/48 | 56 3/4 0.2 148/48/50 | 59 3/4 0.0 152/52/53 | 60 3/4 0.4 154/54/55 | 53 3/4 0.4 142/43/47 | 56 3/4 0.4 146/46/50 | 58 3/4 0.5 148/49/53 | 60 3/4 0.3 151/51/55 |
| 68 | 61 3/4 0.3 144/44/45 | 63 3/4 0.5 148/48/49 | 65 3/4 0.6 151/51/52 | 67 3/4 0.3 153/53/54 | 61 3/4 0.3 142/42/45 | 63 3/4 0.5 145/45/48 | 65 3/4 0.4 148/48/52 | 66 4/4 0.6 149/49/53 |
| 64 | 68 3/4 0.5 143/43/44 | 69 3/4 1.1 147/47/48 | 69 3/4 2.2 151/51/52 | 69 3/4 3.0 153/53/54 | 68 3/4 0.6 141/41/44 | 69 3/4 1.0 144/44/47 | 69 4/4 2.0 147/47/50 | 69 4/4 2.7 147/47/50 |
| 60 | 69 3/4 4.0 143/43/44 | * 69 7/9 * 0.0 * 114/27/29 | * 69 7/9 * 0.0 * 114/32/33 | * 69 7/9 * 0.0 * 114/32/33 | * 69 7/9 * 4.0 * 141/41/44 | * 69 7/9 * 0.0 * 112/26/29 | * 69 7/9 * 0.0 * 112/26/29 | * 69 7/9 * 0.0 * 112/26/29 |
| 56 | * 69 7/9 * 0.0 * 114/27/29 | * 69 7/9 * 0.0 * 114/27/29 | DO NOT USE FOR OPERATIONAL PURPOSE | | | | * 69 7/9 * 0.0 * 112/21/24 | * 69 7/9 * 0.0 * 112/21/24 |
| 52 | * 69 7/9 * 0.0 * 114/22/24 | * 69 7/9 * 0.0 * 114/22/24 | | | | | * 69 7/7 * 0.0 * 112/19/22 | * 69 7/7 * 0.0 * 112/19/22 |
| 48 | * 69 7/7 * 0.0 * 118/20/22 | * 69 7/7 * 0.0 * 115/20/22 | * 69 7/7 * 0.0 * 115/20/22 | * 69 7/7 * 0.0 * 113/18/22 | * 69 7/7 * 0.0 * 113/18/22 | * 69 7/7 * 0.0 * 113/18/22 | * 69 7/7 * 0.0 * 113/18/22 | |
| GRAD1/GRAD2 (KG/C) | | | | | | | | |
| 50/**** | | 50/**** | | 60/**** | | 50/**** | | 60/**** |
| 50/470 | | 50/470 | | 60/460 | | 50/470 | | 60/470 |

Enter the 10 kt head wind column CONF 1 + F, to read for 25 °C
 The lowest temperature of the column is 45 °C, use Grad 1/Grad 2 to extrapolate the maximum
 takeoff weight.



A318/A319/A320/A321
FLIGHT CREW
OPERATING MANUAL

PERFORMANCE

TAKEOFF

TAKEOFF CHARTS - MTOW CALCULATION (WEIGHT ENTRY)

| A320XXX | ENGINES | | AIRPORT NAME | | | | 15L | VERSION | DATE |
|---|----------------------------------|----------------------------------|---|----------------------------------|----------------------------------|----------------------------------|----------------------------------|----------------------------------|----------|
| QNH Air cond. Anti-icing All reversers operating No reversers on dry runway | 1013.25 HPA AC OFF AI OFF | | Elevation Isa temp Rwy slope | 489 FT 15 C .08 % | TORA TODA ASDA | 3000 M 3000 M 3000 M | | 4 obstacles | AXXXXXX* |
| | | | | | | | DRY | | |
| WEIGHT 1000KG | CONF 1 + F | | | | CONF 2 | | | | |
| | TAILWIND - 10 KT | TAILWIND - 5 KT | WIND 0 KT | HEADWIND 10 KT | TAILWIND - 10 KT | TAILWIND - 5 KT | WIND 0 KT | HEADWIND 10 KT | |
| 80 | -18 4/6 0.0 155/56/58 | 9 4/6 0.0 154/57/59 | 37 4/6 0.0 153/55/57 | 45 4/6 0.6 155/56/58 | -15 4/6 0.0 153/53/58 | 12 4/6 0.0 151/52/57 | 40 4/6 0.1 150/51/56 | 46 3/4 0.3 152/53/58 | |
| 76 | 44 4/6 0.1 141/49/51 | 48 4/6 0.2 148/50/52 | 51 3/4 0.4 153/53/55 | 52 2/4 0.3 152/52/53 | 44 4/6 0.3 140/43/49 | 48 4/6 0.4 146/47/51 | 51 3/4 0.4 150/50/54 | 52 2/4 0.4 150/50/55 | |
| 72 | 53 4/6 0.3 145/48/48 | 56 3/4 0.2 148/48/50 | 59 3/4 0.0 152/52/53 | 60 3/4 0.4 154/54/55 | 53 3/4 0.4 142/43/47 | 56 3/4 0.2 146/46/50 | 58 3/4 0.5 149/49/53 | 60 3/4 0.3 151/51/55 | |
| 68 | 61 3/4 0.3 144/44/45 | 63 3/4 0.5 148/48/49 | 65 3/4 0.6 151/51/52 | 67 3/4 0.3 153/53/54 | 61 3/4 0.3 142/42/45 | 63 3/4 0.5 145/45/48 | 65 3/4 0.4 148/48/52 | 66 4/4 0.6 148/48/53 | |
| 64 | 68 3/4 0.5 143/43/44 | 69 3/4 1.1 147/47/48 | 69 3/4 2.2 151/51/52 | 69 3/4 3.0 153/53/54 | 68 3/4 0.6 141/41/44 | 69 3/4 1.0 144/44/47 | 69 4/4 2.0 147/47/50 | 69 4/4 2.7 147/47/50 | |
| 60 | 69 3/4 4.0 143/43/44 | * 69 7/9 * 0.0 * 114/27/29 | * 69 7/9 * 0.0 * 114/32/33 | * 69 7/9 * 0.0 * 114/32/33 | * 69 7/9 * 4.0 * 141/41/44 | * 69 7/9 * 0.0 * 112/26/29 | * 69 7/9 * 0.0 * 112/26/29 | * 69 7/9 * 0.0 * 112/26/29 | |
| 56 | * 69 7/9 * 0.0 * 114/27/29 | * 69 7/9 * 0.0 * 114/27/29 | DO NOT USE FOR OPERATIONAL PURPOSE | | | | * 69 7/9 * 0.0 * 112/21/24 | * 69 7/9 * 0.0 * 112/21/24 | |
| 52 | * 69 7/9 * 0.0 * 114/22/24 | * 69 7/9 * 0.0 * 114/22/24 | | | | | * 69 7/7 * 0.0 * 112/19/22 | * 69 7/7 * 0.0 * 112/19/22 | |
| 48 | * 69 7/7 * 0.0 * 115/20/22 | * 69 7/7 * 0.0 * 115/20/22 | * 69 7/7 * 0.0 * 115/20/22 | * 69 7/7 * 0.0 * 115/20/22 | * 69 7/7 * 0.0 * 113/18/22 | * 69 7/7 * 0.0 * 113/18/22 | * 69 7/7 * 0.0 * 113/18/22 | * 69 7/7 * 0.0 * 113/18/22 | |
| GRAD1/GRAD2 (KG/C) | | | | | | | | | |
| | 50**** | 50**** | 60**** | 60-460 | 50**** | 50**** | 60**** | 50-470 | |

T_{ref} value is available on the bottom of this table.

Here, T_{ref} is equal to 44 °C.

MAX TO weight (1 000 kg) air conditioning OFF = 80.6 + 0.46 × 1 + 0.06 × 19 = 82.2

Enter the 10 kt head wind column CONF 2, to read for 25 °C

The lowest temperature of the column is 46 °C, use Grad 1/Grad 2 to extrapolate the maximum takeoff weight.

MAX TO weight (1 000 kg) air conditioning OFF = 80.3 + 0.47 × 2 + 0.05 × 19 = 82.1

Retain CONF 1 + F as takeoff configuration.

Maximum TO weight (1 000 kg) air conditioning OFF..... 82.2

Use the QNH/BLEEDS correction page (*Refer to PER-TOF-TOD-24 EFFECT OF QNH AND BLEEDS*):

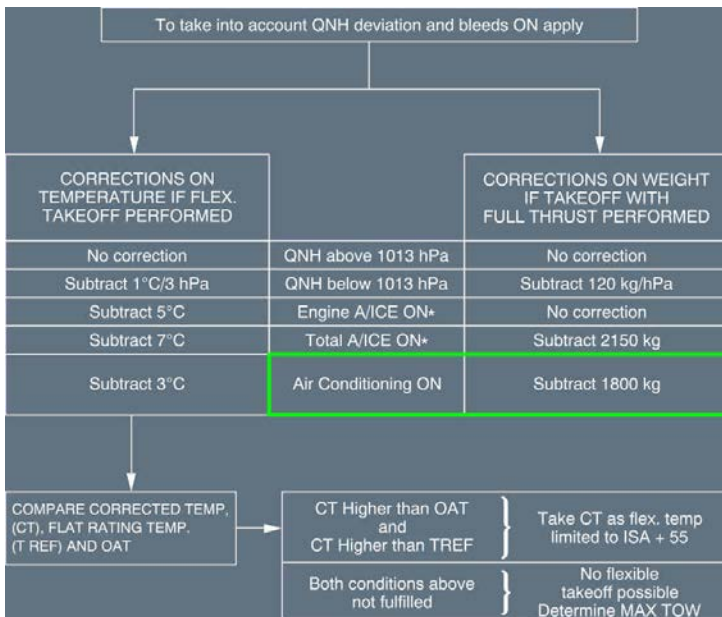

Air conditioning..... -1.8
 Maximum permissible TO weight (1 000 kg) air conditioning ON..... = 80.4
 Determine takeoff speeds for 80.4 (1 000 kg) in the 10 kt head wind column CONF 1 + F
 (interpolate when necessary).



A318/A319/A320/A321
FLIGHT CREW
OPERATING MANUAL

PERFORMANCE

TAKEOFF

TAKEOFF CHARTS - MTOW CALCULATION (WEIGHT ENTRY)

| A320XXX | ENGINES | | AIRPORT NAME | | | | 15L | VERSION | DATE |
|---|----------------------------------|----------------------------------|---|----------------------------------|----------------------------------|----------------------------------|----------------------------------|----------------------------------|-----------|
| QNH Air cond. Anti-icing All reversers operating No reversers on dry runway | 1013.25 HPA AC OFF AI OFF | | Elevation Isa temp Rwy slope | 489 FT 15 C .08 % | TORA TODA ASDA | 3000 M 3000 M 3000 M | | 4 obstacles | AXXXXXX * |
| | | | | | | | DRY | | |
| WEIGHT 1000KG | CONF 1 + F | | | | CONF 2 | | | | |
| | TAILWIND - 10 KT | TAILWIND - 5 KT | WIND 0 KT | HEADWIND 10 KT | TAILWIND - 10 KT | TAILWIND - 5 KT | WIND 0 KT | HEADWIND 10 KT | |
| 80 | -18 4/6 0.0 155/56/58 | 9 4/6 0.0 154/57/59 | 37 4/6 0.0 153/55/57 | 45 4/6 0.6 155/56/58 | -15 4/6 0.0 153/53/56 | 12 4/6 0.0 151/52/57 | 40 4/6 0.1 150/51/56 | 46 3/4 0.3 152/53/56 | |
| 76 | 44 4/6 0.1 141/49/51 | 48 4/6 0.2 148/50/52 | 51 3/4 0.4 153/53/55 | 52 2/4 0.3 152/52/53 | 44 4/6 0.3 140/43/49 | 48 4/6 0.4 146/47/51 | 51 3/4 0.4 150/50/54 | 52 2/4 0.4 150/50/55 | |
| 72 | 53 4/6 0.3 145/46/48 | 56 3/4 0.2 148/48/50 | 59 3/4 0.0 152/52/53 | 60 3/4 0.4 154/54/55 | 53 3/4 0.4 142/43/47 | 56 3/4 0.2 146/46/50 | 58 3/4 0.5 149/49/53 | 60 3/4 0.3 151/51/55 | |
| 68 | 61 3/4 0.3 144/44/45 | 63 3/4 0.5 148/48/49 | 65 3/4 0.6 151/51/52 | 67 3/4 0.3 153/53/54 | 61 3/4 0.3 142/42/45 | 63 3/4 0.5 145/45/48 | 65 3/4 0.4 148/48/52 | 66 4/4 0.6 148/48/53 | |
| 64 | 68 3/4 0.5 143/43/44 | 69 3/4 1.1 147/47/48 | 69 3/4 2.2 151/51/52 | 69 3/4 3.0 153/53/54 | 68 3/4 0.6 141/41/44 | 69 3/4 1.0 144/44/47 | 69 4/4 2.0 147/47/50 | 69 4/4 2.7 147/47/50 | |
| 60 | 69 3/4 4.0 143/43/44 | * 69 7/9 * 0.0 * 114/27/29 | * 69 7/9 * 0.0 * 114/32/33 | * 69 7/9 * 0.0 * 114/32/33 | * 69 7/9 * 4.0 * 141/41/44 | * 69 7/9 * 0.0 * 112/26/29 | * 69 7/9 * 0.0 * 112/26/29 | * 69 7/9 * 0.0 * 112/26/29 | |
| 56 | * 69 7/9 * 0.0 * 114/27/29 | * 69 7/9 * 0.0 * 114/27/29 | DO NOT USE FOR OPERATIONAL PURPOSE | | | | * 69 7/9 * 0.0 * 112/21/24 | * 69 7/9 * 0.0 * 112/21/24 | |
| 52 | * 69 7/9 * 0.0 * 114/22/24 | * 69 7/9 * 0.0 * 114/22/24 | | | | | * 69 7/7 * 0.0 * 112/19/22 | * 69 7/7 * 0.0 * 112/19/22 | |
| 48 | * 69 7/7 * 0.0 * 115/20/22 | * 69 7/7 * 0.0 * 115/20/22 | * 69 7/7 * 0.0 * 115/20/22 | * 69 7/7 * 0.0 * 115/20/22 | * 69 7/7 * 0.0 * 113/18/22 | * 69 7/7 * 0.0 * 113/18/22 | * 69 7/7 * 0.0 * 113/18/22 | * 69 7/7 * 0.0 * 113/18/22 | |
| GRAD1/GRAD2 (KG/C) | | | | | | | | | |
| 50**** | | 50**** | | 60**** | | 60-460 | | 50**** | |
| 50**** | | 60**** | | 60**** | | 60**** | | 50-470 | |

V1 = 155 kt, VR = 156 kt, V2 = 158 kt

CORRECTIONS FOR WET OR CONTAMINATED RUNWAYS

Ident.: PER-TOF-TOC-18-10-00004071.0001001 / 10 DEC 09

Applicable to: **ALL**

(Refer to PER-TOF-CTA-10 GENERAL)

| | |
|---|--|
|  A318/A319/A320/A321 FLIGHT CREW OPERATING MANUAL | PERFORMANCE TAKEOFF TAKEOFF CHARTS - MTOW CALCULATION (WEIGHT ENTRY) |
|---|--|

CORRECTIONS PRODUCED ON THE RTOW CHART

Ident.: PER-TOF-TOC-18-10-00014721.0001001 / 29 JUL 16

Applicable to: ALL

The following data and graphs are for example only, and are not for operational use. Even if the data in the following example is in “kg” and “m”, the same method can be applied for “lb” and “ft”.

(Refer to PER-TOF-TOC-16-30 RTOW EXAMPLE).

A description of this correction is given in PER-TOF-TOC-16-20 (Refer to PER-TOF-TOC-16-20 DESCRIPTION OF THE CORRECTIONS ON TAKEOFF CHART). The list of corrections is not exhaustive, however the most commonly used corrections are wet runway, QNH, air conditioning and/or anti ice. A maximum of three corrections can be produced on one chart.

To apply the corrections, proceed as follows:

1. Determine the maximum takeoff weight before correction for the given OAT and wind condition.

2. Apply the first correction:

If OAT is less than or equal to TVMC (line 3), apply ΔW correction from line 1 and $\Delta V1 / \Delta VR / \Delta V2$ corrections from line 2.

Else, (for OAT greater than TVMC), apply ΔW correction from line 3 and $\Delta V1 / \Delta VR / \Delta V2$ corrections from line 4.

3. To combine a second (and third, as applicable) correction:

If OAT is less than or equal to TVMC (line 3), apply ΔW correction from line 1 and $\Delta V1 / \Delta VR / \Delta V2$ corrections from line 2.

Check that the resulting speeds are higher than the minimum speeds displayed on the RTOW chart and that V2 is higher than the VMU limited speed (Refer to PER-TOF-TOD-25-20 MINIMUM V2 LIMITED BY VMU/VMCA (KT IAS)).

If OAT is higher than TVMC (line 3) or if the above speed check is not fulfilled, apply ΔW correction from line 3 and $\Delta V1 / \Delta VR / \Delta V2$ corrections from line 4. No speed check is required.

- Note:
- QNH correction is given for ± 10 hPa. It is allowed to extrapolate linearly for greater QNH deviation.
 - When using a takeoff chart with failure cases, it is not allowed to combine two failure cases.
 - Corrections from the chart must be applied from top to bottom, i.e. in the RTOW (Refer to PER-TOF-TOC-16-30 RTOW EXAMPLE), apply the wet correction first.
 - If asterisk or dotted lines appear in the correction boxes, refer to more conservative corrections provided in the FCOM.
 - No speed check is required for the first correction. However, if the first influence correction follows a conservative FCOM correction, a speed check is required.

EXAMPLE B

DATA : CONF 1+F

PERFORMANCE

TAKEOFF

TAKEOFF CHARTS - MTOW CALCULATION (WEIGHT ENTRY)

OAT = 45 °C
Head wind = 10 kt
QNH = 998 hPa
WET runway

In this example, we will consider CONF 1+F as takeoff configuration. But same computation has to be done in CONF 2 and you must retain the best configuration.
Use the chart *Refer to PER-TOF-TOC-16-30 RTOW EXAMPLE*).

| A320XXX | ENGINES | | AIRPORT NAME | | | | 15L | VERSION | DATE |
|---|----------------------------------|----------------------------------|---|----------------------------------|----------------------------------|----------------------------------|----------------------------------|----------------------------------|----------------------------------|
| QNH Air cond. Anti-icing All reversers operating No reversers on dry runway | 1013.25 HPA AC OFF AI OFF | | Elevation Isa temp Rwy slope | 489 15 .08 | FT C % | TORA TODA ASDA | | 3000 M 3000 M 3000 M | 4 obstacles |
| WEIGHT 1000KG | CONF 1 + F | | | | CONF 2 | | | | |
| | TAILWIND -10 KT | TAILWIND -5 KT | WIND 0 KT | HEADWIND 10 KT | TAILWIND -10 KT | TAILWIND -5 KT | WIND 0 KT | HEADWIND 10 KT | |
| 80 | -18 4/6 0.0 155/56/58 | 9 4/6 0.0 154/57/59 | 37 4/6 0.0 153/55/57 | 45 4/6 0.6 155/56/58 | -15 4/6 0.0 153/53/58 | 12 4/6 0.0 151/52/57 | 40 4/6 0.1 150/51/56 | 46 3/4 0.3 152/53/58 | |
| 76 | 44 4/6 0.1 141/49/51 | 48 4/6 0.2 148/50/52 | 51 3/4 0.4 153/53/55 | 52 2/4 0.3 152/52/53 | 44 4/6 0.3 140/43/49 | 48 4/6 0.4 146/47/51 | 51 3/4 0.4 150/50/54 | 52 2/4 0.4 150/50/55 | |
| 72 | 53 4/6 0.3 145/48/48 | 56 3/4 0.2 148/48/50 | 59 3/4 0.0 152/52/53 | 60 3/4 0.4 154/54/55 | 53 3/4 0.4 142/43/47 | 56 3/4 0.2 146/46/50 | 58 3/4 0.5 149/49/53 | 60 3/4 0.3 151/51/55 | |
| 68 | 61 3/4 0.3 144/44/45 | 63 3/4 0.5 148/48/49 | 65 3/4 0.6 151/51/52 | 67 3/4 0.3 153/53/54 | 61 3/4 0.3 142/42/45 | 63 3/4 0.5 145/45/48 | 65 3/4 0.4 148/48/52 | 66 4/4 0.6 149/49/53 | |
| 64 | 68 3/4 0.5 143/43/44 | 69 3/4 1.1 147/47/48 | 69 3/4 2.2 151/51/52 | 69 3/4 3.0 153/53/54 | 68 3/4 0.6 141/41/44 | 69 3/4 1.0 144/44/47 | 69 4/4 2.0 147/47/50 | 69 4/4 2.7 147/47/50 | |
| 60 | 69 3/4 4.0 143/43/44 | * 69 7/9 * 0.0 * 114/27/29 | * 69 7/9 * 0.0 * 114/32/33 | * 69 7/9 * 0.0 * 114/32/33 | * 69 7/9 * 4.0 * 141/41/44 | * 69 7/9 * 0.0 * 112/26/29 | * 69 7/9 * 0.0 * 112/26/29 | * 69 7/9 * 0.0 * 112/26/29 | |
| 56 | * 69 7/9 * 0.0 * 114/27/29 | * 69 7/9 * 0.0 * 114/27/29 | DO NOT USE FOR OPERATIONAL PURPOSE | | | | * 69 7/9 * 0.0 * 112/21/24 | * 69 7/9 * 0.0 * 112/21/24 | |
| 52 | * 69 7/9 * 0.0 * 114/22/24 | * 69 7/9 * 0.0 * 114/22/24 | | | | | * 69 7/7 * 0.0 * 115/20/22 | * 69 7/7 * 0.0 * 113/18/22 | * 69 7/7 * 0.0 * 113/18/22 |
| 48 | * 69 7/7 * 0.0 * 115/20/22 | * 69 7/7 * 0.0 * 115/20/22 | * 69 7/7 * 0.0 * 115/20/22 | * 69 7/7 * 0.0 * 115/20/22 | * 69 7/7 * 0.0 * 113/18/22 | * 69 7/7 * 0.0 * 113/18/22 | * 69 7/7 * 0.0 * 113/18/22 | * 69 7/7 * 0.0 * 113/18/22 | |
| GRAD1/GRAD2 (KG/C) | | | | | | | | | |
| 50**** | | 50**** | | 60**** | | 60**** | | 50/470 | |

- Enter the 10 kt head wind column CONF 1+F, to read for 45 °C max TO weight (1 000 kg).....80.6
- Read associated speeds as V1 = 155 kt, VR = 156 kt, V2 = 158 kt
- Apply WET correction

| | | | | | | | | | |
|---|---|---|---|---|---|--|---|--|--|
| A320XXX | ENGINES | AIRPORT NAME | | | | 15L | VERSION | DATE | |
| QNH | 1013.25 HPA | Elevation | 489 FT | TORA | 3000 M | | AXXXXXXX * | +20 | |
| Air cond. | AC OFF | Isa temp | 15 C | TODA | 3000 M | 4 obstacles | DRY | | |
| Anti-icing | AI OFF | Rwy slope | .08 % | ASDA | 3000 M | | | | |
| All reversers operating No reversers on dry runway | | | | | | | | | |
| WEIGHT | CONF 1 + F | | | | CONF 2 | | | | |
| 1000KG | TAILWIND -10 KT | TAILWIND -5 KT | WIND 0 KT | HEADWIND 10 KT | TAILWIND -10 KT | TAILWIND -5 KT | WIND 0 KT | HEADWIND 10 KT | |
| INFLUENCE OF RUNWAY CONDITION | | | | | | | | | |
| WET | -1.4/-3 -11/-17/-1 (+89) -1.4/-3 -11/0/0 | -1.1/-3 -10/-17/-1 (+69) -1.1/-3 -10/0/0 | -0.7/-2 -9/-21/-2 (+69) -0.7/-2 -9/0/0 | -0.7/-2 -8/-21/-2 (+69) -0.7/-2 -8/0/0 | -1.3/-3 -10/-21/-2 (+69) -1.3/-3 -10/0/0 | -1.3/-3 -9/-4/-4 (+69) -1.3/-3 -9/0/0 | -0.4/-1 -7/-21/-2 (+69) -0.4/-1 -7/0/0 | -0.2/-1 -5/0/0 (+89) -0.2/-1 -5/0/0 | |
| INFLUENCE OF DELTA PRESSURE | | | | | | | | | |
| QNH HPA | | | | | | | | | |
| -10.0 | -0.8/-2 0/0/-1 (+61) -0.8/-2 0/0/0 | -1.2/-3 0/0/-1 (+61) -1.2/-3 0/0/0 | -0.7/-2 -1/-1/-1 (+61) -0.7/-2 -1/0/0 | -0.7/-2 -1/-1/-1 (+61) -0.7/-2 -1/0/0 | -0.7/-2 0/0/0 (+61) -0.7/-2 0/0/0 | -0.7/-2 0/0/-1 (+61) -0.7/-2 0/0/0 | -0.7/-2 0/0/-1 (+61) -0.7/-2 0/0/0 | -0.7/-2 0/0/-1 (+61) -0.7/-2 0/0/0 | |
| +10.0 | +0.2/0 0/0/0 (+69) +0.2/0 0/0/0 | +0.2/0 0/0/0 (+69) +0.2/0 0/0/0 | 0.0/0 0/0/0 (+69) 0.0/0 0/0/0 | +0.2/0 0/0/0 (+69) +0.2/0 0/0/0 | +0.2/0 0/0/0 (+69) +0.2/0 0/0/0 | +0.2/0 0/0/0 (+69) +0.2/0 0/0/0 | +0.2/0 0/0/0 (+69) +0.2/0 0/0/0 | +0.2/0 +1/+1/+1 (+69) +0.2/0 +1/+1/+1 | |
| LABEL FOR INFLUENCE DW (1000 KG) DTFLEX DV1 -DVR -DV2 (KT) (TVMC OAT C) DW (1000 KG) DTFLEX DV1 -DVR -DV2 (KT) | OAT C DW CODES V1min/VRV2 (kt) | * VMC * LIMITATION | Tref (OAT) = 88 C Tmax(OAT) = 54 C | Min asc height: 515 FT Max asc height: 1934 FT | Min QNH alt: 1004 FT Max QNH alt: 2423 FT | Min V1/VRV2 = 115/20/22 CHECK VMU LIMITATION Correct: V1/VRV2 = 0.1 KT/1000 KG | | | |
| LIMITATION CODES: 1-1st segment 2-2nd segment 3-runway length 4-obstacles 5-tire speed 6-brake energy 7-max weight 8-final take-off 9-VMU | | | | | | | | | |

For OAT < TVMC (69 °C), ΔW = - 0.7
Intermediate weight (1 000 kg)..... = 79.9

Associated speeds,

V1 = 155 kt - 8 = 147 kt

VR = 156 kt - 2 = 154 kt

V2 = 158 kt - 2 = 156 kt

(No speed check required for first correction)

- Apply QNH correction

| | | | | | | | | | | |
|---|---|---|--|--|--|--|--|--|---|---|
| A320XXX | | ENGINES | | AIRPORT NAME | | | | 15L | VERSION | DATE |
| QNH Air cond. Anti-icing All reversers operating No reversers on dry runway | | 1013.25 HPA AC OFF AI OFF | | Elevation Sea temp Rwy slope | 489 FT 15 C .08 % | TORA TODA ASDA | 3000 M 3000 M 3000 M | 4 obstacles | AXXXXXXX * | *20 |
| | | | | | | | | DRY | | |
| WEIGHT | | CONF 1 + F | | | | CONF 2 | | | | |
| 1000KG | TAILWIND -10 KT | TAILWIND -5 KT | WIND 0 KT | HEADWIND 10 KT | TAILWIND -10 KT | TAILWIND -5 KT | WIND 0 KT | HEADWIND 10 KT | | |
| INFLUENCE OF RUNWAY CONDITION | | | | | | | | | | |
| WET | -1.4/-3 -1.1/-1-1 (+69) -1.4/-3 -1.1/0/0 | -1.1/-3 -1.0/-1-1 (+69) -1.1/-3 -1.0/0/0 | -0.7/-2 -0/-2/-2 (+69) -0.7/-2 -9/0/0 | -0.7/-2 -8/-2/-2 (+69) -0.7/-2 -8/0/0 | -1.3/-3 -1.0/-2/-2 (+69) -1.3/-3 -1.0/0/0 | -1.3/-3 -9/-4/-4 (+69) -1.3/-3 -9/0/0 | -0.4/-1 -7/-2/-2 (+69) -0.4/-1 -7/0/0 | -0.2/-1 -5/0/0 (+69) -0.2/-1 -5/0/0 | | |
| INFLUENCE OF DELTA PRESSURE | | | | | | | | | | |
| QNH HPA | -10.0 | -10.0 | -10.0 | -10.0 | -10.0 | -10.0 | -10.0 | -10.0 | -10.0 | -10.0 |
| | -0.8/-2 0/0/-1 (+61) -0.8/-2 0/0/0 | -1.2/-3 0/0/-1 (+61) -1.2/-3 0/0/0 | -0.7/-2 -1/-1-1 (+61) -0.7/-2 -1/0/0 | -0.7/-2 -1/-1-1 (+61) -0.7/-2 -1/0/0 | -0.7/-2 0/0/0 (+61) -0.7/-2 0/0/0 | -0.7/-2 0/0/0 (+61) -0.7/-2 0/0/0 | -0.7/-2 0/0/-1 (+61) -0.7/-2 0/0/0 | -0.7/-2 0/0/-1 (+61) -0.7/-2 0/0/0 | -0.7/-2 0/0/-1 (+61) -0.7/-2 0/0/0 | -0.7/-2 0/0/-1 (+61) -0.7/-2 0/0/0 |
| | +10.0 | +10.0 | +10.0 | +10.0 | +10.0 | +10.0 | +10.0 | +10.0 | +10.0 | +10.0 |
| | +0.2/0 0/0/0 (+69) +0.2/0 0/0/0 | +0.2/0 0/0/0 (+69) +0.2/0 0/0/0 | 0/0/0 0/0/0 (+69) 0/0/0 0/0/0 | +0.2/0 0/0/0 (+69) +0.2/0 0/0/0 | +0.2/0 0/0/0 (+69) +0.2/0 0/0/0 | +0.2/0 0/0/0 (+69) +0.2/0 0/0/0 | +0.2/0 0/0/0 (+69) +0.2/0 0/0/0 | +0.2/0 0/0/0 (+69) +0.2/0 0/0/0 | +0.2/0 0/0/0 (+69) +0.2/0 0/0/0 | +0.2/0 0/0/0 (+69) +0.2/0 0/0/0 |
| LABEL FOR INFLUENCE DW (1000 KG) DTFFLEX DVI -DVR -DV2 (KT) (TVMC OAT C) DW (1000 KG) DTFFLEX DVI -DVR -DV2 (KT) | OAT C DW CODES V1max/VR/V2 (kt) | | *VMC * LIMITATION | Tref (OAT) = 44 C Tmax(OAT) = 54 C | Min acc height 318 FT Max acc height 1924 FT | Min QNH alt 1094 FT Max QNH alt 2423 FT | Min V1/VR/V2 = 115/20/22 CHECK VMU LIMITATION Correct. V1/VR/V2 = 0.1 KT/1000 KG | | | |

For OAT < TVMC (61 °C), $\Delta W = -0.7 \times 15/10 = \dots\dots\dots - 1$
 Maximum permissible takeoff weight (1 000 kg)..... = 78.9

Associated speeds,

$V1 = 147 \text{ kt} - 1 \times 15/10 = 145 \text{ kt}$

$VR = 154 \text{ kt} - 1 \times 15/10 = 153 \text{ kt}$

$V2 = 156 \text{ kt} - 1 \times 15/10 = 155 \text{ kt}$

- Check that the speeds are higher than minimum speeds from the chart and from VMU table (Refer to PER-TOF-TOD-25-20 MINIMUM V2 LIMITED BY VMU/VMCA (KT IAS)).

It is reminded that if the speed checks are not fulfilled, the corrections must be recalculated using those provided on lines 3 and 4.

| | Takeoff Configuration: 1 + F | | | |
|--------------------|------------------------------|-----|-----|-----|
| | TOW | V1 | VR | V2 |
| TOW (RTOW) | 80.6 | 155 | 156 | 158 |
| FCOM correction(s) | | | | |
| Intermediate value | 80.6 | 155 | 156 | 158 |
| WET Correction | - 0.7 | -8 | -2 | -2 |
| Intermediate value | 79.9 | 147 | 154 | 156 |
| QNH Correction | - 1 | -2 | -1 | -1 |
| Final value | 78.9 | 145 | 153 | 155 |

| | |
|---|--|
|  <p>A318/A319/A320/A321 FLIGHT CREW OPERATING MANUAL</p> | <p style="text-align: center;">PERFORMANCE TAKEOFF</p> <p style="text-align: center;">TAKEOFF CHARTS - MTOW CALCULATION (WEIGHT ENTRY)</p> |
|---|--|

COMBINING CORRECTIONS FROM FCOM AND CHART

Ident.: PER-TOF-TOC-18-10-00014722.0001001 / 29 JUL 16
Applicable to: ALL

The following data and graphs are for example only, and are not for operational use. Even if the data in the following example is in “kg” and “m”, the same method can be applied for “lb” and “ft”.

Proceed as follows:

1. Determine the maximum takeoff weight by entering the chart with selected configuration, OAT and wind.
2. Apply corrections from FCOM to determine an intermediate weight. Interpolate associated speeds for intermediate weight in the same column (same wind and configuration).
3. Apply corrections from RTOW chart as explained above.

EXAMPLE C

DATA : OAT = 25 °C
CONF 1+F
Head wind = 10 kt
Air conditioning ON
QNH = 998 hPa
WET runway

In this example, we will consider CONF 1+F as takeoff configuration. But same computation has to be done in CONF 2 and you must retain the best configuration.

1. Use the chart (*Refer to PER-TOF-TOC-16-30 RTOW EXAMPLE*).

| A320XXX | ENGINES | | AIRPORT NAME | | | | 15L | VERSION | DATE |
|---|----------------------------------|----------------------------------|---|----------------------------------|----------------------------------|----------------------------------|----------------------------------|----------------------------------|-----------|
| QNH Air cond. Anti-icing All reversers operating No reversers on dry runway | 1013.25 HPA AC OFF AI OFF | | Elevation Sea level Rwy slope | 489 FT 15 C .08 % | TORA TODA ASDA | 3000 M 3000 M 3000 M | | 4 obstacles | AXXXXXX * |
| | | | | | | | DRY | | |
| WEIGHT 1000KG | CONF 1 + F | | | | CONF 2 | | | | |
| | TAILWIND -10 KT | TAILWIND -5 KT | WIND 0 KT | HEADWIND 10 KT | TAILWIND -10 KT | TAILWIND -5 KT | WIND 0 KT | HEADWIND 10 KT | |
| 80 | -18 4/6 0.0 155/56/58 | 9 4/6 0.0 154/57/59 | 37 4/6 0.0 153/55/57 | 45 4/6 0.6 155/56/58 | -15 4/6 0.0 153/53/58 | 12 4/6 0.0 151/52/57 | 40 4/6 0.1 150/51/56 | 46 3/4 0.3 152/53/58 | |
| 76 | 44 4/6 0.1 141/49/51 | 48 4/6 0.2 148/50/52 | 51 3/4 0.4 153/53/55 | 52 2/4 0.3 152/52/53 | 44 4/6 0.3 140/43/49 | 48 4/6 0.4 146/47/51 | 51 3/4 0.4 150/50/54 | 52 2/4 0.4 150/50/55 | |
| 72 | 53 4/6 0.3 145/46/48 | 56 3/4 0.2 148/48/50 | 59 3/4 0.4 152/52/53 | 60 3/4 0.4 154/54/55 | 53 3/4 0.4 142/43/47 | 56 3/4 0.2 146/46/50 | 58 3/4 0.5 149/49/53 | 60 3/4 0.3 151/51/55 | |
| 68 | 61 3/4 0.3 144/44/45 | 63 3/4 0.5 148/48/49 | 65 3/4 0.6 151/51/52 | 67 3/4 0.3 153/53/54 | 61 3/4 0.3 142/42/45 | 63 3/4 0.5 145/45/48 | 65 3/4 0.4 148/48/52 | 68 4/4 0.6 149/49/53 | |
| 64 | 68 3/4 0.5 143/43/44 | 69 3/4 1.1 147/47/48 | 69 3/4 2.2 151/51/52 | 69 3/4 3.0 153/53/54 | 68 3/4 0.6 141/41/44 | 69 3/4 1.0 144/44/47 | 69 4/4 2.0 147/47/50 | 69 4/4 2.7 147/47/50 | |
| 60 | 69 3/4 4.0 143/43/44 | * 69 7/9 * 0.0 * 114/27/29 | * 69 7/9 * 0.0 * 114/32/33 | * 69 7/9 * 0.0 * 114/32/33 | * 69 7/9 * 4.0 * 112/26/29 | * 69 7/9 * 0.0 * 112/26/29 | * 69 7/9 * 0.0 * 112/26/29 | * 69 7/9 * 0.0 * 112/26/29 | |
| 56 | * 69 7/9 * 0.0 * 114/27/29 | * 69 7/9 * 0.0 * 114/27/29 | DO NOT USE FOR OPERATIONAL PURPOSE | | | | * 69 7/9 * 0.0 * 112/21/24 | * 69 7/9 * 0.0 * 112/21/24 | |
| 52 | * 69 7/9 * 0.0 * 114/22/24 | * 69 7/9 * 0.0 * 114/22/24 | | | | | * 69 7/7 * 0.0 * 113/18/22 | * 69 7/7 * 0.0 * 113/18/22 | |
| 48 | * 69 7/7 * 0.0 * 115/20/22 | * 69 7/7 * 0.0 * 115/20/22 | * 69 7/7 * 0.0 * 115/20/22 | * 69 7/7 * 0.0 * 113/18/22 | * 69 7/7 * 0.0 * 113/18/22 | * 69 7/7 * 0.0 * 113/18/22 | * 69 7/7 * 0.0 * 113/18/22 | * 69 7/7 * 0.0 * 113/18/22 | |
| GRAD1/GRAD2 (KG/C) | | | | | | | | | |
| | 50**** | 50**** | 60**** | 60/460 | 50**** | 50**** | 60**** | 50/470 | |

Enter the 10 kt head wind column CONF 1 + F, to read for 25 °C

MAX TO weight (1 000 kg) air conditioning OFF = 80.6 + 0.46 x 1 + 0.06 x 19 = 82.2

In this example, Tref is equal to 44 °C, therefore the correction for 25 °C is 19 x GRAD1 correction (60kg) + 1 x GRAD2 correction(460kg).

2. First, apply the QNH/BLEEDS correction (*Refer to PER-TOF-TOD-24 EFFECT OF QNH AND BLEEDS*).

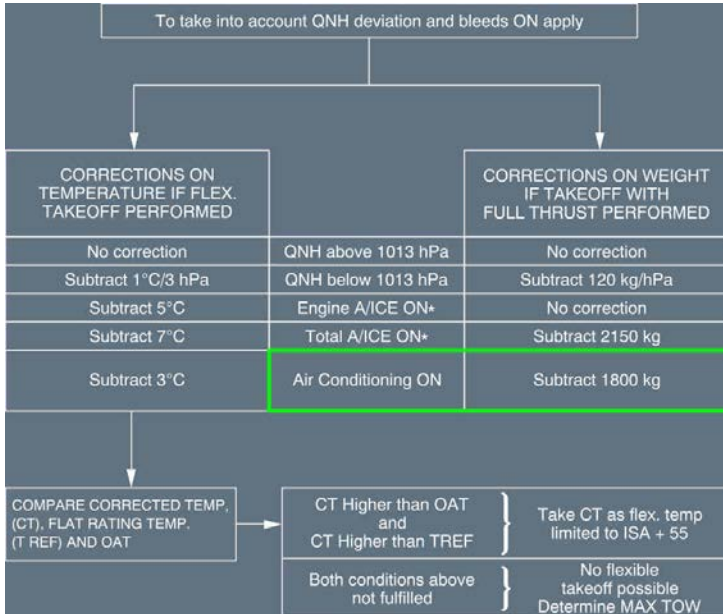

Max TO weight (1 000 kg) air conditioning OFF..... 82.2
 Air conditioning correction..... -1.8
 Intermediate weight..... = 80.4
 Interpolate takeoff speeds for 80.4 (1 000 kg) in the 10 kt head wind column,
 V1 = 155 kt, VR = 156 kt, V2 = 158 kt

| A320XXX | ENGINES | AIRPORT NAME | | | | 15L | VERSION | DATE |
|---|----------------------------------|------------------------------------|---|----------------------------------|----------------------------------|----------------------------------|----------------------------------|----------------------------------|
| QNH Air cond. Anti-icing All reversers operating No reversers on dry runway | 1013.25 HPA AC OFF AI OFF | Elevation Isa temp Rwy slope | 489 FT 15 C .08 % | TORA TODA ASDA | 3000 M 3000 M 3000 M | | 4 obstacles | AXXXXXX * |
| | | | | | | DRY | | |
| WEIGHT 1000KG | CONF 1 + F | | | | CONF 2 | | | |
| | TAILWIND - 10 KT | TAILWIND - 5 KT | WIND 0 KT | HEADWIND 10 KT | TAILWIND - 10 KT | TAILWIND - 5 KT | WIND 0 KT | HEADWIND 10 KT |
| 80 | -18 4/6 0.0 155/56/58 | 9 4/6 0.0 154/57/59 | 37 4/6 0.0 153/55/57 | 45 4/6 0.6 155/56/58 | -15 4/6 0.0 153/53/56 | 12 4/6 0.0 151/52/57 | 40 4/6 0.1 150/51/56 | 46 3/4 0.3 152/53/58 |
| 76 | 44 4/6 0.1 141/49/51 | 48 4/6 0.2 148/50/52 | 51 3/4 0.4 153/53/55 | 52 2/4 0.3 152/52/53 | 44 4/6 0.3 140/43/49 | 48 4/6 0.4 146/47/51 | 51 3/4 0.4 150/50/54 | 52 2/4 0.4 150/50/55 |
| 72 | 53 4/6 0.3 145/46/48 | 56 3/4 0.2 148/48/50 | 59 3/4 0.0 152/52/53 | 60 3/4 0.4 154/54/55 | 53 3/4 0.4 142/43/47 | 56 3/4 0.2 146/46/50 | 58 3/4 0.5 149/49/53 | 60 3/4 0.3 151/51/55 |
| 68 | 61 3/4 0.3 144/44/45 | 63 3/4 0.5 148/48/49 | 65 3/4 0.6 151/51/52 | 67 3/4 0.3 153/53/54 | 61 3/4 0.3 142/42/45 | 63 3/4 0.5 145/45/48 | 65 3/4 0.4 148/48/52 | 66 4/4 0.6 148/48/53 |
| 64 | 68 3/4 0.5 143/43/44 | 69 3/4 1.1 147/47/48 | 69 3/4 2.2 151/51/52 | 69 3/4 3.0 153/53/54 | 68 3/4 0.6 141/41/44 | 69 3/4 1.0 144/44/47 | 69 4/4 2.0 147/47/50 | 69 4/4 2.7 147/47/50 |
| 60 | 69 3/4 4.0 143/43/44 | * 69 7/9 * 0.0 * 114/27/29 | * 69 7/9 * 0.0 * 114/32/33 | * 69 7/9 * 0.0 * 114/32/33 | * 69 7/9 * 4.0 * 141/41/44 | * 69 7/9 * 0.0 * 112/26/29 | * 69 7/9 * 0.0 * 112/26/29 | * 69 7/9 * 0.0 * 112/26/29 |
| 56 | * 69 7/9 * 0.0 * 114/27/29 | * 69 7/9 * 0.0 * 114/27/29 | DO NOT USE FOR OPERATIONAL PURPOSE | | | | * 69 7/9 * 0.0 * 112/21/24 | * 69 7/9 * 0.0 * 112/21/24 |
| 52 | * 69 7/9 * 0.0 * 114/22/24 | * 69 7/9 * 0.0 * 114/22/24 | | | | | * 69 7/7 * 0.0 * 112/19/22 | * 69 7/7 * 0.0 * 112/19/22 |
| 48 | * 69 7/7 * 0.0 * 115/20/22 | * 69 7/7 * 0.0 * 115/20/22 | * 69 7/7 * 0.0 * 115/20/22 | * 69 7/7 * 0.0 * 115/20/22 | * 69 7/7 * 0.0 * 113/18/22 | * 69 7/7 * 0.0 * 113/18/22 | * 69 7/7 * 0.0 * 113/18/22 | * 69 7/7 * 0.0 * 113/18/22 |
| GRAD1/GRAD2 (KG/C) | | | | | | | | |
| | 50**** | 50**** | 60**** | 60/460 | 50**** | 50**** | 60**** | 50/470 |

3. Apply WET correction



A318/A319/A320/A321
FLIGHT CREW
OPERATING MANUAL

PERFORMANCE

TAKEOFF

TAKEOFF CHARTS - MTOW CALCULATION (WEIGHT ENTRY)

| A320XXX | ENGINES | AIRPORT NAME | | | | 15L | VERSION | DATE |
|--|--|--|--|---|--|--|--|--|
| QNH Air cond. Anti-icing All reversers operating No reversers on dry runway | 1013.25 HPA AC OFF AI OFF | Elevation 489 FT Isa temp 15 C Rwy slope .08 % | TORA 3000 M TODA 3000 M ASDA 3000 M | | | 4 obstacles | AXXXXXXX * | +20 |
| | | | | | | DRY | | |
| WEIGHT | CONF 1 + F | | | | CONF 2 | | | |
| 1000KG | TAILWIND -10 KT | TAILWIND -5 KT | WIND 0 KT | HEADWIND 10 KT | TAILWIND -10 KT | TAILWIND -5 KT | WIND 0 KT | HEADWIND 10 KT |
| INFLUENCE OF RUNWAY CONDITION | | | | | | | | |
| WET | -1.4/-3 -11/-1/-1 (+89) -1.4/-3 -11/0/0 | -1.1/-3 -10/-1/-1 (+89) -1.1/-3 -10/0/0 | -0.7/-2 -9/-2/-2 (+89) -0.7/-2 -9/0/0 | -0.7/-2 -8/-2/-2 (+89) -0.7/-2 -8/0/0 | -1.3/-3 -10/-2/-2 (+89) -1.3/-3 -10/0/0 | -1.3/-3 -9/-4/-4 (+89) -1.3/-3 -9/0/0 | -0.4/-1 -7/-2/-2 (+89) -0.4/-1 -7/0/0 | -0.2/-1 -5/0/0 (+89) -0.2/-1 -5/0/0 |
| INFLUENCE OF DELTA PRESSURE | | | | | | | | |
| QNH HPA | | | | | | | | |
| -10.0 | -0.8/-2 0/0/-1 (+81) -0.8/-2 0/0/0 | -1.2/-3 0/0/-1 (+81) -1.2/-3 0/0/0 | -0.7/-2 -1/-1/-1 (+81) -0.7/-2 -1/0/0 | -0.7/-2 -1/-1/-1 (+81) -0.7/-2 -1/0/0 | -0.7/-2 0/0/0 (+81) -0.7/-2 0/0/0 | -0.7/-2 0/0/-1 (+81) -0.7/-2 0/0/0 | -0.7/-2 0/0/-1 (+81) -0.7/-2 0/0/0 | -0.7/-2 0/0/-1 (+81) -0.7/-2 0/0/0 |
| +10.0 | +0.2/0 0/0/0 (+89) +0.2/0 0/0/0 | +0.2/0 0/0/0 (+89) +0.2/0 0/0/0 | 0.0/0 0/0/0 (+89) 0.0/0 0/0/0 | +0.2/0 0/0/0 (+89) +0.2/0 0/0/0 | +0.2/0 0/0/0 (+89) +0.2/0 0/0/0 | +0.2/0 0/0/0 (+89) +0.2/0 0/0/0 | +0.2/0 0/0/0 (+89) +0.2/0 0/0/0 | +0.2/0 +1/+1/+1 (+89) +0.2/0 +1/+1/+1 |
| LABEL FOR INFLUENCE DW (1000 KG) DTFLEX DV1 -DVR -DV2 (KT) (TVMC OAT C) DW (1000 KG) DTFLEX DV1 -DVR -DV2 (KT) | OAT C DW CODES V1min/VRV2 (kt) | * VMIC ** LIMITATION | TIR (OAT) = 88 C Tmax(OAT) = 54 C | Min asc height: 515 FT Max asc height: 1934 FT | Min QNH alt: 1004 FT Max QNH alt: 2423 FT | Min V1/VRV2 = 115/20/22 CHECK VMU LIMITATION Correct: V1/VRV2 = 0.1 KT/1000 KG | | |
| LIMITATION CODES: 1-1st segment 2-2nd segment 3-turbine length 4-obstacles 5-tire speed 6-brake energy 7-max weight 8-final take-off 9-VMU | | | | | | | | |

For OAT < TVMC (69 °C), ΔW =-0.7
 Intermediate weight..... = 79.7

- Associated speeds,
- V1 = 155 kt - 8 = 147 kt
- VR = 156 kt - 2 = 154 kt
- V2 = 158 kt - 2 = 156 kt
- Apply QNH correction

PERFORMANCE

TAKEOFF

TAKEOFF CHARTS - MTOW CALCULATION (WEIGHT ENTRY)

| | | | | | | | | | | | |
|---|--|--|--|--|--|--|--|---|--|--|------|
| A320XXX | | ENGINES | | AIRPORT NAME | | | | 15L | | VERSION | DATE |
| QNH | | 1013.25 HPA | | Elevation 489 FT | | TORA 3000 M | | 4 obstacles | | AXXXXXX * | *20 |
| Air cond. | | AC OFF | | Iea temp 15 C | | TODA 3000 M | | | | DRY | |
| Anti-icing | | AI OFF | | Rwy slope .08 % | | ASDA 3000 M | | | | | |
| All reversers operating | | | | | | | | | | | |
| No reversers on dry runway | | | | | | | | | | | |
| WEIGHT | | CONF 1 + F | | | | CONF 2 | | | | | |
| 1000KG | TAILWIND -10 KT | TAILWIND -5 KT | WIND 0 KT | HEADWIND 10 KT | TAILWIND -10 KT | TAILWIND -5 KT | WIND 0 KT | HEADWIND 10 KT | | | |
| INFLUENCE OF RUNWAY CONDITION | | | | | | | | | | | |
| WET | -1.4/-3 -1.1/-1/-1 (+69) -1.4/-3 -1.1/0/0 | -1.1/-3 -1.0/-1/-1 (+69) -1.1/-3 -1.0/0/0 | -0.7/-2 -9/-2/-2 (+69) -0.7/-2 -9/0/0 | -0.7/-2 -8/-2/-2 (+69) -0.7/-2 -8/0/0 | -1.3/-3 -1.0/-2/-2 (+69) -1.3/-3 -1.0/0/0 | -1.3/-3 -9/-4/-4 (+69) -1.3/-3 -9/0/0 | -0.4/-1 -7/-2/-2 (+69) -0.4/-1 -7/0/0 | -0.2/-1 -5/0/0 (+69) -0.2/-1 -5/0/0 | | | |
| INFLUENCE OF DELTA PRESSURE | | | | | | | | | | | |
| QNH HPA | | | | | | | | | | | |
| -10.0 | -0.8/-2 0/0/-1 (+61) -0.8/-2 0/0/0 | -1.2/-3 0/0/-1 (+61) -1.2/-3 0/0/0 | -0.7/-2 -1/-1/-1 (+61) -0.7/-2 -1/0/0 | -0.7/-2 -1/-1/-1 (+61) -0.7/-2 -1/0/0 | -0.7/-2 0/0/0 (+61) -0.7/-2 0/0/0 | -0.7/-2 0/0/-1 (+61) -0.7/-2 0/0/0 | -0.7/-2 0/0/-1 (+61) -0.7/-2 0/0/0 | -0.7/-2 0/0/-1 (+61) -0.7/-2 0/0/0 | | | |
| +10.0 | +0.2/0 0/0/0 (+69) +0.2/0 0/0/0 | +0.2/0 0/0/0 (+69) +0.2/0 0/0/0 | 0/0/0 0/0/0 (+69) 0/0/0 0/0/0 | +0.2/0 0/0/0 (+69) +0.2/0 0/0/0 | +0.2/0 0/0/0 (+69) +0.2/0 0/0/0 | +0.2/0 0/0/0 (+69) +0.2/0 0/0/0 | +0.2/0 0/0/0 (+69) +0.2/0 0/0/0 | +0.2/0 0/0/0 (+69) +0.2/0 0/0/0 | | | |
| LABEL FOR INFLUENCE DW (1000 KG) DTFFLEX DV1-DVR-DV2 (KT) (TVMC OAT C) | | OAT C DW CODES V1Min/VRVZ (kt) | | * VMCA * LIMITATION | | Tref (OAT) = 44 C Tmax(OAT) = 54 C | | Min acc height 515 FT Max acc height 1924 FT | | Min QNH alt 1094 FT Max QNH alt 2423 FT | |
| DW (1000 KG) DTFFLEX DV1-DVR-DV2 (KT) | | LIMITATION CODES: 1=1st segment 2=2nd segment 3=runway length 4=obstacles 5=brake speed 6=brake energy 7=fix weight 8=final take-off 9=VMU | | | | | | | | Min V1/VR/V2 = 115/20/22 CHECK VMU LIMITATION Correct: V1/VR/V2 = 0.1 KT/1000 KG | |

For OAT < TVMC (61 °C), $\Delta W = -0.7 \times 15/10 = \dots\dots\dots -1$
 Maximum permissible takeoff weight..... = 78.7

Associated speed,
 $V1 = 147 \text{ kt} - 1 \times 15/10 = 145 \text{ kt}$
 $VR = 154 \text{ kt} - 1 \times 15/10 = 153 \text{ kt}$
 $V2 = 156 \text{ kt} - 1 \times 15/10 = 155 \text{ kt}$

Check that the speeds are higher than minimum speeds from the chart and from VMU table (Refer to PER-TOF-TOD-25-20 MINIMUM V2 LIMITED BY VMU/VMCA (KT IAS)). It is reminded that if the speed checks are not fulfilled, the corrections must be recalculated using those provided on lines 3 and 4.

Since the speed check is fulfilled:
 MAX permissible takeoff weight = 78.7 (1 000 kg)
 $V1 = 145 \text{ kt}$, $VR = 153 \text{ kt}$, $V2 = 155 \text{ kt}$.

| | Takeoff Configuration: 1 + F | | | |
|--------------------|------------------------------|-----|-----|-----|
| | TOW | V1 | VR | V2 |
| TOW (RTOW) | 82.2 | | | |
| FCOM correction(s) | -1.8 | | | |
| Intermediate value | 80.4 | 155 | 156 | 158 |

Continued on the following page



A318/A319/A320/A321
FLIGHT CREW
OPERATING MANUAL

PERFORMANCE

TAKEOFF

TAKEOFF CHARTS - MTOW CALCULATION (WEIGHT ENTRY)

Continued from the previous page

| | Takeoff Configuration: 1 + F | | | |
|---------------------------|------------------------------|-----|-----|-----|
| | TOW | V1 | VR | V2 |
| WET Correction | -0.7 | -9 | -2 | -2 |
| Intermediate value | 79.7 | 147 | 154 | 156 |
| QNH Correction | -1 | -2 | -1 | -1 |
| Final value | 78.7 | 145 | 153 | 155 |



A318/A319/A320/A321
FLIGHT CREW
OPERATING MANUAL

PERFORMANCE

TAKEOFF

TAKEOFF CHARTS - MTOW CALCULATION (WEIGHT ENTRY)

Intentionally left blank



A318/A319/A320/A321

**FLIGHT CREW
OPERATING MANUAL**

PERFORMANCE

TAKEOFF

TAKEOFF CHARTS - MTOW CALCULATION (WEIGHT ENTRY)

EXTRAPOLATION

EXTRAPOLATION

Ident.: PER-TOF-TOC-18-20-00001740.0002001 / 08 MAR 11

Applicable to: ALL

For OAT lower than the lowest temperature value of a wind column, it is possible to obtain a higher maximum permissible takeoff weight by using Grad 1/Grad 2 values. *Refer to PER-TOF-TOC-18-10 MTOW DETERMINATION* for more details.



A318/A319/A320/A321
FLIGHT CREW
OPERATING MANUAL

PERFORMANCE

TAKEOFF

TAKEOFF CHARTS - MTOW CALCULATION (WEIGHT ENTRY)

Intentionally left blank



A318/A319/A320/A321
FLIGHT CREW
OPERATING MANUAL

PERFORMANCE

TAKEOFF

TAKEOFF CHARTS - MTOW CALCULATION (WEIGHT ENTRY)

MAXIMUM STRUCTURAL TAKEOFF WEIGHT

MAXIMUM STRUCTURAL TAKEOFF WEIGHT

Ident.: PER-TOF-TOC-18-30-00001741.0001001 / 01 MAR 11

Applicable to: ALL

The maximum structural takeoff weight is a weight limitation depending on the aircraft. This limitation is provided in the Flight Manual and in the limitation chapter (*Refer to LIM-AG-WGHT Weight Limitations*).

Compare the maximum structural takeoff weight to the maximum permissible takeoff weight computed for given conditions and retain the lower of the two values.



A318/A319/A320/A321
FLIGHT CREW
OPERATING MANUAL

PERFORMANCE

TAKEOFF

TAKEOFF CHARTS - MTOW CALCULATION (WEIGHT ENTRY)

Intentionally left blank



A318/A319/A320/A321

FLIGHT CREW
OPERATING MANUAL

PERFORMANCE

TAKEOFF

TAKEOFF CHARTS - MTOW CALCULATION (WEIGHT ENTRY)

SUMMARY

SUMMARY

Ident.: PER-TOF-TOC-18-40-00006114.0001001 / 17 MAR 11

Applicable to: **ALL**

The following flow diagram gives the different steps to follow.

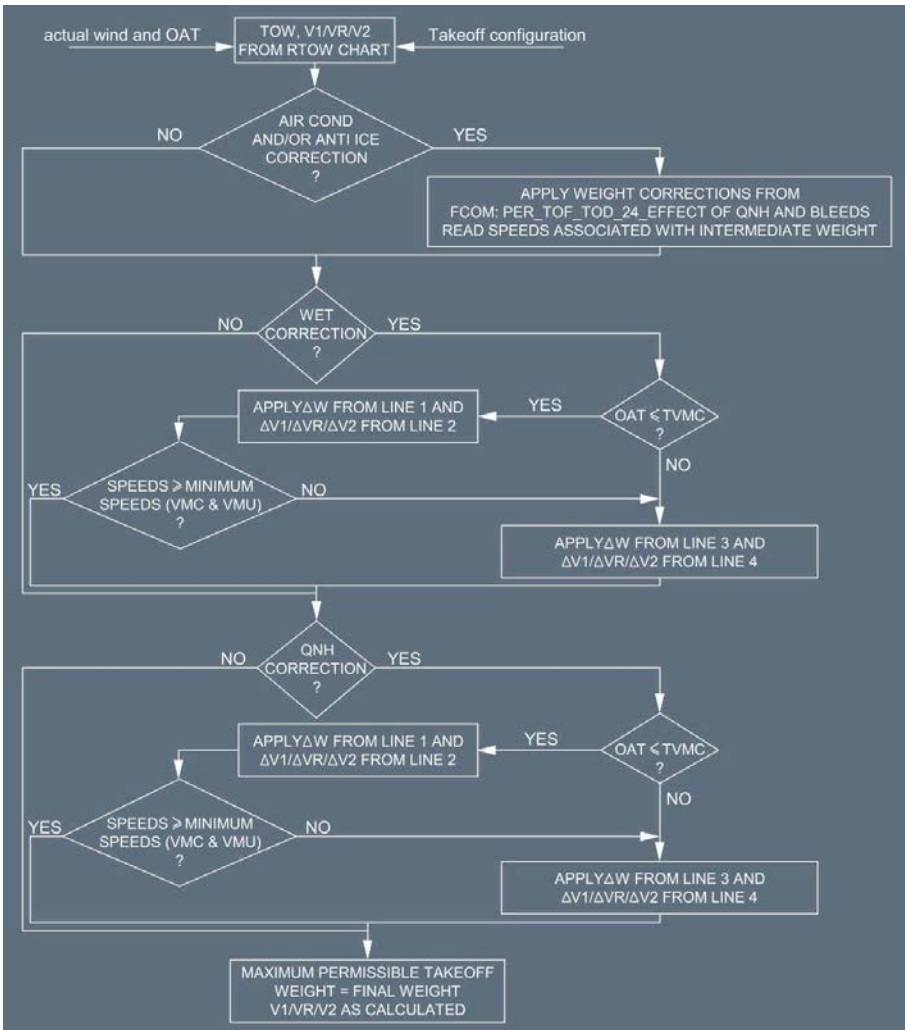

DETERMINATION OF FLEXIBLE TAKEOFF TEMPERATURE AND SPEEDS

GENERAL

Ident.: PER-TOF-TOC-20-10-00013509.0002001 / 23 FEB 11

Applicable to: ALL

Before determining the flexible temperature, calculate the maximum permissible takeoff weight (see previous section) and ensure that the actual takeoff weight is lower than the determined maximum takeoff weight.

- For a given configuration and wind value, enter the RTOW chart with the actual takeoff weight to read the flexible temperature and associated speeds. It is reminded that the takeoff weight is the sum of the weight entry and the delta weight displayed in each box. It is allowed to interpolate between two consecutive rows and/or columns for weight and for wind values not displayed on the chart.
- Repeat this process for the other configuration available. Select that configuration giving the highest flexible temperature.

CORRECTIONS DUE TO DIFFERENT TAKEOFF CONDITIONS

Ident.: PER-TOF-TOC-20-10-00013506.0001001 / 12 MAY 16

Applicable to: ALL

When the takeoff conditions are different from those provided on the chart, apply the associated corrections.

- Note:
- *If the RTOW chart is based on the CG being at 25 %, the crew can determine the flexible temperature at a more forward CG by decreasing the flexible temperature by 2 °C. V1 , VR and V2 must be increased by 1 kt.*
 - *25 % CG is the basic certified limit, on which all takeoff computation are based. To take into account the operational margins, the above penalties must be applied when operational CG is forward 27 %CG.*

CONSERVATIVE CORRECTIONS FOR QNH AND BLEEDS

Ident.: PER-TOF-TOC-20-10-00014723.0001001 / 29 JUL 16

Applicable to: ALL

The following data and graphs are for example only, and are not for operational use. Even if the data in the following example is in “kg” and “m”, the same method can be applied for “lb” and “ft”.

Corrections are given for QNH \neq 1 013 hPa, air conditioning ON, anti ice ON.

1. For a given takeoff weight and wind condition, read the flexible temperature. Retain the takeoff speeds associated with the actual weight.
2. Apply the published temperature correction. To combine two or more corrections, add the different corrections and apply to temperature value.
(No speed corrections required).

EXAMPLE D

DATA : Actual takeoff weight = 68 000 kg
 Head wind = 10 kt
 Air conditioning ON
 QNH = 1 013 hPa

Use the chart from *Refer to PER-TOF-TOC-16-30 RTOW EXAMPLE*. Determine the maximum permissible takeoff weight. The actual weight being lower than the maximum one, flexible takeoff is possible.



A318/A319/A320/A321
FLIGHT CREW
OPERATING MANUAL

PERFORMANCE

TAKEOFF

TAKEOFF CHARTS - FLEXIBLE TAKEOFF (WEIGHT ENTRY)

| A320XXX | ENGINES | AIRPORT NAME | | | | 15L | VERSION | DATE |
|---|----------------------------------|----------------------------------|---|----------------------------------|----------------------------------|----------------------------------|----------------------------------|----------------------------------|
| QNH | 1013.25 HPA | Elevation | 489 FT | TORA | 3000 M | 4 obstacles | AXXXXXX * | *20 |
| Air cond. | AC OFF | Isla temp | 15 C | TODA | 3000 M | | DRY | |
| Anti-icing | AI OFF | Rwy slope | .08 % | ASDA | 3000 M | | | |
| All reversers operating No reversers on dry runway | | | | | | | | |
| WEIGHT 1000KG | CONF 1 + F | | | | CONF 2 | | | |
| | TAILWIND - 10 KT | TAILWIND - 5 KT | WIND 0 KT | HEADWIND 10 KT | TAILWIND - 10 KT | TAILWIND - 5 KT | WIND 0 KT | HEADWIND 10 KT |
| 80 | -18 4/6 0.0 155/50/58 | 9 4/6 0.0 154/57/59 | 37 4/6 0.0 153/55/57 | 45 4/6 0.6 155/56/58 | -15 4/6 0.0 153/53/56 | 12 4/6 0.0 151/52/57 | 40 4/6 0.1 150/51/56 | 46 3/4 0.3 152/53/58 |
| 76 | 44 4/6 0.1 141/49/51 | 48 4/6 0.2 148/50/52 | 51 3/4 0.4 153/53/55 | 52 2/4 0.3 152/52/53 | 44 4/6 0.3 140/45/49 | 48 4/6 0.4 146/47/51 | 51 3/4 0.4 150/50/54 | 52 2/4 0.4 150/50/55 |
| 72 | 53 4/6 0.3 145/46/48 | 56 3/4 0.2 148/48/50 | 59 3/4 0.0 152/52/53 | 60 3/4 0.4 154/54/55 | 53 3/4 0.4 142/43/47 | 56 3/4 0.4 146/46/50 | 56 3/4 0.5 148/49/53 | 60 3/4 0.3 151/51/55 |
| 68 | 61 3/4 0.3 144/44/45 | 63 3/4 0.5 148/48/49 | 65 3/4 0.6 151/51/52 | 67 3/4 0.3 153/53/54 | 61 3/4 0.3 142/42/45 | 63 3/4 0.5 145/45/48 | 65 3/4 0.4 148/48/52 | 66 4/4 0.6 149/49/53 |
| 64 | 68 3/4 0.5 143/43/44 | 69 3/4 1.1 147/47/48 | 69 3/4 2.2 151/51/52 | 69 3/4 3.0 153/53/54 | 68 3/4 0.6 141/41/44 | 69 3/4 1.0 144/44/47 | 69 4/4 2.0 147/47/50 | 69 4/4 2.7 147/47/50 |
| 60 | 69 3/4 4.0 143/43/44 | * 69 7/9 * 0.0 * 114/32/33 | * 69 7/9 * 0.0 * 114/32/33 | * 69 7/9 * 0.0 * 114/32/33 | * 69 7/9 * 4.0 * 141/41/44 | * 69 7/9 * 0.0 * 112/26/29 | * 69 7/9 * 0.0 * 112/26/29 | * 69 7/9 * 0.0 * 112/26/29 |
| 56 | * 69 7/9 * 0.0 * 114/27/29 | * 69 7/9 * 0.0 * 114/27/29 | DO NOT USE FOR OPERATIONAL PURPOSE | | | | * 69 7/9 * 0.0 * 112/21/24 | * 69 7/9 * 0.0 * 112/21/24 |
| 52 | * 69 7/9 * 0.0 * 114/22/24 | * 69 7/9 * 0.0 * 114/22/24 | | | | | * 69 7/7 * 0.0 * 112/19/22 | * 69 7/7 * 0.0 * 112/19/22 |
| 48 | * 69 7/7 * 0.0 * 118/20/22 | * 69 7/7 * 0.0 * 115/20/22 | * 69 7/7 * 0.0 * 115/20/22 | * 69 7/7 * 0.0 * 115/20/22 | * 69 7/7 * 0.0 * 113/18/22 | * 69 7/7 * 0.0 * 113/18/22 | * 69 7/7 * 0.0 * 113/18/22 | * 69 7/7 * 0.0 * 113/18/22 |
| GRAD1/GRAD2 (KG/C) | | | | | | | | |
| 50**** | | 50**** | | 60**** | | 60**** | | 50**** |
| 50**** | | 50**** | | 60**** | | 60**** | | 50**** |

Enter the 10 kt head wind column and interpolate for 68 000 kg, CONF 1 + F,
 Flexible temperature..... 67 °C

Enter the 10 kt head wind column and interpolate for 68 000 kg, CONF 2,
 Flexible temperature..... 66 °C

Retain CONF 1 + F for takeoff configuration.
 Takeoff speeds are V1 = 153 kt, VR = 153 kt, V2 = 154 kt

Flexible temperature with air conditioning OFF..... 67 °C

Use the QNH/BLEEDS corrections (*Refer to PER-TOF-TOD-24 EFFECT OF QNH AND BLEEDS*):

PERFORMANCE

TAKEOFF

TAKEOFF CHARTS - FLEXIBLE TAKEOFF (WEIGHT ENTRY)

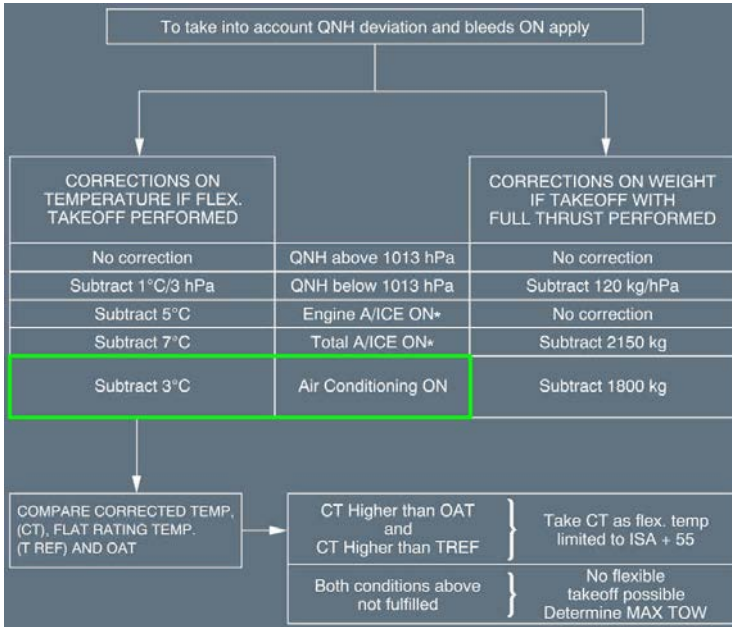

Air conditioning correction..... -3 °C
 Flexible temperature..... = 64 °C

CORRECTIONS FOR WET RUNWAY

Ident.: PER-TOF-TOC-20-10-00013280.0001001 / 18 FEB 11

Applicable to: **ALL**

Refer to *PER-TOF-CTA-10 GENERAL*

| | |
|---|--|
|  <p>A318/A319/A320/A321 FLIGHT CREW OPERATING MANUAL</p> | <p style="text-align: center;">PERFORMANCE TAKEOFF</p> <p style="text-align: center;">TAKEOFF CHARTS - FLEXIBLE TAKEOFF (WEIGHT ENTRY)</p> |
|---|--|

CORRECTIONS PRODUCED ON THE RTOW CHART

Ident.: PER-TOF-TOC-20-10-00014724.0001001 / 29 JUL 16

Applicable to: ALL

The following data and graphs are for example only, and are not for operational use. Even if the data in the following example is in “kg” and “m”, the same method can be applied for “lb” and “ft”. A description of this correction is given on *Refer to PER-TOF-TOC-16-20 CORRECTIONS DUE TO DIFFERENT TAKEOFF CONDITIONS*. The list of corrections is not exhaustive, however the most commonly used corrections are wet runway, QNH, air conditioning and/or anti-icing. A maximum of three corrections can be produced on one chart.

To apply the correction, proceed as follows:

1. Enter the chart with selected configuration, wind and actual takeoff weight to read the flexible temperature associated with this weight.
2. Apply the first correction:
 - If the flexible temperature is less than or equal to TVMC (line 3), apply ΔT_{flex} correction from line 1 and apply speed corrections ($\Delta V1 / \Delta VR / \Delta V2$) from line 2.
 - Else, (flexible temperature greater than TVMC), apply ΔT_{flex} from line 3 and $\Delta V1 / \Delta VR / \Delta V2$ corrections from line 4.

Check V2 against VMU limitation (*Refer to PER-TOF-TOD-25-20 MINIMUM V2 LIMITED BY VMU/VMCA (KT IAS)*). If V2 is lower than V2 limited by VMU, flexible takeoff is not possible. Set TOGA thrust and retain the speeds associated with maximum permissible takeoff weight or the speeds read in the chart for the actual weight if they are all lower.

No speed correction is required for QNH and bleeds influence (Not applicable to maximum takeoff weight determination).
3. To combine a second and/or a third correction, proceed as per point 2.
4. Check that the final flexible temperature is:
 - Higher than OAT and TREF
 - Limited to TMAX FLEX

If the check is fulfilled, retain final flexible temperature as the one to be inserted in the MCDU
 If the check is not fulfilled, (final flexible temperature lower than OAT or TREF), no flexible takeoff is possible.

Use TOGA thrust and retain speeds that have been calculated for the maximum permissible takeoff weight. (*Refer to PER-TOF-TOC-20-20 FLEXIBLE TAKEOFF NOT POSSIBLE*)

Note: - QNH correction is given for ± 10 hPa . It is allowed to extrapolate linearly for greater QNH deviation.

- Corrections from the chart must be applied from the top to bottom, i.e in the RTOW on *Refer to PER-TOF-TOC-16-30 RTOW EXAMPLE*, apply the wet influence first

Note: - When the flexible temperature is higher than TVMC, it is allowed to limit the flexible temperature to TVMC and apply only corrections from lines 1 and 2.

- If asterisk or dotted lines appear in the correction boxes, refer to more conservative corrections provided in the FCOM.

EXAMPLE E

DATA : CONF 1+F
Actual takeoff weight = 68 000 kg
Head wind = 10 kt
QNH = 998 hPa
WET runway
Air conditioning OFF

In this example, we will consider CONF 1+F as takeoff configuration. But same computation has to be done in CONF 2 and you must retain the best configuration.
Use the chart from *Refer to PER-TOF-TOC-16-30 RTOW EXAMPLE*.
Determine the maximum permissible takeoff weight.
The actual weight being lower than the maximum one, flexible takeoff is possible.

| A320XXX | | ENGINES | | AIRPORT NAME | | | | 15L | VERSION | DATE | |
|----------------------------|------------------------------------|------------------------------------|---|------------------------------------|------------------------------------|------------------------------------|------------------------------------|------------------------------------|------------------------------------|------------------------------------|------------------------------------|
| QNH | | 1013.25 HPA | | Elevation | 489 FT | TORA | 3000 M | | AXXXXXX * | *20 | |
| Air cond. | | AC OFF | | Isa temp | 15 C | TODA | 3000 M | 4 obstacles | DRY | | |
| Anti-icing | | AI OFF | | Rwy slope | .08 % | ASDA | 3000 M | | | | |
| All reversers operating | | | | | | | | | | | |
| No reversers on dry runway | | | | | | | | | | | |
| WEIGHT 1000KG | CONF 1 + F | | | | CONF 2 | | | | | | |
| | TAILWIND - 10 KT | TAILWIND - 5 KT | WIND 0 KT | HEADWIND 10 KT | TAILWIND - 10 KT | TAILWIND - 5 KT | WIND 0 KT | HEADWIND 10 KT | | | |
| 80 | -18 - 4/6 0.0 155/56/58 | 9 - 4/6 0.0 154/57/59 | 37 - 4/6 0.0 153/55/57 | 45 - 4/6 0.6 155/56/58 | -15 - 4/6 0.0 153/53/58 | 12 - 4/6 0.0 151/52/57 | 40 - 4/6 0.1 150/51/56 | 48 - 3/4 0.3 152/53/58 | | | |
| 76 | 44 - 4/6 0.1 141/49/51 | 48 - 4/6 0.2 148/50/52 | 51 - 3/4 0.4 153/53/55 | 52 - 2/4 0.3 152/52/53 | 44 - 4/6 0.3 140/43/49 | 48 - 4/6 0.4 146/47/51 | 51 - 3/4 0.4 150/50/54 | 52 - 2/4 0.4 150/50/55 | | | |
| 72 | 53 - 4/6 0.3 145/46/48 | 56 - 3/4 0.2 148/48/50 | 59 - 3/4 0.0 152/52/53 | 60 - 3/4 0.4 154/54/55 | 53 - 3/4 0.4 142/43/47 | 56 - 3/4 0.2 146/46/50 | 58 - 3/4 0.5 149/49/53 | 60 - 3/4 0.3 151/51/55 | | | |
| 68 | 61 - 3/4 0.3 144/44/45 | 63 - 3/4 0.5 148/48/49 | 65 - 3/4 0.6 151/51/52 | 67 - 3/4 0.3 153/53/54 | 61 - 3/4 0.3 142/42/45 | 63 - 3/4 0.5 145/45/48 | 65 - 3/4 0.4 148/48/52 | 68 - 4/4 0.6 149/49/53 | | | |
| 64 | 68 - 3/4 0.5 143/43/44 | 69 - 3/4 1.1 147/47/48 | 69 - 3/4 2.2 151/51/52 | 69 - 3/4 3.0 153/53/54 | 66 - 3/4 0.6 141/41/44 | 69 - 3/4 1.0 144/44/47 | 69 - 4/4 2.0 147/47/50 | 69 - 4/4 2.7 147/47/50 | | | |
| 60 | 69 - 3/4 4.0 143/43/44 | * 69 - 7/9 * 0.0 * 114/27/29 | * 69 - 7/9 * 0.0 * 114/32/33 | * 69 - 7/9 * 0.0 * 114/32/33 | * 69 - 7/9 * 4.0 * 141/41/44 | * 69 - 7/9 * 4.0 * 112/26/29 | * 69 - 7/9 * 0.0 * 112/26/29 | * 69 - 7/9 * 0.0 * 112/26/29 | | | |
| 56 | * 69 - 7/9 * 0.0 * 114/27/29 | * 69 - 7/9 * 0.0 * 114/27/29 | DO NOT USE FOR OPERATIONAL PURPOSE | | | | * 69 - 7/9 * 0.0 * 112/21/24 | * 69 - 7/9 * 0.0 * 112/21/24 | | | |
| 52 | * 69 - 7/9 * 0.0 * 114/22/24 | * 69 - 7/9 * 0.0 * 114/22/24 | | | | | * 69 - 7/7 * 0.0 * 112/19/22 | * 69 - 7/7 * 0.0 * 112/19/22 | * 69 - 7/7 * 0.0 * 113/18/22 | * 69 - 7/7 * 0.0 * 113/18/22 | * 69 - 7/7 * 0.0 * 112/19/22 |
| 48 | * 69 - 7/7 * 0.0 * 115/20/22 | * 69 - 7/7 * 0.0 * 115/20/22 | * 69 - 7/7 * 0.0 * 115/20/22 | * 69 - 7/7 * 0.0 * 115/20/22 | * 69 - 7/7 * 0.0 * 113/18/22 | * 69 - 7/7 * 0.0 * 113/18/22 | * 69 - 7/7 * 0.0 * 113/18/22 | * 69 - 7/7 * 0.0 * 113/18/22 | | | |
| GRAD1\GRAD2 (KG/C) | | | | | | | | | | | |
| 50**** | | 50**** | | 60**** | | 60-460 | | 50**** | | 50**** | |
| | | | | | | | | 60**** | | 50-470 | |

Enter the 10 kt head wind column and interpolate for 68 000 kg, CONF 1+F,
Flexible temperature..... 67 °C



A318/A319/A320/A321
FLIGHT CREW
OPERATING MANUAL

PERFORMANCE

TAKEOFF

TAKEOFF CHARTS - FLEXIBLE TAKEOFF (WEIGHT ENTRY)

Takeoff speeds are V1 = 153 kt, VR = 153 kt, V2 = 154 kt
 Apply WET correction

| A320XXX | ENGINES | | AIRPORT NAME | | | | 15L | VERSION | DATE | |
|--|--|--|--|---|--|--|--|--|--|-----|
| QNH Air cond. Anti-icing All reversers operating No reversers on dry runway | 1013.25 HPA AC OFF AI OFF | | Elevation Iss temp Rwy slope | 489 FT 15 C .08 % | TORA TODA ASDA | 3000 M 3000 M 3000 M | | +4 obstacles | AXXXXXXX * | *20 |
| DRY | | | | | | | | | | |
| WEIGHT 1000KG | CONF 1 + F | | | | CONF 2 | | | | | |
| | TAILWIND -10 KT | TAILWIND -5 KT | WIND 0 KT | HEADWIND 10 KT | TAILWIND -10 KT | TAILWIND -5 KT | WIND 0 KT | HEADWIND 10 KT | | |
| INFLUENCE OF RUNWAY CONDITION | | | | | | | | | | |
| WET | -1.4/-3 -11/-1/-1 (+99) -1.4/-3 -11/0/0 | -1.1/-3 -10/-1/-1 (+99) -1.1/-3 -10/0/0 | -0.7/-2 -9/-2/-2 (+99) -0.7/-2 -9/0/0 | -0.7/-2 -8/-2/-2 (+99) -0.7/-2 -8/0/0 | -1.3/-3 -10/-2/-2 (+99) -1.3/-3 -10/0/0 | -1.3/-3 -9/-4/-4 (+99) -1.3/-3 -9/0/0 | -0.4/-1 -7/-2/-2 (+99) -0.4/-1 -7/0/0 | -0.2/-1 -5/0/0 (+99) -0.2/-1 -5/0/0 | | |
| INFLUENCE OF DELTA PRESSURE | | | | | | | | | | |
| D QNH HPA | | | | | | | | | | |
| -10.0 | -0.8/-2 0/0/-1 (+61) -0.8/-2 0/0/0 | -1.2/-3 0/0/-1 (+61) -1.2/-3 0/0/0 | -0.7/-2 -1/-1/-1 (+61) -0.7/-2 -1/0/0 | -0.7/-2 -1/-1/-1 (+61) -0.7/-2 -1/0/0 | -0.7/-2 0/0/0 (+61) -0.7/-2 0/0/0 | -0.7/-2 0/0/-1 (+61) -0.7/-2 0/0/0 | -0.7/-2 0/0/-1 (+61) -0.7/-2 0/0/0 | -0.7/-2 0/0/-1 (+61) -0.7/-2 0/0/0 | -0.7/-2 0/0/-1 (+61) -0.7/-2 0/0/0 | |
| +10.0 | +0.2/0 0/0/0 (+99) +0.2/0 0/0/0 | +0.2/0 0/0/0 (+99) +0.2/0 0/0/0 | 0/0/0 0/0/0 (+99) 0.0/0 0/0/0 | +0.2/0 0/0/0 (+99) +0.2/0 0/0/0 | +0.2/0 0/0/0 (+99) +0.2/0 0/0/0 | +0.2/0 0/0/0 (+99) +0.2/0 0/0/0 | +0.2/0 0/0/0 (+99) +0.2/0 0/0/0 | +0.2/0 0/0/0 (+99) +0.2/0 0/0/0 | +0.2/0 +1/+1/+1 (+99) +0.2/0 +1/+1/+1 | |
| LABEL FOR INFLUENCE DW (1000 KG) DTFLEX DVT1-DVR-DV2 (KT) (TVMC-QAT) (°C) DW (1000 KG) DTFLEX DVT1-DVR-DV2 (KT) | QAT C/DW CODES V1min/VR/V2 (kt) | *VMC * LIMITATION | Tref (QAT) = 44 C Tmax(QAT) = 54 C | Min acc height 515 FT Max acc height 1934 FT | Min QNH alt 1004 FT Max QNH alt 2423 FT | Min V1/VR/V2 = 115/20/22 CHECK VMU LIMITATION Correct, V1/VR/V2 = 0.1 KT/1000 KG | | | | |

For flexible temperature < TVMC (69 °C), ΔTflex = -2 °C
 Intermediate flex temperature..... = 65 °C

Associated speeds,
 V1 = 153 kt - 8 = 145 kt
 VR = 153 kt - 2 = 151 kt
 V2 = 154 kt - 2 = 152 kt

Check V2 against VMU limitation (Refer to PER-TOF-TOD-25-20 MINIMUM V2 LIMITED BY VMU/VMCA (KT IAS)). It is reminded that if the speed checks are not fulfilled, the corrections must be recalculated using those provided on lines 3 and 4.
 Apply QNH correction

PERFORMANCE

TAKEOFF

TAKEOFF CHARTS - FLEXIBLE TAKEOFF (WEIGHT ENTRY)

| | | | | | | | | | | | |
|---|--|---|--|--|--|--|--|--|---|--|------|
| A320XXX | | ENGINES | | AIRPORT NAME | | | | 15L | | VERSION | DATE |
| QNH | | 1013.25 HPA | | Elevation 489 FT | | TORA 3000 M | | 4 obstacles | | AAXXXXXX * *20 | |
| Air cond. | | AC OFF | | Isa temp 15 C | | TODA 3000 M | | | | | |
| Anti-icing | | AI OFF | | Rwy slope .08 % | | ASDA 3000 M | | | | | |
| All reversers operating | | | | | | | | | | DRY | |
| No reversers on dry runway | | | | | | | | | | | |
| WEIGHT | | CONF 1 + F | | | | CONF 2 | | | | | |
| 1000KG | TAILWIND -10 KT | TAILWIND -5 KT | WIND 0 KT | HEADWIND 10 KT | TAILWIND -10 KT | TAILWIND -5 KT | WIND 0 KT | HEADWIND 10 KT | | | |
| INFLUENCE OF RUNWAY CONDITION | | | | | | | | | | | |
| WET | -1.4/-3 -1.1/-1 -1 (+69) -1.4/-3 -1.1/0/0 | -1.1/-3 -1.0/-1 -1 (+69) -1.1/-3 -1.0/0/0 | -0.7/-2 -0/-2/-2 (+69) -0.7/-2 -9/0/0 | -0.7/-2 -8/-2/-2 (+69) -0.7/-2 -8/0/0 | -1.3/-3 -10/-2/-2 (+69) -1.3/-3 -10/0/0 | -1.3/-3 -9/-4/-4 (+69) -1.3/-3 -9/0/0 | -0.4/-1 -7/-2/-2 (+69) -0.4/-1 -7/0/0 | -0.2/-1 -5/0/0 (+69) -0.2/-1 -5/0/0 | | | |
| INFLUENCE OF DELTA PRESSURE | | | | | | | | | | | |
| QNH HPA | | | | | | | | | | | |
| -10.0 | -0.8/-2 0/0/-1 (+61) -0.8/-2 0/0/0 | -1.2/-3 0/0/-1 (+61) -1.2/-3 0/0/0 | -0.7/-2 -1/-1 -1 (+61) -0.7/-2 -1/0/0 | -0.7/-2 -1/-1 -1 (+61) -0.7/-2 -1/0/0 | -0.7/-2 0/0/0 (+61) -0.7/-2 0/0/0 | -0.7/-2 0/0/-1 (+61) -0.7/-2 0/0/0 | -0.7/-2 0/0/-1 (+61) -0.7/-2 0/0/0 | -0.7/-2 0/0/-1 (+61) -0.7/-2 0/0/0 | -0.7/-2 0/0/-1 (+61) -0.7/-2 0/0/0 | | |
| +10.0 | +0.2/0 0/0/0 (+69) +0.2/0 0/0/0 | +0.2/0 0/0/0 (+69) +0.2/0 0/0/0 | 0/0/0 0/0/0 (+69) 0/0/0 0/0/0 | +0.2/0 0/0/0 (+69) +0.2/0 0/0/0 | +0.2/0 0/0/0 (+69) +0.2/0 0/0/0 | +0.2/0 0/0/0 (+69) +0.2/0 0/0/0 | +0.2/0 0/0/0 (+69) +0.2/0 0/0/0 | +0.2/0 0/0/0 (+69) +0.2/0 0/0/0 | +0.2/0 0/0/0 (+69) +0.2/0 0/0/0 | | |
| LABEL FOR INFLUENCE DW (1000 KG) DTFFLEX DV1 -DVR -DV2 (KT) (TVMC OAT C) | | OAT C DW CODES V1min/VR/V2 (kt) | | * TVMC + LIMITATION | | Tref (OAT) = 44 C Tmax(OAT) = 54 C | | Min acc height 315 FT Max acc height 1924 FT | | Min QNH alt 1094 FT Max QNH alt 2423 FT | |
| DW (1000 KG) DTFFLEX DV1 -DVR -DV2 (KT) | | LIMITATION CODES: 1=1st segment 2=2nd segment 3=runway length 4=obstacles 5=brake speed 6=brake energy 7=mass weight 8=final take-off 9=VMU | | | | | | Min V1/VR/V2 = 115/20/22 CHECK VMU LIMITATION Correct. V1/VR/V2 = 0.1 KT/1000 KG | | | |

For flex temperature \geq TVMC (61 °C), $\Delta T_{flex} = -2 \times 15/10 = \dots \dots \dots -3 \text{ } ^\circ\text{C}$
 Flexible temperature $\dots \dots \dots = 62 \text{ } ^\circ\text{C}$

No speed correction is required for QNH and bleed influence.

Takeoff speeds are V1 = 145 kt, VR = 151 kt, V2 = 152 kt

Check that OAT/TREF < flex temperature \leq TMAXFLEX.

TMAXFLEX is specified in LIM-70.

For this example, if TMAXFLEX is equal to ISA + 45 °C (60 °C at airport elevation), Flex takeoff is not possible.

| | Takeoff Configuration : 1 + F | | | |
|--------------------|-------------------------------|-----|-----|-----|
| | Tflex | V1 | VR | V2 |
| Chart temperature | 67 | 153 | 153 | 154 |
| FCOM correction(s) | | | | |
| Intermediate value | 67 | 153 | 153 | 154 |
| WET Correction | -2 | -8 | -2 | -2 |
| Intermediate value | 65 | 145 | 151 | 152 |
| QNH Correction | -3 | 0 | 0 | 0 |
| Final value | 62 | 145 | 151 | 152 |

| | |
|---|--|
|  <p>A318/A319/A320/A321 FLIGHT CREW OPERATING MANUAL</p> | <p style="text-align: center;">PERFORMANCE TAKEOFF</p> <p style="text-align: center;">TAKEOFF CHARTS - FLEXIBLE TAKEOFF (WEIGHT ENTRY)</p> |
|---|--|

COMBINING CORRECTIONS FROM FCOM AND CHART

Ident.: PER-TOF-TOC-20-10-00014725.0001001 / 29 JUL 16
Applicable to: ALL

The following data and graphs are for example only, and are not for operational use. Even if the data in the following example is in “kg” and “m”, the same method can be applied for “lb” and “ft”.

1. Apply corrections from FCOM (*Refer to PER-TOF-TOD-24 EFFECT OF QNH AND BLEEDS*).
2. Apply corrections from the RTOW chart.
Apply speed corrections except for QNH and bleed influences.

EXAMPLE F

DATA : Actual takeoff weight = 68 000 kg
CONF 1+F
Head wind = 10 kt
Air conditioning ON
QNH = 998 hPa
WET runway

In this example, we will consider CONF 1+F as takeoff configuration. But same computation has to be done in CONF 2 and you must retain the best configuration.
Use the chart (*Refer to PER-TOF-TOC-16-30 RTOW EXAMPLE*).
Determine the maximum permissible takeoff weight (see example C). The actual weight being lower than the maximum one, flexible takeoff is possible.

PERFORMANCE

TAKEOFF

TAKEOFF CHARTS - FLEXIBLE TAKEOFF (WEIGHT ENTRY)

| A320XXX | ENGINES | | AIRPORT NAME | | | | 15L | VERSION | DATE |
|---|----------------------------------|----------------------------------|---|----------------------------------|----------------------------------|----------------------------------|----------------------------------|----------------------------------|-----------|
| QNH Air cond. Anti-icing All reversers operating No reversers on dry runway | 1013.25 HPA AC OFF AI OFF | | Elevation Sea temp Rwy slope | 489 FT 15 C .08 % | TORA TODA ASDA | 3000 M 3000 M 3000 M | | 4 obstacles | AXXXXXX * |
| | | | | | | | DRY | | |
| WEIGHT 1000KG | CONF 1 + F | | | | CONF 2 | | | | |
| | TAILWIND -10 KT | TAILWIND -5 KT | WIND 0 KT | HEADWIND 10 KT | TAILWIND -10 KT | TAILWIND -5 KT | WIND 0 KT | HEADWIND 10 KT | |
| 80 | -18 4/6 0.0 155/56/58 | 9 4/6 0.0 154/57/59 | 37 4/6 0.0 153/55/57 | 45 4/6 0.6 155/56/58 | -15 4/6 0.0 153/53/58 | 12 4/6 0.0 151/52/57 | 40 4/6 0.1 150/51/56 | 46 3/4 0.3 152/53/58 | |
| 76 | 44 4/6 0.1 141/49/51 | 48 4/6 0.2 148/50/52 | 51 3/4 0.4 153/53/55 | 52 2/4 0.3 152/52/53 | 44 4/6 0.3 140/43/49 | 48 4/6 0.4 146/47/51 | 51 3/4 0.4 150/50/54 | 52 2/4 0.4 150/50/55 | |
| 72 | 53 4/6 0.3 145/46/48 | 56 3/4 0.2 148/48/50 | 59 3/4 0.0 152/52/53 | 60 3/4 0.4 154/54/55 | 53 3/4 0.4 142/43/47 | 56 3/4 0.2 146/46/50 | 58 3/4 0.5 149/49/53 | 60 3/4 0.3 151/51/55 | |
| 68 | 61 3/4 0.3 144/44/45 | 63 3/4 0.5 148/48/49 | 65 3/4 0.6 151/51/52 | 67 3/4 0.3 153/53/54 | 61 3/4 0.3 142/42/45 | 63 3/4 0.5 145/45/48 | 65 3/4 0.4 148/48/52 | 68 4/4 0.6 149/49/53 | |
| 64 | 68 3/4 0.5 143/43/44 | 69 3/4 1.1 147/47/48 | 69 3/4 2.2 151/51/52 | 69 3/4 3.0 153/53/54 | 65 3/4 0.6 141/41/44 | 69 3/4 1.0 144/44/47 | 69 4/4 2.0 147/47/50 | 69 4/4 2.7 147/47/50 | |
| 60 | 69 3/4 4.0 143/43/44 | * 69 7/9 * 0.0 * 114/27/29 | * 69 7/9 * 0.0 * 114/32/33 | * 69 7/9 * 0.0 * 114/32/33 | * 69 7/9 * 4.0 * 141/41/44 | * 69 7/9 * 0.0 * 112/26/29 | * 69 7/9 * 0.0 * 112/26/29 | * 69 7/9 * 0.0 * 112/26/29 | |
| 56 | * 69 7/9 * 0.0 * 114/27/29 | * 69 7/9 * 0.0 * 114/27/29 | DO NOT USE FOR OPERATIONAL PURPOSE | | | | * 69 7/9 * 0.0 * 112/21/24 | * 69 7/9 * 0.0 * 112/21/24 | |
| 52 | * 69 7/9 * 0.0 * 114/22/24 | * 69 7/9 * 0.0 * 114/22/24 | | | | | * 69 7/7 * 0.0 * 112/19/22 | * 69 7/7 * 0.0 * 112/19/22 | |
| 48 | * 69 7/7 * 0.0 * 115/20/22 | * 69 7/7 * 0.0 * 115/20/22 | * 69 7/7 * 0.0 * 115/20/22 | * 69 7/7 * 0.0 * 113/19/22 | * 69 7/7 * 0.0 * 113/18/22 | * 69 7/7 * 0.0 * 113/18/22 | * 69 7/7 * 0.0 * 113/18/22 | * 69 7/7 * 0.0 * 113/18/22 | |
| GRAD1/GRAD2 (KG/C) | | | | | | | | | |
| 50**** | | 50**** | | 60**** | | 60/460 | | 50**** | |
| 50**** | | 50**** | | 60**** | | 60**** | | 50/470 | |

- Enter the 10 kt head wind column and interpolate for 68 000 kg, CONF 1+F, Flexible temperature..... 67 °C
- Takeoff speeds are V1 = 153 kt, VR = 153 kt, V2 = 154 kt
- First, apply the correction from FCOM (*Refer to PER-TOF-TOD-24 EFFECT OF QNH AND BLEEDS*).

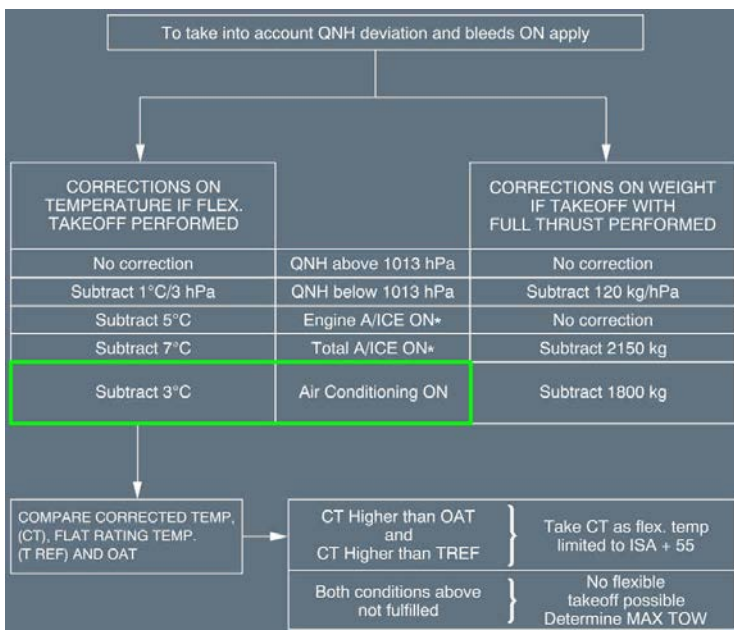

Flexible temperature with air conditioning OFF..... 67 °C
 Air conditioning correction..... -3 °C
 Intermediate flexible temperature..... = 64 °C

- Apply WET correction

| | | | | | | | | | |
|---|--|--|--|--|--|--|--|--|------|
| A320XXX | ENGINES | | AIRPORT NAME | | | | 15L | VERSION | DATE |
| QNH Air cond. Anti-icing All reversers operating No reversers on dry runway | 1013.25 HPA AC OFF AI OFF | | Elevation Sea temp Rwy slope | 489 FT 15 C .08 % | TORA TODA ASDA | 3000 M 3000 M 3000 M | | AXXXXXXX * | *20 |
| WEIGHT | | CONF 1 + F | | | | CONF 2 | | | |
| 1000KG | TAILWIND -10 KT | TAILWIND -5 KT | WIND 0 KT | HEADWIND 10 KT | TAILWIND -10 KT | TAILWIND -5 KT | WIND 0 KT | HEADWIND 10 KT | |
| INFLUENCE OF RUNWAY CONDITION | | | | | | | | | |
| WET | -1.4/-3 -1.1/-1/-1 (+69) -1.4/-3 -1.1/0/0 | -1.1/-3 -1.0/-1/-1 (+69) -1.1/-3 -1.0/0/0 | -0.7/-2 -0/-2/-2 (+69) -0.7/-2 -0/0/0 | -0.7/-2 -0/-2/-2 (+69) -0.7/-2 -0/0/0 | -1.3/-3 -1.0/-2/-2 (+69) -1.3/-3 -1.0/0/0 | -1.3/-3 -0.9/-4/-4 (+69) -1.3/-3 -0.9/0/0 | -0.4/-1 -0.2/-2 (+69) -0.4/-1 -0.2/0/0 | -0.2/-1 -0/0/0 (+69) -0.2/-1 -0.2/0/0 | |
| INFLUENCE OF DELTA PRESSURE | | | | | | | | | |
| -10.0 | -0.8/-2 0/0/-1 (+61) -0.8/-2 0/0/0 | -1.2/-3 0/0/-1 (+61) -1.2/-3 0/0/0 | -0.7/-2 -1/-1/-1 (+61) -0.7/-2 -1/0/0 | -0.7/-2 -1/-1/-1 (+61) -0.7/-2 -1/0/0 | -0.7/-2 0/0/0 (+61) -0.7/-2 0/0/0 | -0.7/-2 0/0/-1 (+61) -0.7/-2 0/0/0 | -0.7/-2 0/0/-1 (+61) -0.7/-2 0/0/0 | -0.7/-2 0/0/-1 (+61) -0.7/-2 0/0/0 | |
| +10.0 | +0.2/0 0/0/0 (+69) +0.2/0 0/0/0 | +0.2/0 0/0/0 (+69) +0.2/0 0/0/0 | 0/0/0 0/0/0 (+69) 0/0/0 0/0/0 | +0.2/0 0/0/0 (+69) +0.2/0 0/0/0 | +0.2/0 0/0/0 (+69) +0.2/0 0/0/0 | +0.2/0 0/0/0 (+69) +0.2/0 0/0/0 | +0.2/0 0/0/0 (+69) +0.2/0 0/0/0 | +0.2/0 +1/+1/+1 (+69) +0.2/0 +1/+1/+1 | |
| LABEL FOR INFLUENCE DW (1000 KG) DTFLX DV1 -DVR -DV2 (KT) (VMC OAT C) | OAT C DW CODES V1max/VRV2 (kt) | | *VMC * LIMITATION | Tref (OAT) = 44 C Tmax(OAT) = 54 C | Min acc height 315 FT Max acc height 1924 FT | Min QNH alt 1094 FT Max QNH alt 2423 FT | Min V1/VR/V2 = 115/20/22 CHECK VMU LIMITATION Correct. V1/VR/V2 = 0.1 KT/1000 KG | | |
| LIMITATION CODES: 1=1st segment 2=2nd segment 3=runway length 4=obstacles 5=brake speed 6=brake energy 7=mass weight 8=final take-off 9=VMU | | | | | | | | | |

For flexible temperature < TVMC (69 °C), $\Delta T_{flex} = \dots \dots \dots -2 \text{ } ^\circ\text{C}$
 Intermediate flex temperature..... = 62 °C

- Associated speeds,
- V1 = 153 kt - 8 = 145 kt
- VR = 153 kt - 2 = 151 kt
- V2 = 154 kt - 2 = 152 kt

Check V2 against VMU limitation on FCOM *Refer to PER-TOF-TOD-25-10 SPEEDS LIMITED BY VMCG/VMCA.*

It is reminded that if the speed checks are not fulfilled, the corrections must be recalculated using those provided on lines 3 and 4.

- Apply QNH correction



A318/A319/A320/A321
FLIGHT CREW
OPERATING MANUAL

PERFORMANCE

TAKEOFF

TAKEOFF CHARTS - FLEXIBLE TAKEOFF (WEIGHT ENTRY)

| A320XXX | ENGINES | AIRPORT NAME | | | | 15L | VERSION | DATE |
|---|--|--|--|--|---|--|--|--|
| QNH Air cond. Anti-icing All reversers operating No reversers on dry runway | 1013.25 HPA AC OFF AI OFF | Elevation 489 FT Isa temp 15 C Rwy slope .08 % | TORA 3000 M TODA 3000 M ASDA 3000 M | | | 4 obstacles | AXXXXXXX * | +20 |
| | | | | | | DRY | | |
| WEIGHT | CONF 1 + F | | | | CONF 2 | | | |
| 1000KG | TAILWIND -10 KT | TAILWIND -5 KT | WIND 0 KT | HEADWIND 10 KT | TAILWIND -10 KT | TAILWIND -5 KT | WIND 0 KT | HEADWIND 10 KT |
| INFLUENCE OF RUNWAY CONDITION | | | | | | | | |
| WET | -1.4/-3 -11/-1/-1 (+89) -1.4/-3 -11/0/0 | -1.1/-3 -10/-1/-1 (+69) -1.1/-3 -10/0/0 | -0.7/-2 -9/-2/-2 (+69) -0.7/-2 -9/0/0 | -0.7/-2 -8/-2/-2 (+69) -0.7/-2 -8/0/0 | -1.3/-3 -10/-2/-2 (+69) -1.3/-3 -10/0/0 | -1.3/-3 -9/-4/-4 (+69) -1.3/-3 -9/0/0 | -0.4/-1 -7/-2/-2 (+69) -0.4/-1 -7/0/0 | -0.2/-1 -5/0/0 (+89) -0.2/-1 -5/0/0 |
| INFLUENCE OF DELTA PRESSURE | | | | | | | | |
| QNH HPA | | | | | | | | |
| -10.0 | -0.8/-2 0/0/-1 (+61) -0.8/-2 0/0/0 | -1.2/-3 0/0/-1 (+61) -1.2/-3 0/0/0 | -0.7/-2 -1/-1/-1 (+61) -0.7/-2 -1/0/0 | -0.7/-2 -1/-1/-1 (+61) -0.7/-2 -1/0/0 | -0.7/-2 0/0/0 (+61) -0.7/-2 0/0/0 | -0.7/-2 0/0/-1 (+61) -0.7/-2 0/0/0 | -0.7/-2 0/0/-1 (+61) -0.7/-2 0/0/0 | -0.7/-2 0/0/-1 (+61) -0.7/-2 0/0/0 |
| +10.0 | +0.2/0 0/0/0 (+69) +0.2/0 0/0/0 | +0.2/0 0/0/0 (+69) +0.2/0 0/0/0 | 0.0/0 0/0/0 (+69) 0.0/0 0/0/0 | +0.2/0 0/0/0 (+69) +0.2/0 0/0/0 | +0.2/0 0/0/0 (+69) +0.2/0 0/0/0 | +0.2/0 0/0/0 (+69) +0.2/0 0/0/0 | +0.2/0 0/0/0 (+69) +0.2/0 0/0/0 | +0.2/0 +1/+1/+1 (+69) +0.2/0 +1/+1/+1 |
| LABEL FOR INFLUENCE DW (1000 KG) DTFLX DV1 -DVR -DV2 (KT) (TVMC OAT C) DW (1000 KG) DTFLX DV1 -DVR -DV2 (KT) | | OAT C DW CODES V1min/VRV2 (kt) | * TVMC * LIMITATION | Tref (OAT) = 88 C Tmax(OAT) = 54 C | Min a/c height: 515 FT Max a/c height: 1934 FT | Min QNH alt: 1004 FT Max QNH alt: 2423 FT | Min V1/VRV2 = 115/20/22 CHECK VMU LIMITATION Correct: V1/VRV2 = 0.1 KT/1000 KG | |

For flexible temperature \geq TVMC (61 °C), $\Delta T_{flex} = -2 \times 15/10 = \dots\dots\dots -3 \text{ }^\circ\text{C}$
 Flexible temperature..... = 59 °C

No speed correction is required for QNH and bleed influence.

Takeoff speeds are V1 = 145 kt, VR = 151 kt, V2 = 152 kt

Check that OAT/TREF < flex temperature \leq TMAXFLEX

TMAXFLEX is specified in LIM-70.

| | Takeoff Configuration : 1 + F | | | |
|---------------------------|-------------------------------|-----|-----|-----|
| | Tflex | V1 | VR | V2 |
| Chart temperature | 67 | 153 | 153 | 154 |
| FCOM correction(s) | -3 | 0 | 0 | 0 |
| Intermediate value | 64 | 153 | 153 | 154 |
| WET Correction | -2 | -8 | -2 | -2 |
| Intermediate value | 62 | 145 | 151 | 152 |
| QNH Correction | -3 | 0 | 0 | 0 |
| Final value | 59 | 145 | 151 | 152 |



A318/A319/A320/A321
FLIGHT CREW
OPERATING MANUAL

PERFORMANCE

TAKEOFF

TAKEOFF CHARTS - FLEXIBLE TAKEOFF (WEIGHT ENTRY)

Intentionally left blank

FLEXIBLE TAKEOFF NOT POSSIBLE

FLEXIBLE TAKEOFF NOT POSSIBLE

Ident.: PER-TOF-TOC-20-20-00013281.0001001 / 18 FEB 11

Applicable to: ALL

In some cases when the actual takeoff weight is lower than the maximum permissible one but no flexible takeoff possible (that is flexible temperature lower than TREF or OAT):

- It is mandatory to use TOGA thrust
- You can retain the speeds that have been calculated for the maximum permissible takeoff weight;
OR
- You can retain the speeds associated with the actual takeoff weight provided they are all lower than the speeds calculated for the maximum permissible takeoff weight.



A318/A319/A320/A321
FLIGHT CREW
OPERATING MANUAL

PERFORMANCE

TAKEOFF

TAKEOFF CHARTS - FLEXIBLE TAKEOFF (WEIGHT ENTRY)

Intentionally left blank



A318/A319/A320/A321

FLIGHT CREW
OPERATING MANUAL

PERFORMANCE

TAKEOFF

TAKEOFF CHARTS - FLEXIBLE TAKEOFF (WEIGHT ENTRY)

SUMMARY



A318/A319/A320/A321
FLIGHT CREW
OPERATING MANUAL

PERFORMANCE

TAKEOFF

TAKEOFF CHARTS - FLEXIBLE TAKEOFF (WEIGHT ENTRY)

SUMMARY

Ident.: PER-TOF-TOC-20-30-00013282.0001001 / 24 MAR 11

Applicable to: ALL

The flow diagram gives the different steps to follow

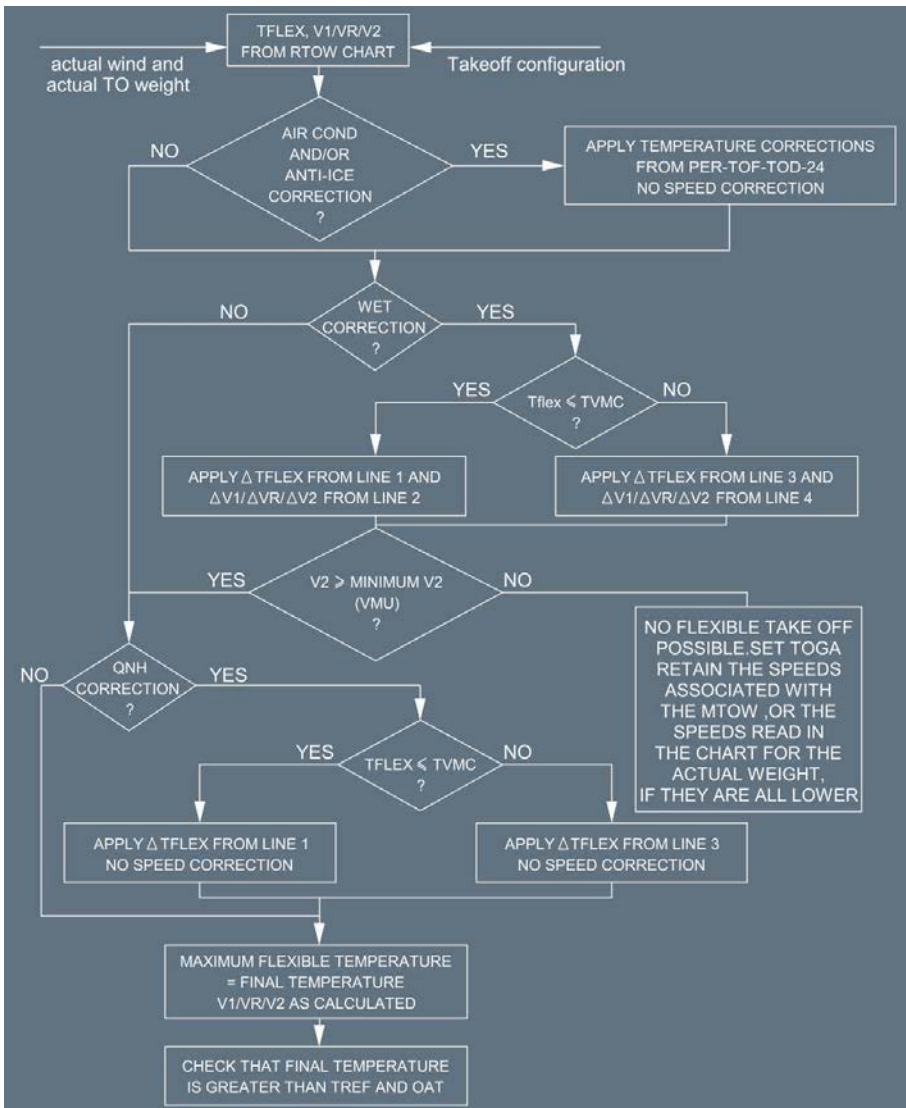



A318/A319/A320/A321
FLIGHT CREW
OPERATING MANUAL

PERFORMANCE

TAKEOFF

TAKEOFF CHARTS - FLEXIBLE TAKEOFF (WEIGHT ENTRY)

Intentionally left blank

EFFECT OF QNH AND BLEEDS (UP TO 9200 FT)

Ident.: PER-TOF-TOD-24-00012927.0090001 / 31 MAR 11

Applicable to: ALL

| To take into account QNH deviation and/or bleeds ON apply | | |
|--|--|---|
| CORRECTIONS ON TEMPERATURE IF FLEX TAKEOFF PERFORMED | | CORRECTIONS ON WEIGHT IF TAKEOFF WITH FULL THRUST IS PERFORMED |
| No correction except if actual pressure altitude is between 2000 ft and 4000 ft: subtract 1°C/3hPa | QNH above 1013 hPa | No correction except if actual pressure altitude is between 2000 ft and 4000 ft: subtract 40 kg/hPa |
| Subtract 1°C/2hPa | QNH below 1013 hPa | Subtract 140 kg/hPa |
| Subtract 5°C | Engine A/ICE ON | Subtract 300 kg |
| Subtract 11°C | Total A/ICE ON | OAT ≤ ISA + 5 Subtract 950 kg |
| Subtract 7°C | Air Conditioning ON | OAT > ISA + 5 Subtract 1650 kg |
| Compare corrected temp (CT), flat rating temp (T REF) and OAT | CT higher than OAT and CT higher than TREF | Take CT as flex temp limited to ISA + 70 |
| | Either conditions above not fulfilled | |

- Note:**
- * Corrections valid only for OAT < 10 °C
 - For high altitude operation, REFER TO PER-TOF-TOD-24 EFFECT OF QNH FOR HIGH ALTITUDE OPERATIONS (if applicable).

EXAMPLE

Ident.: PER-TOF-TOD-24-00014726.0001001 / 29 JUL 16

Applicable to: ALL

TAKEOFF CHART DATA

The following data and graphs are for example only, and are not for operational use. Even if the data in the following example is in “kg” and “m”, the same method can be applied for “lb” and “ft”.

Airport geometric elevation = 450 ft

QNH = 1 013 hPa

Anti ice OFF

Air conditioning OFF

EXAMPLE 1 - FULL THRUST TAKEOFF

Actual data : OAT = 5 °C

QNH = 998 hPa

Engine anti ice ON

Air conditioning OFF

Weight read in the takeoff chart: 73 000 kg.

Use the QNH/BLEEDS corrections (*Refer to PER-TOF-TOD-24 EFFECT OF QNH AND BLEEDS*) or (*Refer to PER-TOF-TOD-24 EFFECT OF QNH AND BLEEDS FOR HIGH ALTITUDE OPERATIONS*) for high altitude operations.

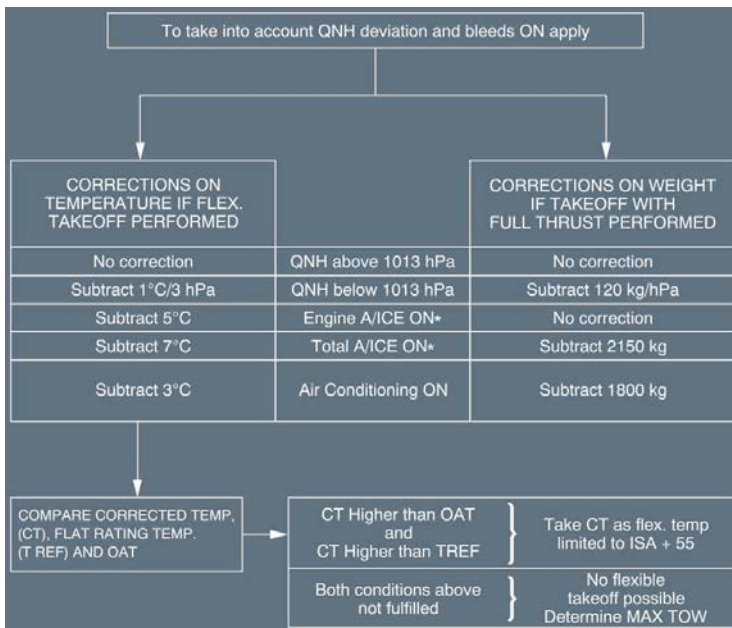

Read in the above table the corrections for high QNH and engine anti ice ON.

QNH correction: $120 \text{ kg} \times (1013 - 998) = 1\,800 \text{ kg}$

Engine anti ice correction: No correction.

The maximum permissible takeoff weight is $73\,000 - 1\,800 - 0 = 71\,200 \text{ kg}$

EXAMPLE 2 - FLEXIBLE THRUST TAKEOFF

Actual data : OAT = 5 °C
 QNH = 1 004 hPa
 Anti ice OFF
 Air conditioning ON
 TOW = 65 000 kg

Flexible temperature read on the takeoff chart: TFLEX = 55 °C.

Read TREF on the takeoff chart or on the quick reference table.

Read in the above table the correction for QNH and air conditioning ON:

QNH correction = $1^\circ\text{C} / 3 \text{ hPa} \times (1\,004 - 1\,013) = -3^\circ\text{C}$

Air conditioning ON correction: -3°C

New flexible temperature = $55 - 3 - 3 = 49^\circ\text{C}$

Check that the flexible temperature is above TREF and actual OAT.

Check that the flexible temperature is less than the maximum flexible temperature.

EFFECT OF QNH AND BLEEDS FOR HIGH ALTITUDE OPERATIONS (ABOVE 9200 FT)

Ident.: PER-TOF-TOD-24-00012926.0207001 / 24 MAR 11

Applicable to: ALL

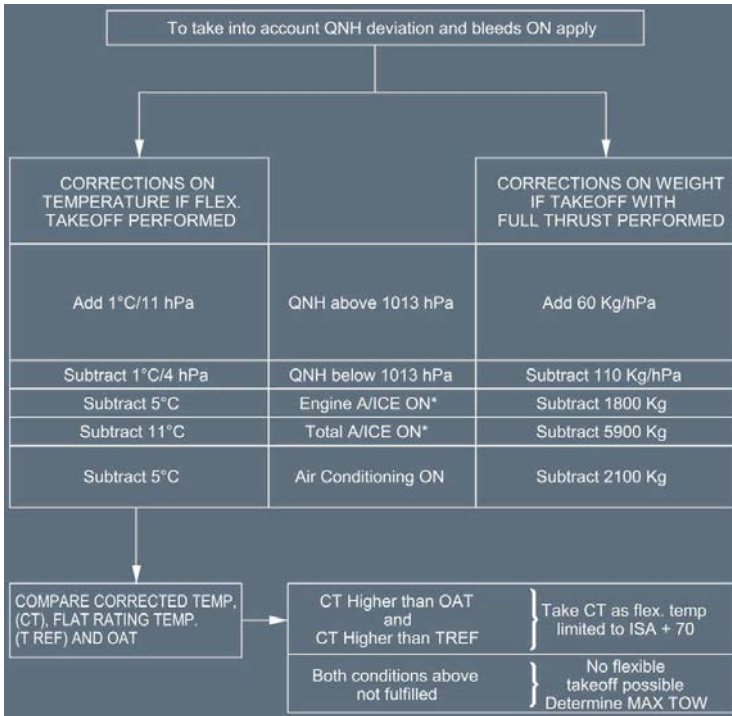

Note: * Corrections valid only for OAT < 10 °C

EXAMPLES FOR HIGH ALTITUDE OPERATIONS

Ident.: PER-TOF-TOD-24-00012925.0070001 / 18 MAR 11

Applicable to: ALL

TAKEOFF CHART DATA

Airport geometric elevation = 11 500 ft

QNH = 1 013 hPa

Anti ice OFF

Air conditioning OFF

OAT = 0 °C

MTOW = 73 000 kg

EXAMPLE 1 - FULL THRUST TAKEOFF

Actual data : QNH = 1 040 hPa

Engine anti ice ON

Air conditioning OFF

Determine the actual airport pressure altitude (1 hPa is equivalent to 28 ft according to the ISA model).

Pressure altitude = $11\,500 - (1\,040 - 1\,013) \times 28 = 10\,744$ ft

Read in the above table the corrections for high QNH and engine anti ice ON.

QNH correction = $60 \text{ kg} \times (11\,500 - 10\,744) / 28 \text{ hPa} = +1\,620$ kg

Engine anti ice correction: 1 800 kg

The maximum permissible takeoff weight is $73\,000 + 1\,620 - 1\,800 = 72\,820$ kg

EXAMPLE 2 - FLEXIBLE THRUST TAKEOFF

Actual data : QNH = 1 040 hPa

Anti ice OFF

Air conditioning ON

TOW = 65 000 kg

TFLEX = 55 °C

Read TREF on the takeoff chart or on the quick reference table.

Determine the actual airport pressure altitude (1 hPa is equivalent to 28 ft according to the ISA model).

Pressure altitude = $11\,500 - (1\,040 - 1\,013) \times 28 = 10\,744$ ft

Read in the above table the correction for QNH and air conditioning ON:

QNH correction = $1 \text{ °C} / 11 \text{ hPa} \times (11\,500 - 10\,744) / 28 \text{ hPa} = +3 \text{ °C}$

Air conditioning ON correction = -5 °C

New flexible temperature = $55 + 3 - 5 = 53 \text{ °C}$

Check that the flexible temperature is above TREF and actual OAT.

PERFORMANCE

TAKEOFF

TAKEOFF DATA - QNH/BLEEDS CORRECTION

Check that the flexible temperature is less than the maximum flexible temperature and retain the lower of the two.



A318/A319/A320/A321
 FLIGHT CREW
 OPERATING MANUAL

PERFORMANCE

TAKEOFF

TAKEOFF DATA - MINIMUM SPEEDS

SPEEDS LIMITED BY VMCG/VMCA

SPEEDS LIMITED BY VMCG/VMCA

Ident.: PER-TOF-TOD-25-10-00001754.0268001 / 08 JUL 15

Applicable to: ALL

All takeoff speeds have a minimum value limited by control. These minimum speeds are usually provided on each RTOW chart. If these speeds are not available, use the following conservative values. These speeds may be slightly higher than the minimum control speeds displayed on the RTOW chart.

| MINIMUM V1 (KT IAS) | | | | | | | | | | | | |
|---------------------|------------------------|-----|-------|-------|-------|-------|------|-------|-------|-------|-------|--------|
| CONF | PRESSURE ALTITUDE (FT) | | | | | | | | | | | |
| | -2 000 | 0 | 1 000 | 2 000 | 3 000 | 4 000 | 5000 | 6 000 | 7 000 | 8 000 | 9 200 | 14 100 |
| 1 + F | 117 | 115 | 114 | 113 | 112 | 112 | 111 | 110 | 109 | 108 | 106 | 100 |
| 2 | 115 | 113 | 112 | 111 | 111 | 110 | 109 | 108 | 107 | 106 | 104 | 100 |
| 3 | 114 | 112 | 111 | 110 | 110 | 110 | 109 | 108 | 107 | 105 | 104 | 100 |

| MINIMUM VR (KT IAS) | | | | | | | | | | | | |
|---------------------|------------------------|-----|-------|-------|-------|-------|------|-------|-------|-------|-------|--------|
| CONF | PRESSURE ALTITUDE (FT) | | | | | | | | | | | |
| | -2 000 | 0 | 1 000 | 2 000 | 3 000 | 4 000 | 5000 | 6 000 | 7 000 | 8 000 | 9 200 | 10 200 |
| 1 + F | 121 | 119 | 118 | 116 | 116 | 116 | 115 | 114 | 113 | 111 | 110 | 102 |
| 2 | 119 | 117 | 116 | 115 | 114 | 114 | 113 | 112 | 111 | 109 | 108 | 100 |
| 3 | 118 | 116 | 115 | 114 | 114 | 114 | 113 | 112 | 110 | 109 | 107 | 100 |

| MINIMUM V2 (KT IAS) | | | | | | | | | | | | |
|---------------------|------------------------|-----|-------|-------|-------|-------|------|-------|-------|-------|-------|--------|
| CONF | PRESSURE ALTITUDE (FT) | | | | | | | | | | | |
| | -2 000 | 0 | 1 000 | 2 000 | 3 000 | 4 000 | 5000 | 6 000 | 7 000 | 8 000 | 9 200 | 10 200 |
| 1 + F | 124 | 121 | 120 | 119 | 119 | 119 | 118 | 117 | 115 | 114 | 112 | 104 |
| 2 | 123 | 121 | 120 | 119 | 119 | 119 | 117 | 116 | 115 | 114 | 112 | 103 |
| 3 | 123 | 121 | 120 | 119 | 119 | 118 | 117 | 116 | 115 | 114 | 112 | 103 |



A318/A319/A320/A321
FLIGHT CREW
OPERATING MANUAL

PERFORMANCE

TAKEOFF

TAKEOFF DATA - MINIMUM SPEEDS

Intentionally left blank



A318/A319/A320/A321
FLIGHT CREW
OPERATING MANUAL

PERFORMANCE

TAKEOFF

TAKEOFF DATA - MINIMUM SPEEDS

V2 LIMITED BY VMU/MCA

MINIMUM V2 LIMITED BY VMU/VMCA (KT IAS)

Ident.: PER-TOF-TOD-25-20-00001756.0095001 / 25 MAR 11

Applicable to: ALL

The following tables, one per configuration, provide the V2 limited by minimum unstick speed and minimum control speed in the air.

| MINIMUM V2 LIMITED BY VMU/VMCA (KT IAS) | | | | | | | | |
|---|--------------------------|-----|-----|-----|-----|-----|-----|-----|
| CONFIGURATION 1+F | | | | | | | | |
| PRESSURE ALTITUDE (FT) | TAKEOFF WEIGHT (1000 KG) | | | | | | | |
| | 45 | 50 | 55 | 60 | 65 | 70 | 75 | 80 |
| -2000 | 124 | 124 | 130 | 135 | 140 | 145 | 150 | 155 |
| 0 | 121 | 124 | 130 | 135 | 140 | 145 | 150 | 155 |
| 1000 | 120 | 124 | 130 | 135 | 140 | 145 | 151 | 155 |
| 2000 | 119 | 124 | 129 | 135 | 140 | 146 | 151 | 155 |
| 3000 | 119 | 124 | 130 | 135 | 140 | 146 | 151 | 156 |
| 4000 | 119 | 124 | 130 | 135 | 141 | 146 | 151 | 156 |
| 5000 | 119 | 124 | 130 | 135 | 141 | 146 | 151 | 156 |
| 6000 | 119 | 124 | 130 | 135 | 141 | 146 | 152 | 156 |
| 7000 | 119 | 124 | 130 | 136 | 141 | 146 | 152 | 156 |
| 8000 | 118 | 124 | 130 | 136 | 141 | 147 | 152 | 157 |
| 9000 | 118 | 124 | 130 | 136 | 141 | 147 | 152 | 157 |
| 10000 | 118 | 124 | 130 | 136 | 141 | 147 | 152 | 157 |
| 11000 | 118 | 124 | 130 | 136 | 142 | 147 | 153 | 157 |
| 12000 | 118 | 124 | 130 | 136 | 142 | 147 | 153 | 158 |
| 13000 | 118 | 124 | 130 | 136 | 142 | 148 | 153 | 158 |
| 14100 | 118 | 124 | 130 | 136 | 142 | 148 | 153 | 158 |

| MINIMUM V2 LIMITED BY VMU/VMCA (KT IAS) | | | | | | | | |
|---|--------------------------|-----|-----|-----|-----|-----|-----|-----|
| CONFIGURATION 2 | | | | | | | | |
| PRESSURE ALTITUDE (FT) | TAKEOFF WEIGHT (1000 KG) | | | | | | | |
| | 45 | 50 | 55 | 60 | 65 | 70 | 75 | 80 |
| -2000 | 123 | 123 | 124 | 129 | 134 | 139 | 144 | 149 |
| 0 | 121 | 121 | 124 | 129 | 134 | 140 | 145 | 149 |
| 1000 | 120 | 120 | 124 | 129 | 135 | 140 | 145 | 149 |
| 2000 | 119 | 119 | 124 | 129 | 135 | 140 | 145 | 149 |
| 3000 | 119 | 119 | 124 | 129 | 135 | 140 | 145 | 150 |
| 4000 | 119 | 119 | 124 | 130 | 135 | 140 | 145 | 150 |
| 5000 | 117 | 119 | 124 | 130 | 135 | 140 | 146 | 150 |
| 6000 | 116 | 119 | 124 | 130 | 135 | 141 | 146 | 150 |
| 7000 | 115 | 119 | 124 | 130 | 135 | 141 | 146 | 150 |
| 8000 | 114 | 119 | 124 | 130 | 136 | 141 | 146 | 151 |
| 9000 | 113 | 119 | 124 | 130 | 136 | 141 | 146 | 151 |
| 10000 | 113 | 119 | 125 | 130 | 136 | 141 | 147 | 151 |
| 11000 | 113 | 119 | 125 | 130 | 136 | 141 | 147 | 151 |
| 12000 | 113 | 119 | 125 | 131 | 136 | 142 | 147 | 152 |
| 13000 | 113 | 119 | 125 | 131 | 136 | 142 | 147 | 152 |
| 14100 | 113 | 119 | 125 | 131 | 137 | 142 | 147 | 152 |

PERFORMANCE

TAKEOFF

TAKEOFF DATA - MINIMUM SPEEDS

| MINIMUM V2 LIMITED BY VMU/VMCA (KT IAS) | | | | | | | | |
|---|--------------------------|-----|-----|-----|-----|-----|-----|-----|
| CONFIGURATION 3 | | | | | | | | |
| PRESSURE ALTITUDE (FT) | TAKEOFF WEIGHT (1000 KG) | | | | | | | |
| | 45 | 50 | 55 | 60 | 65 | 70 | 75 | 80 |
| -2000 | 123 | 123 | 123 | 124 | 129 | 134 | 139 | 143 |
| 0 | 121 | 121 | 121 | 124 | 129 | 135 | 140 | 144 |
| 1000 | 120 | 120 | 120 | 124 | 129 | 135 | 140 | 144 |
| 2000 | 119 | 119 | 119 | 124 | 130 | 135 | 140 | 144 |
| 3000 | 119 | 119 | 119 | 124 | 130 | 135 | 140 | 144 |
| 4000 | 118 | 118 | 119 | 124 | 130 | 135 | 140 | 144 |
| 5000 | 117 | 117 | 119 | 125 | 130 | 135 | 140 | 144 |
| 6000 | 116 | 116 | 120 | 125 | 130 | 135 | 140 | 145 |
| 7000 | 115 | 115 | 120 | 125 | 130 | 136 | 141 | 145 |
| 8000 | 114 | 114 | 119 | 125 | 130 | 136 | 141 | 145 |
| 9000 | 112 | 114 | 120 | 125 | 131 | 136 | 141 | 145 |
| 10000 | 110 | 114 | 120 | 125 | 131 | 136 | 141 | 145 |
| 11000 | 109 | 114 | 120 | 125 | 131 | 136 | 141 | 145 |
| 12000 | 109 | 114 | 120 | 126 | 131 | 137 | 142 | 146 |
| 13000 | 108 | 114 | 120 | 126 | 131 | 137 | 142 | 146 |
| 14100 | 109 | 115 | 120 | 126 | 132 | 137 | 142 | 146 |

| | |
|---|--|
|  <p>A318/A319/A320/A321 FLIGHT CREW OPERATING MANUAL</p> | <p align="center">PERFORMANCE</p> <p align="center">TAKEOFF</p> <p align="center">RUNWAY CONTAMINATION - GENERAL</p> |
|---|--|

GENERAL

Ident.: PER-TOF-CTA-10-00001781.0001001 / 21 JUL 14

Applicable to: ALL

This section presents the recommendations of Airbus for operations from wet runways or from runways which are covered with contaminants such as standing water, slush or snow.

| | |
|-----------------------|--|
| <p>CAUTION</p> | <p>Takeoff is not recommended:</p> <ul style="list-style-type: none"> - From an icy runway - From a runway for which the depth of contaminant is greater than the performance levels or the equivalences published in the documentation or performance software. |
|-----------------------|--|



A318/A319/A320/A321
FLIGHT CREW
OPERATING MANUAL

PERFORMANCE

TAKEOFF

RUNWAY CONTAMINATION - GENERAL

Intentionally left blank

| | |
|---|---|
|  <p>A318/A319/A320/A321 FLIGHT CREW OPERATING MANUAL</p> | <p>PERFORMANCE</p> <p>TAKEOFF</p> <p>RUNWAY CONTAMINATION - DEFINITIONS</p> |
|---|---|

| |
|--------------------|
| DEFINITIONS |
|--------------------|

Ident.: PER-TOF-CTA-20-00001782.0001001 / 22 MAY 13

Applicable to: ALL

- DAMP : A runway is damp when the surface is not dry, but when the water on it does not give it a shiny appearance.
- WET : A runway is considered as wet when the surface has a shiny appearance due to a thin layer of water. When this layer does not exceed 3 mm depth, there is no substantial risk of hydroplaning.
- STANDING WATER : is caused by heavy rainfall and /or insufficient runway drainage with a depth of more than 3 mm.
- SLUSH : is water saturated with snow which spatters when stepping firmly on it. It is encountered at temperatures around 5 °C and its density is approximately 0.85 kg/l (7.1 lb/US Gal).
- WET SNOW : is a condition where, if compacted by hand, snow will stick together and tend to form a snowball. Its density is approximately 0.4 kg/l (3.35 lb/US Gal).
- DRY SNOW : is a condition where snow can be blown if loose, or if compacted by hand, will fall apart again upon release. Its density is approximately 0.2 kg/l (1.7 lb/US Gal).
- COMPACTED SNOW : is a condition where snow has been compressed.
- ICY : is a condition where the friction coefficient is 0.05 or below.



A318/A319/A320/A321
FLIGHT CREW
OPERATING MANUAL

PERFORMANCE

TAKEOFF

RUNWAY CONTAMINATION - DEFINITIONS

EQUIVALENCES

Ident.: PER-TOF-CTA-20-00014919.0001001 / 21 JUL 14

Applicable to: ALL

For the below-listed reported contaminants, the following equivalent runway conditions can be retained for the takeoff performance determination.

| Reported contaminant | | Equivalent Runway Condition |
|----------------------|----------------------|-----------------------------|
| Type of contaminant | Depth of contaminant | |
| Slush | ≤ 3 mm (1/8 in) | Wet |
| Water | ≤ 3 mm (1/8 in) | |
| | ≤ 3 mm (1/8 in) | |
| Wet snow | ≤ 12.7 mm (1/2 in) | 6.3 mm (1/4 in) Slush |
| | ≤ 25.4 mm (1 in) | 12.7 mm (1/2 in) Slush |
| | | |
| Dry snow | ≤ 3 mm (1/8 in) | Wet |
| | ≤ 50.8 mm (2 in) | 6.3 mm (1/4 in) Slush |
| | ≤ 100 mm (4 in) | 12.7 mm (1/2 in) Slush |

| | |
|---|---|
|  <p>A318/A319/A320/A321 FLIGHT CREW OPERATING MANUAL</p> | <p align="center">PERFORMANCE TAKEOFF</p> <p align="center">RUNWAY CONTAMINATION - OPERATIONAL CONDITIONS</p> |
|---|---|

OPERATIONAL CONDITIONS

Ident.: PER-TOF-CTA-30-00001783.0001001 / 14 DEC 09

Applicable to: ALL

Performance penalties for takeoff as published in this section are computed with the following assumptions :

- The contaminant is in a layer of uniform depth and density over the entire length of the runway.
- Antiskid and spoilers are operative.
- The friction coefficient is based on studies and checked by actual tests.
- The screen height at the end of takeoff segment is 15 ft, not 35 ft.

In addition, for contaminated runways only :

- There is drag due to rolling resistance of the wheels.
- There is drag due to spray on the airframe and gears.
- Reverse thrust is used for the deceleration phase.
- Maximum thrust is used for takeoff.

Note: The net flight path clears obstacles by 15 ft instead of 35 ft.



A318/A319/A320/A321
FLIGHT CREW
OPERATING MANUAL

PERFORMANCE

TAKEOFF

RUNWAY CONTAMINATION - OPERATIONAL CONDITIONS

Intentionally left blank

TAKEOFF PERFORMANCE

TAKEOFF PERFORMANCE

Ident.: PER-TOF-CTA-40-10-00013660.0003001 / 23 JUN 15

Applicable to: ALL

CAUTION

The method is based on the use of the RTOW charts established at optimum V2 /VS and optimum V1 /VR . In addition, when applying corrections for a wet runway, the RTOW charts should also have been established with V1 min (minimum V1 of the V1 range). The method should not be used with takeoff charts computed for other conditions. All tables have been established for TOGA (and Flexible Takeoff for wet runways). Do not use them for Derated thrust.

Correct the determined maximum takeoff weight on dry runway to take into account QNH and bleed effects, then apply the corrections given on the following pages.

- Note:
1. *The results obtained with this method may be different from the influence given at the bottom of the RTOW chart.*
 2. *On contaminated runway, in some cases, no MTOW can be determined with this method (box dashed below a given weight). A specific RTOW chart must then be computed.*
 3. *The published corrections are valid for charts calculated with forward CG and basic CG.*



A318/A319/A320/A321
FLIGHT CREW
OPERATING MANUAL

PERFORMANCE

TAKEOFF

RUNWAY CONTAMINATION - TAKEOFF PERFORMANCE

Intentionally left blank



A318/A319/A320/A321
FLIGHT CREW
OPERATING MANUAL

PERFORMANCE

TAKEOFF

RUNWAY CONTAMINATION - TAKEOFF PERFORMANCE

TAKEOFF FROM A WET RUNWAY

HOW TO PROCEED

Ident.: PER-TOF-CTA-40-20-00012966.0004001 / 24 MAR 11

Applicable to: ALL

1. Determine the maximum takeoff weight or flexible temperature and associated speeds on dry runway.
2. Two sets of tables are given depending on the use of thrust reversers and the presence of clearway. Select the table to use as applicable to your case.
The runway length in the table corresponds to the available takeoff run (TORA).
3. Apply the corrections shown in the table to the maximum takeoff weight or flexible temperature and associated speeds determined on dry runway.
4. Check that takeoff speeds are greater than the minimum values shown on the RTOW chart.

If one or more speeds are lower than these minimum values, apply the following procedure :

- Actual TOW = maximum TOW

- If V1 is lower than the minimum V1 (V1 limited by VMCG), take this last value as V1 and further decrease weight by 3 000 kg (6 600 lb) per knot difference between them. Check that VR and V2 are higher than or equal to the minimum values.
- If VR or/and V2 falls below the minimum values, takeoff is not possible.

- Actual TOW lower than maximum TOW

- If V1 corresponding to actual TOW is lower than the minimum V1 (V1 limited by VMCG) :
 - If maximum TOW has a V1 equal to or above minimum V1 , retain minimum V1 as V1 and decrease the flexible temperature by 4 °C per knot difference between them.
 - In the rare case when the V1 corresponding to maximum TOW falls below the minimum V1 , decrease maximum TOW by 3 000 kg (6 600 lb) per knot difference between them. Limit the actual TOW to the value found after this decrement. Take V1 equal to minimum V1 and decrease the flexible temperature by 4 °C per knot difference between this last value and the V1 corresponding to the actual TOW . Check that VR and V2 are higher than or equal to the minimum values.
- If VR or V2 corresponding to actual TOW falls below the minimum values, and if VR and V2 corresponding to maximum TOW are above the minimum values, retain the minimum speed value for VR and V2.

5. Check that V2 is above the minimum V2 value due to VMU (*Refer to PER-TOF-TOD-25-10 SPEEDS LIMITED BY VMCG/VMCA*).

6. Check that the corrected flexible temperature is higher than OAT and Tref.

Note: - Do not extrapolate below the shortest runway length provided in the table.

- If no minimum speed value is available, use the conservative values provided on Refer to PER-TOF-TOD-25-10 SPEEDS LIMITED BY VMCG/VMCA.

NO THRUST REVERSERS OPERATIVE (NO CLEARWAY)

Ident.: PER-TOF-CTA-40-20-00012743.0048001 / 04 MAR 11

Applicable to: ALL

| TAKEOFF CONFIGURATION | 1 + F | | | 2 | | | 3 | | |
|--|------------------------------|----------------|-----------------|------------------------------|----------------|----------------|------------------------------|----------------|----------------|
| | RUNWAY LENGTH (m) (ft) | 2 500 8 000 | 3 000 10 000 | 3 500 11 500 and above | 2 000 6 500 | 2 500 8 000 | 3 000 10 000 and above | 1 750 5 750 | 2 000 6 500 |
| FLEX TO Temperature decrement (°C) | 8 | 5 | 3 | 8 | 6 | 2 | 6 | 6 | 2 |
| MAX TO Weight decrement (1 000 kg) (1 000 lb) | 2.6 5.8 | 2.0 4.5 | 1.3 2.9 | 2.5 5.6 | 2.2 4.9 | 0.7 1.6 | 2.1 4.7 | 2.1 4.7 | 0.7 1.6 |
| V1 decrement (kt) | 15 | 14 | 14 | 16 | 14 | 14 | 14 | 15 | 13 |
| VR and V2 decrement (kt) | 2 | 1 | 1 | 2 | 1 | 2 | 1 | 2 | 0 |

ALL THRUST REVERSERS OPERATIVE (NO CLEARWAY)

Ident.: PER-TOF-CTA-40-20-00012744.0084001 / 04 MAR 11

Applicable to: ALL

| TAKEOFF CONFIGURATION | 1 + F | | | 2 | | | 3 | | |
|--|------------------------------|--------------|---------------|----------------------------|--------------|--------------|----------------------------|--------------|--------------|
| | RUNWAY LENGTH (m) (ft) | 2500 8000 | 3000 10000 | 3500 11500 and above | 2000 6500 | 2500 8000 | 3000 10000 and above | 1750 5750 | 2000 6500 |
| FLEX TO Temperature decrement (°C) | 3 | 2 | 0 | 3 | 1 | 0 | 2 | 1 | 1 |
| MAX TO Weight decrement (1000 kg) (1000 lb) | 1.0 2.3 | 0.6 1.4 | 0.0 0.0 | 0.8 1.8 | 0.3 0.7 | 0.0 0.0 | 0.6 1.4 | 0.2 0.5 | 0.1 0.3 |
| V1 decrement (kt) | 9 | 9 | 9 | 10 | 8 | 9 | 10 | 9 | 8 |
| VR and V2 decrement (kt) | 0 | 0 | 0 | 0 | 0 | 0 | 0 | 0 | 0 |

PERFORMANCE

TAKEOFF

RUNWAY CONTAMINATION - TAKEOFF PERFORMANCE

NO THRUST REVERSERS OPERATIVE (WITH CLEARWAY)

Ident.: PER-TOF-CTA-40-20-00012745.0044001 / 08 FEB 11

Applicable to: ALL

| TAKEOFF CONFIGURATION | 1 + F | | | 2 | | | 3 | | |
|--|----------------|-----------------|------------------------------|----------------|----------------|------------------------------|----------------|----------------|-----------------------------|
| RUNWAY LENGTH (m) (ft) | 2 500 8 000 | 3 000 10 000 | 3 500 11 500 and above | 2 000 6 500 | 2 500 8 000 | 3 000 10 000 and above | 1 750 5 750 | 2 000 6 500 | 2 500 8 000 and above |
| FLEX TO Temperature decrement (°C) | 15 | 9 | 9 | 14 | 11 | 4 | 15 | 12 | 5 |
| MAX TO Weight decrement (1 000 kg) (1 000 lb) | 5.4 12.0 | 4.1 9.1 | 3.8 8.4 | 4.6 10.2 | 4.2 9.3 | 1.6 3.6 | 4.5 10.0 | 4.5 10.0 | 2.2 4.9 |
| V1 decrement (kt) | 14 | 15 | 15 | 14 | 14 | 15 | 13 | 13 | 14 |
| VR and V2 decrement (kt) | 4 | 3 | 6 | 4 | 4 | 6 | 3 | 4 | 5 |

ALL THRUST REVERSERS OPERATIVE (WITH CLEARWAY)

Ident.: PER-TOF-CTA-40-20-00012941.0044001 / 28 JAN 11

Applicable to: ALL

| TAKEOFF CONFIGURATION | 1 + F | | | 2 | | | 3 | | |
|--|----------------|-----------------|------------------------------|----------------|----------------|------------------------------|----------------|----------------|-----------------------------|
| RUNWAY LENGTH (m) (ft) | 2 500 8 000 | 3 000 10 000 | 3 500 11 500 and above | 2 000 6 500 | 2 500 8 000 | 3 000 10 000 and above | 1 750 5 750 | 2 000 6 500 | 2 500 8 000 and above |
| FLEX TO Temperature decrement (°C) | 11 | 5 | 2 | 10 | 8 | 3 | 11 | 9 | 3 |
| MAX TO Weight decrement (1 000 kg) (1 000 lb) | 3.9 8.6 | 2.3 5.1 | 0.9 2.0 | 3.3 7.3 | 3.1 6.9 | 1.0 2.3 | 3.3 7.3 | 3.3 7.3 | 1.3 2.5 |
| V1 decrement (kt) | 9 | 10 | 12 | 9 | 9 | 10 | 8 | 9 | 9 |
| VR and V2 decrement (kt) | 3 | 2 | 3 | 3 | 3 | 4 | 2 | 2 | 4 |



A318/A319/A320/A321
FLIGHT CREW
OPERATING MANUAL

PERFORMANCE

TAKEOFF

RUNWAY CONTAMINATION - TAKEOFF PERFORMANCE

TAKEOFF FROM A CONTAMINATED RUNWAY

PERFORMANCE

TAKEOFF

RUNWAY CONTAMINATION - TAKEOFF PERFORMANCE

TAKEOFF FROM A 6.3 MM (1/4 INCH) WATER COVERED RUNWAY

Ident.: PER-TOF-CTA-40-30-00001786.0373001 / 22 FEB 17

Applicable to: ALL

- Determine maximum takeoff weight on dry runway.
- Apply the following weight decrement versus takeoff configuration, runway length and clearway availability to determine a corrected weight.

| TAKEOFF CONFIGURATION | CONF 1 + F | | | | CONF 2 | | | CONF 3 | | |
|--|----------------|-----------------|-----------------|--------------------------------|----------------|----------------|---------------------------------|---------------|----------------|--------------------------------|
| RUNWAY LENGTH (m) (ft) | 2 500 8 000 | 3 000 10 000 | 3 500 11 500 | 4 000 13 00 and above | 2 000 6 500 | 2 500 8 000 | 3 000 10 000 and above | 1 750 5750 | 2 000 6 500 | 2 500 8 000 and above |
| Δ Weight (1 000 kg) With clearway Without clearway | 12.8 10.5 | 11.7 10.1 | 9.8 9.0 | 9.8 9.0 | 13.9 11.1 | 13.2 11.1 | 11.4 10.4 | 14.9 11.4 | 14.5 11.8 | 13.1 11.8 |

- Enter the following tables with the corrected weight to determine MTOW then determine takeoff speeds associated with actual TOW.

CONF 1 + F

| | | | | | | | | | | | |
|--------------------------------|-------|------|----|----|---------------------------|--|--|--|--|--|--|
| CORRECTED WEIGHT (1 000 kg) | <55.2 | 55.2 | 56 | 58 | 58 to 78 | | | | | | |
| MTOW (1 000 kg) | - | 46.7 | 50 | 58 | EQUAL TO CORRECTED WEIGHT | | | | | | |

| | | | | | | | | | | | | | | | | | | |
|-----------------------------|-------|------|-----|-----|-----|-----|-----|-----|-----|-----|-----|-----|-----|-----|-----|-----|-----|-----|
| ACTUAL WEIGHT (1 000 kg) | <46.7 | 46.7 | 48 | 50 | 52 | 54 | 56 | 58 | 60 | 62 | 64 | 66 | 68 | 70 | 72 | 74 | 76 | 78 |
| V2 (kt IAS) | 124 | 124 | 126 | 129 | 131 | 134 | 136 | 138 | 141 | 143 | 145 | 148 | 150 | 152 | 155 | 157 | 159 | 161 |
| VR (kt IAS) | 121 | 121 | 123 | 126 | 128 | 131 | 133 | 135 | 138 | 140 | 142 | 145 | 147 | 149 | 152 | 154 | 156 | 158 |
| V1 (kt IAS) | 117 | 117 | 117 | 117 | 117 | 117 | 117 | 117 | 120 | 122 | 124 | 127 | 129 | 131 | 134 | 136 | 138 | 140 |

CONF 2

| | | | | | | | | | | | |
|--------------------------------|-------|------|----|----|---------------------------|--|--|--|--|--|--|
| CORRECTED WEIGHT (1 000 kg) | <56.8 | 56.8 | 58 | 59 | 59 to 78 | | | | | | |
| MTOW (1 000 kg) | - | 48.7 | 55 | 59 | EQUAL TO CORRECTED WEIGHT | | | | | | |



AEROLINEAS GALAPAGOS S.A.

A318/A319/A320/A321

FLIGHT CREW
OPERATING MANUAL

PERFORMANCE

TAKEOFF

RUNWAY CONTAMINATION - TAKEOFF PERFORMANCE

| ACTUAL WEIGHT (1 000 kg) | <48.7 | 48.7 | 50 | 52 | 54 | 56 | 58 | 59 | 60 | 62 | 64 | 66 | 68 | 70 | 72 | 74 | 76 | 78 |
|-----------------------------|-------|------|-----|-----|-----|-----|-----|-----|-----|-----|-----|-----|-----|-----|-----|-----|-----|-----|
| V2 (kt IAS) | 125 | 125 | 127 | 129 | 132 | 134 | 137 | 138 | 139 | 141 | 143 | 146 | 148 | 150 | 153 | 155 | 157 | 159 |
| VR (kt IAS) | 119 | 119 | 121 | 123 | 126 | 128 | 131 | 132 | 133 | 135 | 137 | 140 | 142 | 144 | 147 | 149 | 151 | 153 |
| V1 (kt IAS) | 115 | 115 | 115 | 115 | 115 | 115 | 115 | 115 | 116 | 118 | 120 | 123 | 125 | 127 | 130 | 132 | 134 | 136 |

CONF 3

| | | | | | | | | | | | | | | | | | | |
|--|-------|------|----|----|---------------------------|--|--|--|--|--|--|--|--|--|--|--|--|--|
| CORRECTED WEIGHT (1 000 kg) | <57.8 | 57.8 | 58 | 60 | 60 to 78 | | | | | | | | | | | | | |
| MTOW (1 000 kg) | - | 48 | 49 | 60 | EQUAL TO CORRECTED WEIGHT | | | | | | | | | | | | | |

| ACTUAL WEIGHT (1 000 kg) | <48 | 48 | 50 | 52 | 54 | 56 | 58 | 60 | 62 | 64 | 66 | 68 | 70 | 72 | 74 | 76 | 78 |
|-----------------------------|-----|-----|-----|-----|-----|-----|-----|-----|-----|-----|-----|-----|-----|-----|-----|-----|-----|
| V2 (kt IAS) | 123 | 126 | 126 | 128 | 131 | 133 | 135 | 138 | 140 | 142 | 145 | 147 | 149 | 151 | 153 | 155 | 157 |
| VR (kt IAS) | 118 | 118 | 121 | 123 | 126 | 128 | 130 | 133 | 135 | 137 | 140 | 142 | 144 | 146 | 148 | 150 | 152 |
| V1 (kt IAS) | 114 | 114 | 114 | 114 | 114 | 114 | 114 | 114 | 116 | 118 | 121 | 123 | 125 | 129 | 129 | 131 | 133 |

PERFORMANCE

TAKEOFF

RUNWAY CONTAMINATION - TAKEOFF PERFORMANCE

TAKEOFF FROM A 12.7 MM (1/2 INCH) WATER COVERED RUNWAY

Ident.: PER-TOF-CTA-40-30-00001794.0117001 / 01 APR 11

Applicable to: ALL

- Determine maximum takeoff weight on dry runway.
- Apply the following weight decrement versus takeoff configuration, runway length and clearway availability to determine a corrected weight.

| TAKEOFF CONFIGURATION | CONF 1 + F | | | | CONF 2 | | | CONF 3 | | |
|--|----------------|-----------------|-----------------|---------------------------------|----------------|----------------|---------------------------------|----------------|----------------|--------------------------------|
| RUNWAY LENGTH (m) (ft) | 2 500 8 000 | 3 000 10 000 | 3 500 11 500 | 4 000 13 000 and above | 2 000 6 500 | 2 500 8 000 | 3 000 10 000 and above | 1 750 5 750 | 2 000 6 500 | 2 500 8 000 and above |
| Δ Weight (1 000 kg) With clearway Without clearway | 16.7 14.4 | 15.7 14.1 | 12.9 12.0 | 10.4 9.6 | 17.3 13.3 | 16.6 14.5 | 15.5 14.5 | 17.5 14.0 | 17.5 14.8 | 16.3 15.0 |

- Enter the following tables with the corrected weight to determine MTOW then determine takeoff speeds associated with actual TOW.

CONF 1 + F

| | | | | | | | | | | | | | | | | | | | | |
|-----------------------------|-------|------|----|------|---------------------------|--|--|--|--|--|--|--|--|--|--|--|--|--|--|--|
| CORRECTED WEIGHT (1 000 kg) | <51.4 | 51.4 | 52 | 52.7 | 52.7 to 78 | | | | | | | | | | | | | | | |
| MTOW (1 000 kg) | - | 46.7 | 49 | 52.7 | EQUAL TO CORRECTED WEIGHT | | | | | | | | | | | | | | | |

| | | | | | | | | | | | | | | | | | | | |
|--------------------------|-------|------|-----|-----|-----|------|-----|-----|-----|-----|-----|-----|-----|-----|-----|-----|-----|-----|-----|
| ACTUAL WEIGHT (1 000 kg) | <46.7 | 46.7 | 48 | 50 | 52 | 52.7 | 54 | 56 | 58 | 60 | 62 | 64 | 66 | 68 | 70 | 72 | 74 | 76 | 78 |
| V2 (kt IAS) | 124 | 124 | 126 | 129 | 131 | 132 | 134 | 136 | 138 | 141 | 143 | 145 | 148 | 150 | 152 | 155 | 157 | 159 | 161 |
| VR (kt IAS) | 122 | 122 | 124 | 127 | 129 | 130 | 132 | 134 | 136 | 139 | 141 | 143 | 146 | 148 | 150 | 153 | 155 | 157 | 159 |
| V1 (kt IAS) | 117 | 117 | 117 | 117 | 117 | 117 | 119 | 121 | 123 | 126 | 128 | 130 | 133 | 135 | 137 | 140 | 142 | 144 | 146 |

CONF 2

| | | | | | | | | | | | | | | | | | | | |
|-----------------------------|-------|------|----|---------------------------|--|--|--|--|--|--|--|--|--|--|--|--|--|--|--|
| CORRECTED WEIGHT (1 000 kg) | <52.9 | 52.9 | 54 | 54 to 78 | | | | | | | | | | | | | | | |
| MTOW (1 000 kg) | - | 48 | 54 | EQUAL TO CORRECTED WEIGHT | | | | | | | | | | | | | | | |



A318/A319/A320/A321
 FLIGHT CREW
 OPERATING MANUAL

PERFORMANCE

TAKEOFF

RUNWAY CONTAMINATION - TAKEOFF PERFORMANCE

| | | | | | | | | | | | | | | | | | |
|---------------------------------|-----|-----|-----|-----|-----|-----|-----|-----|-----|-----|-----|-----|-----|-----|-----|-----|-----|
| ACTUAL WEIGHT (1 000 kg) | <48 | 48 | 50 | 52 | 54 | 56 | 58 | 60 | 62 | 64 | 66 | 68 | 70 | 72 | 74 | 76 | 78 |
| V2 (kt IAS) | 124 | 124 | 127 | 129 | 132 | 134 | 137 | 139 | 141 | 143 | 146 | 148 | 150 | 153 | 155 | 157 | 159 |
| VR (kt IAS) | 119 | 119 | 122 | 124 | 127 | 129 | 132 | 134 | 136 | 138 | 141 | 143 | 145 | 148 | 150 | 152 | 154 |
| V1 (kt IAS) | 115 | 115 | 115 | 115 | 115 | 117 | 120 | 122 | 124 | 126 | 129 | 131 | 133 | 136 | 138 | 140 | 142 |

CONF 3

| | | | | | | | | | | | | | | | | | |
|------------------------------------|-----|----|----|----------------------------------|--|--|--|--|--|--|--|--|--|--|--|--|--|
| CORRECTED WEIGHT (1 000 kg) | <54 | 54 | 56 | 56 to 78 | | | | | | | | | | | | | |
| MTOW (1 000 kg) | - | 48 | 56 | EQUAL TO CORRECTED WEIGHT | | | | | | | | | | | | | |

| | | | | | | | | | | | | | | | | | |
|---------------------------------|-----|-----|-----|-----|-----|-----|-----|-----|-----|-----|-----|-----|-----|-----|-----|-----|-----|
| ACTUAL WEIGHT (1 000 kg) | <48 | 48 | 50 | 52 | 54 | 56 | 58 | 60 | 62 | 64 | 66 | 68 | 70 | 72 | 74 | 76 | 78 |
| V2 (kt IAS) | 123 | 123 | 126 | 128 | 131 | 133 | 135 | 138 | 140 | 142 | 145 | 147 | 149 | 151 | 153 | 155 | 157 |
| VR (kt IAS) | 118 | 118 | 121 | 123 | 126 | 128 | 130 | 133 | 135 | 137 | 140 | 142 | 144 | 146 | 148 | 150 | 152 |
| V1 (kt IAS) | 114 | 114 | 114 | 114 | 114 | 114 | 116 | 119 | 121 | 123 | 126 | 128 | 130 | 132 | 134 | 136 | 138 |



A318/A319/A320/A321
FLIGHT CREW
OPERATING MANUAL

PERFORMANCE

TAKEOFF

RUNWAY CONTAMINATION - TAKEOFF PERFORMANCE

TAKEOFF FROM A 6.3 MM (1/4 INCH) SLUSH COVERED RUNWAY

Ident.: PER-TOF-CTA-40-30-00001787.0374001 / 25 MAR 11

Applicable to: ALL

- Determine maximum takeoff weight on dry runway.
- Apply the following weight decrement versus takeoff configuration, runway length and clearway availability to determine a corrected weight.

| TAKEOFF CONFIGURATION | CONF 1 + F | | | | CONF 2 | | | CONF 3 | | |
|--|----------------|-----------------|-----------------|---------------------------------|----------------|----------------|---------------------------------|----------------|----------------|--------------------------------|
| RUNWAY LENGTH (m) (ft) | 2 500 8 000 | 3 000 10 000 | 3 500 11 500 | 4 000 13 000 and above | 2 000 6 500 | 2 500 8 000 | 3 000 10 000 and above | 1 750 5 750 | 2 000 6 500 | 2 500 8 000 and above |
| Δ Weight (1 000 kg) With clearway Without clearway | 13.2 10.9 | 11.8 10.2 | 9.8 9.0 | 9.8 9.0 | 14.5 11.7 | 13.8 11.7 | 11.6 10.6 | 15.2 11.5 | 15.2 12.5 | 13.9 12.6 |

- Enter the following tables with the corrected weight to determine MTOW then determine takeoff speeds associated with actual TOW.

CONF 1 + F

| | | | | | | | | | | | | | | | | | | | | |
|-----------------------------|-------|------|----|----|---------------------------|--|--|--|--|--|--|--|--|--|--|--|--|--|--|--|
| CORRECTED WEIGHT (1 000 kg) | <53.2 | 53.2 | 54 | 55 | 55 to 78 | | | | | | | | | | | | | | | |
| MTOW (1 000 kg) | - | 46.7 | 51 | 55 | EQUAL TO CORRECTED WEIGHT | | | | | | | | | | | | | | | |

| | | | | | | | | | | | | | | | | | | | |
|--------------------------|-------|------|-----|-----|-----|-----|-----|-----|-----|-----|-----|-----|-----|-----|-----|-----|-----|-----|-----|
| ACTUAL WEIGHT (1 000 kg) | <46.7 | 46.7 | 48 | 50 | 52 | 54 | 55 | 56 | 58 | 60 | 62 | 64 | 66 | 68 | 70 | 72 | 74 | 76 | 78 |
| V2 (kt IAS) | 124 | 124 | 126 | 129 | 131 | 134 | 135 | 136 | 138 | 141 | 143 | 145 | 148 | 150 | 152 | 155 | 157 | 159 | 161 |
| VR (kt IAS) | 122 | 122 | 124 | 127 | 129 | 132 | 133 | 134 | 136 | 139 | 141 | 143 | 146 | 148 | 150 | 153 | 155 | 157 | 159 |
| V1 (kt IAS) | 117 | 117 | 117 | 117 | 117 | 117 | 117 | 118 | 120 | 123 | 125 | 127 | 130 | 132 | 134 | 137 | 139 | 141 | 143 |

CONF 2

| | | | | | | | | | | | | | | | | | | | | |
|-----------------------------|-------|------|----|------|---------------------------|--|--|--|--|--|--|--|--|--|--|--|--|--|--|--|
| CORRECTED WEIGHT (1 000 kg) | <54.8 | 54.8 | 56 | 56.7 | 56.7 to 76 | | | | | | | | | | | | | | | |
| MTOW (1 000 kg) | - | 48 | 53 | 56.7 | EQUAL TO CORRECTED WEIGHT | | | | | | | | | | | | | | | |



A318/A319/A320/A321
 FLIGHT CREW
 OPERATING MANUAL

PERFORMANCE

TAKEOFF

RUNWAY CONTAMINATION - TAKEOFF PERFORMANCE

| | | | | | | | | | | | | | | | | | | |
|---------------------------------|-----|-----|-----|-----|-----|-----|------|-----|-----|-----|-----|-----|-----|-----|-----|-----|-----|-----|
| ACTUAL WEIGHT (1 000 kg) | <48 | 48 | 50 | 52 | 54 | 56 | 56.7 | 58 | 60 | 62 | 64 | 66 | 68 | 70 | 72 | 74 | 76 | 78 |
| V2 (kt IAS) | 124 | 124 | 127 | 129 | 132 | 134 | 135 | 137 | 139 | 141 | 143 | 146 | 148 | 150 | 153 | 155 | 157 | 159 |
| VR (kt IAS) | 119 | 119 | 122 | 124 | 127 | 129 | 130 | 132 | 134 | 136 | 138 | 141 | 143 | 145 | 148 | 150 | 152 | 154 |
| V1 (kt IAS) | 115 | 115 | 115 | 115 | 115 | 115 | 115 | 117 | 119 | 121 | 123 | 126 | 128 | 130 | 133 | 135 | 137 | 139 |

CONF 3

| | | | | | | | | | | | | | | | | | | |
|------------------------------------|-------|------|----|------|----------------------------------|--|--|--|--|--|--|--|--|--|--|--|--|--|
| CORRECTED WEIGHT (1 000 kg) | <56.3 | 56.3 | 58 | 58.7 | 58.7 to 78 | | | | | | | | | | | | | |
| MTOW (1 000 kg) | - | 48 | 55 | 58.7 | EQUAL TO CORRECTED WEIGHT | | | | | | | | | | | | | |

| | | | | | | | | | | | | | | | | | | |
|---------------------------------|-----|-----|-----|-----|-----|-----|-----|------|-----|-----|-----|-----|-----|-----|-----|-----|-----|-----|
| ACTUAL WEIGHT (1 000 kg) | <48 | 48 | 50 | 52 | 54 | 56 | 58 | 58.7 | 60 | 62 | 64 | 66 | 68 | 70 | 72 | 74 | 76 | 78 |
| V2 (kt IAS) | 123 | 123 | 126 | 128 | 131 | 133 | 135 | 136 | 138 | 140 | 142 | 145 | 147 | 149 | 151 | 153 | 155 | 157 |
| VR (kt IAS) | 118 | 118 | 121 | 123 | 126 | 128 | 130 | 131 | 133 | 135 | 137 | 140 | 142 | 144 | 146 | 148 | 150 | 152 |
| V1 (kt IAS) | 114 | 114 | 114 | 114 | 114 | 114 | 114 | 114 | 116 | 118 | 120 | 123 | 125 | 127 | 129 | 131 | 133 | 135 |



A318/A319/A320/A321
 FLIGHT CREW
 OPERATING MANUAL

PERFORMANCE

TAKEOFF

RUNWAY CONTAMINATION - TAKEOFF PERFORMANCE

TAKEOFF FROM A 12.7 MM (1/2 INCH) SLUSH COVERED RUNWAY

Ident.: PER-TOF-CTA-40-30-00001788.0369001 / 23 JUN 15

Applicable to: ALL

- Determine maximum takeoff weight on dry runway.
- Apply the following weight decrement versus takeoff configuration, runway length and clearway availability to determine a corrected weight.

| TAKEOFF CONFIGURATION | CONF 1 + F | | | | CONF 2 | | | CONF 3 | | |
|---|------------------------------|-------------------------------|-------------------------------|---|------------------------------|------------------------------|---|------------------------------|------------------------------|--|
| RUNWAY LENGTH (m) (ft) | 2 500 8 000 | 3 000 10 000 | 3 500 11 500 | 4 000 13 000 and above | 2 000 6 500 | 2 500 8 000 | 3 000 10 000 and above | 1 750 5 750 | 2 000 6 500 | 2 500 8 000 and above |
| Δ Weight (1 000 kg) With clearway Without clearway | 18.9 17.3 | 18.9 17.3 | 16.3 15.4 | 15.4 14.6 | 18.7 14.7 | 18.7 16.6 | 17.9 16.9 | 18.9 15.4 | 18.4 15.7 | 18.3 17.0 |

- Enter the following tables with the corrected weight to determine MTOW then determine takeoff speeds associated with actual TOW.

CONF 1 + F

| | | | | | | | | | | | | | | | | | | | | |
|---------------------------------------|-------|------|----|---------------------------|--|--|--|--|--|--|--|--|--|--|--|--|--|--|--|--|
| CORRECTED WEIGHT (1 000 kg) | <47.8 | 47.8 | 48 | 48 to 78 | | | | | | | | | | | | | | | | |
| MTOW (1 000 kg) | - | 46.7 | 48 | EQUAL TO CORRECTED WEIGHT | | | | | | | | | | | | | | | | |

| ACTUAL WEIGHT (1 000 kg) | <46.7 | 46.7 | 48 | 50 | 52 | 54 | 56 | 58 | 60 | 62 | 64 | 66 | 68 | 70 | 72 | 74 | 76 | 78 |
|-----------------------------|-------|------|-----|-----|-----|-----|-----|-----|-----|-----|-----|-----|-----|-----|-----|-----|-----|-----|
| V2 (kt IAS) | 124 | 124 | 126 | 129 | 131 | 134 | 136 | 138 | 141 | 143 | 145 | 148 | 150 | 152 | 155 | 157 | 159 | 161 |
| VR (kt IAS) | 123 | 123 | 125 | 128 | 130 | 133 | 135 | 137 | 140 | 142 | 144 | 147 | 149 | 151 | 154 | 156 | 158 | 160 |
| V1 (kt IAS) | 117 | 117 | 117 | 120 | 122 | 125 | 127 | 129 | 132 | 134 | 136 | 139 | 141 | 143 | 146 | 148 | 150 | 152 |

CONF 2

| | | | | | | | | | | | | | | | | | | | | |
|---------------------------------------|-------|------|----|---------------------------|--|--|--|--|--|--|--|--|--|--|--|--|--|--|--|--|
| CORRECTED WEIGHT (1 000 kg) | <49.5 | 49.5 | 50 | 50 to 78 | | | | | | | | | | | | | | | | |
| MTOW (1 000 kg) | - | 47 | 50 | EQUAL TO CORRECTED WEIGHT | | | | | | | | | | | | | | | | |



A318/A319/A320/A321
 FLIGHT CREW
 OPERATING MANUAL

PERFORMANCE

TAKEOFF

RUNWAY CONTAMINATION - TAKEOFF PERFORMANCE

| ACTUAL WEIGHT (1 000 kg) | <47 | 47 | 48 | 50 | 52 | 54 | 56 | 58 | 60 | 62 | 64 | 66 | 68 | 70 | 72 | 74 | 76 | 78 |
|-----------------------------|-----|-----|-----|-----|-----|-----|-----|-----|-----|-----|-----|-----|-----|-----|-----|-----|-----|-----|
| V2 (kt IAS) | 123 | 123 | 124 | 127 | 129 | 132 | 134 | 137 | 139 | 141 | 143 | 146 | 148 | 150 | 153 | 155 | 157 | 159 |
| VR (kt IAS) | 119 | 119 | 120 | 123 | 125 | 128 | 130 | 133 | 135 | 137 | 139 | 142 | 144 | 146 | 149 | 151 | 153 | 155 |
| V1 (kt IAS) | 115 | 115 | 115 | 115 | 117 | 120 | 122 | 125 | 127 | 129 | 131 | 134 | 136 | 138 | 141 | 143 | 145 | 147 |

CONF 3

| CORRECTED WEIGHT (1 000 kg) | <51 | 51 | 52 | 52 to 78 | | | | | | | | | | | | | | | |
|--------------------------------|-----|----|----|---------------------------|--|--|--|--|--|--|--|--|--|--|--|--|--|--|--|
| MTOW (1 000 kg) | - | 48 | 52 | EQUAL TO CORRECTED WEIGHT | | | | | | | | | | | | | | | |

| ACTUAL WEIGHT (1 000 kg) | <48 | 48 | 50 | 52 | 54 | 56 | 58 | 60 | 62 | 64 | 66 | 68 | 70 | 72 | 74 | 76 | 78 |
|-----------------------------|-----|-----|-----|-----|-----|-----|-----|-----|-----|-----|-----|-----|-----|-----|-----|-----|-----|
| V2 (kt IAS) | 123 | 123 | 126 | 128 | 131 | 133 | 135 | 138 | 140 | 142 | 145 | 147 | 149 | 151 | 153 | 155 | 157 |
| VR (kt IAS) | 119 | 119 | 122 | 124 | 127 | 129 | 131 | 134 | 136 | 138 | 141 | 143 | 145 | 147 | 149 | 151 | 153 |
| V1 (kt IAS) | 114 | 114 | 114 | 114 | 117 | 119 | 121 | 124 | 126 | 128 | 131 | 133 | 135 | 137 | 139 | 141 | 143 |

PERFORMANCE

TAKEOFF

RUNWAY CONTAMINATION - TAKEOFF PERFORMANCE

TAKEOFF FROM A COMPACTED SNOW COVERED RUNWAY

Ident.: PER-TOF-CTA-40-30-00001789.0347001 / 23 JUN 15

Applicable to: ALL

- Determine maximum takeoff weight on dry runway.
- Apply the following weight decrement versus takeoff configuration and runway length to determine a corrected weight.

| TAKEOFF CONFIGURATION | CONF 1 + F | | | | CONF 2 | | | CONF 3 | | |
|---|------------------------------|----------------|-----------------|--------------------|---------------------------------|----------------|----------------|---------------------------------|----------------|----------------|
| | RUNWAY LENGTH (m) (ft) | 2 500 8 000 | 3 000 10 000 | 3 500 11 500 | 4 000 13 000 and above | 2 000 6 500 | 2 500 8 000 | 3 000 10 000 and above | 1 750 5 750 | 2 000 6 500 |
| Δ Weight decrement (1 000 kg) With clearway Without clearway | 8.6 6.3 | 8.5 6.3 | 8.5 7.4 | 9.8 9.0 | 10.5 7.7 | 7.4 5.3 | 5.6 4.6 | 13.1 9.6 | 10.3 7.6 | 8.2 6.9 |

- Enter the following tables with the corrected weight to determine MTOW then determine takeoff speeds associated with actual TOW.

CONF 1 + F₁

| | | | | | | | | | | | | | | | | | | | |
|--------------------------------|-------|------|----|---------------------------|--|--|--|--|--|--|--|--|--|--|--|--|--|--|--|
| CORRECTED WEIGHT (1 000 kg) | <52.7 | 52.7 | 54 | 54 to 78 | | | | | | | | | | | | | | | |
| MTOW (1 000 kg) | - | 46.7 | 54 | EQUAL TO CORRECTED WEIGHT | | | | | | | | | | | | | | | |

| | | | | | | | | | | | | | | | | | | |
|-----------------------------|-------|------|-----|-----|-----|-----|-----|-----|-----|-----|-----|-----|-----|-----|-----|-----|-----|-----|
| ACTUAL WEIGHT (1 000 kg) | <46.7 | 46.7 | 48 | 50 | 52 | 54 | 56 | 58 | 60 | 62 | 64 | 66 | 68 | 70 | 72 | 74 | 76 | 78 |
| V ₂ (kt IAS) | 124 | 124 | 126 | 129 | 131 | 134 | 136 | 138 | 141 | 143 | 145 | 148 | 150 | 152 | 155 | 157 | 159 | 161 |
| VR (kt IAS) | 123 | 123 | 125 | 128 | 130 | 133 | 135 | 137 | 140 | 142 | 144 | 147 | 149 | 151 | 154 | 156 | 158 | 160 |
| V ₁ (kt IAS) | 117 | 117 | 117 | 117 | 117 | 117 | 119 | 121 | 124 | 126 | 128 | 131 | 133 | 135 | 138 | 140 | 142 | 144 |

CONF 2

| | | | | | | | | | | | | | | | | | | |
|--------------------------------|-------|------|----|------|---------------------------|--|--|--|--|--|--|--|--|--|--|--|--|--|
| CORRECTED WEIGHT (1 000 kg) | <54.8 | 54.8 | 56 | 56.7 | 56.7 to 78 | | | | | | | | | | | | | |
| MTOW | - | 48 | 53 | 56.7 | EQUAL TO CORRECTED WEIGHT | | | | | | | | | | | | | |

Continued on the following page



A318/A319/A320/A321
 FLIGHT CREW
 OPERATING MANUAL

PERFORMANCE

TAKEOFF

RUNWAY CONTAMINATION - TAKEOFF PERFORMANCE

Continued from the previous page

| | | | | | | | | | | | | | | | | | | |
|------------------------------------|-------|------|----|------|-------------------|--|--|--|--|--|--|--|--|--|--|--|--|--|
| CORRECTED WEIGHT (1 000 kg) | <54.8 | 54.8 | 56 | 56.7 | 56.7 to 78 | | | | | | | | | | | | | |
| (1 000 kg) | | | | | | | | | | | | | | | | | | |

| | | | | | | | | | | | | | | | | | | |
|---------------------------------|-----|-----|-----|-----|-----|-----|------|-----|-----|-----|-----|-----|-----|-----|-----|-----|-----|-----|
| ACTUAL WEIGHT (1 000 kg) | <48 | 48 | 50 | 52 | 54 | 56 | 56.7 | 58 | 60 | 62 | 64 | 66 | 68 | 70 | 72 | 74 | 76 | 78 |
| V2 (kt IAS) | 124 | 124 | 127 | 129 | 132 | 134 | 135 | 137 | 139 | 141 | 143 | 146 | 148 | 150 | 153 | 155 | 157 | 159 |
| VR (kt IAS) | 119 | 119 | 122 | 124 | 127 | 129 | 130 | 132 | 134 | 136 | 138 | 141 | 143 | 145 | 148 | 150 | 152 | 154 |
| V1 (kt IAS) | 115 | 115 | 115 | 115 | 115 | 115 | 115 | 117 | 119 | 121 | 123 | 126 | 128 | 130 | 133 | 135 | 137 | 139 |

CONF 3

| | | | | | | | | | | | | | | | | | | |
|------------------------------------|-------|------|----|------|---------------------------|--|--|--|--|--|--|--|--|--|--|--|--|--|
| CORRECTED WEIGHT (1 000 kg) | <56.3 | 56.3 | 58 | 58.7 | 58.7 to 78 | | | | | | | | | | | | | |
| MTOW (1 000 kg) | - | 48 | 55 | 58.7 | EQUAL TO CORRECTED WEIGHT | | | | | | | | | | | | | |

| | | | | | | | | | | | | | | | | | | |
|---------------------------------|-----|-----|-----|-----|-----|-----|-----|------|-----|-----|-----|-----|-----|-----|-----|-----|-----|-----|
| ACTUAL WEIGHT (1 000 kg) | <48 | 48 | 50 | 52 | 54 | 56 | 58 | 58.7 | 60 | 62 | 64 | 66 | 68 | 70 | 72 | 74 | 76 | 78 |
| V2 (kt IAS) | 123 | 123 | 126 | 128 | 131 | 133 | 135 | 136 | 138 | 140 | 142 | 145 | 147 | 149 | 151 | 153 | 155 | 157 |
| VR (kt IAS) | 119 | 119 | 122 | 124 | 127 | 129 | 131 | 132 | 134 | 136 | 138 | 141 | 143 | 145 | 147 | 149 | 151 | 153 |
| V1 (kt IAS) | 114 | 114 | 114 | 114 | 114 | 114 | 114 | 114 | 116 | 118 | 120 | 123 | 125 | 127 | 129 | 131 | 133 | 135 |



A318/A319/A320/A321
FLIGHT CREW
OPERATING MANUAL

PERFORMANCE

TAKEOFF

RUNWAY CONTAMINATION - TAKEOFF PERFORMANCE

Intentionally left blank

EXAMPLE

TAKEOFF PERFORMANCE ON DRY RUNWAY

Ident.: PER-TOF-CTA-40-40-00014730.0001001 / 29 JUL 16

Applicable to: ALL

DATA

The following data and graph are for example only, and are not for operational use. Even if the data in the following example is in "kg" and "m", the same method can be applied for "lb" and "ft".
 Runway length : 3 000 m, OAT = 36 °C, no wind, CONF 1+F
 Determine maximum takeoff weight on dry runway from RTOW chart (*Refer to PER-TOF-TOC-10-30 EXAMPLE OF TAKEOFF CHART*).

| OAT °C | CONF 1 + F | | | | |
|-----------|-----------------------|-----------------------|-----------------------|-----------------------|-----------------------|
| | TAILWIND -10 KT | TAILWIND -5 KT | WIND 0 KT | HEADWIND 10 KT | HEADWIND 20 KT |
| 34.0 | 76.7 4/6 143/50/52 | 78.4 4/6 148/53/55 | 80.2 4/6 154/56/58 | 81.5 4/6 157/57/60 | 82.8 4/6 160/60/62 |
| | 76.6 4/6 143/49/52 | 78.4 4/6 148/52/54 | 80.1 4/6 153/56/58 | 81.4 4/6 156/57/59 | 82.7 4/6 160/60/62 |

Maximum TOW = 80 100 kg, V1 = 153 kt, VR = 156 kt, V2 = 158 kt.

TAKEOFF PERFORMANCE ON WET RUNWAY

Ident.: PER-TOF-CTA-40-40-00014731.0001001 / 29 JUL 16

Applicable to: ALL

The following data and graphs are for example only, and are not for operational use. Even if the data in the following example is in “kg” and “m”, the same method can be applied for “lb” and “ft”.

With no thrust reversers operating and assuming that no clearway was used to compute the dry RTOW chart, use the table *Refer to PER-TOF-CTA-40-20 NO THRUST REVERSERS OPERATIVE (NO CLEARWAY)*.

| TAKEOFF CONFIGURATION | 1+F | | | 2 | | | 3 | | |
|------------------------------------|------|-------|-----------|------|------|-----------|------|------|-----------|
| RUNWAY LENGTH | 2500 | 3000 | 3500 | 2000 | 2500 | 3000 | 1750 | 2000 | 2500 |
| (m) | 8000 | 10000 | 11500 | 6500 | 8000 | 10000 | 5750 | 6500 | 8000 |
| (ft) | | | AND ABOVE | | | AND ABOVE | | | AND ABOVE |
| FLEX TO TEMPERATURE DECREMENT (°C) | 8 | 3 | 2 | 10 | 7 | 6 | 9 | 5 | 5 |
| MAX TO WEIGHT DECREMENT (1000 kg) | 2.4 | 0.9 | 0.8 | 2.8 | 2.2 | 2.2 | 2.5 | 1.5 | 1.5 |
| (1000 lb) | 5.3 | 2.0 | 1.8 | 6.2 | 4.9 | 4.9 | 5.6 | 3.4 | 3.4 |
| V1 DECREMENT (kt) | 16 | 16 | 14 | 16 | 15 | 15 | 15 | 15 | 15 |
| VR AND V2 DECREMENT (kt) | 3 | 3 | 2 | 3 | 4 | 7 | 1 | 3 | 4 |

- Maximum takeoff weight correction :
 $MTOW = 80\ 100 - 900 = 79\ 200\ kg$, $V1 = 153 - 16 = 137\ kt$, $VR = 156 - 3 = 153\ kt$, $V2 = 158 - 3 = 155\ kt$.
- Flex temperature correction :
 Assuming an actual takeoff weight of 75 000 kg and an initial flex temperature of 53 °C
 $TOW = 75\ 000\ kg \Rightarrow$ Flex temperature = $53 - 3 = 50\ ^\circ C$
 $V1 = 152 - 16 = 136\ kt$, $VR = 153 - 3 = 150\ kt$, $V2 = 154 - 3 = 151\ kt$.

Check the resulting speeds against the minimum speeds as per procedure *Refer to PER-TOF-CTA-40-20 HOW TO PROCEED*.



A318/A319/A320/A321
FLIGHT CREW
OPERATING MANUAL

PERFORMANCE

TAKEOFF

RUNWAY CONTAMINATION - TAKEOFF PERFORMANCE

TAKEOFF PERFORMANCE ON RUNWAY COVERED WITH 1/2 INCH SLUSH

Ident.: PER-TOF-CTA-40-40-00014732.0001001 / 29 JUL 16

Applicable to: ALL

DATA

The following data and graphs are for example only, and are not for operational use. Even if the data in the following example is in “kg” and “m”, the same method can be applied for “lb” and “ft”. Runway length 3 000 m (no clearway), OAT = 5 °C, 5 kt tailwind, CONF 1 + F
 Determine maximum takeoff weight on dry runway (Refer to PER-TOF-TOC-10-30 EXAMPLE OF TAKEOFF CHART)

| OAT °C | CONF 1 + F | | | | | | | | | |
|-----------|--------------------|------------------|-------------------|------------------|--------------|------------------|-------------------|------------------|-------------------|------------------|
| | TAILWIND -10 KT | | TAILWIND -5 KT | | WIND 0 KT | | HEADWIND 10 KT | | HEADWIND 20 KT | |
| 0.0 | 78.8 | 4/6 151/54/57 | 80.6 | 4/6 156/57/59 | 82.5 | 4/6 162/62/64 | 83.7 | 3/4 165/65/67 | 84.7 | 3/4 168/68/70 |
| 10.0 | 78.2 | 4/6 148/53/55 | 80.0 | 4/6 154/57/59 | 81.8 | 4/6 159/60/62 | 83.1 | 4/6 163/63/65 | 84.2 | 3/4 166/66/67 |

Maximum takeoff weight on dry runway = 80 300 kg

Determine a corrected weight (Refer to PER-TOF-CTA-40-30 TAKEOFF FROM A 12.7 MM (1/2 INCH) SLUSH COVERED RUNWAY). As no clearway, use the correction displayed on the second line (without clearway).

| TAKEOFF CONFIGURATION | CONF 1 + F | | | | CONF 2 | | | CONF 3 | | |
|------------------------|--------------|---------------|---------------|----------------------------|--------------|--------------|----------------------------|--------------|--------------|---------------------------|
| RUNWAY LENGTH (m) (ft) | 2500 8000 | 3000 10000 | 3500 11500 | 4000 13000 and above | 2000 6500 | 2500 8000 | 3000 10000 and above | 1750 5700 | 2000 6500 | 2500 8000 and above |
| ΔWEIGHT (1000 kg) | 16.8 | 15.9 | 14.5 | 13.0 | 17.4 | 16.3 | 15.9 | 19.0 | 17.3 | 17.3 |
| With clearway | 14.7 | 14.7 | 13.5 | 12.1 | 15.1 | 15.1 | 15.1 | 16.6 | 16.2 | 16.2 |
| Without clearway | | | | | | | | | | |

Corrected weight = 80 300 – 14 700 = 65 600 kg

Determine maximum takeoff weight and associated speeds :

| CONF 1 + F | CORRECTED WEIGHT (1000 kg) | <47 | 47 | 47 to 78 | | | | | | | | | | | | | | | |
|------------|----------------------------|-----|-----|---------------------------|-----|-----|-----|-----|-----|-----|-----|-----|-----|-----|-----|-----|-----|-----|-----|
| | MTOW (1000 kg) | - | 47 | EQUAL TO CORRECTED WEIGHT | | | | | | | | | | | | | | | |
| | ACTUAL WEIGHT (1000 kg) | <47 | 47 | 48 | 50 | 52 | 54 | 56 | 58 | 60 | 62 | 64 | 66 | 68 | 70 | 72 | 74 | 76 | 78 |
| | V2 (kt IAS) | 124 | 124 | 126 | 129 | 131 | 134 | 136 | 139 | 141 | 143 | 146 | 148 | 150 | 153 | 155 | 157 | 159 | 161 |
| | VR (kt IAS) | 123 | 123 | 125 | 128 | 130 | 133 | 135 | 138 | 140 | 142 | 145 | 147 | 149 | 152 | 154 | 156 | 158 | 160 |
| | V1 (kt IAS) | 118 | 118 | 120 | 123 | 125 | 128 | 130 | 133 | 135 | 137 | 140 | 142 | 144 | 147 | 149 | 151 | 153 | 155 |

MTOW = 65 600 kg



A318/A319/A320/A321
FLIGHT CREW
OPERATING MANUAL

PERFORMANCE

TAKEOFF

RUNWAY CONTAMINATION - TAKEOFF PERFORMANCE

V1 = 141 kt, VR = 147 kt, V2 = 148 kt

PERFORMANCE

FLIGHT PLANNING

Intentionally left blank

PER-FPL-GEN GENERAL

PER-FPL-GEN-MFR MINIMUM RECOMMENDED FUEL REQUIREMENTS

MINIMUM RECOMMENDED FUEL REQUIREMENTS..... A

PER-FPL-GEN-FPL FLIGHT PLAN

FLIGHT PLAN..... A

PER-FPL-FLP FLIGHT PREPARATION

PER-FPL-FLP-QFP QUICK DETERMINATION OF FLIGHT PLANNING

PER-FPL-FLP-QFP-10 INTRODUCTION

INTRODUCTION..... A

PER-FPL-FLP-QFP-20 CORRECTION FOR DEVIATION FROM REFERENCE LANDING

WEIGHT

CORRECTION FOR DEVIATION FROM REFERENCE LANDING WEIGHT..... A

PER-FPL-FLP-QFP-30 EXAMPLE

EXAMPLE..... A

PER-FPL-FLP-QFP-40 FLIGHT PLANNING AT A GIVEN MACH NUMBER

FLIGHT PLANNING M.78..... A

PER-FPL-FLP-QFP-50 FLIGHT PLANNING AT LONG RANGE SPEED

FLIGHT PLANNING LRC..... A

PER-FPL-FLP-ALN ALTERNATE

PER-FPL-FLP-ALN-20 ALL ENGINES OPERATIVE

GENERAL..... A

CORRECTION FOR DEVIATION FROM REFERENCE WEIGHT..... B

ALTERNATE PLANNING ISA..... C



A318/A319/A320/A321
FLIGHT CREW
OPERATING MANUAL

PERFORMANCE
FLIGHT PLANNING

PRELIMINARY PAGES - TABLE OF CONTENTS

Intentionally left blank

| | |
|---|---|
|  <p>A318/A319/A320/A321 FLIGHT CREW OPERATING MANUAL</p> | <p align="center">PERFORMANCE FLIGHT PLANNING</p> <p align="center">GENERAL - MINIMUM RECOMMENDED FUEL REQUIREMENTS</p> |
|---|---|

MINIMUM RECOMMENDED FUEL REQUIREMENTS

Ident.: PER-FPL-GEN-MFR-00001837.0001001 / 08 FEB 11

Applicable to: ALL

The total fuel quantity required to fly a given sector is the sum of the following quantities:

TAXI FUEL

Quantity required for startup and taxi. Fuel calculation is based on a consumption of 11.5 kg/min or 25 lb/min

Average quantity (12 min) → 140 kg or 300 lb

TRIP FUEL

Fuel required from departure to destination includes the following quantities:

- Takeoff and climb at selected speed.
- Cruise at selected speed.
- Descent from cruising level to 1 500 ft above destination airport.
- Approach and landing. Fuel calculation is based on a consumption of 20 kg/min or 45 lb/min
Average quantity (6 min IFR) → 120 kg or 270 lb

RESERVE FUEL

This quantity includes :

“EN ROUTE” RESERVE FUEL (CONTINGENCY FUEL)

- According to national regulations and company policy (generally based on a percentage of trip fuel).

ALTERNATE FUEL

- Fuel required to fly from destination to alternate airport.

It includes go-around 100 kg or 220 lb, climb to cruising level, cruise at long range speed, descent and approach procedure.

80 kg or 180 lb for 4 min VFR

HOLDING FUEL

Calculation of holding fuel should take into account the altitude of the alternate and the landing weight at the alternate. To use holding charts *Refer to PER-HLD-GEN GENERAL.*

A conservative quantity corresponding to a 30 min holding at 1 500 ft above alternate airport elevation at “green dot” speed in the clean configuration is 1 200 kg or 2 700 lb

APU FUEL

During ground operations, APU fuel consumption is about 130 kg/h or 290 lb/h (Packs ON, 90 KVA load on APU GEN).

FLIGHT PLAN

Ident.: PER-FPL-GEN-FPL-00001835.0001001 / 22 MAR 11

Applicable to: ALL

When no precalculated flight plan is available, flight planning can be determined by using the tables given in this chapter.

Fuel policy will be the same as for precalculated flight plan.

The graph on the following page defines the different terms used in this chapter.

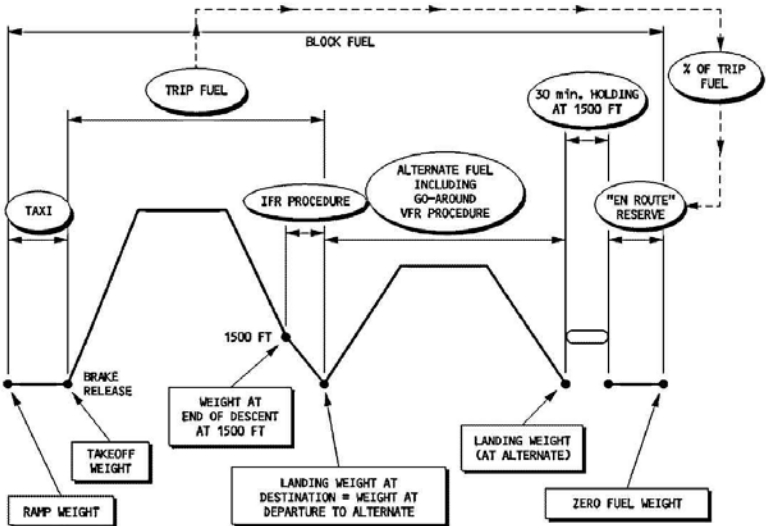



A318/A319/A320/A321
FLIGHT CREW
OPERATING MANUAL

PERFORMANCE

FLIGHT PLANNING

GENERAL - FLIGHT PLAN

Intentionally left blank

INTRODUCTION

INTRODUCTION

Ident.: PER-FPL-FLP-QFP-10-00001827.0003001 / 02 MAY 12

Applicable to: ALL

The following flight planning tables allow the planner to determine trip fuel consumption and trip time required to cover a given air distance.

These tables are established for:

- Takeoff
- Climb profile 250 kt/300 kt/M 0.78
- Cruise Mach number M 0.78/LR
- Descent profile M 0.78/300 kt/250 kt
- Approach and landing 120 kg - 6 min IFR
- ISA
- CG = 33 %
- Normal air conditioning
- Anti ice OFF

They are based upon a reference landing weight of 55 000 kg and have been calculated using databases for CFM 56–5–B/P. If the engines fitted on the aircraft are neither /P, nor /3, the fuel consumption has to be increased by 3 %.

- Note:
1. In the tables, the asterisk (*) means that a step climb of 4 000 ft must be flown to reach the corresponding FL.
 2. To obtain a flight plan at optimum cruise level, the highest flight level desired within the flight has to be selected in the table.
 3. For each degree Celsius above ISA temperature apply fuel correction $0.015 \text{ (kg/}^\circ\text{C/NM)} \times \Delta\text{ISA (}^\circ\text{C)} \times \text{Air Distance (NM)}$.



A318/A319/A320/A321
FLIGHT CREW
OPERATING MANUAL

PERFORMANCE
FLIGHT PLANNING

FLIGHT PREPARATION - QUICK DETERMINATION OF FLIGHT PLANNING

Intentionally left blank



A318/A319/A320/A321

**FLIGHT CREW
OPERATING MANUAL**

PERFORMANCE

FLIGHT PLANNING

FLIGHT PREPARATION - QUICK DETERMINATION OF FLIGHT PLANNING

CORRECTION FOR DEVIATION FROM REFERENCE LANDING WEIGHT

CORRECTION FOR DEVIATION FROM REFERENCE LANDING WEIGHT

Ident.: PER-FPL-FLP-QFP-20-00001828.0001001 / 03 MAR 11

Applicable to: ALL

The fuel consumption must be corrected when the actual landing weight is different from the reference landing weight.

If it is lower (or greater) than the reference landing weight, subtract (or add) the value given in the correction part of the table per 1 000 kg below (or above) the reference landing weight.



A318/A319/A320/A321
FLIGHT CREW
OPERATING MANUAL

PERFORMANCE
FLIGHT PLANNING

FLIGHT PREPARATION - QUICK DETERMINATION OF FLIGHT PLANNING

Intentionally left blank



A318/A319/A320/A321

FLIGHT CREW
OPERATING MANUAL

PERFORMANCE

FLIGHT PLANNING

FLIGHT PREPARATION - QUICK DETERMINATION OF FLIGHT PLANNING

EXAMPLE

EXAMPLE

Ident.: PER-FPL-FLP-QFP-30-00014738.0001001 / 04 JUL 17

Applicable to: ALL

INTRODUCTION

This section provides an example explaining step by step how to perform a quick planning. This example is based on an A320-232 aircraft, which most likely does not reflect your actual aircraft. Nevertheless, the principle is valid for any aircraft, provided the appropriate performance tables are used.

For actual calculations, access the appropriate tables corresponding to your current aircraft and desired flight profile by following the "refer to" indications specified at each step, and do not use the tables provided in the example.

EXAMPLE

The example is based on the following parameters:

- | | |
|---|-------------------|
| - Aircraft used for the example | A320-232 |
| - Zero Fuel Weight | 60 000 kg |
| - Temperature | ISA conditions |
| - Air conditioning | Normal |
| - Anti-ice | Off |
| - Cruise | M 0.78 at FL 370 |
| - Departure - destination ground distance | 1 800 NM |
| - Average wind on the leg to destination | -40 kt (headwind) |
| - Reserve fuel | 5 % |
| - Destination - alternate ground distance | 200 NM at FL 200 |
| - Average wind on the leg to alternate | 0 kt |

To calculate the flight plan, it is necessary to start from the minimum landing fuel at the alternate airport.

1. Determine the 30 minutes holding fuel required at alternate airport (at 1 500 ft AGL).
(Refer to *PER-FPL-GEN-MFR MINIMUM RECOMMENDED FUEL REQUIREMENTS* for actual 30 min fuel value).
For the example, the conservative value of 1 200 kg is chosen.
The resulting landing weight at alternate is 60 000 + 1 200 = 61 200 kg.
2. Determine time, trip fuel, and fuel correction for the leg from destination to alternate airport:

| ALTERNATE PLANNING FROM DESTINATION TO ALTERNATE AIRPORT GO-AROUND : 100 KG - CLIMB : 250KT/300KT/M.78 - CRUISE : LONG RANGE DESCENT : M.78/300KT/250KT - VMC PROCEDURE : 80 KG (4MIN) | | | | | | | | | |
|--|--------------|-------------------------------------|--------------|--------------|--------------|--|----------------|----------------|----------------|
| REF LDG. WT AT ALTERNATE = 55000 KG NORMAL AIR CONDITIONING ANTI-ICING OFF | | ISA CG = 33.0 % | | | | FUEL CONSUMED (KG) | | | |
| AIR DIST. (NM) | FLIGHT LEVEL | | | | | CORRECTION ON FUEL CONSUMPTION (KG/1000KG) | | | |
| | 100 | 120 | 140 | 160 | 180 | 200 | FL100 FL120 | FL140 FL160 | FL180 FL200 |
| 20 | | | | | | | | | |
| 40 | 529 0.12 | | | | | | 2 | | |
| 60 | 680 0.16 | 658 0.15 | | | | | 3 | | |
| 80 | 832 0.20 | 805 0.20 | 803 0.20 | 803 0.20 | 805 0.19 | | 5 | 4 | 4 |
| 100 | 984 0.24 | 952 0.24 | 945 0.24 | 941 0.23 | 939 0.23 | 938 0.22 | 6 | 6 | 5 |
| 120 | 1136 0.28 | 1099 0.28 | 1088 0.28 | 1080 0.27 | 1072 0.26 | 1065 0.26 | 7 | 7 | 6 |
| 140 | 1289 0.32 | 1246 0.32 | 1230 0.32 | 1218 0.30 | 1206 0.29 | 1192 0.29 | 9 | 8 | 6 |
| 160 | 1441 0.36 | 1393 0.36 | 1373 0.35 | 1357 0.34 | 1340 0.33 | 1319 0.32 | 10 | 10 | 7 |
| 180 | 1594 0.40 | 1541 0.40 | 1517 0.39 | 1496 0.38 | 1474 0.36 | 1446 0.35 | 11 | 11 | 8 |
| 200 | 1747 0.45 | 1689 0.44 | 1660 0.43 | 1635 0.41 | 1608 0.39 | 1573 0.38 | 13 | 12 | 9 |
| 220 | 1900 0.49 | 1837 0.48 | 1804 0.47 | 1774 0.45 | 1742 0.42 | 1701 0.42 | 14 | 14 | 9 |
| 240 | 2054 0.53 | 1995 0.52 | 1947 0.51 | 1914 0.48 | 1877 0.46 | 1828 0.45 | 15 | 15 | 10 |
| 260 | 2208 0.57 | 2134 0.56 | 2091 0.55 | 2054 0.52 | 2011 0.49 | 1955 0.48 | 17 | 16 | 11 |
| 280 | 2361 1.01 | | | | | | 18 | 18 | 12 |
| 300 | 2515 1.05 | | | | | | 20 | 19 | 12 |
| 320 | 2670 1.09 | 2580 1.08 | 2525 1.06 | 2474 1.02 | 2416 0.98 | 2338 0.98 | 21 | 20 | 13 |
| 340 | 2824 1.13 | 2730 1.12 | 2670 1.10 | 2615 1.06 | 2551 1.02 | 2466 1.01 | 22 | 22 | 14 |
| 360 | 2979 1.17 | 2879 1.16 | 2815 1.14 | 2755 1.09 | 2686 1.05 | 2593 1.04 | 24 | 23 | 14 |
| 380 | 3134 1.21 | 3029 1.20 | 2960 1.17 | 2896 1.13 | 2821 1.08 | 2721 1.07 | 25 | 24 | 15 |
| 400 | 3289 1.25 | 3179 1.23 | 3105 1.21 | 3037 1.16 | 2957 1.11 | 2849 1.10 | 26 | 26 | 16 |
| 420 | 3444 1.29 | 3329 1.27 | 3251 1.25 | 3178 1.20 | 3092 1.14 | 2977 1.13 | 28 | 27 | 17 |
| 440 | 3599 1.33 | 3479 1.31 | 3396 1.29 | 3319 1.23 | 3227 1.18 | 3105 1.17 | 29 | 28 | 17 |
| 460 | 3755 1.37 | 3629 1.35 | 3542 1.32 | 3461 1.27 | 3362 1.21 | 3233 1.20 | 31 | 30 | 18 |
| 480 | 3911 1.41 | 3780 1.39 | 3688 1.36 | 3602 1.30 | 3498 1.24 | 3361 1.23 | 32 | 31 | 19 |
| 500 | 4067 1.45 | 3931 1.43 | 3834 1.40 | 3744 1.33 | 3653 1.27 | 3489 1.26 | 33 | 32 | 19 |
| LOW AIR CONDITIONING ΔFUEL = - 0.3 % | | ENGINE ANTI ICE ON ΔFUEL = + 2 % | | | | TOTAL ANTI ICE ON ΔFUEL = + 5 % | | | |

- Convert the ground distance to air distance.
(Refer to PER-OPD-CON-AEO GENERAL for conversion).
On this leg, the average wind is zero. Therefore, the air distance equals the ground distance.
- Enter the table with the air distance and desired flight level to obtain time, trip fuel, and fuel correction.

(Refer to *PER-FPL-FLP-ALN-20 GENERAL* for actual table).

For 200 NM air distance at FL 200, the table provides 0 h 38 min, 1 573 kg and 9 kg/1 000 kg.

- c. Calculate the fuel burn correction regarding the estimated landing weight at the alternate airport.

Table reference weight : 55 000 kg

Estimated landing weight : 61 200 kg

Fuel correction 9 kg per 1 000 kg difference

The extra fuel burn is $(61.2 - 55.0) \times 9 = 56$ kg.

- d. Calculate the total trip fuel from destination to alternate.

Trip fuel : $1\ 573 + 56 = 1\ 629$ kg

The estimated landing weight at destination is $61\ 200 + 1\ 629 = 62\ 829$ kg.

3. Determine time, trip fuel, and fuel correction for the leg from departure to destination airport at M 0.78:

| FLIGHT PLANNING FROM BRAKE RELEASE TO LANDING | | | | | | | | | |
|---|---------------|---------------|---------------|--------------------|--------------|--|-------------------|----------------|----------------|
| CLIMB : 250KT/300KT/M.78 - CRUISE : M.78 - DESCENT : M.78/300KT/250KT | | | | | | | | | |
| IMC PROCEDURE : 120 KG (6MIN) | | | | | | | | | |
| REF. LANDING WEIGHT = 55000 KG | | | | ISA | | FUEL CONSUMED (KG) | | | |
| NORMAL AIR CONDITIONING | | | | CG = 33.0 % | | TIME (H.MIN) | | | |
| ANTI-ICING OFF | | | | | | | | | |
| AIR DIST. (NM) | FLIGHT LEVEL | | | | | CORRECTION ON FUEL CONSUMPTION (KG/1000KG) | | | |
| | 290 | 310 | 330 | 350 | 370 | 390 | FL290 FL310 | FL330 FL350 | FL370 FL390 |
| 1450 | 8794 3.22 | 8379 3.23 | 8063 3.25 | 7792 3.26 | 589 3.27 | 7563 3.27 | 46 | 67 | 103 |
| 1475 | 8940 3.25 | 8518 3.26 | 8196 3.28 | 7919 3.29 | 693 3.30 | 7689 3.30 | 47 | 68 | 105 |
| 1500 | 9085 3.28 | 8657 3.30 | 8328 3.31 | 8046 3.33 | 816 3.34 | 7814 3.34 | 48 | 69 | 107 |
| 1525 | 9231 3.32 | 8795 3.33 | 8461 3.35 | 8174 3.36 | 939 3.37 | 7940 3.37 | 49 | 71 | 109 |
| 1550 | 9377 3.35 | 8934 3.36 | 8594 3.38 | 8301 3.39 | 1063 3.40 | 8067 3.40 | 50 | 72 | 111 |
| 1575 | 9523 3.38 | 9073 3.40 | 8727 3.41 | 8429 3.43 | 1187 3.44 | 8193 3.44 | 51 | 73 | 113 |
| 1600 | 9669 3.41 | 9213 3.43 | 8861 3.45 | 8557 3.46 | 1311 3.47 | 8320 3.47 | 50 | 74 | 115 |
| 1625 | 9815 3.45 | 9352 3.46 | 8994 3.48 | 8685 3.50 | 1435 3.50 | 8447 3.50 | 52 | 75 | 117 |
| 1650 | 9962 3.48 | 9492 3.49 | 9128 3.51 | 8813 3.53 | 1559 3.54 | 8575 3.54 | 53 | 76 | 119 |
| 1675 | | | | | 1683 3.57 | 8703 3.57 | 54 | 78 | 121 |
| 1700 | | | | | 1808 4.01 | 8831 4.01 | 55 | 79 | 123 |
| 1725 | 10401 3.58 | 9911 3.59 | 9530 4.01 | 9198 4.03 | 1933 4.04 | 8959 4.04 | 56 | 80 | 125 |
| 1750 | 10548 4.01 | 10051 4.03 | 9664 4.04 | 9326 4.06 | 2058 4.07 | 9087 4.07 | 57 | 81 | 127 |
| 1775 | 10695 4.04 | 10191 4.06 | 9798 4.08 | 9455 4.10 | 2183 4.11 | 9216 4.11 | 58 | 82 | 129 |
| 1800 | 10842 4.07 | 10332 4.09 | 9933 4.11 | 9584 4.13 | 2309 4.14 | 9345 4.14 | 59 | 84 | 132 |
| 1825 | 10988 4.11 | 10472 4.12 | 10068 4.14 | 9713 4.16 | 2436 4.17 | 9475 4.17 | 60 | 85 | 134 |
| 1850 | 11135 4.14 | 10613 4.16 | 10203 4.18 | 9842 4.20 | 2563 4.21 | 9605 4.21 | 61 | 86 | 136 |
| 1875 | 11282 4.17 | 10754 4.19 | 10338 4.21 | 9972 4.23 | 2691 4.24 | 9747 4.24 | 62 | 87 | 138 |
| 1900 | 11430 4.20 | 10895 4.22 | 10473 4.24 | 10101 4.26 | 2819 4.27 | 9877 4.27 | 63 | 89 | 140 |
| 1925 | 11577 4.24 | 11036 4.26 | 10608 4.28 | 10231 4.30 | 2948 4.31 | 10006 4.31 | 64 | 90 | 142 |
| 1950 | 11724 4.27 | 11177 4.29 | 10744 4.31 | 10361 4.33 | 3076 4.34 | 10136 4.34 | 65 | 91 | 144 |
| 1975 | 11872 4.30 | 11318 4.32 | 10879 4.34 | 10491 4.36 | 3205 4.37 | 10266 4.38 | 66 | 93 | 146 |
| 2000 | 12019 4.33 | 11460 4.35 | 11015 4.38 | 10621 4.40 | 3334 4.41 | 10396 4.41 | 67 | 94 | 149 |
| 2025 | 12167 4.37 | 11601 4.39 | 11151 4.41 | 10751 4.43 | 3463 4.44 | 10526 4.44 | 68 | 95 | 151 |
| 2050 | 12314 4.40 | 11743 4.42 | 11287 4.44 | 10881 4.46 | 3592 4.48 | 10657 4.48 | 70 | 97 | 153 |
| 2075 | 12462 4.43 | 11885 4.45 | 11424 4.48 | 11012 4.50 | 3721 4.51 | 10787 4.51 | 71 | 98 | 155 |
| LOW AIR CONDITIONING | | | | ENGINE ANTI ICE ON | | | TOTAL ANTI ICE ON | | |
| ΔFUEL = - 0.4 % | | | | ΔFUEL = + 3 % | | | ΔFUEL = + 5.5 % | | |

a. Convert the ground distance to air distance.

(Refer to PER-OPD-CON-AEO GENERAL for conversion).

For 1 800 NM ground distance and 40 kt headwind at M 0.78, the interpolation from the table provides 1 979 NM air distance.

b. Enter the table with the air distance and desired flight level to obtain time, trip fuel, and fuel correction.

(Refer to *PER-FPL-FLP-QFP-40 FLIGHT PLANNING M.78* for actual M 0.78 table).

For 1 979 NM air distance at FL 370, the interpolation from the M 0.78 table provides 4 h 38 min, 10 226 kg and 146 kg/10 000 kg.

c. Calculate the fuel burn correction regarding the estimated landing weight at the destination airport.

Table reference weight : 55 000 kg

Estimated landing weight : 62 829 kg

Fuel correction 146 kg per 1 000 kg difference

The extra fuel burn is $(62.829 - 55) \times 146 = 1\,143$ kg.

d. Calculate the total trip fuel from departure to destination.

Trip fuel : $10\,226 + 1\,143 = 11\,369$ kg

4. Determine the contingency (reserve) fuel.

(Refer to company policy for fuel reserve value).

The five percent of the departure - destination trip fuel is:

$11\,369 \times 0.05 = 568$ kg.

5. Determine the taxi fuel at departure.

(Refer to *PER-FPL-GEN-MFR MINIMUM RECOMMENDED FUEL REQUIREMENTS* for actual taxi fuel).

For the example, the conservative value of 140 kg (12 min taxi time) is chosen.

6. Calculate the final block fuel.

| | |
|--|------------------|
| - 30 min holding at alternate (1 500 ft AGL) | 1 200 kg |
| - Trip fuel to alternate | 1 629 kg |
| - Trip fuel to destination | 11 369 kg |
| - Contingency (reserve) fuel | 568 kg |
| - Taxi fuel | 140 kg |
| Total block fuel | 14 906 kg |
| Block weight | 74 906 kg |



A318/A319/A320/A321

FLIGHT CREW
OPERATING MANUAL

PERFORMANCE

FLIGHT PLANNING

FLIGHT PREPARATION - QUICK DETERMINATION OF FLIGHT PLANNING

FLIGHT PLANNING AT A GIVEN MACH NUMBER

FLIGHT PLANNING M.78

Ident.: PER-FPL-FLP-QFP-40-00001830.0024001 / 25 FEB 11

Applicable to: ALL

| FLIGHT PLANNING FROM BRAKE RELEASE TO LANDING | | | | | | | | | |
|---|--------------|--------------|--------------|---------------------------|--------------|--|--------------------------|----------------|----------------|
| CLIMB : 250KT/300KT/M.78 - CRUISE : M.78 - DESCENT : M.78/300KT/250KT | | | | | | | | | |
| IMC PROCEDURE : 120 KG (6MIN) | | | | | | | | | |
| REF. LANDING WEIGHT = 55000 KG | | | | ISA | | FUEL CONSUMED (KG) | | | |
| NORMAL AIR CONDITIONING | | | | CG = 33.0 % | | | | | |
| ANTI-ICING OFF | | | | TIME (H.MIN) | | | | | |
| AIR DIST. (NM) | FLIGHT LEVEL | | | | | CORRECTION ON FUEL CONSUMPTION (KG/1000KG) | | | |
| | 290 | 310 | 330 | 350 | 370 | 390 | FL290 FL310 | FL330 FL350 | FL370 FL390 |
| 200 | 1628 0.38 | 1616 0.38 | 1610 0.38 | 1610 0.38 | | | 13 | 15 | |
| 225 | 1775 0.42 | 1754 0.42 | 1741 0.42 | 1734 0.42 | 1734 0.42 | | 13 | 16 | 17 |
| 250 | 1921 0.45 | 1892 0.45 | 1871 0.45 | 1858 0.45 | 1853 0.45 | 1855 0.45 | 14 | 17 | 19 |
| 275 | 2068 0.48 | 2030 0.48 | 2002 0.48 | 1982 0.48 | 1972 0.49 | 1972 0.49 | 15 | 18 | 21 |
| 300 | 2215 0.51 | 2188 0.52 | 2132 0.52 | 2107 0.52 | 2092 0.52 | 2089 0.52 | 15 | 19 | 22 |
| 325 | 2361 0.55 | 2306 0.55 | 2263 0.55 | 2231 0.55 | 2211 0.55 | 2206 0.55 | 16 | 19 | 24 |
| 350 | 2508 0.58 | 2444 0.58 | 2394 0.58 | 2355 0.58 | 2331 0.59 | 2324 0.59 | 16 | 20 | 25 |
| 375 | 2655 1.01 | 2583 1.01 | 2525 1.02 | 2480 1.02 | 2451 1.02 | 2441 1.02 | 17 | 21 | 27 |
| 400 | 2802 1.04 | 2721 1.05 | 2656 1.05 | 2605 1.05 | 2571 1.05 | 2559 1.05 | 18 | 22 | 28 |
| 425 | 2950 1.08 | 2860 1.08 | 2787 1.08 | 2730 1.09 | 2691 1.09 | 2677 1.09 | 18 | 23 | 29 |
| 450 | 3097 1.11 | 2998 1.11 | 2918 1.12 | 2855 1.12 | 2811 1.12 | 2795 1.12 | 19 | 24 | 31 |
| 475 | 3244 1.14 | 3137 1.15 | 3050 1.15 | 2980 1.15 | 2932 1.15 | 2913 1.15 | 20 | 25 | 32 |
| 500 | 3391 1.17 | 3276 1.18 | 3181 1.18 | 3105 1.19 | 3052 1.19 | 3032 1.19 | 20 | 26 | 34 |
| 525 | 3539 1.21 | 3415 1.21 | 3312 1.21 | 3230 1.22 | 3173 1.22 | 3151 1.22 | 21 | 27 | 36 |
| 550 | 3687 1.24 | 3554 1.24 | 3444 1.25 | 3355 1.25 | 3294 1.25 | 3269 1.25 | 22 | 28 | 37 |
| 575 | 3834 1.27 | 3693 1.28 | 3576 1.28 | 3481 1.29 | 3415 1.29 | 3389 1.29 | 22 | 29 | 39 |
| 600 | 3982 1.30 | 3832 1.31 | 3708 1.31 | 3607 1.32 | 3536 1.32 | 3508 1.32 | 23 | 30 | 41 |
| 625 | 4130 1.34 | 3971 1.34 | 3840 1.35 | 3732 1.35 | 3657 1.36 | 3627 1.36 | 24 | 31 | 42 |
| 650 | 4278 1.37 | 4111 1.38 | 3972 1.38 | 3858 1.39 | 3779 1.39 | 3747 1.39 | 25 | 32 | 44 |
| 675 | 4426 1.40 | 4250 1.41 | 4104 1.41 | 3984 1.42 | 3900 1.42 | 3867 1.42 | 25 | 33 | 46 |
| 700 | 4574 1.43 | 4390 1.44 | 4236 1.45 | 4110 1.45 | 4022 1.46 | 3987 1.46 | 26 | 34 | 48 |
| 725 | 4722 1.47 | 4530 1.47 | 4369 1.48 | 4237 1.49 | 4144 1.49 | 4107 1.49 | 27 | 35 | 49 |
| 750 | 4870 1.50 | 4670 1.51 | 4501 1.51 | 4363 1.52 | 4267 1.52 | 4228 1.52 | 27 | 36 | 51 |
| 775 | 5019 1.53 | 4810 1.54 | 4634 1.55 | 4490 1.55 | 4389 1.56 | 4349 1.56 | 28 | 37 | 53 |
| 800 | 5167 1.57 | 4950 1.57 | 4767 1.58 | 4617 1.59 | 4512 1.59 | 4471 1.59 | 29 | 38 | 55 |
| 825 | 5316 2.00 | 5090 2.01 | 4900 2.01 | 4744 2.02 | 4634 2.02 | 4592 2.02 | 29 | 39 | 56 |
| LOW AIR CONDITIONING | | | | ENGINE ANTI ICE ON | | | TOTAL ANTI ICE ON | | |
| ΔFUEL = -0.5 % | | | | ΔFUEL = + 2 % | | | ΔFUEL = + 4.5 % | | |

FUP23D A320 214 CFM56 584P SA3420 03301.000011 0250300 7800 .00200 120 0300350 55 0 100100 40100 18580 FCOM:02 05 40 003 180



A318/A319/A320/A321
FLIGHT CREW
OPERATING MANUAL

PERFORMANCE
FLIGHT PLANNING

FLIGHT PREPARATION - QUICK DETERMINATION OF FLIGHT PLANNING

| FLIGHT PLANNING FROM BRAKE RELEASE TO LANDING CLIMB : 250KT/300KT/M.78 - CRUISE = M.78 - DESCENT : M.78/300KT/250KT IMC PROCEDURE : 120 KG (6MIN) | | | | | | | | | |
|--|--------------|--------------|--|--------------|--------------------|--------------------------|----------------|----------------|----------------|
| REF. LANDING WEIGHT = 55000 KG | | | ISA | | FUEL CONSUMED (KG) | | | | |
| NORMAL AIR CONDITIONING | | | CG = 33.0 % | | TIME (H.MIN) | | | | |
| ANTI-ICING OFF | | | CORRECTION ON FUEL CONSUMPTION (KG/1000KG) | | | | | | |
| AIR DIST. (NM) | FLIGHT LEVEL | | | | | | | | |
| | 290 | 310 | 330 | 350 | 370 | 390 | FL290 FL310 | FL330 FL350 | FL370 FL390 |
| 825 | 5316 2.00 | 5090 2.01 | 4900 2.01 | 4744 2.02 | 4634 2.02 | 4592 2.02 | 29 | 39 | 56 |
| 850 | 5464 2.03 | 5231 2.04 | 5033 2.05 | 4871 2.05 | 4757 2.06 | 4714 2.06 | 30 | 40 | 58 |
| 875 | 5613 2.06 | 5371 2.07 | 5166 2.08 | 4998 2.09 | 4880 2.09 | 4836 2.09 | 31 | 41 | 60 |
| 900 | 5762 2.10 | 5512 2.10 | 5299 2.11 | 5125 2.12 | 5004 2.13 | 4958 2.13 | 32 | 42 | 62 |
| 925 | 5911 2.13 | 5652 2.14 | 5433 2.15 | 5253 2.15 | 5127 2.16 | 5080 2.16 | 32 | 43 | 63 |
| 950 | 6060 2.16 | 5793 2.17 | 5566 2.18 | 5380 2.19 | 5251 2.19 | 5203 2.19 | 33 | 44 | 65 |
| 975 | 6209 2.19 | 5934 2.20 | 5700 2.21 | 5508 2.22 | 5374 2.23 | 5326 2.23 | 34 | 45 | 67 |
| 1000 | 6358 2.23 | 6075 2.24 | 5833 2.24 | 5636 2.25 | 5498 2.26 | 5449 2.26 | 35 | 46 | 69 |
| 1025 | 6507 2.26 | 6216 2.27 | 5967 2.28 | 5763 2.29 | 5622 2.29 | 5572 2.29 | 35 | 47 | 71 |
| 1050 | 6657 2.29 | 6357 2.30 | 6101 2.31 | 5892 2.32 | 5746 2.33 | 5695 2.33 | 36 | 48 | 73 |
| 1075 | 6806 2.32 | 6498 2.33 | 6235 2.34 | 6020 2.35 | 5871 2.36 | 5819 2.36 | 37 | 49 | 74 |
| 1100 | 6955 2.36 | 6639 2.37 | 6369 2.38 | 6148 2.39 | 5995 2.39 | 5943 2.39 | 38 | 50 | 76 |
| 1125 | 7105 2.39 | 6781 2.40 | 6503 2.41 | 6276 2.42 | 6120 2.43 | 6067 2.43 | 38 | 51 | 78 |
| 1150 | 7255 2.42 | 6923 2.43 | 6638 2.44 | 6405 2.45 | 6245 2.46 | 6191 2.46 | 39 | 52 | 80 |
| 1175 | 7405 2.45 | 7064 2.47 | 6772 2.48 | 6534 2.49 | 6370 2.49 | 6316 2.49 | 40 | 53 | 82 |
| 1200 | 7555 2.49 | 7206 2.50 | 6907 2.51 | 6662 2.52 | 6495 2.53 | 6441 2.53 | 41 | 55 | 84 |
| 1225 | 7705 2.52 | 7348 2.53 | 7041 2.54 | 6791 2.56 | 6621 2.56 | 6566 2.56 | 41 | 56 | 86 |
| 1250 | 7855 2.55 | 7490 2.56 | 7176 2.58 | 6921 2.59 | 6746 3.00 | 6691 3.00 | 42 | 57 | 87 |
| 1275 | 8005 2.58 | 7632 3.00 | 7311 3.01 | 7050 3.02 | 6872 3.03 | 6817 3.03 | 43 | 58 | 89 |
| 1300 | 8155 3.02 | 7775 3.03 | 7446 3.04 | 7179 3.06 | 6998 3.06 | 6943 3.06 | 44 | 59 | 91 |
| 1325 | 8305 3.05 | 7917 3.06 | 7582 3.08 | 7309 3.09 | 7124 3.10 | 7069 3.10 | 45 | 60 | 93 |
| 1350 | 8456 3.08 | 8059 3.10 | 7717 3.11 | 7439 3.12 | 7251 3.13 | 7195 3.13 | 45 | 61 | 95 |
| 1375 | 8606 3.12 | 8202 3.13 | 7852 3.14 | 7569 3.16 | 7377 3.16 | 7322 3.16 | 46 | 63 | 97 |
| 1400 | 8757 3.15 | 8345 3.16 | 7988 3.18 | 7699 3.19 | 7504 3.20 | 7449 3.20 | 47 | 64 | 99 |
| 1425 | 8908 3.18 | 8488 3.19 | 8124 3.21 | 7829 3.22 | 7631 3.23 | 7576 3.23 | 48 | 65 | 101 |
| 1450 | 9059 3.21 | 8630 3.23 | 8259 3.24 | 7959 3.26 | 7758 3.26 | 7704 3.26 | 49 | 66 | 103 |
| LOW AIR CONDITIONING | | | ENGINE ANTI ICE ON | | | TOTAL ANTI ICE ON | | | |
| ΔFUEL = -0.5 % | | | ΔFUEL = + 2 % | | | ΔFUEL = + 4.5 % | | | |

FLIP23D A320-214 CFM56-5B4/P SA3420 03301.000011 0250300 .7800 .00200 120 0300350 55 0 100100 40100 18590 FCOM.02.05.40.004-180

| FLIGHT PLANNING FROM BRAKE RELEASE TO LANDING | | | | | | | | | | |
|--|---------------|---------------|--|---------------|--------------------|--|-------|-------|-------|--|
| CLIMB : 250KT/300KT/M.78 - CRUISE : M.78 - DESCENT : M.78/300KT/250KT | | | | | | | | | | |
| IMC PROCEDURE : 120 KG (6MIN) | | | | | | | | | | |
| REF. LANDING WEIGHT = 55000 KG | | | ISA | | FUEL CONSUMED (KG) | | | | | |
| NORMAL AIR CONDITIONING | | | CG = 33.0 % | | TIME (H.MIN) | | | | | |
| ANT-ICING OFF | | | CORRECTION ON FUEL CONSUMPTION (KG/1000KG) | | | | | | | |
| AIR | FLIGHT LEVEL | | | | | CORRECTION ON FUEL CONSUMPTION (KG/1000KG) | | | | |
| DIST. | | | | | | FL290 | FL330 | FL370 | | |
| (NM) | 290 | 310 | 330 | 350 | 370 | 390 | FL310 | FL350 | FL390 | |
| 1450 | 9059 3.21 | 8630 3.23 | 8259 3.24 | 7959 3.26 | 7758 3.26 | 7704 3.26 | 49 | 66 | 103 | |
| 1475 | 9210 3.25 | 8773 3.26 | 8395 3.27 | 8089 3.29 | 7885 3.30 | 7832 3.30 | 49 | 67 | 105 | |
| 1500 | 9361 3.28 | 8917 3.29 | 8531 3.31 | 8220 3.32 | 8013 3.33 | 7944 3.33* | 50 | 68 | 107 | |
| 1525 | 9512 3.31 | 9060 3.33 | 8668 3.34 | 8351 3.36 | 8141 3.37 | 8074 3.37* | 51 | 70 | 109 | |
| 1550 | 9664 3.34 | 9203 3.36 | 8804 3.37 | 8481 3.39 | 8268 3.40 | 8205 3.40* | 52 | 71 | 111 | |
| 1575 | 9815 3.38 | 9347 3.39 | 8940 3.41 | 8612 3.42 | 8396 3.43 | 8336 3.43* | 53 | 72 | 113 | |
| 1600 | 9967 3.41 | 9490 3.42 | 9077 3.44 | 8744 3.46 | 8525 3.47 | 8467 3.47* | 53 | 73 | 115 | |
| 1625 | 10119 3.44 | 9634 3.46 | 9214 3.47 | 8875 3.49 | 8653 3.50 | 8598 3.50* | 54 | 74 | 117 | |
| 1650 | 10271 3.47 | 9778 3.49 | 9351 3.51 | 9006 3.52 | 8782 3.53 | 8730 3.53* | 55 | 76 | 119 | |
| 1675 | 10423 3.51 | 9922 3.52 | 9498 3.54 | 9138 3.56 | 8910 3.57 | 8862 3.57* | 56 | 77 | 121 | |
| 1700 | 10575 3.54 | 10066 3.56 | 9625 3.57 | 9270 3.59 | 9039 4.00 | 8993 4.00* | 57 | 78 | 123 | |
| 1725 | 10727 3.57 | 10210 3.59 | 9762 4.01 | 9402 4.02 | 9168 4.03 | 9125 4.03* | 58 | 79 | 125 | |
| 1750 | 10880 4.00 | 10354 4.02 | 9900 4.04 | 9534 4.06 | 9298 4.07 | 9257 4.07* | 59 | 81 | 127 | |
| 1775 | 11032 4.04 | 10499 4.05 | 10038 4.07 | 9667 4.09 | 9427 4.10 | 9390 4.10* | 59 | 82 | 129 | |
| 1800 | 11185 4.07 | 10643 4.09 | 10176 4.11 | 9800 4.12 | 9558 4.13 | 9522 4.13* | 60 | 83 | 131 | |
| 1825 | 11337 4.10 | 10799 4.12 | 10314 4.14 | 9933 4.16 | 9689 4.17 | 9655 4.17* | 61 | 84 | 133 | |
| 1850 | 11490 4.13 | 10932 4.15 | 10452 4.17 | 10066 4.19 | 9820 4.20 | 9788 4.20* | 62 | 86 | 135 | |
| 1875 | 11643 4.17 | 11077 4.19 | 10590 4.21 | 10199 4.22 | 9951 4.24 | 9921 4.23* | 63 | 87 | 137 | |
| 1900 | 11796 4.20 | 11222 4.22 | 10729 4.24 | 10333 4.26 | 10082 4.27 | 10054 4.27* | 64 | 88 | 139 | |
| 1925 | 11949 4.23 | 11367 4.25 | 10867 4.27 | 10466 4.29 | 10214 4.30 | 10188 4.30* | 65 | 90 | 141 | |
| 1950 | 12102 4.26 | 11512 4.28 | 11006 4.30 | 10600 4.33 | 10346 4.34 | 10321 4.33* | 66 | 91 | 144 | |
| 1975 | 12255 4.30 | 11659 4.32 | 11145 4.34 | 10734 4.36 | 10478 4.37 | 10455 4.37* | 66 | 92 | 146 | |
| 2000 | 12408 4.33 | 11803 4.35 | 11283 4.37 | 10868 4.39 | 10610 4.40 | 10589 4.40* | 67 | 94 | 148 | |
| 2025 | 12562 4.36 | 11948 4.38 | 11423 4.40 | 11002 4.43 | 10742 4.44 | 10723 4.44* | 68 | 95 | 150 | |
| 2050 | 12716 4.40 | 12094 4.42 | 11562 4.44 | 11137 4.46 | 10875 4.47 | 10858 4.47* | 69 | 97 | 152 | |
| 2075 | 12869 4.43 | 12240 4.45 | 11701 4.47 | 11271 4.49 | 11008 4.50 | 10992 4.50* | 70 | 98 | 155 | |
| LOW AIR CONDITIONING | | | ENGINE ANTI ICE ON | | | TOTAL ANTI ICE ON | | | | |
| ΔFUEL = -0.5 % | | | ΔFUEL = + 2 % | | | ΔFUEL = + 4.5 % | | | | |

FLIP23D A320-214 CFM56-584/P SA3420 03301.000011 0250300.7800.00200 120 0300350 55 0 100100 40100 18590 FCOM-02-05-40-005-180

| FLIGHT PLANNING FROM BRAKE RELEASE TO LANDING | | | | | | | | | |
|---|---------------|---------------|---------------------------|---------------|---------------|--|----------------|----------------|----------------|
| CLIMB : 250KT/300KT/M.78 - CRUISE : M.78 - DESCENT : M.78/300KT/250KT | | | | | | | | | |
| IMC PROCEDURE : 120 KG (6MIN) | | | | | | | | | |
| REF. LANDING WEIGHT = 55000 KG | | | | ISA | | FUEL CONSUMED (KG) | | | |
| NORMAL AIR CONDITIONING | | | | CG = 33.0 % | | TIME (H.MIN) | | | |
| ANTI-ICING OFF | | | | | | CORRECTION ON FUEL CONSUMPTION (KG/1000KG) | | | |
| AIR DIST. (NM) | FLIGHT LEVEL | | | | | | | | |
| | 290 | 310 | 330 | 350 | 370 | 390 | FL290 FL310 | FL330 FL350 | FL370 FL390 |
| 2075 | 12869 4.43 | 12240 4.45 | 11701 4.47 | 11271 4.49 | 11008 4.50 | 10992 4.50* | 70 | 98 | 155 |
| 2100 | 13023 4.46 | 12386 4.48 | 11840 4.50 | 11406 4.53 | 11141 4.54 | 11127 4.54* | 71 | 99 | 157 |
| 2125 | 13177 4.49 | 12532 4.51 | 11980 4.54 | 11541 4.56 | 11275 4.57 | 11262 4.57* | 72 | 101 | 159 |
| 2150 | 13321 4.53 | 12678 4.55 | 12120 4.57 | 11676 4.59 | 11400 5.01 | 11387 5.00* | 73 | 102 | 161 |
| 2175 | 13485 4.56 | 12824 4.58 | 12260 5.00 | 11811 5.03 | 11542 5.04 | 11532 5.04* | 74 | 104 | 163 |
| 2200 | 13640 4.59 | 12970 5.01 | 12400 5.04 | 11947 5.06 | 11676 5.07 | 11667 5.07* | 75 | 105 | 165 |
| 2225 | 13794 5.02 | 13117 5.05 | 12540 5.07 | 12082 5.09 | 11810 5.11 | 11803 5.10* | 76 | 107 | 168 |
| 2250 | 13948 5.06 | 13264 5.08 | 12680 5.10 | 12218 5.13 | 11945 5.14 | 11939 5.14* | 77 | 108 | 170 |
| 2275 | 14103 5.09 | 13410 5.11 | 12821 5.14 | 12354 5.16 | 12080 5.17 | 12074 5.17* | 78 | 109 | 172 |
| 2300 | 14258 5.12 | 13557 5.14 | 12962 5.17 | 12490 5.19 | 12214 5.21 | 12210 5.20* | 79 | 111 | 174 |
| 2325 | 14412 5.15 | 13704 5.18 | 13102 5.20 | 12627 5.23 | 12350 5.24 | 12347 5.24* | 80 | 112 | 177 |
| 2350 | 14567 5.19 | 13851 5.21 | 13243 5.24 | 12764 5.26 | 12485 5.27 | 12483 5.27* | 81 | 114 | 179 |
| 2375 | 14723 5.22 | 13998 5.24 | 13384 5.27 | 12900 5.29 | 12621 5.31 | 12620 5.30* | 81 | 115 | 181 |
| 2400 | 14878 5.25 | 14146 5.28 | 13526 5.30 | 13037 5.33 | 12758 5.34 | 12757 5.34* | 82 | 117 | 183 |
| 2425 | 15034 5.28 | 14293 5.31 | 13667 5.33 | 13174 5.36 | 12894 5.37 | 12894 5.37* | 83 | 119 | 186 |
| 2450 | 15190 5.32 | 14441 5.34 | 13808 5.37 | 13312 5.39 | 13031 5.41 | 13032 5.40* | 84 | 120 | 188 |
| 2475 | 15346 5.35 | 14588 5.37 | 13950 5.40 | 13449 5.43 | 13168 5.44 | 13169 5.44* | 85 | 122 | 190 |
| 2500 | 15502 5.38 | 14736 5.41 | 14092 5.43 | 13587 5.46 | 13305 5.48 | 13307 5.47* | 86 | 123 | 192 |
| 2525 | 15658 5.41 | 14884 5.44 | 14234 5.47 | 13725 5.49 | 13442 5.51 | 13445 5.50* | 87 | 125 | 195 |
| 2550 | 15815 5.45 | 15033 5.47 | 14376 5.50 | 13863 5.53 | 13580 5.54 | 13584 5.54* | 88 | 126 | 197 |
| 2575 | 15971 5.48 | 15181 5.51 | 14518 5.53 | 14001 5.56 | 13718 5.58 | 13722 5.57* | 89 | 128 | 199 |
| 2600 | 16128 5.51 | 15330 5.54 | 14660 5.57 | 14139 5.59 | 13856 6.01 | 13861 6.00* | 90 | 129 | 201 |
| 2625 | 16284 5.55 | 15479 5.57 | 14803 6.00 | 14278 6.03 | 13994 6.04 | 14000 6.04* | 91 | 131 | 204 |
| 2650 | 16441 5.58 | 15628 6.00 | 14946 6.03 | 14416 6.06 | 14133 6.08 | 14139 6.07* | 92 | 133 | 206 |
| 2675 | 16598 6.01 | 15777 6.04 | 15089 6.07 | 14555 6.09 | 14271 6.11 | 14279 6.10* | 93 | 134 | 209 |
| 2700 | 16755 6.04 | 15926 6.07 | 15232 6.10 | 14694 6.13 | 14410 6.14 | 14418 6.14* | 94 | 136 | 211 |
| LOW AIR CONDITIONING | | | ENGINE ANTI ICE ON | | | TOTAL ANTI ICE ON | | | |
| ΔFUEL = -0.5 % | | | ΔFUEL = + 2 % | | | ΔFUEL = + 4.5 % | | | |

FLIP23D A320-214 CFM56-5B4/P SA3420 03301.000011 0250300 .7800 .00200 120 0300350 55 0 100100 40100 18590 FCOM.02.05.40.006-180

| FLIGHT PLANNING FROM BRAKE RELEASE TO LANDING | | | | | | | | | |
|---|---------------|---------------|--------------------|---------------|--------------------|-------------------|--|-------|-------|
| CLIMB : 250KT/300KT/M.78 - CRUISE : M.78 - DESCENT : M.78/300KT/250KT | | | | | | | | | |
| IMC PROCEDURE : 120 KG (6MIN) | | | | | | | | | |
| REF. LANDING WEIGHT = 55000 KG | | | ISA | | FUEL CONSUMED (KG) | | | | |
| NORMAL AIR CONDITIONING | | | CG = 33.0 % | | TIME (H.MIN) | | | | |
| ANTHICING OFF | | | FLIGHT LEVEL | | | | CORRECTION ON FUEL CONSUMPTION (KG/1000KG) | | |
| AIR | | | | | | | FL290 | FL330 | FL370 |
| DIST. | | | | | | | FL310 | FL350 | FL390 |
| (NM) | 290 | 310 | 330 | 350 | 370 | 390 | | | |
| 2700 | 16755 6.04 | 15926 6.07 | 15232 6.10 | 14694 6.13 | 14410 6.14 | 14418 6.14* | 94 | 136 | 211 |
| 2725 | 16912 6.08 | 16076 6.10 | 15375 6.13 | 14833 6.16 | 14550 6.18 | 14558 6.17* | 95 | 137 | 214 |
| 2750 | 17070 6.11 | 16225 6.14 | 15519 6.17 | 14973 6.20 | 14689 6.21 | 14698 6.20* | 96 | 139 | 216 |
| 2775 | 17227 6.14 | 16375 6.17 | 15663 6.20 | 15113 6.23 | 14829 6.25 | 14838 6.24* | 97 | 141 | 218 |
| 2800 | 17385 6.17 | 16525 6.20 | 15807 6.23 | 15254 6.26 | 14969 6.28 | 14979 6.27* | 99 | 142 | 220 |
| 2825 | 17542 6.21 | 16675 6.24 | 15951 6.27 | 15395 6.30 | 15109 6.31 | 15119 6.31* | 100 | 144 | 222 |
| 2850 | 17700 6.24 | 16825 6.27 | 16095 6.30 | 15535 6.33 | 15251 6.35 | 15260 6.34* | 101 | 146 | 225 |
| 2875 | 17858 6.27 | 16975 6.30 | 16240 6.33 | 15677 6.36 | 15393 6.38 | 15402 6.37* | 102 | 148 | 227 |
| 2900 | 18016 6.30 | 17125 6.33 | 16384 6.36 | 15818 6.40 | 15535 6.41 | 15543 6.41* | 103 | 150 | 229 |
| 2925 | 18175 6.34 | 17275 6.37 | 16529 6.40 | 15960 6.43 | 15675 6.45 | 15685 6.44* | 104 | 151 | 231 |
| 2950 | 18333 6.37 | 17426 6.40 | 16674 6.43 | 16101 6.46 | 15820 6.48* | 15827 6.47* | 105 | 153 | 234 |
| 2975 | 18492 6.40 | 17577 6.43 | 16819 6.46 | 16243 6.50 | 15964 6.52* | 15969 6.51* | 106 | 155 | 236 |
| 3000 | 18650 6.43 | 17727 6.47 | 16964 6.50 | 16385 6.53 | 16109 6.55* | 16112 6.54* | 107 | 157 | 238 |
| 3025 | 18809 6.47 | 17878 6.50 | 17109 6.53 | 16528 6.56 | 16255 6.58* | 16254 6.57* | 108 | 159 | 240 |
| 3050 | 18968 6.50 | 18030 6.53 | 17255 6.56 | 16670 7.00 | 16400 7.01* | 16397 7.01* | 109 | 161 | 243 |
| 3075 | 19127 6.53 | 18181 6.56 | 17401 7.00 | 16813 7.03 | 16545 7.05* | 16540 7.04* | 110 | 162 | 245 |
| 3100 | 19286 6.56 | 18333 7.00 | 17546 7.03 | 16956 7.06 | 16691 7.08* | 16683 7.07* | 111 | 164 | 247 |
| LOW AIR CONDITIONING | | | ENGINE ANTI ICE ON | | | TOTAL ANTI ICE ON | | | |
| ΔFUEL = -0.5 % | | | ΔFUEL = + 2 % | | | ΔFUEL = + 4.5 % | | | |

FPL230 A320-214 CFM56-5B4/P SA3420 03301 030011 0250300 .7800 .00200 120 0300350 55 0 100100 40100 18590 FCOM-02-05-40-007-180



A318/A319/A320/A321

FLIGHT CREW
OPERATING MANUAL

PERFORMANCE

FLIGHT PLANNING

FLIGHT PREPARATION - QUICK DETERMINATION OF FLIGHT PLANNING

FLIGHT PLANNING AT LONG RANGE SPEED

FLIGHT PLANNING LRC

Ident.: PER-FPL-FLP-QFP-50-00001831.0071001 / 17 MAR 11

Applicable to: ALL

| FLIGHT PLANNING FROM BRAKE RELEASE TO LANDING | | | | | | | | | |
|---|--------------|--------------|--------------|---------------------------|--------------|--|----------------|----------------|----------------|
| CLIMB : 250KT/300KT/M.78 - CRUISE : LONG RANGE - DESCENT : M.78/300KT/250KT | | | | | | | | | |
| IMC PROCEDURE : 120 KG (6MIN) | | | | | | | | | |
| REF. LANDING WEIGHT = 55000 KG | | | | ISA | | FUEL CONSUMED (KG) | | | |
| NORMAL AIR CONDITIONING | | | | CG = 33.0 % | | TIME (H.MIN) | | | |
| ANTI-ICING OFF | | | | | | | | | |
| AIR DIST. (NM) | FLIGHT LEVEL | | | | | CORRECTION ON FUEL CONSUMPTION (KG/1000KG) | | | |
| | 290 | 310 | 330 | 350 | 370 | 390 | FL290 FL310 | FL330 FL350 | FL370 FL390 |
| 200 | 1599 0.39 | 1602 0.39 | 1605 0.39 | 1609 0.38 | | | 15 | 16 | |
| 225 | 1732 0.43 | 1731 0.43 | 1730 0.42 | 1731 0.42 | 1733 0.42 | | 16 | 17 | 18 |
| 250 | 1865 0.47 | 1860 0.46 | 1855 0.46 | 1852 0.45 | 1852 0.45 | 1855 0.45 | 18 | 19 | 20 |
| 275 | 1998 0.51 | 1999 0.50 | 1980 0.49 | 1974 0.49 | 1971 0.49 | 1973 0.48 | 19 | 20 | 21 |
| 300 | 2132 0.54 | 2118 0.54 | 2105 0.53 | 2096 0.52 | 2090 0.52 | 2090 0.52 | 20 | 21 | 23 |
| 325 | 2265 0.58 | 2247 0.57 | 2231 0.56 | 2218 0.56 | 2209 0.55 | 2208 0.55 | 22 | 23 | 25 |
| 350 | 2399 1.02 | 2377 1.01 | 2357 1.00 | 2341 0.99 | 2329 0.99 | 2325 0.99 | 23 | 24 | 26 |
| 375 | 2532 1.06 | 2507 1.05 | 2483 1.04 | 2463 1.03 | 2448 1.02 | 2443 1.02 | 24 | 26 | 28 |
| 400 | 2666 1.09 | 2637 1.08 | 2609 1.07 | 2586 1.06 | 2568 1.06 | 2562 1.05 | 25 | 27 | 30 |
| 425 | 2801 1.13 | 2767 1.12 | 2735 1.11 | 2708 1.10 | 2688 1.09 | 2680 1.09 | 27 | 28 | 31 |
| 450 | 2935 1.17 | 2897 1.16 | 2861 1.14 | 2831 1.13 | 2808 1.12 | 2798 1.12 | 28 | 30 | 33 |
| 475 | 3069 1.21 | 3027 1.19 | 2988 1.18 | 2954 1.17 | 2928 1.16 | 2917 1.15 | 29 | 31 | 35 |
| 500 | 3204 1.24 | 3158 1.23 | 3114 1.21 | 3078 1.20 | 3048 1.19 | 3036 1.19 | 31 | 33 | 37 |
| 525 | 3339 1.28 | 3289 1.26 | 3241 1.25 | 3201 1.23 | 3169 1.22 | 3155 1.22 | 32 | 34 | 38 |
| 550 | 3474 1.32 | 3420 1.30 | 3368 1.28 | 3325 1.27 | 3290 1.26 | 3275 1.25 | 33 | 36 | 40 |
| 575 | 3609 1.36 | 3551 1.34 | 3496 1.32 | 3448 1.30 | 3411 1.29 | 3394 1.29 | 35 | 37 | 42 |
| 600 | 3744 1.39 | 3682 1.37 | 3623 1.35 | 3572 1.34 | 3532 1.32 | 3514 1.32 | 36 | 38 | 44 |
| 625 | 3880 1.43 | 3813 1.41 | 3750 1.39 | 3696 1.37 | 3653 1.36 | 3634 1.35 | 38 | 40 | 46 |
| 650 | 4016 1.47 | 3945 1.45 | 3878 1.42 | 3821 1.41 | 3774 1.39 | 3754 1.39 | 39 | 41 | 48 |
| 675 | 4152 1.50 | 4076 1.48 | 4006 1.46 | 3945 1.44 | 3896 1.43 | 3875 1.42 | 40 | 43 | 49 |
| 700 | 4288 1.54 | 4208 1.52 | 4134 1.49 | 4070 1.47 | 4018 1.46 | 3996 1.45 | 42 | 44 | 51 |
| 725 | 4424 1.58 | 4340 1.55 | 4262 1.53 | 4194 1.51 | 4140 1.49 | 4117 1.49 | 43 | 46 | 53 |
| 750 | 4561 2.02 | 4473 1.59 | 4391 1.56 | 4319 1.54 | 4262 1.53 | 4238 1.52 | 44 | 47 | 55 |
| 775 | 4697 2.05 | 4605 2.03 | 4520 2.00 | 4445 1.98 | 4385 1.96 | 4360 1.95 | 46 | 48 | 57 |
| 800 | 4834 2.09 | 4738 2.06 | 4648 2.03 | 4570 2.01 | 4507 1.99 | 4482 1.99 | 47 | 50 | 59 |
| 825 | 4971 2.13 | 4870 2.10 | 4777 2.07 | 4696 2.05 | 4630 2.03 | 4604 2.02 | 48 | 51 | 60 |
| LOW AIR CONDITIONING | | | | ENGINE ANTI ICE ON | | TOTAL ANTI ICE ON | | | |
| ΔFUEL = -0.5 % | | | | ΔFUEL = + 2.5 % | | ΔFUEL = + 5 % | | | |

FPL23D A320 214 CFM56 584P SA3420 03301.000011 0250300 .7801 .00200 120 0300350 55 0 100100 40100 18580 FCOM:02:05:40-008-180



A318/A319/A320/A321
FLIGHT CREW
OPERATING MANUAL

PERFORMANCE
FLIGHT PLANNING

FLIGHT PREPARATION - QUICK DETERMINATION OF FLIGHT PLANNING

| FLIGHT PLANNING FROM BRAKE RELEASE TO LANDING | | | | | | | | | |
|---|--------------|--------------|--------------|---------------------------|--------------|--|----------------|----------------|----------------|
| CLIMB : 250KT/300KT/M.78 - CRUISE : LONG RANGE - DESCENT : M.78/300KT/250KT | | | | | | | | | |
| IMC PROCEDURE : 120 KG (6MIN) | | | | | | | | | |
| REF. LANDING WEIGHT = 55000 KG | | | | ISA | | FUEL CONSUMED (KG) | | | |
| NORMAL AIR CONDITIONING | | | | CG = 33.0 % | | | | | |
| ANTI-ICING OFF | | | | TIME (H.MIN) | | | | | |
| AIR DIST. (NM) | FLIGHT LEVEL | | | | | CORRECTION ON FUEL CONSUMPTION (KG/1000KG) | | | |
| | 290 | 310 | 330 | 350 | 370 | 390 | FL290 FL310 | FL330 FL350 | FL370 FL390 |
| 825 | 4971 2.13 | 4870 2.10 | 4777 2.07 | 4696 2.05 | 4630 2.03 | 4604 2.02 | 48 | 51 | 60 |
| 850 | 5108 2.16 | 5003 2.13 | 4907 2.10 | 4821 2.08 | 4753 2.06 | 4726 2.05 | 50 | 53 | 62 |
| 875 | 5246 2.20 | 5137 2.17 | 5036 2.14 | 4947 2.11 | 4876 2.09 | 4849 2.09 | 51 | 54 | 64 |
| 900 | 5383 2.24 | 5270 2.21 | 5166 2.17 | 5073 2.15 | 5000 2.13 | 4971 2.12 | 53 | 56 | 66 |
| 925 | 5521 2.27 | 5403 2.24 | 5295 2.21 | 5200 2.18 | 5123 2.16 | 5094 2.15 | 54 | 57 | 68 |
| 950 | 5659 2.31 | 5537 2.28 | 5425 2.24 | 5326 2.22 | 5247 2.20 | 5218 2.19 | 55 | 59 | 70 |
| 975 | 5797 2.35 | 5671 2.31 | 5555 2.28 | 5453 2.25 | 5371 2.23 | 5341 2.22 | 57 | 60 | 72 |
| 1000 | 5936 2.38 | 5805 2.35 | 5686 2.31 | 5580 2.28 | 5495 2.26 | 5465 2.25 | 58 | 62 | 74 |
| 1025 | 6074 2.42 | 5939 2.38 | 5816 2.35 | 5707 2.32 | 5620 2.30 | 5589 2.29 | 60 | 63 | 75 |
| 1050 | 6213 2.46 | 6073 2.42 | 5947 2.38 | 5834 2.35 | 5744 2.33 | 5713 2.32 | 61 | 65 | 77 |
| 1075 | 6352 2.49 | 6207 2.46 | 6077 2.42 | 5961 2.39 | 5869 2.36 | 5837 2.35 | 62 | 66 | 79 |
| 1100 | 6491 2.53 | 6342 2.49 | 6208 2.45 | 6089 2.42 | 5994 2.40 | 5962 2.39 | 64 | 67 | 81 |
| 1125 | 6630 2.57 | 6477 2.53 | 6340 2.49 | 6217 2.45 | 6119 2.43 | 6087 2.42 | 65 | 69 | 83 |
| 1150 | 6770 3.00 | 6612 2.56 | 6471 2.52 | 6345 2.49 | 6244 2.46 | 6212 2.45 | 67 | 70 | 85 |
| 1175 | 6910 3.04 | 6747 3.00 | 6603 2.56 | 6473 2.52 | 6370 2.50 | 6337 2.49 | 68 | 72 | 87 |
| 1200 | 7049 3.08 | 6883 3.03 | 6734 2.59 | 6601 2.55 | 6495 2.53 | 6463 2.52 | 69 | 73 | 89 |
| 1225 | 7190 3.11 | 7018 3.07 | 6866 3.02 | 6729 2.59 | 6621 2.56 | 6589 2.55 | 71 | 75 | 91 |
| 1250 | 7330 3.15 | 7154 3.10 | 6999 3.06 | 6858 3.02 | 6747 3.00 | 6715 2.99 | 72 | 76 | 93 |
| 1275 | 7470 3.18 | 7290 3.14 | 7131 3.09 | 6987 3.06 | 6874 3.03 | 6841 3.02 | 74 | 78 | 95 |
| 1300 | 7611 3.22 | 7426 3.18 | 7264 3.13 | 7116 3.09 | 7000 3.06 | 6968 3.05 | 75 | 79 | 97 |
| 1325 | 7752 3.26 | 7562 3.21 | 7396 3.16 | 7246 3.12 | 7127 3.10 | 7095 3.09 | 77 | 81 | 99 |
| 1350 | 7893 3.29 | 7699 3.25 | 7529 3.20 | 7375 3.16 | 7254 3.13 | 7223 3.12 | 78 | 83 | 101 |
| 1375 | 8035 3.33 | 7836 3.28 | 7663 3.23 | 7505 3.19 | 7381 3.16 | 7350 3.15 | 80 | 84 | 103 |
| 1400 | 8176 3.37 | 7973 3.32 | 7796 3.26 | 7635 3.22 | 7509 3.20 | 7478 3.19 | 81 | 86 | 105 |
| 1425 | 8318 3.40 | 8110 3.35 | 7930 3.30 | 7765 3.26 | 7637 3.23 | 7606 3.22 | 82 | 87 | 107 |
| 1450 | 8460 3.44 | 8247 3.39 | 8063 3.33 | 7896 3.29 | 7764 3.26 | 7735 3.25 | 84 | 89 | 109 |
| LOW AIR CONDITIONING | | | | ENGINE ANTI ICE ON | | TOTAL ANTI ICE ON | | | |
| ΔFUEL = -0.5 % | | | | ΔFUEL = + 2.5 % | | ΔFUEL = + 5 % | | | |

FLIP23D A320-214 CFM56-5B4/P SA3420 03301.000011 0250300 .7801 .00200 120 0300350 55 0 100100 40100 18590 FCOM.02.05.40.009-180

| FLIGHT PLANNING FROM BRAKE RELEASE TO LANDING | | | | | | | | | | |
|---|---------------|---------------|--|---------------|--------------------|--|--------------------------|----------------|----------------|--|
| CLIMB : 250KT/300KT/M.78 - CRUISE : LONG RANGE - DESCENT : M.78/300KT/250KT | | | | | | | | | | |
| IMC PROCEDURE : 120 KG (6MIN) | | | | | | | | | | |
| REF. LANDING WEIGHT = 55000 KG | | | ISA | | FUEL CONSUMED (KG) | | | | | |
| NORMAL AIR CONDITIONING | | | CG = 33.0 % | | TIME (H.MIN) | | | | | |
| ANTHICING OFF | | | CORRECTION ON FUEL CONSUMPTION (KG/1000KG) | | | | | | | |
| AIR DIST. (NM) | FLIGHT LEVEL | | | | | CORRECTION ON FUEL CONSUMPTION (KG/1000KG) | | | | |
| | 290 | 310 | 330 | 350 | 370 | 390 | FL290 FL310 | FL330 FL350 | FL370 FL390 | |
| 1450 | 8460 3.44 | 8247 3.39 | 8063 3.33 | 7896 3.29 | 7764 3.26 | 7735 3.25 | 84 | 89 | 109 | |
| 1475 | 8502 3.47 | 8384 3.42 | 8197 3.37 | 8026 3.32 | 7892 3.30 | 7863 3.29 | 85 | 90 | 111 | |
| 1500 | 8744 3.51 | 8522 3.46 | 8332 3.40 | 8157 3.36 | 8021 3.33 | 7990 3.32* | 87 | 92 | 113 | |
| 1525 | 8887 3.55 | 8660 3.49 | 8466 3.43 | 8289 3.39 | 8149 3.36 | 8121 3.35* | 88 | 93 | 115 | |
| 1550 | 9029 3.58 | 8798 3.53 | 8600 3.47 | 8419 3.42 | 8278 3.40 | 8251 3.39* | 90 | 95 | 117 | |
| 1575 | 9172 4.02 | 8936 3.56 | 8735 3.50 | 8550 3.46 | 8407 3.43 | 8400 3.42* | 91 | 96 | 119 | |
| 1600 | 9315 4.05 | 9075 4.00 | 8870 3.54 | 8682 3.49 | 8536 3.46 | 8513 3.45* | 93 | 98 | 121 | |
| 1625 | 9458 4.09 | 9213 4.03 | 9005 3.57 | 8813 3.52 | 8665 3.50 | 8644 3.49* | 94 | 100 | 123 | |
| 1650 | 9601 4.12 | 9352 4.07 | 9141 4.00 | 8945 3.56 | 8795 3.53 | 8775 3.52* | 96 | 101 | 125 | |
| 1675 | 9745 4.16 | 9491 4.10 | 9276 4.04 | 9078 3.59 | 8924 3.56 | 8907 3.55* | 97 | 103 | 127 | |
| 1700 | 9888 4.20 | 9630 4.14 | 9411 4.07 | 9210 4.02 | 9054 3.59 | 9039 3.59* | 99 | 104 | 129 | |
| 1725 | 10032 4.23 | 9770 4.17 | 9546 4.11 | 9342 4.06 | 9185 4.03 | 9170 4.02* | 100 | 106 | 131 | |
| 1750 | 10176 4.27 | 9910 4.21 | 9682 4.14 | 9474 4.09 | 9315 4.06 | 9303 4.05* | 102 | 108 | 133 | |
| 1775 | 10321 4.30 | 10050 4.24 | 9818 4.17 | 9607 4.12 | 9446 4.09 | 9435 4.09* | 103 | 109 | 135 | |
| 1800 | 10465 4.34 | 10190 4.27 | 9954 4.21 | 9740 4.16 | 9577 4.13 | 9567 4.12* | 105 | 111 | 138 | |
| 1825 | 10610 4.37 | 10330 4.31 | 10090 4.24 | 9873 4.19 | 9708 4.16 | 9700 4.15* | 106 | 113 | 140 | |
| 1850 | 10755 4.41 | 10470 4.34 | 10226 4.28 | 10006 4.22 | 9840 4.19 | 9833 4.19* | 108 | 114 | 142 | |
| 1875 | 10900 4.45 | 10611 4.38 | 10363 4.31 | 10140 4.26 | 9972 4.23 | 9966 4.22* | 109 | 116 | 144 | |
| 1900 | 11045 4.48 | 10752 4.41 | 10500 4.34 | 10273 4.29 | 10105 4.26 | 10100 4.26* | 111 | 118 | 146 | |
| 1925 | 11191 4.52 | 10893 4.45 | 10637 4.38 | 10407 4.32 | 10237 4.29 | 10233 4.29* | 112 | 119 | 148 | |
| 1950 | 11337 4.55 | 11034 4.48 | 10774 4.41 | 10541 4.36 | 10370 4.33 | 10367 4.32* | 114 | 121 | 151 | |
| 1975 | 11483 4.59 | 11176 4.52 | 10911 4.45 | 10675 4.39 | 10503 4.36 | 10501 4.36* | 115 | 123 | 153 | |
| 2000 | 11629 5.02 | 11318 4.55 | 11049 4.48 | 10810 4.42 | 10636 4.39 | 10635 4.39* | 117 | 124 | 155 | |
| 2025 | 11775 5.06 | 11460 4.58 | 11187 4.51 | 10944 4.46 | 10769 4.43 | 10769 4.42* | 118 | 126 | 157 | |
| 2050 | 11922 5.09 | 11602 5.02 | 11325 4.55 | 11079 4.49 | 10903 4.46 | 10904 4.46* | 120 | 128 | 159 | |
| 2075 | 12068 5.13 | 11744 5.05 | 11463 4.58 | 11214 4.52 | 11037 4.49 | 11039 4.49* | 121 | 129 | 162 | |
| LOW AIR CONDITIONING | | | ENGINE ANTI ICE ON | | | | TOTAL ANTI ICE ON | | | |
| ΔFUEL = -0.5 % | | | ΔFUEL = + 2.5 % | | | | ΔFUEL = + 5 % | | | |

FLIP23D A320-214 CFM56-584/P SA3420 03301.000011 0250300.7801 .00200 120 0300350 55 0 100100 40100 18590 FCOM-02-05-40-010-180



A318/A319/A320/A321
FLIGHT CREW
OPERATING MANUAL

PERFORMANCE
FLIGHT PLANNING

FLIGHT PREPARATION - QUICK DETERMINATION OF FLIGHT PLANNING

| FLIGHT PLANNING FROM BRAKE RELEASE TO LANDING | | | | | | | | | |
|---|---------------|---------------|---------------------------|--|---------------|--------------------------|-------|-------|-------|
| CLIMB : 250KT/300KT/M.78 - CRUISE : LONG RANGE - DESCENT : M.78/300KT/250KT | | | | | | | | | |
| IMC PROCEDURE : 120 KG (6MIN) | | | | | | | | | |
| REF. LANDING WEIGHT = 55000 KG | | | | ISA | | FUEL CONSUMED (KG) | | | |
| NORMAL AIR CONDITIONING | | | | CG = 33.0 % | | TIME (H.MIN) | | | |
| ANTI-ICING OFF | | | | CORRECTION ON FUEL CONSUMPTION (KG/1000KG) | | | | | |
| AIR DIST. (NM) | FLIGHT LEVEL | | | | | | FL290 | FL330 | FL370 |
| | 290 | 310 | 330 | 350 | 370 | 390 | FL310 | FL350 | FL390 |
| 2075 | 12068 5.13 | 11744 5.05 | 11463 4.58 | 11214 4.52 | 11037 4.49 | 11039 4.49* | 121 | 129 | 162 |
| 2100 | 12215 5.16 | 11887 5.09 | 11601 5.01 | 11349 4.56 | 11171 4.53 | 11174 4.52* | 123 | 131 | 164 |
| 2125 | 12363 5.20 | 12029 5.12 | 11739 5.05 | 11485 4.59 | 11306 4.56 | 11309 4.56* | 124 | 133 | 166 |
| 2150 | 12510 5.23 | 12172 5.16 | 11978 5.08 | 11620 5.02 | 11440 4.59 | 11444 4.59* | 126 | 134 | 168 |
| 2175 | 12658 5.27 | 12315 5.19 | 12017 5.11 | 11756 5.06 | 11575 5.03 | 11579 5.02* | 127 | 136 | 170 |
| 2200 | 12806 5.30 | 12459 5.22 | 12156 5.15 | 11892 5.09 | 11710 5.06 | 11715 5.06* | 129 | 138 | 173 |
| 2225 | 12954 5.34 | 12603 5.26 | 12295 5.18 | 12028 5.12 | 11846 5.09 | 11851 5.09* | 130 | 139 | 175 |
| 2250 | 13102 5.37 | 12746 5.29 | 12435 5.22 | 12165 5.16 | 11981 5.13 | 11987 5.12* | 132 | 141 | 177 |
| 2275 | 13251 5.41 | 12891 5.33 | 12575 5.25 | 12301 5.19 | 12117 5.16 | 12124 5.16* | 134 | 143 | 179 |
| 2300 | 13400 5.44 | 13035 5.36 | 12715 5.28 | 12438 5.22 | 12253 5.19 | 12260 5.19* | 135 | 145 | 181 |
| 2325 | 13549 5.48 | 13179 5.39 | 12855 5.32 | 12576 5.25 | 12390 5.23 | 12397 5.22* | 137 | 146 | 184 |
| 2350 | 13698 5.51 | 13324 5.43 | 12996 5.35 | 12713 5.29 | 12527 5.26 | 12534 5.26* | 138 | 148 | 186 |
| 2375 | 13848 5.55 | 13469 5.46 | 13136 5.38 | 12851 5.32 | 12664 5.29 | 12672 5.29* | 140 | 150 | 188 |
| 2400 | 13997 5.58 | 13614 5.50 | 13277 5.42 | 12989 5.35 | 12801 5.33 | 12809 5.32* | 141 | 152 | 190 |
| 2425 | 14147 6.02 | 13760 5.53 | 13418 5.45 | 13127 5.39 | 12939 5.36 | 12947 5.36* | 143 | 153 | 193 |
| 2450 | 14297 6.05 | 13906 5.56 | 13559 5.48 | 13265 5.42 | 13077 5.39 | 13085 5.39* | 144 | 155 | 195 |
| 2475 | 14448 6.09 | 14051 6.00 | 13701 5.52 | 13404 5.45 | 13215 5.43 | 13223 5.42* | 146 | 157 | 197 |
| 2500 | 14598 6.12 | 14197 6.03 | 13842 5.55 | 13542 5.49 | 13354 5.46 | 13362 5.45* | 148 | 159 | 199 |
| 2525 | 14748 6.16 | 14344 6.06 | 13984 5.58 | 13681 5.52 | 13492 5.49 | 13500 5.49* | 149 | 161 | 201 |
| 2550 | 14898 6.19 | 14490 6.10 | 14126 6.02 | 13820 5.55 | 13631 5.53 | 13639 5.52* | 151 | 162 | 204 |
| 2575 | 15048 6.22 | 14637 6.13 | 14269 6.05 | 13960 5.58 | 13770 5.56 | 13778 5.55* | 152 | 164 | 206 |
| 2600 | 15199 6.26 | 14784 6.17 | 14411 6.08 | 14099 5.62 | 13910 5.59 | 13917 5.59* | 154 | 166 | 208 |
| 2625 | 15350 6.29 | 14931 6.20 | 14554 6.11 | 14239 6.05 | 14050 6.03 | 14057 6.02* | 156 | 168 | 211 |
| 2650 | 15501 6.33 | 15078 6.23 | 14697 6.15 | 14379 6.08 | 14190 6.06 | 14197 6.05* | 157 | 170 | 213 |
| 2675 | 15652 6.36 | 15225 6.27 | 14840 6.18 | 14519 6.11 | 14330 6.09 | 14337 6.09* | 159 | 171 | 215 |
| 2700 | 15804 6.40 | 15373 6.30 | 14984 6.21 | 14660 6.15 | 14471 6.13 | 14477 6.12* | 160 | 173 | 217 |
| LOW AIR CONDITIONING | | | ENGINE ANTI ICE ON | | | TOTAL ANTI ICE ON | | | |
| ΔFUEL = -0.5 % | | | ΔFUEL = + 2.5 % | | | ΔFUEL = + 5 % | | | |

FLIP23D A320-214 CFM56-5B4/P SA3420 03301.000011 0250300 .7801 .00200 120 0300350 55 0 100100 40100 18590 FCOM.02.05.40.011-180

| FLIGHT PLANNING FROM BRAKE RELEASE TO LANDING | | | | | | | | | |
|---|---------------|---------------|--|---------------|--------------------|-------------------|--|-------|-------|
| CLIMB : 250KT/300KT/M.78 - CRUISE : LONG RANGE - DESCENT : M.78/300KT/250KT | | | | | | | | | |
| IMC PROCEDURE : 120 KG (6MIN) | | | | | | | | | |
| REF. LANDING WEIGHT = 55000 KG | | | ISA | | FUEL CONSUMED (KG) | | | | |
| NORMAL AIR CONDITIONING | | | CG = 33.0 % | | TIME (H.MIN) | | | | |
| ANTHICING OFF | | | CORRECTION ON FUEL CONSUMPTION (KG/1000KG) | | | | | | |
| AIR | FLIGHT LEVEL | | | | | | CORRECTION ON FUEL CONSUMPTION (KG/1000KG) | | |
| DIST. | | | | | | | FL290 | FL330 | FL370 |
| (NM) | 290 | 310 | 330 | 350 | 370 | 390 | FL310 | FL350 | FL390 |
| 2700 | 15804 6.40 | 15373 6.30 | 14984 6.21 | 14660 6.15 | 14471 6.13 | 14477 6.12* | 180 | 173 | 217 |
| 2725 | 15955 6.43 | 15521 6.33 | 15127 6.25 | 14801 6.18 | 14612 6.16 | 14618 6.15* | 162 | 175 | 220 |
| 2750 | 16107 6.47 | 15669 6.37 | 15272 6.28 | 14941 6.21 | 14753 6.19 | 14758 6.19* | 164 | 177 | 222 |
| 2775 | 16260 6.50 | 15818 6.40 | 15416 6.31 | 15082 6.25 | 14894 6.23 | 14899 6.22* | 165 | 179 | 224 |
| 2800 | 16412 6.53 | 15966 6.43 | 15561 6.35 | 15224 6.28 | 15036 6.26 | 15041 6.25* | 167 | 181 | 226 |
| 2825 | 16564 6.57 | 16115 6.47 | 15706 6.38 | 15366 6.31 | 15178 6.29 | 15182 6.29* | 169 | 183 | 229 |
| 2850 | 16717 7.00 | 16264 6.50 | 15851 6.41 | 15508 6.34 | 15321 6.33 | 15324 6.32* | 170 | 184 | 231 |
| 2875 | 16870 7.04 | 16413 6.53 | 15996 6.44 | 15650 6.38 | 15470 6.36* | 15466 6.35* | 172 | 186 | 233 |
| 2900 | 17023 7.07 | 16563 6.57 | 16142 6.48 | 15792 6.41 | 15614 6.39* | 15609 6.39* | 174 | 188 | 235 |
| 2925 | 17177 7.10 | 16713 7.00 | 16288 6.51 | 15935 6.44 | 15758 6.43* | 15751 6.42* | 175 | 190 | 238 |
| 2950 | 17330 7.14 | 16863 7.03 | 16434 6.54 | 16078 6.48 | 15903 6.46* | 15894 6.45* | 177 | 192 | 240 |
| 2975 | 17484 7.17 | 17013 7.07 | 16580 6.57 | 16221 6.51 | 16048 6.49* | 16037 6.49* | 179 | 194 | 242 |
| 3000 | 17638 7.21 | 17163 7.10 | 16726 7.01 | 16364 6.54 | 16193 6.53* | 16181 6.52* | 180 | 196 | 245 |
| 3025 | 17792 7.24 | 17314 7.13 | 16873 7.04 | 16508 6.58 | 16338 6.56* | 16324 6.55* | 182 | 198 | 247 |
| 3050 | 17947 7.27 | 17465 7.16 | 17020 7.07 | 16652 7.01 | 16483 6.59* | 16468 6.59* | 184 | 200 | 249 |
| 3075 | 18102 7.31 | 17616 7.20 | 17167 7.10 | 16796 7.04 | 16629 7.03* | 16612 7.02* | 185 | 202 | 252 |
| 3100 | 18257 7.34 | 17767 7.23 | 17315 7.14 | 16940 7.07 | 16775 7.06* | 16756 7.05* | 187 | 204 | 254 |
| LOW AIR CONDITIONING | | | ENGINE ANTI ICE ON | | | TOTAL ANTI ICE ON | | | |
| ΔFUEL = -0.5 % | | | ΔFUEL = + 2.5 % | | | ΔFUEL = + 5 % | | | |

FPL230 A320-214 CFM56-5B4/P SA3420 03301 000011 0250300 .7801 .00200 120 0300350 55 0 100100 40100 18590 FCOM-02-05-40-012-180

ALL ENGINES OPERATIVE

GENERAL

Ident.: PER-FPL-FLP-ALN-20-00001832.0009001 / 25 FEB 14

Applicable to: ALL

The alternate planning tables enable the flight crew to determine the fuel consumption and time required to cover a given air distance from go-around at destination airport to landing at alternate airport.

These tables are established for:

- Go-around: 100 kg or 220 lb
- Climb profile: 250 kt/300 kt/M .78
- Long range speed
- Descent profile: M .78/300 kt/250 kt
- Approach and landing at alternate airport: 80 kg or 180 lb (4 min)
- ISA
- CG = 33 %
- Normal air conditioning
- Anti ice OFF

Following tables have been calculated using databases for CFM 56-5-B /P. If the engines fitted on the aircraft are not /P or /3, the fuel consumption has to be increased by 3 %.

- Note:
1. In the tables, the asterisk (*) means that a step climb of 4 000 ft must be flown to reach the corresponding flight level.
 2. The flight level shown on the top of each column is the final flight level.
 3. For each degree Celsius above ISA temperature apply a fuel correction of
 $0.015 \text{ (kg/}^\circ\text{C/NM)} \times \Delta\text{ISA (}^\circ\text{C)} \times \text{Air distance (NM)}$
or $0.033 \text{ (lb/}^\circ\text{C/NM)} \times \Delta\text{ISA (}^\circ\text{C)} \times \text{Air distance (NM)}$

CORRECTION FOR DEVIATION FROM REFERENCE WEIGHT

Ident.: PER-FPL-FLP-ALN-20-00001834.0001001 / 28 FEB 11

Applicable to: ALL

The alternate planning tables are based on a reference landing weight at alternate.

The fuel consumption must be corrected when the landing weight is different from the reference landing weight.

If it is lower (or greater) than the reference weight, subtract (or add) the value given in the correction part of the table per 1 000 kg or 1 000 lb below (or above) the reference weight.

ALTERNATE PLANNING ISA

Ident.: PER-FPL-FLP-ALN-20-00001833.0025001 / 02 MAR 11

Applicable to: ALL

| ALTERNATE PLANNING FROM DESTINATION TO ALTERNATE AIRPORT GO-AROUND : 100 KG - CLIMB : 250KT/300KT/M.78 - CRUISE : LONG RANGE DESCENT : M.78/300KT/250KT - VMC PROCEDURE : 80 KG (4MIN) | | | | | | | | | |
|--|--------------|--------------|-------------------------------------|--------------|--------------|--------------------------------------|--|----------------|----------------|
| REF. LDG. WT AT ALTERNATE = 55000 KG NORMAL AIR CONDITIONING ANTI-CICING OFF | | | ISA CG = 33.0 % | | | FUEL CONSUMED (KG) | | | |
| AIR DIST. (NM) | FLIGHT LEVEL | | | | | | CORRECTION ON FUEL CONSUMPTION (KG/1000KG) | | |
| | 100 | 120 | 140 | 160 | 180 | 200 | FL100 FL120 | FL140 FL160 | FL180 FL200 |
| 20 | | | | | | | | | |
| 40 | 522 0.12 | | | | | | 2 | | |
| 60 | 676 0.16 | 659 0.16 | 660 0.16 | | | | 3 | 4 | |
| 80 | 831 0.19 | 807 0.20 | 802 0.20 | 801 0.19 | 805 0.19 | | 5 | 5 | 5 |
| 100 | 986 0.23 | 955 0.23 | 943 0.23 | 937 0.23 | 934 0.23 | 937 0.22 | 6 | 5 | 6 |
| 120 | 1140 0.27 | 1103 0.27 | 1085 0.27 | 1072 0.25 | 1064 0.25 | 1061 0.25 | 7 | 6 | 7 |
| 140 | 1296 0.31 | 1251 0.31 | 1227 0.30 | 1208 0.30 | 1193 0.30 | 1185 0.29 | 8 | 7 | 8 |
| 160 | 1451 0.34 | 1400 0.34 | 1369 0.34 | 1344 0.33 | 1323 0.33 | 1309 0.33 | 9 | 8 | 9 |
| 180 | 1606 0.38 | 1548 0.38 | 1511 0.37 | 1480 0.37 | 1452 0.36 | 1434 0.36 | 10 | 9 | 10 |
| 200 | 1762 0.42 | 1697 0.42 | 1653 0.41 | 1616 0.40 | 1582 0.40 | 1559 0.40 | 11 | 10 | 11 |
| 220 | 1918 0.46 | 1846 0.45 | 1796 0.44 | 1752 0.44 | 1712 0.43 | 1684 0.43 | 12 | 11 | 12 |
| 240 | 2074 0.49 | 1995 0.49 | 1938 0.48 | 1889 0.47 | 1842 0.47 | 1809 0.46 | 13 | 12 | 12 |
| 260 | 2231 0.53 | 2144 0.53 | 2081 0.51 | 2025 0.51 | 1972 0.50 | 1934 0.50 | 14 | 13 | 13 |
| 280 | 2387 0.57 | 2294 0.56 | 2224 0.55 | 2162 0.54 | 2103 0.54 | 2059 0.53 | 15 | 14 | 14 |
| 300 | 2544 1.00 | 2443 1.00 | 2367 0.59 | 2299 0.57 | 2233 0.57 | 2184 0.57 | 16 | 15 | 15 |
| 320 | 2701 1.04 | 2593 1.04 | 2510 1.02 | 2436 1.01 | 2364 1.01 | 2310 1.00 | 17 | 16 | 16 |
| 340 | 2858 1.08 | 2743 1.07 | 2653 1.06 | 2573 1.04 | 2494 1.04 | 2435 1.04 | 18 | 16 | 17 |
| 360 | 3014 1.12 | 2893 1.11 | 2796 1.09 | 2710 1.08 | 2625 1.08 | 2561 1.07 | 19 | 17 | 18 |
| 380 | 3171 1.15 | 3043 1.14 | 2940 1.13 | 2847 1.11 | 2756 1.11 | 2687 1.11 | 20 | 18 | 19 |
| 400 | 3329 1.19 | 3193 1.18 | 3084 1.16 | 2984 1.15 | 2886 1.15 | 2813 1.14 | 21 | 19 | 20 |
| 420 | 3486 1.23 | 3343 1.22 | 3227 1.20 | 3122 1.18 | 3018 1.18 | 2939 1.17 | 22 | 20 | 21 |
| 440 | 3643 1.26 | 3494 1.25 | 3371 1.23 | 3259 1.22 | 3149 1.22 | 3065 1.21 | 23 | 21 | 22 |
| 460 | 3801 1.30 | 3644 1.29 | 3515 1.27 | 3397 1.25 | 3280 1.25 | 3192 1.24 | 24 | 22 | 23 |
| 480 | 3959 1.34 | 3795 1.32 | 3659 1.30 | 3534 1.28 | 3412 1.29 | 3318 1.28 | 25 | 23 | 24 |
| 500 | 4117 1.37 | 3946 1.36 | 3803 1.34 | 3672 1.32 | 3543 1.32 | 3445 1.31 | 26 | 24 | 25 |
| LOW AIR CONDITIONING ΔFUEL = - 0.5 % | | | ENGINE ANTI ICE ON ΔFUEL = + 3 % | | | TOTAL ANTI ICE ON ΔFUEL = + 6.5 % | | | |

F1P23D A320-214 CFM56-58A/P SA3520 03901.000010 100250300 .7801 .00200 80 0300300 55 0 100100 40100 18590 FCOM-02-05-50-002-180

| ALTERNATE PLANNING FROM DESTINATION TO ALTERNATE AIRPORT | | | | | | | | |
|---|--------------|--------------|---------------------------|--|--------------|--------------------------|-------|-------|
| GO-AROUND : 100 KG - CLIMB : 250KT/300KT/M.78 - CRUISE : LONG RANGE | | | | | | | | |
| DESCENT : M.78/300KT/250KT - VMC PROCEDURE : 80 KG (4MIN) | | | | | | | | |
| REF. LANDING WEIGHT = 55000 KG | | | | ISA | | FUEL CONSUMED (KG) | | |
| NORMAL AIR CONDITIONING | | | | CG = 33.0 % | | TIME (H.MIN) | | |
| ANTI-ICING OFF | | | | CORRECTION ON FUEL CONSUMPTION (KG/1000KG) | | | | |
| AIR DIST. (NM) | FLIGHT LEVEL | | | | | FL230 | FL310 | FL390 |
| | 230 | 270 | 310 | 350 | 390 | FL270 | FL350 | FL390 |
| 100 | | | | | | | | 0 |
| 120 | 1065 0.25 | | | | | 7 | | 0 |
| 140 | 1183 0.29 | 1193 0.28 | | | | 9 | | 0 |
| 160 | 1301 0.32 | 1303 0.31 | 1319 0.30 | | | 10 | 10 | 0 |
| 180 | 1419 0.35 | 1413 0.34 | 1422 0.33 | | | 11 | 12 | 0 |
| 200 | 1538 0.38 | 1523 0.37 | 1524 0.36 | 1531 0.35 | | 12 | 13 | 0 |
| 220 | 1656 0.42 | 1633 0.40 | 1627 0.39 | 1629 0.38 | | 13 | 14 | 0 |
| 240 | 1775 0.45 | 1744 0.43 | 1730 0.42 | 1724 0.41 | | 14 | 15 | 0 |
| 260 | 1893 0.48 | 1854 0.46 | 1832 0.45 | 1822 0.44 | 1822 0.43 | 15 | 16 | 17 |
| 280 | 2012 0.52 | 1965 0.49 | 1935 0.48 | 1919 0.46 | 1915 0.46 | 16 | 17 | 18 |
| 300 | 2131 0.55 | 2076 0.52 | 2038 0.51 | 2016 0.49 | 2009 0.49 | 17 | 18 | 20 |
| 320 | 2250 0.58 | 2186 0.55 | 2142 0.54 | 2113 0.52 | 2103 0.51 | 18 | 19 | 21 |
| 340 | 2369 1.02 | 2297 0.58 | 2245 0.56 | 2211 0.55 | 2196 0.54 | 19 | 21 | 23 |
| 360 | 2489 1.05 | 2408 1.01 | 2348 0.59 | 2308 0.58 | 2290 0.57 | 20 | 22 | 24 |
| 380 | 2608 1.08 | 2519 1.04 | 2452 1.02 | 2406 1.00 | 2385 0.59 | 21 | 23 | 26 |
| 400 | 2728 1.12 | 2630 1.07 | 2555 1.05 | 2504 1.03 | 2479 1.02 | 22 | 24 | 27 |
| 420 | 2847 1.15 | 2742 1.10 | 2659 1.08 | 2602 1.06 | 2573 1.05 | 23 | 25 | 27 |
| 440 | 2967 1.18 | 2853 1.13 | 2763 1.11 | 2700 1.09 | 2668 1.07 | 24 | 26 | 28 |
| 460 | 3087 1.21 | 2965 1.16 | 2867 1.14 | 2798 1.11 | 2762 1.10 | 25 | 27 | 30 |
| 480 | 3207 1.25 | 3076 1.19 | 2971 1.17 | 2896 1.14 | 2857 1.13 | 26 | 28 | 31 |
| 500 | 3327 1.28 | 3188 1.22 | 3075 1.20 | 2994 1.17 | 2952 1.16 | 27 | 29 | 32 |
| LOW AIR CONDITIONING | | | ENGINE ANTI ICE ON | | | TOTAL ANTI ICE ON | | |
| ΔFUEL = - 0.5 % | | | ΔFUEL = + 3 % | | | ΔFUEL = + 5 % | | |

FLP23D A320-214 CFM56-584/P SA3520 03301.000010 100250300 7801.00200 80 0300300 55 0 100100 40100 18590 FCOM-02-05-50-003-180



A318/A319/A320/A321
FLIGHT CREW
OPERATING MANUAL

PERFORMANCE

FLIGHT PLANNING

FLIGHT PREPARATION - ALTERNATE

Intentionally left blank

PERFORMANCE

CLIMB

Intentionally left blank



A318/A319/A320/A321
FLIGHT CREW
OPERATING MANUAL

PERFORMANCE

CLIMB

PRELIMINARY PAGES - TABLE OF CONTENTS

PER-CLB-GEN GENERAL

GENERAL..... A

PER-CLB-CLT CLIMB TABLES

CLIMB - ISA +10..... A

CLIMB - ISA +20..... B



A318/A319/A320/A321
FLIGHT CREW
OPERATING MANUAL

PERFORMANCE

CLIMB

PRELIMINARY PAGES - TABLE OF CONTENTS

Intentionally left blank

| | |
|---|--|
|  <p>A318/A319/A320/A321 FLIGHT CREW OPERATING MANUAL</p> | <p>PERFORMANCE</p> <p>CLIMB</p> <p>GENERAL</p> |
|---|--|

GENERAL

Ident.: PER-CLB-GEN-00001982.0001001 / 15 FEB 11

Applicable to: ALL

Climb tables are established at MAX CLIMB THRUST with air conditioning in normal mode and anti ice OFF.

The climb speed profile is :

- 250 kt from 1 500 ft up to FL 100
- acceleration from 250 kt to 300 kt
- climb at 300 kt then M .78 up to selected altitude.

All charts are established with a center of gravity corresponding to 33 %.



A318/A319/A320/A321
FLIGHT CREW
OPERATING MANUAL

PERFORMANCE

CLIMB

GENERAL

Intentionally left blank

CLIMB - ISA +10

Ident.: PER-CLB-CLT-00001987.0065001 / 15 FEB 11

Applicable to: ALL

| CLIMB - 250KT/300KT/M.78 | | | | | | | | | | | | | | |
|---------------------------------|----------------------------------|------|------------------------------|------|---------------------------|------|-----------|--------------------------|-----|------|-----|------|-----|------|
| MAX. CLIMB THRUST | | | ISA+10 | | FROM BRAKE RELEASE | | | | | | | | | |
| NORMAL AIR CONDITIONING | | | CG=33.0% | | TIME (MIN) | | FUEL (KG) | | | | | | | |
| ANTI-ICING OFF | | | | | DISTANCE (NM) | | TAS (KT) | | | | | | | |
| FL | WEIGHT AT BRAKE RELEASE (1000KG) | | | | | | | | | | | | | |
| | 52 | 54 | 56 | 58 | 60 | 62 | 64 | | | | | | | |
| 390 | 19 | 1392 | 20 | 1470 | 21 | 1552 | 23 | 1642 | 24 | 1742 | 26 | 1853 | | |
| | 124 | 396 | 132 | 397 | 141 | 398 | 150 | 400 | 161 | 401 | 173 | 403 | | |
| 370 | 17 | 1301 | 18 | 1369 | 19 | 1440 | 20 | 1514 | 21 | 1594 | 22 | 1679 | 23 | 1770 |
| | 109 | 389 | 115 | 390 | 122 | 391 | 129 | 392 | 136 | 392 | 144 | 393 | 153 | 395 |
| 350 | 15 | 1225 | 16 | 1287 | 17 | 1351 | 18 | 1418 | 19 | 1487 | 20 | 1561 | 21 | 1639 |
| | 98 | 382 | 103 | 383 | 108 | 384 | 114 | 384 | 120 | 385 | 126 | 386 | 133 | 387 |
| 330 | 14 | 1156 | 15 | 1213 | 15 | 1272 | 16 | 1333 | 17 | 1396 | 18 | 1462 | 19 | 1532 |
| | 88 | 375 | 92 | 376 | 97 | 376 | 102 | 377 | 107 | 378 | 113 | 378 | 118 | 379 |
| 310 | 13 | 1088 | 14 | 1140 | 14 | 1195 | 15 | 1251 | 16 | 1309 | 16 | 1370 | 17 | 1433 |
| | 79 | 367 | 83 | 368 | 87 | 368 | 91 | 369 | 96 | 369 | 100 | 370 | 105 | 370 |
| 290 | 12 | 1015 | 12 | 1063 | 13 | 1113 | 13 | 1165 | 14 | 1218 | 15 | 1273 | 15 | 1330 |
| | 70 | 357 | 73 | 357 | 77 | 358 | 80 | 358 | 84 | 359 | 88 | 359 | 92 | 360 |
| 270 | 10 | 927 | 11 | 971 | 11 | 1016 | 12 | 1062 | 12 | 1109 | 13 | 1158 | 14 | 1209 |
| | 59 | 343 | 62 | 344 | 65 | 344 | 68 | 345 | 71 | 345 | 75 | 345 | 78 | 346 |
| 250 | 9 | 847 | 10 | 887 | 10 | 927 | 11 | 969 | 11 | 1012 | 11 | 1056 | 12 | 1101 |
| | 51 | 330 | 53 | 331 | 56 | 331 | 58 | 332 | 61 | 332 | 64 | 332 | 66 | 332 |
| 240 | 9 | 810 | 9 | 847 | 10 | 886 | 10 | 925 | 10 | 966 | 11 | 1008 | 11 | 1051 |
| | 47 | 324 | 49 | 324 | 51 | 325 | 54 | 325 | 56 | 325 | 59 | 326 | 61 | 326 |
| 220 | 8 | 739 | 8 | 773 | 8 | 808 | 9 | 844 | 9 | 880 | 10 | 918 | 10 | 957 |
| | 40 | 311 | 42 | 312 | 44 | 312 | 46 | 312 | 48 | 313 | 50 | 313 | 52 | 313 |
| 200 | 7 | 673 | 7 | 703 | 8 | 735 | 8 | 767 | 8 | 800 | 9 | 834 | 9 | 869 |
| | 34 | 298 | 36 | 299 | 37 | 299 | 39 | 299 | 41 | 300 | 43 | 300 | 44 | 300 |
| 180 | 6 | 609 | 6 | 637 | 7 | 665 | 7 | 694 | 7 | 724 | 8 | 755 | 8 | 786 |
| | 29 | 285 | 30 | 285 | 32 | 286 | 33 | 286 | 34 | 286 | 36 | 287 | 37 | 287 |
| 160 | 5 | 549 | 6 | 574 | 6 | 600 | 6 | 626 | 6 | 652 | 7 | 680 | 7 | 708 |
| | 24 | 271 | 25 | 272 | 27 | 272 | 28 | 272 | 29 | 273 | 30 | 273 | 31 | 273 |
| 140 | 5 | 492 | 5 | 514 | 5 | 537 | 5 | 560 | 6 | 584 | 6 | 609 | 6 | 634 |
| | 20 | 257 | 21 | 257 | 22 | 258 | 23 | 258 | 24 | 258 | 25 | 259 | 26 | 259 |
| 120 | 4 | 437 | 4 | 457 | 5 | 477 | 5 | 498 | 5 | 519 | 5 | 541 | 5 | 564 |
| | 17 | 242 | 18 | 242 | 18 | 243 | 19 | 243 | 20 | 243 | 21 | 243 | 22 | 244 |
| 100 | 3 | 349 | 3 | 365 | 4 | 381 | 4 | 398 | 4 | 415 | 4 | 432 | 4 | 450 |
| | 12 | 214 | 12 | 214 | 13 | 215 | 13 | 215 | 14 | 216 | 14 | 216 | 15 | 216 |
| 50 | 2 | 227 | 2 | 237 | 2 | 248 | 2 | 259 | 2 | 270 | 3 | 281 | 3 | 293 |
| | 6 | 176 | 6 | 177 | 7 | 177 | 7 | 178 | 7 | 178 | 8 | 178 | 8 | 179 |
| 15 | 1 | 142 | 1 | 148 | 1 | 155 | 2 | 161 | 2 | 168 | 2 | 175 | 2 | 183 |
| | 3 | 128 | 3 | 128 | 3 | 129 | 3 | 129 | 3 | 130 | 4 | 130 | 4 | 130 |
| LOW AIR CONDITIONING | | | HIGH AIR CONDITIONING | | ENGINE ANTI ICE ON | | | TOTAL ANTI ICE ON | | | | | | |
| ΔFUEL = - 0.6 % | | | ΔFUEL = + 0.6 % | | ΔFUEL = + 2.5 % | | | ΔFUEL = + 5 % | | | | | | |

11.0.08FOA320-214 CPM56-5B4/P SA2110000055KG330 0 018590 0 0 2 1.0 500.0 300.00 1 03250.000300.000 790 10 FCOM-NO-03-05-10-004-170

PERFORMANCE

CLIMB

CLIMB TABLES

| CLIMB - 250KT/300KT/M.78 | | | | | | | | |
|---------------------------------|----------------------------------|--------------------|------------------------------|--------------------|--------------------|---------------------------|--------------------|--------------------------|
| MAX. CLIMB THRUST | | | ISA+10 | | | FROM BRAKE RELEASE | | |
| NORMAL AIR CONDITIONING | | | CG=33.0% | | | TIME (MIN) | | FUEL (KG) |
| ANTI-ICING OFF | | | | | | DISTANCE (NM) | | TAS (KT) |
| FL | WEIGHT AT BRAKE RELEASE (1000KG) | | | | | | | |
| | 66 | 68 | 70 | 72 | 74 | 76 | 78 | |
| 390 | | | | | | | | |
| 370 | 25 1870 163 396 | 26 1981 175 398 | 28 2106 189 400 | | | | | |
| 350 | 22 1721 141 388 | 23 1809 149 389 | 24 1904 158 390 | 26 2008 168 392 | 27 2124 179 394 | 29 2254 192 396 | 31 2403 208 399 | |
| 330 | 20 1604 124 380 | 21 1680 131 381 | 22 1761 138 382 | 23 1848 145 383 | 24 1941 153 384 | 25 2042 163 386 | 27 2152 173 388 | |
| 310 | 18 1498 110 371 | 19 1566 116 372 | 20 1638 121 373 | 20 1714 127 374 | 21 1794 134 375 | 22 1879 141 376 | 24 1970 149 377 | |
| 290 | 16 1389 97 360 | 17 1451 101 361 | 18 1515 106 362 | 18 1582 111 363 | 19 1653 116 364 | 20 1728 122 365 | 21 1806 128 366 | |
| 270 | 14 1261 82 346 | 15 1315 85 347 | 15 1372 89 348 | 16 1430 93 348 | 17 1491 97 349 | 17 1555 102 350 | 18 1622 106 351 | |
| 250 | 12 1148 69 333 | 13 1196 72 334 | 14 1246 75 334 | 14 1297 79 335 | 15 1351 82 336 | 15 1407 86 337 | 16 1465 89 337 | |
| 240 | 12 1095 64 326 | 12 1140 67 327 | 13 1188 69 328 | 13 1236 72 328 | 14 1287 76 329 | 14 1339 79 330 | 15 1394 82 331 | |
| 220 | 10 996 54 313 | 11 1037 57 314 | 11 1079 59 315 | 12 1123 61 315 | 12 1168 64 316 | 13 1214 67 317 | 13 1263 69 318 | |
| 200 | 9 904 46 301 | 10 941 48 301 | 10 979 50 302 | 10 1018 52 302 | 11 1058 54 303 | 11 1099 56 304 | 12 1142 59 305 | |
| 180 | 8 818 39 287 | 8 851 41 288 | 9 885 42 288 | 9 920 44 289 | 9 955 46 290 | 10 992 48 291 | 10 1031 49 291 | |
| 160 | 7 737 33 274 | 7 766 34 274 | 8 797 36 275 | 8 828 37 275 | 8 860 38 276 | 9 893 40 277 | 9 927 41 278 | |
| 140 | 6 660 27 259 | 7 686 28 260 | 7 713 30 261 | 7 741 31 261 | 7 769 32 262 | 8 799 33 263 | 8 829 35 264 | |
| 120 | 6 586 23 244 | 6 610 23 245 | 6 634 24 246 | 6 659 25 246 | 6 684 26 247 | 7 710 27 248 | 7 737 28 249 | |
| 100 | 4 468 16 217 | 5 487 16 218 | 5 506 17 218 | 5 526 18 219 | 5 546 18 220 | 5 567 19 221 | 5 588 20 222 | |
| 50 | 3 304 8 180 | 3 316 9 180 | 3 328 9 182 | 3 341 9 183 | 3 354 10 184 | 3 367 10 185 | 3 380 10 186 | |
| 15 | 2 190 4 131 | 2 198 4 132 | 2 205 4 133 | 2 213 4 134 | 2 221 4 136 | 2 229 5 137 | 2 237 5 139 | |
| LOW AIR CONDITIONING | | | HIGH AIR CONDITIONING | | | ENGINE ANTI ICE ON | | TOTAL ANTI ICE ON |
| ΔFUEL = - 0.6 % | | | ΔFUEL = + 0.6 % | | | ΔFUEL = + 2.5 % | | ΔFUEL = + 5 % |

11.0-08FOA320-214 CFM56-5B4/P SA21100000C5K6390 0 018590 0 0 2 1.0 500.0 300.00 1 03250.000300.000 .780 10 FCOM-NO-03-05-10-005-170

CLIMB - ISA +20

Ident.: PER-CLB-CLT-00001989.0021001 / 15 FEB 11

Applicable to: ALL

| CLIMB - 250KT/300KT/M.78 | | | | | | | | |
|---------------------------------|----------------------------------|--------------------|---------------------------|--------------------|--------------------------|--------------------|--------------------|--|
| MAX. CLIMB THRUST | | | ISA+20 | | FROM BRAKE RELEASE | | | |
| NORMAL AIR CONDITIONING | | | CG=33.0% | | TIME (MIN) | | FUEL (KG) | |
| ANTI-ICING OFF | | | | | DISTANCE (NM) | | TAS (KT) | |
| FL | WEIGHT AT BRAKE RELEASE (1000KG) | | | | | | | |
| | 52 | 54 | 56 | 58 | 60 | 62 | 64 | |
| 390 | 25 1691 174 412 | 27 1799 187 413 | 29 1920 202 415 | | | | | |
| 370 | 22 1558 150 404 | 24 1648 159 405 | 25 1743 169 406 | 27 1845 181 407 | 28 1957 193 408 | 30 2081 207 410 | 33 2221 224 412 | |
| 350 | 20 1458 133 397 | 21 1538 141 398 | 22 1622 149 399 | 24 1711 158 400 | 25 1806 168 401 | 27 1907 178 402 | 28 2018 190 403 | |
| 330 | 18 1367 119 390 | 19 1440 126 391 | 20 1516 133 391 | 21 1596 140 392 | 23 1680 148 393 | 24 1769 157 394 | 25 1864 166 395 | |
| 310 | 17 1277 106 381 | 18 1343 112 382 | 18 1412 118 383 | 19 1484 124 383 | 20 1559 131 384 | 21 1639 138 385 | 23 1723 145 386 | |
| 290 | 15 1178 92 370 | 16 1238 97 371 | 17 1300 102 371 | 17 1364 107 372 | 18 1431 113 373 | 19 1502 119 373 | 20 1575 125 374 | |
| 270 | 13 1062 77 355 | 14 1115 81 356 | 14 1169 85 356 | 15 1226 89 357 | 16 1284 94 357 | 17 1345 99 358 | 17 1408 103 358 | |
| 250 | 11 962 65 341 | 12 1008 68 342 | 13 1057 72 342 | 13 1106 75 343 | 14 1158 79 343 | 14 1211 83 344 | 15 1267 86 344 | |
| 240 | 11 915 60 334 | 11 959 63 335 | 12 1005 66 335 | 12 1052 69 336 | 13 1100 72 336 | 13 1151 76 337 | 14 1202 79 337 | |
| 220 | 9 829 51 321 | 10 868 53 321 | 10 909 56 322 | 11 950 58 322 | 11 994 61 322 | 12 1038 64 323 | 12 1084 67 323 | |
| 200 | 8 748 43 307 | 9 783 45 307 | 9 819 47 308 | 10 856 49 308 | 10 895 51 308 | 10 934 53 309 | 11 975 56 309 | |
| 180 | 7 673 36 293 | 8 704 37 293 | 8 736 39 293 | 8 769 41 294 | 9 804 43 294 | 9 839 44 294 | 9 875 46 295 | |
| 160 | 6 602 30 278 | 7 630 31 278 | 7 659 32 279 | 7 689 34 279 | 8 719 35 279 | 8 750 37 280 | 8 783 39 280 | |
| 140 | 6 537 24 263 | 6 561 26 263 | 6 587 27 263 | 6 613 28 264 | 7 640 29 264 | 7 668 31 264 | 7 696 32 265 | |
| 120 | 5 474 20 246 | 5 496 21 246 | 5 518 22 247 | 5 542 23 247 | 6 565 24 247 | 6 590 25 248 | 6 615 26 248 | |
| 100 | 4 375 14 216 | 4 392 14 217 | 4 410 15 217 | 4 429 16 217 | 4 448 16 218 | 5 467 17 218 | 5 487 18 219 | |
| 50 | 2 243 7 176 | 3 254 7 177 | 3 265 8 177 | 3 277 8 177 | 3 289 8 178 | 3 302 9 178 | 3 314 9 179 | |
| 15 | 2 150 3 123 | 2 157 3 124 | 2 164 3 124 | 2 172 4 124 | 2 179 4 125 | 2 187 4 125 | 2 195 4 126 | |
| LOW AIR CONDITIONING | HIGH AIR CONDITIONING | | ENGINE ANTI ICE ON | | TOTAL ANTI ICE ON | | | |
| | $\Delta FUEL = - 0.6 \%$ | | $\Delta FUEL = + 0.6 \%$ | | $\Delta FUEL = + 2.5 \%$ | | | |
| | | | | | $\Delta FUEL = + 5 \%$ | | | |

11.0.08FOA320-214 CPM56-584/P SA211000005KG330 0 018590 0 0 2 1.0 500.0 300.00 1 03250.000300.000 790 20 FCOM-NO-03-05-10-008-170

PERFORMANCE

CLIMB

CLIMB TABLES

| CLIMB - 250KT/300KT/M.78 | | | | | | | | | | | | | | |
|---------------------------------|----------------------------------|------|------------------------------|------|-----|---------------------------|-----|-----------|--------------------------|------|-----|------|-----|------|
| MAX. CLIMB THRUST | | | ISA+20 | | | FROM BRAKE RELEASE | | | | | | | | |
| NORMAL AIR CONDITIONING | | | CG=33.0% | | | TIME (MIN) | | FUEL (KG) | | | | | | |
| ANTI-ICING OFF | | | | | | DISTANCE (NM) | | TAS (KT) | | | | | | |
| FL | WEIGHT AT BRAKE RELEASE (1000KG) | | | | | | | | | | | | | |
| | 66 | | 68 | | 70 | | 72 | | 74 | | 76 | | 78 | |
| 390 | | | | | | | | | | | | | | |
| 370 | | | | | | | | | | | | | | |
| 350 | 30 | 2138 | 32 | 2271 | 34 | 2423 | | | | | | | | |
| | 203 | 405 | 218 | 406 | 235 | 409 | | | | | | | | |
| 330 | 27 | 1966 | 28 | 2075 | 30 | 2195 | 32 | 2328 | 34 | 2478 | 37 | 2650 | | |
| | 176 | 396 | 187 | 398 | 199 | 399 | 213 | 401 | 229 | 403 | 248 | 405 | | |
| 310 | 24 | 1811 | 25 | 1906 | 27 | 2007 | 28 | 2118 | 30 | 2238 | 32 | 2370 | 34 | 2517 |
| | 154 | 387 | 162 | 388 | 172 | 389 | 183 | 391 | 194 | 392 | 207 | 394 | 222 | 396 |
| 290 | 21 | 1653 | 22 | 1734 | 23 | 1821 | 25 | 1914 | 26 | 2014 | 27 | 2121 | 29 | 2237 |
| | 132 | 375 | 139 | 376 | 146 | 377 | 154 | 378 | 163 | 379 | 173 | 380 | 184 | 382 |
| 270 | 18 | 1474 | 19 | 1543 | 20 | 1616 | 21 | 1692 | 22 | 1774 | 23 | 1860 | 24 | 1952 |
| | 109 | 359 | 114 | 360 | 120 | 361 | 126 | 361 | 132 | 362 | 139 | 363 | 147 | 364 |
| 250 | 16 | 1324 | 16 | 1384 | 17 | 1447 | 18 | 1512 | 19 | 1581 | 20 | 1654 | 21 | 1731 |
| | 91 | 345 | 95 | 345 | 99 | 346 | 104 | 347 | 109 | 347 | 114 | 348 | 120 | 349 |
| 240 | 15 | 1256 | 15 | 1313 | 16 | 1371 | 17 | 1432 | 18 | 1496 | 18 | 1564 | 19 | 1635 |
| | 83 | 338 | 87 | 338 | 91 | 339 | 95 | 339 | 100 | 340 | 104 | 341 | 109 | 342 |
| 220 | 13 | 1132 | 13 | 1181 | 14 | 1233 | 15 | 1286 | 15 | 1342 | 16 | 1400 | 17 | 1461 |
| | 70 | 324 | 73 | 324 | 76 | 325 | 79 | 325 | 83 | 326 | 87 | 326 | 91 | 327 |
| 200 | 11 | 1017 | 12 | 1061 | 12 | 1106 | 13 | 1153 | 13 | 1202 | 14 | 1253 | 14 | 1306 |
| | 58 | 309 | 61 | 310 | 63 | 310 | 66 | 311 | 69 | 311 | 72 | 312 | 75 | 313 |
| 180 | 10 | 912 | 10 | 951 | 11 | 991 | 11 | 1033 | 12 | 1075 | 12 | 1120 | 13 | 1166 |
| | 48 | 295 | 51 | 295 | 53 | 296 | 55 | 296 | 57 | 297 | 60 | 297 | 62 | 298 |
| 160 | 9 | 816 | 9 | 850 | 9 | 886 | 10 | 922 | 10 | 960 | 11 | 999 | 11 | 1040 |
| | 40 | 280 | 42 | 281 | 44 | 281 | 46 | 282 | 47 | 282 | 49 | 283 | 52 | 283 |
| 140 | 8 | 726 | 8 | 756 | 8 | 788 | 8 | 820 | 9 | 853 | 9 | 888 | 10 | 924 |
| | 33 | 265 | 35 | 265 | 36 | 266 | 38 | 266 | 39 | 267 | 41 | 267 | 42 | 268 |
| 120 | 7 | 641 | 7 | 668 | 7 | 696 | 7 | 724 | 8 | 753 | 8 | 784 | 8 | 816 |
| | 27 | 249 | 28 | 249 | 29 | 250 | 31 | 250 | 32 | 251 | 33 | 251 | 35 | 252 |
| 100 | 5 | 508 | 5 | 529 | 5 | 551 | 6 | 574 | 6 | 597 | 6 | 621 | 6 | 646 |
| | 19 | 219 | 19 | 220 | 20 | 220 | 21 | 221 | 22 | 222 | 23 | 223 | 24 | 223 |
| 50 | 3 | 327 | 3 | 341 | 3 | 355 | 4 | 369 | 4 | 384 | 4 | 399 | 4 | 415 |
| | 10 | 179 | 10 | 180 | 10 | 181 | 11 | 182 | 11 | 182 | 12 | 183 | 12 | 184 |
| 15 | 2 | 203 | 2 | 211 | 2 | 220 | 2 | 229 | 2 | 238 | 2 | 247 | 2 | 257 |
| | 4 | 127 | 4 | 127 | 5 | 128 | 5 | 129 | 5 | 130 | 5 | 131 | 5 | 132 |
| LOW AIR CONDITIONING | | | HIGH AIR CONDITIONING | | | ENGINE ANTI ICE ON | | | TOTAL ANTI ICE ON | | | | | |
| ΔFUEL = - 0.6 % | | | ΔFUEL = + 0.6 % | | | ΔFUEL = + 2.5 % | | | ΔFUEL = + 5 % | | | | | |

11.0-08FOA320-214 CFM56-5B4/P SA21100000C5KG390 0 018590 0 0 2 1.0 500.0 300.00 1 03250.000300.000 .780 20 FCOM-NO-03-05-10-009-170

PERFORMANCE

CRUISE

Intentionally left blank

PER-CRZ-ALT ALTITUDE

PER-CRZ-ALT-10 OPTIMUM AND MAXIMUM ALTITUDES

DEFINITIONS.....A

PER-CRZ-ALT-20 WIND ALTITUDE TRADE FOR CONSTANT SPECIFIC RANGE

WIND ALTITUDE TRADE FOR CONSTANT SPECIFIC RANGE.....A

PER-CRZ-CRT CRUISE TABLES

PER-CRZ-CRT-10 GENERAL

GENERAL.....A

PER-CRZ-CRT-20 CRUISE AT M.78

CRUISE - M.78 - ISA.....A

CRUISE - M.78 - ISA+20.....B

PER-CRZ-CRT-30 CRUISE AT LONG RANGE

LONG RANGE CRUISE - ISA.....A

LONG RANGE CRUISE - ISA+20.....B

PER-CRZ-ICQ IN CRUISE QUICK CHECK

PER-CRZ-ICQ-10 GENERAL

GENERAL.....A

CORRECTION FOR DEVIATION FROM REFERENCE WEIGHT.....B

PER-CRZ-ICQ-20 EXAMPLE

EXAMPLE FOR THE QRH USE.....A



A318/A319/A320/A321
FLIGHT CREW
OPERATING MANUAL

PERFORMANCE

CRUISE

PRELIMINARY PAGES - TABLE OF CONTENTS

Intentionally left blank

| | |
|---|---|
|  <p>A318/A319/A320/A321 FLIGHT CREW OPERATING MANUAL</p> | <p style="text-align: center;">PERFORMANCE CRUISE</p> <p style="text-align: center;">ALTITUDE - OPTIMUM AND MAXIMUM ALTITUDES</p> |
|---|---|

DEFINITIONS

Ident.: PER-CRZ-ALT-10-00001995.0001001 / 22 MAR 17

Applicable to: ALL

- Optimum altitude : the altitude at which the airplane covers the maximum distance per kilogram (pound) of fuel (best specific range). It depends on the actual weight and the deviation from ISA.
- Maximum altitude is defined as the lower of:
 - maximum altitude at maximum cruise thrust in level flight and
 - maximum altitude at maximum climb thrust with 300 ft/min vertical speed.

Refer to QRH/PER-M Optimum & Maximum Altitudes (Paper Only) or use the performance application of FlySmart with Airbus.

The QRH charts are established for a center of gravity at 33 % MAC.

Maximum and optimum altitudes are given for different temperatures at long range speed and M 0.78.

- Note:
1. The $n = 1.3 g$ ($n = 1.4 g$) curve indicates the buffet margin.
 2. Definition of the maximum altitude in the FMGC is different (Refer to DSC-22_20-50-10 MCDU).



A318/A319/A320/A321
FLIGHT CREW
OPERATING MANUAL

PERFORMANCE

CRUISE

ALTITUDE - OPTIMUM AND MAXIMUM ALTITUDES

Intentionally left blank

WIND ALTITUDE TRADE FOR CONSTANT SPECIFIC RANGE

Ident.: PER-CRZ-ALT-20-00001998.0007001 / 10 DEC 09

Applicable to: ALL

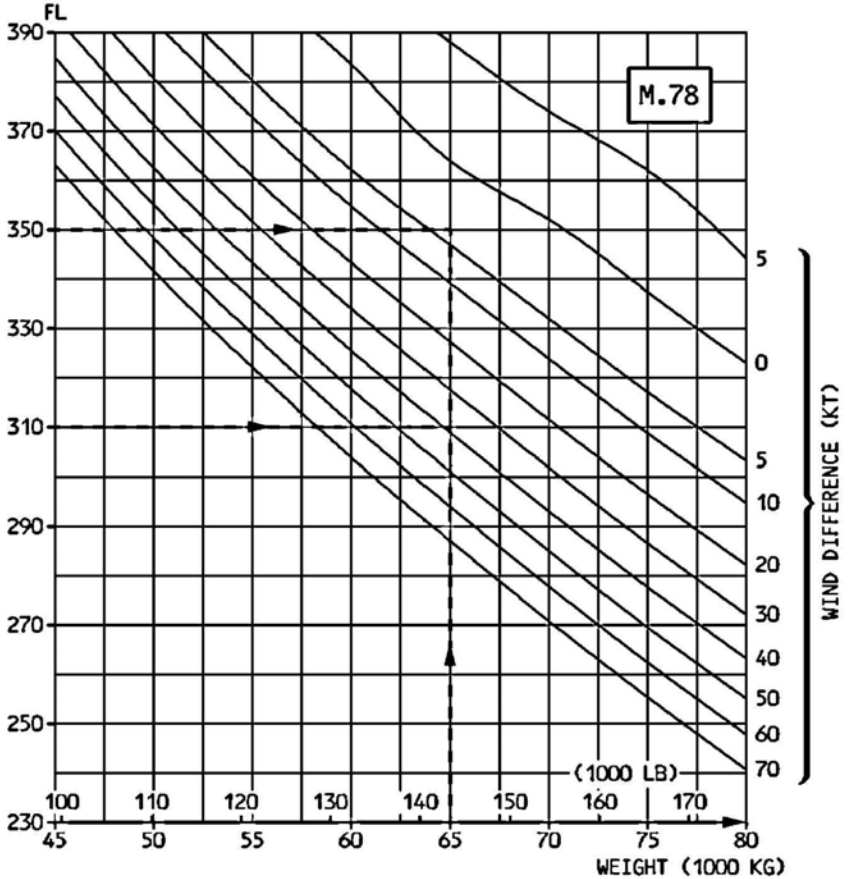

GIVEN : Weight : 65 000 kg (143 300 lb)
 Wind at FL 350 : 10 kt head

FIND : Minimum wind difference to descend to FL 310 : $(40 - 4) = 36$ kt

RESULTS : Descent to FL 310 may be considered provided the tail wind at this altitude is more than $(36 - 10) = 26$ kt.



A318/A319/A320/A321
FLIGHT CREW
OPERATING MANUAL

PERFORMANCE

CRUISE

ALTITUDE - WIND ALTITUDE TRADE FOR CONSTANT SPECIFIC RANGE

Intentionally left blank



A318/A319/A320/A321
FLIGHT CREW
OPERATING MANUAL

PERFORMANCE

CRUISE

CRUISE TABLES - GENERAL

GENERAL

Ident.: PER-CRZ-CRT-10-00004112.0002001 / 01 DEC 14

Applicable to: ALL

Cruise tables are established:

- for ISA and ISA + 20
- with normal air conditioning and anti ice OFF
- from FL 290 to FL 390 at M 0.78
- from FL 100 to FL 390 at long range speed
- with a 33 % center of gravity.



A318/A319/A320/A321
FLIGHT CREW
OPERATING MANUAL

PERFORMANCE

CRUISE

CRUISE TABLES - GENERAL

Intentionally left blank



A318/A319/A320/A321
FLIGHT CREW
OPERATING MANUAL

PERFORMANCE

CRUISE

CRUISE TABLES - CRUISE AT M.78

CRUISE - M.78 - ISA

Ident.: PER-CRZ-CRT-20-00002005.0010001 / 09 DEC 09

Applicable to: ALL

| CRUISE - M.78 | | | | | | | | | | | | |
|--|-------|------|-------|---|-------|---------------------------------|-------|--|-------|------|-------|------|
| MAX. CRUISE THRUST LIMITS NORMAL AIR CONDITIONING ANTI-ICING OFF | | | | ISA CG=33.0% | | N1 (%) KG/H/ENG NM/1000KG | | MACH IAS (KT) TAS (KT) | | | | |
| WEIGHT (1000KG) | FL290 | | FL310 | | FL330 | | FL350 | | FL370 | | FL390 | |
| 50 | 80.8 | .780 | 80.6 | .780 | 80.4 | .780 | 80.4 | .780 | 80.9 | .780 | 82.0 | .780 |
| | 1305 | 302 | 1211 | 289 | 1127 | 277 | 1053 | 264 | 994 | 252 | 954 | 241 |
| | 176.9 | 462 | 188.9 | 458 | 201.3 | 454 | 213.5 | 450 | 225.0 | 447 | 234.6 | 447 |
| 52 | 80.9 | .780 | 80.7 | .780 | 80.6 | .780 | 80.7 | .780 | 81.3 | .780 | 82.5 | .780 |
| | 1315 | 302 | 1222 | 289 | 1139 | 277 | 1066 | 264 | 1011 | 252 | 975 | 241 |
| | 175.6 | 462 | 187.3 | 458 | 199.2 | 454 | 210.8 | 450 | 221.2 | 447 | 229.3 | 447 |
| 54 | 81.1 | .780 | 80.9 | .780 | 80.9 | .780 | 81.0 | .780 | 81.7 | .780 | 82.9 | .780 |
| | 1324 | 302 | 1232 | 289 | 1152 | 277 | 1082 | 264 | 1030 | 252 | 1000 | 241 |
| | 174.3 | 462 | 185.7 | 458 | 196.8 | 454 | 207.8 | 450 | 217.2 | 447 | 223.6 | 447 |
| 56 | 81.2 | .780 | 81.1 | .780 | 81.1 | .780 | 81.3 | .780 | 82.1 | .780 | 83.5 | .780 |
| | 1335 | 302 | 1244 | 289 | 1166 | 277 | 1098 | 264 | 1051 | 252 | 1030 | 241 |
| | 173.0 | 462 | 184.0 | 458 | 194.6 | 454 | 204.7 | 450 | 212.9 | 447 | 217.1 | 447 |
| 58 | 81.4 | .780 | 81.3 | .780 | 81.4 | .780 | 81.7 | .780 | 82.5 | .780 | 84.1 | .780 |
| | 1345 | 302 | 1257 | 289 | 1180 | 277 | 1116 | 264 | 1074 | 252 | 1063 | 241 |
| | 171.6 | 462 | 182.1 | 458 | 192.2 | 454 | 201.5 | 450 | 208.3 | 447 | 210.5 | 447 |
| 60 | 81.6 | .780 | 81.6 | .780 | 81.7 | .780 | 82.1 | .780 | 83.0 | .780 | 84.7 | .780 |
| | 1356 | 302 | 1271 | 289 | 1196 | 277 | 1135 | 264 | 1099 | 252 | 1097 | 241 |
| | 170.2 | 462 | 180.1 | 458 | 189.6 | 454 | 198.1 | 450 | 203.6 | 447 | 203.9 | 447 |
| 62 | 81.8 | .780 | 81.8 | .780 | 82.0 | .780 | 82.5 | .780 | 83.5 | .780 | 85.4 | .780 |
| | 1368 | 302 | 1284 | 289 | 1213 | 277 | 1157 | 264 | 1129 | 252 | 1133 | 241 |
| | 168.7 | 462 | 178.2 | 458 | 187.0 | 454 | 194.4 | 450 | 198.1 | 447 | 197.4 | 447 |
| 64 | 82.0 | .780 | 82.0 | .780 | 82.3 | .780 | 82.9 | .780 | 84.0 | .780 | | |
| | 1382 | 302 | 1299 | 289 | 1231 | 277 | 1180 | 264 | 1162 | 252 | | |
| | 167.1 | 462 | 176.2 | 458 | 184.3 | 454 | 190.5 | 450 | 192.6 | 447 | | |
| 66 | 82.2 | .780 | 82.3 | .780 | 82.7 | .780 | 83.3 | .780 | 84.6 | .780 | | |
| | 1396 | 302 | 1315 | 289 | 1250 | 277 | 1205 | 264 | 1196 | 252 | | |
| | 165.4 | 462 | 174.0 | 458 | 181.4 | 454 | 186.5 | 450 | 187.1 | 447 | | |
| 68 | 82.4 | .780 | 82.6 | .780 | 83.1 | .780 | 83.7 | .780 | 85.2 | .780 | | |
| | 1409 | 302 | 1332 | 289 | 1272 | 277 | 1235 | 264 | 1232 | 252 | | |
| | 163.8 | 462 | 171.8 | 458 | 178.3 | 454 | 182.1 | 450 | 181.6 | 447 | | |
| 70 | 82.6 | .780 | 82.9 | .780 | 83.4 | .780 | 84.2 | .780 | 85.9 | .780 | | |
| | 1424 | 302 | 1350 | 289 | 1296 | 277 | 1267 | 264 | 1269 | 252 | | |
| | 162.1 | 462 | 169.5 | 458 | 175.1 | 454 | 177.4 | 450 | 176.3 | 447 | | |
| 72 | 82.9 | .780 | 83.2 | .780 | 83.8 | .780 | 84.7 | .780 | | | | |
| | 1441 | 302 | 1370 | 289 | 1321 | 277 | 1301 | 264 | | | | |
| | 160.2 | 462 | 167.1 | 458 | 171.7 | 454 | 172.8 | 450 | | | | |
| 74 | 83.1 | .780 | 83.6 | .780 | 84.2 | .780 | 85.3 | .780 | | | | |
| | 1458 | 302 | 1391 | 289 | 1348 | 277 | 1337 | 264 | | | | |
| | 158.4 | 462 | 164.5 | 458 | 168.2 | 454 | 168.2 | 450 | | | | |
| 76 | 83.4 | .780 | 83.9 | .780 | 84.6 | .780 | 85.9 | .780 | | | | |
| | 1475 | 302 | 1414 | 289 | 1380 | 277 | 1374 | 264 | | | | |
| | 156.5 | 462 | 161.8 | 458 | 164.3 | 454 | 163.7 | 450 | | | | |
| 78 | 83.7 | .780 | 84.3 | .780 | 85.1 | .780 | 86.5 | .780 | | | | |
| | 1495 | 302 | 1439 | 289 | 1414 | 277 | 1411 | 264 | | | | |
| | 154.4 | 462 | 159.0 | 458 | 160.5 | 454 | 159.3 | 450 | | | | |
| LOW AIR CONDITIONING ΔFUEL = -0.5 % | | | | ENGINE ANTI ICE ON ΔFUEL = +2.0 % | | | | TOTAL ANTI ICE ON ΔFUEL = +4.5 % | | | | |



A318/A319/A320/A321
FLIGHT CREW
OPERATING MANUAL

PERFORMANCE

CRUISE

CRUISE TABLES - CRUISE AT M.78

CRUISE - M.78 - ISA+20

Ident.: PER-CRZ-CRT-20-00002015.0009001 / 09 DEC 09

PERFORMANCE

CRUISE

CRUISE TABLES - CRUISE AT M.78

Applicable to: ALL

| CRUISE - M.78 | | | | | | | | | | | | |
|--|-------|------|-------|------|-------|---------------------------|-------|---------------------------------|--------------------------|------------------------------|-------|------|
| MAX. CRUISE THRUST LIMITS NORMAL AIR CONDITIONING ANTI-ICING OFF | | | | | | ISA+20 CG=33.0% | | N1 (%) KG/H/ENG NM/1000KG | | MACH IAS (KT) TAS (KT) | | |
| WEIGHT (1000KG) | FL290 | | FL310 | | FL330 | | FL350 | | FL370 | | FL390 | |
| 50 | 84.3 | .780 | 84.1 | .780 | 84.0 | .780 | 84.0 | .780 | 84.6 | .780 | 85.7 | .780 |
| | 1376 | 302 | 1278 | 289 | 1188 | 277 | 1112 | 264 | 1049 | 252 | 1007 | 241 |
| | 174.9 | 481 | 186.8 | 477 | 199.3 | 474 | 211.3 | 470 | 222.8 | 468 | 232.2 | 468 |
| 52 | 84.4 | .780 | 84.3 | .780 | 84.2 | .780 | 84.3 | .780 | 85.0 | .780 | 86.2 | .780 |
| | 1386 | 302 | 1288 | 289 | 1201 | 277 | 1126 | 264 | 1067 | 252 | 1030 | 241 |
| | 173.6 | 481 | 185.3 | 477 | 197.1 | 474 | 208.7 | 470 | 219.1 | 468 | 227.0 | 468 |
| 54 | 84.6 | .780 | 84.5 | .780 | 84.5 | .780 | 84.6 | .780 | 85.4 | .780 | 86.7 | .780 |
| | 1396 | 302 | 1300 | 289 | 1216 | 277 | 1142 | 264 | 1087 | 252 | 1057 | 241 |
| | 172.3 | 481 | 183.7 | 477 | 194.8 | 474 | 205.6 | 470 | 215.1 | 468 | 221.1 | 468 |
| 56 | 84.8 | .780 | 84.7 | .780 | 84.7 | .780 | 85.0 | .780 | 85.8 | .780 | 87.2 | .780 |
| | 1407 | 302 | 1312 | 289 | 1230 | 277 | 1160 | 264 | 1109 | 252 | 1089 | 241 |
| | 171.0 | 481 | 181.9 | 477 | 192.6 | 474 | 202.5 | 470 | 210.8 | 468 | 214.7 | 468 |
| 58 | 84.9 | .780 | 84.9 | .780 | 85.0 | .780 | 85.4 | .780 | 86.2 | .780 | | |
| | 1418 | 302 | 1326 | 289 | 1245 | 277 | 1178 | 264 | 1133 | 252 | | |
| | 169.7 | 481 | 180.0 | 477 | 190.2 | 474 | 199.4 | 470 | 206.3 | 468 | | |
| 60 | 85.1 | .780 | 85.1 | .780 | 85.3 | .780 | 85.8 | .780 | 86.7 | .780 | | |
| | 1430 | 302 | 1340 | 289 | 1262 | 277 | 1198 | 264 | 1161 | 252 | | |
| | 168.3 | 481 | 178.1 | 477 | 187.7 | 474 | 196.0 | 470 | 201.4 | 468 | | |
| 62 | 85.3 | .780 | 85.4 | .780 | 85.6 | .780 | 86.2 | .780 | 87.2 | .780 | | |
| | 1443 | 302 | 1355 | 289 | 1280 | 277 | 1221 | 264 | 1193 | 252 | | |
| | 166.8 | 481 | 176.2 | 477 | 185.0 | 474 | 192.3 | 470 | 196.0 | 468 | | |
| 64 | 85.5 | .780 | 85.6 | .780 | 86.0 | .780 | 86.5 | .780 | | | | |
| | 1457 | 302 | 1370 | 289 | 1299 | 277 | 1246 | 264 | | | | |
| | 165.1 | 481 | 174.2 | 477 | 182.3 | 474 | 188.5 | 470 | | | | |
| 66 | 85.7 | .780 | 85.9 | .780 | 86.4 | .780 | 87.0 | .780 | | | | |
| | 1472 | 302 | 1388 | 289 | 1319 | 277 | 1273 | 264 | | | | |
| | 163.5 | 481 | 172.0 | 477 | 179.5 | 474 | 184.5 | 470 | | | | |
| 68 | 85.9 | .780 | 86.2 | .780 | 86.7 | .780 | 87.4 | .780 | | | | |
| | 1486 | 302 | 1406 | 289 | 1342 | 277 | 1305 | 264 | | | | |
| | 161.9 | 481 | 169.8 | 477 | 176.4 | 474 | 180.0 | 470 | | | | |
| 70 | 86.2 | .780 | 86.5 | .780 | 87.1 | .780 | 87.9 | .780 | | | | |
| | 1502 | 302 | 1425 | 289 | 1367 | 277 | 1339 | 264 | | | | |
| | 160.2 | 481 | 167.6 | 477 | 173.2 | 474 | 175.4 | 470 | | | | |
| 72 | 86.4 | .780 | 86.9 | .780 | 87.5 | .780 | | | | | | |
| | 1519 | 302 | 1445 | 289 | 1394 | 277 | | | | | | |
| | 158.4 | 481 | 165.2 | 477 | 169.9 | 474 | | | | | | |
| 74 | 86.7 | .780 | 87.2 | .780 | 87.9 | .780 | | | | | | |
| | 1537 | 302 | 1468 | 289 | 1424 | 277 | | | | | | |
| | 156.5 | 481 | 162.6 | 477 | 166.3 | 474 | | | | | | |
| 76 | 87.0 | .780 | 87.6 | .780 | | | | | | | | |
| | 1556 | 302 | 1492 | 289 | | | | | | | | |
| | 154.7 | 481 | 160.0 | 477 | | | | | | | | |
| 78 | 87.3 | .780 | 87.9 | .780 | | | | | | | | |
| | 1576 | 302 | 1519 | 289 | | | | | | | | |
| | 152.6 | 481 | 157.2 | 477 | | | | | | | | |
| LOW AIR CONDITIONING | | | | | | ENGINE ANTI ICE ON | | | TOTAL ANTI ICE ON | | | |
| ΔFUEL = -0.5 % | | | | | | ΔFUEL = +2.0 % | | | ΔFUEL = +4.5 % | | | |



A318/A319/A320/A321
FLIGHT CREW
OPERATING MANUAL

PERFORMANCE

CRUISE

CRUISE TABLES - CRUISE AT LONG RANGE

LONG RANGE CRUISE - ISA

Ident.: PER-CRZ-CRT-30-00002018.0009001 / 10 DEC 09

Applicable to: ALL

| LONG RANGE CRUISE | | | | | | | | | | | | |
|--|-------|------|-------|------|---|------|---------------------------------|--|------------------------------|------|-------|------|
| MAX. CRUISE THRUST LIMITS NORMAL AIR CONDITIONING ANTI-ICING OFF | | | | | ISA CG=33.0% | | N1 (%) KG/H/ENG NM/1000KG | | MACH IAS (KT) TAS (KT) | | | |
| WEIGHT (1000KG) | FL100 | | FL150 | | FL200 | | FL230 | | FL250 | | FL270 | |
| 50 | 58.3 | .439 | 64.1 | .513 | 67.8 | .557 | 68.9 | .571 | 70.3 | .590 | 72.2 | .620 |
| | 1028 | 242 | 1065 | 259 | 1014 | 255 | 964 | 246 | 951 | 244 | 957 | 247 |
| | 136.2 | 280 | 151.0 | 321 | 168.8 | 342 | 179.8 | 347 | 186.6 | 355 | 193.5 | 370 |
| 52 | 59.5 | .450 | 65.0 | .522 | 68.1 | .558 | 69.7 | .579 | 71.2 | .600 | 73.6 | .640 |
| | 1075 | 249 | 1099 | 263 | 1029 | 255 | 995 | 249 | 987 | 248 | 1007 | 255 |
| | 133.7 | 287 | 148.7 | 327 | 166.6 | 343 | 176.5 | 351 | 183.0 | 361 | 189.7 | 382 |
| 54 | 61.9 | .482 | 66.4 | .536 | 68.6 | .561 | 70.6 | .588 | 72.3 | .615 | 75.0 | .657 |
| | 1171 | 267 | 1145 | 270 | 1050 | 257 | 1029 | 253 | 1030 | 255 | 1055 | 262 |
| | 131.3 | 308 | 146.6 | 336 | 164.1 | 345 | 173.3 | 357 | 179.6 | 370 | 186.0 | 392 |
| 56 | 63.6 | .502 | 67.7 | .549 | 69.4 | .568 | 71.5 | .597 | 73.6 | .633 | 75.7 | .666 |
| | 1240 | 278 | 1189 | 277 | 1082 | 260 | 1065 | 258 | 1081 | 263 | 1086 | 266 |
| | 129.1 | 320 | 144.5 | 344 | 161.3 | 349 | 170.2 | 362 | 176.3 | 381 | 182.9 | 397 |
| 58 | 64.6 | .513 | 68.5 | .555 | 70.1 | .575 | 72.4 | .609 | 74.9 | .650 | 76.2 | .669 |
| | 1283 | 284 | 1219 | 280 | 1113 | 263 | 1105 | 263 | 1130 | 270 | 1110 | 267 |
| | 127.5 | 327 | 142.7 | 348 | 158.6 | 353 | 167.2 | 370 | 173.1 | 391 | 180.0 | 400 |
| 60 | 65.6 | .521 | 68.8 | .557 | 70.8 | .582 | 73.5 | .624 | 75.9 | .663 | 76.6 | .672 |
| | 1321 | 289 | 1236 | 281 | 1145 | 267 | 1152 | 270 | 1172 | 276 | 1131 | 268 |
| | 126.0 | 333 | 141.1 | 349 | 156.0 | 357 | 164.4 | 379 | 170.2 | 399 | 177.3 | 401 |
| 62 | 66.5 | .530 | 69.1 | .558 | 71.5 | .590 | 74.7 | .640 | 76.4 | .667 | 77.3 | .679 |
| | 1358 | 294 | 1252 | 282 | 1180 | 270 | 1202 | 277 | 1198 | 278 | 1164 | 272 |
| | 124.6 | 338 | 139.6 | 349 | 153.5 | 362 | 161.6 | 389 | 167.7 | 402 | 174.2 | 405 |
| 64 | 67.3 | .538 | 69.4 | .559 | 72.3 | .598 | 75.8 | .654 | 76.9 | .670 | 78.0 | .687 |
| | 1393 | 298 | 1268 | 282 | 1216 | 274 | 1249 | 284 | 1220 | 279 | 1199 | 275 |
| | 123.2 | 343 | 138.0 | 350 | 151.1 | 367 | 159.0 | 397 | 165.3 | 404 | 171.1 | 410 |
| 66 | 68.2 | .545 | 69.7 | .560 | 73.2 | .610 | 76.6 | .665 | 77.3 | .673 | 78.7 | .696 |
| | 1427 | 302 | 1285 | 283 | 1259 | 280 | 1288 | 289 | 1242 | 280 | 1235 | 279 |
| | 121.9 | 348 | 136.5 | 351 | 148.8 | 374 | 156.6 | 404 | 163.0 | 405 | 168.1 | 415 |
| 68 | 68.8 | .550 | 70.3 | .565 | 74.1 | .623 | 77.1 | .669 | 77.9 | .680 | 79.4 | .704 |
| | 1453 | 305 | 1315 | 285 | 1306 | 286 | 1314 | 290 | 1276 | 284 | 1273 | 282 |
| | 120.7 | 351 | 134.6 | 354 | 146.5 | 383 | 154.5 | 406 | 160.3 | 409 | 165.2 | 420 |
| 70 | 69.4 | .554 | 70.9 | .571 | 75.2 | .637 | 77.5 | .672 | 78.5 | .688 | 80.1 | .713 |
| | 1479 | 307 | 1347 | 288 | 1356 | 293 | 1337 | 292 | 1312 | 287 | 1312 | 286 |
| | 119.6 | 354 | 132.7 | 358 | 144.3 | 391 | 152.5 | 408 | 157.7 | 414 | 162.4 | 422 |
| 72 | 69.8 | .557 | 71.5 | .577 | 76.2 | .650 | 77.9 | .674 | 79.2 | .695 | 80.8 | .726 |
| | 1500 | 309 | 1381 | 292 | 1404 | 299 | 1359 | 293 | 1349 | 290 | 1350 | 290 |
| | 118.4 | 355 | 130.9 | 361 | 142.2 | 399 | 150.5 | 409 | 155.1 | 419 | 159.6 | 431 |
| 74 | 70.1 | .558 | 72.1 | .583 | 77.0 | .661 | 78.4 | .681 | 79.8 | .703 | 81.2 | .729 |
| | 1518 | 310 | 1413 | 295 | 1448 | 305 | 1394 | 296 | 1386 | 294 | 1386 | 293 |
| | 117.3 | 356 | 129.1 | 365 | 140.2 | 406 | 148.2 | 413 | 152.6 | 423 | 157.0 | 435 |
| 76 | 70.3 | .559 | 72.7 | .589 | 77.6 | .667 | 79.0 | .687 | 80.5 | .712 | 81.7 | .737 |
| | 1535 | 310 | 1449 | 298 | 1480 | 308 | 1428 | 299 | 1426 | 298 | 1424 | 296 |
| | 116.3 | 357 | 127.4 | 369 | 138.5 | 410 | 146.0 | 417 | 150.2 | 429 | 154.3 | 440 |
| 78 | 70.6 | .560 | 73.4 | .596 | 78.0 | .671 | 79.6 | .693 | 81.1 | .720 | 82.2 | .744 |
| | 1551 | 311 | 1485 | 302 | 1506 | 309 | 1463 | 302 | 1465 | 301 | 1463 | 299 |
| | 115.2 | 357 | 125.7 | 373 | 136.8 | 412 | 143.8 | 421 | 147.9 | 433 | 151.8 | 444 |
| LOW AIR CONDITIONING ΔFUEL = -0.5 % | | | | | ENGINE ANTI ICE ON ΔFUEL = +2.5 % | | | TOTAL ANTI ICE ON ΔFUEL = +5 % | | | | |

PERFORMANCE

CRUISE

CRUISE TABLES - CRUISE AT LONG RANGE

| LONG RANGE CRUISE | | | | | | | | | | | | |
|--|-------|------|-------|---------------------------|-------|---------------------------------|-------|------------------------------|-------|------|-------|------|
| MAX. CRUISE THRUST LIMITS NORMAL AIR CONDITIONING ANTI-ICING OFF | | | | ISA CG = 33.0% | | N1 (%) KG/H/ENG NM/1000KG | | MACH IAS (KT) TAS (KT) | | | | |
| WEIGHT (1000KG) | FL290 | | FL310 | | FL330 | | FL350 | | FL370 | | FL390 | |
| 50 | 74.8 | .662 | 75.5 | .671 | 76.9 | .694 | 78.4 | .722 | 79.9 | .749 | 81.8 | .771 |
| | 976 | 253 | 941 | 246 | 933 | 244 | 932 | 243 | 935 | 242 | 939 | 238 |
| | 200.6 | 392 | 209.3 | 394 | 216.4 | 404 | 223.4 | 416 | 229.9 | 430 | 235.7 | 442 |
| 52 | 75.3 | .666 | 76.3 | .680 | 77.8 | .706 | 79.1 | .733 | 80.6 | .759 | 82.4 | .778 |
| | 1000 | 255 | 974 | 249 | 970 | 248 | 969 | 247 | 970 | 245 | 972 | 240 |
| | 197.2 | 394 | 204.9 | 399 | 211.6 | 410 | 218.1 | 423 | 224.3 | 435 | 229.5 | 446 |
| 54 | 75.8 | .669 | 77.1 | .690 | 78.7 | .718 | 79.8 | .745 | 81.3 | .768 | 83.1 | .783 |
| | 1022 | 256 | 1009 | 253 | 1009 | 253 | 1008 | 251 | 1007 | 248 | 1007 | 242 |
| | 193.9 | 396 | 200.6 | 405 | 207.0 | 418 | 213.0 | 429 | 218.7 | 441 | 222.9 | 449 |
| 56 | 76.5 | .676 | 77.9 | .699 | 79.3 | .727 | 80.5 | .754 | 82.0 | .775 | 83.6 | .783 |
| | 1051 | 259 | 1043 | 257 | 1044 | 256 | 1043 | 255 | 1041 | 251 | 1038 | 242 |
| | 190.4 | 400 | 196.5 | 410 | 202.6 | 423 | 208.3 | 434 | 213.4 | 445 | 216.3 | 449 |
| 58 | 77.2 | .685 | 78.8 | .710 | 80.0 | .738 | 81.2 | .763 | 82.5 | .781 | 84.3 | .786 |
| | 1086 | 263 | 1082 | 261 | 1083 | 260 | 1080 | 258 | 1075 | 253 | 1076 | 243 |
| | 186.6 | 406 | 192.6 | 417 | 198.2 | 429 | 203.6 | 440 | 208.2 | 448 | 209.3 | 451 |
| 60 | 78.0 | .694 | 79.5 | .721 | 80.6 | .747 | 81.8 | .771 | 83.1 | .784 | 85.0 | .788 |
| | 1122 | 266 | 1121 | 266 | 1119 | 264 | 1116 | 261 | 1109 | 254 | 1116 | 244 |
| | 183.0 | 411 | 188.7 | 423 | 194.1 | 434 | 199.0 | 444 | 202.8 | 450 | 202.5 | 452 |
| 62 | 78.7 | .703 | 80.1 | .730 | 81.2 | .755 | 82.4 | .777 | 83.6 | .784 | 85.8 | .789 |
| | 1158 | 270 | 1157 | 269 | 1155 | 267 | 1150 | 263 | 1140 | 254 | 1156 | 244 |
| | 179.6 | 416 | 185.0 | 428 | 190.1 | 439 | 194.7 | 448 | 197.2 | 450 | 195.8 | 453 |
| 64 | 79.5 | .713 | 80.7 | .739 | 81.8 | .764 | 82.9 | .781 | 84.2 | .786 | 86.1 | .780 |
| | 1197 | 274 | 1197 | 273 | 1194 | 270 | 1182 | 265 | 1179 | 255 | 1170 | 241 |
| | 176.3 | 422 | 181.3 | 434 | 186.1 | 444 | 190.3 | 450 | 191.4 | 451 | 191.1 | 447 |
| 66 | 80.2 | .723 | 81.3 | .748 | 82.5 | .771 | 83.4 | .784 | 84.9 | .788 | | |
| | 1235 | 278 | 1233 | 276 | 1231 | 273 | 1217 | 266 | 1218 | 255 | | |
| | 173.1 | 428 | 177.9 | 439 | 182.2 | 449 | 185.8 | 452 | 185.6 | 452 | | |
| 68 | 80.7 | .730 | 81.8 | .755 | 83.0 | .776 | 83.9 | .784 | 85.6 | .789 | | |
| | 1272 | 281 | 1270 | 279 | 1264 | 275 | 1247 | 266 | 1258 | 256 | | |
| | 170.0 | 432 | 174.5 | 443 | 178.6 | 452 | 181.3 | 452 | 180.0 | 453 | | |
| 70 | 81.3 | .739 | 82.4 | .764 | 83.5 | .780 | 84.4 | .786 | 86.2 | .789 | | |
| | 1311 | 285 | 1309 | 283 | 1296 | 277 | 1285 | 267 | 1296 | 256 | | |
| | 166.8 | 437 | 171.1 | 448 | 175.0 | 454 | 176.3 | 453 | 174.7 | 453 | | |
| 72 | 81.8 | .747 | 83.0 | .771 | 83.9 | .783 | 85.0 | .788 | 86.4 | .772 | | |
| | 1348 | 288 | 1346 | 285 | 1331 | 278 | 1324 | 267 | 1291 | 250 | | |
| | 163.9 | 442 | 167.9 | 452 | 171.2 | 456 | 171.6 | 454 | 171.5 | 443 | | |
| 74 | 82.3 | .753 | 83.5 | .776 | 84.4 | .784 | 85.6 | .789 | | | | |
| | 1394 | 291 | 1392 | 289 | 1362 | 278 | 1363 | 268 | | | | |
| | 161.1 | 446 | 164.8 | 455 | 167.5 | 456 | 166.8 | 455 | | | | |
| 76 | 82.8 | .761 | 84.0 | .780 | 84.8 | .785 | 86.2 | .789 | | | | |
| | 1423 | 294 | 1415 | 289 | 1398 | 279 | 1402 | 268 | | | | |
| | 158.3 | 450 | 161.8 | 458 | 163.4 | 457 | 162.3 | 455 | | | | |
| 78 | 83.4 | .768 | 84.4 | .782 | 85.4 | .787 | 86.5 | .782 | | | | |
| | 1462 | 297 | 1446 | 290 | 1436 | 279 | 1417 | 265 | | | | |
| | 155.5 | 455 | 158.7 | 459 | 159.4 | 458 | 159.0 | 451 | | | | |
| LOW AIR CONDITIONING | | | | ENGINE ANTI ICE ON | | | | TOTAL ANTI ICE ON | | | | |
| ΔFUEL = -0.5 % | | | | ΔFUEL = +2.5 % | | | | ΔFUEL = +5 % | | | | |

LONG RANGE CRUISE - ISA+20

Ident.: PER-CRZ-CRT-30-00002033.0009001 / 10 DEC 09

Applicable to: ALL

| LONG RANGE CRUISE | | | | | | |
|--|-----------|-----------|---|---------------------|--|------------------------------|
| MAX. CRUISE THRUST LIMITS NORMAL AIR CONDITIONING ANTI-ICING OFF | | | | ISA +20 CG=33.0% | N1 (%) KG/H/ENG NM/1000KG | MACH IAS (KT) TAS (KT) |
| WEIGHT (1000KG) | FL100 | FL150 | FL200 | FL230 | FL250 | FL270 |
| 50 | 60.7 .440 | 67.8 .528 | 70.4 .553 | 71.7 .568 | 73.2 .587 | 75.0 .614 |
| | 1083 243 | 1144 266 | 1045 253 | 998 245 | 985 243 | 987 244 |
| | 134.6 291 | 149.9 343 | 169.0 353 | 179.9 359 | 186.6 368 | 193.4 382 |
| 52 | 64.0 .482 | 68.7 .534 | 70.8 .554 | 72.6 .576 | 74.1 .596 | 76.5 .634 |
| | 1207 267 | 1173 269 | 1062 254 | 1031 248 | 1022 247 | 1041 252 |
| | 132.1 319 | 148.0 347 | 166.7 354 | 176.5 364 | 182.9 374 | 189.4 394 |
| 54 | 66.3 .508 | 69.5 .541 | 71.3 .558 | 73.4 .584 | 75.1 .610 | 78.0 .652 |
| | 1295 281 | 1203 273 | 1086 255 | 1065 252 | 1065 253 | 1092 260 |
| | 129.8 336 | 146.2 352 | 164.1 356 | 173.2 369 | 179.4 382 | 185.6 405 |
| 56 | 67.1 .514 | 70.4 .547 | 72.1 .565 | 74.3 .593 | 76.4 .627 | 78.8 .661 |
| | 1325 285 | 1232 276 | 1119 259 | 1101 256 | 1116 260 | 1128 264 |
| | 128.4 340 | 144.5 356 | 161.2 361 | 170.0 374 | 176.0 393 | 182.3 411 |
| 58 | 67.6 .518 | 71.0 .552 | 72.8 .572 | 75.1 .602 | 77.8 .643 | 79.3 .665 |
| | 1347 287 | 1256 278 | 1153 262 | 1138 260 | 1167 267 | 1154 266 |
| | 127.2 343 | 142.8 359 | 158.5 365 | 167.0 380 | 172.7 403 | 179.3 414 |
| 60 | 68.3 .523 | 71.3 .553 | 73.6 .579 | 76.2 .616 | 78.9 .658 | 79.8 .668 |
| | 1375 290 | 1274 279 | 1187 265 | 1187 266 | 1215 274 | 1177 267 |
| | 125.8 346 | 141.1 360 | 155.8 370 | 164.0 389 | 169.6 412 | 176.5 415 |
| 62 | 69.1 .530 | 71.7 .555 | 74.4 .587 | 77.4 .633 | 79.5 .663 | 80.5 .676 |
| | 1408 294 | 1293 280 | 1223 269 | 1240 274 | 1243 276 | 1213 270 |
| | 124.5 350 | 139.5 361 | 153.2 375 | 161.2 400 | 167.0 415 | 173.2 420 |
| 64 | 69.8 .535 | 72.0 .556 | 75.1 .594 | 78.7 .649 | 80.0 .666 | 81.2 .684 |
| | 1437 297 | 1311 281 | 1259 273 | 1292 281 | 1269 277 | 1250 273 |
| | 123.2 354 | 137.9 361 | 150.8 380 | 158.4 409 | 164.5 418 | 170.1 425 |
| 66 | 70.5 .541 | 72.4 .557 | 75.9 .603 | 79.6 .660 | 80.5 .670 | 81.9 .692 |
| | 1467 300 | 1330 281 | 1298 277 | 1336 286 | 1296 279 | 1289 277 |
| | 121.9 358 | 136.3 362 | 148.4 385 | 155.9 417 | 162.0 420 | 167.0 430 |
| 68 | 71.2 .546 | 73.0 .563 | 76.8 .616 | 80.1 .664 | 81.1 .677 | 82.6 .700 |
| | 1496 303 | 1363 284 | 1347 283 | 1365 288 | 1333 282 | 1328 281 |
| | 120.7 361 | 134.3 366 | 146.1 393 | 153.7 420 | 159.2 424 | 164.0 436 |
| 70 | 71.9 .551 | 73.6 .568 | 77.9 .631 | 80.5 .667 | 81.8 .685 | 83.4 .710 |
| | 1525 305 | 1396 287 | 1401 290 | 1390 290 | 1371 286 | 1370 285 |
| | 119.5 364 | 132.4 370 | 143.7 403 | 151.6 421 | 156.6 429 | 161.1 441 |
| 72 | 72.3 .554 | 74.2 .574 | 79.0 .643 | 81.0 .670 | 82.4 .692 | 84.1 .719 |
| | 1548 307 | 1431 290 | 1451 296 | 1416 291 | 1409 289 | 1412 289 |
| | 118.3 366 | 130.5 373 | 141.6 411 | 149.5 423 | 154.0 434 | 158.3 447 |
| 74 | 72.6 .555 | 74.8 .580 | 80.0 .656 | 81.6 .677 | 83.1 .700 | 84.6 .727 |
| | 1567 308 | 1464 293 | 1500 302 | 1453 294 | 1448 292 | 1452 292 |
| | 117.2 367 | 128.7 377 | 139.5 419 | 147.2 428 | 151.4 439 | 155.6 452 |
| 76 | 72.9 .556 | 75.4 .586 | 80.6 .663 | 82.2 .684 | 83.8 .708 | 85.1 .735 |
| | 1585 308 | 1500 296 | 1537 306 | 1491 297 | 1490 296 | 1494 295 |
| | 116.0 368 | 127.0 381 | 137.7 423 | 144.9 432 | 149.0 444 | 152.9 457 |
| 78 | 73.2 .557 | 76.1 .592 | 81.0 .666 | 82.8 .691 | 84.5 .717 | 85.7 .743 |
| | 1603 309 | 1538 300 | 1564 307 | 1529 300 | 1533 300 | 1537 299 |
| | 114.9 369 | 125.3 385 | 136.0 425 | 142.6 436 | 146.6 449 | 150.3 462 |
| LOW AIR CONDITIONING ΔFUEL = -0.5 % | | | ENGINE ANTI ICE ON ΔFUEL = +2.5 % | | TOTAL ANTI ICE ON ΔFUEL = +5 % | |

PERFORMANCE

CRUISE

CRUISE TABLES - CRUISE AT LONG RANGE

| LONG RANGE CRUISE | | | | | | | | | | | | |
|--|-------|------|-------|---|-------|---------------------------------|-------|--|-------|------|-------|------|
| MAX. CRUISE THRUST LIMITS NORMAL AIR CONDITIONING ANTI-ICING OFF | | | | ISA +20 CG = 33.0% | | N1 (%) KG/H/ENG NM/1000KG | | MACH IAS (KT) TAS (KT) | | | | |
| WEIGHT (1000KG) | FL290 | | FL310 | | FL330 | | FL350 | | FL370 | | FL390 | |
| 50 | 77.9 | .657 | 78.7 | .667 | 80.3 | .691 | 81.9 | .719 | 83.5 | .748 | 85.5 | .769 |
| | 1012 | 251 | 979 | 244 | 973 | 242 | 974 | 242 | 982 | 241 | 987 | 237 |
| | 200.2 | 405 | 208.6 | 408 | 215.5 | 419 | 222.1 | 433 | 228.1 | 448 | 233.6 | 461 |
| 52 | 78.5 | .662 | 79.6 | .677 | 81.1 | .700 | 82.6 | .730 | 84.2 | .757 | 86.1 | .776 |
| | 1039 | 253 | 1016 | 248 | 1010 | 246 | 1015 | 246 | 1021 | 244 | 1023 | 240 |
| | 196.6 | 409 | 204.0 | 415 | 210.6 | 425 | 216.7 | 440 | 222.4 | 454 | 227.3 | 465 |
| 54 | 79.0 | .666 | 80.4 | .686 | 82.1 | .713 | 83.4 | .742 | 85.0 | .766 | 86.7 | .781 |
| | 1064 | 255 | 1052 | 252 | 1052 | 251 | 1057 | 250 | 1059 | 248 | 1061 | 242 |
| | 193.1 | 411 | 199.7 | 420 | 205.8 | 433 | 211.5 | 447 | 216.8 | 459 | 220.8 | 468 |
| 56 | 79.7 | .673 | 81.3 | .696 | 82.8 | .724 | 84.1 | .751 | 85.6 | .774 | 87.3 | .781 |
| | 1096 | 258 | 1090 | 256 | 1092 | 255 | 1095 | 254 | 1096 | 250 | 1093 | 242 |
| | 189.4 | 415 | 195.4 | 426 | 201.2 | 439 | 206.7 | 453 | 211.5 | 464 | 214.3 | 468 |
| 58 | 80.5 | .682 | 82.1 | .707 | 83.5 | .735 | 84.7 | .760 | 86.2 | .780 | 87.3 | .756 |
| | 1133 | 261 | 1130 | 260 | 1135 | 259 | 1134 | 257 | 1133 | 252 | 1082 | 233 |
| | 185.7 | 421 | 191.3 | 432 | 196.6 | 446 | 201.9 | 458 | 206.3 | 468 | 209.4 | 453 |
| 60 | 81.3 | .691 | 82.9 | .717 | 84.2 | .745 | 85.4 | .768 | 86.8 | .782 | | |
| | 1172 | 265 | 1172 | 264 | 1176 | 263 | 1173 | 260 | 1167 | 253 | | |
| | 182.0 | 426 | 187.4 | 439 | 192.4 | 453 | 197.3 | 463 | 200.9 | 469 | | |
| 62 | 82.1 | .700 | 83.5 | .727 | 84.8 | .754 | 86.0 | .774 | 87.3 | .783 | | |
| | 1209 | 268 | 1213 | 268 | 1215 | 267 | 1209 | 262 | 1203 | 254 | | |
| | 178.5 | 432 | 183.5 | 445 | 188.4 | 458 | 192.9 | 466 | 195.2 | 470 | | |
| 64 | 82.9 | .709 | 84.2 | .738 | 85.4 | .762 | 86.5 | .780 | 87.7 | .778 | | |
| | 1250 | 273 | 1256 | 272 | 1255 | 270 | 1245 | 264 | 1224 | 252 | | |
| | 175.1 | 438 | 179.8 | 451 | 184.4 | 463 | 188.5 | 470 | 190.5 | 467 | | |
| 66 | 83.6 | .719 | 84.8 | .746 | 86.0 | .770 | 87.1 | .783 | 87.8 | .750 | | |
| | 1292 | 277 | 1296 | 276 | 1294 | 273 | 1281 | 265 | 1210 | 242 | | |
| | 171.8 | 444 | 176.3 | 457 | 180.6 | 467 | 184.0 | 471 | 185.6 | 449 | | |
| 68 | 84.1 | .727 | 85.4 | .754 | 86.6 | .775 | 87.6 | .783 | | | | |
| | 1331 | 280 | 1334 | 279 | 1330 | 275 | 1315 | 266 | | | | |
| | 168.6 | 449 | 172.9 | 461 | 176.9 | 470 | 179.4 | 472 | | | | |
| 70 | 84.7 | .736 | 85.9 | .761 | 87.1 | .779 | 88.0 | .782 | | | | |
| | 1374 | 284 | 1375 | 282 | 1364 | 276 | 1346 | 265 | | | | |
| | 165.4 | 454 | 169.5 | 466 | 173.3 | 473 | 175.0 | 471 | | | | |
| 72 | 85.3 | .745 | 86.5 | .768 | 87.6 | .783 | 88.1 | .761 | | | | |
| | 1415 | 287 | 1414 | 284 | 1403 | 278 | 1335 | 257 | | | | |
| | 162.4 | 460 | 166.3 | 470 | 169.5 | 475 | 171.6 | 458 | | | | |
| 74 | 85.8 | .752 | 87.0 | .773 | 88.0 | .783 | | | | | | |
| | 1454 | 290 | 1450 | 287 | 1435 | 278 | | | | | | |
| | 159.6 | 464 | 163.2 | 473 | 165.7 | 475 | | | | | | |
| 76 | 86.3 | .759 | 87.5 | .777 | 88.1 | .768 | | | | | | |
| | 1494 | 293 | 1484 | 288 | 1430 | 272 | | | | | | |
| | 156.7 | 468 | 160.2 | 475 | 163.0 | 466 | | | | | | |
| 78 | 86.9 | .766 | 87.9 | .781 | 88.1 | .743 | | | | | | |
| | 1535 | 296 | 1522 | 290 | 1419 | 262 | | | | | | |
| | 153.9 | 473 | 157.1 | 478 | 159.1 | 451 | | | | | | |
| LOW AIR CONDITIONING ΔFUEL = -0.5 % | | | | ENGINE ANTI ICE ON ΔFUEL = +2.5 % | | | | TOTAL ANTI ICE ON ΔFUEL = +5 % | | | | |

| | |
|---|--|
|  A318/A319/A320/A321 FLIGHT CREW OPERATING MANUAL | PERFORMANCE CRUISE IN CRUISE QUICK CHECK - GENERAL |
|---|--|

GENERAL

Ident.: PER-CRZ-ICQ-10-00002036.0001001 / 22 MAR 17

Applicable to: ALL

In cruise, a quick check table (*Refer to QRH/PER-M In Cruise Quick Check at a Given Mach Number (Paper Only)*) or use the performance application of FlySmart with Airbus) allows the flight crew to determine the fuel consumption and the time required to cover a given air distance from any moment in cruise to land.

The QRH table is established for:

- Cruise Mach number: M 0.78
- Descent profile: M 0.78/300 kt/250 kt
- Approach and landing: 120 kg or 270 lb -6 min IMC
- ISA
- CG = 33 %
- Normal air conditioning
- Anti ice OFF

- Note:
1. In the table, the asterisk "*" means that a step climb of 4 000 ft has been made to reach the corresponding flight level.
 2. The flight level shown on the top of each column is the final flight level.
 3. For each degree celsius above ISA apply a fuel correction of
 $0.005 \text{ (kg/}^\circ\text{C/NM)} \times \Delta\text{ISA (}^\circ\text{C)} \times \text{Air Distance (NM)}$
 or $0.011 \text{ (lb/}^\circ\text{C/NM)} \times \Delta\text{ISA (}^\circ\text{C)} \times \text{Air Distance (NM)}$

CORRECTION FOR DEVIATION FROM REFERENCE WEIGHT

Ident.: PER-CRZ-ICQ-10-00002039.0001001 / 22 MAR 16

Applicable to: ALL

The in cruise quick check table is based on a reference initial weight.

The fuel consumption must be corrected when the actual weight is different from the reference initial weight.

If it is lower (or greater) than the reference weight, subtract (or add) the value given in the correction part of the table per 1 000 kg or 1 000 lb below (or above) the reference weight.



A318/A319/A320/A321
FLIGHT CREW
OPERATING MANUAL

PERFORMANCE

CRUISE

IN CRUISE QUICK CHECK - GENERAL

Intentionally left blank



A318/A319/A320/A321
FLIGHT CREW
OPERATING MANUAL

PERFORMANCE

CRUISE

IN CRUISE QUICK CHECK - EXAMPLE

EXAMPLE FOR THE QRR USE

Ident.: PER-CRZ-ICQ-20-00014741.0001001 / 22 MAR 17

Applicable to: ALL

The following data and graphs are for example only, and are not for operational use. Even if the data in the following example is in “kg” and “m”, the same method can be applied for “lb” and “ft”.

In-cruise quick check with cruise at M.78

FL 370

Actual cruise weight : 55 000 kg

Remaining ground distance : 800 NM

ISA +10

Average wind during flight : -40 kt (head wind)

- Evaluation of air distance to be covered

- Use the “Ground Distance/Air Distance” conversion table (*Refer to PER-OPD-CON-AEO M.78*)

| AIR DISTANCE (NM) - M.78 | | | | | | | |
|--------------------------|----------------------|------|------|------|------|------|------------------|
| GROUND DIST. (NM) | WIND COMPONENTS (KT) | | | | | | |
| | TAILWIND +150 | +100 | +50 | 0 | -50 | -100 | HEADWIND -150 |
| 10 | 7 | 8 | 9 | 10 | 11 | 13 | 15 |
| 20 | 15 | 16 | 18 | 20 | 23 | 26 | 30 |
| 30 | 22 | 25 | 27 | 30 | 34 | 39 | 45 |
| 40 | 30 | 33 | 36 | 40 | 45 | 51 | 60 |
| 50 | 37 | 41 | 45 | 50 | 56 | 64 | 75 |
| 100 | 75 | 82 | 90 | 100 | 113 | 129 | 150 |
| 200 | 150 | 164 | 180 | 200 | 225 | 257 | 300 |
| 300 | 225 | 245 | 270 | 300 | 338 | 386 | 450 |
| 400 | 300 | 327 | 360 | 400 | 450 | 514 | 600 |
| 500 | 375 | 409 | 450 | 500 | 563 | 643 | 750 |
| 1000 | 750 | 818 | 900 | 1000 | 1125 | 1286 | 1501 |
| 1500 | 1125 | 1227 | 1350 | 1500 | 1688 | 1929 | 2251 |
| 2000 | 1500 | 1636 | 1800 | 2000 | 2250 | 2572 | 3001 |
| 2500 | 1875 | 2045 | 2250 | 2500 | 2813 | 3215 | 3752 |
| 3000 | 2250 | 2454 | 2700 | 3000 | 3375 | 3858 | 4502 |
| 3500 | 2624 | 2863 | 3150 | 3500 | 3938 | 4501 | 5252 |
| 4000 | 2999 | 3272 | 3600 | 4000 | 4500 | 5144 | 6003 |
| 4500 | 3374 | 3681 | 4050 | 4500 | 5063 | 5787 | 6753 |
| 5000 | 3749 | 4090 | 4500 | 5000 | 5626 | 6430 | 7503 |

A318/A319/A320/A321

**FLIGHT CREW
OPERATING MANUAL**

The corresponding air distance is : 880 NM

- Determination of the fuel consumption and time for the reference initial weight in cruise.
- Enter table (*Refer to QRH/PER-M In Cruise Quick Check at a Given Mach Number (Paper Only)*) with an air distance of 880 NM and FL 370 for ISA.

| IN CRUISE QUICK CHECK FROM ANY MOMENT IN CRUISE TO LANDING | | | | | | | | | | |
|--|--------------|--------------|---------------------------------------|--------------|--------------|--|----------------|----------------|----------------|----|
| CRUISE : M.78 - DESCENT : M.78/300KT/250KT | | | | | | | | | | |
| IMC PROCEDURE : 120 KG (6MIN) | | | | | | | | | | |
| REF. INITIAL WEIGHT = 60000 KG | | | ISA | | | FUEL CONSUMED (KG) | | | | |
| NORMAL AIR CONDITIONING | | | CG = 33.0 % | | | | | | | |
| ANTI-ICING OFF | | | | | | TIME (H.MIN) | | | | |
| AIR DIST. (NM) | FLIGHT LEVEL | | | | | CORRECTION ON FUEL CONSUMPTION (KG/1000KG) | | | | |
| | 290 | 310 | 330 | 350 | 370 | 390 | FL290 FL310 | FL330 FL350 | FL370 FL390 | |
| 725 | 4001 1.43 | 3772 1.44 | 3583 1.45 | 3427 1.46 | 3313 1.46 | 3278 1.46 | 16 | 24 | 42 | |
| 750 | 4145 1.47 | 3909 1.47 | 3712 1.48 | 3551 1.49 | 3433 1.49 | 3397 1.49 | 17 | 25 | 43 | |
| 775 | 4290 1.50 | 4045 1.51 | 3842 1.52 | 3675 1.52 | 3552 1.53 | 3516 1.53 | 18 | 26 | 45 | |
| 800 | 4434 1.53 | 4181 1.54 | 3971 1.55 | 3799 1.56 | 3672 1.56 | 3634 1.56 | 18 | 27 | 46 | |
| 825 | 4578 1.56 | 4317 1.57 | 4100 1.58 | 3922 1.59 | 3791 2.00 | 3752 2.00 | 19 | 28 | 48 | |
| 850 | 4722 2.00 | 4452 2.01 | 4229 2.01 | 4046 2.02 | 3910 2.03 | 3870 2.03 | 20 | 29 | 49 | |
| 875 | 4866 2.03 | 4588 2.04 | 4358 2.05 | 4169 2.06 | 4029 2.06 | 3988 2.06 | 20 | 30 | 51 | |
| 900 | 5010 2.06 | 4724 2.07 | 4486 2.08 | 4292 2.09 | 4148 2.10 | 4106 2.10 | 21 | 31 | 52 | |
| 925 | 5153 2.09 | 4859 2.10 | 4615 2.11 | 4415 2.12 | 4266 2.13 | 4222 2.13 | 22 | 32 | 54 | |
| 950 | 5297 2.13 | 4995 2.14 | 4743 2.15 | 4538 2.16 | 4385 2.16 | 4340 2.16 | 22 | 33 | 55 | |
| 975 | 5440 2.16 | 5130 2.17 | 4871 2.18 | 4661 2.19 | 4503 2.20 | 4456 2.20 | 23 | 34 | 57 | |
| 1000 | 5584 2.19 | 5265 2.20 | DO NOT USE FOR OPERATIONAL PURPOSE | | | | | | | 58 |
| 1025 | 5727 2.22 | 5400 2.23 | DO NOT USE FOR OPERATIONAL PURPOSE | | | | | | | 60 |
| 1050 | 5870 2.25 | 5535 2.27 | 5258 2.28 | 5028 2.29 | 4857 2.30 | 4806 2.30 | 25 | 36 | 61 | |
| 1075 | 6013 2.29 | 5670 2.30 | 5383 2.31 | 5150 2.32 | 4974 2.33 | 4922 2.33 | 26 | 37 | 63 | |
| 1100 | 6156 2.32 | 5805 2.33 | 5511 2.34 | 5272 2.36 | 5092 2.36 | 5038 2.36 | 26 | 38 | 64 | |
| 1125 | 6299 2.35 | 5940 2.37 | 5639 2.38 | 5394 2.39 | 5209 2.40 | 5153 2.40 | 27 | 39 | 65 | |
| 1150 | 6442 2.39 | 6074 2.40 | 5766 2.41 | 5516 2.42 | 5326 2.43 | 5269 2.43 | 28 | 40 | 67 | |
| 1175 | 6584 2.42 | 6209 2.43 | 5893 2.44 | 5637 2.46 | 5443 2.46 | 5384 2.46 | 28 | 41 | 68 | |
| 1200 | 6727 2.45 | 6343 2.46 | 6020 2.48 | 5759 2.49 | 5560 2.50 | 5499 2.50 | 29 | 42 | 70 | |
| 1225 | 6869 2.48 | 6477 2.50 | 6148 2.51 | 5880 2.52 | 5676 2.53 | 5614 2.53 | 30 | 43 | 71 | |
| 1250 | 7012 2.52 | 6611 2.53 | 6274 2.54 | 6001 2.56 | 5793 2.56 | 5729 2.56 | 30 | 44 | 72 | |
| 1275 | 7154 2.55 | 6745 2.56 | 6401 2.58 | 6122 2.59 | 5909 3.00 | 5843 3.00 | 31 | 45 | 74 | |
| 1300 | 7296 2.58 | 6879 2.59 | 6528 3.01 | 6243 3.02 | 6025 3.03 | 5957 3.03 | 31 | 46 | 75 | |
| 1325 | 7439 3.01 | 7013 3.03 | 6655 3.04 | 6364 3.06 | 6141 3.07 | 6071 3.07 | 32 | 46 | 76 | |
| 1350 | 7581 3.05 | 7147 3.06 | 6781 3.08 | 6485 3.09 | 6257 3.10 | 6185 3.10 | 33 | 47 | 78 | |
| LOW AIR CONDITIONING | | | ENGINE ANTI ICE ON | | | TOTAL ANTI ICE ON | | | | |
| ΔFUEL = - 0.5 % | | | ΔFUEL = + 3 % | | | ΔFUEL = + 6 % | | | | |

Fuel consumption : 4 053 kg

Time needed : 2 h 07 min

- Correction due to real in cruise weight of 55 000 kg
 - Δ fuel consumption : -51 kg per 1 000 kg below reference
 - Δ fuel : $-51 \times (60 - 55) = -255$ kg
- Temperature correction :
 - Δ fuel consumption : +0.005 kg per 1 °above ISA and per 1 NM Air distance
 - Δ fuel : $+0.005 \times 10 \times 880 = 44$ kg

RESULT

Fuel : $4\ 053 - 255 + 44 = 3\ 842$ kg

Time : 2 h 07 min



A318/A319/A320/A321
FLIGHT CREW
OPERATING MANUAL

PERFORMANCE

CRUISE

IN CRUISE QUICK CHECK - EXAMPLE

Intentionally left blank

PERFORMANCE

HOLDING

Intentionally left blank



A318/A319/A320/A321
FLIGHT CREW
OPERATING MANUAL

PERFORMANCE

HOLDING

PRELIMINARY PAGES - TABLE OF CONTENTS

PER-HLD-GEN GENERAL

GENERAL.....A

PER-HLD-HLD HOLDING TABLES

CONF 0 - GREEN DOT SPEED.....A



A318/A319/A320/A321
FLIGHT CREW
OPERATING MANUAL

PERFORMANCE

HOLDING

PRELIMINARY PAGES - TABLE OF CONTENTS

Intentionally left blank

| | |
|---|--|
|  <p>A318/A319/A320/A321 FLIGHT CREW OPERATING MANUAL</p> | <p>PERFORMANCE</p> <p>HOLDING</p> <p>GENERAL</p> |
|---|--|

GENERAL

Ident.: PER-HLD-GEN-00002129.0001001 / 01 DEC 14

Applicable to: ALL

Holding table contains information about the total fuel flow that allows the flight crew to plan holding and reserve fuel requirements.

It is established for flight in a race track holding pattern in clean configuration at green dot speed.

This chart is established with air conditioning in normal mode and the center of gravity at 33 %.



A318/A319/A320/A321
FLIGHT CREW
OPERATING MANUAL

PERFORMANCE

HOLDING

GENERAL

Intentionally left blank



A318/A319/A320/A321
FLIGHT CREW
OPERATING MANUAL

PERFORMANCE
HOLDING
HOLDING TABLES

CONF 0 - GREEN DOT SPEED

Ident.: PER-HLD-HLD-00002146.0023001 / 16 FEB 11

Applicable to: ALL

| RACE TRACK HOLDING PATTERN - GREEN DOT SPEED | | | | | | | | |
|---|---|--------------|--|--------------|--|--------------|---------------------------------------|--------------|
| MAX. CRUISE THRUST LIMITS | | | | | ISA | | N1 (%) | |
| CLEAN CONFIGURATION | | | | | CG=33.0% | | FF (KG/H/ENG) | |
| NORMAL AIR CONDITIONING | | | | | | | | |
| ANTI-ICING OFF | | | | | | | | |
| WEIGHT (1000KG) | FL 15 | FL 50 | FL100 | FL140 | FL180 | FL200 | FL220 | FL250 |
| 46 | 45.6 890 | 47.9 873 | 51.1 839 | 54.0 813 | 57.5 794 | 58.9 789 | 60.6 787 | 63.5 784 |
| 48 | 46.5 926 | 48.9 908 | 52.1 871 | 55.1 844 | 58.4 828 | 59.9 823 | 61.7 821 | 64.7 818 |
| 50 | 47.4 962 | 49.8 940 | 53.0 901 | 56.2 876 | 59.4 861 | 61.0 859 | 62.8 855 | 65.8 851 |
| 52 | 48.3 997 | 50.6 971 | 53.9 931 | 57.3 908 | 60.3 896 | 62.0 892 | 63.9 889 | 66.7 884 |
| 54 | 49.2 1033 | 51.4 1002 | 54.9 963 | 58.3 942 | 61.3 931 | 63.0 926 | 65.0 924 | 67.7 916 |
| 56 | 50.1 1065 | 52.2 1033 | 55.8 994 | 59.1 975 | 62.2 964 | 64.0 960 | 66.1 955 | 68.6 949 |
| 58 | 50.8 1097 | 52.9 1063 | 56.8 1026 | 59.9 1008 | 63.2 997 | 65.1 994 | 66.9 988 | 69.5 982 |
| 60 | 51.5 1128 | 53.7 1094 | 57.7 1059 | 60.7 1043 | 64.1 1031 | 66.1 1026 | 67.7 1021 | 70.4 1016 |
| 62 | 52.2 1158 | 54.5 1125 | 58.7 1092 | 61.6 1078 | 65.1 1065 | 66.9 1058 | 68.6 1054 | 71.2 1049 |
| 64 | 52.9 1189 | 55.3 1156 | 59.4 1126 | 62.4 1110 | 66.0 1097 | 67.7 1091 | 69.4 1087 | 72.1 1084 |
| 66 | 53.6 1219 | 56.1 1188 | 60.1 1159 | 63.2 1143 | 67.0 1129 | 68.5 1124 | 70.3 1120 | 72.9 1119 |
| 68 | 54.3 1250 | 56.9 1221 | 60.9 1193 | 64.1 1176 | 67.7 1162 | 69.3 1157 | 71.1 1154 | 73.7 1155 |
| 70 | 55.0 1282 | 57.8 1254 | 61.6 1228 | 64.9 1210 | 68.4 1195 | 70.1 1191 | 71.8 1188 | 74.6 1192 |
| 72 | 55.8 1314 | 58.6 1287 | 62.3 1261 | 65.7 1243 | 69.2 1228 | 70.8 1224 | 72.5 1223 | 75.4 1230 |
| 74 | 56.5 1347 | 59.4 1321 | 63.1 1294 | 66.6 1275 | 69.9 1262 | 71.6 1258 | 73.3 1258 | 76.1 1269 |
| 76 | 57.2 1380 | 60.2 1355 | 63.8 1327 | 67.4 1307 | 70.6 1296 | 72.3 1292 | 74.0 1295 | 76.9 1309 |
| 78 | 58.0 1413 | 60.8 1389 | 64.5 1360 | 68.2 1339 | 71.3 1330 | 73.0 1328 | 74.8 1332 | 77.6 1350 |
| LOW AIR CONDITIONING $\Delta FF = - 0.3 \%$ | ENGINE ANTI ICE ON $\Delta FF = + 5 \%$ | | TOTAL ANTI ICE ON $\Delta FF = + 9 \%$ | | PER 1° ABOVE ISA $\Delta FF = + 0.3 \%$ | | STRAIGHT LINE $\Delta FF = - 5 \%$ | |



A318/A319/A320/A321
FLIGHT CREW
OPERATING MANUAL

PERFORMANCE

HOLDING

HOLDING TABLES

Intentionally left blank

PERFORMANCE

DESCENT

Intentionally left blank



A318/A319/A320/A321
FLIGHT CREW
OPERATING MANUAL

PERFORMANCE

DESCENT

PRELIMINARY PAGES - TABLE OF CONTENTS

PER-DES-GEN GENERAL

GENERAL..... A

PER-DES-STD STANDARD

DESCENT- M.78/300KT/250KT..... A

PER-DES-EMG EMERGENCY

EMER Descent..... A



A318/A319/A320/A321
FLIGHT CREW
OPERATING MANUAL

PERFORMANCE

DESCENT

PRELIMINARY PAGES - TABLE OF CONTENTS

Intentionally left blank

| | |
|---|---|
|  <p>A318/A319/A320/A321 FLIGHT CREW OPERATING MANUAL</p> | <p align="center">PERFORMANCE</p> <p align="center">DESCENT</p> <p align="center">GENERAL</p> |
|---|---|

GENERAL

Ident.: PER-DES-GEN-00002131.0001001 / 09 DEC 09

Applicable to: ALL

Descent tables are established for normal descent speed M .78 / 300 kt /250 kt and emergency descent at MMO/VMO with airbrakes extended, down to 1 500 ft with :

- Normal air conditioning
- CG = 33 %
- Anti ice OFF

For normal descent, cabin vertical speed is limited to 350 ft/min



A318/A319/A320/A321
FLIGHT CREW
OPERATING MANUAL

PERFORMANCE

DESCENT

GENERAL

Intentionally left blank



A318/A319/A320/A321
 FLIGHT CREW
 OPERATING MANUAL

PERFORMANCE

DESCENT

STANDARD

DESCENT- M.78/300KT/250KT

Ident.: PER-DES-STD-00002133.0037001 / 09 DEC 09

Applicable to: ALL

| DESCENT - M.78/300KT/250KT | | | | | | | | | |
|----------------------------|-----------------------------|---------------|---------------------------|---------------|---|---------------|-------------------------|---------------|-------------|
| IDLE THRUST | | | ISA | | MAXIMUM CABIN RATE OF DESCENT 350FT/MIN | | | | |
| NORMAL AIR CONDITIONING | | | CG=33.0% | | | | | | |
| ANTI-ICING OFF | | | | | | | | | |
| WEIGHT (1000KG) | 45 | | | | 65 | | | | IAS (KT) |
| | FL | TIME (MIN) | FUEL (KG) | DIST. (NM) | N1 | TIME (MIN) | FUEL (KG) | DIST. (NM) | |
| 390 | 16.1 | 204 | 101 | 68.8 | 17.4 | 165 | 106 | IDLE | 241 |
| 370 | 14.6 | 174 | 89 | 69.9 | 16.7 | 160 | 100 | IDLE | 252 |
| 350 | 12.9 | 134 | 77 | 72.1 | 16.0 | 156 | 95 | IDLE | 264 |
| 330 | 12.0 | 119 | 70 | IDLE | 15.4 | 153 | 91 | IDLE | 277 |
| 310 | 11.6 | 117 | 67 | IDLE | 14.8 | 149 | 86 | IDLE | 289 |
| 290 | 11.1 | 114 | 64 | IDLE | 14.2 | 145 | 82 | IDLE | 300 |
| 270 | 10.6 | 110 | 59 | IDLE | 13.4 | 141 | 76 | IDLE | 300 |
| 250 | 10.0 | 107 | 55 | IDLE | 12.7 | 136 | 71 | IDLE | 300 |
| 240 | 9.7 | 105 | 53 | IDLE | 12.3 | 133 | 68 | IDLE | 300 |
| 220 | 9.1 | 100 | 49 | IDLE | 11.5 | 127 | 62 | IDLE | 300 |
| 200 | 8.5 | 94 | 45 | IDLE | 10.6 | 119 | 56 | IDLE | 300 |
| 180 | 7.8 | 86 | 40 | IDLE | 9.8 | 109 | 51 | IDLE | 300 |
| 160 | 7.1 | 78 | 36 | IDLE | 8.8 | 97 | 45 | IDLE | 300 |
| 140 | 6.3 | 67 | 31 | IDLE | 7.9 | 83 | 39 | IDLE | 300 |
| 120 | 5.6 | 57 | 27 | IDLE | 6.9 | 70 | 33 | IDLE | 300 |
| 100 | 4.9 | 48 | 23 | IDLE | 6.0 | 58 | 28 | IDLE | 300 |
| 50 | 1.7 | 15 | 7 | IDLE | 2.1 | 18 | 9 | IDLE | 250 |
| 15 | .0 | 0 | 0 | IDLE | .0 | 0 | 0 | IDLE | 250 |
| CORRECTIONS | LOW AIR CONDITIONING | | ENGINE ANTI ICE ON | | TOTAL ANTI ICE ON | | PER 1° ABOVE ISA | | |
| TIME | - | | + 6 % | | + 6 % | | - | | |
| FUEL | - 2 % | | + 28 % | | + 44 % | | + 0.2 % | | |
| DISTANCE | - | | + 3 % | | + 4 % | | + 0.3 % | | |

11.0.08F0A320.214 CFM56-5B4/P SA23100000C5KG330 0 018590 0 0-1.350.0 15.0 .00 0 03 .780300.000250.000 0 FCOM-ND 03-05-30-002-170



A318/A319/A320/A321
FLIGHT CREW
OPERATING MANUAL

PERFORMANCE

DESCENT

STANDARD

Intentionally left blank



A318/A319/A320/A321
 FLIGHT CREW
 OPERATING MANUAL

PERFORMANCE

DESCENT

EMERGENCY

EMER DESCENT

Ident.: PER-DES-EMG-00002134.0201001 / 21 MAR 17

Applicable to: ALL

| EMERGENCY DESCENT - M.82/350KT | | | | | | | | | |
|--|-----|---------------|--------------|-----------------|-----|--------------------|--------------|---------------|-------------|
| IDLE THRUST NORMAL AIR CONDITIONING ANTI-ICING OFF | | | | ISA CG=33.0% | | AIRBRAKES EXTENDED | | | |
| WEIGHT (1000KG) | 45 | | | | 65 | | | | IAS (KT) |
| | FL | TIME (MIN) | FUEL (KG) | DIST. (NM) | N1 | TIME (MIN) | FUEL (KG) | DIST. (NM) | |
| 390 | 4.8 | 48 | 34 | IDLE | 6.6 | 66 | 47 | IDLE | 255 |
| 370 | 4.5 | 46 | 32 | IDLE | 6.2 | 64 | 44 | IDLE | 267 |
| 350 | 4.3 | 45 | 30 | IDLE | 5.9 | 62 | 42 | IDLE | 279 |
| 330 | 4.0 | 43 | 28 | IDLE | 5.6 | 60 | 40 | IDLE | 292 |
| 310 | 3.8 | 42 | 27 | IDLE | 5.3 | 59 | 38 | IDLE | 306 |
| 290 | 3.6 | 41 | 25 | IDLE | 5.1 | 57 | 35 | IDLE | 319 |
| 270 | 3.4 | 40 | 24 | IDLE | 4.8 | 56 | 33 | IDLE | 333 |
| 250 | 3.3 | 38 | 22 | IDLE | 4.6 | 54 | 32 | IDLE | 347 |
| 240 | 3.2 | 38 | 21 | IDLE | 4.5 | 53 | 31 | IDLE | 350 |
| 220 | 2.9 | 36 | 20 | IDLE | 4.1 | 51 | 28 | IDLE | 350 |
| 200 | 2.7 | 33 | 18 | IDLE | 3.8 | 47 | 25 | IDLE | 350 |
| 180 | 2.4 | 30 | 16 | IDLE | 3.4 | 42 | 22 | IDLE | 350 |
| 160 | 2.2 | 27 | 14 | IDLE | 3.1 | 38 | 20 | IDLE | 350 |
| 140 | 1.9 | 23 | 12 | IDLE | 2.7 | 32 | 17 | IDLE | 350 |
| 120 | 1.6 | 19 | 10 | IDLE | 2.3 | 26 | 14 | IDLE | 350 |
| 100 | 1.4 | 15 | 8 | IDLE | 1.9 | 21 | 12 | IDLE | 350 |
| 50 | .7 | 7 | 4 | IDLE | 1.0 | 9 | 6 | IDLE | 350 |
| 0 | .0 | 0 | 0 | IDLE | .0 | 0 | 0 | IDLE | 350 |

11.0-08FOA320-214 CFM56-5B4/P SA23310000C5KG330 0 018590 0 0-1 .0 .0 .00 0 02 .820950.000 .000 0 FCOM-NO.03.05.30.003-170



A318/A319/A320/A321
FLIGHT CREW
OPERATING MANUAL

PERFORMANCE

DESCENT

EMERGENCY

Intentionally left blank

PERFORMANCE

GO AROUND

Intentionally left blank



A318/A319/A320/A321
FLIGHT CREW
OPERATING MANUAL

PERFORMANCE

GO AROUND

PRELIMINARY PAGES - TABLE OF CONTENTS

PER-GOA-GEN GENERAL

GENERAL..... A
PROCEDURE..... B

PER-GOA-ACG APPROACH CLIMB LIMITING WEIGHT

PER-GOA-ACG-NOR NORMAL

CONF 2..... A
CONF 3..... B

PER-GOA-ACG-CAT CAT II

CAT II - CONF 2..... A
CAT II - CONF 3..... B



A318/A319/A320/A321
FLIGHT CREW
OPERATING MANUAL

PERFORMANCE

GO AROUND

PRELIMINARY PAGES - TABLE OF CONTENTS

Intentionally left blank

| | |
|---|--|
|  <p>A318/A319/A320/A321 FLIGHT CREW OPERATING MANUAL</p> | <p>PERFORMANCE</p> <p>GO AROUND</p> <p>GENERAL</p> |
|---|--|

GENERAL

Ident.: PER-GOA-GEN-00002140.0001001 / 28 JAN 11

Applicable to: ALL

In the go around configuration corresponding to the all engine procedure, the minimum steady gradient one engine inoperative required by the regulations is 2.1 % at a speed not exceeding 1.4 Vs. This requirement is also called approach climb performance by regulations.

The following tables allow to determine the go around limiting weight which satisfies the required gradient with the certified go around configurations 3 and 2.

The required gradient of 2.1 % is considered at the airport reference altitude. The power setting is "GO AROUND" thrust with the air conditioning ON. The speed is 1.23 Vs of the specified configuration. For the occasional cases where approach climb performance is found restrictive, a correction is given for an increased speed, up to 1.4 Vs.

Note: Landing climb performance (2 engines running) is never limiting.

PROCEDURE

Ident.: PER-GOA-GEN-00002141.0001001 / 21 MAR 17

Applicable to: ALL

According to airport pressure altitude and temperature determine if the slats/flaps setting must be restricted as a function of the landing weight, in order to meet the go around gradient requirement of 2.1 %.

Establish the final approach configuration with one more step of flaps. If the approach is interrupted, retract the flaps by one step during the go-around.

In case of category 2 and 3 approaches, JAR -OPS requires a regulatory approach climb gradient of 2.5 % to be maintained.

Use the tables for CAT II & III approaches to determine the maximum approach climb limiting weight according to airport pressure altitude and temperature.

- Note:**
- 1. If circumstances dictate, landing may be made at a weight corresponding to the maximum structural takeoff weight. (Refer to PRO-ABN-MISC [QRH] OVERWEIGHT LANDING).*
 - 2. When icing conditions are predicted during the flight and TAT is 10 °C or below and there is an evidence of significant ice accretion, to take into account ice formation on the non heated structure:*
 - Decrease the approach climb limiting weight by 4.5 %*
 - In CONF FULL, the approach speed must not be lower than VREF +5 kt, or in CONF 3, the approach speed must not be lower than VLS +10 kt.**For Landing Performance assessment, refer to QRH PER-A.*
 - 3. In the following tables corrections for anti ice are only valid for OAT lower than 10 °C.*
 - 4. Use the CAT II tables in case of CAT III approach calculation.*

CONF 2

Ident.: PER-GOA-ACG-NOR-00002142.0322001 / 24 MAR 11

Applicable to: ALL

| APPROACH CLIMB LIMITING WEIGHT (1000 KG) - CONF 2 | | | | | | | | | | | | |
|--|------------------------|------|------|---|------|------|--|------|------|------------------------------|-------|-------|
| ONE ENGINE OUT | | | | | | | High Air Conditioning | | | Gradient : 2.1 % | | |
| ONE ENGINE AT GO AROUND THRUST | | | | | | | Anti Ice OFF | | | V = 1.23 Vs | | |
| OAT (°C) | PRESSURE ALTITUDE (FT) | | | | | | | | | | | |
| | -2000 | 0 | 200 | 400 | 600 | 800 | 1000 | 2000 | 5000 | 9200 | 12000 | 14100 |
| ≤10 | 84.6 | 83.6 | 83.4 | 83.1 | 82.9 | 82.7 | 82.4 | 81.3 | 81.6 | 73.1 | 65.9 | 60.4 |
| 20 | 84.2 | 83.3 | 83.1 | 82.8 | 82.6 | 82.4 | 82.1 | 81.1 | 81.3 | 70.5 | 60.5 | 54.4 |
| 22 | 84.1 | 83.2 | 83.0 | 82.8 | 82.5 | 82.3 | 82.1 | 81.0 | 81.3 | 69.3 | 59.5 | 53.6 |
| 24 | 84.1 | 83.2 | 82.9 | 82.7 | 82.5 | 82.2 | 82.0 | 81.0 | 80.9 | 68.1 | 58.6 | |
| 26 | 84.0 | 83.1 | 82.9 | 82.7 | 82.4 | 82.2 | 82.0 | 80.9 | 79.9 | 66.8 | 57.7 | |
| 28 | 83.9 | 83.1 | 82.8 | 82.6 | 82.4 | 82.1 | 81.9 | 80.9 | 79.0 | 65.7 | | |
| 30 | 83.9 | 83.0 | 82.8 | 82.6 | 82.3 | 82.1 | 81.9 | 80.8 | 78.0 | 64.6 | | |
| 32 | 83.8 | 83.0 | 82.8 | 82.5 | 82.3 | 82.1 | 81.8 | 80.8 | 77.0 | 63.5 | | |
| 34 | 83.8 | 82.9 | 82.7 | 82.5 | 82.3 | 82.0 | 81.8 | 80.8 | 76.2 | 62.3 | | |
| 36 | 83.7 | 82.9 | 82.7 | 82.5 | 82.2 | 82.0 | 81.8 | 80.7 | 74.7 | 61.2 | | |
| 38 | 83.7 | 82.9 | 82.7 | 82.4 | 82.2 | 82.0 | 81.8 | 80.7 | 72.9 | | | |
| 40 | 83.7 | 82.9 | 82.6 | 82.4 | 82.2 | 82.0 | 81.8 | 80.7 | 71.1 | | | |
| 42 | 83.6 | 82.8 | 82.6 | 82.4 | 82.2 | 81.9 | 81.7 | 78.8 | 69.4 | | | |
| 44 | 83.6 | 82.8 | 82.2 | 81.6 | 81.0 | 80.4 | 79.9 | 77.0 | 67.7 | | | |
| 46 | 83.5 | 80.9 | 80.3 | 79.8 | 79.2 | 78.6 | 78.1 | 75.5 | | | | |
| 48 | 83.4 | 79.1 | 78.5 | 78.0 | 77.4 | 76.8 | 76.4 | 73.7 | | | | |
| 50 | 81.5 | 77.3 | 76.7 | 76.3 | 75.8 | 75.3 | 74.7 | 72.0 | | | | |
| 52 | 79.6 | 75.7 | 75.1 | 74.6 | 74.0 | 73.5 | 73.0 | | | | | |
| 54 | 77.6 | 73.9 | 73.3 | 72.8 | | | | | | | | |
| 55 | 76.8 | 73.0 | | | | | | | | | | |
| CORRECTIONS | AIR CONDITIONING OFF | | | ENGINE ANTI ICE ON | | | TOTAL ANTI ICE ON | | | SPEED INCREASE (PER 0.01 Vs) | | |
| WEIGHT | + 1400 kg | | | - 300 kg up to 9200 ft - 3600 kg above 9200 ft | | | - 1100 kg up to 5000 ft - 7000 kg above 5000 ft | | | + 200 kg | | |

PERFORMANCE

GO AROUND

APPROACH CLIMB LIMITING WEIGHT - NORMAL

CONF 3

Ident.: PER-GOA-ACG-NOR-00002143.0387001 / 24 MAR 11

Applicable to: ALL

| APPROACH CLIMB LIMITING WEIGHT (1000 KG) - CONF 3 | | | | | | | | | | | | |
|--|------------------------|------|---|------|--|------|------------------------------|-----------------------|------|------------------|-------|-------|
| ONE ENGINE OUT | | | | | | | | High Air Conditioning | | Gradient : 2.1 % | | |
| ONE ENGINE AT GO AROUND THRUST | | | | | | | | Anti Ice OFF | | V = 1.23 Vs | | |
| OAT (°C) | PRESSURE ALTITUDE (FT) | | | | | | | | | | | |
| | -2000 | 0 | 200 | 400 | 600 | 800 | 1000 | 2000 | 5000 | 9200 | 12000 | 14100 |
| ≤10 | 84.4 | 83.4 | 83.2 | 82.9 | 82.7 | 82.5 | 82.2 | 81.1 | 81.4 | 72.8 | 65.6 | 60.1 |
| 20 | 84.0 | 83.1 | 82.9 | 82.6 | 82.4 | 82.2 | 81.9 | 80.8 | 81.1 | 70.2 | 60.2 | 54.2 |
| 22 | 83.9 | 83.0 | 82.8 | 82.6 | 82.3 | 82.1 | 81.9 | 80.8 | 81.1 | 69.0 | 59.2 | 53.3 |
| 24 | 83.9 | 83.0 | 82.7 | 82.5 | 82.3 | 82.0 | 81.8 | 80.7 | 80.6 | 67.8 | 58.3 | |
| 26 | 83.8 | 82.9 | 82.7 | 82.5 | 82.2 | 82.0 | 81.8 | 80.7 | 79.7 | 66.5 | 57.5 | |
| 28 | 83.7 | 82.9 | 82.6 | 82.4 | 82.2 | 81.9 | 81.7 | 80.6 | 78.8 | 65.4 | | |
| 30 | 83.7 | 82.8 | 82.6 | 82.4 | 82.1 | 81.9 | 81.7 | 80.6 | 77.8 | 64.4 | | |
| 32 | 83.6 | 82.8 | 82.6 | 82.3 | 82.1 | 81.9 | 81.6 | 80.6 | 76.8 | 63.3 | | |
| 34 | 83.6 | 82.7 | 82.5 | 82.3 | 82.1 | 81.8 | 81.6 | 80.6 | 75.9 | 62.1 | | |
| 36 | 83.5 | 82.7 | 82.5 | 82.3 | 82.0 | 81.8 | 81.6 | 80.5 | 74.4 | 60.9 | | |
| 38 | 83.5 | 82.7 | 82.5 | 82.2 | 82.0 | 81.8 | 81.6 | 80.5 | 72.6 | | | |
| 40 | 83.5 | 82.7 | 82.4 | 82.2 | 82.0 | 81.8 | 81.6 | 80.5 | 70.8 | | | |
| 42 | 83.4 | 82.6 | 82.4 | 82.2 | 82.0 | 81.7 | 81.5 | 78.6 | 69.1 | | | |
| 44 | 83.4 | 82.5 | 82.0 | 81.4 | 80.8 | 80.3 | 79.7 | 76.8 | 67.5 | | | |
| 46 | 83.3 | 80.7 | 80.2 | 79.6 | 79.0 | 78.5 | 77.9 | 75.2 | | | | |
| 48 | 83.2 | 78.9 | 78.3 | 77.8 | 77.2 | 76.7 | 76.2 | 73.4 | | | | |
| 50 | 81.3 | 77.1 | 76.6 | 76.1 | 75.6 | 75.0 | 74.5 | 71.7 | | | | |
| 52 | 79.4 | 75.4 | 74.9 | 74.3 | 73.8 | 73.2 | 72.7 | | | | | |
| 54 | 77.5 | 73.6 | 73.1 | 72.5 | | | | | | | | |
| 55 | 76.6 | 72.7 | | | | | | | | | | |
| CORRECTIONS | AIR CONDITIONING OFF | | ENGINE ANTI ICE ON | | TOTAL ANTI ICE ON | | SPEED INCREASE (PER 0.01 Vs) | | | | | |
| WEIGHT | + 1400 kg | | - 300 kg up to 9200 ft - 3600 kg above 9200 ft | | - 1100 kg up to 5000 ft - 6900 kg above 5000 ft | | + 200 kg | | | | | |



A318/A319/A320/A321
FLIGHT CREW
OPERATING MANUAL

PERFORMANCE

GO AROUND

APPROACH CLIMB LIMITING WEIGHT - CAT II

CAT II - CONF 2

Ident.: PER-GOA-ACG-CAT-00002144.0062001 / 24 MAR 11

Applicable to: ALL

| APPROACH CLIMB LIMITING WEIGHT (1000 KG) - CONF 2 - CAT II | | | | | | | | | | | | |
|---|------------------------|------|---|------|------|------|------|--|------|------------------|-------|-------|
| ONE ENGINE OUT | | | | | | | | High Air Conditioning | | Gradient : 2.5 % | | |
| ONE ENGINE AT GO AROUND THRUST | | | | | | | | Anti Ice OFF | | | | |
| OAT (°C) | PRESSURE ALTITUDE (FT) | | | | | | | | | | | |
| | -2000 | 0 | 200 | 400 | 600 | 800 | 1000 | 2000 | 5000 | 9200 | 12000 | 14100 |
| ≤10 | 83.0 | 82.0 | 81.8 | 81.6 | 81.4 | 81.1 | 80.9 | 79.8 | 80.0 | 71.7 | 64.7 | 59.4 |
| 20 | 82.6 | 81.7 | 81.5 | 81.3 | 81.1 | 80.8 | 80.6 | 79.5 | 79.8 | 69.2 | 59.5 | 53.6 |
| 22 | 82.6 | 81.7 | 81.4 | 81.2 | 81.0 | 80.8 | 80.5 | 79.5 | 79.7 | 68.0 | 58.5 | 52.8 |
| 24 | 82.5 | 81.6 | 81.4 | 81.2 | 80.9 | 80.7 | 80.5 | 79.4 | 79.3 | 66.9 | 57.6 | |
| 26 | 82.4 | 81.6 | 81.3 | 81.1 | 80.9 | 80.7 | 80.4 | 79.4 | 78.4 | 65.6 | 56.8 | |
| 28 | 82.4 | 81.5 | 81.3 | 81.1 | 80.8 | 80.6 | 80.4 | 79.3 | 77.5 | 64.6 | | |
| 30 | 82.3 | 81.5 | 81.2 | 81.0 | 80.8 | 80.6 | 80.3 | 79.3 | 76.6 | 63.5 | | |
| 32 | 82.3 | 81.4 | 81.2 | 81.0 | 80.8 | 80.5 | 80.3 | 79.3 | 75.8 | 62.4 | | |
| 34 | 82.2 | 81.4 | 81.2 | 80.9 | 80.7 | 80.5 | 80.3 | 79.2 | 74.8 | 61.3 | | |
| 36 | 82.2 | 81.3 | 81.1 | 80.9 | 80.7 | 80.5 | 80.3 | 79.2 | 73.3 | 60.1 | | |
| 38 | 82.2 | 81.3 | 81.1 | 80.9 | 80.7 | 80.5 | 80.3 | 79.2 | 71.5 | | | |
| 40 | 82.1 | 81.3 | 81.1 | 80.9 | 80.7 | 80.4 | 80.2 | 79.1 | 69.8 | | | |
| 42 | 82.1 | 81.3 | 81.1 | 80.9 | 80.6 | 80.4 | 80.2 | 77.3 | 68.1 | | | |
| 44 | 82.0 | 81.2 | 80.6 | 80.1 | 79.5 | 79.0 | 78.4 | 75.8 | 66.6 | | | |
| 46 | 82.0 | 79.4 | 78.9 | 78.3 | 77.8 | 77.2 | 76.7 | 74.1 | | | | |
| 48 | 81.9 | 77.6 | 77.1 | 76.6 | 76.1 | 75.7 | 75.1 | 72.4 | | | | |
| 50 | 80.0 | 76.0 | 75.5 | 75.0 | 74.5 | 73.9 | 73.4 | 70.7 | | | | |
| 52 | 78.1 | 74.3 | 73.8 | 73.3 | 72.7 | 72.2 | 71.7 | | | | | |
| 54 | 76.4 | 72.6 | 72.0 | 71.5 | | | | | | | | |
| 55 | 75.6 | 71.7 | | | | | | | | | | |
| CORRECTIONS | AIR CONDITIONING OFF | | ENGINE ANTI ICE ON | | | | | TOTAL ANTI ICE ON | | | | |
| WEIGHT | + 1400 kg | | - 300 kg up to 9200 ft - 3400 kg above 9200 ft | | | | | - 1000 kg up to 5000 ft - 6700 kg above 5000 ft | | | | |

PERFORMANCE

GO AROUND

APPROACH CLIMB LIMITING WEIGHT - CAT II

CAT II - CONF 3

Ident.: PER-GOA-ACG-CAT-00002145.0062001 / 24 MAR 11

Applicable to: ALL

| APPROACH CLIMB LIMITING WEIGHT (1000 KG) - CONF 3 - CAT II | | | | | | | | | | | | |
|---|------------------------|------|---|------|------|------|--|-----------------------|------|------------------|-------|-------|
| ONE ENGINE OUT | | | | | | | | High Air Conditioning | | Gradient : 2.5 % | | |
| ONE ENGINE AT GO AROUND THRUST | | | | | | | | Anti Ice OFF | | | | |
| OAT (°C) | PRESSURE ALTITUDE (FT) | | | | | | | | | | | |
| | -2000 | 0 | 200 | 400 | 600 | 800 | 1000 | 2000 | 5000 | 9200 | 12000 | 14100 |
| ≤10 | 81.0 | 80.1 | 79.9 | 79.7 | 79.4 | 79.2 | 79.0 | 77.9 | 78.2 | 69.9 | 63.1 | 57.9 |
| 20 | 80.7 | 79.8 | 79.6 | 79.4 | 79.2 | 78.9 | 78.7 | 77.7 | 77.9 | 67.5 | 58.0 | 52.3 |
| 22 | 80.6 | 79.8 | 79.6 | 79.3 | 79.1 | 78.9 | 78.7 | 77.6 | 77.9 | 66.3 | 57.1 | 51.5 |
| 24 | 80.6 | 79.7 | 79.5 | 79.3 | 79.0 | 78.8 | 78.6 | 77.5 | 77.4 | 65.2 | 56.2 | |
| 26 | 80.5 | 79.7 | 79.4 | 79.2 | 79.0 | 78.8 | 78.5 | 77.5 | 76.6 | 64.0 | 55.4 | |
| 28 | 80.5 | 79.6 | 79.4 | 79.2 | 78.9 | 78.7 | 78.5 | 77.5 | 75.8 | 63.0 | | |
| 30 | 80.4 | 79.6 | 79.3 | 79.1 | 78.9 | 78.7 | 78.5 | 77.4 | 74.9 | 62.0 | | |
| 32 | 80.4 | 79.5 | 79.3 | 79.1 | 78.9 | 78.6 | 78.4 | 77.4 | 73.9 | 60.9 | | |
| 34 | 80.3 | 79.5 | 79.3 | 79.1 | 78.8 | 78.6 | 78.4 | 77.4 | 73.0 | 59.8 | | |
| 36 | 80.3 | 79.5 | 79.2 | 79.0 | 78.8 | 78.6 | 78.4 | 77.4 | 71.5 | 58.7 | | |
| 38 | 80.2 | 79.4 | 79.2 | 79.0 | 78.8 | 78.6 | 78.4 | 77.4 | 69.8 | | | |
| 40 | 80.2 | 79.4 | 79.2 | 79.0 | 78.8 | 78.6 | 78.4 | 77.3 | 68.1 | | | |
| 42 | 80.1 | 79.4 | 79.2 | 79.0 | 78.7 | 78.5 | 78.3 | 75.6 | 66.5 | | | |
| 44 | 80.1 | 79.3 | 78.8 | 78.2 | 77.7 | 77.1 | 76.6 | 74.0 | 65.0 | | | |
| 46 | 80.1 | 77.6 | 77.0 | 76.6 | 76.1 | 75.6 | 75.0 | 72.3 | | | | |
| 48 | 80.0 | 76.0 | 75.5 | 74.9 | 74.4 | 73.9 | 73.3 | 70.6 | | | | |
| 50 | 78.1 | 74.3 | 73.8 | 73.2 | 72.7 | 72.2 | 71.7 | 69.0 | | | | |
| 52 | 76.4 | 72.6 | 72.1 | 71.5 | 71.0 | 70.5 | 70.0 | | | | | |
| 54 | 74.7 | 70.9 | 70.4 | 69.8 | | | | | | | | |
| 55 | 73.8 | 70.0 | | | | | | | | | | |
| CORRECTIONS | AIR CONDITIONING OFF | | ENGINE ANTI ICE ON | | | | TOTAL ANTI ICE ON | | | | | |
| WEIGHT | + 1300 kg | | - 300 kg up to 9200 ft - 3400 kg above 9200 ft | | | | - 1000 kg up to 5000 ft - 6600 kg above 5000 ft | | | | | |

PERFORMANCE

LANDING

Intentionally left blank

PER-LDG-GEN GENERAL

| | |
|----------------------------------|---|
| GENERAL..... | A |
| DISPATCH..... | B |
| Use of the Autobrake System..... | C |

PER-LDG-CTA RUNWAY CONTAMINATION

PER-LDG-CTA-10 GENERAL

| | |
|--------------|---|
| GENERAL..... | A |
|--------------|---|

PER-LDG-CTA-20 DEFINITIONS

| | |
|-------------------|---|
| DEFINITIONS..... | A |
| EQUIVALENCES..... | B |

PER-LDG-DIS DISPATCH

PER-LDG-DIS-MAT Runway Condition Assessment Matrix for Landing

| | |
|---|---|
| Runway Condition Assessment Matrix for Landing..... | A |
|---|---|

PER-LDG-DIS-RLD REQUIRED LANDING DISTANCES / MANUAL LANDING

| | |
|--------------------|---|
| RLD CONF FULL..... | A |
| RLD CONF 3..... | B |
| Example..... | C |

PER-LDG-DIS-RLA REQUIRED LANDING DISTANCES

| | |
|--------------------------------------|---|
| AUTOMATIC LANDING ON DRY RUNWAY..... | A |
|--------------------------------------|---|



A318/A319/A320/A321
FLIGHT CREW
OPERATING MANUAL

PERFORMANCE

LANDING

PRELIMINARY PAGES - TABLE OF CONTENTS

Intentionally left blank

| | |
|---|--|
|  <p>A318/A319/A320/A321 FLIGHT CREW OPERATING MANUAL</p> | <p>PERFORMANCE</p> <p>LANDING</p> <p>GENERAL</p> |
|---|--|

GENERAL

Ident.: PER-LDG-GEN-00013287.0001001 / 19 APR 17

Applicable to: ALL

REQUIRED LANDING DISTANCE (RLD) AT DISPATCH

The RLD is the regulatory reference to be used for dispatch landing performance computation.

The RLD is the factored certified landing distance based on:

- Maximum manual braking initiated immediately after main gear touchdown
- Prompt selection of max reverse thrust, maintained to 70kt, and idle thrust to full stop (when credit is used)
- Antiskid and all spoilers operative
- The regulatory dispatch factor.

MANUAL LANDING

CONTAMINATED RUNWAY

If the surface is contaminated, EU-OPS operators must use the longer of the RLD for wet runway and the RLD for the applicable contaminant for dispatch.

AUTOMATIC LANDING

The RLD for automatic landing is defined as the RLD in manual landing corrected with the increment given in AFM. These increments assume maximum manual braking from main gear touchdown.

IN-FLIGHT LANDING DISTANCE

The flight crew should use the Landing Distances published in the QRH as the reference for In-Flight landing performance computation. The In-Flight Landing Distances reflect the performance achievable in a typical operational landing without margin, assuming realistic airborne phase from threshold to touchdown and deceleration on ground to full stop.

The In-Flight Landing Distances consider:

- Airborne phase of 7 seconds from threshold to touchdown
- Maximum manual braking initiated immediately after main gear touchdown
- Normal system delays in braking activation in case of autobrake
- Prompt selection of max reverse thrust, maintained to 70kt, and idle thrust to full stop (when credit is used)
- Antiskid and all spoilers operative.

FACTORED IN-FLIGHT LANDING DISTANCE

The flight crew should apply an appropriate margin to the In-Flight Landing Distances published in the QRH to account for operational variability (e.g. in wind and runway condition reporting) and flying technique (e.g. speed and height above threshold, flare).

This factor should account for:

- The Applicable Regulations
- The Airline Policy
- The discretion of the Pilot.

The Factored In-Flight Landing Distance may in some cases, and in particular on contaminated runway, exceed the RLD considered at dispatch.

The requirements for dispatch remain unchanged and are based on the RLD. However, when arrival conditions are expected to be marginal it is recommended to make a preliminary calculation of In-Flight Landing Distance or Factored In-Flight Landing Distance at dispatch in order to nominate suitable destination alternates.

DISPATCH

Ident.: PER-LDG-GEN-00013288.0001001 / 18 MAR 11

Applicable to: **ALL**

The pilot must check before departure that the available runway length at destination is at least equal to the required landing distance for the forecasted landing weight.

In case of aircraft system failure affecting landing distance known before the dispatch, the available runway length must be at least equal to the required landing distance with failure, i.e. the required landing distance without failure multiplied by the coefficient given in the Flight Manual or the MMEL.

| | |
|---|--|
|  <p>A318/A319/A320/A321 FLIGHT CREW OPERATING MANUAL</p> | <p>PERFORMANCE</p> <p>LANDING</p> <p>GENERAL</p> |
|---|--|

USE OF THE AUTOBRAKE SYSTEM

Ident.: PER-LDG-GEN-00012045.0001001 / 22 MAY 12

Applicable to: ALL

The autobrake system is designed to help the pilot in case of :

- aborted takeoff or
- landing on short runways or
- operation with low visibility weather conditions

Furthermore, it ensures a straight roll-out and optimizes the landing distance on contaminated runways provided the contamination is evenly distributed.

At landing, select the braking mode according to :

- runway length
- configuration
- runway condition



A318/A319/A320/A321
FLIGHT CREW
OPERATING MANUAL

PERFORMANCE

LANDING

GENERAL

Intentionally left blank



A318/A319/A320/A321
FLIGHT CREW
OPERATING MANUAL

PERFORMANCE

LANDING

RUNWAY CONTAMINATION - GENERAL

GENERAL

Ident.: PER-LDG-CTA-10-00013002.0001001 / 21 JUL 14

Applicable to: ALL

This section presents the recommendations of Airbus for operations from wet runways or from runways which are covered with contaminants such as standing water, slush or snow.



A318/A319/A320/A321
FLIGHT CREW
OPERATING MANUAL

PERFORMANCE

LANDING

RUNWAY CONTAMINATION - GENERAL

Intentionally left blank

| | |
|---|--|
|  <p>A318/A319/A320/A321 FLIGHT CREW OPERATING MANUAL</p> | <p align="center">PERFORMANCE</p> <p align="center">LANDING</p> <p align="center">RUNWAY CONTAMINATION - DEFINITIONS</p> |
|---|--|

DEFINITIONS

Ident.: PER-LDG-CTA-20-00013004.0001001 / 31 AUG 17

Applicable to: ALL

- DAMP : A runway is considered as damp, when the surface of the runway is not dry, but the water on the surface does not cause a shiny appearance.
- WET : A runway is considered as wet, when the surface of the runway has a shiny appearance due to a thin film of water. When this film does not exceed 3 mm, there is no significant danger of hydroplaning.
- FROST : The deposit of ice crystals on the runway is referred to as frost. The direct sublimation of humidity contained in the air on a runway, when the surface temperature is below freezing, causes frost.
- COMPACTED SNOW : The maintenance personnel use a snow groomer to compress snow on a runway in order to obtain a hard surface.
- SLIPPERY WHEN WET: Notice to Airmen (NOTAM) report a runway as "slippery when wet", when the runway partially or entirely fails to satisfy the minimum (regulatory) friction requirement of the responsible authority.
- DRY SNOW : Dry snow is snow that, if compacted by hand, does not stay compressed when released. The wind can blow dry snow. The density of dry snow is approximately 0.2 kg/l (1.7 lb/US Gal).
- WET SNOW : Wet snow is snow that, if compacted by hand, stays compressed when released, and with which snowballs can be created. The density of wet snow is approximately 0.4 kg/l (3.35 lb/US Gal).
- STANDING WATER : Standing water occurs due to heavy rain and/or insufficient runway drainage with a depth of more than 3 mm.
- SLUSH : Slush is snow soaked with water, which spatters when stepped on firmly. Slush occurs at temperatures around 5 °C and has a density of approximately 0.85 kg/l (7.1 lb/US Gal).
- ICE (Cold and Dry) : Situation in which ice occurs on the runway in cold and dry conditions.
- WET ICE : When the ice on a runway melts, or there are loose/fluid contaminants on top of the ice, the ice is referred to as "wet ice". When there is wet ice on a runway, braking and directional control are difficult or not possible, because the runway surface is very slippery.

PERFORMANCE

LANDING

RUNWAY CONTAMINATION - DEFINITIONS

EQUIVALENCES

Ident.: PER-LDG-CTA-20-00014917.0001001 / 21 JUL 14

Applicable to: **ALL**

For the below-listed reported contaminants, the following equivalent runway conditions can be retained for the landing performance determination.

| Reported contaminant | | Equivalent Runway Condition |
|----------------------|----------------------|-----------------------------|
| Type of contaminant | Depth of contaminant | |
| Slush | ≤ 3 mm (1/8 in) | Wet |
| Water | ≤ 3 mm (1/8 in) | |
| Wet snow | ≤ 3 mm (1/8 in) | Slush |
| | ≤ 30 mm (6/5 in) | |
| Dry snow | ≤ 3 mm (1/8 in) | Wet |
| | ≤ 100 mm (4 in) | Slush |



A318/A319/A320/A321
 FLIGHT CREW
 OPERATING MANUAL

PERFORMANCE

LANDING

DISPATCH - RUNWAY CONDITION ASSESSMENT MATRIX FOR LANDING

RUNWAY CONDITION ASSESSMENT MATRIX FOR LANDING

Ident.: PER-LDG-DIS-MAT-00014450.0001001 / 17 MAR 17

Applicable to: ALL

| Runway Surface Conditions | | Observations on Deceleration and Directional Control | Related Landing Performance | | Maximum Crosswind for Landing (Gust included) |
|--|--|--|-----------------------------|-----------------------|---|
| Runway State or / and Runway Contaminant | ESF ⁽¹⁾ or PIREP ⁽²⁾ | | Code | Level | |
| Dry | - | - | 6 | DRY | 38 kt |
| Damp Wet Up to 3 mm (1/8") of water Slush Up to 3 mm (1/8") Dry snow Up to 3 mm (1/8") Wet snow Up to 3 mm (1/8") Frost | Good | Braking deceleration is normal for the wheel braking effort applied. Directional control is normal. | 5 | GOOD | 38 kt |
| Compacted snow OAT at or below -15 °C | Good to Medium | Braking deceleration and controllability is between Good and Medium. | 4 | GOOD TO MEDIUM | 29 kt |
| Dry snow More than 3 mm (1/8"), up to 100 mm (4") Wet snow More than 3 mm (1/8"), up to 30 mm (6/5") Compacted snow OAT above -15 °C Dry snow over compacted snow Wet snow over compacted snow Slippery when wet | Medium | Braking deceleration is noticeably reduced for the wheel braking effort applied. Directional control may be reduced. | 3 | MEDIUM | 25 kt |
| Water More than 3 mm (1/8"), up to 12.7 mm (1/2") Slush More than 3 mm (1/8"), up to 12.7 mm (1/2") | Medium to Poor | Braking deceleration and controllability is between Medium and Poor. Potential for hydroplaning exists. | 2 | MEDIUM TO POOR | 20 kt |
| Ice (cold & dry) | Poor | Braking deceleration is significantly reduced for the wheel braking effort applied. Directional | 1 | POOR | 15 kt |

Continued on the following page

PERFORMANCE

LANDING

DISPATCH - RUNWAY CONDITION ASSESSMENT MATRIX FOR LANDING

Continued from the previous page

| Runway Surface Conditions | | Observations on Deceleration and Directional Control | Related Landing Performance | | Maximum Crosswind for Landing (Gust included) |
|--|--|---|-----------------------------|-------|---|
| Runway State or / and Runway Contaminant | ESF ⁽¹⁾ or PIREP ⁽²⁾ | | Code | Level | |
| | | control may be significantly reduced. | | | |
| Wet ice Water on top of Compacted Snow Dry Snow or Wet Snow over ice | Nil | Braking deceleration is minimal to non-existent for the wheel braking effort applied. Directional control may be uncertain. | - | - | - |

⁽¹⁾ *ESF: Estimated Surface Friction*

⁽²⁾ *PIREP: Pilot Report of Braking Action*

Note: Refer for FCOM LIM-AFS chapter for Automatic Approach, Landing and Rollout limitations.



A318/A319/A320/A321
FLIGHT CREW
OPERATING MANUAL

PERFORMANCE

LANDING

DISPATCH - REQUIRED LANDING DISTANCES / MANUAL LANDING

RLD CONF FULL

Ident.: PER-LDG-DIS-RLD-00013995.0036001 / 22 MAY 12

Applicable to: ALL

The RLD in the first table considers: Sea Level (SL), ISA, no wind, no slope, no engine reverse thrust, manual landing, and VAPP=VLS.

| Required landing distances (ft) | | | | | | |
|---------------------------------|--|-------|-------|----------------|-------|----------------|
| Runway State | | Dry | Wet | Compacted snow | Slush | Standing Water |
| Weight (1000 kg) | | | | | | |
| 46 | | 3 820 | 4 390 | 4 490 | 4 450 | 4 600 |
| 50 | | 3 990 | 4 590 | 4 760 | 4 750 | 4 900 |
| 54 | | 4 160 | 4 790 | 5 030 | 5 040 | 5 210 |
| 58 | | 4 350 | 5 000 | 5 300 | 5 340 | 5 550 |
| 62 | | 4 550 | 5 230 | 5 570 | 5 650 | 5 960 |
| 66 | | 4 930 | 5 660 | 5 840 | 5 960 | 6 390 |

| Corrections on landing distances (ft) | | | | | | |
|---------------------------------------|-------------------------------|-------|-------|----------------|-------|----------------|
| Runway State | | Dry | Wet | Compacted snow | Slush | Standing Water |
| Altitude | Per 1 000 ft ABOVE SL | + 180 | + 210 | + 260 | + 420 | + 410 |
| Speed | Per 5 kt | + 310 | + 370 | + 300 | + 380 | + 570 |
| Wind | Per 5 kt TW | + 480 | + 550 | + 510 | + 780 | + 1 070 |
| Reverse | Per Thrust Reverser Operative | - | - | - 240 | - 240 | - 250 |
| CG | Extended Forward CG | + 80 | + 110 | + 150 | + 140 | + 170 |

PERFORMANCE

LANDING

DISPATCH - REQUIRED LANDING DISTANCES / MANUAL LANDING

RLD CONF 3

Ident.: PER-LDG-DIS-RLD-00013996.0036001 / 22 MAY 12

Applicable to: ALL

The RLD in the first table considers: Sea Level (SL), ISA, no wind, no slope, no engine reverse thrust, manual landing, and VAPP=VLS.

| Required landing distances (ft) | | | | | | |
|---------------------------------|--|-------|-------|----------------|-------|----------------|
| Runway State | | Dry | Wet | Compacted snow | Slush | Standing Water |
| Weight (1000 kg) | | | | | | |
| 46 | | 4 070 | 4 680 | 4 900 | 4 890 | 5 050 |
| 50 | | 4 270 | 4 900 | 5 200 | 5 220 | 5 390 |
| 54 | | 4 460 | 5 120 | 5 490 | 5 540 | 5 770 |
| 58 | | 4 670 | 5 370 | 5 780 | 5 880 | 6 250 |
| 62 | | 4 980 | 5 730 | 6 080 | 6 220 | 6 740 |
| 66 | | 5 470 | 6 290 | 6 380 | 6 630 | 7 250 |

| Corrections on landing distances (ft) | | | | | | |
|---------------------------------------|-------------------------------|-------|-------|----------------|-------|----------------|
| Runway State | | Dry | Wet | Compacted snow | Slush | Standing Water |
| Altitude | Per 1 000 ft ABOVE SL | | | | | |
| Speed | Per 5 kt | + 340 | + 390 | + 320 | + 500 | + 660 |
| Wind | Per 5 kt TW | + 490 | + 560 | + 530 | + 880 | + 1 220 |
| Reverse | Per Thrust Reverser Operative | - | - | - 290 | - 300 | - 300 |
| CG | Extended Forward CG | + 90 | + 100 | + 170 | + 210 | + 200 |

| | |
|---|--|
|  A318/A319/A320/A321 FLIGHT CREW OPERATING MANUAL | PERFORMANCE LANDING DISPATCH - REQUIRED LANDING DISTANCES / MANUAL LANDING |
|---|--|

EXAMPLE

Ident.: PER-LDG-DIS-RLD-00014743.0001001 / 29 JUL 16

Applicable to: ALL

EXAMPLE 1

The following data and graphs are for example only, and are not for operational use. Even if the data in the following example is in “kg” and “m”, the same method can be applied for “lb” and “ft”.

Required Landing Distance (RLD) determination with multiple corrections

Data: Landing CONF = CONF FULL

LW = 58 T

DRY runway

Airport altitude = 2 000 ft

Approach speed = VLS

5 kt TW

ISA conditions

No slope

Read the reference distance for 58 T from RLD table:

| Required Landing Distances (m) | | | | | |
|--------------------------------|------------------------------------|-------|----------------|-------|----------------|
| Runway State | Dry | Wet | Compacted snow | Slush | Standing Water |
| Weight (1000 kg) | | | | | |
| 46 | 1 150 | 1 320 | 1 310 | 1 300 | 1 350 |
| 50 | Do not use for operational purpose | | | | |
| 54 | 1 260 | 1 450 | 1 480 | 1 480 | 1 530 |
| 58 | 1 320 | 1 510 | 1 560 | 1 570 | 1 630 |
| 62 | 1 380 | 1 580 | 1 640 | 1 670 | 1 750 |
| 66 | 1 480 | 1 710 | 1 730 | 1 760 | 1 880 |

RLD (DRY, 0 ft, VLS, no wind) = 1 320 m

Read the different corrections:

| Corrections on Landing Distances (m) | | | | | | |
|--------------------------------------|-------------------------------|-------|-------|----------------|-------|----------------|
| Runway State | | Dry | Wet | Compacted snow | Slush | Standing Water |
| Altitude | Per 1 000 ft ABOVE SL | + 60 | + 70 | + 90 | + 130 | + 140 |
| Speed | Per 5 kt | + 100 | + 100 | + 80 | + 110 | + 160 |
| Wind | Per 5 kt TW | + 140 | + 170 | + 150 | + 220 | + 300 |
| Reverse | Per Thrust Reverser Operative | - | - | - 90 | - 90 | - 110 |
| CG | Extended Forward CG | + 30 | + 30 | + 40 | + 40 | + 50 |

Altitude correction: $60 \times 2 = +120 \text{ m}$

Wind correction: $140 \times 1 = +140 \text{ m}$

RLD (DRY, 2 000 ft, VLS, 5 kt TW) = $1\ 320 + 120 + 140 = 1\ 580 \text{ m}$

EXAMPLE 2

Required Landing Distance (RLD) calculation with WET CHECK (Mandatory for EASA operators)

Data: Landing CONF = CONF FULL

LW = 58 T

Runway covered with STANDING WATER

Airport altitude = 2 000 ft

Approach speed = VLS

Credit for all thrust reversers

ISA conditions

No slope

Required Landing Distances (m)

| Runway State | | Dry | Wet | Compacted snow | Slush | Standing Water |
|--------------|--|-------|-------|----------------|-------|----------------|
| | | | | | | |
| 46 | | 1 150 | 1 320 | 1 310 | 1 300 | 1 350 |
| 50 | | 1 210 | 1 390 | 1 400 | 1 390 | 1 440 |
| 54 | | 1 260 | 1 450 | 1 480 | 1 480 | 1 530 |
| 58 | | 1 320 | 1 510 | 1 560 | 1 570 | 1 630 |
| 62 | | 1 380 | 1 580 | 1 640 | 1 670 | 1 750 |
| 66 | | 1 480 | 1 710 | 1 730 | 1 760 | 1 880 |

Corrections on Landing Distances (m)

| Runway State | | Dry | Wet | Compacted snow | Slush | Standing Water |
|--------------|-------------------------------|-------|-------|----------------|-------|----------------|
| Altitude | Per 1 000 ft ABOVE SL | + 60 | + 70 | + 90 | + 130 | + 140 |
| Speed | Per 5 kt | + 100 | + 100 | + 80 | + 110 | + 160 |
| Wind | Per 5 kt TW | + 140 | + 170 | + 150 | + 220 | + 300 |
| Reverse | Per Thrust Reverser Operative | - | - | - 90 | - 90 | - 110 |
| CG | Extended Forward CG | + 30 | + 30 | + 40 | + 40 | + 50 |

RLD (WATER, 2 000 ft, VLS, no wind, all reversers) = $1\ 630 + 140 \times 2 - 110 \times 2 = 1\ 690 \text{ m}$

Compare this distance to the landing distance in the same conditions on WET runway:

RLD (WET, 2 000 ft, VLS, no wind) = $1\ 510 + 70 \times 2 = 1\ 650 \text{ m}$



A318/A319/A320/A321
FLIGHT CREW
OPERATING MANUAL

PERFORMANCE

LANDING

DISPATCH - REQUIRED LANDING DISTANCES / MANUAL LANDING

RLD (WET) < RLD (WATER), therefore RLD = 1 690 m



A318/A319/A320/A321
FLIGHT CREW
OPERATING MANUAL

PERFORMANCE

LANDING

DISPATCH - REQUIRED LANDING DISTANCES / MANUAL LANDING

Intentionally left blank

| | |
|---|---|
|  <p>A318/A319/A320/A321 FLIGHT CREW OPERATING MANUAL</p> | <p align="center">PERFORMANCE</p> <p align="center">LANDING</p> <p align="center">DISPATCH - REQUIRED LANDING DISTANCES</p> |
|---|---|

AUTOMATIC LANDING ON DRY RUNWAY

Ident.: PER-LDG-DIS-RLA-00013359.0204001 / 18 MAR 11
Applicable to: ALL

Determine the corrected required landing distance for manual landing from the data above.

The required landing distance for automatic landing is equal to the corrected required landing distance for manual landing except in the following case:

- In case of landing in CONF 3 with landing weight equal to or less than 55 000 kg and with no wind or headwind, it is equal to the corrected required landing distance for manual required landing increased by 310 ft.
- In case of landing in CONF FULL with landing weight equal to or less than 70 000 kg it is equal to the corrected required landing distance for manual required landing increased by 290 ft.



A318/A319/A320/A321
FLIGHT CREW
OPERATING MANUAL

PERFORMANCE

LANDING

DISPATCH - REQUIRED LANDING DISTANCES

Intentionally left blank

PERFORMANCE

ONE ENGINE INOPERATIVE

Intentionally left blank

PER-OEI-GEN GENERAL

INTRODUCTION.....A
 FLIGHT PREPARATION.....B
 STRATEGY.....C

PER-OEI-ALT ALTITUDE

PER-OEI-ALT-10 CEILINGS

Ceilings.....A

PER-OEI-CRT CRUISE TABLES

PER-OEI-CRT-10 STANDARD AND OBSTACLE STRATEGIES

LONG RANGE CRUISE - 1 ENGINE OUT - ISA.....A
 LONG RANGE CRUISE - 1 ENGINE OUT - ISA +20.....B

PER-OEI-CRT-20 FIXED SPEED STRATEGIES

CRUISE - MCT/VMO - 1 ENGINE OUT - ISA.....A
 CRUISE - MCT/VMO - 1 ENGINE OUT - ISA +20.....B
 CRUISE - MCT/320KT - 1 ENGINE OUT - ISA.....C
 CRUISE - MCT/320KT - 1 ENGINE OUT - ISA +20.....D

PER-OEI-ICQ IN CRUISE QUICK CHECK

PER-OEI-ICQ-10 STANDARD STRATEGIES

IN CRUISE QUICK CHECK AT LONG RANGE SPEED.....A
 CORRECTION FOR DEVIATION FROM REFERENCE WEIGHT.....B

PER-OEI-ICQ-20 FIXED SPEED STRATEGIES

GENERAL.....A
 CORRECTION FOR DEVIATION FROM REFERENCE WEIGHT.....B
 IN CRUISE QUICK CHECK VMO.....C
 IN CRUISE QUICK CHECK 320KT.....D

PER-OEI-HLD HOLDING

HOLDING.....A

PER-OEI-DES DESCENT

PER-OEI-DES-10 STANDARD STRATEGY

DESCENT - M.78/300KT.....A

PER-OEI-DES-15 OBSTACLE STRATEGY

GROSS FLIGHT PATH DESCENT AT GREEN DOT SPEED - ISA.....A
 GROSS FLIGHT PATH DESCENT AT GREEN DOT SPEED - ISA +20.....B

Continued on the following page



AEROLINEAS GALAPAGOS S.A.

A318/A319/A320/A321

**FLIGHT CREW
OPERATING MANUAL**

PERFORMANCE

ONE ENGINE INOPERATIVE

PRELIMINARY PAGES - TABLE OF CONTENTS

Continued from the previous page

PER-OEI-DES-20 FIXED SPEED STRATEGIES

DESCENT - M.80/350KT A

DESCENT - M.78/320KT B

PER-OEI-DES-30 DESCENT TO LANDING

DESCENT TO LANDING..... A

INTRODUCTION

Ident.: PER-OEI-GEN-00002064.0001001 / 10 DEC 09

Applicable to: ALL

This chapter provides the single engine performance data to be used for the conduct and monitoring of the flight following an engine failure.

The diversion strategy (descent and cruise speed schedules) shall be selected, and specified in the operator's routes specifications, as a function of the prevailing operational factors (e.g. obstacles clearance requirements and/or ETOPS operation).

FLIGHT PREPARATION

Ident.: PER-OEI-GEN-00002065.0001001 / 01 DEC 14

Applicable to: ALL

In readiness for a possible engine failure occurring during the flight, any flight shall be planned so as to comply with any of the following requirements, as applicable :

- obstacle clearance,
- oxygen,
- maximum diversion distance (ETOPS operation).

The following FCOM sections provide flight preparation and fuel planning information :

- *Refer to PER-FPL-GEN-MFR MINIMUM RECOMMENDED FUEL REQUIREMENTS*, for Standard Fuel Planning,
- *Refer to PRO-SPO-40-10 General*, for Extended Range Operation (ETOPS) and associated fuel requirements.

STRATEGY

Ident.: PER-OEI-GEN-00002067.0001001 / 23 NOV 11

Applicable to: ALL

Depending on the prevailing operational constraints, the most appropriate diversion strategy shall be selected, out of the following options:

| | STANDARD STRATEGY | OBSTACLE STRATEGY | FIXED SPEED STRATEGIES | |
|---|---|---|---|---|
| | | | 320 kt | VMO |
| DESCENT TO CEILING | <ul style="list-style-type: none"> M .78/300 kt MCT | <ul style="list-style-type: none"> Green Dot Speed MCT | <ul style="list-style-type: none"> M .78/320 kt MCT | <ul style="list-style-type: none"> M .80/350 kt MCT |
| CRUISE | LR ceiling LR speed | <ul style="list-style-type: none"> <u>Obstacle not cleared:</u> Maintain Green Dot Speed at MCT <u>Obstacle cleared :</u> Revert to standard strategy | FL per Refer to PRO-SPO-40-60 ETOPS Fuel Requirement from Critical Point to Landing - One Engine Out - Cruise at 320kt MCT/320 kt | FL per Refer to PRO-SPO-40-60 ETOPS Fuel Requirement from Critical Point to Landing - One Engine Out - Cruise at 350kt MCT/350 kt |
| DESCENT TO LANDING | IDLE/M .78/300 kt/250 kt | | | |
| Approx increase in fuel consumption compared with both engines operative | +33 % | | | |

For ETOPS operations, any of the above diversion strategies can be used provided that the selected strategy and speed schedule is used in:

- establishing the area of operation (maximum diversion distance), Refer to PRO-SPO-40-60 General,
- calculating the diversion fuel requirements for the single engine ETOPS critical scenario, Refer to PRO-SPO-40-30 ETOPS Fuel Scenarios,
- demonstrating the applicable obstacle clearance requirements (net flight path and net ceiling).

During the diversion, the flight crew is expected to use the planned speed schedule.

However, based on the evaluation of the actual situation, the pilot in command has the authority to deviate from this planned one engine inoperative speed.



A318/A319/A320/A321
FLIGHT CREW
OPERATING MANUAL

PERFORMANCE
ONE ENGINE INOPERATIVE

ALTITUDE - CEILINGS

CEILINGS

Ident.: PER-OEI-ALT-10-00016065.0001001 / 22 MAR 17

Applicable to: ALL

Refer to QRH/PER-L Ceilings (Paper Only) or use the performance application of FlySmart with Airbus.



A318/A319/A320/A321
FLIGHT CREW
OPERATING MANUAL

PERFORMANCE
ONE ENGINE INOPERATIVE

ALTITUDE - CEILINGS

Intentionally left blank



A318/A319/A320/A321
FLIGHT CREW
OPERATING MANUAL

PERFORMANCE
ONE ENGINE INOPERATIVE

CRUISE TABLES - STANDARD AND OBSTACLE STRATEGIES

LONG RANGE CRUISE - 1 ENGINE OUT - ISA

Ident.: PER-OEI-CRT-10-00002108.0020001 / 10 DEC 09

Applicable to: ALL

| LONG RANGE CRUISE - 1 ENGINE OUT | | | | | | | | | | | | |
|---|-------|------|-------|------|-------|---|-------|-----------------------------|-------|------------------------------|-------|------|
| MAX. CONTINUOUS THRUST LIMITS PACK FLOW HI ANTI-ICING OFF | | | | | | ISA CG=33.0% | | N1 (%) KG/H NM/1000KG | | MACH IAS (KT) TAS (KT) | | |
| WEIGHT (1000KG) | FL100 | | FL120 | | FL140 | | FL160 | | FL180 | | FL200 | |
| 50 | 75.5 | .453 | 77.4 | .472 | 78.9 | .487 | 80.3 | .500 | 81.8 | .516 | 82.7 | .525 |
| | 1891 | 251 | 1888 | 251 | 1867 | 250 | 1842 | 247 | 1824 | 245 | 1783 | 240 |
| | 153.0 | 289 | 158.3 | 299 | 163.9 | 306 | 169.6 | 312 | 175.1 | 319 | 180.8 | 322 |
| 52 | 76.7 | .463 | 78.5 | .480 | 79.7 | .492 | 81.3 | .508 | 82.5 | .520 | 83.6 | .532 |
| | 1967 | 256 | 1959 | 256 | 1924 | 253 | 1908 | 251 | 1876 | 247 | 1852 | 243 |
| | 150.1 | 295 | 155.3 | 304 | 160.9 | 309 | 166.1 | 317 | 171.5 | 322 | 176.6 | 327 |
| 54 | 77.8 | .471 | 79.3 | .486 | 80.7 | .499 | 82.2 | .515 | 83.1 | .524 | 84.5 | .540 |
| | 2041 | 261 | 2021 | 259 | 1991 | 256 | 1973 | 254 | 1929 | 249 | 1924 | 247 |
| | 147.4 | 301 | 152.5 | 308 | 157.8 | 314 | 162.8 | 321 | 168.1 | 324 | 172.5 | 332 |
| 56 | 78.9 | .479 | 80.1 | .492 | 81.6 | .507 | 82.9 | .519 | 83.9 | .530 | 85.4 | .547 |
| | 2112 | 265 | 2078 | 262 | 2059 | 260 | 2029 | 257 | 1998 | 252 | 1995 | 250 |
| | 144.9 | 306 | 149.9 | 311 | 154.7 | 319 | 159.7 | 324 | 164.4 | 328 | 168.6 | 336 |
| 58 | 79.7 | .485 | 80.9 | .498 | 82.5 | .513 | 83.5 | .523 | 84.7 | .537 | 86.0 | .552 |
| | 2175 | 268 | 2141 | 265 | 2126 | 264 | 2081 | 258 | 2068 | 256 | 2057 | 253 |
| | 142.4 | 310 | 147.3 | 315 | 151.9 | 323 | 156.7 | 326 | 160.9 | 333 | 164.9 | 339 |
| 60 | 80.4 | .490 | 81.8 | .504 | 83.3 | .519 | 84.2 | .528 | 85.6 | .545 | 86.7 | .556 |
| | 2233 | 271 | 2209 | 269 | 2187 | 266 | 2145 | 261 | 2141 | 259 | 2119 | 255 |
| | 140.1 | 313 | 144.6 | 320 | 149.1 | 326 | 153.7 | 330 | 157.5 | 337 | 161.3 | 342 |
| 62 | 81.1 | .495 | 82.7 | .511 | 83.8 | .522 | 84.9 | .534 | 86.3 | .550 | 87.3 | .561 |
| | 2292 | 274 | 2277 | 272 | 2239 | 268 | 2214 | 264 | 2209 | 262 | 2183 | 256 |
| | 137.9 | 316 | 142.1 | 324 | 146.5 | 328 | 150.6 | 333 | 154.3 | 341 | 157.7 | 344 |
| 64 | 82.0 | .502 | 83.5 | .517 | 84.4 | .525 | 85.7 | .541 | 86.9 | .555 | 88.1 | .567 |
| | 2363 | 278 | 2343 | 276 | 2293 | 270 | 2289 | 268 | 2272 | 264 | 2259 | 259 |
| | 135.5 | 320 | 139.7 | 327 | 144.0 | 330 | 147.6 | 338 | 151.1 | 343 | 154.1 | 348 |
| 66 | 82.8 | .508 | 84.1 | .520 | 85.1 | .531 | 86.5 | .548 | 87.5 | .558 | 88.7 | .570 |
| | 2431 | 281 | 2399 | 278 | 2362 | 273 | 2362 | 271 | 2334 | 266 | 2325 | 261 |
| | 133.3 | 324 | 137.4 | 330 | 141.3 | 334 | 144.7 | 342 | 148.1 | 346 | 150.6 | 350 |
| 68 | 83.6 | .514 | 84.6 | .523 | 85.8 | .537 | 87.1 | .552 | 88.1 | .562 | 89.2 | .571 |
| | 2499 | 284 | 2453 | 279 | 2433 | 276 | 2426 | 273 | 2401 | 268 | 2383 | 261 |
| | 131.2 | 328 | 135.2 | 332 | 138.7 | 338 | 142.0 | 344 | 145.0 | 348 | 147.2 | 351 |
| 70 | 84.3 | .519 | 85.1 | .527 | 86.5 | .543 | 87.6 | .556 | 88.8 | .569 | 90.2 | .581 |
| | 2563 | 287 | 2510 | 281 | 2506 | 279 | 2488 | 275 | 2481 | 271 | 2492 | 266 |
| | 129.1 | 331 | 133.0 | 334 | 136.2 | 341 | 139.4 | 347 | 141.9 | 352 | 143.1 | 357 |
| 72 | 84.8 | .522 | 85.8 | .532 | 87.2 | .549 | 88.2 | .559 | 89.4 | .571 | 91.1 | .588 |
| | 2619 | 289 | 2582 | 284 | 2580 | 282 | 2553 | 277 | 2544 | 272 | 2595 | 270 |
| | 127.1 | 333 | 130.7 | 337 | 133.7 | 345 | 136.7 | 349 | 139.0 | 353 | 139.3 | 361 |
| 74 | 85.3 | .524 | 86.5 | .538 | 87.7 | .553 | 88.8 | .563 | 89.9 | .572 | 92.0 | .595 |
| | 2672 | 291 | 2655 | 287 | 2645 | 284 | 2618 | 279 | 2602 | 273 | 2697 | 273 |
| | 125.3 | 335 | 128.4 | 341 | 131.4 | 348 | 134.2 | 351 | 136.1 | 354 | 135.6 | 366 |
| 76 | 85.8 | .528 | 87.1 | .544 | 88.2 | .556 | 89.4 | .568 | 90.8 | .580 | 93.1 | .606 |
| | 2731 | 293 | 2729 | 291 | 2707 | 286 | 2697 | 282 | 2710 | 277 | 2821 | 278 |
| | 123.4 | 337 | 126.3 | 345 | 129.2 | 350 | 131.5 | 355 | 132.6 | 359 | 132.0 | 372 |
| 78 | 86.4 | .533 | 87.8 | .549 | 88.8 | .559 | 90.0 | .572 | 91.6 | .588 | 93.7 | .607 |
| | 2802 | 295 | 2802 | 293 | 2772 | 288 | 2767 | 283 | 2817 | 281 | 2883 | 279 |
| | 121.4 | 340 | 124.2 | 348 | 126.9 | 352 | 128.9 | 357 | 129.3 | 364 | 129.3 | 373 |
| ENGINE ANTI ICE ON ΔFUEL = + 3.5 % | | | | | | TOTAL ANTI ICE ON ΔFUEL = + 7 % | | | | | | |

PERFORMANCE
ONE ENGINE INOPERATIVE

CRUISE TABLES - STANDARD AND OBSTACLE STRATEGIES

| LONG RANGE CRUISE - 1 ENGINE OUT | | | | | | | | | | | | |
|----------------------------------|-------|-----|-------|-----|-------|-------------------|-------|-----------|-------|----------|-------|-----|
| MAX. CONTINUOUS THRUST LIMITS | | | | | | ISA | | N1 (%) | | MACH | | |
| PACK FLOW HI | | | | | | CG = 33.0% | | KG/H | | IAS (KT) | | |
| ANTI-ICING OFF | | | | | | | | NM/1000KG | | TAS (KT) | | |
| WEIGHT (1000KG) | FL210 | | FL220 | | FL230 | | FL240 | | FL250 | | FL260 | |
| 50 | 83.3 | 533 | 84.1 | 541 | 84.7 | 549 | 85.2 | 554 | 85.8 | 560 | 86.5 | 567 |
| | 1778 | 238 | 1777 | 237 | 1771 | 236 | 1759 | 233 | 1750 | 231 | 1752 | 229 |
| | 183.3 | 326 | 185.6 | 330 | 188.0 | 333 | 190.4 | 335 | 192.5 | 337 | 194.1 | 340 |
| 52 | 84.3 | 541 | 85.0 | 548 | 85.5 | 554 | 86.0 | 559 | 86.7 | 567 | 87.2 | 568 |
| | 1851 | 242 | 1846 | 241 | 1833 | 238 | 1821 | 235 | 1825 | 234 | 1807 | 230 |
| | 178.8 | 331 | 181.1 | 334 | 183.4 | 336 | 185.4 | 338 | 187.0 | 341 | 188.5 | 341 |
| 54 | 85.2 | 548 | 85.7 | 553 | 86.2 | 558 | 86.9 | 566 | 87.4 | 568 | 88.4 | 580 |
| | 1920 | 246 | 1907 | 243 | 1896 | 240 | 1898 | 239 | 1880 | 235 | 1912 | 235 |
| | 174.6 | 335 | 176.8 | 337 | 178.8 | 339 | 180.4 | 342 | 181.8 | 342 | 181.8 | 348 |
| 56 | 85.9 | 553 | 86.4 | 558 | 87.0 | 565 | 87.6 | 569 | 88.4 | 577 | 88.6 | 568 |
| | 1983 | 248 | 1970 | 245 | 1969 | 243 | 1958 | 240 | 1975 | 238 | 1917 | 229 |
| | 170.7 | 338 | 172.6 | 340 | 174.2 | 343 | 175.5 | 344 | 175.9 | 347 | 177.5 | 340 |
| 58 | 86.5 | 557 | 87.1 | 564 | 87.7 | 569 | 88.5 | 574 | 89.5 | 586 | 88.5 | 539 |
| | 2045 | 250 | 2041 | 248 | 2035 | 245 | 2039 | 242 | 2075 | 242 | 1899 | 217 |
| | 166.8 | 341 | 168.3 | 344 | 169.7 | 345 | 170.3 | 347 | 170.1 | 353 | 170.2 | 323 |
| 60 | 87.2 | 562 | 87.9 | 569 | 88.4 | 571 | 89.5 | 585 | 90.6 | 595 | | |
| | 2112 | 252 | 2112 | 250 | 2100 | 246 | 2144 | 247 | 2178 | 246 | | |
| | 162.9 | 344 | 164.2 | 347 | 165.2 | 347 | 164.9 | 353 | 164.5 | 358 | | |
| 62 | 88.0 | 569 | 88.5 | 570 | 89.6 | 583 | 90.6 | 593 | 92.1 | 610 | | |
| | 2190 | 255 | 2169 | 251 | 2211 | 251 | 2243 | 250 | 2302 | 253 | | |
| | 159.0 | 348 | 160.2 | 347 | 160.0 | 354 | 159.7 | 358 | 159.3 | 367 | | |
| 64 | 88.6 | 570 | 89.5 | 579 | 90.5 | 590 | 91.8 | 605 | 92.4 | 601 | | |
| | 2247 | 256 | 2270 | 255 | 2306 | 254 | 2362 | 256 | 2323 | 249 | | |
| | 155.2 | 349 | 155.5 | 353 | 155.2 | 358 | 154.8 | 366 | 155.7 | 362 | | |
| 66 | 89.4 | 575 | 90.4 | 587 | 91.5 | 599 | 92.6 | 605 | 92.6 | 582 | | |
| | 2327 | 258 | 2371 | 259 | 2413 | 258 | 2422 | 256 | 2315 | 241 | | |
| | 151.2 | 352 | 150.9 | 358 | 150.6 | 363 | 151.0 | 366 | 151.3 | 350 | | |
| 68 | 90.3 | 584 | 91.4 | 595 | 92.7 | 609 | 92.9 | 594 | | | | |
| | 2434 | 263 | 2473 | 262 | 2523 | 263 | 2434 | 251 | | | | |
| | 146.9 | 358 | 146.6 | 363 | 146.5 | 370 | 147.5 | 359 | | | | |
| 70 | 91.2 | 591 | 92.6 | 606 | 93.1 | 601 | 93.0 | 569 | | | | |
| | 2529 | 266 | 2595 | 267 | 2547 | 260 | 2418 | 240 | | | | |
| | 142.9 | 362 | 142.4 | 370 | 143.3 | 365 | 142.3 | 344 | | | | |
| 72 | 92.2 | 599 | 93.2 | 605 | 93.3 | 585 | | | | | | |
| | 2638 | 269 | 2648 | 267 | 2543 | 252 | | | | | | |
| | 138.9 | 366 | 139.3 | 369 | 139.7 | 355 | | | | | | |
| 74 | 93.3 | 609 | 93.5 | 597 | 93.5 | 554 | | | | | | |
| | 2752 | 274 | 2666 | 263 | 2524 | 238 | | | | | | |
| | 135.4 | 373 | 136.4 | 364 | 133.1 | 336 | | | | | | |
| 76 | 93.6 | 603 | 93.6 | 577 | | | | | | | | |
| | 2778 | 271 | 2656 | 254 | | | | | | | | |
| | 132.7 | 369 | 132.3 | 351 | | | | | | | | |
| 78 | 93.9 | 591 | | | | | | | | | | |
| | 2784 | 265 | | | | | | | | | | |
| | 129.8 | 361 | | | | | | | | | | |
| ENGINE ANTI ICE ON | | | | | | TOTAL ANTI ICE ON | | | | | | |
| ΔFUEL = + 3.5 % | | | | | | ΔFUEL = + 7 % | | | | | | |



A318/A319/A320/A321
FLIGHT CREW
OPERATING MANUAL

PERFORMANCE
ONE ENGINE INOPERATIVE

CRUISE TABLES - STANDARD AND OBSTACLE STRATEGIES

LONG RANGE CRUISE - 1 ENGINE OUT - ISA +20

Ident.: PER-OEI-CRT-10-00002111.0063001 / 04 MAR 11

Applicable to: ALL

| LONG RANGE CRUISE - 1 ENGINE OUT | | | | | | | | | | | | |
|---|-------|------|-------|------|-------|---|-------|-----------------------------|-------|------------------------------|-------|------|
| MAX. CONTINUOUS THRUST LIMITS PACK FLOW HI ANTI-ICING OFF | | | | | | ISA +20 CG=33.0% | | N1 (%) KG/H NM/1000KG | | MACH IAS (KT) TAS (KT) | | |
| WEIGHT (1000KG) | FL100 | | FL120 | | FL140 | | FL160 | | FL180 | | FL200 | |
| 50 | 78.2 | .450 | 80.2 | .468 | 81.8 | .484 | 83.3 | .498 | 84.9 | .513 | 85.9 | .523 |
| | 1957 | 249 | 1957 | 249 | 1940 | 248 | 1916 | 246 | 1901 | 244 | 1864 | 239 |
| | 152.2 | 298 | 157.3 | 308 | 162.7 | 316 | 168.2 | 322 | 173.6 | 330 | 179.1 | 334 |
| 52 | 79.4 | .459 | 81.3 | .477 | 82.6 | .489 | 84.3 | .506 | 85.6 | .517 | 86.8 | .530 |
| | 2036 | 254 | 2032 | 254 | 1999 | 251 | 1989 | 250 | 1958 | 246 | 1937 | 242 |
| | 149.3 | 304 | 154.3 | 313 | 159.6 | 319 | 164.7 | 328 | 169.9 | 333 | 174.8 | 339 |
| 54 | 80.5 | .468 | 82.2 | .483 | 83.7 | .497 | 85.4 | .513 | 86.3 | .521 | 87.8 | .538 |
| | 2113 | 259 | 2098 | 258 | 2075 | 255 | 2060 | 253 | 2015 | 248 | 2012 | 246 |
| | 146.5 | 309 | 151.4 | 318 | 156.4 | 324 | 161.3 | 332 | 166.4 | 335 | 170.7 | 343 |
| 56 | 81.7 | .476 | 83.0 | .488 | 84.7 | .504 | 86.0 | .517 | 87.1 | .529 | 88.6 | .545 |
| | 2190 | 263 | 2158 | 260 | 2147 | 259 | 2118 | 255 | 2090 | 251 | 2087 | 249 |
| | 143.8 | 315 | 148.7 | 321 | 153.3 | 329 | 158.1 | 335 | 162.7 | 340 | 166.8 | 348 |
| 58 | 82.6 | .482 | 83.9 | .495 | 85.6 | .511 | 86.6 | .521 | 88.0 | .536 | 89.4 | .550 |
| | 2260 | 267 | 2229 | 264 | 2217 | 262 | 2175 | 257 | 2165 | 255 | 2155 | 252 |
| | 141.3 | 319 | 145.9 | 325 | 150.4 | 333 | 155.1 | 337 | 159.2 | 345 | 163.0 | 351 |
| 60 | 83.3 | .487 | 84.9 | .502 | 86.3 | .516 | 87.4 | .526 | 88.9 | .543 | 90.0 | .554 |
| | 2322 | 270 | 2303 | 268 | 2280 | 265 | 2244 | 260 | 2243 | 258 | 2222 | 254 |
| | 138.9 | 323 | 143.3 | 330 | 147.6 | 337 | 152.0 | 341 | 155.7 | 349 | 159.4 | 354 |
| 62 | 84.1 | .493 | 85.8 | .509 | 86.9 | .519 | 88.2 | .533 | 89.6 | .548 | 90.7 | .559 |
| | 2388 | 273 | 2375 | 271 | 2337 | 267 | 2318 | 264 | 2314 | 261 | 2290 | 256 |
| | 136.6 | 326 | 140.7 | 334 | 145.0 | 339 | 148.9 | 345 | 152.4 | 353 | 155.8 | 357 |
| 64 | 85.0 | .500 | 86.6 | .515 | 87.5 | .523 | 89.0 | .539 | 90.2 | .553 | 91.5 | .565 |
| | 2464 | 277 | 2446 | 275 | 2396 | 269 | 2396 | 269 | 2381 | 263 | 2372 | 259 |
| | 134.2 | 331 | 138.2 | 338 | 142.4 | 341 | 145.9 | 350 | 149.3 | 356 | 152.1 | 361 |
| 66 | 85.8 | .506 | 87.2 | .518 | 88.3 | .529 | 89.8 | .546 | 90.8 | .557 | 92.1 | .567 |
| | 2537 | 280 | 2505 | 276 | 2471 | 272 | 2472 | 270 | 2449 | 265 | 2437 | 260 |
| | 131.9 | 335 | 135.9 | 340 | 139.7 | 345 | 143.0 | 354 | 146.2 | 358 | 148.6 | 362 |
| 68 | 86.6 | .511 | 87.7 | .521 | 89.0 | .535 | 90.4 | .550 | 91.5 | .561 | 92.7 | .569 |
| | 2607 | 283 | 2563 | 278 | 2546 | 275 | 2541 | 272 | 2520 | 267 | 2506 | 261 |
| | 129.8 | 338 | 133.7 | 343 | 137.1 | 349 | 140.3 | 356 | 143.2 | 361 | 145.1 | 364 |
| 70 | 87.4 | .516 | 88.3 | .525 | 89.7 | .541 | 90.9 | .554 | 92.2 | .567 | 93.7 | .580 |
| | 2674 | 286 | 2627 | 280 | 2624 | 278 | 2607 | 274 | 2604 | 270 | 2626 | 266 |
| | 127.7 | 342 | 131.4 | 345 | 134.5 | 353 | 137.6 | 359 | 140.1 | 365 | 141.0 | 370 |
| 72 | 87.9 | .519 | 89.0 | .531 | 90.4 | .547 | 91.5 | .557 | 92.8 | .569 | 94.5 | .584 |
| | 2732 | 288 | 2703 | 284 | 2701 | 281 | 2675 | 276 | 2668 | 271 | 2715 | 268 |
| | 125.7 | 343 | 129.1 | 349 | 132.1 | 357 | 135.0 | 361 | 137.1 | 366 | 137.4 | 373 |
| 74 | 88.3 | .522 | 89.7 | .536 | 91.0 | .551 | 92.1 | .562 | 93.3 | .570 | 94.6 | .573 |
| | 2789 | 289 | 2779 | 287 | 2772 | 284 | 2750 | 278 | 2735 | 272 | 2711 | 262 |
| | 123.8 | 345 | 126.9 | 353 | 129.7 | 360 | 132.3 | 364 | 134.1 | 367 | 134.8 | 366 |
| 76 | 88.9 | .526 | 90.4 | .542 | 91.5 | .555 | 92.8 | .567 | 93.9 | .572 | 94.6 | .556 |
| | 2856 | 291 | 2857 | 290 | 2839 | 285 | 2832 | 281 | 2803 | 272 | 2706 | 254 |
| | 121.9 | 348 | 124.7 | 356 | 127.5 | 362 | 129.7 | 367 | 131.2 | 368 | 131.1 | 355 |
| 78 | 89.5 | .531 | 91.0 | .547 | 92.1 | .558 | 93.3 | .569 | 94.0 | .561 | 94.8 | .528 |
| | 2930 | 294 | 2934 | 292 | 2909 | 287 | 2900 | 282 | 2801 | 267 | 2700 | 241 |
| | 119.9 | 351 | 122.6 | 360 | 125.2 | 364 | 127.2 | 369 | 128.8 | 361 | 124.8 | 337 |
| ENGINE ANTI ICE ON ΔFUEL = + 3.5 % | | | | | | TOTAL ANTI ICE ON ΔFUEL = + 7 % | | | | | | |

PERFORMANCE
ONE ENGINE INOPERATIVE

CRUISE TABLES - STANDARD AND OBSTACLE STRATEGIES

| LONG RANGE CRUISE - 1 ENGINE OUT | | | | | | | | | | | | |
|---|-------|-----|-------|-----|-------|------------------------------------|-------|-----------------------------|-------|------------------------------|-------|-----|
| MAX. CONTINUOUS THRUST LIMITS PACK FLOW HI ANTI-ICING OFF | | | | | | ISA +20 CG = 33.0% | | N1 (%) KG/H NM/1000KG | | MACH IAS (KT) TAS (KT) | | |
| WEIGHT (1000KG) | FL210 | | FL220 | | FL230 | | FL240 | | FL250 | | FL260 | |
| 50 | 86.6 | 531 | 87.4 | 540 | 88.1 | 547 | 88.6 | 552 | 89.2 | 558 | 89.5 | 556 |
| | 1863 | 238 | 1862 | 237 | 1857 | 235 | 1846 | 233 | 1838 | 230 | 1799 | 225 |
| | 181.5 | 338 | 183.7 | 342 | 186.0 | 345 | 188.3 | 348 | 190.3 | 350 | 193.1 | 347 |
| 52 | 87.6 | 539 | 88.3 | 547 | 88.9 | 552 | 89.4 | 558 | 90.1 | 564 | 89.5 | 539 |
| | 1937 | 241 | 1934 | 240 | 1923 | 238 | 1914 | 235 | 1913 | 233 | 1787 | 217 |
| | 177.0 | 343 | 179.2 | 347 | 181.3 | 349 | 183.3 | 351 | 184.9 | 354 | 188.3 | 336 |
| 54 | 88.5 | 546 | 89.0 | 552 | 89.6 | 557 | 90.4 | 565 | 90.8 | 565 | 89.5 | 500 |
| | 2010 | 245 | 2000 | 242 | 1990 | 240 | 1993 | 238 | 1972 | 233 | 1764 | 201 |
| | 172.8 | 347 | 174.9 | 350 | 176.8 | 352 | 178.2 | 355 | 179.7 | 354 | 177.0 | 312 |
| 56 | 89.2 | 551 | 89.8 | 556 | 90.5 | 564 | 91.0 | 566 | 92.0 | 576 | | |
| | 2076 | 247 | 2066 | 244 | 2069 | 243 | 2052 | 239 | 2083 | 238 | | |
| | 168.8 | 351 | 170.6 | 353 | 172.1 | 356 | 173.4 | 356 | 173.5 | 361 | | |
| 58 | 89.9 | 555 | 90.6 | 562 | 91.2 | 566 | 92.0 | 574 | 92.6 | 574 | | |
| | 2142 | 249 | 2142 | 247 | 2133 | 244 | 2149 | 242 | 2131 | 237 | | |
| | 164.9 | 353 | 166.4 | 356 | 167.6 | 358 | 168.0 | 361 | 168.7 | 360 | | |
| 60 | 90.6 | 560 | 91.3 | 566 | 92.0 | 571 | 93.0 | 580 | 92.6 | 554 | | |
| | 2215 | 251 | 2212 | 249 | 2212 | 246 | 2242 | 245 | 2121 | 229 | | |
| | 160.9 | 356 | 162.2 | 359 | 162.9 | 360 | 162.8 | 365 | 163.8 | 347 | | |
| 62 | 91.4 | 566 | 91.9 | 567 | 93.1 | 580 | 93.0 | 565 | 92.7 | 489 | | |
| | 2294 | 254 | 2273 | 249 | 2323 | 250 | 2234 | 238 | 2095 | 201 | | |
| | 157.0 | 360 | 158.1 | 359 | 157.8 | 366 | 159.2 | 356 | 146.4 | 307 | | |
| 64 | 92.0 | 567 | 93.0 | 578 | 93.4 | 574 | 93.1 | 540 | | | | |
| | 2354 | 254 | 2388 | 254 | 2350 | 247 | 2223 | 227 | | | | |
| | 153.3 | 361 | 153.3 | 366 | 154.2 | 362 | 152.9 | 340 | | | | |
| 66 | 92.9 | 574 | 93.7 | 581 | 93.4 | 555 | | | | | | |
| | 2449 | 258 | 2469 | 256 | 2341 | 239 | | | | | | |
| | 149.0 | 365 | 149.1 | 368 | 149.8 | 351 | | | | | | |
| 68 | 93.9 | 582 | 93.8 | 567 | 93.6 | 517 | | | | | | |
| | 2560 | 262 | 2463 | 249 | 2327 | 222 | | | | | | |
| | 144.8 | 371 | 146.0 | 360 | 140.3 | 327 | | | | | | |
| 70 | 94.2 | 576 | 93.9 | 546 | | | | | | | | |
| | 2587 | 259 | 2455 | 240 | | | | | | | | |
| | 141.7 | 367 | 141.1 | 346 | | | | | | | | |
| 72 | 94.2 | 561 | | | | | | | | | | |
| | 2582 | 252 | | | | | | | | | | |
| | 138.3 | 357 | | | | | | | | | | |
| 74 | 94.3 | 537 | | | | | | | | | | |
| | 2574 | 241 | | | | | | | | | | |
| | 132.8 | 342 | | | | | | | | | | |
| 76 | | | | | | | | | | | | |
| | | | | | | | | | | | | |
| | | | | | | | | | | | | |
| 78 | | | | | | | | | | | | |
| | | | | | | | | | | | | |
| | | | | | | | | | | | | |
| ENGINE ANTI ICE ON ΔFUEL = + 3.5 % | | | | | | TOTAL ANTI ICE ON ΔFUEL = + 7 % | | | | | | |



A318/A319/A320/A321
FLIGHT CREW
OPERATING MANUAL

PERFORMANCE

ONE ENGINE INOPERATIVE

CRUISE TABLES - FIXED SPEED STRATEGIES

CRUISE - MCT/VMO - 1 ENGINE OUT - ISA

Ident.: PER-OEI-CRT-20-00002112.0023001 / 09 DEC 09

PERFORMANCE
ONE ENGINE INOPERATIVE

CRUISE TABLES - FIXED SPEED STRATEGIES

Applicable to: ALL

| CRUISE - MCT/VMO - 1 ENGINE OUT | | | | | | | | | | | | |
|--|-------|------|-------|------|-----------------|--------------------------|-----------------------------|------|------------------------------|------|-------|------|
| MAX. CONTINUOUS THRUST PACK FLOW HI ANTI-ICING OFF | | | | | ISA CG=33.0% | | N1 (%) KG/H NM/1000KG | | MACH IAS (KT) TAS (KT) | | | |
| WEIGHT (1000KG) | FL100 | | FL150 | | FL160 | | FL180 | | FL200 | | FL220 | |
| 50 | 89.6 | .609 | 91.3 | .641 | 91.4 | .645 | 91.1 | .644 | 91.3 | .649 | 91.1 | .647 |
| | 3249 | 338 | 3072 | 325 | 3010 | 321 | 2798 | 308 | 2663 | 299 | 2480 | 286 |
| | 119.6 | 389 | 130.7 | 402 | 133.7 | 403 | 142.5 | 399 | 149.7 | 399 | 158.9 | 394 |
| 52 | 89.6 | .608 | 91.3 | .640 | 91.5 | .644 | 91.2 | .643 | 91.4 | .647 | 91.2 | .645 |
| | 3251 | 338 | 3076 | 325 | 3015 | 321 | 2804 | 308 | 2673 | 298 | 2490 | 285 |
| | 119.3 | 388 | 130.3 | 401 | 133.3 | 402 | 141.9 | 398 | 148.7 | 398 | 157.8 | 393 |
| 54 | 89.6 | .607 | 91.3 | .639 | 91.5 | .642 | 91.2 | .641 | 91.5 | .645 | 91.3 | .642 |
| | 3252 | 337 | 3080 | 324 | 3019 | 320 | 2811 | 307 | 2683 | 297 | 2500 | 284 |
| | 119.1 | 387 | 129.9 | 400 | 132.8 | 401 | 141.2 | 397 | 147.8 | 397 | 156.5 | 391 |
| 56 | 89.6 | .605 | 91.4 | .637 | 91.6 | .641 | 91.3 | .639 | 91.6 | .644 | 91.5 | .640 |
| | 3254 | 337 | 3084 | 323 | 3024 | 319 | 2820 | 306 | 2694 | 296 | 2512 | 283 |
| | 118.8 | 386 | 129.4 | 399 | 132.2 | 400 | 140.4 | 396 | 146.8 | 395 | 155.2 | 390 |
| 58 | 89.6 | .604 | 91.4 | .636 | 91.6 | .639 | 91.4 | .638 | 91.8 | .642 | 91.6 | .637 |
| | 3255 | 336 | 3088 | 322 | 3029 | 318 | 2828 | 305 | 2705 | 295 | 2525 | 281 |
| | 118.4 | 386 | 128.9 | 398 | 131.7 | 399 | 139.6 | 395 | 145.7 | 394 | 153.8 | 388 |
| 60 | 89.6 | .603 | 91.5 | .634 | 91.7 | .637 | 91.5 | .636 | 91.9 | .639 | 91.8 | .634 |
| | 3257 | 335 | 3093 | 321 | 3035 | 317 | 2836 | 304 | 2717 | 294 | 2539 | 280 |
| | 118.1 | 385 | 128.4 | 397 | 131.1 | 398 | 138.8 | 394 | 144.6 | 393 | 152.2 | 386 |
| 62 | 89.7 | .601 | 91.5 | .632 | 91.7 | .636 | 91.6 | .634 | 92.0 | .637 | 91.9 | .630 |
| | 3259 | 334 | 3098 | 320 | 3041 | 316 | 2845 | 303 | 2731 | 293 | 2554 | 278 |
| | 117.7 | 384 | 127.8 | 396 | 130.4 | 397 | 137.9 | 392 | 143.3 | 391 | 150.4 | 384 |
| 64 | 89.7 | .600 | 91.6 | .630 | 91.8 | .634 | 91.7 | .631 | 92.2 | .634 | 92.1 | .627 |
| | 3260 | 333 | 3104 | 319 | 3047 | 315 | 2856 | 302 | 2745 | 292 | 2571 | 277 |
| | 117.4 | 383 | 127.2 | 395 | 129.8 | 395 | 136.9 | 391 | 142.0 | 390 | 148.6 | 382 |
| 66 | 89.7 | .598 | 91.6 | .628 | 91.9 | .631 | 91.8 | .629 | 92.3 | .632 | 92.3 | .622 |
| | 3258 | 332 | 3109 | 318 | 3054 | 314 | 2868 | 301 | 2761 | 291 | 2587 | 275 |
| | 117.1 | 381 | 126.5 | 393 | 129.1 | 394 | 135.8 | 389 | 140.5 | 388 | 146.6 | 379 |
| 68 | 89.7 | .595 | 91.7 | .626 | 91.9 | .629 | 91.9 | .626 | 92.5 | .629 | 92.6 | .617 |
| | 3257 | 331 | 3116 | 317 | 3061 | 313 | 2881 | 300 | 2779 | 289 | 2605 | 272 |
| | 116.7 | 380 | 125.9 | 392 | 128.3 | 393 | 134.6 | 388 | 139.0 | 386 | 144.4 | 376 |
| 70 | 89.7 | .593 | 91.7 | .624 | 92.0 | .627 | 92.0 | .623 | 92.7 | .625 | 92.9 | .612 |
| | 3255 | 330 | 3122 | 316 | 3068 | 312 | 2896 | 298 | 2797 | 287 | 2625 | 270 |
| | 116.3 | 379 | 125.1 | 391 | 127.5 | 391 | 133.3 | 386 | 137.3 | 384 | 142.1 | 373 |
| 72 | 89.7 | .591 | 91.8 | .621 | 92.1 | .624 | 92.2 | .620 | 92.9 | .621 | 93.2 | .605 |
| | 3253 | 328 | 3129 | 315 | 3077 | 310 | 2911 | 297 | 2817 | 286 | 2648 | 267 |
| | 115.9 | 377 | 124.4 | 389 | 126.6 | 390 | 131.9 | 384 | 135.5 | 382 | 139.3 | 369 |
| 74 | 89.7 | .588 | 91.9 | .619 | 92.2 | .621 | 92.4 | .617 | 93.1 | .617 | 93.5 | .597 |
| | 3251 | 327 | 3137 | 313 | 3086 | 309 | 2928 | 295 | 2836 | 283 | 2666 | 263 |
| | 115.5 | 376 | 123.5 | 387 | 125.6 | 388 | 130.4 | 382 | 133.6 | 379 | 136.4 | 364 |
| 76 | 89.7 | .586 | 92.0 | .616 | 92.3 | .618 | 92.5 | .613 | 93.4 | .612 | 93.6 | .577 |
| | 3249 | 325 | 3145 | 312 | 3097 | 307 | 2946 | 293 | 2857 | 281 | 2656 | 254 |
| | 115.1 | 374 | 122.6 | 386 | 124.6 | 386 | 128.8 | 380 | 131.6 | 376 | 132.3 | 351 |
| 78 | 89.7 | .583 | 92.0 | .612 | 92.4 | .615 | 92.7 | .609 | 93.7 | .607 | | |
| | 3246 | 324 | 3154 | 310 | 3109 | 305 | 2967 | 291 | 2883 | 279 | | |
| | 114.6 | 372 | 121.6 | 384 | 123.3 | 383 | 127.1 | 377 | 129.3 | 373 | | |
| ENGINE ANTI ICE ON | | | | | | TOTAL ANTI ICE ON | | | | | | |
| ΔFUEL = + 1.5 % | | | | | | ΔFUEL = + 4 % | | | | | | |



A318/A319/A320/A321
FLIGHT CREW
OPERATING MANUAL

PERFORMANCE

ONE ENGINE INOPERATIVE

CRUISE TABLES - FIXED SPEED STRATEGIES

CRUISE - MCT/VMO - 1 ENGINE OUT - ISA +20

Ident.: PER-OEI-CRT-20-00002115.0043001 / 09 DEC 09

PERFORMANCE
ONE ENGINE INOPERATIVE

CRUISE TABLES - FIXED SPEED STRATEGIES

Applicable to: ALL

| CRUISE - MCT/VMO - 1 ENGINE OUT | | | | | | | | | | | | |
|--|-------|------|-------|------|---|-----------------------------|-------|------------------------------|-------|------|-------|------|
| MAX. CONTINUOUS THRUST PACK FLOW HI ANTI-ICING OFF | | | | | ISA+20 CG=33.0% | N1 (%) KG/H NM/1000KG | | MACH IAS (KT) TAS (KT) | | | | |
| WEIGHT (1000KG) | FL100 | | FL150 | | FL160 | | FL180 | | FL200 | | FL220 | |
| 50 | 90.1 | .577 | 92.5 | .612 | 92.7 | .617 | 92.8 | .620 | 93.1 | .626 | 92.8 | .621 |
| | 3029 | 321 | 2912 | 310 | 2864 | 307 | 2712 | 297 | 2595 | 288 | 2402 | 274 |
| | 126.1 | 382 | 136.6 | 398 | 139.5 | 400 | 147.2 | 399 | 154.0 | 400 | 163.9 | 394 |
| 52 | 90.1 | .576 | 92.5 | .610 | 92.8 | .615 | 92.9 | .619 | 93.2 | .624 | 92.9 | .619 |
| | 3028 | 320 | 2916 | 309 | 2869 | 306 | 2720 | 296 | 2604 | 287 | 2411 | 273 |
| | 125.8 | 381 | 136.1 | 397 | 138.9 | 399 | 146.3 | 398 | 153.0 | 398 | 162.6 | 392 |
| 54 | 90.1 | .574 | 92.5 | .609 | 92.8 | .613 | 93.0 | .617 | 93.3 | .622 | 93.0 | .616 |
| | 3027 | 319 | 2921 | 308 | 2874 | 305 | 2729 | 295 | 2615 | 286 | 2422 | 272 |
| | 125.5 | 380 | 135.5 | 396 | 138.3 | 397 | 145.4 | 397 | 151.8 | 397 | 161.1 | 390 |
| 56 | 90.1 | .573 | 92.6 | .607 | 92.9 | .612 | 93.0 | .615 | 93.5 | .620 | 93.2 | .612 |
| | 3026 | 318 | 2926 | 307 | 2880 | 304 | 2738 | 294 | 2626 | 285 | 2434 | 270 |
| | 125.2 | 379 | 134.9 | 395 | 137.6 | 396 | 144.4 | 395 | 150.7 | 396 | 159.4 | 388 |
| 58 | 90.1 | .571 | 92.6 | .605 | 92.9 | .610 | 93.1 | .613 | 93.6 | .617 | 93.3 | .608 |
| | 3025 | 317 | 2932 | 306 | 2886 | 303 | 2749 | 293 | 2637 | 284 | 2447 | 268 |
| | 124.9 | 378 | 134.2 | 393 | 136.8 | 395 | 143.4 | 394 | 149.4 | 394 | 157.6 | 386 |
| 60 | 90.1 | .569 | 92.7 | .603 | 93.0 | .607 | 93.2 | .610 | 93.7 | .614 | 93.5 | .604 |
| | 3023 | 316 | 2938 | 305 | 2892 | 302 | 2759 | 292 | 2650 | 282 | 2463 | 266 |
| | 124.5 | 376 | 133.4 | 392 | 136.1 | 394 | 142.3 | 393 | 148.0 | 392 | 155.5 | 383 |
| 62 | 90.1 | .567 | 92.7 | .601 | 93.0 | .605 | 93.4 | .608 | 93.9 | .611 | 93.7 | .599 |
| | 3022 | 314 | 2944 | 304 | 2899 | 300 | 2771 | 290 | 2665 | 281 | 2478 | 264 |
| | 124.1 | 375 | 132.7 | 391 | 135.2 | 392 | 141.1 | 391 | 146.5 | 390 | 153.3 | 380 |
| 64 | 90.1 | .564 | 92.8 | .598 | 93.1 | .603 | 93.5 | .605 | 94.0 | .608 | 93.7 | .591 |
| | 3020 | 313 | 2945 | 303 | 2906 | 299 | 2784 | 289 | 2680 | 279 | 2474 | 260 |
| | 123.6 | 373 | 132.0 | 389 | 134.4 | 390 | 139.8 | 389 | 144.9 | 388 | 151.5 | 375 |
| 66 | 90.1 | .562 | 92.8 | .595 | 93.2 | .600 | 93.6 | .602 | 94.2 | .604 | 93.7 | .581 |
| | 3018 | 312 | 2943 | 301 | 2913 | 298 | 2798 | 288 | 2699 | 277 | 2469 | 256 |
| | 123.1 | 372 | 131.4 | 387 | 133.4 | 389 | 138.4 | 387 | 143.0 | 386 | 149.1 | 368 |
| 68 | 90.1 | .559 | 92.8 | .591 | 93.2 | .596 | 93.7 | .598 | 94.4 | .600 | 93.8 | .567 |
| | 3017 | 310 | 2941 | 299 | 2911 | 296 | 2808 | 286 | 2720 | 275 | 2463 | 249 |
| | 122.6 | 370 | 130.7 | 385 | 132.7 | 386 | 137.1 | 385 | 140.9 | 383 | 146.0 | 360 |
| 70 | 90.1 | .556 | 92.8 | .588 | 93.2 | .592 | 93.8 | .593 | 94.5 | .593 | 93.9 | .546 |
| | 3014 | 308 | 2939 | 297 | 2909 | 294 | 2807 | 283 | 2718 | 272 | 2455 | 240 |
| | 122.0 | 368 | 130.0 | 382 | 131.8 | 383 | 135.9 | 382 | 139.3 | 379 | 141.1 | 346 |
| 72 | 90.1 | .553 | 92.8 | .583 | 93.2 | .587 | 93.8 | .587 | 94.5 | .584 | | |
| | 3012 | 307 | 2937 | 295 | 2907 | 291 | 2805 | 280 | 2715 | 268 | | |
| | 121.4 | 366 | 129.1 | 379 | 130.8 | 380 | 134.6 | 378 | 137.4 | 373 | | |
| 74 | 90.1 | .549 | 92.8 | .579 | 93.3 | .582 | 93.8 | .580 | 94.6 | .573 | | |
| | 3010 | 305 | 2935 | 292 | 2905 | 289 | 2804 | 277 | 2711 | 262 | | |
| | 120.7 | 363 | 128.2 | 376 | 129.8 | 377 | 133.1 | 373 | 134.8 | 366 | | |
| 76 | 90.1 | .545 | 92.9 | .573 | 93.3 | .576 | 93.9 | .572 | 94.6 | .556 | | |
| | 3007 | 302 | 2932 | 290 | 2903 | 286 | 2803 | 272 | 2706 | 254 | | |
| | 119.9 | 361 | 127.1 | 373 | 128.5 | 373 | 131.2 | 368 | 131.1 | 355 | | |
| 78 | 90.1 | .540 | 92.9 | .567 | 93.3 | .569 | 94.0 | .561 | 94.8 | .528 | | |
| | 3005 | 300 | 2929 | 287 | 2901 | 282 | 2801 | 267 | 2700 | 241 | | |
| | 119.0 | 358 | 126.0 | 369 | 127.1 | 369 | 128.8 | 361 | 124.8 | 337 | | |
| ENGINE ANTI ICE ON ΔFUEL = + 1.5 % | | | | | TOTAL ANTI ICE ON ΔFUEL = + 4 % | | | | | | | |



A318/A319/A320/A321
FLIGHT CREW
OPERATING MANUAL

PERFORMANCE

ONE ENGINE INOPERATIVE

CRUISE TABLES - FIXED SPEED STRATEGIES

CRUISE - MCT/320KT - 1 ENGINE OUT - ISA

Ident.: PER-OEI-CRT-20-00002116.0023001 / 09 DEC 09

PERFORMANCE

ONE ENGINE INOPERATIVE

CRUISE TABLES - FIXED SPEED STRATEGIES

Applicable to: ALL

| CRUISE - MCT/320KT - 1 ENGINE OUT | | | | | | | | | | | | |
|--|-------|------|-------|------|-----------------|--------------------------|-----------------------------|------|------------------------------|------|-------|------|
| MAX. CONTINUOUS THRUST PACK FLOW HI ANTI-ICING OFF | | | | | ISA CG=33.0% | | N1 (%) KG/H NM/1000KG | | MACH IAS (KT) TAS (KT) | | | |
| WEIGHT (1000KG) | FL100 | | FL150 | | FL160 | | FL180 | | FL200 | | FL220 | |
| 50 | 86.7 | .576 | 90.5 | .631 | 91.2 | .643 | 91.1 | .644 | 91.3 | .649 | 91.1 | .647 |
| | 2868 | 320 | 2958 | 320 | 2984 | 320 | 2798 | 308 | 2663 | 299 | 2480 | 286 |
| | 128.3 | 368 | 133.6 | 395 | 134.4 | 401 | 142.5 | 399 | 149.7 | 399 | 158.9 | 394 |
| 52 | 86.8 | .576 | 90.6 | .631 | 91.4 | .643 | 91.2 | .643 | 91.4 | .647 | 91.2 | .645 |
| | 2883 | 320 | 2976 | 320 | 3004 | 320 | 2804 | 308 | 2673 | 298 | 2490 | 285 |
| | 127.6 | 368 | 132.8 | 395 | 133.5 | 401 | 141.9 | 398 | 148.7 | 398 | 157.8 | 393 |
| 54 | 87.0 | .576 | 90.7 | .631 | 91.5 | .642 | 91.2 | .641 | 91.5 | .645 | 91.3 | .642 |
| | 2899 | 320 | 2996 | 320 | 3019 | 320 | 2811 | 307 | 2683 | 297 | 2500 | 284 |
| | 126.9 | 368 | 132.0 | 395 | 132.8 | 401 | 141.2 | 397 | 147.8 | 397 | 156.5 | 391 |
| 56 | 87.1 | .576 | 90.9 | .631 | 91.6 | .641 | 91.3 | .639 | 91.6 | .644 | 91.5 | .640 |
| | 2917 | 320 | 3017 | 320 | 3024 | 319 | 2820 | 306 | 2694 | 296 | 2512 | 283 |
| | 126.1 | 368 | 131.0 | 395 | 132.2 | 400 | 140.4 | 396 | 146.8 | 395 | 155.2 | 390 |
| 58 | 87.3 | .576 | 91.1 | .631 | 91.6 | .639 | 91.4 | .638 | 91.8 | .642 | 91.6 | .637 |
| | 2934 | 320 | 3039 | 320 | 3029 | 318 | 2828 | 305 | 2705 | 295 | 2525 | 281 |
| | 125.4 | 368 | 130.1 | 395 | 131.7 | 399 | 139.6 | 395 | 145.7 | 394 | 153.8 | 388 |
| 60 | 87.4 | .576 | 91.3 | .631 | 91.7 | .637 | 91.5 | .636 | 91.9 | .639 | 91.8 | .634 |
| | 2954 | 320 | 3064 | 320 | 3035 | 317 | 2836 | 304 | 2717 | 294 | 2539 | 280 |
| | 124.5 | 368 | 129.0 | 395 | 131.1 | 398 | 138.8 | 394 | 144.6 | 393 | 152.2 | 386 |
| 62 | 87.6 | .576 | 91.4 | .631 | 91.7 | .636 | 91.6 | .634 | 92.0 | .637 | 91.9 | .630 |
| | 2975 | 320 | 3089 | 320 | 3041 | 316 | 2845 | 303 | 2731 | 293 | 2554 | 278 |
| | 123.7 | 368 | 128.0 | 395 | 130.4 | 397 | 137.9 | 392 | 143.3 | 391 | 150.4 | 384 |
| 64 | 87.8 | .576 | 91.6 | .630 | 91.8 | .634 | 91.7 | .631 | 92.2 | .634 | 92.1 | .627 |
| | 2997 | 320 | 3104 | 319 | 3047 | 315 | 2856 | 302 | 2745 | 292 | 2571 | 277 |
| | 122.8 | 368 | 127.2 | 395 | 129.8 | 395 | 136.9 | 391 | 142.0 | 390 | 148.6 | 382 |
| 66 | 88.0 | .576 | 91.6 | .628 | 91.9 | .631 | 91.8 | .629 | 92.3 | .632 | 92.3 | .622 |
| | 3019 | 320 | 3109 | 318 | 3054 | 314 | 2868 | 301 | 2761 | 291 | 2587 | 275 |
| | 121.8 | 368 | 126.5 | 393 | 129.1 | 394 | 135.8 | 389 | 140.5 | 388 | 146.6 | 379 |
| 68 | 88.2 | .576 | 91.7 | .626 | 91.9 | .629 | 91.9 | .626 | 92.5 | .629 | 92.6 | .617 |
| | 3043 | 320 | 3116 | 317 | 3061 | 313 | 2881 | 300 | 2779 | 289 | 2605 | 272 |
| | 120.9 | 368 | 125.9 | 392 | 128.3 | 393 | 134.6 | 388 | 139.0 | 386 | 144.4 | 376 |
| 70 | 88.4 | .576 | 91.7 | .624 | 92.0 | .627 | 92.0 | .623 | 92.7 | .625 | 92.9 | .612 |
| | 3067 | 320 | 3122 | 316 | 3068 | 312 | 2896 | 298 | 2797 | 287 | 2625 | 270 |
| | 120.0 | 368 | 125.1 | 391 | 127.5 | 391 | 133.3 | 386 | 137.3 | 384 | 142.1 | 373 |
| 72 | 88.6 | .576 | 91.8 | .621 | 92.1 | .624 | 92.2 | .620 | 92.9 | .621 | 93.2 | .605 |
| | 3092 | 320 | 3129 | 315 | 3077 | 310 | 2911 | 297 | 2817 | 286 | 2648 | 267 |
| | 119.0 | 368 | 124.4 | 389 | 126.6 | 390 | 131.9 | 384 | 135.5 | 382 | 139.3 | 369 |
| 74 | 88.8 | .576 | 91.9 | .619 | 92.2 | .621 | 92.4 | .617 | 93.1 | .617 | 93.5 | .597 |
| | 3119 | 320 | 3137 | 313 | 3086 | 309 | 2928 | 295 | 2836 | 283 | 2666 | 263 |
| | 118.0 | 368 | 123.5 | 387 | 125.6 | 388 | 130.4 | 382 | 133.6 | 379 | 136.4 | 364 |
| 76 | 89.0 | .576 | 92.0 | .616 | 92.3 | .618 | 92.5 | .613 | 93.4 | .612 | 93.6 | .577 |
| | 3148 | 320 | 3145 | 312 | 3097 | 307 | 2946 | 293 | 2857 | 281 | 2656 | 254 |
| | 116.9 | 368 | 122.6 | 386 | 124.6 | 386 | 128.8 | 380 | 131.6 | 376 | 132.3 | 351 |
| 78 | 89.2 | .576 | 92.0 | .612 | 92.4 | .615 | 92.7 | .609 | 93.7 | .607 | | |
| | 3178 | 320 | 3154 | 310 | 3109 | 305 | 2967 | 291 | 2883 | 279 | | |
| | 115.8 | 368 | 121.6 | 384 | 123.3 | 383 | 127.1 | 377 | 129.3 | 373 | | |
| ENGINE ANTI ICE ON | | | | | | TOTAL ANTI ICE ON | | | | | | |
| ΔFUEL = + 2 % | | | | | | ΔFUEL = + 5 % | | | | | | |



A318/A319/A320/A321
FLIGHT CREW
OPERATING MANUAL

PERFORMANCE

ONE ENGINE INOPERATIVE

CRUISE TABLES - FIXED SPEED STRATEGIES

CRUISE - MCT/320KT - 1 ENGINE OUT - ISA +20

Ident.: PER-OEI-CRT-20-00002119.0023001 / 09 DEC 09

PERFORMANCE
ONE ENGINE INOPERATIVE

CRUISE TABLES - FIXED SPEED STRATEGIES

Applicable to: ALL

| CRUISE - MCT/320KT - 1 ENGINE OUT | | | | | | | | | | | | |
|--|-------|------|-------|------|---|-----------------------------|-------|------------------------------|-------|------|-------|------|
| MAX. CONTINUOUS THRUST PACK FLOW HI ANTI-ICING OFF | | | | | ISA+20 CG=33.0% | N1 (%) KG/H NM/1000KG | | MACH IAS (KT) TAS (KT) | | | | |
| WEIGHT (1000KG) | FL100 | | FL150 | | FL160 | | FL180 | | FL200 | | FL220 | |
| 50 | 90.0 | .576 | 92.5 | .612 | 92.7 | .617 | 92.8 | .620 | 93.1 | .626 | 92.8 | .621 |
| | 3017 | 320 | 2912 | 310 | 2864 | 307 | 2712 | 297 | 2595 | 288 | 2402 | 274 |
| | 126.4 | 381 | 136.6 | 398 | 139.5 | 400 | 147.2 | 399 | 154.0 | 400 | 163.9 | 394 |
| 52 | 90.1 | .576 | 92.5 | .610 | 92.8 | .615 | 92.9 | .619 | 93.2 | .624 | 92.9 | .619 |
| | 3028 | 320 | 2916 | 309 | 2869 | 306 | 2720 | 296 | 2604 | 287 | 2411 | 273 |
| | 125.8 | 381 | 136.1 | 397 | 138.9 | 399 | 146.3 | 398 | 153.0 | 398 | 162.6 | 392 |
| 54 | 90.1 | .574 | 92.5 | .609 | 92.8 | .613 | 93.0 | .617 | 93.3 | .622 | 93.0 | .616 |
| | 3027 | 319 | 2921 | 308 | 2874 | 305 | 2729 | 295 | 2615 | 286 | 2422 | 272 |
| | 125.5 | 380 | 135.5 | 396 | 138.3 | 397 | 145.4 | 397 | 151.8 | 397 | 161.1 | 390 |
| 56 | 90.1 | .573 | 92.6 | .607 | 92.9 | .612 | 93.0 | .615 | 93.5 | .620 | 93.2 | .612 |
| | 3026 | 318 | 2926 | 307 | 2880 | 304 | 2738 | 294 | 2626 | 285 | 2434 | 270 |
| | 125.2 | 379 | 134.9 | 395 | 137.6 | 396 | 144.4 | 395 | 150.7 | 396 | 159.4 | 388 |
| 58 | 90.1 | .571 | 92.6 | .605 | 92.9 | .610 | 93.1 | .613 | 93.6 | .617 | 93.3 | .608 |
| | 3025 | 317 | 2932 | 306 | 2886 | 303 | 2749 | 293 | 2637 | 284 | 2447 | 268 |
| | 124.9 | 378 | 134.2 | 393 | 136.8 | 395 | 143.4 | 394 | 149.4 | 394 | 157.6 | 386 |
| 60 | 90.1 | .569 | 92.7 | .603 | 93.0 | .607 | 93.2 | .610 | 93.7 | .614 | 93.5 | .604 |
| | 3023 | 316 | 2938 | 305 | 2892 | 302 | 2759 | 292 | 2650 | 282 | 2463 | 266 |
| | 124.5 | 376 | 133.4 | 392 | 136.1 | 394 | 142.3 | 393 | 148.0 | 392 | 155.5 | 383 |
| 62 | 90.1 | .567 | 92.7 | .601 | 93.0 | .605 | 93.4 | .608 | 93.9 | .611 | 93.7 | .599 |
| | 3022 | 314 | 2944 | 304 | 2899 | 300 | 2771 | 290 | 2665 | 281 | 2478 | 264 |
| | 124.1 | 375 | 132.7 | 391 | 135.2 | 392 | 141.1 | 391 | 146.5 | 390 | 153.3 | 380 |
| 64 | 90.1 | .564 | 92.8 | .598 | 93.1 | .603 | 93.5 | .605 | 94.0 | .608 | 93.7 | .591 |
| | 3020 | 313 | 2945 | 303 | 2906 | 299 | 2784 | 289 | 2680 | 279 | 2474 | 260 |
| | 123.6 | 373 | 132.0 | 389 | 134.4 | 390 | 139.8 | 389 | 144.9 | 388 | 151.5 | 375 |
| 66 | 90.1 | .562 | 92.8 | .595 | 93.2 | .600 | 93.6 | .602 | 94.2 | .604 | 93.7 | .581 |
| | 3018 | 312 | 2943 | 301 | 2913 | 298 | 2798 | 288 | 2699 | 277 | 2469 | 256 |
| | 123.1 | 372 | 131.4 | 387 | 133.4 | 389 | 138.4 | 387 | 143.0 | 386 | 149.1 | 368 |
| 68 | 90.1 | .559 | 92.8 | .591 | 93.2 | .596 | 93.7 | .598 | 94.4 | .600 | 93.8 | .567 |
| | 3017 | 310 | 2941 | 299 | 2911 | 296 | 2808 | 286 | 2720 | 275 | 2463 | 249 |
| | 122.6 | 370 | 130.7 | 385 | 132.7 | 386 | 137.1 | 385 | 140.9 | 383 | 146.0 | 360 |
| 70 | 90.1 | .556 | 92.8 | .588 | 93.2 | .592 | 93.8 | .593 | 94.5 | .593 | 93.9 | .546 |
| | 3014 | 308 | 2939 | 297 | 2909 | 294 | 2807 | 283 | 2718 | 272 | 2455 | 240 |
| | 122.0 | 368 | 130.0 | 382 | 131.8 | 383 | 135.9 | 382 | 139.3 | 379 | 141.1 | 346 |
| 72 | 90.1 | .553 | 92.8 | .583 | 93.2 | .587 | 93.8 | .587 | 94.5 | .584 | | |
| | 3012 | 307 | 2937 | 295 | 2907 | 291 | 2805 | 280 | 2715 | 268 | | |
| | 121.4 | 366 | 129.1 | 379 | 130.8 | 380 | 134.6 | 378 | 137.4 | 373 | | |
| 74 | 90.1 | .549 | 92.8 | .579 | 93.3 | .582 | 93.8 | .580 | 94.6 | .573 | | |
| | 3010 | 305 | 2935 | 292 | 2905 | 289 | 2804 | 277 | 2711 | 262 | | |
| | 120.7 | 363 | 128.2 | 376 | 129.8 | 377 | 133.1 | 373 | 134.8 | 366 | | |
| 76 | 90.1 | .545 | 92.9 | .573 | 93.3 | .576 | 93.9 | .572 | 94.6 | .556 | | |
| | 3007 | 302 | 2932 | 290 | 2903 | 286 | 2803 | 272 | 2706 | 254 | | |
| | 119.9 | 361 | 127.1 | 373 | 128.5 | 373 | 131.2 | 368 | 131.1 | 355 | | |
| 78 | 90.1 | .540 | 92.9 | .567 | 93.3 | .569 | 94.0 | .561 | 94.8 | .528 | | |
| | 3005 | 300 | 2929 | 287 | 2901 | 282 | 2801 | 267 | 2700 | 241 | | |
| | 119.0 | 358 | 126.0 | 369 | 127.1 | 369 | 128.8 | 361 | 124.8 | 337 | | |
| ENGINE ANTI ICE ON ΔFUEL = + 2 % | | | | | TOTAL ANTI ICE ON ΔFUEL = + 5 % | | | | | | | |



A318/A319/A320/A321
FLIGHT CREW
OPERATING MANUAL

PERFORMANCE

ONE ENGINE INOPERATIVE

IN CRUISE QUICK CHECK - STANDARD STRATEGIES

IN CRUISE QUICK CHECK AT LONG RANGE SPEED

Ident.: PER-OEI-ICQ-10-00002122.0001001 / 22 MAR 17

Applicable to: ALL

In cruise quick check tables (*Refer to QRH/PER-L In Cruise Quick Check Long Range (Paper Only)*) or use the performance application of FlySmart with Airbus) allow the flight crew to determine the fuel consumption and the time required to cover a given air distance from any moment in cruise to landing, with one engine inoperative.

The QRH tables are established for:

- Cruise Mach number : long range
- Descent profile : M .78/300 kt/250 kt
- Approach and landing : 120 kg or 270 lb - 6 min IMC
- ISA
- CG = 33 %
- Pack flow HI
- Anti ice OFF

- Note:
1. In the tables, the asterisk (*) means that a step climb of 4 000 ft must be flown to reach the corresponding flight level.
 2. The flight level shown on the top of each column is the final flight level.
 3. For each degree Celsius above ISA temperature apply a fuel correction of 0.015 (kg/°C/NM) × Δ ISA (°C) × air distance (NM) or 0.033 (lb/°C/NM) × ΔISA (°C) × air distance (NM).

CORRECTION FOR DEVIATION FROM REFERENCE WEIGHT

Ident.: PER-OEI-ICQ-10-00002123.0001001 / 21 MAR 17

Applicable to: ALL

The in cruise quick check tables are based on a reference initial weight.

A correction on the fuel consumption has to be made, when the actual initial weight is different from the reference initial weight.

If it is lower (or greater) than the reference weight, subtract (or add) the value given in the correction part of the table per 1 000 kg or 1 000 lb below (or above) the reference initial weight (*Refer to PER-OEI-DES-20 DESCENT - M.80/350KT*).



A318/A319/A320/A321
FLIGHT CREW
OPERATING MANUAL

PERFORMANCE

ONE ENGINE INOPERATIVE

IN CRUISE QUICK CHECK - STANDARD STRATEGIES

Intentionally left blank

| | |
|---|--|
|  <p>A318/A319/A320/A321 FLIGHT CREW OPERATING MANUAL</p> | <p>PERFORMANCE</p> <p>ONE ENGINE INOPERATIVE</p> <p>IN CRUISE QUICK CHECK - FIXED SPEED STRATEGIES</p> |
|---|--|

GENERAL

Ident.: PER-OEI-ICQ-20-00002125.0001001 / 14 NOV 11
Applicable to: ALL

The following in cruise quick check tables allow the flight crew to determine the fuel consumption and the time required to cover a given air distance from any moment in cruise to landing with one engine inoperative.

These tables are established for:

- Cruise speed: MCT /VMO , MCT/320 kt.
- Descent profile: M .78/300 kt/250 kt
- Approach and landing: 120 kg or 270 lb - 6 min IMC
- ISA
- CG = 33 %
- Pack flow HI
- Anti ice OFF

- Note:
1. In the tables, the asterisk "*" means that a step climb of 4 000 ft has been made to reach the corresponding flight level.
 2. The flight level shown on the top of each column is the final flight level.
 3. For each degree Celsius above ISA apply a fuel correction of
 $0.015 \text{ (kg/}^\circ\text{C/NM)} \times \Delta\text{ISA (}^\circ\text{C)} \times \text{Air Distance (NM)}$
or $0.033 \text{ (lb/}^\circ\text{C/NM)} \times \Delta\text{ISA (}^\circ\text{C)} \times \text{Air Distance (NM)}$

CORRECTION FOR DEVIATION FROM REFERENCE WEIGHT

Ident.: PER-OEI-ICQ-20-00002126.0001001 / 21 MAR 17
Applicable to: ALL

The in cruise quick check tables are based on a reference initial weight. The fuel consumption must be corrected when the actual weight is different from the reference initial weight. If it is lower (or greater) than the reference weight, subtract (or add) the value given in the correction part of the table per 1 000 kg or 1 000 lb below (or above) the reference weight (*Refer to PER-OEI-DES-20 DESCENT - M.80/350KT*).

IN CRUISE QUICK CHECK VMO

Ident.: PER-OEI-ICQ-20-00002127.0022001 / 10 DEC 09

Applicable to: ALL

| IN CRUISE QUICK CHECK FROM ANY MOMENT IN CRUISE TO LANDING - ONE ENGINE FAILURE | | | | | | | | | |
|---|---------------|---------------|---------------|--------------------|--------------|--------------------|--|----------------|----------------|
| CRUISE : MCT/VMO - DESCENT : M.78/300KT/250KT | | | | | | | | | |
| IMC PROCEDURE : 120 KG (6MIN) | | | | | | | | | |
| REF. INITIAL WEIGHT = 55000 KG NORMAL AIR CONDITIONING ANTI-ICING OFF | | | | ISA CG = 33.0 % | | FUEL CONSUMED (KG) | | | |
| TIME (H.MIN) | | | | | | | | | |
| AIR DIST. (NM) | FLIGHT LEVEL | | | | | | CORRECTION ON FUEL CONSUMPTION (KG/1000KG) | | |
| | 100 | 150 | 160 | 180 | 200 | 220 | FL100 FL150 | FL160 FL180 | FL200 FL220 |
| 200 | 1548 0.38 | 1399 0.38 | 1357 0.38 | 1257 0.38 | 1180 0.38 | 1098 0.38 | 0 | 0 | 0 |
| 250 | 2069 0.45 | 1785 0.45 | 1735 0.45 | 1612 0.46 | 1520 0.46 | 1418 0.46 | 0 | 0 | 1 |
| 300 | 2489 0.53 | 2171 0.53 | 2112 0.53 | 1967 0.53 | 1859 0.53 | 1738 0.54 | 1 | 1 | 2 |
| 350 | 2909 1.01 | 2556 1.00 | 2489 1.00 | 2322 1.01 | 2198 1.01 | 2058 1.01 | 1 | 2 | 4 |
| 400 | 3329 1.08 | 2941 1.08 | 2866 1.08 | 2676 1.08 | 2536 1.08 | 2378 1.09 | 2 | 2 | 5 |
| 450 | 3748 1.16 | 3326 1.15 | 3242 1.15 | 3030 1.16 | 2874 1.16 | 2697 1.17 | 2 | 3 | 6 |
| 500 | 4168 1.24 | 3711 1.23 | 3619 1.23 | 3383 1.23 | 3211 1.23 | 3015 1.24 | 3 | 4 | 7 |
| 550 | 4589 1.32 | 4095 1.30 | 3985 1.30 | 3737 1.31 | 3549 1.31 | 3333 1.32 | 3 | 5 | 8 |
| 600 | 5008 1.39 | 4479 1.38 | 4371 1.38 | 4090 1.38 | 3885 1.38 | 3651 1.39 | 4 | 5 | 9 |
| 650 | 5427 1.47 | 4863 1.45 | 4746 1.45 | 4442 1.46 | 4222 1.46 | 3968 1.47 | 4 | 6 | 10 |
| 700 | 5846 1.55 | 5247 1.53 | 5122 1.52 | 4795 1.53 | 4558 1.54 | 4286 1.55 | 5 | 7 | 11 |
| 750 | 6265 2.03 | 5631 2.00 | 5497 2.00 | 5147 2.01 | 4894 2.01 | 4602 2.02 | 5 | 7 | 12 |
| 800 | 6683 2.10 | 6014 2.08 | 5872 2.07 | 5499 2.08 | 5230 2.09 | 4919 2.10 | 6 | 8 | 13 |
| 850 | 7102 2.18 | 6397 2.15 | 6246 2.15 | 5851 2.16 | 5565 2.16 | 5235 2.18 | 6 | 9 | 14 |
| 900 | 7520 2.26 | 6780 2.22 | 6621 2.22 | 6202 2.23 | 5899 2.24 | 5550 2.25 | 7 | 9 | 15 |
| 950 | 7938 2.33 | 7162 2.30 | 6995 2.30 | 6553 2.31 | 6234 2.31 | 5865 2.33 | 7 | 10 | 16 |
| 1000 | 8356 2.41 | 7545 2.37 | 7369 2.37 | 6904 2.38 | 6568 2.39 | 6180 2.40 | 7 | 11 | 17 |
| 1050 | 8773 2.49 | 7927 2.45 | 7743 2.44 | 7254 2.46 | 6902 2.46 | 6495 2.48 | 8 | 11 | 18 |
| 1100 | 9191 2.56 | 8309 2.52 | 8116 2.52 | 7605 2.53 | 7235 2.54 | 6809 2.56 | 8 | 12 | 19 |
| 1150 | 9608 3.04 | 8690 3.00 | 8489 2.99 | 7955 3.01 | 7568 3.01 | 7123 3.03 | 9 | 13 | 20 |
| 1200 | 10025 3.12 | 9072 3.07 | 8862 3.07 | 8305 3.08 | 7901 3.09 | 7435 3.11 | 9 | 13 | 21 |
| 1250 | 10442 3.19 | 9454 3.14 | 9235 3.14 | 8654 3.16 | 8233 3.16 | 7750 3.18 | 10 | 14 | 22 |
| 1300 | 10859 3.27 | 9835 3.22 | 9608 3.22 | 9004 3.23 | 8565 3.24 | 8063 3.26 | 10 | 14 | 23 |
| 1350 | 11275 3.35 | 10216 3.29 | 9980 3.29 | 9353 3.31 | 8897 3.31 | 8375 3.33 | 12 | 15 | 24 |
| 1400 | 11692 3.43 | 10597 3.37 | 10352 3.36 | 9701 3.38 | 9228 3.39 | 8687 3.41 | 12 | 16 | 25 |

F1P23D A320-214 CFM56-5B4/P SA3611 03301.001011 0250300.7800.00100 120 0300350 55 0 100100 40100 18590 FCOM-N0-03-06-50-014-170



A318/A319/A320/A321
FLIGHT CREW
OPERATING MANUAL

PERFORMANCE
ONE ENGINE INOPERATIVE

IN CRUISE QUICK CHECK - FIXED SPEED STRATEGIES

IN CRUISE QUICK CHECK 320KT

Ident.: PER-OEI-ICQ-20-00002128.0022001 / 10 DEC 09

Applicable to: ALL

| IN CRUISE QUICK CHECK FROM ANY MOMENT IN CRUISE TO LANDING - ONE ENGINE FAILURE | | | | | | | | | | |
|---|---------------|---------------|---------------|--------------|--------------------------|--|-------|-------|-------|--|
| CRUISE : MCT/320KT - DESCENT : M.78/300KT/250KT | | | | | | | | | | |
| IMC PROCEDURE : 120 KG (6MIN) | | | | | | | | | | |
| REF. INITIAL WEIGHT = 55000 KG | | | | ISA | | FUEL CONSUMED (KG) | | | | |
| NORMAL AIR CONDITIONING | | | | CG = 33.0 % | | | | | | |
| ANTI-ICING OFF | | | | TIME (H.MIN) | | | | | | |
| AIR | FLIGHT LEVEL | | | | | CORRECTION ON FUEL CONSUMPTION (KG/1000KG) | | | | |
| DIST. | | | | | | FL100 | FL160 | FL200 | | |
| (N.M) | 100 | 150 | 160 | 180 | 200 | 220 | FL150 | FL180 | FL220 | |
| 200 | 1556 0.39 | 1381 0.38 | 1358 0.38 | 1257 0.38 | 1180 0.38 | 1098 0.38 | 2 | 0 | 0 | |
| 250 | 1950 0.47 | 1760 0.46 | 1737 0.45 | 1612 0.46 | 1520 0.46 | 1418 0.46 | 3 | 1 | 1 | |
| 300 | 2344 0.55 | 2139 0.53 | 2115 0.53 | 1967 0.53 | 1859 0.53 | 1738 0.54 | 4 | 1 | 2 | |
| 350 | 2737 1.03 | 2518 1.01 | 2493 1.00 | 2322 1.01 | 2198 1.01 | 2058 1.01 | 5 | 2 | 4 | |
| 400 | 3130 1.12 | 2896 1.08 | 2870 1.08 | 2676 1.08 | 2536 1.08 | 2378 1.09 | 6 | 3 | 5 | |
| 450 | 3523 1.20 | 3274 1.16 | 3248 1.15 | 3030 1.16 | 2874 1.16 | 2697 1.17 | 7 | 4 | 6 | |
| 500 | 3915 1.28 | 3651 1.24 | 3618 1.23 | 3383 1.23 | 3211 1.23 | 3015 1.24 | 8 | 5 | 7 | |
| 550 | 4306 1.36 | 4028 1.31 | 3993 1.30 | 3737 1.31 | 3549 1.31 | 3333 1.32 | 9 | 6 | 8 | |
| 600 | 4698 1.44 | 4404 1.39 | 4368 1.38 | 4090 1.38 | 3885 1.38 | 3651 1.39 | 10 | 7 | 9 | |
| 650 | 5089 1.52 | 4780 1.46 | 4742 1.45 | 4442 1.46 | 4222 1.46 | 3968 1.47 | 11 | 8 | 10 | |
| 700 | 5479 2.01 | 5156 1.54 | 5116 1.53 | 4795 1.53 | 4558 1.54 | 4286 1.55 | 12 | 9 | 11 | |
| 750 | 5869 2.09 | 5531 2.02 | 5489 2.00 | 5147 2.01 | 4894 2.01 | 4602 2.02 | 13 | 10 | 12 | |
| 800 | 6258 2.17 | 5906 2.09 | 5862 2.07 | 5499 2.08 | 5230 2.09 | 4919 2.10 | 14 | 11 | 13 | |
| 850 | 6648 2.25 | 6280 2.17 | 6234 2.15 | 5851 2.16 | 5565 2.16 | 5235 2.18 | 15 | 11 | 14 | |
| 900 | 7036 2.33 | 6654 2.24 | 6606 2.22 | 6202 2.23 | 5899 2.24 | 5550 2.25 | 16 | 12 | 15 | |
| 950 | 7425 2.41 | 7027 2.32 | 6977 2.30 | 6553 2.31 | 6234 2.31 | 5865 2.33 | 17 | 13 | 16 | |
| 1000 | 7813 2.49 | 7400 2.39 | 7348 2.37 | 6904 2.38 | 6568 2.39 | 6180 2.40 | 18 | 14 | 17 | |
| 1050 | 8201 2.58 | 7773 2.47 | 7719 2.45 | 7254 2.46 | 6902 2.46 | 6495 2.48 | 19 | 15 | 18 | |
| 1100 | 8588 3.06 | 8145 2.55 | 8089 2.52 | 7605 2.53 | 7235 2.54 | 6809 2.56 | 20 | 16 | 19 | |
| 1150 | 8975 3.14 | 8517 3.02 | 8459 3.00 | 7955 3.01 | 7568 3.01 | 7123 3.03 | 21 | 17 | 20 | |
| 1200 | 9361 3.22 | 8889 3.10 | 8828 3.07 | 8305 3.08 | 7901 3.09 | 7436 3.11 | 22 | 18 | 21 | |
| 1250 | 9748 3.30 | 9260 3.17 | 9197 3.15 | 8654 3.16 | 8233 3.16 | 7750 3.18 | 23 | 19 | 22 | |
| 1300 | 10134 3.38 | 9631 3.25 | 9565 3.22 | 9004 3.23 | 8565 3.24 | 8063 3.26 | 25 | 20 | 23 | |
| 1350 | 10519 3.46 | 10001 3.32 | 9933 3.30 | 9353 3.31 | 8897 3.31 | 8375 3.33 | 26 | 21 | 24 | |
| 1400 | 10905 3.55 | 10371 3.40 | 10301 3.37 | 9701 3.38 | 9228 3.39 | 8687 3.41 | 28 | 22 | 25 | |
| ENGINE ANTI ICE ON | | | | | TOTAL ANTI ICE ON | | | | | |
| ΔFUEL = + 2.5 % | | | | | ΔFUEL = + 6 % | | | | | |

FLP23D A320-214 CFM56-5B4/P SA3611 03301.001011 0250300 .7800 .00100 120 0300350 55 0 100100 40100 18590 FCOM-NO-03-06-50-015-170



A318/A319/A320/A321
FLIGHT CREW
OPERATING MANUAL

PERFORMANCE

ONE ENGINE INOPERATIVE

IN CRUISE QUICK CHECK - FIXED SPEED STRATEGIES

Intentionally left blank



A318/A319/A320/A321
FLIGHT CREW
OPERATING MANUAL

PERFORMANCE
ONE ENGINE INOPERATIVE

HOLDING

HOLDING

Ident.: PER-OEI-HLD-00002130.0024001 / 28 FEB 11

Applicable to: ALL

| RACE TRACK HOLDING PATTERN - GREEN DOT SPEED - 1 ENGINE OUT | | | | | | | | |
|---|--------------|--------------|---|--------------|--------------|--|--------------|--------------|
| MAX. CRUISE THRUST LIMITS | | | | | ISA | | N1 (%) | |
| CLEAN CONFIGURATION | | | | | CG=33.0% | | FF (KG/H) | |
| PACK FLOW HI | | | | | | | | |
| ANTI-ICING OFF | | | | | | | | |
| WEIGHT (1000KG) | FL 15 | FL 50 | FL100 | FL120 | FL140 | FL160 | FL180 | FL200 |
| 48 | 61.2 1573 | 63.7 1562 | 68.1 1553 | 69.7 1549 | 71.4 1545 | 73.2 1544 | 75.1 1544 | 77.1 1549 |
| 50 | 62.2 1637 | 64.8 1626 | 69.2 1617 | 70.8 1613 | 72.5 1610 | 74.4 1610 | 76.4 1611 | 78.2 1618 |
| 52 | 63.1 1701 | 65.9 1691 | 70.2 1681 | 71.9 1677 | 73.7 1676 | 75.6 1677 | 77.5 1682 | 79.4 1687 |
| 54 | 64.1 1766 | 67.0 1758 | 71.2 1745 | 73.0 1742 | 74.8 1742 | 76.8 1744 | 78.6 1751 | 80.6 1757 |
| 56 | 65.1 1831 | 68.1 1823 | 72.3 1810 | 74.0 1808 | 75.9 1809 | 77.8 1815 | 79.7 1820 | 81.5 1830 |
| 58 | 66.1 1896 | 69.2 1885 | 73.3 1875 | 75.1 1875 | 77.1 1877 | 78.9 1884 | 80.8 1890 | 82.4 1906 |
| 60 | 67.1 1963 | 70.2 1949 | 74.3 1941 | 76.1 1943 | 78.1 1947 | 79.9 1953 | 81.7 1963 | 83.4 1982 |
| 62 | 68.1 2027 | 71.0 2014 | 75.3 2009 | 77.2 2011 | 79.0 2017 | 80.9 2024 | 82.6 2038 | 84.3 2066 |
| 64 | 69.1 2090 | 71.9 2079 | 76.3 2077 | 78.2 2081 | 80.0 2087 | 81.9 2095 | 83.4 2114 | 85.2 2153 |
| 66 | 70.1 2153 | 72.8 2145 | 77.2 2146 | 79.1 2150 | 80.9 2158 | 82.7 2170 | 84.3 2193 | |
| 68 | 70.9 2217 | 73.7 2211 | 78.2 2215 | 80.0 2220 | 81.8 2229 | 83.5 2246 | 85.2 2278 | |
| 70 | 71.7 2284 | 74.6 2278 | 79.1 2283 | 80.8 2291 | 82.7 2302 | 84.3 2322 | | |
| 72 | 72.5 2350 | 75.4 2346 | 79.9 2354 | 81.7 2363 | 83.4 2377 | 85.1 2402 | | |
| 74 | 73.3 2417 | 76.3 2416 | 80.7 2426 | 82.6 2436 | 84.2 2454 | | | |
| 76 | 74.1 2486 | 77.1 2486 | 81.6 2499 | 83.4 2510 | 85.0 2531 | | | |
| ENGINE ANTI ICE ON ΔFF = + 3 % | | | TOTAL ANTI ICE ON ΔFF = + 6 % | | | PER 1° ABOVE ISA ΔFF = + 0.3 % | | |

11.0-08FOA320-214 CFM56-584/P SA14300010C6KG330 0.018590 0.0 1.0 1.0 180.0 30.00 0.01 1.000 .000 .000 0 FCOM-N0-03-06-55-001-200



A318/A319/A320/A321
FLIGHT CREW
OPERATING MANUAL

PERFORMANCE
ONE ENGINE INOPERATIVE

HOLDING

Intentionally left blank

DESCENT - M.78/300KT

Ident.: PER-OEI-DES-10-00002135.0020001 / 09 MAR 11

Applicable to: ALL

| DESCENT - M.78/300KT - 1 ENGINE OUT | | | | | | | | | |
|--|---------------|---------------------------|---------------|--------------------------|---------------|-----------------------------------|---------------|------|-------------|
| MAX. CONTINUOUS THRUST LIMITS | | | | ISA | | MINIMUM RATE OF DESCENT 500FT/MIN | | | |
| PACK FLOW HI | | | | CG=33.0% | | | | | |
| ANTI-ICING OFF | | | | | | | | | |
| WEIGHT (1000KG) | 50 | | | | 70 | | | | IAS (KT) |
| | TIME (MIN) | FUEL (KG) | DIST. (NM) | MODE | TIME (MIN) | FUEL (KG) | DIST. (NM) | MODE | |
| 390 | 41.6 | 1408 | 280 | MCT | | | | | 241 |
| 370 | 39.8 | 1372 | 267 | MCT | 39.4 | 1386 | 264 | MCT | 252 |
| 350 | 38.1 | 1330 | 255 | MCT | 38.0 | 1353 | 253 | MCT | 264 |
| 330 | 36.5 | 1288 | 243 | MCT | 36.5 | 1315 | 243 | MCT | 277 |
| 310 | 35.1 | 1246 | 231 | MCT | 35.0 | 1274 | 231 | MCT | 289 |
| 290 | 33.6 | 1201 | 220 | MCT | 33.5 | 1226 | 219 | MCT | 300 |
| 270 | 31.5 | 1134 | 205 | MCT | 31.3 | 1156 | 203 | MCT | 300 |
| 250 | 29.1 | 1052 | 187 | MCT | 28.8 | 1072 | 185 | MCT | 300 |
| 230 | 26.0 | 942 | 165 | MCT | 25.9 | 967 | 164 | MCT | 300 |
| 220 | 24.0 | 867 | 151 | V/S | 24.0 | 896 | 151 | V/S | 300 |
| 210 | 22.0 | 793 | 137 | V/S | 22.0 | 818 | 137 | V/S | 300 |
| 200 | 20.0 | 719 | 124 | V/S | 20.0 | 741 | 124 | V/S | 300 |
| 190 | 18.0 | 645 | 111 | V/S | 18.0 | 665 | 111 | V/S | 300 |
| 180 | 16.0 | 572 | 98 | V/S | 16.0 | 589 | 98 | V/S | 300 |
| 170 | 14.0 | 499 | 85 | V/S | 14.0 | 514 | 85 | V/S | 300 |
| 160 | 12.0 | 427 | 72 | V/S | 12.0 | 439 | 72 | V/S | 300 |
| 150 | 10.0 | 355 | 60 | V/S | 10.0 | 365 | 60 | V/S | 300 |
| 140 | 8.0 | 283 | 47 | V/S | 8.0 | 291 | 47 | V/S | 300 |
| 100 | .0 | 0 | 0 | V/S | .0 | 0 | 0 | V/S | 300 |
| CORRECTIONS | | ENGINE ANTI ICE ON | | TOTAL ANTI ICE ON | | PER 1° ABOVE ISA | | | |
| TIME | | - 0.3 % | | - 1.5 % | | - | | | |
| FUEL | | + 2 % | | + 4 % | | + 0.3 % | | | |
| DISTANCE | | - 0.5 % | | - 1.5 % | | + 0.2 % | | | |

11.0-08FOA320-214 CFM56-5B4/P SA23200010C6KG330 0 018590 0 0 3 .0 500.00 0 02 .780300.000 .000 0 FCOM-NO-03-06-30-003-200



A318/A319/A320/A321
FLIGHT CREW
OPERATING MANUAL

PERFORMANCE

ONE ENGINE INOPERATIVE

DESCENT - STANDARD STRATEGY

Intentionally left blank

GROSS FLIGHT PATH DESCENT AT GREEN DOT SPEED - ISA

Ident.: PER-OEI-DES-15-00002080.0022001 / 09 DEC 09

Applicable to: ALL

| GROSS FLIGHT PATH DESCENT AT GREEN DOT SPEED | | | | | | | | | |
|--|----------------------------|----------------------------|----------------------------|----------------------------|----------------------------|----------------------------|----------------------------|----------------------------|----------------------------|
| MAX. CONTINUOUS THRUST | | | | ISA | | DISTANCE (NM) | | TIME (MIN) | |
| PACK FLOW HI | | | | CG=33.0% | | INITIAL SPEED(KT) | | FUEL(1000KG) | |
| ANTI-ICING OFF | | | | LEVEL OFF (FT) | | | | | |
| INIT. GW (1000KG) | INITIAL FLIGHT LEVEL | | | | | | | | |
| | 230 | 250 | 270 | 290 | 310 | 330 | 350 | 370 | 390 |
| 50 | | | | | 83 16 196 .4 30700 | 205 38 198 1.0 31000 | 253 47 200 1.2 31200 | 284 52 202 1.3 31200 | 308 56 204 1.4 31300 |
| 52 | | | | | 170 32 200 .9 29900 | 237 44 202 1.2 30000 | 273 51 204 1.3 30100 | 301 55 206 1.5 30200 | 322 58 208 1.5 30200 |
| 54 | | | | 102 20 202 .6 28700 | 207 39 204 1.1 29000 | 255 48 206 1.3 29100 | 287 53 208 1.5 29200 | 311 57 210 1.5 29200 | 331 60 212 1.6 29200 |
| 56 | | | | 174 33 206 1.0 27800 | 238 45 208 1.3 28000 | 276 51 210 1.5 28100 | 304 56 212 1.6 28200 | 324 59 214 1.6 28200 | 345 62 216 1.7 28200 |
| 58 | | | 111 21 208 .6 26600 | 215 41 210 1.2 26900 | 262 49 212 1.5 27000 | 294 55 214 1.6 27100 | 320 59 216 1.7 27200 | 339 62 218 1.8 27200 | 358 65 220 1.8 27200 |
| 60 | | | 179 34 212 1.1 25800 | 244 46 214 1.4 26000 | 283 53 216 1.6 26100 | 311 58 218 1.7 26100 | 334 61 220 1.8 26200 | 353 64 222 1.9 26200 | 369 67 224 1.9 26300 |
| 62 | | | 101 19 216 .6 25300 | 176 33 218 1.0 25400 | 220 41 220 1.2 25400 | 240 44 222 1.3 25400 | 267 48 224 1.4 25400 | 302 54 226 1.6 25400 | 321 57 228 1.7 25400 |
| 64 | | | 72 13 220 .4 25200 | 117 21 222 .7 25200 | 149 27 224 .8 25200 | 175 31 226 .9 25300 | 197 35 228 1.0 25300 | 216 37 230 1.1 25300 | 233 40 232 1.2 25300 |
| 66 | | | 61 11 224 .4 25100 | 98 18 226 .6 25100 | 126 22 228 .7 25100 | 149 26 230 .8 25100 | 169 29 232 .9 25100 | 187 32 234 .9 25100 | 203 34 236 1.0 25100 |
| 68 | | 26 5 226 .2 24900 | 62 11 228 .4 25000 | 94 17 230 .5 25000 | 120 21 232 .7 25000 | 141 24 234 .8 25000 | 153 26 236 .8 25000 | 170 28 238 .8 25000 | 185 30 240 .9 25000 |
| 70 | | 119 21 230 .8 24500 | 158 28 232 1.1 24600 | 182 32 234 1.2 24600 | 205 36 236 1.3 24600 | 222 39 238 1.3 24700 | 238 41 240 1.4 24700 | 253 43 242 1.4 24700 | |
| 72 | | 153 27 234 1.1 23900 | 190 34 236 1.3 24000 | 214 38 238 1.4 24000 | 234 41 240 1.5 24100 | 252 44 242 1.6 24100 | 268 46 244 1.6 24100 | 284 48 246 1.7 24100 | |
| 74 | | 178 32 238 1.3 23400 | 210 37 240 1.5 23400 | 232 41 242 1.6 23500 | 253 44 244 1.7 23500 | 270 47 246 1.7 23500 | 286 49 248 1.8 23500 | 300 51 250 1.8 23500 | |
| 76 | 106 19 240 .8 22600 | 196 35 242 1.4 22800 | 223 39 244 1.6 22900 | 246 43 246 1.7 22900 | 264 46 248 1.8 22900 | 280 48 250 1.8 22900 | 295 50 252 1.9 23000 | 311 52 254 1.9 23000 | |
| 78 | 145 26 244 1.1 22100 | 209 37 246 1.6 22300 | 236 41 248 1.7 22300 | 256 44 250 1.8 22300 | 274 47 252 1.9 22300 | 291 50 254 1.9 22400 | 306 52 256 2.0 22400 | | |
| CORRECTIONS | | DISTANCE | | TIME | | FUEL | | LEVEL OFF | |
| ENGINE ANTI ICE ON | | + 3 % | | + 3 % | | + 7 % | | - 100 FT | |
| TOTAL ANTI ICE ON | | + 8 % | | + 8 % | | + 10 % | | - 700 FT | |

PERFORMANCE

ONE ENGINE INOPERATIVE

DESCENT - OBSTACLE STRATEGY

A318/A319/A320/A321
FLIGHT CREW
OPERATING MANUAL

GROSS FLIGHT PATH DESCENT AT GREEN DOT SPEED - ISA +20

Ident.: PER-OEI-DES-15-00002088.0022001 / 22 MAR 17

Applicable to: ALL

| GROSS FLIGHT PATH DESCENT AT GREEN DOT SPEED | | | | | | | | | | |
|--|----------------------------|----------------------------|----------------------------|----------------------------|----------------------------|----------------------------|----------------------------|----------------------------|----------------------------|--|
| MAX. CONTINUOUS THRUST | | ISA +20 | | | | DISTANCE (NM) | | TIME (MIN) | | |
| PACK FLOW HI | | CG=33.0% | | | | INITIAL SPEED(KT) | | FUEL(1000KG) | | |
| ANTI-ICING OFF | | LEVEL OFF (FT) | | | | | | | | |
| INIT. GW (1000KG) | INITIAL FLIGHT LEVEL | | | | | | | | | |
| | 230 | 250 | 270 | 290 | 310 | 330 | 350 | 370 | 390 | |
| 50 | | | | 119 23 194 .6 28600 | 224 42 196 1.1 28900 | 273 51 198 1.3 29000 | 307 57 202 1.5 29100 | 333 61 202 1.5 29100 | 354 64 204 1.6 29200 | |
| 52 | | | | 191 36 198 1.0 27700 | 255 48 200 1.3 27900 | 295 55 202 1.5 27900 | 324 60 204 1.6 28000 | 348 63 206 1.7 28100 | 368 66 208 1.7 28100 | |
| 54 | | | 138 27 200 .8 26400 | 231 44 202 1.2 26700 | 280 53 204 1.5 26800 | 314 58 206 1.6 26900 | 339 62 208 1.7 26900 | 362 66 210 1.8 27000 | 381 69 212 1.8 27000 | |
| 56 | | | 200 38 204 1.1 25500 | 262 50 206 1.4 25700 | 301 56 208 1.6 25800 | 330 61 210 1.7 25800 | 353 65 212 1.8 25900 | 374 68 214 1.9 25900 | 392 71 216 1.9 26000 | |
| 58 | | | 96 18 208 .5 25200 | 152 28 210 .8 25300 | 212 39 212 1.1 25300 | 243 44 214 1.3 25300 | 268 48 216 1.4 25300 | 291 52 218 1.4 25300 | 309 54 220 1.5 25300 | |
| 60 | | | 74 14 212 .4 25100 | 118 21 214 .6 25100 | 150 27 216 .8 25100 | 176 31 218 .9 25100 | 198 35 220 1.0 25100 | 218 38 222 1.0 25100 | 236 40 224 1.1 25100 | |
| 62 | | 26 5 214 .2 24900 | 64 12 216 .4 25000 | 100 18 218 .5 25000 | 128 23 220 .7 25000 | 152 26 222 .8 25000 | 173 30 224 .8 25000 | 191 32 226 .9 25000 | 208 35 228 .9 25000 | |
| 64 | | 121 22 218 .8 24500 | 165 30 220 1.0 24500 | 194 35 222 1.2 24600 | 214 38 224 1.2 24600 | 234 41 226 1.3 24600 | 253 44 228 1.4 24700 | 268 46 230 1.4 24700 | | |
| 66 | | 159 29 222 1.1 23900 | 197 35 224 1.2 24000 | 223 40 226 1.4 24000 | 245 43 228 1.5 24000 | 265 46 230 1.5 24100 | 281 49 232 1.6 24100 | 299 51 234 1.6 24100 | | |
| 68 | 11 2 224 .1 22900 | 183 33 226 1.2 23300 | 216 39 228 1.4 23400 | 240 43 230 1.5 23400 | 260 46 232 1.6 23400 | 281 49 234 1.7 23500 | 296 51 236 1.7 23500 | 313 53 238 1.8 23500 | | |
| 70 | 92 17 228 .7 22500 | 201 36 230 1.4 22700 | 230 41 232 1.5 22800 | 253 45 234 1.6 22800 | 273 48 236 1.7 22800 | 291 50 238 1.8 22900 | 308 53 240 1.8 22900 | 323 55 242 1.9 22900 | | |
| 72 | 153 27 232 1.1 22000 | 215 38 234 1.5 22100 | 242 43 236 1.6 22200 | 263 46 238 1.7 22200 | 282 49 240 1.8 22200 | 298 51 242 1.9 22300 | 316 54 244 1.9 22300 | | | |
| 74 | 177 31 236 1.3 21500 | 227 40 238 1.6 21600 | 251 44 240 1.7 21600 | 272 47 242 1.8 21600 | 289 50 244 1.9 21700 | 307 52 246 1.9 21700 | 324 55 248 2.0 21700 | | | |
| 76 | 195 34 240 1.4 20900 | 237 41 242 1.7 21000 | 260 45 244 1.8 21100 | 279 48 246 1.9 21100 | 297 51 248 2.0 21100 | 314 53 250 2.0 21100 | 328 55 252 2.1 21100 | | | |
| 78 | 210 37 244 1.6 20400 | 245 43 246 1.8 20500 | 267 46 248 1.9 20500 | 287 49 250 2.0 20500 | 303 51 252 2.0 20500 | 320 54 254 2.1 20600 | 335 56 256 2.1 20600 | | | |
| CORRECTIONS | | DISTANCE | | | TIME | | FUEL | | LEVEL OFF | |
| ENGINE ANTI ICE ON | | + 3 % | | | + 3 % | | + 7 % | | - 100 FT | |
| TOTAL ANTI ICE ON | | + 8 % | | | + 8 % | | + 10 % | | - 700 FT | |

- For LONG RANGE CRUISE table *Refer to PER-OEI-CRT-10 LONG RANGE CRUISE - 1 ENGINE OUT - ISA*
- For IN CRUISE QUICK CHECK *Refer to QRH/PER-L In Cruise Quick Check Long Range (Paper Only)* or use the performance application of FlySmart with Airbus.



A318/A319/A320/A321
FLIGHT CREW
OPERATING MANUAL

PERFORMANCE

ONE ENGINE INOPERATIVE

DESCENT - OBSTACLE STRATEGY

Intentionally left blank



A318/A319/A320/A321
 FLIGHT CREW
 OPERATING MANUAL

PERFORMANCE
ONE ENGINE INOPERATIVE
 DESCENT - FIXED SPEED STRATEGIES

DESCENT - M.80/350KT

Ident.: PER-OEI-DES-20-00002136.0023001 / 22 FEB 11

Applicable to: ALL

| DESCENT - M.80/350KT - 1 ENGINE OUT | | | | | | | | | |
|-------------------------------------|---------------|--------------------|---------------|-------------------|---------------|-----------------------------------|---------------|------|-------------|
| MAX. CONTINUOUS THRUST LIMITS | | | | ISA | | MINIMUM RATE OF DESCENT 500FT/MIN | | | |
| PACK FLOW HI | | | | CG=33.0% | | | | | |
| ANTI-ICING OFF | | | | | | | | | |
| WEIGHT (1000KG) | 50 | | | | 70 | | | | IAS (KT) |
| | TIME (MIN) | FUEL (KG) | DIST. (NM) | MODE | TIME (MIN) | FUEL (KG) | DIST. (NM) | MODE | |
| 390 | 24.8 | 1011 | 183 | MCT | | | | | 248 |
| 370 | 23.3 | 980 | 172 | MCT | 25.3 | 1060 | 188 | MCT | 260 |
| 350 | 21.9 | 946 | 162 | MCT | 24.1 | 1030 | 178 | MCT | 272 |
| 330 | 20.6 | 911 | 151 | MCT | 22.8 | 998 | 169 | MCT | 284 |
| 310 | 19.4 | 876 | 142 | MCT | 21.6 | 962 | 159 | MCT | 297 |
| 290 | 18.3 | 842 | 133 | MCT | 20.4 | 924 | 149 | MCT | 311 |
| 270 | 17.3 | 809 | 126 | MCT | 19.2 | 886 | 140 | MCT | 324 |
| 250 | 16.4 | 778 | 119 | MCT | 18.1 | 849 | 131 | MCT | 338 |
| 230 | 15.6 | 749 | 112 | MCT | 17.1 | 811 | 123 | MCT | 350 |
| 220 | 15.1 | 728 | 108 | MCT | 16.4 | 785 | 118 | MCT | 350 |
| 210 | 14.5 | 705 | 103 | MCT | 15.6 | 756 | 112 | MCT | 350 |
| 200 | 13.8 | 679 | 98 | MCT | 14.8 | 724 | 105 | MCT | 350 |
| 190 | 13.2 | 651 | 93 | MCT | 14.0 | 689 | 99 | MCT | 350 |
| 180 | 12.4 | 620 | 87 | MCT | 13.1 | 651 | 92 | MCT | 350 |
| 170 | 11.5 | 582 | 81 | MCT | 12.1 | 607 | 84 | MCT | 350 |
| 160 | 10.5 | 534 | 73 | MCT | 10.9 | 551 | 76 | MCT | 350 |
| 150 | 9.2 | 473 | 64 | MCT | 9.4 | 483 | 65 | MCT | 350 |
| 140 | 7.8 | 399 | 53 | MCT | 7.8 | 402 | 54 | MCT | 350 |
| 100 | .0 | 0 | 0 | V/S | .0 | 0 | 0 | V/S | 350 |
| CORRECTIONS | | ENGINE ANTI ICE ON | | TOTAL ANTI ICE ON | | PER 1° ABOVE ISA | | | |
| TIME | | - 1.5 % | | - 4.5 % | | - | | | |
| FUEL | | + 0.5 % | | - | | + 0.3 % | | | |
| DISTANCE | | - 1.5 % | | - 5 % | | + 0.3 % | | | |

11.0.0BFOA320.214 CFM56-5B4/P SA23200010C6KG330 0 018590 0 0 3 .0 500.00 0 02 .800350.000 .000 0 FCOM-NO-03-06-50-003-200

PERFORMANCE

ONE ENGINE INOPERATIVE

DESCENT - FIXED SPEED STRATEGIES

DESCENT - M.78/320KT

Ident.: PER-OEI-DES-20-00002137.0023001 / 02 FEB 11

Applicable to: ALL

| DESCENT - M.78/320KT - 1 ENGINE OUT | | | | | | | | | |
|-------------------------------------|---------------|--------------------|---------------|-------------------|-----------------------------------|--------------|------------------|------|-------------|
| MAX. CONTINUOUS THRUST LIMITS | | | ISA | | MINIMUM RATE OF DESCENT 500FT/MIN | | | | |
| PACK FLOW HI | | | CG=33.0% | | | | | | |
| ANTI-ICING OFF | | | | | | | | | |
| WEIGHT (1000KG) | 50 | | | | 70 | | | | IAS (KT) |
| | TIME (MIN) | FUEL (KG) | DIST. (NM) | MODE | TIME (MIN) | FUEL (KG) | DIST. (NM) | MODE | |
| 390 | 35.7 | 1327 | 250 | MCT | | | | | 241 |
| 370 | 34.0 | 1290 | 237 | MCT | 34.4 | 1315 | 240 | MCT | 252 |
| 350 | 32.3 | 1249 | 224 | MCT | 33.0 | 1282 | 230 | MCT | 264 |
| 330 | 30.7 | 1207 | 212 | MCT | 31.6 | 1244 | 219 | MCT | 277 |
| 310 | 29.2 | 1164 | 201 | MCT | 30.1 | 1202 | 208 | MCT | 289 |
| 290 | 27.8 | 1123 | 191 | MCT | 28.6 | 1158 | 197 | MCT | 302 |
| 270 | 26.6 | 1082 | 181 | MCT | 27.2 | 1113 | 186 | MCT | 315 |
| 250 | 25.2 | 1032 | 170 | MCT | 25.6 | 1056 | 173 | MCT | 320 |
| 230 | 23.3 | 966 | 156 | MCT | 23.5 | 981 | 157 | MCT | 320 |
| 220 | 22.3 | 927 | 148 | MCT | 22.3 | 938 | 149 | MCT | 320 |
| 210 | 21.1 | 882 | 140 | MCT | 21.1 | 890 | 140 | MCT | 320 |
| 200 | 19.7 | 828 | 130 | MCT | 19.7 | 834 | 130 | MCT | 320 |
| 190 | 18.0 | 755 | 118 | V/S | 18.0 | 763 | 118 | MCT | 320 |
| 180 | 16.0 | 669 | 104 | V/S | 16.0 | 678 | 104 | V/S | 320 |
| 170 | 14.0 | 584 | 90 | V/S | 14.0 | 591 | 90 | V/S | 320 |
| 160 | 12.0 | 499 | 77 | V/S | 12.0 | 505 | 77 | V/S | 320 |
| 150 | 10.0 | 415 | 64 | V/S | 10.0 | 420 | 64 | V/S | 320 |
| 140 | 8.0 | 332 | 50 | V/S | 8.0 | 335 | 50 | V/S | 320 |
| 100 | .0 | 0 | 0 | V/S | .0 | 0 | 0 | V/S | 320 |
| CORRECTIONS | | ENGINE ANTI ICE ON | | TOTAL ANTI ICE ON | | | PER 1° ABOVE ISA | | |
| TIME | | - 0.6 % | | - 3 % | | | - | | |
| FUEL | | + 1.5 % | | + 5 % | | | + 0.3 % | | |
| DISTANCE | | - 0.8 % | | - 2.5 % | | | + 0.3 % | | |

11.0.08FDA320-214 CFM56-5B4/P SA23200010C6KG330 0 018590 0 0 3 .0 500.00 0 02 .750320.000 .000 0 FCOM-ND-03-06-50-004-200

PERFORMANCE

ONE ENGINE INOPERATIVE

DESCENT - DESCENT TO LANDING

DESCENT TO LANDING

Ident.: PER-OEI-DES-30-00002138.0022001 / 09 DEC 09

Applicable to: ALL

| DESCENT - M.78/300KT/250KT - 1 ENGINE OUT | | | | | | | | | |
|--|------|--------------------|--------------|-----------------|-------------------|---------------|--------------|------------------|-------------|
| IDLE THRUST NORMAL AIR CONDITIONING ANTI-ICING OFF | | | | ISA CG=33.0% | | | | | |
| WEIGHT (1000KG) | 50 | | | | 70 | | | | IAS (KT) |
| | FL | TIME (MIN) | FUEL (KG) | DIST. (NM) | N1 | TIME (MIN) | FUEL (KG) | DIST. (NM) | |
| 390 | 14.1 | 66 | 85 | IDLE | | | | | 241 |
| 370 | 13.5 | 64 | 80 | IDLE | 16.5 | 79 | 99 | IDLE | 252 |
| 350 | 12.9 | 62 | 76 | IDLE | 15.8 | 77 | 94 | IDLE | 264 |
| 330 | 12.4 | 61 | 72 | IDLE | 15.2 | 75 | 90 | IDLE | 277 |
| 310 | 11.9 | 59 | 69 | IDLE | 14.6 | 73 | 85 | IDLE | 289 |
| 290 | 11.4 | 58 | 65 | IDLE | 14.1 | 71 | 81 | IDLE | 300 |
| 270 | 10.9 | 56 | 61 | IDLE | 13.3 | 69 | 75 | IDLE | 300 |
| 250 | 10.3 | 54 | 56 | IDLE | 12.5 | 66 | 69 | IDLE | 300 |
| 240 | 9.9 | 53 | 54 | IDLE | 12.1 | 65 | 67 | IDLE | 300 |
| 220 | 9.3 | 51 | 50 | IDLE | 11.3 | 62 | 61 | IDLE | 300 |
| 200 | 8.7 | 48 | 45 | IDLE | 10.5 | 58 | 55 | IDLE | 300 |
| 180 | 8.0 | 44 | 41 | IDLE | 9.6 | 53 | 50 | IDLE | 300 |
| 160 | 7.3 | 39 | 37 | IDLE | 8.8 | 48 | 44 | IDLE | 300 |
| 140 | 6.6 | 34 | 32 | IDLE | 7.9 | 41 | 39 | IDLE | 300 |
| 120 | 5.9 | 29 | 28 | IDLE | 7.0 | 35 | 33 | IDLE | 300 |
| 100 | 5.2 | 25 | 24 | IDLE | 6.0 | 29 | 28 | IDLE | 300 |
| 50 | 1.9 | 8 | 8 | IDLE | 2.2 | 9 | 9 | IDLE | 250 |
| 15 | .0 | 0 | 0 | IDLE | .0 | 0 | 0 | IDLE | 250 |
| CORRECTIONS | | ENGINE ANTI ICE ON | | | TOTAL ANTI ICE ON | | | PER 1° ABOVE ISA | |
| TIME | | + 2.5 % | | | + 3 % | | | + 0.2 % | |
| FUEL | | + 22 % | | | + 38 % | | | + 0.5 % | |
| DISTANCE | | + 2.5 % | | | + 3 % | | | + 0.5 % | |

11.0.08FOA320-214 CFM56-5B4/P SA23100010C5KG330 0 018590 0 0-1 .0 .0 .00 0 03 .780300.000250.000 0 FCOM-ND-03-06-60-001-200



A318/A319/A320/A321
FLIGHT CREW
OPERATING MANUAL

PERFORMANCE

ONE ENGINE INOPERATIVE

DESCENT - DESCENT TO LANDING

Intentionally left blank