

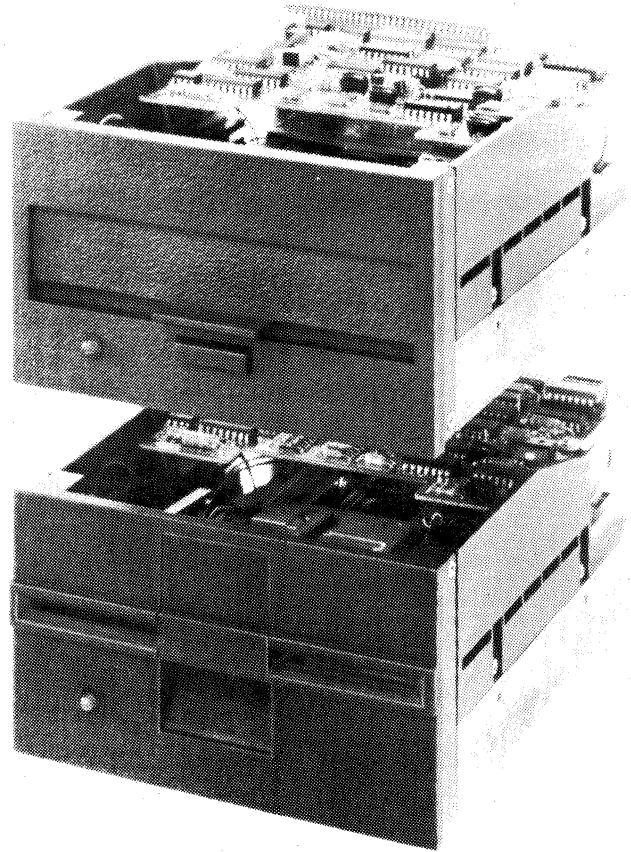

MICRO PERIPHERALS INC.

FLEXIBLE DISK DRIVE

INTERFACING GUIDE



**REPRESENTED
BY**



14431 MIRANDA CT.
LOS ALTOS HILLS
CALIFORNIA 94022
(415) 941-4133

PROPRIETARY NOTICE

Information contained in this manual is copyrighted, and may not be duplicated in full or in part by any person without prior written approval from Micro Peripherals, Inc. (MPI)

The purpose of this manual is to provide the user of MPI's Model 51/52 Flexible Disk Drives with adequately detailed documentation necessary for efficient installation, operation and interfacing for the equipment supplied.

Every effort has been made to keep the information contained in this manual current and accurate as of the date of publication or revision. However, no guarantee is given or implied that the manual is error free, or that it is accurate with regard to any particular specification.

Published February 1980



9754 Deering Avenue
Chatsworth, California 91311
(213) 709-4202
TWX: 910-494-1213

TABLE OF CONTENTS

Section 1	Specifications	Page 1
Section 2	Installation	Page 1
Section 3	Interfacing Requirements	Page 5
Section 4	Data Encoding and Recovery	Page 10

SECTION 1
SPECIFICATIONS

1.0 INTRODUCTION

This section provides the mechanical and electrical specifications for the Model 51/52 Flexible Disk Drives.

1.1 SPECIFICATIONS

The mechanical and electrical specifications for the Model 51/52 Flexible Disk Drives are given in Table 1-2. Data capacity for the Model 51/52 Flexible Disk Drives is given in Table 1-1.

TABLE 1-1
DATA CAPACITY UNFORMATTED (K BYTES)

PARAMETER	SINGLE DENSITY (FM)		DOUBLE DENSITY (MFM, M ² FM)	
	51	52	51	52
Track	3.13	3.13	6.25	6.25
Disk	125	250	250	500

SECTION 2

INSTALLATION

2.0 INTRODUCTION

This section provides the information and procedures necessary for installing the Model 51/52 Flexible Disk Drives.

2.1 UNPACKING

During unpacking, care must be exercised to ensure that all tools are nonmagnetic and do not inflict damage to the unit. As the unit is unpacked, inspect it for possible shipping damage. All claims for this type of damage should be filed promptly with the transporter involved. If a claim is filed for damages, save the original packing material. Most packing material may be reuseable if reasonable care is used in unpacking. Unpack the drive as follows:

- A. Remove external packing material carefully.
- B. Remove the drive from the container.
- C. Remove internal packing materials, following instructions provided on the package.
- D. Ensure that front access door opens and closes, and that the head load arm raises when door is opened.
- E. Ensure that bezel is secured.
- F. Ensure that drive hub manually rotates freely.
- G. Ensure that stepper motor/head carriage assembly is not binding at any point, by manually moving carriage back and forth.

TABLE 1-2

MECHANICAL AND ELECTRICAL SPECIFICATIONS

PARAMETER	CHARACTERISTICS
Media	ANSI standard 5 1/4 inch diskette
Number of Tracks	40/51 80/52
Track Density	48 TPI
Rotational Speed	300 rpm \pm 1 1/2%
Average Latency	100 msec
Head loading time	35 msec
Access time	5 msec, track-to-track
Head settling time	15 msec
Head life	20,000 hours
Media life	3×10^6 passes on a single track
Recording method	FM, MFM, M ² FM
Recording density	2938/5876 bpi max.
Flux density	5876 fci max.
Data-transfer rate	125K/250K bits/sec.
Power-up Delay	0.5 sec
Height	3.25 inches (8.255 cm)
Width	5.75 inches (14.605 cm)
Length	7.6 inches (19.30 cm)
Weight	3.0 pounds (1.36 kg)
Power	+12 VDC \pm 5%, 0.8A (1.5A surge), .2 V ripple +5 VDC \pm 5%, 0.4A, .1 V ripple
Typical Power Dissipation	12W Operation 6W Standby
Operating Temperature	40°F to 115°F (4.4°C to 46.1°C)
Non Operating Temperature	-40°F to 160°F (-40°C to 71°C)
Operating Humidity	20% to 80% (noncondensing)
Non Operating Humidity	5% to 95% (noncondensing)
Operating Altitude	-500 ft to 10,000 ft (-152.4m to 3,048m)
Non Operating Altitude	-1000 ft to 50,000 ft (-304.8m to 15,240m)
Vibration and Shock (Operating)	6 to 600 Hz, 0.5g
MTBF	9,200 Hours
MTTR	0.5 Hours

2.2 INSTALLATION

Due to its small size and light weight, the Model 51/52 can be installed or mounted in any convenient location or position. However, the drive must be installed in a location that will prevent the I/O cable from exceeding 10 feet in length. Refer to Figure 2-1 for dimensions and mounting provisions.

2.3 HARDWARE

The flexible disk drive is a precision device in which certain critical internal alignments must be maintained. Therefore, in keeping with rigid disk requirements, it is important that the mounting hardware does not introduce significant stress on the drive. Any mounting scheme in which the drive is part of the structural integrity of the enclosure is not permitted. Since the disk drive cannot be subjected to significant stress when it is slide mounted, this type of mounting generally satisfies the foregoing requirements. Mounting schemes should allow for adjustable brackets or incorporate resilient members to accommodate tolerances. Mounting schemes involving more than two hard mounting points and a third point should be avoided.

2.4 DUST COVER

Since the flexible disk drive is not provided with a dust cover, the design of an enclosure should incorporate a means to prevent direct ingress of loose items, e.g., dust, paper punch waste, etc.

2.5 COOLING

Heat dissipation from a single disk drive is normally 12 watts (32 Btu/Hr). When the drive is mounted so that the components have access to free flow of air, normal convection cooling allows operation over the specified temperature range. When the drive is mounted in a confined environment, air flow may have to be provided to maintain specified air temperatures in the vicinity of the motors, PCBA, and the diskette.

2.6 INPUT/OUTPUT CABLE

Refer to Table 2-1 for cable connector part number and attachment. The maximum cable length from connector to connector is 10 feet. All inputs and outputs are paired, one line for function, one for ground. Figure 3-9 provides information relative to the connector pin/signal assignments for the I/O cable.

TABLE 2-1
RECOMMENDED CONNECTORS - P1

TYPE OF CABLE	MANUFACTURER	CONNECTOR P/N	CONTACT P/N
Twisted Pair, 26	AMP	583717-5	1-583616-1
Flat Cable	3M "Scotchflex"	3463-0001	N.A.

Bottom View

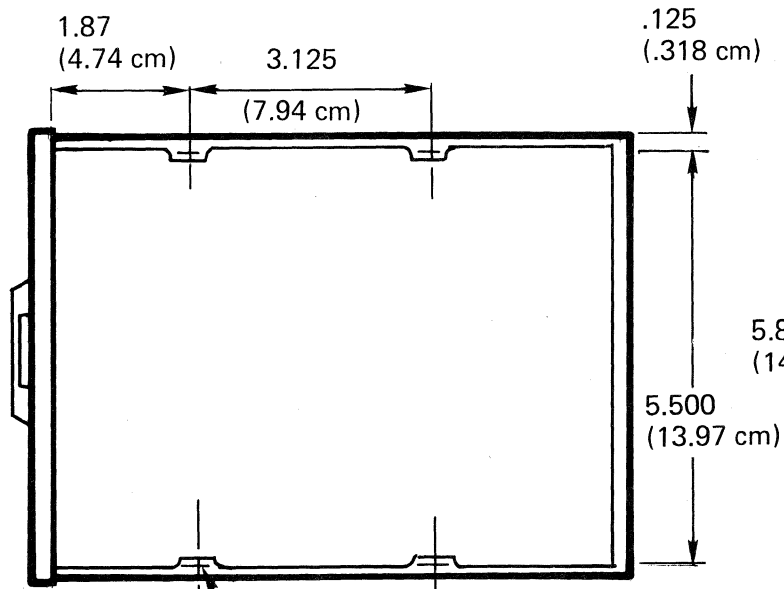

Top View

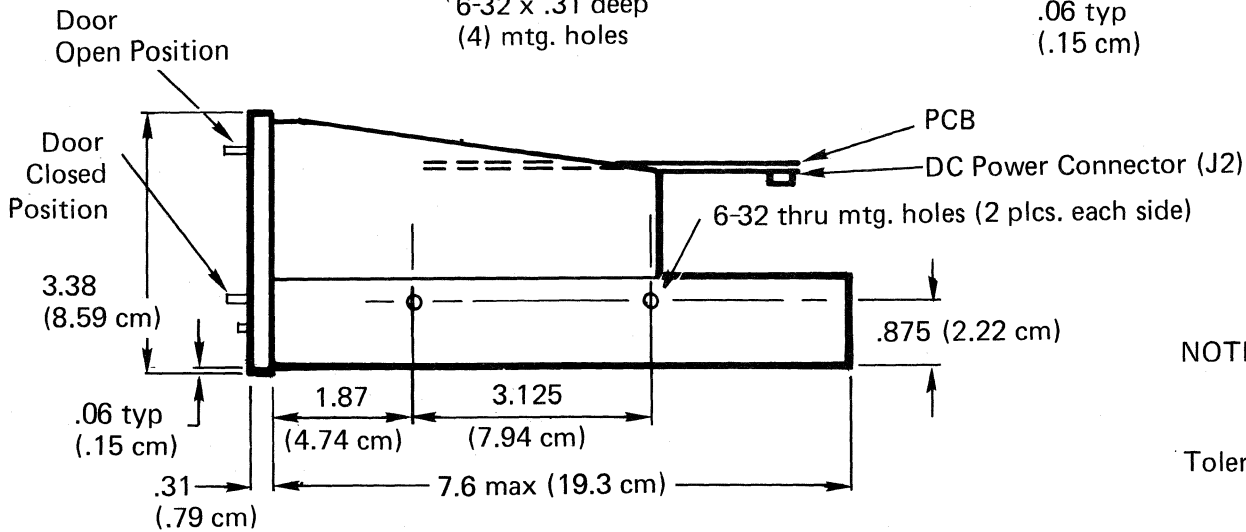
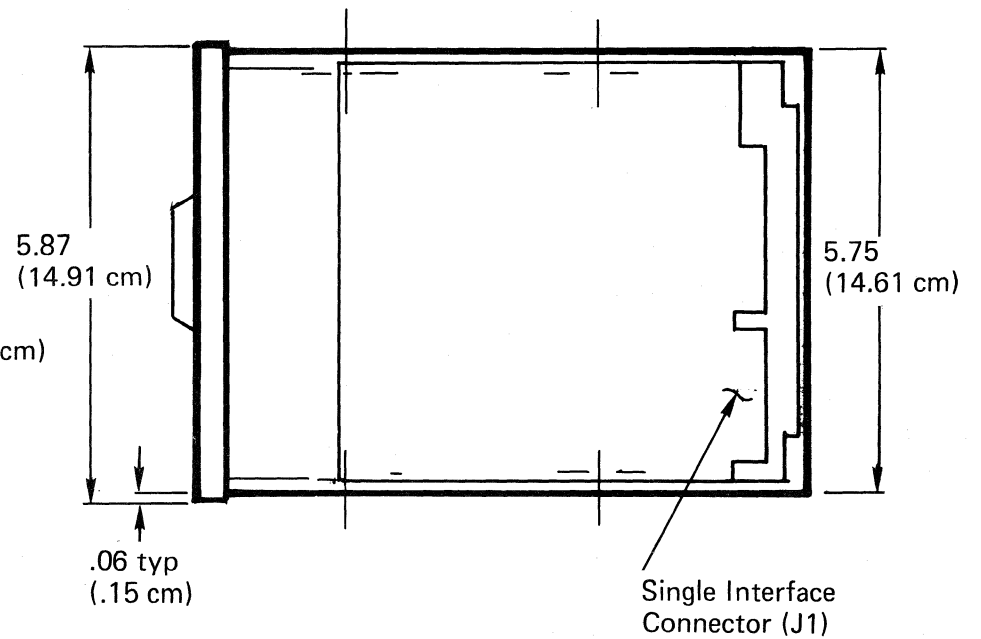

Side View

NOTE: Unless otherwise stated, dimensions are in inches.

Tolerances: .xxx ± 0.010
 . xx ± 0.020

Figure 2-1 Outline and Mounting Dimensions

2.7 DC POWER

DC power to the drive is via connector J2, which is located on the non-component side of the PCBA near the spindle motor. The drive uses +12V DC and +5V DC. Table 1-2 outlines the voltage and current requirements. The connector is an AMP Mate-N-Lock Part No. 1-480424-0.

SECTION 3

INTERFACING REQUIREMENTS

3.0 INTRODUCTION

This section contains the interfacing requirements between the host system and the Model 51/52 Flexible Disk Drive. Communication is established via two connectors. Connector J1 establishes a communication link for all input/output signals. These signals are TTL compatible. Connector J2 provides DC power to the device.

3.1 INPUT LINES

The input control lines have the following electrical specifications:

- A. True, Logical Zero = 0V to 0.4V (@ I_{in} = 48 ma max).
- B. False, Logical One = +2.5V to +5V (open collector @ I_{out} = 250 μ a max).

3.1.1 Line Termination

The signal interface used by the Model 51/52 is of the "bus" or "daisy-chain" type. Only one 51/52 unit is logically connected to the interface at any given time. All input signals are terminated directly by a 150 ohm or a 220/330 ohm resistor network. In a daisy-chain configuration, only the last device in the daisy chain should have the terminating network; while in a star configuration, every device should be terminated.

3.1.2 Programmable Shunt

The main function of this device is to assign the proper address to the drive in a multidrive configuration. In addition, it also determines when the head load solenoid should be activated by using either position 1-14 (with Select) or 7-8 (with Motor On). If position 5-10 is left shorted, the drive is essentially always selected, but the activity light will not come on, and the solenoid will not be activated until the drive position is selected. The programmable shunt is AMP P/N 435704-6 (MPI P/N 1-79600-005). For convenience, the programmable shunt could be replaced by a dip switch, AMP P/N 435626-4 (MPI P/N 1-79601-001). (If dip switch is used, maximum height is exceeded by .150.) The seven lines channeled through the shunt are:

	Designator	Pins
a. Head Load w/Select	T1	1-14
b. Drive Select 1	T2	2-13
c. Drive Select 2	T3	3-12
d. Drive Select 3	T4	4-11
e. MUX	T5	5-10
f. Drive Select 4	T6	6-9
g. Head Load w/Motor On	T7	7-8

3.1.3 Drive Select 1 to 4

The Drive Select lines provide a means of selecting and deselecting one of up to four disk drives. When the signal logic level is true, the disk drive electronics are activated, the head is loaded, and the drive is conditioned to respond to step or read/write commands. When the logic level is false, the input control lines and output status lines are disabled. A select line must remain stable in the true state until the execution of a step or read/write command is completed. After the desired device is selected, allow a 35 msec delay before initiating a read (see Figure 3-2) or write (see Figure 3-4).

3.1.4 Motor On

This input is provided to extend the life of the DC spindle motor. The motor should be turned off if no activity is required of the Model 51/52 after 10 revolutions of the diskette. A true level on this line turns on the drive motor. A minimum of 0.5 second is required before performing a read or write after a MOTOR ON command is transmitted to the device (see Figures 3-2 and 3-4).

3.1.5 Direction Select

The direction of motion of the read/write head is defined by the state of this input line. A true level defines direction as "IN" (towards center of the disk); a false level defines the direction as "OUT" (see Figure 3-1).

3.1.6 Step

Together with the direction line, a single pulse on this input will move the read/write head one track in or out, dependent on the state of the direction line. The motion of the head is initiated on the trailing edge of the step pulse. A minimum of 0.2 μ s pulse width at a maximum frequency of 200 Hz should be maintained to assure step integrity (see Figure 3-1).

3.1.7 Write Gate

When true, this input line permits writing of data. When false, it permits transmitting data to the controller. Write gate must be high for 10 ms minimum after turning off DC power (see Figure 3-6). Allow a minimum of 1 msec after dropping write gate before expecting valid Read Data (see Figures 3-2 and 3-6). During this 1 msec period, Side Select (see paragraph 3.1.9) must remain stable.

3.1.8 Write Data

This input, in conjunction with the write gate input, provides data to be written on the diskette. The frequency of the write oscillator should be held within 0.1% with a pulse width of a minimum of 0.2 μ sec and maximum of 3.5 μ sec. The frequency is dependent upon the encoding scheme used and the density option exercised (see Figures 3-4 and 3-5). It is recommended that the first leading edge of Write Data occurs no sooner than 4 μ sec and no later than 8 μ sec after leading edge of Write Gate. The same recommendation exists for the last Write Data and trailing edge of Write Gate.

3.1.9 Side Select

This input is used to select either the upper or lower head. A true level selects the upper head, a false level selects the lower head. A 35 μ sec delay should be allowed for the read amp to recover after a head select event occurs. Only then will valid data be present. (For Model 51, this line should always be high.)

3.1.10 In Use (optional feature)

This line is connected to a driver which could be used for an indicator light or a solenoid for locking the drive door.

3.2 OUTPUT LINES

The control output signals are driven with an open-collector output stage capable of sinking a maximum of 48 ma at logical zero with maximum voltage of 0.4V measured at the driver. When the output is at a logical one, the collector cutoff current is a maximum of 250 μ a.

3.2.1 Track 00

This output, when true, indicates that the read/write head(s) are located at Track 00.

3.2.2 Index/Sector

This output, when true, indicates that an index or sector hole in the diskette is present at the index sensor (see Figure 3-7 and 3-8).

3.2.3 Write Protect

This output, when true, indicates that a write protected diskette is installed in the drive. When an unprotected diskette is installed, this output is false. When a protected diskette is installed, the write and erase logic on the PCBA is disabled. By making a small modification to the PCBA and using only protected diskettes, this output can be used as a Diskette Installed indicator.

3.2.4 Read Data

This output represents digitized data as detected by the drive electronics. Information transmitted will be in the encoding scheme used. Pulse width of both clock and data bits will be 1 μ sec \pm 350 nsec. Maximum bit shift from nominal for various encoding schemes is given in table 3-1 (see Figure 3-3).

TABLE 3-1

BIT SHIFT

Maximum bit shift (ns)	FM	MFM	M ² FM
clock	\pm 700	\pm 700	\pm 475
data	\pm 400	\pm 700	\pm 700

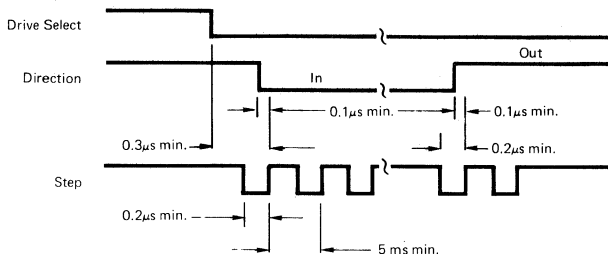

Figure 3-1 Track Access Timing

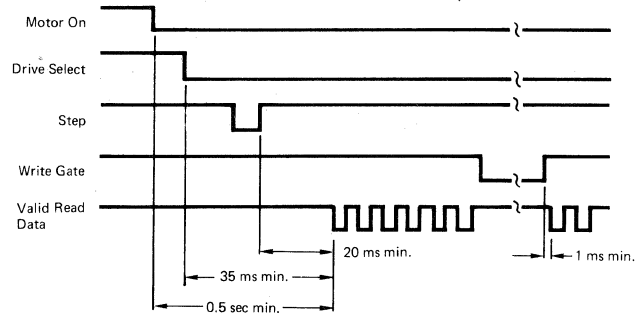

Figure 3-2 Read Initiate Timing

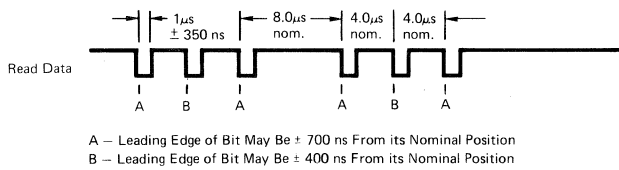

Figure 3-3 Read Signal Timing

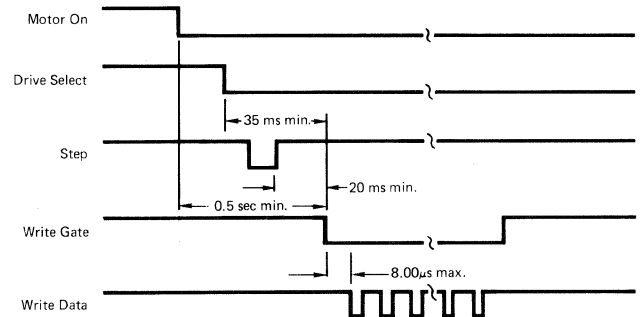

Figure 3-4 Write Initiate Timing

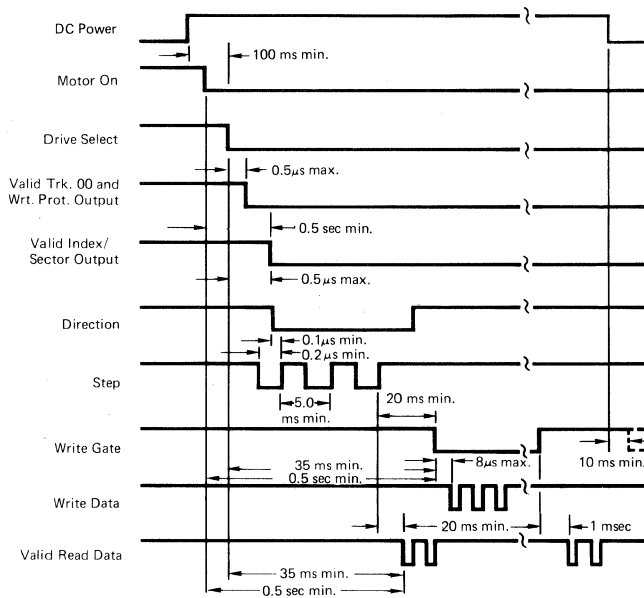

Figure 3-6 General Control and Data Timing Requirements (Head Load Solenoid is Activated with Drive Select)

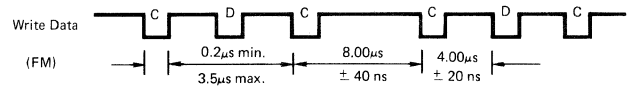

Figure 3-5 Write Data Timing

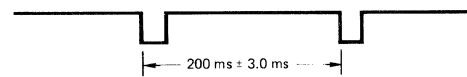

Figure 3-7 Index Sector Timing (soft sector)

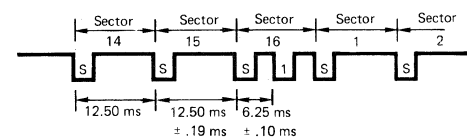
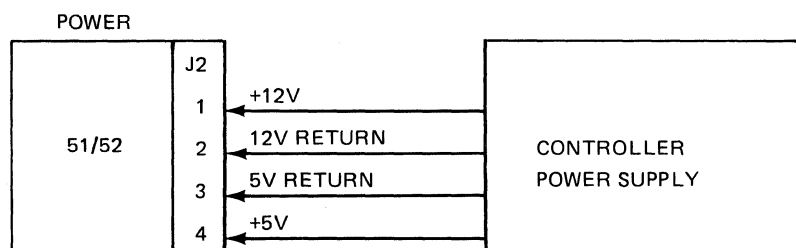
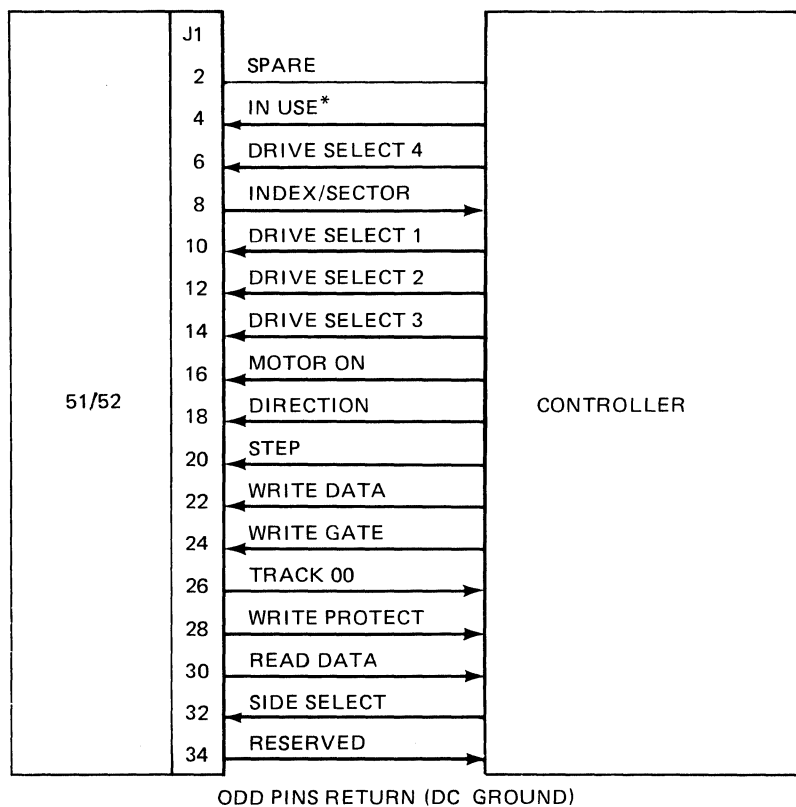
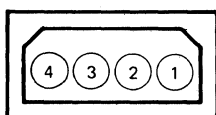

Figure 3-8 Index Sector Timing (hard sector)



*IN USE may be configured as Door Lock or Activity Light.

Figure 3-9 Interface Signals – 51/52



- Pin 1 +12V DC
- Pin 2 12V Return
- Pin 3 5V Return
- Pin 4 +5V DC

Figure 3-10 DC Power Connector, J2

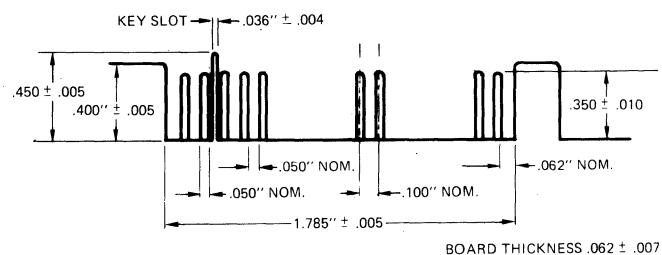

Figure 3-11 J1 Connector Dimensions

3.3 CONNECTOR J2

The DC power connector is located on the non-component side of the printed circuit board. The recommended mating connector is AMP P/N 1-480424-0 using AMP pins P/N 60619-1 (see Figure 3-10).

3.4 CONNECTOR J1

Connection to J1 is through a 34-pin PCBA edge connector. Even numbered pins are located on the component side while odd numbered pins are located on the solder side. A key slot is provided between pins 4 and 6. The recommended connector is 3M Scotchflex P/N 3463-001, or AMP P/N 583717-5 using AMP contacts P/N 1-583616-1 (see figure 3-11).

SECTION 4

DATA ENCODING AND RECOVERY

4.0 INTRODUCTION

This section provides applications information relevant to the recording and recovery of data with the Model 51/52 Flexible Disk Drives.

4.1 ENCODING METHODS

The three most common methods for encoding data are described in the following paragraphs. Table 4-1 shows a comparison of these encoding techniques.

4.1.1 FM

FM (frequency modulation) encoding has the following rules.

- A. A data bit, if it is a "1", occurs at the center of the bit cell.
- B. A clock bit occurs at the start of the bit cell.

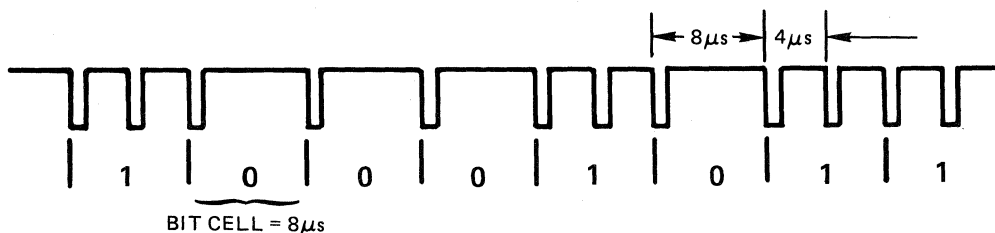

Figure 4-1 FM Encoding

4.1.2 MFM

MFM (modified FM) encoding has the following rules:

- A. A data bit, if it is a "1", occurs at the center of the bit cell.
- B. A clock bit occurs at the start of the bit cell, but only if no data bit occurred in the previous bit cell and no data bit will occur in the current bit cell.

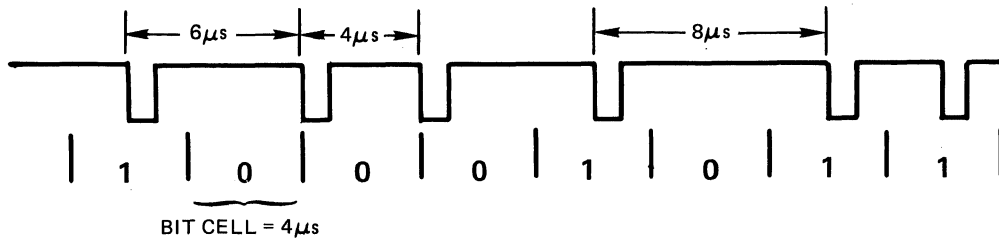

Figure 4-2 MFM Encoding

4.1.3 M²FM

M²FM (modified MFM) encoding has the following rules:

- A. A data bit, if it is a "1", occurs at the center of the bit cell.
- B. A clock bit occurs at the start of the bit cell, but only if neither a data bit nor a clock bit occurred in the previous bit cell and no data bit will occur in the current bit cell.

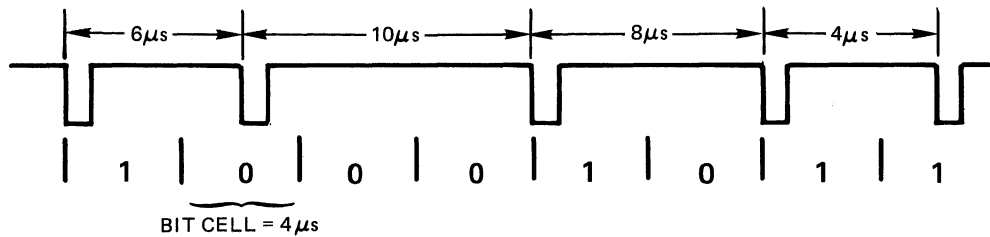

Figure 4-3 M² FM Encoding

4.2 DATA RECOVERY

Data recovery refers to the retrieving of data off of the flexible diskette. The following paragraphs describe the problems associated with data recovery and methods to ensure data reliability.

4.2.1 Bit Shift

Bit shift refers to the displacement of a bit, as detected by the drive, from its nominal position. The causes of bit shift are manifold -- R/W head resolution, media resolution, diskette speed variation, signal-to-noise ratio of read head output. Any data separation technique used must have a read window of at least 1500 ns to handle this bit shift.

4.2.2 Write Precompensation

Certain data patterns cause more bit shift than other patterns. This bit shift is predictable and can thus be partially compensated for. For example, if it is known that a bit will be shifted by 500 ns when it is read back, then the bit

can be deliberately written 200 ns early. This would give a bit shift of about 350 ns when it is read back. This method of reducing bit shift is called write precompensation.

Bit shift is greater on the inner tracks of the diskette than on the outer tracks, making write precompensation necessary only on the inner tracks. Write precomp of 250 to 300 ns should be used on tracks 18 through 39. If due to controller limitations, write precomp must be used on all tracks, then 125 to 150 ns should be used. Table 4-1 shows which encoding methods require the use of write precompensation.

4.2.3 Data Separation

Data separation refers to the separating of the composite data coming from the drive into separate clock and separate data bits.

For FM recording, a one-shot data separator is quite sufficient. For double density recording, a phase-lock oscillator (PLO) data separator should be used. There is another method of data separation, the digital counter method. This method is a very poor approximation of a PLO. It has a theoretical read window of only 1000 ns which, as per paragraph 4.2.1, is not sufficient to handle bit shift.

In MFM recording, data bits and clock bits are subject to the same amount of bit shift. A PLO separator with a 50% data window and a 50% clock window should be used.

In M²FM recording, data bits are subject to more bit shift than clock bits. A PLO separator with a 60% data window and a 40% clock window should be used for best data reliability.

It should be noted that the +700 ns bit shift is meaningful only when associated with an error rate. The Model 51/52 drives have error rates of 1 error in 10⁹ bits read. Thus, for every 10⁹ bits, there will be no more than 1 bit shifted more than +700 ns.

4.3 TRACK FORMAT

When determining the track format to be used, the following timing restraints should be considered (see Figure 4-4).

4.3.1 Postamble

The postamble period must be at least 3 ms to allow for spindle speed variation of $\pm 1\frac{1}{2}\%$.

4.3.2 Data Gap

The data gap period must be at least 1 ms to allow for tunnel erase turn off time.

TABLE 4-1

COMPARISON OF ENCODING TECHNIQUES

Encoding Technique	FM	MFM	M ² FM
Bit Cell Time	8 μs	4 μs	4 μs
Possible pulse spacing	4 μs 8 μs	4 μs 6 μs 8 μs	4 μs 6 μs 8 μs 10 μs
Frequency components of read signal	125 KHz 62.5 KHz	125 KHz 93.75 KHz 62.5 KHz	125 KHz 93.75 KHz 62.5 KHz 50 KHz
Encoder complexity	Simple	Moderate	Moderate
Write precompensation needed	No	Yes	Yes
Data separator recommended	One-shot	PL0(50-50 window)	PL0(60-40 window)
Data separator complexity	Simple	Moderate	Moderate

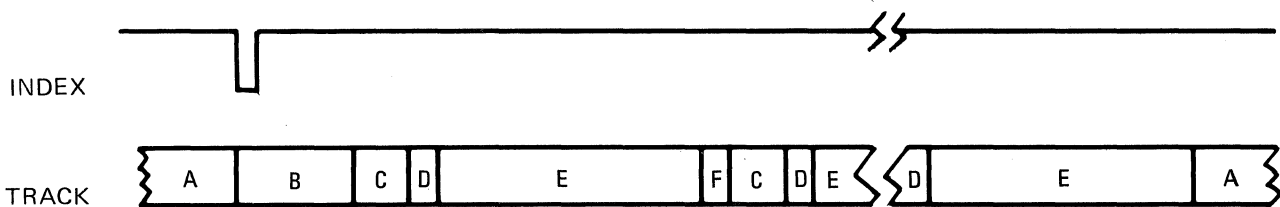

A - Postamble D - ID Gap
 B - Preamble E - Data Record
 C - ID Record F - Data Gap

Figure 4-4 Typical Track Format

