

Schaltnetzgeräte IO-Link

BAE PS-XA-...-601-I/-602-I/-603-I/-604-I/-605-I/-606-I/-607-I



EU-Richtlinie 2004/108/EG (EMV-Richtlinie)

Niederspannungsrichtlinie 2006/95/EG

Produktnorm EN 61204-3. Sicherheit von IT-Einrichtungen EN 60950

Gültigkeit

Diese Anleitung gilt für folgende Geräte:

- BAE PS-XA-1W-24-038-601-I (Bestellcode BAE00TH)
- BAE PS-XA-1W-24-038-602-I (Bestellcode BAE00TJ)
- BAE PS-XA-1W-24-038-603-I (Bestellcode BAE00TK)
- BAE PS-XA-1W-24-080-604-I (Bestellcode BAE00TL)
- BAE PS-XA-1W-24-080-605-I (Bestellcode BAE00TM)
- BAE PS-XA-1W-24-080-606-I (Bestellcode BAE00TN)
- BAE PS-XA-1W-24-038-607-I (Bestellcode BAE00TP)



Download der Betriebsanleitung

Die gleiche Betriebsanleitung erhalten Sie auch im Internet unter www.balluff.com.

Bestimmungsgemäße Verwendung

Dieses Gerät ist ein primär getaktetes Schaltnetzgerät für die Verwendung in Schalttafelinstallationen oder Einbauanwendungen, bei denen der Zugang zum Netzgerät beschränkt ist (Berührungsschutz). Das Gerät ist einsetzbar bei Verschmutzungsgrad 3.

Veränderungen am Gerät oder eine nicht bestimmungsgemäße Verwendung sind nicht zulässig und führen zum Verlust von Gewährleistungs- und Haftungsansprüchen gegenüber dem Hersteller.

Sicherheitshinweise



Vor Inbetriebnahme ist die Betriebsanleitung sorgfältig zu lesen!

Diese Geräte dürfen nicht in Anwendungen eingesetzt werden, in denen die Sicherheit von Personen von der Gerätefunktion abhängt (kein Sicherheitsbauteil gem. EU-Maschinenrichtlinie).



GEFAHR durch Hochspannung!

Die Berührung ungeschützter Leiter und Komponenten kann zum Tod durch Stromschlag oder zu schweren Verbrennungen führen. Vor Arbeiten am Gerät die Stromversorgung unterbrechen und gegen Wiedereinschalten sichern. Keine Gegenstände in das Gerät einführen. Von Feuer fernhalten.

Die **Installation und die Inbetriebnahme** sind nur durch geschultes Fachpersonal zulässig.

Der **Betreiber** hat die Verantwortung, dass die örtlich geltenden Sicherheitsvorschriften eingehalten werden. Insbesondere muss der Betreiber Maßnahmen treffen, dass bei einem Defekt des Geräts keine Gefahren für Personen und Sachen entstehen können. Bei Defekten und nicht behebbaren Störungen des Schaltnetzgeräts ist dieses außer Betrieb zu nehmen und gegen unbefugte Benutzung zu sichern.

Installation



Achtung!

Das Gerät gemäß den lokalen Vorschriften und Normen ans Stromnetz anschließen. Das Gerät nicht abdecken! Für die Kühlung ausreichenden Raum um das Gerät herum vorsehen, sonst kann das Gerät durch Überhitzung abgeschaltet werden. Die Lebensdauer des Geräts sinkt, sobald es länger im überhitzten Zustand betrieben wird. Die Stress Level Anzeige signalisiert eine ungenügende Kühlung. Das Gehäuse kann im Betrieb heiß werden!

Elektrische Anschlüsse

- Daten für zulässige Lasten siehe Tabelle "Technische Daten".
- Ausschließlich kommerzielle Kabel verwenden, die für die angegebenen Spannungs- und Stromwerte geeignet sind.
- Bei Flexkabeln sicherstellen, dass alle Litzen in der Klemme gesichert sind.
- Korrekte Polarität am Ausgang sicherstellen.
- Steckverbindungen nur bei ausgeschaltetem Strom anschließen oder trennen.
- Bei Bedarf muss ein manuell steuerbares Trennelement zur Trennung vom Versorgungsnetz verwendet werden.
- Geräte- und Stromkabel müssen korrekt abgesichert sein.
- Der ungesicherte Erdungsleiter muss an GND (Schutzklasse 1) angeschlossen sein.
- Solange das Gerät in Betrieb ist, die Installation nicht ändern! Dasselbe gilt für die Sekundärseite. Gefahr durch elektrische Bögen und tödlichen Stromschlag.

Installation (Fortsetzung)

Interne Sicherung

Die interne Eingangssicherung dient dem Schutz des Geräts und kann nicht ausgetauscht werden. Bei einem internen Fehler ist das Gerät aus Sicherheitsgründen an den Hersteller zurückzuschicken.

Montage mit Flansch

- ▶ Das Lochbild des Flansches beachten.
- ▶ Das Gerät mit Schrauben an Maschine oder Anlage anbringen.



Ausbau

- ▶ Stromversorgung ausschalten und System vom Versorgungsnetz trennen.
- ▶ Alle Steckverbinder vom Netzgerät trennen.

Anzeigeelemente

Stress Level Anzeige (Stressniveau)



Die LEDs grün, gelb und rot signalisieren die elektrische und die thermische Belastung. Diese Daten werden innerhalb eines 3 Stunden Zyklus ermittelt und ausgewertet. Der Betreiber ist hiermit in der Lage die Umgebungsbedingungen zu überprüfen und so zu verändern, dass negative Auswirkungen auf das Gerät verhindert werden.

Symbol	Bedeutung
 grün	Niedrige Puls-Geschwindigkeit: alles in Ordnung, lange Lebenszeit ist zu erwarten.
 gelb	Puls-Geschwindigkeit steigt: thermischer Zustand nicht optimal. Kein unmittelbares Überhitzungsrisiko. Leicht beschleunigte Alterung. Die Belastung reduzieren oder die Belüftung verbessern!
 rot	Hohe Puls-Geschwindigkeit: interner thermischer Zustand schlecht, Lebensdauer ernsthaft gefährdet. Die Belastung prüfen und die Belüftung verbessern!

Anzeigeelemente (Fortsetzung)



Lifetime Anzeige (Lebensdauer)

Die LEDs signalisieren die verbleibende Lebensdauer des Geräts. Sie basiert auf der Summe sämtlicher vorhergehenden Belastungen. Die Lebensdauer beginnt bei 15 Jahren und nimmt entsprechend des Stressniveaus und der Belastung ab.

Symbol	Bedeutung
 grün	Netzgerät mit langer Lebensdauer
 gelb	Lebensdauer unter 3 Jahren, im nächsten Wartungszyklus ersetzen
 rot	Lebensdauer des Netzgerätes am Ende, unverzüglich ersetzen

Load Level Anzeige (Belastungsniveau)

Die LEDs signalisieren verzögerungsfrei die aktuelle Auslastung des Geräts:

Symbol	Bedeutung
 grün	0...80% Belastung
 gelb	81...100% Belastung
 rot	>100...150% Belastung, typisch wenn Stromerhöhung notwendig ist, max. 4 s

Fehleranzeige



Sobald die Ausgangsspannung außerhalb des Arbeitsbereichs 22...28 V DC liegt (z.B. Kurzschluss), leuchtet nur die Load Level Anzeige rot. Die beiden anderen Anzeigen sind ausgeschaltet.

Schaltnetzgeräte IO-Link BAE PS-XA-...-601-I/-602-I/-603-I/-604-I/-605-I/-606-I/-607-I

Abmessungen

BAE PS-XA-1W-24-038-...

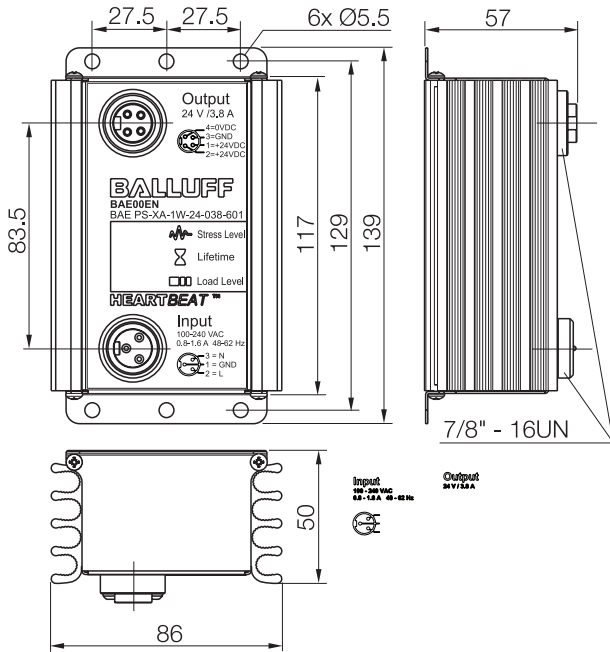

Anschlüsse

Pin	Typ BAE PS-...		
	...-604 ...-607	...-601	...-602 ...-606
Pin 1	+24 V	+24 V	+24 V
Pin 2	+24 V	+24 V	+24 V
Pin 3	0 V	GND	0 V / GND
Pin 4	0 V	0 V	0 V / GND

Pin	BAE PS-...
	...-603 ...-605
Pin 1	0 V
Pin 2	0 V
Pin 3	GND
Pin 4	+24 V
Pin 5	+24 V

Pin	BAE PS-...-60x
Pin 1	GND
Pin 2	L
Pin 3	N

BAE PS-XA-1W-24-080-...

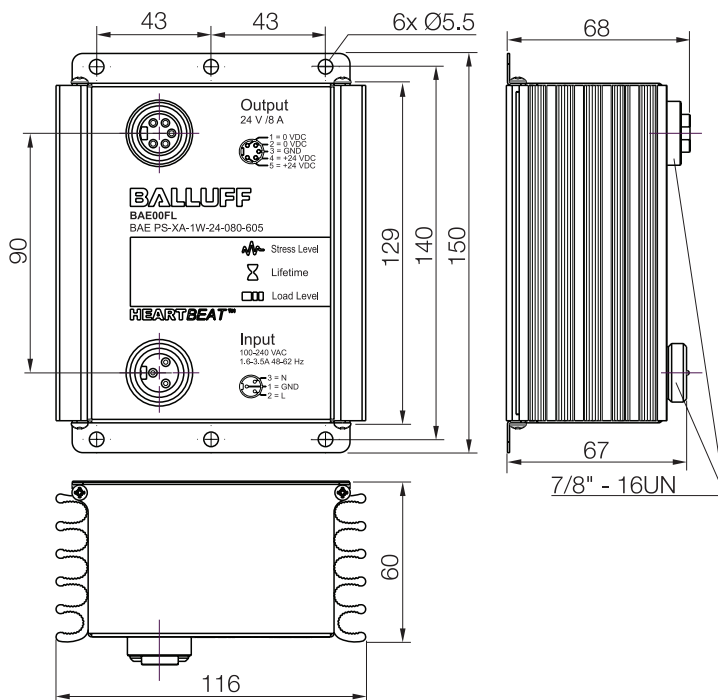

IO-Link Interface (nur in Verbindung mit Clip-On BAE SC-AE-I01)

Allgemeine Device-Infos

Baudrate	COM 2 (38,4 kBaud)
Prozessdatenlänge Eingang	4 byte
Minimale Zykluszeit	20 ms
IO-Link Version	V1.1
SIO-Modus	nein

IO-Link Modus (Kommunikationsmodus)

Die IO-Link Kommunikation läuft über Pin 4 des M12 Steckverbinders.

Prozessdaten

Die Prozessdatenlänge des Netzteils beträgt 32 bit. In den Prozessdaten werden die Schaltzustände der 4 Schaltausgänge (BDC1 ... BDC4), sowie die aktuellen Messwerte von Strom und Spannung übertragen.

31...20 bits	19...8	7	6...4	3	2	1	0
Output Voltage Measure 0...30 V Value 0...300 Multiplier 0.1	Output Current Measure 0...80 A Value 0...800 Multiplier 0.1	PSU On/Off	N/C	BDC3/Output drop	BDC2/Over temperature	BDC1/Over voltage	BDC0/Over load

Error Codes

Error Code	Description
0x8011	Index not available
0x8012	Subindex not available
0x8023	Access Denied
0x8030	Parameter Value out of Range
0x8033	Parameter length overrun
0x8034	Parameter length underrun
0x8035	Function not available

Event Codes

Definition	Event-Codes IO-Link 1.1	Event-Codes IO-Link 1.0	Device status	Type
No malfunction	0x0000	0x0000	0	Notification
General malfunction. Unknown error	0x1000	0x1000	4	Error
Process variable range over-run. Process Data uncertain	0x8C10	0x8C10	2	Warning
Process variable range under-run. Process Data uncertain	0x8C30	0x8C10	2	Warning
PSU disconnected from Clip	0xB000	0x1800	4	Error
Bad connection between PSU and Clip	0xB001	0x1801	4	Error
PSU changed	0xB004	0x1804	4	Error
High stress level	0xB005	0x1805	4	Warning
Fast aging	0xB006	0x1806	4	Warning
Over Temperature	0xB007	0x1807	4	Warning
Over load	0xB008	0x1808	4	Warning

Schaltnetzgeräte IO-Link

BAE PS-XA-...-601-I/-602-I/-603-I/-604-I/-605-I/-606-I/-607-I

IO-Link Interface (nur in Verbindung mit Clip-On BAE SC-AE-I01)

Parameterdaten

Die Parameterdaten des Schaltnetzgeräts entsprechen dem Smart Sensor Profil.

Index hex	Subindex hex	Object name	Access	Length bytes	Range	Gradient	Unit
0x0D	0x00	Profile Characteristics	R	6			
0x0E	0x00	Input Process Data Descriptor	R	9			
0x10	0x00	Vendor Name	R	7	"BALLUFF"		
0x11	0x00	Vendor Text	R	15	www.balluff.com		
0x12	0x00	Product Name	R	max 30	Depending the device connected to Clip		
0x13	0x00	Product ID	R	max 30	Depending the device connected to Clip		
0x14	0x00	Product Text	R	max 50	Depending the device connected to Clip		
0x16	0x00	Hardware Revision	R	5	Depending the device connected to Clip		
0x17	0x00	Firmware Revision	R	5	Depending the device connected to Clip		
0x18	0x00	Application Tag	R/W	32			
0x24	0x00	Device Status	R	1	0...4		
0x3C	0x01	BDC1 SetPoint 1	R/W	2	Process Data (Over load)	0.1	A
0x3D	0x03	BDC1 Hysteresis	R/W	2	0...0xFFFF	0.1	A
0x3E	0x01	BDC2 SetPoint 1	R/W	2	Process Data (Over voltage)	0.1	V
0x3F	0x03	BDC2 Hysteresis	R/W	2	0...0xFFFF	0.1	V
0x500	0x00	Stress level	R	1	1...3		
0x501	0x00	Expected Life Time LED coded	R	1	1...3		
0x502	0x00	Expected Life Time in years	R	1	0...15		Years
0x503	0x00	Primary Capacitor Temperature	R	2	-40...+125		C
0x504	0x00	Secondary Capacitor Temperature	R	2	-40...+125		C
0x505	0x00	Input Voltage	R	2	70...300		V
0x506	0x00	Operating Hours	R	4	0...300000		h
0x507	0x00	Lowest Recorded Temperature	R	2	-40...+125		C
0x508	0x00	Highest Recorded Temperature	R	2	-40...+125		C
0x509	0x00	Output Voltage	R	4	0...30		V
0x50A	0x00	Output Current	R	4	0...80		A
0x50B	0x00	Highest Capacitor Temperature	R	2	-40...+125		C
0x4000	0x01	BDC3 Setpoint 1	R/W	2	0...150 (Over Temperature)		C
0x4001	0x03	BDC3 Hysteresis	R/W	2	0...0xFFFF		C
0x4002	0x01	BDC4 Setpoint 1	R/W	2	0...300 (Output Drop)	0.1	V
0x4003	0x03	BDC4 Hysteresis	R/W	2	0...0xFFFF	0.1	V

Schaltnetzgeräte IO-Link

BAE PS-XA-...-601-I/-602-I/-603-I/-604-I/-605-I/-606-I/-607-I

Technische Daten

Elektrische Daten	
Isolationsspannung Ein-/Ausgang	3.000 V AC
Isolationswiderstand	> 100 M Ohm
Einschaltzeit	< 1 s
Schaltfrequenz f BAE PS-...-601/602/603/607 BAE PS-...-604/605/606	140 kHz (typisch) 110 kHz (typisch)
Schaltmodus parallel Schaltmodus in Reihe	nicht möglich max. 2 Geräte
Einschwingzeit	1 ms
Temperaturkoeffizient	±0,03%/°C
Ripple & Noise	50 mV p-p (f _{max} 20 MHz)
Netzausfallüberbrückung BAE PS-...-601/602/603/607 BAE PS-...-604/605/606	> 200 ms 230 V AC >35 ms 115 V AC > 150 ms 230 V AC >20 ms 115 V AC
Überlast / Power Boost	150% 4 s
Wirkungsgrad BAE PS-...-601/602/603/607 BAE PS-...-604/605/606	> 88% typ. > 90% typ.
Interner Kurzschlusschutz I _{kurz} BAE PS-...-601/602/603/607 BAE PS-...-604/605/606	4 A Dauerkurzschlussfest (6 A für max. 4 s) 8,4 A Dauerkurzschlussfest (12 A für max. 4 s)
Eingangsdaten	
Eingangsnennspannung	100...240 V AC
Eingangsspannungsbereich	90...254 V AC
Eingangsnennstrom BAE PS-...-038-...-I BAE PS-...-080-...-I	0,8 A 240 V AC/ 1,6 A 100 V AC 1,6 A 240 V AC/ 3,6 A 100 V AC
Einschaltstrom BAE PS-...-038-...-I BAE PS-...-080-...-I	< 30 A < 20 A
Frequenzbereich	48...62 Hz
Eingangssicherung	In der Vergussmasse. Nicht auswechselbar.

Ausgangsdaten	
Ausgangsnennspannung	24 V DC
Ausgangsnennstrom BAE PS-...-038-...-I BAE PS-...-080-...-I	3,8 A 8 A
Ausgangsleistung BAE PS-...-038-...-I BAE PS-...-080-...-I	91,2 W 192 W
Ausgangsgenauigkeit	-1...+3 %
Spannungsregelung	±1%
Lastregelung	±1%
Mechanische Daten	
Werkstoff Gehäuse	Metall
Gewicht BAE PS-...-038-...-I BAE PS-...-080-...-I	1 kg 1,65 kg
Gerät voll vergossen	PUR
Abmessungen B x H x T mm BAE PS-...-038-...-I BAE PS-...-080-...-I	86 x 139 x 58 116 x 150 x 68
Steckverbinder für BAE PS-...-601-I/602-I/604-I/ 606-I/607-I BAE PS-...-603-I/605-I	3/4polig, 7/8" 3/5polig, 7/8"
Befestigung	über Flansch
Anzeigen	
Stress Level (Spannungsniveau)	LEDs grün, gelb, rot
Lifetime (Lebensdauer)	LEDs grün, gelb, rot
Load Level (Belastungsniveau)	LEDs grün, gelb, rot
Umgebungsbedingungen	
Betriebstemperatur	-25...+70 °C
Derating	-2,5 % / °C ab +60 °C
Lagertemperatur	-25...+85 °C
relative Luftfeuchtigkeit	100% RH
Kühlung	freie Konvektion
Schutzart nach IEC 60529	IP 67, nicht korrosiv
Schutztrennung BAE PS-...-601/603/604/605/607 BAE PS-...-602/606	SELV PELV, Ausgang geerdet
Übertemperatur	geschützt

Schaltnetzgeräte IO-Link

BAE PS-XA-...-601-I/-602-I/-603-I/-604-I/-605-I/-606-I/-607-I

Zubehör (extra bestellen)

Steckverbinder für Eingang	Technische Daten	Bezeichnung	Bestellcode
	3-polig, 300 V DC / 9 A, PUR	BCC A313-A313-A313-T0021-000	BCC0AA5
	Buchse, 3-polig, Winkel, 3x1,5 mm ² 300 V DC / 9 A, PUR	BCC A323-0000-10-097-PX03A5-050	BCC0AJ3
	Stecker + Buchse, 3-polig, 3x1,5 mm ² , 300 V DC / 9 A, PUR	BCC A313-A313-30-365-PX03A5-020	BCC0ARH
Steckverbinder für Ausgang	Technische Daten	Bezeichnung	Bestellcode
	4-polig, 300 V DC / 9 A, PUR	BCC A314-A314-A314-T0022-000	BCC0AA6
	Buchse, 4-polig, Winkel, 4x1,5 mm ² , 300 V DC / 9 A, PUR	BCC A324-0000-20-003-PX04A5-050	BCC06HR
	Stecker + Buchse, 4-polig, 4x1,5 mm ² , 300 V DC / 9 A, PUR	BCC A314-A314-30-304-PX04A5-020	BCC06J3
	5-polig, 300 V DC / 9 A, PUR	BCC A315-A315-A315-T0023-000	BCC0AA7
	Buchse, 5-polig, Winkel, 5x1,5 mm ² , 300 V DC / 9 A, PUR	BCC A325-0000-20-063-PX05A5-050	BCC088A
	Stecker + Buchse, 5-polig, 5x1,5 mm ² , 300 V DC / 9 A, PUR	BCC A315-A315-30-335-PX05A5-020	BCC06FN

Hinweis:

Weitere Steckverbinder-Varianten verfügbar.

Schaltnetzgeräte IO-Link
BAE PS-XA-...-601-I/-602-I/-603-I/-604-I/-605-I/-606-I/-607-I



Balluff GmbH
Schurwaldstraße 9
73765 Neuhausen a.d.F.
Deutschland
Tel. +49 7158 173-0
Fax +49 7158 5010
balluff@balluff.de

Balluff GmbH
Industriestraße B16
2345 Brunn am Gebirge
Österreich
Tel. +43 2236 32521-0
Fax +43 2236 32521-46
sensor@balluff.at

Balluff Sensortechnik AG
Riedstrasse 6
8953 Dietikon
Schweiz
Tel. +41 43 3223240
Fax +41 43 3223241
sensortechnik@balluff.ch

Nr. 923 210 D · Ausgabe G15; Änderungen vorbehalten.

Switching power supplies IO-Link BAE PS-XA-...-601-I/-602-I/-603-I/-604-I/-605-I/-606-I/-607-I



EU Directive 2004/108/EC (EMC Directive)
Low Voltage Directive 2006/95/EC
Product standard EN 61204-3. Safety of Information Technology Equipment EN 60950

Scope

This guide is valid for the following devices:

- BAE PS-XA-1W-24-038-601-I (ordering code BAE00TH)
- BAE PS-XA-1W-24-038-602-I (ordering code BAE00TJ)
- BAE PS-XA-1W-24-038-603-I (ordering code BAE00TK)
- BAE PS-XA-1W-24-080-604-I (ordering code BAE00TL)
- BAE PS-XA-1W-24-080-605-I (ordering code BAE00TM)
- BAE PS-XA-1W-24-080-606-I (ordering code BAE00TN)
- BAE PS-XA-1W-24-038-607-I (ordering code BAE00TP)



Download of the user's guide

The user's guide can also be found on the internet at www.balluff.com.

Intended use

This device is a primary switched-mode power supply for integration in control panel installations or integral applications where access to the power supply is restricted (contact protection). The device is suitable for contamination class 3.

Modifications to the device or non-approved use are not permitted and will result in loss of warranty and void any liability claims against the manufacturer.

Safety instructions



Before commissioning, read the user's guide carefully!
These devices must not be used in applications in which the safety of persons is dependent on the function of the device (not a safety component acc. to EU Machinery Directive).



DANGER from high voltages!
Contact with unprotected conductors and components can result in a fatal electric shock or severe burns.
Before starting work on the device, interrupt the power supply and secure against restart. Do not insert foreign objects into the device. Keep away from fire.

Installation and commissioning must only be performed by trained specialist personnel.

The **operator** is responsible for ensuring that local safety regulations are observed.

In particular, the operator must take measures to ensure that a defect in the device will not result in hazards to persons or equipment.

If defects and persistent faults occur in the switching power supply, take it out of service and secure against unauthorized use.

Installation



Attention!

Connect the device to mains in accordance with local regulations and standards.
Do not cover the device! Ensure that there is sufficient space around the device to allow for cooling, otherwise the device may shut down due to overheating. The service life of the device is shortened once it is operated for a longer period of time in an overheated state. The stress level indicator signals inadequate cooling.
The housing may become hot during operation!

Electrical connections

- Data for permissible loads, see table "Technical data".
- Only use commercial cables suitable for the specified current and voltage values.
- For flexible cables, make sure that all strands are secured in the terminal.
- Make sure the polarity at the output is correct.
- Always switch the power off before connecting or disconnecting plug connections.
- If necessary, a manually controlled element for isolating the mains power supply must be used.
- Device and power cables must be fused correctly.
- The unsecured ground conductor must be connected to GND (insulation class 1).
- Do not modify the installation while the device is operating! The same applies for the secondary side. Danger from electric arcing and deadly electric shocks.

Switching power supplies IO-Link

BAE PS-XA-...-601-I/-602-I/-603-I/-604-I/-605-I/-606-I/-607-I

Installation (continued)

Internal fuse

The internal input fuse protects the device and cannot be replaced. If an internal fault occurs, return the device to the manufacturer as a precautionary measure.

Assembly with flange

- ▶ Observe the flange hole pattern.
- ▶ Attach the device to the machine or plant using screws.



Removal

- ▶ Switch off the power supply and disconnect the system from mains.
- ▶ Disconnect all connectors from the power supply.

Display elements

Stress level indicator



The green, yellow and red LEDs indicate the electrical and thermal load. This data is collected and evaluated during a three-hour cycle. The operator is thereby able to check and then modify the ambient conditions to prevent negative influences on the device.

Symbol	Meaning
 Green	Low pulse speed: everything OK, a long service life can be expected.
 Yellow	Pulse speed increasing: thermal load not optimum. No immediate risk of overheating. Slightly accelerated aging. Reduce the load or improve ventilation!
 Red	High pulse speed: poor internal thermal state, service life at serious risk. Check the load and improve ventilation!

Indicator elements (continued)



Lifetime indicators (service life)

The LEDs indicate the remaining service life of the device. It is based on the sum of all loads. The service life starts at 15 years and decreases depending on the stress level and the load.

Symbol	Meaning
 Green	Power supply with long service life
 Yellow	Service life less than 3 years, replace during next maintenance cycle
 Red	Power supply at end of service life, replace immediately

Load level indicator (load level)

The LEDs indicate the current load of the device without any delay:

Symbol	Meaning
 Green	0...80% load
 Yellow	81...100% load
 Red	>100...150% load, typically when a higher current is required, max. 4 s

Error indicator



As soon as the output voltage lies outside of the working range 22...28 V DC (e.g., short circuit), only the load level indicator illuminates red. The other two indicators are switched off.

Switching power supplies IO-Link BAE PS-XA-...-601-I/-602-I/-603-I/-604-I/-605-I/-606-I/-607-I

Dimensions

BAE PS-XA-1W-24-038-...

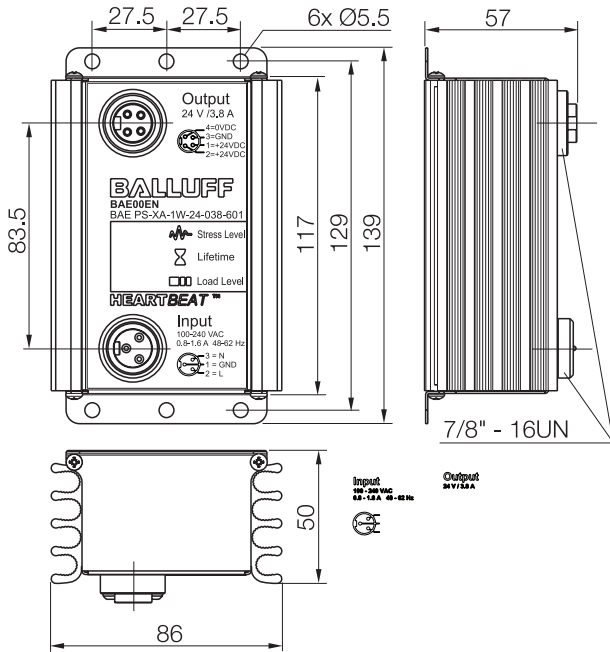

Connections

Pin	Model BAE PS-...		
	...-604 ...-607	...-601	...-602 ...-606
Pin 1	+24 V	+24 V	+24 V
Pin 2	+24 V	+24 V	+24 V
Pin 3	0 V	GND	0 V / GND
Pin 4	0 V	0 V	0 V / GND

Pin	BAE PS-...
	...-603 ...-605
Pin 1	0 V
Pin 2	0 V
Pin 3	GND
Pin 4	+24 V
Pin 5	+24 V

Pin	BAE PS-...-60x
Pin 1	GND
Pin 2	L
Pin 3	N

BAE PS-XA-1W-24-080-...

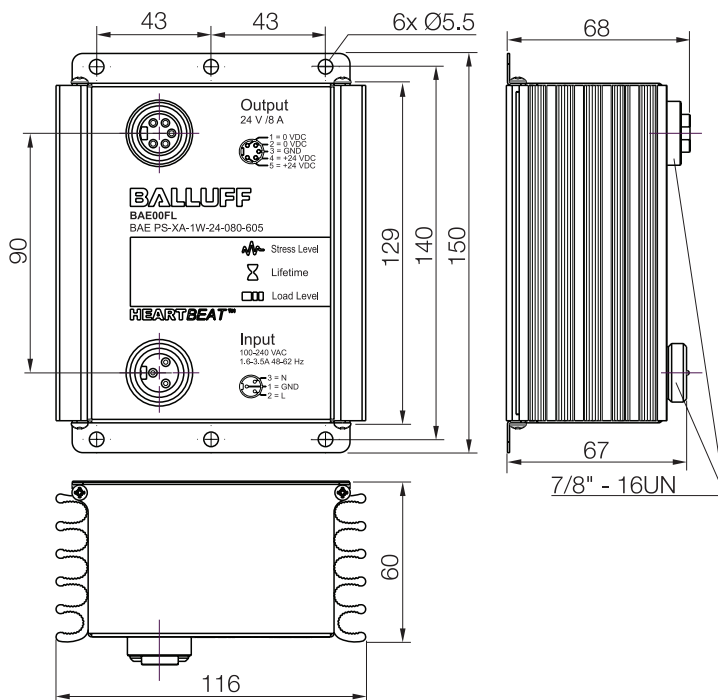

Switching power supplies IO-Link

BAE PS-XA-...-601-I/-602-I/-603-I/-604-I/-605-I/-606-I/-607-I

IO-Link Interface (only together with Clip-On BAE SC-AE-I01)

General device info

Baud rate	COM 2 (38,4 kBaud)
Process data length input	4 bytes
Minimum cycle time	20 ms
IO-Link Version	V1.1
SIO mode	no

IO-Link mode (communication mode)

IO-Link communication is through Pin 4 of the M12 connector.

Process data

The process data length of the power supply is 32 bits. Included in the process data are the switching states of the 4 switching outputs (BDC1 ... BDC4) as well as the actual measurement values for current and voltage.

31...20 bits	19...8	7	6...4	3	2	1	0
Output Voltage Measure 0...30 V Value 0...300 Multiplier 0.1	Output Current Measure 0...80 A Value 0...800 Multiplier 0.1	PSU On/Off	N/C	BDC3/Output drop	BDC2/Over temperature	BDC1/Over voltage	BDC0/Over load

Error Codes

Error Code	Description
0x8011	Index not available
0x8012	Subindex not available
0x8023	Access Denied
0x8030	Parameter Value out of Range
0x8033	Parameter length overrun
0x8034	Parameter length underrun
0x8035	Function not available

Event Codes

Definition	Event-Codes IO-Link 1.1	Event-Codes IO-Link 1.0	Device status	Type
No malfunction	0x0000	0x0000	0	Notification
General malfunction. Unknown error	0x1000	0x1000	4	Error
Process variable range over-run. Process Data uncertain	0x8C10	0x8C10	2	Warning
Process variable range under-run. Process Data uncertain	0x8C30	0x8C10	2	Warning
PSU disconnected from Clip	0xB000	0x1800	4	Error
Bad connection between PSU and Clip	0xB001	0x1801	4	Error
PSU changed	0xB004	0x1804	4	Error
High stress level	0xB005	0x1805	4	Warning
Fast aging	0xB006	0x1806	4	Warning
Over Temperature	0xB007	0x1807	4	Warning
Over load	0xB008	0x1808	4	Warning

Switching power supplies IO-Link BAE PS-XA-...-601-I/-602-I/-603-I/-604-I/-605-I/-606-I/-607-I

IO-Link Interface (only together with Clip-On BAE SC-AE-I01)

Parameter data

The switching power supply parameter data corresponds to the smart sensor profile.

Index hex	Subindex hex	Object name	Access	Length bytes	Range	Gradient	Unit
0x0D	0x00	Profile Characteristics	R	6			
0x0E	0x00	Input Process Data Descriptor	R	9			
0x10	0x00	Vendor Name	R	7	"BALLUFF"		
0x11	0x00	Vendor Text	R	15	www.balluff.com		
0x12	0x00	Product Name	R	max 30	Depending the device connected to Clip		
0x13	0x00	Product ID	R	max 30	Depending the device connected to Clip		
0x14	0x00	Product Text	R	max 50	Depending the device connected to Clip		
0x16	0x00	Hardware Revision	R	5	Depending the device connected to Clip		
0x17	0x00	Firmware Revision	R	5	Depending the device connected to Clip		
0x18	0x00	Application Tag	R/W	32			
0x24	0x00	Device Status	R	1	0..4		
0x3C	0x01	BDC1 SetPoint 1	R/W	2	Process Data (Over load)	0.1	A
0x3D	0x03	BDC1 Hysteresis	R/W	2	0..0xFFFF	0.1	A
0x3E	0x01	BDC2 SetPoint 1	R/W	2	Process Data (Over voltage)	0.1	V
0x3F	0x03	BDC2 Hysteresis	R/W	2	0..0xFFFF	0.1	V
0x500	0x00	Stress level	R	1	1..3		
0x501	0x00	Expected Life Time LED coded	R	1	1..3		
0x502	0x00	Expected Life Time in years	R	1	0..15		Years
0x503	0x00	Primary Capacitor Temperature	R	2	-40...+125		C
0x504	0x00	Secondary Capacitor Temperature	R	2	-40...+125		C
0x505	0x00	Input Voltage	R	2	70...300		V
0x506	0x00	Operating Hours	R	4	0...300000		h
0x507	0x00	Lowest Recorded Temperature	R	2	-40...+125		C
0x508	0x00	Highest Recorded Temperature	R	2	-40...+125		C
0x509	0x00	Output Voltage	R	4	0...30		V
0x50A	0x00	Output Current	R	4	0...80		A
0x50B	0x00	Highest Capacitor Temperature	R	2	-40...+125		C
0x4000	0x01	BDC3 Setpoint 1	R/W	2	0...150 (Over Temperature)		C
0x4001	0x03	BDC3 Hysteresis	R/W	2	0..0xFFFF		C
0x4002	0x01	BDC4 Setpoint 1	R/W	2	0...300 (Output Drop)	0.1	V
0x4003	0x03	BDC4 Hysteresis	R/W	2	0..0xFFFF	0.1	V

Switching power supplies IO-Link

BAE PS-XA-...-601-I/-602-I/-603-I/-604-I/-605-I/-606-I/-607-I

Technical data

Electrical data	
Input/output insulation voltage	3,000 V AC
Insulation resistance	> 100M Ohm
Switch-on time	< 1 s
Switching frequency f BAE PS-...-038-...-I BAE PS-...-080-...-I	140 kHz (typical) 110 kHz (typical)
Switching mode in parallel Switching mode in series	Not possible max. 2 devices
Settling time	1 ms
Temperature coefficient	±0.03%/°C
Ripple & noise	50 mV p-p (fmax. 20 MHz)
Holdup time BAE PS-...-038-...-I BAE PS-...-080-...-I	> 200 ms 230 V AC > 35 ms 115 V AC > 150 ms 230 V AC > 20 ms 115 V AC
Power boost	150% 4 s
Efficiency BAE PS-...-038-...-I BAE PS-...-080-...-I	> 88% typ. > 90% typ.
Internal short-circuit protection I _{short} BAE PS-...-038-...-I BAE PS-...-080-...-I	4 A sustained short-circuit proof (6 A for max. 4 s) 8.4 A sustained short-circuit proof (12 A for max. 4 s)
Input data	
Rated input voltage	100...240 V AC
Input voltage range	90...254 V AC
Rated input current BAE PS-...-038-...-I BAE PS-...-080-...-I	0.8 A 240 V AC/ 1.6 A 100 V AC 1.6 A 240 V AC/ 3.6 A 100 V AC
Inrush current BAE PS-...-038-...-I BAE PS-...-080-...-I	< 30 A < 20 A
Frequency range	48...62 Hz
Input fuse	In the potting compound. Cannot be replaced.

Output data	
Rated output voltage	24 V DC
Rated output current BAE PS-...-038-...-I BAE PS-...-080-...-I	3.8 A 8 A
Output power BAE PS-...-038-...-I BAE PS-...-080-...-I	91.2 W 192 W
Output accuracy	-1...+3 %
Voltage control	±1%
Load control	±1%
Mechanical data	
Housing material	Metal
Weight BAE PS-...-038-...-I BAE PS-...-080-...-I	1 kg 1.65 kg
Device fully potted	PUR
Dimensions W x H x D mm BAE PS-...-038-...-I BAE PS-...-080-...-I	86 x 139 x 58 116 x 150 x 68
Connector for BAE PS-...-601-I/602-I/604-I/ 606-I/607-I BAE PS-...-603-I/605-I	3/4-pin, 7/8" 3/5-pin, 7/8"
Fasteners	Via flange
Indicators	
Stress level	Green, yellow, red LEDs
Lifetime (service life)	Green, yellow, red LEDs
Load level	Green, yellow, red LEDs
Environmental conditions	
Operating temperature	-25...+70 °C
Derating	-2.5 % / °C above +60 °C
Storage temperature	-25...+85 °C
Relative air humidity	100% RH
Cooling	Free convection
Degree of protection per IEC 60529	IP 67, non-corrosive
Protective separation BAE PS-...-601-I/603-I/604-I/ 605-I/607-I BAE PS-...-602-I/606-I	SELV PELV, output grounded
Excess temperature	Protected

Switching power supplies IO-Link BAE PS-XA-...-601-I/-602-I/-603-I/-604-I/-605-I/-606-I/-607-I

Accessories (order extra)

Connector for input	Technical data	Description	Ordering code
	3-pin, 300 V DC / 9 A, PUR	BCC A313-A313-A313-T0021-000	BCC0AA5
	Socket, 3-pin, Bracket, 3x1.5 mm ² 300 V DC / 9 A, PUR	BCC A323-0000-10-097-PX03A5-050	BCC0AJ3
	Plug + socket, 3-pin, 3x1.5 mm ² , 300 V DC / 9 A, PUR	BCC A313-A313-30-365-PX03A5-020	BCC0ARH
Connector for output	Technical data	Description	Ordering code
	4-pin, 300 V DC / 9 A, PUR	BCC A314-A314-A314-T0022-000	BCC0AA6
	Socket, 4-pin, Bracket, 4x1.5 mm ² , 300 V DC / 9 A, PUR	BCC A324-0000-20-003-PX04A5-050	BCC06HR
	Plug + socket, 4-pin, 4x1.5 mm ² , 300 V DC / 9 A, PUR	BCC A314-A314-30-304-PX04A5-020	BCC06J3
	5-pin, 300 V DC / 9 A, PUR	BCC A315-A315-A315-T0023-000	BCC0AA7
	Socket, 5-pin, bracket, 5x1.5 mm ² , 300 V DC / 9 A, PUR	BCC A325-0000-20-063-PX05A5-050	BCC088A
	Plug + socket, 5-pin, 5x1.5 mm ² , 300 V DC / 9 A, PUR	BCC A315-A315-30-335-PX05A5-020	BCC06FN

Note:
Other connector variants available.

Switching power supplies IO-Link
BAE PS-XA-...-601-I/-602-I/-603-I/-604-I/-605-I/-606-I/-607-I



Balluff GmbH
Schurwaldstraße 9
73765 Neuhausen a.d.F.
Germany
Tel. +49 7158 173-0
Fax +49 7158 5010
balluff@balluff.de

Balluff GmbH
Industriestraße B16
2345 Brunn am Gebirge
Austria
Tel. +43 2236 32521-0
Fax +43 2236 32521-46
sensor@balluff.at

Balluff Sensortechnik AG
Riedstrasse 6
8953 Dietikon
Switzerland
Phone +41 43 3223240
Fax +41 43 3223241
sensortechnik@balluff.ch

Alimentations à découpage IO-Link BAE PS-XA-...-601-I/-602-I/-603-I/-604-I/-605-I/-606-I/-607-I



Directive européenne 2004/108/EG (directive EMV)
Directive Basse Tension 2006/95/EG
Norme produit EN 61204-3. Norme EN 60950 sur la sécurité des équipements informatiques

Validité

Les présentes instructions sont applicables aux appareils suivants:

- BAE PS-XA-1W-24-038-601-I (référence BAE00TH)
- BAE PS-XA-1W-24-038-602-I (référence BAE00TJ)
- BAE PS-XA-1W-24-038-603-I (référence BAE00TK)
- BAE PS-XA-1W-24-080-604-I (référence BAE00TL)
- BAE PS-XA-1W-24-080-605-I (référence BAE00TM)
- BAE PS-XA-1W-24-080-606-I (référence BAE00TN)
- BAE PS-XA-1W-24-038-607-I (référence BAE00TP)



Téléchargement de la notice d'utilisation

Vous pouvez télécharger la même notice d'utilisation sur Internet, à l'adresse www.balluff.com.

Utilisation conforme aux prescriptions

Cet appareil est une alimentation à découpage à cadence primaire à utiliser dans des systèmes de panneaux de commande ou dans des applications encastrées, pour lesquelles l'accès au bloc d'alimentation est limité (protection contre les contacts accidentels). Il peut être utilisé dans le cadre du degré de pollution 3.

Une modification de l'appareil ou une utilisation non conforme aux prescriptions est interdite et entraîne la perte du droit à la garantie vis à vis du fabricant.

Consignes de sécurité



La notice d'utilisation doit être minutieusement lue avant la mise en service !

Ces dispositifs ne doivent pas être utilisés dans les applications, au sein desquelles la sécurité de personnes dépend du fonctionnement des appareils (pas de composant de sécurité, conformément à la directive machines de l'UE).



DANGER lié à la haute tension !

L'entrée en contact d'un conducteur non protégé avec des composants peut provoquer une décharge électrique mortelle ou de graves brûlures.

Avant de manipuler l'appareil, couper l'alimentation électrique et s'assurer qu'aucune remise en marche n'est possible. Ne pas insérer d'objets dans le dispositif. Tenir éloigné des flammes.

Seul un personnel spécialisé et formé est autorisé à exécuter les opérations d'**installation et de mise en service**.

L'**exploitant** est responsable du respect des prescriptions de sécurité en vigueur sur le site.

L'exploitant doit notamment prendre des mesures visant à exclure tout danger pour les personnes et les biens en cas de défaillance de l'appareil.

En cas de défaillances et de défauts non éliminables de l'alimentation à découpage, celle-ci doit être mise hors service et rangée de telle manière à empêcher toute utilisation non autorisée.

Installation



Attention !

Relier l'appareil au réseau électrique conformément aux normes et aux directives locales. Ne pas couvrir le dispositif ! Afin d'assurer le refroidissement d'un espace suffisant pour l'appareil, celui-ci peut également être arrêté via une surchauffe. La durée de vie du dispositif diminue, dès lors qu'il fonctionne de manière prolongée en état de surchauffe. L'indicateur de niveau de tension signale un refroidissement insuffisant.

Le boîtier peut chauffer durant le fonctionnement !

Connexions électriques

- Afin de consulter les données pour les charges autorisées, voir le tableau « Caractéristiques techniques ».
- Utiliser uniquement des câbles du commerce adaptés aux valeurs de courant et de tension indiquées.
- Dans le cadre de câbles flexibles, vérifier que l'ensemble des torons sont raccordés à la borne.
- S'assurer de la polarité adéquate à la sortie.
- Connecter ou débrancher les prises débrochables uniquement lorsque le courant est coupé.
- Si nécessaire, un sectionneur à commande manuelle doit être utilisé pour isoler le réseau d'alimentation.
- Les câbles d'alimentation et de l'appareil doivent être protégés correctement.
- Le conducteur de terre non sécurisé doit être mis à la masse (classe de protection 1).
- Ne pas modifier l'installation lorsque l'appareil est en marche ! Cela s'applique également pour le secondaire. Risque d'arcs électriques et de décharge d'électricité mortelle.

Alimentations à découpage IO-Link

BAE PS-XA-...-601-I/-602-I/-603-I/-604-I/-605-I/-606-I/-607-I

Installation (suite)

Fusible interne

Le fusible d'entrée interne est conçu pour protéger l'appareil et ne peut être remplacé. En cas de défaillance interne, pour des raisons de sécurité, le dispositif doit être renvoyé au fabricant.

Montage avec flasque

- ▶ Veillez à prendre en compte la configuration des orifices de la flasque.
- ▶ Fixer l'appareil à une machine ou à un équipement à l'aide de vis.



Consolidation

- ▶ Couper l'alimentation et déconnecter le système du réseau d'alimentation.
- ▶ Débrancher l'ensemble des connecteurs du bloc d'alimentation.

Indicateurs

Indicateur de niveau de tension



Les témoins lumineux (LED) vert, jaune et rouge indiquent les charges électrique et thermique. Ces données sont établies et analysées au sein d'un cycle de 3 heures. Ainsi, l'exploitant est en mesure de contrôler l'environnement de travail et de le modifier, afin d'éviter toute répercussion négative sur l'appareil.

Symbole	Signification
 vert	Vitesse d'impulsion faible : rien à signaler, une longue durée de vie est anticipée.
 jaune	La vitesse d'impulsion augmente : état thermique non optimal. Aucun risque immédiat de surchauffe. Usure légèrement accélérée. Réduire la charge ou fournir une meilleure aération !
 rouge	Vitesse d'impulsion élevée : mauvais état thermique interne, durée de vie sérieusement menacée. Vérifier la charge et fournir une meilleure aération !

Indicateurs (suite)



Indicateur de durée de vie

Les témoins lumineux signalent la durée de vie restante de l'appareil. Elle est basée sur la somme de l'ensemble des charges mentionnées précédemment. La durée de vie commence à 15 ans et diminue en fonction du niveau de tension et de charge.

Symbole	Signification
 vert	Bloc d'alimentation avec une longue durée de vie
 jaune	Durée de vie inférieure à 3 ans ; remplacer lors du prochain cycle de maintenance
 rouge	Durée de vie du bloc d'alimentation arrivée à terme, remplacer sans attendre

Indicateur de niveau de charge

Les témoins lumineux signalent instantanément la charge actuelle de l'appareil :

Symbole	Signification
 vert	Charge de 0 à 80 %
 jaune	Charge de 81 à 100 %
 rouge	Charge supérieure à 100-150 %, habituel lorsqu'une hausse de la courant est nécessaire, max. 4 s

Signalement des défauts

Dès que la tension de sortie se situe hors de l'intervalle de fonctionnement de 22 à 28 V CC (exemple : court-circuit), l'indicateur de niveau de charge apparaît uniquement en rouge. Les deux autres indicateurs sont éteints.

Alimentations à découpage IO-Link BAE PS-XA-...-601-I/-602-I/-603-I/-604-I/-605-I/-606-I/-607-I

Dimensions

BAE PS-XA-1W-24-038-...

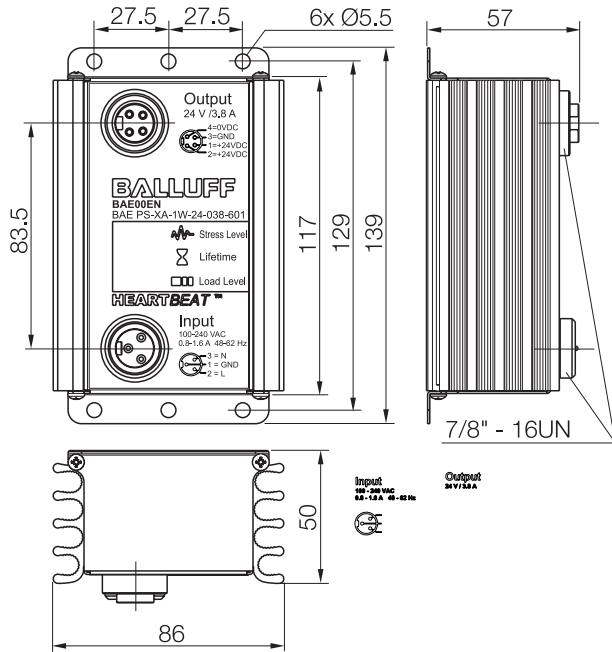

Connexions

Pin	De type BAE PS-		
	...-604 ...-607	...-601	...-602 ...-606
Broche 1	+24 V	+24 V	+24 V
Broche 2	+24 V	+24 V	+24 V
Broche 3	0 V	GND	0 V / GND
Broche 4	0 V	0 V	0 V / GND

Pin	BAE PS-
	...-603 ...-605
Broche 1	0 V
Broche 2	0 V
Broche 3	GND
Broche 4	+24 V
Broche 5	+24 V

Pin	BAE PS-...-60x
Broche 1	GND
Broche 2	L
Broche 3	N

BAE PS-XA-1W-24-080-...

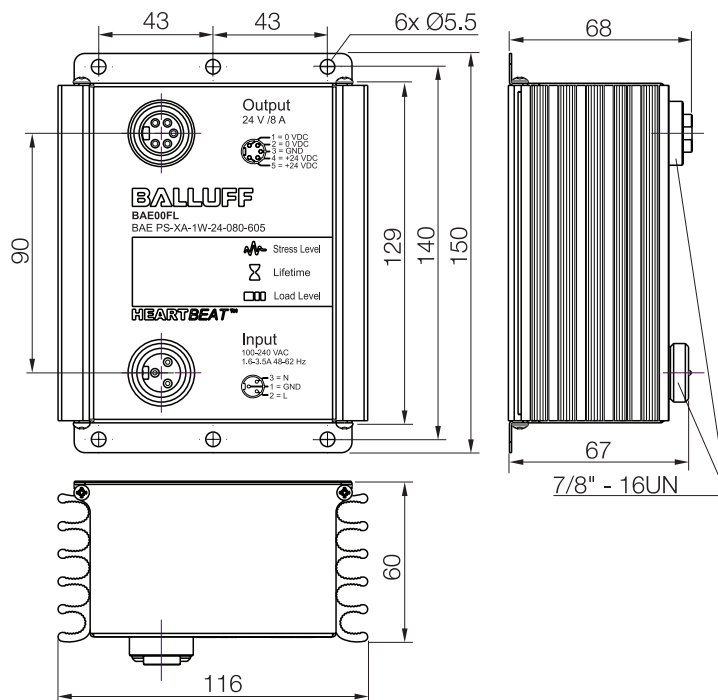

Alimentations à découpage IO-Link

BAE PS-XA-...-601-I/-602-I/-603-I/-604-I/-605-I/-606-I/-607-I

Interface IO-Link (uniquement en combinaison avec Clip-On BAE SC-AE-I01)

Informations générales sur le dispositif

Vitesse de transmission en bauds	COM 2 (38,4 kBaud)
Longueur des données de processus entrée	4 octets
Temps de cycle minimal	20 ms
Version IO-Link	V1.1
Mode SIO	non

Mode IO-Link (mode communication)

La communication IO-Link passe alors par la broche 4 du connecteur M12.

Données de processus

La longueur des données de processus du bloc d'alimentation est de 32 bits.

Les données de processus transmettent les états de commutation des 4 sorties de commutation (BDC1 ... BDC4), ainsi que les valeurs mesurées actuelles du courant et de la tension.

31...20 bits	19...8	7	6...4	3	2	1	0
Output Voltage Measure 0...30 V Value 0...300 Multiplier 0.1	Output Current Measure 0...80 A Value 0...800 Multiplier 0.1	PSU On/Off	N/C	BDC3/Output drop	BDC2/Over temperature	BDC1/Over voltage	BDC0/Over load

Event Codes

Definition	Event-Codes IO-Link 1.1	Event-Codes IO-Link 1.0	Device status	Type
No malfunction	0x0000	0x0000	0	Notification
General malfunction. Unknown error	0x1000	0x1000	4	Error
Process variable range over-run. Process Data uncertain	0x8C10	0x8C10	2	Warning
Process variable range under-run. Process Data uncertain	0x8C30	0x8C10	2	Warning
PSU disconnected from Clip	0xB000	0x1800	4	Error
Bad connection between PSU and Clip	0xB001	0x1801	4	Error
PSU changed	0xB004	0x1804	4	Error
High stress level	0xB005	0x1805	4	Warning
Fast aging	0xB006	0x1806	4	Warning
Over Temperature	0xB007	0x1807	4	Warning
Over load	0xB008	0x1808	4	Warning

Error Codes

Error Code	Description
0x8011	Index not available
0x8012	Subindex not available
0x8023	Access Denied
0x8030	Parameter Value out of Range
0x8033	Parameter length overrun
0x8034	Parameter length underrun
0x8035	Function not available

Alimentations à découpage IO-Link BAE PS-XA-...-601-I/-602-I/-603-I/-604-I/-605-I/-606-I/-607-I

Interface IO-Link (uniquement en combinaison avec Clip-On BAE SC-AE-I01)

Données de paramétrage

Les données de paramétrage de l'alimentation à découpage correspondent au profil Smart Sensor.

Index hex	Subindex hex	Object name	Access	Length bytes	Range	Gradient	Unit
0x0D	0x00	Profile Characteristics	R	6			
0x0E	0x00	Input Process Data Descriptor	R	9			
0x10	0x00	Vendor Name	R	7	"BALLUFF"		
0x11	0x00	Vendor Text	R	15	www.balluff.com		
0x12	0x00	Product Name	R	max 30	Depending the device connected to Clip		
0x13	0x00	Product ID	R	max 30	Depending the device connected to Clip		
0x14	0x00	Product Text	R	max 50	Depending the device connected to Clip		
0x16	0x00	Hardware Revision	R	5	Depending the device connected to Clip		
0x17	0x00	Firmware Revision	R	5	Depending the device connected to Clip		
0x18	0x00	Application Tag	R/W	32			
0x24	0x00	Device Status	R	1	0..4		
0x3C	0x01	BDC1 SetPoint 1	R/W	2	Process Data (Over load)	0.1	A
0x3D	0x03	BDC1 Hysteresis	R/W	2	0..0xFFFF	0.1	A
0x3E	0x01	BDC2 SetPoint 1	R/W	2	Process Data (Over voltage)	0.1	V
0x3F	0x03	BDC2 Hysteresis	R/W	2	0..0xFFFF	0.1	V
0x500	0x00	Stress level	R	1	1..3		
0x501	0x00	Expected Life Time LED coded	R	1	1..3		
0x502	0x00	Expected Life Time in years	R	1	0..15		Years
0x503	0x00	Primary Capacitor Temperature	R	2	-40...+125		C
0x504	0x00	Secondary Capacitor Temperature	R	2	-40...+125		C
0x505	0x00	Input Voltage	R	2	70...300		V
0x506	0x00	Operating Hours	R	4	0...300000		h
0x507	0x00	Lowest Recorded Temperature	R	2	-40...+125		C
0x508	0x00	Highest Recorded Temperature	R	2	-40...+125		C
0x509	0x00	Output Voltage	R	4	0...30		V
0x50A	0x00	Output Current	R	4	0...80		A
0x50B	0x00	Highest Capacitor Temperature	R	2	-40...+125		C
0x4000	0x01	BDC3 Setpoint 1	R/W	2	0...150 (Over Temperature)		C
0x4001	0x03	BDC3 Hysteresis	R/W	2	0..0xFFFF		C
0x4002	0x01	BDC4 Setpoint 1	R/W	2	0...300 (Output Drop)	0.1	V
0x4003	0x03	BDC4 Hysteresis	R/W	2	0..0xFFFF	0.1	V

Alimentations à découpage IO-Link BAE PS-XA-...-601-I/-602-I/-603-I/-604-I/-605-I/-606-I/-607-I

Caractéristiques techniques

Caractéristiques électriques	
Tension d'isolation entrée/sortie	3 000 V AC
Résistance d'isolement	> 100 M Ohm
Temps de mise en route	< 1 s
Fréquence de commutation f BAE PS-...-038-...-I BAE PS-...-080-...-I	140 kHz (habituellement) 110 kHz (habituellement)
Mode de commutation parallèle Mode de commutation de lignes	non accessible max. 2 appareils
Temps de montée	1 ms
Coefficient de température	± 0,03 %/°C
Ondulation et bruit	50 mV p-p (f _{max} 20 MHz)
Autonomie en cas de coupure de courant BAE PS-...-038-...-I BAE PS-...-080-...-I	>200 ms 230 V CA >35 ms 115 V CA >150 ms 230 V CA >20 ms 115 V CA
Charge excessive / amplificateur de puissance	150 % 4 s
Rendement BAE PS-...-038-...-I BAE PS-...-080-...-I	> 88 % (habituellement) > 90 % (habituellement)
Protection contre les court-circuits interne I _{court} BAE PS-...-038-...-I BAE PS-...-080-...-I	4 A résistant aux court-circuits en continu (6 A pour max. 4 s) 8,4 A résistant aux court-circuits en continu (12 A pour max. 4 s)
Données d'entrée	
Tension d'entrée nominale	110 à 240 V CA
Plage de tension d'entrée	90 à 254 V CA/ 135 à 340 V CC
Courant d'entrée nominal BAE PS-...-038-...-I BAE PS-...-080-...-I	0,8 A 240 V AC/ 1,6 A 100 V AC 1,6 A 240 V AC/ 3,6 A 100 V AC
Courant transitoire BAE PS-...-038-...-I BAE PS-...-080-...-I	< 30 A < 20 A
Plage de fréquence	48...62 Hz
Fusible d'entrée	Dans l'élément de scellement. Non remplaçable.

Données de sortie	
Tension de sortie nominale	24 V DC
Courant de sortie nominal BAE PS-...-038-...-I BAE PS-...-080-...-I	3,8 A 8 A
Puissance de sortie BAE PS-...-038-...-I BAE PS-...-080-...-I	91,2 W 192 W
Précision de la tension de sortie	-1...+3 %
Régulation de tension	±1 %
Régulation de charge	±1 %
Caractéristiques mécaniques	
Matériau boîtier	Métal
Poids BAE PS-...-038-...-I BAE PS-...-080-...-I	1 kg 1,65 kg
Appareil surmoulé	PUR
Dimensions L x H x P mm BAE PS-...-038-...-I BAE PS-...-080-...-I	86 x 139 x 58 116 x 150 x 68
Connecteurs pour BAE PS-...-601-I/602-I/604-I/ 606-I/607-I BAE PS-...-603-I/605-I	3/4 pôles, 7/8" 3/5 pôles, 7/8"
Fixation	sur flasque
Indicateurs	
Niveau de tension	Témoins lumineux vert, jaune, rouge
Durée de vie	Témoins lumineux vert, jaune, rouge
Niveau de charge	Témoins lumineux vert, jaune, rouge
Conditions ambiantes	
Température de service	-25 à +70 °C
Réduction de puissance	-2,5 % / °C jusqu'à +60 °C
Température de stockage	-25 à +85 °C
Humidité relative	100 % RH
Refroidissement	Convection naturelle
Classe de protection selon CEI 60529	IP 67, non corrosif
Séparation de protection BAE PS-...-601-I/603-I/604-I/ 605-I/607-I BAE PS-...-602-I/606-I	TBTS TBTP, sortie mise à la terre
Échauffement	protégé

Alimentations à découpage IO-Link BAE PS-XA-...-601-I/-602-I/-603-I/-604-I/-605-I/-606-I/-607-I

Accessoires (en supplément)

Connecteur pour entrée	Caractéristiques techniques	Désignation	Référence
	3 pôles, 300 V CC / 9 A, PUR	BCC A313-A313-A313-T0021-000	BCC0AA5
	Connecteur femelle, 3 pôles, angle, 3 x 1,5 mm ² 300 V CC / 9 A, PUR	BCC A323-0000-10-097-PX03A5-050	BCC0AJ3
	Prise mâle + prise femelle, 3 pôles, 3 x 1,5 mm ² , 300 V CC / 9 A, PUR	BCC A313-A313-30-365-PX03A5-020	BCC0ARH
Connecteur pour sortie	Caractéristiques techniques	Désignation	Référence
	4 pôles, 300 V CC / 9 A, PUR	BCC A314-A314-A314-T0022-000	BCC0AA6
	Prise femelle, 4 pôles, angle, 4 x 1,5 mm ² , 300 V CC / 9 A, PUR	BCC A324-0000-20-003-PX04A5-050	BCC06HR
	Prise mâle + prise femelle, 4 pôles, 4 x 1,5 mm ² , 300 V CC / 9 A, PUR	BCC A314-A314-30-304-PX04A5-020	BCC06J3
	5 pôles, 300 V CC / 9 A, PUR	BCC A315-A315-A315-T0023-000	BCC0AA7
	Prise femelle, 5 pôles, angle, 5 x 1,5 mm ² , 300 V CC / 9 A, PUR	BCC A325-0000-20-063-PX05A5-050	BCC088A
	Prise mâle + prise femelle, 5 pôles, 5 x 1,5 mm ² , 300 V CC / 9 A, PUR	BCC A315-A315-30-335-PX05A5-020	BCC06FN

Remarque :
D'autres modèles de connecteurs sont disponibles.

Alimentations à découpage IO-Link
BAE PS-XA-...-601-I/-602-I/-603-I/-604-I/-605-I/-606-I/-607-I



Balluff GmbH
Schurwaldstraße 9
73765 Neuhausen a.d.F.
Allemagne
Téléphone : +49 7158 173-0
Télécopie : +49 7158 5010
balluff@balluff.de

Balluff GmbH
Industriestraße B16
2345 Brunn am Gebirge
Autriche
Téléphone : +43 2236 32521-0
Télécopie : +43 2236 32521-46
sensor@balluff.at

Balluff Sensortechnik AG
Riedstrasse 6
8953 Dietikon
Suisse
Téléphone : +41 43 3223240
Télécopie : +41 43 3223241
sensortechnik@balluff.ch

Alimentatori di comando IO-Link BAE PS-XA-...-601-I/-602-I/-603-I/-604-I/-605-I/-606-I/-607-I



Direttiva UE 2004/108/CE (Direttiva sulla compatibilità elettromagnetica, EMC)

Direttiva Bassa Tensione 2006/95/CE

Norma di prodotto EN 61204-3. Sicurezza di apparecchi per la tecnologia dell'informazione EN 60950

Validità

Le presenti istruzioni valgono per i seguenti apparecchi:

- BAE PS-XA-1W-24-038-601-I (codice d'ordine BAE00TH)
- BAE PS-XA-1W-24-038-602-I (codice d'ordine BAE00TJ)
- BAE PS-XA-1W-24-038-603-I (codice d'ordine BAE00TK)
- BAE PS-XA-1W-24-080-604-I (codice d'ordine BAE00TL)
- BAE PS-XA-1W-24-080-605-I (codice d'ordine BAE00TM)
- BAE PS-XA-1W-24-080-606-I (codice d'ordine BAE00TN)
- BAE PS-XA-1W-24-038-607-I (codice d'ordine BAE00TP)



Download delle Istruzioni d'uso

Le identiche Istruzioni d'uso sono disponibili anche in Internet, all'indirizzo www.balluff.com.

Utilizzo conforme

Il presente apparecchio è un alimentatore di comando a tempificazione primaria, utilizzato nell'installazione di quadri comando oppure nelle applicazioni a incasso che presentino un accesso limitato all'alimentatore (protezione contro le scariche). L'apparecchio può essere utilizzato in caso di grado di impurità 3.

Modifiche all'apparecchio o un utilizzo non conforme dello stesso non sono consentiti e comporteranno la perdita dei diritti di garanzia e responsabilità nei confronti del costruttore.

Avvertenze di sicurezza



Leggere attentamente le Istruzioni d'uso prima di mettere in funzione l'apparecchio. Questi apparecchi non andranno utilizzati in applicazioni in cui la sicurezza delle persone dipenda dalla funzione dell'apparecchio (non si tratta di componenti di sicurezza ai sensi della Direttiva Macchine UE).



PERICOLO dovuto all'alta tensione!
Il contatto con cavi e componenti non protetti può causare la morte per scossa elettrica oppure gravi ustioni.
Prima di lavorare sull'apparecchio interrompere l'alimentazione e bloccarlo onde evitare che venga riattivato. Non inserire alcun oggetto nell'apparecchio. Tenere lontano dal fuoco.

L'**installazione e la messa in funzione** sono consentiti esclusivamente a personale specializzato ed appositamente addestrato.

Sarà responsabilità del **gestore** far rispettare le prescrizioni di sicurezza locali in vigore.

In particolare, il gestore dovrà adottare provvedimenti che evitino pericoli per persone e cose in caso di guasto dell'apparecchio.

In caso di guasti e di anomalie non eliminabili all'alimentatore di comando, esso andrà messo fuori servizio e assicurato in modo da impedirne utilizzi non autorizzati.

Installazione



Attenzione!

Collegare l'apparecchio alla rete elettrica seguendo le disposizioni e le norme locali. Non coprire l'apparecchio! Per consentire il raffreddamento dell'apparecchio assicurarsi che esso abbia spazio sufficiente intorno a sé, in caso contrario il surriscaldamento potrà causarne lo spegnimento. La durata dell'apparecchio si riduce se azionato in condizioni di surriscaldamento per un tempo prolungato. L'indicatore del livello di stress segnala un raffreddamento insufficiente. La custodia può diventare bollente durante il funzionamento!

Collegamenti elettrici

- Per i dati relativi ai carichi consentiti, consultare la tabella "Dati Tecnici".
- Utilizzare esclusivamente cavi presenti in commercio, adatti per i valori di tensione e di corrente indicati.
- In presenza di cavi flessibili assicurarsi che tutti i cavetti siano fissati nel morsetto.
- Accertarsi che vi sia la corretta polarità in uscita.
- Collegare o separare i raccordi a innesto solo dopo aver spento la corrente.
- Se necessario utilizzare un divisorio regolabile manualmente, per separare la rete di alimentazione.
- Mettere correttamente in sicurezza i cavi dell'apparecchio e della corrente.
- Collegare il connettore di terra non protetto al GND (classe di isolamento 1).
- Durante il funzionamento dell'apparecchio non modificare l'installazione! Lo stesso vale per il secondario. Pericolo dovuto agli archi elettrici e a scossa elettrica mortale.

Alimentatori di comando IO-Link BAE PS-XA-...-601-I/-602-I/-603-I/-604-I/-605-I/-606-I/-607-I

Installazione (seguito)

Fusibile interno

Il fusibile di ingresso interno serve a proteggere l'apparecchio e non può essere sostituito. In presenza di un'anomalia interna, per motivi di sicurezza è necessario rispedire l'apparecchio al produttore.

Montaggio con flangia

- ▶ Osservare il foro della flangia.
- ▶ Unire l'apparecchio alla macchina o all'impianto, servendosi di viti.

Smontaggio

- ▶ Staccare la corrente e separare il sistema dalla rete di alimentazione.
- ▶ Separare tutti i connettori dall'alimentatore.

Elementi di visualizzazione

Indicatore del livello di stress (livello tensionale)



I LED verde, giallo e rosso segnalano il carico elettrico e termico. Questi dati verranno trasmessi e analizzati in un ciclo di 3 ore. L'operatore sarà quindi in grado di verificare le condizioni ambientali e di modificarle onde evitare che effetti negativi si ripercuotano sull'apparecchio.

Simbolo	Definizione
 Verde	Bassa velocità degli impulsi: nessun problema, si prospetta una lunga durata.
 Giallo	La velocità degli impulsi aumenta: condizione termica non ottimale. Non sussiste alcun pericolo imminente di surriscaldamento. Invecchiamento leggermente accelerato. Ridurre il carico o migliorare l'aerazione!
 Rosso	Alta velocità degli impulsi: cattiva condizione termica interna, durata dell'apparecchio seriamente minacciata. Verificare carico e migliorare l'aerazione!

Elementi di visualizzazione (seguito)



Indicatore Lifetime (durata)

I LED segnalano la durata rimanente dell'apparecchio, basata sulla somma di tutti i carichi precedenti. La durata è inizialmente di 15 anni e diminuisce a seconda del livello di stress e del carico.

Simbolo	Definizione
 Verde	Alimentatore di lunga durata
 Giallo	Durata inferiore ai 3 anni: sostituire nel prossimo ciclo di manutenzione
 Rosso	Durata dell'apparecchio giunta al termine: sostituire immediatamente

Indicatore Load Level (livello carico)

I LED segnalano immediatamente il carico attuale dell'apparecchio:

Simbolo	Definizione
 Verde	Carico 0...80%
 Giallo	Carico 81...100%
 Rosso	Carico >100...150%: tipico quando è necessario aumentare il corrente, max. 4 s

Visualizzazione anomalie



Appena la tensione di uscita va a collocarsi al di fuori del campo di lavoro da 22...28 V DC (per es. in caso di corto circuito), si illumina solo l'indicatore Load Level rosso. Gli altri due indicatori sono spenti.

Alimentatori di comando IO-Link BAE PS-XA-...-601-I/-602-I/-603-I/-604-I/-605-I/-606-I/-607-I

Dimensioni

BAE PS-XA-1W-24-038-...

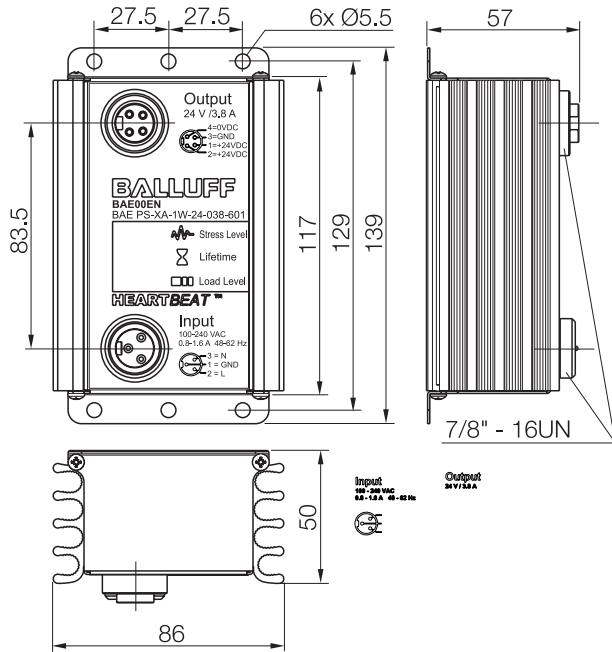

Collegamenti

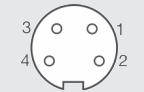
	Tipo BAE PS-...		
	...-604 ...-607	...-601	...-602 ...-606
Pin 1	+24 V	+24 V	+24 V
Pin 2	+24 V	+24 V	+24 V
Pin 3	0 V	GND	0 V / GND
Pin 4	0 V	0 V	0 V / GND

	BAE PS-...
	...-603 ...-605
Pin 1	0 V
Pin 2	0 V
Pin 3	GND
Pin 4	+24 V
Pin 5	+24 V

	BAE PS-...-60x
Pin 1	GND
Pin 2	L
Pin 3	n

BAE PS-XA-1W-24-080-...

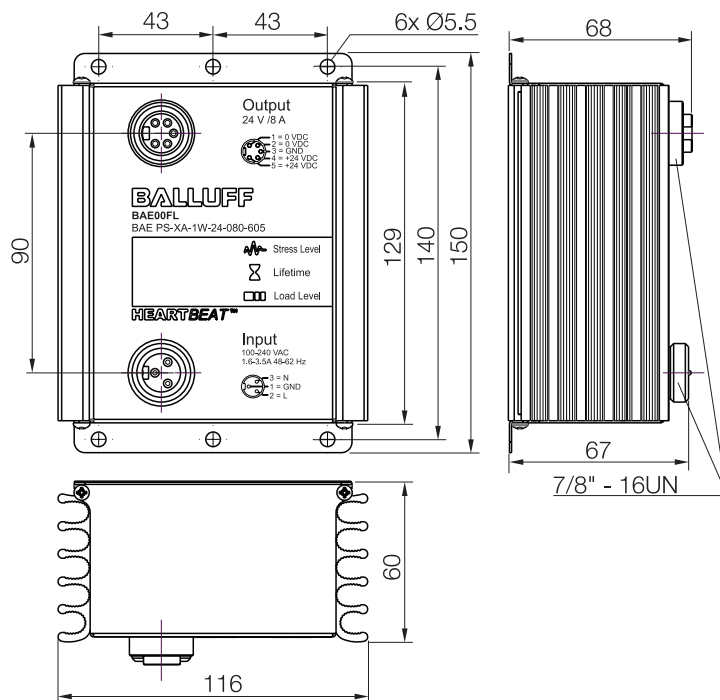

Alimentatori di comando IO-Link BAE PS-XA-...-601-I/-602-I/-603-I/-604-I/-605-I/-606-I/-607-I

Interfaccia IO-Link (solo in combinazione con Clip-On BAE SC-AE-I01)

Informazioni generali sull'apparecchio

Baudrate	COM 2 (38,4 kBaud)
Ingresso lunghezza dati di processo	4 byte
Durata minima del ciclo	20 ms
Versione IO-Link	V1.1
Modalità SIO	no

Modalità IO-Link (modalità di comunicazione)

La comunicazione IO-Link avviene attraverso il pin 4 del connettore M12.

Dati di processo

La lunghezza dati di processo dell'alimentatore è di 32 bit. Nei dati di processo vengono trasmessi gli stati di commutazione delle 4 uscite di commutazione (BDC1 - BDC4), nonché i valori di misura attuali di corrente e tensione.

31...20 bits	19...8	7	6...4	3	2	1	0
Output Voltage Measure 0...30 V Value 0...300 Multiplier 0.1	Output Current Measure 0...80 A Value 0...800 Multiplier 0.1	PSU On/Off	N/C	BDC3/Output drop	BDC2/Over temperature	BDC1/Over voltage	BDC0/Over load

Error Codes

Error Code	Description
0x8011	Index not available
0x8012	Subindex not available
0x8023	Access Denied
0x8030	Parameter Value out of Range
0x8033	Parameter length overrun
0x8034	Parameter length underrun
0x8035	Function not available

Event Codes

Definition	Event-Codes IO-Link 1.1	Event-Codes IO-Link 1.0	Device status	Type
No malfunction	0x0000	0x0000	0	Notification
General malfunction. Unknown error	0x1000	0x1000	4	Error
Process variable range over-run. Process Data uncertain	0x8C10	0x8C10	2	Warning
Process variable range under-run. Process Data uncertain	0x8C30	0x8C10	2	Warning
PSU disconnected from Clip	0xB000	0x1800	4	Error
Bad connection between PSU and Clip	0xB001	0x1801	4	Error
PSU changed	0xB004	0x1804	4	Error
High stress level	0xB005	0x1805	4	Warning
Fast aging	0xB006	0x1806	4	Warning
Over Temperature	0xB007	0x1807	4	Warning
Over load	0xB008	0x1808	4	Warning

Alimentatori di comando IO-Link BAE PS-XA-...-601-I/-602-I/-603-I/-604-I/-605-I/-606-I/-607-I

Interfaccia IO-Link (solo in combinazione con Clip-On BAE SC-AE-I01)

Dati parametri

I dati parametri dell'alimentatore di comando corrispondono al profilo Smart Sensor.

Index hex	Subindex hex	Object name	Access	Length bytes	Range	Gradient	Unit
0x0D	0x00	Profile Characteristics	R	6			
0x0E	0x00	Input Process Data Descriptor	R	9			
0x10	0x00	Vendor Name	R	7	"BALLUFF"		
0x11	0x00	Vendor Text	R	15	www.balluff.com		
0x12	0x00	Product Name	R	max 30	Depending the device connected to Clip		
0x13	0x00	Product ID	R	max 30	Depending the device connected to Clip		
0x14	0x00	Product Text	R	max 50	Depending the device connected to Clip		
0x16	0x00	Hardware Revision	R	5	Depending the device connected to Clip		
0x17	0x00	Firmware Revision	R	5	Depending the device connected to Clip		
0x18	0x00	Application Tag	R/W	32			
0x24	0x00	Device Status	R	1	0...4		
0x3C	0x01	BDC1 SetPoint 1	R/W	2	Process Data (Over load)	0.1	A
0x3D	0x03	BDC1 Hysteresis	R/W	2	0...0xFFFF	0.1	A
0x3E	0x01	BDC2 SetPoint 1	R/W	2	Process Data (Over voltage)	0.1	V
0x3F	0x03	BDC2 Hysteresis	R/W	2	0...0xFFFF	0.1	V
0x500	0x00	Stress level	R	1	1...3		
0x501	0x00	Expected Life Time LED coded	R	1	1...3		
0x502	0x00	Expected Life Time in years	R	1	0...15		Years
0x503	0x00	Primary Capacitor Temperature	R	2	-40...+125		C
0x504	0x00	Secondary Capacitor Temperature	R	2	-40...+125		C
0x505	0x00	Input Voltage	R	2	70...300		V
0x506	0x00	Operating Hours	R	4	0...300000		h
0x507	0x00	Lowest Recorded Temperature	R	2	-40...+125		C
0x508	0x00	Highest Recorded Temperature	R	2	-40...+125		C
0x509	0x00	Output Voltage	R	4	0...30		V
0x50A	0x00	Output Current	R	4	0...80		A
0x50B	0x00	Highest Capacitor Temperature	R	2	-40...+125		C
0x4000	0x01	BDC3 Setpoint 1	R/W	2	0...150 (Over Temperature)		C
0x4001	0x03	BDC3 Hysteresis	R/W	2	0...0xFFFF		C
0x4002	0x01	BDC4 Setpoint 1	R/W	2	0...300 (Output Drop)	0.1	V
0x4003	0x03	BDC4 Hysteresis	R/W	2	0...0xFFFF	0.1	V

Alimentatori di comando IO-Link

BAE PS-XA-...-601-I/-602-I/-603-I/-604-I/-605-I/-606-I/-607-I

Dati tecnici

Dati elettrici	
Tensione d'isolamento ingresso/uscita	3.000 V AC
Resistenza d'isolamento	> 100 M Ohm
Orario di azionamento	< 1 s
Frequenza di commutazione f BAE PS-...-038-...-I BAE PS-...-080-...-I	140 kHz (tipico) 110 kHz (tipico)
Modalità di commutazione parallela Modalità di commutazione in sequenza	Non consentita max. 2 apparecchi
Tempo di stabilizzazione	1 ms
Coefficiente di temperatura	±0,03 %/°C
Ripple & Noise	50 mV p-p (f _{max.} 20 MHz)
Tempo di mantenimento in caso di mancanza di rete BAE PS-...-038-...-I BAE PS-...-080-...-I	>200 ms 230 V AC >35 ms 115 V AC >150 ms 230 V AC >20 ms 115 V AC
Sovraccarico / Power Boost	150 % 4 s
Rendimento BAE PS-...-038-...-I BAE PS-...-080-...-I	> 88% (tipico) > 90% (tipico)
Protezione interna da cortocircuito I _{corto} BAE PS-...-038-...-I BAE PS-...-080-...-I	4 A Resistente ai cortocircuiti in modo permanente (6 A per max. 4 s) 8,4 A Resistente ai cortocircuiti in modo permanente (12 A per max. 4 s)
Dati ingresso	
Tensione d'ingresso	110...240 V AC
Range di tensione d'ingresso	90...254 V AC/ 135...340 V DC
Corrente nominale d'ingresso BAE PS-...-038-...-I BAE PS-...-080-...-I	0,8 A 240 V AC/ 1,6 A 100 V AC 1,6 A 240 V AC/ 3,6 A 100 V AC
Corrente di entrata BAE PS-...-038-...-I BAE PS-...-080-...-I	< 30 A < 20 A
Range di frequenza	48...62 Hz
Fusibile d'ingresso	Nella sostanza sigillante. Non intercambiabile.

Dati di uscita	
Tensione nominale di uscita	24 V DC
Corrente nominale di uscita BAE PS-...-038-...-I BAE PS-...-080-...-I	3,8 A 8 A
Potenza di uscita BAE PS-...-038-...-I BAE PS-...-080-...-I	91,2 W 192 W
Precisione di uscita	-1...+3 %
Regolazione di tensione	±1,0%
Regolazione del carico	±1,0%
Dati meccanici	
Materiale della custodia	Metallo
Peso BAE PS-...-038-...-I BAE PS-...-080-...-I	1 kg 1,65 kg
Apparecchio completamente inglobato	PUR
Dimensioni B x H x T mm BAE PS-...-038-...-I BAE PS-...-080-...-I	86 x 139 x 58 116 x 150 x 68
Connettore per BAE PS-...-601-I/602-I/604-I/ 606-I/607-I BAE PS-...-603-I/605-I	a 3/4 poli, 7/8" a 3/5 poli, 7/8"
Fissaggio	tramite flangia
Indicatori	
Stress Level (livello tensionale)	LED verde, giallo, rosso
Lifetime (durata)	LED verde, giallo, rosso
Load Level (livello di carico)	LED verde, giallo, rosso
Condizioni ambientali	
Temperatura d'esercizio	-25...+70 °C
Derating	-2,5 % / °C a partire da +60 °C
Temperatura di immagazzinamento	-25...+85 °C
Umidità relativa	100% RH
Raffreddamento	Convezione libera
Tipo di protezione secondo IEC 60529	IP 67, non corrosivo
Separazione di protezione BAE PS-...-601-I/603-I/604-I/ 605-I/607-I BAE PS-...-602-I/606-I	SELV PELV, uscita collegata alla presa a terra
Sovratemperatura	isolata

Alimentatori di comando IO-Link BAE PS-XA-...-601-I/-602-I/-603-I/-604-I/-605-I/-606-I/-607-I

Accessori (andranno ordinati separatamente)

Connettore per ingresso	Dati tecnici	Denominazione	Codice d'ordine
	a 3 poli, 300 V DC / 9 A, PUR	BCC A313-A313-A313-T0021-000	BCC0AA5
	Boccola, a 3 poli, angolo, 3 x 1,5 mm ² 300 V DC / 9 A, PUR	BCC A323-0000-10-097-PX03A5-050	BCC0AJ3
	Presa + boccola, a 3 poli, 3 x 1,5 mm ² , 300 V DC / 9 A, PUR	BCC A313-A313-30-365-PX03A5-020	BCC0ARH
Connettore per uscita	Dati tecnici	Denominazione	Codice d'ordine
	a 4 poli, 300 V DC / 9 A, PUR	BCC A314-A314-A314-T0022-000	BCC0AA6
	Boccola, a 4 poli, angolo, 4 x 1,5 mm ² 300 V DC / 9 A, PUR	BCC A324-0000-20-003-PX04A5-050	BCC06HR
	Presa + boccola, a 4 poli, 4 x 1,5 mm ² , 300 V DC / 9 A, PUR	BCC A314-A314-30-304-PX04A5-020	BCC06J3
	a 5 poli, 300 V DC / 9 A, PUR	BCC A315-A315-A315-T0023-000	BCC0AA7
	Boccola, a 5 poli, angolo, 5 x 1,5 mm ² 300 V DC / 9 A, PUR	BCC A325-0000-20-063-PX05A5-050	BCC088A
	Presa + boccola, a 5 poli, 5 x 1,5 mm ² , 300 V DC / 9 A, PUR	BCC A315-A315-30-335-PX05A5-020	BCC06FN

Avvertenza:
Sono disponibili altri modelli di connettori.

Alimentatori di comando IO-Link
BAE PS-XA-...-601-I/-602-I/-603-I/-604-I/-605-I/-606-I/-607-I



Balluff GmbH
Schurwaldstraße 9
73765 Neuhausen a.d.F.
Germania
Tel. +49 7158 173-0
Fax +49 7158 5010
balluff@balluff.de

Balluff GmbH
Industriestraße B16
2345 Brunn am Gebirge
Austria
Tel. +43 2236 32521-0
Fax +43 2236 32521-46
sensor@balluff.at

Balluff Sensortechnik AG
Riedstrasse 6
8953 Dietikon
Svizzera
Tel. +41 43 3223240
Fax +41 43 3223241
sensortechnik@balluff.ch

Aparatos conmutadores de red IO-Link BAE PS-XA-...-601-I/-602-I/-603-I/-604-I/-605-I/-606-I/-607-I



Directiva UE 2004/108/CE (directiva CEM)
Directiva de baja tensión 2006/95/CE
Norma de producto EN 61204-3. Seguridad de instalaciones TIC EN 60950

Validez

Estas instrucciones son aplicables a los siguientes aparatos: código de pedido

- BAE PS-XA-1W-24-038-601-I (código de pedido BAE00TH)
- BAE PS-XA-1W-24-038-602-I (código de pedido BAE00TJ)
- BAE PS-XA-1W-24-038-603-I (código de pedido BAE00TK)
- BAE PS-XA-1W-24-080-604-I (código de pedido BAE00TL)
- BAE PS-XA-1W-24-080-605-I (código de pedido BAE00TM)
- BAE PS-XA-1W-24-080-606-I (código de pedido BAE00TN)
- BAE PS-XA-1W-24-038-607-I (código de pedido BAE00TP)



Indicaciones de seguridad



¡Antes de la puesta en servicio deben leerse detenidamente las instrucciones de servicio! Estos aparatos no deben utilizarse en aplicaciones en las que la seguridad de las personas dependa de la función del aparato (no se trata de un componente de seguridad según la directiva europea sobre máquinas).



¡PELIGRO por alta tensión!
Cualquier contacto con conductores y componentes desprotegidos puede provocar la muerte por descarga eléctrica o quemaduras de carácter grave.
Antes de realizar trabajos en el aparato debe interrumpirse la alimentación de corriente y asegurarla contra cualquier reconexión. No introducir objetos en el aparato. Mantener alejado del fuego.

Sólo personal técnico cualificado debe realizar la **instalación y puesta en servicio**.

El **dueño** es responsable de que se cumplan las prescripciones de seguridad locales vigentes.

Especialmente se trata de que el dueño tome medidas de modo que en caso de defecto del aparato no se puedan producir peligros para las personas ni los bienes materiales.

En caso de cualquier defecto y anomalía del aparato conmutador de red, éste debe ponerse fuera de funcionamiento y asegurar contra cualquier uso no autorizado.

Descarga de las instrucciones de servicio

También puede obtener las mismas instrucciones de servicio en Internet en www.balluff.com.

Utilización conforme al uso previsto

Este aparato es un aparato conmutador de red de sincronización primaria para la utilización en instalaciones con paneles de conmutación o aplicaciones de montaje en cuyo caso el acceso a la fuente de alimentación está limitado (protección contra contacto). El aparato puede utilizarse con un grado de suciedad 3.

Las modificaciones en el aparato o una utilización indebida no son admisibles e implican la pérdida de todos los derechos de garantía y responsabilidad frente al fabricante.

Instalación



¡Atención!

Conectar el aparato según las normas y disposiciones locales a la red eléctrica.
¡No cubrir el aparato! Disponer suficiente espacio alrededor del aparato para la refrigeración para evitar que el aparato pueda desconectarse debido a un calentamiento excesivo. La vida útil del aparato se reduce si funciona durante un tiempo prolongado en estado sobrecalentado. La indicación "Stress Level" señala una refrigeración insuficiente.
¡La carcasa puede calentarse en funcionamiento!

Conexiones eléctricas

- Datos para cargas admisibles, ver tabla "Datos técnicos".
- Utilizar exclusivamente cables comerciales que resulten adecuados para los valores de tensión y corriente indicados.
- En caso de cables flexibles debe asegurarse que todos los hilos estén asegurados en el borne.
- Asegurar la polaridad correcta en la salida.
- Conectar o separar las conexiones enchufables sólo con la corriente desconectada.
- En caso de necesidad debe utilizarse un elemento de separación de control manual para la separación de la red de alimentación.
- Los cables de aparato y corriente deben estar correctamente protegidos.
- El conductor de conexión a tierra sin protección debe estar conectado a GND (clase de protección 1).
- ¡No cambiar la instalación mientras el aparato se encuentra en funcionamiento! Lo mismo es aplicable al lado secundario. Peligro producido por arcos eléctricos y descarga eléctrica mortal.

Aparatos conmutadores de red IO-Link BAE PS-XA-...-601-I/-602-I/-603-I/-604-I/-605-I/-606-I/-607-I

Instalación (continuación)

Fusible interno

El fusible de entrada interno sirve para la protección del aparato y no puede ser sustituido. En caso de un error interno debe devolverse el aparato por motivos de seguridad al fabricante.

Montaje con brida

- ▶ Tener en cuenta la plantilla de orificios de la brida.
- ▶ Montar el aparato con los tornillos en la máquina o la instalación.

Desmontaje

- ▶ Desconectar la alimentación de corriente y separar el sistema de la red de alimentación.
- ▶ Separar todos los conectores de la fuente de alimentación.

Elementos de indicación

Indicación "Stress Level" (nivel de tensión)



Los LEDs verde, amarillo y rojo señalan la carga eléctrica y térmica. Estos datos se determinan dentro de un ciclo de 3 horas y se evalúan. De este modo, el dueño es capaz de comprobar y modificar las condiciones de trabajo de tal modo que se evitan los efectos negativos sobre el aparato.

Símbolo	Significado
 Verde	Baja velocidad de pulsación: todo en orden, se puede esperar una larga vida útil.
 Amarillo	La velocidad de pulsación aumenta: el estado térmico no es óptimo. No existe un peligro inminente de que se produzca un calentamiento excesivo. Envejecimiento ligeramente acelerado. ¡Reducir la carga o mejorar la ventilación!
 Rojo	Alta velocidad de pulsación: el estado térmico interno es malo, la vida útil está seriamente perjudicada. ¡Comprobar la carga y mejorar la ventilación!

Elementos de indicación (continuación)



Indicación "Lifetime" (vida útil)

Los LEDs señalan la vida útil restante del aparato. Ésta se basa en la suma de todas las cargas anteriores. La vida útil comienza en 15 años y se va reduciendo según el nivel de estrés y la carga.

Símbolo	Significado
 Verde	Fuente de alimentación con larga vida útil
 Amarillo	Vida útil inferior a 3 años, sustituir con motivo del próximo ciclo de mantenimiento
 Rojo	La vida útil de la fuente de alimentación ha finalizado, sustituir inmediatamente

Indicación "Load Level" (nivel de carga)

Los LEDs señalan sin retraso la carga actual del aparato:

Símbolo	Significado
 Verde	0...80% de carga
 Amarillo	81...100% de carga
 Rojo	>100...150% de carga, típico cuando se requiere un aumento de corriente, máx. 4 s

Indicación de errores



Cuando la tensión de salida se encuentra fuera del margen de trabajo de 22...28 V CC (por ejemplo, cortocircuito), sólo se ilumina la indicación "Load Level" en rojo. Las otras dos indicaciones están desconectadas.

Aparatos conmutadores de red IO-Link BAE PS-XA-...-601-I/-602-I/-603-I/-604-I/-605-I/-606-I/-607-I

Dimensiones

BAE PS-XA-1W-24-038-...

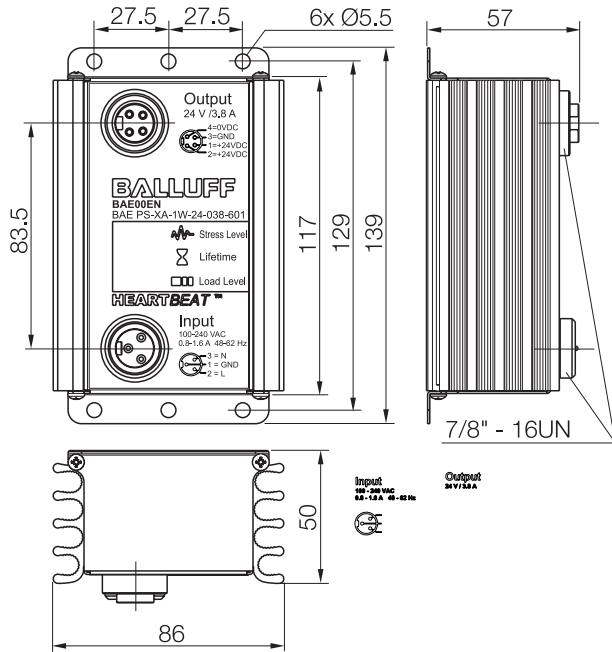

Conexiones

Pin	Tipo BAE PS-...		
	...-604 ...-607	...-601	...-602 ...-606
Pin 1	+24 V	+24 V	+24 V
Pin 2	+24 V	+24 V	+24 V
Pin 3	0 V	GND	0 V / GND
Pin 4	0 V	0 V	0 V / GND

Pin	BAE PS-...
	...-603 ...-605
Pin 1	0 V
Pin 2	0 V
Pin 3	GND
Pin 4	+24 V
Pin 5	+24 V

Pin	BAE PS-...-60x
Pin 1	GND
Pin 2	L
Pin 3	N

BAE PS-XA-1W-24-080-...

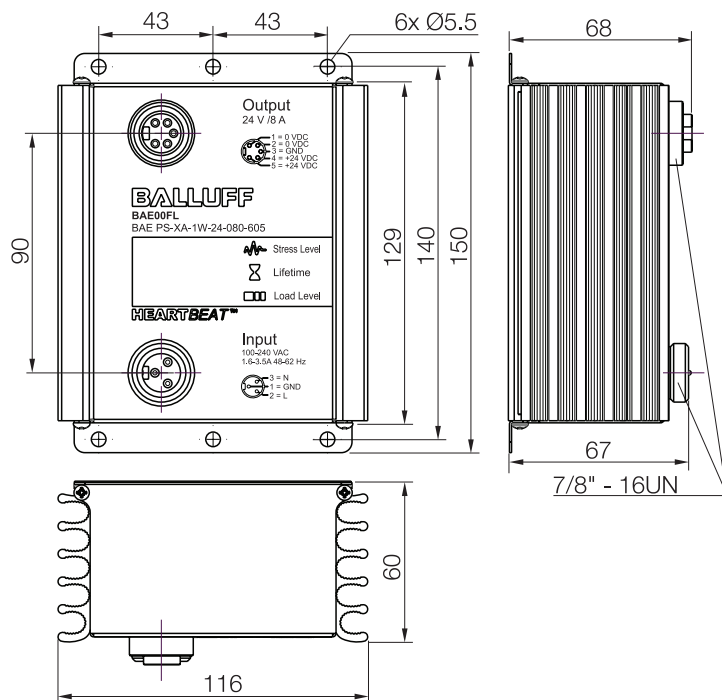

Aparatos conmutadores de red IO-Link BAE PS-XA-...-601-I/-602-I/-603-I/-604-I/-605-I/-606-I/-607-I

Interfaz IO-Link (solo en combinación con Clip-On BAE0 SC-AE-I01)

Información general de dispositivo

Velocidad de baudios	COM 2 (38,4 Kbaudios)
Entrada de longitud de pasos de proceso	4 byte
Tiempo de ciclo mínimo	20 ms
Versión IO-Link	V1.1
Modo SIO	no

Modo IO-Link (modo de comunicación)

La comunicación IO-Link funciona a través del pin 4 del conector M12.

Datos de proceso

La longitud de datos de proceso de la unidad de alimentación es de 32 bits.

En los datos de proceso se transmiten los estados de conexión de las 4 salidas de conmutación (BDC1 ... BDC4), así como los valores de medición actuales de corriente y tensión.

31...20 bits	19...8	7	6...4	3	2	1	0
Output Voltage Measure 0...30 V Value 0...300 Multiplier 0.1	Output Current Measure 0...80 A Value 0...800 Multiplier 0.1	PSU On/Off	N/C	BDC3/Output drop	BDC2/Over temperature	BDC1/Over voltage	BDC0/Over load

Event Codes

Definition	Event-Codes IO-Link 1.1	Event-Codes IO-Link 1.0	Device status	Type
No malfunction	0x0000	0x0000	0	Notification
General malfunction. Unknown error	0x1000	0x1000	4	Error
Process variable range over-run. Process Data uncertain	0x8C10	0x8C10	2	Warning
Process variable range under-run. Process Data uncertain	0x8C30	0x8C10	2	Warning
PSU disconnected from Clip	0xB000	0x1800	4	Error
Bad connection between PSU and Clip	0xB001	0x1801	4	Error
PSU changed	0xB004	0x1804	4	Error
High stress level	0xB005	0x1805	4	Warning
Fast aging	0xB006	0x1806	4	Warning
Over Temperature	0xB007	0x1807	4	Warning
Over load	0xB008	0x1808	4	Warning

Error Codes

Error Code	Description
0x8011	Index not available
0x8012	Subindex not available
0x8023	Access Denied
0x8030	Parameter Value out of Range
0x8033	Parameter length overrun
0x8034	Parameter length underrun
0x8035	Function not available

Aparatos conmutadores de red IO-Link BAE PS-XA-...-601-I/-602-I/-603-I/-604-I/-605-I/-606-I/-607-I

Interfaz IO-Link (solo en combinación con Clip-On BAE0 SC-AE-I01)

Datos de parámetros

Los datos de parámetros del aparato conmutador de red corresponden al perfil de Smart sensor.

Index hex	Subindex hex	Object name	Access	Length bytes	Range	Gradient	Unit
0x0D	0x00	Profile Characteristics	R	6			
0x0E	0x00	Input Process Data Descriptor	R	9			
0x10	0x00	Vendor Name	R	7	"BALLUFF"		
0x11	0x00	Vendor Text	R	15	www.balluff.com		
0x12	0x00	Product Name	R	max 30	Depending the device connected to Clip		
0x13	0x00	Product ID	R	max 30	Depending the device connected to Clip		
0x14	0x00	Product Text	R	max 50	Depending the device connected to Clip		
0x16	0x00	Hardware Revision	R	5	Depending the device connected to Clip		
0x17	0x00	Firmware Revision	R	5	Depending the device connected to Clip		
0x18	0x00	Application Tag	R/W	32			
0x24	0x00	Device Status	R	1	0..4		
0x3C	0x01	BDC1 SetPoint 1	R/W	2	Process Data (Over load)	0.1	A
0x3D	0x03	BDC1 Hysteresis	R/W	2	0..0xFFFF	0.1	A
0x3E	0x01	BDC2 SetPoint 1	R/W	2	Process Data (Over voltage)	0.1	V
0x3F	0x03	BDC2 Hysteresis	R/W	2	0..0xFFFF	0.1	V
0x500	0x00	Stress level	R	1	1..3		
0x501	0x00	Expected Life Time LED coded	R	1	1..3		
0x502	0x00	Expected Life Time in years	R	1	0..15		Years
0x503	0x00	Primary Capacitor Temperature	R	2	-40...+125		C
0x504	0x00	Secondary Capacitor Temperature	R	2	-40...+125		C
0x505	0x00	Input Voltage	R	2	70...300		V
0x506	0x00	Operating Hours	R	4	0...300000		h
0x507	0x00	Lowest Recorded Temperature	R	2	-40...+125		C
0x508	0x00	Highest Recorded Temperature	R	2	-40...+125		C
0x509	0x00	Output Voltage	R	4	0...30		V
0x50A	0x00	Output Current	R	4	0...80		A
0x50B	0x00	Highest Capacitor Temperature	R	2	-40...+125		C
0x4000	0x01	BDC3 Setpoint 1	R/W	2	0...150 (Over Temperature)		C
0x4001	0x03	BDC3 Hysteresis	R/W	2	0..0xFFFF		C
0x4002	0x01	BDC4 Setpoint 1	R/W	2	0...300 (Output Drop)	0.1	V
0x4003	0x03	BDC4 Hysteresis	R/W	2	0..0xFFFF	0.1	V

Aparatos conmutadores de red IO-Link

BAE PS-XA-...-601-I/-602-I/-603-I/-604-I/-605-I/-606-I/-607-I

Datos técnicos

Datos eléctricos	
Tensión de aislamiento entrada/salida	3.000 V CA
Resistencia de aislamiento	> 100 M Ohm
Tiempo de conexión	< 1 s
Frecuencia de conmutación f BAE PS-...-038-...-I BAE PS-...-080-...-I	140 kHz (típico) 110 kHz (típico)
Modo de conmutación en paralelo Modo de conmutación en serie	No es posible 2 aparatos como máximo
Tiempo transitorio	1 ms
Coeficiente de temperatura	±0,03%/°C
Ripple & Noise	50 mV p-p (f _{máx.} 20 MHz)
Puenteado de avería de red BAE PS-...-038-...-I BAE PS-...-080-...-I	>200 ms 230 V CA >35 ms 115 V CA >150 ms 230 V CA >20 ms 115 V CA
Sobrecarga/aceleración de potencia	150% 4 s
Eficiencia BAE PS-...-038-...-I BAE PS-...-080-...-I	> 88% (típico) > 90% (típico)
Protección interna contra cortocircuito I _{corto} BAE PS-...-038-...-I BAE PS-...-080-...-I	4 A a prueba de cortocircuito sostenido (6 A durante máx. 4 s) 8,4 A a prueba de cortocircuito sostenido (12 A durante máx. 4 s)
Datos de entrada	
Tensión nominal de entrada	110...240 V CA
Margen de tensión de entrada	90...254 V CA / 135...340 V CC
Corriente nominal de entrada BAE PS-...-038-...-I BAE PS-...-080-...-I	0,8 A 240 V AC/ 1,6 A 100 V AC 1,6 A 240 V AC/ 3,6 A 100 V AC
Corriente de conexión BAE PS-...-038-...-I BAE PS-...-080-...-I	< 30 A < 20 A
Margen de frecuencia	48...62 Hz
Fusible de entrada	En la masa de sellado. No sustituible.

Datos de salida	
Tensión nominal de salida	24 V CC
Corriente nominal de salida BAE PS-...-038-...-I BAE PS-...-080-...-I	3,8 A 8 A
Potencia de salida BAE PS-...-038-...-I BAE PS-...-080-...-I	91,2 W 192 W
Precisión de salida	-1...+3 %
Regulación de tensión	±1%
Regulación de carga	±1%
Datos mecánicos	
Material de la carcasa	Metal
Peso BAE PS-...-038-...-I BAE PS-...-080-...-I	1 kg 1,65 kg
Aparato totalmente moldeado	PUR
Dimensiones B x H x T mm BAE PS-...-038-...-I BAE PS-...-080-...-I	86 x 139 x 58 116 x 150 x 68
Conector para BAE PS-...-601-I/602-I/604-I/ 606-I/607-I BAE PS-...-603-I/605-I	3/4 polos, 7/8" 3/5 polos, 7/8"
Fijación	Mediante brida
Indicaciones	
Stress Level (nivel de tensión)	LED verde, amarillo, rojo
Lifetime (vida útil)	LED verde, amarillo, rojo
Load Level (nivel de carga)	LED verde, amarillo, rojo
Condiciones de trabajo	
Temperatura de servicio	-25...+70 °C
Reducción de los valores de servicio	-2,5 % / °C a partir de +60 °C
Temperatura de almacenamiento	-25...+85 °C
Humedad relativa del aire	100% RH
Refrigeración	Convección libre
Grado de protección según IEC 60529	IP 67, no corrosivo
Separación de protección BAE PS-...-601-I/603-I/604-I/ 605-I/607-I BAE PS-...-602-I/606-I	SELV PELV, salida puesta a tierra
Sobretemperatura	protegido

Aparatos conmutadores de red IO-Link
BAE PS-XA-...-601-I/-602-I/-603-I/-604-I/-605-I/-606-I/-607-I

Accesorios (pedir por separado)

Conector para la entrada	Datos técnicos	Denominación	Código de pedido
	3 polos, 300 V CC / 9 A, PUR	BCC A313-A313-A313-T0021-000	BCC0AA5
	Casquillo, 3 polos, Angular, 3x1,5 mm ² 300 V CC / 9 A, PUR	BCC A323-0000-10-097-PX03A5-050	BCC0AJ3
	Conector + casquillo, 3 polos, 3x1,5 mm ² , 300 V CC / 9 A, PUR	BCC A313-A313-30-365-PX03A5-020	BCC0ARH
Conector para la salida	Datos técnicos	Denominación	Código de pedido
	4 polos, 300 V CC / 9 A, PUR	BCC A314-A314-A314-T0022-000	BCC0AA6
	Casquillo, 4 polos, Angular, 4x1,5 mm ² , 300 V CC / 9 A, PUR	BCC A324-0000-20-003-PX04A5-050	BCC06HR
	Conector + casquillo, 4 polos, 4x1,5 mm ² , 300 V CC / 9 A, PUR	BCC A314-A314-30-304-PX04A5-020	BCC06J3
	5 polos, 300 V CC / 9 A, PUR	BCC A315-A315-A315-T0023-000	BCC0AA7
	Casquillo, 5 polos, Angular, 5x1,5 mm ² , 300 V CC / 9 A, PUR	BCC A325-0000-20-063-PX05A5-050	BCC088A
	Conector + casquillo, 5 polos, 5x1,5 mm ² , 300 V CC / 9 A, PUR	BCC A315-A315-30-335-PX05A5-020	BCC06FN

Advertencia:
 Hay otras variantes de conectores disponibles.

Aparatos conmutadores de red IO-Link
BAE PS-XA-...-601-I/-602-I/-603-I/-604-I/-605-I/-606-I/-607-I



Balluff GmbH
Schurwaldstraße 9
73765 Neuhausen a.d.F.
Alemania
Tel. +49 7158 173-0
Fax +49 7158 5010
balluff@balluff.de

Balluff GmbH
Industriestraße B16
2345 Brunn am Gebirge
Austria
Tel. +43 2236 32521-0
Fax +43 2236 32521-46
sensor@balluff.at

Balluff Sensortechnik AG
Riedstrasse 6
8953 Dietikon
Suiza
Tel. +41 43 3223240
Fax +41 43 3223241
sensortechnik@balluff.ch