

# Clemas & Co Ltd

Industrial Cleaning Equipment  
Sales - Hire - Service

## TENNANT T300 SCRUBBER DRYER OPERATOR MANUAL



**Clemas & Co.** Unit 5 Ashchurch Business Centre, Alexandra Way, Tewkesbury,  
Gloucestershire, GL20 8NB.

**Tel:** 01684 850777

**Fax:** 01684 850707

**Email:** [info@clemas.co.uk](mailto:info@clemas.co.uk)

**Web:** [www.clemas.co.uk](http://www.clemas.co.uk)

---

## INTRODUCTION

---

This manual is furnished with each new model. It provides necessary operation and maintenance instructions.



**Read this manual completely and understand the machine before operating or servicing it.**

This machine will provide excellent service. However, the best results will be obtained at minimum costs if:

- The machine is operated with reasonable care.
- The machine is maintained regularly - per the maintenance instructions provided.
- The machine is maintained with manufacturer supplied or equivalent parts.

To view, print or download manuals online visit [www.tennantco.com/manuals](http://www.tennantco.com/manuals)



### PROTECT THE ENVIRONMENT

Please dispose of packaging materials and used machine components such as batteries in an environmentally safe way according to your local waste disposal regulations.



Always remember to recycle.

## Tennant Company

PO Box 1452

Minneapolis, MN 55440

Phone: (800) 553- 8033

[www.tennantco.com](http://www.tennantco.com)

Pro-Membrane, Membrane, Severe Environment, Zone Settings, Quiet-Mode are trademarks of Tennant Company.

Trojan and HydroLINK are registered trademarks of Trojan Battery Company.

This product may contain portions of software that have various 3<sup>rd</sup> party licenses. More information can be found at: [www.tennantco.com/opensource](http://www.tennantco.com/opensource)

Specifications and parts are subject to change without notice.

Original Instructions. Copyright ©2015- 2017 Tennant Company. All rights reserved.

---

## INTENDED USE

---

The automatic floor scrubber is intended for commercial use, for example in hotels, schools, hospitals, factories, shops, offices and rental businesses. It is designed to scrub hard floor surfaces (concrete, tile, stone, synthetic, etc.) in an indoor environment. This machine is not intended for cleaning carpets or sanding wood floors. Use only recommended pads/brushes and commercially available floor cleaning detergents. Do not use this machine other than described in this Operator Manual.

---

## MACHINE DATA

---

Please fill out at time of installation for future reference.

Model No. - \_\_\_\_\_

Serial No. - \_\_\_\_\_

Installation Date - \_\_\_\_\_

---

## SERIAL NUMBER LOCATION

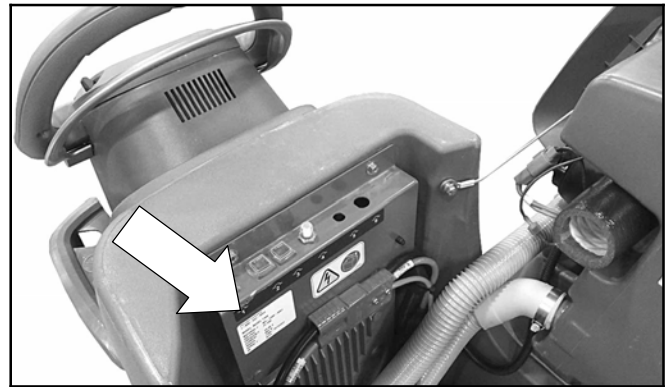

---

## UNCRATING MACHINE

---

Carefully check machine for signs of damage. Report damages at once to carrier. Contact distributor or Tennant for missing items.

To uncrate the machine, remove straps, wheel blocks and shipping brackets. Using the supplied ramp carefully back the machine off the pallet. Make sure scrub head is in the raised position.

**ATTENTION: Do not remove machine from pallet without using ramp, machine damage may occur.**

---

---

## TABLE OF CONTENTS

---

<b>OPERATION</b>			
<b>IMPORTANT SAFETY INSTRUCTIONS</b> .....	4	<b>SERVICE INDICATOR CODES</b> .....	28
<b>SAFETY LABELS</b> .....	6	ON-BOARD BATTERY CHARGER	
<b>MACHINE COMPONENTS</b> .....	7	SERVICE INDICATOR CODES .....	29
<b>MACHINE SYMBOLS</b> .....	8	ec-H2O SYSTEM SERVICE INDICATOR	
<b>CONTROL PANEL COMPONENTS</b> .....	8	CODES - OPTION .....	30
T300 Model with Membrane Control Panel			
(Manual Down Pressure Model) .....	8		
T300 Model with Pro-Membrane Control Panel			
(Actuated Down Pressure Model) .....	9		
T300 Model with Pro-Panel Controls			
(LCD - Liquid Crystal Display) .....	9		
<b>INSTALLING BATTERIES</b> .....	10		
BATTERY PACK LIFT- OUT TRAY (Option) .	10		
<b>HOW THE MACHINE WORKS</b> .....	11		
<b>BRUSH AND PAD INFORMATION</b> .....	11		
<b>MACHINE SETUP</b> .....	12		
ATTACHING SQUEEGEE ASSEMBLY .....	12		
INSTALLING BRUSH/PAD			
- Insta-Click Magnetic Disk .....	12		
INSTALLING PAD - Orbital .....	13		
INSTALLING CYLINDRICAL BRUSHES .....	13		
FILLING SOLUTION TANK .....	14		
FILLING SEVERE ENVIRONMENT TANK			
(ec-H2O model Option) .....	15		
ec-H2O NanoClean WATER CONDITIONING			
CARTRIDGE (ec-H2O model) .....	15		
ACCESSORY RAILS .....	16		
<b>CONTROL PANEL OPERATION</b> .....	17		
T300 WITH MEMBRANE CONTROL PANEL			
(Manual Down Pressure Model) .....	17		
T300 WITH PRO-MEMBRANE CONTROL			
PANEL (Actuated Down Pressure Model) ...	18		
T300 MODEL WITH PRO-PANEL			
CONTROLS .....	19		
<b>MACHINE OPERATION</b> .....	23		
PRE-OPERATION CHECK LIST .....	23		
OPERATING MACHINE .....	23		
WHILE OPERATING MACHINE .....	24		
EMERGENCY SHUT-OFF BUTTON			
(Drive models) .....	25		
BATTERY DISCHARGE INDICATOR .....	25		
CIRCUIT BREAKER PANEL .....	25		
HOUR METER .....	26		
<b>DRAINING TANKS</b> .....	26		
DRAINING RECOVERY TANK .....	26		
DRAINING SOLUTION TANK .....	27		
		<b>MAINTENANCE</b>	
		<b>MAINTENANCE CHART</b> .....	31
		<b>MACHINE MAINTENANCE</b> .....	32
		AFTER DAILY USE .....	32
		AFTER WEEKLY USE .....	33
		AFTER EVERY 50 HOURS OF USE .....	34
		AFTER EVERY 100 HOURS OF USE .....	34
		ELECTRIC MOTORS .....	34
		BELTS .....	35
		ORBITAL SCRUB HEAD ISOLATORS .....	35
		<b>BATTERIES</b> .....	35
		Maintenance-free batteries .....	35
		Flooded (WET) LEAD-ACID BATTERIES ...	35
		CHECKING CONNECTIONS / CLEANING ..	36
		CHARGING BATTERIES .....	36
		BATTERY CHARGER SETTINGS .....	37
		HYDROLINK® BATTERY WATERING SYSTEM	
		(Trojan 150AH Battery Option) .....	39
		<b>SQUEEGEE BLADE REPLACEMENT</b> .....	40
		<b>ec-H2O NanoClean WATER CONDITIONING</b>	
		<b>CARTRIDGE REPLACEMENT</b> .....	41
		<b>LOADING/UNLOADING MACHINE FOR</b>	
		<b>TRANSPORTING</b> .....	42
		<b>STORING MACHINE</b> .....	43
		Freeze Protection .....	43
		<b>TROUBLESHOOTING</b> .....	44
		<b>SPECIFICATIONS</b>	
		<b>GENERAL MACHINE</b>	
		<b>DIMENSIONS/CAPACITIES/PERFORMANCE</b> ..	46
		<b>MACHINE DIMENSIONS</b> .....	48
		<b>SUPERVISOR CONTROLS</b>	
		<b>SUPERVISOR CONTROLS</b> .....	53
		T300 MODEL WITH PRO-MEMBRANE CONTROL	
		PANEL .....	53
		T300 MODEL WITH PRO-PANEL	
		CONTROLS .....	54

### IMPORTANT SAFETY INSTRUCTIONS - SAVE THESE INSTRUCTIONS

---

The following warning precautions are used throughout this manual as indicated in their description:

**⚠ WARNING:** To warn of hazards or unsafe practices which could result in severe personal injury or death.

**FOR SAFETY:** To identify actions which must be followed for safe operation of equipment.

The following information signals potentially dangerous conditions to the operator. Know when these conditions can exist. Locate all safety devices on the machine. Report machine damage or faulty operation immediately.

**⚠ WARNING:** To Reduce the Risk of Fire, Explosion, Electric Shock or Injury:

- Read manual before operating machine.
- Do not use or pick up flammable materials.
- Do not use near flammable liquids, vapors or combustible dusts.

This machine is not equipped with an explosion proof motor. The electric motor will spark upon start up and during operation which could cause a flash fire or explosion if machine is used in an area where flammable vapors/liquids or combustible dusts are present.

- Batteries emit hydrogen gas. Explosion or fire can result. Keep sparks and open flame away when charging.
- Disconnect battery cables and charger cord before cleaning and servicing machine.
- Do not charge batteries with damaged cord. Do not modify plug.

If the charger supply cord is damaged or broken, it must be replaced by the manufacturer or its service agent or a similarly qualified person in order to avoid a hazard.

- Do not use outdoors. Store indoors.
- Spinning pad/brush, keep hands away.

**⚠ WARNING:** Magnetic Field Hazard. Magnetic pad driver/brush can be harmful to pacemaker wearers or medical implants.

**WARNING:** This machine contains chemicals known to the state of California to cause cancer, birth defects, or other reproductive harm.

This machine may be equipped with technology that automatically communicates over the cellular network. If the machine will be operated where cell phone use is restricted because of concerns related to equipment interference, please contact a Tennant representative for information on how to disable the cellular communication functionality.

**FOR SAFETY:**

**1. Do not operate machine:**

- Unless trained and authorized.
- Unless operator manual is read and understood.
- Unless mentally and physically capable of following machine instructions.
- Under the influence of alcohol or drugs.
- While using a cell phone or other types of electronic devices.
- If not in proper operating condition.
- In outdoor areas. This machine is for indoor use only.
- In areas where flammable vapors/liquids or combustible dusts are present.
- With pads or accessories not supplied or approved by Tennant. The use of other pads may impair safety.
- In areas with possible falling objects.
- In areas that are too dark to safely see the controls or operate machine.

**2. Before operating machine:**

- Check machine for fluid leaks.
- Make sure all safety devices are in place and operate properly.

**3. When operating machine:**

- Use only as described in this manual.
- Report machine damage or faulty operation immediately.
- Wear closed-toe, non-slip work shoes.
- Reduce speed when turning.
- Go slowly on inclines and slippery surfaces.
- Do not scrub on inclines that exceed 9% grade or transport on inclines that exceed 21% grade.
- Follow site safety guidelines concerning wet floors.
- Follow mixing, handling and disposal instructions on chemical containers.

- Do not carry passengers on machine.
  - Use care when reversing machine.
  - Keep children and unauthorized persons away from machine.
  - Do not allow machine to be used as a toy.
4. Before leaving or servicing machine:
- Stop on level surface.
  - Set the parking brake, if equipped.
  - Turn off machine and remove key.
5. When servicing machine:
- Disconnect battery connection and charger cord before working on machine.
  - All work must be done with sufficient lighting and visibility.
  - All repairs must be performed by trained personnel.
  - Use Tennant supplied or approved replacement parts.
  - Do not modify the machine from its original design.
  - Do not jack up machine.
  - Avoid moving parts. Do not wear loose clothing or jewelry and secure long hair.
  - Do not disconnect the off-board charger's DC cord from the machine's receptacle when the charger is operating. Arcing may result. If the charger must be interrupted during charging cycle, disconnect the AC power supply cord first.
  - Do not use incompatible battery chargers as this may damage battery packs and potentially cause a fire hazard.
  - Inspect charger cord regularly for damage.
  - Keep work area well ventilated.
  - Avoid contact with battery acid.
  - Keep all metal objects off batteries.
  - Do not power spray or hose off machine.
  - Use a hoist or adequate assistance when lifting batteries.
  - Battery installation must be done by trained personnel.
  - Wear personal protection equipment as needed and where recommended in this manual.
6. When loading/unloading machine onto/off truck or trailer:
- Drain tanks before loading machine.
  - Use a ramp, truck or trailer that can support the machine weight and operator.
  - Do not operate the machine on a ramp incline that exceeds a 21% grade level.
  - Use a winch if ramp incline exceeds a 21% grade level.
  - Lower the scrub head and squeegee before tying down machine.
  - Turn machine off and remove key.
  - Set parking brake (if equipped).
  - Block machine wheels.
  - Use tie-down straps to secure machine.



For Safety: wear protective gloves.



For Safety: wear eye protection.

# OPERATION

## SAFETY LABELS

The safety labels appear on the machine in the locations indicated. Replace labels if they are missing or become damaged or illegible.

**WARNING LABEL** - Located on recovery tank cover.

	<b>⚠ WARNING</b>	<b>⚠ AVERTISSEMENT</b>	<b>⚠ ADVERTENCIA</b>
	<b>TO REDUCE THE RISK OF FIRE, EXPLOSION, ELECTRICAL SHOCK, OR INJURY:</b>	<b>POUR RÉDUIRE LES RISQUES D'INCENDIE, L'EXPLOSION, DE CHOC ÉLECTRIQUE OU DE LESSURE:</b>	<b>PARA REDUCIR EL RIESGO DE INCENDIO, EXPLOSION, CHOQUE ELÉCTRICO, O LESIONES:</b>
	• Read manual before operating machine.	• Lisez le manuel avant d'utiliser la machine.	• Lea el manual antes de utilizar la máquina.
	• Do not use or pick up flammable materials.	• N'utilisez pas ou ne ramassez pas de matériaux inflammables.	• No utilice ni recoja materiales inflamables.
	• Do not use near flammable liquids, vapors or combustible dusts.	• N'utilisez pas près de liquides, vapeurs ou poussières inflammables.	• No utilice la máquina cerca de líquidos, polvos o vapores inflamables.
	• Batteries emit hydrogen gas. Explosion or fire can result. Keep sparks and open flame away when charging.	• Les batteries émettent de l'hydrogène gazeux. Risque d'incendie et d'explosion. Évitez toute étincelle et toute flamme nue lors de la charge des batteries.	• Las baterías emiten hidrógeno. Peligro de incendio o explosión. Mantenga la máquina alejada de chispas y llamas cuando se esté cargando.
	• Disconnect battery cables and charger plug before servicing machine.	• Débranchez les câbles des batteries et le cordon du chargeur avant l'entretien de la machine.	• Desconecte los cables de la batería antes de realizar el servicio a la máquina.
	• Do not charge batteries with damaged cord.	• Ne chargez pas les batteries avec un cordon endommagé.	• No cargue las baterías si el cable está dañado.
	• Do not use outdoors. Store indoors.	• N'utilisez pas à l'extérieur. Entrez-les à l'intérieur.	• No utilice la máquina al aire libre. Guárdela en un lugar cerrado.

1215281



**FOR SAFETY LABEL - Do not power spray or hose off machine. Electrical malfunction may occur.**

Located on control console

	<b>⚠ WARNING</b>
	<b>Spinning Pad. Keep Hands Away.</b>
	<b>⚠ AVERTISSEMENT</b>
	<b>Patin En Rotation. Éloignez Vos Mains.</b>
	<b>⚠ ADVERTENCIA</b>
	<b>Almohadilla Giratoria. Mantenga Alejadas Las Manos.</b>

1208788

**WARNING LABEL - Spinning pad. Keep hands away.**

Located on disk scrub head model.

	<b>⚠ WARNING</b>
	<b>Spinning Brush. Keep Hands Away.</b>
	<b>⚠ AVERTISSEMENT</b>
	<b>Brosse En Rotation. Éloignez Vos Mains.</b>
	<b>⚠ ADVERTENCIA</b>
	<b>Cepillo Giratorio. Mantenga Alejadas Las Manos.</b>

1215780

**WARNING LABEL - Spinning brush. Keep hands away.**

Located on cylindrical scrub head model.

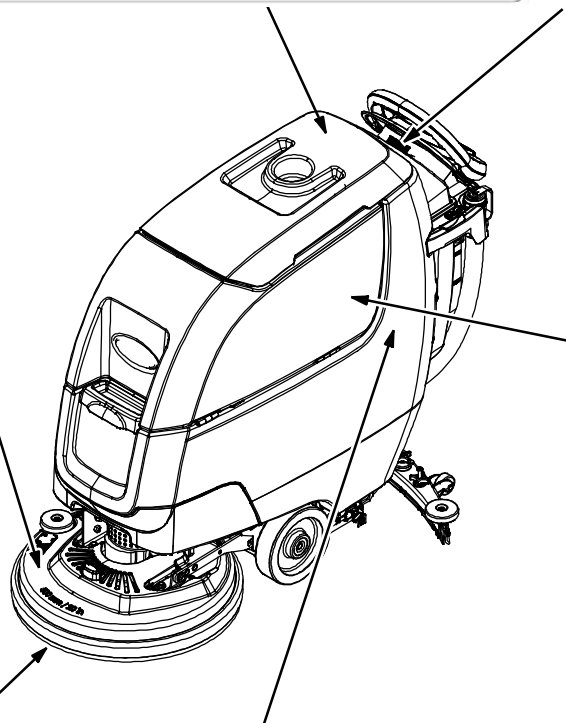

**WARNING LABEL - Batteries emit hydrogen gas. Explosion or fire can result. Keep sparks and open flame away when charging.**

Located on bottom side of recovery tank.



**WARNING LABEL - Magnetic Field Hazard. Magnetic pad driver/brush can be harmful to pacemaker wearers or medical implants.**

Located on Insta-Click magnetic pad driver/brush.



**WARNING LABEL - Electrical hazard. Disconnect battery cables before servicing machine.**

Located on circuit breaker panel.



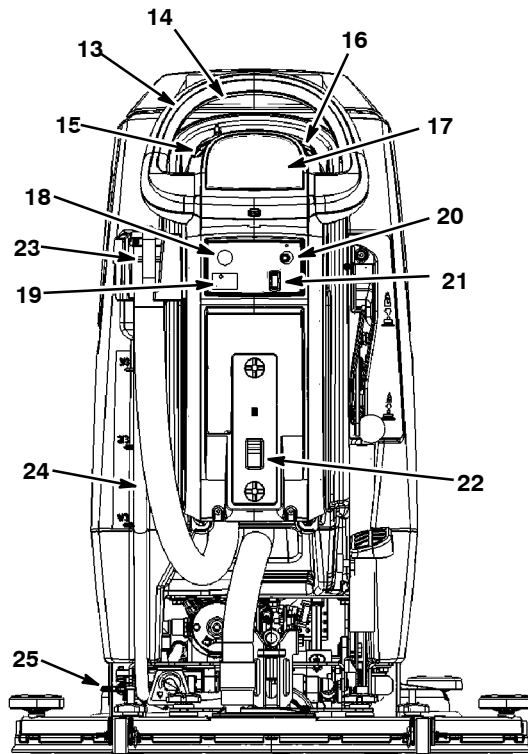
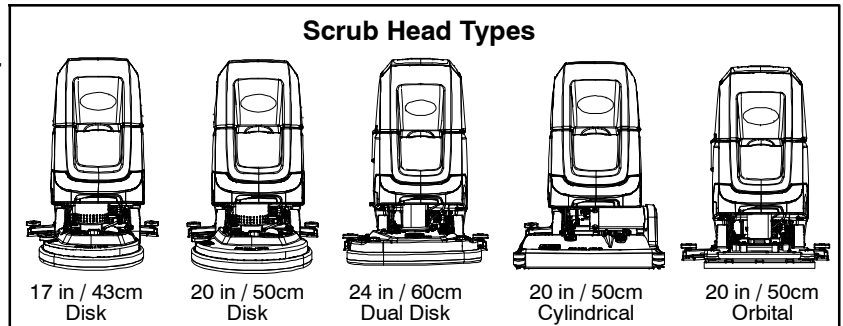
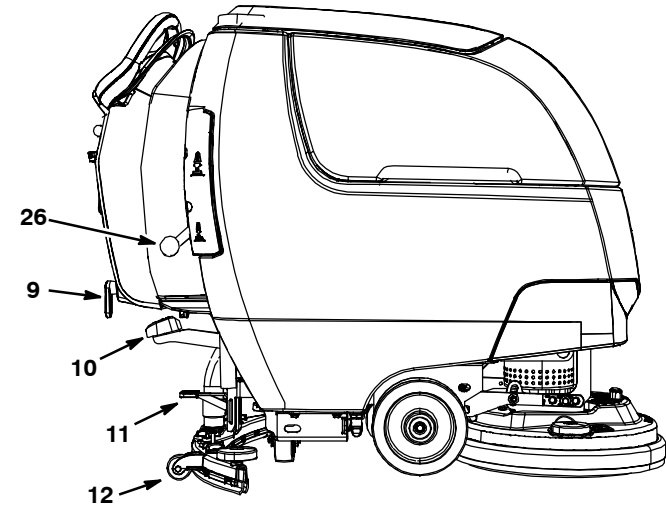
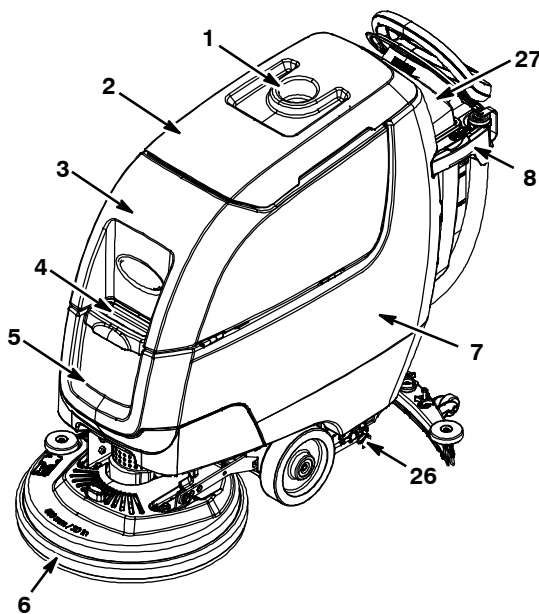







MACHINE COMPONENTS

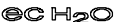
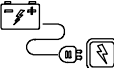

- 1. Cup holder/tray
- 2. Recovery tank lid
- 3. Recovery tank
- 4. Solution tank fill-port
- 5. Solution tank
- 6. Scrub head
- 7. Battery compartment
- 8. Accessory rail
- 9. On-board battery charger cord hooks
- 10. Scrub head lift pedal
- 11. Squeegee foot pad
- 12. Squeegee assembly
- 13. Control handle
- 14. Control handle start bail
- 15. Speed control knob (drive model)
- 16. Forward/Reverse lever (drive model)
- 17. Control panel display
- 18. Emergency stop button (option)
- 19. Hour meter
- 20. Key switch
- 21. ec-H2O on/off switch (option)
- 22. Off-board battery charger receptacle
- 23. Recovery tank drain hose
- 24. Solution tank level/drain hose
- 25. Parking brake (option)
- 26. Dual down pressure lever (Manual down pressure model)
- 27. Circuit breaker panel splash guard.

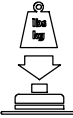
# OPERATION

## MACHINE SYMBOLS

	Fast speed (drive model)
	Slow speed (drive model)
	Forward / Reverse (drive model)
	On
	Off
	ec-H2O scrubbing (option)
	Battery charge
	Do not lift by accessory rails
	No step
	Dual down pressure (Manual down pressure model)
	Parking brake (option)
	No detergent (ec-H2O option)
	Water temperature (ec-H2O option)
	Circuit breaker

## CONTROL PANEL COMPONENTS

**T300 Model with Membrane Control Panel**  
(Manual Down Pressure Model)

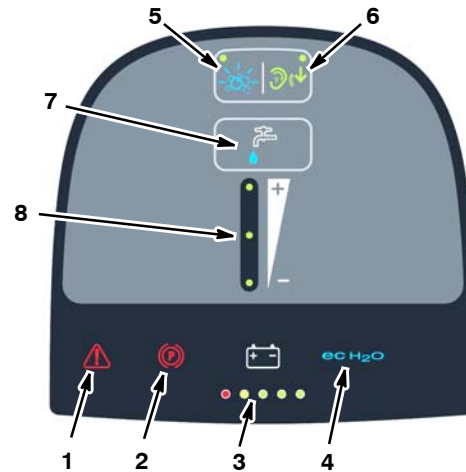

1. **Service indicator** - Lights up when a machine or charger fault is detected.
2. **Parking brake indicator (option)** - Lights up when parking brake lever is engaged. To turn off indicator, disengage parking brake lever near left rear wheel.
3. **Battery discharge indicator (BDI)** - The battery discharge indicator serves two functions. In normal scrub mode it displays the charge level of the batteries. It also, in conjunction when the service indicator is flashing, provides specific LED codes when a machine or charger fault is detected.
4. **ec-H2O indicator (Option)** - Lights up blue when ec-H2O system is activated and operating normally.
5. **Severe Environment on/off button (ec-H2O Model Option)** - Press button to dispense cleaning detergent as needed for excessive soil buildup while operating.
6. **Quiet mode on/off button** - Press button to reduce the vacuum motor sound for noise restricted areas.
7. **Solution flow adjustment button** - Press button to adjust the solution flow setting from low, medium, high or to turn off solution flow.
8. **Solution flow indicator** - Displays solution flow setting.



### T300 Model with Pro-Membrane Control Panel (Actuated Down Pressure Model)

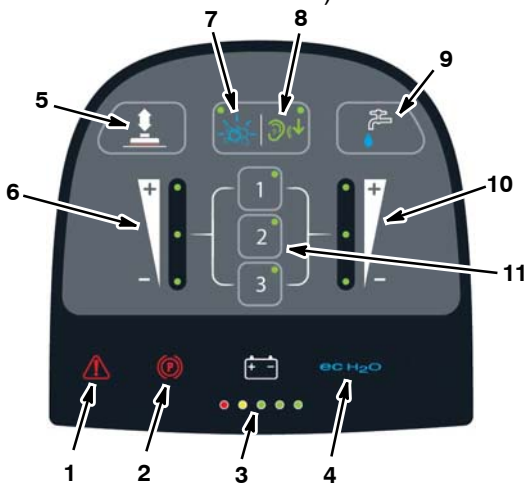

1. **Service indicator** - Lights up when a machine or charger fault is detected.
2. **Parking brake indicator (option)** - Lights up when parking brake lever is engaged. To turn off indicator, disengage parking brake lever near left rear wheel.
3. **Battery discharge indicator (BDI)** - The battery discharge indicator serves two functions. In normal scrub mode it displays the charge level of the batteries. It also, in conjunction when the service indicator is flashing, provides specific LED codes when a machine or charger fault is detected.
4. **ec-H<sub>2</sub>O indicator (Option)** - Lights up blue when ec-H<sub>2</sub>O system is activated and operating normally.
5. **Down pressure adjustment button** - Press button to adjust the down pressure from low, medium or high.
6. **Down pressure indicator** - Displays down pressure setting.
7. **Severe Environment on/off button (ec-H<sub>2</sub>O Model Option)** - Press button to dispense cleaning detergent as needed for excessive soil buildup while operating.
8. **Quiet mode on/off button** - Press button to reduce the vacuum motor sound for noise restricted areas.
9. **Solution flow adjustment button** - Press button to adjust the solution flow setting from low, medium, high or to turn off solution flow.
10. **Solution flow indicator** - Displays solution flow setting.
11. **Zone Settings buttons** - Machine comes with three factory default Zone Settings for quick operation. The factory zone settings are configured with different solution flow rates, down pressures and maximum scrub speeds.

### T300 Model with Pro-Panel Controls (LCD - Liquid Crystal Display)

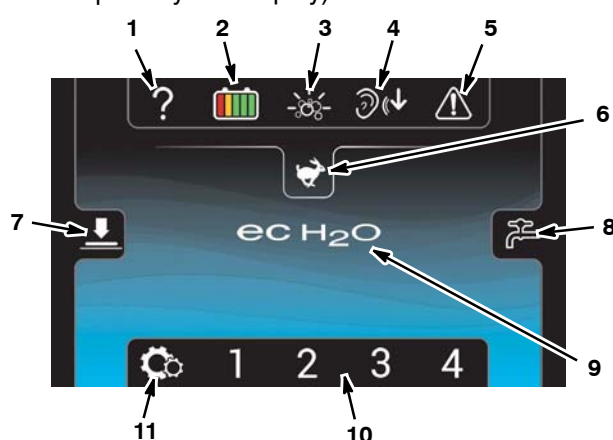

1. **Help icon** - For first time users. Use to select display language, identify control panel symbols and view start-up videos.
2. **Battery discharge indicator (BDI)** - Displays the discharge level of batteries.
3. **Severe Environment icon (ec-H<sub>2</sub>O Model Option)** - Press icon to dispense cleaning detergent as needed for excessive soil buildup.
4. **Quiet mode icon** - Press icon to reduce the vacuum motor sound for noise restricted areas.
5. **Service indicator** - Lights up and begins flashing when a machine or charger fault is detected.
6. **Maximum scrub speed icon** - Press icon to adjust the maximum scrubbing speed. Supervisor mode accessible only.
7. **Down pressure icon** - Press icon to adjust the down pressure setting from low, medium to high.
8. **Solution flow icon** - Press icon to adjust the solution flow setting from low, medium, high or to turn off solution flow.
9. **ec-H<sub>2</sub>O indicator (Option)** - The ecH<sub>2</sub>O icon is displayed when ec-H<sub>2</sub>O system is activated and operating normally.
10. **Zone Settings** - Machine comes with four zone settings for quick operation. The factory default zone settings are configured with different solution flow rates, down pressures and maximum scrub speeds.
11. **Settings icon** - Provides access to training video tutorials, machine software information, battery type selection and supervisor controls. A supervisor can setup users with operator login ID with the ability to program the machine's settings with lock-out functionality.

# OPERATION

## INSTALLING BATTERIES

**⚠ WARNING: Batteries emit hydrogen gas. Explosion or fire can result. Keep sparks and open flame away when charging.**

**FOR SAFETY: When servicing machine, wear appropriate personal protection equipment as needed. Avoid contact with battery acid.**

### BATTERY SPECIFICATIONS

Two 12 volt deep-cycle batteries.

Contact distributor or Tennant for battery recommendations.

**FOR SAFETY: Before leaving or servicing machine, stop on level surface, turn off machine, remove key and set parking brake if equipped.**

1. Lift the recovery tank to access the battery compartment (Figure 1).



FIG. 1

2. With adequate assistance, carefully install the batteries into the battery compartment. Arrange the batteries as shown (Figure 2).

**FOR SAFETY: When servicing machine, use a hoist or adequate assistance when lifting batteries.**

3. Using the supplied battery post boots, connect the cables to the battery posts as shown (Figure 2). Connect the machine's black (-) battery cable last. Use insulated tools when working near batteries.

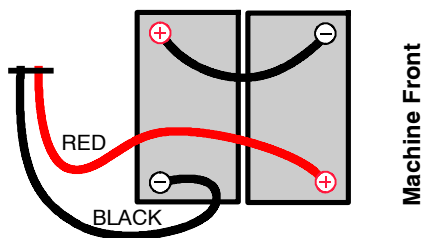

FIG. 2

**IMPORTANT: Make sure that the machine's battery charger is properly set before charging. See BATTERY CHARGER SETTINGS.**

For machines shipped without batteries and equipped with an off-board battery charger, the machine's battery discharge indicator (BDI) is factory programmed for GEL batteries as the default.

If installing flooded (wet) lead/acid or AGM batteries, the BDI MUST be reprogrammed to prevent battery damage and/or short run-time. See BATTERY CHARGER SETTINGS.

### **IRIS® Battery Charging Metrics Notification:**

*Machines equipped with capability to report battery charging data via IRIS are supplied with a charger and set of batteries from the factory. When a battery reaches its end of life and must be replaced, Tennant highly recommends that the same battery type be used to continue to maximize the machines performance. In the event a battery with a different amp hour (AH), type (Flooded, AGM, Gel), or manufacturer is selected for replacement please contact Tennant technical service department for assistance in determining the feasibility of the replacement batteries and if so, selecting the correct charging profile. Availability of IRIS battery metric reporting is not guaranteed with third party supplied batteries.*

### BATTERY PACK LIFT-OUT TRAY (Option)

Models equipped with the optional battery lift-out tray for quick or frequent battery pack exchange.

**FOR SAFETY: Before leaving or servicing machine, stop on level surface, turn off machine, remove key and set parking brake if equipped.**

**⚠ WARNING: Batteries emit hydrogen gas. Explosion or fire can result. Keep sparks and open flame away when charging.**

1. Disconnect the battery cable connection at machine (Figure 3).



FIG. 3

**FOR SAFETY: When servicing machine, wear appropriate personal protection equipment as needed. Avoid contact with battery acid.**

2. Using an approved lift strap that supports the weight of battery pack, connect the strap to the two lift brackets as shown. Using a lift hoist rated to handle the weight of the battery pack, carefully lift the battery packs to and from machine. Keep one hand on the battery lift-out tray when lifting for stability (Figure 4).

Before lifting battery pack, make sure the batteries are secured to the battery lift-out tray with the supplied battery strap as shown (Figure 4).



FIG. 4

3. Reconnect the battery cable connection after installing battery pack.

## HOW THE MACHINE WORKS

### Conventional scrubbing:

When using the conventional scrubbing mode, water and detergent mixture from the solution tank flows to the floor and the rotating brush(es)/pad(s) scrub the floor clean. As the machine moves forward, the squeegee with vacuum suction picks up the dirty solution from the floor into the recovery tank.

### ec-H<sub>2</sub>O NanoClean Technology (option):

When using the ec-H<sub>2</sub>O NanoClean technology, normal water passes through a module where it is electrically converted into a cleaning solution. The electrically converted water attacks the dirt, allowing the machine to easily scrub away the suspended soil. The converted water then returns to normal water in the recovery tank.

## BRUSH AND PAD INFORMATION

For best cleaning results use the appropriate brush or pad for your cleaning application. Listed below are brushes and pads and the applications for which each is best suited.

*NOTE: The amount and type of soilage play an important role in determining the type of brush or pad to use. Contact a Tennant representative for specific recommendations.*

### Soft nylon bristle scrub brush (White) -

Recommended for cleaning coated floors without removing finish. Cleans without scuffing.

### Polypropylene bristle scrub brush (Black) -

This general purpose polypropylene bristle scrub brush is used for scrubbing lightly compacted soilage. This brush works well for maintaining concrete, wood and grouted tile floors.

### Super abrasive bristle scrub brush (Gray) -

Nylon fiber impregnated with abrasive grit to remove stains and soilage. Strong action on any surface. Performs well on buildup, grease, or tire marks.

### Polishing pad (White) -

Used to maintain highly polished or burnished floors.

**Buffing pad (Red)** - Used for light duty scrubbing without removing floor finish.

**Scrubbing pad (Blue)** - Used for medium to heavy-duty scrubbing. Removes dirt, spills, and scuffs and leaves surface clean ready for recoating.

**Stripping pad (Brown)** - Used for stripping of floor finish to prepare the floor for recoating.

**Heavy duty stripping pad (Black)** - Used for aggressive stripping of heavy finishes/sealers, or very heavy duty scrubbing.

**Surface preparation pad (Maroon)** - Used for very aggressive chemical free removal of floor finish to prepare the floor for re-coating

# OPERATION

## MACHINE SETUP

### ATTACHING SQUEEGEE ASSEMBLY

**FOR SAFETY:** Before leaving or servicing machine, stop on level surface, turn off machine, remove key and set parking brake if equipped.

1. Lift the squeegee mount bracket to the raised position. Place toe under pedal to lift (Figure 5).



FIG. 5

2. Mount the squeegee assembly to the squeegee mount bracket (Figure 6). Tighten knobs to secure squeegee assembly to bracket.

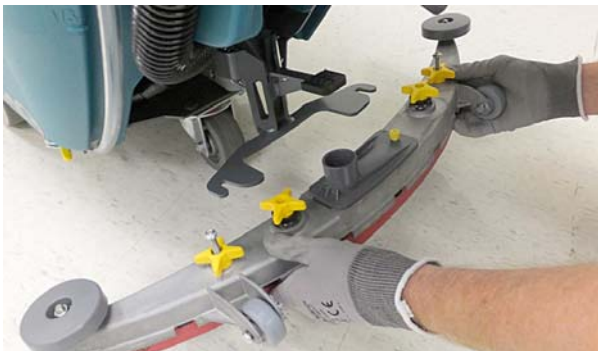

FIG. 6

3. Connect the vacuum hose to the squeegee assembly (Figure 7).

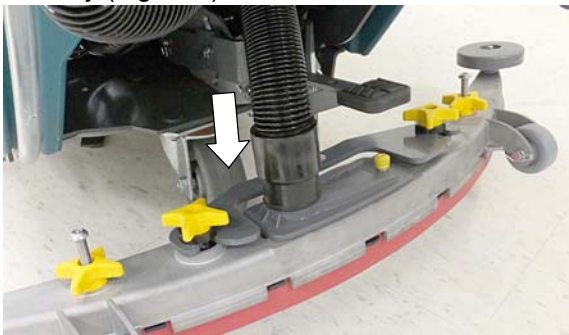

FIG. 7

### INSTALLING BRUSH/PAD - Insta-Click Magnetic Disk

**FOR SAFETY:** Before leaving or servicing machine, stop on level surface, turn off machine, remove key and set parking brake if equipped.

**⚠ WARNING:** Magnetic Field Hazard. Magnetic pad driver/brush can be harmful to pacemaker wearers or medical implants.

1. Step down on the scrub head lift pedal to raise the scrub head off the floor (Figure 8).



FIG. 8

2. Attach the pad to the pad driver before installing the driver (Figure 9). Secure pad with centerlock.

**FOR SAFETY:** Do not operate machine with pads or accessories not supplied or approved by Tennant. The use of other pads may impair safety.

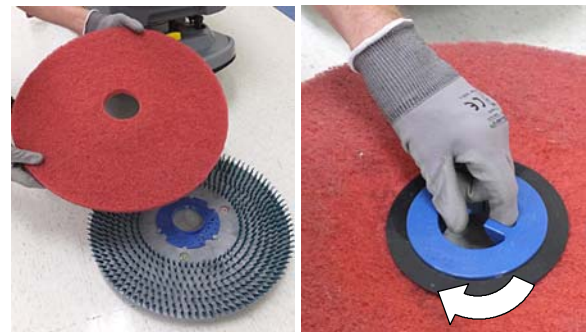

FIG. 9

3. Place the pad driver/brush under the scrub head and lift into position. The Insta-Click pad driver/brush will automatically click into position (Figure 10).



FIG. 10

- To remove the pad driver(s)/brush(es), raise the scrub head and press the yellow plunger button with foot or hand (Figure 11). Pad will drop to floor.

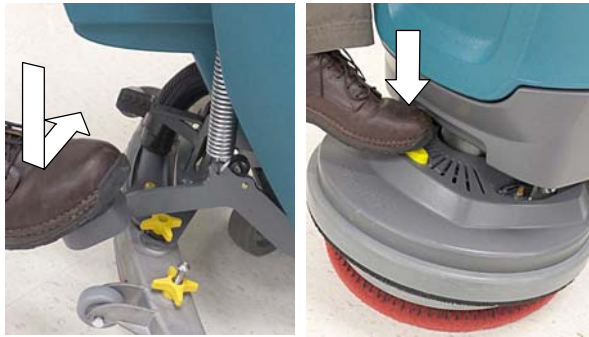

**FIG. 11**

**INSTALLING PAD - Orbital**

For best cleaning performance and to avoid damaging the pad driver plate or floor surface, always use backer pad with work pads (Figure 12).

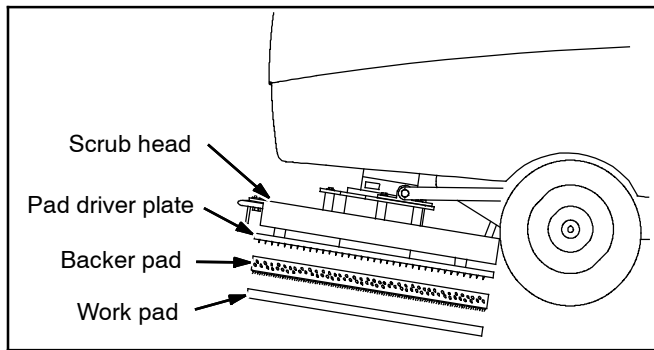

**FIG. 12**

**FOR SAFETY: Before leaving or servicing machine, stop on level surface, turn off machine, remove key and set parking brake if equipped.**

- Step down on the scrub head lift pedal to raise the scrub head off the floor (Figure 13).



**FIG. 13**

- Install the backer pad, retaining strips facing outward, to bottom of scrub head (Figure 14). Make sure pad is centered on scrub head.



**FIG. 14**

- Attach the work pad to the backer pad (Figure 15).



**FIG. 15**

**INSTALLING CYLINDRICAL BRUSHES**

**FOR SAFETY: Before leaving or servicing machine, stop on level surface, turn off machine, remove key and set parking brake if equipped.**

- Step down on the scrub head lift pedal to raise the scrub head off the floor (Figure 16).



**FIG. 16**

## OPERATION

2. Remove the debris tray by sliding it out from the scrub head (Figure 17).

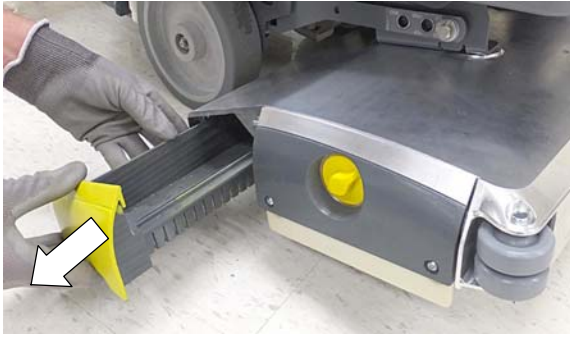

FIG. 17

3. Remove the idler plate from the scrub head by unscrewing the yellow knob (Figure 18).



FIG. 18

4. Slide the brushes into the scrub head and connect the slotted ends of each brush into the drive hubs (Figure 19).

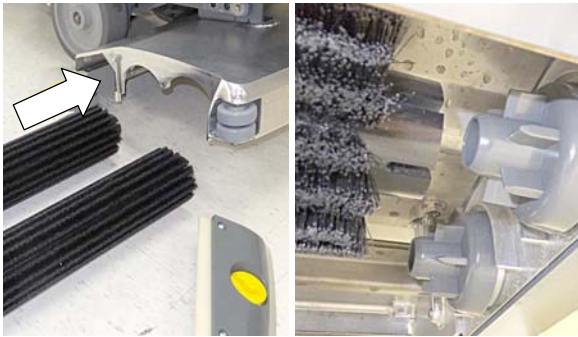

FIG. 19

5. Connect the idler plate to the brush ends and reattach the idler plate. Make sure the idler plate hooks are engaged before tightening knob (Figure 20).



FIG. 20

6. Replace debris tray.

## FILLING SOLUTION TANK

**FOR SAFETY: Before leaving or servicing machine, stop on level surface, turn off machine, remove key and set parking brake if equipped.**

Remove the solution tank lid and fill the solution tank. Stop filling tank when the level reaches the “3/3” mark on the solution tank drain hose indicator (Figure 21).

**ec-H<sub>2</sub>O Scrubbing** - Fill solution tank with only cool clean water (less than 70°F/21°C). Do not add conventional floor cleaning detergents. An ec-H<sub>2</sub>O system fault will occur if cleaning detergents are added.

**Conventional Scrubbing** - Fill solution tank with water (not to exceed 60°C/140°F). Pour a recommended cleaning detergent into the solution tank according to mixing instructions on the container.

*NOTE: Do not use the ec-H<sub>2</sub>O system when there are conventional cleaning detergents in the solution tank. Drain, rinse, and refill the solution tank with clear cool water before operating the ec-H<sub>2</sub>O system. Conventional cleaning detergents will cause an ec-H<sub>2</sub>O system fault.*

**⚠ WARNING: Flammable materials can cause an explosion or fire. Do not use flammable materials in tank(s).**

**ATTENTION:** For Conventional Scrubbing, only use commercially approved cleaning detergents. Machine damage due to improper detergent usage will void the manufacturer's warranty.



FIG. 21

The solution tank fill-port is equipped with two hose clips to hold hose while filling. The two clips are different hose diameter sizes (Figure 22).

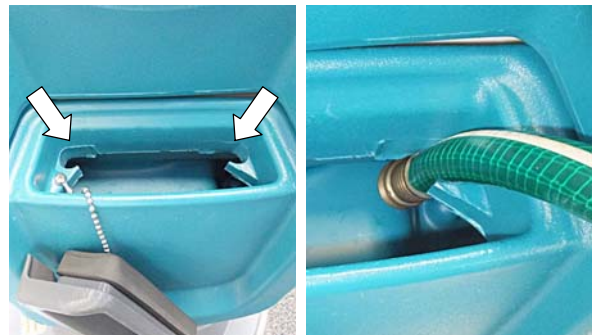

FIG. 22

### FILLING SEVERE ENVIRONMENT TANK (ec-H2O model Option)

The ec-H2O NanoClean model may come equipped with the optional Severe Environment mode. The Severe Environment button allows you to dispense cleaning detergent as needed for excessive soil buildup.

1. Lift the recovery tank to access the severe environment tank (Figure 23). Drain recovery tank before lifting tank.



FIG. 23

2. Remove cap from tank and add a recommended cleaning detergent at full concentration (Figure 24). Do not add water. Replace cap.



FIG. 24

**⚠ WARNING: Flammable materials can cause an explosion or fire. Do not use flammable materials in tank(s).**

**ATTENTION:** Only use commercially approved cleaning detergents in the severe environment tank. Do not use cleaners based with d-limonene. Machine damage due to improper detergent usage will void the manufacturer's warranty.

**NOTE:** To prevent from running out of detergent while operating, it is recommended to refill the severe environment tank when refilling the solution tank.

3. Adjust the mixing ratio knob according to the cleaning detergent's mixing instructions (Figure 25).



FIG. 25

### ec-H2O NanoClean WATER CONDITIONING CARTRIDGE (ec-H2O model)

The ec-H2O system is equipped with a water conditioning cartridge (Figure 26). The cartridge is designed to protect the machine's plumbing system from potential scaling.

The cartridge is required to be replaced when it reaches its maximum water usage or expiration time of when the cartridge was activated, whichever comes first.

Depending on machine usage a new cartridge can last anywhere from 12 to 24 months.

The control panel will signal a code when it's time to replace cartridge. See SERVICE INDICATOR CODES for further details.



FIG. 26

All cartridges are labeled with a manufacture date. The shelf-life of an un-installed cartridge is one year from manufacture date. For new cartridge replacement, the ecH2O module timer must be reset. See ec-H2O NanoClean WATER CONDITIONING CARTRIDGE REPLACEMENT.

**ATTENTION:** During first time use and after replacing the water conditioning cartridge, the ec-H2O system will automatically override the selected solution flow rate for up to 75 minutes.

# OPERATION

## ACCESSORY RAIL

The machine is equipped with an accessory rail which also serves as the recovery tank and solution tank drain hose holder.

The accessory rail is designed to store the squeegee assembly and other accessory items (Figure 27).

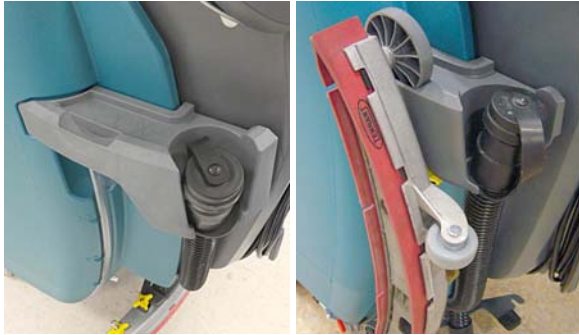

FIG. 27

Actuated Down Pressure Models - A debris bag hook is located on the left side of the control console (Figure 28).



FIG. 28

**ACCESSORY CLIPS (Option)** - If model is equipped with the optional accessory clips, the clips easily clip on and off the rail for additional accessory storage (Figure 29).

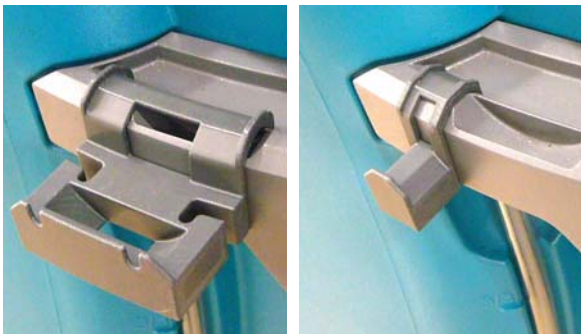

FIG. 29

To install the accessory clips, hook the clip over the rail and push downward until it snaps into position. To remove the accessory clip, reach under the clip and carefully pull the latch tab downward to release from rail. (Figure 30)

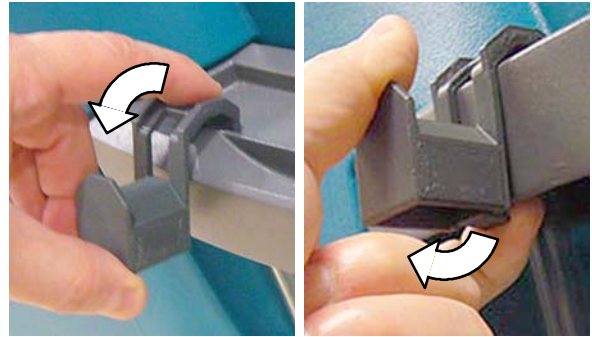

FIG. 30

The optional accessory clips allow for storage of wet floor signs, spray bottles, squeegee assembly, debris bags and other items (Figure 31).



FIG. 31



**ATTENTION:** Do not use the accessory rails to lift machine, damage may occur.



**ATTENTION:** Do not step on accessory rails, damage may occur.



## CONTROL PANEL OPERATION

### T300 WITH MEMBRANE CONTROL PANEL (Manual Down Pressure Model)

1. Turn the key to on ( I ) position to power up machine.

Models equipped with the ec-H2O option - The ecH2O system will automatically turn on at start up. A blue ec-H2O icon will appear on the control panel (Figure 32). This indicates that the ecH2O system is turned on and ready for operation. To turn off the ec-H2O system, press the ec-H2O switch located below the key switch.

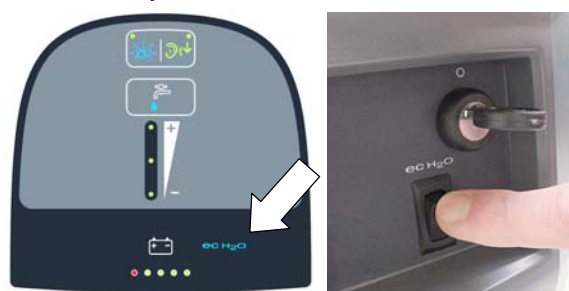

FIG. 32

2. Press the solution flow button to increase or decrease the solution flow rate (Figure 33). The solution flow indicator will display flow setting. No LED = No flow, One LED = Low flow, two LED's = Medium flow, three LED's = High flow.

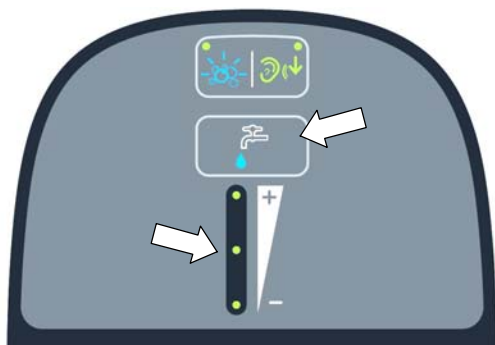

FIG. 33

3. Models equipped with Severe Environment button option - Press Severe Environment button one time to dispense cleaning detergent for 30 seconds (Figure 34). A green LED in the corner will blink slowly when dispensing. During the last 5 seconds, the LED will blink rapidly as an alert that the dispensing is about to stop. For continuous dispense, press and hold the button for 2 seconds until LED turns solid green. Press button at anytime to turn off.

The icon will blink blue when the severe environment tank needs to be refilled.

*NOTE: When the severe environment mode is turned on, the solution flow setting will automatically increase to the high setting. When turned off, the setting will revert back to the original setting. When operating the Severe Environment mode for extended periods, if desired, the solution flow rate can be decreased to a lower setting to conserve solution and detergent usage.*

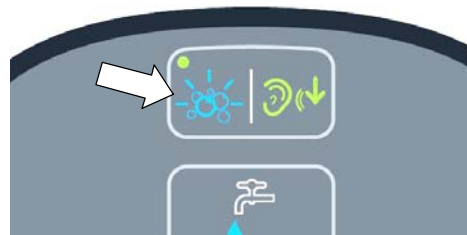

FIG. 34

4. Press the Quiet-Mode button to reduce the vacuum motor sound (Figure 35). A green LED in the corner will turn on when mode is activated. Press button to turn off.

*NOTE: Water pickup will reduce slightly when Quiet-Mode is activated.*



FIG. 35

5. If a machine fault is detected during operation, the service indicator will light up and begin flashing (Figure 36). See SERVICE INDICATOR CODES.

If the ec-H2O system detects a fault during operation, the ec-H2O icon will turn red or blink red. See SERVICE INDICATOR CODES.

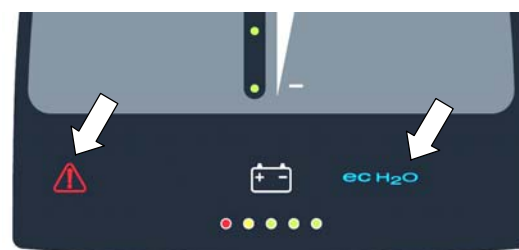

FIG. 36

ec-H2O INDICATOR	CONDITION
Solid blue	Normal operation
Blinking blue/red	Water conditioning cartridge expired. Replace cartridge.
Solid or blinking red	See Service Indicator Codes.

# OPERATION

## T300 WITH PRO-MEMBRANE CONTROL PANEL (Actuated Down Pressure Model)

The control panel operation can be set up with lockout functionality by using the supervisor controls feature. This will prevent an operator from changing or saving the Zone Settings. See SUPERVISOR CONTROLS instructions at back of manual.

1. Turn the key to on ( I ) position to power up machine.

Models equipped with the ec-H<sub>2</sub>O option - The ecH<sub>2</sub>O system will automatically turn on at start up. A blue ec-H<sub>2</sub>O icon will appear on the control panel (Figure 37). This indicates that the ecH<sub>2</sub>O system is turned on and ready for operation. To turn off the ec-H<sub>2</sub>O system, press the ec-H<sub>2</sub>O switch located below the key switch.



FIG. 37

2. Press the down pressure button to increase or decrease the down pressure (Figure 38). The down pressure indicator will display the pressure setting. One LED = Low pressure, two LED's = Medium pressure, three LED's = High pressure.

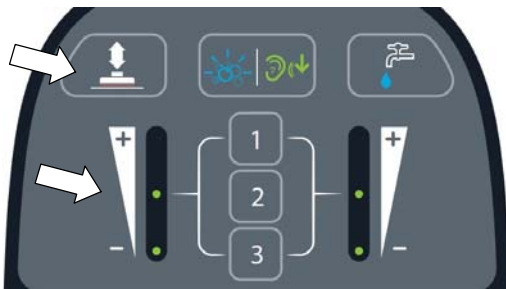

FIG. 38

3. Press the solution flow button to increase or decrease the solution flow rate (Figure 39). The solution flow indicator will display flow setting. No LED = No flow, One LED = Low flow, two LED's = Medium flow, three LED's = High flow.

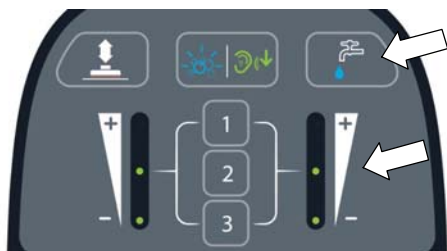

FIG. 39

4. Models equipped with Severe Environment button option - Press Severe Environment button one time to dispense cleaning detergent for 30 seconds (Figure 40). A green LED in the corner will blink slowly when dispensing. During the last 5 seconds, the LED will blink rapidly as an alert that the dispensing is about to stop. For continuous dispense, press and hold the button for 2 seconds until LED turns solid green. Press button at anytime to turn off.

The icon will blink blue when the severe environment tank needs to be refilled.

*NOTE: When the severe environment mode is turned on, the down pressure and solution flow settings automatically increase to the high setting. When turned off, the settings revert back to the original settings. When operating the Severe Environment mode for extended periods, if desired, the solution flow rate and the down pressure can be decreased to a lower setting to conserve solution and detergent usage and optimize battery run time.*



FIG. 40

5. Press the Quiet-Mode button to reduce the vacuum motor sound (Figure 41). A green LED in the corner will turn on when mode is activated. Press button to turn off.

*NOTE: Water pickup will reduce slightly when Quiet-Mode is activated.*



FIG. 41

- Press the Zone Setting numbers for quick operation (Figure 42). The three preset zones are factory configured with different solution flow rates and down pressures.

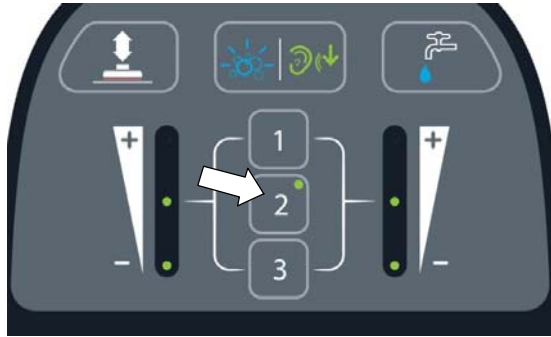

FIG. 42

To change the Zone Settings for a specific scrubbing application, configure the new zone settings and press and hold the zone button until it blinks three times to save new zone setting.

The zone settings can configure the following controls:

- Down pressure rate
- Solution flow rate
- Quiet-Mode on or off (option)
- ec-H2O mode on or off (option)
- Severe Environment mode on or off (option).

*NOTE: The severe environment mode and ec-H2O mode cannot be configured together.*

- If a machine fault is detected during operation, the service indicator will light up and begin flashing (Figure 43). See SERVICE INDICATOR CODES.

If the ec-H2O system detects a fault during operation, the ec-H2O icon will turn or blink red. See SERVICE INDICATOR CODES.

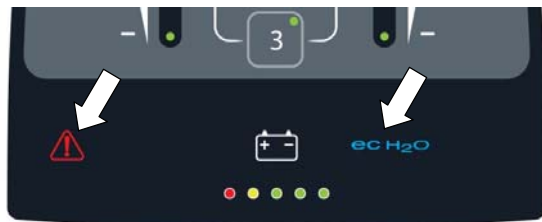

FIG. 43

ec-H2O INDICATOR	CONDITION
Solid blue	Normal operation
Blinking blue/red	Water conditioning cartridge expired. Replace cartridge.
Solid or blinking red	See Service Indicator Codes.

### T300 MODEL WITH PRO-PANEL CONTROLS

There are two types of user modes that will interface with the operator home screen:

**Operator Mode** - Capable of machine operation with permissions and restrictions controlled by the supervisor.

**Supervisor Mode** - Capable of machine operation with full use of all controls, along with configuring permissions and restrictions for the operator mode.

A new machine from the factory will automatically start up in the supervisor mode by default. To configure the control panel with permissions and restrictions for the operator mode, see SUPERVISOR CONTROLS instructions at back of manual.

- Turn the key to on ( I ) position. At start up, a Tennant logo screen will first appear followed by the operator home screen as shown below (Figure 44).



FIG. 44

Models equipped with the ec-H2O option, the ec-H2O icon will appear at the center of the display. This indicates the ec-H2O system is turned on and ready for operation. The ec-H2O system will automatically turn on at start up.

To turn off the ec-H2O system, press the ec-H2O on/off switch located below the key switch. A slash mark over the icon will indicate that the ec-H2O system is turned off (Figure 45).



FIG. 45

# OPERATION

When supervisor controls are configured for the operator mode, a login screen will appear at start up (Figure 46 ). Enter the login number assigned by the supervisor and press the green arrow to access the operator home screen. See SUPERVISOR CONTROLS instructions at back of manual.



FIG. 46

- For first time users, press the help icon on the operator home screen (Figure 44). The help screen, shown below, will allow you to select a different display language, help identify control panel icons and view start-up operator videos (Figure 47).

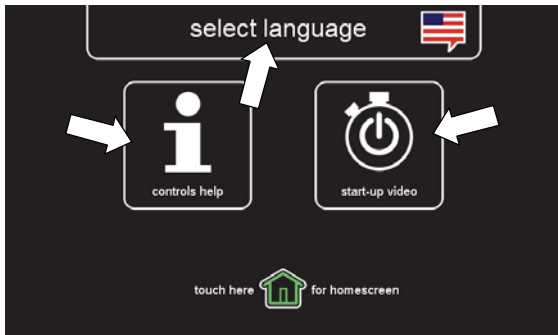

FIG. 47

Press the home screen icon at anytime to return to the operator home screen.

- Press the down pressure icon to display the down pressure scale (Figure 48). Press the (+) symbol to increase down pressure. Press the (-) symbol to decrease the down pressure.

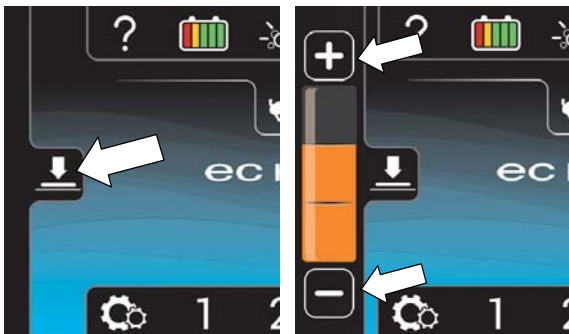

FIG. 48

- Press the solution flow icon to display the solution flow scale (Figure 49). Press the (+) symbol to increase solution flow. Press the (-) symbol to decrease the flow solution or to turn it off.

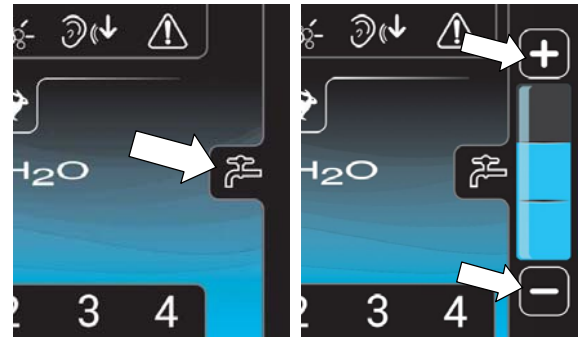

FIG. 49

- Press the maximum scrub speed icon to display the maximum speed scale (Figure 50). Press (+) symbol to increase the maximum scrub speed. Press the (-) symbol to decrease the maximum scrub speed. Only accessible in Supervisor Mode.

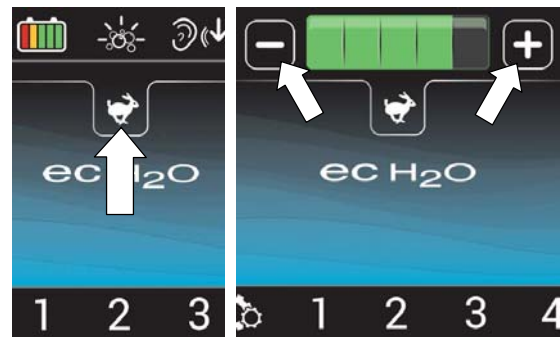

FIG. 50

- Models equipped with Severe Environment option - Press the Severe Environment icon once to dispense cleaning detergent for 30 seconds. The icon will turn green and a 30 second count down timer will start. For continuous dispensing of detergent, press and hold the icon for 2 seconds until a continuous timer is displayed. Press the icon at anytime to turn off. (Figure 51). The icon will blink yellow when the severe environment tank needs to be refilled.

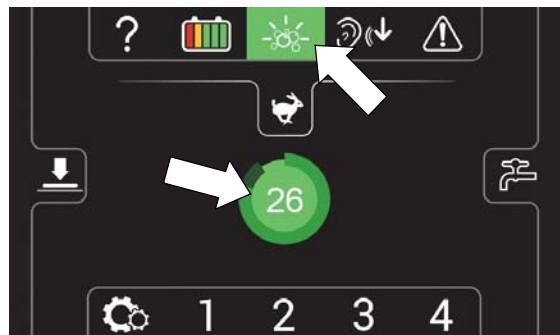



FIG. 51

*NOTE: When the severe environment mode is turned on, the down pressure and solution flow settings automatically increase to the high setting. When turned off, the settings revert back to the original settings. When operating the Severe Environment mode for extended periods, if desired, the solution flow rate and the down pressure can be decreased to a lower setting to conserve solution and detergent usage and optimize battery run time.*

7.  Press the quiet mode icon to reduce the vacuum motor sound for noise restricted areas (Figure 52). The icon will turn green when activated. Press again to turn off.

*NOTE: When the Quiet-Mode is activated the water pickup will slightly be reduced.*

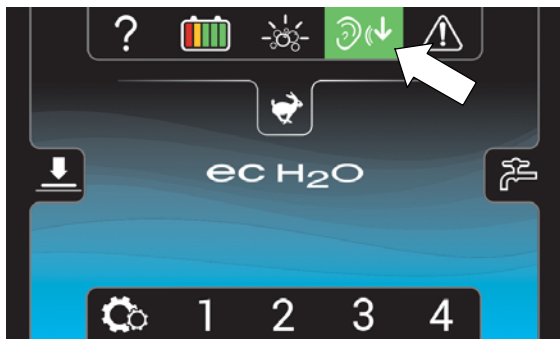

FIG. 52

8. Press the Zone Setting numbers for quick operation (Figure 53). The zone number will turn green when activated. Each Zone Setting number is factory configured with different solution flow rates, down pressures and maximum scrub speeds.

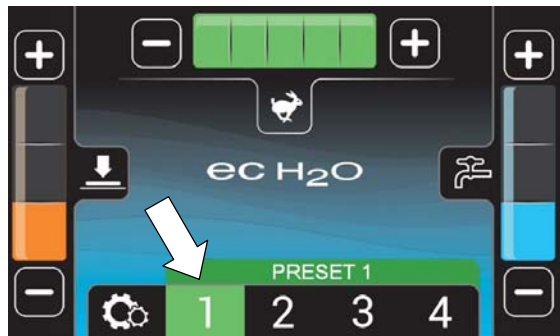

FIG. 53

To change the default zone settings - Configure the desired zone settings then press and hold the zone number button until it prompts you to name the new zone setting. Select “yes” to enter a new name (Figure 54). By selecting “no”, the preset name will be removed.

*NOTE: Only the supervisor mode has the capability to change the factory zone settings (See SUPERVISOR CONTROLS instructions at back of manual).*

The zone settings can configure the following controls:

- Down pressure rate
- Solution flow rate
- Quiet-Mode on or off (option)
- Maximum scrub speed (drive model)
- ec-H2O mode on or off (option)
- Severe Environment mode on or off (option).

*NOTE: The Severe Environment and ec-H2O modes cannot be configured together.*



FIG. 54

If the zone settings are configured to scrub a lobby for example, rename the zone “LOBBY” (Figure 55). Press the green arrow to set new zone setting.



FIG. 55

The name will appear above the zone setting number when the zone button is pressed (Figure 56). Repeat process for other zone settings.

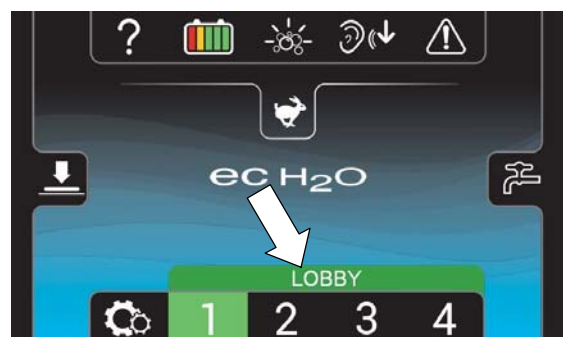



FIG. 56

## OPERATION

9.  Press the Settings icon on the operator home screen to access the following screen (Figure 57). The buttons are explained as follows.

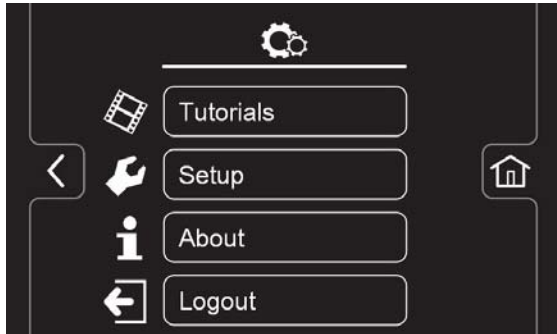



FIG. 57

-  Tutorials button - Includes videos on how to perform specific operation and maintenance procedures. Press the video icons to start videos (Figure 58).

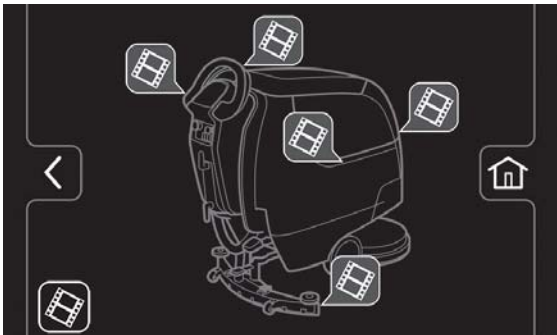





FIG. 58

-  Setup button - Requires the user to be in supervisor mode to access machine setup. See SUPERVISOR CONTROLS instructions at back of manual.

-  About button - Includes machine systems information.

-  Logout button - Required when supervisor controls are configured with assigned login numbers. See SUPERVISOR CONTROLS instructions at back of manual.

10.  The service indicator icon on the home screen will flash yellow or red when a machine fault is detected (Figure 59).



FIG. 59

In conjunction with a flashing service indicator icon, the following fault screens will automatically pop up to indicate the problem.

**Yellow machine fault icon** (Figure 60). See SERVICE INDICATOR CODES to diagnose machine fault.



FIG. 60

**Red or Yellow ec-H2O system fault icon** (Figure 61). See SERVICE INDICATOR CODES to diagnose ec-H2O system fault.

When the ec-H2O system fault icon is **blinking Blue and Red**, the water conditioning cartridge has expired and needs to be replaced. See ec-H2O NanoClean WATER CONDITIONING CARTRIDGE REPLACEMENT.



FIG. 61

**Yellow Parking brake Icon** (figure 62). Parking brake lever must be released before operating.



FIG. 62

Press arrows at top of screen to cycle through fault screens.

## MACHINE OPERATION

**FOR SAFETY: Do not operate machine unless operator manual is read and understood.**

### PRE-OPERATION CHECK LIST

- Sweep area and remove any obstructions.
- Check brushes/pads for wear and damage.
- Check squeegee blades for wear and damage.
- Confirm recovery tank empty and screen and debris tray is clean.
- Check scrub head skirt for wear and damage.
- Cylindrical brush model - confirm scrub head debris tray is empty and clean.
- ec-H2O Scrubbing: Confirm solution tank is filled with clear cool water only.
- ec-H2O Scrubbing: Ensure all conventional cleaning agents/restorers are drained and rinsed from solution tank.
- Check machine for proper operation.

### OPERATING MACHINE

For control panel operating instructions, see CONTROL PANEL OPERATION.

1. Release the parking brake lever, if equipped (Figure 63)
2. Turn the key to the on ( I ) position (Figure 63).

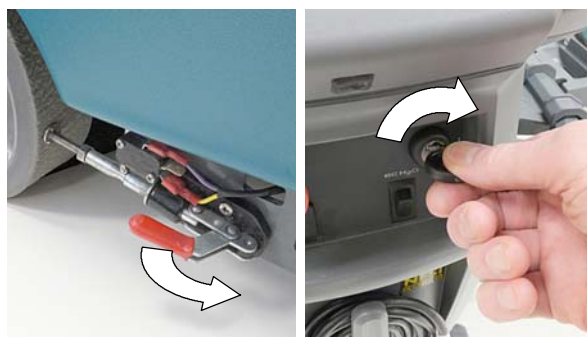

FIG. 63

3. ec-H2O models - The ec-H2O system will automatically turn on at start up. To turn off the ec-H2O system, press the ec-H2O switch located below the key switch.

**ATTENTION:** During first time use and after replacing the water conditioning cartridge, the ec-H2O system will automatically override the selected solution flow rate for up to 75 minutes.

**ATTENTION:** If cleaning detergent is accidentally cycled through ec-H2O system, immediately turn the ec-H2O system off. Drain solution tank, refill with cool water and operate the ec-H2O system to flush out detergent.

4. Lower the scrub head to the floor by stepping on the scrub head lift pedal as shown (Figure 64).



FIG. 64

5. Lower the squeegee assembly to floor by stepping on foot pad as shown (Figure 65). To raise squeegee assembly, place toe under foot pad and lift. The vacuum motor will start when squeegee assembly is lowered.

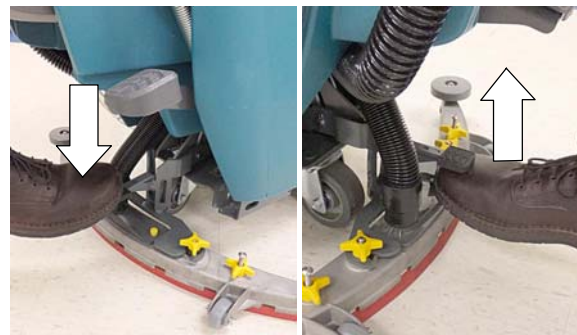

FIG. 65

6. Drive models - push the directional lever to the forward position to go forward (Figure 66). To reverse the machine pull the directional lever backwards.



FIG. 66

## OPERATION

7. To begin scrubbing, pull the start bail (Figure 67).



FIG. 67

8. Drive models - Adjust the scrubbing speed by turning the speed dial to the desired speed (Figure 68).

Push models - Slowly push the machine forward. The rotating brush(es) will help assist the machine forward.



FIG. 68

9. Manual down pressure model - When extra brush pressure is needed for heavily soiled areas lift the dual down pressure lever (Figure 69).

*NOTE: Release the down pressure lever before raising scrub head.*



FIG. 69

10. To stop scrubbing, release the start bail and raise the scrub head and squeegee assembly off floor. Turn key off and set parking brake, if equipped.

## WHILE OPERATING MACHINE

**⚠ WARNING: Flammable materials materials or reactive metals can cause an explosion or fire. Do not pick up.**

1. Overlap each scrub path by 2 inches (5 cm).
2. Keep machine moving to prevent damage to floor finish.
3. Wipe squeegee blades with a cloth if blades leave streaks.
4. Avoid bumping the machine into posts and walls.
5. When draining and refilling machine, always top off the optional Severe Environment tank with detergent.

**FOR SAFETY: When operating machine, do not scrub on inclines that exceed 9% grade or transport on inclines that exceed 21% grade.**

6. Pour a recommended foam control solution into the recovery tank if excessive foam appears.

**ATTENTION:** Foam buildup will not activate the float shut-off screen, vacuum motor damage will result.

7. Use the double scrubbing method for heavily soiled areas. First scrub the area with the squeegee up, let solution set for 3-5 minutes, then scrub the area a second time with squeegee down.
8. Orbital Scrub Head Model - Use caution when working near the tile cove (Figure 70) and floor mounted fixtures such as pedestal sinks and other breakable items. Keep the metal scrub head edge away to avoid possible damage.

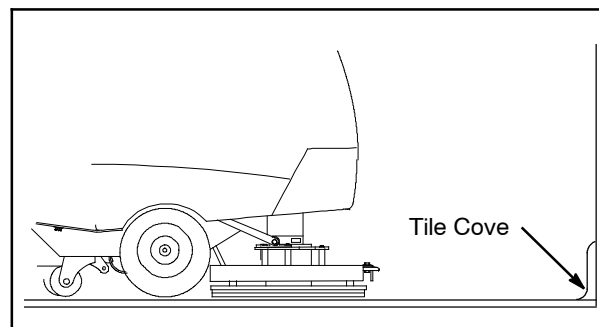

FIG. 70

9. When leaving the machine unattended, remove the key and set the parking brake, if equipped.
10. Do not operate machine in areas where the ambient temperature is above 110°F/43°C or below freezing 32°F/0°C.



**EMERGENCY SHUT-OFF BUTTON (Drive models)**

Push the emergency shut-off button in the event of an emergency (Figure 71). This red button shuts off all power to machine. To regain power, turn the button clockwise and restart the key.

Only use this button in the event of an emergency. It is not intended for routine machine shutdown.



FIG. 71

**BATTERY DISCHARGE INDICATOR**

The battery discharge indicator (BDI) displays the charge level of the batteries while the machine is operating. When the batteries are fully charged, all five indicators are lit (Figure 72). When the discharge level reaches the red light, stop scrubbing and recharge the batteries. If the red light begins to flash, the scrubbing function will automatically shut off to protect the batteries from total discharge. Drive Model: The machine will still propel when the red light is flashing, this will allow user to transport machine to charging station.

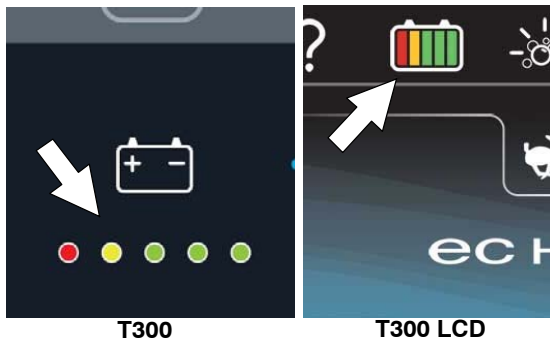

FIG. 72

**CIRCUIT BREAKER PANEL**

The machine is equipped with resettable circuit breakers to protect the machine from a current overload. If a circuit breaker trips, disconnect the battery cable connections and reset the breaker by pressing the reset button after the breaker has cooled down. Reconnect the battery cable connections. If the circuit breaker does not reset or continues to trip contact service personnel.

The circuit breaker panel is located near the battery compartment and identified as described below (Figure 73).

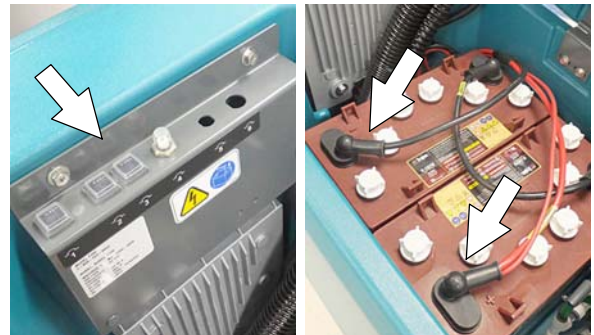

FIG. 73

Circuit Breaker	Rating	Circuit protected
CB1	4 A	Key switch, control board
CB2	4 A	ec-H2O module
CB3	4 A	ec-H2O pump
CB4	30 A	Propel

**FOR SAFETY: When servicing machine, all repairs must be performed by trained personnel.**

The circuit breaker panel is protected by a splash guard. To access the circuit breaker panel when the recovery tank is in the down position lift the splash guard as shown (Figure 74).



FIG. 74

# OPERATION

## HR METER

The hour meter records the number of hours the machine has been operated. Use the hour meter to perform specific maintenance procedures and to record service history (Figure 75).



FIG. 75

## DRAINING TANKS

**FOR SAFETY:** Before leaving or servicing machine, stop on level surface, turn off machine, remove key and set parking brake if equipped.

### DRAINING RECOVERY TANK

Drain and clean the recovery tank daily and between solution tank refills.

1. Transport the machine to drain area.
2. For models equipped with drain hose caps, hold the hose upward, remove cap then slowly lower hose to drain. For models equipped with flow control valve drain hose, lower hose and slowly open valve to drain (Figure 76).



FIG. 76

**NOTE:** When using a bucket to drain the machine, do not use the same bucket to fill the solution tank.

3. Remove and clean the float shut-off screen (Figure 77).

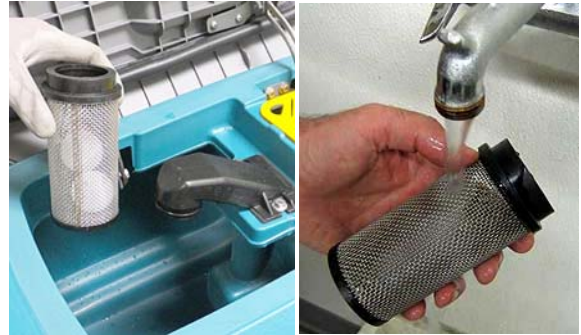

FIG. 77

4. Remove the debris tray and empty (Figure 78).



FIG. 78

5. Rinse out the recovery tank with clean water and wipe clean of any soil residue (Figure 79).

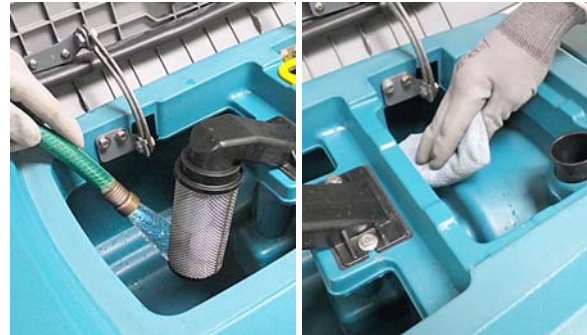

FIG. 79

## DRAINING SOLUTION TANK

Drain the solution tank daily.

1. Transport the machine to drain area.

**FOR SAFETY: Before leaving or servicing machine, stop on level surface, turn off machine, remove key and set parking brake if equipped.**

2. To drain remaining water from solution tank, pull the solution hose from the accessory rail (Figure 80).

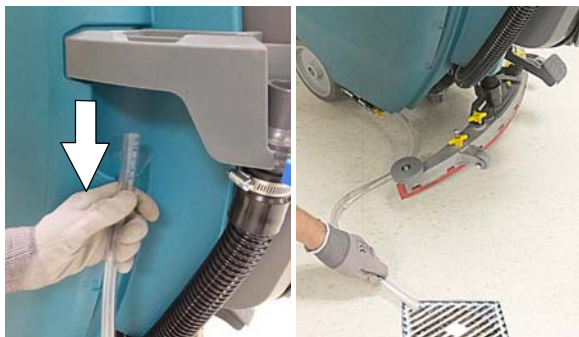

FIG. 80

Firmly reconnect the solution hose to accessory rail after draining tank.

3. Rinse out solution tank with clean water (Figure 81).



FIG. 81

4. Remove the solution tank filter and clean screen after every 50 hours of use (Figure 82). Solution filter is located under machine at rear. Drain solution tank before removing filter.

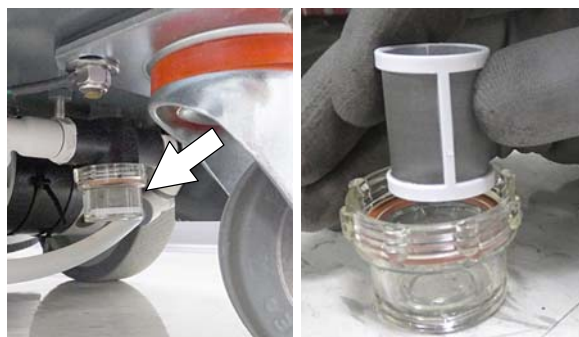

FIG. 82

# OPERATION

## SERVICE INDICATOR CODES

When the machine or battery charger detects a fault, the service indicator will flash. A fault code will be provided to determine problem as described below.

### T300 Membrane Control Panels

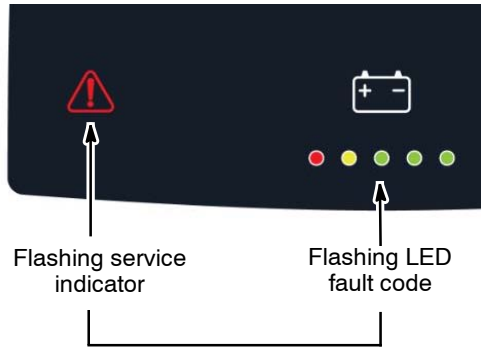

### T300 Pro-Panel Controls (LCD)

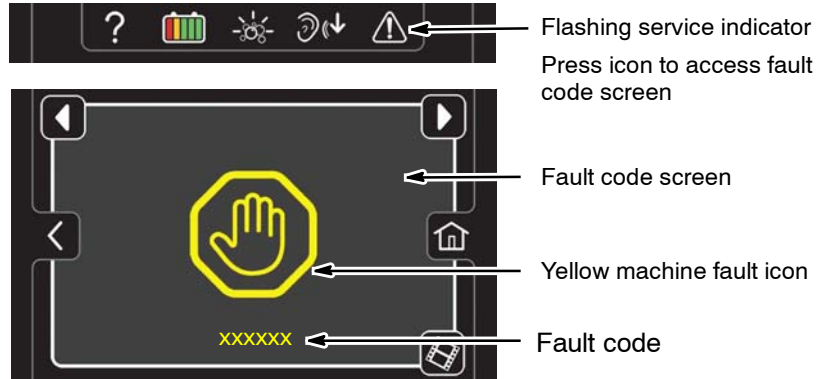

LED Fault Code * = Flashing	LCD Fault Code	CAUSE	SOLUTION
* * * * *	0xFFF0	Emergency stop button activated.	Release emergency stop button and restart machine.
. . . * .	0x0201	Head lift actuator, wiring, connector or control board problem.	Contact service.
. . . * *	0x0101	Brush motor wiring, connector or control board problem.	Contact service.
* * * * .	0x0102	Voltage loss.	Contact service.
. * . . *	0x0301	Solution valve wiring, connector or control board problem.	Check connections. Contact service.
. * . * *	0x0303	Solution valve over current.	Contact service.
* . * * .	0x0307	Solution valve control board fault.	Contact service.
. . * . .	0x0501	Vacuum motor wiring, connector or control board problem.	Contact service.
. . * . *	0x0601	Severe environment detergent pump wiring, connector or control board problem.	Contact service.
. . * * .	0x0910	Propel circuit breaker tripped.	Disconnect battery and reset circuit breaker. If trip repeats, contact service.
. . * * *	0x0901	Propel motor wiring, connector or control board problem.	Contact service.
. * . * *	0xFF00	Software load failure.	Contact service.
* . . . *	0x0900 0x0903 0x0904 0x0905 0x0908→0x0942 0x090A→0x093B	Propel I-Drive fault Propel I-Drive communication lost Propel power cycle fault Propel current limit fault Propel faults Propel faults	Restart machine. If fault repeats, contact service.
* . . * .	0x0906 0x0907	Propel motor shorted fault	Contact service.

## SERVICE INDICATOR CODES - Continued

LED Fault Code * = Flashing	LCD Fault Code	CAUSE	SOLUTION
* • • * *	0x0103 0x0104 0x0105	Brush motor over current	Contact service.
* • * • *	0x0902	Start bail is pulled or obstructed before turning machine on.	Release start bail or remove bail obstruction before turning machine on.
* • * * •	0x0107 0x0207 0x0507 0x0607	Brush motor control board fault Actuator motor control board fault Vacuum motor control board fault Detergent pump control board fault	Disconnect battery cable connection and contact service to replace control board.
* • * * *	0x0503 0x0504 0x0505	Vacuum motor over current.	Contact service.
* * • • •	0x0506	Vacuum motor shorted fault.	Contact service.
* * • • *	0x0603 0x0604 0x0605	Severe environment detergent pump over current.	Contact service.
* * • * •	0x0606	Severe environment detergent pump shorted fault.	Contact service.
* * * • *	0x0106	Brush motor shorted fault.	Contact service.
• * * * •	0xF103 0xFF20 0x0704	Charger communication fault Scrub control board comm. fault ec-H2O system comm. fault	Restart. If fault code persists, contact service.

## ON-BOARD BATTERY CHARGER SERVICE INDICATOR CODES

LED Fault Code * = Flashing	LCD Fault Code	CAUSE	SOLUTION
* * * • •	0xF100	Charger error condition.	Contact service.
• * * • •	0xF101	Charger is not connected to battery pack.	Check cable connections.
• * • • •	0xF102	Charger overheated.	Let charger cool. Move to well ventilated area. Charge batteries in areas with temperatures 80°F/27°C or less. If fault persists, contact service.
• * * * •	0xF103	Charger communication fault	Restart charger. If fault code persists, contact service.
• * * • *	0xF104	Charger timer exceeded maximum charging time. Interrupts charging cycle.	Replace Batteries.

# OPERATION

## ec-H2O SYSTEM SERVICE INDICATOR CODES - OPTION

### T300 Membrane Control Panel

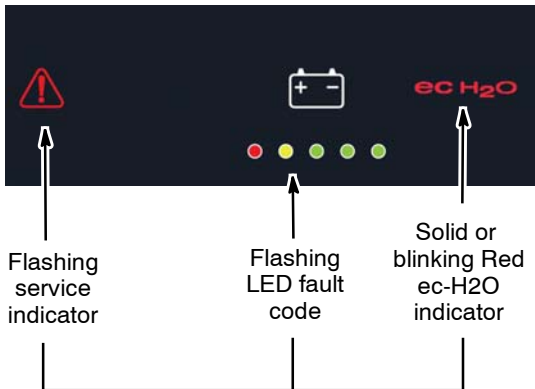

### T300 Pro-Panel Controls (LCD)

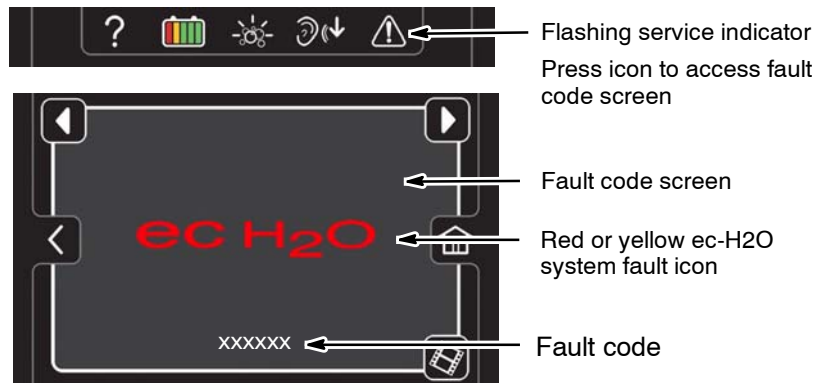

LED Fault Code * = Flashing	LCD Fault Code	CAUSE	SOLUTION
• * * * •	0x0704	ec-H <sub>2</sub> O system comm. fault	Restart. If fault code persists, contact service.
• * • * •	0x0711	ec-H <sub>2</sub> O pump wiring, connector or control board problem.	Contact service.
• * * * *	0x0713 0x0714	ec-H <sub>2</sub> O pump over current	Contact service.
* • * • •	0x0703 0x0712	ec-H <sub>2</sub> O system breaker tripped ec-H <sub>2</sub> O pump breaker tripped	Reset circuit breaker. If trip repeats, contact service.
ecH <sub>2</sub> O indicator solid red	0x0716 0x0717 0x0727 0x0741 0x0746 0x0747	ec-H <sub>2</sub> O pump shorted fault ec-H <sub>2</sub> O pump control board fault ec-H <sub>2</sub> O control board fault Water conditioning pump open Water conditioning pump fault Water conditioning pump control board fault	Contact service.
ecH <sub>2</sub> O indicator blinking red*	0x0702 0x0708* 0x072A 0x0721 0x0723 0x0726	ec-H <sub>2</sub> O pressure switch trip ec-H <sub>2</sub> O system over regulation ec-H <sub>2</sub> O electrode fault No ec-H <sub>2</sub> O cell current ec-H <sub>2</sub> O cell over current ec-H <sub>2</sub> O cell shorted fault	Contact service.
ecH <sub>2</sub> O indicator blinking blue/red		Water conditioning cartridge expired	Replace water conditioning cartridge.

\*Verify if cleaning detergent was added to solution tank. If ec-H<sub>2</sub>O system was operated with cleaning detergent, drain solution tank, add clear water and operate the ec-H<sub>2</sub>O system until the fault code clears.

MAINTENANCE CHART

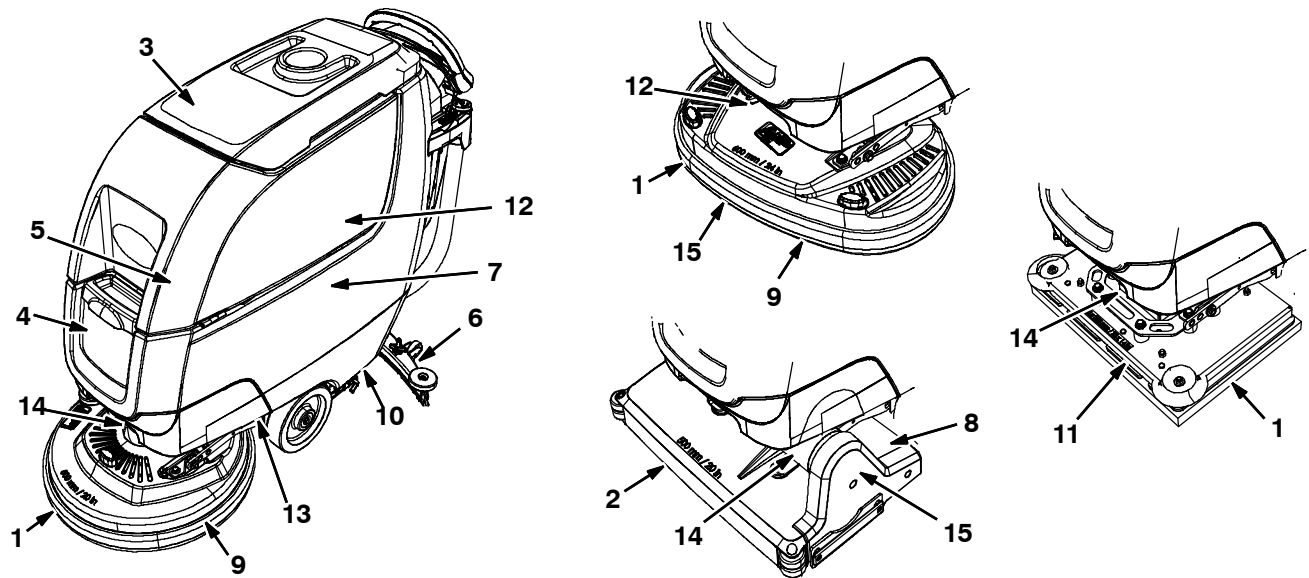

Interval	Person Resp.	Key	Description	Procedure
Daily	O	1	Pad(s)	Check, flip or replace
	O	1	Brush(es)	Check, clean
	O	2	Cylindrical Brushes	Check, clean
	O	3	Recovery tank	Drain, rinse, clean float shut-off screen and debris tray if equipped
	O	4	Solution tank	Drain, rinse
	O	5	Severe environment tank (option)	Check, refill
	O	6	Squeegee	Clean, check for damage and wear
	O	7	Batteries	Charge if necessary
	O	8	Debris trough	Clean
	O	9	Scrub head skirt	Check for damage and wear
Weekly	O	7	Battery cells	Check electrolyte level
	O	6	Squeegee assembly drip trap reservoir	Check, clean
50 Hours	O	2	Cylindrical brushes.	Rotate brushes. Check for wear
	O	2	Cylindrical scrub head	Clean underside of scrub head
	O	3	Recovery tank lid seal	Check for wear.
	O	10	Solution tank filter	Clean
100 Hours	O	7	Battery watering system (option)	Check hoses for damage and wear
200 Hours	O	7	Batteries, terminals and cables	Check and clean
500 Hours	T	11	Lower orbital isolators	Replace (4 qty)
750 Hours	T	12	Vacuum motor	Replace carbon brushes
1250 Hours	T	13	Propel motor	Replace carbon brushes
	T	14	Brush motor	Replace carbon brushes
	T	15	Brush belt	Replace belt

O = Operator T = Trained Personnel

# MAINTENANCE

## MACHINE MAINTENANCE

To keep the machine in good working condition, simply perform the following maintenance procedures.

**FOR SAFETY: Before leaving or servicing machine, stop on level surface, turn off machine, remove key and set parking brake if equipped.**

**FOR SAFETY: When servicing machine wear personal protection equipment as needed. All repairs must be performed by trained personnel**

### AFTER DAILY USE

1. Drain and rinse out the recovery tank (Figure 83). See DRAINING TANKS.



FIG. 83

2. Remove the debris tray and empty (Figure 84).



FIG. 84

3. Remove and clean the float shut-off screen (Figure 85).



FIG. 85

4. Drain and rinse out the solution tank (Figure 86).



FIG. 86

5. Disk scrub head - Turn pad over or replace when worn (Figure 87).

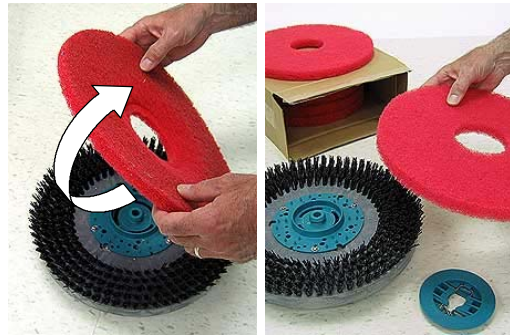

FIG. 87

Orbital scrub head - Turn the work pad over or replace when worn (Figure 88).



FIG. 88

6. Insta-Click pad driver/brushes - clean any debris buildup from hub connection area (Figure 89).



FIG. 89



- Wipe the squeegee blades clean. Inspect blades for wear and damage (Figure 90). Rotate blade if worn. See SQUEEGEE BLADE REPLACEMENT.



**FIG. 90**

- Check the scrub head skirt for wear or damage (Figure 91). Replace if worn or damaged.



**FIG. 91**

- Clean the outside surface of the machine with an all purpose cleaner and damp cloth (Figure 92).



**FIG. 92**

- Cylindrical scrub head - Remove and clean debris trough (Figure 93).



**FIG. 93**

- Severe environment option - Refill the severe environment tank with a recommended cleaning detergent at full concentration (Figure 94). Replace cap.



**FIG. 94**

- Charge batteries (Figure 95). See BATTERIES.



**FIG. 95**

**AFTER WEEKLY USE**

- Check the electrolyte level in all batteries (Figure 96). See BATTERIES.

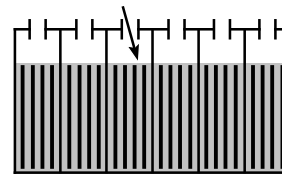

**FIG. 96**

- Remove the drip trap cover from the squeegee assembly and clean reservoir (Figure 97).



**FIG. 97**

# MAINTENANCE

## AFTER EVERY 50 HOURS OF USE

1. Remove the solution tank filter and clean screen (Figure 98). Turn the filter bowl counter-clockwise to remove. Make sure to drain solution tank before removing filter.

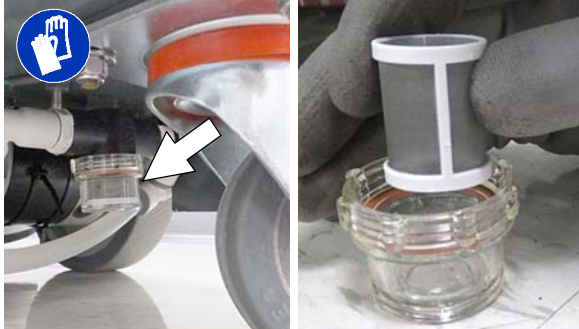

FIG. 98

2. Cylindrical brushes - Rotate brushes from front to rear (Figure 99). Replace brushes when they no longer clean effectively.



FIG. 99

3. Cylindrical scrub head - Remove debris buildup from underside of scrub head (Figure 100).



FIG. 100

4. Inspect and clean the seal on the recovery tank lid (Figure 101). Replace seal if damaged.



FIG. 101

## AFTER EVERY 100 HOURS OF USE

If machine is equipped with the optional battery watering system, check the watering hoses and connections for damage and wear (Figure 102). Replace system if damaged.

**FOR SAFETY: When servicing batteries, wear personal protection equipment as needed. Avoid contact with battery acid.**

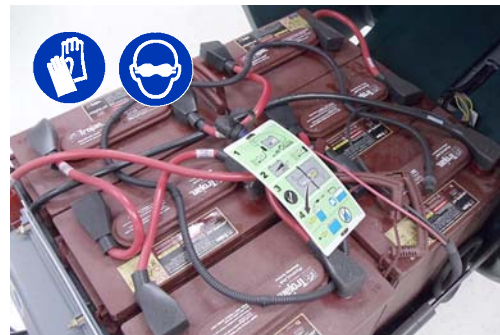

FIG. 102

## ELECTRIC MOTORS

Replace motor carbon brushes as indicated. Contact trained personnel for carbon brush replacement.

Carbon Brush Replacement	Hours
Vacuum motor	750
Propel motor (drive model)	1250
Disk brush motor	1250
Cylindrical brush motor	1250
Orbital brush motor	1250

## BELTS

**FOR SAFETY:** Before leaving or servicing machine, stop on level surface, turn off machine, remove key and set parking brake if equipped.

Replace belts every 1250 hours. Contact trained personnel for belt replacement (Figure 103).

### Cylindrical Brush Drive Belt

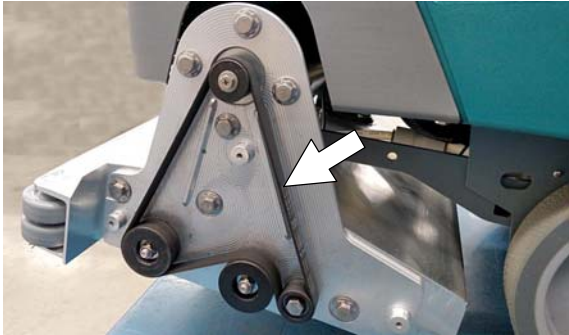

### Dual Disk Brush Drive Belt

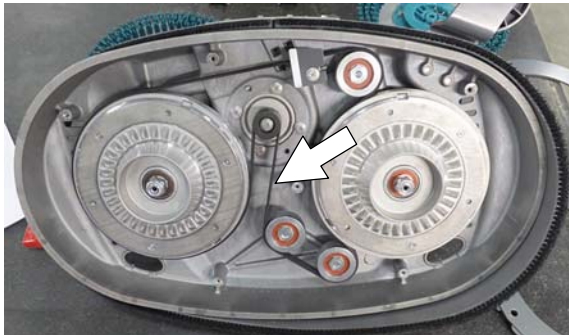

FIG. 103

## ORBITAL SCRUB HEAD ISOLATORS

**FOR SAFETY:** Before leaving or servicing machine, stop on level surface, turn off machine, remove key and set parking brake if equipped.

Replace the four lower vibration isolators every 500 hours. The lower isolators (hidden) are located between the deck plate the driver plate. Contact trained personnel for isolator replacement (Figure 104).



FIG. 104

## BATTERIES

**FOR SAFETY:** Before servicing machine, stop on level surface, turn off machine, remove key and set parking brake if equipped.

The lifetime of the batteries depends on their proper maintenance. To get the most life from the batteries;

- Do not charge the batteries more than once a day and only after running the machine for a minimum of 15 minutes.
- Do not leave the batteries partially discharged for long period of time.
- Only charge the batteries in a well-ventilated area to prevent gas build up. Charge batteries in areas with ambient temperatures 80°F / 27°C or less.
- Allow the charger to complete charging the batteries before re-using the machine.
- Maintain the proper electrolyte levels of flooded (wet) batteries by checking levels weekly.

Your machine is equipped with either flooded (wet) lead-acid or maintenance-free batteries supplied by Tennant.

**FOR SAFETY:** When servicing machine, keep all metal objects off batteries. Avoid contact with battery acid.

### MAINTENANCE-FREE BATTERIES

Maintenance-free (Sealed AGM) batteries do not require watering. Cleaning and other routine maintenance is still required.

### FLOODED (WET) LEAD-ACID BATTERIES

The flooded (wet) lead-acid batteries require routine watering as described below. Check the battery electrolyte level weekly.

**NOTE:** ***Do Not** check the electrolyte level if the machine is equipped with the optional battery watering system. Proceed to the BATTERY WATERING SYSTEM.*

The electrolyte level should be slightly above the battery plates as shown before charging (Figure 105). Add distilled water if low. **DO NOT OVERFILL.** The electrolyte will expand and may overflow when charging. After charging, distilled water can be added up to about 3 mm (0.12 in) below the sight tubes.

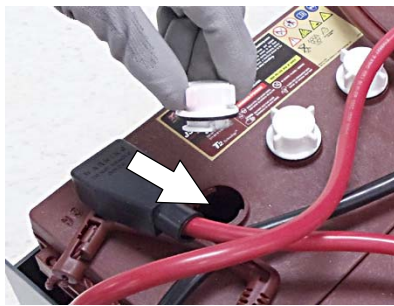

Before Charging

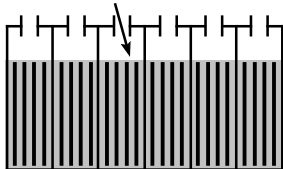

After Charging

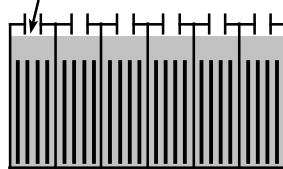

FIG. 105

*NOTE: Make sure the battery caps are in place while charging. There may be a sulfur smell after charging batteries. This is normal.*

## CHECKING CONNECTIONS / CLEANING

After every 200 hours of use, check for loose battery connections and clean the surface of the batteries, including terminals and cable clamps to prevent battery corrosion. Use a scrub brush with a strong mixture of baking soda and water (Figure 106). Do not remove battery caps when cleaning batteries.



FIG. 106

## CHARGING BATTERIES

The charging instructions in this manual are intended for the battery charger supplied with your machine. The use of other battery chargers that are not supplied and approved by Tennant are prohibited.

If your machine is equipped with an off-board battery charger refer to the charger's owners manual for operating instructions. Contact distributor or Tennant for battery charger recommendations if machine is not equipped with charger.

**FOR SAFETY: The use of incompatible battery chargers may damage battery packs and potentially cause a fire hazard.**

**IMPORTANT NOTICE:** The battery charger is set to charge the battery type supplied with your machine. If you choose to change to a different battery type or capacity (i.e. flooded (wet) lead-acid, maintenance-free, sealed, AGM batteries, etc.), the charger's charging profile must be changed to prevent battery damage. See BATTERY CHARGER SETTINGS.

1. Transport the machine to a well-ventilated area.

**⚠ WARNING: Batteries emit hydrogen gas. Explosion or fire can result. Keep sparks and open flame away when charging.**

2. Park the machine on a flat, dry surface, turn off machine and remove key.

**FOR SAFETY: When servicing batteries, stop on level surface, turn off machine, remove key and set parking brake if equipped.**

3. If the machine is equipped with flooded (wet) lead-acid batteries check the battery electrolyte level weekly before charging. See **FLOODED (WET) LEAD-ACID BATTERIES**.
4. For models equipped with on-board chargers, remove the charger's power cord from the storage hooks and plug power cord into a properly grounded wall outlet (Figure 107).



FIG. 107

For models equipped with off-board chargers, first connect the charger's DC cord into the machine's battery charge receptacle then plug the AC power supply cord into a properly grounded wall outlet (Figure 108). Refer to the off-board battery charger's owner manual for operating instructions.

**FOR SAFETY: Do not disconnect the off-board charger's DC cord from the machine's receptacle when the charger is operating. Arcing may result. If the charger must be interrupted during charging, disconnect the AC power supply cord first.**



FIG. 108

- The charger will automatically begin charging and shut off when fully charged. The maximum charging cycle may take up to 6- 12 hours depending on battery type.

On-board battery charger: The battery discharge indicator lights will ripple back and forth during the charging cycle. When all five lights repeatedly flash two times, the charging cycle is complete (Figure 109).

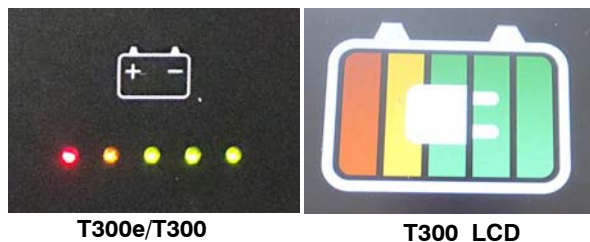

FIG. 109

- After charging batteries unplug the power supply cord and wrap cord around the cord hooks (Figure 110). For models equipped with an off-board charger, always disconnect the AC power supply cord first before disconnecting charger from machine.



FIG. 110

## BATTERY CHARGER SETTINGS

The battery charger is set to charge the battery type supplied with your machine. If you choose to change to a different battery type or capacity, the charger's charging profile must be changed to prevent battery damage.

The machine's battery discharge indicator (BDI) must also be reprogrammed to match battery type to prevent battery damage and/or short run- time.

*NOTE: For machines shipped without batteries, the battery discharge indicator and the on-board battery charger are set for GEL batteries as the default. If you choose to use a different battery type, the settings must be changed as described as below.*

*NOTE: For machines shipped without batteries and supplied with an Off-Board Charger, the off-board battery charger is set for wet lead-acid batteries from the factory. The machine's battery discharge indicator is set for GEL batteries as the default. The machine's battery discharge indicator must be reprogrammed to match charger settings (See OFF-BOARD BATTERY CHARGER below).*

**IRIS MODELS:** For models equipped with capability to report battery charging data via IRIS, Tennant recommends using the same battery type. If a different amp hour or battery type is desired, contact Tennant Service Department.

### OFF- BOARD BATTERY CHARGER:

- To change the off-board battery charger settings, refer to the off-board charger's owner manual.
- To reprogram the machine's battery discharge indicator (BDI), see below:

**Pro/Membrane Models** - Service application software required, contact service.

**Pro- Panel Model** - See *CHANGING ON-BOARD BATTERY CHARGER SETTINGS* for Pro- Panel model.



## MAINTENANCE

### ON-BOARD BATTERY CHARGER:

**Pro/Membrane Models** - To change the on-board battery charger settings, service application software required, contact service. As an alternative, the charger settings may be manually changed. See *CHANGING ON-BOARD BATTERY CHARGER SETTINGS* for Pro-Membrane model. The battery discharge indicator will automatically reprogram to match battery type when the battery charger profile is changed.

**Pro-Panel Model** - To change the on-board battery charger settings, see *CHANGING ON-BOARD BATTERY CHARGER SETTINGS* for Pro-Panel model. The battery discharge indicator will automatically reprogram to match battery selection.

### CHANGING ON-BOARD BATTERY CHARGER SETTINGS (Pro/Membrane models)

To manually change the on-board battery charger settings for a different battery type, carefully follow instructions as described below :

*NOTE: The manual method is only an alternative if unable to change setting by use of the Service Application Software performed by Service.*

1. Disconnect battery cables (Figure 111).

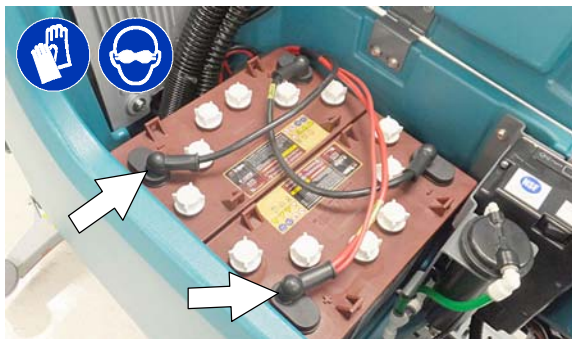

FIG. 111

2. Unwrap the battery charger power cord from the cord hooks.
3. Using a T25 star screwdriver, remove the two screws located at the bottom of the control console to access battery charger (Figure 112).

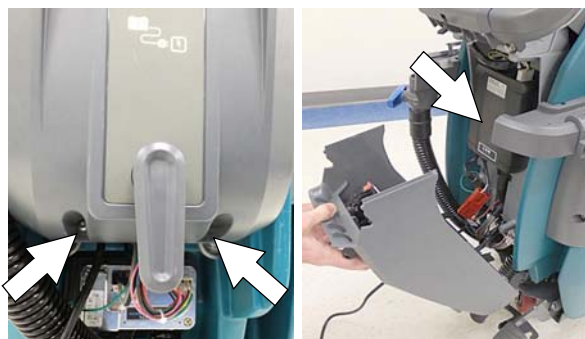

FIG. 112

4. Disconnect the battery cable, power cord and wire harness from charger. Using a T25 star screwdriver, remove the four screws that mount

charger to machine (Figure 113). Remove charger from machine.

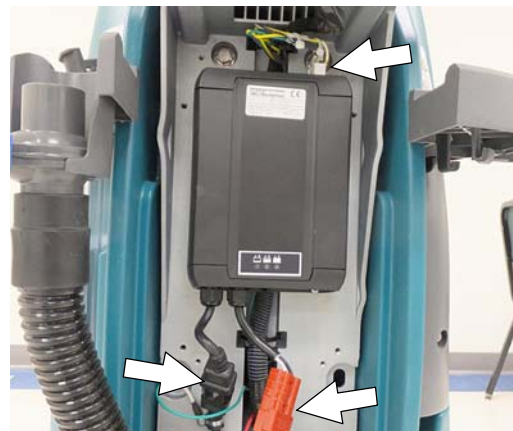

FIG. 113

5. Remove the black cap from bottom side of charger to access the profile dial (Figure 114)



FIG. 114

6. Using a small standard screwdriver, turn the dial to the appropriate battery type according to the following chart (Figure 115).



FIG. 115

Dial Position	Battery Description Settings with AH Ranges
0	CAN- BUS setting*
1	Wet, Trojan 105- 155 AH
2	Wet, Energys/Tab 105- 155 AH
3	AGM, Discover 80- 150 AH
4	AGM, Fullriver 80- 150 AH
5	AGM, TPPL, Energys 20- 40 AH
6	Gel, Sonnenschein 80- 150 AH

\* The CAN-BUS setting, dial position “0”, is the software setting that is programmed to match battery type supplied with machine. When the dial is manually changed to a different setting, it should not be reset back to “0” otherwise battery damage may result. Service Application Software is required to reset dial back to “0”. Contact Service.

7. Replace the black cap on charger, reinstall battery charger and replace control console.
8. Reconnect the battery cable connection.
9. To set the BDI for the new battery type, plug the on-board battery charger cord into an electrical outlet. The machine’s software will automatically reprogram the BDI to the new battery type.

### CHANGING ON-BOARD BATTERY CHARGER SETTINGS (Pro-Panel model)

NOTE: To perform this procedure, machine must be in supervisor mode. See SUPERVISOR CONTROLS instructions at back of manual.

To change the on-board battery charger settings for a different battery type :

1. Turn the key to the on position.
2.  Press the settings button located on the home screen (Figure 116).

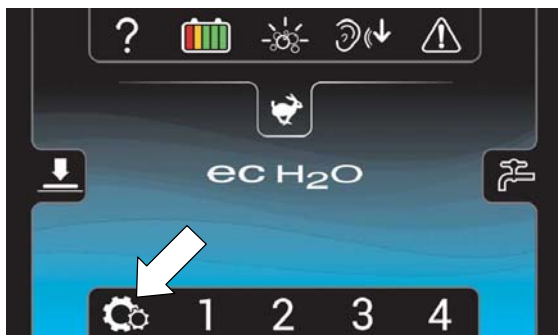



FIG. 116

3.  Press the Setup button to access the Setup screen (Figure 117).

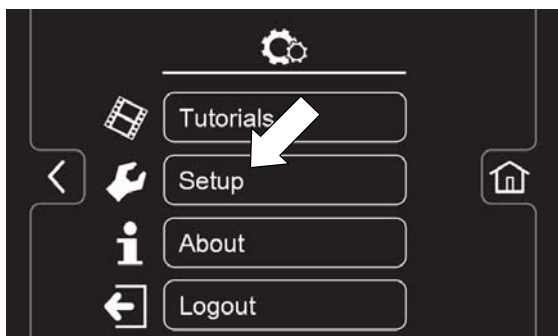



FIG. 117

4.  Press the Battery Type button to select the battery type installed in machine (Figure 118).

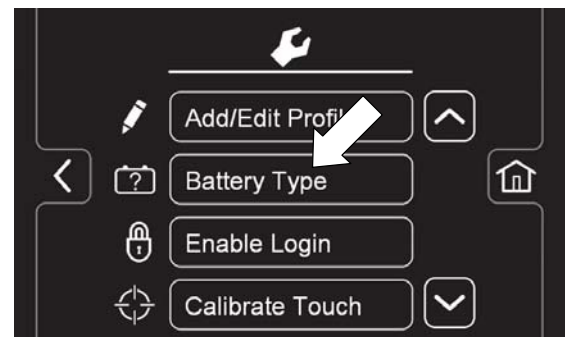
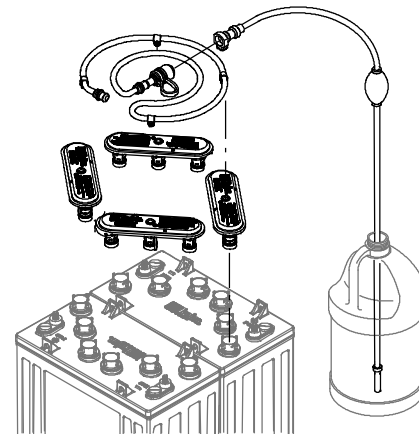

FIG. 118

### HYDROLINK® BATTERY WATERING SYSTEM (Trojan 150AH Battery Option)

The following instructions are for models equipped with the HydroLINK battery watering system option.



The optional HydroLINK battery watering system provides a safe and easy way to maintain the proper electrolyte levels in your batteries. It is designed exclusively for Trojan® flooded (wet) lead-acid batteries.

**FOR SAFETY: When servicing machine, wear personal protection equipment as needed. Avoid contact with battery acid.**

Before using the battery watering system check hoses and connections for damage or wear.

1. Fully charge batteries prior to using the battery watering system. Do not add water to batteries before charging, the electrolyte level will expand and may overflow when charging.

## MAINTENANCE

2. After charging batteries, check the battery electrolyte level indicators located on the battery covers (Figure 119). If the level indicator is white add water as described in the following instructions. If the level indicators are black the electrolyte is at the correct level, no water is required.



FIG. 119

3. Locate the battery fill hose coupler inside the battery compartment. Remove the dust cap and connect the hand pump hose (Figure 120).

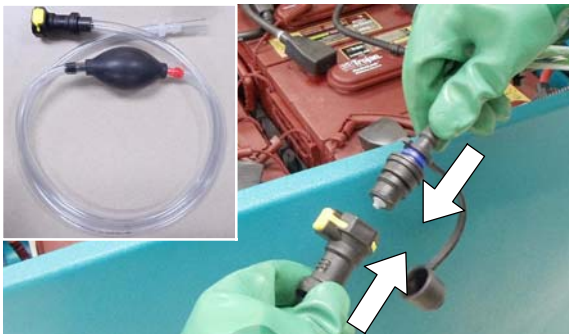

FIG. 120

4. Submerge the other end of the hand pump hose into a bottle of distilled water (Figure 121).



FIG. 121

5. Squeeze the bulb on the hand pump hose until firm (Figure 122). The level indicators will turn black when full.



FIG. 122

6. After adding water, replace the dust cap on the battery fill hose and store the hand pump hose inside the machine's battery compartment for future use.

## SQUEEGEE BLADE REPLACEMENT

**FOR SAFETY: Before leaving or servicing machine, stop on level surface, turn off machine, remove key and set parking brake if equipped.**

Each squeegee blade has four wiping edges. When the blades become worn, simply rotate the blades end-for-end or top-to-bottom for a new wiping edge. Replace blade if all four edges are worn.

1. Remove the squeegee assembly from the machine.
2. Fully loosen the two outside knobs on squeegee assembly. This will separate the spring loaded blade retainer from squeegee frame (Figure 123). To loosen the knobs quickly, squeeze the blade retainer and squeegee frame together.

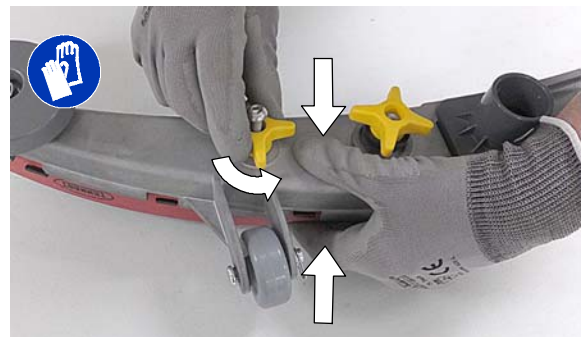

FIG. 123



- Remove worn blade(s) from the blade retainer (Figure 124).

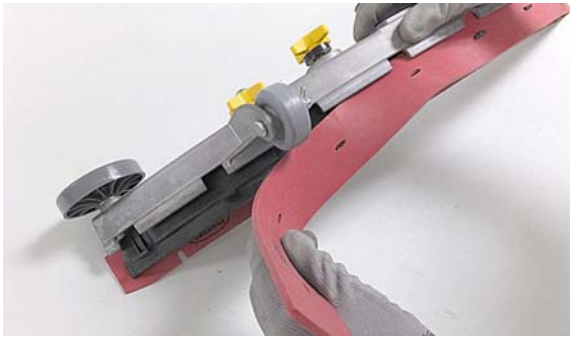

FIG. 124

- Rotate the rear blade to a new wiping edge (Figure 125). Make sure to align the slots in the blade with retainer tabs.

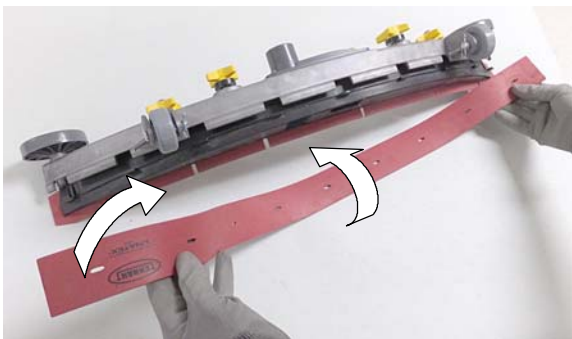

FIG. 125

- Squeeze the squeegee frame and blade retainer together and re-tighten the two outside knobs (Figure 126).



FIG. 126

## ec-H<sub>2</sub>O NanoClean WATER CONDITIONING CARTRIDGE REPLACEMENT

**FOR SAFETY:** Before leaving or servicing machine, stop on level surface, turn off machine, remove key and set parking brake if equipped.

The water conditioning cartridge is required to be replaced when it reaches its maximum water usage or expiration time of when the cartridge was activated, which ever comes first. The control panel will signal a code when it's time to replace cartridge. See CONTROL PANEL OPERATION for further details.

Depending on machine usage, on average, a new cartridge can last anywhere from 12 months for heavy machine usage to 24 months for light machine usage.

**ATTENTION:** During first time use and after replacing the water conditioning cartridge, the ec-H<sub>2</sub>O system will automatically override the solution flow setting to the maximum flow rate for up to 60 minutes to properly prime the cartridge. During this time, the machine can be operated as normal.

- Park the machine on a level surface, remove the key and set parking brake, if equipped.
- Lift the recovery tank to access the ec-H<sub>2</sub>O water conditioning cartridge (Figure 127). Drain recovery tank before lifting tank.



FIG. 127

- Disconnect the two hose connectors from the top of the cartridge by pressing the gray collars inward and pulling the connectors outward (Figure 128). Lift cartridge to remove.



FIG. 128

- Fill in the installation date on the new cartridge label (Figure 129).



FIG. 129

- Install the new cartridge and reconnect the two hoses. Make sure the hose connectors are fully inserted into the cartridge.
- Reset timer for new cartridge.

Carefully read and understand all steps first before performing procedure.

- Turn key on.
- Press and hold the service switch, located on the ec-H<sub>2</sub>O module, for 10 seconds. After releasing service switch, the three solution flow indicator lights will begin to (ripple) move back and forth (Figure 130).
- Within 5 seconds after releasing the service switch, while the three indicator lights are moving back and forth, quickly press and release the solution flow button located on ec-H<sub>2</sub>O module (Figure 130).

The three indicator lights will then blink three times to indicate timer has been reset.

Repeat process if the three indicator lights do not blink three times.

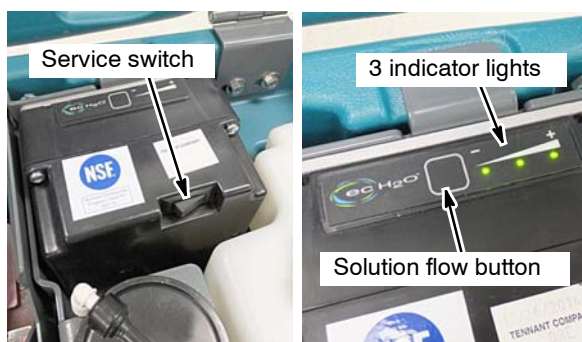

FIG. 130

## LOADING/UNLOADING MACHINE FOR TRANSPORTING

When transporting the machine by use of trailer or truck, carefully follow the loading and tie-down procedure:

- Raise the scrub head and remove squeegee assembly.
- Use a ramp that can support the machine weight and operator and carefully load machine. Do not operate the machine on a ramp incline that exceeds a 21% grade level (Figure 131). A winch must be used when ramp incline exceeds a 21% grade level.

**FOR SAFETY: When loading/unloading machine onto/off truck or trailer, use a ramp that can support the machine weight and operator.**

**FOR SAFETY: Do not operate the machine on a ramp incline that exceeds a 21% grade level.**

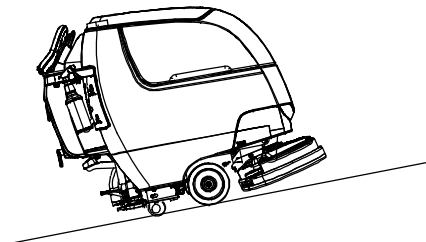

FIG. 131

- Once loaded, position the front of the machine up against the front of the trailer or truck. Lower the scrub head, turn key off and set parking brake, if equipped (Figure 132).
- Place a block behind each wheel (Figure 132).
- Using tie-down straps, secure the machine using the four tie-down brackets located on the machine frame (Figure 132). It may be necessary to install tie-down brackets to the floor of your trailer or truck.

**NOTE: When transporting machine in an open truck or trailer, secure recovery tank lid.**

**ATTENTION: Do not use control console area or accessory storage rails for tie-down locations, damage may occur.**

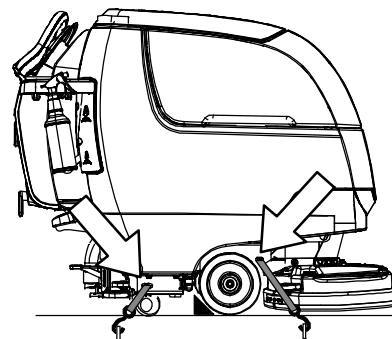

FIG. 132

---

## STORING MACHINE

---

The following steps should be taken when storing the machine for extended periods of time.

1. Charge the batteries before storing machine to prolong the life of the batteries. Recharge batteries once a month.
2. Disconnect batteries before storing.
3. Drain and rinse recovery tank and solution tank.
4. Store the machine in a dry area with squeegee and scrub head in the up position.

**ATTENTION: Do not expose machine to rain, store indoors.**

5. Open the recovery tank lid to promote air circulation.

*NOTE: To prevent potential machine damage store machine in a rodent and insect free environment.*

---

## FREEZE PROTECTION

Storing machine in freezing temperatures.

1. Completely drain solution tank and recovery tank.
2. Empty the water from the solution tank filter located under machine. Replace filter.
3. Pour 1 gallon / 4 liters of propylene glycol based recreational vehicle (RV) antifreeze into the solution tank.

Models equipped with optional Severe Environment detergent tank - Lift out the tank and empty the detergent from tank. Pour a 1/4 gallon / 1 liter of propylene glycol based recreational vehicle (RV) antifreeze into the detergent tank.

4. Turn machine on and operate the solution flow system. Turn the machine off when the antifreeze is visible on floor.

Models equipped with ec-H2O option - Operate ec-H2O scrubbing to cycle antifreeze through system.

Models equipped with Severe Environment mode option - Press the Severe Environment button to cycle antifreeze through system.

5. After storing machine in freezing temperatures, drain any remaining antifreeze from the solution tank and from the optional Severe Environment detergent tank. Add clean water to solution tank and to optional detergent tank and operate the machine to flush system.

## MAINTENANCE

### TROUBLESHOOTING

PROBLEM	CAUSE	SOLUTION
Service indicator icon is blinking	Machine or on-board battery charger fault has been detected	See SERVICE INDICATOR CODES
ec-H2o indicator icon is red or blinking red	ec-H2O system fault has been detected	See SERVICE INDICATOR CODES
Machine will not operate	Emergency stop button activated	Turn button to reset
	Machine fault detected	See SERVICE INDICATOR CODES
	Batteries discharged	Recharge batteries
	Loose battery cable(s)	Tighten loose cables
	Faulty battery(s)	Replace battery(s)
	Faulty key switch	Contact service
	Faulty start bail switch	Contact service
	Circuit breaker tripped	Reset circuit breaker
	Faulty control board	Contact service
On-board battery charger will not operate	Plug not connected to power supply	Check plug connection
	Batteries over discharged	Replace batteries
	Battery charger fault detected	See SERVICE INDICATOR CODES
	Faulty charger	Replace charger
Machine will not propel (Drive Model)	Propel fault has been detected.	See SERVICE INDICATOR CODES
	Circuit breaker tripped	Reset circuit breaker
	Faulty propel motor or wiring	Contact service
	Worn carbon brushes in motor	Contact service
Brush motor will not operate	Brush motor fault has been detected.	See SERVICE INDICATOR CODES
	Faulty pad motor or wiring	Contact service
	Worn carbon brushes in motor	Contact service
	Broken or loose belt (dual disk/cylindrical models)	Contact service
Vacuum motor will not operate	Squeegee assembly is raised off floor	Lower squeegee assembly to floor
	Vacuum motor fault has been detected	See SERVICE INDICATOR CODES
	Faulty vacuum motor or wiring	Contact service
Poor scrubbing performance	Debris caught in brush/pad	Remove debris
	Worn brush/pad	Replace brushes/pad
	Incorrect brush pressure	Adjust brush pressure
	Wrong brush/pad type	Use correct brush/pad for application
	Low battery charge	Recharge batteries

**TROUBLESHOOTING - Continued**

<b>PROBLEM</b>	<b>CAUSE</b>	<b>SOLUTION</b>
Trailing water - poor or not water pickup	Full recovery tank or excessive foam buildup	Drain recovery tank
	Loose drain hose cap or flow control valve is open	Replace cap or close flow control valve on drain hose
	Worn squeegee blades	Rotate or replace squeegee blades
	Clogged drip trap (Squeegee assembly)	Remove cover and clean
	Clogged squeegee assembly	Clean squeegee assembly
	Loose vacuum hose connection	Secure vacuum hose connection
	Clogged vacuum hose	Flush vacuum hose
	Clogged vacuum hose	Flush vacuum hose
	Damaged vacuum hose	Replace vacuum hose
	Clogged float shut-off screen in recovery tank	Clean screen
	Recovery tank lid not completely closed	Check lid for obstructions
Defective seals on recovery tank lid	Replaced seal	
Little or no solution flow	Empty solution tank	Refill solution tank
	Low solution flow rate set	Increase solution flow rate
	Clogged solution tank filter	Clean filter
	Plugged solution supply line	Flush solution supply line
Severe environment tank does not dispense detergent	No detergent	Refill tank
	Faulty float switch	Contact service
	Defective pump	Contact service
	Defective pump potentiometer	Contact service
	Faulty control panel	Contact service
Short run time	Low battery charge	Charge batteries
	Batteries need maintenance	See BATTERIES
	Defective battery or end of battery life	Replace batteries
	Battery discharge indicator (BDI) programmed incorrectly	See BATTERY CHARGER SETTINGS
	Faulty charger	Replace battery charger
	Brush pressure set too high	Lower brush pressure.

# SPECIFICATIONS

## GENERAL MACHINE DIMENSIONS/CAPACITIES/PERFORMANCE

MODEL	17 in / 43 cm Disk (Push)	20 in / 50 cm Disk (Push)	17 in / 43 cm Disk (Drive)	20 in / 50 cm Disk (Drive)
Length	51.25 in / 1302 mm	54 in / 1372 mm	51.25 in / 1302 mm	54 in / 1372 mm
Width	20 in / 508 mm	22 in / 559 mm	20 in / 508 mm	22 in / 559 mm
Height	43.1 in / 1095 mm	43.1 in / 1095 mm	43.1 in / 1095 mm	43.1 in / 1095 mm
Weight	220 lb / 98 kg	230 lb / 104 kg	230 lb / 104 kg	240 lb / 109 kg
Weight (with batteries)	366 lb / 166 kg	376 lb / 171 kg	390 lb / 177 kg	400 lb / 181 kg
GVW	457 lb / 207 kg	467 lb / 212 kg	482 lb / 219 kg	492 lb / 223 kg
Squeegee width	30.4 in / 772 mm			
Recovery tank capacity	14 gal / 53 L			
Solution tank capacity	11 gal / 42 L			
Severe Environment tank capacity	.4 gal / 1.5 L			
Scrubbing path width	16.9 in / 430 mm	19.9 in / 505 mm	16.9 in / 430 mm	19.9 in / 505 mm
Down pressure - Actuated model	Low: 47 lbs / 21.3 kg Med: 73 lbs / 33 kg High: 88 lbs / 40 kg	Low: 52 lbs / 23.5 kg Med: 77 lbs / 35 kg High: 92 lbs / 41.7 kg	Low: 47 lbs / 21.3 kg Med: 71 lbs / 32 kg High: 86 lbs / 39 kg	Low: 51 lbs / 23 kg Med: 76 lbs / 34.5 kg High: 90 lbs / 41 kg
Down pressure - Manual model	47 lbs / 21.3 kg	52 lbs / 23.5 kg	47 lbs / 21.3 kg	51 lbs / 23 kg
Dual down pressure - Manual model	88 lbs / 40 kg	92 lbs / 41.7 kg	86 lbs / 39 kg	90 lbs / 41 kg
Scrubbing speed	Pad assist		200 fpm / 61 mpm	
Transport speed	n/a	n/a	240 fpm / 73 mpm	
Reverse speed	n/a	n/a	144 fpm / 44 mpm	
Productivity rate - estimated actual	9,340ft <sup>2</sup> /hr / 868m <sup>2</sup> /hr	11,208ft <sup>2</sup> /hr / 1041m <sup>2</sup> /hr	12,453ft <sup>2</sup> /hr / 1157m <sup>2</sup> /hr	14,943ft <sup>2</sup> /hr / 1388m <sup>2</sup> /hr
ec-H2O productivity rate - est. actual	9,668 ft <sup>2</sup> /hr / 898 m <sup>2</sup> /hr	11,602ft <sup>2</sup> /hr / 1078m <sup>2</sup> /hr	12,891ft <sup>2</sup> /hr / 1198m <sup>2</sup> /hr	15,469ft <sup>2</sup> /hr / 1437m <sup>2</sup> /hr
Aisle turnaround width	52 in / 1321 mm	54.5 in / 1384 mm	52 in / 1321 mm	54.5 in / 1384 mm
Ramp incline for scrubbing	9% maximum			
Ramp incline for transporting	21% maximum			
Ramp incline for loading- empty tanks	21% maximum			
Solution flow rate	Low: .15 gpm / .57 L/min, Med: .35 gpm / 1.3 L/min, High: .5 gpm / 1.9 L/min			
ec-H2O solution flow rate	Low: .12 gpm / .45 L/min, Med: .25 gpm / .94 L/min, High: .35 gpm / 1.3 L/min			
Brush motor	24 VDC, 1hp / .75kW			
Propel motor	n/a	n/a	24 VDC, .23 hp / .175 kW	
Vacuum motor	24 VDC, .6hp / .47kW			
Water lift	42 in / 1067 mm			
Water lift Quiet- Mode	28 in / 711 mm			
ec-H2O solution pump	24 VDC, 1.0 gpm / 3.8 L/min, min open flow			
Machine voltage	24 VDC			
Battery capacity	2- 12V 105AH C/20 Wet, 2- 12V 130AH C/20 Wet, 2- 12V 150AH C/20 Wet, 2- 12V 140AH C/20 Sealed/AGM			
Total power consumption	31.5A nominal	36.5A nominal	34.5A nominal	39.5A nominal
Battery Charger - on-board	100- 240VAC, 50/60Hz, 24VDC, 13A			
Battery Charger - smart off-board	100- 240VAC, 50/60Hz, 24VDC, 13A			
Protection grade	IPX3			
Sound pressure level L <sub>pA</sub> *	64.9 dB(A)	64.9 dB(A)	64.9 dB(A)	64.9 dB(A)
Sound pressure level L <sub>pA</sub> * - Quiet mode	57.8 dB(A)	57.8 dB(A)	57.8 dB(A)	57.8 dB(A)
Sound uncertainty K <sub>pA</sub> *	0.8 dB(A)	0.8 dB(A)	0.8 dB(A)	0.8 dB(A)
Sound power level uncertainty L <sub>pA</sub> - uncertainty K <sub>pA</sub> *	84.3 dB(A)	84.3 dB(A)	84.3 dB(A)	84.3 dB(A)
Machine vibration at hand-arm*	<2.5 m/s <sup>2</sup>			
Ambient operating temperature	Min: 32°F/0°C, Max: 110°F/43°C			

\*Values per IEC 60335-2-72. Specifications are subject to change without notice.

**GENERAL MACHINE DIMENSIONS/CAPACITIES/PERFORMANCE**

MODEL	24 in / 60 cm Dual Disk	20 in / 50 cm Cylindrical Brush	20 in / 50 cm Orbital
Length	51.75 in / 1314 mm	50.5 in / 1283 mm	49 in / 1245 mm
Width	26 in / 660 mm	25 in / 635 mm	20.5 in / 521 mm
Height	43.1 in / 1095 mm	43.1 in / 1095 mm	43.1 in / 1095 mm
Weight	250 lb / 113 kg	250 lb / 113 kg	255 lb / 116 kg
Weight (with batteries)	410 lb / 186 kg	410 lb / 186 kg	415 lb / 188 kg
GVW	502 lb / 228 kg	502 lb / 228 kg	507 lb / 230 kg
Squeegee width	30.4 in / 772 mm		
Recovery tank capacity	14 gal / 53 L		
Solution tank capacity	11 gal / 42 L		
Severe Environment tank capacity	.4 gal / 1.5 L		
Scrubbing path width	23.6 in / 600 mm	19.7 in / 500 mm	19.7 in / 500 mm
Down pressure - Actuated model	Low: 57 lbs / 26 kg Med: 81 lbs / 36.7 kg High: 97 lbs / 44 kg	Low: 53 lbs / 24 kg Med: 60 lbs / 27 kg High: 64 lbs / 29 kg	Low: 63 lbs / 28.5 kg Med: 92 lbs / 42 kg High: 109 lbs / 49.5 kg
Down pressure - Manual model	57 lbs / 26 kg	53 lbs / 24 kg	63 lbs / 28.5 kg
Dual down pressure - Manual model	97 lbs / 44 kg	64 lbs / 29 kg	109 lbs / 49.5 kg
Scrubbing speed	200 fpm / 61 mpm		
Transport speed	240 fpm / 73 mpm		
Reverse speed	144 fpm / 44 mpm		
Productivity rate - estimated actual	18,264ft <sup>2</sup> /hr / 1697m <sup>2</sup> /hr	14,943ft <sup>2</sup> /hr / 1388m <sup>2</sup> /hr	14,943ft <sup>2</sup> /hr / 1388m <sup>2</sup> /hr
ec-H <sub>2</sub> O productivity rate - est. actual	18,906ft <sup>2</sup> /hr / 1756m <sup>2</sup> /hr	15,469ft <sup>2</sup> /hr / 1437m <sup>2</sup> /hr	15,469ft <sup>2</sup> /hr / 1437m <sup>2</sup> /hr
Aisle turnaround width	53.5 in / 1346 mm	52 in / 1321 mm	49 in / 1245 mm
Ramp incline for scrubbing	9% max.		
Ramp incline for transporting	21% max.		
Ramp incline for loading- empty tanks	21% max.		
Solution flow rate	Low: .15 gpm / .57 L/min Med: .35 gpm / 1.3 L/min High: .5 gpm / 1.9 L/min	Low: .15 gpm / .57 L/min Med: .28 gpm / 1.0 L/min High: .35 gpm / 1.3 L/min	Low: .15 gpm / .57 L/min Med: .35 gpm / 1.3 L/min High: .5 gpm / 1.9 L/min
ec- H <sub>2</sub> O solution flow rate	Low: .12 gpm / .45 L/min, Med: .25 gpm / .94 L/min, High: .35 gpm / 1.3 L/min		
Brush motor	24 VDC, 1hp / .75kW		
Propel motor	24 VDC, .23 hp / .175kW		
Vacuum motor	24 VDC, .6 hp / .47 kW		
Water lift	42 in / 1067 mm		
Water lift - Quiet-Mode	28 in / 711 mm		
ec- H <sub>2</sub> O solution pump	24 VDC, 1.0 gpm / 3.8 L/min, min open flow		
Machine voltage	24 VDC		
Battery capacity	2- 12V 105AH C/20 Wet 2- 12V 130AH C/20 Wet, 2- 12V 150AH C/20 Wet 2- 12V 140AH C/20 Sealed/AGM	2- 12V 150AH C/20 Wet 2- 12V 140AH C/20 Sealed/AGM	2- 12V 105AH C/20 Wet 2- 12V 130AH C/20 Wet, 2- 12V 150AH C/20 Wet 2- 12V 140AH C/20 Sealed/AGM
Total power consumption	36A nominal	40A nominal	30A nominal
Battery Charger - on-board	100- 240VAC, 50/60Hz, 24VDC, 13A		
Battery Charger - smart off-board	100- 240VAC, 50/60Hz, 24VDC, 13A		
Protection grade	IPX3		
Sound pressure level L <sub>pA</sub> *	66.5 dB(A)	64.7 dB(A)	65.3 dB(A)
Sound pressure level L <sub>pA</sub> * - Quiet mode	59.1 dB(A)	61.3 dB(A)	57.6 dB(A)
Sound uncertainty K <sub>pA</sub> *	0.8 dB(A)	0.8 dB(A)	0.8 dB(A)
Sound power level uncertainty L <sub>pA</sub> - uncertainty K <sub>pA</sub> *	83.8 dB(A)	84.2 dB(A)	83.5 dB(A)
Machine vibration at hand-arm*	<2.5 m/s <sup>2</sup>		
Ambient operating temperature	Min: 32°F/0°C, Max: 110°F/43°C		

\*Values per IEC 60335-2-72. Specifications are subject to change without notice.

# SPECIFICATIONS

## MACHINE DIMENSIONS

### SINGLE DISK MODEL

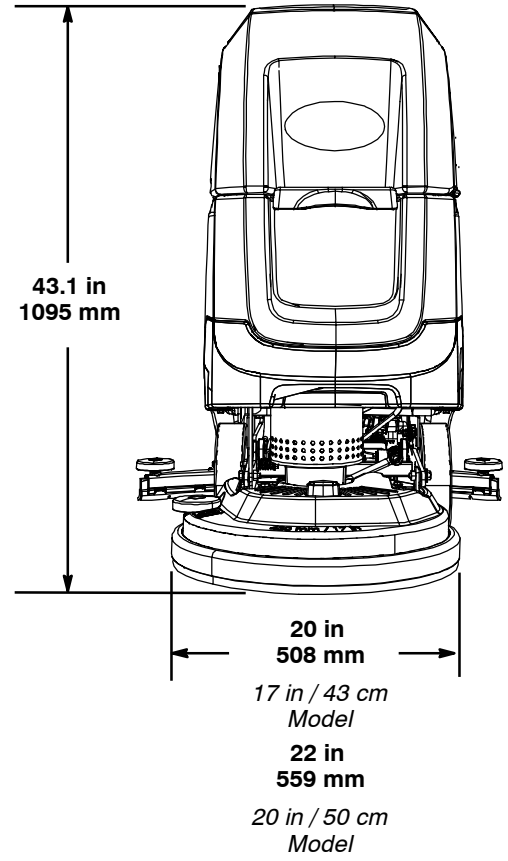
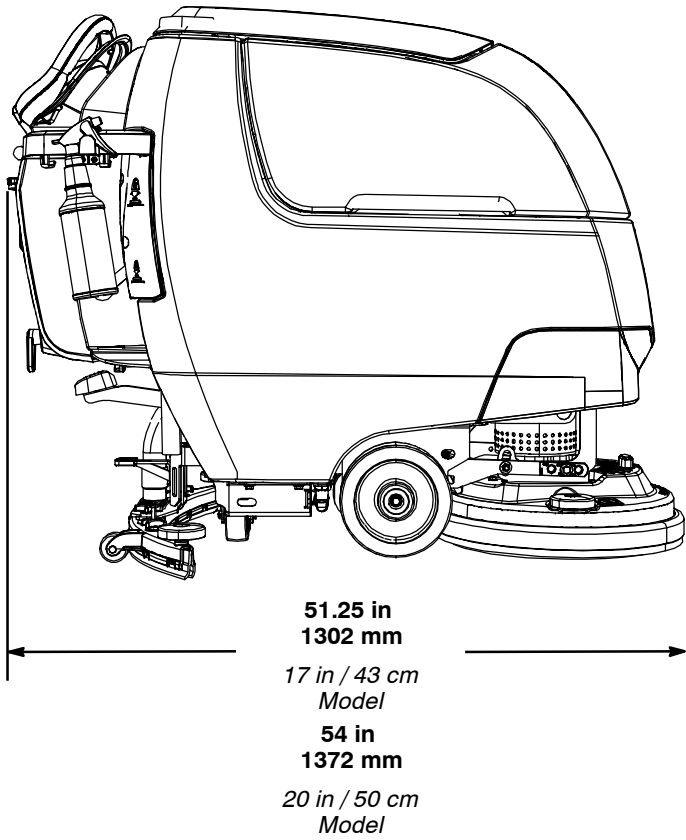
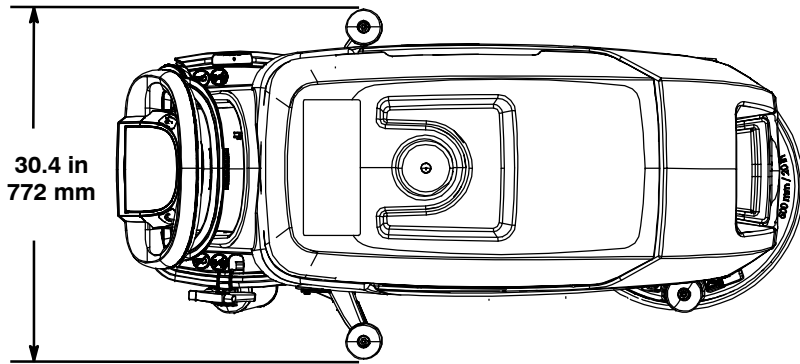



**DUAL DISK MODEL**

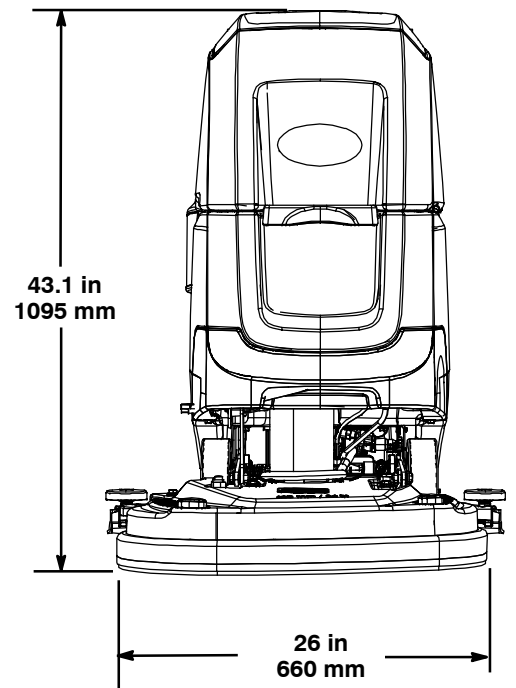
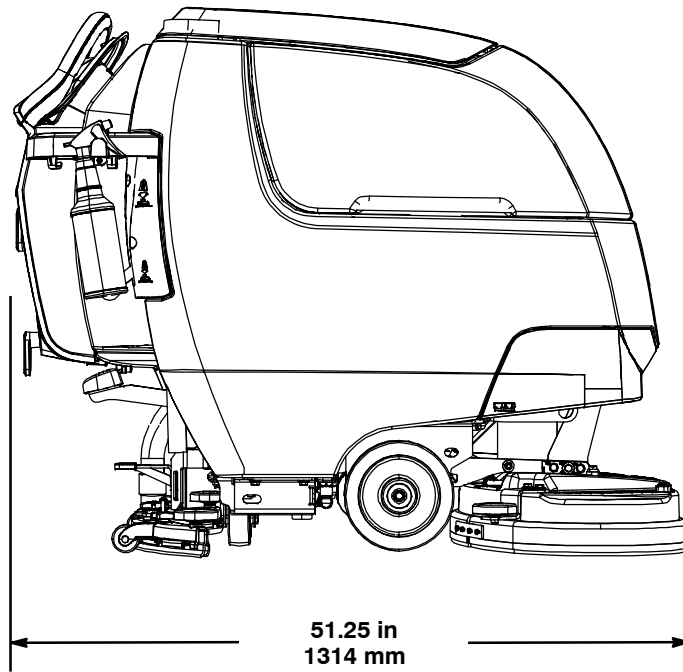
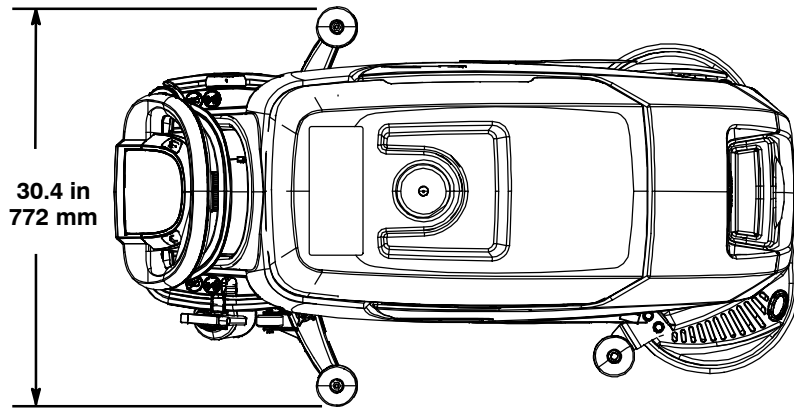

# SPECIFICATIONS

---

## CYLINDRICAL BRUSH MODEL

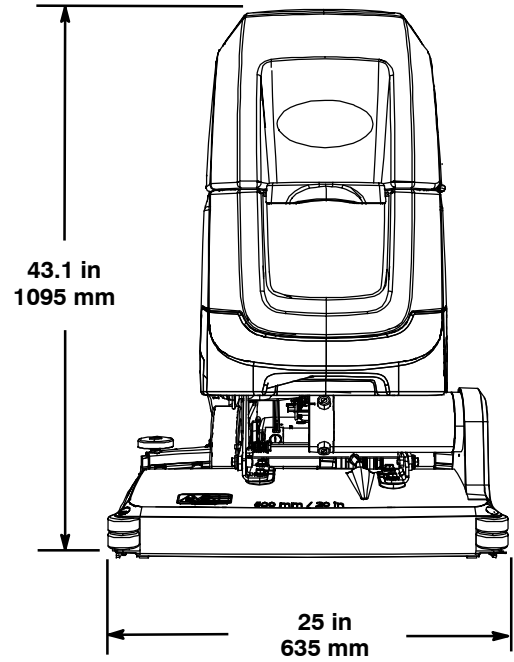
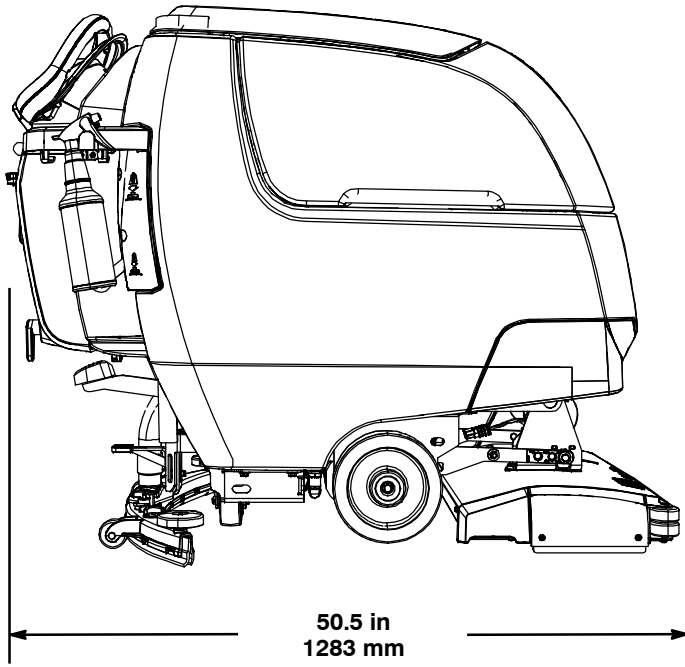
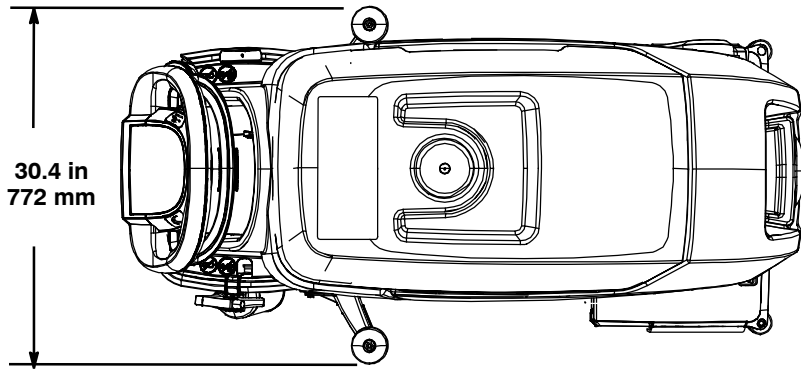

**ORBITAL PAD MODEL**

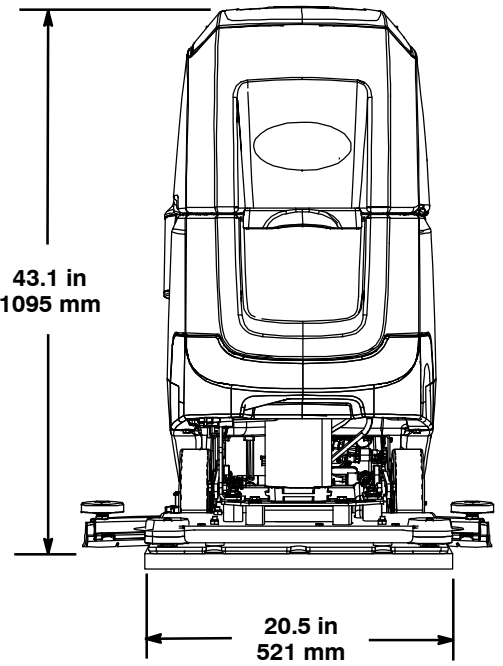
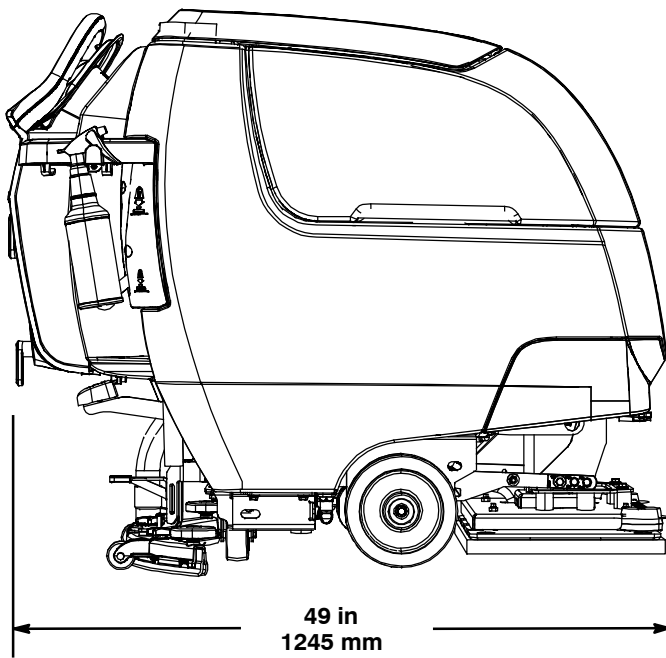
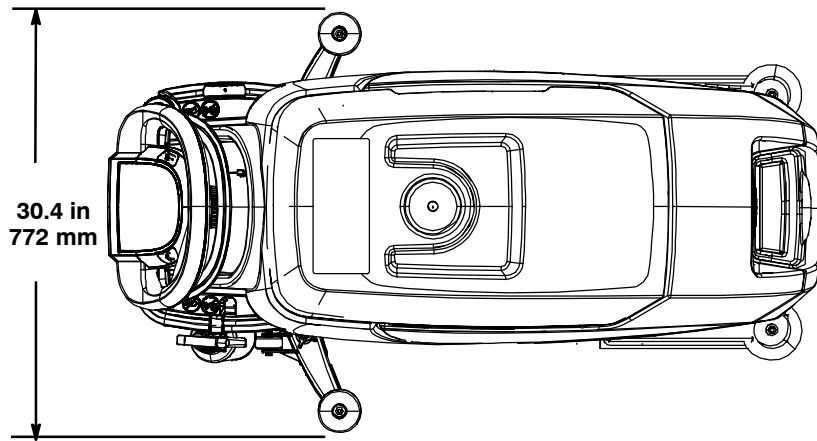



**ATTENTION:** The following instructions are intended for supervisor use only. Remove pages from manual if necessary.

**SUPERVISOR CONTROLS**

The supervisor controls feature allows a supervisor to program the machine's scrubbing settings for operator use. The lockout functionality will prevent the operator from changing or saving the Zone Settings.

The supervisor controls feature will lower machine variability for consistent, repeatable cleaning results, machine quality assurance regardless of user experience, and reduce user training requirements.

**T300 MODEL WITH PRO-MEMBRANE CONTROL PANEL**

The machine has three supervisor control modes of operation to choose from:

**Unlocked Mode 1:** Operator has full control of all scrubbing parameters with the ability to save Zone Settings. The Unlocked Mode 1 is the factory default setting.

**Lockout Mode 2:** Zone Settings are configured and locked by supervisor. Operator has control to reconfigure the zone settings, but are not able to save them.

**Lockout Mode 3:** Zone Settings are configured and locked by supervisor. Operator is restricted to only use the Zone Settings configured by supervisor.

To enter the supervisor controls mode follow the instructions below:

1. Park the machine on a level surface and turn the key to off ( O ) position.
2. Press and hold the Down Pressure button while turning the key on. Release button when the far right battery discharge indicator LED turns on (Figure 133).

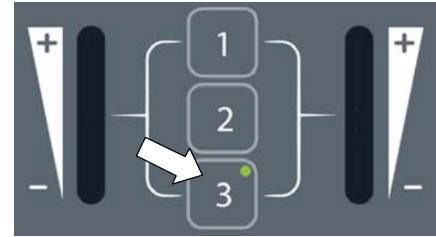

**FIG. 133**

3. Select the preferred supervisor control mode by pressing the following Zone Setting buttons as described:

- Zone 1 button = Unlocked mode 1
- Zone 2 button = Lockout mode 2
- Zone 3 button = Lockout mode 3

Hold down the Zone Setting button until it blinks three times to save the preferred supervisor control mode (Figure 134). In this example, Lockout mode 3 was selected.



**FIG. 134**

4. If Lockout mode 2 or 3 was selected, press the Solution Flow button. This will allow you to configure the Zone Settings for the selected supervisor control mode (Figure 135).



**FIG. 135**

5. Configure the following Zone Settings for zone 1. After the Zone Settings are configured, press and hold the zone button until it blinks three times to save Zone Setting. Repeat process for other zones.

**Zone Settings:**

- Down pressure rate
- Solution flow rate
- Quiet-Mode on or off (option)
- ec-H2O mode on or off (option)
- Maximum scrubbing speed (drive model)

To adjust the maximum scrub speed, press the circled button to cycle through the five speed selections as described below (Figure 136).

The speed selection is displayed by the battery discharge indicator LED's. The red LED represents the lowest speed. The far right green LED represents the highest speed (Figure 136).

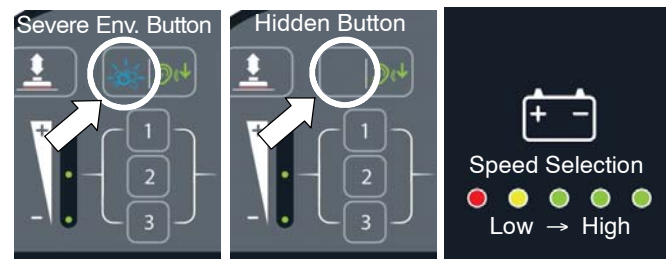

**FIG. 136**

6. To exit the supervisor control mode, turn key off.

# SUPERVISOR CONTROLS

## T300 MODEL WITH PRO-PANEL CONTROLS

There are two types of user modes that will interface with the operator home screen:

**Operator Mode** - Capable of machine operation with permissions and restrictions controlled by the supervisor.

**Supervisor Mode** - Capable of machine operation with full use of all controls, along with configuring permissions and restrictions for the operator mode.

A new machine from the factory will automatically start up in the supervisor mode with a preassigned default supervisor profile. The machine's factory-assigned supervisor login number is "1234". This login number is not required until it's enabled. The default supervisor profile name and login number can be changed as described in this section. If the new assigned supervisor mode login number is forgotten, use the recovery login code 836626826.

To enter the supervisor controls follow the instructions below:

1. Park the machine on a level surface and turn the key to the on ( I ) position. The home screen will display at start up (Figure 137). This is the factory default screen at start up.

*NOTE: If a login screen appears at start up. Enter the factory-assigned supervisor login number or your saved personalized supervisor login number to access the operator home screen.*

2.  Press the settings button located on the home screen (Figure 137).

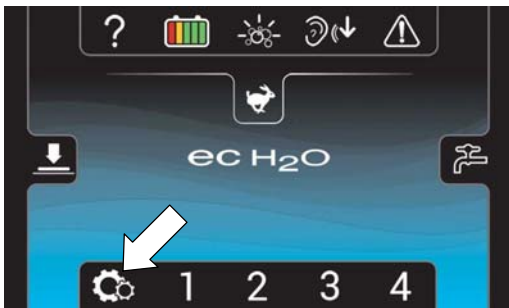



FIG. 137

3.  Press the Setup button to access the Setup screen (Figure 138). The Setup screen is only accessible with an assigned supervisor login number.

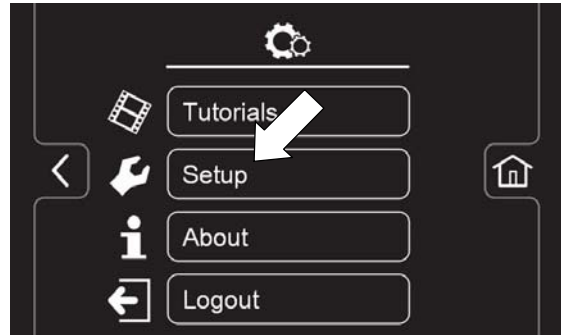

FIG. 138

4. The Setup screen allows supervisor access to the following controls as described below.

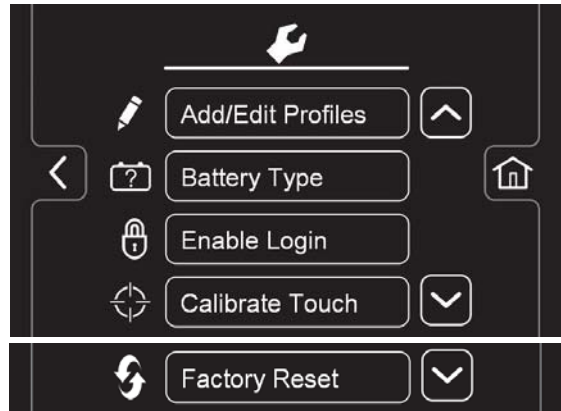





FIG. 139

 **Add/Edit Profiles** - Provides the capability to add, edit, copy or delete user profiles.

 **Battery Type** - Use this to select battery type installed in machine. This ensures the on-board battery charger charging profile is properly programmed to your battery type. See BATTERIES.

 **Enable Login** - Activates a required login number at machine start up for all user profiles to operate machine.

 **Calibrate Touch Icon** - Use this to calibrate the touch screen if the touch points become misaligned.

 **Factory Reset** - Resets the supervisor login number back to the factory default number 1234, removes user profiles and resets any custom preset zone setting names back to the factory preset names.

**To Add/Edit User Profiles**

Before adding new user profiles, it is recommended to configure the four Zone Settings in advance (See CONTROL PANEL OPERATION).

1.  Press the “Add/Edit Profiles” button to enter the user profile settings (Figure 140).

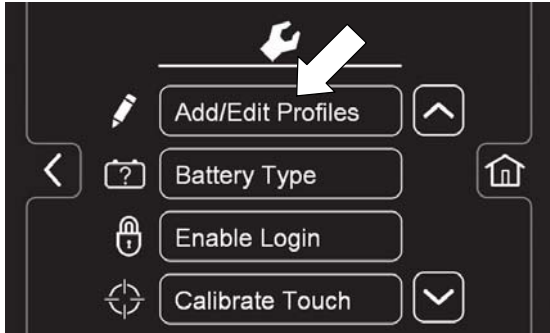

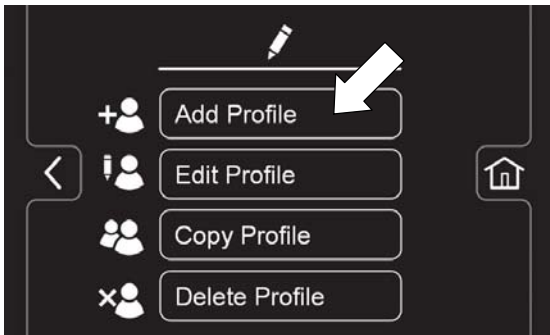

**FIG. 140**

2.  Press the “Add Profile” button to add a new user profile (Figure 141).



**FIG. 141**

3.  Press the “Operator” button to add a new operator (Figure 142).

 Or press the “Supervisor” button to add an additional supervisor (Figure 142).  
 Note: The machine’s default supervisor profile can not be deleted from profile list.

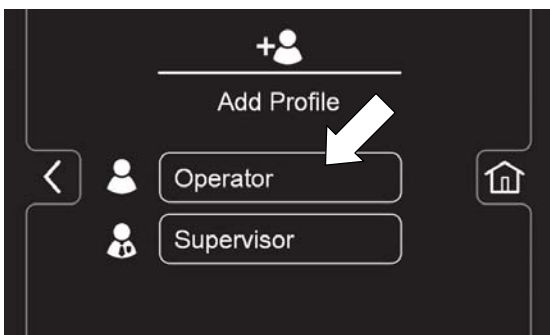

**FIG. 142**

4. Enter the new user’s profile ID (identification) then press the green forward arrow (Figure 143).



**FIG. 143**

5. Create an assigned login number for the new user profile then press the green arrow (Figure 144). The new login number can be any combination of numbers ranging from 3 to 8 digits long.

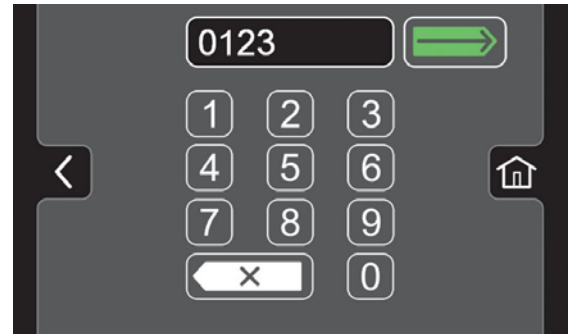

**FIG. 144**

6. Now select the controls that the new user should have access to use (Figure 145). Green represents unlocked controls and gray represents locked controls. Press the blinking save icon to save new profile.

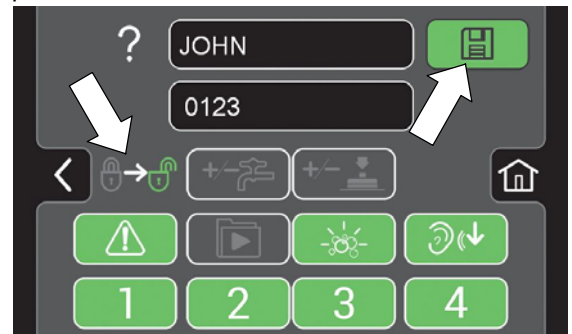

**FIG. 145**

7. The new user profile is now saved to the operator profile list as shown (Figure 146). Multiple Operator and Supervisor user profiles can be added. Press the back arrow to return to the previous screen to add more user profiles or to enable login.

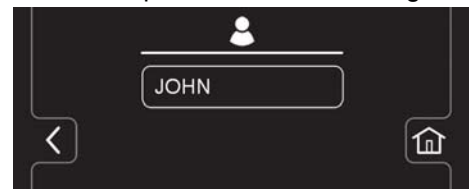

**FIG. 146**

## SUPERVISOR CONTROLS

8. To enable the login number at start up, press the “Enable Login” button (Figure 147). This button will change from “Enable Login” to “Disable Login”. This will allow you to disable a required login number at start up as described in step 13.

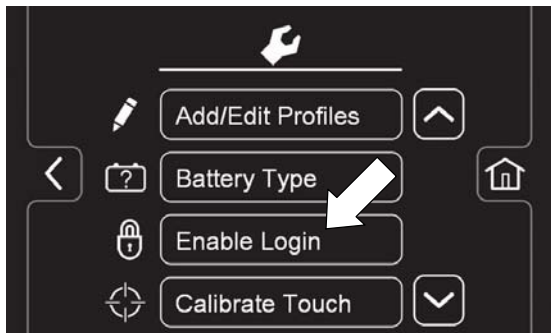

FIG. 147

9. Now at machine start up, a login screen will display (Figure 148). The new user will need to enter their assigned login number to operate machine

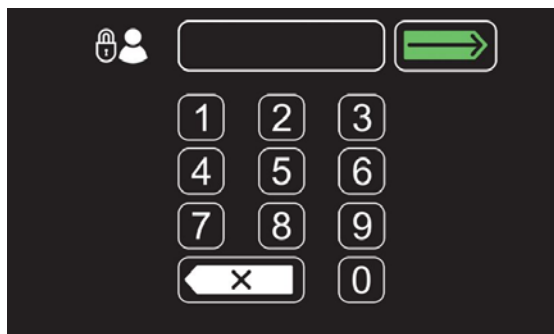

FIG. 148

10. When the user is done operating the machine, it is recommended to have the user log out by pressing the Settings button, then pressing the logout button (Figure 149). Turning the key to the off position is another way to also logout.

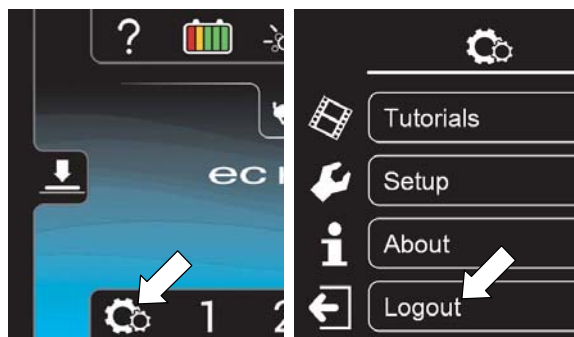

FIG. 149

11. Use the edit, copy and delete profile buttons to manage the current user profiles (Figure 150).

For example, to edit any user profile settings including the factory-assigned default supervisor login number, press the “Edit Profile” button

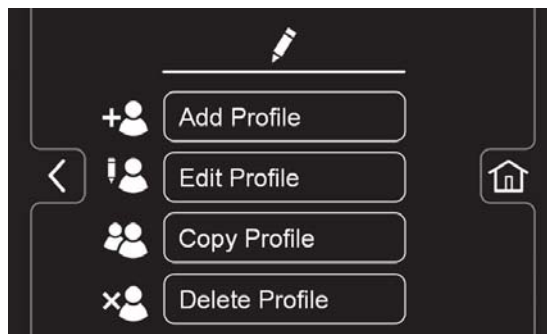

FIG. 150

To change the factory-assigned default supervisor login number, press the Supervisor button. Then press the “DEFAULT SUPER” profile button to enter the profile settings (Figure 151).

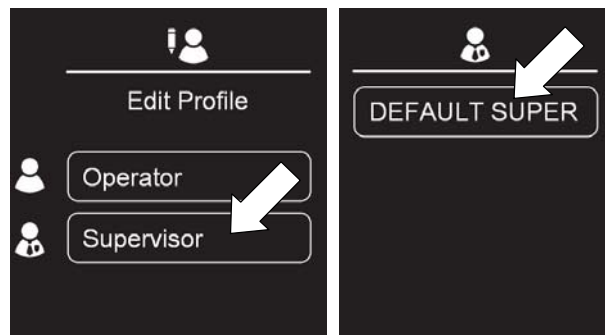



FIG. 151

Within the profile settings screen, press the factory-assigned login number and enter a new login number (Figure 152).

 Press the blinking save icon to save the new login number.

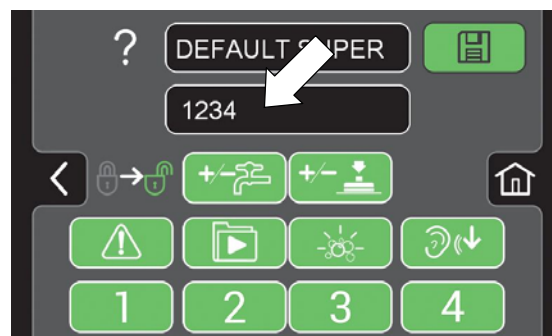

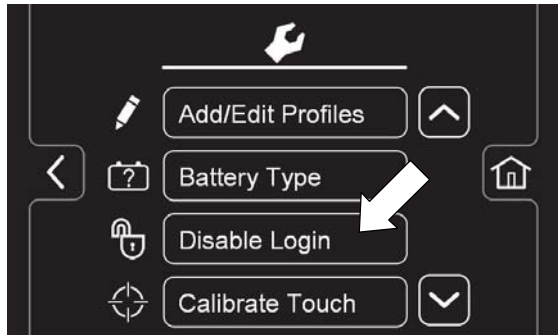

FIG. 152



13. To setup the machine without a login number requirement for a specific user profile as the default, follow the instructions below:

- a.  Press the “Disable Login” button (Figure 153).



**FIG. 153**

- b. Press the “yes” button to enter the Default User screen (Figure 154).

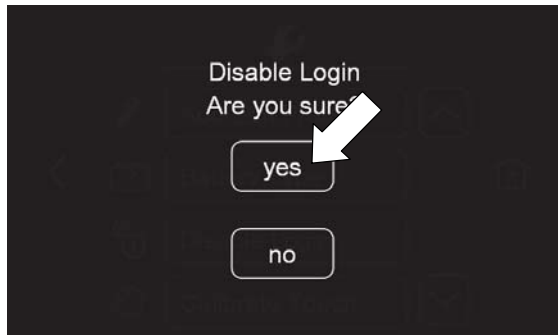

**FIG. 154**

- c. Select the desired default user by pressing the Operator or Supervisor button (Figure 155).

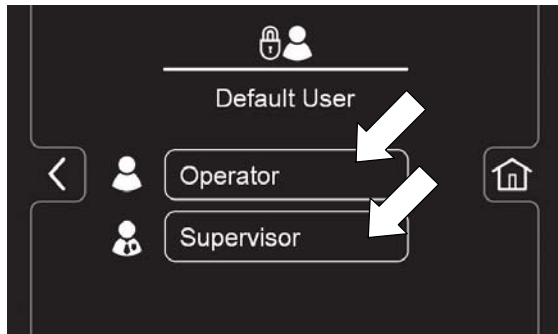

**FIG. 155**

- d. Select a pre-assigned user profile. In this example, operator profile “JOHN” is selected (Figure 156). Turn the key off to apply the setting.

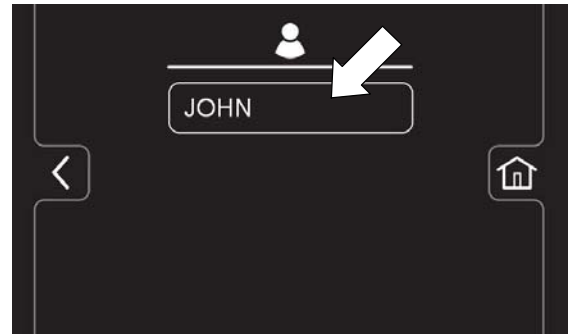

**FIG. 156**

- e. At start up, the home screen is now set without a login requirement for John’s operator profile as the default.