

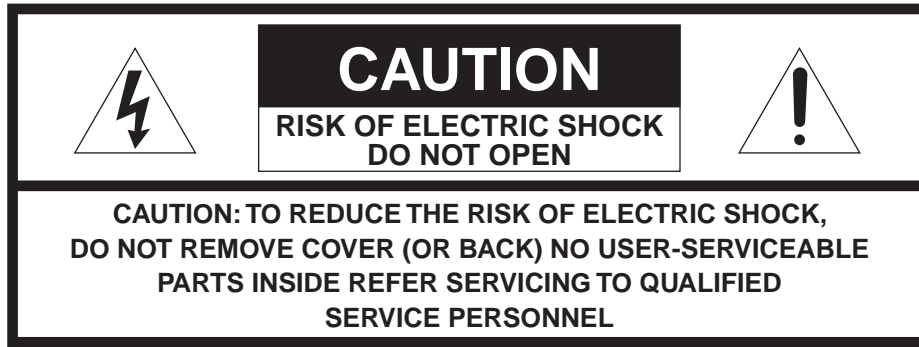

marantz[®] AV Surround Receiver
NR1501

User Guide



The lightning flash with arrowhead symbol within an equilateral triangle is intended to alert the user to the presence of uninsulated "dangerous voltage" within the product's enclosure that may be of sufficient magnitude to constitute a risk of electric shock to persons.



The exclamation point within an equilateral triangle is intended to alert the user to the presence of important operating and maintenance (servicing) instructions in the literature accompanying the product.

WARNING

TO REDUCE THE RISK OF FIRE OR ELECTRIC SHOCK, DO NOT EXPOSE THIS APPLIANCE TO RAIN OR MOISTURE.

CAUTION: TO PREVENT ELECTRIC SHOCK, MATCH WIDE BLADE OF PLUG TO WIDE SLOT, FULLY INSERT.

ATTENTION: POUR EVITER LES CHOCS ELECTRIQUES, INTRODUIRE LA LAME LA PLUS LARGE DE LA FICHE DANS LA BORNE CORRESPONDANTE DE LA PRISE ET POUSSER JUSQU'AU FOND.

NOTE TO CATV SYSTEM INSTALLER:

This reminder is provided to call the CATV (Cable-TV) system installer's attention to Section 820-40 of the NEC which provides guidelines for proper grounding and, in particular, specifies that the cable ground shall be connected to the grounding system of the building, as close to the point of cable entry as practical.

NOTE:

This equipment has been tested and found to comply with the limits for a Class B digital device, pursuant to Part 15 of the FCC Rules. These limits are designed to provide reasonable protection against harmful interference in a residential installation. This equipment generates, uses and can radiate radio frequency energy and, if not installed and used in accordance with the instructions, may cause harmful interference to radio communications. However, there is no guarantee that interference will not occur in a particular installation. If this equipment does cause harmful interference to radio or television reception, which can be determined by turning the equipment off and on, the user is encouraged to try to correct the interference by one or more of the following measures:

- Reorient or relocate the receiving antenna.
- Increase the separation between the equipment and receiver.
- Connect the equipment into an outlet on a circuit different from that to which the receiver is connected.
- Consult the dealer or an experienced radio/TV technician for help.

NOTE:

Changes or modifications may cause this unit to fail to comply with Part 15 of the FCC Rules and may void the user's authority to operate the equipment.

This Class B digital apparatus complies with Canadian ICES-003.

Cet appareil numérique de la Classe B est conforme a la norme NMB-003 du Canada.

CAUTION:

To completely disconnect this product from the mains, disconnect the plug from the wall socket outlet.

The mains plug is used to completely interrupt the power supply to the unit and must be within easy access by the user.

IMPORTANT SAFETY INSTRUCTIONS

READ BEFORE OPERATING EQUIPMENT

This product was designed and manufactured to meet strict quality and safety standards. There are, however, some installation and operation precautions which you should be particularly aware of.

1. Read these instructions.
2. Keep these instructions.
3. Heed all warnings.
4. Follow all instructions.
5. Do not use this apparatus near water.
6. Clean only with dry cloth.
7. Do not block any ventilation openings. Install in accordance with the manufacture's instructions.
8. Do not install near any heat sources such as radiators, heat registers, stoves, or other apparatus (including amplifiers) that produce heat.
9. Do not defeat the safety purpose of the polarized or grounding-type plug. A polarized plug has two blades with one wider than the other. A grounding type plug has two blades and a third grounding prong. The wide blade or the third prong are provided for your safety. If the provided plug does not fit into your outlet, consult an electrician for replacement of the obsolete outlet.
10. Protect the power cord from being walked on or pinched particularly at plugs, convenience receptacles, and the point where they exit from the apparatus.
11. Only use attachments/accessories specified by the manufacturer.
12. Use only with the cart, stand, tripod, bracket, or table specified by the manufacturer, or sold with the apparatus. When a cart is used, use caution when moving the cart/apparatus combination to avoid injury from tip-over.



13. Unplug this apparatus during lightning storms or when unused for long periods of time.
14. Refer all servicing to qualified service personnel. Servicing is required when the apparatus has been damaged in any way, such as power-supply cord or plug is damaged, liquid has been spilled or objects have fallen into the apparatus, the apparatus has been exposed to rain or moisture, does not operate normally, or has been dropped.

Additional Safety Information!

- This product should not be placed in a built-in installation such as a bookcase or rack unless proper ventilation is provided or the manufacturer's instructions have been adhered to.
- Apparatus shall not be exposed to dripping or splashing and that no objects filled with liquids, such as vases, shall be placed on the apparatus.
- When the switch is in the OFF position, the apparatus isn't completely switched-off from the MAINS.
- Do not expose the unit and batteries to excessive heat such as direct sunlight, fire or the like.
- Make a space of about 8 inches (0.2 m) around the unit.

Thank you for choosing the Marantz product.
 Please read this User Guide thoroughly to ensure proper operation and installation before using this product.
 After reading this User Guide, be sure to keep this for your future reference.

ACCESSORIES CHECK

Before use, check the below accessories were included in the package.

- Remote controller 1
- Batteries (AAA)..... 2
- AC power cord 1
- AM loop antenna..... 1
- FM antenna 1
- Microphone 1
- User guide 1
- Warranty Card
 - USA 1
 - Canada..... 1

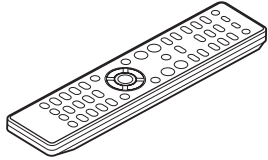

CONTENTS

FEATURES	2	SETUP	17
BEFORE USE	2	ONSCREEN DISPLAY MENU SYSTEM.....	17
EQUIPMENT MAINS WORKING SETTING	2	1. SYSTEM SETUP.....	19
DO NOT LOCATE IN THE FOLLOWING PLACES.....	2	2. INPUT SETUP	20
USAGE OF REMOTE CONTROLLER	3	3. SPEAKER/R. EQ SETUP.....	21
NAMES AND FUNCTIONS.....	4	4. CH LEVEL SETUP	24
FRONT PANEL.....	4	5. SOUND PARAMETER.....	25
FL DISPLAY AND INDICATOR.....	4	ADVANCED OPERATION.....	26
REAR PANEL	5	AMP OPERATION.....	26
REMOTE CONTROLLER.....	6	TUNER OPERATIONS (PRESET MEMORY)	30
BASIC CONNECTIONS	8	REMOTE CONTROLLER OPERATION	31
SPEAKER PLACEMENT	8	TROUBLESHOOTING.....	34
CONNECTING SPEAKERS.....	8	GENERAL	34
CONNECTING AUDIO COMPONENTS	9	SURROUND	34
CONNECTING VIDEO COMPONENTS	10	VIDEO	36
CONNECTING HDMI COMPONENTS	11	HDMI	36
CONNECTING THE ANTENNAS.....	12	TUNER	37
CONNECTING OF AC POWER CABLE.....	12	WHEN MALFUNCTIONING HAS OCCURRED	37
BASIC OPERATION	12	OTHERS	38
AMP OPERATION.....	12	SURROUND MODE	38
TUNER OPERATION.....	14	DESCRIPTION	40
REMOTE CONTROLLER OPERATION	15	SPECIFICATIONS	42
ADVANCED CONNECTIONS.....	16	USING HEADPHONES.....	42
CONNECTING THE REMOTE CONTROL JACKS ...	16	COPYRIGHT	42
		CLEANING OF EQUIPMENT EXTERNAL SURFACES	42
		REPAIRS.....	42

NAMES AND FUNCTIONS

BASIC CONNECTIONS

BASIC OPERATION

ADVANCED CONNECTIONS

SETUP

ADVANCED OPERATION

TROUBLESHOOTING

OTHERS

FEATURES

HD AUDIO DECODER FEATURED

This unit comes with the latest digital surround sound decoding technologies listed below. For further details, refer to "SURROUND MODE" (page 40).

- Dolby True HD
- Dolby Digital Plus
- Dolby Digital, Dolby Digital EX
- DTS-HD (Master Audio, Hi-Resolution Audio)
- DTS, DTS ES, DTS Neo:6, DTS 96/24
- Dolby Pro-Logic IIx

AUTO SETUP SYSTEM

The unit has been provided with an auto setup function that uses a high-performance DSP (digital signal processor) to analyze the data obtained by measuring the characteristics of the speakers and the characteristics of the listening room using the high-performance microphone supplied and which, based on the results of this analysis and arithmetic calculation processing, compensates the frequency characteristics in such a way that the entire listening room becomes the optimum listening environment.

7-CHANNEL DISCRETE AMPLIFIER

A 7-channel discrete amplifier boasting a wide range over which it exhibits the same high-level performance is employed.

HDMI TERMINALS INCORPORATED

Incorporating an IC for HDMI (High-Definition Multimedia Interface) that is compatible with HDMI Ver1.3a, which is the most up-to-date version, makes it possible for the HDMI terminals to support the transmission of video signals compliant with the Deep Color and x.v.Color standards, while at the same time enabling them to support Dolby TrueHD, DTS-HD and Dolby Digital Plus used with Blu-ray discs and HD DVDs.

VIDEO CONVERTER FEATURED

The unit has an up-converter (that converts composite and component signals into HDMI signals) for the video signals using full digital processing.

WIDE-BAND COMPONENT VIDEO SELECTOR

Three input lines and one output line for the component video signals are featured. High-definition and other wide-band (80 MHz (-3 dB)) video signals are supported.

SLIM-LINE DESIGN FOR GREATER FREEDOM OF INSTALLATION

By endowing this unit with slim dimensions for a multi-channel AV receiver, users can even install it where space is at a premium.

OTHER FEATURES

- 32-bit latest DSP
- OSD (on-screen display) menu system enabling the settings to be selected on the TV screen
- Remote controller with preset functions
- Environmentally friendly low-power-consumption STANDBY mode
- Cursor buttons provided on the front panel
- AUX1 input terminals enabling a digital audio player or other component to be connected using 3.5 mm ϕ stereo mini jacks provided on the front panel

BEFORE USE

EQUIPMENT MAINS WORKING SETTING

Your Marantz product has been prepared to comply with the household power and safety requirements that exist in your area.

This unit can be powered by 120V AC only.

DO NOT LOCATE IN THE FOLLOWING PLACES

To ensure long-lasting use, do not locate the unit where:

- Exposed to direct sunlight.
- Near to sources of heat such as heaters.
- Highly humid or poorly ventilated.
- Dusty.
- Subjected to mechanical vibrations.
- On wobbly, inclined or otherwise unstable surfaces
- Near windows where there is a chance of exposure to rain, etc.
- On top of an amplifier or other component which dissipates a great deal of heat

To ensure proper heat radiation, ensure the below clearance from walls and other equipment.

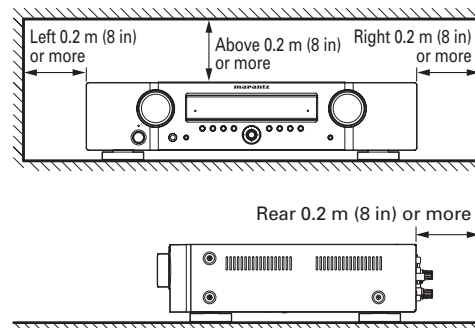

KEEP OBJECTS OFF

Keep objects off the unit. Blocking the vent can result in accident and damage.

USAGE OF REMOTE CONTROLLER

LOADING BATTERIES

Before using the remote controller for the first time, load the batteries in the remote controller. The batteries provided are used to verify the operations of the remote controller only.

1. Remove the battery cover.
2. Paying close attention to polarity indicators (+ plus and - minus), be sure to insert batteries correctly and as indicated.
3. Return the battery cover to its original position.

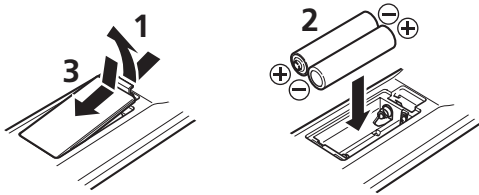

CAUTIONS ON HANDLING BATTERIES

Misusing batteries can lead to fire, injury or soiling of surrounding area as a result of leakage, rupture or corrosion.

Carefully read the following precautions before using batteries.

- Insert the batteries while ensuring that their ⊕ and ⊖ poles are properly aligned with the corresponding markings on the remote controller.
- Batteries of the same size and shape may have different voltages. Do not use any battery except the type indicated. Do not use old and new batteries together, and do not use different types of batteries together.
- Do not recharge batteries.
- Keep batteries out of the reach of children. Seek medical attention if accidentally ingested.
- Do not carry or store batteries together with metal ball point pens, necklaces, coins, hair pins, etc.
- If you will not be using the remote controller for an extended time (1 month or more), remove the batteries to prevent leakage. If batteries leak, do not touch the fluid with bare hands. Wipe away any fluid in the case and put in new batteries. When doing so, handle with care, because fluid on skin or clothing presents a burn risk. If you accidentally get fluid on your skin, immediately wash with water and seek medical attention.
- Do not heat or take apart batteries or put them in flame or water.

- When disposing of used batteries, please comply with governmental regulations or environmental public instruction's rules that apply in your country or area.
- Do not expose the batteries to excessive heat such as direct sunlight, fire or the like.

OPERATIONAL RANGE

Operate the unit with the remote controller within the range of the illustration below.

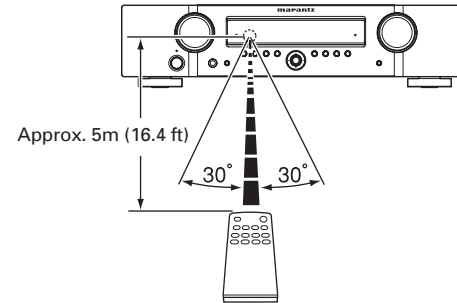

Caution

- Do not allow direct sunlight, an inverter fluorescent light or other strong source of light to shine onto the player's infrared receptor window. Otherwise, the operation of the remote controller may be disabled.
- Bear in mind that operating the remote controller may cause other devices operated by infrared rays to be operated by mistake.
- The remote controller cannot be operated if the space between the controller and the player's infrared receptor window is obstructed.
- Do not place any objects on top of the remote controller.
Doing so may cause one or more buttons to be held down which will cause the batteries to run down.

NAMES AND FUNCTIONS

FRONT PANEL

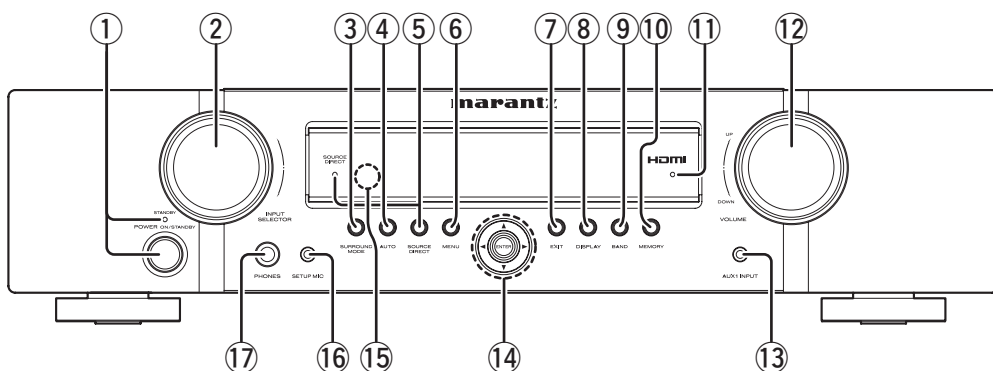

① POWER switch and STANDBY indicator

When this switch is pressed once, the unit turns ON and the display illuminates. When pressed again, the unit turns OFF and the STANDBY indicator will be illuminated.

② INPUT SELECTOR knob

This knob is used to select the input sources. (See page 13)

③ SURROUND MODE button

Press this button to select the surround mode.

④ AUTO button

Press this button to select the AUTO mode from the surround modes. When this mode is selected, the unit determines the surround mode corresponding to a digital input signal automatically. (See page 27)

⑤ SOURCE DIRECT button and indicator

When this button is pressed, the audio signal will bypass the tone control circuit to provide the pure sound quality. In order not to bypass the tone control circuit, press SOURCE DIRECT button again.

⑥ MENU button

Press this button to enter the SETUP MAIN MENU.

⑦ EXIT button

Press this button to exit from the SETUP MAIN MENU.

⑧ DISPLAY button

Press this button to change the FL display mode. (See page 26)

⑨ BAND button

Press this button to switch between FM and AM in the TUNER mode.

⑩ MEMORY button

Press this button to enter the tuner preset memory numbers or station names. (See page 30)

⑪ HDMI indicator

This indicator is illuminated when input terminal of the HDMI component is connected to the unit.

⑫ VOLUME control knob

This knob is used to adjust the overall sound level. Turning the control clockwise increases the sound level.

⑬ AUX1 INPUT jack

This audio input jack accept the connections of the portable audio player etc.

⑭ Cursor (▲, ▼, ◀, ▶) / ENTER button

Press these buttons to operate the SETUP MAIN MENU and TUNER function.

⑮ INFRARED receiving sensor window

This window receives infrared signals for the remote controller.

⑯ SETUP MIC jack

Automatically measure speaker characteristics using the included microphone. (See page 22)

⑰ PHONES jack

This jack may be used to listen to the unit's output through a pair of headphones. (See page 28)

FL DISPLAY AND INDICATOR

(1) Main Information Display

This display shows messages relating to the status, input source, surround mode, tuner, volume level or other aspects of unit's operation.

(2) AUTO indicator

This indicator is illuminated when the AUTO SURROUND mode is in use.

(3) TUNER's indicators

ST : This indicator is illuminated in the AUTO STEREO mode during tuner operations.
TUNED : This indicator illuminates when the tuner receives a sufficiently strong radio signal.

(4) * indicator

This indicator is illuminated when the sleep timer function is in use.

(5) MEM indicator

This indicator is illuminated when the MEMORY function is working during tuner operations.

(6) PRESET indicator

This indicator is illuminated in the PRESET mode during tuner operations.

(7) HDMI indicator

This indicator is illuminated when a HDMI input source has been selected.

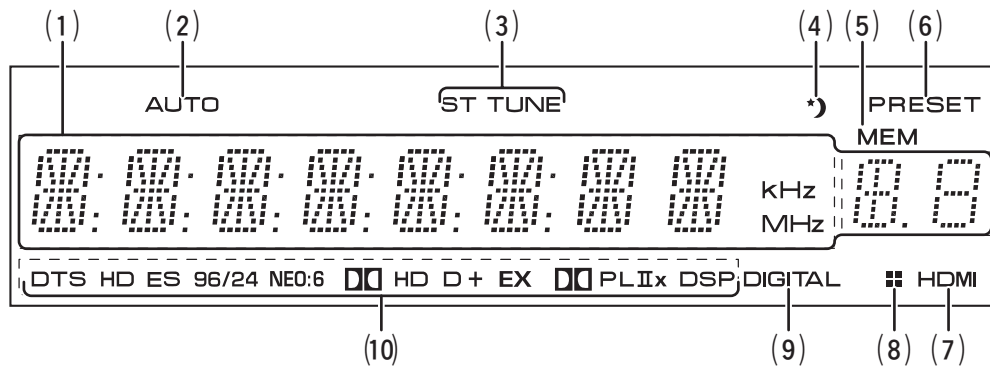
**(8) ■ indicator**

This indicator is illuminated when this unit is in the display off mode.

(9) DIGITAL Indicator

This indicator is illuminated when a digital input has been selected.

(11) SIGNAL FORMAT indicators**DTS**

This indicator is illuminated when a DTS signal is input.

DTS HD

This indicator is illuminated when a DTS-HD signal is input.

DTS ES

This indicator is illuminated when a DTS ES signal is input.

DTS 96/24

This indicator is illuminated when a DTS 96/24 signal is input.

NEO:6

This indicator is illuminated when the sound is output with the DTS Neo:6.

■ HD

This indicator is illuminated when a Dolby Digital True HD signal is input.

■ D

This indicator is illuminated when a Dolby Digital signal is input.

■ D +

This indicator is illuminated when a Dolby Digital Plus signal is input.

■ D EX

This indicator is illuminated when a Dolby Digital EX signal is input.

■ PLIIx

This indicator is illuminated when the sound is output with the Dolby Pro Logic IIx.

DSP

This indicator is illuminated when the sound is output with the VIRTUAL or MULTI CH STEREO.

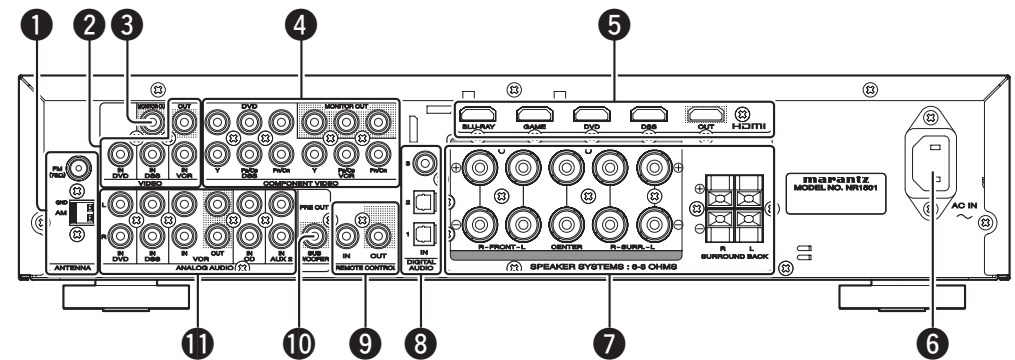
REAR PANEL**1 ANTENNA terminals
FM (75 Ω)**

Connect an external FM antenna with a coaxial cable, or a cable network FM source.

AM

Connect the supplied AM loop antenna. Position the loop antenna until you hear the best reception.

2 VIDEO terminals (DVD, DSS, VCR)

There are 3 video inputs and 1 video output. Connect VCRs, DVD players, and other video components to the video inputs.

3 MONITOR OUT terminal

This is a monitor outputs.

**4 COMPONENT VIDEO terminals
(DVD, DSS, VCR)**

This unit has 3 component video input connectors to obtain the color information (Y, Pb/Cb, Pr/Cr) directly from the recorded DVD signal or other video component and 1 component video output connector to output it directly into the matrix decoder of the display device.

**5 HDMI terminals
(BLU-RAY, GAME, DVD, DSS)**

The unit has 4 HDMI inputs and 1 HDMI output.

6 AC INLET

Plug the supplied power cable into this AC INLET and then into the power outlet on the wall. This unit can be powered by 120V AC only.

7 SPEAKER SYSTEMS terminals

Seven terminals are provided for the front left, front right, front center, surround left, surround right, surround back left and surround back right speakers.

8 DIGITAL AUDIO IN 1, 2, 3

The unit has 1 digital input with coaxial jacks, 2 with optical jacks.

The inputs accept digital audio signals from a CD, DVD, or other digital source component. The input function can be selected from the OSD menu system. (See page 20)

9 REMOTE CONTROL IN/OUT terminals

Connect to a Marantz component equipped with remote control (RC-5) terminals.

10 SUB WOOFER PRE OUT terminal

Connect this jack to the line level input of a powered subwoofer.

**11 ANALOG AUDIO terminals
(CD, DVD, DSS, VCR, AUX2)**

There are 5 audio inputs and 1 audio outputs. The audio inputs and outputs require RCA-type connectors.

NAMES AND FUNCTIONS

REMOTE CONTROLLER

The provided remote controller is a universal remote controller. The POWER button, numeric buttons and control buttons are used in common across different input source components. The input source controlled with the remote controller changes when one of the input selector buttons is pressed.

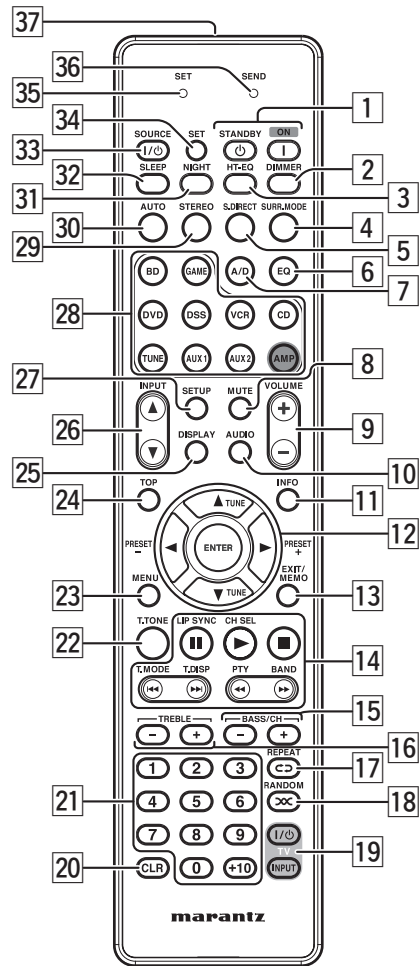

1 ON I / STANDBY buttons

(When AMP mode is selected)

These buttons are used to turn the unit on or off.

2 DIMMER button

This button is pressed when dimming the unit's display.

3 HT-EQ button

(When AMP mode is selected)

This button is used to turn on or off HT(Home Theater)-EQ mode.

4 SURR. MODE button

This button is used to select the surround mode.

5 S.DIRECT button

This button is used to select SOURCE DIRECT mode.

6 EQ button

This button is used to select Room EQ mode.

7 A/D button

This button is used to switch between the analog and digital inputs.

8 MUTE button

This button is used to mute the audio for the amplifier.

9 VOLUME +/- buttons

This button is used to adjust the volume for the amplifier.

10 AUDIO button

This button is used to select play using either the MAIN (main channel) sound or SUB (sub channel) sound in the Dolby Digital or DTS bilingual mode.

11 INFO button

This button is not used with this unit.

12 , , , (CURSOR) / ENTER buttons

These buttons are used when controlling the cursor of the unit, DVD or other AV equipment.

(When Tuner mode mode is selected)

PRESET + / PRESET - buttons

Used to select a preset station up and down.

TUNE / TUNE buttons

Used to tune a frequency station up and down.

13 EXIT / MEMO button

(When AMP mode is selected)

This button is used to cancel setting in the setup menu.

(When TUNER mode is selected)

This button is used to store the setting of preset channel and others.

14 CONTROL buttons

These buttons are used when operating PLAY, STOP, PAUSE and other commands of a source.

(When AMP mode is selected)

LIP SYNC button

This button is used to select LIP SYNC mode.

CH SEL button

This button is used to call up CH LEVEL ADJUST and adjust speaker levels.

(When TUNER mode is selected)

T.MODE button

This button is used to select auto stereo mode or mono mode when the FM band is selected.

T.DISP button

This button is not used for this unit.

PTY button

This button is not used for this unit.

BAND button

This button is used to select a radio band.

15 BASS / CH +/- buttons

(When AMP mode is selected)

These buttons are used to adjust the tone control of low frequency sound for left and right speaker.

(When DSS mode are selected)

These buttons are used to change channels.

16 TREBLE +/- buttons

(When AMP mode is selected)

These buttons are used to adjust the tone control of high frequency sound for left and right speaker.

17 REPEAT button

This button is used to select the REPEAT mode of a source.

18 RANDOM button

This button is used to select the RANDOM mode of a source.

19 TV CONTROL buttons

These buttons are used when operating of TV and Monitor.

20 CLR button

This button is used to erase the memory or program of a source.

21 Numeric buttons

These buttons are used to switch between 0 to +10 of the source components.

22 T.TONE button

This button is used to output test tones and set the speaker levels.

23 MENU button

(When AMP mode is selected)

This button is used to call up the SETUP MAIN MENU of the unit.

24 TOP button

Pressing this button during setup returns you to the top screen of the setup main menu.

25 DISPLAY button

This button is used to select the display mode for the front display of the unit.

26 INPUT ▲ button

This button is for forward-feeding the input source to select a desired source.

INPUT ▼ button

This button is for backward-feeding the input source to select a desired source.

27 SETUP button

This button is used to setup for DVD and other device.

28 SOURCE button

These buttons are used to switch the source of your A/V Receiver. Each time a source button is pressed, the remote controller changes to the source which was pressed.

This remote controller can control 10 types of equipment. To change the A/V Receiver source, press this button twice within two seconds. The signal is sent when it is pressed the second time.

Notes

- Press the AMP button to operate the unit's amplifier functions.
- Press the TUNE button to operate the unit's tuner functions.

29 STEREO button

This button is used to select STEREO mode.

30 AUTO button

This button is used to select auto surround.

31 NIGHT button

Pressing this button prevents the Dolby Digital signal from playback at a loud voice.

32 SLEEP button

This button is used for setting the sleep timer.

33 I / ⏻ SOURCE ON/OFF button

This button is used to turn a specific source (such as a DVD player) on or off independently from the rest of the system.

34 SET button

This button is used to enter preset mode.

35 SET indicator

Indicates when the preset codes of the remote controller are operated.

36 SEND indicator

Indicates when the remote controller is transmitting a signal.

37 Infrared Transmitter

This transmitter emits infrared light. Press the buttons while pointing the transmitter towards the infrared receiver window of the unit or other AV equipment.

BASIC CONNECTIONS

SPEAKER PLACEMENT

The ideal surround speaker system for this unit is 7-speaker systems, using front left and right speakers, a center speaker, surround left and right speakers, a surround back left and right speakers, and a subwoofer. For best results we recommend that all front speakers be of the same type, with identical or similar driver units. This will deliver smooth pans across the front sound stage as the action moves from side to side. Your center channel speaker is very important as over 80% of the dialog from a typical motion picture emanates from the center channel.

It should possess similar sonic characteristics to the main speakers. Surround channel speakers need not be identical to the front channel speakers, but they should be of high quality.

The surround center speaker is useful for playback of Dolby Digital Surround EX or DTS-ES.

One of the benefits of both Dolby Digital and DTS is that surround channels are discrete full range, while they were frequency limited in earlier "Pro Logic" type systems.

Bass effects are an important part of home theater. For optimal enjoyment a subwoofer should be used as it is optimized for low frequency reproduction. If you have full range front speakers, however, they may be used in place of a subwoofer with proper setting of the switches in the menu system.

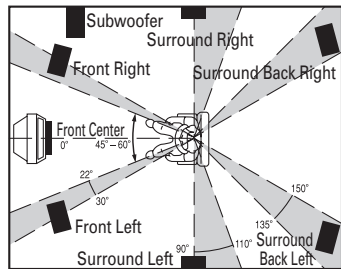

FRONT LEFT AND RIGHT SPEAKERS

We recommend to set the front L and R speakers with 45-60 degrees from the listening position.

CENTER SPEAKER

Align the front line of the center speaker with the front L/R speakers. Or place the center speaker a little backward from the line.

SURROUND LEFT AND RIGHT SPEAKERS

When this unit is used in surround operation, the preferred location for surround speakers is on the side walls of the room, at or slightly behind the listening position.

The center of the center speaker should face the center of the room.

SURROUND BACK LEFT AND RIGHT SPEAKERS

Surround back speakers are required when a full 7.1-channel system is installed.

Speakers should be placed on a rear wall, behind the listening position.

The center of the speaker should face into the room.

SUBWOOFER

We recommend using a sub-woofer to have maximum bass effect. As the subwoofer only handles low frequencies, you can place it anywhere in the room.

HEIGHT OF THE SPEAKER UNITS

FRONT LEFT AND RIGHT SPEAKERS, AND A CENTER SPEAKER

Align the tweeters and mid-range drivers on the three front speakers at the same height, as best as possible.

Note

Use magnetically-shielded speakers for front left, right and the center speakers when the speakers are installed near the TV.

SURROUND LEFT AND RIGHT SPEAKERS

Place the surround left, right and surround back speakers higher than your ears by about 70cm-1m. Also place the speakers at the same height, as best as possible.

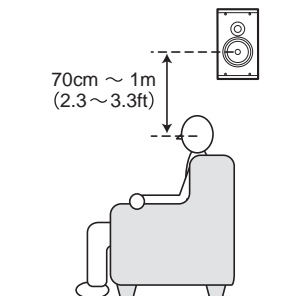

CONNECTING SPEAKERS

- Be sure to use speakers with the specified impedance as shown on the rear panel of this unit.
- When connecting a powered subwoofer (one with a built-in amplifier), connect it to the PRE OUT subwoofer output terminal.

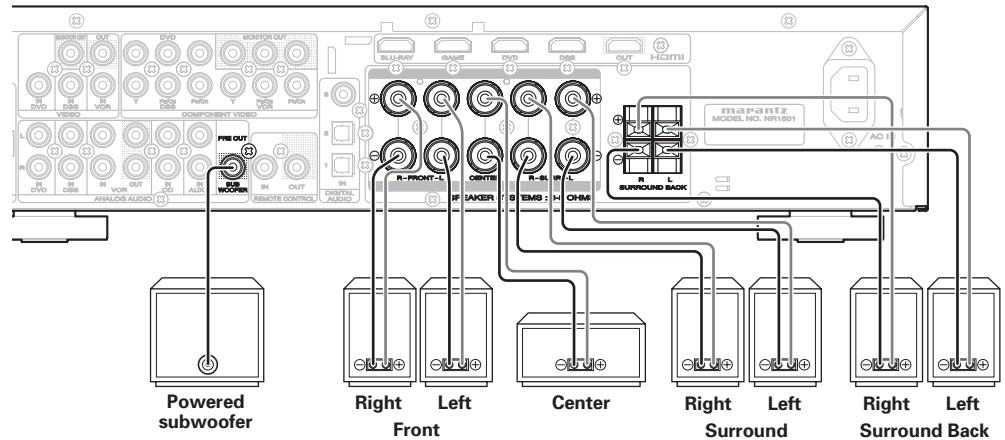

Notes

- To prevent damage to circuitry, do not let the bare speaker wires touch each other and do not let them touch any metal part of this unit.

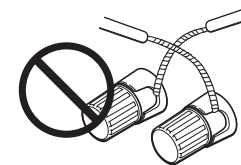

- Do not touch the speaker terminals when the power is on. It may cause you to receive an electric shocks.
- Do not connect more than one speaker cable to one speaker terminal. Doing so may damage this unit.
- Be sure to connect the positive and negative cables for the speaker properly. If they are miss-connected, the signal phase will be reversed and the signal quality will be corrupted.

CONNECTING SPEAKER WIRE

- Strip away approx. 10 mm (3/8 inch) of wire insulation.
- Twist the bared wire ends tight, to prevent short circuits.

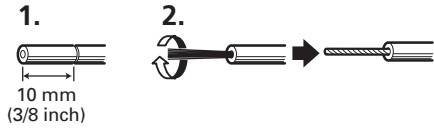

**FRONT R/L
CENTER
SURROUND R/L**

- Loosen the knob by turning it counterclockwise.
- Insert the bare part of the wire into the hole in side of each terminal.
- Tighten the knob by turning it clockwise to secure the wire.

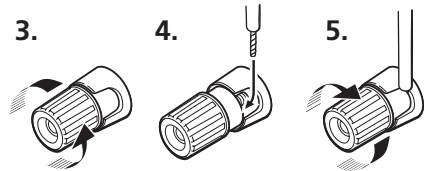

SURROUND BACK R/L

- Push the lever and hold it down.
- Insert the twisted ends of the wires into the hole in the terminal.
- Release the lever.

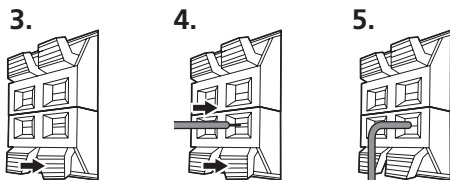

CONNECTING AUDIO COMPONENTS

The VCR OUT terminals are for recording purposes. The sound of the analog input source component currently selected is output from these terminals. The digital sound, which has been input to the DIGITAL IN or HDMI terminal, is not output from the VCR OUT terminals.

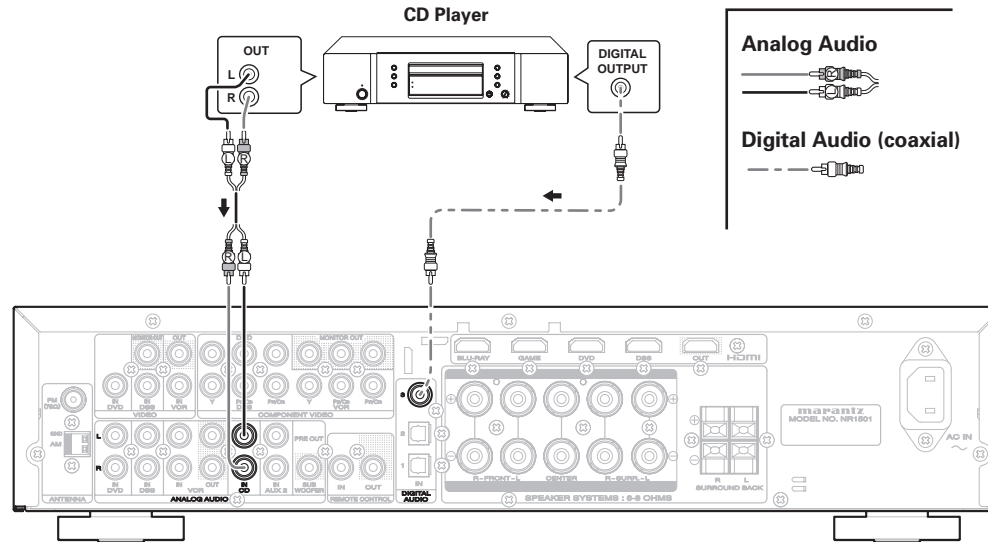

Notes

- Do not connect this unit and other components to mains power until all connections between components have been completed.
- Insert all plugs and connectors securely. Incomplete connections may make noise.
- Be sure to connect the left and right channels properly. Red connectors are for the R (right) channel, and white connectors are for the L (left) channel.
- Be sure to connect input and output properly.
- Refer to the instructions for each component that is connected to this unit.
- Do not bundle the connected cables with the power cord or speaker cables. Doing so may produce noise.

CONNECTING DIGITAL AUDIO COMPONENTS

- There are 3 digital inputs, 2 coaxial jacks and 1 optical jack, on the rear panel. You can use these jacks to input PCM, Dolby Digital and DTS bitstream signals from a CD, DVD, or other digital source components.
- Refer to the instructions for each component. To setup the digital audio format of DVD player, or other digital source's connected to digital input jacks.
- Use fiber optical cables (optical) for DIGITAL AUDIO-1,2 input jacks. Use 75 ohms coaxial cables (for digital audio or video) for DIGITAL AUDIO-3 input jacks.
- You can designate the input for each digital input/output jacks according to your component. (See page 20)

Note

The digital signal jacks on this unit conform to the EIA standard. If you use a cable that does not conform to this standard, this unit may not function properly.

BASIC CONNECTIONS

CONNECTING VIDEO COMPONENTS

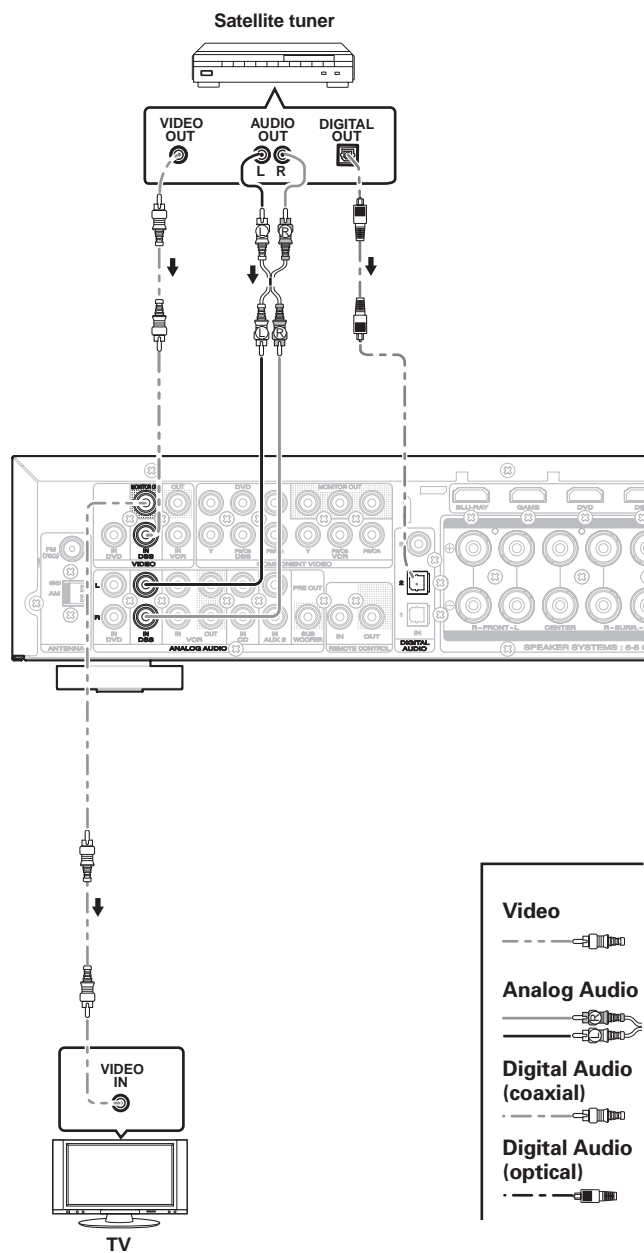
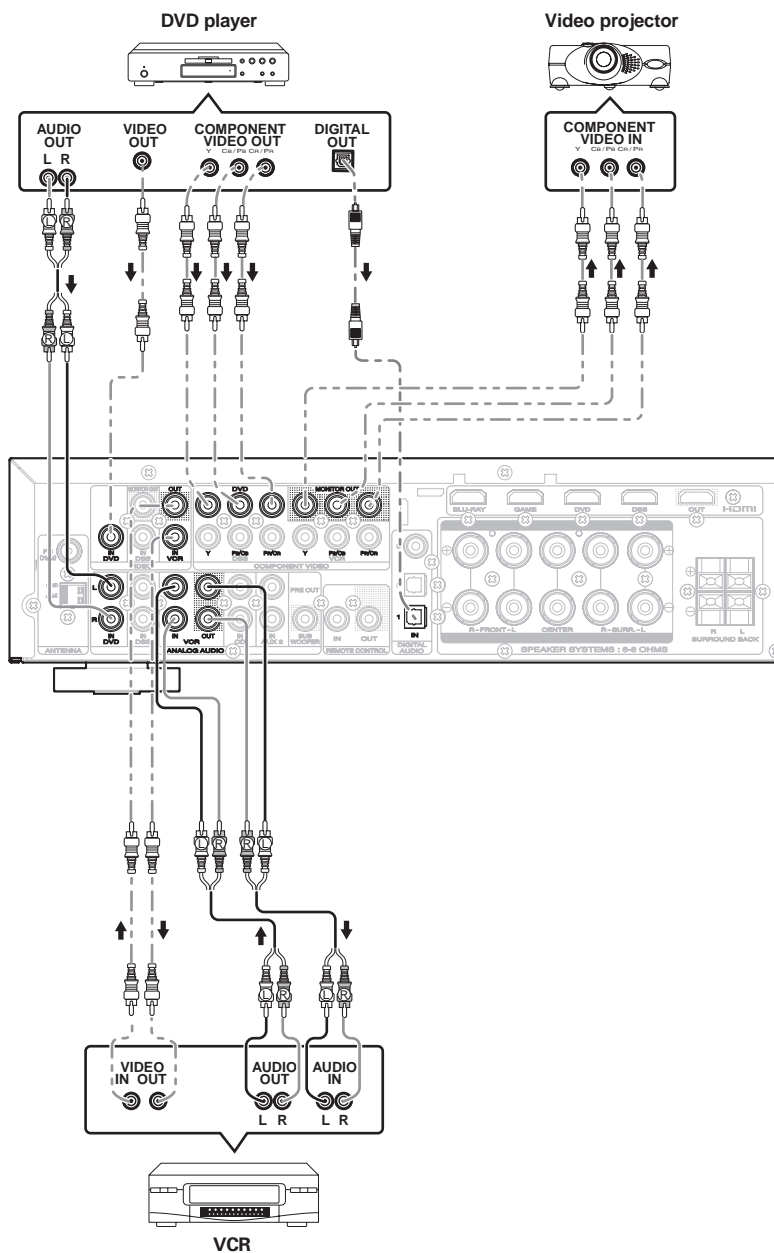

VIDEO COMPONENT JACKS

There are 2 types of video jacks on the rear panel.

VIDEO JACK

The video signal for the VIDEO jacks is the conventional composite video signal.

COMPONENT JACK

Make component video connections to a TV or monitor with component inputs to produce higher quality video images. Use a component video cable or 3 video cords to connect the component video out jacks on the unit to the monitor.

Notes

- Be sure to connect the left and right audio channels properly. Red connectors are for the R (right) channel, and white connectors are for the L (left) channel.
- Be sure to connect the inputs and outputs of the video signals properly.
- The unit has a video convert function. For details on video input/output, refer to page 29.
- You may need to setup the digital audio output format of your DVD player, or other digital source components. Refer to the instructions of the each component connected to the digital input jacks.

NAMES AND FUNCTIONS
BASIC CONNECTIONS
BASIC OPERATION
ADVANCED CONNECTIONS
SETUP
ADVANCED OPERATION
TROUBLESHOOTING
OTHERS

CONNECTING HDMI COMPONENTS

HDMI JACKS

This unit has 4 HDMI inputs and 1 HDMI output. It can send digital video and audio signals from Blu-ray's and other sources directly to a display. It minimizes signal degradation caused by analog conversion so that high quality images can be enjoyed.

Notes

- When the HDMI output is connected to a display monitor that does not support HDCP*, signals are not output. To view images in HDMI, it is necessary to connect to a display that supports HDCP.
- Refer to the instruction manual of the TV or display to be connected to the unit for detailed information regarding the HDMI terminal.

* **HDCP: High-bandwidth Digital Content Protection**

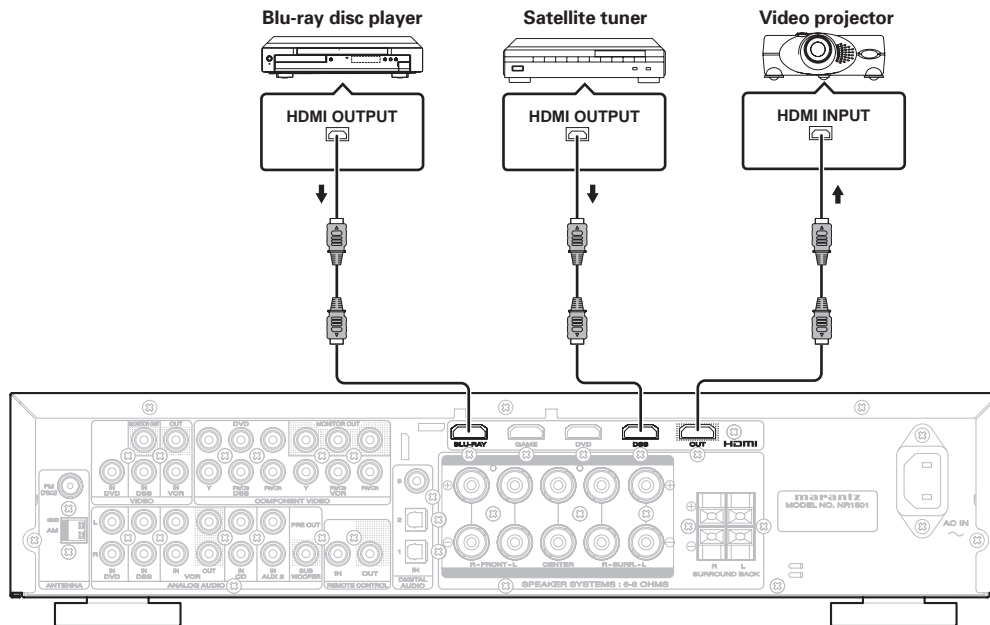

CONNECTING HDMI COMPONENTS

An HDMI cable (sold separately) is used to connect the HDMI jack on the unit with the HDMI jack on the Blu-ray disc player, TV, projector or other component. To transmit multichannel audio via HDMI, the connected player must support multichannel audio transmission through its HDMI jack.

Notes

- Some source devices such as DVD players or set top box do not support HDMI repeater operations like those of the unit. In such case, pictures are not properly projected on monitors such as TVs and projectors.
- When multiple components are connected to this unit, turn power to unused components off to prevent interference between them.
- Disconnecting or connecting cables with the power on can damage the equipment. Turn the power off before disconnecting or connecting cables.
- The following functions are not available when the unit is connected to equipment that does not support HDMI 1.3a.
 - Deep Color
 - x.v. Color
 - Bitstream audio signal decoding, as for Dolby Digital Plus, Dolby TrueHD, DTS-HD, and so on. For details, refer to the user's manuals of connected equipment.
- Depending on the quality of the cable used, the HDMI signal may be affected by noise.
- The unit does not support HDMI control. However, it can be connected between devices that support HDMI control, and the HDMI control signals can be passed through the unit to exercise the control concerned ("HDMI control through" function). "HDMI control" is a function that lets one device control another when both feature HDMI CEC (Consumer Electronics Control). By using HDMI cables to connect the devices, linked operations can be performed between them.

BASIC CONNECTIONS

CONNECTING THE ANTENNAS

CONNECTING THE SUPPLIED ANTENNAS

The supplied antennas are for indoor use only.

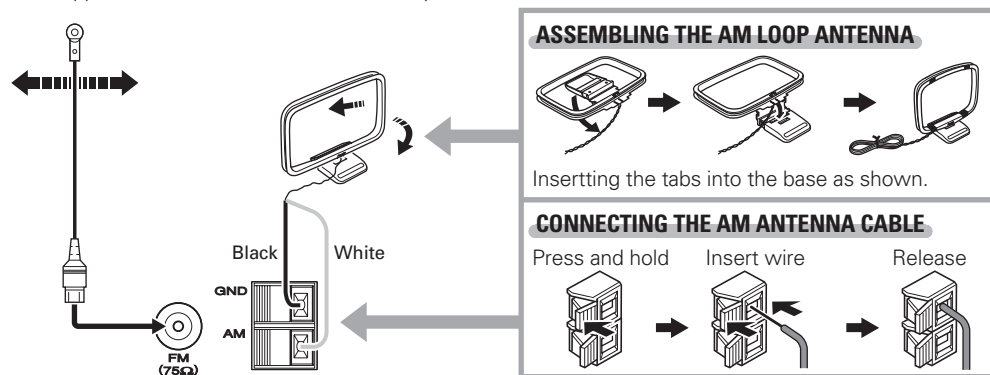

Notes

- During use, extend the FM antenna and move it in various directions until the clearest sound is received. Fix it with push pins or similar implements in that cause the least amount of distortion.
- Set in the direction and position it to where you receive the clearest sound. Put it as far away as possible from the unit, televisions, speaker cables and power cable.

CONNECTING AN OUTDOOR ANTENNAS

If you experience poor reception quality, an outdoor antenna may improve the quality. Keep the antenna from noise sources (neon signs, busy roads, power lines, transformers, etc)

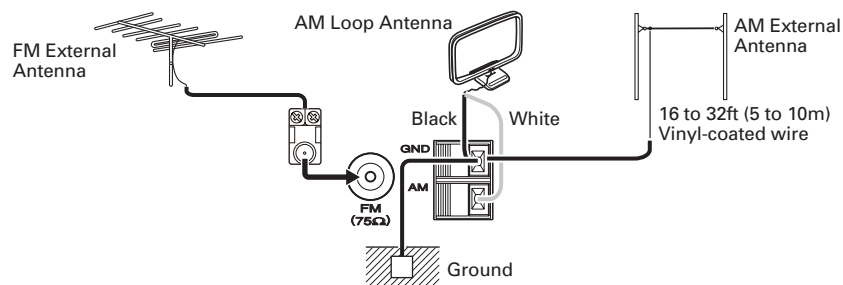

Notes

- Do not remove the AM loop antenna.
- Do not connect the supplied FM antenna.
- The GND terminal on this unit does not function as a safety ground.

CONNECTING OF AC POWER CABLE

1. Plug the supplied AC power cable to the AC IN socket on the rear panel of the main unit.

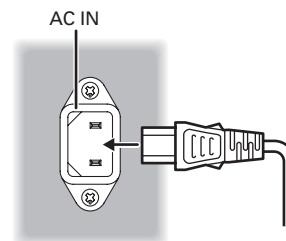

2. Plug the power cable into an AC outlet.

BASIC OPERATION

AMP OPERATION

TURNING ON THE UNIT

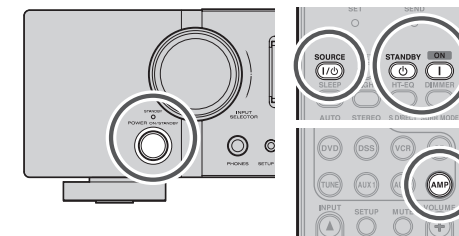

1. Connect the AC power cable to the wall outlet.
2. Turn the power on to other units connected to this unit.
3. Press the **POWER ON/STANDBY** button of this unit. Every time the button is pressed, the power to this unit toggles between on and standby.
To activate power using the remote controller, press the **AMP** button, followed by the **ON** button and **SOURCE ON/OFF** button of the remote controller.

SELECTING AN INPUT SOURCE

Before you can listen to any input media, you must first select the input source on the unit.

Example : DVD

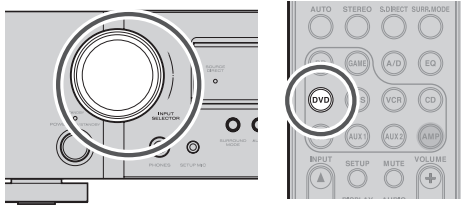

To select DVD, turn the **INPUT SELECTOR** knob on the front panel or press the **DVD** button on the remote controller two times in a row. After you have selected DVD, simply turn on the DVD player and play the DVD.

- As the input source is changed, the input name will appear in the display, on the front-panel.
- If you use the FUNCTION RENAME feature (see page 20), the renamed name appears on the display.
- As the input is changed, this unit will automatically switch to the digital input and surround mode, which were entered during the configuration process for that source.

ADJUSTING THE MAIN VOLUME

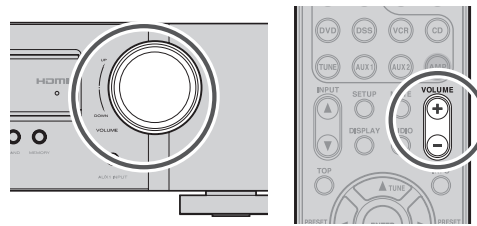

Adjust the volume to a comfortable level using the **VOLUME** control knob on the front panel or **VOLUME + / -** buttons on the remote controller. To increase the volume, turn the **VOLUME** knob clockwise or press **VOLUME +** button on the remote controller, to decrease the volume, turn counterclockwise or press **VOLUME -** button on the remote controller.

Note

- *If the channel level has been set to +1 dB or more using the CHANNEL LEVEL setting, the maximum volume level will be reduced to below 80. (See page 24.)*

ADJUSTING THE TONE (BASS & TREBLE) CONTROL

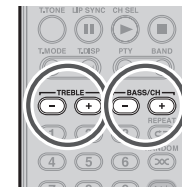

During a listening session you may wish to adjust the Bass and Treble Control to suit your listening tastes or room acoustics.

(Using the remote controller)

To adjust the tone, press the **AMP** button.

To adjust the bass effect, press **BASS +** or **BASS -** button.

To adjust the treble effect, **TREBLE +** or **TREBLE -** button.

Notes

The tone control functions cannot be used in the modes given below.

- *SOURCE DIRECT mode*
- *When the ROOM EQ function is used*

TEMPORARILY TURNING OFF THE SOUND



To temporarily silence all speaker outputs such as when interrupted by a phone call, press the **MUTE** button on the remote controller.

This will interrupt the output to all speakers and the head-phone jack, but it will not affect any recording or dubbing that may be in progress.

When the system is muted, the display will show "MUTE".

Press the **MUTE** button again to return to normal operation.

BASIC OPERATION

TUNER OPERATION

To operate the unit from the remote controller, press the **TUNE** button on the remote controller so that the tuner mode is engaged.

LISTENING TO THE TUNER

Frequency scan step for AM is selectable.

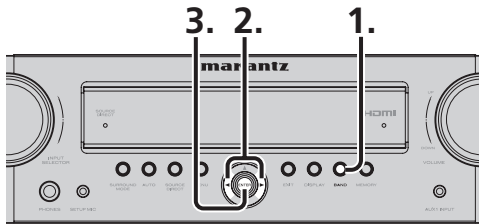

1. Default setup is 10 kHz step, if your country's standard is 9 kHz step. Press **BAND** button on the front panel.
 - "AM 10 kHz" appears on the display.
2. Press the ◀ or ▶ cursor buttons on the front panel.
 - "AM 9 kHz" appears on the display, and the tuning increment is switched to 9 kHz.
3. Press **ENTER** button on the front panel.

Note

- Preset memory for the tuner will clear by changing this setup.

AUTO TUNING

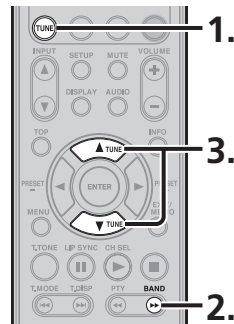
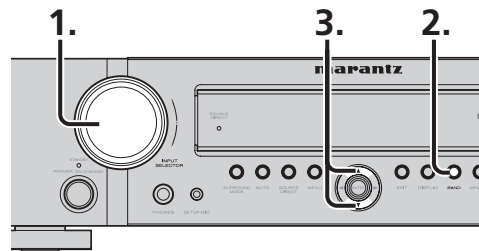

(Using the unit)

1. Turn the **INPUT SELECTOR** knob to select "TUNER".
2. Press the **BAND** button to select either FM or AM.
3. Press the ▲ or ▼ cursor buttons on the front panel for more than 0.5 second to start the auto tuning function.
4. Automatic searching begins then stops when a station is tuned in.

(Using the remote controller)

1. To select tuner, press the **TUNE** button twice within two second on the remote controller.
2. Press the **BAND** button to select either FM or AM.
3. Press and hold the **TUNE** ▲ or ▼ button for 0.5 second or more.
4. Automatic searching begins then stops when a station is tuned in.

If tuning does not stop at the desired station, use to the "Manual tuning" operation.

MANUAL TUNING

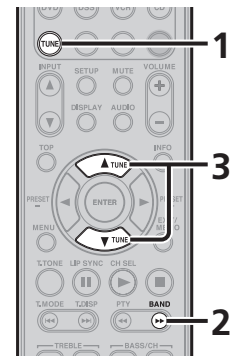
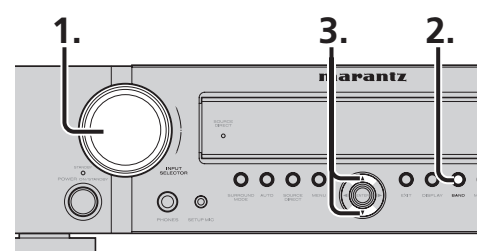

(Using the unit)

1. Turn the **INPUT SELECTOR** knob to select "TUNER".
2. Press the **BAND** button to select either FM or AM.
3. Press the ▲ or ▼ cursor buttons on the front panel to select the desired station.

(Using the remote controller)

1. To select tuner, press the **TUNE** button twice within two seconds on the remote controller.
2. Press the **BAND** button to select either FM or AM.
3. Press the **TUNE** ▲ or ▼ button to tune in the deseired station.

SWITCHING THE FM MODE

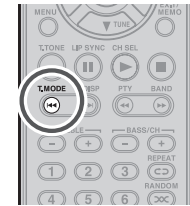

FM broadcasts are usually received in stereo, but when the quality of the signals received from a station that broadcasts programs in stereo is poor, the amount of accompanying noise may be significant.

In a case like this, by selecting the FM monaural mode, the level of the noise will be reduced, making it more pleasant to listen to the FM program.

1. When the **T.MODE** button on the remote controller is pressed during FM reception, the **ST** indicator on the display goes off, and the FM monaural mode is established.
2. When the **T.MODE** button is pressed again, the **ST** indicator illuminates, and the stereo mode is restored.

REMOTE CONTROLLER OPERATION

To control the unit by your remote controller, you have to select the device AMP or TUNER by pressing the **SOURCE** button. Please refer below for the details in AMP and TUNER mode.

AMP MODE

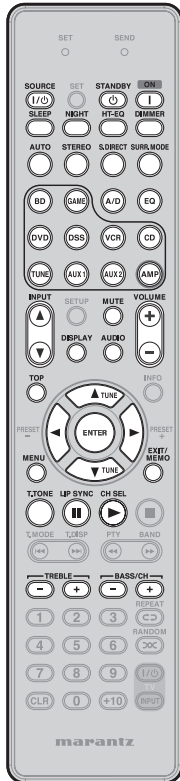

SOURCE	Turns on the unit's power; sets the power to standby
STANDBY	Sets the unit's power to standby
ON	Turns on the unit's power
SLEEP	Sets or releases the sleep timer
NIGHT	Turns the NIGHT mode on and off
HT-EQ	Turns the HT-EQ on and off
DIMMER	Switches the brightness level of the display
AUTO	Selects the AUTO SURROUND mode
STEREO	Selects the STEREO mode
S.DIRECT	Selects the SOURCE DIRECT mode
SURRE.MODE	Switches the surround mode
SOURCE	Selects the source components
A/D	Switches between auto, HDMI, digital and analog input
EQ	Turns the ROOM EQ on and off
AMP	Sets the remote controller to the AMP mode
INPUT ▲/▼	Selects the unit's input selector setting
MUTE	Temporarily mutes the sound
VOLUME+/-	Adjusts the volume level
DISPLAY	Selects the display mode
TOP	Returns to the top of the menu screen while the setup menu is displayed
Cursor	Moves the cursor while the setup menu is displayed
ENTER	Checks the settings while the setup menu is displayed
MENU	Displays the setup menu
EXIT/MEMO	Exits the setup menu
T.TONE	Starts the test tones
LIP SYNC	Sets the LIP SYNC function
CH-SEL	Adjusts the level between the speakers
TREBLE+/-	Adjusts the treble sound
BASS+/-	Adjusts the bass sound

TUNER MODE

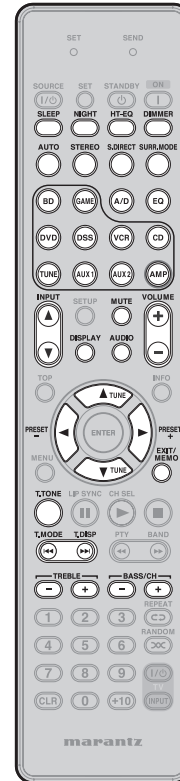

SLEEP	
NIGHT	
HT-EQ	
DIMMER	
AUTO	
STEREO	
S.DIRECT	
SURRE.MODE	
SOURCE	Enables the corresponding function in the AMP mode
A/D	
EQ	
AMP	
INPUT ▲/▼	
MUTE	
VOLUME+/-	
DISPLAY	
AUDIO	
TUNE ▲/▼	Adjusts the frequency tuned
PRESET+/-	Selects a station stored in the preset memory
EXIT/MEMO	Registers a station in the preset memory
T-TONE	Enables the corresponding function in the AMP mode
T-MODE	Switches between FM auto stereo and monaural
BAND	Switches the frequency band (between FM and AM)
TREBLE+/-	
BASS+/-	Enables the corresponding function in the AMP mode

ADVANCED CONNECTIONS

CONNECTING THE REMOTE CONTROL JACKS

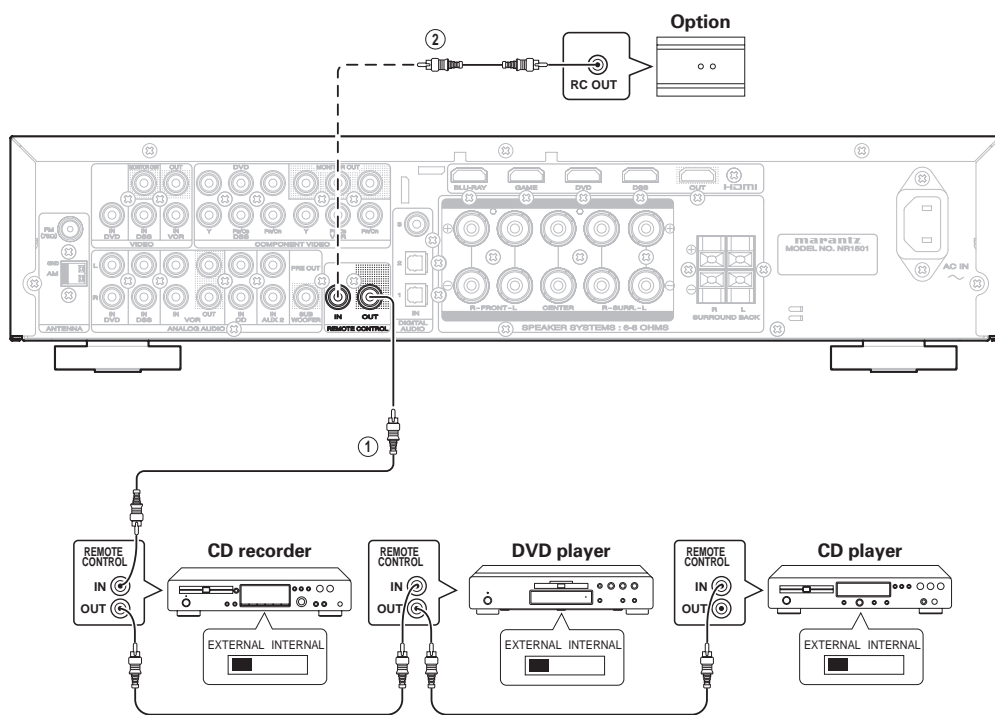

①

You can control other Marantz products through this unit with the remote controller by connecting the REMOTE CONTROL terminals on each unit.

The signal transmitted from the remote controller is received by the remote sensor on this unit. Then the signal is sent to the connected device through this terminal. Therefore you need to aim the remote control only at the unit. Also, if a Marantz power amplifier (some models excluded) is connected to one of these terminals, the power amplifier's, power switch is synchronized with this unit's power switch.

Set the REMOTE CONTROL SWITCH on the back of other units (not the NR1501) to "EXT." (EXTERNAL) to use this feature.

②

Whenever external infrared sensors or similar devices are connected to RC-5 IN of the unit, be sure to always disable operation of the infrared sensor on the unit by using the following procedure.

1. Hold down the **▲** cursor button and the **MENU** button on the front panel at the same time for five seconds.
2. The setting "ENABLE" is shown on the FL DISPLAY.
3. Press the **CURSOR** buttons (**◀**, **▶**) to change this to "DISABLE".
4. Press the **ENTER** button. Once this setting is made, the infrared sensor on the unit is disabled.

Note

• Be sure to set to "ENABLE" when external infrared sensors or similar devices are not connected. Otherwise, the unit will be unable to receive remote control commands.

5. To restore the original setting, perform steps 1 to 4 to set to "ENABLE".

SETUP

After all components are connected, initial setup must be performed.

ONSCREEN DISPLAY MENU SYSTEM

This unit incorporates an onscreen menu system, which makes various operations possible by using the **cursor** (▲, ▼, ◀, ▶) and **ENTER** buttons on the remote controller or on the front panel.

Note

- To view the onscreen displays, make certain you have connected the **MONITOR OUT** jack on the rear panel to the composite, component video or HDMI input of your TV or projector. (See page 10, 11)

- Press the **AMP** button on the remote controller. (This step is not needed when operating the setup menus from the unit.)
- Press the **MENU** button on the remote controller or press the **MENU** button on the front panel. The **"MAIN MENU"** of the OSD menu system is displayed. There are 5 items in the MAIN MENU.
- Select the desired sub-menu with the ▲ or ▼ cursor buttons and press the **ENTER** button. The display will change to the selected sub-menu.
- To exit from OSD menu system, press the **EXIT** button, or move the cursor to **EXIT** and press the **ENTER** button.

SWITCHING THE ON SCREEN DISPLAY OUTPUT MODE

Set whether the on screen display menu is operated by the monitor connected to the VIDEO OUT terminal or the monitor connected to the COMPONENT VIDEO MONITOR OUT terminal.

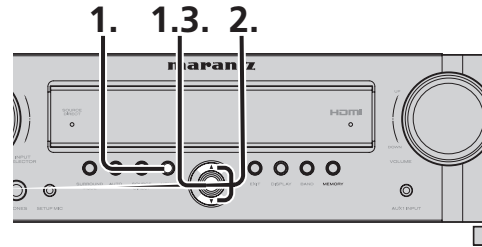

- Hold the **MENU** and **ENTER** buttons down simultaneously on the front panel for 3 seconds.
 - "PAL"** appears on the display.
- Press the ▲ or ▼ cursor button on the front panel.
 - "COLOR OFF"** appears on the display. Menu operation switches to the monitor connected to the COMPONENT VIDEO MONITOR OUT terminal.
 - "COLOR ON"** appears on the display. Menu operation switches to the monitor connected to the VIDEO OUT terminal.
- Press the **ENTER** button on the front panel.

Note

When operating the on screen display menu using the monitor connected to the **HDMI OUT** terminal, either setting may be used without problem.

RC006SR BUTTON CONTROL

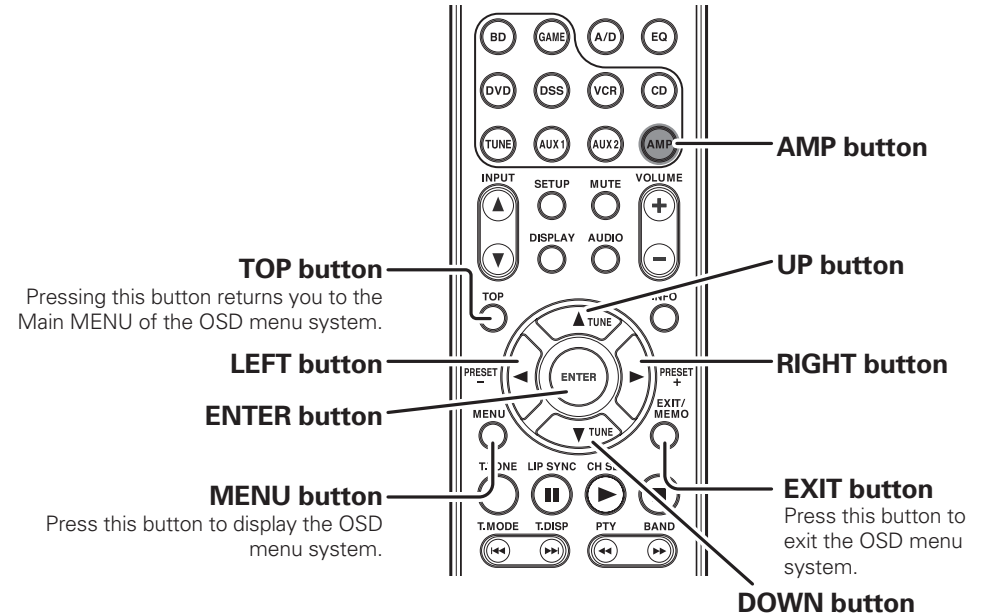

NR1501 FRONT BUTTON CONTROL

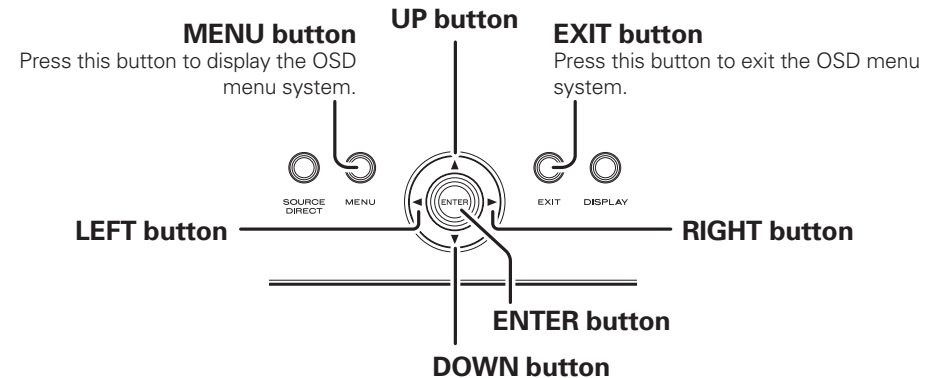

SETUP

Note

- After you complete this portion of the setup, move cursor to "RETURN TO MAIN MENU" with the ▲, ▼, ◀ and ▶ cursor buttons and press the ENTER button.

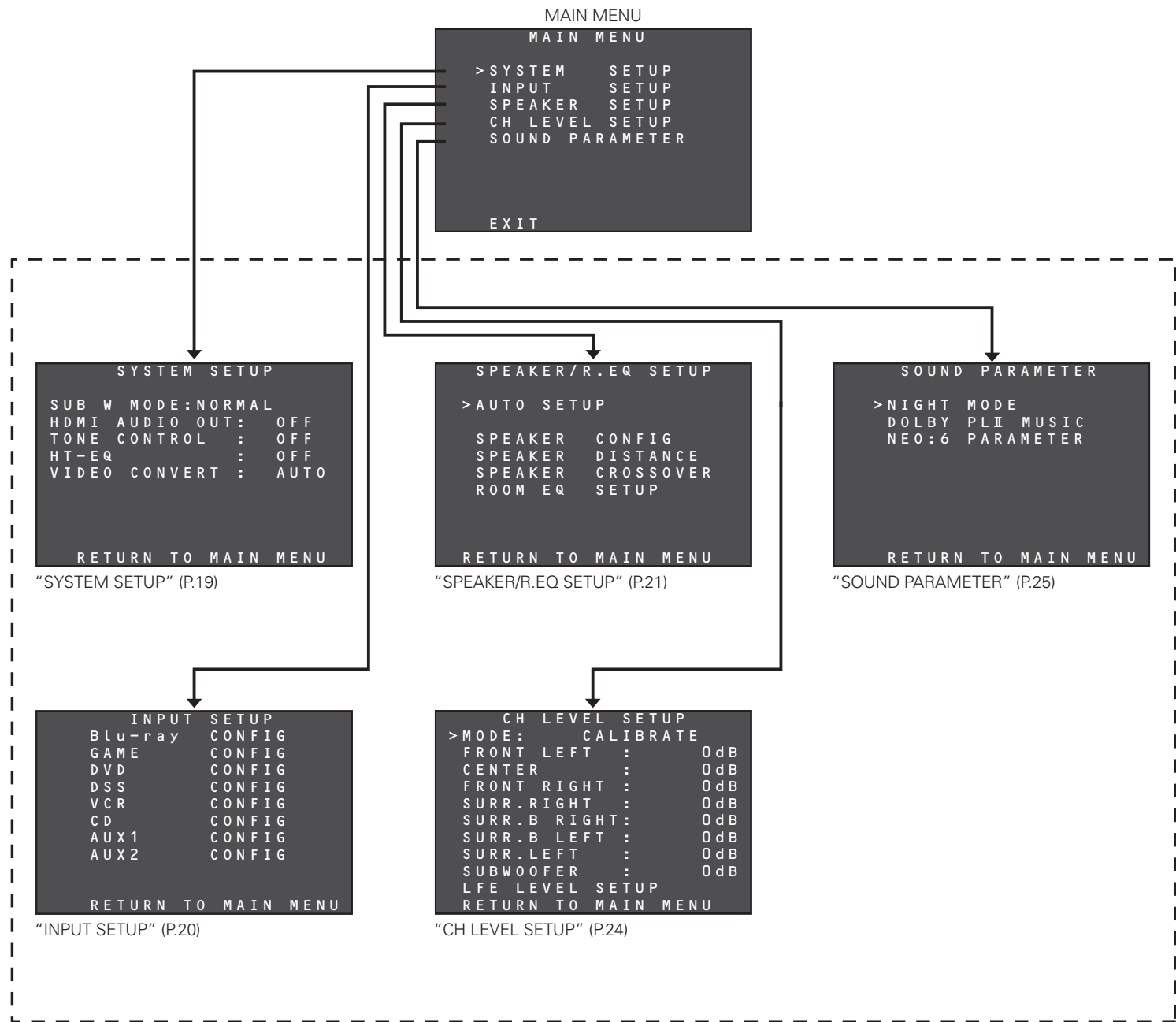

1. SYSTEM SETUP

The unit's main functions are set following the steps below.

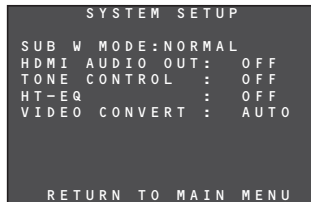

Press the ▲/▼ cursor buttons to move the cursor to the items to be set up.

1-1 SUB W MODE

The subwoofer mode setting takes effect only when the front speaker has been set to FULL RANGE and the subwoofer to YES.

This menu item setting takes effect only when PCM or analog stereo source signals are played.

Tip

For the settings of each speaker, refer to "3. SPEAKER/R.EQ SETUP" (page 21).

Press the ◀▶ cursor buttons to select NORMAL or SW PLUS+.

• NORMAL

The bass sound is reproduced through the main left and right speakers only.

• SW PLUS+

The bass sound is reproduced through the main left and right speakers and subwoofer. In this playback mode, the bass sound disperses uniformly throughout the entire room. However, depending on the size and shape of the room, interference may arise, reducing the actual volume level of the bass sound.

1-2 HDMI AUDIO OUT

This menu item is used to set whether the audio signals that have been input from the HDMI terminal are to be reproduced through the speakers connected to the unit or through the TV or projector connected to the unit's HDMI OUT terminal.

Press the ◀▶ cursor buttons to select ON or OFF.

• OFF

The audio signals that have been input from the HDMI terminal are reproduced through the unit. In this case, sound audio signals will not be output from the TV or projector connected to the unit's HDMI OUT terminal.

• ON

The audio signals that have been input to the HDMI terminal are not output from the unit's speaker terminals. Instead, the audio data is output straight to the TV or projector connected to the unit's HDMI OUT terminal. This menu setting is used to listen to sound through a TV with a multi-channel capability.

1-3 TONE CONTROL

This menu item is used to switch the tone controls to ON or OFF and set the tone controls.

Press the ◀▶ cursor buttons to select ON or OFF.

• OFF

The tone control function is disabled.

• ON

The tone control function is enabled.

If the **ENTER** button on the remote controller is now pressed, the OSD menu appears on the display, and the tone control settings can be selected.

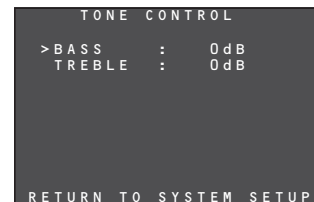

Press the ▲/▼ cursor buttons to select BASS or TREBLE. Then press the ◀▶ cursor buttons to increment or decrement the decibel values shown. The tone controls can be adjusted in 1 dB steps up to +/-10 dB.

After adjusting the tone controls, move the cursor to RETURN TO SYSTEM SETUP, and press the **ENTER** button.

Notes

The tone control function cannot be used in the modes listed below.

- SOURCE DIRECT mode

1-4 HT-EQ

When movies are played using audio components designed for the home, the treble range in their sound tracks is boosted, sometimes producing a somewhat shrill sound. This is because these sound tracks are designed to be played in the very large spaces inside movie theaters. However, if the HT-EQ function is enabled when watching movies designed for viewing at the movie theater, the sound will be compensated so that the appropriate tonal balance is attained.

Press the ◀▶ cursor buttons to select ON or OFF.

The HT-EQ function cannot be used in the mode listed below.

1-5 VIDEO CONVERT

This menu item is used to set the function for up-converting the analog video signals (video and component video signals) that are input to the unit to HDMI output signals.

Press the ◀▶ cursor buttons to select AUTO, COMPONENT, CVBS or OFF.

• AUTO

With this menu item setting, when there are no HDMI signals in the selected input function, the video or component video signals are detected automatically and up-converted to HDMI output signals.

When both video and component video signals have been input, priority is given to up-converting the component video signals.

• COMPONENT

With this menu item setting, the component video signals that have been input to the unit are up-converted to HDMI output signals.

• CVBS

With this menu item setting, the video signals that have been input to the unit are up-converted to HDMI output signals.

• OFF

With this menu item setting, the unit's video-convert function is shut down.

Notes

- Only HDMI input signals can be connected to the BLU-RAY and GAME terminals on the unit's rear panel, so the video-convert function will not work.
- HDMI digital video signals cannot be down-converted to analog video signals.
- The signals up-converted to HDMI output signals are output without any processing at the resolution of the analog video signals that were input. When up-converting video or component video signals with a 480i resolution, a video monitor (TV set) supporting the 480i resolution must be connected to the unit.
- Some analog video signals that are input to the unit cannot be detected automatically. In a case like this, select COMPONENT or CVBS, and use the signals in a fixed mode.
- When HDMI signals have been input, priority will be given to the output of the HDMI signals, even while the COMPONENT or CVBS fixed mode is set. (The up-converted signals will not be output to HDMI output signals.)

SETUP

2. INPUT SETUP

The input source connected to the unit is set by following the steps below.

```

      INPUT SETUP
>Blu-ray  CONFIG
  GAME    CONFIG
  DVD     CONFIG
  DSS     CONFIG
  VCR     CONFIG
  CD      CONFIG
  AUX1    CONFIG
  AUX2    CONFIG

RETURN TO MAIN MENU

```

1. On the INPUT SETUP OSD menu, press the ▲/▼ cursor buttons to select the function whose settings are to be established. When the ENTER button is now pressed, the corresponding sub-menu is displayed.

```

Blu-ray CONFIG
>NAME      :BLU-RAY
DIGITAL IN :---
AUDIO MODE :HDMI
AUTO SURROUND:AUTO
LIP SYNC   :0ms

RETURN TO INPUT SETUP

```

2-1 NAME

The names of the input functions can be changed as desired.

The maximum number of characters that can be registered for these names is 8 including spaces.

The function names that have been registered appear on the unit's display.

1. Press the ▲/▼ cursor buttons to select NAME on the INPUT SETUP sub-menu, and press the ENTER button.
2. The cursor moves to the renaming area.

```

Blu-ray CONFIG
>NAME      :BLU-RAY
DIGITAL IN :---
AUDIO MODE :HDMI
AUTO SURROUND:AUTO
LIP SYNC   :0ms

RETURN TO INPUT SETUP

```

3. Press the ◀▶ cursor buttons to move the cursor (blinking display) to the position of the character that is to be changed.
4. Press the ▲/▼ cursor buttons to select the character.
Any of the characters listed below can be selected to replace the existing characters.
A ~ Z 0 ~ 9 () * + , - . /
5. After all the changes have been made, press the ENTER button to enter the changes.

2-2 DIGITAL IN

The DIGITAL AUDIO IN1, 2 and 3 terminals on the unit's rear panel can be allocated to the desired input functions.
(The numbers of the input terminals are allocated.)

1. Press the ▲/▼ cursor buttons to move the cursor to DIGITAL IN on the INPUT SETUP sub-menu.

```

Blu-ray CONFIG
NAME      :BLU-RAY
>DIGITAL IN :1
AUDIO MODE :HDMI
AUTO SURROUND:AUTO
LIP SYNC   :0ms

RETURN TO INPUT SETUP

```

2. Press the ◀▶ cursor buttons to select the digital input.
1: Optical input
2: Optical input
3: Coaxial cable input
If "___" is selected at this point, no digital input will be allocated.

2-3 AUDIO MODE

The audio signals (analog input, digital input, HDMI input) that are to be input to the unit are set by following the steps below.

1. Press the ▲/▼ cursor buttons to move the cursor to AUDIO MODE on the INPUT SETUP sub-menu.

```

Blu-ray CONFIG
NAME      :BLU-RAY
DIGITAL IN :---
>AUDIO MODE :HDMI
AUTO SURROUND:AUTO
LIP SYNC   :0ms

RETURN TO INPUT SETUP

```

2. Press the ◀▶ cursor buttons to select the AUTO, HDMI, DIGITAL or ANALOG audio mode.

• AUTO

At this setting, the audio signals that are input to the unit are detected.

The playback signals are selected automatically in the sequence of HDMI input → digital input → analog input.

• HDMI

At this setting, the HDMI input signals are played. Select this mode to use only HDMI signals.

Note

A function with no HDMI input (functions other than Blu-ray, GAME, DVD or DSS) cannot be set to this mode.

• DIGITAL

At this setting, the digital input signals are played. Select this mode to use only digital signals.

• ANALOG

At this setting, the analog input signals are played. Select this mode to use only analog signals.

Note

A function with no analog input (such as Blu-ray or GAME) cannot be set to this mode.

2-4 AUTO SURROUND

The function which automatically selects the surround mode that supports the input signals is set by following the steps below.

1. Press the ▲/▼ cursor buttons to move the cursor to AUTO SURROUND on the INPUT SETUP sub-menu.

```

Blu-ray CONFIG
NAME      :BLU-RAY
DIGITAL IN :---
AUDIO MODE :HDMI
>AUTO SURROUND:AUTO
LIP SYNC   :0ms

RETURN TO INPUT SETUP

```

2. Press the ◀▶ cursor buttons to select ON or OFF.

• ON

At this setting, the surround mode that supports the audio signals which have been input is selected automatically, and played.

• OFF

At this setting, the manual mode is established. Set the surround mode desired.

Tip

For details on the surround mode manual settings, refer to "SURROUND MODE" (page 38).

2-5 LIP SYNC

With some video components connected to the unit, there may be a time lag between the video signal processing and the audio signals. While it may be a mere time lag, it can seriously affect the enjoyment of movies or music.

The LIP.SYNC function delays the audio signals and adjusts the difference in their timing from the video signals.

The default setting is 0 ms, and adjustment up to 200 ms is possible.

1. Press the ▲/▼ cursor buttons to move the cursor to LIP SYNC on the INPUT SETUP sub-menu.

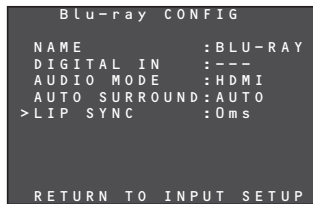

- Press the ◀▶ cursor buttons to adjust the time lag.

Tip

For adjusting the time lag while monitoring the images on the display, projector or other video component, refer to "LIP.SYNC FUNCTION" (page 28).

Note

• 0 ms is set for this function in the SOURCE DIRECT mode. When the SOURCE DIRECT mode is released, the value that has been set is restored.

3 SPEAKER/R. EQ SETUP

After you have installed the unit connected all the components and determined the speaker layout, it is now time to perform the settings in the Speaker Setup menu for the optimum sound acoustics for your environment and speaker layout.

Before you perform the following settings, it is important that you first determine the following characteristics:

- **AUTO SETUP:** "3-1 AUTO SETUP" (see page 22)
- **MANUAL SETUP:** "SPEAKER COFIG" (see page 22)
"SPEAKER DISTANCE" (see page 23)
"SPEAKER CROSSOVER" (see page 23)
"ROOM EQ SETUP" (see page 23)

1. Select "SPEAKER SETUP" from the MAIN MENU with ▲ or ▼ cursor buttons and press the ENTER button.



2. Select the desired menu with the ▲ or ▼ cursor buttons, and press the ENTER button.

Note

• After you complete this the portion of the setup, press the ▲, ▼, ◀, and ▶ cursor button. The cursor will move to "RETURN TO SETUP MENU" and press the ENTER button to go to the Sub-menu.

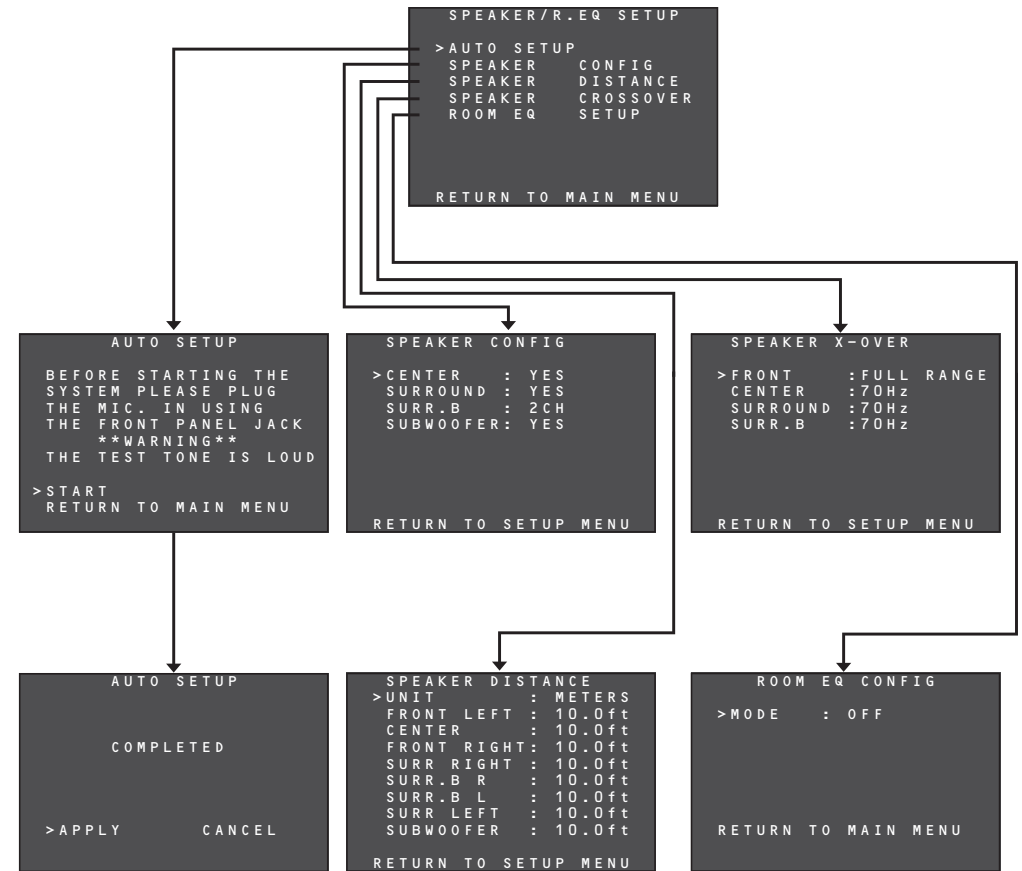

SETUP

3-1 AUTO SETUP

The unit's AUTO SETUP function automatically measures the acoustic characteristics of the speaker systems and listening room where the unit is installed using the microphone provided, and sets the optimum listening environment.

HOW TO OPERATE AUTO SETUP

During the measurement process, as the current statuses will be displayed on the OSD menu screen, turn on the monitor's power.

1. Connect the microphone provided to the SETUP MIC jack on the front panel.

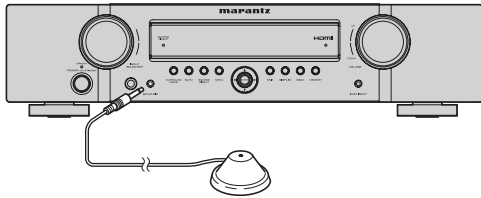

2. Position the microphone at the main listening point.

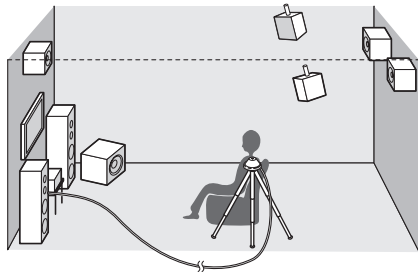

Notes

- Place the microphone at the main listening point before carrying out the measurements.
- With the microphone pointed straight up at the ceiling at the listening point, use a stand or tripod to adjust the microphone to the same height above the floor level as your ears.
- Be sure not to place any obstacles between the speakers and microphone.
- When using a subwoofer with built-in amplifier, set the volume control to the center position, and set the crossover frequency to off or the highest frequency.

- While the measurements are being performed, do not stand between the microphone and either speaker. Make the listening room as quiet as possible. Dark noise may adversely affect the indoor measurements. Close the windows, and turn off the power of all devices (such as cell phones, TV, radio, air conditioner, fluorescent lights, electrical appliances or dimmers).
- During the measurement process, place your cell phone at a distance from all the audio electronic devices. Cell phones, even when they are not being used, may adversely affect the measurements due to RFI (radio frequency interference).
- We recommend that the AUTO SETUP operation be performed using the remote controller rather than the front panel controls.
- The volume levels of the test tones played from each channel will exceed the peripheral noise in the listening environment and continue to increase until the optimum signal-to-noise ratio is attained.
- Proceed while taking the environment and any nearby children into consideration.

3. Select SPEAKER SETUP on the MAIN MENU, press the ▲/▼ cursor buttons to select AUTO SETUP, and press the ENTER button to display the start screen.

```

AUTO SETUP
BEFORE STARTING THE
SYSTEM PLEASE PLUG
THE MIC. IN USING
THE FRONT PANEL JACK
**WARNING**
THE TEST TONE IS LOUD
> START
RETURN TO MAIN MENU
  
```

4. Press the ▲/▼ cursor buttons to select START, and press the ENTER button to start the measurements. When the measurements have been completed, the screen shown below will appear.

```

AUTO SETUP
COMPLETED
> APPLY      CANCEL
  
```

To reflect the measurement results, move the cursor to APPLY, and press the ENTER button. The results that have been set by the AUTO SETUP can be monitored on the menu setting screens shown below.

- SPEAKER CONFIG (see page 22)
- SPEAKER DISTANCE (see page 23)
- SPEAKER CROSSOVER (see page 23)
- ROOM EQ SETUP (see page 23)
- CH LEVEL SETUP (see page 24)

3-2 MANUAL SETUP

When you want to set up the system to your specifications rather than using AUTO SETUP, set the following items.

- SPEAKER CONFIG
- SPEAKER DISTANCE
- SPEAKER CROSSOVER
- ROOM EQ SETUP
- CH LEVEL SETUP

```

SPEAKER/R.EQ SETUP
> AUTO SETUP
SPEAKER  CONFIG
SPEAKER  DISTANCE
SPEAKER  CROSSOVER
ROOM EQ  SETUP
RETURN TO SETUP MENU
  
```

1. Select SPEAKER SETUP from the MAIN MENU.
2. Press the ▲/▼ cursor buttons to select an item.
3. Press the ENTER button to enter what has been selected.
4. Repeat steps 2 and 3 until all the settings have been selected. Then press the ▲/▼ cursor buttons to select RETURN TO SETUP MENU, and press the ENTER button.

SPEAKER CONFIG

```

SPEAKER CONFIG
> CENTER   : YES
SURROUND  : YES
SURR. B   : 2CH
SUBWOOFER : YES
RETURN TO SETUP MENU
  
```

The configuration of the speakers connected to the unit is set by following the steps below.

1. Press the ▲/▼ cursor buttons to select the speakers of each channel.
2. Press the ◀▶ cursor buttons to set whether a speaker is to be selected (YES) or not (NO).

CENTER:

Set whether the center speaker is to be selected (YES) or not (NO).

SURROUND:

Select whether the surround left and right speakers are to be selected (YES) or not (NO).

SURR. B:

Set the surround back left and right speakers.

2CH:

Select this when using the surround back left and right speakers.

1CH:

Select this when using one surround back speaker. The audio signals will be output from the SURR.-L terminal. Check the connections.

NO:

Select this when not using both surround back left and right speakers.

SUBWOOFER:

Select whether the subwoofer is to be selected (YES) or not (NO).

3. When all the settings have been selected, press the ▲/▼/◀▶ cursor buttons to select RETURN TO SETUP MENU, and press the ENTER button to return to the menu (SPEAKER/R.EQ SETUP).

SPEAKER DISTANCE

```

SPEAKER DISTANCE
>UNIT      : METERS
FRONT LEFT : 10.0ft
CENTER     : 10.0ft
FRONT RIGHT: 10.0ft
SURR RIGHT : 10.0ft
SURR.B R   : 10.0ft
SURR.B L   : 10.0ft
SURR LEFT  : 10.0ft
SUBWOOFER  : 10.0ft
RETURN TO SETUP MENU

```

The distances from the listening position to each speaker are set by following the steps below. The delay time will be calculated automatically based on these distances.

First, determine the ideal position where you usually sit in the listening room.

This is an important step for setting the acoustic timing that creates the best available sound field.

Note

- If NO has been set on the SPEAKER CONFIG menu for a speaker, that speaker cannot be set on the SPEAKER DISTANCE menu.

1. Press the ◀▶ cursor buttons to set UNIT (display unit) to meters or feet.
2. Press the ▲▼ cursor buttons to select channels.
3. Press the ◀▶ cursor buttons to set the distances to the speakers.

FRONT LEFT:

Set here the distance from the regular listening position to the front left speaker.

CENTER:

Set here the distance from the regular listening position to the center speaker.

FRONT RIGHT:

Set here the distance from the regular listening position to the front right speaker.

SURR RIGHT:

Set here the distance from the regular listening position to the surround right speaker.

SURR. B R:

Set here the distance from the regular listening position to the surround back right speaker.

SURR. B L:

Set here the distance from the regular listening position to the surround back left speaker.

SURR LEFT:

Set here the distance from the regular listening position to the surround left speaker.

SUBWOOFER:

Set the distance from the subwoofer to your normal listening position.

Notes

- The distances to the speakers are set in meters (METER) or feet (FEET) as below.
 - METERS:

The distances can be set in 0.3-meter increments from 0.0 to 9 m.
 - FEET:

The distances can be set in 1-foot increments from 0.5 to 30.0 ft.

(These distances are displayed in their approximate value on the monitor.)
 - The speaker that has been set to NO is not displayed on the SPEAKER DISTANCE menu.
 - If 2CH was selected as the surround back speaker setting on the SPEAKER CONFIG menu, the SURR.B L and SURR.B R settings are displayed.
 - The SURR.BACK setting is displayed if YES was selected as the surround back speaker setting on the SPEAKER CONFIG menu.
4. When all the settings have been completed, press the ▲▼ cursor buttons to move the cursor to RETURN TO SETUP MENU, and press the ENTER button to return to the menu (SPEAKER/R.EQ SETUP).

SPEAKER X-OVER

```

SPEAKER X-OVER
>FRONT     : FULL RANGE
CENTER     : 70Hz
SURROUND   : 70Hz
SURR.B     : 70Hz
RETURN TO SETUP MENU

```

When the subwoofer is to be used, the speaker's cutoff frequency can be selected. The crossover frequency levels are selected in accordance with the sizes of the speakers by following the steps below.

The bass components below the frequency set here will be output from the subwoofer.

Sound in all frequency bands will be output from speakers with the FULL RANGE setting.

1. Press the ▲▼ cursor buttons to select the channels.
2. Press the ◀▶ cursor buttons to set the crossover frequencies.

Notes

- No setting on the SPEAKER X-OVER menu is possible for a speaker if NO has been set for that speaker on the SPEAKER CONFIG menu.
 - If settings other than FULL RANGE have been selected for the front speakers while NO was set for the subwoofer on the SPEAKER CONFIG menu, ON will be automatically selected as the subwoofer setting on the SPEAKER CONFIG menu.
3. When all the settings have been completed, press the ▲▼ cursor buttons to move the cursor to RETURN TO SETUP MENU, and press the ENTER button to return to the menu (SPEAKER/R.EQ SETUP).

ROOM EQ CONFIG

In order for the acoustic characteristics of the listening room measured at the AUTO SETUP stage to be adjusted to achieve the optimum environment, the frequency characteristics of all the speakers are compensated for by following the steps below.

```

ROOM EQ CONFIG
>MODE      : OFF
RETURN TO MAIN MENU

```

1. Press the ◀▶ cursor buttons to set the mode.

MODE**ON:**

The frequency characteristics are compensated for.

OFF:

The frequency characteristics are not compensated for.

2. When all the settings have been completed, press the ▲▼ cursor buttons to move the cursor to RETURN TO MAIN MENU, and press the ENTER button to return to the menu (SPEAKER/R.EQ SETUP).

SETUP

4. CH LEVEL SETUP

Each channel level can be adjusted to suit the program source played as well as your own preferences.

A maximum of two channel levels that have been adjusted can be stored in the unit's memory.

4-1 MEMORY MODE

The channel level settings can be stored in the memory and the stored settings can be called by following the steps below.

1. Press the ▲/▼ cursor buttons to move the cursor to MODE on the CH LEVEL SETUP menu.

```

CH LEVEL SETUP
>MODE: CALIBRATE
FRONT LEFT : 0dB
CENTER : 0dB
FRONT RIGHT : 0dB
SURR. RIGHT : 0dB
SURR. B RIGHT : 0dB
SURR. B LEFT : 0dB
SURR. LEFT : 0dB
SUBWOOFER : 0dB
LFE LEVEL SETUP
RETURN TO MAIN MENU
  
```

2. Press the ◀/▶ cursor buttons to select CALIBRATE, AUTO, REFERENCE 1 or REFERENCE 2 as the memory mode.

CALIBRATE:

Each channel level that has been set is displayed. In this state, the channel levels that you want to change can be changed.

For details on the level adjustments, refer to "4-2 ADJUSTING THE CHANNEL LEVELS."

AUTO:

The channel levels automatically set by the AUTO SETUP function are displayed.

(For details on AUTO SETUP, refer to page 22.)

In this state, the channel levels that you want to change can be changed.

For details on the level adjustments, refer to "4-2 ADJUSTING THE CHANNEL LEVELS."

REFERENCE 1, REFERENCE 2:

The settings stored in the memory by the user can be called.

For details on storing the channel levels in the memory, refer to "4-4 STORING THE CHANNEL LEVELS IN THE MEMORY."

4-2 ADJUSTING THE CHANNEL LEVELS

Each channel level is adjusted by following the steps below.

1. Press the ▲/▼ cursor buttons to move the cursor to the channel on the CH LEVEL SETUP menu whose level is to be adjusted.

```

CH LEVEL SETUP
MODE: CALIBRATE
FRONT LEFT : 0dB
>CENTER : 0dB
FRONT RIGHT : 0dB
SURR. RIGHT : 0dB
SURR. B RIGHT : 0dB
SURR. B LEFT : 0dB
SURR. LEFT : 0dB
SUBWOOFER : 0dB
LFE LEVEL SETUP
RETURN TO MAIN MENU
  
```

2. Press the ◀/▶ cursor buttons to adjust the volume level.

- Adjust the volume from all the speakers to the same level.
- Each channel can be adjusted to any level in the range from -15 dB to +15 dB.

3. Repeat steps 1 and 2 to adjust the levels of all the channels.

4-3 LFE LEVEL SETUP

The output level of the LFE signals included in the Dolby Digital signals or DTS signals can be adjusted by following the steps below.

1. Press the ▲/▼ cursor buttons to move the cursor to LFE LEVEL SETUP on the CH LEVEL SETUP menu.

```

CH LEVEL SETUP
MODE: CALIBRATE
FRONT LEFT : 0dB
CENTER : 0dB
FRONT RIGHT : 0dB
SURR. RIGHT : 0dB
SURR. B RIGHT : 0dB
SURR. B LEFT : 0dB
SURR. LEFT : 0dB
SUBWOOFER : 0dB
>LFE LEVEL SETUP
RETURN TO MAIN MENU
  
```

2. If the ENTER button is now pressed, a sub-menu will appear.

```

LFE LEVEL SETUP
>DOLBY : 0dB
DTS : 0dB
RETURN TO SETUP MENU
  
```

3. Press the ▲/▼ cursor buttons to select the DOLBY or DTS signals, and press the ◀/▶ cursor buttons to adjust their levels.

- The LFE signals can be adjusted to any level within the range from 0 dB to -10 dB.

4. When all the level adjustments have been completed, press the ▲/▼ cursor buttons to move the cursor to RETURN TO SETUP MENU, and press the ENTER button to return to the CH LEVEL SETUP menu.

```

LFE LEVEL SETUP
DOLBY : 0dB
DTS : 0dB
>RETURN TO SETUP MENU
  
```

4-4 STORING THE CHANNEL LEVELS IN THE MEMORY

Each channel level that has been adjusted can be stored in the memory, whether in memory mode REFERENCE 1 or memory mode REFERENCE 2.

1. When the adjustment of all the channel levels has been completed, press the ENTER button on the CH LEVEL SETUP menu.

Note

If the cursor is now moved to LFE LEVEL SETUP, a sub-menu appears. Move the cursor to a position other than LFE LEVEL SETUP.

```

CH LEVEL SETUP
MODE: CALIBRATE
>FRONT LEFT : 2dB
CENTER : 1dB
FRONT RIGHT : 2dB
SURR. RIGHT : -1dB
SURR. B RIGHT : 0dB
SURR. B LEFT : 0dB
SURR. LEFT : -1dB
SUBWOOFER : 3dB
LFE LEVEL SETUP
RETURN TO MAIN MENU
  
```

2. Move the cursor to MODE, and highlight REFERENCE 1 for memory mode.

```

CH LEVEL SETUP
>MODE: REFERENCE 1
FRONT LEFT : 2dB
CENTER : 1dB
FRONT RIGHT : 2dB
SURR. RIGHT : -1dB
SURR. B RIGHT : 0dB
SURR. B LEFT : 0dB
SURR. LEFT : -1dB
SUBWOOFER : 3dB
LFE LEVEL SETUP
RETURN TO MAIN MENU
  
```

3. Press the ◀/▶ cursor buttons to select REFERENCE 1 or REFERENCE 2, and press the ENTER button to store the settings in the memory.

4. When all the settings have been completed, press the ▲/▼ cursor buttons to move the cursor to RETURN TO MAIN MENU, and press the ENTER button to return to MAIN MENU.

```

CH LEVEL SETUP
MODE: REFERENCE 1
FRONT LEFT : 2dB
CENTER : 1dB
FRONT RIGHT : 2dB
SURR. RIGHT : -1dB
SURR. B RIGHT : 0dB
SURR. B LEFT : 0dB
SURR. LEFT : -1dB
SUBWOOFER : 3dB
LFE LEVEL SETUP
>RETURN TO MAIN MENU
  
```

5. SOUND PARAMETER

The NIGHT mode, the Dolby PLII MUSIC and NEO:6 PARAMETER are set by following the steps below.

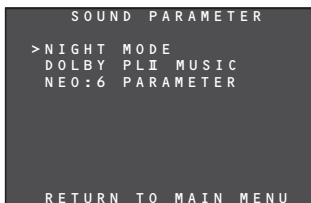

5-1 NIGHT MODE

In the NIGHT mode, the dynamic range of the sound played is reduced, making it possible to listen more clearly to a softer sound while keeping the overall volume level relatively low at night or in similar circumstances. This mode works only with Dolby digital sound.

1. Press the ▲/▼ cursor buttons to move the cursor to NIGHT MODE on the SOUND PARAMETER menu, and when the selection is entered using the ENTER button, a sub-menu appears.

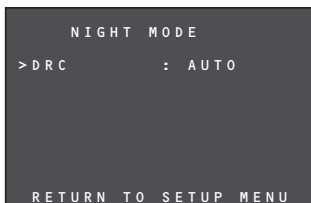

2. Press the ◀▶ cursor buttons to set AUTO or set the compression rate from 0.0 to 1.0.
 - When AUTO is set, the signals contained in the Dolby TrueHD software are detected, and the NIGHT mode is automatically activated. The NIGHT mode is deactivated with any Dolby digital sound signals that are not Dolby TrueHD signals.
 - When the compression rate is set to 0.0, the NIGHT mode function is deactivated.
 - When the NIGHT mode is activated, the parameter is set in 0.1-step increments from 0.1 (low) to 1.0 (high).

3. When all the settings have been completed, press the ▲/▼ cursor buttons to move the cursor to RETURN TO SETUP MENU, and press the ENTER button to return to SOUND PARAMETER menu.

5-2 DOLBY PLII MUSIC

The Dolby PLII MUSIC mode creates an environment for playing CDs and other stereo sources in which the listener is enveloped by a full and rich sound.

1. Press the ▲/▼ cursor buttons to move the cursor to DOLBY PLII MUSIC on the SOUND PARAMETER menu, and when the selection is entered using the ENTER button, a sub-menu appears.

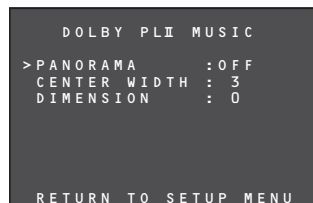

PANORAMA:

In the PANORAMA mode, the sound delivered from the front left and right speakers envelops the listener to create a 3-dimensional sound space. Press the ◀▶ cursor buttons to set the PANORAMA mode to ON or OFF.

CENTER WIDTH:

This function gradually assigns the center channel components to the front left and right speakers. By assigning them in this way, inconsistencies in the tone colors between the speakers can be smoothed out. Adjustment in eight steps from 0 to 7 is possible using the ◀▶ cursor buttons. This setting cannot be selected if NO has been selected as the center speaker setting.

DIMENSION:

The DIMENSION function is used to adjust level differences between the front and rear. Depending on the input source, some sound is heard more strongly at the front and others more strongly at the rear. When this function is used, the desired balance can be achieved. Adjustment in seven steps from -3 to 3 is possible using the ◀▶ cursor buttons.

2. When all the settings have been completed, press the ▲/▼ cursor buttons to move the cursor to RETURN TO SETUP MENU, and press the ENTER button to return to the SOUND PARAMETER menu.

5-3 NEO:6 PARAMETER

The DTS NEO:6 mode allows the sound of up to 6.1 channels to be output when 2-channel sound has been input. (It also supports the input of 5.1-channel sound.)

In this mode, the sound images of the center speaker are expanded.

1. Press the ▲/▼ cursor buttons to select NEO:6 PARAMETER.
2. Press the ENTER button to enter the selection.

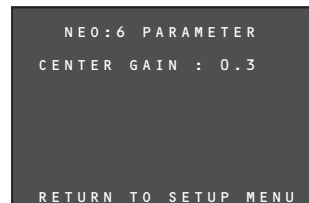

3. The CENTER GAIN level can be selected in 0.1 increments from 0.0 to 1.0 using the ◀▶ cursor buttons.

Notes

- This setting takes effect only in the NEO:6 MUSIC mode.

4. When all the settings have been completed, press the ▲/▼ cursor buttons to move the cursor to RETURN TO SETUP MENU, and press the ENTER button.

ADVANCED OPERATION

AMP OPERATION

USING THE SLEEP TIMER



To program this unit for automatic standby, press the **SLEEP** button on the remote controller. Each press of the button will increase the time before shut down in the following sequence.

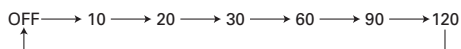

The sleep time will be shown for a few seconds in the display on the front panel, and it will count down until the time has elapsed.

When the programmed sleep time has elapsed, the unit will automatically turn off.

Note that the **•** indicator on the display will illuminate when the Sleep function is programmed.

To cancel the sleep function, repeatedly press the **SLEEP** button on the remote controller until the timer time is cleared. When it is canceled, the **•** indicator on the display goes off.

DISPLAY MODE

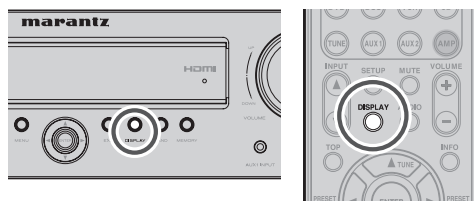

You can select the display mode for the front display of the unit.

To select this mode, press the **DISPLAY** on the remote controller or the front panel.

When this button is pressed, the display mode is switched in the following sequence.

Input function → Volume → Surround → Input signals → Input function

Input function:

The status of the input function that was set in **FUNCTION INPUT SETUP** (see page 20) is displayed.

Volume:

The current volume level is displayed.

Surround:

The status of the selected surround mode is displayed.

Input signals:

The status of the signals that have been input to the selected function is displayed.

DIMMER

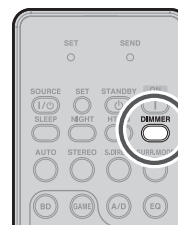

When this button is pressed once, the display is dimmed.

When this button is pressed twice, the display is turned off and the **■** indicator lights up.

Press this button again to turn the display on again.

Note

- In the display off status, only the **■** indication on the unit's display illuminates to indicate that this function is operational.

RECORDING AN ANALOG SOURCE

In normal operation, the audio or video source selected for listening through this unit is sent to the record outputs.

This means that any program you are watching or listening to may be recorded simply by placing machines connected to the outputs for **VCR OUT** in the record mode.

To record the input source signal you are currently watching or listening to

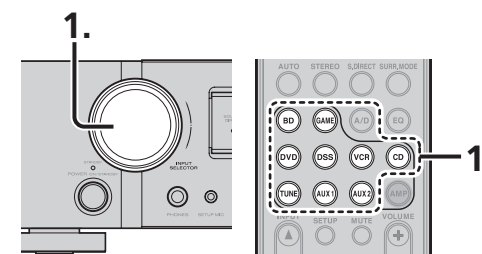

- Select the input source to record by turning the **INPUT SELECTOR** knob on the front panel or simply press the input selector buttons on the remote controller. The input source is now selected and you may watch or listen to it as desired.
- The currently selected input source signal is output to the **VCR OUT** outputs for recording.
- Start recording to the recording component as desired.

Notes

- When connecting only digital signal input, output cannot be made to the **VCR OUT** terminals. When using recording functions, be sure to also make connections for analog signal input.
- No conversion is made from component video signal input to Video signal output. Always use the same signal type for both input and output.
- Video or audio signals input to **HDMI** input terminals cannot be recorded.

SELECTING ANALOG AUDIO INPUT OR DIGITAL AUDIO INPUT

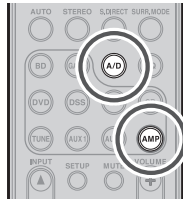

If you have already assigned the digital inputs, you can temporarily select the audio input mode for each input source as following procedures. Press the **AMP** button and press the **A/D** button. When this button is pressed, the input mode is switched in the following sequence. Auto → HDMI → Digital → Analog → Auto

Auto mode:

The types of signals being input to the digital and analog input jacks for the selected input source are detected automatically. If no digital signal is being input, the analog input jacks are selected automatically.

HDMI mode:

HDMI mode can be selected only when an HDMI input has been assigned as an input source. When "HDMI AUDIO" under PREFERENCE of the SETUP MENU is set to "THROUGH", the HDMI mode cannot be selected.

Digital mode:

The input signal is fixed to an assigned digital input terminal.

Analog mode:

The analog input jacks are selected.

SELECTING THE SURROUND MODE
example: AUTO SURROUND

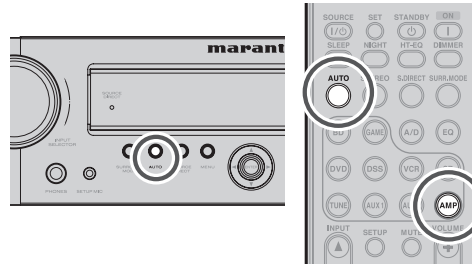

(Using the unit)

To select the Auto surround mode during playback, press the **AUTO** button on the front panel.

(Using the remote controller)

To select the Auto surround mode, press the **AMP** button and press the **AUTO** button.

- For surround modes, see "Surround Mode" on page 38.

NIGHT MODE

In the NIGHT mode, the dynamic range of the sound played is reduced, making it possible to listen more clearly to a softer sound while keeping the overall volume level relatively low at night or in similar circumstances.

This mode works only with Dolby digital sound.

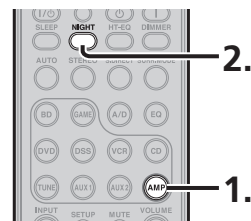

1. Press the **AMP** button on the remote controller.
2. Each time the **NIGHT** button is pressed, the NIGHT mode value changes as below. AUTO → 0.0 → 0.1 → 0.2 → → 1.0 → AUTO
The value represents the dynamic range level.

- When the NIGHT mode is set to 0.0, it is deactivated; when set to 1.0, it is at the maximum.
- When the NIGHT mode is set to AUTO, the signals contained in the Dolby TrueHD software are detected, and the NIGHT mode is automatically activated.
- The NIGHT mode is deactivated with any Dolby digital sound signals which are not Dolby TrueHD signals.
- When the SOURCE DIRECT mode has been selected, the NIGHT mode is deactivated.

ADJUSTING THE DIFFERENCE IN THE VOLUME LEVELS BETWEEN SPEAKERS (WITH TEST TONES)

Test tones can be output from each speaker, and any difference in the volume levels between speakers can be adjusted.

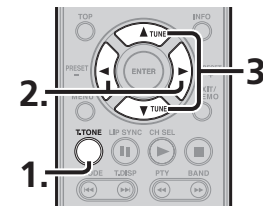

1. Press the **T.TONE** button on the remote controller.

The test tones are output for 2 seconds each for each channel in the following sequence which is repeated: Front left → center → front right → surround right → surround back right → surround back left → surround left → subwoofer → front left ...

- The test tone will not be output for a speaker if NO has been set for that speaker on the SPEAKER CONFIG menu.
2. Press the **◀▶** cursor buttons to adjust the volume level of the speaker.
 3. Press the **▲▼** cursor buttons to select the speaker from which to output the test tone.
 4. Repeat steps 2 and 3, and adjust the volume level of the test tone that is output from each speaker until the level for all the speakers is the same.

REGISTERING THE SPEAKER VOLUME LEVEL SETTING

Up to two volume levels that have been set as desired can be stored in the memory.

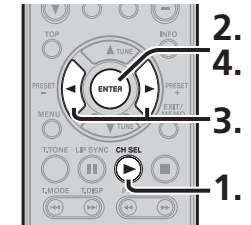

1. Press the **CH SEL** button on the remote controller.
2. Press the **ENTER** button. "REF-1" blinks for several seconds on the monitor and display.
3. Press the **◀▶** cursor buttons to switch the storage location from REF1 to REF2 or vice versa, and press the **ENTER** button.
4. Press the **ENTER** button to store the current volume level setting.

CALLING REGISTERED SPEAKER VOLUME LEVEL SETTINGS

The volume level settings that have been registered can be called.

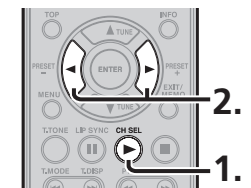

1. Press the **CH SEL** button on the remote controller.
2. Each time the **◀▶** cursor buttons are pressed, the volume level setting is switched between AUTO, REF1 and REF2.

Tip

- When AUTO is selected, the speaker level that was set automatically by AUTO SETUP is called. For details on AUTO SETUP, see page 22.

ADVANCED OPERATION

ADJUSTING DIFFERENCES IN VOLUME LEVELS BETWEEN SPEAKERS (WITHOUT TEST TONES)

Differences in the volume levels between speakers can be adjusted without using test tones.

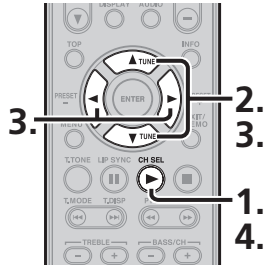

1. Press the **CH SEL** button on the remote controller.
2. Each time the **▲/▼** cursor buttons are pressed, the display changes in the following sequence.
CAL (or AUTO, REF1, REF2) ↔ FL ↔ C ↔ FR ↔ SR ↔ (SBR ↔ SBL) or SB ↔ SL ↔ SUB ↔ (LFE) ↔ CAL (or AUTO, REF1, REF2)
3. Press the **◀▶** cursor buttons to adjust the volume level of the speaker displayed. When the **▶** button is pressed, the volume level is increased; conversely, when the **◀** button is pressed, it is reduced.
4. When the level adjustments for all the speakers have been completed, press the **CH.SEL** button to exit the settings.

- There is no display for a speaker if NO has been set for that speaker on the **SPEAKER CONFIG** menu.

LISTENING THROUGH HEADPHONES

This jack may be used to listen to the unit's output through a pair of headphones. Be certain that the headphones have a standard 1/4" stereo phono plug.

Note that the speakers will automatically be turned off when the headphone jack is in use.

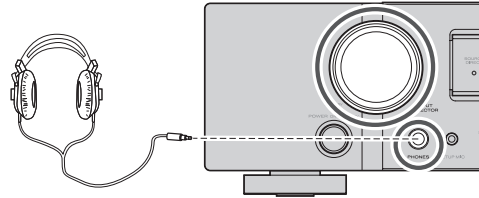

Note

The surround mode returns to the previous setting as soon as the headphone plug is removed from the jack.

HT-EQ

The remote controller is used for the HT-EQ setting.

For details on the HT-EQ function, see page 19.

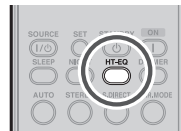

1. Press the **HT-EQ** button on the remote controller.
2. Each time the **HT-EQ** button is pressed, the function is switched between OFF and ON.
ON : The HT-EQ function is used.
OFF : The HT-EQ function is not used.

ROOM EQ

The ROOM EQ (room equalizer) function for compensating for the acoustic characteristics of the listening room that was measured by the AUTO SETUP function is set to ON or OFF.

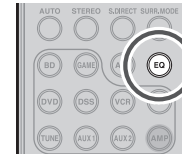

For details on AUTO SETUP, see page 22.

1. Press the **EQ** button on the remote controller.
2. Each time the **EQ** button is pressed, the function is switched between OFF and ON.
ON : The ROOM EQ function is used.
OFF : The ROOM EQ function is not used.

LIP.SYNC FUNCTION

The LIP.SYNC function adjusts the difference in the timing between the video signals and audio signals by delaying the audio signals before outputting them.

For details on LIP.SYNC, see page 21.

1. Press the **LIP.SYNC** button on the remote controller.
2. Each time the **LIP.SYNC** button is pressed, the difference in the timing can be adjusted in 10-ms increments using the **◀▶** cursor buttons.

The default setting is 0 ms, and adjustment up to 200 ms is possible.

Perform the adjustment while monitoring the images on the display, projector or other video component.



Note

This function is deactivated (0 ms) in the SOURCE DIRECT mode. When the SOURCE DIRECT mode is released, the value that has been set is restored.

BILINGUAL FUNCTION

When the input source contains Dolby or DTS bilingual sound, this function enables selection of the sound to be played.



1. Press the **AUDIO** button on the remote controller.
2. Each time the **AUDIO** button is pressed, the audio mode is switched.

MAIN:

B I L M A I N

The sound of the main channel (left) is played.

SUB:

B I L S U B

The sound of the sub-channel (right) is played.

MAIN + Sub:

B I L M + S

The sound of the main and sub-channels is played.

VIDEO CONVERT FUNCTION

The unit is equipped with a video convert function which outputs analog video input (video input or component video input) signals to HDMI.

This means that these signals can be viewed simply by connecting one HDMI cable between the unit's HDMI OUT terminal and monitor regardless of the method used to connect the player and the unit's VIDEO terminals or COMPONENT VIDEO terminals.

(For the setting procedure, see page 19.)

Notes

- With this function, the media may not be properly played in the still, fast forward, reverse play and other modes.
- With the video-convert function, out-of-sync or other types of trouble may arise depending on the TV, projector or component used. In such cases, deactivate the video-convert function.

EXAMPLES OF CONNECTIONS

- When the monitor has been connected to the unit's HDMI OUT terminal

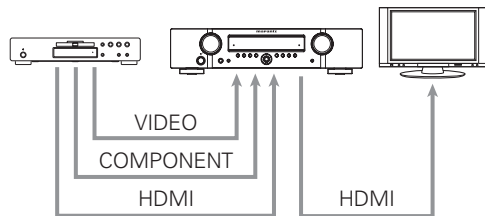

Note

- The signals up-converted to HDMI output signals are output without any processing at the resolution of the analog video signals that were input. When up-converting video or component video signals with a 480i resolution, a video monitor (TV set) supporting the 480i resolution must be connected to the unit.

- When the monitor has been connected to the unit's VIDEO MONITOR OUT terminal

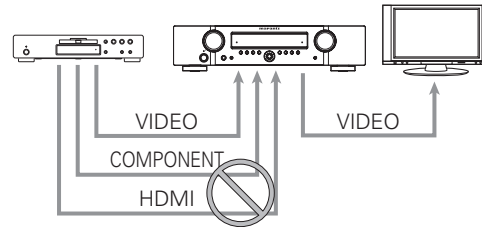

Note

- The HDMI video signals and component video signals that are input from the player are not output from the unit's VIDEO MONITOR OUT terminal.

- When the monitor has been connected to the unit's COMPONENT VIDEO MONITOR OUT terminal

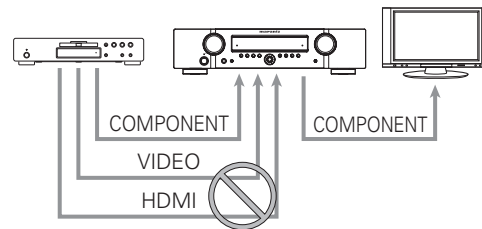

Note

- The HDMI video signals and video signals that are input from the player are not output from the unit's COMPONENT MONITOR OUT terminal.

ADVANCED OPERATION

**TUNER OPERATIONS
(PRESET MEMORY)**

With this unit, up to 30 FM and AM broadcast stations can be preset in the sequence desired. For each of these stations, the frequency and reception mode can be stored in the memory as needed.

AUTO PRESET MEMORY

This function makes it possible to scan the FM band automatically and store all stations with suitable signal strength in the unit's preset memories.

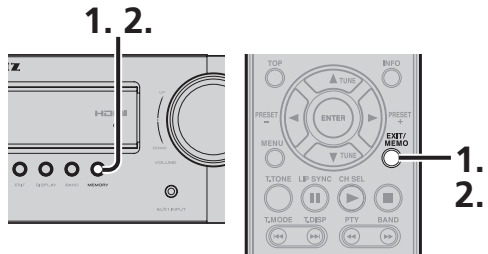

1. Hold down the unit's **MEMORY** button or the **EXIT/MEMO** button on the remote controller for at least two seconds. "AUTO MEM" appears on the display, and scanning starts from the lowest frequency.
2. Scanning automatically stops when all 30 preset memories have been set or when auto scanning has reached the uppermost limit of the band. To stop the auto preset memory operation at any time, press the unit's **MEMORY** button or the **EXIT/MEMO** button on the remote controller.

Note

The auto preset cannot be performed for AM stations. Perform the manual preset instead.

MANUAL PRESET MEMORY

(When performing the operations using the unit's controls)

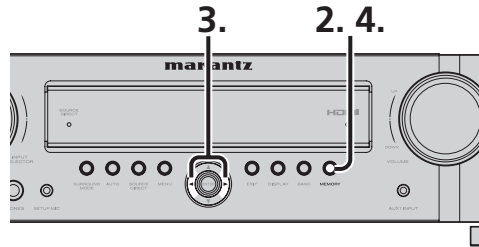

1. Tune into the frequency of the broadcast station to be set. (Refer to the section on "MANUAL TUNING" or "AUTO TUNING".)
2. Press the unit's **MEMORY** button. The MEM indicator starts blinking on the display.



3. While the MEM indicator is still blinking, press the ◀▶ cursor buttons to select the preset number.
4. Press the **MEMORY** button again to enter the selection. The indicator stops blinking, and the broadcast station is stored in the preset memory selected.

(When performing the operations using the remote controller)

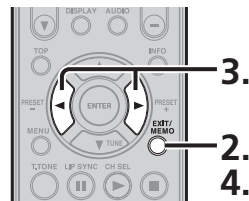

1. Tune into the frequency of the broadcast station to be set. (Refer to the section on "MANUAL TUNING" or "AUTO TUNING".)

2. Press the **EXIT/MEMO** button on the remote controller. The MEM indicator starts blinking on the display.



3. While the MEM indicator is still blinking, press the ◀▶ cursor buttons to select the preset number.
4. Press the **EXIT/MEMO** button again to enter the selection.

CALLING PRESET STATIONS

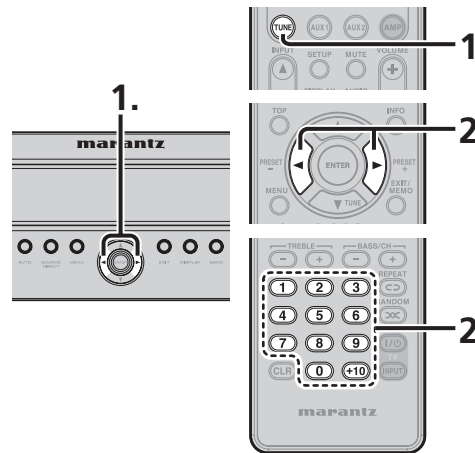

(When performing the operations using the unit's controls)

1. Press the unit's ◀▶ cursor buttons to select the preset station to be called.

(When performing the operations using the remote controller)

1. Press the **TUNE** button on the remote controller twice in succession.
2. Press the ◀▶ cursor buttons to select the preset station whose programs are to be heard. Alternatively, press the numeric buttons to select the preset station.

REMOTE CONTROLLER OPERATION

NORMAL MODE

WHEN OPERATING MARANTZ AV EQUIPMENT PRODUCTS

This remote controller is preset with a total of 10 types of remote codes, including Marantz BD (Blu-ray), GAME, DVD, VCR (VCR deck), DSS (satellite broadcasting tuner), TUNER, CD, AUX1, AUX2, and AMP (amplifier).

1. Press the **SOURCE** button. For this example, press DVD. Pressing the **SOURCE** button once changes the remote control to the settings for the source that was pressed. To change the amplifier on other source, press the **SOURCE** button twice (double-click). The code is sent, and then the amplifier source changes to DVD.

PRESET MODE

WHEN OPERATING NON-MARANTZ AV EQUIPMENT PRODUCTS

This remote controller is preset with remote control codes from AV equipment by other manufacturers. The preset codes are TV, CD, DVD, BD and DSS. Settings can be made in one of two ways. When the preset codes are set, the following codes are contained in the source button of the remote controller.

See the attached manufacturer number list for the preset manufacturers, devices, preset numbers, and other settings.

Remote controller source name	Corresponding preset code	Device name
TV	TV	Television
BD		
DVD	DVD	DVD player
CD	CD	CD player
DSS	SATELLITE	Satellite broadcasting tuner equipment

Important

- Some codes may be not match your equipment.
- The preset codes do not cover full functions.
- When the batteries are getting weak, the preset procedure is not successful.

PROGRAMMING WITH THE 4-DIGIT CODE

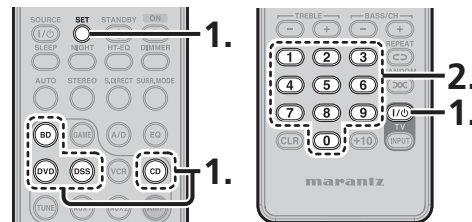

1. Press and hold down the **SOURCE** button for the appliance which should be controlled and press **SET** button until the SEND indicator blinks twice. Then SET indicator flashes. In case of TV, press and hold down the **TV Power On/off** button and **SET** button.
2. Press the 4-digit code by **numeric** buttons for appliance (code table at the end of this book) When the procedure is successful, the SEND indicator will blink twice.

Note

If the indicator did not blink twice, then repeat steps 1 through 2 and try entering the same code again.

SCANNING THE CODE TABLE

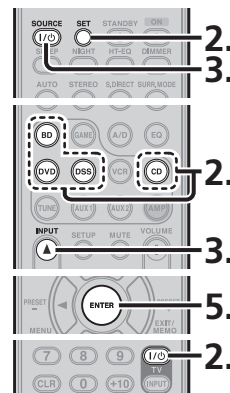

1. Switch on the appliance which should be controlled.
2. Press and hold down the **SOURCE** button for appliance which should be controlled and press **SET** button until the SEND indicator blinking twice. Then SET indicator flashes. In case of TV, press and hold down the **TV Power On/off** button and **SET** button.
3. Aim the remote control at the appliance and slowly alternate between pressing **INPUT ▲** button and the **SOURCE ON/OFF** button for the appliance. In case of TV, press **INPUT ▲** button and the **TV Power On/off** button alternately.
4. Stop when the appliance turns off.
5. Press **ENTER** button once to lock in the code.

CHECKING THE CODE

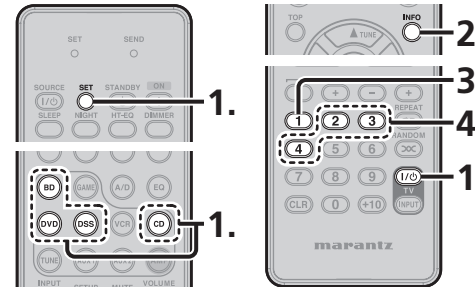

1. Press and hold down the **SOURCE** button for appliance which should be controlled and press **SET** button until the SEND indicator blinking twice then SET indicator flashes. In case of TV, press and hold down the **TV Power On/off** button and **SET** button.
2. Press the **INFO** button. The SEND indicator will blink twice.
3. To view the code for first digit, press 1 once. Wait 3 seconds, count the SEND indicator blinks (e.g. 3 blinks = 3) and write down the number.

ADVANCED OPERATION

Note

If a code digit is "0", the SEND indicator will not blink.

4. Repeat step 3 three more times for remaining digits. Use 2 for the second digit, 3 for the third digit, and 4 for the fourth digit.

RESETTING THE CODE

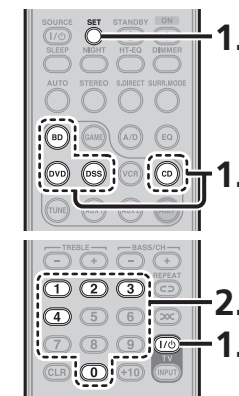

1. Press and hold down the **SOURCE** button for appliance which should be controlled and press **SET** button until the SEND indicator blinking twice. Then SET indicator flashes. In case of TV, press and hold down the **TV Power On/off** button and **SET** button.
2. Press the below codes to reset.
 - TV : 1000
 - DVD : 2000
 - CD : 3000
 - DSS : 4000
 - BD : 5000
 The indicator will blink twice.

Note

After this procedure, the selected **SOURCE** button is set initial code.

ADVANCED OPERATION

CONTROLLING MARANTZ COMPONENTS

1. Press the desired **SOURCE** button.
2. Press the desired operation buttons to play the selected component.
 - For details, refer to the component's user guide.
 - It may not be possible to operate some models.

BLU-RAY DISC MODE

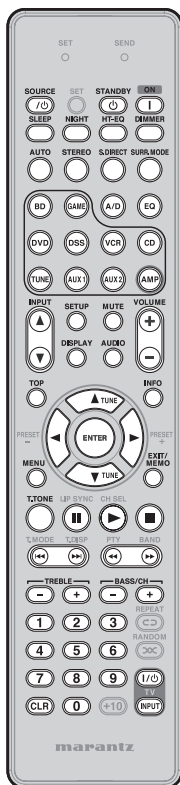

SOURCE	Turns on the Blu-ray disc player's power; sets the power to standby
STANDBY	Sets the Blu-ray disc player's power to standby
ON	Turns on the Blu-ray disc player's power
SLEEP	
NIGHT	
HT-EQ	
DIMMER	
AUTO	
STEREO	Enables the corresponding function in the AMP mode
S.DIRECT	
SURR	
SOURCE	
A/D	
EQ	
AMP	
INPUT ▲/▼	
SETUP	Calls the Blu-ray disc player's setting menu
MUTE	
VOLUME+/-	Enables the corresponding function in the AMP mode
DISPLAY	
AUDIO	
TOP	Calls the Blu-ray disc player's top menu
INFO	Displays the Blu-ray disc information (*)
Cursor	Moves the cursor
ENTER	Enters the selected item
MENU	Calls the Blu-ray disc menus
EXIT	Exits the Blu-ray disc player setting menu
T-TONE	Enables the corresponding function in the AMP mode
II	Pauses disc play
▶	Plays the discs
■	Stops disc play
◀ / ▶	Moves the chapters or tracks
◀◀ / ▶▶	Initiates fast forward or fast reverse
TREBLE+/-	Enables the corresponding function in the AMP mode
BASS+/-	Enables the corresponding function in the AMP mode
0-9	Inputs the numbers (*)
CL	Clears the input (*)
↺	Initiates repeat play (*)
⊘	Initiates random play (*)
TV POWER	Turns the power of the TV on and off
TV INPUT	Selects the TV input

(*) The preset code libraries of products made by other manufacturers are not provided for these buttons.

DVD MODE

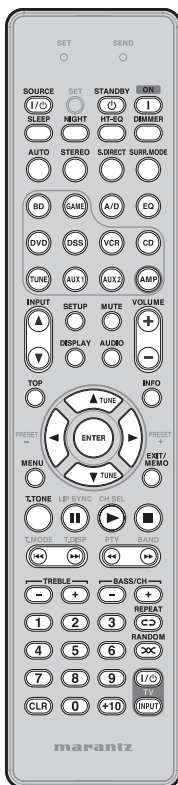

SOURCE	Turns on the DVD player's power; sets the power to standby
STANDBY	Sets the DVD player's power to standby
ON	Turns on the DVD player's power
SLEEP	
NIGHT	
HT-EQ	
DIMMER	
AUTO	
STEREO	Enables the corresponding function in the AMP mode
S.DIRECT	
SURR	
SOURCE	
A/D	
EQ	
AMP	
INPUT ▲/▼	
SETUP	Calls the DVD player's setting menu
MUTE	
VOLUME+/-	Enables the corresponding function in the AMP mode
DISPLAY	
AUDIO	
TOP	Calls the DVD player's top menu
INFO	Displays the DVD disc information (*)
Cursor	Moves the cursor
ENTER	Enters the selected item
MENU	Calls the DVD disc menus
EXIT	Exits the DVD player setting menu
T-TONE	Enables the corresponding function in the AMP mode
II	Pauses disc play
▶	Plays the discs
■	Stops disc play
◀ / ▶	Moves the chapters or tracks
◀◀ / ▶▶	Initiates fast forward or fast reverse
TREBLE+/-	Enables the corresponding function in the AMP mode
BASS+/-	Enables the corresponding function in the AMP mode
0-9,+10	Inputs the numbers (*)
CL	Clears the input (*)
↺	Initiates repeat play (*)
⊘	Initiates random play (*)
TV POWER	Turns the power of the TV on and off
TV INPUT	Selects the TV input

(*) The preset code libraries of products made by other manufacturers are not provided for these buttons.

DSS MODE

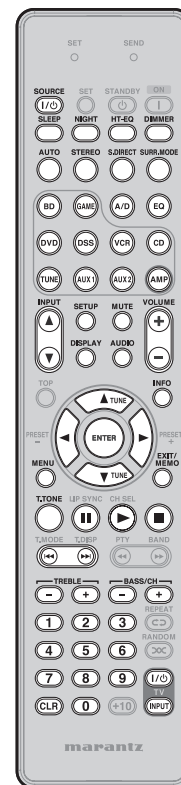

SOURCE	Turns on the satellite broadcast tuner's power; sets the power to standby
SLEEP	
NIGHT	
HT-EQ	
DIMMER	
AUTO	
STEREO	Enables the corresponding function in the AMP mode
S.DIRECT	
SURR	
SOURCE	
A/D	
EQ	
AMP	
INPUT ▲/▼	
SETUP	
MUTE	
VOLUME+/-	Enables the corresponding function in the AMP mode
DISPLAY	
AUDIO	
INFO	Displays the satellite broadcast tuner's information (*)
Cursor	Moves the cursor
ENTER	Enters the selected item
MENU	Calls the menus
EXIT	Exits the menus
T-TONE	
TREBLE+/-	Enables the corresponding function in the AMP mode
BASS+/-	Enables the corresponding function in the AMP mode
0-9	Inputs the numbers (*)
CL	Clears the input (*)
TV POWER	Turns the power of the TV on and off
TV INPUT	Selects the TV input

(*) The preset code libraries of products made by other manufacturers are not provided for these buttons.

CD MODE

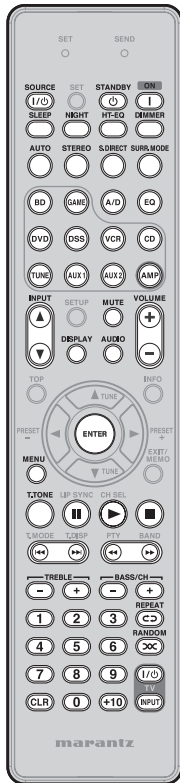

SOURCE	Turns on the CD player's power; sets the power to standby
STANDBY	Sets the CD player's power to standby
ON	Turns on the CD player's power
SLEEP	
NIGHT	
HT-EQ	
DIMMER	
AUTO	
STEREO	
S.DIRECT	
SURR	
SOURCE	Enables the corresponding function in the AMP mode
A/D	
EQ	
AMP	
INPUT ▲/▼	
MUTE	
VOLUME+/-	
DISPLAY	
AUDIO	
ENTER	Enters the selected items
MENU	Calls the menus
T-TONE	Enables the corresponding function in the AMP mode
II	Pauses disc play
▶	Plays the discs
■	Stops disc play
⏮ / ⏭	Moves the chapters or tracks
⏮ / ⏭	Initiates fast forward or fast reverse
TREBLE+/-	
BASS+/-	Enables the corresponding function in the AMP mode
0-9,+10	Inputs the numbers (*)
CL	Clears the input (*)
↺	Initiates repeat play (*)
∞	Initiates random play (*)
TV POWER	Turns the power of the TV on and off
TV INPUT	Selects the TV input

(*) The preset code libraries of products made by other manufacturers are not provided for these buttons.

AUX2 MODE

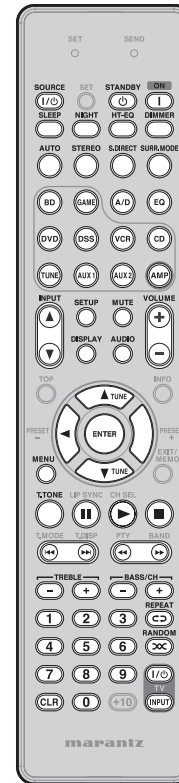

SOURCE	Turns on the universal dock's power; sets the power to standby
STANDBY	Sets the universal dock's power to standby
ON	Turns on the universal dock's power
SLEEP	
NIGHT	
HT-EQ	
DIMMER	
AUTO	
STEREO	
S.DIRECT	Enables the corresponding function in the AMP mode
SURR	
SOURCE	
A/D	
EQ	
AMP	
INPUT ▲/▼	
SETUP	Changes the user interface
MUTE	
VOLUME+/-	Enables the corresponding function in the AMP mode
DISPLAY	
AUDIO	
Cursor	Moves the cursor
ENTER	Enters the selected items
MENU	Calls the menus
T-TONE	Enables the corresponding function in the AMP mode
II	Pauses play
▶	Initiates play
■	Stops play
⏮ / ⏭	Moves the chapters or tracks
⏮ / ⏭	Initiates fast forward or fast reverse
TREBLE+/-	
BASS+/-	Enables the corresponding function in the AMP mode
0-9	Inputs the numbers (*)
CL	Clears the input (*)
↺	Initiates repeat play (*)
∞	Initiates random play (*)
TV POWER	Turns the power of the TV on and off
TV INPUT	Selects the TV input

(*) The preset code libraries of products made by other manufacturers are not provided for these buttons.

TROUBLESHOOTING

If you have any problem using this product, please be sure to check the items in the following table.
If your trouble cannot be solved, please unplug the power cable immediately and contact your Marantz authorized dealer or service center.

GENERAL

Symptom	Cause	Solution	Page
The unit does not turn on.	The AC power cord is not properly connected.	Check AC power cord connections.	12
		Make sure the AC power cord is firmly inserted into the unit.	12
		Make sure the power plug is firmly inserted into the power outlet.	12
There is no sound.	The input cables are not fully connected.	Check the connection of the input cables between this unit and the source component (CD player, etc.), referring to the connection diagram.	9, 10, 11
		The input selector is in the wrong position.	Set the input selector to the input terminal to which the source component (CD player, etc.) is connected.
	The volume is too low.	Adjust the volume.	13
	The mute function has been activated.	Cancel the mute function.	13
	Headphones are connected to the unit.	Remove the headphones.	28
	There is no sound from a certain speaker.	The speaker is not properly connected.	Refer to the connection diagram to properly connect the speaker.
The sound image does not localize correctly and is unnatural.	<ul style="list-style-type: none"> The polarity (+/-) of some speaker cables is incorrect. Speaker position and speaker cable connections are incorrect. 	Unplug the AC power cord and check the speaker cable connections.	8
The STANDBY indicator is blinking slowly (twice a second).	<ul style="list-style-type: none"> The speaker cable has short-circuited. The unit was played at a higher volume than it was designed to be played. You are using speakers with lower impedance than required. The unit was placed and used on a narrow rack or similar confined space and became overheated inside. 	<ul style="list-style-type: none"> Unplug the AC power cord and check the speaker cable connections. Turn the volume down a bit. 	2, 8
		<ul style="list-style-type: none"> Always use speakers with the required impedance. For safety's sake, always leave enough space around the unit. Use the remote controller to turn on the power. If the same problem occurs again, unplug the AC power cord and have the unit serviced at the nearest service center. 	

Symptom	Cause	Solution	Page
The STANDBY indicator is blinking fast (8 times a second).	There may be something wrong with the unit.	Immediately unplug the AC power cord and have the unit serviced at the nearest service center.	–
The display is not displaying properly.	The unit uses a computer that on rare occasions can malfunction if affected by static electricity, lightning or so on.	Unplug the AC power cord and then plug it in again.	12
Cannot use the remote controller to operate the unit.	The batteries are dead.	Replace the batteries with new ones.	3
	The remote controller is out of range.	Use the remote controller within range of the unit.	3
	There is an obstacle between the unit and remote controller.	Remove the obstacle.	3
	Strong light is falling on the unit's infrared receptor window.	Prevent strong light from falling on the infrared receptor window.	3
	The mode of the remote controller is not properly set.	Press the remote controller's AMP button before operating.	7
	The unit is set to IR = DISABLE.	Change the setting to IR = ENABLE.	16
A hissing noise (residual noise) is generated when there is no input signal.	The unit has a surround DSP, which can sometimes make a noticeable hissing noise.	If the noise bothers you when listening to a 2CH source, listen in SOURCE DIRECT mode.	–
A humming noise is generated from inside the unit.	Sometimes a sound will result depending on power source conditions in the home.	Turn off electric heaters, etc.	–

SURROUND

Symptom	Cause	Solution	Page
There is no sound from the front speaker.	An AM program, TV sound or other monaural source is being played in a surround mode other than STEREO.	<ul style="list-style-type: none"> Sound is heard from the center speaker. There is nothing wrong with the unit. Set the speaker selector to the correct position. 	8
There is no sound from the center speaker.	The surround mode is set to STEREO.	When the surround mode is set to STEREO, no sound will come from the center speaker. Set the unit to another surround mode.	38
	CENTER = NO is selected on the SPEAKER CONFIG menu.	Set CENTER to YES.	22

TROUBLESHOOTING

Symptom	Cause	Solution	Page
There is no sound from the surround speakers.	The surround mode is set to STEREO.	When the surround mode is set to STEREO, no sound will come from the surround speakers. Set the unit to another surround mode.	
	SURROUND = NO is selected on the SPEAKER CONFIG menu.	Set SURROUND to YES.	22
There is no sound from the surround back speakers.	The PL IIx mode or other 6.1 or 7.1 channel surround sound mode has not been set as the surround mode.	See the surround mode table.	38
	SURROUND BACK = NO is selected on the SPEAKER CONFIG menu.	Set SURROUND BACK to YES or 2CH.	22
	Connection has been made to SURROUND BACK R even though the system is being used with the surround back speakers set to YES.	Connect the speaker to SURROUND BACK L when SURROUND BACK is set to YES.	8, 22
There is no sound from the subwoofer.	<ul style="list-style-type: none"> The subwoofer is not turned on. The subwoofer level is too low. SUBWOOFER = NO is selected on the SPEAKER CONFIG menu. 	<ul style="list-style-type: none"> Turn on the power to the subwoofer. Raise the subwoofer level. Select SUBWOOFER = YES. 	22
	FRONT : FULL RANGE is set on on the SPEAKER X-OVER menu, SUB W MODE: NORMAL is set on the SYSTEM SETUP menu, and an analog or PCM source is being played.	When SW PLUS+ is selected as the SUB W MODE setting, the bass components are played from the front speakers and subwoofer, and the sound heard may be unnatural because of interference.	19, 23
	The playback source does not contain any LFE or sound in the low range.		-
Cannot select the NEO:6 mode.	There is no interchangeability in the input signals.	Use 2-channel DTS input signals, PCM input signals or analog input signals.	-
NIGHT mode does not function. (Only applies to units with NIGHT mode)	A source that is not recorded in Dolby Digital is being played.	Use a source recorded in Dolby Digital.	-
Cannot select the desired surround mode.	The surround modes available are limited by input signal and speaker settings.	See the surround mode table.	38
A noise is generated during playback of DTS-encoded CDs, etc.	<ul style="list-style-type: none"> The unit is connected using an analog connection. The player is conducting search playback. Some inappropriate digital processing (level adjustment, change of sampling frequency, etc.) is happening in the player. 	<ul style="list-style-type: none"> Use a digital (optical or coaxial) or HDMI connection. Noise may occur during search playback depending on the component. There is nothing wrong with the unit. See the player's instruction manual. 	9, 11

Symptom	Cause	Solution	Page
Cannot play back audio like Dolby Digital or DTS. (Indicator does not light up.)	<ul style="list-style-type: none"> The digital signal output of the player, etc., is set to PCM. The unit is connected using an analog connection. 	<ul style="list-style-type: none"> See the instruction manual of the player, etc. Use a digital or HDMI connection. 	-
Cannot play back audio like Dolby TrueHD or DTS-HD. (Indicator does not light up.)	<ul style="list-style-type: none"> The player or other source component does not support these audio mode outputs. The audio output of the player is not set properly. The HDMI connections have not been performed. 	<ul style="list-style-type: none"> Connect a component (with HDMI version 1.3a or higher) which supports Dolby TrueHD and DTS-HD. Set the output so that the source component will be able to output these audio modes. 	11
When playing a CD on a DVD player, the next track is played with part of the beginning missing when track skipping, etc., is conducted.	Depending on the player, the digital signal may be interrupted when a track is skipped. The start of the song may be slightly interrupted in order to determine the surround system.	If using such a DVD player, you can play back the audio without problem by using an analog connection.	10

NAMES AND FUNCTIONS

BASIC CONNECTIONS

BASIC OPERATION

ADVANCED CONNECTIONS

SETUP

ADVANCED OPERATION

TROUBLESHOOTING

OTHERS

TROUBLESHOOTING

VIDEO

Symptom	Cause	Solution	Page
No image on the monitor TV.	<ul style="list-style-type: none"> The monitor TV connection, input switching, etc., are not set up correctly. The unit has an HDMI connection to the source component, but no HDMI connection to the monitor TV. 	<ul style="list-style-type: none"> See the monitor TV's instruction manual. Make an HDMI connection to the monitor TV. 	11
The audio or the image does not match the selected source.	The input cables are not correctly connected.	Connect the cables properly, referring to the connection diagram.	9, 10, 11
Cannot record to a VCR, etc.	<ul style="list-style-type: none"> The video recording component jack does not match the source component jack. A copy-protected signal is being received. 	<ul style="list-style-type: none"> Make sure the recording component jack matches the source component jack. (Video input) Video signals that include copy-protected signals cannot be recorded. 	10
The converted video signals are disturbed.	When special playback is performed by the video deck, the conversion may not be carried out normally, causing the video signals to be disturbed and preventing the images from being shown.	Connect a monitor TV using the same format (video or component) as the source component.	10

HDMI

Symptom	Cause	Solution	Page
There is no picture with the HDMI connection.	The HDMI cable is improperly connected.	Check the HDMI cable connection.	11
	The unit is connected with a non-spec HDMI cable.	Use of a cable no longer than 5 meters is recommended to ensure stable operation, prevent picture degradation, etc.	11
	The connection between components over an HDMI connection has not been authenticated.	Turn the power on again to all the components on the HDMI connection.	–
	The HDMI settings are incorrect.	Make sure the unit's HDMI settings are correct.	–
		Set the unit for HDMI input, as explained in the instruction manual of the video component (TV, projector, etc.).	–
		Make settings to enable HDMI output, as explained in the instruction manual of the source device (Blu-ray disc player, Set Top Box, etc.).	19
		Match the resolution for both components, as explained in the instruction manual of the component on the HDMI connection.	–
	The unit is connected to the video component (TV, projector, etc.) by DVI connector.	Connect an HDCP-compatible video component.	–
	The power to the unit is turned off. (HDMI connections are not enabled when the unit is in STANDBY mode.)	Turn on the main power to the unit.	12
	It takes time for the image to be displayed over an HDMI connection.	The connection is being authenticated between components on the HDMI connection.	Some HDMI components require time for authentication. There is nothing wrong with the unit.
There is no audio playback over an HDMI connection.	The HDMI settings are incorrect.	Make settings to enable HDMI audio output, as explained in the instruction manual of the source device (Blu-ray disc player, Set Top Box, etc.).	19
		Set so that the HDMI audio output setting matches the signals supported by the unit, as explained in the instruction manual of the source device (Blu-ray disc player, Set Top Box, etc.).	–
	ON has been set for HDMI AUDIO OUT on the SYSTEM SETUP menu.	No sound is heard from the unit when ON is set for HDMI AUDIO OUT. Select OFF as this menu item's setting.	19

Symptom	Cause	Solution	Page
No sound is heard from the monitor TV connected to the HDMI terminal.	OFF has been set for HDMI AUDIO OUT on the SYSTEM SETUP menu.	No sound is heard from the monitor TV in the OFF mode. Select ON.	19
Image and audio are unstable over an HDMI connection. (There is noise, the stream is interrupted, etc.)	The connection uses a long cable.	Use a short cable. Use of a cable no longer than 5 meters is recommended.	11
		Use a Category 2 (high-speed supported) cable.	11

TUNER

Symptom	Cause	Solution	Page
Cannot receive AM or FM signals.	The antennas have not been connected properly.	Make sure the AM and FM antennas are properly connected to the AM and FM antenna terminals, respectively.	12
A noise is generated when receiving an AM signal.	The unit is receiving interference from other equipment.	Change the location of the AM antenna.	12
A noise is generated when receiving an FM signal.	The signal from the broadcasting station is weak.	Install an outdoor FM antenna.	12

WHEN MALFUNCTIONING HAS OCCURRED

If an abnormal display or malfunction display appears on the unit's display, turn off the power immediately.

If the trouble persists even after the power has been turned back on, disconnect the AC power cord.

Then contact the dealer where you purchased the unit, your nearest Marantz sales office or Marantz service center.

MEMORY BACKUP

Even when the unit's main power is off, the various settings that have been selected will remain stored in the non-volatile memory inside the unit.

TO RESTORE THE DEFAULT SETTINGS (RESETTING)

If the trouble cannot be resolved even by following the instructions in the "TROUBLESHOOTING" sections, try resetting the unit.

However, bear in mind that resetting the unit will cause all the information on the settings selected on the setup menu and on the surround mode settings to be erased from the memory.

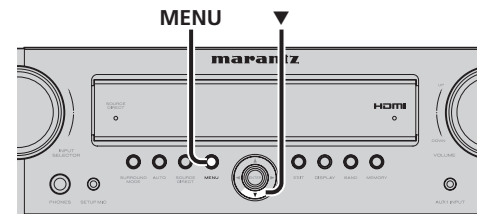

1. Check that the power is on.
2. While pressing the unit's **MENU** button, hold down the **▼** cursor button for at least 3 seconds. After "M-CLEAR" has appeared on the display, the STANDBY mode is established, the settings that were selected are initialized, and the default settings are restored.

OTHERS

SURROUND MODE

This unit is equipped with many surround modes. These are provided to reproduce a variety of surround sound effects, according to the content of the source to be played.

The available surround modes may be restricted depending on the input signal and speaker setup.

The relationship between the selected surround mode and the input signal

The surround mode is selected with the surround mode selector on the unit or the remote controller. However, the sound you hear is subject to the relationship between the selected surround mode and the input signal. That relationship is as follows:

Surround Mode	Input Signal	Decoding	Output Channel					Front information display
			L/R	C	SL/SR	SBL/SBR	SubW	Signal format indicators
AUTO	Dolby Surr.EX	Dolby Digital EX	○	○	○	○	○	DD D, EX
	Dolby D (5.1ch)	Dolby Digital 5.1	○	○	○	-	○	DD D
	Dolby D (2ch)	Dolby Digital 2.0	○	-	-	-	○	DD D
	Dolby D (2ch Surr)	Pro Logic IIx movie	○	○	○	○	○	DD D
	Dolby Digital Plus (2ch)	DolbyDigital +	○	-	-	-	○	DD D, +
	Dolby Digital Plus (5.1ch)	DolbyDigital +	○	○	○	-	○	DD D, +
	Dolby Digital Plus (6.1ch)	DolbyDigital +	○	○	○	○	○	DD D, +
	Dolby Digital Plus (7.1ch)	DolbyDigital +	○	○	○	○	○	DD D, +
	Dolby TrueHD (2ch)	DolbyTrueHD	○	-	-	-	○	DD HD
	Dolby TrueHD (5.1ch)	DolbyTrueHD	○	○	○	-	○	DD HD
	Dolby TrueHD (6.1ch)	DolbyTrueHD	○	○	○	○	○	DD HD
	Dolby TrueHD (7.1ch)	DolbyTrueHD	○	○	○	○	○	DD HD
	DTS-ES	DTS-ES	○	○	○	○	○	DTS, ES
	DTS 96/24	DTS-96/24	○	○	○	-	○	DTS, 96/24
	DTS (5.1ch)	DTS 5.1	○	○	○	-	○	DTS
	DTS-HD (2ch)	DTS-HD	○	-	-	-	○	DTS, HD
	DTS-HD (5.1ch)	DTS-HD	○	○	○	-	○	DTS, HD
	DTS-HD (6.1ch)	DTS-HD	○	○	○	○	○	DTS, HD
	DTS-HD (7.1ch)	DTS-HD	○	○	○	○	○	DTS, HD
	Multi Ch-PCM	Multi Ch-PCM	○	○	○	○	○	
Multi Ch-PCM 96kHz	Multi Ch-PCM 96kHz	○	○	○	○	○		
PCM (Audio)	PCM (Stereo)	○	-	-	-	○		
PCM 96kHz	PCM (Stereo 96kHz)	○	-	-	-	○		
Analog	Stereo	○	-	-	-	○		
SOURCE DIRECT	Dolby Surr.EX	Dolby Digital EX	○	○	○	○	○	DD D, EX
	Dolby D (5.1ch)	Dolby Digital 5.1	○	○	○	-	○	DD D
	Dolby D (2ch)	Dolby Digital 2.0	○	-	-	-	○	DD D
	Dolby D (2ch Surr)	Dolby Digital 2.0	○	-	-	-	○	DD D
	Dolby Digital Plus (2ch)	DolbyDigital +	○	-	-	-	○	DD D, +
	Dolby Digital Plus (5.1ch)	DolbyDigital +	○	○	○	-	○	DD D, +
	Dolby Digital Plus (6.1ch)	DolbyDigital +	○	○	○	○	○	DD D, +
	Dolby Digital Plus (7.1ch)	DolbyDigital +	○	○	○	○	○	DD D, +
	Dolby TrueHD (2ch)	DolbyTrueHD	○	-	-	-	○	DD HD
	Dolby TrueHD (5.1ch)	DolbyTrueHD	○	○	○	-	○	DD HD
	Dolby TrueHD (6.1ch)	DolbyTrueHD	○	○	○	○	○	DD HD
	Dolby TrueHD (7.1ch)	DolbyTrueHD	○	○	○	○	○	DD HD
	DTS-ES	DTS-ES	○	○	○	○	○	DTS, ES
	DTS 96/24	DTS-96/24	○	○	○	-	○	DTS, 96/24
	DTS (5.1ch)	DTS 5.1	○	○	○	-	○	DTS
	DTS-HD (2ch)	DTS-HD	○	-	-	-	○	DTS, HD
	DTS-HD (5.1ch)	DTS-HD	○	○	○	-	○	DTS, HD
	DTS-HD (6.1ch)	DTS-HD	○	○	○	○	○	DTS, HD
	DTS-HD (7.1ch)	DTS-HD	○	○	○	○	○	DTS, HD
	Multi Ch-PCM	Multi Ch-PCM	○	○	○	○	○	
Multi Ch-PCM 96kHz	Multi Ch-PCM 96kHz	○	○	○	○	○		
PCM (Audio)	PCM (Stereo)	○	-	-	-	○		
PCM 96kHz	PCM (Stereo 96kHz)	○	-	-	-	○		
Analog	Stereo	○	-	-	-	○		
DOLBY (PLIIx movie) (PLIIx music) (PLIIx game)	Dolby Surr.EX	Dolby Digital EX	○	○	○	○	○	DD D, EX
	Dolby D (5.1ch)	Dolby Digital 5.1	○	○	○	-	○	DD D
	Dolby D (5.1ch)	Dolby Digital 5.1 + PLIIx	○	○	○	○	○	DD D
	Dolby D (2ch)	Pro Logic IIx	○	○	○	○	○	DD D
	Dolby D (2ch Surr)	Pro Logic IIx	○	○	○	○	○	DD D

Surround Mode	Input Signal	Decoding	Output Channel					Front information display
			L/R	C	SL/SR	SBL/SBR	SubW	Signal format indicators
DOLBY (PLIIx movie) (PLIIx music) (PLIIx game)	Dolby Digital Plus (2ch)	Pro Logic IIx	○	○	○	○	○	DD D, +
	Dolby Digital Plus (5.1ch)	DolbyDigital +	○	○	○	-	○	DD D, +
	Dolby TrueHD (2ch)	Pro Logic IIx	○	○	○	○	○	DD HD
	Dolby TrueHD (5.1ch)	DolbyTrueHD	○	○	○	-	○	DD HD
	Multi Ch-PCM	Multi Ch-PCM + PLIIx	○	○	○	○	○	DD PLIIx
	PCM (Audio)	Pro Logic IIx	○	○	○	○	○	DD PLIIx
	Analog	Pro Logic IIx	○	○	○	○	○	DD PLIIx
DTS (Neo:6 Cinema) (Neo:6 Music)	DTS-ES	DTS 5.1	○	○	○	-	○	DTS, ES
	DTS 96/24	DTS-96/24	○	○	○	-	○	DTS, 96/24
	DTS (5.1ch)	DTS 5.1	○	○	○	-	○	DTS
	DTS-HD (2ch)	Neo:6	○	○	○	○	○	DTS, HD
	DTS-HD (5.1ch)	DTS-HD	○	○	○	-	○	DTS, HD
	DTS-HD (6.1ch)	DTS-HD	○	○	○	○	○	DTS, HD
	DTS-HD (7.1ch)	DTS-HD	○	○	○	○	○	DTS, HD
	PCM (Audio)	Neo:6	○	○	○	○	○	NEO:6
	Analog	Neo:6	○	○	○	○	○	NEO:6
	STEREO	Dolby Surr.EX	Stereo	○	-	-	-	○
Dolby D (5.1ch)		Stereo	○	-	-	-	○	DD D
Dolby D (2ch)		Stereo	○	-	-	-	○	DD D
Dolby D (2ch Surr)		Stereo	○	-	-	-	○	DD D
Dolby Digital Plus (2ch)		Stereo	○	-	-	-	○	DD D, +
Dolby Digital Plus (5.1ch)		Stereo	○	-	-	-	○	DD D, +
Dolby Digital Plus (6.1ch)		Stereo	○	-	-	-	○	DD D, +
Dolby Digital Plus (7.1ch)		Stereo	○	-	-	-	○	DD D, +
Dolby TrueHD (2ch)		Stereo	○	-	-	-	○	DD HD
Dolby TrueHD (5.1ch)		Stereo	○	-	-	-	○	DD HD
Dolby TrueHD (6.1ch)		Stereo	○	-	-	-	○	DD HD
Dolby TrueHD (7.1ch)		Stereo	○	-	-	-	○	DD HD
DTS-ES		Stereo	○	-	-	-	○	DTS, ES
DTS 96/24		Stereo	○	-	-	-	○	DTS, 96/24
DTS (5.1ch)		Stereo	○	-	-	-	○	DTS
DTS-HD (2ch)		Stereo	○	-	-	-	○	DTS, HD
DTS-HD (5.1ch)		Stereo	○	-	-	-	○	DTS, HD
DTS-HD (6.1ch)		Stereo	○	-	-	-	○	DTS, HD
DTS-HD (7.1ch)		Stereo	○	-	-	-	○	DTS, HD
Multi Ch-PCM		Stereo	○	-	-	-	○	
Multi Ch-PCM 96kHz	Stereo	○	-	-	-	○		
PCM (Audio)	Stereo	○	-	-	-	○		
PCM 96kHz	Stereo	○	-	-	-	○		
Analog	Stereo	○	-	-	-	○		
MULTI CH STEREO	PCM (Audio)	Multi channel stereo	○	○	○	○	○	
	PCM 96kHz	Multi channel stereo	○	○	○	○	○	
	Analog	Multi channel stereo	○	○	○	○	○	
VIRTUAL	PCM (Audio)	Virtual	○	○	○	○	○	
	PCM 96kHz	Virtual	○	○	○	○	○	
	Analog	Virtual	○	○	○	○	○	

Notes

- *Dolby Digital (2 channel L/R): Speakers for signal with Dolby Surround are fully equipped.*
- *No sound is outputs from the surround speaker, center speaker and subwoofer if the DVD disc has no surround data.*
- *Surround modes other than Stereo are not available during Dolby TrueHD, Dolby Digital Plus, or DTS-HD playback.*

If surround modes other than Stereo are selected and Dolby TrueHD, Dolby Digital Plus, or DTS-HD content is played, the surround mode setting is disabled.

Abbreviations

- L/R : Front speakers
- C : Center speaker
- SL/SR : Surround speakers
- SBL/SBR : Surround back speakers
- SubW : Subwoofer

AUTO

When this mode is selected, the unit determines whether the digital input signal is Dolby Digital, Dolby Digital Surround EX, Dolby Digital Plus, Dolby TrueHD, DTS-HD, DTS, DTS-ES, DTS 96/24 or PCM audio.

Surround EX & DTS-ES will operate for multichannel sources that have a Dolby Digital Surround EX or DTS-ES auto trigger flag in the digital signal.

When a Dolby Digital or DTS signal is input, the number of channels for which the corresponding signal is encoded will be played.

Inputting a Dolby Digital two channel signal with Dolby surround status automatically subjects that signal to Pro Logic IIx movie processing before play.

PCM 96 kHz source material can be played in this mode.

Notes

- When you use this mode with certain DVD and CD players, performing operations such as skip or stop may momentarily interrupt the output.
- When the signal is not decoded, the mode is changed to AUTO mode automatically. See page 38 to confirm the available decoding modes.

SOURCE DIRECT

In SOURCE DIRECT mode, the tone control circuit ROOM EQ and HT-EQ are bypassed for full-range frequency response and the purest audio reproduction.

Dolby Digital EX

In a movie theater, film soundtracks that have been encoded with Dolby Digital Surround EX technology are able to reproduce an extra channel which has been added during the mixing of the program.

This channel, called surround back, places sounds behind the listener in addition to the currently available front left, front center, front right, surround right, surround left and subwoofer channels.

This additional channel provides the opportunity for more detailed imaging behind the listener and brings more depth, spacious ambience and sound localization than ever before.

Dolby Digital EX is not available in systems that do not have without surround back speaker(s).

DTS-ES (Discrete 6.1, Matrix 6.1)

DTS-ES adds the surround center channel audio to the DTS 5.1 channel format to improve the acoustic positioning, and makes acoustic image movement more natural with the 6.1 channel reproduction.

This unit incorporates a DTS-ES-decoder, which can handle DTS-ES Discrete-encoded and DTS-ES Matrix-encoded program sources from DVD, etc.

DTS-ES Discrete 6.1 features digital discrete recording of all channels, including the surround back channel(s), and higher quality audio reproduction.

DTS-ES is not available in systems that do not have surround back speakers.

MODE

(Dolby Digital, Pro Logic IIx MOVIE, Pro Logic IIx MUSIC, Pro Logic IIx GAME)

This mode is used with source materials encoded in Dolby Digital and Dolby Surround.

DOLBY DIGITAL

This mode is enabled when playing source materials encoded in Dolby Digital.

Playing multichannel-encoded 5.1 channel Dolby Digital sources provides 5 main audio channels (left, center, right, surround left and surround right) and a Low Frequency Effect channel.

Dolby Digital EX decoding is not available in this mode.

Dolby Pro Logic IIx has 5 modes:

Pro Logic IIx MOVIE

This mode provides 6.1 or 7.1 channel surround sound from Dolby Surround, encoded stereo movie soundtracks.

Pro Logic IIx MUSIC

This mode provides 6.1 or 7.1 channel surround sound from conventional stereo sources (analog or digital), such as CD, tape, FM, TV, stereo VCR, etc.

Pro Logic IIx GAME

This mode restores the impact low-frequency surround effects by routing them to the system's subwoofer.

5.1ch + Pro Logic IIx Movie

This mode provides 7.1 channel surround sound from 5.1 channel sources movie soundtracks.

5.1ch + Pro Logic IIx Music

This mode provides 6.1 or 7.1 channel surround sound from 5.1 channel sources music soundtracks.

Notes

- Pro Logic IIx mode will decode as Pro Logic II mode when the Surr. B is set to "NO" from SPEAKER SETUP menu. (See page 22)
- Pro Logic IIx mode is available for a 2 channel input signal which is encoded in Dolby Digital, HDCD or PCM format.

DTS

dts, Neo:6 Cinema, Neo:6 Music

This mode is for DTS-encoded source materials such as laserdisc, CD and DVD. Neo:6 is for some 2 channel sources.

dts

This mode is enabled when playing source materials encoded in dts multichannel.

Playing multichannel encoded-5.1 channel dts sources provides five main audio channels (left, center, right, surround left and surround right) and a Low Frequency Effects channel.

dts-ES decoding is not available in this mode.

The DTS mode cannot be used when an analog input has been selected.

Neo:6 Cinema, Neo:6 Music

This mode decodes 2 channel signals into 6 channel signals using high-accuracy digital matrix technology.

The DTS Neo:6 decoder has near-discrete properties in the frequency characteristics of the channels as well as in channel separation.

According to the signals to be played back, DTS Neo:6 uses either the Neo:6 Cinema mode optimized for movie playback or the Neo:6 Music mode optimized for music playback.

Note

- The Neo:6 mode is available for 2 channel input signals which are encoded in Dolby Digital, HDCD or PCM format.

STEREO

This mode bypasses all surround processing.

In stereo program sources, the left and right channels play normally when PCM audio or analog stereo is input.

With Dolby Digital and DTS sources, the 5.1 channels are converted to two channel stereo. 96 kHz PCM source material can be played back in stereo mode.

OTHERS

MULTI CH STEREO

This mode is used to create a wider, deeper and more natural soundstage from two channel source material. This is done by feeding the left channel signal to both the left front and left surround speakers and the right channel signal to both the right front and right surround speakers. Additionally, the center channel reproduces a mix of the right and left channels.

Note

- Audio is not output from the CENTER channel when using MULTI CH. MUSIC mode.

VIRTUAL

This mode provides a dynamic and broad sound space to heighten the overall impact of the sound track.

CAUTION

Note for DTS

- To connected DVD player, laserdisc player or CD player needs to support DTS digital output. You may not be able to play some DTS source signals from certain CD players and LD players even if you connect the player to the unit digitally. This is because the digital signal has been processed (such as the output level, sampling frequency or frequency response), and the unit cannot recognize the signal as DTS data.
- Depending on the player used, DTS play may produce a short noise. This is not a malfunction.
- While signals from a DTS laserdisc or CD are playing in another surround mode, you cannot switch to digital input or from digital input to analog input from the INPUT SETUP in the MAIN MENU or by pressing the **A/D** button.
- The outputs for VCR OUT output analog audio signals only. Do not record from CDs or LDs that support DTS using these outputs. If you do, the DTS-encoded signal will be recorded as noise.

Note or Dolby Digital Surround EX

- When playing Dolby Digital Surround EX-encoded software in 6.1 channels, it is required to set the EX/ES mode.
- Note that some Dolby Digital Surround EX-encoded software does not contain the identification signal. In this case, set the EX/ES mode manually.

Note for 96 kHz PCM audio

- The AUTO, Pure Direct, and Stereo modes can be used when playing PCM signals with a sampling frequency of 96 kHz (such as from DVD-Video/Audio discs).
- Certain DVD player models inhibit digital output. For details, refer to the player's operation manual.
- Some DVD discs feature copy protection. When using such disc, 96 kHz PCM signal are not output from the DVD player. For details, refer to the player's operation manual.

DESCRIPTION



Manufactured under license under U.S. Patent #'s: 5,451,942; 5,956,674; 5,974,380; 5,978,762; 6,226,616; 6,487,535; 7,003,467 & other U.S. and worldwide patents issued & pending. DTS, DTS Digital Surround, ES, and Neo:6 are registered trademarks and the DTS logos, Symbol and DTS 96/24 are trademarks of DTS, Inc. © 1996-2007 DTS, Inc. All Rights Reserved.

• dts Digital Surround

DTS was introduced in 1994 to provide 5.1 channels of discrete digital audio into home theater systems. DTS brings you premium quality discrete multichannel digital sound to both movies and music. DTS is a multichannel sound system designed to create full range digital sound reproduction. The no compromise DTS digital process sets the standard of quality for cinema sound by delivering an exact copy of the studio master recordings to neighborhood and home theaters. Now, every moviegoer can hear the sound exactly as the moviemaker intended. DTS can be enjoyed in the home for either movies or music on of DVD's, LD's, and CD's.

• dts Neo:6®

The advantages of discrete multichannel systems over matrix are well known. But even in homes equipped for discrete multichannel, there remains a need for high-quality matrix decoding. This is because of the large library of matrix surround motion pictures available on disc and on VHS tape; and analog television broadcasts. The typical matrix decoder of today derives a center channel and a mono surround channel from two-channel matrix stereo material. It is better than a simple matrix in that it includes steering logic to improve separation, but because of its mono, band-limited surround it can be disappointing to users accustomed to discrete multichannel.

Neo:6 offers several important improvements as follow,

- Neo:6 provides up to six full-band channels of matrix decoding from stereo matrix material. Users with 6.1 and 5.1 systems will derive six and five separate channels, respectively, corresponding to the standard home-theater speaker layouts.
- Neo:6 technology allows various sound elements within a channel or channels to be steered separately, and in a way which follows naturally from the original presentation.
- Neo:6 offers a music mode to expand stereo nonmatrix recordings into the five- or six-channel layout, in a way which does not diminish the subtlety and integrity of the original stereo recording.

• dts Digital Surround ES®

DTS-ES Extended Surround is a new multichannel digital signal format developed by Digital Theater Systems Inc. While offering high compatibility with the conventional DTS Digital Surround format, DTS-ES Extended Surround greatly improves the 360-degree surround impression and space expression thanks to further expanded surround signals. This format has been used professionally in movie theaters since 1999.

In addition to the 5.1 surround channels (FL, FR, C, SL, SR and LFE), DTS-ES Extended Surround also offers the SB (Surround Back) channel for surround playback with a total of 6.1 channels. DTS-ES Extended Surround includes two signal formats with different surround signal recording methods, as DTS-ES Discrete 6.1 and DTS-ES Matrix 6.1.

• dts Digital Surround 96/24

The stereo CD is a 16-bit medium with sampling at 44.1 kHz. Professional audio has been 20- or 24-bit for some time, and there is increasing interest in higher sampling rates both for recording and for delivery into the home. Greater bit depths provide extended dynamic range. Higher sampling rates allow wider frequency response and the use of anti-alias and reconstruction filters with more favorable aural characteristics.

DTS 96/24 allows for 5.1-channel sound tracks to be encoded at a rate of 96kHz/24bits on DVD-Video titles.

When DVD-video appeared, it became possible to deliver 24-bit, 96 kHz audio into the home, but only in two channels, and with serious limitations on picture. This capability has had little use.

DVD-audio allows 96/24 in six channels, but a new player is needed, and only analog outputs are provided, necessitating the use of the D/A converters and analog electronics provided in the player.

DTS 96/24 offers the following:

1. Sound quality transparent to the original 96/24 master.
2. Full backward compatibility with all existing decoders. (Existing decoders will output a 48 kHz signal)
3. No new player required: DTS 96/24 can be carried on DVD-video, or in the video zone of DVD-audio, accessible to all DVD players.
4. 96/24 5.1-channel sound with full-quality full-motion video, for music programs and motion picture soundtracks on DVD-video.



DTS-HD Master Audio is capable of delivering audio that is a bit-for-bit identical to the studio master. DTS-HD Master Audio delivers audio at super high variable bit rates -24.5 mega-bits per second (Mbps) on Blu-ray discs and 18.0 Mbps on HD-DVD - that are significantly higher than standard DVDs. This bit stream is so "fast" and the transfer rate is so "high" that it can deliver the Holy Grail of audio: 7.1 audio channels at 96k sampling frequency/24 bit depths that are identical to the original. With DTS-HD Master Audio, you will be able to experience movies and music, exactly as the artist intended: clear, pure, and uncompromised.

Manufactured under license under U.S. Patent #'s: 5,451,942; 5,956,674; 5,974,380; 5,978,762; 6,226,616; 6,487,535 & other U.S. and worldwide patents issued & pending.

DTS is a registered trademark and the DTS logos, Symbol, DTS-HD and DTS-HD Master Audio are trademarks of DTS, Inc. © 1996-2007 DTS, Inc. All Rights Reserved.



DTS-HD High Resolution Audio can deliver up to 7.1 channels of sound that is virtually indistinguishable from the original. DTS-HD High Resolution Audio delivers audio at high constant bit rates superior to standard DVDs—6.0 Mbps on Blu-ray discs and 3.0 Mbps on HD-DVD to produce outstanding sound quality. It is capable of delivering up to 7.1 channels at 96k sampling frequency/24 bit depth resolution. It allows content creators to deliver rich, high definition audio on movies where disc space may not allow for DTS-HD Master Audio.

Manufactured under license under U.S. Patent #'s: 5,451,942; 5,956,674; 5,974,380; 5,978,762; 6,226,616; 6,487,535 & other U.S. and worldwide patents issued & pending. DTS is a registered trademark and the DTS logos, Symbol, DTS-HD, DTS-HD High Resolution

Audio and DTS-HD High Res Audio are trademarks of DTS, Inc. © 1996-2007 DTS, Inc. All Rights Reserved.



Dolby Digital identifies the use of Dolby Digital audio coding for such consumer formats as DVD and DTV. As with film sound, Dolby Digital can provide up to five full-range channels for left, center, and right screen channels, independent left and right surround channels, and a sixth (".1") channel for low-frequency effects.

Dolby Surround Pro Logic II is an improved matrix decoding technology that provides better spatiality and directionality on Dolby Surround program material; provides a convincing three-dimensional soundfield on conventional stereo music recordings; and is ideally suited to bring the surround experience to automotive sound. While conventional surround programming is fully compatible with Dolby Surround Pro Logic II decoders, soundtracks will be able to be encoded specifically to take full advantage of Pro Logic II playback, including separate left and right surround channels. (Such material is also compatible with conventional Pro Logic decoders.)

Dolby Digital EX creates six full-bandwidth output channels from 5.1-channel sources. This is done using a matrix decoder that derives three surround channels from the two in the original recording. For best results, Dolby Digital EX should be used with movies soundtracks recorded with Dolby Digital Surround EX.

About Dolby Pro Logic IIx

Dolby Pro Logic IIx technology delivers a natural and immersing 7.1-channel listening experience to the home theater environment. A product of Dolby's expertise in surround sound and matrix decoding technologies, Dolby Pro Logic IIx is a complete surround sound solution that maximizes the entertainment experience from stereo as well as 5.1-channel encoded sources.

Dolby Pro Logic IIx is fully compatible with Dolby Surround Pro Logic technology and can optimally decode the thousands of commercially available Dolby Surround encoded video cassettes and television programs with enhanced depth and spatiality. It can also process any high-quality stereo or Advanced Resolution 5.1-channel music content into a seamless 6.1- or 7.1-channel listening experience.



Dolby® TrueHD is Dolby's next-generation lossless technology developed for high-definition disc-based media. Dolby TrueHD delivers tantalizing sound that is bit-for-bit identical to the studio master, unlocking the true high-definition entertainment experience on next-generation discs. When coupled with high-definition video, Dolby TrueHD offers an unprecedented home theater experience that lets you enjoy sound as stunning as the high-definition picture.



Dolby Digital Plus is a highly sophisticated and versatile audio codec based on Dolby Digital and designed specifically to adapt to the changing demands of future audio, video delivery, and audio storage systems while simultaneously retaining backwards compatibility with the existing Dolby Digital 5.1-channel home theater systems in use today.

Manufactured under license from Dolby Laboratories. "Dolby", "Pro Logic", "Surround EX", and the double-D symbol are trademarks of Dolby Laboratories.



HDMI, the **HDMI** and High-Definition Multimedia Interface are trademarks or registered trademarks of HDMI Licensing LLC.

OTHERS

SPECIFICATIONS

FM TUNER SECTION

Frequency Range	87.5 MHz to 108.0 MHz
Usable Sensitivity	IHF 1.8 μ V/16.4 dBf
Signal to Noise Ratio (Mono/Stereo)	75 dB / 70 dB
Distortion (Mono/Stereo)	0.3 % / 0.5 %
Stereo Separation.....	1 kHz 35 dB
Alternate Channel Selectivity ... \pm 300 kHz	60 dB
Image Rejection	98 MHz 60 dB
Tuner Output Level (1 kHz, \pm 75 kHz Dev)	500 mV

AM TUNER SECTION

Frequency Range	530 kHz to 1710 kHz
Signal to Noise Ratio.....	40 dB
Usable Sensitivity (Loop Antenna).....	400 μ V/m
Distortion.....	400 Hz, 30 % Mod. 0.7 %
Selectivity.....	\pm 18 kHz 70 dB

AUDIO SECTION

Power Output (20 Hz – 20 kHz/THD=0.08%)	
Front L&R (8 ohm load, Per channel) ..	50 W
Center (8 ohm load, Per channel)	50 W
Surround L&R (8 ohm load, Per channel)	50 W
Surround Back L&R (8 ohm load, Per channel).....	50 W
Power Output	
Front L&R (6 ohm load, Per channel)	60 W
Center (6 ohm load, Per channel)	60 W
Surround L&R (6 ohm load, Per channel)	60 W
Surround Back L&R (6 ohm load, Per channel).....	60 W
Input Sensitivity/Impedance	200 mV / 47 k Ω
Signal to Noise Ratio(Analog Input / Pure Direct)	100 dB

Frequency Response (Analog Input / Pure Direct)	8 Hz to 100 kHz (\pm 3 dB)
(Digital Input / 96 kHz PCM)	8 Hz to 45 kHz (\pm 3 dB)

VIDEO

Television Format	NTSC
Input Level/Impedance	1 Vp-p / 75 Ω
Output Level/Impedance.....	1 Vp-p / 75 Ω
Video Frequency Response	5 Hz to 8 MHz (- 1 dB)
Video Frequency (Component)	5 Hz to 80 MHz (- 1 dB)
S/N	60 dB
HDMI Version	1.3a [INPUT] 1.3a [OUTPUT]

GENERAL

Power Requirement.....	AC 120 V 60 Hz
Power Consumption	250 W
Standby Power Consumption.....	0.5 W

Specifications subject to change without prior notice.

USING HEADPHONES

Take care not to turn up the volume too high while you are using headphones. Listening to sound at high-volume levels for prolonged periods can negatively affect your hearing.

COPYRIGHT

Recording and playback of any material may require consent. For further information refer to the following:

- Copyright Act 1956
- Dramatic and Musical Performers Act 1958
- Performers Protection Acts 1963 and 1972
- Any subsequent statutory enactments and orders

CLEANING OF EQUIPMENT EXTERNAL SURFACES

The exterior finish of your unit will last indefinitely with proper care and cleaning. Never use scouring pads, steel wool, scouring powders or harsh chemical agents (e.g., lye solution), alcohol, thinner, benzene, insecticide or other volatile substances as these will mar the finish of the equipment. Likewise, never use cloths containing chemical substances. If the equipment get dirty, wipe the external surfaces with a soft, lint-free cloth.

If the equipment becomes heavily soiled:

- dilute some washing up liquid in water, in a ratio of one part detergent to six parts water.
- dip a soft, lint free in the solution and wring the it is damp.
- wipe the equipment with the damp cloth.
- dry the equipment by wiping it with a dry cloth.



REPAIRS

Only the most competent and qualified service technicians should be allowed to service the factory-trained warranty station personnel have the knowledge and special facilities needed for repair and calibration of this precision equipment. After the warranty period has expired, repairs will be performed for a charge if the equipment can be returned to normal operation.

In the event of difficulty, refer to your dealer or write directly to the nearest location to you that is listed on the Marantz Authorized Service Station list. If writing, please include the model and serial number of the equipment together with a full description of what you think is abnormal about the equipment's behavior.

SETUP CODES

TV

Acer.....	1141
Admiral.....	1002, 1009, 1089
Aiko.....	1059
Aiwa.....	1117, 1118
Akai.....	1001
Amtron.....	1023
Anam.....	1113
Anam National.....	1023, 1069, 1092
AOC.....	1003, 1024, 1049, 1127
Audiovox.....	1023
Bell & Howell.....	1009, 1025
Benq.....	1104, 1142
Broksonic.....	1003, 1097, 1098, 1113
Celebrity.....	1001
Citizen.....	1003, 1013, 1023 1026, 1059, 1063
Colortyme.....	1003, 1043
Contec.....	1113
Contec/Cony.....	1023, 1045, 1047
Craig.....	1020, 1022, 1023, 1113
Crown.....	1023, 1067
Curtis Mathes.....	1003, 1013, 1025 1026, 1062, 1103, 1110
Daewoo.....	1003, 1013, 1024, 1035 1036, 1059, 1084, 1101
Daytron.....	1003, 1013, 1016
Dimensia.....	1103, 1110
Dumont.....	1003, 1010, 1153
Electroband.....	1001
Electrohome.....	1001, 1003, 1069, 1133
Emerson.....	1003, 1013, 1015 1020, 1021, 1022, 1023 1025, 1038, 1044, 1045 1048, 1055, 1061, 1094 1096, 1099, 1101, 1113
Envision.....	1003
Fisher.....	1025, 1051, 1091, 1160
Fujitsu.....	1038, 1124, 1125, 1155
Funai.....	1023, 1038, 1113
Gateway.....	1150
GE.....	1003, 1018, 1022, 1046 1054, 1069, 1085, 1103 1110, 1113, 1133, 1136, 1153
Goldstar.....	1003, 1013, 1024 1030, 1045, 1080 1100, 1112, 1154

Hallmark.....	1003
Hisense.....	1116
Hitachi.....	1003, 1012, 1031, 1032 1037, 1041, 1045, 1047 1065, 1068, 1082, 1088 1094, 1139, 1140, 1145, 1159
Infinity.....	1067
Janeil.....	1134
JBL.....	1067
JC Penney.....	1003, 1013, 1018 1019, 1024, 1026 1046, 1047, 1054 1063, 1083, 1085 1100, 1103, 1110 1112, 1133, 1154
Jensen.....	1003
JVC.....	1028, 1029, 1045 1047, 1050, 1060, 1065
Kawasho.....	1001, 1003
Kenwood.....	1003
Kloss Novabeam.....	1023, 1056, 1057, 1134
KTV.....	1013, 1023, 1033 1034, 1073, 1099, 1113
LG.....	1024, 1030
M.Wards.....	1002, 1009, 1038
Magnavox.....	1003, 1052, 1053 1056, 1057, 1063 1067, 1081, 1106
Marantz.....	1003, 1031, 1067, 1122
Mitsubishi.....	1003, 1024, 1051 1115, 1122, 1133
Motorola.....	1014, 1069
NEC.....	1003, 1012, 1024, 1043, 1069
NET-TV.....	1137, 1150
Orion.....	1020, 1096
Panasonic.....	1017, 1067, 1069, 1095, 1111
Philips.....	1003, 1011, 1045, 1052 1054, 1056, 1057, 1058 1063, 1067, 1069, 1106
Pioneer.....	1003, 1018, 1037 1070, 1071, 1094 1145, 1147, 1149
Plasmsync.....	1135
Portland.....	1003, 1013, 1024, 1059
Price Club.....	1026
Prism.....	1018
Proscan.....	1004, 1005, 1006, 1007 1008, 1085, 1103, 1110
Proton.....	1003, 1045
Quasar.....	1010, 1069, 1073, 1111, 1153

Radio Shack.....	1003, 1013, 1015 1023, 1024, 1025, 1045 1100, 1103, 1110, 1113
RCA.....	1003, 1004, 1005 1006, 1007, 1008 1014, 1024, 1049, 1069 1075, 1079, 1085, 1087 1088, 1093, 1094, 1101 1103, 1110, 1113, 1153
Realistic.....	1025, 1103
Runco.....	1010, 1153
Sampo.....	1150
Samsung.....	1003, 1013, 1024, 1026 1040, 1045, 1062, 1078 1083, 1090, 1100, 1105, 1114 1120, 1121, 1146, 1148, 1157
Sansui.....	1119
Sanyo.....	1003, 1025, 1051, 1072 1077, 1091, 1156, 1157, 1158
Sharp.....	1003, 1013, 1014 1015, 1045, 1055, 1064 1066, 1076, 1089, 1123
Signature.....	1009
Sony.....	1001, 1102, 1108
Soundesign.....	1003, 1023, 1038, 1063, 1113
Starlite.....	1023
Supre-Macy.....	1134
Sylvania.....	1003, 1039, 1042 1052, 1053, 1056, 1057 1063, 1067, 1089, 1151
Symphonic.....	1023, 1039, 1044
Tandy.....	1014
Tatung.....	1069
Technics.....	1018
Techwood.....	1003, 1018
Teknika.....	1003, 1009, 1013, 1023 1024, 1026, 1038, 1045 1047, 1059, 1063, 1111, 1113
Telecaption.....	1074
Toshiba.....	1003, 1019, 1025 1026, 1042, 1074, 1098 1107, 1111, 1135, 1136
Totevision.....	1013
Universal.....	1046, 1054
Video Concepts.....	1113
Viewsonic.....	1006, 1022, 1109 1128, 1129, 1130, 1131 1138, 1143, 1145, 1150

Wards.....	1003, 1009, 1015 1024, 1038, 1044, 1046 1052, 1054, 1056, 1057 1067, 1086, 1103, 1110
White Westinghouse.....	1001, 1101
Yamaha.....	1003, 1024
Zenith.....	1003, 1009, 1010 1132, 1144, 1153

CD

AIWA.....	3001, 3002, 3003
AKAI.....	3004, 3005, 3006
AUDIO.....	3007
AUDIO LABS.....	3008
CALIFORNIA.....	3008
CARVER.....	3009, 3010, 3011
CASIO.....	3012, 3020
CURTIS.....	3012, 3020
DENON.....	3013
EMERSON.....	3014
FISHER.....	3011, 3015, 3016, 3017, 3018
GE.....	3019
GENEXXA.....	3014, 3020, 3021
HARMON.....	3022, 3023, 3051
HITACHI.....	3020
INKEL.....	3024
JC PENNEY.....	3012, 3020, 3025
JVC.....	3026, 3027
KARDON.....	3022, 3023, 3051
KENWOOD.....	3028, 3029, 3030, 3031 3032, 3033
KRELL.....	3010
LUXMAN.....	3035, 3036, 3037, 3038
LX I.....	3012, 3014, 3020
MAGNAVOX.....	3010, 3039, 3040
MARANTZ.....	3010, 3041, 3042, 3043
MATHES.....	3012, 3020
MCS.....	3012, 3020
MGA.....	3023
MISSION.....	3010
MITSUBISHI.....	3023, 3044
NAD.....	3034, 3045
NAKAMICHI.....	3046, 3047, 3048
NEC MCS.....	3025
NIKKO.....	3007, 3016
ONKYO.....	3049, 3050, 3051, 3052 3055, 3102, 3103

OPTIMUS.....	3011, 3014, 3020, 3028, 3053 3054, 3056, 3057, 3058, 3059
PANASONIC.....	3008, 3060, 3061
PHILIPS.....	3009, 3040
PIONEER.....	3020, 3021, 3062, 3063, 3064
QUASAR.....	3008
RCA.....	3011, 3014, 3065, 3066, 3067 3068, 3069
REALISTIC.....	3011, 3014, 3020, 3042 3054, 3057
ROTEL.....	3010
RS ORIGINAL.....	3070
SAE.....	3010, 3083
SAMSUNG.....	3071
SANSUI.....	3014, 3068, 3072, 3073
SANYO.....	3011, 3018, 3074, 3075, 3076
SCOTT.....	3014
SEARS.....	3012, 3014, 3020, 3028, 3042
SHARP.....	3028, 3042, 3077
SHERWOOD.....	3024, 3042, 3056, 3070, 3078
SHURE.....	3025
SONY.....	3039, 3079, 3080, 3081, 3082, 3097 3098, 3099, 3100, 3101
SYLVANIA.....	3010
SYMPHONIC.....	3083
TEAC.....	3016, 3042, 3057, 3083, 3084 3085, 3086
TECHNICA.....	3007, 3008, 3061, 3087, 3088
THETA DIGITAL.....	3040
TOSHIBA.....	3045
VICTOR.....	3026
YAMAHA.....	3007, 3089, 3090, 3091, 3092
ZENITH.....	3016, 3093, 3094, 3095, 3096

DVD

Aiwa.....	2036, 2037
Apex.....	2012, 2017, 2018, 2019, 2021, 2034
BOSE.....	2038, 2039, 2063
Denon.....	2047, 2048
Funai.....	2049
GE.....	2009, 2020, 2029, 2033
Harman Kardon.....	2061
Hitachi.....	2008, 2012, 2031
JVC.....	2006, 2010, 2040 2041, 2042, 2043
Kenwood.....	2053, 2054
Koss.....	2058
Magnavox.....	2007, 2011, 2023, 2025
Marantz.....	2025, 2065
Mitsubishi.....	2011, 2015
Onkyo.....	2062
Oritron.....	2009, 2030
Panasonic.....	2003, 2015, 2016, 2055
Philips.....	2007, 2011, 2058
Pioneer.....	2002, 2014, 2056
Proscan.....	2009, 2020, 2032
RCA.....	2005, 2009, 2020, 2035, 2057
Sampo.....	2041
Samsung.....	2008, 2012, 2022, 2024, 2027
Sanyo.....	2050, 2052
Sharp.....	2044, 2045
Sherwood.....	2051
Sony.....	2001, 2013, 2059
Toshiba.....	2004, 2008, 2026, 2028
Yamaha.....	2046, 2060
Zenith.....	2010

DSS

Alphastar.....	4027
Amstrad.....	4046, 4047, 4050
Atsky.....	4048
B Sky B.....	4021, 4045, 4046
Chaparral.....	4039
DIRECTV.....	4001, 4016, 4044
DISH Network.....	4030
Drake.....	4026
Echostar.....	4007, 4017, 4018, 4019, 4020, 4062, 4063, 4064
Eurosky.....	4047, 4056
Express Vu.....	4017
Foxtel.....	4051
Freesat.....	4056
Fujitsu.....	4025
GE.....	4002, 4008, 4009
General Instruments.....	4036, 4037
Gradiente.....	4044, 4057
Hitachi.....	4001, 4015
Hughes.....	4001, 4016
Humax.....	4049, 4050, 4051, 4052, 4053
Janeil.....	4025
JVC.....	4001, 4017
Mitsubishi.....	4001, 4016
Nokia.....	4058, 4059, 4060, 4061
Optima.....	4048
Panasonic.....	4004, 4010
Philips.....	4031, 4035, 4044, 4057
Proscan.....	4002, 4008, 4009, 4011
Radio Shack.....	4036, 4037
RCA.....	4002, 4008, 4009, 4029
Realistic.....	4040
Rural Cable.....	4036
Samsung.....	4022, 4027, 4042, 4043, 4050, 4054, 4055
Schneider.....	4041, 4043
SKY.....	4044, 4045, 4057
Skyplus.....	4048
Skysat.....	4041, 4047, 4056
Sony.....	4003, 4012, 4014, 4065, 4066, 4067
Star Choice.....	4032
Star Trak.....	4024
STS.....	4038
SuperDish.....	4028
Teac.....	4049
Thomson.....	4046, 4056
Toshiba.....	4001, 4034
Uniden.....	4005, 4006, 4013
Universum.....	4056
Video Pall.....	4025
Zenith.....	4023, 4025, 4033

BD (Blu-ray)

Denon.....	5034, 5035, 5036
Hitachi.....	5031, 5032, 5033
Integra.....	5013
JVC.....	5014, 5015, 5017, 5018, 5019, 5020
LG.....	5010, 5011
Marantz.....	5026, 5027
Mitsubishi.....	5024, 5025
Onkyo.....	5013
Panasonic.....	5001, 5002, 5003
Philips.....	5004
Pioneer.....	5005
RCA.....	5012
Samsung.....	5005
Sharp.....	5028, 5029, 5030
Sony.....	5007, 5008, 5009, 5016
Toshiba.....	5012
Yamaha.....	5021, 5022, 5023

DIMENSIONS

Unit : mm (in)

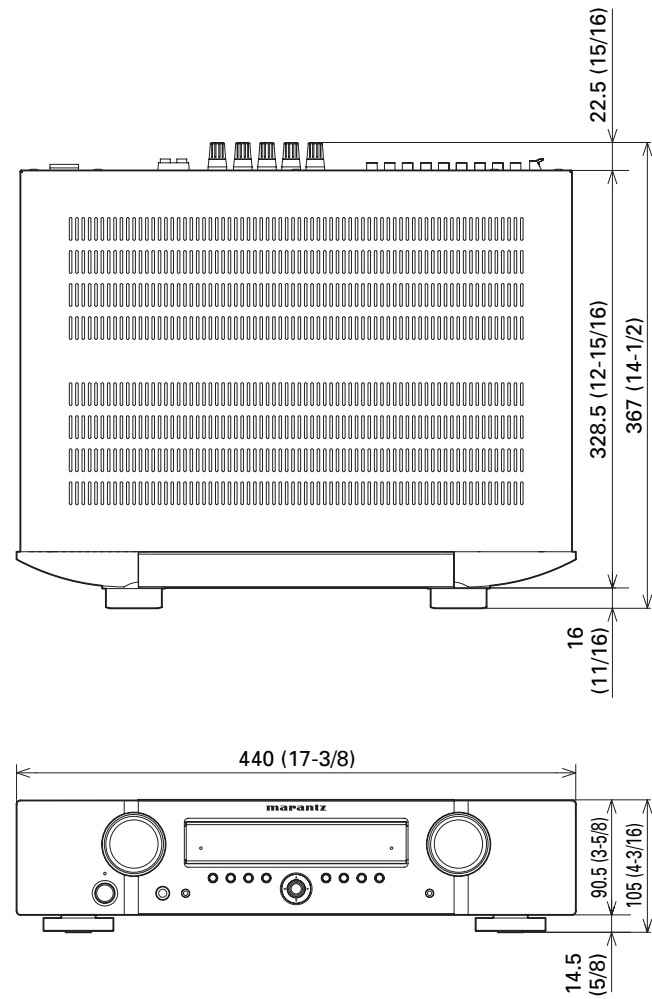

Weight: 8.6 kg (19.0 lb)

Specifications subject to change without prior notice.

www.marantz.com

You can find your nearest authorized distributor or dealer on our website.

marantz[®] is a registered trademark.

