

# What is ProBuilder?

**ProBuilder** is a tool for building and editing 3D objects, directly in Unity. You can use it for visual things like buildings or custom vehicles and weapons, or to make custom collision geometry, trigger zones, nav meshes, etc. The choice is yours!

## ProBuilder Advanced vs. ProBuilder Basic

**ProBuilder Basic** is entirely free, and includes the core ProBuilder features for building and editing basic geometry.

[Download ProBuilder Basic](#)

**ProBuilder Advanced** is a paid extension that adds advanced features such as Edge Loop Modeling, UV Unwrapping, and specialized optimization.

[Purchase ProBuilder Advanced](#)

### Important!

This documentation encompasses *all* features, actions, and tools available in both ProBuilder Basic and Advanced. If you are using ProBuilder Basic, please view the full [Advanced vs Basic Comparison](#).

## Optional: Register for access to Source Files and Online Downloads

1. Forward your Unity Asset Store invoice to [register@procore3d.com](mailto:register@procore3d.com)
2. Create an account on the [User Toolbox](#) (if you don't already have one)
3. Once we have verified the invoice, the latest downloads will always be available via your [User Toolbox](#) account

*Thanks for purchasing ProBuilder, your support allows us to continue updating and developing all the ProCore tools!*

## Helpful Links and Info

- [ProCore3D Website](#)
- [Email](#)
- [Facebook](#)
- [Twitter](#)
- [Online Documentation](#)
- [Tutorial Videos](#)
- [Support and Troubleshooting](#)

**Video Tutorials:** Take a short break to watch the video tutorials before using ProBuilder. You'll be an expert in no time!

# Fundamentals

First time using ProBuilder? Start here for an overview of creating your first mesh, editing geometry, applying materials, and UV editing.

---

## The ProBuilder Toolbar

All of ProBuilder's specialized editing functions are available via the [ProBuilder Toolbar](#), which dynamically adapts to your Edit Mode and selection.



Each Toolbar button will display detailed information about its use, options, and keyboard shortcuts when hovered over. Viewing tooltips is a great way to start learning about ProBuilder's functionality.

*More Info:* [ProBuilder Toolbar](#)

---

## Creating a New Mesh

Press **CTRL K** on your keyboard to spawn in a new ProBuilder-editable cube.

To start with a more complex shape, ProBuilder also includes a library of shapes (cylinder, torus, stairs, etc), to begin modeling with. Which each of these shapes, you can customize both starting dimensions and unique parameters.

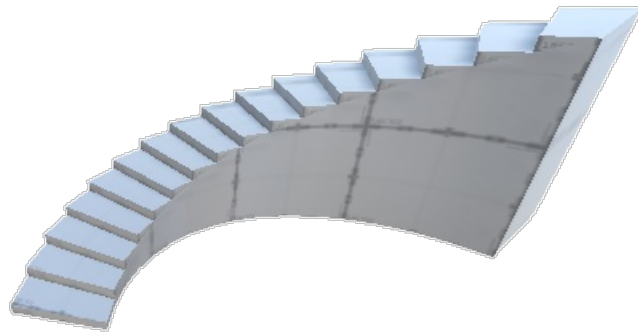
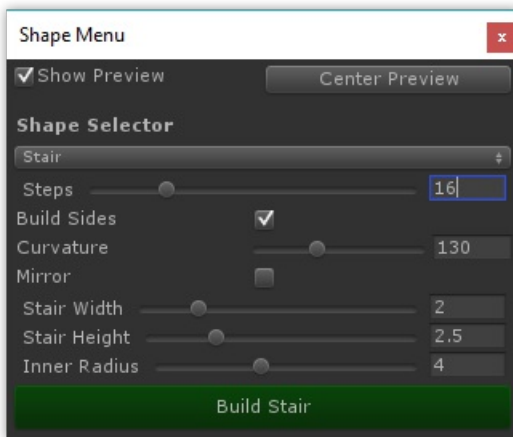

*More Info:* [Shape Tool](#)

---

## Editing Meshes

### Object vs Element

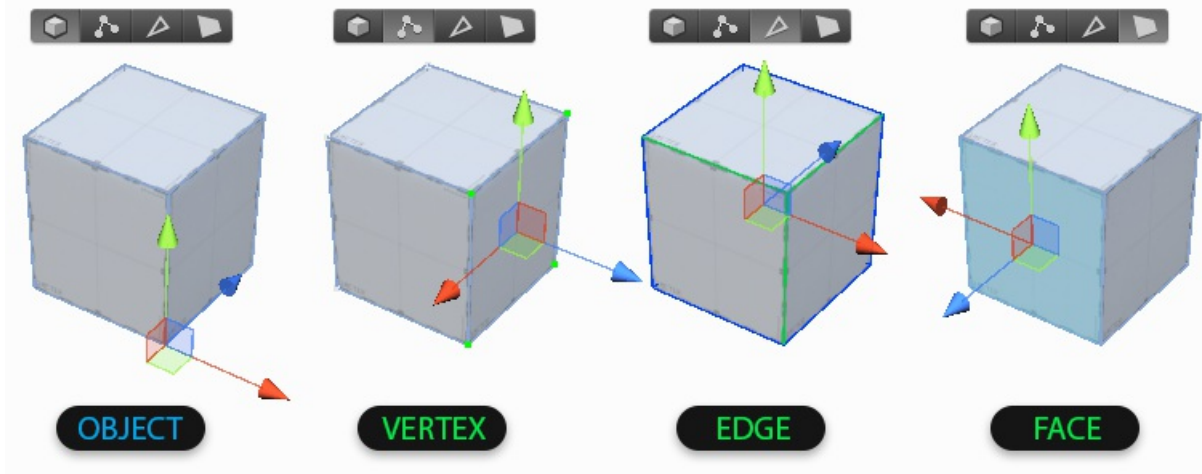

**Object Mode** is standard Unity mode, no surprises.

**Elements** are the individual parts that make up a mesh: **Vertices**, **Edges**, and **Faces**. If it helps, you can think of these like levels of detail on a map- for example, "city, state, country". Click in the [Edit Mode Toolbar](#) to change Mode, or use it's shortcut keys.

- **Vertex Editing:** Select and edit Vertices for detailed editing and functions like vertex splitting and connecting.
- **Edge Editing:** Select and edit Edges for semi-complex geometry editing, and Edge Loop Modeling techniques.
- **Face Editing:** Select and edit Faces on an object, performing basic tasks like deleting faces and extruding.

## Element Selection and Manipulation

First, choose which Element type you'd like to edit by clicking it's button in the [Edit Mode Toolbar](#).

Then, use any of the standard Unity selection methods (click, drag, etc) and manipulation controls (move, rotate, scale), just as you would on any other object(s).

## Building and Editing Complex Meshes

ProBuilder follows many of the same conventions as other 3D modeling applications, so experienced 3D artists will likely be able to jump right in after reading the [ProBuilder Toolbar](#) section.

If you are new to 3D modeling, ProBuilder is a great way to get your feet wet. Now would be a good time to check out the tutorial videos on the ProCore [Youtube playlist](#).

---

## Texturing and UVs

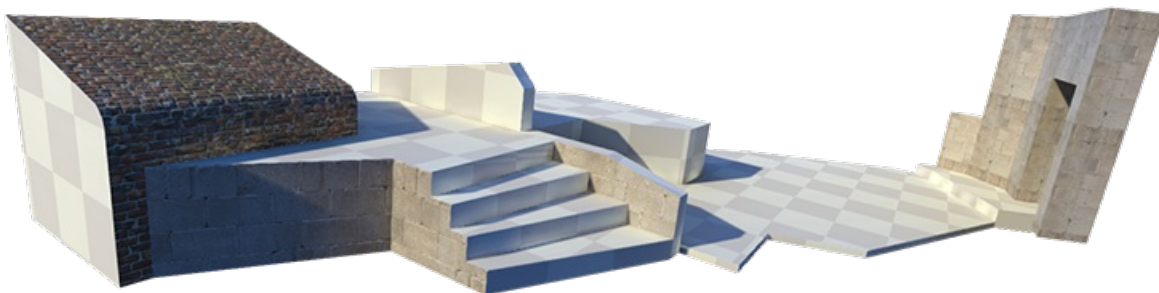

## Applying Materials

You can apply **any** material (including Substance) to ProBuilder meshes using the Unity drag and drop method or the [Material Palette](#).

Materials can also be applied to individual faces of a ProBuilder mesh, while in [Element Mode](#).

*More Info:* [Material Tools](#)

## Editing UVs

ProBuilder includes both [Auto UVs](#) (default), and a complete [Manual UV Editing and Unwrapping](#) system.

**Auto UV** mode lets you tweak basics like Offset, Tiling, and Rotation, while ProBuilder handles the complex UV work automatically.

**Manual UV** mode enables complete control of the UVs, including Projection Mapping, UV Stitching, and more, similar to UV editors in major tools like 3DS Max, Blender, etc.

**You may use whichever you prefer, or a mix of both, even on the same mesh.**

*More Info:* [Texturing and UVs](#)

# Toolbar Overview

ProBuilder is controlled via the **Main Toolbar**, which contains all commonly used functions.

A second toolbar, the **Edit Mode Toolbar**, is available to quickly switch between editing modes. This toolbar can always be found floating at the top-middle of your currently active scene view.

## Tool Categories

The Toolbar is color-coded to help you quickly choose tools by type:

- **Orange** for [Tool Panels](#)
- **Blue** for [Selection Tools](#)
- **Green** for [Object Actions](#)
- **Red** for Geometry Actions ([Vertex](#), [Edge](#), [Face](#))

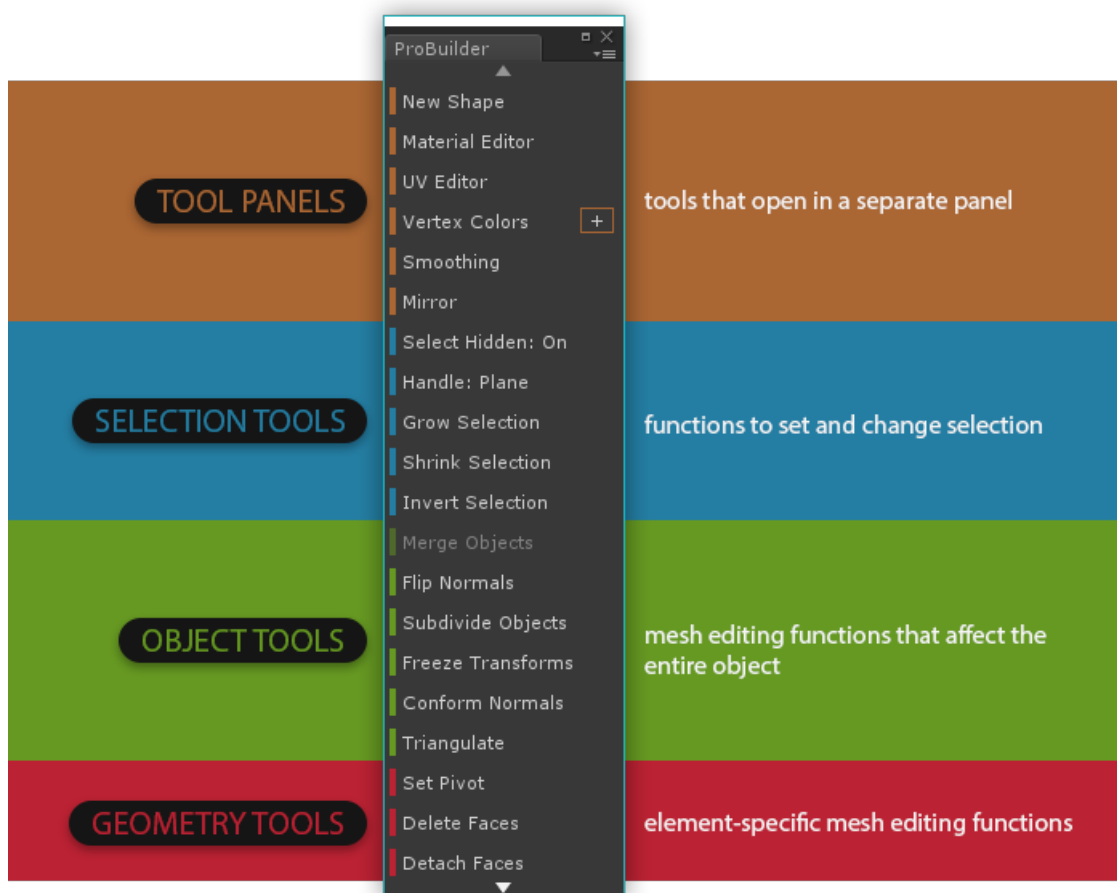

## Resizing and Text vs Icon Mode

You can resize the Toolbar however you like; ProBuilder will re-order the icon or text contents to best fit the window size.

Prefer the good ol' Text Buttons? Right click on the toolbar in the empty space and choose "Use Text Mode". In this menu you can also change how this window is displayed (docking or floating).



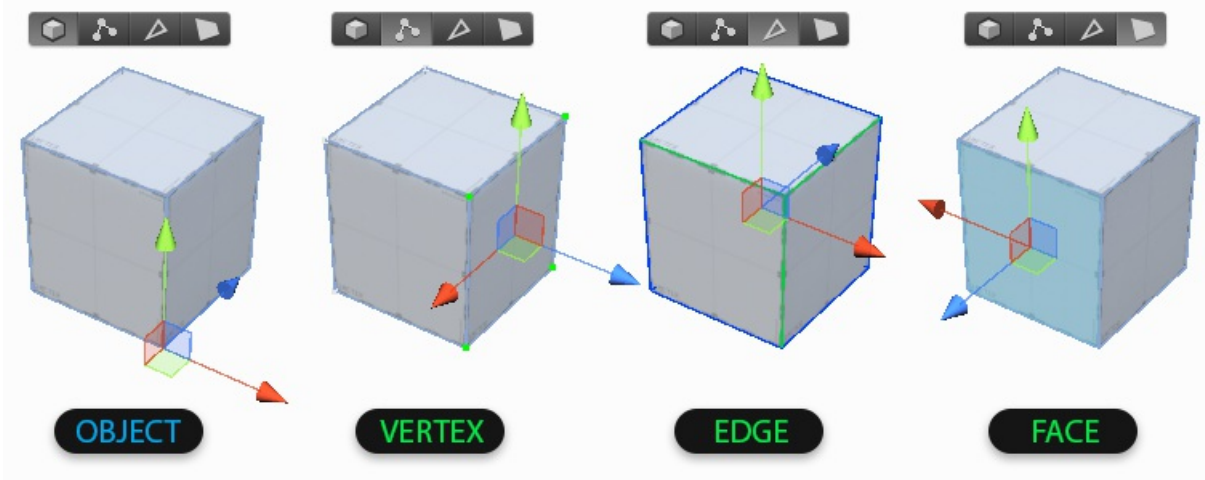

If you prefer to have dedicated keys for each mode (ex, **J** opens *Vertex Mode* , **K** opens *Face Mode* , etc) you can enable "Unique Mode Shortcuts" in the Preferences window.

# Tool Windows

These **Tool Panels** contain important tools for [Shape Creation](#), [Materials](#), [Texturing and UVs](#), [Vertex Coloring](#), and [Smoothing Groups](#).

**Note:** Each panel can be docked, kept floating, or simply closed immediately after use.



## Shape Tool

**Keyboard Shortcut :** CTRL SHIFT K

**Purpose :** Create new editable shapes such as Cylinder, Arch, and Stairs.

Each shape has specific properties which can be customized before creation- for example, the Stairs shape lets you choose items like Step Height, Arc, and which parts of the Stairway to build.

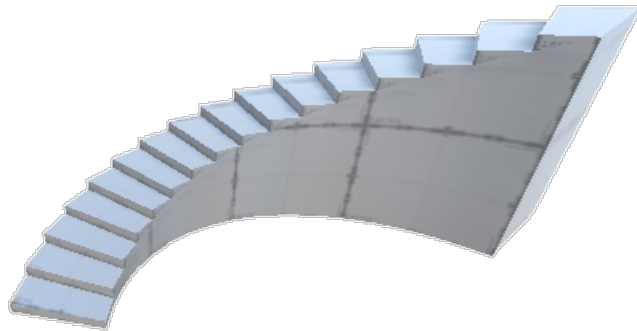
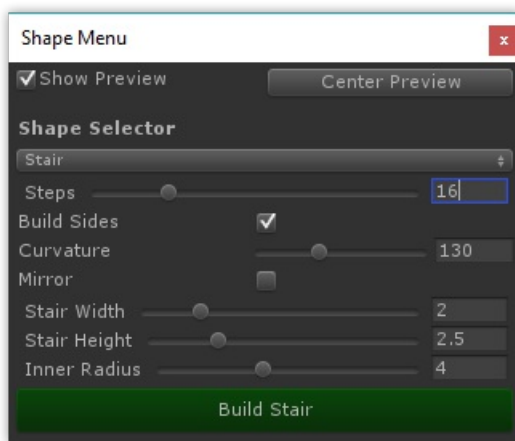

**Usage :** To create a new shape, do the following:

1. Open the New Shape Tool
2. If "Shape Preview" is enabled, you will see a blue Preview Object in the scene
3. Choose the Shape you'd like to create (ex, Cube, Cylinder, Torus, etc)
4. Set the options (ex, width, height, radius, number of stairs, etc)
5. You may Move or Rotate the Preview Object within your scene
6. Once ready, click "Build Shape" to create your final Shape

## Material Tools

**Purpose :** Save and apply your most frequently used materials, using Quick Material one-click or Material Palette keyboard shortcuts.



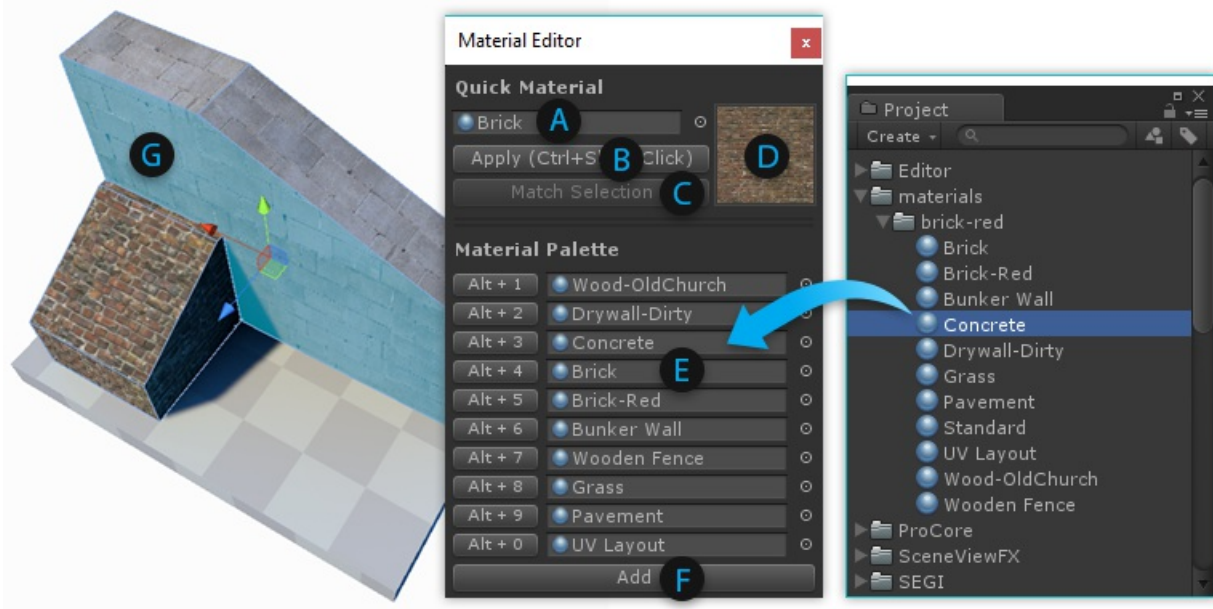

### Quick Material Usage:

- (A) The current "Quick Material"
- (B) Apply the Quick Material to the selected faces
- (C) Pick your Quick Material from the selected face
- (D) Preview of the current Quick Material

Hold **CTRL SHIFT** while clicking on a face to apply the Quick Material.

### Material Palette Usage :

- (E) Drag-and-drop your often-used materials to these slots
- (F) Create additional Material Palette slots

You can also press **ALT (number key)** to apply materials from the Palette.

## Texturing and UVs

**Purpose** : Opens the UV Editor Panel, for controlling how materials are displayed on your mesh (tiling, offset, unwrapping, etc).

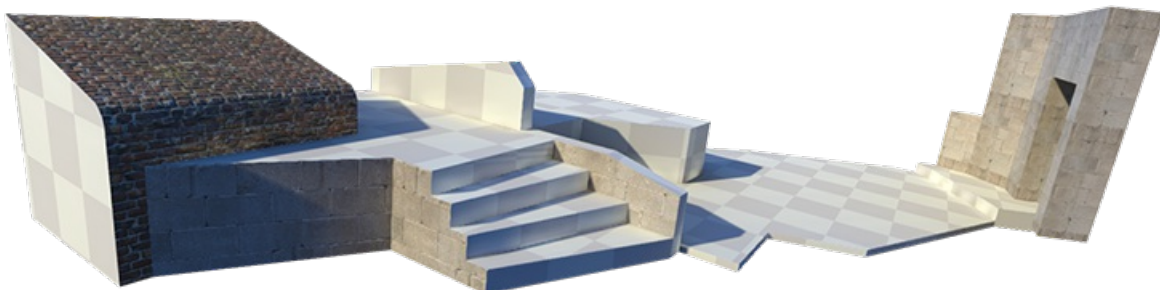

The UV Editor Panel includes both [Auto UV](#) tools, and a complete [Manual UV Editing and Unwrapping](#) system.

*More Info:* [Texturing and UVs](#)

## Vertex Color Tools

**Purpose** : Opens the Vertex Coloring controls, for applying or painting vertex colors onto meshes.

**Warning!** Not all shaders will show vertex colors on a mesh.

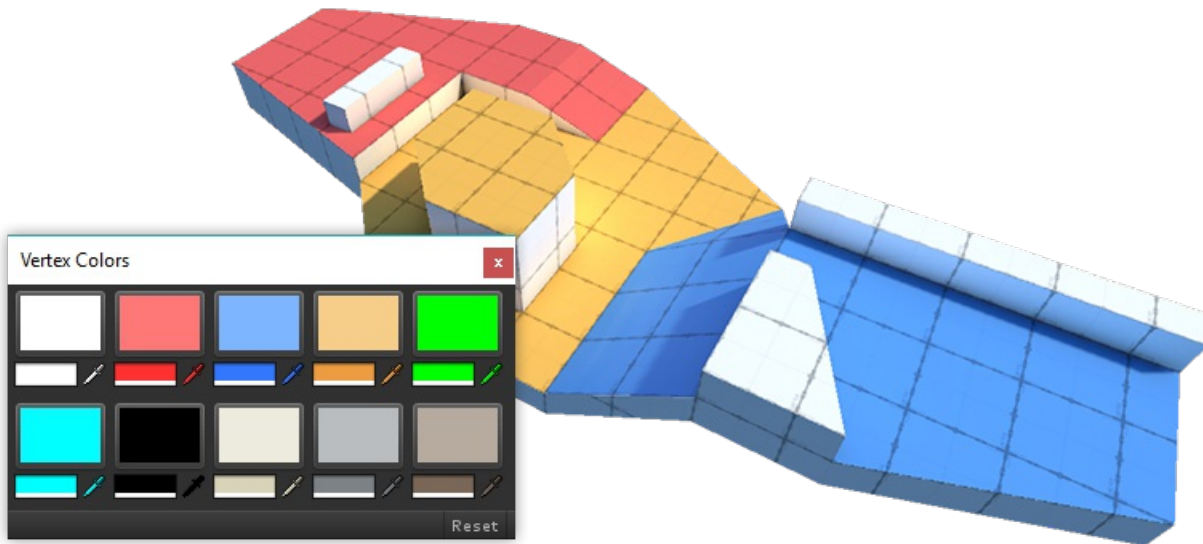

Applying Vertex Colors is a great way to colorize levels for prototyping, team layout, zones, etc.

## Smoothing Groups

**Purpose:** Create a smooth and rounded look, or sharp-edged and faceted.

**Usage:**

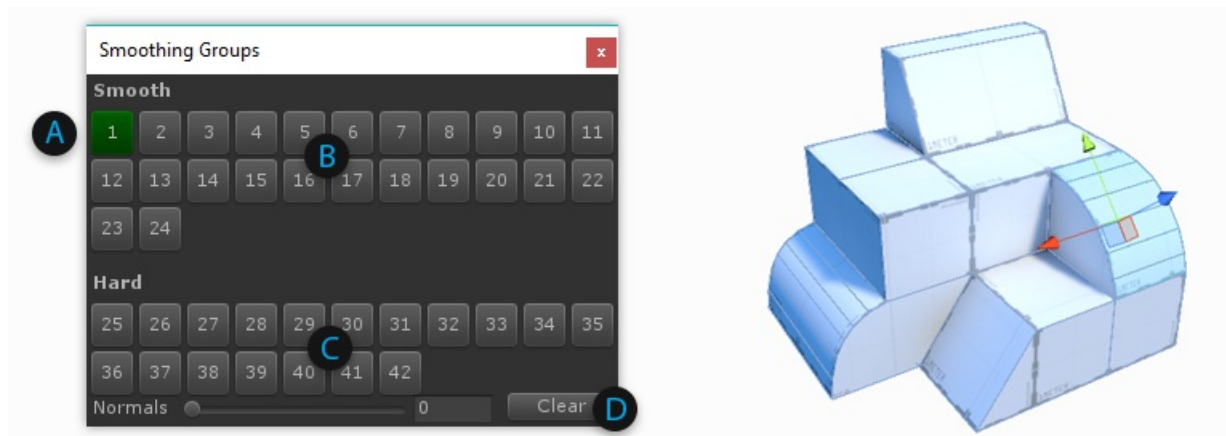

- Choose Face editing from the [Edit Mode Toolbar](#)
- Select a group of faces that you want to be smooth
  - *If no faces are selected, or you are in [Object Mode](#), any Smoothing actions will be applied to the entire object*
- **(A)** If any selected faces already have Smoothing Groups assigned, they will be highlighted. Clicking on a highlighted group will un-assign it.
- **(B)** To assign the selected faces to a new Smoothing Group, click any available group button
- **(C)** You can also assign Hard groups
- **(D)** Press the "Clear" button to clear all Smoothing from the selected faces

# Selection Actions

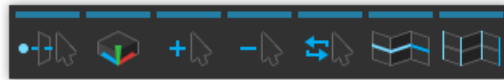



## Select Hidden

Section Video: [Selection Tools: Select Hidden](#)

Determines whether hidden elements are selected or ignored, when drag-selecting. This is a toggle button, click to change modes:

### Toolbar Icon Description

-  **On:** all [elements](#) are selectable, regardless of their visibility
-  **Off:** drag selection will ignore any [elements](#) that cannot currently be seen

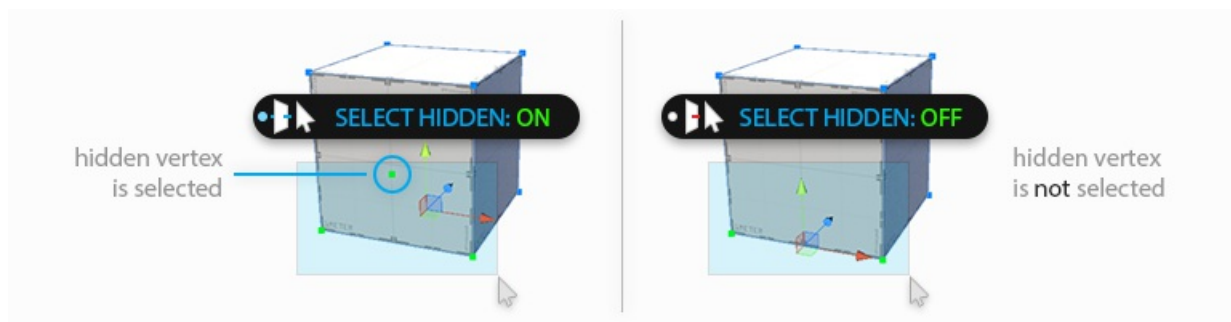



## Handle Alignment

Section Video: [Selection Tools: Handle Alignment](#)

### Keyboard Shortcut : P

Choose how the scene handles will be oriented when selecting [elements](#). This is a toggle button; click to change modes:

### Toolbar Icon Description

-  **Global:** Similar to a compass, the handle orientation is always the same, regardless of local rotation.
-  **Local:** Similar to "left vs right", handle orientation is relative the object's rotation.
-  **Planar:** This special mode aligns the handles to exact normal direction of the selected face.



## + Grow Selection

Section Video: [Selection Tools: Grow Selection](#)

**Keyboard Shortcut:** ALT G

Expands the selection outward to adjacent faces, edges, or vertices.

⚙️ **Options:**

Setting	Description
<b>Restrict To Angle</b>	Only Grow Selection to faces within a specified angle
<b>Max Angle</b>	The angle to use when Restrict to Angle is <b>On</b>
<b>Iterative</b>	Only Grow Selection to adjacent faces, with each button press

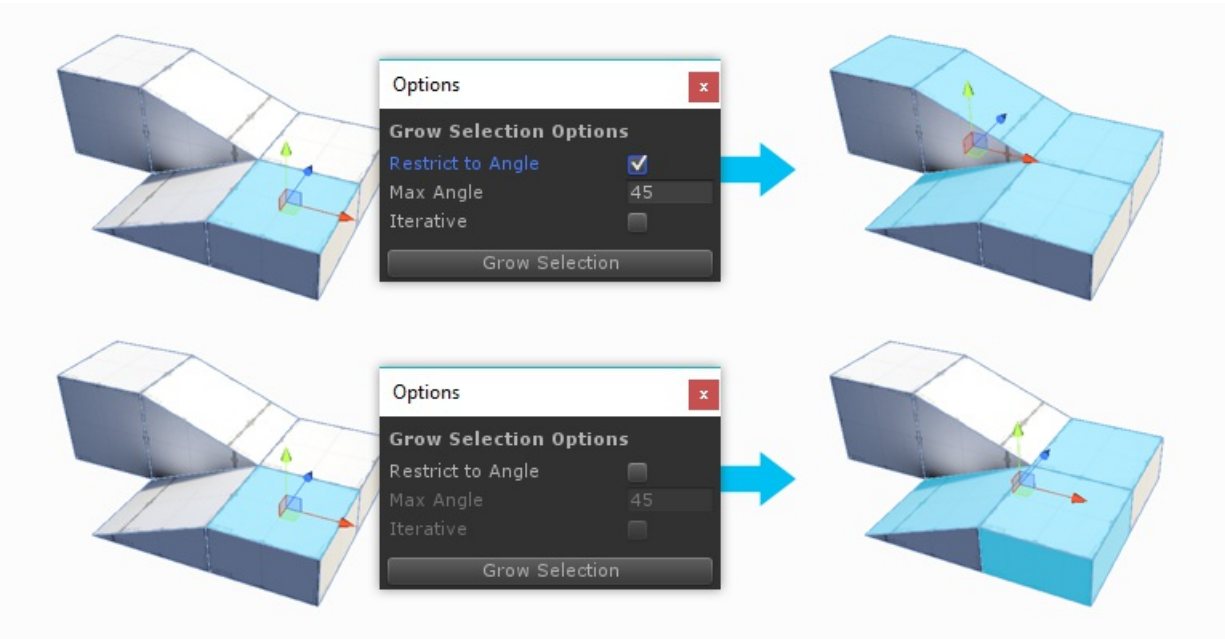

## - Shrink Selection

Section Video: [Selection Tools: Shrink Selection](#)

**Keyboard Shortcut :** ALT SHIFT G

Does the opposite of Grow Selection: removes the elements on the perimeter of the current selection.

## Invert Selection

Section Video: [Selection Tools: Invert Selection](#)

**Keyboard Shortcut :** CTRL SHIFT I

Selects the inverse of the current selection. All unselected elements will become selected, the current selection will be unselected.

## Select Edge Loop

Section Video: [Selection Tools: Select Edge Loop](#)

**Keyboard Shortcut :** ALT L

Selects an edge loop from each selected edge.

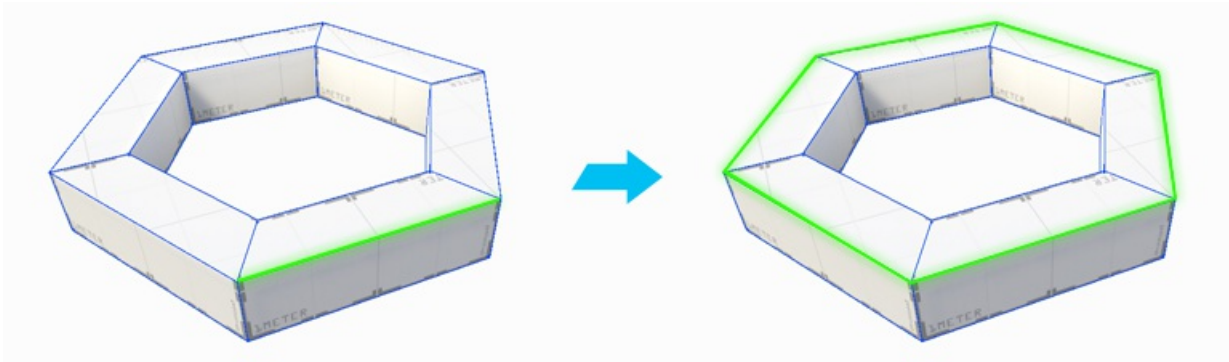

## Select Edge Ring

Section Video: [Selection Tools: Select Edge Ring](#)

**Keyboard Shortcut :** ALT R

Selects an edge ring from each selected edge.

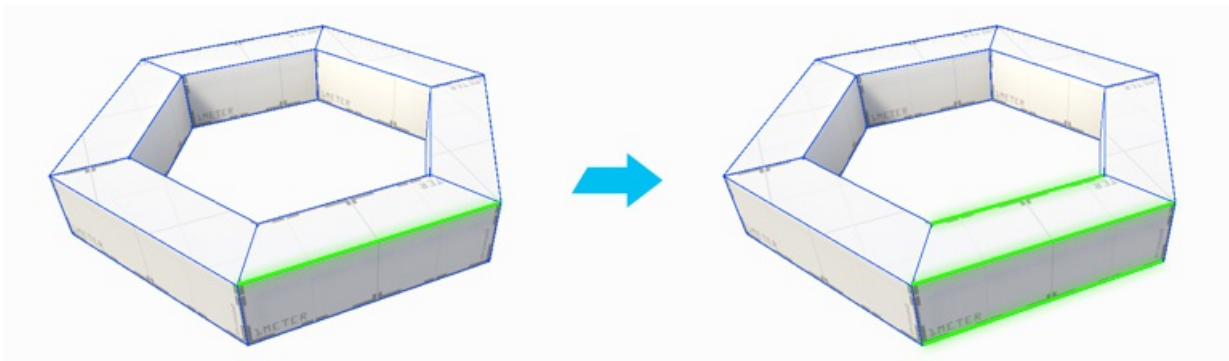

## Select Hole

With an open vertex or edge selected, click **Select Hole** to select all elements along opening.

With no elements selected, clicking **Select Hole** will automatically select **all** holes in the selected object.

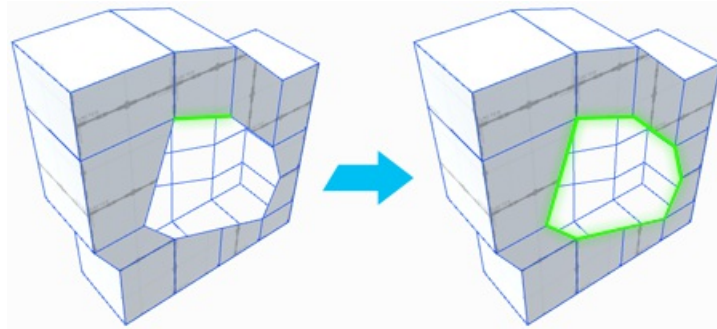

---

## **Select by Material**

Click to select all faces on this object, which use the same material as the selected face.

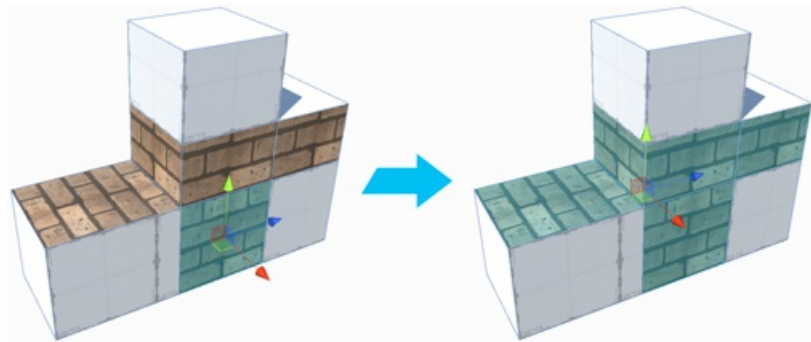

---

## **Select by Vertex Color**

Click to select all faces on this object, which have the same vertex color as the selected face.

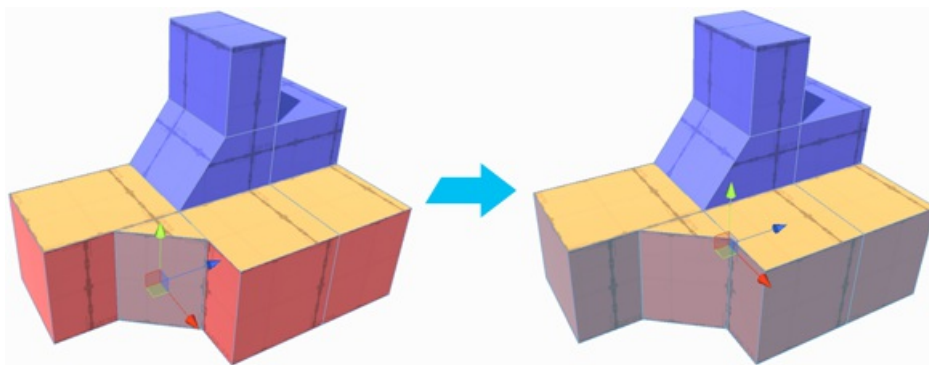

# Object Actions



## Merge Objects

Section Video: [Object Actions: Merge Objects](#)

Merges the selected objects into a single object.

## Flip Object Normals

Section Video: [Object Actions: Flip Object Normals](#)

Flips the normals of **all** faces on the selected object(s).

Especially useful for converting an exterior modeled shape into an interior space.

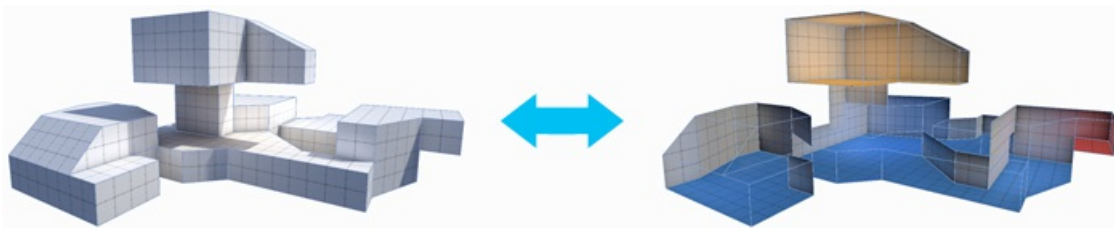

## Subdivide Object

Section Video: [Object Actions: Subdivide Object](#)

Divides every face on selected objects, allowing for greater levels of detail when modeling.

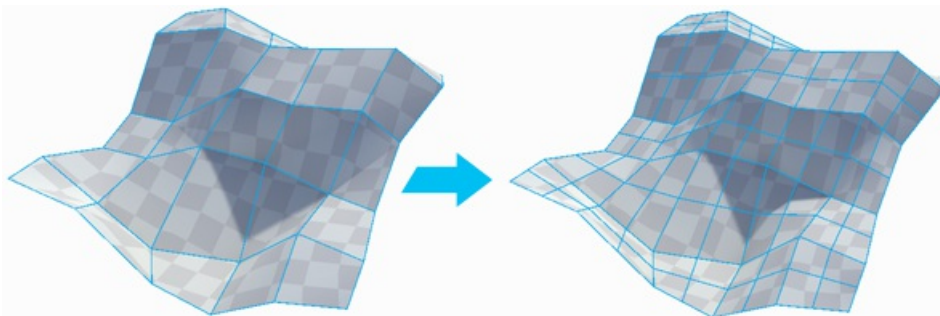

## Reset / Freeze Transform

Section Video: [Object Actions: Reset / Freeze Transform](#)

Sets the selected objects position, rotation, and scale to world-relative  $\{0,0,0\}$  without changing any vertex positions.

## Move Pivot to Center of Object

Section Video: [Object Actions: Center Pivot](#)

**Keyboard Shortcut :** **CTRL J**

Moves the mesh pivot to the center of the object's bounds.

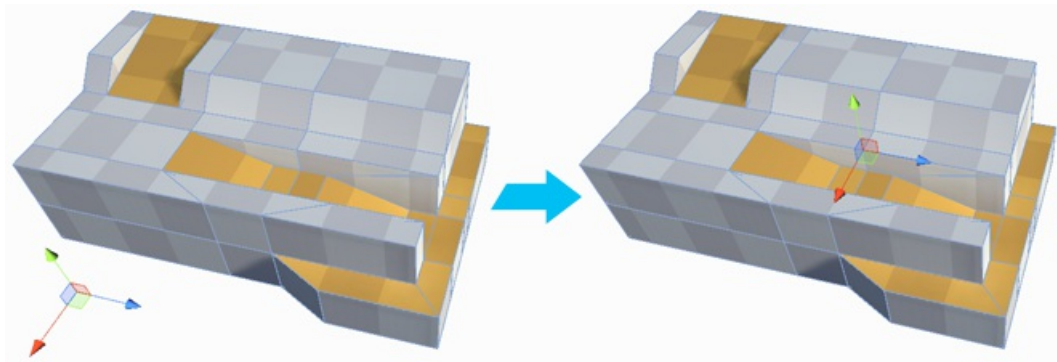

## Conform Normals

Section Video: [Object Actions: Conform Normals](#)

Sets all face normals on the selected object to the same relative direction.

## Triangulate

Section Video: [Object Actions: Triangulate](#)

Reduces all polygons to their base triangles, creating a "Polyworld-like" effect.

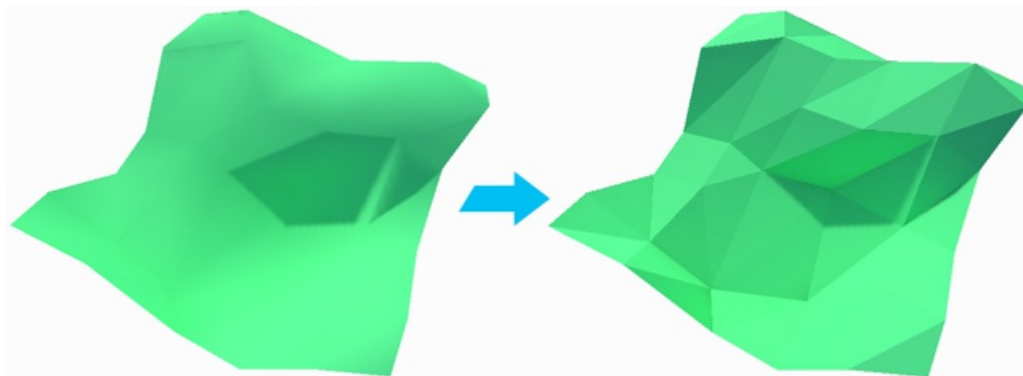



# Mirror Tool

Section Video: [ProBuilder Toolbar: Mirror Tool](#)

Use the Mirror action to create mirrored copies of objects.

Mirror is especially useful when creating symmetrical items- build one half, mirror it, then weld the two together for a perfectly symmetrical result.

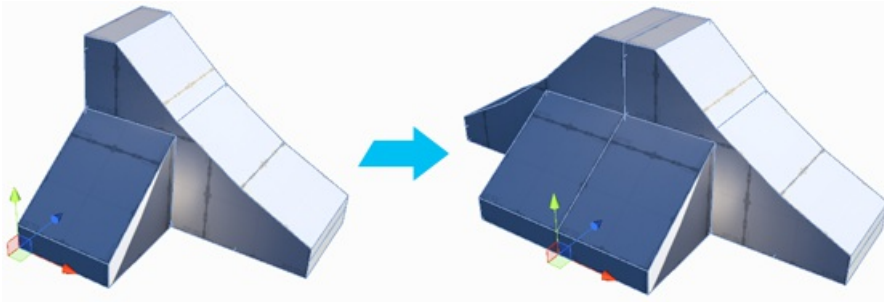

## Custom Settings Available :

Setting	Description
---------	-------------

X, Y, Z	Choose which axis (single or multiple) to mirror on
---------	-----------------------------------------------------

Duplicate	When <b>On</b> , a duplicate object will be created and mirrored, leaving the original unchanged.
-----------	---------------------------------------------------------------------------------------------------

---

## Generate UV2

Builds the UV2 channel for each selected mesh, or all meshes in the scene if the "Generate Scene UVs" option is toggled.

## Custom Settings Available :

Setting	Description
---------	-------------

Generate Scene UV2s	If <b>On</b> , will generate UV2s for all meshes in the scene. Otherwise, only UV2s on the selected object(s) will be generated.
---------------------	----------------------------------------------------------------------------------------------------------------------------------

Enable Auto UV2	If <b>On</b> , UV2s will be auto-generated as needed.
-----------------	-------------------------------------------------------

---

## ProBuilderize Object

Converts the selected object(s) into ProBuilder-editable objects.

## Custom Settings Available :

Setting	Description
---------	-------------

Preserve Faces	If <b>On</b> , ProBuilder will attempt to keep ngons. Otherwise, all the mesh will be converted to hard tris.
----------------	---------------------------------------------------------------------------------------------------------------

# Vertex Actions



## Collapse Vertices

Section Video: [Vertex Actions: Collapse Vertices](#)

**Keyboard Shortcut :** ALT C

Collapses all selected vertices to a single point, regardless of distance.

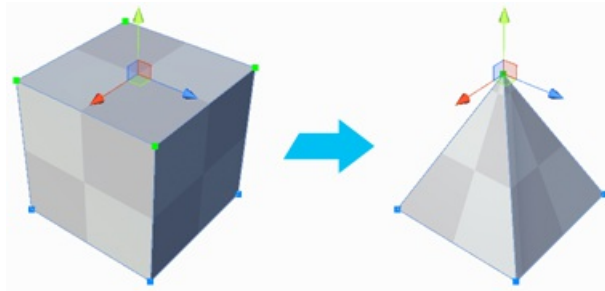

 **Custom Settings Available :**

Setting	Description
<b>Collapse To First</b>	Collapse to first-selected vertex position, instead of selection center.

## Weld Vertices

Section Video: [Vertex Actions: Weld Vertices](#)

**Keyboard Shortcut :** ALT V

Merge vertices within a set distance of one another.

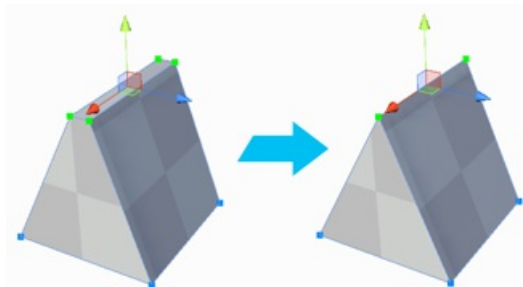

 **Custom Settings Available :**

Setting	Description
<b>Collapse To First</b>	Collapse to first-selected vertex position, instead of selection center.

## Connect Vertices

**Keyboard Shortcut :** ALT E

Create a new edge connecting the selected vertices.

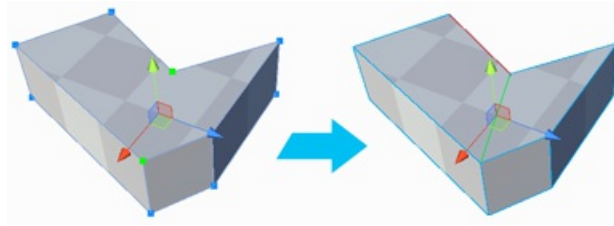

## Split Vertices

**Keyboard Shortcut :** ALT X

Splits a vertex into it's individual vertices so that they may be moved independently of one another.

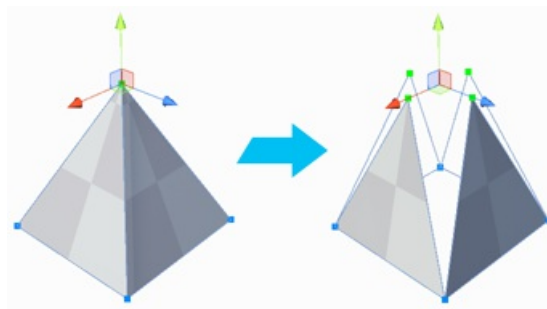

**Note :** When a vertex is **Split**, the newly separated vertices will not actually move apart on their own. This was done for the image, to better illustrate the effect of this action.

# Edge Actions



## Bridge Edges

Section Video: [Vertex Actions: Bridge Edges](#)

**Keyboard Shortcut :** ALT B

Create a new face between two selected edges. Each edge must have a free side.

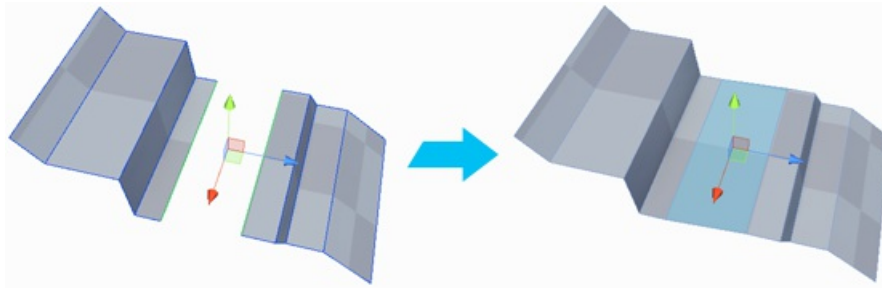

## Bevel

Section Video: [Vertex Actions: Bevel Edges](#)

Splits the selected edge(s) into two edges, with a new face between.

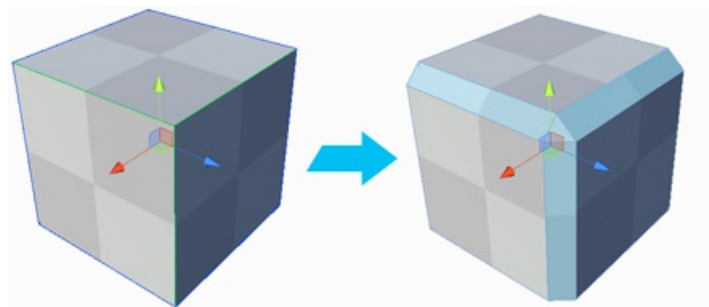

 **Custom Settings Available :**

**Setting**   **Description**

**Distance** Sets the distance each new edge is moved, from the position of the original.

## Connect Edges

Section Video: [Vertex Actions: Connect Edges](#)

**Keyboard Shortcut :** ALT E

Insert an edge connecting the centers of each selected edge.

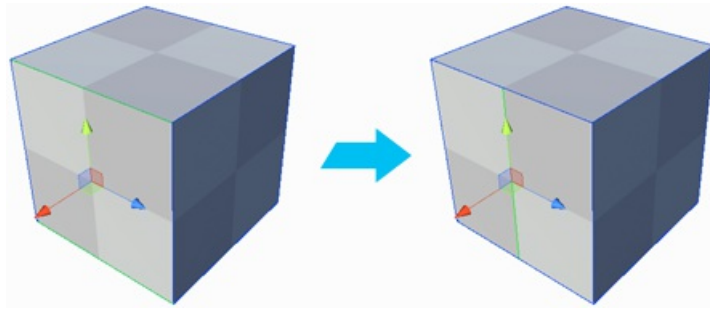

## ▶ Extrude Edges

Section Video: [Vertex Actions: Extrude Edges](#)

**Keyboard Shortcut :** **SHIFT DRAG** / **CONTROL E** (PC) / **COMMAND E** (Mac)

Pushes a new edge out from the selected edge, connected by a new face.

You can also extrude edges by holding **SHIFT** while moving, rotating, or scaling them.

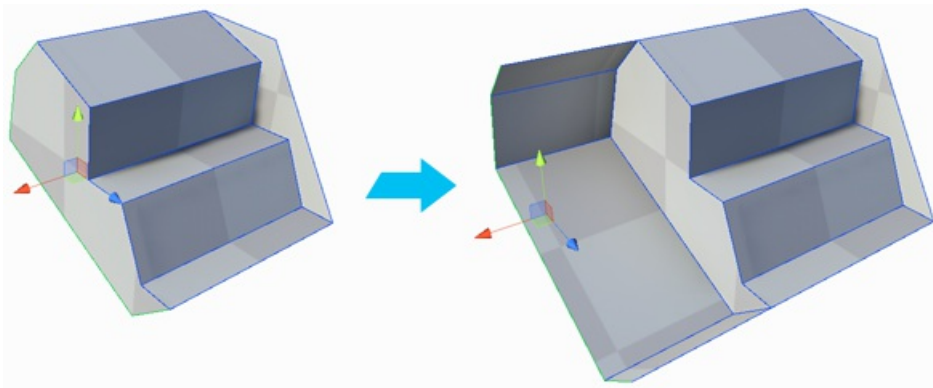

Note: By default, only open edges can be **Extruded**. You can change this in the [ProBuilder Preferences](#).

⚙️ **Custom Settings Available :**

Setting	Description
<b>Distance</b>	Distance to extrude the edge(s).

## 📄 Subdivide Edge

Section Video: [Vertex Actions: Subdivide Edge](#)

**Keyboard Shortcut :** **ALT S**

Divides the selected edge(s) into multiple edges.

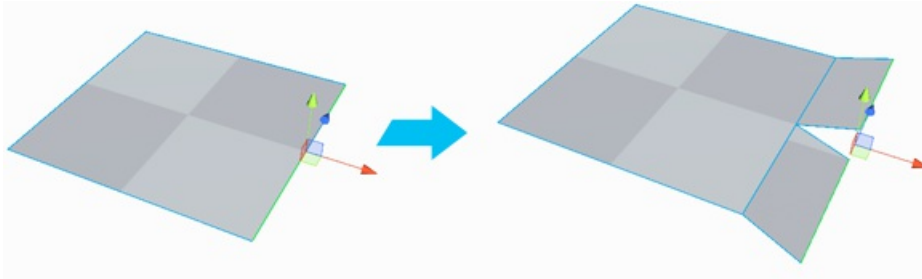

### ⚙ Custom Settings Available :

Setting	Description
Subdivisions	Number of divisions to make in the selected edge(s).

---

## 📖 Insert Edge Loop

Section Video: [Vertex Actions: Subdivide Edge](#)

**Keyboard Shortcut :** ALT U

Adds a new edge loop from the selected edge(s).

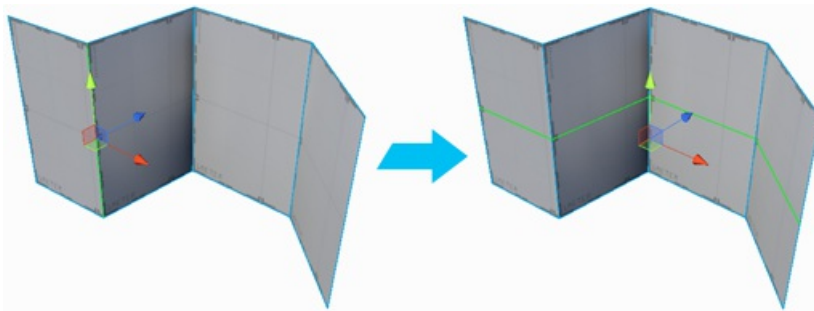

# Face Actions



## Delete Face

Section Video: [Face Actions: Delete Faces](#)

**Keyboard Shortcut :** **BACKSPACE**

Deletes the selected face(s).

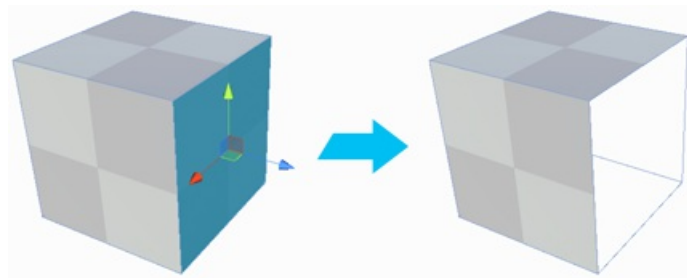

## Detach Face

Section Video: [Face Actions: Detach Faces](#)

Detach the selected face(s) to a new sub-mesh, or separate object.

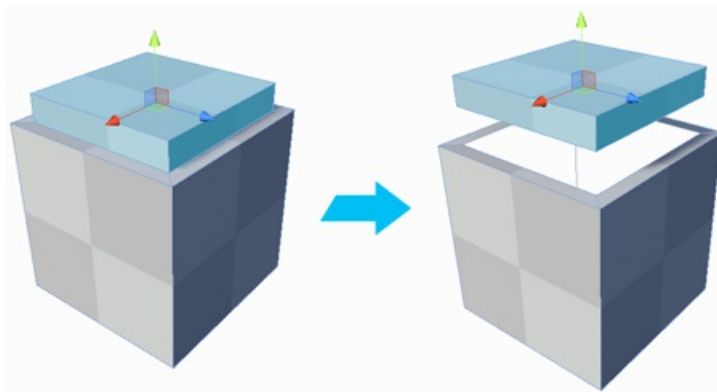

 **Custom Settings Available :**

Setting	Description
<b>Detach To New Object</b>	If <b>On</b> , the face(s) will be detached to a new, separate object. Otherwise, they will be detached to a sub-mesh within the original object.

## Extrude Face

Section Video: [Face Actions: Extrude Faces](#)

## Keyboard Shortcut : **SHIFT DRAG**

Creates a new face by pulling out the currently selected face and attaching sides to each edge.

You can also extrude by holding **SHIFT** while moving, rotating, or scaling the faces.

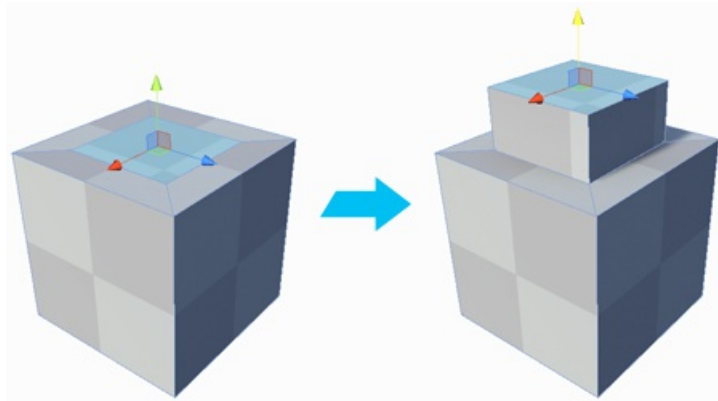

### Custom Settings Available :

#### Setting Description

**As** If **On**, adjacent faces in the selection will be extruded together, along an averaged normal direction. Otherwise, all faces will be extruded

**Group** individually, along their own normal direction.

**Distance** Distance to extrude the selected face(s).

## Flip Normals

Section Video: [Face Actions: Flip Normals](#)

Flips the normals on the selected face(s).

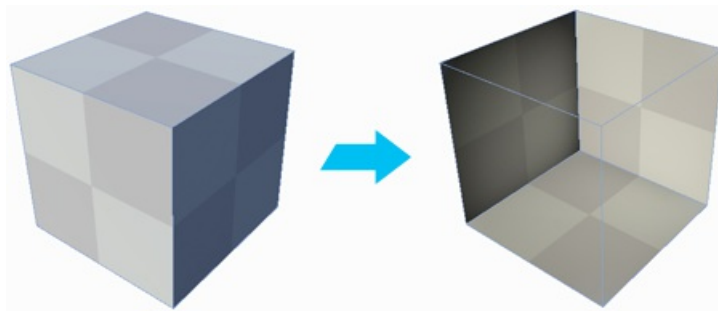

## Flip Face Edge

Section Video: [Face Actions: Flip Face Edge](#)

Swap the triangle orientation on the selected face(s). This will only work on quads (faces with 4 sides).



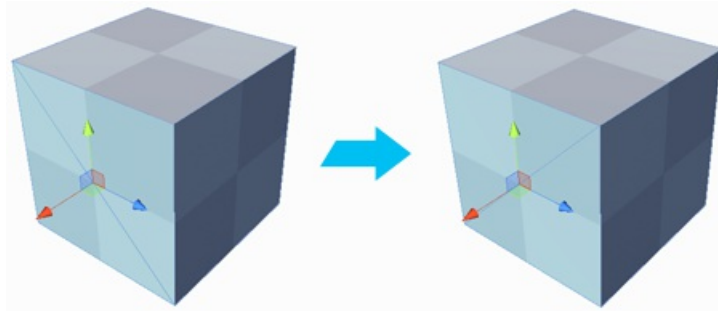

## Conform Normals

Section Video: [Face Actions: Conform Normals](#)

Sets all selected face normals to the same relative direction.

## Merge Faces

Section Video: [Face Actions: Merge Faces](#)

Merges selected faces into a single face, and removes any dividing edges.

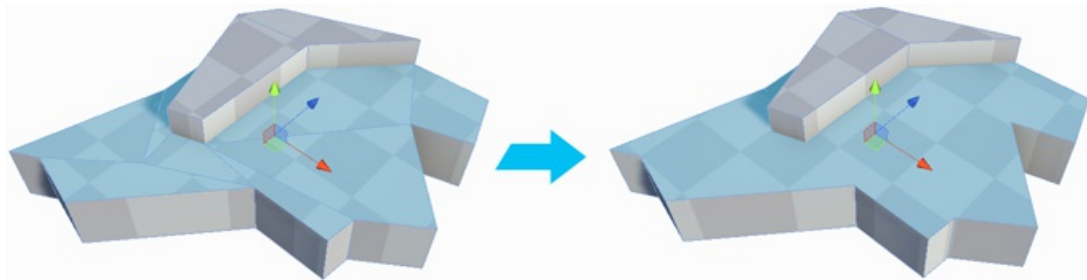

## Subdivide Face

Section Video: [Face Actions: Subdivide Face](#)

Split each selected face by adding a vertex at the center of each edge and connecting them in the center.

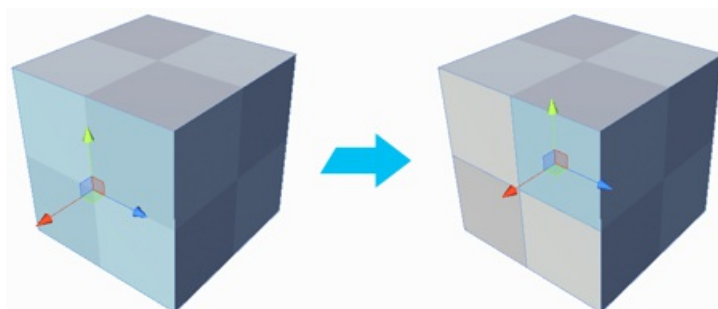

# Bevel

Section Video: [Face Actions: Bevel Face](#)

Performs the [Bevel Edge](#) action on all the edges of the selected face(s).

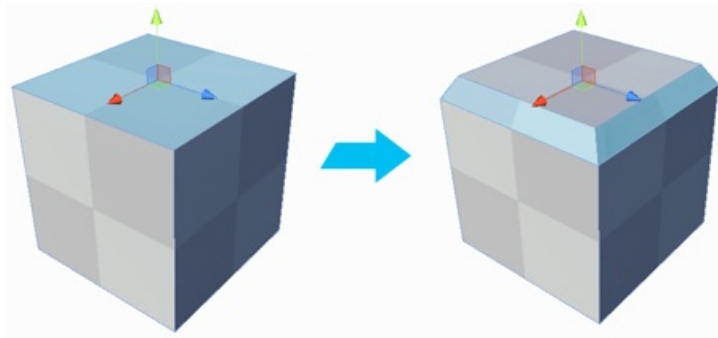

## Custom Settings Available :

**Setting**   **Description**

**Distance** Sets the distance each new edge is moved, from the position of the original.

---

# Element Actions

---

## Move Pivot to Center of Selected Elements

Section Video: [Element Actions: Set Pivot](#)

**Keyboard Shortcut :** ALT J

Move the pivot point of this mesh to the average center of the selected elements.

This action is available in all Element modes (Vertex, Edge, Face).

## Fill Hole

Section Video: [Element Actions: Fill Hole](#)

Creates a new face filling any holes that touch the selected edges/vertices.

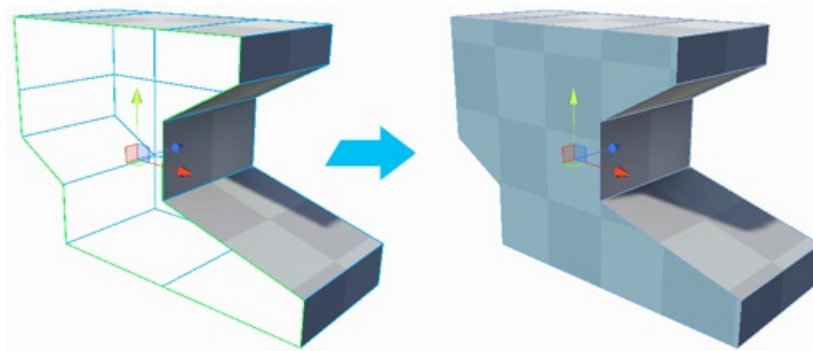

 **Custom Settings Available :**

Setting	Description
---------	-------------

<b>Fill Entire Hole</b> if <b>On</b> ,	the entire mesh opening will be filled. Otherwise, only the selected open edges/vertices will be capped.
----------------------------------------	----------------------------------------------------------------------------------------------------------

---

# Texturing Overview

---

## Texture Mapping 101

**Texture Mapping** is the process of applying materials ("textures") to an object, and adjusting the Offset, Rotation, and Tiling of the object's UVs.

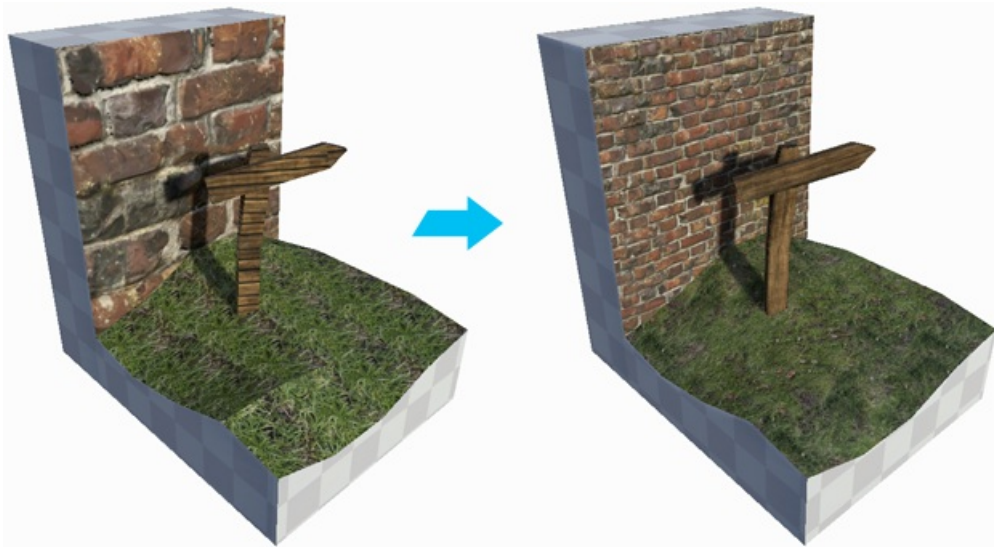

**UVs** are how the mesh stores this data. These are basically 2D "fold-outs" of the actual 3D mesh, like the image below.

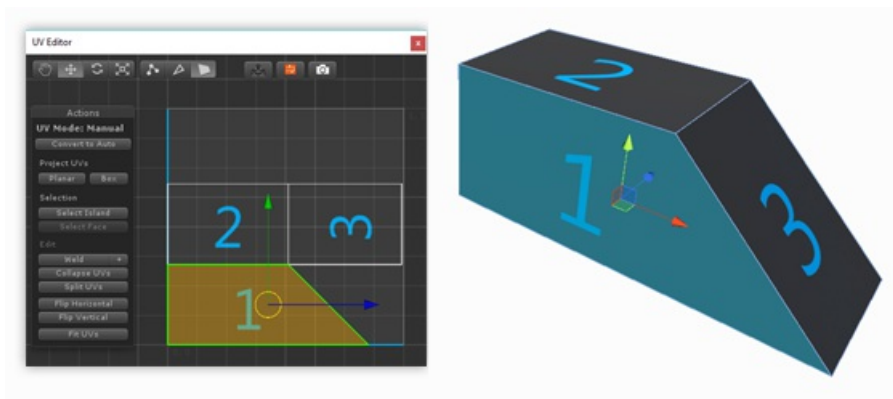

---

## Auto vs Manual UVs

ProBuilder provides both "Automatic" and "Manual" Texturing methods:

- **Auto UVs** : Use this for simple Texturing work, especially architectural or hard-surface items. Tiling, Offset, Rotation, and other controls are available, while ProBuilder automatically handles projection and updates as you work.
- **Manual UV Editing** : Use a full UV Editor to precisely unwrap and edit UVs, render UV Templates, project UVs, and more.

You can use a mix of Auto and Manual UVs, even on the same object. This is especially useful when some parts of a model need to have tiling textures, while others are unwrapped.

---

## The UV Editor Window

Both **Auto-Texturing** and **Manual UV Editing** controls are located in UV Editor Window.

To open this window, click it's button in the [Main Toolbar](#).

- In Text Mode, this will be the button labeled **UV Editor**
- In Icon Mode, use the button with this icon: 

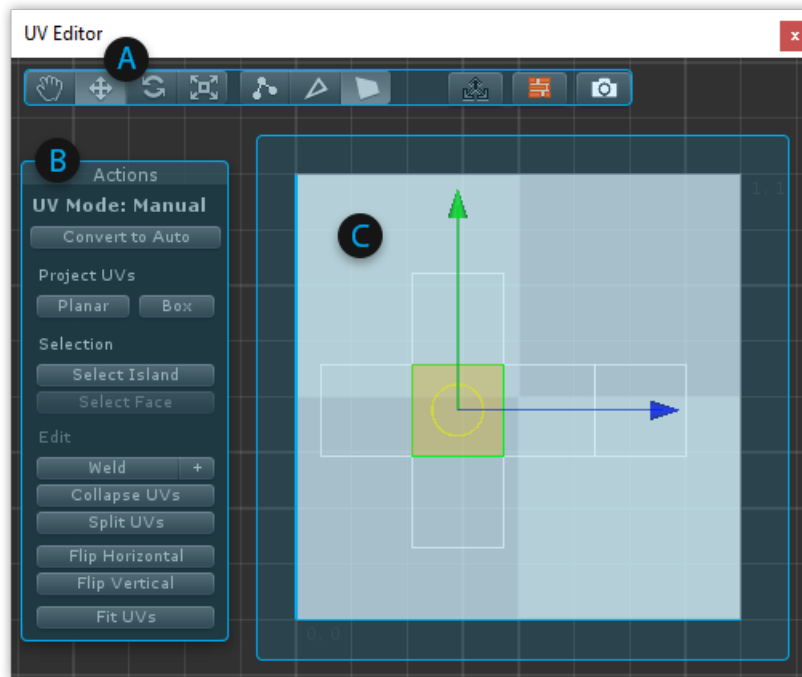

## **A** UV Editor Toolbar

General tools and shortcuts for working with UVs- see the [UV Editor Toolbar](#) section for details.

## **B** Actions Panel

This is a dynamic Panel, similar to the [Main Toolbar](#)- only actions available for the selected UV Element(s) type will be shown.

For full info, see the [Auto UVs Actions](#) and [Manual UVs Actions](#) sections.

## **C** UV Viewer

Here you can view and edit the selected object's UV Elements directly- see the [Manual UVs](#) section for full details.

# UV Editor Toolbar



## Select, Move, Rotate, Scale

This first group of buttons contains shortcuts to the standard Unity manipulation modes. Clicking these will have the exact same effect as clicking on the main Unity toolbar buttons.

## Vertex, Edge Face

The second button group contains shortcuts to ProBuilder's [Element Editing Modes](#). When using [Manual UV Editing](#), this allows you to select and manipulate UVs by Vertex, Edge, or Face. When using [Auto UVs](#) you may only edit UVs per-face.

## In-Scene Controls

When **On**, you can use Unity's standard Move, Rotate, and Scale tools to directly manipulate UVs in the scene, without affecting geometry.

### Toolbar Icon Description

 **On**: Move, Rotate, and Scale tools will affect UVs, geometry will not be affected

 **Off**: Move, Rotate, and Scale tools will return to normal geometry actions

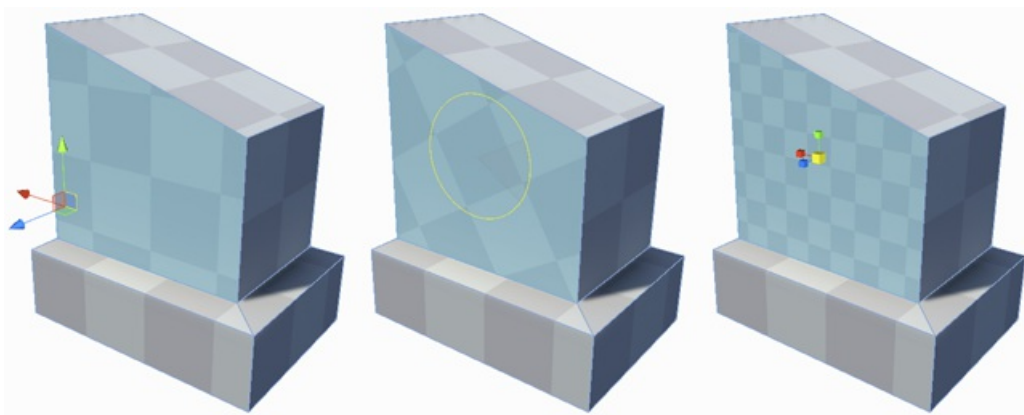

Snap to increments by holding **CTRL**. You can customize these increment values via the [ProBuilder Preferences](#)

## Texture Preview

When **On**, the selected face's main texture will be displayed in the UV Viewer.

### Toolbar Icon Description

 **On**: Selected element's Texture will be displayed in the UV Viewer

 **Off**: No texture will be displayed in the UV Viewer

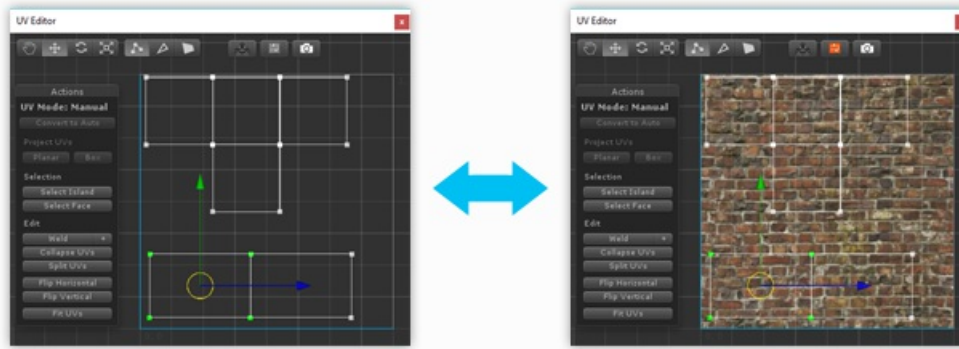

## Render UV Template

Opens the Render UVs tool panel, for rendering UV Templates to be used with texture map painting, atlasing, sprite sheets, etc.

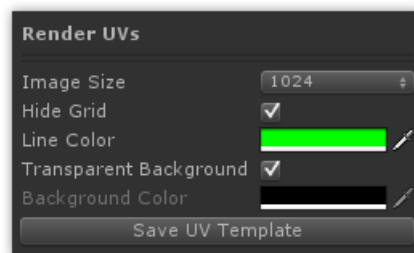

- **Image Size** : Total size of the rendered template (always square)
- **Hide Grid** : Should the grid be hidden in the render?
- **Line Color** : What color should UV lines be rendered as?
- **Transparent Background** : Should the background be rendered transparent?
- **Background Color** : If you want a non-transparent background, set the color here
- **Save UV Template** : Click to render the UV Template - a file dialog will be opened to save the file.

# Auto UV Actions

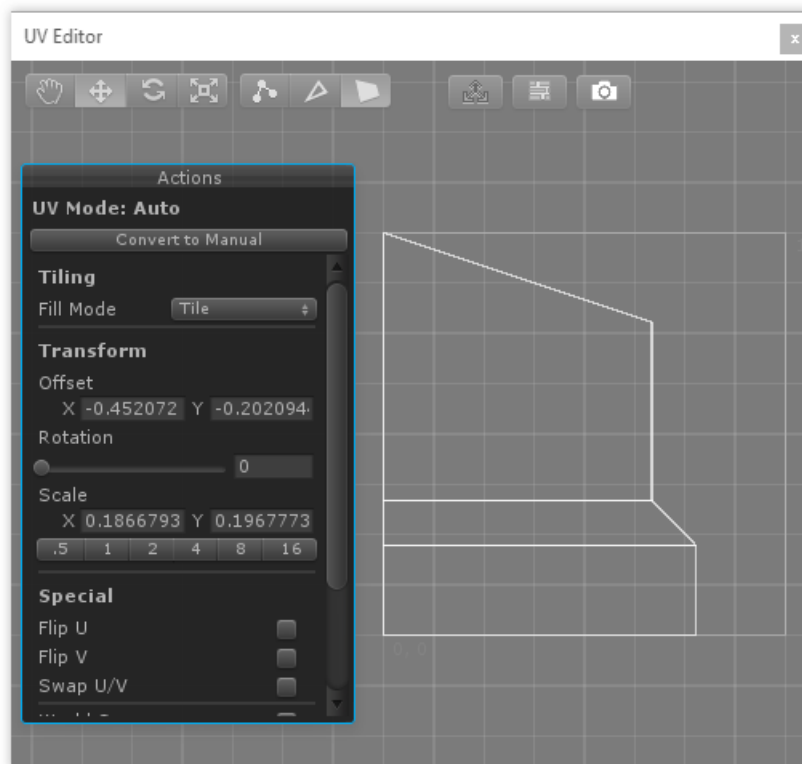

---

## Convert to Manual

Converts the selected Face(s) to using Manual UVs.

When converting from Auto UVs to Manual there will be no loss of resolution, but if you modify vertices or edges individually in Manual Mode those changes will not be transferable to Auto Mode.

---

## Fill Mode

**Option** **Description**

**Tile** Continuously tiles (repeats) the UVs across the object

**Fit** Uniformly scales UVs to size

**Stretch** Expands the selection on all sides to fill space

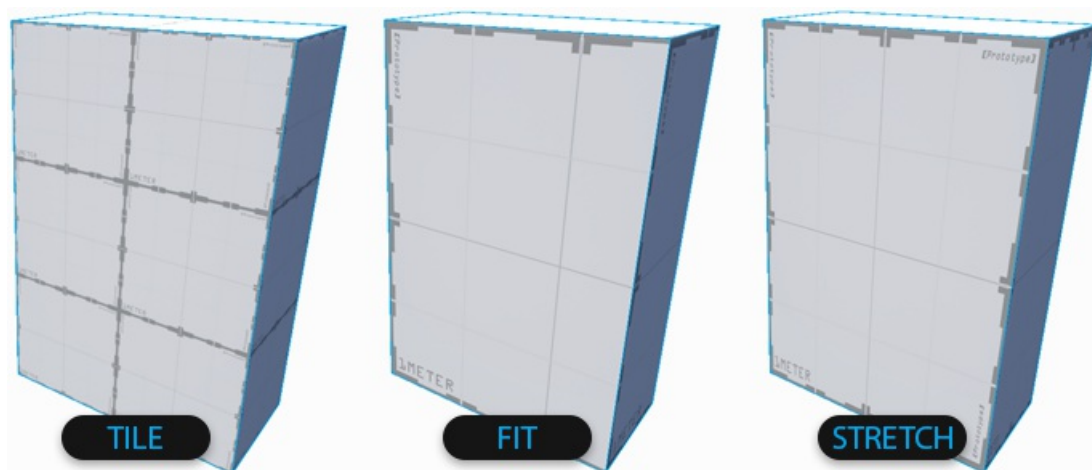



## Offset

Enter exact offset values here, or drag the input field to adjust.

---

## Rotation

Enter exact rotation values here, or drag the slider to adjust.

---

## Scale

Enter exact Scale values here, or click the preset buttons.

---

## Flip U

Flip the UVs horizontally.

---

## Flip V

Flip the UVs vertically.

---

## Swap U/V

Invert the horizontal and vertical UVs.

---

## World Space

UVs are aligned to the World - this ensures textures on same-angle faces will always line up, but UVs will not stay put when moving the object.

---

## Texture Group Number

Shows the Texture Group ID of the currently selected face, if applicable.

---

## Group Selected Faces

Create a new Texture Group from the selected faces.

---

## Select Texture Group

Select all faces in the the Texture Group.

---

# Manual UV Actions

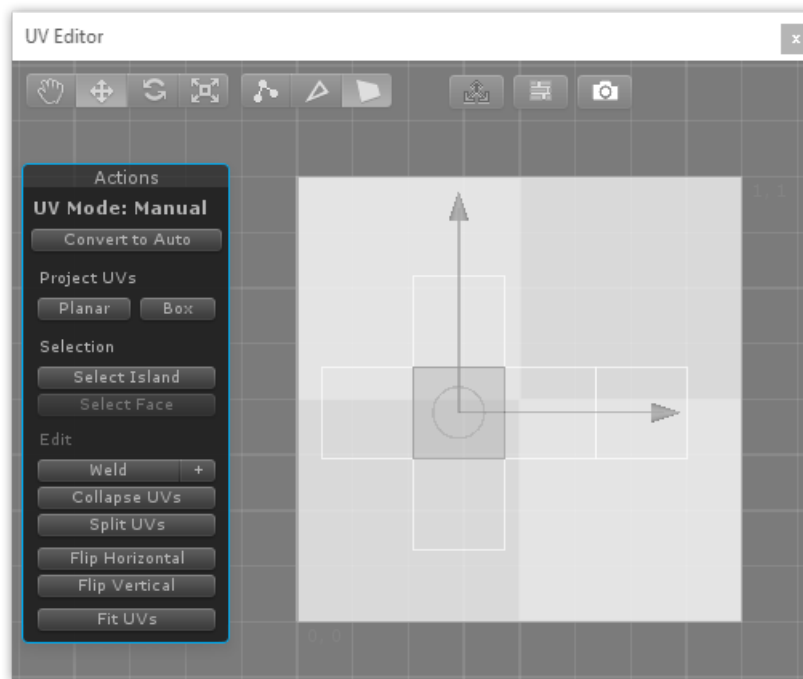

---

## Convert to Auto

Converts all selected faces to [Auto UVs](#).

---

## Project UVs: Planar

Unwraps the selected face(s) using a Planar Projection method.

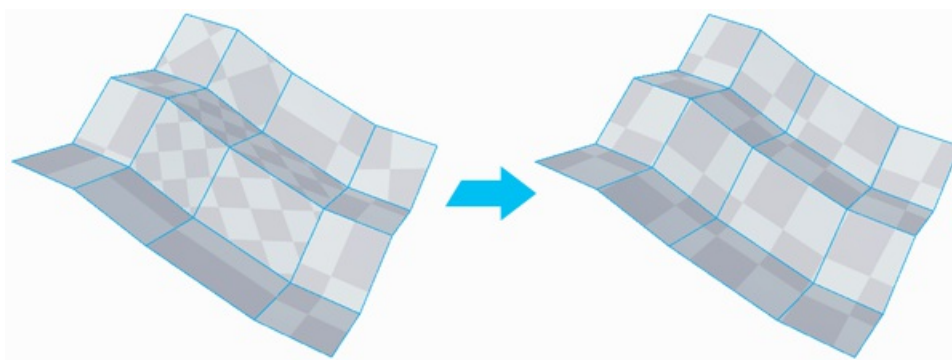

---

## Project UVs: Box

Unwraps the selected face(s) using a Box Projection method.

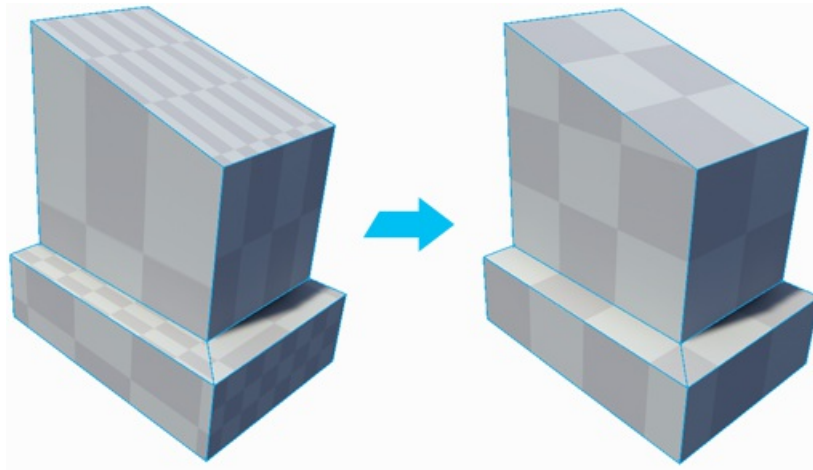

## Select Island

With a UV element selected, clicking this will expand the selection to include all other connected UV elements.

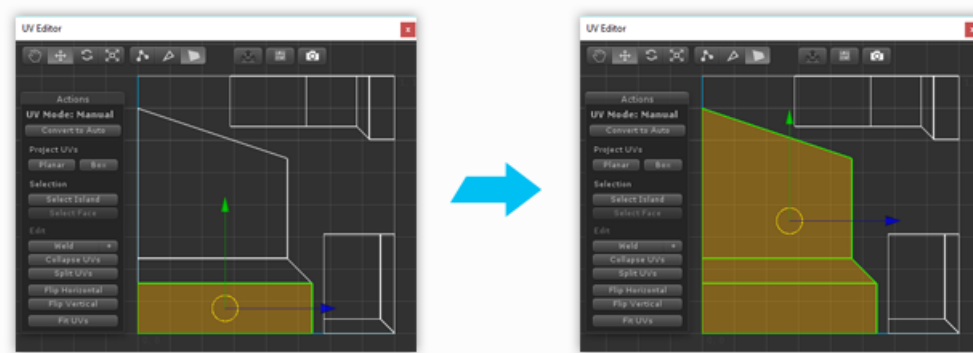

## Select Face

With a Vertex or Edge selected, click to select all elements on the same face.

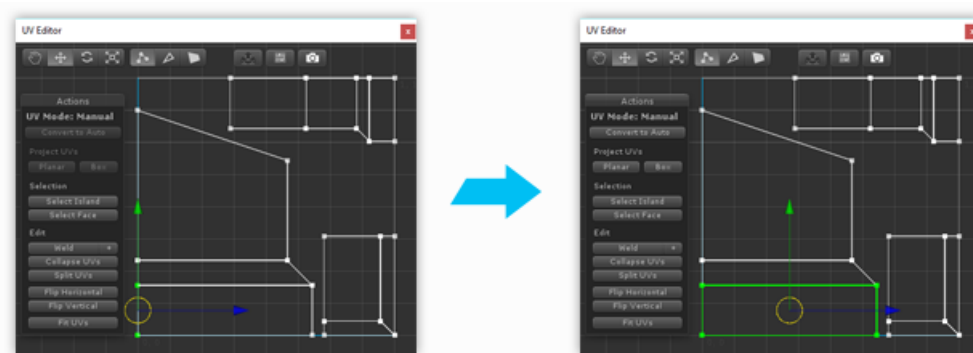

## Weld

Collapses selected vertices together, but only if they are within a set distance.

To adjust the distance modifier, click the "+" button on the right side of the Weld button.

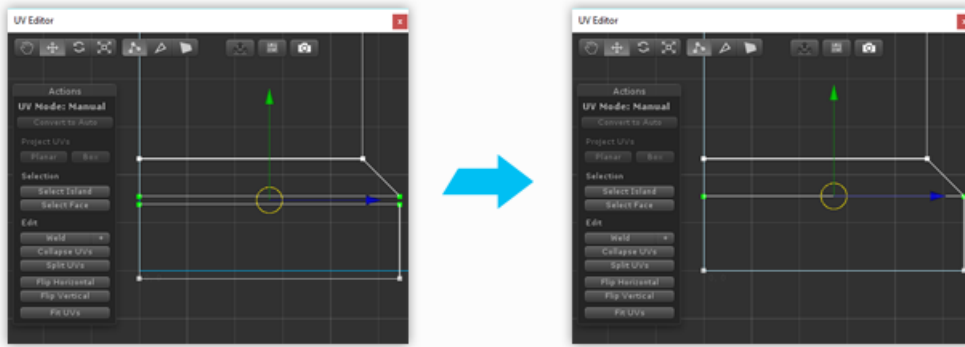

## Collapse UVs

Collapses all selected vertices to a single vertex, regardless of distance.

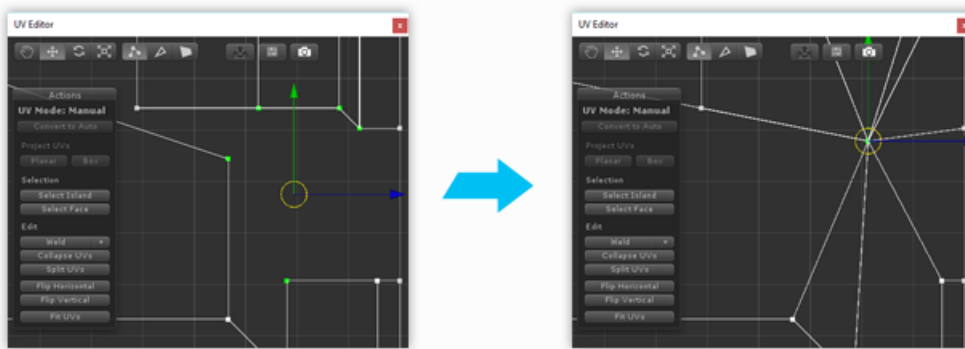

## Split UVs

Breaks off the selected UV element(s) from any UV element(s), allowing them to be manipulated independently.

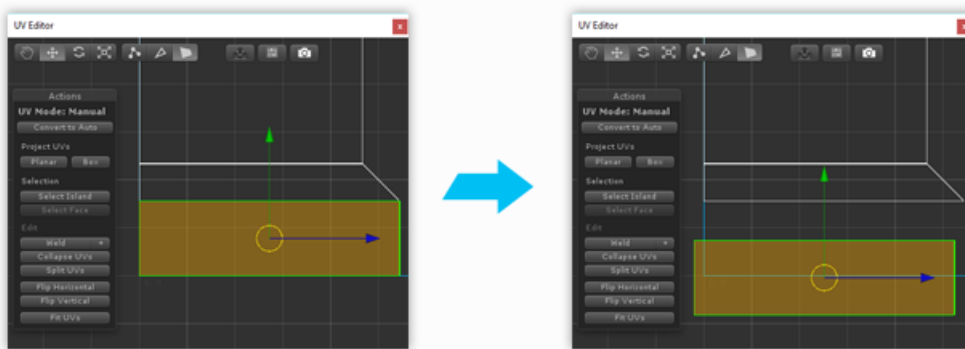

## Flip Horizontal

Flip the selected UV element(s) in the horizontal direction.

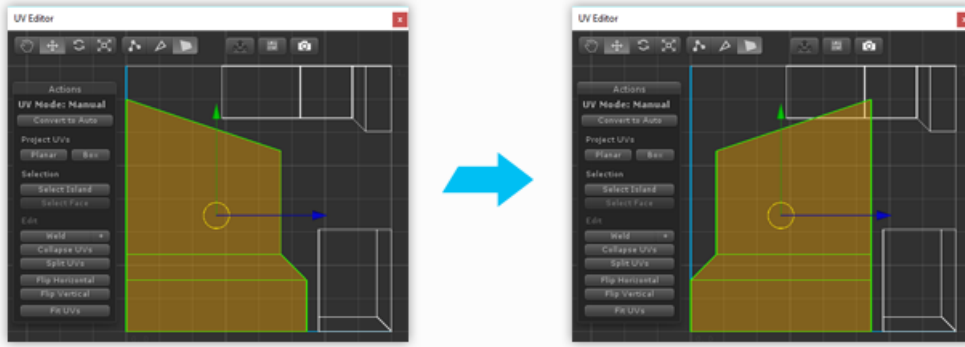

## Flip Vertical

Flip the selected UV element(s) in the vertical direction.

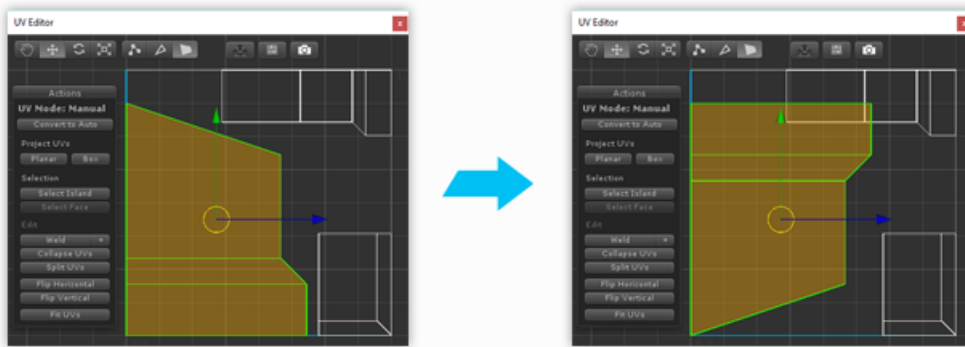

## Fit

Scale and move the selected UV element(s) to fit exactly within the UV space.

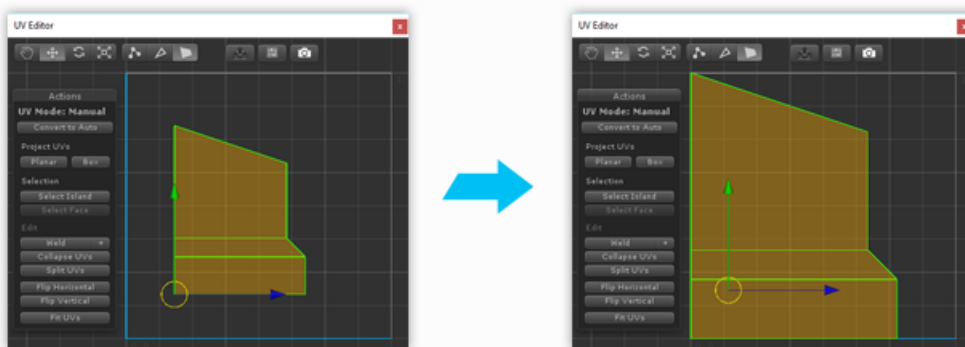

# Preferences

ProBuilder contains many settings that can be customized to suit your needs.

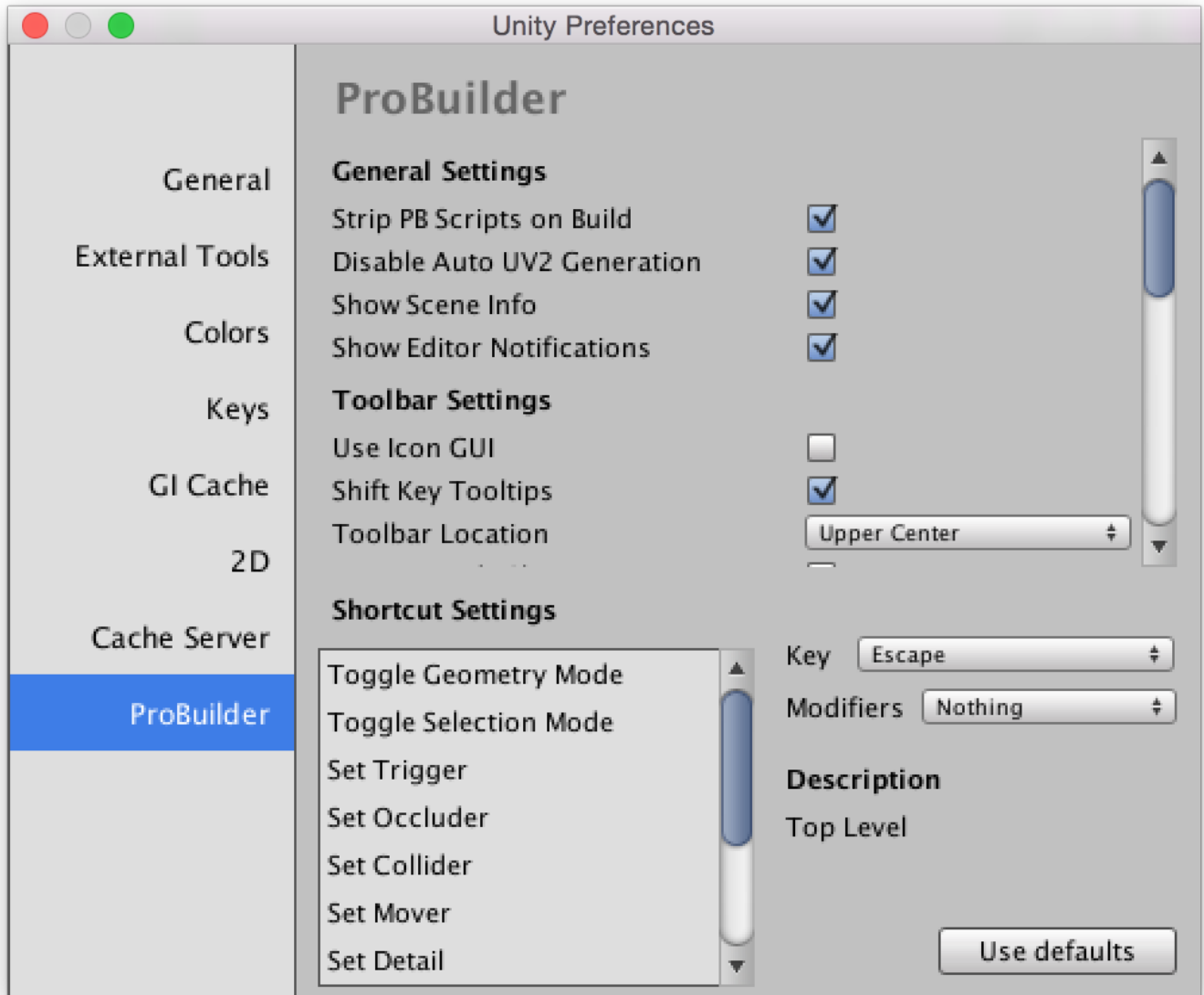

## General Settings

### Strip PB Scripts on Build

If enabled ProBuilder will automatically remove the extra data ProBuilder stores in a scene. This includes all ProBuilder scripts, so if you are making use of the runtime API you will need to disable this feature.

### Disable Auto UV2 Generation

Generating a UV2 channel for meshes is necessary for lighting, but can be a time consuming operation. If you are editing objects with large vertex counts it is beneficial to skip generating the UV2 channel after every geometry edit and do it manually (using the [Generate UV2](#) toolbar item).

### Show Scene Info

Show or hide the mesh information overlay in the top left of the Scene View.

### Show Editor Notifications

This preference enables or disables notification popups when performing actions.

## Toolbar Settings

### Use Icon GUI

Toggles the toolbar between using Icons or Text.

## Shift Key Tooltips

If enabled the ProBuilder toolbar will only show tooltips when the mouse is hovering an item and the **Shift** key is held.

By default tooltips are shown when the mouse hovers an action for more than a second.

## Toolbar Location

Controls where the [Element Mode Toolbar](#) is shown in the Scene View.

## Unique Mode Shortcuts

If Unique Mode Shortcuts is enabled ProBuilder assigns the **G, H, J, K** keys to **Object**, **Vertex**, **Edge**, and **Face** modes respectively. You can change which keys are mapped to these actions in the Shortcut Settings section.

By default ProBuilder assigns the **G** key to toggle between **Object** mode and **Vertex/Edge/Face** modes. **H** toggles between the different element modes **Vertex/Edge/Face**.

\*More Info on Modes: [Object and Element Modes](#);

## Open in Dockable Window

If enabled the ProBuilder toolbar will be opened as a dockable window. If disabled the window will be floating and always on top.

## Resource Defaults

### Default Material

What material new shapes will be instantiated with.

### Default Entity

What entity type new shapes will be instantiated as.

### Default Collider

The type of collider new shapes will be instantiated with.

### Force Convex Mesh Collider

If the default collider is **Mesh Collider**, this setting controls the **Is Convex** setting of the collider.

## Miscellaneous Settings

### Limit Drag Check to Selection

When enabled ProBuilder will restrict drag selection of elements to the current selection. If disabled drag selecting in a scene will test every ProBuilder object, which may be slow in larger scenes.

### Only PBO are Selectable

If enabled while ProBuilder is open only ProBuilder created GameObjects may be selected.

### Close Shape Window After Building

If enabled the [Shape Tool](#) will automatically close itself after a new object is created.

### Dimension Overlay Lines

Hide or show the bounding lines in the Dimensions Overlay.

## Geometry Editing Settings

### Precise Element Selection

This controls how close to an element the cursor must be to register for selection. By default this is disabled, meaning that vertex and edge selection are very forgiving when clicking.

If enabled, the selectable area for vertices and edges is smaller, but you may also select faces by clicking outside of vertices.

## Colors

ProBuilder allows users to set the colors for element selections.

## Vertex Handle Size

Determines how large vertex points are rendered in the scene. This setting does not affect selection.

## Force Pivot to Vertex Point

When instantiating new shapes ProBuilder will guarantee that the pivot point of the object coincides with a vertex position.

## Force Pivot to Grid

When instantiating a new object ProBuilder will snap the object to the nearest grid point (as determined by ProGrids).

## Bridge Perimeter Edges Only

When enabled ProBuilder will not allow users to extrude edges from manifold edges. Disable to remove this restriction.

## Experimental

Warning! Enabling experimental features may break your project! Please exercise caution.

## Meshes Are Assets

ProBuilder will store mesh information in the Project instead of per-scene.

## UV Editing Settings

### UV Snap Increment

Set the snap increment in the UV Editor window.

### Editor Window Floating

Make the UV Editor window floating or dock-able.



# Troubleshooting

## Error building Player

Usually seen with console errors:

- **Error building Player: UnityException: Failed to run serialization weaver with command**

To get things compiling again, you need to mark the ProBuilder DLLs as Editor only.

This does mean you won't be able to access any of the ProBuilder API at runtime. Fortunately if you're just using ProBuilder to build levels you don't need to worry about that.

### Steps to Fix

1. First make sure that **Strip PB Scripts on Build** is checked in the Preferences/ProBuilder panel.

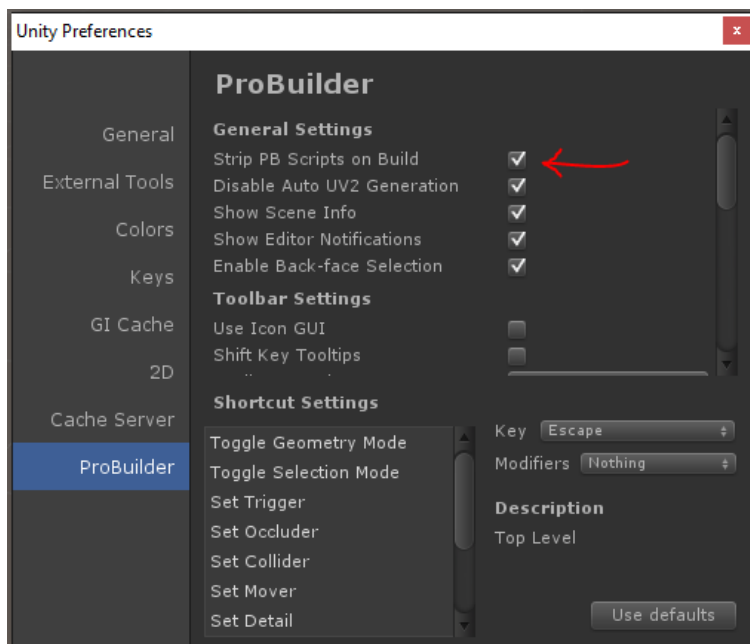

2. Next, locate **ProBuilderCore-Unity5.dll** and **ProBuilderMeshOps-Unity5.dll** in your project.

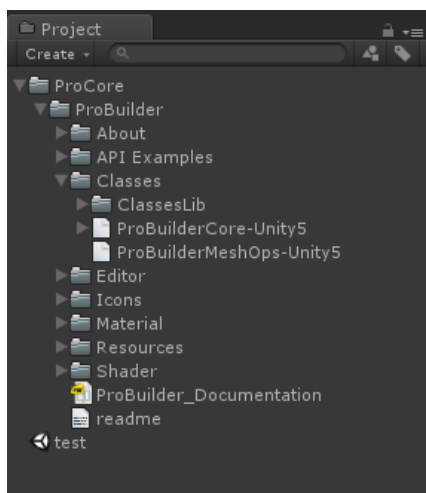

3. With both **ProBuilderCore-Unity5** and **ProBuilderMeshOps-Unity5** selected, in the Inspector window un-check "Any Platform." Then toggle both "Editor" and "Standalone."

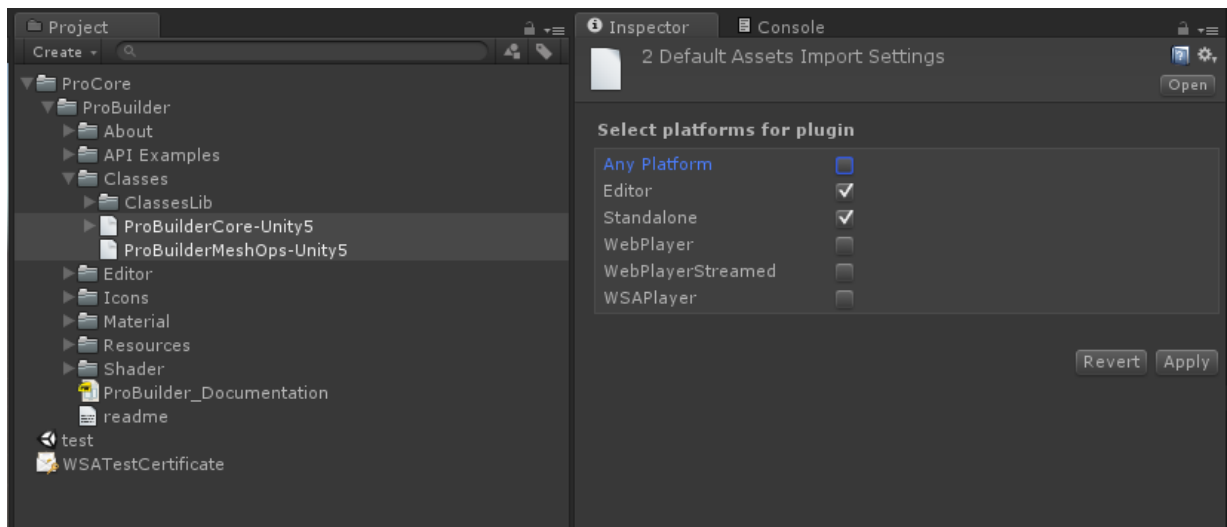

If you're using ProBuilder 2.5 or lower, some errors will appear when scripts reload. Open the following files (in ProBuilder/API Examples):

- IcoBumpin.cs
- HueCube.cs
- RuntimeEdit.cs

In each of these files, place this line at the very beginning:

```
#if UNITY_EDITOR || UNITY_STANDALONE
```

and this line at the very end:

```
#endif
```

For example, here's what `RuntimeEdit.cs` looks like:

```
#if UNITY_STANDALONE || UNITY_EDITOR
using UnityEngine;
using System.Collections;
using ProBuilder2.Common;

namespace ProBuilder2.Examples
{
    /**
     * \brief This class allows the user to select a single face at a time and move it forwards or backwards.
     * More advanced usage of the ProBuilder API should make use of the pb_Object->SelectedFaces list to keep
     * track of the selected faces.
     */
    public class RuntimeEdit : MonoBehaviour
    {
        // ... etc
    }
}
#endif
```

Now compile your project and run!

## Missing Icons

If you upgraded ProBuilder and are now missing icons in the toolbar, first try restarting Unity.

If that does not work,

1. Delete this folder: [ProCore/ProBuilder/Resources/GUI](#)
2. Re-import ProBuilder from Asset Store / ProCore Downloads

## Spotty Textures on Lightmapped Objects

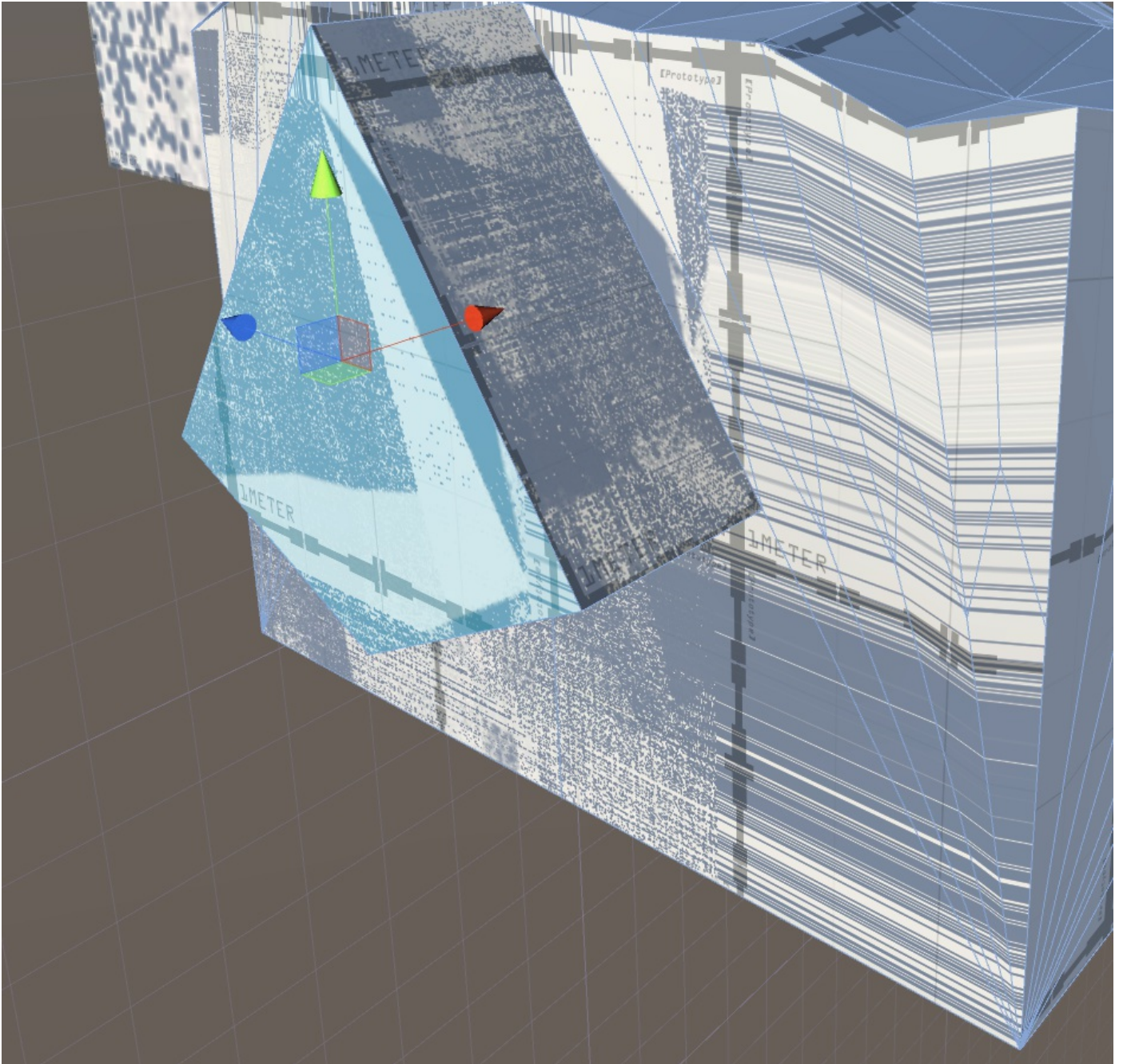

The object does not have a UV2 channel built.

- Select the affected objects
- Click [Generate UV2](#) in the ProBuilder Toolbar

# Credits

---

## Triangle.NET

- <https://github.com/zon/triangle>

## CSG

- Original by Evan Wallace: <https://github.com/evanw/csg.js>
- C# port: [https://github.com/karl-pb\\_CSG](https://github.com/karl-pb_CSG)

## kd-sharp

- <https://code.google.com/p/kd-sharp/>

## MkDocs

- <http://www.mkdocs.org/>

## Asset Submissions

- **Pivot Tool** : @Matt1988
- **Diffuse Vertex Color Shaders** : @Snoopbaron (Fernando Zapata)
- **Standard Vertex Color Shaders** : Unity Forums user [@defaxer](#)