

 Roland

RHYTHM COMPOSER

TR-909

OWNER'S MANUAL

Contents

Panel Description	
Connection	
Operation	
▶ Basic Course	
1 Sound Check	7
1. Manual Play	7
2. Rhythm Pattern Play	7
2 Pattern Write and Play	9
1. Step Write	9
2. Some more useful Information for Pattern Write	12
3. Tap Write	14
4. Pattern Play	14
3 Track Program and Play	15
1. Track Program	15
2. Editing Rhythm Track	16
3. Additional Information	17
4. Track Play	18
4 Tape Interface	19
▶ Advanced Course	
5 Variations of Writing Rhythm Patterns	24
1. Selecting a Scale	24
2. Setting Last Step	24
3. Accent	25
4. Shuffle	26
5. Flam	26
6 Edit Functions	27
1. Copy	27
2. Chain Function	28
3. Delete	28
4. Insert	30
5. Copy	31
7 Other Functions	32
1. Tempo Memory	32
2. Multi Out	32
3. Memory Cartridge	33
4. Sync Functions	34
5. External Instrument Mode	37
★ MIDI	38
6. Trigger Out Stop/Start	38
Specifications/Option	39

Panel Description

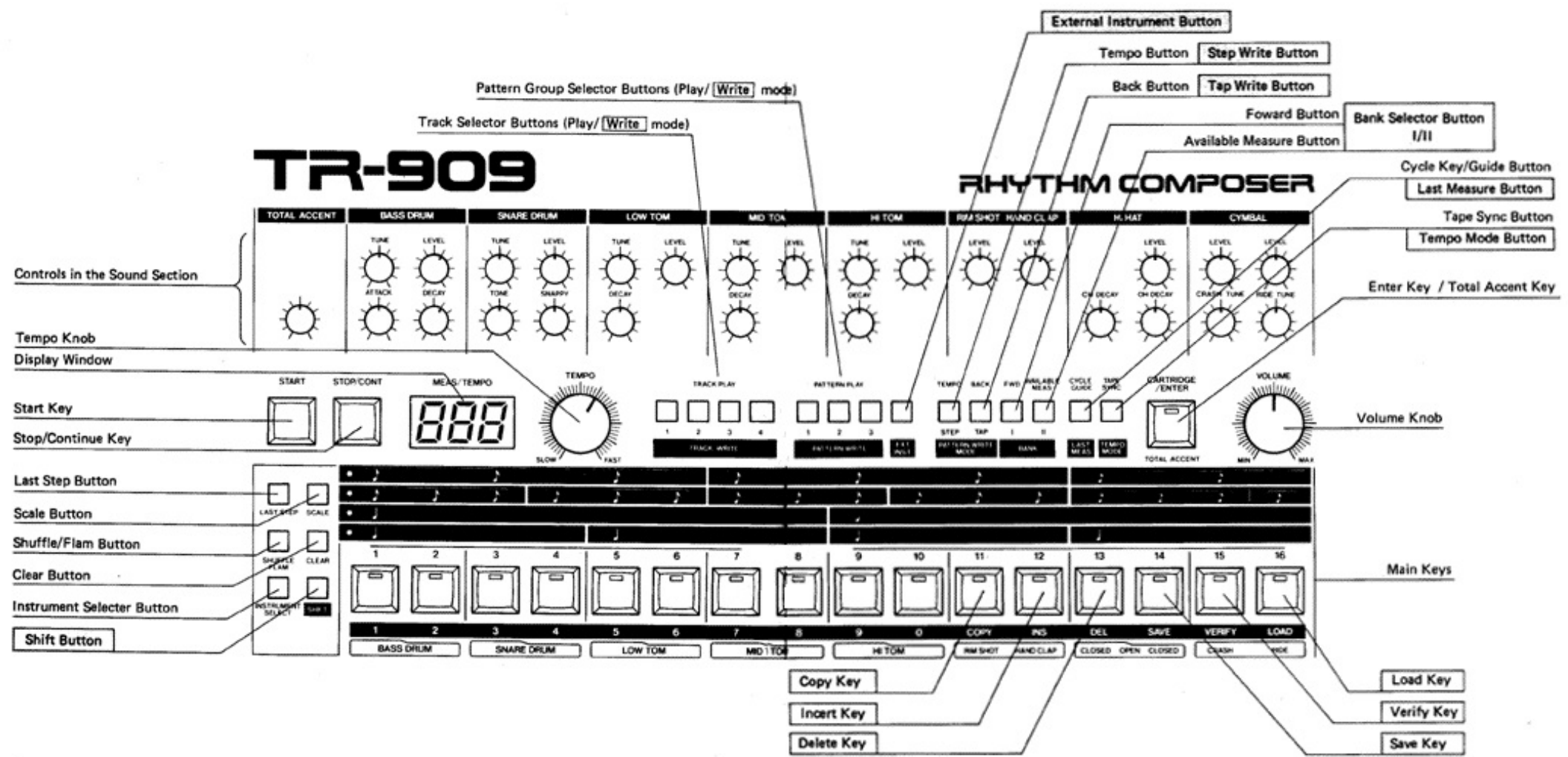

The Keys and Buttons enclosed with should be always pushed while the **Shift Button** is being held down.

RHYTHM COMPOSER

TR-909

The Roland TR-909 rhythm composer is a fully programmable rhythm machine with various attractive functions.

Features

- By using up to 48 kinds of Rhythm Patterns, you can program 4 Rhythm Tracks (altogether 896 measures) in a Bank, and there are two separate Banks, which doubles the capacity of the TR-909.
- It is possible to write accent data independently to Bass Drum, Snare Drum, Low, Mid, and Hi Toms and Closed Hi-hat, as well as Total accent to all the voices within each step.
- Each sound source includes Control knobs of Level, Decay, Tune, etc, allowing spontaneous timber setting according to the tempo of the rhythm.
- Flam and Shuffle functions are featured enabling richer expressing of rhythms.
- The Tape Interface makes it possible to save the programmed data in the TR-909's Memory onto an ordinary audio tape.
- The Memory Cartridge is optional for instantaneous saving and loading.
- The Display Window allows quick visual grasp of the tempo, measure number, etc.
- MIDI BUS Interface on the back panel enables setting up with other MIDI devices, therefore, external sound source and Sync with external devices are now available.

■ Important Notes

- Using the TR-909 near a neon or fluorescent lamp may cause noise interference. If so, change the angle or position of the TR-909.
- Avoid using the TR-909 in extreme heat or humidity or where it may be affected by dust.
- Use a soft cloth and clean only with mild detergent.
- Do not use solvents such as paint thinner.

■ Memory Back-up

The TR-909 features memory back-up system that retains Rhythm Patterns and Track compositions even when switched off. The TR-909 relies on its batteries for its back-up circuit. Be sure to keep the battery securely connected even while using the AC Adaptor. Also, always replace with a complete set of the new batteries once a year. If you have changed the batteries with the TR-909 switched on, the memory can retain the data.

- If the TR-909 is not to be used for long periods of time, please be sure to switch the power off and remove the batteries, or various troubles may be caused by battery leakage.
- Please observe "Battery Replacement" on the next page.
- Please be sure that the polarities of the batteries are correct.

■ Battery Replacement

Use two 1.5V (UM-3) batteries.

- ① Remove the battery cover on the bottom of the unit.
 - ② Take out the battery case.
 - ③ Remove the batteries from the battery case.
 - ④ Place a new set of batteries taking care of the polarities.
 - ⑤ Return the battery case into the housing.
 - ⑥ Return the battery cover.
- Please be sure to do the entire battery replacing procedure with the unit switched on. Then the data in memory will be retained.
 - Please do not pull the cord hard.

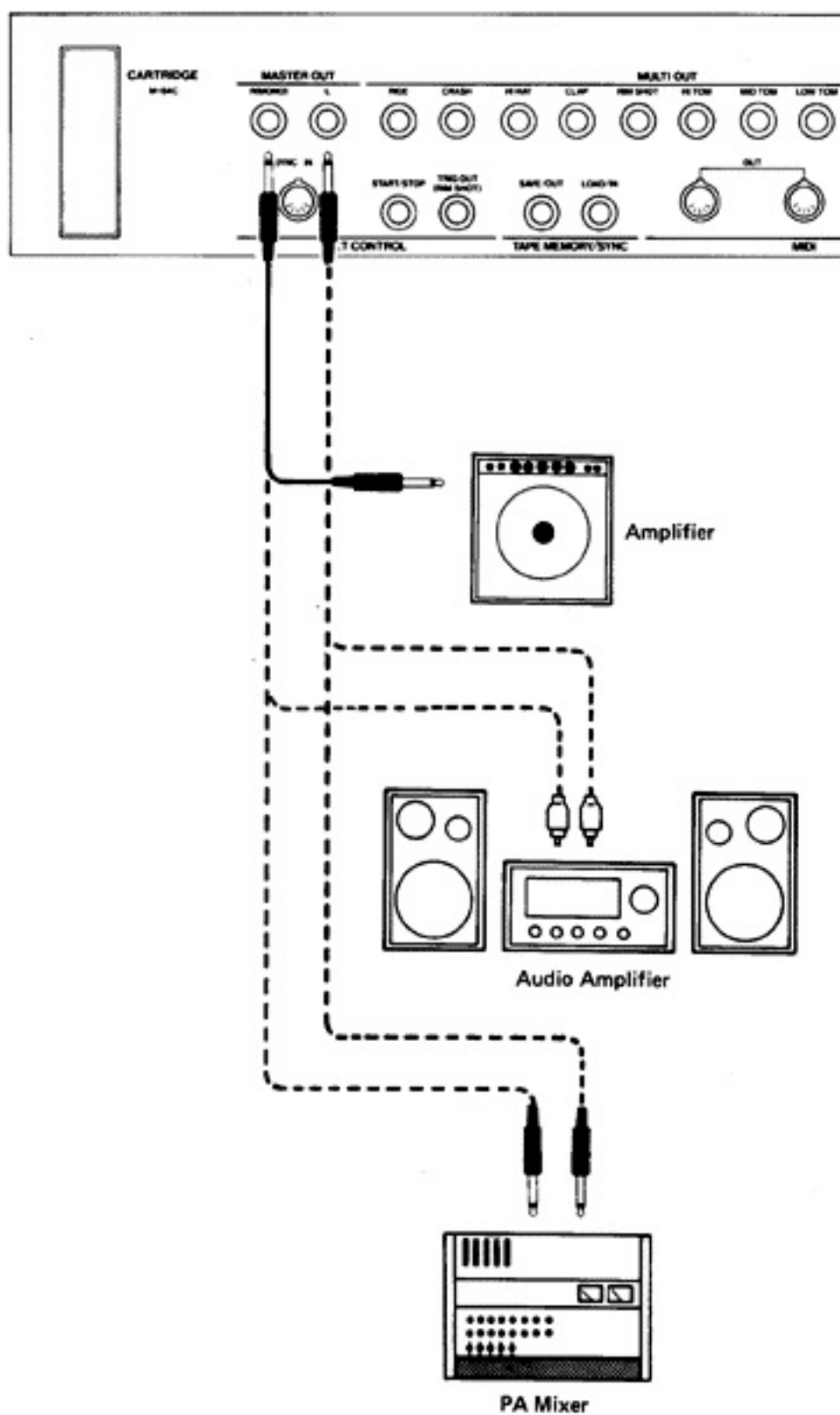

▶ Basic Course

1 Sound Check

1. Manual Play

Hitting the Main Key, you will hear the corresponding sound source.

[Operation]

① Set up the TR-909 as shown in "Connection" on p. 6.

② Turn the TR-909 on.

Note: Please try handling the Power Switch as gently as possible.

③ Set the Level Control of each sound source to its middle.

④ Tap each Main Key, and the corresponding voice will be heard. Here, adjust the overall volume to pleasant level.

2. Rhythm Pattern Play

Simple demonstration data is pre-programmed into the TR-909 (Bank 1, Track 1, Rhythm Patterns 1 to 8). You can erase it and write your own data.

[Operation]

① Set up the TR-909 as shown in "Connection" on p. 6.

② Turn the TR-909 on.
Note: Please try handling the power switch as gently as possible.

③ Set the Level Control of each sound source to its middle.

④ Press the Start Key. 



■ Sound Sources

BASS DRUM . . . 1 – With accent

2 – Without accent
(Normal volume)

SNARE DRUM . . 3 – With accent

4 – Without accent

LOW TOM } . . .

MID TOM } . . .

HI TOM } . . .

5, 7, 9 – With accent
6, 8, 10 – Without
accent

HI HAT 13 – Closed hi-hat with
accent

14 – Closed hi-hat
without accent
Pressing both 13 and 14
at the same time will
make Open Hi-hat (in
normal volume).

CRASH 15

RIDE 16

RIM SHOT 11

HAND CLAP . . . 12

■ Controls in the Sound Section**● Level knob**

This is provided for every sound source and controls each volume. Rotating this clockwise (↻) will increase the volume.

[BASS DRUM]**● Attack**

This is to control the attack sound. Rotating this knob clockwise (↻) increases it.

● Decay

This adjusts the decay time. If you wish to mute the kick drum sound, rotate this knob counterclockwise (↺).

● Tune

This is to control the pitch. Whatever the position this knob is set, the Decay knob works at its set time.

[SNARE DRUM]**● Tone**

This is to change timber of the sound. As you rotate this knob, the sound will become brighter.

● Tune

This is to control the pitch of the Snare Drum sound.

● Snappy

This corresponds to the snappiness of the Snare Drum. At its fully counterclockwise (↺) position, Snare Drum sound with snappy removed will be obtained.

[LOW TOM/MID TOM/HI TOM]**● Tune**

Rotating the knob clockwise (↻) increases the pitch. Controlling the pitch of these three Tom sounds, you can use them as Melody Tom.

● Decay

This adjusts the decay time. If you wish to mute the Tom sound, rotate this knob counterclockwise (↺).

[HI-HAT]**● Decay**

This knob controls the Decay time of Hi-hat sound. If you wish to mute the Hi-hat sound, rotate this knob counterclockwise (↺).

[CRASH/RIDE]**● Tone**

This is to adjust the pitch of the Cymbal sound.

2 Pattern Write and Play

To store a measure of Rhythm Pattern into the TR-909 is called "Write" in this manual.

There are two main methods of writing, Step Write and Tap Write.

In either mode, you will hear the Rhythm you are writing.

1. Step Write

Let us write an example pattern.

The diagram shows a 16-step rhythm pattern. The notation includes T.ACC (Toms), CH (Cymbals), SD (Snare Drum), and T.ACC (Toms). The grid below shows the timing for each instrument across 16 steps.

Step No.	1	2	3	4	5	6	7	8	9	10	11	12	13	14	15	16
CH	•	•	•	•	•	•	•	•	•	•	•	•	•	•	•	•
SD					•											
T.ACC	•				•				•							

[Operation]

① Make sure that the TR-909 is turned on but not running. (The TR-909's Main Keys's indicators flash from the left to right showing that it is now in the running mode. So, it is easily recognized whether the TR-909 is running or not.)

② While holding the Shift Button down, press the Pattern Group Selector Button 2, and it will start flashing. (2)

③ While holding the Clear Button, press the Main Key 1. This procedure will erase the Rhythm Pattern previously written there (Bank 1, Pattern Group 2, Pattern Number 1). Even if there is no Rhythm Pattern written there, this procedure does you no harm. (3)

④ Press the Start Key. You will see the Indicator on the Main Key flashing from the left end to the right (from 1 to 16). (4)

⑤ To select a Voice you like, press the appropriate Sound Key (= Main Key). For instance, if you want the Snare Drum, simply press either the Main Key 3 or 4, while holding the Instrument Selector Button. (5)

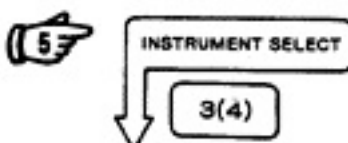
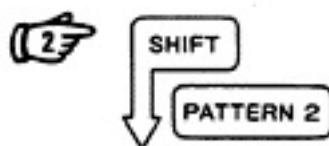
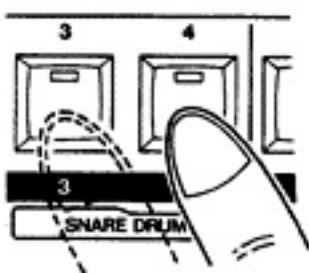

●Selecting Sound Source

[Choosing]

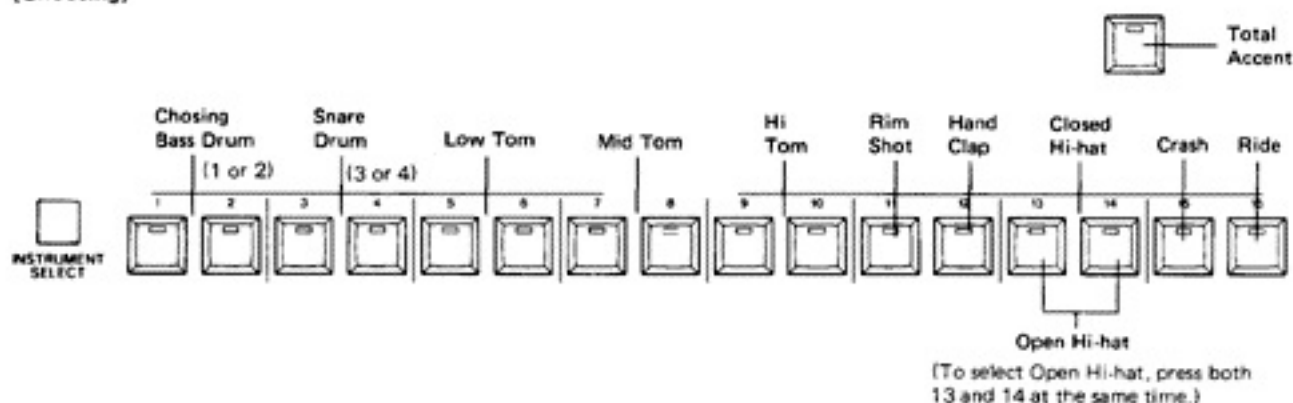

* Be sure to press the Main Key while holding the Instrument Selector Button down.

* You may notice that the indicators on the left of the Bass Drum, Snare Drum, Tom (Hi, Mid, Low) and Closed Hi-hat light dimmer than the right ones. There is a reason for it; the left ones give sounds with accents and the right ones in normal volume. This allows you to select either of normal or accent sound depending which you prefer. (Refer to Advanced Course for the details.)

* In selecting Bass Drum, Snare Drum or Tom (Hi, Mid, Low), if you happen to press both of the two keys simultaneously by mistake (e. g. 1 and 2 in case selecting Bass Drum), the TR-909 will turn to the Flam Write mode. (This mode will be explained later in "Advanced Course"). To leave this mode, simply press the appropriate key (1 or 2 in case selecting Bass Drum).

⑥ Now press the relevant Main Key according to the Rhythm Chart shown on the next page.

● This operation will cause the indicator on the pressed Main Key to light up. The corresponding sound source will be heard when the flashing of the indicators (moving through the row of the Main Keys from right to left) reaches that Main Key.

● If you find the tempo too slow or fast, adjust it to the comfortable speed.

● If you have pressed an irrelevant key by mistake, you need to cancel it by pressing the same key once (or twice depending on the keys as follows).

★BASS DRUM	}	Press the Key twice.
SNARE DRUM		
LOW TOM		
MID TOM		
HI-TOM		
C. HI-HAT	}	Press the Key just once.
RIM SHOT		
HAND CLAP		
O. HI-HAT		
CRASH		
RIDE		

* The flashing indicator on the key will go out to show that the relevant sound source is cancelled.

● Rhythm Chart

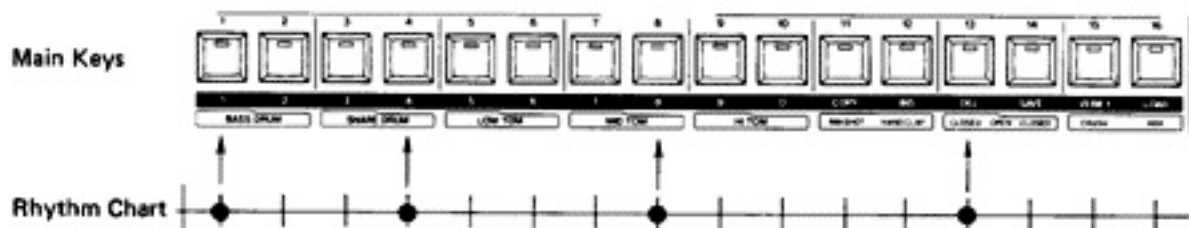

* Press the Main Key corresponding to ● position on the Rhythm Chart one after another.

● How the Main Keys work in writing

The Indicator on the Main key changes by pressing the key as shown below.

* If writing Bass Drum, Snare Drum, Tom (Low/Mid/Hi), or C. Hi-hat,

* If writing the other sound sources e. g. Rim Shot, etc.

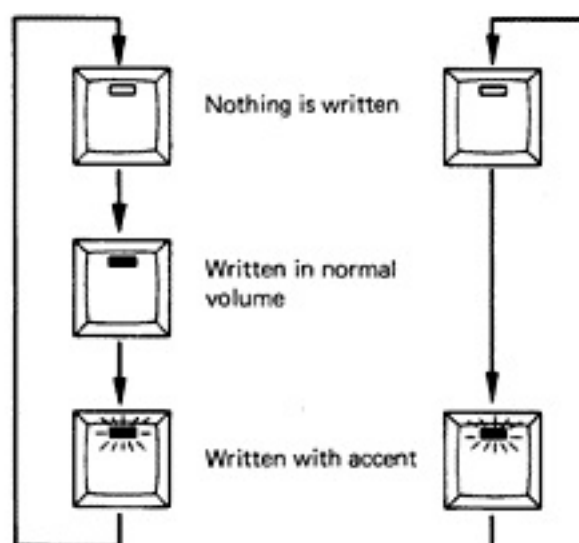

⑦ Write other sound sources and accent (Total accent) in the same way as procedures ⑤ and ⑥.

⑧ If writing has been completed, press the Stop/Continue Key, and it will stop playing the Rhythm. 



2. Some more useful information for Pattern Write

A. Memory System of the TR-909

Before writing any Rhythm Pattern, you need to select a Bank (I or II) Pattern Group (1, 2 or 3) and Pattern Number (Main Key 1 to 16).

B. Selecting Bank

In "Step Write" on P. 9, nothing is mentioned on changing Banks. Actually, turning the TR-909 on automatically selects Bank I, but if you want Bank II, do as shown below.

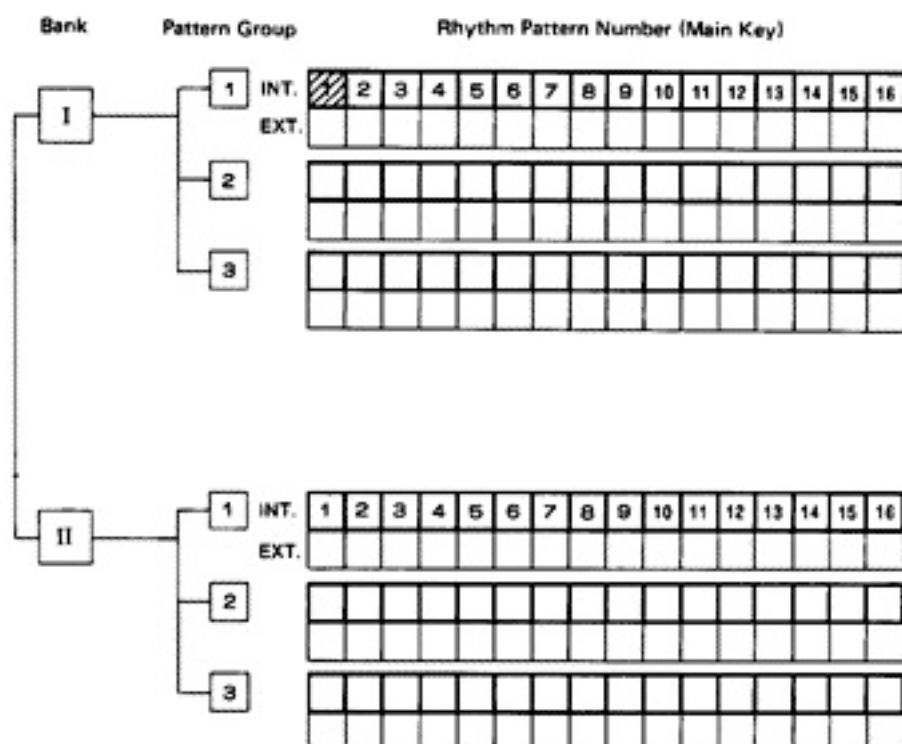



* Each Bank consists of 3 Pattern Groups, and 16 Rhythm Patterns can be written in each Group. Therefore, 48 (16 x 3) kinds of Rhythm Patterns are available within a Bank.

* If you select Bank I, Pattern Group 1 and Main Key (Rhythm Number),  in the figure will be the one available for you to write a Rhythm Pattern.

* Refer to P. 37 for external instrument.

[Operation]

- ① Make sure that the TR-909 is not running.
 - ② Press any Track Selector Button 1 you like. This operation turns the TR-909 into Track Program mode. 
 - ③ While holding the Shift Button down, press the Bank Selector I or II. This causes the indicator of the selected Bank to go on. 
- If the TR-909 has been just turned on, you may skip the operations ① and ②.
 - Now the TR-909 is ready for Step Write or Pattern Play.

If you have changed the Banks, please be aware of the following points.

Note 1

It is not possible to play the Rhythm Pattern in Bank I and the one in Bank II continually. This is because turning the TR-909 into the Track Play mode is necessary before changing the Banks.

Note 2

Later when programming a Rhythm Track (one whole music piece) by combining the Rhythm Patterns you have written, you are not allowed to use the Rhythm Patterns in different Banks. Please remember this, and try writing the Rhythm Patterns you may need for programming a Track into the same Bank.

C. Key Point for Writing

In the TR-909, Rhythms are written in a step sequence process which breaks each measure (and each beat) down into a series of steps. Before start writing a Rhythm, you need to modify the score accordingly. Let's study the score shown below. In this modifying procedure, timing value is ignored as percussive sounds are all very short. Also the TR-909 allows selection of 3 other Scales apart from ♩ used in this example, which is to change how many steps there will be for each beat. Therefore, even triplet or 32 beats can be written. (The details will be explained later in "Advanced Course")

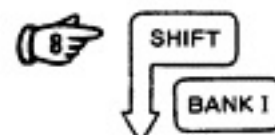

Score

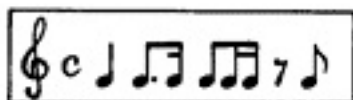

Modified Score

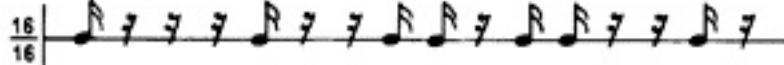

Rhythm Chart

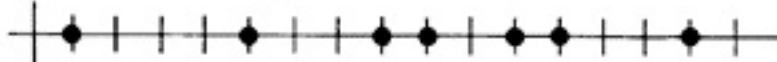





Main Keys



3. Tap Write

[Operation]

- ① Make sure that the TR-909 is not running.
- ② While holding the Shift Button down, press any Pattern Selector. 
- ③ While holding the Shift Button down, press the Tap Write Button. 
- ④ While holding the Clear Button press the Main Key corresponding to the Pattern Number where you are to write a Rhythm. 
- ⑤ Press the Start Key. 
- ⑥ Press the Guide Button, then the Indicator will light up and Rim Shot sound will be heard in quarter note intervals.

⑦ Simply tap the sound source (Main Key) to this guiding sound, then it will be written into memory as it has been tapped.

● Refer to "Manual Play" on P. 7.

⑧ If unnecessary sound happens to be written, press the relevant Main Key (if it is Snare Drum, 3 or 4), while holding the Clear Button down. 

* Please do not release the key until you are convinced that all sequences of that sound source are cleared. Then tap this time correctly.

⑨ If writing is completed, press the Stop/Continue Key. 



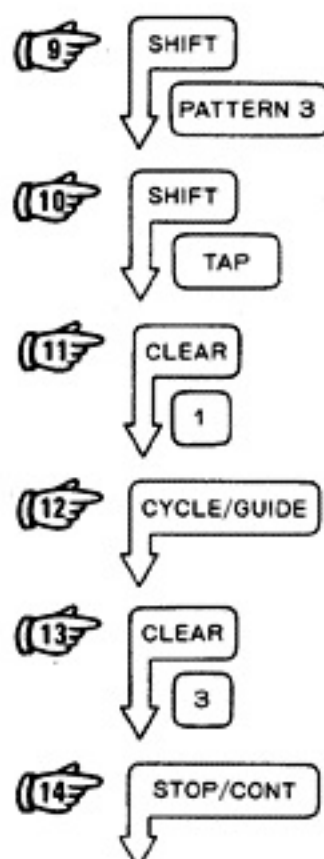

[Note] It is not possible to write shorter timing than the one set with the Scale. Therefore, if you write a Rhythm with the tempo set slow, in later playback, it may turn out different from what you expect.



4. Pattern Play (Playing Rhythm Patterns)

As now you have written some Rhythm Patterns into your TR-909, you may play them at anytime you like.

[Operation]

- ① Be sure that the TR-909 is not running.
- ② Select the Rhythm Pattern to be played by pressing a Pattern Group Button and a Main Key. (Be sure that you are not selecting an empty Pattern Number where you have not yet written any Rhythm.)  
- ③ Press the Start Key, and the selected Rhythm Pattern will be played again and again until the Stop/Continue Key is pressed. 
- ④ If you like to change the Rhythm Patterns during one Rhythm running, simply select any Rhythm Pattern you like, with the Pattern Group Key (1, 2 or 3) or Main Key (1 to 16). 

* The new Rhythm will be played from the beginning of the next measure.

⑤ Press the Stop/Continue Key to stop the Rhythm. Here, if you press the Stop/Continue Key again, the Rhythm will continue playing from where it stopped. (Continue Play Function) 

● Block Pattern Play

neously after the Pattern Group Button, all the Rhythm Patterns between those two keys will be played one after another (e. g. if 1 and 5 are pressed, the Rhythm Patterns 1, 2, 3, 4 and 5 will be sequentially played.) 

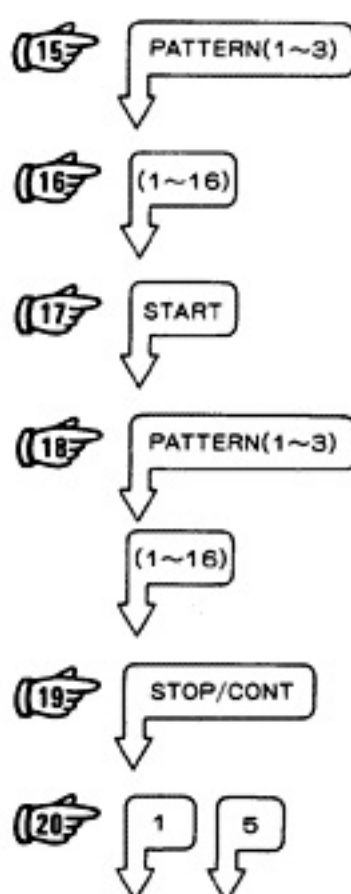

3 Track Program and Play

Another attractive function of the TR-909 is that you can program a Rhythm Track of a whole music piece by combining Rhythm Patterns in memory. There

are 8 Tracks (4 in Bank 1, and another 4 in Bank 2), and altogether 896 measures are available in each Bank.

1. Track Program (Programming Rhythm Track)

[Operation]

- ① Be sure that the TR-909 is not running.
- ② Select either Bank I or II by pressing the relevant Bank Selector while holding the Shift Button down. (21)
- ③ While holding the Shift Button down, press any Track Selector Button you like (1 to 4). (22)

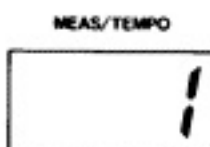

* This causes the TR-909 to turn to the Track Program mode.

- ④ With the Shift Key still held down, do the following three procedures. (23)
 1. Press the DEL Key (Main Key 13).
 2. Press the Last Measure Button.
 3. Press the Enter Key.

* Even if any data is written in the Track, it will be erased by the above procedure.
- ⑤ Press the Start Key to start the Rhythm. (24)
- ⑥ Select the Rhythm to be programmed into the first measure, by using the Pattern Group Selector and the Main Keys. (25)

- ⑦ Press the Enter Key. (26)
 - * This will enter the Rhythm Pattern selected in operation ⑥ and proceed to the second measure as is shown on the Display Window.



- ⑧ By repeating the above procedures, program the Rhythms one after another up to the last measure.
- ⑨ Press the Stop/Continue Key.

[Track Play (Playing a Rhythm Track)]

As now you have programmed a whole Rhythm Track, play it to see whether it has been successfully done.

- ① Select the Track by pressing the Track Selector Button. Here, be sure that you are not selecting an empty Track. You should select the same Track you have programmed in Track Program procedure. (27)
- ② Press the Start Key. (28)
 - * The Rhythm starts from the first measure and ends when the last measure is played up.



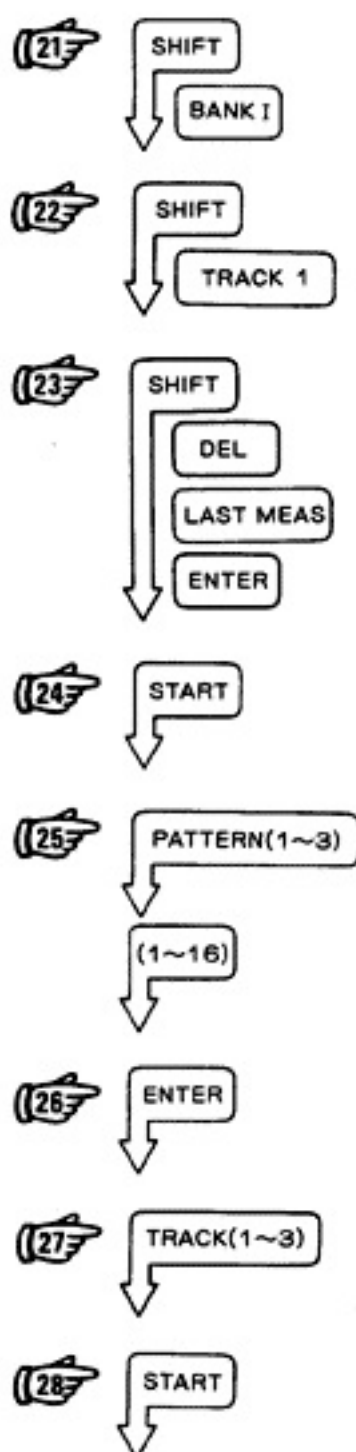

If you find any mistake, please go on to the following "Editing Rhythm Track".



2. Editing Rhythm Track

It is possible to edit your Rhythm Track. If you wish to add or delete Rhythm Pattern, refer to "[6] Edit Functions" in Advanced Course on P. 27.

A. Operation

- ① While holding the Shift Button down, press the Track Selector Button of the relevant Rhythm Track. This will turn the TR-909 into the Track Program mode.
- ② Press the Start Key, and the Rhythm will start running. 
- ③ Recall the measure which you are to edit by pressing the Forward Button. 
 - Each time you press the Forward Button, the number on the Display will change showing that measure is advanced one by one. If you come to the measure number you wish to replace with new data, press no longer the Enter Key.
 - * The Enter Key can be used instead of the Forward Button.
- ④ Select the Rhythm Pattern to be replaced. This will cause the selected Rhythm to start playing, so that it will be easier for you to edit. 
- ⑤ Press the Enter Key, and new Rhythm Pattern will replace the existing data (without increasing the total measure number). 
- ⑥ Press the Stop/Continue Key. 

★ If you notice that you have entered the wrong Rhythm Pattern immediately after entering it, simply back one measure up by using the Back Button, select the correct Rhythm Pattern, and hit the Enter Key, then continue Track Program. 

B. Some More Helpful Information for Editing

1. It is also possible to stop running the Rhythm, then edit the Track. In this case, simply skip the procedure ② in "A. Operation". (In this mode, each time you press the Enter Key (or Forward Button), the indicator (on the Main Key) of the Rhythm currently selected will light up. And this is the only way to tell which Rhythm Pattern is recalled.
2. There is another way to recall the measure to be replaced, that is, instead of procedure ③, do the following two procedures while holding the Shift Button down. 
 - ① Assign the measure number by pressing the Main Keys (here, they serve as Number Keys). For instance, to recall measure number 25, press 2 then 5.
 - ② Press the Enter Key.

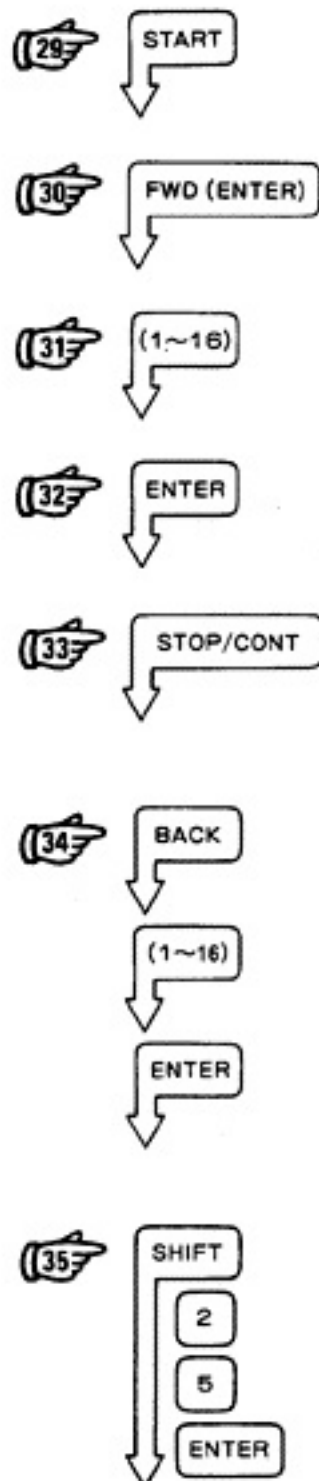

3. Additional Information

A. Track Memory

The system of the Track Memory of the TR-909 is as shown in the figure below. Before programming Rhythm Track, it is necessary to select one of 8 Tracks (4 in Bank I, and another 4 in Bank II). 

B. Changing Banks

To change banks, firstly, turn the MSQ-700 into the Track Program mode by pressing any of the Track Selector Button. Then press the Bank Button while holding the Shift Button. 

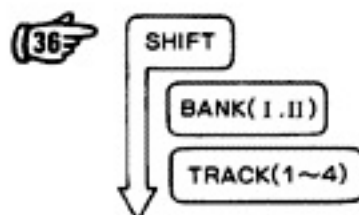

●Track Memory

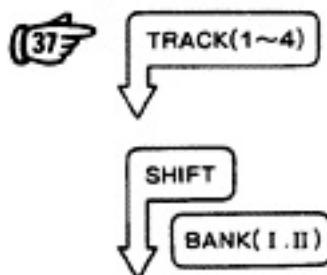
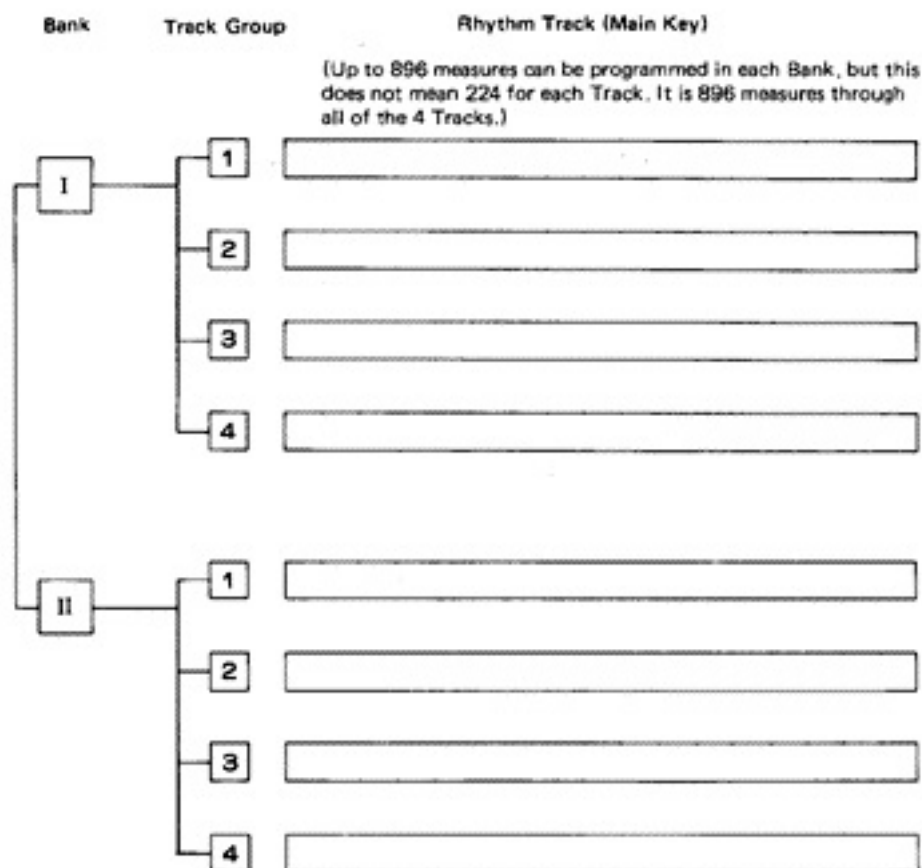

C. Available Measure Button

Pressing the Available Measure Button will cause the Display to show the number of how many measures are left to be written.

* Pressing the Enter Key during Track Program mode may cause the Display to show "0" instead of the next measure number. This tells that there is no memory left.

4. Track Play (Playing Rhythm Track)

[Operation]

- ① Select the Track to be played simply by pressing a relevant Track Selector Button. Here, the first measure of the Track will be automatically ready to be played. (38)

*Selecting an empty Track will cause the Display to show 0.

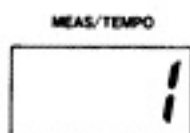

- ② Press the Start Key to start the Rhythm. It will automatically stop playing when played up to the end. (39)

●If you press the Stop/Continue Key during Rhythm playing, the Rhythm stops there, and it will continue playing by pressing the same key. (40)

★Cycle Play

Pressing the Cycle Key will turn The TR-909 to the Cycle mode (the indicator lights up), so the Track will play repeatedly until you press the Stop/Continue Key or the Cycle Button again. Pressing the Stop/Continue will immediately stop the Rhythm, but if the Cycle Key is pressed, the Rhythm will stop at the end of the music. Also, you can turn this Cycle Play function on even during Rhythm play. (41)

★Track Play from the set measure

It is possible to start playing the Rhythm from any measure you like. While holding the Shift Button down, set the measure number where you wish the Rhythm to start by using the Main Keys, and hit the Enter Key. Then press the Stop/Continue Key, and the Rhythm will start from the beginning of the set measure. Here, if you, by mistake, press the Start Key instead of the Start/Continue Key, normal Rhythm play (starting from the first measure) will follow. Please be careful. (42) (43)

★Tempo Display

Pressing the Tempo Button will cause the Display Window to show the tempo of the current Rhythm. (44)

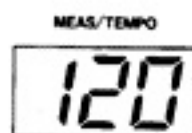

★Real Time Playing along with the Track playing

It is possible to play each sound source by tapping the Main Keys during Track play. So you can enjoy real time play along with the Track play.

★See P. 34 for Rhythm Sync.

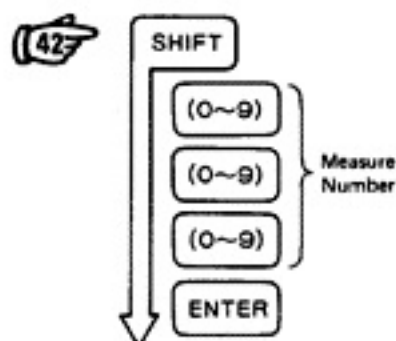
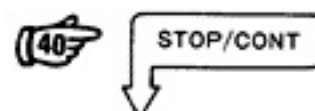

4 Tape Interface

The TR-909 features Tape Interface function that allows saving the data (Rhythm Patterns and Tracks) written in the Memory onto an ordinary audio tape for storage and later retrieval.

[NOTE]

The data in the Bank I and II cannot be saved at the same time (by one sequence of procedures), so you are required to save one Bank and the other Bank later. In other words, you need to know which one of the Banks is to be saved before saving.

A. Save

[Connection]

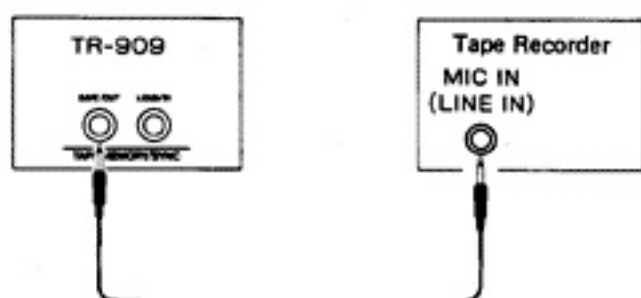

[Operation]

① Set the tape recorder to recording mode.

* If your tape recorder features a recording level control, set the level around +3VU.

② While holding the Shift Button down, press the Save Key then the Enter Key.

Then swiftly set the tape recorder to recording mode (usually by unlatching the Pause Button).

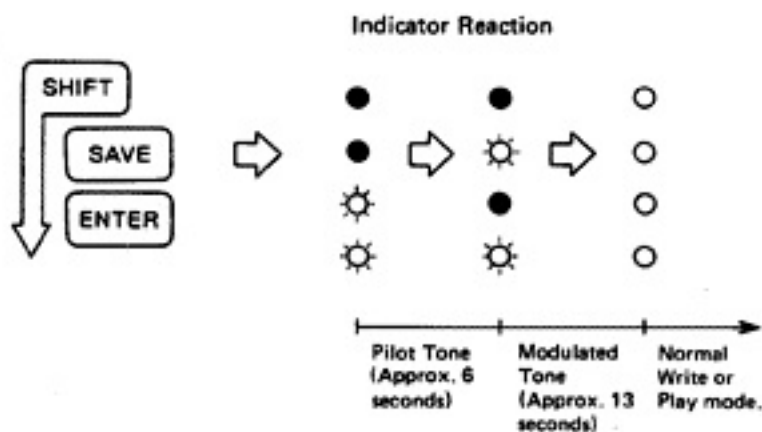
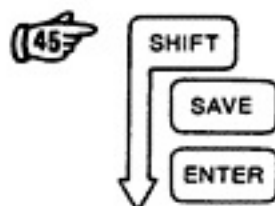

* For about 6 seconds after the Enter Key is pressed, Pilot tone (which is not exactly the same as the one heard in the beginning) will be heard. Then for about 13 seconds, Modulated Tone will be heard. During this, only the Scale Indicator lights.

③ When the other Indicators light just like before the Saving procedure is taken and Modulated Tone turns to pilot Tone, stop the tape recorder.

B. VERIFY

Verify function is featured to make sure if the data has been correctly saved.

[Connection]

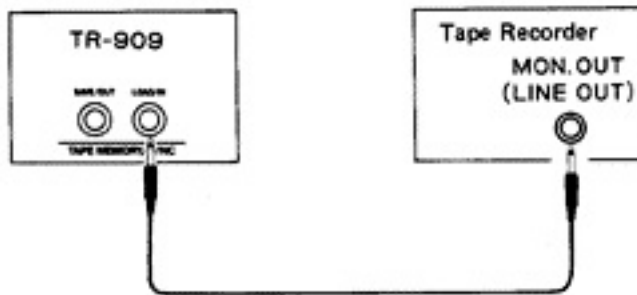

[Operation]

① Set the tape recorder so that the tape will start from the beginning of the data.

* Set the level of the tape recorder to medium.

② While holding the Shift Button down, press the Verify Key, then Enter Key.

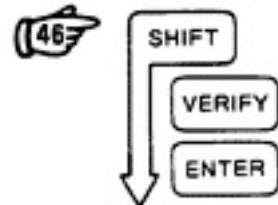

Indicator Reaction

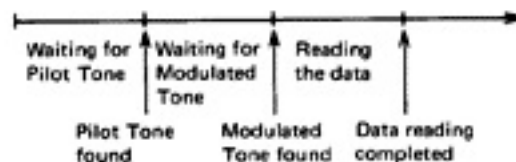
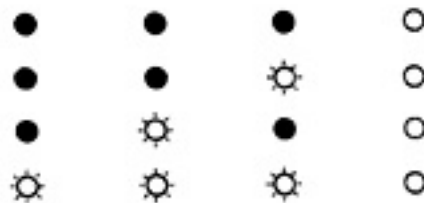
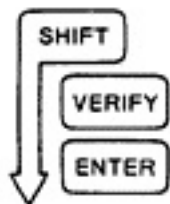

③ Then set the tape recorder to playback mode.

* Here, on pressing the Enter Key, all the Indicators except the Scale Indicator will go out.

④ If the indicators come in just like before Verify procedure is taken (as this indicates that data is properly saved), stop the tape recorder.

★If the Indicators do not return to the normal condition as they should. . . . Rewind the tape and play it back once again in different playback level.

If you fail again and again, press the Main Key 1 (Cancel command), and repeat saving.

*Errors are often caused by wrong operation, tape drop-out, or contaminated head of the tape recorder.

▶Preserving the Data Tape

Please do not keep the data recorded tape in extreme heat or humidity or near a strongly magnetic unit such as a speaker or an amplifier.

C. Load

[Connection]

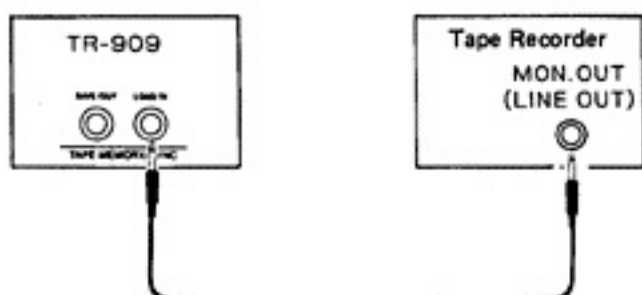

[Operation]

* Loading procedure is exactly the same as the verify, except that you should press the Load Key instead of the Verify Key.

*Set the volume of the tape recorder the same as set in Verify.

① Set the tape recorder so that the tape will be played back from the beginning of the data.

② While holding the Shift Button down, press the Load Key then Enter Key. (47)

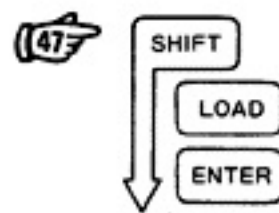

Indicator Reaction

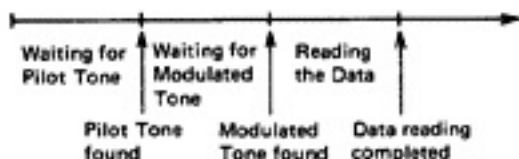
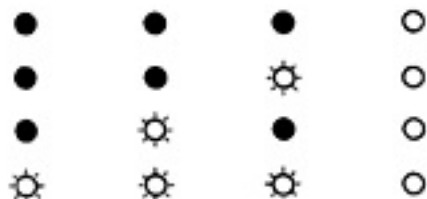
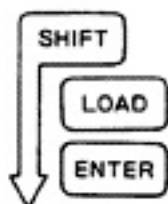

③ Then swiftly set the tape recorder to playback mode.

*On pressing the Enter Key, all the indicators except the Scale Indicator will go out.

④ If the Indicators come in just like before the loading procedure is taken, data is loaded successfully, so stop the tape recorder.

D. Other Functions of TR-909

(1) Cancel Command

If the Main Key 1 is pressed during saving, verify or loading procedure, the TR-909 will leave each mode. (48)

(2) File Number

If you put a File Number (0 to 999) to your data in saving, it will be considerably easier and quicker to load the data.

● To put a File Number, simply press appropriate Main Keys (e. g. 1, 2 and 3 for File Number 123) after pressing the Save Key in Saving procedure (2), then hit the Enter Key. Now, the File Number will be shown in the Display. (49)

* If you do not put any File Number, "0" will be shown in the Display.

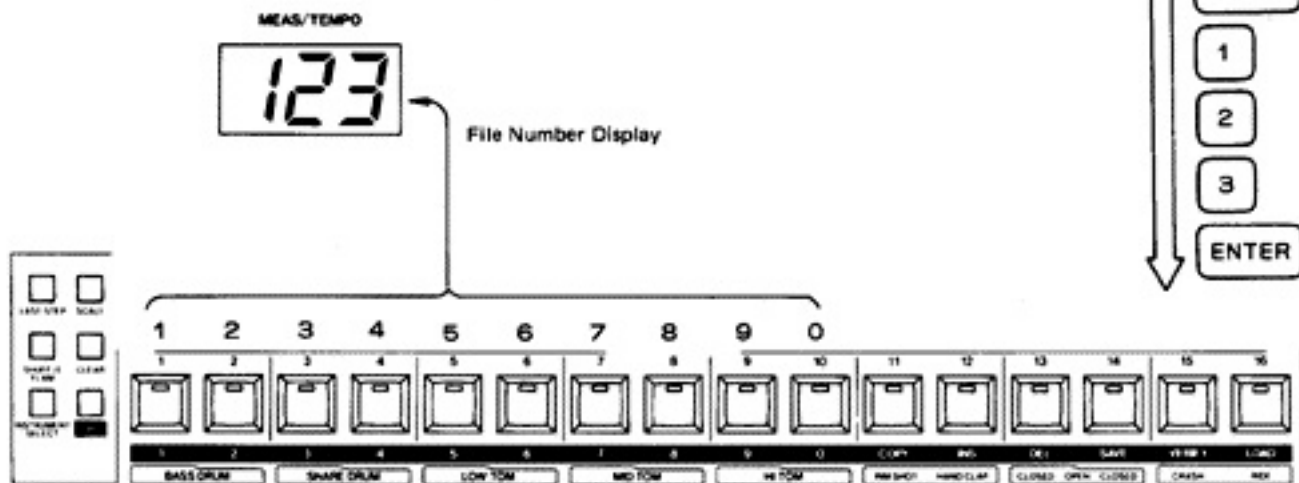

● The File Number put in Saving will be shown in the Display in Verify operation, but proceed the usual verify operation.

● To load the data you want, assign the File Number (by pressing the Main Keys) after pressing the Load Key in Load procedure (2), then press the Enter Key. (50)

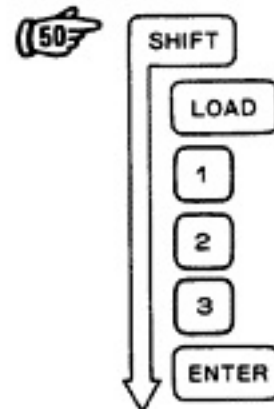

★ Loading File Number "2".

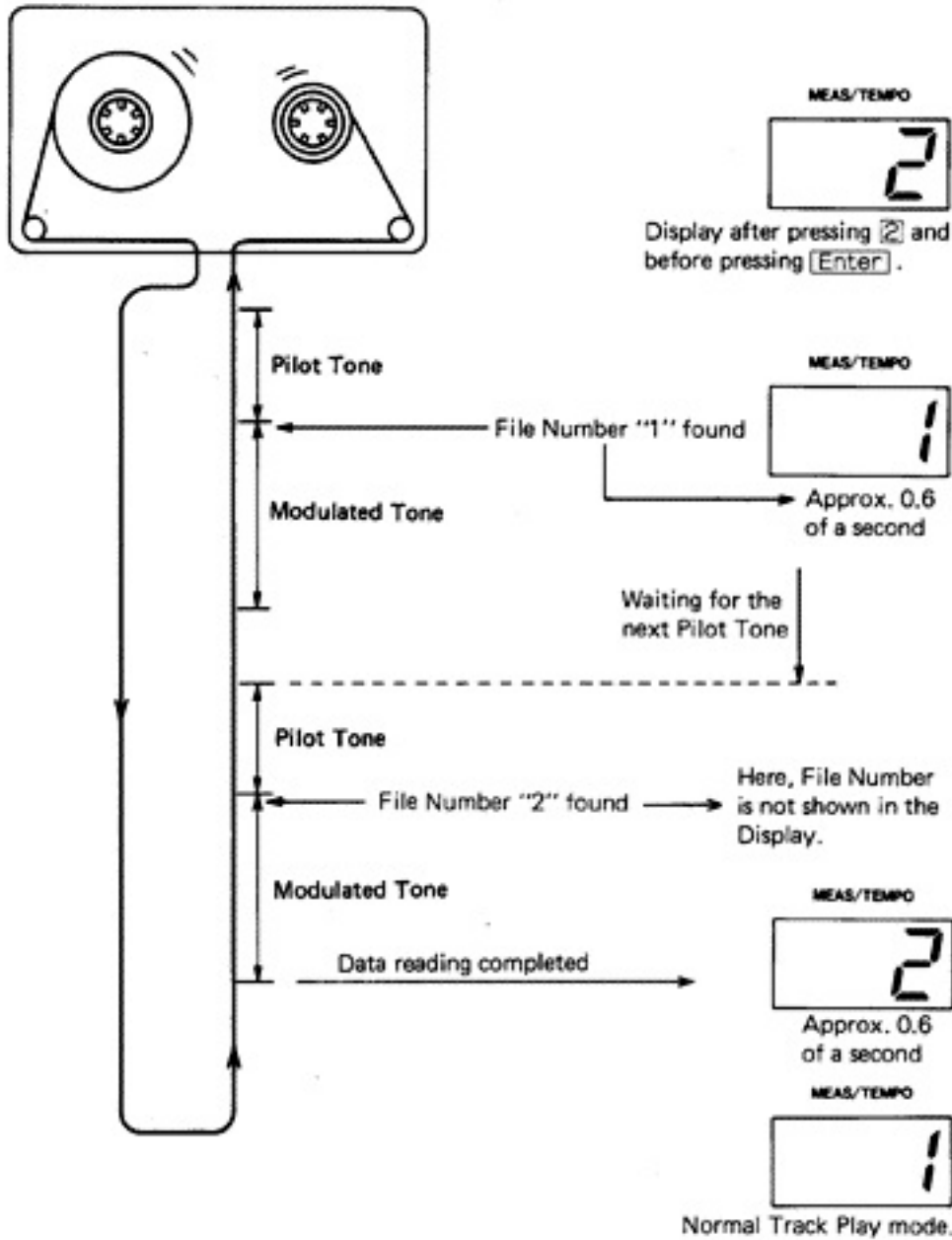

*If you have not assigned any File Number in loading, automatically the data first found will be loaded.

⇒ It is also possible to save the TR-909's data onto a Memory Cartridge. (Refer to P. 33)

► Advanced Course

⑤ Variations of Writing Rhythm Patterns

1. Selecting a Scale (Number of steps for each beat)

By changing Scales, you can enjoy wider variety of Rhythm Patterns.

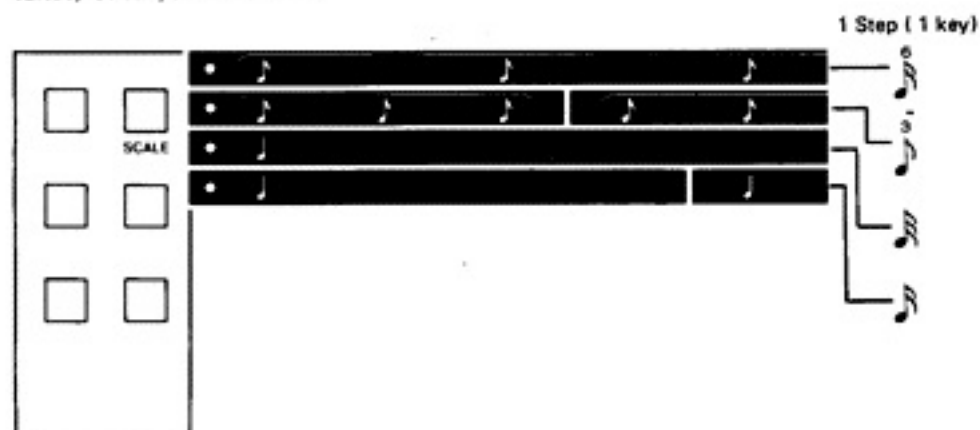

[Operation]

Each time you press the Scale Button, the number of steps for each beat will change as shown below. 

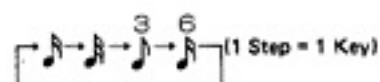

- This Scale selection procedure should be done after Step Write procedure ④, or Tap Write procedure ⑤. (That is during the TR-909 running).

- Depending on the Scale currently chosen, the tempo of the blinking Indicator on the Main Keys will change. (That is because all the Rhythms are in tune with each other). Here, the last step is automatically set $\text{♪} \rightarrow 16$, $\text{♪} \rightarrow 12$.



2. Setting Last Step

The TR-909 allows you to freely change the number of steps in a Rhythm Pattern, so even odd rhythm can be written.

[Operation]

While holding the Last Step Button, set any number you like by using the Main Keys. 

- This Last Step setting is to be done before Step Write procedure ④ or Tap Write procedure ⑤. (That is during the TR-909 running.)



3. Accent

There are 2 types of Accents available in the TR-909.

Accent A

This accent is to be set by each step. All the voices in that step will take on accents.

Accent B

You can put accent to any voice in any step you like.

*This accent is available only for Bass Drum, Snare Drum, Low Tom, Mid Tom, Hi Tom, and Closed Hi-hat.

• In this manual we call Accent A Total Accent, and B merely Accent.

A. Writing Total Accent

How to write Total Accent has been already explained in the "Basic Course" in this manual.

[Operation]

① While holding the Instrument Selector Button, press the Total Accent (Enter) Key. (53)

② Select the step where you wish to put accent by using the Main Keys. (54)

* This Total Accent cannot be written in Tap Write mode.

③ Adjust the intensity of the accent by using the Total Accent Knob.

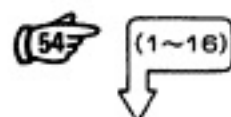
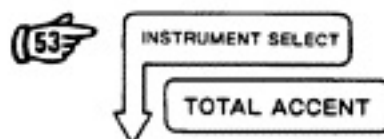

B. Accent

(1) In Step Write mode

While holding the Bass Drum, Snare Drum, Low Tom, Mid Tom, Hi Tom or Closed Hi-hat down, the Indicator of the corresponding Main Key will act as shown below.

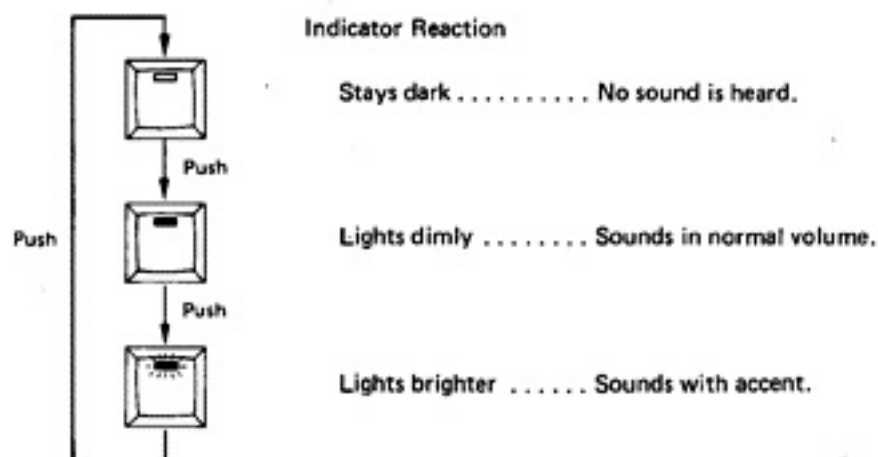

In short, pressing the Main Key twice will add an accent exclusively to the voice in that step.

(2) Tap Write mode

Tapping the left key of the voice will write the sound with accent and right one in normal volume. In short, sounds are written faithfully as the keys have been tapped in real time.

Naturally, the voice featuring only one Main Key does not give you this option of with or without accent.

* The intensity of this Accent cannot be changed.

* It is possible to set both Total Accent and Accent at the same time, but if the Total Accent Knob is set high, Accent may not be noticed.

4. Shuffle

You may enjoy Shuffle Rhythm arrangement.

• This function is available only when ♩ or ♪ Scale is selected (i.e. 1 step = ♩ or ♪).

The intensity of the bounce can be changed (seven options for ♩ and four for ♪), by using the Main Keys.

[Operation]

While holding the Shuffle/Flam Button down, press any of the Main Keys of 1 to 7. 

◦ Scale ♩ : 1 gives no effect, and faster bounce will be obtained towards 7.

◦ Scale ♪ : There is no difference between 1 and 2, 3 and 4 or 5 and 6.

1 and 2 give not effect (no shuffle) and faster bounce will be obtained towards 7. That is there are four options of bounce speeds; 1(=2), 3(=4), 5(=6) and 7.

• This bounce setting procedure can be done only when Rhythm is running in step write.

• If you wish to know the bounce intensity currently set, simply press the Shuffle/Flam Button, and the indicator of the corresponding Main Key will light up. (If intensity 3 is selected, the Indicator of the Main Key 3 will light up.) 

• If the total number of measures are odd number, the last step will not take on the bounce.

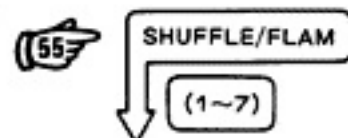

5. Flam

You can write Flam (♩) into the Bass Drum, Snare Drum, Low Tom, Mid Tom, or Hi Tom. The eight options of Flam interval (between ♩ and ♩) can be selected by using the Main Keys.

[Operation]

① While holding the Instrument Selector Button, press the two Main Keys corresponding to the voice to which you wish to write Flam. 

② Just like "Step Write" procedure explained in Basic Course, tap the Main Keys.

③ While holding the Shuffle/Flam Button down, press any of the Main Keys of 9 to 16 to set the Flam interval. 

• Longer interval is obtained towards 16.

• The Flam interval setting procedure can be done only when the Rhythm is running in Step Write.

• If you wish to know the Flam interval currently set, simply press the Shuffle/Flam Button, and the indicator of the Corresponding Main Key will light up. 

• It is not possible to dub a voice with Flam on the one without Flam, or the voice without Flam on the voice with Flam. That is, new data always has priority, therefore replaces the data previously written.

• In the TR-909, the first sound (♩) of Flam (♩) is in time for a step, and the second one (♩) will follow. The position of the Tempo Knob does not affect the interval between ♩ and ♩ .

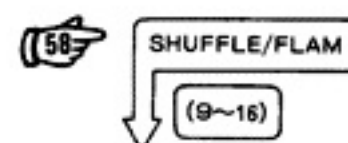
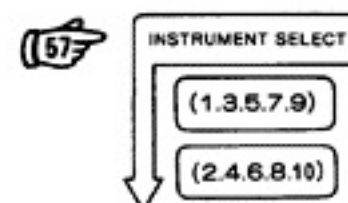

6 Edit Functions

A. Edit Function in Pattern Write mode

1. Copy

It is possible to copy a Rhythm Pattern even in a different Pattern Group or Bank.

[Operation]

① To assign the Pattern Number which is to receive the original Rhythm Pattern, press any Pattern Group Selector Button, while holding the Shift Button down. Then press the appropriate Main Key. 

② To assign the Rhythm Pattern to be copied, while holding the Shift Button down, press the Copy Key (Main Key 11), the Bank Button, the Pattern Group Button, the Main Key, then the Enter Key. 

[Example]

☆ Try copying the Rhythm Pattern 5 of the Pattern Group 3 into Rhythm Pattern 1 of the Pattern Group 2. 

* If you need the Rhythm Pattern(s) saved on a tape or cartridge, load the whole Bank that includes the Pattern you want into either Bank. Then using the Copy function, copy the Rhythm Pattern(s) you want to another Bank.

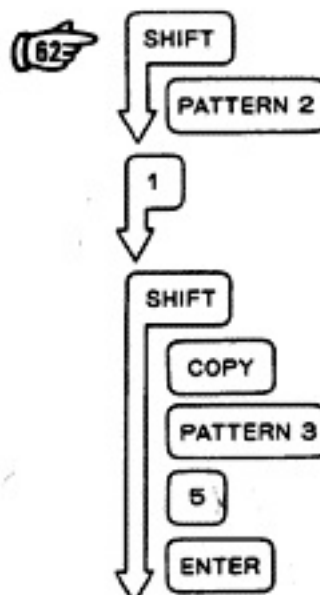
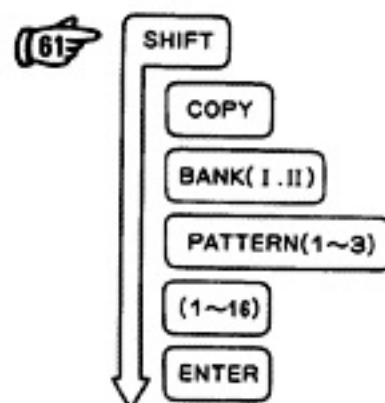
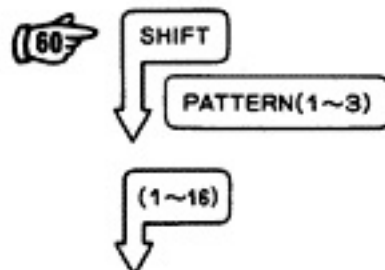

B. Edit Function in Pattern Play and Track Write

2. Chain Function



Chain function is used to allow for Rhythm that requires more than sixteen steps for programming. This may be in the form of the thirty second notes as would be used in the Scale ($\text{♩} = 16$) to complete a 4/4 measure, or can be to accommodate odd rhythms (5/4, 7/8, etc.) that require more than sixteen steps. Such a Rhythm would cost more than two Rhythm Patterns, but the Chain function enables to combine these patterns (we call it Chain Patterns) to be counted one. If you have set the Chain Patterns in Pattern Write mode, you can use them in later Pattern Play or Track Program mode just by selecting the Rhythm Pattern included in the set Chain Patterns.

[Operation]

●Setting the Chain Patterns

With the TR-909 in the Pattern Write Mode, press the left and the right ends of the relevant Main Keys. Then without releasing them, hit the Enter Key. Also, to release a Pattern from the set Chain Patterns, while holding down the relevant Main Key, hit the Enter Key.

[Example]

- To Chain Pattern 1 and 2. 
- To Chain Patterns 7, 8, 9 and 10. 
- To release 8 from the Chain 7, 8, 9 and 10. 
 - * The Chain 9 and 10 will remain.

[Note]

- It is not possible to Chain the Rhythm Patterns which are not adjoining.
- Even the entire Pattern Group (16 Rhythm Patterns) can be Chained.
- The Chain Patterns will play in the tempo as they would usually do. You need to change the Scale before writing the Rhythm Patterns themselves so that they will play in the same tempo throughout.
- The Rhythm Pattern cleared will go out of the memory, consequently be released from the Chain Patterns.

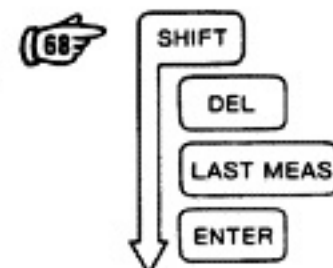
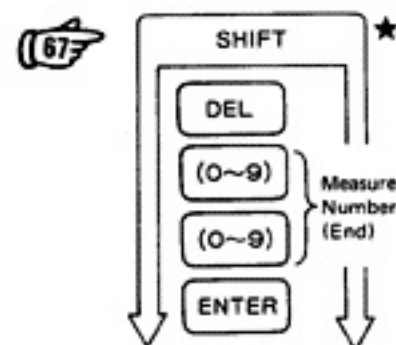
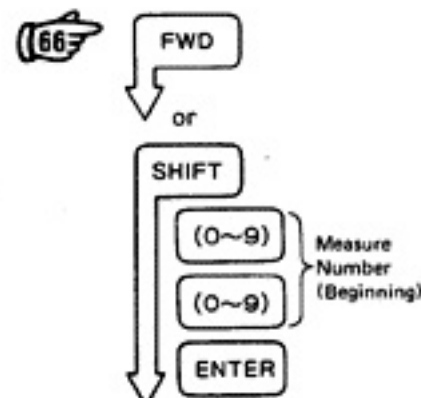
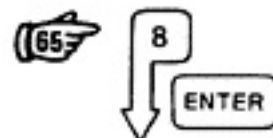
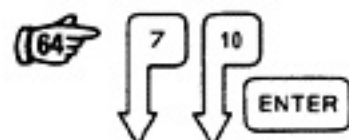
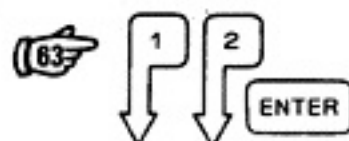



C. Editing Functions in Track Program mode



3. Delete

It is possible to delete any Rhythm Pattern programmed into a Track. To delete a series of Rhythm Patterns, you need to designate the first and the last measures of the series.

[Operation]

- ① To designate the measure number of the first Rhythm of the series that you wish to delete, hold the Shift Button down and without releasing it, press the relevant Main Keys then the Enter Key. If you do not remember the measure number, try recalling it by using the Forward Button. 

- ② While holding the Shift Button down, press the Delete Key, the Main Key(s) corresponding to the last measure of the series then the Enter Key. 

- To delete a single measure, you do not need to assign last measure number, so skip pressing the Main Keys and continue to hitting the Enter Key right after pressing the Delete Key.  *
- To delete the whole Rhythm Patterns from a certain measure up to the end of the music, you may press the Last Measure Button instead of assigning the number of the last measure by pressing the Main Keys in the above operation (2). 

- To delete 21st to 24th measures.

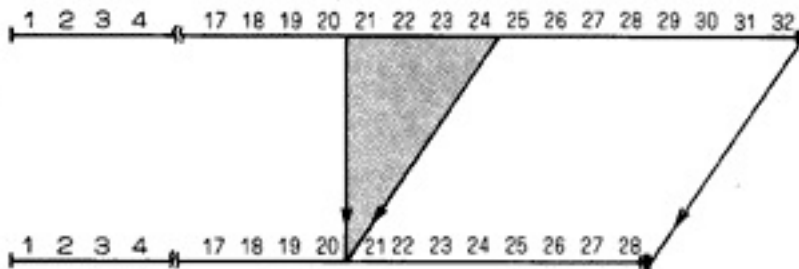

- Recall the 21st measure (Measure Assign)

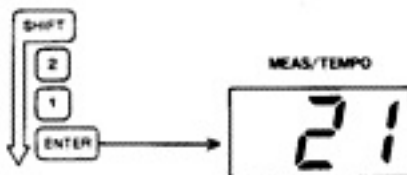

- Take Delete procedure and delete up to 24th measure.

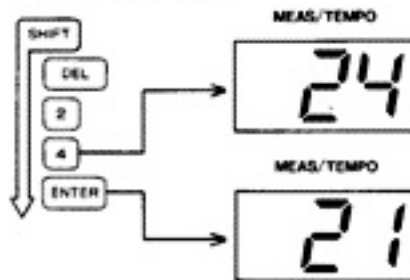

- To delete 25th to the last measures.

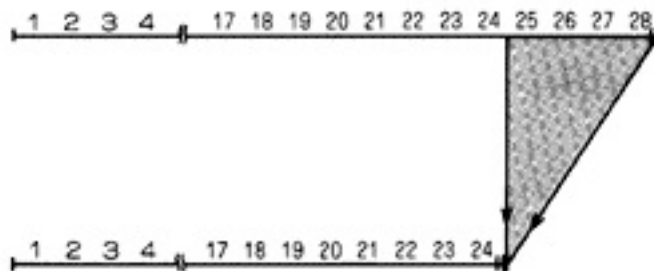

- Recall the 25th measure



- Delete up to the last measure.



- To delete only 19th measure.

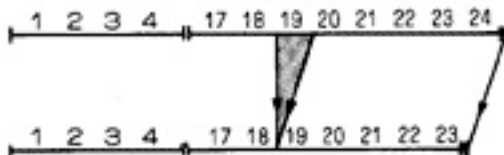

- Recall the 19th measure

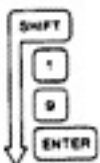

- Take Delete procedure.

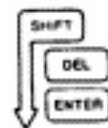

4. Insert

You can insert any Rhythm Pattern into any existing Rhythm Track.

[Operation]

- ① Assign the measure number where you wish to insert a Rhythm. (68)
- ② Select the Rhythm you wish to insert (Pattern Group and the Pattern Number). (65)
- ③ While holding the Shift Button down, press the Insert Key, then the Enter Key. (71)

● It is possible to insert a series of the adjoining Rhythm Patterns. Refer to "2 4 Pattern Play."

● To insert Rhythm Pattern 1 into the 3rd measure.

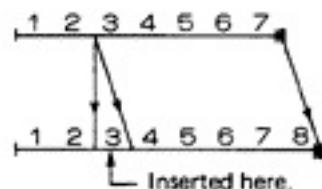

● Recall the 3rd measure

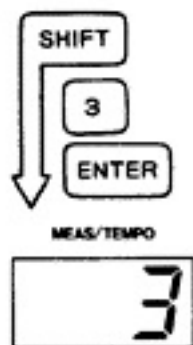

● Select the Rhythm Pattern (Pattern Group, Pattern Number).

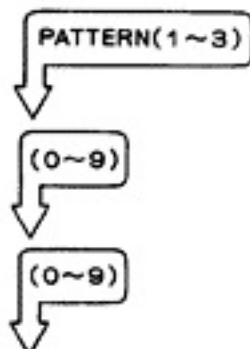

● Take insert procedure.

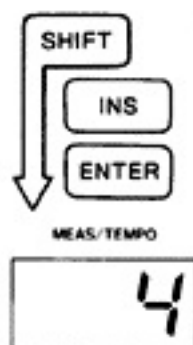

★ Adding Rhythm Pattern to the existing Rhythm Track.

[Operation]

- ① Assign the last measure of the Track. (72)
 - By using the Forward Key.
 - While holding the Shift Button, press the Last Measure Key and the Enter Key.

○ While holding the Shift Button down, press the Main Keys and the Enter Key.

② Hit the Enter Key. (73)

- There comes a measure ready to accept the additional Rhythm Patterns to be programmed into the Track.

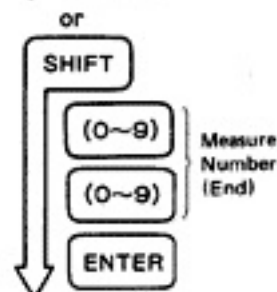
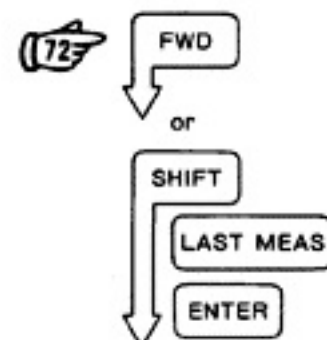
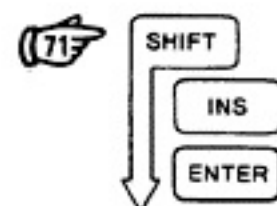
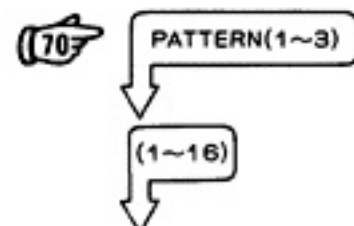
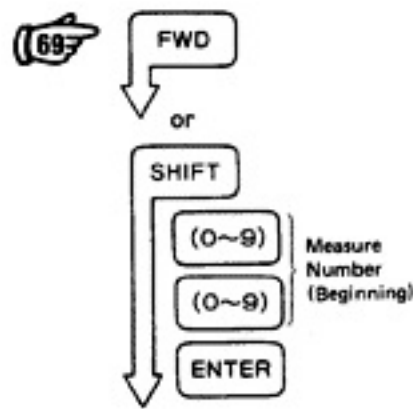

5. Copy

It is possible to copy any Rhythm Pattern or a series of Rhythm Patterns even in different Banks. The existing Rhythm Patterns that follow the new come will be shifted forward increasing the total number of measures by that many.

[Operation]

① Assign the measure number where you wish to send the copy of a Rhythm or series of Rhythms. (74)

② While holding the Shift Button down, press the Copy Key, the Main Keys (to assign the first measure of the series of Rhythm Patterns), the Enter Key, then the Main Keys (assigning the last measure of the series of the Rhythm Patterns), then finally the Enter Key again. (75)

If you wish to copy only a single measure, skip assigning the last measure of a series of the Rhythm Patterns.

● To copy 23rd to 26th measures into the 19th measure.

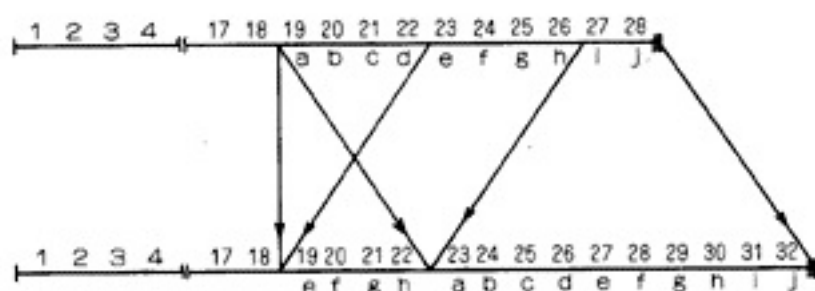

- Recall the 19th measure. (74)
- Take copy procedure and copy 23rd to 26th measures. (75)

● To copy 13th to 16th measures into the 19th measure.

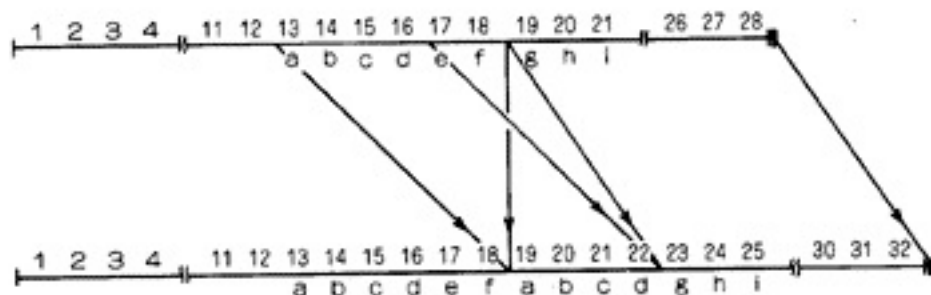

- Recall the 19th measure. (74)
- Take copy procedure and copy 13th to 16th measures. (75)

[Note]

● Be sure that Rhythm is not running before start copying.

● It is not possible to copy a series of Rhythms into the middle of the series. That is, for instance, copying the Rhythm Patterns 15 to 21 measures to the 19th measure is not possible.

If copy is not possible, the Display Window will respond as shown below.

MEAS/TEMPO

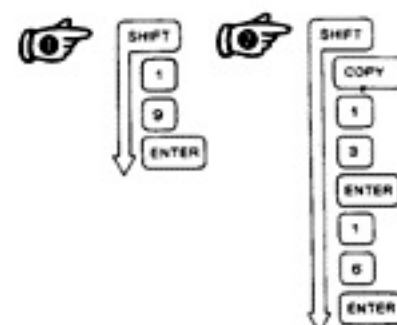
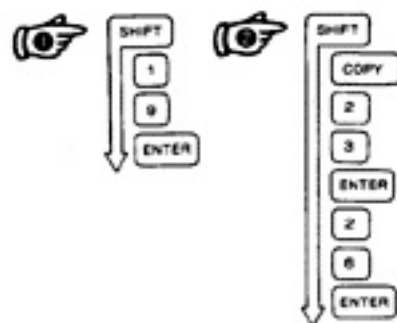
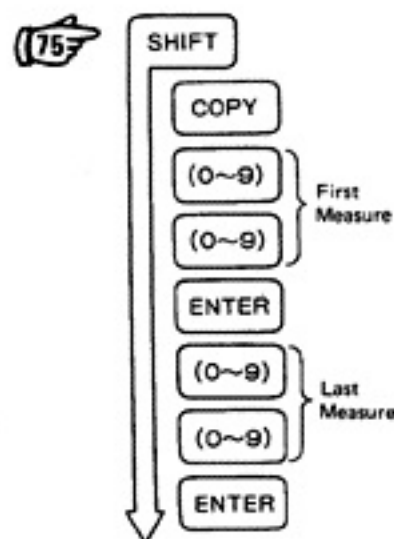
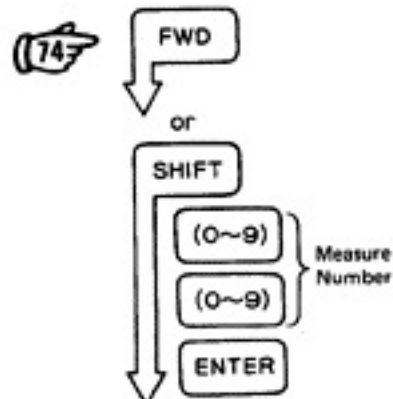



7 Other Functions

1. Tempo Memory (in Track Play mode)

Tempo can be independently set to each Track.

[Operation]

While holding the Tempo Button, hit the Enter Key, and the current tempo will be programmed throughout the Track. 

In later recalling a Track, if you press a Track Button while holding the Tempo Button down, the tempo set in that Track is recalled. 

That is, the Track will play in that set tempo, therefore, the Tempo Knob on the TR-909 does not work. If you just press the Track Button (without holding the Tempo Button down), the tempo of the Track is controlled with the Tempo Knob.

Set a new tempo data will automatically replace the existing one.

To erase the tempo data from the memory, simply rotate the Tempo Knob through left to right while holding the Tempo Button down.

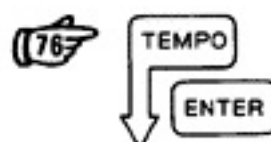

2. Multi Out

The TR-909's back panel includes a separate Multi Out Jack for each individual voice. Connecting any of these jacks removes that sound from the sum-

med Master Out signal, sending it off separately at a level determined by its own level control.

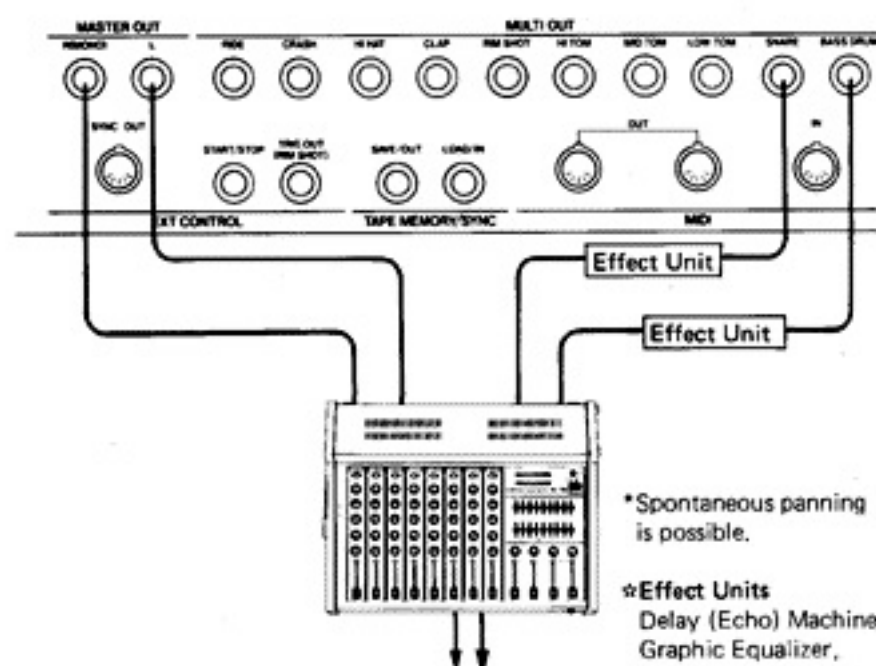

* Spontaneous panning is possible.

★ Effect Units
Delay (Echo) Machine,
Graphic Equalizer,
Flanger, etc.

3. Memory Cartridge

By using Memory Cartridge M-64C (optional) instead of an audio tape, saving and loading can be done instantly and more accurately.

It is also made possible to play the Rhythm Track of the TR-909 by the data stored in the Cartridge externally without loading the data back to the TR-909.

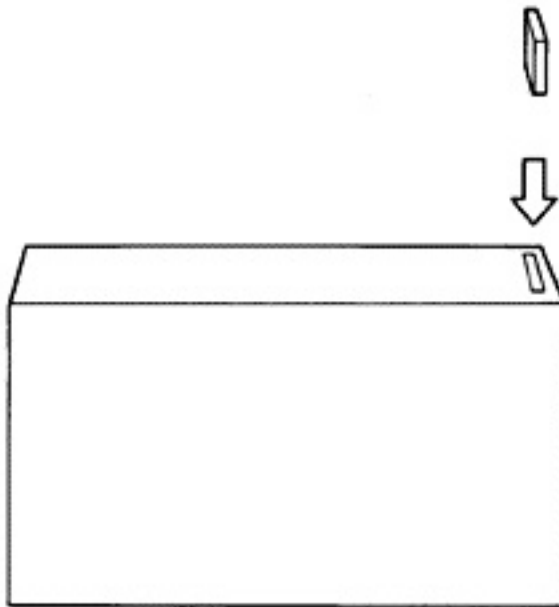

Insert the M-64C to the slot with its label and Protect Switch on the left (in front view).

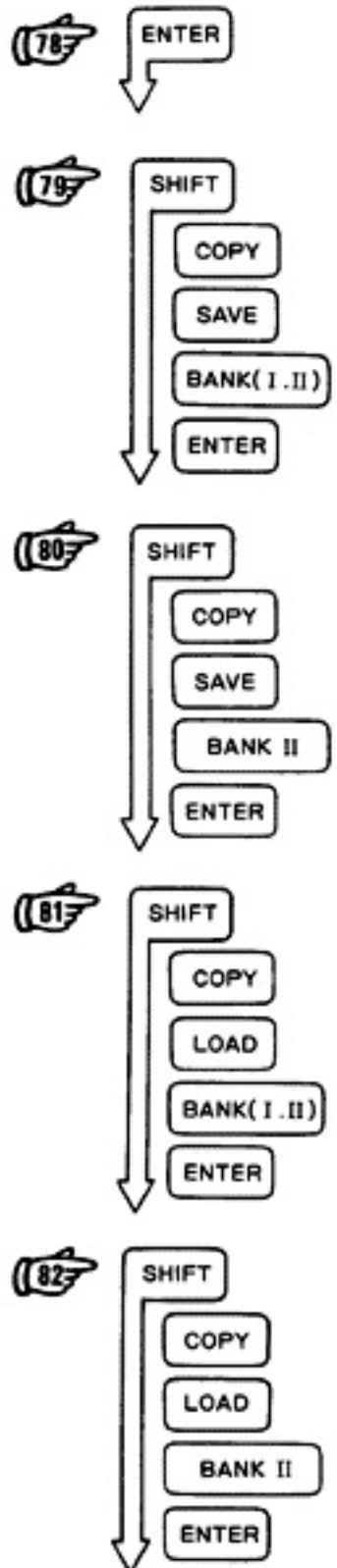

[Operation]

First of all, to turn the TR-909 to the Memory Cartridge mode, insert the Memory Cartridge into the slot on the back panel, and hit the Enter Key. (78)

● Once the TR-909 is turned to this Memory Cartridge mode, you can easily save, load or play Rhythm Track data saved on the Cartridge.

(1) If you wish to play Rhythm Tracks externally by the Cartridge data.

- ① Select a Rhythm Track (on the Cartridge) to be played by pressing a Track Button.
- ② Hit the Start Key.

(2) If you wish to save the data onto the Cartridge.

- ① Set the Protect Switch on the Cartridge to OFF.
- ② While holding the Shift Button down, press the Copy Key, the Save Key, Bank Button (I or II), then finally the Enter Key. (79)

★ To save the data in Bank I of the TR-909 into the Bank II of the Cartridge.

① Assign Bank I of the TR-909 by pressing the Bank Button I while holding Shift Button.

② While holding the Shift Button down, press the Copy Key, the Save Key, Bank Button (II), then finally the Enter Key. (80)

(3) If you wish to load the data on the Cartridge into the TR-909. (81)

While holding the Shift Button down, press the Copy Key, Load Key, Bank Button I or II, then finally the Enter Key.

★ To load the Bank II data of the Cartridge into the Bank I of the TR-909.

① Assign the Bank I of the TR-909 by pressing the Bank Button I while holding the Shift Button.

② While holding the Shift Button down, press the Copy Button, the Load Key, the Bank Button II, then finally the Enter Key. (82)

4. Sync Function

The TR-909 include several Sync Jacks allowing three kinds of synchronization with external devices.

A. MIDI In/Out Jacks (For Tempo Sync)
The MIDI In/Out Jacks of the TR-909 allow it to be synchronized perfectly with the units featuring MIDI system. The TR-909 can serve either as a slave or master device.

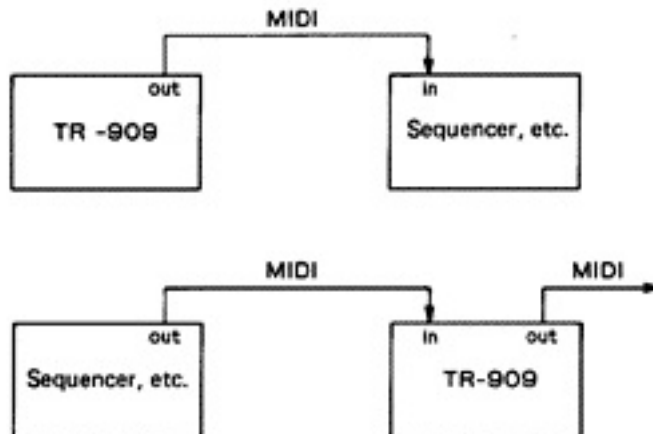

[Operation]

If you wish to use the TR-909 as a slave device (the one to be controlled by the external devices), press the Tempo Mode Button while holding the Shift Button

Down. Each time you press the Tempo Mode Button, the Sync mode will change INT → MIDI → DIN.

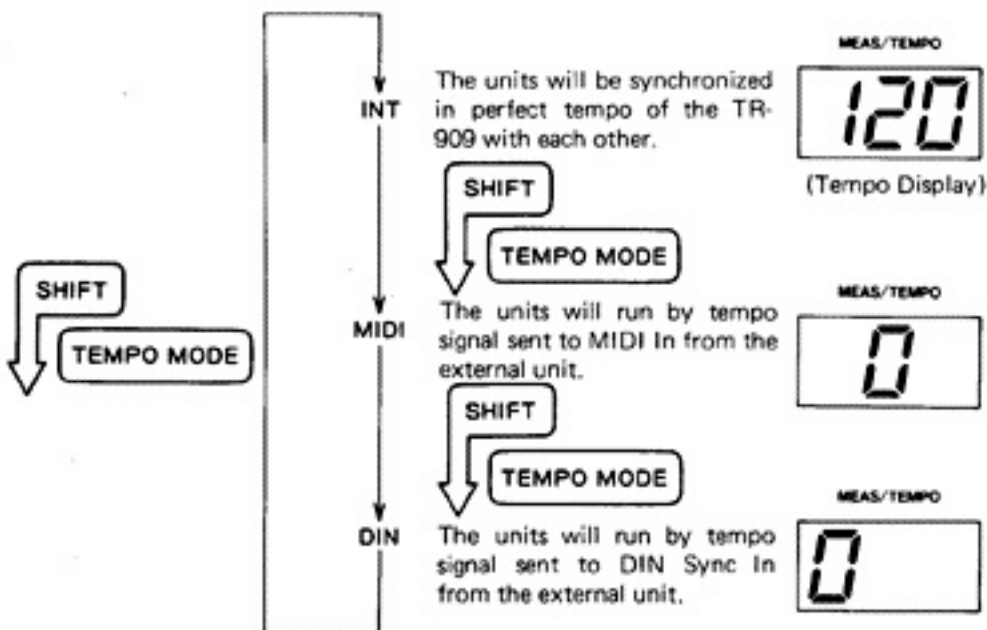
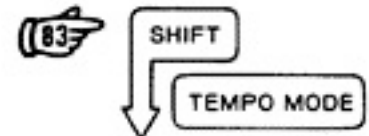

*When you change the Sync modes, please be sure that the Rhythme is not running.

*When the Sync mode is either MIDI or DIN, only the external unit can start or stop the units.

*Turning the TR-909 will automatically set it to the Sync mode INT.

B. Sync In (DIN)

This jack allows the connection of the TR-909 and an external unit featuring DIN Sync Out. Here, the TR-909 serves only as a slave unit.

[Operation]

While holding the Shift Button down, press the Tempo Mode Button. Then do the same procedure once again. (If the TR-909 was initially set to INT mode.)

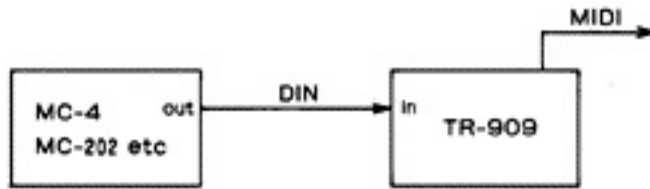

(M)

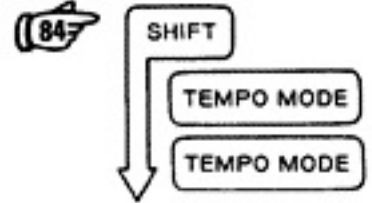

C. TAPE SYNC JACK

The Tape Sync In/Out Jacks on the back panel allows the TR-909 to play to the Sync signal recorded on a tape.

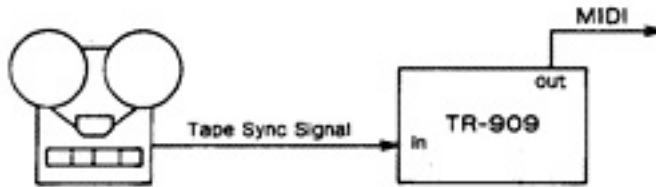

[Operation]

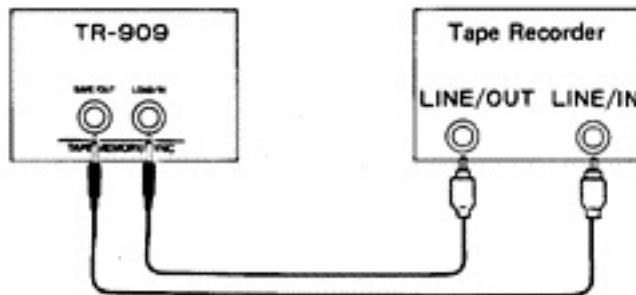

a. Recording Sync signal onto a tape.

- 1 Connect the Save/Out Jack on the back panel of the TR-909 to the Line In on the tape recorder.



- 2 When the TR-909 is not running, it emits signal of a certain level. Set the recording level of the tape recorder so that it reads about -10 to -3 VU.
- 3 Turn the TR-909 to the Track Play mode, then select the Rhythm Track to be played.
- 4 Turn the tape recorder to recording mode, and in a few seconds, start the TR-909 by pressing the Start Key.
- 5 When the entire Rhythm Track is played up (the TR-909 automatically stops running), stop the tape recorder.

b. Playing the TR-909 to the Sync signal recorded on a tape.

- ① Connect the Sync In on the TR-909 to the Line Out of the tape recorder.
- ② Press the Tape Sync Button of the TR-909. 
- ③ Turn the TR-909 to the Track Play mode, then select the Rhythm Track to be played.
- ④ Turn the tape recorder to playback mode. Be sure to start playback from the tape while the Pilot Tone is heard.
- ⑤ Press the Start Key or Stop/Continue Key of the TR-909. Please be sure to press it before the Pilot tone turns to Modulated tone. Now the TR-909 will play the Rhythm Track to the Synchro signal. 

*If you wish to leave the Tape Sync mode before the TR-909 starts running, press the Tape Sync Button. And if you wish to leave the Tape Sync mode during the TR-909 playing, press the Stop/Continue Key.

*While the TR-909 is running in the Tape Sync mode, the tempo is not shown in the Display.

*When the Sync mode is either MIDI or DIN, pressing the Tape Sync Key has no effect.

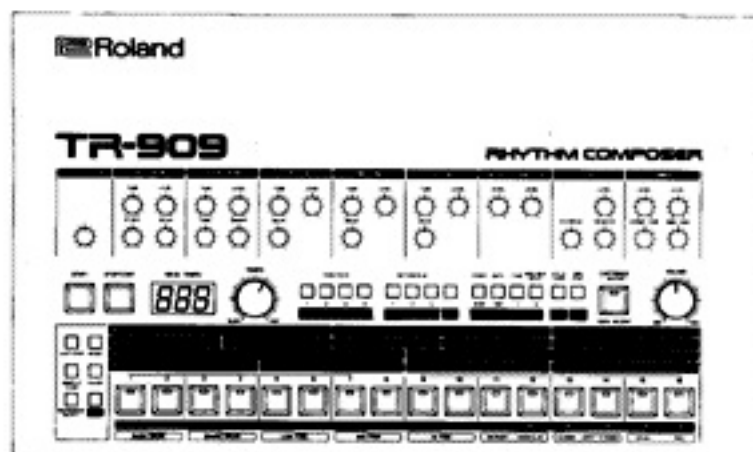
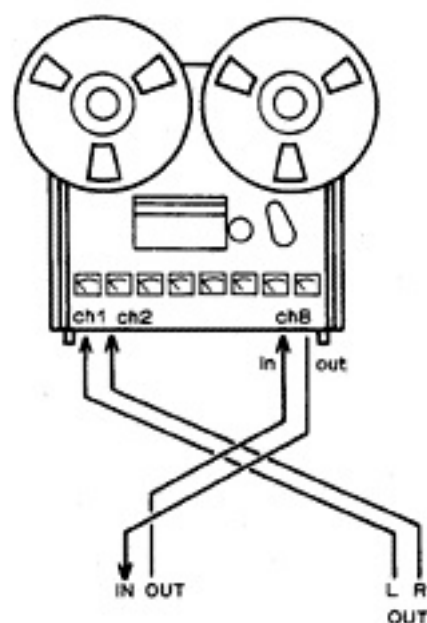
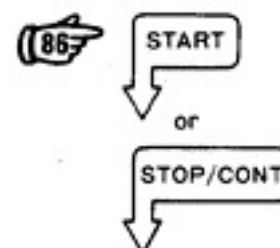

5. External Instrument Mode

This mode is provided for potential control of external sound source through MIDI.

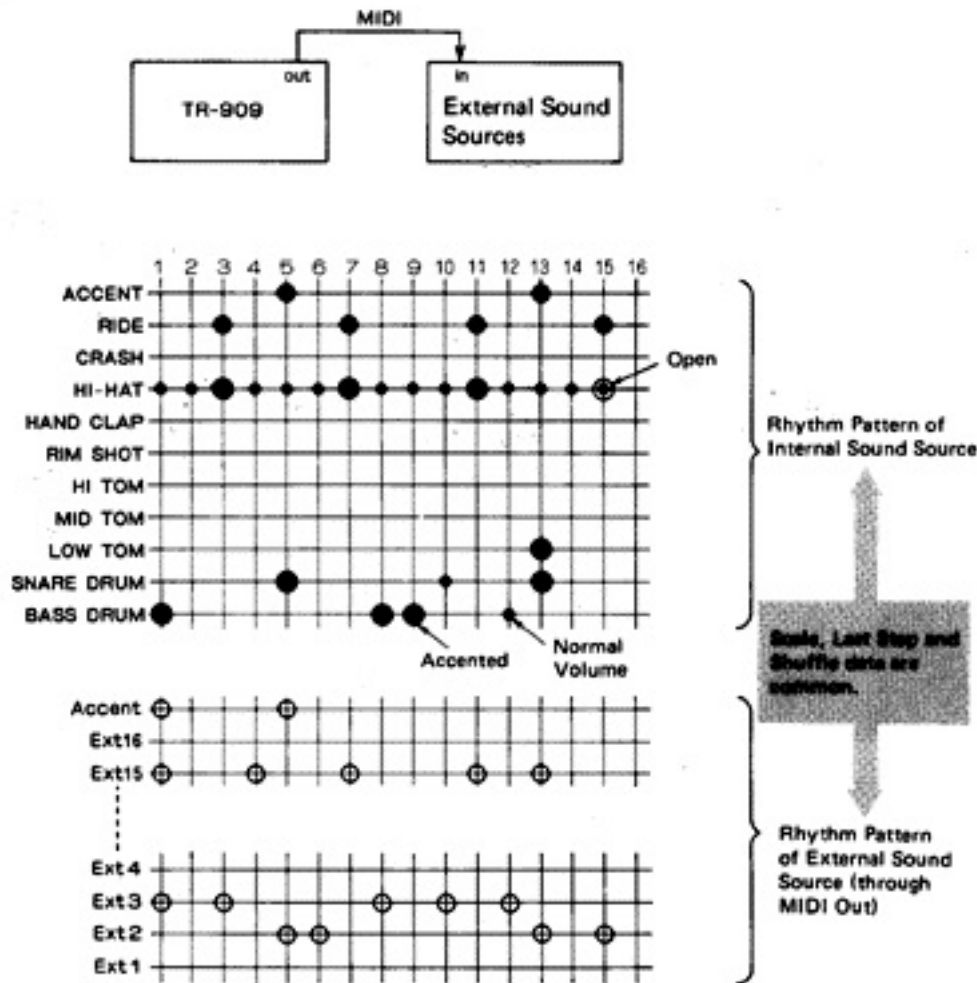

When using external sound sources, the Main Keys (1~16) select the 16 kinds of musical instruments. (Flam is not available.)

When using a synthesizer featuring MIDI (JP-6, JX-3P, HP-300/400, etc.), Main keys correspond to the keyboard as shown below.

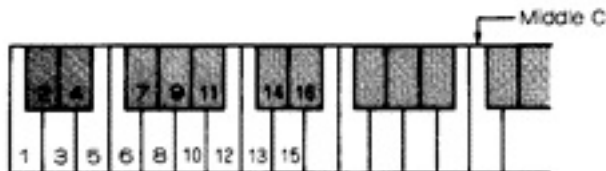

[Operation]

Turn the TR-909 into the Pattern Write mode (be sure that Rhythm is not running). Then while holding the Shift Button down, press the External Instrument Key. Each time you press it, the mode will alternately change between Internal and External. (When the Indicator lights, external sound source is

selected.) Writing procedures to follow are exactly the same as the case of internal sound source. 

* Here, even if you have cleared Rhythm Pattern, Scale, Last Step Shuffle or Flam data will remain in memory.

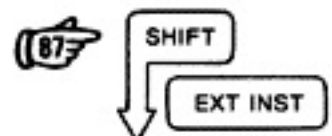

•MIDI

MIDI (Musical Instrument Digital Interface) is international standard that enables communication of units by digital signal.

•Information which can be communicated are as follows.

- 1) Rhythm Pattern
- 2) Tempo Syncro
- 3) Start/Stop
- 4) Dynamics
- 5) Song Selection
- 6) Song Position Point
- 7) Through Function

[Note]

Please never connect MIDI device to non MIDI device. Especially, when using several devices, be careful not to cause loop effect.

•Setting the MIDI Channel

Please take this setting procedure in Track Play mode.

Setting Receiving Channel: To set the Channel number for MIDI information which controls the internal sound source, press the appropriate Main Key, while holding the Shuffle/Flam Button.

Setting Sending Channel: To set the Channel number for the MIDI information which controls external sound source, press the appropriate Main Key, while holding the Last Step Button.

If the unit has been just turned on, the receiving Channel is automatically set to 0, and the transmit Channel to 11. "0" is Omni mode that receives all Channel information.

6. Trigger Out Start/Stop

The TR-909 provides Trigger pulse of a positive 14V, 18ms sent out in the same intervals as the Rim Shot written.

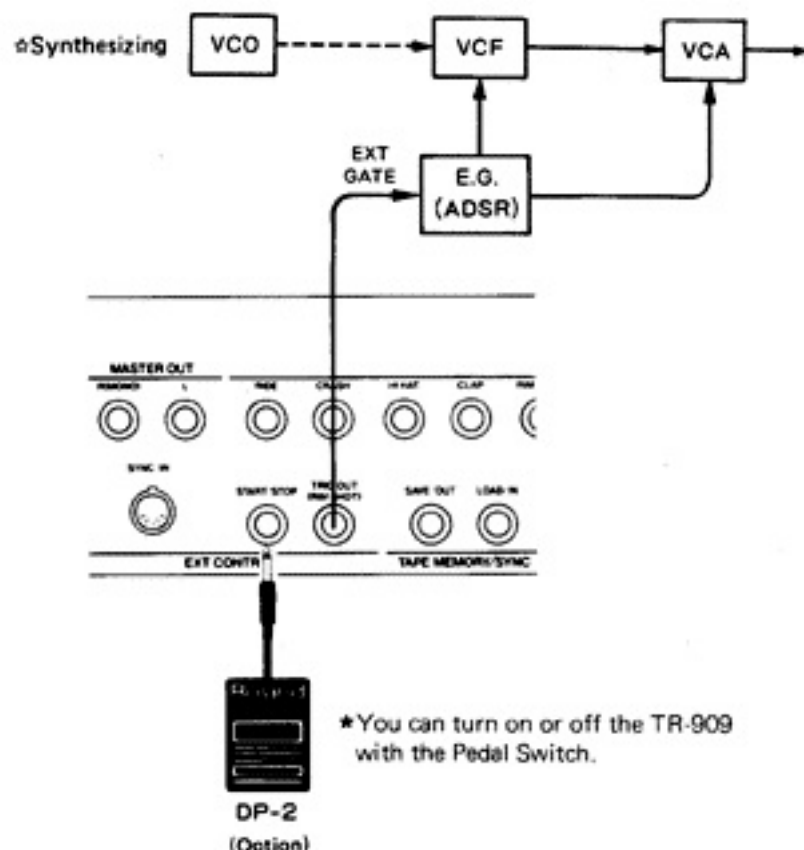

■ **TR-909 ■ RHYTHM COMPOSER**

● **Memory Capacity**

48 Rhythm Patterns (16 x 3 Pattern Groups) x 2 (Bank I, II)

● **Tracks**

4 Tracks (1 to 4: Continuous Maximum measures 896) x 2 (Banks I, II)

● **Steps (per measure)**

1 to 16 steps

● **Sound Sources (and Controls)**

- Bass Drum* (Level, Tune, Decay, Attack)
- Snare Drum* (Level, Tune, Tone, Snappy)
- Low Tom* (Level, Tune, Decay)
- Mid Tom* (Level, Tune, Decay)
- Hi Tom* (Level, Tune, Decay)
- Rim Shot (Level)
- Hand Clap (Level)
- Closed*/Open Hi-Hat (Level, Decay)
- Crash Cymbal (Level, Tune)
- Ride Cymbal (Level, Tune)

The ones with *mark features the sound with and without accent.

● **Controls and Indicators**

- Start Key
- Stop/Continue Key
- Tempo Knob (♩ = 37 to 290)
- Track Selector Buttons (1 to 4: Play/Write)
- Pattern Group Selector Buttons (1 to 3: Play/Write)
- External Instrument Button
- Pattern Write Mode Button
- Bank Buttons (I, II)
- Last Measure Button
- Tempo Mode Button
- Tempo Button
- Forward Step Button
- Back Step Button
- Available Measure Button
- Cycle Play/Guide Button
- Tape Sync Button
- Total Accent Key
- Enter Key/Memory Cartridge Key
- Volume Knob
- Shift Button
- Clear Button
- Scale Button
- Instrument Selector Button
- Shuffle/Flam Button
- Last Step Button
- Main Keys (1 to 16)

● **Rear Panel**

- Master Out (L, R/MONO) [6 Vp-p, 1 kΩ]
- Multi Out
 - Bass Drum, Snare, Low Tom, Mid Tom, Rim Shot, Clap, Hi-Hat, Crash, Ride
- MIDI
 - IN
 - OUT (x2)
- Tape Memory/Sync
 - Save/Out
 - Load/In
- External Control
 - Trigger Out (Rim Shot: +14V, 20 ms pulse)
 - Start/Stop (DP-2)
 - Sync In (5P-DIN) (1: Run/Stop, 2: GND, 3: Clock, 5: Continue)
- Memory Cartridge Slot (for M-64C)

■ **Consumption: 14W**

■ **Dimensions:**

486(W) x 105(H) x 300(D) mm/
19-1/8(W) x 4-1/8(H) x 11-13/16 (D) in

■ **Weight: 4.5 kg/9 lb 15 oz**

■ **Accessories: AC Cord**

- Connection Cord
- Owner's Manual

■ **Option: Memory cartridge M-46C**

Pedal Switch DP-2

*Specifications are subject to change without notice.

Pattern # :

BANK:

PATTERN GROUP:

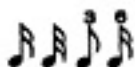
Scale : 

SHUFFLE: 1 2 3 4 5 6 7

FLAM: 9 10 11 12 13 14 15 16

Step

1 2 3 4 5 6 7 8 9 10 11 12 13 14 15 16

ACCENT

RIDE

CRASH

HI-HAT

HAND CLAP

RIM SHOT

HI-TOM

MID-TOM

LOW-TOM

SNARE DRUM

BASS DRUM

1 2 3 4 5 6 7 8 9 10 11 12 13 14 15 16

Pattern # :

BANK:

PATTERN GROUP:

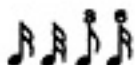
Scale : 

SHUFFLE: 1 2 3 4 5 6 7

FLAM: 9 10 11 12 13 14 15 16

Step

1 2 3 4 5 6 7 8 9 10 11 12 13 14 15 16

ACCENT

RIDE

CRASH

HI-HAT

HAND CLAP

RIM SHOT

HI-TOM

MID-TOM

LOW-TOM

SNARE DRUM

BASS DRUM

1 2 3 4 5 6 7 8 9 10 11 12 13 14 15 16

