

SLING SERIES SG

Cat.#	
Job	Type



HUBBELL
Outdoor Lighting

Approvals

SPECIFICATIONS

Intended Use:

Slender wallpack/floodlight available in two sizes for a variety of applications including building perimeter/security lighting, entrances, stairways, loading docks or facades for schools, apartments or commercial buildings.

Construction:

Rugged die-cast aluminum housing with corrosion resistant powder coat finish both protects and provides architectural appearance. Heat dissipating fins provide superior thermal performance extending the life of the electronic components.

Electrical:

- 120-277V, 50/60Hz electronic drivers
- 347V and 480V available in larger SG2 housing
- 10KA surge protection included

LED(s) Optics, CCT:

- 3000K, 4000K and 5000K CCT nominal with 70 CRI
- Smaller SG1 housing has 2 LEDs, larger SG2 housing has 3 LEDs, see page 2 for electrical and photometric data

Lenses:

- Impact resistant tempered glass offers zero uplight
- Comfort lens available as an option or accessory to reduce glare (7-10% lumen reduction) and provide better uniformity

Installation:

- Side hinge allows for easy installation and wiring.
- Side movement avoids damage to the lens and helps prevent injury common in drop down hinge designs.
- Mounts to 4" junction box and includes a gasket to help seal electrical connections.
- Four ½" threaded conduit hubs for surface conduit provided

Options/Controls

- Button photocontrol for dusk to dawn energy savings. Stock versions include 120V-277V PC with a cover which provides a choice to engage photocontrol or not. PC is installed in top hub.
- Occupancy sensor available for on/off and dimming control in larger SG2 housing.
- SiteSync™ wireless lighting control delivers flexible control strategies for reducing power consumption and minimizing maintenance costs while delivering the right light levels with a simple and affordable wireless solution. See ordering information or visit www.hubbellighting.com/sitesync for more details.
- Battery backup options available in larger SG2 housing rated for either 0° C or -30° C. Performance exceeds NEC requirement providing 1 fc minimum over 10'x10' at 11' mounting height
- Diffused comfort lens provides glare control and improved uniformity. Available as an option or accessory

Listings

- DesignLights Consortium® (DLC) qualified. Please refer to the DLC website for specific product qualifications at www.designlights.org
- Listed to UL1598 for use in wet location, listed for -40C to 40C applications
- IDA approved with zero uplight for 3000K and warmer CCTs
- IP65

Warranty:

Five year limited warranty (for more information visit: <http://www.hubbellighting.com/resources/warranty/>)

PRODUCT IMAGE(S)



DIMENSIONS

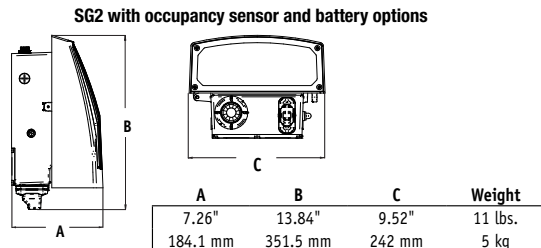
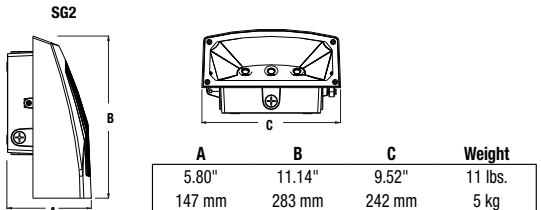
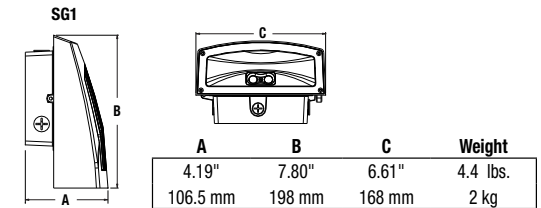

CERTIFICATIONS/LISTINGS



tradeSELECT®

C US

*3000K and warmer CCTs only

SHIPPING INFORMATION

Catalog Number	G.W(kg)/CTN	Carton Dimensions			Carton Qty. per Master Pack	Pallet Qty.
		Length Inch (cm)	Width Inch (cm)	Height Inch (cm)		
SG1	4.35lbs (2 kg)	9.5 (24)	8.25 (21)	5.25 (13.32)	6	98
SG2	11lbs (5 kg)	14 (35.5)	11.5 (29.2)	8 (20.3)	2	64

ORDERING INFORMATION – ORDERING EXAMPLE: SG1-20-4K7-FT-UNV-DB



FAMILY	CCT/CRI	DISTRIBUTION	VOLTAGE	COLOR/FINISH	CONTROL OPTIONS	OPTIONS
SG1-20 Size 1, 20w	3K7 3000K, 70 CRI	FT Fwd Throw	UNV 120V-277V	DB Textured Dark Bronze	PCU Button Photocontrol 120-277V	CS Comfort lens
SG1-30 Size 1, 30w	4K7 4000K, 70 CRI		120 ¹ 120V	BL Textured Black	SCO ^{1,2} Sensor Control, on/off	E ^{1,2} Battery 0°C
SG2-50 Size 2, 50w	5K7 5000K, 70 CRI		277 ¹ 277V	WH Textured White	SCP ^{1,2,3} Sensor Control, Programmable	EH ^{1,2} Battery w/ heater -20°C
SG2-80 Size 2, 80w			UHV ¹ 347V-480V	GYS Smooth Gray	SWP ^{1,2} SiteSync, Precommission	
				PS Smooth Plat. Silver	SWPM ^{1,2} SiteSync, Precommission, Motion	
				CC Custom Color	Specify MTG HT for SCO/SCP & SWPM	
					8F Up to 8'	
					20F Up to 20'	

¹ UHV available in SG2-50 only

² Sensor controls & battery backup can not be used with flood accessory or kit or for inverted/up mounting.

³ 120-277V only for SCO/SCP, 120 or 277 only for SWP, SWPM, E & EH

⁴ Must order minimum of one remote control to program dimming settings, 0-10V fully adjustable dimming with automatic daylight calibration and different time delay settings, 120-277V only

WINTER 2017 E/EH Battery backup



HUBBELL
Outdoor Lighting

Hubbell Outdoor Lighting • 701 Millennium Boulevard • Greenville, SC 29607 • Phone: 864-678-1000

Due to our continued efforts to improve our products, product specifications are subject to change without notice.

© 2017 HUBBELL OUTDOOR LIGHTING, All Rights Reserved • For more information visit our website: www.hubbelloutdoor.com • Printed in USA SG-SPEC OCTOBER 11, 2017 8:19 AM

ORDERING INFORMATION - Stock Versions

Catalog Number	CCT/CRI	Wattage	Mounting Height	Voltage	Color	Lumens	LPW	Weight lbs. (kg)
SG1-20-PCU	5000K/70	21w	8-12ft	120-277V	Dark Bronze	2263	108	4.3 (2)
SG1-20-4K-PCU	4000K/70					2310	110	
SG1-30-PCU	5000K/70	29w	10-15ft			3270	113	
SG1-30-4K-PCU	4000K/70					3060	105	
Catalog Number	CCT/CRI	Wattage	Mounting Height	Voltage	Color	Lumens	LPW	Weight lbs. (kg)
SG2-50-PCU	5000K/70	51w	12-18ft	120-277V	Dark Bronze	5548	110	11 (5)
SG2-50-4K-PCU	4000K/70					5526	109	
SG2-80-PCU	5000K/70	80w	15-25ft			8061	101	
SG2-80-4K-PCU	4000K/70					8079	101	

PERFORMANCE DATA

Catalog number	# of LEDs	Drive Current	System Watts	5K (5000K nominal, 70 CRI)				4K (4000K nominal, 70 CRI)				3K (3000K nominal, 80 CRI)						
				Lumens	LPW ¹	B	U	G	Lumens	LPW ¹	B	U	G	Lumens	LPW ¹	B	U	G
SG1-20	2	250mA	21	2449	115	1	0	0	2310	110	1	0	0	2054	95	1	0	0
SG1-30		350mA	29	3332	117	2	0	0	3060	106	1	0	0	2913	100	1	0	0
SG2-50-UHV	3	350mA	44	4633	106	2	0	0	4609	105	2	0	0	3895	90	2	0	0
SG2-50	3	415mA	51	5548	109	2	0	0	5526	107	2	0	0	4700	92	2	0	0
SG2-80		650mA	80	7851	98	2	0	1	8079	103	2	0	1	6721	86	2	0	1

1. Lumen values are from photometric tests performed in accordance with IESNA LM-79-08. Data is considered to be representative of the configurations shown. Actual performance may differ as a result of end-user environment and application.

ELECTRICAL DATA

Configurable Versions

Catalog number	# of Drivers	Input Voltage	Current (Amps)	System Power
SG1-20	1	120	0.18	21.0
		277	0.08	21.0
SG1-30	1	120	0.24	28.9
		277	0.10	28.9
SG2-50-UHV	1	347	0.13	43.5
		480	0.18	43.5
SG2-50	1	120	0.42	50.6
		277	0.18	50.6
SG2-80	1	120	0.68	79.8
		277	0.29	79.8

PROJECTED LUMEN MAINTENANCE

Ambient Temp.	OPERATING HOURS					
	0	25,000	50,000	TM-21-11' L96 60,000	100,000	L70 (hours)
25°C / 77°F	1.00	0.98	0.97	0.96	0.95	>791,000
40°C / 104°F	0.99	0.98	0.96	0.96	0.94	>635,000

1. Projected per IESNA TM-21-11 * (Nichia 219B, 700mA, 85°C Ts, 10,000hrs) Data references the extrapolated performance projections for the LNC-12LU-5K base model in a 40°C ambient, based on 10,000 hours of LED testing per IESNA LM-80-08.

LUMINAIRE AMBIENT TEMPERATURE FACTOR (LATF)

AMBIENT TEMPERATURE	LUMEN MULTIPLIER	
0° C	32° F	1.02
10° C	50° F	1.01
20° C	68° F	1.00
25° C	77° F	1.00
30° C	86° F	1.00
40° C	104° F	0.99
50° C	122° F	0.96

Use these factors to determine relative lumen output for average ambient temperatures from 0-40°C (32-104°F).

Wireless and Occupancy Controls



SiteSync™ Lighting Control delivers flexible control strategies for reducing power consumption and minimizing maintenance costs while delivering the right light levels with a simple and affordable wireless solution.



Hubbell Outdoor Lighting • 701 Millennium Boulevard • Greenville, SC 29607 • Phone: 864-678-1000

Due to our continued efforts to improve our products, product specifications are subject to change without notice.

© 2017 HUBBELL OUTDOOR LIGHTING, All Rights Reserved • For more information visit our website: www.hubbelloutdoor.com • Printed in USA SG-SPEC OCTOBER 11, 2017 8:19 AM

OPTIONS AND ACCESSORIES

Catalog Number	Description	Weight lbs. (kg)
SG1-CS	Acrylic comfort lens for SG1	1 (.45)
SG2-CS	Acrylic comfort lens for SG2	1 (.45)
SG1-YOKE	SG1 Series Yoke/Floodlight mount kit, includes visor	2.0 (1.0)
SG1-KNUCKLE	SG1 Series Knuckle/Floodlight mount kit, includes visor	2.0 (1.0)
SG2-YOKE	SG2 Series Yoke/Floodlight mount kit, includes visor	2.0 (1.0)
SG2-KNUCKLE	SG2 Series Knuckle/Floodlight mount kit, includes visor	2.0 (1.0)
SCP-REMOTE*	Remote control for SCP option. Order at least one per project to program and control fixtures	1 (.45)
SG2-PMA-3-XX	3" Pole Mount arm for SG2, both square and round, XX= finish	7 (3.5)
SG2-PMA-4-XX	4" Pole Mount arm for SG2, both square and round, XX= finish	7 (3.5)
SG2-PMA-5-XX	5" Pole Mount arm for SG2, both square and round, XX= finish	7 (3.5)
SG2-PMA-6-XX	6" Pole Mount arm for SG2, both square and round, XX= finish	7 (3.5)
SG1-SPC	Vandal Resistant Lens (shield polycarbonate), SG1	3 (1.5)
SG2-SPC	Vandal Resistant Lens (shield polycarbonate), SG2	3 (1.5)
SG1-WCP	Universal Wall Cover Plate, Dark Bronze, SG1	10 (5)
SG2-WCP-H	Horizontal Mount Wall Cover Plate, Dark Bronze, SG2	10 (5)
SG2-WCP-V	Vertical Mount Wall Cover Plate, Dark Bronze, SG2	10 (5)
SG2XL-WCP-H	Horizontal Mount Wall Cover Plate, DB, SG2 with battery or sensor	10 (5)
SG2XL-WCP-V	Vertical Mount Wall Cover Plate, DB, SG2 with battery or sensor	10 (5)

*Must order minimum of one remote control to program dimming settings, 0-10V fully adjustable dimming with automatic daylight calibration and different time delay settings, 120V or 277V only

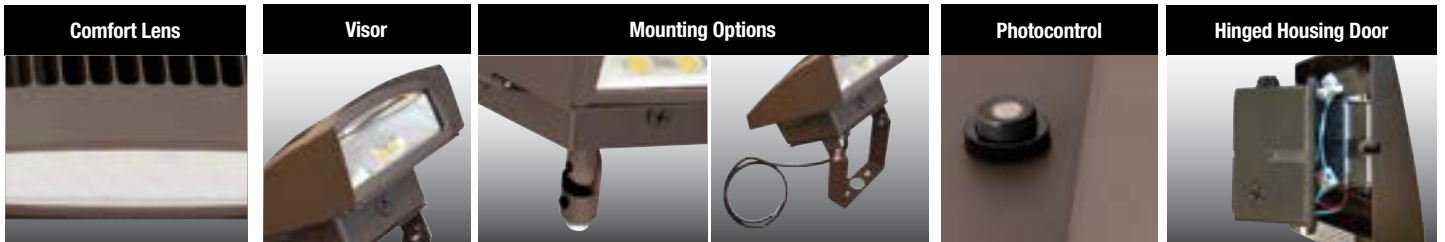

Acrylic comfort lens provides glare control, improved visual comfort and better uniformity

Visor accessory included Flood mounting accessories - 1/2" threaded knuckle with mounting accessory or yoke (includes grommet and 3' SO cord) kits

Photocontrol option available for energy-saving dusk-to-dawn operation

Side hinged for easy installation and wiring access, single screw secures housing closure

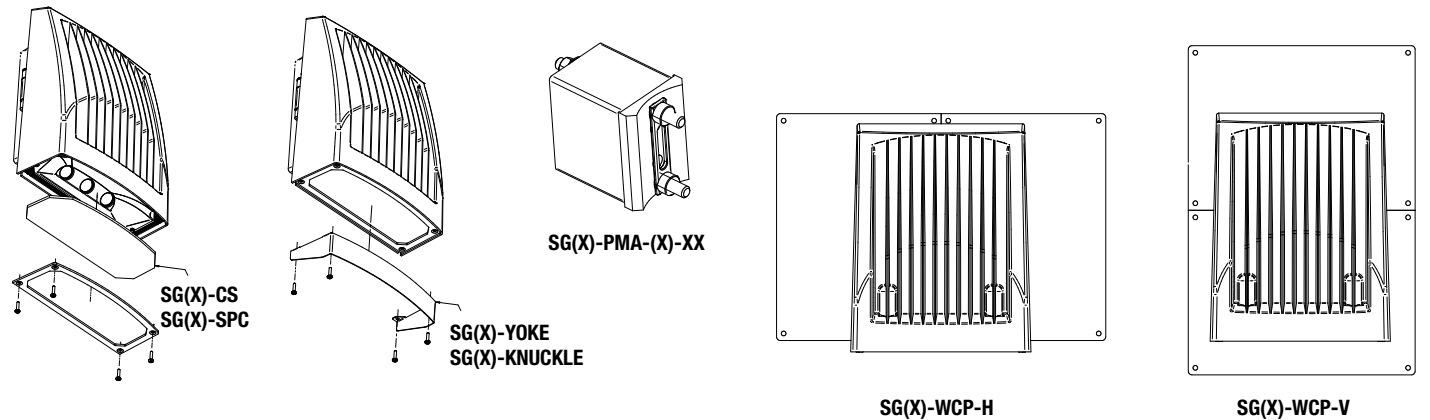

PHOTOMETRICS

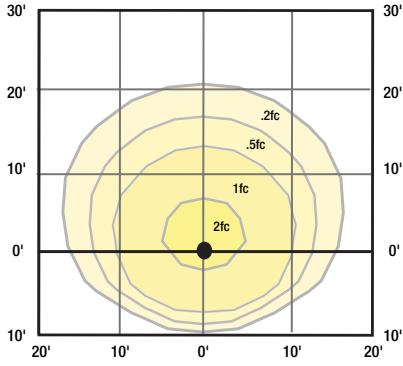

SG1-20

Mounting Height 10ft

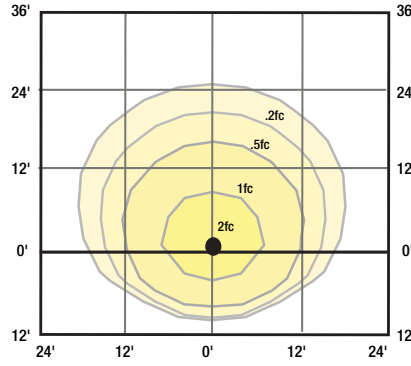

SG1-30

Mounting Height 12ft

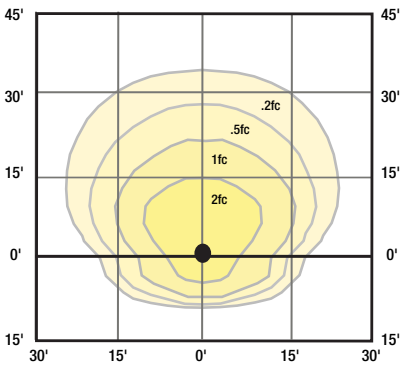

SG2-50

Mounting Height 15ft

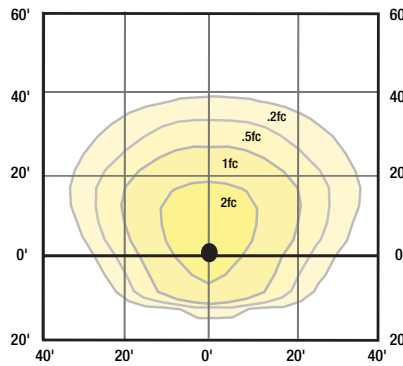

SG2-80

Mounting Height 20ft

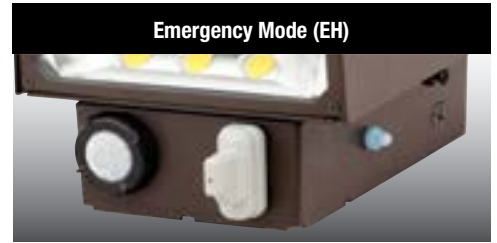

Battery back up feature with side indicator.

Exceeds Life Safety Code average illuminance of 1.0 fc. at 12ft mounting height. Assumes open space with no obstructions.

Diagrams for illustration purposes only, please consult factory for application layout.

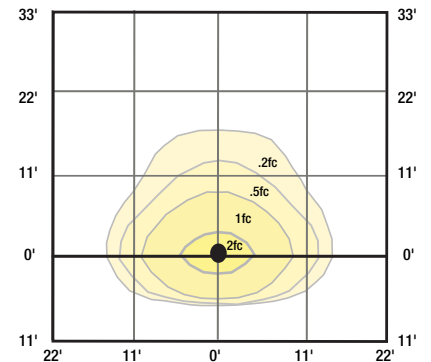

SG2 in E or EH Emergency mode

Mounting Height 11ft